

# MARKS PUBLISHED FOR OPPOSITION

The following marks are published in compliance with section 12(a) of the Trademark Act of 1946. Applications for the registration of marks in more than one class have been filed as provided in section 30 of said act as amended by Public Law 772, 87th Congress, approved Oct. 9, 1962, 76 Stat. 769. Opposition under section 13 may be filed within thirty days of the date of this publication. See rules 2.101 to 2.105.

A separate fee of three hundred dollars (\$300.00) for opposing each mark in each class must accompany the opposition.

## SECTION 1.— INTERNATIONAL CLASSIFICATION

The short titles associated below with the international class numbers are terms designed merely for quick identification and are not an official part of the international classification. The full names of international classes are given in section 6.1 of the trademark rules of practice.

The designation "U.S. Cl." appearing in this section refers to the U.S. class in effect prior to Sep. 1, 1973 rather than the international class which applies to applications filed on or after that date. For adoption of international classification see notice in the OFFICIAL GAZETTE of Jun. 26, 1973 (911 O.G. TM 210).

### Application in more than one class

SN 76-713,054. PACO RABANNE, NEUILLY SUR SEINE, FRANCE, FILED 12-14-2012.

#### CLASS 34—SMOKERS' ARTICLES

FOR CIGAR AND CIGARETTE CASES OF PRECIOUS METAL (U.S. CLS. 2, 8, 9 AND 17).  
STEPHANIE ALI, EXAMINING ATTORNEY

## PACO RABANNE

SN 76-713,220. WHITEN, LLC, IMLAY CITY, MI. FILED 1-14-2013.

THE MARK CONSISTS OF STANDARD CHARACTERS WITHOUT CLAIM TO ANY PARTICULAR FONT, STYLE, SIZE, OR COLOR.

OWNER OF EUROPEAN UNION REG. NO. 003540267, DATED 4-26-2005, EXPIRES 10-31-2023.

OWNER OF U.S. REG. NOS. 1,219,762, 4,223,749 AND OTHERS.

THE NAME "PACO RABANNE" IS THE PSEUDONYM OF MR. FRANCESCO RABANNE CUERVO, A LIVING INDIVIDUAL WHOSE CONSENT IS OF RECORD.



NO CLAIM IS MADE TO THE EXCLUSIVE RIGHT TO USE "WHITEN", APART FROM THE MARK AS SHOWN.

THE MARK CONSISTS OF THE WORDS "WHITEN SMILE MORE." WITH A CURVED LINE FORMING A SMILE.

#### CLASS 8—HAND TOOLS

FOR TABLEWARE, NAMELY, KNIVES, FORKS, AND SPOONS MADE OF PRECIOUS METAL (U.S. CLS. 23, 28 AND 44).

#### CLASS 3—COSMETICS AND CLEANING PREPARATIONS

FOR TEETH WHITENING SYSTEM COMPRISED OF TEETH WHITENING GELS AND A MOUTHPIECE, SOLD TOGETHER IN A UNIT; TEETH WHITENING SYSTEM COMPRISED OF TEETH WHITENING GELS, A MOUTHPIECE AND A TIMER, ALL SOLD TOGETHER IN A UNIT; AND TEETH WHITENING GELS (U.S. CLS. 1, 4, 6, 50, 51 AND 52).

FIRST USE 7-0-2012; IN COMMERCE 7-0-2012.

#### CLASS 9—ELECTRICAL AND SCIENTIFIC APPARATUS

FOR OPTICAL APPARATUS AND INSTRUMENTS, NAMELY, SPECTACLES, SUNGLASSES, SPORTS GOGGLES FOR SPORTS, CASES FOR SPECTACLES, SPECTACLE CORDS, SPECTACLE FRAMES AND LENSES (U.S. CLS. 21, 23, 26, 36 AND 38).

#### CLASS 9—ELECTRICAL AND SCIENTIFIC APPARATUS

FOR TIMER SYSTEMS FOR TEETH WHITENING COMPRISED OF A TIMER FOR TIMING CONTACT OF TEETH WHITENING GEL IN A MOUTHPIECE, AND THE MOUTHPIECE, SOLD TOGETHER IN A UNIT; AND TIMERS FOR TIMING CONTACT OF TEETH WHITENING GEL IN A MOUTHPIECE (U.S. CLS. 21, 23, 26, 36 AND 38).

FIRST USE 7-0-2012; IN COMMERCE 7-0-2012.

#### CLASS 14—JEWELRY

FOR JEWELRY, COSTUME JEWELRY, PRECIOUS STONES; HOROLOGICAL AND CHRONOMETRIC INSTRUMENTS, PRECIOUS METALS AND THEIR ALLOYS; WORKS OF ART OF PRECIOUS METAL; JEWELRY CASES OR BOXES OF PRECIOUS METALS; JEWELRY CASES, BRACELETS, JEWELRY CHAINS, WATCH SPRINGS; AND WATCH GLASSES; KEY RINGS OF PRECIOUS METALS; STATUES OF PRECIOUS METAL, FIGURINES OF PRECIOUS METAL; CASES FOR WATCHES; MEDALS (U.S. CLS. 2, 27, 28 AND 50).

**CLASS 10—MEDICAL APPARATUS**

FOR DENTAL MOUTHPIECES FOR HOLDING TEETH WHITENING GEL (U.S. CLS. 26, 39 AND 44). FIRST USE 7-0-2012; IN COMMERCE 7-0-2012. DAVID MURRAY, EXAMINING ATTORNEY

SN 76-714,701. BENEFACTORS COUNSEL, LLC, COLUMBUS, OH. FILED 8-5-2013.



THE MARK CONSISTS OF AN OAK LEAF DESIGN INSIDE AN INCOMPLETE CIRCLE. TO ITS RIGHT APPEARS THE WORDING "BENEFACTOR" IN STYLIZED FONT.

SEC. 2(F) AS TO "BENEFACTOR".

SN 76-714,318. GLOBAL SUPPLY CO., EUGENE, OR. FILED 6-6-2013.



NO CLAIM IS MADE TO THE EXCLUSIVE RIGHT TO USE "GLOBAL", APART FROM THE MARK AS SHOWN.

THE MARK CONSISTS OF A CIRCLE WHICH IS BISECTED BY A RECTANGLE IN WHICH THE WORD "GLOBAL" APPEARS.

**CLASS 7—MACHINERY**

FOR POWER OPERATED GRINDSTONES; POWER OPERATED GRINDING WHEELS; PNEUMATIC GREASE GUNS AND COMPONENT PARTS THEREFOR; DRILLING MACHINES AND PARTS THEREFOR; POWER OPERATED SAWS AND COMPONENT PARTS THEREFOR; MACHINE PARTS, NAMELY, POWER DRILL BITS, POWER SAW BLADES, FINGER JOINT MACHINE PARTS, NAMELY, JOINTS, AND ROUTER BITS; ELECTRIC MOULDER KNIVES; ELECTRIC MILLWORK KNIVES; ELECTRIC PLANER KNIVES; POWER TOOLS, NAMELY, POWER OPERATED ROUTERS AND COMPONENT PARTS THEREFOR (U.S. CLS. 13, 19, 21, 23, 31, 34 AND 35).

FIRST USE 8-0-1996; IN COMMERCE 8-0-1996.

**CLASS 8—HAND TOOLS**

FOR MANUALLY OPERATED GRINDSTONES AND COMPONENT PARTS THEREFOR; MANUALLY OPERATED GRINDING WHEELS AND COMPONENT PARTS THEREFOR; MANUALLY OPERATED GREASE GUNS AND COMPONENT PARTS THEREFOR; MANUALLY OPERATED SAWS AND COMPONENT PARTS THEREFOR; AND MANUALLY OPERATED KNIVES (U.S. CLS. 23, 28 AND 44).

FIRST USE 8-0-1996; IN COMMERCE 8-0-1996. ANNE FARRELL, EXAMINING ATTORNEY

**CLASS 35—ADVERTISING AND BUSINESS**

FOR BUSINESS CONSULTATION IN THE FIELD OF VOLUNTEER AND NONPROFIT LEADERSHIP DEVELOPMENT; BUSINESS CONSULTING AND INFORMATION SERVICES IN THE FIELD OF NONPROFIT ORGANIZATION BOARD GOVERNANCE; BUSINESS CONSULTATION AND BUSINESS STRATEGY DEVELOPMENT SERVICES IN THE FIELD OF PHILANTHROPIC SERVICES; BUSINESS STRATEGY DEVELOPMENT SERVICES FEATURING FINANCIAL STRATEGIES IN THE FIELD OF PHILANTHROPIC SERVICES (U.S. CLS. 100, 101 AND 102).

FIRST USE 3-0-2000; IN COMMERCE 3-0-2000.

**CLASS 36—INSURANCE AND FINANCIAL**

FOR FINANCIAL CONSULTATION IN THE FIELD OF PHILANTHROPIC SERVICES; FINANCIAL CONSULTATION IN THE FIELD OF CHARITABLE FUNDRAISING (U.S. CLS. 100, 101 AND 102).

FIRST USE 3-0-2000; IN COMMERCE 3-0-2000.

DAWN HAN, EXAMINING ATTORNEY

SN 76-714,921. MEAD JOHNSON & COMPANY, LLC, EVANSVILLE, IN. FILED 9-10-2013.



OWNER OF U.S. REG. NOS. 696,534, 3,795,918 AND OTHERS.

NO CLAIM IS MADE TO THE EXCLUSIVE RIGHT TO USE "PREMIUM", APART FROM THE MARK AS SHOWN.

THE MARK CONSISTS OF THE INITIAL-CAPS WORD "ENFAMIL" IN A LARGE FONT AND WITH THE ALL-CAPS WORD "PREMIUM" IN A SMALL FONT BENEATH THE "MIL". THE WORDS ARE WITHIN A SLENDER MODIFIED OVAL DESIGN AND WITH A RIBBON AND BOW EXTENDING FROM THE UPPER LEFT TOP OF THE DESIGN.

**CLASS 5—PHARMACEUTICALS**

FOR INFANT FORMULAS AND FOOD FOR INFANTS; DIETARY, NUTRITIONAL AND FOOD SUPPLEMENTS AND VITAMIN AND MINERAL PREPARATIONS FOR USE AS INGREDIENTS IN THE FOOD AND PHARMACEUTICAL INDUSTRY; SIMULATED BREAST MILK FORMULA IN LIQUID AND POWDER FORM FOR INFANTS; ELECTROLYTE REPLENISHMENT PREPARATIONS; FORMULA FOR USE IN FEEDING INFANTS IN PREMEASURED PACKETS; INFANT FOODS; NUTRITIONALLY ENHANCED FRUIT JUICES (U.S. CLS. 6, 18, 44, 46, 51 AND 52).

**CLASS 29—MEATS AND PROCESSED FOODS**

FOR MILK AND MILK PRODUCTS, EXCLUDING, ICE CREAM, ICE MILK AND FROZEN YOGURT; POWDERED MILK; MILK BASED DRINKS, NAMELY, EVAPORATED MILK; MILK SUBSTITUTES, SPECIFICALLY, RICE MILK, SOY MILK, AND HEMP MILK USED AS A MILK SUBSTITUTE; AND POWDERED PREPARATION FOR MAKING MILK BEVERAGES, SPECIFICALLY, MILK POWDER (U.S. CL. 46).  
 KELLY BOULTON, EXAMINING ATTORNEY

**CLASS 16—PAPER GOODS AND PRINTED MATTER**

FOR COOK BOOKS; RECIPE CARD FILES; DATE BOOKS; DESK TOP ORGANIZERS; ENGAGEMENT BOOKS; RECIPE FILE CARDS; RECIPE INDEX CARDS; GIFT CARDS; GENERAL FEATURE MAGAZINES; MAGAZINES ABOUT FOOD PREPARATION; MAGAZINES ABOUT DINING; MAGAZINES ABOUT RESTAURANT REVIEWS; PERSONAL ORGANIZERS; RECIPE BOOKS (U.S. CLS. 2, 5, 22, 23, 29, 37, 38 AND 50).

SN 77-147,751. JASCOR HOME PRODUCTS INC., DOLLARD-DES-ORMEAUX, CANADA, FILED 4-3-2007.

**DELFINO**

THE MARK CONSISTS OF STANDARD CHARACTERS WITHOUT CLAIM TO ANY PARTICULAR FONT, STYLE, SIZE, OR COLOR.  
 OWNER OF CANADA REG. NO. TMA846134, DATED 3-14-2013, EXPIRES 3-14-2028.  
 THE ENGLISH TRANSLATION OF "DELFINO" IN THE MARK IS "DOLPHIN".

**CLASS 32—LIGHT BEVERAGES**

FOR AERATED FRUIT JUICES; AERATED WATER; ALE; ALOE VERA DRINKS; ALOE VERA JUICES; APPLE JUICE BEVERAGES; BEER; BEER WORT; BLACK BEER; BOTTLED WATER, NAMELY, DISTILLED DRINKING WATER, FLAVORED WATER, MINERAL WATER, SPRING WATER; COCONUT MILK; COCONUT WATER; COFFEE FLAVORED SOFT DRINKS; COLAS; CONCENTRATES, SYRUPS OR POWDERS USED IN THE PREPARATION OF SOFT DRINKS; COOLERS, NAMELY, BEER-BASED COOLERS AND NON-ALCOHOLIC MALT COOLERS; DE-ALCOHOLIZED WINES; ENERGY DRINKS; ESSENCES FOR THE MANUFACTURE OF LIQUEURS NOT IN THE NATURE OF ESSENTIAL OILS; FRUIT DRINKS; FRUIT JUICE BASES; FRUIT JUICES, NAMELY, POMEGRANATE JUICE, GRAPEFRUIT JUICE, LEMON JUICE, LIME JUICE; FRUIT-BASED SOFT DRINKS FLAVORED WITH TEA; GINGER ALE; GINGER BEER; GUARANA DRINKS; HERBAL JUICES; HOP EXTRACTS FOR MANUFACTURING BEER; HORCHATA; ISOTONIC DRINKS; LAGERS; LEMONADE; NON-ALCOHOLIC BEER; NON-ALCOHOLIC MALT BEVERAGES; NON-CARBONATED SOFT DRINKS; NON ALCOHOLIC BEVERAGES, NAMELY, CARBONATED BEVERAGES; REFRIGERATED JUICES, NAMELY, REFRIGERATED TOMATO JUICE, REFRIGERATED ORANGE JUICE, REFRIGERATED APPLE JUICE, REFRIGERATED GRAPEFRUIT JUICE, REFRIGERATED POMEGRANATE JUICE, REFRIGERATED PINEAPPLE JUICE, REFRIGERATED LIME JUICE, REFRIGERATED LEMON JUICE AND REFRIGERATED FRUIT JUICE BLENDS; FROZEN JUICES AND DRINKS, NAMELY, FROZEN FRUIT BEVERAGES AND NON-CARBONATED, NON-ALCOHOLIC FROZEN FLAVORED FRUIT BEVERAGES, FROZEN ORANGE JUICE, FROZEN APPLE JUICE, FROZEN GRAPEFRUIT JUICE, FROZEN LIMEADE, FROZEN LEMONADE, FROZEN JUICE BLENDS; QUININE WATER; SARSAPARILLA; SELTZER WATER; SODA WATER; SPORTS DRINKS; SWEET CIDER; VEGETABLE JUICE BEVERAGES (U.S. CLS. 45, 46 AND 48).  
 MARK T. MULLEN, EXAMINING ATTORNEY

**CLASS 7—MACHINERY**

FOR ELECTRICAL APPLIANCES, NAMELY, FOOD BLENDERS, ELECTRIC COFFEE GRINDERS FOR DOMESTIC USE, FOOD PROCESSORS, FOOD CHOPPERS, MIXERS (U.S. CLS. 13, 19, 21, 23, 31, 34 AND 35).

**CLASS 11—ENVIRONMENTAL CONTROL APPARATUS**

FOR ELECTRICAL APPLIANCES, NAMELY, COFFEE MAKERS, FRYING PANS, GRILLS, PORTABLE COOKING RANGES, KETTLES, TOASTER AND CONVECTION OVENS, COMBINATION TOASTER-CONVECTION OVEN THAT PRODUCE STEAM FOR BAKING OR ROASTING, PANINI GRILLS, RICE COOKER, SANDWICH PRESSES, NAMELY, ELECTRIC PANINI MAKERS, TOASTERS (U.S. CLS. 13, 21, 23, 31 AND 34).  
 BILL DAWE, EXAMINING ATTORNEY

SN 77-174,774. FIG & OLIVE USA INC., NEW YORK, NY. FILED 5-7-2007.



OWNER OF U.S. REG. NOS. 2,981,952 AND 3,135,516.  
 THE MARK CONSISTS OF THE WORDS "FIG & OLIVE" AND A DESIGN OF AN OLIVE BRANCH.

SN 77-203,346. T-MOBILE USA, INC., BELLEVUE, WA. FILED 6-11-2007.

**PLAY**

THE MARK CONSISTS OF STANDARD CHARACTERS WITHOUT CLAIM TO ANY PARTICULAR FONT, STYLE, SIZE, OR COLOR.

**CLASS 9—ELECTRICAL AND SCIENTIFIC APPARATUS**

FOR WIRELESS TELECOMMUNICATIONS AND INFORMATION TECHNOLOGY EQUIPMENT, NAMELY, WIRELESS TELEPHONES, WIRELESS MODEMS, WIRELESS HANDHELD COMPUTERS, AND RELATED ACCESSORIES, NAMELY, SMART CARDS CONTAINING PROGRAMMING USED TO INTERACT WITH A WIRELESS TELEPHONE OR HANDHELD COMPUTER AND RESPOND TO A SIGNAL CONTACT THAT REQUESTS CUSTOMER IDENTIFICATION AND ACCOUNT INFORMATION, CARRYING CASES FOR WIRELESS TELEPHONES AND COMPUTERS, HANDS-FREE MICROPHONE AND EARPHONE ADAPTERS, HEADSET ADAPTERS, WIRELESS TELEPHONE AND HANDHELD COMPUTER MOUNTS, BATTERIES, BATTERY CHARGERS, AND FACEPLATES FOR WIRELESS DEVICES (U.S. CLS. 21, 23, 26, 36 AND 38).

**CLASS 38—COMMUNICATION**

FOR TELECOMMUNICATIONS SERVICES, NAMELY, WIRELESS VOICE AND DATA TRANSMISSION (U.S. CLS. 100, 101 AND 104).

MATTHEW EINSTEIN, EXAMINING ATTORNEY

SN 77-664,031. AVIDIAMED GMBH, HAMBURG, FED REP GERMANY, FILED 2-5-2009.

**AVIDIAMED**

THE MARK CONSISTS OF STANDARD CHARACTERS WITHOUT CLAIM TO ANY PARTICULAR FONT, STYLE, SIZE, OR COLOR.

PRIORITY CLAIMED UNDER SEC. 44(D) ON FED REP GERMANY APPLICATION NO. 302008052761, FILED 8-13-2008, REG. NO. 302008052761, DATED 10-29-2008, EXPIRES 8-13-2018.

**CLASS 5—PHARMACEUTICALS**

FOR SANITARY PREPARATIONS FOR MEDICAL PURPOSES; DIETETIC FOOD AND SUGAR ADAPTED FOR MEDICAL USE; FOOD FOR BABIES; MEDICAL PLASTERS, MATERIALS IN THE NATURE OF MEDICAL DRESSINGS; MATERIAL FOR STOPPING TEETH, DENTAL WAX; DISINFECTANTS, NAMELY, ALL-PURPOSE DISINFECTANTS AND DISINFECTANTS FOR SANITARY PURPOSES; PREPARATIONS FOR DESTROYING VERMIN; FUNGICIDES, HERBICIDES; PHARMACEUTICAL PREPARATIONS INDIVIDUALLY COMPILED BASED UPON A PATIENTS PRESCRIBED MEDICATION TO TREAT DISEASES AND DISORDERS OF THE CENTRAL NERVOUS SYSTEM, AUTOIMMUNE DISEASES, INFLAMMATION, CANCER, INFECTIOUS DISEASES, CARDIOVASCULAR DISEASES, NEURODEGENERATIVE AND CHRONIC DISEASES, DIABETES, EYE DISEASES AND CONDITIONS, PSYCHIATRIC DISEASES AND DISORDERS, GASTRO-INTESTINAL DISEASES, ASTHMA, SKIN DISORDERS, UROLOGY, KIDNEY DISEASE, PAIN RELIEF AND ALLERGIES; VETERINARY PREPARATIONS INDIVIDUALLY COMPILED BASED UPON AN ANIMAL'S PRESCRIBED MEDICATION TO TREAT DISEASES AND DISORDERS OF THE CENTRAL NERVOUS SYSTEM, AUTOIMMUNE DISEASES, INFLAMMATION, CANCER, INFECTIOUS DISEASES, CARDIOVASCULAR DISEASES, NEURODEGENERATIVE AND CHRONIC DISEASES, DIABETES, EYE DISEASES AND CONDITIONS, PSYCHIATRIC DISEASES AND DISORDERS, GASTRO-INTESTINAL DISEASES, ASTHMA, SKIN DISORDERS, UROLOGY, KIDNEY DISEASE, PAIN RELIEF, COAT AND ALLERGIES (U.S. CLS. 6, 18, 44, 46, 51 AND 52).

**CLASS 35—ADVERTISING AND BUSINESS**

FOR WHOLESALE STORE SERVICES AND WHOLESALE DISTRIBUTORSHIPS IN THE FIELD OF PHARMACY; RETAIL STORE SERVICES IN THE FIELD OF PHARMACY; SERVICES RENDERED BY A FRANCHISOR, NAMELY, ASSISTANCE IN THE RUNNING OR MANAGEMENT OF INDUSTRIAL OR COMMERCIAL ENTERPRISES BY CONVEYING OF TECHNICAL KNOW-HOW; BUSINESS PROCESS RE-ENGINEERING SERVICES, NAMELY, BUSINESS PROCESS RE-ENGINEERING CONSULTATION IN THE AREAS OF TASK MANAGEMENT AND WORK FLOWS IN THE FIELD OF PACKING AND PACKAGING GOODS; TECHNICAL AND ELECTRONIC DATA PROCESSING CONSULTATION IN THE FIELD OF PACKING AND PACKAGING OF GOODS; TRANSPORTATION LOGISTICS SERVICES, NAMELY, ARRANGING THE TRANSPORTATION OF GOODS FOR OTHERS (U.S. CLS. 100, 101 AND 102).

**CLASS 39—TRANSPORTATION AND STORAGE**

FOR TRANSPORT OF GOODS; PACKAGING AND STORAGE OF GOODS; DELIVERY OF GOODS; DELIVERY, NAMELY, DISTRIBUTION OF PHARMACEUTICAL AND VETERINARY PRODUCTS; STORAGE AND STOCKING IN THE NATURE OF TRANSPORT AND DELIVERY OF GOODS; WAREHOUSING SERVICES, NAMELY, BOXING, PACKING, UNPACKING, REPACKING AND PORTIONING OF GOODS, PARTICULARLY OF PHARMACEUTICAL AND VETERINARY PRODUCTS; SUPPLY-CHAIN LOGISTICS AND REVERSE LOGISTICS SERVICES, NAMELY, PACKING AND SHIPPING OF GOODS FOR OTHERS; PACKING OF PHARMACEUTICAL AND VETERINARY PRODUCTS IN PUSH-THROUGH FOIL BLISTER PACKAGING; COURIER SERVICES FOR GOODS; TRANSPORT OF PHARMACEUTICALS; TECHNICAL CONSULTATION IN THE FIELD OF PACKING AND PACKAGING OF GOODS (U.S. CLS. 100 AND 105).

**CLASS 44—MEDICAL, BEAUTY AND AGRICULTURAL SERVICES**

FOR MEDICAL AND VETERINARY SERVICES; HYGIENIC AND BEAUTY CARE FOR HUMAN BEINGS OR ANIMALS; HEALTH-CARE CONSULTANCY; TELEMEDICINE SERVICES; MEDICAL CARE; PREPARATION OF PRESCRIPTIONS IN PHARMACIES; MEDICAL AND CLINICAL EXAMINATIONS; PHARMACY ADVICE, NAMELY, PHARMACEUTICAL ADVICE; PHARMACISTS' SERVICES TO MAKE UP PRESCRIPTIONS, NAMELY, PHARMACISTS' SERVICES TO MAKE UP PATIENT-SPECIFIC COMPOSITIONS OF PHARMACEUTICAL PREPARATIONS ACCORDING TO THE PATIENT'S PRESCRIPTION (U.S. CLS. 100 AND 101).

BRENDAN REGAN, EXAMINING ATTORNEY

SN 77-854,977. CATCH MEDIA, INC., DOUGLASVILLE, GA, FILED 10-22-2009.

**PLAY ANYWHERE**

THE MARK CONSISTS OF STANDARD CHARACTERS WITHOUT CLAIM TO ANY PARTICULAR FONT, STYLE, SIZE, OR COLOR.

NO CLAIM IS MADE TO THE EXCLUSIVE RIGHT TO USE "PLAY", APART FROM THE MARK AS SHOWN.

**CLASS 9—ELECTRICAL AND SCIENTIFIC APPARATUS**

FOR COMPUTER SOFTWARE AND HARDWARE FOR DELIVERING AUDIO CONTENT, VIDEO CONTENT, AND ELECTRONIC BOOKS (E-BOOKS) TO MOBILE DEVICES; COMPUTER SOFTWARE AND HARDWARE FOR REGISTERING, TRACKING AND ROUTING AUDIO AND VIDEO CONTENT; COMPUTER SOFTWARE AND HARDWARE FOR SYNCHRONIZING AUDIO AND VIDEO CONTENT BETWEEN DEVICES; COMPUTER SOFTWARE AND HARDWARE FOR REPORTING AUDIO AND VIDEO CONTENT USAGE AND PURCHASES; COMPUTER SOFTWARE AND HARDWARE FOR CALCULATING DISBURSEMENT OF REVENUES GENERATED FROM USING AND PURCHASING AUDIO AND VIDEO CONTENT, FROM SUBSCRIPTIONS TO AUDIO AND VIDEO CONTENT SERVICES, AND FROM IN-CONTENT ADVERTISING; COMPUTER SOFTWARE AND HARDWARE FOR MANAGING AND ORGANIZING ELECTRONIC BOOKS (E-BOOKS); COMPUTER SOFTWARE AND HARDWARE FOR TRACKING AND REPORTING E-BOOK USAGE AND E-BOOK PURCHASES; COMPUTER SOFTWARE AND HARDWARE FOR SYNCHRONIZING E-BOOKS BETWEEN DEVICES; COMPUTER SOFTWARE AND HARDWARE FOR CALCULATING DISBURSEMENT OF REVENUES GENERATED FROM E-BOOK USAGE AND PURCHASES, FROM SUBSCRIPTIONS TO E-BOOK SERVICES, AND FROM IN-BOOK ADVERTISING; COMPUTER HARDWARE AND SOFTWARE FOR TRACKING, MANAGING AND DISPLAYING MEDICAL INFORMATION AND CONTENT IN THE NATURE OF PERSONAL MEDICAL RECORDS, MEDICAL SCANS AND MEDICAL TEST RESULTS; COMPUTER SOFTWARE AND HARDWARE FOR TRACKING AND REPORTING DELIVERY, DISPLAY, PLAYBACK AND USAGE OF MEDICAL INFORMATION; COMPUTER SOFTWARE AND HARDWARE FOR TRACKING AND MANAGING MEDICAL INFORMATION AND CONTENT IN THE NATURE OF PERSONAL MEDICAL RECORDS, MEDICAL SCANS AND MEDICAL TEST RESULTS IN CONJUNCTION WITH HOSPITAL INFORMATION SYSTEMS; COMPUTER SOFTWARE AND HARDWARE FOR CALCULATING DISBURSEMENT OF REVENUES GENERATED FROM DELIVERY OF MEDICAL INFORMATION AND CONTENT, FROM DISPLAY OF MEDICAL INFORMATION AND CONTENT, AND FROM SUBSCRIPTIONS TO MEDICAL INFORMATION AND CONTENT SERVICES; COMPUTER E-COMMERCE SOFTWARE TO ALLOW USERS TO PERFORM ELECTRONIC BUSINESS TRANSACTIONS VIA A GLOBAL COMPUTER NETWORK (U.S. CLS. 21, 23, 26, 36 AND 38).

**CLASS 35—ADVERTISING AND BUSINESS**

FOR BUSINESS SERVICES, NAMELY, SALES VOLUME TRACKING FOR OTHERS IN THE NATURE OF TRACKING ONLINE BUSINESS PURCHASES, DOWNLOADS OF PURCHASED AUDIO AND VIDEO CONTENT, TRANSFER OF PURCHASED AUDIO AND VIDEO CONTENT, PURCHASES OF E-BOOKS; ACCOUNTING SERVICES, NAMELY, PROVIDING ONLINE TRACKING REPORTS IN THE FIELD OF REVENUES; PROVIDING INFORMATION IN THE FIELD OF BILLING; ARRANGING SUBSCRIPTIONS TO THE ONLINE PUBLICATIONS OF OTHERS AND ONLINE CONTENT SUBSCRIPTIONS; ADVERTISING SERVICES; PROVIDING INFORMATION IN THE FIELD OF ADVERTISING SERVICES, NAMELY TRACKING OF ADVERTISING INFORMATION AND DISBURSEMENT OF ADVERTISING REVENUES AND SUCCESS RATES OF VARIOUS TYPES OF ADVERTISING; ADMINISTRATION AND RECONCILIATION OF ACCOUNTS ON BEHALF OF OTHERS, NAMELY, DISBURSEMENT OF ADVERTISING REVENUES; BILLING SERVICES; MEDICAL BILLING SUPPORT SERVICES; PROVIDING AN ON-LINE DEPOSITORY OF AUDIO AND VIDEO CONTENT AVAILABLE FOR RETAIL AND WHOLESALE PURCHASE AND/OR DOWNLOAD; ONLINE SERVICES, NAMELY, SALES VOLUME TRACKING AND MONITORING FOR OTHERS OF ONLINE SALES OF AUDIO AND VIDEO CONTENT AND OF ONLINE SUBSCRIPTIONS FOR AUDIO AND VIDEO CONTENT (U.S. CLS. 100, 101 AND 102).

**CLASS 36—INSURANCE AND FINANCIAL**

FOR INSURANCE INFORMATION AND CONSULTANCY; INSURANCE ADMINISTRATION; INSURANCE BROKERAGE (U.S. CLS. 100, 101 AND 102).

**CLASS 38—COMMUNICATION**

FOR INFORMATION ABOUT TELECOMMUNICATION, NAMELY, PROVIDING INFORMATION REGARDING THE VOLUME, ORIGIN, AND DESTINATION OF AUDIO, VIDEO, AND AUDIOVISUAL MATERIAL TRANSMITTED BY MEANS OF A GLOBAL COMPUTER NETWORK (U.S. CLS. 100, 101 AND 104).

**CLASS 42—SCIENTIFIC AND COMPUTER SERVICES**

FOR PROVIDING TEMPORARY USE OF ONLINE, NONDOWNLOADABLE SOFTWARE FOR TRACKING ACQUISITION AND DELIVERY OF AUDIO AND VIDEO CONTENT; PROVIDING TEMPORARY USE OF ONLINE, NONDOWNLOADABLE SOFTWARE FOR USE IN BILLING CUSTOMERS IN CONNECTION WITH DOWNLOADS OF AND SUBSCRIPTIONS TO AUDIO AND VIDEO CONTENT; PROVIDING TEMPORARY USE OF ONLINE, NONDOWNLOADABLE SOFTWARE FOR AUDIO AND VIDEO USAGE TRACKING, REVENUE TRACKING, REVENUE DISBURSEMENT, AND CLEARING SERVICES; PROVISION OF INTERNET SEARCH ENGINES; REMOTE ONLINE BACKUP OF COMPUTER DATA, INCLUDING AUDIO AND VIDEO CONTENT AND BILLING INFORMATION; PROVIDING TEMPORARY USE OF ONLINE, NONDOWNLOADABLE SOFTWARE FOR TRACKING ACQUISITION AND DELIVERY OF MEDICAL INFORMATION AND CONTENT IN THE NATURE OF PERSONAL MEDICAL RECORDS, MEDICAL SCANS AND MEDICAL TEST RESULTS (U.S. CLS. 100 AND 101).

**CLASS 44—MEDICAL, BEAUTY AND AGRICULTURAL SERVICES**

FOR PROVIDING MEDICAL INFORMATION (U.S. CLS. 100 AND 101).  
NORA BUCHANAN WILL, EXAMINING ATTORNEY

SN 77-898,720. GEETA P. ARORA, PALO ALTO, CA. FILED 12-21-2009.

---

**MANTRA**

THE MARK CONSISTS OF STANDARD CHARACTERS WITHOUT CLAIM TO ANY PARTICULAR FONT, STYLE, SIZE, OR COLOR.

THE ENGLISH TRANSLATION OF "MANTRA" IN THE MARK IS "SACRED WORD" OR "SECRET".

**CLASS 3—COSMETICS AND CLEANING PREPARATIONS**

FOR AROMATHERAPY FACE AND BODY CARE PRODUCTS, NAMELY, BODY LOTION, SHOWER GEL, CUTICLE CREAM, NON-MEDICATED LIP BALM, SOAP, BODY POLISH, BODY AND FOOT EXFOLIANT; AROMATHERAPY OILS; BEAUTY MILKS; BEAUTY SERUMS; DECORATIVE TRANSFERS AND SKIN JEWELS FOR COSMETIC PURPOSES; MASSAGE LOTIONS; MASSAGE OILS; NON-MEDICATED HAIR RESTORATION OILS; NON-MEDICATED SKIN CARE PREPARATIONS; SKIN CLARIFIERS; SKIN CLEANSERS; SKIN FRESHENERS; SKIN LIGHTENERS; SKIN LIGHTENING CREAMS; SKIN LOTIONS; SKIN MASKS; SKIN MOISTURIZER; SKIN MOISTURIZER MASKS; SKIN TEXTURIZE CREAMS; SKIN TONERS; SKIN WHITENING CREAMS; WAX FOR REMOVING BODY HAIR (U.S. CLS. 1, 4, 6, 50, 51 AND 52).

**CLASS 30—STAPLE FOODS**

FOR EDIBLE SPICES; FLAVORINGS AND SEASONINGS; HERBAL FOOD BEVERAGES; HERBAL INFUSIONS; MASALA POWDER AND SPICES; SEASONING MIXES; SPICE BLENDS (U.S. CL. 46).  
SUZANNE BLANE, EXAMINING ATTORNEY

SN 79-109,775. SCHENCK PROCESS GMBH, FED REP GERMANY, FILED 7-11-2011.

**macprocess**

THE MARK CONSISTS OF STANDARD CHARACTERS WITHOUT CLAIM TO ANY PARTICULAR FONT, STYLE, SIZE, OR COLOR.

PRIORITY DATE OF 5-18-2011 IS CLAIMED.  
OWNER OF INTERNATIONAL REGISTRATION 1108364 DATED 7-11-2011, EXPIRES 7-11-2021.  
OWNER OF U.S. REG. NOS. 652,998, 1,151,453 AND OTHERS.

**CLASS 6—METAL GOODS**

FOR TANKS AND SILOS OF METAL OR MAINLY OF METAL, NAMELY, CONTAINERS OF METAL OR MAINLY OF METAL FOR THE STORAGE AND TRANSPORTATION OF BULK MATERIAL (U.S. CLS. 2, 12, 13, 14, 23, 25 AND 50).

**CLASS 7—MACHINERY**

FOR MACHINES FOR THE CHEMICAL AND PHARMACEUTICAL INDUSTRY, FOOD INDUSTRY, PLASTICS, PAPER AND CELLULOSE INDUSTRY, HEAVY INDUSTRY AND ENVIRONMENTAL INDUSTRY, NAMELY, MACHINES FOR SEPARATING, GRADING, HANDLING, LOADING AND UNLOADING, CONVEYING, PRESSING AND CRUSHING OF REFUSE; ENGINES NOT FOR LAND VEHICLES; MACHINES FOR COOLING AND DRYING, IN PARTICULAR FOR COOLING AND DRYING OF CONVEYOR OR BULK MATERIAL FOR USE IN A WIDE VARIETY OF INDUSTRIES; MACHINE COUPLINGS AND POWER TRANSMISSION COMPONENTS, EXCEPT FOR LAND VEHICLES; MACHINES WITH MECHANICAL CARRYING DEVICES FOR HOLDING AND EMPTYING OF BULK MATERIAL CONTAINERS, PRINCIPALLY MACHINE EQUIPMENT AS MACHINE PARTS FOR STIRRING AND CONVEYING OF BULK MATERIAL WITHIN BULK MATERIAL CONTAINERS; MACHINES, NAMELY, VOLUME CONVEYORS; BULK MATERIAL MIXING MACHINES; BOTTLE FILLING MACHINES; MACHINES FOR SORTING BULK MATERIAL; DUST FILTERS AND DUST FILTRATION APPARATUS, NAMELY, DUST FILTERS AND BAGS FOR VACUUM CLEANERS; MIXING MACHINES; DRAINAGE SIEVES AS MACHINES OR MACHINE PARTS; CAST IRON UNPACKING MACHINES; MECHANICAL VIBRATION APPARATUS FOR CONVEY-

ING, SHAKING, FEEDING, SCREENING, COMPACTING AND SORTING OF MATERIALS; VIBRATING CONVEYOR CHANNELS AND VIBRATING SIEVES AS MACHINES OR MACHINE PARTS; BASE COMPACTING MACHINES FOR COMPACTING WASTE; PARTS OF VIBRATING MACHINES, NAMELY, DIRECTIONAL EXCITERS, CIRCLE EXCITERS, UNBALANCE MOTORS, MAGNETIC EXCITERS; SPRINGS AS COMPONENT PARTS OF MACHINES AND CARDAN SHAFTS AS MACHINE PARTS; MACHINE-OPERATED TRANSPORTATION APPARATUS, NAMELY, CONVEYORS, CONVEYOR BELTS, CONVEYOR MATS AND PNEUMATIC TRANSPORTERS; SCREW CONVEYORS AND FEEDING SCREW CONVEYORS AS MACHINES OR MACHINE PARTS; CONVEYOR BELTS; CELL SLUICES AS MACHINES FOR CONVEYING AND MEASURING OF BULK MATERIAL; CHAIN CONVEYORS; SHEET BANDS, NAMELY, BELTS FOR MACHINES AND CONVEYOR BELTS AS MACHINE PARTS; LIFTING JACKS, NAMELY, POWER-OPERATED MECHANICAL EQUIPMENT FOR LIFTING AND LOWERING OF LOADS; BUCKET CONVEYORS; ELEVATORS; BELT CONVEYORS; PATERNOSTER BELTS AS MECHANICAL COMPONENTS; APRON CONVEYORS; MACHINE-OPERATED WAGON LOADING AND WAGON UNLOADING APPARATUS; MECHANICAL CONVEYORS FOR PITS; MACHINES FOR CLEANING COAL AND PARTS BELONGING THERETO, IN PARTICULAR CRUSHERS; CHUTES AS COMPONENT PARTS OF SORTING MACHINES; ELECTRIC, HYDRAULIC, CENTRIFUGAL, PNEUMATIC, AND MECHANICAL PUMPS; CONVEYORS; CYCLONES AND SPIRAL SEPARATORS; HYDRO CYCLONES; SPIRAL CONCENTRATORS; MAGNETIC SEPARATORS; DRAINAGE MACHINES IN THE NATURE OF SCREEN SEPARATORS FOR THE DRAINAGE OF LIQUIDS FROM SOLIDS; MECHANICAL EQUIPMENT FOR ADDING OF FLAKE SUBSTANCES, NAMELY, DISPENSING MACHINES FOR ADDING AND MIXING FLAKED SUBSTANCES FOR INDUSTRIAL PURPOSES; PRESSURE FILTER MACHINES; MACHINES FOR FILLING, FILTERING, AND DISCHARGING OF POWDER AND BULK MATERIAL CONTAINERS; PNEUMATIC AND MECHANICAL CONVEYING MACHINES FOR THE TRANSPORTATION OF POWDERS AND BULK MATERIALS; PARTS OF INDUSTRIAL CONVEYING, FILLING, FILTERING, AND DISPENSING MACHINES, NAMELY, VALVES AND FLOW PROMOTION DEVICES TO START, RESTRICT AND ARREST THE FLOW OF POWDERS AND BULK MATERIALS (U.S. CLS. 13, 19, 21, 23, 31, 34 AND 35).

**CLASS 9—ELECTRICAL AND SCIENTIFIC APPARATUS**

FOR PHYSICAL, OPTICAL, ELECTRO TECHNICAL AND ELECTRONIC DEVICES FOR CONTROL SYSTEMS AND SURVEILLANCE OF MACHINES, NAMELY, PROCESS CONTROL SYSTEMS FOR EQUIPMENT USED IN AIR POLLUTION AND FILTRATION, PNEUMATIC CONVEYING AND MECHANICAL BULK MATERIAL HANDLING COMPRISED OF LOGIC BASED HARDWARE AND MICRO-PROCESSOR BASED HARDWARE AND SOFTWARE FOR MEASUREMENT OF PRESSURE, ACCELERATION, FORCE AND FLOW; MEASURING APPARATUS, NAMELY, BASE AND DERIVED-UNIT MEASURING MACHINES AND APPARATUS; SIGNALING AND REGULATING APPARATUS AND INSTRUMENTS, NAMELY, APPARATUS AND INSTRUMENTS FOR GAGING, REGULATING, CONTROLLING, AND RECORDING THE FLOW AND LEVELS OF AIR, LIQUID, AND BULK MATERIAL, AND FOR GAGING, REGULATING, CONTROLLING, AND RECORDING MACHINE OPERATIONS; MEASUREMENT RECORDERS, NAMELY, ELECTRONIC MEASUREMENT RECORDERS FOR PRESSURE DATA, ACCELERATION DATA, FORCE DATA AND FLOW DATA; EQUIPMENT FOR THE PURPOSES OF VIBRATION MEASUREMENT, VIBRATION MONITORING, AND MONITORING MACHINES, NAMELY, VIBRATION METERS, VIBRATION SENSORS FOR MONITORING VIBRATION IN INDUSTRIAL MACHINES; DENSIMETERS; LEVEL MEASURING INSTRUMENTS; PRESSURE RECORDERS; SCALES; WEIGHING EQUIPMENT, NAMELY, MECHANICAL SCALES AND PARTS OF SCALES; MASS FLOW MEASURING APPARATUS; VEHICLE SCALES; MACHINES FOR MEASURING AND TESTING OF FORCE TRANSDUCERS; BELT SCALES; MEASURING BELT SCALES; DIFFERENTIAL MEASURING SCALES;

ELECTRONIC APPARATUS AND DATA ACQUISITION FOR AIR POLLUTION AND FILTRATION, PNEUMATIC CONVEYING AND MECHANICAL BULK MATERIAL HANDLING, MONITORING AND CONTROL SYSTEMS COMPRISED PRIMARILY OF VIDEO MONITORS AND COMPUTER HARDWARE FOR SUCH MACHINES; SECURITY INSTALLATIONS, NAMELY, ALARM MONITORING SYSTEMS FOR MACHINES; ELECTRONIC PROTECTION DEVICES, NAMELY, ALARM MONITORING SYSTEMS FOR MACHINES; SENSORS FOR MONITORING AND CONTROL PURPOSES FOR USE WITH MACHINES, NAMELY, PRESSURE SENSORS FOR MACHINES, ACCELERATION SENSORS FOR MACHINES, FORCE SENSORS FOR MACHINES AND FLOW SENSORS FOR MACHINES; CALCULATORS AND RELATED COMPUTER PERIPHERAL APPARATUS FOR CONTROL, SYSTEMS AND AUTOMATIC CONTROL OF ALARM MONITORING SYSTEMS AND INDUSTRIAL MACHINES; COMPUTER PROGRAMS RECORDED ON DATA CARRIERS FOR OPERATING CONTROL SYSTEMS FOR, AND AUTOMATIC CONTROL OF, ALARM MONITORING SYSTEMS AND INDUSTRIAL MACHINES (U.S. CLS. 21, 23, 26, 36 AND 38).

#### **CLASS 11—ENVIRONMENTAL CONTROL APPARATUS**

FOR APPARATUS AND INSTALLATIONS FOR COOLING AND DRYING OF CONVEYOR AND BULK MATERIAL, NAMELY, INDUSTRIAL COOLING UNITS, COOLING EVAPORATORS, AND DEHUMIDIFIERS FOR COOLING AND DRYING OF CONVEYOR AND BULK MATERIAL FOR USE IN A WIDE VARIETY OF INDUSTRIES; AIR FILTRATION APPARATUS AND MACHINES, NAMELY, AIR FILTERING INSTALLATIONS AND INDUSTRIAL AIR FILTER MACHINES; AIR PURIFYING APPARATUS AND MACHINES (U.S. CLS. 13, 21, 23, 31 AND 34).

#### **CLASS 12—VEHICLES**

FOR AERIAL CONVEYORS (U.S. CLS. 19, 21, 23, 31, 35 AND 44).

#### **CLASS 20—FURNITURE AND ARTICLES NOT OTHERWISE CLASSIFIED**

FOR NON-METAL CONTAINERS FOR STORAGE AND TRANSPORTATION OF BULK MATERIALS, FOR COMMERCIAL OR INDUSTRIAL USE (U.S. CLS. 2, 13, 22, 25, 32 AND 50).

#### **CLASS 37—CONSTRUCTION AND REPAIR**

FOR INSTALLATION, MAINTENANCE AND REPAIR OF MACHINES FOR THE CHEMICAL AND PHARMACEUTICAL INDUSTRY, FOOD INDUSTRY, PLASTICS, PAPER AND CELLULOSE INDUSTRY, HEAVY INDUSTRY AND ENVIRONMENTAL INDUSTRY, NAMELY, MACHINES FOR SEPARATING, GRADING, HANDLING, LOADING AND UNLOADING, CONVEYING, PRESSING AND CRUSHING OF REFUSE; INSTALLATION, MAINTENANCE AND REPAIR OF ENGINES NOT FOR LAND VEHICLES; INSTALLATION, MAINTENANCE AND REPAIR OF MACHINES FOR COOLING AND DRYING, IN PARTICULAR FOR COOLING AND DRYING OF CONVEYOR OR BULK MATERIAL FOR USE IN A WIDE VARIETY OF INDUSTRIES; INSTALLATION, MAINTENANCE AND REPAIR OF COUPLINGS AND APPLIANCES FOR POWER TRANSMISSION COMPONENTS, EXCEPT FOR LAND VEHICLES, CONVEYORS, AND MACHINES WITH MECHANICAL CARRYING DEVICES FOR HOLDING AND EMPTYING OF BULK MATERIAL CONTAINERS, PRINCIPALLY MACHINE EQUIPMENT AS MACHINE PARTS FOR STIRRING AND CONVEYING OF BULK MATERIAL WITHIN BULK MATERIAL CONTAINERS; INSTALLATION, MAINTENANCE AND REPAIR OF MACHINES, NAMELY, VOLUME CONVEYORS, BULK MATERIAL MIXING MACHINES, BOTTLE FILLING MACHINES, AND MACHINES FOR SORTING BULK MATERIAL; INSTALLATION, MAINTENANCE AND REPAIR OF DUST FILTERS AND DUST FILTRATION APPARATUS; MAINTENANCE AND REPAIR OF MIXING MACHINES AND OF DRAINAGE SIEVES AS

MACHINES OR MACHINE PARTS; INSTALLATION, MAINTENANCE AND REPAIR OF CAST IRON UNPACKING MACHINES; INSTALLATION, MAINTENANCE AND REPAIR OF MECHANICAL VIBRATION APPARATUS FOR CONVEYING, SHAKING, FEEDING, SCREENING, COMPACTING AND SORTING OF MATERIALS, OF VIBRATING CONVEYOR CHANNELS AND VIBRATING SIEVES AS MACHINES OR MACHINE PARTS, OF BASE COMPACTING MACHINES, AND PARTS OF VIBRATING MACHINES, IN PARTICULAR DIRECTIONAL EXCITERS, CIRCLE EXCITERS, UNBALANCE MOTORS, AND MAGNETIC EXCITERS; INSTALLATION, MAINTENANCE AND REPAIR OF SPRINGS AS COMPONENT PARTS OF MACHINES AND CARDAN SHAFTS AS MACHINE PARTS; INSTALLATION, MAINTENANCE AND REPAIR OF MACHINE-OPERATED TRANSPORTATION APPARATUS IN THE NATURE OF CONVEYORS, CONVEYOR BELTS, CONVEYOR MATS AND PNEUMATIC TRANSPORTERS, SCREW CONVEYORS AND FEEDING SCREW CONVEYORS AS MACHINES OR MACHINE PARTS, OF CONVEYOR BELTS, CELL SLUICES AS MACHINES FOR CONVEYING AND MEASURING OF BULK MATERIAL, OF CHAIN CONVEYORS, AND OF SHEET BANDS, NAMELY, BELTS FOR MACHINES AND CONVEYOR BELTS AS MACHINE PARTS; INSTALLATION, MAINTENANCE AND REPAIR OF LIFTING JACKS, NAMELY, POWER-OPERATED MECHANICAL EQUIPMENT FOR LIFTING AND LOWERING OF LOADS, OF BUCKET CONVEYORS, AND OF ELEVATORS; INSTALLATION, MAINTENANCE AND REPAIR OF BELT CONVEYORS, PATERNOSTER BELTS AS MECHANICAL COMPONENTS, APRON CONVEYORS, AND OF MACHINE-OPERATED WAGON LOADING AND WAGON UNLOADING APPARATUS; INSTALLATION, MAINTENANCE AND REPAIR OF MECHANICAL CONVEYORS FOR PITS AND OF MACHINES FOR CLEANING COAL AND CRUSHERS BELONGING THERETO; INSTALLATION, MAINTENANCE AND REPAIR OF CHUTES AS COMPONENT PARTS OF SORTING MACHINES; INSTALLATION, MAINTENANCE AND REPAIR OF ELECTRIC, HYDRAULIC, CENTRIFUGAL, PNEUMATIC, AND MECHANICAL PUMPS; INSTALLATION, MAINTENANCE AND REPAIR OF CONVEYORS, CYCLONES AND SPIRAL SEPARATORS, HYDRO CYCLONES, SPIRAL CONCENTRATORS, MAGNETIC SEPARATORS, CENTRIFUGES, AND OF DRAINAGE MACHINES, NAMELY, SCREEN SEPARATORS FOR THE DRAINAGE OF LIQUIDS FROM SOLIDS; INSTALLATION, MAINTENANCE AND REPAIR OF MECHANICAL EQUIPMENT FOR ADDING OF FLAKE SUBSTANCES, NAMELY, DISPENSING MACHINES FOR ADDING AND MIXING FLAKED SUBSTANCES FOR INDUSTRIAL PURPOSES; INSTALLATION, MAINTENANCE AND REPAIR OF PRESSURE FILTER MACHINES; INSTALLATION, MAINTENANCE AND REPAIR OF MACHINES FOR FILLING AND DISCHARGING OF POWDER AND BULK MATERIAL CONTAINERS, OF PNEUMATIC AND MECHANICAL CONVEYING MACHINES FOR THE TRANSPORTATION OF POWDERS AND BULK MATERIALS, AND OF PARTS OF INDUSTRIAL CONVEYING, FILLING, FILTERING, AND DISPENSING MACHINES, NAMELY, VALVES AND FLOW PROMOTION DEVICES TO START, RESTRICT AND ARREST THE FLOW OF POWDERS AND BULK MATERIALS; INSTALLATION, MAINTENANCE AND REPAIR OF PHYSICAL, OPTICAL, ELECTRO TECHNICAL AND ELECTRONIC DEVICES FOR CONTROL SYSTEMS AND SURVEILLANCE OF MACHINES, NAMELY, PROCESS CONTROL SYSTEMS FOR EQUIPMENT USED IN AIR POLLUTION AND FILTRATION, AND OF PNEUMATIC CONVEYING AND MECHANICAL BULK MATERIAL HANDLING COMPRISED OF LOGIC BASED HARDWARE AND MICRO-PROCESSOR BASED HARDWARE AND SOFTWARE FOR MEASUREMENT OF PRESSURE, ACCELERATION, FORCE AND FLOW; INSTALLATION, MAINTENANCE AND REPAIR OF MEASURING APPARATUS, NAMELY, BASE AND DERIVED-UNIT MEASURING MACHINES AND APPARATUS; INSTALLATION, MAINTENANCE AND REPAIR OF SIGNALLING AND REGULATING APPARATUS AND INSTRUMENTS, NAMELY, APPARATUS AND INSTRUMENTS FOR GAGING, REGULATING, CONTROLLING, AND RECORDING THE FLOW AND LEVELS OF AIR, LIQUID, AND BULK MATERIAL, AND FOR GAGING, REGULATING, CONTROLLING, AND RECORDING MACHINE OPERATIONS; INSTALLATION, MAINTENANCE AND REPAIR OF MEASUREMENT RECOR-

DERS, NAMELY, MEASUREMENT RECORDERS OF PRESSURE DATA, ACCELERATION DATA, FORCE DATA AND FLOW DATA; MAINTENANCE AND REPAIR OF EQUIPMENT FOR THE PURPOSES OF VIBRATION MEASUREMENT, VIBRATION MONITORING, AND MONITORING MACHINES, NAMELY, VIBRATION METERS, VIBRATION SENSORS FOR MONITORING VIBRATION IN INDUSTRIAL MACHINES; INSTALLATION, MAINTENANCE AND REPAIR OF DENSIMETERS; INSTALLATION, MAINTENANCE AND REPAIR OF LEVEL MEASURING INSTRUMENTS, PRESSURE RECORDERS, SCALES AND WEIGHING EQUIPMENT IN THE NATURE OF MECHANICAL SCALES AND PARTS OF SCALES, MASS FLOW MEASURING APPARATUS, VEHICLE SCALES, MACHINES FOR MEASURING AND TESTING OF FORCE TRANSDUCERS, BELT SCALES, MEASURING BELT SCALES, AND DIFFERENTIAL MEASURING SCALES; INSTALLATION, MAINTENANCE AND REPAIR OF ELECTRONIC APPARATUS AND DATA ACQUISITION FOR AIR POLLUTION AND FILTRATION, PNEUMATIC CONVEYING AND MECHANICAL BULK MATERIAL HANDLING, AND OF MONITORING AND CONTROL SYSTEMS FOR SUCH MACHINES; INSTALLATION, MAINTENANCE AND REPAIR OF SECURITY INSTALLATIONS AND OF ELECTRONIC PROTECTION DEVICES, NAMELY, MONITORING SYSTEMS FOR MACHINES; INSTALLATION, MAINTENANCE AND REPAIR OF SENSORS FOR MONITORING AND CONTROL PURPOSES FOR USE WITH MACHINES, NAMELY, PRESSURE SENSORS FOR MACHINES, ACCELERATION SENSORS FOR MACHINES, FORCE SENSORS FOR MACHINES AND FLOW SENSORS FOR MACHINES; INSTALLATION, MAINTENANCE AND REPAIR OF CALCULATORS AND RELATED COMPUTER PERIPHERAL APPARATUS FOR CONTROL SYSTEMS AND AUTOMATIC CONTROL OF ALARM MONITORING SYSTEMS AND INDUSTRIAL MACHINES, OF COMPUTER PROGRAMS RECORDED ON DATA CARRIERS FOR OPERATING CONTROL SYSTEMS FOR, AND AUTOMATIC CONTROL OF, ALARM MONITORING SYSTEMS AND INDUSTRIAL MACHINES; INSTALLATION, MAINTENANCE AND REPAIR OF PARTS FOR INDUSTRIAL CONVEYING APPARATUS, CONVEYORS, ELECTRONIC CONTROLLERS FOR INDUSTRIAL MACHINES, OF INDUSTRIAL COOLING UNITS, COOLING EVAPORATORS, AND DEHUMIDIFIERS FOR COOLING AND DRYING OF CONVEYOR AND BULK MATERIAL, OF AIR FILTRATION APPARATUS AND MACHINES, NAMELY, AIR FILTERING INSTALLATIONS AND INDUSTRIAL AIR FILTER MACHINES, OF AIR PURIFYING APPARATUS AND MACHINES AND OF PROCESS CONTROLS EQUIPMENT AND SYSTEMS FOR INDUSTRIAL PROCESS MACHINERY (U.S. CLS. 100, 103 AND 106).

#### **CLASS 42—SCIENTIFIC AND COMPUTER SERVICES**

FOR TECHNOLOGICAL SERVICES, NAMELY, DESIGN OF INDUSTRIAL PROCESS MACHINERY; SERVICES OF ENGINEERS, NAMELY, ENGINEERING; ENGINEERING PROJECT MANAGEMENT SERVICES; TESTING SERVICES, NAMELY, TESTING OF MACHINES, INDUSTRIAL PRODUCTS, OF MATERIALS, AND OF PROCESS MANUFACTURING SYSTEMS; DEVELOPMENT OF SCIENTIFIC TESTING METHODS FOR TESTING OF MACHINES, INDUSTRIAL PRODUCTS, OF MATERIALS, AND OF PROCESS MANUFACTURING SYSTEMS TECHNICAL CONSTRUCTION DRAFTING; TECHNICAL PROJECT PLANNING, NAMELY, DRAFTING; PLANNING OF INSTALLATIONS, NAMELY, ENGINEERING OF INDUSTRIAL PLANTS; TECHNICAL CONSULTANCY IN THE FIELD OF ENGINEERING; DESIGN SERVICES, IN PARTICULAR DESIGN OF MATERIAL MANAGEMENT SYSTEMS AND DESIGN OF AIR FILTRATION SYSTEMS (U.S. CLS. 100 AND 101).

DAVID TOOLEY, EXAMINING ATTORNEY

SN 79-112,952. REXAM DISPENSING SYSTEMS, FRANCE, FILED 11-7-2011.

# PANACHE

THE MARK CONSISTS OF STANDARD CHARACTERS WITHOUT CLAIM TO ANY PARTICULAR FONT, STYLE, SIZE, OR COLOR.

PRIORITY DATE OF 6-7-2011 IS CLAIMED.

OWNER OF INTERNATIONAL REGISTRATION 1116025 DATED 11-7-2011, EXPIRES 11-7-2021.

#### **CLASS 6—METAL GOODS**

FOR METAL VALVES, NAMELY, MANUALLY OPERATED METAL VALVES, ALL OF THE FOREGOING FOR USE IN THE COMMERCIAL PACKAGING OF PERFUME AND COSMETIC PREPARATIONS (U.S. CLS. 2, 12, 13, 14, 23, 25 AND 50).

#### **CLASS 20—FURNITURE AND ARTICLES NOT OTHERWISE CLASSIFIED**

FOR PLASTIC SEALING CAPS, AND OTHER SEALING DEVICES, NAMELY, PLASTIC BOTTLES STOPPERS, PLASTIC CLIPS AND PLUGS, PLASTIC CLOSURES FOR CONTAINERS, ALL OF THE FOREGOING FOR USE IN THE COMMERCIAL PACKAGING OF PERFUME AND COSMETIC PREPARATIONS; PLASTIC VALVE CLOSURES, NAMELY, PARTS OF PLASTIC VALVES THAT ARE NOT MACHINE PARTS, ALL OF THE FOREGOING FOR USE IN THE COMMERCIAL PACKAGING OF PERFUME AND COSMETIC PREPARATIONS (U.S. CLS. 2, 13, 22, 25, 32 AND 50).

#### **CLASS 21—HOUSEWARES AND GLASS**

FOR COMMERCIAL PACKAGING OF GLASS, NAMELY, GLASS STOPPERS FOR CONTAINERS AND DISPENSERS; MINIATURE SPRAY BOTTLES MADE OF PLASTIC AND METAL, SOLD EMPTY, FOR USE IN THE COMMERCIAL PACKAGING OF PERFUME AND COSMETIC PREPARATIONS; PLASTIC DISPENSERS FOR PERFUMES AND COSMETIC PREPARATIONS; METAL PUMPS FOR PERFUMES AND COSMETIC PREPARATIONS; MANUALLY ACTUATED PUMP DISPENSERS MADE OF METAL FOR ATTACHMENT TO AEROSOL SPRAY CANS AND CONTAINERS FOR USE IN DISPENSING BEAUTY AND COSMETIC PREPARATIONS; MANUALLY ACTUATED PLASTIC PUMPS DISPENSERS FOR ATTACHMENT TO AEROSOL SPRAY CANS AND CONTAINERS FOR USE IN DISPENSING BEAUTY AND COSMETIC PREPARATIONS; PLASTIC BOTTLES AND SMALL PLASTIC SHAMPOO BOTTLES, SOLD EMPTY, ALL OF THE FOREGOING FOR USE IN THE COMMERCIAL PACKAGING OF PERFUME AND COSMETIC PREPARATIONS; DEVICES MADE OF PLASTIC TO BE FIXED ON CONTAINERS FOR THE DISTRIBUTION OF THE CONTENT OF SAID CONTAINERS, NAMELY, MANUALLY ACTUATED PLASTIC MECHANISMS FOR ATTACHMENT TO CONTAINERS FOR USE IN DISPENSING BEAUTY AND COSMETIC PREPARATIONS; PLASTIC CONTAINERS FOR DOMESTIC AND HOUSEHOLD USE, SOLD EMPTY, FOR STORAGE OF BEAUTY AND COSMETIC PREPARATIONS; PLASTIC CLOSURES FOR CONTAINERS; PLASTIC PUMPS FOR PERFUMES AND COSMETIC PREPARATIONS (U.S. CLS. 2, 13, 23, 29, 30, 33, 40 AND 50).

APRIL ROACH, EXAMINING ATTORNEY



SN 79-113,480. AMY HOLDEN, SPAIN, FILED 3-27-2012.



PRIORITY DATE OF 3-16-2012 IS CLAIMED.  
OWNER OF INTERNATIONAL REGISTRATION 1117618  
DATED 3-27-2012, EXPIRES 3-27-2022.

THE MARK CONSISTS OF THE WORDING "AQUA DRAGONS" IN STYLIZED FONT, OUTLINED AND SHADED, IN WHICH THE WORD "AQUA" IS ABOVE THE WORD "DRAGONS". A STYLIZED EYE IS WITHIN THE LETTER "G" IN "DRAGONS".

THE ENGLISH TRANSLATION OF THE FOREIGN WORD(S) IN THE MARK IS: WATER DRAGONS.

#### CLASS 28—TOYS AND SPORTING GOODS

FOR EDUCATIONAL SCIENCE TOYS, NAMELY, PRE-PACKAGED BRINE SHRIMP EGGS, AND HABITATS AND FOOD THEREFOR SOLD AS A UNIT; EDUCATIONAL TOYS CONSISTING OF KITS COMPRISING LIVE CRUSTACEAN EGGS, FOOD, A SPOON, A PIPETTE, AND AN AQUARIUM OR TRAY (U.S. CLS. 22, 23, 38 AND 50).

#### CLASS 35—ADVERTISING AND BUSINESS

FOR BUSINESS MANAGEMENT; RETAIL STORE SERVICES AND ON-LINE RETAIL STORE SERVICES FEATURING GOODS FOR ANIMALS (U.S. CLS. 100, 101 AND 102).

STEVEN JACKSON, EXAMINING ATTORNEY

SN 79-114,189. BÖHLER-UDDEHOLM PRECISION; STRIP GMBH, AUSTRIA, FILED 12-15-2011.



PRIORITY DATE OF 10-20-2011 IS CLAIMED.  
OWNER OF INTERNATIONAL REGISTRATION 1119585  
DATED 12-15-2011, EXPIRES 12-15-2021.

THE NAME(S), PORTRAIT(S), AND/OR SIGNATURE(S) SHOWN IN THE MARK DOES NOT IDENTIFY A PARTICULAR LIVING INDIVIDUAL.

THE MARK CONSISTS OF THE TERMS "MARTIN MILLER" WITH A VIKING HELMET PLACED BETWEEN THEM.

#### CLASS 6—METAL GOODS

FOR STRIP STEEL, NAMELY, STEEL IN STRIP FORM, IN PARTICULAR FOR THE PRODUCTION OF PUNCHING KNIVES AND LINES; STRIP STEEL FOR THE MANUFACTURE OF CIRCULAR SAWS FOR WOOD, BAND SAWS FOR WOOD (U.S. CLS. 2, 12, 13, 14, 23, 25 AND 50).

#### CLASS 7—MACHINERY

FOR CUTTING, GROOVING, SCORING, WAVE EDGE, ROTARY, ZIPPER EDGE, KEYING, BREAKING, DISTANCE, PRESSURE COMPENSATION, TUB, PUNCHING, UNIVERSAL AND PERFORATION STEEL RULES AND KNIVES; HOLLOW PUNCHES, PUNCHING CYLINDERS INCLUDING OTHER MOULD MAKING FITTINGS FOR PUNCHING OF CARDBOARD PACKAGING, PACKAGING MATERIAL, FOILS, TAGS, LEATHER OR TEXTILES; ALL AFOREMENTIONED GOODS AS MACHINES OR MACHINE PARTS; JOGGING, PUNCHING, BENDING, CUTTING, NOTCHING, GROOVING AND SLOTTING MACHINES FOR PUNCHING TOOLS; STONE BAND SAWS AND GANG SAWS, MEAT BAND SAWS (U.S. CLS. 13, 19, 21, 23, 31, 34 AND 35).

LINDA MICKLEBURGH, EXAMINING ATTORNEY

SN 79-116,652. CHRISTINE CHOACHUY, 1100 QUEZON CITY, PHILIPPINES, AND CATHERINE CHOACHUY, 1100 QUEZON CITY, PHILIPPINES, AND JASON CARL CHOACHUY, 1100 QUEZON CITY, PHILIPPINES, AND KAREN JOYCE CHOACHUY, 1100 QUEZON CITY, PHILIPPINES, FILED 6-12-2012.



PRIORITY DATE OF 12-12-2011 IS CLAIMED.  
OWNER OF INTERNATIONAL REGISTRATION 1125978  
DATED 6-12-2012, EXPIRES 6-12-2022.

THE NAME(S), PORTRAIT(S), AND/OR SIGNATURE(S) SHOWN IN THE MARK DOES NOT IDENTIFY A PARTICULAR LIVING INDIVIDUAL.

THE COLOR(S) RED AND WHITE IS/ARE CLAIMED AS A FEATURE OF THE MARK.

THE MARK CONSISTS OF THE COLOR RED APPEARS AS CHINESE CHARACTERS AND IT IS ENCLOSED IN A ROUNDED EDGE SQUARE BORDER; THE COLOR WHITE APPEARS AS BACKGROUND.

THE NON-LATIN CHARACTERS IN THE MARK TRANSLITERATE TO "CHOA KOK SUI" AND THIS HAS NO MEANING IN A FOREIGN LANGUAGE.

#### CLASS 16—PAPER GOODS AND PRINTED MATTER

FOR PAPER AND CARDBOARD GOODS, NAMELY, PRINTED PAPER AND CARDBOARD ADVERTISEMENTS, AND PAPER INDEXES COMPRISED OF PAPER FORMS WITH DATA; PRINTED MATTER, IN PARTICULAR BOOKS AND PERIODICALS IN THE FIELD OF ANECDOTES, APHORISMS AND PROVERBS, AUTOBIOGRAPHIES, CLASSICAL ARTICLES, CORRECTED AND REPUBLISHED ARTICLES ABOUT CLASSIC LITERATURE, DOCUMENTARIES AND FACTUAL FILMS (U.S. CLS. 2, 5, 22, 23, 29, 37, 38 AND 50).

**CLASS 41—EDUCATION AND ENTERTAINMENT**

FOR EDUCATION SERVICES, NAMELY, CLASSES IN THE FIELD OF HEALTH AID AND HEALTH CARE INSTRUCTION; PROVISION OF TRAINING AND FURTHER TRAINING IN THE FIELD OF PROFESSIONAL DEVELOPMENT, APPRENTICESHIP, AND SELF-DEFENSE; ENTERTAINMENT, NAMELY, LIVE PERFORMANCES BY A MUSICAL GROUP; SPORTING AND CULTURAL ACTIVITIES, NAMELY, YOGA INSTRUCTION AND TRAINING (U.S. CLS. 100, 101 AND 107).

**CLASS 44—MEDICAL, BEAUTY AND AGRICULTURAL SERVICES**

FOR MEDICAL SERVICES; HYGIENIC AND BEAUTY CARE (U.S. CLS. 100 AND 101).  
COLLEEN KEARNEY, EXAMINING ATTORNEY

SN 79-117,232. OOO "VIZZLE", RU-115191 MOSCOW, RUSSIAN FED., FILED 4-2-2012.



PRIORITY DATE OF 1-31-2012 IS CLAIMED.  
OWNER OF INTERNATIONAL REGISTRATION 1127493 DATED 4-2-2012, EXPIRES 4-2-2022.

THE COLOR(S) RED, WHITE, AND GREY IS/ARE CLAIMED AS A FEATURE OF THE MARK.

THE MARK CONSISTS OF THE WORDING "VIZZLE" IN FANTASY RED LATIN LETTERS OUTLINED IN WHITE WITH GREY CONTOUR.

**CLASS 28—TOYS AND SPORTING GOODS**

FOR GAMES AND PLAYTHINGS, NAMELY, BOARD GAMES; GYMNASIAC AND SPORTING ARTICLES, NAMELY, DUMBBELLS; DECORATIONS FOR CHRISTMAS TREES; ARCADE-TYPE ELECTRONIC VIDEO GAMES; VIDEO GAME MACHINES, NAMELY, HOME VIDEO GAME MACHINES; GAMING MACHINES FOR GAMBLING; AUTOMATIC AND COIN-OPERATED AMUSEMENT MACHINES; TOY VEHICLES; PLAY SWIMMING POOLS; TRAMPOLINES; NOVELTIES TOY ITEMS FOR PARTIES IN THE NATURE OF STUFFED TOY ANIMALS, DANCES PARTY FAVORS IN THE NATURE OF SMALL TOYS; FAVORS, NAMELY, NOISE MAKING PARTY FAVORS; SCRATCH CARDS FOR PLAYING LOTTERY GAMES; STARTING BLOCKS FOR SPORTS; BODY BOARDS; SKATING BOOTS WITH SKATES ATTACHED; DOLLS' FEEDING BOTTLES; STATIONARY EXERCISE BICYCLES; FISHING CREELS; FISHING TRAPS; SHUTTLECOCKS; SPINNING TOPS TOYS; JIGSAW PUZZLES; CLAY PIGEONS TARGETS; PUNCHING BAGS; BITE SENSORS; HANG GLIDERS; FLYING DISCS; DISCUSSES FOR SPORTS; DOLLS' HOUSES; DOMINOES; SWIMMING KICK BOARDS; SURF BOARDS; SPRING BOARDS; SKATEBOARDS; SAILBOARDS; CHESSBOARDS; CHECKERBOARDS; DARTS; CHRISTMAS TREES OF SYNTHETIC MATERIAL; CUPS FOR DICE; SWIMMING JACKETS; ASCENDERS; KITES; TOYS, NAMELY, BEACH BALLS; TOYS FOR DOMESTIC PETS; STUFFED TOYS; PLASTIC CHARACTER TOYS; PLUSH TOYS; TOY MOBILES; PRACTICAL JOKES NOVELTIES, NAMELY, WHOPEE CUSHIONS; PARLOR GAMES; BOARD GAMES; RING GAMES; BUILDING GAMES; KALEIDOSCOPIES; BLADDERS OF BALLS FOR GAMES; ROSIN USED BY ATHLETES; EDGES OF SKIS; BINGO CARDS; PLAYING CARDS; FAIRGROUND RIDE APPARATUS, NAMELY, AMUSEMENT PARK RIDES; REELS FOR FISHING; ROCKING HORSES; SWINGS; SKITTLES; NINEPINS;

BILLIARD CUES; GOLF CLUBS; HOCKEY STICKS; SEAL SKINS COVERINGS FOR SKIS; BELLS FOR CHRISTMAS TREES; DOLLS' ROOMS; CONFETTI; EXPLOSIVE BONBONS; ICE SKATES; ROLLER SKATES; IN-LINE ROLLER SKATES; DICE; PAINTBALL GUNS SPORTS APPARATUS; SKI BINDINGS; DOLLS' BEDS; ROULETTE WHEELS; FISH HOOKS; TOY BUILDING BLOCKS; DOLLS; FLIPPERS FOR SWIMMING; LINES FOR FISHING; GUT FOR FISHING; BOWS FOR ARCHERY; SKIS; WATERSKIS; SURF SKIS; MAHJONG; WAX FOR SKIS; HUNTING GAME CALLS; PUPPETS; TOY MASKS; THEATRICAL MASKS; FENCING MASKS; MASTS FOR SAILBOARDS; TEDDY BEARS; CHALK FOR BILLIARD CUES; TARGETS; ELECTRONIC TARGETS FOR GAMES AND SPORTS; SCALE MODEL KITS; SCALE MODEL VEHICLES; KITE REELS; BALLS FOR GAMES; ARTIFICIAL FISHING BAIT; BILLIARD TABLE CUSHIONS; KNEE GUARDS FOR ATHLETIC USE; BILLIARD CUE TIPS; ELBOW GUARDS FOR ATHLETIC USE; BACKGAMMON GAMES; SPORTS EQUIPMENT, NAMELY, CORNER FLAGS, DOLLS' CLOTHES; FENCING WEAPONS; TWIRLING BATONS; PARAGLIDERS; PACHINKOS; BASEBALL GLOVES; BOXING GLOVES; GOLF GLOVES; GLOVES FOR GAMES, NAMELY, LACROSSE GLOVES; BATTING GLOVES; FENCING GAUNTLETS; PIFIATAS; TOY PISTOLS; TOY AIR PISTOLS; TOY PERCUSSION CAPS; TOY CAPS FOR PISTOLS; BABY RATTLES; HORSESHOE GAMES; CANDLE HOLDERS FOR CHRISTMAS TREES; CHRISTMAS TREE STANDS; SOLE COVERINGS FOR SKIS; WATER WINGS; FLOATS FOR FISHING; HAND-HELD PORTABLE GAMES WITH LIQUID CRYSTAL DISPLAYS; SWIMMING BELTS; ANIMAL HUNTING AND FISHING DECOYS; SCENT LURES FOR HUNTING OR FISHING; ARCHERY IMPLEMENTS; SOAP BUBBLES TOYS IN THE NATURE OF BUBBLE-MAKING SOLUTION; DIVOT REPAIR TOOLS; BILLIARD MARKERS; PROTECTIVE PADDINGS FOR PLAYING FOOTBALL; RACKETS; SURFBOARD LEASHES; HARNESS FOR SAILBOARDS; WEIGHT LIFTING BELTS; SLING SHOTS; ROLLERS FOR STATIONARY EXERCISE BICYCLES; HARPOON GUNS; TOY SCOOTERS; SLEIGHS; BOB-SLEIGHS; BUTTERFLY NETS; LANDING NETS FOR ANGLERS; NETS FOR SPORTS; TENNIS NETS; BITE INDICATORS; SCRAPERS FOR SKIS; GAMING MACHINES, NAMELY, SLOT MACHINES; APPLIANCES FOR GYMNASIACS, NAMELY, POMMEL HORSES; QUILTS; DUMB-BELLS; CLIMBERS' HARNESS; FISHING TACKLE; ARTIFICIAL SNOW FOR CHRISTMAS TREES; SNOWSHOES; SNOWBOARDS; CLAY PIGEON TRAPS; BILLIARD TABLES; COIN-OPERATED BILLIARD TABLES; TABLES FOR TABLE TENNIS; TABLES FOR INDOOR FOOTBALL; STRINGS FOR RACKETS; GUT FOR RACKETS; CRICKET BAGS; BAGS ESPECIALLY DESIGNED TO HOLD CRICKET EQUIPMENT; GOLF BAGS, WITH OR WITHOUT WHEELS; PLAYGROUND SLIDES; SPORTING ARTICLES, NAMELY, SPRINGBOARDS; RADIO-CONTROLLED TOY VEHICLES; BODY-BUILDING APPARATUS; MACHINES FOR PHYSICAL EXERCISES; MEN'S ATHLETIC SUPPORTERS; RODS FOR FISHING; ORNAMENTS FOR CHRISTMAS TREES, EXCEPT ILLUMINATION ARTICLES AND CONFECTIONERY; TENNIS BALL THROWING APPARATUS; CONJURING APPARATUS, NAMELY, MAGIC TRICKS; GAME APPARATUS, NAMELY, BASES FOR PLAYING INDOOR AND OUTDOOR GAMES; BOWLING APPARATUS AND MACHINERY; COUNTERS DISCS FOR GAMES, NAMELY, GAME CHIPS; CHIPS FOR GAMBLING; BAGS ESPECIALLY DESIGNED FOR SKIS AND SURFBOARDS; MARBLES FOR GAMES; BILLIARD BALLS; PLAYING BALLS; PLAY BALLOONS; PAINTBALLS AMMUNITION FOR PAINTBALL GUNS BEING SPORTS APPARATUS; SNOW GLOBES; CHESS GAMES; CHECKERS GAMES; POLES FOR POLE VAULTING; PAPER PARTY HATS; SHIN GUARDS; CAMOUFLAGE SCREENS; CHEST EXPANDERS (U.S. CLS. 22, 23, 38 AND 50).

**CLASS 35—ADVERTISING AND BUSINESS**

FOR ADVERTISING SERVICES; BUSINESS MANAGEMENT; BUSINESS ADMINISTRATION CONSULTANCY; PROVIDING OFFICE FUNCTIONS; GOODS IMPORT-EXPORT AGENCIES; DEMONSTRATION OF GOODS; PROVIDING TELEVISION HOME SHOPPING SERVICES IN THE FIELD OF GENERAL CONSUMER MERCHANDISE; AUCTIONEERING; SALES PROMOTION FOR OTHERS PROVIDED THROUGH THE DISTRIBUTION AND THE ADMINISTRATION OF PRIVILEGED USER CARDS; TELEMARKETING SERVICES; PROCUREMENT SERVICES FOR OTHERS, NAMELY, PURCHASING OF SAFETY EQUIPMENT AND HANDLING MATERIALS FOR OTHERS; OUTSOURCING SERVICES (U.S. CLS. 100, 101 AND 102).

FLORENTINA BLANDU, EXAMINING ATTORNEY

**CLASS 42—SCIENTIFIC AND COMPUTER SERVICES**

FOR COMPUTER SYSTEM INTEGRATION SERVICES; COMPUTER CONSULTATION SERVICES; CONSULTING SERVICES IN THE FIELD OF DESIGN, SELECTION, IMPLEMENTATION AND USE OF COMPUTER HARDWARE AND SOFTWARE SYSTEMS FOR OTHERS; TECHNICAL SUPPORT SERVICES, NAMELY, TROUBLESHOOTING PROBLEMS IN THE NATURE OF DIAGNOSING IN COMPUTERS, SERVERS AND COMPUTER PROGRAM PROBLEMS; COMPUTER SYSTEM DESIGN SERVICES FOR OTHERS; COMPUTER SYSTEM ANALYSIS; INTERCONNECTION OF COMPUTERS AND COMPUTER PROGRAMS, NAMELY, INTEGRATION OF COMPUTER SYSTEMS AND COMPUTER NETWORKS; COMPUTER SERVICES, NAMELY, TESTING COMPUTER PROGRAMS AND COMPUTER HARDWARE, COMPUTERS AND COMPUTER SERVERS FOR OTHERS AND SOFTWARE TESTING FOR OTHERS TO ASSURE PROPER FUNCTIONALITY AND COMPLIANCE WITH COMPUTER INDUSTRY STANDARDS; INSTALLATION, UPDATING AND MAINTENANCE OF COMPUTER PROGRAMS; COMPUTER PROGRAMMING SERVICES FOR OTHERS (U.S. CLS. 100 AND 101).

JUHI KAVEESHVAR, EXAMINING ATTORNEY

SN 79-117,349. INTERNATIONAL BUSINESS MACHINES CORPORATION, UNITED STATES, FILED 7-30-2012.

SN 79-118,004. ONKYO KABUSHIKI KAISHA; D/B/A ONKYO CORPORATION, JAPAN, FILED 4-19-2012.

**IBM FLEX SYSTEM MANAGER**

THE MARK CONSISTS OF STANDARD CHARACTERS WITHOUT CLAIM TO ANY PARTICULAR FONT, STYLE, SIZE, OR COLOR.

PRIORITY DATE OF 2-13-2012 IS CLAIMED.

OWNER OF INTERNATIONAL REGISTRATION 1127834 DATED 7-30-2012, EXPIRES 7-30-2022.

OWNER OF U.S. REG. NOS. 1,205,090, 3,002,164 AND 4,181,289.

NO CLAIM IS MADE TO THE EXCLUSIVE RIGHT TO USE "SYSTEM MANAGER", APART FROM THE MARK AS SHOWN.

**CLASS 9—ELECTRICAL AND SCIENTIFIC APPARATUS**

FOR COMPUTER HARDWARE, NAMELY, COMPUTERS, COMPUTER SERVERS AND COMPUTER STORAGE APPARATUS, NAMELY, HIGH-SPEED STORAGE SUBSYSTEMS FOR STORAGE AND BACKUP OF ELECTRONIC DATA EITHER LOCALLY OR VIA A TELECOMMUNICATIONS NETWORK; COMPUTER PROGRAMS FOR CONTROLLING OPERATIONS AND EXECUTING COMPUTER SYSTEMS, SOFTWARE AND COMPUTER NETWORKS; COMPUTER PROGRAMS FOR CONNECTING COMPUTER NETWORKS AND COMPUTER SYSTEMS, COMPUTER SERVERS AND DISPARATE COMPUTER STORAGE APPARATUS, NAMELY, HIGH-SPEED STORAGE SUBSYSTEMS FOR STORAGE AND BACKUP OF ELECTRONIC DATA EITHER LOCALLY OR VIA A TELECOMMUNICATIONS NETWORK; OPERATING SYSTEM SOFTWARE; COMPUTER PROGRAMS FOR CONNECTING COMPUTERS TO EACH OTHER AND FOR ENABLING COMPUTING OPERATIONS VIA A GLOBAL COMPUTER NETWORK; COMPUTER PROGRAMS FOR MANAGING COMPUTER SYSTEMS AND COMPUTING PROCESSES IN AN INFORMATION TECHNOLOGY ENVIRONMENT, AND INSTRUCTION MANUALS SOLD AS A UNIT THEREWITH (U.S. CLS. 21, 23, 26, 36 AND 38).

**Cloud Jam**

THE MARK CONSISTS OF STANDARD CHARACTERS WITHOUT CLAIM TO ANY PARTICULAR FONT, STYLE, SIZE, OR COLOR.

PRIORITY DATE OF 2-13-2012 IS CLAIMED.

OWNER OF INTERNATIONAL REGISTRATION 1129539 DATED 4-19-2012, EXPIRES 4-19-2022.

NO CLAIM IS MADE TO THE EXCLUSIVE RIGHT TO USE "CLOUD", APART FROM THE MARK AS SHOWN.

**CLASS 9—ELECTRICAL AND SCIENTIFIC APPARATUS**

FOR TELEPHONE APPARATUS; FACSIMILE MACHINES; INTERNET RADIOS; PERSONAL STEREO; STEREO AMPLIFIERS; STEREO RECEIVERS; RADIO SIGNAL TUNERS; STEREO TUNERS; DIGITAL BROADCASTING RECEIVING TUNERS; TELEVISION RECEIVERS; AUDIO AND VIDEO RECEIVERS; DIGITAL AUDIO AND VIDEO NETWORK RECEIVERS; DIGITAL AUDIO AND VIDEO NETWORK PLAYERS; OPTICAL DISC PLAYERS AND RECORDERS; AUDIO CASSETTE PLAYERS; AUDIO CASSETTE RECORDERS; VIDEO CASSETTE PLAYERS; VIDEO CASSETTE RECORDERS; PORTABLE DIGITAL AUDIO AND VIDEO PLAYERS; CASES FOR PORTABLE DIGITAL AUDIO AND VIDEO PLAYERS; CRADLE FOR PORTABLE AUDIO AND VIDEO PLAYERS; APPARATUS FOR REPRODUCTION AND RECORDING OF AUDIO AND VIDEO MEMORY CARDS; RECORD PLAYERS; PHONE EQUALIZER; CAR STEREO; VIDEO RECORDERS, VIDEO PLAYERS, AUDIO RECORDERS, AND AUDIO PLAYERS WITH BUILT-IN HARD DISK DRIVES; VIDEO PROJECTORS; VIDEO PROJECTOR SCREENS; VIDEO DISPLAY APPARATUS, NAMELY, MONITORS, PLASMA DISPLAYS, LIQUID CRYSTAL DISPLAYS (LCD), CATHODE RAY TUBE DISPLAYS (CRT); AUDIO AND VIDEO SIGNAL ANALOG-TO-DIGITAL CONVERTER; AUDIO AND VIDEO SIGNAL DIGITAL-TO-ANALOG CONVERTER; LOUDSPEAKERS; MEGAPHONES; AUDIO SPEAKERS; CABINETS FOR LOUDSPEAKERS; SPEAKER MOUNTING BRACKETS; SPEAKER MOUNTING STANDS; HEADPHONES; EARPHONES; HORNS FOR LOUDSPEAKERS; LOUD SPEAKER SYSTEMS; MICROPHONES; AUDIO AND VIDEO SIGNAL PROCESSING APPARATUS; PORTABLE RADIO COMMUNICATION MACHINES AND APPARATUS, NAMELY, PORTABLE RADIO TRANSMITTERS, AND PORTABLE WIRELESS DATA TRANSMITTERS; PORTABLE TELEPHONES; BLANK MAGNETIC DATA CARRIERS; BLANK OPTICAL DATA CARRIERS; BLANK OPTICAL DATA CAR-

RIERS FOR CDS; BLANK OPTICAL DATA CARRIERS FOR DVDS; BLANK OPTICAL DATA CARRIERS FOR BLUE-LASER-READABLE DISCS; PERSONAL DIGITAL ASSISTANTS; CABINETS ADAPTED FOR AUDIO AND VIDEO APPARATUS AND COMPUTERS; REMOTE CONTROLLERS AND REMOTE CONTROL APPARATUS FOR USE WITH AUDIO AND VIDEO APPARATUS AND COMPUTERS; DIGITAL RADIO TRANSCEIVERS; COMPUTERS AND COMPUTER PERIPHERAL DEVICES; PORTABLE COMPUTERS; LAPTOP COMPUTERS; INTERFACES FOR COMPUTERS; COMPUTER KEYBOARDS; POINTING DEVICES FOR COMPUTERS; MONITORS FOR COMPUTERS; SOUND CIRCUIT BOARDS FOR COMPUTERS; VIDEO CIRCUIT BOARDS FOR COMPUTERS; SPEAKERS FOR COMPUTERS; RADIO TUNERS FOR COMPUTERS; OPTICAL DISK DRIVES; HARD DISK DRIVES; SEMI-CONDUCTOR MEMORIES UNITS; USB (UNIVERSAL SERIAL BUS) HARDWARE; FLASH MEMORY CARDS; DIGITAL AUDIO AND VIDEO NETWORK SERVERS; COMPUTER SOFTWARE FOR RECORDING, TRANSMISSION, REPRODUCTION, RECEIVING, DOWNLOADING, STORAGE AND/OR EDITING OF SOUND OR IMAGES; COMPUTER SOFTWARE FOR TRANSMITTING AND RECEIVING EMAILS AND OTHER INFORMATION; COMPUTER SOFTWARE FOR RECORDING, TRANSMISSION, REPRODUCTION, RECEIVING, DOWNLOADING, STORAGE AND/OR EDITING OF SOUND OR IMAGES; ROUTERS FOR TELECOMMUNICATION AND COMPUTER NETWORK; COMMUNICATION HUBS AND COMPUTER NETWORK HUBS; MODEMS; PRINTERS; PHONOGRAPH RECORDS FOR MUSIC, PHONOGRAPH RECORDS FOR SPOKEN WORD POETRY, PHONOGRAPH RECORDS FOR SPEECH, PHONOGRAPH RECORDS FOR ENTERTAINMENT; DOWNLOADABLE MUSIC FILES; SOUND OR VIDEO RECORDED MAGNETIC CARDS, SHEETS, TAPES, AND OPTICAL DISCS FOR MUSIC; SOUND OR VIDEO RECORDED MAGNETIC CARDS, SHEETS, TAPES, AND OPTICAL DISCS FOR MOVIES, SOUND OR VIDEO, NAMELY, MUSICAL RECORDINGS, SPOKEN WORD RECORDINGS, TELEVISION PROGRAMS, MUSIC VIDEOS, FEATURE MOTION PICTURES AND ANIMATED PICTURES AND VIDEO GAMES; RECORDED MAGNETIC CARDS, SHEETS, TAPES, AND OPTICAL DISCS FOR CARTOONS, SOUND OR VIDEO, NAMELY, MUSICAL RECORDINGS, SPOKEN WORD RECORDINGS, TELEVISION PROGRAMS, MUSIC VIDEOS, FEATURE MOTION PICTURES AND ANIMATED PICTURES AND VIDEO GAMES; RECORDED MAGNETIC CARDS, SHEETS, TAPES, AND OPTICAL DISCS FOR DOCUMENTARIES; EXPOSED CINEMATOGRAPHIC FILMS; EXPOSED SLIDE FILM; SLIDE FILM MOUNTS; DOWNLOADABLE VIDEO FILES FOR MUSIC; DOWNLOADABLE VIDEO FILES FOR MOVIES; DOWNLOADABLE VIDEO FILES FOR CARTOONS; DOWNLOADABLE VIDEO FILES FOR DOCUMENTARIES; RECORDED VIDEO DISCS AND VIDEO TAPES FEATURING MUSIC; RECORDED VIDEO DISCS AND VIDEO TAPES FEATURING MOVIES; RECORDED VIDEO DISCS AND VIDEO TAPES FEATURING CARTOONS; RECORDED VIDEO DISCS AND VIDEO TAPES FEATURING DOCUMENTARIES; POWER SUPPLY DEVICE; BATTERY FOR COMPUTERS; CABLES FOR USE WITH AUDIO AND VIDEO APPARATUS AND COMPUTERS (U.S. CLS. 21, 23, 26, 36 AND 38).

#### **CLASS 41—EDUCATION AND ENTERTAINMENT**

FOR PRESENTATION OF MOVIES, LIVE SHOWS, PLAYS OR MUSICAL PERFORMANCES; PROVIDING INFORMATION ABOUT SHOWING MOVIES, SHOWS, PLAYS OR MUSICAL PERFORMANCES; PRESENTATION OF LIVE SHOW PERFORMANCES; THEATRE PRODUCTIONS; PRESENTATION OF MUSICAL PERFORMANCES; PROVIDING IMAGES AND MUSIC VIA TELECOMMUNICATIONS LINES, NAMELY, PROVIDING A WEBSITE FOR ENTERTAINMENT PURPOSES FEATURING PHOTOGRAPHS, VIDEOS, SOUNDS AND MUSIC; PROVIDING AMUSEMENT FACILITIES; GAME SERVICES PROVIDED VIA TELECOMMUNICATIONS LINES, NAMELY, PROVIDING ONLINE ELECTRONIC GAMES (U.S. CLS. 100, 101 AND 107).

ALLISON SCHRÖDY, EXAMINING ATTORNEY

SN 79-118,741. MEI KO LONG METALLIC PRODUCTS; (CHINA) CO., LTD, CHINA, FILED 2-2-2012.

# MEIKOLONG

PRIORITY DATE OF 12-8-2011 IS CLAIMED.  
OWNER OF INTERNATIONAL REGISTRATION 1131301  
DATED 2-2-2012, EXPIRES 2-2-2022.  
THE WORDING "MEIKOLONG" HAS NO MEANING IN A FOREIGN LANGUAGE.

#### **CLASS 6—METAL GOODS**

FOR METAL BEAMS FOR BUILDING SUPPORT; GREENHOUSES OF METAL, TRANSPORTABLE; SILOS OF METAL; GREENHOUSE FRAMES OF METAL; METAL FENCES; FRAMES OF METAL; METAL FENCES; FRAMES OF METAL FOR BUILDING DOORS, WINDOWS, AND GREENHOUSES; TRANSPORT PALLETS OF METAL; CONTAINERS OF METAL FOR STORAGE AND TRANSPORT; BASKETS OF ALUMINUM, STEEL OR STAINLESS STEEL (U.S. CLS. 2, 12, 13, 14, 23, 25 AND 50).

#### **CLASS 10—MEDICAL APPARATUS**

FOR WATER BEDS FOR MEDICAL PURPOSES; MEDICAL PATIENT TREATMENT CHAIRS; BED VIBRATORS; MEDICAL PATIENT TREATMENT BEDS; INVALIDS' HOISTS; COMMUNE CHAIRS; CONTAINERS FOR MEDICAL WASTE; WHEELED STRETCHERS; AMBULANCE STRETCHERS (U.S. CLS. 26, 39 AND 44).

#### **CLASS 20—FURNITURE AND ARTICLES NOT OTHERWISE CLASSIFIED**

FOR METAL DISPLAY STANDS, CABINETS AND SHELVING (U.S. CLS. 2, 13, 22, 25, 32 AND 50).  
DEBORAH MEINERS, EXAMINING ATTORNEY

SN 79-119,118. JANNY M.T., FRANCE, FILED 8-3-2012.

# JANNY

THE MARK CONSISTS OF STANDARD CHARACTERS WITHOUT CLAIM TO ANY PARTICULAR FONT, STYLE, SIZE, OR COLOR.

PRIORITY DATE OF 3-27-2012 IS CLAIMED.  
OWNER OF INTERNATIONAL REGISTRATION 1132243  
DATED 8-3-2012, EXPIRES 8-3-2022.

#### **CLASS 17—RUBBER GOODS**

FOR WATERPROOF PACKINGS FOR THE LIDS OR COVERS OF CASES, BOXES, CRATES, CONTAINERS OR BINS; NON-METAL SEALING RINGS FOR USE AS CONNECTION SEALS; INSULATING MATERIALS; INSULATORS FOR CASES, BOXES, CRATES, CONTAINERS OR BINS TO RESIST THE FLOW OF HEAT OR OF AIR; NONMETAL WEATHER STRIPS FOR CASES, BOXES, CRATES, CONTAINERS, BINS AND NON-METAL SEALING JOINTS FOR CASES, BOXES, CRATES, CONTAINERS, BINS; SYNTHETIC RUBBER, BOTH RAW AND SEMI-WORKED; CLACK VALVES OF RUBBER FOR USE IN STORAGE AND TRANSPORTATION OF GOODS, NAMELY, WATERPROOF AND AIRPROOF LIDS AND COVERS FOR CASES, BOXES, CRATES, CONTAINERS, BINS; WATERPROOF AND AIRPROOF LIDS AND COVERS FOR STORAGE AND TRANSPORTATION FOR GOODS, NAMELY, WATERPROOF AND AIRPROOF LIDS AND COVERS FOR CASES, BOXES, CRATES, CONTAINERS, BINS; THERMAL INSULATION COVERS FOR STORAGE AND TRANSPORTATION OF GOODS (U.S. CLS. 1, 5, 12, 13, 35 AND 50).

**CLASS 20—FURNITURE AND ARTICLES NOT OTHERWISE CLASSIFIED**

FOR BOXES OF PLASTIC; NON-METAL CASES, CONTAINERS AND CHESTS FOR STORAGE AND TRANSPORT; CLOSURES NOT OF METAL FOR CONTAINERS; TRANSPORT PALLETS NOT OF METAL (U.S. CLS. 2, 13, 22, 25, 32 AND 50).

CAITLIN WATTS-FITZGERALD, EXAMINING ATTORNEY

**CLASS 11—ENVIRONMENTAL CONTROL APPARATUS**

FOR WINDSCREEN DEFROSTING SYSTEMS, NAMELY, DEFROSTING APPARATUS FOR VEHICLES, HEATING APPARATUS FOR DEFROSTING WINDOWS OF VEHICLES (U.S. CLS. 13, 21, 23, 31 AND 34).

**CLASS 12—VEHICLES**

FOR RESTRAINTS FOR FITTING IN MOTOR VEHICLES, NAMELY, BELT TIGHTENERS, AIRBAGS AND ELECTRIC SENSORS SOLD AS A COMPONENT OF VEHICLE AIRBAGS; SERVO BRAKES AND AIR BRAKES FOR LAND AND AIR VEHICLES; ANTILOCK BRAKE SYSTEMS FOR LAND VEHICLES; TRACTION CONTROL SYSTEMS COMPRISED OF BRAKES FOR VEHICLES; GEAR CONTROLS, NAMELY, GEARBOXES; VEHICLE DYNAMICS CONTROL SYSTEMS COMPRISED OF AERO-DYNAMIC FAIRINGS FOR VEHICLES; WINDSCREEN WIPERS; PARTS FOR THE ABOVEMENTIONED GOODS OF THIS CLASS INsofar AS THEY ARE CONTAINED IN THIS CLASS, NAMELY, AXLE BEARINGS FOR LAND VEHICLES, WHEEL BEARING KITS FOR USE WITH LAND VEHICLES, TRANSMISSION SEALS FOR AUTOMOBILES, BELT PULLEYS FOR LAND VEHICLES; ELECTRIC MOTORS FOR LAND VEHICLES (U.S. CLS. 19, 21, 23, 31, 35 AND 44).

**CLASS 40—MATERIAL TREATMENT**

FOR TREATMENT OF MATERIALS, NAMELY, METAL TREATING, METAL CASTING, METAL PLATING, BURNISHING BY ABRASION, PROCESSING OF PLASTICS, PROCESSING OF RUBBER (U.S. CLS. 100, 103 AND 106).

MAYUR VAGHANI, EXAMINING ATTORNEY

SN 79-119,265. ROBERT BOSCH GMBH, FED REP GERMANY, FILED 5-18-2012.

# HC-Parts

THE MARK CONSISTS OF STANDARD CHARACTERS WITHOUT CLAIM TO ANY PARTICULAR FONT, STYLE, SIZE, OR COLOR.

OWNER OF INTERNATIONAL REGISTRATION 1132664 DATED 5-18-2012, EXPIRES 5-18-2022.

**CLASS 7—MACHINERY**

FOR STARTER MOTORS EXCLUDING THOSE FOR LAND VEHICLES; POWER GENERATORS, NAMELY, PORTABLE ELECTRIC POWER GENERATORS, DC GENERATORS; IGNITION SYSTEMS FOR COMBUSTION ENGINES COMPRISED OF IGNITION POINTS, IGNITION MAGNETOS AND IGNITION WIRES; GLOW PLUGS, SPARK PLUGS, LAMBDA PROBES, NAMELY, OXYGEN SENSORS SOLD AS AN INTEGRAL COMPONENT OF ELECTRIC GENERATORS; IGNITION DISTRIBUTORS FOR VEHICLES; IGNITION COILS; IGNITION MAGNETOS FOR ENGINES; PARTS FOR LAND VEHICLE INTERNAL COMBUSTION ENGINES, NAMELY, SPARK PLUG SOCKETS; INJECTION PUMPS FOR MACHINES; FUEL PUMPS FOR LAND VEHICLES; SPEED GOVERNORS, NAMELY, VARIABLE SPEED DRIVES FOR MACHINES; FUEL INJECTORS AND FUEL NOZZLE HOLDERS FOR COMBUSTION ENGINES, ENGINES FOR MACHINES; FUEL FILTERS, OIL FILTERS, AND AIR FILTERS FOR AUTOMOBILE ENGINES; HYDRAULIC PUMPS AND MOTORS FOR HYDROSTATIC SYSTEMS, COMPRISED OF PUMPS, MOTORS, VALVES, SWITCHES, SENSORS AND ELECTRONIC CONTROLS, FOR HYDRAULIC DRIVES AND FORCE TRANSMISSION IN MACHINES, MACHINE TOOLS, GRINDING AND FOOD PROCESSING MACHINES; HYDRAULIC CYLINDERS FOR MOTORS AND ENGINES; HYDRAULIC RESERVOIRS FOR MACHINES; HYDRAULIC FILTERS FOR MOTORS AND ENGINES; COMPRESSED-AIR BRAKES FOR MACHINES, PNEUMATIC DEVICES, NAMELY PNEUMATIC VALVES BEING PARTS OF MACHINES; COMPRESSORS, NAMELY, PARTS FOR PNEUMATIC BLOW GUNS, NAMELY, INFLATOR TIPS, INFLATOR VALVES, VALVE ADAPTERS, NOZZLES, NIPPLES, COUPLERS, CONNECTORS AND PIVOTS; PARTS FOR COMPRESSED-AIR TOOLS, NAMELY, BRAKES, FILTERS, HOSES, PIPES, COUPLINGS VALVES, SWITCHES, COMPRESSORS, CLAMPING TOOLS AND INJECTORS; CONTROL VALVES FOR MACHINES; BRAKE VALVES BEING PARTS OF MACHINES; TURBO AIR COMPRESSORS; IGNITION DEVICES FOR INTERNAL COMBUSTION ENGINES (U.S. CLS. 13, 19, 21, 23, 31, 34 AND 35).

**CLASS 9—ELECTRICAL AND SCIENTIFIC APPARATUS**

FOR RADIO FREQUENCY GENERATORS FOR SUPPLYING RADIO-FREQUENCY ENERGY (U.S. CLS. 21, 23, 26, 36 AND 38).

SN 79-120,076. KION MATERIAL HANDLING GMBH, FED REP GERMANY, FILED 5-8-2012.

# KION™

PRIORITY DATE OF 11-9-2011 IS CLAIMED.  
OWNER OF INTERNATIONAL REGISTRATION 1134792 DATED 5-8-2012, EXPIRES 5-8-2022.

OWNER OF U.S. REG. NOS. 3,749,885 AND 3,823,654.  
THE MARK CONSISTS OF THE WORD "KION" IN STYLIZED LETTERING WITH A RAISED BAR AFTER THE LETTER "N".

**CLASS 7—MACHINERY**

FOR POWER-OPERATED LIFTING AND MOVING EQUIPMENT, NAMELY, MACHINES AND MACHINE TOOLS IN THE INDUSTRIAL TRUCKS AREA FOR TOWING, LIFTING, AND TRANSPORTING EQUIPMENT IN THE NATURE OF LIFTING DRIVES FOR LIFTING MACHINES AND FOR STORAGE TECHNOLOGY AND SHELF STORAGE TECHNOLOGY; MECHANICAL DEVICE FOR PICKING UP, GRABBING AND MOVING LOADS AND GOODS TO BE CONVEYED, NAMELY, FORKS, FORK TEETH, PLATFORMS, SUPPORTING RODS, TONGS, GRIPPERS, CRANE ARMS; ENGINES NOT FOR LAND VEHICLES; CLUTCHES, GEARS AND DEVICES FOR FORCE TRANSMISSION NOT FOR LAND VEHICLES; PUMPS FOR MACHINES; STORAGE MACHINES, NAMELY, VERTICAL HOISTS FOR RAISING AND STORING GOODS; FILTERS FOR VEHICLE MOTORS AND ENGINES; MACHINE PARTS, NAMELY, HYDRAULIC REGULATORS AND CONTROLS; IGNITION MAGNETS FOR ENGINES; MECHANICAL SEALS; MACHINE PARTS, NAMELY, CONNECTING JOINTS; PARTS OF MACHINES, NAMELY, HOLDERS FOR HOLDING TOOLS; AND PARTS AND REPLACEMENT STRUCTURAL PARTS OF THE AFOREMENTIONED GOODS (U.S. CLS. 13, 19, 21, 23, 31, 34 AND 35).

**CLASS 9—ELECTRICAL AND SCIENTIFIC APPARATUS**

FOR MONITORING, WEIGHING, MEASURING AND SIGNALLING DEVICES AND INSTRUMENTS, NAMELY, ELECTRONIC MONITORS AND MONITOR MODULES FOR MONITORING ELECTRIC CURRENT AND ELECTRICAL SIGNALS, OR THE STATUS OF INDUSTRIAL PROCESS, NAMELY, POWER GENERATION, ELECTRICAL DISTRIBUTION AND OIL AND GAS PROCESSING, BATTERY MONITORS, LIQUID CRYSTAL DISPLAY (LCD) MONITORS, TOUCH SCREEN MONITORS AND ON-BOARD-VEHICULAR SURVEILLANCE SYSTEM COMPRISED OF CAMERAS AND MONITORS FOR EXPOSING, MONITORING AND ELIMINATING BLIND SPOTS ON BOTH SIDES OF VEHICLE, SCALES AND BALANCES, SIGNAL BELLS; DEVICES AND INSTRUMENTS FOR CONDUITS, DISTRIBUTION, CONVERSION, STORAGE, REGULATION AND/OR CONTROLLING ELECTRICAL CURRENTS, NAMELY, SWITCHES; DEVICES FOR RECORDING, TRANSMISSION AND PLAYBACK OF VEHICLE DATA; ELECTRONIC, ELECTRONIC AND AUTOMATIC CONTROLLERS, CONTROLLER OPERATIONS AND EMITTERS FOR CONTROLLING ELECTRIC CURRENT; ELECTRIC LOCKS, LIGHT CONTROLS, NAMELY, DIMMERS; BATTERIES AND BATTERY CHARGERS AND THEIR PARTS; ELECTRONIC DISPLAY BOARDS; ELECTRONIC LOCK ASSEMBLIES; ELECTRONIC DISPLAY INTERFACES; BAR CODE SCANNERS; COMPUTER SWITCHES, ELECTRIC SWITCHES; CALCULATORS, DATA PROCESSING EQUIPMENT AND COMPUTERS, COMPUTER HARDWARE, NAMELY, MONITORS; COMPUTER SOFTWARE FOR STORING AND ANALYZING OTHER COMPUTER PROGRAMS; COMPUTER PROGRAMS RECORDED ON MEDIA FOR STORING AND ANALYZING OTHER COMPUTER PROGRAMS; FIRE EXTINGUISHERS (U.S. CLS. 21, 23, 26, 36 AND 38).

**CLASS 12—VEHICLES**

FOR LAND VEHICLES; APPARATUS FOR LOCOMOTION BY LAND, AIR OR WATER, NAMELY, INDUSTRIAL TRUCKS FOR TOWING AND LIFTING, AERIAL CONVEYORS, FORK LIFT TRUCKS, TRANSPORT AND STACKING TROLLEYS, INDUSTRIAL TRUCKS INCORPORATING RACK FEEDERS; MANUALLY OPERATED CARTS FOR LIFTING INCORPORATING FORKLIFTS; HAND PALLET TRUCKS INCORPORATING SCALES; FORKLIFT TRUCKS AND LIFTING TRUCKS INCORPORATING FORKS, FORK EXTENSIONS, PLATFORMS, SPIKES, CLAMPS, CRANE ARMS, MANIPULATORS; MANUAL WINCH CARTS; PARTS FOR ALL AFOREMENTIONED GOODS (U.S. CLS. 19, 21, 23, 31, 35 AND 44).

**CLASS 20—FURNITURE AND ARTICLES NOT OTHERWISE CLASSIFIED**

FOR METAL SHELVES AND THEIR PARTS (U.S. CLS. 2, 13, 22, 25, 32 AND 50).

**CLASS 36—INSURANCE AND FINANCIAL**

FOR INSURANCE SERVICES, NAMELY, CONSULTING AND INFORMATION CONCERNING INSURANCE IN THE FIELD OF PROPERTY AND CASUALTY INSURANCE, VEHICLE INSURANCE AND MARINE AND LAND TRANSPORTING INSURANCE; FINANCIAL AFFAIRS, NAMELY, FINANCIAL ANALYSIS, ADVISORY, PLANNING, RESEARCH AND CONSULTANCY SERVICES; MONETARY AFFAIRS, NAMELY, CREDIT BROKERAGE, FINANCING OF INVESTMENTS, PROJECTS AND LOANS; FINANCING OF RENTAL FLEETS; REAL ESTATE AFFAIRS, NAMELY, REAL ESTATE MANAGEMENT (U.S. CLS. 100, 101 AND 102).

**CLASS 39—TRANSPORTATION AND STORAGE**

FOR TRANSPORT OF GOODS; PACKAGING OF GOODS FOR TRANSPORTATION AND STORAGE OF GOODS; COORDINATING TRAVEL ARRANGEMENTS FOR INDIVIDUALS AND GROUPS (U.S. CLS. 100 AND 105).

KATHLEEN M. VANSTON, EXAMINING ATTORNEY

SN 79-120,521. FIRMENICH SA, SWITZERLAND, FILED 9-26-2012.

# NATACTONE

THE MARK CONSISTS OF STANDARD CHARACTERS WITHOUT CLAIM TO ANY PARTICULAR FONT, STYLE, SIZE, OR COLOR.

PRIORITY DATE OF 4-17-2012 IS CLAIMED.  
OWNER OF INTERNATIONAL REGISTRATION 1136028  
DATED 9-26-2012, EXPIRES 9-26-2022.

**CLASS 1—CHEMICALS**

FOR CHEMICAL PRODUCTS FOR USE IN THE MANUFACTURE OF PERFUMES; CHEMICAL PRODUCTS FOR USE IN COMPOSITIONS FOR PERFUMERY, COSMETICS, SOAPS, DETERGENTS, DEODORANTS FOR PERSONAL USE AND DEODORANTS OTHER THAN FOR PERSONAL USE; CHEMICAL PRODUCTS FOR USE IN THE MANUFACTURE OF FOOD, FOOD PRODUCTS, FOOD SUPPLEMENTS, BEVERAGES AND FOR USE AS INGREDIENTS FOR FOOD AND BEVERAGES; CHEMICAL PRODUCTS FOR USE AS FLAVORINGS (U.S. CLS. 1, 5, 6, 10, 26 AND 46).

**CLASS 3—COSMETICS AND CLEANING PREPARATIONS**

FOR PERFUMERY, ESSENTIAL OILS FOR PERSONAL USE; ESSENTIAL OILS AND PERFUME COMPOSITIONS, NAMELY, ESSENTIAL OILS FOR USE IN THE MANUFACTURE OF PERFUMED PRODUCTS; ESSENTIAL OILS FOR USE AS COSMETIC INGREDIENTS; ESSENTIAL OILS FOR FLAVORING FOOD AND BEVERAGES; FOOD FLAVORINGS IN THE FORM OF ESSENTIAL OILS; FOOD FLAVORINGS PREPARED FROM ESSENTIAL OILS (U.S. CLS. 1, 4, 6, 50, 51 AND 52).

**CLASS 30—STAPLE FOODS**

FOR FLAVORINGS FOR FOOD AND BEVERAGES; FLAVORINGS FOR FOOD AND BEVERAGES, OTHER THAN ESSENTIAL OILS; FLAVOR ENHANCERS FOR USE IN FOOD PRODUCTS AND BEVERAGES; FLAVORING ADDITIVES, NOT FOR NUTRITIONAL PURPOSES, FOR USE IN FOOD PRODUCTS AND BEVERAGES (U.S. CL. 46).

CHRISTINE MARTIN, EXAMINING ATTORNEY

OWNER OF INTERNATIONAL REGISTRATION 1137142 DATED 9-11-2012, EXPIRES 9-11-2022.

OWNER OF U.S. REG. NOS. 3,667,011, 3,673,306 AND 3,679,995.

THE MARK CONSISTS OF THE WORDS "SOURCE TREE BY ATLISSIAN" ACCOMPANIED BY A CIRCLE AND TWO ARROWS POINTING IN THE OPPOSITION DIRECTIONS.

THE WORDING "ATLISSIAN" HAS NO MEANING IN A FOREIGN LANGUAGE.

SN 79-120,749. INTERSTORE ITALIA S.R.L., ITALY, FILED 8-1-2012.

**INTERSTORE DESIGN**

PRIORITY DATE OF 7-20-2012 IS CLAIMED.

OWNER OF INTERNATIONAL REGISTRATION 1136589 DATED 8-1-2012, EXPIRES 8-1-2022.

NO CLAIM IS MADE TO THE EXCLUSIVE RIGHT TO USE "DESIGN", APART FROM THE MARK AS SHOWN.

**CLASS 16—PAPER GOODS AND PRINTED MATTER**

FOR PAPER, CARDBOARD AND GOODS MADE FROM THESE MATERIALS, NAMELY, BANNERS, BUSINESS CARDS, AND SIGNS; PRINTED MATTER, NAMELY, RETAIL DESIGN MAGAZINES AND BROCHURES ABOUT RETAIL DESIGN, FOOD, FASHION, RETAIL AND CATERING; BOOKBINDING MATERIAL; PHOTOGRAPHS; STATIONERY; ADHESIVES FOR STATIONERY OR HOUSEHOLD PURPOSES; ARTISTS' MATERIALS, NAMELY, PAINT BRUSHES; TYPEWRITERS AND OFFICE REQUISITES EXCEPT FURNITURE, NAMELY, PENS, PENCILS, FILE FOLDERS, NOTEBOOKS, BINDERS AND CALENDARS; PRINTED INSTRUCTIONAL AND TEACHING MATERIAL IN THE FIELD OF RETAIL DESIGN, FOOD, FASHION, RETAIL AND CATERING; PLASTIC MATERIAL FOR PACKAGING, NAMELY, PLASTIC BAGS FOR PACKAGING; PRINTERS' TYPE; PRINTING BLOCKS (U.S. CLS. 2, 5, 22, 23, 29, 37, 38 AND 50).

**CLASS 35—ADVERTISING AND BUSINESS**

FOR ADVERTISING; BUSINESS MANAGEMENT; BUSINESS ADMINISTRATION; OFFICE FUNCTIONS (U.S. CLS. 100, 101 AND 102).

**CLASS 42—SCIENTIFIC AND COMPUTER SERVICES**

FOR ARCHITECTURAL DESIGN SERVICES IN THE FIELDS OF FOOD, FASHION, RETAIL AND CATERING; INDUSTRIAL ANALYSIS AND RESEARCH SERVICES IN THE FIELDS OF FOOD, FASHION, RETAIL AND CATERING; DESIGN AND DEVELOPMENT OF COMPUTER HARDWARE AND SOFTWARE FOR THE FOOD, FASHION, RETAIL AND CATERING INDUSTRIES (U.S. CLS. 100 AND 101).

KRISTINA MORRIS, EXAMINING ATTORNEY

**CLASS 9—ELECTRICAL AND SCIENTIFIC APPARATUS**

FOR DOWNLOADABLE COMPUTER SOFTWARE FOR PRIORITIZING, ASSIGNING, TRACKING, REPORTING AND AUDITING ISSUES RELATING TO BUSINESS INFORMATION TECHNOLOGY, MEASURING COMPUTER CODE COVERAGE, CREATING AND SHARING ELECTRONIC PAGES, DOCUMENTS AND RICH CONTENT WITH OTHER USERS AND SUPPORTING SINGLE SIGN-ON ELECTRONIC AUTHENTICATION FOR COMPUTER USERS, WEB APPLICATIONS AND ELECTRONIC DIRECTORY SERVERS; COMPUTER SOFTWARE FOR PRIORITIZING, ASSIGNING, TRACKING, REPORTING AND AUDITING ISSUES RELATING TO BUSINESS INFORMATION TECHNOLOGY, MEASURING COMPUTER CODE COVERAGE, CREATING AND SHARING ELECTRONIC PAGES, DOCUMENTS AND RICH CONTENT WITH OTHER USERS AND SUPPORTING SINGLE SIGN-ON ELECTRONIC AUTHENTICATION FOR COMPUTER USERS, WEB APPLICATIONS AND ELECTRONIC DIRECTORY SERVERS; COMPUTER PROGRAMS AND RECORDED SOFTWARE FOR PRIORITIZING, ASSIGNING, TRACKING, REPORTING AND AUDITING ISSUES RELATING TO BUSINESS INFORMATION TECHNOLOGY, MEASURING COMPUTER CODE COVERAGE, CREATING AND SHARING ELECTRONIC PAGES, DOCUMENTS AND RICH CONTENT WITH OTHER USERS AND SUPPORTING SINGLE SIGN-ON ELECTRONIC AUTHENTICATION FOR COMPUTER USERS, WEB APPLICATIONS AND ELECTRONIC DIRECTORY SERVERS AND; PRE-RECORDED, ELECTRONIC PUBLICATIONS IN THE NATURE OF MANUALS, BROCHURES, NEWSLETTERS, TECHNICAL DATA SHEETS AND PRODUCT SPECIFICATIONS, INCLUDING THOSE SOLD AND; ELECTRONIC PUBLICATIONS, NAMELY, NEWSLETTERS IN THE FIELD OF COMPUTER SOFTWARE PROGRAMS AND APPLICATIONS, RECORDED ON COMPUTER MEDIA, INSTRUCTIONAL MATERIALS IN ELECTRONIC FORM IN THE NATURE OF MANUALS, BROCHURES, NEWSLETTERS, TECHNICAL DATA SHEETS AND PRODUCT SPECIFICATIONS IN THE FIELD OF COMPUTER SOFTWARE PROGRAMS AND APPLICATIONS; NONE OF THESE GOODS BEING COMPUTER SOFTWARE FOR THE PRODUCTION OF ANIMATION AND GRAPHICS OR INSTRUCTIONAL MANUALS SOLD AS A UNIT THEREWITH (U.S. CLS. 21, 23, 26, 36 AND 38).

**CLASS 38—COMMUNICATION**

FOR PROVISION OF ACCESS TO COMPUTER DATABASES (U.S. CLS. 100, 101 AND 104).

**CLASS 42—SCIENTIFIC AND COMPUTER SERVICES**

FOR COMPUTER SERVICES, NAMELY, HOSTING AND MAINTAINING AN ON-LINE WEB SITE FOR OTHERS TO COLLABORATIVELY DEVELOP SOFTWARE; HOSTING AN ON-LINE COMMUNITY WEB SITE FEATURING A DISTRIBUTED CONTROL SYSTEM FOR THE COLLABORATIVE DEVELOPMENT OF SOFTWARE; CONSULTING SERVICES IN THE FIELD OF DESIGN AND DEVELOPMENT OF COMPUTER SOFTWARE; SERVICE AS OF AN APPLICATION SERVICE PROVIDER, NAMELY, HOSTING SOFTWARE OF OTHERS; COMPUTER SOFTWARE DESIGN; INSTALLATION MODIFICATION AND MAINTENANCE OF COMPUTER SOFTWARE; COMPUTER SYSTEM DESIGN AND ANALYSIS; DATA HOSTING SERVICES, NAMELY, APPLICATION SERVICE PROVIDER IN THE FIELD OF KNOWLEDGE MANAGEMENT TO HOST

SN 79-120,957. ATLISSIAN PTY LTD, SYDNEY NSW 2000, AUSTRALIA, FILED 9-11-2012.



PRIORITY DATE OF 3-12-2012 IS CLAIMED.

COMPUTER APPLICATION SOFTWARE FOR CREATING SEARCHABLE DATABASES OF INFORMATION AND DATA AND INTERACTIVE HOSTING SERVICES WHICH ALLOW THE USER TO PUBLISH AND SHARE THEIR OWN CONSENT AND IMAGES ONLINE; DATA CONVERSION OF COMPUTER PROGRAMS AND DATA, NOT PHYSICAL CONVERSION; CONSULTANCY SERVICES IN THE FIELD OF COMPUTERS AND SOFTWARE; PROVIDING ONLINE INFORMATION AND CONSULTANCY SERVICES IN RESPECT OF THE ABOVE SERVICES VIA A GLOBAL COMPUTER NETWORK (U.S. CLS. 100 AND 101).

FLORENTINA BLANDU, EXAMINING ATTORNEY

SN 79-121,247. AF CORSE S.R.L., ITALY, FILED 9-3-2012.

# AF CORSE

THE MARK CONSISTS OF STANDARD CHARACTERS WITHOUT CLAIM TO ANY PARTICULAR FONT, STYLE, SIZE, OR COLOR.

OWNER OF INTERNATIONAL REGISTRATION 1137894 DATED 9-3-2012, EXPIRES 9-3-2022.

NO CLAIM IS MADE TO THE EXCLUSIVE RIGHT TO USE "CORSE". APART FROM THE MARK AS SHOWN.

THE ENGLISH TRANSLATION OF "AF CORSE" IN THE MARK IS "AF RACING".

## CLASS 25—CLOTHING

FOR SHORT-SLEEVED AND LONG-SLEEVED T-SHIRTS; CAPS (U.S. CLS. 22 AND 39).

## CLASS 41—EDUCATION AND ENTERTAINMENT

FOR ENTERTAINMENT IN THE NATURE OF AUTOMOBILE RACES; ENTERTAINMENT SERVICES, NAMELY, PARTICIPATION IN SPORTS CAR RACES (U.S. CLS. 100, 101 AND 107).

GEOFFREY FOSDICK, EXAMINING ATTORNEY

SN 79-121,497. ROMONET LTD, UNITED KINGDOM, FILED 1-11-2012.

# ROMONET

THE MARK CONSISTS OF STANDARD CHARACTERS WITHOUT CLAIM TO ANY PARTICULAR FONT, STYLE, SIZE, OR COLOR.

PRIORITY DATE OF 12-23-2011 IS CLAIMED.

OWNER OF INTERNATIONAL REGISTRATION 1138588 DATED 1-11-2012, EXPIRES 1-11-2022.

## CLASS 9—ELECTRICAL AND SCIENTIFIC APPARATUS

FOR COMPUTER HARDWARE, SOFTWARE, FIRMWARE AND PROGRAMS FOR THE DESIGN, PLANNING, SIMULATION, MODELLING, EVALUATION, ANALYSIS, COMPARISON AND OPERATION OF DATA CENTRES AND OF COMPUTER, TELECOMMUNICATIONS, DATA STORAGE, POWER, ENVIRONMENTAL CONTROL, PROTECTION AND SECURITY SYSTEMS; COMPUTER HARDWARE, SOFTWARE, FIRMWARE AND PROGRAMS FOR ANALYSING AND OPTIMISING PERFORMANCE, UTILISATION, EFFICIENCY, COST AND RISK MANAGEMENT OF DATA CENTRES AND OF COMPUTER, TELECOMMUNICATIONS, DATA STORAGE, POWER, ENVIRONMENTAL CONTROL, PROTECTION AND SECURITY SYSTEMS; DOWNLOADABLE ELECTRONIC PUBLICATIONS, NAMELY, BOOKS, BROCHURES, INFORMATIONAL CARDS, MAGAZINES, MANUALS, NEWSLETTERS, PERIODICALS IN THE FIELD OF INFORMATION TECHNOLOGY; DOWNLOADABLE DOCUMENTS IN THE FIELD OF INFORMATION TECHNOLOGY PROVIDED VIA A WEBSITE; DOWNLOADABLE REPORTS AND ELECTRONIC DATA FILES IN DIGITAL FORM CONCERNING THE DESIGN, PLANNING, SIMULATION, MODELLING, EVALUATION, ANALYSIS, COMPARISON AND OPERATION OF DATA CENTRES AND OF COMPUTER, TELECOMMUNICATIONS, DATA STORAGE, POWER, ENVIRONMENTAL CONTROL, PROTECTION AND SECURITY SYSTEMS; DOWNLOADABLE REPORTS AND ELECTRONIC DATA FILES IN DIGITAL FORM CONCERNING ANALYSING AND OPTIMISING PERFORMANCE, UTILISATION, EFFICIENCY, COST AND RISK MANAGEMENT OF DATA CENTRES AND OF COMPUTER, TELECOMMUNICATIONS, DATA STORAGE, POWER, ENVIRONMENTAL CONTROL, PROTECTION AND SECURITY SYSTEMS; ELECTRONIC APPARATUS AND INSTRUMENTS, ALL FOR PROCESSING, STORAGE, INPUT, OUTPUT, TRANSFER AND DISPLAY OF DATA (U.S. CLS. 21, 23, 26, 36 AND 38).

## CLASS 16—PAPER GOODS AND PRINTED MATTER

FOR PRINTED PUBLICATIONS NAMELY, BOOKS, BROCHURES, INFORMATIONAL CARDS, MAGAZINES, MANUALS, NEWSLETTERS, PRINTED PERIODICALS IN THE FIELD OF INFORMATION TECHNOLOGY; PRINTED REPORTS REGARDING THE DESIGN, PLANNING, SIMULATION, MODELLING, EVALUATION, ANALYSIS, COMPARISON AND OPERATION OF DATA CENTRES AND OF COMPUTER, TELECOMMUNICATIONS, DATA STORAGE, POWER, ENVIRONMENTAL CONTROL, PROTECTION AND SECURITY SYSTEMS; PRINTED REPORTS REGARDING ANALYSING AND OPTIMISING THE PERFORMANCE, UTILISATION, EFFICIENCY, COST AND RISK MANAGEMENT OF DATA CENTRES AND OF COMPUTER, TELECOMMUNICATIONS, DATA STORAGE, POWER, ENVIRONMENTAL CONTROL, PROTECTION AND SECURITY SYSTEMS (U.S. CLS. 2, 5, 22, 23, 29, 37, 38 AND 50).

## CLASS 35—ADVERTISING AND BUSINESS

FOR BUSINESS PLANNING, ASSISTANCE AND MANAGEMENT SERVICES; BUSINESS CONSULTANCY AND ADVISORY SERVICES; ASSISTANCE SERVICES IN THE FIELD OF BUSINESS MANAGEMENT; PREPARATION OF BUSINESS REPORTS AND PROJECT STUDIES RELATING TO BUSINESS MATTERS, NAMELY, BUSINESS MANAGEMENT, BUSINESS RISK MANAGEMENT, INFORMATION TECHNOLOGY, DATA PROCESSING, DATA SECURITY, DATABASE MANAGEMENT AND DATA STORAGE AND RETRIEVAL; PROVISION OF PERSONNEL FOR THE OPERATION OF SPECIALISED SYSTEMS; COMPILATION OF STATISTICS FOR BUSINESS PURPOSES; PROVIDING BUSINESS ASSISTANCE TO OTHERS IN THE OPERATION OF DATA CENTRES, DATA PROCESSING AND DATA STORAGE FACILITIES AND OF COMPUTER, TELECOMMUNICATIONS, DATA STORAGE, POWER, ENVIRONMENTAL CONTROL,



PROTECTION AND SECURITY SYSTEMS; BUSINESS RISK MANAGEMENT SERVICES; BUSINESS CONSULTANCY, ANALYSIS, EVALUATION, ADVISORY AND INFORMATION SERVICES IN THE FIELDS OF BUSINESS MANAGEMENT, BUSINESS RISK MANAGEMENT, INFORMATION TECHNOLOGY, DATA PROCESSING AND DATA SECURITY; BUSINESS CONSULTANCY, ANALYSIS, EVALUATION, ADVISORY AND INFORMATION SERVICES IN THE FIELD OF DATABASE MANAGEMENT AND TO PROCESSING, STORAGE AND RETRIEVAL OF DATA; COST ANALYSES (U.S. CLS. 100, 101 AND 102).

#### **CLASS 36—INSURANCE AND FINANCIAL**

FOR FINANCIAL ANALYSIS; PREPARATION AND FINANCIAL ANALYSIS OF FINANCIAL REPORTS; FINANCIAL ANALYSIS AND PREPARATION OF FINANCIAL REPORTS IN THE FIELD OF DESIGN, PLANNING, EVALUATION, ANALYSIS, COMPARISON, OPERATION, PERFORMANCE, UTILISATION, EFFICIENCY, COST AND RISK MANAGEMENT OF DATA CENTRES AND OF COMPUTER, TELECOMMUNICATIONS, DATA STORAGE, POWER, ENVIRONMENTAL CONTROL, PROTECTION AND SECURITY SYSTEMS; FINANCIAL CONSULTANCY, EVALUATION, ADVISORY AND INFORMATION SERVICES IN THE FIELD OF DESIGN, PLANNING, EVALUATION, ANALYSIS, COMPARISON, OPERATION, PERFORMANCE, UTILISATION, EFFICIENCY, COST AND RISK MANAGEMENT OF DATA CENTRES AND OF COMPUTER, TELECOMMUNICATIONS, DATA STORAGE, POWER, ENVIRONMENTAL CONTROL, PROTECTION AND SECURITY SYSTEMS (U.S. CLS. 100, 101 AND 102).

#### **CLASS 37—CONSTRUCTION AND REPAIR**

FOR CONSTRUCTION CONSULTANCY, ADVISORY AND INFORMATION SERVICES RELATING TO THE INSTALLATION, COMMISSIONING, REPAIR AND MAINTENANCE OF DATA CENTRES AND OF COMPUTER, TELECOMMUNICATIONS, DATA STORAGE, POWER, ENVIRONMENTAL CONTROL, PROTECTION AND SECURITY SYSTEMS (U.S. CLS. 100, 103 AND 106).

#### **CLASS 38—COMMUNICATION**

FOR PROVIDING ACCESS TO COMPUTER DATABASES AND COMPUTER NETWORKS; PROVIDING AN INTERNET WEBSITE PORTAL, NAMELY, PROVIDING ACCESS TO COMPUTER DATABASES AND PROVIDING MULTIPLE USER ACCESS TO GLOBAL COMPUTER INFORMATION NETWORKS FOR THE TRANSFER AND DISSEMINATION OF A WIDE RANGE OF INFORMATION; PROVIDING USER ACCESS TO DATASETS AND DATA ON THE INTERNET IN THE FIELD OF BUSINESS MANAGEMENT, BUSINESS RISK MANAGEMENT AND INFORMATION TECHNOLOGY; PROVIDING ACCESS TO DATABASES; COMMUNICATION SERVICES, NAMELY, TRANSMISSION OF DATA BY TELECOMMUNICATIONS NETWORKS, WIRELESS COMMUNICATION NETWORKS, THE INTERNET, INFORMATION SERVICES NETWORKS AND DATA NETWORKS; COMMUNICATION SERVICES BETWEEN DATA BANKS, NAMELY PROVIDING ACCESS TO DATABASES; DATA BANK INTERCONNECTION SERVICES, NAMELY, PROVIDING TELECOMMUNICATION CONNECTIONS TO DATA BANKS; ELECTRONIC DATA TRANSMISSION; PROVIDING ON-LINE COMMUNICATIONS LINKS WHICH TRANSFER THE WEB SITE USER TO OTHER LOCAL AND GLOBAL WEB PAGES; TELECOMMUNICATIONS CONSULTANCY, ANALYSIS, EVALUATION, ADVISORY AND INFORMATION SERVICES IN THE FIELD OF COMMUNICATIONS (U.S. CLS. 100, 101 AND 104).

#### **CLASS 41—EDUCATION AND ENTERTAINMENT**

FOR EDUCATIONAL SERVICES, NAMELY, PROVIDING PROFESSIONAL LEVEL COURSES OF INSTRUCTION, IN THE FIELD OF DATA CENTRES, COMPUTER HARDWARE, SOFTWARE, FIRMWARE AND PROGRAMS, AND COMPUTER, TELECOMMUNICATIONS, DATA STORAGE, POWER, ENVIRONMENTAL CONTROL, PROTECTION AND SECURITY SYSTEMS; COMPUTER TRAINING; SOFTWARE TRAINING; ARRANGING AND CONDUCTING SEMINARS IN THE FIELD OF DATA CENTRES, COMPUTER HARDWARE, SOFTWARE, FIRMWARE AND PROGRAMS, AND COMPUTER, TELECOMMUNICATIONS, DATA STORAGE, POWER, ENVIRONMENTAL CONTROL, PROTECTION AND SECURITY SYSTEMS; TRAINING SERVICES, NAMELY, PROVIDING EDUCATIONAL DEMONSTRATIONS OF THE INSTALLATION, CONFIGURATION AND OPERATION OF DATA CENTRES, OF COMPUTER HARDWARE, SOFTWARE, FIRMWARE AND PROGRAMS AND OF COMPUTER, TELECOMMUNICATIONS, DATA STORAGE, POWER, ENVIRONMENTAL CONTROL, PROTECTION AND SECURITY SYSTEMS; PUBLISHING OF ELECTRONIC PUBLICATIONS; PROVISION ON-LINE FROM A COMPUTER DATABASE OR THE INTERNET OF EDUCATIONAL INFORMATION IN THE FIELD OF ONLINE HIGHER EDUCATION RESOURCES AND ONLINE PROFESSIONAL EDUCATION RESOURCES RELATING TO COMPUTER HARDWARE, SOFTWARE, FIRMWARE AND PROGRAMS, AND TO COMPUTER, TELECOMMUNICATIONS, DATA STORAGE, POWER, ENVIRONMENTAL CONTROL, PROTECTION AND SECURITY SYSTEMS; PROVIDING NON-DOWNLOADABLE ON-LINE ELECTRONIC PUBLICATIONS, NAMELY, BOOKS, BROCHURES, MANUALS AND NEWSLETTERS IN THE FIELD OF DATA CENTRES, COMPUTER HARDWARE, SOFTWARE, FIRMWARE AND PROGRAMS, AND COMPUTER, TELECOMMUNICATIONS, DATA STORAGE, POWER, ENVIRONMENTAL CONTROL, PROTECTION AND SECURITY SYSTEMS; EDUCATIONAL CONSULTANCY AND ADVISORY SERVICES IN THE FIELD OF DATA CENTRES, COMPUTER HARDWARE, SOFTWARE, FIRMWARE AND PROGRAMS, AND COMPUTER, TELECOMMUNICATIONS, DATA STORAGE, POWER, ENVIRONMENTAL CONTROL, PROTECTION AND SECURITY SYSTEMS (U.S. CLS. 100, 101 AND 107).

#### **CLASS 42—SCIENTIFIC AND COMPUTER SERVICES**

FOR TECHNICAL DESIGN, PLANNING, SIMULATING, MODELLING, QUALITY EVALUATION, ANALYSING AND COMPARING DATA CENTRES, AND COMPUTER, TELECOMMUNICATIONS, DATA STORAGE, POWER, ENVIRONMENTAL CONTROL, PROTECTION AND SECURITY SYSTEMS; ANALYSIS OF DATA CENTRES AND OF COMPUTER, TELECOMMUNICATIONS, DATA STORAGE, POWER, ENVIRONMENTAL CONTROL, PROTECTION AND SECURITY SYSTEMS TO ASSURE COMPLIANCE WITH INDUSTRY STANDARDS; TECHNICAL CONSULTATION IN THE FIELD OF DATA CENTRE ENGINEERING, NAMELY, TESTING AND EVALUATION OF COMPUTER, TELECOMMUNICATIONS, DATA STORAGE, POWER, ENVIRONMENTAL CONTROL, PROTECTION AND SECURITY SYSTEMS TO IMPROVE PERFORMANCE AND EFFICIENCY OF SUCH SYSTEMS; COMPUTER SECURITY CONSULTANCY, NAMELY, INFORMATION SECURITY RISK MANAGEMENT FOR DATA CENTRES AND OF COMPUTER, TELECOMMUNICATIONS, DATA STORAGE, POWER, ENVIRONMENTAL CONTROL, PROTECTION AND SECURITY SYSTEMS; PROVIDING TECHNICAL INFORMATION IN THE FIELD OF COMPUTER SYSTEMS, TELECOMMUNICATIONS TECHNOLOGY, DATA SECURITY SYSTEMS, AND ENVIRONMENTAL CONTROL SYSTEMS FOR FACILITIES HOUSING DATA CENTRES, VIA REPORTS AND TECHNICAL PROJECT STUDIES; DESIGN AND DEVELOPMENT OF COMPUTER HARDWARE, SOFTWARE, FIRMWARE AND PROGRAMS; COMPUTER PROGRAMMING; LEASING AND RENTAL OF COMPUTERS, COMPUTER HARDWARE, COMPUTER FIRMWARE, COMPUTER SOFTWARE AND COMPUTER SYSTEMS; MAINTENANCE OF COMPUTER SOFTWARE; UPDATING OF COMPUTER SOFTWARE; COMPUTER PROJECT MANAGEMENT SERVICES;

COMPUTER SECURITY CONSULTANCY, ADVISORY AND INFORMATION SERVICES IN THE FIELD OF DATA CENTRES, AND COMPUTER, TELECOMMUNICATIONS, DATA STORAGE, POWER, ENVIRONMENTAL CONTROL, PROTECTION AND SECURITY SYSTEMS; COMPUTER SOFTWARE CONSULTANCY, ADVISORY AND INFORMATION SERVICES IN THE FIELD OF DATA CENTRES, AND COMPUTER, TELECOMMUNICATIONS, DATA STORAGE, POWER, ENVIRONMENTAL CONTROL, PROTECTION AND SECURITY SYSTEMS; TECHNICAL RESEARCH ADVISORY SERVICES RELATING TO THE USE OF ENERGY; SCIENTIFIC CONSULTANCY IN THE FIELD OF ENERGY-SAVING; ENERGY AUDITING. RECORDING DATA FOR OTHERS ON OPTICAL, DIGITAL AND MAGNETIC MEDIA FOR ELECTRONIC STORAGE IN THE FIELD OF ENERGY CONSUMPTION IN BUILDINGS; SCIENTIFIC TESTING, ANALYSIS AND EVALUATION OF THE ENERGY EFFICIENCY OF BUILDINGS AND OF DATA CENTRES, NAMELY, ENERGY MEASUREMENT TO IMPROVE ENERGY EFFICIENCY; COMPUTER SECURITY TESTING, ANALYSIS AND EVALUATION SERVICES, NAMELY, SCANNING AND PENETRATION TESTING OF DATA CENTRES, COMPUTER HARDWARE, SOFTWARE, FIRMWARE AND PROGRAMS, AND COMPUTER, TELECOMMUNICATIONS, DATA STORAGE, POWER, ENVIRONMENTAL CONTROL, PROTECTION AND SECURITY SYSTEMS TO ASSESS INFORMATION SECURITY VULNERABILITY; TECHNICAL CONSULTATION IN THE FIELD OF DATA CENTRES, NAMELY, TESTING ANALYSIS AND EVALUATION OF COMPUTER HARDWARE, SOFTWARE, FIRMWARE AND PROGRAMS, AND TO COMPUTER, TELECOMMUNICATIONS, DATA STORAGE, POWER, ENVIRONMENTAL CONTROL, PROTECTION AND SECURITY SYSTEMS TO IMPROVE PERFORMANCE AND EFFICIENCY OF SUCH SYSTEMS; TESTING, ANALYSIS AND EVALUATION SERVICES FOR DATA CENTRES, COMPUTER HARDWARE, SOFTWARE, FIRMWARE AND PROGRAMS, AND COMPUTER, TELECOMMUNICATIONS, DATA STORAGE, POWER, ENVIRONMENTAL CONTROL, PROTECTION AND SECURITY SYSTEMS, TO ASSURE COMPLIANCE WITH INDUSTRY STANDARDS (U.S. CLS. 100 AND 101).

#### CLASS 45—PERSONAL AND LEGAL SERVICES

FOR LICENSING OF SOFTWARE (U.S. CLS. 100 AND 101).

SHANNON TWOHIG, EXAMINING ATTORNEY

SN 79-121,644. SHANGHAI SYNTHALL; PHARMACEUTICAL CO., LTD., CHINA, FILED 7-10-2012.



OWNER OF INTERNATIONAL REGISTRATION 1138987 DATED 7-10-2012, EXPIRES 7-10-2022.

THE MARK CONSISTS OF THREE HIGHLY STYLIZED ENGLISH LETTERS "S", "T", AND "A", TO THE RIGHT OF AN EIGHT SIDED GEOMETRIC DESIGN FORMED BY FOUR SEGMENTS WHEREIN NONE OF THE SEGMENTS CONNECTS TO THE ADJACENT SEGMENT.

#### CLASS 1—CHEMICALS

FOR ALKALOIDS FOR INDUSTRIAL PURPOSES; ALKALOIDS FOR THE MANUFACTURE OF SYNTHETIC DRUGS; ALKALOIDS FOR MEDICAL PURPOSES, NAMELY, MEDICAL RESEARCH; ACIDS, NAMELY, BORACIC ACID, CARBONIC ACID, BENZENE-BASED ACID, AND CITRIC ACID; ALKALIES; PROTEIN IN RAW MATERIAL FORM FOR SCIENTIFIC AND MEDICAL RESEARCH; UNPROCESSED ARTIFICIAL AND SYNTHETIC RESINS (U.S. CLS. 1, 5, 6, 10, 26 AND 46).

#### CLASS 5—PHARMACEUTICALS

FOR MEDICINES FOR HUMAN PURPOSES, NAMELY, ANTI-ALLERGIC MEDICINES; PRESCRIPTION AND NON-PRESCRIPTION MEDICINES FOR HUMAN PURPOSES FOR THE PREVENTION AND TREATMENT OF DERMATOLOGICAL AND GYNECOLOGICAL DISEASES; BACTERIOLOGICAL PREPARATIONS FOR MEDICAL AND VETERINARY USE; MICONAZOLE NITRATE FOR USE IN THE MANUFACTURE OF MEDICINES, NAMELY, ANTI-ALLERGIC MEDICINES, AND PRESCRIPTION AND NON-PRESCRIPTION MEDICINES FOR THE PREVENTION AND TREATMENT OF BACTERIAL, DERMATOLOGICAL AND GYNECOLOGICAL DISEASES (U.S. CLS. 6, 18, 44, 46, 51 AND 52).

#### CLASS 40—MATERIAL TREATMENT

FOR SYNTHESIZING AND IMPROVING CHEMICAL REAGENTS, NAMELY, REFINING, DRYING AND GRINDING CHEMICAL REAGENTS; HANDLING OF CHEMICAL REAGENTS, NAMELY, DRYING, FILTERING AND GRINDING; PROCESSING OF MEDICINAL MATERIALS, NAMELY, CUSTOM MANUFACTURING OF PHARMACEUTICALS, ANTI-ALLERGIC DRUGS, AND PRESCRIPTION AND NON-PRESCRIPTION MEDICINES FOR THE PREVENTION AND TREATMENT OF DERMATOLOGICAL, BACTERIAL, AND GYNECOLOGICAL DISEASES BY PHARMACEUTICAL COMPOUNDERS (U.S. CLS. 100, 103 AND 106).

#### CLASS 42—SCIENTIFIC AND COMPUTER SERVICES

FOR TECHNICAL RESEARCH IN THE FIELD OF PHARMACEUTICALS; RESEARCH AND DEVELOPMENT FOR OTHERS IN THE FIELD OF PHARMACEUTICALS; CHEMICAL ANALYSIS; CHEMISTRY SERVICES, NAMELY, RESEARCHING OF PRODUCTION METHODS FOR MANUFACTURING OR TRANSFORMING THE SUBSTANCE IN THE LABORATORY AND MASS PRODUCED IN FACTORIES; CHEMISTRY CONSULTATION, NAMELY, PROVIDING CLIENTS WITH DETAILED METHODS FOR CHEMISTRY PRODUCTION AND QUALITY TESTING; CHEMICAL RESEARCH; BIOLOGICAL RESEARCH (U.S. CLS. 100 AND 101).

ELLEN B. AWRICH, EXAMINING ATTORNEY

SN 79-121,672. CITY AND COUNTRY HOTELS LIMITED; C/O MANAGEMENT OFFICE CAMPBELL COURT, UNITED KINGDOM, FILED 9-24-2012.

# The Wellesley

THE MARK CONSISTS OF STANDARD CHARACTERS WITHOUT CLAIM TO ANY PARTICULAR FONT, STYLE, SIZE, OR COLOR.

PRIORITY DATE OF 6-27-2012 IS CLAIMED.

OWNER OF INTERNATIONAL REGISTRATION 1139045 DATED 9-24-2012, EXPIRES 9-24-2022.

**CLASS 32—LIGHT BEVERAGES**

FOR MINERAL AND AERATED WATERS; NON-ALCOHOLIC DRINKS, NAMELY, SOFT DRINKS, CARBONATED BEVERAGES; FRUIT DRINKS (U.S. CLS. 45, 46 AND 48).

**CLASS 33—WINES AND SPIRITS**

FOR SPIRITS AND LIQUEURS; PREPARED ALCOHOLIC COCKTAILS (U.S. CLS. 47 AND 49).

**CLASS 34—SMOKERS' ARTICLES**

FOR TOBACCO, RAW OR MANUFACTURED; CIGARS; CIGARETTES; CIGAR CASES; CIGAR CUTTERS; HUMIDORS; SMOKERS' ARTICLES, NAMELY, CIGARETTE PAPERS, CIGARETTE HOLDERS, CIGARETTE-ROLLING MACHINES, CIGARETTE STORAGE TUBES, CIGAR BOXES, CIGAR HUMIDIFIERS; MATCHES; MATCHBOXES; MATCH HOLDERS; LIGHTERS FOR SMOKERS; ASHTRAYS FOR SMOKERS (U.S. CLS. 2, 8, 9 AND 17).

GENE MACIOL, EXAMINING ATTORNEY

**CLASS 24—FABRICS**

FOR TEXTILES AND TEXTILE GOODS INCLUDED IN THIS CLASS, NAMELY, HAND TOWELS OF TEXTILE, PILLOW CASES OF TEXTILE, BED SHEETS OF TEXTILE, BED BLANKETS OF TEXTILE, BED LINEN OF TEXTILE, QUILTS OF TEXTILE, DUVET COVERS OF TEXTILE, BED COVERS OF TEXTILE; MATTRESS PROTECTORS OF TEXTILE; BED COVERS AND TABLE COVERS, NAMELY, PLASTIC TABLE COVERS, TABLE CLOTHS NOT OF PAPER; BED LINEN; BED SHEETS; BED BLANKETS; QUILTS; DUVETS; DUVET COVERS; MATTRESS PROTECTORS; TOWELS; FLANNELS, NAMELY, FLANNEL TOWELS, FLANNEL PILLOW CASES, FLANNEL BED SHEETS, FLANNEL BED BLANKETS, FLANNEL QUILTS, FLANNEL DUVET COVERS, FLANNEL BED COVERS, FLANNEL MATTRESS PROTECTORS; CURTAINS (U.S. CLS. 42 AND 50).

KEVIN CORWIN, EXAMINING ATTORNEY

SN 79-122,345. ANDRÉ SIMON, FED REP GERMANY, FILED 2-14-2012.

politrue

THE MARK CONSISTS OF STANDARD CHARACTERS WITHOUT CLAIM TO ANY PARTICULAR FONT, STYLE, SIZE, OR COLOR.

PRIORITY DATE OF 8-15-2011 IS CLAIMED.

OWNER OF INTERNATIONAL REGISTRATION 1140851 DATED 2-14-2012, EXPIRES 2-14-2022.

SN 79-121,951. HANDY BABY PRODUCTS LIMITED, IRELAND, FILED 11-8-2012.

CLEVAMAMA

THE MARK CONSISTS OF STANDARD CHARACTERS WITHOUT CLAIM TO ANY PARTICULAR FONT, STYLE, SIZE, OR COLOR.

OWNER OF INTERNATIONAL REGISTRATION 1139811 DATED 11-8-2012, EXPIRES 11-8-2022.

OWNER OF U.S. REG. NO. 3,554,606.

**CLASS 20—FURNITURE AND ARTICLES NOT OTHERWISE CLASSIFIED**

FOR FURNITURE, MIRRORS, PICTURE FRAMES; MATTRESSES, PILLOWS; FOAM MATTRESSES; FOAM PILLOWS; FOAM SUPPORTS FOR BABIES, NAMELY, BABY HEAD SUPPORT CUSHIONS; BABY CHANGING MATS; BUMPER GUARDS FOR FURNITURE, NAMELY, BUMPER GUARDS FOR CRIBS; CUSHIONS; NON-METAL SAFETY GATES FOR INFANTS; SAFETY FITTINGS AND LOCKS FOR WINDOWS AND FOR DOORS, NAMELY, NON-METAL CHILD SAFETY PRODUCTS IN THE NATURE OF STRING AND CORD WINDERS FOR USE ON BLINDS, CURTAINS, DRAPES, WINDOW COVERINGS, AND DOOR COVERINGS AND NON-METAL CATCHES FOR DOORS, CUPBOARDS AND TOILET SEATS; FIREGUARDS AND FIREPLACE SCREENS; FURNITURE PROTECTORS, NAMELY, BUMPER GUARDS FOR FURNITURE; PLASTIC DOOR STOPS; CONTAINERS MADE OF PLASTIC, NAMELY, PLASTIC CONTAINERS FOR COMMERCIAL USE IN THE NATURE OF CONTAINERS OF PLASTIC FOR STORAGE OF BULK FOODS, NAMELY, BABY FORMULA (U.S. CLS. 2, 13, 22, 25, 32 AND 50).

**CLASS 35—ADVERTISING AND BUSINESS**

FOR ADVERTISING SERVICES; BUSINESS MANAGEMENT CONSULTING; BUSINESS ADMINISTRATION CONSULTANCY; BUSINESS ADMINISTRATION ASSISTANCE; PROVIDING OFFICE FUNCTIONS; UPDATING OF ADVERTISING MATERIAL; COST PRICE ANALYSIS; BUSINESS INFORMATION AND INQUIRIES; BUSINESS MANAGEMENT AND ORGANIZATION CONSULTANCY; BUSINESS MANAGEMENT CONSULTANCY; IMPORT AND EXPORT AGENCIES; GOODS IMPORT-EXPORT AGENCIES; PROFESSIONAL BUSINESS CONSULTANCY; BOOK-KEEPING; COMPUTERIZED FILE MANAGEMENT; ADVERTISING AGENCIES; AUCTIONEERING; RELOCATION SERVICES FOR BUSINESS; BUSINESS INVESTIGATIONS; COMPILATIONS OF STATISTICS; BUSINESS EFFICIENCY EXPERT SERVICES; ACCOUNTING SERVICES, NAMELY, DRAWING UP OF STATEMENTS OF ACCOUNTS; TAX PREPARATION; ECONOMIC FORECASTING AND ANALYSIS; BUSINESS ADVICE AND COMMERCIAL INFORMATION; COMMERCIAL INFORMATION AND ADVICE FOR CONSUMERS (CONSUMER ADVICE SHOP); INVOICING; TELEVISION ADVERTISING; BUSINESS MANAGEMENT FOR PERFORMING ARTISTS; BUSINESS MANAGEMENT OF HOTELS; PHOTOCOPYING; PUBLICATION OF PUBLICITY TEXTS, ESPECIALLY PUBLICATION OF STATISTICS; COMMERCIAL AND INDUSTRIAL MANAGEMENT ASSISTANCE; PROVIDING BUSINESS INFORMATION VIA A WEBSITE; COMMERCIAL ADMINISTRATION OF THE LICENSING OF THE GOODS AND SERVICES OF OTHERS; LAYOUT SERVICES FOR ADVERTISING PURPOSES; PAYROLL PREPARATION; MODELING FOR ADVERTISING OR SALES PROMOTION; MARKETING RESEARCH; MARKETING OPINION POLLING STUDIES; ANALYSIS OF MARKET RESEARCH DATA AND STATISTICS IN COMPUTER FILES FOR OTHERS; BUSINESS RESEARCH; PUBLIC RELATIONS; ONLINE ADVERTISING ON A COMPUTER NETWORK; ORGANIZATION OF EXHIBITIONS FOR COMMERCIAL OR ADVERTISING SERVICES; BUSINESS ORGANIZATION AND OPERATION CONSULTANCY; OUTSOURCING SERVICES; EMPLOYMENT AGENCIES; PERSONNEL PLACEMENT AND RECRUITMENT; PSYCHOLOGICAL

TESTING FOR THE SELECTION OF PERSONNEL; PERSONNEL MANAGEMENT CONSULTANCY; ADVERTISING SERVICES, NAMELY, POSTING OF BILLS; BUSINESS MANAGEMENT ASSISTANCE; PROVIDING TELEVISION HOME SHOPPING SERVICES IN THE FIELD OF GENERAL CONSUMER MERCHANDISE; PRICE COMPARISON SERVICES; RADIO ADVERTISING; NEWS CLIPPING SERVICES; MARKET RESEARCH, NAMELY, COLLECTION OF CUSTOMER INFORMATION AND MARKET RESEARCH IN THE FIELD OF POLITICS; WORD PROCESSING; SECRETARY AND CLERICAL SERVICES; SPONSORSHIP SEARCH; SHORTHAND SECRETARIAL SERVICES; COMPILATION AND SYSTEMIZATION OF INFORMATION INTO COMPUTER DATABASES; TELEPHONE ANSWERING SERVICES FOR UNAVAILABLE SUBSCRIBERS; DISSEMINATION OF ADVERTISING MATTER; SALES PROMOTION FOR OTHERS PROVIDED THROUGH THE DISTRIBUTION AND THE ADMINISTRATION OF PRIVILEGED USER CARDS; OFFICE MACHINES AND EQUIPMENT RENTAL; RENTAL OF PHOTOCOPYING MACHINES; RENTAL OF VENDING MACHINES; RENTAL OF ADVERTISING SPACE; PROVIDING AND RENTAL OF ADVERTISING SPACE ON THE INTERNET; ARRANGING SUBSCRIPTIONS TO TELECOMMUNICATION SERVICES FOR OTHERS; ADVERTISING BY MAIL, NAMELY, DIRECT MAIL ADVERTISING; DISTRIBUTION OF SAMPLES FOR PUBLICITY PURPOSES; DIRECT MAIL ADVERTISING; DOCUMENT COPYING SERVICES; ADMINISTRATIVE PROCESSING OF PURCHASE ORDER; DEMONSTRATION OF GOODS; PREPARATION OF PUBLICITY TEXT AND MATERIALS; BUSINESS APPRAISALS (U.S. CLS. 100, 101 AND 102).

### **CLASS 38—COMMUNICATION**

FOR TELECOMMUNICATION SERVICES, NAMELY, TELECOMMUNICATION ACCESS SERVICES, PERSONAL COMMUNICATION SERVICES, TELEPHONE COMMUNICATIONS SERVICES; INFORMATION ABOUT TELECOMMUNICATION; TELEVISION BROADCASTING; RADIO BROADCASTING; CABLE TELEVISION BROADCASTING; PROVIDING MULTIPLE USER ACCESS TO A GLOBAL COMPUTER NETWORK; INTERNET SERVICE PROVIDER; PROVIDING TELECOMMUNICATIONS CONNECTIONS TO A GLOBAL COMPUTER NETWORK FOR TEleshopping SERVICES; PROVIDING TELECOMMUNICATIONS CONNECTIONS TO A GLOBAL COMPUTER NETWORK; PROVIDING INTERNET CHAT ROOMS; PROVIDING ACCESS TO THE INTERNET, ESPECIALLY TO PORTALS THROUGH WHICH POLITICIANS OF ALL PARTIES MAY PLACE THEIR OWN, UNFILTERED TEXTS; ELECTRONIC BULLETIN BOARD SERVICES; ELECTRONIC MAIL; INTERNATIONAL, INTERSTATE AND MOBILETELEPHONE SERVICES; COMMUNICATION BY FIBER OPTIC NETWORKS; TELECOMMUNICATIONS ROUTING AND JUNCTION SERVICES; CELLULAR TELEPHONE COMMUNICATION; COMPUTER AIDED TRANSMISSION OF MESSAGES AND IMAGES; PAGING SERVICES; NEWS AGENCY SERVICES FOR ELECTRONIC TRANSMISSION; SATELLITE TRANSMISSION; VOICE MAIL SERVICES; TELEGRAPH SERVICES; COMMUNICATIONS BY TELEGRAMS; TRANSMISSION OF TELEGRAMS; TELECONFERENCING SERVICES; FACSIMILE TRANSMISSION; ELECTRONIC MESSAGE SENDING; RENTAL OF COMMUNICATION EQUIPMENT, NAMELY, MESSAGE SENDING APPARATUS; RENTAL OF MODEMS; RENTAL OF TELECOMMUNICATION EQUIPMENT; PROVIDING ACCESS TO DATABASES (U.S. CLS. 100, 101 AND 104).

### **CLASS 41—EDUCATION AND ENTERTAINMENT**

FOR EDUCATION SERVICES, NAMELY CONDUCTING SEMINARS, CLASSES AND SYMPOSIA IN THE FIELD OF POLITICS AND MARKETING FOR POLITICIANS; EDUCATIONAL SERVICES, NAMELY, PROVIDING INTERNSHIPS AND APPRENTICESHIPS IN THE FIELD OF POLITICS; ENTERTAINMENT SERVICES, NAMELY ONGOING TELEVISION OR RADIO TALK SHOWS AND TELEVISION NEWS SHOWS; TRANSLATION; VIDEOTAPING; PROVIDING INFORMATION, NEWS AND COMMENTARY IN THE FIELD OF RECREATION AND LEISURE ACTIVITIES; PROVIDING INFORMATION AND NEWS IN THE FIELD OF TEACHING METHODOLOGY AND EDUCATION; PROVIDING ON-LINE NON-DOWNLOADABLE PUBLICATIONS, NAMELY, MAGAZINES, JOURNALS, BOOKS IN THE NATURE OF POLITICS; HOSTING SOCIAL ENTERTAINMENT EVENTS, NAMELY, KARAOKE PARTIES, FOR OTHERS; VOCATIONAL GUIDANCE; DISCOTHEQUE SERVICES; MODELING FOR ARTISTS; MOBILE LIBRARY SERVICES; BOARDING SCHOOLS; PROVIDING CASINO FACILITIES; SUMMER CAMP SERVICES; HEALTH CLUB SERVICES, NAMELY, PROVIDING INSTRUCTION AND EQUIPMENT IN THE FIELD OF PHYSICAL EXERCISE; PROVIDING GOLF FACILITIES; NURSERY SCHOOLS; MOVIE THEATERS; MUSEUMS; NIGHT CLUBS; PROVIDING AMUSEMENT ARCADE SERVICES; SPORT CAMP SERVICES; RECORDING STUDIO SERVICES; MUSIC-HALLS; AMUSEMENT PARKS; ZOOLOGICAL GARDENS; LENDING LIBRARIES; PROVIDING EDUCATIONAL DEMONSTRATIONS; ELECTRONIC DESKTOP PUBLISHING; PROVIDING RECREATION FACILITIES; NEWS REPORTER SERVICES; SIGN LANGUAGE INTERPRETATION; PRESENTATION OF LIVE SHOW PERFORMANCES; EDUCATIONAL EXAMINATION SERVICES; TICKET AGENCY SERVICES FOR ENTERTAINMENT EVENTS; PHOTOGRAPHIC REPORTING; SUBTITLING; ACADEMIES, NAMELY, EDUCATING AT SENIOR HIGH SCHOOLS; PROVIDING EDUCATION IN THE FIELD OF POLITICS RENDERED THROUGH CORRESPONDENCE COURSES; ENTERTAINMENT IN THE NATURE OF ON-GOING TELEVISION PROGRAMS IN THE FIELD OF POLITICS; FILM PRODUCTION; RENTAL OF CINE-FILMS; PHOTOGRAPHY; GAMING SERVICES IN THE NATURE OF CASINO GAMING; GYMNASIUM INSTRUCTION; PUBLICATION OF TEXTS, OTHER THAN PUBLICITY TEXTS; ENTERTAINMENT INFORMATION; CALLIGRAPHY SERVICES; MUSIC COMPOSITION SERVICES; LAYOUT SERVICES, OTHER THAN FOR ADVERTISING PURPOSES; MICROFILMING FOR OTHERS; VIDEOTAPE EDITING; ORCHESTRA SERVICES; PROVIDING ONLINE VIDEO AND COMPUTER GAMES; PUBLICATION OF ELECTRONIC BOOKS AND JOURNALS ACCESSIBLE VIA A GLOBAL COMPUTER NETWORK; ARRANGING AND CONDUCTING OF EDUCATIONAL CONFERENCES; PROVIDING FACILITIES FOR EDUCATIONAL CONVENTIONS; ARRANGING AND CONDUCTING OF CONCERTS; ARRANGING AND CONDUCTING OF EDUCATIONAL SYMPOSIUMS; PARTY PLANNING; BOOKING OF SEATS FOR SHOWS; PRODUCTION OF RADIO AND TELEVISION PROGRAMS; EDUCATIONAL SERVICES, NAMELY, CONDUCTING EDUCATIONAL PROGRAMS IN THE FIELD OF RELIGION; ENTERTAINMENT SERVICES, NAMELY, PROVIDING AN ON-GOING RADIO PROGRAM IN THE FIELD OF POLITICS; RADIO ENTERTAINMENT PRODUCTION; DUBBING; ENTERTAINMENT IN THE NATURE OF THEATRE PRODUCTIONS; ANIMAL TRAINING; PHYSICAL EDUCATION SERVICES; ORGANIZATION OF SPORT COMPETITIONS; ARRANGING AND CONDUCTING OF SEMINARS IN THE FIELD OF POLITICS; ARRANGING AND CONDUCTING OF WORKSHOPS IN THE FIELD OF POLITICS; ARRANGING AND CONDUCTING OF EDUCATIONAL COLLOQUIUMS IN THE FIELD OF POLITICS; ORGANIZATION OF EXHIBITIONS FOR CULTURAL AND EDUCATIONAL PURPOSES; HOSTING SOCIAL ENTERTAINMENT EVENTS, NAMELY, BALLS, FOR OTHERS; OPERATION OF LOTTERIES; ARRANGING OF BEAUTY CONTESTS; ORGANIZATION OF CULTURAL SHOWS; ORGANIZATION OF SPORTS COMPETITIONS; SCRIPTWRITING SERVICES; WRITING OF TEXTS, OTHER THAN PUBLICITY TEXTS; RENTAL OF AUDIO EQUIPMENT; RENTAL OF LIGHTING APPARATUS FOR THEATRICAL SETS OR TELEVISION STUDIOS; RENTAL OF SHOW SCEN-

ERY; RENTAL OF VIDEO CAMERAS; RENTAL OF MOVIE PROJECTORS AND ACCESSORIES; RENTAL OF CINE-FILMS; RENTAL OF RADIO AND TELEVISION SETS; RENTAL OF SPORT EQUIPMENT, EXCEPT VEHICLES; RENTAL OF SKIN DIVING EQUIPMENT; RENTAL OF STADIUM FACILITIES; RENTAL OF TENNIS COURTS; RENTAL OF STAGE SCENERY; RENTAL OF SOUND RECORDINGS; PUBLICATION OF BOOKS, INSTRUCTION MANUALS AND USER GUIDES; PROVIDING ON-LINE PUBLICATIONS IN THE NATURE OF BOOKS IN THE FIELD OF POLITICS; VIDEOTAPE FILM PRODUCTION; RENTAL OF VIDEOTAPES; TIMING OF SPORT EVENTS; CIRCUSES (U.S. CLS. 100, 101 AND 107).

#### CLASS 42—SCIENTIFIC AND COMPUTER SERVICES

FOR SCIENTIFIC RESEARCH; DESIGN AND DEVELOPMENT OF COMPUTER HARDWARE AND SOFTWARE; ARCHITECTURAL DESIGN CONSULTING; BACTERIOLOGICAL RESEARCH; CONSULTING SERVICES IN THE FIELDS OF ENERGY MEASUREMENT TO IMPROVE ENERGY EFFICIENCY; PROVIDING SEARCH ENGINES FOR THE INTERNET; BIOLOGICAL RESEARCH; CONSULTANCY ON THE FIELD OF DESIGN AND DEVELOPMENT COMPUTER HARDWARE; CONSULTANCY ON THE FIELD OF COMPUTER SOFTWARE; COMPUTER SYSTEM ANALYSIS; COMPUTER SYSTEM DESIGN; COMPUTER SOFTWARE DESIGN; INDUSTRIAL DESIGN; DRESS DESIGNING; PHYSICS RESEARCH; PACKAGING DESIGN; ARCHITECTURAL SERVICES; DESIGN OF INTERIOR DECOR; ENGINEERING; CHEMISTRY CONSULTATION SERVICES; RESEARCH IN THE FIELD OF CHEMISTRY; COMPUTER VIRUS PROTECTION SERVICES; CHEMICAL ANALYSIS; OIL PROSPECTING; AUTHENTICATING WORKS OF ART; CALIBRATION; COMPUTER PROGRAMMING; SCIENTIFIC RESEARCH AND ANALYSIS FOR OILFIELD EXPLOITATION; SURVEYING; CONDUCTING GEOLOGICAL SURVEYS; RESEARCH IN FIELD OF ENVIRONMENTAL PROTECTION; BACTERIOLOGICAL RESEARCH; CHEMICAL RESEARCH; COSMETICS RESEARCH; GEOLOGICAL RESEARCH; GEOLOGICAL PROSPECTING; COMPUTER SERVICES, NAMELY, CREATING, MAINTAINING, DESIGNING, AND IMPLEMENTING WEBSITES FOR OTHERS IN THE FIELD OF POLITICS; INSTALLATION OF COMPUTER SOFTWARE; CONSTRUCTION DRAFTING; DATA CONVERSION OF COMPUTER PROGRAMS AND DATA, NOT PHYSICAL CONVERSION; DUPLICATION OF COMPUTER PROGRAMS; LAND SURVEYING; MATERIAL TESTING FOR TEXTILES; MEDICAL AND MEDICAL TECHNICAL RESEARCH; QUALITY CONTROL FOR OTHERS; RESEARCH AND DEVELOPMENT OF NEW PRODUCTS FOR OTHERS; URBAN PLANNING; INDUSTRIAL DESIGN SERVICES; VEHICLE ROADWORTHINESS TESTING; OIL-WELL TESTING; UNDERWATER EXPLORATION; HOSTING OF COMPUTER WEBSITES; RENTAL OF COMPUTERS; RENTAL OF WEB SERVERS; MAINTENANCE OF COMPUTER SOFTWARE; MATERIAL TESTING; WEATHER FORECASTING; RECOVERY OF COMPUTER DATA; SCIENTIFIC RESEARCH; CLOUD SEEDING; QUALITY EVALUATION OF STANDING TIMBER; GRADING OF WOOL (U.S. CLS. 100 AND 101).

JOHN SCHUYLER YARD, EXAMINING ATTORNEY

SN 79-122,516. RAINPOWER ASA, NORWAY, FILED 4-17-2012.



PRIORITY DATE OF 2-20-2012 IS CLAIMED.  
OWNER OF INTERNATIONAL REGISTRATION 1141274  
DATED 4-17-2012, EXPIRES 4-17-2022.

THE COLOR(S) BLUE, WHITE AND BLACK IS/ARE CLAIMED AS A FEATURE OF THE MARK.

THE MARK CONSISTS OF A DESIGN OF A BLUE AND WHITE RAINDROP UNDERNEATH THEREOF APPEARS THE STYLIZED WORD "RAINPOWER" IN THE COLOR BLACK.

#### CLASS 7—MACHINERY

FOR TURBINES AND HYDRO ELECTRIC GENERATORS FOR POWER PLANTS (U.S. CLS. 13, 19, 21, 23, 31, 34 AND 35).

#### CLASS 9—ELECTRICAL AND SCIENTIFIC APPARATUS

FOR ELECTRIC AGGREGATE REGULATORS AND ELECTRIC REGULATING SYSTEMS, NAMELY, HYDRO-ELECTRIC POWER PLANT CONTROL SYSTEMS CONSISTING OF TURBINE GOVERNORS, VOLTAGE REGULATORS, WATER LEVEL CONTROLLERS, OIL PRESSURE CONTROLLERS, GENERATOR SYNCHRONIZERS, AND TURBINE SPEED MONITORS AND RELAYS (U.S. CLS. 21, 23, 26, 36 AND 38).

#### CLASS 37—CONSTRUCTION AND REPAIR

FOR INSTALLATION, SERVICING AND REPAIR OF POWER PLANTS (U.S. CLS. 100, 103 AND 106).

#### CLASS 42—SCIENTIFIC AND COMPUTER SERVICES

FOR ENGINEERING, WATER PASSAGE ANALYSIS, TURBINE DESIGN, HYDRAULIC MODEL TESTING, AND CALIBRATION OF HYDRO POWER TURBINES (U.S. CLS. 100 AND 101).

CHRISTOPHER BUONGIORNO, EXAMINING ATTORNEY

SN 79-122,902. CRISTALICA GMBH, FED REP GERMANY, FILED 8-30-2012.



PRIORITY DATE OF 3-7-2012 IS CLAIMED.  
OWNER OF INTERNATIONAL REGISTRATION 1142134  
DATED 8-30-2012, EXPIRES 8-30-2022.

OWNER OF U.S. REG. NO. 4,062,068.  
NO CLAIM IS MADE TO THE EXCLUSIVE RIGHT TO USE "ART GLASS", APART FROM THE MARK AS SHOWN.

THE COLOR(S) PURPLE AND WHITE IS/ARE CLAIMED AS A FEATURE OF THE MARK.

THE MARK CONSISTS OF THE FOLLOWING: THE DEPICTION OF A MAN BLOWING A GLASS VASE IN THE COLOR WHITE WITH THE WORDING "CRISTALICA ART GLASS" ALSO IN THE COLOR WHITE ON A PURPLE BACKGROUND WITH SCALLOPED EDGES IN THE COLOR WHITE.

**CLASS 14—JEWELRY**

FOR JEWELRY AMULETS; JEWELRY PINS; JEWELRY BRACELETS; JEWELRY BROOCHES; JEWELRY NECKLACES; JEWELLERY; JEWELRY CHAINS; JEWELRY MEDALLIONS; JEWELRY RINGS; KEY RINGS OF PRECIOUS METAL (U.S. CLS. 2, 27, 28 AND 50).

**CLASS 21—HOUSEWARES AND GLASS**

FOR GLASS JARS; ENAMELED GLASS; CONTAINERS FOR HOUSEHOLD USE, NAMELY, GLASS BULBS; POWDERED GLASS FOR DECORATION; INSULATING FLASKS; THERMAL INSULATED CONTAINERS FOR BEVERAGES; COFFEE SERVICES; CERAMICS FOR HOUSEHOLD PURPOSES, NON-ELECTRIC CANDELABRA; OPAL GLASS; OPALINE GLASS; PERFUME VAPORIZERS SOLD EMPTY; FITTED PICNIC BASKETS INCLUDING DISHES; PORCELAIN WARE, NAMELY, BOWLS, CUPS, PLATES, POTS, MUGS, SIGNBOARDS, VASES; DISHES, TRIVETS; GROUND PLATE GLASS; TOILET CASES, NAMELY, FITTED VANITY CASES; TOILET PAPER HOLDERS; TOILET PAPER DISPENSERS; POTTERY, NAMELY, BOWLS, CUPS, PLATES, POTS, MUGS, SIGNBOARDS, VASES; DRINKING GLASSES; GOBLETS; CONTAINERS FOR HOUSEHOLD AND KITCHEN USE; BEER MUGS; HOLDERS FOR FLOWERS AND PLANTS; BUSTS OF CHINA, TERRACOTTA OR GLASS; BUTTER-DISH COVERS; EGG CUPS; BUCKETS; ICE BUCKETS; CRUETS; OIL CRUETS; CHOPSTICKS; FIGURINES OF CHINA, TERRACOTTA OR GLASS; FLASKS; BOTTLES SOLD EMPTY; FRUIT PRESSES, NON-ELECTRIC, FOR HOUSEHOLD PURPOSES; CONTAINERS FOR HOUSEHOLD OR KITCHEN USE; SPICE RACKS; GLASS, UNWORKED OR SEMI-WORKED, EXCEPT BUILDING GLASS; GLASS DRINKING FLASKS; BOXES OF GLASS; DRINKING GLASSES; GLASS BOWLS; MOSAICS OF GLASS, NOT FOR BUILDING; GLASS STOPPERS; PAINTED BEVERAGE GLASSWARE; CABARET SERVING TRAYS; JUGS; DECANTERS; COASTERS, NOT OF PAPER AND OTHER THAN TABLE LINEN; CHEESE-DISH COVERS; COOKIE JARS; NON-ELECTRIC CANDELABRAS; DEMIJOHNS; CRYSTAL GLASSWARE; WORKS OF ART, OF PORCELAIN, TERRA-COTTA OR GLASS; SERVING SET FOR LIQUEUR; KNIFE RESTS FOR THE TABLE; COCKTAIL SHAKERS; FRUIT CUPS; PEPPER MILLS, HAND-OPERATED; PEPPER POTS; DISHES; MIXING STICKS FOR COCKTAILS; SALAD BOWLS; SALT CELLARS; BOWLS; SCOOPS; CUTTING BOARDS FOR THE KITCHEN; BASTING SPOONS, FOR KITCHEN USE; SIGNBOARDS OF PORCELAIN, TERRA-COTTA OR GLASS; SOAP BOXES; SOAP HOLDERS; SOAP DISPENSERS; LAZY SUSANS; NAPKIN RINGS; PIGGY BANKS, NOT OF METAL; MENU CARD HOLDERS; STATUES OF PORCELAIN, TERRA-COTTA OR GLASS; SOUP BOWLS; TRAYS FOR DOMESTIC PURPOSES; EPERGNES; SERVICES, NAMELY, DISHES; CUPS; TEA CADDIES; TEAPOTS; TEA SERVICES; TABLE PLATES; PIE SERVERS; DRINKING TROUGHS; DRINKING VESSELS; FEEDING TROUGHS; SAUCERS; VASES; WINE-TASTING PIPETTES; TOOTHPICK HOLDERS; SUGAR BOWLS (U.S. CLS. 2, 13, 23, 29, 30, 33, 40 AND 50).

**CLASS 35—ADVERTISING AND BUSINESS**

FOR PRESENTATION OF GOODS ON COMMUNICATION MEDIA FOR RETAIL PURPOSES, NAMELY, FOR WATCHES AND JEWELRY, PRINTING PRODUCTS, FURNITURE AND DECORATION, ELECTRICAL AND ELECTRONIC GOODS; PRESENTATION OF GOODS ON COMMUNICATION MEDIA FOR RETAIL PURPOSES, NAMELY, ON-LINE AND PRINTED CATALOGUES, NAMELY, FOR WATCHES AND JEWELRY, PRINTING PRODUCTS, FURNITURE AND DECORATION, ELECTRICAL AND ELECTRONIC GOODS (U.S. CLS. 100, 101 AND 102).

**CLASS 39—TRANSPORTATION AND STORAGE**

FOR ORGANIZATION OF SIGHTSEEING TOURS AND EXCURSIONS, STORAGE OF GOODS, WRAPPING SERVICES FOR BAGGAGE PROTECTION DURING TRAVEL (U.S. CLS. 100 AND 105).

ANNE E. GUSTASON, EXAMINING ATTORNEY

SN 79-123,756. S.A. LHOJST RECHERCHE ET DEVELOPEMENT; EN ABRÉGÉ L.R.D. (SOCIÉTÉ ANONYME), BELGIUM, FILED 11-8-2012.

# LIMEFLEX

THE MARK CONSISTS OF STANDARD CHARACTERS WITHOUT CLAIM TO ANY PARTICULAR FONT, STYLE, SIZE, OR COLOR.

PRIORITY DATE OF 6-21-2012 IS CLAIMED.

OWNER OF INTERNATIONAL REGISTRATION 1144315 DATED 11-8-2012, EXPIRES 11-8-2022.

**CLASS 1—CHEMICALS**

FOR CHEMICALS USED IN INDUSTRY AND SCIENCE; CHEMICALS USED IN AGRICULTURE, HORTICULTURE AND FORESTRY, EXCEPT FUNGICIDES, HERBICIDES, INSECTICIDES AND PARASITICIDES; INDUSTRIAL CHEMICAL PRODUCTS BASED ON LIME AND LIME-BASED PRODUCTS, NAMELY, DOLOMITIC LIME, DOLIME, HYDRATED LIME AND MILK OF LIME, FOR USE IN THE MANUFACTURE OF THE ABOVE-MENTIONED GOODS AND LIME-BASED CHEMICALS FOR USE IN THE FIELD OF METALLURGY, CHEMISTRY, ENVIRONMENT, AGRICULTURE, FOOD MANUFACTURING, BUILDING AND CONSTRUCTION, CIVIL ENGINEERING, PAPER AND GLASS PRODUCTION (U.S. CLS. 1, 5, 6, 10, 26 AND 46).

**CLASS 19—NON-METALLIC BUILDING MATERIALS**

FOR NON-METALLIC BUILDING MATERIALS IN FORM OF AGGREGATES, GRAIN, SAND-FRACTIONS, POWDERS OR SUSPENSION OUT OF LIME, HYDRATED LIME, LIMESTONE, DOLIME, DOLOMITE, HYDRATED DOLIME AND MIXTURES OUT OF THE ABOVE MENTIONED MATERIALS; LIME, LIMESTONE; SAND LIME BRICKS, AERATED CONCRETES, MORTARS, PLASTERS, LIME RENDERS; LIME, HYDRATED LIME, LIMESTONE FOR THE MANUFACTURE OF THE ABOVE MENTIONED GOODS (U.S. CLS. 1, 12, 33 AND 50).

**CLASS 42—SCIENTIFIC AND COMPUTER SERVICES**

FOR SCIENTIFIC AND TECHNOLOGICAL SERVICES, NAMELY, SCIENTIFIC RESEARCH, ANALYSIS, AND TESTING IN THE FIELD OF METALLURGY, CHEMISTRY, ENVIRONMENT, AGRICULTURE, FOOD MANUFACTURING, BUILDING AND CONSTRUCTION, CIVIL ENGINEERING, PAPER, AND GLASS PRODUCTION; SCIENTIFIC RESEARCH AND DESIGN IN THE FIELD OF METALLURGY, CHEMISTRY, ENVIRONMENT, AGRICULTURE, FOOD MANUFACTURING, BUILDING AND CONSTRUCTION, CIVIL ENGINEERING, PAPER AND GLASS PRODUCTION; INDUSTRIAL RESEARCH AND SCIENTIFIC AND CHEMICAL ANALYSES IN THE FIELD OF ENVIRONMENTAL PROTECTION, WATER TREATMENT, INDUSTRIAL WASTE TREATMENT, CIVIL ENGINEERING, CHEMISTRY, METALLURGY, PAPER AND GLASS PRODUCTION (U.S. CLS. 100 AND 101).

TRACY CROSS, EXAMINING ATTORNEY

SN 79-123,936. QEST QUANTENELEKTRONISCHE SYSTEME GMBH, FED REP GERMANY, FILED 8-20-2012.



PRIORITY DATE OF 2-20-2012 IS CLAIMED.  
OWNER OF INTERNATIONAL REGISTRATION 1144812  
DATED 8-20-2012, EXPIRES 8-20-2022.

THE COLOR(S) BLUE AND LIGHT GREY IS/ARE CLAIMED AS A FEATURE OF THE MARK.

THE MARK CONSISTS OF THE WORD "QEST" IN STYLIZED BLUE FONT, WITH AN ANGLED LIGHT GRAY LINE SUPERIMPOSED ON THE LETTER "Q" AND EXTENDING BENEATH THE LETTERS "E", "S", "T".

### CLASS 9—ELECTRICAL AND SCIENTIFIC APPARATUS

FOR SCIENTIFIC, NAUTICAL, SURVEYING, PHOTOGRAPHIC, CINEMATOGRAPHIC, OPTICAL, WEIGHING, MEASURING, SIGNALING, CHECKING AND SUPERVISION, LIFE-SAVING AND TEACHING APPARATUS AND INSTRUMENTS, NAMELY, DIGITAL SIGNAL PROCESSORS, CAMERAS, THERMOMETERS, FOR USE IN ANTENNAE SYSTEMS; APPARATUS AND INSTRUMENTS FOR CONDUCTING, SWITCHING TRANSFORMING, ACCUMULATING, REGULATING OR CONTROLLING ELECTRICITY AND PROVISION OF ELECTRICITY, NAMELY, ADAPTERS, ELECTRIC ACCUMULATORS, ELECTRIC ACTUATORS, FOR USE IN ANTENNAE SYSTEMS; COMPUTER SOFTWARE FOR OPERATING AND CONTROLLING TRANSCEIVER APPARATUS FOR USE IN ANTENNAE SYSTEMS; AERIALS, IN PARTICULAR RADIO ELECTRIC AERIALS, ZONE PLATE AERIALS, RADIO WAVE RECEIVING AERIALS, RADIO WAVE TRANSMITTING AERIALS; AERIAL SOCKETS, NAMELY, ELECTRICAL CONNECTORS FOR ANTENNA CABLES; AERIAL FILTERS, NAMELY, ANTENNA FILTERS; AERIAL GROUPS, NAMELY, AERIALS COMPRISED OF CLUSTERS OF MULTIPLE ANTENNA ELEMENTS; AERIAL CONVERTERS, NAMELY, IMPEDANCE CONVERTERS FOR ANTENNA CABLE AND WAVE GUIDES; AERIAL TRANSMISSION CABLES; AERIAL AMPLIFIERS; AERIAL COMBINERS; AERIAL PARAMETER MEASURING APPARATUS; AERIAL POSITIONERS, NAMELY, ELECTRONIC ROTORS FOR TUNING DIRECTIONAL ANTENNA POSITION; ENCODERS FOR DATA PROCESSING FOR USE IN ANTENNAE SYSTEMS; COMPUTER PERIPHERAL DEVICES FOR USE IN ANTENNAE SYSTEMS; DATA COMMUNICATION APPARATUS, NAMELY, DIGITAL TRANSCEIVERS FOR USE IN ANTENNAE SYSTEMS; DATA TRANSMISSION APPARATUS, NAMELY, DIGITAL TRANSCEIVERS FOR USE IN ANTENNAE SYSTEMS; ELECTRIC CABLES; RECEIVERS FOR SOUNDS AND IMAGES FOR USE IN ANTENNAE SYSTEMS; ANTI-INTERFERENCE DEVICES FOR ELECTRICITY, NAMELY, ANTENNA FILTERS; AUTOMATIC CONTROL DEVICES FOR VEHICLES, NAMELY, REMOTE CONTROL STARTERS FOR VEHICLES FOR USE IN ANTENNAE SYSTEMS; TELEPHONE APPARATUS; RADIO AERIALS; RADIO RECEIVERS; RADIO FREQUENCY POWER METERS; RADIO FREQUENCY COMPONENTS, NAMELY, RF AMPLIFIERS; ELECTRONIC ASSEMBLIES, NAMELY, COMPUTER CHASSIS FOR USE IN ANTENNAE SYSTEMS; ELECTRIC OR ELECTRONIC CONTROL MODULES, NAMELY, ELECTRICAL TRANSFORMERS; MAGNETIC SENSORS AND AMPLIFIERS FOR MAGNETIC SENSORS FOR WIRELESS INFORMATION AND COMMUNICATION TRANSMISSION FOR USE IN ANTENNAE SYSTEMS; RADIO FREQUENCY IDENTIFICATION DEVICES, NAMELY, TRANSPONDERS; RADIO FREQUENCY FILTERS; RADIO APPARATUS AND THE COMPONENTS THEREOF; RADIO PAGERS; APPARATUS FOR THE REMOTE CONTROL OF ELECTRODYNAMIC SIGNALS; FREQUENCY METERS; SPARK ARRESTORS, NAMELY, LIGHTNING ARRESTERS;

RADIOTELEPHONY APPARATUS; RADIOTELEGRAPHY APPARATUS; PRINTED CIRCUIT BOARDS; PRINTED CIRCUITS; CURRENT RECTIFIERS; GPS DEVICES, NAMELY, GPS NAVIGATION DEVICES, GPS TRACKING DEVICES FOR USE IN ANTENNAE SYSTEMS; COAXIAL CABLES; BRANCH BOXES FOR ELECTRICITY; JUNCTION BOXES FOR ELECTRICITY; ELECTRIC CONTROL APPARATUS, NAMELY, ELECTRIC SWITCHES; ELECTRONIC COUPLERS FOR DATA PROCESSING; ELECTRIC COUPLINGS; CONNECTORS FOR ELECTRIC LINES; NAVIGATION INSTRUMENTS, NAMELY, GPS NAVIGATION DEVICES; PHYSICAL APPARATUS AND INSTRUMENTS, NAMELY, GPS NAVIGATION DEVICES; RADAR APPARATUS; ELECTRIC SWITCHING APPARATUS, NAMELY, AUTOMATIC SWITCHING APPARATUS FOR TELECOMMUNICATION; INTEGRATED CIRCUITS; INTERCOMMUNICATION APPARATUS, NAMELY, COMPUTER NETWORK SWITCHES FOR USE IN ANTENNAE SYSTEMS; SOUND TRANSMISSION APPARATUS; TRANSPONDERS; TELEPHONE TRANSMITTERS; ELECTRIC MONITORING APPARATUS, NAMELY, BATTERY MONITORS, SIGNAL MONITORS; AERONAUTICAL COMMUNICATION APPARATUS, NAMELY, RADIOS, AIRPLANE BASED ANTENNA SYSTEMS; COMMUNICATION AERIALS; SHIP-TO-SHORE COMMUNICATION APPARATUS, NAMELY, RADIOS; RADOMES (RADAR DOMES) AND RADIO, TRANSMITTERS AND TRANSCEIVERS ON VEHICLES FOR LOCOMOTION BY LAND, AIR OR WATER (U.S. CLS. 21, 23, 26, 36 AND 38).

### CLASS 12—VEHICLES

FOR COMPONENTS OF VEHICLES AND APPARATUS FOR LOCOMOTION BY LAND, AIR OR WATER, NAMELY, STRUCTURAL PARTS FOR BOATS, AIRPLANES, AND LAND VEHICLES (U.S. CLS. 19, 21, 23, 31, 35 AND 44).

### CLASS 42—SCIENTIFIC AND COMPUTER SERVICES

FOR SCIENTIFIC AND TECHNOLOGICAL SERVICES, NAMELY, ENGINEERING; RESEARCH AND DESIGN, NAMELY, RESEARCH AND DESIGN OF NEW PRODUCTS FOR OTHERS; INDUSTRIAL ANALYSIS AND RESEARCH SERVICES, NAMELY, ANALYSIS OF INDUSTRIAL FLUIDS; DESIGN AND DEVELOPMENT OF COMPUTER HARDWARE AND SOFTWARE; PROGRAMMING OF DATA PROCESSING EQUIPMENT; TECHNOLOGICAL CONSULTANCY RELATING TO DATA PROCESSING; ENGINEERING SERVICES RELATING TO DATA PROCESSING; ENGINEERING SERVICES RELATING TO DATA PROCESSING TECHNOLOGY; RESEARCH RELATING TO DATA PROCESSING; DEVELOPMENT OF TECHNOLOGIES FOR THE FABRICATION OF CIRCUITS FOR WIRELESS COMMUNICATION, ELECTRONIC DATA PROCESSING, CONSUMER ELECTRONICS AND AUTOMOTIVE ELECTRONICS; DEVELOPMENT OF SYSTEMS FOR DATA PROCESSING; ENGINEERING SERVICES; DEVELOPMENT AND RESEARCH SERVICES WITH REGARD TO NEW PRODUCTS FOR THIRD PARTIES; RESEARCH IN THE FIELD OF MECHANICAL ENGINEERING; RESEARCH IN THE FIELD OF TELECOMMUNICATION TECHNOLOGY; PHYSICAL RESEARCH, NAMELY, PHYSICS RESEARCH; SERVICES PROVIDED BY A PHYSICIST; CONSTRUCTION PLANNING; TECHNICAL PROJECT STUDIES, NAMELY, CONDUCTING OF FEASIBILITY STUDIES; COMPUTER PROGRAMMING; DESIGN OF COMMUNICATION SYSTEMS; ENGINEERING SERVICES REGARDING THE DESIGN OF COMMUNICATION SYSTEMS (U.S. CLS. 100 AND 101).  
LIEF MARTIN, EXAMINING ATTORNEY

SN 79-123,942. VOLKSWAGEN AKTIENGESELLSCHAFT,  
FED REP GERMANY, FILED 9-7-2012.

# CLIMALOGIC

THE MARK CONSISTS OF STANDARD CHARACTERS WITHOUT CLAIM TO ANY PARTICULAR FONT, STYLE, SIZE, OR COLOR.

PRIORITY DATE OF 3-14-2012 IS CLAIMED.  
OWNER OF INTERNATIONAL REGISTRATION 1144821  
DATED 9-7-2012, EXPIRES 9-7-2022.  
OWNER OF U.S. REG. NO. 3,170,360.

## CLASS 11—ENVIRONMENTAL CONTROL APPARATUS

FOR APPARATUS FOR AIR CONDITIONING, HEATING, REFRIGERATING AND VENTILATING FOR USE IN AUTOMOBILES, NAMELY, CLIMATE CONTROL SYSTEMS FOR AUTOMOBILES CONSISTING OF AIR CONDITIONERS FOR AUTOMOBILES, HEATERS FOR AUTOMOBILES; CLIMATE CONTROL SYSTEMS CONSISTING OF AIR CONDITIONERS AND HEATERS FOR AUTOMOBILES AND ALSO INCLUDING HYGROMETERS, AIR SPEED INDICATORS, CONTROL SWITCHES, CONTROL PANELS, AND CONTROL BUTTONS, ALL SOLD AS A UNIT; HEATING APPARATUS FOR DEFROSTING WINDOWS OF AUTOMOBILES, DEFROSTERS FOR AUTOMOBILES (U.S. CLS. 13, 21, 23, 31 AND 34).

## CLASS 12—VEHICLES

FOR AUTOMOBILES, TRUCKS, VANS, SPORT UTILITY VEHICLES, LORRIES, TRAILERS, BUSES, TRAINS, BEING RAIL VEHICLES, LOCOMOTIVES, BICYCLES, TRICYCLES, MOTORCYCLES, SNOWMOBILES, AIRPLANES, BOATS AND SHIPS, VEHICULAR HOT AIR BALLOONS AND VEHICULAR DIRIGIBLES, CAMPING TRAILERS, FOLDING AND HARD SIDE TRUCK CAMPING TRAILERS, MOTOR HOMES, CONVERSION VANS, TRAVEL TRAILERS, CAMPER COACHES AND STRUCTURAL PARTS FOR ALL OF THE AFORESAID GOODS; COMPLETE ENGINES FOR LAND VEHICLES (U.S. CLS. 19, 21, 23, 31, 35 AND 44).

## CLASS 37—CONSTRUCTION AND REPAIR

FOR REPAIR, DISMANTLING AND MAINTENANCE OF VEHICLES IN THE NATURE OF VEHICLE REPAIR IN THE COURSE OF VEHICLE BREAKDOWN SERVICE, CLEANING, WASHING AND VARNISHING OF VEHICLES (U.S. CLS. 100, 103 AND 106).  
LIEF MARTIN, EXAMINING ATTORNEY

SN 79-124,459. TURBOMECA, FRANCE, FILED 7-20-2012.

# ANETO

THE MARK CONSISTS OF STANDARD CHARACTERS WITHOUT CLAIM TO ANY PARTICULAR FONT, STYLE, SIZE, OR COLOR.

PRIORITY DATE OF 1-23-2012 IS CLAIMED.  
OWNER OF INTERNATIONAL REGISTRATION 1145824  
DATED 7-20-2012, EXPIRES 7-20-2022.

## CLASS 7—MACHINERY

FOR GENERATORS FOR AIRCRAFT; ELECTRIC COMPRESSORS; AIR COMPRESSORS; COMPRESSORS FOR MACHINES; MACHINE COUPLING AND TRANSMISSION AND PROPULSION COMPONENTS OTHER THAN FOR LAND VEHICLES, NAMELY, AIRCRAFT ENGINES SYSTEMS USING PROPULSIVE AND NON-PROPULSIVE POWER FOR AIRCRAFT FOR AERONAUTICAL FLIGHT COMPRISED OF TURBINES, MOTORS, ENGINES, THRUSTERS, NACELLES, AND THRUST REVERSERS; AUXILIARY POWER UNITS FOR SUPPLYING ELECTRICAL POWER TO AIR VEHICLES; LUBRICATION SYSTEMS COMPRISED OF LUBRICATING PUMPS AND LUBRICATION MACHINES FOR MOTORS, ENGINES AND TURBINES OF AIR VEHICLES; ELECTRIC AND ELECTRONIC APPARATUS AND INSTRUMENTS, NAMELY, ELECTRIC GENERATORS AND/OR STARTERS AND ALTERNATORS FOR STATIONARY OR MOBILE INSTALLATIONS FOR AIRCRAFT; STRUCTURAL PARTS AND SPARE PARTS FOR MOTORS, ENGINES, TURBINES AND THRUSTERS FOR AEROSPACE VEHICLES, NAMELY, NACELLES AND MACHINE COUPLINGS FOR TRANSMISSION AND PROPULSION (U.S. CLS. 13, 19, 21, 23, 31, 34 AND 35).

## CLASS 9—ELECTRICAL AND SCIENTIFIC APPARATUS

FOR ELECTRIC, ELECTRONIC AND MAGNETIC PRESSURE, SPEED, DISPLACEMENT, TEMPERATURE, POSITION AND VIBRATION SENSORS; ELECTRONIC ON-BOARD OR GROUND SYSTEMS, APPARATUS AND EQUIPMENT FOR DATA AND PARAMETER ACQUISITION AND PROCESSING, NAMELY, COMPUTER HARDWARE AND SOFTWARE FOR ACQUIRING AND PROCESSING INFORMATION RELATED TO THE OPERATION, MAINTENANCE, SERVICING AND REPAIR OF AIRCRAFT ENGINES, AIRCRAFT ENGINE MODULES AND REPLACEMENT PARTS THEREOF; ELECTRIC AND ELECTRONIC MAINTENANCE AND CONTROL EQUIPMENT AND COMPUTER HARDWARE FOR GENERATORS, STARTERS AND INTEGRATED SETS FOR GENERATING PROPULSIVE AND NON-PROPULSIVE POWER (U.S. CLS. 21, 23, 26, 36 AND 38).

## CLASS 12—VEHICLES

FOR APPARATUS FOR LOCOMOTION BY AIR, NAMELY, AIRCRAFT, AIRPLANES, AND HELICOPTERS (U.S. CLS. 19, 21, 23, 31, 35 AND 44).

## CLASS 37—CONSTRUCTION AND REPAIR

FOR REPAIR AND MAINTENANCE OF AEROSPACE VEHICLES AND COMPONENT PARTS THEREOF; CONSTRUCTION AND INSTALLATION OF INDUSTRIAL BUILDINGS AND TEST BENCHES FOR AEROSPACE VEHICLE PARTS, EQUIPMENT AND SYSTEMS; REPAIR OF ELECTRIC AND ELECTRONIC APPARATUS, INSTRUMENTS, SYSTEMS, HARDWARE AND EQUIPMENT FOR USE IN THE AEROSPACE FIELD; REPAIR, OVERHAUL, SERVICING AND MAINTENANCE OF AEROSPACE VEHICLE SYSTEMS, EQUIPMENT AND PARTS AND COMPONENT PARTS THEREOF, INCLUDING MOTORS, ENGINES, TURBINES, ENGINE NACELLES, REACTORS, THRUSTERS, THRUST REVERSERS, BRAKING SYSTEMS, LANDING SYSTEMS, AND WIRING; UNDER-WING REPAIR, OVERHAUL, SERVICING AND MAINTENANCE SERVICES FOR ALL KINDS OF AEROSPACE VEHICLE SYSTEMS, EQUIPMENT AND PARTS; STANDARDIZATION IN THE NATURE OF MAINTENANCE, CORRECTIVE MAINTENANCE AND STANDARD REPLACEMENT OF AEROSPACE VEHICLE SYSTEMS, EQUIPMENT AND PARTS; ON-LINE ROUND-THE-CLOCK SEVEN-DAYS-A-WEEK ASSISTANCE TO PROVIDE ONLINE INFORMATION TO ASSIST CUSTOMERS IN THE REPAIR, OVERHAUL, RESTORATION, SERVICING, MAINTENANCE



NANCE AND STANDARD REPLACEMENT OF AEROSPACE VEHICLE SYSTEMS, EQUIPMENT AND PARTS; TECHNICAL ADVICE CONCERNING THE MAINTENANCE, REPAIR, AND SERVICING OF AERONAUTICAL VEHICLES AND COMPONENT PARTS THEREOF, INCLUDING MOTORS, ENGINES, TURBINES, ENGINE NACELLES, REACTORS, THRUSTERS, THRUST REVERSERS, AERONAUTICAL VEHICLES, BRAKING SYSTEMS, LANDING SYSTEMS, AND WIRING; REPAIR OF ANCILLARY EQUIPMENT AND TOOLS FOR AEROSPACE VEHICLE SYSTEMS, EQUIPMENT AND PARTS (U.S. CLS. 100, 103 AND 106).

#### **CLASS 42—SCIENTIFIC AND COMPUTER SERVICES**

FOR ENGINEERING AND SCIENTIFIC AND INDUSTRIAL RESEARCH RELATING TO THE AEROSPACE FIELD; TESTING OF MACHINES; TESTING OF MATERIALS; AIRPLANE AND HELICOPTER FLIGHT TESTS IN THE NATURE OF ENGINEERING SERVICES; ENGINEERING SERVICES, NAMELY, TESTING OF AEROSPACE VEHICLE SYSTEMS, EQUIPMENT AND PARTS; QUALITY CONTROL SERVICES FOR OTHERS, NAMELY, INSPECTION OF AEROSPACE VEHICLE SYSTEMS, EQUIPMENT AND PARTS; ENGINEERING SERVICES IN THE NATURE OF ANALYZING TEST DATA FROM AEROSPACE VEHICLE SYSTEMS AND COMPONENT EQUIPMENT THEREOF; RESEARCH AND DEVELOPMENT OF NEW PRODUCTS RELATING TO THE AEROSPACE FIELD (U.S. CLS. 100 AND 101).

ADA HAN, EXAMINING ATTORNEY

#### **CLASS 42—SCIENTIFIC AND COMPUTER SERVICES**

FOR SCIENTIFIC RESEARCH SERVICES IN THE FIELD OF DIAGNOSTIC TESTING, SPECIFICALLY RELATING TO THE DECONTAMINATION OF SAMPLES OF DNA OR RNA, SEQUENCING OF DNA OR RNA AND PCR (POLYMERASE CHAIN REACTION) ANALYSIS (U.S. CLS. 100 AND 101).

EVELYN BRADLEY, EXAMINING ATTORNEY

SN 79-125,276. DUALO, FRANCE, FILED 10-24-2012.

# DUALO

THE MARK CONSISTS OF STANDARD CHARACTERS WITHOUT CLAIM TO ANY PARTICULAR FONT, STYLE, SIZE, OR COLOR.

PRIORITY DATE OF 4-25-2012 IS CLAIMED.

OWNER OF INTERNATIONAL REGISTRATION 1147788 DATED 10-24-2012, EXPIRES 10-24-2022.

THE WORD(S) "DUALO" HAS NO MEANING IN A FOREIGN LANGUAGE.

#### **CLASS 15—MUSICAL INSTRUMENTS**

FOR MUSICAL INSTRUMENTS USING BLADES, STRINGS, REEDS OR SKINS FOR THE PRODUCTION OF SOUND, ELECTRONIC MUSICAL INSTRUMENTS, MUSICAL INSTRUMENT COVERS, NAMELY, MUSICAL INSTRUMENT BAGS AND CASES (U.S. CLS. 2, 21 AND 36).

#### **CLASS 41—EDUCATION AND ENTERTAINMENT**

FOR INSTRUCTION IN THE FIELD OF MUSIC, NAMELY, TRAINING IN MUSIC AND MUSICAL EDUCATION (U.S. CLS. 100, 101 AND 107).

#### **CLASS 45—PERSONAL AND LEGAL SERVICES**

FOR PROVIDING INFORMATION IN THE FIELD OF INTELLECTUAL PROPERTY RIGHTS RELATED TO THE PRODUCTION OF MUSICAL WORKS; ACQUISITION, MANAGEMENT AND EXPLOITATION OF COPYRIGHTS TO MUSICAL WORKS ON BEHALF OF THE AUTHORS, COMPOSERS OR CONDUCTORS OF SUCH WORKS, NAMELY, COPYRIGHT MANAGEMENT (U.S. CLS. 100 AND 101).

MIAH ROSENBERG, EXAMINING ATTORNEY

SN 79-124,866. ARCTICZYMES AS, NORWAY, FILED 10-11-2012.

# Heat&Run

THE MARK CONSISTS OF STANDARD CHARACTERS WITHOUT CLAIM TO ANY PARTICULAR FONT, STYLE, SIZE, OR COLOR.

PRIORITY DATE OF 4-12-2012 IS CLAIMED.

OWNER OF INTERNATIONAL REGISTRATION 1146799 DATED 10-11-2012, EXPIRES 10-11-2022.

#### **CLASS 1—CHEMICALS**

FOR ENZYMES AND ENZYME PREPARATIONS FOR USE IN THE CHEMICAL AND AGROCHEMICAL INDUSTRIES; ENZYMES AND ENZYME PREPARATIONS FOR INDUSTRIAL USE, SPECIFICALLY FOR USE IN THE PHARMACEUTICAL INDUSTRY AND FOR USE IN SCIENTIFIC RESEARCH (U.S. CLS. 1, 5, 6, 10, 26 AND 46).

#### **CLASS 5—PHARMACEUTICALS**

FOR ENZYMES AND ENZYME PREPARATIONS FOR MEDICAL PURPOSES; ENZYMES AND ENZYME PREPARATIONS FOR MEDICAL PURPOSES, SPECIFICALLY FOR MEDICAL DIAGNOSTIC TESTING, ENZYMES AND ENZYME PREPARATIONS FOR MEDICAL PURPOSES, SPECIFICALLY FOR DECONTAMINATING SAMPLES OF DNA OR RNA, FOR SEQUENCING OF DNA OR RNA, OR FOR USE IN PCR (POLYMERASE CHAIN REACTION) ANALYSIS, ALL FOR USE IN MEDICAL DIAGNOSIS OR TREATMENT (U.S. CLS. 6, 18, 44, 46, 51 AND 52).

SN 79-125,596. INTERNATIONAL BUSINESS MACHINES CORPORATION, ARMONK, NY. FILED 12-15-2012.

# SMARTER ANALYTICS

THE MARK CONSISTS OF STANDARD CHARACTERS WITHOUT CLAIM TO ANY PARTICULAR FONT, STYLE, SIZE, OR COLOR.

PRIORITY DATE OF 10-30-2012 IS CLAIMED.

OWNER OF INTERNATIONAL REGISTRATION 1148668 DATED 12-15-2012, EXPIRES 12-15-2022.

OWNER OF U.S. REG. NOS. 3,913,273, 3,919,025 AND 4,033,245.

NO CLAIM IS MADE TO THE EXCLUSIVE RIGHT TO USE "ANALYTICS" , APART FROM THE MARK AS SHOWN.

**CLASS 9—ELECTRICAL AND SCIENTIFIC APPARATUS**

FOR COMPUTER HARDWARE, NAMELY, COMPUTERS, COMPUTER SERVERS AND STORAGE APPARATUS, NAMELY, HIGH-SPEED STORAGE SUBSYSTEMS FOR STORAGE AND BACKUP OF ELECTRONIC DATA EITHER LOCALLY OR VIA A TELECOMMUNICATIONS NETWORK; COMPUTER OPERATING SOFTWARE; COMPUTER PROGRAMS FOR EXECUTING COMPUTER PROGRAMS; COMPUTER PROGRAMS FOR CONNECTING NETWORKS AND COMPUTER SYSTEMS, COMPUTER SERVERS AND COMPUTER STORAGE DEVICES; COMPUTER SOFTWARE FOR OPERATING SYSTEM PROGRAMS; COMPUTER PROGRAMS FOR CONNECTING COMPUTERS TO EACH OTHER AND FOR ALLOWING COMPUTER ACTIVITIES ACROSS A GLOBAL COMPUTER NETWORK; COMPUTER PROGRAMS FOR MANAGING COMPUTER SYSTEMS, SOFTWARE AND PROCESSES THAT EXIST WITHIN AN INFORMATION TECHNOLOGY ENVIRONMENT; INSTRUCTION MANUALS SOLD AS A UNIT WITH THE ABOVE MENTIONED GOODS (U.S. CLS. 21, 23, 26, 36 AND 38).

**CLASS 42—SCIENTIFIC AND COMPUTER SERVICES**

FOR COMPUTER SYSTEM INTEGRATION SERVICES; COMPUTER CONSULTATION SERVICES; CONSULTING SERVICES IN THE FIELD OF DESIGN, SELECTION, IMPLEMENTATION AND USE OF COMPUTER HARDWARE AND SOFTWARE SYSTEMS FOR OTHERS; TECHNICAL SUPPORT SERVICES, NAMELY, TROUBLESHOOTING IN THE NATURE OF DIAGNOSING COMPUTER HARDWARE, COMPUTER SERVERS AND COMPUTER PROGRAM PROBLEMS; COMPUTER SYSTEM DESIGN SERVICES FOR OTHERS; COMPUTER SYSTEM ANALYSIS; INTERCONNECTION OF COMPUTERS AND COMPUTER PROGRAMS, NAMELY, INTEGRATION OF COMPUTER SYSTEMS AND COMPUTER NETWORKS; SERVICES FOR TESTING COMPUTER PROGRAMS AND COMPUTER HARDWARE, NAMELY, TESTING OF COMPUTER HARDWARE, COMPUTER SERVERS AND COMPUTER SOFTWARE; INSTALLATION, UPDATING AND MAINTENANCE OF COMPUTER PROGRAMS; COMPUTER PROGRAMMING SERVICES FOR OTHERS; SERVICES OF SOFTWARE AS A SERVICE (SAAS), NAMELY, HOSTING OF SOFTWARE PROVIDED TO OTHERS FOR USE TO ANTICIPATE AND SHARE BUSINESS RESULTS AND TAKE ACTION BASED ON THOSE RESULTS; AND CONSULTING SERVICES IN THE FIELD OF SOFTWARE AS A SERVICE (SAAS) (U.S. CLS. 100 AND 101).

EVELYN BRADLEY, EXAMINING ATTORNEY

**CLASS 16—PAPER GOODS AND PRINTED MATTER**

FOR PRINTED MATTER, NAMELY, BOOKS, PAMPHLETS, NEWS SHEETS, INSTRUCTION MANUALS, WRITTEN PRESENTATIONS, TEACHING AND INSTRUCTIONAL MATERIALS, ALL IN THE FIELD OF COMPUTERS, COMPUTER SERVICES, INFORMATION TECHNOLOGY AND ELECTRONIC BUSINESS TRANSACTIONS CONDUCTED VIA A GLOBAL COMPUTER NETWORK (U.S. CLS. 2, 5, 22, 23, 29, 37, 38 AND 50).

**CLASS 35—ADVERTISING AND BUSINESS**

FOR ADVICE ON COMPANY MANAGEMENT AND BUSINESS ADVICE; BUSINESS DEVELOPMENT SERVICES; MARKET RESEARCH STUDIES; ARRANGING AND CONDUCTING COMMERCIAL EXHIBITIONS IN THE FIELD OF COMPUTERS, COMPUTING SERVICES AND INFORMATION TECHNOLOGY (U.S. CLS. 100, 101 AND 102).

**CLASS 41—EDUCATION AND ENTERTAINMENT**

FOR EDUCATIONAL SERVICES, NAMELY, CONDUCTING CONFERENCES, EXHIBITIONS FOR EDUCATIONAL PURPOSES, COLLOQUIUMS, PRESENTATIONS, EDUCATIONAL TECHNICAL DEMONSTRATIONS AND TRAINING COURSES, ALL IN THE FIELD OF INFORMATION TECHNOLOGY AND COMPUTER PRODUCTS AND SERVICES (U.S. CLS. 100, 101 AND 107).

SN 79-126,251. OUT FIT 7 LIMITED, CYPRUS, FILED 8-27-2012.

# Talking Angela

THE MARK CONSISTS OF STANDARD CHARACTERS WITHOUT CLAIM TO ANY PARTICULAR FONT, STYLE, SIZE, OR COLOR.

OWNER OF INTERNATIONAL REGISTRATION 1150229 DATED 8-27-2012, EXPIRES 8-27-2022.

**CLASS 3—COSMETICS AND CLEANING PREPARATIONS**

FOR AFTER-SHAVE; ANTIPERSPIRANTS; AROMATHERAPY PREPARATIONS, NAMELY, ESSENTIAL OILS FOR AROMATHERAPY USE, NON-MEDICATED AROMATIC BATH PREPARATIONS, AROMATHERAPY COSMETIC CREAMS, AROMATHERAPY SKIN LOTIONS, AROMATHERAPY UNDERARM DEODORANTS, AROMATHERAPY PERFUMES, AROMATHERAPY LIP BALMS, FRAGRANCED FACE CARE PREPARATIONS, NAMELY, AROMATHERAPY FACIAL STEAMS, AROMATHERAPY SKIN SCRUBS; AROMATICS, NAMELY, AROMATIC ESSENTIAL OILS, AROMATIC POTPOURRIS, AROMATIC LOTIONS; BABY WIPES; BATH SALTS; BEAUTY MASKS; BUBBLE BATH; BREATH FRESHENING SPRAYS; CAKE FLAVOURINGS BEING ESSENTIAL OILS; CLEANSING MILK FOR TOILET PURPOSES; COSMETIC CREAMS; COSMETIC KITS COMPRISED OF LIP GLOSS, BRUSHES, EYE SHADOWS, EYELINERS, MASCARAS, LIPSTICKS, LIP LINERS, LIP STAINS, POWDER, BLUSH, CLEANSERS, EYELASH CURLERS, MIRRORS, PALETTES; COSMETIC PENCILS; COSMETIC PENCILS; COSMETIC PREPARATIONS FOR BATHS; COSMETICS FOR ANIMALS; COSMETICS; COTTON STICKS FOR COSMETIC PURPOSES; COTTON WOOL FOR COSMETIC PURPOSES; DECORATIVE TRANSFERS FOR COSMETIC PURPOSES; DENTIFRICES; PERSONAL DEODORANTS; DETERGENTS FOR HOUSEHOLD USE; EAU DE COLOGNE; ESSENTIAL OILS; EYEBROW COSMETICS; EYEBROW PENCILS; FACE GLITTER; FALSE EYELASHES; FALSE NAILS; FINGERNAIL EMBELLISHMENTS; HAIR COLOR; HAIR CONDITIONER AND HAIR MOISTENING PREPARATIONS; HAIR CREAM; HAIR DYES; HAIR GEL; HAIR LOTIONS; HAIR SPRAY; HAIR WAVING PREPARATIONS; INCENSE; LIP BALMS; LIPSTICKS; LOTIONS FOR COSMETIC PURPOSES; MAKE-UP POWDER; MAKE-UP PREPARATIONS; MAKE-UP REMOVING PREPARATIONS; MAKE-UP; MASCARA; MOISTURIZING PREPARATIONS FOR THE SKIN; MOUTH WASHES, NOT FOR MEDICAL PURPOSES; NAIL CARE PREPARATIONS; NAIL POLISHES AND VARNISHES AND THINERS THEREFOR; NON-MEDICATED BATH PREPARATIONS; PERFUMERY; PERFUMES; POMADES FOR COSMETIC PURPOSES; POTPOURRIS BEING FRAGRANCES; PRODUCTS AND PREPARATIONS FOR THE CARE AND CLEANSING OF HAIR AND SKIN, NAMELY, HAIR CARE CREAMS, HAIR CARE LOTIONS, SHAMPOOS, HAIR CONDITIONERS, HAIR GLUES, HAIR MASSES, HAIR SPRAYS, HAIR TONICS, HAIR WAXES, SKIN CLEANSING CREAMS, SKIN CLEANSING LOTIONS, COSMETIC CREAMS FOR SKIN CARE, AND NON-MEDICATED CREAMS, SKIN LOTIONS, SKIN GELS, SKIN TONERS, SKIN CLEANERS AND SKIN PEELS; SCENTED ROOM SPRAYS; SHAVING PREPARATIONS; SHAMPOOS FOR PETS; SHAMPOOS; NON-MEDICATED SKIN AND FACE CREAMS AND LOTIONS; SKIN MOISTURIZER; SOAPS; SUN BLOCK; SUN-TANNING PREPARATIONS; TEMPORARY TATTOO SPRAYS AND STENCILS THEREFOR SOLD AS A UNIT; TISSUES IMPREGNATED WITH COSMETIC LOTIONS; TOILET WATER; NON-MEDICATED TOILETRIES (U.S. CLS. 1, 4, 6, 50, 51 AND 52).

**CLASS 9—ELECTRICAL AND SCIENTIFIC APPARATUS**

FOR APPLICATION DEVELOPMENT TOOL PROGRAMS FOR PERSONAL COMPUTERS, MOBILE DIGITAL ELECTRONIC DEVICES, HAND HELD COMPUTERS, AND MOBILE TELEPHONES; CARRYING CASES FOR CELL PHONES, TELEPHONES, PAGER AND MOBILE COMPUTERS; COMPUTER GAME SOFTWARE AND ENTERTAINMENT SOFTWARE IN THE NATURE OF COMPUTER GAMES FOR USE ON MOBILE AND CELLULAR PHONES, HANDHELD COMPUTERS, COMPUTERS, VIDEO GAME CONSOLES, BOTH HANDHELD AND FREE STANDING, AND OTHER WIRELESS POS DEVICES; COMPUTER GAME SOFTWARE FEATURING CHARACTER RECOGNITION, VOICE RECOGNITION, TOUCH SENSITIVITY, LIGHT SENSITIVITY, GRAVITY SENSITIVITY; COMPUTER GAME SOFTWARE FOR ELECTRONIC COMPUTER APPARATUS FEATURING INTERACTIVE AND MULTIMEDIA FUNCTIONS THAT ENABLE THE USER TO INTEGRATE TEXT, AUDIO, GRAPHICS, STILL

IMAGES AND MOVING PICTURES; COMPUTER GAME SOFTWARE; DECORATIVE MAGNETS; DIGITAL MEDIA, NAMELY, CDS, DVDS, MEMORY CARDS, AND DOWNLOADABLE AUDIO, VIDEO, AND MULTIMEDIA FILES, FEATURING MUSIC, MOTION PICTURE AND ANIMATED CARTOON CHARACTERS; BLANK DIGITAL MEMORY DEVICES, NAMELY, BLANK CDS AND DVDS, AUDIO/VIDEO DISCS, MINIDISCS, USB FLASH DRIVES, FLASH MEMORY CARDS, MEMORY CARDS, DISC MEMORIES, ELECTRONIC MEMORIES, RAM (RANDOM ACCESS MEMORY) CARDS, COMPUTER MEMORIES; DOWNLOADABLE COMPUTER GAME SOFTWARE FOR PLAYING VIDEO, COMPUTER AND ON-LINE GAMES; DOWNLOADABLE COMPUTER GAME SOFTWARE FOR PLAYING VIDEO, COMPUTER AND ON-LINE GAMES; DOWNLOADABLE RING TONES, MUSIC, MUSIC VIDEOS, ANIMATED VIDEOS, AND ELECTRONIC GAMES, VIA THE INTERNET AND WIRELESS DEVICES; DOWNLOADABLE SOFTWARE FOR DEVELOPING, DESIGNING, MODIFYING, RECORDING AND CUSTOMIZING SOUND AND SPEECH; DOWNLOADABLE SOFTWARE FOR DEVELOPING, DESIGNING, MODIFYING, RECORDING AND CUSTOMIZING VIDEO, COMPUTER AND ON-LINE GAMES; DOWNLOADABLE VIDEO GAME SOFTWARE FEATURING TOUCH AND VOICE CONTROL; EARPHONES; EYEWEAR CASES; EYEWEAR; GAME CONTROLLERS FOR COMPUTER GAMES; HEADPHONES; INTERACTIVE MULTIMEDIA COMPUTER GAME SOFTWARE PROGRAMS; MOUSE PADS; SOFTWARE FOR ENABLING VIDEO COMPUTER AND ON-LINE GAMES TO BE RUN ON MULTIPLE PLATFORMS; SPEECH RECOGNITION SOFTWARE; TOUCH AND VOICE DRIVEN INTERACTIVE VIDEO GAME SOFTWARE; LOUD-SPEAKERS; CAMERAS; MICROPHONES; APPARATUS FOR RECORDING, TRANSMISSION OR REPRODUCTION OF SOUND OR IMAGES; BLANK OPTICAL DISKS (U.S. CLS. 21, 23, 26, 36 AND 38).

**CLASS 11—ENVIRONMENTAL CONTROL APPARATUS**

FOR AIR PURIFIERS; BARBECUES; BED WARMERS; BEVERAGES COOLING APPARATUS; BICYCLE LIGHTS; BICYCLE REFLECTORS; CHANDELIERS; DISINFECTANT DISPENSERS FOR TOILETS; DISPENSING UNITS FOR AIR FRESHENERS; ELECTRIC BLANKETS; ELECTRIC FANS; ELECTRIC KETTLES; ELECTRIC LAMPS; ELECTRIC LIGHTS FOR CHRISTMAS TREES; ELECTRIC POPCORN POPPERS; ELECTRIC TOASTERS; ELECTRIC VAPORIZERS; FLASHLIGHTS; GLOBES FOR LAMPS; HAIR DRYERS; ICE BOXES; LAMP CASINGS; LAMP MANTLES; LAMP REFLECTORS; LAMP SHADES; LAMPS; LAMP SHADE HOLDERS; LANTERNS FOR LIGHTNING; NON-ELECTRIC POCKET WARMERS, NAMELY, CHEMICALLY-ACTIVATED HEATING PACKETS FOR WARMING HANDS; ORNAMENTAL FOUNTAINS; OUTDOOR PORTABLE LIGHTING PRODUCTS, NAMELY, HEADLAMPS; PEN LIGHTS; READING LIGHTS; TOILET SEATS; WATER PURIFYING APPARATUS; WATER STERILIZERS (U.S. CLS. 13, 21, 23, 31 AND 34).

**CLASS 14—JEWELRY**

FOR BRACELETS; BUCKLES FOR WATCHSTRAPS; CLOCKS; HOROLOGICAL AND CHRONOMETRIC INSTRUMENTS AND PARTS THEREOF; IMITATION JEWELRY; JEWELRY CHAINS; JEWELRY; KEY CHAINS AS JEWELRY; LAPEL PINS; NECKLACES; ORNAMENTS OF PRECIOUS METAL IN THE NATURE OF JEWELRY; PENDANTS; WATCHES; NON-METAL AND NON-LEATHER KEY CHAINS, NAMELY, KEY CHAINS AS JEWELLERY; NON-METAL KEY RINGS (U.S. CLS. 2, 27, 28 AND 50).

**CLASS 16—PAPER GOODS AND PRINTED MATTER**

FOR BALL PENS; BIBS OF PAPER; BOOKMARKS; BOOKS IN THE FIELD OF CARTOON CHARACTERS; BOXES OF CARDBOARD OR PAPER; CALENDARS; CHALKS; CHILDREN'S BOOKS; COLOR PENCIL SETS; COLOR PENCILS; CRAYONS; COLORING BOOKS; COMIC BOOKS; DRAWING INSTRUMENTS; DRAWING PAPER; DRAWING RULERS; ERASING PRODUCTS, NAMELY, CHALK ERASERS, RUBBER ERASERS, WHITEBOARD ERASERS, ERASERS, ERASING FLUIDS IN THE NATURE OF INK ERASERS, CORRECTION FLUIDS FOR DOCUMENTS; FOUNTAIN PENS; GIFT BOXES; GLUE FOR STATIONERY OR HOUSEHOLD PURPOSES; GREETING CARDS; LOOSE-LEAF BINDERS; LUNCH BAGS OF PAPER AND PLASTIC; MUSICAL GREETING CARDS; NOTE BOOKS; PACKING PAPER, WRAPPING PAPER AND PACKAGING MATERIALS, NAMELY, PACKAGING CONTAINERS OF PAPER, PAPER BAGS FOR PACKAGING, BOXES, CARTONS, STORAGE CONTAINERS AND PACKAGING CONTAINERS MADE OF PAPER OR CARDBOARD; PADS, NAMELY, ART PADS, INK PADS; PAINTINGS; PAPER NAPKINS; PAPER STAPLERS; PARTY ORNAMENTS OF PAPER; PASTE FOR STATIONERY OR HOUSEHOLD PURPOSES; PEN AND PENCIL CASES AND BOXES; PENCIL SHARPENERS; PENCILS; PENS; PHOTOGRAPH ALBUMS; PLACE MATS AND COASTERS OF PAPER OR CARDBOARD; POSTERS; PRINTED PUBLICATIONS, NAMELY, BOOKS, HAND-OUTS, WORKBOOKS, COLORING BOOKS, NEWSPAPERS AND MAGAZINES ALL IN THE FIELDS OF VIDEO GAMES, ANIMATED CHARACTERS, AND ONLINE VIDEO GAMES, ONLINE MUSIC VIDEOS AND ONLINE ANIMATED VIDEOS; RUBBER STAMPS; STATIONERY; STICKERS; TABLE CLOTHS OF PAPER; TABLE LINEN OF PAPER; WRITING INSTRUMENTS; WRITING PADS, MEMO PADS, WRITING PAPER; WALLPAPER STENCILS (U.S. CLS. 2, 5, 22, 23, 29, 37, 38 AND 50).

**CLASS 18—LEATHER GOODS**

FOR ALL-PURPOSE CARRYING BAGS; ANIMAL LEASHES; BACKPACKS; BAGS FOR SPORTS; BOOK BAGS; BRIEFCASES; CARRYING CASES; COLLARS FOR PETS; DUFFEL BAGS; HANDBAGS; KEY CASES; LEATHER OR LEATHER-BOARD BOXES; LUGGAGE TAGS; LUGGAGE; MESSENGER BAGS; POUCHES OF LEATHER; POUCHES OF TEXTILE; PURSES; SCHOOL SATCHELS; SLING BAGS FOR CARRYING INFANTS; SUITCASES; TOILETRY BAGS SOLD EMPTY; TOILETRY CASES SOLD EMPTY; TOTE BAGS; TRAVELLING BAGS; UMBRELLAS; WALLETS (U.S. CLS. 1, 2, 3, 22 AND 41).

**CLASS 20—FURNITURE AND ARTICLES NOT OTHERWISE CLASSIFIED**

FOR BAMBOO BLINDS; BEDS; BOOK SHELVES; BOXES OF WOOD OR PLASTIC; CHAIRS; CORKS; CRADLES; CUPBOARDS; CURTAIN HOOKS; CURTAIN RAILS; CURTAIN RINGS; CURTAIN RODS; CURTAIN TIE-BACKS IN THE NATURE OF NON-TEXTILE CURTAIN HOLDERS; CUSHIONS; DESKS; DRESSING TABLES; EASY CHAIRS; FIGURINES AND STATUETTES MADE OF PLASTER, PLASTIC, WAX AND WOOD; FIRE SCREENS FOR DOMESTIC USE; FURNITURE; GARMENT COVERS, NAMELY, WARDROBES; HIGH CHAIRS FOR BABIES; MIRRORS; NON-METAL BASKETS, NAMELY, BASKETS FOR TRANSPORTING GOODS FOR COMMERCIAL PURPOSES, BAKER'S BREAD BASKETS, BAMBOO BASKETS FOR INDUSTRIAL PURPOSES; NON-METAL BED FITTINGS; NON-METAL CLOTHES HOOKS; PHOTOGRAPH FRAMES; PICTURE FRAMES; PILLOWS; PLAYPENS FOR BABIES; SLEEPING BAGS; STATUES OF WOOD, WAX, PLASTER AND PLASTIC; TOY BOXES; WIND CHIMES; WORKS OF ART AND ORNAMENTS MADE OF PLASTER, PLASTIC, WAX AND WOOD (U.S. CLS. 2, 13, 22, 25, 32 AND 50).

**CLASS 21—HOUSEWARES AND GLASS**

FOR BABY BATHTUBS; BASINS; BASKETS FOR DOMESTIC USE, NOT OF METAL; BATH BRUSHES; BATH PRODUCTS, NAMELY, BODY SPONGES; BEVERAGE GLASSWARE; BEVERAGEWARE; BIRD CAGES; BOTTLES, SOLD EMPTY; BOWLS; BUCKETS; CAGES FOR HOUSEHOLD PETS; CAKE MOLDS; CANDLESTICKS; CANDY BOXES; CANTEENS; CLEANING CLOTHS; COASTERS, NOT OF PAPER AND OTHER THAN TABLE LINEN; COCKTAIL SHAKERS; COMBS; COOKIE JARS; CORKSCREWS; CROCKERY, NAMELY, POTS, DISHES, DRINKING CUPS AND SAUCERS, BOWLS, SERVING BOWLS AND TRAYS; CUPS; CUTTING BOARDS; DENTAL FLOSS; DRINKING FLASKS; DUST BINS; EGG CUPS; FLY SWATTERS; FOAM DRINK HOLDERS; FRAGRANCES OIL BURNERS; GLOVES FOR HOUSEHOLD PURPOSES; GROOMING TOOLS FOR PETS, NAMELY, COMBS AND BRUSHES; HAIRBRUSHES; HEAT-INSULATED VESSELS; ICE BUCKETS; ICE CUBE MOLDS; IRONING BOARD COVERS; JUGS; KETTLES; LUNCH BOXES; MIXING BOWLS; MIXING SPOONS; MUGS; NAPKIN HOLDERS; NON-ELECTRIC FOOD BLENDERS; NON-METAL PIGGY BANKS; ORNAMENTS OF CERAMICS, CHINA, GLASS, CRYSTAL, EARTHENWARE, TERRA-COTTA, AND PORCELAIN; PAPER PLATES; PASTRY CUTTERS; PICNIC BASKETS SOLD EMPTY; PITCHERS; PORTABLE COOLERS; SOAP BOXES; SOAP DISPENSERS; SOAP HOLDERS; SPONGES FOR HOUSEHOLD PURPOSES; STATUES OF PORCELAIN, TERRA-COTTA OR GLASS; STOPPERS FOR BOTTLES OF CERAMICS, CHINA, GLASS, CRYSTAL, EARTHENWARE, TERRA-COTTA AND PORCELAIN; TEA POTS; TOILET BRUSHES; TOILET ROLL HOLDERS; TOOTHBRUSHES; TOOTHPICK HOLDERS; TOOTHPICKS; TRASH CANS; TRAYS FOR DOMESTIC PURPOSES; TROUGH; VACUUM BOTTLES; VASES; WASTE BASKETS; WATERING CANS; WORKS OF ART OF PORCELAIN, TERRA-COTTA OR GLASS (U.S. CLS. 2, 13, 23, 29, 30, 33, 40 AND 50).

**CLASS 24—FABRICS**

FOR BANNERS AND FLAGS OF TEXTILE; BATH LINEN; BED LINEN; BEDSPREADS; BLANKETS, NAMELY, BED BLANKETS, SILK BLANKETS, BABY BLANKETS; CLOTHS, NAMELY, TABLE CLOTHS OF TEXTILE, COTTON CLOTHS, WOOLEN CLOTHS, ZEPHYR CLOTHS, TAFFETA CLOTHS, SILK CLOTHS, MARABOU CLOTHS, NAMELY, SILK CLOTH, LINEN CLOTHS, GUMMED CLOTHS, OTHER THAN FOR STATIONERY, GAUZE CLOTHS, CHEVIOTS CLOTHS, BOLTING CLOTHS, CLOTHS USED FOR WRAPPING GOODS, DISH CLOTHS, FACE CLOTHS, BURP CLOTHS, WASH CLOTHS; COTTON FABRICS; COVERS FOR CUSHIONS; CURTAIN TIEBACKS IN THE NATURE OF TEXTILE CURTAIN HOLDERS; CURTAINS; FABRICS FOR TEXTILE USE; UNFITTED FURNITURE COVERINGS OF TEXTILE; HANDKERCHIEFS OF TEXTILE; MATTRESS COVERS; PILLOWCASES; QUILTS; TEXTILE PLACE MATS; TEXTILE TABLECLOTHS; TOWELS; WALL HANGINGS OF TEXTILE (U.S. CLS. 42 AND 50).

**CLASS 25—CLOTHING**

FOR ARTICLES OF CLOTHING, NAMELY, SWIMWEAR, SWIMSUITS, SPORTSWEAR, NAMELY, UNIFORMS, SPORTS OVER UNIFORMS, SHIRTS, BOTTOMS, TOPS, SPORTS JERSEYS, TRACK JACKETS; WATERPROOF JACKETS AND PANTS, RAIN WEAR, GLOVES, MITTENS, BELTS, UNDERWEAR, SLEEP WEAR, PAJAMAS, BATHROBES, HATS, CAPS, SUN VISORS, BERETS, SOCKS, STOCKINGS, PANTY HOSE, SHOES, SPORTS SHOES, SLIPPERS, SNEAKERS, BEACH SHOES, MASQUERADE COSTUMES, BANDANAS, JACKETS, KNITWEAR, NAMELY, KNITTED SWEATERS, KNIT SHIRTS, KNITTED JACKETS; KNITTED JERSEYS, KNITTED PIQUE SHIRTS; T-SHIRTS, SHIRTS,

SHORTS, DRESSES, SKIRTS, COATS, VESTS, SWEATERS, TIES, SCARVES, SWEATSHIRTS, HOODED SWEATSHIRTS, GOWNS; BIBS, NOT OF PAPER; CHILDREN'S AND INFANT'S APPAREL, NAMELY, SPORTS JUMPERS, ROMPERS AND ONE-PIECE GARMENTS, T-SHIRTS, ARM AND LEG WARMERS, BOTTOMS, COATS AND JACKETS, COSTUMES, NAMELY, COSTUMES FOR USE IN CHILDREN'S DRESS UP PLAY AND HALLOWEEN COSTUMES, GLOVES AND MITTENS, HATS, OVERALL SLEEPWEAR, PAJAMAS, TIGHTS, SOCKS, TOPS; FOOTWEAR; HEADWEAR; WRIST BANDS (U.S. CLS. 22 AND 39).

#### **CLASS 27—FLOOR COVERINGS**

FOR BATH MATS; CARPETS AND RUGS; DOOR MATS; FLOOR COVERINGS; FOAM MATS FOR USE ON PLAY AREA SURFACES; LINOLEUM; NON-TEXTILE WALL HANGINGS; WALLPAPER (U.S. CLS. 19, 20, 37, 42 AND 50).

#### **CLASS 28—TOYS AND SPORTING GOODS**

FOR ACTION FIGURE TOYS; ARCADE GAMES; ARCADE-TYPE ELECTRONIC VIDEO GAMES; ARTICLES OF CLOTHING FOR TOYS; BALLOONS; BALLS FOR GAMES; BATH TOYS; BATTERY OPERATED ACTION TOYS; BOARD GAMES; BOB-SLEIGHS; BUBBLE MAKING WAND AND SOLUTION SETS; CARD GAMES; CHRISTMAS TREE ORNAMENTS AND DECORATIONS; DOLLS DESIGNED TO RESEMBLE COMPUTER GAME CHARACTERS; ELECTRONIC NOVELTY TOYS, NAMELY, TOYS THAT ELECTRONICALLY RECORD, PLAY BACK, AND DISTORT OR MANIPULATE VOICES AND SOUNDS; GAMBLING MACHINES; ICE SKATES; INFANT TOYS; INFLATABLE TOYS; IN-LINE ROLLER SKATES; INTERACTIVE HAND-HELD AUDIO-VISUAL GAMES WITH LIQUID CRYSTAL DISPLAYS NOT FOR USE WITH TELEVISION RECEIVERS; KITE REELS; KITES; MECHANICAL TOYS; MUSICAL TOYS; PARLOR GAMES; PARTY FAVORS IN THE NATURE OF SMALL TOYS; PARTY GAMES; PINBALL GAMES; PLASTIC CHARACTER TOYS; PLUSH TOYS; PROTECTIVE PADDING FOR PLAYING SPORTS, NAMELY, SKATEBOARDING, ROLLER BLADING, BASEBALL, BASKETBALL, BMX BICYCLE MOTOCROSS, FIELD HOCKEY, FOOTBALL, HOCKEY, INLINE SKATING, LACROSSE, MARTIAL ARTS, MOTOCROSS, MOUNTAIN BIKING, SKI, SNOWBOARD, SOFTBALL, VOLLEYBALL; PUPPETS; ROLLER SKATES; RUBBER CHARACTER TOYS; SAILBOARDS; SANDBOX TOYS; SKATEBOARDS; SKATING BOOTS WITH SKATES ATTACHED; SKILL GAMES; SKIS; SNOW BOARDS; SQUEEZE TOYS; STAND-ALONE VIDEO OUTPUT GAME MACHINES; SURF BOARDS; SWINGS; TABLETOP GAMES; TALKING DOLLS; TALKING TOYS; TOY BOXES; TOY MASKS; TOY SNOW GLOBES; TOY VEHICLES; WATER TOYS; WIND-UP TOYS; HOME VIDEO GAME MACHINES FOR USE WITH EXTERNAL DISPLAY SCREENS OR MONITORS; VIRTUAL REALITY HEADSETS AND HELMETS ADAPTED FOR USE IN PLAYING VIDEO GAMES (U.S. CLS. 22, 23, 38 AND 50).

#### **CLASS 41—EDUCATION AND ENTERTAINMENT**

FOR AMUSEMENT PARK AND THEME PARK SERVICES; ANIMATION FILM AND VIDEO PRODUCTION SERVICES; DISTRIBUTION OF RADIO PROGRAMS FOR OTHERS; DISTRIBUTION OF TELEVISION PROGRAMS FOR OTHERS; ENTERTAINMENT IN THE NATURE OF COMPETITIONS IN THE FIELD OF COMPUTER AND VIDEO GAMES; ENTERTAINMENT IN THE NATURE OF LIVE STAGE PERFORMANCES FEATURING ANIMATED CHARACTERS; ENTERTAINMENT IN THE NATURE OF THEATER PRODUCTIONS; ENTERTAINMENT SERVICES, NAMELY PRODUCTION OF ENTERTAINMENT SHOWS AND INTERACTIVE PROGRAMS FOR DISTRIBUTION VIA TELEVISION, CABLE, SATELLITE, AUDIO AND VIDEO MEDIA, CARTRIDGES, LASER DISCS, COMPUTER DISCS AND ELECTRONIC MEANS; ENTERTAINMENT SERVICES, NAMELY PROVIDING ONLINE COMPUTER GAMES AND ONLINE VIDEO GAMES THAT ARE ACCESSIBLE AND PLAYABLE VIA MOBILE AND CELLULAR PHONES AND OTHER WIRELESS DEVICES; ENTERTAINMENT SERVICES, NAMELY THE PROVISION OF CONTINUING ENTERTAINMENT AND NEWS PROGRAMS FEATURING ENTERTAINMENT INFORMATION DELIVERED BY COMMUNICATION AND COMPUTER NETWORKS; ENTERTAINMENT SERVICES, NAMELY, LIVE, TELEVISED AND MOVIE APPEARANCES BY A PROFESSIONAL ENTERTAINER; ENTERTAINMENT SERVICES, NAMELY, PROVIDING A WEB SITE FEATURING NON-DOWNLOADABLE MUSICAL PERFORMANCES, MUSICAL VIDEOS, RELATED FILM CLIPS, PHOTOGRAPHS AND OTHER MULTIMEDIA ENTERTAINMENT MATERIALS FEATURING ANIMATED CARTOON CHARACTERS; ENTERTAINMENT SERVICES, NAMELY PROVIDING A WEB SITE IN THE FIELD OF MUSIC, VIDEO GAMES, AND ANIMATED CARTOON CHARACTERS; ENTERTAINMENT SERVICES, NAMELY, PROVIDING ON-LINE COMPUTER GAMES; ENTERTAINMENT SERVICES, NAMELY, PROVIDING TOUCH AND VOICE DRIVEN ONLINE COMPUTER GAMES FOR DIGITAL MOBILE DEVICES; ENTERTAINMENT, NAMELY, A CONTINUING ENTERTAINMENT ANIMATED CARTOON SHOW BROADCASTED OVER GLOBAL AND LOCAL AREA COMPUTER NETWORKS; MULTIMEDIA PUBLISHING OF BOOKS, MAGAZINES, JOURNALS, SOFTWARE, GAMES, MUSIC, AND ELECTRONIC PUBLICATIONS; ON-LINE GAMING SERVICES, NAMELY, PROVIDING ON-LINE POKER GAMES, PROVIDING ON-LINE COMPUTER GAMES; ONLINE MULTIPLAYER VIDEO GAME TOURNAMENTS; PRODUCTION AND PROVISION OF ENTERTAINMENT AND NEWS VIA COMMUNICATION AND COMPUTER NETWORKS, NAMELY, PRODUCTION AND DISTRIBUTION OF RADIO PROGRAMS; PRODUCTION OF AUDIO, VIDEO, AND MULTIMEDIA RECORDINGS; PRODUCTION OF RADIO AND TELEVISION PROGRAMS; PRODUCTION OF SOUND RECORDINGS; PRODUCTION AND DISTRIBUTION OF MOTION PICTURES AND RENTAL OF MOTION PICTURE FILMS; PROVIDING DOWNLOADABLE AUDIO AND VIDEO FILES IN THE FIELD OF ENTERTAINMENT RELATING TO INTERACTIVE COMPUTER GAME SOFTWARE, INTERACTIVE VIDEO GAME SOFTWARE AND INTERACTIVE COMPUTER AND VIDEO GAMES; PROVIDING ON-LINE GAMES FOR USE ON MOBILE DEVICES; PROVIDING NEWS AND INFORMATION IN THE FIELD OF ENTERTAINMENT REGARDING INTERACTIVE COMPUTER GAME SOFTWARE, INTERACTIVE VIDEO GAME SOFTWARE AND INTERACTIVE COMPUTER AND VIDEO GAMES, VIA ELECTRONIC, WIRELESS AND COMPUTER NETWORKS; PROVIDING NON-DOWNLOADABLE VIDEO AND AUDIO RECORDINGS ABOUT ANIMATED CARTOON CHARACTERS MADE WITHIN COMPUTER GAMES VIA A WEBSITE; PROVIDING ONLINE COMPUTER AND VIDEO GAMES ACCESSED AND PLAYED VIA ELECTRONIC, WIRELESS AND COMPUTER NETWORKS; RENTAL OF SOUND RECORDINGS; VIDEO PRODUCTION SERVICES; VIDEO FILM PRODUCTION; VIDEO RECORDING SERVICES (U.S. CLS. 100, 101 AND 107).

FOR COMPUTER GRAPHICS DESIGN SERVICES, NAMELY, CREATION OF COMPUTER GENERATED CARTOON ANIMATED IMAGES; COMPUTER HARDWARE AND SOFTWARE CONSULTING SERVICES, NAMELY, CONSULTING SERVICES IN THE FIELD OF DESIGN, SELECTION, IMPLEMENTATION AND USE OF COMPUTER HARDWARE AND SOFTWARE SYSTEMS FOR OTHERS; COMPUTER PROGRAMMING; COMPUTER SOFTWARE CONSULTING; COMPUTER SYSTEMS ANALYSIS; CONVERSION OF DATA FROM PHYSICAL TO ELECTRONIC MEDIA; DESIGN OF COMPUTER SYSTEMS; DEVELOPMENT, CONSULTANCY ON AND DESIGNING OF COMPUTER SOFTWARE; DEVELOPMENT, CONSULTANCY ON AND

#### **CLASS 42—SCIENTIFIC AND COMPUTER SERVICES**

FOR COMPUTER GRAPHICS DESIGN SERVICES, NAMELY, CREATION OF COMPUTER GENERATED CARTOON ANIMATED IMAGES; COMPUTER HARDWARE AND SOFTWARE CONSULTING SERVICES, NAMELY, CONSULTING SERVICES IN THE FIELD OF DESIGN, SELECTION, IMPLEMENTATION AND USE OF COMPUTER HARDWARE AND SOFTWARE SYSTEMS FOR OTHERS; COMPUTER PROGRAMMING; COMPUTER SOFTWARE CONSULTING; COMPUTER SYSTEMS ANALYSIS; CONVERSION OF DATA FROM PHYSICAL TO ELECTRONIC MEDIA; DESIGN OF COMPUTER SYSTEMS; DEVELOPMENT, CONSULTANCY ON AND DESIGNING OF COMPUTER SOFTWARE; DEVELOPMENT, CONSULTANCY ON AND

DESIGNING OF TOUCH AND VOICE DRIVEN COMPUTER SOFTWARE FOR ELECTRONIC DIGITAL MOBILE DEVICES; ENGINEERING IN THE FIELD OF COMPUTER SCIENCE; HOSTING A WEB SITE FEATURING USER GENERATED CONTENT; SERVICES OF ASSEMBLING, MAINTENANCE AND SERVICING OF COMPUTER SOFTWARE, NAMELY, INSTALLATION, MAINTENANCE AND REPAIR OF COMPUTER SOFTWARE; UPDATING AND MAINTENANCE OF COMPUTER SOFTWARE, INCLUDING TOUCH AND VOICE DRIVEN COMPUTER SOFTWARE FOR ELECTRONIC DIGITAL MOBILE DEVICES (U.S. CLS. 100 AND 101).  
HAI-LY LAM, EXAMINING ATTORNEY

SN 79-126,482. PHARUS B.V., NETHERLANDS, FILED 1-18-2013.

The logo consists of the words 'HOOG' and 'HOUDT.' stacked vertically. 'HOOG' is on the left and 'HOUDT.' is on the right. Both words are rendered in a bold, black, sans-serif font with a slight 3D effect, where the letters are slightly offset from each other to create depth. The period at the end of 'HOUDT.' is also present.

PRIORITY DATE OF 8-3-2012 IS CLAIMED.  
OWNER OF INTERNATIONAL REGISTRATION 1150777 DATED 1-18-2013, EXPIRES 1-18-2023.  
OWNER OF U.S. REG. NOS. 3,873,047 AND 4,024,637.  
THE MARK CONSISTS OF THE STYLIZED WORDING "HOOG HOUDT."; THE WORDING IS VERTICAL WITH "HOOG" TO THE RIGHT OF "HOUDT".  
THE ENGLISH TRANSLATION OF "HOOG HOUDT" IN THE MARK IS "HIGH KEEPS".

#### CLASS 33—WINES AND SPIRITS

FOR ALCOHOLIC BEVERAGES EXCEPT BEER (U.S. CLS. 47 AND 49).

#### CLASS 35—ADVERTISING AND BUSINESS

FOR RETAIL STORE SERVICES FEATURING ALCOHOLIC BEVERAGES; WHOLESALE STORE SERVICES FEATURING ALCOHOLIC BEVERAGES (U.S. CLS. 100, 101 AND 102).  
LYNDSY KUYKENDALL, EXAMINING ATTORNEY

SN 79-126,903. SCHWEERS INFORMATIONSTECHNOLOGIE GMBH, FED REP GERMANY, FILED 2-19-2013.

The logo consists of the word 'ticketman' in a bold, black, sans-serif font. The letters are lowercase and have a slightly irregular, hand-drawn appearance. The 't' at the beginning is particularly large and prominent.

THE MARK CONSISTS OF STANDARD CHARACTERS WITHOUT CLAIM TO ANY PARTICULAR FONT, STYLE, SIZE, OR COLOR.  
PRIORITY DATE OF 10-11-2012 IS CLAIMED.  
OWNER OF INTERNATIONAL REGISTRATION 1151902 DATED 2-19-2013, EXPIRES 2-19-2023.  
OWNER OF U.S. REG. NO. 3,169,011.

#### CLASS 9—ELECTRICAL AND SCIENTIFIC APPARATUS

FOR PHOTOGRAPHIC APPARATUS, NAMELY, CAMERAS AND VIDEO CAMERA; APPARATUS FOR RECORDING, TRANSMISSION OR REPRODUCTION OF SOUND OR IMAGES; MAGNETIC DATA CARRIERS, NAMELY, BLANK MAGNETIC DATA CARRIERS AND MAGNETIC DATA CARRIERS PRERECORDED WITH COMPUTER SOFTWARE FOR GRAPHICAL USER INTERFACE SURVEILLANCE OF VEHICULAR TRAFFIC AND PARKING FACILITIES, DATA PROCESSING, DATABASE MANAGEMENT, FOR USE AS A SPREAD SHEET, WORD PROCESSING, FOR OPERATING SYSTEMS PROGRAMS AND FOR CONTROLLING INDUSTRIAL PROCESSES, NAMELY, SURVEILLANCE OF VEHICULAR TRAFFIC AND PARKING FACILITIES; RECORDING DISCS, NAMELY, BLANK RECORDING DISCS AND RECORDING DISCS PRERECORDED WITH COMPUTER SOFTWARE FOR GRAPHICAL USER INTERFACE SURVEILLANCE OF VEHICULAR TRAFFIC AND PARKING FACILITIES, DATA PROCESSING, DATABASE MANAGEMENT, FOR USE AS A SPREAD SHEET, WORD PROCESSING, FOR OPERATING SYSTEMS PROGRAMS AND FOR CONTROLLING INDUSTRIAL PROCESSES, NAMELY, SURVEILLANCE OF VEHICULAR TRAFFIC AND PARKING FACILITIES; COMPACT DISCS, NAMELY, BLANK RECORDABLE COMPACT DISCS AND COMPACT DISCS PRERECORDED WITH COMPUTER SOFTWARE FOR GRAPHICAL USER INTERFACE SURVEILLANCE OF VEHICULAR TRAFFIC AND PARKING FACILITIES, DATA PROCESSING, DATABASE MANAGEMENT, FOR USE AS A SPREAD SHEET, WORD PROCESSING, FOR OPERATING SYSTEMS PROGRAMS AND FOR CONTROLLING INDUSTRIAL PROCESSES, NAMELY, SURVEILLANCE OF VEHICULAR TRAFFIC AND PARKING FACILITIES; DVDS, NAMELY, BLANK RECORDABLE DVDS AND DVDS PRERECORDED WITH COMPUTER SOFTWARE FOR GRAPHICAL USER INTERFACE SURVEILLANCE OF VEHICULAR TRAFFIC AND PARKING FACILITIES, DATA PROCESSING, DATABASE MANAGEMENT, FOR USE AS A SPREAD SHEET, WORD PROCESSING, FOR OPERATING SYSTEMS PROGRAMS AND FOR CONTROLLING INDUSTRIAL PROCESSES, NAMELY, SURVEILLANCE OF VEHICULAR TRAFFIC AND PARKING FACILITIES; AND OTHER DIGITAL RECORDING MEDIA, NAMELY, BLANK RECORDABLE CD-RS AND CD-RS PRERECORDED WITH COMPUTER SOFTWARE FOR GRAPHICAL USER INTERFACE SURVEILLANCE OF VEHICULAR TRAFFIC AND PARKING FACILITIES, DATA PROCESSING, DATABASE MANAGEMENT, FOR USE AS A SPREAD SHEET, WORD PROCESSING, FOR OPERATING SYSTEMS PROGRAMS AND FOR CONTROLLING INDUSTRIAL PROCESSES, NAMELY, SURVEILLANCE OF VEHICULAR TRAFFIC AND PARKING FACILITIES; MECHANISMS FOR COIN-OPERATED APPARATUS; CASH REGISTERS, CALCULATING MACHINES, DATA PROCESSING EQUIPMENT; COMPUTERS; COMPUTER SOFTWARE, NAMELY, GRAPHICAL USER INTERFACE SOFTWARE, SOFTWARE FOR INDIVIDUAL AND VIDEO SURVEILLANCE OF VEHICULAR TRAFFIC AND PARKING FACILITIES; COMPUTER PROGRAMS FOR USE IN DATA PROCESSING, FOR USE IN DATABASE MANAGEMENT, FOR USE AS A SPREAD SHEET, FOR WORD PROCESSING, AND FOR CONTROLLING INDUSTRIAL PROCESSES, NAMELY, INDIVIDUAL AND VIDEO SURVEILLANCE OF VEHICULAR TRAFFIC AND PARKING FACILITIES; DATABASE MANAGEMENT SOFTWARE; AND COMPUTER OPERATING SYSTEMS PROGRAMS; FIRE-EXTINGUISHING APPARATUS (U.S. CLS. 21, 23, 26, 36 AND 38).

**CLASS 38—COMMUNICATION**

FOR TELECOMMUNICATIONS BY EMAIL, SHORT MESSAGE SERVICE AND OTHER DATA TRANSMISSIONS AND DATA TELECOMMUNICATIONS, NAMELY, ELECTRONIC DATA COMMUNICATIONS, NAMELY, DATA COMMUNICATIONS BY ELECTRONIC MAIL AND SHORT MESSAGE SERVICE, ELECTRONIC TRANSMISSION OF MESSAGES AND DATA, WIRELESS ELECTRONIC TRANSMISSION OF DATA AND INFORMATION, DATA TRANSMISSION AND RECEPTION SERVICES VIA TELECOMMUNICATION MEANS AND USE-PROVIDED INFORMATION, PERSONAL PROFILES AND CONTACT INFORMATION VIA THE INTERNET; TELECOMMUNICATIONS CONSULTATION (U.S. CLS. 100, 101 AND 104).

**CLASS 42—SCIENTIFIC AND COMPUTER SERVICES**

FOR SCIENTIFIC AND TECHNOLOGICAL SERVICES, NAMELY, RESEARCH AND DESIGN IN THE FIELD OF COMPUTER NETWORK HARDWARE, COMPUTER NETWORK SOFTWARE, COMPUTER DATACENTER ARCHITECTURE, DATABASE MANAGEMENT, DATA PROCESSING; INDUSTRIAL DESIGN AND DATA ANALYSIS AND RESEARCH SERVICES IN THE FIELD OF SURVEILLANCE OF VEHICULAR TRAFFIC AND PARKING FACILITIES; DESIGN AND DEVELOPMENT OF COMPUTER HARDWARE AND SOFTWARE (U.S. CLS. 100 AND 101).

DEBORAH MEINERS, EXAMINING ATTORNEY

SN 79-126,948. ONETWOTRIP LTD., BR. VIRGIN ISLANDS, FILED 2-12-2013.



OWNER OF INTERNATIONAL REGISTRATION 1152035 DATED 2-12-2013, EXPIRES 2-12-2023.

NO CLAIM IS MADE TO THE EXCLUSIVE RIGHT TO USE "TRIP", APART FROM THE MARK AS SHOWN.

THE MARK CONSISTS OF WORDING "ONE TWO TRIP!" SUPERIMPOSED UPON A DESIGN OF A SUITCASE WITH A CURVED ARROW IN THE HANDLE OF THE SUITCASE.

**CLASS 39—TRANSPORTATION AND STORAGE**

FOR BOOKING OF SEATS FOR TRAVEL; TRAVEL TICKET RESERVATION SERVICE; TRANSPORT RESERVATION; AIR TRANSPORT; BOAT RENTAL; RENTAL OF VEHICLE ROOF RACKS; TRANSPORTATION INFORMATION; ARRANGING OF CRUISES; ARRANGING OF TRAVEL TOURS; TRANSPORT OF TRAVELERS; BUS TRANSPORT; CAR TRANSPORT; RAILWAY TRANSPORT; MARINE TRANSPORT; PASSENGER TRANSPORT; RIVER TRANSPORT BY BOAT AND SHIP; SHIP BROKERAGE; TRANSPORT BROKERAGE; CAR RENTAL; VEHICLE RENTAL; TAXI TRANSPORT; TOURISM, NAMELY, CONDUCTING OF SIGHTSEEING TRAVEL TOURS FOR OTHERS (U.S. CLS. 100 AND 105).

**CLASS 43—HOTEL AND RESTAURANT SERVICES**

FOR ACCOMMODATION BUREAU, NAMELY, PROVIDING HOTEL SERVICES AND BOARDING HOUSES; MAKING HOTEL RESERVATIONS FOR OTHERS; HOTELS; BOOKING OF BOARDING HOUSE ACCOMMODATIONS; TEMPORARY ACCOMMODATION RESERVATIONS; RENTAL OF TEMPORARY ACCOMMODATION; RENTAL OF MEETING ROOMS; MOTELS; BOARDING HOUSES; RESORT LODGING, NAMELY, PROVIDING TEMPORARY HOLIDAY CAMP LODGING SERVICES; PROVIDING CAMPGROUND FACILITIES (U.S. CLS. 100 AND 101).

KRISTIN CARLSON, EXAMINING ATTORNEY

SN 79-127,419. MAN TRUCK & BUS AG, FED REP GERMANY, FILED 12-19-2012.

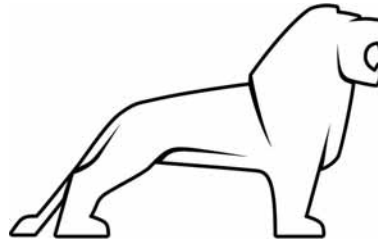

PRIORITY DATE OF 7-18-2012 IS CLAIMED. OWNER OF INTERNATIONAL REGISTRATION 1153302 DATED 12-19-2012, EXPIRES 12-19-2022.

THE MARK CONSISTS OF THE FULL PROFILE OF A MALE LION WITH MOUTH OPEN.

**CLASS 12—VEHICLES**

FOR AUTOMOBILES; LAND AND COMMERCIAL VEHICLES, NAMELY, LORRIES, SEMITRAILER TRACTORS AND OMNIBUSES, AND STRUCTURAL PARTS THEREFOR; CHASSIS FOR COMMERCIAL LAND VEHICLES, LORRIES AND OMNIBUSES; TRUCKS; TRUCK CHASSIS FOR COMMERCIAL LAND VEHICLES AND REPLACEMENT PARTS THEREFOR; MOTORS, ENGINES, AND COMBUSTION ENGINES FOR LAND VEHICLES; RAILWAY ROLLING STOCK; MINING AND UNDERGROUND MINING LAND VEHICLES; SUSPENSION SHOCK ABSORBERS FOR LAND VEHICLES; UNDERCARRIAGES FOR LAND VEHICLES; AUTOMOBILE CHAINS; AUTOMOBILE HOODS; AUTOMOBILE BODIES; BUMPERS FOR AUTOMOBILES; TRANSMISSION DRIVE SHAFTS FOR LAND VEHICLES; SPOILERS FOR VEHICLES; AIR BAG SAFETY DEVICES FOR AUTOMOBILES; DRIVING CHAINS FOR LAND VEHICLES; MINE CAR PUSHERS AND PULLERS AND STRUCTURAL AND REPLACEMENT PARTS THEREFOR; CHASSIS FOR LORRIES AND OMNIBUSES; AXLES FOR BUSES, NAMELY, AXLES AND TRANSFER CASES FOR LORRIES; MOTORS AND ENGINES FOR BUSES, RAILCARS, LOCOMOTIVES, TRACTORS, SWAP-BODY LAND VEHICLES, AND LAND VEHICLES, AND REPLACEMENT PARTS THEREFOR; BOATS; LAND VEHICLES FOR LOCOMOTION BY LAND; AIRPLANES FOR LOCOMOTION BY AIR; BOATS FOR LOCOMOTION BY WATER (U.S. CLS. 19, 21, 23, 31, 35 AND 44).

**CLASS 25—CLOTHING**

FOR CLOTHING, NAMELY, JACKETS, ANORAKS, BLOUSON JACKETS, WAISTCOATS, PULLOVERS, SHIRTS, TEE-SHIRTS, POLO SHIRTS, FLEECE SHIRTS, TROUSERS, SPORTS JACKETS, SUITS, OVERALLS, NECKTIES, COLLAR PROTECTORS, SHAWLS; FOOTWEAR; HEADWEAR (U.S. CLS. 22 AND 39).

**CLASS 36—INSURANCE AND FINANCIAL**

FOR INSURANCE ADMINISTRATION, CONSULTANCY, AND INFORMATION; FINANCIAL ANALYSIS, CONSULTATION, PLANNING, ADVICE, INFORMATION, AND MANAGEMENT; MONETARY AFFAIRS AND STRATEGY, NAMELY, CONSULTATION, ADVICE, ANALYSIS, ASSET MANAGEMENT, RESEARCH, PLANNING, AND INFORMATION SERVICES (U.S. CLS. 100, 101 AND 102).

MATTHEW GALAN, EXAMINING ATTORNEY

SN 79-127,660. ACCURATE EQUITY AS, NORWAY, FILED 12-14-2012.

# Accurate Equity

THE MARK CONSISTS OF STANDARD CHARACTERS WITHOUT CLAIM TO ANY PARTICULAR FONT, STYLE, SIZE, OR COLOR.

PRIORITY DATE OF 7-6-2012 IS CLAIMED.

OWNER OF INTERNATIONAL REGISTRATION 1153869 DATED 12-14-2012, EXPIRES 12-14-2022.

**CLASS 9—ELECTRICAL AND SCIENTIFIC APPARATUS**

FOR COMPUTERS (U.S. CLS. 21, 23, 26, 36 AND 38).

**CLASS 35—ADVERTISING AND BUSINESS**

FOR BUSINESS MANAGEMENT; BUSINESS ADMINISTRATION; SERVICES CONSISTING OF THE REGISTRATION, TRANSCRIPTION, COMPOSITION, COMPILATION AND SYSTEMATIZATION OF WRITTEN COMMUNICATIONS AND ALSO THE COMPILATION OF MATHEMATICAL OR STATISTICAL DATA; ACCOUNTING SERVICES (U.S. CLS. 100, 101 AND 102).

**CLASS 42—SCIENTIFIC AND COMPUTER SERVICES**

FOR DEVELOPMENT OF COMPUTER SOFTWARE (U.S. CLS. 100 AND 101).

GENE MACIOL, EXAMINING ATTORNEY

SN 79-127,458. DEUTSCHE BANK AKTIENGESELLSCHAFT, FED REP GERMANY, FILED 12-21-2012.

**Deutsche Bank Global Impact Tracking**

THE MARK CONSISTS OF STANDARD CHARACTERS WITHOUT CLAIM TO ANY PARTICULAR FONT, STYLE, SIZE, OR COLOR.

PRIORITY DATE OF 6-27-2012 IS CLAIMED.

OWNER OF INTERNATIONAL REGISTRATION 1153392 DATED 12-21-2012, EXPIRES 12-21-2022.

OWNER OF U.S. REG. NOS. 1,782,926 AND 3,424,547.

NO CLAIM IS MADE TO THE EXCLUSIVE RIGHT TO USE "BANK" IN CLASS 36 AND "GLOBAL IMPACT TRACKING" IN CLASSES 35 AND 36, APART FROM THE MARK AS SHOWN.

THE ENGLISH TRANSLATION OF "DEUTSCHE" IN THE MARK IS "GERMAN".

SEC. 2(F) "DEUTSCHE BANK".

SN 79-127,804. HYGINEX INC., UNITED STATES, FILED 10-18-2012.

# HYGINEX

PRIORITY DATE OF 4-23-2012 IS CLAIMED.

OWNER OF INTERNATIONAL REGISTRATION 1154331 DATED 10-18-2012, EXPIRES 10-18-2022.

**CLASS 35—ADVERTISING AND BUSINESS**

FOR ADVERTISING; BUSINESS MANAGEMENT; BUSINESS ADMINISTRATION; OFFICE FUNCTIONS; COLLECTION, SYSTEMIZATION AND ANALYSIS OF MARKET, CUSTOMER AND BUSINESS DATA (U.S. CLS. 100, 101 AND 102).

**CLASS 36—INSURANCE AND FINANCIAL**

FOR FINANCIAL AFFAIRS, NAMELY, BANKING SERVICES AND FINANCIAL INVESTMENT ANALYSIS SERVICES; REAL ESTATE AFFAIRS, NAMELY, REAL ESTATE FUNDS INVESTMENT ANALYSIS (U.S. CLS. 100, 101 AND 102).

**CLASS 41—EDUCATION AND ENTERTAINMENT**

FOR EDUCATION AND ENTERTAINMENT, NAMELY, CLASSES AND SEMINARS IN THE FIELD OF EDUCATION SCIENCE AND TEACHER TRAINING, PROVIDING MOTIVATIONAL AND EDUCATIONAL SPEAKERS IN THE FIELD OF BUSINESS ADMINISTRATION AND BANKING; SEMINARS AND COACHING IN THE FIELD OF BUSINESS ADMINISTRATION; PROVIDING OF TRAINING IN THE FIELD OF BUSINESS ADMINISTRATION; SPORTING AND CULTURAL ACTIVITIES, NAMELY, ORGANIZATION OF CONCERTS, OPERA, MUSICALS, THEATER PLAYS, DANCE SHOWS AND WORKSHOPS IN THE FIELD OF DRAMATIC ARTS AND MUSIC, ORGANIZATION OF FINE ARTS EXHIBITIONS AND ORGANIZATION OF SPORTS TOURNAMENTS, NAMELY, GOLF AND SAILING (U.S. CLS. 100, 101 AND 107).

YAT SYE, LEE, EXAMINING ATTORNEY

**CLASS 9—ELECTRICAL AND SCIENTIFIC APPARATUS**

FOR HAND HYGIENE CONTROL SYSTEM FOR MONITORING, MEASURING, IMPROVING AND REPORTING HAND HYGIENE COMPLIANCE, COMPRISED OF ELECTRONIC WIRELESS SENSORS AND DEVICES, NAMELY, ELECTRONICALLY ENCODED BRACELETS, WIRELESS DIGITAL TRANSMITTER LOCATION BEACONS PLACED IN THE ENVIRONMENT OF INTEREST, WIRELESS ELECTRONIC DONGLES CONNECTED VIA USB TO AN ELECTRONIC NETWORK, COMPUTER SERVER, AND WIRELESS ELECTRIC SENSORS AND TRANSMITTERS EMBEDDED IN AND ATTACHED TO HAND HYGIENE PRODUCT DISPENSERS, THAT TOGETHER AGGREGATE INFORMATION FROM AND PROVIDE REAL TIME FEEDBACK TO USERS AND STAFF REGARDING HAND HYGIENE HABITS (U.S. CLS. 21, 23, 26, 36 AND 38).

**CLASS 42—SCIENTIFIC AND COMPUTER SERVICES**

FOR DEVELOPING HARDWARE AND SOFTWARE SYSTEMS FOR THIRD PARTIES TO MONITOR, MEASURE, ANALYSE AND PREPARE REPORTS IN CONNECTION WITH HAND HYGIENE COMPLIANCE IN HEALTH CARE, FOOD, RETAIL AND INDUSTRIAL FIELDS (U.S. CLS. 100 AND 101).



JULIE VEPPUMTHARA, EXAMINING ATTORNEY

SN 79-127,861. RECKITT BENCKISER N.V., NETHERLANDS, FILED 9-10-2012.



PRIORITY DATE OF 8-13-2012 IS CLAIMED.  
OWNER OF INTERNATIONAL REGISTRATION 1154489  
DATED 9-10-2012, EXPIRES 9-10-2022.

THE COLOR(S) WHITE, BLUE, ORANGE, PURPLE,  
GREEN AND PINK IS/ARE CLAIMED AS A FEATURE OF  
THE MARK.

THE MARK CONSISTS OF A HOUSE DESIGN OUT-  
LINED IN WHITE AND MADE UP OF GEOMETRIC  
SHAPES THAT ARE EACH OUTLINED IN WHITE. THE  
ROOF OF THE HOUSE IS MADE UP OF A BLUE TRI-  
ANGLE ON THE LEFT AND AN ORANGE TRIANGLE WITH  
RECTANGULAR CHIMNEY ON THE RIGHT. THE MID-  
DLE OF THE HOUSE IS COMPRISED OF A PURPLE  
SQUARE ON THE LEFT AND A GREEN RECTANGLE ON  
THE RIGHT AND THE BOTTOM OF THE HOUSE IS A PINK  
RECTANGLE WITH A WHITE SMILE. THE COLOR GRAY  
REPRESENTS BACKGROUND AND IS NOT PART OF THE  
MARK.

### CLASS 3—COSMETICS AND CLEANING PRE- PARATIONS

FOR HOUSEHOLD CLEANING, SCOURING AND  
ABRASIVE PREPARATIONS; BLEACHING PREPARA-  
TIONS AND OTHER SUBSTANCES IN THE NATURE  
OF DETERGENTS FOR LAUNDRY USE AND DISH-  
WASHING; DISHWASHING PREPARATIONS; DISH-  
WASHER CLEANER, FRESHENER AND DEODORISER;  
RINSE AGENTS FOR MACHINE DISHWASHERS; POL-  
ISHING PREPARATIONS FOR KITCHEN AND GLASS-  
WARE; LAUNDRY PREPARATIONS, NAMELY,  
LAUNDRY STARCH, LAUNDRY BLEACH, LAUNDRY  
BLUEING, LAUNDRY PRE-SOAK, AND FABRIC SOFT-  
ENERS; CARPET CLEANERS; DETERGENTS; SOAPS;  
FABRIC SOFTENERS, STAIN REMOVING PREPARA-  
TIONS; PREWASH AND STAIN LOOSENING PREPARA-  
TIONS IN THE NATURE OF LAUNDRY PRE-SOAK;  
LAUNDRY STARCH; LAUNDRY BLUEING; POLISH-  
ING PREPARATIONS FOR KITCHEN AND GLASS-  
WARE; DECALCIFYING AND DESCALING  
PREPARATIONS FOR CLEANING HOUSEHOLD PRO-  
DUCTS; RUST REMOVERS; GREASE REMOVERS,  
NAMELY, STAIN REMOVERS; DRAIN AND SINK UN-  
BLOCKING PREPARATIONS, IN THE NATURE OF  
DRAIN OPENERS, CLEANING PREPARATIONS FOR  
CLEANSING DRAINS; PREPARATIONS FOR PREVEN-  
TION OF LIMESCALE, RUST OR GREASE, NAMELY,  
CLEANING PREPARATIONS WHICH PREVENT THE  
BUILD-UP OF LIMESCALE OR GREASE IN THE DISH-  
WASHER AND ON GLASSES AND DISHES; HAIR  
LOTIONS; NON-MEDICATED SKIN CARE PREPARA-  
TIONS; COSMETIC AND BEAUTY PREPARATIONS,  
NAMELY, SKIN CLEANSERS, SKIN TONERS; SKIN  
MOISTURIZERS, BODY DEODORIZERS; COSMETIC  
CREAMS AND LOTIONS FOR THE SKIN AND BODY;  
MOISTURIZING CREAMS, LOTIONS AND GELS; EX-  
FOLIANTS FOR THE SKIN AND BODY; BLEACHING  
PREPARATIONS ALL FOR PERSONAL USE; PREPARA-

TIONS FOR SHAVING; DEPILATORY PREPARATIONS;  
DEPILATORY WAXES; PREPARATIONS, INCLUDING  
CREAMS, GELS AND MOUSSES, FOR USE BEFORE,  
DURING AND AFTER SHAVING; PERFUMES; ESSEN-  
TIAL OILS; NON-MEDICATED PREPARATIONS FOR  
THE BATH IN THE FORM OF SALTS (OILS AND  
SOAKS); MOISTURIZING PREPARATIONS FOR THE  
SKIN, BODY AND HAIR; MASSAGE OILS; MASSAGE  
CREAMS; MASSAGE GELS OTHER THAN FOR MEDI-  
CAL PURPOSES; NON-MEDICATED PREPARATIONS  
FOR THE CARE OF INTIMATE PARTS OF THE BODY  
IN THE NATURE OF DOUCHES, CREAMS AND LO-  
TIONS FOR THE AREA OF THE VAGINA AND PENIS;  
NON-MEDICATED OINTMENTS, NON-MEDICATED  
PREPARATIONS FOR THE CARE OF THE FEET, BODY  
AND SKIN; NAIL CARE PREPARATIONS; CREAMS,  
GELS, LOTIONS, OILS, BALSAMS, POWDERS, TALCUM  
POWDERS AND SPRAYS FOR USE ON THE FEET,  
BODY AND SKIN; NON-MEDICATED PREPARATIONS  
FOR THE TREATMENT, CARE, CLEANSING, SOOTH-  
ING, REVITALIZING AND RELAXING OF THE FEET,  
BODY AND SKIN; NON-MEDICATED PREPARATIONS  
FOR THE BATH IN THE FORM OF SALTS, OILS AND  
NON-MEDICATED SOAKS FOR THE FEET, HANDS  
AND BODY; NON-MEDICATED SOAKS IN THE FORM  
OF TABLETS FOR THE FEET, HANDS AND BODY;  
DEODORANTS, DEODORIZING CREAMS, GELS, LO-  
TIONS, POWDERS, TALCUM POWDERS AND SPRAYS  
FOR PERSONAL USE; DEODORANTS IMPREGNATED  
INTO INSOLES; SCENTED ROOM SPRAYS (FRA-  
GRANCES, OTHER THAN FOR PERSONAL USE); PER-  
FUMING PREPARATIONS FOR THE ATMOSPHERE IN  
THE NATURE OF ROOM FRAGRANCES; INCENSE  
AND INCENSE CONES (U.S. CLS. 1, 4, 6, 50, 51 AND 52).

### CLASS 5—PHARMACEUTICALS

FOR PHARMACEUTICALS, NAMELY, ANALGESICS,  
GASTRIC REFLUX SUPPRESSANTS, LAXATIVES, AN-  
TACIDS, EXPECTORANTS, DECONGESTANTS, AND  
PHARMACEUTICAL PREPARATIONS FOR THE REL-  
IEF OF COUGH AND COLD SYMPTOMS AND FOR  
THE TREATMENT OF OPIATE ADDICTION; MEDI-  
CATED BEVERAGES AND PREPARATIONS FOR MAK-  
ING MEDICATED BEVERAGES, NAMELY,  
NUTRITIONALLY FORTIFIED BEVERAGES; MEDI-  
CATED BEVERAGES AND INGREDIENTS FOR MAK-  
ING SUCH BEVERAGES ALL FOR THE USE IN THE  
TREATMENT OF COLDS, COUGHS, INFLUENZA AND  
SORE THROATS; MEDICATED PREPARATIONS FOR  
TREATMENT OF ORAL AILMENTS; PREPARATIONS  
FOR DISPERSING DECONGESTANTS, NAMELY, DE-  
CONGESTANT CAPSULES AND NASAL SPRAYS;  
MEDICATED THROAT LOZENGES; MEDICATED CON-  
FECTIONERY; NATURAL NATURAL FIBER BULKING  
AGENTS, NAMELY, FOR THE RELIEF OF CONSTIPA-  
TION AND MAINTENANCE OF BOWEL REGULARITY;  
PHARMACEUTICAL PREPARATIONS AND SUB-  
STANCES HAVING ANTI-INFLAMMATORY, ANTI-  
PYRETIC AND ANALGESIC PROPERTIES, NAMELY,  
ANTI-INFLAMMATORIES, ANTI-PYRETICS AND AN-  
ALGESICS; MEDICATED BEVERAGES AND PREPARA-  
TIONS FOR MAKING SUCH BEVERAGES, NAMELY,  
FOR THE RELIEF OF COUGH AND COLD SYMPTOMS;  
MEDICATED CONFECTIONERY; MEDICATED SKIN  
CARE PREPARATIONS; SANITARY PREPARATIONS  
FOR MEDICAL PURPOSES; MEDICINAL TINCTURES;  
MEDICATED PREPARATIONS FOR THE CARE OF THE  
FEET, BODY AND SKIN; MEDICATED CREAMS, GELS,  
LOTIONS, OILS, BALMS, POWDERS, TALCUM POW-  
DERS AND SPRAYS FOR USE ON THE FEET, BODY  
AND SKIN; MEDICATED, SANITARY OR DISINFECT-  
ING PREPARATIONS FOR THE TREATMENT OF THE  
FEET, BODY AND SKIN; MEDICINAL AND THERA-  
PEUTIC PREPARATIONS AND ADDITIVES FOR THE  
BATH IN THE FORM OF SALTS, OILS AND BODY  
SOAKS; MEDICATED OR DISINFECTING SOAKS IN  
THE FORM OF TABLETS FOR THE FEET AND HANDS;  
MEDICATED OR PHARMACEUTICAL PREPARATIONS  
AGAINST PERSPIRATION IN THE NATURE OF ANTI-  
PERSPIRANTS; MEDICINAL LIQUIDS FOR MASSA-  
GING; MEDICATED TOILET PREPARATIONS,  
NAMELY, MEDICATED SKIN LOTIONS AND CREAMS,  
MEDICATED TALCUM POWDERS, MEDICATED  
SOAPS; MEDICATED OR PHARMACEUTICAL PRO-  
DUCTS FOR THE TREATMENT OF CORNS AND  
CHILBLAINS; PADS AND CUSHIONS FOR THE PRE-  
VENTION OF INFLAMMATION OF THE TOES AND OF

THE THICKENING OF SKIN CALLUSES; MEDICATED PREPARATIONS FOR CURING INGROWN TOE-NAILS; MEDICATED PADS AND INSOLES FOR THE TREATMENT OF CORNS, BUNIONS AND IMPREGNATED WITH ANTI-FUNGAL SUBSTANCES; MATERIALS FOR DRESSINGS IN THE NATURE OF, NAMELY, GAUZE, COMPOSITE DRESSINGS, FOAM DRESSINGS, SKIN SUBSTITUTES, SURGICAL TAPES AND ADHESIVE SKIN CLOSURES; MEDICAL PLASTERS, CORN PLASTER RINGS, RINGS FOR CORNS, ADHESIVE PLASTERS, BANDAGING MATERIALS IN THE NATURE OF ADHESIVE BANDAGES; BANDAGES FOR DRESSINGS AND SKIN WOUNDS; DISINFECTANT PREPARATIONS, ANTISEPTIC PRODUCTS, NAMELY, PREPARATIONS FOR THE APPLICATION TO THE SKIN, AND PADS AND WIPES IMPREGNATED WITH ANTISEPTIC PREPARATIONS; ANTI-FUNGAL PREPARATIONS; MATERIALS IMPREGNATED WITH, OR INCORPORATING, ANTI-FUNGAL PREPARATIONS; BANDAGES FOR WOUNDS; PADS; CONTRACEPTIVE PREPARATIONS AND SUBSTANCES; SPERMICIDAL GELS, LIQUIDS AND CREAMS; HYGIENIC LUBRICANTS AND DISINFECTANTS FOR USE IN THE AREA OF THE VAGINA, PENIS AND ANUS; PERSONAL LUBRICANTS; LUBRICANTS, GELS, LIQUIDS AND CREAMS FOR SEXUAL HEALTH AND/OR ENHANCING SEXUAL PERFORMANCE; DIETARY, NUTRITIONAL AND VITAMIN SUPPLEMENTS FOR SEXUAL HEALTH AND/OR ENHANCING SEXUAL PERFORMANCE; PHARMACEUTICAL PREPARATIONS AND SUBSTANCES FOR THE REGULATION OF SEXUAL HEALTH AND/OR SEXUAL PERFORMANCE; DIAGNOSTIC PREPARATIONS AND SUBSTANCES ALL FOR GYNECOLOGICAL TESTING PURPOSES OR FOR THE DIAGNOSIS OF SEXUALLY TRANSMITTED DISEASES; DISINFECTANTS (OTHER THAN FOR LAYING OR ABSORBING DUST) IN THE NATURE OF ALL-PURPOSE DISINFECTANTS; DISINFECTANTS FOR HOUSEHOLD USE OR FOR HYGIENE OR SANITARY PURPOSES; ARTICLES IMPREGNATED WITH AN ANTISEPTIC PRODUCT, NAMELY, PADS, WIPES AND TISSUES IMPREGNATED WITH ANTISEPTIC PREPARATIONS; ANTISEPTIC PREPARATIONS, ANTIBACTERIAL PREPARATIONS, NAMELY, ANTIBACTERIAL PREPARATIONS FOR MEDICAL USES, DISINFECTING PREPARATIONS IN THE NATURE OF ALL-PURPOSE DISINFECTANTS, GERMICIDES; INSECTICIDES AND MITICIDES FOR HOUSEHOLD USE; INSECT REPELLANTS; PREPARATIONS FOR DESTROYING AND REPELLING VERMIN; FUNGICIDES; DEODORANTS NOT FOR PERSONAL USE IN THE NATURE OF HOUSEHOLD AND ROOM DEODORANTS; AIR DEODORIZING PREPARATIONS AND AIR PURIFYING PREPARATIONS IN THE NATURE OF AIR DEODORANTS; FABRIC DEODORIZERS AND REFRESHERS, NAMELY, DEODORIZERS FOR CLOTHING, CARPETS AND UPHOLSTERY (U.S. CLS. 6, 18, 44, 46, 51 AND 52).

#### **CLASS 8—HAND TOOLS**

FOR NAIL CLIPPERS; NAIL FILES; NAIL BUFFERS; MANICURE SETS; MANICURE APPARATUS AND INSTRUMENTS, ORANGE STICKS, CUTICLE PUSHERS, TWEEZERS, CUTICLE SCISSORS; NAIL SCISSORS; FINGER NAIL AND TOENAIL POLISHERS (U.S. CLS. 23, 28 AND 44).

#### **CLASS 10—MEDICAL APPARATUS**

FOR ARTIFICIAL LIMBS, EYES AND TEETH; SUTURE MATERIALS; INSTRUMENTS, EQUIPMENT AND APPARATUS FOR HYGIENE, ORTHOPEDICS AND FOR THE TREATMENT AND CARE OF THE FEET AND SKIN, NAMELY, CORN KNIVES AND SKIN ABRASERS; ORTHOPEDIC CUSHIONS FOR CARE OF THE FEET; AIDS FOR THE CORRECTION OF THE FEET INCLUDING SUPPORTS FOR THE ARCH OF THE FOOT; APPARATUS FOR THE SEPARATION AND THE STRAIGHTENING OF THE TOES; PROTECTIVE MEDICAL APPARATUS AGAINST THE HARDENING OF AREAS OF SKIN CALLUSES AND INFLAMMATION OF THE TOES; CUSHIONS FOR THE HEELS, UNDERHEELS; PROTECTION FOR METATARSAL CUSHIONS; ORTHOPEDIC BOOT INSERTS ORTHOPEDIC FOOT SUPPORTS; ORTHOPEDIC SHOE INSOLES, ORTHOPEDIC INSOLES, DISPOSABLE INSOLES, DEODORIZED ORTHOPEDIC INSOLES FOR ORTHOPEDIC FOOT-

WEAR; COMPRESSION MEDICAL HOSIERY; GRADUATED COMPRESSION MEDICAL HOSIERY; MEDICAL SUPPORT HOSIERY; ORTHOPEDIC AND THERAPEUTIC MEDICAL HOSIERY; HOSIERY FOR MEDICAL, SURGICAL AND/OR PROPHYLACTIC PURPOSES; MEDICAL AND SURGICAL SOCKS; MEDICAL STOCKINGS FOR VARICOSE VEINS; APPARATUS NAMELY, ORTHOPEDIC DEVICE FOR EXERCISING THE FOOT; INSTRUMENTS AND APPARATUS, NAMELY, MEDICAL DEVICE FOR PLACING BANDAGES; MEDICAL APPARATUS FOR THE FIXING OF FINGERS AND TOES, NAMELY, SPLINTS; ELASTIC BANDAGES FOR JOINTS, ELASTIC GAITERS, ELASTIC KNEE JOINTS, ELASTIC BANDAGES, BANDAGES FOR ORTHOPEDIC PURPOSES; MEDICAL APPARATUS FOR MEASURING, EXAMINING AND TAKING IMPRESSIONS OF THE FEET ; BODY MASSAGERS; ELECTRICALLY OPERATED VIBRATING MASSAGERS; FOOT MASSAGERS; THERAPEUTIC APPARATUS AND APPLIANCES FOR MASSAGING AND/OR BATHING, NAMELY, FOOT BATHS; CONDOMS; CONTRACEPTIVE OR PROPHYLACTIC DEVICES, NAMELY, DIAPHRAGMS, SHEATHS, UTERINE LOOPS, INTRAUTERINE DEVICES, CERVICAL CAPS, FEMALE CONDOMS, AND PESSARIES; MASSAGE APPARATUS, INSTRUMENTS AND APPLIANCES; ELECTRIC AND ELECTRONIC MASSAGE APPARATUS, INSTRUMENTS AND APPLIANCES; BODY MASSAGERS; PERSONAL MASSAGERS; VIBRATORS; VIBRATING RINGS; SEX TOYS, NAMELY, VIBRATORS, PENIS RINGS, BUTT PLUGS, AND TONGUE RINGS SPECIFICALLY ADAPTED FOR SEXUAL STIMULATION; ADULT SEXUAL STIMULATION AIDS, NAMELY, VIBRATORS, VIBRATING RINGS; SEX TOYS, NAMELY, VIBRATORS, PENIS RINGS, BUTT PLUGS, AND TONGUE RINGS SPECIFICALLY ADAPTED FOR SEXUAL STIMULATION; PARTS AND FITTINGS FOR ALL THE AFORESAID GOODS SOLD AS A UNIT THEREWITH; ARCH SUPPORTS FOR BOOTS OR SHOES (U.S. CLS. 26, 39 AND 44).

#### **CLASS 11—ENVIRONMENTAL CONTROL APPARATUS**

FOR ELECTRIC AND BATTERY POWERED DISPENSING UNITS FOR SCENTING, PURIFYING OR FRESHENING THE ATMOSPHERE; ELECTRICAL POWERED AIR PURIFIERS FOR THE NEUTRALIZATION, REDUCTION OR CONTROL OF ALLERGENS; WATER DECALCIFYING AND DESCALING APPARATUS, NAMELY, WATER PURIFYING APPARATUS; WATER FILTERING APPARATUS; WATER SOFTENING APPARATUS; WATER FILTERS; WATER SOFTENERS; FILTER CARTRIDGES FOR WATER PURIFICATION AND WATER SOFTENING FOR HOUSEHOLD USE; WATER TREATMENT FILTERS (U.S. CLS. 13, 21, 23, 31 AND 34).

#### **CLASS 25—CLOTHING**

FOR CLOTHING, NAMELY COATS, TROUSERS, JEANS, SKIRTS, DRESSES, JACKETS, SHIRTS, BLOUSES, LINGERIE, T-SHIRTS, SHORTS, JUMPERS, UNDERWEAR, NIGHTWEAR, GLOVES, SCARVES, SOCKS, HOSIERY AND STOCKINGS, SWIMWEAR, BELTS, TIES; FOOTWEAR, NAMELY, SHOES AND BOOTS; HEADWEAR, NAMELY HATS, CAPS, HEADBANDS AND SCARVES; FITTINGS FOR FOOTWEAR, SOCKS AND STOCKINGS; SHOES, SLIPPERS, BOOTS, SANDALS, CLOGS; SOLES; INSOLES FOR FOOTWEAR; HOSIERY; MEDICATED INSOLES; BOOT INSERTS; HEEL CUSHIONS AND HEEL GRIPS, NAMELY, HEEL INSERTS AND HEEL PIECES FOR SHOES (U.S. CLS. 22 AND 39).

**CLASS 35—ADVERTISING AND BUSINESS**

FOR PROVISION OF BUSINESS INFORMATION; ADVERTISING; BUSINESS MANAGEMENT; BUSINESS ADMINISTRATION AND OFFICE WORK; PROVIDING OFFICE FUNCTIONS; MARKETING SERVICES; COMMERCIAL OR INDUSTRIAL MANAGEMENT SERVICES; ORGANIZATION, OPERATION AND SUPERVISION OF LOYALTY AND INCENTIVE SCHEMES IN THE NATURE OF COUPONS, VOUCHERS, MONEY BACK OFFERS, LOYALTY CARDS; RENTAL AND LEASING OF VENDING MACHINES; RETAIL STORE SERVICES FEATURING A VARIETY OF CONSUMER GOODS, NAMELY, BLEACHING PREPARATIONS AND OTHER SUBSTANCES FOR LAUNDRY USE, DISHWASHER PREPARATIONS, PREPARATIONS FOR REMOVING STAINS, CARPET CLEANERS, SOAPS, DETERGENTS, DECALCIFYING AND DESCALING PREPARATIONS, LIMESCALE REMOVERS, RUST REMOVERS, FABRIC SOFTENERS, LAUNDRY ADDITIVES, WATER SOFTENING PREPARATIONS, GREASE REMOVERS, DRAIN AND SINK UNBLOCKING PREPARATIONS, PREPARATIONS FOR PREVENTION OF LIMESCALE, RUST OR GREASE, NON-MEDICATED TOILET PREPARATIONS, NON-MEDICATED PREPARATIONS FOR THE CARE OF FEET, FOOT CARE PREPARATIONS, SKIN CARE PREPARATIONS, MEDICATED SKIN CARE PREPARATIONS, PREPARATIONS FOR TREATMENT OF ACNE, DEPI-LATORY PREPARATIONS, PHARMACEUTICAL PREPARATIONS, MEDICATED BEVERAGES AND CONFECTIONERY, CONTRACEPTIVE PREPARATIONS AND SUBSTANCES, SPERMICIDAL GELS, LIQUIDS AND CREAMS, CONDOMS, SANITARY PREPARATIONS, ANTISEPTIC PREPARATIONS, ANTI-BACTERIAL PREPARATIONS, DISINFECTING PREPARATIONS, ARTICLES IMPREGNATED WITH A DISINFECTANT OR ANTI-BACTERIAL PRODUCT, ARTICLES IMPREGNATED WITH AN ANTISEPTIC PRODUCT, INSECTICIDES, INSECT REPELLENTS, PESTICIDES, RODENTICIDES, MITICIDES, PREPARATIONS FOR DESTROYING VERMIN, GERMICIDES, DEODORANTS (NOT FOR PERSONAL USE), AIR FRESHENING PREPARATIONS, AIR FRESHENERS, NAIL CLIPPERS, NAIL FILES, NAIL SCISSORS, FOOTWEAR (U.S. CLS. 100, 101 AND 102).

**CLASS 41—EDUCATION AND ENTERTAINMENT**

FOR EDUCATION, ADVICE AND TRAINING, NAMELY, PROVIDING SEMINARS AND WORKSHOPS IN THE FIELD OF FOOD, HOME CONSUMER PRODUCTS, AND PERSONAL CARE AND HEALTHCARE CONSUMER PRODUCTS; EDUCATION, ADVICE AND TRAINING, NAMELY, PROVIDING SEMINARS AND WORKSHOPS IN THE FIELD OF HOME CARE, PERSONAL CARE, SEXUAL HEALTH AND WELL BEING AND HEALTHCARE MANAGEMENT AND WELFARE; ARRANGING AND CONDUCTING OF EDUCATIONAL SEMINARS, WORKSHOPS AND EDUCATIONAL DISCUSSION GROUPS, IN THE FIELD OF FOOD, HOME CARE, PERSONAL CARE, SEXUAL HEALTH AND WELL BEING AND HEALTHCARE PRODUCTS, MANAGEMENT AND WELFARE; ORGANIZING COMMUNITY SPORTING AND CULTURAL EVENTS; PUBLICATION OF TEXTS IN THE NATURE OF BOOKS, LEAFLETS, MAGAZINES, POSTERS AND ELECTRONIC PUBLICATIONS; ORGANIZATION OF EXHIBITIONS FOR CULTURAL OR EDUCATIONAL PURPOSES; PRESENTATION OF WORKS OF VISUAL ART AND LITERATURE TO THE PUBLIC FOR CULTURAL OR EDUCATIONAL PURPOSES, NAMELY, BOOKS, LEAFLETS, MAGAZINES, POSTERS AND ELECTRONIC PUBLICATIONS; PROVIDING ENTERTAINMENT INFORMATION SERVICES (U.S. CLS. 100, 101 AND 107).  
JENNIFER WILLISTON, EXAMINING ATTORNEY

SN 79-127,878. FOREVER JEWELS PTE LTD, SINGAPORE, FILED 12-27-2012.

FOREVER *by* FAI

PRIORITY DATE OF 12-24-2012 IS CLAIMED.  
OWNER OF INTERNATIONAL REGISTRATION 1154534 DATED 12-27-2012, EXPIRES 12-27-2022.  
THE MARK CONSISTS OF THE WORDING "FOREVER BY FAI" IN STYLIZED TEXT.

**CLASS 14—JEWELRY**

FOR WATCHES, WRIST WATCHES, STRAPS FOR WRIST WATCHES, ALARM CLOCKS, CLOCKS AND TRAVEL CLOCKS; JEWELLERY; DIAMONDS, PEARLS, PRECIOUS AND SEMI-PRECIOUS STONES; CHAINS JEWELLERY, BRACELETS JEWELLERY, NECKLACES JEWELLERY, EARRINGS, RINGS JEWELLERY, CUFF LINKS, BROOCHES, PENDANTS, MEDALS, CHARMS JEWELLERY, JEWELLERY CASES; WORKS OF ART OF PRECIOUS METAL; GOLD AND ITS ALLOYS; SILVERWARE, OTHER THAN CUTLERY, FORKS AND SPOONS, NAMELY, SILVER INGOTS; ALL MADE OF PRECIOUS METAL OR COATED THEREWITH (U.S. CLS. 2, 27, 28 AND 50).

**CLASS 35—ADVERTISING AND BUSINESS**

FOR THE BRINGING TOGETHER, FOR THE BENEFIT OF OTHERS, OF A VARIETY OF GOODS, NAMELY, WATCHES, WRIST WATCHES, STRAPS FOR WRIST WATCHES, ALARM CLOCKS, CLOCKS AND TRAVEL CLOCKS, JEWELLERY, DIAMONDS, PEARLS, PRECIOUS AND SEMI-PRECIOUS STONES, CHAINS JEWELLERY, BRACELETS JEWELLERY, NECKLACES JEWELLERY, EARRINGS, RINGS JEWELLERY, CUFF LINKS, BROOCHES, PENDANTS, MEDALS, CHARMS JEWELLERY, JEWELLERY CASES, WORKS OF ART OF PRECIOUS METAL, GOLD AND SILVER WARES OTHER THAN CUTLERY, FORKS AND SPOONS MADE OF PRECIOUS METAL OR COATED THEREWITH, SPECTACLES, SUNGLASSES AND HANDBAGS EXCLUDING THE TRANSPORT THEREOF, ENABLING CUSTOMERS TO CONVENIENTLY VIEW AND PURCHASE THOSE GOODS IN A RETAIL STORE (U.S. CLS. 100, 101 AND 102).

SHANNON TWOHIG, EXAMINING ATTORNEY

SN 79-127,974. FULL FAT PRODUCTIONS LIMITED, UNITED KINGDOM, FILED 12-24-2012.

SUGAR RUSH

THE MARK CONSISTS OF STANDARD CHARACTERS WITHOUT CLAIM TO ANY PARTICULAR FONT, STYLE, SIZE, OR COLOR.

PRIORITY DATE OF 6-27-2012 IS CLAIMED.  
OWNER OF INTERNATIONAL REGISTRATION 1154737 DATED 12-24-2012, EXPIRES 12-24-2022.

**CLASS 9—ELECTRICAL AND SCIENTIFIC APPARATUS**

FOR COMPUTER GAME PROGRAMS AND SOFTWARE, VIDEO GAMES SOFTWARE, ELECTRONIC GAMES SOFTWARE, SOFTWARE FOR PLAYING VIDEO, COMPUTER AND ON-LINE GAMES, COMPUTER GAME SOFTWARE FOR USE ON CELLULAR AND MOBILE PHONES, COMPUTER GAME SOFTWARE FOR USE ON HANDHELD DEVICES, COMPUTER GAME DISCS, COMPUTER GAMES SOFTWARE FOR USE ON MOBILE TELEPHONE DEVICES, COMPUTER GAMES SOFTWARE FOR PERSONAL COMPUTERS AND HOME VIDEO CONSOLES, COMPUTER GAMES SOFTWARE DOWNLOADABLE FROM A GLOBAL COMPUTER NETWORK, DOWNLOADABLE COMPUTER GAME PROGRAMS (U.S. CLS. 21, 23, 26, 36 AND 38).

**CLASS 41—EDUCATION AND ENTERTAINMENT**

FOR ENTERTAINMENT SERVICES, NAMELY, PROVIDING ONLINE COMPUTER GAMES; PROVIDING NON-DOWNLOADABLE ELECTRONIC PUBLICATIONS IN THE NATURE OF INSTRUCTION MANUALS AND HINT BOOKS IN THE FIELD OF COMPUTER AND VIDEO GAMES; PROVIDING INFORMATION REGARDING GAME PLAY IN RELATION TO COMPUTER AND VIDEO GAMES PROVIDED VIA THE INTERNET, CELLULAR AND MOBILE TELEPHONE COMMUNICATION, AND GLOBAL COMPUTER NETWORK; PROVIDING INFORMATION IN RELATION TO THE DEVELOPMENT OF COMPUTER GAMES AND VIDEO GAMES PROVIDED VIA THE INTERNET, CELLULAR AND MOBILE TELEPHONE COMMUNICATION, AND GLOBAL COMPUTER NETWORK; ENTERTAINMENT SERVICES, NAMELY, ONLINE ELECTRONIC GAMES VIA MOBILE AND CELLULAR TELEPHONE COMMUNICATION; PRODUCTION OF VIDEO AND COMPUTER SOFTWARE; RENTAL OF COMPUTER GAME SOFTWARE AND PROGRAMS (U.S. CLS. 100, 101 AND 107).

KEVIN CORWIN, EXAMINING ATTORNEY

SN 79-127,994. MARSHALL AMPLIFICATION PLC, UNITED KINGDOM, FILED 3-8-2013.



PRIORITY DATE OF 11-16-2012 IS CLAIMED.  
OWNER OF INTERNATIONAL REGISTRATION 1154799 DATED 3-8-2013, EXPIRES 3-8-2023.  
THE MARK CONSISTS OF THE LETTER "M" IN A STYLIZED FONT ON A SHADED BACKGROUND.

**CLASS 32—LIGHT BEVERAGES**

FOR BEERS; WATERS, NAMELY, MINERAL WATER, SELTZER WATER, FLAVOURED WATERS; NON-ALCOHOLIC DRINKS, NAMELY, VEGETABLE JUICE, NON-ALCOHOLIC BEER, LEMONADE, GINGER ALE; FRUIT DRINKS AND FRUIT JUICES; SYRUPS FOR MAKING BEVERAGES (U.S. CLS. 45, 46 AND 48).

**CLASS 33—WINES AND SPIRITS**

FOR ALCOHOLIC BEVERAGES EXCEPT BEER; WINE; SPIRITS (U.S. CLS. 47 AND 49).

**CLASS 43—HOTEL AND RESTAURANT SERVICES**

FOR PROVIDING TEMPORARY HOUSING ACCOMMODATION; HOTEL SERVICES; SERVICES FOR PROVIDING FOOD AND DRINK; BAR SERVICES; RESTAURANT SERVICES; CAFE SERVICES; CATERING SERVICES; HOTEL RESERVATIONS (U.S. CLS. 100 AND 101).

ZACHARY CROMER, EXAMINING ATTORNEY

SN 79-128,080. SOFRALAB, F-51530 MAGENTA, FRANCE, FILED 2-20-2013.

# CHARM

THE MARK CONSISTS OF STANDARD CHARACTERS WITHOUT CLAIM TO ANY PARTICULAR FONT, STYLE, SIZE, OR COLOR.

PRIORITY DATE OF 2-12-2013 IS CLAIMED.  
OWNER OF INTERNATIONAL REGISTRATION 1155081 DATED 2-20-2013, EXPIRES 2-20-2023.

**CLASS 1—CHEMICALS**

FOR CHEMICAL PRODUCTS FOR PRESERVING, IMPROVING AND TREATING ALL FOODSTUFFS AND FOOD SUBSTANCES, WHETHER SOLID OR LIQUID (U.S. CLS. 1, 5, 6, 10, 26 AND 46).

**CLASS 5—PHARMACEUTICALS**

FOR FOOD SUPPLEMENTS (U.S. CLS. 6, 18, 44, 46, 51 AND 52).

ANGELA M. MICHELI, EXAMINING ATTORNEY

SN 79-128,158. LIBRATONE A/S, DENMARK, FILED 2-26-2013.

PRIORITY DATE OF 10-31-2012 IS CLAIMED.  
OWNER OF INTERNATIONAL REGISTRATION 1155265 DATED 2-26-2013, EXPIRES 2-26-2023.

THE MARK CONSISTS OF TWO CONNECTED CIRCLES, ONE LARGE AND ONE SMALL, WITH THE WORDING "PLAYDIRECT" TO THE RIGHT.

**CLASS 9—ELECTRICAL AND SCIENTIFIC APPARATUS**

FOR ELECTRIC AND ELECTRONIC APPARATUS, INSTRUMENTS AND EQUIPMENT FOR USE IN CONNECTION WITH THE RECORDING, TRANSMISSION, REPRODUCTION, RECEPTION, CONTROL, OPERATING AND AMPLIFICATION OF SOUND OR IMAGES, NAMELY, LOUDSPEAKERS, LOUDSPEAKER SYSTEMS, STEREO TUNERS, AMPLIFIERS, DVD AND COMPACT DISC PLAYERS AND RECORDERS, MICROPHONES AND SOUND MIXERS; ANALOGUE AND DIGITAL PRODUCTS FOR AUDIO ROOM CORRECTION, NAMELY, DISTRIBUTION AMPLIFIERS FOR AUDIO AND VIDEO SIGNALS; AUDIO AND SIGNAL PROCESSING APPARATUS AND SURROUND-SOUND PROCESSING APPARATUS, NAMELY, DIGITAL SIGNAL PROCESSORS; STRUCTURAL PARTS AND FITTINGS FOR ALL THE AFORESAID GOODS, NAMELY, HEADPHONES, SUBWOOFERS, REMOTE CONTROL UNITS, AERIALS, CONVERTERS, TELEVISION DECODERS; COMPUTER HARDWARE AND SOFTWARE, NAMELY, APPLICATION SOFTWARE, FOR USE IN CONNECTION WITH THE RECORDING, TRANSMISSION, REPRODUCTION, RECEPTION, CONTROL, OPERATING AND AMPLIFICATION OF SOUND OR IMAGES, INCLUDING LOUDSPEAKERS AND LOUDSPEAKER UNITS/SYSTEMS, TUNERS, AMPLIFIERS, DVD AND COMPACT DISC PLAYERS, MICROPHONES AND SOUND MIXERS; ELECTRIC AND ELECTRONIC APPARATUS, INSTRUMENTS AND EQUIPMENT, NAMELY, LOUDSPEAKERS, FOR COMPUTERS, LAPTOPS AND OTHER HANDHELD COMPUTERS AND FOR TELEPHONES, INCLUDING PORTABLE TELEPHONES, AND OTHER MOBILE DIGITAL ELECTRONIC DEVICES FOR THE SENDING AND RECEIVING OF TELEPHONE CALLS, E-MAILS, VIDEO, MUSIC AND OTHER DIGITAL DATA, FOR MP3 AND OTHER DIGITAL FORMAT AUDIO AND VIDEO PLAYERS (U.S. CLS. 21, 23, 26, 36 AND 38).

**CLASS 20—FURNITURE AND ARTICLES NOT OTHERWISE CLASSIFIED**

FOR FURNITURE, INCLUDING FURNITURE FOR ALL KIND OF MUSIC AND VIDEO PLAYING DEVICES (U.S. CLS. 2, 13, 22, 25, 32 AND 50).  
ALICE BENMAMAN, EXAMINING ATTORNEY

SN 79-128,232. C.B.C. ROYAL FIRST S.R.L., ITALY, FILED 2-4-2013.



OWNER OF INTERNATIONAL REGISTRATION 1131045 DATED 5-24-2012, EXPIRES 5-24-2022.

NO CLAIM IS MADE TO THE EXCLUSIVE RIGHT TO USE "ESPRESSO", APART FROM THE MARK AS SHOWN. THE MARK CONSISTS OF THE STYLIZED WORDING, "ESPRESSO BY ROYAL," WITH A CROWN LOCATED IN BETWEEN THE WORDS "BY" AND "ROYAL".

**CLASS 7—MACHINERY**

FOR ELECTRIC COFFEE GRINDERS, POWER-OPERATED COFFEE GRINDERS (U.S. CLS. 13, 19, 21, 23, 31, 34 AND 35).

**CLASS 9—ELECTRICAL AND SCIENTIFIC APPARATUS**

FOR DISPENSERS THAT COUNT OR MEASURE OUTPUT FOR USE WITH COFFEE; MECHANICAL DEVICES, NAMELY, DISPENSERS OF PRESET PORTIONS OF FLUIDS, SOLID GRANULES AND POWDER FOR DOSING PURPOSES, ALL NOT FOR MEDICAL USE (U.S. CLS. 21, 23, 26, 36 AND 38).

**CLASS 11—ENVIRONMENTAL CONTROL APPARATUS**

FOR ELECTRIC COFFEE BREWERS; ELECTRIC ESPRESSO AND CAPPUCINO COFFEE MACHINES (U.S. CLS. 13, 21, 23, 31 AND 34).  
LANA PHAM, EXAMINING ATTORNEY

SN 79-128,610. SIEMENS WIND POWER A/S, DENMARK, FILED 2-14-2013.



THE MARK CONSISTS OF STANDARD CHARACTERS WITHOUT CLAIM TO ANY PARTICULAR FONT, STYLE, SIZE, OR COLOR.

PRIORITY DATE OF 11-8-2012 IS CLAIMED.  
OWNER OF INTERNATIONAL REGISTRATION 1156346 DATED 2-14-2013, EXPIRES 2-14-2023.

**CLASS 7—MACHINERY**

FOR ELECTRIC MOTORS NOT FOR LAND VEHICLES, DRIVES FOR MOTORS, STARTERS FOR MOTORS AND ENGINES, ELECTRIC GENERATORS, WIND POWERED ELECTRICITY GENERATORS, WIND TURBINES; COMPRESSORS FOR WIND POWERED ELECTRICITY GENERATORS; STARTERS FOR ENGINES AND DRIVE MOTORS; COMPRESSORS FOR CHARGING COMBUSTION ENGINES; CATALYTIC CONVERTERS FOR COMBUSTION ENGINES; AIR COMPRESSORS, COMPRESSORS AS PARTS OF MACHINES, MOTORS AND ENGINES; PUMPS FOR WINDMILLS AND WIND POWERED MACHINES (U.S. CLS. 13, 19, 21, 23, 31, 34 AND 35).

**CLASS 9—ELECTRICAL AND SCIENTIFIC APPARATUS**

FOR ELECTRO-TECHNICAL AND ELECTRIC SIGNALING, MEASURING, COUNTING, RECORDING, MONITORING, CONTROL AND SWITCHING DEVICES, NAMELY, COMPUTER HARDWARE FOR USE IN CONTROLLING, OPERATING AND MONITORING WIND TURBINES, ELECTRICAL MONITORS AND ELECTRICAL CONTROLLERS FOR USE IN WIND POWERED ELECTRICITY GENERATORS TO MONITOR AND CONTROL VOLTAGE FREQUENCIES, PHASE CONDITIONS, ROTOR SPEED, BLADE ANGLE, WIND DIRECTION AND STRENGTH; ELECTRICAL DATA INPUT, PROCESSING, TRANSMISSION, STORAGE AND OUTPUT DEVICES, NAMELY, ELECTRONIC INTERFACE EQUIPMENT FOR WIND TURBINES TO INPUT OR OUTPUT COMPUTER NUMERICAL CONTROL DATA; COMPUTER SOFTWARE FOR MONITORING, RECORDING AND CONTROLLING WIND TURBINE OPERATIONS AND POWER OUTPUT FROM WIND TURBINES (U.S. CLS. 21, 23, 26, 36 AND 38).

GIANCARLO CASTRO, EXAMINING ATTORNEY

SN 79-128,660. EPAI LIVE AUCTION CO., LTD., CHINA,  
FILED 9-24-2012.

epaiLive

PRIORITY DATE OF 5-10-2012 IS CLAIMED.  
OWNER OF INTERNATIONAL REGISTRATION 1156423  
DATED 9-24-2012, EXPIRES 9-24-2022.

#### **CLASS 9—ELECTRICAL AND SCIENTIFIC APPARATUS**

FOR DATA PROCESSING APPARATUS; COMPUTER MEMORIES; RECORDED COMPUTER OPERATING PROGRAMS; COMPUTER PERIPHERAL DEVICES; NOTEBOOK COMPUTERS; CENTRAL PROCESSING UNIT; RECORDED COMPUTER SOFTWARE FOR NETWORKED TRANSACTIONS, NETWORK DELIVERY, LIVE BROADCASTS AND AUCTIONS FOR PRODUCTS AND SERVICES; DOWNLOADABLE ELECTRONIC PUBLICATIONS IN THE NATURE OF MAGAZINES, BROCHURES AND NEWSLETTERS IN THE FIELD OF ART, CULTURE, AUCTIONS FOR PRODUCTS AND SERVICES, AND ARTWORK SALES AND INVESTMENT; DOWNLOADABLE SOFTWARE BEING COMPUTER PROGRAMS IN THE FIELD OF NETWORKED TRANSACTIONS, NETWORK DELIVERY, LIVE BROADCASTS AND AUCTIONS FOR PRODUCTS AND SERVICES; MONITORS BEING COMPUTER HARDWARE (U.S. CLS. 21, 23, 26, 36 AND 38).

#### **CLASS 16—PAPER GOODS AND PRINTED MATTER**

FOR STATIONERY; POSTERS; PRINTED PUBLICATIONS AND MATTER, NAMELY, PERIODICALS, PAMPHLETS, BROCHURES AND BOOKS IN THE FIELD OF ART, CULTURE, AUCTIONS FOR PRODUCTS AND SERVICES, AND ARTWORK SALES AND INVESTMENT; PAPER; PICTURES; OIL PAINTINGS; PRINTED PHOTOGRAPHS (U.S. CLS. 2, 5, 22, 23, 29, 37, 38 AND 50).

#### **CLASS 35—ADVERTISING AND BUSINESS**

FOR ADVERTISING SERVICES; RENTAL OF ADVERTISING SPACE; ON-LINE ADVERTISING ON A COMPUTER NETWORK; PRESENTATION OF GOODS ON COMMUNICATION MEDIA, FOR RETAIL PURPOSES, NAMELY, PROVIDING AN ONLINE SHOPPING SITE IN THE FIELD OF GENERAL CONSUMER MERCHANDISE; AUCTION SERVICES; IMPORT-EXPORT AGENCIES; SALES PROMOTION FOR OTHERS; PROCUREMENT SERVICES FOR OTHERS, NAMELY, PURCHASING GOODS AND SERVICES FOR OTHER BUSINESSES, NAMELY, ARTWORKS, CULTURAL RELICS, ADORNMENT AND LUXURY GOODS; WORD PROCESSING; BUSINESS MANAGEMENT CONSULTANCY SERVICES (U.S. CLS. 100, 101 AND 102).

#### **CLASS 36—INSURANCE AND FINANCIAL**

FOR INSURANCE UNDERWRITING IN THE FIELD OF ART, LUXURY GOODS AND SERVICES, ARTWORK INSURANCE AND ARTWORK TRANSPORT; FINANCIAL CONSULTANCY; ANTIQUE APPRAISAL; ART APPRAISAL; JEWELRY APPRAISAL; REAL ESTATE MANAGEMENT; BROKERAGE IN THE FIELD OF ARTWORKS AND LUXURY GOODS; SURETY SERVICES; FIDUCIARY SERVICES, NAMELY, FIDUCIARY REPRESENTATIVE SERVICES; PAWN BROKERAGE (U.S. CLS. 100, 101 AND 102).

#### **CLASS 41—EDUCATION AND ENTERTAINMENT**

FOR ARRANGING AND CONDUCTING SYMPOSIUMS IN THE FIELD OF ART, CULTURE, AUCTIONS FOR PRODUCTS AND SERVICES, AND ARTWORK SALES AND INVESTMENT; MOBILE LIBRARY SERVICES; PUBLICATION OF ELECTRONIC BOOKS AND JOURNALS ON-LINE; PROVIDING ON-LINE ELECTRONIC PUBLICATIONS NOT DOWNLOADABLE, NAMELY, ON-LINE BOOKS AND BROCHURES IN THE FIELD OF ART, CULTURE, AUCTIONS FOR PRODUCTS AND SERVICES, AND ARTWORK SALES AND INVESTMENT; PRODUCTION OF SHOWS, NAMELY, TELEVISION SHOWS AND INTERNET VIDEO; VIDEOTAPE FILM PRODUCTION; MEMBERSHIP CLUB SERVICES, NAMELY, PROVIDING TRAINING TO MEMBERS IN THE FIELD OF ART, CULTURE, AUCTIONS FOR PRODUCTS AND SERVICES, AND ARTWORK SALES AND INVESTMENT; PROVIDING AMUSEMENT ARCADE SERVICES; MODELING FOR ARTISTS (U.S. CLS. 100, 101 AND 107).

#### **CLASS 42—SCIENTIFIC AND COMPUTER SERVICES**

FOR TECHNOLOGICAL RESEARCH IN THE FIELD OF ART, CULTURE, AUCTIONS FOR PRODUCTS AND SERVICES, AND ARTWORK SALES AND INVESTMENT; QUALITY CONTROL FOR OTHERS; CREATING AND MAINTAINING WEB SITES FOR OTHERS; AUTHENTICATING WORKS OF ART; GRAPHIC ARTS DESIGN; QUALITY ASSESSMENT OF INTANGIBLE ASSETS IN THE FIELD OF ART, CULTURE, AUCTIONS FOR PRODUCTS AND SERVICES, AND ARTWORK SALES AND INVESTMENT; INDUSTRIAL DESIGN; COMPUTER SOFTWARE DESIGN; MAINTENANCE OF COMPUTER SOFTWARE; CONVERSION OF DATA OR DOCUMENTS FROM PHYSICAL TO ELECTRONIC MEDIA (U.S. CLS. 100 AND 101).

BERNICE MIDDLETON, EXAMINING ATTORNEY

SN 79-128,688. DAMAG JOËLLE, FRANCE, FILED 1-21-2013.

**R.E.I.N.E.** *Return on Economics, Innovation, Nature & Ethnology*

PRIORITY DATE OF 7-31-2012 IS CLAIMED.  
OWNER OF INTERNATIONAL REGISTRATION 1156490  
DATED 1-21-2013, EXPIRES 1-21-2023.

#### **CLASS 16—PAPER GOODS AND PRINTED MATTER**

FOR BOOKBINDING MATERIAL; PHOTOGRAPHS; STATIONERY; ADHESIVES FOR STATIONERY OR HOUSEHOLD PURPOSES; PAINTBRUSHES; TYPEWRITERS; PRINTING TYPE; PRINTING BLOCKS; PAPER; CARDBOARD; BOXES OF CARDBOARD OR PAPER; POSTERS; NEWSPAPERS; CALENDARS; WRITING INSTRUMENTS; ENGRAVINGS OR LITHOGRAPHIC WORKS OF ART; GRAPHIC PRINTS (U.S. CLS. 2, 5, 22, 23, 29, 37, 38 AND 50).

#### **CLASS 41—EDUCATION AND ENTERTAINMENT**

FOR PROVIDING RECREATION FACILITIES; PUBLICATION OF BOOKS; VIDEOTAPE FILM PRODUCTION; PHOTOGRAPHY SERVICES; ORGANIZATION OF EXHIBITIONS FOR CULTURAL OR EDUCATIONAL PURPOSES; BOOKING OF SEATS FOR SHOWS; PUBLICATION OF ELECTRONIC BOOKS AND JOURNALS ON-LINE (U.S. CLS. 100, 101 AND 107).

**CLASS 42—SCIENTIFIC AND COMPUTER SERVICES**

FOR RESEARCH AND DEVELOPMENT OF NEW PRODUCTS FOR OTHERS; COMPUTER PROGRAMMING; COMPUTER SYSTEM ANALYSIS; COMPUTER SYSTEM DESIGN; CONSULTANCY RELATING TO COMPUTERS; CONVERSION OF COMPUTER PROGRAMS AND DATA NOT PHYSICAL CONVERSION; CONVERSION OF DATA OR DOCUMENTS FROM PHYSICAL TO ELECTRONIC MEDIA; PROGRAMMING FOR ELECTRONIC INSTRUMENTS AND APPARATUS, FOR COMPUTERS, FOR REMOTE INFORMATION TECHNOLOGY AND TELEMATIC SYSTEMS, FOR MULTIMEDIA EQUIPMENT; CREATING AND MAINTAINING WEB SITES FOR OTHERS; PROVIDING SEARCH ENGINES FOR THE INTERNET (U.S. CLS. 100 AND 101).

KATHERINE CHANG, EXAMINING ATTORNEY

SN 79-128,705. ETABLISSEMENTS DELHAIZE FRÈRES; ET CIE "LE LION"; (GROUPE DELHAIZE); EN NEERLANDAIS GEBROEDERS, BELGIUM, FILED 2-8-2013.



PRIORITY DATE OF 1-7-2013 IS CLAIMED.  
OWNER OF INTERNATIONAL REGISTRATION 1156568 DATED 2-8-2013, EXPIRES 2-8-2023.

NO CLAIM IS MADE TO THE EXCLUSIVE RIGHT TO USE "BIGGEST COOKING EVENT" IN CLASSES 41 AND 43, APART FROM THE MARK AS SHOWN.

THE COLOR(S) LIGHT GREEN, DARK GREEN AND WHITE IS/ARE CLAIMED AS A FEATURE OF THE MARK.

THE MARK CONSISTS OF THE WORDS "BIGGEST COOKING" IN WHITE AND "EVENT" IN LIGHT GREEN AND A DARK GREEN BACKGROUND AND THE DESIGN OF A CHEF'S HAT IN WHITE AND A LIGHT AND DARK GREEN BOOK BEING HELD BY WHITE HANDS.

**CLASS 29—MEATS AND PROCESSED FOODS**

FOR MEAT, FISH, POULTRY AND GAME; MEAT EXTRACTS; PRESERVED, FROZEN, DRIED AND COOKED FRUIT AND VEGETABLES; JELLIES, JAMS, COMPOTES; EGGS; MILK AND DAIRY PRODUCTS EXCLUDING ICE CREAM, ICE MILK AND FROZEN YOGURT; EDIBLE OILS AND FATS; FROZEN, PREPARED OR PACKAGED ENTREES CONSISTING PRIMARILY OF MEAT, FISH, POULTRY OR VEGETABLES (U.S. CL. 46).

**CLASS 30—STAPLE FOODS**

FOR COFFEE, TEA, COCOA AND ARTIFICIAL COFFEE; RICE; TAPIOCA AND SAGO; FLOUR; PREPARATIONS MADE FROM CEREALS, NAMELY, BREAD, PASTA, FLOUR, PASTRIES, FLAKES, MUESLI; CONFECTIONERY MADE OF SUGAR AND FROZEN CONFECTIONERY; EDIBLE ICES; SUGAR, HONEY, TREACLE; YEAST, BAKING-POWDER; SALT; MUSTARD; VINEGAR, SAUCERS; SPICES; ICE FOR REFRESHMENT; FROZEN, PREPARED OR PACKAGED ENTREES CONSISTING PRIMARILY OF PASTA OR RICE (U.S. CL. 46).

**CLASS 41—EDUCATION AND ENTERTAINMENT**

FOR EDUCATION IN THE FIELD OF CULINARY ARTS RENDERED THROUGH CORRESPONDENCE COURSES, VIDEO CONFERENCES AND BROADCAST OVER TELEVISION, SATELLITE, AUDIO, AND VIDEO MEDIA; EDUCATION SERVICES IN THE NATURE OF COOKING AND FOOD PREPARATION INSTRUCTION; TRAINING IN THE USE OF COOKING AND FOOD PREPARATION EQUIPMENT, SMALL COUNTERTOP ELECTRIC EQUIPMENT; ENTERTAINMENT IN THE NATURE OF COMPETITIONS IN THE ART OF COOKING, TELEVISION COOKING PROGRAMS OR SERIES; ENTERTAINMENT SERVICES, NAMELY, ARRANGING AND CONDUCTING OF COMPETITION AND CONTESTS IN THE FIELD OF CULINARY ARTS; EDUCATIONAL SERVICES, NAMELY, CONDUCTING COURSES IN THE FIELD OF CULINARY ARTS AND OENOLOGY; PUBLISHING OF COOKING BOOKS, NOTEBOOKS AND RECIPE CARDS (U.S. CLS. 100, 101 AND 107).

**CLASS 43—HOTEL AND RESTAURANT SERVICES**

FOR SERVICES FOR PROVIDING FOOD AND DRINK (U.S. CLS. 100 AND 101).

ANGELA M. MICHELI, EXAMINING ATTORNEY

SN 79-128,707. KERING, FRANCE, FILED 2-21-2013.



PRIORITY DATE OF 9-28-2012 IS CLAIMED.  
OWNER OF INTERNATIONAL REGISTRATION 1156571 DATED 2-21-2013, EXPIRES 2-21-2023.  
THE MARK CONSISTS OF A STYLIZED OWL WITH WINGS OUTSTRETCHED.

**CLASS 3—COSMETICS AND CLEANING PREPARATIONS**

FOR BLEACHING PREPARATIONS AND DETERGENTS FOR LAUNDRY USE; CLEANING, POLISHING, SCOURING AND ABRASIVE PREPARATIONS; SOAPS FOR PERSONAL USE; PERFUMERY; ESSENTIAL OILS; COSMETICS; HAIR LOTIONS; DENTIFRICES (U.S. CLS. 1, 4, 6, 50, 51 AND 52).

**CLASS 14—JEWELRY**

FOR PRECIOUS METALS AND THEIR ALLOYS; JEWELRY, PRECIOUS STONES; TIMEPIECES AND CHRONOMETRIC INSTRUMENTS; WORKS OF ART OF PRECIOUS METAL (U.S. CLS. 2, 27, 28 AND 50).

**CLASS 18—LEATHER GOODS**

FOR LEATHER AND IMITATION LEATHER, AND GOODS MADE OF THESE MATERIALS AND NOT INCLUDED IN OTHER CLASSES, NAMELY, BRIEFCASES, WALLETS, PURSES, HANDBAGS, BACKPACKS, TRAVEL BAGS, BEACH BAGS, SPORTS BAGS, GARMENT BAGS FOR TRAVEL, LEATHER KEY CASES; ANIMAL SKINS; TRUNKS AND SUITCASES; UMBRELLAS, PARASOLS AND WALKING STICKS; WHIPS, HARNESSES AND SADDLERY (U.S. CLS. 1, 2, 3, 22 AND 41).

**CLASS 25—CLOTHING**

FOR CLOTHING, NAMELY, TOPS, BOTTOMS, SOCKS, DRESSES, BELTS, SHIRTS, PANTS, NIGHTWEAR, SLEEPWEAR, SWIMWEAR; FOOTWEAR; HEADWEAR (U.S. CLS. 22 AND 39).

**CLASS 28—TOYS AND SPORTING GOODS**

FOR GAMES AND TOYS, NAMELY, BOARD GAMES, PLUSH TOYS, CARD GAMES, DICE GAMES, PARTY GAMES, PARLOR GAMES; ARTICLES FOR GYMNASTICS AND SPORTS, NAMELY, GYMNASTIC APPARATUS, SURF BOARDS; SKI EQUIPMENT, NAMELY, SKIS, SKI POLES AND SKI BAGS; PLAY AND SPORTS BALLS AND BALLOONS; TENNIS, TABLE TENNIS, BADMINTON AND SQUASH BATS AND RACKETS; CRICKET BATS, GOLF CLUBS, HOCKEY STICKS; TENNIS BALLS AND SHUTTLECOCKS; TABLE TENNIS TABLES; ROLLER SKATES; NETS FOR SPORTS; SPORTS GLOVES, NAMELY, BASEBALL GLOVES, BATTING GLOVES, FOOTBALL GLOVES, GOLF GLOVES, HOCKEY GLOVES, RACQUET BALL GLOVES, RUNNING GLOVES, WORK-OUT GLOVES; KNEE GUARDS, ELBOW GUARDS, ANKLE PADS AND SHIN GUARDS FOR SPORTS; GOLF BAGS; BAGS AND COVERS FOR TENNIS EQUIPMENT, TABLE TENNIS EQUIPMENT, BADMINTON EQUIPMENT, SQUASH RACKETS AND BATS, CRICKET BATS AND HOCKEY STICKS (U.S. CLS. 22, 23, 38 AND 50).

**CLASS 35—ADVERTISING AND BUSINESS**

FOR BUSINESS MANAGEMENT; BUSINESS ADMINISTRATION; OFFICE FUNCTIONS; BUSINESS INFORMATION; COMMERCIAL AND INDUSTRIAL MANAGEMENT ASSISTANCE; BUSINESS MANAGEMENT AND ORGANIZATION CONSULTANCY; ADVERTISING; TAX PREPARATION; CONDUCTING MARKETING STUDIES; BUSINESS EFFICIENCY EXPERTS SERVICES; ECONOMIC FORECASTING; MARKETING RESEARCH; MARKETING SERVICES; AUCTION SERVICES; COMPUTER FILE MANAGEMENT; DATA PROCESSING SERVICES, NAMELY, COLLECTING AND PROCESSING OF STATISTICAL DATA; PUBLIC RELATIONS; PUBLIC OPINION POLLING; MARKET OPINION POLLING; RETAIL STORE SERVICES AND ONLINE RETAIL STORE SERVICES FEATURING COSMETICS, PERFUMERY, JEWELRY, TIMEPIECES, LEATHERWARE, CLOTHING, FOOTWEAR, GYMNASTIC AND SPORTING ARTICLES, BOOKS, CD-ROMS AND DIGITAL COMPACT DISKS; BUSINESS MANAGEMENT ASSISTANCE AND BUSINESS ORGANIZATION AND MANAGEMENT CONSULTANCY IN THE SOCIO-EDUCATIONAL, CULTURAL, ENVIRONMENTAL PROTECTION, NEW ENERGY AND SUSTAINABLE DEVELOPMENT FIELDS (U.S. CLS. 100, 101 AND 102).

**CLASS 36—INSURANCE AND FINANCIAL**

FOR INSURANCE UNDERWRITING IN THE FIELDS OF LIFE, HEALTH, ACCIDENT AND FIRE; FINANCIAL AFFAIRS AND MONETARY AFFAIRS, NAMELY, FINANCIAL INFORMATION, MANAGEMENT AND ANALYSIS SERVICES; FINANCIAL OPERATIONS, NAMELY, FINANCIAL MANAGEMENT; MONETARY EXCHANGE OPERATIONS; REAL-ESTATE OPERATIONS, NAMELY, REAL ESTATE BROKERAGE; REAL ESTATE MANAGEMENT; REAL ESTATE APPRAISAL; BANKING; FINANCIAL ANALYSIS; INSURANCE INFORMATION; CAPITAL INVESTMENTS SERVICES; CREDIT CARD SERVICES; EXCHANGING MONEY; FINANCIAL CONSULTANCY; BUSINESS BROKERAGE, COMMODITY BROKERAGE, FINANCIAL INVESTMENT BROKERAGE, SECURITIES BROKERAGE, CREDIT AGENCIES; HIRE-PURCHASE FINANCING, SAVINGS ACCOUNT SERVICES; FINANCIAL EVALUATION IN THE FIELD OF INSURANCE, BANKING, AND REAL ESTATE; FISCAL ASSESSMENTS; TRUSTEESHIP REPRESENTATIVES; FINANCING SERVICES; FINANCIAL INFORMATION; MUTUAL FUNDS, NAMELY, MUTUAL FUNDS AND CAPITAL INVESTMENT, ESTABLISHING

MUTUAL FUNDS FOR OTHERS, MUTUAL FUND INVESTMENT; CAPITAL INVESTMENTS FOR HELPING TO ESTABLISH NEW COMPANIES; FINANCIAL SERVICES PROVIDED OVER THE INTERNET, NAMELY, ONLINE BANKING SERVICES; FINANCIAL SPONSORSHIP OF SPORT AND CULTURAL ACTIVITIES; PHILANTHROPIC SERVICES CONCERNING MONETARY DONATIONS; SECURE PAYMENT PROCESSING SERVICES PROVIDED VIA TELECOMMUNICATIONS AND COMPUTER NETWORKS; ISSUING OF PAYMENT VOUCHERS, TRAVELER'S CHECKS, CHECKS AND LETTERS OF CREDIT (U.S. CLS. 100, 101 AND 102).

**CLASS 38—COMMUNICATION**

FOR TELECOMMUNICATIONS ACCESS SERVICES; PROVISION OF ACCESS TO COMMERCIAL TRANSACTIONS BY MEANS OF ELECTRONIC COMMUNICATION NETWORKS; TELEVISION BROADCASTING SERVICES; CABLE TELEVISION BROADCASTING SERVICES; CELLULAR TELEPHONE SERVICES; RADIO COMMUNICATION SERVICES; TELEPHONE COMMUNICATION SERVICES; ELECTRONIC TRANSMISSION OF DATA AND DOCUMENTS BY MEANS OF COMPUTER TERMINALS; DELIVERY OF MESSAGES VIA ELECTRONIC TRANSMISSION; ELECTRONIC MAIL SERVICES; SENDING OF ELECTRONIC MESSAGES; FACSIMILE TRANSMISSION SERVICES; PAY-PER-VIEW TELEVISION PROGRAM BROADCASTING SERVICES; VIDEO TELECONFERENCING; TELEGRAPHY SERVICE; TELETXT SERVICE; PROVISION OF ACCESS TO ONLINE PORTALS; ELECTRONIC VOICE MESSAGING SERVICES; PROVIDING VOICE COMMUNICATIONS OVER THE INTERNET; SATELLITE TRANSMISSION (U.S. CLS. 100, 101 AND 104).

**CLASS 41—EDUCATION AND ENTERTAINMENT**

FOR EDUCATION SERVICES, NAMELY, PROVIDING TRAINING CLASSES, SEMINARS AND WORKSHOPS IN THE FIELD OF FASHION, LUXURY GOODS, BUSINESS MANAGEMENT; PROVIDING ONLINE TRAINING CLASSES, SEMINARS, WORKSHOPS IN THE FIELD OF FASHION, LUXURY GOODS, BUSINESS MANAGEMENT; ENTERTAINMENT IN THE NATURE OF FASHION SHOWS, CONDUCTING CONTESTS; ARRANGING AND CONDUCTING OF SPORTS COMPETITIONS; ORGANIZATION AND CONDUCTING OF SPORTS COMPETITIONS; PHYSICAL EDUCATION; OPERATION OF FITNESS CLUBS AND PHYSICAL TRAINING CENTERS, NAMELY, ORGANIZATION AND CONDUCTING OF PHYSICAL EXERCISE AND FITNESS, EXERCISE TRAINING CLASSES; OPERATION OF COVERED STADIUMS, GYMS AND SPORTS HALLS USING GYMNASTIC AND SPORTING APPARATUS (U.S. CLS. 100, 101 AND 107).

JAMES GRIFFIN, EXAMINING ATTORNEY

SN 79-128,799. FARINA (JINAN) WELDTEC & MACHINERY; CO., LTD., CHINA, FILED 12-21-2012.

# FARINA

OWNER OF INTERNATIONAL REGISTRATION 1156891 DATED 12-21-2012, EXPIRES 12-21-2022.

THE MARK IS COMPOSED OF ENGLISH CHARACTERS OF "FARINA", WHICH HAS NO MEANING.

**CLASS 6—METAL GOODS**

FOR SOLDERING WIRE OF METAL; RODS OF METAL FOR WELDING; IRON WIRE; NAILS; WIRE OF COMMON METAL ALLOYS, EXCEPT FUSE WIRE; GOLD SOLDER; STEEL WIRE (U.S. CLS. 2, 12, 13, 14, 23, 25 AND 50).



**CLASS 7—MACHINERY**

FOR GAS-OPERATED SOLDERING APPARATUS; ELECTRIC WELDING TORCHES; GAS-OPERATED WELDING MACHINES; SOLDERING BLOW PIPES, GAS-OPERATED (U.S. CLS. 13, 19, 21, 23, 31, 34 AND 35).  
JOHN DWYER, EXAMINING ATTORNEY

SN 79-128,864. DÜRR ECOCLEAN GMBH, FED REP GERMANY, AND DÜRR AKTIENGESELLSCHAFT, FED REP GERMANY, FILED 11-23-2012.

# ECOCSTEAM

THE MARK CONSISTS OF STANDARD CHARACTERS WITHOUT CLAIM TO ANY PARTICULAR FONT, STYLE, SIZE, OR COLOR.

PRIORITY DATE OF 5-25-2012 IS CLAIMED.  
OWNER OF INTERNATIONAL REGISTRATION 1157059 DATED 11-23-2012, EXPIRES 11-23-2022.

**CLASS 6—METAL GOODS**

FOR BUILDING MATERIALS, NAMELY, COMPOSITE PANELS COMPOSED PRIMARILY OF METAL; TRANSPORTABLE BUILDINGS OF METAL; PAINT SPRAYING BOOTHS OF METAL; FRAMES OF METAL FOR BUILDING; METAL PROFILES MADE OF STEEL, IRON, NICKEL, TITANIUM AND OTHER METALS AND THEIR ALLOYS; METAL RAILS; PIPEWORK OF METAL, INCLUDING OF STAINLESS STEEL, COPPER AND ALUMINUM ALLOYS; UPRIGHT SIGNBOARDS OF COMMON METAL; STRUCTURAL PARTS FOR ALL THE AFORESAID GOODS; PRESSURE VESSELS MADE OF METAL ALLOYS, NAMELY, PRESSURIZED STORAGE TANKS FOR LIQUIDS, GASES AND STEAM; NON-ELECTRIC CABLES AND WIRES OF COMMON METAL; SMALL ITEMS OF METAL HARDWARE, NAMELY, NUTS, SPRINGS, WASHERS; CONTAINERS OF METAL FOR TRANSPORT AND STORAGE, IN PARTICULAR OF STAINLESS STEEL; SLIDING VALVES OF METAL OTHER THAN PARTS OF MACHINES INCLUDING THOSE FROM ALLOY STEEL AND TITANIUM; METAL VALVES NOT BEING PARTS OF MACHINES; METAL, WASH DOWN SPRAY NOZZLES FOR COMMERCIAL AND INDUSTRIAL USE; COUPLINGS MADE OF METAL FOR PIPES; COUPLINGS FOR PIPES AND HOSES, OF METAL; CLIPS AND CLAMPS OF METAL FOR PIPES; METAL FLANGES; METAL FASTENERS, NAMELY, BOLTS, NAILS, RIVETS, SCREWS, CLIPS, CLAMPS, BRACKETS; PLUGS OF METAL; KNOBS OF METAL; STEEL MOUNTING BRACKETS FOR GENERAL USE (U.S. CLS. 2, 12, 13, 14, 23, 25 AND 50).

**CLASS 7—MACHINERY**

FOR MACHINES FOR CLEANING SURFACES USING HIGH PRESSURE WATER; CARPET CLEANING MACHINES; DRY CLEANING MACHINES; STEAM CLEANING MACHINES; SPRAY CHAMBERS FOR CLEANING AND DEGREASING SURFACES AND WORKPIECES; CONTAINER EMPTYING MACHINES; MACHINE PARTS, NAMELY, MACHINE HOUSINGS FOR MOTORS AND ENGINES; MACHINE PARTS, NAMELY, BOILERS FOR STEAM GENERATION; PRESSURE VESSELS AS MACHINE PARTS, NAMELY, PRESSURIZED STORAGE CHAMBERS FOR LIQUIDS, GASES AND STEAM; COMPRESSORS FOR MACHINES; PNEUMATIC COMPRESSORS; TURBINES OTHER THAN FOR LAND VEHICLES; PUMPS FOR MACHINES; COMPRESSED AIR PUMPS; POWER-OPERATED BLOWERS; MACHINE PARTS, NAMELY, POWER-OPERATED FANS; OIL, GAS AND AIR FILTERS FOR MACHINES, MOTORS AND ENGINES; SEPARATING MACHINES; SLIDING VALVES BEING PARTS OF MACHINES; VALVES BEING PARTS OF MACHINES; COMPRESSED AIR PILOT VALVES BEING PARTS OF MACHINES; MACHINE PARTS, NAMELY, NOZZLES WHICH ARE PARTS OF POWER-OPERATED SPRAYERS; TAPS AND CLACK VALVES BEING PARTS OF MACHINES, MOTORS OR

ENGINES; MACHINE PARTS, NAMELY, FLANGE JOINTS FOR CONNECTING PIPES; INDUSTRIAL ROBOTS BEING MACHINES; CONVEYORS; LIFTING DEVICES, NAMELY, ELEVATORS, ELEVATING OR LIFTING WORK PLATFORMS, POWER-OPERATED JACKS, CRANES, HOISTS; GRIPPING DEVICES AS PARTS OF MACHINES; TRANSMISSION GEARS FOR MACHINES OTHER THAN FOR LAND VEHICLES; MOTOR DRIVES FOR MACHINES, OTHER THAN FOR LAND VEHICLES; CLUTCHES FOR MACHINES; MACHINE COUPLING AND TRANSMISSION COMPONENTS, EXCEPT FOR LAND VEHICLES; BEARINGS, AS PARTS OF MACHINES; LEVELING MOUNTS FOR MACHINES; ELECTRIC MOTORS FOR MACHINES; ELECTRIC GENERATORS; HYDRAULIC CONTROLS FOR MACHINES; PNEUMATIC CONTROLS FOR MACHINES; CLEANING INSTALLATIONS FOR CLEANING, WASHING AND/OR DEGREASING SURFACES AND WORKPIECES; STRUCTURAL PARTS FOR THE AFORESAID GOODS (U.S. CLS. 13, 19, 21, 23, 31, 34 AND 35).

**CLASS 9—ELECTRICAL AND SCIENTIFIC APPARATUS**

FOR WEIGHING APPARATUS AND INSTRUMENTS; WEIGHING EQUIPMENT, NAMELY, SCALES AND BALANCES; SCIENTIFIC APPARATUS, NAMELY, SENSING AND SIGNALING DEVICES FOR MEASUREMENT AND QUALITY CONTROL OF MATERIALS PROCESSING BY LASER; TECHNICAL MEASURING, TESTING AND CHECKING APPARATUS AND INSTRUMENTS FOR MEASURING, TESTING AND CHECKING THE TEMPERATURE, PRESSURE, QUANTITY AND CONCENTRATION OF GAS AND LIQUIDS; POWER SUPPLIES; ELECTRIC CONDUCTOR RAILS; ELECTRICAL CONNECTORS; ELECTRICAL SWITCHES; ELECTRIC PUSH-BUTTON SWITCHES; ELECTRIC CABLES; ELECTRIC PLUGS; ELECTRIC COUPLINGS; ELECTRICAL SENSORS; OPTICAL SENSORS; LIQUID LEVEL SENSORS, PRESSURE SENSORS; ELECTRICAL CONTROLLERS; ELECTRIC CONTROLS FOR VALVES; ELECTRIC, ELECTRONIC AND ELECTROMAGNETIC RELAYS; THERMOMETERS; TEMPERATURE REGULATORS FOR COMMERCIAL USE; WATER METERS; TRANSFORMERS; ELECTRIC FUSES; ELECTRIC SWITCH HOUSINGS; COMPUTER CENTRAL PROCESSING UNITS; COMPUTER DATA INPUT DEVICES FOR COMPUTERS; ELECTRIC SWITCHBOARDS; COMPUTER MONITORS; KEYBOARDS; DEVICES FOR WIRELESS RADIO TRANSMISSION; INTERFACES FOR COMPUTERS; MEMORY CARDS; CARDS BEARING INTEGRATED CIRCUITS; STRUCTURAL PARTS FOR ALL THE AFORESAID GOODS; ELECTRIC VALVES FOR CONTROLLING AND REGULATING THE FLOW OF GASES OR LIQUIDS NOT BEING PARTS OF PLUMBING, HEATING, COOLING INSTALLATIONS OR MACHINES; DOWNLOADABLE COMPUTER SOFTWARE FOR ENGINEERING PURPOSES, FOR CALCULATING TECHNICAL PROBLEMS OR CONTROLLING MACHINES; INDUSTRIAL PROCESS CONTROL SOFTWARE (U.S. CLS. 21, 23, 26, 36 AND 38).

**CLASS 11—ENVIRONMENTAL CONTROL APPARATUS**

FOR APPARATUS FOR HEATING, STEAM GENERATING, REFRIGERATING, DRYING, VENTILATING AND WATER SUPPLY PURPOSES, NAMELY, INDUSTRIAL HEATING AND COOLING DEVICES FOR HEATING AND/OR COOLING OF LIQUIDS INCLUDING WATER AND/OR GASES; INDUSTRIAL DEVICES FOR EVAPORATING LIQUIDS INCLUDING WATER TO PRODUCE STEAM FROM THE LIQUID; INDUSTRIAL DEVICES FOR SEPARATING LIQUID DROPLETS FROM FLUIDS INCLUDING STEAM; INDUSTRIAL DEVICES FOR THE SUPPLY OF FLUIDS INCLUDING WATER STEAM, LIQUID WATER, OR AIR INTO CLEANING SYSTEMS; STEAM GENERATORS; STEAM GENERATING BOILERS FOR WARMING UP LIQUIDS AND/OR GENERATING STEAM FROM LIQUIDS; DRYING APPARATUS AND INSTALLATIONS, NAMELY, HOT AIR, VACUUM AND RADIATION DRYERS FOR USE IN HEATING, VENTILATION SYSTEMS, AIR CONDITIONING SYSTEMS AND REFRIGERATION SYSTEMS; WATER TREATMENT APPARATUS, NAMELY, WASTE WATER PURIFICATION APPARATUS, INSTAL-

LATION TANKS, WATER FILTRATION UNITS; WATER SOFTENING APPARATUS AND INSTALLATIONS; REGULATING ACCESSORIES FOR WATER SUPPLY, NAMELY, METERED VALVES; STEAM VALVES FOR REGULATING STEAM SUPPLY; VENTILATING FANS FOR COMMERCIAL AND INDUSTRIAL USE; AIR AND WATER FILTERS FOR INDUSTRIAL INSTALLATIONS; TAPS AND STRUCTURAL PARTS FOR THE AFOREMENTIONED APPARATUS AND INSTALLATIONS; TAPS FEATURING BALL COCKS AND STOPCOCKS; ELECTRIC LIGHTS FOR USE IN INDUSTRIAL INSTALLATIONS; STRUCTURAL PARTS OF THE AFORESAID GOODS (U.S. CLS. 13, 21, 23, 31 AND 34).

#### CLASS 17—RUBBER GOODS

FOR NON-METALLIC HOSES; NON-METAL COUPLINGS FOR USE WITH THE AFORESAID HOSES; NON-METALLIC FLEXIBLE PIPES OR PIPEWORK, NOT FOR USE IN BUILDING; NON-METALLIC PIPE COUPLINGS; STRUCTURAL PARTS FOR THE AFORESAID GOODS (U.S. CLS. 1, 5, 12, 13, 35 AND 50).

#### CLASS 19—NON-METALLIC BUILDING MATERIALS

FOR TRANSPORTABLE AND STATIONARY NON-METAL BOOTHS FOR AT LEAST PARTIALLY ENCASED OR PROTECTING OPERATING MACHINES, ROBOTS OR CLEANING APPARATUS; STRUCTURAL PARTS FOR THE AFOREMENTIONED GOODS (U.S. CLS. 1, 12, 33 AND 50).

#### CLASS 37—CONSTRUCTION AND REPAIR

FOR INSTALLATION, MAINTENANCE AND REPAIR OF MACHINES FOR CLEANING SURFACES USING FLUID INCLUDING WATER STEAM OR LIQUIDS UNDER PRESSURE (U.S. CLS. 100, 103 AND 106).

#### CLASS 42—SCIENTIFIC AND COMPUTER SERVICES

FOR ENGINEERING; SURVEYING; CONDUCTING OF TECHNICAL PROJECT FEASIBILITY STUDIES; PLANNING AND DESIGN INDUSTRIAL FACILITIES; TECHNOLOGICAL CONSULTATION IN THE TECHNOLOGY FIELD OF DESIGN OF CLEANING MACHINES AND INSTALLATIONS; DESIGN, INSTALLATION, MAINTENANCE, DEVELOPMENT AND UPDATING OF COMPUTER SOFTWARE (U.S. CLS. 100 AND 101).

CAROL SPILS, EXAMINING ATTORNEY

THE ENGLISH TRANSLATION OF "KOYO" IN THE MARK IS "LIGHT OF THE SEA".

#### CLASS 7—MACHINERY

FOR INDUSTRIAL WELDING ROBOTS; INDUSTRIAL METALWORKING ROBOTS; METALWORKING MACHINES, NAMELY, GRINDING MACHINES, SHAPING MACHINES, MACHINING CENTERS, CUTTING MACHINES, LATHES, AND PUNCHING PRESSES; METALWORKING MACHINE TOOLS; OIL HYDRAULIC PRESSES FOR METALWORKING; ELECTRIC WELDING MACHINES; PRESS DIES FOR METALFORMING; FORGING MOLDS; HIGH PRECISION METALWORKING MACHINE TOOLS; INDUSTRIAL MINING ROBOTS; MINING MACHINES AND APPARATUS, NAMELY, MINE BORERS, MINING BITS, AND DRILLS FOR THE MINING INDUSTRY; INDUSTRIAL CONSTRUCTION ROBOTS; CONSTRUCTION MACHINES AND APPARATUS, NAMELY, CONCRETE CONSTRUCTION MACHINES; LOADING-UNLOADING MACHINES; LOADING-UNLOADING MACHINES AND APPARATUS, NAMELY, CONVEYORS; INDUSTRIAL FISHING ROBOTS; NET HAULING MACHINES; INDUSTRIAL CHEMICAL PROCESSING ROBOTS; CHEMICAL PROCESSING MACHINES AND APPARATUS, NAMELY, DISSOLVING MACHINES AND EXTRACTING MACHINES; INDUSTRIAL ROBOTS FOR THE TEXTILE INDUSTRY; TEXTILE MACHINES AND APPARATUS, NAMELY, TEXTILE TENTERING MACHINES AND TEXTILE BONDING MACHINES; INDUSTRIAL FOOD OR BEVERAGE PROCESSING ROBOTS; FOOD OR BEVERAGE PROCESSING MACHINES AND APPARATUS, NAMELY, FOOD CUTTING MACHINES FOR COMMERCIAL USE, FOOD SLICING MACHINES FOR COMMERCIAL USE, AND BEVERAGE PROCESSING MACHINES; INDUSTRIAL LUMBERING, WOODWORKING, OR VENEER OR PLYWOOD MAKING ROBOTS; LUMBERING, WOODWORKING, OR VENEER OR PLYWOOD MAKING MACHINES AND APPARATUS, NAMELY, WOOD MILLING MACHINES AND WOOD SAWING MACHINES; INDUSTRIAL PULP MAKING, PAPERMAKING OR PAPER-WORKING ROBOTS; PULP MAKING, PAPERMAKING OR PAPER-WORKING MACHINES AND APPARATUS, NAMELY, PAPER CUTTING MACHINES AND PAPER COATING MACHINES; INDUSTRIAL PRINTING OR BOOKBINDING ROBOTS; PRINTING OR BOOKBINDING MACHINES AND APPARATUS, NAMELY, PRINTING PRESSES AND BOOKBINDING MACHINES FOR INDUSTRIAL PURPOSES; SEWING MACHINES; INDUSTRIAL AGRICULTURAL ROBOTS; AGRICULTURAL MACHINES, NAMELY, COMBINES AND HARVESTERS; AGRICULTURAL IMPLEMENTS OTHER THAN HAND-OPERATED, NAMELY, HAY BALERS AND COULTERS; INDUSTRIAL SHOE MAKING ROBOTS; SHOE MAKING MACHINES; INDUSTRIAL LEATHER TANNING ROBOTS; LEATHER TANNING MACHINES; INDUSTRIAL TOBACCO PROCESSING ROBOTS; TOBACCO PROCESSING MACHINES; INDUSTRIAL GLASSWARE MANUFACTURING ROBOTS; GLASSWARE MANUFACTURING MACHINES AND APPARATUS, NAMELY, GLASSWARE MANUFACTURING MACHINES; INDUSTRIAL PAINTING ROBOTS; PAINTING MACHINES AND APPARATUS, NAMELY, PAINTING MACHINES; INDUSTRIAL PACKAGING OR WRAPPING ROBOTS; PACKAGING OR WRAPPING MACHINES AND APPARATUS, NAMELY, VACUUM PACKING MACHINES; POWER-OPERATED POTTERS' WHEELS; INDUSTRIAL PLASTIC PROCESSING ROBOTS; PLASTIC PROCESSING MACHINES; INDUSTRIAL SEMICONDUCTOR MANUFACTURING ROBOTS; SEMICONDUCTOR MANUFACTURING MACHINES AND SYSTEMS, NAMELY, SEMICONDUCTOR MANUFACTURING MACHINES AND SEMICONDUCTOR WAFER PROCESSING MACHINES; INDUSTRIAL ROBOTS FOR MANUFACTURING RUBBER GOODS; MACHINES AND APPARATUS FOR MANUFACTURING RUBBER GOODS, NAMELY, RUBBER VULCANIZING APPARATUS; INDUSTRIAL STONE WORKING ROBOTS; STONE WORKING MACHINES AND APPARATUS, NAMELY, ROCK DRILLS AND MACHINE TOOLS FOR CRUSHING ROCK; NON-ELECTRIC PRIME MOVERS, NAMELY, GAS TURBINE ENGINES NOT FOR LAND VEHICLES; PNEUMATIC OR HYDRAULIC MACHINES, NAMELY, OIL PUMPS FOR LAND VEHICLES; ADHESIVE TAPE DISPENSING MACHINES; AUTOMATIC STAMPING MACHINES; DISHWASHERS; ELECTRIC WAX-POLISH-

SN 79-129,112. JTEKT CORPORATION, JAPAN, FILED 5-31-2012.



PRIORITY DATE OF 12-1-2011 IS CLAIMED.  
OWNER OF INTERNATIONAL REGISTRATION 1157716 DATED 5-31-2012, EXPIRES 5-31-2022.  
OWNER OF U.S. REG. NOS. 700,097, 3,576,218 AND 4,223,676.

THE COLOR(S) BLACK, RED, BLUE AND GRAY IS/ARE CLAIMED AS A FEATURE OF THE MARK.

THE MARK CONSISTS OF A GRAY STYLIZED "T" DESIGN WITH A WORD "JTEKT" IN BLACK WITH A RED HORIZONTAL LINE IN THE "E"; THE WORD "KOYO" IN BLUE IN THE BOTTOM LEFT; AND A RED STYLIZED "T" DESIGN IN THE BOTTOM RIGHT.

ING MACHINES FOR INDUSTRIAL PURPOSES; WASHING MACHINES FOR INDUSTRIAL PURPOSES; VACUUM CLEANERS; ELECTRIC FOOD BLENDERS FOR HOUSEHOLD PURPOSES; MACHINES AND APPARATUS FOR REPAIRING AND FIXING, NAMELY, MACHINES FOR REPAIRING SHOES; MECHANICAL PARKING SYSTEMS; VEHICLE WASHING INSTALLATIONS; POWER SPRAYERS FOR DISINFECTING, INSECTICIDES AND DEODORANTS NOT FOR AGRICULTURAL PURPOSES; BEARINGS AS MACHINE ELEMENTS NOT FOR LAND VEHICLES; POWER TRANSMISSIONS AND GEARING FOR MACHINES, NOT FOR LAND VEHICLES; MACHINE ELEMENTS NOT FOR LAND VEHICLES, NAMELY, CAM SHAFTS, AXLES OR SPINDLES, SPRINGS, BRAKES AND VALVES; LAWNMOWERS; CURTAIN DRAWING DEVICES ELECTRICALLY OPERATED; WASTE COMPACTING MACHINES; WASTE CRUSHING MACHINES; STARTERS FOR MOTORS AND ENGINES; AC MOTORS AND DC MOTORS FOR TOYS AND MACHINES; AC GENERATORS; DC GENERATORS; DYNAMO BRUSHES; ELECTRIC ARC WELDING MACHINES; ELECTRIC METAL CUTTING MACHINES THAT USE ARC, GAS OR PLASMA; ELECTRIC WELDING APPARATUS, NAMELY, ELECTRIC WELDING MACHINES AND GAS WELDING MACHINES FOR METALWORKING (U.S. CLS. 13, 19, 21, 23, 31, 34 AND 35).

#### CLASS 12—VEHICLES

FOR ROPEWAYS FOR CARGO OR FREIGHT HANDLING, NAMELY, TOW ROPES FOR VEHICLES AND CARGO SLINGS OF ROPE; UNLOADING TIPPLERS FOR TILTING RAILWAY FREIGHT CARS; PUSHER CARS FOR MINING; PULLER CARS FOR MINING; TRACTION ENGINE; NON-ELECTRIC PRIME MOVERS FOR LAND VEHICLES, NAMELY, AUTOMOBILE ENGINES; WHEEL BEARINGS FOR LAND VEHICLES; AXLE BEARINGS FOR LAND VEHICLES; POWER TRANSMISSIONS AND GEARINGS FOR LAND VEHICLES; DRIVE SHAFTS, AXLES AND SPINDLES FOR LAND VEHICLES; SHAFT COUPLINGS OR CONNECTORS IN THE NATURE OF COUPLINGS FOR LAND VEHICLES; SHOCK ABSORBERS FOR LAND VEHICLES; SPRINGS, NAMELY, SHOCK ABSORBING SPRINGS FOR LAND VEHICLES AND SUSPENSION SPRINGS FOR LAND VEHICLES; BRAKES FOR LAND VEHICLES; STEERING UNITS FOR LAND VEHICLES AND THEIR PARTS AND FITTINGS; POWER STEERING UNITS FOR LAND VEHICLES AND THEIR PARTS AND FITTINGS; DIFFERENTIALS FOR LAND VEHICLES AND THEIR PARTS AND FITTINGS; PARACHUTES; ANTI-THEFT ALARMS FOR VEHICLES; WHEELCHAIRS; AC MOTORS OR DC MOTORS FOR LAND VEHICLES; VESSELS AND THEIR STRUCTURAL PARTS AND FITTINGS; AIRCRAFT AND THEIR STRUCTURAL PARTS AND FITTINGS; RAILWAY ROLLING STOCK AND THEIR STRUCTURAL PARTS AND FITTINGS; AUTOMOBILES AND THEIR STRUCTURAL PARTS AND FITTINGS; TWO-WHEELED MOTOR VEHICLES, BICYCLES AND THEIR STRUCTURAL PARTS AND FITTINGS; BABY CARRIAGES; RICKSHAW; SLEIGHS AND SLEDS FOR TRANSPORT PURPOSES; WHEELBARROWS; CARTS; HORSE DRAWN CARRIAGES; BICYCLE TRAILERS; ADHESIVE RUBBER PATCHES FOR REPAIRING TUBES OR TIRES (U.S. CLS. 19, 21, 23, 31, 35 AND 44).

MAYUR VAGHANI, EXAMINING ATTORNEY

#### CLASS 9—ELECTRICAL AND SCIENTIFIC APPARATUS

FOR ELECTROLYSERS; SIMULATORS FOR THE STEERING AND CONTROL OF VEHICLES; SPORTS TRAINING SIMULATORS; LABORATORY APPARATUS AND INSTRUMENTS, NAMELY, CENTRIFUGES AND SYRINGELESS FILTERS; PHOTOGRAPHIC INSTRUMENTS AND APPARATUS, NAMELY, CAMERAS AND VIDEO CAMERAS; CINEMATOGRAPHIC INSTRUMENTS AND APPARATUS, NAMELY, VIDEO CAMERAS; OPTICAL APPARATUS AND INSTRUMENTS, NAMELY, MICROSCOPES AND EYEGASSES; MEASURING OR TESTING MACHINES AND INSTRUMENTS, NAMELY, TEMPERATURE SENSORS, PRESSURE SENSORS AND LIQUID LEVEL SENSORS; POWER DISTRIBUTION OR CONTROL MACHINES AND APPARATUS, NAMELY, ELECTRICAL POWER DISTRIBUTION UNITS AND POWER DISTRIBUTION BOXES; ROTARY CONVERTERS; PHASE MODIFIERS, NAMELY, OPTICAL PHASE SHIFTERS; BATTERIES AND DRY CELLS; ELECTRIC OR MAGNETIC METERS AND TESTERS, NAMELY, FLOW METERS, GAS METERS, ELECTRIC METERS AND CIRCUIT TESTERS; ELECTRIC WIRES AND CABLES; TELECOMMUNICATION DEVICES AND APPARATUS, NAMELY, TELEPHONE ANSWERING MACHINES, ELECTRIC INSTALLATIONS FOR THE REMOTE CONTROL OF INDUSTRIAL OPERATIONS, AND ELECTRONIC APPARATUS FOR THE REMOTE CONTROL OF INDUSTRIAL OPERATIONS; ELECTRONIC MACHINES, APPARATUS AND THEIR PARTS, NAMELY, COMPUTER HARDWARE AND COMPUTER PERIPHERAL DEVICES, COMPUTER PROGRAMS FOR CONTROLLING AND OPERATING MACHINE TOOLS AND ELECTRIC POWER STEERING, AND PROGRAMMABLE LOGIC CONTROLLERS; PROGRAMMABLE ELECTRICAL CONTROLLERS; PROGRAMMABLE BRAKE CONTROLLERS; MAGNETIC CORES; RESISTANCE WIRES; FUEL CELL ELECTRODES; AIR TANKS FOR SCUBA DIVING; ELECTRONIC PUBLICATIONS, NAMELY, MANUALS FEATURING MACHINES, MACHINE PARTS, AUTOMOBILE PARTS AND MACHINE TOOLS, RECORDED ON COMPUTER MEDIA (U.S. CLS. 21, 23, 26, 36 AND 38).

SN 79-129,120. HICAT GMBH, BONN, FED REP GERMANY, FILED 11-27-2012.

---

# Hicat

THE MARK CONSISTS OF STANDARD CHARACTERS WITHOUT CLAIM TO ANY PARTICULAR FONT, STYLE, SIZE, OR COLOR.

OWNER OF INTERNATIONAL REGISTRATION 1157733 DATED 11-27-2012, EXPIRES 11-27-2022.

**CLASS 9—ELECTRICAL AND SCIENTIFIC APPARATUS**

FOR SCIENTIFIC OR ELECTRICAL MEASURING, SIGNALING AND CONTROLLING APPARATUS AND INSTRUMENTS FOR IMAGING METHODS AND TECHNIQUES IN THE FIELD OF MEDICAL TECHNOLOGY, NAMELY, COMPUTER HARDWARE FOR IMAGING IN THE MEDICAL, DENTAL, AND VETERINARY FIELDS; APPARATUS FOR REPRODUCTION OF IMAGES IN THE FIELD OF MEDICAL TECHNOLOGY, NAMELY, DATA PROCESSORS, OPTICAL SENSORS, RADIOSENSITIVE SENSORS, ELECTROMECHANICAL SENSORS, ELECTRICAL AND OPTICAL DETECTORS, WIRELESS TRANSMITTERS AND RECEIVERS, FILM CAMERAS, SCANNERS, COMPUTER MONITORS, COMPUTERS AND PRINTERS; SOFTWARE FOR SUPPORTING SURGICAL, MEDICAL AND DENTAL DIAGNOSIS, PLANNING AND THERAPY, IN RELATION TO IMAGING METHODS AND TECHNIQUES, NAMELY, COMPUTER SOFTWARE FOR PROCESSING, DISPLAYING, RETRIEVING, MANAGING, STORING, AND TRANSMITTING RADIOGRAPHIC IMAGES AND DATA FOR USE IN THE MEDICAL, DENTAL, AND VETERINARY FIELDS AND SOFTWARE FOR MANAGING MEDICAL OR DENTAL PRACTICES, AND FOR CLINICAL AND DIAGNOSTIC APPLICATIONS AND SOFTWARE FOR IMAGING IN THE MEDICAL, DENTAL, AND VETERINARY FIELDS (U.S. CLS. 21, 23, 26, 36 AND 38).

**CLASS 10—MEDICAL APPARATUS**

FOR INSTRUMENTS AND APPARATUS FOR SUPPORTING MEDICAL, DENTAL, AND SURGICAL PLANNING AND THERAPY, NAMELY, SURGICAL INSTRUMENTS AND APPARATUS FOR MEDICAL AND DENTAL USE; INSTRUMENTS AND APPARATUS FOR SUPPORTING MEDICAL, DENTAL, AND SURGICAL PLANNING AND THERAPY, NAMELY, ORTHODONTIC SPLINTS AND ORTHOSES, NAMELY, ORTHOTICS FOR THE MOUTH AND TEETH FOR TREATING SNORING AND SLEEPING DISORDERS (U.S. CLS. 26, 39 AND 44).

**CLASS 41—EDUCATION AND ENTERTAINMENT**

FOR TRAINING IN THE FIELD OF SOFTWARE THAT ARE USED FOR SUPPORTING SURGICAL, MEDICAL AND DENTAL DIAGNOSIS, PLANNING AND THERAPY, IN RELATION TO IMAGING PROCEDURES AND TECHNIQUE (U.S. CLS. 100, 101 AND 107).

**CLASS 42—SCIENTIFIC AND COMPUTER SERVICES**

FOR SCIENTIFIC AND INDUSTRIAL RESEARCH IN THE FIELD OF MEDICAL TECHNOLOGY IN CONNECTION WITH IMAGING METHODS AND TECHNIQUES; COMPUTER PROGRAMMING FOR ELECTRONIC DATA PROCESSING (EDP) IN RELATION TO IMAGING METHODS AND TECHNIQUES IN THE FIELD OF MEDICAL TECHNOLOGY; DEVELOPMENT OF COMPUTER PROGRAMS FOR SUPPORTING SURGICAL, MEDICAL AND DENTAL DIAGNOSIS, PLANNING AND THERAPY, IN RELATION TO IMAGING METHODS AND TECHNIQUES; COMPUTER SOFTWARE CONSULTANCY (U.S. CLS. 100 AND 101).

**CLASS 45—PERSONAL AND LEGAL SERVICES**

FOR LICENSING OF COMPUTER SOFTWARE (U.S. CLS. 100 AND 101).  
HAI-LY LAM, EXAMINING ATTORNEY

SN 79-129,141. JUST ONE PIECE S.R.L., ITALY, FILED 2-26-2013.

# JUST ONE PIECE

THE MARK CONSISTS OF STANDARD CHARACTERS WITHOUT CLAIM TO ANY PARTICULAR FONT, STYLE, SIZE, OR COLOR.

PRIORITY DATE OF 2-4-2013 IS CLAIMED.  
OWNER OF INTERNATIONAL REGISTRATION 1157782 DATED 2-26-2013, EXPIRES 2-26-2023.

**CLASS 11—ENVIRONMENTAL CONTROL APPARATUS**

FOR LIGHTING FIXTURES, LAMPS (U.S. CLS. 13, 21, 23, 31 AND 34).

**CLASS 20—FURNITURE AND ARTICLES NOT OTHERWISE CLASSIFIED**

FOR FURNITURE, FURNISHINGS; DESIGN OBJECTS MADE OF WOOD, WAX, PLASTER OR PLASTIC, NAMELY, DECORATIVE CENTERPIECES, BUSTS, PLASTIC THREE DIMENSIONAL DESIGNS TO BE ATTACHED TO WALLS, THREE DIMENSIONAL DECORATIVE PLASTIC ORNAMENTS TO BE ATTACHED TO WALLS, WINDOWS, MIRRORS AND OTHER SOLID SURFACES, FIGURINES OF WOOD, WAX, PLASTER OR PLASTIC, WORKS OF ART OF WOOD, WAX, PLASTER OR PLASTIC, SCULPTURES OF WOOD, WAX, PLASTER OR PLASTIC; MIRRORS, PICTURE FRAMES (U.S. CLS. 2, 13, 22, 25, 32 AND 50).

CHRISTINE MARTIN, EXAMINING ATTORNEY

SN 79-129,148. FINAPRES MEDICAL SYSTEMS B.V., NETHERLANDS, FILED 3-5-2013.

# MODELFLOW

THE MARK CONSISTS OF STANDARD CHARACTERS WITHOUT CLAIM TO ANY PARTICULAR FONT, STYLE, SIZE, OR COLOR.

OWNER OF INTERNATIONAL REGISTRATION 1157810 DATED 3-5-2013, EXPIRES 3-5-2023.

**CLASS 9—ELECTRICAL AND SCIENTIFIC APPARATUS**

FOR COMPUTER PROGRAMS FOR DERIVING HEMODYNAMIC PARAMETERS FROM BLOOD PRESSURE DATA, WAVEFORMS AND PATIENT DATA (U.S. CLS. 21, 23, 26, 36 AND 38).

**CLASS 42—SCIENTIFIC AND COMPUTER SERVICES**

FOR SCIENTIFIC AND TECHNOLOGICAL SERVICES, NAMELY, DESIGN AND DEVELOPMENT OF SOFTWARE FOR MONITORING MEDICAL PATIENTS; DESIGN AND DEVELOPMENT OF COMPUTER PROGRAMS FOR DERIVING HEMODYNAMIC PARAMETERS (U.S. CLS. 100 AND 101).

JUHI KAVEESHVAR, EXAMINING ATTORNEY

SN 79-129,167. J. D. NEUHAUS GMBH & CO. KG, FED REP GERMANY, FILED 1-10-2013.

SN 79-129,257. KABUSHIKI KAISHA SEGA, DBA SEGA CORPORATION, TOKYO 144-8531, JAPAN, FILED 3-19-2013.

# J.D. NEUHAUS

THE MARK CONSISTS OF STANDARD CHARACTERS WITHOUT CLAIM TO ANY PARTICULAR FONT, STYLE, SIZE, OR COLOR.

PRIORITY DATE OF 7-23-2012 IS CLAIMED.  
OWNER OF INTERNATIONAL REGISTRATION 1157850 DATED 1-10-2013, EXPIRES 1-10-2023.

OWNER OF U.S. REG. NO. 2,912,125.  
THE NAME "J.D. NEUHAUS" DOES NOT IDENTIFY A LIVING INDIVIDUAL.

## CLASS 7—MACHINERY

FOR INSTALLATIONS, APPARATUS AND EQUIPMENT FOR MATERIAL HANDLING TECHNOLOGY, NAMELY, ELECTRICALLY, PNEUMATICALLY, AND HYDRAULICALLY OPERATED CRANES, CONVEYORS, AND HOISTS; INSTALLATIONS, APPARATUS AND EQUIPMENT FOR MATERIAL HANDLING TECHNOLOGY, NAMELY, HAND-OPERATED CRANES, CONVEYORS, AND HOISTS; ELECTRICALLY, PNEUMATICALLY AND HYDRAULICALLY OPERATED TROLLEYS, NAMELY, BEAM TROLLEYS, CRANE TROLLEYS, SHUNTING TROLLEYS, GRADIENT TROLLEYS, AND GEAR TROLLEYS, FOR ATTACHING TO HOISTS FOR USE WITH CRANES OR STATIONARY BEAMS; WINCHES, LIFTING WINCHES, DRAW WINCHES, AND WIRE CABLE WINCHES; COMPRESSED AIR MOTORS; COMPRESSED AIR GEAR MOTORS; PNEUMATIC, HYDRAULIC, CABLE, AND LEVER CONTROLS SPECIALLY ADAPTED FOR USE WITH THE AFORESAID MENTIONED GOODS; PARTS OF THE AFORESAID GOODS, NAMELY, METAL PARTS AND FITTINGS FOR POWER-OPERATED LIFTING EQUIPMENT (U.S. CLS. 13, 19, 21, 23, 31, 34 AND 35).

## CLASS 37—CONSTRUCTION AND REPAIR

FOR INSTALLATION, MAINTENANCE AND REPAIR OF CRANES, HOISTS, AND MATERIAL HANDLING EQUIPMENT; REBUILDING OF MACHINES AND MOTORS FOR CRANES AND MATERIAL HANDLING INSTALLATIONS THAT HAVE BEEN WORN OR PARTIALLY DESTROYED; RENTAL OF CRANES, HOISTS, INSTALLATIONS, APPARATUS AND MATERIAL HANDLING EQUIPMENT (U.S. CLS. 100, 103 AND 106).

## CLASS 42—SCIENTIFIC AND COMPUTER SERVICES

FOR SCIENTIFIC AND TECHNOLOGICAL SERVICES, NAMELY, RESEARCH AND DESIGN IN THE FIELDS OF MATERIAL HANDLING TECHNOLOGY AND ENGINEERING; INDUSTRIAL ANALYSIS AND RESEARCH SERVICES IN THE FIELDS OF MATERIAL HANDLING TECHNOLOGY AND ENGINEERING; CONSTRUCTION DRAFTING; SURVEYING; ENGINEERING SERVICES IN THE NATURE OF TECHNICAL PROJECT PLANNING; TECHNICAL CONSULTANCY, NAMELY, ENGINEERING; MATERIAL TESTING; PRODUCT TESTING, NAMELY, TESTING THE FUNCTIONING OF NEW PRODUCTS FOR OTHERS; RENTAL OF TEST WEIGHTS FOR CRANE INSTALLATIONS; ENVIRONMENTAL TESTING AND INSPECTION SERVICES; TESTING SERVICES FOR THE CERTIFICATION OF QUALITY AND STANDARDS, NAMELY, TESTING OF THE GOODS OF OTHERS FOR THE PURPOSE OF CERTIFICATION; ALL THE AFORESAID SERVICES IN THE FIELD OF CRANES, HOISTS, AND MATERIAL HANDLING TECHNOLOGY (U.S. CLS. 100 AND 101).

TRACY FLETCHER, EXAMINING ATTORNEY

# SONIC JUMP

THE MARK CONSISTS OF STANDARD CHARACTERS WITHOUT CLAIM TO ANY PARTICULAR FONT, STYLE, SIZE, OR COLOR.

PRIORITY DATE OF 10-16-2012 IS CLAIMED.  
OWNER OF INTERNATIONAL REGISTRATION 1158074 DATED 3-19-2013, EXPIRES 3-19-2023.

OWNER OF U.S. REG. NOS. 1,861,048, 2,349,452 AND OTHERS.

## CLASS 9—ELECTRICAL AND SCIENTIFIC APPARATUS

FOR COMPUTER GAME PROGRAMS; COMPUTER GAME SOFTWARE; VIDEO GAME SOFTWARE; VIDEO GAME PROGRAMS; VIDEO GAME DISCS AND CARTRIDGES; COMPUTER GAME SOFTWARE FOR USE ON MOBILE AND CELLULAR PHONES (U.S. CLS. 21, 23, 26, 36 AND 38).

## CLASS 41—EDUCATION AND ENTERTAINMENT

FOR ENTERTAINMENT SERVICES, NAMELY, PROVIDING ON-LINE VIDEO GAMES AND ON-LINE COMPUTER GAMES; PROVIDING INFORMATION ON ON-LINE GAMES (U.S. CLS. 100, 101 AND 107).  
GENE MACIOL, EXAMINING ATTORNEY

SN 79-129,299. SEOUL SEMICONDUCTOR CO., LTD., REPUBLIC OF KOREA, FILED 3-20-2013.

# NPOLAS

THE MARK CONSISTS OF STANDARD CHARACTERS WITHOUT CLAIM TO ANY PARTICULAR FONT, STYLE, SIZE, OR COLOR.

OWNER OF INTERNATIONAL REGISTRATION 1132453 DATED 7-2-2012, EXPIRES 7-2-2022.

## CLASS 9—ELECTRICAL AND SCIENTIFIC APPARATUS

FOR DIODES; LIGHT EMITTING DIODES; TOP LIGHT EMITTING DIODES; POWER LIGHT EMITTING DIODES; CHIP LIGHT EMITTING DIODES; BIG TOP LIGHT EMITTING DIODES; HIGH FLUX LIGHT EMITTING DIODES; SIDE VIEW LIGHT EMITTING DIODES; ELECTROLUMINESCENCE DIODES; LASER DIODES; LUMINOFLUX METERS; TRAFFIC-LIGHT APPARATUS LUMINOUS OR MECHANICAL; TRAFFIC SIGNALING PANELS LUMINOUS OR MECHANICAL; ROAD SIGNS LUMINOUS OR MECHANICAL; SAFETY SIGNALING PANELS LUMINOUS OR MECHANICAL; SAFETY DISPLAY PANELS LUMINOUS OR MECHANICAL; SIGNALING PANELS LUMINOUS OR MECHANICAL; LUMINOUS SIGNS; LUMINOUS BEACONS; VEHICLE BREAKDOWN WARNING TRIANGLES LUMINOUS; LIGHTING BALLASTS; SEMI-CONDUCTORS (U.S. CLS. 21, 23, 26, 36 AND 38).

**CLASS 11—ENVIRONMENTAL CONTROL APPARATUS**

FOR GAS LAMPS; OIL LAMPS; LIGHTS FOR SHIPS; LAMPS FOR DIRECTIONAL SIGNALS OF SHIPS; LIGHT BULBS FOR DIRECTIONAL SIGNALS FOR SHIPS; HEADLIGHTS FOR SHIPS; LIGHTS FOR AIRCRAFTS; LAMPS FOR DIRECTIONAL SIGNALS OF AIRCRAFTS; LIGHT BULBS FOR DIRECTIONAL SIGNALS OF AIRCRAFTS; HEADLIGHTS FOR AIRCRAFTS; LIGHTS FOR RAILWAY VEHICLES; LAMPS FOR DIRECTIONAL SIGNALS OF RAILWAY VEHICLES; HEADLIGHTS FOR RAILWAY VEHICLES; CYCLE LIGHTS, NAMELY, MOTORCYCLE VEHICLE HEADLIGHTS; AUTOMOBILE LIGHTS; LAMPS FOR DIRECTIONAL SIGNALS OF AUTOMOBILES; LIGHT BULBS FOR DIRECTIONAL SIGNALS OF AUTOMOBILES; HEADLIGHTS FOR AUTOMOBILES; BICYCLE LIGHTS (U.S. CLS. 13, 21, 23, 31 AND 34).  
SIMON TENG, EXAMINING ATTORNEY

**CLASS 41—EDUCATION AND ENTERTAINMENT**

FOR EDUCATION AND TRAINING SERVICES, NAMELY, EDUCATIONAL COURSES AND TRAINING IN THE FIELD OF SELF-HELP; ACADEMIC AND VOCATIONAL EDUCATION SERVICES, NAMELY, TRAINING COURSES IN THE FIELD OF SELF-HELP; PROVISION OF COURSES OF INSTRUCTION, LECTURES AND SEMINARS IN THE FIELD OF SELF-HELP; ARRANGING AND CONDUCTING CONFERENCES, WORKSHOPS AND SEMINARS IN THE FIELD OF SELF-HELP; LIBRARY SERVICES; PUBLICATION OF BOOKS, TEXTS, MAGAZINES, JOURNALS, AND PERIODICALS; INFORMATION, ADVISORY AND CONSULTANCY SERVICES RELATING TO THE AFORESAID SERVICES (U.S. CLS. 100, 101 AND 107).  
JENNIFER BUTTON, EXAMINING ATTORNEY

SN 79-129,477. NEWSLUX, LUXEMBOURG, FILED 2-14-2013.

# i24news

THE MARK CONSISTS OF STANDARD CHARACTERS WITHOUT CLAIM TO ANY PARTICULAR FONT, STYLE, SIZE, OR COLOR.

PRIORITY DATE OF 12-27-2012 IS CLAIMED.  
OWNER OF INTERNATIONAL REGISTRATION 1158558 DATED 2-14-2013, EXPIRES 2-14-2023.

SN 79-129,409. MARK ROWE, IRELAND, FILED 2-14-2013.

**HOW STRONG IS YOUR TRAMPOLINE**

THE MARK CONSISTS OF STANDARD CHARACTERS WITHOUT CLAIM TO ANY PARTICULAR FONT, STYLE, SIZE, OR COLOR.

PRIORITY DATE OF 8-17-2012 IS CLAIMED.  
OWNER OF INTERNATIONAL REGISTRATION 1158388 DATED 2-14-2013, EXPIRES 2-14-2023.

**CLASS 9—ELECTRICAL AND SCIENTIFIC APPARATUS**

FOR ELECTRONIC PUBLICATIONS DOWNLOADABLE, NAMELY, NEWSLETTERS IN THE FIELD OF SELF-HELP; PUBLICATIONS, NAMELY, NEWSLETTERS DOWNLOADED IN ELECTRONIC FORM FROM THE INTERNET IN THE FIELD OF SELF-HELP; APPARATUS FOR RECORDING, TRANSMISSION AND REPRODUCTION OF SOUND, DATA AND/OR IMAGES; DATA STORAGE MEDIA, NAMELY, BLANK CDS AND DVDS; COMPUTER OPERATING PROGRAMS; PRE-RECORDED MAGNETIC DATA CARRIERS FEATURING SELF-HELP INFORMATION; DISCS FEATURING INFORMATION REGARDING SELF-HELP; COMPACT DISCS FEATURING INFORMATION REGARDING SELF-HELP; DVDS FEATURING INFORMATION REGARDING SELF-HELP; DOWNLOADABLE PODCASTS IN THE FIELD OF SELF-HELP; PARTS AND FITTINGS FOR THE AFORESAID GOODS (U.S. CLS. 21, 23, 26, 36 AND 38).

**CLASS 16—PAPER GOODS AND PRINTED MATTER**

FOR PAPER, CARDBOARD AND GOODS MADE FROM THESE MATERIALS, NAMELY, BOOKS IN THE FIELD OF SELF-HELP; PRINTED MATTER, NAMELY, BOOKS IN THE FIELD OF SELF-HELP; PRINTED PUBLICATIONS, NAMELY, WORKBOOKS IN THE FIELD OF SELF-HELP; NEWSPAPERS; NEWSLETTERS, PERIODICALS, CATALOGUES, BROCHURES, MAGAZINES, BOOKS, AND MANUALS IN THE FIELD OF SELF-HELP; STATIONERY; PRINTED INSTRUCTIONAL AND TEACHING MATERIALS IN THE FIELD OF SELF-HELP; PHOTOGRAPHS; PARTS AND FITTINGS FOR THE AFORESAID GOODS (U.S. CLS. 2, 5, 22, 23, 29, 37, 38 AND 50).

**CLASS 9—ELECTRICAL AND SCIENTIFIC APPARATUS**

FOR APPARATUS FOR THE RECORDING, REPRODUCTION, TRANSMISSION OF SOUND OR IMAGES; SOFTWARE FOR THE TRANSMISSION OF NEWS INFORMATION, COMPUTER PERIPHERALS, PHOTOGRAPHIC, CINEMATOGRAPHIC AND TEACHING APPARATUS AND INSTRUMENTS, NAMELY, CAMERAS, AUDIOVISUAL AND MAGNETIC RECORDING MEDIA, NAMELY, BLANK CDS AND DVDS; MEDIA APPARATUS AND INSTRUMENTS FOR THE TRANSMISSION, REPRODUCTION AND DUPLICATION OF SOUND AND/OR IMAGES; DATA MEDIA, RECORDED OR BLANK, NAMELY, BLANK CDS AND DVDS AND PRERECORDED CDS AND DVDS CONTAINING NEWS INFORMATION; PRE-RECORDED VIDEO CASSETTES AND VIDEO DISKS CONTAINING NEWS INFORMATION AND BLANK VIDEO CASSETTES AND VIDEO DISKS, PRE-RECORDED LASER CASSETTES AND LASER DISCS, MAGNETIC TAPE CASSETTES AND SOUND RECORDING DISCS, SOUND AND AUDIOVISUAL RECORDINGS ALL CONTAINING NEWS INFORMATION AND BLANK LASER CASSETTES AND LASER DISCS, MAGNETIC TAPE CASSETTES AND SOUND RECORDING DISCS, SOUND AND AUDIOVISUAL RECORDINGS; COMPACT DISCS, VIDEO DISCS, OPTICAL DISCS, DIGITAL OPTICAL DISCS ALL CONTAINING NEWS INFORMATION; BLANK VIDEO DIGITAL VERSATILE DISCS; ELECTRONIC CARDS AND ELECTRONIC GAME CARDS FOR PROCESSING IMAGES; MAGNETIC AND ELECTRONIC PENS, COMPUTER PROGRAMS FOR DATA PROCESSING, DOWNLOADABLE TELEVISION PROGRAMS ON VIDEOTAPE FEATURING NEWS INFORMATION, SOFTWARE FOR PROVIDING NEWS INFORMATION ON ALL TYPES OF MEDIA; PROGRAMS, NAMELY, DOWNLOADABLE SOFTWARE AND INTERACTIVE TELEVISION VIDEO GAME CARTRIDGES AND AUDIOVISUAL COMPUTER GAMES FEATURING DIGITAL MEDIA FOR COMPILATION AND COMPUTERIZED EDITING, DIGITIZATION OF TEXTS AND/OR FIXED OR ANIMATED IMAGES AND/OR SOUNDS, MUSICAL OR NOT, FOR INTERACTIVE OR NON-INTERACTIVE USE AND FOR PROVIDING DATABASES ESPECIALLY VOICE DATABASES, TEXT AND SOUND DATA BANKS AND IMAGE BANKS; COMPUTERS; DATA COMMUNICATION SOFTWARE RECORDED FLOPPY DISCS AND DIGITAL COMPACT DISCS CONTAINING NEWS INFORMATION; VIDEO AND COMPUTER GAMES ON

DIGITAL OPTICAL DISKS; VIDEO AND COMPUTER GAMES ON COMPACT DISCS (U.S. CLS. 21, 23, 26, 36 AND 38).

#### **CLASS 16—PAPER GOODS AND PRINTED MATTER**

FOR PAPER; CARDBOARD; CARDBOARD ARTICLES, NAMELY, BOXES; PRINTED MATTER, NAMELY, PAPER; NEWSPAPERS; BOOKS IN THE FIELD OF TELECOMMUNICATIONS; MANUALS IN THE FIELD OF TELECOMMUNICATIONS; PROMOTIONAL PAMPHLETS IN THE FIELD OF TELECOMMUNICATIONS; PAMPHLETS IN THE FIELD OF TELECOMMUNICATIONS; PUBLICATIONS, NAMELY, NEWSLETTERS IN THE FIELD OF TELECOMMUNICATIONS; MAGAZINES IN THE FIELD OF TELECOMMUNICATIONS; PRINTED PERIODICAL REVIEWS IN THE FIELD OF TELECOMMUNICATIONS, PAINTINGS AND ENGRAVINGS, WRAPPING PAPER; PAPER OR PLASTIC BAGS, SACHETS AND SHEETS FOR PACKAGING; SHIELDS IN THE NATURE OF PAPER SEALS; PRINTED PAPER OR CARDBOARD SIGNS, NON-TEXTILE PAPER LABELS, FLAGS OF PAPER; POSTERS; POSTCARDS, TRANSFERS DECALCOMANIAS; GRAPHIC PRINTS; ENGRAVINGS; PICTURES; BANDS OF PAPER OR CARDBOARD FOR RECORDING COMPUTER PROGRAMS; TEACHING MATERIAL IN THE FORM OF BOOKS FEATURING GAMES; PRINTED MATTER IN THE NATURE OF PRINTING PRODUCTS, NAMELY, PAPER AND INK SHEETS; PRINTING TYPE; PRINTING BLOCKS; PRINTED INSTRUCTIONAL AND TEACHING MATERIAL IN THE FIELD OF TELECOMMUNICATIONS AND NEWS INFORMATION (U.S. CLS. 2, 5, 22, 23, 29, 37, 38 AND 50).

#### **CLASS 25—CLOTHING**

FOR CLOTHING, NAMELY, SHIRTS AND PANTS, FOOTWEAR, HEADGEAR, NAMELY, HATS AND CAPS (U.S. CLS. 22 AND 39).

#### **CLASS 28—TOYS AND SPORTING GOODS**

FOR BOARD GAMES, PLUSH TOYS; PLAYING CARDS; GYMNAS TIC AND SPORTING ARTICLES EXCLUDING CLOTHING, FOOTWEAR, MATS, NAMELY, GYMNAS TIC APPARATUS; AUTOMATIC AND ELECTRONIC GAMES OTHER THAN COIN-OPERATED AND THOSE DESIGNED TO BE USED ONLY WITH A TELEVISION SET (U.S. CLS. 22, 23, 38 AND 50).

#### **CLASS 35—ADVERTISING AND BUSINESS**

FOR ADVERTISING AND BUSINESS INFORMATION SERVICE; UPDATING OF ADVERTISING MATERIAL; ASSISTANCE AND ADVICE FOR BUSINESS ORGANIZATION AND MANAGEMENT; BUSINESS CONSULTANCY; BILLBOARD ADVERTISING, DISTRIBUTION OF ADVERTISING MATERIAL, PARTICULARLY FOR NATIONAL OR INTERNATIONAL MAIL-ORDER SALE; SERVICES OF A FRANCHISER, NAMELY, COMMERCIAL OR INDUSTRIAL MANAGEMENT OR OPERATIONAL ASSISTANCE; COMMERCIAL INFORMATION AND ADVICE SERVICES; COMMERCIAL PROMOTION FOR OTHERS IN ALL FORMS, AND ESPECIALLY VIA THE PROVISION OF PRIVILEGED USER CARDS; CARRYING OUT COMMERCIAL ACTIVITIES, NAMELY, BUSINESS MANAGEMENT AND SALES PROMOTION FOR OTHERS OF ALL KINDS AND ON ALL MEDIA, ESPECIALLY FOR NATIONAL OR INTERNATIONAL MAIL ORDER SALE; CLERICAL AND BUSINESS ADMINISTRATION SERVICES, NAMELY, DATA INPUT, EDITING, COMPILATION AND PROCESSING SERVICES AND, IN GENERAL, SERVICES RELATING TO THE RECORDING, TRANSCRIPTION, TRANSMISSION AND SYSTEMATIZATION OF WRITTEN COMMUNICATIONS AND SOUND AND/OR VISUAL RECORDINGS; SUBSCRIPTION MANAGEMENT SERVICES AS A SUBSCRIPTION AGENT BETWEEN PUBLISHERS AND CUSTOMERS IN THE FIELD OF PRINTED GOODS AND ALL INFORMATION MEDIA, TEXTS, SOUNDS AND/OR IMAGES, AUDIOVISUAL GOODS OR MULTIMEDIA GOODS; POST-PRODUCTION EDITING SERVICES FOR VIDEO AND AUDIO COMMERCIALS, NAMELY, EDIT-

ING OF TEXTS AND STILL OR ANIMATED IMAGES, AND MUSICAL OR NON-MUSICAL SOUNDS, FOR INTERACTIVE OR NON-INTERACTIVE USE, ON THE APPROPRIATE MEDIA, NAMELY, AUDIO DIGITAL COMPACT DISCS AND DIGITAL VIDEO DISCS; DOCUMENT REPRODUCTION; RENTAL OF SIGNS AND COMMERCIAL PRESENTATIONS FOR ADVERTISING PURPOSES; COMPUTERIZED FILE MANAGEMENT, BUSINESS ADVICE AND ADVERTISING RELATED TO DATA COMMUNICATION SERVICES; ORGANIZATION OF EXHIBITIONS FOR COMMERCIAL AND ADVERTISING PURPOSES; ARRANGING SUBSCRIPTIONS TO A TELEPHONE OR COMPUTER INTERNET SERVICE FOR OTHERS; BUSINESS ADMINISTRATION OF EXHIBITION SITES; ARRANGING NEWSPAPER SUBSCRIPTIONS FOR OTHERS TO DIGITAL, ELECTRONIC OR NON-ELECTRONIC PUBLICATIONS; ARRANGING SUBSCRIPTIONS TO A DATA COMMUNICATION SERVICE FOR OTHERS; ARRANGING OF SUBSCRIPTIONS TO A TELEVISION CHANNEL FOR OTHERS FOR OTHERS (U.S. CLS. 100, 101 AND 102).

#### **CLASS 38—COMMUNICATION**

FOR TELECOMMUNICATIONS SERVICES, NAMELY, ACCESS; DATA TRANSMISSION VIA MULTISERVICE COMPANY TELECOMMUNICATION NETWORKS; SECURE ELECTRONIC MAIL SERVICES; NEWS INFORMATION AND NEWS AGENCY SERVICES IN THE FIELD OF ELECTRONIC TRANSMISSION; COMMUNICATION SERVICES VIA RADIO, TELEPHONE AND TELEGRAPH EQUIPMENT AS WELL AS VIA ALL TELEPROCESSING MEANS, VIA INTERACTIVE VIDEO, AND IN PARTICULAR COMPUTER TERMINALS AND PERIPHERALS OR ELECTRONIC AND/OR DIGITAL EQUIPMENT, VIDEOPHONE AND VIDEOCONFERENCING EQUIPMENT; SENDING, TRANSMITTING DISPATCHES AND MESSAGES, NAMELY, ELECTRONIC TRANSMISSION OF MESSAGES; ELECTRONIC DATA TRANSMISSION SERVICES, IN PARTICULAR PACKET TRANSMISSION SERVICES, ELECTRONIC DOCUMENT DISPATCHING, TRANSMISSION, ELECTRONIC MAIL SERVICES; TELEPHONE CALL TRANSFER OR TELECOMMUNICATION SERVICES; SATELLITE TRANSMISSION; BROADCASTING OF TELEVISION PROGRAMS AND MORE GENERALLY OF MULTIMEDIA COMPUTER WORKS CONSISTING OF TEXTS AND/OR STILL OR ANIMATED IMAGES, AND/OR MUSICAL OR NON-MUSICAL SOUNDS, FOR INTERACTIVE OR NON-INTERACTIVE USE; TELEVISION AND RADIO BROADCASTING, NAMELY, AUDIOVISUAL AND MULTIMEDIA PROGRAMS FEATURING COMPUTER TEXTS AND/OR STILL OR ANIMATED IMAGES, AND/OR MUSICAL OR NON-MUSICAL SOUNDS FOR INTERACTIVE OR OTHER USE; TRANSMISSION OF INFORMATION BY TELEPRINTER; COMMUNICATION BY COMPUTER TERMINALS; TRANSMISSION OF INFORMATION BY TELEMATIC MEANS WITH A VIEW TO OBTAINING INFORMATION CONTAINED IN DATA BANKS AND IMAGE BANKS; COMMUNICATION, NAMELY, ELECTRONIC TRANSMISSION VIA COMPUTER NETWORKS IN GENERAL; RENTAL SERVICES FOR COMPUTER, REMOTE COMPUTING AND DATA COMMUNICATIONS APPARATUS AND INSTRUMENTS, NAMELY, TELEPHONES, TELECOMMUNICATIONS APPARATUS, FACSIMILE MACHINES, MESSAGE SENDING APPARATUS, MODEMS; RENTAL OF ACCESS TIME TO A DATABASE SERVER CENTER (U.S. CLS. 100, 101 AND 104).

#### **CLASS 41—EDUCATION AND ENTERTAINMENT**

FOR SERVICES FOR TEACHING AND TRAINING, EDUCATION AND ENTERTAINMENT, NAMELY, PROVIDING EDUCATIONAL COURSES IN THE FIELD OF TELECOMMUNICATIONS; SPORTING AND CULTURAL ACTIVITIES, NAMELY, ORGANIZING COMMUNITY SPORTING AND CULTURAL EVENTS; EDUCATIONAL CORRESPONDENCE COURSES IN THE FIELD OF TELECOMMUNICATIONS; POST-PRODUCTION EDITING AND PUBLICATION OF TEXTS OTHER THAN ADVERTISING TEXTS, ILLUSTRATIONS, BOOKS, JOURNALS, NEWSPAPERS, PERIODICALS, MAGAZINES, PUBLICATIONS OF ALL KINDS AND IN ALL FORMS OTHER THAN FOR ADVERTISING PURPOSES INCLUDING ELECTRONIC AND DIGITAL PUBLICA-

TIONS, OTHER THAN FOR ADVERTISING, OF AUDIO AND/OR VISUAL MEDIA, MULTIMEDIA ENTERTAINMENT CONTENT AND PROGRAMS, GAMES AND IN PARTICULAR TELEVISED GAMES, AUDIOVISUAL GAMES, GAMES ON COMPACT DISCS AND DIGITAL-AUDIO COMPACT DISCS AND ON MAGNETIC MEDIA; POST PRODUCTION EDITING OF RADIO AND TELEVISION PROGRAMS, AUDIOVISUAL AND MULTIMEDIA ENTERTAINMENT PROGRAMS FOR INTERACTIVE USE OR NON-INTERACTIVE USE; ORGANIZATION OF COMPETITIONS RELATING TO COMPUTER GAMES; ENTERTAINMENT SERVICES IN THE NATURE OF CREATION AND PRODUCTION SERVICES OF MULTIMEDIA ENTERTAINMENT CONTENT, NAMELY, NEWS PROGRAMS, RADIO AND TELEVISION ENTERTAINMENT AND AUDIOVISUAL AND MULTIMEDIA PROGRAMS, FOR INTERACTIVE OR OTHER USE; ORGANIZATION OF CULTURAL SHOWS; ARTISTIC FILM PRODUCTION AND RENTAL OF FILMS AND CASSETTES, NAMELY, VIDEO CASSETTES, AND MORE GENERALLY ALL AUDIO AND/OR VIDEO MEDIA AND MULTIMEDIA CARRIERS, NAMELY, INTERACTIVE DISCS AND DIGITAL-AUDIO CD-ROMS; LEISURE SERVICES, NAMELY, ARRANGING LEISURE EVENTS IN THE NATURE OF FILM FESTIVALS; EDITING OF VIDEOTAPE, PHOTOGRAPHIC REPORTING; SCRIPTWRITING SERVICES FOR NON-ADVERTISING PURPOSES; TRANSLATION SERVICES; VIDEOTAPING (U.S. CLS. 100, 101 AND 107).

#### CLASS 42—SCIENTIFIC AND COMPUTER SERVICES

FOR HOSTING OF WEB SITES; FRANCHISING SERVICES, NAMELY, PLANNING AND DESIGN OF INFORMATION TECHNOLOGY SYSTEMS FOR BUSINESS FRANCHISES IN THE FIELDS OF TRANSFER OF KNOW-HOW, LEGAL DATA BANK AND DATABASE SET-UP, DESIGN AND DEVELOPMENT AND OPERATION, NAMELY, PROGRAMMING; COMPUTER PROGRAMMING FOR ELECTRONIC INSTRUMENTS AND APPARATUS, COMPUTERS, REMOTE COMPUTING AND COMPUTER COMMUNICATION SYSTEMS, MULTIMEDIA EQUIPMENT, PROGRAMMING OF MULTIMEDIA EQUIPMENT; RENTAL OF COMPUTER, REMOTE COMPUTING AND COMPUTER COMMUNICATION APPARATUS AND INSTRUMENTS, NAMELY, COMPUTERS, SOFTWARE, SCANNER, RECORDERS IN THE NATURE OF COMPUTER HARDWARE PARTS, PRINTERS, PRINTER PERIPHERALS; DESIGN AND DEVELOPMENT OF WEBSITES ON GLOBAL COMPUTER NETWORKS (U.S. CLS. 100 AND 101).

JENNIFER BUTTON, EXAMINING ATTORNEY

SN 79-129,504. ARCADIA GROUP BRANDS LIMITED, UNITED KINGDOM, FILED 8-6-2012.

PRIORITY DATE OF 2-6-2012 IS CLAIMED.  
OWNER OF INTERNATIONAL REGISTRATION 1158624  
DATED 8-6-2012, EXPIRES 8-6-2022.

THE MARK CONSISTS OF THE STYLIZED LETTERS "CJG" IN A DIAGONAL ORIENTATION FROM THE UPPER LEFT TO THE LOWER RIGHT WITH THE DESIGN OF AN OUTLINE OF A HEART ON THE LOWER RIGHT OF THE LETTERS.

#### CLASS 14—JEWELRY

FOR JEWELLERY; IMITATION JEWELLERY; TIARAS; CHARMS OF COMMON METALS, PRECIOUS METALS AND OF SEMI-PRECIOUS METALS; CUFF LINKS; KEY RINGS OF PRECIOUS METALS, KEY CHAINS AS JEWELLERY; LAPEL BADGES AND PINS OF PRECIOUS METAL; TIE CLIPS; TIE PINS; ORNAMENTAL PINS; CHARITY WRIST BANDS, NAMELY, BRACELETS, WATCH BANDS, AND WATCH STRAPS; PRECIOUS METALS AND ALLOYS THEREOF; GOODS OF PRECIOUS METALS AND COATED THEREWITH, NAMELY, PERSONAL ORNAMENTS OF PRECIOUS METAL, BASKETS OF PRECIOUS METAL, BOXES OF PRECIOUS METAL, BUSTS OF PRECIOUS METAL, DRAWER PULLS OF PRECIOUS METAL, FIGURINES OF PRECIOUS METAL, INGOTS OF PRECIOUS METAL, INSIGNIAS OF PRECIOUS METAL, THREADS OF PRECIOUS METAL, WALL PLAQUES OF PRECIOUS METAL; PRECIOUS STONES; WATCHES; WATCH STRAPS; WATCH BANDS; WATCH BRACELETS; PARTS AND FITTINGS FOR ALL THE AFORESAID GOODS; JEWELLERY BOXES; TRINKET BOXES, NAMELY, BOXES FOR TIMEPIECES, DECORATIVE BOXES MADE OF PRECIOUS METAL, LEATHER JEWELRY AND ACCESSORY BOXES; CASES FOR JEWELS, NAMELY, JEWELRY CASES (U.S. CLS. 2, 27, 28 AND 50).

#### CLASS 18—LEATHER GOODS

FOR BAGS, NAMELY, ALL-PURPOSE ATHLETIC BAGS, ALL-PURPOSE CARRYING BAGS, AMENITY BAGS SOLD EMPTY, BELT BAGS, CARRY-ALL BAGS, COURIER BAGS, DUFFEL BAGS, KEY BAGS; HANDBAGS; SHOULDER BAGS; TOILETRY BAGS SOLD EMPTY; CARRIER BAGS, NAMELY, ALL-PURPOSE CARRYING BAGS; RUCKSACKS; BACKPACKS; SATCHELS; BUMBAGS; SPORTS BAGS; CASUAL BAGS, NAMELY, CLUTCH BAGS, BELT BAGS, LEATHER BAGS; HOLDALLS; HAVERSACKS; SLING BAGS; TOTE BAGS; GARMENT BAGS FOR TRAVEL, NAMELY, HAT BAGS FOR TRAVEL; SHOPPING BAGS, NAMELY, CANVAS SHOPPING BAGS, LEATHER SHOPPING BAGS, MESH SHOPPING BAGS, REUSABLE SHOPPING BAGS, SHOPPING BAGS MADE OF SKIN, TEXTILE SHOPPING BAGS; WHEELED SHOPPING BAGS; BAG COVERS, NAMELY, FITTED PROTECTIVE COVERS FOR HANDBAGS, BRIEFCASES, VALISES, SUITCASES, AND BRIEFCASE-LIKE PORTFOLIOS; TRUNKS; TRAVELLING BAGS; TRAVEL CASES; LUGGAGE; SUITCASES; PORTMANTEAUX; VALISES; CASES, NAMELY, BUSINESS CASES, CARRYING CASES, CASES FOR KEYS, UNFITTED VANITY CASES, TRAVEL CASES, LEATHER CASES; BRIEFCASES; ATTACHÉ CASES; MUSIC CASES, NAMELY, CASES OF LEATHER AND IMITATION LEATHER, NOT SPECIFICALLY ADAPTED FOR ANY PARTICULAR TYPE OF INSTRUMENT OR MUSICAL ACCESSORY; POUCHES, NAMELY, DRAWSTRING POUCHES, POUCHES OF LEATHER AND TEXTILE, JEWELRY POUCHES, POUCHES MADE FROM IMITATION LEATHER, AND POUCHES FOR HOLDING MAKE-UP, KEY AND OTHER PERSONAL ITEMS; BEAUTY CASES, NAMELY, VANITY CASES SOLD EMPTY, TRAVEL CASES, TOILETRY CASES SOLD EMPTY, COSMETIC CASES SOLD EMPTY; VANITY CASES SOLD EMPTY; WASH BAGS FOR CARRYING TOILETRIES, GARMENT BAGS FOR TRAVEL AND CARRIERS IN THE NATURE OF CARRYALLS; TIE CASES; NOTECASES, NAMELY, DOCUMENT CASES, AND CARRYING CASES FOR DOCUMENTS; DOCUMENT CASES; HOLDERS, NAMELY, BANKNOTE HOLDERS; FOLIO CASES, NAMELY, BRIEFCASE-TYPE PORTFOLIOS; CREDIT CARD CASES AND HOLDERS; WALLETS; PURSES; CARD CASES, NAMELY, BUSINESS CARD CASES, CALLING CARD CASES, CREDIT CARD CASES, NAME CARD CASES; KEY CASES MADE PRINCIPALLY OF IMITATION LEATHER; KEY CASES MADE PRINCIPALLY OF LEATHER; BILLFOLDS; BELT BAGS; BELT POUCHES, NAMELY, WEARABLE STRAPON POUCHES; JEWELLERY ROLLS FOR TRAVEL; UMBRELLAS; PARASOLS; WALKING STICKS; WALK-



ING STICKS MODIFIED WITH A BUILT-IN SEAT, NAMELY, SHOOTING STICKS; CANES; CANE HANDLES; COMBINATION WALKING STICKS AND UMBRELLAS; UMBRELLA BAGS; ARTICLES MADE OF LEATHER AND IMITATION LEATHER, NAMELY, ALL-PURPOSE LEATHER STRAPS, BAGS FOR PACKAGING OF LEATHER, CASES OF LEATHER AND IMITATION LEATHER, IMITATION LEATHER, LEATHER, LEATHER AND IMITATION LEATHER BAGS, LEATHER FOR FURNITURE, LEATHER LACES, LEATHER THONGS, AND SADDLERY OF LEATHER AND IMITATION LEATHER; PARTS AND FITTINGS FOR ALL OF THE AFORESAID GOODS (U.S. CLS. 1, 2, 3, 22 AND 41).

**CLASS 25—CLOTHING**

FOR CLOTHING, NAMELY, TOPS, BOTTOMS, UNDERWEAR, HEADWEAR, JACKETS, COATS, SOCKS, BEACHWEAR, INFANTWEAR, LOUNGEWEAR, NIGHTWEAR, RAINWEAR, SKIWEAR, SWIMWEAR, TENNISWEAR; FOOTWEAR; HEADGEAR, NAMELY, HEADWEAR; SHOE LINERS, NAMELY, BOOT LINERS (U.S. CLS. 22 AND 39).

**CLASS 35—ADVERTISING AND BUSINESS**

FOR RETAIL STORE SERVICES, RETAIL DEPARTMENT STORE SERVICES, ELECTRONIC SHOPPING RETAIL STORE SERVICES AND MAIL ORDER RETAIL STORE SERVICES FEATURING COSMETICS, PERFUMERY, TOILETRIES, ESSENTIAL OILS, COTTON WOOL, DENTIFRICES, HEALTH AND BEAUTY PRODUCTS, SUNGLASSES, EYESHADES, GOGGLES, SPECTACLES, CASES FOR PORTABLE ELECTRONIC DEVICES, JEWELLERY, IMITATION JEWELLERY, TIARAS, CHARMS, CUFF LINKS, KEY RINGS, LAPEL BADGES, PINS, TIE CLIPS, CHARITY WRIST BANDS, PRECIOUS METALS AND THEIR ALLOYS AND GOODS IN PRECIOUS METALS OR COATED THEREWITH, PRECIOUS STONES, WATCHES, JEWELLERY BOXES, TRINKET BOXES, CASES FOR JEWELS, BAGS, RUCKSACKS, BACKPACKS, SATCHELS, BUMBAGS, HOLDALLS, HAVESACKS, BAG COVERS, TRUNKS, TRAVEL CASES, LUGGAGE, SUITCASES, PORTMANTEAUX, VALISES, CASES, BRIEFCASES, POUCHES, BEAUTY CASES, VANITY CASES, WASH BAGS, GARMENT BAGS AND CARRIERS, NOTECASES, NOTEBOOK HOLDERS, DOCUMENT CASES AND HOLDERS, CREDIT CARD CASES AND HOLDERS, CHECKBOOK HOLDERS, WALLET, PURSES, KEY CASES, BILLFOLDS, BELT BAGS, BELT POUCHES, JEWELLERY ROLLS, UMBRELLAS, PARASOLS, WALKING STICKS AND UMBRELLAS, UMBRELLA BAGS, BOOT LINERS, CLOTHING, FOOTWEAR, HEADGEAR, AND PARTS AND FITTINGS FOR THE AFORESAID GOODS (U.S. CLS. 100, 101 AND 102).  
JAY BESCH, EXAMINING ATTORNEY

SN 79-129,527. BRIDGESTONE CORPORATION, TOKYO 104-8340, JAPAN, FILED 11-14-2012.

**C A I S**

THE MARK CONSISTS OF STANDARD CHARACTERS WITHOUT CLAIM TO ANY PARTICULAR FONT, STYLE, SIZE, OR COLOR.  
PRIORITY DATE OF 6-11-2012 IS CLAIMED.  
OWNER OF INTERNATIONAL REGISTRATION 1158688 DATED 11-14-2012, EXPIRES 11-14-2022.  
OWNER OF U.S. REG. NO. 3,669,602.

**CLASS 9—ELECTRICAL AND SCIENTIFIC APPARATUS**

FOR VIBRATION ACCELEROMETERS; STRAIN SENSORS; MEASURING OR TESTING MACHINES AND INSTRUMENTS, NAMELY, APPARATUS FOR CENTRALLY MONITORING DRIVING CONDITIONS BY COMPUTER THROUGH DETECTING OSCILLATING WAVES FROM TIRES AND STRAIN STATE OF TIRES BOTH OF WHICH ARE CAUSED WHILE THE VEHICLE IS MOVING (U.S. CLS. 21, 23, 26, 36 AND 38).

**CLASS 12—VEHICLES**

FOR VEHICLE TIRES (U.S. CLS. 19, 21, 23, 31, 35 AND 44).  
CORY BOONE, EXAMINING ATTORNEY

SN 79-129,549. BRABLO AG, SWITZERLAND, FILED 2-12-2013.

**brablo**

THE MARK CONSISTS OF STANDARD CHARACTERS WITHOUT CLAIM TO ANY PARTICULAR FONT, STYLE, SIZE, OR COLOR.  
PRIORITY DATE OF 11-5-2012 IS CLAIMED.  
OWNER OF INTERNATIONAL REGISTRATION 1158761 DATED 2-12-2013, EXPIRES 2-12-2023.  
THE WORDING "BRABLO" HAS NO MEANING IN A FOREIGN LANGUAGE.

**CLASS 3—COSMETICS AND CLEANING PREPARATIONS**

FOR BLEACHING PREPARATIONS AND OTHER SUBSTANCES FOR LAUNDRY USE, NAMELY, LAUNDRY DETERGENTS, FURBISHING MATERIALS, NAMELY, METAL POLISH, GLASS POLISH, WOOD POLISH, POLISHING PREPARATIONS, GRINDING AGENTS, NAMELY, ABRASIVE CLOTH AND PAPER, DEGREASING PREPARATIONS NOT USED IN MANUFACTURING PROCESSES FOR FLOORS, GLASSES, WOOD, METAL; SOAPS; PERFUMERY, ESSENTIAL OILS, COSMETICS, HAIR LOTIONS; DENTIFRICE (U.S. CLS. 1, 4, 6, 50, 51 AND 52).

**CLASS 9—ELECTRICAL AND SCIENTIFIC APPARATUS**

FOR SUNGLASSES; SPECTACLE FRAMES; SPECTACLE CASES; SPECTACLES IN THE NATURE OF OPTICS (U.S. CLS. 21, 23, 26, 36 AND 38).

**CLASS 14—JEWELRY**

FOR PRECIOUS METALS AND THEIR ALLOYS AND GOODS IN PRECIOUS METALS OR COATED THEREWITH, NAMELY, JEWELRY, RINGS AND WATCHES, INCLUDED IN THIS CLASS; JEWELRY, PRECIOUS STONES; TIMEPIECES AND CHRONOMETRIC INSTRUMENTS (U.S. CLS. 2, 27, 28 AND 50).

**CLASS 18—LEATHER GOODS**

FOR LEATHER AND IMITATION LEATHER, AND GOODS MADE OF THESE MATERIALS AND NOT INCLUDED IN OTHER CLASSES, NAMELY, BAGS, BOXES, BRIEFCASES, CASES, HANDBAGS, PURSES, SUITCASES, THONGS, WALLETS, CASES FOR KEYS, CREDIT CARD CASES, SHOPPING BAGS, SHOULDER BELTS, SHOULDER STRAPS; ANIMAL HIDES; TRUNKS AND SUITCASES; UMBRELLAS AND PARASOLS; WALKING STICKS; WHIPS, HARNESS AND SADDLERY (U.S. CLS. 1, 2, 3, 22 AND 41).

**CLASS 25—CLOTHING**

FOR CLOTHING, NAMELY, BABIES' PANTS AS CLOTHING, BANDANAS, NECKERCHIEFS, BATH ROBES, BATHING SUITS, SWIMSUITS, BELTS BEING CLOTHING, BOAS AND NECKLETS, BODICES AND LINGERIE, CLOTHING FOR GYMNASTICS, NAMELY, UNITARDS, COATS, COLLAR PROTECTORS, COLLARS BEING CLOTHING, SHOULDER WRAPS, COMBINATIONS CLOTHING, NAMELY, TRACK SUITS, CYCLISTS' CLOTHING, NAMELY, JERSEYS, SHIRTS, SHORTS, LEGGINGS, AND PULLOVERS; DRESS SHIELDS, DRESSES, GLOVES BEING CLOTHING, HOODS AS CLOTHING, JACKETS AS CLOTHING, JERSEYS AS CLOTHING, KNITWEAR, NAMELY, KNIT BOTTOMS, KNIT DRESSES, KNIT JACKETS, KNIT SKIRTS, AND KNIT TOPS, SWEATERS; LEGGINGS, TROUSERS, MOTORISTS' CLOTHING, NAMELY, SWEATERS, GLOVES, HATS, CAPS, SOCKS, NECKERCHIEFS, NECKTIES, PARKAS, RACING PANTS, RACING SUITS, SHIRT FRONTS, SHOES AND BOOTS FOR AUTOMOBILE RACING, SLIPPERS, SPORTS JERSEYS, SPORTS SHOES, STOCKINGS, SUITS, SUN VISORS, SWEATSHIRT AND SWEATPANTS, SWEATERS, TEE-SHIRTS, UNIFORMS, VESTS, VISORS, WAISTCOATS, WORKWEAR, NAMELY, SWEATERS, GLOVES, HATS, CAPS, SOCKS, DRIVING GLOVES; MUFFS AS CLOTHING, OVERALLS AND SMOCKS, OVERCOATS AND TOPCOATS, PANTS AND DRAWERS AS CLOTHING, PARKAS, PONCHOS, PULLOVERS AND JUMPERS, PYJAMAS AND PAJAMAS, SCARVES, SHAWLS, SHIRT YOKES, SHIRT FRONTS, SHIRTS, SINGLETS, SPORTS JERSEYS, SKIRTS, SLIPS AS UNDERGARMENTS, SOCK SUSPENDERS, SOCKS, SUITS, SWEATERS, TEDDIES AS UNDERGARMENTS, TEE-SHIRTS, TROUSER STRAPS AND GAITER STRAPS, UNDERPANTS, UNDERWEAR AND BODY LINENS, UNDERCLOTHING, WATERPROOF CLOTHING, NAMELY, WATERPROOF FOOTWEAR, WATERPROOF JACKETS AND WATERPROOF PANTS; FOOTWEAR, HEADGEAR, NAMELY, HATS AND CAPS (U.S. CLS. 22 AND 39).

DOMINIC FATHY, EXAMINING ATTORNEY

SN 79-129,575. AVIATION GLASS & TECHNOLOGY B.V., EA ARNHEM, NETHERLANDS, FILED 12-4-2012.



AVIATION GLASS & TECHNOLOGY

PRIORITY DATE OF 10-11-2012 IS CLAIMED.  
OWNER OF INTERNATIONAL REGISTRATION 1158854 DATED 12-4-2012, EXPIRES 12-4-2022.

NO CLAIM IS MADE TO THE EXCLUSIVE RIGHT TO USE "AVIATION GLASS & TECHNOLOGY", APART FROM THE MARK AS SHOWN.

THE MARK CONSISTS OF A STYLIZED IMAGE OF A PAPER AIRPLANE, WHICH IS UNDERLINED AND APPEARS TO THE LEFT OF THE WORDING "AVIATION GLASS & TECHNOLOGY".

**CLASS 12—VEHICLES**

FOR VEHICLE PARTS, NAMELY, WINDOWS AND OTHER GLASS PARTS, NAMELY, GLASS PARTS FOR VEHICLES, NAMELY, REAR VIEW MIRRORS FOR USE IN AIRCRAFT (U.S. CLS. 19, 21, 23, 31, 35 AND 44).

**CLASS 35—ADVERTISING AND BUSINESS**

FOR COMMERCIAL INTERMEDIARY SERVICES RELATED TO PRODUCING, DISTRIBUTING AND TRADING OF PARTS OF VEHICLES, NAMELY, WINDOWS AND OTHER GLASS PARTS FOR VEHICLES, INCLUDING AIRCRAFTS (U.S. CLS. 100, 101 AND 102).

**CLASS 37—CONSTRUCTION AND REPAIR**

FOR INSTALLATION, MAINTENANCE, REPAIR AND RESTORATION OF PARTS OF VEHICLES, NAMELY, WINDOWS AND OTHER GLASS PARTS FOR VEHICLES, INCLUDING AIRCRAFTS (U.S. CLS. 100, 103 AND 106).

**CLASS 40—MATERIAL TREATMENT**

FOR MANUFACTURING, PROCESSING AND SHAPING OF GLASS AND GLASS PRODUCTS, IN PARTICULAR FOR VEHICLE COMPONENTS, NAMELY, WINDOWS AND OTHER GLASS PARTS FOR VEHICLES, INCLUDING AIRCRAFTS (U.S. CLS. 100, 103 AND 106).

RICHARD WHITE, EXAMINING ATTORNEY

SN 79-129,757. KABUSHIKI KAISHA UNBALANCE; (UNBALANCE CORPORATION), JAPAN, FILED 3-15-2013.

# AquaFish

PRIORITY DATE OF 3-1-2013 IS CLAIMED.  
OWNER OF INTERNATIONAL REGISTRATION 1159262 DATED 3-15-2013, EXPIRES 3-15-2023.

**CLASS 9—ELECTRICAL AND SCIENTIFIC APPARATUS**

FOR RECORDING MEDIA STORED WITH COMPUTER GAME PROGRAMS, NAMELY, PRE-RECORDED DVDS AND CDS FEATURING COMPUTER GAMES; COMPUTER GAME PROGRAMS, DOWNLOADABLE IMAGE FILES CONTAINING COMPUTER FISH GAMES HAVING A VIRTUAL AQUARIUM DOWNLOADABLE VIA COMMUNICATION NETWORKS; GAME PROGRAMS FOR HOME VIDEO GAME MACHINES; ELECTRONIC CIRCUITS AND PRE-RECORDED CD-ROMS FEATURING COMPUTER SOFTWARE FOR USE WITH HAND-HELD GAMES WITH LIQUID CRYSTAL DISPLAYS; DOWNLOADABLE IMAGE FILES CONTAINING COMPUTER FISH GAMES HAVING A VIRTUAL AQUARIUM; PRE-RECORDED VIDEO DISCS AND VIDEO TAPES FEATURING COMPUTER FISH GAMES HAVING A VIRTUAL AQUARIUM (U.S. CLS. 21, 23, 26, 36 AND 38).

**CLASS 41—EDUCATION AND ENTERTAINMENT**

FOR PROVIDING ON-LINE COMPUTER GAMES; GAME SERVICES PROVIDED ON-LINE FROM A COMPUTER NETWORK, NAMELY, PROVIDING TEMPORARY USE OF NON-DOWNLOADABLE COMPUTER GAMES (U.S. CLS. 100, 101 AND 107).

INGRID C. EULIN, EXAMINING ATTORNEY

SN 79-129,829. PROVEL TÜKETİM ÜRÜNLERİ; SANAYİ VE  
TİCARET ANONİM ŞİRKETİ, TURKEY, FILED 2-14-2013.



OWNER OF INTERNATIONAL REGISTRATION 1159454  
DATED 2-14-2013, EXPIRES 2-14-2023.

THE COLOR(S) PINK, DARK BLUE, LIGHT BLUE, AND  
WHITE IS/ARE CLAIMED AS A FEATURE OF THE MARK.

THE MARK CONSISTS OF A SHIELD DESIGN, FLAT ON  
TOP AND ROUNDED ON BOTTOM, IN THE COLOR PINK;  
FEATURING A CURLED SHEET OF PAPER OR FABRIC,  
DARK BLUE ON ONE SIDE AND LIGHT BLUE ON THE  
OTHER, WITH THE WHITE WORDING "PAREX" WITH  
THE FIRST CHARACTER "P" IN UPPERCASE AND THE  
REST IN ALL LOWERCASE AGAINST THE DARK BLUE  
BACKGROUND, AND WITH THE TAILS OF THE PAPER  
OR FABRIC POINTING UPWARD TO THE RIGHT TO  
INTERSECT LARGE AND SMALL TEAR-DROP SHAPED  
LEAVES, THE LARGE LEAF IN DARK BLUE POINTING  
DIRECTLY UPWARD, THE SMALLER LEAF IN LIGHT  
BLUE POINTING DIRECTLY TO THE LEFT; THE REMAIN-  
ING UPPER HALF SECTION OF THE SHIELD FEATURES  
LARGE AND SMALL HORIZONTAL STREAMS IN WHITE/  
PINK GRADATION EXTENDING TO THE LEFT, THE  
SMALLER ONE ABOVE THE LARGER ONE, THE LARGER  
ONE EXTENDING SLIGHTLY LOWER TO THE LEFT AND  
THE SMALLER ONE EXTENDING NEARLY PARALLEL  
TO THE LARGER ONE AND SLIGHTLY UPWARD TO THE  
LEFT; AND ALONG THE TWO STREAMS A DOZEN  
LARGER AND SMALL SHINING 'STARS' IN WHITE  
EXTENDING FROM THE MIDDLE TO THE UPPER RIGHT  
CORNER.

#### CLASS 5—PHARMACEUTICALS

FOR SANITARY PREPARATIONS FOR MEDICAL  
PURPOSES; MATERIALS FOR DRESSING, NAMELY,  
GAUZE AND PLASTERS FOR MEDICAL PURPOSES;  
DISINFECTANTS FOR SANITARY PURPOSES; PRE-  
PARATIONS FOR DESTROYING VERMIN; FUNGI-  
CIDES AND HERBICIDES (U.S. CLS. 6, 18, 44, 46, 51  
AND 52).

#### CLASS 11—ENVIRONMENTAL CONTROL AP- PARATUS

FOR APPARATUS FOR LIGHTING, HEATING,  
STEAM GENERATING, COOKING, REFRIGERATING,  
DRYING, VENTILATING, WATER SUPPLY AND SANI-  
TARY PURPOSES, NAMELY, APPARATUS FOR WATER  
SOFTENING, WATER PURIFICATION, WATER FIL-  
TRATION, WASTE WATER TREATMENT, AND WASTE  
WATER PURIFICATION INSTALLATIONS, FAUCETS,  
SHOWERS, TOILETS, BATHTUBS, SINKS; HEAT ACCU-  
MULATORS (U.S. CLS. 13, 21, 23, 31 AND 34).

#### CLASS 16—PAPER GOODS AND PRINTED MATTER

FOR PAPER AND CARDBOARD; GOODS MADE  
FROM PAPER AND CARDBOARD, NAMELY, PAPER  
TOWELS, TOILET PAPER, PAPER NAPKINS, PAPER  
FOR WRAPPING AND PACKAGING, CARDBOARD  
BOXES; PRINTED PUBLICATIONS, NAMELY, BRO-  
CHURES, IN THE FIELD OF CONSUMER AND INDUS-  
TRIAL PAPER PRODUCTS AND KITCHEN AND  
HOUSEHOLD CLEANING PRODUCTS, CALENDARS,  
POSTERS, PAINTINGS, STICKERS; BOOK BINDING  
MATERIALS; PHOTOGRAPHS; STATIONERY; ADHE-  
SIVES FOR STATIONERY OR HOUSEHOLD PURPOSES;  
ARTISTS' MATERIALS, NAMELY, PAINT ROLLERS,  
PLASTERS, MODELING CLAY, ARTISTS' BRUSHES;  
PAINT BRUSHES; OFFICE REQUISITES, NAMELY,  
PRINT LETTERS AND BLOCKS, OFFICE STATIONERY,  
OFFICE PAPER STATIONERY, WRITING PADS, DRAW-  
ING PADS; PRINTED INSTRUCTIONAL AND TEACH-  
ING MATERIALS IN THE FIELD OF CONSUMER AND  
INDUSTRIAL PAPER PRODUCTS AND KITCHEN AND  
HOUSEHOLD CLEANING PRODUCTS; PLASTIC BAGS  
AND BUBBLE PACKS FOR PACKAGING; PRINTER'S  
TYPE; PRINTING BLOCKS (U.S. CLS. 2, 5, 22, 23, 29, 37,  
38 AND 50).

DAVID ELTON, EXAMINING ATTORNEY

SN 79-130,016. L.I.F.E. CORPORATION S.A., L-2449 LUXEM-  
BOURG, LUXEMBOURG, FILED 11-2-2012.

PRIORITY DATE OF 5-3-2012 IS CLAIMED.  
OWNER OF INTERNATIONAL REGISTRATION 1159939  
DATED 11-2-2012, EXPIRES 11-2-2022.

#### CLASS 2—PAINTS

FOR PAINTS, VARNISHES, LACQUERS; DYESTUFFS;  
DYES FOR CLOTHING, INK FOR SKIN-DRESSING;  
INKS FOR LEATHER; COATINGS, NAMELY, EXTER-  
IOR SURFACE PROTECTIVE COATINGS, INTERIOR  
SURFACE PROTECTIVE COATINGS, COATINGS HAV-  
ING PROPERTIES THAT PERMIT THE SENSING OF  
ENVIRONMENTAL OR CHEMICAL CHARACTERIS-  
TICS (U.S. CLS. 6, 11 AND 16).

**CLASS 9—ELECTRICAL AND SCIENTIFIC APPARATUS**

FOR SCIENTIFIC, NAUTICAL, SURVEYING, CHECKING, LIFE-SAVING AND TEACHING APPARATUS AND INSTRUMENTS, NAMELY, COMPUTERS, MP3 PLAYERS; APPARATUS FOR RECORDING, TRANSMISSION OR REPRODUCTION OF SOUND OR IMAGES; DATA PROCESSING EQUIPMENT, NAMELY, COMPUTERS; SOFTWARE, NAMELY, COMPUTER GAME SOFTWARE, SOFTWARE FOR DATABASE MANAGEMENT; DIAGNOSTIC APPARATUS NOT FOR MEDICAL USE, NAMELY, DIAGNOSTIC APPARATUS FOR TESTING FOOD; COMPUTER PERIPHERALS; VIDEO MONITORS; COMPUTER INTERFACES; INTERCOMMUNICATION APPARATUS, NAMELY, INTERCOMS, COMMUNICATION HEADSETS FOR USE WITH INTERCOM SYSTEMS; INTEGRATED CIRCUITS; TESTING APPARATUS NOT FOR MEDICAL USE, NAMELY, ELECTRONIC APPARATUS FOR TESTING CHEMICAL CHARACTERISTICS OF FOODS, CHEMICALS, AND PHARMACEUTICALS; TEMPERATURE INDICATORS; TELEPHONES; TELEPHONE TRANSMITTERS; TELEPHONE RECEIVERS; TELEPHONE APPARATUS; THERMOSTAT; TIME CLOCKS; TIME RECORDING APPARATUS; MEASURING INSTRUMENTS, NAMELY, INSTRUMENTS FOR MEASURING LENGTH; ALARMS, NAMELY, ELECTRONIC DOOR ALARMS; SPECIAL CLOTHING FOR LABORATORIES, NAMELY, PROTECTIVE CLOTHING ESPECIALLY MADE FOR USE IN LABORATORIES; NONE OF THE FOREGOING TO INCLUDE DEVICES USED TO PROVIDE TELEPHONY SERVICES, MOBILE PHONE DEVICES, TABLET DEVICES, DEVICES HAVING A SCREEN, OR ACCESSORIES THEREFOR (U.S. CLS. 21, 23, 26, 36 AND 38).

**CLASS 10—MEDICAL APPARATUS**

FOR SURGICAL APPARATUS AND INSTRUMENTS FOR MEDICAL DENTAL OR VETERINARY USE, NAMELY, MEDICAL, SURGICAL AND VETERINARY INSTRUMENTS; ORTHOPEDIC ARTICLES, NAMELY, ORTHOPEDIC BELTS AND BRACES, ORTHOPEDIC CUSHIONS, ORTHOPEDIC SUPPORTS; SPECIAL CLOTHING FOR OPERATING THEATERS, NAMELY, SURGICAL GOWNS; SURGICAL SHEETS, NAMELY, MEDICAL TABLE SHEETS FOR EXAMINING TABLES AND OPERATING TABLES; ORTHOPEDIC FOOTWEAR; BEDS SPECIALLY MADE FOR MEDICAL CARE AND MEDICAL PURPOSES, NAMELY, THERAPEUTIC MATTRESSES, BEDS, SEATS AND CUSHIONS; BODY REHABILITATION APPARATUS FOR MEDICAL USE (U.S. CLS. 26, 39 AND 44).

**CLASS 14—JEWELRY**

FOR BRACELETS; TIMEPIECES AND CHRONOMETRIC INSTRUMENTS (U.S. CLS. 2, 27, 28 AND 50).

**CLASS 24—FABRICS**

FOR TEXTILES, NAMELY, COTTON, SILK, WOOL BASE MIXED, WOOL YARN, WOOL-COTTON MIXED, POLYESTER AND NYLON FABRICS; TEXTILE GOODS NOT INCLUDED IN OTHER CLASSES, NAMELY, BED LINENS, HOUSEHOLD LINENS, BATH LINENS, KITCHEN LINENS; BED BLANKETS; BED LINEN; CANVASES, NAMELY, CANVAS FOR TAPESTRY OR EMBROIDERY (U.S. CLS. 42 AND 50).

**CLASS 25—CLOTHING**

FOR CLOTHING, NAMELY, SHIRTS, SHORTS, PANTS, SKIRTS, DRESSES, SUITS, JACKETS, SOCKS, COATS, UNDERWEAR, SWIMMING SUITS; FOOTWEAR, HEADGEAR, NAMELY, HATS, CAPS; FOOTWEAR FOR SPORTS, SPORTS SHOES; PAJAMAS; PULLOVERS; SOCKS; SWEATERS; TEE-SHIRTS, SUITS; LINGERIE (U.S. CLS. 22 AND 39).

**CLASS 28—TOYS AND SPORTING GOODS**

FOR GAMES, NAMELY, ACTION SKILL GAMES, BOARD GAMES, PARLOR GAMES; TOYS, NAMELY, CONSTRUCTION TOYS, DRAWING TOYS, PLUSH TOYS, ACTION FIGURES; GYMNASTIC AND SPORTING ARTICLES NOT INCLUDED IN OTHER CLASSES, NAMELY, GYMNASTIC HORIZONTAL BARS, HURDLES, JAVELINS, FOOTBALLS, SOCCER BALLS, BASEBALLS, BASEBALL MITTS, GOLF BALLS, GOLF CLUBS, HOCKEY STICKS, EXERCISE MACHINES, EXERCISE BARS; APPARATUS FOR GAMES OTHER THAN THOSE DESIGNED FOR USE WITH A SEPARATE DISPLAY SCREEN OR MONITOR, NAMELY, ARCADE GAME MACHINES; MACHINES FOR PHYSICAL EXERCISES, NAMELY, EXERCISE TREADMILLS; REHABILITATION APPARATUS, NAMELY, EXERCISE BALLS, STRESS RELIEF EXERCISE BALLS, STRETCHING CORDS IN THE NATURE OF STRETCH BANDS USE FOR YOGA AND PHYSICAL FITNESS PURPOSES; GAME APPARATUS FOR USE WITH A SEPARATE DISPLAY SCREEN OR MONITOR, NAMELY, VIDEO GAME MACHINES FOR USE WITH EXTERNAL DISPLAY SCREEN OR MONITOR (U.S. CLS. 22, 23, 38 AND 50).

**CLASS 38—COMMUNICATION**

FOR TELECOMMUNICATIONS, NAMELY, TELECOMMUNICATION ACCESS SERVICES; RENTAL OF ACCESS TIME TO GLOBAL COMPUTER NETWORKS, COMMUNICATIONS VIA COMPUTER TERMINALS, COMMUNICATIONS VIA FIBER-OPTIC NETWORKS; COMMUNICATIONS BY TELEPHONE; COMPUTER-AIDED TRANSMISSION OF MESSAGES AND IMAGES; TRANSMISSION OF DIGITAL DATA; TRANSMISSION OF MESSAGES AND IMAGES; TELECOMMUNICATIONS ROUTING AND JUNCTION SERVICES; AND ALL OF THE FOREGOING TO SPECIFICALLY EXCLUDE TELEPHONY SERVICES (U.S. CLS. 100, 101 AND 104).

**CLASS 41—EDUCATION AND ENTERTAINMENT**

FOR SPORTING AND CULTURAL ACTIVITIES, NAMELY, ORGANIZATION OF SPORTS COMPETITIONS, ORGANIZATION OF CULTURAL SHOWS; GYMNASTICS INSTRUCTION SERVICES; HEALTH CLUBS, NAMELY, PROVIDING INSTRUCTION AND EQUIPMENT IN THE FIELD OF PHYSICAL EXERCISE; FITNESS CLUBS, NAMELY, PROVIDING FITNESS AND EXERCISE FACILITIES; ADVICE RELATING TO EDUCATION OR TRAINING, NAMELY, PROVIDING ADVICE IN THE FIELD OF EDUCATIONAL ACTIVITIES AND EVENTS FOR CHILDREN, PROVIDING INFORMATION IN THE FIELD OF EXERCISE TRAINING, PROVIDING LIVE AND ONLINE COURSES AND SEMINARS IN THE FIELD OF CHEMICAL ENGINEERING AND COATINGS; PROFESSIONAL SERVICES, NAMELY, ARRANGING PROFESSIONAL WORKSHOP AND TRAINING COURSES; COACHING (TEACHING), NAMELY, COACHING IN THE FIELD OF SPORTS; ENTERTAINMENT SERVICES, NAMELY, PROVIDING LIVE MUSIC PERFORMANCES; SHOW SERVICES, NAMELY, ENTERTAINMENT IN THE NATURE OF TELEVISION NEWS SHOWS; ENTERTAINMENT INFORMATION (U.S. CLS. 100, 101 AND 107).

**CLASS 42—SCIENTIFIC AND COMPUTER SERVICES**

FOR SCIENTIFIC AND TECHNOLOGICAL SERVICES AND RELATED RESEARCH AND DESIGN SERVICES, NAMELY, RESEARCH AND DESIGN SERVICES IN THE FIELD OF COMPUTER NETWORKING HARDWARE, COMPUTER DATA CENTER ARCHITECTURE, INDUSTRIAL ANALYSIS AND RESEARCH SERVICES, NAMELY, ANALYSIS OF INDUSTRIAL FLUIDS; DESIGN AND DEVELOPMENT OF COMPUTERS AND SOFTWARE; PROGRAMMING FOR COMPUTERS; CONSULTANCY RELATING TO SOFTWARE; COMPUTER SOFTWARE MAINTENANCE; CONVERSION OF DATA OR DOCUMENTS FROM PHYSICAL TO ELECTRONIC MEDIA; CONVERSION OF COMPUTER PROGRAMS AND DATA OTHER THAN PHYSICAL CONVERSION; TESTING OF MATERIALS, NAMELY, TESTING OF RAW MATERIALS (U.S. CLS. 100 AND 101).

**CLASS 44—MEDICAL, BEAUTY AND AGRICULTURAL SERVICES**

FOR MEDICAL SERVICES; VETERINARY SERVICES; MEDICAL ASSISTANCE; CLINICAL SERVICES, NAMELY, CLINICAL MENTAL HEALTH COUNSELING SERVICES (U.S. CLS. 100 AND 101).

**CLASS 45—PERSONAL AND LEGAL SERVICES**

FOR SECURITY GUARD SERVICES FOR THE PROTECTION OF PROPERTY AND INDIVIDUALS (U.S. CLS. 100 AND 101).

ANGELA DUONG, EXAMINING ATTORNEY

SN 79-130,039. COMPTOIR MEDITERRANEEN DE L'OLIVE, F-34200 SÈTE, FRANCE, FILED 12-26-2012.

PRIORITY DATE OF 12-20-2012 IS CLAIMED. OWNER OF INTERNATIONAL REGISTRATION 1159980 DATED 12-26-2012, EXPIRES 12-26-2022.

NO CLAIM IS MADE TO THE EXCLUSIVE RIGHT TO USE "LES OLIVES", APART FROM THE MARK AS SHOWN. THE MARK CONSISTS OF THE UNDERLINED STYLED FOREIGN WORDING "LES OLIVES DU MARCHÉ" WITH THE "LES" ABOVE THE WORDING.

THE ENGLISH TRANSLATION OF THE FOREIGN WORD(S) IN THE MARK IS "OLIVES OF THE MARKET".

**CLASS 29—MEATS AND PROCESSED FOODS**

FOR PRESERVED OLIVES IN ALL CONTAINERS; PROCESSED OLIVES, DRIED FRUITS, EDIBLE OILS OF ALL KINDS, FRUITS AND VEGETABLES BEING PRESERVED, DRIED AND COOKED, PRESERVED AND SEMI-PRESERVED; PROCESSED STUFFED OLIVES; PROCESSED OLIVES OF ALL KINDS AND OF ALL ORIGINS (U.S. CL. 46).

**CLASS 31—NATURAL AGRICULTURAL PRODUCTS**

FOR FRESH FRUITS AND VEGETABLES; FRESH OLIVES (U.S. CLS. 1 AND 46).

SCOTT BIBB, EXAMINING ATTORNEY

SN 79-130,090. E&A EVENTS, NETHERLANDS, FILED 10-26-2012.

PRIORITY DATE OF 4-26-2012 IS CLAIMED. OWNER OF INTERNATIONAL REGISTRATION 1160134 DATED 10-26-2012, EXPIRES 10-26-2022.

THE COLOR(S) RED, BLACK, AND WHITE IS/ARE CLAIMED AS A FEATURE OF THE MARK.

BLACK: LETTERS; RED: TRIANGLES; WHITE: BACKGROUND.

THE MARK CONSISTS OF THE WORDING "DON'T LET DADDY KNOW" WHERE THE APOSTROPHE AND LETTER "A" IN "DADDY" ARE REPRESENTED BY A RED TRIANGLE WITH THE REMAINING WORDING IN BLACK ON A WHITE BACKGROUND.

**CLASS 25—CLOTHING**

FOR CLOTHING, NAMELY, SHIRTS, TOPS, HOODED SWEATSHIRTS; FOOTWEAR; HEADGEAR, NAMELY, CAPS, HATS, AND BASEBALL CAPS (U.S. CLS. 22 AND 39).

**CLASS 35—ADVERTISING AND BUSINESS**

FOR ADVERTISING SERVICES; BUSINESS MANAGEMENT; BUSINESS ADMINISTRATION; PROFESSIONAL MANAGEMENT IN ARTISTIC MATTERS; DATABASE MANAGEMENT; COLLECTING DATA IN A CENTRAL FILE, NAMELY, COLLECTION OF EMAIL ADDRESSES FOR DATABASE MARKETING; MARKET RESEARCH; DISSEMINATION OF ADVERTISING MATTER (U.S. CLS. 100, 101 AND 102).

**CLASS 41—EDUCATION AND ENTERTAINMENT**

FOR ENTERTAINMENT, NAMELY, ORGANIZING OF INTERNATIONAL DANCE EVENTS, ARRANGING AND CONDUCTING OF CONCERTS, MUSICAL, AND CULTURAL EVENTS, AND HOSTING ENTERTAINMENT EVENTS; ENTERTAINMENT, NAMELY, LIVE DISC JOCKEY PERFORMANCES WITH AUDIO/VIDEO RECORDINGS FOR SPECIALS EVENTS AND CONCERTS; AMUSEMENTS, NAMELY, ORGANIZING MUSICAL EVENTS; PROVIDING INFORMATION ON ENTERTAINMENT AND RECREATIONAL INFORMATION, NAMELY, INFORMATION ON DANCE EVENTS; DISCOTHEQUES; NIGHT CLUBS; ORGANISATION OF PARTIES AND EVENTS, NAMELY, HOSTING ENTERTAINMENT EVENTS, NAMELY, DANCE EVENTS FOR OTHERS; MUSICAL AND DANCE PERFORMANCES, NAMELY, ENTERTAINMENT SERVICES IN THE NATURE OF LIVE PERFORMANCE OF MUSIC AND LIVE DANCE PERFORMANCES; FILM PRODUCTION; FILM RECORDINGS, NAMELY, MULTIMEDIA ENTERTAINMENT SERVICES IN THE NATURE OF RECORDING SERVICES IN THE FIELD OF INTERNATIONAL DANCE EVENTS; PROVIDING RECREATION FACILITIES (U.S. CLS. 100, 101 AND 107).

BERNICE MIDDLETON, EXAMINING ATTORNEY

SN 79-130,117. KBA-NOTASYS SA, SWITZERLAND, FILED 3-12-2013.

SN 79-130,150. SPENCER 1508 LIMITED, UNITED KINGDOM, FILED 10-5-2012.

## SOUND OF INTAGLIO

THE MARK CONSISTS OF STANDARD CHARACTERS WITHOUT CLAIM TO ANY PARTICULAR FONT, STYLE, SIZE, OR COLOR.

PRIORITY DATE OF 10-1-2012 IS CLAIMED.  
OWNER OF INTERNATIONAL REGISTRATION 1160201 DATED 3-12-2013, EXPIRES 3-12-2023.

NO CLAIM IS MADE TO THE EXCLUSIVE RIGHT TO USE "INTAGLIO", APART FROM THE MARK AS SHOWN.

### CLASS 9—ELECTRICAL AND SCIENTIFIC APPARATUS

FOR CHECKING INSPECTION APPARATUS AND INSTRUMENTS, NAMELY, ELECTRONIC APPARATUS AND INSTRUMENTS FOR MEASURING AND CONTROLLING BIOMETRIC DATA AND FOR VERIFYING FINGERPRINT, FACE, EYE, AND/OR PUPIL ON SECURITY DOCUMENTS; DATA PROCESSING EQUIPMENT; COMPUTERS; IMAGE PROCESSING APPARATUS FOR AUTHENTICATING SECURITY DOCUMENTS SUCH AS BANKNOTES, NAMELY, CAMERAS, SCANNERS; SOFTWARE RECORDED ON COMPUTER MEDIA AND DOWNLOADABLE COMPUTER PROGRAMS FOR USE WITH SMARTPHONES FOR AUTHENTICATING SECURITY DOCUMENTS SUCH AS BANKNOTES; ALL THE FOREGOING GOODS EXCLUDING COMPUTER SOFTWARE FOR CREATING AND PRINTING CUSTOM, ON-DEMAND LABELS (U.S. CLS. 21, 23, 26, 36 AND 38).

### CLASS 16—PAPER GOODS AND PRINTED MATTER

FOR PRINTED MATTER AND PRINTING PRODUCTS, NAMELY, PRINTED BANK-NOTES, SECURITY PAPER, BANK CHECKS, PRINTED TRAVELERS CHECKS, NON-MAGNETICALLY-ENCODED IDENTITY CARDS, TRAVEL DOCUMENTS, NAMELY, PRINTED PASSPORTS, PAPER RIBBONS, AND PRESS-READY PAPER SUBSTRATES, NAMELY, PRESS-READY PAPER SUBSTRATES INCORPORATING PRINTED OR OTHER SECURITY FEATURES NOT MAGNETICALLY CODED FOR USE IN BUSINESS TRANSACTIONS; ALL OF THE FOREGOING GOODS EXCLUDING PRINTED CUSTOM, ON-DEMAND LABELS (U.S. CLS. 2, 5, 22, 23, 29, 37, 38 AND 50).

### CLASS 42—SCIENTIFIC AND COMPUTER SERVICES

FOR DESIGN AND DEVELOPMENT OF COMPUTERS AND SOFTWARE; INSTALLATION, RENTAL, MAINTENANCE AND UPDATING OF SOFTWARE, IN PARTICULAR SOFTWARE FOR AUTHENTICATING SECURITY DOCUMENTS SUCH AS BANKNOTES; SERVICES FOR AUTHENTICATING SECURITY DOCUMENTS SUCH AS BANKNOTES (U.S. CLS. 100 AND 101).  
TRACY FLETCHER, EXAMINING ATTORNEY



PRIORITY DATE OF 5-2-2012 IS CLAIMED.  
OWNER OF INTERNATIONAL REGISTRATION 1160306 DATED 10-5-2012, EXPIRES 10-5-2022.

THE MARK CONSISTS OF THE DESIGN COMPRISING A LOWER CROWN, THE HEAD AND WINGS OF A GRIFFON, AND AN UPPER CROWN.

### CLASS 6—METAL GOODS

FOR COMMON METALS AND THEIR ALLOYS; TRANSPORTABLE BUILDINGS OF METAL; MATERIALS OF METAL FOR RAILWAY TRACKS; NON-ELECTRIC CABLES AND WIRES OF COMMON METAL; PIPES AND TUBES OF METAL; FIGURINES OF COMMON METALS; FOOT SCRAPERS OF METAL; IDENTIFICATION TAGS OF METAL FOR ANIMALS; TRANSPORTABLE GREENHOUSES OF METAL FOR HOUSEHOLD USE; CONSERVATORIES OF METAL; METAL TRELLIS FOR SUPPORTING PLANTS; PLUGS OF METAL FOR BATHS; METAL BUILDING MATERIALS, NAMELY, NAILS; IRONMONGERY, NAMELY, METAL GATES; SMALL ITEMS OF METAL HARDWARE, NAMELY, NUTS AND BOLTS; GOODS OF COMMON METAL NOT INCLUDED IN OTHER CLASSES, NAMELY, CAST IRON; METAL SAFES; IRON ORES; DOOR FURNITURE OF METAL, NAMELY, FRAMES, HANDLES, JAMBS (U.S. CLS. 2, 12, 13, 14, 23, 25 AND 50).

### CLASS 8—HAND TOOLS

FOR HAND-OPERATED HAND TOOLS AND IMPLEMENTS, NAMELY, HAMMERS; CUTLERY AND SILVERWARE CUTLERY, NAMELY, KNIVES; FORKS; SPOONS; KITCHEN KNIVES; SERVING SPOONS; WINE LADLES; ICE TONGS; MANUAL CLIPPERS; RAZORS; SHAVING BLADES; SHAVING CASES; MANICURE SETS; PEDICURE SETS; PENKNIVES; SCISSORS; TWEEZERS; SHARPENING STONES; FIRE IRONS; NON-ELECTRIC GARDENING TOOLS, NAMELY, GARDEN SHEARS; GARDEN KNIVES AND CUTTERS, NAMELY, PRUNING SHEARS; SECATEURS; SIDE ARMS, NAMELY, SWORDS (U.S. CLS. 23, 28 AND 44).

**CLASS 11—ENVIRONMENTAL CONTROL APPARATUS**

FOR LAMPS; CEILING LIGHTS; CHANDELIERS; HOT WATER BOTTLES; HAIR DRYERS; ELECTRIC FANS FOR PERSONAL USE; REFRIGERATORS; FREEZERS; HOT PLATES; MICROWAVE OVENS; ELECTRIC DEEP FRYERS; ELECTRIC KETTLES; ELECTRIC COFFEE MACHINES; ELECTRIC COFFEE PERCOLATORS; ELECTRIC TEA MAKERS; BARBECUES; BREAD BAKING MACHINES; LIGHTING APPARATUS AND INSTALLATIONS, NAMELY, LED AND HID LIGHT FIXTURES; COOKING APPARATUS AND INSTALLATIONS, NAMELY, ELECTRIC STOVES; ELECTRIC LANTERNS; ELECTRIC TORCHES FOR LIGHTING; BURNERS FOR LAMPS; ELECTRIC SLOW COOKERS; GAS STOVES; GAS GRILLS AND ELECTRIC GRILLS; ELECTRIC COOKING UTENSILS, NAMELY, GRIDDLERS, EGG BOILERS, DEHYDRATORS; ELECTRIC TOASTERS; ELECTRIC COFFEE FILTERS NOT OF PAPER BEING PART OF ELECTRIC COFFEE MAKERS (U.S. CLS. 13, 21, 23, 31 AND 34).

**CLASS 20—FURNITURE AND ARTICLES NOT OTHERWISE CLASSIFIED**

FOR FURNITURE, MIRRORS, PICTURE FRAMES; FURNITURE CHESTS; CHESTS OF DRAWERS; CUPBOARDS; MAGAZINE RACKS; DRESSING TABLES; DESKS; ARMCHAIRS; SETTEES; SOFAS; EASY CHAIRS; OFFICE CHAIRS; DECK CHAIRS; STOOLS; FOOTSTOOLS; BEDS; MATTRESSES; COTS; BOTTLE RACKS; BATH PILLOWS; CUSHIONS; PILLOWS; NECK-SUPPORTING PILLOWS; COAT STANDS; UMBRELLA STANDS; HAT STANDS; COAT HANGERS; COAT STANDS; UMBRELLA STANDS; HAT STANDS; COAT HANGERS; BOOK SHELVES; LIBRARY SHELVES; TABLES; FURNITURE TABLES; SEATS; CHAIRS SEATS; FURNITURE CHAIRS; CHAISE LONGUE; FOLDING CHAIRS; HAND HELD MIRRORS; WALL MIRRORS; FIGURINES MADE OF WOOD, PLASTER, PLASTICS, WAX, BONE AND IVORY; GARDEN FURNITURE; CABINET WORK AND FURNITURE CABINETS, NAMELY, KITCHEN CABINETS; FURNITURE IN THE NATURE CLOTHES STORAGE CEDAR BOXES, STORAGE CEDAR CASES AND HAT RACKS; NEWSPAPER DISPLAY STANDS; BEDDING, EXCEPT LINEN, NAMELY, BEDS; CURTAIN TIE-BACKS IN THE NATURE OF CURTAIN HOLDERS, NOT OF TEXTILE; NON-TEXTILE CURTAIN HOOKS, RAILS, RINGS, RODS, ROLLERS AND TIE-BACKS; BASKETS, BINS, HAMPERS BASKETS, NOT OF METAL, NAMELY, HAMPERS IN THE NATURE OF BASKETS FOR TRANSPORTING GOODS FOR COMMERCIAL PURPOSES; STEP LADDERS, NOT OF METAL; MAGNETIZED PHOTO FRAMES; KNEELING STOOLS; PLANT SUPPORTS, NAMELY, PLANT STANDS (U.S. CLS. 2, 13, 22, 25, 32 AND 50).

**CLASS 21—HOUSEWARES AND GLASS**

FOR HAIRBRUSHES; CLOTHES BRUSHES; TOOTHBRUSHES; TOOTHBRUSH CASES; BATH BRUSHES; CANDLESTICKS; CANDLE HOLDERS; CANDLE SNUFFERS; FITTED VANITY CASES; COAL SCUTTLES; VASES; FRUIT BOWLS; EPERGNES; SERVING PLATTERS; TEA SETS; TEA STRAINERS; TEA CADDIES; NON-ELECTRIC COFFEE MAKERS; DRINKING GLASSES; JUGS; COOLERS FOR WINE; DECANTERS; KITCHEN LADLES; COLANDERS; BUTTER DISHES; EGG CUPS; SALT MILLS; PEPPER POTS; BREAD BINS; FLASKS; GARDENING GLOVES; MIXING SPOONS; SERVING SPOONS; BRUSH-MAKING MATERIALS; BRUSHES FOR GROOMING PET ANIMALS; SOAP HOLDERS AND RACKS FOR THE BATH; SPONGE HOLDERS AND RACKS FOR THE BATH; DRINK HOLDERS FOR THE BATH; WASTEPAPER BINS AND BASKETS FOR DOMESTIC USE; FIGURINES MADE OF CERAMIC, CHINA, CRYSTAL, EARTHENWARE, GLASS, CRYSTAL, PORCELAIN AND TERRA COTTA; ORNAMENTAL PLATES; BISCUIT JARS; HOUSEHOLD OR KITCHEN UTENSILS AND CONTAINERS, NAMELY, NON-ELECTRIC EGG BEATERS; GLASSWARE, PORCELAIN, EARTHENWARE AND STONWARE NOT INCLUDED IN OTHER CLASSES, NAMELY, MUGS AND BEVERAGE GLASSES; COMBS AND BATH SPONGES; GOLF BRUSHES; ARTICLES

FOR CLEANING PURPOSES, NAMELY, CLEANING RAGS; UNWORKED OR SEMI-WORKED GLASS EXCEPT GLASS USED IN BUILDING; CHINAWARE, NAMELY, DESSERT PLATES; CRYSTAL GLASSWARE, NAMELY, BEVERAGE GLASSES; CROCKERY, NAMELY, COOKIE JARS; DECORATIVE PILL BOXES MADE OF CERAMIC, CHINA, CRYSTAL, EARTHENWARE, GLASS, CRYSTAL, PORCELAIN AND TERRA COTTA; NON-ELECTRIC CANDELABRA; NON-ELECTRIC TEA POTS; NON-ELECTRIC COOKING POTS AND PANS; DECORATIVE GLASSWARE, PORCELAIN, EARTHENWARE AND STONWARE, NAMELY, DECORATIVE PLATES; CONDIMENT SETS COMPRISING PRIMARILY OF SAUCE BOWLS; COFFEE SETS COMPRISING PRIMARILY OF COFFEE CUPS; SERVING PLATTERS; SAUCEBOATS NOT MADE OF PRECIOUS METALS; CAFETIERES, NAMELY, FRENCH COFFEE PRESS; PLASTIC COASTERS; NON-ELECTRIC WHISKS; FITTED PICNIC BASKETS; WOODEN CHIPPING BLOCKS AS UTENSILS; DISPENSERS FOR SALT, NAMELY, SALT MILLS; COOKING UTENSILS FOR DOMESTIC BARBECUES AND NON-ELECTRIC HAND IMPLEMENTS FOR USE IN BARBECUE COOKING, NAMELY, BRANDERS, FORKS, TONGS AND TURNERS; PLANTERS FOR FLOWERS AND PLANTS, NAMELY, PLANTERS MADE OF CERAMIC, CHINA, CLAY, EARTHENWARE, GLASS AND PLASTIC, PLANTERS OF COMMON METAL, AND PLANTERS MADE OF WOOD (U.S. CLS. 2, 13, 23, 29, 30, 33, 40 AND 50).

**CLASS 24—FABRICS**

FOR TEXTILES AND TEXTILE GOODS, NOT INCLUDED IN OTHER CLASSES, NAMELY, COTTON FABRIC; PLASTIC TABLE COVERS; BED COVERS; TAPESTRIES OF TEXTILES; SOFT FURNISHINGS, NAMELY, QUILTS; THROWS; BED BLANKETS; TRAVEL BLANKETS; COVERS FOR PILLOWS; TOWELS; FLANNEL; TABLE LINEN; TEA CLOTHS, NAMELY, TEA TOWELS; UNFITTED COVERS FOR GARDEN FURNITURE (U.S. CLS. 42 AND 50).

**CLASS 27—FLOOR COVERINGS**

FOR CARPETS, RUGS, MATS AND MATTING, LINOLEUM FOR COVERING EXISTING FLOORS; NON-TEXTILE WALL HANGINGS; WALLPAPER; BATH MATS (U.S. CLS. 19, 20, 37, 42 AND 50).

**CLASS 35—ADVERTISING AND BUSINESS**

FOR ADVERTISING; BUSINESS MANAGEMENT; BUSINESS ADMINISTRATION; OFFICE FUNCTIONS; DEMONSTRATION OF GOODS; PRESENTATION OF GOODS ON COMMUNICATION MEDIA, FOR RETAIL PURPOSES, NAMELY, PROVIDING TELEVISION HOME SHOPPING SERVICES IN THE FIELD OF GENERAL CONSUMER MERCHANDISE; COMMERCIAL INFORMATION AND ADVICE FOR CONSUMERS, NAMELY, CONSUMER ADVICE SHOP; OUTSOURCING SERVICES, NAMELY, BUSINESS ASSISTANCE; SALES PROMOTION FOR OTHERS; PROCUREMENT SERVICES FOR OTHERS, NAMELY, PURCHASING GOODS AND SERVICES FOR OTHER BUSINESSES; BUSINESS ADVICE AND BUSINESS ASSISTANCE IN THE SELECTION OF GOODS; RETAIL STORE SERVICES IN CONNECTION WITH PAINTS, VARNISHES, LACQUERS, PRESERVATIVES, COLORANTS, MORDANTS, RAW NATURAL RESINS, COMMON METALS AND THEIR ALLOYS, HAND TOOLS AND IMPLEMENTS, CUTLERY, APPARATUS FOR LIGHTING, HEATING, STEAM GENERATING, COOKING, REFRIGERATING, DRYING AND VENTILATING, FURNITURE, MIRRORS, PICTURE FRAMES, GOODS OF WOOD, CORK, REED, CANE, WICKER, HORN, BONE, IVORY, WHALEBONE, SHELL, AMBER, MOTHER-OF-PEARL, MEERSCHAUM AND SUBSTITUTES FOR ALL THESE MATERIALS, OR OF PLASTICS, HOUSEHOLD OR KITCHEN UTENSILS AND CONTAINERS, GLASSWARE, PORCELAIN, EARTHENWARE, STONWARE, TEXTILES AND TEXTILE GOODS, TABLE COVERS, BED COVERS, SOFT FURNISHINGS, CARPETS, RUGS, MATS AND MATTING (U.S. CLS. 100, 101 AND 102).

HANNO RITTNER, EXAMINING ATTORNEY

SN 79-130,242. ZAKRYTOE AKTSIONERNOE OBSHCHESTVO "SHUPET", MOSCOW, RUSSIAN FED., FILED 2-6-2013.

*Choupette*

OWNER OF INTERNATIONAL REGISTRATION 1119715 DATED 4-19-2012, EXPIRES 4-19-2022.

THE MARK CONSISTS OF THE STYLIZED WORDING "CHOUPEPTE" WITH A "C" HAVING A CURVE LINE REPRESENTING ANOTHER "C" AROUND IT.

THE WORDING "CHOUPEPTE" HAS NO MEANING IN A FOREIGN LANGUAGE.

#### CLASS 24—FABRICS

FOR TEXTILE AND TEXTILE GOODS, NOT INCLUDED IN OTHER CLASSES, NAMELY, TEXTILE LABELS, SPANDEX AND COTTON FABRIC FOR USE IN THE MANUFACTURE OF CLOTHING, FURNITURE UPHOLSTERY, AND CURTAINS OF TEXTILE; BED COVERS; TABLE COVERS, NAMELY, TABLE CLOTH OF TEXTILE AND PLASTIC TABLE COVERS; BED LINEN; SLEEPING BAGS IN THE NATURE OF SHEETING; PILLOWCASES; MATTRESS COVERS; BED BLANKETS; BED COVERS; GUMMED WATERPROOF CLOTH, OTHER THAN FOR STATIONERY; MOSQUITO NETS; LINGERIE FABRIC (U.S. CLS. 42 AND 50).

#### CLASS 25—CLOTHING

FOR CLOTHING, NAMELY, UNDERWEAR, BLOUSES, TROUSERS, NECKTIES, VESTS, TIGHTS, OVERALLS; SUITS, JACKETS, OVERCOATS, GLOVES, PAJAMAS, DRESSES, SHIRTS, JUMPER DRESSES, SWEATERS, KNITWEAR, NAMELY, KNIT DRESSES, KNIT SHIRTS, KNIT TOPS, KNITTED GLOVES, KNITTED BOTTOMS, TEE-SHIRTS, SCARVES, BABIES' PANTS, SKIRTS, FOOTWEAR, HEADWEAR, NAMELY, HATS AND CAPS (U.S. CLS. 22 AND 39).

MAYUR VAGHANI, EXAMINING ATTORNEY

#### CLASS 3—COSMETICS AND CLEANING PREPARATIONS

FOR ALL-PURPOSE CLEANING, SCOURING AND ABRASIVE PREPARATIONS; BLEACHING PREPARATIONS AND OTHER SUBSTANCES FOR LAUNDRY USE, NAMELY, LAUNDRY BLEACH, LAUNDRY BLUEING, LAUNDRY BRIGHTENER, LAUNDRY PRE-SOAK, LAUNDRY STAIN REMOVERS, LAUNDRY STARCH, LAUNDRY DETERGENT, AND OTHER SUBSTANCES FOR DISHWASHING, NAMELY, DISHWASHING DETERGENTS IN SOLID, FLUID, POWDER AND GEL FORM; DISHWASHING PREPARATIONS; DISHWASHER CLEANER; RINSE AGENTS FOR DISHWASHING MACHINES; POLISHING PREPARATIONS FOR KITCHEN AND GLASSWARE; CARPET CLEANERS; DETERGENTS; SOAPS; FABRIC SOFTENERS; STAIN REMOVING PREPARATIONS; PREWASH AND STAIN LOOSENING PREPARATIONS; DECALCIFYING AND DESCALING PREPARATIONS FOR CLEANING HOUSEHOLD PRODUCTS; RUST REMOVERS, GREASE REMOVERS; DRAIN AND SINK UNBLOCKING PREPARATIONS; PREPARATIONS FOR CLEANING AND REMOVING LIMESCALE, RUST OR GREASE; NON-MEDICATED TOILETRIES; HAIR LOTIONS; NON-MEDICATED SKIN CARE PREPARATIONS; COSMETICS; COSMETIC CREAMS AND LOTIONS; MOISTURIZING CREAMS, LOTIONS AND GELS; EXFOLIANTS FOR SKIN; BLEACHING PREPARATIONS ALL FOR PERSONAL USE; PREPARATIONS FOR SHAVING; DEPILATORY PREPARATIONS; DEPILATORY WAXES; PREPARATIONS, INCLUDING CREAMS, GELS AND MOUSSES, FOR USE BEFORE, DURING AND AFTER SHAVING; PERFUMES; ESSENTIAL OILS; NON-MEDICATED PREPARATIONS FOR THE BATH, NAMELY BATH SALTS AND OILS; MOISTURIZING PREPARATIONS FOR THE SKIN; MASSAGE OILS; MASSAGE CREAMS; MASSAGE GELS; NON-MEDICATED PREPARATIONS FOR THE CARE OF INTIMATE PARTS OF THE BODY; NON-MEDICATED OINTMENTS, NON-MEDICATED PREPARATIONS FOR THE CARE OF THE FEET, BODY AND SKIN; NAIL CARE PREPARATIONS; CREAMS, GELS, LOTIONS, OILS, BALSAMS, POWDERS, TALCUM POWDERS AND SPRAYS FOR USE ON THE FEET, BODY AND SKIN; NON-MEDICATED PREPARATIONS FOR THE TREATMENT, CARE, CLEANSING, SOOTHING, REVITALIZING AND RELAXING OF THE FEET, BODY AND SKIN; NON-MEDICATED PREPARATIONS FOR THE BATH IN THE FORM OF SALTS, OILS AND NON-MEDICATED BODY SOAKS; NON-MEDICATED BODY SOAKS IN THE FORM OF TABLETS; DEODORANTS; DEODORIZING CREAMS, GELS, LOTIONS, POWDERS, TALCUM POWDERS AND SPRAYS; DEODORANTS IMPREGNATED INTO INSOLES; ROOM SPRAYS IN THE NATURE OF FRAGRANCES AND PERFUMES, OTHER THAN FOR PERSONAL USE; PERFUMING PREPARATIONS FOR THE ATMOSPHERE, NAMELY, INCENSE AND INCENSE CONES, ROOM FRAGRANCES, ROOM PERFUME SPRAYS (U.S. CLS. 1, 4, 6, 50, 51 AND 52).

#### CLASS 5—PHARMACEUTICALS

FOR PHARMACEUTICALS, MEDICINAL, VETERINARY AND SANITARY PREPARATIONS AND PRODUCTS, NAMELY, PHARMACEUTICAL PREPARATIONS FOR THE TREATMENT OF OPIATE, COCAINE AND ALCOHOL ADDICTION; PHARMACEUTICAL PREPARATIONS AND SUBSTANCES HAVING ANTI-INFLAMMATORY, ANTI-PYRETIC AND ANALGESIC PROPERTIES, NAMELY, ANTI-INFLAMMATORIES, ANTIPYRETIC ANALGESICS, AND ANALGESICS; PHARMACEUTICAL PREPARATIONS FOR THE TREATMENT OF GASTROINTESTINAL CONDITIONS, DISORDERS OR COMPLAINTS; GASTRIC REFLUX SUPPRESSANTS; LAXATIVES; NATURAL FIBER BULKING AGENTS; PHARMACEUTICAL PREPARATIONS FOR THE RELIEF OF COUGH, COLD AND INFLUENZA SYMPTOMS; PHARMACEUTICAL PREPARATIONS FOR THE TREATMENT AND RELIEF OF SORE THROATS; DECONGESTANTS; EXPECTORANTS; MEDICATED BEVERAGES AND PREPARATIONS FOR MAKING SUCH BEVERAGES; MEDICATED CONFECTIONERY; MEDICATED SKIN CARE PREPARATIONS; SANITARY PREPARATIONS FOR MEDICAL PURPOSES; DIETETIC SUBSTANCES ADAPTED FOR MEDICAL USE, NAMELY, DIETARY, HERBAL OR VITAMIN SUPPLEMENTS IN THE FORM

SN 79-130,304. RECKITT BENCKISER N.V., NETHERLANDS, FILED 8-17-2012.



PRIORITY DATE OF 4-20-2012 IS CLAIMED.

OWNER OF INTERNATIONAL REGISTRATION 1160628 DATED 8-17-2012, EXPIRES 8-17-2022.

THE MARK CONSISTS OF A HEART DESIGN ON THE LEFT WITH A CROSS IN THE CENTER OF THE HEART, A DROPLET DESIGN IN THE CENTER WITH A CROSS APPEARING IN THE CENTER OF THE DROPLET, AND ON THE RIGHT A STYLIZED HOUSE DESIGN WITH A STYLIZED TRIANGULAR DESIGN APPEARING WITHIN THE HOUSE AND CURVED SWOOSH DESIGN APPEARING BELOW THE TRIANGULAR DESIGN.



OF TABLET, LIQUID OR POWDER; FOOD FOR BABIES; MEDICINAL TINCTURES IN THE NATURE OF IODINE; MEDICATED PREPARATIONS FOR THE CARE OF THE FEET, BODY AND SKIN; MEDICATED CREAMS, GELS, LOTIONS, OILS, BALMS, POWDERS, AND SPRAYS FOR USE ON THE FEET, BODY AND SKIN; MEDICATED, SANITARY OR DISINFECTING PREPARATIONS FOR THE TREATMENT OF THE FEET, BODY AND SKIN; MEDICINAL AND THERAPEUTIC PREPARATIONS AND ADDITIVES FOR THE BATH IN THE FORM OF SALTS, OILS AND BODY SOAKS; MEDICATED OR DISINFECTING SOAKS IN THE FORM OF TABLETS; MEDICATED OR PHARMACEUTICAL PREPARATIONS AGAINST PERSPIRATION; MEDICINAL OILS FOR MASSAGING; MEDICATED TOILET PREPARATIONS, NAMELY, MEDICATED SHAMPOOS FOR FLAKY AND ITCHY SCALPS, DANDRUFF CONTROL AND SKIN CONDITIONS; MEDICATED OR PHARMACEUTICAL PRODUCTS FOR TREATMENT OF CORNS AND CHILBLAINS; PADS AND CUSHIONS FOR THE PREVENTION OF INFLAMMATION OF THE TOES AND OF THE THICKENING OF SKIN CALLUSES; MEDICATED PREPARATIONS FOR CURING INGROWN TOE NAILS; MEDICATED PADS AND INSOLES FOR TREATMENT OF BUNIONS; MATERIALS FOR DRESSING PLASTERS, PLASTER RINGS, RINGS FOR CORNS, ADHESIVE CORN PLASTERS, BANDAGING MATERIALS IN THE NATURE OF SKIN BANDAGES, ADHESIVE BANDAGES; DISINFECTANT PREPARATIONS, ANTISEPTIC PRODUCTS ANTI-FUNGAL SUBSTANCES, NAMELY, PHARMACEUTICAL PREPARATIONS FOR TREATING FUNGAL INFECTIONS OF THE SKIN AND NAIL; MATERIALS IMPREGNATED WITH, OR INCORPORATING, ANTI-FUNGAL PREPARATIONS; BANDAGES FOR WOUNDS; CONTRACEPTIVE PREPARATIONS; SPERMICIDAL GELS, LIQUIDS AND CREAMS; HYGIENIC LUBRICANTS AND DISINFECTANTS FOR USE IN THE AREA OF THE VAGINA, PENIS AND ANUS; PERSONAL LUBRICANTS; LUBRICANTS, GELS, LIQUIDS AND CREAMS FOR SEXUAL HEALTH AND FOR ENHANCING SEXUAL PERFORMANCE; DIETARY, VITAMIN AND NUTRITIONAL SUPPLEMENTS FOR SEXUAL HEALTH AND/OR ENHANCING SEXUAL PERFORMANCE; PHARMACEUTICAL PREPARATIONS AND SUBSTANCES ALL RELATING TO SEXUAL HEALTH AND/OR SEXUAL PERFORMANCE; DIAGNOSTIC PREPARATIONS AND SUBSTANCES ALL FOR GYNECOLOGICAL TESTING PURPOSES OR FOR THE DIAGNOSIS OF SEXUALLY TRANSMITTED DISEASES; DISINFECTANTS OTHER THAN FOR LAYING OR ABSORBING DUST, NAMELY, ALL-PURPOSE DISINFECTANTS; DISINFECTANTS FOR HOUSEHOLD USE OR FOR HYGIENE OR SANITARY PURPOSES; ARTICLES IMPREGNATED WITH AN ANTISEPTIC PRODUCT; ANTISEPTIC PREPARATIONS, ANTI-BACTERIAL PREPARATIONS IN THE NATURE OF ANTI-BACTERIAL SOAPS, DISINFECTING PREPARATIONS IN, NAMELY, ALL-PURPOSE DISINFECTANTS, GERMICIDES; INSECTICIDES AND MITICIDES; INSECT REPELLANTS; PREPARATIONS FOR DESTROYING AND REPELLING VERMIN; FUNGICIDES; DEODORANTS NOT FOR PERSONAL USE IN THE NATURE OF HOUSEHOLD AND ROOM DEODORANTS; AIR DEODORIZING PREPARATIONS AND AIR PURIFYING PREPARATIONS IN THE NATURE OF AIR DEODORANTS; FABRIC DEODORIZERS AND REFRESHENERS, NAMELY, DEODORIZERS FOR CLOTHING, CARPETS AND UPHOLSTERY (U.S. CLS. 6, 18, 44, 46, 51 AND 52).

#### CLASS 8—HAND TOOLS

FOR NAIL CLIPPERS; NAIL FILES; NAIL BUFFERS; MANICURE SETS; MANICURE APPARATUS AND INSTRUMENTS, NAMELY, ORANGE STICKS, CUTICLE PUSHERS, TWEEZERS, CUTICLE SCISSORS; NAIL SCISSORS; FINGERNAIL AND TOENAIL POLISHERS (U.S. CLS. 23, 28 AND 44).

#### CLASS 10—MEDICAL APPARATUS

FOR SUTURE MATERIALS; INSTRUMENTS, EQUIPMENT AND APPARATUS FOR HYGIENE, ORTHOPEDICS AND FOR THE TREATMENT AND CARE OF THE FEET AND SKIN, NAMELY, SURGICAL KNIVES, CORN AND CALLUS SHAVERS, CORN KNIVES, SURGICAL SCISSORS, ABRASIVE APPARATUS TO REMOVE HARD SKIN OR CALLUSES; ORTHOPEDIC CUSHIONS FOR CARE OF THE FEET; AIDS FOR THE CORRECTION OF THE FEET, NAMELY, SUPPORTS FOR THE ARCH OF THE FOOT; MEDICAL APPARATUS FOR THE SEPARATION AND THE STRAIGHTENING OF THE TOES; PROTECTIVE PADS TO PREVENT HARDENING OF AREAS OF SKIN CALLUSES AND INFLAMMATION OF THE TOES; ORTHOPEDIC CUSHIONS FOR THE HEELS, UNDER-HEELS; PROTECTION FOR METATARSAL IN THE NATURE OF ORTHOPEDIC METATARSAL CUSHIONS; ORTHOPEDIC BOOT INSERTS, FOOT RINGS IN THE NATURE OF ORTHOPEDIC SUPPORTS FOR FEET AND ORTHOPEDIC FOOT SUPPORTS; ORTHOPEDIC SHOE INSOLES, ORTHOPEDIC INSOLES, DISPOSABLE ORTHOPEDIC INSOLES, DEODORIZED ORTHOPEDIC INSOLES FOR ORTHOPEDIC FOOTWEAR; MEDICAL COMPRESSION HOSIERY; GRADUATED COMPRESSION HOSIERY; MEDICAL SUPPORT HOSIERY; ORTHOPEDIC AND THERAPEUTIC MEDICAL HOSIERY; HOSIERY FOR MEDICAL, SURGICAL AND/OR PROPHYLACTIC PURPOSES; MEDICAL AND SURGICAL SOCKS; MEDICAL STOCKINGS FOR VARICOSE VEINS; APPARATUS, NAMELY ORTHOPEDIC DEVICE, FOR EXERCISING THE FOOT; INSTRUMENTS AND APPARATUS FOR PLACING BANDAGES, NAMELY, MEDICAL DEVICE FOR PLACING BANDAGES; APPARATUS FOR THE FIXING OF FINGERS AND TOES, NAMELY, SPLINTS; ELASTIC BANDAGES FOR JOINTS, ELASTIC GAITERS, ELASTIC KNEE JOINTS, ELASTIC BANDAGES, BANDAGES FOR THE WAIST, NAMELY, BANDAGES FOR ORTHOPEDIC PURPOSES; APPARATUS FOR MEASURING, EXAMINING AND TAKING IMPRESSIONS OF THE FEET; BODY MASSAGERS, NAMELY ELECTRICAL AND BATTERY OPERATED MASSAGE APPARATUS FOR USE ON DIFFERENT PARTS OF THE BODY; ELECTRICALLY OPERATED MASSAGERS; FOOT MASSAGERS; THERAPEUTIC APPARATUS AND APPLIANCES FOR MASSAGING AND/OR BATHING, NAMELY, THERAPEUTIC APPARATUS AND APPLIANCES FOR THE RELIEF OF MUSCLE TENSION; CONDOMS; CONTRACEPTIVE OR PROPHYLACTIC DEVICES, NAMELY CONDOMS, DIAPHRAGMS, SHEATHS, UTERINE LOOPS, INTRAUTERINE DEVICES, CERVICAL CAPS, FEMALE CONDOMS, AND PESSARIES; MASSAGE APPARATUS, INSTRUMENTS AND APPLIANCES; ELECTRIC AND ELECTRONIC MASSAGE APPARATUS, INSTRUMENTS AND APPLIANCES; PERSONAL MASSAGERS; VIBRATORS; VIBRATING RINGS FOR SEXUAL AROUSEMENT PURPOSES; MARITAL AIDS, NAMELY, VIBRATORS, BENWA BALLS, BUTT PLUGS, TONGUE RINGS, PENIS RINGS, RINGS FOR GENITAL STIMULATION, AND VIBRATING RINGS; SEX TOYS, NAMELY, VIBRATORS, BENWA BALLS, BUTT PLUGS, TONGUE RINGS, PENIS RINGS, RINGS FOR GENITAL STIMULATION, AND VIBRATING RINGS; SEX AIDS, NAMELY, VIBRATORS, BENWA BALLS, BUTT PLUGS, TONGUE RINGS, PENIS RINGS, RINGS FOR GENITAL STIMULATION, AND VIBRATING RINGS; ARCH SUPPORTS FOR BOOTS OR SHOES (U.S. CLS. 26, 39 AND 44).

#### CLASS 11—ENVIRONMENTAL CONTROL APPARATUS

FOR APPARATUS AND INSTRUMENTS, NAMELY, DISPENSING UNITS AND DIFFUSERS FOR ROOM FRAGRANCES, AIR FRESHENERS AND ROOM DEODORANTS, ALL FOR SCENTING, PURIFYING OR FRESHENING THE ATMOSPHERE; ELECTRICAL POWERED AIR PURIFIERS FOR THE NEUTRALIZATIONS, REDUCTION OR CONTROL OF ALLERGENS; WATER DECALCIFYING AND DESCALING APPARATUS, NAMELY, WATER PURIFYING APPARATUS; WATER FILTERING APPARATUS; WATER SOFTENING APPARATUS; WATER FILTERS; WATER SOFTENERS; FILTER CARTRIDGES FOR WATER PURIFICATION AND WATER SOFTENING FOR HOUSEHOLD USE; WATER TREATMENT FILTERS (U.S. CLS. 13, 21, 23, 31 AND 34).

**CLASS 25—CLOTHING**

FOR CLOTHING, NAMELY, COATS, TROUSERS, JEANS, SKIRTS, DRESSES, JACKETS, SHIRTS, BLOUSES, LINGERIE, T-SHIRTS, SHORTS, JUMPERS, UNDERWEAR, NIGHTWEAR, GLOVES, SCARVES, SOCKS, HOSIERY AND STOCKINGS, SWIMWEAR, BELTS, TIES; FOOTWEAR, HEADWEAR, NAMELY HATS, CAPS, HEADBANDS AND SCARVES; FITTINGS FOR FOOTWEAR, SOCKS AND STOCKINGS; SHOES, SLIPPERS, BOOTS, SANDALS, CLOGS; SOLES; HOSIERY; INSERTS AND INSOLES FOR FOOTWEAR; HEEL CUSHIONS AND HEEL GRIPS, NAMELY, HEEL INSERTS AND HEEL PIECES FOR SHOES (U.S. CLS. 22 AND 39).

**CLASS 35—ADVERTISING AND BUSINESS**

FOR PROVISION OF BUSINESS INFORMATION; ADVERTISING; BUSINESS MANAGEMENT; BUSINESS ADMINISTRATION AND OFFICE WORK; PROVIDING OFFICE FUNCTIONS; MARKETING SERVICES; COMMERCIAL OR INDUSTRIAL BUSINESS MANAGEMENT SERVICES; ORGANIZATION, OPERATION AND SUPERVISION OF LOYALTY AND INCENTIVE PROGRAMS IN THE NATURE OF COUPONS, VOUCHERS, MONEY BACK OFFERS, LOYALTY CARDS; RENTAL AND LEASING OF VENDING MACHINES; RETAIL STORE SERVICES FEATURING A VARIETY OF CONSUMER GOODS, NAMELY, BLEACHING PREPARATIONS AND OTHER SUBSTANCES FOR LAUNDRY USE, DISHWASHER PREPARATIONS, PREPARATIONS FOR REMOVING STAINS, CARPET CLEANERS, SOAPS, DETERGENTS, DECALCIFYING AND DESCALING PREPARATIONS, LIMESCALE REMOVERS, RUST REMOVERS, FABRIC SOFTENERS, LAUNDRY ADDITIVES, WATER SOFTENING PREPARATIONS, GREASE REMOVERS, DRAIN AND SINK UNBLOCKING PREPARATIONS, PREPARATIONS FOR PREVENTION OF LIMESCALE, RUST OR GREASE, NON-MEDICATED TOILET PREPARATIONS, NON-MEDICATED PREPARATIONS FOR THE CARE OF FEET, FOOT CARE PREPARATIONS, SKIN CARE PREPARATIONS, MEDICATED SKIN CARE PREPARATIONS, PREPARATIONS FOR TREATMENT OF ACNE, DEPLATORY PREPARATIONS, PHARMACEUTICAL PREPARATIONS, MEDICATED BEVERAGES AND CONFECTIONERY, CONTRACEPTIVE PREPARATIONS AND SUBSTANCES, SPERMICIDAL GELS, LIQUIDS AND CREAMS, CONDOMS, SANITARY PREPARATIONS, ANTISEPTIC PREPARATIONS, ANTI-BACTERIAL PREPARATIONS, DISINFECTING PREPARATIONS, ARTICLES IMPREGNATED WITH A DISINFECTANT OR ANTI-BACTERIAL PRODUCT, ARTICLES IMPREGNATED WITH AN ANTISEPTIC PRODUCT, INSECTICIDES, INSECT REPELLENTS, PESTICIDES, RODENTICIDES, MITICIDES, PREPARATIONS FOR DESTROYING VERMIN, GERMICIDES, DEODORANTS NOT FOR PERSONAL USE, AIR FRESHENING PREPARATIONS, AIR FRESHENERS, NAIL CLIPPERS, NAIL FILES, NAIL SCISSORS, AND FOOTWEAR (U.S. CLS. 100, 101 AND 102).

**CLASS 41—EDUCATION AND ENTERTAINMENT**

FOR EDUCATION, ADVICE AND TRAINING, NAMELY, PROVIDING SEMINARS AND WORKSHOPS IN THE FIELD OF FOOD STORAGE AND PREPARATION, USE OF HOME CONSUMER PRODUCTS, AND PERSONAL CARE AND HEALTHCARE CONSUMER PRODUCTS; EDUCATION, ADVICE AND TRAINING, NAMELY, PROVIDING SEMINARS AND WORKSHOPS IN THE FIELD OF HOME CARE, PERSONAL CARE, SEXUAL HEALTH AND WELL BEING AND HEALTHCARE MANAGEMENT AND WELFARE; ARRANGING AND CONDUCTING OF EDUCATIONAL SEMINARS, WORKSHOPS AND EDUCATIONAL DISCUSSION GROUPS IN THE FIELD OF FOOD, HOME CARE, PERSONAL CARE, SEXUAL HEALTH AND WELL BEING AND HEALTHCARE PRODUCTS, MANAGE-

MENT AND WELFARE; ORGANIZING COMMUNITY SPORTING AND CULTURAL EVENTS; PUBLICATION OF TEXTS IN THE NATURE OF BOOKS, LEAFLETS, MAGAZINES, POSTERS AND ELECTRONIC PUBLICATIONS; ORGANIZATION OF EXHIBITIONS FOR CULTURAL OR EDUCATIONAL PURPOSES; PRESENTATION OF WORKS OF VISUAL ART AND LITERATURE, NAMELY, BOOKS, LEAFLETS, MAGAZINES, POSTERS AND ELECTRONIC PUBLICATIONS TO THE PUBLIC FOR CULTURAL OR EDUCATIONAL PURPOSES; PROVIDING ENTERTAINMENT INFORMATION SERVICES (U.S. CLS. 100, 101 AND 107).

WARREN L. OLANDRIA, EXAMINING ATTORNEY

SN 79-130,420. KATRONIC TECHNOLOGIES LTD., UNITED KINGDOM, FILED 3-12-2013.

# KATflow

THE MARK CONSISTS OF STANDARD CHARACTERS WITHOUT CLAIM TO ANY PARTICULAR FONT, STYLE, SIZE, OR COLOR.

PRIORITY DATE OF 9-20-2012 IS CLAIMED.

OWNER OF INTERNATIONAL REGISTRATION 1160987 DATED 3-12-2013, EXPIRES 3-12-2023.

**CLASS 9—ELECTRICAL AND SCIENTIFIC APPARATUS**

FOR SURVEYING, OPTICAL, MEASURING AND REGULATING APPARATUS AND INSTRUMENTS, NAMELY, FLOWMETERS AND FLOW VELOCITY MEASURING DEVICES FOR LIQUIDS, GASES AND MULTI-PHASE PRODUCTS; GAS TESTING INSTRUMENTS; SPEED INDICATORS; HIGH-FREQUENCY APPARATUS, NAMELY, SOUND VELOCITY MEASURING DEVICES FOR LIQUIDS, GASES AND MULTI-PHASE PRODUCTS; QUANTITY INDICATORS, NAMELY, LIQUID LEVEL METERS AND CONTROL DEVICES, CONCENTRATION AND DENSITY MEASURING DEVICES, WATER-IN-OIL AND OIL-IN-WATER MONITORS, SAND AND SOLID PARTICLE MONITORS (U.S. CLS. 21, 23, 26, 36 AND 38).

**CLASS 11—ENVIRONMENTAL CONTROL APPARATUS**

FOR REGULATING AND SAFETY ACCESSORIES FOR WATER OR GAS APPARATUS AND PIPES, NAMELY, LIQUID AND GAS REGULATORS; APPARATUS FOR REGULATING OF GAS AND WATER FLOW, NAMELY, FLOW REGULATORS FOR LIQUIDS, GASES AND MULTIPHASE PRODUCTS (U.S. CLS. 13, 21, 23, 31 AND 34).

**CLASS 42—SCIENTIFIC AND COMPUTER SERVICES**

FOR SCIENTIFIC AND TECHNOLOGICAL SERVICES, NAMELY, SCIENTIFIC RESEARCH AND INDUSTRIAL ANALYSIS IN THE FIELD OF LIQUID AND GAS FLOW; ENGINEERING; QUALITY CONTROL FOR OTHERS; RENTAL OF SURVEYING, OPTICAL, MEASURING AND REGULATING APPARATUS AND INSTRUMENTS, GAS TESTING INSTRUMENTS, SPEED INDICATORS, HIGH-FREQUENCY APPARATUS AND QUANTITY INDICATORS (U.S. CLS. 100 AND 101).

COLLEEN KEARNEY, EXAMINING ATTORNEY

SN 79-130,502. AHLSTROM CORPORATION, HELSINKI, FINLAND, FILED 10-15-2012.

SN 79-130,506. AGRAFERM TECHNOLOGIES AG, FED REP GERMANY, FILED 12-14-2012.

**EXTIA** **agraferm**

PRIORITY DATE OF 9-25-2012 IS CLAIMED.  
OWNER OF INTERNATIONAL REGISTRATION 1161233 DATED 10-15-2012, EXPIRES 10-15-2022.  
THE WORDING "EXTIA" HAS NO MEANING IN A FOREIGN LANGUAGE.

THE MARK CONSISTS OF STANDARD CHARACTERS WITHOUT CLAIM TO ANY PARTICULAR FONT, STYLE, SIZE, OR COLOR.

PRIORITY DATE OF 6-18-2012 IS CLAIMED.  
OWNER OF INTERNATIONAL REGISTRATION 1161242 DATED 12-14-2012, EXPIRES 12-14-2022.

#### **CLASS 16—PAPER GOODS AND PRINTED MATTER**

FOR PAPER, CARDBOARD; PAPER FOR USE IN THE MANUFACTURE OF PACKAGING FOR STERILE AND NON-STERILE MEDICAL DEVICES AND EQUIPMENT; PAPER FOR USE IN THE MANUFACTURE OF PACKAGING REQUIRING STRENGTH, BREATHABILITY AND BARRIER PROPERTIES; POUCHES, WRAPPERS AND OTHER PACKAGING, ALL MADE OF PAPER AND USED FOR MERCHANDISE PACKAGING OF MEDICAL DEVICES AND EQUIPMENT; PACKAGING MADE OF PAPER AND REQUIRING STRENGTH, BREATHABILITY AND BARRIER PROPERTIES; BAGS AND BOXES OF PAPER, CARDBOARD OR PLASTIC, FOR PACKAGING; ENVELOPES; SULPHURIZED PAPER AND VEGETABLE PARCHMENT PAPER USED FOR FOOD PACKAGING, WRAPPERS AND BAGS FOR USE IN HOUSEHOLD AND INDUSTRIAL KITCHENS; FOOD SAFE PACKAGING, WRAPPERS AND BAGS MADE OF SULPHURIZED PAPER OR VEGETABLE PARCHMENT PAPER (U.S. CLS. 2, 5, 22, 23, 29, 37, 38 AND 50).

#### **CLASS 22—CORDAGE AND FIBERS**

FOR MAILING POUCHES AND MAIL BAGS, OF TEXTILE; POUCHES, BAGS AND BOXES, ALL MADE OF NONWOVEN FABRICS AND USED FOR MERCHANDISE PACKAGING OF MEDICAL DEVICES AND EQUIPMENT; POUCHES, BAGS AND BOXES, ALL MADE OF NONWOVEN FABRICS AND REQUIRING STRENGTH, BREATHABILITY AND BARRIER PROPERTIES FOR STORAGE OF MAIL, FOOD AND MEDICAL DEVICES AND EQUIPMENT (U.S. CLS. 1, 2, 7, 19, 22, 42 AND 50).

#### **CLASS 24—FABRICS**

FOR TEXTILE FABRICS OF SYNTHETIC AND/OR NATURAL FIBERS FOR USE IN THE MANUFACTURE OF MAILERS, ENVELOPES, MAILING POUCHES AND MAIL BAGS; NONWOVEN FABRICS OF SYNTHETIC AND/OR NATURAL FIBERS FOR USE IN THE MANUFACTURE OF MAILERS, ENVELOPES, MAILING POUCHES AND BOXES, MAIL BAGS AND INDUSTRIAL PACKAGING; NONWOVEN FABRICS OF SYNTHETIC AND/OR NATURAL FIBERS FOR USE IN THE MANUFACTURE OF CARGO COVERS AND COVERS PROTECTING AUTOMOTIVE VEHICLES, IN THE MANUFACTURE OF PROTECTIVE APPAREL AND BARRIER MATERIALS PROTECTING BUILDINGS FROM WIND AND MOISTURE, IN THE MANUFACTURE OF FURNITURE COVERS, DESICCANT BAGS, CARE LABELS AND TAGS, TAPE BASE AND BANNERS AND IN THE MANUFACTURE OF MATERIAL FOR DIGITAL PRINT; NONWOVEN FABRICS OF SYNTHETIC AND/OR NATURAL FIBERS FOR USE IN THE MANUFACTURE OF PACKAGING FOR STERILE AND NON-STERILE MEDICAL DEVICES AND EQUIPMENT, AND FOR USE IN THE MANUFACTURE OF PACKAGING REQUIRING STRENGTH, BREATHABILITY AND BARRIER PROPERTIES; CALENDERED NONWOVEN FABRICS, SMS (SPUNBOND-MELTBLOWN-SPUNBOND) AND MULTI-LAYER NONWOVEN FABRICS USED IN THE MANUFACTURE OF PACKAGING FOR MEDICAL DEVICES AND EQUIPMENT (U.S. CLS. 42 AND 50).

BERNICE MIDDLETON, EXAMINING ATTORNEY

#### **CLASS 1—CHEMICALS**

FOR CHEMICALS USED IN INDUSTRY, SCIENCE AND PHOTOGRAPHY, AS WELL AS IN AGRICULTURE, HORTICULTURE AND FORESTRY EXCEPT FUNGICIDES, HERBICIDES, INSECTICIDES AND PARASITICIDES; CHEMICALS FOR BIOGAS INSTALLATIONS; MANURES (U.S. CLS. 1, 5, 6, 10, 26 AND 46).

#### **CLASS 7—MACHINERY**

FOR MACHINES FOR USE IN BIOGAS INSTALLATIONS, IN PARTICULAR MECHANICAL CONVEYORS, MECHANICAL TRANSPORT AND CONVEYOR BELTS, CRUSHING MACHINES, MECHANICAL PRESSES, MECHANICAL PUMPS, MOTORS AND TURBINES; MOTORS AND ENGINES EXCEPT FOR LAND VEHICLES; MACHINE COUPLING AND TRANSMISSION COMPONENTS EXCEPT FOR LAND VEHICLES; ELECTRIC GENERATORS FOR GENERATING ELECTRICITY FROM BIOMASS (U.S. CLS. 13, 19, 21, 23, 31, 34 AND 35).

#### **CLASS 9—ELECTRICAL AND SCIENTIFIC APPARATUS**

FOR SCIENTIFIC, NAUTICAL, SURVEYING, PHOTOGRAPHIC, CINEMATOGRAPHIC, OPTICAL, WEIGHING, MEASURING, SIGNALING, CHECKING, SUPERVISION, LIFE-SAVING AND TEACHING APPARATUS AND INSTRUMENTS, NAMELY, LIMIT INDICATORS, RADAR APPARATUS, ULTRASOUND INSPECTION DEVICES FOR NON-MEDICAL, NON-DESTRUCTIVE TESTING, PRESSURE SENSORS, THERMOMETERS, ELECTRONIC DETECTORS FOR OBSERVING AND MEASURING THE INFRARED SPECTRUM, NAMELY, INFRARED DETECTORS; SCIENTIFIC MEASURING INSTRUMENTS FOR THE ONLINE AND IN-LINE ASCERTAINMENT OF MINING PARAMETERS IN BIOGAS INSTALLATIONS; TECHNICAL APPARATUS, NAMELY, GAS MEASURING APPARATUS (U.S. CLS. 21, 23, 26, 36 AND 38).

#### **CLASS 11—ENVIRONMENTAL CONTROL APPARATUS**

FOR APPARATUS FOR LIGHTING, HEATING, STEAM GENERATING, COOKING, REFRIGERATING, DRYING, VENTILATING AND WATER SUPPLY, IN PARTICULAR HEATING INSTALLATIONS FOR RECOVERING HEAT FROM BIOGAS; FERMENTING CONTAINERS AND AIR-CONDITIONING, AIR COOLING AND VENTILATION APPARATUS AND INSTRUMENTS, BEING PARTS OF BIOGAS INSTALLATIONS; SANITARY INSTALLATIONS, NAMELY, FERMENTATION VESSELS OF BIOGAS PLANTS AND HOT WATER HEATING SYSTEMS (U.S. CLS. 13, 21, 23, 31 AND 34).

#### **CLASS 35—ADVERTISING AND BUSINESS**

FOR BUSINESS ORGANIZATIONAL PREPARATION OF BUILDING PROJECTS, IN PARTICULAR OF BIOGAS INSTALLATIONS AND COMBINED HEAT AND POWER PLANTS FOR BIOGAS INSTALLATIONS (U.S. CLS. 100, 101 AND 102).

**CLASS 37—CONSTRUCTION AND REPAIR**

FOR INSTALLATION AND CONSTRUCTION SERVICES FOR THE INITIAL ASSEMBLY AND START-UP OF BIOGAS INSTALLATIONS; MAINTENANCE AND REPAIR OF BIOGAS INSTALLATIONS; BUILDING CONSTRUCTION, IN PARTICULAR IN THE FIELD OF BIOGAS INSTALLATIONS; CONDUCTING BUILDING PROJECTS, NAMELY, CONSTRUCTING BIOGAS INSTALLATIONS (U.S. CLS. 100, 103 AND 106).

**CLASS 42—SCIENTIFIC AND COMPUTER SERVICES**

FOR SCIENTIFIC AND TECHNOLOGICAL SERVICES, NAMELY, SCIENTIFIC ANALYSIS AND TESTING IN THE FIELD OF BIOGAS INSTALLATIONS AND RESEARCH AND DESIGN RELATING THERETO; INDUSTRIAL ANALYSIS AND RESEARCH SERVICES FOR BIOGAS INSTALLATIONS; TECHNICAL PROJECT STUDIES, NAMELY, SCIENTIFIC RESEARCH IN THE FIELD OF BIOGAS INSTALLATIONS; TECHNICAL PREPARATION OF BUILDING PROJECTS, NAMELY, DESIGN OF BIOGAS INSTALLATIONS; ENGINEERING SURVEYING FOR BIOGAS INSTALLATIONS, CONSTRUCTION DRAFTING, TECHNICAL PROJECT STUDIES, NAMELY, SCIENTIFIC RESEARCH IN THE FIELD OF BIOGAS INSTALLATIONS; TECHNICAL AND SCIENTIFIC MICROBIOLOGICAL CONSULTANCY IN RELATION TO THE FEASIBILITY AND OPERATION OF BIOGAS INSTALLATIONS; ARCHITECTURAL CONSULTANCY; EVALUATION, NAMELY, QUALITY EVALUATION AND EVALUATION TO ASSURE COMPLIANCE WITH INDUSTRY STANDARDS OF BUILDING PROJECTS RELATING TO BIOGAS INSTALLATIONS (U.S. CLS. 100 AND 101).

BERNICE MIDDLETON, EXAMINING ATTORNEY

**CLASS 16—PAPER GOODS AND PRINTED MATTER**

FOR PAPER; CARDBOARD; NOTEBOOKS; PHOTOGRAPH AND SCRAPBOOK ALBUMS; DOCUMENT FOLDERS IN THE FORM OF WALLETS; PRINTED MATTER, NAMELY, BOOKS, PERIODICALS, AND JOURNALS, ALL IN THE FIELD OF SCIENCE, ART, HISTORY, MATH, LANGUAGE; NEWSPAPERS; CHILDREN'S INTERACTIVE EDUCATIONAL BOOKS; CHILDREN'S BOOKS; CHILDREN'S ACTIVITY BOOKS; ADHESIVES FOR STATIONERY OR HOUSEHOLD PURPOSES; WRITING PAPER AND ENVELOPES; ARTISTS' MATERIALS, NAMELY, PAINTBRUSHES, PAINT BOXES, AND DRAWING KITS COMPRISED OF DRAWING BOARDS, DRAWING TEMPLATES, AND DRAWING INSTRUMENTS; PRINTED TEACHING MATERIALS IN THE FIELD OF SCIENCE, ART, HISTORY, MATH, LANGUAGE; PLASTIC MATERIALS FOR PACKAGING, NAMELY, BAGS, SMALL BAGS, AND POUCHES; PRINTING TYPE; PRINTING BLOCKS; PENS; STATIONERY FOLDERS FOR CONFERENCES; MEMO NOTE BLOCKS; WRITING PADS; VISITING CARDS; CHECK BOOKS; POSTCARDS; STICKERS; POSTERS; LITHOGRAPHIC WORKS OF ART; ATLASES; COMIC BOOKS; FLAGS AND PENNANTS OF PAPER; MODELING CLAY AND COMPOUNDS; BLUEPRINTS; MODELING PASTES; FUN AND EDUCATIONAL WORKSHEETS FOR USE IN SCHOOLS IN THE FIELD OF SCIENCE, ART, HISTORY, MATH, LANGUAGE (U.S. CLS. 2, 5, 22, 23, 29, 37, 38 AND 50).

**CLASS 28—TOYS AND SPORTING GOODS**

FOR GAMES, NAMELY, CARD GAMES, DICE GAMES, PARTY GAMES, BOARD GAMES, BUILDING GAMES, MEMORY GAMES; TOYS, NAMELY, DOLLS, ACTION FIGURES, TOY VEHICLES; CHRISTMAS TREE DECORATIONS; ELECTRONIC GAMES OTHER THAN COIN-OPERATED AND THOSE DESIGNED TO BE USED ONLY WITH A TELEVISION SET; PLAYING CARDS; FIGURINES; ACCESSORIES FOR FIGURINES, NAMELY, TOY WEAPONS, CLOTHING, FOOTWEAR, CAPS AND HATS FOR FIGURINES; PUPPETS; SCALE MODEL VEHICLES; BUILDING GAMES; TOY BUILDING BLOCKS; SCALE MODEL KITS; TOY ANIMAL FIGURES; RUBBER BALLS; BALLOONS; ELECTRONIC GAMES OTHER THAN THOSE ADAPTED FOR USE WITH TELEVISION RECEIVERS ONLY; AUDIOVISUAL GAMES, NAMELY, CONSOLES FOR VIDEOGAMES DESIGNED FOR USE ONLY WITH A TELEVISION SET (U.S. CLS. 22, 23, 38 AND 50).

**CLASS 41—EDUCATION AND ENTERTAINMENT**

FOR EDUCATION, NAMELY, SEMINARS, WORKSHOPS AND CLASSES IN THE FIELD OF ART, HISTORY, SCIENCE AND MATH; ARRANGING INTERACTIVE DANCE AND VOCAL COMPETITIONS; PRODUCTION OF RADIO AND TELEVISION PROGRAMS; ORGANIZING COMMUNITY CULTURAL EVENTS; PUBLICATION AND EDITING OF TEXTS OTHER THAN ADVERTISING TEXTS, ILLUSTRATIONS, BOOKS, JOURNALS, NEWSPAPERS, PERIODICALS, MAGAZINES, AND PUBLICATIONS OF ALL TYPES AND IN ALL FORMS, INCLUDING ELECTRONIC AND DIGITAL PUBLICATIONS, AUDIO AND/OR VISUAL MEDIA, AND MULTIMEDIA DATA CARRIERS FOR OTHERS; EDUCATIONAL SERVICES, NAMELY, TEACHING GENERAL INTEREST COURSES OF INSTRUCTION AT THE PRIMARY, SECONDARY, AND COLLEGE LEVELS; ARRANGING OF SEMINARS; PROVIDING INTERNSHIPS AND TRAINING COURSES IN THE FIELD OF EARLY CHILDHOOD EDUCATION; ARRANGING OF EDUCATIONAL CONFERENCES, FORUMS, CONGRESSES AND COLLOQUIUMS, ALL IN THE FIELDS OF EARLY CHILDHOOD EDUCATION; PRODUCTION OF RADIO AND TELEVISION PROGRAMS, AS WELL AS AUDIOVISUAL AND MULTIMEDIA PROGRAMS, FOR INTERACTIVE OR NON-INTERACTIVE USE; COMPETITIONS; PRODUCTION OF INFORMATIVE OR RECREATIONAL RADIO AND TELEVISION PROGRAMS, AUDIOVISUAL AND MULTIMEDIA PROGRAMS, FOR INTERACTIVE OR NON-INTERACTIVE USE; ORGANIZATION OF SHOWS FOR CULTURAL PURPOSES; RENTAL OF FILMS, AUDIO

SN 79-130,511. EDITIONS PLAY BAC, PARIS, FRANCE, FILED 2-21-2013.

# BRAIN STAR

THE MARK CONSISTS OF STANDARD CHARACTERS WITHOUT CLAIM TO ANY PARTICULAR FONT, STYLE, SIZE, OR COLOR.

PRIORITY DATE OF 2-20-2013 IS CLAIMED.  
OWNER OF INTERNATIONAL REGISTRATION 1161257  
DATED 2-21-2013, EXPIRES 2-21-2023.

**CLASS 9—ELECTRICAL AND SCIENTIFIC APPARATUS**

FOR INTERACTIVE ENTERTAINMENT SOFTWARE, NAMELY, COMPUTER GAME SOFTWARE; DOWNLOADABLE COMPUTER GAME SOFTWARE; GAME SOFTWARE AND VIDEO GAME PROGRAMS, ALL FOR USE WITH COMPUTERS, COMMUNICATION DEVICES AND MOBILE TELEPHONES; EDUCATIONAL GAME SOFTWARE (U.S. CLS. 21, 23, 26, 36 AND 38).

CASSETTES, VIDEO CASSETTES, AND SOUND AND VISUAL MEDIA; LENDING OF BOOKS AND OTHER PUBLICATIONS; TOY LENDING LIBRARY SERVICES; SOCIAL CLUB SERVICES, NAMELY, ARRANGING, ORGANIZING, AND HOSTING SOCIAL EVENTS, GET-TOGETHERS, AND PARTIES FOR CLUB MEMBERS; MEMBERSHIP CLUB SERVICES, NAMELY, PROVIDING INFORMATION TO MEMBERS IN THE FIELDS OF RECREATION AND LEISURE ACTIVITIES; ARRANGING AND CONDUCTING OF TRAINING WORKSHOPS IN THE FIELD OF INSTRUCTION AT THE PRIMARY, SECONDARY, AND COLLEGE LEVELS (U.S. CLS. 100, 101 AND 107).

ANN E. SAPPENFIELD, EXAMINING ATTORNEY

SN 79-130,793. CASADA GROUP GMBH, PADERBORN, FED REP GERMANY, FILED 3-13-2013.

# Deep Code

THE MARK CONSISTS OF STANDARD CHARACTERS WITHOUT CLAIM TO ANY PARTICULAR FONT, STYLE, SIZE, OR COLOR.

PRIORITY DATE OF 9-24-2012 IS CLAIMED.

OWNER OF INTERNATIONAL REGISTRATION 1161965 DATED 3-13-2013, EXPIRES 3-13-2023.

SN 79-130,742. DEVINANT R&D.; SOCIETE PAR ACTIONS SIMPLIFIEE, FRANCE, FILED 11-16-2012.



OWNER OF INTERNATIONAL REGISTRATION 1161848 DATED 11-16-2012, EXPIRES 11-16-2022.

THE COLOR(S) ORANGE, BLACK AND WHITE IS/ARE CLAIMED AS A FEATURE OF THE MARK.

THE MARK CONSISTS OF THE FOLLOWING: AN ORANGE FOX FACE WITH WHITE EARS AND EYES AND BLACK PUPILS AND NOSE.

## CLASS 9—ELECTRICAL AND SCIENTIFIC APPARATUS

FOR COMPUTER SOFTWARE RECORDED ON DATA MEDIA FOR MEASURING SOUND LEVELS, TIMING NOISE EXPOSURE, CALCULATING HEARING RECOVERY TIME AND MANAGING SOUND EXPOSURE; COMPUTER SOFTWARE FOR MOBILE DEVICES FOR MEASURING SOUND LEVELS, TIMING NOISE EXPOSURE, CALCULATING HEARING RECOVERY TIME AND MANAGING SOUND EXPOSURE; COMPUTER SOFTWARE FOR MOBILE TELEPHONES FOR MEASURING SOUND LEVELS, TIMING NOISE EXPOSURE, CALCULATING HEARING RECOVERY TIME AND MANAGING SOUND EXPOSURE; ALL THESE GOODS RELATING TO THE FIELD OF PREVENTING RISKS TO HEARING (U.S. CLS. 21, 23, 26, 36 AND 38).

## CLASS 38—COMMUNICATION

FOR TELECOMMUNICATION SERVICES VIA MOBILE DEVICES AND MOBILE TELEPHONES, NAMELY, ELECTRONIC DATA TRANSMISSION; ELECTRONIC TRANSMISSION OF INFORMATION; INFORMATION ABOUT TELECOMMUNICATION; ALL THESE SERVICES RELATING TO THE FIELD OF PREVENTING RISKS TO HEARING (U.S. CLS. 100, 101 AND 104).

KEVIN MITTLER, EXAMINING ATTORNEY

## CLASS 3—COSMETICS AND CLEANING PREPARATIONS

FOR COSMETICS FOR THE SKIN, BEAUTY CARE PREPARATIONS IN THE FORM OF CREAMS, NAMELY, BEAUTY CREAMS FOR BODY CARE (U.S. CLS. 1, 4, 6, 50, 51 AND 52).

## CLASS 10—MEDICAL APPARATUS

FOR MEDICAL EQUIPMENTS, IN PARTICULAR MEDICAL APPARATUS FOR APPLYING CREAM TO HUMAN SKIN (U.S. CLS. 26, 39 AND 44).

## CLASS 21—HOUSEWARES AND GLASS

FOR COSMETIC EQUIPMENT, IN PARTICULAR COSMETIC EQUIPMENTS FOR APPLYING CREAM TO HUMAN SKIN, NAMELY, ELECTRICAL APPLICATORS FOR APPLYING COSMETICS TO THE SKIN (U.S. CLS. 2, 13, 23, 29, 30, 33, 40 AND 50).

MATTHEW EINSTEIN, EXAMINING ATTORNEY

SN 79-131,026. WU YONGHUI, CHINA, FILED 5-8-2013.



OWNER OF INTERNATIONAL REGISTRATION 1162494 DATED 5-8-2013, EXPIRES 5-8-2023.

THE MARK CONSISTS OF THE TEXT "NEWSEGA" WITH CHINESE CHARACTERS WITH A CIRCLE AROUND THE LETTERS "GA" AND A DOT WITHIN THE LETTER "A".

THE ENGLISH TRANSLATION OF THE FOREIGN WORD(S) IN THE MARK IS THE FIRST CHINESE CHARACTER "XIN" MEANS "NEW", THE SECOND CHINESE CHARACTER "SHI" MEANS "WORLD" AND THE THIRD CHINESE CHARACTER "JIA" MEANS "FINE"; WHEN COMBINED, THESE CHARACTERS HAVE NO SPECIFIC MEANING, THEY DO NOT INDICATE THE GEOGRAPHIC NAME AND DO NOT HAVE SPECIAL MEANING IN THE RELATED INDUSTRIAL SECTOR.

THE TRANSLITERATION OF THE NON-LATIN CHARACTERS IN THE MARK IS "XIN SHI JIA".

## CLASS 20—FURNITURE AND ARTICLES NOT OTHERWISE CLASSIFIED

FOR PILLOWS; SLEEPING BAGS FOR CAMPING; BOLSTERS; STRAW MATTRESSES; CUSHIONS; MATS FOR INFANT PLAYPENS (U.S. CLS. 2, 13, 22, 25, 32 AND 50).

**CLASS 24—FABRICS**

FOR FABRIC BEING FABRICS FOR TEXTILE USE; COTTON FABRICS; LINGERIE FABRIC; CLOTH, NAMELY, WOOL, HEMP, JUTE, CREPE, COTTON, SILK CLOTH; FABRIC FOR FOOTWEAR; WALL HANGINGS OF TEXTILE; TOWELS OF TEXTILE; HANDKERCHIEFS OF TEXTILE; BED COVERS; QUILTS; MATTRESS COVERS; BED SHEETS; MOSQUITO NETS; PILLOWCASES; EIDERDOWNS; SLEEPING BAGS IN THE NATURE OF SHEETING; BED CLOTHES, NAMELY, BED SHEETS; BED BLANKETS; TICKS BEING MATTRESS COVERS; CURTAINS OF TEXTILE OR PLASTIC; COVERS FOR FURNITURE, NAMELY, UNFITTED FABRIC FURNITURE COVERS; TABLECLOTHS, NOT OF PAPER (U.S. CLS. 42 AND 50).

**CLASS 27—FLOOR COVERINGS**

FOR CARPETS; MATS, NAMELY, FLOOR MATS, BATH MATS; REED MATS; ARTIFICIAL TURF; DOOR MATS; CARPETS FOR AUTOMOBILES; GYMNASIUM MATS; FLOOR COVERINGS; BATH MATS; GYMNASIUM EXERCISE MATS; WALLPAPER; WALL HANGINGS, NOT OF TEXTILE (U.S. CLS. 19, 20, 37, 42 AND 50).

CARYN GLASSER, EXAMINING ATTORNEY

SN 79-131,273. EMSLAND-STÄRKE GMBH, FED REP GERMANY, FILED 5-21-2013.

# EMPURE

THE MARK CONSISTS OF STANDARD CHARACTERS WITHOUT CLAIM TO ANY PARTICULAR FONT, STYLE, SIZE, OR COLOR.

OWNER OF INTERNATIONAL REGISTRATION 1116794 DATED 4-3-2012, EXPIRES 4-3-2022.

**CLASS 1—CHEMICALS**

FOR STARCH FOR INDUSTRIAL PURPOSES, NAMELY, FOR USE IN THE MANUFACTURE OF PAPER AND TEXTILES (U.S. CLS. 1, 5, 6, 10, 26 AND 46).

**CLASS 29—MEATS AND PROCESSED FOODS**

FOR PROCESSED POTATOES IN THE FORM OF POTATO FLAKES AND POTATO GRANULES FOR THE FOOD INDUSTRY (U.S. CL. 46).

**CLASS 30—STAPLE FOODS**

FOR STARCH FOR USE IN MANUFACTURING FOOD; FOODSTUFFS TREATED WITH STARCH, NAMELY, STARCH-BASED BINDING AGENTS FOR ICE CREAM, STARCH-BASED THICKENERS FOR WHIPPED CREAM AND STARCH-BASED CANDIES; CEREAL PREPARATIONS, NAMELY, CORN STARCH, WHEAT STARCH AND RICE STARCH FLOUR; STARCH PRODUCTS FOR THE FOOD INDUSTRY, NAMELY, STARCH-BASED MIXTURES FOR FRIED FOODS, SWEET PANADE BREAD MADE PRIMARILY OF STARCH AND MODIFIED STARCH (U.S. CL. 46).

MARTHA SANTOMARTINO, EXAMINING ATTORNEY

SN 79-131,817. MOBILE SANITARY SOLUTIONS B.V., OIRSCHOT, NETHERLANDS, FILED 12-20-2012.

# POP UP3

THE MARK CONSISTS OF STANDARD CHARACTERS WITHOUT CLAIM TO ANY PARTICULAR FONT, STYLE, SIZE, OR COLOR.

PRIORITY DATE OF 7-3-2012 IS CLAIMED.

OWNER OF INTERNATIONAL REGISTRATION 1164654 DATED 12-20-2012, EXPIRES 12-20-2022.

**CLASS 11—ENVIRONMENTAL CONTROL APPARATUS**

FOR MOBILE SANITARY FACILITIES, NAMELY, MOBILE TOILETS AND MOBILE TOILET CUBICLES; TOILET CISTERNS, URINALS, SINKS; TOILET AND SHOWER TRAILERS, NAMELY, PORTABLE URINALS AND SHOWERS FOR OUTDOOR ACTIVITIES; DISINFECTANT DISPENSERS FOR TOILETS; DEODORIZING DEVICES, NAMELY, ELECTRIC AIR DEODORIZERS AND ELECTRIC ROOM DEODORIZING UNITS; SANITARY APPARATUS AND INSTALLATIONS, NAMELY, SANITARY INSTALLATIONS IN THE NATURE OF PORTABLE TOILETS; ELECTRIC HAND DRYING APPARATUS FOR WASHROOMS (U.S. CLS. 13, 21, 23, 31 AND 34).

**CLASS 44—MEDICAL, BEAUTY AND AGRICULTURAL SERVICES**

FOR RENTAL OF MOBILE SANITARY FACILITIES, IN PARTICULAR SANITARY CONTAINERS, TOILET CONTAINERS, MOBILE TOILETS, TOILET CUBICLES, TOILET TANKS, URINALS AND PORTABLE TOILETS FOR OUTDOOR ACTIVITIES; RENTAL OF SANITARY APPARATUS AND INSTALLATIONS, NAMELY, PORTABLE TOILETS AND TEMPORARY RESTROOMS; RENTAL OF APPARATUS AND EQUIPMENT FOR MOBILE SANITARY FACILITIES, NAMELY, PORTABLE TOILETS, PORTABLE URINALS, SHOWERS FOR OUTDOOR ACTIVITIES (U.S. CLS. 100 AND 101).

MAYUR VAGHANI, EXAMINING ATTORNEY

SN 79-132,005. PARASERVE INTERNATIONAL LIMITED, NEW ZEALAND, FILED 2-15-2013.

# PARASERVE

THE MARK CONSISTS OF STANDARD CHARACTERS WITHOUT CLAIM TO ANY PARTICULAR FONT, STYLE, SIZE, OR COLOR.

OWNER OF INTERNATIONAL REGISTRATION 1165162 DATED 2-15-2013, EXPIRES 2-15-2023.

**CLASS 37—CONSTRUCTION AND REPAIR**

FOR CLEANING SERVICES, NAMELY, INTERIOR AND EXTERIOR BUILDING CLEANING, NAMELY, WINDOW CLEANING, CARPET CLEANING, CLEANING OF HOSPITALITY AREAS, WATER BLASTING OF BUILDINGS, FLOOR CLEANING AND GRAFFITI REMOVAL; DECONTAMINATION CLEANING SERVICES, NAMELY, LOCALIZATION, DRYING AND CLEANING OF PARTICULATE AND MOISTURE CONTAMINANTS FOR BUILDINGS AND CONTENTS THEREIN; OFFICE EQUIPMENT SANITIZING; KITCHEN EXHAUST SANITATION SERVICES; PEST CONTROL; CLEANING OF COMMERCIAL PREMISES; CLEANING OF DOMESTIC PREMISES; RESIDENTIAL HOUSE CLEANING SERVICES; JANITORIAL CLEANING SERVICES; WASTE DISPOSAL SERVICES; WINDOW CLEANING; BUILDING CLEANING SERVICES; FLOOR BUFFING SERVICES; FLOOR POLISHING SERVICES (U.S. CLS. 100, 103 AND 106).

**CLASS 40—MATERIAL TREATMENT**

FOR RECYCLING OF MATERIALS; RECYCLING OF DOMESTIC AND COMMERCIAL WASTE (U.S. CLS. 100, 103 AND 106).

TASNEEM HUSSAIN, EXAMINING ATTORNEY

SN 79-132,017. JAM MEDIA MAURER, JANA MAURER, SWITZERLAND, FILED 4-29-2013.

# TIME DYNASTY

THE MARK CONSISTS OF STANDARD CHARACTERS WITHOUT CLAIM TO ANY PARTICULAR FONT, STYLE, SIZE, OR COLOR.

OWNER OF INTERNATIONAL REGISTRATION 1165191 DATED 4-29-2013, EXPIRES 4-29-2023.

**CLASS 9—ELECTRICAL AND SCIENTIFIC APPARATUS**

FOR AUDIO BOOKS FEATURING ALL AGE STORIES, EBOOKS FEATURING ALL AGE STORIES (U.S. CLS. 21, 23, 26, 36 AND 38).

**CLASS 16—PAPER GOODS AND PRINTED MATTER**

FOR PRINTED MATTER OF ALL KINDS, PARTICULARLY NEWSPAPERS, PERIODICALS AND BOOKS IN THE FIELD OF ALL AGE STORIES (U.S. CLS. 2, 5, 22, 23, 29, 37, 38 AND 50).

**CLASS 35—ADVERTISING AND BUSINESS**

FOR ADVERTISING; PRODUCTION OF ADVERTISING FILMS; CLASSIFIED ADVERTISING SERVICES; ONLINE ADVERTISING AND MARKETING SERVICES; BILL-POSTING; ADVERTISING, PROMOTIONAL AND MARKETING SERVICES RELATING TO VEHICLES; BUSINESS AND PRODUCT MERCHANDISING SERVICES (U.S. CLS. 100, 101 AND 102).

JENNIFER BUTTON, EXAMINING ATTORNEY

SN 79-132,020. L R GROUP (INTERNATIONAL) LIMITED, SURREY, UNITED KINGDOM, FILED 5-14-2013.

# LRG International

THE MARK CONSISTS OF STANDARD CHARACTERS WITHOUT CLAIM TO ANY PARTICULAR FONT, STYLE, SIZE, OR COLOR.

OWNER OF INTERNATIONAL REGISTRATION 1165201 DATED 5-14-2013, EXPIRES 5-14-2023.

NO CLAIM IS MADE TO THE EXCLUSIVE RIGHT TO USE "INTERNATIONAL", APART FROM THE MARK AS SHOWN.

**CLASS 35—ADVERTISING AND BUSINESS**

FOR BRAND CONSULTANCY SERVICES, NAMELY, BRAND CONCEPT AND DEVELOPMENT FOR CORPORATE CLIENTS (U.S. CLS. 100, 101 AND 102).

**CLASS 42—SCIENTIFIC AND COMPUTER SERVICES**

FOR DESIGN OF BESPOKE CONSUMER PRODUCTS FOR CORPORATE CLIENTS, NAMELY, NEW PRODUCT DESIGN AND DEVELOPMENT SERVICES FOR CLIENTS WISHING TO CREATE OWN-BRAND CONSUMER PRODUCTS (U.S. CLS. 100 AND 101).

APRIL ROACH, EXAMINING ATTORNEY

SN 79-132,074. KING JIM CO., LTD., JAPAN, FILED 5-17-2013.

# SHOT DOCS

OWNER OF INTERNATIONAL REGISTRATION 1135022 DATED 9-3-2012, EXPIRES 9-3-2022.

OWNER OF U.S. REG. NO. 4,078,754.

NO CLAIM IS MADE TO THE EXCLUSIVE RIGHT TO USE "DOCS", APART FROM THE MARK AS SHOWN.

**CLASS 9—ELECTRICAL AND SCIENTIFIC APPARATUS**

FOR PHOTOGRAPHIC INSTRUMENTS AND APPARATUS, NAMELY, CAMERAS; CINEMATOGRAPHIC INSTRUMENTS AND APPARATUS, NAMELY, CINEMATOGRAPHIC CAMERAS AND CINEMATOGRAPHIC PROJECTORS; OPTICAL APPARATUS AND INSTRUMENTS, NAMELY, TELESCOPES AND MICROSCOPES; TELECOMMUNICATION DEVICES AND APPARATUS, NAMELY, TELEPHONES, CELL PHONES AND SMART PHONES; COMPUTER PROGRAMS FOR PROCESSING HANDWRITTEN DATA INTO DIGITAL IMAGE DATA AND FOR USE IN DATA MANAGEMENT; DOWNLOADABLE COMPUTER PROGRAMS VIA THE INTERNET FOR PROCESSING HANDWRITTEN DATA INTO DIGITAL IMAGE DATA AND FOR USE IN DATA MANAGEMENT; ELECTRONIC WHITEBOARDS; ELECTRONIC MACHINES, APPARATUS AND THEIR PARTS, NAMELY, COMPUTER HARDWARE (U.S. CLS. 21, 23, 26, 36 AND 38).

**CLASS 16—PAPER GOODS AND PRINTED MATTER**

FOR PAPER AND CARDBOARD; NOTEPADS; STATIONERY; ADHESIVE NOTEPADS; NOTEBOOKS; WRITING PADS BEING STATIONERY; NOTEBOOK COVERS; DOCUMENT FILES BEING OFFICE REQUISITES; PAPERS FOR FILES; LOOSE-LEAF BINDERS; LOOSE-LEAF PADS; WHITEBOARDS, NAMELY, DRY-ERASE BOARDS; PRICE TAGS; PAINTINGS AND CALLIGRAPHIC WORKS; PRINTED MATTER, NAMELY, MAGAZINES AND MANUALS IN THE FIELD OF DOCUMENT MANAGEMENT; PHOTOGRAPHS; PHOTOGRAPH STANDS; PASTES AND OTHER ADHESIVES FOR STATIONERY OR HOUSEHOLD PURPOSES (U.S. CLS. 2, 5, 22, 23, 29, 37, 38 AND 50).

EVELYN BRADLEY, EXAMINING ATTORNEY

SN 79-132,298. G-STAR RAW C.V., AMSTERDAM ZUIDOOST, NETHERLANDS, FILED 5-16-2013.



OWNER OF INTERNATIONAL REGISTRATION 1165898 DATED 5-16-2013, EXPIRES 5-16-2023.

THE MARK CONSISTS OF AN ELONGATED STYLIZED RECTANGULAR SHAPE WITH A DOWNWARD POINT ON THE LEFT SIDE, REPRESENTING A HORIZONTAL NUMBER ONE.

### CLASS 3—COSMETICS AND CLEANING PREPARATIONS

FOR SOAPS; PERFUMERY, ESSENTIAL OILS, COSMETICS, HAIR LOTIONS (U.S. CLS. 1, 4, 6, 50, 51 AND 52).

### CLASS 9—ELECTRICAL AND SCIENTIFIC APPARATUS

FOR SPECTACLES; SUNGLASSES, SUNGLASS PRODUCTS, NAMELY, HEAD STRAPS, SUNGLASS RETAINERS, EYEGLASS CASES, AND SUNGLASSES CASES (U.S. CLS. 21, 23, 26, 36 AND 38).

### CLASS 14—JEWELRY

FOR JEWELRY; WATCHES AND CLOCKS (U.S. CLS. 2, 27, 28 AND 50).  
ROBIN MITTLER, EXAMINING ATTORNEY

SN 79-132,431. IMPERO INTERNATIONAL LIMITED, LOUGHBOROUGH; LEICESTERSHIRE, UNITED KINGDOM, FILED 3-13-2013.

# Impero

THE MARK CONSISTS OF STANDARD CHARACTERS WITHOUT CLAIM TO ANY PARTICULAR FONT, STYLE, SIZE, OR COLOR.

OWNER OF INTERNATIONAL REGISTRATION 1166255 DATED 3-13-2013, EXPIRES 3-13-2023.

THE ENGLISH TRANSLATION OF "IMPERO" IN THE MARK IS "EMPIRE".

### CLASS 9—ELECTRICAL AND SCIENTIFIC APPARATUS

FOR COMPUTER SOFTWARE FOR USE IN NETWORK MANAGEMENT, DESKTOP MANAGEMENT, CLASSROOM MANAGEMENT, NETWORK SUPPORT, COMMUNICATION AND TECHNICAL ASSISTANCE; COMPUTER SOFTWARE THAT PROVIDES WEB-BASED ACCESS TO APPLICATIONS AND SERVICES THROUGH A WEB OPERATING SYSTEM OR PORTAL INTERFACE; CHILDREN'S EDUCATIONAL SOFTWARE (U.S. CLS. 23, 26, 36 AND 38).

### CLASS 42—SCIENTIFIC AND COMPUTER SERVICES

FOR COMPUTER SOFTWARE DESIGN, COMPUTER SOFTWARE DEVELOPMENT (U.S. CLS. 100 AND 101).  
FLORENTINA BLANDU, EXAMINING ATTORNEY

SN 79-132,751. CLARKE, MODET Y COMPAÑIA, S.L., SPAIN, FILED 3-26-2013.



PRIORITY DATE OF 9-27-2012 IS CLAIMED.  
OWNER OF INTERNATIONAL REGISTRATION 1167022 DATED 3-26-2013, EXPIRES 3-26-2023.

THE COLOR(S) LIGHT YELLOW, DARK YELLOW, LIGHT RED AND DARK RED IS/ARE CLAIMED AS A FEATURE OF THE MARK.

THE MARK CONSISTS OF A LARGER AND SMALLER TRAPEZOIDAL SHAPE WITH THE COLORS LIGHT YELLOW AND DARK YELLOW IN THE SMALLER ONE AND LIGHT RED AND DARK RED IN THE LARGER ONE.

### CLASS 16—PAPER GOODS AND PRINTED MATTER

FOR PAPER, CARDBOARD AND GOODS MADE FROM THESE MATERIALS NOT INCLUDED IN OTHER CLASSES, NAMELY, BIBS OF PAPER; FLAGS OF PAPER; GARBAGE BAGS OF PAPER; PAPER BAGS, PAPER ENVELOPES, AND PAPER POUCHES FOR PACKAGING; BOXES OF CARDBOARD OR PAPER; ADVERTISEMENT SIGNS OF PAPER OR CARDBOARD; SHEETS OF RECLAIMED CELLULOSE FOR WRAPPING; WRITING PADS AND OR DRAWING PADS; PAPER BAGS HAVING A CONICAL SHAPE; BOTTLE WRAPPERS OF CARDBOARD OR PAPER; BOTTLE ENVELOPES OF CARDBOARD OR PAPER; FOLDERS; HUMIDITY CONTROL SHEETS OF PAPER FOR FOODSTUFF PACKAGING; ABSORBENT SHEETS OF PAPER FOR FOODSTUFF PACKAGING; SIGNBOARDS OF PAPER OR CARDBOARD; TABLE LINEN OF PAPER; TABLECLOTHS OF PAPER; PLACE MATS OF PAPER; PRINTERS' BLANKETS, NOT OF TEXTILE; HANDKERCHIEFS OF PAPER; FILTER PAPER; SILVER PAPER; WAXED PAPER; TOILET PAPER; LUMINOUS PAPER; PAPIER MACHE; DRAWER LINERS OF PAPER, PERFUMED OR NOT; PARCHMENT PAPER; PAPER CONTAINERS; PLACARDS OF PAPER OR CARDBOARD; TABLE MATS OF PAPER; TABLE NAPKINS OF PAPER; ENVELOPES; HAT BOXES OF CARDBOARD; PAPER TOWELS; NAPKINS OF PAPER FOR REMOVING MAKE-UP; FACE TOWELS OF PAPER; WRITING PAPER; PACKING PAPER; NOTE BOOKS; COASTERS OF PAPER; COASTERS MADE OF CARDBOARD; PRINTING PRODUCTS BEING PRINTED MATTER, NAMELY, PHOTOGRAPH ALBUMS; ALMANACS; STAMP PADS; PRINTED TICKETS; CALENDARS; BOOKLETS IN THE FIELD OF AIR TRANSPORT AND AERONAUTICS; CATALOGUES IN THE FIELD OF AIR TRANSPORT AND AERONAUTICS; NEWSLETTERS IN THE FIELD OF AIR TRANSPORT AND AERONAUTICS; CHROMOS; TRADING CARDS OTHER THAN FOR GAMES; NEWSPAPERS; GREETING CARDS; INDEX CARDS; PRINTED PHOTOGRAPHS; PAMPHLETS IN THE FIELD OF AIR TRANSPORT AND AERONAUTICS; PRINTED FORMS; PRINTED TIMETABLES; BOOKS IN THE FIELD OF AIR TRANSPORT AND AERONAUTICS; HANDBOOKS IN THE FIELD OF AIR TRANSPORT AND AERONAUTICS; GEOGRAPHICAL MAPS; INFORMATIONAL FLYERS FEATURING AIR TRANSPORT AND AERONAUTICS; MUSICAL GREETING CARDS; PORTRAITS; MAGAZINES IN THE FIELD OF AIR TRANSPORT AND AERONAUTICS; POSTCARDS; POSTERS; PRINTED PERIODICALS IN THE FIELD OF AIR TRANSPORT AND AERONAUTICS; ANNOUNCEMENT CARDS; BOOKBINDING MATERIAL; STATIONERY; ADHESIVES BEING GLUES FOR STATIONERY OR HOUSEHOLD PURPOSES; ARTISTS' MATERIALS, NAMELY, PAINTBRUSHES; PAINTERS' EASELS;



CHARCOAL PENCILS; DRAWING INSTRUMENTS; PEN AND PENCIL; DRAWING SQUARES; DRAWING SETS COMPRISED OF PENS, PENCILS, INK, DRAWING PAD; STENCIL CASES; RUBBER ERASERS; CANVAS FOR PAINTING; PALETTES FOR PAINTERS; DRAWING INSTRUMENT, NAMELY, PANTOGRAPH; TYPEWRITERS AND OFFICE REQUISITES EXCEPT FURNITURE, NAMELY, SELF-ADHESIVE TAPES FOR STATIONERY; STICKERS; LETTER TRAYS; ERASERS; DESKTOP STATIONERY CABINETS; DOCUMENT FILES; CORRECTING TAPES; PAPER RIBBONS; GUMMED TAPE FOR STATIONERY USE; INKING RIBBONS; TYPEWRITER RIBBONS; SQUARE RULERS; DOCUMENT LAMINATORS FOR OFFICE USE; BOOKBINDING MATERIAL; BOOKBINDINGS; BOOKBINDING MACHINES FOR OFFICE USE; HAND HELD LABELING DEVICE; PAPER LABELS; BOOK COVERS; PHOTOGRAPH STANDS; POSTAGE METERS FOR OFFICE USE; DOCUMENT HOLDERS; MARKING PENS; BOOKMARKERS; TAGS FOR INDEX CARDS; PENCIL HOLDERS; PENCIL LEAD HOLDERS; CLIP BOARD; PEN HOLDERS; STAMP STANDS; ADHESIVE BANDS FOR STATIONERY OR HOUSEHOLD PURPOSES; PAPER SHREDDERS FOR OFFICE USE; INSTRUCTIONAL OR TEACHING MATERIAL EXCEPT APPARATUS, NAMELY, PRINTED TEACHING MATERIALS IN THE FIELD OF TRANSPORT AND AERONAUTICS; PLASTIC MATERIALS FOR PACKAGING, NAMELY, GARBAGE BAGS OF PLASTICS; PLASTIC BAGS, PLASTIC ENVELOPES, AND PLASTIC POUCHES FOR PACKAGING; HUMIDITY CONTROL SHEETS OF PLASTIC FOR FOODSTUFF PACKAGING; BUBBLE PACKS OF PLASTIC FOR WRAPPING OR PACKAGING; PLASTIC CLING FILM; PLASTIC FILM FOR WRAPPING; PRINTING TYPE; PRINTING BLOCKS (U.S. CLS. 2, 5, 22, 23, 29, 37, 38 AND 50).

#### CLASS 35—ADVERTISING AND BUSINESS

FOR RETAIL STORE SERVICES AND RETAIL ONLINE STORE SERVICES VIA GLOBAL COMPUTER NETWORKS FEATURING JEWELRY, PERFUMERY, COSMETICS, CLOTHING, FASHION ACCESSORIES, GAMES AND TOYS, CAMERAS, PERSONAL GROOMING PRODUCTS, DECORATIVE ORNAMENTS, PRINTED MATTER, KITCHEN AND HOUSEHOLD UTENSILS, TABLE NAPKINS OF PAPER, FURNITURE, BUILDING MATERIALS, WRITING UTENSILS, STATIONERY, HAND TOOL BAGS, WALLETS AND GOODS OF LEATHER, CONFECTIONERY, LINEN AND FABRICS, LAND VEHICLES, AIR VEHICLES, BOATS, CHEMICAL PRODUCTS, PHARMACEUTICAL PRODUCTS, ALCOHOLIC BEVERAGES, NON-ALCOHOLIC BEVERAGES, PREPARED DISHES, FOODSTUFFS, TOBACCO, CARPETS, FABRICS, YARNS, ROPES, ICES, COFFEE, TEA, COCOA, FOODSTUFFS FOR ANIMALS, SMOKERS' ARTICLES, MACHINE TOOLS, MOTORS AND ENGINES; ADVERTISING SERVICES; MARKETING AND PROMOTIONAL SERVICES FOR AIRLINES; ASSISTANCE IN THE BUSINESS MANAGEMENT OF COMMERCIAL OR INDUSTRIAL COMPANIES, BUSINESS MANAGEMENT, BUSINESS ADMINISTRATION, OFFICE FUNCTIONS, DOCUMENT REPRODUCTION, PUBLIC RELATIONS, FINANCIAL ACCOUNT STATEMENT PREPARATION; BUSINESS MANAGEMENT OF PROMOTIONAL BONUSES AND CUSTOMER AND PERSONNEL LOYALTY PROGRAMS VIA PROMOTIONAL OR ADVERTISING CAMPAIGNS, BUSINESS MANAGEMENT OF A LOYALTY PROGRAM IN THE FIELD OF AIR TRANSPORT; COMPUTERIZED ONLINE ORDERING SERVICES IN THE FIELD OF TAX-FREE PRODUCTS IN THE NATURE OF JEWELRY, PERFUMERY, COSMETICS, CLOTHING, FASHION ACCESSORIES, GAMES AND TOYS, CAMERAS, PERSONAL GROOMING PRODUCTS, DECORATIVE ORNAMENTS, PRINTED MATTER, WRITING UTENSILS, KITCHEN AND HOUSEHOLD UTENSILS, TABLE NAPKINS OF PAPER, FURNITURE, BUILDING MATERIALS, STATIONERY, HAND TOOL BAGS, WALLETS AND GOODS OF LEATHER, CONFECTIONERY, LINEN AND FABRICS, LAND VEHICLES, AIR VEHICLES, BOATS, CHEMICAL PRODUCTS, PHARMACEUTICAL PRODUCTS, ALCOHOLIC BEVERAGES, NON-ALCOHOLIC BEVERAGES, PREPARED DISHES, FOODSTUFFS, TOBACCO, CARPETS, FABRICS, YARNS, ROPES, ICES, COFFEE, TEA, COCOA, FOODSTUFFS FOR ANIMALS, SMOKERS' ARTICLES, MACHINE TOOLS, MOTORS AND ENGINES; MARKET STUDIES, MAINLY IN THE

FIELD OF AIR TRANSPORT AND AERONAUTICS; PROMOTIONAL AND MARKETING REPRESENTATION OF AIRLINES AND OF VEHICLE RENTAL COMPANIES (U.S. CLS. 100, 101 AND 102).

#### CLASS 39—TRANSPORTATION AND STORAGE

FOR TRANSPORT, PACKAGING AND STORAGE OF GOODS FOR THE TRANSPORT OF GOODS; PASSENGER TRANSPORT, TRAVELER TRANSPORT, ANIMAL TRANSPORT, TRAVEL ARRANGEMENT FOR INDIVIDUALS AND GROUPS, ESCORTING OF TRAVELERS, AIR HOSTESS SERVICES NAMELY, ESCORTING OF TRAVELER, AIR TRANSPORT, AERONAUTICAL TRANSPORT, FREIGHT TRANSPORT BY TRAIN, AIR, LAND OR SHIP, TOURIST OFFICES EXCLUDING HOTEL AND BOARDING HOUSE RESERVATION, TRAVEL AGENCY SERVICES, NAMELY, FOR MAKING RESERVATIONS AND BOOKING FOR TRANSPORTATION, BUS TRANSPORT, CAR TRANSPORT, CHAUFFEUR SERVICES, PARCEL DELIVERY, PACKAGING OF GOODS FOR TRANSPORT, MESSAGE DELIVERY, NEWSPAPER DELIVERY, STORAGE OF GOODS, DELIVERY OF LUGGAGE, OF GOODS, OF MERCHANDISE, WRAPPING, BEING PACKAGING OF GOODS FOR TRANSPORT, INFORMATION ABOUT STORAGE OF GOODS, ORGANIZATION OF TRAVEL EXCURSIONS, FREIGHT FORWARDING, FREIGHT SHIP TRANSPORT, INFORMATION ON TRANSPORT AND VEHICLE RENTAL, INFORMATION ON TRANSPORTING PASSENGERS, GOODS AND ANIMALS, VEHICLE RENTAL, COURIER SERVICES FOR MESSAGES OR MERCHANDISE, CAR PARKING, BOOKING OF SEATS FOR TRAVEL, WAREHOUSING, TAXI TRANSPORT, ORGANIZING SIGHTSEEING TRAVEL TOURS, FREIGHT FORWARDING, RESERVATION FOR TRANSPORT, RESERVATION OF TRANSPORT FOR PASSENGERS, GOODS AND ANIMALS, BOOKING FOR TRAVEL AND VEHICLE RENTAL, ARRANGING OF AIRLINE TICKET RESERVATION SERVICES, GUARDED TRANSPORT OF VALUABLES, SHUTTLE SERVICES BY BUS, CAR, TRAIN AND BOAT, REGISTRATION OF LUGGAGE, GOODS AND PASSENGERS IN THE NATURE OF CHECKING OF BAGGAGE AND PASSENGERS CHECK-IN SERVICES, LOADING AND UNLOADING OF AIRCRAFT CARGO, PROVISION OF AIR VEHICLES, VEHICLE TOWING, CAR RENTAL, RENTAL OF STORAGE CONTAINERS, FREIGHT BROKERAGE, TRANSPORT BROKERAGE, RENTAL OF WAREHOUSES, OF GARAGES, INFORMATION ON TRANSPORT, RENTAL OF WHEELCHAIRS, PARKING SPACE RENTAL, PILOTING, SALVAGING SERVICES, NAMELY, AUTOMOBILE SALVAGE, AIRCRAFT SALVAGE, TRAIN SALVAGE, BOAT SALVAGE, RESCUE OPERATIONS TRANSPORT, AIRPLANE LENDING AND RENTAL, INFORMATION SERVICES RELATING TO ALL THE AFORESAID SERVICES (U.S. CLS. 100 AND 105).

CARYN GLASSER, EXAMINING ATTORNEY

SN 79-132,786, SHENZHEN ZTE NETVIEW TECHNOLOGY CO., LTD., CHINA, FILED 6-12-2013.

OWNER OF INTERNATIONAL REGISTRATION 1167127 DATED 6-12-2013, EXPIRES 6-12-2023.

THE MARK CONSISTS OF THE LETTERS "ZNV" IN STYLIZED FONT WITH A CURVED BAND EXTENDING FROM THE BOTTOM OF THE LETTER "Z" ACROSS THE LETTER "N" TO THE TOP OF THE LETTER "V".

**CLASS 9—ELECTRICAL AND SCIENTIFIC APPARATUS**

FOR DATA PROCESSING APPARATUS; COMPUTER MEMORY DEVICES, NAMELY, BLANK FLASH MEMORY CARDS, COMPUTER MEMORIES, COMPUTER MEMORY HARDWARE; RECORDED COMPUTER PROGRAMS FOR USE IN DATABASE MANAGEMENT, DATA ANALYSIS, VIDEO MONITORING AND INFORMATION RESEARCH; OPTICAL COMMUNICATION APPARATUS, NAMELY, OPTICAL CABLES, OPTICAL READERS, OPTICAL SCANNERS; RECORDED COMPUTER SOFTWARE FOR USE IN DATABASE MANAGEMENT, DATA ANALYSIS, VIDEO MONITORING AND INFORMATION RESEARCH; ENCODED MAGNETIC CARDS CONTAINING PROGRAMMING USED TO DATABASE MANAGEMENT, DATA ANALYSIS, VIDEO MONITORING AND INFORMATION RESEARCH; MICROPROCESSORS; NETWORK COMMUNICATION APPARATUS, NAMELY, COMPUTER NETWORK ADAPTERS, COMPUTER NETWORK INTERFACE DEVICES, COMPUTER NETWORK SERVER; DATA PROCESSING EQUIPMENT, NAMELY, BAR CODE READERS, ELECTRONIC CARD READERS, FLASH CARD READERS, MAGNETIC ENCODED CARD READERS; INTEGRATED CIRCUIT CARDS; SMART CARDS, NAMELY, BLANK SMART CARDS, ENCODED SMART CARDS CONTAINING PROGRAMMING USED FOR DATABASE MANAGEMENT, DATA ANALYSIS, VIDEO MONITORING AND INFORMATION RESEARCH; DOWNLOADABLE COMPUTER SOFTWARE FOR USE IN DATABASE MANAGEMENT, DATA ANALYSIS, VIDEO MONITORING AND INFORMATION RESEARCH; ELECTRICITY ANTI-INTERFERENCE DEVICES, NAMELY, INTERFEROMETERS; ELECTRICITY LIMITERS, ELECTRICITY CONDUITS; TRANSMITTERS OF ELECTRONIC SIGNALS; INTERCOMMUNICATION APPARATUS, NAMELY, INTERCOMS, COMMUNICATION HUBS, COMMUNICATIONS COMPUTERS; ELECTRO-DYNAMIC APPARATUS FOR THE REMOTE CONTROL OF SIGNALS; MODEMS; VIDEO TELEPHONES; CAMCORDERS; ACOUSTIC SOUND ALARMS; ELECTRIC THEFT PREVENTION INSTALLATIONS, NAMELY, THEFT ALARMS, BURGLAR ALARMS (U.S. CLS. 21, 23, 26, 36 AND 38).

**CLASS 37—CONSTRUCTION AND REPAIR**

FOR BUILDING CONSTRUCTION SUPERVISION; PROVIDING INFORMATION RELATED TO THE REPAIR OF BUILDING, FURNITURE, PIPELINE, WATER AND ELECTRICITY EQUIPMENT; CONSTRUCTION PROJECT MANAGEMENT SERVICES FOR CHECK OF PROJECT PROGRESS; PIPELINE CONSTRUCTION AND MAINTENANCE; UPHOLSTERY REPAIR; UPHOLSTERING; AIR CONDITIONING APPARATUS INSTALLATION AND REPAIR; ELECTRIC APPLIANCE INSTALLATION AND REPAIR; BURGLAR ALARM INSTALLATION AND REPAIR; FIRE ALARM INSTALLATION AND REPAIR (U.S. CLS. 100, 103 AND 106).

**CLASS 38—COMMUNICATION**

FOR COMMUNICATIONS BY COMPUTER TERMINALS; COMPUTER-AIDED INFORMATION AND IMAGE TRANSMISSION; COMPUTER AIDED TRANSMISSION OF MESSAGES AND IMAGES; INFORMATION ABOUT TELECOMMUNICATION; PROVIDING INFORMATION ABOUT TELECOMMUNICATIONS, NAMELY, TELEPHONE COMMUNICATION, TELEGRAM COMMUNICATION AND RADIO APPARATUS COMMUNICATION (U.S. CLS. 100, 101 AND 104).

TINA BROWN, EXAMINING ATTORNEY

SN 79-132,908. EASY WINE GLASS TM B.V., NETHERLANDS, FILED 5-3-2013.



PRIORITY DATE OF 12-6-2012 IS CLAIMED.  
OWNER OF INTERNATIONAL REGISTRATION 1167445  
DATED 5-3-2013, EXPIRES 5-3-2023.

OWNER OF U.S. REG. NO. 4,181,345.

NO CLAIM IS MADE TO THE EXCLUSIVE RIGHT TO USE "WINE GLASS" IN INTERNATIONAL CLASS 21, AND "WINE" IN INTERNATIONAL CLASSES 33 AND 35, APART FROM THE MARK AS SHOWN.

THE MARK CONSISTS OF THE STYLIZED WORDING "EASY WINE GLASS", WITH THE STYLIZED DESIGN OF A WINE GLASS REPLACING THE "Y" IN "EASY".

**CLASS 21—HOUSEWARES AND GLASS**

FOR HOUSEHOLD OR KITCHEN UTENSILS AND CONTAINERS, WHETHER REUSABLE OR DISPOSABLE, MADE OF PAPER, CARDBOARD, PLASTIC OR ALUMINUM, NAMELY, MUGS, CUPS, AND PLASTIC GLASSES (U.S. CLS. 2, 13, 23, 29, 30, 33, 40 AND 50).

**CLASS 33—WINES AND SPIRITS**

FOR ALCOHOLIC BEVERAGES EXCEPT BEERS (U.S. CLS. 47 AND 49).

**CLASS 35—ADVERTISING AND BUSINESS**

FOR COMMERCIAL INTERMEDIARY SERVICES RELATING TO THE PURCHASE AND SALE OF WINES; IMPORT AND EXPORT AGENCIES IN THE FIELD OF WINES (U.S. CLS. 100, 101 AND 102).

ANDREW LEASER, EXAMINING ATTORNEY

SN 79-132,989. CLIMATE INVEST B.V., MALTA, FILED 5-24-2013.



PRIORITY DATE OF 12-7-2012 IS CLAIMED.  
OWNER OF INTERNATIONAL REGISTRATION 1167591  
DATED 5-24-2013, EXPIRES 5-24-2023.

THE COLOR(S) RED ("C=0, M=100, Y=100, K=0"), PURPLE ("C=55, M=85, Y=0, K=0") AND BLUE ("C=100, M=50, Y=0, K=0") IS/ARE CLAIMED AS A FEATURE OF THE MARK.

THE MARK CONSISTS OF THE WORD "BOAT" APPEARING IN BLUE IN THE UPPER LEFT OF THE MARK, AND THE WORD "SKIN", IN WHICH THE "S" IS IN A FAR LARGER, BOLD AND RIGHT-SLANTED PURPLE FONT. A RED LINE CUTS HORIZONTALLY ACROSS THE MARK RUNNING BENEATH "BOAT" AND BEHIND THE "S", AND ALONG THE TOP OF THE LETTERS "KIN" IN BLUE TO THE RIGHT OF THE PURPLE "S".

**CLASS 16—PAPER GOODS AND PRINTED MATTER**

FOR PLASTIC FOILS AND FILMS, FOR PACKAGING PURPOSES (U.S. CLS. 2, 5, 22, 23, 29, 37, 38 AND 50).

**CLASS 17—RUBBER GOODS**

FOR PLASTIC FOILS AND FILMS, NAMELY SUN-RESISTANT AND HEAT-RESISTANT FOILS AND FILMS, UV-RESISTANT FOILS AND FILMS, SAFETY FOILS AND FILMS, ANTI-THEFT FOILS AND FILMS, LIGHT-FILTERING FOILS AND FILMS, PRIVACY FOILS AND FILMS, COLOURED FOILS AND FILMS, INVISIBLE FOILS AND FILMS, FOILS AND FILMS FOR DECORATION, FOILS AND FILMS FOR WINDOWS OF VEHICLES AND FOILS AND FILMS FOR USE IN BUILDINGS (U.S. CLS. 1, 5, 12, 13, 35 AND 50).

**CLASS 27—FLOOR COVERINGS**

FOR WALLPAPER, NON-TEXTILE WALL HANGINGS; WALL COVERINGS; FLOOR COVERINGS OF PLASTIC (U.S. CLS. 19, 20, 37, 42 AND 50).

CAITLIN WATTS-FITZGERALD, EXAMINING ATTORNEY

**CLASS 10—MEDICAL APPARATUS**

FOR LAMPS AND LIGHTS FOR MEDICAL OR TECHNICAL APPLICATIONS, IN PARTICULAR FOR OPHTHALMOLOGY, ENDOSCOPY AND BOROSCOPY, FOR MICROSCOPY, FOR DENTISTRY, LED MODULES FOR SURGICAL, MEDICAL, DENTAL AND VETERINARY PURPOSES; QUARTZ LAMPS FOR MEDICAL PURPOSES; ULTRAVIOLET RAY LAMPS FOR MEDICAL PURPOSES; INFRARED LAMPS AND UV LAMPS FOR STERILIZATION OR FOR MEDICAL APPLICATIONS (U.S. CLS. 26, 39 AND 44).

**CLASS 11—ENVIRONMENTAL CONTROL APPARATUS**

FOR ELECTRIC LIGHTS IN THE NATURE OF ELECTRIC LAMPS, IN PARTICULAR LAMPS FOR LIGHTING; ARC LAMPS; GAS LAMPS; HALOGEN LAMPS FOR LOW, MEDIUM OR HIGH VOLTAGE; LABORATORY LAMPS; PROJECTOR LAMPS ULTRAVIOLET RAY LAMPS; NOT FOR MEDICAL PURPOSES; SAFETY LAMPS FOR UNDERGROUND USE; LUMINOUS TUBES FOR LIGHTING; ELECTRIC DISCHARGE TUBES FOR LIGHTING; LED LAMPS, LIGHT EMITTING DIODE LIGHTS AND LED MODULES IN THE NATURE OF LED LAMPS; COMPACT FLUORESCENT LAMPS; FLUORESCENT LAMPS; DISCHARGE LAMPS; AIR FIELD BEACONS IN THE NATURE OF AIR FIELD LAMPS; LAMPS FOR STAGE, FILM, TELEVISION, SHOW AND EFFECTS LIGHTING; COLOR FILTERS, CORRECTION FILTERS, ULTRAVIOLET FILTERS, DIFFUSION FILTERS, HIGH TEMPERATURE FILTERS, COLOR FILTER FILMS, CORRECTION FILTER FILMS, ALL OF THE AFORESAID GOODS BEING FOR LIGHTING ENGINEERING PROPOSES (U.S. CLS. 13, 21, 23, 31 AND 34).

SN 79-133,182. MULTI-LITE LICHTTECHNIK HANDELS GMBH, FED REP GERMANY, FILED 3-5-2013.

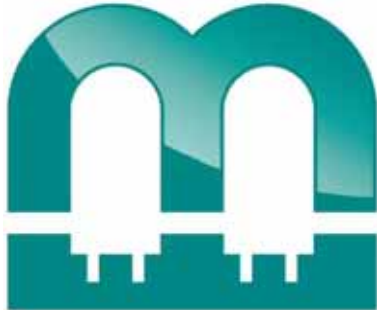

PRIORITY DATE OF 9-5-2012 IS CLAIMED. OWNER OF INTERNATIONAL REGISTRATION 1168213 DATED 3-5-2013, EXPIRES 3-5-2023.

THE COLOR(S) GREEN AND WHITE IS/ARE CLAIMED AS A FEATURE OF THE MARK.

THE MARK CONSISTS OF TWO WHITE LEDS FORMING A STYLIZED GREEN "M" WITH A ONE WHITE AND ONE GREEN HORIZONTAL LINE APPEARING UNDERNEATH THE "M".

**CLASS 9—ELECTRICAL AND SCIENTIFIC APPARATUS**

FOR OPTICAL LANTERNS; FLASH-BULBS FOR PHOTOGRAPHY; DARKROOM LAMPS FOR PHOTOGRAPHY; SIGNALING LAMPS IN THE NATURE OF LED VEHICLE TRAFFIC SIGNALS, AND SIGNALING LAMPS IN THE NATURE OF ROTATING LIGHTS FOR SIGNALING; COLOR FILTERS, CORRECTING FILTERS, ULTRAFILTRATION FILTERS, DIFFUSION FILTERS, HIGH TEMPERATURE FILTERS, COLOR FILTER FILMS, CORRECTION FILTER FILMS, ALL THE AFORESAID GOODS BEING FOR PHOTOGRAPHIC PURPOSES; LEDS (U.S. CLS. 21, 23, 26, 36 AND 38).

**CLASS 35—ADVERTISING AND BUSINESS**

FOR WHOLESALE AND RETAIL STORE SERVICES FEATURING LAMPS AND LIGHTS OF ALL KINDS, IN PARTICULAR OF OPTICAL LAMPS, FLASH-BULBS, DARK ROOM LAMPS, LAMPS FOR MEDICAL OR TECHNICAL USE, LAMPS FOR DENTISTRY, LED LAMPS, LED LIGHTS AND LED MODULES, QUARTZ LAMPS, INFRARED LAMPS, UV LAMPS, ELECTRIC LAMPS, LABORATORY LAMPS, PROJECTOR LAMPS, ULTRAVIOLET LAMPS, SAFETY LAMPS, LUMINOUS TUBES, FLUORESCENT LAMPS, DISCHARGE LAMPS, SIGNAL LAMPS, AIRFIELD LIGHTING AND AIRFIELD LAMPS, ENTERTAINMENT LIGHTS, LAMPS FOR STAGE FILM, TELEVISION, SHOW AND EFFECT LIGHTING; WHOLESALE AND RETAIL STORE SERVICES FEATURING COLOR FILTERS, CORRECTION FILTERS, ULTRAVIOLET FILTERS, DIFFUSION FILTERS, HIGH TEMPERATURE FILTERS, COLOR FILTER FILMS AND CORRECTION FILTER FILMS (U.S. CLS. 100, 101 AND 102).

SEAN CROWLEY, EXAMINING ATTORNEY

SN 79-133,806. OCCHIO GMBH, FED REP GERMANY, FILED 6-13-2013.



THE MARK CONSISTS OF STANDARD CHARACTERS WITHOUT CLAIM TO ANY PARTICULAR FONT, STYLE, SIZE, OR COLOR.

PRIORITY DATE OF 12-13-2012 IS CLAIMED. OWNER OF INTERNATIONAL REGISTRATION 1169766 DATED 6-13-2013, EXPIRES 6-13-2023.

THE ENGLISH TRANSLATION OF "PIU" IN THE MARK IS "MORE".

SN 79-134,288. FUTUREWHIZ MEDIA B.V., NETHERLANDS, FILED 6-13-2013.

**CLASS 9—ELECTRICAL AND SCIENTIFIC APPARATUS**

FOR COMPACT DISCS READ-ONLY MEMORY; COMPACT DISCS AUDIO-VIDEO; FLOPPY DISKS; ELECTRONIC PUBLICATIONS (DOWNLOADABLE); SOUND RECORDING CARRIERS; ELECTRIFIED RAILS FOR MOUNTING SPOT LIGHTS; CONNECTOR BOXES (ELECTRICITY); CONNECTIONS FOR ELECTRIC LINES; LIGHT REGULATORS (DIMMERS) (ELECTRIC) (U.S. CLS. 21, 23, 26, 36 AND 38).

**SQULA**

THE MARK CONSISTS OF STANDARD CHARACTERS WITHOUT CLAIM TO ANY PARTICULAR FONT, STYLE, SIZE, OR COLOR.

OWNER OF INTERNATIONAL REGISTRATION 1171026 DATED 6-13-2013, EXPIRES 6-13-2023.

**CLASS 11—ENVIRONMENTAL CONTROL APPARATUS**

FOR LAMPS; LAMPS; ARC LAMPS; CEILING LIGHTS; FLOOR LAMPS; LAMP SHADES; SOCKETS FOR ELECTRIC LIGHTS; LAMPSHADE HOLDERS; LAMP FIXTURES; LIGHTING APPARATUS AND INSTALLATIONS; LAMP BULBS; LIGHT BULBS; LUMINOUS TUBES FOR LIGHTING; ELECTRIC DISCHARGE TUBES FOR LIGHTING; LAMP GLASSES; LAMP CHIMNEYS; LAMP GLOBES; LAMP REFLECTORS; LIGHT DIFFUSERS (U.S. CLS. 13, 21, 23, 31 AND 34).  
HEATHER SAPP, EXAMINING ATTORNEY

**CLASS 9—ELECTRICAL AND SCIENTIFIC APPARATUS**

FOR EDUCATIONAL COMPUTER GAME PROGRAMS (U.S. CLS. 21, 23, 26, 36 AND 38).

**CLASS 38—COMMUNICATION**

FOR TELECOMMUNICATIONS, NAMELY, TRANSMISSION OF DATA, GRAPHICS, IMAGES, AUDIO AND VIDEO BY MEANS OF TELECOMMUNICATIONS NETWORKS AND THE INTERNET, IN THE FIELD OF EDUCATION; EDUCATIONAL RADIO AND TELEVISION BROADCASTING; PROVIDING ON-LINE FORUMS IN THE FIELD OF EDUCATION FOR TRANSMISSION OF MESSAGES AMONGST COMPUTER USERS; PROVIDING ACCESS TO EDUCATIONAL DATABASES; PROVIDING MULTIPLE-USER ACCESS TO A GLOBAL COMPUTER INFORMATION NETWORK FOR EDUCATIONAL PURPOSES (U.S. CLS. 100, 101 AND 104).

SN 79-134,071. ODEVIE, F-16110 LA ROCHEFOUCAULD, FRANCE, FILED 6-14-2013.

**ARCANE, THE ART OF PURE FRESH CANE**

OWNER OF INTERNATIONAL REGISTRATION 1105171 DATED 12-8-2011, EXPIRES 12-8-2021.

**CLASS 41—EDUCATION AND ENTERTAINMENT**

FOR EDUCATION SERVICES IN THE NATURE OF EARLY CHILDHOOD INSTRUCTION AND PROVIDING COURSES OF INSTRUCTION AT THE PRIMARY LEVEL; ONLINE MULTIMEDIA PUBLICATION OF EDUCATIONAL MATERIAL, NAMELY, EDUCATIONAL COMPUTER GAME PROGRAMS; PUBLICATION OF ELECTRONIC NEWSLETTERS, BOOKS, MAGAZINES AND PERIODICALS IN THE FIELD OF EDUCATION; ENTERTAINMENT SERVICES, NAMELY, PROVIDING ONLINE EDUCATIONAL ELECTRONIC GAMES (U.S. CLS. 100, 101 AND 107).

ANNE FARRELL, EXAMINING ATTORNEY

**CLASS 30—STAPLE FOODS**

FOR COFFEE, TEA, COCOA, SUGAR, RICE, TAPIOCA, SAGO, ARTIFICIAL COFFEE; FLOUR AND PREPARATIONS MADE FROM CEREALS, NAMELY, CEREAL BAR; BREAD, PASTRY AND CONFECTIONERY, NAMELY, PASTILLES, EDIBLE ICES; HONEY, TREACLE; YEAST, BAKING-POWDER; SALT, MUSTARD; VINEGAR, SAUCES IN THE NATURE OF CONDIMENTS; SPICES; ICE FOR REFRESHMENT; SANDWICHES, PIZZAS; PANCAKES; COOKIES; CAKES; RUSKS; CONFECTIONERY, NAMELY, PASTILLES; CHOCOLATE; BEVERAGES MADE WITH COCOA, COFFEE, CHOCOLATE OR TEA (U.S. CL. 46).

SN 79-134,564. FROONT OY, FINLAND, FILED 7-22-2013.

**CLASS 32—LIGHT BEVERAGES**

FOR BEER; MINERAL AND AERATED WATERS; FRUIT DRINKS AND FRUIT JUICES; SYRUPS AND OTHER PREPARATIONS, NAMELY, POWDERS FOR MAKING BEVERAGES; LEMONADES; FRUIT NECTARS; SODA WATER; APERITIFS, NON-ALCOHOLIC (U.S. CLS. 45, 46 AND 48).



PRIORITY DATE OF 1-22-2013 IS CLAIMED. OWNER OF INTERNATIONAL REGISTRATION 1171686 DATED 7-22-2013, EXPIRES 7-22-2023.

THE MARK CONSISTS OF THE LITERAL ELEMENT "FROONT", "FRO ONT", "FR OO NT" AND A DESIGN ELEMENT COMPRISING THREE STYLIZED ELECTRONIC DEVICES, ARRANGED IN A HORIZONTAL MANNER. THE WORD "FROONT" APPEARS ON A STYLIZED COMPUTER MONITOR. THE WORD "FRO ONT" APPEARS ON A STYLIZED TABLET COMPUTER. THE WORD "FR OO NT" APPEARS ON A STYLIZED MOBILE DEVICE.

**CLASS 33—WINES AND SPIRITS**

FOR ALCOHOLIC BEVERAGES, EXCEPT BEER; CIDER; DIGESTERS IN THE NATURE OF LIQUEURS AND SPIRITS; WINE; SPIRITS; ALCOHOLIC EXTRACTS OR ESSENCES (U.S. CLS. 47 AND 49).

JULIE VEPPUMTHARA, EXAMINING ATTORNEY

**CLASS 9—ELECTRICAL AND SCIENTIFIC APPARATUS**

FOR DATA PROCESSING EQUIPMENT; COMPUTERS; RECORDED COMPUTER SOFTWARE FOR USE IN WEB DESIGN AND DEVELOPMENT; RECORDED COMPUTER PROGRAMMES FOR USE IN WEB DESIGN AND DEVELOPMENT; DOWNLOADABLE COMPUTER PROGRAMS AND SOFTWARE FOR USE IN WEB DESIGN AND DEVELOPMENT (U.S. CLS. 21, 23, 26, 36 AND 38).

**CLASS 41—EDUCATION AND ENTERTAINMENT**

FOR TRAINING SERVICES CONCERNED WITH THE CREATING WEB SITES AND USE OF COMPUTER SOFTWARE (U.S. CLS. 100, 101 AND 107).

**CLASS 42—SCIENTIFIC AND COMPUTER SERVICES**

FOR COMPUTER PROGRAMMING; DESIGN AND DEVELOPMENT OF COMPUTER HARDWARE AND SOFTWARE; CREATING AND MAINTAINING WEB SITES FOR OTHERS; HOSTING COMPUTER WEB SITES; GRAPHIC ARTS DESIGNING (U.S. CLS. 100 AND 101).

Laurie Kaufman, Examining Attorney

SN 79-134,635. RAIDYBOER FASHION GARMENT CO., LTD., SICHUAN, CHINA, FILED 7-23-2013.



# Raidy Boer

OWNER OF INTERNATIONAL REGISTRATION 1171858 DATED 7-23-2013, EXPIRES 7-23-2023.

THE NAME(S), PORTRAIT(S), AND/OR SIGNATURE(S) SHOWN IN THE MARK DOES NOT IDENTIFY A PARTICULAR LIVING INDIVIDUAL.

THE MARK CONSISTS OF THE STYLIZED WORDING "RAIDY BOER" BELOW THE STYLIZED DESIGN OF A SET OF WINGS WITH TWO SHIELDS AND THE LETTER "R" INSIDE OF A CIRCLE IN BETWEEN THE WINGS.

**CLASS 18—LEATHER GOODS**

FOR IMITATION LEATHER; PURSES; PORTE-MONNAIE IN THE NATURE OF POCKETBOOKS, WALLETS; TRAVELLING BAGS; BRIEFCASES; HAVERSACKS; FURNITURE COVERINGS OF LEATHER; UMBRELLAS; WALKING STICKS; FUR, NAMELY, FAUX FUR, SYNTHETIC FUR, FURS SOLD IN BULK, FUR PELTS (U.S. CLS. 1, 2, 3, 22 AND 41).

**CLASS 25—CLOTHING**

FOR BODY LINEN; CLOTHING, NAMELY, SHIRTS, PANTS, DRESSES; TROUSERS; TEE-SHIRTS; CLOTHING OF LEATHER, NAMELY, SHIRTS, PANTS, DRESSES; CAPS; FOOTWEAR; GIRDLES; NECKTIES; HOSIERY (U.S. CLS. 22 AND 39).

Kimberly Parks, Examining Attorney

SN 79-134,798. TOY POLLOI PTY LTD, CLAYTON, AUSTRALIA, AND P FALK & CO PTY LTD, CLAYTON, AUSTRALIA, FILED 6-19-2013.



OWNER OF INTERNATIONAL REGISTRATION 0863198 DATED 4-15-2005, EXPIRES 4-15-2015.

NO CLAIM IS MADE TO THE EXCLUSIVE RIGHT TO USE "WOOD", APART FROM THE MARK AS SHOWN.

THE MARK CONSISTS OF THE WORDS "WOOD WORX" IN STYLIZED FONT ON A RECTANGULAR BACKGROUND.

**CLASS 16—PAPER GOODS AND PRINTED MATTER**

FOR CRAFT AND ACTIVITY PACKS, NAMELY, CRAFT KITS FOR PAINTING, CRAFT KITS FOR PAINTING, CRAFT KITS FOR POSTERS AND PAPER MACHE CONSTRUCTIONS, COMPONENTS IN THIS CLASS FOR CRAFT KITS, NAMELY, PAINT BRUSHES, PAINT BOXES, GLUE FOR STATIONERY OR HOUSEHOLD PURPOSES, STICKERS IN THE NATURE OF DECALCOMANIA (U.S. CLS. 2, 5, 22, 23, 29, 37, 38 AND 50).

**CLASS 28—TOYS AND SPORTING GOODS**

FOR CRAFT KITS FOR MAKING, ASSEMBLING AND DECORATING TOYS, NAMELY, TOY VEHICLES, TOY AEROPLANES, TOY TRAINS, TOY RACING CARS, TOY ROBOTS, DOLLS, TOY DINOSAURS, TOY JEWELRY BOXES, TOY TREASURE BOXES, TOY ANIMAL FIGURINES, TOY HOUSES, COMPRISING TOY PARTS, TOY COMPONENTS, POTS OF PAINT, PAINT BRUSHES, STICKERS IN THE NATURE OF DECALCOMANIA (U.S. CLS. 22, 23, 38 AND 50).

Ernest Shosho, Examining Attorney

SN 79-134,940. MARK HOBLEY, UNITED KINGDOM, FILED 7-2-2013.

# Filamart

THE MARK CONSISTS OF STANDARD CHARACTERS WITHOUT CLAIM TO ANY PARTICULAR FONT, STYLE, SIZE, OR COLOR.

PRIORITY DATE OF 6-16-2013 IS CLAIMED.

OWNER OF INTERNATIONAL REGISTRATION 1172527 DATED 7-2-2013, EXPIRES 7-2-2023.

**CLASS 17—RUBBER GOODS**

FOR SOLDERING THREADS OF PLASTIC (U.S. CLS. 1, 5, 12, 13, 35 AND 50).

**CLASS 35—ADVERTISING AND BUSINESS**

FOR RETAIL STORE SERVICES FEATURING THE SALE OF ADDITIVE FABRICATION PRINTERS, FABRICATION EQUIPMENT, NAMELY, LASERS, SCANNERS, SOFTWARE AND PRINTER PARTS, COMPUTER PERIPHERALS, FABRICATION PRINTING MATERIALS NAMELY, PAPER, GLASS, PLASTIC, CONCRETE, SANDS, METAL AND ALLOYS AND EXTRUDABLE FOOD, SUPPLIED IN SPOOLS, CARTRIDGES AND TANKS IN FORM OF RODS, PELLETS, GRANULAR AND POWDERS; RETAIL STORE SERVICES FEATURING FABRICATION PRINTING OBJECTS, NAMELY, PROTOTYPES OF FABRICATIONS, THREE-DIMENSIONAL FABRICATED SHAPES, MATERIALS FOR FABRICATION PRODUCTS AND FABRICATED MACHINE PARTS; ADVERTISING SERVICES FOR OTHERS; PROVISION OF ADVERTISING SPACE ON WEBSITE (U.S. CLS. 100, 101 AND 102).

SAMUAL PAQUIN, EXAMINING ATTORNEY

ING CAR RACES AND THE HISTORY OF AUTOMOBILE MANUFACTURERS; CD-ROMS FEATURING HIGH-PERFORMANCE CARS AND AUTOMOBILES; DVDS FEATURING HIGH-PERFORMANCE CARS AND AUTOMOBILES; LANYARDS ESPECIALLY ADAPTED FOR HOLDING MOBILE PHONES, MP3 PLAYERS, CAMERAS, VIDEO CAMERAS, EYEGLASSES, SUNGLASSES, MAGNETIC ENCODED CARDS, NAMELY, MAGNETICALLY ENCODED GIFT CARDS; SPEED CHECKING APPARATUS FOR VEHICLES, NAMELY, RADAR DETECTORS; AUTOMATIC STEERING APPARATUS FOR VEHICLES, NAMELY, SIMULATORS FOR THE STEERING AND CONTROL OF VEHICLES; AUTOMATIC INDICATORS OF LOW PRESSURE IN VEHICLE TIRES; VOLTAGE REGULATORS FOR VEHICLES; MILEAGE RECORDERS FOR VEHICLES, NAMELY, ODOMETERS; AIRBAG DEACTIVATION SWITCHES FOR AUTOMOBILES; STEERING WHEELS FOR PCS WITH DOUBLE GEAR-SHIFTING SYSTEMS; EARPHONES EXCLUSIVELY USED FOR CONNECTING TO HAND-HELD GAMES (U.S. CLS. 21, 23, 26, 36 AND 38).

SN 79-135,059. FERRARI S.P.A., ITALY, FILED 7-12-2012.



PRIORITY DATE OF 2-1-2012 IS CLAIMED.  
OWNER OF INTERNATIONAL REGISTRATION 1172849 DATED 7-12-2012, EXPIRES 7-12-2022.

THE MARK CONSISTS OF AN IMPRINT DEPICTING THE WORD "F2012" IN FANCY PROFILED CHARACTERS SLIGHTLY INCLINED TO THE RIGHT AND INSERTED IN A SUBSTANTIALLY QUADRILATERAL LABEL WITH THE UPPER CORNERS ROUNDED AND THE TOP EDGE FOLLOWING THE PROGRESSION OF THE NUMERAL "2012", SAID WORD HAVING THE PORTIONS "F2" AND "12" RESPECTIVELY UNDERLINED BY TWO HORIZONTAL BANDS.

**CLASS 9—ELECTRICAL AND SCIENTIFIC APPARATUS**

FOR EYEGLASSES; SUNGLASSES; ANTI-GLARE GLASSES; GOGGLES FOR SPORTS; SWIMMING GOGGLES; EYEGLASS AND SUNGLASS CASES; EYEGLASS AND SUNGLASS LENSES; EYEGLASS AND SUNGLASS FRAMES; EYEGLASS AND SUNGLASS CHAINS; EYEGLASS AND SUNGLASS CORDS; PINCE-NEZ; PINCE-NEZ CASES; PINCE-NEZ CHAINS; PINCE-NEZ CORDS; PINCE-NEZ MOUNTINGS; CORRECTING LENSES, BEING OPTICS; JOYSTICKS FOR CONSUMER VIDEO GAME MACHINES ADAPTED FOR USE WITH AN EXTERNAL DISPLAY SCREEN OR MONITOR; JOYSTICK CHARGERS; MEMORY CARDS FOR CONSUMER VIDEO GAME MACHINES ADAPTED FOR USE WITH AN EXTERNAL DISPLAY SCREEN OR MONITOR; MICE FOR CONSUMER VIDEO GAME MACHINES ADAPTED FOR USE WITH AN EXTERNAL DISPLAY SCREEN OR MONITOR; RECORDED PROGRAMS FOR HAND-HELD GAMES WITH LIQUID CRYSTAL DISPLAYS; CARTRIDGES FOR ELECTRONIC GAMES; COMPUTER GAME CARTRIDGES; VIDEO GAME CARTRIDGES; COMPUTER GAME PROGRAMS; RECORDED PROGRAMS FOR ELECTRONIC PRE-RECORDED GAMES; SIMULATORS FOR THE STEERING AND CONTROL OF VEHICLES; ELECTRONIC SPORTS TRAINING SIMULATORS; DISKS FOR ELECTRONIC GAMES; PROTECTIVE HELMETS; PROTECTIVE HELMETS FOR SPORTS; FIREPROOF AUTOMOBILE RACING SUITS FOR SAFETY PURPOSES; FACE PROTECTION SHIELDS, OTHER THAN FOR MEDICAL PURPOSES; GLOVES FOR PROTECTION AGAINST ACCIDENTS; FLAME-RETARDANT BALACLAVAS; SHOES FOR PROTECTION AGAINST ACCIDENTS, IRRADIATION AND FIRE; BOOTS FOR PROTECTION AGAINST ACCIDENTS, IRRADIATION AND FIRE; PROTECTION DEVICES FOR PERSONAL USE AGAINST ACCIDENTS, NAMELY, INFLATABLE FLOTATION DEVICES; CD-ROMS FEATURING CAR RACES AND THE HISTORY OF AUTOMOBILE MANUFACTURERS; DVDS FEATUR-

**CLASS 12—VEHICLES**

FOR AUTOMOBILES; CARS; RACING CARS; MOTORCARS FOR TRANSPORT ON LAND; SPORTS CARS; LAND VEHICLES; ALL-TERRAIN VEHICLES; TRUCKS; LORRIES; BODIES FOR VEHICLES; VEHICLE CHASSIS, NAMELY, AUTOMOBILE CHASSIS; HOODS FOR VEHICLES; MOTORS, ELECTRIC, FOR LAND VEHICLES; MOTORS FOR LAND VEHICLES; DRIVING MOTORS FOR LAND VEHICLES; ENGINES FOR LAND VEHICLES; STEERING WHEELS FOR VEHICLES; BRAKES FOR VEHICLES; SAFETY BELTS FOR VEHICLE SEATS; UPHOLSTERY FOR VEHICLES; CRANKCASES FOR LAND VEHICLE COMPONENTS, OTHER THAN FOR ENGINES; VEHICLE WHEELS; VEHICLE WHEEL TIRES; AUTOMOBILE TIRES; PNEUMATIC TIRES; VEHICLE SEATS; RACING SEATS FOR AUTOMOBILES; FITTED COVERS FOR VEHICLES; MOTORCYCLES; SCOOTERS; BICYCLES; CYCLES; TRICYCLES; SECURITY HARNESS FOR VEHICLE SEATS; AIR BAGS, BEING SAFETY DEVICES FOR AUTOMOBILES; NON-SKID DEVICES FOR VEHICLE TIRES, NAMELY, ANTI-SKID CHAINS FOR VEHICLE TIRES (U.S. CLS. 19, 21, 23, 31, 35 AND 44).

**CLASS 16—PAPER GOODS AND PRINTED MATTER**

FOR FLAGS OF PAPER; FLAGS AND PENNANTS OF PAPER; PASSES MADE OF PAPER, NAMELY, NOVELTY IDENTIFICATION DOCUMENTS IN THE NATURE OF IMITATION PASSPORTS; PRINTED TICKETS; ADHESIVE LABELS; DECALCOMANIAS; STICKERS AS STATIONERY; STICKER BOOKS; STICKER ALBUMS; EVENT ALBUMS; POSTERS; PHOTOGRAPHIC ALBUMS; COLORING CARDS FOR CHILDREN; STAMPS FOR COLLECTORS, EXCLUDING POSTAGE STAMPS; CALENDARS; BROCHURES, BOOKLETS, BOOKS, CATALOGUES, MAGAZINES, PRINTED PERIODICALS IN THE FIELD OF AUTOMOBILE RACING AND AUTOMOBILE COMPETITIONS AND THE HISTORY OF THE OWNER AND ITS PARTICIPATION IN AUTOMOBILE RACING AND COMPETITIONS; DESK PADS; DESKTOP ORGANIZERS FOR STATIONERY USE; EXERCISE BOOKS; DIARIES; AGENDAS AND WEEKLY PLANNERS; WRITING PENS; PENCILS; PENCIL AND PEN TOPPERS; PEN CASES; PENCIL HOLDERS; NOTE BOOKS; NOTE PADS (U.S. CLS. 2, 5, 22, 23, 29, 37, 38 AND 50).

**CLASS 25—CLOTHING**

FOR AUTOMOBILE RACING SUITS NOT IN THE NATURE OF PROTECTIVE CLOTHING; DRIVING GLOVES; POLO SHIRTS; SHIRTS; T-SHIRTS; SWEATSHIRTS; SWEATERS; JACKETS; RAIN JACKETS; ANORAKS; SHORTS; TRACK SUITS; RACING ROMPER SUITS FOR BABIES; ROMPERS; JERSEYS AS CLOTHING; SPORTS JERSEYS; SHOES; SPORTS SHOES; SCARVES; BANDANAS; NECKERCHIEFS; GLOVES AS CLOTHING; CAPS; SUN VISORS AS CLOTHING; BEREETS; HEADBANDS AS CLOTHING; HOODS AS CLOTHING (U.S. CLS. 22 AND 39).

**CLASS 28—TOYS AND SPORTING GOODS**

FOR AMUSEMENT APPARATUS ADAPTED FOR USE WITH AN EXTERNAL DISPLAY SCREEN OR MONITOR; AMUSEMENT APPARATUS ADAPTED FOR USE WITH AN EXTERNAL DISPLAY SCREEN OR MONITOR TO BE USED IN AMUSEMENT PARKS; APPARATUS FOR GAMES ADAPTED FOR USE WITH AN EXTERNAL DISPLAY SCREEN OR MONITOR; VIDEO GAME MACHINES FOR USE WITH TELEVISION; VIDEO GAME MACHINES; TELEVISION GAME SETS; ELECTRONIC GAMES ADAPTED FOR USE WITH TELEVISION SETS AND WITH AN EXTERNAL DISPLAY SCREEN OR MONITOR; AMUSEMENT MACHINES, AUTOMATIC AND COIN-OPERATED; APPARATUS FOR PLAYING VIDEO GAMES; POCKET-SIZED APPARATUS FOR PLAYING VIDEO GAMES; POCKET-SIZED VIDEO GAMES; POCKET-SIZED ELECTRONIC GAMES; HAND-HELD VIDEO GAMES; PORTABLE ELECTRONIC GAMES; PORTABLE ELECTRONIC TOYS; HAND-HELD UNITS FOR PLAYING VIDEO GAMES; STAND ALONE VIDEO GAME MACHINES; COMPUTER GAME EQUIPMENT; ELECTRONIC GAMES CONSOLES ADAPTED FOR USE WITH AN EXTERNAL DISPLAY SCREEN OR MONITOR; SCALE MODEL VEHICLES; SCALE MODEL CARS; SCALE MODEL RACING CARS; SCALE MODEL RACING VEHICLES; RACING CAR MODEL SILHOUETTES; TOY FULL-SIZE CAR REPLICAS; TOY FULL-SIZE VEHICLE REPLICAS; RESIN MODELS FEATURING RACING SCENES; SCALE MODEL DRIVERS; SCALE MODEL PIT CREWS; VEHICLE CONSTRUCTION TOYS; TOY VEHICLE TRUCKS; TOY VEHICLES; TOY RACING CARS TRACKS; TOY STEERING WHEELS; PULL-ALONG TOY VEHICLES; TOY TRUCKS WITH CARS; TOY PEDAL KARTS FOR KIDS; RIDE-ON TOY CARS FOR CHILDREN IN PEDAL VERSION OR WORKING WITH BATTERIES; TOY CARS FOR CHILDREN IN PEDAL VERSION OR WORKING WITH BATTERIES; TOY GO-KARTS FOR CHILDREN IN PEDAL VERSION OR WORKING WITH BATTERIES; TOYS, NAMELY, RACE PIT-STOPS; TOYS, NAMELY, RACE TRACKS; TOY TRUCKS; TOY TRAILERS FOR TRANSPORTING CARS; RADIO-CONTROLLED TOY VEHICLES; RADIO-CONTROLLED TOY CARS; NOVELTY ITEMS, NAMELY, STICKS FOR FANS AND FOR ENTERTAINMENT INCORPORATING FIBER OPTICS; NOVELTY ITEMS, NAMELY, TOY STICKS FOR FANS AND FOR ENTERTAINMENT SHAPED AS FLAGS INCORPORATING FIBER OPTICS; TOY LANYARDS (U.S. CLS. 22, 23, 38 AND 50).

JAMES STEIN, EXAMINING ATTORNEY

SN 79-135,067. DENKI KAGAKU KOGYO KABUSHIKI KAISHA, JAPAN, FILED 11-29-2012.



**AKROSTRADING**

PRIORITY DATE OF 7-23-2012 IS CLAIMED.  
OWNER OF INTERNATIONAL REGISTRATION 1172863  
DATED 11-29-2012, EXPIRES 11-29-2022.  
THE MARK CONSISTS OF THE STYLIZED WORDING  
"AKROSTRADING".

**CLASS 35—ADVERTISING AND BUSINESS**

FOR IMPORT-EXPORT AGENCIES; RETAIL AND WHOLESALE STORE SERVICES FEATURING CHEMICALS, HYDROCHLORIC ACID, SULPHURIC ACID, PHOSPHORIC ACID, ACETIC ACID, AMMONIA WATER, CAUSTIC POTASH, CAUSTIC SODA, POTASSIUM CARBONATE, CALCIUM CARBONATE, ARGON, CHLORINE, NITROGEN, HYDROGEN PEROXIDE, ZINC OXIDE, CALCIUM CARBIDE, ETHYLENE, TRICHLOROETHYLENE, ANTHRAQUINONE, BENZYL ALCOHOL, WOOD ALCOHOL, ETHYL ACETATE, BUTYL ACETATE, ETHYLENE GLYCOL, BENZENE, TOLUENE, XYLENE, ACRYLIC ACID, ACRYLIC ACID ESTER, STARCHES, SURFACE-ACTIVE CHEMICAL AGENTS, DEFOAMING AGENTS, DEFOAMING AGENTS FOR PAPER, DEINKING AGENTS FOR PAPER, WATER RESISTANT ADDITIVES FOR PAPER, ANTI-STATIC

PREPARATIONS NOT FOR HOUSEHOLD USE, DISPERSING AGENTS, ANTI-CORROSIVE PREPARATIONS, CHEMICAL AGENTS, REDUCING AGENTS, OXIDIZING AGENTS, CEMENT SET ACCELERATORS, CEMENT BLENDING AGENTS, FIREPROOFING PREPARATIONS, WATER RESISTANT AGENTS, UNGLUING PREPARATIONS, HEAT GENERATING COMPOUNDS, MILDEW PROOFING AGENTS, SOLVENTS, ANTIOXIDANT AGENTS, STABILIZING AGENTS FOR PLASTIC MATERIALS, FLUXES, PHOSPHOR FOR LIGHT-EMITTING DIODES, PHOSPHOR FOR LIGHTING, DETERGENTS FOR SILICON WAFER USED FOR SOLAR CELLS, ETCHING AGENTS, METAL ETCHING AGENTS, CHELATING AGENT, PASTES AND ADHESIVES EXCLUSIVE OF THOSE FOR OFFICE OR DOMESTIC USE, PLASTIC ADHESIVES, NONFERROUS METALS, LUTETIUM, YTTRIUM, GALLIUM, STRONTIUM, EUROPIUM, LANTHANUM, LITHIUM, TACKIFIER AGENTS, PLANT GROWTH REGULATING AGENTS, SOIL CONDITIONING PREPARATIONS, FERTILIZERS, CHEMICAL FERTILIZERS, POTASSIUM CHLORIDE FERTILIZERS, NITROGENOUS LIME, NON-METALLIC MINERALS, KAOLIN, FLUORITE, NON-METALLIC MINERALS FOR REFRACTORIES, SILICA, PHOTORESIST, DEVELOPERS, UNGLUING LIQUID FOR SEMICONDUCTORS, METAL SILICON, FERROSILICON, MATERIAL PLASTICS, SILICON RESINS, EPOXY RESINS, PHENOLIC RESINS, ACRYLIC RESINS, POLYURETHANE RESINS, POLYETHYLENE RESINS, POLYPROPYLENE RESINS, POLYVINYL CHLORIDE RESINS, POLYVINYL ACETATE RESINS, POLYSTYRENE RESINS, POLYVINYLIDENE CHLORIDE RESINS, FLUORINE RESINS, ETHYLENE VINYL ALCOHOL RESINS, ACRYLONITRILE BUTADIENE STYRENE RESINS, LIQUID CRYSTAL POLYMER RESINS, POLYMER ALLOYS, SYNTHETIC RESIN COMPOUNDS, PULP; RETAIL AND WHOLESALE STORE SERVICES FEATURING DYESTUFFS, PIGMENTS, PAINTS, THERMAL BARRIER PAINTS, FLUORESCENT DYESTUFFS, ANTIRUST AGENTS, RUST PREVENTIVE GREASE, INK FOR PHOTOCOPIERS; RETAIL AND WHOLESALE STORE SERVICES FEATURING RUST REMOVING AGENTS; RETAIL AND WHOLESALE STORE SERVICES FEATURING SOLID LUBRICANTS, LUBRICANTS, LUBRICATING OIL, LUBRICATING GREASE; RETAIL AND WHOLESALE STORE SERVICES FEATURING ANTISEPTICS; RETAIL AND WHOLESALE STORE SERVICES FEATURING IRONS, STEELS, STEEL PIPES, NONFERROUS METALS AND THEIR ALLOYS, PIPES MADE OF METAL, ROLLED STEELS, STEEL FENCES, STEEL PLATES AND SHEETS, STAINLESS STEEL PLATES AND SHEETS, FOILS MADE OF METAL, IRON OR STEEL SCRAPS, COPPER, COPPER ALLOYS, ZINC, ZINC OXIDE, ALUMINUM, ALUMINUM ALLOYS, NICKEL ALLOYS, STAINLESS STEEL, METAL MATERIALS USED EXCLUSIVELY FOR BUILDINGS AND CONSTRUCTION, GRATING, GAS CONTAINERS MADE OF METAL, STEEL DRUMS, LARGE CANS WITH HANDLES, WELDING RODS, STEEL FRAMES, REINFORCING STEEL, METAL MOLDS FOR FORMING CEMENT PRODUCTS; RETAIL AND WHOLESALE STORE SERVICES FEATURING ELECTRICAL MACHINERY AND APPARATUSES, CONVEYOR BELTS, DIESEL GENERATORS, HOT PRESSING MACHINES, WELDING APPARATUS, EXTRUSION MOLDING MACHINES, INJECTION MOLDING MACHINES, MOLDS FOR PLASTICS, MACHINES FOR MANUFACTURING PLASTIC PELLETS, PARTS OF MOTOR VEHICLES, PARTS OF MOTOR BICYCLES, WINDSCREEN WIPERS, SUSPENSION; RETAIL AND WHOLESALE STORE SERVICES FEATURING ELECTRIC WIRES, CABLES, ELECTRON GENERATING MACHINES FOR ELECTRONIC MICROSCOPES, ELECTRONIC CIRCUITS EXCLUSIVE OF THOSE RECORDED WITH COMPUTER PROGRAMS, SEMI CONDUCTOR WAFERS, PRINTED CIRCUIT BOARDS, METALLIC BOARDS, CIRCUIT BOARDS MADE OF CERAMICS, MEASURING AND TESTING APPARATUS, BIODEGRADABLE MEASURING AND TESTING APPARATUS; RETAIL AND WHOLESALE STORE SERVICES FEATURING DRYING APPARATUS, DUST COLLECTING APPARATUS, POWDER COLLECTING APPARATUS, AUXILIARY APPARATUS FOR POWDER COLLECTING APPARATUS, CRUCIBLES; RETAIL AND WHOLESALE STORE SERVICES FEATURING PAPERS AND STATIONERY, PAPER KAOLIN, USED PAPER; RETAIL AND WHOLESALE STORE SERVICES FEATURING VALVES MADE OF RUBBER, PIPE COUPLERS EXCLUSIVE OF THOSE MADE OF METAL,

INSULATING TAPES, ELECTRICAL INSULATING RUBBER PRODUCTS, CHEMICAL FIBER EXCLUSIVE OF THOSE FOR FABRICS, ROCKFIBRE, PLASTIC BASIC PRODUCTS, PLASTIC BOARDS, PLASTIC CONTAINERS FOR FOOD, PLASTIC SPONGES, PLASTIC SHEETS, PLASTIC FILMS, ADHESIVE-COATED PLASTIC SHEETS, STICKING TAPES FOR PACKAGING, RUBBER, SYNTHETIC RUBBER, ACRYLIC RUBBER, FLUORINE RUBBER, SILICONE RUBBER, BUTADIENE RUBBER, ETHYLENE-PROPYLENE RUBBER, WATER EXPANSIVE RUBBER, BUTYL RUBBER, CHLOROPRENE RUBBER; RETAIL AND WHOLESALE STORE SERVICES FEATURING FERROSILICON, GRANULATED BLAST FURNACE SLAG, FERRONICKEL SLAG, BRICKS AND REFRACTORIES, ALUMINA FIBER REFRACTORIES, REFRACTORIES FOR INDUSTRIAL FURNACES, BUILDING MATERIALS, PLASTIC MATERIALS USED EXCLUSIVELY FOR BUILDING, PLASTIC WALLBOARDS, PLASTIC FLOORBOARDS, PLASTIC PIPES, DRAIN PIPES MADE OF PLASTICS, PLASTIC DECORATIVE COATING MATERIALS FOR WATER-PROOFING EXTERNAL WALLS, SYNTHETIC BOARDS, SOUNDPROOFING MATERIALS FOR FLOORS, WALLS OR CEILINGS, CEMENT, ALUMINA CEMENT, CEMENT MORTAL, PORTLAND CEMENT, PORTLAND BLAST-FURNACE SLAG CEMENT, EXPANSIVE CEMENT; RETAIL AND WHOLESALE STORE SERVICES FEATURING PLASTIC VALVES EXCLUSIVE OF THOSE BELONGING UNDER MACHINE ELEMENTS, FLEXIBLE CONTAINER PACKS, PACKAGING CONTAINERS MADE OF PLASTICS, PACKAGING TRAYS MADE OF PLASTICS; RETAIL AND WHOLESALE STORE SERVICES FEATURING CANISTERS AND CONTAINERS MADE OF METAL (U.S. CLS. 100, 101 AND 102).

SN 79-135.126. NIRA DYNAMICS AB, LINKÖPING, SWEDEN, FILED 6-27-2013.



THE MARK CONSISTS OF STANDARD CHARACTERS WITHOUT CLAIM TO ANY PARTICULAR FONT, STYLE, SIZE, OR COLOR.

PRIORITY DATE OF 1-9-2013 IS CLAIMED.

OWNER OF INTERNATIONAL REGISTRATION 1173022 DATED 6-27-2013, EXPIRES 6-27-2023.

#### **CLASS 37—CONSTRUCTION AND REPAIR**

FOR CONSTRUCTION OF ATHLETIC FACILITIES, RESIDENTIAL BUILDINGS, COMMERCIAL BUILDINGS, BRIDGES, COMMERCIAL PROPERTY, OFFICES AND OFFICE SPACE; GENERAL BUILDING CONSTRUCTION WORKS; GLAZING OF WINDOWS; PLASTERING; CARPENTRY; BUILDING REINFORCING; PAINTING; SCAFFOLDING; EARTHWORKS OR CONCRETE CONSTRUCTION; UPHOLSTERING; BUILDING DAMP-PROOFING; ROOFING SERVICES; THERMAL INSULATING INSTALLATION FOR BUILDINGS; CONSTRUCTION CONSULTANCY; MAINTENANCE AND REPAIR OF BUILDINGS; REPAIR OR MAINTENANCE OF CHEMICAL PROCESSING MACHINES AND APPARATUS; REPAIR OR MAINTENANCE OF PLASTIC PROCESSING MACHINES AND APPARATUS; REPAIR OR MAINTENANCE OF STORAGE TANKS (U.S. CLS. 100, 103 AND 106).

#### **CLASS 42—SCIENTIFIC AND COMPUTER SERVICES**

FOR DESIGNING OF MACHINES, APPARATUS, INSTRUMENTS INCLUDING THEIR PARTS OR SYSTEMS COMPOSED OF SUCH MACHINES, APPARATUS AND INSTRUMENTS; DESIGNING OF GRAPHIC ARTS FOR OTHERS, INDUSTRIAL DESIGN FOR OTHERS, DESIGNING OF INTERIOR DECOR FOR OTHERS, PACKAGING DESIGN FOR OTHERS (U.S. CLS. 100 AND 101).

DAVID HOFFMAN, EXAMINING ATTORNEY

#### **CLASS 9—ELECTRICAL AND SCIENTIFIC APPARATUS**

FOR SOFTWARE FOR MONITORING VEHICLE COMPONENTS, NAMELY, TIRE PRESSURE AND ENGINE PERFORMANCE; MANOMETERS; PRESSURE INDICATORS; COMPUTER SOFTWARE PROGRAMS FOR USE IN THE OPERATION OF VEHICLE SAFETY AND DRIVER ASSISTANCE COMPONENTS, AND FOR USE IN MEASURING, TRANSMITTING AND PROCESSING DATA FROM VEHICLE SAFETY AND DRIVER ASSISTANCE COMPONENTS; SENSORS FOR SENSING VEHICLE ENGINE PERFORMANCE; SENSORS FOR SENSING TIRE PRESSURE; SENSORS FOR SENSING CHASSIS AND ROAD CONDITIONS (U.S. CLS. 21, 23, 26, 36 AND 38).

#### **CLASS 42—SCIENTIFIC AND COMPUTER SERVICES**

FOR DESIGN AND DEVELOPMENT OF SOFTWARE; INFORMATION SERVICES RELATED TO COMPUTER SYSTEM APPLICATIONS; MONITORING OF MACHINES AND ENGINE CONDITION TO ENSURE PROPER FUNCTIONING; CONSULTANCY WITH REGARD TO COMPUTER SOFTWARE; COMPUTER PROGRAMMING; ALL THE AFORESAID SERVICES IN RELATION TO THE AUTOMOTIVE INDUSTRY (U.S. CLS. 100 AND 101).

#### **CLASS 45—PERSONAL AND LEGAL SERVICES**

FOR LICENSING OF INTELLECTUAL PROPERTY; LICENSING OF COMPUTER PROGRAMS FOR MONITORING; ALL THE AFORESAID SERVICES IN RELATION TO THE AUTOMOTIVE INDUSTRY (U.S. CLS. 100 AND 101).

DANIEL CAPSHAW, EXAMINING ATTORNEY



SN 79-135,264. GLOBE INTERNATIONAL NOMINEES PTY LTD, AUSTRALIA, FILED 12-18-2012.



PRIORITY DATE OF 7-6-2012 IS CLAIMED.  
OWNER OF INTERNATIONAL REGISTRATION 1173322 DATED 12-18-2012, EXPIRES 12-18-2022.  
OWNER OF U.S. REG. NO. 4,273,800.  
THE MARK CONSISTS OF THE LETTERS "F X D" INSIDE A RECTANGLE BORDER WITH A CIRCLE IN BETWEEN THE LETTERS "F" AND "X" AND THE LETTERS "X" AND "D". ABOVE THE LETTERS IS A STYLIZED ANVIL INSIDE A SEPARATE RECTANGLE BORDER.

#### CLASS 9—ELECTRICAL AND SCIENTIFIC APPARATUS

FOR ARTICLES OF PROTECTIVE CLOTHING FOR WEAR FOR PROTECTION AGAINST ACCIDENT OR INJURY FOR USE IN SKATEBOARDING, SURFING, SKIING, SNOWBOARDING, CAR RACING, MOTOCROSS, MOTORCYCLING, BICYCLING, MOTORSPORTS, WATER SPORTS, PHYSICAL ACTIVITIES, EXTREME SPORTS AND WORKERS, AND WATER SKI SAFETY VESTS; CLOTHING FOR PROTECTION AGAINST ACCIDENTS; BLAST RESISTANT CLOTHING AND GARMENTS; INSULATED CLOTHING FOR PROTECTION AGAINST ACCIDENT OR INJURY; PROTECTIVE CLOTHING ESPECIALLY MADE FOR USE IN LABORATORIES, FOOTWEAR AND SHOES FOR PROTECTION AGAINST ACCIDENTS; ARTICLES OF PROTECTIVE FOOTWEAR FOR WEAR FOR PROTECTION AGAINST ACCIDENT OR INJURY FOR USE IN SKATEBOARDING, SURFING, SKIING, SNOWBOARDING, CAR RACING, MOTOCROSS, MOTORCYCLING, BICYCLING, MOTORSPORTS, WATER SPORTS, PHYSICAL ACTIVITIES, EXTREME SPORTS AND WORKERS; ARTICLES OF PROTECTIVE HEADWEAR FOR WEAR FOR PROTECTION AGAINST ACCIDENT OR INJURY FOR USE IN SKATEBOARDING, SURFING, SKIING, SNOWBOARDING, CAR RACING, MOTOCROSS, MOTORCYCLING, BICYCLING, MOTORSPORTS, WATER SPORTS, PHYSICAL ACTIVITIES, EXTREME SPORTS AND WORKERS; CLOTHING FOR PROTECTION AGAINST ACCIDENTS; PROTECTIVE CLOTHING FOR WORKERS, HELMETS, AND EYEWEAR; EYEWEAR, NAMELY, EYE COVERS FOR PROTECTIVE PURPOSES, GOGGLES, SAFETY EYEWEAR, SPORTS EYEWEAR, PROTECTIVE EYEWEAR AND COMPONENT PARTS THEREOF, SUNGLASSES, EYEGASSES; PROTECTIVE AND SAFETY HELMETS, PROTECTIVE HELMETS FOR SPORTS; PROTECTIVE SPORTS HELMETS, CHIN STRAPS, FACE MASKS, JAW PADS AND EYE SHIELDS; PROTECTIVE FACE-SHIELDS FOR PROTECTIVE HELMETS; SPORTS HELMETS; SAFETY HELMETS; GLOVES FOR PROTECTION AGAINST ACCIDENTS; SUPPORT BELTS FOR WORKERS; ELBOW PADS, KNEE PADS AND SHIN GUARDS FOR WORKERS, REFLECTIVE AND ILLUMINATED CLOTHING FOR SAFETY PURPOSES, CLOTHING FOR PROTECTION AGAINST ACCIDENTS, IRRADIATION AND FIRE, PROTECTIVE GLOVES FOR INDUSTRIAL USE, PROTECTIVE HEAD GUARDS FOR INDUSTRIAL PURPOSES, PROTECTIVE INDUSTRIAL BOOTS, PROTECTIVE INDUSTRIAL SHOES, PROTECTIVE WORK GLOVES, REFLECTIVE

AND ILLUMINATED CLOTHING FOR SAFETY PURPOSES, CLOTHING FOR PROTECTION AGAINST CHEMICALS (U.S. CLS. 21, 23, 26, 36 AND 38).

#### CLASS 18—LEATHER GOODS

FOR BAGS, NAMELY, ALL PURPOSE SPORTS BAGS, ALL-PURPOSE ATHLETIC BAGS, ALL-PURPOSE CARRYING BAGS, ATHLETIC BAGS, BOOK BAGS, BAGS FOR SPORTS CLOTHING, BAGS FOR SPORTS, BEACH BAGS, BOOK BAGS, CARRY-ON BAGS, GYM BAGS, OVERNIGHT BAGS, SCHOOL BAGS, TRAVEL BAGS; BACKPACKS; SUITCASES; TRUNKS AND TRAVELING BAGS; PURSES; WALLETS; SATCHELS, BRIEF CASES; ATTACHE CASES; KEY CASES; UMBRELLAS; LEATHER AND IMITATION LEATHER; LEATHER AND IMITATION LEATHER BACKPACKS, PURSES, ATTACHE CASES, KEY CASES, KEY CHAINS, WALLETS, SATCHELS, BRIEF CASES, LEATHER CASES, CREDIT CARD CASES, DOCUMENT CASES, OVERNIGHT CASES, SPORTS BAGS, TOOL BAGS SOLD EMPTY (U.S. CLS. 1, 2, 3, 22 AND 41).

#### CLASS 25—CLOTHING

FOR CLOTHING, NAMELY, TOPS, BOTTOMS, T-SHIRTS, SHIRTS, SWEATSHIRTS, PANTS, BEACHWEAR, LOUNGEWEAR, JACKETS, PULLOVERS, SKI WEAR, SURF WEAR, SWIM WEAR; PAINTER'S PANTS, CARPENTER'S PANTS, OVERALLS, COVERALLS, RAIN WEAR, SUN PROTECTIVE CLOTHING, NAMELY, TOPS AND BOTTOMS, LIGHT-REFLECTING JACKETS; FOOTWEAR; HEADGEAR, NAMELY, HEADWEAR; ACCESSORIES IN THIS CLASS, NAMELY, BELTS, SCARVES, GLOVES, NECKTIES, SOCKS, HEADBANDS, FITTED SHOE OR BOOT COVERING TO PROTECT THE SHOES OR BOOTS FROM WATER OR OTHER DAMAGE (U.S. CLS. 22 AND 39).

REBECCA SMITH, EXAMINING ATTORNEY

SN 79-135,427. MAHOU, S.A., SPAIN, FILED 7-8-2013.



PRIORITY DATE OF 2-5-2013 IS CLAIMED.  
OWNER OF INTERNATIONAL REGISTRATION 1173700 DATED 7-8-2013, EXPIRES 7-8-2023.  
OWNER OF U.S. REG. NOS. 3,280,977, 3,927,942 AND 3,940,049.

THE COLOR(S) RED AND BLACK IS/ARE CLAIMED AS A FEATURE OF THE MARK.

THE MARK CONSISTS OF A STYLIZED RED LETTER "M" ON THE LEFT, AND THE STYLIZED BLACK WORD "MAHOU" ON THE UPPER RIGHT, AND THE STYLIZED BLACK WORDING "SANMIGUEL" ON THE LOWER RIGHT.

THE ENGLISH TRANSLATION OF "SAN MIGUEL" IN THE MARK IS "SAINT MICHAEL". THE WORDING "MAHOU" HAS NO MEANING IN A FOREIGN LANGUAGE.

#### CLASS 32—LIGHT BEVERAGES

FOR BEER; MINERAL AND AERATED WATERS AND NON-ALCOHOLIC FRUIT JUICES; FRUIT BEVERAGES AND FRUIT JUICES; SYRUPS FOR MAKING BEVERAGES (U.S. CLS. 45, 46 AND 48).

**CLASS 35—ADVERTISING AND BUSINESS**

FOR PROMOTION AND ADVERTISING SERVICES; BUSINESS MANAGEMENT; BUSINESS ADMINISTRATION; OFFICE FUNCTIONS; WHOLESALE AND RETAIL STORE SERVICES, AND ONLINE WHOLESALE AND RETAIL STORE SERVICES, ALL FEATURING ALL KINDS OF BEVERAGES; IMPORT AND EXPORT AGENCIES (U.S. CLS. 100, 101 AND 102).

JAMES A. RAUEN, EXAMINING ATTORNEY

**CLASS 44—MEDICAL, BEAUTY AND AGRICULTURAL SERVICES**

FOR MEDICAL SERVICES, MEDICAL CARE, PHYSICAL REHABILITATION SERVICES; HOSPITAL SERVICES; CONSULTANCY RELATING TO MEDICAL ANALYSIS FOR THE DIAGNOSIS AND TREATMENT OF PERSONS; CONSULTANCY SERVICES RELATING TO HEALTH (U.S. CLS. 100 AND 101).

MICHELE SWAIN, EXAMINING ATTORNEY

SN 79-135,549. UMBERTO VERONESI, MILANO, ITALY, FILED 4-4-2013.

**UMBERTO VERONESI**

THE MARK CONSISTS OF STANDARD CHARACTERS WITHOUT CLAIM TO ANY PARTICULAR FONT, STYLE, SIZE, OR COLOR.

PRIORITY DATE OF 3-13-2013 IS CLAIMED.

OWNER OF INTERNATIONAL REGISTRATION 1174024 DATED 4-4-2013, EXPIRES 4-4-2023.

THE NAME(S), PORTRAIT(S), AND/OR SIGNATURE(S) SHOWN IN THE MARK IDENTIFIES "UMBERTO VERONESI", WHOSE CONSENT(S) TO REGISTER IS MADE OF RECORD.

SN 79-136,250. EIFFAGE TP, FRANCE, FILED 7-4-2013.



THE MARK CONSISTS OF STANDARD CHARACTERS WITHOUT CLAIM TO ANY PARTICULAR FONT, STYLE, SIZE, OR COLOR.

OWNER OF INTERNATIONAL REGISTRATION 0866845 DATED 5-20-2005, EXPIRES 5-20-2015.

OWNER OF U.S. REG. NO. 3,258,844.

**CLASS 5—PHARMACEUTICALS**

FOR PHARMACEUTICAL PRODUCTS FOR THE DERMATOLOGICAL, CARDIOVASCULAR, HEMATOLOGIC TREATMENT OF THE SKELETAL APPARATUS, OF THE BREATHING APPARATUS, OF THE CENTRAL NERVOUS SYSTEM, OF THE ENDOCRINE SYSTEM, OF THE CIRCULATORY SYSTEM AS WELL AS OF KIDNEY DISORDERS, HORMONAL AND DIABETIC DISORDERS, COUGH, COLD, FLU, HEADACHE, STOMACH AND DIGESTIVE DISORDERS, MUSCULAR AND/OR RHEUMATIC DISORDERS, ANTI-INFLAMMATORY AGENTS, IMMUNE SYSTEM DISORDERS AND RELATED DISEASES, ALLERGIC REACTIONS, METABOLIC DISORDERS, ANTI-INFECTIVES, EYE DISORDERS, AND FOR USE IN ONCOLOGY; DIAGNOSTIC PREPARATIONS AND/OR REAGENTS FOR CLINICAL OR MEDICAL LABORATORY USE; HORMONES; DIETETIC SUBSTANCES FOR MEDICAL PURPOSES, NAMELY, NUTRITIONAL SUPPLEMENTS, VITAMINS, HERBAL AND MINERAL SUPPLEMENTS AND IN SNACK BAR FORM FOR USE TO BE USED AS SUBSTITUTE MEAL; FOOD AND BEVERAGES FOR INFANTS, CHILDREN AND DISABLED, NAMELY, FOODS FOR INFANTS, INFANT FORMULAS, FOOD FOR ENTERAL ADMINISTRATION AND DIETETIC FOODS IN THE NATURE OF PASTA, RICE, SUGAR, BREAD, CRACKERS, RICE BASED SNACKS, CEREAL BASED SNACKS, COCOA BASED SNACKS, PROCESSED FRUIT BASED SNACKS, CHEESE, FRUITS AND VEGETABLES FOR USE IN MEDICAL DIETS (U.S. CLS. 6, 18, 44, 46, 51 AND 52).

**CLASS 41—EDUCATION AND ENTERTAINMENT**

FOR EDUCATION AND TRAINING, NAMELY, ORGANIZATION OF SEMINARS, WORKSHOPS, COURSES, CULTURAL EVENTS, SYMPOSIA ALL IN THE FIELD OF HEALTH AND MEDICINE; PUBLISHING OF BOOKS, MAGAZINES, NEWSPAPERS, CASE STUDIES, AND ARTICLES IN THE FIELD OF MEDICINE; PROVIDING SCIENTIFIC AND PERIODICAL PUBLICATIONS, NAMELY, PROVIDING ONLINE NON-DOWNLOADABLE BOOKS, MAGAZINES, NEWSPAPERS, CASE STUDIES, AND ARTICLES IN THE FIELD OF HEALTH AND MEDICINE; ORGANIZATION OF CONFERENCES AND SYMPOSIA IN THE FIELD OF MEDICAL SCIENCE; INTERNATIONAL EXCHANGE PROGRAMS FOR STUDENTS; ALL ABOVE SERVICES RELATED TO THE FIELD OF MEDICINE AND HEALTH (U.S. CLS. 100, 101 AND 107).

**CLASS 19—NON-METALLIC BUILDING MATERIALS**

FOR NON-METALLIC BUILDING MATERIALS, NAMELY, PLASTER, MORTAR BOARD, CEMENT, TIMBER, LUMBER, BRICKS, CEMENT MIXES, FILLING CEMENT, GLASS BRICKS, GLASS PANES, GLASS TILES, SAFETY GLASS, GLASS PANELS, INSULATED GLASS, LAMINATED FLAT GLASS AND MODIFIED SHEET GLASS; NON-METALLIC RIGID PIPES FOR BUILDING; ASPHALT; PITCH; BITUMEN ASPHALT; CONSTRUCTION AND WORKED TIMBER; BRICKS; CEMENT MIX FOR BUILDING; CEMENT PARTITIONS AND BUILDING COMPONENTS, NAMELY, SLABS OF CEMENT; NON-METALLIC TRANSPORTABLE BUILDINGS; NON-METALLIC MONUMENTS OF STONE, CONCRETE, OR MARBLE; CONCRETE; CONCRETE BUILDING ELEMENTS, NAMELY, BLOCKS, BRICKS, POSTS, SLABS AND PANELS; NON-METALLIC EXTERIOR ROLL SHUTTERING FOR CONCRETE; MORTAR FOR BUILDING (U.S. CLS. 1, 12, 33 AND 50).

**CLASS 37—CONSTRUCTION AND REPAIR**

FOR CONSTRUCTION AND REPAIR OF STRUCTURES, NAMELY, INDUSTRIAL COMPLEXES, WORKS OF ART, BUILDINGS, AND FACTORIES; CONSTRUCTION OF MARITIME AND RIVER INSTALLATIONS, NAMELY, BRIDGES, ABUTMENTS, BRIDGE ABUTMENTS, DIKES, EMBANKMENTS, DAMS, MILL PONDS, RIVER BASINS, TIDAL BASINS, HOLDING BASINS AND RESERVOIRS; ASPHALTING; RENTAL OF CONSTRUCTION EQUIPMENT; CONSTRUCTION SUPERVISION AND MANAGEMENT OF BUILDING SITE WORK; CONSTRUCTION AND REPAIR INFORMATION; DEMOLITION OF BUILDINGS; MASONRY; PLASTERING; SCAFFOLDING ERECTION AND REPAIR (U.S. CLS. 100, 103 AND 106).

**CLASS 42—SCIENTIFIC AND COMPUTER SERVICES**

FOR ENGINEERING AND SURVEYING SERVICES; ENGINEERING SERVICES, NAMELY, CARRYING OUT EVALUATIONS, APPRAISALS, RESEARCH WORK AND WRITING REPORTS IN THE FIELDS OF SCIENCE AND TECHNOLOGY; SCIENTIFIC RESEARCH; INDUSTRIAL RESEARCH RELATING TO CIVIL AND MECHANICAL ENGINEERING IN THE FIELDS OF RESIDENTIAL CONSTRUCTION, CONSTRUCTION OF BRIDGES, ABUTMENTS, BRIDGE ABUTMENTS, STABILIZED STRUCTURES ON LAND, MECHANICAL STABILIZATION OF LAND AND STRUCTURES, FILLS AND EMBANKMENTS, RETAINING WALLS, DIKES, TUNNELS, DAMS, MILL PONDS, RIVER BASINS, TIDAL BASINS, HOLDING BASINS, RESERVOIRS AND SILOS; CHEMICAL LABORATORIES; TESTING OF MATERIALS; TECHNICAL PROJECT STUDIES AND RESEARCH RELATING TO CIVIL AND MECHANICAL ENGINEERING, NAMELY, STUDIES IN THE FIELDS OF RESIDENTIAL CONSTRUCTION, CONSTRUCTION OF BRIDGES, ABUTMENTS, BRIDGE ABUTMENTS, STABILIZED STRUCTURES ON LAND, MECHANICAL STABILIZATION OF LAND AND STRUCTURES, FILLS AND EMBANKMENTS, RETAINING WALLS, DIKES, TUNNELS, DAMS, MILL PONDS, RIVER BASINS, TIDAL BASINS, HOLDING BASINS, RESERVOIRS AND SILOS; CONSTRUCTION CONSULTATION; TECHNICAL RESEARCH RELATING TO CIVIL AND MECHANICAL ENGINEERING IN THE FIELDS OF RESIDENTIAL CONSTRUCTION, CONSTRUCTION OF BRIDGES, ABUTMENTS, BRIDGE ABUTMENTS, STABILIZED STRUCTURES ON LAND, MECHANICAL STABILIZATION OF LAND AND STRUCTURES, FILLS AND EMBANKMENTS, RETAINING WALLS, DIKES, TUNNELS, DAMS, MILL PONDS, RIVER BASINS, TIDAL BASINS, HOLDING BASINS, RESERVOIRS AND SILOS (U.S. CLS. 100 AND 101).

TARAH HARDY, EXAMINING ATTORNEY

SN 79-136,448. VIDICORE GMBH, FED REP GERMANY, FILED 5-6-2013.

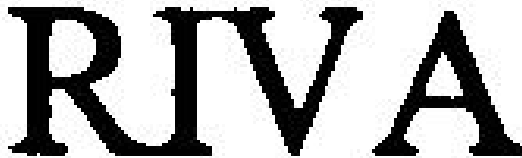

THE MARK CONSISTS OF STANDARD CHARACTERS WITHOUT CLAIM TO ANY PARTICULAR FONT, STYLE, SIZE, OR COLOR.

PRIORITY DATE OF 11-16-2012 IS CLAIMED.

OWNER OF INTERNATIONAL REGISTRATION 1176366 DATED 5-6-2013, EXPIRES 5-6-2023.

THE ENGLISH TRANSLATION OF THE WORD "RIVA" IN THE MARK IS "BANK" OR "SHORE".

**CLASS 9—ELECTRICAL AND SCIENTIFIC APPARATUS**

FOR VIDEO SURVEILLANCE CAMERAS FOR THE INNER AREA AND OUTSIDE AREA, NAMELY, STATIONARY, REMOTELY CONTROLLABLE, TILTABLE, BENDABLE, FOCUSABLE, ZOOMABLE VIDEO SURVEILLANCE CAMERAS, ALSO INFRARED (THERMIC PICTURE) VIDEO SURVEILLANCE CAMERAS; HARDWARE ENCODER/DECODER FOR VIDEO SURVEILLANCE RACKS SOLD TOGETHER WITH SPECIALLY ADAPTED INSERTION RACKS FOR AFORESAID HARDWARE AND CAMERAS; HARDWARE PICTURE STABILIZERS FOR VIDEO SURVEILLANCE CAMERAS; FIXTURES IN THE NATURE OF CAMERA MOUNTS AND SUPPORTS FOR THE INSTALLATION AND AFFIXING OF VIDEO SURVEILLANCE CAMERAS TO BUILDINGS, WALLS, CEILINGS AND POLES; WEATHER PROTECTION HOUSINGS IN THE NATURE OF CAMERA CASES FOR VIDEO SURVEILLANCE CAMERAS (U.S. CLS. 21, 23, 26, 36 AND 38).

**CLASS 37—CONSTRUCTION AND REPAIR**

FOR INSTALLATION, MAINTENANCE AND REPAIR OF VIDEO SURVEILLANCE CAMERAS (U.S. CLS. 100, 103 AND 106).

**CLASS 42—SCIENTIFIC AND COMPUTER SERVICES**

FOR TECHNICAL CONSULTANCY AND TECHNICAL PROJECT MANAGEMENT IN THE NATURE OF HARDWARE AND SOFTWARE PROJECT MANAGEMENT IN THE FIELD OF VIDEO SURVEILLANCE TECHNOLOGY (U.S. CLS. 100 AND 101).

ADA HAN, EXAMINING ATTORNEY

SN 79-136,777. SOCIAL POINT, S.L., SPAIN, FILED 5-16-2013.

**MONSTER LEGENDS**

THE MARK CONSISTS OF STANDARD CHARACTERS WITHOUT CLAIM TO ANY PARTICULAR FONT, STYLE, SIZE, OR COLOR.

OWNER OF INTERNATIONAL REGISTRATION 1177250 DATED 5-16-2013, EXPIRES 5-16-2023.

**CLASS 9—ELECTRICAL AND SCIENTIFIC APPARATUS**

FOR COMPUTER GAME JOYSTICKS; PERSONAL COMPUTERS; WEB CONSOLES; TABLET COMPUTERS; ELECTRONIC GAME PROGRAMS; DOWNLOADABLE ELECTRONIC GAME PROGRAMS; ELECTRONIC GAME SOFTWARE; COMPUTER GAME PROGRAMS; DOWNLOADABLE COMPUTER GAME PROGRAMS; INTERACTIVE GAME PROGRAMS; INTERACTIVE GAME SOFTWARE; COMPUTER GAME SOFTWARE DOWNLOADABLE VIA A GLOBAL COMPUTER NETWORK AND WIRELESS DEVICES; DOWNLOADABLE ELECTRONIC PUBLICATIONS IN THE FIELD OF COMPUTER GAMES; PRE-RECORDED VIDEO DISCS AND VIDEO TAPES FEATURING COMPUTER GAMES SOFTWARE AND COMPUTER GAMES; CINEMATOGRAPHIC APPARATUS; PROTECTIVE CARRYING CASES SPECIALLY ADAPTED FOR PHONES AND HANDHELD COMPUTERS (U.S. CLS. 21, 23, 26, 36 AND 38).

**CLASS 16—PAPER GOODS AND PRINTED MATTER**

FOR BOOKLETS AND MANUALS REGARDING VIDEO GAMES; BOOKS IN THE FIELD OF VIDEO GAMES; CALENDARS; CHILDREN'S BOOKS; COMIC BOOKS; ADDRESS BOOKS; COLORING BOOKS AND ACTIVITY BOOKS; BOOK COVERS; BOOKMARKS; ERASERS; GIFT WRAPPING PAPER; GIFT BOXES MADE OF CARDBOARD; INVITATION CARDS; MAGAZINES REGARDING GAMES; MEMO PADS; NOTE PADS; NOTEBOOKS; PAPER NAPKINS; PARTY DECORATIONS MADE OF PAPER; PAPERBACK BOOKS IN THE FIELD OF COMPUTER GAMES; PENCIL SHARPENERS; PENS AND CRAYONS; PICTURE STORYBOOKS; POSTERS; POSTCARDS; RING BINDERS; RUBBER STAMPS; SCRATCH PADS; PAPER STAPLERS; STATIONERY; STATIONERY-TYPE PORTFOLIOS AND FOLDERS; STICKER ALBUMS; STICKERS; TRADING CARDS; GENERAL PURPOSE PLASTIC BAGS; PROTECTIVE COVERS FOR NOTEBOOKS; PACKAGING MATERIALS MADE OF PAPER AND CARDBOARD; PACKAGING MATERIALS MADE OF PLASTIC, NAMELY, PLASTIC BAGS FOR PACKAGING, PLASTIC FILM FOR PACKAGING; EDUCATIONAL PUBLICATIONS, NAMELY, WORKBOOKS, TEXTBOOKS, ACTIVITY BOOKS, STORY BOOKS, TEACHER GUIDES, MANUALS, POSTERS AND EDUCATIONAL BOOKLETS IN THE FIELD OF COMPUTER GAMES (U.S. CLS. 2, 5, 22, 23, 29, 37, 38 AND 50).

**CLASS 28—TOYS AND SPORTING GOODS**

FOR MOBILE HAND HELD UNITS FOR PLAYING VIDEO GAMES OTHER THAN THOSE ADAPTED FOR USE WITH AN EXTERNAL DISPLAY SCREEN OR MONITOR; MOBILE DEVICES; BOARD GAMES; ELECTRONIC GAME EQUIPMENT FOR PLAYING VIDEO GAMES, NAMELY, HAND HELD UNITS FOR PLAYING VIDEO GAMES OTHER THAN THOSE ADAPTED FOR USE WITH AN EXTERNAL DISPLAY SCREEN OR MONITOR; GAME CARDS; COMPUTER GAME CONSOLES FOR USE WITH AN EXTERNAL DISPLAY SCREEN OR MONITOR; NON ELECTRIC HAND-HELD SKILL GAMES; SOFT DOLLS, NOT FOR ANIMALS; PUZZLES; TOY ACTION FIGURES, NOT FOR ANIMALS; BALLOONS AND YO-YOS; PLUSH TOYS, NOT FOR ANIMALS; CHRISTMAS TREE DECORATIONS; TOY FIGURES ATTACHABLE TO PENCILS; PLUSH TOYS THAT CONNECT TO BELTS BY A HOOK; NON-ARTICULATED PVC TOY FIGURES; RUBBER BALLS; APPARATUS FOR GAMES ADAPTED FOR USE WITH TELEVISION RECEIVERS; PAPER PARTY HATS; PLAYING CARDS (U.S. CLS. 22, 23, 38 AND 50).

**CLASS 41—EDUCATION AND ENTERTAINMENT**

FOR PROVIDING ENTERTAINMENT INFORMATION FROM A WEB SITE IN THE FIELDS OF ELECTRONIC GAME PROGRAMS, ELECTRONIC GAME PRODUCTS, AND ELECTRONIC GAME PROGRAMS AND PRODUCTS; MULTIMEDIA PUBLISHING OF BOOKS, MAGAZINES, JOURNALS, SOFTWARE, GAMES, MUSIC, AND ELECTRONIC PUBLICATIONS; ENTERTAINMENT SERVICES, NAMELY, PROVIDING ONLINE ELECTRONIC GAMES; ELECTRONIC GAMES SERVICES PROVIDED BY MEANS OF THE INTERNET; PRODUCTION OF TELEVISION PROGRAMS IN THE FIELD OF ENTERTAINMENT; ENTERTAINMENT SERVICES IN THE NATURE OF CREATION, DEVELOPMENT, AND PRODUCTION OF FILMS, ANIMATION OR ANIMATED FILMS, AND TELEVISION PROGRAMS (U.S. CLS. 100, 101 AND 107).

Laurie Kaufman, Examining Attorney

**CLASS 11—ENVIRONMENTAL CONTROL APPARATUS**

FOR LIGHT BULBS; LAMPS; SOCKETS FOR ELECTRIC LIGHTS; SPOTLIGHTS; DECORATIVE LIGHTING IN THE NATURE OF ELECTRICALLY-ILLUMINATED FAIRY FIGURINES; FLUORESCENT LIGHTING TUBES; LIGHTING APPARATUS FOR VEHICLES; ORNAMENTAL FOUNTAINS; SOLAR COLLECTORS; ELECTRIC LIGHT BULBS; ELECTRIC LAMPS; ELECTRIC TORCHES FOR LIGHTING; LAMP GLOBES; LUMINOUS TUBES FOR LIGHTING; STREET LAMPS; AUTOMOTIVE LIGHTS, NAMELY, HEADLIGHTS; PLUMBING FITTINGS, NAMELY, COCKS; SPIGOTS (U.S. CLS. 13, 21, 23, 31 AND 34).

Gene Maciol, Examining Attorney

SN 79-137,252. FOX BROTHERS & CO. LIMITED, WELLINGTON, SOMERSET, UNITED KINGDOM, FILED 6-17-2013.

SN 79-136,874. NINGBO YOURLITE; IMPORT & EXPORT CO.,LTD., ZHEJIANG PROVINCE, CHINA, FILED 7-3-2013.

**ELECWISH**

OWNER OF INTERNATIONAL REGISTRATION 1177520 DATED 7-3-2013, EXPIRES 7-3-2023.  
THE MARK CONSISTS OF THE STYLIZED TERM "ELECWISH".

**CLASS 9—ELECTRICAL AND SCIENTIFIC APPARATUS**

FOR PORTABLE TELEPHONES; CABINETS FOR LOUDSPEAKERS; MICROPHONES; HEADPHONES; FLASHLIGHTS FOR USE IN PHOTOGRAPHY; ELECTRIC DOOR BELLS; CALCULATING MACHINES; DATA PROCESSING EQUIPMENT, NAMELY, COMPUTER MOUSE; MOUSE PADS; OPTICAL LANTERNS; TELEPHONE APPARATUS; ELECTRICAL INDUCTORS; CABLES, ELECTRIC; ELECTRIC WIRES; SILICON WAFERS FOR INTEGRATED CIRCUITS; BURGLAR ALARMS (U.S. CLS. 21, 23, 26, 36 AND 38).



**FOX**

OWNER OF INTERNATIONAL REGISTRATION 1178466 DATED 6-17-2013, EXPIRES 6-17-2023.  
THE MARK CONSISTS OF A STYLIZED DRAWING OF A FOX THAT IS SITTING AND FACING LEFT. THE WORD "FOX" APPEARS UNDER THE STYLIZED DRAWING OF THE FOX.

**CLASS 24—FABRICS**

FOR TEXTILES AND TEXTILE GOODS, NOT INCLUDED IN OTHER CLASSES, NAMELY, BED COVERS, PLASTIC TABLE COVERS; BATH LINEN, EXCEPT CLOTHING; BED BLANKETS; BED CLOTHES, NAMELY, BED COVERS OF PAPER; BED LINEN; BEDSPREADS; BILLIARD CLOTH; BROCADES; BUCKRAM; CLOTH BUNTING; CALICO; PRINTED CALICO CLOTH; CANVAS FOR TAPESTRY OR EMBROIDERY; CHEESE CLOTH; CHENILLE FABRIC; CHEVIOTS CLOTH; TABLE LINEN; CLOTH COASTERS; FABRICS FOR TEXTILE USE; FACE TOWELS OF TEXTILE; FELT; FILTERING MATERIALS OF TEXTILE, NAMELY, MOSQUITO NETS; CLOTH FLAGS; FABRIC FLANNEL; SANITARY FLANNEL; FABRIC FOR FOOTWEAR, NAMELY, FABRIC FOR BOOTS AND SHOES; FRIEZE CLOTH; UNFITTED FURNITURE COVERINGS OF TEXTILE, NAMELY, PLASTIC; FUSTIAN; GAUZE FABRIC; GLASS CLOTHS TOWELS; GUMMED WATERPROOF CLOTH, OTHER THAN FOR STATIONERY; HAIR-CLOTH, NAMELY, SACKCLOTH; HANDKERCHIEFS OF TEXTILE; TEXTILE USED AS LINING FOR CLOTHING, NAMELY, HAT LININGS; HEMP CLOTH; HEMP YARN FABRIC; HOUSEHOLD LINEN; JERSEY FABRIC FOR CLOTHING; JUTE FABRIC; KNITTED FABRIC; LABELS OF CLOTH; LINEN CLOTH; HOUSEHOLD LINEN; LINGERIE FABRIC; LINEN LINING FABRIC FOR SHOES; MARABOUTS CLOTH; TEXTILE MATERIAL, NAMELY, RIBBONS OF TEXTILE MATERIALS; MATTRESS COVERS; MOLESKIN FABRIC NOT FOR MEDICAL USE; NAPKINS OF CLOTH FOR REMOVING MAKE-UP; TABLE NAPKINS OF TEXTILE; NET CURTAINS; NON-WOVEN TEXTILE FABRICS; OILCLOTH FOR USE AS TABLECLOTHS; PILLOW SHAMS; PILLOWCASES; PLACE MATS, NOT OF PAPER; PRINTERS' BLANKETS OF TEXTILE; QUILTS; RAMIE FABRIC; RAYON FABRIC; TRAVELLING RUGS, NAMELY, LAP ROBES; FABRIC TABLE RUNNERS; SERVIETTES OF TEXTILE; SHROUDS; SILK CLOTH; SILK FABRICS FOR PRINTING PATTERNS; SLEEPING BAGS IN THE NATURE OF SHEETING; TABLE LINEN, NOT OF PAPER; TAFFETA CLOTH; TAPESTRY-STYLE WALL HANGINGS OF TEXTILE; FUTON TICKS, NAMELY, UNSTUFFED FUTON COVERS NOT OF PAPER; TULLE OF TEXTILE; TRACED CLOTHS FOR EMBROIDERY; UPHOLSTERY FABRICS; VELVET; WALL HANGINGS OF TEXTILE; WASHING MITTS; WOOLLEN CLOTH; WOOLLEN FABRIC; ZEPHYR FABRIC (U.S. CLS. 42 AND 50).

**CLASS 25—CLOTHING**

FOR FOOTWEAR; HEADGEAR, NAMELY, HATS, CAPS; CLOTHING, NAMELY, APRONS, ASCOTS; INFANT WEAR, NAMELY, BABIES' PANTS; BANDANAS; BATH SLIPPERS; BATH SANDALS; BATH ROBES; BATHING SUITS AND SWIMSUITS; BATHING TRUNKS AND BATHING DRAWERS; BATHING CAPS; BEACH SHOES; BEACH CLOTHES, NAMELY, BEACH COVER-UPS; BELTS; BERETS; BIBS NOT OF PAPER; BOAS; BODICES; BOOT UPPERS; BOOTS FOR SPORTS; BOOTS; BRASSIERES; BREECHES FOR WEAR; CAMISOLES; CAP PEAKS; CAPS AS HEADWEAR; CHASUBLES; CLOTHING FOR GYMNASTICS, NAMELY, GYMNASTIC SHOES; CLOTHING OF LEATHER, NAMELY, LEATHER COATS; CLOTHING, NAMELY, COATS OF IMITATION LEATHER; COATS; COLLAR PROTECTORS; COLLARS; SHOULDER WRAPS; COMBINATIONS AS CLOTHING ARTICLES; CORSELETS; CORSETS AS FOUNDATION CLOTHING; CUFFS; WRISTBANDS; CYCLISTS' CLOTHING, NAMELY, CYCLISTS' JERSEYS; DETACHABLE COLLARS; DRESS SHIELDS; DRESSES; DRESSING GOWNS; EAR MUFFS; FISHING VESTS; FITTINGS OF METAL FOR FOOTWEAR, NAMELY, METAL CLEATS FOR ATTACHMENT TO SPORTS SHOES; FOOTBALL SHOES AND FOOTBALL BOOTS; FOOTMUFFS, NOT ELECTRICALLY HEATED; FOOTWEAR UPPERS; FUR STOLE; FURS, NAMELY, FUR COATS; GALOSHES; GARTERS; GIRDLES; GLOVES; GYMNASTIC SHOES; HALF-BOOTS; HATS; HEADBANDS; HEADGEAR FOR WEAR, NAMELY, HATS, CAPS; HEELPIECES FOR FOOTWEAR; HEELPIECES FOR STOCKINGS; HEELS; HOODS; HOSIERY; INNER SOLES; JACKETS; JERSEYS; JUMPER DRESSES; PINAFORE DRESSES; KNITWEAR, NAMELY, KNIT JACKETS; LACE BOOTS; LAYETTES; LEGGINGS; LEG WARMERS; LIVERIES; MANIPLES; MANTILLAS;

MASQUERADE COSTUMES; HATS; MITTENS; MONEY BELTS; MOTORISTS' CLOTHING, NAMELY, JACKETS; MUFFS; NECKTIES; NON-SLIPPING DEVICES FOR FOOTWEAR, NAMELY, RUBBER HEELS; OUTER-CLOTHING, NAMELY, OVERALLS, SMOCKS, OVERCOATS, TOPCOATS; PANTS; PAPER HATS FOR USE AS CLOTHING ITEMS; PAPER CLOTHING, NAMELY, PAPER HATS; PARKAS; PELERINES; PELISSES; PETTI-COATS; POCKET SQUARES; POCKETS FOR CLOTHING; PONCHOS; PULLOVERS; PAJAMAS; READY-MADE LININGS, NAMELY, FINISHED TEXTILE LININGS FOR GARMENTS; READY-MADE CLOTHING, NAMELY, PANTS, SHIRTS; SANDALS; SARIS; SARONGS; SASHES FOR WEAR; SCARVES AND SCARFS; SHAWLS; SHIRT YOKES; SHIRT FRONTS; SHIRTS; SHOES; SHORT-SLEEVE SHIRTS; SHOWER CAPS; SINGLET; SPORTS JERSEYS; SKI BOOTS; SKI GLOVES; SKIRTS; SKORTS; SKULL CAPS; SLEEP MASKS; SLIPPERS; SLIPS; SOCK SUSPENDERS; SOCKS; SOLES FOR FOOTWEAR; SPATS; GAITERS; SPORTS SHOES; STOCKING SUSPENDERS; SWEAT-ABSORBENT STOCKINGS; STOCKINGS; STUDS FOR FOOTBALL BOOTS; STUFF JACKETS; SUITS; SUSPENDERS FOR CLOTHING; SWEAT-ABSORBENT UNDER-CLOTHING; SWEATERS; TEDDIES; TEE-SHIRTS; TIGHTS; TIPS FOR FOOTWEAR; TOGAS; TOP HATS; TROUSER STRAPS; GAITER STRAPS; TROUSERS; TURBANS; UNDERPANTS; VEILS; VISORS AS HEADWEAR; WAISTCOATS; VESTS; WATERPROOF CLOTHING, NAMELY, WATERPROOF JACKETS AND PANTS; WELTS FOR FOOTWEAR; WET SUITS FOR WATER-SKIING; WIMPLES; WOODEN SHOES (U.S. CLS. 22 AND 39).

DAVID MURRAY, EXAMINING ATTORNEY

SN 79-137,350. GENERAL ADMIXTURES S.P.A., ITALY, FILED 7-9-2013.

**GENERAL ADMIXTURES**

THE MARK CONSISTS OF STANDARD CHARACTERS WITHOUT CLAIM TO ANY PARTICULAR FONT, STYLE, SIZE, OR COLOR.

OWNER OF INTERNATIONAL REGISTRATION 0881407 DATED 9-9-2005, EXPIRES 9-9-2015.

NO CLAIM IS MADE TO THE EXCLUSIVE RIGHT TO USE "ADMIXTURES", APART FROM THE MARK AS SHOWN.

**CLASS 1—CHEMICALS**

FOR CHEMICAL CONCRETE ADMIXTURES (U.S. CLS. 1, 5, 6, 10, 26 AND 46).

**CLASS 19—NON-METALLIC BUILDING MATERIALS**

FOR ASPHALT, PITCH AND BITUMEN-BASED SEALANTS (U.S. CLS. 1, 12, 33 AND 50).

CAITLIN WATTS-FITZGERALD, EXAMINING ATTORNEY

SN 79-137,390. JOULES LIMITED, LEICESTERSHIRE LE16 7QU, UNITED KINGDOM, FILED 6-17-2013.

**LITTLE JOULE**

THE MARK CONSISTS OF STANDARD CHARACTERS WITHOUT CLAIM TO ANY PARTICULAR FONT, STYLE, SIZE, OR COLOR.

PRIORITY DATE OF 6-5-2013 IS CLAIMED.

OWNER OF INTERNATIONAL REGISTRATION 1178768 DATED 6-17-2013, EXPIRES 6-17-2023.

OWNER OF U.S. REG. NOS. 3,619,577, 3,696,021 AND 3,705,427.

**CLASS 9—ELECTRICAL AND SCIENTIFIC APPARATUS**

FOR EYE GLASSES, SUN GLASSES, GLASSES FRAMES AND GLASSES CASES (U.S. CLS. 21, 23, 26, 36 AND 38).

**CLASS 24—FABRICS**

FOR FABRICS FOR TEXTILE USE; FABRIC WINDOW COVERINGS AND TREATMENTS, NAMELY, CURTAINS, DRAPERIES, SHEERS, SWAGS AND VALANCES; UPHOLSTERY FABRICS; FABRICS THAT MAY OR MAY NOT HAVE PRINTED PATTERNS AND DESIGNS THEREON FOR USE IN TEXTILE APPLICATIONS, NAMELY, THE MANUFACTURE OF APPAREL, UPHOLSTERY, SIGNAGE, FLAGS, BANNERS AND WALLPAPER; BED AND TABLE COVERS; THROWS; BED SHEETS; BED BLANKETS; PICNIC BLANKETS; PET BLANKETS; TOWELS; TEA TOWELS; TABLE NAPKINS OF TEXTILE; TABLE CLOTHS NOT OF PAPER; CLOTH TABLE COASTERS; CLOTH PLACE MATS; BLANKETS FOR BABIES, INFANTS AND CHILDREN; TOWELS FOR BABIES, INFANTS AND CHILDREN; BED AND COT LINEN FOR BABIES, INFANTS AND CHILDREN (U.S. CLS. 42 AND 50).

TEJBIR SINGH, EXAMINING ATTORNEY

**CLASS 16—PAPER GOODS AND PRINTED MATTER**

FOR ADVERTISEMENT BOARDS OF PAPER, BOOKLETS IN THE FIELDS OF EXHIBITION AND CONVENTION CENTERS, ORGANIZERS OF EXHIBITIONS, CONFERENCES AND EVENTS, EXHIBITORS AND ATTENDEES AT EVENTS AND CONFERENCES, CONFERENCES AND EVENTS SPONSORS, AND EXHIBITION VISITORS; CARDS, NAMELY, NOTE CARDS; CATALOGUES IN THE FIELDS OF EXHIBITION AND CONVENTION CENTERS, ORGANIZERS OF EXHIBITIONS, CONFERENCES AND EVENTS, EXHIBITORS AND ATTENDEES AT EVENTS AND CONFERENCES, CONFERENCES AND EVENTS SPONSORS, AND EXHIBITION VISITORS; PRINTED FORMS; GRAPHIC REPRESENTATIONS; NEWSLETTERS IN THE FIELDS OF EXHIBITION AND CONVENTION CENTERS, ORGANIZERS OF EXHIBITIONS, CONFERENCES AND EVENTS, EXHIBITORS AND ATTENDEES AT EVENTS AND CONFERENCES, CONFERENCES AND EVENTS SPONSORS, AND EXHIBITION VISITORS; PICTURES; PRINTED PLANS; POSTERS; PRINTED PUBLICATIONS, NAMELY, BOOKS, MAGAZINES, NEWSLETTERS IN THE FIELDS OF EXHIBITION AND CONVENTION CENTERS, ORGANIZERS OF EXHIBITIONS, CONFERENCES AND EVENTS, EXHIBITORS AND ATTENDEES AT EVENTS AND CONFERENCES, CONFERENCES AND EVENTS SPONSORS, AND EXHIBITION VISITORS; PRINTED PROSPECTUSES (U.S. CLS. 2, 5, 22, 23, 29, 37, 38 AND 50).

**CLASS 35—ADVERTISING AND BUSINESS**

FOR ADVERTISING; ADVERTISING BY MAIL ORDER, UPDATING OF ADVERTISING MATERIAL; DISSEMINATION OF ADVERTISING MATERIAL; COMMERCIAL INFORMATION AND ADVICE FOR CONSUMERS; COST PRICE ANALYSIS; BUSINESS INFORMATION; BUSINESS INQUIRIES; BUSINESS RESEARCH; PRESENTATION OF GOODS ON COMMUNICATION MEDIA FOR RETAIL PURPOSES; DEMONSTRATION OF GOODS; DIRECT MAIL ADVERTISING; MARKETING SERVICES; MARKETING RESEARCH; SALES PROMOTIONS FOR OTHERS; ALL THE AFOREMENTIONED SERVICES IN THE FIELDS OF EXHIBITION AND CONVENTION CENTERS, ORGANIZERS OF EXHIBITIONS, CONFERENCES AND EVENTS, EXHIBITORS AND ATTENDEES AT EVENTS AND CONFERENCES, CONFERENCES AND EVENTS SPONSORS, AND EXHIBITION VISITORS (U.S. CLS. 100, 101 AND 102).

**CLASS 38—COMMUNICATION**

FOR COMMUNICATION BY COMPUTER TERMINALS; COMPUTER AIDED TRANSMISSION OF MESSAGES AND IMAGES; ELECTRONIC MAIL; PROVIDING ACCESS TO DATABASES; PROVIDING TELECOMMUNICATION CONNECTION TO A GLOBAL COMPUTER NETWORK; PROVIDING USER ACCESS TO GLOBAL COMPUTER NETWORKS; ALL THE AFOREMENTIONED SERVICES IN THE FIELDS OF EXHIBITION AND CONVENTION CENTERS, ORGANIZERS OF EXHIBITIONS, CONFERENCES AND EVENTS, EXHIBITORS AND ATTENDEES AT EVENTS AND CONFERENCES, CONFERENCES AND EVENTS SPONSORS, AND EXHIBITION VISITORS (U.S. CLS. 100, 101 AND 104).

**CLASS 42—SCIENTIFIC AND COMPUTER SERVICES**

FOR COMPUTER SOFTWARE CONSULTANCY; COMPUTER SOFTWARE DESIGN; INSTALLATION OF COMPUTER SOFTWARE; UPDATING OF COMPUTER SOFTWARE; MAINTENANCE OF COMPULSION SOFTWARE; PROVIDING SEARCH ENGINES FOR THE INTERNET; SERVICES OF AN APPLICATION SERVICE PROVIDER (ASP) FEATURING COMPUTER SOFTWARE FOR USE IN THE FIELD OF EXHIBITIONS OF ANY KIND FROM ALL OVER THE WORLD; ALL THE AFOREMENTIONED IN THE FIELD OF EXHIBITIONS OF ANY KIND FROM ALL OVER THE WORLD (U.S. CLS. 100 AND 101).

KRISTIN CARLSON, EXAMINING ATTORNEY

SN 79-138,021. DAMCO ENERGY S.A, GREECE, FILED 7-10-2013.



PRIORITY DATE OF 1-11-2013 IS CLAIMED. OWNER OF INTERNATIONAL REGISTRATION 1180507 DATED 7-10-2013, EXPIRES 7-10-2023.

NO CLAIM IS MADE TO THE EXCLUSIVE RIGHT TO USE "EXPO", APART FROM THE MARK AS SHOWN.

THE COLOR(S) BLUE, DARK BLUE AND WHITE IS/ARE CLAIMED AS A FEATURE OF THE MARK.

THE MARK CONSISTS OF A BLUE RECTANGLE WITH CURVED CORNERS AND WITH DARK BLUE SHADING AT THE BOTTOM OF THE RECTANGLE. AT THE TOP OF THE RECTANGLE IS A WHITE HORIZONTAL OBLONG CUTOUT WITH DARK BLUE SHADING ABOVE IT. BELOW THE OBLONG CUTOUT IS A HORIZONTAL WHITE DASHED LINE. BELOW THE DASHED LINE APPEARS THE WHITE LETTERING "NEXT EXPO" AGAINST THE DARK BLUE COLOR OF THE FRONT OF THE RECTANGLE.

SN 79-138,112. DSM IP ASSETS B.V., NETHERLANDS,  
FILED 9-18-2013.

**HighQ**  
The lightweight container for heavyweight challenges

PRIORITY DATE OF 3-20-2013 IS CLAIMED.  
OWNER OF INTERNATIONAL REGISTRATION 1180786  
DATED 9-18-2013, EXPIRES 9-18-2023.

THE MARK CONSISTS OF THE WORDING "HIGHQ"  
WHEREIN THE LETTERS "IQ" ARE EMPHASIZED BY  
DARKER SHADING, BELOW WHICH THE PHRASE "THE  
LIGHTWEIGHT CONTAINER FOR HEAVYWEIGHT CHAL-  
LENGES" APPEARS.

#### CLASS 6—METAL GOODS

FOR CONTAINERS OF METAL FOR STORAGE AND  
TRANSPORT OF GOODS (U.S. CLS. 2, 12, 13, 14, 23, 25  
AND 50).

#### CLASS 20—FURNITURE AND ARTICLES NOT OTHERWISE CLASSIFIED

FOR CONTAINERS, NOT OF METAL, FOR COMMER-  
CIAL AND INDUSTRIAL STORAGE AND TRANSPORT  
OF GOODS (U.S. CLS. 2, 13, 22, 25, 32 AND 50).

#### CLASS 39—TRANSPORTATION AND STO- RAGE

FOR WAREHOUSE CONTAINER STORAGE; TRANS-  
PORT OF FREIGHT CONTAINERS BY TRUCK, TRAIN,  
AIR AND SHIP (U.S. CLS. 100 AND 105).

HANNO RITNER, EXAMINING ATTORNEY

SN 79-138,487. LA BODEGA NEGRA S.A.R.L., LUXEM-  
BOURG, FILED 5-30-2013.

**CASA NEGRA**

THE MARK CONSISTS OF STANDARD CHARACTERS  
WITHOUT CLAIM TO ANY PARTICULAR FONT, STYLE,  
SIZE, OR COLOR.

PRIORITY DATE OF 4-16-2013 IS CLAIMED.

OWNER OF INTERNATIONAL REGISTRATION 1181775  
DATED 5-30-2013, EXPIRES 5-30-2023.

THE ENGLISH TRANSLATION OF "CASA NEGRA" IN  
THE MARK IS "BLACK HOUSE".

#### CLASS 29—MEATS AND PROCESSED FOODS

FOR MEAT, FISH, POULTRY AND GAME, NOT LIVE;  
MEAT EXTRACTS; PRESERVED, DRIED AND COOKED  
FRUITS AND VEGETABLES; JELLIES, JAMS, COM-  
POTES; EGGS, MILK AND MILK PRODUCTS EXCLUD-  
ING ICE CREAM, ICE MILK AND FROZEN YOGURT;  
EDIBLE OILS AND FATS; PREPARED MEALS CONS-  
ISTING PRIMARILY OF MEAT, FISH, POULTRY OR  
VEGETABLES; SOUPS AND POTATO CRISPS (U.S. CL.  
46).

#### CLASS 30—STAPLE FOODS

FOR COFFEE, TEA, COCOA, SUGAR, RICE, TAPIO-  
CA, SAGO, ARTIFICIAL COFFEE; FLOUR AND PRE-  
PARATIONS MADE FROM CEREALS, NAMELY,  
CEREAL BARS, CRISPS MADE FROM CEREALS,  
BREAKFAST CEREALS, CRACKERS MADE OF PRE-  
PARED CEREALS; BREAD, PASTRY AND CONFECTION-  
ERY, NAMELY, CANDY BARS, LOLLIPOPS,  
TRUFFLES, BOILED SWEETS, PASTILLES, MARSH-  
MALLOWS, LIQUORICE; ICES; HONEY, TREACLE;  
YEAST, BAKING-POWDER; SALT, MUSTARD; VINE-  
GAR, SAUCES (CONDIMENTS); SPICES; ICE; SAND-  
WICHES; PREPARED MEALS CONSISTING PRIMARILY  
OF PASTA, NOODLES OR RICE; PIZZAS, PIES AND  
PREPARED PASTA DISHES (U.S. CL. 46).

#### CLASS 32—LIGHT BEVERAGES

FOR BEERS; MINERAL AND AERATED WATERS;  
NON-ALCOHOLIC DRINKS NAMELY SOFT DRINKS  
AND FRUIT JUICES; FRUIT DRINKS AND FRUIT  
JUICES; SYRUPS FOR MAKING BEVERAGES; SHAN-  
DY, DE-ALCOHOLISED DRINKS, NON-ALCOHOLIC  
BEERS AND WINES (U.S. CLS. 45, 46 AND 48).

#### CLASS 33—WINES AND SPIRITS

FOR ALCOHOLIC WINES; SPIRITS AND LIQUEURS;  
FLAVOURED BREWED MALT BEVERAGES, BEV-  
ERAGES CONTAINING WINE AND/OR SPIRITS, BEV-  
ERAGES CONTAINING DISTILLED AND/OR DILUTED  
ALCOHOL, FRUIT FLAVOURED ALCOHOLIC BEV-  
ERAGES EXCEPT BEERS; PREPARED ALCOHOLIC  
COCKTAILS (U.S. CLS. 47 AND 49).

#### CLASS 43—HOTEL AND RESTAURANT SER- VICES

FOR SERVICES FOR PROVIDING FOOD AND  
DRINK; PROVIDING TEMPORARY ACCOMMODA-  
TION; RESTAURANT, BAR AND CATERING SERVICES;  
PROVISION OF HOLIDAY ACCOMMODATION; BOOK-  
ING AND RESERVATION SERVICES FOR RESTAU-  
RANTS (U.S. CLS. 100 AND 101).

KELLY TRUSILO, EXAMINING ATTORNEY

SN 79-140,571. PROTOTIPO S.P.A., ITALY, FILED 7-19-2013.



**RE.VE.A.L.**  
by  
**PROTOTIPO**

PRIORITY DATE OF 6-11-2013 IS CLAIMED.  
OWNER OF INTERNATIONAL REGISTRATION 1187112  
DATED 7-19-2013, EXPIRES 7-19-2023.

THE MARK CONSISTS OF THE EXPRESSION "RE.VE.A.L.  
BY PROTOTIPO" WITH THE FIGURATIVE ELEMENT.

**CLASS 9—ELECTRICAL AND SCIENTIFIC APPARATUS**

FOR COMPUTERS, SOFTWARE, HARDWARE, ELECTRONIC APPARATUS FOR VEHICLES, INTERFACE APPARATUS BETWEEN VEHICLE ELECTRONIC COMPONENTS, APPARATUS AND INSTRUMENTS FOR SUPPLYING, SWITCHING, TRANSFORMING, ADJUSTING AND CONTROLLING VEHICLE ELECTRICITY/ELECTRONICS (U.S. CLS. 21, 23, 26, 36 AND 38).

**CLASS 42—SCIENTIFIC AND COMPUTER SERVICES**

FOR SCIENTIFIC AND TECHNOLOGICAL SERVICES AND RELATED RESEARCH AND DESIGN SERVICES; ANALYSIS AND INDUSTRIAL RESEARCH SERVICES; DESIGN AND DEVELOPMENT OF COMPUTER HARDWARE AND SOFTWARE; RENTAL OF SOFTWARE; CONSULTING IN COMPUTER MATTERS, UPDATING AND DEVELOPING OF SOFTWARE, ENGINEERING DESIGNS, INDUSTRIAL DESIGNS, QUALITY CONTROL, PROJECT EVALUATIONS, TECHNICAL RESEARCH, MATERIAL TESTS, TECHNOLOGICAL KNOW-HOW TRANSFER (SERVICES FOR THIRD PARTIES), SCIENTIFIC AND TECHNOLOGICAL SERVICES SUCH AS RELATED RESEARCH AND DESIGN SERVICES; ANALYSIS AND INDUSTRIAL RESEARCH SERVICES, DESIGN AND DEVELOPMENT OF COMPUTERS AND COMPUTER SOFTWARE, DESIGN SERVICES OF LAND VEHICLES, OTHER VEHICLES AND THEIR PARTS (U.S. CLS. 100 AND 101).

**CLASS 45—PERSONAL AND LEGAL SERVICES**

FOR INDUSTRIAL PROPERTY LICENSING, PATENT EXPLOITATION (U.S. CLS. 100 AND 101).  
SUZANNE BLANE, EXAMINING ATTORNEY

SN 85-003,682. EVALUE AG, DUSSELDORF, FED REP GERMANY, FILED 3-31-2010.

**EVALUE**

THE MARK CONSISTS OF STANDARD CHARACTERS WITHOUT CLAIM TO ANY PARTICULAR FONT, STYLE, SIZE, OR COLOR.

PRIORITY CLAIMED UNDER SEC. 44(D) ON ERPN CMNTY TM OFC APPLICATION NO. 008994428, FILED 3-30-2010, REG. NO. 008994428, DATED 11-6-2010, EXPIRES 3-30-2020.

**CLASS 35—ADVERTISING AND BUSINESS**

FOR ONLINE BUSINESS NETWORKING SERVICES; MERGERS AND ACQUISITIONS CONSULTING SERVICES; PUBLIC RELATIONS SERVICES; HUMAN RESOURCES MANAGEMENT (U.S. CLS. 100, 101 AND 102).

**CLASS 36—INSURANCE AND FINANCIAL**

FOR VENTURE CAPITAL FINANCING SERVICES; VENTURE CAPITAL MANAGEMENT; CAPITAL INVESTMENT SERVICES; PRIVATE PLACEMENTS OF HEDGE FUNDS, PRIVATE EQUITY FUNDS, SECURITIES AND DERIVATIVES FOR OTHERS; FINANCIAL ADVICE; FINANCIAL SERVICES, NAMELY, INVESTMENT MANAGEMENT, ASSET MANAGEMENT SERVICES, UNIT FINANCIAL TRUST MANAGEMENT SERVICES, AND PRIVATE EQUITY FUND MANAGEMENT SERVICES; FINANCIAL AFFAIRS AND MONETARY AFFAIRS, NAMELY, FINANCIAL INFORMATION, MANAGEMENT AND ANALYSIS SERVICES; PROVISION OF FINANCIAL INFORMATION ON-LINE FROM A COMPUTER DATABASE, THE INTERNET AND OTHERWISE; STRATEGIC CORPORATE FINANCIAL ADVISORY SERVICES; WEALTH MANAGEMENT; BANKING SERVICES; INVESTMENT BANKING SERVICES; FINANCIAL INVESTMENT BROKERAGE SERVICES; REAL ESTATE BROKERAGE SERVICES; LAND ACQUISITION SERVICES; REAL PROPERTY PORTFOLIO MANAGEMENT AND ADMINISTRATION, NAMELY, PROVIDING INVESTMENT ADVICE; EQUITY CAPITAL INVESTMENT; PROVIDING TEMPORARY LOANS; FINANCIAL MANAGEMENT AND CONSULTANCY RELATING THERETO; FINANCIAL CONSULTANCY, INFORMATION AND ADVISORY SERVICES RELATING TO THE AFORESAID SERVICES; FINANCIAL INFORMATION RELATING TO ALL THE AFOREMENTIONED SERVICES PROVIDED ON-LINE FROM A COMPUTER DATABASE OR THE INTERNET (U.S. CLS. 100, 101 AND 102).  
CURTIS FRENCH, EXAMINING ATTORNEY

SN 85-003,686. EVALUE AG, DUSSELDORF, FED REP GERMANY, FILED 3-31-2010.



PRIORITY CLAIMED UNDER SEC. 44(D) ON ERPN CMNTY TM OFC APPLICATION NO. 008994535, FILED 3-30-2010, REG. NO. 008994535, DATED 4-19-2011, EXPIRES 3-30-2020.

THE MARK CONSISTS OF THE WORD "EVALUE" NEXT TO A TWISTING DESIGN.

**CLASS 35—ADVERTISING AND BUSINESS**

FOR ONLINE BUSINESS NETWORKING SERVICES; MERGERS AND ACQUISITIONS CONSULTING SERVICES; PUBLIC RELATIONS SERVICES; HUMAN RESOURCES MANAGEMENT (U.S. CLS. 100, 101 AND 102).



**CLASS 36—INSURANCE AND FINANCIAL**

FOR VENTURE CAPITAL FINANCING SERVICES; VENTURE CAPITAL MANAGEMENT; CAPITAL INVESTMENT SERVICES; PRIVATE PLACEMENTS OF HEDGE FUNDS, PRIVATE EQUITY FUNDS, SECURITIES AND DERIVATIVES FOR OTHERS; FINANCIAL ADVICE; FINANCIAL SERVICES, NAMELY, INVESTMENT MANAGEMENT, ASSET MANAGEMENT SERVICES, UNIT FINANCIAL TRUST MANAGEMENT SERVICES, AND PRIVATE EQUITY FUND MANAGEMENT SERVICES; FINANCIAL AFFAIRS AND MONETARY AFFAIRS, NAMELY, FINANCIAL INFORMATION, MANAGEMENT AND ANALYSIS SERVICES; PROVISION OF FINANCIAL INFORMATION ON-LINE FROM A COMPUTER DATABASE, THE INTERNET AND OTHERWISE; STRATEGIC CORPORATE FINANCIAL ADVISORY SERVICES; WEALTH MANAGEMENT; BANKING SERVICES; INVESTMENT BANKING SERVICES; FINANCIAL INVESTMENT BROKERAGE SERVICES; REAL ESTATE BROKERAGE SERVICES; LAND ACQUISITION SERVICES; REAL PROPERTY PORTFOLIO MANAGEMENT AND ADMINISTRATION, NAMELY, PROVIDING INVESTMENT ADVICE; EQUITY CAPITAL INVESTMENT; PROVIDING TEMPORARY LOANS; FINANCIAL MANAGEMENT AND CONSULTANCY RELATING THERETO; FINANCIAL CONSULTANCY, INFORMATION AND ADVISORY SERVICES RELATING TO THE AFORESAID SERVICES; FINANCIAL INFORMATION RELATING TO ALL THE AFOREMENTIONED SERVICES PROVIDED ON-LINE FROM A COMPUTER DATABASE OR THE INTERNET (U.S. CLS. 100, 101 AND 102).

CURTIS FRENCH, EXAMINING ATTORNEY

SN 85-020,993. EDATANETWORKS INC., EDMONTON, ALBERTA, CANADA, FILED 4-22-2010.

**NEXT GENERATION LOYALTY**

THE MARK CONSISTS OF STANDARD CHARACTERS WITHOUT CLAIM TO ANY PARTICULAR FONT, STYLE, SIZE, OR COLOR.

PRIORITY CLAIMED UNDER SEC. 44(D) ON CANADA APPLICATION NO. 1477352, FILED 4-16-2010, REG. NO. TMA855,186, DATED 7-15-2013, EXPIRES 7-15-2028.

NO CLAIM IS MADE TO THE EXCLUSIVE RIGHT TO USE "LOYALTY", APART FROM THE MARK AS SHOWN.

**CLASS 9—ELECTRICAL AND SCIENTIFIC APPARATUS**

FOR COMPUTER DATABASE SOFTWARE FOR USE IN PROMOTING THE INITIATIVES OF CHARITABLE ORGANIZATIONS THROUGH ON-LINE COMPUTER MEDIA; COMPUTER SOFTWARE FOR USE IN DEVELOPING, IMPLEMENTING, MANAGING AND MEASURING PROMOTIONAL STRATEGIES THAT LINK COMPANIES' SALES CAMPAIGNS DIRECTLY TO NON-PROFIT ORGANIZATIONS; MAGNETICALLY ENCODED MEMBERSHIP CARDS, NAMELY, LOYALTY AND GIFT CARDS; MAGNETICALLY ENCODED LOYALTY CARDS; MAGNETIC SWIPE CARDS FOR MEMBERSHIP CARDS, NAMELY, LOYALTY CARDS, GIFT CARDS, STORED-VALUE CARDS, BRAND LOYALTY CARDS, VENDOR LOYALTY CARDS, AND PRE-PAID TELEPHONE CARDS; MAGNETICALLY ENCODED MEMBERSHIP CARDS, NAMELY, LOYALTY AND GIFT CARDS; MAGNETICALLY ENCODED STORED-VALUE CARDS; MAGNETICALLY ENCODED BRAND LOYALTY CARDS AND MAGNETICALLY ENCODED VENDOR LOYALTY CARDS; MAGNETICALLY ENCODED PRE-PAID TELEPHONE CARDS (U.S. CLS. 21, 23, 26, 36 AND 38).

**CLASS 16—PAPER GOODS AND PRINTED MATTER**

FOR NON-MAGNETICALLY ENCODED MEMBERSHIP CARDS, NAMELY, LOYALTY AND GIFT CARDS; NON-MAGNETICALLY ENCODED LOYALTY CARDS; NON-MAGNETICALLY ENCODED STORED VALUE CARDS; NON-MAGNETICALLY ENCODED BRAND LOYALTY CARDS AND VENDOR LOYALTY CARDS; NON-MAGNETICALLY ENCODED PLASTIC MEMBERSHIP CARDS (U.S. CLS. 2, 5, 22, 23, 29, 37, 38 AND 50).

**CLASS 35—ADVERTISING AND BUSINESS**

FOR CUSTOMER LOYALTY SERVICES FOR COMMERCIAL, PROMOTIONAL AND ADVERTISING PURPOSES; ADMINISTRATION OF ONLINE CONSUMER LOYALTY PROGRAMS WHICH INTEGRATE A BANK'S CARDHOLDERS, MERCHANTS AND CHARITABLE ORGANIZATIONS TO PROMOTE THE SALE OF GOODS AND SERVICES OF OTHERS THROUGH ELECTRONIC COUPONING AND DISCOUNTS AND INCENTIVES FROM MERCHANTS OR BANKS TO CARDHOLDERS IN THE NATURE OF INCENTIVE AWARD PROGRAMS TO PROMOTE THE SALE OF PRODUCTS AND SERVICES OF OTHERS; PROVIDING INCENTIVE AWARD PROGRAMS FOR CUSTOMERS AND EMPLOYEES THROUGH THE DISTRIBUTION OF PREPAID STORED VALUE CARDS FOR THE PURPOSE OF PROMOTING AND REWARDING LOYALTY TO EXISTING BANK CARDHOLDERS AND CHARITABLE ORGANIZATIONS, AND ADMINISTRATION OF SUCH AWARDS; ELECTRONIC MEMBERSHIP CLUB SERVICE THAT ALLOWS MEMBERS TO REGISTER THEIR CREDIT AND DEBIT CARDS AND OBTAIN COUPONS ENTITLING THEM TO SPECIFIC DISCOUNTS AND SAVINGS AT PARTICIPATING MERCHANTS AND REWARDING MEMBERS WITH COUPONS, DISCOUNTS AND INCENTIVES BASED ON USE; DATABASE MANAGEMENT, NAMELY, COMPILATION AND MANAGEMENT OF CLIENT DATA; PROVISION OF TRANSACTION BASED CUSTOMER INCENTIVE, LOYALTY AND COUPON PROGRAMS AND SYSTEMS AND DEVELOPMENT OF MARKETING STRATEGIES FEATURING TRANSACTION BASED INCENTIVE, LOYALTY AND COUPON PROGRAMS AND SYSTEMS; PROVIDING INTEGRATION OF LOYALTY PROGRAMS AND SYSTEMS OF OTHERS, NAMELY, IN THE NATURE OF PROVIDING CUSTOMER LOYALTY SERVICES AND CUSTOMER CLUB SERVICES FOR COMMERCIAL, PROMOTIONAL AND/OR ADVERTISING SERVICES; ARRANGING AND CONDUCTING INCENTIVE REWARD PROGRAMS TO PROMOTE PARTICIPATING MERCHANTS AND/OR THEIR PRODUCTS OR SERVICES, NAMELY, THE OPERATION, MANAGEMENT AND PROMOTION OF A TRANSACTION BASED LOYALTY, COUPON AND INCENTIVE PROGRAM IN WHICH POINTS, REBATES, CREDITS, PAYMENTS, DISCOUNTS, COUPONS, SAVINGS CARDS, DISCOUNT VOUCHERS, VOUCHER BOOKS, INCENTIVES, PRIZES, FREE GIFTS, MONEY, FINANCIAL INSTRUMENTS AND ANYTHING ELSE OF ECONOMIC VALUE ARE MADE AVAILABLE BY PARTICIPATING MERCHANTS TO CHARITABLE ORGANIZATIONS AND TO MEMBERS WHO UTILIZE REGISTERED CREDIT AND DEBIT CARDS FOR PURCHASES; ADMINISTERING A CUSTOMER LOYALTY PROGRAM THROUGH THE OFFERING OF COUPONS DISCOUNTS AND INCENTIVES; PROMOTING THE SALE OF PARTICIPATING MERCHANTS' WARES AND SERVICES THROUGH THE IMPLEMENTATION AND ADMINISTRATION OF LOYALTY, COUPON AND INCENTIVE PROGRAMS BASED ON CONSUMER PURCHASE BEHAVIOR AND ALSO THROUGH DISSEMINATION OF INFORMATION VIA ON-LINE COMPUTER MEDIA; ADVERTISING THE GOODS, SERVICES AND CHARITABLE INITIATIVES FOR OTHERS, NAMELY, PROMOTION OF PRODUCTS, SERVICES AND CHARITABLE INITIATIVES OF OTHERS BY WAY OF LOYALTY, COUPON AND INCENTIVE PROGRAMS; OPERATION, MANAGEMENT AND PROMOTION OF A TRANSACTION BASED LOYALTY, COUPON AND INCENTIVE PROGRAM IN WHICH MEMBERS ARE ENTERED TO WIN PRIZES, DISCOUNTS AND OTHER INCENTIVE REWARDS WHEN MAKING PURCHASES WITH REGISTERED CREDIT AND DEBIT CARDS AT PARTICIPATING MERCHANTS; COMPUTER SERVICES, NAMELY, PROVIDING AN ON-LINE TRANSACTION BASED CUSTOMER LOYALTY, COUPON AND

INCENTIVE PROGRAM VIA A GLOBAL COMPUTER NETWORK AND OTHER TELECOMMUNICATIONS NETWORKS; PROVIDING ON-LINE LIAISON SERVICES BETWEEN BANKS, CARDHOLDERS, MERCHANTS AND CHARITABLE ORGANIZATIONS VIA A GLOBAL COMPUTER NETWORK AND OTHER TELECOMMUNICATIONS NETWORKS, NAMELY, PROMOTING THE SALE OF GOODS AND SERVICES OF OTHERS THROUGH ELECTRONIC COUPONING AND DISCOUNTS AND INCENTIVES FROM MERCHANTS OR BANKS TO CARDHOLDERS IN THE NATURE OF INCENTIVE AWARD PROGRAMS TO PROMOTE THE SALE OF PRODUCTS AND SERVICES OF OTHERS; PROMOTING THE GOODS AND SERVICES OF OTHERS BY PROVIDING SUPPLEMENTAL COUPONS, REWARDS AND INCENTIVES TO EXISTING LOYALTY, COUPON, REWARD, AND INCENTIVE PROGRAMS OPERATED BY BANKS, MERCHANTS AND CHARITABLE ORGANIZATIONS; PROVIDING MARKETING ASSISTANCE AND CONSULTING TO BANKS, MERCHANTS AND CHARITABLE ORGANIZATIONS TO ASSIST IN THE ATTRACTION OF NEW CLIENTS AND DONORS, AND TO INCREASE TRANSACTION VOLUMES; OPERATING A BUYING CLUB AND PROMOTING THE SALE OF MEMBERSHIPS AND CREDIT CARD ACCOUNTS THROUGH THE CREATION AND ADMINISTRATION OF INCENTIVE AWARD PROGRAMS; BUSINESS MARKETING CONSULTING SERVICES; CONDUCTING AUTOMATED CUSTOMER SATISFACTION SURVEYS FOR THE PURPOSE OF CUSTOMER SATISFACTION MONITORING AND CUSTOMER RETENTION; CONDUCTING AND PROVIDING CONSULTANCY AND INFORMATION SERVICES ON CONSUMER AND BUSINESS INCENTIVE AND LOYALTY AWARD PROGRAMS TO PROMOTE THE PURCHASING OF GOODS AND SERVICES OF OTHERS, AND TO PROMOTE TRAFFIC TO AND USAGE OF SITES ON A GLOBAL COMPUTER NETWORK; PROVIDING INCENTIVE AWARD PROGRAMS FOR CUSTOMERS THROUGH THE ISSUING AND PROCESSING OF LOYALTY COUPONS AND POINTS FOR CONSUMER AND BUSINESS INCENTIVE AND LOYALTY AWARD PROGRAMS TO PROMOTE THE PURCHASING OF GOODS AND SERVICES OF OTHERS, AND TO PROMOTE TRAFFIC TO AND USAGE OF SITES ON A GLOBAL COMPUTER NETWORK; ANALYZING BUSINESS AND MARKETING DATA RELATING TO CONSUMER AND BUSINESS INCENTIVE AND LOYALTY AWARD PROGRAMS TO PROMOTE THE PURCHASING OF GOODS AND SERVICES OF OTHERS, AND TO PROMOTE TRAFFIC TO AND USAGE OF SITES ON A GLOBAL COMPUTER NETWORK; BUSINESS MONITORING SERVICES, NAMELY, TRACKING VISITORS TO WEB SITE (U.S. CLS. 100, 101 AND 102).

#### **CLASS 36—INSURANCE AND FINANCIAL**

FOR VALUE EXCHANGE SERVICES, NAMELY, AUTHORIZING AND FACILITATING THE SECURE EXCHANGE OF FINANCIAL VALUE, INCLUDING ELECTRONIC CASH, OVER COMPUTER NETWORKS ACCESSIBLE BY MEANS OF RADIO FREQUENCY IDENTIFICATION (RFID) DEVICES, NEAR FIELD COMMUNICATION (NFC) DEVICES, STORED VALUE CARDS, MAGNETIC SWIPE CARDS, CREDIT CARDS, DEBIT CARDS, PREPAID CARDS, SMART CHIP CARDS, CELL PHONES, PDA'S, TELEPHONES, AND THE INTERNET (U.S. CLS. 100, 101 AND 102).

LEIGH CAROLINE CASE, EXAMINING ATTORNEY

SN 85-033,171. CAMOMILLA S.P.A., 20090 BUCCINASCIO (MI), ITALY, FILED 5-7-2010.

# CAMOMILLA

THE MARK CONSISTS OF STANDARD CHARACTERS WITHOUT CLAIM TO ANY PARTICULAR FONT, STYLE, SIZE, OR COLOR.

OWNER OF ERPN CMNTY TM OFC REG. NO. 007077555, DATED 9-9-2009, EXPIRES 7-21-2018.

THE ENGLISH TRANSLATION OF THE WORD "CAMOMILLA" IN THE MARK IS "CHAMOMILE".

#### **CLASS 9—ELECTRICAL AND SCIENTIFIC APPARATUS**

FOR SPECTACLES; PARTS AND ACCESSORIES THEREFOR, NAMELY, CHAINS FOR SPECTACLES, CORDS FOR SPECTACLES AND CASES FOR SPECTACLES; MOBILE TELEPHONE CASES; MOTORCYCLE HELMETS; CALCULATING MACHINES (U.S. CLS. 21, 23, 26, 36 AND 38).

#### **CLASS 11—ENVIRONMENTAL CONTROL APPARATUS**

FOR LAMPS AND CHANDELIERS; ELECTRIC TORCHES FOR LIGHTING; FLASH LIGHTS; PATIO TORCHES; CANDLE TORCHES; ELECTRIC NIGHT LIGHTS; WATER DISPENSERS, NAMELY, WATER COOLERS (U.S. CLS. 13, 21, 23, 31 AND 34).

#### **CLASS 14—JEWELRY**

FOR COSTUME JEWELRY OF PRECIOUS AND NON-PRECIOUS MATERIALS; NECKLACES; EARRINGS; BRACELETS; RINGS; JEWELRY PINS; HOROLOGICAL INSTRUMENTS; WATCH STRAPS (U.S. CLS. 2, 27, 28 AND 50).

#### **CLASS 16—PAPER GOODS AND PRINTED MATTER**

FOR STATIONERY; DRAWING BOOKS IN THE NATURE OF SKETCH PADS; BALL-POINT PENS, SYNTHETIC-TIPPED PENS, ROLLER BALL PENS, MARKER PENS, FOUNTAIN PENS, FIBER-TIPPED PENS; DIARIES; PHOTOGRAPH ALBUMS; ADHESIVES FOR STATIONERY OR HOUSEHOLD PURPOSES; STICKER ALBUMS; ADHESIVE LABELS (U.S. CLS. 2, 5, 22, 23, 29, 37, 38 AND 50).

#### **CLASS 18—LEATHER GOODS**

FOR LEATHER AND IMITATION LEATHER; TRUNKS; TRAVELING BAGS; UMBRELLAS; RUCKSACKS; KEY CASES; BRIEFCASES; POCKET WALLETS; PURSES; BAGS, NAMELY, MAKE-UP BAGS SOLD EMPTY; UNFITTED VANITY CASES (U.S. CLS. 1, 2, 3, 22 AND 41).

#### **CLASS 20—FURNITURE AND ARTICLES NOT OTHERWISE CLASSIFIED**

FOR FURNITURE; MIRRORS; SOFAS; ARMCHAIRS; CHAIRS; TABLES; TEA TABLES; COFFEE TABLES (U.S. CLS. 2, 13, 22, 25, 32 AND 50).

**CLASS 21—HOUSEWARES AND GLASS**

FOR DISHES MADE OF PORCELAIN AND EARTHENWARE; GLASS BEVERAGeware; BOWLS, CUPS AND TEA CUPS ALL MADE OF PORCELAIN AND EARTHENWARE; ICE BUCKETS; PORTABLE ICE CONTAINERS MADE OF CERAMIC AND/OR PORCELAIN; PEPPER POTS; SALT POTS; SUGAR BOWLS; SERVING TRAYS; SOAP HOLDERS; COMBS; SPONGES FOR HOUSEHOLD PURPOSES; HAIR BRUSHES; CLEANING BRUSHES FOR HOUSEHOLD USE (U.S. CLS. 2, 13, 23, 29, 30, 33, 40 AND 50).

**CLASS 24—FABRICS**

FOR TEXTILE GOODS AND TEXTILE ACCESSORIES, NAMELY, BLANKETS, BEDSPREADS, SHEETS, CURTAINS, TOWELS, TABLECLOTHS, NAPKINS; HANDKERCHIEFS (U.S. CLS. 42 AND 50).

**CLASS 25—CLOTHING**

FOR CLOTHING, NAMELY, COATS, SHAWLS, BLOUSES, PULLOVERS; JACKETS, TROUSERS, SKIRTS, DRESSES, SUITS, SHIRTS, SWEATERS, UNDERWEAR, SOCKS, STOCKINGS; GLOVES, SCARVES; HEADWEAR; BATH ROBES; FOOTWEAR; HEADBANDS (U.S. CLS. 22 AND 39).

**CLASS 27—FLOOR COVERINGS**

FOR CARPETS; RUGS; NON-TEXTILE WALL HANGINGS (U.S. CLS. 19, 20, 37, 42 AND 50).

**CLASS 28—TOYS AND SPORTING GOODS**

FOR PARLOR GAMES; PLAYTHINGS, NAMELY, DOLLS; SPORT BAGS SPECIFICALLY DESIGNED TO HOLD SOCCER EQUIPMENT (U.S. CLS. 22, 23, 38 AND 50).

JERI J. FICKES, EXAMINING ATTORNEY

SN 85-033,241, CAMOMILLA S.P.A., 20090 BUCCINASCO (MI), ITALY, FILED 5-7-2010.



OWNER OF ITALY REG. NO. 0001409078, DATED 1-24-2011, EXPIRES 5-3-2020.

THE MARK CONSISTS OF THE WORD "CAMOMILLA" IN STYLIZED LETTERING FORMED BY A SERIES OF DOTS, WITH A STYLIZED LOOP DESIGN FORMED BY DOTS BELOW THE LETTER "C".

THE ENGLISH TRANSLATION OF THE WORD "CAMOMILLA" IN THE MARK IS "CHAMOMILE".

**CLASS 9—ELECTRICAL AND SCIENTIFIC APPARATUS**

FOR SPECTACLES; PARTS AND ACCESSORIES THEREFOR, NAMELY, CHAINS FOR SPECTACLES, CORDS FOR SPECTACLES AND CASES FOR SPECTACLES; MOBILE TELEPHONE CASES; MOTORCYCLE HELMETS; RADIOS; PERSONAL STEREOs; CD AND DVD PLAYERS; SCALES; TIMERS; CALCULATING MACHINES (U.S. CLS. 21, 23, 26, 36 AND 38).

**CLASS 11—ENVIRONMENTAL CONTROL APPARATUS**

FOR LAMPS AND CHANDELIERS; ELECTRIC TORCHES FOR LIGHTING; FLASH LIGHTS; PATIO TORCHES; CANDLE TORCHES; ELECTRIC NIGHT LIGHTS; WATER DISPENSERS, NAMELY, WATER COOLERS (U.S. CLS. 13, 21, 23, 31 AND 34).

**CLASS 14—JEWELRY**

FOR COSTUME JEWELRY OF PRECIOUS AND NON-PRECIOUS MATERIALS; NECKLACES; EARRINGS; BRACELETS; RINGS; JEWELRY PINS; HOROLOGICAL AND CHRONOMETRIC INSTRUMENTS; WATCH STRAPS (U.S. CLS. 2, 27, 28 AND 50).

**CLASS 16—PAPER GOODS AND PRINTED MATTER**

FOR STATIONERY; DRAWING BOOKS IN THE NATURE OF SKETCH PADS; NOTE BOOKS; AGENDAS; ADDRESS BOOKS; BALL-POINT PENS, SYNTHETIC TIPPED PENS, ROLLER BALL PENS, FIBER-TIPPED PENS; DIARIES; PHOTOGRAPH ALBUMS; ADHESIVES FOR STATIONERY OR HOUSEHOLD PURPOSES; STICKER ALBUMS; ADHESIVE LABELS (U.S. CLS. 2, 5, 22, 23, 29, 37, 38 AND 50).

**CLASS 18—LEATHER GOODS**

FOR LEATHER AND IMITATION LEATHER; TRUNKS; TRAVELING BAGS; UMBRELLAS; RUCKSACKS; KEY CASES; BRIEFCASES; WALLETS; PURSES; BAGS, NAMELY, MAKE-UP BAGS SOLD EMPTY; UNFITTED VANITY CASES (U.S. CLS. 1, 2, 3, 22 AND 41).

**CLASS 20—FURNITURE AND ARTICLES NOT OTHERWISE CLASSIFIED**

FOR FURNITURE; MIRRORS AND MIRROR FRAMES; SOFAS; ARMCHAIRS; CHAIRS; TABLES; TEA TABLES; COFFEE TABLES (U.S. CLS. 2, 13, 22, 25, 32 AND 50).

**CLASS 21—HOUSEWARES AND GLASS**

FOR DISHES; GLASS BEVERAGeware; BOWLS; CUPS; TEA CUPS; ICE BUCKETS; PORTABLE ICE CONTAINERS; PEPPER POTS; SALT POTS; SUGAR BOWLS; SERVING TRAYS; SOAP HOLDERS; COMBS; SPONGES FOR HOUSEHOLD PURPOSES; HAIR BRUSHES; CLEANING BRUSHES FOR HOUSEHOLD USE (U.S. CLS. 2, 13, 23, 29, 30, 33, 40 AND 50).

**CLASS 24—FABRICS**

FOR TEXTILE GOODS AND TEXTILE ACCESSORIES, NAMELY, BLANKETS, BEDSPREADS, SHEETS, CURTAINS, TOWELS, TABLECLOTHS, NAPKINS; HANDKERCHIEFS (U.S. CLS. 42 AND 50).

**CLASS 26—FANCY GOODS**

FOR HAIR CLIPS; RIBBONS FOR HAIR; HAIR BANDS; HAIR ELASTICS; HAT PINS FOR SECURING HATS; HAIR PINS (U.S. CLS. 37, 39, 40, 42 AND 50).

**CLASS 27—FLOOR COVERINGS**

FOR CARPETS; RUGS; NON-TEXTILE WALL HANGINGS (U.S. CLS. 19, 20, 37, 42 AND 50).

**CLASS 28—TOYS AND SPORTING GOODS**

FOR PARLOR GAMES; TOYS AND PLAYTHINGS, NAMELY, DOLLS; SPORT BAGS SPECIFICALLY DESIGNED TO HOLD SOCCER EQUIPMENT (U.S. CLS. 22, 23, 38 AND 50).

**CLASS 35—ADVERTISING AND BUSINESS**

FOR RETAIL STORE SERVICES IN THE FIELD OF GENERAL CONSUMER MERCHANDISE, EXCLUDING GOODS WHICH COULD BE MADE OF CHAMOMILE AND EXCLUDING CLOTHING, HEADWEAR AND FOOTWEAR, NAMELY, SPECTACLES; PARTS AND ACCESSORIES THEREFOR, NAMELY, CHAINS FOR SPECTACLES, CORDS FOR SPECTACLES AND CASES FOR SPECTACLES; MOBILE TELEPHONE CASES; MOTORCYCLE HELMETS; RADIOS; PERSONAL STEREO; CD AND DVD PLAYERS; SCALES; TIMERS; CALCULATING MACHINES; LAMPS AND CHANDELIERS; ELECTRIC TORCHES FOR LIGHTING; FLASH LIGHTS; PATIO TORCHES; CANDLE TORCHES; ELECTRIC NIGHT LIGHTS; WATER DISPENSERS, NAMELY, WATER COOLERS; COSTUME JEWELRY OF PRECIOUS AND NON-PRECIOUS MATERIALS; NECKLACES; EARRINGS; BRACELETS; RINGS; JEWELRY PINS; HOROLOGICAL AND CHRONOMETRIC INSTRUMENTS; WATCH STRAPS; STATIONERY; DRAWING BOOKS IN THE NATURE OF SKETCH PADS; NOTE BOOKS; AGENDAS; ADDRESS BOOKS; BALL-POINT PENS, SYNTHETIC TIPPED PENS, ROLLER BALL PENS, FIBER-TIPPED PENS; DIARIES; PHOTOGRAPH ALBUMS; ADHESIVES FOR STATIONERY OR HOUSEHOLD PURPOSES; STICKER ALBUMS; ADHESIVE LABELS; LEATHER AND IMITATION LEATHER; TRUNKS; TRAVELING BAGS; UMBRELLAS; RUCKSACKS; KEY CASES; BRIEFCASES; WALLETS; PURSES; BAGS, NAMELY, MAKE-UP BAGS SOLD EMPTY; UNFITTED VANITY CASES; FURNITURE; MIRRORS AND MIRROR FRAMES; SOFAS; ARMCHAIRS; CHAIRS; TABLES; TEA TABLES; COFFEE TABLES; DISHES; GLASS BEVERAGE WARE; BOWLS; CUPS; TEA CUPS; ICE BUCKETS; PORTABLE ICE CONTAINERS; PEPPER POTS; SALT POTS; SUGAR BOWLS; SERVING TRAYS; SOAP HOLDERS; COMBS; SPONGES FOR HOUSEHOLD PURPOSES; HAIR BRUSHES; CLEANING BRUSHES FOR HOUSEHOLD USE; TEXTILE GOODS AND TEXTILE ACCESSORIES, NAMELY, BLANKETS, BEDSPREADS, SHEETS, CURTAINS, TOWELS, TABLECLOTHS, NAPKINS; HANDKERCHIEFS; HAIR CLIPS; RIBBONS FOR HAIR; HAIR BANDS; HAIR ELASTICS; HAT PINS FOR SECURING HATS; HAIR PINS; CARPETS; RUGS; NON-TEXTILE WALL HANGINGS; PARLOR GAMES; TOYS AND PLAYTHINGS, NAMELY, DOLLS; SPORT BAGS SPECIFICALLY DESIGNED TO HOLD SOCCER EQUIPMENT (U.S. CLS. 100, 101 AND 102).

JERI J. FICKES, EXAMINING ATTORNEY

SN 85-041,364, OXFORD EXPERIENCE LIMITED, OXFORD, UNITED KINGDOM, FILED 5-18-2010.

**OXFORD TEDDY BEAR  
UNIVERSITY**

THE MARK CONSISTS OF STANDARD CHARACTERS WITHOUT CLAIM TO ANY PARTICULAR FONT, STYLE, SIZE, OR COLOR.

PRIORITY CLAIMED UNDER SEC. 44(D) ON ERPN CMNTY TM OFC APPLICATION NO. 008739641, FILED 12-8-2009, REG. NO. 008739641, DATED 11-22-2013, EXPIRES 8-12-2019.

OWNER OF U.S. REG. NO. 2,448,035.

NO CLAIM IS MADE TO THE EXCLUSIVE RIGHT TO USE "OXFORD", APART FROM THE MARK AS SHOWN.

**CLASS 9—ELECTRICAL AND SCIENTIFIC APPARATUS**

FOR COMPUTER GAME SOFTWARE; VIDEO GAME SOFTWARE; DOWNLOADABLE COMPUTER GAME PROGRAMS; DOWNLOADABLE VIDEO GAME PROGRAMS; COMPUTER GAMES PROGRAMS; SOFTWARE FOR PLAYING VIDEO, COMPUTER AND ON-LINE GAMES; MULTIMEDIA, INTERACTIVE COMPUTER GAMES PROGRAMS; DOWNLOADABLE ELECTRONIC PUBLICATIONS, NAMELY, BROCHURES, NEWSLETTERS AND MAGAZINES ALL RELATING TO COMPUTER GAMING AND VIDEO GAMING; COMPUTER GAME SOFTWARE, INTERACTIVE AND ENTERTAINMENT SOFTWARE FOR USE ON ELECTRONIC DEVICES, NAMELY, HAND-HELD DEVICES, MOBILE DEVICES AND OTHER WIRELESS DEVICES (U.S. CLS. 21, 23, 26, 36 AND 38).

**CLASS 41—EDUCATION AND ENTERTAINMENT**

FOR ENTERTAINMENT SERVICES IN THE NATURE OF ON-LINE INTERACTIVE COMPUTER GAMES PROVIDED ON-LINE AND ACCESSED BY MEANS OF A GLOBAL COMPUTER NETWORK; ENTERTAINMENT SERVICES IN THE NATURE OF ON-LINE INTERACTIVE VIDEO GAMES PROVIDED ON-LINE AND ACCESSED BY MEANS OF A GLOBAL COMPUTER NETWORK; ENTERTAINMENT SERVICES, NAMELY, PROVIDING ON-LINE, INTERACTIVE VIDEO GAMES; ENTERTAINMENT SERVICES, NAMELY, PROVIDING ON-LINE, INTERACTIVE COMPUTER GAMES (U.S. CLS. 100, 101 AND 107).

DOUGLAS LEE, EXAMINING ATTORNEY

SN 85-169,441, FAI FONDO PER L'AMBIENTE ITALIANO, MILANO, ITALY, FILED 11-4-2010.

**FRIENDS OF FAI**

THE MARK CONSISTS OF STANDARD CHARACTERS WITHOUT CLAIM TO ANY PARTICULAR FONT, STYLE, SIZE, OR COLOR.

PRIORITY CLAIMED UNDER SEC. 44(D) ON ITALY APPLICATION NO. MI2010C00473, FILED 5-5-2010.

OWNER OF ITALY REG. NO. 1407824, DATED 1-20-2011, EXPIRES 1-20-2021.

**CLASS 35—ADVERTISING AND BUSINESS**

FOR ADVERTISING; BUSINESS MANAGEMENT; BUSINESS ADMINISTRATION; OFFICE FUNCTIONS; BUSINESS MANAGEMENT AND ORGANIZATION OF ACTIVITIES FOR CHARITABLE PURPOSES AND CHARITY WORK; PROMOTING SERVICES FOR INITIATIVES OF PUBLIC AWARENESS CONCERNING ENVIRONMENTAL ISSUES AND THE CONSERVATION OF CULTURAL ASSETS; SERVICES PROMOTING THE COLLECTION OF DONATIONS FOR CHARITABLE PURPOSES; PUBLICATION AND EDITING OF PUBLICITY TEXTS PROMOTING PUBLIC ENVIRONMENTAL AWARENESS (U.S. CLS. 100, 101 AND 102).

**CLASS 36—INSURANCE AND FINANCIAL**

FOR FUNDRAISING FOR CHARITABLE PURPOSES; FINANCIAL SERVICES IN THE NATURE OF COLLECTION OF DONATIONS FOR CHARITABLE PURPOSES; FUNDRAISING FOR ACTIVITIES AND EVENTS; ORGANIZATION OF FUNDRAISING ACTIVITIES AND EVENTS IN THE FIELDS OF ART, ENVIRONMENTAL AWARENESS AND CONSERVATION, HISTORICAL MONUMENT, BUILDING AND STRUCTURE AWARENESS AND RESTORATION (U.S. CLS. 100, 101 AND 102).

**CLASS 41—EDUCATION AND ENTERTAINMENT**

FOR EDUCATION, NAMELY, PROVIDING CLASSES, SEMINARS, WORKSHOPS, LECTURES, TELEMSEMINARS, TELECLASSES IN THE FIELD OF ART, ART APPRECIATION, ENVIRONMENTAL AWARENESS AND CONSERVATION, HISTORICAL MONUMENT, BUILDING AND STRUCTURE AWARENESS AND PRESERVATION; PROVIDING OF TRAINING IN THE FIELD OF ART, ENVIRONMENTAL AWARENESS AND CONSERVATION, HISTORICAL MONUMENT, BUILDING AND STRUCTURE AWARENESS AND RESTORATION; ENTERTAINMENT IN THE NATURE OF :CONDUCTING FAIRS, LIVE PERFORMANCES BY MUSICAL BANDS, ORCHESTRAL EVENTS, THEATER COMPANIES AND PERFORMANCES, AND, PROVIDING ONLINE VIRTUAL ENVIRONMENTS IN WHICH USERS CAN INTERACT WITH HISTORICAL FIGURES AND HISTORIC SITES FOR GAMING AND ENTERTAINMENT PURPOSES; CULTURAL ACTIVITIES, NAMELY, ORGANIZING COMMUNITY CULTURAL EVENTS, ORGANIZING EXHIBITIONS FOR CULTURAL PURPOSES; PROVIDING A WEB SITE FEATURING INFORMATION ON HISTORIC FIGURES AND SITES; PUBLICATION AND EDITING OF WRITTEN TEXTS, BOOKS, MAGAZINES AND OTHER PRINTED AND WEB MATTER IN THE FIELD OF ART, PUBLIC ENVIRONMENTAL AWARENESS AND CONSERVATION, HISTORICAL MONUMENT, BUILDING AND STRUCTURE AWARENESS AND RESTORATION (U.S. CLS. 100, 101 AND 107).

HANNO RITTNER, EXAMINING ATTORNEY

**CLASS 9—ELECTRICAL AND SCIENTIFIC APPARATUS**

FOR TELEPHONE SETS; WIRELESS TELEPHONE SETS; PORTABLE COMMUNICATIONS APPARATUS, NAMELY, MOBILE PHONE HANDSETS, WALKIE-TALKIES, SATELLITE TELEPHONES AND PERSONAL DIGITAL ASSISTANTS; MOBILE PHONES; MPEG AUDIO LAYER-3 PLAYERS; TELEVISION RECEIVERS; TELEVISION REMOTE CONTROLLERS; BLANK UNIVERSAL SERIAL BUS DRIVES; DIGITAL MEDIA BROADCASTING PLAYERS; HEADSETS FOR MOBILE PHONES; ELECTRONIC PHOTO ALBUMS FOR DISPLAYING DIGITAL PICTURES, VIDEO CLIPS AND MUSIC; DIGITAL PICTURE FRAMES FOR DISPLAYING DIGITAL PICTURES, VIDEO CLIPS AND MUSIC; MONITORS FOR COMPUTERS; LAPTOP COMPUTERS; COMPUTERS; DIGITAL VERSATILE DISC PLAYERS; PORTABLE HARD DISK DRIVES; APPARATUS FOR RECORDING, TRANSMISSION OR REPRODUCTION OF SOUND OR IMAGES FOR USE IN TELECOMMUNICATIONS; APPARATUS FOR RECORDING, TRANSMISSION OR REPRODUCTION OF SOUND OR IMAGES; COMPUTER SOFTWARE FOR MOBILE PHONES, NAMELY, FOR MOBILE OPERATING SYSTEMS, SENDING AND RECEIVING INFORMATION, TO PROVIDE WEB-BASED ACCESS TO APPLICATIONS, PRODUCTS AND SERVICES; DIGITAL VERSATILE DISC PLAYERS FOR HOME THEATERS; SPEAKERS FOR HOME THEATERS; AUDIO-VIDEO RECEIVERS FOR HOME THEATERS; PROJECTORS FOR HOME THEATERS; INTEGRATED CIRCUITS; AUDIO RECEIVERS; ON BOARD COMPUTER UNITS ON VEHICLES AND ELECTRONIC TOLL SMART CARDS USED FOR HIGHWAY ELECTRONIC TOLL COLLECTION; TRANSPONDERS, NAMELY, ELECTRONIC TERMINALS EQUIPPED IN VEHICLES FOR ELECTRONIC COMMERCIAL TRANSACTIONS; CLOSED-CIRCUIT TELEVISION CAMERAS; NETWORK MONITORING CAMERAS, NAMELY, FOR SURVEILLANCE; DIGITAL SIGNAGE (U.S. CLS. 21, 23, 26, 36 AND 38).

SN 85-284,046. LG ELECTRONICS INC., SEOUL 150-721, REPUBLIC OF KOREA, FILED 4-1-2011.

THINGQ 

PRIORITY CLAIMED UNDER SEC. 44(D) ON REPUBLIC OF KOREA APPLICATION NO. 402011001456, FILED 3-22-2011, REG. NO. 0949379, DATED 1-17-2013, EXPIRES 1-17-2023.

OWNER OF REPUBLIC OF KOREA REG. NO. 0988685, DATED 8-14-2013, EXPIRES 8-14-2023.

THE MARK CONSISTS OF THE WORD "THINGQ" FOLLOWED BY A DESIGN OF A HOUSE WITH A CIRCLE IN ITS LOWER LEFT CORNER, AND WITH TWO CURVED DIAGONAL LINES APPEARING ON THE HOUSE.

**CLASS 7—MACHINERY**

FOR ELECTRIC VACUUM CLEANERS; ELECTRIC CLOTHES WASHING MACHINES; AUTOMATIC DISHWASHERS (U.S. CLS. 13, 19, 21, 23, 31, 34 AND 35).

**CLASS 10—MEDICAL APPARATUS**

FOR MASSAGE APPARATUS; VIBRATING MASSAGE APPARATUS; ELECTRIC MASSAGE APPARATUS FOR HOUSEHOLD USE; MASSAGE APPARATUS FOR HUMAN BODY; BED VIBRATORS; ELECTRIC MASSAGE CHAIRS; ESTHETIC MASSAGE APPARATUS (U.S. CLS. 26, 39 AND 44).

**CLASS 11—ENVIRONMENTAL CONTROL APPARATUS**

FOR ELECTRIC REFRIGERATORS; REFRIGERATORS FOR KIMCHI; ELECTRIC LIGHTWAVE OVENS FOR COOKING, GRILLING AND MICROWAVING; TEMPERATURE CONTROLLED ELECTRIC WINE CELLARS FOR HOUSEHOLD USE; ELECTRIC COOKING OVENS; ELECTRIC FREEZERS; ELECTRIC LAUNDRY DRYERS; GAS RANGES; MICROWAVE OVENS; GAS COOKTOPS; ELECTRIC RANGES FOR HOUSEHOLD USE; AIR PURIFIERS; AIR CONDITIONERS; HOT AIR APPARATUS, NAMELY, HOT-AIR SPACE HEATING APPARATUS; HUMIDIFIERS; ELECTRIC DEHUMIDIFIER FOR HOUSEHOLD USE; GAS GRILLS; DISH DISINFECTANT APPARATUS FOR HOUSEHOLD PURPOSES; ELECTRIC WATER PURIFIERS FOR HOUSEHOLD USE; WATER IONIZERS; WATER IONIZATION APPARATUS FOR HOUSEHOLD PURPOSES; WATER PURIFYING APPARATUS; ELECTRIC FOOTWARMERS (U.S. CLS. 13, 21, 23, 31 AND 34).

KRISTIN CARLSON, EXAMINING ATTORNEY

SN 85-286,905. KYORIN PHARMACEUTICAL CO., LTD., TOKYO, JAPAN, FILED 4-5-2011.



OWNER OF JAPAN REG. NO. 4968040, DATED 7-7-2006, EXPIRES 7-7-2016.

THE COLOR(S) PURPLE, ORANGE AND GREEN IS/ARE CLAIMED AS A FEATURE OF THE MARK.

THE MARK CONSISTS OF A FANCIFUL HEART DESIGN CONSISTING OF A CURVED PURPLE BAND ON THE LEFT, AN ORANGE CURVED BAND IN THE CENTER AND A GREEN CURVED BAND ON THE RIGHT.

#### CLASS 7—MACHINERY

FOR (BASED ON 44(E)) AUTOMATED WASHERS FOR CLEANING MEDICAL EQUIPMENT (U.S. CLS. 13, 19, 21, 23, 31, 34 AND 35).

#### CLASS 11—ENVIRONMENTAL CONTROL APPARATUS

FOR (BASED ON 44(E)) AIR PURIFYING APPARATUS AND MACHINES (U.S. CLS. 13, 21, 23, 31 AND 34).  
ODESSA BIBBINS, EXAMINING ATTORNEY

SN 85-299,715. MIYAKI CO., LTD., SHIZUOKA, JAPAN, FILED 4-20-2011.

**KASHIMA COAT**

OWNER OF U.S. REG. NO. 3,908,789.

NO CLAIM IS MADE TO THE EXCLUSIVE RIGHT TO USE "COAT", APART FROM THE MARK AS SHOWN.

THE MARK CONSISTS OF THE STYLED WORDING "KASHIMA COAT" WITH A DIAGONAL LINE IN THE LETTER "K" IN THE WORDING "KASHIMA" AND A DIAGONAL LINE IN THE LETTER "C" IN THE WORDING "COAT".

#### CLASS 6—METAL GOODS

FOR METAL PULLEYS FOR MOTORCYCLES AND BICYCLES (U.S. CLS. 2, 12, 13, 14, 23, 25 AND 50).

#### CLASS 12—VEHICLES

FOR VEHICLE PARTS, NAMELY, SHOCK ABSORBERS; SHOCK ABSORBERS FOR AUTOMOBILES, MOTORCYCLES AND BICYCLES; MOTORCYCLE AND BICYCLE PARTS, NAMELY, FORKS AND STRUCTURAL PARTS OF MOTORCYCLES AND BICYCLES; SPROCKETS FOR MOTORCYCLES AND BICYCLES (U.S. CLS. 19, 21, 23, 31, 35 AND 44).

#### CLASS 40—MATERIAL TREATMENT

FOR CUSTOM COATING, FINISHING, AND TREATING OF METAL AND METAL PRODUCTS (U.S. CLS. 100, 103 AND 106).

SAMUEL E. SHARPER JR., EXAMINING ATTORNEY

SN 85-301,601. LEHMAN BROTHERS HOLDINGS INC., NEW YORK, NY, FILED 4-21-2011.

**SETAI**

THE MARK CONSISTS OF STANDARD CHARACTERS WITHOUT CLAIM TO ANY PARTICULAR FONT, STYLE, SIZE, OR COLOR.

#### CLASS 6—METAL GOODS

FOR WORKS OF ART OF COMMON METAL; FLOOR TILES OF METAL; SMALL ITEMS OF METAL HARDWARE, NAMELY, DOOR FITTINGS AND BATHROOM HOOKS AND PULLS; GOODS OF COMMON METAL, NAMELY, KEY CHAINS, KEY RINGS, METAL BAG CLOSURES, METAL BAG HANDLES, BUCKLES, CLOSURES OF METAL FOR CONTAINERS, BOTTLE CAPS OF METAL, BOTTLE CLOSURES OF METAL, KNOBS OF METAL, FERRULES OF METAL FOR UMBRELLAS, PARASOLS AND WALKING STICKS, METAL CLOSURES FOR TRUNKS AND TRAVELLING BAGS (U.S. CLS. 2, 12, 13, 14, 23, 25 AND 50).

#### CLASS 16—PAPER GOODS AND PRINTED MATTER

FOR MONEY CLIPS (U.S. CLS. 2, 5, 22, 23, 29, 37, 38 AND 50).

KATHERINE CHANG, EXAMINING ATTORNEY

SN 85-325,994. BENTLEY MOTORS LIMITED, CREWE, CHESHIRE, UNITED KINGDOM, FILED 5-20-2011.

**BENTLEY**

THE MARK CONSISTS OF STANDARD CHARACTERS WITHOUT CLAIM TO ANY PARTICULAR FONT, STYLE, SIZE, OR COLOR.

PRIORITY CLAIMED UNDER SEC. 44(D) ON ERPN CMNTY TM OFC APPLICATION NO. 9984031, FILED 5-20-2011, REG. NO. 9984031, DATED 10-24-2011, EXPIRES 5-20-2021.

OWNER OF U.S. REG. NOS. 645,703, 2,985,659 AND OTHERS.

#### CLASS 3—COSMETICS AND CLEANING PREPARATIONS

FOR PERFUME, COLOGNE, AFTERSHAVE, PERSONAL DEODORANTS, COSMETICS, HAIR LOTIONS, SOAPS, ALL OF THE FOREGOING SOLD EXCLUSIVELY THROUGH AUTHORIZED VEHICLE DEALERS AND AUTHORIZED VEHICLE SERVICE OUTLETS (U.S. CLS. 1, 4, 6, 50, 51 AND 52).

**CLASS 21—HOUSEWARES AND GLASS**

FOR ARTICLES OF GLASS, NAMELY, PERFUME BOTTLES AND PERFUME DECANTERS, ALL OF THE FOREGOING SOLD EXCLUSIVELY THROUGH AUTHORIZED VEHICLE DEALERS AND AUTHORIZED VEHICLE SERVICE OUTLETS (U.S. CLS. 2, 13, 23, 29, 30, 33, 40 AND 50).

CHARLES L. JENKINS, EXAMINING ATTORNEY

SN 85-335,804. INSTALLALL, INC., VERNON, BC, CANADA, FILED 6-1-2011.

# installAll

SN 85-332,664. PHILLIPS MACHINE SERVICE, INC., BECKLEY, WV. FILED 5-27-2011.

# PHILLIPS

THE MARK CONSISTS OF STANDARD CHARACTERS WITHOUT CLAIM TO ANY PARTICULAR FONT, STYLE, SIZE, OR COLOR.

OWNER OF U.S. REG. NO. 4,190,843.  
SEC. 2(F).

**CLASS 7—MACHINERY**

FOR MINING MACHINES AND PARTS AND ACCESSORIES FOR USE IN MINING, NAMELY, ROAD HEADERS, CONTINUOUS MINERS, POWER DRILLS, ROOF BOLTERS, COAL MACHINES FOR HAULING OF COAL, EARTH MOVING MACHINES IN THE NATURE OF SCOOP LOADERS USED TO MOVE EARTH AND RAW MATERIALS FOR MINING PURPOSES, FEEDER BREAKERS, BATTERY HAULING MACHINES FOR USE IN MINING, POWER SHEARING MACHINES, PAN LINES, CRUSHERS, WHEEL UNITS NAMELY WHEELS BEING PARTS OF MACHINES, GEAR BOXES BEING PARTS OF MACHINES, PRESSURE REDUCERS AS PARTS OF MACHINES, DRIVES FOR MACHINES, CUTTER DRUMS FOR USE IN MINING MACHINES AND BIT BLOCKS AND BITS FOR MINING MACHINES (U.S. CLS. 13, 19, 21, 23, 31, 34 AND 35).

**CLASS 12—VEHICLES**

FOR SHUTTLE CARS FOR USE IN MINING; VEHICLES FOR HAULING COAL, NAMELY, COAL HAULERS; MANLIFT VEHICLES, NAMELY, PERSONNEL CARRIERS AND MAN TRIPS; VEHICLES, NAMELY, BATTERY HAULERS FOR USE IN MINING; UTILITY VEHICLES, NAMELY, MINING SCOOPS USED TO MOVE EARTH AND RAW MATERIALS FOR MINING PURPOSES (U.S. CLS. 19, 21, 23, 31, 35 AND 44).

**CLASS 42—SCIENTIFIC AND COMPUTER SERVICES**

FOR CUSTOM DESIGN AND DEVELOPMENT OF MINING EQUIPMENT AND PARTS (U.S. CLS. 100 AND 101).

BARNEY CHARLON, EXAMINING ATTORNEY

THE MARK CONSISTS OF STANDARD CHARACTERS WITHOUT CLAIM TO ANY PARTICULAR FONT, STYLE, SIZE, OR COLOR.

PRIORITY CLAIMED UNDER SEC. 44(D) ON CANADA APPLICATION NO. 1506288, FILED 12-2-2010, REG. NO. TMA866914, DATED 12-9-2013, EXPIRES 12-9-2028.

**CLASS 9—ELECTRICAL AND SCIENTIFIC APPARATUS**

FOR COMPUTER INSTALLATION SOFTWARE, NAMELY, AUTOMATED REMOTE SOFTWARE INSTALLER; COMPUTER INSTALLATION SOFTWARE, NAMELY, AUTOMATED REMOTE SOFTWARE INSTALLER PROVIDED VIA CUSTOM-BRANDED PORTALS; COMPUTER SOFTWARE FOR INSTALLATION OF OTHER SOFTWARE AND COMPUTER FILES TO A REMOTE HOST (U.S. CLS. 21, 23, 26, 36 AND 38).

**CLASS 42—SCIENTIFIC AND COMPUTER SERVICES**

FOR PROVIDING NON-DOWNLOADABLE COMPUTER INSTALLATION SOFTWARE, NAMELY, AUTOMATED REMOTE SOFTWARE INSTALLER PROVIDED VIA CUSTOM-BRANDED PORTALS; PROVIDING AN ONLINE SEARCHABLE COMPUTER DATABASE FEATURING THIRD PARTY SOFTWARE AND OTHER COMPUTER FILES FOR WEBSITES; WEBSITE DEVELOPMENT AND DESIGN FOR OTHERS; PROVIDING AN INTERACTIVE WEBSITE FEATURING INFORMATION REGARDING WEBSITE DEVELOPMENT (U.S. CLS. 100 AND 101).

DEIRDRE ROBERTSON, EXAMINING ATTORNEY

SN 85-338,301. RENTOR PRODUCTIONS S.R.L., BOLOGNA, ITALY, FILED S.R. 6-5-2011; AM. P.R. 6-5-2011.

# IL VOLO

THE MARK CONSISTS OF STANDARD CHARACTERS WITHOUT CLAIM TO ANY PARTICULAR FONT, STYLE, SIZE, OR COLOR.

PRIORITY CLAIMED UNDER SEC. 44(D) ON ERPNTY TM OFC APPLICATION NO. 009704107, FILED 2-2-2011, REG. NO. 009704107, DATED 5-25-2011, EXPIRES 2-2-2021.

THE ENGLISH TRANSLATION OF "IL VOLO" IN THE MARK IS "THE FLIGHT".

**CLASS 9—ELECTRICAL AND SCIENTIFIC APPARATUS**

FOR OPTICAL APPARATUS AND INSTRUMENTS, NAMELY, BLANK OPTICAL DATA CARRIERS, SPECTACLES, EYE GLASSES, SUN GLASSES, GOGGLES FOR SPORTS, AND MOTORCYCLE GOGGLES; LIFE-SAVING APPARATUS AND INSTRUMENTS, NAMELY, BICYCLE HELMETS, MOTORCYCLE HELMETS, PROTECTIVE HELMETS FOR SPORTS, AND PROTECTIVE HELMETS; APPARATUS AND DEVICES, NAMELY, COMPUTER SOFTWARE FOR INTEGRATION OF TEXT, AUDIO, GRAPHICS, STILL IMAGES AND MOVING PICTURES INTO AN INTERACTIVE DELIVERY FOR MULTIMEDIA APPLICATIONS; BLANK MAGNETIC DATA CARRIERS; PRERECORDED MAGNETIC DATA CARRIERS, NAMELY, PRERECORDED MAGNETIC DATA CARRIERS FEATURING MUSIC, SINGING, LYRICS, OPERA, AND CONCERTS PERFORMED BY THE IL VOLO MUSICAL GROUP, AND MAGNETIC CODED GIFT CARDS; BLANK RECORDING DISCS; PRERECORDED COMPACT DISCS AND DIGITAL VIDEO DISCS FEATURING MUSIC, SINGING, LYRICS, OPERA, AND CONCERTS PERFORMED BY THE IL VOLO MUSICAL GROUP; DOWNLOADABLE ELECTRONIC PUBLICATIONS IN THE NATURE OF MP3 FILES, DIGITAL MUSIC FILES, COMPUTER DATA FILES, CDS, DVDS, POD CASTS AND MANUALS IN THE FIELDS OF MUSIC, SINGING, LYRICS, OPERA, AND CONCERTS, ALL FOR ENTERTAINMENT PURPOSES AND PREPARED BY, PERFORMED BY, AND SOLELY IN CONNECTION WITH, THE IL VOLO MUSICAL GROUP; ALL OF THE FOREGOING EXCLUDING COMPUTERS AND COMPUTER PERIPHERALS, PHONES, MOBILE PHONES, AND SMARTPHONES (U.S. CLS. 21, 23, 26, 36 AND 38).

**CLASS 16—PAPER GOODS AND PRINTED MATTER**

FOR PAPER, CARDBOARD AND GOODS MADE FROM THESE MATERIALS, NAMELY, BOXES, WRITING PADS; PRINTED MATTER, NAMELY, PHOTO SETS COMPRISED OF PHOTOGRAPHS AND PHOTO ALBUMS, PHOTO ALBUMS, MINI PHOTO ALBUMS, PAPER GIFT CERTIFICATES, POSTERS, MAGAZINES, NEWSLETTERS, AND BROCHURES IN THE FIELD OF MUSIC, SINGING, LYRICS, OPERA, AND CONCERTS PREPARED BY, PERFORMED BY, AND SOLELY RELATING TO THE IL VOLO MUSICAL GROUP; PHOTOGRAPHS; STATIONERY; ARTISTS' MATERIALS, NAMELY, PENS, PENCILS; INSTRUCTIONAL AND TEACHING MATERIAL, EXCEPT APPARATUS, NAMELY, PRINTED INSTRUCTIONAL AND TEACHING MATERIAL IN THE FIELD OF LEARNING MUSIC, MUSIC, SINGING, LYRICS, OPERA, AND CONCERTS PREPARED BY, PERFORMED BY, AND SOLELY RELATING TO THE IL VOLO MUSICAL GROUP, EXCLUDING BOOKS; ALL OF THE FOREGOING EXCLUDING FICTION AND NON-FICTION BOOKS (U.S. CLS. 2, 5, 22, 23, 29, 37, 38 AND 50).

**CLASS 41—EDUCATION AND ENTERTAINMENT**

FOR EDUCATION, NAMELY, PROVIDING CLASSES, SEMINARS, AND WORKSHOPS ABOUT LEARNING MUSIC, MUSIC, SINGING, LYRICS, OPERA, AND CONCERTS; PROVIDING OF TRAINING IN THE FIELD OF MUSIC, SINGING, LYRICS, OPERA, AND CONCERTS; ENTERTAINMENT, NAMELY, ARRANGING AND CONDUCTING LIVE MUSICAL CONCERTS, OPERA, AND RADIO AND TELEVISION PROGRAMS FEATURING OPERA AND CONCERTS THAT ARE BROADCAST VIA TELEVISION, RADIO, SATELLITE, THE INTERNET, OR LIVE; PUBLISHING OF ELECTRONIC PUBLICATIONS IN THE FIELD OF MUSIC, SINGING, LYRICS, OPERA, AND CONCERTS, AND ENTERTAINMENT SERVICES, NAMELY, AN ONGOING SERIES FEATURING MUSIC, SINGING, LYRICS, OPERA, AND CONCERTS PROVIDED THROUGH TELEVISION, CABLE TELEVISION, WEBCASTS, RADIO BROADCASTS, AND POD CASTS; SPORTING AND CULTURAL ACTIVITIES, NAMELY, ORGANIZING COMMUNITY SPORTING AND CULTURAL EVENTS, ORGANIZING SHOWS AND EVENTS FOR CULTURAL PURPOSES (U.S. CLS. 100, 101 AND 107).

JEAN IM, EXAMINING ATTORNEY

SN 85-341,549. LOCUS SCIENCE FICTION FOUNDATION, OAKLAND, CA. FILED 6-8-2011.

# LOCUS

THE MARK CONSISTS OF STANDARD CHARACTERS WITHOUT CLAIM TO ANY PARTICULAR FONT, STYLE, SIZE, OR COLOR.

**CLASS 16—PAPER GOODS AND PRINTED MATTER**

FOR MAGAZINE FEATURING NEWS, REVIEWS, COMMENTARY, AND INFORMATION IN THE FIELDS OF PUBLISHING, SCIENCE FICTION, FANTASY, AND HORROR; BOOKS IN THE FIELDS OF SCIENCE FICTION, FANTASY AND HORROR (U.S. CLS. 2, 5, 22, 23, 29, 37, 38 AND 50).

FIRST USE 4-0-1968; IN COMMERCE 6-27-1968.

**CLASS 41—EDUCATION AND ENTERTAINMENT**

FOR PROVIDING A WEBSITE FEATURING INFORMATION, ELECTRONIC PUBLICATIONS, AND PROVIDING SEARCHABLE COMPUTER DATABASES FOCUSING ON SCIENCE FICTION, FANTASY AND HORROR, AND ALSO CONTAINING AN INDEX TO PUBLICATIONS IN THE FIELDS OF SCIENCE FICTION, FANTASY AND HORROR (U.S. CLS. 100, 101 AND 107).

FIRST USE 4-17-1997; IN COMMERCE 4-17-1997.

MARLENE BELL, EXAMINING ATTORNEY

SN 85-353,086. AMTRAN VIDEO CORPORATION, IRVINE, CA. FILED 6-22-2011.

# AVC AMTRAN VIDEO CORPORATION

THE MARK CONSISTS OF STANDARD CHARACTERS WITHOUT CLAIM TO ANY PARTICULAR FONT, STYLE, SIZE, OR COLOR.

NO CLAIM IS MADE TO THE EXCLUSIVE RIGHT TO USE "VIDEO CORPORATION", APART FROM THE MARK AS SHOWN.

**CLASS 9—ELECTRICAL AND SCIENTIFIC APPARATUS**

FOR STEREOS AND RADIOS; AUDIO SPEAKERS; 3D GLASSES; AND LIQUID CRYSTAL DISPLAY (LCD) MONITORS AND COMPUTER MONITORS (U.S. CLS. 21, 23, 26, 36 AND 38).

**CLASS 11—ENVIRONMENTAL CONTROL APPARATUS**

FOR LED LIGHT BULBS AND LIGHTING FIXTURES (U.S. CLS. 13, 21, 23, 31 AND 34).



**CLASS 35—ADVERTISING AND BUSINESS**

FOR RETAIL STORE SERVICES AND ON-LINE RETAIL STORE SERVICES FEATURING STEREO'S AND RADIOS, AUDIO SPEAKERS, 3D GLASSES, LIQUID CRYSTAL DISPLAY (LCD) MONITORS AND COMPUTER MONITORS, LED LIGHT BULBS, AND LED LIGHTING FIXTURES (U.S. CLS. 100, 101 AND 102).

JULIE GUTTADAURO, EXAMINING ATTORNEY

SN 85-353,118. AMTRAN VIDEO CORPORATION, IRVINE, CA. FILED 6-22-2011.



NO CLAIM IS MADE TO THE EXCLUSIVE RIGHT TO USE "VIDEO CORPORATION", APART FROM THE MARK AS SHOWN.

THE MARK CONSISTS OF THE LETTERS "AVC" IN A STYLIZED FORMAT WITH THE WORDS "AMTRAN VIDEO CORPORATION" UNDERNEATH THE STYLIZED LETTERING.

**CLASS 9—ELECTRICAL AND SCIENTIFIC APPARATUS**

FOR STEREO'S AND RADIOS; AUDIO SPEAKERS; 3D GLASSES; AND LIQUID CRYSTAL DISPLAY (LCD) MONITORS AND COMPUTER MONITORS (U.S. CLS. 21, 23, 26, 36 AND 38).

**CLASS 11—ENVIRONMENTAL CONTROL APPARATUS**

FOR LED LIGHT BULBS AND LIGHTING FIXTURES (U.S. CLS. 13, 21, 23, 31 AND 34).

**CLASS 35—ADVERTISING AND BUSINESS**

FOR RETAIL STORE SERVICES AND ON-LINE RETAIL STORE SERVICES FEATURING STEREO'S AND RADIOS, AUDIO SPEAKERS, 3D GLASSES, LIQUID CRYSTAL DISPLAY (LCD) MONITORS AND COMPUTER MONITORS, LED LIGHT BULBS, AND LED LIGHTING FIXTURES (U.S. CLS. 100, 101 AND 102).

JULIE GUTTADAURO, EXAMINING ATTORNEY

SN 85-373,014. T.G. SERVICES INC, PANAMA CITY, PANAMA, FILED 7-15-2011.

# TOPGAME

THE MARK CONSISTS OF STANDARD CHARACTERS WITHOUT CLAIM TO ANY PARTICULAR FONT, STYLE, SIZE, OR COLOR.

**CLASS 41—EDUCATION AND ENTERTAINMENT**

FOR ENTERTAINMENT SERVICES, NAMELY, PROVIDING TEMPORARY USE OF NON-DOWNLOADABLE COMPUTER GAMES FOR ONLINE GAMING AND ENTERTAINMENT (U.S. CLS. 100, 101 AND 107).

FIRST USE 12-31-2007; IN COMMERCE 12-31-2007.

**CLASS 42—SCIENTIFIC AND COMPUTER SERVICES**

FOR COMPUTER SOFTWARE DEVELOPMENT AND COMPUTER PROGRAMMING DEVELOPMENT FOR OTHERS; MAINTENANCE OF COMPUTER SOFTWARE; PROVIDING TEMPORARY USE OF NON-DOWNLOADABLE COMPUTER SOFTWARE PLATFORMS FOR INTEGRATING AFFILIATE TRACKING SYSTEMS AND PAYMENT SYSTEMS IN THE FIELD OF ON-LINE GAMING AND ENTERTAINMENT (U.S. CLS. 100 AND 101).

FIRST USE 12-31-2007; IN COMMERCE 12-31-2007.

BRIAN CALLAGHAN, EXAMINING ATTORNEY

SN 85-395,304. SCHÜCO INTERNATIONAL KG, BIELEFELD, FED REP GERMANY, FILED 8-11-2011.

# PROSOL

THE MARK CONSISTS OF STANDARD CHARACTERS WITHOUT CLAIM TO ANY PARTICULAR FONT, STYLE, SIZE, OR COLOR.

OWNER OF ERPN CMNTY TM OFC REG. NO. 010388221, DATED 5-15-2012, EXPIRES 11-3-2021.

OWNER OF U.S. REG. NO. 4,297,347.

**CLASS 7—MACHINERY**

FOR SOLAR-POWERED ELECTRICITY GENERATORS (U.S. CLS. 13, 19, 21, 23, 31, 34 AND 35).

**CLASS 9—ELECTRICAL AND SCIENTIFIC APPARATUS**

FOR SOLAR CELL MODULES FOR ELECTRICAL ENERGY PRODUCTION, SOLAR CELLS SOLD AS A COMPONENT OF GLASS COMPONENTS FOR WINDOWS (U.S. CLS. 21, 23, 26, 36 AND 38).

**CLASS 11—ENVIRONMENTAL CONTROL APPARATUS**

FOR SOLAR COLLECTORS SOLD AS A COMPONENT OF GLASS COMPONENTS FOR WINDOWS, SOLAR COLLECTORS, SOLAR-POWERED HEAT GENERATORS (U.S. CLS. 13, 21, 23, 31 AND 34).

**CLASS 19—NON-METALLIC BUILDING MATERIALS**

FOR BUILDING MATERIALS, NAMELY, WINDOWS WITH INTEGRATED SOLAR CELLS AND SOLAR COLLECTORS; ENERGY GENERATING GLASS COMPONENTS FOR WINDOWS FOR BUILDING PURPOSES (U.S. CLS. 1, 12, 33 AND 50).

**CLASS 37—CONSTRUCTION AND REPAIR**

FOR CONSTRUCTION, REPAIR, INSTALLATION AND MAINTENANCE OF EQUIPMENT FOR REGENERATIVE ENERGY GENERATION, ESPECIALLY WITH REGARD TO SOLAR TECHNIQUE, WINDPOWER, GEOTHERMAL ENERGY; CONSTRUCTION CONSULTATION IN THE FIELDS OF REGENERATIVE ENERGY GENERATION, ESPECIALLY WITH REGARD TO SOLAR TECHNIQUE, WINDPOWER, AND GEOTHERMAL ENERGY (U.S. CLS. 100, 103 AND 106).

SN 85-403,776. DELTA DENTAL OF VIRGINIA, ROANOKE, VA. FILED 8-22-2011.

**TROOTH**

THE MARK CONSISTS OF STANDARD CHARACTERS WITHOUT CLAIM TO ANY PARTICULAR FONT, STYLE, SIZE, OR COLOR.

**CLASS 41—EDUCATION AND ENTERTAINMENT**

FOR ORGANIZING AND CONDUCTING OF LECTURES, SEMINARS, SYMPOSIUMS, EDUCATIONAL CONFERENCES, COLLOQUIUMS, TRAINING COURSES, EDUCATIONAL CONGRESSES AND WORKSHOPS IN THE FIELDS OF ENERGY, ENERGY CONSERVATION, ENERGY EFFICIENCY, ENERGY GENERATION, INSTALLATION AND OPERATION OF ENERGY SAVING AND ENERGY GENERATION EQUIPMENT; PUBLICATION OF ELECTRONIC BOOKS AND JOURNALS ONLINE; EDUCATION IN THE FIELDS OF ENERGY EFFICIENCY, ENERGY GENERATION, INSTALLATION AND OPERATION OF ENERGY SAVING AND ENERGY GENERATION EQUIPMENT RENDERED THROUGH CORRESPONDENCE COURSES; VOCATIONAL GUIDANCE; EDUCATION INFORMATION; ENTERTAINMENT AND EDUCATIONAL FAIRS, EXHIBITIONS AND LIVE SHOWS IN THE FIELDS OF ENERGY, ENERGY GENERATION AND ENERGY CONSERVATION (U.S. CLS. 100, 101 AND 107).

**CLASS 36—INSURANCE AND FINANCIAL**

FOR DENTAL INSURANCE UNDERWRITING AND ADMINISTRATION (U.S. CLS. 100, 101 AND 102).

**CLASS 44—MEDICAL, BEAUTY AND AGRICULTURAL SERVICES**

FOR PROVIDING INFORMATION REGARDING ORAL DISEASE AND ITS CAUSES, SYMPTOMS, AND PREVENTION (U.S. CLS. 100 AND 101).

HENRY S. ZAK, EXAMINING ATTORNEY

---

SN 85-404,899. HIFI ENGINEERING INC., CALGARY, AB T2G 5N6, CANADA, FILED 8-23-2011.

**VENTMETER****CLASS 42—SCIENTIFIC AND COMPUTER SERVICES**

FOR SCIENTIFIC AND TECHNOLOGICAL SERVICES, NAMELY, RESEARCH AND DESIGN IN THE FIELDS OF SCIENCES, TECHNOLOGY, ENERGY, ENERGY CONSERVATION, ENERGY EFFICIENCY, ENERGY GENERATION, INSTALLATION AND OPERATION OF ENERGY SAVING AND ENERGY GENERATION EQUIPMENT AND ENERGY ENGINEERING; INDUSTRIAL ANALYSIS AND RESEARCH IN THE FIELDS OF ENERGY, ENERGY CONSERVATION, ENERGY EFFICIENCY, ENERGY GENERATION, INSTALLATION AND OPERATION OF ENERGY SAVING AND ENERGY GENERATION EQUIPMENT; ARCHITECTURAL CONSULTATION; SERVICES OF AN ENGINEER, NAMELY, CONSTRUCTIONAL PLANNING AND CONSULTATION CONCERNING THERMIC AND PHOTOVOLTAIC SOLAR INSTALLATIONS AS WELL AS CONCERNING ENERGY SAVING BUILDING SERVICES; TECHNICAL CONSULTING SERVICES, NAMELY, STUDIES FOR DETERMINING THE EFFECTIVENESS AND EFFICIENCY OF ENERGY GENERATION AND ENERGY CONSERVATION AND STUDIES FOR FACILITATING BUILDINGS WITH ENERGY GENERATION AND ENERGY CONSERVATION TECHNIQUES; SURVEYING; DESIGNING AND DEVELOPING OF COMPUTER HARDWARE AND SOFTWARE; COMPUTER SERVICES, NAMELY, CONVERTING OF DATA OR DOCUMENTS FROM PHYSICAL TO ELECTRONIC MEDIA; TECHNICAL DEVELOPMENT OF MEASURING, SIGNALING, CONTROLLING, SURVEYING AND INSPECTING DEVICES AND INSTALLATIONS FOR THIRD AS WELL AS TECHNICAL CONSULTANCY IN THIS REGARD. ALL AFOREMENTIONED SERVICES ESPECIALLY WITH REGARD TO SOLAR TECHNIQUE (U.S. CLS. 100 AND 101).

DOMINICK J. SALEMI, EXAMINING ATTORNEY

THE MARK CONSISTS OF STANDARD CHARACTERS WITHOUT CLAIM TO ANY PARTICULAR FONT, STYLE, SIZE, OR COLOR.

OWNER OF CANADA REG. NO. TMA859655, DATED 9-9-2013, EXPIRES 9-9-2028.

**CLASS 9—ELECTRICAL AND SCIENTIFIC APPARATUS**

FOR METERING DEVICE USED TO MEASURE AND MONITOR MIGRATING GAS FROM OIL AND GAS WELLS; ELECTRONIC PUBLICATIONS, NAMELY, DATA REPORTS RECORDED ON CD-ROMS AND COMPUTER MEDIA FEATURING INFORMATION ABOUT MIGRATING GAS FROM OIL AND GAS WELLS (U.S. CLS. 21, 23, 26, 36 AND 38).

**CLASS 16—PAPER GOODS AND PRINTED MATTER**

FOR PRINTED MATERIALS, NAMELY, PRINTED FORMS, GRAPHS AND DATA REPORT SHEETS FEATURING INFORMATION ABOUT DOWNHOLE ACOUSTIC MEASUREMENTS (U.S. CLS. 2, 5, 22, 23, 29, 37, 38 AND 50).

**CLASS 45—PERSONAL AND LEGAL SERVICES**

FOR LICENSING OF DOWNHOLE ACOUSTIC SENSORS (U.S. CLS. 100 AND 101).

MICHAEL SOUDERS, EXAMINING ATTORNEY

SN 85-421,845. LAPACO PAPER PRODUCTS LTD., STE-CATHERINE, QUEBEC, CANADA, FILED 9-13-2011.

# LAPACO

THE MARK CONSISTS OF STANDARD CHARACTERS WITHOUT CLAIM TO ANY PARTICULAR FONT, STYLE, SIZE, OR COLOR.

PRIORITY CLAIMED UNDER SEC. 44(D) ON CANADA APPLICATION NO. 1542169, FILED 9-2-2011, REG. NO. TMA844818, DATED 2-26-2013, EXPIRES 2-26-2028.  
OWNER OF U.S. REG. NO. 1,290,997.

## CLASS 16—PAPER GOODS AND PRINTED MATTER

FOR PAPER PRODUCTS, NAMELY, NAPKINS, NAPKIN BANDS, PAPER LACE DOILIES, PRINTED PLACEMATS, EMBOSSED PLACEMATS, PRINTED TRAY COVERS, EMBOSSED TRAY COVERS, FRENCH FRY CONTAINERS, BATHMATS, CAR MATS, BIBS, TUMBLER BAGS, COASTERS, PAPER TABLE LINENS, NAMELY, TABLEWARE NAPKINS, FOLDED TABLE COVERS, PAPER TABLECLOTHS, NAMELY, BANQUET ROLLS, HAIR NETS, GREASE FILTERS, TOILET SEAT BANDS, TOILET SEAT COVERS, AND WET NAPPS (U.S. CLS. 2, 5, 22, 23, 29, 37, 38 AND 50).  
FIRST USE 0-0-1970; IN COMMERCE 0-0-1970.

## CLASS 21—HOUSEWARES AND GLASS

FOR PAPER NAPKIN RINGS; PAPER PLATES; PAPER BAKING CUPS (U.S. CLS. 2, 13, 23, 29, 30, 33, 40 AND 50).  
FIRST USE 0-0-1997; IN COMMERCE 0-0-1997.

## CLASS 25—CLOTHING

FOR CHEF'S HATS; SANITARY CAPS (U.S. CLS. 22 AND 39).

## CLASS 26—FANCY GOODS

FOR PAPER HAIR NETS (U.S. CLS. 37, 39, 40, 42 AND 50).

## CLASS 27—FLOOR COVERINGS

FOR BATH MATS; FLOOR MATS FOR CARS (U.S. CLS. 19, 20, 37, 42 AND 50).  
LINDA M. KING, EXAMINING ATTORNEY

SN 85-433,751. LOVE LINE, INC., HOUSTON, TX. FILED 9-28-2011.



THE MARK CONSISTS OF A STYLIZED KEY THAT HAS A HEART-SHAPED INSET ON THE HANDLE AND THE WORD "AMOR" AS ITS BIT.

## CLASS 14—JEWELRY

FOR JEWELRY (U.S. CLS. 2, 27, 28 AND 50).

## CLASS 25—CLOTHING

FOR CLOTHING, NAMELY, BLOUSES, SHIRTS, JERSEYS, TOPS, SKIRTS, DRESSES, PANTS, JACKETS, SWEATERS, HATS, CAPS, AND BELTS (U.S. CLS. 22 AND 39).

B. PARADEWELAI, EXAMINING ATTORNEY

SN 85-441,013. JUST BE FRIENDS NETWORK INC., REGINA SASKATCHEWAN, CANADA, FILED 10-6-2011.

# JUST BE FRIENDS

THE MARK CONSISTS OF STANDARD CHARACTERS WITHOUT CLAIM TO ANY PARTICULAR FONT, STYLE, SIZE, OR COLOR.

PRIORITY CLAIMED UNDER SEC. 44(D) ON CANADA APPLICATION NO. 1531479, FILED 6-13-2011, REG. NO. TMA854531, DATED 7-4-2013, EXPIRES 7-4-2028.

## CLASS 9—ELECTRICAL AND SCIENTIFIC APPARATUS

FOR DOWNLOADABLE COMPUTER APPLICATION SOFTWARE FOR MOBILE PHONES THAT ALLOWS USERS TO ACCESS INFORMATION VIA THE INTERNET IN THE FIELD OF RELATIONSHIPS, FINANCIAL ADVICE, HISTORY, HEALTH, EXERCISE, BEAUTY, WELLNESS AND FASHION, FAMILY, ARTS, POLITICS, LEISURE, AND WORK, AND INFORMATION ON A WIDE VARIETY OF TOPICS OF GENERAL INTEREST TO WOMEN AND THE GENERAL PUBLIC (U.S. CLS. 21, 23, 26, 36 AND 38).

## CLASS 25—CLOTHING

FOR CASUAL CLOTHING, NAMELY, SHIRTS, PANTS, JACKETS, HATS, SHORTS AND SWEATERS; ATHLETIC CLOTHING, NAMELY, SHIRTS, PANTS, JACKETS, HATS, SHORTS AND SWEATERS (U.S. CLS. 22 AND 39).

**CLASS 35—ADVERTISING AND BUSINESS**

FOR PROVIDING AN ONLINE DIRECTORY INFORMATION SERVICE FEATURING INFORMATION REGARDING A LISTING OF BUSINESSES THAT OFFER SOCIAL NETWORKING SERVICES, ON-LINE FORUMS, BLOGS, AND DISCUSSION GROUPS IN THE FIELDS OF RELATIONSHIPS, FINANCIAL ADVICE, HISTORY, EXERCISE, BEAUTY, WELLNESS, FASHION, HEALTH, FAMILY, ARTS, POLITICS, LEISURE, AND CAREERS; PROMOTING THE GOODS AND SERVICES OF OTHERS OVER GLOBAL COMPUTER AND WIRELESS NETWORKS; PROVIDING AN ONLINE BUSINESS INFORMATION DIRECTORY FEATURING CLOTHING INFORMATION FOR WOMEN ON GLOBAL COMPUTER AND WIRELESS NETWORKS; ONLINE RETAIL STORE SERVICES ON BEHALF OF OTHERS FEATURING CLOTHING, SPECIFICALLY PROVIDED VIA GLOBAL COMPUTER AND WIRELESS NETWORKS; ADVERTISING AND INFORMATION DISTRIBUTION SERVICES, NAMELY, PROVIDING CLASSIFIED ADVERTISING SPACE VIA GLOBAL COMPUTER AND WIRELESS NETWORKS; ELECTRONIC PUBLISHING SERVICES ON BEHALF OF OTHERS FOR PUBLICITY PURPOSES, NAMELY, PUBLICATION OF PUBLICITY MATERIALS IN THE NATURE TEXT, AUDIO, VIDEOS AND GRAPHIC WORKS ONLINE; ORGANIZATION, OPERATION AND SUPERVISION OF AN INCENTIVE ONLINE FREQUENT USER REWARD AND LOYALTY PROGRAM TO PROMOTE THE SALE OF PRODUCTS AND SERVICES OF OTHERS; BUSINESS INFORMATION SERVICES, NAMELY, REPORTING INFORMATION REGARDING ONLINE FREQUENT USER REWARD AND LOYALTY AWARD TRANSACTIONS THAT ARE MADE AVAILABLE TO OTHER COMPANIES FOR COMMERCIAL PURPOSES; ACCOUNT RECONCILIATION ON BEHALF OF OTHERS OF ONLINE FREQUENT USER REWARD AND LOYALTY AWARD TRANSACTIONS (U.S. CLS. 100, 101 AND 102).

SN 85-441,071. JUST BE FRIENDS NETWORK INC., REGINA SASKATCHEWAN, CANADA, FILED 10-6-2011.

**CLASS 38—COMMUNICATION**

FOR VIDEO BROADCASTING SERVICES OVER THE INTERNET OR OTHER COMMUNICATIONS NETWORK; AUDIO BROADCASTING SERVICES OVER THE INTERNET OR OTHER COMMUNICATIONS NETWORK; PROVIDING ACCESS TO DATABASES FEATURING INFORMATION, AUDIO, AND VIDEO VIA WEBSITES, ONLINE FORUMS AND BLOGS OVER THE INTERNET; PROVIDING ELECTRONIC BULLETIN BOARDS FOR TRANSMISSION OF MESSAGES AMONG USERS IN THE FIELD OF RELATIONSHIPS, FINANCIAL ADVICE, HISTORY, EXERCISE, BEAUTY, WELLNESS AND FASHION, HEALTH, FAMILY, ARTS, POLITICS, LEISURE, AND WORK, AND INFORMATION ON A WIDE VARIETY OF TOPICS OF GENERAL INTEREST TO WOMEN AND THE GENERAL PUBLIC (U.S. CLS. 100, 101 AND 104).

PRIORITY CLAIMED UNDER SEC. 44(D) ON CANADA APPLICATION NO. 1531480, FILED 6-13-2011, REG. NO. TMA854667, DATED 7-8-2013, EXPIRES 7-8-2028.

THE MARK CONSISTS OF LOWER CASE LETTERS "JBF" AND THE WORDS "JUST BE FRIENDS" BELOW THE LETTERS "B" AND "F" AND TO THE RIGHT OF THE LOWER PART OF THE LETTER "J". THE WEBSITE ADDRESS "WWW.JUSTBEFRIENDS.CA" IS BELOW THE WORDS "JUST BE FRIENDS".

**CLASS 42—SCIENTIFIC AND COMPUTER SERVICES**

FOR COMPUTER SERVICES, NAMELY, HOSTING ONLINE WEB FACILITIES AND INFORMATION SERVICES IN THE NATURE OF ONLINE SOCIAL NETWORKING WEBSITES FOR WOMEN FOR ORGANIZING AND CONDUCTING COMMUNITY EVENTS ALONG WITH ONLINE MEETINGS AND INTERACTIVE DISCUSSIONS; COMPUTER SERVICES FOR OTHERS IN THE NATURE OF DESIGNING AND HOSTING CUSTOMIZED WEB PAGES AND WEBSITES FEATURING BLOGS WITH USER-DEFINED INFORMATION, PERSONAL PROFILES AND INFORMATION (U.S. CLS. 100 AND 101).

SHAILA LEWIS, EXAMINING ATTORNEY

**CLASS 9—ELECTRICAL AND SCIENTIFIC APPARATUS**

FOR DOWNLOADABLE COMPUTER APPLICATION SOFTWARE FOR MOBILE PHONES THAT ALLOWS USERS TO ACCESS INFORMATION VIA THE INTERNET IN THE FIELD OF RELATIONSHIPS, FINANCIAL ADVICE, HISTORY, HEALTH, EXERCISE, BEAUTY, WELLNESS AND FASHION, FAMILY, ARTS, POLITICS, LEISURE, AND WORK, AND INFORMATION ON A WIDE VARIETY OF TOPICS OF GENERAL INTEREST TO WOMEN AND THE GENERAL PUBLIC (U.S. CLS. 21, 23, 26, 36 AND 38).

**CLASS 25—CLOTHING**

FOR PROMOTIONAL PRODUCTS IN THE NATURE OF CLOTHING FOR MEN, WOMEN AND CHILDREN, NAMELY, HOODED SWEATSHIRTS, CASUAL CLOTHING, ATHLETIC CLOTHING, YOGA SHIRTS, YOGA JACKETS, SOCKS, PANTS, SHORTS, GOLF SHIRTS, BABY ONE PIECES, BASEBALL CAPS, VISORS, AND TOQUES (U.S. CLS. 22 AND 39).

**CLASS 35—ADVERTISING AND BUSINESS**

FOR PROVIDING AN ONLINE DIRECTORY INFORMATION SERVICE FEATURING INFORMATION REGARDING A LISTING OF BUSINESSES THAT OFFER SOCIAL NETWORKING SERVICES, ON-LINE FORUMS, BLOGS, AND DISCUSSION GROUPS IN THE FIELDS OF RELATIONSHIPS, FINANCIAL ADVICE, HISTORY, EXERCISE, BEAUTY, WELLNESS, FASHION, HEALTH, FAMILY, ARTS, POLITICS, LEISURE, AND CAREERS; PROMOTING THE GOODS AND SERVICES OF OTHERS OVER GLOBAL COMPUTER AND WIRELESS NETWORKS; PROVIDING AN ONLINE BUSINESS INFORMATION DIRECTORY FEATURING CLOTHING INFORMATION FOR WOMEN ON GLOBAL COMPUTER AND WIRELESS NETWORKS; ONLINE RETAIL STORE SERVICES ON BEHALF OF OTHERS FEATURING CLOTHING, SPECIFICALLY PROVIDED VIA GLOBAL COMPUTER AND WIRELESS NETWORKS; ADVERTISING AND INFORMATION DISTRIBUTION SERVICES, NAMELY, PROVIDING CLASSIFIED ADVERTISING SPACE VIA GLOBAL COMPUTER AND WIRELESS NETWORKS; ELECTRONIC PUBLISHING SERVICES ON BEHALF OF OTHERS FOR PUBLICITY PURPOSES, NAMELY, PUBLICATION OF PUBLICITY MATERIALS IN THE NATURE TEXT, AUDIO, VIDEOS AND GRAPHIC WORKS ONLINE; ORGANIZATION, OPERATION AND SUPERVISION OF AN INCENTIVE ONLINE FREQUENT USER REWARD AND LOYALTY PROGRAM TO PROMOTE THE SALE OF PRODUCTS AND SERVICES OF OTHERS; BUSINESS INFORMATION SERVICES, NAMELY, REPORTING INFORMATION REGARDING ONLINE FREQUENT USER REWARD AND LOYALTY AWARD TRANSACTIONS THAT ARE MADE AVAILABLE TO OTHER COMPANIES FOR COMMERCIAL PURPOSES; ACCOUNT RECONCILIATION ON BEHALF OF OTHERS OF ONLINE FREQUENT USER REWARD AND LOYALTY AWARD TRANSACTIONS (U.S. CLS. 100, 101 AND 102).

**CLASS 38—COMMUNICATION**

FOR VIDEO BROADCASTING SERVICES OVER THE INTERNET OR OTHER COMMUNICATIONS NETWORK; AUDIO BROADCASTING SERVICES OVER THE INTERNET OR OTHER COMMUNICATIONS NETWORK; PROVIDING ACCESS TO DATABASES FEATURING INFORMATION, AUDIO, AND VIDEO VIA WEBSITES, ONLINE FORUMS AND BLOGS OVER THE INTERNET; PROVIDING ELECTRONIC BULLETIN BOARDS FOR TRANSMISSION OF MESSAGES AMONG USERS IN THE FIELD OF RELATIONSHIPS, FINANCIAL ADVICE, HISTORY, EXERCISE, BEAUTY, WELLNESS AND FASHION, HEALTH, FAMILY, ARTS, POLITICS, LEISURE, AND WORK, AND INFORMATION ON A WIDE VARIETY OF TOPICS OF GENERAL INTEREST TO WOMEN AND THE GENERAL PUBLIC (U.S. CLS. 100, 101 AND 104).

**CLASS 42—SCIENTIFIC AND COMPUTER SERVICES**

FOR COMPUTER SERVICES, NAMELY, HOSTING ONLINE WEB FACILITIES AND INFORMATION SERVICES IN THE NATURE OF ONLINE SOCIAL NETWORKING WEBSITES FOR WOMEN FOR ORGANIZING AND CONDUCTING COMMUNITY EVENTS ALONG WITH ONLINE MEETINGS AND INTERACTIVE DISCUSSIONS; COMPUTER SERVICES FOR OTHERS IN THE NATURE OF DESIGNING AND HOSTING CUSTOMIZED WEB PAGES AND WEBSITES FEATURING BLOGS WITH USER-DEFINED INFORMATION, PERSONAL PROFILES AND INFORMATION (U.S. CLS. 100 AND 101).

SHAILA LEWIS, EXAMINING ATTORNEY

SN 85-442,271. TAKE-TWO INTERACTIVE SOFTWARE, INC., NEW YORK, NY. FILED 10-7-2011.

**ROCKSTAR PASS**

THE MARK CONSISTS OF STANDARD CHARACTERS WITHOUT CLAIM TO ANY PARTICULAR FONT, STYLE, SIZE, OR COLOR.

**CLASS 9—ELECTRICAL AND SCIENTIFIC APPARATUS**

FOR COMPUTER GAME SOFTWARE DOWNLOADABLE FROM A GLOBAL COMPUTER NETWORK (U.S. CLS. 21, 23, 26, 36 AND 38).

FIRST USE 5-30-2011; IN COMMERCE 5-30-2011.

**CLASS 41—EDUCATION AND ENTERTAINMENT**

FOR ENTERTAINMENT SERVICES, NAMELY, PROVIDING A WEBSITE FEATURING INFORMATION IN THE FIELD OF VIDEO GAMES (U.S. CLS. 100, 101 AND 107).

FIRST USE 5-30-2011; IN COMMERCE 5-30-2011.  
BARBARA A. GOLD, EXAMINING ATTORNEY

SN 85-448,215. ACTS 29 NETWORK, SEATTLE, WA. FILED 10-14-2011.

**ACTS 29 NETWORK**

THE MARK CONSISTS OF STANDARD CHARACTERS WITHOUT CLAIM TO ANY PARTICULAR FONT, STYLE, SIZE, OR COLOR.

OWNER OF U.S. REG. NO. 2,335,332.

NO CLAIM IS MADE TO THE EXCLUSIVE RIGHT TO USE "NETWORK", APART FROM THE MARK AS SHOWN.

**CLASS 9—ELECTRICAL AND SCIENTIFIC APPARATUS**

FOR SOUND RECORDINGS FEATURING RELIGIOUS INSTRUCTION; DIGITAL MEDIA, NAMELY, DOWNLOADABLE AUDIO AND VIDEO RECORDINGS FEATURING RELIGIOUS INSTRUCTION (U.S. CLS. 21, 26, 36 AND 38).

FIRST USE 0-0-2004; IN COMMERCE 0-0-2004.

**CLASS 41—EDUCATION AND ENTERTAINMENT**

FOR EDUCATION SERVICES, NAMELY, LECTURES, COURSES OF INSTRUCTION AND WORKSHOPS IN THE FIELD OF THEOLOGY; ON-LINE JOURNALS, NAMELY, BLOGS AND NON-DOWNLOADABLE PUBLICATIONS IN THE NATURE OF ARTICLES IN THE FIELD OF THEOLOGY; PROVIDING ON-LINE NON-DOWNLOADABLE PUBLICATIONS IN THE NATURE OF ARTICLES IN THE FIELD OF THEOLOGY; ARRANGING AND CONDUCTING SPECIAL EVENTS FOR RELIGIOUS INSTRUCTIONAL AND EDUCATIONAL PURPOSES IN THE FIELDS OF CHURCH PLANTING AND CHURCH LEADERSHIP; PROVIDING A WEBSITE FOR PROVIDING INFORMATION ABOUT EDUCATION AND RELATING TO EDUCATIONAL SERVICES IN THE FIELD OF CHURCH PLANTING AND CHURCH LEADERSHIP AND PROVIDING NON-DOWNLOADABLE SOUND AND VIDEO RECORDINGS FEATURING INSTRUCTION, ALL OF A RELIGIOUS NATURE, BUT NOT INCLUDING A SERIAL MAGAZINE OR CHURCH RENEWAL CONFERENCES, SEMINARS OR LESSONS (U.S. CLS. 100, 101 AND 107).

FIRST USE 0-0-2004; IN COMMERCE 0-0-2004.

**CLASS 45—PERSONAL AND LEGAL SERVICES**

FOR CHURCH RELATED SERVICES, NAMELY, MINISTERIAL SERVICES AND EVANGELISTIC SERVICES, NOT INCLUDING CHURCH RENEWAL CONFERENCES, SEMINARS OR LESSONS, ARRANGING AND CONDUCTING SPECIAL EVENTS FOR RELIGIOUS PURPOSES, NAMELY, PROVIDING GATHERINGS FOR CHURCH PLANTERS AND CHURCH LEADERS TO ENHANCE THE SPIRITUAL LIVES OF INDIVIDUALS; PROVIDING A WEBSITE FEATURING INFORMATION ABOUT RELIGION RELATING TO CHURCH PLANTING AND CHURCH LEADERSHIP, BUT NOT INCLUDING A SERIAL MAGAZINE OR CHURCH RENEWAL CONFERENCES, SEMINARS OR LESSONS (U.S. CLS. 100 AND 101).

FIRST USE 0-0-2004; IN COMMERCE 0-0-2004.  
JAY BESCH, EXAMINING ATTORNEY

SN 85-454,471. ZODIAK RIGHTS LIMITED, LONDON, UNITED KINGDOM, FILED 10-24-2011.



PRIORITY CLAIMED UNDER SEC. 44(D) ON UNITED KINGDOM APPLICATION NO. 2595639, FILED 9-23-2011, REG. NO. 2595639, DATED 12-30-2011, EXPIRES 9-23-2021.

THE MARK CONSISTS OF THE STYLIZED WORDS "TICKETY TOC" WITH A GRAPHIC DEPICTION OF MACHINE PARTS.

**CLASS 9—ELECTRICAL AND SCIENTIFIC APPARATUS**

FOR APPARATUS AND INSTRUMENTS FOR CONDUCTING, SWITCHING, TRANSFORMING, ACCUMULATING, REGULATING OR CONTROLLING ELECTRICITY, NAMELY, TRANSFORMERS, ELECTRICAL SWITCHES AND VOLTAGE REGULATORS; PRE-RECORDED DISCS FEATURING CHILDREN'S TELEVISION PROGRAMMES, SERIALS, MOVIES AND CARTOONS; BLANK CDS, CD ROMS, DVDS, MINIDISKS; AUDIO, VIDEO AND AUDIO-VISUAL RECORDINGS FEATURING CHILDREN'S TELEVISION PROGRAMMES, SERIALS, MOVIES AND CARTOONS; CINEMATOGRAPHIC FILMS FEATURING CHILDREN'S TELEVISION PROGRAMMES, SERIALS, MOVIES AND CARTOONS; RECORDINGS OF MUSIC; DATA PROCESSING EQUIPMENT AND COMPUTERS; COMPUTER HARDWARE; COMPUTER FIRMWARE FOR USE IN DATABASE MANAGEMENT; APPARATUS FOR USE IN BROADCASTING, TRANSMISSION, RECEIVING, PROCESSING, REPRODUCING, ENCODING AND DECODING OF RADIO AND TELEVISION PROGRAMS AND DATA, NAMELY, DECODER SOFTWARE, TRANSMITTERS AND ANTENNAE; ELECTRONIC PUBLICATIONS PROVIDED ON-LINE FROM DATABASES OR THE INTERNET, NAMELY, DOWNLOADABLE MAGAZINES, PERIODICALS, BOOKS OR NEWSLETTERS IN THE FIELD OF CHILDREN'S ENTERTAINMENT; COMPUTER SOFTWARE FOR CONNECTING TELECOMMUNICATIONS APPARATUS TO THE INTERNET; BINOCULARS; MAGNETS; SUNGLASSES; SUNGLASSES CASES; AUTOMATIC VENDING MACHINES INCLUDING TICKET VENDING MACHINES AND DISPENSERS; GRADUATED RULERS; AND COMPONENT PARTS AND FITTINGS FOR ALL THE AFORESAID GOODS (U.S. CLS. 21, 23, 26, 36 AND 38).

**CLASS 18—LEATHER GOODS**

FOR CARRIER BAGS, NAMELY, ALL-PURPOSE CARRY BAGS; SPORTS BAGS (U.S. CLS. 1, 2, 3, 22 AND 41).

**CLASS 28—TOYS AND SPORTING GOODS**

FOR GAMES AND PLAYTHINGS, NAMELY, ACTION FIGURES AND DOLLS; GYMNASTIC AND SPORTING ARTICLES NOT INCLUDED IN OTHER CLASSES, NAMELY, SKITTLES; HAND-HELD COMPUTER GAMES EQUIPMENT WHICH IS SELF CONTAINED AND NOT ADAPTED FOR USE WITH TV RECEIVERS; ELECTRONIC ACTION TOYS; ELECTRONIC LEARNING TOYS; ARCADE-TYPE ELECTRONIC VIDEO GAMES; ELECTRONIC DART GAMES; DOLLS AND DOLLS' CLOTHING; ACCESSORIES FOR DOLLS; DOLLS' HOUSES; DOLLS' FURNITURE; DOLLS' FURNITURE ACCESSORIES; TEDDY BEARS; TOY ACTION FIGURES; TOY VEHICLES; SCALE MODEL VEHICLES; TOY BUILDING STRUCTURES AND TOY VEHICLE TRACKS; SOFT TOYS; PLUSH TOYS; PLAY SETS FOR ACTION FIGURES; ROLE PLAYING TOYS IN THE NATURE OF PLAY SETS WITH PLAY CASES FOR CHILDREN TO IMITATE REAL LIFE OCCUPATIONS; BALLOONS; PLAYING CARDS; NOVELTIES FOR PLAYING JOKES AND FOR PARTIES, NAMELY, FAKE TEETH AND TOY MASKS; TOY FACE MASKS; PUZZLES; COSTUME MASKS; DECORATIONS FOR CHRISTMAS TREES; SKATEBOARDS; SKATES; SKATING BOOTS WITH SKATES ATTACHED; CASES SPECIALLY ADAPTED FOR CARRYING SPORTS ARTICLES, NAMELY, GOLF, SOCCER, BASEBALL, SOFTBALL, LACROSSE AND RUNNING EQUIPMENT; GOLF GLOVES; GLOVES FOR GAMES, NAMELY, LACROSSE GLOVES, SOFTBALL GLOVES, RUNNING GLOVES AND WATER SKIING GLOVES; PUPPETS; MARIONETTES; PLAYING BALLS; KITES; BATS FOR GAMES; SPORTS BALLS; MARBLES; COMPONENT PARTS AND FITTINGS FOR ALL THE AFORESAID GOODS (U.S. CLS. 22, 23, 38 AND 50).

**CLASS 35—ADVERTISING AND BUSINESS**

FOR PUBLICATION OF PUBLICITY TEXTS (U.S. CLS. 100, 101 AND 102).

**CLASS 38—COMMUNICATION**

FOR TELECOMMUNICATIONS SERVICES, NAMELY, E-MAIL SERVICES; PROVIDING USER ACCESS TO THE INTERNET; AUDIO AND VIDEO BROADCASTING SERVICES; RADIO BROADCASTING SERVICES; TELEVISION BROADCASTING SERVICES; INTERNET BROADCASTING SERVICES; WEBCASTING SERVICES; ELECTRONIC COMMUNICATION SERVICES, NAMELY, INFORMATION TRANSMISSION VIA ELECTRONIC COMMUNICATIONS NETWORKS; ELECTRONIC TRANSMISSION OF MESSAGES, DATA AND CONTENT VIA THE INTERNET AND OTHER COMPUTER AND COMMUNICATIONS NETWORKS; PROVIDING ONLINE FORUMS, CHAT ROOMS AND LISTSERVICES FOR THE TRANSMISSION OF MESSAGES, COMMENTS AND MULTIMEDIA CONTENT AMONG USERS IN THE FIELD OF ENTERTAINMENT; PROVIDING ACCESS TO DATABASES; ELECTRONIC TRANSMISSION OF ELECTRONIC MEDIA, MULTIMEDIA CONTENT, VIDEOS, MOVIES, PICTURES, IMAGES, TEXT, PHOTOS, GAMES, USER-GENERATED CONTENT, AUDIO CONTENT, AND INFORMATION VIA THE INTERNET AND OTHER COMPUTER AND COMMUNICATIONS NETWORKS; PROVIDING ONLINE COMMUNITY FORUMS FOR THE TRANSMISSION OF MESSAGES BY USERS WHO POST, SEARCH, WATCH, SHARE, CRITIQUE, RATE, AND COMMENT ON, VIDEOS, AND OTHER MULTIMEDIA CONTENT IN THE FIELD OF ENTERTAINMENT; AUDIO AND VIDEO BROADCASTING SERVICES IN THE NATURE OF PROVIDING DIGITAL PROGRAM DISTRIBUTION OF AUDIO AND VIDEO BROADCASTS OVER A GLOBAL COMPUTER NETWORK (U.S. CLS. 100, 101 AND 104).

**CLASS 42—SCIENTIFIC AND COMPUTER SERVICES**

FOR PROVIDING A VIDEO SHARING PORTAL, NAMELY, PROVIDING A WEB SITE THAT GIVES COMPUTER USERS THE ABILITY TO UPLOAD, EXCHANGE AND SHARE VIDEOS AND VIDEO LOGS (U.S. CLS. 100 AND 101).

TRACY FLETCHER, EXAMINING ATTORNEY

SN 85-492,236, NCH MANAGEMENT SYSTEMS, INC., DBA NEW CENTURY HEALTH, BREA, CA. FILED 12-10-2011.



NO CLAIM IS MADE TO THE EXCLUSIVE RIGHT TO USE "HEALTH", APART FROM THE MARK AS SHOWN. THE COLOR(S) BLUE, GREEN AND WHITE IS/ARE CLAIMED AS A FEATURE OF THE MARK.

THE MARK CONSISTS OF THE STYLIZED TERMS "NEW CENTURY HEALTH" IN BLUE. ABOVE THE TERM "HEALTH" IS A STYLIZED DESIGN OF A BLUE AND WHITE CHECK MARK IN A GREEN BOX.

**CLASS 35—ADVERTISING AND BUSINESS**

FOR HEALTH CARE COST CONTAINMENT; HEALTH CARE COST REVIEW; HEALTH CARE UTILIZATION AND REVIEW SERVICES; MANAGED CARE SERVICES, NAMELY, ELECTRONIC PROCESSING OF HEALTH CARE INFORMATION (U.S. CLS. 100, 101 AND 102).

FIRST USE 4-22-2011; IN COMMERCE 4-22-2011.

**CLASS 36—INSURANCE AND FINANCIAL**

FOR CLAIMS ADMINISTRATION SERVICES IN THE FIELD OF HEALTH INSURANCE (U.S. CLS. 100, 101 AND 102).

FIRST USE 4-22-2011; IN COMMERCE 4-22-2011.

**CLASS 44—MEDICAL, BEAUTY AND AGRICULTURAL SERVICES**

FOR HEALTH CARE; HEALTH CARE SERVICES, NAMELY, PROVIDING A DATABASE IN THE FIELD OF SPECIALTY CARE MANAGEMENT INFORMATION AND FEATURING INPUTTING AND COLLECTION OF DATA AND INFORMATION ALL FOR TREATMENT AND DIAGNOSTIC PURPOSES; MANAGED HEALTH CARE SERVICES (U.S. CLS. 100 AND 101).

FIRST USE 4-22-2011; IN COMMERCE 4-22-2011.

JOHN GARTNER, EXAMINING ATTORNEY

SN 85-517,132, PARTICLE MEASURING SYSTEMS, INC., DBA PARTICLE MEASURING SYSTEMS, INC., BOULDER, CO. FILED 1-16-2012.

**PARTICLE COLLEGE**

THE MARK CONSISTS OF STANDARD CHARACTERS WITHOUT CLAIM TO ANY PARTICULAR FONT, STYLE, SIZE, OR COLOR.

SEC. 2(F).

**CLASS 16—PAPER GOODS AND PRINTED MATTER**

FOR WRITTEN MATERIALS, NAMELY, INSTRUCTIONAL AND TEACHING MATERIALS RELATING TO PARTICLE DETECTION, SIZING, COUNTING, CONTAMINATION MONITORING, INSTRUMENTATION AND/OR TECHNIQUES FOR PARTICLE ANALYSIS (U.S. CLS. 2, 5, 22, 23, 29, 37, 38 AND 50).

FIRST USE 3-16-2000; IN COMMERCE 3-16-2000.

**CLASS 41—EDUCATION AND ENTERTAINMENT**

FOR PROVIDING A WEBSITE FEATURING NON-DOWNLOADABLE EDUCATIONAL MATERIALS, NAMELY, INSTRUCTIONAL AND TEACHING MATERIALS RELATING TO PARTICLE DETECTION, SIZING, COUNTING, CONTAMINATION MONITORING, INSTRUMENTATION AND/OR TECHNIQUES FOR PARTICLE ANALYSIS (U.S. CLS. 100, 101 AND 107).

FIRST USE 3-16-2000; IN COMMERCE 3-16-2000.

LINDSEY BEN, EXAMINING ATTORNEY

SN 85-523,161, BUDNITZ BICYCLES LLC, BOULDER, CO. FILED 1-23-2012.



THE MARK CONSISTS OF A STYLIZED LETTER "B" INSIDE A DIAMOND AND THE NAME "BUDNITZ".

**CLASS 12—VEHICLES**

FOR BICYCLE BELLS; BICYCLE BRAKES; BICYCLE CARRIERS FOR VEHICLES; BICYCLE CHAINS; BICYCLE FRAMES AND BICYCLE HANDLEBAR GRIPS; BICYCLE GEARS; BICYCLE HANDLEBAR GRIPS; BICYCLE KICKSTANDS; BICYCLE PARTS, NAMELY, BRAKE SHOES; BICYCLE PARTS, NAMELY, CHANGE-SPEED GEARS; BICYCLE PARTS, NAMELY, DERAILLEURS; BICYCLE PARTS, NAMELY, DISK WHEELS; BICYCLE PARTS, NAMELY, DRIVE CHAINS; BICYCLE PARTS, NAMELY, DRIVE TRAINS; BICYCLE PARTS, NAMELY, FORK CROWN COVERS; BICYCLE PARTS, NAMELY, FRONT FORK JOINTS; BICYCLE PARTS, NAMELY, GEAR WHEELS; BICYCLE PARTS, NAMELY, HANDLE BAR ENDS; BICYCLE PEDALS; BICYCLE SADDLES; BICYCLE SEATS; BICYCLE WATER BOTTLE CAGES; BICYCLE WHEELS; BICYCLE WHEELS, RIMS AND STRUCTURAL PARTS THEREFOR; BICYCLE-MOUNTED PET SEAT; CELL PHONE CASES ADAPTED FOR BICYCLES; COMPONENTS FOR BICYCLES, NAMELY, HEADSETS WHICH PROVIDE A ROTATABLE INTERFACE BETWEEN THE BICYCLE FORK AND THE BICYCLE FRAME; DELIVERY BICYCLES; FITTED BICYCLE COVERS; FRAMES FOR BICYCLES; FRAMES, FOR LUGGAGE CARRIERS, FOR BICYCLES; FRONT AND REAR BICYCLE RACK PACKS; GEAR LEVERS FOR BICYCLE WHEELS; INNER TUBES FOR BICYCLES; MOUNTAIN BICYCLES; MUDGUARDS; PANNIER BAGS FOR BICYCLES; RACING BICYCLES; RIMS FOR BICYCLE WHEELS; ROAD RACING BICYCLES; SADDLE COVERS FOR BICYCLES; SADDLEBAGS FOR BICYCLES; SADDLES FOR BICYCLES; SAFETY PADS FOR BICYCLES; SHOCK ABSORBERS FOR BICYCLES; SPOKE CLIPS FOR BICYCLE WHEELS; SPOKES FOR BICYCLE WHEELS; STRUCTURAL PARTS OF BICYCLES; TANDEM BICYCLES; TIRE INFLATORS; TIRES; TIRES FOR CHILDREN'S BICYCLES; TOURING BICYCLES; WATER BOTTLE CAGES FOR BICYCLES; WATER BOTTLE HOLDERS FOR BICYCLES; WHEEL HUBS; WHEEL RIMS; WHEELS FOR BICYCLES (U.S. CLS. 19, 21, 23, 31, 35 AND 44).

**CLASS 25—CLOTHING**

FOR BELTS; BICYCLE GLOVES; BICYCLING GLOVES; CLOTHING, NAMELY, ATHLETIC SLEEVES; CLOTHING, NAMELY, NECK TUBES; CLOTHING, NAMELY, WRAP-AROUNDS; GLOVES FOR APPAREL; HEADBANDS FOR CLOTHING; HOODS; JACKETS; JERSEYS; LEATHER BELTS; TIES; TOPS; TRAVEL CLOTHING CONTAINED IN A PACKAGE COMPRISING REVERSIBLE JACKETS, PANTS, SKIRTS, TOPS AND A BELT OR SCARF; TRIATHLON CLOTHING, NAMELY, TRIATHLON TIGHTS, TRIATHLON SHORTS, TRIATHLON SINGLET, TRIATHLON SHIRTS, TRIATHLON SUITS; UNDERARM CLOTHING SHIELDS; WEARABLE GARMENTS AND CLOTHING, NAMELY, SHIRTS; WOMEN'S CLOTHING, NAMELY, SHIRTS, DRESSES, SKIRTS, BLOUSES; WRIST BANDS (U.S. CLS. 22 AND 39).

RUDY R. SINGLETON, EXAMINING ATTORNEY

SN 85-523,388. DE ROBLIN, INC., CITY OF INDUSTRY, CA.  
FILED 1-24-2012.

# MIA SECRET

THE MARK CONSISTS OF STANDARD CHARACTERS WITHOUT CLAIM TO ANY PARTICULAR FONT, STYLE, SIZE, OR COLOR.

OWNER OF U.S. REG. NOS. 3,338,658, 3,980,489 AND 3,980,575.

THE ENGLISH TRANSLATION OF "MIA" IN THE MARK IS "MY".

**CLASS 3—COSMETICS AND CLEANING PREPARATIONS**

FOR COSMETICS; ADHESIVES FOR AFFIXING FALSE EYELASHES, FALSE EYELASHES, HAIR AND NAILS, FALSE NAILS; NAIL CARE PREPARATIONS, NAMELY, NAIL CONDITIONER; NAIL-POLISH CORRECTOR PEN; FALSE NAILS, NAMELY, ACRYLIC ARTIFICIAL NAILS IN LIQUID FORM; FALSE NAILS, NAMELY, ACRYLIC ARTIFICIAL NAILS IN POWDER FORM; LOTIONS FOR STRENGTHENING THE NAILS, NAIL CARE PREPARATIONS, NAIL BUFFING PREPARATIONS, NAIL CARE PREPARATIONS, NAMELY, NAIL SOFTENERS; NAIL CREAM; NAIL ENAMEL; NAIL ENAMELS; NAIL GLITTER; NAIL GROOMING PRODUCTS, NAMELY, TIPS, GLUE, LACQUER AND GLITTER; NAIL HARDENERS; NAIL POLISH; NAIL POLISH BASE COAT; NAIL POLISH REMOVER; NAIL POLISH TOP COAT; NAIL STENCILS; NAIL STRENGTHENERS; NAIL TIPS; NAIL VARNISH FOR COSMETIC PURPOSES; GEL NAIL POLISH, TINT NAIL POLISH; GLITTER NAIL POLISH; AND ULTRA VIOLET GEL NAIL POLISH; ULTRA VIOLET NAIL POWDER; NAIL ART LINER, GEL EYE MASKS; ACRYLIC NAIL HARDENERS; GLITTER FOR COSMETIC PURPOSES; FINGERNAIL DECALS AND STICKERS FOR COSMETIC OR NAIL ART PURPOSES; BEADS FOR NAIL ART PURPOSES; NAIL PAINT FOR NAIL ART PURPOSES; COLORING PENS FOR NAIL ART PURPOSES; NAIL TAPE FOR NAIL ART PURPOSES; STRIPING TAPE FOR NAIL ART PURPOSES; NAIL WRAPS FOR NAIL REPAIR PURPOSES, NAIL CARE PREPARATIONS; COLORING PREPARATIONS FOR COSMETIC PURPOSES; NAIL CARE OILS; CUTICLE REMOVER; ACETONE FOR COSMETIC PURPOSES, NAMELY, ACETONE FOR NAIL POLISH REMOVAL, ARTIFICIAL NAILS; NAIL ART KITS CONSISTING OF ADHESIVES, GLITTER AND DECORATIVE ADHESIVE DECALS; PREPARATIONS FOR FORMING ARTIFICIAL NAILS, NAMELY, ACRYLIC NAIL MAKER AND SCULPTURE GEL; NAIL ART DECALS, NAMELY, CRUSHED SEA SHELL, ICE POLYESTER FILM, METALLIC BEAD, GIMO, AND DRY FLOWERS, MOOD COLOR CHANGING NAIL POLISH; FALSE NAIL EXTENSIONS TIPS; NAIL ART DROPPER; FINGERNAIL COSMETICS KIT CONTAINING FINGER REST, NAIL POLISH, FALSE NAILS, NAIL GLITTER, NAIL DECALS, NAIL STAMP DEVICE, NAIL SEQUINS, AND EMERY BOARD; PUMICE PADS FOR PERSONAL USE (U.S. CLS. 1, 4, 6, 50, 51 AND 52).

FIRST USE 12-0-2006; IN COMMERCE 12-0-2006.

**CLASS 8—HAND TOOLS**

FOR NAIL CLIPPERS; NAIL TIP CUTTER; ELECTRIC MANICURE SET; CUTICLE SCISSORS; CUTICLE PUSHER, NIPPERS, AND SCISSORS; EYELASH SEPARATORS; EYELASH CURLERS; HAND TOOLS, NAMELY, STONE PICKERS FOR DECORATING FINGERNAILS; FOOT CARE IMPLEMENTS; NAMELY, FOOT FILES, CALLUS CUTTERS AND RASPS, CERAMIC FOOT FILES, DOTTING TOOLS FOR DECORATING FINGERNAILS; NAIL NIPPERS; NAIL BUFFERS; RAZORS; MANICURE IMPLEMENTS, NAMELY, WOODEN STICKS; TWEEZERS; HAIR CUTTING SCISSORS; HAND TOOLS, NAMELY, ENGRAVERS AND EAR PIERCING DRILLS FOR COSMETIC PURPOSES; FINGERNAIL FILES; EAR PIERCING DRILL; AND CORN PLANER; HAND TOOLS, NAMELY, NAIL SETS; MANICURE IMPLEMENTS, NAMELY, NAIL FILES, NAIL CLIPPERS, CUTICLE PUSHERS, TWEEZERS, NAIL AND CUTICLE SCISSORS; NON-ELECTRIC NAIL BUFFERS; NAIL NIPPERS; NAIL SCISSORS; NAIL SKIN TREATMENT TRIMMERS; PEDICURE IMPLEMENTS, NAMELY, NAIL FILES, NAIL CLIPPERS, CUTICLE PUSHERS, TWEEZERS, NAIL AND CUTICLE SCISSORS; PERSONAL CARE TOOLS AND IMPLEMENTS, NAMELY, NAIL FILES, NAIL CLIPPERS, CUTICLE PUSHERS, TWEEZERS, NAIL AND CUTICLE SCISSORS; FINGER REST (U.S. CLS. 23, 28 AND 44).

FIRST USE 12-0-2006; IN COMMERCE 12-0-2006.



**CLASS 11—ENVIRONMENTAL CONTROL APPARATUS**

FOR ULTRA VIOLET LAMP NOT FOR MEDICAL PURPOSES; LIGHT BULBS FOR MANICURE EQUIPMENT AND SKINCARE EQUIPMENT; FACE AND HAIR STEAMERS FOR BEAUTY SALON USE; ELECTRIC FANS; LOTION WARMING MACHINES; LAMPS, NAMELY, INFRARED SKIN CARE MAGNIFYING UV AND TABULTRA VIOLET LAMP NOT FOR MEDICAL PURPOSES; LIGHT BULBS FOR MANICURE EQUIPMENT AND SKINCARE EQUIPMENT; FACE AND HAIR STEAMERS FOR BEAUTY SALON USE; ELECTRIC FANS; LOTION WARMING MACHINES; LAMPS, NAMELY, INFRARED SKIN CARE MAGNIFYING UV AND TABLE; WAX WARMER MACHINES; FINGERNAIL SALON EQUIPMENT, MACHINERY AND SALON WARE, NAMELY, DRYERS CONTAINING UV LIGHT, HEATERS, ELECTRONIC SENSORS, TIMERS AND A FAN FOR USE IN DRYING FINGERNAILS, POLISH, GELS AND FINGERNAIL TREATMENTS; ULTRASONIC ARTIFICIAL NAIL REMOVERS; ACETONE WARMER MACHINES TO AID IN REMOVING ARTIFICIAL FINGERNAILS; SANITIZER BOXES AND MINI-SANITIZERS USED TO STORE, CLEAN AND DISINFECT TOOLS AND IMPLEMENTS USED IN THE TREATMENT AND REMOVAL OF ARTIFICIAL FINGERNAILS; ELECTRIC TOWEL STEAMERS WITH UV LIGHTS; PERSONAL CARE FOOT SPA LE; WAX WARMER MACHINES; FINGERNAIL SALON EQUIPMENT, MACHINERY AND SALON WARE, NAMELY, DRYERS CONTAINING UV LIGHT, HEATERS, ELECTRONIC SENSORS, TIMERS AND A FAN FOR USE IN DRYING FINGERNAILS, POLISH, GELS AND FINGERNAIL TREATMENTS; ULTRASONIC ARTIFICIAL NAIL REMOVERS, NAMELY, A ULTRASOUND DEVICE; ACETONE WARMER MACHINES TO AID IN REMOVING ARTIFICIAL FINGERNAILS; SANITIZER BOXES AND MINI-SANITIZERS USED TO STORE, CLEAN AND DISINFECT TOOLS AND IMPLEMENTS USED IN THE TREATMENT AND REMOVAL OF ARTIFICIAL FINGERNAILS; ELECTRIC TOWEL STEAMERS WITH UV LIGHTS; PORTABLE FOOT BATHS FOR USE IN PEDICURE SALONS AND DAY SPAS (U.S. CLS. 13, 21, 23, 31 AND 34).

FIRST USE 12-0-2006; IN COMMERCE 12-0-2006.

**CLASS 20—FURNITURE AND ARTICLES NOT OTHERWISE CLASSIFIED**

FOR FOAM TOE SEPARATORS FOR USE IN PEDICURES; BEAUTY SALON FURNITURE, NAMELY, ARM REST FOR MANICURE PURPOSES (U.S. CLS. 2, 13, 22, 25, 32 AND 50).

FIRST USE 12-0-2006; IN COMMERCE 12-0-2006.

**CLASS 21—HOUSEWARES AND GLASS**

FOR NAIL BRUSHES; EYELASH FORMERS; HAIR BRUSHES; DUSTING BRUSHES; FACIAL BRUSHES FOR COSMETIC PURPOSES; NAIL ART BRUSHES; MANICURE BRUSH; GEL BRUSH FOR FINGERNAILS; ACCESSORIES FOR FINGERNAIL SALONS, NAMELY, MANUALLY ACTUATED PUMP DISPENSERS FOR ATTACHMENT TO CONTAINERS FOR USE IN DISPENSING ACETONE AND LOTION; ACRYLIC JARS AND JAR HOLDERS, NON-METALLIC IMPLEMENT TRAYS, NON-METALLIC ORGANIZER TRAYS, SOAKING BOWLS, NON-METALLIC SOAKING TRAY, REPLACEMENT NAIL BRUSHES, AND DUST BRUSHES; DAPPEN DISHES FOR USE IN APPLYING ARTIFICIAL NAILS; DROPPERS SOLD EMPTY FOR COSMETIC PURPOSES; PLASTIC STORAGE CONTAINERS FOR COSMETIC GOODS; DISPOSABLE LATEX GLOVES FOR GENERAL USE; PLASTIC STORAGE CONTAINER FOR NAIL POLISH; PLASTIC STORAGE CONTAINER FOR NAIL BRUSHES; COTTON BALL DISPENSER (U.S. CLS. 2, 13, 23, 29, 30, 33, 40 AND 50).

FIRST USE 12-0-2006; IN COMMERCE 12-0-2006.

**CLASS 35—ADVERTISING AND BUSINESS**

FOR ONLINE RETAIL STORE SERVICES FEATURING COSMETICS AND ACCESSORIES THEREOF, NAIL CARE PRODUCTS AND ACCESSORIES THEREOF, AND SALON EQUIPMENT AND ACCESSORIES THEREOF; RETAIL STORE SERVICES FEATURING COSMETICS AND ACCESSORIES THEREOF, NAIL CARE PRODUCTS AND ACCESSORIES THEREOF, AND SALON EQUIPMENT AND ACCESSORIES THEREOF (U.S. CLS. 100, 101 AND 102).

FIRST USE 12-0-2006; IN COMMERCE 12-0-2006.

LINDA ORNDORFF, EXAMINING ATTORNEY

SN 85-527,160. RADIANT MEDIA, LLC, BENTONVILLE, VA.  
FILED 1-27-2012.

**RADIANT MEDIA**

THE MARK CONSISTS OF STANDARD CHARACTERS WITHOUT CLAIM TO ANY PARTICULAR FONT, STYLE, SIZE, OR COLOR.

NO CLAIM IS MADE TO THE EXCLUSIVE RIGHT TO USE "MEDIA", APART FROM THE MARK AS SHOWN.

**CLASS 9—ELECTRICAL AND SCIENTIFIC APPARATUS**

FOR HAND-HELD COMPUTERS; PERSONAL DIGITAL ASSISTANTS; GLOBAL POSITIONING SYSTEM (GPS) DEVICES; ELECTRONIC ORGANIZERS AND ELECTRONIC NOTEPADS; PERSONAL COMPUTERS; COMPUTER PROGRAMS FOR ACCESSING, BROWSING AND SEARCHING ONLINE DATABASES (U.S. CLS. 21, 23, 26, 36 AND 38).

**CLASS 35—ADVERTISING AND BUSINESS**

FOR PROVIDING AN ONLINE INTERACTIVE WEBSITE OBTAINING USERS' COMMENTS CONCERNING CONSUMER INFORMATION ABOUT BUSINESSES, SERVICE PROVIDERS, EVENTS, PUBLIC SERVICES AND GOVERNMENT AGENCIES, PARKS AND RECREATIONAL AREAS, RELIGIOUS AND NON-PROFIT ORGANIZATIONS; PROVIDING CONSUMER INFORMATION, NAMELY, COMPILATIONS, RANKINGS, RATINGS, REVIEWS, REFERRALS AND RECOMMENDATIONS RELATING TO BUSINESS ORGANIZATIONS AND SERVICE PROVIDERS, USING A GLOBAL COMPUTER NETWORK; PROVIDING TELEPHONE DIRECTORY INFORMATION VIA GLOBAL COMMUNICATIONS NETWORKS; ADVERTISING AND COMMERCIAL INFORMATION SERVICES, VIA THE INTERNET; ADVERTISING VIA ELECTRONIC MEDIA AND SPECIFICALLY THE INTERNET; MARKET MANIPULATION, RESEARCH AND ANALYSIS; PROVIDING AND RENTAL OF ADVERTISING SPACE ON THE INTERNET; PROVIDING CONSUMER PRODUCT INFORMATION VIA THE INTERNET; PROVIDING ADVISORY AND CONSULTANCY SERVICES RELATING TO ALL THE AFORESAID (U.S. CLS. 100, 101 AND 102).

**CLASS 41—EDUCATION AND ENTERTAINMENT**

FOR ENTERTAINMENT SERVICES NAMELY, PROVIDING ONLINE COMPUTER DATABASES FEATURING INFORMATION IN THE FIELDS OF ENTERTAINMENT, CURRENT EVENT NEWS, SPORTS, AND PUBLICATIONS, ENTERTAINMENT SERVICES, NAMELY, PROVIDING NON-DOWNLOADABLE PRE-RECORDED MUSIC, AUDIO, VIDEO AND GRAPHICS VIA A GLOBAL COMPUTER NETWORK AND WIRELESS NETWORKS; EDUCATION SERVICES IN THE NATURE OF COURSES AT THE UNIVERSITY LEVEL OFFERED IN PERSON AND OVER COMPUTER NETWORKS; EDUCATION SERVICES, NAMELY, PROVIDING KINDERGARTEN THROUGH 12TH GRADE (K-12) CLASSROOM INSTRUCTION OFFERED IN PERSON AND OVER COMPUTER NETWORKS; ENTERTAINMENT AND EDUCATIONAL SERVICES, NAMELY, PROVIDING ONLINE PUBLICATIONS, NAMELY, ELECTRONIC BOOKS, MAGAZINES, NEWSPAPERS, JOURNALS, PERIODICALS, AND MANUALS, ALL IN THE FIELDS OF ENTERTAINMENT, NEWS, WEATHER, CURRENT EVENTS, HISTORY, SPORTS, GAMES, HOBBIES, PUBLICATIONS, AND TOPICS OF GENERAL INTEREST; ENTERTAINMENT AND EDUCATIONAL SERVICES, NAMELY, PROVIDING PODCASTS IN THE FIELDS OF ENTERTAINMENT, NEWS, WEATHER, CURRENT EVENTS, HISTORY, SPORTS, GAMES, HOBBIES, PUBLICATIONS, AND TOPICS OF GENERAL INTEREST; EDUCATIONAL SERVICES, NAMELY, PROVIDING DISPLAYS AND EXHIBITS IN THE FIELDS OF ENTERTAINMENT, NEWS, WEATHER, CURRENT EVENTS, HISTORY, SPORTS, GAMES, HOBBIES, AND PUBLICATIONS; EDUCATIONAL SERVICES, NAMELY, ARRANGING AND CONDUCTING WORKSHOPS, SEMINARS, CONFERENCES, AND LECTURES IN THE FIELDS OF ENTERTAINMENT, NEWS, WEATHER, CURRENT EVENTS, HISTORY, SPORTS, GAMES, HOBBIES, AND PUBLICATIONS; PROVIDING ADVISORY AND CONSULTANCY SERVICES RELATING TO ALL THE AFORESAID (U.S. CLS. 100, 101 AND 107).

**CLASS 45—PERSONAL AND LEGAL SERVICES**

FOR PROVIDING ONLINE SOCIAL NETWORKING (U.S. CLS. 100 AND 101).  
TEJBIR SINGH, EXAMINING ATTORNEY

SN 85-529,806. SURFER GIRL INTERNATIONAL PTY LTD,  
CARLTON VICTORIA, AUSTRALIA, FILED 1-31-2012.



NO CLAIM IS MADE TO THE EXCLUSIVE RIGHT TO USE "SURFERGIRL" WITH RESPECT TO THE FOLLOWING GOODS IN CLASS 9 "EYEGLASS CASES; EYEGLASS CHAINS; NOSE CLIPS FOR DIVERS AND SWIMMERS; AUDIO/VIDEO COMPACT DISCS, NAMELY, PRE-RECORDED CDS FEATURING CHILD, ADOLESCENT AND TEEN ENTERTAINMENT AND SPORT CONTENT; ROM COMPACT DISCS, NAMELY, PRE-RECORDED CDS FEATURING CHILD, ADOLESCENT AND TEEN ENTERTAINMENT AND SPORT CONTENT; COMPUTER SOFTWARE DOWNLOADED FROM THE INTERNET, NAMELY, COMPUTER GAME SOFTWARE FOR USE ON MOBILE AND CELLULAR PHONES, CHILDREN, ADOLESCENT AND TEEN EDUCATIONAL SOFTWARE; RECORDED COMPU-

TER SOFTWARE, NAMELY, COMPUTER GAME SOFTWARE FOR USE ON MOBILE AND CELLULAR PHONES, CHILDREN, ADOLESCENT AND TEEN EDUCATIONAL SOFTWARE; DIVERS' APPARATUS, NAMELY, EAR PLUGS FOR DIVERS, DIVING GLOVES, DIVING GOGGLES, DIVING HELMETS; DIVERS' MASKS; DIVING SUITS; EYEGLASS CORDS; EYEGLASS FRAMES; EYEGLASSES; GOGGLES FOR SPORTS; SUNGLASSES" AND ALL THE GOODS IN CLASS 25, APART FROM THE MARK AS SHOWN.

THE MARK CONSISTS OF THE STYLIZED WORDS "SURFER GIRL" WITH A FLOWER, ALL SURROUNDED BY AN ELLIPSE WITH AN IMAGE OF A GIRL'S HEAD IN THE LOWER LEFT CORNER.

**CLASS 9—ELECTRICAL AND SCIENTIFIC APPARATUS**

FOR CAMERAS; EYEGLASS CASES; EYEGLASS CHAINS; NOSE CLIPS FOR DIVERS AND SWIMMERS; COMPACT DISC PLAYERS; AUDIO/VIDEO COMPACT DISCS, NAMELY, PRE-RECORDED CDS FEATURING CHILD, ADOLESCENT AND TEEN ENTERTAINMENT AND SPORT CONTENT; ROM COMPACT DISCS, NAMELY, PRE-RECORDED CDS FEATURING CHILD, ADOLESCENT AND TEEN ENTERTAINMENT AND SPORT CONTENT; COMPUTER SOFTWARE DOWNLOADED FROM THE INTERNET, NAMELY, COMPUTER GAME SOFTWARE FOR USE ON MOBILE AND CELLULAR PHONES CHILDREN, ADOLESCENTS AND TEEN EDUCATIONAL SOFTWARE; INTERACTIVE GAME SOFTWARE; COMPUTER SCREEN SAVER SOFTWARE; COMPUTER GAME PROGRAMS; COMPUTER GAMES PROGRAMS DOWNLOADED VIA THE INTERNET; COMPUTER PERIPHERAL DEVICES; RECORDED COMPUTER SOFTWARE, NAMELY, COMPUTER GAME SOFTWARE FOR USE ON MOBILE AND CELLULAR PHONES, CHILDREN, ADOLESCENTS AND TEEN EDUCATIONAL SOFTWARE, INTERACTIVE GAME SOFTWARE, COMPUTER SCREEN SAVER SOFTWARE; CONTACT LENSES; CONTAINERS FOR CONTACT LENSES; DIVERS' APPARATUS, NAMELY, EAR PLUGS FOR DIVERS, DIVING GLOVES, DIVING GOGGLES, DIVING HELMETS; DIVERS' MASKS; DIVING SUITS; EYEGLASS CORDS; EYEGLASS FRAMES; EYEGLASSES; GOGGLES FOR SPORTS; PERSONAL STEREO; SUNGLASSES (U.S. CLS. 21, 23, 26, 36 AND 38).

**CLASS 14—JEWELRY**

FOR CLOCKS (U.S. CLS. 2, 27, 28 AND 50).

**CLASS 16—PAPER GOODS AND PRINTED MATTER**

FOR PAPER AND CARDBOARD; PRINTED MATTER, NAMELY, NOTE PAPER AND LOOSE LEAF PAPER, SERIES OF FICTION BOOKS, DECALS, BUMPER STICKERS, TRADING CARDS, NOTE CARDS, POSTERS, FOLDERS, CALENDARS, STATIONERY WRITING PAPER AND ENVELOPES, NOTEBOOKS, BLANK JOURNALS, ADDRESS BOOKS, DIARIES, DAILY PLANNERS, DESKTOP PLANNERS, PERSONAL PLANNERS, BOOKMARKS, CRAFT BOOKS, COMIC BOOKS, PLAYING CARDS, GREETING CARDS, PAPER LUNCH BAGS, COLORING BOOKS; BOOKBINDING MATERIAL; PHOTOGRAPHS; STATIONERY; ADHESIVES FOR STATIONERY OR HOUSEHOLD PURPOSES; ARTISTS' MATERIALS; PAINT BRUSHES; TYPEWRITERS AND OFFICE REQUISITES EXCEPT FURNITURE, NAMELY, LABEL PRINTING MACHINES, DUPLICATING MACHINES, ADHESIVE APPLYING MACHINES FOR HOME AND OFFICE USE, PAPER TRIMMERS; PRINTED INSTRUCTIONAL, EDUCATIONAL, AND TEACHING MATERIALS EXCEPT APPARATUS IN THE FIELD OF LANGUAGE, MATH, GEOGRAPHY, SCIENCE, HISTORY, LITERATURE, ART, WRITING AND READING; PRINTERS' TYPE; PRINTING BLOCKS; PHOTO ALBUMS; EMBROIDERY DESIGNS DESIGN PATTERNS PRINTED ON PAPER; PASSPORT HOLDERS; PHOTOGRAPH STANDS; STENCILS; IRON-ON TRANSFERS; PLASTIC TRANSFERS (U.S. CLS. 2, 5, 22, 23, 29, 37, 38 AND 50).

**CLASS 17—RUBBER GOODS**

FOR PLASTIC MATERIALS FOR PACKAGING IN THE FORM OF ADHESIVE PLASTIC FILM FOR COMMERCIAL AND INDUSTRIAL USE; EXPANDED PLASTIC PELLETS FOR PACKAGING (U.S. CLS. 1, 5, 12, 13, 35 AND 50).

**CLASS 20—FURNITURE AND ARTICLES NOT OTHERWISE CLASSIFIED**

FOR SLEEPING BAGS (U.S. CLS. 2, 13, 22, 25, 32 AND 50).

**CLASS 24—FABRICS**

FOR TEXTILES AND TEXTILE GOODS, NOT INCLUDED IN OTHER CLASSES, NAMELY, TEXTILE PLACEMATS, TEXTILE NAPKINS, TEXTILE HANDKERCHIEFS, PRINTED TEXTILE LABELS, TABLECLOTHS OF TEXTILE, TAPESTRIES OF TEXTILE; BED AND PLASTIC TABLE COVERS; BED BLANKETS; BED LINENS; TEXTILE OR CLOTH COASTERS; TABLE LINEN; COVERS FOR CUSHIONS; DOOR CURTAINS; TRACED CLOTH FOR EMBROIDERY; FIBERGLASS FABRICS, FOR TEXTILE USE; PLACE MATS NOT OF PAPER; PILLOW SHAMS; PILLOWCASES; TRAVELLING RUGS; LAP ROBES; FABRIC TABLE RUNNERS; SHOWER CURTAINS OF TEXTILE OR PLASTIC; SLEEPING BAGS IN THE NATURE OF SHEETING (U.S. CLS. 42 AND 50).

**CLASS 25—CLOTHING**

FOR READY-MADE CLOTHING, NAMELY, CAPS, FOOTWEAR, DRESSING GOWNS, NIGHTCAPS, PAJAMAS AND ROBES, BLOUSES, HALTER TOPS, SHIRTS, LONG SLEEVED SHIRTS, SHORT SLEEVED SHIRTS, T SHIRTS, JEANS, PANTS, LONG PANTS, SHORT PANTS, LEATHER PANTS, SHORTS, TROUSERS, CULOTTES, SKIRTS, DRESSES, EAR MUFFS, FUR STOLEES, GLOVES, MITTENS, MUFFLERS, SCARVES, SHAWLS, JUMPERS, SWEATERS, PULLOVERS, JACKETS, JEANS JACKET, LEATHER JACKET, PARKAS, COATS, OVERCOATS, NECKERCHIEFS, NECKTIES, SARONGS, VESTS, BELTS, LEATHER BELTS AND WAISTBANDS, SUSPENDERS, GARTERS, BODICES, BRASSIERES, CAMISOLES, HOSE, SINGLETS, TEDDIES AND UNDERWEAR; ARTICLES OF CLOTHING FOR USE IN SPORTS, NAMELY, CAPS, FOOTWEAR, SHIRTS, LONG SLEEVED SHIRTS, SHORT SLEEVED SHIRTS, T SHIRTS, PANTS, LONG PANTS, SHORT PANTS, SHORTS, TROUSERS, CULOTTES, SKIRTS, DRESSES, EAR MUFFS, SWEATERS, PULLOVERS, JACKETS, JEANS JACKET, LEATHER JACKET, PARKAS, COATS, OVERCOATS, NECKERCHIEFS, NECKTIES, SARONGS, VESTS, BELTS, LEATHER BELTS AND WAISTBANDS, SUSPENDERS, SPORTS BRA, SINGLETS, UNDERWEAR; SPORTS FOOTWEAR; BATH CAPS; BATH ROBES; BEACHWEAR AND SWIMWEAR, NAMELY, BIKINIS, RASH VESTS, SWIMSUITS, BATHING SUITS, BATHING TRUNKS, BATHING CAPS, BEACH CLOTHES, BEACH FOOTWEAR AND WETSUITS; ARTIFICIAL LEATHER CLOTHING, NAMELY, CAPS, FOOTWEAR, BELTS, GAITERS, SANDALS, BOOTS, COATS, HATS, JACKETS, PANTS, SHIRTS, SHOES, SKIRTS, SLIPPERS, VESTS, SUITS, TROUSERS, UNDERWEAR; LEATHER CLOTHING, NAMELY, CAPS, FOOTWEAR, BELTS, GAITERS, SANDALS, BOOTS, COATS, HATS, JACKETS, PANTS, SHIRTS, SHOES, SKIRTS, SLIPPERS, VESTS, SUITS, TROUSERS, UNDERWEAR; FOOTWEAR, NAMELY, SPORTS FOOTWEAR AND SPORTS SHOES IN THE NATURE OF BASKETBALL SNEAKERS, BOOTS, FLIP FLOPS, LEATHER SHOES, SANDALS, SHOES, SLIPPERS, SOCKS AND STOCKINGS; HEADWEAR, NAMELY, BANDANAS, BASEBALL CAPS, CAPS, CAPS WITH VISORS, GOLF CAPS, HATS, HEADBANDS, AND HOODS; NIGHTWEAR, NAMELY, DRESSING GOWNS, NIGHTCAPS, PAJAMAS AND ROBES; BLOUSES, HALTER TOPS, SHIRTS, LONG/SHORT SLEEVED SHIRTS, T SHIRTS, JEANS, PANTS, LONG/SHORT PANTS, LEATHER PANTS, SHORTS, TROUSERS, CULOTTES, SKIRTS, DRESSES, EAR MUFFS, FUR STOLEES, GLOVES, MITTENS, MUFFLERS, SCARVES, SHAWLS, JUMPERS, SWEATERS, PULLOVERS, JACKETS, JEANS JACKET, LEATHER JACKET, PARKAS, COATS, OVER-

COATS, NECKERCHIEFS, NECKTIES, SARONGS, VESTS, BELTS, LEATHER BELTS AND WAISTBANDS; UNDERCLOTHING, NAMELY, SUSPENDERS, GARTERS, BODICES, BRASSIERES, CAMISOLES, HOSE, SINGLETS, TEDDIES AND UNDERWEAR (U.S. CLS. 22 AND 39).

**CLASS 28—TOYS AND SPORTING GOODS**

FOR GAMES AND PLAYTHINGS, NAMELY, DOLLS, ACTION FIGURES AND ACCESSORIES THEREOF, AND BOARD GAMES, DEVELOPMENT TOYS, CRIB TOYS, TOY MOBILES, INFANT AND BABY RATTLES, BATH TOYS, INFANT EXERCISE SEATS, NAMELY, JUMPERS, SAUCERS AND SWINGS, CARD GAMES, AMUSEMENT GAME MACHINES, ARCADE GAME MACHINES, ELECTRONIC EDUCATIONAL GAME MACHINES FOR CHILDREN, HAND-HELD GAMES WITH LIQUID CRYSTAL DISPLAYS, STAND ALONE VIDEO GAME MACHINES, STAND ALONE AUDIO OUTPUT GAME MACHINES; GYMNASIUM AND SPORTING ARTICLES NOT INCLUDED IN OTHER CLASSES, NAMELY, BALLS FOR SPORTS, GOLF CLUBS, BASEBALL AND SOFTBALL BATS, LACROSSE STICKS, FIELD HOCKEY STICKS, HOCKEY STICKS, BASEBALL AND SOFTBALL GLOVES, SWIM FINS; DECORATIONS FOR CHRISTMAS TREES EXCEPT CONFECTIONERY OR ILLUMINATION ARTICLES; SURFBOARDS; BODY BOARDS; BODY BOARD LEASHES, LEASHES FOR SURFBOARDS, LEG ROPES; BAGS ESPECIALLY DESIGNED FOR SKIS, SURFBOARDS AND BODY BOARDS; SURFBOARD AND BODY BOARD COVERS; AMUSEMENT APPARATUS ADAPTED FOR USE WITH TELEVISION RECEIVERS ONLY; FLOATS FOR BATHING AND SWIMMING; SWIMMING BELTS; SWIMMING JACKETS (U.S. CLS. 22, 23, 38 AND 50).

NAAKWAMA ANKRAH, EXAMINING ATTORNEY

SN 85-536,415. DEUTZ AG, COLOGNE, FED REP GERMANY, FILED 2-7-2012.



PRIORITY CLAIMED UNDER SEC. 44(D) ON FED REP GERMANY APPLICATION NO. 30211043757, FILED 8-8-2011, REG. NO. 30211043757, DATED 9-5-2011, EXPIRES 8-31-2021.

OWNER OF U.S. REG. NOS. 1,029,906 AND 3,524,261. NO CLAIM IS MADE TO THE EXCLUSIVE RIGHT TO USE "ADVANCED ENGINEERING", APART FROM THE MARK AS SHOWN.

THE MARK CONSISTS OF THE WORDING "DEUTZ ADVANCED ENGINEERING", WITH THE LETTERS "ENGINE" AND THE WORD "DEUTZ" IN BOLD AND THE WORD "DEUTZ" UNDERLINED, WITH THE WORD "DEUTZ" APPEARING ABOVE THE WORDS "ADVANCED ENGINEERING" AND A STYLIZED ROCKET DESIGN APPEARING OVER THE WORD "DEUTZ".

**CLASS 7—MACHINERY**

FOR STATIONARY AND MOBILE COMBUSTION ENGINES NOT FOR LAND VEHICLES, NAMELY, DIESEL ENGINES, ENGINES POWERED BY BIOGENIC FUEL, HYBRID ENGINES AND GAS ENGINES AS NEW, PARTIAL AND REPLACEMENT ENGINES AND REPLACEMENT PART THEREFOR; UNITS WITH COMBUSTION ENGINES AND ELECTRICITY GENERATORS OR PUMPS OR COMPRESSORS, NAMELY, GENERATOR SETS, ROTARY PUMPS, AIR COMPRESSORS AND REPLACEMENT PART THEREFOR; PARTS FOR LAND AND WATER VEHICLE ENGINES, NAMELY, ELECTRONIC FUEL INJECTION MODULES, EMISSION REDUCTION UNITS FOR MOTORS AND ENGINES, NAMELY, EGR VALVES, EMISSION REDUCTION UNITS FOR MOTORS AND ENGINES; COMBUSTION ENGINES, NAMELY, DIESEL ENGINES, BIOGENIC FUEL-POWERED ENGINES, HYBRID AND GAS ENGINES FOR WATER VEHICLES; REPLACEMENT PARTS FOR STATIONARY AND MOBILE COMBUSTION ENGINES NOT FOR LAND VEHICLES, NAMELY, DIESEL ENGINES, ENGINES POWERED BY BIOGENIC FUEL, HYBRID ENGINES AND GAS ENGINES AS NEW, PARTIAL AND REPLACEMENT ENGINES, FOR UNITS WITH COMBUSTION ENGINES AND ELECTRICITY GENERATORS OR PUMPS OR COMPRESSORS, NAMELY, GENERATOR SETS, ROTARY PUMPS, AIR COMPRESSOR AND PARTS FOR LAND AND WATER VEHICLE ENGINES, NAMELY, ELECTRONIC FUEL INJECTION MODULES, EMISSION REDUCTION UNITS FOR MOTORS AND ENGINES, NAMELY, EGR VALVES, EMISSION REDUCTION UNITS FOR MOTORS AND ENGINES, NAMELY, CRANK SHAFTS AND CRANKCASES FOR MACHINES, MOTORS AND ENGINES; CYLINDER HEADS FOR ENGINES; CYLINDERS FOR MOTORS AND ENGINES, EMISSION REDUCTION UNITS FOR MOTORS AND ENGINES, NAMELY, EGR VALVES AND CATALYTIC CONVERTERS; ENGINE CAMSHAFTS, ENGINE CYLINDERS FOR VEHICLES, ENGINE EXHAUST SYSTEMS COMPRISED OF PIPES, COLLECTOR AND MUFFLER, ENGINE EXHAUST SYSTEM COMPRISED OF A PARTICULATE TRAP, ENGINE INJECTORS, ENGINE MUFFLERS, ENGINE PARTS, NAMELY, CONTACT POINTS, ELECTRONIC FUEL INJECTION MODULE AND OIL DIPSTICKS, ENGINE RODS, ENGINE TIMING COMPONENTS, NAMELY, CAM SPROCKETS AND CHAINS, FUEL CATALYSTS, EXHAUST MANIFOLD FOR ENGINES, EXHAUST PIPES FOR LAND VEHICLES, EXHAUST SILENCERS FOR ENGINES; FILTER ELEMENTS FOR FUEL FILTERS; FILTERS FOR MOTORS AND ENGINES, FUEL FILTERS, FUEL INJECTORS, FUEL PUMPS FOR LAND VEHICLES, GASKETS FOR INTERNAL COMBUSTION ENGINES, GLOW PLUGS, GLOW PLUGS FOR DIESEL ENGINES, HEADERS AS PART OF VEHICLE EXHAUST SYSTEM, HEAT EXCHANGERS BEING PARTS OF MACHINES, HEAT EXCHANGERS BEING PARTS OF ENGINES NOT FOR LAND VEHICLES, HYDRAULIC CONTROLS FOR MAC (U.S. CLS. 13, 19, 21, 23, 31, 34 AND 35).

**CLASS 9—ELECTRICAL AND SCIENTIFIC APPARATUS**

FOR MECHANICAL REMOTE CONTROLS FOR MOTORS; ELECTRONIC REGULATION, CONTROL AND MONITORING APPARATUSES, DEVICES AND INSTRUMENTS FOR MACHINE CONTROL, FUEL INJECTION AND EXHAUST GAS AFTER— TREATMENT IN STATIONARY AND MOBILE INTERNAL COMBUSTION ENGINES AND IN INTERNAL COMBUSTION ENGINES FOR VEHICLES, NAMELY, CRUISE CONTROLS FOR MOTOR VEHICLES, CONTROL UNITS FOR REGULATING START-UP ELECTRICAL MOTORS; ELECTRONIC CONTROL SYSTEMS FOR MACHINES FOR STATIONARY AND MOBILE INTERNAL COMBUSTION ENGINES AND IN INTERNAL COMBUSTION ENGINES FOR VEHICLES; ELECTRONIC CONTROLLERS FOR MOTORS FOR STATIONARY AND MOBILE INTERNAL COMBUSTION ENGINES AND IN INTERNAL COMBUSTION ENGINES FOR VEHICLES; ELECTRONIC CONTROLS FOR MOTORS AND GASOLINE ENGINES FOR LAND VEHICLES FOR STATIONARY AND MOBILE

INTERNAL COMBUSTION ENGINES AND IN INTERNAL COMBUSTION ENGINES FOR VEHICLES; MECHANICAL REMOTE CONTROLS FOR MOTORS FOR STATIONARY AND MOBILE INTERNAL COMBUSTION ENGINES AND IN INTERNAL COMBUSTION ENGINES FOR VEHICLES; COMPUTER SOFTWARE AND MEMORIES FOR DATA PROCESSING EQUIPMENT FOR MACHINE CONTROL, AND FUEL INJECTION AND EXHAUST GAS AFTER-TREATMENT IN STATIONARY AND MOBILE INTERNAL COMBUSTION ENGINES AND INTERNAL COMBUSTION ENGINES FOR VEHICLES (U.S. CLS. 21, 23, 26, 36 AND 38).

**CLASS 12—VEHICLES**

FOR COMBUSTION ENGINES, NAMELY, DIESEL ENGINES, BIOGENIC FUEL-POWERED ENGINES, HYBRID AND GAS ENGINES FOR LAND VEHICLES; COMPONENTS AND PARTS FOR COMBUSTION ENGINES FOR LAND VEHICLES, NAMELY, CONNECTING RODS FOR LAND VEHICLES OTHER THAN PARTS OF MOTORS AND ENGINES; LAND VEHICLE PARTS, NAMELY, TRANSMISSIONS, DRIVE BELTS, DRIVE GEARS AND AXLES (U.S. CLS. 19, 21, 23, 31, 35 AND 44).

**CLASS 16—PAPER GOODS AND PRINTED MATTER**

FOR PAPER, CARDBOARD, PAPER AND CARDBOARD BOXES AND PACKING PAPER FOR PACKING AND STORING PARTS OF COMBUSTION ENGINES, PAPER BAGS FOR PACKING, ENVELOPES, SLEEVES FOR PACKING MADE OF PAPER OR PLASTIC, PRINTED PRODUCTS, NAMELY, SPARE PARTS CATALOGUES, TRAINING LITERATURE, OPERATING MANUALS, MAGAZINES AND NEWSPAPERS IN THE FIELD OF COMBUSTION ENGINES AND PARTS THEREFOR; OFFICE ARTICLES, NAMELY, STATIONERY, PENCILS, AND BALLPOINT PENS; PAPER BAGS FOR PACKAGING, ENVELOPES (U.S. CLS. 2, 5, 22, 23, 29, 37, 38 AND 50).

**CLASS 25—CLOTHING**

FOR CLOTHING, NAMELY, SHIRTS, PANTS, COATS, DRESSES; CAPS; JACKETS; FOOTWEAR, MILLINERY, NAMELY, FASCINATORS (U.S. CLS. 22 AND 39).

**CLASS 35—ADVERTISING AND BUSINESS**

FOR MARKETING, MARKET RESEARCH AND MARKET ANALYSIS REGARDING COMBUSTION ENGINES, UNITS WITH COMBUSTION ENGINES AND MACHINE SYSTEMS, VEHICLES; DISTRIBUTION OF GOODS FOR ADVERTISING PURPOSES; ADVERTISING, ESPECIALLY ADVERTISING IN THE PRINT MEDIA; CUSTOMER SERVICES, NAMELY, RESPONDING TO CUSTOMERS INQUIRIES FOR OTHERS IN THE FIELD OF COMBUSTION ENGINES; ORGANIZATION OF TRADE FAIRS AND COMMERCIAL PRESENTATIONS (U.S. CLS. 100, 101 AND 102).

**CLASS 37—CONSTRUCTION AND REPAIR**

FOR TECHNICAL SUPPORT SERVICES, NAMELY, TECHNICAL ADVICE RELATED TO THE REPAIR OF COMBUSTION ENGINES; TECHNICAL CONSULTING RELATING TO THE REPAIR OF COMBUSTION ENGINES (U.S. CLS. 100, 103 AND 106).

**CLASS 41—EDUCATION AND ENTERTAINMENT**

FOR EDUCATIONAL SERVICES, NAMELY, PROVIDING TRAINING OF TEACHERS, ENGINEERS FOR CERTIFICATION IN THE FIELD OF COMBUSTION ENGINES, MACHINE SYSTEMS AND VEHICLES; TEACHING, TRAINING, AND INSTRUCTION IN THE FIELD OF COMBUSTION ENGINES, MACHINE SYSTEMS AND VEHICLES, INSTRUCTION OF PROFESSIONAL STAFF, TECHNICIANS, SALES AND MARKETING PERSONS IN CONNECTION WITH COMBUSTION ENGINES, MACHINE SYSTEMS AND VEHICLES; PUBLICATION AND DISTRIBUTION OF BOOKS, MAGAZINES, TRAINING MANUALS, CONSULTING AND CUSTOMER SERVICE LITERATURE, MAINTENANCE AND OPERATING MANUALS (U.S. CLS. 100, 101 AND 107).

**CLASS 42—SCIENTIFIC AND COMPUTER SERVICES**

FOR CONSTRUCTION AND DESIGN PLANNING AND CONSULTING, ESPECIALLY TECHNICAL-ENGINEERING CONSULTING IN CONNECTION WITH COMBUSTION ENGINES, UNITS AND SYSTEMS OF COMBUSTION ENGINES AND POWER STATIONS, SERVICES OF AN ARCHITECT, CHEMIST AND ENGINEER AND PHYSICIST; TECHNOLOGY CONSULTATION IN THE FIELD OF COMBUSTION ENGINES; CREATION OF PROGRAMS FOR DATA PROCESSING; MATERIAL TESTING; TECHNICAL CONSULTING RELATING TO ENGINEERING COMBUSTION ENGINES (U.S. CLS. 100 AND 101).

\_\_\_\_\_  
 GEOFFREY FOSDICK, EXAMINING ATTORNEY

\_\_\_\_\_  
 SN 85-538,639. ELM PLACE INC., NORTH YORK, ONTARIO, CANADA, FILED 2-9-2012.

**CONNECTED BY FAMILY VALUES**

THE MARK CONSISTS OF STANDARD CHARACTERS WITHOUT CLAIM TO ANY PARTICULAR FONT, STYLE, SIZE, OR COLOR.

PRIORITY CLAIMED UNDER SEC. 44(D) ON CANADA APPLICATION NO. 1562503, FILED 2-2-2012, REG. NO. TMA866,240, DATED 11-29-2013, EXPIRES 11-29-2028.

**CLASS 36—INSURANCE AND FINANCIAL**

FOR REAL ESTATE MANAGEMENT SERVICES; PROPERTY LETTING SERVICES IN THE NATURE OF RENTAL OF COMMERCIAL AND RETAIL PROPERTY; REAL ESTATE SERVICES, NAMELY, RENTAL OF COMMERCIAL PROPERTIES AND CONDOMINIUMS; PROVIDING INFORMATION AND CONSULTATION RELATED THERETO; REAL ESTATE BROKERAGE FEATURING CONDOMINIUMS; PROVIDING INFORMATION AND CONSULTATION RELATED THERETO (U.S. CLS. 100, 101 AND 102).

**CLASS 37—CONSTRUCTION AND REPAIR**

FOR REAL ESTATE DEVELOPMENT OF COMMERCIAL AND RETAIL PROPERTY; REAL ESTATE PROPERTY DEVELOPMENT; REAL ESTATE PROPERTY MAINTENANCE SERVICES; PROVIDING INFORMATION AND CONSULTATION RELATED THERETO (U.S. CLS. 100, 103 AND 106).

**CLASS 43—HOTEL AND RESTAURANT SERVICES**

FOR MAKING RESERVATIONS AND BOOKINGS FOR TEMPORARY LODGING IN THE NATURE OF VACATION SUITES; PROVIDING INFORMATION AND CONSULTATION RELATED THERETO (U.S. CLS. 100 AND 101).

TARAH HARDY, EXAMINING ATTORNEY

\_\_\_\_\_  
 SN 85-538,648. ELM PLACE INC., NORTH YORK, ONTARIO, CANADA, FILED 2-9-2012.

**CHERISHOME LIVING**

THE MARK CONSISTS OF STANDARD CHARACTERS WITHOUT CLAIM TO ANY PARTICULAR FONT, STYLE, SIZE, OR COLOR.

PRIORITY CLAIMED UNDER SEC. 44(D) ON CANADA APPLICATION NO. 1562504, FILED 2-2-2012, REG. NO. TMA866,243, DATED 11-29-2013, EXPIRES 11-29-2028.

**CLASS 36—INSURANCE AND FINANCIAL**

FOR REAL ESTATE MANAGEMENT SERVICES; PROPERTY LETTING SERVICES IN THE NATURE OF RENTAL OF COMMERCIAL AND RETAIL PROPERTY; REAL ESTATE SERVICES, NAMELY, RENTAL OF COMMERCIAL PROPERTIES AND CONDOMINIUMS; PROVIDING INFORMATION AND CONSULTATION RELATED THERETO; REAL ESTATE BROKERAGE FEATURING CONDOMINIUMS; PROVIDING INFORMATION AND CONSULTATION RELATED THERETO (U.S. CLS. 100, 101 AND 102).

**CLASS 37—CONSTRUCTION AND REPAIR**

FOR REAL ESTATE DEVELOPMENT OF COMMERCIAL AND RETAIL PROPERTY; REAL ESTATE PROPERTY DEVELOPMENT; REAL ESTATE PROPERTY MAINTENANCE SERVICES; PROVIDING INFORMATION AND CONSULTATION RELATED THERETO (U.S. CLS. 100, 103 AND 106).

**CLASS 43—HOTEL AND RESTAURANT SERVICES**

FOR MAKING RESERVATIONS AND BOOKINGS FOR TEMPORARY LODGING IN THE NATURE OF VACATION SUITES; PROVIDING INFORMATION AND CONSULTATION RELATED THERETO (U.S. CLS. 100 AND 101).

TARAH HARDY, EXAMINING ATTORNEY

\_\_\_\_\_  
 SN 85-539,773. CLASSICS LLC, TWIN FALLS, ID. FILED 2-10-2012.

**TURN BACK TIME**

THE MARK CONSISTS OF STANDARD CHARACTERS WITHOUT CLAIM TO ANY PARTICULAR FONT, STYLE, SIZE, OR COLOR.

**CLASS 41—EDUCATION AND ENTERTAINMENT**

FOR PERSONAL FITNESS TRAINING SERVICES AND CONSULTANCY; PHYSICAL FITNESS TRAINING SERVICES; PROVIDING FITNESS AND EXERCISE FACILITIES (U.S. CLS. 100, 101 AND 107).

**CLASS 44—MEDICAL, BEAUTY AND AGRICULTURAL SERVICES**

FOR PHYSICAL THERAPY; PROVIDING ASSISTANCE, FITNESS EVALUATION AND CONSULTATION TO INDIVIDUALS TO HELP THEM MAKE HEALTH, WELLNESS AND NUTRITIONAL CHANGES IN THEIR DAILY LIVING TO IMPROVE HEALTH (U.S. CLS. 100 AND 101).

AMEEN IMAM, EXAMINING ATTORNEY

SN 85-546,215. HYUNDAI MARINE & FIRE INSURANCE CO., LTD., SEOUL, REPUBLIC OF KOREA, FILED 2-17-2012.

**HYUNDAI MARINE & FIRE  
INSURANCE**

THE MARK CONSISTS OF STANDARD CHARACTERS WITHOUT CLAIM TO ANY PARTICULAR FONT, STYLE, SIZE, OR COLOR.

OWNER OF REPUBLIC OF KOREA REG. NO. 0235515, DATED 7-11-2012, EXPIRES 7-11-2022.

NO CLAIM IS MADE TO THE EXCLUSIVE RIGHT TO USE "MARINE & FIRE INSURANCE", APART FROM THE MARK AS SHOWN.

**CLASS 35—ADVERTISING AND BUSINESS**

FOR FRANCHISE SERVICES, NAMELY, OFFERING TECHNICAL AND BUSINESS MANAGEMENT ASSISTANCE IN THE ESTABLISHMENT AND OPERATION OF AUTOMOBILE REPAIR AND MAINTENANCE SERVICES, INSTALLATION SERVICES OF MACHINERY FOR AUTOMOBILE REPAIR, PROVIDING RUST PROOFING TREATMENTS FOR AUTOMOBILES, AUTOMOBILE POLISHING SERVICES, AUTOMOBILE WASHING SERVICES AND INSTALLATION AND MAINTENANCE SERVICES OF ANTI-THEFT ALARMS FOR AUTOMOBILES (U.S. CLS. 100, 101 AND 102).

**CLASS 36—INSURANCE AND FINANCIAL**

FOR SECURITIES BROKERAGE SERVICES; LOAN FINANCING SERVICES; INSURANCE SERVICES, NAMELY, WRITING PROPERTY AND CASUALTY INSURANCE; LIFE INSURANCE UNDERWRITING SERVICES; GUARANTEE ASSURANCE UNDERWRITING SERVICES; RE-INSURANCE UNDERWRITING SERVICES IN THE FIELD OF AUTOMOBILES, HEALTH, LIFE AND FIRE; INSURANCE AGENCY SERVICES; INSURANCE BROKERAGE SERVICES; UNDERWRITING EXTENDED WARRANTY CONTRACTS IN THE FIELD OF AUTOMOBILES; INSURANCE CONSULTING SERVICES IN THE FIELD OF AUTOMOBILES, HEALTH, LIFE AND FIRE; PROVIDING INFORMATION IN INSURANCE MATTERS; APPRAISALS FOR INSURANCE CLAIMS OF PERSONAL PROPERTY AND REAL ESTATE; INSURANCE ADMINISTRATION SERVICES, NAMELY, ASSISTING OTHERS WITH ADJUSTING INSURANCE CLAIMS; INSURANCE ACTUARIAL SERVICES; INDUSTRIAL ACCIDENT INSURANCE UNDERWRITING SERVICES FOR PERSONAL INJURIES AND INJURY TO REAL PROPERTY; INSURANCE UNDERWRITING IN THE FIELD OF PENSION PLANS; PRODUCT LIABILITY INSURANCE UNDERWRITING SERVICES; FIRE INSURANCE UNDERWRITING SERVICES; REAL ESTATE LEASING SERVICES (U.S. CLS. 100, 101 AND 102).

**CLASS 37—CONSTRUCTION AND REPAIR**

FOR AUTOMOBILE BODY REPAIR AND FINISHING FOR OTHERS; AUTOMOBILE REPAIR AND MAINTENANCE; AUTOMOBILE SERVICE STATION SERVICES AND GARAGE SERVICES, NAMELY, REPAIR OF AUTOMOBILES; AUTOMOBILE WASHING SERVICES; ANTI-RUST TREATMENT FOR AUTOMOBILES; INSTALLATION AND MAINTENANCE OF ANTI-THEFT ALARMS FOR AUTOMOBILES; AUTOMOBILE REPAIR AND MAINTENANCE SERVICES, INCLUDING EVALUATION AND DIAGNOSIS OF VEHICLE PARTS REQUIRING REPAIR (U.S. CLS. 100, 103 AND 106).

SUSAN RICHARDS, EXAMINING ATTORNEY

SN 85-546,295. HYUNDAI MARINE & FIRE INSURANCE CO., LTD., SEOUL, REPUBLIC OF KOREA, FILED 2-17-2012.

**HYUNDAI INSURANCE**

THE MARK CONSISTS OF STANDARD CHARACTERS WITHOUT CLAIM TO ANY PARTICULAR FONT, STYLE, SIZE, OR COLOR.

OWNER OF REPUBLIC OF KOREA REG. NO. 0235514, DATED 7-11-2012, EXPIRES 7-11-2022.

NO CLAIM IS MADE TO THE EXCLUSIVE RIGHT TO USE "INSURANCE", APART FROM THE MARK AS SHOWN.

**CLASS 35—ADVERTISING AND BUSINESS**

FOR FRANCHISE SERVICES, NAMELY, OFFERING TECHNICAL AND BUSINESS MANAGEMENT ASSISTANCE IN THE ESTABLISHMENT AND OPERATION OF AUTOMOBILE REPAIR AND MAINTENANCE SERVICES, INSTALLATION SERVICES OF MACHINERY FOR AUTOMOBILE REPAIR, PROVIDING RUST PROOFING TREATMENTS FOR AUTOMOBILES, AUTOMOBILE POLISHING SERVICES, AUTOMOBILE WASHING SERVICES AND INSTALLATION AND MAINTENANCE SERVICES OF ANTI-THEFT ALARMS FOR AUTOMOBILES (U.S. CLS. 100, 101 AND 102).

**CLASS 36—INSURANCE AND FINANCIAL**

FOR SECURITIES BROKERAGE SERVICES; LOAN FINANCING SERVICES; INSURANCE SERVICES, NAMELY, WRITING PROPERTY AND CASUALTY INSURANCE; LIFE INSURANCE UNDERWRITING SERVICES; GUARANTEE ASSURANCE UNDERWRITING SERVICES; RE-INSURANCE UNDERWRITING SERVICES IN THE FIELD OF AUTOMOBILES, HEALTH, LIFE AND FIRE; INSURANCE AGENCY SERVICES; INSURANCE BROKERAGE SERVICES; UNDERWRITING EXTENDED WARRANTY CONTRACTS IN THE FIELD OF AUTOMOBILES; INSURANCE CONSULTING SERVICES IN THE FIELD OF AUTOMOBILES, HEALTH, LIFE AND FIRE; PROVIDING INFORMATION IN INSURANCE MATTERS; APPRAISALS FOR INSURANCE CLAIMS OF PERSONAL PROPERTY AND REAL ESTATE; INSURANCE ADMINISTRATION SERVICES, NAMELY, ASSISTING OTHERS WITH ADJUSTING INSURANCE CLAIMS; INSURANCE ACTUARIAL SERVICES; INDUSTRIAL ACCIDENT INSURANCE UNDERWRITING SERVICES FOR PERSONAL INJURIES AND INJURY TO REAL PROPERTY; INSURANCE UNDERWRITING IN THE FIELD OF PENSION PLANS; PRODUCT LIABILITY INSURANCE UNDERWRITING SERVICES; FIRE INSURANCE UNDERWRITING SERVICES; REAL ESTATE LEASING SERVICES (U.S. CLS. 100, 101 AND 102).

**CLASS 37—CONSTRUCTION AND REPAIR**

FOR AUTOMOBILE BODY REPAIR AND FINISHING FOR OTHERS; AUTOMOBILE REPAIR AND MAINTENANCE; AUTOMOBILE SERVICE STATION SERVICES AND GARAGE SERVICES, NAMELY, REPAIR OF AUTOMOBILES; AUTOMOBILE WASHING SERVICES; ANTI-RUST TREATMENT FOR AUTOMOBILES; INSTALLATION AND MAINTENANCE OF ANTI-THEFT ALARMS FOR AUTOMOBILES; AUTOMOBILE REPAIR AND MAINTENANCE SERVICES, INCLUDING EVALUATION AND DIAGNOSIS OF VEHICLE PARTS REQUIRING REPAIR (U.S. CLS. 100, 103 AND 106).  
SUSAN RICHARDS, EXAMINING ATTORNEY

SN 85-550,904. PHYSICAL APPS, LLC, HOLLIS, NH. FILED 2-23-2012.

## PHYSICAL APPS

THE MARK CONSISTS OF STANDARD CHARACTERS WITHOUT CLAIM TO ANY PARTICULAR FONT, STYLE, SIZE, OR COLOR.

NO CLAIM IS MADE TO THE EXCLUSIVE RIGHT TO USE "APPS", APART FROM THE MARK AS SHOWN.

**CLASS 9—ELECTRICAL AND SCIENTIFIC APPARATUS**

FOR VIDEO GAME SOFTWARE FOR MOBILE DEVICES, DIGITAL MEDIA PLAYERS, SMARTPHONES AND TABLETS; DOWNLOADABLE ELECTRONIC GAME PROGRAMS; DOWNLOADABLE COMPUTER GAME SOFTWARE; INTERACTIVE GAME SOFTWARE; COMPUTER APPLICATION SOFTWARE FOR MOBILE DEVICES, DIGITAL MEDIA PLAYERS, SMARTPHONES AND TABLETS FOR PROVIDING EXERCISE AND PHYSICAL FITNESS INSTRUCTION, ROUTINES, TECHNIQUES, AND PROGRAMS, AND FOR USE IN PLAYING GAMES IN THE FIELDS OF SPORTS, EDUCATION, EXERCISE, PHYSICAL THERAPY OR REHABILITATION (U.S. CLS. 21, 23, 26, 36 AND 38).

**CLASS 10—MEDICAL APPARATUS**

FOR BODY REHABILITATION APPARATUS FOR MEDICAL PURPOSES (U.S. CLS. 26, 39 AND 44).

**CLASS 28—TOYS AND SPORTING GOODS**

FOR BALLS FOR GAMES, SPORTS, EDUCATIONAL ACTIVITIES, AND EXERCISE; FOAM GAME BALLS FOR ENCASING MOBILE DEVICES, DIGITAL MEDIA PLAYERS, SMARTPHONES, AND TABLETS; GAME EQUIPMENT FOR USE WITH INTERACTIVE GAME SOFTWARE, NAMELY, BALLS, BATS, RACKETS, DARTS AND DISCS FOR ENCASING MOBILE DEVICES, DIGITAL MEDIA PLAYERS, SMARTPHONES, AND TABLETS; BATH TOYS; BENDABLE TOYS; DISC TOSS TOYS; TOY BLOCKS; TOYS FOR ENCASING MOBILE DEVICES, DIGITAL MEDIA PLAYERS, SMARTPHONES, AND TABLETS, FOR USE WITH INTERACTIVE GAME SOFTWARE AND COMPUTER SOFTWARE APPLICATIONS; EXERCISE EQUIPMENT, NAMELY, KETTLE BELLS, WEIGHT-TRAINING APPARATUS, WEIGHT-LIFTING APPARATUS; BODY-TRAINING APPARATUS FOR PHYSICAL EXERCISES (U.S. CLS. 22, 23, 38 AND 50).

**CLASS 42—SCIENTIFIC AND COMPUTER SERVICES**

FOR COMPUTER SERVICES, NAMELY, CLOUD HOSTING PROVIDER SERVICES; CLOUD COMPUTING FEATURING COMPUTER GAME SOFTWARE; CLOUD COMPUTING FEATURING INTERACTIVE GAME SOFTWARE; CLOUD COMPUTING FEATURING COMPUTER APPLICATION SOFTWARE FOR MOBILE DEVICES, DIGITAL MEDIA PLAYERS, SMARTPHONES AND TABLETS FOR PROVIDING EXERCISE AND PHYSICAL FITNESS INSTRUCTION, ROUTINES, TECHNIQUES, AND PROGRAMS, AND FOR PLAYING GAMES IN THE FIELDS OF SPORTS, EDUCATION, EXERCISE, PHYSICAL THERAPY OR REHABILITATION; SOFTWARE AS A SERVICE (SAAS) SERVICES, NAMELY, HOSTING COMPUTER SOFTWARE GAMES FOR OTHERS; SOFTWARE AS A SERVICE (SAAS) SERVICES, NAMELY, HOSTING INTERACTIVE GAME SOFTWARE; SOFTWARE AS A SERVICE (SAAS) SERVICES, NAMELY, HOSTING COMPUTER APPLICATION SOFTWARE FOR MOBILE DEVICES, DIGITAL MEDIA PLAYERS, SMARTPHONES AND TABLETS FOR PROVIDING EXERCISE AND PHYSICAL FITNESS INSTRUCTION, ROUTINES, TECHNIQUES, AND PROGRAMS, AND FOR PLAYING GAMES IN THE FIELDS OF SPORTS, EDUCATION, EXERCISE, PHYSICAL THERAPY OR REHABILITATION; HOSTING AN ONLINE COMMUNITY WEB SITE ALLOWING USERS TO PARTICIPATE IN DISCUSSIONS, GET FEEDBACK FROM THEIR PEERS, FORM VIRTUAL COMMUNITIES, ENGAGE IN SOCIAL NETWORKING, PARTICIPATE IN MULTI-PLAYER GAMING SESSIONS, PARTICIPATE IN APPLICATION DEVELOPER COMMUNITIES, AND PARTICIPATE IN FAQ GROUPS AND FORUMS (U.S. CLS. 100 AND 101).

TEJBIR SINGH, EXAMINING ATTORNEY

SN 85-564,482. BODYWISDOM MEDIA, INC., CONGERS, NY. FILED 3-8-2012.

## Body Wisdom

THE MARK CONSISTS OF STANDARD CHARACTERS WITHOUT CLAIM TO ANY PARTICULAR FONT, STYLE, SIZE, OR COLOR.

OWNER OF U.S. REG. NO. 2,783,287.

NO CLAIM IS MADE TO THE EXCLUSIVE RIGHT TO USE "BODY", APART FROM THE MARK AS SHOWN.

**CLASS 9—ELECTRICAL AND SCIENTIFIC APPARATUS**

FOR PRE-RECORDED VIDEOS, CASSETTES, CDS, RECORDS, DVDS, AND CD-ROMS FEATURING AUDIO AND/OR VIDEO PERFORMANCES IN THE NATURE OF MUSICAL PERFORMANCES WITHOUT VOCALS, MUSICAL PERFORMANCES WITH VOCALS, VOCAL ONLY PERFORMANCES AND VIDEO COMBINED WITH SUCH PERFORMANCES, AND COMPUTER SOFTWARE FOR RECORDING, TRANSMITTING, RECEIVING, AND DOWNLOADING SUCH AUDIO AND/OR VIDEO PERFORMANCES (U.S. CLS. 21, 23, 26, 36 AND 38).

**CLASS 25—CLOTHING**

FOR CLOTHING AND APPAREL, NAMELY, T-SHIRTS, SHIRTS, TANK TOPS, SWEATSHIRTS, SWEATERS, PANTS, SWEAT PANTS, SHORTS, ACCESSORIES, NAMELY, SCARFS AND BELTS, HEADWEAR, SOCKS, LEOTARDS, UNITARDS, TIGHTS, COVER-UPS, NAMELY, POOL OR BEACH COVER-UPS, LEGGINGS, LEG WARMERS, JACKETS, COATS (U.S. CLS. 22 AND 39).

**CLASS 28—TOYS AND SPORTING GOODS**

FOR EXERCISE, FITNESS, AND ATHLETIC EQUIPMENT, NAMELY, STABILITY BALLS, MEDICINE BALLS, BALANCE DISKS, RESISTANCE BANDS, RESISTANCE CORDS, STEP PLATFORMS, HAND WEIGHTS, KETTLEBELLS WEIGHTED BARS, HAND WRAPS, AND STRIKING GUARDS, NAMELY, MOUTH GUARDS FOR ATHLETIC USE AND ELBOW GUARDS FOR ATHLETIC USE; AND YOGA EQUIPMENT, NAMELY, YOGA STRAPS, YOGA BRICKS, YOGA MATS, YOGA BLANKETS, AND BAGS SPECIALLY ADOPTED TO CARRY YOGA EQUIPMENT (U.S. CLS. 22, 23, 38 AND 50).

**CLASS 38—COMMUNICATION**

FOR STREAMING OF PRE-RECORDED AUDIO AND AUDIO-VISUAL RECORDINGS VIA A GLOBAL COMPUTER NETWORK THAT ARE PLAYED BACK VIA THE STREAMS (U.S. CLS. 100, 101 AND 104).

**CLASS 41—EDUCATION AND ENTERTAINMENT**

FOR ON-LINE INFORMATION SERVICES, NAMELY, PROVIDING INFORMATION ON PRACTICING PHYSICAL FITNESS, EXERCISE, YOGA, AND PILATES IN THE COMFORT OF ONE'S OWN HOME ON THE SUBJECTS OF PHYSICAL FITNESS, EXERCISE, YOGA AND PILATES THROUGH A GLOBAL COMPUTER NETWORK (U.S. CLS. 100, 101 AND 107).

**CLASS 44—MEDICAL, BEAUTY AND AGRICULTURAL SERVICES**

FOR ON-LINE INFORMATION SERVICES, NAMELY, PROVIDING INFORMATION ON ENHANCING AND MAINTAINING HEALTH, BEAUTY, AND WELLNESS ON THE SUBJECTS OF HEALTH, NUTRITION, PERSONAL CARE, NAMELY, COSMETIC BEAUTY CARE, AND WELLNESS THROUGH A GLOBAL COMPUTER NETWORK (U.S. CLS. 100 AND 101).

HEATHER BIDDULPH, EXAMINING ATTORNEY

SN 85-567,756. NANCY GOSSLING, TORONTO, ONTARIO, CANADA, FILED 3-13-2012.

# FLIP4GOLD

THE MARK CONSISTS OF STANDARD CHARACTERS WITHOUT CLAIM TO ANY PARTICULAR FONT, STYLE, SIZE, OR COLOR.

PRIORITY CLAIMED UNDER SEC. 44(D) ON CANADA APPLICATION NO. 1567624, FILED 3-7-2012, REG. NO. TMA856926, DATED 8-2-2013, EXPIRES 8-2-2028.

**CLASS 9—ELECTRICAL AND SCIENTIFIC APPARATUS**

FOR VIDEO GAME SOFTWARE FOR MOBILE DEVICES, PERSONAL COMPUTERS, CONSOLES, TABLETS; ELECTRONIC GAME PROGRAMS; DOWNLOADABLE ELECTRONIC GAME PROGRAMS; ELECTRONIC GAME SOFTWARE; COMPUTER GAME PROGRAMS; DOWNLOADABLE COMPUTER GAME PROGRAMS; INTERACTIVE GAME PROGRAMS; INTERACTIVE GAME SOFTWARE; COMPUTER GAME PROGRAMS; COMPUTER GAME SOFTWARE DOWNLOADABLE FROM A GLOBAL COMPUTER NETWORK; COMPUTER GAME SOFTWARE FOR GAMING MACHINES INCLUDING SLOT MACHINES OR VIDEO LOTTERY TERMINALS; COMPUTER SOFTWARE AND FIRMWARE FOR GAMES OF CHANCE ON ANY COMPUTORIZED PLATFORM, INCLUDING DEDICATED GAMING CONSOLES, VIDEO BASED SLOT MACHINES, REEL BASED SLOT MACHINES, AND VIDEO LOTTERY TERMINALS; DOWNLOADABLE ELECTRONIC GAME PROGRAMS; DOWNLOADABLE ELECTRONIC GAMES VIA THE INTERNET AND WIRELESS DEVICES; ELECTRONIC GAME SOFTWARE FOR CELLULAR TELEPHONES; ELECTRONIC GAME SOFTWARE FOR HANDHELD ELECTRONIC DEVICES; ELECTRONIC GAME SOFTWARE FOR WIRELESS DEVICES; GAMING SOFTWARE THAT GENERATES OR DISPLAYS WAGER OUTCOMES OF GAMING MACHINES (U.S. CLS. 21, 23, 26, 36 AND 38).

**CLASS 28—TOYS AND SPORTING GOODS**

FOR APPARATUS FOR GAMES ADAPTED FOR USE WITH TELEVISION RECEIVERS, NAMELY, VIDEO GAME CONSOLES; BOARD GAMES (U.S. CLS. 22, 23, 38 AND 50).

JENNIFER RICHARDSON, EXAMINING ATTORNEY

SN 85-574,842. TOWER PUBLISHING, DBA ROGUE INDUSTRIES, STANDISH, ME. FILED 3-20-2012.

# rogue industries

THE MARK CONSISTS OF STANDARD CHARACTERS WITHOUT CLAIM TO ANY PARTICULAR FONT, STYLE, SIZE, OR COLOR.

NO CLAIM IS MADE TO THE EXCLUSIVE RIGHT TO USE "INDUSTRIES", APART FROM THE MARK AS SHOWN.



**CLASS 9—ELECTRICAL AND SCIENTIFIC APPARATUS**

FOR CARRYING CASES FOR MOBILE COMPUTERS; CASES FOR MOBILE PHONES (U.S. CLS. 21, 23, 26, 36 AND 38).  
FIRST USE 3-1-2012; IN COMMERCE 3-1-2012.

**CLASS 16—PAPER GOODS AND PRINTED MATTER**

FOR BLANK WRITING JOURNALS (U.S. CLS. 2, 5, 22, 23, 29, 37, 38 AND 50).  
FIRST USE 3-1-2012; IN COMMERCE 3-1-2012.  
JASON TURNER, EXAMINING ATTORNEY

SN 85-576,567. TRILLIUM, INC., FLOWOOD, MS. FILED 3-22-2012.

**TRILLIUM INC.**

THE MARK CONSISTS OF STANDARD CHARACTERS WITHOUT CLAIM TO ANY PARTICULAR FONT, STYLE, SIZE, OR COLOR.  
NO CLAIM IS MADE TO THE EXCLUSIVE RIGHT TO USE "INC.", APART FROM THE MARK AS SHOWN.

**CLASS 35—ADVERTISING AND BUSINESS**

FOR BUSINESS CONSULTING; ADVERTISING, MARKETING AND BUSINESS MANAGEMENT SERVICES IN THE FIELD OF AUTOMOTIVE AND INDUSTRIAL PRODUCTS; BUSINESS CONSULTING SERVICES IN THE FIELD OF AUTOMOTIVE AND INDUSTRIAL ENGINEERING; EXPORT AND IMPORT AGENCY SERVICES; INDEPENDENT SALES REPRESENTATIVE SERVICES IN THE FIELD OF AUTOMOTIVE AND INDUSTRIAL PRODUCTS (U.S. CLS. 100, 101 AND 102).  
FIRST USE 1-31-2007; IN COMMERCE 1-31-2007.

**CLASS 42—SCIENTIFIC AND COMPUTER SERVICES**

FOR PRODUCT RESEARCH; TECHNICAL CONSULTING SERVICES IN THE FIELD OF AUTOMOTIVE AND INDUSTRIAL ENGINEERING (U.S. CLS. 100 AND 101).  
FIRST USE 1-31-2007; IN COMMERCE 1-31-2007.  
ANN E. SAPPENFIELD, EXAMINING ATTORNEY

SN 85-576,585. TRILLIUM, INC., FLOWOOD, MS. FILED 3-22-2012.



NO CLAIM IS MADE TO THE EXCLUSIVE RIGHT TO USE "INC.", APART FROM THE MARK AS SHOWN.  
THE COLOR(S) RED, BLACK, AND WHITE IS/ARE CLAIMED AS A FEATURE OF THE MARK.

THE MARK CONSISTS OF THE WORD "TRILLIUM" IN BLACK APPEARING ACROSS A RED GLOBE WITH A BLACK BORDER AND WHITE GRID LINES APPEARING THROUGHOUT. THE WORD "TRILLIUM" IS UNDERLINED IN BLACK WITH THE WORD "INC." APPEARING UNDERNEATH.

**CLASS 35—ADVERTISING AND BUSINESS**

FOR BUSINESS CONSULTING; ADVERTISING, MARKETING AND BUSINESS MANAGEMENT SERVICES IN THE FIELD OF AUTOMOTIVE AND INDUSTRIAL PRODUCTS; BUSINESS CONSULTING SERVICES IN THE FIELD OF AUTOMOTIVE AND INDUSTRIAL ENGINEERING; EXPORT AND IMPORT AGENCY SERVICES; INDEPENDENT SALES REPRESENTATIVE SERVICES IN THE FIELD OF AUTOMOTIVE AND INDUSTRIAL PRODUCTS (U.S. CLS. 100, 101 AND 102).  
FIRST USE 1-31-2007; IN COMMERCE 1-31-2007.

**CLASS 42—SCIENTIFIC AND COMPUTER SERVICES**

FOR PRODUCT RESEARCH; TECHNICAL CONSULTING SERVICES IN THE FIELD OF AUTOMOTIVE AND INDUSTRIAL ENGINEERING (U.S. CLS. 100 AND 101).  
FIRST USE 1-31-2007; IN COMMERCE 1-31-2007.  
ANN E. SAPPENFIELD, EXAMINING ATTORNEY

SN 85-577,108. STONE SOUP, INC., FAIRFAX, VA. FILED 3-22-2012.



OWNER OF U.S. REG. NO. 3,158,030.  
NO CLAIM IS MADE TO THE EXCLUSIVE RIGHT TO USE "EST. 2005" AND "BOOKSTORE", APART FROM THE MARK AS SHOWN.

THE MARK CONSISTS OF GRAPHIC DEPICTION OF A SQUARE OF NOTE PAPER ON WHICH IS PRINTED "BUSBOYS" OVER A SECOND LINE THAT VERTICALLY PRINTS "AND" NEXT TO A HORIZONTAL PRINT OF "POETS" AND WITH GRAPHIC DEPICTIONS OF TAPE APPEAR AT MIDDLE OF THE TOP OF THE SQUARE AND ON THE BOTTOM CORNERS. THE MIDDLE OF THE BOTTOM OF THE SQUARE HAS A CIRCLE STAMPED OVER ITS EDGE AND THE TEXT "EST." APPEARS ON A SINGLE LINE ABOVE THE TEXT "2005" ON A LOWER SINGLE LINE WITHIN THIS CIRCLE. THE WORD "BOOKSTORE" IS PRINTED IN AN ARC OF A SEMICIRCLE TO THE RIGHT OF THE PREVIOUSLY DESCRIBED TEXT AND GRAPHICAL MATERIAL.

**CLASS 9—ELECTRICAL AND SCIENTIFIC APPARATUS**

FOR PRERECORDED AUDIO CLIPS, PRERECORDED VIDEO CLIPS, TEXT, SCREENSAVERS AND IMAGES HELD IN ELECTRONIC FORMAT, NAMELY, RECORDED ON MAGNETIC MEDIA AND MEMORY CARDS, FEATURING ARTS, ENTERTAINMENT, NEWS, CURRENT EVENTS, HISTORY, SPORTS, GAMES, HOBBIES, AND TOPICS OF GENERAL INTEREST; PRERECORDED ENTERTAINMENT AND MEMORY CARD AND MAGNETIC DATA CARRIERS FEATURING PRERECORDED AUDIO CLIPS, PRERECORDED VIDEO CLIPS TEXT, COMPUTER SCREENSAVER SOFTWARE AND IMAGES HELD IN ELECTRONIC FORMAT, FEATURING ARTS, ENTERTAINMENT, NEWS, CURRENT EVENTS, HISTORY, SPORTS, GAMES, HOBBIES, AND TOPICS OF GENERAL INTEREST; PRERECORDED ENTERTAINMENT AND EDUCATIONAL AUDIO AND VIDEO PRESENTATIONS, SHOWS AND CLIPS RECORDED ON AUDIO AND VIDEO STORAGE MEDIA, NAMELY, MAGNETIC DATA CARRIERS AND MEMORY CARDS, DIGITAL VIDEO DISCS (DVDS) AND VIDEO COMPACT DISCS (DVDS), COMPACTS DISCS (CDS), VIDEO CASSETTES, CASSETTES, VIDEOTAPES, AND AUDIO TAPES, FEATURING ARTS, ENTERTAINMENT, NEWS, CURRENT EVENTS, HISTORY, SPORTS, GAMES, HOBBIES, AND TOPICS OF GENERAL INTEREST; ELECTRONIC EDUCATIONAL, INSTRUCTIONAL AND TRAINING PUBLICATIONS RECORDED ON AUDIO AND VIDEO STORAGE MEDIA, NAMELY, MAGNETIC DATA CARRIERS AND MEMORY CARDS, DIGITAL VIDEO DISCS (DVDS) AND VIDEO COMPACT DISCS (VCDS), COMPACTS DISCS (CDS), VIDEO CASSETTES, CASSETTES, VIDEOTAPES, AND AUDIO TAPES, NAMELY, BOOKS, MAGAZINES, E-ZINES AND MANUALS IN THE FIELD OF ARTS, ENTERTAINMENT, NEWS, CURRENT EVENTS, HISTORY, SPORTS, GAMES, HOBBIES, AND TOPICS OF GENERAL INTEREST; DOWNLOADABLE ELECTRONIC EDUCATIONAL, INSTRUCTIONAL, AND TRAINING PUBLICATIONS IN THE NATURE OF MAGAZINE AND E-ZINES IN THE FIELD OF ARTS, ENTERTAINMENT, NEWS, CURRENT EVENTS, HISTORY, SPORTS, GAMES, HOBBIES, AND TOPICS OF GENERAL INTEREST; SOFTWARE FOR THE UPLOADING, DOWNLOADING, STREAMING, POSTING, DISPLAYING, BLOGGING, LINKING, AND SHARING INFORMATION AND DATA OVER COMMUNICATION NETWORKS; COMPUTER SOFTWARE FOR SEARCHING REMOTELY THE CONTENTS OF COMPUTERS AND COMPUTER NETWORKS FOR USE IN PROVIDING INFORMATION FROM SEARCHABLE INDEXES AND DATABASES OF INFORMATION, INCLUDING TEXT, ELECTRONIC DOCUMENTS, DATABASES, GRAPHICS AND AUDIO VISUAL INFORMATION (U.S. CLS. 21, 23, 26, 36 AND 38).

**CLASS 16—PAPER GOODS AND PRINTED MATTER**

FOR PRINTED PUBLICATIONS, NAMELY, MAGAZINES, PERIODICALS, NEWSPAPERS, PAMPHLETS, BOOKLETS, NEWSLETTERS AND BOOKS IN THE FIELD OF ARTS, ENTERTAINMENT, NEWS, CURRENT EVENTS, HISTORY, SPORTS, GAMES, HOBBIES AND TOPICS OF GENERAL INTEREST; PERIODICAL PUBLICATIONS, NAMELY, MAGAZINES, PERIODICALS, NEWSPAPERS, PAMPHLETS, BOOKLETS, NEWSLETTERS AND BOOKS IN THE FIELD OF ARTS, ENTERTAINMENT, NEWS, CURRENT EVENTS, HISTORY, SPORTS, GAMES, HOBBIES AND TOPICS OF GENERAL INTEREST (U.S. CLS. 2, 5, 22, 23, 29, 37, 38 AND 50).

**CLASS 18—LEATHER GOODS**

FOR TOTE BAGS; BACKPACKS; DUFFEL BAGS; BRIEFCASES; DRAWSTRING POUCHES; POCKETBOOKS; PURSES; ALL-PURPOSE CARRYING BAGS; ATHLETIC BAGS; BOOK BAGS; GYM BAGS; SCHOOL BAGS; UMBRELLAS (U.S. CLS. 1, 2, 3, 22 AND 41).

**CLASS 21—HOUSEWARES AND GLASS**

FOR BEER MUGS, COFFEE CUPS, MUGS, DRINKING STEINS, CUPS, CUPS AND MUGS, PLATES, DINNERWARE, NAMELY, CUPS AND GLASSES, DRINKING CUPS, DRINKING GLASSES, SPORTS WATER BOTTLES SOLD EMPTY, PLASTIC, STAINLESS STEEL AND ALUMINUM WATER BOTTLES SOLD EMPTY, PLASTIC COASTERS, ICE BUCKETS, GLASS DISHES, GLASS MUGS, GOBLETS, MUGS, PILSNER DRINKING GLASSES, BEER TUBS BEING ICE CHESTS FOR HOLDING BEER, BEER BUCKETS, THERMAL INSULATED BEVERAGE HOLDERS, PORTABLE ICE CHESTS FOR FOOD AND BEVERAGE, BOTTLE OPENERS (U.S. CLS. 2, 13, 23, 29, 30, 33, 40 AND 50).

**CLASS 25—CLOTHING**

FOR CLOTHING, NAMELY, T-SHIRTS, GOLF SHIRTS, SWEAT SHIRTS, SHIRTS, HOODED SWEAT SHIRTS, KNIT SHIRTS, SHORT-SLEEVED SHIRTS, LONG-SLEEVED SHIRTS, NIGHT SHIRTS, POLO SHIRTS, RUGBY SHIRTS, SHIRTS, BLOUSES, SPORT SHIRTS, SWEAT PANTS, SWEAT SHORTS, SWEAT SUITS, LOUNGE PANTS, PANTS, TROUSERS, ATHLETIC SHOES, BEACH SHOES, SHOES, ANKLETS AND SOCKS, BELTS, JERSEYS, SHORT SETS, TIES, NECKTIES, TOPS, WRAPS, JACKETS, DENIM JACKETS, FUR JACKETS, LEATHER JACKETS, RAIN JACKETS, WIND RESISTANT JACKETS, WRAP-AROUNDS, BRIEFS, THONGS AND UNDERWEAR, HEADGEAR, NAMELY, HATS AND CAPS, CAPS WITH VISORS, KNITTED CAPS (U.S. CLS. 22 AND 39).

**CLASS 35—ADVERTISING AND BUSINESS**

FOR RETAIL STORES FEATURING BOOKS, CLOTHING, JEWELRY, ACCESSORIES, FOOD, GIFT ITEMS, FAIR-TRADE MARKET ITEMS, STATIONERY PRODUCTS, NOTIONS, HOME ACCESSORIES, HOME GOODS, INTERIOR DECORATIONS, EXTERIOR DECORATIONS AND DECORATIVE ACCESSORIES; ON-LINE RETAIL STORES FEATURING BOOKS, CLOTHING, JEWELRY, ACCESSORIES, FOOD, GIFT ITEMS, FAIR-TRADE MARKET ITEMS, STATIONERY PRODUCTS, NOTIONS, HOME ACCESSORIES, HOME GOODS, INTERIOR DECORATIONS, EXTERIOR DECORATIONS AND DECORATIVE ACCESSORIES; ELECTRONIC CATALOG SERVICES FEATURING BOOKS, CLOTHING, JEWELRY, ACCESSORIES, FOOD, GIFT ITEMS, FAIR-TRADE MARKET ITEMS, STATIONERY PRODUCTS, NOTIONS, HOME ACCESSORIES, HOME GOODS, INTERIOR DECORATIONS, EXTERIOR DECORATIONS AND DECORATIVE ACCESSORIES; RETAIL GIFT SHOPS AND RETAIL STORE SERVICES FEATURING RETAILING OF BOOKS, CLOTHING, JEWELRY, ACCESSORIES, FOOD, GIFT ITEMS, FAIR-TRADE MARKET ITEMS, STATIONERY PRODUCTS, NOTIONS, HOME ACCESSORIES, HOME GOODS, INTERIOR DECORATIONS, EXTERIOR DECORATIONS AND DECORATIVE ACCESSORIES; RETAIL SOUVENIR SHOPS AND STORES, NAMELY, VENDING IN THE FIELD OF SOUVENIRS; RETAIL CONVENIENCE STORES; COMPUTERIZED ON-LINE ORDERING SERVICES IN THE FIELD OF RETAILING OF BOOKS, CLOTHING, JEWELRY, ACCESSORIES, FOOD, GIFT ITEMS, FAIR-TRADE MARKET ITEMS, STATIONERY PRODUCTS, NOTIONS, HOME ACCESSORIES, HOME GOODS, INTERIOR DECORATIONS, EXTERIOR DECORATIONS AND DECORATIVE ACCESSORIES; ISSUING GIFT CERTIFICATES WHICH MAY THEN BE REDEEMED FOR GOODS OR SERVICES; ADVERTISING AND PROMOTION SERVICES AND RELATED CONSULTING; DISTRIBUTION AND DISSEMINATION OF ADVERTISING MATERIALS; ADVERTISING SERVICES, NAMELY, PROMOTING AND ADVERTISING THE GOODS AND SERVICES OF OTHERS VIA ELECTRONIC MEDIA; BUSINESS PROMOTION AND ADVERTISING THE GOODS AND SERVICES OF OTHERS VIA ELECTRONIC MEDIA; PROVIDING ON-LINE SERVICES AND INFORMATION TO WHOLESALEERS, RETAILERS AND DEALERS, NAMELY, PROMOTION,

ADVERTISING AND MARKETING INFORMATION; COOPERATIVE ADVERTISING AND MARKETING; PROVIDING ONLINE ADVERTISING SERVICES FOR THE GOODS AND SERVICES OF OTHERS; ADVERTISING, INCLUDING PROMOTION RELATING TO THE SALE OF ARTICLES AND SERVICES FOR THIRD PARTIES BY THE TRANSMISSION OF ADVERTISING MATERIAL AND THE DISSEMINATION OF ADVERTISING MESSAGES ONLINE; COOPERATIVE ADVERTISING AND MARKETING SERVICES BY WAY OF SOLICITATION, CUSTOMER SERVICE AND PROVIDING MARKETING INFORMATION ONLINE; PROVIDING AN ON-LINE DIRECTORY INFORMATION SERVICES FEATURING INFORMATION REGARDING SOCIAL NETWORKING SITES, VIRTUAL COMMUNITIES, ADVERTISING AND CLASSIFIED SERVICES; ADVERTISING AND INFORMATION DISTRIBUTION SERVICES, NAMELY, PROVIDING CLASSIFIED ADVERTISING SPACE VIA THE INTERNET AND GLOBAL COMPUTER NETWORKS; PROMOTING THE GOODS AND SERVICES OF OTHERS VIA THE INTERNET AND GLOBAL COMPUTER NETWORKS; PROMOTING THE GOODS AND SERVICES OF OTHERS BY PROVIDING LINKS TO THE WEB SITES OF OTHERS; PROVIDING ON-LINE COMPUTER DATABASES AND ON-LINE SEARCHABLE DATABASES IN THE FIELD OF ADVERTISING AND CLASSIFIED ADS; PROVIDING AN ON-LINE INTERACTIVE WEBSITE OBTAINING USERS COMMENTS CONCERNING BUSINESS ORGANIZATIONS, SERVICE PROVIDERS, AND OTHER RESOURCES; PROVIDING INFORMATION, NAMELY, COMPILATIONS, RANKINGS, RATINGS, REVIEWS, REFERRALS AND RECOMMENDATIONS RELATING TO BUSINESS ORGANIZATIONS, SERVICE PROVIDERS, AND OTHER RESOURCES USING A GLOBAL COMPUTER NETWORK; PROVIDING TELEPHONE DIRECTORY INFORMATION VIA GLOBAL COMMUNICATIONS NETWORKS; ADVERTISING AND COMMERCIAL INFORMATION SERVICES, VIA THE INTERNET; ADVERTISING VIA ELECTRONIC MEDIA AND SPECIFICALLY THE INTERNET; MARKET MANIPULATION, RESEARCH AND ANALYSIS; PROVIDING AND RENTAL OF ADVERTISING SPACE ON THE INTERNET; PROVIDING CONSUMER PRODUCT INFORMATION VIA THE INTERNET (U.S. CLS. 100, 101 AND 102).

#### **CLASS 41—EDUCATION AND ENTERTAINMENT**

FOR PROVIDING FACILITIES FOR EDUCATIONAL AND ENTERTAINMENT ACTIVITIES AND EVENTS AND RECREATIONAL ACTIVITIES AND EVENTS, NAMELY, PERFORMANCE, STAGE AND AUDITORIUM FACILITIES; ORGANIZING EXHIBITIONS FOR ENTERTAINMENT PURPOSES, NAMELY, THE PRODUCTION AND PRESENTATION OF ART AND LIVE, THEATRICAL, MUSICAL AND CINEMATIC SHOWS AND PERFORMANCES; EDUCATIONAL AND ENTERTAINMENT SERVICES, NAMELY, THE PRODUCTION AND PRESENTATION OF ART AND LIVE, THEATRICAL, MUSICAL AND CINEMATIC SHOWS AND PERFORMANCES; EDUCATION SERVICES, NAMELY, PROVIDING PROGRAMS, CLASSES, CONFERENCES, WORKSHOPS AND SEMINARS IN THE FIELD OF ART AND LIVE, THEATRICAL, MUSICAL AND CINEMATIC SHOWS AND PERFORMANCES; EDUCATION AND ENTERTAINMENT SERVICES, NAMELY, PROVIDING A WEB SITE FEATURING PHOTOGRAPHIC, AUDIO, VIDEO AND PROSE PRESENTATIONS FEATURING ART AND LIVE, THEATRICAL, MUSICAL AND CINEMATIC SHOWS AND PERFORMANCES; EDUCATION AND ENTERTAINMENT SERVICES, NAMELY, PROVIDING PODCASTS FEATURING ART AND LIVE, THEATRICAL, MUSICAL AND CINEMATIC SHOWS AND PERFORMANCES; EXHIBITION SERVICES OF ART AND LIVE, THEATRICAL, MUSICAL AND CINEMATIC SHOWS AND PERFORMANCES; EDUCATIONAL AND ENTERTAINMENT SERVICES, NAMELY, PROVIDING WEBCASTS FEATURING ART AND LIVE, THEATRICAL, MUSICAL AND CINEMATIC SHOWS AND PERFORMANCES; PROVIDING EDUCATIONAL DISPLAYS AND INTERACTIVE EXHIBITS FEATURING ART AND LIVE, THEATRICAL, MUSICAL AND CINEMATIC SHOWS AND PERFORMANCES; EDUCATION AND ENTERTAINMENT SERVICES DISTRIBUTED VIA TELEVISION, SATELLITE, COMPUTER NETWORKS, GLOBAL COMPUTER NETWORKS, IN-

TERNET, AUDIO, VIDEO, RADIO AND BROADCAST MEDIA, NAMELY, VIDEO, AUDIO AND GRAPHIC AND PHOTOGRAPHIC PROGRAMS FEATURING ART AND LIVE, THEATRICAL, MUSICAL AND CINEMATIC SHOWS AND PERFORMANCES; ON-LINE JOURNALS, NAMELY, BLOGS FEATURING ART AND LIVE, THEATRICAL, MUSICAL AND CINEMATIC INFORMATION, SHOWS AND PERFORMANCES; PROVIDING A WEB SITE FEATURING EDUCATION INFORMATION FEATURING ART AND LIVE, THEATRICAL, MUSICAL AND CINEMATIC SHOWS AND PERFORMANCES AND ENTERTAINMENT INFORMATION; PROVIDING CURRENT EVENT NEWS AND INFORMATION VIA A GLOBAL COMPUTER NETWORK; PROVIDING NON-DOWNLOADABLE ON-LINE MAGAZINES FEATURING ART AND LIVE, THEATRICAL, MUSICAL AND CINEMATIC SHOWS AND PERFORMANCES; PROVISION OF INFORMATION RELATING TO ART, NEWS, THE FIELD OF EDUCATION, CULTURE, LITERATURE AND ENTERTAINMENT SERVICES OF LIVE, THEATRICAL, MUSICAL AND CINEMATIC SHOWS AND PERFORMANCES; EDUCATIONAL SERVICES, NAMELY, THE TRAINING OF OTHERS THROUGH COURSES, SEMINARS, PROGRAMS AND WORKSHOPS IN THE FIELD OF ART AND LIVE, THEATRICAL, MUSICAL AND CINEMATIC SHOWS AND PERFORMANCES; ENTERTAINMENT AND EDUCATION SERVICES, NAMELY, PROVIDING A WEBSITE FEATURING PRE-RECORDED NON-DOWNLOADABLE VIDEOS AND AUDIO CLIPS FEATURING ART AND LIVE, THEATRICAL, MUSICAL AND CINEMATIC SHOWS AND PERFORMANCES; ENTERTAINMENT SERVICES, NAMELY, PROVIDING ONLINE COMPUTER DATABASES FEATURING INFORMATION IN THE FIELDS OF ENTERTAINMENT, CURRENT EVENTS, HISTORY, SPORTS, GAMES, HOBBIES, PUBLICATIONS, AND TOPICS OF GENERAL INTEREST FEATURING ART AND LIVE, THEATRICAL, MUSICAL AND CINEMATIC SHOWS AND PERFORMANCES; ENTERTAINMENT SERVICES, NAMELY, PROVIDING NON-DOWNLOADABLE PRE-RECORDED MUSIC, AUDIO, VIDEO AND GRAPHICS VIA A GLOBAL COMPUTER NETWORK AND WIRELESS NETWORKS; EDUCATIONAL SERVICES IN THE NATURE OF CLASSES AND TRAINING SERVICES OFFERED IN-PERSON AND OVER COMPUTER NETWORKS IN THE FIELDS OF K-12 EDUCATION, UNIVERSITY-LEVEL SUBJECTS, COMPUTER HARDWARE AND SOFTWARE, DIGITAL MOBILE DEVICES, TECHNOLOGY, GADGETS, COMPUTER SOFTWARE, COMPUTER HARDWARE, CONSUMER ELECTRONICS, TELEPHONES AND TELECOMMUNICATIONS, MULTIMEDIA APPARATUS AND INSTRUMENTS; ENTERTAINMENT AND EDUCATIONAL SERVICES, NAMELY, PROVIDING NON-DOWNLOADABLE ONLINE PUBLICATIONS, NAMELY, ELECTRONIC BOOKS, MAGAZINES, NEWSPAPERS, JOURNALS, PERIODICALS, AND MANUALS, ALL IN THE FIELDS OF ENTERTAINMENT, NEWS, CURRENT EVENTS, HISTORY, SPORTS, GAMES, HOBBIES, PUBLICATIONS, AND TOPICS OF GENERAL INTEREST; ENTERTAINMENT AND EDUCATIONAL SERVICES, NAMELY, PROVIDING PODCASTS IN THE FIELDS OF ENTERTAINMENT, NEWS, CURRENT EVENTS, HISTORY, SPORTS, GAMES, HOBBIES, PUBLICATIONS, AND TOPICS OF GENERAL INTEREST; ENTERTAINMENT AND EDUCATION SERVICES, NAMELY, ORGANIZING AND CONDUCTING EXHIBITIONS, DISPLAYS, EXHIBITS, WORKSHOPS, SEMINARS, TRAINING, CONFERENCES, AND LECTURES IN THE FIELDS OF ENTERTAINMENT, NEWS, CURRENT EVENTS, HISTORY, SPORTS, GAMES, HOBBIES, PUBLICATIONS, AND ART AND LIVE, THEATRICAL, MUSICAL AND CINEMATIC SHOWS AND PERFORMANCES; NIGHT CLUB SERVICES; NIGHT CLUBS AND CABARETS (U.S. CLS. 100, 101 AND 107).

**CLASS 42—SCIENTIFIC AND COMPUTER SERVICES**

FOR COMPUTER SERVICES IN THE NATURE OF DEVELOPMENT OF CUSTOMIZED WEB PAGES FOR OTHERS FEATURING USER-DEFINED INFORMATION, PERSONAL PROFILES AND INFORMATION IN THE FIELD OF THE ARTS AND SOCIAL, BUSINESS AND COMMUNITY NETWORKING; COMPUTER SERVICES, NAMELY, CREATING AN ON-LINE COMMUNITY FOR REGISTERED USERS TO PARTICIPATE IN DISCUSSION, GET FEEDBACK FROM THEIR PEERS, FORM VIRTUAL COMMUNITIES, AND ENGAGE IN SOCIAL NETWORKING FIELD OF THE ARTS AND SOCIAL, BUSINESS AND COMMUNITY NETWORKING; PEER-TO-BROWSER PHOTO SHARING SERVICES, NAMELY, PROVIDING A WEBSITE FEATURING TECHNOLOGY ENABLING USERS TO UPLOAD, VIEW AND DOWNLOAD DIGITAL PHOTOS; COMPUTER SERVICES, NAMELY, CREATING VIRTUAL COMMUNITIES FOR REGISTERED USERS TO ORGANIZE GROUPS AND EVENTS, PARTICIPATE IN DISCUSSIONS, AND ENGAGE IN SOCIAL, BUSINESS AND COMMUNITY NETWORKING; APPLICATION SERVICE PROVIDER (ASP) SERVICES, NAMELY, HOSTING COMPUTER SOFTWARE APPLICATIONS OF OTHERS; APPLICATION SERVICE PROVIDER (ASP) FEATURING SOFTWARE TO ENABLE OR FACILITATE THE UPLOADING, DOWNLOADING, STREAMING, POSTING, DISPLAYING, BLOGGING, LINKING, SHARING OR OTHERWISE PROVIDING ELECTRONIC MEDIA OR INFORMATION OVER COMMUNICATION NETWORKS; PROVIDING AN ONLINE NETWORK SERVICE THAT ENABLES USERS TO TRANSFER PERSONAL IDENTITY DATA TO AND SHARE PERSONAL IDENTITY DATA WITH AND AMONG MULTIPLE WEBSITES, NAMELY, SOCIAL MEDIA BOARDS AND CONFERENCE AND CHAT ROOM FACILITIES; PROVIDING A WEB SITE FEATURING TECHNOLOGY THAT ENABLES ONLINE USERS TO CREATE PERSONAL PROFILES FEATURING SOCIAL NETWORKING INFORMATION AND TO TRANSFER AND SHARE SUCH INFORMATION AMONG MULTIPLE WEBSITES; COMPUTER SERVICES IN THE NATURE OF DEVELOPING CUSTOMIZED WEB PAGES FEATURING USER-DEFINED OR SPECIFIED INFORMATION, PERSONAL PROFILES, AUDIO, VIDEO, PHOTOGRAPHIC IMAGES, TEXT, GRAPHICS AND DATA; PROVIDING TEMPORARY ACCESS TO NON-DOWNLOADABLE SOFTWARE FOR THE UPLOADING, DOWNLOADING, STREAMING, POSTING, DISPLAYING, BLOGGING, LINKING, AND SHARING INFORMATION AND DATA OVER COMMUNICATION NETWORKS; PROVIDING TEMPORARY ACCESS TO NON-DOWNLOADABLE COMPUTER SOFTWARE FOR SEARCHING REMOTELY THE CONTENTS OF COMPUTERS AND COMPUTER NETWORKS FOR USE IN PROVIDING INFORMATION FROM SEARCHABLE INDEXES AND DATABASES OF INFORMATION, INCLUDING TEXT, ELECTRONIC DOCUMENTS, DATABASES, GRAPHICS AND AUDIO VISUAL INFORMATION (U.S. CLS. 100 AND 101).

**CLASS 43—HOTEL AND RESTAURANT SERVICES**

FOR RESTAURANT, CATERING AND BAR SERVICES; RESTAURANT SERVICES; RESTAURANTS; RESTAURANTS FEATURING HOME DELIVERY; CAFE RESTAURANTS; CARRY-OUT RESTAURANTS; COCKTAIL LOUNGES (U.S. CLS. 100 AND 101).

**CLASS 45—PERSONAL AND LEGAL SERVICES**

FOR ONLINE SOCIAL NETWORKING; SPECIAL EVENT PLANNING CONSULTATION SERVICES; INTERNET-BASED AND GLOBAL COMPUTER NETWORK BASED INTRODUCTION AND SOCIAL NETWORKING SERVICES; PROVIDING ON-LINE COMPUTER DATABASES AND ON-LINE SEARCHABLE DATABASES IN THE FIELD OF SOCIAL NETWORKING; SOCIAL INTRODUCTION AND NETWORKING SERVICES; INFORMATION IN THE FIELD OF PERSONAL DEVELOPMENT, NAMELY, SELF-IMPROVEMENT AND SELF-FULFILLMENT; PROVIDING AN ONLINE COMPUTER DATABASE IN THE FIELD OF SOCIAL NETWORKING; PROVIDING INFORMATION ON CHARITABLE AND HUMANITARIAN EFFORTS IN THE FIELDS OF SOCIAL JUSTICE (U.S. CLS. 100 AND 101).

EUGENIA MARTIN, EXAMINING ATTORNEY

SN 85-579,868. EDMONTON RUNNING ROOM LTD., EDMONTON, CANADA, FILED 3-26-2012.

PRIORITY CLAIMED UNDER SEC. 44(D) ON CANADA APPLICATION NO. 1553043, FILED 11-21-2011, REG. NO. TMA866874, DATED 12-6-2013, EXPIRES 12-6-2028.

THE MARK CONSISTS OF THE LETTERS "RRX" IN UPPER CASE WITH OUTLINE BORDERS FOR EACH LETTER.

**CLASS 18—LEATHER GOODS**

FOR GYM BAGS (U.S. CLS. 1, 2, 3, 22 AND 41).

**CLASS 21—HOUSEWARES AND GLASS**

FOR HYDRATION PACKS AS A PERSONAL FLUID HYDRATION SYSTEM COMPRISING A FLUID COMPARTMENT AND A DRINK TUBE (U.S. CLS. 2, 13, 23, 29, 30, 33, 40 AND 50).

**CLASS 25—CLOTHING**

FOR CLOTHING, NAMELY, SWEATERS, TANK TOPS, T-SHIRTS, LONG SLEEVE T-SHIRTS, JACKETS, SHORTS, PANTS, TIGHTS, BRAS, ARM SLEEVES, VESTS, HEADBANDS, HATS, TOQUES, SOCKS, MITTENS AND GLOVES, UNDERWEAR, CALF SLEEVES, NECK WARMERS; ATHLETIC FOOTWEAR (U.S. CLS. 22 AND 39).

WILLIAM ROSSMAN, EXAMINING ATTORNEY

SN 85-587,371. ALSAYED MOHAMMED, RIYADH 11564, SAUDI ARABIA, FILED 4-3-2012.

THE MARK CONSISTS OF STANDARD CHARACTERS WITHOUT CLAIM TO ANY PARTICULAR FONT, STYLE, SIZE, OR COLOR.

PRIORITY CLAIMED UNDER SEC. 44(D) ON ERPN CMNTY TM OFC APPLICATION NO. 010769479, FILED 3-29-2012.

NO CLAIM IS MADE TO THE EXCLUSIVE RIGHT TO USE "TV", APART FROM THE MARK AS SHOWN.

#### **CLASS 9—ELECTRICAL AND SCIENTIFIC APPARATUS**

FOR SOUND RECORDINGS, VIDEO RECORDINGS AND AUDIOVISUAL RECORDINGS, NAMELY, AUDIO AND VIDEO RECORDINGS FEATURING NEWS REPORTING; AUDIO AND AUDIOVISUAL RECORDED MEDIA, NAMELY, CASSETTES, RECORDS, COMPACT DISCS, DVD'S, CD-ROM'S, HARD DISK DRIVES AND FLASH MEMORY FEATURING NEWS REPORTING AND STORIES CONCERNING RELIGION AND FAITH; DOWNLOADABLE ELECTRONIC PUBLICATIONS IN THE NATURE OF ELECTRONIC NEWSLETTERS IN THE FIELD OF RELIGION AND FAITH; MOVIE, TELEVISION AND PHOTOGRAPHIC FILMS CONCERNING RELIGION AND FAITH (U.S. CLS. 21, 23, 26, 36 AND 38).

#### **CLASS 38—COMMUNICATION**

FOR TELECOMMUNICATIONS AND BROADCASTING SERVICES, NAMELY, BROADCASTING MUSIC AND SPEECH OVER THE RADIO; TELEVISION BROADCASTING; DATA COMMUNICATION, NAMELY, ELECTRONIC TRANSMISSION OF DATA AND DOCUMENTS AMONG COMPUTER USERS (U.S. CLS. 100, 101 AND 104).

#### **CLASS 41—EDUCATION AND ENTERTAINMENT**

FOR PRODUCTION AND PRESENTATION OF PROGRAMS CONCERNING RELIGION AND FAITH AND DISTRIBUTION THEREOF VIA TELEVISION BROADCAST AND CABLE NETWORKS, SATELLITE AND THE INTERNET (U.S. CLS. 100, 101 AND 107).

KELLY TRUSILO, EXAMINING ATTORNEY

---

SN 85-595,223. AMERICAN BUREAU OF SHIPPING, HOUSTON, TX. FILED 4-11-2012.

# ICLASS

THE MARK CONSISTS OF STANDARD CHARACTERS WITHOUT CLAIM TO ANY PARTICULAR FONT, STYLE, SIZE, OR COLOR.

#### **CLASS 9—ELECTRICAL AND SCIENTIFIC APPARATUS**

FOR DOWNLOADABLE SOFTWARE IN THE FIELD OF DESIGN, EVALUATION AND OPERATIONAL MAINTENANCE OF MARINE AND OFFSHORE VESSELS AND STRUCTURES AND MARINE-RELATED FACILITIES USED FOR PERFORMING TECHNICAL REVIEWS, AUDITS AND SURVEYS FOR MARINE AND OFFSHORE VESSELS AND STRUCTURES AND MARINE-RELATED FACILITIES FOR CERTIFICATION OF COMPLIANCE WITH INDUSTRY AND REGULATORY STANDARDS (U.S. CLS. 21, 23, 26, 36 AND 38).

#### **CLASS 37—CONSTRUCTION AND REPAIR**

FOR TECHNICAL SUPPORT SERVICES, NAMELY, PROVIDING TECHNICAL ADVICE IN THE FIELD OF CONSTRUCTION, AND OPERATIONAL MAINTENANCE OF MARINE AND OFFSHORE VESSELS AND STRUCTURES AND MARINE-RELATED FACILITIES (U.S. CLS. 100, 103 AND 106).

#### **CLASS 38—COMMUNICATION**

FOR PROVIDING AN ON-LINE FORUM IN THE FIELD OF DESIGN, CONSTRUCTION, EVALUATION AND OPERATION MAINTENANCE OF MARINE AND OFFSHORE VESSELS AND STRUCTURES AND MARINE-RELATED FACILITIES (U.S. CLS. 100, 101 AND 104).

#### **CLASS 41—EDUCATION AND ENTERTAINMENT**

FOR PROVIDING EDUCATIONAL SERVICES, NAMELY, CONDUCTING LIVE AND ON-LINE CLASSES, SEMINARS AND WORKSHOPS IN THE FIELD OF DESIGN, CONSTRUCTION, EVALUATION AND OPERATIONAL MAINTENANCE OF MARINE AND OFFSHORE VESSELS AND STRUCTURES AND MARINE-RELATED FACILITIES, AND DISTRIBUTION OF TRAINING MATERIALS IN CONNECTION THEREWITH (U.S. CLS. 100, 101 AND 107).

#### **CLASS 42—SCIENTIFIC AND COMPUTER SERVICES**

FOR CONDUCTING TECHNICAL ANALYSIS AND INSPECTIONS OF MARINE AND OFFSHORE VESSELS AND STRUCTURES AND MARINE-RELATED FACILITIES FOR COMPLIANCE WITH INDUSTRY AND REGULATORY STANDARDS; DEVELOPMENT OF TECHNICAL STANDARDS FOR THE DESIGN, CONSTRUCTION AND OPERATIONAL MAINTENANCE OF MARINE AND OFFSHORE VESSELS AND STRUCTURES AND MARINE-RELATED FACILITIES; PROVIDING AN ONLINE PORTAL THAT FEATURES THE TEMPORARY USE OF NON-DOWNLOADABLE SOFTWARE THAT PERMITS USERS TO ACCESS APPLICATIONS AND SERVICES RELATING TO THE DESIGN, EVALUATION AND OPERATIONAL MAINTENANCE OF MARINE AND OFFSHORE VESSELS AND STRUCTURES AND MARINE-RELATED FACILITIES AND FOR PERFORMING TECHNICAL REVIEWS, AUDITS AND SURVEYS FOR MARINE AND OFFSHORE VESSELS AND STRUCTURES AND MARINE-RELATED FACILITIES FOR CERTIFICATION OF COMPLIANCE WITH INDUSTRY AND REGULATORY STANDARDS; DESIGN AND EVALUATION OF MARINE AND OFFSHORE VESSELS AND STRUCTURES AND MARINE-RELATED FACILITIES (U.S. CLS. 100 AND 101).

AHSEN KHAN, EXAMINING ATTORNEY

---

SN 85-613,758. THE EXPLORATORIUM, SAN FRANCISCO, CA. FILED 5-1-2012.

# THE TINKERING STUDIO

THE MARK CONSISTS OF STANDARD CHARACTERS WITHOUT CLAIM TO ANY PARTICULAR FONT, STYLE, SIZE, OR COLOR.

NO CLAIM IS MADE TO THE EXCLUSIVE RIGHT TO USE "STUDIO", APART FROM THE MARK AS SHOWN.

**CLASS 9—ELECTRICAL AND SCIENTIFIC APPARATUS**

FOR SCIENTIFIC KITS COMPRISED OF WOOD, CIRCUITRY, LED LIGHTS, FABRIC AND WIRE; ACCESSORIES FOR SCIENTIFIC KITS COMPRISED OF WOOD, CIRCUITRY, LED LIGHTS, FABRIC AND WIRE, NAMELY, RINGERS, SWITCHES, WOOD, PLASTIC AND METAL MOVING MECHANISMS, FABRICS, THREAD, ELECTRONIC PARTS SUCH AS BATTERIES AND CONDUCTIVE THREAD, PAINT, PINS, NEEDLES, AND TOOLS SUCH AS RULERS, PLIERS, WIRE CUTTERS, AND SCISSORS; SCIENTIFIC EXPERIMENT EXHIBITS, NAMELY, CIRCUITRY BOARDS, BALL/MARBLE RUNS, WIND TUBES, CONDUCTIVE MATERIALS FOR SEWING, AND ANIMATION STATIONS; ACCESSORIES FOR SCIENTIFIC EXPERIMENT EXHIBITS, NAMELY, PLIERS, SCISSORS, RULERS, CLAMPS, TAPE, CONDUCTIVE PAINT, CONDUCTIVE THREAD, NEEDLES, AND WOOD RAILS FOR BALL/MARBLE RUNS (U.S. CLS. 21, 23, 26, 36 AND 38).

**CLASS 16—PAPER GOODS AND PRINTED MATTER**

FOR CHILDREN'S BOOKS; CHILDREN'S INTERACTIVE EDUCATIONAL BOOKS; PICTURE POSTCARDS; PENCILS; NOTE CARDS; BOOKMARKS; PENCIL BOXES; PUBLICATIONS AND PRINTED MATERIALS, NAMELY, BOOKS ON THE TOPIC OF SCIENCE, MATH, EDUCATION AND GENERAL INTEREST; BOOKLETS ON THE TOPIC OF EDUCATION (U.S. CLS. 2, 5, 22, 23, 29, 37, 38 AND 50).

**CLASS 18—LEATHER GOODS**

FOR TOTE BAGS (U.S. CLS. 1, 2, 3, 22 AND 41).

**CLASS 21—HOUSEWARES AND GLASS**

FOR MUGS (U.S. CLS. 2, 13, 23, 29, 30, 33, 40 AND 50).

**CLASS 25—CLOTHING**

FOR CLOTHING, NAMELY, SHIRTS, T-SHIRTS AND SWEATSHIRTS (U.S. CLS. 22 AND 39).

**CLASS 28—TOYS AND SPORTING GOODS**

FOR EDUCATIONAL TOYS FOR DEVELOPING CRITICAL THINKING SKILLS, TOOL USE AND UNDERSTANDING OF SCIENTIFIC PHENOMENON FOR USE IN ARTISTIC EXPRESSION; GAMES AND PLAYTHINGS, NAMELY, ACTION FIGURES AND THEIR ACCESSORIES, TOY FIGURES, STUFFED TOY FIGURES, TOY MODEL HOBBY CRAFT KITS, AND MECHANICAL TOYS; BOARD GAMES; ELECTRONIC EDUCATIONAL GAME MACHINES FOR CHILDREN; ELECTRONIC EDUCATIONAL GAMES FOR THE TEACHING OF CHILDREN; AND PUZZLES (U.S. CLS. 22, 23, 38 AND 50).

KATHERINE CHANG, EXAMINING ATTORNEY

SN 85-624,696. KÜNZLI SWISSSCHUH AG, CH-5210 WINDISCH, SWITZERLAND, FILED 5-14-2012.



PRIORITY CLAIMED UNDER SEC. 44(D) ON ERPN CMNTY TM OFC APPLICATION NO. 010749554, FILED 3-22-2012, REG. NO. 010749554, DATED 8-1-2012, EXPIRES 3-22-2022.

OWNER OF U.S. REG. NOS. 2,065,715, 2,153,113 AND 3,956,857.

THE COLOR(S) RED AND WHITE IS/ARE CLAIMED AS A FEATURE OF THE MARK.

THE MARK CONSISTS OF THE WORD "KÜNZLI" IN RED FOLLOWED BY A RED SQUARE WITH A WHITE CENTER. BELOW THE WORDING ARE FIVE SOLID, RED SQUARES. THE LETTER "U" IN THE MARK APPEARS WITH A STYLIZED UMLAUT OVER IT COMPRISED OF TWO RECTANGLES IN RED.

**CLASS 9—ELECTRICAL AND SCIENTIFIC APPARATUS**

FOR GOODS MADE OF LEATHER AND IMITATION LEATHER, NAMELY, HOLSTERS AND CARRYING CASES FOR MOBILE PHONES (U.S. CLS. 21, 23, 26, 36 AND 38).

**CLASS 14—JEWELRY**

FOR PRECIOUS METALS AND THEIR ALLOYS AND GOODS IN PRECIOUS METALS OR COATED THEREWITH, NAMELY, JEWELRY OF PRECIOUS METAL; JEWELLERY, PRECIOUS STONES; HOROLOGICAL AND CHRONOMETRIC INSTRUMENTS, MADE OF PRECIOUS METAL (U.S. CLS. 2, 27, 28 AND 50).

**CLASS 18—LEATHER GOODS**

FOR LEATHER AND IMITATIONS OF LEATHER; ANIMAL SKINS, HIDES; TRUNKS AND TRAVELLING BAGS; HANDBAGS; BACKPACKS; UMBRELLAS, PARASOLS AND WALKING STICKS; WHIPS, HARNESSES AND SADDLERY (U.S. CLS. 1, 2, 3, 22 AND 41).

**CLASS 25—CLOTHING**

FOR CLOTHING, NAMELY, PANTS, SKIRTS, DRESSES, JACKETS, SHIRTS; FOOTWEAR; HEADGEAR, NAMELY, HATS, CAPS; BELTS (U.S. CLS. 22 AND 39).

LIEF MARTIN, EXAMINING ATTORNEY

SN 85-640,908. JASON KINGSLEY, OXFORD, OXFORDSHIRE, UNITED KINGDOM, AND CHRISTOPHER KINGSLEY, OXFORD, OXFORDSHIRE, UNITED KINGDOM, FILED 6-1-2012.

**RAVENSTONE**

THE MARK CONSISTS OF STANDARD CHARACTERS WITHOUT CLAIM TO ANY PARTICULAR FONT, STYLE, SIZE, OR COLOR.

PRIORITY CLAIMED UNDER SEC. 44(D) ON ERPN CMNTY TM OFC APPLICATION NO. 010934172, FILED 6-1-2012, REG. NO. 010934172, DATED 5-11-2012, EXPIRES 5-11-2022.

### **CLASS 9—ELECTRICAL AND SCIENTIFIC APPARATUS**

FOR DOWNLOADABLE PUBLICATIONS, NAMELY, BOOKS, MAGAZINES, NOVELS AND A SERIES OF WRITTEN ARTICLES IN THE FIELD OF FICTION, ROMANCE AND SCIENCE FICTION; DOWNLOADABLE COMPUTER GAME PROGRAMS; DOWNLOADABLE VIDEOS AND FILMS IN THE FIELD OF FICTION, ROMANCE AND SCIENCE FICTION; DOWNLOADABLE SOUND RECORDINGS FEATURING MUSIC AND THE READING OF BOOKS AND MAGAZINES IN THE FIELD OF FICTION, NON-FICTION, CHILDREN'S FICTION, TEEN FICTION, HORROR, SUSPENSE, MYSTERY, CRIME, POETRY, ACTION, SCIENCE FICTION, ROMANCE, DRAMA, COMEDY, ADVENTURE, THEATRE AND MUSIC (U.S. CLS. 21, 23, 26, 36 AND 38).

### **CLASS 16—PAPER GOODS AND PRINTED MATTER**

FOR PRINTED MATTER AND PUBLICATIONS, NAMELY, BOOKS, MAGAZINES, NOVELS AND A SERIES OF WRITTEN ARTICLES AND SCRIPTS FOR PLAYS IN THE FIELD OF FICTION, SCIENCE FICTION, ROMANCE, DRAMA, COMEDY, ADVENTURES, THEATRE AND MUSIC; COMICS IN THE FIELD OF FICTION, ROMANCE AND SCIENCE FICTION AND A SERIES OF WRITTEN ARTICLES IN THE FIELD OF SCIENCE FICTION, FICTION, NON-FICTION, CHILDREN'S FICTION, TEEN FICTION, HORROR, SUSPENSE, MYSTERY, CRIME, COMEDY, ACTION, DRAMA, POETRY, ROMANCE, ADVENTURE, THEATRE AND MUSIC; BOOKS IN THE FIELD OF LITERATURE, FICTION, SCIENCE FICTION, ROMANCE, DRAMA, COMEDY, ADVENTURES, THEATRE AND MUSIC, FICTION, FANTASY AND HORROR; PAMPHLETS IN THE FIELD OF LITERATURE, MUSIC, VIDEO GAMES, FICTION, ROMANCE AND SCIENCE FICTION AND A SERIES OF WRITTEN ARTICLES IN THE FIELD OF SCIENCE FICTION, FICTION, NON-FICTION, CHILDREN'S FICTION, TEEN FICTION, HORROR, SUSPENSE, MYSTERY, CRIME, COMEDY, ACTION, DRAMA, POETRY, ROMANCE, ADVENTURE, THEATRE AND MUSIC; MAGAZINES IN THE FIELD OF LITERATURE, MUSIC, VIDEO GAMES, FICTION, ROMANCE AND SCIENCE FICTION AND A SERIES OF WRITTEN ARTICLES IN THE FIELD OF SCIENCE FICTION, FICTION, NON-FICTION, CHILDREN'S FICTION, TEEN FICTION, HORROR, SUSPENSE, MYSTERY, CRIME, COMEDY, ACTION, DRAMA, POETRY, ROMANCE, ADVENTURE, THEATRE AND MUSIC; PRINTED TEACHING MATERIALS IN THE FIELD OF LITERATURE INCLUDING FICTION, ROMANCE AND SCIENCE FICTION, MUSIC, VIDEO GAMES, AND A SERIES OF WRITTEN ARTICLES IN THE FIELD OF SCIENCE FICTION, FICTION, NON-FICTION, CHILDREN'S FICTION, TEEN FICTION, HORROR, SUSPENSE, MYSTERY, CRIME, COMEDY, ACTION, DRAMA, POETRY, ROMANCE, ADVENTURE, THEATRE AND MUSIC; PHOTOGRAPHS; POSTERS; TRADING CARDS FEATURING FICTION, GAMES AND GAME CHARACTERS (U.S. CLS. 2, 5, 22, 23, 29, 37, 38 AND 50).

### **CLASS 41—EDUCATION AND ENTERTAINMENT**

FOR PROVIDING ONLINE PUBLICATIONS IN THE NATURE OF A SERIES OF WRITTEN ARTICLES IN THE FIELD OF SCIENCE FICTION, FICTION, NON-FICTION, CHILDREN'S FICTION, TEEN FICTION, HORROR, SUSPENSE, MYSTERY, CRIME, COMEDY, ACTION, DRAMA, POETRY, ROMANCE, ADVENTURE, THEATRE AND MUSIC; ADVISORY SERVICES, NAMELY, PROVIDING INFORMATION IN THE FIELD OF PUBLISHING OF PERIODICALS IN THE FIELD OF LITERATURE, MUSIC, VIDEO GAMES, FICTION, ROMANCE AND SCIENCE FICTION NOVELS AND A SERIES OF WRITTEN ARTICLES IN THE FIELD OF

SCIENCE FICTION, FICTION, NON-FICTION, CHILDREN'S FICTION, TEEN FICTION, HORROR, SUSPENSE, MYSTERY, CRIME, COMEDY, ACTION, DRAMA, POETRY, ROMANCE, COMEDY, ADVENTURE, THEATRE AND MUSIC; BOOK PUBLISHING, NAMELY, PUBLISHING OF BOOKS, PUBLISHING OF BOOKS AND MAGAZINES, PUBLISHING OF BOOKS OF MUSIC, PUBLISHING OF BOOKS IN THE NATURE OF PAMPHLETS, PUBLISHING OF BOOKS OF STORIES, PUBLISHING OF BOOKS IN THE NATURE OF PERIODICALS, PUBLISHING OF BOOKS OF PHOTOGRAPHS, PUBLISHING OF BOOKS OF DRAWINGS, PUBLISHING OF BOOKS OF ART; DESKTOP PUBLISHING FOR OTHERS, NAMELY, PUBLISHING OF BOOKS, PUBLISHING OF MAGAZINES, PUBLISHING OF PAMPHLETS, PUBLISHING OF STORIES, PUBLISHING OF PERIODICALS; ELECTRONIC DESKTOP PUBLISHING FOR OTHERS WHOLLY BASED ON THE PUBLISHING OF FICTION, FANTASY AND HORROR PUBLICATIONS; ELECTRONIC TEXT PUBLISHING SERVICES FOR OTHERS, NAMELY, PUBLICATION OF TEXT AND GRAPHIC WORKS OF OTHERS IN THE NATURE OF MAGAZINES, FICTION NOVELS AND DRAMATIC NOVELS FEATURING CHILDREN'S FICTION, TEEN FICTION, HORROR, SUSPENSE, MYSTERY, CRIME, COMEDY, ACTION, DRAMA, ADVENTURE, THEATRE, MUSIC, POETRY, ROMANCE AND SCIENCE FICTION ON CD, DVD AND ON-LINE; PROVISION OF INFORMATION RELATING TO PUBLISHING OF PERIODICALS WHOLLY BASED ON FICTION, FANTASY OR HORROR; MULTIMEDIA PUBLISHING OF PERIODICALS, BOOKS, PAMPHLETS, MAGAZINES, STORIES, PHOTOGRAPHS, DRAWINGS, ART, MANUALS, DICTIONARIES BY ELECTRONIC MEANS IN THE FIELD OF FICTION NOVELS, DRAMATIC NOVELS, SCIENCE FICTION, ACTION STORIES, FACT BASED MAGAZINES AND FANTASY; ONLINE ELECTRONIC PUBLISHING OF BOOKS, COMICS, PICTURE BOOKS, NOVELS, MAGAZINES, NEWSPAPERS, FEATURING SCIENCE FICTION, FICTION, NON-FICTION, CHILDREN'S FICTION, TEEN FICTION, HORROR, SUSPENSE, MYSTERY, CRIME, COMEDY, ACTION, DRAMA, POETRY, ROMANCE, COMEDY, ADVENTURE, THEATRE AND MUSIC; PUBLISHING OF DOCUMENTS IN THE NATURE OF FICTION NOVELS, DRAMATIC NOVELS IN THE FIELD OF SCIENCE FICTION, ACTION STORIES, FACT BASED PUBLICATION MAGAZINES AND FANTASY; PUBLISHING OF PRINTED MATTER, NAMELY, BOOKS, PAMPHLETS, MAGAZINES, STORIES, PERIODICALS, PHOTOGRAPHS, DRAWINGS, ART IN THE NATURE OF FICTION NOVELS, DRAMATIC NOVELS IN THE FIELD OF SCIENCE FICTION, ACTION STORIES, FACT BASED MAGAZINES AND FANTASY; PUBLISHING OF STORIES IN THE NATURE OF FICTION NOVELS, DRAMATIC NOVELS IN THE FIELD OF SCIENCE FICTION, ACTION STORIES, FACT BASED PUBLICATION MAGAZINES AND FANTASY; PUBLISHING SERVICES, NAMELY, ELECTRONIC PUBLISHING OF E-BOOKS, MAGAZINES, NEWSPAPERS, ELECTRONIC PUBLICATIONS IN DIGITAL FORMAT, MULTIMEDIA PUBLISHING, DIGITAL AUDIO AND VIDEO PUBLISHING, FEATURING CONTENT IN THE FIELD OF HORROR, GAMES, VIDEOS, FILMS INCLUDING SOUND RECORDINGS, BOOKS, MAGAZINES, ARTICLES, NOVELS IN THE FIELD OF SCIENCE FICTION, FICTION, NON-FICTION, CHILDREN'S FICTION, TEEN FICTION, HORROR, SUSPENSE, MYSTERY, CRIME, ACTION, POETRY, ROMANCE, PLAYS, DRAMA, COMEDY, ADVENTURES, THEATRE OR MUSIC, COMMISSIONED WRITING, NAMELY, WRITING OF BOOKS, PAMPHLETS, MAGAZINES, SHORT STORIES, DRAWINGS, ART, MANUALS, DICTIONARIES, PLAYS, MUSICALS, DRAMATIC NOVELS, IN THE FIELD OF SCIENCE FICTION AND FANTASY; PUBLICATION OF ELECTRONIC BOOKS AND JOURNALS ON-LINE IN THE NATURE OF FICTION NOVELS, DRAMATIC NOVELS IN THE FIELD OF SCIENCE FICTION, ACTION STORIES, FACT BASED MAGAZINES AND FANTASY; ARRANGING AND ORGANIZATION OF GAMES; ORGANIZING AND ARRANGING MUSICAL AND CINEMATOGRAPHIC EXHIBITIONS FOR CULTURAL, ENTERTAINMENT OR EDUCATIONAL PURPOSES; CONSULTANCY, ADVISORY AND INFORMATION SERVICES RELATED TO THE FORESAID SERVICES (U.S. CLS. 100, 101 AND 107).

SAIMA MAKHDOOM, EXAMINING ATTORNEY

SN 85-649,156. WILLIAM MORRIS LONDON LIMITED, HERTFORDSHIRE, UNITED KINGDOM, FILED 6-12-2012.

## WILLIAM MORRIS LONDON

THE MARK CONSISTS OF STANDARD CHARACTERS WITHOUT CLAIM TO ANY PARTICULAR FONT, STYLE, SIZE, OR COLOR.

OWNER OF ERPN CMNTY TM OFC REG. NO. 009721771, DATED 7-14-2011, EXPIRES 7-14-2021.

NO CLAIM IS MADE TO THE EXCLUSIVE RIGHT TO USE "LONDON", APART FROM THE MARK AS SHOWN.

THE NAME(S), PORTRAIT(S), AND/OR SIGNATURE(S) SHOWN IN THE MARK IDENTIFIES WILLIAM MORRIS, WHOSE CONSENT(S) TO REGISTER IS MADE OF RECORD.

### CLASS 9—ELECTRICAL AND SCIENTIFIC APPARATUS

FOR OPTICAL APPARATUS AND INSTRUMENTS, NAMELY, EYEWEAR, SPECTACLES, SUNGLASSES; GLASSES CASES; FRAMES FOR GLASSES AND SUNGLASSES; OPTICAL LENSES; LENSES FOR GLASSES AND SUNGLASSES; PARTS AND ACCESSORIES FOR ALL THE AFORESAID GOODS IN THE NATURE OF EYE GLASS CHAINS, EYE GLASS CORDS, REPLACEMENT LENSES, FRAMES, EARSTEMS, NOSE PIECES (U.S. CLS. 21, 23, 26, 36 AND 38).

### CLASS 35—ADVERTISING AND BUSINESS

FOR RETAIL AND ON-LINE STORE SERVICES FEATURING OPTICAL APPARATUS AND INSTRUMENTS, EYEWEAR, SPECTACLES, SUNGLASSES, GLASSES CASES, FRAMES FOR GLASSES AND SUNGLASSES, OPTICAL LENSES, LENSES FOR GLASSES AND SUNGLASSES, AND PARTS AND ACCESSORIES FOR ALL THE AFORESAID GOODS (U.S. CLS. 100, 101 AND 102).  
KYLE PEETE, EXAMINING ATTORNEY

---

SN 85-649,368. RANIA INVESTMENTS AND HOLDINGS LTD, PICTON, ONTARIO, CANADA, FILED 6-12-2012.

## NOTCH

THE MARK CONSISTS OF STANDARD CHARACTERS WITHOUT CLAIM TO ANY PARTICULAR FONT, STYLE, SIZE, OR COLOR.

PRIORITY CLAIMED UNDER SEC. 44(D) ON ERPN CMNTY TM OFC APPLICATION NO. 010877447, FILED 5-11-2012.

### CLASS 9—ELECTRICAL AND SCIENTIFIC APPARATUS

FOR DOWNLOADABLE ELECTRONIC PUBLICATIONS IN THE NATURE OF GENERAL FEATURE MAGAZINES AND MAGAZINES IN THE FIELDS OF ENTERTAINMENT, FASHION, ART, STYLE, TRAVEL, TRENDS AND FOOD; DOWNLOADABLE MULTIMEDIA RECORDINGS CONTAINING VIDEO AND SOUND ON THE SUBJECTS OF ENTERTAINMENT, FASHION, ART, STYLE, TRAVEL, TRENDS AND FOOD; PRE-RECORDED DIGITAL MEDIA CONTAINING IMAGES, TEXT, GRAPHICS, VIDEO AND SOUND ON THE SUBJECTS OF ENTERTAINMENT, FASHION, ART, STYLE, TRAVEL, TRENDS AND FOOD; DOWNLOADABLE ELECTRONIC DATA AND MULTIMEDIA FILES CONTAINING IMAGES, TEXT, GRAPHICS, VIDEO AND SOUND IN THE FIELDS OF ENTERTAINMENT, FASHION, ART, STYLE, TRAVEL, TRENDS AND FOOD; DOWNLOADABLE SOFTWARE IN THE NATURE OF A MOBILE APPLICATION FOR VIEWING AND INTERACTING WITH DIGITAL MAGAZINES; DOWNLOADABLE MUSICAL SOUND RECORDINGS; DOWNLOADABLE MULTIMEDIA FILES CONTAINING VIDEO RELATING TO ENTERTAINMENT, FASHION, ART, STYLE, TRAVEL, TRENDS AND FOOD; DOWNLOADABLE ELECTRONIC MEDIA FOR TELEPHONES FEATURING MUSIC; DOWNLOADABLE ELECTRONIC MEDIA FOR TELEPHONES FEATURING VIDEOS RELATING TO ENTERTAINMENT, FASHION, ART, STYLE, TRAVEL, TRENDS AND FOODS; AUDIO AND VISUAL RECORDINGS FEATURING MUSIC AND VIDEO CONTENT IN THE FIELDS OF ENTERTAINMENT, FASHION, ART, STYLE, TRAVEL, TRENDS AND FOOD; DOWNLOADABLE WEBCASTS IN THE FIELDS OF ENTERTAINMENT, FASHION, ART, STYLE, TRAVEL, TRENDS AND FOOD (U.S. CLS. 21, 23, 26, 36 AND 38).

### CLASS 41—EDUCATION AND ENTERTAINMENT

FOR PROVIDING A WEBSITE FEATURING INFORMATION IN THE FIELDS OF ENTERTAINMENT, ART HISTORY, ART APPRECIATION, ART CULTURE, AND POP CULTURE, CULTURE AND ENTERTAINMENT TRENDS IN THE FORM OF ELECTRONIC MEDIA, MULTIMEDIA CONTENT, VIDEOS, IMAGES, TEXT, PHOTOS, USER-GENERATED CONTENT, AND AUDIO CONTENT; DIGITAL VIDEO, AUDIO AND MULTIMEDIA ENTERTAINMENT SERVICES, NAMELY, DIGITAL MAGAZINE PUBLISHING SERVICES; PROVIDING ON-LINE PUBLICATIONS NAMELY, DIGITAL MAGAZINES IN THE FIELDS OF ENTERTAINMENT, FASHION, ART, STYLE, TRAVEL, TRENDS AND FOOD; PROVIDING ONLINE NON-DOWNLOADABLE GENERAL FEATURE MAGAZINES; PROVIDING ONLINE GENERAL FEATURE MAGAZINES AND MAGAZINES IN THE FIELDS OF ENTERTAINMENT, FASHION, ART, STYLE, TRAVEL, TRENDS AND FOOD; PUBLICATION OF BOOKS, PRINTED MATTER, TEXTS AND MAGAZINES; PUBLICATION OF ELECTRONIC MAGAZINES; ONLINE DIGITAL PUBLISHING SERVICES OF PERIODICALS; PRODUCTION OF AUDIO, VIDEO AND AUDIO/VIDEO RECORDINGS; PRODUCTION OF TELEVISION AND RADIO PROGRAMMES; PROVIDING NEWS IN THE NATURE OF CURRENT EVENT REPORTING; PROVISION OF INFORMATION FOR ACCESSING VIA COMPUTER NETWORKS RELATING TO ENTERTAINMENT, LEISURE ACTIVITIES OR MUSIC; ORGANISING AND PRODUCTION OF PARTIES, EVENTS, AWARDS SHOWS, AND FASHION SHOWS FOR ENTERTAINMENT PURPOSES; ORGANISATION OF SPECIAL EVENTS FOR CULTURAL AND SOCIAL ENTERTAINMENT PURPOSES; PROVIDING INTERACTIVE INFORMATION RELATING TO LEISURE ACTIVITIES, ENTERTAINMENT, SPORT, CULTURE, FASHION AND CELEBRITIES PROVIDED ON-LINE FROM THE INTERNET OR VIA TELEPHONY TO MOBILE PHONES; PROVIDING ELECTRONIC AND DIGITAL PUBLICATIONS PROVIDED ON-LINE FROM DATABASES OR THE INTERNET IN THE NATURE OF GENERAL FEATURE MAGAZINES AND MAGAZINES IN THE FIELDS OF ENTERTAINMENT, FASHION, ART, STYLE, TRAVEL, TRENDS AND FOOD (U.S. CLS. 100, 101 AND 107).

SUNG IN, EXAMINING ATTORNEY



SN 85-658,735. BRAIN DYNAMICS, S.L., 29590 MALAGA, SPAIN, FILED 6-22-2012.



Brain Dynamics

**CLASS 44—MEDICAL, BEAUTY AND AGRICULTURAL SERVICES**

FOR MEDICAL SERVICES, NAMELY, PUBLICATION OF REPORTS IN THE FIELD OF NEUROSCIENCE, NAMELY, REPORTS BASED ON POST PROCESSING OF BIOLOGICAL SIGNALS, VOLUMETRIC QUANTIFICATION OF BRAIN AREAS, DETERMINATION OF LESION LOAD ACQUIRED FROM IMAGING, AND INTERRELATION OF THESE FINDINGS WITH OTHER GENOMIC-BASED INFORMATION (U.S. CLS. 100 AND 101).

BRIDGETT SMITH, EXAMINING ATTORNEY

SN 85-658,854. SIGMA-ALDRICH CO. LLC, ST. LOUIS, MO. FILED 6-22-2012.

OWNER OF ERPN CMNTY TM OFC REG. NO. 9804253, DATED 8-22-2011, EXPIRES 3-11-2021.

THE COLOR(S) RED, LIGHT GREEN, YELLOWY ORANGE, ORANGE, SKY BLUE, VIOLET AND BLACK IS/ARE CLAIMED AS A FEATURE OF THE MARK.

THE MARK CONSISTS OF THE FOLLOWING: THE TERM "BRAIN DYNAMICS" DEPICTED IN THE COLOR BLACK BELOW A DEPICTION OF A BRAIN DEPICTED IN THE COLORS RED, LIGHT GREEN, YELLOWY ORANGE, ORANGE, SKY BLUE, AND VIOLET.

**STRATEGIC SERVICE SOLUTIONS**

**CLASS 9—ELECTRICAL AND SCIENTIFIC APPARATUS**

FOR ELECTRONIC DATA PROCESSING APPARATUS FOR STORING MEDICAL IMAGES; HIGH-PERFORMANCE COMPUTERS WITH HIGH STORAGE CAPACITY AND COMPUTING, MULTI-CORE PROCESSORS AND GPUS FOR ONE TO THREE PARALLEL COMPUTER GRAPHICS-BASED PLATFORMS; RECORDED COMPUTER OPERATING SYSTEMS PROGRAMS; RECORDED COMPUTER PROGRAMS, NAMELY, KNOWLEDGE MANAGEMENT SYSTEM IN THE FIELD OF NEUROSCIENCE; COMPUTER SOFTWARE FOR VOLUMETRIC QUANTIFICATION, CALCULATING STRUCTURAL AND FUNCTIONAL CONNECTIVITY ACQUIRED FROM NEUROIMAGING, NEURONAVIGATION, AND RESEARCH ON THE HUMAN BRAIN; AUDIO COMPACT DISCS FEATURING INTERACTIVE SYSTEMS FOR TEACHING PRACTICE, DIAGNOSIS, THERAPY AND CARE IN THE FIELD OF NEUROSCIENCE (U.S. CLS. 21, 23, 26, 36 AND 38).

THE MARK CONSISTS OF STANDARD CHARACTERS WITHOUT CLAIM TO ANY PARTICULAR FONT, STYLE, SIZE, OR COLOR.

NO CLAIM IS MADE TO THE EXCLUSIVE RIGHT TO USE "SERVICE SOLUTIONS", APART FROM THE MARK AS SHOWN.

**CLASS 35—ADVERTISING AND BUSINESS**

FOR COMPOUND MANAGEMENT SERVICES, NAMELY, INVENTORYING AND BUSINESS MANAGEMENT OF CHEMICAL AND BIOLOGICAL SUBSTANCES FOR OTHERS; WHOLESALE DISTRIBUTORSHIP OF CHEMICAL AND BIOLOGICAL SUBSTANCES; MONITORING OF REGULATORY AND SAFETY DATA FOR BUSINESS PURPOSES; BUSINESS SERVICES, NAMELY, PROCURING CHEMICALS FOR OTHERS (U.S. CLS. 100, 101 AND 102).

**CLASS 38—COMMUNICATION**

FOR TELECOMMUNICATIONS SERVICES, NAMELY, TRANSFER OF MEDICAL IMAGES AND PROVIDING KNOWLEDGE MANAGEMENT SYSTEM SERVICES IN THE NATURE OF TRANSFER OF DATA AND IMAGES ON THE NORMAL AND DISEASED HUMAN BRAIN, ALL BY MEANS OF TELECOMMUNICATION NETWORKS, WIRELESS COMMUNICATION NETWORKS, AND THE INTERNET (U.S. CLS. 100, 101 AND 104).

**CLASS 39—TRANSPORTATION AND STORAGE**

FOR PACKAGING ARTICLES TO THE ORDER AND SPECIFICATION OF OTHERS; HAZARDOUS MATERIALS HANDLING, NAMELY, STORING AND TRANSPORTING HAZARDOUS MATERIALS (U.S. CLS. 100 AND 105).

**CLASS 42—SCIENTIFIC AND COMPUTER SERVICES**

FOR SCIENTIFIC AND TECHNOLOGICAL SERVICES, NAMELY, RESEARCH AND DESIGN IN THE FIELD OF MEDICAL IMAGE PROCESSING OF THE BRAIN; INDUSTRIAL ANALYSIS AND RESEARCH SERVICES IN THE FIELD OF DESIGN AND DEVELOPMENT OF ALGORITHMS FOR MEDICAL IMAGE PROCESSING, BRAIN SIGNALS AND ELECTROENCEPHALOGRAPHIC; KNOWLEDGE MANAGEMENT SERVICES IN THE NATURE OF RESEARCH AND DEVELOPMENT IN THE FIELD OF NEUROSCIENCE; DESIGN AND DEVELOPMENT OF COMPUTER HARDWARE AND SOFTWARE IN THE FIELD OF NEUROSCIENCE (U.S. CLS. 100 AND 101).

**CLASS 40—MATERIAL TREATMENT**

FOR CUSTOM MANUFACTURE OF CHEMICALS; PRIVATE LABEL MANUFACTURING OF CHEMICALS AND BIOLOGICAL MATERIALS; CONTRACT MANUFACTURING OF CHEMICALS AND BIOLOGICAL MATERIALS; CUSTOM MANUFACTURE OF REAGENTS AND STANDARDS (U.S. CLS. 100, 103 AND 106).

**CLASS 41—EDUCATION AND ENTERTAINMENT**

FOR CONDUCTING WORKSHOPS AND SEMINARS IN THE FIELDS OF BIOLOGY, BIOCHEMISTRY, AND LABORATORY TECHNIQUE (U.S. CLS. 100, 101 AND 107).

**CLASS 42—SCIENTIFIC AND COMPUTER SERVICES**

FOR CUSTOM DEVELOPMENT OF BIOPHARMACEUTICALS; CUSTOM DEVELOPMENT OF GENOMIC MATERIALS AND PROCESSES; CUSTOM DEVELOPMENT OF PROTEOMIC MATERIALS AND PROCESSES; CUSTOM DEVELOPMENT OF REAGENTS AND STANDARDS; BIOLOGICAL CLONING SERVICES; LABORATORY RESEARCH SERVICES IN THE FIELDS OF PROTEIN EXPRESSION AND CHARACTERIZATION, CELL ENGINEERING, SOLID FORM STUDIES, AND CHIRAL SEPARATION STUDIES; ANALYTICAL TESTING SERVICES OF CHEMICALS AND BIOLOGICAL MATERIALS; DEVELOPMENT OF GENOMIC MATERIALS AND PROCESSES; TECHNICAL CONSULTING SERVICES IN THE FIELD OF BIOLOGICAL AND LIFE SCIENCES LABORATORY RESEARCH; TESTING, ANALYSIS, AND EVALUATION OF CHEMICAL AND BIOLOGICAL SUBSTANCES TO ASSURE COMPLIANCE WITH INDUSTRY STANDARDS; CONDUCTING WORK-SITE SURVEYS TO DETERMINE IF BIOLOGY, CHEMISTRY AND BIOCHEMISTRY WORKSITES MEET EMPLOYEE HEALTH CONDITION REQUIREMENTS AND STANDARDS (U.S. CLS. 100 AND 101).

**CLASS 44—MEDICAL, BEAUTY AND AGRICULTURAL SERVICES**

FOR CUSTOM DEVELOPMENT IN THE NATURE OF BREEDING OF LABORATORY ANIMALS (U.S. CLS. 100 AND 101).

**CLASS 45—PERSONAL AND LEGAL SERVICES**

FOR SAFETY INSPECTION AUDITS TO IMPROVE SAFETY OF BIOLOGY, CHEMISTRY AND BIOCHEMISTRY LABORATORIES AND FACILITIES; ENVIRONMENTAL AUDITS, NAMELY, REVIEWING ENVIRONMENTAL DATA, ANALYZING THE DATA IN CONNECTION WITH ENVIRONMENTAL LAWS AND REGULATIONS, AND PREPARING ENVIRONMENTAL COMPLIANCE REPORTS IN THE FIELDS OF BIOLOGY, CHEMICAL AND BIOCHEMISTRY (U.S. CLS. 100 AND 101).

ANNE MADDEN, EXAMINING ATTORNEY

SN 85-659,114. STEPHEN F. AUSTIN STATE UNIVERSITY, NACOGDOCHES, TX. FILED 6-22-2012.

**STEPHEN F. AUSTIN**

THE MARK CONSISTS OF STANDARD CHARACTERS WITHOUT CLAIM TO ANY PARTICULAR FONT, STYLE, SIZE, OR COLOR.

THE NAME(S), PORTRAIT(S), AND/OR SIGNATURE(S) SHOWN IN THE MARK DOES NOT IDENTIFY A PARTICULAR LIVING INDIVIDUAL.

**CLASS 16—PAPER GOODS AND PRINTED MATTER**

FOR DECALS, LETTERHEAD PAPER, BUSINESS CARDS, AND GRADUATION ANNOUNCEMENT CARDS (U.S. CLS. 2, 5, 22, 23, 29, 37, 38 AND 50).

FIRST USE 0-0-1923; IN COMMERCE 0-0-1923.

**CLASS 25—CLOTHING**

FOR SWEATSHIRTS, T-SHIRTS, SWEATPANTS, AND CAPS (U.S. CLS. 22 AND 39).

FIRST USE 0-0-1923; IN COMMERCE 0-0-1923.

**CLASS 41—EDUCATION AND ENTERTAINMENT**

FOR ENTERTAINMENT AND EDUCATIONAL SERVICES, NAMELY, PROVIDING COURSES OF INSTRUCTION AT THE UNIVERSITY LEVEL; ARRANGING AND CONDUCTING ATHLETIC COMPETITIONS, ATHLETIC EVENTS, ATHLETIC TOURNAMENTS, AND ATHLETIC EXHIBITIONS (U.S. CLS. 100, 101 AND 107).

FIRST USE 0-0-1923; IN COMMERCE 0-0-1923.

NAAKWAMA ANKRAH, EXAMINING ATTORNEY

SN 85-660,581. KABUSHIKI KAISHA SQUARE ENIX HOLDINGS (ALSO TRADING AS SQUARE ENIX HOLDINGS CO., LTD.), TOKYO, JAPAN, FILED 6-25-2012.



OWNER OF JAPAN REG. NO. 5555598, DATED 2-8-2013, EXPIRES 2-8-2023.

OWNER OF U.S. REG. NOS. 2,730,129, 3,712,065 AND OTHERS.

THE MARK CONSISTS OF THE WORDS "FINAL FANTASY" FOLLOWED BY THE STYLIZED ROMAN NUMERALS "XIV".

**CLASS 9—ELECTRICAL AND SCIENTIFIC APPARATUS**

FOR COMPUTER GAME SOFTWARE; VIDEO GAME SOFTWARE; SOUND RECORDINGS IN THE FORM OF OPTICAL DISCS, MAGNETIC DISCS AND SEMICONDUCTOR ROMS ALL FEATURING MUSIC AND FICTIONAL STORIES; AUDIO VISUAL RECORDINGS IN THE FORM OF OPTICAL DISCS, MAGNETIC DISCS AND SEMICONDUCTOR ROMS ALL FEATURING MUSIC AND ANIMATED FICTIONAL STORIES; PRERECORDED COMPACT DISCS FEATURING MUSIC; PRERECORDED VIDEO DISCS FEATURING MUSIC AND ANIMATED FICTIONAL STORIES; STRAPS FOR CELLULAR PHONES; DOWNLOADABLE MUSICAL SOUND RECORDINGS; DOWNLOADABLE RING TONES FOR MOBILE PHONES; DOWNLOADABLE WALLPAPER GRAPHICS FOR MOBILE PHONES; DOWNLOADABLE ELECTRONIC PUBLICATIONS IN THE NATURE OF MAGAZINES, JOURNALS AND NEWSLETTERS IN THE FIELD OF COMPUTER GAMES AND VIDEO GAMES (U.S. CLS. 21, 23, 26, 36 AND 38).

**CLASS 41—EDUCATION AND ENTERTAINMENT**

FOR PROVIDING ON-LINE COMPUTER GAMES; PROVIDING ON-LINE VIDEO GAMES; PROVIDING INFORMATION ON COMPUTER GAME STRATEGIES AND VIDEO GAME STRATEGIES VIA COMPUTER NETWORKS AND GLOBAL COMMUNICATION NETWORKS; PROVIDING INFORMATION ON ENTERTAINMENT IN THE FIELD OF COMPUTER GAMES, VIDEO GAMES AND CARD GAMES; PROVIDING ON-LINE NON-DOWNLOADABLE COMICS; PROVIDING ON-LINE NON-DOWNLOADABLE MAGAZINES, JOURNALS AND NEWSLETTERS IN THE FIELD OF COMPUTER GAMES, VIDEO GAMES, CARTOONS AND GENERAL ENTERTAINMENT (U.S. CLS. 100, 101 AND 107).

WON TEAK OH, EXAMINING ATTORNEY

SN 85-663,202. EASI-DEC ACCESS SYSTEMS LTD, BEDFORDSHIRE, UNITED KINGDOM, FILED 6-27-2012.

SN 85-663,636. WENGER CORPORATION, OWATONNA, MN. FILED 6-28-2012.

## EASI-DEC

THE MARK CONSISTS OF STANDARD CHARACTERS WITHOUT CLAIM TO ANY PARTICULAR FONT, STYLE, SIZE, OR COLOR.

PRIORITY CLAIMED UNDER SEC. 44(D) ON ERPNTY TM OFC APPLICATION NO. 010923969, FILED 5-30-2012, REG. NO. 010923969, DATED 11-27-2012, EXPIRES 5-30-2022.

### CLASS 6—METAL GOODS

FOR ACCESS PLATFORMS BEING PREFABRICATED METAL PLATFORMS NOT FOR CONCRETE SHORING AND PARTS AND FITTINGS THEREFOR; METAL WORK PLATFORMS FOR PROVIDING ACCESS TO BUILDINGS AND STRUCTURES FOR MAINTENANCE AND REPAIRS; MOBILE AERIAL WORK PLATFORMS, NAMELY, PREFABRICATED METAL PLATFORMS; TEMPORARY SURFACES FOR FACILITATING ACCESS AND TRAVEL ALONG FRIABLE AND OTHER ROOF STRUCTURES, NAMELY, EXTENDED METAL PLATFORMS; ROOF VALLEY WALKING FRAMES, NAMELY, FRAMEWORKS OF METAL; METAL LADDERS FOR STRUCTURAL ACCESS AND MAINTENANCE OPERATIONS NOT FOR USE WITH TRUCK TRAILER RUB RAILS; METAL STAYS FOR ROOF LADDERS, ROOF VALLEY SAFETY DEVICES, NAMELY, METAL BASES, METAL WALL TIES, METAL STABILISING FEET, METAL RUNG-LOCKS, METAL TOOL TRAYS, METAL STABILISERS, METAL PULLEYS AND METAL HOISTS, LADDER SPURS; ELEVATED HEIGHT AND ROOF WALKING SAFETY FRAMES, NAMELY, METAL PLATFORMS AND HANDRAILS; SAFETY EQUIPMENT FOR USE DURING BUILDING MAINTENANCE OPERATIONS, NAMELY, METAL HANDRAILS, METAL LOCKS, METAL SAFETY GATES, METAL SAFETY MATS AND COVERS, METAL SAFETY RAILS, METAL BRAKED CASTORS, METAL ANCHOR BOLTS, METAL HOOKS, METAL CLAMPS; METAL ANTI-SLIP DECKING (U.S. CLS. 2, 12, 13, 14, 23, 25 AND 50).

### CLASS 7—MACHINERY

FOR ACCESS PLATFORMS, NAMELY, ELEVATING WORK PLATFORMS; AERIAL PLATFORMS BEING LIFTING WORK PLATFORMS FOR USE WITH HOISTS; WINCHES; LADDER MOUNTABLE WINCH UNITS (U.S. CLS. 13, 19, 21, 23, 31, 34 AND 35).

### CLASS 9—ELECTRICAL AND SCIENTIFIC APPARATUS

FOR SAFETY HARNESSSES OTHER THAN FOR VEHICLES OR SPORTS PURPOSES (U.S. CLS. 21, 23, 26, 36 AND 38).

HAI-LY LAM, EXAMINING ATTORNEY

## STAGETEK

THE MARK CONSISTS OF STANDARD CHARACTERS WITHOUT CLAIM TO ANY PARTICULAR FONT, STYLE, SIZE, OR COLOR.

### CLASS 6—METAL GOODS

FOR METAL PORTABLE AND MOBILE PRE-FABRICATED PLATFORMS AND SEATED RISERS FEATURING ALUMINUM FRAMES AND LEGS AND PLYWOOD CORE DECKS SOLD PREDOMINANTLY TO EDUCATIONAL INSTITUTIONS (U.S. CLS. 2, 12, 13, 14, 23, 25 AND 50).

### CLASS 19—NON-METALLIC BUILDING MATERIALS

FOR PORTABLE AND MOBILE STAGING; NON-METAL PORTABLE AND MOBILE PRE-FABRICATED PLATFORMS COMPRISING PLYWOOD CORE DECKS WITH ALUMINUM FRAMES AND LEGS SOLD PREDOMINANTLY TO EDUCATIONAL INSTITUTIONS (U.S. CLS. 1, 12, 33 AND 50).

### CLASS 20—FURNITURE AND ARTICLES NOT OTHERWISE CLASSIFIED

FOR PORTABLE AND MOBILE NON-METAL SEATED RISERS COMPRISING PLYWOOD CORE DECKS WITH ALUMINUM FRAMES AND LEGS SOLD PREDOMINANTLY TO EDUCATIONAL INSTITUTIONS (U.S. CLS. 2, 13, 22, 25, 32 AND 50).

Laurie Kaufman, Examining Attorney

SN 85-665,173. CASIO KEISANKI KABUSHIKI KAISHA, DBA CASIO COMPUTER CO., LTD., SHIBUYA-KU, TOKYO, JAPAN, FILED 6-29-2012.

## WHITE HOLE

THE MARK CONSISTS OF STANDARD CHARACTERS WITHOUT CLAIM TO ANY PARTICULAR FONT, STYLE, SIZE, OR COLOR.

PRIORITY CLAIMED UNDER SEC. 44(D) ON JAPAN APPLICATION NO. 2012-029448, FILED 4-13-2012, REG. NO. 5603675, DATED 8-2-2013, EXPIRES 8-2-2023.

### CLASS 9—ELECTRICAL AND SCIENTIFIC APPARATUS

FOR COMPUTERS; TABLET COMPUTERS; PERSONAL DIGITAL ASSISTANTS; ELECTRONIC COMMUNICATION EQUIPMENT AND INSTRUMENTS, NAMELY, APPARATUS FOR TRANSMISSION OF COMMUNICATION; MOBILE DIGITAL ELECTRONIC DEVICES, NAMELY, MOBILE DATA TERMINALS, DIGITAL CAMERAS, PORTABLE AND HANDHELD DIGITAL ELECTRONIC DEVICES FOR RECORDING, ORGANIZING, TRANSMITTING, MANIPULATING, AND REVIEWING TEXT, DATA, IMAGE, AND AUDIO FILES; MOBILE TELEPHONES; WIRELESS COMMUNICATION DEVICES FOR VOICE, DATA OR IMAGE TRANSMISSION; COM-

PUTER SOFTWARE FOR DISTRIBUTING DATA TO MULTIPLE SOFTWARE APPLICATIONS; SOFTWARE DEVELOPMENT KITS COMPRISED OF COMPUTER SOFTWARE DEVELOPMENT TOOLS; EAI (ENTERPRISE APPLICATION INTEGRATION) SOFTWARE; ERP (ENTERPRISE RESOURCE PLANNING) SOFTWARE; IDE (INTEGRATED DEVELOPMENT ENVIRONMENT) FOR ENTERPRISE APPLICATION, NAMELY, COMPUTER SOFTWARE DEVELOPMENT TOOLS; COMPUTER SOFTWARE TO MANAGE, ANALYZE, RETRIEVE, MONITOR, MAINTAIN, REPORT ON, STRUCTURE, MODEL, FORECAST, PRESENT AND DISPLAY DATA AND INFORMATION FROM COMPUTER DATABASES AND THE INTERNET, AND FOR THE DEVELOPMENT, ANALYSIS, MANAGEMENT, INTEGRATION, DEPLOYMENT AND MAINTENANCE OF COMPUTER SOFTWARE; WEB SERVICES SOFTWARE AND APPLICATION SERVER SOFTWARE, NAMELY, COMPUTER SOFTWARE THAT PROVIDES WEB-BASED ACCESS TO APPLICATIONS AND SERVICES THROUGH A WEB OPERATING SYSTEM OR PORTAL INTERFACE, DATABASE SOFTWARE FOR MANAGING INFORMATION IN THE FIELD OF COMPUTER SOFTWARE DEVELOPMENT, BUSINESS INTELLIGENCE SOFTWARE, NAMELY, COMPUTER SOFTWARE THAT PROVIDES REAL-TIME, INTEGRATED BUSINESS MANAGEMENT INTELLIGENCE BY COMBINING INFORMATION FROM VARIOUS DATABASES AND PRESENTING IT IN AN EASY-TO-UNDERSTAND USER INTERFACE, INTERNET AND INTRANET PORTAL SOFTWARE, NAMELY, COMPUTER SOFTWARE FOR CONTROLLING AND MANAGING ACCESS TO GLOBAL AND INTERNAL NETWORKS, DATA WAREHOUSING SOFTWARE, CONTENT MANAGEMENT SOFTWARE, ONLINE TRADING SOFTWARE, ONLINE TRAINING SOFTWARE FOR DEVELOPING COMPUTER AND DATA STORAGE APPLICATIONS, COMPUTER TELEPHONY SOFTWARE, FAX MESSAGING SOFTWARE, ELECTRONIC MAIL SOFTWARE, SCHEDULING SOFTWARE, WIRELESS COMMUNICATIONS SOFTWARE, NAMELY, COMPUTER SOFTWARE FOR WIRELESS CONTENT DELIVERY, AND VOICE ENABLEMENT SOFTWARE; COMPUTER SOFTWARE APPLICATIONS FOR UPDATING AND RECEIVING DATA STORED IN AN ENTERPRISE'S COMPUTER DATABASES IN REAL TIME IN THE FIELDS OF MARKETING, SALES, CUSTOMER SERVICE, CONTRACTS, HUMAN RESOURCES, CLINICAL RESEARCH, HEALTH CARE, EDUCATION, COMMUNICATIONS AND TELECOMMUNICATIONS, CALL CENTERS, PUBLIC SECTOR ADMINISTRATION, PUBLIC AND PRIVATE UTILITIES, PROCESSING, ANALYSIS AND MANAGEMENT OF FINANCIAL TRANSACTIONS, MANAGEMENT OF SUPPLY CHAINS, ORDERS, PROCUREMENT, INVENTORY, ASSETS, PROJECTS AND MANUFACTURING, BUSINESS CONSOLIDATION MANAGEMENT, BUSINESS RISK MANAGEMENT, BUSINESS QUALITY MANAGEMENT, BUSINESS PROJECT MANAGEMENT, BUSINESS STAKEHOLDER-SHAREHOLDER RELATIONSHIP MANAGEMENT, AND STRATEGIC BUSINESS, SIMULATION, ENTERPRISE AND RESOURCE PLANNING, AND INSTRUCTIONAL MANUALS SOLD AS A UNIT; ARTIFICIAL INTELLIGENCE SOFTWARE FOR DISTRIBUTING DATA TO MULTIPLE SOFTWARE APPLICATIONS; VOICE RECOGNITION APPARATUS; POINT-OF-SALE SYSTEM COMPRISED OF POINT-OF-SALE TERMINALS, BAR CODE READERS, PRINTERS AND COMPUTER OPERATING SOFTWARE; ELECTRONIC CASH REGISTER; COMPUTER SYSTEM OPERATING SOFTWARE; DATA SYNCHRONIZATION SOFTWARE; APPLICATION DEVELOPMENT SOFTWARE; COMPUTER SOFTWARE FOR PERSONAL INFORMATION MANAGEMENT; COMPUTER SOFTWARE FOR SALES PROMOTION; COMPUTER SOFTWARE FOR RESERVATION SYSTEM, ORDER SYSTEM OR INVENTORY CHECK SYSTEM; VIRTUAL FITTING SYSTEM FOR FITTING APPAREL, PROSTHETICS AND SPORTS EQUIPMENT COMPRISED OF COMPUTER HARDWARE AND SOFTWARE, APPARATUS FOR RECORDING, TRANSMISSION AND REPRODUCTION OF IMAGES; DATABASE MANAGEMENT SOFTWARE FOR GENERAL USE; DATABASE SYNCHRONIZATION SOFTWARE; ELECTRONIC MAIL AND MESSAGING SOFTWARE; VOICE RECOGNITION SOFTWARE; SPEECH TO TEXT CONVERSION SOFTWARE; VOICE-ENABLED SOFTWARE APPLICATIONS FOR VOICE COMMAND CONTROL; DATA MINING SOFTWARE; ELECTRONIC APPARATUS WITH INTERACTIVE FUNCTIONS FOR USE IN

ALL OF THE AFORESAID GOODS, NAMELY, COMPUTER HARDWARE; BATTERIES; CHARGERS FOR ELECTRIC BATTERIES (U.S. CLS. 21, 23, 26, 36 AND 38).

## CLASS 42—SCIENTIFIC AND COMPUTER SERVICES

FOR SCIENTIFIC AND TECHNOLOGICAL SERVICES AND RESEARCH AND DESIGN RELATING THERETO, NAMELY, RESEARCH SERVICES IN THE FIELD OF INFORMATION AND TELECOMMUNICATIONS TECHNOLOGY; COMPUTER PROGRAMMING; COMPUTER HARDWARE AND SOFTWARE CONSULTING SERVICES; DESIGN AND DEVELOPMENT OF COMPUTER HARDWARE AND SOFTWARE; TECHNOLOGICAL SUPPORT IN THE NATURE OF CONSULTATION SERVICES FOR DEVELOPING COMPUTER SYSTEMS, DATABASES AND COMPUTER APPLICATIONS; PROVIDING COMPUTER HARDWARE OR SOFTWARE INFORMATION ONLINE, NAMELY, PROVIDING A WEBSITE THAT FEATURES INFORMATION ON COMPUTER TECHNOLOGY AND PROGRAMMING; PROVIDING INFORMATION REFERENCE LINKS TO WEBSITES FEATURING INFORMATION ON COMPUTER TECHNOLOGY AND PROGRAMMING; WEBSITE CREATION, DESIGN AND MAINTENANCE SERVICES; WEBSITE HOSTING SERVICES; APPLICATION SERVICE PROVIDER (ASP) SERVICES FEATURING SOFTWARE FOR USE IN CONNECTION WITH VOICE RECOGNITION SOFTWARE AND VOICE-ENABLED, OR VOICE COMMAND CONTROL, SOFTWARE APPLICATIONS; APPLICATION SERVICE PROVIDER (ASP) SERVICES, NAMELY, HOSTING COMPUTER SOFTWARE APPLICATIONS OF OTHERS; PROVIDING ONLINE NON-DOWNLOADABLE SOFTWARE FOR USE IN DATABASE MANAGEMENT; COMPUTER SERVICES, NAMELY, CONSULTATION IN THE FIELD OF COMPUTER SOFTWARE DESIGN; PROGRAMMING, DESIGN, DEVELOPMENT, TECHNOLOGICAL ANALYSIS, IMPLEMENTATION, MANAGEMENT, INTEGRATION, DEPLOYMENT, MAINTENANCE, UPDATING AND REPAIR OF COMPUTER SOFTWARE FOR OTHERS; TECHNICAL SUPPORT SERVICE PROVIDER, NAMELY, HOSTING, MANAGING AND ADMINISTERING COMPUTER SOFTWARE FOR OTHERS; TECHNICAL ASSISTANCE AND CONSULTATION SERVICES, NAMELY, TROUBLESHOOTING, MANAGING, AND MAINTAINING COMPUTER SOFTWARE FOR OTHERS; LEASING AND RENTAL OF COMPUTER SOFTWARE; TESTING, ANALYSIS AND EVALUATION OF THE GOODS AND SERVICES OF OTHERS FOR THE PURPOSE OF CERTIFICATION; COMPUTER DATABASE DEVELOPMENT SERVICES; COMPUTER SERVICES, NAMELY, CREATING AND MAINTAINING WEB SITES FOR OTHERS; HOSTING THE WEB SITES OF OTHERS ON COMPUTER SERVERS FOR LOCAL AREA NETWORKS, INTRANETS, AND THE INTERNET; CONSULTATION SERVICES AND PROVIDING TECHNICAL ASSISTANCE RELATED TO THE DESIGN, CREATION, HOSTING, MAINTENANCE, OPERATION, AND MANAGEMENT OF WEB SITES FOR OTHERS; AND PROVIDING INFORMATION IN THE FIELDS OF COMPUTER TECHNOLOGY AND COMPUTER SOFTWARE TECHNOLOGY (U.S. CLS. 100 AND 101).

ANDREA HACK, EXAMINING ATTORNEY

SN 85-666,838, EASI-DEC ACCESS SYSTEMS LTD, BEDFORDSHIRE, UNITED KINGDOM, FILED 7-2-2012.

## SOLAR PLATFORM

THE MARK CONSISTS OF STANDARD CHARACTERS WITHOUT CLAIM TO ANY PARTICULAR FONT, STYLE, SIZE, OR COLOR.

OWNER OF ERPN CMNTY TM OFC REG. NO. 010994432, DATED 11-21-2012, EXPIRES 6-26-2022.

NO CLAIM IS MADE TO THE EXCLUSIVE RIGHT TO USE "PLATFORM", APART FROM THE MARK AS SHOWN.

THE WORDING "HAROL" HAS NO MEANING IN A FOREIGN LANGUAGE.

### CLASS 6—METAL GOODS

FOR ACCESS PLATFORMS BEING PREFABRICATED METAL PLATFORMS AND PARTS AND FITTINGS THEREOF; METAL WORK PLATFORMS AND PARTS AND FITTINGS THEREOF; METAL FRAMES FOR SUPPORTING WORK AND ACCESS PLATFORMS; METAL WORK TOWERS IN THE NATURE OF METAL SCAFFOLDING; MOBILE AERIAL WORK PLATFORMS, NAMELY, PREFABRICATED METAL PLATFORMS SUPPORTED BY METAL FRAME WORK; TEMPORARY SURFACES FOR FACILITATING ACCESS AND TRAVEL ALONG FRIABLE AND OTHER ROOF STRUCTURES, NAMELY, EXTENDABLE METAL PLATFORMS; ROOF VALLEY WALKING FRAMES, NAMELY, FRAMEWORKS OF METAL; METAL LADDERS; METAL BRIDGING LADDERS; METAL BRACES FOR LADDERS AND METAL SUPPORTS AGAINST SLIPPAGE; METAL STABILIZERS FOR LADDERS; ROOF LADDER SAFETY DEVICES, NAMELY, METAL BASES, METAL WALL TIES, METAL STABILIZING FEET, METAL RUNGLOCKS, METAL TOOL TRAYS, METAL STABILIZERS, METAL PULLEYS AND METAL HOISTS AND METAL STAYS FOR ROOF LADDERS; LADDER SPURS; ELEVATED HEIGHT AND ROOF WALKING SAFETY FRAMES, NAMELY, MOBILE METAL CAGES FOR MAINTENANCE OF VALLEY GUTTERS; SAFETY EQUIPMENT FOR USE DURING BUILDING CONSTRUCTION AND MAINTENANCE OPERATIONS, NAMELY, METAL HANDRAILS, METAL SUPPORT FRAMES, METAL BRACES, METAL CLUTCHES, METAL LOCKS, METAL SAFETY GATES, METAL SAFETY MATS AND COVERS, METAL SAFETY RAILS, METAL BRAKED CASTORS, METAL ANCHOR BOLTS, METAL HOOKS, METAL CLAMPS AND METAL TOP-ENDS; METAL LADDER TIES; METAL ANTI-SLIP DECKING; SAFETY MATTING, NAMELY, METAL MATS FOR USE AS LOAD SUPPORT SURFACES IN THE CONSTRUCTION INDUSTRY (U.S. CLS. 2, 12, 13, 14, 23, 25 AND 50).

### CLASS 7—MACHINERY

FOR ACCESS PLATFORMS, NAMELY, ELEVATING WORK PLATFORMS, AERIAL PLATFORMS BEING LIFTING WORK PLATFORMS FOR USE WITH HOISTS; WINCHES, LADDER MOUNTABLE WINCH UNIT (U.S. CLS. 13, 19, 21, 23, 31, 34 AND 35).

### CLASS 9—ELECTRICAL AND SCIENTIFIC APPARATUS

FOR SAFETY HARNESSES OTHER THAN FOR VEHICLES OR SPORTS PURPOSES (U.S. CLS. 21, 23, 26, 36 AND 38).

HAI-LY LAM, EXAMINING ATTORNEY

SN 85-668,196. LUTHUFUDDEEN PUTHIYA KUTTY MAPPELAGATH, DUBAI, UNITED ARAB EMIR., FILED 7-3-2012.

# HAROL

THE MARK CONSISTS OF STANDARD CHARACTERS WITHOUT CLAIM TO ANY PARTICULAR FONT, STYLE, SIZE, OR COLOR.

PRIORITY CLAIMED UNDER SEC. 44(D) ON INDIA APPLICATION NO. 2311571, FILED 4-9-2012, REG. NO. 2311571, DATED 4-9-2012, EXPIRES 4-9-2022.

PRIORITY CLAIMED UNDER SEC. 44(D) ON INDIA APPLICATION NO. 2311570, FILED 4-9-2012, REG. NO. 2311570, DATED 4-9-2012, EXPIRES 4-9-2022.

### CLASS 29—MEATS AND PROCESSED FOODS

FOR COMPOTES; EDIBLE OILS AND FATS; EGGS; JELLIES, JAMS; MEAT EXTRACTS; MEAT, FISH, POULTRY AND GAME; MILK; MILK PRODUCTS EXCLUDING ICE CREAM, ICE MILK AND FROZEN YOGURT; PRESERVED, DRIED AND COOKED FRUIT AND VEGETABLES (U.S. CL. 46).

### CLASS 31—NATURAL AGRICULTURAL PRODUCTS

FOR AGRICULTURAL GRAINS FOR PLANTING; AGRICULTURAL SEEDS; ANIMAL FOODSTUFFS; BULBS FOR AGRICULTURAL PURPOSES; BULBS FOR HORTICULTURAL PURPOSES; FRESH FRUIT AND VEGETABLES; LIVE ANIMALS; MALT FOR BREWING AND DISTILLING; NATURAL PLANTS AND FLOWERS; SEEDS AND BULBS; SEEDS FOR AGRICULTURAL PURPOSES; SEEDS FOR FRUIT AND VEGETABLES; SEEDS FOR HORTICULTURAL PURPOSES; SOWING SEEDS; SPORES AND SPAWN; UNPROCESSED CEREAL SEEDS; UNPROCESSED EDIBLE SEEDS; UNPROCESSED GRAIN; UNPROCESSED GRAINS FOR EATING; UNPROCESSED SEEDS FOR AGRICULTURAL USE; VEGETABLE SEEDS FOR PLANTING; WHEAT SEED (U.S. CLS. 1 AND 46).

ALEXANDER L. POWERS, EXAMINING ATTORNEY

SN 85-668,504. VARIOVAC PS SYSTEMPACK GMBH, ZARRENTIN, FED REP GERMANY, FILED 7-3-2012.

# VARIOVAC

THE MARK CONSISTS OF STANDARD CHARACTERS WITHOUT CLAIM TO ANY PARTICULAR FONT, STYLE, SIZE, OR COLOR.

OWNER OF ERPN CMNTY TM OFC REG. NO. 003109601, DATED 1-19-2005, EXPIRES 1-19-2015.

### CLASS 7—MACHINERY

FOR PACKAGING MACHINES AND PARTS THEREOF; DEEP DRAWING PACKAGING MACHINES; VACUUM PACKAGING MACHINES; MACHINES FOR DISPENSING PACKING MATERIAL; FILLING MACHINES AND PARTS THEREOF; FILLING SYSTEMS, NAMELY, MACHINES FOR FILLING LIQUIDS, SEMI-SOLIDS AND SOLIDS INTO CONTAINERS OR PACKAGING (U.S. CLS. 13, 19, 21, 23, 31, 34 AND 35).

FIRST USE 12-14-2001; IN COMMERCE 12-14-2001.

### CLASS 37—CONSTRUCTION AND REPAIR

FOR REPAIR AND MAINTENANCE OF PACKAGING MACHINES AND FILLING SYSTEMS, NAMELY, MACHINES FOR FILLING LIQUIDS, SEMI-SOLIDS AND SOLIDS INTO CONTAINERS OR PACKAGING (U.S. CLS. 100, 103 AND 106).

FIRST USE 12-14-2001; IN COMMERCE 12-14-2001.

MICHAEL ENGEL, EXAMINING ATTORNEY

SN 85-673,548. CAPPELLO'S INC., DBA CAPPELLO'S GLUTEN FREE, LOUISVILLE, CO. FILED 7-10-2012.



THE MARK CONSISTS OF A STYLIZED BLACK TOP HAT CENTERED ABOVE THE WORD "CAPPELLO'S" IN STYLIZED DOUBLE BLACK LINED FONT THAT IS SLIGHTLY ARCHED AT EACH OPEN END OF EACH LETTER.

#### CLASS 5—PHARMACEUTICALS

FOR WHEAT-FREE AND GLUTEN-FREE GRAIN-FREE PASTA PRODUCTS FOR THE TREATMENT OF SPECIAL MEDICAL AND HEALTH CONDITIONS (U.S. CLS. 6, 18, 44, 46, 51 AND 52).

FIRST USE 5-1-2012; IN COMMERCE 5-1-2012.

#### CLASS 30—STAPLE FOODS

FOR FRESH PASTA; GLUTEN-FREE PASTA; PASTA AND NOODLES (U.S. CL. 46).

FIRST USE 5-1-2012; IN COMMERCE 5-1-2012.

MICHAEL ENGEL, EXAMINING ATTORNEY

SN 85-673,920. TIERRA CALIENTE MUSIC GROUP, S.A. DE C.V., S. PEDRO GZA GCIA, NL, MEXICO, FILED 7-11-2012.



THE NAME(S), PORTRAIT(S), AND/OR SIGNATURE(S) SHOWN IN THE MARK IDENTIFIES "DIEGO HERRERA", WHOSE CONSENT(S) TO REGISTER IS MADE OF RECORD.

THE COLOR(S) BLACK AND RED IS/ARE CLAIMED AS A FEATURE OF THE MARK.

THE MARK CONSISTS OF THE WORDS "DIEGO HERRERA" IN BLACK WITH A DESIGN OF A MUSICAL BRASS INSTRUMENT, NAMELY, A FRENCH HORN, IN RED WITH BLACK SHADING.

#### CLASS 9—ELECTRICAL AND SCIENTIFIC APPARATUS

FOR DIGITAL MEDIA, NAMELY, PRE-RECORDED DVDS, DOWNLOADABLE AUDIO AND VIDEO RECORDINGS, AND CDS FEATURING AND PROMOTING MUSIC; PRE-RECORDED CDS, VIDEO TAPES, LASER DISKS AND DVDS FEATURING MUSIC (U.S. CLS. 21, 23, 26, 36 AND 38).

FIRST USE 1-3-2010; IN COMMERCE 1-3-2010.

#### CLASS 41—EDUCATION AND ENTERTAINMENT

FOR ENTERTAINMENT IN THE NATURE OF VISUAL AND AUDIO PERFORMANCES BY A VOCAL AND INSTRUMENTAL MUSICAL ARTIST (U.S. CLS. 100, 101 AND 107).

FIRST USE 1-3-2010; IN COMMERCE 1-3-2010.

SUSAN RICHARDS, EXAMINING ATTORNEY

SN 85-674,355. ALLPHASE CLINICAL RESEARCH SERVICES, INC., OTTAWA, ONTARIO, CANADA, FILED 7-11-2012.

ICE

THE MARK CONSISTS OF STANDARD CHARACTERS WITHOUT CLAIM TO ANY PARTICULAR FONT, STYLE, SIZE, OR COLOR.

PRIORITY CLAIMED UNDER SEC. 44(D) ON CANADA APPLICATION NO. 1559356, FILED 1-11-2012, REG. NO. TMA861355, DATED 9-26-2013, EXPIRES 9-26-2028.

#### CLASS 35—ADVERTISING AND BUSINESS

FOR QUALITY ASSURANCE AND PERFORMANCE ASSESSMENT SERVICES, NAMELY, PROVIDING OBJECTIVE ASSESSMENTS OF THE QUALITY AND PERFORMANCE OF PERSONNEL IN THE HEALTHCARE, PHARMACEUTICAL, MEDICAL DEVICE, CLINICAL TRIAL AND CLINICAL OPERATIONS FIELDS TO ASSESS QUALITY OF SERVICE, AND COMPLIANCE WITH CLIENT AND REGULATORY LAWS, EXPECTATIONS, STUDY PROTOCOLS, POLICIES, AND PROCEDURES, AND GOOD CLINICAL AND DOCUMENTATION PRACTICES; PREPARATION OF AUDIT PLANS AND CHECKLISTS; ASSESSMENT OF COMPLIANCE WITH PROTOCOLS, PROCESSES AND INTERNAL CONTROLS IN THE HEALTHCARE, PHARMACEUTICAL, MEDICAL DEVICE, CLINICAL TRIAL AND CLINICAL OPERATIONS FIELDS; PREPARATION OF AUDIT REPORTS; CONDUCTING AUDIT SERVICES RELATING TO THE CONDUCT OF CLINICAL TRIALS (U.S. CLS. 100, 101 AND 102).

#### CLASS 44—MEDICAL, BEAUTY AND AGRICULTURAL SERVICES

FOR CONSULTING IN THE FIELD OF PROTOCOLS, POLICIES AND PROCEDURES FOR CUSTOMERS SPECIALIZING IN SYSTEMIC TREATMENT PRODUCTS ADMINISTERED IN AMBULATORY HEALTHCARE FACILITIES; ASSESSMENT OF SAFE MEDICATION HANDLING PRACTICES; ASSESSMENT OF COMPLIANCE WITH EXISTING PRACTICE GUIDELINES FOR THE CONDUCT OF CLINICAL TRIALS (U.S. CLS. 100 AND 101).

KATINA MISTER, EXAMINING ATTORNEY

SN 85-674,836. AMERICAN SOCIETY OF CRIME LABORATORY DIRECTORS/LABORATORY ACCREDITATION BOARD, GARNER, NC. FILED 7-12-2012.

SN 85-680,392. GAME FACE PRODUCTIONS, BERKELEY, CA. FILED 7-18-2012.

## QUALITY MATTERS

THE MARK CONSISTS OF STANDARD CHARACTERS WITHOUT CLAIM TO ANY PARTICULAR FONT, STYLE, SIZE, OR COLOR.

### CLASS 41—EDUCATION AND ENTERTAINMENT

FOR EDUCATION SERVICES, NAMELY, PROVIDING TRAINING REGARDING STANDARDS FOR CRIME LABS (U.S. CLS. 100, 101 AND 107).  
FIRST USE 7-9-2012; IN COMMERCE 7-9-2012.

### CLASS 42—SCIENTIFIC AND COMPUTER SERVICES

FOR ACCREDITATION SERVICES, NAMELY, DEVELOPING, EVALUATING, AND TESTING STANDARDS FOR CRIME LABS FOR THE PURPOSE OF ACCREDITATION (U.S. CLS. 100 AND 101).  
FIRST USE 7-9-2012; IN COMMERCE 7-9-2012.  
ZACHARY CROMER, EXAMINING ATTORNEY

SN 85-680,319. MEDIVERSE INTERNATIONAL, INC., ARCADIA, CA. FILED 7-18-2012.

## Utopia

THE MARK CONSISTS OF STANDARD CHARACTERS WITHOUT CLAIM TO ANY PARTICULAR FONT, STYLE, SIZE, OR COLOR.

### CLASS 5—PHARMACEUTICALS

FOR NUTRITIONAL SUPPLEMENTS; DIETARY SUPPLEMENTS; INFANT FORMULA (U.S. CLS. 6, 18, 44, 46, 51 AND 52).

### CLASS 32—LIGHT BEVERAGES

FOR SPORTS DRINKS (U.S. CLS. 45, 46 AND 48).  
IRA J. GOODSАID, EXAMINING ATTORNEY



NO CLAIM IS MADE TO THE EXCLUSIVE RIGHT TO USE "PREGNANCY IN THE AMERICAN WORKPLACE", APART FROM THE MARK AS SHOWN.

THE COLOR(S) GOLD, GRAY AND BLACK IS/ARE CLAIMED AS A FEATURE OF THE MARK.

THE MARK CONSISTS OF THE FOLLOWING: THE WORD "SHOWING" APPEARS IN THE COLOR GRAY IN LOWERCASE WITH THE LETTER "O" THICKENED, BOLD AND IN THE COLOR GOLD. THE WORD "SHOWING" IS ON TOP OF THE WORDS "PREGNANCY IN THE AMERICAN WORKPLACE" WHICH IS IN ALL CAPS AND APPEARS IN THE COLOR BLACK.

### CLASS 16—PAPER GOODS AND PRINTED MATTER

FOR PRINTED EDUCATIONAL MATERIALS IN THE FIELD OF BALANCING WORK AND FAMILY (U.S. CLS. 2, 5, 22, 23, 29, 37, 38 AND 50).

### CLASS 41—EDUCATION AND ENTERTAINMENT

FOR ORGANIZATION OF EXHIBITIONS FOR CULTURAL OR EDUCATIONAL PURPOSES (U.S. CLS. 100, 101 AND 107).  
JAY FLOWERS, EXAMINING ATTORNEY

SN 85-682,597. FENNER DRIVES, INC., DBA SOLESIS MEDICAL TECHNOLOGIES, MANHEIM, PA. FILED 7-20-2012.

## SOLESIS

THE MARK CONSISTS OF STANDARD CHARACTERS WITHOUT CLAIM TO ANY PARTICULAR FONT, STYLE, SIZE, OR COLOR.

### CLASS 5—PHARMACEUTICALS

FOR COMBINATION NATURAL BIOLOGIC AND ARTIFICIAL MATERIALS SOLD AS AN INTEGRAL COMPONENT OF SURGICAL IMPLANTS, NAMELY, IMPLANTABLE MEDICAL TEXTILES AND POLYMERIC TEXTILES COMPOSED OF NATURAL AND ARTIFICIAL BIOMATERIALS (U.S. CLS. 6, 18, 44, 46, 51 AND 52).

### CLASS 10—MEDICAL APPARATUS

FOR SURGICAL IMPLANTS COMPRISING ARTIFICIAL MATERIALS; ARTIFICIAL MATERIALS SOLD AS AN INTEGRAL COMPONENT OF SURGICAL IMPLANTS; COMBINATION NATURAL, NON-LIVING MATERIALS AND SYNTHETIC MATERIALS SOLD AS INTEGRAL COMPONENTS OF SURGICAL IMPLANTS (U.S. CLS. 26, 39 AND 44).

**CLASS 44—MEDICAL, BEAUTY AND AGRICULTURAL SERVICES**

FOR RESEARCH, DESIGN AND DEVELOPMENT SERVICES IN THE FIELD OF MEDICAL DEVICES; DESIGN AND DEVELOPMENT OF MEDICAL DEVICE MANUFACTURING METHODS; MEDICAL DEVICE PRODUCT EVALUATION SERVICES; RESEARCH FOR AND DESIGN AND DEVELOPMENT OF NEW MEDICAL DEVICES FOR OTHERS; RESEARCH IN THE FIELD OF SYNTHETIC IMPLANTS; RESEARCH RELATING TO SYNTHETIC TISSUE (U.S. CLS. 100 AND 101).

MICHAEL SOUDERS, EXAMINING ATTORNEY

SN 85-685,480. BRAINSKINZ HELMET SYSTEMS, LLC, SAINT LOUIS, MO. FILED 7-24-2012.

brainskinz

THE MARK CONSISTS OF STANDARD CHARACTERS WITHOUT CLAIM TO ANY PARTICULAR FONT, STYLE, SIZE, OR COLOR.

SN 85-682,712. RUSSULA S.A., LA CORUÑA, SPAIN, FILED 7-20-2012.

RUSSULA

THE MARK CONSISTS OF STANDARD CHARACTERS WITHOUT CLAIM TO ANY PARTICULAR FONT, STYLE, SIZE, OR COLOR.

OWNER OF U.S. REG. NO. 3,482,150.

**CLASS 7—MACHINERY**

FOR ELECTRICAL AND MECHANICAL PRODUCTS FOR USE IN STEEL MILL INSTALLATION, NAMELY, MILLING CUTTERS AND MILLING GRINDING MOTORS; PRODUCTION EQUIPMENT FOR USE IN THE STEEL MILL INDUSTRY, NAMELY, MILLING MACHINES (U.S. CLS. 13, 19, 21, 23, 31, 34 AND 35).

FIRST USE 0-0-1998; IN COMMERCE 0-0-2002.

**CLASS 9—ELECTRICAL AND SCIENTIFIC APPARATUS**

FOR PROGRAMMABLE LOGIC CONTROLLER (PLC); ELECTRIC CONTROL PANELS; ELECTRONIC CONTROL PANEL; ELECTRIC CONVERTERS FOR PRODUCTION AUTOMATION; ELECTRIC AND ELECTRONIC COMPONENTS AND COMPONENT PARTS, NAMELY, INDUSTRIAL AUTOMATION CONTROLS FOR PRODUCT AUTOMATION; COMPUTER SOFTWARE FOR PROCESS CONTROL FOR USE IN THE STEEL MILL INDUSTRY (U.S. CLS. 21, 23, 26, 36 AND 38).

FIRST USE 0-0-1998; IN COMMERCE 0-0-2002.

**CLASS 11—ENVIRONMENTAL CONTROL APPARATUS**

FOR TURN KEY WATER TREATMENT PLANT AND WATER FILTRATION UNITS FOR INDUSTRIAL USE, RING WATER FILTERS, AND REPLACEMENT PARTS FOR USE THEREWITH, NAMELY, PURIFICATION UNITS AND REPLACEMENT CARTRIDGES AND FILTERS, SEPARATORS FOR THE CLEANING AND PURIFICATION OF LIQUIDS; WATER FILTERS SOLD AS A UNIT WITH WATER FILTRATION UNITS FOR INDUSTRIAL USE; REFRIGERATING MACHINES IN THE NATURE OF COOLING TOWER FOR REFRIGERATION PROCESS (U.S. CLS. 13, 21, 23, 31 AND 34).

FIRST USE 0-0-1998; IN COMMERCE 0-0-2002.  
NELSON SNYDER, EXAMINING ATTORNEY

**CLASS 9—ELECTRICAL AND SCIENTIFIC APPARATUS**

FOR PROTECTIVE HELMETS USED FOR RECREATIONAL PURPOSES IN THE NATURE OF BIKING, SKATEBOARDING, INLINE SKATING, NON-MOTORIZED SCOOTERING AND SLEDDING; PROTECTIVE HELMET SYSTEMS COMPRISED OF A BASE HELMET WITH A SECURING CHIN STRAP, WITH AN ADJUSTABLE FIT INNER-LINER, AND WITH INTERCHANGEABLE OUTER SHELLS, ALL USED FOR RECREATIONAL PURPOSES IN THE NATURE OF BIKING, SKATEBOARDING, INLINE SKATING, NON-MOTORIZED SCOOTERING AND SLEDDING; INTERCHANGEABLE OUTER PLASTIC SHELLS FOR PROTECTIVE HELMETS USED FOR RECREATIONAL PURPOSES IN THE NATURE OF BIKING, SKATEBOARDING, INLINE SKATING, NON-MOTORIZED SCOOTERING AND SLEDDING (U.S. CLS. 21, 23, 26, 36 AND 38).

**CLASS 25—CLOTHING**

FOR ADJUSTABLE FIT INNER-LINERS FOR PROTECTIVE HELMETS USED FOR RECREATIONAL PURPOSES IN THE NATURE OF BIKING, SKATEBOARDING, INLINE SKATING, NON-MOTORIZED SCOOTERING AND SLEDDING (U.S. CLS. 22 AND 39).

TRACY WHITTAKER-BROWN, EXAMINING ATTORNEY

SN 85-685,951. SQUARE PIE LIMITED, LONDON, UNITED KINGDOM, FILED 7-24-2012.

square pie<sup>®</sup>

OWNER OF UNITED KINGDOM REG. NO. 2351742, DATED 6-4-2004, EXPIRES 12-17-2023.

NO CLAIM IS MADE TO THE EXCLUSIVE RIGHT TO USE "PIE", APART FROM THE MARK AS SHOWN.

THE COLOR(S) RED AND WHITE IS/ARE CLAIMED AS A FEATURE OF THE MARK.

THE MARK CONSISTS OF THE PHRASE "SQUARE PIE" SHOWN IN WHITE, LOWER-CASE LETTERS AGAINST A RED BACKGROUND, FOLLOWED BY A WHITE SQUARE IN SUPERScript.



**CLASS 30—STAPLE FOODS**

FOR PREPARED FOODS, NAMELY, READY MEALS AND PREPARED MEALS CONSISTING PRIMARILY OF OR INCORPORATING FILLED OR TOPPED PASTRY PRODUCTS, PIES, PASTIES, PIZZAS, PASTA, OR RICE; PIES; SNACKS, NAMELY, CEREAL AND PASTRY-BASED SNACKS; SAVOURY SNACKS, NAMELY, SAUSAGE ROLLS, SNACK SIZED PIES, CANAPES; SANDWICHES; PUDDINGS; DESSERTS, NAMELY, SWEET PIES, APPLE PIES, FRUIT PIES, CUSTARD PIES, CUSTARD TARTS, BAKED TARTS, DANISH PASTRIES, BAKERY DESSERTS, MOUSSE AND ICE CREAM BASED DESSERTS; BAKED GOODS, NAMELY, CRUMBLES (U.S. CL. 46).

**CLASS 43—HOTEL AND RESTAURANT SERVICES**

FOR RESTAURANT SERVICES; CAFE SERVICES; SNACK-BAR SERVICES; PROVISION OF FOOD AND DRINK (U.S. CLS. 100 AND 101).

SHANNON TWOHIG, EXAMINING ATTORNEY

**CLASS 9—ELECTRICAL AND SCIENTIFIC APPARATUS**

FOR COMPUTER APPLICATION SOFTWARE FOR WIRELESS TELECOMMUNICATIONS FOR USE WITH WIRELESS DEVICES, NAMELY, SOFTWARE FOR USE IN DATABASE MANAGEMENT STORAGE, CREATION, MAINTENANCE AND UPDATING; COMPUTER SOFTWARE TO ENABLE UPLOADING, DOWNLOADING, ACCESSING, POSTING, DISPLAYING, TAGGING, BLOGGING, STREAMING, LINKING, SHARING OR OTHERWISE PROVIDING ELECTRONIC MEDIA OR INFORMATION VIA COMPUTER AND COMMUNICATION NETWORKS; COMPUTER SOFTWARE FOR ALLOWING COMMUNICATION AND INTERACTION BETWEEN PHONES, MOBILE DEVICES, TELEVISIONS, VIDEO GAME CONSOLES, MEDIA PLAYERS, COMPUTERS, DIGITAL MEDIA HUBS, AND AUDIOVISUAL DEVICES; COMPUTER SOFTWARE FOR USE BY COMPUTER NETWORK ADMINISTRATORS TO DEPLOY AND MANAGE APPLICATION SOFTWARE AND NETWORK SERVER SOFTWARE; COMPUTER NETWORK SERVER SOFTWARE FOR MANAGING USER CONTENT ON COMPUTER NETWORKS AND GLOBAL COMPUTER NETWORKS; COMPUTER SOFTWARE FOR MANAGING SECURE COMMUNICATIONS OVER COMPUTER NETWORKS AND GLOBAL COMPUTER NETWORKS; COMPUTER SOFTWARE FOR DEVELOPING, MANAGING AND OPERATING INTRANET SITES; COMPUTER NETWORK OPERATING SOFTWARE AND COMPUTER UTILITY PROGRAMS; COMPUTER SOFTWARE DEVELOPMENT TOOLS FOR NETWORK SERVERS AND APPLICATIONS; COMPUTER SOFTWARE FOR INVENTORYING AND MONITORING COMPUTER HARDWARE AND SOFTWARE ASSETS WITHIN AN ORGANIZATION; COMPUTER APPLICATION PROGRAMS AND OPERATING SYSTEM PROGRAMS FOR USE WITH COMMUNICATIONS SERVERS, NAMELY, COMPUTER SOFTWARE FOR USE IN DATABASE MANAGEMENT AND USE IN ELECTRONIC STORAGE OF DATA; COMPUTER PROGRAMS FOR MANAGING COMMUNICATIONS AND DATA EXCHANGE BETWEEN COMPUTERS AND ELECTRONIC DEVICES; OPERATING SYSTEMS SOFTWARE FOR USE IN PLAYING ELECTRONIC GAMES; COMPUTER SOFTWARE FOR THE DEPLOYMENT OF CLOUD COMPUTING SERVICES, COMPUTER SOFTWARE TO ENSURE THE SECURITY OF CLOUD COMPUTING SERVICE; LAPTOPS, NOTEBOOK COMPUTERS (U.S. CLS. 21, 23, 26, 36 AND 38).

SN 85-687,539, CLEMENS TÖNNIES, OELDE, FED REP GERMANY, FILED 7-26-2012.

**CLASS 25—CLOTHING**

FOR CLOTHING, NAMELY, T-SHIRTS, SHIRTS, PANTS, COATS, DRESSES, SWEATSHIRTS, SHORTS, DENIMS, SWEATERS, JACKETS, SOCKS, BELTS; HEADGEAR, NAMELY, HATS, CAPS AND BEANIES (U.S. CLS. 22 AND 39).

**CLASS 35—ADVERTISING AND BUSINESS**

FOR ADVERTISING SERVICES (U.S. CLS. 100, 101 AND 102).

**CLASS 38—COMMUNICATION**

FOR TELECOMMUNICATION SERVICES, NAMELY, ELECTRIC, DIGITAL, CELLULAR AND WIRELESS TRANSMISSION OF VOICE, DATA, INFORMATION, IMAGES, SIGNALS AND MESSAGES AND TRANSMISSION OF VOICE, DATA, IMAGES, AUDIO, VIDEO AND INFORMATION VIA TELEPHONE, TELEVISION AND GLOBAL COMMUNICATION NETWORKS; PROVIDING TELECOMMUNICATIONS CONNECTIONS TO A GLOBAL COMMUNICATIONS NETWORK, ELECTRONIC MAIL, VOICE MAIL AND MESSAGING SERVICES, NAMELY, THE RECORDING AND SUBSEQUENT TRANSMISSION OF VOICE MESSAGES BY TELEPHONE; RENTAL OF TELECOMMUNICATIONS EQUIP-

# TROLOLO

THE MARK CONSISTS OF STANDARD CHARACTERS WITHOUT CLAIM TO ANY PARTICULAR FONT, STYLE, SIZE, OR COLOR.

PRIORITY CLAIMED UNDER SEC. 44(D) ON ERP CMNTY TM OFC APPLICATION NO. 010791424, FILED 3-23-2012, REG. NO. 010791424, DATED 8-22-2012, EXPIRES 3-23-2022.

MENT; AUDIO AND VIDEO BROADCASTING; PROVIDING MULTIPLE USER DIALOGUE DEDICATED ACCESS TO THE INTERNET; PERSONAL ELECTRONIC MESSAGING SERVICES; PAGING SERVICES; TRANSMISSION AND BROADCAST OF AUDIO AND VIDEO PROGRAMMING BY SATELLITE; LEASING OF TELECOMMUNICATIONS EQUIPMENT, COMPONENTS AND SYSTEMS; PROVIDING INFORMATION VIA THE TELEPHONE AND THE GLOBAL COMMUNICATION NETWORKS IN THE FIELD OF TELECOMMUNICATIONS; CONSULTING IN THE FIELD OF TELECOMMUNICATIONS (U.S. CLS. 100, 101 AND 104).

#### **CLASS 42—SCIENTIFIC AND COMPUTER SERVICES**

FOR INSTALLATION, MAINTENANCE AND UPDATING OF COMPUTER SOFTWARE; TECHNICAL ASSISTANCE FOR CLOUD COMPUTING SERVICES, NAMELY, MAINTENANCE OF CLOUD COMPUTING COMPUTER SOFTWARE (U.S. CLS. 100 AND 101).  
COLLEEN DOMBROW, EXAMINING ATTORNEY

#### **CLASS 35—ADVERTISING AND BUSINESS**

FOR DRIVE-THROUGH RETAIL STORE SERVICES FEATURING COFFEE AND RELATED GOODS; RETAIL STORE SERVICES FEATURING ICE CREAM FOR CONSUMPTION OFF THE PREMISES (U.S. CLS. 100, 101 AND 102).

#### **CLASS 40—MATERIAL TREATMENT**

FOR COFFEE ROASTING AND PROCESSING (U.S. CLS. 100, 103 AND 106).

#### **CLASS 43—HOTEL AND RESTAURANT SERVICES**

FOR COFFEE BARS; COFFEE SHOPS; COFFEE SUPPLY SERVICES FOR OFFICES; ICE CREAM PARLORS; ICE CREAM SHOP SERVICES IN THE NATURE OF A RESTAURANT (U.S. CLS. 100 AND 101).  
WON TEAK OH, EXAMINING ATTORNEY

---

SN 85-690,016. ALLEN CHAMBERS LIMITED, TA ZUMO COFFEE COMPANY, NELSON, NEW ZEALAND, FILED 7-30-2012.



THE MARK CONSISTS OF TWO CIRCLES OF DIFFERING DIAMETER SMALLER THAN THE LENGTH OF THE STYLIZED AND OVERLAID WORDING "ZUMO".

THE ENGLISH TRANSLATION OF "ZUMO" IN THE MARK IS "JUICE".

#### **CLASS 21—HOUSEWARES AND GLASS**

FOR COFFEE CUPS, TEA CUPS AND MUGS (U.S. CLS. 2, 13, 23, 29, 30, 33, 40 AND 50).

#### **CLASS 29—MEATS AND PROCESSED FOODS**

FOR DAIRY-BASED FOOD BEVERAGES ALSO CONTAINING COCOA (U.S. CL. 46).

#### **CLASS 30—STAPLE FOODS**

FOR BEVERAGES MADE OF COFFEE; BEVERAGES MADE OF TEA; BEVERAGES WITH A TEA BASE; BLACK TEA; CAFFEINE-FREE COFFEE; CHAI TEA; COCOA; COCOA; COCOA BEVERAGES WITH MILK; COCOA POWDER; COCOA-BASED BEVERAGES; COFFEE; COFFEE; COFFEE AND TEA; COFFEE BASED BEVERAGES; COFFEE BEANS; COFFEE BEVERAGES WITH MILK; COFFEE-BASED BEVERAGES; GROUND COFFEE BEANS; ICE CREAM; ICE-CREAM; ICED COFFEE; ICED TEA; PREPARED COCOA AND COCOA-BASED BEVERAGES; PREPARED COFFEE AND COFFEE-BASED BEVERAGES; ROASTED COFFEE BEANS; TEA; TEA BAGS; TEA-BASED BEVERAGES (U.S. CL. 46).

#### **CLASS 31—NATURAL AGRICULTURAL PRODUCTS**

FOR UNPROCESSED TEA LEAVES (U.S. CLS. 1 AND 46).

---

SN 85-690,887. NFP GEAR, LLC, NEW BERLIN, WI. FILED 7-31-2012.

## New Found Power

THE MARK CONSISTS OF STANDARD CHARACTERS WITHOUT CLAIM TO ANY PARTICULAR FONT, STYLE, SIZE, OR COLOR.

#### **CLASS 5—PHARMACEUTICALS**

FOR DIETARY AND NUTRITIONAL SUPPLEMENTS (U.S. CLS. 6, 18, 44, 46, 51 AND 52).

#### **CLASS 25—CLOTHING**

FOR CLOTHING FOR ATHLETIC USE, NAMELY, SHIRTS, PANTS, JACKETS, SOCKS, FOOTWEAR (U.S. CLS. 22 AND 39).

#### **CLASS 41—EDUCATION AND ENTERTAINMENT**

FOR PERSONAL TRAINER SERVICES; PERSONAL FITNESS TRAINING SERVICES (U.S. CLS. 100, 101 AND 107).  
DANIEL CAPSHAW, EXAMINING ATTORNEY

SN 85-691,424. HH ASSOCIATES LIMITED, SUTTON, SURREY, UNITED KINGDOM, FILED 7-31-2012.



PRIORITY CLAIMED UNDER SEC. 44(D) ON UNITED KINGDOM APPLICATION NO. 2625520, FILED 6-22-2012, REG. NO. 2625520, DATED 6-22-2012, EXPIRES 6-22-2022.

NO CLAIM IS MADE TO THE EXCLUSIVE RIGHT TO USE "LID", APART FROM THE MARK AS SHOWN.

THE MARK CONSISTS OF A SOLID CIRCLE WITH A SMALL PORTION FOLDED OVER, AND THE WORD "LIDD" DEPICTED ON THE CIRCLE.

#### CLASS 16—PAPER GOODS AND PRINTED MATTER

FOR PRINTED MATTER, NAMELY, PRINTED PLASTIC FILMS FOR PACKAGING; ADHESIVE LABELS; PEELABLE PAPER LABELS WITH ADHESIVE BACKING; PLASTIC FILMS USED AS PACKAGING FOR FOOD AND DRINKS (U.S. CLS. 2, 5, 22, 23, 29, 37, 38 AND 50).

#### CLASS 17—RUBBER GOODS

FOR PEELABLE LABELS AND LABELING FILM IN THE NATURE OF ADHESIVE-BACKED PLASTIC FILMS FOR USE IN THE MANUFACTURE OF DURABLE LABELS AND NAMEPLATES (U.S. CLS. 1, 5, 12, 13, 35 AND 50).

#### CLASS 20—FURNITURE AND ARTICLES NOT OTHERWISE CLASSIFIED

FOR PACKAGING MATERIALS MADE OF PLASTIC, NAMELY, PLASTIC LIDS (U.S. CLS. 2, 13, 22, 25, 32 AND 50).

SEAN CROWLEY, EXAMINING ATTORNEY

SN 85-693,064. AMY'S KITCHEN, INC., PETALUMA, CA. FILED 8-1-2012.

WE LOVE TO COOK FOR YOU

THE MARK CONSISTS OF STANDARD CHARACTERS WITHOUT CLAIM TO ANY PARTICULAR FONT, STYLE, SIZE, OR COLOR.

#### CLASS 29—MEATS AND PROCESSED FOODS

FOR FROZEN PREPARED AND PACKAGED VEGETARIAN MEALS CONSISTING PRIMARILY OF VEGETABLES, CHEESE, POTATOES, TOFU, AND/OR BEANS, NAMELY, BURGERS, MEATLOAF AND STEAK CONSISTING PRIMARILY OF A VEGETABLE BASED MEAT SUBSTITUTE; INDIAN STYLE PRE-PACKAGED DINNERS CONSISTING PRIMARILY OF CHEESE AND/OR VEGETABLES; MEXICAN-STYLE PRE-PACKAGED DINNER CASSEROLES CONSISTING PRIMARILY OF BEANS AND/OR VEGETABLES; PRE-PACKAGED MEATLESS CHILI DINNERS; AND SOUTHERN-STYLE PRE-PACKAGED DINNERS CONSISTING PRIMARILY OF VEGETABLES AND/OR BEANS; CANNED SOUPS; CANNED REFRIED BEANS, BAKED BEANS, AND MEATLESS CHILI (U.S. CL. 46).

#### CLASS 30—STAPLE FOODS

FOR FROZEN PREPARED AND PACKAGED VEGETARIAN MEALS CONSISTING PRIMARILY OF PASTA, NOODLES, RICE, AND/OR POLENTA, NAMELY, MACARONI AND CHEESE DINNERS, SPAGHETTI DISHES, STUFFED PASTA SHELLS, TORTELLINI, VEGETARIAN LASAGNA, RAVIOLI, ROASTED POLENTA; ASIAN-STYLE MEALS CONSISTING PRIMARILY OF NOODLES OR RICE; FROZEN MEATLESS POT PIES; FROZEN PIZZAS AND POCKET PIZZAS; FROZEN ENCHILADAS WITH VARIOUS FILLINGS; BURRITOS; TAMALES; TACO DISHES CONSISTING PRIMARILY OF TORTILLAS AND ALSO INCLUDING RICE, VEGETABLES, CORN, BEANS, AND CHEESE; FROZEN POCKET SANDWICHES CONSISTING OF GRAIN BASED SHELLS WITH VARIOUS FILLINGS; FROZEN TOASTER PASTRIES WITH VARIOUS FILLINGS; FROZEN SNACK FOODS CONSISTING OF MINIATURE GRAIN BASED SHELLS WITH VARIOUS FILLINGS; FROZEN PORRIDGE-STYLE BREAKFAST CEREALS; PASTA SAUCES, SALSA; PIES, CANDY BARS, COOKIES, CAKES (U.S. CL. 46).

TIMOTHY O. SCHIMPF, EXAMINING ATTORNEY

SN 85-695,232. KICENIUK, ALEXANDRA, AKA DEVARENNE, ALEXANDRA KICENIUK, PETALUMA, CA. AND MILLER, PAUL, COONALPYN, S.A. 5265, AUSTRALIA, FILED 8-3-2012.

EXTRA VIRGIN ALLIANCE

THE MARK CONSISTS OF STANDARD CHARACTERS WITHOUT CLAIM TO ANY PARTICULAR FONT, STYLE, SIZE, OR COLOR.

SEC. 2(F).

#### CLASS 35—ADVERTISING AND BUSINESS

FOR ASSOCIATION SERVICES, NAMELY, PROMOTING THE INTERESTS OF OLIVE OIL PRODUCERS AND OTHERS ASSOCIATED WITH THE PRODUCTION AND DISTRIBUTION OF OLIVE OIL; CONDUCTING BUSINESS AND MARKET RESEARCH SURVEYS FEATURING SUPPLY CHAIN ANALYSIS; AND PRODUCT DEMONSTRATIONS FEATURING OLIVE OIL (U.S. CLS. 100, 101 AND 102).

FIRST USE 1-0-2013; IN COMMERCE 1-0-2013.

**CLASS 41—EDUCATION AND ENTERTAINMENT**

FOR EDUCATIONAL SERVICES, NAMELY, PROVIDING CLASSES, SEMINARS, WORKSHOPS AND EDUCATIONAL DEMONSTRATIONS ON OLIVE OIL PRODUCTION AND DISTRIBUTION, AND THE APPRECIATION AND CONSUMPTION OF OLIVE OIL (U.S. CLS. 100, 101 AND 107).

FIRST USE 4-25-2013; IN COMMERCE 4-25-2013.  
ALEXANDER L. POWERS, EXAMINING ATTORNEY

---

SN 85-695,268. HEADCOVERS UNLIMITED, INC., LEAGUE CITY, TX. FILED 8-3-2012.

# CARDANI

THE MARK CONSISTS OF STANDARD CHARACTERS WITHOUT CLAIM TO ANY PARTICULAR FONT, STYLE, SIZE, OR COLOR.

THE ENGLISH TRANSLATION OF "CARDANI" IN THE MARK IS "GIMBALS".

**CLASS 3—COSMETICS AND CLEANING PREPARATIONS**

FOR FALSE EYELASHES; FALSE EYEBROWS; COSMETICS (U.S. CLS. 1, 4, 6, 50, 51 AND 52).  
FIRST USE 1-5-2012; IN COMMERCE 1-5-2012.

**CLASS 25—CLOTHING**

FOR HEADWEAR AND SCARVES (U.S. CLS. 22 AND 39).  
FIRST USE 1-5-2012; IN COMMERCE 1-5-2012.

**CLASS 26—FANCY GOODS**

FOR WIGS AND HAIR PIECES (U.S. CLS. 37, 39, 40, 42 AND 50).  
FIRST USE 1-5-2012; IN COMMERCE 1-5-2012.  
SUNG IN, EXAMINING ATTORNEY

---

SN 85-698,725. CLUTTER MEDIA GROUP, BEACON, NY. FILED 8-8-2012.



THE MARK CONSISTS OF A STYLIZED WRITING OF THE WORD "CLUTTER", WITH BOLD OUTLINE AROUND THE WORDS.

**CLASS 16—PAPER GOODS AND PRINTED MATTER**

FOR PRINTED MATERIALS, NAMELY, MAGAZINES IN THE FIELD OF TOYS, ART AND POPULAR CULTURE; AND ART PRINTS (U.S. CLS. 2, 5, 22, 23, 29, 37, 38 AND 50).

FIRST USE 12-0-2004; IN COMMERCE 12-0-2004.

**CLASS 25—CLOTHING**

FOR T-SHIRTS (U.S. CLS. 22 AND 39).  
FIRST USE 12-0-2004; IN COMMERCE 12-0-2004.

**CLASS 28—TOYS AND SPORTING GOODS**

FOR COLLECTABLE TOY FIGURES (U.S. CLS. 22, 23, 38 AND 50).

FIRST USE 12-0-2004; IN COMMERCE 12-0-2004.

**CLASS 41—EDUCATION AND ENTERTAINMENT**

FOR PROVIDING ONLINE, NON - DOWNLOADABLE MAGAZINES IN THE FIELDS OF TOYS, ART AND POPULAR CULTURE. PROVIDING A WEBSITE FEATURING NON - DOWNLOADABLE MAGAZINES IN THE FIELDS OF TOYS, ART AND POPULAR CULTURE (U.S. CLS. 100, 101 AND 107).

FIRST USE 12-0-2004; IN COMMERCE 12-0-2004.  
AISHA CLARKE, EXAMINING ATTORNEY

---

SN 85-699,167. PSC INTANGIBLE HOLDING COMPANY, WILMINGTON, DE. FILED 8-9-2012.

# REVSRING

THE MARK CONSISTS OF STANDARD CHARACTERS WITHOUT CLAIM TO ANY PARTICULAR FONT, STYLE, SIZE, OR COLOR.

**CLASS 36—INSURANCE AND FINANCIAL**

FOR ELECTRONIC PAYMENT SERVICES INVOLVING ELECTRONIC PROCESSING AND ENHANCEMENT OF PAYMENT DATA (U.S. CLS. 100, 101 AND 102).

**CLASS 38—COMMUNICATION**

FOR ELECTRONIC MAIL SERVICES (U.S. CLS. 100, 101 AND 104).

**CLASS 39—TRANSPORTATION AND STORAGE**

FOR POSTAL, FREIGHT AND COURIER SERVICES (U.S. CLS. 100 AND 105).

**CLASS 40—MATERIAL TREATMENT**

FOR DIGITAL DOCUMENT IMAGING SERVICES, NAMELY, ON DEMAND DIGITAL PRINTING (U.S. CLS. 100, 103 AND 106).

**CLASS 41—EDUCATION AND ENTERTAINMENT**

FOR DIGITAL DOCUMENT IMAGING SERVICES, NAMELY, ON DEMAND DIGITAL IMAGING (U.S. CLS. 100, 101 AND 107).

DORITT L. CARROLL, EXAMINING ATTORNEY

SN 85-700,260. CHRISTIAN EAGER, LONDON, UNITED KINGDOM, FILED 8-10-2012.

**CARDBODS**

THE MARK CONSISTS OF STANDARD CHARACTERS WITHOUT CLAIM TO ANY PARTICULAR FONT, STYLE, SIZE, OR COLOR.

PRIORITY CLAIMED UNDER SEC. 44(D) ON ERPNTY TM OFC APPLICATION NO. 011056892, FILED 7-19-2012, REG. NO. 011056892, DATED 11-12-2012, EXPIRES 7-19-2022.

SN 85-700,200. YE GUANHUA, YUNFU CITY, GUANGDONG, CHINA, FILED 8-10-2012.

**CLASS 9—ELECTRICAL AND SCIENTIFIC APPARATUS**

FOR (BASED ON 44(E)) PRE-RECORDED COMPACT DISKS, DIGITAL VIDEO DISCS, DIGITAL VERSATILE DISCS, DOWNLOADABLE AUDIO AND VIDEO RECORDINGS, DVDS, AND HIGH DEFINITION DIGITAL DISCS FEATURING CHILDREN'S STORIES AND GAMES; INTERACTIVE GAME SOFTWARE (U.S. CLS. 21, 23, 26, 36 AND 38).

**CLASS 16—PAPER GOODS AND PRINTED MATTER**

FOR (BASED ON 44(E)) PRINTED MATTER, NAMELY, 3-DIMENSIONAL GREETING CARDS, CHILDREN'S BOOKS (U.S. CLS. 2, 5, 22, 23, 29, 37, 38 AND 50).

**CLASS 28—TOYS AND SPORTING GOODS**

FOR (BASED ON 44(E)) EDUCATIONAL CARD GAMES; CHILDREN'S MULTIPLE ACTIVITY TOYS (U.S. CLS. 22, 23, 38 AND 50).

**CLASS 41—EDUCATION AND ENTERTAINMENT**

FOR (BASED ON 44(E)) EDUCATIONAL AND ENTERTAINMENT SERVICES, NAMELY, PROVIDING ON-LINE INTERACTIVE CHILDREN'S STORIES; ENTERTAINMENT AND EDUCATIONAL SERVICES IN THE NATURE OF ON-LINE COMPETITIONS IN THE FIELD OF ENTERTAINMENT, EDUCATION, CULTURE, SPORTS, AND OTHER NON-BUSINESS AND NON-COMMERCIAL FIELDS; (BASED ON INTENT TO USE) PUBLISHING OF BOOKS, E-BOOKS, AUDIO BOOKS AND ILLUSTRATIONS; ANIMATION PRODUCTION SERVICES (U.S. CLS. 100, 101 AND 107).

AMY KERTGATE, EXAMINING ATTORNEY

NO CLAIM IS MADE TO THE EXCLUSIVE RIGHT TO USE "DELUXE METAL PRODUCTS", APART FROM THE MARK AS SHOWN.

THE MARK CONSISTS OF THE STYLIZED LETTERS "DMP" ABOVE A HORIZONTAL LINE AND THE WORDS "DELUXE METAL PRODUCTS" AT THE BOTTOM.

**CLASS 8—HAND TOOLS**

FOR CLEAVERS; HAND TOOLS, NAMELY, PRUNERS; HAND-OPERATED CHOPPERS; KNIVES; LADLES FOR WINE; NON-ELECTRIC CAN OPENERS; SHARPENING STONES; TABLEWARE, NAMELY, KNIVES, FORKS AND SPOONS; VEGETABLE KNIVES; VEGETABLE SLICERS (U.S. CLS. 23, 28 AND 44).

**CLASS 11—ENVIRONMENTAL CONTROL APPARATUS**

FOR APPARATUS FOR COOKING, NAMELY, COOK-TOPS; ELECTRIC AUTOCLAVES; ELECTRIC COFFEE MACHINES; ELECTRIC COFFEE PERCOLATORS; ELECTRIC COOKING OVENS; ELECTRIC DEEP FRYERS; ELECTRIC PRESSURE COOKERS; ELECTRIC TOASTERS; GAS STOVES; HOT WATER BOTTLES (U.S. CLS. 13, 21, 23, 31 AND 34).

**CLASS 21—HOUSEWARES AND GLASS**

FOR CHOPPING BOARDS FOR KITCHEN USE; COFFEE SERVICES; CONTAINERS FOR HOUSEHOLD OR KITCHEN USE; COOKING POTS; HEAT-INSULATED CONTAINERS FOR HOUSEHOLD USE; KETTLES; METAL COOKING PANS; NON-ELECTRIC PRESSURE COOKERS; PLATES; TEA SERVICES; TOILET TISSUE HOLDERS; TRASH CANS; VACUUM BOTTLES (U.S. CLS. 2, 13, 23, 29, 30, 33, 40 AND 50).

KERI CANTONE, EXAMINING ATTORNEY

SN 85-701,996. TIGER COMPANY LTD., GWANGJU-SI GYEONGGI-DO, REPUBLIC OF KOREA, FILED 8-13-2012.

THE MARK CONSISTS OF THE HIGHLY STYLIZED WORD "TIGER".

**CLASS 7—MACHINERY**

FOR CEREAL DISPENSERS FOR PROFESSIONAL USE, NAMELY, CEREAL DISPENSING VENDING MACHINES (U.S. CLS. 13, 19, 21, 23, 31, 34 AND 35).

**CLASS 8—HAND TOOLS**

FOR TABLEWARE, NAMELY, KNIVES, FORKS, SPOONS (U.S. CLS. 23, 28 AND 44).

**CLASS 11—ENVIRONMENTAL CONTROL APPARATUS**

FOR CHAFING DISHES (U.S. CLS. 13, 21, 23, 31 AND 34).

**CLASS 21—HOUSEWARES AND GLASS**

FOR NON-ELECTRIC HEATING POTS; NON-ELECTRIC POTS; NON-ELECTRIC KETTLES; NON-ELECTRIC COFFEE POTS; NON-ELECTRIC HOT POTS; JUGS; NON-ELECTRIC CONTAINERS FOR DISPENSING BEVERAGES (U.S. CLS. 2, 13, 23, 29, 30, 33, 40 AND 50).

KAPIL BHANOT, EXAMINING ATTORNEY

---

SN 85-702,742. OPEN ENERGI LIMITED, LONDON, UNITED KINGDOM, FILED 8-14-2012.

**OPEN ENERGI**

THE MARK CONSISTS OF STANDARD CHARACTERS WITHOUT CLAIM TO ANY PARTICULAR FONT, STYLE, SIZE, OR COLOR.

PRIORITY CLAIMED UNDER SEC. 44(D) ON UNITED KINGDOM APPLICATION NO. 2621818, FILED 4-11-2012, REG. NO. 00002621818, DATED 11-2-2012, EXPIRES 4-11-2022.

NO CLAIM IS MADE TO THE EXCLUSIVE RIGHT TO USE "ENERGY", APART FROM THE MARK AS SHOWN.

**CLASS 9—ELECTRICAL AND SCIENTIFIC APPARATUS**

FOR COMPUTER SOFTWARE FOR CONDUCTING, SWITCHING, TRANSFORMING, ACCUMULATING, REGULATING OR CONTROLLING ELECTRICITY; APPARATUS AND INSTRUMENTS FOR USE IN ADJUSTING OR CONTROLLING POWER USAGE OR ELECTRICAL LOAD, NAMELY, ELECTRICAL CONTROLLERS USED TO ADJUST POWER CONSUMPTION IN RESPONSE TO FLUCTUATIONS IN THE ELECTRICAL GRID FREQUENCY; COMPUTER SOFTWARE FOR ADJUSTING OR CONTROLLING POWER USAGE OR ELECTRICAL LOAD; COMPUTER SOFTWARE FOR MONITORING, MANAGING AND/OR RESPONDING TO FLUCTUATIONS IN THE SUPPLY OF ELECTRICITY; STRUCTURAL PARTS AND FITTINGS THEREFOR FOR THE AFORESAID GOODS (U.S. CLS. 21, 23, 26, 36 AND 38).

**CLASS 37—CONSTRUCTION AND REPAIR**

FOR INSTALLATION, MAINTENANCE AND REPAIR SERVICES RELATING TO DEVICES AND EQUIPMENT THAT CONSUME ELECTRICAL POWER, NAMELY, ELECTRICAL APPLIANCES AND MACHINERY; INSTALLATION, MAINTENANCE AND REPAIR SERVICES RELATING TO APPARATUS AND INSTRUMENTS FOR ADJUSTING OR CONTROLLING POWER USAGE OR ELECTRICAL LOAD; INSTALLATION, MAINTENANCE AND REPAIR SERVICES RELATING TO APPARATUS AND INSTRUMENTS FOR MONITORING, MANAGING AND/OR RESPONDING TO FLUCTUATIONS IN THE SUPPLY OF ELECTRICITY; ADVISORY AND CONSULTANCY SERVICES RELATING TO ALL OF THE AFORESAID (U.S. CLS. 100, 103 AND 106).

**CLASS 42—SCIENTIFIC AND COMPUTER SERVICES**

FOR ADVISORY AND CONSULTANCY SERVICES RELATING TO POWER SUPPLY AND POWER USAGE, NAMELY, MONITORING THE USE OF ELECTRICAL CONTROLLERS TO ADJUST POWER CONSUMPTION IN RESPONSE TO FLUCTUATIONS IN THE ELECTRICITY GRID FREQUENCY TO ENSURE PROPER FUNCTIONING; ADVISORY AND CONSULTANCY SERVICES RELATING TO COMPUTER SOFTWARE FOR ADJUSTING OR CONTROLLING POWER USAGE OR ELECTRICAL LOAD; ADVISORY AND CONSULTANCY SERVICES RELATING TO COMPUTER SOFTWARE FOR MONITORING, MANAGING AND/OR RESPONDING TO FLUCTUATIONS IN THE SUPPLY OF ELECTRICITY; DESIGN, INSTALLATION, MAINTENANCE AND UPDATING OF COMPUTER SOFTWARE, AND ADVISORY AND CONSULTANCY SERVICES RELATING THERETO; INSTALLATION, MAINTENANCE AND REPAIR SERVICES RELATING TO COMPUTER SOFTWARE FOR ADJUSTING OR CONTROLLING POWER USAGE OR ELECTRICAL LOAD; INSTALLATION, MAINTENANCE AND REPAIR SERVICES RELATING TO COMPUTER SOFTWARE FOR MONITORING, MANAGING AND/OR RESPONDING TO FLUCTUATIONS IN THE SUPPLY OF ELECTRICITY; RESEARCH AND DEVELOPMENT SERVICES RELATING TO APPARATUS, INSTRUMENTS AND COMPUTER SOFTWARE FOR ADJUSTING OR CONTROLLING POWER USAGE OR ELECTRICAL LOAD (U.S. CLS. 100 AND 101).

SAMUEL E. SHARPER JR., EXAMINING ATTORNEY

---

SN 85-703,000. CHARLES DAHER'S COMMONWEALTH MOTORS, INC., LAWRENCE, MA. FILED 8-14-2012.

**SHOP US LAST**

THE MARK CONSISTS OF STANDARD CHARACTERS WITHOUT CLAIM TO ANY PARTICULAR FONT, STYLE, SIZE, OR COLOR.

**CLASS 35—ADVERTISING AND BUSINESS**

FOR AUTOMOBILE DEALERSHIPS (U.S. CLS. 100, 101 AND 102).

**CLASS 36—INSURANCE AND FINANCIAL**

FOR FINANCING RELATING TO AUTOMOBILES (U.S. CLS. 100, 101 AND 102).

**CLASS 37—CONSTRUCTION AND REPAIR**

FOR MAINTENANCE AND/OR REPAIR OF AUTOMOBILES (U.S. CLS. 100, 103 AND 106).

**CLASS 39—TRANSPORTATION AND STORAGE**

FOR LEASING OF AUTOMOBILES (U.S. CLS. 100 AND 105).  
KAREN SEVERSON, EXAMINING ATTORNEY

SN 85-708,661. AMAZON TECHNOLOGIES, INC., RENO, NV.  
FILED 8-21-2012.

SN 85-703,294. YU-NU WANG, CHANG HWA, TAIWAN,  
FILED 8-14-2012.

**NJK**

THE MARK CONSISTS OF STANDARD CHARACTERS WITHOUT CLAIM TO ANY PARTICULAR FONT, STYLE, SIZE, OR COLOR.

**CLASS 7—MACHINERY**

FOR METAL OIL SEALS AND METAL AND NON-METAL SEALS FOR LAND VEHICLE ENGINES AND MACHINERY; METAL RINGS, NAMELY, PISTON RINGS AND OIL RING GASKETS FOR VEHICLES (U.S. CLS. 13, 19, 21, 23, 31, 34 AND 35).

**CLASS 17—RUBBER GOODS**

FOR PIPE GASKETS; SYNTHETIC RUBBER (U.S. CLS. 1, 5, 12, 13, 35 AND 50).  
WILLIAM VERHOSEK, EXAMINING ATTORNEY

SN 85-703,672. GILA RIVER GAMING ENTERPRISES, INC.,  
CHANDLER, AZ. FILED 8-14-2012.

**VEE QUIVA**



THE MARK CONSISTS OF "VEE QUIVA" IN ALL CAPITAL LETTERS, WITH AN UNDERLINE GRAPHIC CONSISTING OF A SEGMENT OF A STRAIGHT HORIZONTAL LINE FOLLOWED BY A ZIG-ZAG LINE FOLLOWED BY ANOTHER SEGMENT OF A STRAIGHT HORIZONTAL LINE.

THE ENGLISH TRANSLATION OF THE WORD "VEE QUIVA" IN THE MARK IS "MOUNTAIN WEST".

**CLASS 41—EDUCATION AND ENTERTAINMENT**

FOR CASINOS (U.S. CLS. 100, 101 AND 107).  
FIRST USE 12-17-1997; IN COMMERCE 12-17-1997.

**CLASS 43—HOTEL AND RESTAURANT SERVICES**

FOR HOTEL SERVICES (U.S. CLS. 100 AND 101).  
FIRST USE 12-17-1997; IN COMMERCE 12-17-1997.  
TINA MAI, EXAMINING ATTORNEY

**AMAZON GLACIER**

THE MARK CONSISTS OF STANDARD CHARACTERS WITHOUT CLAIM TO ANY PARTICULAR FONT, STYLE, SIZE, OR COLOR.

OWNER OF U.S. REG. NOS. 2,633,281, 4,089,910 AND OTHERS.

**CLASS 9—ELECTRICAL AND SCIENTIFIC APPARATUS**

FOR COMPUTER SOFTWARE FOR SEARCHING, LOCATING, COMPILING, INDEXING, CORRELATING, NAVIGATING, OBTAINING, DOWNLOADING, RECEIVING, ENCODING, DECODING, PLAYING, STORING AND ORGANIZING TEXT, DATA, IMAGES, GRAPHICS, AUDIO AND VIDEO ON A GLOBAL COMPUTER NETWORK; DOWNLOADABLE APPLICATION SOFTWARE FOR WIRELESS DELIVERY OF CONTENT, TEXT, DATA, IMAGES TO ELECTRONIC DEVICES (U.S. CLS. 21, 23, 26, 36 AND 38).

**CLASS 35—ADVERTISING AND BUSINESS**

FOR ADVERTISING SERVICES; BUSINESS MANAGEMENT; BUSINESS ADMINISTRATION; PROVIDING OFFICE FUNCTIONS (U.S. CLS. 100, 101 AND 102).

**CLASS 39—TRANSPORTATION AND STORAGE**

FOR PACKAGING GOODS TO THE ORDER AND SPECIFICATION OF OTHERS; STORAGE OF GOODS (U.S. CLS. 100 AND 105).

**CLASS 42—SCIENTIFIC AND COMPUTER SERVICES**

FOR DESIGN AND DEVELOPMENT OF COMPUTER SOFTWARE FOR SEARCHING, LOCATING, COMPILING, INDEXING, CORRELATING, NAVIGATING, OBTAINING, DOWNLOADING, RECEIVING, ENCODING, DECODING, PLAYING, STORING AND ORGANIZING TEXT, DATA, IMAGES, GRAPHICS, AUDIO AND VIDEO ON A GLOBAL COMPUTER NETWORK (U.S. CLS. 100 AND 101).

**CLASS 45—PERSONAL AND LEGAL SERVICES**

FOR COMPUTER SECURITY SERVICES IN THE NATURE OF MAINTAINING SECURITY AND INTEGRITY OF DATABASES AND DIGITAL INFORMATION (U.S. CLS. 100 AND 101).

BARBARA GAYNOR, EXAMINING ATTORNEY

SN 85-708,758, INGHAM, WILLIAM RUPERT, LONDON NW6 6RD, UNITED KINGDOM, AND INGHAM, TESSA NANCY, LONDON NW6 6RD, UNITED KINGDOM, FILED 8-21-2012.



PRIORITY CLAIMED UNDER SEC. 44(D) ON ERPN CMNTY TM OFC APPLICATION NO. 010744365, FILED 3-21-2012, REG. NO. 010744365, DATED 8-20-2012, EXPIRES 3-21-2022.

THE MARK CONSISTS OF A STYLIZED "W" ABOVE THE WORD "WING".

#### **CLASS 9—ELECTRICAL AND SCIENTIFIC APPARATUS**

FOR PRE-RECORDED MAGNETIC DATA CARRIERS RELATING TO SPORTS, MUSIC, ADVERTISING AND ENTERTAINMENT IN THE FIELD OF MOVIES, ANIMATED FEATURES, TELEVISION FILMS, DOCUMENTARIES, FILMS, SPORTS; PRE-RECORDED RECORDING DISCS, NAMELY, CDS IN THE FIELD OF MUSIC, FILMS; PRE-RECORDED COMPACT DISCS RELATING TO SPORTS, MUSIC, ADVERTISING AND ENTERTAINMENT IN THE FIELD OF MOVIES, ANIMATED FEATURES, TELEVISION FILMS, DOCUMENTARIES, FILMS, SPORTS; PRE-RECORDED DVDS RELATING TO SPORTS, MUSIC, ADVERTISING AND ENTERTAINMENT IN THE FIELD OF MOVIES, ANIMATED FEATURES, TELEVISION FILMS, DOCUMENTARIES, FILMS, SPORTS.; AND OTHER DIGITAL RECORDING MEDIA, NAMELY, BLANK ELECTRONIC STORAGE MEDIA, MP3 RECORDERS RELATING TO SPORTS, MUSIC, ADVERTISING AND ENTERTAINMENT IN THE FIELD OF MOVIES, ANIMATED FEATURES, TELEVISION FILMS, DOCUMENTARIES, FILMS, SPORTS.; COMPUTER SOFTWARE FOR RELATING TO SPORTS, MUSIC, ADVERTISING AND ENTERTAINMENT IN RELATION TO ELECTRONIC STORAGE DATA, FOR STORAGE OF SPORTS, MUSIC, ADVERTISING AND ENTERTAINMENT IN THE FIELD OF MOVIES, ANIMATED FEATURES, TELEVISION FILMS, DOCUMENTARIES, FILMS, SPORTS (U.S. CLS. 21, 23, 26, 36 AND 38).

#### **CLASS 35—ADVERTISING AND BUSINESS**

FOR ADVERTISING; BUSINESS MANAGEMENT; BUSINESS ADMINISTRATION SERVICES, NAMELY, PROJECT MANAGEMENT; PRODUCTION OF ADVERTISING MATTER AND COMMERCIALS, NAMELY, PRODUCTION OF SOUND RECORDINGS FOR PUBLICITY, MARKETING AND ADVERTISING PURPOSES; ADVERTISING SERVICES, NAMELY, PROMOTION OF PRODUCTS AND SERVICES OF THIRD PARTIES THROUGH SPONSORING ARRANGEMENTS AND LICENSE AGREEMENTS RELATING TO INTERNATIONAL SPORTS AND CULTURAL EVENTS; ADVERTISING AGENCY SERVICES; COMPILATION OF ADVERTISEMENTS FOR USE AS WEB PAGES ON THE INTERNET, ON TV OR RETAIL OUTLETS AND ON-LINE RETAIL OUTLETS; PREPARATION OF ADVERTISEMENTS FOR OTHERS; PRODUCTION OF ADVERTISING MATTER AND COMMERCIALS, NAMELY, PRODUCTION OF VIDEO AND AUDIOVISUAL FOOTAGE FOR ADVERTISEMENTS; ARRANGING AND CONDUCTING SPECIAL EVENTS FOR BUSINESS PURPOSES, NAMELY, PRODUCT LAUNCHES (U.S. CLS. 100, 101 AND 102).

#### **CLASS 38—COMMUNICATION**

FOR BROADCASTING OF MOTION PICTURES BY SATELLITE; BROADCASTING OF MOTION PICTURES BY TELEVISION; BROADCASTING OF RADIO AND TELEVISION PROGRAMMES; BROADCASTING PROGRAMS VIA A GLOBAL COMPUTER NETWORK; BROADCASTING OF RADIO, TELEVISION, CABLE TELEVISION, MOTION PICTURE PROGRAMS FEATURING MUSIC; SATELLITE TRANSMISSION SERVICES, TELEVISION AND RADIO BROADCASTING SERVICES; SATELLITE TRANSMISSION SERVICES, TELEVISION AND RADIO BROADCASTING SERVICES FEATURING SPORTING EVENTS (U.S. CLS. 100, 101 AND 104).

#### **CLASS 41—EDUCATION AND ENTERTAINMENT**

FOR ENTERTAINMENT IN THE NATURE OF MUSICAL GROUP, TELEVISION COMEDY SERIES, ETHNIC FESTIVAL, SPORTS EVENTS LIVE SPORTS EVENTS, MUSIC EVENTS, LIVE MUSIC EVENTS, DISPLAYING A SERIES OF FILMS, AND DOCUMENTARY FILMS, TELEVISION SERIES FEATURING COMEDY, ACTION ADVENTURE, NEWS, COMMENTARY, ANIMATED FEATURES, TELEVISION FILMS, SPORTS, DOCUMENTARIES, FILMS, LIVE WEB EVENTS FEATURING MOVIES, ANIMATED FEATURES, TELEVISION FILMS, DOCUMENTARIES, FILMS, SPORTS, LIVE INTERACTIVE EVENTS FEATURING MOVIES, ANIMATED FEATURES, TELEVISION FILMS, DOCUMENTARIES, FILMS, SPORTS, CHILDREN'S ENTERTAINMENT, NAMELY, CLOWN SHOWS AND CHILDREN'S SHOWS VIA THE INTERNET; EDITING OR RECORDING OF SOUNDS AND IMAGES; PRODUCTION OF EDUCATIONAL SOUND AND VIDEO RECORDINGS; PRODUCTION OF VIDEO AND SOUND RECORDINGS; PREPARATION OF ENTERTAINMENT PROGRAMS FOR BROADCASTING, NAMELY, TELEVISION, MOTION PICTURE FILM AND RADIO PROGRAM PRODUCTION SERVICES; ELECTRONIC LIBRARY SERVICES FOR THE SUPPLY OF ELECTRONIC INFORMATION, INCLUDING ARCHIVE INFORMATION, IN THE FORM OF ELECTRONIC TEXTS, AUDIO AND VIDEO INFORMATION AND DATA, GAMES AND AMUSEMENTS (U.S. CLS. 100, 101 AND 107).

GRETTA YAO, EXAMINING ATTORNEY



SN 85-710,262. ZESPRI GROUP LIMITED, MOUNT MAUNGANUI SOUTH, NEW ZEALAND, FILED 8-22-2012.

SN 85-711,300. DESIGNER PROTEIN, LLC, CARLSBAD, CA, FILED 8-23-2012.



PRIORITY CLAIMED UNDER SEC. 44(D) ON NEW ZEALAND APPLICATION NO. 964091, FILED 8-21-2012, REG. NO. 964091, DATED 8-21-2012, EXPIRES 8-21-2022.

OWNER OF U.S. REG. NOS. 2,330,343, 2,386,593 AND OTHERS.

THE MARK CONSISTS OF THE STYLIZED WORD "ZESPRI" WITH A STYLIZED AND SEGMENTED HALF CIRCLE ABOVE AND SEPARATE FROM THE WORD "ZESPRI" WITH A SOLID HALF CIRCLE BELOW AND SEPARATE FROM THE WORD "ZESPRI" ALL SURROUNDED BY A THIN OUTLINE OF THE DESIGN PLUS ADDITIONAL WHITE SPACE TO THE RIGHT OF THE DESIGN.

#### CLASS 16—PAPER GOODS AND PRINTED MATTER

FOR PRINTED MATTER RELATING TO AGRICULTURE AND HORTICULTURE, NAMELY, BOOKS AND MAGAZINES; PRINTED PROMOTIONAL MATERIALS, NAMELY, FLYERS, NOTEBOOKS AND BROCHURES FEATURING AND PROVIDING INFORMATION ABOUT AGRICULTURAL AND HORTICULTURAL PRODUCTS; PACKAGING MATERIALS MADE FROM PAPER, CARDBOARD OR PLASTIC, NAMELY, BAGS, SHEETS; BOXES MADE FROM PAPER AND CARDBOARD; BOOKS AND BOOKLETS IN THE FIELD OF AGRICULTURE AND HORTICULTURE; STATIONERY IN THIS CLASS, NAMELY, WRITING PAPER, ENVELOPES, NOTEPADS, CARDS, LETTERS, PENS AND PENCILS; PAPER; CARDBOARD AND GOODS MADE FROM THESE MATERIALS, NAMELY, CARDBOARD, CARDBOARD CARTONS, CARDBOARD CONTAINERS; PHOTOGRAPHS; PRINTED INSTRUCTIONAL AND TEACHING MATERIALS EXCEPT APPARATUS, NAMELY, BOOKS, GUIDES, CHARTS, MANUALS IN THE FIELD OF AGRICULTURE AND HORTICULTURE; PRINTED PUBLICATIONS, NAMELY, MAGAZINES, NEWSLETTERS AND NEWSPAPERS IN THE FIELD OF AGRICULTURE AND HORTICULTURE (U.S. CLS. 2, 5, 22, 23, 29, 37, 38 AND 50).

FIRST USE 9-0-2011; IN COMMERCE 9-0-2011.

#### CLASS 31—NATURAL AGRICULTURAL PRODUCTS

FOR AGRICULTURAL AND HORTICULTURAL PRODUCTS IN THIS CLASS, NAMELY, FRESH FRUITS AND VEGETABLES; SEEDS FOR AGRICULTURAL AND HORTICULTURAL USES; NATURAL PLANTS (U.S. CLS. 1 AND 46).

FIRST USE 9-0-2011; IN COMMERCE 9-0-2011.

HEATHER THOMPSON, EXAMINING ATTORNEY

# Designer Whey

OWNER OF U.S. REG. NOS. 3,111,771, 3,765,938 AND 3,791,180.

NO CLAIM IS MADE TO THE EXCLUSIVE RIGHT TO USE "WHEY", APART FROM THE MARK AS SHOWN.

THE MARK CONSISTS OF THE WORDS "DESIGNER WHEY" IN STYLIZED FONT, ARRANGED WITH "DESIGNER" CENTERED ABOVE "WHEY" SUCH THAT "ES" IS OVER "W" AND "I" IS ALIGNED WITH STEM OF "H".

SEC. 2(F).

#### CLASS 5—PHARMACEUTICALS

FOR DIETARY AND NUTRITIONAL SUPPLEMENTS, NAMELY, WHEY PROTEINS FOR USE AS A NUTRITIONAL INGREDIENT IN PROTEIN SUPPLEMENTS, NAMELY, POWDERED DRINK BEVERAGES; DIETARY AND NUTRITIONAL SUPPLEMENTS, NAMELY, WHEY PROTEINS FOR USE AS A NUTRITIONAL INGREDIENT IN PROTEIN-BASED SNACK BARS; DIETARY AND NUTRITIONAL SUPPLEMENTS, NAMELY, WHEY PROTEINS FOR USE AS A NUTRITIONAL INGREDIENT IN VARIOUS READY-TO-DRINK BEVERAGES (U.S. CLS. 6, 18, 44, 46, 51 AND 52).

FIRST USE 5-16-2012; IN COMMERCE 5-16-2012.

#### CLASS 32—LIGHT BEVERAGES

FOR NON-ALCOHOLIC BEVERAGES CONTAINING WHEY PROTEIN, NAMELY, CARBONATED BEVERAGES AND NON-CARBONATED BEVERAGES IN THE NATURE OF DRINKING WATERS, FRUIT JUICE BASED BEVERAGES, VEGETABLE JUICE BASED BEVERAGES, MALT BEVERAGES, SPORTS DRINKS, WATER-BASED BEVERAGES CONTAINING FRUIT FLAVORING AND WHEY PROTEIN, AND ENERGY DRINKS; CONCENTRATED POWDERS FOR MAKING THE ABOVE BEVERAGES, NAMELY, PREPACKAGED INDIVIDUAL SERVING CONCENTRATED POWDERS, BULK PACKAGED CONCENTRATED POWDERS, AND MULTI-PACKS OF PREPACKAGED INDIVIDUAL SERVING CONCENTRATED POWDERS (U.S. CLS. 45, 46 AND 48).

FIRST USE 5-16-2012; IN COMMERCE 5-16-2012.

SANI KHOURI, EXAMINING ATTORNEY

SN 85-717,099. OCEANCONNECTION, LLC, SANTE FE, NM, FILED 8-30-2012.

## OCEANCONNECTION

THE MARK CONSISTS OF STANDARD CHARACTERS WITHOUT CLAIM TO ANY PARTICULAR FONT, STYLE, SIZE, OR COLOR.

**CLASS 9—ELECTRICAL AND SCIENTIFIC APPARATUS**

FOR DOWNLOADABLE ELECTRONIC EDUCATIONAL PUBLICATIONS IN THE NATURE OF TEACHING GUIDES, ACTIVITY GUIDES, RESOURCE GUIDES AND CURRICULUM GUIDES, ALL THE FOREGOING IN THE FIELDS OF OCEAN CONSERVATION AWARENESS, OCEANOGRAPHY AND MARINE BIOLOGY; ELECTRONIC GAME PROGRAMS (U.S. CLS. 21, 23, 26, 36 AND 38).

SN 85-717,147. TOTALZERO, INC., AUSTIN, TX. FILED 8-30-2012.

# DCSR

THE MARK CONSISTS OF STANDARD CHARACTERS WITHOUT CLAIM TO ANY PARTICULAR FONT, STYLE, SIZE, OR COLOR.

**CLASS 21—HOUSEWARES AND GLASS**

FOR WATER BOTTLES SOLD EMPTY (U.S. CLS. 2, 13, 23, 29, 30, 33, 40 AND 50).

**CLASS 38—COMMUNICATION**

FOR TELECOMMUNICATION SERVICES, NAMELY, TRANSMISSION OF DIGITAL FILES, SOFTWARE APPLICATIONS, AUDIO, VIDEO, ELECTRONIC DOCUMENTS, DIGITAL COMMUNICATIONS, DATA AND IMAGES ALL VIA ELECTRONIC COMMUNICATION NETWORKS (U.S. CLS. 100, 101 AND 104).

**CLASS 25—CLOTHING**

FOR CLOTHING, NAMELY, T-SHIRTS; HEADWEAR, NAMELY, CAPS AND HATS (U.S. CLS. 22 AND 39).

**CLASS 28—TOYS AND SPORTING GOODS**

FOR GAMES, NAMELY, BOARD GAMES AND PLAYING CARD GAMES (U.S. CLS. 22, 23, 38 AND 50).  
BERYL GARDNER, EXAMINING ATTORNEY

**CLASS 42—SCIENTIFIC AND COMPUTER SERVICES**

FOR APPLICATION SERVICE PROVIDER, NAMELY, PROVIDING TEMPORARY USE OF NON-DOWNLOADABLE SOFTWARE FOR USE IN HOSTING, REMOTELY ACCESSING, UPLOADING, DOWNLOADING, SHARING, SEARCHING, INTEGRATING, AND ORGANIZING SOFTWARE APPLICATIONS, DIGITAL AUDIO, DIGITAL VIDEO, ELECTRONIC DOCUMENTS, ELECTRONIC COMMUNICATIONS, DATA AND IMAGES ALL VIA ELECTRONIC COMMUNICATIONS NETWORKS; SOFTWARE AS A SERVICE (SAAS) SERVICES FEATURING SOFTWARE THAT ALLOWS USERS TO ACCESS MULTIPLE SOFTWARE APPLICATIONS ON A SINGLE ELECTRONIC DEVICE; SOFTWARE AS A SERVICE (SAAS) SERVICES FEATURING COMMUNICATIONS SOFTWARE FOR WIRELESS DELIVERY OF CONTENT AND DATA SECURITY TO HANDHELD COMPUTERS, LAPTOPS AND MOBILE ELECTRONIC DEVICES; COMPUTER SERVICES, NAMELY, INTEGRATION OF COMPUTER SOFTWARE APPLICATIONS, ELECTRONIC COMMUNICATIONS, DIGITAL DATA AND ELECTRONIC DATABASES ALL INTO MULTIPLE SYSTEMS AND NETWORKS (U.S. CLS. 100 AND 101).

SN 85-717,115. TOTALZERO, INC., AUSTIN, TX. FILED 8-30-2012.

# TotalZero

THE MARK CONSISTS OF STANDARD CHARACTERS WITHOUT CLAIM TO ANY PARTICULAR FONT, STYLE, SIZE, OR COLOR.

BERYL GARDNER, EXAMINING ATTORNEY

**CLASS 38—COMMUNICATION**

FOR TELECOMMUNICATION SERVICES, NAMELY, TRANSMISSION OF DIGITAL FILES, SOFTWARE APPLICATIONS, AUDIO, VIDEO, ELECTRONIC DOCUMENTS, DIGITAL COMMUNICATIONS, DATA AND IMAGES ALL VIA ELECTRONIC COMMUNICATION NETWORKS (U.S. CLS. 100, 101 AND 104).

SN 85-717,158. TOTALZERO, INC., AUSTIN, TX. FILED 8-30-2012.

**CLASS 42—SCIENTIFIC AND COMPUTER SERVICES**

FOR APPLICATION SERVICE PROVIDER, NAMELY, PROVIDING TEMPORARY USE OF NON-DOWNLOADABLE SOFTWARE FOR USE IN HOSTING, REMOTELY ACCESSING, UPLOADING, DOWNLOADING, SHARING, SEARCHING, INTEGRATING, AND ORGANIZING SOFTWARE APPLICATIONS, DIGITAL AUDIO, DIGITAL VIDEO, ELECTRONIC DOCUMENTS, ELECTRONIC COMMUNICATIONS, DATA AND IMAGES ALL VIA ELECTRONIC COMMUNICATIONS NETWORKS; SOFTWARE AS A SERVICE (SAAS) SERVICES FEATURING SOFTWARE THAT ALLOWS USERS TO ACCESS MULTIPLE SOFTWARE APPLICATIONS ON A SINGLE ELECTRONIC DEVICE; SOFTWARE AS A SERVICE (SAAS) SERVICES FEATURING COMMUNICATIONS SOFTWARE FOR WIRELESS DELIVERY OF CONTENT AND DATA SECURITY TO HANDHELD COMPUTERS, LAPTOPS AND MOBILE ELECTRONIC DEVICES; COMPUTER SERVICES, NAMELY, INTEGRATION OF COMPUTER SOFTWARE APPLICATIONS, ELECTRONIC COMMUNICATIONS, DIGITAL DATA AND ELECTRONIC DATABASES ALL INTO MULTIPLE SYSTEMS AND NETWORKS (U.S. CLS. 100 AND 101).

BERYL GARDNER, EXAMINING ATTORNEY

# MCSR

THE MARK CONSISTS OF STANDARD CHARACTERS WITHOUT CLAIM TO ANY PARTICULAR FONT, STYLE, SIZE, OR COLOR.

**CLASS 38—COMMUNICATION**

FOR TELECOMMUNICATION SERVICES, NAMELY, TRANSMISSION OF DIGITAL FILES, SOFTWARE APPLICATIONS, AUDIO, VIDEO, ELECTRONIC DOCUMENTS, DIGITAL COMMUNICATIONS, DATA AND IMAGES ALL VIA ELECTRONIC COMMUNICATION NETWORKS (U.S. CLS. 100, 101 AND 104).

**CLASS 42—SCIENTIFIC AND COMPUTER SERVICES**

FOR APPLICATION SERVICE PROVIDER, NAMELY, PROVIDING TEMPORARY USE OF NON-DOWNLOADABLE SOFTWARE FOR USE IN HOSTING, REMOTELY ACCESSING, UPLOADING, DOWNLOADING, SHARING, SEARCHING, INTEGRATING, AND ORGANIZING SOFTWARE APPLICATIONS, DIGITAL AUDIO, DIGITAL VIDEO, ELECTRONIC DOCUMENTS, ELECTRONIC COMMUNICATIONS, DATA AND IMAGES ALL VIA ELECTRONIC COMMUNICATIONS NETWORKS; SOFTWARE AS A SERVICE (SAAS) SERVICES FEATURING SOFTWARE THAT ALLOWS USERS TO ACCESS MULTIPLE SOFTWARE APPLICATIONS ON A SINGLE ELECTRONIC DEVICE; SOFTWARE AS A SERVICE (SAAS) SERVICES FEATURING COMMUNICATIONS SOFTWARE FOR WIRELESS DELIVERY OF CONTENT AND DATA SECURITY TO HANDHELD COMPUTERS, LAPTOPS AND MOBILE ELECTRONIC DEVICES; COMPUTER SERVICES, NAMELY, INTEGRATION OF COMPUTER SOFTWARE APPLICATIONS, ELECTRONIC COMMUNICATIONS, DIGITAL DATA AND ELECTRONIC DATABASES ALL INTO MULTIPLE SYSTEMS AND NETWORKS (U.S. CLS. 100 AND 101).

BERYL GARDNER, EXAMINING ATTORNEY

---

SN 85-717,319. ENVY MEDICAL, INC., WESTLAKE VILAGE, CA. FILED 8-30-2012.

**ENVY**  
specialized skincare

NO CLAIM IS MADE TO THE EXCLUSIVE RIGHT TO USE "SPECIALIZED SKINCARE", APART FROM THE MARK AS SHOWN.

THE MARK CONSISTS OF THE WORD "ENVY" IN STYLIZED FONT ABOVE THE WORDS "SPECIALIZED SKINCARE" IN STYLIZED, ITALIC FONT.

**CLASS 5—PHARMACEUTICALS**

FOR ACNE TREATMENT PREPARATIONS NAMELY, FACE CREAMS AND CLEANSERS; MEDICATED SKIN CARE PREPARATIONS, NAMELY, CREAMS, LOTIONS, CLEANSERS AND PEALS (U.S. CLS. 6, 18, 44, 46, 51 AND 52).

FIRST USE 6-23-2009; IN COMMERCE 6-23-2009.

**CLASS 21—HOUSEWARES AND GLASS**

FOR COSMETIC APPARATUS, NAMELY AN ELECTRONIC SKIN TREATMENT DEVICE USED TO EXFOLIATE SKIN (U.S. CLS. 2, 13, 23, 29, 30, 33, 40 AND 50).

FIRST USE 6-23-2009; IN COMMERCE 6-23-2009.  
CHRISIE B. KING, EXAMINING ATTORNEY

SN 85-720,255. HAIR SALON ZERO LTD., FUKUOKA, JAPAN, FILED 9-4-2012.

**PORICA**

THE MARK CONSISTS OF STANDARD CHARACTERS WITHOUT CLAIM TO ANY PARTICULAR FONT, STYLE, SIZE, OR COLOR.

**CLASS 6—METAL GOODS**

FOR ACCESSORIES FOR HEAD MODELS FOR HAIR DRESSING AND BEAUTY TECHNIQUE TRAINING, NAMELY, METAL PINS FOR ATTACHING PAPER AND FOAM STRIPS TO HEAD MODELS (U.S. CLS. 2, 12, 13, 14, 23, 25 AND 50).

**CLASS 16—PAPER GOODS AND PRINTED MATTER**

FOR ACCESSORIES FOR HEAD MODELS FOR HAIR DRESSING AND BEAUTY TECHNIQUE TRAINING, NAMELY, PAPER STRIPS FOR ATTACHING TO HEAD MODELS TO SIMULATE HAIR (U.S. CLS. 2, 5, 22, 23, 29, 37, 38 AND 50).

**CLASS 20—FURNITURE AND ARTICLES NOT OTHERWISE CLASSIFIED**

FOR HAIR MANNEQUINS, NAMELY, HEAD MODELS FOR HAIR DRESSING AND BEAUTY TECHNIQUE TRAINING; ACCESSORIES FOR HEAD MODELS FOR HAIR DRESSING AND BEAUTY TECHNIQUE TRAINING, NAMELY, EXPANDED POLYSTYRENE FOAM STRIPS FOR ATTACHING TO HEAD MODELS TO SIMULATE HAIR; ACCESSORIES FOR HEAD MODELS FOR HAIR DRESSING AND BEAUTY TECHNIQUE TRAINING, NAMELY, NON-METAL PINS FOR ATTACHING PAPER AND FOAM STRIPS TO HEAD MODELS; MANNEQUINS (U.S. CLS. 2, 13, 22, 25, 32 AND 50).

**CLASS 26—FANCY GOODS**

FOR WIGS, NAMELY, HUMAN HAIR SAMPLES FOR BARBERS OR HAIR SALONS (U.S. CLS. 37, 39, 40, 42 AND 50).

B. PARADEWELAI, EXAMINING ATTORNEY

---

SN 85-723,055. SHIBUYA KOGYO CO., LTD., ISHIKAWA-KEN, JAPAN, FILED 9-7-2012.

**SHIBUYA**

THE MARK CONSISTS OF STANDARD CHARACTERS WITHOUT CLAIM TO ANY PARTICULAR FONT, STYLE, SIZE, OR COLOR.

**CLASS 7—MACHINERY**

FOR (BASED ON USE IN COMMERCE) BEER BREWING MACHINES AND STRUCTURAL PARTS AND FITTINGS THEREFOR; BREWING MACHINES FOR MAKING ALCOHOLIC BEVERAGES AND STRUCTURAL PARTS AND FITTINGS THEREFOR; AUTOMATIC INDUSTRIAL LABELING MACHINES FOR APPLYING LABELS TO CONTAINERS AND BOTTLES; FOOD OR BEVERAGE PROCESSING MACHINES AND APPARATUS, NAMELY, FILLING MACHINES FOR FOODS AND BEVERAGES; FOOD OR BEVERAGE PROCESSING MACHINES AND APPARATUS, NAMELY, BOTTLE FILLING MACHINES FOR FOODS AND BEVERAGES; PACKAGING MACHINES; WRAPPING MACHINES; LOADING AND UNLOADING MACHINES; LASER MACHINES FOR CUTTING, MARKING, AND ENGRAVING FABRIC DESIGNED FOR INSTALLATION DIRECTLY ABOVE EMBROIDERY MACHINES; SEMICONDUCTOR MANUFACTURING MACHINES AND PARTS THEREOF; BOTTLING MACHINES, NAMELY, BOTTLE WASHERS, BOTTLE FILLERS AND BOTTLE CAPPERS, ALL SOLD AS A UNIT; BOTTLE CAPPER MACHINES; BOTTLE WASHING MACHINES; MACHINES FOR THE INDUSTRIAL PRODUCTION OF PHARMACEUTICALS, NAMELY, VIAL WASHER, AMPOULE WASHER, SYRINGE WASHER, FILLING/STOPPERING MACHINE, FREEZE DRYER LOADER AND UNLOADER, ALUMINUM OVER CAPPING MACHINE, RUBBER STOPPER RINSER, PACKAGING HANDLING MACHINE, FORMULATION MACHINE, ISOLATORS, SILICONIZING UNIT, SHEATH STOPPERING MACHINE, VACUUM STOPPERING MACHINE, SEALING MACHINE FOR FREEZE DRIED PRODUCTS, TRAY LOADER, AND FINAL PACKAGING MACHINE; MACHINES FOR FILLING CAPSULES, VIALS, AMPOULES, AND SUPPOSITORIES; PACKAGING MACHINES FOR PACKAGING BLISTER CARDS AND CARTONS AND BOTTLES; PACKAGING SYSTEMS CONSISTING OF SEVERAL PACKAGING MACHINES, PARTICULARLY FOR PACKAGING OBLONG OBJECTS, NAMELY, AMPOULES, SMALL FLASKS AND SYRINGES FOR THE PHARMACEUTICAL INDUSTRY; MACHINES FOR MANUFACTURING PACKAGING MATERIAL SUCH AS COLLAPSIBLE BOXES OR CUSHIONING PACKAGING MATERIAL (BASED ON INTENT TO USE) INDUSTRIAL TRASH COMPACTING MACHINES; WASHING MACHINE FOR INDUSTRIAL PARTS; MACHINES FOR CLEANING AND STRIPPING SURFACES USING HIGH-SPEED WATER JET; CUTTING MACHINES; VEHICLE WASHING INSTALLATIONS; MACHINES FOR BLAST CLEANING A SURFACE; MACHINES FOR CLEANING SURFACES USING HIGH PRESSURE WATER; ORGANIC WASTE PROCESSING MACHINES, NAMELY, WASTE CRUSHING MACHINES; AGRICULTURAL MACHINES, NAMELY, CULTIVATORS, HARVESTERS, DISK HARROWS, AND SEEDERS; AGRICULTURAL MACHINES, NAMELY, REAPERS (U.S. CLS. 13, 19, 21, 23, 31, 34 AND 35).

FIRST USE 5-0-1979; IN COMMERCE 5-0-1987.

**CLASS 11—ENVIRONMENTAL CONTROL APPARATUS**

FOR (BASED ON USE IN COMMERCE) DECONTAMINATION MACHINES AND APPARATUS TO BE USED IN THE PROCESS OF MANUFACTURING OF PHARMACEUTICALS FOR DECONTAMINATION OF ASEPTIC PHARMACEUTICAL MANUFACTURING ENVIRONMENTS FOR STERILIZATION PURPOSES, NAMELY, ISOLATOR SYSTEMS FOR ISOLATING THE EXTERIOR ENVIRONMENT OR PERSONS PHYSICALLY TO DECONTAMINATE THEM AND ELIMINATE RISK OF POLLUTION, WHICH ISOLATOR SYSTEMS COMPRISED OF MACHINES AND APPARATUS FOR FILTERING AIR AND EMITTING GAS, AND CLEAN ROOMS; DECONTAMINATION MACHINES AND APPARATUS TO BE USED FOR STERILIZATION PURPOSES IN THE PROCESS OF MANUFACTURING OF PHARMACEUTICALS, NAMELY, STERILIZERS FOR DECONTAMINATION; MACHINES USED FOR STERILIZATION PURPOSES IN THE PROCESS OF THE INDUSTRIAL PRODUCTION OF PHARMACEUTICALS (U.S. CLS. 13, 21, 23, 31 AND 34).

FIRST USE 5-0-1979; IN COMMERCE 5-0-1987.  
MEREDITH MARESCA, EXAMINING ATTORNEY

SN 85-723,068. SHIBUYA KOGYO CO., LTD., ISHIKAWA-KEN, JAPAN, FILED 9-7-2012.



THE MARK CONSISTS OF THE STYLIZED WORD "SHIBUYA".

**CLASS 7—MACHINERY**

FOR (BASED ON USE IN COMMERCE) BEER BREWING MACHINES AND STRUCTURAL PARTS AND FITTINGS THEREFOR; BREWING MACHINES FOR MAKING ALCOHOLIC BEVERAGES AND STRUCTURAL PARTS AND FITTINGS THEREFOR; AUTOMATIC INDUSTRIAL LABELING MACHINES FOR APPLYING LABELS TO CONTAINERS AND BOTTLES; FOOD OR BEVERAGE PROCESSING MACHINES AND APPARATUS, NAMELY, FILLING MACHINES FOR FOODS AND BEVERAGES; FOOD OR BEVERAGE PROCESSING MACHINES AND APPARATUS, NAMELY, BOTTLE FILLING MACHINES FOR FOODS AND BEVERAGES; PACKAGING MACHINES; WRAPPING MACHINES; LOADING AND UNLOADING MACHINES; LASER MACHINES FOR CUTTING, MARKING, AND ENGRAVING FABRIC DESIGNED FOR INSTALLATION DIRECTLY ABOVE EMBROIDERY MACHINES; SEMICONDUCTOR MANUFACTURING MACHINES AND PARTS THEREOF; BOTTLING MACHINES, NAMELY, BOTTLE WASHERS, BOTTLE FILLERS AND BOTTLE CAPPERS, ALL SOLD AS A UNIT; BOTTLE CAPPER MACHINES; BOTTLE WASHING MACHINES; MACHINES FOR THE INDUSTRIAL PRODUCTION OF PHARMACEUTICALS, NAMELY, VIAL WASHER, AMPOULE WASHER, SYRINGE WASHER, FILLING/STOPPERING MACHINE, FREEZE DRYER LOADER AND UNLOADER, ALUMINUM OVER CAPPING MACHINE, RUBBER STOPPER RINSER, PACKAGING HANDLING MACHINE, FORMULATION MACHINE, ISOLATORS, SILICONIZING UNIT, SHEATH STOPPERING MACHINE, VACUUM STOPPERING MACHINE, SEALING MACHINE FOR FREEZE DRIED PRODUCTS, TRAY LOADER, AND FINAL PACKAGING MACHINE; MACHINES FOR FILLING CAPSULES, VIALS, AMPOULES, AND SUPPOSITORIES; PACKAGING MACHINES FOR PACKAGING BLISTER CARDS AND CARTONS AND BOTTLES; PACKAGING SYSTEMS CONSISTING OF SEVERAL PACKAGING MACHINES, PARTICULARLY FOR PACKAGING OBLONG OBJECTS, NAMELY, AMPOULES, SMALL FLASKS AND SYRINGES FOR THE PHARMACEUTICAL INDUSTRY; MACHINES FOR MANUFACTURING PACKAGING MATERIAL SUCH AS COLLAPSIBLE BOXES OR CUSHIONING PACKAGING MATERIAL (BASED ON INTENT TO USE) INDUSTRIAL TRASH COMPACTING MACHINES; WASHING MACHINE FOR INDUSTRIAL PARTS; MACHINES FOR CLEANING AND STRIPPING SURFACES USING HIGH-SPEED WATER JET; CUTTING MACHINES; VEHICLE WASHING INSTALLATIONS; MACHINES FOR BLAST CLEANING A SURFACE; MACHINES FOR CLEANING SURFACES USING HIGH PRESSURE WATER; ORGANIC WASTE PROCESSING MACHINES, NAMELY, WASTE CRUSHING MACHINES; AGRICULTURAL MACHINES, NAMELY, CULTIVATORS, HARVESTERS, DISK HARROWS, AND SEEDERS; AGRICULTURAL MACHINES, NAMELY, REAPERS (U.S. CLS. 13, 19, 21, 23, 31, 34 AND 35).

FIRST USE 5-0-1979; IN COMMERCE 5-0-1987.

**CLASS 11—ENVIRONMENTAL CONTROL APPARATUS**

FOR (BASED ON USE IN COMMERCE) DECONTAMINATION MACHINES AND APPARATUS TO BE USED IN THE PROCESS OF MANUFACTURING OF PHARMACEUTICALS FOR DECONTAMINATION OF ASEPTIC PHARMACEUTICAL MANUFACTURING ENVIRONMENTS FOR STERILIZATION PURPOSES, NAMELY, ISOLATOR SYSTEMS FOR ISOLATING THE EXTERIOR ENVIRONMENT OR PERSONS PHYSICALLY TO DECONTAMINATE THEM AND ELIMINATE RISK OF POLLUTION, WHICH ISOLATOR SYSTEMS COMPRISED OF MACHINES AND APPARATUS FOR FILTERING AIR AND EMITTING GAS, AND CLEAN ROOMS; DECONTAMINATION MACHINES AND APPARATUS TO BE USED FOR STERILIZATION PURPOSES IN THE PROCESS OF MANUFACTURING OF PHARMACEUTICALS, NAMELY, STERILIZERS FOR DECONTAMINATION; MACHINES USED FOR STERILIZATION PURPOSES IN THE PROCESS OF THE INDUSTRIAL PRODUCTION OF PHARMACEUTICALS (U.S. CLS. 13, 21, 23, 31 AND 34).

FIRST USE 5-0-1979; IN COMMERCE 5-0-1987.

MEREDITH MARESCA, EXAMINING ATTORNEY

SN 85-723,149. WALK THE WALK WORLDWIDE, EDINBURGH, UNITED KINGDOM, FILED 9-7-2012.

# WALK WEAR

THE MARK CONSISTS OF STANDARD CHARACTERS WITHOUT CLAIM TO ANY PARTICULAR FONT, STYLE, SIZE, OR COLOR.

OWNER OF ERPN CMNTY TM OFC REG. NO. 004418562, DATED 6-28-2006, EXPIRES 6-28-2016.

**CLASS 9—ELECTRICAL AND SCIENTIFIC APPARATUS**

FOR DOWNLOADABLE ELECTRONIC PUBLICATIONS IN THE NATURE OF NEWSLETTERS, BOOKS, TRAINING MANUALS IN THE FIELD OF EDUCATION, SPORTING EVENTS, CHARITABLE FUNDRAISING ACTIVITIES, CLOTHING, TRAINING, EXERCISE, FITNESS, HEALTH, DIET, LIFESTYLE, WALKING, POWER WALKING, RUNNING, PHYSICAL FITNESS TRAINING PROGRAMS, BREAST CANCER RESEARCH, CANCER RESEARCH, MEDICAL RESEARCH, CANCER DIAGNOSIS, MEDICAL DIAGNOSIS, TREATMENT FOR CANCER AND OTHER ILLNESS SUPPORT FOR MEDICAL PATIENTS, PREVENTION OF ILLNESS, GENERAL HEALTH AND MEDICAL RELATED ISSUES; EYEGLASSES; SUNGLASSES; DIGITAL SOUND AND VIDEO RECORDINGS FEATURING EDUCATION, SPORTING EVENTS, CHARITABLE FUNDRAISING ACTIVITIES, CLOTHING, TRAINING, EXERCISE, FITNESS, HEALTH, DIET, LIFESTYLE, WALKING, POWER WALKING, RUNNING, PHYSICAL FITNESS TRAINING PROGRAMS, BREAST CANCER RESEARCH, CANCER RESEARCH, MEDICAL RESEARCH, CANCER DIAGNOSIS, MEDICAL DIAGNOSIS, TREATMENT FOR CANCER AND OTHER ILLNESS SUPPORT FOR MEDICAL PATIENTS, PREVENTION OF ILLNESS, GENERAL HEALTH AND MEDICAL RELATED ISSUES (U.S. CLS. 21, 23, 26, 36 AND 38).

**CLASS 16—PAPER GOODS AND PRINTED MATTER**

FOR LEATHER GOODS, NAMELY, BOOKMARKS; BOOKS, NEWSLETTERS, AND JOURNALS, ALL FEATURING EDUCATION, SPORTING EVENTS, CHARITABLE FUNDRAISING ACTIVITIES, CLOTHING, TRAINING, EXERCISE, FITNESS, HEALTH, DIET, LIFESTYLE, WALKING, POWER WALKING, RUNNING, PHYSICAL FITNESS TRAINING PROGRAMS, BREAST CANCER RESEARCH, CANCER RESEARCH, MEDICAL RESEARCH, CANCER DIAGNOSIS, MEDICAL DIAGNOSIS, TREATMENT FOR CANCER AND OTHER ILLNESS SUPPORT FOR MEDICAL PATIENTS, PREVENTION OF ILLNESS, GENERAL HEALTH AND MEDICAL RELATED ISSUES; BUSINESS CARDS; STATIONERY; DIARIES; PRINTED INSTRUCTIONAL AND TEACHING MATERIAL IN THE FIELD OF EDUCATION, SPORTING EVENTS, CHARITABLE FUNDRAISING ACTIVITIES, CLOTHING, TRAINING, EXERCISE, FITNESS, HEALTH, DIET, LIFESTYLE, WALKING, POWER WALKING, RUNNING, PHYSICAL FITNESS TRAINING PROGRAMS, BREAST CANCER RESEARCH, CANCER RESEARCH, MEDICAL RESEARCH, CANCER DIAGNOSIS, MEDICAL DIAGNOSIS, TREATMENT FOR CANCER AND OTHER ILLNESS SUPPORT FOR MEDICAL PATIENTS, PREVENTION OF ILLNESS, GENERAL HEALTH AND MEDICAL RELATED ISSUES; CHRISTMAS CARDS; TRAINING MATERIALS, NAMELY, PLASTIC OVERHEAD PROJECTION TRANSPARENCIES; PAPER; CARDBOARD; GOODS MADE FROM PAPER AND CARDBOARD, NAMELY, PRINTED APPLICATION FORMS, NOTE CARDS; PRINTED PUBLICATIONS, NAMELY, LEAFLETS, BOOKLETS, BROCHURES, AND MAGAZINES, ALL FEATURING EDUCATION, SPORTING EVENTS, CHARITABLE FUNDRAISING ACTIVITIES, CLOTHING, TRAINING, EXERCISE, FITNESS, HEALTH, DIET, LIFESTYLE, WALKING, POWER WALKING, RUNNING, PHYSICAL FITNESS TRAINING PROGRAMS, BREAST CANCER RESEARCH, CANCER RESEARCH, MEDICAL RESEARCH, CANCER DIAGNOSIS, MEDICAL DIAGNOSIS, TREATMENT FOR CANCER AND OTHER ILLNESS SUPPORT FOR MEDICAL PATIENTS, PREVENTION OF ILLNESS, GENERAL HEALTH AND MEDICAL RELATED ISSUES; BLANK SPONSOR FORMS; BLANK APPLICATION FORMS; POSTERS; FILE CARDS, PREPRINTED GREETING, PLACE AND ANNOUNCEMENT CARDS; POSTCARDS; PAPER BANNERS; PRESENTATIONAL BOARDS OF PAPER OR CARDBOARD FOR ADVERTISEMENTS; PAPER FLAGS; PRINTED CERTIFICATES; PHOTOGRAPHS; CALENDARS; PENS; PENCILS; BOXES FOR PENS AND PENCILS; MAPS; STICKERS; PAPER CARRIER BAGS (U.S. CLS. 2, 5, 22, 23, 29, 37, 38 AND 50).

**CLASS 18—LEATHER GOODS**

FOR ALL PURPOSE CARRIER BAGS; LEATHER GOODS, NAMELY, PURSES, WALLETS, CREDIT CARD HOLDERS, BAGS, LUGGAGE, LEATHER SHOULDER BELTS (U.S. CLS. 1, 2, 3, 22 AND 41).

**CLASS 36—INSURANCE AND FINANCIAL**

FOR CHARITABLE FUNDRAISING; FINANCIAL SPONSORSHIP OF SPORTING, CULTURAL AND CHARITABLE ACTIVITIES; CHARITABLE FUND RAISING SERVICES BY MEANS OF COLLECTING AND REDEEMING RECYCLABLES FOR DONATION OF REDEMPTION PROCEEDS TO CHARITABLE ORGANIZATIONS; CHARITABLE FUNDRAISING SERVICES, NAMELY, ORGANIZING FUNDRAISING ACTIVITIES AND EVENTS; CHARITABLE FUNDRAISING SERVICES, NAMELY, ORGANIZING FUNDRAISING WALKS AND MARATHONS (U.S. CLS. 100, 101 AND 102).

**CLASS 41—EDUCATION AND ENTERTAINMENT**

FOR EDUCATION SERVICES, NAMELY, PROVIDING CLASSES, SEMINARS, WORKSHOPS, TUTORIALS AND TRAINING SESSIONS IN THE FIELD OF EDUCATION, SPORTING EVENTS, CHARITABLE FUNDRAISING ACTIVITIES, CLOTHING, TRAINING, EXERCISE, FITNESS, HEALTH, DIET, LIFESTYLE, WALKING, POWER WALKING, RUNNING, PHYSICAL FITNESS TRAINING PROGRAMS, BREAST CANCER RESEARCH, CANCER RESEARCH, MEDICAL RESEARCH, CANCER DIAGNOSIS, MEDICAL DIAGNOSIS, TREATMENT FOR CANCER AND OTHER ILLNESS SUPPORT FOR MEDICAL PATIENTS, PREVENTION OF ILLNESS, GENERAL HEALTH AND MEDICAL RELATED ISSUES; TRAINING SERVICES IN THE FIELD OF EDUCATION, SPORTING EVENTS, CHARITABLE FUNDRAISING ACTIVITIES, CLOTHING, TRAINING, EXERCISE, FITNESS, HEALTH, DIET, LIFESTYLE, WALKING, POWER WALKING, RUNNING, PHYSICAL FITNESS TRAINING PROGRAMS, BREAST CANCER RESEARCH, CANCER RESEARCH, MEDICAL RESEARCH, CANCER DIAGNOSIS, MEDICAL DIAGNOSIS, TREATMENT FOR CANCER AND OTHER ILLNESS SUPPORT FOR MEDICAL PATIENTS, PREVENTION OF ILLNESS, GENERAL HEALTH AND MEDICAL RELATED ISSUES; ENTERTAINMENT, NAMELY, LIVE MUSIC CONCERTS, AND LIVE VAUDEVILLE SHOW PERFORMANCES; SPORTING AND CULTURAL ACTIVITIES, NAMELY, WALKING EVENTS, POWER WALKING EVENTS, RUNNING EVENTS, ORGANIZING COMMUNITY SPORTING AND CULTURAL EVENTS; PROVIDING A WEBSITE THAT FEATURES NON-DOWNLOADABLE ELECTRONIC MATERIALS IN THE NATURE OF NEWSLETTERS, BOOKS, TRAINING MANUALS IN THE FIELD OF EDUCATION, SPORTING EVENTS, CHARITABLE FUNDRAISING ACTIVITIES, CLOTHING, TRAINING, EXERCISE, FITNESS, HEALTH, DIET, LIFESTYLE, WALKING, POWER WALKING, RUNNING, PHYSICAL FITNESS TRAINING PROGRAMS, BREAST CANCER RESEARCH, CANCER RESEARCH, MEDICAL RESEARCH, CANCER DIAGNOSIS, MEDICAL DIAGNOSIS, TREATMENT FOR CANCER AND OTHER ILLNESS SUPPORT FOR MEDICAL PATIENTS, PREVENTION OF ILLNESS, GENERAL HEALTH AND MEDICAL RELATED ISSUES (U.S. CLS. 100, 101 AND 107).

CHRISTINA SOBRAL, EXAMINING ATTORNEY

SN 85-724,807. PENTON BUSINESS MEDIA, INC., NEW YORK, NY. FILED 9-10-2012.

**Trusts & Estates**

THE MARK CONSISTS OF STANDARD CHARACTERS WITHOUT CLAIM TO ANY PARTICULAR FONT, STYLE, SIZE, OR COLOR.

OWNER OF U.S. REG. NOS. 1,197,227 AND 2,524,774. SEC. 2(F).

**CLASS 9—ELECTRICAL AND SCIENTIFIC APPARATUS**

FOR DOWNLOADABLE ELECTRONIC PUBLICATIONS IN THE NATURE OF NEWSLETTERS, GUIDES, WHITE PAPERS, MAGAZINES, AND NEWSPAPERS IN THE FIELD OF FINANCE, ASSET MANAGEMENT, FINANCIAL PLANNING, FINANCIAL ADVISORY SERVICES, AND FINANCIAL MANAGEMENT; DOWNLOADABLE SOFTWARE IN THE NATURE OF A MOBILE APPLICATION FOR USE IN READING NEWS AND COMMENTARY IN THE FIELD OF FINANCE, ASSET MANAGEMENT, FINANCIAL PLANNING, FINANCIAL ADVISORY SERVICES, AND FINANCIAL MANAGEMENT (U.S. CLS. 21, 23, 26, 36 AND 38).

FIRST USE 9-10-2012; IN COMMERCE 9-10-2012.

**CLASS 16—PAPER GOODS AND PRINTED MATTER**

FOR MAGAZINES IN THE FIELD OF FINANCE, ASSET MANAGEMENT, FINANCIAL PLANNING, FINANCIAL ADVISORY SERVICES, AND FINANCIAL MANAGEMENT (U.S. CLS. 2, 5, 22, 23, 29, 37, 38 AND 50). FIRST USE 0-0-1939; IN COMMERCE 0-0-1939.

**CLASS 41—EDUCATION AND ENTERTAINMENT**

FOR ENTERTAINMENT SERVICES, NAMELY, PROVIDING WEBCASTS IN THE FIELD OF FINANCE, ASSET MANAGEMENT, FINANCIAL PLANNING, FINANCIAL ADVISORY SERVICES, AND FINANCIAL MANAGEMENT; ON-LINE JOURNALS, NAMELY, BLOGS FEATURING INFORMATION, NEWS AND COMMENTARY IN THE FIELD OF FINANCE, ASSET MANAGEMENT, FINANCIAL PLANNING, FINANCIAL ADVISORY SERVICES, AND FINANCIAL MANAGEMENT; PROVIDING A WEBSITE FEATURING BLOGS AND NON-DOWNLOADABLE PUBLICATIONS IN THE NATURE OF NEWSLETTERS, GUIDES, WHITE PAPERS, MAGAZINES, AND NEWSPAPERS IN THE FIELD(S) OF FINANCE, ASSET MANAGEMENT, FINANCIAL PLANNING, FINANCIAL ADVISORY SERVICES, AND FINANCIAL MANAGEMENT; PROVIDING ON-LINE PUBLICATIONS IN THE NATURE OF NEWSLETTERS, GUIDES, WHITE PAPERS, MAGAZINES, AND NEWSPAPERS IN THE FIELD OF FINANCE, ASSET MANAGEMENT, FINANCIAL PLANNING, FINANCIAL ADVISORY SERVICES, AND FINANCIAL MANAGEMENT; PROVIDING ONLINE NEWSLETTERS IN THE FIELD OF FINANCE, ASSET MANAGEMENT, FINANCIAL PLANNING, FINANCIAL ADVISORY SERVICES, AND FINANCIAL MANAGEMENT VIA E-MAIL (U.S. CLS. 100, 101 AND 107).

FIRST USE 11-0-1998; IN COMMERCE 11-0-1998.

TEJBIR SINGH, EXAMINING ATTORNEY

SN 85-725,436. OK APPS LIMITED, DUBLIN, IRELAND, FILED 9-11-2012.

**INSTACOACH**

THE MARK CONSISTS OF STANDARD CHARACTERS WITHOUT CLAIM TO ANY PARTICULAR FONT, STYLE, SIZE, OR COLOR.

**CLASS 9—ELECTRICAL AND SCIENTIFIC APPARATUS**

FOR COMMUNICATIONS SOFTWARE FOR CONNECTING MOBILE PHONES; COMPUTER APPLICATION SOFTWARE FOR MOBILE PHONES, NAMELY, SOFTWARE FOR SPORTS COACHING OR TRAINING; COMPUTER APPLICATION SOFTWARE FOR MOBILE PHONE DEVICES, NAMELY, SOFTWARE FOR SPORTS COACHING OR TRAINING; COMPUTER SOFTWARE FOR COMMUNICATING WITH USERS OF HAND-HELD COMPUTERS; ELECTRONIC COMMUNICATIONS SYSTEMS COMPRISED OF COMPUTER HARDWARE AND SOFTWARE FOR THE TRANSMISSION OF DATA BETWEEN TWO POINTS; WIRELESS COMMUNICATION DEVICE FEATURING VOICE, DATA AND IMAGE TRANSMISSION INCLUDING VOICE, TEXT AND PICTURE MESSAGING, A VIDEO AND STILL IMAGE CAMERA, ALSO FUNCTIONAL TO PURCHASE MUSIC, GAMES, VIDEO AND SOFTWARE APPLICATIONS OVER THE AIR FOR DOWNLOADING TO THE DEVICE (U.S. CLS. 21, 23, 26, 36 AND 38).

**CLASS 41—EDUCATION AND ENTERTAINMENT**

FOR COACHING IN THE FIELD OF SPORTS (U.S. CLS. 100, 101 AND 107).

**CLASS 42—SCIENTIFIC AND COMPUTER SERVICES**

FOR APPLICATION SERVICE PROVIDER, NAMELY, HOSTING, MANAGING, DEVELOPING, AND MAINTAINING APPLICATIONS, SOFTWARE, AND WEB SITES, IN THE FIELDS OF PERSONAL PRODUCTIVITY, WIRELESS COMMUNICATION, MOBILE INFORMATION ACCESS, AND REMOTE DATA MANAGEMENT FOR WIRELESS DELIVERY OF CONTENT TO HANDHELD COMPUTERS, LAPTOPS AND MOBILE ELECTRONIC DEVICES; PROVIDING A WEB SITE FEATURING TECHNOLOGY THAT ENABLES USERS TO CONNECT WITH OTHER PEOPLE IN THEIR NEIGHBORHOOD OR CITY FOR ANY NUMBER OF USER-SPECIFIED REASONS, INCLUDING PROVIDING A SERVICE OR ORGANIZING AN EVENT; PROVIDING CUSTOMER-DEFINED GENERATED CONTENT AND CONTENT OF OTHERS AUTOMATICALLY SELECTED AND CUSTOMIZED BASED ON THE KNOWN OR ESTIMATED GEOGRAPHICAL LOCATION OF AN INTERNET, MOBILE TELEPHONE OR OTHER WIRED OR WIRELESS DIGITAL NETWORK BASED CUSTOMER; PROVIDING INFORMATION RELATING TO ON-LINE NON-DOWNLOADABLE SOFTWARE TO FACILITATE ELECTRONIC COMMUNICATION BETWEEN INDIVIDUALS PROVIDED VIA THE INTERNET (U.S. CLS. 100 AND 101).

TIMOTHY FINNEGAN, EXAMINING ATTORNEY

**CLASS 9—ELECTRICAL AND SCIENTIFIC APPARATUS**

FOR VIDEOTAPES AND VIDEO RECORDINGS FEATURING ANIMATED CARTOONS; AUDIO-VIDEO CDS FEATURING ANIMATED CARTOONS, MUSIC, MUSICAL DRAMA, SONG AND DANCE DRAMA, TV ENTERTAINMENT PROGRAMS, DRAMA AND STAGE SHOWS; AUDIO-VIDEO CDS FEATURING MOVIE DRAMAS, COMEDIES, AND DOCUMENTARIES; COMPUTER GAME PROGRAMS; VIDEOTAPES FEATURING ANIMATED CARTOONS, MUSIC, MUSICAL DRAMA, SONG AND DANCE DRAMA, TV ENTERTAINMENT PROGRAMS, DRAMA AND STAGE SHOWS; VIDEOTAPES FEATURING MOVIE DRAMAS, COMEDIES, AND DOCUMENTARIES; CINEMATOGRAPHIC CAMERAS; EDITING APPLIANCES FOR CINEMATOGRAPHIC FILMS; PROJECTION SCREENS; PHOTOGRAPHIC AND DARKROOM EQUIPMENT, NAMELY, WASHING TRAYS; SLIDE AND PHOTOGRAPH PROJECTION APPARATUS; PHOTOGRAPHY SLIDES; EXPOSED CINEMATOGRAPHIC FILM; SOUND RECORDING CARRIERS, NAMELY, BLANK CDS, BLANK USB FLASH DRIVES; ELECTRONIC PUBLICATIONS DOWNLOADABLE FROM THE INTERNET, NAMELY, MAGAZINES, MANUALS AND JOURNALS IN THE FIELDS OF: MUSIC AND POPULAR ENTERTAINMENT; INFORMATION ABOUT ENTERTAINMENT COMPANIES; COMMERCIAL AND PROMOTIONAL INFORMATION FOR MOVIE THEATRES, AMUSEMENT PARKS, HOTELS AND DEPARTMENT STORES; FILMS, MUSICAL DRAMA, SONG AND DANCE DRAMA, STAGE SHOWS, TV ENTERTAINMENT PROGRAMS, AND TV DRAMAS (U.S. CLS. 21, 23, 26, 36 AND 38).

**CLASS 41—EDUCATION AND ENTERTAINMENT**

FOR RENTAL OF MOVIE PROJECTORS AND ACCESSORIES; CINEMA THEATERS; VIDEOTAPE EDITING; SUBTITLING; TRANSLATION AND DUBBING; DISTRIBUTION AND PRODUCTION OF CINEMATOGRAPHIC FILMS; DUBBING IN FOREIGN LANGUAGES FOR MOVIES; ACADEMIES (EDUCATION), NAMELY, PROVIDING COURSES OF INSTRUCTION AT THE COLLEGE LEVEL IN FILM-MAKING, BUSINESS MANAGEMENT OF HOTELS AND DESIGN OF INTERIOR DECOR; TEACHING IN THE FIELD OF COURSES OF INSTRUCTION AT THE COLLEGE LEVEL IN FILM-MAKING, BUSINESS MANAGEMENT OF HOTELS AND DESIGN OF INTERIOR DECOR; PUBLICATION OF TEXTS OTHER THAN FOR PUBLICITY; PUBLICATION OF BOOKS; PUBLICATION OF ELECTRONIC BOOKS AND JOURNALS ON-LINE; ELECTRONIC DESKTOP PUBLISHING; PROVIDING ON-LINE NOT DOWNLOADABLE ELECTRONIC PUBLICATIONS, NAMELY, MAGAZINES AND JOURNALS IN THE FIELDS OF: MUSIC AND ENTERTAINMENT; COURSES OF INSTRUCTION IN FILM MAKING, BUSINESS MANAGEMENT OF HOTELS AND DESIGN OF INTERIOR DECOR; INFORMATION ABOUT ENTERTAINMENT COMPANIES; COMMERCIAL AND PROMOTIONAL INFORMATION FOR MOVIE THEATRES, AMUSEMENT PARKS, HOTELS AND DEPARTMENT STORES; FILMS, MUSICAL DRAMA, SONG AND DANCE DRAMA, STAGE SHOWS, TV ENTERTAINMENT PROGRAMS AND TV DRAMAS; PRODUCTION OF VIDEOTAPES; ENTERTAINMENT SERVICES IN THE NATURE OF LIVE PERFORMANCES OF STAGE SHOWS, MUSICAL DRAMA, SONG AND DANCE DRAMA PERFORMED BY MUSICAL GROUPS, PROFESSIONAL ARTISTS OR ENTERTAINERS; ENTERTAINER SERVICES, NAMELY, LIVE APPEARANCES BY PROFESSIONAL ENTERTAINERS; PROVIDING RECREATION FACILITIES; CLUB SERVICES FOR ENTERTAINMENT OR EDUCATION, NAMELY, DANCE AND COMEDY CLUBS; ENTERTAINMENT INFORMATION; PROVIDING AMUSEMENT ARCADE SERVICES; PROVIDING ONLINE COMPUTER GAMES; NIGHT CLUBS; PRODUCTION OF TELEVISION AND LIVE PERFORMANCE SHOWS; PROVIDING KARAOKE SERVICES; PRESENTATION OF LIVE MUSIC AND DANCE PERFORMANCES; DISCOTHEQUE SERVICES; PRODUCTION OF RADIO AND TELEVISION PROGRAMS; THEATRE PRODUCTIONS, TELEVISION ENTERTAINMENT, NAMELY, PRODUCTION AND DISTRIBUTION OF TELEVISION SHOWS, PROVIDING AN ONGOING TELEVISION SHOW IN THE

SN 85-727,063, DALIAN WANDA GROUP CO., LTD., DALIAN, CHINA, FILED 9-12-2012.

万达

THE NON-LATIN CHARACTERS IN THE MARK TRANSLITERATE TO "WANDA" AND THIS HAS NO MEANING IN A FOREIGN LANGUAGE.

FIELD OF COMEDY AND MUSIC; PHOTOGRAPHY; TRANSLATION SERVICES; PRODUCTION OF MUSIC; MUSIC-HALLS; PRODUCTION OF LIVE VARIETY SHOWS; AMUSEMENT PARKS; CIRCUSES; ORGANIZATION OF EDUCATION OR ENTERTAINMENT COMPETITIONS IN THE NATURE OF TALENT SHOWS, INTELLIGENCE CONTESTS, COMPETITIONS FOR AMUSEMENT PARK ENTERTAINMENT EVENTS; ARRANGING OF BEAUTY CONTESTS; ORGANIZATION OF FASHION SHOWS FOR ENTERTAINMENT PURPOSES; IMPRESARIO SERVICES, NAMELY, ORGANIZATION OF LIVE THEATER PERFORMANCES; ORGANIZATION OF BALLS FOR ENTERTAINMENT PURPOSES; ARRANGING AND CONDUCTING OF CONCERTS; SCRIPTWRITING SERVICES; MODELING FOR ARTISTS; TOY RENTAL; PROVIDING SPORTS FACILITIES; PROVIDING GOLF FACILITIES; HEALTH CLUB SERVICES, NAMELY, PROVIDING INSTRUCTION AND EQUIPMENT IN THE FIELD OF PHYSICAL EXERCISE; RENTAL OF SPORTS EQUIPMENT EXCEPT VEHICLES; RENTAL OF STADIUM FACILITIES; RENTAL OF TENNIS COURTS; RENTAL OF SPORTS GROUNDS; PERSONAL TRAINER SERVICES FOR FITNESS TRAINING; GAMES EQUIPMENT RENTAL (U.S. CLS. 100, 101 AND 107).

**CLASS 44—MEDICAL, BEAUTY AND AGRICULTURAL SERVICES**

FOR HEALTH CLUB SERVICES, NAMELY, HEALTH SPA SERVICES FOR HEALTH AND WELLNESS OF THE BODY AND SPIRIT OFFERED AT A HEALTH CLUB FACILITY (U.S. CLS. 100 AND 101).  
KIMBERLY FRYE, EXAMINING ATTORNEY

SN 85-728,754. EVOLUTION FRESH, INC., SAN BERNARDINO, CA. FILED 9-13-2012.

**GARDEN GATHERING**

THE MARK CONSISTS OF STANDARD CHARACTERS WITHOUT CLAIM TO ANY PARTICULAR FONT, STYLE, SIZE, OR COLOR.

PRIORITY CLAIMED UNDER SEC. 44(D) ON AUSTRALIA APPLICATION NO. 1480737, FILED 3-16-2012, REG. NO. 1480737, DATED 3-16-2012, EXPIRES 3-16-2022.

**CLASS 29—MEATS AND PROCESSED FOODS**

FOR CONCENTRATES AND SYRUPS FOR MAKING FROZEN, BLENDED MILK-BASED BEVERAGES; SOY BASED FOOD BEVERAGES USED AS A MILK SUBSTITUTE; NUT BASED MILK (U.S. CL. 46).

**CLASS 30—STAPLE FOODS**

FOR FLAVORING SYRUPS; FLAVORING SYRUP FOR TEA AND HERBAL TEA-BASED BEVERAGES; CONCENTRATES AND SYRUPS FOR MAKING FROZEN, BLENDED TEA-BASED BEVERAGES; SYRUPS FOR MAKING TEA-FLAVORED DRINKS (U.S. CL. 46).

**CLASS 32—LIGHT BEVERAGES**

FOR FRUIT JUICES; FRUIT AND FRUIT JUICE BASED BEVERAGES; FRUIT DRINKS AND SOFT DRINKS CONTAINING FRUIT JUICES; FROZEN FRUIT BEVERAGES AND FROZEN FRUIT-BASED BEVERAGES; FRUIT CONCENTRATES AND PUREES USED AS INGREDIENTS OF BEVERAGES; CONCENTRATES AND SYRUPS FOR MAKING FROZEN, BLENDED FRUIT BEVERAGES; CONCENTRATES AND SYRUPS FOR MAKING FROZEN, BLENDED SOFT-DRINK BEVERAGES; CONCENTRATES AND SYRUPS FOR MAKING FROZEN, BLENDED FRUIT-DRINK BEVERAGES; SPARKLING FRUIT AND FRUIT JUICE BASED BEVERAGES AND SODA BEVERAGES; VEGETABLE-FRUIT JUICES; VEGETABLE-BASED BEVERAGES; BEVERAGES CONTAINING VEGETABLE JUICES, NAMELY, VEGETABLE JUICE BEVERAGES; LIQUID AND POWDERED BEVERAGE MIXES FOR MAKING SOFT DRINKS AND FRUIT BASED BEVERAGES; SYRUPS FOR MAKING TEA AND HERBAL TEA-BASED BEVERAGES; DRINKING WATER, SPRING WATER, MINERAL WATER, SPARKLING WATER, DRINKING WATER WITH VITAMINS; SOFT DRINKS; SODA POP BEVERAGES; SYRUPS FOR MAKING FRUIT-FLAVORED DRINKS; FLAVORED AND UNFLAVORED BOTTLED WATERS; ENERGY DRINKS; SOY-BASED BEVERAGES NOT BEING MILK SUBSTITUTES; NUT JUICE BEVERAGES (U.S. CLS. 45, 46 AND 48).  
DOUGLAS LEE, EXAMINING ATTORNEY

SN 85-728,759. EVOLUTION FRESH, INC., SAN BERNARDINO, CA. FILED 9-13-2012.

**EASY EVOLUTION**

THE MARK CONSISTS OF STANDARD CHARACTERS WITHOUT CLAIM TO ANY PARTICULAR FONT, STYLE, SIZE, OR COLOR.

PRIORITY CLAIMED UNDER SEC. 44(D) ON AUSTRALIA APPLICATION NO. 1480744, FILED 3-16-2012, REG. NO. 1480744, DATED 3-16-2012, EXPIRES 3-16-2022.

OWNER OF U.S. REG. NOS. 3,774,723 AND 3,774,724.

**CLASS 29—MEATS AND PROCESSED FOODS**

FOR CONCENTRATES AND SYRUPS FOR MAKING FROZEN, BLENDED MILK-BASED BEVERAGES; SOY BASED FOOD BEVERAGES USED AS A MILK SUBSTITUTE; NUT BASED MILK (U.S. CL. 46).

**CLASS 30—STAPLE FOODS**

FOR FLAVORING SYRUPS; FLAVORING SYRUP FOR TEA AND HERBAL TEA-BASED BEVERAGES; CONCENTRATES AND SYRUPS FOR MAKING FROZEN, BLENDED TEA-BASED BEVERAGES; SYRUPS FOR MAKING TEA-FLAVORED DRINKS (U.S. CL. 46).



**CLASS 32—LIGHT BEVERAGES**

FOR FRUIT JUICES; FRUIT AND FRUIT JUICE BASED BEVERAGES; FRUIT DRINKS AND SOFT DRINKS CONTAINING FRUIT JUICES; FROZEN FRUIT BEVERAGES AND FROZEN FRUIT-BASED BEVERAGES; FRUIT CONCENTRATES AND PUREES USED AS INGREDIENTS OF BEVERAGES; CONCENTRATES AND SYRUPS FOR MAKING FROZEN, BLENDED FRUIT BEVERAGES; CONCENTRATES AND SYRUPS FOR MAKING FROZEN, BLENDED SOFT-DRINK BEVERAGES; CONCENTRATES AND SYRUPS FOR MAKING FROZEN, BLENDED FRUIT-DRINK BEVERAGES; SPARKLING FRUIT AND FRUIT JUICE BASED BEVERAGES AND SODA BEVERAGES; VEGETABLE-FRUIT JUICES; VEGETABLE-BASED BEVERAGES; BEVERAGES CONTAINING VEGETABLE JUICES, NAMELY, VEGETABLE JUICE BEVERAGES; LIQUID AND POWDERED BEVERAGE MIXES FOR MAKING SOFT DRINKS AND FRUIT BASED BEVERAGES; SYRUPS FOR MAKING TEA AND HERBAL TEA-BASED BEVERAGES; DRINKING WATER, SPRING WATER, MINERAL WATER, SPARKLING WATER, DRINKING WATER WITH VITAMINS; SOFT DRINKS; SODA POP BEVERAGES; SYRUPS FOR MAKING FRUIT-FLAVORED DRINKS; FLAVORED AND UNFLAVORED BOTTLED WATERS; ENERGY DRINKS; SOY-BASED BEVERAGES NOT BEING MILK SUBSTITUTES; NUT JUICE BEVERAGES (U.S. CLS. 45, 46 AND 48).

DOUGLAS LEE, EXAMINING ATTORNEY

SN 85-730,940. KINN, INC., ALISO VIEJO, CA. FILED 9-17-2012.

**NURTURE BY DESIGN**

THE MARK CONSISTS OF STANDARD CHARACTERS WITHOUT CLAIM TO ANY PARTICULAR FONT, STYLE, SIZE, OR COLOR.

**CLASS 10—MEDICAL APPARATUS**

FOR PILL CUTTERS AND PILL CRUSHERS FOR PETS (U.S. CLS. 26, 39 AND 44).  
FIRST USE 8-13-2012; IN COMMERCE 8-13-2012.

**CLASS 21—HOUSEWARES AND GLASS**

FOR NON-ELECTRIC PET TREAT MAKER, NAMELY, HOUSEHOLD-BASED DEVICE FOR MAKING TREATS IN THE FORM OF CAPSULES (U.S. CLS. 2, 13, 23, 29, 30, 33, 40 AND 50).

FIRST USE 8-13-2012; IN COMMERCE 8-13-2012.  
SALLY SHIH, EXAMINING ATTORNEY

SN 85-731,323. EVOLUTION FRESH, INC., SAN BERNARDINO, CA. FILED 9-18-2012.

**NOURISH YOUR EVOLUTION**

THE MARK CONSISTS OF STANDARD CHARACTERS WITHOUT CLAIM TO ANY PARTICULAR FONT, STYLE, SIZE, OR COLOR.

PRIORITY CLAIMED UNDER SEC. 44(D) ON AUSTRALIA APPLICATION NO. 1481195, FILED 3-20-2012, REG. NO. 1481195, DATED 3-20-2012, EXPIRES 3-20-2022.

OWNER OF U.S. REG. NOS. 3,774,723 AND 3,774,724.

**CLASS 29—MEATS AND PROCESSED FOODS**

FOR CONCENTRATES AND SYRUPS FOR MAKING FROZEN, BLENDED MILK-BASED BEVERAGES; SOY BASED FOOD BEVERAGES USED AS A MILK SUBSTITUTE; NUT BASED MILK (U.S. CL. 46).

**CLASS 30—STAPLE FOODS**

FOR FLAVORING SYRUPS; FLAVORING SYRUP FOR TEA AND HERBAL TEA-BASED BEVERAGES; CONCENTRATES AND SYRUPS FOR MAKING FROZEN, BLENDED TEA-BASED BEVERAGES; SYRUPS FOR MAKING TEA-FLAVORED DRINKS (U.S. CL. 46).

**CLASS 32—LIGHT BEVERAGES**

FOR FRUIT JUICES; FRUIT AND FRUIT JUICE BASED BEVERAGES; FRUIT DRINKS AND SOFT DRINKS CONTAINING FRUIT JUICES; FROZEN FRUIT BEVERAGES AND FROZEN FRUIT-BASED BEVERAGES; FRUIT CONCENTRATES AND PUREES USED AS INGREDIENTS OF BEVERAGES; CONCENTRATES AND SYRUPS FOR MAKING FROZEN, BLENDED FRUIT BEVERAGES; CONCENTRATES AND SYRUPS FOR MAKING FROZEN, BLENDED SOFT-DRINK BEVERAGES; CONCENTRATES AND SYRUPS FOR MAKING FROZEN, BLENDED FRUIT-DRINK BEVERAGES; SPARKLING FRUIT AND FRUIT JUICE BASED BEVERAGES AND SODA BEVERAGES; VEGETABLE-FRUIT JUICES; VEGETABLE-BASED BEVERAGES; BEVERAGES CONTAINING VEGETABLE JUICES, NAMELY, VEGETABLE JUICE BEVERAGES; LIQUID AND POWDERED BEVERAGE MIXES FOR MAKING SOFT DRINKS AND FRUIT BASED BEVERAGES; SYRUPS FOR MAKING TEA AND HERBAL TEA-BASED BEVERAGES; DRINKING WATER, SPRING WATER, MINERAL WATER, SPARKLING WATER, DRINKING WATER WITH VITAMINS; SOFT DRINKS; SODA POP BEVERAGES; SYRUPS FOR MAKING FRUIT-FLAVORED DRINKS; FLAVORED AND UNFLAVORED BOTTLED WATERS; ENERGY DRINKS; SOY-BASED BEVERAGES NOT BEING MILK SUBSTITUTES; NUT JUICE BEVERAGES (U.S. CLS. 45, 46 AND 48).

**CLASS 43—HOTEL AND RESTAURANT SERVICES**

FOR RESTAURANT, CAFE, CAFETERIA, SNACK BAR, CARRY OUT RESTAURANTS, TAKE OUT RESTAURANTS; CATERING SERVICES; CONTRACT CATERING SERVICES; FOOD PREPARATION; CARRY OUT RESTAURANT SERVICES (U.S. CLS. 100 AND 101).  
DOUGLAS LEE, EXAMINING ATTORNEY

SN 85-731,373. PREMIER, INC., CHARLOTTE, NC. FILED 9-18-2012.

**PREMIERPRO**

THE MARK CONSISTS OF STANDARD CHARACTERS WITHOUT CLAIM TO ANY PARTICULAR FONT, STYLE, SIZE, OR COLOR.

OWNER OF U.S. REG. NOS. 3,597,963, 3,666,078 AND OTHERS.

**CLASS 3—COSMETICS AND CLEANING PREPARATIONS**

FOR BABY POWDER; SHAVE CREAMS (U.S. CLS. 1, 4, 6, 50, 51 AND 52).

SN 85-743,361. FRONTIER DEVELOPMENTS PLC, CAMBRIDGE, UNITED KINGDOM, FILED 10-2-2012.

**CLASS 5—PHARMACEUTICALS**

FOR ADHESIVE BANDAGES; COTTON STICKS FOR MEDICAL PURPOSES; DISPOSABLE SANITIZING WIPES; EYE PADS FOR MEDICAL USE; GAUZE FOR DRESSINGS; KITS COMPRISING SANITIZER GEL, DISINFECTING WIPES, SANITARY MASKS, PLASTIC GLOVES AND HAND CREAM USED FOR GERM PREVENTION; MEDICAL AND SURGICAL DRESSINGS; MEDICATED BABY POWDERS; SANITARY PADS; SURGICAL BANDAGES (U.S. CLS. 6, 18, 44, 46, 51 AND 52).

PRIORITY CLAIMED UNDER SEC. 44(D) ON ERPNTY TM OFC APPLICATION NO. 010821213, FILED 4-19-2012, REG. NO. 010821213, DATED 9-26-2012, EXPIRES 4-19-2022.

THE COLOR(S) GOLD, BLACK, AND GRAY IS/ARE CLAIMED AS A FEATURE OF THE MARK.

THE MARK CONSISTS OF A GOLD BIRD WITH RAISED WINGS ON A BLACK BACKGROUND, AS SEEN FROM THE FRONT OF THE BIRD, AND THE WORD "ELITE" IN GOLD, BLACK AND GRAY ACROSS THE BIRD'S WINGS AND CHEST AREA.

**CLASS 10—MEDICAL APPARATUS**

FOR ABDOMINAL PADS FOR MEDICAL USE; ABDOMINAL TOWELS FOR MEDICAL AND SURGICAL USE; BACK SUPPORTS FOR MEDICAL PURPOSES; BAGS FOR MEDICAL WASTE; CASES FITTED FOR MEDICAL INSTRUMENTS AND/OR FOR USE BY DOCTORS; CRUTCHES; CUPS FOR DISPENSING MEDICINE; CURETTES; DISPOSABLE MEDICAL STERILIZATION POUCHES; DROPPING PIPETTES FOR MEDICAL PURPOSES; ELASTIC BANDAGES; ELASTIC STOCKINGS; FACE MASKS FOR USE BY HEALTH CARE PROVIDERS; LANCETS; MEDICAL AND SURGICAL CUTTERS FOR CUTTING HUMAN OR ANIMAL TISSUE OR ORGANS; MEDICAL APPARATUS AND UNITS FOR DOSAGE, MEASURING AND MONITORING, NAMELY, DRUG DELIVERY DEVICES AND SYSTEMS; MEDICAL DEVICES FOR USE IN CANNULATION OR TO STEM THE FLOW OF TRAUMATIC BLEEDING, NAMELY, TOURNIQUETS; MEDICAL GOWNS; MEDICAL INSTRUMENTS FOR USE IN PERFORMING BIOPSIES; MEDICAL INSTRUMENTS FOR USE IN INFANT FOOT PRINTING; MEDICAL SPECIMEN CUPS; MEDICAL TUBING FOR AIRWAY; NEBULIZERS FOR RESPIRATION THERAPY; PILL AND TABLET CUTTERS AND CRUSHERS; PLASTIC BAGS FOR TRANSMITTING MEDICAL SPECIMENS; ROLLATORS; SPECULUMS; STETHOSCOPES AND SPHYGMOMANOMETERS; SUCTION CUPS FOR MEDICAL PURPOSES; SUPPORT BANDAGES; SURGICAL CAPS; SURGICAL DRAPES; SURGICAL INSTRUMENTS, NAMELY, SAFETY SCALPELS, SCALPEL BLADES AND SCALPEL STRAWS; SURGICAL SCISSORS; SURGICAL SHOE COVERS; SURGICAL SKIN STAPLERS; SURGICAL SPONGES; SUTURE MATERIALS; THERMAL PACKS FOR FIRST AID PURPOSES; TONGUE DEPRESSORS (U.S. CLS. 26, 39 AND 44).

**CLASS 9—ELECTRICAL AND SCIENTIFIC APPARATUS**

FOR COMPUTER HARDWARE AND SOFTWARE FOR PLAYING COMPUTER AND ELECTRONIC GAMES; COMPUTER GAME PROGRAMS; COMPUTER GAMES PROGRAMS AND SOFTWARE; SOFTWARE FOR COMPUTER, VIDEO AND ON-LINE GAMES; COMPUTER GAMES CARTRIDGES AND DISCS; TELEPHONE GAMES, NAMELY, ELECTRONIC GAME SOFTWARE FOR MOBILE PHONES; DOWNLOADABLE ELECTRONIC PUBLICATIONS IN THE NATURE OF INSTRUCTION MANUALS AND TUTORIALS FEATURING INSTRUCTIONS FOR COMPUTER GAMES, VIDEO GAMES AND ELECTRONIC GAMES; INTERACTIVE MULTIMEDIA COMPUTER GAME PROGRAMS; DOWNLOADABLE ELECTRONIC GAME SOFTWARE FOR USE WITH COMPUTERS; ELECTRONIC GAMES CARTRIDGES; HAND-HELD COMPUTER GAMES; MICROCOMPUTERS ADAPTED FOR USE IN PLAYING GAMES; DOWNLOADABLE ELECTRONIC INTERNET GAMES; COMPUTER GAME PROGRAMS; VIDEO AND AUDIO GAME PROGRAMS; COMPUTER GAMES ADAPTED FOR USE WITH TELEVISION RECEIVERS; DOWNLOADABLE ELECTRONIC GAMES AND COMPUTER GAMES FOR USE WITH OR ACCESSIBLE BY MOBILE AND CELLULAR PHONES AND OTHER WIRELESS DEVICES; HAND-HELD COMPUTERS FOR PLAYING COMPUTER AND ELECTRONIC GAMES; PERSONAL COMPUTERS FOR PLAYING COMPUTER AND ELECTRONIC GAMES; DESKTOP COMPUTERS; DESKTOP COMPUTERS FOR PLAYING COMPUTER AND ELECTRONIC GAMES; LAPTOP COMPUTERS FOR PLAYING COMPUTER AND ELECTRONIC GAMES; TABLET COMPUTERS FOR PLAYING COMPUTER AND ELECTRONIC GAMES; SOFTWARE FOR USE ON COMPUTERS, TELEPHONES, MOBILE TELEPHONES, SMART PHONES, TABLET COMPUTERS, PERSONAL DIGITAL ASSISTANTS, TELEVISIONS, SET-TOP BOXES, WATCHES OR OTHER ELECTRONIC APPARATUS FOR PLAYING COMPUTER AND ELECTRONIC GAMES; SOFTWARE DOWNLOADED IN ELECTRONIC FORM FOR USE ON COMPUTERS, TELEPHONES, MOBILE TELEPHONES, SMART PHONES, TABLET COMPUTERS, PERSONAL DIGITAL ASSISTANTS, TELEVISIONS, SET-TOP BOXES, WATCHES OR OTHER ELECTRONIC APPARATUS (U.S. CLS. 21, 23, 26, 36 AND 38).

**CLASS 25—CLOTHING**

FOR COVERALLS; GLOVES; LAB COATS; SLIPPER SOCKS (U.S. CLS. 22 AND 39).  
APRIL ROACH, EXAMINING ATTORNEY

**CLASS 28—TOYS AND SPORTING GOODS**

FOR GAMES AND PLAYTHINGS, NAMELY, ARCADE GAMES; APPARATUS FOR GAMES, NAMELY, GAME TABLES, AMUSEMENT GAME MACHINES; APPARATUS FOR ELECTRONIC GAMES, NAMELY, HAND-HELD UNIT FOR PLAYING ELECTRONIC GAMES, FLOOR STANDING AND TABLETOP UNITS FOR PLAYING ELECTRONIC GAMES OTHER THAN IN CONJUNCTION WITH A TELEVISION OR COMPUTER; STAND ALONE VIDEO GAME MACHINES; ELECTRONIC GAMES OTHER THAN THOSE ADAPTED FOR USE WITH TELEVISION RECEIVERS ONLY; HAND-HELD ELECTRONIC COMPUTER GAMES ADAPTED FOR USE WITH EXTERNAL DISPLAY SCREEN OR MONITOR; ELECTRONIC GAMES OTHER THAN THOSE ADAPTED FOR USE WITH EXTERNAL DISPLAY SCREEN OR MONITOR; HAND-HELD COMPUTER GAMES ADAPTED FOR USE WITH TELEVISION RECEIVERS ONLY; HAND-HELD ELECTRONIC GAMES ADAPTED FOR USE WITH TELEVISION RECEIVERS ONLY; DOWNLOADABLE ELECTRONIC GAME SOFTWARE FOR USE WITH MOBILE AND CELLULAR PHONES AND OTHER WIRELESS DEVICES; HOME VIDEO GAME MACHINES; COMPUTER GAME MACHINES, HAND-HELD VIDEO AND COMPUTER GAME MACHINES, NAMELY, HAND-HELD UNITS FOR PLAYING VIDEO GAMES OTHER THAN THOSE ADAPTED FOR USE WITH AN EXTERNAL DISPLAY SCREEN OR MONITOR; ELECTRONIC GAMES CONSOLES FOR USE WITH AN EXTERNAL DISPLAY OR MONITOR; ELECTRONIC GAMES FOR USE WITH GAMES CONSOLES OTHER THAN THOSE ADAPTED FOR USE WITH TELEVISION RECEIVERS ONLY; ELECTRONIC GAMES FOR USE WITH COMPUTERS; COMPUTER GAMES ADAPTED FOR USE WITH TELEVISION RECEIVERS; COMPUTER GAMES CONSOLES FOR USE WITH AN EXTERNAL DISPLAY OR MONITOR; HAND-HELD DIGITAL ELECTRONIC DEVICES, NAMELY, HAND-HELD GAMES WITH LIQUID CRYSTAL DISPLAYS AND HAND-HELD UNITS FOR PLAYING ELECTRONIC GAMES FOR USE WITH EXTERNAL DISPLAY SCREEN OR MONITOR; AMUSEMENT AND GAME APPARATUS ADAPTED FOR USE WITH AN EXTERNAL DISPLAY SCREEN OR MONITOR, NAMELY, COMPUTER GAME JOYSTICKS, THROTTLES AND WHEELS, GAME CONTROLLERS FOR COMPUTER GAMES, AND VIRTUAL REALITY AND AUGMENTED REALITY GAMING HEADSETS AND HELMETS ADAPTED FOR USE IN PLAYING VIDEO GAMES; APPARATUS AND INSTRUMENTS FOR PLAYING COMPUTER AND VIDEO GAMES, ADAPTED FOR USE WITH AN EXTERNAL DISPLAY SCREEN OR MONITOR, NAMELY, COMPUTER GAME JOYSTICKS, THROTTLES AND WHEELS, GAME CONTROLLERS FOR COMPUTER GAMES, AND VIRTUAL REALITY AND AUGMENTED REALITY GAMING HEADSETS AND HELMETS ADAPTED FOR USE IN PLAYING VIDEO GAMES; APPARATUS AND INSTRUMENTS FOR ELECTRONIC GAMES ADAPTED FOR USE WITH AN EXTERNAL DISPLAY SCREEN OR MONITOR, NAMELY, COMPUTER GAME JOYSTICKS, THROTTLES AND WHEELS, GAME CONTROLLERS FOR COMPUTER GAMES, AND VIRTUAL REALITY AND AUGMENTED REALITY GAMING HEADSETS AND HELMETS ADAPTED FOR USE IN PLAYING VIDEO GAMES (U.S. CLS. 22, 23, 38 AND 50).

**CLASS 41—EDUCATION AND ENTERTAINMENT**

FOR ENTERTAINMENT SERVICES IN THE NATURE OF TEMPORARY USE OF A NON-DOWNLOADABLE ON-LINE INTERACTIVE GAME PROVIDED BY MEANS OF A GLOBAL COMPUTER OR ELECTRONIC NETWORK; ON-LINE GAMING SERVICES, NAMELY, PROVIDING AN ON-LINE VIDEO GAME; NON-DOWNLOADABLE ELECTRONIC PUBLICATIONS IN THE NATURE OF INSTRUCTION MANUALS AND TUTORIALS FEATURING INSTRUCTIONS FOR COMPUTER GAMES, VIDEO GAMES AND ELECTRONIC GAMES; NON-DOWNLOADABLE INTERNET ONLINE VIDEO GAMES; ELECTRONIC GAMES SERVICES PROVIDED BY MEANS OF THE INTERNET; PROVISION OF GAMES BY MEANS OF A COMPUTER BASED SYSTEM, NAMELY, ONLINE VIDEO GAMES; ELECTRONIC ON-LINE VIDEO GAMES PROVIDED BY MEANS OF A

MOBILE PHONE NETWORK; PROVIDING TEMPORARY USE OF NON-DOWNLOADABLE COMPUTER AND VIDEO GAMES ACCESSED AND PLAYED VIA MOBILE AND CELLULAR PHONES AND OTHER WIRELESS DEVICES; ELECTRONIC GAMES SERVICES PROVIDED FROM A COMPUTER DATABASE; ENTERTAINMENT SERVICES, NAMELY, PROVIDING ONLINE COMPUTER GAMES; PROVIDING ON-LINE COMPUTER GAMES, NAMELY, ONLINE VIDEO GAMES; GAMES SERVICES PROVIDED ON-LINE FROM A COMPUTER NETWORK, NAMELY, ONLINE VIDEO GAMES (U.S. CLS. 100, 101 AND 107).

ALEX KEAM, EXAMINING ATTORNEY

SN 85-744,344. REDBOX AUTOMATED RETAIL, LLC, OAK-BROOK TERRACE, IL. FILED 10-3-2012.



THE MARK CONSISTS OF "R" WITH AN ARCH OVER IT.

**CLASS 9—ELECTRICAL AND SCIENTIFIC APPARATUS**

FOR COMPUTER APPLICATION SOFTWARE FOR MOBILE PHONES, PORTABLE MEDIA PLAYERS, AND HANDHELD COMPUTERS, NAMELY, SOFTWARE FOR VIEWING AND RENTING ENTERTAINMENT CONTENT IN THE NATURE OF MOVIES AND TELEVISION PROGRAMS AND FOR RESERVING ENTERTAINMENT CONTENT IN THE NATURE OF VIDEO GAMES, MOVIES AND TELEVISION PROGRAMS AT A VENDING MACHINE; COMPUTER APPLICATION SOFTWARE FOR MOBILE PHONES, PORTABLE MEDIA PLAYERS, AND HANDHELD COMPUTERS, NAMELY, SOFTWARE FOR PURCHASING TICKETS, NAMELY, MOVIE TICKETS, SPORTING EVENT TICKETS, THEATER TICKETS, BROADWAY TICKETS, CONCERT TICKETS, ATTRACTION TICKETS, MUSEUM TICKETS AND STATE FAIR TICKETS (U.S. CLS. 21, 23, 26, 36 AND 38).

**CLASS 35—ADVERTISING AND BUSINESS**

FOR RETAIL STORE SERVICES FEATURING VIDEO GAMES AND VIDEO RECORDINGS, FEATURING MOVIES AND TELEVISION PROGRAMS, AND TICKETS, NAMELY, MOVIE TICKETS, SPORTING EVENT TICKETS, THEATER TICKETS, BROADWAY TICKETS, CONCERT TICKETS, ATTRACTION TICKETS, MUSEUM TICKETS AND STATE FAIR TICKETS; COMPUTERIZED AND/OR AUTOMATED ON-LINE RETAIL STORE SERVICES IN THE FIELD OF TICKETS, NAMELY, MOVIE TICKETS, SPORTING EVENT TICKETS, THEATER TICKETS, BROADWAY TICKETS, ATTRACTION TICKETS, MUSEUM TICKETS, STATE FAIR TICKETS AND CONCERT TICKETS, VIA AN INTERACTIVE GLOBAL COMPUTER NETWORK, NETWORKED KIOSKS, COMPUTERS, MOBILE DEVICES, GAME CONSOLES, APP-ENABLED TVS, AND/OR OPTICAL DISC PLAYERS; COMPUTERIZED ON-LINE ORDERING SERVICES IN THE FIELD OF TICKETS, NAMELY, MOVIE TICKETS, SPORTING EVENT TICKETS, THEATER TICKETS, BROADWAY TICKETS, ATTRACTION TICKETS, MUSEUM TICKETS, STATE FAIR TICKETS AND CONCERT TICKETS VIA AN INTERACTIVE GLOBAL COMPUTER NETWORK, NETWORKED KIOSKS, COMPUTERS, MOBILE DEVICES, GAME CONSOLES, APP-ENABLED TVS, AND/OR OPTICAL DISC PLAYERS; VENDING MACHINE SERVICES IN THE NATURE OF KIOSKS USED FOR THE RENTAL AND SALE OF ENTERTAINMENT CONTENT IN THE NATURE OF VIDEO GAMES, MOVIES, TELEVISION PROGRAMS, AND TICKETS (U.S. CLS. 100, 101 AND 102).

**CLASS 38—COMMUNICATION**

FOR VIDEO-ON-DEMAND TRANSMISSION SERVICES, VIDEO BROADCASTING; TRANSMISSION SERVICES, NAMELY, INTERNET TRANSMISSION SERVICES; TRANSMISSION OF VOICE, DATA, IMAGES, DATA SIGNALS, MESSAGES AND INFORMATION BY ELECTRONIC COMMUNICATION NETWORKS; SECURE DELIVERY SERVICES IN THE FIELD OF TICKETS VIA AN INTERACTIVE GLOBAL COMPUTER NETWORK, NETWORKED KIOSKS, COMPUTERS, MOBILE DEVICES, GAME CONSOLES, APP-ENABLED TVS, AND/OR OPTICAL DISC PLAYERS; BOOKING OF SEATS FOR TRAVEL (U.S. CLS. 100, 101 AND 104).

**CLASS 41—EDUCATION AND ENTERTAINMENT**

FOR RENTAL OF VIDEO RECORDINGS AND VIDEO GAMES BY MEANS OF COMMUNICATIONS NETWORKS AND PROVIDING INFORMATION IN THE FIELD OF ENTERTAINMENT BY MEANS OF COMMUNICATIONS NETWORKS; ENTERTAINMENT SERVICES, NAMELY, RESERVATION OF ENTERTAINMENT CONTENT IN THE NATURE OF VIDEO GAME DISCS, AND PRE-RECORDED DVD'S FEATURING MOVIES AND TELEVISION PROGRAMS FROM A VENDING MACHINE; BOOKING OF SEATS FOR SHOWS AND SPORTS EVENTS; ENTERTAINMENT TICKET AGENCY SERVICES; ON-LINE ENTERTAINMENT TICKET AGENCY SERVICES; PROVIDING INFORMATION IN THE FIELD OF ENTERTAINMENT VIA AN INTERACTIVE GLOBAL COMPUTER NETWORK, NETWORKED KIOSKS, COMPUTERS, MOBILE DEVICES, GAME CONSOLES, APP-ENABLED TVS, AND/OR OPTICAL DISC PLAYERS (U.S. CLS. 100, 101 AND 107).

WON TEAK OH, EXAMINING ATTORNEY

SN 85-744,573. COHNREZNICK LLP, ROSELAND, NJ. FILED 10-3-2012.



THE COLOR(S) ORANGE IS/ARE CLAIMED AS A FEATURE OF THE MARK.

THE MARK CONSISTS OF AN ORANGE CIRCLE OVERLAYED BY THREE ADJACENT SCALENE TRIANGLES, EACH ARRANGED FROM BOTTOM LEFT TO UPPER RIGHT, WITH EACH COMING TO ITS THINNEST POINT TOWARDS THE UPPER RIGHT; THE MIDDLE ANGLE OF THE RIGHT-MOST TRIANGLE POINTS TO THE RIGHT, AND TRIANGLE EXTENDS BEYOND THE OUTER BORDER OF THE CIRCLE ON BOTH BOTTOM AND TOP; THE LEFT-MOST TRIANGLE BEGINS IN, BUT DOES NOT EXTEND BEYOND, THE BOTTOM LEFT OF THE CIRCLE AND COMES TO ITS UPPER ANGLE JUST SHORT OF REACHING THE TOP RIGHT OF THE CIRCLE; BOTH THE RIGHT-MOST AND LEFT-MOST TRIANGLES ARE ORANGE AND CONTAIN NO BORDER DISTINGUISHING THEM FROM THE CIRCLE; THE MIDDLE TRIANGLE IS FORMED BY THE ABSENCE OF COLORED DESIGN ELEMENTS AND IS VISIBLE DUE TO THE TWO BORDERING TRIANGLES, AND ITS THINNEST ANGLE COMES TO A POINT CONCURRENT WITH THE RIGHT-MOST TRIANGLE; THE MIDDLE TRIANGLE INTERRUPTS THE ORANGE CIRCLE WITH A SMALL GAP TO THE UPPER RIGHT AND A LARGER GAP TO THE BOTTOM LEFT.

**CLASS 35—ADVERTISING AND BUSINESS**

FOR ACCOUNTING, AUDITING, AND TAX ADVISORY AND CONSULTING SERVICES; BUSINESS MANAGEMENT ADVISORY AND CONSULTING SERVICES; BUSINESS TRANSACTION ADVISORY AND CONSULTING SERVICES, NAMELY, DUE DILIGENCE CONCERNING PROCESS/CONTROLS AND STRATEGIC AND OPERATIONAL ANALYSIS; TAX PREPARATION, COMPLIANCE AND CONSULTING SERVICES; FORENSIC ACCOUNTING SERVICES (U.S. CLS. 100, 101 AND 102).

**CLASS 36—INSURANCE AND FINANCIAL**

FOR FINANCIAL ANALYSIS, MANAGEMENT AND CONSULTING SERVICES; BUSINESS TRANSACTION ADVISORY AND CONSULTING SERVICES, NAMELY, FINANCIAL DUE DILIGENCE; FINANCIAL ADVISORY AND CONSULTING SERVICES RELATING TO BUSINESS INSOLVENCY; BUSINESS RESEARCH AND VALUATIONS, NAMELY, VALUATIONS OF BUSINESS ENTERPRISES, SECURITIES, AND TANGIBLE AND INTANGIBLE ASSETS (U.S. CLS. 100, 101 AND 102).

**CLASS 41—EDUCATION AND ENTERTAINMENT**

FOR EDUCATIONAL SERVICES, NAMELY, CONDUCTING SEMINARS AND COURSES IN THE FIELDS OF ACCOUNTING, AUDITING, TAXES, AND BUSINESS MANAGEMENT (U.S. CLS. 100, 101 AND 107).

**CLASS 42—SCIENTIFIC AND COMPUTER SERVICES**

FOR INFORMATION TECHNOLOGY ADVISORY AND CONSULTING SERVICES, NAMELY, ADVISORY AND CONSULTING SERVICES CONCERNING INFORMATION SYSTEMS POLICIES AND PROTOCOLS, INFORMATION RISK AND SECURITY ASSESSMENT, AND INFORMATION APPLICATION CONTROLS; PROVIDING INFORMATION TECHNOLOGY AUDITS (U.S. CLS. 100 AND 101).

**CLASS 45—PERSONAL AND LEGAL SERVICES**

FOR REGULATORY COMPLIANCE SERVICES, NAMELY, CONSULTING TO ASSIST CLIENTS WITH COMPLIANCE WITH GOVERNMENTAL REGULATIONS IN THE FIELDS OF THE SARBANES-OXLEY ACT; LITIGATION SUPPORT SERVICES; EXPERT WITNESS SERVICES IN LEGAL MATTERS IN THE FIELD OF ACCOUNTING, FINANCIAL MATTERS, AND TAX COMPLIANCE (U.S. CLS. 100 AND 101).

WILLIAM P. SHANAHAN, EXAMINING ATTORNEY

**CLASS 42—SCIENTIFIC AND COMPUTER SERVICES**

FOR INFORMATION TECHNOLOGY ADVISORY AND CONSULTING SERVICES, NAMELY, ADVISORY AND CONSULTING SERVICES CONCERNING INFORMATION SYSTEMS POLICIES AND PROTOCOLS, INFORMATION RISK AND SECURITY ASSESSMENT, AND INFORMATION APPLICATION CONTROLS; PROVIDING INFORMATION TECHNOLOGY AUDITS (U.S. CLS. 100 AND 101).

FIRST USE 10-8-2012; IN COMMERCE 10-8-2012.

**CLASS 45—PERSONAL AND LEGAL SERVICES**

FOR REGULATORY COMPLIANCE SERVICES, NAMELY, CONSULTING TO ASSIST CLIENTS WITH COMPLIANCE WITH GOVERNMENTAL REGULATIONS IN THE FIELDS OF THE SARBANES-OXLEY ACT; LITIGATION SUPPORT SERVICES; EXPERT WITNESS SERVICES IN LEGAL MATTERS IN THE FIELD OF ACCOUNTING, FINANCIAL MATTERS, AND TAX COMPLIANCE (U.S. CLS. 100 AND 101).

FIRST USE 10-8-2012; IN COMMERCE 10-8-2012.

WILLIAM P. SHANAHAN, EXAMINING ATTORNEY

SN 85-744,580. COHNREZNICK LLP, ROSELAND, NJ. FILED 10-3-2012.

SN 85-749,042. BRACKET GLOBAL, LLC, WAYNE, PA. FILED 10-9-2012.

**COHNREZNICK**

**COGNITIVE DRUG RESEARCH**

THE MARK CONSISTS OF STANDARD CHARACTERS WITHOUT CLAIM TO ANY PARTICULAR FONT, STYLE, SIZE, OR COLOR.

**CLASS 35—ADVERTISING AND BUSINESS**

FOR ACCOUNTING, AUDITING, AND TAX ADVISORY AND CONSULTING SERVICES; BUSINESS MANAGEMENT ADVISORY AND CONSULTING SERVICES; BUSINESS TRANSACTION ADVISORY AND CONSULTING SERVICES, NAMELY, DUE DILIGENCE CONCERNING PROCESS/CONTROLS AND STRATEGIC AND OPERATIONAL ANALYSIS; TAX PREPARATION, COMPLIANCE AND CONSULTING SERVICES; FORENSIC ACCOUNTING SERVICES (U.S. CLS. 100, 101 AND 102).

FIRST USE 10-8-2012; IN COMMERCE 10-8-2012.

**CLASS 36—INSURANCE AND FINANCIAL**

FOR FINANCIAL ANALYSIS, MANAGEMENT AND CONSULTING SERVICES; BUSINESS TRANSACTION ADVISORY AND CONSULTING SERVICES, NAMELY, FINANCIAL DUE DILIGENCE; FINANCIAL ADVISORY AND CONSULTING SERVICES RELATING TO BUSINESS INSOLVENCY; BUSINESS RESEARCH AND VALUATIONS, NAMELY, VALUATIONS OF BUSINESS ENTERPRISES, SECURITIES, AND TANGIBLE AND INTANGIBLE ASSETS (U.S. CLS. 100, 101 AND 102).

FIRST USE 10-8-2012; IN COMMERCE 10-8-2012.

**CLASS 41—EDUCATION AND ENTERTAINMENT**

FOR EDUCATIONAL SERVICES, NAMELY, CONDUCTING SEMINARS AND COURSES IN THE FIELDS OF ACCOUNTING, AUDITING, TAXES, AND BUSINESS MANAGEMENT (U.S. CLS. 100, 101 AND 107).

FIRST USE 10-8-2012; IN COMMERCE 10-8-2012.

THE MARK CONSISTS OF STANDARD CHARACTERS WITHOUT CLAIM TO ANY PARTICULAR FONT, STYLE, SIZE, OR COLOR.

NO CLAIM IS MADE TO THE EXCLUSIVE RIGHT TO USE "DRUG RESEARCH" FOR INTERNATIONAL CLASS 42, APART FROM THE MARK AS SHOWN.

SEC. 2(F).

**CLASS 35—ADVERTISING AND BUSINESS**

FOR BUSINESS CONSULTING SERVICES PROVIDED TO PHARMACEUTICAL INDUSTRY CLIENTS INVOLVED IN PHASE I, II AND III TRIALS WHICH MEASURE COGNITIVE FUNCTION; BUSINESS FEASIBILITY STUDY PLANNING; BUSINESS STUDY DATA INTERPRETATION (U.S. CLS. 100, 101 AND 102).

FIRST USE 3-0-1986; IN COMMERCE 3-0-1986.

**CLASS 41—EDUCATION AND ENTERTAINMENT**

FOR TRAINING OF SITE STAFF IN THE FIELD OF PHARMACEUTICAL STUDIES (U.S. CLS. 100, 101 AND 107).

FIRST USE 3-0-1986; IN COMMERCE 3-0-1986.

**CLASS 42—SCIENTIFIC AND COMPUTER SERVICES**

FOR SCIENTIFIC STUDY PLANNING IN THE FIELD OF PHARMACEUTICALS; RENTAL SERVICES RELATING TO DATA PROCESSING EQUIPMENT AND COMPUTERS FOR USE IN STUDIES; SCIENTIFIC STUDY DATA ANALYSIS IN THE FIELD OF PHARMACEUTICALS (U.S. CLS. 100 AND 101).

FIRST USE 3-0-1986; IN COMMERCE 3-0-1986.

KRISTIN CARLSON, EXAMINING ATTORNEY

SN 85-753,714. BORGELLA, KAREEN, DBA K. BORGELLA, HEMPSTEAD, NY. FILED 10-14-2012.

# K. Borgella

THE MARK CONSISTS OF STANDARD CHARACTERS WITHOUT CLAIM TO ANY PARTICULAR FONT, STYLE, SIZE, OR COLOR.

THE NAME "K. BORGELLA" IDENTIFIES A LIVING INDIVIDUAL WHOSE CONSENT IS OF RECORD.

## CLASS 14—JEWELRY

FOR WOMEN'S JEWELRY; WOMEN'S WATCHES (U.S. CLS. 2, 27, 28 AND 50).

FIRST USE 10-0-2009; IN COMMERCE 10-0-2009.

## CLASS 25—CLOTHING

FOR BATHING SUITS; CUSTOM MADE TO MEASURE SUITS FOR MEN AND WOMEN; FOOTWEAR FOR WOMEN; LADIES' SUITS; MEN'S AND WOMEN'S JACKETS, COATS, TROUSERS, VESTS; MEN'S SUITS, WOMEN'S SUITS; SWEATSHIRTS FOR WOMEN; SWIM WEAR FOR GENTLEMEN AND LADIES; T-SHIRTS FOR WOMEN; WOMEN'S CLOTHING, NAMELY, SHIRTS, DRESSES, SKIRTS, BLOUSES; WOMEN'S SHOES; WOMEN'S TOPS, NAMELY, CAMIS (U.S. CLS. 22 AND 39).

FIRST USE 10-0-2009; IN COMMERCE 10-0-2009.

GENE MACIOL, EXAMINING ATTORNEY

## CLASS 9—ELECTRICAL AND SCIENTIFIC APPARATUS

FOR COMPUTER SOFTWARE FOR CONDUCTING, SWITCHING, TRANSFORMING, ACCUMULATING, REGULATING OR CONTROLLING ELECTRICITY; APPARATUS AND INSTRUMENTS FOR USE IN ADJUSTING OR CONTROLLING POWER USAGE OR ELECTRICAL LOAD, NAMELY, ELECTRICAL CONTROLLERS USED TO ADJUST POWER CONSUMPTION IN RESPONSE TO FLUCTUATIONS IN THE ELECTRICAL GRID FREQUENCY; COMPUTER SOFTWARE FOR ADJUSTING OR CONTROLLING POWER USAGE OR ELECTRICAL LOAD; COMPUTER SOFTWARE FOR MONITORING, MANAGING AND/OR RESPONDING TO FLUCTUATIONS IN THE SUPPLY OF ELECTRICITY; STRUCTURAL PARTS AND FITTINGS THEREFOR FOR THE AFORESAID GOODS (U.S. CLS. 21, 23, 26, 36 AND 38).

## CLASS 37—CONSTRUCTION AND REPAIR

FOR INSTALLATION, MAINTENANCE AND REPAIR SERVICES RELATING TO DEVICES AND EQUIPMENT THAT CONSUME ELECTRICAL POWER, NAMELY, ELECTRICAL APPLIANCES AND MACHINERY; INSTALLATION, MAINTENANCE AND REPAIR SERVICES RELATING TO APPARATUS AND INSTRUMENTS FOR ADJUSTING OR CONTROLLING POWER USAGE OR ELECTRICAL LOAD; INSTALLATION, MAINTENANCE AND REPAIR SERVICES RELATING TO APPARATUS AND INSTRUMENTS FOR MONITORING, MANAGING AND/OR RESPONDING TO FLUCTUATIONS IN THE SUPPLY OF ELECTRICITY; ADVISORY AND CONSULTANCY SERVICES RELATING TO ALL OF THE AFORESAID (U.S. CLS. 100, 103 AND 106).

SN 85-754,809. OPEN ENERGI LIMITED, LONDON, UNITED KINGDOM, FILED 10-16-2012.



PRIORITY CLAIMED UNDER SEC. 44(D) ON UNITED KINGDOM APPLICATION NO. 2636522, FILED 9-28-2012, REG. NO. 2636522, DATED 3-5-2013, EXPIRES 9-28-2022.

THE COLOR(S) LIGHT GREY, DARK GREY AND YELLOW IS/ARE CLAIMED AS A FEATURE OF THE MARK.

THE MARK CONSISTS OF THE LETTERS "O" AND "E" IN STYLIZED FORM SHOWN IN LIGHT GREY AND OVERLAPPING, WITH THE OVERLAPPED PORTION APPEARING IN DARK GREY. THE CENTER OF THE LETTER "O" IS YELLOW.

## CLASS 42—SCIENTIFIC AND COMPUTER SERVICES

FOR ADVISORY AND CONSULTANCY SERVICES RELATING TO POWER SUPPLY AND POWER USAGE, NAMELY, MONITORING THE USE OF ELECTRICAL CONTROLLERS TO ADJUST POWER CONSUMPTION IN RESPONSE TO FLUCTUATIONS IN THE ELECTRICITY GRID FREQUENCY TO ENSURE PROPER FUNCTIONING; ADVISORY AND CONSULTANCY SERVICES RELATING TO COMPUTER SOFTWARE FOR ADJUSTING OR CONTROLLING POWER USAGE OR ELECTRICAL LOAD; ADVISORY AND CONSULTANCY SERVICES RELATING TO COMPUTER SOFTWARE FOR MONITORING, MANAGING AND/OR RESPONDING TO FLUCTUATIONS IN THE SUPPLY OF ELECTRICITY; DESIGN, INSTALLATION, MAINTENANCE AND UPDATING OF COMPUTER SOFTWARE, AND ADVISORY AND CONSULTANCY SERVICES RELATING THERETO; INSTALLATION, MAINTENANCE AND REPAIR SERVICES RELATING TO COMPUTER SOFTWARE FOR ADJUSTING OR CONTROLLING POWER USAGE OR ELECTRICAL LOAD; INSTALLATION, MAINTENANCE AND REPAIR SERVICES RELATING TO COMPUTER SOFTWARE FOR MONITORING, MANAGING AND/OR RESPONDING TO FLUCTUATIONS IN THE SUPPLY OF ELECTRICITY; RESEARCH AND DEVELOPMENT SERVICES RELATING TO APPARATUS, INSTRUMENTS AND COMPUTER SOFTWARE FOR ADJUSTING OR CONTROLLING POWER USAGE OR ELECTRICAL LOAD (U.S. CLS. 100 AND 101).

SAMUEL E. SHARPER JR., EXAMINING ATTORNEY

SN 85-757,055. SHANGHAI TINGTOP FOOD CO., LTD,  
SHANGHAI, CHINA, FILED 10-17-2012.



THE MARK CONSISTS OF A STRAIGHT UP RECTANGULAR-SHAPED BANNER WITH THREE STYLIZED CHINESE CHARACTERS THAT TRANSLITERATE TO "YI" "ZHI" "DING" ON THE LEFT, AND AN OVAL SHAPED, SMILEY-FACED FIGURE OF TWO THIRDS OF THE BANNER'S HEIGHT STANDING ON ITS TWO FEET ON THE RIGHT.

THE ENGLISH TRANSLATION OF "YI ZHI DING" IN THE MARK IS "AN ANCIENT COOKING VESSEL".

#### CLASS 29—MEATS AND PROCESSED FOODS

FOR FISH, NOT ALIVE; JELLYFISH SKIN; PICKLES; DEEPFROZEN CONVENIENCE VEGETABLES; PRESERVED FISH; DRIED BAMBOO SHOOTS; DRIED VEGETABLE BAMBOO SHOOTS; SHELLFISH, NOT LIVE; AQUATIC PRODUCT TIN IN THE NATURE OF CANNED FISH; PRESERVED VEGETABLES; PRESERVED PERIWINKLE MEAT (U.S. CL. 46).

FIRST USE 10-1-2002; IN COMMERCE 10-1-2002.

#### CLASS 30—STAPLE FOODS

FOR CANDY; TEA; RICE CAKE; PREPARATIONS MADE FROM CEREAL, NAMELY, PROCESSED CEREAL-BASED FOOD TO BE USED AS A BREAKFAST FOOD, SNACK FOOD OR INGREDIENT FOR MAKING OTHER FOODS; FLOUR-MILLED PRODUCTS, NAMELY, BREAD AND PASTRY; FARINACEOUS FOODS, NAMELY, FARINACEOUS FOOD PASTES FOR HUMAN CONSUMPTION; CONDIMENTS, NAMELY, PICKLED SAUCE, LOBSTER SAUCE, SAUCES, BECHAMEL, KETCHUP; VERMICELLI; PASTRIES; HONEY (U.S. CL. 46).

FIRST USE 10-1-2002; IN COMMERCE 10-1-2002.  
RON FAIRBANKS, EXAMINING ATTORNEY

SN 85-761,006. ALL-WIND GMBH, HAMBURG, FED REP GERMANY, FILED 10-23-2012.

# All-Wind

THE MARK CONSISTS OF STANDARD CHARACTERS WITHOUT CLAIM TO ANY PARTICULAR FONT, STYLE, SIZE, OR COLOR.

PRIORITY CLAIMED UNDER SEC. 44(D) ON RUSSIAN FED. APPLICATION NO. RU2012713515, FILED 4-25-2012, REG. NO. 491986, DATED 7-17-2013, EXPIRES 4-22-2022.

#### CLASS 7—MACHINERY

FOR EMERGENCY POWER GENERATORS, ALTERNATORS, DYNAMOS, CURRENT GENERATORS, GENERATORS OF ELECTRICITY, WIND TURBINES, MOTORS, ELECTRIC, OTHER THAN FOR LAND VEHICLES (U.S. CLS. 13, 19, 21, 23, 31, 34 AND 35).

#### CLASS 37—CONSTRUCTION AND REPAIR

FOR MACHINERY INSTALLATION, MAINTENANCE AND REPAIR (U.S. CLS. 100, 103 AND 106).

WILLIAM P. SHANAHAN, EXAMINING ATTORNEY

SN 85-762,574. FRUTI FRUIT, INC., SHERMAN OAKS, CA, FILED 10-24-2012.

# SEPER'S

THE MARK CONSISTS OF STANDARD CHARACTERS WITHOUT CLAIM TO ANY PARTICULAR FONT, STYLE, SIZE, OR COLOR.

#### CLASS 29—MEATS AND PROCESSED FOODS

FOR CUT FRUITS; PACKAGED FRUITS, NAMELY, CUT FRESH, FROZEN OR DRIED FRUIT IN INDIVIDUAL PACKAGES (U.S. CL. 46).

#### CLASS 31—NATURAL AGRICULTURAL PRODUCTS

FOR FRESH FRUITS (U.S. CLS. 1 AND 46).  
PAUL E. FAHRENKOPF, EXAMINING ATTORNEY

SN 85-768,800. THE ARTS CLUB (LONDON) LIMITED, LONDON, UNITED KINGDOM, FILED 11-1-2012.



## THE ARTS CLUB

PRIORITY CLAIMED UNDER SEC. 44(D) ON ERP CMNTY TM OFC APPLICATION NO. 011311099, FILED 10-31-2012, REG. NO. 011311099, DATED 4-1-2013, EXPIRES 10-31-2022.

NO CLAIM IS MADE TO THE EXCLUSIVE RIGHT TO USE "1863" AS TO BOTH CLASSES OF GOODS AND SERVICES AND "CLUB" AS TO CLASS 43, APART FROM THE MARK AS SHOWN.

THE MARK CONSISTS OF THE NUMBER "1863" ABOVE A PROFILE OF A MAN WEARING A HAT WITH A BEARD AND LONG HAIR, THE LETTER "A" TO THE LEFT OF THE MAN'S FACE AND THE LETTER "C" IS TO THE RIGHT OF THE BACK OF THE MAN'S HAT, ALL OF THESE ELEMENTS ARE ENCLOSED IN A SINGLE LINE CIRCLE; THE WORDING "THE ARTS CLUB" APPEARS BENEATH THE CIRCLE.

**CLASS 33—WINES AND SPIRITS**

FOR ALCOHOLIC BEVERAGES EXCEPT BEERS; WINE, CHAMPAGNE (U.S. CLS. 47 AND 49).

**CLASS 43—HOTEL AND RESTAURANT SERVICES**

FOR PRIVATE RESIDENCE CLUB SERVICES, NAMELY, PROVIDING CLUB MEMBERS WITH TEMPORARY LODGING ACCOMMODATION AND FOOD AND DRINK (U.S. CLS. 100 AND 101).

CHRISTOPHER BUONGIORNO, EXAMINING ATTORNEY

SN 85-770,309. SAUK-PRAIRIE MEMORIAL HOSPITAL, INC., PRAIRIE DU SAC, WI. FILED 11-2-2012.

SAUK PRAIRIE

THE MARK CONSISTS OF STANDARD CHARACTERS WITHOUT CLAIM TO ANY PARTICULAR FONT, STYLE, SIZE, OR COLOR.  
SEC. 2(F).

**CLASS 36—INSURANCE AND FINANCIAL**

FOR CHARITABLE FOUNDATION SERVICES, NAMELY, PROVIDING FUNDRAISING ACTIVITIES AND INVESTMENT MANAGEMENT SERVICES TO SUPPORT MEDICAL EDUCATION AND RESEARCH AND PROCEDURES FOR THOSE IN NEED (U.S. CLS. 100, 101 AND 102).

**CLASS 41—EDUCATION AND ENTERTAINMENT**

FOR MEDICAL TRAINING AND TEACHING; PERSONAL TRAINER SERVICES; PHYSICAL FITNESS INSTRUCTION; PROVIDING FITNESS AND EXERCISE FACILITIES (U.S. CLS. 100, 101 AND 107).

**CLASS 44—MEDICAL, BEAUTY AND AGRICULTURAL SERVICES**

FOR HEALTH CARE; MEDICAL SERVICES; EMERGENCY MEDICAL SERVICES; SURGERY; HOSPITALS; MEDICAL CLINICS; URGENT MEDICAL CARE CENTERS; PHYSICAL REHABILITATION FACILITIES; SURGICAL AND MEDICAL ORTHOPEDIC SERVICES; SPORTS MEDICINE SERVICES; HIP AND KNEE SURGERY; BIRTHING SERVICES; WOMEN'S HEALTH SERVICES; GERIATRIC HEALTH CARE MANAGEMENT SERVICES; OCCUPATIONAL THERAPY, PHYSICAL REHABILITATION AND PHYSICAL THERAPY SERVICES; MEDICAL TESTING FOR DIAGNOSTIC OR TREATMENT PURPOSES; MEDICAL IMAGING SERVICES; SPEECH AND HEARING THERAPY; WELLNESS AND HEALTH-RELATED CONSULTING SERVICES; PHARMACISTS' SERVICES TO MAKE UP PRESCRIPTIONS; PREPARATION AND DISPENSING OF MEDICATIONS; PROVIDING HEALTH, HEALTH CARE, AND MEDICAL INFORMATION (U.S. CLS. 100 AND 101).

HAI-LY LAM, EXAMINING ATTORNEY

SN 85-781,854. OKA DIRECT LIMITED, OXFORDSHIRE OX14 4SE, UNITED KINGDOM, FILED 11-16-2012.

OKA

THE MARK CONSISTS OF STANDARD CHARACTERS WITHOUT CLAIM TO ANY PARTICULAR FONT, STYLE, SIZE, OR COLOR.

OWNER OF UNITED KINGDOM REG. NO. 2338998, DATED 6-16-2006, RENEWED AS REG. NO. 2338998, DATED 7-28-2013, EXPIRES 7-28-2023.

THE WORDING "OKA" HAS NO MEANING IN A FOREIGN LANGUAGE.

**CLASS 4—LUBRICANTS AND FUELS**

FOR CANDLES; BEESWAX; CARNAUBA WAX; FIRELIGHTERS; LAMP WICKS; WICKS FOR CANDLES; TAPERS (U.S. CLS. 1, 6 AND 15).

**CLASS 5—PHARMACEUTICALS**

FOR AIR DEODORIZING APPARATUS, NAMELY, REEDS AND SCENTED OILS SOLD AS A UNIT FOR USE IN ROOM DEODORIZING DIFFUSERS (U.S. CLS. 6, 18, 44, 46, 51 AND 52).

**CLASS 8—HAND TOOLS**

FOR CUTLERY; HAND OPERATED GARDEN TOOLS AND IMPLEMENTS, NAMELY, TROWELS, WEEDING FORKS, SPADES, HOES; NON-ELECTRIC CAN OPENERS; NON ELECTRIC CHEESE SLICERS; CLEAVERS; FIRE IRONS; FIREPLACE BELLOWS; MANICURE SETS; PALETTE KNIVES; NUTCRACKERS; PIZZA CUTTERS; RAZOR CASES; RAZORS; SWORDS; SWORD SCABBARDS; SCISSORS; SUGAR TONGS; KNIVES; FORKS; SPOONS; TONGS, NAMELY, FIREPLACE TONGS AND ICE TONGS; HOUSEHOLD AND KITCHEN UTENSILS, NOT OF PRECIOUS METAL OR COATED THEREWITH, NAMELY, HAND-OPERATED SLICERS AND CHOPPERS (U.S. CLS. 23, 28 AND 44).

**CLASS 11—ENVIRONMENTAL CONTROL APPARATUS**

FOR LIGHTING APPARATUS, NAMELY, LIGHTING INSTALLATIONS; ELECTRIC AIR DEODORIZERS; ALCOHOL BURNERS; BARBEQUES; CEILING LIGHTS; CHANDELIERS; ELECTRIC LANTERNS; LANTERNS FOR LIGHTING; ELECTRIC CHRISTMAS TREE LIGHTS; ELECTRIC COFFEE MACHINES; LIGHT DIFFUSERS; ELECTRIC LAMPS; ELECTRIC FANS; DOMESTIC FIREPLACES; ORNAMENTAL FOUNTAINS; HANGINGS FOR LAMPS, NAMELY, ORNAMENTAL DECORATIONS SPECIALLY ADAPTED FOR AFFIXATION TO LAMPS; LAMP GLASSES AND GLOBES; LAMP SHADES; PARTS AND FITTINGS FOR ALL THE AFORESAID GOODS, NAMELY, LIGHT BULBS AND SOCKETS FOR ELECTRIC LIGHTS; ICE CHESTS; ELECTRIC CANDELABRAS; ELECTRIC CLOTHES RACK FOR DRYING CLOTHES; ELECTRIC COFFEE PERCOLATORS (U.S. CLS. 13, 21, 23, 31 AND 34).

**CLASS 14—JEWELRY**

FOR JEWELRY BOXES; JEWELRY OF WOOD, REED, CANE, WICKER, IVORY, SHELL, AMBER, AND SUBSTITUTES FOR ALL THESE MATERIALS; BASKETS OF PRECIOUS METAL; JEWELLERY CASES; WALL PLAQUES MADE OF PRECIOUS METAL; PRECIOUS AND SEMI-PRECIOUS CRYSTAL STONES; BROOCHES; BUCKLES FOR WATCHSTRAPS; HAT ORNAMENTS OF PRECIOUS METAL; LAPEL AND TIE PINS (U.S. CLS. 2, 27, 28 AND 50).



**CLASS 16—PAPER GOODS AND PRINTED MATTER**

FOR PAPER; CARDBOARD; WRITING PAPER PADS; PRINTED PERIODICALS, MAGAZINES, BOOKS, PRINTED GUIDES, AND CATALOGUES IN THE FIELD OF FURNITURE, DOMESTIC FURNISHING AND LIGHTING; STATIONERY; PRINTED FORMS; OFFICE REQUISITES, NAMELY, STAPLERS, ADHESIVE TAPE DISPENSERS; WRITING IMPLEMENTS; CALENDARS; STICKERS AND DECALCOMANIAS; PENS, PENCILS, AND CRAYONS; DRAWING MATERIALS, NAMELY, PADS OF DRAWING PAPER; PAINTERS EASELS; FIGURINES OF PAPER MACHE; MAPS; GRAPHIC PRINTS; GRAPHIC ART REPRODUCTIONS; GREETING CARDS; PAPER TISSUES AND CARDBOARD TISSUE BOXES; HAT BOXES OF CARDBOARD; CHEQUE BOOK HOLDERS; PASSPORT HOLDERS; HOUSE PAINTER'S ROLLERS; PAINT BRUSHES; LITHOGRAPHIC WORKS OF ART; LITHOGRAPHS; PAPER NAPKINS; PAINTINGS FRAMED AND UNFRAMED; PAPER KNIVES; PAPERWEIGHTS; PEN AND PENCIL CASES; PHOTOGRAPH STANDS; PHOTOGRAPHS AND PICTURES; ERASERS; PHOTOGRAPH ALBUMS; TABLE LINEN OF PAPER; CARDBOARD AND PAPER BOXES; DIARIES AND CALENDARS; ALL OF THE FOREGOING GOODS BEING OR RELATED TO FURNITURE PRODUCTS FOR THE PERSON, THE HOME AND THE GARDEN, LIFESTYLE PRODUCTS, AND EXTERIOR/INTERIOR DESIGN, AND NONE OF THE AFORESAID GOODS BEING PRINTED MATTER, PRINTED PUBLICATIONS OR BOOKS RELATING TO NEWS, FASHION, ENTERTAINMENT, CELEBRITIES OR SOCIAL EVENTS; FITTED CASES FOR NOTEBOOKS; PAPER AND CORRUGATED CONTAINERS; COASTERS OF PAPER AND CARDBOARD; PEN AND PENCIL TRAYS; TABLE COVERS, NAMELY, PAPER TABLE CLOTHS; PAPER BANNERS; PAPER BUNTING; LOOSE COVERS FOR FURNITURE OF PAPER; PAPER FLAGS; PAPER PLACE MATS; PAPER TABLE RUNNERS; PAPER TABLE CLOTHS; PAPER MATS; MATTING, NAMELY, ART MOUNTS (U.S. CLS. 2, 5, 22, 23, 29, 37, 38 AND 50).

**CLASS 18—LEATHER GOODS**

FOR GOODS OF LEATHER AND IMITATIONS OF LEATHER, NAMELY, CASES AND BAGS; BOXES OF LEATHER OR LEATHER BOARD; HAT BOXES OF LEATHER; NOTECASES, NAMELY, CASES FOR CARRYING DOCUMENTS; UMBRELLAS; PARASOLS; GARMENT BAGS FOR TRAVEL; KEY CASES; WALLETTS; PURSES; LUGGAGE; HOLDALLS; CARRYALLS; TRAVELING BAGS; TRAVELING BAGGAGE SETS; TRAVELING TRUNKS; VALISES; WALKING STICKS; WALKING STICK SEATS (U.S. CLS. 1, 2, 3, 22 AND 41).

**CLASS 20—FURNITURE AND ARTICLES NOT OTHERWISE CLASSIFIED**

FOR FURNITURE; MIRRORS; PICTURE FRAMES; GOODS OF WOOD, REED, CANE, WICKER, IVORY, SHELL, AMBER, AND SUBSTITUTES FOR ALL THESE MATERIALS, NAMELY, DRAWER PULLS, ORNAMENTS, AND FIGURINES; ART WORKS OF WOOD, WAX, PLASTER AND PLASTIC; CUPBOARDS; TELEVISION STANDS; BOOKCASES; BEDS; DIVANS; BEDS FOR HOUSEHOLD PETS; BENCHES; BOTTLE RACKS; BOXES OF WOOD AND PLASTIC; CABINETS; CASES OF WOOD AND PLASTIC; NON-METAL CASKS; CHESTS OF DRAWERS; WIND CHIMES; CHESTS, NAMELY, FURNITURE CHESTS, NON-METAL CHESTS, AND TOY CHESTS; COAT STANDS; COTS; CRADLES; CRIBS; CURTAIN TIE-BACKS IN THE NATURE OF NON-TEXTILE CURTAIN HOLDERS; CURTAIN HOOKS, RAILS, RINGS, RODS, AND ROLLERS; CUSHIONS; PET CUSHIONS; DESKS; DISPLAY BOARDS AND STANDS; DRESSING TABLES; HAND FANS; FIRE SCREENS FOR DOMESTIC USE AND FIREGUARDS; FLOWER STANDS; FOOTSTOOLS; FURNITURE PARTITIONS OF WOOD; INDOOR WINDOW BLINDS; MAGAZINE RACKS; MATTRESSES; DECORATIVE MOBILES; OFFICE FURNITURE; PILLOWS; RATTAN; SIDEBOARDS; SHELVES; SOFAS; WALL PLAQUES MADE OF BONE, IVORY, PLASTER, PLASTIC, WAX, AND WOOD; WICKERWORK FURNITURE; WRITING

DESKS; NONMETAL AND NONPAPER CONTAINERS FOR STORAGE AND TRANSPORT; SUNBEDS, NAMELY, LOUNGE CHAIRS; GARDEN FURNITURE; OTTOMANS; NON-METAL HANGERS FOR LAMPS; PLASTIC MATERIALS FOR PACKAGING, NAMELY, PACKAGING CONTAINERS OF PLASTIC AND PLASTIC LIDS; FITTED FURNITURE COVERINGS OF LEATHER; DRAWER PULLS OF PORCELAIN AND EARTHENWARE; NON-METAL BINS; PLASTIC BANNERS; PLASTIC BUNTING; FITTED FURNITURE COVERINGS OF TEXTILE MATERIALS; PLASTIC FLAGS (U.S. CLS. 2, 13, 22, 25, 32 AND 50).

**CLASS 21—HOUSEWARES AND GLASS**

FOR HOUSEHOLD AND KITCHEN UTENSILS, NOT OF PRECIOUS METAL OR COATED THEREWITH, NAMELY, SIEVES, GRATERS, CHOPPING BOARDS, SPATULAS AND STRAINERS; HOUSEHOLD AND KITCHEN CONTAINERS, NOT OF PRECIOUS METAL OR COATED THEREWITH; UNWORKED OR SEMI-WORKED GLASS, EXCEPT GLASS USED IN BUILDING; BEVERAGE GLASSWARE; PORCELAIN MUGS; EARTHENWARE MUGS; BASINS; BOWLS; BASKETS FOR DOMESTIC USE, NOT OF METAL; MUGS; CUPS; BREAD BINS; BREAD BOARDS; PERFUME BURNERS; BUSTS OF CHINA, TERRACOTTA AND GLASS; DISHES; NON-ELECTRIC CANDELABRA; CANDLESTICKS; CANDLE RINGS; CANDY BOXES; CHINA ORNAMENTS; GLASSWARE ORNAMENTS; CHOPSTICKS; CLOTHES RACKS FOR DRYING; COASTERS NOT OF PAPER AND NOT BEING TABLE LINEN; COFFEE SERVICES; NON-ELECTRIC COFFEE PERCOLATORS; COFFEEPOTS; TEAPOTS; CONTAINERS FOR HOUSEHOLD OR KITCHEN USE; COOKIE JARS; COOKING POTS; COOKING POT SETS; COOKING UTENSILS, NAMELY, GRILLS AND WIRE BASKETS; CROCKERY, NAMELY, POTS, DISHES, DRINKING CUPS AND SAUCERS, BOWLS, SERVING BOWLS AND TRAYS; CRUETS; CRYSTAL ORNAMENTS; DECANTERS; CUTTING BOARDS; DRINKING GLASSES; PLATES; FLASKS; TRAYS FOR DOMESTIC PURPOSES; VASES; DISH DRYING RACKS; BUCKETS; FIGURINES OF PORCELAIN, TERRACOTTA AND GLASS; FLOWER POTS; GLASS JARS; JUGS; KETTLES; KITCHEN CONTAINERS; FITTED PICNIC BASKETS; PICNIC BASKETS SOLD EMPTY; POTS; POTTERY, NAMELY, CLAY POTS; TRASH CANS; TRIVETS; WORKS OF ART, OF PORCELAIN, TERRACOTTA AND GLASS; LUNCH BOXES; CANDLEHOLDERS; TONGS, NAMELY, BARBECUE TONGS, SERVING TONGS, AND SALAD TONGS; JAPANESE-STYLE WOODEN PESTLES; RICE CHESTS; WALL PLAQUES OF CHINA, CRYSTAL, EARTHENWARE, GLASS, PORCELAIN, AND TERRA COTTA; BAKING MATS (U.S. CLS. 2, 13, 23, 29, 30, 33, 40 AND 50).

**CLASS 24—FABRICS**

FOR TABLE COVERS, NAMELY, TABLE CLOTHS NOT OF PAPER; CLOTH BANNERS; BATH LINEN; BED BLANKETS; BED LINEN; BED COVERS; BEDSPREADS; BROCADES; BUCKRAM; CLOTH BUNTING; CALICO; QUILTS AND THROWS; CANVAS FOR TAPESTRY OR EMBROIDERY; TABLE LINEN; TABLE LINEN COASTERS; UNFITTED FURNITURE COVERINGS OF TEXTILE MATERIALS; FURNISHING FABRICS; COVERS FOR CUSHIONS; LOOSE COVERS FOR FURNITURE NOT OF PAPER; CURTAINS OF TEXTILE OR PLASTIC; DAMASK; EIDERDOWNS; FABRIC OF IMITATION ANIMAL SKINS; FABRICS FOR TEXTILE USE; CLOTH FLAGS; HOUSEHOLD LINENS; MATTRESS COVERS; PILLOW SHAMS; PILLOW CASES; PLACE MATS, NOT OF PAPER; TABLE RUNNERS, NOT OF PAPER; TABLE CLOTHS, NOT OF PAPER; WALL HANGINGS OF TEXTILE; TAPESTRY WALL HANGINGS OF TEXTILE; TOWELS; UPHOLSTERY FABRICS; PIECE GOODS, NAMELY, PRECUT TEXTILE FABRICS FOR USE IN MAKING CLOTHING AND HOUSEHOLD FURNISHINGS; BED CANOPIES; TAPESTRIES OF TEXTILE; UNFITTED FURNITURE COVERINGS OF LEATHER; CURTAIN TIE-BACKS IN THE NATURE OF TEXTILE CURTAIN HOLDERS; DUVETS (U.S. CLS. 2 AND 50).

**CLASS 26—FANCY GOODS**

FOR LACE AND EMBROIDERY; RIBBON AND BRAID; BUTTONS; HOOKS AND EYES; SEWING PINS AND NEEDLES; ARTIFICIAL FLOWERS; HAIR BANDS; HAIR SLIDES; BELT CLASPS; BOWS FOR THE HAIR; SEWING BOXES; BROOCHES FOR CLOTHING; BUCKLES, NAMELY, BELT BUCKLES, CLOTHING BUCKLES, HAIR BUCKLES, SHOE BUCKLES, AND STRAP BUCKLES; NEEDLE CUSHIONS; PIN CUSHIONS; WREATHS OF ARTIFICIAL FLOWERS; HAIR ORNAMENTS; HAT ORNAMENTS NOT OF PRECIOUS METAL; LACE TRIMMINGS; ORNAMENTAL NOVELTY BADGES; RIBBONS; SEWING BASKETS (U.S. CLS. 37, 39, 40, 42 AND 50).

**CLASS 27—FLOOR COVERINGS**

FOR CARPETS; RUGS; FLOOR MATS; MATTING FOR COVERING EXISTING FLOORING; LINOLEUM; MATERIALS FOR COVERING EXISTING FLOORS; NON TEXTILE WALL HANGINGS; BATH MATS; CARPET UNDERLAY; FLOOR COVERINGS; DOOR MATS; REED MATS; TAPESTRY WALL HANGINGS NOT OF TEXTILE; WALLPAPER (U.S. CLS. 19, 20, 37, 42 AND 50).

**CLASS 30—STAPLE FOODS**

FOR SPICE SETS, NAMELY, A VARIETY OF SPICES SOLD TOGETHER AS A UNIT (U.S. CL. 46).

**CLASS 35—ADVERTISING AND BUSINESS**

FOR RETAIL STORE SERVICES FEATURING FURNITURE, HOUSEHOLD GOODS, GLASSWARE, TABLE WARE, BEDS, BEDDING, CARPETS, FLOOR COVERINGS, WINDOW COVERINGS, CANDLE HOLDERS, CURTAINS, BLINDS, LIGHTING APPARATUS AND FIXTURES, WORKS OF ART, TEXTILE GOODS AND FURNISHING FABRICS; RETAIL STORE SERVICES, INTERNET AND MAIL ORDER CATALOGUE SERVICES FEATURING FURNITURE, HOUSEHOLD GOODS, GLASSWARE, TABLEWARE, INDOOR AND OUTDOOR FURNITURE, RUGS, CARPETS, LAMPS AND LIGHTING FIXTURES, CURTAINS, CURTAIN RODS OR POLES, CANDLE HOLDERS, MIRRORS, VASES, BASKETS, WINDOW COVERINGS AND FLOOR COVERINGS, TEXTILE GOODS AND FURNISHING FABRICS; DESIGN OF ADVERTISING AND MARKETING MATERIALS FOR OTHERS AND INFORMATION, ADVISORY, AND CONSULTANCY SERVICES RELATING THERETO (U.S. CLS. 100, 101 AND 102).

**CLASS 42—SCIENTIFIC AND COMPUTER SERVICES**

FOR DESIGN SERVICES IN THE FIELD OF CLOTHING, FURNITURE AND FURNISHINGS; INTERIOR DESIGN SERVICES; INFORMATION, ADVISORY AND CONSULTANCY SERVICES RELATING TO THE AFORESAID (U.S. CLS. 100 AND 101).

KIM MONINGHOFF, EXAMINING ATTORNEY

SN 85-781.903. PUDGE BROTHERS PIZZA CORPORATION, CENTENNIAL, CO. FILED 11-16-2012.

PUDGE BROS. PIZZA HOME OF  
THE MONSTER

THE MARK CONSISTS OF STANDARD CHARACTERS WITHOUT CLAIM TO ANY PARTICULAR FONT, STYLE, SIZE, OR COLOR.

NO CLAIM IS MADE TO THE EXCLUSIVE RIGHT TO USE "BROS. PIZZA", APART FROM THE MARK AS SHOWN.

**CLASS 30—STAPLE FOODS**

FOR FRESH PIZZA; FROZEN DOUGH FOR USE AS PIZZA, BREAD OR OTHER BREAD-TYPE PRODUCTS; KITS COMPRISED OF INGREDIENTS FOR PREPARING PIZZA; PIZZA; PIZZA CHEESE STICKS; PIZZA CRUST; PIZZA CRUST MIXES; PIZZA DOUGH; PIZZA SAUCE; PIZZAS (U.S. CL. 46).

FIRST USE 11-9-1991; IN COMMERCE 2-1-1996.

**CLASS 35—ADVERTISING AND BUSINESS**

FOR ASSISTANCE IN BUSINESS MANAGEMENT AND PRODUCT COMMERCIALIZATION, WITHIN THE FRAMEWORK OF A FRANCHISE CONTRACT; FRANCHISING, NAMELY, CONSULTATION AND ASSISTANCE IN BUSINESS MANAGEMENT, ORGANIZATION AND PROMOTION (U.S. CLS. 100, 101 AND 102).

FIRST USE 11-9-1991; IN COMMERCE 2-1-1996.

**CLASS 43—HOTEL AND RESTAURANT SERVICES**

FOR PIZZA PARLORS; RESTAURANT SERVICES; RESTAURANT SERVICES FEATURING PIZZA; RESTAURANTS FEATURING HOME DELIVERY (U.S. CLS. 100 AND 101).

FIRST USE 11-9-1991; IN COMMERCE 2-1-1996.

ROBERT STRUCK, EXAMINING ATTORNEY

SN 85-790.098. WAGENINGEN UNIVERSITEIT, WAGENINGEN, NETHERLANDS, FILED 11-29-2012.

# FUNBRICKS

THE MARK CONSISTS OF STANDARD CHARACTERS WITHOUT CLAIM TO ANY PARTICULAR FONT, STYLE, SIZE, OR COLOR.

PRIORITY CLAIMED UNDER SEC. 44(D) ON ERPNTY TM OFC APPLICATION NO. 010966109, FILED 6-14-2012, REG. NO. 010966109, DATED 2-5-2013, EXPIRES 6-14-2022.

**CLASS 1—CHEMICALS**

FOR CHEMICAL COMPOUNDS FROM FUNGI AND/OR BACTERIA IN THE NATURE OF SPECIALIZED CHEMICALS AND CHEMICAL COMPOSITIONS FOR USE IN A WIDE VARIETY OF INDUSTRIES (U.S. CLS. 1, 5, 6, 10, 26 AND 46).

**CLASS 42—SCIENTIFIC AND COMPUTER SERVICES**

FOR SCIENTIFIC AND TECHNOLOGICAL SERVICES IN THE AREA OF DEVELOPMENT AND RESEARCH OF COMPOUNDS FROM FUNGI AND/OR BACTERIA FOR THE PURPOSE OF SPECIALIZED CHEMICALS AND/OR CHEMICAL COMPOSITIONS (U.S. CLS. 100 AND 101).

LINDA ORNDORFF, EXAMINING ATTORNEY

SN 85-795,401. LUMONDI, INC., SAN RAFAEL, CA. FILED 12-5-2012.



OWNER OF U.S. REG. NOS. 2,125,932, 2,329,580 AND 2,750,686.

THE MARK CONSISTS OF A SHIELD DESIGN DIVIDED IN THE MIDDLE; ON THE UPPER PART IS THE WORD "LUMI" AND BELOW IT IS THE WORD "NOX" IN STYLIZED LETTERS.

THE ENGLISH TRANSLATION OF "LUMI" IN THE MARK IS "LIGHT".

#### CLASS 9—ELECTRICAL AND SCIENTIFIC APPARATUS

FOR EYEWEAR, NAMELY, SUNGLASSES, EYEGLASSES AND OPHTHALMIC FRAMES AND CASES THEREFOR (U.S. CLS. 21, 23, 26, 36 AND 38).

#### CLASS 18—LEATHER GOODS

FOR HANDBAGS, LUGGAGE, ALL-PURPOSE SPORTS BAGS, TRAVELING BAGS, COSMETIC BAGS SOLD EMPTY, COSMETIC CLUTCH BAGS SOLD EMPTY, TISSUE CASES BEING TOILETRY CASES FOR HOLDING TISSUE SOLD EMPTY, BELT BAGS, WALLETS, KEY CHANGE POUCHES IN THE NATURE OF POUCHES FOR HOLDING KEYS AND MONETARY COINS, LUGGAGE GARMENT BAGS FOR TRAVEL, NYLON SHOPPING BAGS FOR CARRYING ARTICLES, TOTE BAGS, SUITCASES THAT ARE EASILY STOWED AWAY, DUFFEL BAGS, ATTACHE CASES, GARMENT BAGS FOR TRAVEL, SATCHELS, UMBRELLAS AND KNAPSACKS (U.S. CLS. 1, 2, 3, 22 AND 41).

MAUREEN DALL, EXAMINING ATTORNEY

SN 85-798,029. LOPEZ, JENNIFER L., DBA SEW FUN, MARLBOROUGH, MA. FILED 12-7-2012.

SEW FUN

THE MARK CONSISTS OF STANDARD CHARACTERS WITHOUT CLAIM TO ANY PARTICULAR FONT, STYLE, SIZE, OR COLOR.

#### CLASS 9—ELECTRICAL AND SCIENTIFIC APPARATUS

FOR DIGITAL MEDIA, NAMELY, CDS, DVDS, AND MULTIMEDIA FILES FEATURING PATTERNS FOR MAKING CLOTHES, BAGS, ACCESSORIES, AND TOYS; DOWNLOADABLE MULTIMEDIA FILES CONTAINING PICTURES, TEXT, AUDIO, VIDEO, AND INTERNET WEB LINKS RELATING TO SEWING AND SEWING PATTERNS; ELECTRONIC PUBLICATIONS, NAMELY, BOOKS, JOURNALS, MANUALS, E-BOOKS, E-ZINES, PAMPHLETS, PERIODICALS, AND NEWSLETTERS FEATURING INFORMATION ABOUT SEWING AND SEWING PATTERNS, RECORDED ON COMPUTER MEDIA OR AVAILABLE FOR DOWNLOAD (U.S. CLS. 21, 23, 26, 36 AND 38).

FIRST USE 6-4-2009; IN COMMERCE 6-4-2009.

#### CLASS 16—PAPER GOODS AND PRINTED MATTER

FOR PATTERNS FOR MAKING CLOTHES; PATTERNS FOR MAKING BAGS, ACCESSORIES, AND TOYS, NAMELY, DIAPER BAGS, BOOK BAGS, MESSENGER BAGS, SHOULDER BAGS, HAND BAGS, SPORTS BAGS, ALL-PURPOSE CARRYING BAGS, MARKET BAGS, CLUTCHES, WRISTLETS, BACK PACKS, GARMENT BAGS, MAKE-UP BAGS AND JEWELRY BAGS, PILLOWS, PILLOW CASES AND QUILTS, QUILTED BALLS, QUILTED BLOCKS, FABRIC BOOKS, FABRIC PUPPETS AND STUFFED ANIMALS (U.S. CLS. 2, 5, 22, 23, 29, 37, 38 AND 50).

FIRST USE 6-4-2009; IN COMMERCE 6-4-2009.

ALICE BENMAMAN, EXAMINING ATTORNEY

SN 85-798,764. FAIR TRADE WORK LTD., VANCOUVER, B.C., CANADA, FILED 12-10-2012.

WE ARE CONSTRUCTION

THE MARK CONSISTS OF STANDARD CHARACTERS WITHOUT CLAIM TO ANY PARTICULAR FONT, STYLE, SIZE, OR COLOR.

PRIORITY CLAIMED UNDER SEC. 44(D) ON CANADA APPLICATION NO. 1,604,665, FILED 11-30-2012, REG. NO. TMA866,601, DATED 12-3-2013, EXPIRES 12-3-2028.

#### CLASS 35—ADVERTISING AND BUSINESS

FOR ESTIMATED CONTRACTING WORK IN THE FIELD OF GENERAL CONTRACTING, CONSTRUCTION AND PROJECT MANAGEMENT; SCHEDULING SERVICES FOR CONSTRUCTION PROJECTS IN THE FIELD OF GENERAL CONTRACTING, CONSTRUCTION AND PROJECT MANAGEMENT; PREPARATION OF JOB COST ACCOUNTING REPORTS IN THE FIELD OF GENERAL CONTRACTING, CONSTRUCTION AND PROJECT MANAGEMENT; ADVERTISING AND MARKETING THE SERVICES OF OTHERS IN THE FIELD OF GENERAL CONTRACTING AND CONSTRUCTION; FRANCHISE SERVICES, NAMELY, OFFERING BUSINESS MANAGEMENT ASSISTANCE IN THE ESTABLISHMENT AND OPERATION OF CONSTRUCTION AND GENERAL CONTRACTING BUSINESSES (U.S. CLS. 100, 101 AND 102).

**CLASS 37—CONSTRUCTION AND REPAIR**

FOR PROVIDING A WEBSITE FEATURING INFORMATION IN THE FIELD OF GENERAL CONSTRUCTION CONTRACTING, BUILDING CONSTRUCTION AND CONSTRUCTION PROJECT MANAGEMENT; GENERAL BUILDING CONTRACTOR SERVICES, BUILDING CONSTRUCTION AND CONSTRUCTION PROJECT MANAGEMENT SERVICES, NAMELY, COORDINATION, SUPERVISION, MANAGEMENT AND IMPLEMENTATION OF CONSTRUCTION PROJECTS (U.S. CLS. 100, 103 AND 106).

**CLASS 42—SCIENTIFIC AND COMPUTER SERVICES**

FOR PLANNING AND DESIGN OF BUILDINGS, COORDINATION, SUPERVISION, MANAGEMENT AND IMPLEMENTATION OF CONSTRUCTION PROJECTS; DRAFTING OF CONSTRUCTION PLANS FOR BUILDINGS IN THE FIELD OF GENERAL CONTRACTING, CONSTRUCTION AND PROJECT MANAGEMENT (U.S. CLS. 100 AND 101).

ELI HELLMAN, EXAMINING ATTORNEY

SN 85-799,056. MARINE COWBOY HOLDINGS LLC, TAMPA, FL. FILED 12-10-2012.

THE MARK CONSISTS OF THE STYLIZED TEXT "MARINE", UNDERNEATH LIES THE STYLIZED TEXT "COWBOY".

**CLASS 16—PAPER GOODS AND PRINTED MATTER**

FOR DECALS; PAPER BANNERS; STICKERS (U.S. CLS. 2, 5, 22, 23, 29, 37, 38 AND 50).  
FIRST USE 8-10-2012; IN COMMERCE 9-21-2012.

**CLASS 25—CLOTHING**

FOR HATS; PANTS; SHIRTS; SHORTS (U.S. CLS. 22 AND 39).  
FIRST USE 8-10-2012; IN COMMERCE 9-21-2012.  
CHRISTINA SOBRAL, EXAMINING ATTORNEY

SN 85-798,950. AGING MEDIA NETWORK, INC., DBA SENIOR HOUSING NEWS, CHICAGO, IL. FILED 12-10-2012.



THE MARK CONSISTS OF A STYLIZED IMAGE OF A HOUSE TO THE LEFT OF THE WORDING "SENIOR HOUSING NEWS", WITH A LINE APPEARING UNDERNEATH THE WORDS "SENIOR HOUSING" AND THE STYLIZED WORD "NEWS" APPEARING AT THE END OF THE LINE AND BELOW THE WORDING "SENIOR HOUSING".

SEC. 2(F).

**CLASS 35—ADVERTISING AND BUSINESS**

FOR ADVERTISING SERVICES (U.S. CLS. 100, 101 AND 102).  
FIRST USE 12-1-2007; IN COMMERCE 12-1-2007.

**CLASS 41—EDUCATION AND ENTERTAINMENT**

FOR ORGANIZING EDUCATIONAL CONFERENCES FEATURING SPEAKERS AND PANEL DISCUSSIONS THAT FOCUS ON FINANCE, TECHNOLOGY, ASSISTED LIVING, INDEPENDENT LIVING, SENIOR LIVING, CONTINUING CARE RETIREMENT COMMUNITIES, HOME HEALTH CARE, HEALTH CARE, AND HOUSING (U.S. CLS. 100, 101 AND 107).

FIRST USE 12-1-2007; IN COMMERCE 12-1-2007.  
GENE MACIOL, EXAMINING ATTORNEY

SN 85-801,571. VIVENDA DO CAMARAO FRANCHISING LIMITADA, COITA, SP, BRAZIL, FILED 12-13-2012.



NO CLAIM IS MADE TO THE EXCLUSIVE RIGHT TO USE "SHRIMP HOUSE SEAFOOD PASTA & GRILL", APART FROM THE MARK AS SHOWN.

THE COLOR(S) ORANGE AND TEAL IS/ARE CLAIMED AS A FEATURE OF THE MARK.

THE MARK CONSISTS OF THE WORDS "SHRIMP HOUSE SEAFOOD PASTA & GRILL" IN STYLIZED LETTERS. THE WORDS "SHRIMP HOUSE" AND "SEAFOOD PASTA & GRILL" ARE SEPARATED BY A CURVED ORANGE LINE. A STYLIZED SHRIMP APPEARS TO THE RIGHT SIDE OF THE WORDING. THE COLOR TEAL APPEARS IN THE WORDING "SHRIMP HOUSE". THE COLOR ORANGE APPEARS IN THE WORDING "SEAFOOD PASTA & GRILL" AND IN THE DRAWING OF THE SHRIMP.

**CLASS 29—MEATS AND PROCESSED FOODS**

FOR SEAFOOD; PREPARED ENTREES CONSISTING PRIMARILY OF SEAFOOD; PREPARED ENTREES CONSISTING PRIMARILY OF SHRIMPS; PREPARED ENTREES CONSISTING PRIMARILY OF CRUSTACEANS; PREPARED ENTREES CONSISTING PRIMARILY OF NOT LIVE FISH; PREPARED FROZEN ENTREES CONSISTING PRIMARILY OF SEAFOOD; PREPARED FROZEN ENTREES CONSISTING PRIMARILY OF SHRIMPS; PREPARED FROZEN ENTREES CONSISTING PRIMARILY OF CRUSTACEANS; PREPARED FROZEN ENTREES CONSISTING PRIMARILY OF FISH (U.S. CL. 46).

**CLASS 30—STAPLE FOODS**

FOR BAKERY DESSERTS; CAKES; CANDIES; DESERT PUDDINGS; FROZEN YOGURT; PUDDINGS (U.S. CL. 46).

**CLASS 35—ADVERTISING AND BUSINESS**

FOR FRANCHISING, NAMELY, OFFERING BUSINESS MANAGEMENT ASSISTANCE IN THE ESTABLISHMENT AND/OR OPERATION OF RESTAURANTS (U.S. CLS. 100, 101 AND 102).

SHAUNIA CARLYLE, EXAMINING ATTORNEY

**CLASS 9—ELECTRICAL AND SCIENTIFIC APPARATUS**

FOR DIGITAL MATERIALS, NAMELY, DOWNLOADABLE AUDIOVISUAL FILES FEATURING DESCRIPTIONS, SUMMARIES, RENDITIONS, ADVERTISEMENTS, AUTHOR INTERVIEWS AND OTHER INFORMATION RELATED TO BOOKS, MUSIC, VIDEOS, MOTION PICTURES AND OTHER WORKS OF ART; PRE-RECORDED ELECTRONIC AND DIGITAL MEDIA FEATURES DESCRIPTIONS, SUMMARIES, RENDITIONS, ADVERTISEMENTS, AUTHOR INTERVIEWS AND OTHER INFORMATION RELATED TO BOOKS, MUSIC, VIDEOS AND OTHER WORKS OF ART (U.S. CLS. 21, 23, 26, 36 AND 38).

**CLASS 35—ADVERTISING AND BUSINESS**

FOR ADVERTISING SERVICES, NAMELY, DISSEMINATION OF ADVERTISING FOR OTHERS VIA AN ON-LINE ELECTRONIC COMMUNICATIONS NETWORK, INCLUDING ADVERTISING FOR BOOKS, MUSIC, VIDEOS, OR OTHER WORKS OF ART; AUTOMATED AND COMPUTERIZED ELECTRONIC RETAIL STORE SERVICES FEATURING A WIDE VARIETY OF CONSUMER GOODS, INCLUDING BOOKS, MUSIC, VIDEOS, OR OTHER WORKS OF ART; PROVIDING CONSUMER PRODUCT INFORMATION VIA THE INTERNET OR OTHER COMMUNICATIONS NETWORKS, INCLUDING INFORMATION ON BOOKS, MUSIC, VIDEOS, OR OTHER WORKS OF ART; COMPUTERIZED ON-LINE ORDERING SERVICES FEATURING A WIDE VARIETY OF CONSUMER GOODS, INCLUDING BOOKS, MUSIC, VIDEOS, OR OTHER WORKS OF ART; PROVIDING A SEARCHABLE ON-LINE ADVERTISING GUIDE FEATURING THE GOODS AND SERVICES OF OTHER ON-LINE VENDORS, INCLUDING VENDORS OF BOOKS, MUSIC, VIDEOS, OR OTHER WORKS OF ART; PROVIDING AN ON-LINE SEARCHABLE DATABASE FEATURING BOOKS, MUSICAL SOUND RECORDINGS, VIDEOS AND OTHER WORKS OF ART BEING OFFERED FOR SALE AND BUYER/SELLER CONTACT INFORMATION (U.S. CLS. 100, 101 AND 102).

SN 85-802,810. CONSTELLATION HR SOLUTIONS, INC., FORT LEE, NJ. FILED 12-14-2012.

**INTAGLIO CREATIONS**

THE MARK CONSISTS OF STANDARD CHARACTERS WITHOUT CLAIM TO ANY PARTICULAR FONT, STYLE, SIZE, OR COLOR.

**CLASS 35—ADVERTISING AND BUSINESS**

FOR ADVERTISING SERVICES, NAMELY, DESIGN OF ADVERTISING FOR OTHERS; PROVIDING ADVERTISING USING 3D AND ANIMATION DESIGNS, NAMELY, 3D MODELING, 3D ANIMATION, 2D ANIMATION AND 3D ARCHITECTURAL VISUALIZATION; BRANDING SERVICES, NAMELY, CONSULTING, DEVELOPMENT, MANAGEMENT AND MARKETING OF BRANDS FOR BUSINESS AND/OR INDIVIDUALS (U.S. CLS. 100, 101 AND 102).

**CLASS 42—SCIENTIFIC AND COMPUTER SERVICES**

FOR WEBSITE DEVELOPMENT FOR OTHERS (U.S. CLS. 100 AND 101).

SKYE YOUNG, EXAMINING ATTORNEY

**CLASS 41—EDUCATION AND ENTERTAINMENT**

FOR PROVIDING AN ON-LINE SEARCHABLE COMPUTER DATABASE IN THE FIELD OF ENTERTAINMENT, NAMELY, BOOKS, MUSIC, VIDEOS AND OTHER WORKS OF ART; PROVIDING AN ON-LINE SEARCHABLE COMPUTER DATABASE IN THE FIELD OF EDUCATION, CULTURAL, SPORTING, OR ENTERTAINMENT EXHIBITIONS FEATURING BOOKS, MUSIC, VIDEOS AND OTHER WORKS OF ART. ENTERTAINMENT SERVICES IN THE NATURE OF DEVELOPMENT, CREATION, PRODUCTION AND POST-PRODUCTION SERVICES OF MULTIMEDIA ENTERTAINMENT CONTENT RELATED TO DESCRIPTIONS, SUMMARIES, RENDITIONS, AUTHOR INTERVIEWS, OR OTHER INFORMATION RELATED TO BOOKS, MUSIC, VIDEOS, OR OTHER WORKS OF ART (U.S. CLS. 100, 101 AND 107).

STEPHANIE ALI, EXAMINING ATTORNEY

SN 85-804,526. BOOKREELS, CORP., OAKLAND, CA. FILED 12-17-2012.

SN 85-805,558. TRIUMPH LEARNING, LLC, NEW YORK, NY. FILED 12-18-2012.



THE MARK CONSISTS OF BOOK WITH A FILM STRIP.

**BOOK JAM**

THE MARK CONSISTS OF STANDARD CHARACTERS WITHOUT CLAIM TO ANY PARTICULAR FONT, STYLE, SIZE, OR COLOR.

NO CLAIM IS MADE TO THE EXCLUSIVE RIGHT TO USE "BOOK", APART FROM THE MARK AS SHOWN.

**CLASS 16—PAPER GOODS AND PRINTED MATTER**

FOR PUBLICATIONS, NAMELY, INSTRUCTIONAL MANUALS AND TEACHER'S GUIDES IN THE FIELD OF READING EDUCATION (U.S. CLS. 2, 5, 22, 23, 29, 37, 38 AND 50).

FIRST USE 1-27-2009; IN COMMERCE 1-27-2009.

**CLASS 41—EDUCATION AND ENTERTAINMENT**

FOR EDUCATIONAL SERVICES, NAMELY, PROVISION OF A LITERATURE BASED READING PROGRAM AND DISTRIBUTION OF COURSE MATERIAL AND EDUCATIONAL MATERIAL IN CONNECTION THEREWITH (U.S. CLS. 100, 101 AND 107).

FIRST USE 1-27-2009; IN COMMERCE 1-27-2009.  
NAAKWAMA ANKRAH, EXAMINING ATTORNEY

**CLASS 9—ELECTRICAL AND SCIENTIFIC APPARATUS**

FOR INTEGRATED COMPUTER AND ELECTRICAL HARDWARE SYSTEMS USED TO MONITOR, CONTROL AND MANAGE ENERGY USAGE IN RESIDENTIAL BUILDINGS; COMPUTER SOFTWARE APPLICATION TO MONITOR, CONTROL AND MANAGE REAL TIME ENERGY USAGE IN RESIDENTIAL BUILDINGS; COMPUTER SOFTWARE AND HARDWARE APPLICATION USED TO FACILITATE CUSTOMIZED UTILITY CONSUMPTION IN RESIDENTIAL BUILDINGS; COMPUTER SOFTWARE AND HARDWARE APPLICATION USED TO FACILITATE CUSTOMIZED UTILITY DEMAND RESPONSE (DR) AND DEMAND SIDE MANAGEMENT (DSM) WITHIN RESIDENTIAL BUILDINGS (U.S. CLS. 21, 23, 26, 36 AND 38).

**CLASS 35—ADVERTISING AND BUSINESS**

FOR ONLINE PORTAL IN THE FIELD OF ENERGY MANAGEMENT, NAMELY, TO MONITOR, CONTROL AND MANAGE ENERGY USAGE IN RESIDENTIAL BUILDINGS; ONLINE PORTAL IN THE FIELD OF ENERGY MANAGEMENT AND USAGE, NAMELY, USED TO OPTIMIZE ENERGY CONSUMPTION AND SCHEDULE APPLIANCE ENERGY USAGE; ONLINE PORTAL IN THE FIELD OF ENERGY USAGE, NAMELY, USED TO INTEGRATE AND FACILITATE CUSTOMIZED UTILITY DEMAND RESPONSE (DR) AND DEMAND SIDE MANAGEMENT (DSM) WITHIN INDUSTRIAL BUILDINGS (U.S. CLS. 100, 101 AND 102).

SN 85-807,533. WING ENTERPRISES, INC., SPRINGVILLE, UT. FILED 12-20-2012.

---

# CAGE

THE MARK CONSISTS OF STANDARD CHARACTERS WITHOUT CLAIM TO ANY PARTICULAR FONT, STYLE, SIZE, OR COLOR.

**CLASS 6—METAL GOODS**

FOR (BASED ON INTENT TO USE) LADDERS, NAMELY, LADDERS MADE SUBSTANTIALLY OF METAL COMPONENTS (U.S. CLS. 2, 12, 13, 14, 23, 25 AND 50).

**CLASS 20—FURNITURE AND ARTICLES NOT OTHERWISE CLASSIFIED**

FOR (BASED ON USE IN COMMERCE) LADDERS, NAMELY, LADDERS MADE SUBSTANTIALLY OF NON-METAL COMPONENTS (U.S. CLS. 2, 13, 22, 25, 32 AND 50).

FIRST USE 2-0-2012; IN COMMERCE 2-0-2012.  
MICHAEL ENGEL, EXAMINING ATTORNEY

**CLASS 42—SCIENTIFIC AND COMPUTER SERVICES**

FOR ONLINE PORTAL FEATURING NON-DOWNLOADABLE SOFTWARE USED TO TRACK AND REDUCE CARBON EMISSIONS; ONLINE PORTAL FEATURING ONLINE NON-DOWNLOADABLE SOFTWARE USED TO MONITOR, CONTROL AND MANAGE ENERGY USAGE IN RESIDENTIAL BUILDINGS; ONLINE PORTAL FEATURING NON-DOWNLOADABLE SOFTWARE USED TO TRACK AND REDUCE CARBON EMISSIONS, OPTIMIZE ENERGY CONSUMPTION AND SCHEDULE APPLIANCES ENERGY USAGE; ONLINE PORTAL FEATURING NON-DOWNLOADABLE SOFTWARE USED TO INTEGRATE AND FACILITATE CUSTOMIZED UTILITY DEMAND RESPONSE (DR) AND DEMAND SIDE MANAGEMENT (DSM) WITHIN RESIDENTIAL BUILDINGS (U.S. CLS. 100 AND 101).

JUSTINE D. PARKER, EXAMINING ATTORNEY

SN 85-811,254. PROJECT MIRACLE IP HOLDINGS, LLC, NEW YORK, NY. FILED 12-27-2012.

---

CRISTINA CARLINO BUTTERFLY

THE MARK CONSISTS OF STANDARD CHARACTERS WITHOUT CLAIM TO ANY PARTICULAR FONT, STYLE, SIZE, OR COLOR.

THE NAME(S), PORTRAIT(S), AND/OR SIGNATURE(S) SHOWN IN THE MARK IDENTIFIES "CRISTINA CARLINO", WHOSE CONSENT(S) TO REGISTER IS MADE OF RECORD.

SN 85-807,565. KOBEN SYSTEMS INC., MISSISSAUGA, ONTARIO, CANADA, FILED 12-20-2012.



THE MARK CONSISTS OF THE WORDS "MYHOMEGRID" IN A STYLIZED FORMAT.

**CLASS 4—LUBRICANTS AND FUELS**

FOR CANDLES; FIRE LIGHTERS; FIREPLACE LOGS; PATIO TORCHES (U.S. CLS. 1, 6 AND 15).

**CLASS 14—JEWELRY**

FOR CLOCKS; JEWELRY; JEWELRY BOXES; JEWELRY CASES; WATCHES (U.S. CLS. 2, 27, 28 AND 50).

**CLASS 18—LEATHER GOODS**

FOR ALL-PURPOSE CARRYING BAGS; ANIMAL LEASHES; BABY CARRIERS WORN ON THE BODY; BACKPACKS; BRIEFCASES; COLLARS FOR PETS; COSMETIC BAGS SOLD EMPTY; DIAPER BAGS; DOG APPAREL; HANDBAGS; KEY CASES; LUGGAGE; LUGGAGE TAGS; UMBRELLAS; WALLETS; JEWELRY ORGANIZER ROLLS FOR TRAVEL (U.S. CLS. 1, 2, 3, 22 AND 41).

**CLASS 24—FABRICS**

FOR BABY BEDDING, NAMELY, BUNDLE BAGS, SWADDLING BLANKETS, CRIB BUMPERS, FITTED CRIB SHEETS, CRIB SKIRTS, CRIB BLANKETS, AND DIAPER CHANGING PAD COVERS NOT OF PAPER; BARBECUE MITTS; BATH LINEN; BEACH TOWELS; BED LINEN; CURTAINS; HANDKERCHIEFS; KITCHEN LINENS; OVEN MITTS; TABLE LINEN; THROWS (U.S. CLS. 42 AND 50).

**CLASS 25—CLOTHING**

FOR BABY BIBS NOT OF PAPER; CHILDREN'S HEADWEAR; COATS; DRESSES; FOOTWEAR; GLOVES; HEAD WEAR; HOSIERY; INFANTS' SHOES AND BOOTS; INFANTWEAR; LINGERIE; NECKWEAR; ROBES; SCARVES; SHAPEWEAR, NAMELY, BODY SHAPERS, BODY SUITS, BRAS, AND GIRDLES; SHIRTS; SHORTS; SLACKS; SLEEPWEAR; SLIPPERS; SOCKS; SWEAT PANTS; SWEAT SHIRTS; SWEATERS; T-SHIRTS; UNDERGARMENTS; WOMEN'S ATHLETIC TOPS WITH BUILT-IN BRAS (U.S. CLS. 22 AND 39).

LIEF MARTIN, EXAMINING ATTORNEY

SN 85-812,311. THE KING'S COLLEGE, NEW YORK, NY. FILED 12-28-2012.

**King's Worldwide**

THE MARK CONSISTS OF STANDARD CHARACTERS WITHOUT CLAIM TO ANY PARTICULAR FONT, STYLE, SIZE, OR COLOR.

NO CLAIM IS MADE TO THE EXCLUSIVE RIGHT TO USE "WORLDWIDE", APART FROM THE MARK AS SHOWN.

**CLASS 9—ELECTRICAL AND SCIENTIFIC APPARATUS**

FOR EDUCATIONAL SOFTWARE FEATURING COLLEGE LEVEL INSTRUCTION IN THE FIELD OF PHILOSOPHY, POLITICS, ECONOMICS, BUSINESS ADMINISTRATION, MEDIA, THE ARTS AND OTHER SUBJECTS (U.S. CLS. 21, 23, 26, 36 AND 38).

**CLASS 41—EDUCATION AND ENTERTAINMENT**

FOR EDUCATIONAL SERVICES, NAMELY, PROVIDING ON-LINE COLLEGE COURSES IN THE FIELD OF PHILOSOPHY, POLITICS, ECONOMICS, BUSINESS ADMINISTRATION, MEDIA, THE ARTS AND OTHER SUBJECTS; EDUCATIONAL SERVICES, NAMELY, PROVIDING ONLINE COURSES OF INSTRUCTION AT THE COLLEGE LEVEL AND DISTRIBUTION OF COURSE MATERIAL IN CONNECTION THEREWITH; EDUCATIONAL SERVICES, NAMELY, PROVIDING ONLINE INSTRUCTION IN THE FIELD OF PHILOSOPHY, POLITICS, ECONOMICS, BUSINESS ADMINISTRATION, MEDIA, THE ARTS AND OTHER SUBJECTS VIA AN ONLINE WEBSITE (U.S. CLS. 100, 101 AND 107).

SIDDHARTH JAGANNATHAN, EXAMINING ATTORNEY

SN 85-816,884. ARGUS MEDIA LIMITED, LONDON, UNITED KINGDOM, FILED 1-7-2013.

**DEWITT**

THE MARK CONSISTS OF STANDARD CHARACTERS WITHOUT CLAIM TO ANY PARTICULAR FONT, STYLE, SIZE, OR COLOR.

PRIORITY CLAIMED UNDER SEC. 44(D) ON ERPN CMNTY TM OFC APPLICATION NO. 011066743, FILED 7-24-2012, REG. NO. 011066743, DATED 12-20-2012, EXPIRES 7-24-2022.

SEC. 2(F).

**CLASS 9—ELECTRICAL AND SCIENTIFIC APPARATUS**

FOR DOWNLOADABLE ELECTRONIC PUBLICATIONS, NAMELY, NEWSLETTERS, BULLETINS AND REPORTS RELATING TO THE FIELDS OF PETROCHEMICALS AND ENERGY; ELECTRONIC PUBLICATIONS, NAMELY, NEWSLETTERS, BULLETINS AND REPORTS RELATING TO THE FIELDS OF PETROCHEMICALS AND ENERGY, RECORDED ON COMPUTER MEDIA; COMPUTER SOFTWARE AND PROGRAMS FOR USE IN DATABASE ACCESS, INTERACTIVE DISPLAY AND ON-LINE INFORMATION STORAGE AND RETRIEVAL (U.S. CLS. 21, 23, 26, 36 AND 38).

**CLASS 16—PAPER GOODS AND PRINTED MATTER**

FOR PRINTED MATTER, NAMELY, REPORTS, CONFERENCE DOCUMENTATION MATERIAL RELATING TO THE FIELDS OF PETROCHEMICALS AND ENERGY; PRINTED PUBLICATIONS, NAMELY, NEWSLETTERS, BULLETINS AND REPORTS RELATING TO THE FIELDS OF PETROCHEMICALS AND ENERGY; PRINTED INSTRUCTIONAL AND EDUCATIONAL MATERIALS RELATING TO THE FIELDS OF PETROCHEMICALS AND ENERGY; PRINTED TEACHING MATERIALS FOR INFORMATION RELATING TO THE FIELDS OF PETROCHEMICALS AND ENERGY (U.S. CLS. 2, 5, 22, 23, 29, 37, 38 AND 50).

**CLASS 35—ADVERTISING AND BUSINESS**

FOR PROVISION OF ONLINE BUSINESS AND COMMERCIAL INFORMATION; PROVISION OF BUSINESS FUNDAMENTALS DATA INFORMATION AND COMMERCIAL FUNDAMENTALS DATA INFORMATION; BUSINESS RESEARCH; BUSINESS INVESTIGATIONS; BUSINESS RESEARCH AND ANALYSIS; MARKET RESEARCH AND ANALYSIS; COMPILATION AND PREPARATION OF STATISTICAL INFORMATION; PROVISION OF BUSINESS DATA INCLUDING VIA AN ON-LINE WEBSITE; BUSINESS DATA RETRIEVAL SERVICES, NAMELY, MARKET RESEARCH AND BUSINESS INTELLIGENCE SERVICES (U.S. CLS. 100, 101 AND 102).

**CLASS 36—INSURANCE AND FINANCIAL**

FOR FINANCIAL ADVISORY AND CONSULTING SERVICES, NAMELY, PROVIDING PRICING INFORMATION SERVICES RELATING TO THE FIELDS OF PETROCHEMICALS AND ENERGY; FINANCIAL ADVISORY AND CONSULTING SERVICES, NAMELY, PROVIDING PRICING INFORMATION IN THE NATURE OF PRICING GUIDELINES AND PRICE QUOTATIONS RELATING TO THE FIELDS OF PETROCHEMICALS AND ENERGY; FINANCIAL ADVISORY AND CONSULTING SERVICES, NAMELY, CREATION, ASSESSMENT, QUOTATION AND PROVISION OF PRICES AND INDICES RELATING TO THE FIELDS OF PETROCHEMICALS AND ENERGY; FINANCIAL ADVISORY AND CONSULTING SERVICES, NAMELY, PRICING SERVICES, IN THE NATURE OF PROVIDING SPOT AND AVERAGE DAILY PRICE INDICES RELATING TO THE FIELDS OF PETROCHEMICALS AND ENERGY; PROVISION OF NUMERIC PRICE DATA VIA AN ON-LINE WEBSITE RELATING TO THE FIELDS OF PETROCHEMICALS AND ENERGY; FINANCIAL INFORMATION SERVICES; PROVISION OF FUNDAMENTALS DATA IN THE FIELD OF COMMODITIES (U.S. CLS. 100, 101 AND 102).

**CLASS 38—COMMUNICATION**

FOR ELECTRONIC TRANSMISSION AND COMMUNICATION OF INFORMATION, IMAGES AND DATA, TRANSMISSION OF STATISTICS, INDEX FIGURES, COMMODITY PRICES AND OTHER ECONOMIC DATA; STREAMING OF AUDIO AND VISUAL CONTENT VIA TELECOMMUNICATIONS NETWORKS AND THE INTERNET; PROVIDING ACCESS TO COMPUTER DATABASES (U.S. CLS. 100, 101 AND 104).

**CLASS 41—EDUCATION AND ENTERTAINMENT**

FOR EDUCATIONAL, TEACHING AND TRAINING SERVICES, NAMELY, PRESENTATIONS, CONFERENCES, SEMINARS AND FORUMS RELATING TO THE FIELDS OF PETROCHEMICALS AND ENERGY; PROVIDING PODCASTS RELATING TO PETROCHEMICALS AND ENERGY; ARRANGING AND CONDUCTING OF CONFERENCES AND SEMINARS RELATING TO THE FIELDS OF PETROCHEMICALS AND ENERGY; PUBLISHING OF NEWSLETTERS, BULLETINS AND REPORTS; PUBLICATION OF PRINTED NEWSLETTERS, BULLETINS AND REPORTS AND ALSO PUBLICATION OF ELECTRONIC NEWSLETTERS, ELECTRONIC BULLETINS, AND ELECTRONIC REPORTS; PUBLICATION OF STATISTICS AND INDEX FIGURES; PROVIDING ON-LINE NON-DOWNLOADABLE PUBLICATIONS, NAMELY, NEWSLETTERS, BULLETINS, REPORTS RELATING TO THE FIELDS OF PETROCHEMICALS AND ENERGY; NEWS REPORTING IN THE NATURE OF CURRENT EVENT REPORTING; ARRANGING AND CONDUCTING OF WEBINARS RELATING TO THE FIELDS OF PETROCHEMICALS AND ENERGY; PROVIDING PODCASTS AND ON-LINE PRESENTATIONS RELATING TO THE FIELDS OF PETROCHEMICALS AND ENERGY (U.S. CLS. 100, 101 AND 107).

**CLASS 42—SCIENTIFIC AND COMPUTER SERVICES**

FOR PROVIDING TEMPORARY USE OF ON-LINE NON-DOWNLOADABLE SOFTWARE FOR USE IN INTERROGATING DATABASES OF BUSINESS AND FINANCIAL INFORMATION (U.S. CLS. 100 AND 101).  
JORDAN BAKER, EXAMINING ATTORNEY

---

SN 85-818,536. KUATRO, LLC, SAN DIEGO, CA. FILED 1-8-2013.

# Craving Cool

THE MARK CONSISTS OF STANDARD CHARACTERS WITHOUT CLAIM TO ANY PARTICULAR FONT, STYLE, SIZE, OR COLOR.

**CLASS 8—HAND TOOLS**

FOR KNIVES, FORKS, AND SPOONS (U.S. CLS. 23, 28 AND 44).

**CLASS 21—HOUSEWARES AND GLASS**

FOR UTENSILS, NAMELY, SERVING SPOONS, SPOON RESTS, SERVING FORKS; VASES; CANDLE-HOLDERS; PLATES; CUPS; SCULPTURES MADE OF CERAMIC (U.S. CLS. 2, 13, 23, 29, 30, 33, 40 AND 50).  
GISELLE AGOSTO, EXAMINING ATTORNEY

---

SN 85-819,889. SNAPPOST, INC., SANTA CRUZ, CA. FILED 1-10-2013.

# SNAPPOST

THE MARK CONSISTS OF STANDARD CHARACTERS WITHOUT CLAIM TO ANY PARTICULAR FONT, STYLE, SIZE, OR COLOR.

**CLASS 9—ELECTRICAL AND SCIENTIFIC APPARATUS**

FOR SOFTWARE FOR DIRECTING AND ASSISTING A USER IN CAPTURING DIGITIZED IMAGE VIEW OF PERSONS, PHYSICAL OBJECTS OR LOCALES WITH A MOBILE COMMUNICATIONS DEVICE OR A DIGITAL CAMERA; SOFTWARE FOR ORGANIZING, ARCHIVING AND CURATING DIGITIZED IMAGES OF PHYSICAL OBJECTS; SOFTWARE PLATFORM FOR VIDEO CAPTURE AND IMAGE RECOGNITION OF PHYSICAL OBJECTS; MOBILE DEVICE APPLICATIONS SOFTWARE ADAPTED FOR VIDEO CAPTURE AND IMAGE RECOGNITION OF PHYSICAL OBJECTS ARCHIVING AND CURATING DIGITIZED IMAGES OF PHYSICAL OBJECTS (U.S. CLS. 21, 23, 26, 36 AND 38).



**CLASS 42—SCIENTIFIC AND COMPUTER SERVICES**

FOR SOFTWARE AS A SERVICE (SAAS) FEATURING COMPUTER SOFTWARE FOR CURATING LIBRARIES OF DIGITIZED IMAGES; SOFTWARE AS A SERVICE (SAAS) FEATURING COMPUTER SOFTWARE FOR ENABLING ACCESS TO COMPUTER DATABASES CONTAINING INFORMATION REGARDING PHYSICAL OBJECTS; WEB SERVICE FOR ENABLING DONATING RECYCLING, REUSING, SELLING, RESELLING, RENTING, LOANING AND BORROWING OF PHYSICAL OBJECTS; SOFTWARE AS A SERVICE (SAAS) FEATURING COMPUTER SOFTWARE FOR PROVIDING AND SUPPORTING SOCIAL NETWORKING AND RELATED COMMUNICATIONS SERVICES BY STORING AND TRANSMITTING DIGITIZED IMAGES OF PHYSICAL OBJECTS; SOFTWARE AS A SERVICE (SAAS) FEATURING COMPUTER SOFTWARE FOR GENERATING AND POSTING IMAGES AND INFORMATION RELATED TO OR DESCRIBING THE NATURE, HISTORY AND ATTRIBUTES OF A PHYSICAL OBJECT; AND SOFTWARE AS A SERVICE (SAAS) FEATURING COMPUTER SOFTWARE ADAPTED TO AUTOMATICALLY GENERATE AND IMPLEMENT ECOMMERCE ADVERTISING SALES AND MARKETING PROCESSES AND CAMPAIGNS (U.S. CLS. 100 AND 101).

MICHAEL KEATING, EXAMINING ATTORNEY

**CLASS 38—COMMUNICATION**

FOR PROVIDING ONLINE, MOBILE AND DIGITAL HEALTH AND MEDICAL INFORMATION FOR CONSUMERS, PATIENTS AND CAREGIVERS IN THE FIELD OF MEDICAL AND HEALTH PRODUCTS, NAMELY, TRANSMISSION OF HEALTH AND MEDICAL INFORMATION BY ELECTRONIC COMMUNICATIONS NETWORKS, HEALTH AND MEDICAL INFORMATION TRANSMISSION SERVICES VIA DIGITAL NETWORKS (U.S. CLS. 100, 101 AND 104).

**CLASS 42—SCIENTIFIC AND COMPUTER SERVICES**

FOR SCIENTIFIC AND TECHNOLOGICAL SERVICES, NAMELY, PROVIDING SCIENTIFIC ANALYSIS AND SCIENTIFIC TESTING IN THE WELLNESS AND MEDICAL FIELDS; DESIGN AND DEVELOPMENT OF COMPUTER SOFTWARE IN THE WELLNESS AND MEDICAL FIELDS (U.S. CLS. 100 AND 101).

**CLASS 44—MEDICAL, BEAUTY AND AGRICULTURAL SERVICES**

FOR PROVIDING ONLINE, MOBILE AND DIGITAL HEALTH AND MEDICAL INFORMATION FOR CONSUMERS, PATIENTS AND CAREGIVERS IN THE FIELD OF MEDICAL AND HEALTH SERVICES AND PRODUCTS (U.S. CLS. 100 AND 101).

HAI-LY LAM, EXAMINING ATTORNEY

SN 85-820,182. WITHINGS INC., SAN FRANCISCO, CA. FILED 1-10-2013.



Baby Companion

NO CLAIM IS MADE TO THE EXCLUSIVE RIGHT TO USE "BABY", APART FROM THE MARK AS SHOWN.

THE COLOR(S) PINK, LIGHT PINK, WHITE AND BLUE IS/ARE CLAIMED AS A FEATURE OF THE MARK.

THE MARK CONSISTS OF THE WORDING "BABY COMPANION" IN BLUE APPEARING TO THE RIGHT OF A PINK AND LIGHT PINK ROUNDED SQUARE CONTAINING A DESIGN OF TWO PINK AND LIGHT PINK HUMAN FIGURES OUTLINED IN WHITE AND A DESIGN OF A CHILD IN WHITE.

**CLASS 9—ELECTRICAL AND SCIENTIFIC APPARATUS**

FOR COMPUTER SOFTWARE FOR PROVIDING ONLINE, MOBILE AND DIGITAL HEALTH AND WELLNESS INFORMATION FOR CONSUMERS, PATIENTS AND CAREGIVERS; HEALTH MONITORING SYSTEM COMPRISED OF ELECTRIC SENSORS, MOBILE TELEPHONES, ELECTRONIC COMPUTER HARDWARE, AND COMPUTER SOFTWARE THAT READS AND TRANSMITS DATA TO AND FROM ELECTRIC SENSORS AND FACILITATES COMMUNICATIONS BETWEEN CONSUMERS, PATIENTS AND CAREGIVERS (U.S. CLS. 21, 23, 26, 36 AND 38).

SN 85-821,316. MARATHON PETROLEUM COMPANY LP, FINDLAY, OH. FILED 1-11-2013.



OWNER OF U.S. REG. NOS. 743,273, 1,200,094 AND OTHERS.

THE MARK CONSISTS OF A POLYGON. SEC. 2(F).

**CLASS 4—LUBRICANTS AND FUELS**

FOR FUEL FOR MOTOR VEHICLES, NAMELY, GASOLINE AND DIESEL FUELS (U.S. CLS. 1, 6 AND 15). FIRST USE 11-8-1961; IN COMMERCE 11-8-1961.

**CLASS 37—CONSTRUCTION AND REPAIR**

FOR AUTOMOBILE SERVICE STATION SERVICES; VEHICLE SERVICE STATIONS (U.S. CLS. 100, 103 AND 106).

FIRST USE 8-10-1961; IN COMMERCE 8-10-1961. HAI-LY LAM, EXAMINING ATTORNEY

SN 85-821,673. SONIC CHROME MUSIC, MOORPARK, CA.  
FILED 1-11-2013.

## SONIC CHROME MUSIC

THE MARK CONSISTS OF STANDARD CHARACTERS WITHOUT CLAIM TO ANY PARTICULAR FONT, STYLE, SIZE, OR COLOR.

NO CLAIM IS MADE TO THE EXCLUSIVE RIGHT TO USE "MUSIC", APART FROM THE MARK AS SHOWN.

### CLASS 41—EDUCATION AND ENTERTAINMENT

FOR MUSIC LIBRARY SERVICES AND MUSIC COMPOSITION FOR OTHERS (U.S. CLS. 100, 101 AND 107).  
FIRST USE 12-5-2012; IN COMMERCE 12-12-2012.

### CLASS 45—PERSONAL AND LEGAL SERVICES

FOR LICENSING OF INTELLECTUAL PROPERTY IN THE FIELD OF MUSIC FOR FILM AND TELEVISION (U.S. CLS. 100 AND 101).

FIRST USE 12-5-2012; IN COMMERCE 12-12-2012.  
DAVID C. REIHNER, EXAMINING ATTORNEY

SN 85-823,840. DE BEERS CENTENARY AG, 6000 LUZERN 6, SWITZERLAND, FILED 1-15-2013.



PRIORITY CLAIMED UNDER SEC. 44(D) ON ERPN CMNTY TM OFC APPLICATION NO. 011095221, FILED 8-3-2012, REG. NO. 011095221, DATED 2-20-2013, EXPIRES 8-2-2022.

OWNER OF U.S. REG. NO. 4,324,606.

NO CLAIM IS MADE TO THE EXCLUSIVE RIGHT TO USE "INTERNATIONAL INSTITUTE OF DIAMOND GRADING & RESEARCH", APART FROM THE MARK AS SHOWN.

THE MARK CONSISTS OF THE FANCIFUL DESIGN OF A FACETED CUT DIAMOND SURROUNDED BY A BAND FORMED BY TWO CONCENTRIC SINGLE LINE CIRCLES WITH THE WORDING "INTERNATIONAL INSTITUTE OF DIAMOND GRADING & RESEARCH" INSIDE THE BAND AND RUNNING AROUND THE CIRCUMFERENCE OF THE DIAMOND WITH A SMALL SHADED CIRCLE AT THE BOTTOM OF THE BAND SEPARATING THE WORDS "INTERNATIONAL" AND "RESEARCH".

### CLASS 14—JEWELRY

FOR PRECIOUS METALS AND THEIR ALLOYS; JEWELLERY MADE OF PRECIOUS METALS AND JEWELLERY PLATED WITH PRECIOUS METALS, NAMELY, RINGS, PENDANTS, EARRINGS, NECKLACES, BRACELETS, BANGLES AND CUFFLINKS; JEWELLERY AND IMITATION JEWELLERY; PRECIOUS AND SEMI-PRECIOUS STONES; HOROLOGICAL AND CHRONOMETRIC INSTRUMENTS (U.S. CLS. 2, 27, 28 AND 50).

### CLASS 42—SCIENTIFIC AND COMPUTER SERVICES

FOR INDUSTRIAL ANALYSIS AND RESEARCH SERVICES ALL RELATING TO THE GRADING, IDENTIFICATION, OBSERVATION, MEASURING, TESTING, CHECKING, ANALYSIS, INSPECTION, INSCRIPTION AND CERTIFICATION OF DIAMONDS, JEWELLERY, PRECIOUS AND SEMI-PRECIOUS STONES; DESIGN AND DEVELOPMENT OF COMPUTER HARDWARE AND SOFTWARE ALL RELATING TO THE GRADING, IDENTIFICATION, OBSERVATION, MEASURING, TESTING, CHECKING, ANALYSIS, INSPECTION, INSCRIPTION AND CERTIFICATION OF DIAMONDS, JEWELLERY, PRECIOUS AND SEMI-PRECIOUS STONES; GEMOLOGICAL SERVICES, NAMELY, THE GRADING, IDENTIFICATION, OBSERVATION, MEASURING, TESTING, ANALYSIS, INSPECTION, INSCRIPTION AND CERTIFICATION OF DIAMONDS, JEWELLERY, PRECIOUS AND SEMI-PRECIOUS STONES (U.S. CLS. 100 AND 101).

BARBARA A. GOLD, EXAMINING ATTORNEY

SN 85-828,221. RED TRUCK SUPPLY, INC., FRANKLINVILLE, NC. FILED 1-21-2013.



THE MARK CONSISTS OF THE LETTERS "R", "T" AND "S".

### CLASS 19—NON-METALLIC BUILDING MATERIALS

FOR POULTRY EQUIPMENT, NAMELY, LIGHT TRAPS COMPRISED OF NON-METAL PANELS FOR USE IN POULTRY HOUSES FOR CONTROLLING VENTILATION AND LIGHTING (U.S. CLS. 1, 12, 33 AND 50).

### CLASS 35—ADVERTISING AND BUSINESS

FOR RETAIL STORE SERVICES FEATURING POULTRY PRODUCTION SUPPLIES, FARM SUPPLIES AND HARDWARE FOR FARM AND GENERAL HOUSEHOLD USE; WHOLESALE DISTRIBUTORSHIP AND STORE SERVICES FEATURING POULTRY PRODUCTION SUPPLIES, FARM SUPPLIES AND HARDWARE FOR FARM AND GENERAL HOUSEHOLD USE (U.S. CLS. 100, 101 AND 102).

BRIDGETT SMITH, EXAMINING ATTORNEY

SN 85-828,355. HEARING BUZZ, INC., GARDEN CITY, NY.  
FILED 1-21-2013.



NO CLAIM IS MADE TO THE EXCLUSIVE RIGHT TO USE "HEARING", APART FROM THE MARK AS SHOWN. THE COLOR(S) BLACK, WHITE, GREY AND ORANGE IS/ARE CLAIMED AS A FEATURE OF THE MARK.

THE MARK CONSISTS OF THE PHRASE "HEARING BUZZ" IN A CAPITALIZED, STYLIZED FONT. THE WORD "HEARING" APPEARS IN A CAPITALIZED, STYLIZED, BLACK FONT AND THE GREY OUTLINE OF A WINGED CREATURE WITH ANTENNAS APPEARS ABOVE THE WORD "HEARING". THE WORD "BUZZ" APPEARS IN A CAPITALIZED, STYLIZED, WHITE FONT AND IS SET OVER A STYLIZED ORANGE COLORED CIRCLE.

#### CLASS 9—ELECTRICAL AND SCIENTIFIC APPARATUS

FOR EARPHONES AND HEADPHONES (U.S. CLS. 21, 23, 26, 36 AND 38).  
FIRST USE 7-0-2012; IN COMMERCE 7-0-2012.

#### CLASS 10—MEDICAL APPARATUS

FOR EAR PLUGS FOR NOISE REDUCTION (U.S. CLS. 26, 39 AND 44).  
FIRST USE 7-0-2012; IN COMMERCE 7-0-2012.

#### CLASS 41—EDUCATION AND ENTERTAINMENT

FOR EDUCATION SERVICES, NAMELY, PROVIDING ONLINE BLOGS AND NON-DOWNLOADABLE PUBLICATIONS, NAMELY, ARTICLES, IN THE FIELD OF HEARING (U.S. CLS. 100, 101 AND 107).  
FIRST USE 7-0-2012; IN COMMERCE 7-0-2012.  
EUGENIA MARTIN, EXAMINING ATTORNEY

SN 85-828,414. HEARING BUZZ, INC., GARDEN CITY, NY.  
FILED 1-21-2013.

# Hearing Buzz

THE MARK CONSISTS OF STANDARD CHARACTERS WITHOUT CLAIM TO ANY PARTICULAR FONT, STYLE, SIZE, OR COLOR.

NO CLAIM IS MADE TO THE EXCLUSIVE RIGHT TO USE "HEARING", APART FROM THE MARK AS SHOWN.

#### CLASS 9—ELECTRICAL AND SCIENTIFIC APPARATUS

FOR EARPHONES AND HEADPHONES (U.S. CLS. 21, 23, 26, 36 AND 38).  
FIRST USE 7-0-2012; IN COMMERCE 7-0-2012.

#### CLASS 10—MEDICAL APPARATUS

FOR EAR PLUGS FOR NOISE REDUCTION (U.S. CLS. 26, 39 AND 44).  
FIRST USE 7-0-2012; IN COMMERCE 7-0-2012.

#### CLASS 41—EDUCATION AND ENTERTAINMENT

FOR EDUCATION SERVICES, NAMELY, PROVIDING ONLINE BLOGS AND NON-DOWNLOADABLE PUBLICATIONS, NAMELY, ARTICLES, IN THE FIELD OF HEARING (U.S. CLS. 100, 101 AND 107).  
FIRST USE 7-0-2012; IN COMMERCE 7-0-2012.  
EUGENIA MARTIN, EXAMINING ATTORNEY

SN 85-829,391. NIOWAVE, INC., LANSING, MI. FILED 1-22-2013.

# NIOWAVE

THE MARK CONSISTS OF STANDARD CHARACTERS WITHOUT CLAIM TO ANY PARTICULAR FONT, STYLE, SIZE, OR COLOR.

#### CLASS 9—ELECTRICAL AND SCIENTIFIC APPARATUS

FOR PARTICLE ACCELERATORS (U.S. CLS. 21, 23, 26, 36 AND 38).  
FIRST USE 1-31-2006; IN COMMERCE 1-31-2006.

#### CLASS 42—SCIENTIFIC AND COMPUTER SERVICES

FOR SCIENTIFIC RESEARCH AND DEVELOPMENT (U.S. CLS. 100 AND 101).  
STEVEN R. FINE, EXAMINING ATTORNEY

SN 85-829,557. PAGE'S PRODUCE COMPANY, DBA LA MEXICANA FOOD PRODUCTS / CROWERS MARKET-ING, VERNON, CA. FILED 1-22-2013.



OWNER OF U.S. REG. NO. 1,720,481.

THE MARK CONSISTS OF THE WORDS "LA MEXICANA" AND A DESIGN OF A CIRCLE CONTAINING A SILHOUETTE OF A ROOSTER IN FRONT OF A SUN WITH RAYS.

THE ENGLISH TRANSLATION OF THE WORD "LA MEXICANA" IN THE MARK IS "THE MEXICAN WOMAN".

#### CLASS 29—MEATS AND PROCESSED FOODS

FOR GUACAMOLE; SNACK DIPS (U.S. CL. 46).  
FIRST USE 2-23-1983; IN COMMERCE 4-22-1983.

**CLASS 30—STAPLE FOODS**

FOR SALSA (U.S. CL. 46).  
FIRST USE 2-23-1983; IN COMMERCE 4-22-1983.  
SUSAN RICHARDS, EXAMINING ATTORNEY

SN 85-830,284. RED HORSE RACING II, LLC, MOORESVILLE, NC. FILED 1-23-2013.



NO CLAIM IS MADE TO THE EXCLUSIVE RIGHT TO USE "RACING", APART FROM THE MARK AS SHOWN.

THE MARK CONSISTS OF A HORSE HEAD WITH "RED HORSE RACING" UNDERNEATH THE HEAD IN A STYLIZED FONT WITH A CIRCLE PARTIALLY ENCLOSING THE HEAD AND THE WORDS.

**CLASS 16—PAPER GOODS AND PRINTED MATTER**

FOR PRINTED MATERIAL, NAMELY, BROCHURES, MAGAZINES, NEWSLETTERS, PAMPHLETS, SOUVENIR PROGRAMS, COMMEMORATIVE SHEETS OF TRADING CARDS IN THE FIELD OF AUTOMOBILE RACING; DECALS, MOUNTED AND UNMOUNTED PHOTOGRAPHS, ART PRINTS, PHOTOGRAPHIC PRINTS, LIMITED EDITION PICTORIAL PRINTS, LITHOGRAPHIC PRINTS, PAPER MAGAZINE COVERS, DECALS FOR MODEL CARS, TRADING CARDS, FRAMED TRADING CARDS, WINDOW DECALS, AND TRADING CARDS MADE OF NON-PRECIOUS METAL (U.S. CLS. 2, 5, 22, 23, 29, 37, 38 AND 50).

FIRST USE 2-1-2007; IN COMMERCE 2-1-2007.

**CLASS 25—CLOTHING**

FOR CLOTHING MARKETED AS GOODS ASSOCIATED WITH A STOCK CAR RACING TEAM, NAMELY, BUTTON DOWN COLLAR SHIRTS, CREW NECK SHIRTS, GOLF SHIRTS, HATS, CAPS, JACKETS, JERSEYS, PANTS, SPORT SHIRTS, POLO SHIRTS, PULLOVER SHIRTS, LONG PANTS, SWEATPANTS, SWEATSHIRTS, T-SHIRTS, TOBOGGAN-TYPE KNIT CAPS, PANTS, TROUSERS, VISORS, COATS, RAINCOATS, PONCHOS, REPLICAS DRIVER SUITS, REPLICAS DRIVER HELMETS (U.S. CLS. 22 AND 39).

FIRST USE 2-1-2007; IN COMMERCE 2-1-2007.

**CLASS 28—TOYS AND SPORTING GOODS**

FOR MINIATURE TOYS, NAMELY, AUTOMOBILES, AUTOMOBILE HOODS, TRUCKS, RADIO-CONTROLLED TOY CARS AND TRUCKSTOY MODEL AUTOMOBILES; TOY ACTION FIGURES; MINIATURE RACING HELMETS; TOY REPLICAS CAR AND TRUCK SIDE PORTIONS OF PLASTIC, TOY REPLICAS CAR AND TRUCK FRONT END PORTIONS MADE OF PLASTIC, TOY REPLICAS HOODS OF PLASTIC, TOY REPLICAS TRUNK LIDS OF PLASTIC; TOY CARS OF PLASTIC AND METAL, TOY VEHICLE HAULERS, TOY MODEL CARS AND RELATED ACCESSORIES SOLD AS A UNIT, TOY TRUCKS, MINIATURE TOY HELMETS, DIECAST TOY CARS, AND DIECAST TOY VEHICLE HAULERS (U.S. CLS. 22, 23, 38 AND 50).

FIRST USE 2-1-2007; IN COMMERCE 2-1-2007.

**CLASS 41—EDUCATION AND ENTERTAINMENT**

FOR ENTERTAINMENT SERVICES IN THE NATURE OF PARTICIPATING IN PROFESSIONAL AUTOMOBILE RACES AND AUTO RACING EXHIBITIONS (U.S. CLS. 100, 101 AND 107).

FIRST USE 2-1-2007; IN COMMERCE 2-1-2007.

JACLYN KIDWELL WALKER, EXAMINING ATTORNEY

SN 85-830,356. RED HORSE RACING II, LLC, MOORESVILLE, NC. FILED 1-23-2013.



THE MARK CONSISTS OF A BLOCK NUMBER "7" INSIDE A SQUARE.

**CLASS 16—PAPER GOODS AND PRINTED MATTER**

FOR PRINTED MATERIAL, NAMELY, BROCHURES, MAGAZINES, NEWSLETTERS, PAMPHLETS, SOUVENIR PROGRAMS, COMMEMORATIVE SHEETS OF TRADING CARDS IN THE FIELD OF AUTOMOBILE RACING; DECALS, MOUNTED AND UNMOUNTED PHOTOGRAPHS, ART PRINTS, PHOTOGRAPHIC PRINTS, LIMITED EDITION PICTORIAL PRINTS, LITHOGRAPHIC PRINTS, PAPER MAGAZINE COVERS, DECALS FOR MODEL CARS, TRADING CARDS, FRAMED TRADING CARDS, WINDOW DECALS, AND TRADING CARDS MADE OF NON-PRECIOUS METAL (U.S. CLS. 2, 5, 22, 23, 29, 37, 38 AND 50).

FIRST USE 2-1-2010; IN COMMERCE 2-1-2010.

**CLASS 25—CLOTHING**

FOR CLOTHING MARKETED AS GOODS ASSOCIATED WITH A STOCK CAR RACING TEAM, NAMELY, SHIRTS AND APPAREL IN THE NATURE OF SHIRTS, T-SHIRTS AND HATS (U.S. CLS. 22 AND 39).

FIRST USE 2-1-2010; IN COMMERCE 2-1-2010.

**CLASS 28—TOYS AND SPORTING GOODS**

FOR MINIATURE TOYS, NAMELY, AUTOMOBILES, AUTOMOBILE HOODS, TRUCKS, RADIO-CONTROLLED TOY CARS AND TRUCKSTOY MODEL AUTOMOBILES; TOY ACTION FIGURES; MINIATURE RACING HELMETS; TOY REPLICAS CAR AND TRUCK SIDE PORTIONS OF PLASTIC, TOY REPLICAS CAR AND TRUCK FRONT END PORTIONS MADE OF PLASTIC, TOY REPLICAS HOODS OF PLASTIC, TOY REPLICAS TRUNK LIDS OF PLASTIC; TOY CARS OF PLASTIC AND METAL, TOY VEHICLE HAULERS, TOY MODEL CARS AND RELATED ACCESSORIES SOLD AS A UNIT, TOY TRUCKS, MINIATURE TOY HELMETS, DIECAST TOY CARS, AND DIECAST TOY VEHICLE HAULERS (U.S. CLS. 22, 23, 38 AND 50).

FIRST USE 2-1-2010; IN COMMERCE 2-1-2010.

**CLASS 41—EDUCATION AND ENTERTAINMENT**

FOR ENTERTAINMENT SERVICES IN THE NATURE OF PARTICIPATING IN PROFESSIONAL AUTOMOBILE RACES AND AUTO RACING EXHIBITIONS (U.S. CLS. 100, 101 AND 107).

FIRST USE 2-1-2010; IN COMMERCE 2-1-2010.  
JACLYN KIDWELL WALKER, EXAMINING ATTORNEY

SN 85-830,796. WORKSTEAD LLC, BROOKLYN, NY. FILED 1-23-2013.

**Workstead**

THE MARK CONSISTS OF STANDARD CHARACTERS WITHOUT CLAIM TO ANY PARTICULAR FONT, STYLE, SIZE, OR COLOR.

**CLASS 11—ENVIRONMENTAL CONTROL APPARATUS**

FOR ELECTRIC LIGHTING FIXTURES; FIXTURES FOR INCANDESCENT LIGHT BULBS (U.S. CLS. 13, 21, 23, 31 AND 34).

FIRST USE 9-1-2009; IN COMMERCE 9-1-2009.

**CLASS 42—SCIENTIFIC AND COMPUTER SERVICES**

FOR INTERIOR DESIGN SERVICES (U.S. CLS. 100 AND 101).

FIRST USE 9-1-2009; IN COMMERCE 9-1-2009.  
REBECCA SMITH, EXAMINING ATTORNEY

SN 85-830,912. RED HORSE RACING II, LLC, MOORESVILLE, NC. FILED 1-24-2013.



THE MARK CONSISTS OF A BLOCK NUMBER "11" INSIDE A SQUARE.

**CLASS 16—PAPER GOODS AND PRINTED MATTER**

FOR PRINTED MATERIAL, NAMELY, BROCHURES, MAGAZINES, NEWSLETTERS, PAMPHLETS, SOUVENIR PROGRAMS, COMMEMORATIVE SHEETS OF TRADING CARDS IN THE FIELD OF AUTOMOBILE RACING; DECALS, MOUNTED AND UNMOUNTED PHOTOGRAPHS, ART PRINTS, PHOTOGRAPHIC PRINTS, LIMITED EDITION PICTORIAL PRINTS, LITHOGRAPHIC PRINTS, PAPER MAGAZINE COVERS, DECALS FOR MODEL CARS, TRADING CARDS, FRAMED TRADING CARDS, WINDOW DECALS AND TRADING CARDS MADE OF NON-PRECIOUS METAL (U.S. CLS. 2, 5, 22, 23, 29, 37, 38 AND 50).

FIRST USE 2-1-2006; IN COMMERCE 2-1-2006.

**CLASS 25—CLOTHING**

FOR CLOTHING MARKETED AS GOODS ASSOCIATED WITH A STOCK CAR RACING TEAM, NAMELY, SHIRTS AND APPAREL IN THE NATURE OF SHIRTS, T-SHIRTS AND HATS (U.S. CLS. 22 AND 39).

FIRST USE 2-1-2006; IN COMMERCE 2-1-2006.

**CLASS 28—TOYS AND SPORTING GOODS**

FOR MINIATURE TOYS, NAMELY, AUTOMOBILES, AUTOMOBILE HOODS, TRUCKS, RADIO-CONTROLLED TOY CARS AND TRUCKSTOY MODEL AUTOMOBILES; TOY ACTION FIGURES; MINIATURE RACING HELMETS; TOY REPLICA CAR AND TRUCK SIDE PORTIONS OF PLASTIC, TOY REPLICA CAR AND TRUCK FRONT END PORTIONS MADE OF PLASTIC, TOY REPLICA HOODS OF PLASTIC, TOY REPLICA TRUNK LIDS OF PLASTIC; TOY CARS OF PLASTIC AND METAL, TOY VEHICLE HAULERS, TOY MODEL CARS AND RELATED ACCESSORIES SOLD AS A UNIT, TOY TRUCKS, MINIATURE TOY HELMETS, DIECAST TOY CARS, AND DIECAST TOY VEHICLE HAULERS (U.S. CLS. 22, 23, 38 AND 50).

FIRST USE 2-1-2006; IN COMMERCE 2-1-2006.

**CLASS 41—EDUCATION AND ENTERTAINMENT**

FOR ENTERTAINMENT SERVICES IN THE NATURE OF PARTICIPATING IN PROFESSIONAL AUTOMOBILE RACES AND AUTO RACING EXHIBITIONS (U.S. CLS. 100, 101 AND 107).

FIRST USE 2-1-2006; IN COMMERCE 2-1-2006.  
JACLYN KIDWELL WALKER, EXAMINING ATTORNEY

SN 85-831,064. THE SAVO GROUP, LTD., CHICAGO, IL. FILED 1-24-2013.

**SMARTER SELLING**

THE MARK CONSISTS OF STANDARD CHARACTERS WITHOUT CLAIM TO ANY PARTICULAR FONT, STYLE, SIZE, OR COLOR.

NO CLAIM IS MADE TO THE EXCLUSIVE RIGHT TO USE "SELLING", APART FROM THE MARK AS SHOWN.

**CLASS 35—ADVERTISING AND BUSINESS**

FOR BUSINESS MANAGEMENT CONSULTING AND ADVISORY SERVICES; BUSINESS MANAGEMENT AND CONSULTING SERVICES IN THE NATURE OF ASSESSING AND IMPROVING THE SALES AND MARKETING PRACTICES OF OTHERS; BUSINESS MANAGEMENT, CONSULTING, AND MARKETING SERVICES IN THE NATURE OF PROVIDING SALES ENABLEMENT AND MARKETING TOOLS TO OTHERS; PROVIDING BUSINESS INTELLIGENCE SERVICES (U.S. CLS. 100, 101 AND 102).

**CLASS 42—SCIENTIFIC AND COMPUTER SERVICES**

FOR ONLINE NON-DOWNLOADABLE CLOUD COMPUTING SOFTWARE FOR ASSESSING AND IMPROVING THE SALES AND MARKETING PRACTICES OF OTHERS; ONLINE NON-DOWNLOADABLE CLOUD COMPUTING SOFTWARE FOR ASSISTING OTHERS WITH SALES ENABLEMENT AND MARKETING; CLOUD COMPUTING SOFTWARE FOR UNDERSTANDING AND PREDICTING CONSUMER ACTIONS, BUSINESS ACTIONS, AND MARKET TRENDS (U.S. CLS. 100 AND 101).

ELIZABETH KAJUBI, EXAMINING ATTORNEY

SN 85-832,017. RED HORSE RACING II, LLC, MOORESVILLE, NC. FILED 1-24-2013.



THE MARK CONSISTS OF A BLOCK NUMBER "17" INSIDE A SQUARE.

SN 85-831,076. NIOWAVE, INC., LANSING, MI. FILED 1-24-2013.



THE MARK CONSISTS OF A SINGLE LINE OUTER CIRCLE. INSIDE THE OUTER CIRCLE IS A SINGLE, SHADED CRESTING WAVE MOVING CLOCKWISE AND FORMING A PARTIAL INNER CIRCLE TO THE RIGHT OF CENTER. WITHIN THE INNER CIRCLE IS THE ATOMIC SYMBOL, CONSISTING OF THREE INTERSECTING OVALS AND A DOT IN THE CENTER.

**CLASS 9—ELECTRICAL AND SCIENTIFIC APPARATUS**

FOR PARTICLE ACCELERATORS (U.S. CLS. 21, 23, 26, 36 AND 38).

FIRST USE 1-31-2006; IN COMMERCE 1-31-2006.

**CLASS 42—SCIENTIFIC AND COMPUTER SERVICES**

FOR SCIENTIFIC RESEARCH AND DEVELOPMENT (U.S. CLS. 100 AND 101).

STEVEN R. FINE, EXAMINING ATTORNEY

**CLASS 16—PAPER GOODS AND PRINTED MATTER**

FOR PRINTED MATERIAL, NAMELY, BROCHURES, MAGAZINES, NEWSLETTERS, PAMPHLETS, SOUVENIR PROGRAMS, COMMEMORATIVE SHEETS OF TRADING CARDS IN THE FIELD OF AUTOMOBILE RACING; DECALS, MOUNTED AND UNMOUNTED PHOTOGRAPHS, ART PRINTS, PHOTOGRAPHIC PRINTS, LIMITED EDITION PICTORIAL PRINTS, LITHOGRAPHIC PRINTS, PAPER MAGAZINE COVERS, DECALS FOR MODEL CARS, TRADING CARDS, FRAMED TRADING CARDS, WINDOW DECALS, AND TRADING CARDS MADE OF NON-PRECIOUS METAL (U.S. CLS. 2, 5, 22, 23, 29, 37, 38 AND 50).

FIRST USE 2-1-2009; IN COMMERCE 2-1-2009.

**CLASS 25—CLOTHING**

FOR CLOTHING MARKETED AS GOODS ASSOCIATED WITH A STOCK CAR RACING TEAM, NAMELY, SHIRTS, HATS AND APPAREL IN THE NATURE OF SHIRTS, T-SHIRTS AND HATS (U.S. CLS. 22 AND 39).

FIRST USE 2-1-2009; IN COMMERCE 2-1-2009.

**CLASS 28—TOYS AND SPORTING GOODS**

FOR MINIATURE TOYS, NAMELY, AUTOMOBILES, AUTOMOBILE HOODS, TRUCKS, RADIO-CONTROLLED TOY CARS AND TRUCKSTOY MODEL AUTOMOBILES; TOY ACTION FIGURES; MINIATURE RACING HELMETS; TOY REPLICAS CAR AND TRUCK SIDE PORTIONS OF PLASTIC, TOY REPLICAS CAR AND TRUCK FRONT END PORTIONS MADE OF PLASTIC, TOY REPLICAS HOODS OF PLASTIC, TOY REPLICAS TRUNK LIDS OF PLASTIC; TOY CARS OF PLASTIC AND METAL, TOY VEHICLE HAULERS, TOY MODEL CARS AND RELATED ACCESSORIES SOLD AS A UNIT, TOY TRUCKS, MINIATURE TOY HELMETS, DIECAST TOY CARS, AND DIECAST TOY VEHICLE HAULERS (U.S. CLS. 22, 23, 38 AND 50).

FIRST USE 2-1-2009; IN COMMERCE 2-1-2009.

**CLASS 41—EDUCATION AND ENTERTAINMENT**

FOR ENTERTAINMENT SERVICES IN THE NATURE OF AUTOMOBILE RACES AND AUTO RACING EXHIBITIONS (U.S. CLS. 100, 101 AND 107).

FIRST USE 2-1-2009; IN COMMERCE 2-1-2009.

JACLYN KIDWELL WALKER, EXAMINING ATTORNEY

SN 85-832,608. NFR INVESTMENTS PTY LTD, THORN-LEIGH NSW 2120, AUSTRALIA, FILED 1-25-2013.

## CREATAPROMOTION

THE MARK CONSISTS OF STANDARD CHARACTERS WITHOUT CLAIM TO ANY PARTICULAR FONT, STYLE, SIZE, OR COLOR.

OWNER OF AUSTRALIA REG. NO. 965623, DATED 8-11-2003, EXPIRES 8-11-2023.

### CLASS 35—ADVERTISING AND BUSINESS

FOR PROCUREMENT AND DISTRIBUTION OF PROMOTIONAL MERCHANDISE FOR OTHERS; PROMOTIONAL MARKETING AGENCY SERVICES; BUSINESS MARKETING AND CONSULTATION SERVICES RELATING TO THE PROMOTION AND ADVERTISING OF THE PRODUCTS AND SERVICES OF OTHERS; DEVELOPING PROMOTIONAL ACTIVITIES FOR BUSINESSES; MARKET RESEARCH AND ANALYSIS SERVICES; PRODUCT MERCHANDISING AND DISPLAY SERVICES; CONDUCTING MARKETING STUDIES; DISTRIBUTION OF PREMIUMS AND PROMOTIONAL MERCHANDISE RELATING TO TOYS, GAMES, AND PLAYTHINGS, STATIONERY, CLOTHING AND HOUSEHOLD ITEMS FOR OR ON BEHALF OF THIRD PARTIES (U.S. CLS. 100, 101 AND 102).

### CLASS 40—MATERIAL TREATMENT

FOR CUSTOM MANUFACTURING FOR OTHERS OF PROMOTIONAL GOODS IN THE NATURE OF TOYS, GAMES AND PLAYTHINGS, CLOTHING, STATIONERY, AND HOUSEHOLD ITEMS (U.S. CLS. 100, 103 AND 106).

JORDAN BAKER, EXAMINING ATTORNEY

SN 85-835,155. ADFORMICS INC., SAN DIEGO, CA. FILED 1-29-2013.

## AdFormics

THE MARK CONSISTS OF STANDARD CHARACTERS WITHOUT CLAIM TO ANY PARTICULAR FONT, STYLE, SIZE, OR COLOR.

### CLASS 9—ELECTRICAL AND SCIENTIFIC APPARATUS

FOR COMPUTER SOFTWARE FOR DISSEMINATING ADVERTISING FOR OTHERS VIA THE INTERNET; COMPUTER PROGRAMS CREATED TO MAKE A VIRTUAL DOOR OR GATEWAY WITH MULTIPLE MONETIZING ELEMENTS INCLUDING TIME CURRENCY, SOCIAL CURRENCY, AND INCENTIVE COST-PER-CLICK (CPC)/COST-PER-ACTION (CPA)/COST-PER-IMPRESSION (CPM) ONLINE ADVERTISING TRANSACTIONS, AND A GATEKEEPER TO DIGITAL CONTENT (U.S. CLS. 21, 23, 26, 36 AND 38).

### CLASS 35—ADVERTISING AND BUSINESS

FOR ADVERTISING AND PROMOTIONAL SERVICES FOR OTHERS VIA THE INTERNET; BUSINESS CONSULTING AND INFORMATION SERVICES; BUSINESS MARKETING SERVICES; BUSINESS MARKETING CONSULTATION, NAMELY, PROVIDING MARKETING RESEARCH AND ANALYSIS SERVICES IN THE FIELD OF ONLINE MARKETING; BUSINESS MARKETING CONSULTATION, NAMELY, PROMOTING THE GOODS AND SERVICES OF OTHERS THROUGH SEARCH ENGINE REFERRAL TRAFFIC ANALYSIS AND REPORTING; BUSINESS MARKETING SERVICES IN THE NATURE OF DEVELOPING ADVERTISEMENTS WHICH ARE DISTRIBUTED VIA THE INTERNET (U.S. CLS. 100, 101 AND 102).

### CLASS 42—SCIENTIFIC AND COMPUTER SERVICES

FOR COMPUTER SOFTWARE INSTALLATION OF INTERNET, MOBILE, AND TABLET SOFTWARE TO BLOCK ACCESS MONETIZING DIGITAL CONTENT; SOFTWARE AS A SERVICE FEATURING SOFTWARE TO MAKE A VIRTUAL DOOR OR GATEWAY WITH MULTIPLE MONETIZING ELEMENTS INCLUDING TIME CURRENCY, SOCIAL CURRENCY, AND INCENTIVE COST-PER-CLICK (CPC)/COST-PER-ACTION (CPA)/COST-PER-IMPRESSION (CPM) TRANSACTIONS, AND A GATEKEEPER TO DIGITAL CONTENT; APPLICATION SERVICE PROVIDER FEATURING SOFTWARE FOR TRACKING WEB SITE ACTIVITY AND MANAGING, MONITORING, TRACKING AND OPTIMIZING THE PERFORMANCE AND EFFECTIVENESS OF WEB SITES, ONLINE MARKETING CAMPAIGNS AND INTERACTIVE USER PERFORMANCE (U.S. CLS. 100 AND 101).

GINA FINK, EXAMINING ATTORNEY

SN 85-839,076. HOWARD, RHEYNARD, HOUSTON, TX. FILED 2-1-2013.

still riding presidential

THE MARK CONSISTS OF STANDARD CHARACTERS WITHOUT CLAIM TO ANY PARTICULAR FONT, STYLE, SIZE, OR COLOR.

### CLASS 9—ELECTRICAL AND SCIENTIFIC APPARATUS

FOR AUDIO AND VIDEO RECORDINGS FEATURING MUSIC (U.S. CLS. 21, 23, 26, 36 AND 38).  
FIRST USE 2-22-2002; IN COMMERCE 2-22-2002.

### CLASS 25—CLOTHING

FOR HATS; PANTS; SHIRTS; SHOES; SOCKS; T-SHIRTS; TIES (U.S. CLS. 22 AND 39).  
FIRST USE 2-22-2002; IN COMMERCE 2-22-2002.  
SHAILA LEWIS, EXAMINING ATTORNEY

SN 85-839,085. LINDA NGUYEN, FOUNTAIN VALLEY, CA.  
FILED 2-1-2013.

SN 85-841,050. SOULBOTTLES WATER & BEVERAGE  
GMBH, BERLIN, FED REP GERMANY, FILED 2-5-2013.

## LOVE MADE

THE MARK CONSISTS OF STANDARD CHARACTERS WITHOUT CLAIM TO ANY PARTICULAR FONT, STYLE, SIZE, OR COLOR.

### CLASS 18—LEATHER GOODS

FOR LEATHER AND IMITATIONS OF LEATHER, NAMELY, HANDBAGS, WALLETS, CHANGE HOLDERS AND PASSPORT HOLDERS; ANIMAL SKINS, HIDES; TRUNKS, SPORTS BAGS, CARRY-ALL BAGS, DUFFEL BAGS, PURSES, BACKPACKS; UMBRELLAS AND PARASOLS; WALKING STICKS; WHIPS, HARNESS AND SADDLERY (U.S. CLS. 1, 2, 3, 22 AND 41).

### CLASS 25—CLOTHING

FOR CLOTHING, NAMELY, PANTS, SHIRTS, T-SHIRTS, SWEATSHIRTS, HOODIES, DRESSES, SKIRTS, JACKETS, COATS, GLOVES, SCARVES, FOOTWEAR, HEADWEAR (U.S. CLS. 22 AND 39).  
SUNG IN, EXAMINING ATTORNEY

SN 85-840,129. INTELLISERV, LLC, HOUSTON, TX. FILED 2-4-2013.

## INTELLISERV

THE MARK CONSISTS OF STANDARD CHARACTERS WITHOUT CLAIM TO ANY PARTICULAR FONT, STYLE, SIZE, OR COLOR.

OWNER OF U.S. REG. NOS. 2,684,805 AND 4,263,700.

### CLASS 7—MACHINERY

FOR PRODUCTION AND EXPLORATION EQUIPMENT AND MACHINERY FOR USE IN OIL, GAS, OR GEOTHERMAL WELLS, NAMELY, DRILLING JARS, DRILLING THRUSTERS, DRILLING ACCELERATORS, REAMERS, STABILIZERS, CASING RUNNING TOOLS, DOWNHOLE DRILLING MOTORS, DRILL BITS, FISHING TOOLS, COMPLETION TOOLS, AND BLOW OUT PREVENTERS (U.S. CLS. 13, 19, 21, 23, 31, 34 AND 35).

### CLASS 9—ELECTRICAL AND SCIENTIFIC APPARATUS

FOR ELECTRONIC COMPONENTS AND DEVICES, CONTROLLERS, AND COMPUTERS FOR USE IN THE EXPLORATION AND PRODUCTION OF OIL, GAS, AND GEOTHERMAL, NAMELY, CIRCUIT BOARDS, COMMUNICATIONS BOOSTERS, COMMUNICATIONS REPEATERS, SENSORS, NETWORK CONTROLLERS, COAXIAL CABLES, ELECTRICAL CABLES, ELECTRICAL CONNECTORS, ELECTRICAL BALUNS, AND ELECTRICAL TERMINAL BOXES; BATTERY PACKS (U.S. CLS. 21, 23, 26, 36 AND 38).

SANI KHOURI, EXAMINING ATTORNEY

## soulbottles

THE MARK CONSISTS OF STANDARD CHARACTERS WITHOUT CLAIM TO ANY PARTICULAR FONT, STYLE, SIZE, OR COLOR.

OWNER OF ERPN CMNTY TM OFC REG. NO. 011112299,  
DATED 12-12-2012, EXPIRES 8-10-2022.

### CLASS 21—HOUSEWARES AND GLASS

FOR HOUSEHOLD OR KITCHEN UTENSILS AND CONTAINERS, NAMELY, BOTTLES FOR SPARKLING BEVERAGES SOLD EMPTY; HOUSEHOLD OR KITCHEN UTENSILS AND CONTAINERS, NAMELY, PORTABLE PLASTIC CONTAINERS FOR BEVERAGES AND PLASTIC LIDS THEREFOR; HOUSEHOLD OR KITCHEN CONTAINERS FOR THE PREPARATION OF SPARKLING BEVERAGES, NOT OF PRECIOUS METAL OR COATED THEREWITH; HOUSEHOLD OR KITCHEN UTENSILS AND CONTAINERS IN THE NATURE OF GAS PRESSURIZED BEVERAGE SIPHON CONTAINERS, NAMELY, SODA WATER HOLDERS AND GAS CARTRIDGES SOLD EMPTY; DRINKING BOTTLES MADE OF GLASS, METAL OR PLASTIC, SOLD EMPTY; STORAGE BOTTLES MADE OF GLASS, METAL OR PLASTIC SOLD EMPTY; DRINKING GLASSES AND DRINKING CUPS MADE OF PLASTIC, EARTHENWARE, GLASS OR PORCELAIN; COFFEE AND TEA CUPS MADE OF PLASTIC, METAL, EARTHENWARE, GLASS OR PORCELAIN; HOUSEHOLD OR KITCHEN UTENSILS AND CONTAINERS, NAMELY, HOUSEHOLD CONTAINERS FOR FOODS AND BEVERAGES; COMBS; SPONGES, NAMELY, CLEANING SPONGES, SCRUBBING SPONGES, SCOURING SPONGES; BRUSHES, NAMELY, CLEANING BRUSHES FOR HOUSEHOLD USE, DISHWASHING BRUSHES, SCRUBBING BRUSHES, SCOURING BRUSHES, DUSTING BRUSHES; BRUSH-MAKING MATERIALS; ARTICLES FOR CLEANING PURPOSES, NAMELY, CLEANING CLOTHS AND WASHING CLOTHS; STEELWOOL; UNWORKED OR SEMI-WORKED GLASS, EXCEPT GLASS USED IN BUILDING; GLASSWARE, PORCELAIN AND EARTHENWARE NOT INCLUDED IN OTHER CLASSES, NAMELY, REUSABLE DRINKING BOTTLES SOLD EMPTY, AND DRINKING GLASSES, CUPS, BOWLS, JUGS, CARAFES, DISHES; DRINKING FLASKS; BOTTLES SOLD EMPTY; GLASS BEVERAGE WARE; DRINKING HORNS; DRINKING STRAWS; DRINKING CUPS; CUPS AND MUGS (U.S. CLS. 2, 13, 23, 29, 30, 33, 40 AND 50).

### CLASS 32—LIGHT BEVERAGES

FOR BEERS; MINERAL AND AERATED WATERS; NON-ALCOHOLIC BEVERAGES, NAMELY, NON-ALCOHOLIC BEER, DRINKING WATER, SPARKLING WATER, WATER BEVERAGES, SOFT DRINKS, SOFT DRINKS FLAVORED WITH TEA, WHEY BEVERAGES; FRUIT BEVERAGES AND FRUIT JUICES; SYRUPS AND ESSENCES, ALL FOR MAKING NON-ALCOHOLIC BEVERAGES; CONCENTRATES OR POWDERS USED IN THE PREPARATION OF SOFT DRINKS; CONCENTRATES OR POWDERS USED IN THE PREPARATION OF WATER BEVERAGES (U.S. CLS. 45, 46 AND 48).

### CLASS 33—WINES AND SPIRITS

FOR ALCOHOLIC BEVERAGES EXCEPT BEERS (U.S. CLS. 47 AND 49).

ZACHARY CROMER, EXAMINING ATTORNEY



SN 85-841,622. ROSE, BRETT CHARLES, SAN DIEGO, CA. AND CHAMBERS, CHRISTINA NICOLE, SAN DIEGO, CA. FILED 2-5-2013.

## WORLD WIDE WED

THE MARK CONSISTS OF STANDARD CHARACTERS WITHOUT CLAIM TO ANY PARTICULAR FONT, STYLE, SIZE, OR COLOR.

NO CLAIM IS MADE TO THE EXCLUSIVE RIGHT TO USE "WORLD WIDE", APART FROM THE MARK AS SHOWN.

### CLASS 9—ELECTRICAL AND SCIENTIFIC APPARATUS

FOR MULTIMEDIA GOODS, NAMELY, PRERECORDED DVDS AND VIDEO DISKS, DOWNLOADABLE AUDIO AND VIDEO RECORDINGS, DOWNLOADABLE WEBCASTS AND DOWNLOADABLE SOFTWARE APPLICATIONS, ALL ON THE SUBJECT OF AN ONGOING REALITY BASED PROGRAM FEATURING DESTINATION WEDDINGS AROUND THE WORLD AND EMPHASIZING CULTURE, TRAVEL, ADVENTURE, TRADITIONS, LOCAL ATTRACTIONS, CUISINE, AND ACTIVITIES (U.S. CLS. 21, 23, 26, 36 AND 38).  
FIRST USE 9-17-2010; IN COMMERCE 8-29-2011.

### CLASS 41—EDUCATION AND ENTERTAINMENT

FOR ENTERTAINMENT SERVICES IN THE NATURE OF AN ONGOING REALITY BASED PROGRAM FEATURING DESTINATION WEDDINGS IN VARIOUS LOCATIONS AROUND THE WORLD EMPHASIZING TRAVEL, CULTURE, ADVENTURE, TRADITIONS, LOCAL ATTRACTIONS AND CUISINE, ACCESSIBLE BY TELEVISION, INTERNET, COMPUTER NETWORKS, WIRELESS NETWORKS, FIBER OPTIC NETWORKS, AUDIO VIDEO, AND SATELLITE (U.S. CLS. 100, 101 AND 107).

FIRST USE 9-17-2010; IN COMMERCE 8-29-2011.  
DEBORAH LOBO, EXAMINING ATTORNEY

SN 85-841,858. ACHOR & EDEN INC., AUGUSTA, GA. FILED 2-6-2013.

THE MARK CONSISTS OF THE WORDS "THE NOTWEDDING" IN A STYLIZED FONT AND THE DRAWING OF A DOVE FOLLOWING THE WORD "WEDDING".

### CLASS 35—ADVERTISING AND BUSINESS

FOR ADVERTISING AND MARKETING SERVICES, NAMELY, PROMOTING THE GOODS AND SERVICES OF OTHERS INVOLVING EVENTS IN THE FORM OF SIMULATED WEDDING RECEPTIONS (U.S. CLS. 100, 101 AND 102).

FIRST USE 11-0-2008; IN COMMERCE 11-0-2008.

### CLASS 41—EDUCATION AND ENTERTAINMENT

FOR PROVIDING INFORMATION IN THE FIELD OF WEDDING PARTY PLANNING INVOLVING EVENTS IN THE FORM OF SIMULATED WEDDING RECEPTIONS (U.S. CLS. 100, 101 AND 107).

FIRST USE 11-0-2008; IN COMMERCE 11-0-2008.  
JAY BESCH, EXAMINING ATTORNEY

SN 85-841,924. GREENSPRING MEDIA GROUP INC, MINNEAPOLIS, MN. FILED 2-6-2013.

## RSVP MN

THE MARK CONSISTS OF STANDARD CHARACTERS WITHOUT CLAIM TO ANY PARTICULAR FONT, STYLE, SIZE, OR COLOR.

OWNER OF U.S. REG. NO. 3,343,186.

NO CLAIM IS MADE TO THE EXCLUSIVE RIGHT TO USE "MN", APART FROM THE MARK AS SHOWN.

### CLASS 16—PAPER GOODS AND PRINTED MATTER

FOR PERIODICAL PUBLICATIONS, NAMELY, MAGAZINES IN THE FIELD OF ORGANIZING SEMINARS AND CONVENTIONS, AND CONTAINING INFORMATION ABOUT FACILITIES, RESORTS AND CONFERENCE CENTERS (U.S. CLS. 2, 5, 22, 23, 29, 37, 38 AND 50).

FIRST USE 1-0-2013; IN COMMERCE 1-0-2013.

### CLASS 41—EDUCATION AND ENTERTAINMENT

FOR PROVIDING ONLINE MAGAZINES, BLOGS, RESOURCE GUIDES AND INFORMATION OF INTEREST TO PROFESSIONALS IN THE MEETING PLANNING INDUSTRY (U.S. CLS. 100, 101 AND 107).

FIRST USE 1-0-2013; IN COMMERCE 1-0-2013.

GRETCHEN ULRICH, EXAMINING ATTORNEY

SN 85-842,093. STATE GARDEN, INC., CHELSEA, MA. FILED 2-6-2013.

## SIMPLE BEGINNINGS

THE MARK CONSISTS OF STANDARD CHARACTERS WITHOUT CLAIM TO ANY PARTICULAR FONT, STYLE, SIZE, OR COLOR.

### CLASS 29—MEATS AND PROCESSED FOODS

FOR VEGETABLE SALAD MIXES, PRECUT VEGETABLE SALAD MIXES (U.S. CL. 46).

### CLASS 31—NATURAL AGRICULTURAL PRODUCTS

FOR FRESH VEGETABLES (U.S. CLS. 1 AND 46).  
JOHN KELLY, EXAMINING ATTORNEY

SN 85-842,183. VALUE PAYMENT SYSTEMS, LLC, NASHVILLE, TN. FILED 2-6-2013.



NO CLAIM IS MADE TO THE EXCLUSIVE RIGHT TO USE "PROPERTY BILL PAY", APART FROM THE MARK AS SHOWN.

THE MARK CONSISTS OF THE WORDING "PROPERTYBILLPAY" IN STYLIZED FONT, WITH AN OFFICE BUILDING DESIGN WITH WINDOWS ON ONE SIDE AND A US DOLLAR SYMBOL APPEARING ABOVE THE WORDING "BILL" THEREOF.

#### CLASS 36—INSURANCE AND FINANCIAL

FOR ELECTRONIC PAYMENT PROCESSING SERVICES, NAMELY, PROVIDING ELECTRONIC PROCESSING OF ELECTRONIC FUNDS TRANSFER, ACH, CREDIT, DEBIT CARD, ELECTRONIC CHECK AND ELECTRONIC PAYMENTS (U.S. CLS. 100, 101 AND 102). FIRST USE 1-1-2012; IN COMMERCE 1-1-2012.

#### CLASS 42—SCIENTIFIC AND COMPUTER SERVICES

FOR COMPUTER SERVICES, NAMELY, CREATING, HOSTING AND MAINTAINING WEBSITES FOR OTHERS IN THE FIELD OF BILL PRESENTMENTS, APPLICATION PROGRAMMING INTERFACE (API) INTEGRATION WITH OTHER SOFTWARE SERVICE COMPANIES, IN-PERSON POINT-OF-SALE (POS) DEVICES; DESIGN AND DEVELOPMENT OF COMPUTER HARDWARE AND SOFTWARE FOR MOBILE PAYMENTS OF RENTS AND PAYMENTS RELATED TO PROPERTY MANAGEMENT (U.S. CLS. 100 AND 101).

FIRST USE 1-1-2012; IN COMMERCE 1-1-2012.  
DAWN HAN, EXAMINING ATTORNEY

SN 85-842,968. ENDEMOL UK LTD., SHEPHERDS BUSH, LONDON, UNITED KINGDOM, AND ENDEMOL USA INC., LOS ANGELES, CA, AND REALAND PRODUCTIONS LLC, WILMINGTON, DE. FILED 2-6-2013.



PRIORITY CLAIMED UNDER SEC. 44(D) ON BENELUX APPLICATION NO. 1253255, FILED 8-23-2012, REG. NO. 0925317, DATED 10-12-2012, EXPIRES 8-23-2022.

THE COLOR(S) BLUE, GRAY, RED, YELLOW, ORANGE, BROWN, GREEN, WHITE AND BLACK IS/ARE CLAIMED AS A FEATURE OF THE MARK.

THE MARK CONSISTS OF THE WORDING "LOVE IN THE WILD". THE WORDING "LOVE" IS IN RED AND OUTLINED IN BLACK, THE WORDING "IN THE" IS IN YELLOW, AND THE WORDING "WILD" IS IN YELLOW AND ORANGE. THE WORDING IS SUPERIMPOSED ON A

SCENE DEPICTING AN ERUPTING VOLCANO AND WATERFALL WITH PALM FRONDS IN EACH OF THE CORNERS AT THE TOP OF THE MARK. THE SKY IS BLUE WITH WHITE AND GRAY CLOUDS. THE VOLCANO AND SURROUNDING LANDSCAPE IS BROWN AND BLACK WITH WHITE BILLOWING CLOUDS EMANATING FROM THE TOP OF THE VOLCANO AND ORANGE LAVA FLOWING DOWNWARD FROM THE PEAK. THE WATER IN THE WATERFALL IS WHITE AND THE PALM FRONDS AND VEGETATION ARE GREEN AND BLACK.

#### CLASS 9—ELECTRICAL AND SCIENTIFIC APPARATUS

FOR PRE-RECORDED VIDEOTAPES, CD'S, CD-ROMS, DVDS AND MP3S FEATURING TELEVISIONS SHOWS; COMPUTER GAMES SOFTWARE; ELECTRONIC GAMES SOFTWARE; DOWNLOADABLE INTERNET GAMES FOR MOBILE PHONES; COMPUTER GAME SOFTWARE FOR USE ON MOBILE PHONES; DOWNLOADABLE INTERACTIVE AND NON-INTERACTIVE ELECTRONIC PUBLICATIONS, NAMELY, BOOKS, MAGAZINES, AND MANUALS FEATURING MUSIC, CHARACTERS, SCENES AND SITUATIONS RELATING TO A TELEVISION SERIES; DOWNLOADABLE MUSICAL SOUND RECORDINGS AND VIDEOS FEATURING SCENES, CHARACTERS AND SITUATIONS FROM A TELEVISION SERIES VIA THE INTERNET (U.S. CLS. 21, 23, 26, 36 AND 38).

#### CLASS 28—TOYS AND SPORTING GOODS

FOR AUTOMATIC AND COIN-OPERATED AMUSEMENT GAME MACHINES; GAMES AND PLAYTHINGS, NAMELY, ACTION SKILL GAMES; GAMES AND PLAYTHINGS, NAMELY, CARD GAMES, HAND-HELD UNITS FOR PLAYING ELECTRONIC GAMES, BOARD GAMES FEATURING QUESTION AND ANSWERS, BOARD GAMES FOR TESTING INTELLIGENCE, BOARD GAMES IN THE FORM OF PUZZLES, WORD GAMES AND TRIVIA AND GRAMMAR GAMES; ELECTRONIC AMUSEMENT GAMES, NAMELY, ELECTRONIC EDUCATIONAL GAME MACHINES FOR CHILDREN; AMUSEMENT GAME MACHINES AND SLOT MACHINES, ADAPTED FOR USE WITH AN EXTERNAL DISPLAY SCREEN OR MONITOR (U.S. CLS. 22, 23, 38 AND 50).

#### CLASS 41—EDUCATION AND ENTERTAINMENT

FOR EDUCATIONAL AND ENTERTAINMENT SERVICES, NAMELY, PRODUCTION OF TELEVISION AND RADIO PROGRAMS AND ENTERTAINMENT PROGRAMS; PRODUCTION OF ENTERTAINMENT PROGRAMS, NAMELY, TELEVISION MOVIES; PRODUCTION OF THEATRE PRODUCTIONS, NAMELY, STAGE PRODUCTIONS AND MUSICAL PERFORMANCES; ARRANGING AND CONDUCTING MUSICAL EVENTS AND CONCERTS; PROVIDING INFORMATION IN THE FIELD OF RADIO AND TELEVISION PROGRAMS CONTENTS; PROVIDING INFORMATION IN THE FORM OF ARTICLES AND ENTERTAINMENT PROGRAMS FEATURING INFORMATION ABOUT ARTS EDUCATION, LOCAL ENTERTAINMENT AND RECREATION VENUES; ORGANIZATION OF CULTURAL AND RECREATIONAL EVENTS, NAMELY, DANCES AND ART SHOWS; ENTERTAINMENT IN THE NATURE OF LIVE PERFORMANCES BY DANCERS, MUSICIANS AND ACTORS; ARRANGING AND CONDUCTING CONCERT PERFORMANCES; PROVIDING ONLINE COMPUTER GAMES VIA THE INTERNET; ENTERTAINMENT SERVICES PROVIDED VIA THE INTERNET, NAMELY, TELEVISION GAME SHOWS PROVIDED OVER THE INTERNET AND VIA MOBILE TELEPHONES AND OTHER ELECTRONIC MEANS, PROVIDING ON-LINE COMPUTER GAMES, PROVIDING NON-DOWNLOADABLE ELECTRONIC IMAGES AND ARTWORK FROM ON-LINE DATABASES AND VIA THE INTERNET; PROVIDING MUSIC AND AUDIOVISUAL MATERIAL, NAMELY, PHOTOGRAPHS, SHORT VIDEOS AND SHORT MOVIES FOR USE AS RING TONES, SCREENSAVERS AND LOGOS (U.S. CLS. 100, 101 AND 107).

SHARON MEIER, EXAMINING ATTORNEY

SN 85-843,853. THARCO CONTAINERS, INC., BOISE, ID.  
FILED 2-7-2013.

# THARCO

THE MARK CONSISTS OF STANDARD CHARACTERS WITHOUT CLAIM TO ANY PARTICULAR FONT, STYLE, SIZE, OR COLOR.

OWNER OF U.S. REG. NO. 1,725,543.

## CLASS 16—PAPER GOODS AND PRINTED MATTER

FOR CORRUGATED CONTAINERS AND CORRUGATED PAPER; CORRUGATED BOXES; LABELS, NAMELY, LITHO-LAMINATE PAPER LABELS (U.S. CLS. 2, 5, 22, 23, 29, 37, 38 AND 50).

FIRST USE 0-0-1974; IN COMMERCE 0-0-1974.

## CLASS 35—ADVERTISING AND BUSINESS

FOR VENDOR-MANAGED INVENTORY SERVICES, NAMELY, INVENTORY CONTROL AND INVENTORY MANAGEMENT FOR OTHERS (U.S. CLS. 100, 101 AND 102).

FIRST USE 0-0-1974; IN COMMERCE 0-0-1974.

## CLASS 40—MATERIAL TREATMENT

FOR PROTOTYPE FABRICATION OF NEW PRODUCTS FOR OTHERS (U.S. CLS. 100, 103 AND 106).

FIRST USE 0-0-1974; IN COMMERCE 0-0-1974.

## CLASS 42—SCIENTIFIC AND COMPUTER SERVICES

FOR PACKAGING DESIGN, ENGINEERING, TESTING OF NEW PRODUCTS FOR OTHERS; ECOMMERCE SOLUTIONS FOR PRODUCTS DISTRIBUTORS, NAMELY, PROVIDING A WEBSITE FEATURING TECHNOLOGY FOR ELECTRONICALLY MANAGING THE RECEIPT, MANAGEMENT AND FULFILLMENT OF PURCHASE ORDERS OF OTHERS VIA A SERVER HOST ON A GLOBAL COMPUTER NETWORK (U.S. CLS. 100 AND 101).

FIRST USE 2-7-2013; IN COMMERCE 2-7-2013.

JAMES LOVELACE, EXAMINING ATTORNEY

SN 85-843,945. STIRLING POWER, INC., ANN ARBOR, MI.  
FILED 2-7-2013.

# FLEXGEN

THE MARK CONSISTS OF STANDARD CHARACTERS WITHOUT CLAIM TO ANY PARTICULAR FONT, STYLE, SIZE, OR COLOR.

## CLASS 7—MACHINERY

FOR MOTOR AND ENGINES EXCEPT FOR LAND VEHICLES, NAMELY, HEAT ENGINES (U.S. CLS. 13, 19, 21, 23, 31, 34 AND 35).

## CLASS 11—ENVIRONMENTAL CONTROL APPARATUS

FOR SOLAR COLLECTORS FOR COLLECTING HEAT; SOLAR ENERGY RECEIVERS FOR COLLECTING HEAT (U.S. CLS. 13, 21, 23, 31 AND 34).

PAUL CROWLEY, EXAMINING ATTORNEY

SN 85-843,979. STIRLING POWER, INC., ANN ARBOR, MI.  
FILED 2-7-2013.

# SUNCATCHER

THE MARK CONSISTS OF STANDARD CHARACTERS WITHOUT CLAIM TO ANY PARTICULAR FONT, STYLE, SIZE, OR COLOR.

## CLASS 7—MACHINERY

FOR ENGINES AND MOTORS FOR THE GENERATION OF ELECTRICITY; MOTOR AND ENGINES EXCEPT FOR LAND VEHICLES; SOLAR-POWERED ELECTRICITY GENERATORS (U.S. CLS. 13, 19, 21, 23, 31, 34 AND 35).

## CLASS 11—ENVIRONMENTAL CONTROL APPARATUS

FOR SOLAR COLLECTORS; SOLAR ENERGY RECEIVERS (U.S. CLS. 13, 21, 23, 31 AND 34).

PAUL CROWLEY, EXAMINING ATTORNEY

SN 85-843,996. DNS INTERNATIONAL LTD, ROAD TOWN,  
TORTOLA, BR.VIRGIN ISLANDS, FILED 2-7-2013.



OWNER OF ERPN CMNTY TM OFC REG. NO. 11140563,  
DATED 1-22-2013, EXPIRES 8-24-2022.

THE COLOR(S) BLUE, BLACK AND WHITE IS/ARE CLAIMED AS A FEATURE OF THE MARK.

THE MARK CONSISTS OF THE WORDS "MY SOUND VISION" ON A BLACK BACKGROUND WITH THE WORDS "MY" AND "VISION" APPEARING IN WHITE AND THE WORD "SOUND" APPEARING IN BLUE, TO THE RIGHT AND ABOVE THE WORD "VISION" THREE BLUE CRESCENT SHAPES APPEAR.

## CLASS 9—ELECTRICAL AND SCIENTIFIC APPARATUS

FOR OPTICAL FILTERS, CHILDREN'S EDUCATIONAL SOFTWARE, CHILDREN'S EDUCATIONAL MUSIC CDS AND DVDS, COMPUTER GAME SOFTWARE, COMPUTER HARDWARE, DIGITAL AUDIO AND VIDEO RECORDERS AND PLAYERS; APPARATUS FOR RECORDING, TRANSMISSION OR REPRODUCTION OF SOUND OR IMAGES; BLANK MAGNETIC DATA CARRIERS AND RECORDING DISCS; DATA PROCESSING EQUIPMENT AND COMPUTERS; GRAMOPHONE RECORDS FEATURING MUSIC; AMPLIFIERS AND OTHER SOUND-AMPLIFYING APPARATUS, NAMELY, SURROUND SOUND SYS-

TEMS, SOUND AMPLIFIERS, SOUND EQUALIZERS AND CROSSOVERS, SOUND MIXERS, SOUND MIXERS WITH INTEGRATED AMPLIFIERS, SOUND TRANSMITTING APPARATUS; RADIO AND TELEVISION AERIALS; AUDIO-VISUAL TEACHING APPARATUS NAMELY, COMPACT DISC PLAYERS, MULTIMEDIA PROJECTORS, COMPUTER HARDWARE, CHILDREN'S EDUCATIONAL SOFTWARE, CHILDREN'S EDUCATIONAL MUSIC CDS AND DVDS; PERSONAL STEREO; TAPE-RECORDERS; BLANK MAGNETIC TAPES FOR TAPE RECORDERS; BLANK MAGNETIC TAPES; HEAD CLEANING TAPES FOR AUDIO AND VIDEO RECORDER; DEMAGNETIZING APPARATUS FOR MAGNETIC TAPES; ELECTRIC BATTERIES; AUDIO SPEAKER ENCLOSURES; TONE ARMS FOR RECORD PLAYERS; COAXIAL CABLES; ELECTRIC CABLES; FRAMES FOR PHOTOGRAPHIC TRANSPARENCIES, NAMELY, TRANSPARENCY PROJECTION APPARATUS; CINEMATOGRAPHIC CAMERAS; VIDEO CAMERAS; BLANK SMART CARDS, BLANK CARDS WITH MICROPROCESSORS; VIDEO GAME CARTRIDGES; HEADPHONES; BLANK VIDEO CASSETTES; EDITING APPLIANCES FOR CINEMATOGRAPHIC FILMS; EXPOSED CINEMATOGRAPHIC FILM; COMPACT DISCS FEATURING MUSIC, GAMES; OPTICAL COMPACT DISCS FEATURING MUSIC, GAMES; ELECTRIC JUNCTION BOXES; ELECTRIC CONVERTERS; CIRCUIT BREAKERS; SHUTTER RELEASES; DIAPHRAGMS FOR CAMERAS; PHOTOGRAPHIC TRANSPARENCIES; CENTERING APPARATUS FOR PHOTOGRAPHIC TRANSPARENCIES, NAMELY, TRANSPARENCY PROJECTION APPARATUS; SLIDE PROJECTORS; CLEANING APPARATUS FOR SOUND RECORDING DISCS, NAMELY, MAGNETIC HEAD CLEANERS; BLANK MAGNETIC DISKS; OPTICAL DISKS FEATURING COMPUTER GAME PROGRAMS, MUSIC; RECORD PLAYERS; OPTICAL DATA MEDIA, NAMELY, BLANK OPTICAL DISKS; BLANK MAGNETIC DATA MEDIA; VIDEO SCREENS, TOUCH SCREENS, FLAT AND DISPLAY SCREENS, COMPUTER SCREENS, ELECTRONIC DISPLAY SCREENS; PROJECTION SCREENS; FLUORESCENT SCREENS; VIDEO DISPLAYS; SOUND REPRODUCTION AND TRANSMITTER APPARATUS, NAMELY, SOUND RECORDINGS STRIPS IN THE NATURE OF BLANK MAGNETIC WIRES; SOUND RECORDING APPARATUS; PRE-RECORDED SOUND CARRIERS, NAMELY, CDS AND DVDS FEATURING MUSIC; SPOOLS FOR CAMERAS; EXPOSED CINEMATOGRAPHIC FILMS; CINEMATOGRAPHIC FILMS FEATURING ADULTS AND CHILDREN'S ENTERTAINMENT; PHOTOGRAPHY FLASH-BULBS; HIGH-FREQUENCY APPARATUS, NAMELY, HIGH FREQUENCY MOBILE ANTENNAS, HIGH FREQUENCY SWITCHES; LOUDSPEAKERS; DATA-PROCESSING APPARATUS; INTERCOMMUNICATION APPARATUS, NAMELY, CELLULAR PHONES; OPTICAL LANTERNS; CASSETTE PLAYERS; COMPACT DISC PLAYERS; DVD PLAYERS; OPTICAL CHARACTER READERS; MAGNETIC CODED GIFT CARDS; VIDEO RECORDERS; MEGAPHONES; MICROPHONES; OPTICAL OBJECTIVES LENSES FOR CAMERAS; CAMERA SHUTTERS; CAMERAS, DIGITAL CAMERAS; RADIO WIRELESS SETS; RADIOTELEGRAPHY SETS; RADIOTELEPHONY SETS; TELEVISION PROJECTION APPARATUS; RADIO SETS; AUDIO RECEIVERS AND VIDEO RECEIVERS; BLANK MAGNETIC TAPES FOR TAPE RECORDERS AND PLAYERS; NEEDLES FOR RECORD PLAYERS; SOUND TRANSMITTING APPARATUS; TELEVISION APPARATUS; TRANSMITTERS FOR TELECOMMUNICATIONS; DOWNLOADABLE MP3 FILES FEATURING MUSIC, PRE-RECORDED ELECTRONIC MEDIA FEATURING MUSIC, COMPUTER SOFTWARE, NAMELY, COMPUTER GAME SOFTWARE, COMPUTER GRAPHICS SOFTWARE, COMPUTER ANTI-VIRUS SOFTWARE, COMPUTER OPERATING SOFTWARE; COMPUTER SOFTWARE, NAMELY, COMPUTER GAME SOFTWARE, COMPUTER GRAPHICS SOFTWARE, COMPUTER ANTI-VIRUS SOFTWARE, COMPUTER OPERATING SOFTWARE, DOWNLOADABLE FROM THE INTERNET; MP3/MP4 PLAYERS; DOWNLOADABLE ELECTRONIC PUBLICATIONS IN THE NATURE OF BOOKS, MAGAZINES, MANUALS IN THE FIELD OF SOFTWARE, TECHNOLOGY, GAMES AND MUSIC; DIGITAL MUSIC DOWNLOADABLE FROM THE INTERNET; PRE-RECORDED AUDIO TAPES, VIDEOTAPES, DISCS AND CASSETTES FEATURING MUSIC AND CINEMATOGRAPHIC FILMS, PRERECORDED DIGITAL AUDIO CASSETTE TAPES, AUDIO AND VIDEO TAPES, CD DISCS, DVDS,

LASER DISCS FEATURING MUSIC AND CINEMATOGRAPHIC FILMS; AUDIO AND VIDEO RECORDINGS FEATURING MUSIC AND CINEMATOGRAPHIC FILMS; VIRTUAL REALITY GAME SOFTWARE; MUSIC, VIDEOS AND RING TONES AND MP3 FILES FEATURING MUSIC, GRAPHICS DOWNLOADABLE VIA A GLOBAL COMPUTER NETWORK TO COMPUTERS AND WIRELESS DEVICES; COMPUTER GAMES IN THE FIELD OF ARTWORK AND GAMES DOWNLOADABLE VIA A GLOBAL COMPUTER NETWORK AND WIRELESS DEVICES; DOWNLOADABLE IMAGES IN THE FIELD OF ARTWORK AND GAMES FOR WIRELESS DEVICES; VIDEO GAMES PROGRAMS, TAPES, CARTRIDGES AND CASSETTES; CELL PHONES AND CELL PHONE ACCESSORIES, NAMELY, CELL PHONE BATTERY CHARGERS FOR USE IN VEHICLES, CELL PHONE BATTERY CHARGERS, HEADSETS, CELL PHONE CASES; VIDEO CAMERAS; DIGITAL CAMERAS; BLANK HARD DISKS FOR COMPUTERS; PORTABLE MULTIMEDIA PLAYERS; COMPUTER MONITORS, VIDEO MONITORS; TELEVISIONS; DECODERS, NAMELY, AUDIO DECODERS, VIDEO DECODERS, TELEVISION DECODERS; WIRELESS HAND-FREE EARPHONES; VEHICLE RADIOS; ACCESSORIES FOR TELEPHONES, NAMELY, WIRED HEADSETS; HEADPHONES; CHARGERS FOR MOBILE PHONES; HI-FI SYSTEMS, NAMELY, SOUND SYSTEMS COMPRISING REMOTE CONTROLS; ACCESSORIES FOR DIGITAL APPARATUS, NAMELY, MEMORY CARDS, DOCKING STATIONS; PLAYERS FOR PRE-RECORDED OPTICAL DISCS; ACCESSORIES FOR MOBILE TELEPHONY, NAMELY, HANDS-FREE KITS FOR PHONES, CELLULAR ADAPTORS, WIRELESS MICROPHONES, COVERS FOR MOBILE TELEPHONES, PORTABLE TELEPHONE HOLDERS (U.S. CLS. 21, 23, 26, 36 AND 38).

#### **CLASS 20—FURNITURE AND ARTICLES NOT OTHERWISE CLASSIFIED**

FOR CABINETS AND FURNITURE FOR AUDIO AND AUDIO VISUAL EQUIPMENT, APPARATUS AND INSTRUMENTS, HI-FI EQUIPMENT, COMPACT DISCS, DVDS AND DATA CARRIERS; COMPARTMENTALIZED FURNITURE FOR THE STORAGE OF CDS; TABLES DESIGNED FOR HOLDING ELECTRIC AND ELECTRONIC APPARATUS; TELEVISION TABLES; DISPLAY BOARDS; FURNITURE; CABINETS; CHESTS, NOT OF METAL; BENCHES; LIBRARY BOOKSHELVES; LIBRARY SHELVES; FURNITURE PARTITIONS OF WOOD; DECORATIVE BOXES OF WOOD OR PLASTIC; SIDEBOARDS; DINNER WAGONS; OFFICE FURNITURE; DESKS; CHESTS, NOT OF METAL; INDEX CABINETS; SERVING TROLLEYS; SHELVES FOR FILING-CABINETS; DISPLAY CASES, NOT OF METAL; FURNITURE CHESTS; CHESTS OF DRAWERS; DISPLAY COUNTERS; STORAGE CONTAINERS, NOT OF METAL; TEACARTS; DRAUGHTMAN'S TABLES; PACKAGING CONTAINERS OF PLASTIC; SIGNBOARDS OF WOOD OR PLASTICS; SHELVES; INDEX CABINETS; NEWSPAPER DISPLAY STANDS; BOOK CASES; OFFICE FURNITURE; FURNITURE FITTINGS, NOT OF METAL; FURNITURE OF METAL; DOORS FOR FURNITURE; FURNITURE SHELVES; NON-METALLIC FURNITURE CASTERS; SCHOOL FURNITURE; SCREENS; TABLE TOPS; BOOK CASES; MAGAZINE RACKS; DISPLAY STANDS; STORAGE RACKS; FURNITURE SHELVES; TABLES; TABLES OF METAL; TABLE TOPS; DESK STORAGE UNITS, NAMELY, CABINETS; LOCKERS; TRESTLE TABLES; FURNITURE, NAMELY, SHOWCASES MODULAR STORAGE UNITS; MODULAR WALL UNITS; BEDS, BUNK BEDS, BED FRAMES, BED HEADBOARDS, BED PILLOWS, BED RAILS, BED RESTS, CHAIR BEDS, FOLDING BEDS, INFANTS BEDS, NON-METAL BED FITTINGS, RODS FOR BEDS, SOFA BEDS, WOODEN BEDS; MIRRORS; DECORATIVE MOBILES; BEAD CURTAINS FOR DECORATION; CURTAIN RODS (U.S. CLS. 2, 13, 22, 25, 32 AND 50).

CHRISTOPHER LAW, EXAMINING ATTORNEY

SN 85-844,139. BELVEDERE DESIGNS, LLC, HENDERSON, NV. FILED 2-7-2013.

textstyles

THE MARK CONSISTS OF STANDARD CHARACTERS WITHOUT CLAIM TO ANY PARTICULAR FONT, STYLE, SIZE, OR COLOR.

**CLASS 16—PAPER GOODS AND PRINTED MATTER**

FOR PRINTED MATTER PRODUCED IN THE FORM OF PHRASES, LETTERS, NUMBERS, AND/OR SHAPES FOR WALL AND WINDOW DECORATION EACH FEATURING TEXTURES AND/OR GRAPHIC ELEMENTS, NAMELY DECALS, STATIC CLING PRODUCTS, ADHESIVE CANVAS PRODUCTS, ADHESIVE-BACKED PRODUCTS, VINYL PRODUCTS, AND IRON-ON TRANSFERS (U.S. CLS. 2, 5, 22, 23, 29, 37, 38 AND 50).  
FIRST USE 11-1-2012; IN COMMERCE 11-1-2012.

**CLASS 24—FABRICS**

FOR ADHESIVE FABRIC PRODUCTS PRODUCED IN THE FORM OF PHRASES, LETTERS, NUMBERS, AND/OR SHAPES EACH FOR APPLICATION BY HEAT (U.S. CLS. 42 AND 50).  
FIRST USE 11-1-2012; IN COMMERCE 11-1-2012.

**CLASS 27—FLOOR COVERINGS**

FOR VINYL AND VINYL-BASED NON-TEXTILE WALL DECORATIONS PRODUCED IN THE FORM OF PHRASES, LETTERS, NUMBERS, AND/OR SHAPES (U.S. CLS. 19, 20, 37, 42 AND 50).  
FIRST USE 11-1-2012; IN COMMERCE 11-1-2012.

**CLASS 42—SCIENTIFIC AND COMPUTER SERVICES**

FOR GRAPHIC DESIGNS SERVICE, DESIGN OF INTERIOR DECOR (U.S. CLS. 100 AND 101).  
FIRST USE 11-1-2012; IN COMMERCE 11-1-2012.  
FRANK LATTUCA, EXAMINING ATTORNEY

SN 85-844,153. FEM, INC., ALISO VIEJO, CA. FILED 2-7-2013.

FUEGA

THE MARK CONSISTS OF STANDARD CHARACTERS WITHOUT CLAIM TO ANY PARTICULAR FONT, STYLE, SIZE, OR COLOR.  
THE WORDING "FUEGA" HAS NO MEANING IN A FOREIGN LANGUAGE.

**CLASS 41—EDUCATION AND ENTERTAINMENT**

FOR ENTERTAINMENT SERVICES, NAMELY, PROVIDING FEMALE-FOCUSED CONTINUING TELEVISION SHOWS FEATURING CONTENT RELATED TO, MOTION PICTURES, NON-DOWNLOADABLE ONLINE VIDEOS, ON-LINE ELECTRONIC GAMES, AND ANIMATION ACCESSIBLE BY COMPUTER NETWORKS VIA WEBCASTS, PODCASTS, WEBSITES FEATURING NON-DOWNLOADABLE VIDEOS, AND/OR BY MEDIA BROADCAST, NAMELY, TELEVISION, SATELLITE, AND VIDEO NETWORKS; PROVIDING AN INTERACTIVE WEBSITE FEATURING ENTERTAINMENT INFORMATION AND HISTORICAL INFORMATION RELATED TO POWERFUL FIGURES, NAMELY, SUCCESSFUL WOMEN IN ACTION-ORIENTED PURSUITS IN REAL-LIFE AND FICTIONAL CAPACITIES; PROVIDING ONLINE WEB JOURNALS, NAMELY, BLOGS FEATURING SUCCESSFUL WOMEN IN REAL-LIFE AND FICTIONAL CAPACITIES; PROVIDING ONLINE INTERACTIVE ENTERTAINMENT PROGRAMS IN THE NATURE OF CONTINUING TELEVISION SHOWS DELIVERED BY THE INTERNET AND ONLINE ELECTRONIC GAMES FEATURING POWERFUL WOMEN IN ACTION-ORIENTED PURSUITS (U.S. CLS. 100, 101 AND 107).

**CLASS 42—SCIENTIFIC AND COMPUTER SERVICES**

FOR PROVIDING A WEBSITE FEATURING TECHNOLOGY THAT ENABLES USERS TO SHARE INFORMATION AIMED AT A FEMALE AUDIENCE (U.S. CLS. 100 AND 101).

**CLASS 45—PERSONAL AND LEGAL SERVICES**

FOR ONLINE SOCIAL NETWORKING SERVICES AIMED AT A FEMALE AUDIENCE (U.S. CLS. 100 AND 101).  
SETH A. RAPPAPORT, EXAMINING ATTORNEY

SN 85-844,190. FEM, INC., ALISO VIEJO, CA. FILED 2-7-2013.

FUEGAS

THE MARK CONSISTS OF STANDARD CHARACTERS WITHOUT CLAIM TO ANY PARTICULAR FONT, STYLE, SIZE, OR COLOR.  
THE WORDING "FUEGAS" HAS NO MEANING IN A FOREIGN LANGUAGE.

**CLASS 41—EDUCATION AND ENTERTAINMENT**

FOR ENTERTAINMENT SERVICES, NAMELY, PROVIDING FEMALE-FOCUSED CONTINUING TELEVISION SHOWS FEATURING CONTENT RELATED TO, MOTION PICTURES, NON-DOWNLOADABLE ONLINE VIDEOS, ON-LINE ELECTRONIC GAMING, AND ANIMATION ACCESSIBLE BY COMPUTER NETWORKS VIA WEBCASTS, PODCASTS, WEBSITES FEATURING NON-DOWNLOADABLE VIDEOS, AND/OR BY MEDIA BROADCAST, NAMELY, TELEVISION, SATELLITE, AND VIDEO NETWORKS; PROVIDING AN INTERACTIVE WEBSITE FEATURING ENTERTAINMENT INFORMATION AND HISTORICAL INFORMATION RELATED TO POWERFUL FIGURES, NAMELY, SUCCESSFUL WOMEN IN ACTION-ORIENTED PURSUITS IN REAL-LIFE AND FICTIONAL CAPACITIES; PROVIDING ONLINE WEB JOURNALS, NAMELY, BLOGS FEATURING SUCCESSFUL WOMEN IN REAL-LIFE AND FICTIONAL CAPACITIES; PROVIDING ONLINE INTERACTIVE ENTERTAINMENT PROGRAMS IN THE NATURE OF CONTINUING TELEVISION SHOWS DELIVERED BY THE INTERNET AND ONLINE ELECTRONIC GAMES FEATURING POWERFUL WOMEN IN ACTION-ORIENTED PURSUITS (U.S. CLS. 100, 101 AND 107).

**CLASS 42—SCIENTIFIC AND COMPUTER SERVICES**

FOR PROVIDING A WEBSITE FEATURING TECHNOLOGY THAT ENABLES USERS TO SHARE INFORMATION AIMED AT A FEMALE AUDIENCE (U.S. CLS. 100 AND 101).

**CLASS 45—PERSONAL AND LEGAL SERVICES**

FOR ONLINE SOCIAL NETWORKING SERVICES AIMED AT A FEMALE AUDIENCE (U.S. CLS. 100 AND 101).

SETH A. RAPPAPORT, EXAMINING ATTORNEY

SN 85-844,574. SECURIBLE, LLC, ALEXANDRIA, VA. FILED 2-8-2013.



NO CLAIM IS MADE TO THE EXCLUSIVE RIGHT TO USE "SCHOOL" WITH RESPECT TO EDUCATION SERVICES IN INTERNATIONAL CLASS 41, APART FROM THE MARK AS SHOWN.

THE MARK CONSISTS OF A SILHOUETTE OF A SPIDER ON THE TOP OF THE GEOMETRICAL SHAPE OF A SHIELD WITH THE FRONT OF THE SHIELD CONTAINING A CIRCLE WITH A SET OF INTER-RELATED CRESCENT SHAPES SURROUNDING THE CIRCLE AND THE INTERIOR OF THE CIRCLE CONTAINING AN IMAGE OF A COMPUTER TO THE LEFT OF THE WORD "WIGGINS" IN ALL CAPITAL LETTERS SLANTED TO THE RIGHT OVER THE WORDS "CYBER BATTLE SCHOOL" IN SMALLER ALL CAPITAL LETTERS SLANTED TO THE RIGHT OVER THE WORDS "TO US CYBER SECURITY IS NOT A GAME" IN AGAIN SMALLER ALL CAPITAL LETTERS.

**CLASS 35—ADVERTISING AND BUSINESS**

FOR CONSULTING RELATED TO DEVELOPMENT OF VOLUNTARY STANDARDS FOR BUSINESS AND SECURITY AND TESTING TO DETERMINE PROFESSIONAL COMPETENCY; BUSINESS DATA AUTOMATION AND COLLECTION SERVICE USING PROPRIETARY SOFTWARE TO EVALUATE, ANALYZE AND COLLECT INFORMATION AND DATA AND FACILITATE DECISION PROCESSING; BUSINESS CONSULTATION SERVICES; BUSINESS CONSULTING SERVICES; COMPILATION OF BUSINESS DATA AS INFORMATION STORES AND PROVISION OF INFORMATION THEREFROM; COMPILATION OF INFORMATION INTO COMPUTER DATABASES; MARKET RESEARCH AND ANALYSIS OF INFORMATION FROM COMPUTER DATABASES AND THE INTERNET; COLLECTION AND SYSTEMATIZATION OF INFORMATION INTO COMPUTER DATABASES; COMPILATION AND SYSTEMATIZATION OF INFORMATION INTO COMPUTER DATABASES; PROVIDING AN ON-LINE SEARCHABLE DATABASE FEATURING BUSINESS INFORMATION, PROVIDING BUSINESS INFORMATION, NAMELY, COMMERCIAL, CORPORATE AND STATISTICAL INFORMATION PROVIDED ON-LINE FROM A COMPUTER DATABASE OR THE INTERNET; PROVIDING BUSINESS INFORMATION OVER GLOBAL, LOCAL AND INTERNAL COMPUTER NETWORKS ON THE SUBJECTS OF BUSINESS PLANNING, BUSINESS REENGINEERING, ON-LINE COMMERCE AND E-COMMERCE; PROVIDING BUSINESS INFORMATION VIA THE INTERNET ON THE SUBJECTS OF BUSINESS PLANNING, BUSINESS REENGINEERING, ON-LINE COMMERCE AND E-COMMERCE; BUSINESS CONSULTANCY SERVICES IN THE FIELD OF BUSINESS PLANNING AND BUSINESS ADMINISTRATION; BUSINESS PLANNING SERVICES; BUSINESS ADMINISTRATION AND MANAGEMENT SERVICES; PROVIDING DATABASE SERVICES FEATURING BUSINESS, COMMERCIAL, ENTERPRISE AND GOVERNMENT CONTACT INFORMATION (U.S. CLS. 100, 101 AND 102).

**CLASS 41—EDUCATION AND ENTERTAINMENT**

FOR CONSULTING SERVICES IN THE FIELD OF PROFESSIONAL AND EDUCATIONAL TESTING; EDUCATIONAL SERVICES, NAMELY, DEVELOPING COURSES OF INSTRUCTION AND TRAINING COURSES IN THE FIELD OF BUSINESS ETHICS AND CONFORMING TO LEGAL AND REGULATORY STANDARDS AND REQUIREMENTS IN THE AREAS OF ANTI-CORRUPTION, PRIVACY AND PERSONAL DATA PROTECTION, PROTECTING CONFIDENTIAL INFORMATION, CONDUCTING INTERNAL BUSINESS COMPLIANCE INVESTIGATIONS, AND DUE DILIGENCE, AND CONSULTING RELATED THERETO; EDUCATIONAL SERVICES, NAMELY, DEVELOPING COURSES OF INSTRUCTION AND TRAINING COURSES IN THE FIELD OF CREATING STANDARDS AND PRACTICES FOR BUSINESS ETHICS AND CONFORMING TO LEGAL AND REGULATORY STANDARDS AND REQUIREMENTS IN THE AREAS OF ANTI-CORRUPTION, PRIVACY AND PERSONAL DATA PROTECTION, PROTECTING CONFIDENTIAL INFORMATION, CONDUCTING INTERNAL BUSINESS COMPLIANCE INVESTIGATIONS, AND DUE DILIGENCE, AND CONSULTING RELATED THERETO; EDUCATIONAL SERVICES, NAMELY, DEVELOPING CONTINUING EDUCATION COURSES FOR PROFESSIONALS IN THE FIELD OF CREATING STANDARDS AND PRACTICES FOR BUSINESS ETHICS AND CONFORMING TO LEGAL AND REGULATORY STANDARDS AND REQUIREMENTS IN THE AREAS OF ANTI-CORRUPTION, PRIVACY AND PERSONAL DATA PROTECTION, PROTECTING CONFIDENTIAL INFORMATION, CONDUCTING INTERNAL BUSINESS COMPLIANCE INVESTIGATIONS, AND DUE DILIGENCE, AND CONSULTING RELATED THERETO (U.S. CLS. 100, 101 AND 107).

**CLASS 42—SCIENTIFIC AND COMPUTER SERVICES**

FOR CONSULTING SERVICES IN THE FIELD OF DESIGN, SELECTION, IMPLEMENTATION AND USE OF COMPUTER HARDWARE AND SOFTWARE SYSTEMS FOR OTHERS; COMPUTER CONSULTING SERVICES FOR PLANNING, DESIGN AND ANALYSIS OF COMPUTER-BASED INFORMATION PROCESSES AND COMPUTER HARDWARE SYSTEMS AND COMPUTER SOFTWARE SYSTEMS; ANALYSIS AND DESIGN OF COMPUTER SYSTEMS FOR OTHERS; ANALYSIS AND DESIGN OF BUSINESS-BASED COMPUTER INFORMATION SYSTEMS FOR OTHERS; INFORMATION TECHNOLOGY CONSULTATION SERVICES; CONSULTATION ON THE COMPUTER-RELATED ASPECTS OF INFORMATION TECHNOLOGY AND INFORMATION TECHNOLOGY SECURITY; CONSULTING SERVICES IN THE FIELD OF DESIGN, SELECTION, IMPLEMENTATION AND USE OF SYSTEMS OF COMPUTER HARDWARE AND NETWORKING EQUIPMENT AND COMBINATIONS OF COMPUTER HARDWARE AND NETWORKING EQUIPMENT AND SOFTWARE, SOFTWARE SYSTEMS AND SOFTWARE SOLUTIONS FOR OTHERS; CONSULTING SERVICES RELATING TO PLANNING, DESIGN AND ANALYSIS OF COMPUTER HARDWARE AND NETWORKING EQUIPMENT, SYSTEMS OF COMPUTER HARDWARE AND NETWORKING EQUIPMENT AND COMBINATIONS OF COMPUTER HARDWARE AND NETWORKING EQUIPMENT AND SOFTWARE, SOFTWARE SYSTEMS AND SOFTWARE SOLUTIONS FOR INFORMATION PROCESSES, SYSTEMS AND BUSINESS REENGINEERING; COMPUTER CONSULTING SERVICES, NAMELY, COMPUTER SYSTEMS ANALYSIS AND DESIGN OF COMPUTER SYSTEMS AND INFORMATION TECHNOLOGY SYSTEMS FOR OTHERS; PROVIDING CONSULTING SERVICES IN DESIGN AND DEVELOPMENT, INTEGRATION AND INTERFACING OF COMPUTER HARDWARE AND SOFTWARE SYSTEMS AND NETWORKS AND COMPUTER NETWORK ARCHITECTURES; CONSULTING SERVICES IN THE FIELD OF DESIGN, SELECTION, IMPLEMENTATION AND USE OF SOFTWARE AND SOFTWARE SYSTEMS FOR OTHERS; CONSULTING SERVICES RELATING TO PLANNING, DESIGN AND ANALYSIS OF SOFTWARE SOLUTIONS FOR INFORMATION PROCESSES, SYSTEMS AND BUSINESS REENGINEERING; COMPUTER CONSULTING SERVICES, NAMELY, COMPUTER SYSTEMS ANALYSIS AND DESIGN OF COMPUTER SYSTEMS AND INFORMATION TECHNOLOGY SYSTEMS FOR OTHERS; INFORMATION TECHNOLOGY CONSULTATION SERVICES; COMPUTER CONSULTING SERVICES, NAMELY, CONSULTATION ON INFORMATION TECHNOLOGY; AND CONSULTING TRAINING RELATED TO ALL OF THE FOREGOING (U.S. CLS. 100 AND 101).

**CLASS 45—PERSONAL AND LEGAL SERVICES**

FOR CONSULTING SERVICES RELATED TO DEVELOPMENT OF PRIVACY AND PERSONAL DATA PROTECTION AND PROTECTING CONFIDENTIAL INFORMATION, QUALITY CONTROL STANDARDS FOR BUSINESS ETHICS AND CONFORMING TO LEGAL AND REGULATORY STANDARDS AND REQUIREMENTS AND CONDUCTING INTERNAL BUSINESS RECORD KEEPING AND COMPLIANCE INVESTIGATIONS, AND DUE DILIGENCE; CONSULTING RELATED TO REVIEWING STANDARDS AND PRACTICES TO ASSURE COMPLIANCE WITH ETHICS LAWS AND REGULATIONS; CONSULTING RELATED TO REVIEWING STANDARDS AND PRACTICES TO ASSURE COMPLIANCE WITH LAWS AND REGULATIONS RELATED TO BUSINESS ETHICS, ANTI-CORRUPTION, PRIVACY AND PERSONAL DATA PROTECTION, AND PROTECTING CONFIDENTIAL INFORMATION (U.S. CLS. 100 AND 101).  
GRETIA YAO, EXAMINING ATTORNEY

SN 85-844,600. SHALE ALLIANCE FOR ENERGY RESEARCH, PENNSYLVANIA, BRIDGEVILLE, PA. FILED 2-8-2013.

# SAFER

THE MARK CONSISTS OF STANDARD CHARACTERS WITHOUT CLAIM TO ANY PARTICULAR FONT, STYLE, SIZE, OR COLOR.

**CLASS 35—ADVERTISING AND BUSINESS**

FOR ASSOCIATION SERVICES, NAMELY, PROMOTING THE SAFETY, SUSTAINABILITY AND DEVELOPMENT OF SHALE ENERGY RESOURCES; ORGANIZING THE FORMATION OF LOCAL ORGANIZATIONS TO ENGAGE IN SUCH SERVICES ON THE STATEWIDE BASIS, PROMOTING THE PUBLIC INTEREST AND AWARENESS OF RESEARCH AND EDUCATION IN THE FIELD OF THE SAFETY, SUSTAINABILITY AND DEVELOPMENT OF SHALE ENERGY RESOURCES (U.S. CLS. 100, 101 AND 102).  
FIRST USE 11-1-2013; IN COMMERCE 11-1-2013.

**CLASS 42—SCIENTIFIC AND COMPUTER SERVICES**

FOR RESEARCH AND DEVELOPMENT IN THE FIELD OF SAFETY, SUSTAINABILITY AND DEVELOPMENT OF SHALE ENERGY RESOURCES (U.S. CLS. 100 AND 101).  
FIRST USE 2-28-2013; IN COMMERCE 2-28-2013.  
BRIDGETT SMITH, EXAMINING ATTORNEY

SN 85-844,762. 7809921 CANADA INC., OTTAWA, ON, CANADA, FILED 2-8-2013.

# WAGOOSH

THE MARK CONSISTS OF STANDARD CHARACTERS WITHOUT CLAIM TO ANY PARTICULAR FONT, STYLE, SIZE, OR COLOR.

PRIORITY CLAIMED UNDER SEC. 44(D) ON CANADA APPLICATION NO. 1,611,033, FILED 1-23-2013.

**CLASS 25—CLOTHING**

FOR ATHLETIC APPAREL, NAMELY, SHIRTS, PANTS, JACKETS, FOOTWEAR, HATS AND CAPS; BEACHWEAR; HEADGEAR, NAMELY, HATS AND CAPS; TOQUES; FOOTWEAR; THONGS; AND SANDALS AND BEACH SHOES (U.S. CLS. 22 AND 39).

**CLASS 35—ADVERTISING AND BUSINESS**

FOR ADVERTISING SERVICES FOR OTHERS (U.S. CLS. 100, 101 AND 102).

**CLASS 41—EDUCATION AND ENTERTAINMENT**

FOR PROVIDING A WEB SITE FOR ENTERTAINMENT PURPOSES FEATURING HUMOR AND NON-DOWNLOADABLE VIDEOS, PHOTOGRAPHS, MOVIES, ARTICLES, COMMENTARY, NEWS, AND GAMES IN THE FIELD OF ENTERTAINMENT NEWS, CELEBRITIES AND POPULAR CULTURE; PROVIDING A WEB SITE FEATURING LINKS TO THE WEB SITES OF OTHERS FEATURING ENTERTAINMENT IN THE NATURE OF HUMOR AND NON-DOWNLOADABLE VIDEOS, PHOTOGRAPHS, MOVIES, ARTICLES, COMMENTARY, NEWS, AND GAMES IN THE FIELD OF ENTERTAINMENT NEWS, CELEBRITIES AND POPULAR CULTURE (U.S. CLS. 100, 101 AND 107).

RONALD MCMORROW, EXAMINING ATTORNEY

SN 85-846,171. TRUPANION, INC., SEATTLE, WA. FILED 2-11-2013.

trupanion EXPRESS

SN 85-845,489. SEVENTH GENERATION, INC., BURLINGTON, VT. FILED 2-9-2013.

**DESIGNED TO BE KIND**

THE MARK CONSISTS OF STANDARD CHARACTERS WITHOUT CLAIM TO ANY PARTICULAR FONT, STYLE, SIZE, OR COLOR.

**CLASS 3—COSMETICS AND CLEANING PREPARATIONS**

FOR NON-MEDICATED SKIN CARE CREAMS, LOTIONS, GELS, SKIN CLEANSERS, AND DIAPER RASH CREAM; NON-MEDICATED SUNSCREEN; HAIR CARE PREPARATIONS, NAMELY, SHAMPOO AND CONDITIONER; NON-MEDICATED BUBBLE BATH PREPARATIONS; DISPOSABLE WIPES IMPREGNATED WITH NON-MEDICATED CLEANSING CHEMICALS OR COMPOUNDS FOR PERSONAL HYGIENE AND SKIN MOISTURIZING; LAUNDRY DETERGENT (U.S. CLS. 1, 4, 6, 50, 51 AND 52).

**CLASS 5—PHARMACEUTICALS**

FOR MEDICATED SKIN CARE CREAMS, LOTIONS, GELS; MEDICATED SKIN CARE PREPARATIONS, NAMELY, CLEANSERS; MEDICATED DIAPER RASH CREAM; MEDICATED SUNSCREENS; INSECT REPELLENTS; DISPOSABLE WIPES IMPREGNATED WITH MEDICATED CLEANSING CHEMICALS OR COMPOUNDS FOR PERSONAL HYGIENE AND SKIN MOISTURIZING; INFANT, BABY AND TODDLER CLOTH DIAPERS; DISPOSABLE CHILDREN'S TRAINING PANTS; DISPOSABLE INFANT, BABY AND TODDLER DIAPERS (U.S. CLS. 6, 18, 44, 46, 51 AND 52).

**CLASS 25—CLOTHING**

FOR NON-DISPOSABLE CLOTH TRAINING PANTS, CHILDREN'S UNDERWEAR (U.S. CLS. 22 AND 39).

MEREDITH MARESCA, EXAMINING ATTORNEY

THE MARK CONSISTS OF STANDARD CHARACTERS WITHOUT CLAIM TO ANY PARTICULAR FONT, STYLE, SIZE, OR COLOR.

OWNER OF U.S. REG. NOS. 3,525,250, 3,634,415 AND 4,400,175.

**CLASS 9—ELECTRICAL AND SCIENTIFIC APPARATUS**

FOR DOWNLOADABLE COMPUTER SOFTWARE FOR MANAGEMENT OF VETERINARY OFFICES; DOWNLOADABLE COMPUTER SOFTWARE FOR MANAGING AND SERVICING VETERINARY ACCOUNTS RECEIVABLE, COLLECTIONS AND FUNDING, FOR MEDICAL BILLING AND MEDICAL PAYMENT COLLECTION FOR VETERINARIANS, AND FOR CLAIMS PROCESSING, DATA ANALYTICS AND REPORTING IN THE VETERINARY FIELD; DOWNLOADABLE COMPUTER SOFTWARE FOR TRACKING PETS' MEDICAL HISTORY, BILLING, PAYMENTS, AND INSURANCE CLAIMS, AND FOR PET HEALTH AND WELLNESS TRACKING (U.S. CLS. 21, 23, 26, 36 AND 38).

**CLASS 16—PAPER GOODS AND PRINTED MATTER**

FOR PAMPHLETS AND BOOKLETS AND INFORMATIONAL FLYERS IN THE FIELD OF ANIMAL BREEDS, PET HEALTH AND WELLNESS, PET CARE, SAFETY AND WELFARE (U.S. CLS. 2, 5, 22, 23, 29, 37, 38 AND 50).

**CLASS 36—INSURANCE AND FINANCIAL**

FOR CLAIMS ADMINISTRATION SERVICES IN THE FIELD OF PET INSURANCE; ELECTRONIC PROCESSING OF PET INSURANCE CLAIMS AND PAYMENT DATA; FINANCIAL TRANSACTION SERVICES, NAMELY, PROVIDING SECURE COMMERCIAL TRANSACTIONS AND PAYMENT OPTIONS; PROCESSING, ADMINISTERING AND MANAGING EMPLOYEE BENEFIT PLANS CONCERNING PET INSURANCE AND FINANCE (U.S. CLS. 100, 101 AND 102).

**CLASS 41—EDUCATION AND ENTERTAINMENT**

FOR ONLINE JOURNALS, NAMELY, BLOGS FEATURING INFORMATION IN THE FIELD OF PETS, PET BREEDS, PET TRAINING, PET HEALTH AND PET WELLNESS; PROVIDING A WEBSITE WITH INFORMATION FOR EDUCATIONAL AND ENTERTAINMENT PURPOSES IN THE FIELD OF PET TRAINING AND PET EXERCISE (U.S. CLS. 100, 101 AND 107).



**CLASS 42—SCIENTIFIC AND COMPUTER SERVICES**

FOR PROVIDING A WEB SITE FEATURING TECHNOLOGY THAT ENABLES VETERINARIANS TO GENERATE, MANAGE, AND EXCHANGE MEDICAL INFORMATION, DOCUMENTS, FINANCIAL INFORMATION, INSURANCE CLAIM AND PAYMENT INFORMATION; PROVIDING AN ONLINE NON-DOWNLOADABLE SOFTWARE APPLICATION FOR MANAGEMENT OF VETERINARY OFFICES, MANAGING AND SERVICING VETERINARY ACCOUNTS RECEIVABLE, MEDICAL BILLING AND MEDICAL PAYMENT COLLECTION FOR VETERINARIANS, AND FOR CLAIMS PROCESSING, DATA ANALYTICS AND REPORTING IN THE VETERINARY FIELD; PROVIDING AN ONLINE NON-DOWNLOADABLE SOFTWARE APPLICATION FOR TRACKING PETS' MEDICAL HISTORY, BILLING, PAYMENTS, AND INSURANCE CLAIMS, AND FOR PET HEALTH AND WELLNESS TRACKING (U.S. CLS. 100 AND 101).

**CLASS 44—MEDICAL, BEAUTY AND AGRICULTURAL SERVICES**

FOR PROVIDING A WEBSITE WITH INFORMATION FOR EDUCATIONAL AND ENTERTAINMENT PURPOSES IN THE FIELD OF PET HEALTH AND PET WELLNESS, PET SELECTION, PET GROOMING, PET FEEDING, PET NUTRITION, PET HEALTH AND WELLNESS IN THE NATURE OF ANIMAL WELFARE AND THE PSYCHOLOGICAL AND PHYSICAL WELL-BEING OF ANIMALS, PHYSICAL CHARACTERISTICS AND TEMPERAMENT OF PET BREEDS, AND GROOMING, FEEDING AND NUTRITION REQUIREMENTS FOR SPECIFIC PET BREEDS (U.S. CLS. 100 AND 101).

JOANNA FIORELLI, EXAMINING ATTORNEY

SN 85-846,342. BOOMER FEST, LLC, SCOTTSDALE, AZ. FILED 2-11-2013.



**BOOMER FEST DAYS**

NO CLAIM IS MADE TO THE EXCLUSIVE RIGHT TO USE "FEST DAYS", APART FROM THE MARK AS SHOWN.

THE MARK CONSISTS OF A PEACE DESIGN OF FLOWERS WITH THE LETTERS "BFD" ON TOP OF THE DESIGN AND THE WORDS "BOOMER FEST DAYS" ON THE BOTTOM OF THE DESIGN.

**CLASS 35—ADVERTISING AND BUSINESS**

FOR ADVERTISING, MARKETING AND PROMOTION SERVICES IN THE FIELD OF FESTIVALS INCLUDING LIVE MUSIC EVENTS (U.S. CLS. 100, 101 AND 102).

**CLASS 41—EDUCATION AND ENTERTAINMENT**

FOR ARRANGING, ORGANIZING, AND CONDUCTING ENTERTAINMENT EVENTS IN THE NATURE OF LIVE MUSIC EVENTS (U.S. CLS. 100, 101 AND 107).

SUSAN RICHARDS, EXAMINING ATTORNEY

SN 85-846,567. PROMOCIONES ANTONIO PEÑA, S.A. DE C.V., MEXICO, D.F. 04000, MEXICO, FILED 2-11-2013.

**MURDER CLOWN**

THE MARK CONSISTS OF STANDARD CHARACTERS WITHOUT CLAIM TO ANY PARTICULAR FONT, STYLE, SIZE, OR COLOR.

OWNER OF MEXICO REG. NO. 1271951, DATED 3-5-2012, EXPIRES 2-22-2021.

NO CLAIM IS MADE TO THE EXCLUSIVE RIGHT TO USE "CLOWN", APART FROM THE MARK AS SHOWN.

THE NAME(S), PORTRAIT(S), AND/OR SIGNATURE(S) SHOWN IN THE MARK DOES NOT IDENTIFY A PARTICULAR LIVING INDIVIDUAL.

**CLASS 28—TOYS AND SPORTING GOODS**

FOR TOYS, NAMELY, ACTION FIGURES AND ACCESSORIES THEREFOR; CASES FOR ACTION FIGURES; TOY WRESTLING RINGS; TOY VEHICLES; BOARD GAMES; PLAYING CARDS; PUZZLES; STUFFED TOYS; PLUSH TOYS; TOY WRESTLING BELTS; KNEE AND ELBOW PADS FOR ATHLETIC USE; TOY FOAM HANDS; COSTUME MASKS; DOLLS (U.S. CLS. 22, 23, 38 AND 50).

**CLASS 41—EDUCATION AND ENTERTAINMENT**

FOR ENTERTAINMENT SERVICES, NAMELY, WRESTLING EXHIBITIONS AND PERFORMANCES BY A PROFESSIONAL WRESTLER AND ENTERTAINER RENDERED LIVE AND THROUGH BROADCAST MEDIA INCLUDING TELEVISION AND RADIO, AND VIA THE INTERNET OR COMMERCIAL ONLINE SERVICE; PROVIDING WRESTLING NEWS AND INFORMATION VIA A GLOBAL COMPUTER NETWORK; PROVIDING INFORMATION IN THE FIELDS OF SPORTS AND ENTERTAINMENT VIA AN ONLINE COMMUNITY PORTAL; PROVIDING A WEBSITE IN THE FIELD OF SPORTS ENTERTAINMENT; FAN CLUB SERVICES; ORGANIZING AND STAGING ENTERTAINMENT EVENTS WITH WRESTLING FAN CLUB MEMBERS; PROVIDING ONLINE NEWSLETTERS IN THE FIELD OF SPORTS ENTERTAINMENT; ONLINE JOURNALS, NAMELY, BLOGS, IN THE FIELD OF SPORTS ENTERTAINMENT; ENTERTAINMENT SERVICES, NAMELY, PERSONAL APPEARANCES BY A WRESTLING CELEBRITY (U.S. CLS. 100, 101 AND 107).

CHRISTOPHER BUONGIORNO, EXAMINING ATTORNEY

SN 85-846,680. MOTORSPORT AFTERMARKET GROUP, INC., IRVINE, CA. FILED 2-11-2013.

**White Brothers**

THE MARK CONSISTS OF STANDARD CHARACTERS WITHOUT CLAIM TO ANY PARTICULAR FONT, STYLE, SIZE, OR COLOR.

NO CLAIM IS MADE TO THE EXCLUSIVE RIGHT TO USE "BROTHERS", APART FROM THE MARK AS SHOWN.

**CLASS 7—MACHINERY**

FOR EXHAUST PIPES FOR LAND VEHICLES; ENGINE EXHAUST TIPS; EXHAUST MANIFOLD FOR ENGINES; EXHAUST SILENCERS FOR ENGINES; ENGINE OR MOTOR MUFFLERS; SPARK ARRESTORS SOLD AS A COMPONENT OF A LAND VEHICLE ENGINE EXHAUST SYSTEM; AIR FILTERS FOR VEHICLE MOTORS AND ENGINES; INTERNAL COMBUSTION ENGINE PARTS, NAMELY, PISTONS, PISTON RINGS, VALVES, HEADS, CRANK SHAFTS, CAM SHAFTS, VALVE SPRINGS, GASKETS, FUEL MIXTURE SCREWS, OIL FILTER CAPS, OIL FILTER PLUGS, ENGINE PLUGS; ENGINE PERFORMANCE KITS COMPRISED OF PISTONS, VALVES, HEADS, CRANK SHAFTS, CAM SHAFTS, VALVE SPRINGS, GASKETS AND FUEL MIXTURE SCREWS; MOTORCYCLE, ATV, UTILITY TERRAIN VEHICLE, MULTI UTILITY VEHICLE, AND RECREATIONAL UTILITY VEHICLE PARTS AND ACCESSORIES, NAMELY, DIP STICKS, COVERS FOR AIR FILTERS FOR VEHICLE MOTORS AND ENGINES; COVERS FOR FUEL AND AIR MIXTURE REGULATORS BEING PARTS OF INTERNAL COMBUSTION ENGINES; COVERS FOR RADIATORS FOR VEHICLES (U.S. CLS. 13, 19, 21, 23, 31, 34 AND 35).

**CLASS 11—ENVIRONMENTAL CONTROL APPARATUS**

FOR MOTORCYCLE, ATV, UTILITY TERRAIN VEHICLE, MULTI UTILITY VEHICLE, AND RECREATIONAL UTILITY VEHICLE PARTS AND ACCESSORIES, NAMELY, LIGHT BARS, LIGHT PANELS, LIGHT REFLECTORS, LIGHT BULBS, HEADLIGHTS, AND TAILLIGHTS (U.S. CLS. 13, 21, 23, 31 AND 34).

**CLASS 12—VEHICLES**

FOR MOTORCYCLE, ATV, UTILITY TERRAIN VEHICLE, MULTI UTILITY VEHICLE, AND RECREATIONAL UTILITY VEHICLE PARTS AND ACCESSORIES, NAMELY, FRONT AND REAR BUMPERS, SKID PLATES, SAFETY PADS, FRAME GUARDS, CLUTCH COVERS, BRAKE FLUID RESERVOIR COVERS, LICENSE PLATE HOLDERS, DISC BRAKE COVERS, HAND GUARDS, TRANSMISSIONS, GEARS, CLUTCHES, CHAIN GUIDES AND SPROCKET COVERS, WHEEL SPROCKETS, TRANSMISSION CHAINS, AIR BOXES, FORKS, FORK DUST BOOTS, HANDLE BAR GRIPS, FENDERS, SIDE PANELS, AND GAS TANKS; MOTORCYCLE, ATV, UTILITY TERRAIN VEHICLE, MULTI UTILITY VEHICLE, AND RECREATIONAL UTILITY VEHICLE SUSPENSION PARTS, NAMELY, COIL SPRINGS, LEAF SPRINGS, EQUALIZERS, STRUTS, AND TORSION BARS, AND SWAY BARS; BICYCLE PARTS, NAMELY, FORKS, FRONT FORK JOINTS, AND FORK CROWN COVERS, FRAMES, BRAKES, HANDLEBARS, GEARS, CHAINS, SPOKES AND RIMS (U.S. CLS. 19, 21, 23, 31, 35 AND 44).

**CLASS 25—CLOTHING**

FOR MOTORCYCLE, ATV, UTILITY TERRAIN VEHICLE, MULTI UTILITY VEHICLE, AND RECREATIONAL UTILITY VEHICLE GLOVES, BOOTS, PANTS, AND JERSEYS (U.S. CLS. 22 AND 39).  
TASNEEM HUSSAIN, EXAMINING ATTORNEY

SN 85-846,725. BRAYDEN AUTOMATION CORPORATION, AKA BRAYDEN AUTOMATION, LOVELAND, CO. FILED 2-11-2013.

**PULSECONNEX**

THE MARK CONSISTS OF STANDARD CHARACTERS WITHOUT CLAIM TO ANY PARTICULAR FONT, STYLE, SIZE, OR COLOR.

**CLASS 35—ADVERTISING AND BUSINESS**

FOR ENERGY USAGE MANAGEMENT INFORMATION SERVICES, NAMELY, REAL-TIME ENERGY USAGE MANAGEMENT AND INFORMATION IN THE FIELD OF ENERGY EFFICIENCY (U.S. CLS. 100, 101 AND 102).

FIRST USE 1-25-2013; IN COMMERCE 1-25-2013.

**CLASS 42—SCIENTIFIC AND COMPUTER SERVICES**

FOR SOFTWARE AS A SERVICE (SAAS) SERVICES, NAMELY, HOSTING SOFTWARE FOR USE BY OTHERS FOR RECEIVING AND TRANSMITTING ENERGY USAGE RELATED INFORMATION TO MONITOR, VIEW, AND MANAGE CUSTOMER ENERGY DEMAND AND USAGE (U.S. CLS. 100 AND 101).

FIRST USE 1-25-2013; IN COMMERCE 1-25-2013.

STEVEN JACKSON, EXAMINING ATTORNEY

SN 85-848,039. WILDE WHISKEY LIMITED, NAAS, CO. KILDARE, IRELAND, FILED 2-12-2013.

**OSCAR WILDE**

THE MARK CONSISTS OF STANDARD CHARACTERS WITHOUT CLAIM TO ANY PARTICULAR FONT, STYLE, SIZE, OR COLOR.

PRIORITY CLAIMED UNDER SEC. 44(D) ON ERP CMNTY TM OFC APPLICATION NO. 011118973, FILED 8-14-2012, REG. NO. 011118973, DATED 1-10-2013, EXPIRES 8-14-2022.

"OSCAR WILDE" DOES NOT IDENTIFY A LIVING INDIVIDUAL.

**CLASS 3—COSMETICS AND CLEANING PREPARATIONS**

FOR CLEANING PREPARATIONS, SOAPS; PERFUMES, PERFUMERY, EAU DE COLOGNE, EAUX DE TOILETTE; ESSENTIAL OILS; COSMETICS; COSMETIC PREPARATIONS; TOILET SOAPS; SKINCARE COSMETICS; LOTIONS AND MILKS FOR COSMETIC USE; SHAVING PREPARATIONS, SHAVING CREAM, SHAVING LOTIONS; AFTER-SHAVE PREPARATIONS, AFTER-SHAVE GEL AND AFTER-SHAVE LOTIONS; PREPARATIONS FOR THE HAIR, NAMELY, HAIR CARE PREPARATIONS, HAIR CURLING PREPARATIONS AND HAIR COLORING PREPARATIONS; SHAMPOOS; CONDITIONING PREPARATIONS FOR THE HAIR; HAIR LOTIONS, HAIR CONDITIONERS; LOTIONS, LACQUERS AND GELS FOR THE HAIR; HAIR DYES; HAIR LACQUERS; PREPARATIONS IN AEROSOL FORM FOR HAIRDRESSING AND HAIRCARE, NAMELY, HAIR CARE PREPARATIONS; ANTI-PERSPIRANTS, DEODORANTS FOR PERSONAL USE; PERFUMED SPRAYS, NAMELY, PERFUME; HAND LOTIONS; TOILET WATERS; LIP BALMS; COSMETIC BALMS, OILS, OINTMENTS, POWDERS AND LOTIONS; CLEANSING MILK AND OILS FOR TOILET PURPOSES; BATH AND SHOWER GELS; BATH SALTS NOT FOR MEDICAL PURPOSES; COSMETICS, IN PARTICULAR CREAMS, MILKS, LOTIONS, GELS AND POWDERS FOR THE FACE, BODY AND HANDS; MAKE-UP PREPARATIONS; HAIR GELS, HAIR MOUSSES AND BEAUTY BALMS CREAMS; NAIL VARNISH; COSMETIC PREPARATIONS FOR BATHING AND FOR SUN-TANNING PURPOSES; SUN-TANNING MILKS, GELS AND OILS AND AFTER-SUN PREPARATIONS BEING COSMETICS; SUN-TANNING PREPARATIONS BEING COSMETICS; SUN-TANNING CREAMS AND OILS; ARTIFICIAL TANNING PREPARATIONS; SELF-TANNING LOTIONS, CREAMS AND PREPARATIONS BEING COSMETICS (U.S. CLS. 1, 4, 6, 50, 51 AND 52).

**CLASS 33—WINES AND SPIRITS**

FOR ALCOHOLIC BEVERAGES EXCEPT BEERS; WHISKEY; WHISKEY BASED LIQUEURS; WINE; DISTILLED SPIRITS; LIQUEURS; CREAM LIQUEURS; ALCOHOLIC PUNCHES; PRE-MIXED ALCOHOLIC BEVERAGES, OTHER THAN BEER-BASED (U.S. CLS. 47 AND 49).

JOHN DWYER, EXAMINING ATTORNEY

SN 85-848,203. YES4ALL LLC, SANTA ANA, CA. FILED 2-12-2013.

# YES4ALL

THE MARK CONSISTS OF STANDARD CHARACTERS WITHOUT CLAIM TO ANY PARTICULAR FONT, STYLE, SIZE, OR COLOR.

**CLASS 20—FURNITURE AND ARTICLES NOT OTHERWISE CLASSIFIED**

FOR ELECTRONIC ACCESSORIES, NAMELY, NON-METAL AUDIO, VIDEO AND COMPUTER WALL AND CEILING MOUNTS, AND NON-METAL AUDIO, VIDEO, AND COMPUTER STANDS (U.S. CLS. 2, 13, 22, 25, 32 AND 50).

FIRST USE 12-3-2002; IN COMMERCE 9-9-2009.

**CLASS 28—TOYS AND SPORTING GOODS**

FOR SPORTING GOODS AND FITNESS EQUIPMENT, NAMELY, DUMBBELLS, KETTLEBELL, YOGA MAT, CHIN UP BAR (U.S. CLS. 22, 23, 38 AND 50).

FIRST USE 12-3-2002; IN COMMERCE 9-9-2009.  
CAROLYN CATALDO, EXAMINING ATTORNEY

SN 85-848,389. AOD MANAGEMENT INC., BROOKLYN, NY. FILED 2-13-2013.

# ANGELS OF HEALTH

THE MARK CONSISTS OF STANDARD CHARACTERS WITHOUT CLAIM TO ANY PARTICULAR FONT, STYLE, SIZE, OR COLOR.

NO CLAIM IS MADE TO THE EXCLUSIVE RIGHT TO USE "HEALTH", APART FROM THE MARK AS SHOWN.

**CLASS 41—EDUCATION AND ENTERTAINMENT**

FOR PHYSICAL FITNESS TRAINING CLASSES (U.S. CLS. 100, 101 AND 107).

**CLASS 44—MEDICAL, BEAUTY AND AGRICULTURAL SERVICES**

FOR NUTRITION COUNSELING (U.S. CLS. 100 AND 101).

KATHLEEN LORENZO, EXAMINING ATTORNEY

SN 85-848,611. ASTONISH RESULTS, LLC, WARWICK, RI. FILED 2-13-2013.

# ASTONISH

THE MARK CONSISTS OF STANDARD CHARACTERS WITHOUT CLAIM TO ANY PARTICULAR FONT, STYLE, SIZE, OR COLOR.

OWNER OF U.S. REG. NOS. 3,413,368, 3,806,528 AND 3,929,601.

**CLASS 35—ADVERTISING AND BUSINESS**

FOR BUSINESS MARKETING SERVICES; DIGITAL MARKETING SERVICES, NAMELY, ONLINE MARKETING; TRACKING INTERNET ADVERTISING TO DETERMINE USER CLICK TRAFFIC AND WEBSITE VISITS; BUSINESS CONSULTING SERVICES (U.S. CLS. 100, 101 AND 102).

FIRST USE 6-1-2006; IN COMMERCE 6-1-2006.

**CLASS 41—EDUCATION AND ENTERTAINMENT**

FOR SALES TRAINING IN THE FIELDS OF INSURANCE AND MORTGAGE SERVICES (U.S. CLS. 100, 101 AND 107).

FIRST USE 6-1-2006; IN COMMERCE 6-1-2006.

**CLASS 42—SCIENTIFIC AND COMPUTER SERVICES**

FOR DEVELOPMENT OF WEB SITES FOR OTHERS; HOSTING WEB SITES FOR OTHERS; OPTIMIZING INTERNET SEARCH ENGINE RESULTS FOR OTHERS (U.S. CLS. 100 AND 101).

FIRST USE 6-1-2006; IN COMMERCE 6-1-2006.  
CHARLES L. JENKINS, EXAMINING ATTORNEY

SN 85-848,648. ASTONISH RESULTS, LLC, WARWICK, RI. FILED 2-13-2013.



OWNER OF U.S. REG. NOS. 3,413,368, 3,806,528 AND 3,929,601.

THE MARK CONSISTS OF AN @ SYMBOL WITH THE WORDING "STONISH" WITHIN AN OVAL DESIGN ELEMENT.

#### CLASS 35—ADVERTISING AND BUSINESS

FOR BUSINESS MARKETING SERVICES; DIGITAL MARKETING SERVICES, NAMELY, ONLINE MARKETING; TRACKING INTERNET ADVERTISING TO DETERMINE USER CLICK TRAFFIC AND WEBSITE VISITS; BUSINESS CONSULTING SERVICES (U.S. CLS. 100, 101 AND 102).

FIRST USE 6-1-2006; IN COMMERCE 6-1-2006.

#### CLASS 41—EDUCATION AND ENTERTAINMENT

FOR SALES TRAINING IN THE FIELDS OF INSURANCE AND MORTGAGE SERVICES (U.S. CLS. 100, 101 AND 107).

FIRST USE 6-1-2006; IN COMMERCE 6-1-2006.

#### CLASS 42—SCIENTIFIC AND COMPUTER SERVICES

FOR DEVELOPMENT OF WEB SITES FOR OTHERS; HOSTING WEB SITES FOR OTHERS; OPTIMIZING INTERNET SEARCH ENGINE RESULTS FOR OTHERS (U.S. CLS. 100 AND 101).

FIRST USE 6-1-2006; IN COMMERCE 6-1-2006.

CHARLES L. JENKINS, EXAMINING ATTORNEY

SN 85-848,672. COLLIER'S RESERVE COUNTRY CLUB, INC., NAPLES, FL. FILED 2-13-2013.

COLLIER'S RESERVE

THE MARK CONSISTS OF STANDARD CHARACTERS WITHOUT CLAIM TO ANY PARTICULAR FONT, STYLE, SIZE, OR COLOR.

#### CLASS 41—EDUCATION AND ENTERTAINMENT

FOR COUNTRY CLUB SERVICES; ENTERTAINMENT SERVICES, NAMELY, PROVIDING FACILITIES FOR SPORTS, SPECIFICALLY, TENNIS COURTS AND SWIMMING POOLS; GOLF CLUB SERVICES; GOLF COURSES; GOLF COURSE SERVICES; PROVIDING INFORMATION TO OTHERS ON THE SUBJECT OF GOLF, TENNIS AND COUNTRY CLUB EVENTS, VIA THE INTERNET (U.S. CLS. 100, 101 AND 107).

FIRST USE 0-0-1992; IN COMMERCE 0-0-1993.

#### CLASS 43—HOTEL AND RESTAURANT SERVICES

FOR RESTAURANT SERVICES; BAR SERVICES (U.S. CLS. 100 AND 101).

FIRST USE 0-0-1992; IN COMMERCE 0-0-1993.

JUDITH HELFMAN, EXAMINING ATTORNEY

SN 85-848,997. MCGRAW-HILL GLOBAL EDUCATION HOLDINGS LLC, NEW YORK, NY. FILED 2-13-2013.



OWNER OF U.S. REG. NOS. 3,712,990, 4,259,039 AND OTHERS.

NO CLAIM IS MADE TO THE EXCLUSIVE RIGHT TO USE "EDUCATION" AS TO CLASSES 38 AND 41 AND "CONNECT" AS TO CLASS 38, APART FROM THE MARK AS SHOWN.

THE MARK CONSISTS OF THE WORDING "MCGRAW HILL EDUCATION CONNECT" WITH THE WORDING "MCGRAW HILL EDUCATION" IN A SHADED SQUARE.

#### CLASS 38—COMMUNICATION

FOR PROVIDING PASSWORD PROTECTED ACCESS TO INTERACTIVE ONLINE CUSTOMIZED HOMEWORK ASSIGNMENTS, TESTS, TEACHING AIDS AND MATERIALS, COURSE LECTURES, PRESENTATIONS CREATED FROM SOFTWARE FEATURING GRAPHICS AND SPECIAL FEATURES, STUDENT ASSESSMENTS, AND ELECTRONIC BOOKS THROUGH A GLOBAL COMPUTER NETWORK FOR STUDENTS AND INSTRUCTORS (U.S. CLS. 100, 101 AND 104).

#### CLASS 41—EDUCATION AND ENTERTAINMENT

FOR EDUCATION SERVICES, NAMELY, PROVIDING A WEBSITE FEATURING COURSE LECTURES AND EDUCATIONAL AUDIO, VIDEO AND PROSE PRESENTATIONS IN THE FIELDS OF ALL COURSES OF STUDY OFFERED BY COLLEGES, UNIVERSITIES AND INSTITUTIONS OF HIGHER EDUCATION (U.S. CLS. 100, 101 AND 107).

Laurie Mayes, Examining Attorney

SN 85-849,222. ONE OF ONE, INC., LOS ANGELES, CA. FILED 2-13-2013.

000

THE MARK CONSISTS OF STANDARD CHARACTERS WITHOUT CLAIM TO ANY PARTICULAR FONT, STYLE, SIZE, OR COLOR.

#### CLASS 9—ELECTRICAL AND SCIENTIFIC APPARATUS

FOR LEATHER GOODS, NAMELY, CASES FOR TELEPHONES, MP3 PLAYERS, AND TABLET COMPUTERS (U.S. CLS. 21, 23, 26, 36 AND 38).

FIRST USE 11-20-2012; IN COMMERCE 11-20-2012.

**CLASS 18—LEATHER GOODS**

FOR LEATHER GOODS, NAMELY, BACKPACKS, BAGS, BELTS, LUGGAGE, POUCHES, AND WALLETS (U.S. CLS. 1, 2, 3, 22 AND 41).  
FIRST USE 11-20-2012; IN COMMERCE 11-20-2012.  
FLORENTINA BLANDU, EXAMINING ATTORNEY

SN 85-849,228. BOOMERBOARD, LLC, BRANFORD, CT.  
FILED 2-13-2013.

**WAVEJET**

THE MARK CONSISTS OF STANDARD CHARACTERS WITHOUT CLAIM TO ANY PARTICULAR FONT, STYLE, SIZE, OR COLOR.

**CLASS 18—LEATHER GOODS**

FOR ALL PURPOSE SPORT BAGS; ALL-PURPOSE CARRYING BAGS; BACKPACKS (U.S. CLS. 1, 2, 3, 22 AND 41).

**CLASS 25—CLOTHING**

FOR CLOTHING, NAMELY, TOPS AND BOTTOMS; HEADWEAR; FOOTWEAR (U.S. CLS. 22 AND 39).

**CLASS 28—TOYS AND SPORTING GOODS**

FOR SURFBOARDS; OTHER WATER SPORTS APPARATUS IN THIS CLASS, NAMELY, BODY BOARDS, PADDLEBOARDS; BAGS ESPECIALLY DESIGNED FOR SURFBOARDS AND OTHER WATER SPORTS EQUIPMENT (U.S. CLS. 22, 23, 38 AND 50).

**CLASS 35—ADVERTISING AND BUSINESS**

FOR ON-LINE RETAIL STORE SERVICES FEATURING SPORTING GOODS AND CLOTHING (U.S. CLS. 100, 101 AND 102).  
NICHOLAS COLEMAN, EXAMINING ATTORNEY

SN 85-849,286. SLAZS INVESTMENTS LTD., STURGEON COUNTY, AB, CANADA, FILED 2-13-2013.



OWNER OF CANADA REG. NO. TMA867815, DATED 12-20-2013, EXPIRES 12-20-2028.

THE MARK CONSISTS OF A BACKGROUND DESIGN OF A JUKEBOX WITH THE WORDING "ROCK N WASH", BEHIND AN IMAGE OF A VINTAGE CAR ON A RECTANGLE WITH THE WORDING "ROCK N WASH" ON THE GRILL OF THE CAR, AND THE WORDING "REVOLUTIONIZING THE CAR WASH EXPERIENCE" BELOW THE CAR.

**CLASS 35—ADVERTISING AND BUSINESS**

FOR RETAIL STORE SERVICES FEATURING 1950S AND 1960S MEMORABILIA, FOOD, CANDY, NEWSPAPERS AND MAGAZINES, AUTOMOTIVE OIL, LUBRICANTS AND FLUIDS, WINDSHIELD WASHER AND ANTIFREEZE FLUIDS, GAS CANS, CLOTHING, HATS, TRAVEL BAGS, MUGS AND TRAVEL MUGS, NEON SIGNS, AUTOMOBILE PRODUCTS FOR CLEANING, DETAILING AND DISINFECTING, PRE-RECORDED MUSIC CDS AND DVDS, TOYS, BARBECUES, PENS (U.S. CLS. 100, 101 AND 102).

**CLASS 37—CONSTRUCTION AND REPAIR**

FOR CAR, TRUCK AND RV WASHING SERVICES (U.S. CLS. 100, 103 AND 106).  
AMY HELLA, EXAMINING ATTORNEY

SN 85-849,539. IRONCLAD GAMES CORPORATION, BURBANY, CANADA, FILED 2-14-2013.

**SINS OF A SOLAR EMPIRE:  
ENTRENCHMENT**

THE MARK CONSISTS OF STANDARD CHARACTERS WITHOUT CLAIM TO ANY PARTICULAR FONT, STYLE, SIZE, OR COLOR.  
OWNER OF U.S. REG. NOS. 4,264,754, 4,264,755 AND 4,308,917.

**CLASS 9—ELECTRICAL AND SCIENTIFIC APPARATUS**

FOR COMPUTER GAME PROGRAMS; COMPUTER GAME SOFTWARE; GAME SOFTWARE (U.S. CLS. 21, 23, 26, 36 AND 38).  
FIRST USE 12-16-2008; IN COMMERCE 12-16-2008.

**CLASS 41—EDUCATION AND ENTERTAINMENT**

FOR ENTERTAINMENT SERVICES, NAMELY, PROVIDING ON-LINE COMPUTER GAMES (U.S. CLS. 100, 101 AND 107).  
FIRST USE 12-16-2008; IN COMMERCE 12-16-2008.  
SHAUNIA CARLYLE, EXAMINING ATTORNEY

SN 85-849,687. HAMM AG, TIRSCHENREUTH, FED REP GERMANY, FILED 2-14-2013.

SN 85-849,912. POTOMAC METALS, INC., STERLING, VA. FILED 2-14-2013.



OWNER OF U.S. REG. NOS. 2,638,857, 2,708,554 AND 2,907,502.

NO CLAIM IS MADE TO THE EXCLUSIVE RIGHT TO USE "COMPACTION QUALITY", APART FROM THE MARK AS SHOWN.

THE MARK CONSISTS OF A STYLIZED ROLLER OR COMPACTOR ON A DEPICTION OF A ROAD WITH THE TERMS "HAMM COMPACTION QUALITY".

#### **CLASS 7—MACHINERY**

FOR CONSTRUCTION MACHINES, NAMELY, ROLLERS AND COMPACTORS; ROAD MAKING MACHINES; ROAD ROLLERS; ROLLERS FOR ROAD ROLLERS (U.S. CLS. 13, 19, 21, 23, 31, 34 AND 35).

#### **CLASS 9—ELECTRICAL AND SCIENTIFIC APPARATUS**

FOR DRIVE, VIBRATION, OSCILLATION AND ENGINE SPEED MEASURING DEVICES FOR ROAD ROLLERS; ELECTRONIC CONTROLLERS FOR ROAD ROLLERS; MATERIAL COMPACTION MEASURING DEVICES; MEASURING DEVICES FOR EXAMINING THE COMPACTION DEGREE ON ROAD ROLLERS (U.S. CLS. 21, 23, 26, 36 AND 38).

#### **CLASS 37—CONSTRUCTION AND REPAIR**

FOR ROAD CONSTRUCTION; ROAD CONSTRUCTION WORK; RENTAL OF ROAD MAKING MACHINES; REPAIR AND MAINTENANCE OF ROAD MAKING MACHINES; INFORMATION ON MAINTENANCE OF MEASURING AND TESTING DEVICES AND ROAD CONSTRUCTION INFORMATION (U.S. CLS. 100, 103 AND 106).

#### **CLASS 42—SCIENTIFIC AND COMPUTER SERVICES**

FOR MEASUREMENT OF THE COMPACTION DEGREE OF THE ROAD SURFACE ON ROAD ROLLERS; MEASUREMENT FOR EXAMINATION OF THE COMPACTION DEGREE OF ROADS (U.S. CLS. 100 AND 101).  
DAVID TOOLEY, EXAMINING ATTORNEY

NO CLAIM IS MADE TO THE EXCLUSIVE RIGHT TO USE "METALS" AND "INCORPORATED" AND THE UNIVERSAL RECYCLE SYMBOL, APART FROM THE MARK AS SHOWN.

THE MARK CONSISTS OF A CIRCULAR RING FRAMED BY A RIM AND WITH THE WORDS "POTOMAC METALS" IN ALL CAPITAL LETTERS ON TOP OF THE UPPER HALF OF THE RING AND THE WORD "INCORPORATED" IN ALL CAPITAL LETTERS ON TOP OF THE LOWER HALF OF THE RING AND WITH A RIM CLOSER TO THE CENTER FRAMING A CIRCLE WITH A UNIVERSALLY USED SYMBOL OF RECYCLING AND THE UPPER CASE LETTERS "PMI" ABOVE A DEPICTION OF THE SPHERE OF THE EARTH WITH NORTH AMERICA FROM THE SOUTH WESTERN COAST OF THE UNITED STATES TO EASTERN COAST LINE OF NORTH AMERICA, CENTRAL AMERICA AND THE NORTHERN AND WESTERN COAST OF SOUTH AMERICA VISIBLE ALONG WITH THE ATLANTIC OCEAN AND THE WESTERN COAST OF AFRICA AND THE SOUTH WESTERN COAST OF EUROPE (PORTUGAL AND SPAIN).

#### **CLASS 6—METAL GOODS**

FOR WASTE MATERIALS STORAGE BINS OF METAL; GENERAL PURPOSE METAL STORAGE UNITS, NAMELY, METAL SKIPS FOR COLLECTION AND STORAGE (U.S. CLS. 2, 12, 13, 14, 23, 25 AND 50).

#### **CLASS 35—ADVERTISING AND BUSINESS**

FOR RETAIL STORE SERVICES AND WHOLESALE DISTRIBUTORSHIPS FEATURING SCRAP METALS AND RECYCLED METALS; COMMERCIAL CONSULTANCY IN THE FIELD OF THE RETAIL AND WHOLESALE SALE OF SCRAP METALS AND RECYCLED METALS (U.S. CLS. 100, 101 AND 102).

#### **CLASS 36—INSURANCE AND FINANCIAL**

FOR BROKERAGE OF SCRAP METALS AND RECYCLED METALS; INFORMATION, ADVISORY AND CONSULTANCY SERVICES IN RELATION TO THE AFORESAID SERVICES (U.S. CLS. 100, 101 AND 102).

#### **CLASS 37—CONSTRUCTION AND REPAIR**

FOR DISPOSAL OF METALS, WASTE, REFUSE AND GARBAGE FOR OTHERS; COLLECTION OF SCRAP METAL FOR RECYCLING; COLLECTION OF METAL AND REFUSE FOR RECYCLING; SOLID WASTE COLLECTION OF METALS FOR OTHERS FOR RECYCLING; INFORMATION, ADVISORY AND CONSULTANCY SERVICES IN RELATION TO THE AFORESAID SERVICES (U.S. CLS. 100, 103 AND 106).

**CLASS 39—TRANSPORTATION AND STORAGE**

FOR TRANSPORTATION OF WASTE MATERIALS AND WASTE PRODUCTS; RECYCLING TRANSPORTATION SERVICES; FREIGHT TRANSPORTATION OF SCRAP METALS FOR OTHERS; FREIGHT TRANSPORTATION PROVIDED FOR THE DISPOSAL OF WASTE MATERIALS FOR OTHERS; STORAGE, DISTRIBUTION, AND TRANSPORTATION OF METALS; WASTE AND REFUSE COLLECTION IN THE NATURE OF GARBAGE COLLECTION; INFORMATION, ADVISORY AND CONSULTANCY SERVICES IN RELATION TO THE AFORESAID SERVICES (U.S. CLS. 100 AND 105).

**CLASS 40—MATERIAL TREATMENT**

FOR PROCESSING OF SCRAP METAL AND RECYCLING OF SCRAP METAL; PROCESSING AND RECYCLING OF WASTE AND WASTE MATERIALS; MATERIAL TREATMENT SERVICES IN CONNECTION WITH RECYCLING; METAL RECLAMATION SERVICES; RECYCLING; RECYCLING PROCESS SERVICES; PROCESSING AND TREATING REFUSE AND WASTE FOR THE RECOVERY OF MATERIALS; SORTING OF WASTE AND RECYCLABLE MATERIAL; WASTE MANAGEMENT; DESTRUCTION OF WASTE; ENVIRONMENTAL REMEDIATION SERVICES, NAMELY, METAL, REFUSE AND WASTE DISPOSAL; INDUSTRIAL TOXIC WASTE DISPOSAL; CONSULTING SERVICES IN THE FIELDS OF SCRAP METAL PROCESSING AND RECYCLING; INFORMATION, ADVISORY AND CONSULTANCY SERVICES IN RELATION TO THE AFORESAID SERVICES (U.S. CLS. 100, 103 AND 106).

NAAKWAMA ANKRAH, EXAMINING ATTORNEY

---

SN 85-849,924. POTOMAC METALS, INC., STERLING, VA. FILED 2-14-2013.

**POTOMAC METALS**

THE MARK CONSISTS OF STANDARD CHARACTERS WITHOUT CLAIM TO ANY PARTICULAR FONT, STYLE, SIZE, OR COLOR.

NO CLAIM IS MADE TO THE EXCLUSIVE RIGHT TO USE "METALS", APART FROM THE MARK AS SHOWN.

**CLASS 6—METAL GOODS**

FOR WASTE MATERIALS STORAGE BINS OF METAL; GENERAL PURPOSE METAL STORAGE UNITS, NAMELY, METAL SKIPS FOR COLLECTION AND STORAGE (U.S. CLS. 2, 12, 13, 14, 23, 25 AND 50).

**CLASS 35—ADVERTISING AND BUSINESS**

FOR RETAIL STORE SERVICES AND WHOLESALE DISTRIBUTORSHIPS FEATURING SCRAP METALS AND RECYCLED METALS; COMMERCIAL CONSULTANCY IN THE FIELD OF THE RETAIL AND WHOLESALE SALE OF SCRAP METALS AND RECYCLED METALS (U.S. CLS. 100, 101 AND 102).

**CLASS 36—INSURANCE AND FINANCIAL**

FOR BROKERAGE OF SCRAP METALS AND RECYCLED METALS; INFORMATION, ADVISORY AND CONSULTANCY SERVICES IN RELATION TO THE AFORESAID SERVICES (U.S. CLS. 100, 101 AND 102).

**CLASS 37—CONSTRUCTION AND REPAIR**

FOR DISPOSAL OF METALS, WASTE, REFUSE AND GARBAGE FOR OTHERS; COLLECTION OF SCRAP METAL; COLLECTION OF METAL AND REFUSE FOR RECYCLING; COLLECTION OF METALS AND WASTE FOR OTHERS; INFORMATION, ADVISORY AND CONSULTANCY SERVICES IN RELATION TO THE AFORESAID SERVICES (U.S. CLS. 100, 103 AND 106).

**CLASS 39—TRANSPORTATION AND STORAGE**

FOR TRANSPORTATION OF WASTE MATERIALS AND WASTE PRODUCTS; RECYCLING TRANSPORTATION SERVICES; FREIGHT TRANSPORTATION OF SCRAP METALS FOR OTHERS; FREIGHT TRANSPORTATION PROVIDED FOR THE DISPOSAL OF WASTE MATERIALS FOR OTHERS; STORAGE, DISTRIBUTION, AND TRANSPORTATION OF METALS; GARBAGE, WASTE, AND REFUSE COLLECTION; INFORMATION, ADVISORY AND CONSULTANCY SERVICES IN RELATION TO THE AFORESAID SERVICES (U.S. CLS. 100 AND 105).

**CLASS 40—MATERIAL TREATMENT**

FOR PROCESSING OF SCRAP METAL AND RECYCLING OF SCRAP METAL; PROCESSING AND RECYCLING OF WASTE AND WASTE MATERIALS; MATERIAL TREATMENT SERVICES IN CONNECTION WITH RECYCLING; METAL RECLAMATION SERVICES; RECYCLING; RECYCLING PROCESS SERVICES; PROCESSING AND TREATING REFUSE AND WASTE FOR THE RECOVERY OF MATERIALS; SORTING OF WASTE AND RECYCLABLE MATERIAL; WASTE MANAGEMENT; DESTRUCTION OF WASTE; ENVIRONMENTAL REMEDIATION SERVICES, NAMELY, METAL, REFUSE AND WASTE DISPOSAL; INDUSTRIAL TOXIC WASTE DISPOSAL; CONSULTING SERVICES IN THE FIELDS OF SCRAP METAL PROCESSING AND RECYCLING; INFORMATION, ADVISORY AND CONSULTANCY SERVICES IN RELATION TO THE AFORESAID SERVICES (U.S. CLS. 100, 103 AND 106).

NAAKWAMA ANKRAH, EXAMINING ATTORNEY

---

SN 85-849,926. ATLANTIS HOLDINGS, INC., TRUJILLO ALTO, PUERTO RICO, FILED 2-14-2013.



NO CLAIM IS MADE TO THE EXCLUSIVE RIGHT TO USE "HEALTHCARE GROUP INC.", APART FROM THE MARK AS SHOWN.

THE COLOR(S) BLUE AND GREY IS/ARE CLAIMED AS A FEATURE OF THE MARK.

THE MARK CONSISTS OF THE WORD "ATLANTIS" IN STYLIZED BLUE FONT. AT THE TOP OF THE LETTERS "A" AND "N" IS A DESIGN OF TWO HUMAN FIGURES JOINED BY A DESIGN OF AN OVOID IN BLUE. THE HUMAN FIGURE ON THE RIGHT IS IN BLUE AND THE HUMAN FIGURE ON THE LEFT IS IN GREY. BELOW THE DESIGN ARE THE WORDS "HEALTHCARE", "GROUP" AND "INC." IN GREY STYLIZED FONT.

**CLASS 35—ADVERTISING AND BUSINESS**

FOR BUSINESS MANAGEMENT SERVICES, NAMELY, MEDICAL PRACTICE MANAGEMENT CONSULTATION RELATING TO HEALTHCARE SERVICES (U.S. CLS. 100, 101 AND 102).

FIRST USE 3-15-2001; IN COMMERCE 3-15-2001.

**CLASS 41—EDUCATION AND ENTERTAINMENT**

FOR EDUCATIONAL SERVICES, NAMELY, EDUCATION, TRAINING, CLASSES AND SEMINARS IN THE FIELD OF HEALTHCARE; EDUCATIONAL SERVICES, NAMELY, CONDUCTING PROGRAMS IN THE FIELD OF PATIENT EDUCATION RELATING TO HUMAN HEALTHCARE (U.S. CLS. 100, 101 AND 107).

FIRST USE 3-15-2001; IN COMMERCE 3-15-2001.

**CLASS 44—MEDICAL, BEAUTY AND AGRICULTURAL SERVICES**

FOR HEALTHCARE SERVICES, NAMELY, RENAL SERVICES; MEDICAL CONSULTING IN THE FIELD OF RENAL HEALTHCARE; MEDICAL SERVICES, NAMELY, HEALTHCARE CENTERS FOR MEDICAL RENAL THERAPY (U.S. CLS. 100 AND 101).

FIRST USE 3-15-2001; IN COMMERCE 3-15-2001.

JESSICA FATHY, EXAMINING ATTORNEY

SN 85-850,040. NIPSEA MANAGEMENT COMPANY PTE LTD. GREAT WORLD CITY, SINGAPORE, FILED 2-14-2013.

# CYGLAZ

THE MARK CONSISTS OF STANDARD CHARACTERS WITHOUT CLAIM TO ANY PARTICULAR FONT, STYLE, SIZE, OR COLOR.

OWNER OF SINGAPORE REG. NO. T1105712G, DATED 4-29-2011, EXPIRES 4-29-2021.

**CLASS 1—CHEMICALS**

FOR COATINGS BEING INORGANIC, NAMELY, CHEMICAL PREPARATIONS FOR USE IN THE MANUFACTURE OF PAINT COATINGS FOR METAL AND NON-METAL SURFACES; INDUSTRIAL ORGANIC CHEMICALS AND INORGANIC CHEMICAL COMPOUNDS, NAMELY, CHEMICAL PREPARATIONS FOR GENERAL INDUSTRIAL MANUFACTURING AND CHEMICAL PREPARATIONS FOR USE IN INDUSTRY; INORGANIC CHEMICALS FOR USE IN SCIENCE, NAMELY, INORGANIC CHEMICAL PREPARATIONS FOR SCIENTIFIC PURPOSES; INORGANIC CHEMICALS FOR USE IN INDUSTRY, NAMELY, INORGANIC CHEMICAL PREPARATIONS FOR USE IN INDUSTRY; INORGANIC SMOKE RETARDANTS, NAMELY, SMOKE SUPPRESSANT CHEMICALS; RAW MATERIALS FOR USE IN POWDER COATING PROCESSES, NAMELY, POLYMER COMPOSITIONS USED IN THE MANUFACTURE OF COMMERCIAL AND INDUSTRIAL GOODS; CHEMICAL COMPOSITIONS, NAMELY, SYNTHETIC RESINS AND POLYMERS, FOR USE IN THE MANUFACTURE OF PLASTICS; COATING COMPOSITIONS OTHER THAN PAINT, NAMELY, ADHESIVE SUBSTANCES FOR USE IN INDUSTRY; COATING COMPOSITIONS FOR APPLICATION TO BRICKWORK, NAMELY, CHEMICAL PREPARATIONS FOR USE IN THE MANUFACTURE OF BRICK PAINTS; POLYESTER COMPOSITIONS IN THE FORM OF POWDERS FOR THE MANUFACTURE OF COATINGS; SYNTHETIC COMPOSITIONS FOR THE MANUFACTURE OF COATINGS OF BOROSILICATE GLASS (U.S. CLS. 1, 5, 6, 10, 26 AND 46).

**CLASS 2—PAINTS**

FOR COATING COMPOSITIONS FOR APPLICATION TO BRICKWORK, CONCRETE AND STONEMWORK, NAMELY, SEALER COATINGS AND ARCHITECTURAL PROTECTIVE COATINGS; COATING COMPOSITIONS IN THE FORM OF OILS FOR USE AS MOISTURE BARRIERS AND CORROSION INHIBITANTS; COATING COMPOSITIONS IN THE FORM OF PAINT; COATING COMPOSITIONS IN THE NATURE OF LACQUERS; COATING COMPOSITIONS IN THE NATURE OF OILS, NAMELY, ANTI-CORROSIVE OILS; COATING COMPOSITIONS IN THE NATURE OF PAINT; CONVERSION COATING COMPOSITIONS, NAMELY, ANTI-CORROSIVE COATINGS; PROTECTIVE COATING COMPOSITIONS, NAMELY, ANTI-CORROSIVE COATINGS AND WATER-RESISTANT COATINGS; SURFACE COATING COMPOSITIONS, NAMELY, COATINGS IN THE NATURE OF INDUSTRIAL SEALANTS FOR WATERPROOFING AND SURFACE HARDENING, AND PENETRATING SEALER COATINGS FOR USE ON STONE, CONCRETE, WOOD, DRYWALL, PAPER, METAL, PLASTICS, COMPOSITES AND GLASS; TRANSPARENT COATING COMPOSITIONS, NAMELY, LACQUERS, SHELLACS AND COATINGS IN THE NATURE OF INDUSTRIAL SEALANTS FOR WATERPROOFING AND SURFACE HARDENING; COATING PREPARATIONS HAVING WATER RESISTANT PROPERTIES; CONCRETE SEALERS IN THE FORM OF A COATING; PENETRATING SEALER COATINGS FOR USE ON MASONRY, STONEMWORK; COATING COMPOSITIONS FOR PROTECTION AGAINST THE EFFECTS OF CHEMICAL ABRASION, NAMELY, ANTI-CORROSIVE COATINGS; COATING COMPOSITIONS FOR PROTECTION AGAINST THE EFFECTS OF CHEMICALS, NAMELY, ANTI-CORROSIVE COATINGS; COATING COMPOSITIONS FOR PROTECTION AGAINST THE EFFECTS OF ENCRUSTATION, NAMELY, ANTI-CORROSIVE COATINGS; COATING COMPOSITIONS FOR PROTECTION AGAINST THE EFFECTS OF INCRUSTATION, NAMELY, ANTI-CORROSIVE COATINGS; ABRASION-RESISTANT COATING COMPOSITIONS FOR POLYMERIC AND OTHER SUBSTRATES; COMPOSITIONS FOR COATING ALUMINUM IN PREPARATION FOR PLATING, NAMELY, ANTI-TARNISHING PREPARATIONS FOR COATING METALS; COATING COMPOSITIONS FOR OPTICAL FIBRES, NAMELY, ANTI-CORROSIVE COATINGS; HEAT-RESISTANT COATINGS FOR INDUSTRIAL APPLICATIONS WHERE ELEVATED TEMPERATURES OCCUR; COATING COMPOSITIONS FOR PROTECTION AGAINST THE EFFECTS OF RADIATION IN INDUSTRIAL APPLICATIONS (U.S. CLS. 6, 11 AND 16).

**CLASS 37—CONSTRUCTION AND REPAIR**

FOR COATING OF METAL ARTICLES WITH POLYMERS BY WET COATING PROCESSES, NAMELY, APPLICATION OF PROTECTIVE COATINGS; PROCESSING OF SEMI-FINISHED METAL GOODS BY COATING, NAMELY, APPLICATION OF PROTECTIVE COATINGS; SEALING OF POROUS ARTICLES WITH CHEMICAL COMPOSITIONS, NAMELY, APPLICATION OF PROTECTIVE COATINGS (U.S. CLS. 100, 103 AND 106).

**CLASS 40—MATERIAL TREATMENT**

FOR APPLICATION OF PROTECTIVE COATINGS BY AUTOCATALYTIC PROCESSES; APPLICATION OF PROTECTIVE COATINGS BY ELECTROLYTIC PROCESSES; APPLICATION OF WEAR RESISTANT COATINGS BY AUTOCATALYTIC PROCESSES; APPLICATION OF WEAR RESISTANCE COATINGS BY ELECTROLYTIC PROCESSES (U.S. CLS. 100, 103 AND 106).

HELENE LIWINSKI, EXAMINING ATTORNEY



SN 85-850,092. FRUTI FRUIT, INC., SHERMAN OAKS, CA.  
FILED 2-14-2013.



THE MARK CONSISTS OF AN ILLUSTRATION OF A CHARACTER WITH A CITRUS BODY, PINEAPPLE TOP, BANANA FEET, ORANGE EYES AND GLOVED HANDS HOLDING A FRUIT.

**CLASS 29—MEATS AND PROCESSED FOODS**

FOR CUT FRUITS; PACKAGED FRUITS (U.S. CL. 46).

**CLASS 31—NATURAL AGRICULTURAL PRODUCTS**

FOR FRESH FRUITS (U.S. CLS. 1 AND 46).  
LEE-ANNE BERNS, EXAMINING ATTORNEY

**CLASS 9—ELECTRICAL AND SCIENTIFIC APPARATUS**

FOR VIDEO AND AUDIO RECORDINGS, FILMS, TELEVISION PROGRAMMES, RADIO PROGRAMMES, AUDIO BOOKS, ALL DOWNLOADABLE ALL IN THE FIELD OF MUSIC AND RECORDING ARTISTS; MUSIC, SOUNDS, IMAGES OF RECORDING ARTISTS AND TAKEN FROM CONCERTS, PROVIDED IN A DOWNLOADABLE FORMAT; DOWNLOADABLE ELECTRONIC PUBLICATIONS IN THE NATURE OF BOOKS, MAGAZINES, BROCHURES, NEWSPAPERS RELATING TO RECORDING ARTISTS, MUSIC AND CONCERTS; DIGITAL MUSIC DOWNLOADABLE PROVIDED FROM THE INTERNET; DOWNLOADABLE PODCASTS IN THE FIELD OF MUSIC AND RECORDING ARTISTS; MOTION PICTURE FILMS AND PROGRAMMES FEATURING MUSIC ENTERTAINMENT, DRAMA, ACTION, ADVENTURE AND/OR ANIMATION; MOTION PICTURE FILMS AND PROGRAMMES FOR BROADCAST ON TELEVISION FEATURING MUSIC ENTERTAINMENT, DRAMA, ACTION, ADVENTURE AND/OR ANIMATION; PROMOTIONAL AND MARKETING MATERIAL IN DIGITAL FORM, NAMELY, DOWNLOADABLE IMAGE FILES FEATURING FLYERS, POSTERS, TICKETS AND INVITATIONS FOR A MUSIC EVENT AND RECORDING ARTIST'S SHOW; TRAINING AIDS AND INSTRUCTIONAL MATERIAL IN DIGITAL FORM, NAMELY, DOWNLOADABLE BOOKS IN THE FIELD OF MUSIC; ELECTRONIC CARDS, BRACELETS FEATURING DIGITALLY RECORDED DATA AND TAGS FEATURING DIGITALLY RECORDED DATA IN THE FORM OF ACCESS CARDS TO A MUSIC EVENT OR RECORDING ARTIST'S CONCERT; COMPUTER GAME PROGRAMS, VIDEO GAME CARTRIDGES, AND DOWNLOADABLE ELECTRONIC GAME SOFTWARE FOR MOBILE PHONES; INTERACTIVE COMPUTER SOFTWARE IN THE FORM OF SINGING GAMES OR KARAOKE; EDUCATIONAL SOFTWARE IN THE FIELD OF MUSIC; MULTIMEDIA APPARATUS AND INSTRUMENTS, NAMELY, MP3 PLAYERS, MEDIA PLAYERS, AND PDAS; STRAPS, CHARMS, CASES, FOR TELEPHONE HANDSETS; DOWNLOADABLE RINGTONES; COMPUTER SCREEN SAVER SOFTWARE THAT DISPLAYS PICTURES AND TEXT ON A SCREEN; MOUSE MATS; SUNGLASSES, EYEGLASSES, AND CASES AND BAGS ADAPTED THEREFOR; NOVELTY MAGNETS, FRIDGE MAGNETS (U.S. CLS. 21, 23, 26, 36 AND 38).

SN 85-850,311. SSM PRODUCTIONS INC., ST. HELIER, JERSEY, FILED 2-14-2013.

**SHIRLEY BASSEY**

THE MARK CONSISTS OF STANDARD CHARACTERS WITHOUT CLAIM TO ANY PARTICULAR FONT, STYLE, SIZE, OR COLOR.

OWNER OF ERPN CMNTY TM OFC REG. NO. 011125747, DATED 4-25-2013, EXPIRES 8-17-2022.

THE NAME(S), PORTRAIT(S), AND/OR SIGNATURE(S) SHOWN IN THE MARK IDENTIFIES "SHIRLEY BASSEY", WHOSE CONSENT(S) TO REGISTER IS MADE OF RECORD.

**CLASS 16—PAPER GOODS AND PRINTED MATTER**

FOR PAPER, CARDBOARD; BOOK BINDING MATERIAL; PHOTOGRAPHS; STATIONERY; ADHESIVES FOR STATIONERY OR HOUSEHOLD PURPOSES; PAINT BRUSHES; TYPEWRITERS PRINTERS' TYPE; PRINTING BLOCKS; MOUNTED AND/OR UNMOUNTED PHOTOGRAPHS; PHOTOGRAPH ALBUMS; ART PAPERS; ARTS AND CRAFTS KITS FOR MODEL MAKING COMPRISED PRIMARILY OF MODELING CLAY, AND ALSO CONTAINING COLORING MATERIALS AND FABRIC; PAINTING SETS COMPRISED OF PAINTBRUSHES, PAINT TRAYS; PACKAGING BAGS OF PLASTIC OR OF PAPER, GARBAGE BAGS OF PLASTICS OR OF PAPER; BOOKS, MAGAZINES, JOURNALS, PERIODICALS, ACTIVITY BOOKS, POP-UP BOOKS ACTIVITY BOOKS, ALL RELATING TO MUSIC OR RECORDING ARTISTS; COMICS, COLORING BOOKS; RECIPE BOOKS; PRINTED RECIPE CARDS; WRITING PAPER, ENVELOPES, NOTEBOOKS, AUTOGRAPH BOOKS, ADDRESS BOOKS, CALENDARS, DIARIES, NOTE CARDS; GREETING CARDS, GIFT WRAPPING PAPER, GIFT TAGS OF PAPER; LITHOGRAPHS; ART PICTURES; POSTERS AND POSTCARDS; PENS, PENCILS, PENCIL CASES, ERASERS, CRAYONS, MARKERS, COLORED PENCILS, PENCIL SHARPENERS; PAINT BRUSHES, CHALK AND CHALKBOARDS; DECORATIVE PENCIL-TOP ORNAMENTS; PRINTING STAMPS AND INK; TRADING CARDS; STICKERS, ALBUMS FOR STICKERS; DECALS;

PRINTED TRANSFERS FOR EMBROIDERY OR FABRIC APPLIQUÉS; PRINTED PATTERNS FOR COSTUMES; TEMPORARY TATTOOS; PAPER PARTY DECORATIONS, PAPER NAPKINS, PAPER DOILIES, PAPER PLACE MATS, CREPE PAPER, PRINTED INVITATIONS, PAPER CAKE DECORATIONS; PAPER BANNERS; COASTERS OF PAPER OR CARDBOARD, TABLE MATS OF PAPER OR CARDBOARD; FIGURINES OF PAPIER MACHE; PRINTED TICKETS; CHRISTMAS CARDS, CHRISTMAS WRAPPING PAPER; CHRISTMAS DECORATIONS OF PAPER OR CARDBOARD (U.S. CLS. 2, 5, 22, 23, 29, 37, 38 AND 50).

SN 85-850,324. SSM PRODUCTIONS INC., ST. HELIER, JERSEY, FILED 2-14-2013.

## DAME SHIRLEY BASSEY

### CLASS 25—CLOTHING

FOR FOOTWEAR; ROMPER SUITS FOR BABIES; EVENING WEAR, NAMELY, EVENING DRESSES, COCKTAIL DRESSES, TUXEDOS; TOPS, BOTTOMS, DRESSES AND GOWNS; EVENING JACKETS, STOLE, FUR JACKETS AND STOLE; EVENING GLOVES; JEANS, SWEATSHIRTS, T-SHIRTS, POLO SHIRTS, LONG SLEEVED POLO SHIRTS, FLEECE TOPS AND FLEECE JACKETS; HOODED TOPS; TRACKSUITS; SWIMWEAR; SWEATERS, SUITS, SHIRTS, BLOUSES, SKIRTS, TROUSERS, WAISTCOATS; BELTS; COATS, GILETS, JACKETS, NIGHTWEAR, LOUNGEWEAR, PYJAMAS, DRESSING GOWNS, BATH ROBES; SOCKS, UNDERWEAR, LINGERIE; SCARVES, TIES, HEAD-SCARVES; SHOES, SANDALS, BOOTS, PUMPS, ATHLETIC SHOES, SLIPPERS; SPORTS FOOTWEAR; GLOVES; BASEBALL CAPS, WOOLLY CAPS AND HATS; APRONS; MASQUERADE COSTUMES; SUN VISORS; PAPER MASQUERADE MASKS (U.S. CLS. 22 AND 39).

THE MARK CONSISTS OF STANDARD CHARACTERS WITHOUT CLAIM TO ANY PARTICULAR FONT, STYLE, SIZE, OR COLOR.

PRIORITY CLAIMED UNDER SEC. 44(D) ON ERPNTY TM OFC APPLICATION NO. 011125689, FILED 8-17-2012, REG. NO. 011125689, DATED 6-19-2013, EXPIRES 8-17-2022.

THE NAME(S), PORTRAIT(S), AND/OR SIGNATURE(S) SHOWN IN THE MARK IDENTIFIES "SHIRLEY BASSEY", WHOSE CONSENT(S) TO REGISTER IS MADE OF RECORD.

### CLASS 36—INSURANCE AND FINANCIAL

FOR CHARITY FUNDRAISING SERVICES; INFORMATION, CONSULTANCY AND ADVICE ABOUT ANY OF THE AFORESAID SERVICES (U.S. CLS. 100, 101 AND 102).

### CLASS 9—ELECTRICAL AND SCIENTIFIC APPARATUS

FOR VIDEO AND AUDIO RECORDINGS, FILMS, TELEVISION PROGRAMMES, RADIO PROGRAMMES, AUDIO BOOKS, ALL DOWNLOADABLE ALL IN THE FIELD OF MUSIC AND RECORDING ARTISTS; MUSIC, SOUNDS, IMAGES OF RECORDING ARTISTS AND TAKEN FROM CONCERTS, PROVIDED IN A DOWNLOADABLE FORMAT; DOWNLOADABLE ELECTRONIC PUBLICATIONS IN THE NATURE OF BOOKS, MAGAZINES, BROCHURES, NEWSPAPERS RELATING TO RECORDING ARTISTS, MUSIC AND CONCERTS; DIGITAL MUSIC DOWNLOADABLE PROVIDED FROM THE INTERNET; DOWNLOADABLE PODCASTS IN THE FIELD OF MUSIC AND RECORDING ARTISTS; MOTION PICTURE FILMS AND PROGRAMMES FEATURING MUSIC ENTERTAINMENT, DRAMA, ACTION, ADVENTURE AND/OR ANIMATION; MOTION PICTURE FILMS AND PROGRAMMES FOR BROADCAST ON TELEVISION FEATURING MUSIC ENTERTAINMENT, DRAMA, ACTION, ADVENTURE AND/OR ANIMATION; PROMOTIONAL AND MARKETING MATERIAL IN DIGITAL FORM, NAMELY, DOWNLOADABLE IMAGE FILES FEATURING FLYERS, POSTERS, TICKETS AND INVITATIONS FOR A MUSIC EVENT AND RECORDING ARTIST'S SHOW; TRAINING AIDS AND INSTRUCTIONAL MATERIAL IN DIGITAL FORM, NAMELY, DOWNLOADABLE BOOKS IN THE FIELD OF MUSIC; ELECTRONIC CARDS, BRACELETS FEATURING DIGITALLY RECORDED DATA AND TAGS FEATURING DIGITALLY RECORDED DATA IN THE FORM OF ACCESS CARDS TO A MUSIC EVENT OR RECORDING ARTIST'S CONCERT; COMPUTER GAME PROGRAMS, VIDEO GAME CARTRIDGES, AND DOWNLOADABLE ELECTRONIC GAME SOFTWARE FOR MOBILE PHONES; INTERACTIVE COMPUTER SOFTWARE IN THE FORM OF SINGING GAMES OR KARAOKE; EDUCATIONAL SOFTWARE IN THE FIELD OF MUSIC; MULTIMEDIA APPARATUS AND INSTRUMENTS, NAMELY, MP3 PLAYERS, MEDIA PLAYERS, AND PDAS; STRAPS, CHARMS, CASES, FOR TELEPHONE HANDSETS; DOWNLOADABLE RINGTONES; COMPUTER SCREEN SAVER SOFTWARE THAT DISPLAYS PICTURES AND TEXT ON A SCREEN; MOUSE MATS; SUNGLASSES, EYEGASSES, AND CASES AND BAGS ADAPTED THEREFOR; NOVELTY MAGNETS, FRIDGE MAGNETS (U.S. CLS. 21, 23, 26, 36 AND 38).

### CLASS 41—EDUCATION AND ENTERTAINMENT

FOR EDUCATION, NAMELY, CLASSES AND TRAINING IN THE FIELD OF MUSIC; MUSIC ENTERTAINMENT, IN THE NATURE OF LIVE MUSICAL PERFORMANCES FEATURING SINGING; PRODUCTION, PRESENTATION, SYNDICATION, DISTRIBUTION AND RENTAL OF FILMS, TELEVISION PROGRAMS AND RADIO PROGRAMS CONTAINING MUSIC RECORDINGS AND VIDEO FOOTAGE OF RECORDING ARTISTS CONCERTS AND DOCUMENTARIES ABOUT RECORDING ARTISTS AND TRIBUTES TO RECORDING ARTISTS; PRODUCTION, PRESENTATION, SYNDICATION, DISTRIBUTION AND RENTAL OF FILMS, TELEVISION AND RADIO PROGRAMMES; ARRANGING AND CONDUCTING OUTDOOR AND INDOOR LIVE MUSIC CONCERTS AND RECORDING ARTISTS SHOWS AND TRIBUTES TO RECORDING ARTISTS, FOR ENTERTAINMENT OR EDUCATIONAL PURPOSES; ARRANGING AND CONDUCTING TRIBUTE SHOWS, CONCERTS, SINGING COMPETITIONS, ALL FOR ENTERTAINMENT OR EDUCATIONAL PURPOSES; THEATRICAL PERFORMANCES BOTH ANIMATED AND LIVE ACTION; MUSIC PUBLISHING SERVICES; BOOK PUBLISHING SERVICES; PUBLISHING OF ELECTRONIC BOOKS; PROVIDING ON-LINE ELECTRONIC COMPUTER GAMES; INFORMATION, CONSULTANCY AND ADVICE ABOUT ANY OF THE AFORESAID SERVICES (U.S. CLS. 100, 101 AND 107).

SEAN CROWLEY, EXAMINING ATTORNEY

**CLASS 16—PAPER GOODS AND PRINTED MATTER**

FOR PAPER, CARDBOARD; BOOK BINDING MATERIAL; PHOTOGRAPHS; STATIONERY; ADHESIVES FOR STATIONERY OR HOUSEHOLD PURPOSES; PAINT BRUSHES; TYPEWRITERS PRINTERS' TYPE; PRINTING BLOCKS; MOUNTED AND /OR UNMOUNTED PHOTOGRAPHS; PHOTOGRAPH ALBUMS; ART PAPERS; ARTS AND CRAFTS KITS FOR MODEL MAKING COMPRISED PRIMARILY OF MODELING CLAY, AND ALSO CONTAINING COLORING MATERIALS AND FABRIC; PAINTING SETS COMPRISED OF PAINTBRUSHES, PAINT TRAYS; PACKAGING BAGS OF PLASTIC OR OF PAPER, GARBAGE BAGS OF PLASTICS OR OF PAPER; BOOKS, MAGAZINES, JOURNALS, PERIODICALS, ., ACTIVITY BOOKS, POP-UP BOOKS ACTIVITY BOOKS, ALL RELATING TO MUSIC OR RECORDING ARTISTS; COMICS, COLOURING BOOKS; RECIPE BOOKS; PRINTED RECIPE CARDS; WRITING PAPER, ENVELOPES, NOTEBOOKS, AUTOGRAPH BOOKS, ADDRESS BOOKS, CALENDARS, DIARIES, NOTE CARDS; GREETING CARDS, GIFT WRAPPING PAPER, GIFT TAGS OF PAPER; LITHOGRAPHS; ART PICTURES; POSTERS AND POSTCARDS; PENS, PENCILS, PENCIL CASES, ERASERS, CRAYONS, MARKERS, COLOURED PENCILS, PENCIL SHARPENERS; PAINT BRUSHES, CHALK AND CHALKBOARDS; DECORATIVE PENCIL-TOP ORNAMENTS; PRINTING STAMPS AND INK; TRADING CARDS; STICKERS, ALBUMS FOR STICKERS; DECALS; PRINTED TRANSFERS FOR EMBROIDERY OR FABRIC APPLIQUES; PRINTED PATTERNS FOR COSTUMES; TEMPORARY TATTOOS; PAPER PARTY DECORATIONS, PAPER NAPKINS, PAPER DOILIES, PAPER PLACE MATS, CREPE PAPER, PRINTED INVITATIONS, PAPER CAKE DECORATIONS; PAPER BANNERS; COASTERS OF PAPER OR CARDBOARD, TABLE MATS OF PAPER OR CARDBOARD; FIGURINES OF PAPIER MACHE; PRINTED TICKETS; CHRISTMAS CARDS, CHRISTMAS WRAPPING PAPER; CHRISTMAS DECORATIONS OF PAPER OR CARDBOARD (U.S. CLS. 2, 5, 22, 23, 29, 37, 38 AND 50).

**CLASS 41—EDUCATION AND ENTERTAINMENT**

FOR EDUCATION, NAMELY, CLASSES AND TRAINING IN THE FIELD OF MUSIC; MUSIC ENTERTAINMENT, IN THE NATURE OF LIVE MUSICAL PERFORMANCES FEATURING SINGING; PRODUCTION, PRESENTATION, SYNDICATION, DISTRIBUTION AND RENTAL OF FILMS, TELEVISION PROGRAMS AND RADIO PROGRAMS CONTAINING MUSIC RECORDINGS AND VIDEO FOOTAGE OF RECORDING ARTISTS CONCERTS AND DOCUMENTARIES ABOUT RECORDING ARTISTS AND TRIBUTES TO RECORDING ARTISTS; PRODUCTION, PRESENTATION, SYNDICATION, DISTRIBUTION AND RENTAL OF FILMS, TELEVISION AND RADIO PROGRAMMES; ARRANGING AND CONDUCTING OUTDOOR AND INDOOR LIVE MUSIC CONCERTS AND RECORDING ARTISTS SHOWS AND TRIBUTES TO RECORDING ARTISTS, FOR ENTERTAINMENT OR EDUCATIONAL PURPOSES; ARRANGING AND CONDUCTING TRIBUTE SHOWS, CONCERTS, SINGING COMPETITIONS, ALL FOR ENTERTAINMENT OR EDUCATIONAL PURPOSES; THEATRICAL PERFORMANCES BOTH ANIMATED AND LIVE ACTION; MUSIC PUBLISHING SERVICES; BOOK PUBLISHING SERVICES; PUBLISHING OF ELECTRONIC BOOKS; PROVIDING ON-LINE ELECTRONIC COMPUTER GAMES; INFORMATION, CONSULTANCY AND ADVICE ABOUT ANY OF THE AFORESAID SERVICES (U.S. CLS. 100, 101 AND 107).

SEAN CROWLEY, EXAMINING ATTORNEY

SN 85-850,346. SSM PRODUCTIONS INC., ST. HELIER, JERSEY, FILED 2-14-2013.

**CLASS 25—CLOTHING**

FOR FOOTWEAR; ROMPER SUITS FOR BABIES; EVENING WEAR, NAMELY, EVENING DRESSES, COCKTAIL DRESSES, TUXEDOS; TOPS, BOTTOMS, DRESSES AND GOWNS; EVENING JACKETS, STOLEES, FUR JACKETS AND STOLEES; EVENING GLOVES; JEANS, SWEATSHIRTS, T-SHIRTS, POLO SHIRTS, LONG SLEEVED POLO SHIRTS, FLEECE TOPS AND FLEECE JACKETS; HOODED TOPS; TRACKSUITS; SWIMWEAR; SWEATERS, SUITS, SHIRTS, BLOUSES, SKIRTS, TROUSERS, WAISTCOATS; BELTS; COATS, GILETS, JACKETS, NIGHTWEAR, LOUNGEWEAR, PYJAMAS, DRESSING GOWNS, BATH ROBES; SOCKS, UNDERWEAR, LINGERIE; SCARVES, TIES, HEAD-SCARVES; SHOES, SANDALS, BOOTS, PUMPS, ATHLETIC SHOES, SLIPPERS; SPORTS FOOTWEAR; GLOVES; BASEBALL CAPS, WOOLLY CAPS AND HATS; APRONS; MASQUERADE COSTUMES; SUN VISORS; PAPER MASQUERADE MASKS (U.S. CLS. 22 AND 39).

DSB

**CLASS 36—INSURANCE AND FINANCIAL**

FOR CHARITY FUNDRAISING SERVICES; INFORMATION, CONSULTANCY AND ADVICE ABOUT ANY OF THE AFORESAID SERVICES (U.S. CLS. 100, 101 AND 102).

THE MARK CONSISTS OF STANDARD CHARACTERS WITHOUT CLAIM TO ANY PARTICULAR FONT, STYLE, SIZE, OR COLOR.

PRIORITY CLAIMED UNDER SEC. 44(D) ON ERPNTY TM OFC APPLICATION NO. 011125721, FILED 8-17-2012, REG. NO. 011125721, DATED 4-25-2013, EXPIRES 8-17-2022.

THE NAME(S), PORTRAIT(S), AND/OR SIGNATURE(S) SHOWN IN THE MARK IDENTIFIES SHIRLEY BASSEY, WHOSE CONSENT(S) TO REGISTER IS MADE OF RECORD.

**CLASS 9—ELECTRICAL AND SCIENTIFIC APPARATUS**

FOR VIDEO AND AUDIO RECORDINGS, FILMS, TELEVISION PROGRAMMES, RADIO PROGRAMMES, AUDIO BOOKS, ALL DOWNLOADABLE ALL IN THE FIELD OF MUSIC AND RECORDING ARTISTS; MUSIC, SOUNDS, IMAGES OF RECORDING ARTISTS AND TAKEN FROM CONCERTS, PROVIDED IN A DOWNLOADABLE FORMAT; DOWNLOADABLE ELECTRONIC PUBLICATIONS IN THE NATURE OF BOOKS, MAGAZINES, BROCHURES, NEWSPAPERS RELATING TO RECORDING ARTISTS, MUSIC AND CONCERTS; DIGITAL MUSIC DOWNLOADABLE PROVIDED FROM THE INTERNET; DOWNLOADABLE PODCASTS IN THE FIELD OF MUSIC AND RECORDING ARTISTS; MOTION PICTURE FILMS AND PROGRAMMES FEATURING MUSIC ENTERTAINMENT, DRAMA, ACTION, ADVENTURE AND/OR ANIMATION; MOTION PICTURE FILMS AND PROGRAMMES FOR BROADCAST ON TELEVISION FEATURING MUSIC ENTERTAINMENT, DRAMA, ACTION, ADVENTURE AND/OR ANIMATION; PROMOTIONAL AND MARKETING MATERIAL IN DIGITAL FORM, NAMELY, DOWNLOADABLE IMAGE FILES FEATURING FLYERS, POSTERS, TICKETS AND INVITATIONS FOR A MUSIC EVENT AND RECORDING ARTIST'S SHOW; TRAINING AIDS AND INSTRUCTIONAL MATERIAL IN DIGITAL FORM, NAMELY, DOWNLOADABLE BOOKS IN THE FIELD OF MUSIC; ELECTRONIC CARDS, BRACELETS FEATURING DIGITALLY RECORDED DATA AND TAGS FEATURING DIGITALLY RECORDED DATA IN THE FORM OF ACCESS CARDS TO A MUSIC EVENT OR RECORDING ARTIST'S CONCERT; COMPUTER GAME PROGRAMS, VIDEO GAME CARTRIDGES, AND DOWNLOADABLE ELECTRONIC GAME SOFTWARE FOR MOBILE PHONES; INTERACTIVE COMPUTER SOFTWARE IN THE FORM OF SINGING GAMES OR KARAOKE; EDUCATIONAL SOFTWARE IN THE FIELD OF MUSIC; MULTIMEDIA APPARATUS AND INSTRUMENTS, NAMELY, MP3 PLAYERS, MEDIA PLAYERS, AND PDAS; STRAPS, CHARMS, CASES, FOR TELEPHONE HANDSETS; DOWNLOADABLE RINGTONES; COMPUTER SCREEN SAVER SOFTWARE THAT DISPLAYS PICTURES AND TEXT ON A SCREEN; MOUSE MATS; SUNGLASSES, EYEGASSES, AND CASES AND BAGS ADAPTED THEREFOR; NOVELTY MAGNETS, FRIDGE MAGNETS (U.S. CLS. 21, 23, 26, 36 AND 38).

**CLASS 16—PAPER GOODS AND PRINTED MATTER**

FOR PAPER, CARDBOARD; BOOK BINDING MATERIAL; PHOTOGRAPHS; STATIONERY; ADHESIVES FOR STATIONERY OR HOUSEHOLD PURPOSES; PAINT BRUSHES; TYPEWRITERS PRINTERS' TYPE; PRINTING BLOCKS; MOUNTED AND /OR UNMOUNTED PHOTOGRAPHS; PHOTOGRAPH ALBUMS; ART PAPERS; ARTS AND CRAFTS KITS FOR MODEL MAKING COMPRISED PRIMARILY OF MODELING CLAY, AND ALSO CONTAINING COLORING MATERIALS AND FABRIC; PAINTING SETS COMPRISED OF PAINTBRUSHES, PAINT TRAYS; PACKAGING BAGS OF PLASTIC OR OF PAPER, GARBAGE BAGS OF PLASTICS OR OF PAPER; BOOKS, MAGAZINES, JOURNALS, PERIODICALS, ACTIVITY BOOKS, POP-UP BOOKS ACTIVITY BOOKS, ALL RELATING TO MUSIC OR RECORDING ARTISTS; COMICS, COLOURING BOOKS; RECIPE BOOKS; PRINTED RECIPE CARDS; WRITING PAPER, ENVELOPES, NOTEBOOKS, AUTOGRAPH BOOKS, ADDRESS BOOKS, CALENDARS, DIARIES, NOTE CARDS; GREETING CARDS, GIFT WRAPPING PAPER, GIFT TAGS OF PAPER; LITHOGRAPHS; ART PICTURES; POSTERS AND POSTCARDS; PENS, PENCILS, PENCIL CASES, ERASERS, CRAYONS, MARKERS, COLOURED PENCILS, PENCIL SHARPENERS; PAINT BRUSHES, CHALK AND CHALKBOARDS; DECORATIVE PENCIL-TOP ORNAMENTS; PRINTING STAMPS AND INK; TRADING CARDS; STICKERS, ALBUMS FOR STICKERS; DECALS;

PRINTED TRANSFERS FOR EMBROIDERY OR FABRIC APPLIQUÉS; PRINTED PATTERNS FOR COSTUMES; TEMPORARY TATTOOS; PAPER PARTY DECORATIONS, PAPER NAPKINS, PAPER DOILIES, PAPER PLACE MATS, CREPE PAPER, PRINTED INVITATIONS, PAPER CAKE DECORATIONS; PAPER BANNERS; COASTERS OF PAPER OR CARDBOARD, TABLE MATS OF PAPER OR CARDBOARD; FIGURINES OF PAPIER MACHE; PRINTED TICKETS; CHRISTMAS CARDS, CHRISTMAS WRAPPING PAPER; CHRISTMAS DECORATIONS OF PAPER OR CARDBOARD (U.S. CLS. 2, 5, 22, 23, 29, 37, 38 AND 50).

**CLASS 25—CLOTHING**

FOR FOOTWEAR; ROMPER SUITS FOR BABIES; EVENING WEAR, NAMELY, EVENING DRESSES, COCKTAIL DRESSES, TUXEDOS; TOPS, BOTTOMS, DRESSES AND GOWNS; EVENING JACKETS, STOLES, FUR JACKETS AND STOLES; EVENING GLOVES; JEANS, SWEATSHIRTS, T-SHIRTS, POLO SHIRTS, LONG SLEEVED POLO SHIRTS, FLEECE TOPS AND FLEECE JACKETS; HOODED TOPS; TRACKSUITS; SWIMWEAR; SWEATERS, SUITS, SHIRTS, BLOUSES, SKIRTS, TROUSERS, WAISTCOATS; BELTS; COATS, GILETS, JACKETS, NIGHTWEAR, LOUNGEWEAR, PYJAMAS, DRESSING GOWNS, BATH ROBES; SOCKS, UNDERWEAR, LINGERIE; SCARVES, TIES, HEAD-SCARVES; SHOES, SANDALS, BOOTS, PUMPS, ATHLETIC SHOES, SLIPPERS; SPORTS FOOTWEAR; GLOVES; BASEBALL CAPS, WOOLLY CAPS AND HATS; APRONS; MASQUERADE COSTUMES; SUN VISORS; PAPER MASQUERADE MASKS (U.S. CLS. 22 AND 39).

**CLASS 36—INSURANCE AND FINANCIAL**

FOR CHARITY FUNDRAISING SERVICES; INFORMATION, CONSULTANCY AND ADVICE ABOUT ANY OF THE AFORESAID SERVICES (U.S. CLS. 100, 101 AND 102).

**CLASS 41—EDUCATION AND ENTERTAINMENT**

FOR EDUCATION, NAMELY, CLASSES AND TRAINING IN THE FIELD OF MUSIC; MUSIC ENTERTAINMENT, IN THE NATURE OF LIVE MUSICAL PERFORMANCES FEATURING SINGING; PRODUCTION, PRESENTATION, SYNDICATION, DISTRIBUTION AND RENTAL OF FILMS, TELEVISION PROGRAMS AND RADIO PROGRAMS CONTAINING MUSIC RECORDINGS AND VIDEO FOOTAGE OF RECORDING ARTISTS CONCERTS AND DOCUMENTARIES ABOUT RECORDING ARTISTS AND TRIBUTES TO RECORDING ARTISTS; PRODUCTION, PRESENTATION, SYNDICATION, DISTRIBUTION AND RENTAL OF FILMS, TELEVISION AND RADIO PROGRAMMES; ARRANGING AND CONDUCTING OUTDOOR AND INDOOR LIVE MUSIC CONCERTS AND RECORDING ARTISTS SHOWS AND TRIBUTES TO RECORDING ARTISTS, FOR ENTERTAINMENT OR EDUCATIONAL PURPOSES; ARRANGING AND CONDUCTING TRIBUTE SHOWS, CONCERTS, SINGING COMPETITIONS, ALL FOR ENTERTAINMENT OR EDUCATIONAL PURPOSES; THEATRICAL PERFORMANCES BOTH ANIMATED AND LIVE ACTION; MUSIC PUBLISHING SERVICES; BOOK PUBLISHING SERVICES; PUBLISHING OF ELECTRONIC BOOKS; PROVIDING ON-LINE ELECTRONIC COMPUTER GAMES; INFORMATION, CONSULTANCY AND ADVICE ABOUT ANY OF THE AFORESAID SERVICES (U.S. CLS. 100, 101 AND 107).

SEAN CROWLEY, EXAMINING ATTORNEY

SN 85-850,386. SSM PRODUCTIONS INC., ST. HELIER, JERSEY, FILED 2-14-2013.



PRIORITY CLAIMED UNDER SEC. 44(D) ON ERP N CMNTY TM OFC APPLICATION NO. 011125788, FILED 8-17-2012, REG. NO. 011125788, DATED 5-16-2013, EXPIRES 8-17-2022.

THE NAME(S), PORTRAIT(S), AND/OR SIGNATURE(S) SHOWN IN THE MARK IDENTIFIES "SHIRLEY BASSEY", WHOSE CONSENT(S) TO REGISTER IS MADE OF RECORD.

THE MARK CONSISTS OF A STYLIZED FORM OF "DAME SHIRLEY BASSEY".

#### CLASS 9—ELECTRICAL AND SCIENTIFIC APPARATUS

FOR VIDEO AND AUDIO RECORDINGS, FILMS, TELEVISION PROGRAMMES, RADIO PROGRAMMES, AUDIO BOOKS, ALL DOWNLOADABLE ALL IN THE FIELD OF MUSIC AND RECORDING ARTISTS; MUSIC, SOUNDS, IMAGES OF RECORDING ARTISTS AND TAKEN FROM CONCERTS, PROVIDED IN A DOWNLOADABLE FORMAT; DOWNLOADABLE ELECTRONIC PUBLICATIONS IN THE NATURE OF BOOKS, MAGAZINES, BROCHURES, NEWSPAPERS RELATING TO RECORDING ARTISTS, MUSIC AND CONCERTS; DIGITAL MUSIC DOWNLOADABLE PROVIDED FROM THE INTERNET; DOWNLOADABLE PODCASTS IN THE FIELD OF MUSIC AND RECORDING ARTISTS; MOTION PICTURE FILMS AND PROGRAMMES FEATURING MUSIC ENTERTAINMENT, DRAMA, ACTION, ADVENTURE AND/OR ANIMATION; MOTION PICTURE FILMS AND PROGRAMMES FOR BROADCAST ON TELEVISION FEATURING MUSIC ENTERTAINMENT, DRAMA, ACTION, ADVENTURE AND/OR ANIMATION; PROMOTIONAL AND MARKETING MATERIAL IN DIGITAL FORM, NAMELY, DOWNLOADABLE IMAGE FILES FEATURING FLYERS, POSTERS, TICKETS AND INVITATIONS FOR A MUSIC EVENT AND RECORDING ARTIST'S SHOW; TRAINING AIDS AND INSTRUCTIONAL MATERIAL IN DIGITAL FORM, NAMELY, DOWNLOADABLE BOOKS IN THE FIELD OF MUSIC; ELECTRONIC CARDS, BRACELETS FEATURING DIGITALLY RECORDED DATA AND TAGS FEATURING DIGITALLY RECORDED DATA IN THE FORM OF ACCESS CARDS TO A MUSIC EVENT OR RECORDING ARTIST'S CONCERT; COMPUTER GAME PROGRAMS, VIDEO GAME CARTRIDGES, AND DOWNLOADABLE ELECTRONIC GAME SOFTWARE FOR MOBILE PHONES; INTERACTIVE COMPUTER SOFTWARE IN THE FORM OF SINGING GAMES OR KARAOKE; EDUCATIONAL SOFTWARE IN THE FIELD OF MUSIC; MULTIMEDIA APPARATUS AND INSTRUMENTS, NAMELY, MP3 PLAYERS, MEDIA PLAYERS, AND PDAS; STRAPS, CHARMS, CASES, FOR TELEPHONE HANDSETS; DOWNLOADABLE RINGTONES; COMPUTER SCREEN SAVER SOFTWARE THAT DISPLAYS PICTURES AND TEXT ON A SCREEN; MOUSE MATS; SUNGLASSES, EYEGLASSES, AND CASES AND BAGS ADAPTED THEREFOR; NOVELTY MAGNETS, FRIDGE MAGNETS (U.S. CLS. 21, 23, 26, 36 AND 38).

#### CLASS 16—PAPER GOODS AND PRINTED MATTER

FOR PAPER, CARDBOARD; BOOK BINDING MATERIAL; PHOTOGRAPHS; STATIONERY; ADHESIVES FOR STATIONERY OR HOUSEHOLD PURPOSES; PAINT BRUSHES; TYPEWRITERS PRINTERS' TYPE; PRINTING BLOCKS; MOUNTED AND /OR UNMOUNTED PHOTOGRAPHS; PHOTOGRAPH ALBUMS; ART PAPERS; ARTS AND CRAFTS KITS FOR MODEL MAKING COMPRISED PRIMARILY OF MODELING CLAY, AND ALSO CONTAINING COLORING MATERIALS AND FABRIC; PAINTING SETS COMPRISED OF PAINTBRUSHES, PAINT TRAYS; PACKAGING BAGS OF PLASTIC OR OF PAPER, GARBAGE BAGS OF PLASTICS OR OF PAPER; BOOKS, MAGAZINES, JOURNALS, PERIODICALS, ACTIVITY BOOKS, POP-UP BOOKS ACTIVITY BOOKS, ALL RELATING TO MUSIC OR RECORDING ARTISTS; COMICS, COLOURING BOOKS; RECIPE BOOKS; PRINTED RECIPE CARDS; WRITING PAPER, ENVELOPES, NOTEBOOKS, AUTOGRAPH BOOKS, ADDRESS BOOKS, CALENDARS, DIARIES, NOTE CARDS; GREETING CARDS, GIFT WRAPPING PAPER, GIFT TAGS OF PAPER; LITHOGRAPHS; ART PICTURES; POSTERS AND POSTCARDS; PENS, PENCILS, PENCIL CASES, ERASERS, CRAYONS, MARKERS, COLOURED PENCILS, PENCIL SHARPENERS; PAINT BRUSHES, CHALK AND CHALKBOARDS; DECORATIVE PENCIL-TOP ORNAMENTS; PRINTING STAMPS AND INK; TRADING CARDS; STICKERS, ALBUMS FOR STICKERS; DECALS; PRINTED TRANSFERS FOR EMBROIDERY OR FABRIC APPLIQUÉS; PRINTED PATTERNS FOR COSTUMES; TEMPORARY TATTOOS; PAPER PARTY DECORATIONS, PAPER NAPKINS, PAPER DOILIES, PAPER PLACE MATS, CREPE PAPER, PRINTED INVITATIONS, PAPER CAKE DECORATIONS; PAPER BANNERS; COASTERS OF PAPER OR CARDBOARD, TABLE MATS OF PAPER OR CARDBOARD; FIGURINES OF PAPIER MACHE; PRINTED TICKETS; CHRISTMAS CARDS, CHRISTMAS WRAPPING PAPER; CHRISTMAS DECORATIONS OF PAPER OR CARDBOARD (U.S. CLS. 2, 5, 22, 23, 29, 37, 38 AND 50).

#### CLASS 25—CLOTHING

FOR FOOTWEAR; ROMPER SUITS FOR BABIES; EVENING WEAR, NAMELY, EVENING DRESSES, COCKTAIL DRESSES, TUXEDOS; TOPS, BOTTOMS, DRESSES AND GOWNS; EVENING JACKETS, STOLES, FUR JACKETS AND STOLES; EVENING GLOVES; JEANS, SWEATSHIRTS, T-SHIRTS, POLO SHIRTS, LONG SLEEVED POLO SHIRTS, FLEECE TOPS AND FLEECE JACKETS; HOODED TOPS; TRACKSUITS; SWIMWEAR; SWEATERS, SUITS, SHIRTS, BLOUSES, SKIRTS, TROUSERS, WAISTCOATS; BELTS; COATS, GILETS, JACKETS, NIGHTWEAR, LOUNGEWEAR, PYJAMAS, DRESSING GOWNS, BATH ROBES; SOCKS, UNDERWEAR, LINGERIE; SCARVES, TIES, HEAD-SCARVES; SHOES, SANDALS, BOOTS, PUMPS, ATHLETIC SHOES, SLIPPERS; SPORTS FOOTWEAR; GLOVES; BASEBALL CAPS, WOOLLY CAPS AND HATS; APRONS; MASQUERADE COSTUMES; SUN VISORS; PAPER MASQUERADE MASKS (U.S. CLS. 22 AND 39).

#### CLASS 36—INSURANCE AND FINANCIAL

FOR CHARITY FUNDRAISING SERVICES; INFORMATION, CONSULTANCY AND ADVICE ABOUT ANY OF THE AFORESAID SERVICES (U.S. CLS. 100, 101 AND 102).

**CLASS 41—EDUCATION AND ENTERTAINMENT**

FOR EDUCATION, NAMELY, CLASSES AND TRAINING IN THE FIELD OF MUSIC; MUSIC ENTERTAINMENT, IN THE NATURE OF LIVE MUSICAL PERFORMANCES FEATURING SINGING; PRODUCTION, PRESENTATION, SYNDICATION, DISTRIBUTION AND RENTAL OF FILMS, TELEVISION PROGRAMS AND RADIO PROGRAMS CONTAINING MUSIC RECORDINGS AND VIDEO FOOTAGE OF RECORDING ARTISTS CONCERTS AND DOCUMENTARIES ABOUT RECORDING ARTISTS AND TRIBUTES TO RECORDING ARTISTS; PRODUCTION, PRESENTATION, SYNDICATION, DISTRIBUTION AND RENTAL OF FILMS, TELEVISION AND RADIO PROGRAMMES; ARRANGING AND CONDUCTING OUTDOOR AND INDOOR LIVE MUSIC CONCERTS AND RECORDING ARTISTS SHOWS AND TRIBUTES TO RECORDING ARTISTS, FOR ENTERTAINMENT OR EDUCATIONAL PURPOSES; ARRANGING AND CONDUCTING TRIBUTE SHOWS, CONCERTS, SINGING COMPETITIONS, ALL FOR ENTERTAINMENT OR EDUCATIONAL PURPOSES; THEATRICAL PERFORMANCES BOTH ANIMATED AND LIVE ACTION; MUSIC PUBLISHING SERVICES; BOOK PUBLISHING SERVICES; PUBLISHING OF ELECTRONIC BOOKS; PROVIDING ON-LINE ELECTRONIC COMPUTER GAMES; INFORMATION, CONSULTANCY AND ADVICE ABOUT ANY OF THE AFORESAID SERVICES (U.S. CLS. 100, 101 AND 107).  
SEAN CROWLEY, EXAMINING ATTORNEY

**CLASS 16—PAPER GOODS AND PRINTED MATTER**

FOR PRINTED MATTER, NAMELY, CALENDARS, GREETING CARDS, CATALOGUES IN THE FIELDS OF COOKING AND HOSPITALITY, INFORMATIONAL FLYERS IN THE FIELDS OF COOKING AND HOSPITALITY; PRINTED MENUS; NAPKINS AND COASTERS OF PAPER; POSTCARDS; WRITING PADS; NOTE PADS; PAPERWEIGHTS; WRITING INSTRUMENTS; POSTERS; PRINTED INSTRUCTIONAL AND TEACHING MATERIALS IN THE FIELD OF COOKING AND HOSPITALITY AND EXCLUDING INSTRUCTIONAL OR TEACHING APPARATUS; PAPER PUBLICATIONS, NAMELY, BOOKS IN THE FIELD OF COOKING AND HOSPITALITY; LEAFLETS ABOUT COOKING AND HOSPITALITY, AND COOK BOOKS, MAGAZINES IN THE FIELD OF COOKING AND HOSPITALITY, NONE OF THE AFORESAID GOODS IN THIS CLASS BEING PHOTOGRAPHIC GOODS OR PHOTOGRAPHY RELATED GOODS OR GOODS RELATING TO OPTICAL APPARATUS, INSTRUMENTS AND EQUIPMENT OR GOODS RELATING TO PHOTOGRAPHIC APPARATUS, INSTRUMENTS AND EQUIPMENT OR GOODS RELATING TO MOVING IMAGES, FILMS, THE PRODUCTION OF FILMS AND APPARATUS, INSTRUMENTS OR EQUIPMENT FOR USE IN THE PRODUCTION OF MOVING IMAGES AND FILMS INCLUDING BUT NOT LIMITED TO CAMCORDERS, VIDEO CAMERAS, VIDEO RECORDERS, MOTION PICTURE CAMERAS, TV CAMERAS AND DIGITAL CAMERAS HAVING VIDEO RECORDING CAPABILITIES, OR BEING GOODS IN THIS CLASS USED IN RELATION TO THE PROVISION OF PHOTOGRAPHIC SERVICES OR PHOTOGRAPHY RELATED SERVICES OR SERVICES RELATING TO OPTICAL APPARATUS, INSTRUMENTS AND EQUIPMENT OR SERVICES RELATING TO PHOTOGRAPHIC APPARATUS, INSTRUMENTS AND EQUIPMENT OR SERVICES RELATING TO MOVING IMAGES, FILMS, THE PRODUCTION OF FILMS AND APPARATUS, INSTRUMENTS OR EQUIPMENT FOR USE IN THE PRODUCTION OF MOVING IMAGES AND FILMS INCLUDING BUT NOT LIMITED TO CAMCORDERS, VIDEO CAMERAS, VIDEO RECORDERS, MOTION PICTURE CAMERAS, TV CAMERAS AND DIGITAL CAMERAS HAVING VIDEO RECORDING CAPABILITIES (U.S. CLS. 2, 5, 22, 23, 29, 37, 38 AND 50).

SN 85-850,406. NIKO ROMITO FORMAZIONE E CONSULENZA S.R.L., L'AQUILA, ITALY, FILED 2-14-2013.

**CLASS 30—STAPLE FOODS**

FOR COFFEE; TEA; COCOA; CHOCOLATE; COFFEE-BASED BEVERAGE CONTAINING MILK; COCOA-BASED BEVERAGES; SUGAR; FLOUR, NAMELY, TAPIOCA FLOUR; BREAKFAST CEREALS; PASTRIES; PIES; BREAD; CONFECTIONERIES, NAMELY, SWEET OR SALTED BISCUITS; WAFERS; WAFFLES; CAKES; BISCUITS, NAMELY, SWEET BISCUITS; ICE CREAM; FROZEN CONFECTIONS; HONEY; SALT; MUSTARD; VINEGAR; SAUCES, NAMELY, SWEET SAUCES IN THE NATURE OF CHOCOLATE AND FRUIT BASED SAUCES, PASTA SAUCES; SPICES; DESSERTS, NAMELY, MILKY DESSERTS IN THE NATURE OF DESSERT PUDDINGS AND DESSERT MOUSSES (U.S. CL. 46).

**NIKO ROMITO**

**CLASS 41—EDUCATION AND ENTERTAINMENT**

FOR EDUCATION SERVICES, NAMELY, CONDUCTING COURSES OF INSTRUCTION IN THE FIELD OF COOKING AND HOSPITALITY; PROVIDING TRAINING FOR OTHERS IN THE FIELD OF COOKING AND HOSPITALITY; ENTERTAINMENT SERVICES IN THE NATURE OF ONGOING TELEVISION AND VIDEO PROGRAMS IN THE FIELD OF COOKING AND HOSPITALITY; ORGANIZING CULTURAL EVENTS IN THE NATURE OF FESTIVALS FEATURING COOKING AND HOSPITALITY; BOOK AND MAGAZINE PUBLISHING; LIBRARY SERVICES FEATURING BOOK LENDING; TELEVISION SHOW AND MOTION PICTURE FILM PRODUCTION SERVICES; BOOKING AGENCIES FOR ARTISTS, NAMELY, ENTERTAINMENT EVENT BOOKING AGENCIES; RENTAL OF FILMS, AUDIO AND VIDEO SOUND RECORDINGS, CINEMATOGRAFIC PROJECTION APPARATUS AND ACCESSORIES, AND THEATER STAGE SETS; ARRANGING COMPETITIONS IN THE FIELD OF COOKING AND HOSPITALITY;

THE MARK CONSISTS OF STANDARD CHARACTERS WITHOUT CLAIM TO ANY PARTICULAR FONT, STYLE, SIZE, OR COLOR.

PRIORITY CLAIMED UNDER SEC. 44(D) ON ERP CMNTY TM OFC APPLICATION NO. 11548724, FILED 2-6-2013, REG. NO. 011548724, DATED 8-9-2013, EXPIRES 2-6-2023.

THE NAME "NIKO ROMITO" IDENTIFIES A LIVING INDIVIDUAL WHOSE CONSENT IS OF RECORD.

ARRANGING AND CONDUCTING OF EDUCATIONAL COLLOQUIUMS, CONFERENCES AND CONVENTIONS IN THE FIELD OF COOKING AND HOSPITALITY; ORGANIZING FOOD AND COOKING EXHIBITIONS FOR CULTURAL OR EDUCATIONAL PURPOSES; NONE OF THE AFOREMENTIONED SERVICES IN THIS CLASS BEING PHOTOGRAPHIC SERVICES OR RELATING TO PHOTOGRAPHY SERVICES OR SERVICES RELATING TO GOODS IN THE FORM OF OPTICAL APPARATUS, INSTRUMENTS AND EQUIPMENT OR SERVICES RELATING TO GOODS IN THE FORM OF PHOTOGRAPHIC APPARATUS, INSTRUMENTS AND EQUIPMENT OR SERVICES RELATING TO GOODS IN THE FORM OF PHOTOGRAPHIC APPARATUS, INSTRUMENTS AND EQUIPMENT OR SERVICES IN THIS CLASS RELATING TO GOODS USED IN THE PRODUCTION OF MOVING IMAGES AND FILMS, INCLUDING BUT NOT LIMITED TO CAMCORDERS, VIDEO CAMERAS, VIDEO RECORDERS, MOTION PICTURE CAMERAS, TV CAMERAS AND DIGITAL CAMERAS HAVING VIDEO RECORDING CAPABILITIES (U.S. CLS. 100, 101 AND 107).

**CLASS 43—HOTEL AND RESTAURANT SERVICES**

FOR PROVIDING FOOD AND DRINK; PROVIDING TEMPORARY HOUSING ACCOMMODATION (U.S. CLS. 100 AND 101).

INGRID C. EULIN, EXAMINING ATTORNEY

SN 85-850,412. HOUSE OF MUSIC LLC, PENNINGTON, NJ. FILED 2-14-2013.



NO CLAIM IS MADE TO THE EXCLUSIVE RIGHT TO USE "MUSIC", APART FROM THE MARK AS SHOWN.

THE MARK CONSISTS OF THE WORD "HOUSE" ABOVE THE WORDS "OF MUSIC" AND WITH THE "H" BEING FORMED BY A DESIGN INCLUDING A STYLIZED MUSICAL QUARTER NOTE.

**CLASS 35—ADVERTISING AND BUSINESS**

FOR RETAIL STORE SERVICES FEATURING MUSICAL INSTRUMENTS, SHEET MUSIC, AND RELATED PARTS AND ACCESSORIES (U.S. CLS. 100, 101 AND 102).

FIRST USE 9-0-2005; IN COMMERCE 9-0-2005.

**CLASS 37—CONSTRUCTION AND REPAIR**

FOR REPAIR OF MUSICAL INSTRUMENTS (U.S. CLS. 100, 103 AND 106).

FIRST USE 9-0-2005; IN COMMERCE 9-0-2005.

**CLASS 41—EDUCATION AND ENTERTAINMENT**

FOR RENTAL OF MUSICAL INSTRUMENTS; AND INSTRUCTION IN THE FIELD OF MUSIC AND MUSICAL INSTRUMENTS (U.S. CLS. 100, 101 AND 107).

FIRST USE 9-0-2005; IN COMMERCE 9-0-2005.

KAREN SEVERSON, EXAMINING ATTORNEY

SN 85-850,626. CEDAR GARDEN FOOD IMPORT & EXPORT, INC., CANTON, MI. FILED 2-14-2013.

# MAWASSEM

THE MARK CONSISTS OF STANDARD CHARACTERS WITHOUT CLAIM TO ANY PARTICULAR FONT, STYLE, SIZE, OR COLOR.

THE ENGLISH TRANSLATION OF THE WORD "MAWASSEM" IN THE MARK IS "SEASONS".

**CLASS 29—MEATS AND PROCESSED FOODS**

FOR FROZEN VEGETABLES; PICKLES; PICKLED CUCUMBERS; OLIVE OIL; PROCESSED NUTS; PROCESSED BEANS; CANNED VEGETABLES; PROCESSED OLIVES; FRUIT JUICES FOR COOKING (U.S. CL. 46).

**CLASS 30—STAPLE FOODS**

FOR FROZEN EGGROLLS; SPICES; RICE; TEA (U.S. CL. 46).

**CLASS 31—NATURAL AGRICULTURAL PRODUCTS**

FOR UNPROCESSED NUTS AND BEANS (U.S. CLS. 1 AND 46).

STEVEN JACKSON, EXAMINING ATTORNEY

SN 85-850,655. B&D 2A, NASHVILLE, TN. FILED 2-14-2013.

# Gunowner Brand

THE MARK CONSISTS OF STANDARD CHARACTERS WITHOUT CLAIM TO ANY PARTICULAR FONT, STYLE, SIZE, OR COLOR.

NO CLAIM IS MADE TO THE EXCLUSIVE RIGHT TO USE "BRAND", APART FROM THE MARK AS SHOWN.

**CLASS 14—JEWELRY**

FOR JEWELRY OF PRECIOUS METAL, OR COATED THEREWITH, AND NON-PRECIOUS METAL, NAMELY, PINS, PENDANTS, BROOCHES, EARRINGS, RINGS, NECKLACES AND BRACELETS; CUFF LINKS; KEY CHAINS OF PRECIOUS METAL (U.S. CLS. 2, 27, 28 AND 50).

**CLASS 25—CLOTHING**

FOR CLOTHING, NAMELY, T-SHIRTS, SWEATSHIRTS, HATS AND BEANIE CAPS (U.S. CLS. 22 AND 39).

KAREN BRACEY, EXAMINING ATTORNEY

SN 85-850,766. GLOBAL MEDICAL INNOVATIONS, LLC, WOBURN, MA. FILED 2-15-2013.

SN 85-850,853. ACTIONET, INC., VIENNA, VA. FILED 2-15-2013.

## TEACHING THE ART AND SCIENCE OF THRIVING

THE MARK CONSISTS OF STANDARD CHARACTERS WITHOUT CLAIM TO ANY PARTICULAR FONT, STYLE, SIZE, OR COLOR.

### CLASS 35—ADVERTISING AND BUSINESS

FOR BUSINESS CONSULTATION PERTAINING TO IDENTIFYING CORPORATE VALUES, MISSION STATEMENTS AND VISION STATEMENTS FOR THE PURPOSE OF DEVELOPING WELLNESS PROGRAMS FOR CORPORATE CLIENTS (U.S. CLS. 100, 101 AND 102).

### CLASS 41—EDUCATION AND ENTERTAINMENT

FOR EDUCATION SERVICES, NAMELY, PROVIDING COURSES, SEMINARS AND NON-DOWNLOADABLE WEBINARS, IN THE FIELD OF WELLNESS, AND DISTRIBUTION OF COURSE MATERIALS IN CONNECTION THEREWITH; PROFESSIONAL COACHING SERVICES IN THE FIELD OF WELLNESS (U.S. CLS. 100, 101 AND 107).

### CLASS 44—MEDICAL, BEAUTY AND AGRICULTURAL SERVICES

FOR PROVIDING MENTAL HEALTH AND WELLNESS INFORMATION; WELLNESS AND HEALTH-RELATED CONSULTING SERVICES (U.S. CLS. 100 AND 101).

EVELYN BRADLEY, EXAMINING ATTORNEY

SN 85-850,773. COLD HOLLOW CIDER MILL, INC., WATERBURY CENTER, VT. FILED 2-15-2013.

## VERMONT TO THE CORE

THE MARK CONSISTS OF STANDARD CHARACTERS WITHOUT CLAIM TO ANY PARTICULAR FONT, STYLE, SIZE, OR COLOR.

### CLASS 32—LIGHT BEVERAGES

FOR NON-ALCOHOLIC APPLE CIDER (U.S. CLS. 45, 46 AND 48).

### CLASS 35—ADVERTISING AND BUSINESS

FOR RETAIL STORE SERVICES FEATURING APPLES, NON-ALCOHOLIC APPLE CIDER, BAKED GOODS, DONUTS, CHEESE, FRUIT PRESERVES, HONEY, MAPLE SYRUP, AND FUDGE; ONLINE RETAIL STORE SERVICES FEATURING APPLES, NON-ALCOHOLIC APPLE CIDER, BAKED GOODS, DONUTS, CHEESE, FRUIT PRESERVES, HONEY, MAPLE SYRUP, AND FUDGE (U.S. CLS. 100, 101 AND 102).

JOHN SCHUYLER YARD, EXAMINING ATTORNEY

## LIVE ANYWHERE.WORK ANYWHERE.PLAY ANYWHERE...

THE MARK CONSISTS OF STANDARD CHARACTERS WITHOUT CLAIM TO ANY PARTICULAR FONT, STYLE, SIZE, OR COLOR.

### CLASS 16—PAPER GOODS AND PRINTED MATTER

FOR PRINTED NEWSLETTERS IN THE FIELD OF INFORMATION TECHNOLOGY (U.S. CLS. 2, 5, 22, 23, 29, 37, 38 AND 50).

### CLASS 41—EDUCATION AND ENTERTAINMENT

FOR TEACHING AND TRAINING IN BUSINESS, INDUSTRY AND INFORMATION TECHNOLOGY; PROVIDING ONLINE NEWSLETTERS IN THE FIELD OF INFORMATION TECHNOLOGY; PROVIDING ONLINE MONTHLY NEWSLETTERS IN THE FIELD OF INFORMATION TECHNOLOGY (U.S. CLS. 100, 101 AND 107).

### CLASS 42—SCIENTIFIC AND COMPUTER SERVICES

FOR INFORMATION TECHNOLOGY CONSULTATION; COMPUTER SERVICES, NAMELY, REMOTE AND ON-SITE MANAGEMENT OF THE INFORMATION TECHNOLOGY (IT) SYSTEMS OF OTHERS; DESIGN, DEVELOPMENT, INSTALLATION AND MAINTENANCE OF COMPUTER SOFTWARE; DEVELOPMENT OF SECURITY SYSTEMS AND CONTINGENCY PLANNING FOR INFORMATION SYSTEMS; COMPUTER SECURITY CONSULTANCY IN THE FIELD OF SCANNING AND PENETRATION TESTING OF COMPUTERS AND NETWORKS TO ASSESS INFORMATION SECURITY VULNERABILITY; DESIGN AND CREATING WEB SITES FOR OTHERS (U.S. CLS. 100 AND 101).

### CLASS 45—PERSONAL AND LEGAL SERVICES

FOR NETWORK INFORMATION SECURITY, NAMELY, MONITORING OF COMPUTER SYSTEMS FOR SECURITY PURPOSES AND COMPUTER VULNERABILITY AND RISK ASSESSMENT (U.S. CLS. 100 AND 101).

ADA HAN, EXAMINING ATTORNEY

SN 85-851,139. CAROLINE LONG LIMITED, INC., AMELIA ISLAND, FL. FILED 2-15-2013.

## TRUNKS BEACH COUTURE

THE MARK CONSISTS OF STANDARD CHARACTERS WITHOUT CLAIM TO ANY PARTICULAR FONT, STYLE, SIZE, OR COLOR.

OWNER OF U.S. REG. NO. 2,954,393.

NO CLAIM IS MADE TO THE EXCLUSIVE RIGHT TO USE "BEACH COUTURE", APART FROM THE MARK AS SHOWN.



**CLASS 18—LEATHER GOODS**

FOR TOTE BAGS (U.S. CLS. 1, 2, 3, 22 AND 41).  
FIRST USE 12-30-2005; IN COMMERCE 12-30-2005.

**CLASS 24—FABRICS**

FOR BLANKETS FOR OUTDOOR USE (U.S. CLS. 42 AND 50).  
FIRST USE 12-30-2005; IN COMMERCE 12-30-2005.  
KRISTINA MORRIS, EXAMINING ATTORNEY

SN 85-851,532. THOMSON REUTERS CANADA LIMITED,  
TORONTO, CANADA, FILED 2-15-2013.

---

INTEGRASCREEN

THE MARK CONSISTS OF STANDARD CHARACTERS WITHOUT CLAIM TO ANY PARTICULAR FONT, STYLE, SIZE, OR COLOR.

OWNER OF U.S. REG. NOS. 3,268,433, 3,480,737 AND 3,562,028.

**CLASS 36—INSURANCE AND FINANCIAL**

FOR FINANCIAL AFFAIRS AND MONETARY AFFAIRS, NAMELY, FINANCIAL INFORMATION, MANAGEMENT AND ANALYSIS SERVICES; REAL ESTATE AGENCY AND BROKERAGE; FINANCIAL ANALYSIS AND RESEARCH SERVICES; FINANCIAL RISK MANAGEMENT; FINANCIAL RESEARCH; FINANCIAL CONSULTANCY; PROVISION OF FINANCIAL INFORMATION; FINANCIAL ANALYSES, NAMELY, ANALYSIS OF FINANCIAL INFORMATION; PROVISION OF DATABASES CONTAINING FINANCIAL INFORMATION; CREDIT REPORTING SERVICES; PROVISION OF INFORMATION IN RELATION TO ANY OF THE AFOREMENTIONED SERVICES, NAMELY, INFORMATION RELATING TO FINANCIAL ANALYSIS AND RESEARCH; PROVISION OF WEBSITE CONTENT, NAMELY, PROVIDING WEBCASTS IN THE FIELD OF FINANCIAL RISK SCREENING; FINANCIAL RESEARCH, FINANCIAL REPORTING AND FINANCIAL MANAGEMENT; PROVISION OF FINANCIAL INFORMATION IN RELATION TO ANY OF THE AFORESAID SERVICES, NAMELY, PROVIDING A WEBSITE FEATURING FINANCIAL RISK SCREENING, FINANCIAL RESEARCH, FINANCIAL REPORTING AND FINANCIAL MANAGEMENT; CONSULTING SERVICES IN THE FIELD OF FINANCIAL RISK ANALYSIS (U.S. CLS. 100, 101 AND 102).

FIRST USE 5-12-2004; IN COMMERCE 5-12-2004.

**CLASS 45—PERSONAL AND LEGAL SERVICES**

FOR MONEY LAUNDERING COMPLIANCE SERVICES, NAMELY, ANALYSIS OF DATA, POLICY AND PROCESS, AND PROVISION OF BUSINESS MANAGEMENT ADVICE AND ASSISTANCE TO ENSURE COMPLIANCE WITH PUBLIC SECTOR PROCUREMENT LAWS AND REGULATIONS; INVESTIGATION SERVICES, NAMELY, MISSING PERSONS INVESTIGATION, PRIVATE INVESTIGATION; SECURITY CONSULTANCY; PRE-EMPLOYMENT BACKGROUND SCREENING; EMPLOYMENT BACKGROUND SCREENING, NAMELY, BACKGROUND SCREENING OF CURRENT EMPLOYEES OF OTHERS; DRUG, ALCOHOL, DNA AND PERSONAL HISTORY SCREENING FOR SECURITY AND EMPLOYMENT PURPOSES; IDENTIFICATION VERIFICATION SERVICES, NAMELY, PROVIDING AUTHENTICATION OF PERSONAL IDENTIFICATION INFORMATION; ADVISORY SERVICES IN THE FIELD OF BUSINESS SECURITY SYSTEMS; SECURITY ASSESSMENT OF RISKS, NAMELY, PROVIDING SECURITY ASSESSMENTS FOR BUSINESSES AND GOVERNMENTAL AGENCIES; PROFESSIONAL CONSULTANCY RELATING TO SECURITY; PROVISION OF INFORMATION IN RELATION TO ANY OF THE AFOREMENTIONED SERVICES, NAMELY, CONSULTING SERVICES IN THE FIELD OF SECURITY AND SECURITY RISK ANALYSIS (U.S. CLS. 100 AND 101).

FIRST USE 5-12-2004; IN COMMERCE 5-12-2004.  
AMY ALFIERI, EXAMINING ATTORNEY

---

SN 85-851,598. RUSTED ROOSTER, LLC, SANFORD, MI.  
FILED 2-15-2013.



THE MARK CONSISTS OF THE LETTER "D" WITH A CROSS WITHIN THE CENTER OF THE "D".

**CLASS 25—CLOTHING**

FOR CLOTHING AND HEADWEAR, NAMELY, SHIRTS, HATS, BALL CAPS, AND T-SHIRTS (U.S. CLS. 22 AND 39).

FIRST USE 12-8-2011; IN COMMERCE 12-8-2011.

**CLASS 41—EDUCATION AND ENTERTAINMENT**

FOR ENTERTAINMENT SERVICES IN THE NATURE OF A LIVE-ACTION HUNTING RELATED TELEVISION SERIES; PRODUCTION OF A LIVE-ACTION HUNTING RELATED TELEVISION SERIES; PRODUCTION OF A LIVE-ACTION HUNTING RELATED MULTIMEDIA PROGRAM SERIES FOR DISPLAY OR BROADCAST OVER AT LEAST ONE COMMUNICATION NETWORK (U.S. CLS. 100, 101 AND 107).

FIRST USE 12-8-2011; IN COMMERCE 12-8-2011.  
KATHERINE CHANG, EXAMINING ATTORNEY

SN 85-852,255. NG SIEW YENG, FORTRESS HILL, HONG KONG, FILED 2-18-2013.

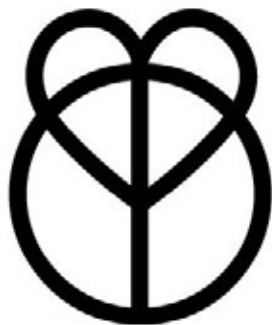

OWNER OF HONG KONG REG. NO. 302241279, DATED 5-3-2012, EXPIRES 5-2-2022.

THE MARK CONSISTS OF AN OUTLINE OF A STYLIZED HEART DESIGN INTERSECTING AN UPSIDE DOWN PEACE SIGN DESIGN.

#### CLASS 18—LEATHER GOODS

FOR LEATHER AND IMITATION LEATHER; BACKPACKS, BRIEFCASES, BUSINESS CARD CASES, CREDIT CARD CASES, CALLING CARD CASES, BANKNOTE HOLDERS, HANDBAGS, KEY CASES, POUCHES OF LEATHER FOR PACKAGING, RUCKSACKS, SCHOOL BAGS, REUSABLE SHOPPING BAGS, BAGS FOR SPORTS, SUITCASES, UNFITTED VANITY CASES, WALLETS, TRUNKS, TRAVELLING BAGS; UMBRELLAS AND PARASOLS; WALKING STICKS; WHIPS, HARNESS AND SADDLERY (U.S. CLS. 1, 2, 3, 22 AND 41).

#### CLASS 25—CLOTHING

FOR CLOTHING, NAMELY, BATH ROBES, BELTS, COATS, DRESSES, GLOVES, HOSIERY, JACKETS, JERSEYS, JUMPERS, PULLOVERS, MASQUERADE COSTUMES, NECKTIES, PYJAMAS, SHIRTS, SKI GLOVES, SKIRTS, SOCKS, SOCK SUSPENDERS, STOCKINGS, STOCKING SUSPENDERS, SUITS, WET SUITS, SWIMWEAR, UNDERWEAR, SLEEPWEAR, SWEATERS, TEE-SHIRTS, TROUSERS AND WAISTCOATS; KNITWEAR, NAMELY, KNIT TOPS, KNIT BOTTOMS, KNIT DRESSES, KNIT JACKETS, KNIT SHIRTS, KNIT SKIRTS, KNIT CAPS AND KNIT GLOVES; SPORTSWEAR, NAMELY, SPORTS SHIRTS, SPORTS PANTS, SPORTS JACKETS, SPORTS JERSEYS, SPORTS VESTS, SPORTS OVER UNIFORMS, SPORTS BRAS, SPORTS CAPS AND HATS; WATERPROOF CLOTHING, NAMELY, WATERPROOF JACKETS, WATERPROOF PANTS AND WATERPROOF WRISTBANDS; FOOTWEAR, NAMELY, SHOES, SPORT SHOES, BOOTS, BOOTS FOR SPORTS, SKI BOOTS, SANDALS AND SLIPPERS; HEADGEAR, NAMELY, SCARVES, CAPS, HATS AND HEADBANDS (U.S. CLS. 22 AND 39).

#### CLASS 28—TOYS AND SPORTING GOODS

FOR TOYS, GAMES AND PLAYTHINGS, NAMELY, TOY FIGURINES; GYMNASTIC AND SPORTING ARTICLES NOT INCLUDED IN OTHER CLASSES, NAMELY, SURFBOARDS, SURF SKIS, SURFBOARD LEASHES, BAGS SPECIALLY ADAPTED FOR SURFBOARDS AND SKIS (U.S. CLS. 22, 23, 38 AND 50).

PAULA MAHONEY, EXAMINING ATTORNEY

SN 85-852,586. BRIDGESTONE CORPORATION, CHUO-KU, JAPAN, FILED 2-18-2013.



NO CLAIM IS MADE TO THE EXCLUSIVE RIGHT TO USE "AFFILIATED RETAILER" AND "NATIONWIDE NETWORK", APART FROM THE MARK AS SHOWN.

THE COLOR(S) BLACK, GREY, RED AND WHITE IS/ARE CLAIMED AS A FEATURE OF THE MARK.

THE MARK CONSISTS OF A SHIELD WITH THE WORDS "AFFILIATED RETAILER" AND "NATIONWIDE NETWORK", SEPARATED BY A CURVED LINE, ALL APPEARING ON TOP OF A HONEYCOMB DESIGN. THE COLOR BLACK APPEARS AS THE BACKGROUND COLOR WITHIN THE SHIELD; THE COLOR GREY APPEARS AS PART OF THE BORDER OF THE SHIELD, IN MOST OF THE HONEY COMB DESIGN AND AS SHADING IN SOME OF THE TEXT; THE COLOR WHITE APPEARS IN THE BORDER OF THE SHIELD AND THE TEXT, AND THE COLOR RED APPEARS IN THE CURVED LINE.

#### CLASS 35—ADVERTISING AND BUSINESS

FOR RETAIL TIRE STORE SERVICES; DISTRIBUTORSHIP SERVICES IN THE FIELD OF TIRES; PROVIDING BUSINESS INFORMATION TO DEALERS IN THE FIELD OF TIRES; BUSINESS CONSULTATION AND MANAGEMENT FOR TIRE DEALERS; SALES PROMOTION, ADVERTISING AND PUBLICITY SERVICES IN THE FIELD OF TIRES; ON-LINE RETAIL STORE SERVICES FEATURE TIRES, MATCHING CONSUMERS WITH DEALERS IN THE FIELD OF TIRES (U.S. CLS. 100, 101 AND 102).

FIRST USE 4-9-2012; IN COMMERCE 4-9-2012.

#### CLASS 37—CONSTRUCTION AND REPAIR

FOR REPAIR OR INSTALLATION OF REPLACEMENT OF TIRES (U.S. CLS. 100, 103 AND 106).

FIRST USE 4-9-2012; IN COMMERCE 4-9-2012.

CARYN GLASSER, EXAMINING ATTORNEY

SN 85-852,824. AMBITION SOLUTIONS, LLC, 800 MARKET STREET, TN. FILED 2-18-2013.

# AMBITION

THE MARK CONSISTS OF STANDARD CHARACTERS WITHOUT CLAIM TO ANY PARTICULAR FONT, STYLE, SIZE, OR COLOR.

**CLASS 9—ELECTRICAL AND SCIENTIFIC APPARATUS**

FOR COMPUTER SOFTWARE USED TO ENTER, VIEW, COLLECT, DISPLAY, COMPARE, MEASURE AND TRACK METRICS OF INTEREST AND TO VIEW THE CHANGING VALUES OF EACH SUCH METRIC OF INTEREST (U.S. CLS. 21, 23, 26, 36 AND 38).

**CLASS 42—SCIENTIFIC AND COMPUTER SERVICES**

FOR HOSTING AN INTERACTIVE WEBSITE AND ONLINE PORTAL FEATURING TECHNOLOGY THAT ALLOWS USERS TO ENTER AND VIEW CERTAIN MEASURABLE METRICS OF WHICH THEY ARE INTERESTED IN TRACKING, AND ALLOWS FOR THE DATA AND VALUE OF EACH SUCH INTERESTED METRIC TO BE COLLECTED AND DISPLAYED AND COMPARED AND MEASURED AS WELL AS FOR THE VIEWING OF THE CHANGING VALUES OF EACH SUCH METRIC IN THE FIELD OF SALES PERFORMANCE (U.S. CLS. 100 AND 101).

MORGAN WYNNE, EXAMINING ATTORNEY

**CLASS 29—MEATS AND PROCESSED FOODS**

FOR PRESERVED, FROZEN, DRIED AND COOKED FRUITS AND VEGETABLES, SNACK FOOD, NAMELY, FRUIT-BASED, NUT-BASED, SOY BASED, VEGETABLE BASED, POTATO-BASED, AND BEAN-BASED SNACK-FOOD (U.S. CL. 46).

**CLASS 30—STAPLE FOODS**

FOR COFFEE, COCOA, TEA, CONFECTIONERY, NAMELY, CHEWING GUM, BISCUITS, COOKIES, CANDY FOR FOOD, CARAMELS, CHOCOLATE, ICE CREAM, CAKES, FRUIT JELLIES AS CONFECTIONERY, EDIBLE ICE, SHERBETS, CEREAL-BASED, GRAIN-BASED, CORN-BASED, CHOCOLATE-BASED, RICE-BASED AND WHEAT-BASED SNACK FOODS, CONFECTIONERY, NAMELY, CHESTNUTS ROASTED WITH SYRUP AS CONFECTIONERY, MIXES FOR MAKING BAKERY PRODUCTS AND CAKES, NAMELY, BREAD MIXES, BUN MIXES, CAKE MIXES, COOKIE MIXES, HOTCAKE MIXES AND DOUGHNUT MIXES, INSTANT CONFECTIONERY MIXES, NAMELY, JELLY MIXES, ICE CREAM MIXES, CUSTARD MIXES, INSTANT CANDY MIXES AND INSTANT DUMPLING MIXES (U.S. CL. 46).

**CLASS 32—LIGHT BEVERAGES**

FOR SOFT DRINKS, MINERAL WATERS, CARBONATED MINERAL WATERS, AERATED WATERS, FRUIT DRINKS, FRUIT JUICES, POWDERS FOR BEVERAGES, NAMELY, POWDERS USED IN THE PREPARATION OF FRUIT-BASED, BEVERAGES AND ISOTONIC BEVERAGES, DRINK MIX POWDERS FOR BEVERAGES, NAMELY, POWDERS USED IN THE PREPARATION OF CARBONATED FRUIT-BASED BEVERAGES, ISOTONIC BEVERAGES AND CARBONATED ISOTONIC BEVERAGES (U.S. CLS. 45, 46 AND 48).

ANDREA K. NADELMAN, EXAMINING ATTORNEY

SN 85-853,121. UDO, INC., ARLINGTON, VA. FILED 2-18-2013.

uDo

THE MARK CONSISTS OF STANDARD CHARACTERS WITHOUT CLAIM TO ANY PARTICULAR FONT, STYLE, SIZE, OR COLOR.

**CLASS 5—PHARMACEUTICALS**

FOR BABY DIAPERS (U.S. CLS. 6, 18, 44, 46, 51 AND 52).

**CLASS 17—RUBBER GOODS**

FOR SILICONE RUBBER (U.S. CLS. 1, 5, 12, 13, 35 AND 50).

**CLASS 21—HOUSEWARES AND GLASS**

FOR MANUAL TOOTHBRUSHES; TOOTH BRUSHES (U.S. CLS. 2, 13, 23, 29, 30, 33, 40 AND 50).

WANDA KAY PRICE, EXAMINING ATTORNEY

SN 85-853,831. C.H.E.F. CLINIC - NUTRITIONAL MEDICAL CORPORATION, SANTA BARBARA, CA. FILED 2-19-2013.

REFUEL

THE MARK CONSISTS OF STANDARD CHARACTERS WITHOUT CLAIM TO ANY PARTICULAR FONT, STYLE, SIZE, OR COLOR.

**CLASS 9—ELECTRICAL AND SCIENTIFIC APPARATUS**

FOR DOWNLOADABLE ELECTRONIC NEWSLETTERS, TEXT, EBOOKS, PODCASTS, AUDIO RECORDINGS, VIDEO RECORDINGS, INSTRUCTIONAL TEACHING MATERIALS, WORKSHEETS, WORKBOOKS, ILLUSTRATIONS, INFORMATION DATA SHEETS, ACTIVITY SHEETS, LINE DRAWINGS, AND PAMPHLETS, ALL FEATURING INFORMATION IN THE FIELDS OF FOOD, COOKING, NUTRITION, HEALTH, EXERCISE, DIET, LIFESTYLE, AND MEDICINE; DVDS AND CDS FEATURING INFORMATION IN THE FIELDS OF FOOD, COOKING, NUTRITION, HEALTH, EXERCISE, DIET, LIFESTYLE, AND MEDICINE (U.S. CLS. 21, 23, 26, 36 AND 38).

SN 85-853,724. KRACIE HOLDINGS, LTD., TOKYO, JAPAN, FILED 2-19-2013.

Kracie

OWNER OF JAPAN REG. NO. 5089736, DATED 11-9-2007, EXPIRES 11-9-2017.  
OWNER OF U.S. REG. NOS. 3,769,260 AND 4,386,532.  
THE MARK CONSISTS OF THE WORDING "KRACIE" IN A STYLIZED FORM.

**CLASS 41—EDUCATION AND ENTERTAINMENT**

FOR PROVIDING A WEBSITE FEATURING INFORMATION IN THE FIELD OF EXERCISE; PROVIDING A WEBSITE FEATURING NON-DOWNLOADABLE ELECTRONIC NEWSLETTERS, TEXT, EBOOKS, PODCASTS, AUDIO RECORDINGS, VIDEO RECORDINGS, INSTRUCTIONAL TEACHING MATERIALS, WORKSHEETS, WORKBOOKS, ILLUSTRATIONS, INFORMATION DATA SHEETS, ACTIVITY SHEETS, LINE DRAWINGS, PAMPHLETS, AND OTHER MATERIALS, ALL FEATURING INFORMATION IN THE FIELDS OF FOOD, COOKING, NUTRITION, HEALTH, EXERCISE, DIET, SLEEP, STRESS MANAGEMENT, WEIGHT MANAGEMENT, LIFESTYLE, AND MEDICINE; PROVIDING INFORMATION IN THE FIELD OF EXERCISE VIA EMAIL, TEXT, AND INSTANT MESSAGING; ENTERTAINMENT SERVICES, NAMELY, APPEARANCES BY MOTIVATIONAL AND EDUCATIONAL SPEAKERS IN THE FIELDS OF FOOD, COOKING, NUTRITION, HEALTH, EXERCISE, DIET, SLEEP, STRESS MANAGEMENT, WEIGHT MANAGEMENT, LIFESTYLE, AND MEDICINE; ARRANGING AND CONDUCTING SPECIAL EVENTS FOR ENTERTAINMENT AND EDUCATIONAL PURPOSES IN THE FIELDS OF FOOD, COOKING, NUTRITION, HEALTH, EXERCISE, DIET, SLEEP, STRESS MANAGEMENT, WEIGHT MANAGEMENT, LIFESTYLE, AND MEDICINE; ACCESSIBLE BY RADIO, TELEVISION, SATELLITE, AUDIO, VIDEO AND COMPUTER NETWORKS, WEB-BASED APPLICATIONS, AND MOBILE PHONE APPLICATIONS; PROVIDING AN ONLINE COLUMN IN THE FIELDS OF FOOD, COOKING, NUTRITION, HEALTH, EXERCISE, DIET, SLEEP, STRESS MANAGEMENT, WEIGHT MANAGEMENT, LIFESTYLE, AND MEDICINE (U.S. CLS. 100, 101 AND 107).

**CLASS 43—HOTEL AND RESTAURANT SERVICES**

FOR PROVIDING A WEBSITE FEATURING INFORMATION AND VIDEO PRESENTATIONS ON FOOD PREPARATION, RECIPES, AND COOKING; PROVIDING A WEBSITE FEATURING INFORMATION IN THE FIELDS OF COOKING AND FOOD PREPARATION; PROVIDING INFORMATION IN THE FIELDS OF COOKING AND FOOD PREPARATION VIA EMAIL, TEXT, AND INSTANT MESSAGING (U.S. CLS. 100 AND 101).

**CLASS 44—MEDICAL, BEAUTY AND AGRICULTURAL SERVICES**

FOR PROVIDING A WEBSITE FEATURING INFORMATION IN THE FIELDS OF NUTRITION, HEALTH, DIET, SLEEP, STRESS MANAGEMENT, WEIGHT MANAGEMENT, AND MEDICINE; PROVIDING INFORMATION IN THE FIELDS OF NUTRITION, HEALTH, DIET, SLEEP, STRESS MANAGEMENT, WEIGHT MANAGEMENT, AND MEDICINE VIA EMAIL, TEXT, AND INSTANT MESSAGING (U.S. CLS. 100 AND 101).  
WILLIAM BRECKENFELD, EXAMINING ATTORNEY

SN 85-853,855. IWS GLOBAL PTY LTD, FORMERLY PC LOCS PTY LTD, MALAGA, AUSTRALIA, FILED 2-19-2013.

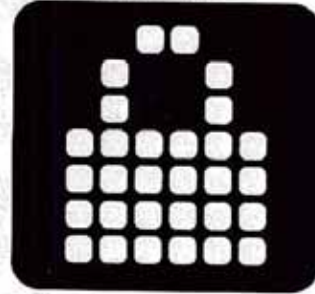

OWNER OF AUSTRALIA REG. NO. 1378585, DATED 3-31-2011, EXPIRES 8-18-2020.

OWNER OF U.S. REG. NO. 4,051,424.

THE MARK CONSISTS OF THE REPRESENTATION OF A CLOSED PADLOCK COMPRISED OF ROUNDED OFF SQUARES FORMING THE SHAPE OF A PADLOCK WITHIN A ROUNDED OFF SQUARE BACKGROUND OF CONTRASTING COLOR.

**CLASS 9—ELECTRICAL AND SCIENTIFIC APPARATUS**

FOR POWER BOARDS, ELECTRICAL TIMERS AND ELECTRIC SOCKETS FOR CHARGING COMPUTER RELATED EQUIPMENT INCLUDING LAPTOPS AND DESKTOP COMPUTERS, ELECTRICAL POWER BOARDS; ELECTRICAL AND VOLTAGE SURGE PROTECTORS; POWER ADAPTORS AND APPARATUS FOR PROTECTING COMPUTERS FROM POWER SUPPLY FAULTS AND RELATED APPARATUS; BATTERY CHARGERS FOR LAPTOP COMPUTERS AND PORTABLE ELECTRONIC DEVICES; ZIPPER LOCKABLE AND SEALED CARRY BAGS ADAPTED TO CARRY COMPUTER EQUIPMENT AND PORTABLE ELECTRONIC DEVICES, NAMELY, LAPTOP COMPUTERS, NOTEBOOK COMPUTERS, TABLET COMPUTERS, PERSONAL DIGITAL ASSISTANTS, ELECTRONIC PERSONAL ORGANIZERS, HANDHELD COMPUTERS, PORTABLE MUSIC PLAYERS AND MP3 PLAYERS, MOBILE PHONES (U.S. CLS. 21, 23, 26, 36 AND 38).

**CLASS 16—PAPER GOODS AND PRINTED MATTER**

FOR ADVERTISING MATERIALS IN PAPER FORM, NAMELY, PRODUCT AND SERVICE CATALOGS AND GUIDES IN THE FIELD OF PORTABLE ELECTRONICS; PRINTED MATERIAL, NAMELY, ADVERTISING LEAFLETS AND BROCHURES FOR ADVERTISING PURPOSES; CARDBOARD PACKAGING, PAPER FOR WRAPPING AND PACKAGING, BOXES AND BAGS OF SYNTHETIC PAPER AND CARDBOARD MATERIALS FOR WRAPPING AND PACKAGING, PLASTIC BAGS FOR PACKAGING (U.S. CLS. 2, 5, 22, 23, 29, 37, 38 AND 50).

**CLASS 20—FURNITURE AND ARTICLES NOT OTHERWISE CLASSIFIED**

FOR LOCKABLE FIXED AND PORTABLE STORAGE CABINET COMBINATIONS MADE OF METAL, TIMBER AND PLASTIC INCLUDING RESIN AND REPLACEMENT PARTS THEREOF FOR THE SECURE STORAGE OF COMPUTER HARDWARE AND PORTABLE ELECTRICAL DEVICES; REINFORCED AND LOCKABLE STORAGE CABINETS FOR STORAGE OF COMPUTER HARDWARE AND RELATED COMPUTER EQUIPMENT (U.S. CLS. 2, 13, 22, 25, 32 AND 50).

**CLASS 35—ADVERTISING AND BUSINESS**

FOR WHOLESALE AND RETAIL STORE SERVICES FEATURING COMPUTER ACCESSORIES; DIRECT MAIL ADVERTISING SERVICES AND ONLINE RETAIL STORE SERVICES FEATURING COMPUTER ACCESSORIES; ADVERTISING SERVICES; RETAIL AND ONLINE MARKETING AND SALES PROMOTIONS, NAMELY, SALES PROMOTIONS AT POINT OF SALE OR PURCHASE, SALES PROMOTIONS BY MEANS OF DISPLAY, PRESENTATION AND DEMONSTRATION ON COMMUNICATION MEDIA FOR RETAIL PURPOSES; DIRECT MAIL MARKETING (U.S. CLS. 100, 101 AND 102).

RON FAIRBANKS, EXAMINING ATTORNEY

---

SN 85-853,872. ONETEAM, INC., SHELBURNE, VT. FILED 2-19-2013.

ALIGN YOUR STARS

THE MARK CONSISTS OF STANDARD CHARACTERS WITHOUT CLAIM TO ANY PARTICULAR FONT, STYLE, SIZE, OR COLOR.

**CLASS 35—ADVERTISING AND BUSINESS**

FOR BUSINESS MANAGEMENT, CONSULTING AND ADVISORY SERVICES IN THE FIELDS OF EXECUTIVE AND LEADERSHIP DEVELOPMENT, BUSINESS MANAGEMENT, STRATEGY, PLANNING AND THE BEST BUSINESS PRACTICES FOR BUSINESS AND LEADERSHIP SUCCESS; BUSINESS CONSULTING SERVICES RELATING TO THE INTEGRATION OF THE AREAS OF BUSINESS PROCESS TECHNOLOGY, ORGANIZATIONAL LEARNING, CHANGE MANAGEMENT, AND OPERATIONAL SUSTAINABILITY; ADVICE RELATING TO THE ORGANIZATION AND MANAGEMENT OF BUSINESS, MERGER AND ACQUISITION MANAGEMENT; BUSINESS MANAGEMENT CONSULTATION IN THE FIELD OF EXECUTIVE AND LEADERSHIP DEVELOPMENT, STRATEGIC PLANNING, AND EFFECTIVE BOARD OF DIRECTORS DEVELOPMENT IN STRATEGIC PLANNING AND OVERSIGHT; BUSINESS MANAGEMENT CONSULTING IN THE FIELD OF TEAM DEVELOPMENT, AND BUSINESS CONSULTING SERVICES IN THE FIELD OF ORGANIZATIONAL CHANGE MANAGEMENT (U.S. CLS. 100, 101 AND 102).

**CLASS 41—EDUCATION AND ENTERTAINMENT**

FOR PROFESSIONAL COACHING SERVICES IN THE FIELDS OF LEADERSHIP DEVELOPMENT, EXECUTIVE TEAM DEVELOPMENT, GROUP BUILDING AND DEVELOPMENT, MERGER AND ACQUISITION MANAGEMENT, ORGANIZATIONAL STRATEGY AND PLANNING, CHANGE MANAGEMENT, AND BOARD EFFECTIVENESS; PROVIDING GROUP COACHING IN THE FIELD OF HIGH PERFORMANCE TEAMWORK IN ORGANIZATIONS INCLUDING COMMUNICATION, DIMINISHING DEFENSIVENESS, COLLABORATION, PROBLEM SOLVING, TEAM BUILDING, AND TRUST; BUSINESS TRAINING IN THE FIELD OF LEADERSHIP DEVELOPMENT, EXECUTIVE COACHING, CONSULTING, COMMUNICATIONS, HIGH PERFORMING ORGANIZATIONS; EDUCATIONAL SERVICES, NAMELY, CONDUCTING CLASSES, SEMINARS, CONFERENCES, AND WORKSHOPS IN THE FIELDS OF ORGANIZATIONAL DEVELOPMENT AND CHANGE, EXECUTIVE AND MANAGEMENT COACHING, MERGER AND ACQUISITION MANAGEMENT, COMMUNICATION SKILLS, HIGH PERFORMANCE SKILLS AND DISTRIBUTION OF TRAINING MATERIALS IN CONNECTION THEREWITH; ON-LINE JOURNALS, NAMELY, BLOGS FEATURING ARTICLES ON PERSONAL DEVELOPMENT, TEAM BUILDING, LEADERSHIP DEVELOPMENT, AND DEVELOPING BUSINESS EXPERTISE; PRODUCTION AND DISTRIBUTION OF VIDEOS IN THE FIELD OF LEADERSHIP DEVELOPMENT, EXECUTIVE TEAM DEVELOPMENT, GROUP BUILDING AND DEVELOPMENT, ORGANIZATIONAL STRATEGY AND PLANNING, CHANGE MANAGEMENT, AND BOARD EFFECTIVENESS (U.S. CLS. 100, 101 AND 107).

SUNG IN, EXAMINING ATTORNEY

---

SN 85-853,891. CONLEY CASTING SUPPLY CORP., WARWICK, RI. FILED 2-19-2013.

TEKCAST

THE MARK CONSISTS OF STANDARD CHARACTERS WITHOUT CLAIM TO ANY PARTICULAR FONT, STYLE, SIZE, OR COLOR.

**CLASS 1—CHEMICALS**

FOR RUBBER, PLASTIC AND WAX COMPOUNDS FOR USE IN MOLD MAKING, AND WAX AND PLASTIC COMPOUNDS FOR CASTING (U.S. CLS. 1, 5, 6, 10, 26 AND 46).

FIRST USE 1-0-1971; IN COMMERCE 1-0-1971.

**CLASS 6—METAL GOODS**

FOR METAL ALLOYS FOR USE IN MOLD MAKING AND CASTING (U.S. CLS. 2, 12, 13, 14, 23, 25 AND 50).

FIRST USE 1-0-1971; IN COMMERCE 1-0-1971.

**CLASS 7—MACHINERY**

FOR CENTRIFUGAL SPIN-CASTING MACHINES; HYDRAULIC VULCANIZING PRESSES; MACHINE PARTS FOR SPIN CASTING MACHINES IN THE NATURE OF MOLD FRAMES; SPIN-CASTING MACHINES; VIBRATORY-TUMBLING MACHINE FOR FINISHING AND POLISHING CAST ITEMS, AND MACHINE PARTS IN THE NATURE OF MEDIA SEPARATOR SET THEREFOR SOLD AS A UNIT (U.S. CLS. 13, 19, 21, 23, 31, 34 AND 35).

FIRST USE 1-0-1971; IN COMMERCE 1-0-1971.

JOHN KELLY, EXAMINING ATTORNEY

SN 85-853,913. CONLEY CASTING SUPPLY CORP., WARWICK, RI. FILED 2-19-2013.



#### CLASS 1—CHEMICALS

FOR RUBBER, PLASTIC AND WAX COMPOUNDS FOR USE IN MOLD MAKING, AND WAX AND PLASTIC COMPOUNDS FOR CASTING (U.S. CLS. 1, 5, 6, 10, 26 AND 46).

FIRST USE 0-0-1972; IN COMMERCE 0-0-1972.

#### CLASS 6—METAL GOODS

FOR METAL ALLOYS FOR USE IN MOLD MAKING AND CASTING (U.S. CLS. 2, 12, 13, 14, 23, 25 AND 50).

FIRST USE 0-0-1972; IN COMMERCE 0-0-1972.

#### CLASS 7—MACHINERY

FOR CENTRIFUGAL SPIN-CASTING MACHINES; HYDRAULIC VULCANIZING PRESSES; MACHINE PARTS FOR SPIN CASTING MACHINES IN THE NATURE OF MOLD FRAMES; SPIN-CASTING MACHINES; VIBRATORY-TUMBLING MACHINE FOR FINISHING AND POLISHING CAST ITEMS, AND MACHINE PARTS IN THE NATURE OF MEDIA SEPARATOR SET THEREFOR SOLD AS A UNIT (U.S. CLS. 13, 19, 21, 23, 31, 34 AND 35).

FIRST USE 0-0-1972; IN COMMERCE 0-0-1972.  
JOHN KELLY, EXAMINING ATTORNEY

SN 85-854,077. BOSTON MOUNTAIN BIOTECH LLC, OMAHA, NE. FILED 2-19-2013.

Lotus

THE MARK CONSISTS OF STANDARD CHARACTERS WITHOUT CLAIM TO ANY PARTICULAR FONT, STYLE, SIZE, OR COLOR.

#### CLASS 1—CHEMICALS

FOR DESIGNER BIOLOGICAL CELLS POSSESSING OPTIMIZED GROWTH AND PURITY, FOR SCIENTIFIC, LABORATORY OR MEDICAL RESEARCH (U.S. CLS. 1, 5, 6, 10, 26 AND 46).

#### CLASS 5—PHARMACEUTICALS

FOR DESIGNER BIOLOGICAL CELLS POSSESSING OPTIMIZED GROWTH AND PURITY, FOR MEDICAL OR CLINICAL USE (U.S. CLS. 6, 18, 44, 46, 51 AND 52).

#### CLASS 42—SCIENTIFIC AND COMPUTER SERVICES

FOR PROVIDING AN ONLINE COMPUTER DATABASE FOR ACCESSING TECHNICAL INFORMATION IN THE NATURE OF PURIFICATION SCHEMES FOR THE BIOENGINEERING OF BIOLOGICAL CELL LINES, NAMELY, A CATALOG OF KEY ATTRIBUTES, GENETIC MODIFICATIONS, AND DOWNSTREAM PURIFICATION IMPROVEMENTS TO BIOLOGICAL CELLS (U.S. CLS. 100 AND 101).

CAITLIN WATTS-FITZGERALD, EXAMINING ATTORNEY

SN 85-854,133. BOSTON MOUNTAIN BIOTECH LLC, OMAHA, NE. FILED 2-19-2013.



THE COLOR(S) YELLOW AND BLACK IS/ARE CLAIMED AS A FEATURE OF THE MARK.

THE MARK CONSISTS OF THE WORD "LOTUS" WITH A BLACK CAPITALIZED "L", THE "O" APPEARING AS A STYLIZED YELLOW LOTUS FLOWER, AND THE "TUS" IN BLACK LOWERCASE.

#### CLASS 1—CHEMICALS

FOR DESIGNER BIOLOGICAL CELLS POSSESSING OPTIMIZED GROWTH AND PURITY, FOR SCIENTIFIC, LABORATORY OR MEDICAL RESEARCH (U.S. CLS. 1, 5, 6, 10, 26 AND 46).

#### CLASS 5—PHARMACEUTICALS

FOR DESIGNER BIOLOGICAL CELLS POSSESSING OPTIMIZED GROWTH AND PURITY, FOR MEDICAL OR CLINICAL USE (U.S. CLS. 6, 18, 44, 46, 51 AND 52).

#### CLASS 42—SCIENTIFIC AND COMPUTER SERVICES

FOR PROVIDING AN ONLINE COMPUTER DATABASE FOR ACCESSING TECHNICAL INFORMATION IN THE NATURE OF PURIFICATION SCHEMES FOR THE BIOENGINEERING OF BIOLOGICAL CELL LINES, NAMELY, A CATALOG OF KEY ATTRIBUTES, GENETIC MODIFICATIONS, AND DOWNSTREAM PURIFICATION IMPROVEMENTS TO BIOLOGICAL CELLS (U.S. CLS. 100 AND 101).

CAITLIN WATTS-FITZGERALD, EXAMINING ATTORNEY

SN 85-854,827. BBN FOUNDATION, NEW YORK, NY. FILED 2-20-2013.

BBN FOUNDATION

THE MARK CONSISTS OF STANDARD CHARACTERS WITHOUT CLAIM TO ANY PARTICULAR FONT, STYLE, SIZE, OR COLOR.

NO CLAIM IS MADE TO THE EXCLUSIVE RIGHT TO USE "FOUNDATION", APART FROM THE MARK AS SHOWN.

#### **CLASS 36—INSURANCE AND FINANCIAL**

FOR CHARITABLE FUNDRAISING; CHARITABLE FUNDRAISING TO SUPPORT EDUCATION IN THE FIELD OF EFFECTIVE AND COMPASSIONATE COMMUNICATION IN HEALTHCARE; CHARITABLE FUNDRAISING SERVICES, BY MEANS OF ELEEMOSYNARY SERVICES IN THE FIELD OF COLLECTION, MANAGEMENT, AND DISBURSEMENTS OF MONEY IN CONNECTION WITH EDUCATION IN THE FIELD OF EFFECTIVE AND COMPASSIONATE COMMUNICATION IN HEALTHCARE; CHARITABLE FUNDRAISING SERVICES FOR PROMOTING RESEARCH, EDUCATION AND OTHER ACTIVITIES RELATING TO EFFECTIVE AND COMPASSIONATE COMMUNICATION IN HEALTHCARE; ACCEPTING AND ADMINISTERING MONETARY CHARITABLE CONTRIBUTIONS; ADMINISTERING MONETARY CHARITABLE CONTRIBUTIONS FOR EDUCATION IN THE FIELD OF EFFECTIVE AND COMPASSIONATE COMMUNICATION IN HEALTHCARE; ELEEMOSYNARY SERVICES IN THE FIELD OF MONETARY DONATIONS; PHILANTHROPIC SERVICES CONCERNING MONETARY DONATIONS; PROVIDING SCHOLARSHIPS AND GRANTS TO CAUSES PROMOTING EFFECTIVE AND COMPASSIONATE COMMUNICATION IN HEALTHCARE; CHARITABLE FUNDRAISING SERVICES, NAMELY, ORGANIZING AND CONDUCTING FUNDRAISING EVENTS TO PROMOTE EFFECTIVE AND COMPASSIONATE COMMUNICATION IN HEALTHCARE; ORGANIZING AND CONDUCTING SPECIAL EVENTS FOR CHARITABLE FUNDRAISING PURPOSES; PROVIDING GRANTS FOR PROMOTING AND SUPPORTING EFFECTIVE AND COMPASSIONATE COMMUNICATION IN HEALTHCARE (U.S. CLS. 100, 101 AND 102).

#### **CLASS 41—EDUCATION AND ENTERTAINMENT**

FOR EDUCATION SERVICES, NAMELY, PROVIDING LIVE AND ON-LINE CLASSES, SEMINARS, AND WORKSHOPS IN THE FIELD OF EFFECTIVE AND COMPASSIONATE COMMUNICATION IN HEALTHCARE AND DISTRIBUTION OF COURSE, EDUCATIONAL AND TRAINING MATERIALS IN CONNECTION THEREWITH; EDUCATION SERVICES, NAMELY, PROVIDING NON-DOWNLOADABLE WEBINARS IN THE FIELD OF EFFECTIVE AND COMPASSIONATE COMMUNICATION IN HEALTHCARE; EDUCATION SERVICES, NAMELY, PROVIDING PANEL DISCUSSIONS IN THE FIELD OF EFFECTIVE AND COMPASSIONATE COMMUNICATION IN HEALTHCARE; EDUCATIONAL SERVICES, NAMELY, PROVIDING CONTINUING PROFESSIONAL EDUCATION COURSES IN THE FIELD OF EFFECTIVE AND COMPASSIONATE COMMUNICATION IN HEALTHCARE (U.S. CLS. 100, 101 AND 107).

LINDA M. KING, EXAMINING ATTORNEY

SN 85-854,847. BBN FOUNDATION, NEW YORK, NY. FILED 2-20-2013.

**BBN**

THE MARK CONSISTS OF STANDARD CHARACTERS WITHOUT CLAIM TO ANY PARTICULAR FONT, STYLE, SIZE, OR COLOR.

#### **CLASS 9—ELECTRICAL AND SCIENTIFIC APPARATUS**

FOR AUDIO AND VIDEO RECORDINGS FEATURING INFORMATION ON EFFECTIVE AND COMPASSIONATE COMMUNICATION IN HEALTHCARE; DIGITAL MEDIA, NAMELY, PRE-RECORDED VIDEO CASSETTES, DIGITAL VIDEO DISCS, DIGITAL VERSATILE DISCS, DOWNLOADABLE AUDIO AND VIDEO RECORDINGS, CDS, DVDS, AND HIGH DEFINITION DIGITAL DISCS FEATURING INFORMATION ON EFFECTIVE AND COMPASSIONATE COMMUNICATION IN HEALTHCARE; DOWNLOADABLE VIDEO RECORDINGS FEATURING INFORMATION ON EFFECTIVE AND COMPASSIONATE COMMUNICATION IN HEALTHCARE; PRE-RECORDED VIDEO DISCS, VIDEO RECORDING AND VIDEO TAPES FEATURING INFORMATION ON EFFECTIVE AND COMPASSIONATE COMMUNICATION IN HEALTHCARE; DOWNLOADABLE ELECTRONIC PUBLICATIONS IN THE NATURE OF BOOKS, BOOKLETS, MAGAZINES, JOURNALS, MANUALS, BROCHURES, LEAFLETS, PAMPHLETS AND NEWSLETTERS, ALL IN THE FIELD OF EFFECTIVE AND COMPASSIONATE COMMUNICATION IN HEALTHCARE; ELECTRONIC PUBLICATIONS, NAMELY, BOOKS, BOOKLETS, MAGAZINES, JOURNALS, MANUALS, BROCHURES, LEAFLETS, PAMPHLETS AND NEWSLETTERS, ALL IN THE FIELD OF EFFECTIVE AND COMPASSIONATE COMMUNICATION IN HEALTHCARE, ALL RECORDED ON CD-ROMS, DISKETTES, FLOPPY DISKS, VIDEO CASSETTES, AND MAGNETIC TAPES (U.S. CLS. 21, 23, 26, 36 AND 38).

#### **CLASS 41—EDUCATION AND ENTERTAINMENT**

FOR EDUCATION SERVICES, NAMELY, PROVIDING LIVE AND ON-LINE CLASSES, SEMINARS, AND WORKSHOPS IN THE FIELD OF EFFECTIVE AND COMPASSIONATE COMMUNICATION IN HEALTHCARE AND DISTRIBUTION OF COURSE, EDUCATIONAL AND TRAINING MATERIALS IN CONNECTION THEREWITH; EDUCATION SERVICES, NAMELY, PROVIDING NON-DOWNLOADABLE WEBINARS IN THE FIELD OF EFFECTIVE AND COMPASSIONATE COMMUNICATION IN HEALTHCARE; EDUCATION SERVICES, NAMELY, PROVIDING PANEL DISCUSSIONS IN THE FIELD OF EFFECTIVE AND COMPASSIONATE COMMUNICATION IN HEALTHCARE; EDUCATIONAL SERVICES, NAMELY, PROVIDING CONTINUING PROFESSIONAL EDUCATION COURSES IN THE FIELD OF EFFECTIVE AND COMPASSIONATE COMMUNICATION IN HEALTHCARE (U.S. CLS. 100, 101 AND 107).

LINDA M. KING, EXAMINING ATTORNEY

SN 85-854,887. LEIGHTON H. ROCKAFELLOW & MILDRED L. ROCKAFELLOW, TUCSON, AZ. FILED 2-20-2013.

**CALVIN THE BOODLE**

THE MARK CONSISTS OF STANDARD CHARACTERS WITHOUT CLAIM TO ANY PARTICULAR FONT, STYLE, SIZE, OR COLOR.

#### **CLASS 16—PAPER GOODS AND PRINTED MATTER**

FOR A SERIES OF CHILDREN'S BOOKS (U.S. CLS. 2, 5, 22, 23, 29, 37, 38 AND 50).

**CLASS 25—CLOTHING**

FOR CLOTHING, NAMELY, SHIRTS, SWEATSHIRTS, HATS, PAJAMAS, SHOES (U.S. CLS. 22 AND 39).

**CLASS 28—TOYS AND SPORTING GOODS**

FOR TOYS, NAMELY, STUFFED TOY ANIMALS, STUFFED DOLLS AND ANIMALS (U.S. CLS. 22, 23, 38 AND 50).

PAUL E. FAHRENKOPF, EXAMINING ATTORNEY

**CLASS 9—ELECTRICAL AND SCIENTIFIC APPARATUS**

FOR COMPUTER SOFTWARE PLATFORMS FOR SOCIAL NETWORKING; COMPUTER SOFTWARE TO ENABLE UPLOADING, POSTING, SHOWING, DISPLAYING, TAGGING, BLOGGING, SHARING OR OTHERWISE PROVIDING ELECTRONIC MEDIA OR INFORMATION IN THE FIELDS OF VIRTUAL COMMUNITIES, ELECTRONIC GAMING, ENTERTAINMENT, AND GENERAL INTEREST (U.S. CLS. 21, 23, 26, 36 AND 38).

**CLASS 42—SCIENTIFIC AND COMPUTER SERVICES**

FOR DEVELOPING, CREATING AND PROVIDING ONLINE NON-DOWNLOADABLE COMPUTER SOFTWARE PLATFORMS FOR COMPUTER AND ELECTRONIC GAMES (U.S. CLS. 100 AND 101).

FONG HSU, EXAMINING ATTORNEY

SN 85-854,935. INTERSECTIONS INC., CHANTILLY, VA. FILED 2-20-2013.

**MY LIFE...MANAGED**

THE MARK CONSISTS OF STANDARD CHARACTERS WITHOUT CLAIM TO ANY PARTICULAR FONT, STYLE, SIZE, OR COLOR.

**CLASS 36—INSURANCE AND FINANCIAL**

FOR PROVIDING REIMBURSEMENT SERVICES IN THE NATURE OF HOME OWNER'S INSURANCE DEDUCTIBLE AND REIMBURSEMENT FOR THE PURCHASE OF TAX SOFTWARE; PROVIDING CREDIT REPORTING DATA MAINTAINED BY OTHERS (U.S. CLS. 100, 101 AND 102).

SN 85-855,272. NICKLAUS COMPANIES, LLC., NORTH PALM BEACH, FL. FILED 2-20-2013.

**CLASS 42—SCIENTIFIC AND COMPUTER SERVICES**

FOR PROVIDING A WEBSITE FEATURING NON-DOWNLOADABLE SOFTWARE, NAMELY, A NON-DOWNLOADABLE SOFTWARE WITH A DASHBOARD TO MANAGE FINANCES, VIEW ACCOUNT ACTIVITY, SET FINANCIAL GOALS, AGGREGATE ALL FINANCIAL ACCOUNTS FROM MULTIPLE FINANCIAL INSTITUTIONS AND CREATE BUDGETS (U.S. CLS. 100 AND 101).

**CLASS 45—PERSONAL AND LEGAL SERVICES**

FOR LEGAL CONSULTATION SERVICES; LEGAL SERVICES; LEGAL DOCUMENT PREPARATION SERVICES AND PROVIDING GENERAL LEGAL INFORMATION VIA A WEBSITE ON GLOBAL COMPUTER NETWORKS (U.S. CLS. 100 AND 101).

ELLEN PERKINS, EXAMINING ATTORNEY



SN 85-855,190. GOUTAM MITRA, LOS ANGELES, CA. FILED 2-20-2013.

**PLAYLOGIC**

THE MARK CONSISTS OF STANDARD CHARACTERS WITHOUT CLAIM TO ANY PARTICULAR FONT, STYLE, SIZE, OR COLOR.

OWNER OF U.S. REG. NOS. 1,860,120, 1,862,892 AND 1,931,530.

THE NAME(S), PORTRAIT(S), AND/OR SIGNATURE(S) SHOWN IN THE MARK IDENTIFIES "JACK NICKLAUS", WHOSE CONSENT(S) TO REGISTER IS MADE OF RECORD.

THE MARK CONSISTS OF "JACK NICKLAUS" SIGNATURE FLOWING INTO PARTIAL SIDE VIEW OF A BEAR.



**CLASS 9—ELECTRICAL AND SCIENTIFIC APPARATUS**

FOR COMPUTER HARDWARE AND SOFTWARE FOR 3-DIMENSIONAL MODELING OF A GOLF COURSE; COMPUTER SOFTWARE FEATURING A 3-DIMENSIONAL SOFTWARE MODEL OF A GOLF COURSE FOR CREATING GOLF COURSE ADVERTISING; COMMUNICATIONS SOFTWARE FOR CONNECTING GOLFERS TO A REMOTE DATABASE OF GOLF COURSE INFORMATION; COMPUTER APPLICATION SOFTWARE FOR PERSONAL COMPUTERS, MOBILE PHONES AND HANDHELD COMPUTER DEVICES, NAMELY, SOFTWARE USED BY GOLFERS TO DISPLAY GOLF COURSE GUIDES WITH STILL AND ANIMATED IMAGES, CALCULATE GOLF BALL LOCATION AND SHOT DISTANCE AND DIRECTION, RECORD SCORING, OBTAIN LIVE WEATHER AND GOLF CLUB FACILITY INFORMATION, AND REMOTELY BOOK ADVANCE TEE TIMES; VIRTUAL REALITY SOFTWARE TO USE 3-DIMENSIONAL MODELS OF GOLF COURSES FOR SPORTS SIMULATION, INSTRUCTION, COMPETITION AND ENTERTAINMENT; COMPUTER SOFTWARE PROVIDING WEB-BASED ACCESS TO APPLICATIONS AND SERVICES THROUGH A WEB OPERATING SYSTEM OR PORTAL INTERFACE; VIDEO GAME SOFTWARE ; COMPUTER HARDWARE AND SOFTWARE FOR MAKING 3-DIMENSIONAL MODELS OF GOLF COURSES ACCESSIBLE BY MEANS OF A TELEPHONE AND/OR A COMPUTER NETWORK; DIGITAL MATERIALS, NAMELY, OPTICAL DISKS, MAGNETIC RECORDINGS AND ENCODED INTEGRATED CIRCUITS FEATURING 3-DIMENSIONAL GOLF COURSE MODELS AND RELATED GRAPHICS FILES, IMAGES AND ANIMATIONS FOR VIRTUAL SPORTS SIMULATION, INSTRUCTION, COMPETITION AND ENTERTAINMENT; DOWNLOADABLE ELECTRONIC DATA FILES FEATURING 3-DIMENSIONAL MODELS OF GOLF COURSES AND RELATED GRAPHICS FILES, IMAGES AND ANIMATIONS FOR VIRTUAL SPORTS SIMULATION, INSTRUCTION, COMPETITION AND ENTERTAINMENT; DOWNLOADABLE SOFTWARE FOR DISPLAY AND USE OF 3-DIMENSIONAL GOLF COURSE MODELS FOR VIRTUAL SPORTS SIMULATION, INSTRUCTION, COMPETITION AND ENTERTAINMENT; DOWNLOADABLE IMAGES IN THE FIELD OF GOLF FOR MOBILE PHONES (U.S. CLS. 21, 23, 26, 36 AND 38).

**CLASS 41—EDUCATION AND ENTERTAINMENT**

FOR GOLF INSTRUCTION SERVICES; ENTERTAINMENT SERVICES, NAMELY, PRODUCTION OF SPECIAL EFFECTS INCLUDING MODEL-MAKING SERVICES, COMPUTER GENERATED IMAGERY AND COMPUTER-GENERATED GRAPHICS FOR THE PRODUCTION OF VIDEOS, TELEVISION PROGRAMS, AND INTERACTIVE COMPUTER GAMES FOR SPORTS SIMULATION; PRODUCTION OF VISUAL EFFECTS FOR VIDEOS, DVDS, TELEVISION AND FOR INTERNET WEB SITES; ANIMATION PRODUCTION SERVICES; DIGITAL IMAGING SERVICES; PROVIDING INFORMATION TO GOLFERS BY MEANS OF A TELEPHONE AND/OR A COMPUTER NETWORK ABOUT TEE TIME AVAILABILITY; PROVIDING A WEB SITE THROUGH WHICH GOLFERS RESERVE TEE TIMES AT GOLF COURSES; PROVIDING A WEB SITE THROUGH WHICH GOLFERS LOCATE INFORMATION ABOUT GOLF COURSES, INCLUDING INFORMATION ABOUT GOLF COURSE LAYOUTS; PROVIDING A WEBSITE FOR ENTERTAINMENT PURPOSES FEATURING 3-DIMENSIONAL GOLF COURSE SOFTWARE MODELS, VIDEOS, PHOTOS AND TEXT ABOUT FACILITIES FOR PLAYING THE SPORT OF GOLF; ELECTRONICS GAMES SERVICES PROVIDED BY MEANS OF THE INTERNET; ENTERTAINMENT AND EDUCATIONAL SERVICES IN THE NATURE OF ON-LINE COMPETITIONS IN THE FIELD OF SPORTS, SUCH AS GOLF, AND OTHER NON-BUSINESS AND NON-COMMERCIAL FIELDS (U.S. CLS. 100, 101 AND 107).  
ZHALEH DELANEY, EXAMINING ATTORNEY

SN 85-856,067. IMAGESOFT, INC., SOUTHFIELD, MI. FILED 2-21-2013.

**TRUECERTIFY**

THE MARK CONSISTS OF STANDARD CHARACTERS WITHOUT CLAIM TO ANY PARTICULAR FONT, STYLE, SIZE, OR COLOR.

OWNER OF U.S. REG. NO. 3,952,561.

**CLASS 9—ELECTRICAL AND SCIENTIFIC APPARATUS**

FOR SOFTWARE FOR THE CREATION, ENCRYPTION, AUTHENTICATION AND DELIVERY OF ELECTRONIC DOCUMENTS (U.S. CLS. 21, 23, 26, 36 AND 38).  
FIRST USE 8-28-2011; IN COMMERCE 8-28-2011.

**CLASS 42—SCIENTIFIC AND COMPUTER SERVICES**

FOR PROVIDING A WEBSITE FEATURING NON-DOWNLOADABLE ON-LINE SOFTWARE FOR DE-ENCRYPTING, AUTHENTICATING AND DELIVERY OF ELECTRONIC DOCUMENTS (U.S. CLS. 100 AND 101).  
FIRST USE 8-28-2011; IN COMMERCE 8-28-2011.  
CATHERINE TARCU, EXAMINING ATTORNEY

SN 85-856,365. IMAGINEERING, INC., ELK GROVE VILLAGE, IL. FILED 2-21-2013.

**IMAGINEERING INC.**

THE MARK CONSISTS OF STANDARD CHARACTERS WITHOUT CLAIM TO ANY PARTICULAR FONT, STYLE, SIZE, OR COLOR.

NO CLAIM IS MADE TO THE EXCLUSIVE RIGHT TO USE "INC.", APART FROM THE MARK AS SHOWN.

**CLASS 40—MATERIAL TREATMENT**

FOR MANUFACTURE OF PRINTED CIRCUIT BOARDS, NAMELY, CUSTOM-DESIGNED PRINTED CIRCUIT BOARDS (U.S. CLS. 100, 103 AND 106).  
FIRST USE 12-1-1987; IN COMMERCE 12-1-1987.

**CLASS 42—SCIENTIFIC AND COMPUTER SERVICES**

FOR DESIGN, DEVELOPMENT, AND TESTING OF PRINTED CIRCUIT BOARDS, NAMELY, CUSTOM-DESIGNED PRINTED CIRCUIT BOARDS (U.S. CLS. 100 AND 101).  
FIRST USE 12-1-1987; IN COMMERCE 12-1-1987.  
ROSELLE HERRERA, EXAMINING ATTORNEY

SN 85-856,648. CAMPUS CRUSADE FOR CHRIST, INC., AKA CRU, HERE'S LIFE INNER CITY, ORLANDO, FL. FILED 2-21-2013.

## SUMMER IN THE CITY

THE MARK CONSISTS OF STANDARD CHARACTERS WITHOUT CLAIM TO ANY PARTICULAR FONT, STYLE, SIZE, OR COLOR.

### CLASS 35—ADVERTISING AND BUSINESS

FOR CHARITABLE SERVICES, NAMELY, ORGANIZING VOLUNTEER PROGRAMS THAT PROVIDE VOLUNTEERS TO ACADEMICALLY MENTOR AND TUTOR SCHOOL AGE CHILDREN AND ASSIST LOCAL CHARITABLE ORGANIZATIONS IN THEIR ONGOING PROGRAMS TO BENEFIT THE NEEDY, THE HOMELESS, SENIOR CITIZENS, AND THE IMPRISONED (U.S. CLS. 100, 101 AND 102).

FIRST USE 12-1-1983; IN COMMERCE 12-1-1983.

### CLASS 41—EDUCATION AND ENTERTAINMENT

FOR CHARITABLE SERVICES, NAMELY, PROVIDING ACADEMIC MENTORING AND TUTORING OF PRIMARY AND SECONDARY EDUCATION STUDENTS IN SUBJECTS AT THE PRIMARY AND SECONDARY LEVEL, AND ON THE SUBJECTS OF LITERACY, LIFE AND JOB SKILLS, ALL PROVIDED BY VOLUNTEERS; PROVIDING FAITH-BASED TRAINING, ONE-ON-ONE PERSONAL COACHING, AND GROUP COACHING FOR VOLUNTEERS IN THE FIELDS OF EVANGELISM AND DISCIPLESHIP, CROSS-CULTURAL MINISTRY, RACIAL RECONCILIATION, URBAN MINISTRY, AND IN THE FIELD OF PROMOTING AWARENESS AND UNDERSTANDING OF THE NEEDY, THE HOMELESS, SENIOR CITIZENS, AND THE IMPRISONED (U.S. CLS. 100, 101 AND 107).

FIRST USE 12-1-1983; IN COMMERCE 12-1-1983.  
MAUREEN DALL, EXAMINING ATTORNEY

SN 85-856,919. AGREEYA MOBILITY INC., MOUNTAIN VIEW, CA. FILED 2-21-2013.



THE MARK CONSISTS OF THE STYLIZED FANCIFUL WORD "ONVELOP" WITH THE SECOND LETTER "O" FORMED OF TWO CURVED ARROWS, AND WITH TWO OVERLAPPING CIRCLES OVERLAPPING AND ON TOP OF THE SECOND LETTER "O".

### CLASS 9—ELECTRICAL AND SCIENTIFIC APPARATUS

FOR COMPUTER SOFTWARE FOR ENABLING SECURE MOBILE ACCESS TO ENTERPRISE SERVER SOFTWARE (U.S. CLS. 21, 23, 26, 36 AND 38).

FIRST USE 9-12-2012; IN COMMERCE 9-12-2012.

### CLASS 42—SCIENTIFIC AND COMPUTER SERVICES

FOR DESIGN, DEVELOPMENT AND IMPLEMENTATION OF SOFTWARE (U.S. CLS. 100 AND 101).  
FIRST USE 9-12-2012; IN COMMERCE 9-12-2012.  
WILLIAM JACKSON, EXAMINING ATTORNEY

SN 85-857,304. VALUE PAYMENT SYSTEMS, LLC, NASHVILLE, TN. FILED 2-22-2013.



NO CLAIM IS MADE TO THE EXCLUSIVE RIGHT TO USE "PAY LOCAL GOV", APART FROM THE MARK AS SHOWN.

THE MARK CONSISTS OF THE WORDING "PAYLOCALGOV" IN STYLIZED FONT, WITH A SHOOTING STAR DESIGN ARCHING ABOVE IT.

### CLASS 36—INSURANCE AND FINANCIAL

FOR ELECTRONIC PAYMENT PROCESSING SERVICES, NAMELY, PROVIDING ELECTRONIC PROCESSING OF ELECTRONIC FUNDS TRANSFER, ACH, CREDIT, DEBIT CARD, ELECTRONIC CHECK AND ELECTRONIC PAYMENTS (U.S. CLS. 100, 101 AND 102).  
FIRST USE 1-1-2010; IN COMMERCE 1-1-2010.

### CLASS 42—SCIENTIFIC AND COMPUTER SERVICES

FOR COMPUTER SERVICES, NAMELY, CREATING, HOSTING AND MAINTAINING WEBSITES FOR OTHERS IN THE FIELD OF BILL PRESENTMENT, APPLICATION PROGRAMMING INTERFACE (API) INTEGRATION WITH OTHER SOFTWARE SERVICE COMPANIES, IN-PERSON POINT-OF-SALE (POS) DEVICES; DESIGN AND DEVELOPMENT OF COMPUTER HARDWARE AND SOFTWARE FOR MOBILE PAYMENTS FOR VARIOUS LOCAL GOVERNMENT COLLECTIONS (U.S. CLS. 100 AND 101).

FIRST USE 1-1-2010; IN COMMERCE 1-1-2010.  
DAWN HAN, EXAMINING ATTORNEY

SN 85-857,315. STATEWIDE TRAFFIC SAFETY & SIGNS, INC., NEWPORT BEACH, CA. FILED 2-22-2013.

## GET IT DONE SAFELY

THE MARK CONSISTS OF STANDARD CHARACTERS WITHOUT CLAIM TO ANY PARTICULAR FONT, STYLE, SIZE, OR COLOR.

### CLASS 6—METAL GOODS

FOR ROAD SIGNS OF METAL (U.S. CLS. 2, 12, 13, 14, 23, 25 AND 50).

FIRST USE 8-30-2012; IN COMMERCE 8-30-2012.

**CLASS 9—ELECTRICAL AND SCIENTIFIC APPARATUS**

FOR ELECTRONIC SIGNS (U.S. CLS. 21, 23, 26, 36 AND 38).

FIRST USE 8-30-2012; IN COMMERCE 8-30-2012.

SN 85-857,317. STATEWIDE TRAFFIC SAFETY & SIGNS, INC., NEWPORT BEACH, CA. FILED 2-22-2013.

**CLASS 35—ADVERTISING AND BUSINESS**

FOR WHOLESALE DISTRIBUTORSHIPS, ONLINE RETAIL STORE SERVICES, AND RETAIL STORE SERVICES FEATURING TRAFFIC WORK ZONE PRODUCTS AND EQUIPMENT, ROADWAY AND PAVEMENT PRODUCTS, SIGNS AND ACCESSORIES, PEDESTRIAN SAFETY SYSTEMS, PARKING LOT PRODUCTS, HIGH-VISIBILITY WORKWEAR, SPECIAL EVENT PRODUCTS, PERSONAL SAFETY PRODUCTS, VEHICLE SAFETY PRODUCTS, SPILL CONTROL PRODUCTS AND STORM WATER PRODUCTS (U.S. CLS. 100, 101 AND 102).

FIRST USE 8-30-2012; IN COMMERCE 8-30-2012.

**STATEWIDE TRAFFIC SAFETY & SIGNS****CLASS 37—CONSTRUCTION AND REPAIR**

FOR RENTAL OF CONSTRUCTION AND TRAFFIC RELATED EQUIPMENT, MACHINES, MESSAGE BOARDS, ARROW BOARDS, RADAR SPEED BOARDS, LIGHT TOWERS, ATTENUATOR TRICKS, FLASHING BEACONS, CRASH CUSHIONS, BARRIERS, CHANNELIZERS, BARRICADES, CONSTRUCTION SIGNS; INSTALLATION OF TRUCK MOUNTED ATTENUATOR, TRUCK MOUNTED BOARDS, WARNING LIGHT AND ALARMS, AND CONSPICUITY TAPE; REPAIR OF MESSAGE AND ARROW BOARDS, TRAFFIC CONTROL EQUIPMENT AND TRAFFIC CONTROL DEVICES, IMPACT ATTENUATORS, AND TRUCK MOUNTED ATTENUATORS; INSTALLATION OF ROADSIDE CONSTRUCTION SIGNS, BARRIERS, CRASH CUSHIONS, ROAD MARKING, CHANNELIZERS, ROADSIDE SIGNS, STREET SIGNS, OVERHEAD SIGNS, CRASH CUSHIONS, ATTENUATORS, GUARDRAIL AND END TREATMENTS (U.S. CLS. 100, 103 AND 106).

FIRST USE 8-30-2012; IN COMMERCE 8-30-2012.

THE MARK CONSISTS OF STANDARD CHARACTERS WITHOUT CLAIM TO ANY PARTICULAR FONT, STYLE, SIZE, OR COLOR.

OWNER OF U.S. REG. NO. 4,294,109.

NO CLAIM IS MADE TO THE EXCLUSIVE RIGHT TO USE "TRAFFIC SAFETY & SIGNS", APART FROM THE MARK AS SHOWN.

SEC. 2(F).

**CLASS 6—METAL GOODS**

FOR ROAD SIGNS OF METAL (U.S. CLS. 2, 12, 13, 14, 23, 25 AND 50).

FIRST USE 8-30-2012; IN COMMERCE 8-30-2012.

**CLASS 9—ELECTRICAL AND SCIENTIFIC APPARATUS**

FOR ELECTRONIC SIGNS (U.S. CLS. 21, 23, 26, 36 AND 38).

FIRST USE 8-30-2012; IN COMMERCE 8-30-2012.

**CLASS 39—TRANSPORTATION AND STORAGE**

FOR TRAFFIC CONTROL SERVICES, NAMELY, VEHICULAR AND PEDESTRIAN CONTROL SERVICES ACCOMPLISHED VIA LAND CLOSURES, DETOURS, FREEWAYS AND ROAD CLOSURES AND FLAGGING SERVICES IN THE NATURE OF DIRECTING VEHICULAR AND PEDESTRIAN TRAFFIC FLOW; MANAGEMENT OF VEHICULAR TRAFFIC FLOW THROUGH ADVANCED COMMUNICATIONS NETWORK AND TECHNOLOGY; TRAFFIC MANAGEMENT SERVICES, NAMELY, CREATING SPECIAL EVENTS TRAFFIC PLANS FOR OTHERS (U.S. CLS. 100 AND 105).

FIRST USE 8-30-2012; IN COMMERCE 8-30-2012.

**CLASS 35—ADVERTISING AND BUSINESS**

FOR WHOLESALE DISTRIBUTORSHIPS, ONLINE RETAIL STORE SERVICES, AND RETAIL STORE SERVICES FEATURING TRAFFIC WORK ZONE PRODUCTS AND EQUIPMENT, ROADWAY AND PAVEMENT PRODUCTS, SIGNS AND ACCESSORIES, PEDESTRIAN SAFETY SYSTEMS, PARKING LOT PRODUCTS, HIGH-VISIBILITY WORKWEAR, SPECIAL EVENT PRODUCTS, PERSONAL SAFETY PRODUCTS, VEHICLE SAFETY PRODUCTS, SPILL CONTROL PRODUCTS AND STORM WATER PRODUCTS (U.S. CLS. 100, 101 AND 102).

FIRST USE 8-30-2012; IN COMMERCE 8-30-2012.

**CLASS 42—SCIENTIFIC AND COMPUTER SERVICES**

FOR TRAFFIC CONTROL SERVICE, NAMELY, TRAFFIC PLANNING SERVICES (U.S. CLS. 100 AND 101).

FIRST USE 8-30-2012; IN COMMERCE 8-30-2012.

**CLASS 37—CONSTRUCTION AND REPAIR**

FOR RENTAL OF CONSTRUCTION AND TRAFFIC RELATED EQUIPMENT, MACHINES, MESSAGE BOARDS, ARROW BOARDS, RADAR SPEED BOARDS, LIGHT TOWERS, ATTENUATOR TRICKS, FLASHING BEACONS, CRASH CUSHIONS, BARRIERS, CHANNELIZERS, BARRICADES, CONSTRUCTION SIGNS; INSTALLATION OF TRUCK MOUNTED ATTENUATOR, TRUCK MOUNTED BOARDS, WARNING LIGHT AND ALARMS, AND CONSPICUITY TAPE; REPAIR OF MESSAGE AND ARROW BOARDS, TRAFFIC CONTROL EQUIPMENT AND TRAFFIC CONTROL DEVICES, IMPACT ATTENUATORS, AND TRUCK MOUNTED ATTENUATORS; INSTALLATION OF ROADSIDE CONSTRUCTION SIGNS, BARRIERS, CRASH CUSHIONS, ROAD MARKING, CHANNELIZERS, ROADSIDE SIGNS, STREET SIGNS, OVERHEAD SIGNS, CRASH CUSHIONS, ATTENUATORS, GUARDRAIL AND END TREATMENTS (U.S. CLS. 100, 103 AND 106).

FIRST USE 8-30-2012; IN COMMERCE 8-30-2012.

**CLASS 45—PERSONAL AND LEGAL SERVICES**

FOR TRAFFIC CONTROL SERVICES, NAMELY, PERMITTING ASSISTANCE IN THE NATURE OF ASSISTING OTHERS IN OBTAINING PERMITS FOR TRAFFIC AND ROAD DEVELOPMENT PROJECTS (U.S. CLS. 100 AND 101).

FIRST USE 8-30-2012; IN COMMERCE 8-30-2012.

CHRISTINA SOBRAL, EXAMINING ATTORNEY

**CLASS 39—TRANSPORTATION AND STORAGE**

FOR TRAFFIC CONTROL SERVICES, NAMELY, VEHICULAR AND PEDESTRIAN CONTROL SERVICES ACCOMPLISHED VIA LAND CLOSURES, DETOURS, FREEWAYS AND ROAD CLOSURES AND FLAGGING SERVICES IN THE NATURE OF DIRECTING VEHICULAR AND PEDESTRIAN TRAFFIC FLOW; MANAGEMENT OF VEHICULAR TRAFFIC FLOW THROUGH ADVANCED COMMUNICATIONS NETWORK AND TECHNOLOGY; TRAFFIC MANAGEMENT SERVICES, NAMELY, CREATING SPECIAL EVENTS TRAFFIC PLANS FOR OTHERS (U.S. CLS. 100 AND 105).

FIRST USE 8-30-2012; IN COMMERCE 8-30-2012.

**CLASS 42—SCIENTIFIC AND COMPUTER SERVICES**

FOR TRAFFIC CONTROL SERVICE, NAMELY, TRAFFIC PLANNING SERVICES (U.S. CLS. 100 AND 101).

FIRST USE 8-30-2012; IN COMMERCE 8-30-2012.

**CLASS 45—PERSONAL AND LEGAL SERVICES**

FOR TRAFFIC CONTROL SERVICES, NAMELY, PERMITTING ASSISTANCE IN THE NATURE OF ASSISTING OTHERS IN OBTAINING PERMITS FOR TRAFFIC AND ROAD DEVELOPMENT PROJECTS (U.S. CLS. 100 AND 101).

FIRST USE 8-30-2012; IN COMMERCE 8-30-2012.  
CHRISTINA SOBRAL, EXAMINING ATTORNEY

---

SN 85-857,510. LEMOND, GREG, MEDINA, MN. FILED 2-22-2013.

**GREG LEMOND**

THE MARK CONSISTS OF STANDARD CHARACTERS WITHOUT CLAIM TO ANY PARTICULAR FONT, STYLE, SIZE, OR COLOR.

OWNER OF U.S. REG. NOS. 3,137,558 AND 3,877,630.

THE NAME "GREG LEMOND" IDENTIFIES A LIVING INDIVIDUAL WHOSE CONSENT IS OF RECORD.

**CLASS 9—ELECTRICAL AND SCIENTIFIC APPARATUS**

FOR PARTS FOR EXERCISE MACHINES, NAMELY, ELECTRONIC DISPLAY INTERFACES (U.S. CLS. 21, 23, 26, 36 AND 38).

**CLASS 28—TOYS AND SPORTING GOODS**

FOR EXERCISE MACHINES; STRUCTURAL PARTS OF EXERCISE MACHINES; EXERCISE EQUIPMENT, NAMELY, STATIONARY EXERCISE BICYCLES; MANUALLY-OPERATED EXERCISE EQUIPMENT; EXERCISE EQUIPMENT IN THE NATURE OF A BICYCLE TRAINER USED TO SUPPORT A BICYCLE FOR STATIONARY EXERCISE; ELLIPTICAL EXERCISE MACHINES; EXERCISE EQUIPMENT, NAMELY, STAIR-STEPPING MACHINES; EXERCISE TREADMILLS; EXERCISING EQUIPMENT, NAMELY, WEIGHT LIFTING MACHINES (U.S. CLS. 22, 23, 38 AND 50).

LINDA LAVACHE, EXAMINING ATTORNEY

SN 85-857,537. LEMOND, GREG, MEDINA, MN. FILED 2-22-2013.

**LEMOND REVMMASTER**

THE MARK CONSISTS OF STANDARD CHARACTERS WITHOUT CLAIM TO ANY PARTICULAR FONT, STYLE, SIZE, OR COLOR.

OWNER OF U.S. REG. NOS. 2,626,035 AND 3,137,558.

THE NAME SHOWN IN THE MARK IDENTIFIES GREG LEMOND, A LIVING INDIVIDUAL WHOSE CONSENT IS OF RECORD.

**CLASS 9—ELECTRICAL AND SCIENTIFIC APPARATUS**

FOR PARTS FOR EXERCISE MACHINES, NAMELY, ELECTRONIC DISPLAY INTERFACES (U.S. CLS. 21, 23, 26, 36 AND 38).

**CLASS 28—TOYS AND SPORTING GOODS**

FOR EXERCISE MACHINES; STRUCTURAL PARTS OF EXERCISE MACHINES; EXERCISE EQUIPMENT, NAMELY, STATIONARY EXERCISE BICYCLES; MANUALLY-OPERATED EXERCISE EQUIPMENT; EXERCISE EQUIPMENT IN THE NATURE OF A BICYCLE TRAINER USED TO SUPPORT A BICYCLE FOR STATIONARY EXERCISE; ELLIPTICAL EXERCISE MACHINES; EXERCISE EQUIPMENT, NAMELY, STAIR-STEPPING MACHINES; EXERCISE TREADMILLS; EXERCISING EQUIPMENT, NAMELY, WEIGHT LIFTING MACHINES (U.S. CLS. 22, 23, 38 AND 50).

LINDA LAVACHE, EXAMINING ATTORNEY

---

SN 85-857,570. THAT'S HOW WE ROLL, LLC, FAIRFIELD, NJ. FILED 2-22-2013.

**PARTY 'TIZERS**

THE MARK CONSISTS OF STANDARD CHARACTERS WITHOUT CLAIM TO ANY PARTICULAR FONT, STYLE, SIZE, OR COLOR.

**CLASS 29—MEATS AND PROCESSED FOODS**

FOR FROZEN APPETIZERS CONSISTING PRIMARILY OF CHICKEN OR SEAFOOD; SNACK DIPS; SNACK FOOD DIPS; SNACK MIXES CONSISTING PRIMARILY OF FRUITS, NUTS AND/OR RAISINS; SOY-BASED SNACK FOODS; TOFU-BASED SNACK FOODS; POTATO CHIPS; HUMMUS; PREPARED FRESH APPETIZERS CONSISTING PRIMARILY OF CHICKEN OR SEAFOOD; NUT-BASED SNACK FOODS (U.S. CL. 46).

**CLASS 30—STAPLE FOODS**

FOR CEREAL-BASED SNACK FOODS; CORN-BASED SNACK FOODS; TORTILLA CHIPS; WHEAT-BASED CHIPS; PRETZEL CHIPS; PRETZELS; BAGEL CHIPS; GRAIN-BASED CHIPS; SALSA; FROZEN APPETIZERS CONSISTING PRIMARILY OF CORNMEAL; FROZEN FOODS, NAMELY, GRAIN AND BREAD BASED APPETIZERS, HORS D'OEUVRES AND CANAPES; CHEESE CURLS, CHEESE-FLAVORED CORN SNACKS, AND CHEESE-FLAVORED PUFFED CORN SNACKS; GRANOLA SNACKS; CRACKERS; RICE CRACKERS; SNACK MIXES CONSISTING PRIMARILY OF CRACKERS, PRETZELS, AND/OR POPPED POPCORN (U.S. CL. 46).  
YAT SYE, LEE, EXAMINING ATTORNEY

SN 85-857,596. LEMOND, GREG, MEDINA, MN. FILED 2-22-2013.

# LEMOND

THE MARK CONSISTS OF STANDARD CHARACTERS WITHOUT CLAIM TO ANY PARTICULAR FONT, STYLE, SIZE, OR COLOR.

OWNER OF U.S. REG. NOS. 3,137,558 AND 3,877,630.

THE NAME "LEMOND" IDENTIFIES A LIVING INDIVIDUAL WHOSE CONSENT IS OF RECORD.  
SEC. 2(F).

**CLASS 9—ELECTRICAL AND SCIENTIFIC APPARATUS**

FOR PARTS FOR EXERCISE MACHINES, NAMELY, ELECTRONIC DISPLAY INTERFACES (U.S. CLS. 21, 23, 26, 36 AND 38).

**CLASS 28—TOYS AND SPORTING GOODS**

FOR EXERCISE MACHINES; STRUCTURAL PARTS OF EXERCISE MACHINES; EXERCISE EQUIPMENT, NAMELY, STATIONARY EXERCISE BICYCLES; MANUALLY-OPERATED EXERCISE EQUIPMENT; EXERCISE EQUIPMENT IN THE NATURE OF A BICYCLE TRAINER USED TO SUPPORT A BICYCLE FOR STATIONARY EXERCISE; ELLIPTICAL EXERCISE MACHINES; EXERCISE EQUIPMENT, NAMELY, STAIR-STEPPING MACHINES; EXERCISE TREADMILLS; EXERCISING EQUIPMENT, NAMELY, WEIGHT LIFTING MACHINES (U.S. CLS. 22, 23, 38 AND 50).

LINDA LAVACHE, EXAMINING ATTORNEY

SN 85-857,603. THAT'S HOW WE ROLL, LLC, FAIRFIELD, NJ. FILED 2-22-2013.

# DIPPIN' CHIPS

THE MARK CONSISTS OF STANDARD CHARACTERS WITHOUT CLAIM TO ANY PARTICULAR FONT, STYLE, SIZE, OR COLOR.

NO CLAIM IS MADE TO THE EXCLUSIVE RIGHT TO USE "CHIPS", APART FROM THE MARK AS SHOWN.

**CLASS 29—MEATS AND PROCESSED FOODS**

FOR POTATO CHIPS; SOY CHIPS; YUCCA CHIPS; PLANTAIN CHIPS; VEGETABLE CHIPS; SHRIMP CHIPS (U.S. CL. 46).

**CLASS 30—STAPLE FOODS**

FOR CORN CHIPS; TORTILLA CHIPS; PITA CHIPS; FLOUR-BASED CHIPS; BAGEL CHIPS; TACO CHIPS; WONTON CHIPS; PRETZEL CHIPS; PRETZELS; GRAIN-BASED CHIPS; WHEAT-BASED CHIPS (U.S. CL. 46).  
YAT SYE, LEE, EXAMINING ATTORNEY

SN 85-857,664. WALTERS, HAPPY, CHICAGO, IL. FILED 2-22-2013.

# SLAP HAPPY MEDIA

THE MARK CONSISTS OF STANDARD CHARACTERS WITHOUT CLAIM TO ANY PARTICULAR FONT, STYLE, SIZE, OR COLOR.

NO CLAIM IS MADE TO THE EXCLUSIVE RIGHT TO USE "MEDIA", APART FROM THE MARK AS SHOWN.

**CLASS 35—ADVERTISING AND BUSINESS**

FOR FILM MARKETING FOR MOTION PICTURE INDUSTRY PARTICIPANTS (U.S. CLS. 100, 101 AND 102).

**CLASS 41—EDUCATION AND ENTERTAINMENT**

FOR ENTERTAINMENT SERVICES, NAMELY, FILM DEVELOPMENT, PRODUCTION AND DISTRIBUTION; MUSIC PRODUCTION (U.S. CLS. 100, 101 AND 107).  
DOMINICK J. SALEMI, EXAMINING ATTORNEY

SN 85-857,726. ARATANA THERAPEUTICS, INC., KANSAS CITY, KS. FILED 2-22-2013.

# ARATANA

THE MARK CONSISTS OF STANDARD CHARACTERS WITHOUT CLAIM TO ANY PARTICULAR FONT, STYLE, SIZE, OR COLOR.

**CLASS 5—PHARMACEUTICALS**

FOR VETERINARY PHARMACEUTICAL PREPARATIONS FOR THE TREATMENT OF ALLERGIES, ANEMIA, BEHAVIORAL DISORDERS, BONE DISEASES AND DISORDERS, CACHEXIA, CANCER, CARDIOVASCULAR DISEASE, EYE DISEASES AND CONDITIONS, DENTAL DISEASES, DIABETES, EPILEPSY, GASTROINTESTINAL DISEASES AND DISORDERS, HORMONAL DISORDERS, INAPPETENCE, INFECTIOUS DISEASES, KIDNEY DISEASES, RESPIRATORY DISEASES AND DISORDERS, OBESITY, PANCREATITIS, PAIN, AND URINARY TRACT DISORDERS IN CATS, DOGS, AND HORSES (U.S. CLS. 6, 18, 44, 46, 51 AND 52).

**CLASS 40—MATERIAL TREATMENT**

FOR MANUFACTURING SERVICES FOR OTHERS IN THE FIELD OF VETERINARY PHARMACEUTICALS (U.S. CLS. 100, 103 AND 106).

**CLASS 42—SCIENTIFIC AND COMPUTER SERVICES**

FOR RESEARCH AND DEVELOPMENT IN THE FIELD OF VETERINARY PHARMACEUTICALS (U.S. CLS. 100 AND 101).

ELI HELLMAN, EXAMINING ATTORNEY

SN 85-857,773. ASESORÍA Y DESARROLLOS URREA, S.A. DE C.V., JALISCO, MEXICO, FILED 2-22-2013.



OWNER OF MEXICO REG. NO. 958180, DATED 10-18-2006, EXPIRES 6-28-2014.

OWNER OF U.S. REG. NO. 3,484,937.

THE MARK CONSISTS OF THE WORD "STANZA" IN STYLIZED LETTERING APPEARING IN THE CENTER OF A SHADED-IN RECTANGLE.

**CLASS 19—NON-METALLIC BUILDING MATERIALS**

FOR BUILDING MATERIALS, NAMELY, NON-METAL SINK COUNTERTOPS OF PLASTIC LAMINATE AND WOOD FOR FURTHER INSTALLATION (U.S. CLS. 1, 12, 33 AND 50).

**CLASS 20—FURNITURE AND ARTICLES NOT OTHERWISE CLASSIFIED**

FOR PLASTIC LAMINATE AND WOOD FURNITURE, NAMELY, LEDGES, SHELVES, CABINETS, AND DRAWERS (U.S. CLS. 2, 13, 22, 25, 32 AND 50).

**CLASS 21—HOUSEWARES AND GLASS**

FOR WOODEN TOWEL BARS (U.S. CLS. 2, 13, 23, 29, 30, 33, 40 AND 50).

CYNTHIA TRIPI, EXAMINING ATTORNEY

SN 85-857,855. LINK SYSTEMS INC., STAMFORD, CT. FILED 2-22-2013.

**PUNCHPRO**

THE MARK CONSISTS OF STANDARD CHARACTERS WITHOUT CLAIM TO ANY PARTICULAR FONT, STYLE, SIZE, OR COLOR.

**CLASS 9—ELECTRICAL AND SCIENTIFIC APPARATUS**

FOR COMPUTER SOFTWARE FOR MANAGING PERSONAL TASK LISTS; COMPUTER SOFTWARE FOR MANAGING CONSTRUCTION PROJECT PUNCH LISTS (U.S. CLS. 21, 23, 26, 36 AND 38).

**CLASS 42—SCIENTIFIC AND COMPUTER SERVICES**

FOR PROVIDING ON-LINE NON-DOWNLOADABLE COMPUTER SOFTWARE FOR MANAGING PERSONAL TASK LISTS; PROVIDING ON-LINE NON-DOWNLOADABLE COMPUTER SOFTWARE FOR MANAGING CONSTRUCTION PROJECT PUNCH LISTS (U.S. CLS. 100 AND 101).

KEVIN MITTLER, EXAMINING ATTORNEY

SN 85-858,009. VIVINT, INC., PROVO, UT. FILED 2-22-2013.

**VIVINT WIRELESS**

THE MARK CONSISTS OF STANDARD CHARACTERS WITHOUT CLAIM TO ANY PARTICULAR FONT, STYLE, SIZE, OR COLOR.

OWNER OF U.S. REG. NOS. 4,094,587, 4,153,443 AND 4,166,498.

NO CLAIM IS MADE TO THE EXCLUSIVE RIGHT TO USE "WIRELESS", APART FROM THE MARK AS SHOWN.

**CLASS 9—ELECTRICAL AND SCIENTIFIC APPARATUS**

FOR COMPUTER HARDWARE; COMPUTER HARDWARE FOR TELECOMMUNICATIONS; COMPUTER AND TELECOMMUNICATIONS NETWORKING COMPUTER HARDWARE; COMPUTER AND TELECOMMUNICATIONS NETWORK HUBS, SWITCHES AND ROUTERS; COMPUTER HARDWARE AND SOFTWARE FOR USE IN CONNECTING TELECOMMUNICATIONS EQUIPMENT, TELEPHONES, COMPUTERS, WIRED AND WIRELESS NETWORKS; TELEPHONE AND AUDIO RECEIVERS AND TRANSMITTERS; COMPUTER TELEPHONY SOFTWARE; COMPUTER SOFTWARE AND HARDWARE FOR PROVIDING VOICEMAIL AND INSTANT MESSAGING SERVICES IN THE FIELD OF TELECOMMUNICATIONS; COMPUTER SOFTWARE AND HARDWARE FOR PROVIDING TRANSMISSION AND EXCHANGE OF VOICE, DATA AND IMAGES IN THE FIELD OF TELECOMMUNICATIONS; COMPUTER HARDWARE AND COMPUTER SOFTWARE MEDIA AND MULTIMEDIA DELIVERY PLATFORMS CONSISTING OF DATA TRANSCEIVERS, COMPUTER HARDWARE, COMPUTER SOFTWARE, AND GATEWAYS FOR TRANSMISSION AND DELIVERY OF DATA; ENTERTAINMENT DELIVERY DEVICES COMPRISED OF AUDIO SPEAKERS; COMPUTER HARDWARE AND SOFTWARE FOR PROVIDING IN-HOME PBX (PRIVATE BRANCH EXCHANGE); COMMUNICATIONS NETWORK HARDWARE AND SOFTWARE FOR COMBINING LANDLINE WITH VOIP SERVICES; COMPUTER HARDWARE AND SOFTWARE FOR COMBINING LANDLINE WITH VOIP SERVICES; NETWORK COMPUTER HARDWARE FOR PROVIDING VOICE OVER INTERNET PROTOCOL (VOIP) COMMUNICATIONS; COMPUTER HARDWARE AND SOFTWARE FOR PROVIDING VOICE OVER INTERNET PROTOCOL (VOIP) COMMUNICATIONS (U.S. CLS. 21, 23, 26, 36 AND 38).

**CLASS 38—COMMUNICATION**

FOR INTERNET SERVICE PROVIDER (ISP); VOICE OVER INTERNET PROTOCOL (VOIP) SERVICES; TELECOMMUNICATION SERVICES, NAMELY, TRANSMISSION OF VOICE, DATA AND SOUND BY MEANS OF DECENTRALIZED ARCHITECTURE; VOICE MAIL SERVICES; SERVICES FOR PROVIDING VOICE OVER INTERNET PROTOCOL (VOIP) COMMUNICATIONS; CABLE TELEVISION BROADCASTING SERVICES; PROVISION OF TELECOMMUNICATION ACCESS TO VIDEO AND AUDIO CONTENT PROVIDED VIA VIDEO-ON-DEMAND, INTERACTIVE TELEVISION, PAY PER VIEW AND PAY TELEVISION SUBSCRIPTION SERVICES; PROVIDING HIGH SPEED ACCESS TO THE INTERNET AND OTHER ELECTRONIC COMMUNICATIONS NETWORKS; STREAMING OF VIDEO AND AUDIO MATERIAL VIA THE INTERNET AND OTHER ELECTRONIC COMMUNICATIONS NETWORKS; PROVIDING ELECTRONIC MAIL, INSTANT MESSAGING, WEB MESSAGING AND WIRELESS DIGITAL MESSAGING SERVICES; TELECOMMUNICATION ACCESS SERVICES; PERSONAL COMMUNICATIONS SERVICES; ELECTRONIC, LOCAL AND LONG DISTANCE TRANSMISSION OF VOICE, DATA AND GRAPHICS BY MEANS OF CABLE, TELEPHONE, WIRELESS, ISDN AND SATELLITE TECHNOLOGIES; PROVIDING FIBER OPTIC NETWORK SERVICES; PROVIDING VOICE COMMUNICATION SERVICES VIA THE INTERNET AND OTHER ELECTRONIC COMMUNICATIONS NETWORKS; TELECOMMUNICATIONS SERVICES, NAMELY, WIRELESS PHONE SERVICES, ELECTRIC, DIGITAL, CELLULAR AND WIRELESS TRANSMISSION OF VOICE, DATA, INFORMATION, IMAGES, SIGNALS, MESSAGES AND TRANSMISSION OF VOICE, DATA, IMAGES, AUDIO, VIDEO AND INFORMATION VIA TELEPHONE, TELEVISION AND GLOBAL COMMUNICATION NETWORKS; PROVIDING TELECOMMUNICATIONS CONNECTIONS OVER A GLOBAL COMMUNICATIONS NETWORK; ELECTRONIC MAIL, VOICE MAIL AND MESSAGING SERVICES, NAMELY, THE RECORDING AND STORAGE AND SUBSEQUENT TRANSMISSION OF VOICE MESSAGES BY TELEPHONE; AUDIO AND VIDEO TELECONFERENCING; RENTAL OF TELECOMMUNICATIONS EQUIPMENT, NAMELY, EQUIPMENT FOR ELECTRONIC ACCESS TO GLOBAL TELECOMMUNICATIONS NETWORK, EQUIPMENT FOR TRANSMITTING, RECEIVING, RECORDING AND MONITORING VOICE, DATA, INFORMATION, IMAGES, SIGNALS, MESSAGES AND TELECOMMUNICATIONS HARDWARE AND SOFTWARE INCLUDING COMPONENTS AND PERIPHERALS THEREOF FOR USE IN THE TELECOMMUNICATIONS INDUSTRY; RENTAL OF EQUIPMENT FOR TRANSMITTING, RECEIVING, RECORDING AND MONITORING COMPUTER PROGRAMS FOR USE IN OPERATING AND ACCESSING TELECOMMUNICATIONS SYSTEMS; AUDIO AND VIDEO BROADCASTING FEATURING ENTERTAINMENT IN THE NATURE OF LIVE VISUAL AND AUDIO PERFORMANCES OF MUSICAL, VARIETY, NEWS AND COMEDY SHOWS; PROVIDING ACCESS TO COMPUTER INFORMATION NETWORKS; PAGER SERVICES; TRANSMISSION AND BROADCAST OF AUDIO AND VIDEO PROGRAMMING; PROVIDING MULTIPLE-USER ACCESS TO A GLOBAL COMMUNICATION NETWORK (U.S. CLS. 100, 101 AND 104).

BRENDAN MCCAULEY, EXAMINING ATTORNEY

SN 85-858,321. NATURAL GAS FUELING SOLUTIONS, ST. PETERS, MO. FILED 2-23-2013.

**CHANGING WHAT DRIVES  
AMERICA**

THE MARK CONSISTS OF STANDARD CHARACTERS WITHOUT CLAIM TO ANY PARTICULAR FONT, STYLE, SIZE, OR COLOR.

**CLASS 35—ADVERTISING AND BUSINESS**

FOR BUSINESS CONSULTATION AND PROJECT MANAGEMENT SERVICES FOR OTHERS FOR BUSINESS PURPOSES IN THE FIELD OF DESIGN OF NATURAL GAS FUELING STATIONS AND NATURAL GAS VEHICLE SERVICING STATIONS; PROCUREMENT SERVICES, NAMELY, PROCUREMENT OF CONTRACTS FOR OTHERS FOR THE PURCHASE OF GOODS AND LABOR CONTRACTING SERVICES FOR THE INSTALLATION OF EQUIPMENT IN THE FIELD OF NATURAL GAS FUELING STATIONS AND NATURAL GAS VEHICLE SERVICING STATIONS (U.S. CLS. 100, 101 AND 102).

**CLASS 37—CONSTRUCTION AND REPAIR**

FOR CONSTRUCTION, BUILDING MAINTENANCE AND CONSTRUCTION PROJECT MANAGEMENT SERVICES IN THE FIELD OF NATURAL GAS FUELING STATIONS AND NATURAL GAS VEHICLE SERVICING FACILITIES; CONSTRUCTION SERVICES IN THE NATURE OF SITE EXCAVATION, GRADING AND PAVING; ELECTRICAL AND MECHANICAL CONTRACTING; CONCRETE PAVING AND FOUNDATION CONSTRUCTION WORK FOR NATURAL GAS FUELING STATIONS AND NATURAL GAS VEHICLE SERVICING STATIONS (U.S. CLS. 100, 103 AND 106).

**CLASS 42—SCIENTIFIC AND COMPUTER SERVICES**

FOR ENGINEERING DESIGN SERVICES IN THE FIELD OF DESIGN AND BUILDING OF NATURAL GAS FUELING AND VEHICLE SERVICING STATIONS; ARCHITECTURE SERVICES IN THE FIELD OF DESIGN AND BUILDING OF NATURAL GAS FUELING AND VEHICLE SERVICING STATIONS; CONSULTING IN THE FIELDS OF ENGINEERING AND ARCHITECTURAL DESIGN (U.S. CLS. 100 AND 101).

CARYN GLASSER, EXAMINING ATTORNEY

SN 85-858,600. DIGITAL ANSWER MEDIA, SMITHTOWN, NY. FILED 2-25-2013.

**DIGITAL ANSWER MEDIA**

THE MARK CONSISTS OF STANDARD CHARACTERS WITHOUT CLAIM TO ANY PARTICULAR FONT, STYLE, SIZE, OR COLOR.

NO CLAIM IS MADE TO THE EXCLUSIVE RIGHT TO USE "DIGITAL" AND "MEDIA", APART FROM THE MARK AS SHOWN.

**CLASS 35—ADVERTISING AND BUSINESS**

FOR ADVERTISING AND MARKETING SERVICES, NAMELY, PROMOTING THE GOODS AND SERVICES OF OTHERS; ADVERTISING AND MARKETING SERVICES PROVIDED BY MEANS OF INDIRECT METHODS OF MARKETING COMMUNICATIONS, NAMELY, SOCIAL MEDIA, SEARCH ENGINE MARKETING, INQUIRY MARKETING, INTERNET MARKETING, MOBILE MARKETING, BLOGGING AND OTHER FORMS OF PASSIVE, SHARABLE OR VIRAL COMMUNICATIONS CHANNELS; ADVERTISING AND PUBLICITY SERVICES, NAMELY, PROMOTING THE GOODS, SERVICES, BRAND IDENTITY AND COMMERCIAL INFORMATION AND NEWS OF THIRD PARTIES THROUGH PRINT, AUDIO, VIDEO, DIGITAL AND ON-LINE MEDIUM; MEDIA BUYING ADVICE, NAMELY, ADVISING THE CLIENT HOW MUCH MEDIA TIME, AND AT WHAT TIMES THE CLIENT SHOULD BE PURCHASING ADVERTISING; MEDIA PRODUCTION LOCATION SCOUTING SERVICES FOR ADVERTISING PURPOSES; PREPARATION AND REALIZATION OF MEDIA AND ADVERTISING PLANS AND CONCEPTS; PROVIDING TELEVISION ADVERTISING FOR OTHERS; PROVIDING ADVERTISING, MARKETING AND PROMOTIONAL SERVICES, NAMELY, DEVELOPMENT OF ADVERTISING CAMPAIGNS PROVIDED THROUGH CABLE TELEVISION BROADCAST, WEB CASTS, RADIO BROADCASTS, NEWSPAPERS, MAGAZINES, ONLINE BANNERS, OUTDOOR BILLBOARDS, WILD POSTINGS, BUS AND SUBWAY ADS (U.S. CLS. 100, 101 AND 102).

**CLASS 38—COMMUNICATION**

FOR BROADCASTING SERVICES, NAMELY, TRANSMISSION OF ADVERTISING PROGRAMS AND MEDIA ADVERTISING COMMUNICATIONS VIA DIGITAL COMMUNICATIONS NETWORKS (U.S. CLS. 100, 101 AND 104).

BERYL GARDNER, EXAMINING ATTORNEY

---

SN 85-858,613. WEBSTORES PTY LTD, FAIRFIELD WEST, AUSTRALIA, FILED 2-25-2013.

JUSTBEDDING.COM

THE MARK CONSISTS OF STANDARD CHARACTERS WITHOUT CLAIM TO ANY PARTICULAR FONT, STYLE, SIZE, OR COLOR.  
SEC. 2(F).

**CLASS 24—FABRICS**

FOR BED COVERS, BED LINEN, BED PADS, BED SHEETS, BED SKIRTS, BED THROWS, FITTED BED SHEETS, PILLOW-TOP, LOW-PROFILE BED SKIRTS, BED BLANKETS, QUILTS, COMFORTERS (U.S. CLS. 42 AND 50).

FIRST USE 4-12-2007; IN COMMERCE 4-12-2007.

**CLASS 35—ADVERTISING AND BUSINESS**

FOR RETAIL STORE AND ONLINE RETAIL STORE FEATURING BEDDINGS, QUILT AND BED COVERS, SHEETS, BABY BEDDING, BEDSPREADS, COMFORTERS, COVERLETS, CUSHIONS, PILLOWS, BED SKIRTS, UNDER BLANKETS, BLANKETS (U.S. CLS. 100, 101 AND 102).

FIRST USE 4-12-2007; IN COMMERCE 4-12-2007.  
LOURDES AYALA, EXAMINING ATTORNEY

SN 85-858,988. NOVARTIS AG, BASEL, SWITZERLAND, FILED 2-25-2013.

**THE SANDOZ ACCESS PROGRAM**

THE MARK CONSISTS OF STANDARD CHARACTERS WITHOUT CLAIM TO ANY PARTICULAR FONT, STYLE, SIZE, OR COLOR.

OWNER OF U.S. REG. NOS. 315,685, 4,179,672 AND OTHERS.

NO CLAIM IS MADE TO THE EXCLUSIVE RIGHT TO USE "ACCESS PROGRAM", APART FROM THE MARK AS SHOWN.

**CLASS 42—SCIENTIFIC AND COMPUTER SERVICES**

FOR DATABASE DEVELOPMENT SERVICES; DESIGN OF COMPUTER DATABASE; MAINTENANCE OF ON-LINE DATABASES FOR OTHERS; MEDICAL AND SCIENTIFIC RESEARCH INFORMATION IN THE FIELD OF PHARMACEUTICALS; MEDICAL RESEARCH (U.S. CLS. 100 AND 101).

**CLASS 44—MEDICAL, BEAUTY AND AGRICULTURAL SERVICES**

FOR MEDICAL INFORMATION; MEDICAL SERVICES (U.S. CLS. 100 AND 101).

RON FAIRBANKS, EXAMINING ATTORNEY

---

SN 85-859,356. VALUE PAYMENT SYSTEMS, LLC, NASHVILLE, TN. FILED 2-25-2013.



NO CLAIM IS MADE TO THE EXCLUSIVE RIGHT TO USE "EDUCATION BILL PAY", APART FROM THE MARK AS SHOWN.

THE MARK CONSISTS OF THE WORDING "EDUCATIONBILLPAY" IN STYLIZED FONT, WITH A GRADUATION HAT DESIGN APPEARING ABOVE THE WORDING "BILL" THEREOF.

**CLASS 36—INSURANCE AND FINANCIAL**

FOR ELECTRONIC PAYMENT PROCESSING SERVICES, NAMELY, PROVIDING ELECTRONIC PROCESSING OF ELECTRONIC FUNDS TRANSFER, ACH, CREDIT, DEBIT CARD, ELECTRONIC CHECK AND ELECTRONIC PAYMENTS (U.S. CLS. 100, 101 AND 102).

FIRST USE 1-1-2013; IN COMMERCE 1-1-2013.



**CLASS 42—SCIENTIFIC AND COMPUTER SERVICES**

FOR COMPUTER SERVICES, NAMELY, CREATING, HOSTING AND MAINTAINING WEBSITES FOR OTHERS IN THE FIELD OF BILL PRESENTMENT, APPLICATION PROGRAMMING INTERFACE (API) INTEGRATION WITH OTHER SOFTWARE SERVICE COMPANIES, IN-PERSON POINT-OF-SALE (POS) DEVICES; DESIGN AND DEVELOPMENT OF COMPUTER HARDWARE AND SOFTWARE FOR MOBILE PAYMENTS FOR VARIOUS LOCAL GOVERNMENT COLLECTIONS (U.S. CLS. 100 AND 101).

FIRST USE 1-1-2013; IN COMMERCE 1-1-2013.  
DAWN HAN, EXAMINING ATTORNEY

SN 85-860,029. NATURE'S BOUNTY INC., RONKONKOMA, NY. FILED 2-26-2013.

**PASSION FOR WELLNESS**

THE MARK CONSISTS OF STANDARD CHARACTERS WITHOUT CLAIM TO ANY PARTICULAR FONT, STYLE, SIZE, OR COLOR.

NO CLAIM IS MADE TO THE EXCLUSIVE RIGHT TO USE "WELLNESS", APART FROM THE MARK AS SHOWN.

**CLASS 5—PHARMACEUTICALS**

FOR VITAMINS, MINERALS, NUTRITIONAL AND DIETARY SUPPLEMENTS (U.S. CLS. 6, 18, 44, 46, 51 AND 52).

**CLASS 35—ADVERTISING AND BUSINESS**

FOR WHOLESALE DISTRIBUTORSHIPS, WHOLESALE ORDERING SERVICES, RETAIL STORE SERVICES, AND DISTRIBUTORSHIPS SERVICES FEATURING VITAMINS, MINERALS, NUTRITIONAL AND DIETARY SUPPLEMENTS (U.S. CLS. 100, 101 AND 102).

**CLASS 40—MATERIAL TREATMENT**

FOR CUSTOM MANUFACTURING OF VITAMINS, MINERALS, NUTRITIONAL AND DIETARY SUPPLEMENTS (U.S. CLS. 100, 103 AND 106).

DARRYL SPRUILL, EXAMINING ATTORNEY

SN 85-860,275. TRUPANION, INC., SEATTLE, WA. FILED 2-26-2013.

trupanion

THE MARK CONSISTS OF STANDARD CHARACTERS WITHOUT CLAIM TO ANY PARTICULAR FONT, STYLE, SIZE, OR COLOR.

OWNER OF U.S. REG. NOS. 3,525,250, 3,634,415 AND 4,400,175.

**CLASS 36—INSURANCE AND FINANCIAL**

FOR CLAIMS ADMINISTRATION SERVICES IN THE FIELD OF PET INSURANCE; ELECTRONIC PROCESSING OF PET INSURANCE CLAIMS AND PAYMENT DATA; FINANCIAL TRANSACTION SERVICES, NAMELY, PROVIDING SECURE COMMERCIAL TRANSACTIONS AND PAYMENT OPTIONS; PROCESSING, ADMINISTERING AND MANAGING EMPLOYEE BENEFIT PLANS CONCERNING PET INSURANCE AND FINANCE (U.S. CLS. 100, 101 AND 102).

FIRST USE 1-18-2008; IN COMMERCE 1-18-2008.

**CLASS 41—EDUCATION AND ENTERTAINMENT**

FOR ONLINE JOURNALS, NAMELY, BLOGS FEATURING INFORMATION IN THE FIELD OF PETS, PET BREEDS, PET TRAINING, PET HEALTH AND PET WELLNESS; PROVIDING A WEBSITE WITH INFORMATION FOR EDUCATIONAL AND ENTERTAINMENT PURPOSES IN THE FIELD OF PET TRAINING AND PET EXERCISE (U.S. CLS. 100, 101 AND 107).

FIRST USE 9-25-2008; IN COMMERCE 9-25-2008.

**CLASS 44—MEDICAL, BEAUTY AND AGRICULTURAL SERVICES**

FOR PROVIDING A WEBSITE WITH INFORMATION FOR EDUCATIONAL AND ENTERTAINMENT PURPOSES IN THE FIELD OF PET HEALTH AND PET WELLNESS, PET SELECTION, PET GROOMING, PET FEEDING, PET NUTRITION, PET HEALTH AND WELLNESS IN THE NATURE OF ANIMAL WELFARE AND THE PSYCHOLOGICAL AND PHYSICAL WELL-BEING OF ANIMALS, PHYSICAL CHARACTERISTICS AND TEMPERAMENT OF PET BREEDS, AND GROOMING, FEEDING AND NUTRITION REQUIREMENTS FOR SPECIFIC PET BREEDS (U.S. CLS. 100 AND 101).

FIRST USE 9-25-2008; IN COMMERCE 9-25-2008.

JOANNA FIORELLI, EXAMINING ATTORNEY

SN 85-862,090. YENCA, THOMAS J., DANIELSVILLE, PA. FILED 2-27-2013.



East Coast Destruction

THE MARK CONSISTS OF A STYLIZED IMAGE OF A BULLET WITH THE LETTERS "ECD" IN THE STYLIZED FORM ON THE FACE OF THE BULLET, AND THE WORDS "EAST COAST DESTRUCTION" CENTERED UNDERNEATH THE BULLET IMAGE.

**CLASS 9—ELECTRICAL AND SCIENTIFIC APPARATUS**

FOR AUDIO AND VIDEO RECORDINGS FEATURING BICYCLE MOTOCROSS STUNTS, MANEUVERS, AND COMPETITIONS AND MUSIC FOR USE WHILE PERFORMING BICYCLE MOTOCROSS STUNTS AND MANEUVERS AND PARTICIPATING IN COMPETITIONS (U.S. CLS. 21, 23, 26, 36 AND 38).

FIRST USE 10-15-1990; IN COMMERCE 10-15-1990.

**CLASS 25—CLOTHING**

FOR BELTS; GLOVES; HATS; PANTS; SHIRTS; SWEATSHIRTS; T-SHIRTS (U.S. CLS. 22 AND 39).

FIRST USE 3-9-1993; IN COMMERCE 3-9-1993.

NANCY CLARKE, EXAMINING ATTORNEY

SN 85-863,064. NUMISMATIC GUARANTY CORPORATION OF AMERICA, SARASOTA, FL. FILED 2-28-2013.

SN 85-863,844. REAMES CONCRETE COMPANY, VALDOSTA, GA. FILED 3-1-2013.



OWNER OF U.S. REG. NOS. 2,686,760, 4,267,062 AND OTHERS.

NO CLAIM IS MADE TO THE EXCLUSIVE RIGHT TO USE "CORPORATION", APART FROM THE MARK AS SHOWN.

THE MARK CONSISTS OF THE DESIGN OF SCALES TO THE LEFT OF THE ACRONYM "NGC" ALL ABOVE THE WORDS "NUMISMATIC GUARANTY CORPORATION".

SEC. 2(F) AS TO "NUMISMATIC GUARANTY CORPORATION".

**CLASS 16—PAPER GOODS AND PRINTED MATTER**

FOR ALBUMS FOR COINS; COIN HOLDERS (U.S. CLS. 2, 5, 22, 23, 29, 37, 38 AND 50).  
FIRST USE 2-20-2001; IN COMMERCE 2-20-2001.

**CLASS 42—SCIENTIFIC AND COMPUTER SERVICES**

FOR QUALITY GRADING OF COLLECTIBLE COINS (U.S. CLS. 100 AND 101).  
FIRST USE 2-20-2001; IN COMMERCE 2-20-2001.  
JULIE VEPPUMTHARA, EXAMINING ATTORNEY

---

SN 85-863,742. SIERRA NEVADA BREWING CO., CHICO, CA. FILED 3-1-2013.

**THE BREWER AND THE BEER GEEK**

THE MARK CONSISTS OF STANDARD CHARACTERS WITHOUT CLAIM TO ANY PARTICULAR FONT, STYLE, SIZE, OR COLOR.

**CLASS 32—LIGHT BEVERAGES**

FOR BEER AND ALE (U.S. CLS. 45, 46 AND 48).

**CLASS 41—EDUCATION AND ENTERTAINMENT**

FOR EDUCATIONAL SERVICES, NAMELY, PROVIDING CLASSES, SEMINARS AND WORKSHOPS VIA VIDEO, PODCASTS AND ON-LINE JOURNALS, NAMELY, BLOGS ON THE SUBJECT OF BEER AND ALE (U.S. CLS. 100, 101 AND 107).  
JEFF DEFORD, EXAMINING ATTORNEY

NO CLAIM IS MADE TO THE EXCLUSIVE RIGHT TO USE "CONCRETE COMPANY" AND "VALDOSTA, GA", APART FROM THE MARK AS SHOWN.

THE COLOR(S) BLACK, RED, AND WHITE IS/ARE CLAIMED AS A FEATURE OF THE MARK.

THE MARK CONSISTS OF THE FOLLOWING: A BLACK CIRCLE WITH A WHITE INNER BORDER WITH THE WORD "REAMES" IN WHITE DIVIDED BY A RED HORIZONTAL ELONGATED BOX WITH A WHITE AND THEN BLACK BORDER WITH THE WORD "CONCRETE" IN WHITE LETTERS; BELOW THE BOX ARE THE WORDS "COMPANY" AND "VALDOSTA, GA" IN WHITE LETTERS.

**CLASS 19—NON-METALLIC BUILDING MATERIALS**

FOR CEMENT; CONCRETE; SAND; STONES (U.S. CLS. 1, 12, 33 AND 50).  
FIRST USE 7-25-1984; IN COMMERCE 7-25-1984.

**CLASS 35—ADVERTISING AND BUSINESS**

FOR DISTRIBUTORSHIP SERVICES IN THE FIELD OF CONCRETE BLOCKS, BRICKS, MORTAR, PAVERS, TROWELS, REBAR, BUILDING MATERIALS AND BUILDING TOOLS; RETAIL STORE SERVICES FEATURING CONCRETE BLOCKS, BRICKS, MORTAR, PAVERS, TROWELS, REBAR, BUILDING MATERIALS AND BUILDING TOOLS (U.S. CLS. 100, 101 AND 102).  
FIRST USE 7-25-1984; IN COMMERCE 7-25-1984.  
JENNIFER BUTTON, EXAMINING ATTORNEY

---

SN 85-863,868. METROPOLITAN MINISTRIES, INC., TAMPA, FL. FILED 3-1-2013.

**METROPOLITAN MINISTRIES**

THE MARK CONSISTS OF STANDARD CHARACTERS WITHOUT CLAIM TO ANY PARTICULAR FONT, STYLE, SIZE, OR COLOR.

NO CLAIM IS MADE TO THE EXCLUSIVE RIGHT TO USE "MINISTRIES", APART FROM THE MARK AS SHOWN.

**CLASS 41—EDUCATION AND ENTERTAINMENT**

FOR CHARITABLE SERVICES, NAMELY, PROVIDING TRAINING IN THE FIELD OF TRANSFORMING PEOPLE FROM HOMELESSNESS TO SELF-SUFFICIENCY, PROVIDING LIFE SKILLS COACHING TO THE HOMELESS, PROVIDING LIFE COACHING FOR JOB TRAINING AND PLACEMENT, PROVIDING LIFE COACHING TO THE HOMELESS TO SECURE PERMANENT HOUSING; CHARITABLE SERVICES IN THE FORM OF PROVIDING ADULT AND VOCATIONAL EDUCATION FOR THE HOMELESS (U.S. CLS. 100, 101 AND 107).

FIRST USE 12-1-1972; IN COMMERCE 12-1-1972.

**CLASS 43—HOTEL AND RESTAURANT SERVICES**

FOR CHARITABLE SERVICES, NAMELY, PROVIDING CHILD CARE FOR PRESCHOOL-AGED CHILDREN AND CHILDREN OF ATTENDEES OF THE PROPRIETOR'S PROGRAMS; CHARITABLE SERVICES, NAMELY, PROVIDING FOOD TO NEEDY PERSONS; CHARITABLE SERVICES, NAMELY, PROVIDING SAFE AND AFFORDABLE HOUSING TO THOSE IN NEED; CHARITABLE SERVICES, NAMELY, PROVIDING TEMPORARY SHELTER FOR THE HOMELESS; PROVIDING AFTER SCHOOL CARE FOR CHILDREN AND YOUTH (U.S. CLS. 100 AND 101).

FIRST USE 12-1-1972; IN COMMERCE 12-1-1972.

**CLASS 45—PERSONAL AND LEGAL SERVICES**

FOR PROVIDING RELIGIOUS COUNSELING TO THE HOMELESS (U.S. CLS. 100 AND 101).

FIRST USE 12-1-1972; IN COMMERCE 12-1-1972.  
RAUL CORDOVA, EXAMINING ATTORNEY

---

SN 85-864,074. ULTIMATE FOODSPEND SOLUTIONS, LLC, JOLIET, IL. FILED 3-1-2013.

**VERIPERFORM**

THE MARK CONSISTS OF STANDARD CHARACTERS WITHOUT CLAIM TO ANY PARTICULAR FONT, STYLE, SIZE, OR COLOR.

**CLASS 35—ADVERTISING AND BUSINESS**

FOR BUSINESS PROCESS OUTSOURCING SERVICES IN THE FOODSERVICE INDUSTRY, NAMELY, ASSISTING WITH THE FORMATION, NEGOTIATION, AND MANAGEMENT OF CONTRACTS; SERVICES FOR PROVISION OF FOODSERVICE INDUSTRY TRADE INFORMATION, NAMELY, ASSISTING WITH THE FORMATION, NEGOTIATION, AND MANAGEMENT OF CONTRACTS (U.S. CLS. 100, 101 AND 102).

**CLASS 42—SCIENTIFIC AND COMPUTER SERVICES**

FOR PROVIDING TEMPORARY USE OF NON-DOWNLOADABLE SOFTWARE FOR BUSINESS PROCESS OUTSOURCING FOR USE IN COLLECTING, EDITING, ORGANIZING, MODIFYING, ANALYZING, REPORTING, STORING, AND SHARING OF INFORMATION, STATISTICS, AND DATA RELATED TO FOODSERVICE TRADE AGREEMENTS; PROVIDING AN ON-LINE COMPUTER DATABASE FEATURING TRADE INFORMATION IN THE FOODSERVICE INDUSTRY (U.S. CLS. 100 AND 101).

ELISSA GARBER KON, EXAMINING ATTORNEY

---

SN 85-864,095. NATIONAL ASSOCIATION OF TOWN WATCH, WYNNEWOOD, PA. FILED 3-1-2013.



OWNER OF U.S. REG. NOS. 1,496,283, 3,724,193 AND OTHERS.

THE MARK CONSISTS OF A BANNER WITH THE LETTERS "NNO" WITHIN IT, THE CENTER OF THE LETTER "O" IS A STAR; BELOW THIS BANNER APPEAR THE WORDS "NATIONAL NIGHT OUT".

SEC. 2(F) AS TO: "NATIONAL".

**CLASS 25—CLOTHING**

FOR CLOTHING, NAMELY, HATS AND SHIRTS (U.S. CLS. 22 AND 39).

FIRST USE 1-10-2013; IN COMMERCE 1-10-2013.

**CLASS 35—ADVERTISING AND BUSINESS**

FOR ASSOCIATION SERVICES, NAMELY, PROMOTING THE INTEREST OF INDIVIDUALS AND ORGANIZATIONS INVOLVED IN ORGANIZED COMMUNITY CRIME PREVENTION PROGRAMS (U.S. CLS. 100, 101 AND 102).

KEVIN CORWIN, EXAMINING ATTORNEY

---

SN 85-864,139. BÜRKLIN OHG, OBERHACHING, FED REP GERMANY, FILED 3-1-2013.



PRIORITY CLAIMED UNDER SEC. 44(D) ON ERPN CMNTY TM OFC APPLICATION NO. 011158482, FILED 9-3-2012, REG. NO. 011158482, DATED 5-13-2013, EXPIRES 9-3-2022.

THE COLOR(S) BLUE IS/ARE CLAIMED AS A FEATURE OF THE MARK.

THE MARK CONSISTS OF FOUR DIAGONAL BLUE BARS ABOVE THE WORD COMPONENT "BÜRKLIN", ALSO IN BLUE.

**CLASS 8—HAND TOOLS**

FOR MANUALLY OPERATED TOOLS, NAMELY, SCREWDRIVERS AND PLIERS; CUTLERY, NAMELY, KNIVES, FORKS AND SPOONS; ELECTRIC AND NON-ELECTRIC SHAVERS (U.S. CLS. 23, 28 AND 44).

**CLASS 9—ELECTRICAL AND SCIENTIFIC APPARATUS**

FOR SCIENTIFIC INSTRUMENTS, NAMELY, ELECTRONIC ANALYZERS FOR MEASURING, TESTING AND DETECTING CONTAMINANTS AND ENVIRONMENTAL POLLUTANTS; SURVEYING MACHINES AND INSTRUMENTS, PHOTOGRAPHIC CAMERAS, FILTERS, SLIDES AND TRANSPARENCIES; FILM MAGAZINES FOR CAMERAS; OPTICAL CABLES, DISK DRIVES, FIBERS AND FILTERS; WEIGHING APPARATUS AND INSTRUMENTS; MEASURING CUPS AND GLASSWARE; SIGNAL PROCESSORS; REMOTE CONTROLS FOR RADIOS, TELEVISIONS AND STEREOS; MEDICAL TEACHING MANNEQUINS; ELECTRICITY CONDUITS AND LIMITERS; ELECTRIC ACTUATORS, CAPACITORS, CONVERTERS AND SWITCHES; VOLTAGE REGULATORS; ELECTRIC STORAGE BATTERIES; APPARATUS FOR RECORDING, TRANSMISSION OR REPRODUCTION OF SOUND AND IMAGES; BLANK MAGNETIC DATA CARRIERS; PHONOGRAPH RECORDS FEATURING MUSIC; BLANK RECORD DISKS; DIGITAL MEDIA, NAMELY, CDS, DVDS AND DOWNLOADABLE AUDIO FILES FEATURING MUSIC; ELECTRONIC MEMORIES; MP3 PLAYERS; RADIOS; MEMORY CARDS; MECHANISMS FOR COIN OPERATED APPARATUS; CASH REGISTERS; CALCULATORS; DATA PROCESSING APPARATUS; COMPUTERS; COMPUTER OPERATING SOFTWARE; ELECTRONIC LOCK ASSEMBLIES; ELECTRONIC COMPONENTS FOR COMPUTERS; SEMICONDUCTORS; INTEGRATED CIRCUITS; OPTOELECTRONIC LIGHTING BALLASTS AND CONTROLS; ELECTRONIC DISPLAY INTERFACES; SILICON RECTIFIERS; SILICON CARBIDE DIODES; BATTERY TESTERS; NICKEL-CADMIIUM STORAGE BATTERIES; BATTERY CHARGERS; HEAT SINKS FOR USE IN COMPUTERS AND ELECTRONIC COMPONENTS; INTERNAL COOLING FANS FOR COMPUTERS; TRANSFORMERS; BLANK MAGNETIC AND OPTICAL DATA CARRIERS; VOLTAGE STABILIZERS; CAPACITORS; OSCILLATORS FOR CRYSTALS; HIGH-FREQUENCY SWITCHING POWER SUPPLIES; CONVERTERS; HIGH-FREQUENCY ANTENNAS; HIGH-FREQUENCY PRESSURE, RADIO, TELEPHONE AND TELEVISION TRANSMITTERS; LABORATORY AND OPTICAL FILTERS; ELECTRIC RESISTORS; LINEAR PROTRACTORS; ENCODERS; THERMISTORS; VARIOMETERS; PLUG CONNECTORS; ADAPTERS; PROBES FOR TESTING INTEGRATED CIRCUITS AND SEMICONDUCTORS; ELECTRIC CORDS; ELECTRIC AND TELEPHONE WIRES; ELECTRIC RELAYS; FLASH LAMPS; FUSES; MAGNETS; AIR PRESSURE GAUGES; BATTERY TERMINAL CONNECTOR CLAMPS; PRINTED CIRCUIT BOARDS; MEASUREMENT STANDARD DEVICES FOR NANOMETROLOGY, NAMELY, MEASURING TOOLS HAVING A PATTERN IN THE MICROMETER OR NANOMETER RANGES; POWER SUPPLIES; ELECTRICAL PLUGS; ELECTRICAL CONNECTORS; ADAPTERS; COMPUTER ACCESSORIES, NAMELY, COMPUTER MICE, MOUSE PADS AND COMPUTER CARRYING CASES; BAGS AND CASES SPECIALLY ADAPTED FOR HOLDING OR CARRYING PORTABLE TELEPHONES AND TELEPHONE EQUIPMENT AND ACCESSORIES; ANTI-INTRUSION, BURGLAR, FIRE AND GAS ALARMS; SIGNAL BELLS, PROCESSORS AND WHISTLES; LOUDSPEAKERS; AMPLIFIERS (U.S. CLS. 21, 23, 26, 36 AND 38).

**CLASS 16—PAPER GOODS AND PRINTED MATTER**

FOR CATALOGS FEATURING A WIDE VARIETY OF CONSUMER GOODS OF OTHERS AND TECHNICAL AND SCIENTIFIC GOODS OF OTHERS, ACCUMULATORS, BATTERIES, BATTERY CHARGERS, CABLES, CONNECTING CABLES, TUBING, ACTIVE ELECTRONIC COMPONENTS, PASSIVE ELECTRONIC COMPONENTS, COMPUTER ACCESSORIES, ELECTRICAL CONNECTORS, HOUSINGS, KNOBS, ELECTRICAL FANS AND FAN ACCESSORIES, FUSES, IDENTIFICATION AND LABELING PRODUCTS, LIGHTING FIXTURES AND LIGHT FIXTURE ACCESSORIES, MEASURING DEVICES, ELECTRIC MOTORS, ELECTRICAL COMPONENT MOUNTING ACCESSORIES, OPTICAL AND ACOUSTIC SIGNAL GENERATORS,

PNEUMATIC CONTROL DEVICES AND ACCESSORIES, ELECTRICAL RELAYS, SEMICONDUCTOR ACCESSORIES, INTEGRATED CIRCUIT SOCKETS, ELECTRONICS COOLING SYSTEMS, SENSORS, SOLDERING DEVICES AND ACCESSORIES, PRINTED CIRCUIT BOARDS, PRINTED CIRCUIT BOARD PRODUCTION ACCESSORIES, SWITCHES AND PUSHBUTTONS, TERMINALS AND TERMINATING MATERIAL, HAND TOOLS, TRANSFORMERS, POWER SUPPLIES, POWER ADAPTERS, AND WORKSHOP, LABORATORY AND WORKPLACE EQUIPMENT (U.S. CLS. 2, 5, 22, 23, 29, 37, 38 AND 50).

**CLASS 35—ADVERTISING AND BUSINESS**

FOR MAIL ORDER SERVICES, ONLINE RETAIL STORE SERVICES, AND ONLINE WHOLESALE STORE SERVICES FEATURING A WIDE VARIETY OF CONSUMER GOODS OF OTHERS AND TECHNICAL AND SCIENTIFIC GOODS OF OTHERS, ACCUMULATORS, BATTERIES, BATTERY CHARGERS, CABLES, CONNECTING CABLES, TUBING, ACTIVE ELECTRONIC COMPONENTS, PASSIVE ELECTRONIC COMPONENTS, COMPUTER ACCESSORIES, ELECTRICAL CONNECTORS, HOUSINGS, KNOBS, ELECTRICAL FANS AND FAN ACCESSORIES, FUSES, IDENTIFICATION AND LABELING PRODUCTS, LIGHTING FIXTURES AND LIGHT FIXTURE ACCESSORIES, MEASURING DEVICES, ELECTRIC MOTORS, ELECTRICAL COMPONENT MOUNTING ACCESSORIES, OPTICAL AND ACOUSTIC SIGNAL GENERATORS, PNEUMATIC CONTROL DEVICES AND ACCESSORIES, ELECTRICAL RELAYS, SEMICONDUCTOR ACCESSORIES, INTEGRATED CIRCUIT SOCKETS, ELECTRONICS COOLING SYSTEMS, SENSORS, SOLDERING DEVICES AND ACCESSORIES, PRINTED CIRCUIT BOARDS, PRINTED CIRCUIT BOARD PRODUCTION ACCESSORIES, SWITCHES AND PUSHBUTTONS, TERMINALS AND TERMINATING MATERIAL, HAND TOOLS, TRANSFORMERS, POWER SUPPLIES, POWER ADAPTERS, AND WORKSHOP, LABORATORY AND WORKPLACE EQUIPMENT (U.S. CLS. 100, 101 AND 102).

**CLASS 39—TRANSPORTATION AND STORAGE**

FOR RENTAL OF STORAGE CONTAINERS; STORAGE OF GOODS; DELIVERY OF GOODS; TRANSPORT AND STORAGE OF GOODS; TEMPORARY ELECTRONIC STORAGE OF INFORMATION AND DATA; TRANSPORTATION LOGISTICS SERVICES, NAMELY, ARRANGING THE TRANSPORTATION OF GOODS FOR OTHERS, AND PLANNING AND SCHEDULING SHIPMENTS FOR USERS OF TRANSPORTATION SERVICES; TRANSPORTATION RESERVATION SERVICES (U.S. CLS. 100 AND 105).

**CLASS 42—SCIENTIFIC AND COMPUTER SERVICES**

FOR SCIENTIFIC RESEARCH; TECHNOLOGICAL PLANNING AND CONSULTING SERVICES IN THE FIELD OF COMPUTER HARDWARE SYSTEMS AND RENEWABLE ENERGY RESOURCES; CHEMICAL AND MECHANICAL RESEARCH; DESIGN AND DEVELOPMENT OF COMPUTERS AND PROGRAMS FOR COMPUTERS; DESIGN AND TESTING FOR NEW PRODUCT DEVELOPMENT; INDUSTRIAL DESIGN; ANALYSIS OF INDUSTRIAL FLUIDS; DESIGN AND DEVELOPMENT OF COMPUTER HARDWARE AND SOFTWARE (U.S. CLS. 100 AND 101).

IRA J. GOODSaid, EXAMINING ATTORNEY

SN 85-864,707. KAHN LUCAS LANCASTER, INC., NEW YORK, NY. FILED 3-1-2013.

SN 85-865,446. RUNNING HEALTH LLC, DOVER, DE. FILED 3-4-2013.

## DOLLIE & ME

THE MARK CONSISTS OF STANDARD CHARACTERS WITHOUT CLAIM TO ANY PARTICULAR FONT, STYLE, SIZE, OR COLOR.

OWNER OF U.S. REG. NOS. 3,713,312, 3,908,955 AND 4,144,344.

### CLASS 24—FABRICS

FOR TEXTILE PRODUCTS, NAMELY, NON-WOVEN TEXTILE FABRICS, SLEEPING BAGS IN THE NATURE OF SHEETING, AND FABRIC WINDOW COVERINGS AND TREATMENTS BEING CURTAINS, DRAPERIES, SHEERS, SWAGS AND VALANCES; BED BLANKETS; BED CANOPIES; BED COVERS; BED LINEN; BED PADS; BED SHEETS; PILLOW CASES; BED SKIRTS; BED SPREADS; BED THROWS; COMFORTERS; DUST RUFFLES; SHAMS; TOWELS (U.S. CLS. 42 AND 50).

### CLASS 28—TOYS AND SPORTING GOODS

FOR DOLL FURNITURE; DOLL ACCESSORIES (U.S. CLS. 22, 23, 38 AND 50).  
JOHN DWYER, EXAMINING ATTORNEY

SN 85-864,724. KAHN LUCAS LANCASTER, INC., NEW YORK, NY. FILED 3-1-2013.

## WHAT A DOLL!

THE MARK CONSISTS OF STANDARD CHARACTERS WITHOUT CLAIM TO ANY PARTICULAR FONT, STYLE, SIZE, OR COLOR.

OWNER OF U.S. REG. NOS. 3,971,579 AND 4,144,343.

### CLASS 24—FABRICS

FOR TEXTILE PRODUCTS, NAMELY, NON-WOVEN TEXTILE FABRICS, SLEEPING BAGS IN THE NATURE OF SHEETING, AND FABRIC WINDOW COVERINGS AND TREATMENTS BEING CURTAINS, DRAPERIES, SHEERS, SWAGS AND VALANCES; BED BLANKETS; BED CANOPIES; BED COVERS; BED LINEN; BED PADS; BED SHEETS; PILLOW CASES; BED SKIRTS; BED SPREADS; BED THROWS; COMFORTERS; DUST RUFFLES; SHAMS; TOWELS (U.S. CLS. 42 AND 50).

### CLASS 28—TOYS AND SPORTING GOODS

FOR DOLL FURNITURE; DOLL ACCESSORIES (U.S. CLS. 22, 23, 38 AND 50).  
JOHN DWYER, EXAMINING ATTORNEY

## HYDRAKLICK

THE MARK CONSISTS OF STANDARD CHARACTERS WITHOUT CLAIM TO ANY PARTICULAR FONT, STYLE, SIZE, OR COLOR.

### CLASS 9—ELECTRICAL AND SCIENTIFIC APPARATUS

FOR ARM BANDS FOR CARRYING ELECTRONIC DEVICES (U.S. CLS. 21, 23, 26, 36 AND 38).

### CLASS 18—LEATHER GOODS

FOR WAIST PACKS; WATER BOTTLE CARRIERS IN THE NATURE OF WAIST STRAPS, WITH OR WITHOUT WATER BOTTLES AND PERSONAL FLUID HYDRATION BOTTLES; WATER BOTTLE CARRIERS AND PERSONAL FLUID HYDRATION BOTTLE CARRIERS AND ATTACHED CLIPS FOR ATTACHMENT TO CLOTHING; POUCHES FOR CARRYING WATER BOTTLES AND PERSONAL FLUID HYDRATION BOTTLES (U.S. CLS. 1, 2, 3, 22 AND 41).

### CLASS 21—HOUSEWARES AND GLASS

FOR WATER BOTTLES AND PERSONAL FLUID HYDRATION BOTTLES, SOLD EMPTY, WITH OR WITHOUT BOTTLE CARRIERS AND CLIPS SOLD AS A UNIT (U.S. CLS. 2, 13, 23, 29, 30, 33, 40 AND 50).  
SUE LAWRENCE, EXAMINING ATTORNEY

SN 85-866,925. PITTSBURGH TRUST FOR CULTURAL RESOURCES, THE, PITTSBURGH, PA. FILED 3-5-2013.



THE LIKENESS (OR, "PORTRAIT") IN THE MARK DOES NOT IDENTIFY A LIVING INDIVIDUAL.

THE MARK CONSISTS OF THE WORDS "PITTSBURGH CULTURAL TRUST", STACKED VERTICALLY AND TO THE RIGHT OF A STYLIZED HUMAN FACE.

SEC. 2(F) AS TO "PITTSBURGH CULTURAL TRUST".

### CLASS 35—ADVERTISING AND BUSINESS

FOR PROMOTING ECONOMIC AND CULTURAL DEVELOPMENT IN THE CITY OF PITTSBURGH AND WESTERN PENNSYLVANIA (U.S. CLS. 100, 101 AND 102).

FIRST USE 4-7-1989; IN COMMERCE 4-7-1989.

### CLASS 41—EDUCATION AND ENTERTAINMENT

FOR ENTERTAINMENT SERVICES IN THE NATURE OF LIVE MUSICAL AND THEATRICAL PERFORMANCES (U.S. CLS. 100, 101 AND 107).

FIRST USE 12-31-1998; IN COMMERCE 12-31-1998.  
HEATHER THOMPSON, EXAMINING ATTORNEY

SN 85-867,170. NAVARRO DISCOUNT PHARMACIES, LLC.,  
MEDLEY, FL. FILED 3-5-2013.

#### NAVARRO DISCOUNT PHARMACY

THE MARK CONSISTS OF STANDARD CHARACTERS WITHOUT CLAIM TO ANY PARTICULAR FONT, STYLE, SIZE, OR COLOR.

OWNER OF U.S. REG. NOS. 2,098,890, 4,134,301 AND 4,145,129.

NO CLAIM IS MADE TO THE EXCLUSIVE RIGHT TO USE "DISCOUNT PHARMACY", APART FROM THE MARK AS SHOWN.

SEC. 2(F).

#### CLASS 35—ADVERTISING AND BUSINESS

FOR WHOLESALE AND RETAIL DISCOUNT STORE SERVICES FEATURING, HEALTHCARE PRODUCTS, BEAUTY AIDS, PREPARATIONS FOR SANITARY USE, COSMETICS, PERFUMERY, PERSONAL CARE PRODUCTS, STATIONERY, CANDY, SNACKS, CAMERAS, GIFTWARE, HARDWARE, TOBACCO PRODUCTS, SOFT DRINKS, BEER, WINE AND OTHER NON-ALCOHOLIC DRINKS, BOOKS, HOUSEHOLD, KITCHEN AND AUTOMOBILE ACCESSORIES, MOBILE PHONES, ELECTRONICS, SMALL HOME APPLIANCES, MEDICAL EQUIPMENT AND FOOD PRODUCTS; RETAIL PHARMACY SERVICES (U.S. CLS. 100, 101 AND 102).

FIRST USE 1-18-1974; IN COMMERCE 1-18-1974.

#### CLASS 41—EDUCATION AND ENTERTAINMENT

FOR PHOTOGRAPHIC COMPOSITION FOR OTHERS (U.S. CLS. 100, 101 AND 107).

FIRST USE 1-18-1974; IN COMMERCE 1-18-1974.

MARTHA SANTOMARTINO, EXAMINING ATTORNEY

SN 85-867,509. S&B INFRASTRUCTURE, LTD., HOUSTON,  
TX. FILED 3-5-2013.



THE COLOR(S) WHITE, BLACK AND BLUE IS/ARE CLAIMED AS A FEATURE OF THE MARK.

THE MARK CONSISTS OF THE TERMS "S&B" SITUATED HORIZONTALLY NEXT TO ONE ANOTHER READING FROM LEFT TO RIGHT WITH THE LETTERS "S" AND "B" APPEARING IN BLACK FONT JOINED BY AN AMPERSAND "&" DEPICTED IN WHITE FONT. THE LETTER "I" APPEARS IN BLUE FONT ON THE FAR RIGHT OF THE DRAWING.

#### CLASS 37—CONSTRUCTION AND REPAIR

FOR CONSTRUCTION PROJECT MANAGEMENT SERVICES; INSPECTION SERVICES IN THE COURSE OF CONSTRUCTION OF ROADS, BRIDGES, LEVEES, DRAINAGE SYSTEMS, WASTEWATER TREATMENT FACILITIES, UNDERGROUND STORAGE CAVERNS, RAIL SYSTEMS, PORTS, AND PIPELINE FACILITIES (U.S. CLS. 100, 103 AND 106).

#### CLASS 42—SCIENTIFIC AND COMPUTER SERVICES

FOR ENGINEERING; ENGINEERING DESIGN SERVICES; ENVIRONMENTAL SERVICES, NAMELY, DESIGN FOR OTHERS IN THE FIELD OF ENVIRONMENTAL ENGINEERING; ENVIRONMENTAL TESTING AND INSPECTION SERVICES; INSPECTION OF OIL FIELDS; MATERIALS TESTING AND EVALUATION; PIPELINE INSPECTION SERVICES; QUALITY MANAGEMENT SERVICES, NAMELY, QUALITY EVALUATION AND ANALYSIS, QUALITY ASSURANCE, AND QUALITY CONTROL, IN THE FIELD OF CONSTRUCTION, PIPELINE AND FACILITIES MANAGEMENT (U.S. CLS. 100 AND 101).

SALLY SHIH, EXAMINING ATTORNEY

SN 85-867,611. SHARKEY, SCOTT, WESTPORT, CT. FILED 3-5-2013.

#### SHARKEY'S SHOUT OUTS!

THE MARK CONSISTS OF STANDARD CHARACTERS WITHOUT CLAIM TO ANY PARTICULAR FONT, STYLE, SIZE, OR COLOR.

THE NAME(S), PORTRAIT(S), AND/OR SIGNATURE(S) SHOWN IN THE MARK IDENTIFIES SCOTT SHARKEY, WHOSE CONSENT(S) TO REGISTER IS MADE OF RECORD.

#### CLASS 6—METAL GOODS

FOR NON-LUMINOUS AND NON-MECHANICAL ALUMINUM SIGNS (U.S. CLS. 2, 12, 13, 14, 23, 25 AND 50).

#### CLASS 16—PAPER GOODS AND PRINTED MATTER

FOR PRINTED PAPER SIGNS, NAMELY, GOLF SIGNS, PARTY SIGNS, POINT OF PURCHASE SIGNS, AND EVENT SIGNS; PAPER AND CARDBOARD LIFE SIZE CUTOUTS, POSTERS, PAPER BANNERS AND FLAGS (U.S. CLS. 2, 5, 22, 23, 29, 37, 38 AND 50).

#### CLASS 20—FURNITURE AND ARTICLES NOT OTHERWISE CLASSIFIED

FOR WOOD LAWN SIGNS; WOOD SUBSTRATES, NAMELY, FIBERBOARD FOR USE IN MANUFACTURING OF SIGNS (U.S. CLS. 2, 13, 22, 25, 32 AND 50).

SHAVELL MCPHERSON, EXAMINING ATTORNEY

SN 85-867,783. GIZMOSPRING.COM, INC., DBA KEY PLEASURE TOYS, SEATTLE, WA. FILED 3-5-2013.

# INNERVIBE

THE MARK CONSISTS OF STANDARD CHARACTERS WITHOUT CLAIM TO ANY PARTICULAR FONT, STYLE, SIZE, OR COLOR.

## CLASS 5—PHARMACEUTICALS

FOR GELS FOR USE AS PERSONAL LUBRICANTS, PERSONAL LUBRICANTS, PERSONAL SEXUAL LUBRICANTS (U.S. CLS. 6, 18, 44, 46, 51 AND 52).

## CLASS 10—MEDICAL APPARATUS

FOR ADULT SEXUAL STIMULATION AIDS, NAMELY, VIBRATORS, PERSONAL MASSAGERS, ARTIFICIAL PENISES, KEGEL BALLS; CONDOMS; VIBRATING CONDOM RINGS FOR AIDING AND ENHANCING SEXUAL AROUSAL AND PERFORMANCE (U.S. CLS. 26, 39 AND 44).

## CLASS 35—ADVERTISING AND BUSINESS

FOR ON-LINE RETAIL STORE SERVICES FEATURING PERSONAL PLEASURE DEVICES AS SEXUAL AIDS FOR ADULTS; RETAIL STORE SERVICES FEATURING PERSONAL PLEASURE DEVICES AS SEXUAL AIDS FOR ADULTS (U.S. CLS. 100, 101 AND 102).  
BRIDGETT SMITH, EXAMINING ATTORNEY

---

SN 85-868,034. PRIMEYIELD ENTERPRISE LTD, ROAD TOWN, TORTOLA, BR.VIRGIN ISLANDS, FILED 3-6-2013.



NO CLAIM IS MADE TO THE EXCLUSIVE RIGHT TO USE "ASIA", APART FROM THE MARK AS SHOWN.

THE MARK CONSISTS OF A TRIANGLE WITH A ROUNDED BASE INSIDE A CIRCLE, WITH THE WORDS "ASIA SYMBOL" ON THE RIGHT.

## CLASS 1—CHEMICALS

FOR WOOD PULP FOR MANUFACTURING PURPOSES; PAPER PULP; CELLULOSE PULP FOR MANUFACTURING PURPOSES; CHLORINE; ALKALI FOR INDUSTRIAL PURPOSES; ACID, NAMELY, SULPHURIC ACID AND HYDROCHLORIC ACID; CALCIUM CARBONATE; CHEMICAL AGENTS IN THE FORM OF SALTS AND INDUSTRIAL STARCHES FOR USE IN THE PULP AND PAPERMAKING INDUSTRIES; INDUSTRIAL STARCH; INDUSTRIAL CHEMICALS; CHEMICAL COMPOSITIONS FOR MAKING PAPER (U.S. CLS. 1, 5, 6, 10, 26 AND 46).

## CLASS 16—PAPER GOODS AND PRINTED MATTER

FOR PAPER; PRINTED PATTERN PAPER; PAPER TAPE; WOOD PULP PAPER; PRINTING PAPER; ART PAPER, NAMELY, COATED PAPER; COPY PAPER IN THE NATURE OF STATIONERY; TOILET PAPER; TISSUE PAPER; CARDBOARD; WHITE PAPER BOARD FOR PACKAGING PURPOSE; CONTAINER BOARD, NAMELY, CONTAINER BOARD FOR PACKAGING PURPOSE; PACKAGING PAPER; WOOD BOARD IN THE NATURE OF STATIONERY, NAMELY, STATIONERY WOOD-PULP BOARD; CARBON PAPER AND/OR CARBONLESS PAPER; PAPER IN THE NATURE OF STATIONERY; ENVELOPE IN THE NATURE OF STATIONERY; PRINTED PUBLICATIONS, NAMELY, BROCHURES AND INSTRUCTION MATERIALS IN THE FIELD OF PAPER MANUFACTURING; PRINTED PUBLICITY MATTER, NAMELY, ADVERTISING PAMPHLETS, ADVERTISING SIGNS OF PAPER OR CARDBOARD; NOTE PAD IN THE NATURE OF STATIONERY; PAPER HANDKERCHIEF; PAPER NAPKINS; KRAFT PAPERBOARD; CORRUGATED PAPER; CARTON BOARD; ARTIFICIAL PAPER, NAMELY, PLASTIC COATED COPYING PAPER, OPAQUE PAPER, CORRUGATED PAPER, FIBER PAPER, PAPER BANNERS, BLANK PAPER TAPES AND CARDS, WRITING TABLETS; GREASEPROOF PAPER; PARCHMENT PAPER; CRAFT PAPER; PACKAGING CONTAINERS OF CARD, CARDBOARD AND PAPER (U.S. CLS. 2, 5, 22, 23, 29, 37, 38 AND 50).

## CLASS 31—NATURAL AGRICULTURAL PRODUCTS

FOR WOOD, NAMELY, WOOD CHIPS FOR THE MANUFACTURE OF WOOD PULP; LIVE CHRISTMAS TREE; UNPROCESSED WOOD LOG; SHRUBS; PRE-PROCESSING SAWN WOOD, NAMELY, FOR THE MANUFACTURE OF PULP; PULP WOOD, NAMELY, WOOD CHIPS FOR THE MANUFACTURE OF WOOD PULP; SOFTWOOD TIMBER, NAMELY, RAW TIMBER FOR THE MANUFACTURE OF PULP; PALM LEAVES, NAMELY, PALM TREE LEAVES; PALM TREE BRANCHES, NAMELY, PALM FRONDS FOR INDUSTRIAL USAGE; RAW BARKS; SEED GERM FOR BOTANICAL PURPOSES; WOOD CHIPS FOR THE MANUFACTURE OF WOOD PULP; UNSAWN TIMBER; PLANT SEEDS (U.S. CLS. 1 AND 46).

KATHERINE M. DUBRAY, EXAMINING ATTORNEY

---

SN 85-868,059. PRIMEYIELD ENTERPRISE LTD, ROAD TOWN, TORTOLA, BR.VIRGIN ISLANDS, FILED 3-6-2013.



THE MARK CONSISTS OF A TRIANGLE WITH A ROUNDED BASE INSIDE A CIRCLE.

**CLASS 1—CHEMICALS**

FOR WOOD PULP FOR MANUFACTURING PURPOSES; PAPER PULP; CELLULOSE PULP FOR MANUFACTURING PURPOSES; CHLORINE; ALKALI FOR INDUSTRIAL PURPOSES; ACID, NAMELY, SULPHURIC ACID AND HYDROCHLORIC ACID; CALCIUM CARBONATE; CHEMICAL AGENTS IN THE FORM OF SALTS AND INDUSTRIAL STARCHES FOR USE IN THE PULP AND PAPERMAKING INDUSTRIES; INDUSTRIAL STARCH; INDUSTRIAL CHEMICALS; CHEMICAL COMPOSITIONS FOR MAKING PAPER (U.S. CLS. 1, 5, 6, 10, 26 AND 46).

**CLASS 16—PAPER GOODS AND PRINTED MATTER**

FOR PAPER; PRINTED PATTERN PAPER; PAPER TAPE; WOOD PULP PAPER; PRINTING PAPER; ART PAPER, NAMELY, COATED PAPER; COPY PAPER IN THE NATURE OF STATIONERY; TOILET PAPER; TISSUE PAPER; CARDBOARD; WHITE PAPER BOARD FOR PACKAGING PURPOSE; CONTAINER BOARD, NAMELY, CONTAINER BOARD FOR PACKAGING PURPOSE; PACKAGING PAPER; WOOD BOARD IN THE NATURE OF STATIONERY, NAMELY, STATIONERY WOOD-PULP BOARD; CARBON PAPER AND/OR CARBONLESS PAPER; PAPER IN THE NATURE OF STATIONERY; ENVELOPE IN THE NATURE OF STATIONERY; PRINTED PUBLICATIONS, NAMELY, BROCHURES AND INSTRUCTION MATERIALS IN THE FIELD OF PAPER MANUFACTURING; PRINTED PUBLICITY MATTER, NAMELY, ADVERTISING PAMPHLETS, ADVERTISING SIGNS OF PAPER OR CARDBOARD; NOTE PAD IN THE NATURE OF STATIONERY; PAPER HANDKERCHIEF; PAPER NAPKINS; KRAFT PAPERBOARD; CORRUGATED PAPER; CARTON BOARD; ARTIFICIAL PAPER, NAMELY, PLASTIC COATED COPYING PAPER, OPAQUE PAPER, CORRUGATED PAPER, FIBER PAPER, PAPER BANNERS, BLANK PAPER TAPES AND CARDS, WRITING TABLETS; GREASEPROOF PAPER; PARCHEMENT PAPER; CRAFT PAPER; PACKAGING CONTAINERS OF CARD, CARDBOARD AND PAPER (U.S. CLS. 2, 5, 22, 23, 29, 37, 38 AND 50).

**CLASS 31—NATURAL AGRICULTURAL PRODUCTS**

FOR WOOD, NAMELY, WOOD CHIPS FOR THE MANUFACTURE OF WOOD PULP; LIVE CHRISTMAS TREE; UNPROCESSED WOOD LOG; SHRUBS; PRE-PROCESSING SAWN WOOD, NAMELY, FOR THE MANUFACTURE OF PULP; PULP WOOD, NAMELY, WOOD CHIPS FOR THE MANUFACTURE OF WOOD PULP; SOFTWOOD TIMBER, NAMELY, RAW TIMBER FOR THE MANUFACTURE OF PULP; PALM LEAVES, NAMELY, PALM TREE LEAVES; PALM TREE BRANCHES, NAMELY, PALM FRONDS FOR INDUSTRIAL USAGE; RAW BARKS; SEED GERM FOR BOTANICAL PURPOSES; WOOD CHIPS FOR THE MANUFACTURE OF WOOD PULP; UNSAWN TIMBER; PLANT SEEDS (U.S. CLS. 1 AND 46).

KATHERINE M. DUBRAY, EXAMINING ATTORNEY

SN 85-868,698. PARTYGAMING IA LIMITED, HAMILTON, BERMUDA, FILED 3-6-2013.

**PARTYPOKER**

THE MARK CONSISTS OF STANDARD CHARACTERS WITHOUT CLAIM TO ANY PARTICULAR FONT, STYLE, SIZE, OR COLOR.

**CLASS 9—ELECTRICAL AND SCIENTIFIC APPARATUS**

FOR DOWNLOADABLE COMPUTER GAME SOFTWARE DISTRIBUTED VIA THE INTERNET; AND DOWNLOADABLE ELECTRONIC NEWSLETTERS IN THE FIELD OF GAMING DELIVERED VIA THE INTERNET AND ELECTRONIC MAIL (U.S. CLS. 21, 23, 26, 36 AND 38).

FIRST USE 7-1-2001; IN COMMERCE 7-1-2001.

**CLASS 41—EDUCATION AND ENTERTAINMENT**

FOR ARRANGING, ORGANIZING AND CONDUCTING ENTERTAINMENT SERVICES IN THE FORM OF ONLINE CONTESTS AND GAMES OF CHANCE (U.S. CLS. 100, 101 AND 107).

FIRST USE 7-1-2001; IN COMMERCE 7-1-2001.  
KEVON CHISOLM, EXAMINING ATTORNEY

SN 85-869,346. REFINERY 29, INC., NEW YORK, NY. FILED 3-7-2013.

**REFINERY29**

THE MARK CONSISTS OF STANDARD CHARACTERS WITHOUT CLAIM TO ANY PARTICULAR FONT, STYLE, SIZE, OR COLOR.

**CLASS 25—CLOTHING**

FOR CLOTHING, NAMELY, DRESSES, SUITS, SWEATERS, TOPS, PANTS, SHORTS, SKIRTS, JACKETS, OUTERWEAR IN THE NATURE OF JACKETS, COATS AND HATS, HEADWEAR, SCARVES, GLOVES, SOCKS, SLEEPWEAR, LINGERIE, FOOTWEAR, BLAZERS, SHIRTS, T-SHIRTS, POLO SHIRTS, SWEATSHIRTS, SWIMWEAR, BELTS, TIES, AND UNDERWEAR (U.S. CLS. 22 AND 39).

FIRST USE 9-15-2005; IN COMMERCE 9-15-2005.

**CLASS 35—ADVERTISING AND BUSINESS**

FOR COMPUTERIZED ON-LINE RETAIL STORE SERVICES IN THE FIELD OF FASHION, BEAUTY, SHOPPING, AND STYLE, FEATURING LUXURY AND FASHION CLOTHING, APPAREL, FOOTWEAR, CLOTHING AND FASHION ACCESSORIES, HANDBAGS, JEWELRY, COSMETICS, AND RELATED GOODS; MARKETING, ADVERTISING, AND PROMOTING THE RETAIL GOODS AND SERVICES OF OTHERS THROUGH THE INTERNET AND WIRELESS ELECTRONIC DEVICES (U.S. CLS. 100, 101 AND 102).

FIRST USE 9-15-2005; IN COMMERCE 9-15-2005.

**CLASS 38—COMMUNICATION**

FOR PROVIDING ONLINE ELECTRONIC BULLETIN BOARDS FOR TRANSMISSION OF MESSAGES AMONG COMPUTER USERS CONCERNING FASHION, BEAUTY, SHOPPING, AND STYLE (U.S. CLS. 100, 101 AND 104).

FIRST USE 9-15-2005; IN COMMERCE 9-15-2005.

**CLASS 41—EDUCATION AND ENTERTAINMENT**

FOR ENTERTAINMENT SERVICES, NAMELY, PROVIDING INFORMATION, NEWS AND COMMENTARY IN THE FIELDS OF POPULAR CULTURE, CELEBRITY LIFESTYLES AND EVENTS, AND ENTERTAINMENT NEWS (U.S. CLS. 100, 101 AND 107).

FIRST USE 9-15-2005; IN COMMERCE 9-15-2005.



**CLASS 44—MEDICAL, BEAUTY AND AGRICULTURAL SERVICES**

FOR PROVIDING ADVICE, INFORMATION, NEWS AND COMMENTARY ABOUT BEAUTY (U.S. CLS. 100 AND 101).

FIRST USE 9-15-2005; IN COMMERCE 9-15-2005.

**CLASS 45—PERSONAL AND LEGAL SERVICES**

FOR PROVIDING ADVICE, INFORMATION, NEWS AND COMMENTARY IN THE FIELD OF FASHION AND STYLE; PROVIDING INFORMATION, NEWS AND COMMENTARY ABOUT PERSONAL SHOPPING (U.S. CLS. 100 AND 101).

FIRST USE 9-15-2005; IN COMMERCE 9-15-2005.  
ARETHA SOMERVILLE, EXAMINING ATTORNEY

**CLASS 44—MEDICAL, BEAUTY AND AGRICULTURAL SERVICES**

FOR PROVIDING ADVICE, INFORMATION, NEWS AND COMMENTARY ABOUT BEAUTY (U.S. CLS. 100 AND 101).

FIRST USE 9-15-2005; IN COMMERCE 9-15-2005.

**CLASS 45—PERSONAL AND LEGAL SERVICES**

FOR PROVIDING ADVICE, INFORMATION, NEWS AND COMMENTARY IN THE FIELD OF FASHION AND STYLE; PROVIDING INFORMATION, NEWS AND COMMENTARY ABOUT PERSONAL SHOPPING (U.S. CLS. 100 AND 101).

FIRST USE 9-15-2005; IN COMMERCE 9-15-2005.  
ARETHA SOMERVILLE, EXAMINING ATTORNEY

SN 85-869,349. REFINERY 29, INC., NEW YORK, NY. FILED 3-7-2013.

R29

THE MARK CONSISTS OF STANDARD CHARACTERS WITHOUT CLAIM TO ANY PARTICULAR FONT, STYLE, SIZE, OR COLOR.

**CLASS 25—CLOTHING**

FOR CLOTHING, NAMELY, DRESSES, SUITS, SWEATERS, TOPS, PANTS, SHORTS, SKIRTS, JACKETS, OUTERWEAR IN THE NATURE OF JACKETS, COATS AND HATS, HEADWEAR, SCARVES, GLOVES, SOCKS, SLEEPWEAR, LINGERIE, FOOTWEAR, BLAZERS, SHIRTS, T-SHIRTS, POLO SHIRTS, SWEATSHIRTS, SWIMWEAR, BELTS, TIES, UNDERWEAR (U.S. CLS. 22 AND 39).

FIRST USE 9-15-2005; IN COMMERCE 9-15-2005.

**CLASS 35—ADVERTISING AND BUSINESS**

FOR COMPUTERIZED ON-LINE RETAIL STORE SERVICES IN THE FIELD OF FASHION, BEAUTY, SHOPPING, AND STYLE, FEATURING LUXURY AND FASHION CLOTHING, APPAREL, FOOTWEAR, CLOTHING AND FASHION ACCESSORIES, HANDBAGS, JEWELRY, COSMETICS, AND RELATED GOODS; MARKETING, ADVERTISING, AND PROMOTING THE RETAIL GOODS AND SERVICES OF OTHERS THROUGH THE INTERNET AND WIRELESS ELECTRONIC DEVICES (U.S. CLS. 100, 101 AND 102).

FIRST USE 9-15-2005; IN COMMERCE 9-15-2005.

**CLASS 38—COMMUNICATION**

FOR PROVIDING ONLINE ELECTRONIC BULLETIN BOARDS FOR TRANSMISSION OF MESSAGES AMONG COMPUTER USERS CONCERNING FASHION, BEAUTY, SHOPPING, AND STYLE (U.S. CLS. 100, 101 AND 104).

FIRST USE 9-15-2005; IN COMMERCE 9-15-2005.

**CLASS 41—EDUCATION AND ENTERTAINMENT**

FOR ENTERTAINMENT SERVICES, NAMELY, PROVIDING INFORMATION, NEWS AND COMMENTARY IN THE FIELDS OF POPULAR CULTURE, CELEBRITY LIFESTYLES AND EVENTS, AND ENTERTAINMENT NEWS (U.S. CLS. 100, 101 AND 107).

FIRST USE 9-15-2005; IN COMMERCE 9-15-2005.

SN 85-869,841. NEW GOLD INC., VANCOUVER, BC, CANADA, FILED 3-7-2013.

newgold

PRIORITY CLAIMED UNDER SEC. 44(D) ON CANADA APPLICATION NO. 1593700, FILED 9-11-2012, REG. NO. TMA862,545, DATED 10-11-2013, EXPIRES 10-11-2028.

OWNER OF U.S. REG. NO. 3,087,755.

THE MARK CONSISTS OF THE WORDING "NEWGOLD", WITH THE "O" COMPRISED OF SMALL TRIANGLES POINTED INWARD TO CREATE THE APPEARANCE OF A SUN.

**CLASS 6—METAL GOODS**

FOR COMMON METALS AND THEIR ALLOYS (U.S. CLS. 2, 12, 13, 14, 23, 25 AND 50).

FIRST USE 7-1-2008; IN COMMERCE 7-1-2008.

**CLASS 14—JEWELRY**

FOR PRECIOUS METALS; PRECIOUS METAL ALLOYS COMPRISED IN SIGNIFICANT PART OF GOLD (U.S. CLS. 2, 27, 28 AND 50).

FIRST USE 7-1-2008; IN COMMERCE 7-1-2008.

**CLASS 37—CONSTRUCTION AND REPAIR**

FOR MINING EXTRACTION (U.S. CLS. 100, 103 AND 106).

FIRST USE 7-1-2008; IN COMMERCE 7-1-2008.

**CLASS 42—SCIENTIFIC AND COMPUTER SERVICES**

FOR MINERAL EXPLORATION AND MINERAL EXPLORATION SERVICES (U.S. CLS. 100 AND 101).

FIRST USE 7-1-2008; IN COMMERCE 7-1-2008.

KATHLEEN M. VANSTON, EXAMINING ATTORNEY

SN 85-869,953. SASSER FAMILY HOLDINGS, INC., CHICAGO, IL. FILED 3-7-2013.

#### CHICAGO FREIGHT CAR LEASING

THE MARK CONSISTS OF STANDARD CHARACTERS WITHOUT CLAIM TO ANY PARTICULAR FONT, STYLE, SIZE, OR COLOR.

NO CLAIM IS MADE TO THE EXCLUSIVE RIGHT TO USE "FREIGHT CAR LEASING", APART FROM THE MARK AS SHOWN.  
SEC. 2(F).

#### CLASS 36—INSURANCE AND FINANCIAL

FOR FINANCIAL CONSULTATION SERVICES RELATING TO THE TRANSPORTATION OF GOODS AND SERVICES OVER RAIL (U.S. CLS. 100, 101 AND 102).  
FIRST USE 0-0-1949; IN COMMERCE 0-0-1949.

#### CLASS 39—TRANSPORTATION AND STORAGE

FOR LEASING OF RAIL EQUIPMENT AND APPARATUS FOR LOCOMOTION AND TRANSPORTATION BY RAIL (U.S. CLS. 100 AND 105).  
FIRST USE 0-0-1949; IN COMMERCE 0-0-1949.  
JILLIAN CANTOR, EXAMINING ATTORNEY

SN 85-869,969. SASSER FAMILY HOLDINGS, INC., CHICAGO, IL. FILED 3-7-2013.

#### UNION LEASING

THE MARK CONSISTS OF STANDARD CHARACTERS WITHOUT CLAIM TO ANY PARTICULAR FONT, STYLE, SIZE, OR COLOR.

NO CLAIM IS MADE TO THE EXCLUSIVE RIGHT TO USE "LEASING", APART FROM THE MARK AS SHOWN.

#### CLASS 35—ADVERTISING AND BUSINESS

FOR LICENSE REGISTRATION AND RENEWAL OF VEHICLES; BUSINESS RISK MANAGEMENT SERVICES; ON-LINE VEHICLE ORDERING SERVICES; VEHICLE LIFECYCLE COST MANAGEMENT; MANAGEMENT SERVICES RELATING TO FLEET MAINTENANCE AND REPAIR, NAMELY, SCHEDULING REPAIRS FOR THE VEHICLES OF OTHERS; ON-LINE REPORTING DATABASE FOR TRACKING OF EXPENSES OF FLEET MAINTENANCE; VEHICLE AUCTION SERVICES; AUTOMOBILE DEALERSHIP SERVICES (U.S. CLS. 100, 101 AND 102).  
FIRST USE 0-0-1988; IN COMMERCE 0-0-1988.

#### CLASS 36—INSURANCE AND FINANCIAL

FOR FINANCIAL CONSULTING AND MANAGEMENT SERVICES RELATING TO NEW AND PRE-OWNED VEHICLE ACQUISITION, FUNDING, AND MANAGEMENT; FINANCIAL RISK MANAGEMENT SERVICES; VEHICLE BROKERAGE SERVICES (U.S. CLS. 100, 101 AND 102).  
FIRST USE 0-0-1988; IN COMMERCE 0-0-1988.

#### CLASS 37—CONSTRUCTION AND REPAIR

FOR CONSULTING SERVICES RELATING TO FLEET MAINTENANCE AND REPAIR; ON-LINE REPORTING DATABASE FOR TRACKING OF FLEET MAINTENANCE AND REPAIRS (U.S. CLS. 100, 103 AND 106).  
FIRST USE 0-0-1988; IN COMMERCE 0-0-1988.

#### CLASS 39—TRANSPORTATION AND STORAGE

FOR VEHICLE FLEET LEASING (U.S. CLS. 100 AND 105).  
FIRST USE 0-0-1988; IN COMMERCE 0-0-1988.  
JILLIAN CANTOR, EXAMINING ATTORNEY

SN 85-871,218. SOUTHWEST INITIATIVE FOUNDATION, HUTCHINSON, MN. FILED 3-8-2013.

#### Southwest Initiative Foundation

THE MARK CONSISTS OF STANDARD CHARACTERS WITHOUT CLAIM TO ANY PARTICULAR FONT, STYLE, SIZE, OR COLOR.

NO CLAIM IS MADE TO THE EXCLUSIVE RIGHT TO USE "FOUNDATION", APART FROM THE MARK AS SHOWN.  
SEC. 2(F).

#### CLASS 36—INSURANCE AND FINANCIAL

FOR CHARITABLE FUNDRAISING AND INVESTMENT OF FUNDS FOR OTHERS, INCLUDING VIA AN ONLINE INTERACTIVE DIGITAL NETWORK, INVOLVING COMMUNITY FOUNDATIONS THAT ARE TAX-EXEMPT, NONPROFIT, AUTONOMOUS, PUBLICLY SUPPORTED, NON-SECTARIAN PHILANTHROPIC INSTITUTIONS WITH A LONG TERM GOAL OF BUILDING PERMANENT, NAMED COMPONENT FUNDS ESTABLISHED BY MANY SEPARATE DONORS FOR THE BROAD-BASED CHARITABLE BENEFIT OF THE RESIDENTS OF A DEFINED GEOGRAPHIC AREA; GRANT MAKING NAMELY, GRANTING FUNDS TO COMMUNITY FOUNDATIONS THAT ARE TAX-EXEMPT, NONPROFIT, AUTONOMOUS, PUBLICLY SUPPORTED, NON-SECTARIAN PHILANTHROPIC INSTITUTIONS WITH A LONG TERM GOAL OF BUILDING PERMANENT, NAMED COMPONENT FUNDS ESTABLISHED BY MANY SEPARATE DONORS FOR THE BROAD-BASED CHARITABLE BENEFIT OF THE RESIDENTS OF A DEFINED GEOGRAPHIC AREA; AND GRANT MAKING PROVIDED VIA AN ONLINE INTERACTIVE DIGITAL NETWORK, NAMELY, GRANTING FUNDS TO COMMUNITY FOUNDATIONS THAT ARE TAX-EXEMPT, NONPROFIT, AUTONOMOUS, PUBLICLY SUPPORTED, NON-SECTARIAN PHILANTHROPIC INSTITUTIONS WITH A LONG TERM GOAL OF BUILDING PERMANENT, NAMED COMPONENT FUNDS ESTABLISHED BY MANY SEPARATE DONORS FOR THE BROAD-BASED CHARITABLE BENEFIT OF THE RESIDENTS OF A DEFINED GEOGRAPHIC AREA (U.S. CLS. 100, 101 AND 102).  
FIRST USE 0-0-2006; IN COMMERCE 0-0-2006.

#### CLASS 41—EDUCATION AND ENTERTAINMENT

FOR EDUCATIONAL SERVICES, NAMELY, DEVELOPING AND PROVIDING TRAINING PROGRAMS IN THE FIELD OF LEADERSHIP TO COMMUNITIES (U.S. CLS. 100, 101 AND 107).  
FIRST USE 0-0-2006; IN COMMERCE 0-0-2006.  
B. PARADEWELAI, EXAMINING ATTORNEY

SN 85-871,375. SOUTHWEST INITIATIVE FOUNDATION,  
HUTCHINSON, MN. FILED 3-8-2013.

SN 85-871,390. FABBRI COSMETICA S.R.L., OZZANO  
DELL'EMILIA, ITALY, FILED 3-8-2013.

One Connection. Unlimited  
Possibilities.



THE MARK CONSISTS OF STANDARD CHARACTERS  
WITHOUT CLAIM TO ANY PARTICULAR FONT, STYLE,  
SIZE, OR COLOR.

#### **CLASS 36—INSURANCE AND FINANCIAL**

FOR CHARITABLE FUNDRAISING AND INVESTMENT OF FUNDS FOR OTHERS, INCLUDING VIA AN ONLINE INTERACTIVE DIGITAL NETWORK, INVOLVING COMMUNITY FOUNDATIONS THAT ARE TAX-EXEMPT, NONPROFIT, AUTONOMOUS, PUBLICLY SUPPORTED, NON-SECTARIAN PHILANTHROPIC INSTITUTIONS WITH A LONG TERM GOAL OF BUILDING PERMANENT, NAMED COMPONENT FUNDS ESTABLISHED BY MANY SEPARATE DONORS FOR THE BROAD-BASED CHARITABLE BENEFIT OF THE RESIDENTS OF A DEFINED GEOGRAPHIC AREA; GRANT MAKING NAMELY, GRANTING FUNDS TO COMMUNITY FOUNDATIONS THAT ARE TAX-EXEMPT, NONPROFIT, AUTONOMOUS, PUBLICLY SUPPORTED, NON-SECTARIAN PHILANTHROPIC INSTITUTIONS WITH A LONG TERM GOAL OF BUILDING PERMANENT, NAMED COMPONENT FUNDS ESTABLISHED BY MANY SEPARATE DONORS FOR THE BROAD-BASED CHARITABLE BENEFIT OF THE RESIDENTS OF A DEFINED GEOGRAPHIC AREA; AND GRANT MAKING PROVIDED VIA AN ONLINE INTERACTIVE DIGITAL NETWORK, NAMELY, GRANTING FUNDS TO COMMUNITY FOUNDATIONS THAT ARE TAX-EXEMPT, NONPROFIT, AUTONOMOUS, PUBLICLY SUPPORTED, NON-SECTARIAN PHILANTHROPIC INSTITUTIONS WITH A LONG TERM GOAL OF BUILDING PERMANENT, NAMED COMPONENT FUNDS ESTABLISHED BY MANY SEPARATE DONORS FOR THE BROAD-BASED CHARITABLE BENEFIT OF THE RESIDENTS OF A DEFINED GEOGRAPHIC AREA (U.S. CLS. 100, 101 AND 102).

FIRST USE 7-0-2012; IN COMMERCE 7-0-2012.

#### **CLASS 41—EDUCATION AND ENTERTAINMENT**

FOR EDUCATIONAL SERVICES, NAMELY, DEVELOPING AND PROVIDING TRAINING PROGRAMS IN THE FIELD OF LEADERSHIP TO COMMUNITIES (U.S. CLS. 100, 101 AND 107).

FIRST USE 7-0-2012; IN COMMERCE 7-0-2012.  
B. PARADEWELAI, EXAMINING ATTORNEY

PRIORITY CLAIMED UNDER SEC. 44(D) ON ITALY APPLICATION NO. 000219, FILED 2-15-2013, REG. NO. 0001532848, DATED 4-4-2013, EXPIRES 2-15-2023.

THE MARK CONSISTS OF THE LETTERS "MAR" AND "V" SEPARATED BY A DOT, ALL WITHIN A SHADED CIRCLE DESIGN.

#### **CLASS 3—COSMETICS AND CLEANING PREPARATIONS**

FOR COSMETICS AND MAKE UP; COSMETIC PREPARATIONS; PERFUMES; SOAPS FOR PERSONAL USE; COSMETIC PREPARATIONS FOR BATH AND SHOWER; MAKE-UP REMOVING PREPARATIONS; COSMETIC SUN TANNING PREPARATIONS; SUN SCREEN PREPARATIONS; COSMETIC PREPARATIONS FOR SLIMMING, COSMETIC CREAMS FOR SKIN CARE (U.S. CLS. 1, 4, 6, 50, 51 AND 52).

#### **CLASS 10—MEDICAL APPARATUS**

FOR MEDICAL APPARATUS, NAMELY, ELECTROTHERAPY STIMULATION DEVICES IN THE NATURE OF ELECTROSTIMULATORS FOR THE TREATMENT OF CELLULITE; VAPORIZERS FOR MEDICAL PURPOSES; NEBULIZERS FOR RESPIRATION THERAPY; BEDS FOR MEDICAL PURPOSES; MEDICAL APPARATUS, NAMELY, PRESSURE THERAPY APPARATUS FOR PERFORMING NON-ABLATIVE AESTHETIC SKIN TREATMENT PROCEDURES; MEDICAL APPARATUS, NAMELY, PNEUMATIC MASSAGERS; MEDICAL APPARATUS, NAMELY, HEAT THERAPY APPARATUS USED FOR SKIN TREATMENT PURPOSES; APPARATUS FOR CLINICAL DIAGNOSIS OF THE SKIN; IONTOPHORESIS AND ELECTROPHORESIS APPARATUS FOR MEDICAL USE; MEDICAL APPARATUS, NAMELY, APPARATUS FOR APPLYING ACTIVE TREATMENTS TO THE SKIN (U.S. CLS. 26, 39 AND 44).

#### **CLASS 44—MEDICAL, BEAUTY AND AGRICULTURAL SERVICES**

FOR BEAUTY ANALYSIS TO DETERMINE COSMETICS THAT ARE BEST SUITED TO PARTICULAR INDIVIDUALS; BEAUTY CONSULTATION SERVICES PROVIDED THROUGH A BEAUTY SALON FEATURING THE SELECTION AND USE OF COSMETICS, FRAGRANCES, BEAUTY AIDS, PERSONAL CARE PRODUCTS, AND BATH, BODY AND BEAUTY PRODUCTS; BEAUTY SALON SERVICES; BEAUTY SALONS; BEAUTY SPA SERVICES, NAMELY, COSMETIC BODY CARE; HYGIENIC AND BEAUTY CARE; MEDICAL, HYGIENIC AND BEAUTY CARE; BEAUTY SALON SERVICES FEATURING INFORMATION ABOUT BEAUTY (U.S. CLS. 100 AND 101).

JUSTINE D. PARKER, EXAMINING ATTORNEY

SN 85-871,455. BEN & JERRY'S HOMEMADE, INC., SOUTH BURLINGTON, VT. FILED 3-8-2013.



NO CLAIM IS MADE TO THE EXCLUSIVE RIGHT TO USE "DAIRY", APART FROM THE MARK AS SHOWN.

THE COLOR(S) BLACK, WHITE, RED, BLUE, PEACH AND GREEN IS/ARE CLAIMED AS A FEATURE OF THE MARK.

THE MARK CONSISTS OF A BLACK CIRCLE CONTAINING THE WORDS "CARING DAIRY" IN WHITE STYLIZED LETTERS, ENCIRCLING A PICTURE OF A MAN WITH A PEACH FACE AND BLACK EYES, EYEBROWS AND HAIR, WEARING A RED JACKET AND A BLUE HAT NEXT TO A BLACK AND WHITE COW WITH A BLUE AND GREEN PLANET EARTH BEHIND THEM.

#### CLASS 35—ADVERTISING AND BUSINESS

FOR PROMOTIONAL ACTIVITIES, NAMELY, PROMOTING SUSTAINABLE DAIRY FARMING (U.S. CLS. 100, 101 AND 102).

#### CLASS 41—EDUCATION AND ENTERTAINMENT

FOR EDUCATION SERVICES, NAMELY, PROVIDING MENTORING, TUTORING, CLASSES, SEMINARS AND WORKSHOPS IN THE FIELD OF SUSTAINABLE DAIRY FARMING, PROVIDING OF TRAINING SERVICES IN THE FIELD OF SUSTAINABLE DAIRY FARMING, ENTERTAINMENT SERVICES, NAMELY, ARRANGING AND CONDUCTING SPECIAL EVENTS CENTERED AROUND THE THEME OF SUSTAINABLE DAIRY FARMING (U.S. CLS. 100, 101 AND 107).

JAMES MACFARLANE, EXAMINING ATTORNEY

SN 85-871,554. SOUTHWEST INITIATIVE FOUNDATION, HUTCHINSON, MN. FILED 3-8-2013.



THE MARK CONSISTS OF TWO SQUARES CONTAINING DIAGONAL LINES, THE SMALLER SQUARE BE- NEATH AND PARTIALLY OVERLAPPING THE LARGER.

#### CLASS 36—INSURANCE AND FINANCIAL

FOR CHARITABLE FUNDRAISING AND INVESTMENT OF FUNDS FOR OTHERS, INCLUDING VIA AN ONLINE INTERACTIVE DIGITAL NETWORK, INVOLVING COMMUNITY FOUNDATIONS THAT ARE TAX-EXEMPT, NONPROFIT, AUTONOMOUS, PUBLICLY SUPPORTED, NON-SECTARIAN PHILANTHROPIC INSTITUTIONS WITH A LONG TERM GOAL OF BUILDING PERMANENT, NAMED COMPONENT FUNDS ESTABLISHED BY MANY SEPARATE DONORS FOR THE BROAD-BASED CHARITABLE BENEFIT OF THE RESIDENTS OF A DEFINED GEOGRAPHIC AREA; GRANT MAKING NAMELY, GRANTING FUNDS TO COMMUNITY FOUNDATIONS THAT ARE TAX-EXEMPT, NONPROFIT, AUTONOMOUS, PUBLICLY SUPPORTED, NON-SECTARIAN PHILANTHROPIC INSTITUTIONS WITH A LONG TERM GOAL OF BUILDING PERMANENT, NAMED COMPONENT FUNDS ESTABLISHED BY MANY SEPARATE DONORS FOR THE BROAD-BASED CHARITABLE BENEFIT OF THE RESIDENTS OF A DEFINED GEOGRAPHIC AREA; AND GRANT MAKING PROVIDED VIA AN ONLINE INTERACTIVE DIGITAL NETWORK, NAMELY, GRANTING FUNDS TO COMMUNITY FOUNDATIONS THAT ARE TAX-EXEMPT, NONPROFIT, AUTONOMOUS, PUBLICLY SUPPORTED, NON-SECTARIAN PHILANTHROPIC INSTITUTIONS WITH A LONG TERM GOAL OF BUILDING PERMANENT, NAMED COMPONENT FUNDS ESTABLISHED BY MANY SEPARATE DONORS FOR THE BROAD-BASED CHARITABLE BENEFIT OF THE RESIDENTS OF A DEFINED GEOGRAPHIC AREA (U.S. CLS. 100, 101 AND 102).

FIRST USE 0-0-1996; IN COMMERCE 0-0-2001.

#### CLASS 41—EDUCATION AND ENTERTAINMENT

FOR EDUCATIONAL SERVICES, NAMELY, DEVELOPING AND PROVIDING TRAINING PROGRAMS IN THE FIELD OF LEADERSHIP TO COMMUNITIES (U.S. CLS. 100, 101 AND 107).

FIRST USE 0-0-1996; IN COMMERCE 0-0-2001.

B. PARADEWELAI, EXAMINING ATTORNEY

SN 85-872,893. VISION IO AS, SANDNES, NORWAY, FILED 3-11-2013.

# VISIONIO

THE MARK CONSISTS OF STANDARD CHARACTERS WITHOUT CLAIM TO ANY PARTICULAR FONT, STYLE, SIZE, OR COLOR.

#### CLASS 7—MACHINERY

FOR MACHINES FOR INSPECTION OF SUBSEA DRILLING, COMPLETION, PLUGGING, AND ABANDONMENT OPERATIONS; MACHINE TOOLS FOR INSPECTION OF SUBSEA DRILLING, COMPLETION, PLUGGING, AND ABANDONMENT OPERATIONS; MOTORS AND ENGINES EXCEPT FOR LAND VEHICLES; MACHINE COUPLING COMPONENTS AND TRANSMISSION COMPONENTS EXCEPT FOR LAND VEHICLES, TRANSMISSIONS EXCEPT FOR LAND VEHICLES; HANDLING MACHINES FOR DRILLING WELLS; PIPELINE MAINTENANCE AND INSPECTION TOOLS, NAMELY, PIGS; PIPE AND RISER INSPECTION TOOLS, NAMELY, TOOLS WHICH ARE PASSABLE THROUGH PIPES FOR THE PURPOSE OF INSPECTION; PARTS FOR THE ABOVE MENTIONED GOODS (U.S. CLS. 13, 19, 21, 23, 31, 34 AND 35).

FIRST USE 5-11-2011; IN COMMERCE 3-28-2012.

**CLASS 9—ELECTRICAL AND SCIENTIFIC APPARATUS**

FOR SCIENTIFIC, NAUTICAL, SURVEYING, ELECTRIC, PHOTOGRAPHIC, OPTICAL, MEASURING, SIGNALING AND SUPERVISION APPARATUS, NAMELY, CAMERAS, VIDEO CAMERAS, AND COMPUTERS; APPARATUS FOR RECORDING, TRANSMISSION OR REPRODUCTION OF IMAGES; BLANK RECORDING DISCS; DATA PROCESSING EQUIPMENT AND COMPUTERS; CAMERAS; VIDEO MONITORS; COMPUTER MONITORS; ELECTRONIC CONTROLLING SYSTEMS FOR PIPE INSPECTION DEVICES; OPTICAL CABLES AND CONVERTERS; CAMERAS FOR INSPECTION OF TUBES AND PIPELINES, APPARATUS TO PROCESS DIGITAL IMAGES; IMAGE PROCESSING SOFTWARE; PARTS FOR THE ABOVE-MENTIONED GOODS; ACCESSORIES FOR THE ABOVE-MENTIONED GOODS, NAMELY, BATTERIES, LENSES, CAMERA HOUSINGS, COMPUTER HOUSINGS, FLASH BULBS, ELECTRIC CABLES, AND CABLE CONNECTORS (U.S. CLS. 21, 23, 26, 36 AND 38).

FIRST USE 5-11-2011; IN COMMERCE 3-28-2012.

**CLASS 37—CONSTRUCTION AND REPAIR**

FOR BUILDING CONSTRUCTION AND REPAIR; INSTALLATION OF SUBSEA OIL AND GAS DRILLING RIGS; MAINTENANCE AND REPAIR SERVICES FOR PIPES; RENTAL OF EQUIPMENT FOR MAINTENANCE AND REPAIR SERVICES FOR PIPES; CONSULTING IN THE FIELD OF INSPECTION, MAINTENANCE AND REPAIR OF PIPELINES, BOREHOLES AND RISERS (U.S. CLS. 100, 103 AND 106).

FIRST USE 5-11-2011; IN COMMERCE 3-28-2012.

**CLASS 42—SCIENTIFIC AND COMPUTER SERVICES**

FOR SCIENTIFIC AND TECHNOLOGICAL SERVICES, NAMELY, RESEARCH AND DESIGN IN THE FIELD OF SUBSEA OIL AND GAS EXTRACTION; ANALYSIS OF INDUSTRIAL FLUIDS; RESEARCH IN THE FIELD OF SUBSEA OIL AND GAS EXTRACTION; DESIGN AND DEVELOPMENT OF COMPUTER HARDWARE AND SOFTWARE; ENGINEERING; MATERIAL TESTING; QUALITY CONTROL FOR OTHERS; CONVERSION OF DATA OR DOCUMENTS FROM PHYSICAL TO ELECTRONIC MEDIA; COMPUTER GRAPHICS DESIGN SERVICES, NAMELY, DEVELOPMENT OF 3D COMPUTER MODELS; PLANNING OF BUILDINGS, CONSTRUCTIONS, WELLS, INSTALLATIONS, AND WORKFLOWS ONSHORE OR OFFSHORE USING COMPUTER SIMULATIONS, COMPUTER PROGRAMS, INDUSTRIAL LASERS, 3D COMPUTER MODELS, AND/OR ILLUSTRATIONS; TESTING OF GOODS AND SERVICES FOR OTHERS, NAMELY, TESTING OF BUILDINGS, CONSTRUCTIONS, WELLS, INSTALLATIONS, AND WORKFLOWS ONSHORE OR OFFSHORE USING COMPUTER SIMULATIONS, COMPUTER PROGRAMS, INDUSTRIAL LASERS, 3D COMPUTER MODELS, AND/OR ILLUSTRATIONS; MONITORING OF GOODS AND SERVICES FOR OTHERS, NAMELY, MONITORING FOR QUALITY CONTROL PURPOSES OF BUILDINGS, CONSTRUCTIONS, WELLS, INSTALLATIONS, AND WORKFLOWS ONSHORE OR OFFSHORE; CONSULTING IN THE FIELD OF INSPECTION, ANALYSIS OF INTEGRITY AND STATUS OF PIPELINES, BOREHOLES AND RISERS, COMPUTERS AND COMPUTER PROGRAMS FOR INSPECTION AND ANALYSIS OF PIPES, BOREHOLES AND RISERS (U.S. CLS. 100 AND 101).

FIRST USE 5-11-2011; IN COMMERCE 3-28-2012.  
LUCY ARANT, EXAMINING ATTORNEY

SN 85-873,409. VISION IO AS, SANDNES, NORWAY, FILED 3-12-2013.

# READYCAM

THE MARK CONSISTS OF STANDARD CHARACTERS WITHOUT CLAIM TO ANY PARTICULAR FONT, STYLE, SIZE, OR COLOR.

**CLASS 7—MACHINERY**

FOR MACHINES FOR INSPECTION OF SUBSEA DRILLING, COMPLETION, PLUGGING, AND ABANDONMENT OPERATIONS; MACHINE TOOLS FOR INSPECTION OF SUBSEA DRILLING, COMPLETION, PLUGGING, AND ABANDONMENT OPERATIONS; MOTORS AND ENGINES EXCEPT FOR LAND VEHICLES; MACHINE COUPLING COMPONENTS AND TRANSMISSION COMPONENTS EXCEPT FOR LAND VEHICLES, TRANSMISSIONS EXCEPT FOR LAND VEHICLES; HANDLING MACHINES FOR DRILLING WELLS; PIPELINE MAINTENANCE AND INSPECTION TOOLS, NAMELY, PIGS; PIPE AND RISER INSPECTION TOOLS, NAMELY, TOOLS WHICH ARE PASSABLE THROUGH PIPES FOR THE PURPOSE OF INSPECTION; PARTS FOR THE ABOVE MENTIONED GOODS (U.S. CLS. 13, 19, 21, 23, 31, 34 AND 35).

FIRST USE 5-11-2011; IN COMMERCE 3-8-2012.

**CLASS 9—ELECTRICAL AND SCIENTIFIC APPARATUS**

FOR SCIENTIFIC, NAUTICAL, SURVEYING, ELECTRIC, PHOTOGRAPHIC, OPTICAL, MEASURING, SIGNALING AND SUPERVISION APPARATUS, NAMELY, CAMERAS, VIDEO CAMERAS, AND COMPUTERS; APPARATUS FOR RECORDING, TRANSMISSION OR REPRODUCTION OF IMAGES; BLANK RECORDING DISCS; DATA PROCESSING EQUIPMENT AND COMPUTERS; CAMERAS; VIDEO MONITORS; COMPUTER MONITORS; ELECTRONIC CONTROLLING SYSTEMS FOR PIPE INSPECTION DEVICES; OPTICAL CABLES AND CONVERTERS; CAMERAS FOR INSPECTION OF TUBES AND PIPELINES, APPARATUS TO PROCESS DIGITAL IMAGES; IMAGE PROCESSING SOFTWARE; PARTS FOR THE ABOVE-MENTIONED GOODS; ACCESSORIES FOR THE ABOVE-MENTIONED GOODS, NAMELY, BATTERIES, LENSES, CAMERA HOUSINGS, COMPUTER HOUSINGS, FLASH BULBS, ELECTRIC CABLES, AND CABLE CONNECTORS (U.S. CLS. 21, 23, 26, 36 AND 38).

FIRST USE 5-11-2011; IN COMMERCE 3-28-2012.

**CLASS 37—CONSTRUCTION AND REPAIR**

FOR BUILDING CONSTRUCTION AND REPAIR; INSTALLATION OF SUBSEA OIL AND GAS DRILLING RIGS; MAINTENANCE AND REPAIR SERVICES FOR PIPES; RENTAL OF EQUIPMENT FOR MAINTENANCE AND REPAIR SERVICES FOR PIPES; CONSULTING IN THE FIELD OF INSPECTION, MAINTENANCE AND REPAIR OF PIPELINES, BOREHOLES AND RISERS (U.S. CLS. 100, 103 AND 106).

FIRST USE 5-11-2011; IN COMMERCE 3-28-2012.

**CLASS 42—SCIENTIFIC AND COMPUTER SERVICES**

FOR SCIENTIFIC AND TECHNOLOGICAL SERVICES, NAMELY, RESEARCH AND DESIGN IN THE FIELD OF SUBSEA OIL AND GAS EXTRACTION; ANALYSIS OF INDUSTRIAL FLUIDS; RESEARCH IN THE FIELD OF SUBSEA OIL AND GAS EXTRACTION; DESIGN AND DEVELOPMENT OF COMPUTER HARDWARE AND SOFTWARE; ENGINEERING; MATERIAL TESTING; QUALITY CONTROL FOR OTHERS; CONVERSION OF DATA OR DOCUMENTS FROM PHYSICAL TO ELECTRONIC MEDIA; COMPUTER GRAPHICS DESIGN SERVICES, NAMELY, DEVELOPMENT OF 3D COMPUTER MODELS; PLANNING OF BUILDINGS, CONSTRUCTIONS, WELLS, INSTALLATIONS, AND WORKFLOWS ONSHORE OR OFFSHORE USING COMPUTER SIMULATIONS, COMPUTER PROGRAMS, INDUSTRIAL LASERS, 3D COMPUTER MODELS, AND/OR ILLUSTRATIONS; TESTING OF GOODS AND SERVICES FOR OTHERS, NAMELY, TESTING OF BUILDINGS, CONSTRUCTIONS, WELLS, INSTALLATIONS, AND WORKFLOWS ONSHORE OR OFFSHORE USING COMPUTER SIMULATIONS, COMPUTER PROGRAMS, INDUSTRIAL LASERS, 3D COMPUTER MODELS, AND/OR ILLUSTRATIONS; MONITORING OF GOODS AND SERVICES FOR OTHERS, NAMELY, MONITORING FOR QUALITY CONTROL PURPOSES OF BUILDINGS, CONSTRUCTIONS, WELLS, INSTALLATIONS, AND WORKFLOWS ONSHORE OR OFFSHORE; CONSULTING IN THE FIELD OF INSPECTION, ANALYSIS OF INTEGRITY AND STATUS OF PIPELINES, BOREHOLES AND RISERS, COMPUTERS AND COMPUTER PROGRAMS FOR INSPECTION AND ANALYSIS OF PIPES, BOREHOLES AND RISERS (U.S. CLS. 100 AND 101).

FIRST USE 5-11-2011; IN COMMERCE 3-28-2012.  
LUCY ARANT, EXAMINING ATTORNEY

**CLASS 9—ELECTRICAL AND SCIENTIFIC APPARATUS**

FOR SCIENTIFIC, NAUTICAL, SURVEYING, ELECTRIC, PHOTOGRAPHIC, OPTICAL, MEASURING, SIGNALING AND SUPERVISION APPARATUS, NAMELY, CAMERAS, VIDEO CAMERAS, AND COMPUTERS; APPARATUS FOR RECORDING, TRANSMISSION OR REPRODUCTION OF IMAGES; BLANK RECORDING DISCS; DATA PROCESSING EQUIPMENT AND COMPUTERS; CAMERAS; VIDEO MONITORS; COMPUTER MONITORS; ELECTRONIC CONTROLLING SYSTEMS FOR PIPE INSPECTION DEVICES; OPTICAL CABLES AND CONVERTERS; CAMERAS FOR INSPECTION OF TUBES AND PIPELINES, APPARATUS TO PROCESS DIGITAL IMAGES; IMAGE PROCESSING SOFTWARE; PARTS FOR THE ABOVE-MENTIONED GOODS; ACCESSORIES FOR THE ABOVE-MENTIONED GOODS, NAMELY, BATTERIES, LENSES, CAMERA HOUSINGS, COMPUTER HOUSINGS, FLASH BULBS, ELECTRIC CABLES, AND CABLE CONNECTORS (U.S. CLS. 21, 23, 26, 36 AND 38).

**CLASS 37—CONSTRUCTION AND REPAIR**

FOR BUILDING CONSTRUCTION AND REPAIR; INSTALLATION OF SUBSEA OIL AND GAS DRILLING RIGS; MAINTENANCE AND REPAIR SERVICES FOR PIPES; RENTAL OF EQUIPMENT FOR MAINTENANCE AND REPAIR SERVICES FOR PIPES; CONSULTING IN THE FIELD OF INSPECTION, MAINTENANCE AND REPAIR OF PIPELINES, BOREHOLES AND RISERS (U.S. CLS. 100, 103 AND 106).

SN 85-873,489. VISION IO AS, SANDNES, NORWAY, FILED 3-12-2013.

# FLEXCAM

THE MARK CONSISTS OF STANDARD CHARACTERS WITHOUT CLAIM TO ANY PARTICULAR FONT, STYLE, SIZE, OR COLOR.

**CLASS 7—MACHINERY**

FOR MACHINES FOR INSPECTION OF SUBSEA DRILLING, COMPLETION, PLUGGING, AND ABANDONMENT OPERATIONS; MACHINE TOOLS FOR INSPECTION OF SUBSEA DRILLING, COMPLETION, PLUGGING, AND ABANDONMENT OPERATIONS; MOTORS AND ENGINES EXCEPT FOR LAND VEHICLES; MACHINE COUPLING COMPONENTS AND TRANSMISSION COMPONENTS EXCEPT FOR LAND VEHICLES, TRANSMISSIONS EXCEPT FOR LAND VEHICLES; HANDLING MACHINES FOR DRILLING WELLS; PIPELINE MAINTENANCE AND INSPECTION TOOLS, NAMELY, PIGS; PIPE AND RISER INSPECTION TOOLS, NAMELY, TOOLS WHICH ARE PASSABLE THROUGH PIPES FOR THE PURPOSE OF INSPECTION; PARTS FOR THE ABOVE MENTIONED GOODS (U.S. CLS. 13, 19, 21, 23, 31, 34 AND 35).

**CLASS 42—SCIENTIFIC AND COMPUTER SERVICES**

FOR SCIENTIFIC AND TECHNOLOGICAL SERVICES, NAMELY, RESEARCH AND DESIGN IN THE FIELD OF SUBSEA OIL AND GAS EXTRACTION; ANALYSIS OF INDUSTRIAL FLUIDS; RESEARCH IN THE FIELD OF SUBSEA OIL AND GAS EXTRACTION; DESIGN AND DEVELOPMENT OF COMPUTER HARDWARE AND SOFTWARE; ENGINEERING; MATERIAL TESTING; QUALITY CONTROL FOR OTHERS; CONVERSION OF DATA OR DOCUMENTS FROM PHYSICAL TO ELECTRONIC MEDIA; COMPUTER GRAPHICS DESIGN SERVICES, NAMELY, DEVELOPMENT OF 3D COMPUTER MODELS; PLANNING OF BUILDINGS, CONSTRUCTIONS, WELLS, INSTALLATIONS, AND WORKFLOWS ONSHORE OR OFFSHORE USING COMPUTER SIMULATIONS, COMPUTER PROGRAMS, INDUSTRIAL LASERS, 3D COMPUTER MODELS, AND/OR ILLUSTRATIONS; TESTING OF GOODS AND SERVICES FOR OTHERS, NAMELY, TESTING OF BUILDINGS, CONSTRUCTIONS, WELLS, INSTALLATIONS, AND WORKFLOWS ONSHORE OR OFFSHORE USING COMPUTER SIMULATIONS, COMPUTER PROGRAMS, INDUSTRIAL LASERS, 3D COMPUTER MODELS, AND/OR ILLUSTRATIONS; MONITORING OF GOODS AND SERVICES FOR OTHERS, NAMELY, MONITORING FOR QUALITY CONTROL PURPOSES OF BUILDINGS, CONSTRUCTIONS, WELLS, INSTALLATIONS, AND WORKFLOWS ONSHORE OR OFFSHORE; CONSULTING IN THE FIELD OF INSPECTION, ANALYSIS OF INTEGRITY AND STATUS OF PIPELINES, BOREHOLES AND RISERS, COMPUTERS AND COMPUTER PROGRAMS FOR INSPECTION AND ANALYSIS OF PIPES, BOREHOLES AND RISERS (U.S. CLS. 100 AND 101).

LUCY ARANT, EXAMINING ATTORNEY

SN 85-873,949. BISTRO MD, LLC, NAPLES, FL. FILED 3-12-2013.

**FOR A LIGHTER, HEALTHIER  
YOU**

THE MARK CONSISTS OF STANDARD CHARACTERS WITHOUT CLAIM TO ANY PARTICULAR FONT, STYLE, SIZE, OR COLOR.

**CLASS 29—MEATS AND PROCESSED FOODS**

FOR FOOD, NAMELY, VEGGIE BURGERS PATTIES; SEAFOOD, NOT LIVE, NAMELY, SALMON, CRABS, TILAPIA, POLLOCK, MAHI-MAHI, TUNA, COD, SEA-SCALLOPS, AND OTHER FISH; CHICKEN; COOKED FROZEN DISH CONSISTING PRIMARILY OF CHICKEN, NAMELY, STUFFED CHICKEN; TURKEY; COOKED FROZEN DISH CONSISTING PRIMARILY OF TURKEY, NAMELY, STUFFED TURKEY; PORK; BEEF; SIRLOIN BEEF; HAM; SOUPS; EGGS; OMELETS; SOY-BASED FOOD BARS; SOY PROTEIN CHIPS; SOY-BASED SNACKS; AND SHAKES (U.S. CL. 46).

FIRST USE 9-1-2012; IN COMMERCE 9-1-2012.

**CLASS 43—HOTEL AND RESTAURANT SERVICES**

FOR FOOD PREPARATION SERVICES; FOOD PREPARATION SERVICES FEATURING HEALTHY MEALS MADE TO ORDER FOR HOME DELIVERY (U.S. CLS. 100 AND 101).

FIRST USE 9-1-2012; IN COMMERCE 9-1-2012.  
KATHERINE STOIDES, EXAMINING ATTORNEY

SN 85-873,963. GLOBAL MEDICAL INNOVATIONS, LLC, WOBURN, MA. FILED 3-12-2013.

**UNLEASHING THE PHYSICIAN  
WITHIN**

THE MARK CONSISTS OF STANDARD CHARACTERS WITHOUT CLAIM TO ANY PARTICULAR FONT, STYLE, SIZE, OR COLOR.

**CLASS 35—ADVERTISING AND BUSINESS**

FOR BUSINESS CONSULTATION PERTAINING TO IDENTIFYING CORPORATE VALUES, MISSION STATEMENTS AND VISION STATEMENTS FOR THE PURPOSE OF DEVELOPING WELLNESS PROGRAMS FOR CORPORATE CLIENTS (U.S. CLS. 100, 101 AND 102).

**CLASS 41—EDUCATION AND ENTERTAINMENT**

FOR EDUCATION SERVICES, NAMELY, PROVIDING COURSES, SEMINARS AND NON-DOWNLOADABLE WEBINARS, IN THE FIELD OF WELLNESS, AND DISTRIBUTION OF COURSE MATERIALS IN CONNECTION THEREWITH; PROFESSIONAL COACHING SERVICES IN THE FIELD OF WELLNESS (U.S. CLS. 100, 101 AND 107).

**CLASS 44—MEDICAL, BEAUTY AND AGRICULTURAL SERVICES**

FOR PROVIDING MENTAL HEALTH AND WELLNESS INFORMATION; WELLNESS AND HEALTH-RELATED CONSULTING SERVICES (U.S. CLS. 100 AND 101).

EVELYN BRADLEY, EXAMINING ATTORNEY

SN 85-874,166. FREERUN TECHNOLOGIES, INC., NAPA, CA. FILED 3-12-2013.

**DREAM. EXPLORE. REMEMBER.**

THE MARK CONSISTS OF STANDARD CHARACTERS WITHOUT CLAIM TO ANY PARTICULAR FONT, STYLE, SIZE, OR COLOR.

**CLASS 35—ADVERTISING AND BUSINESS**

FOR ADVERTISING, MARKETING, AND PROMOTION SERVICES; PROMOTING THE GOODS AND SERVICES OF OTHERS BY PROVIDING A WEB SITE AT WHICH USERS CAN LINK TO INFORMATION REGARDING WINES AND WINE REGIONS, TRAVEL TO AND WITHIN WINE COUNTRY, WINE TASTING, WINE MAKING, RESTAURANTS, LODGING, EVENTS, AND ACTIVITIES IN WINE REGIONS (U.S. CLS. 100, 101 AND 102).

**CLASS 41—EDUCATION AND ENTERTAINMENT**

FOR EDUCATIONAL SERVICES, NAMELY, PROVIDING ONLINE INSTRUCTION IN THE FIELD OF WINE AND WINE REGIONS, TRAVEL TO AND WITHIN WINE COUNTRY, WINE TASTING, WINE MAKING, RESTAURANTS, LODGING, EVENTS AND ACTIVITIES IN WINE REGIONS VIA AN ONLINE WEBSITE (U.S. CLS. 100, 101 AND 107).

MARIA-VICTORIA SUAREZ, EXAMINING ATTORNEY

SN 85-874,272. FREERUN TECHNOLOGIES, INC., NAPA, CA. FILED 3-12-2013.



THE COLOR(S) RED, BLACK, AND GREY IS/ARE CLAIMED AS A FEATURE OF THE MARK.

THE MARK CONSISTS OF THE FOLLOWING: THE IMAGE OF A SPLASH OF RED WINE POURED INTO AN INVISIBLE WINE GLASS WITH BLACK SHADING WITH AN OVAL GRAY SHADOW DIRECTLY BELOW.

### CLASS 35—ADVERTISING AND BUSINESS

FOR ADVERTISING, MARKETING, AND PROMOTION SERVICES; PROMOTING THE GOODS AND SERVICES OF OTHERS BY PROVIDING A WEB SITE AT WHICH USERS CAN LINK TO INFORMATION REGARDING WINES AND WINE REGIONS, TRAVEL TO AND WITHIN WINE COUNTRY, WINE TASTING, WINE MAKING, RESTAURANTS, LODGING, EVENTS, AND ACTIVITIES IN WINE REGIONS (U.S. CLS. 100, 101 AND 102).

### CLASS 41—EDUCATION AND ENTERTAINMENT

FOR EDUCATIONAL SERVICES, NAMELY, PROVIDING ONLINE INSTRUCTION IN THE FIELD OF WINE AND WINE REGIONS, TRAVEL TO AND WITHIN WINE COUNTRY, WINE TASTING, WINE MAKING, RESTAURANTS, LODGING, EVENTS AND ACTIVITIES IN WINE REGIONS VIA AN ONLINE WEBSITE (U.S. CLS. 100, 101 AND 107).

MARIA-VICTORIA SUAREZ, EXAMINING ATTORNEY

SN 85-874,661. HSUEH SHAOLAN, LONDON, UNITED KINGDOM, FILED 3-13-2013.



THE COLOR(S) RED AND WHITE IS/ARE CLAIMED AS A FEATURE OF THE MARK.

THE MARK CONSISTS OF A RECTANGULAR BOX IN RED BACKGROUND WITH TEXT "CHINEASY" IN UNIQUE DESIGN WORD MARK COLOURED WHITE.

### CLASS 9—ELECTRICAL AND SCIENTIFIC APPARATUS

FOR CHILDREN'S EDUCATIONAL MUSIC CDS AND DVDS; CHILDREN'S EDUCATIONAL SOFTWARE; COMPUTER APPLICATION SOFTWARE FOR MOBILE PHONES, NAMELY, SOFTWARE FOR LEARNING CHINESE; COMPUTER APPLICATION SOFTWARE FOR MOBILES, COMPUTERS, NOTEPADS, NAMELY, SOFTWARE FOR LEARNING CHINESE; COMPUTER GAME SOFTWARE; COMPUTER GAME SOFTWARE FOR USE ON MOBILE AND CELLULAR PHONES; COMPUTER GAME SOFTWARE FOR USE WITH PERSONAL COMPUTERS, HOME VIDEO GAME CONSOLES USED WITH TELEVISIONS AND ARCADE-BASED VIDEO GAME CONSOLES; EDUCATIONAL SOFTWARE FEATURING INSTRUCTION IN TEACHING CHINESE (U.S. CLS. 21, 23, 26, 36 AND 38).

### CLASS 16—PAPER GOODS AND PRINTED MATTER

FOR A SERIES OF BOOKS, WRITTEN ARTICLES, HANDOUTS AND WORKSHEETS IN THE FIELD OF TEACHING CHINESE; CHILDREN'S INTERACTIVE EDUCATIONAL BOOKS; EDUCATIONAL BOOKS FEATURING TEACHING CHINESE; EDUCATIONAL KITS SOLD AS A UNIT IN THE FIELD OF TEACHING CHINESE CONSISTING PRIMARILY OF PRINTED INSTRUCTIONAL MATERIALS AND ALSO INCLUDING AUDIO CDS; EDUCATIONAL KITS SOLD AS A UNIT IN THE FIELD OF TEACHING CHINESE CONSISTING PRIMARILY OF EDUCATIONAL BOOKS AND ALSO INCLUDING DVDS AND T-SHIRTS; EDUCATIONAL PUBLICATIONS, NAMELY, TRAINING MANUALS IN THE FIELD OF TEACHING CHINESE; GIFT BOOKS FEATURING TEACHING CHINESE (U.S. CLS. 2, 5, 22, 23, 29, 37, 38 AND 50).

### CLASS 41—EDUCATION AND ENTERTAINMENT

FOR EDUCATIONAL SERVICES, NAMELY, PROVIDING LIVE AND ON-LINE CLASSES AND INSTRUCTIONS IN THE FIELD OF TEACHING CHINESE; ENTERTAINMENT SERVICES, NAMELY, PROVIDING A WEBSITE FEATURING GAMES AND PUZZLES; ENTERTAINMENT SERVICES, NAMELY, PROVIDING AN ON-LINE BOARD GAME; ENTERTAINMENT SERVICES, NAMELY, PROVIDING AN ON-LINE COMPUTER GAME; ENTERTAINMENT SERVICES, NAMELY, PROVIDING ON-LINE COMPUTER GAMES; ENTERTAINMENT SERVICES, NAMELY, PROVIDING ONLINE ELECTRONIC GAMES; ENTERTAINMENT SERVICES, NAMELY, PROVIDING ONLINE VIDEO GAMES; ENTERTAINMENT SERVICES, NAMELY, PROVIDING PODCASTS IN THE FIELD OF TEACHING CHINESE; ENTERTAINMENT SERVICES, NAMELY, PROVIDING TEMPORARY USE OF NON-DOWNLOADABLE COMPUTER GAMES; ENTERTAINMENT SERVICES, NAMELY, PROVIDING TEMPORARY USE OF NON-DOWNLOADABLE COMPUTER LEARNING GAMES; ENTERTAINMENT SERVICES, NAMELY, PROVIDING TEMPORARY USE OF NON-DOWNLOADABLE ELECTRONIC GAMES; ENTERTAINMENT SERVICES, NAMELY, PROVIDING TEMPORARY USE OF NON-DOWNLOADABLE INTERACTIVE GAMES; ENTERTAINMENT SERVICES, NAMELY, PROVIDING TEMPORARY USE OF NON-DOWNLOADABLE VIDEO GAMES; ENTERTAINMENT SERVICES, NAMELY, PROVIDING VIDEO PODCASTS IN THE FIELD OF TEACHING CHINESE; ENTERTAINMENT SERVICES, NAMELY, PROVIDING WEBCASTS IN THE FIELD OF REACHING CHINESE (U.S. CLS. 100, 101 AND 107).

DORITT L. CARROLL, EXAMINING ATTORNEY

SN 85-874,838. GARY AND MARY WEST HEALTH INSTITUTE, LA JOLLA, CA. FILED 3-13-2013.

# WESTECH

THE MARK CONSISTS OF STANDARD CHARACTERS WITHOUT CLAIM TO ANY PARTICULAR FONT, STYLE, SIZE, OR COLOR.



**CLASS 35—ADVERTISING AND BUSINESS**

FOR BUSINESS COLLABORATION SERVICES, NAMELY, OUTPATIENT CARE COORDINATION SUPPORT IN THE FIELD OF HEALTH CARE; RESEARCH AND ENGAGEMENT CONSULTATION IN THE FIELD OF DEVELOPING RELATIONSHIPS AND COLLABORATIONS FOR INDIVIDUALS AND ENTITIES ENGAGED IN THE HEALTH CARE INDUSTRY TO, AMONG OTHER THINGS, FACILITATE THE CREATION, PROMOTION, AND SHARING OF IDEAS, ANALYSIS, INNOVATIVE STRATEGIES, COST MANAGEMENT TECHNIQUES, PROVIDER INTEGRATION STRUCTURES, NEW CARE METHODS, AND INNOVATIVE RELATIONSHIPS BETWEEN HEALTH CARE PRODUCT AND SERVICE PROVIDERS (U.S. CLS. 100, 101 AND 102).

**CLASS 42—SCIENTIFIC AND COMPUTER SERVICES**

FOR PROVIDING TECHNOLOGICAL INFORMATION REGARDING DEVELOPMENT OF AUTOMATED CARE COORDINATION GUIDANCE FOR USE IN THE FIELDS OF MEDICINE, THE PREVENTION, TREATMENT AND MANAGEMENT OF CHRONIC DISEASE; SCIENTIFIC STUDY AND APPLIED TECHNOLOGICAL RESEARCH IN THE FIELDS OF MEDICINE, THE PREVENTION, TREATMENT AND MANAGEMENT OF CHRONIC DISEASE, EMERGING AND CURRENT HEALTH CARE DELIVERY MODELS, AND THE RELATED ASPECTS OF HEALTH CARE POLICY, QUALITY, COST MANAGEMENT, AND CARE DELIVERY FINANCING (U.S. CLS. 100 AND 101).

**CLASS 44—MEDICAL, BEAUTY AND AGRICULTURAL SERVICES**

FOR THINK TANK SERVICES, NAMELY, PROVIDING NEW IDEAS AND CONCEPTS, RESEARCH, AND CONSULTATION SERVICES IN THE FIELD OF HEALTH CARE; PROVISION OF HEALTH CARE AND MEDICAL SERVICES BY HEALTH CARE PROFESSIONALS VIA THE INTERNET OR TELECOMMUNICATIONS NETWORKS IN CONJUNCTION WITH A HEALTH CARE PROVIDER OR HOSPITAL (U.S. CLS. 100 AND 101).

RAMONA ORTIGA, EXAMINING ATTORNEY

SN 85-875,052. ZUMTOBEL LIGHTING GMBH, LEMGO, FED REP GERMANY, FILED 3-13-2013.

SWARMCONTROL

THE MARK CONSISTS OF STANDARD CHARACTERS WITHOUT CLAIM TO ANY PARTICULAR FONT, STYLE, SIZE, OR COLOR.

PRIORITY CLAIMED UNDER SEC. 44(D) ON ERPNCMNTY TM OFC APPLICATION NO. 011275369, FILED 10-4-2012, REG. NO. 011275369, DATED 3-4-2013, EXPIRES 10-4-2022.

**CLASS 9—ELECTRICAL AND SCIENTIFIC APPARATUS**

FOR ELECTRIC AND ELECTRONIC CONTROL DEVICES FOR THE OPERATION OF LIGHTING INSTALLATIONS AND LIGHTS, NAMELY, SMALL TRANSFORMERS, CHOKES, CONDENSERS, RECTIFIERS, RELAYS, OHMIC RESISTANCES; ELECTRIC AND ELECTRONIC EQUIPMENT FOR THE OPERATION OF LIGHT-EMITTING DIODES AND ELECTROLUMINESCENT FILM, NAMELY, BALLASTS AND IGNITION DEVICES FOR FLUORESCENT LAMPS; ELECTRONIC SWITCHING DEVICES FOR OPERATING LIGHT DIODES; LIGHT DIODES (U.S. CLS. 21, 23, 26, 36 AND 38).

**CLASS 11—ENVIRONMENTAL CONTROL APPARATUS**

FOR LIGHTING INSTALLATIONS, INCLUDING WITH A PLURALITY OF LIGHTS, LIGHTING APPARATUS AND EQUIPMENT AND LIGHTS, NAMELY, ELECTRIC LIGHTING FIXTURES AND LAMPS; LED STANDARD LIGHTS; LIGHT MODULES AND LIGHTS WITH LIGHT EMITTING DIODES AS THE MEANS OF LIGHTING; LIGHT SOURCES INCLUDING LIGHT DIODES, NAMELY, LIGHT EMITTING DIODE LIGHTING FIXTURES (U.S. CLS. 13, 21, 23, 31 AND 34).

**CLASS 42—SCIENTIFIC AND COMPUTER SERVICES**

FOR PLANNING AND DESIGN OF LIGHTING SYSTEMS; COMPUTER PROGRAMMING FOR OTHERS, NAMELY, PROGRAMMING OF COMPUTING ROUTINES FOR ELECTRONIC DATA PROCESSING EQUIPMENT FOR REGULATING LIGHT (U.S. CLS. 100 AND 101).

JACQUELINE ABRAMS, EXAMINING ATTORNEY

SN 85-875,379. CASA LATINA ENTERPRISES, NEW YORK, NY. FILED 3-13-2013.



The logo for CASA Latina features the word "CASA" in a bold, red, serif font, followed by "Latina" in a black, cursive script font. A red dot is placed over the letter "i" in "Latina".

NO CLAIM IS MADE TO THE EXCLUSIVE RIGHT TO USE "LATINA" FOR INTERNATIONAL CLASS 038, APART FROM THE MARK AS SHOWN.

THE COLOR(S) RED AND BLACK IS/ARE CLAIMED AS A FEATURE OF THE MARK.

THE MARK CONSISTS OF THE WORD "CASA" IS A DEEP RED COLOR. THE LETTER "L" IN THE SECOND WORD "LATINA" IS A DEEP RED COLOR. THE LETTERS "ATINA" IN THE SECOND WORD "LATINA" ARE BLACK. THERE IS A DEEP RED COLOR DOT OVER THE "I" IN THE WORD "LATINA".

**CLASS 20—FURNITURE AND ARTICLES NOT OTHERWISE CLASSIFIED**

FOR BATHROOM FURNITURE; BEDROOM FURNITURE; BUFFETS; CABINET DOORS FOR FURNITURE CABINETS; CABINET DRAWERS FOR FURNITURE CABINETS; CABINETS; COMPUTER FURNITURE; CUSHIONS; CUSTOM FURNITURE; DINNER WAGONS; DOORS FOR FURNITURE; DRAFTING TABLES; DRAWERS; ENTERTAINMENT CENTERS; FABRIC SOLD AS AN INTEGRAL COMPONENT OF FINISHED FURNITURE; FITTED FABRIC FURNITURE COVERS; FITTED FABRIC SLIPCOVERS FOR FURNITURE; FITTED FURNITURE COVER NOT OF FABRIC; FLOWER-STANDS; FREESTANDING PARTITIONS; FURNITURE; FURNITURE CHESTS; FURNITURE FITTINGS, NOT OF METAL; FURNITURE FOR HOUSE, OFFICE AND GARDEN; FURNITURE FOR MOTOR HOMES; FURNITURE FRAMES; FURNITURE MADE FROM WOOD OR SUBSTITUTES FOR WOOD; FURNITURE MOLDINGS; FURNITURE OF METAL; FURNITURE PARTITIONS; FURNITURE PRIMARILY OF METAL, NAMELY, MIRRORS, BED FRAMES, DINING TABLES, COFFEE TABLES, END TABLES, DESKS, DISPLAY CASES, SHELVING, DOG GATES, AND BABY GATES; FURNITURE, MIRRORS, PICTURE FRAMES; FURNITURE, NAMELY, DISPLAY UNITS; FURNITURE, NAMELY, DRESSERS; FURNITURE, NAMELY, POUFS; FURNITURE, NAMELY, WALL UNITS; FURNITURE, NAMELY, WARDROBES; FUTONS; HEAD-RESTS; INDOOR WINDOW BLINDS; KITCHEN FURNITURE, NAMELY, READY TO ASSEMBLE MOBILE KITCHEN ISLANDS; LAMINATED VINYL TO BE AFFIXED TO THE SURFACE OF FURNITURE; LAWN FURNITURE; LIVING ROOM FURNITURE; METAL FURNITURE; METAL FURNITURE AND FURNITURE FOR CAMPING; MIRRORS; OFFICE FURNITURE; OUTDOOR FURNITURE; PATIO FURNITURE; PET FURNITURE; PLASTIC FURNITURE FOR GARDENS; RECLINERS; RESIDENTIAL AND COMMERCIAL FURNITURE; RESIDENTIAL AND COMMERCIAL WROUGHT IRON FURNITURE; SCREENS; SEATING FURNITURE; SEATS; STONE FURNITURE; TABLES; TELEVISION STANDS; TOOL BOXES NOT OF METAL; TOOL CHESTS NOT OF METAL; TOWEL CLOSETS; TOY BOXES; UPHOLSTERED FURNITURE; WASHSTANDS (U.S. CLS. 2, 13, 22, 25, 32 AND 50).

**CLASS 38—COMMUNICATION**

FOR AUDIO AND VIDEO BROADCASTING SERVICES OVER THE INTERNET; AUDIO AND VIDEO BROADCASTING SERVICES OVER THE INTERNET IN THE FIELD OF EDUCATION; AUDIO BROADCASTING; BROADCAST COMMUNICATION SERVICES, NAMELY, TRANSMITTING E-MAILS, FAXES, TEXT MESSAGES AND TELEPHONE VOICE MESSAGES TO DESIGNATED RECIPIENTS FOR OTHERS; BROADCAST OF CABLE TELEVISION PROGRAMMES; BROADCASTING OF RADIO AND TELEVISION PROGRAMMES; BROADCASTING OF RADIO PROGRAMMES; BROADCASTING OF TELEVISION PROGRAMMES; BROADCASTING OF VIDEO AND AUDIO PROGRAMMING OVER THE INTERNET; BROADCASTING OF MOBILE VIDEO PROGRAMS; BROADCASTING PROGRAMS VIA A GLOBAL COMPUTER NETWORK; BROADCASTING SERVICES AND PROVISION OF TELECOMMUNICATION ACCESS TO FILMS AND TELEVISION PROGRAMMES PROVIDED VIA A VIDEO-ON-DEMAND SERVICE; BROADCASTING SERVICES AND PROVISION OF TELECOMMUNICATION ACCESS TO VIDEO AND AUDIO CONTENT PROVIDED VIA A VIDEO-ON-DEMAND SERVICE VIA THE INTERNET; BROADCASTING SERVICES, NAMELY, TRANSMISSION OF ADVERTISING PROGRAMS AND MEDIA ADVERTISING COMMUNICATIONS VIA DIGITAL COMMUNICATIONS NETWORKS; CABLE RADIO BROADCASTING; CABLE TELEVISION BROADCASTING; CABLE TELEVISION BROADCASTING SERVICES; ELECTRONIC TRANSMISSION OF VOICE, DATA AND IMAGES BY TELEVISION AND VIDEO BROADCASTING; INTERNET BROADCASTING SERVICES; INTERNET RADIO BROADCASTING SERVICES; RADIO AND TELEVISION BROADCASTING SERVICES; RADIO AND TELEVISION PROGRAMME BROADCASTING; RADIO BROADCASTING; RADIO BROADCASTING CONSULTATION; RADIO BROADCASTING INFORMATION; RADIO BROADCASTING OF INFORMATION AND OTHER

PROGRAMS; RADIO PROGRAM BROADCASTING; RADIO PROGRAMME BROADCASTING; RENTAL OF EQUIPMENT FOR BROADCASTING; SATELLITE TELEVISION BROADCASTING; SATELLITE TRANSMISSION SERVICES; TELEVISION AND RADIO BROADCASTING SERVICES; SIMULCASTING BROADCAST TELEVISION OVER GLOBAL COMMUNICATION NETWORKS, THE INTERNET AND WIRELESS NETWORKS; SUBSCRIPTION TELEVISION BROADCASTING; TELEVISION AND RADIO BROADCASTING SERVICES; TELEVISION BROADCASTING CONSULTATION; TELEVISION BROADCASTING INFORMATION; TELEVISION PROGRAMME BROADCASTING; TELEVISION PROGRAMME BROADCASTING VIA CABLE; VIDEO BROADCASTING; VIDEO BROADCASTING AND TRANSMISSION SERVICES VIA THE INTERNET, FEATURING FILMS AND MOVIES; VIDEO BROADCASTING SERVICES OVER THE INTERNET OR OTHER COMMUNICATIONS NETWORK FEATURING THE UPLOADED, POSTED AND TAGGED VIDEOS OF OTHERS; VIDEO BROADCASTING SERVICES OVER THE INTERNET OR OTHER COMMUNICATIONS NETWORK, NAMELY, ELECTRONICALLY TRANSMITTING VIDEO CLIPS; VIDEO BROADCASTING SERVICES VIA THE INTERNET; WIRELESS BROADCASTING (U.S. CLS. 100, 101 AND 104).

FIRST USE 12-4-2008; IN COMMERCE 4-23-2012.  
KALIE KUNG, EXAMINING ATTORNEY

SN 85-875,490. CAPPER, DAVID G., NOVATO, CA. FILED 3-13-2013.

**TOOTH TRACKS**

THE MARK CONSISTS OF STANDARD CHARACTERS WITHOUT CLAIM TO ANY PARTICULAR FONT, STYLE, SIZE, OR COLOR.

NO CLAIM IS MADE TO THE EXCLUSIVE RIGHT TO USE "TRACKS", APART FROM THE MARK AS SHOWN.

**CLASS 9—ELECTRICAL AND SCIENTIFIC APPARATUS**

FOR COMPUTER SOFTWARE FOR PLAYING INTERACTIVE GAMES, ACTION SKILL GAMES, AND LEARNING GAMES IN THE FIELD OF ORAL CARE; INTERACTIVE MULTIMEDIA COMPUTER PROGRAM FOR TEACHING PROPER BRUSHING TECHNIQUES AND ORAL CARE INCORPORATING THE USE OF A TOOTHBRUSH TO DETECT AND TRACK OBJECTS IN AN CONTROL COMPUTERIZED ENVIRONMENT; DOWNLOADABLE ELECTRONIC GAMES VIA THE INTERNET; INTERACTIVE VIDEO GAME PROGRAMS (U.S. CLS. 21, 23, 26, 36 AND 38).

**CLASS 21—HOUSEWARES AND GLASS**

FOR TOOTHBRUSHES (U.S. CLS. 2, 13, 23, 29, 30, 33, 40 AND 50).

**CLASS 42—SCIENTIFIC AND COMPUTER SERVICES**

FOR COMPUTER SERVICES, NAMELY, PROVIDING TEMPORARY USE OF ONLINE NON-DOWNLOADABLE COMPUTER SOFTWARE FOR PLAYING INTERACTIVE GAMES, ACTION SKILL GAMES, AND LEARNING GAMES IN THE FIELD OF ORAL CARE; INTERACTIVE MULTIMEDIA COMPUTER PROGRAM FOR TEACHING PROPER BRUSHING TECHNIQUES AND ORAL CARE INCORPORATING THE USE OF A TOOTHBRUSH TO DETECT AND TRACK OBJECTS IN AN CONTROL COMPUTERIZED ENVIRONMENT; COMPUTER SERVICES, NAMELY, PROVIDING TEMPORARY USE OF ONLINE NON-DOWNLOADABLE ELECTRONIC GAMES VIA THE INTERNET; COMPUTER SERVICES, NAMELY, PROVIDING TEMPORARY USE OF ONLINE NON-DOWNLOADABLE INTERACTIVE VIDEO GAME PROGRAMS (U.S. CLS. 100 AND 101).

STEPHANIE ALI, EXAMINING ATTORNEY

SN 85-877,297. TOYO SHINYAKU CO., LTD., FUKUOKA-SHI, FUKUOKA, JAPAN, FILED 3-15-2013.

フラバンジェノール

PRIORITY CLAIMED UNDER SEC. 44(D) ON JAPAN APPLICATION NO. 2013-015371, FILED 3-5-2013, REG. NO. 5596160, DATED 7-5-2013, EXPIRES 7-5-2023.

OWNER OF JAPAN REG. NO. 5544517, DATED 12-21-2012, EXPIRES 12-21-2022.

THE MARK CONSISTS OF KATAKANA CHARACTERS. THE NON-LATIN CHARACTERS IN THE MARK TRANSLITERATE TO "FLAVANGENOL" AND THIS HAS NO MEANING IN A FOREIGN LANGUAGE.

**CLASS 1—CHEMICALS**

FOR INDUSTRIAL CHEMICALS; CHEMICALS FOR USE IN THE MANUFACTURE OF COSMETIC PRODUCTS; CHEMICALS FOR USE IN THE MANUFACTURE OF SUPPLEMENTS; CHEMICALS FOR USE IN THE MANUFACTURE OF FOODS AND BEVERAGES; INDUSTRIAL CHEMICALS, NAMELY, PINE BARK EXTRACTS FOR INDUSTRIAL USE; POLYPHENOL FOR INDUSTRIAL USE; PROANTHOCYANIDIN FOR INDUSTRIAL USE; OLIGOMERIC PROANTHOCYANIDIN FOR INDUSTRIAL USE; CHEMICALS MADE FROM POWERED RAW MATERIALS PROCESSED FROM PINE BARK EXTRACTS USED AS RAW MATERIALS FOR FOODS, COSMETICS, SUPPLEMENTS; DRY POWDER CHEMICALS MADE FROM PINE BARK EXTRACT COMPONENTS USED AS RAW MATERIALS FOR FOODS, COSMETICS, SUPPLEMENTS; INDUSTRIAL CHEMICALS, NAMELY, POWDERED PINE BARK EXTRACTS USED AS RAW MATERIALS FOR FOODS, COSMETICS, SUPPLEMENTS; PLANT GROWTH REGULATING PREPARATIONS; FERTILIZERS; FATTY ACIDS FOR USE IN THE MANUFACTURE OF FOODS, COSMETICS AND FOOD SUPPLEMENTS; CHEMICAL TEST PAPER; ARTIFICIAL SWEETENERS; FLOUR AND STARCH FOR INDUSTRIAL PURPOSES (U.S. CLS. 1, 5, 6, 10, 26 AND 46).

**CLASS 3—COSMETICS AND CLEANING PREPARATIONS**

FOR COSMETICS; SOAPS AND DETERGENTS (U.S. CLS. 1, 4, 6, 50, 51 AND 52).

**CLASS 5—PHARMACEUTICALS**

FOR DIETARY AND NUTRITIONAL SUPPLEMENTS CONTAINING PINE BARK EXTRACTS; DIETARY AND NUTRITIONAL SUPPLEMENTS; VITAMIN SUPPLEMENTS (U.S. CLS. 6, 18, 44, 46, 51 AND 52).

**CLASS 32—LIGHT BEVERAGES**

FOR BEAUTY BEVERAGES, NAMELY, SOFT DRINKS AND NON-ALCOHOLIC FRUIT JUICE BEVERAGES CONTAINING POLYPHENOL OR COLLAGEN; NON-ALCOHOL BEVERAGES, NAMELY, SOFT DRINKS AND FRUIT JUICE BEVERAGES; PREPARATIONS FOR MAKING BEVERAGE, NAMELY, CARBONATED SOFT DRINKS, VEGETABLE JUICES, NON-ALCOHOLIC FRUIT JUICE BEVERAGES AND WHEY BEVERAGES; GREEN JUICE BEVERAGES NAMELY, YOUNG SWEET POTATO LEAF JUICES; PREPARATIONS FOR MAKING YOUNG SWEET POTATO LEAF JUICES; GREEN JUICE BEVERAGES, NAMELY, YOUNG BARLEY LEAF JUICES AND KALE JUICES; PREPARATIONS FOR MAKING YOUNG BARLEY LEAF JUICES; PREPARATIONS FOR MAKING KALE JUICES (U.S. CLS. 45, 46 AND 48).

CHRISTINE MARTIN, EXAMINING ATTORNEY

SN 85-878,499. FROSTIE BOTTOM TREESTANDS, LLC, DBA (DOING BUSINESS AS), CLAREMONT, NC. FILED 3-18-2013.

**FROSTIE BOTTOM**  
**treestands**

NO CLAIM IS MADE TO THE EXCLUSIVE RIGHT TO USE "TREESTANDS", APART FROM THE MARK AS SHOWN.

THE MARK CONSISTS OF THE WORDING "FROSTIE BOTTOM" IN CAPITAL, WITH STYLIZED FROST AT THE BOTTOM OF EACH LETTER. THE WORDING "TREESTANDS" IN LOWER-CASED FONT BELOW AND RIGHT CENTERED FROM THE WORDING "FROSTIE" BOTTOM.

**CLASS 20—FURNITURE AND ARTICLES NOT OTHERWISE CLASSIFIED**

FOR PORTABLE FOLDING STADIUM SEATS (U.S. CLS. 2, 13, 22, 25, 32 AND 50).  
FIRST USE 3-1-2013; IN COMMERCE 3-1-2013.

**CLASS 28—TOYS AND SPORTING GOODS**

FOR TREESTANDS FOR HUNTING HAVING A CONSTRUCTION THAT MECHANICALLY JOINS THE COMPONENTS OF THE STAND TOGETHER FOR A SECURED CONNECTION (U.S. CLS. 22, 23, 38 AND 50).  
FIRST USE 3-1-2013; IN COMMERCE 3-1-2013.  
JAY FLOWERS, EXAMINING ATTORNEY

SN 85-879,360. GURUCOOL LEARNING LLC, RICHMOND, TX. FILED 3-18-2013.

# GuruCool

THE MARK CONSISTS OF STANDARD CHARACTERS WITHOUT CLAIM TO ANY PARTICULAR FONT, STYLE, SIZE, OR COLOR.

## CLASS 9—ELECTRICAL AND SCIENTIFIC APPARATUS

FOR COMPUTER SOFTWARE FEATURING EDUCATIONAL COMPUTER LESSONS IN THE FIELD OF ENGLISH, MATH, SCIENCE AND SOCIAL STUDIES, PRACTICE STUDY QUESTIONS, STUDY DRILLS, PROBLEMS; COMPUTER GAME SOFTWARE FOR USE ON MOBILE AND CELLULAR PHONES AND ELECTRONIC DEVICES, HANDHELD AND PORTABLE DEVICES, DESKTOP COMPUTERS, INTERNET BROWSERS, GAMING DEVICES, AND ANY PROGRAMMABLE COMPUTER DEVICE; SERIES OF DOWNLOADABLE WORKSHEETS IN THE FIELD OF K-12 EDUCATION IN THE FIELD OF ENGLISH, MATH, SCIENCE AND SOCIAL STUDIES (U.S. CLS. 21, 23, 26, 36 AND 38).

FIRST USE 7-1-1999; IN COMMERCE 7-1-1999.

## CLASS 16—PAPER GOODS AND PRINTED MATTER

FOR A SERIES OF WORKSHEETS AND WORKBOOKS IN THE FIELD OF K-12 EDUCATION, NAMELY, FEATURING INFORMATION IN THE FIELDS OF MATH, SCIENCE, LANGUAGES, SOCIAL STUDIES, HISTORY, LANGUAGE AND ART (U.S. CLS. 2, 5, 22, 23, 29, 37, 38 AND 50).

FIRST USE 7-1-1999; IN COMMERCE 7-1-1999.

## CLASS 41—EDUCATION AND ENTERTAINMENT

FOR EDUCATION SERVICES, NAMELY, PROVIDING TUTORING IN THE FIELD OF K-12 EDUCATION SUBJECTS, NAMELY, ENGLISH, MATH, SCIENCE AND SOCIAL STUDIES; ENTERTAINMENT SERVICES, NAMELY, PROVIDING ON-LINE COMPUTER CLASSES FEATURING LESSONS, PRACTICE STUDY QUESTIONS, STUDY DRILLS, PROBLEMS, AND GAMES IN THE FIELD OF K-12 EDUCATION SUBJECTS, NAMELY, ENGLISH, MATH, SCIENCE AND SOCIAL STUDIES (U.S. CLS. 100, 101 AND 107).

FIRST USE 7-1-1999; IN COMMERCE 7-1-1999.

ANDREA K. NADELMAN, EXAMINING ATTORNEY

SN 85-879,913. BANK OF MONTREAL, TORONTO, ONTARIO, CANADA, FILED 3-19-2013.

# BMO NESBITT BURNS 360° WEALTH SOLUTIONS

THE MARK CONSISTS OF STANDARD CHARACTERS WITHOUT CLAIM TO ANY PARTICULAR FONT, STYLE, SIZE, OR COLOR.

OWNER OF U.S. REG. NOS. 2,615,684, 3,422,953 AND OTHERS.

NO CLAIM IS MADE TO THE EXCLUSIVE RIGHT TO USE "WEALTH SOLUTIONS", APART FROM THE MARK AS SHOWN.

THE NAME(S), PORTRAIT(S), AND/OR SIGNATURE(S) SHOWN IN THE MARK DOES NOT IDENTIFY A PARTICULAR LIVING INDIVIDUAL.

## CLASS 35—ADVERTISING AND BUSINESS

FOR ADVISORY SERVICES IN THE FIELD OF TAX PLANNING (U.S. CLS. 100, 101 AND 102).

## CLASS 36—INSURANCE AND FINANCIAL

FOR BANKING SERVICES; FINANCIAL SERVICES, NAMELY, INVESTMENT ADVISOR SERVICES, FINANCIAL ADVISORY SERVICES IN THE AREAS OF INVESTMENTS, PORTFOLIO MANAGEMENT, FINANCIAL PLANNING, INSURANCE, ESTATE PLANNING, CASH MANAGEMENT SERVICES, FINANCIAL TRUSTS, AND CHARITABLE MONETARY AND PLANNED GIVING (U.S. CLS. 100, 101 AND 102).

KIMBERLY FRYE, EXAMINING ATTORNEY

SN 85-880,393. CONOPCO, INC., ENGLEWOOD CLIFFS, NJ. FILED 3-19-2013.



THE MARK CONSISTS OF THE WORD "PITCH" IN STYLIZED LETTERING WITH A DESIGN ELEMENT OVER THE LETTER "I" CONSISTING OF TWO INTERCONNECTED SPEECH BALLOONS.

## CLASS 41—EDUCATION AND ENTERTAINMENT

FOR EDUCATION AND TRAINING IN THE FIELD OF PERSONAL CARE IN THE FIELDS OF BEAUTY, COSMETICS AND PERSONAL HYGIENE (U.S. CLS. 100, 101 AND 107).

## CLASS 42—SCIENTIFIC AND COMPUTER SERVICES

FOR RESEARCH, DEVELOPMENT AND INNOVATION, NAMELY, DESIGN, TESTING AND ENGINEERING IN THE FIELD OF PERSONAL CARE (U.S. CLS. 100 AND 101).

HENRY S. ZAK, EXAMINING ATTORNEY

SN 85-880,397. CONOPCO, INC., ENGLEWOOD CLIFFS, NJ.  
FILED 3-19-2013.

SN 85-882,208. NOVOGOMA LTD., SLIEMA, MALTA, FILED  
3-21-2013.

# PITCH

THE MARK CONSISTS OF STANDARD CHARACTERS WITHOUT CLAIM TO ANY PARTICULAR FONT, STYLE, SIZE, OR COLOR.

## CLASS 41—EDUCATION AND ENTERTAINMENT

FOR EDUCATION AND TRAINING IN THE FIELD OF PERSONAL CARE IN THE FIELDS OF BEAUTY, COSMETICS AND PERSONAL HYGIENE (U.S. CLS. 100, 101 AND 107).

## CLASS 42—SCIENTIFIC AND COMPUTER SERVICES

FOR RESEARCH, DEVELOPMENT AND INNOVATION, NAMELY, DESIGN, TESTING AND ENGINEERING IN THE FIELD OF PERSONAL CARE (U.S. CLS. 100 AND 101).

HENRY S. ZAK, EXAMINING ATTORNEY

SN 85-880,697. SIGNATURE FOOD MARKETING, LLC,  
PENDERGRASS, GA. FILED 3-20-2013.

# SIGNATURE PICK 5

THE MARK CONSISTS OF STANDARD CHARACTERS WITHOUT CLAIM TO ANY PARTICULAR FONT, STYLE, SIZE, OR COLOR.

## CLASS 29—MEATS AND PROCESSED FOODS

FOR PROCESSED FROZEN POTATOES, FRENCH FRIES, SEASONED POTATO WEDGES, SWEET POTATO FRIES, FROZEN CHICKEN, NAMELY, CHICKEN STRIPS, GRILLED CHICKEN BREAST FILLETS, BONELESS CHICKEN BREASTS, CHICKEN WINGS, CHICKEN PATTIES, CHICKEN TENDERS, CHICKEN NUGGETS, AND CHICKEN FRIES, FROZEN BEEF PATTIES, SALMON CROQUETTES, PORK CHOPS, SHRIMP, NOT LIVE, CRAB CAKES, MEATBALLS, ONION RINGS, CORN DOGS, PORK RIBLETS, FROZEN VEGETABLES, PRESERVED PEAS, FROZEN MIXED VEGETABLES, PROCESSED OKRA, PROCESSED LIMA BEANS, PROCESSED COLLARD GREENS, PROCESSED BROCCOLI, PRESERVED PURPLE HULL PEAS, PROCESSED GREEN BEANS, PROCESSED TURNIP GREENS, AND PROCESSED YAM PATTIES (U.S. CL. 46).

FIRST USE 6-0-2006; IN COMMERCE 6-0-2006.

## CLASS 30—STAPLE FOODS

FOR PROCESSED CORN, PROCESSED CORN-ON-THE-COB (U.S. CL. 46).

FIRST USE 1-0-2010; IN COMMERCE 1-0-2010.  
DAVID MURRAY, EXAMINING ATTORNEY

# BLACK PEARL CASINO

THE MARK CONSISTS OF STANDARD CHARACTERS WITHOUT CLAIM TO ANY PARTICULAR FONT, STYLE, SIZE, OR COLOR.

NO CLAIM IS MADE TO THE EXCLUSIVE RIGHT TO USE "CASINO", APART FROM THE MARK AS SHOWN.

## CLASS 9—ELECTRICAL AND SCIENTIFIC APPARATUS

FOR COMPUTER GAME PROGRAMS; COMPUTER GAME PROGRAMS DOWNLOADABLE VIA THE INTERNET; COMPUTER GAME SOFTWARE; COMPUTER GAME SOFTWARE FOR GAMING MACHINES INCLUDING SLOT MACHINES OR VIDEO LOTTERY TERMINALS; COMPUTER GAME SOFTWARE FOR PERSONAL COMPUTERS AND HOME VIDEO GAME CONSOLES; COMPUTER GAME SOFTWARE FOR USE ON MOBILE AND CELLULAR PHONES; COMPUTER SOFTWARE PLATFORMS FOR SOCIAL NETWORKING; COMPUTER SOFTWARE TO ENABLE UPLOADING, POSTING, SHOWING, DISPLAYING, TAGGING, BLOGGING, SHARING OR OTHERWISE PROVIDING ELECTRONIC MEDIA OR INFORMATION IN THE FIELDS OF VIRTUAL COMMUNITIES, ELECTRONIC GAMING, ENTERTAINMENT, AND GENERAL INTEREST VIA THE INTERNET OR OTHER COMMUNICATIONS NETWORKS WITH THIRD PARTIES; INTERACTIVE MULTIMEDIA COMPUTER GAME PROGRAM; VISUAL RECORDINGS AND AUDIOVISUAL RECORDINGS FEATURING MUSIC AND ANIMATION; COMPUTER CURSOR CONTROL DEVICES, NAMELY, DIGITIZER TABLETS; TABLET COMPUTER; MOBILE TELEPHONES; SOFTWARE FOR USE WITH GAMES, ENTERTAINMENT, RECREATIONAL, AMUSEMENT, GAMING AND VIDEO GAME TERMINALS, MACHINES AND APPARATUS, NAMELY, SOFTWARE FOR INTERACTIVE SCRATCH CARDS AND SCRATCH CARD GAMES; COMPUTER SOFTWARE PLATFORMS FOR COMPUTER SOFTWARE PROGRAMS RUNNING ON, OR IN CONNECTION WITH, MOBILE DEVICES (U.S. CLS. 21, 23, 26, 36 AND 38).

## CLASS 41—EDUCATION AND ENTERTAINMENT

FOR PROVIDING TEMPORARY USE OF NON-DOWNLOADABLE INTERACTIVE, MULTIPLAYER AND SINGLE PLAYER GAMES; PROVIDING AN INTERNET WEBSITE PORTAL IN THE FIELD OF COMPUTER GAMES AND GAMING; ENTERTAINMENT SERVICES, NAMELY, PROVIDING VIRTUAL ENVIRONMENTS IN WHICH USERS CAN INTERACT THROUGH SOCIAL GAMES FOR RECREATIONAL, LEISURE OR ENTERTAINMENT PURPOSES; PROVIDING A WEB-BASED SYSTEM AND ON-LINE PORTAL FOR CUSTOMERS TO PLAY ONLINE COMPUTER AND ELECTRONIC GAMES; INFORMATION RELATING TO ONLINE COMPUTER GAMES; PROVIDING A COMPUTER GAME THAT MAY BE ACCESSED NETWORK-WIDE BY NETWORK USERS; PROVISION OF GAMING SERVICES BY MEANS OF A COMPUTER BASED SYSTEM; PROVIDING TEMPORARY USE OF NON-DOWNLOADABLE INTERNET GAMES; ENTERTAINMENT, GAMING AND GAME SERVICES, NAMELY, PROVIDING ONLINE ELECTRONIC GAMES, CONDUCTING LIVE TOURNAMENTS OF CARD GAMES; PROVIDING GAMES ONLINE, NAMELY, INTERACTIVE SCRATCH CARDS AND SCRATCH CARD GAMES BY WIRELESS, MOBILE PHONE, TELEPHONE, TELEVISION, INTERNET OR BY REMOTE OR NETWORK COMMUNICATION; LOTTERY SERVICES; CASINO AND LOTTERY GAMING SERVICES, NAMELY, PRIZE DRAWS, SLOTS, TABLE GAMES, KENO GAMES, BINGO GAMES, CARD GAMES; GAMING SERVICES, NAMELY, CASINO GAM-

ING; PROVIDING ONLINE ELECTRONIC GAMES; ENTERTAINMENT IN THE NATURE OF QUIZ SHOWS AND ELECTRONIC GAMING COMPETITIONS PROVIDED BY MEANS OF THE INTERNET OR ON-LINE FROM A COMPUTER NETWORK OR DATABASE; PROVIDING ONLINE REVIEWS OF COMPUTER GAMES, AND PROVIDING OF INFORMATION RELATING TO COMPUTER GAMES; ENTERTAINMENT SERVICES IN THE NATURE OF RECORDING, PRODUCTION AND POST-PRODUCTION SERVICES IN THE FIELD OF ONLINE GAMES AND NON-DOWNLOADABLE INTERACTIVE GAMES; SPECIAL EFFECTS ANIMATION SERVICES FOR FILM, VIDEO AND COMPUTER GAMES; PROVIDING ON-LINE NON-DOWNLOADABLE INTERACTIVE GAMING SOFTWARE, AND A WEBSITE FEATURING ON-LINE NON-DOWNLOADABLE INTERACTIVE GAMING SOFTWARE (U.S. CLS. 100, 101 AND 107).

SN 85-882.324. INGENUITY SUN MEDIA LLC, RANDOLPH, NJ. FILED 3-21-2013.



#### **CLASS 42—SCIENTIFIC AND COMPUTER SERVICES**

FOR DESIGN AND DEVELOPMENT OF COMPUTER GAME SOFTWARE, DESIGNING AND DEVELOPING COMPUTER GAME SOFTWARE AND VIDEO GAME SOFTWARE FOR USE WITH COMPUTERS, VIDEO GAME PROGRAM SYSTEMS AND COMPUTER NETWORKS; COMPUTER SERVICES, NAMELY, HOSTING AN INTERACTIVE WEB SITE FEATURING TECHNOLOGY THAT ALLOWS USERS TO PARTICIPATE IN ONLINE GAMES; COMPUTER PROGRAMMING OF COMPUTER GAMES; COMPUTER GRAPHICS DESIGN SERVICES, DESIGN AND DEVELOPMENT OF COMPUTER SOFTWARE AND GRAPHIC ARTS; COMPUTER SERVICES, NAMELY, ELECTRONIC DIGITIZING OF VISUAL MATERIAL INTO COMPUTER READABLE MEDIA, NAMELY, PHOTOGRAPHIC IMAGES, ARTWORK, AND PAINTINGS; COMPUTER SERVICES, NAMELY, CREATING AN ON-LINE VIRTUAL ENVIRONMENT FOR ELECTRONIC SLOT MACHINES, ELECTRONIC INSTANT CARD GAMES AND SCRATCH CARD GAMES; PROVIDING VIRTUAL COMPUTER SYSTEMS AND VIRTUAL COMPUTER ENVIRONMENTS THROUGH CLOUD COMPUTING; COMPUTER SERVICES, NAMELY, INTERACTIVE HOSTING SERVICES WHICH ALLOW THE USER TO PUBLISH AND SHARE THEIR OWN CONTENT AND IMAGES ONLINE; DESIGN AND DEVELOPMENT OF MULTIMEDIA PRODUCTS, PROGRAMMING OF MULTIMEDIA APPLICATIONS; HOSTING WEBSITES ON THE INTERNET; CREATION, DESIGN, DEVELOPMENT AND MAINTENANCE OF WEBSITES FOR THIRD PARTIES; HOSTING INTERNET SITES FOR THIRD PARTIES; COMPUTER SERVICES, NAMELY, CREATING AN ON-LINE COMMUNITY FOR REGISTERED USERS TO PARTICIPATE IN COMPETITIONS, SHOWCASE THEIR SKILLS, GET FEEDBACK FROM THEIR PEERS, FORM VIRTUAL COMMUNITIES, AND ENGAGE IN SOCIAL NETWORKING; PROVIDING TEMPORARY USE OF NON-DOWNLOADABLE SOFTWARE FOR USE IN CONNECTION WITH INTERACTIVE, MULTIPLAYER AND SINGLE PLAYER GAMES; PROVIDING A WEB HOSTING PLATFORM FOR USE OF NON-DOWNLOADABLE SOFTWARE IN CONNECTION WITH INTERACTIVE, MULTIPLAYER AND SINGLE PLAYER GAMES FOR THIRD PARTIES; DESIGN OF SCRATCH CARDS AND ELECTRONIC SCRATCH CARDS AND SCRATCH CARD GAMES (U.S. CLS. 100 AND 101).

ELI HELLMAN, EXAMINING ATTORNEY

NO CLAIM IS MADE TO THE EXCLUSIVE RIGHT TO USE "SUN MEDIA", APART FROM THE MARK AS SHOWN.

THE MARK CONSISTS OF A RECTANGULAR BOX AT THE BOTTOM OF WHICH ARE THE WORDS "INGENUITY SUN MEDIA"; ABOVE THE WORDS AND WITHIN THE RECTANGLE IN THE BACKGROUND ARE A SERIES OF LINES ARRANGED TO REPRESENT A SUNBURST; SUPERIMPOSED UPON THESE LINES ARE TWO CRESCENT-SHAPED LINES WHICH MEET AT THEIR PINCHED POINT AND WITHIN THE TWO LINES IS A CIRCLE SUCH THAT THE DESIGN GIVES THE IMPRESSION OF A HUMAN EYE WITH THE CIRCLE MEANT TO REPRESENT THE IRIS.

#### **CLASS 9—ELECTRICAL AND SCIENTIFIC APPARATUS**

FOR SOLAR POWER-ASSISTED DIGITAL SIGNAGE (U.S. CLS. 21, 23, 26, 36 AND 38).

#### **CLASS 35—ADVERTISING AND BUSINESS**

FOR DEVELOPMENT, OPERATION AND ADMINISTRATION OF SOLAR POWERED DIGITAL SIGNAGE SYSTEMS AND DIGITAL ADVERTISING SYSTEMS FOR OTHERS, NAMELY, PROVIDING ADVERTISING SPACE BY ELECTRONIC MEANS AND GLOBAL COMPUTER INFORMATION NETWORKS; PROMOTING THE GOODS OF OTHERS, NAMELY, PROVIDING INFORMATION REGARDING DISCOUNTS, COUPONS, REBATES, VOUCHERS AND SPECIAL OFFERS FOR THE GOODS OF OTHERS (U.S. CLS. 100, 101 AND 102).

#### **CLASS 37—CONSTRUCTION AND REPAIR**

FOR INSTALLATION AND MAINTENANCE OF SOLAR-POWERED DIGITAL SIGNAGE (U.S. CLS. 100, 103 AND 106).

#### **CLASS 38—COMMUNICATION**

FOR DIGITAL TRANSMISSION OF EMERGENCY INFORMATION AND ALERTS VIA SOLAR POWERED DIGITAL SIGNAGE (U.S. CLS. 100, 101 AND 104).

#### **CLASS 40—MATERIAL TREATMENT**

FOR CUSTOM MANUFACTURE OF OUTDOOR LED AND LCD DIGITAL SCREENS (U.S. CLS. 100, 103 AND 106).

**CLASS 42—SCIENTIFIC AND COMPUTER SERVICES**

FOR CUSTOM DESIGN AND ENGINEERING OF SOLAR-POWERED DIGITAL SIGNAGE; COMPUTER NETWORK CONFIGURATION SERVICES; COMPUTER SERVICES, NAMELY, IMPLEMENTATION OF A DIGITAL COMPUTER NETWORK ACROSS MULTIPLE SYSTEMS AND LOCATIONS FOR OTHERS; INTEGRATION OF COMPUTER SOFTWARE INTO MULTIPLE SYSTEMS, NETWORKS AND LOCATIONS; INTEGRATION OF COMPUTER SYSTEMS AND NETWORKS; PROVIDING PLANNING AND ENGINEERING SERVICES IN THE FIELD OF INFORMATION AND COMMUNICATIONS NETWORKS (U.S. CLS. 100 AND 101).

WENDY GOODMAN, EXAMINING ATTORNEY

SN 85-883,351. NANO TECH CO., LTD., CHUNGCHEONGBUK-DO, REPUBLIC OF KOREA, FILED 3-22-2013.



PRIORITY CLAIMED UNDER SEC. 44(D) ON REPUBLIC OF KOREA APPLICATION NO. 402012-72802, FILED 11-23-2012, REG. NO. 40-0996959, DATED 9-25-2013, EXPIRES 9-25-2023.

PRIORITY CLAIMED UNDER SEC. 44(D) ON REPUBLIC OF KOREA APPLICATION NO. 402012-72801, FILED 11-23-2012, REG. NO. 40-0989385, DATED 8-19-2013, EXPIRES 8-19-2023.

PRIORITY CLAIMED UNDER SEC. 44(D) ON REPUBLIC OF KOREA APPLICATION NO. 402012-72803, FILED 11-23-2012, REG. NO. 0987818, DATED 8-9-2013, EXPIRES 8-9-2023.

PRIORITY CLAIMED UNDER SEC. 44(D) ON REPUBLIC OF KOREA APPLICATION NO. 40-2012-0072, FILED 11-23-2012, REG. NO. 402012-72802, DATED 9-25-2013, EXPIRES 9-25-2023.

NO CLAIM IS MADE TO THE EXCLUSIVE RIGHT TO USE "NANO TOOLS", APART FROM THE MARK AS SHOWN.

THE COLOR(S) GREEN, WHITE AND BLACK IS/ARE CLAIMED AS A FEATURE OF THE MARK.

THE MARK CONSISTS OF A WHITE LETTER "N" WITHIN A GREEN CIRCLE, A WHITE SYMBOL "&" WITHIN AN OVERLAPPING PART OF TWO GREEN CIRCLES, A WHITE LETTER "T" WITHIN ANOTHER GREEN CIRCLE, AND THE WORDS OF "NANO TOOLS" IN BLACK APPEARING NEXT TO IT.

**CLASS 1—CHEMICALS**

FOR CEMENTED CARBIDE POWDER FOR USE IN THE MANUFACTURE OF CEMENTED CARBIDE TOOLS (U.S. CLS. 1, 5, 6, 10, 26 AND 46).

**CLASS 6—METAL GOODS**

FOR CEMENTED CARBIDE METAL ALLOY POWDER; TUNGSTEN POWDER; COBALT POWDER; TUNGSTEN HEAVY ALLOY; CEMENTED CARBIDE METAL ALLOY; TUNGSTEN IRON; STEEL ALLOYS; ALLOYED IRON (U.S. CLS. 2, 12, 13, 14, 23, 25 AND 50).

**CLASS 7—MACHINERY**

FOR MACHINE TOOLS, NAMELY, POWERED MACHINES FOR CUTTING OR SHAPING OR FINISHING METALS OR OTHER MATERIALS; MACHINES AND MACHINE TOOLS FOR THE CUTTING AND FORMING OF MATERIALS; CEMENTED CARBIDE CUTTING TOOLS; POWER TOOLS, NAMELY, END MILLS; SHEARING MACHINES FOR METALWORKING; CUTTING MACHINES FOR METALWORKING; INDUSTRIAL MACHINE PRESS; GRINDING MACHINES FOR METALWORKING; MACHINES, NAMELY, CRUSHERS FOR INDUSTRIAL APPLICATIONS; BALL MILL; POWER TOOLS, NAMELY, INSERTS (U.S. CLS. 13, 19, 21, 23, 31, 34 AND 35).

**CLASS 9—ELECTRICAL AND SCIENTIFIC APPARATUS**

FOR RARE EARTH MAGNETS; MAGNETIC CORES; CATHODES; ANODES; ELECTRIC SOCKETS; MAGNETS FOR INDUSTRIAL PURPOSES (U.S. CLS. 21, 23, 26, 36 AND 38).

**CLASS 35—ADVERTISING AND BUSINESS**

FOR EXPORT AND IMPORT AGENCIES; PROCUREMENT, NAMELY, PURCHASING MECHANICAL TOOLS, MECHANICAL APPARATUS AND METALLIC MATERIALS FOR OTHERS; MARKETING SERVICES; COMMERCIAL INFORMATION AGENCIES; WHOLESALE STORE SERVICES FEATURING MECHANICAL TOOLS AND APPARATUS; RETAIL STORE SERVICES FEATURING MECHANICAL TOOLS AND APPARATUS; WHOLESALE STORE SERVICES FEATURING METALLIC MATERIALS; RETAIL STORE SERVICES FEATURING METALLIC MATERIALS (U.S. CLS. 100, 101 AND 102).

NAKWAMA ANKRAH, EXAMINING ATTORNEY

SN 85-883,431. ARATANA THERAPEUTICS, INC., KANSAS CITY, KS. FILED 3-22-2013.



NO CLAIM IS MADE TO THE EXCLUSIVE RIGHT TO USE "THERAPEUTICS", APART FROM THE MARK AS SHOWN.

THE COLOR(S) RED, WHITE AND BLACK IS/ARE CLAIMED AS A FEATURE OF THE MARK.

THE MARK CONSISTS OF A RED SQUARE WITH A WHITE "X" APPEARING THEREIN AND THE WORD "ARATANA" APPEARING IN BLACK DIRECTLY TO THE RIGHT, WITH THE "R" AND "A" OVERLAPPING TO FORM AN "X" AND THE WORD "THERAPEUTICS" IN RED APPEARING DIRECTLY UNDER "ARATANA".

**CLASS 5—PHARMACEUTICALS**

FOR VETERINARY PHARMACEUTICAL PREPARATIONS FOR THE TREATMENT OF ALLERGIES, ANEMIA, BEHAVIORAL DISORDERS, BONE DISEASES AND DISORDERS, CACHEXIA, CANCER, CARDIOVASCULAR DISEASE, EYE DISEASES AND CONDITIONS, DENTAL DISEASES, DIABETES, EPILEPSY, GASTROINTESTINAL DISEASES AND DISORDERS, HORMONAL DISORDERS, INAPPETENCE, INFECTIOUS DISEASES, KIDNEY DISEASES, RESPIRATORY DISEASES AND DISORDERS, OBESITY, PANCREATITIS, PAIN, AND URINARY TRACT DISORDERS IN CATS, DOGS, AND HORSES (U.S. CLS. 6, 18, 44, 46, 51 AND 52).

**CLASS 40—MATERIAL TREATMENT**

FOR MANUFACTURING SERVICES FOR OTHERS IN THE FIELD OF VETERINARY PHARMACEUTICALS (U.S. CLS. 100, 103 AND 106).

**CLASS 42—SCIENTIFIC AND COMPUTER SERVICES**

FOR RESEARCH AND DEVELOPMENT IN THE FIELD OF VETERINARY PHARMACEUTICALS (U.S. CLS. 100 AND 101).

ELI HELLMAN, EXAMINING ATTORNEY

SN 85-883,900. IBRANDS LIMITED, MONTE CARLO, MONACO, FILED 3-22-2013.

SN 85-883,666. WITHINGS INC., SAN FRANCISCO, CA. FILED 3-22-2013.



NO CLAIM IS MADE TO THE EXCLUSIVE RIGHT TO USE "HEALTH", APART FROM THE MARK AS SHOWN.

THE COLOR(S) MAGENTA, ORANGE, GREEN, BLUE, GREY, AND WHITE IS/ARE CLAIMED AS A FEATURE OF THE MARK.

THE MARK CONSISTS OF A BUTTERFLY DESIGN IN WHICH THE UPPER PORTION OF THE LEFT WING IS MAGENTA AND THE LOWER PORTION IS BLUE AND THE UPPER PORTION OF THE RIGHT WING IS ORANGE AND THE LOWER PORTION IS GREEN. THE HEAD AND BODY OF THE BUTTERFLY ARE GREY AND THE BUTTERFLY DESIGN IS SUPERIMPOSED ON A WHITE AND GRAY RECTANGULAR CARRIER. THE WORDING "HEALTH MATE" IN BLUE LETTERS APPEARS TO THE RIGHT OF THE BUTTERFLY AND RECTANGULAR CARRIER.

#### CLASS 9—ELECTRICAL AND SCIENTIFIC APPARATUS

FOR COMPUTER SOFTWARE FOR PROVIDING ONLINE, MOBILE AND DIGITAL HEALTH AND WELLNESS INFORMATION FOR CONSUMERS, PATIENTS AND CAREGIVERS; HEALTH MONITORING SYSTEM COMPRISED OF ELECTRIC SENSORS, MOBILE TELEPHONES, ELECTRONIC COMPUTER HARDWARE AND COMPUTER SOFTWARE THAT READS AND TRANSMITS DATA TO AND FROM ELECTRIC SENSORS AND FACILITATES COMMUNICATIONS BETWEEN CONSUMERS, PATIENTS AND CAREGIVERS (U.S. CLS. 21, 23, 26, 36 AND 38).

#### CLASS 38—COMMUNICATION

FOR PROVIDING ONLINE, MOBILE AND DIGITAL HEALTH AND MEDICAL INFORMATION FOR CONSUMERS, PATIENTS AND CAREGIVERS IN THE FIELD OF MEDICAL AND HEALTH PRODUCTS, NAMELY, TRANSMISSION OF HEALTH AND MEDICAL INFORMATION BY ELECTRONIC COMMUNICATIONS NETWORKS, HEALTH AND MEDICAL INFORMATION TRANSMISSION SERVICES VIA DIGITAL NETWORKS (U.S. CLS. 100, 101 AND 104).

#### CLASS 42—SCIENTIFIC AND COMPUTER SERVICES

FOR SCIENTIFIC AND TECHNOLOGICAL SERVICES, NAMELY, PROVIDING SCIENTIFIC ANALYSIS AND SCIENTIFIC TESTING IN THE WELLNESS AND MEDICAL FIELDS; DESIGN AND DEVELOPMENT OF COMPUTER SOFTWARE IN THE WELLNESS AND MEDICAL FIELDS (U.S. CLS. 100 AND 101).

#### CLASS 44—MEDICAL, BEAUTY AND AGRICULTURAL SERVICES

FOR PROVIDING ONLINE, MOBILE AND DIGITAL HEALTH AND MEDICAL INFORMATION FOR CONSUMERS, PATIENTS AND CAREGIVERS IN THE FIELD OF MEDICAL AND HEALTH SERVICES AND PRODUCTS (U.S. CLS. 100 AND 101).

HAI-LY LAM, EXAMINING ATTORNEY

# MAXIMPACT

THE MARK CONSISTS OF STANDARD CHARACTERS WITHOUT CLAIM TO ANY PARTICULAR FONT, STYLE, SIZE, OR COLOR.

OWNER OF U.S. REG. NO. 4,355,366.

#### CLASS 9—ELECTRICAL AND SCIENTIFIC APPARATUS

FOR PROVIDING DOWNLOADABLE MAGAZINES, BOOKS, BROCHURES AND REPORTS IN THE FIELDS OF FINANCE AND INVESTMENTS ONLINE (U.S. CLS. 21, 23, 26, 36 AND 38).

#### CLASS 16—PAPER GOODS AND PRINTED MATTER

FOR PRINTED MAGAZINES, BOOKS, BROCHURES AND REPORTS IN THE FIELDS OF FINANCE AND INVESTMENTS (U.S. CLS. 2, 5, 22, 23, 29, 37, 38 AND 50).

#### CLASS 36—INSURANCE AND FINANCIAL

FOR PROVIDING AN INTERNET WEBSITE FEATURING FINANCIAL AND INVESTMENT INFORMATION (U.S. CLS. 100, 101 AND 102).

#### CLASS 41—EDUCATION AND ENTERTAINMENT

FOR PROVIDING A WEBSITE FEATURING RESOURCES, NAMELY, NON-DOWNLOADABLE PUBLICATIONS IN THE NATURE OF MAGAZINES, BOOKS, BROCHURES AND REPORTS IN THE FIELDS OF FINANCE AND INVESTMENTS; PROVIDING NON-DOWNLOADABLE MAGAZINES, BOOKS, BROCHURES AND REPORTS IN THE FIELDS OF FINANCE AND INVESTMENTS ONLINE (U.S. CLS. 100, 101 AND 107).

#### CLASS 42—SCIENTIFIC AND COMPUTER SERVICES

FOR PROVIDING AN INTERNET-BASED INTERACTIVE PORTAL THAT PROVIDES USERS THE ABILITY TO SHARE AND COLLABORATE ON FINANCIAL AND INVESTMENT MATTERS; APPLICATION SERVICE PROVIDER (ASP) FEATURING NON-DOWNLOADABLE SOFTWARE FOR USE IN ONLINE COLLABORATION AND DOCUMENT SHARING IN THE FIELDS OF FINANCE AND INVESTMENT (U.S. CLS. 100 AND 101).

GENE MACIOL, EXAMINING ATTORNEY

SN 85-885,002. HA MING TSE, BURLINGAME, CA. FILED 3-25-2013.



THE COLOR(S) GOLD, RED, GREEN IS/ARE CLAIMED AS A FEATURE OF THE MARK.



THE MARK CONSISTS OF THE WORDING "XIANG JU" AND CHINESE CHARACTERS IN A STYLIZED FONT IN GOLD AND A DESIGN THAT CONSISTS OF DAISIES IN RED AND GREEN. THE WORDING "XIANG JU" APPEARS 10 TIMES IN THE FORM OF A CIRCLE AROUND THE DAISIES.

THE ENGLISH TRANSLATION OF "XIANG JU" IN THE MARK IS "CHRYSANTHEMUM".

THE NON-LATIN CHARACTERS IN THE MARK TRANSLITERATE TO "XIANG JU" AND THIS MEANS "CHRYSANTHEMUM" IN ENGLISH.

#### **CLASS 29—MEATS AND PROCESSED FOODS**

FOR STICK DRIED BEAN CURD; PIECE DRIED BEAN CURD (U.S. CL. 46).

FIRST USE 6-4-2004; IN COMMERCE 6-4-2004.

#### **CLASS 30—STAPLE FOODS**

FOR GLUTEN ADDITIVES FOR CULINARY PURPOSES (U.S. CL. 46).

FIRST USE 6-4-2004; IN COMMERCE 6-4-2004.  
RENEE MCCRAY, EXAMINING ATTORNEY

#### **CLASS 20—FURNITURE AND ARTICLES NOT OTHERWISE CLASSIFIED**

FOR FURNITURE, NAMELY, BEDS, CHAIRS, COUCHES, BENCHES, OTTOMANS, LOVE SEATS, SOFAS, SLEEPER SOFAS, BEDS, DAYBEDS, CRIBS, DRESSERS, NIGHTSTANDS, CHAISE LOUNGES, LOUNGE CHAIRS, SIDE CHAIRS, ARM CHAIRS, DINING CHAIRS, BEAN BAG CHAIRS, COFFEE TABLES, SIDE TABLES, CONSOLE TABLES, DINING TABLES, OCCASIONAL TABLES, BABY CHANGING TABLES, BABY CHANGING MATS, BOOKCASES, FURNITURE CHESTS, ARMOIRES, DESKS, SIDEBOARDS, CABINETS, MEDIA CABINETS, AND TRAVELLING TRUNKS FOR USE AS TABLES; PEDESTALS; STOOLS; NON-METAL STEP STOOLS; OUTDOOR FURNITURE; FITTED FABRIC FURNITURE COVERS; CUSHIONS; PILLOWS; FLOOR PILLOWS; BED PILLOWS; BOLSTERS; MATTRESSES; MATTRESS TOPPERS, NAMELY, FEATHER BEDS; KNEELERS FOR GARDENING; SLEEPING BAGS; BASSINETS; BATHROOM FURNITURE, NAMELY, MIRRORS, CABINETS, WASHSTANDS, MEDICINE CABINETS, CUPBOARDS, SHELVING, VANITIES, ETAGERES, TOWEL STANDS, BATH STOOLS, BATH CARTS, SHOWER CURTAIN RODS; PICTURE FRAMES; BULLETIN BOARDS; DRESSMAKER'S DUMMIES; DRAPERY HARDWARE, NAMELY, CURTAIN RODS, CURTAIN HOOKS AND FINIALS; WINDOW SHADES; WALL DECOR, NAMELY, SHELVING AND MIRRORS; COAT RACKS; MAGAZINE RACKS; TOWEL RACKS; LUGGAGE RACKS IN THE NATURE OF FURNITURE; WINE RACKS; DISPLAY RACKS; METAL RACKS FOR STORING FIREWOOD; DECORATIVE BOXES MADE OF WOOD; WOOD GARDEN AND HOUSEHOLD ORNAMENTS; DECORATIVE WOOD PANELS; CAST RESIN GARDEN AND HOUSEHOLD ORNAMENTS; DRAWER PULLS OF GLASS, PORCELAIN, AND EARTHENWARE; AND NON-METALLIC PLANT MARKERS (U.S. CLS. 2, 13, 22, 25, 32 AND 50).

DAVID C. REIHNER, EXAMINING ATTORNEY

SN 85-885,863. RESTORATION HARDWARE, INC., CORTE MADERA, CA. FILED 3-25-2013.

SN 85-887,429. ASSURITY RIVER GROUP, INC., MINNEAPOLIS, MN. FILED 3-27-2013.

#### **BEYOND THE CHECKMARK**

THE MARK CONSISTS OF STANDARD CHARACTERS WITHOUT CLAIM TO ANY PARTICULAR FONT, STYLE, SIZE, OR COLOR.

#### **CLASS 35—ADVERTISING AND BUSINESS**

FOR DISASTER RECOVERY SERVICES, NAMELY, BUSINESS PLANNING AND BUSINESS CONTINUITY CONSULTING (U.S. CLS. 100, 101 AND 102).

FIRST USE 12-16-2012; IN COMMERCE 12-16-2012.

#### **CLASS 42—SCIENTIFIC AND COMPUTER SERVICES**

FOR CONSULTING SERVICES IN THE FIELD OF COMPUTER-BASED INFORMATION SYSTEMS; COMPUTER SECURITY CONSULTANCY, NAMELY, PROVIDING SECURITY ASSESSMENTS OF COMPUTER, NETWORKS, INTERNET, AND INFORMATION SYSTEMS; ASSESSMENT OF SECURITY MEASURES FOR COMPUTER-BASED INFORMATION SYSTEMS; TESTING OF SECURITY MEASURES FOR COMPUTER BASED INFORMATION SYSTEMS TO ASSURE COMPLIANCE WITH APPLICABLE REGULATIONS AND/OR INDUSTRY STANDARDS; PLANNING SECURITY MEASURES OF COMPUTER-BASED INFORMATION SYSTEMS (U.S. CLS. 100 AND 101).

FIRST USE 12-16-2012; IN COMMERCE 12-16-2012.

THE MARK CONSISTS OF STANDARD CHARACTERS WITHOUT CLAIM TO ANY PARTICULAR FONT, STYLE, SIZE, OR COLOR.

#### **CLASS 19—NON-METALLIC BUILDING MATERIALS**

FOR BUILDING MATERIALS, NAMELY, NON-METAL COUNTERTOPS FOR FURTHER INSTALLATION (U.S. CLS. 1, 12, 33 AND 50).

RH

**CLASS 45—PERSONAL AND LEGAL SERVICES**

FOR SECURITY INSPECTION SERVICES FOR OTHERS, NAMELY, REVIEWING STANDARDS AND PRACTICES TO ASSURE COMPLIANCE WITH INFORMATION SYSTEMS SECURITY LAWS AND REGULATION (U.S. CLS. 100 AND 101).

FIRST USE 12-16-2012; IN COMMERCE 12-16-2012.  
GENE MACIOL, EXAMINING ATTORNEY

SN 85-887,513. SORTIMO INTERNATIONAL AUSRÜSTUNGSSYSTEME FÜR SERVICEFAHRZEUGE GMBH, ZUSMARSHAUSEN, FED REP GERMANY, FILED 3-27-2013.

# HD-SHELL

THE MARK CONSISTS OF STANDARD CHARACTERS WITHOUT CLAIM TO ANY PARTICULAR FONT, STYLE, SIZE, OR COLOR.

PRIORITY CLAIMED UNDER SEC. 44(D) ON ERP CMNTY TM OFC APPLICATION NO. 011549029, FILED 2-6-2013, REG. NO. 011549029, DATED 6-17-2013, EXPIRES 2-6-2023.

**CLASS 6—METAL GOODS**

FOR CONTAINERS OF METAL FOR SMALL PARTS AND TOOLS (U.S. CLS. 2, 12, 13, 14, 23, 25 AND 50).

**CLASS 12—VEHICLES**

FOR TRANSPORT TRUCKS, PLASTIC TUBS AND PARTITIONS FOR MOTOR VEHICLES WHICH ARE SPECIALLY ADAPTED FOR USE ONLY IN A MOTOR VEHICLE (U.S. CLS. 19, 21, 23, 31, 35 AND 44).

**CLASS 20—FURNITURE AND ARTICLES NOT OTHERWISE CLASSIFIED**

FOR CONTAINERS WHOLLY OR PARTLY OF PLASTIC FOR SMALL PARTS AND TOOLS, NAMELY, TOOL BOXES PRIMARILY MADE OF PLASTIC; TOOL CUPBOARDS (U.S. CLS. 2, 13, 22, 25, 32 AND 50).

SANI KHOURI, EXAMINING ATTORNEY

SN 85-887,941. GOLDWIN INC., TOYAMA-KEN, JAPAN, FILED 3-27-2013.



THE MARK CONSISTS OF OF AN AMPERSAND SIGN SIMULATING A DUCK.

**CLASS 18—LEATHER GOODS**

FOR LEATHER AND IMITATIONS OF LEATHER; ANIMAL SKINS AND HIDES; TRUNKS; TRAVELING BAGS; UMBRELLAS, PARASOLS AND WALKING STICKS; WHIPS, HARNESS AND SADDLERY; PURSES; BACKPACKS; RUCKSACKS; POCKET WALLET; HANDBAGS; VANITY CASES, NOT FITTED; KEY-CASES OF LEATHER; BAGS FOR SPORTS; GOLF UMBRELLAS; TRAVELLING CASES FOR GOLF SHOES (U.S. CLS. 1, 2, 3, 22 AND 41).

**CLASS 25—CLOTHING**

FOR SUITS; JACKETS; SKIRTS; TROUSERS; COATS; SHIRTS; PAJAMAS; UNDERWEAR; UNDERPANTS; UNDERSHIRTS; PANTS; BRASSIERES; CAMISOLES; SOCKS; STOCKINGS; TIGHTS; SCARVES; CAPS IN THE NATURE OF HEADWEAR; GLOVES; BELTS; FOOTWEAR; HEADWEAR; INSOLES; SPORTS SHIRTS; SPORTS PANTS; SPORTS JACKETS; GOLF TROUSERS; GOLF SHIRTS; GOLF SKIRTS; GOLF SHOES; CASES FITTED FOR GOLF SHOES (U.S. CLS. 22 AND 39).

**CLASS 28—TOYS AND SPORTING GOODS**

FOR GOLF BAGS WITH OR WITHOUT WHEELS; GOLF GLOVES (U.S. CLS. 22, 23, 38 AND 50).

LINDA POWELL, EXAMINING ATTORNEY

SN 85-889,608. RT FISHER EDUCATIONAL ENTERPRISES, INC., OAKLAND, CA. FILED 3-28-2013.

## R. T. Fisher Educational Enterprises, Inc.

THE MARK CONSISTS OF STANDARD CHARACTERS WITHOUT CLAIM TO ANY PARTICULAR FONT, STYLE, SIZE, OR COLOR.

NO CLAIM IS MADE TO THE EXCLUSIVE RIGHT TO USE "EDUCATIONAL ENTERPRISES, INC.", APART FROM THE MARK AS SHOWN.

"ROBYN T. FISHER" IDENTIFIES A LIVING INDIVIDUAL WHOSE CONSENT IS OF RECORD.

**CLASS 16—PAPER GOODS AND PRINTED MATTER**

FOR EDUCATIONAL PUBLICATIONS, NAMELY, BOOKS, WORKBOOKS AND HANDOUTS IN THE FIELDS OF K-12 EDUCATION, CULTURALLY RELEVANT K-12 CURRICULUM, TEST PREPARATION AND TEACHER TRAINING; PADFOLIO AND NOTEBOOKS (U.S. CLS. 2, 5, 22, 23, 29, 37, 38 AND 50).

FIRST USE 1-1-1999; IN COMMERCE 1-1-1999.

**CLASS 25—CLOTHING**

FOR T-SHIRTS; SWEATSHIRTS; POLO SHIRTS; DRESS SHIRTS (U.S. CLS. 22 AND 39).

FIRST USE 1-1-1999; IN COMMERCE 1-1-1999.

**CLASS 35—ADVERTISING AND BUSINESS**

FOR CONDUCTING PUBLIC OUTREACH IN THE NATURE OF PROMOTING PUBLIC AWARENESS OF THE NEED FOR K-12 TEACHER TRAINING AND CULTURALLY RELEVANT K-12 CURRICULUM; CONDUCTING PUBLIC OUTREACH IN THE NATURE OF ORGANIZING VOLUNTEER AND COMMUNITY SERVICE IN THE FIELD OF K-12 TEACHER TRAINING AND CULTURALLY RELEVANT K-12 CURRICULUM (U.S. CLS. 100, 101 AND 102).

FIRST USE 1-1-1999; IN COMMERCE 1-1-1999.

**CLASS 41—EDUCATION AND ENTERTAINMENT**

FOR PROVIDING EDUCATIONAL PROGRAMS FOR CHILDREN IN GRADES K-12; CONSULTATION IN THE FIELD OF K-12 EDUCATIONAL SYSTEMS; CONSULTATION SERVICES IN THE FIELD OF DEVELOPING CURRICULUM FOR TEACHERS; CONSULTATION SERVICES IN THE FIELD OF PROFESSIONAL DEVELOPMENT AS IT RELATES TO CAREER AND EDUCATIONAL COUNSELING; EDUCATIONAL SERVICES IN THE NATURE OF PROVIDING PROFESSIONAL DEVELOPMENT THROUGH CLASSES, SEMINARS, AND WORKSHOPS IN THE FIELD OF CAREER AND EDUCATIONAL COUNSELING, PROVIDING TRAINING SERVICES IN THE FIELD OF PROFESSIONAL DEVELOPMENT FOR K-12 TEACHERS, AND DEVELOPING CURRICULUM FOR TEACHERS; EDUCATIONAL SERVICES, NAMELY, DEVELOPING, ARRANGING AND CONDUCTING EDUCATIONAL CONFERENCES AND PROGRAMS AND PROVIDING COURSES OF INSTRUCTION IN THE FIELD OF K-12 TEACHER TRAINING AND CULTURALLY RELEVANT K-12 CURRICULUM; PROVIDING CONTINUING PROFESSIONAL EDUCATIONAL COURSES OF INSTRUCTION IN THE FIELD OF K-12 TEACHER TRAINING AND CULTURALLY RELEVANT K-12 CURRICULUM; CONDUCTING PUBLIC OUTREACH IN THE NATURE OF CONDUCTING SEMINARS, CLASSES, AND WORKSHOPS IN THE FIELD OF K-12 TEACHER TRAINING AND CULTURALLY RELEVANT K-12 CURRICULUM; PROVIDING INFORMATION, NEWS AND COMMENTARY IN THE FIELD OF CURRENT EVENTS RELATING TO K-12 TEACHER TRAINING AND CULTURALLY RELEVANT K-12 CURRICULUM (U.S. CLS. 100, 101 AND 107).

FIRST USE 1-1-1999; IN COMMERCE 1-1-1999.  
MEREDITH MARESCA, EXAMINING ATTORNEY

---

SN 85-889,639. UTICA COFFEE ROASTING COMPANY, UTICA, NY. FILED 3-28-2013.

## Wake the Hell Up!

THE MARK CONSISTS OF STANDARD CHARACTERS WITHOUT CLAIM TO ANY PARTICULAR FONT, STYLE, SIZE, OR COLOR.

**CLASS 30—STAPLE FOODS**

FOR ARTIFICIAL COFFEE; BEVERAGES MADE OF COFFEE; CHOCOLATE COVERED ROASTED COFFEE BEANS; COFFEE; COFFEE BEANS; GROUND COFFEE BEANS; PREPARED COFFEE AND COFFEE-BASED BEVERAGES; ROASTED COFFEE BEANS; SUGAR-COATED COFFEE BEANS (U.S. CL. 46).

FIRST USE 6-0-2011; IN COMMERCE 6-0-2011.

**CLASS 32—LIGHT BEVERAGES**

FOR BOTTLED DRINKING WATER; BOTTLED WATER (U.S. CLS. 45, 46 AND 48).

FIRST USE 6-0-2011; IN COMMERCE 6-0-2011.  
LOURDES AYALA, EXAMINING ATTORNEY

SN 85-890,036. SPAULDING & ASSOCIATES INC., BRIGHTON, MI. FILED 3-29-2013.

OWNER OF U.S. REG. NO. 3,318,080.

THE MARK CONSISTS OF THE WORD "VITORRI!" IN A SERIF FONT CONTAINING A CAPITAL LETTER "V", WHICH CONTINUES OVER THE MIDDLE OF THE WORD. THE REST OF THE WORD IS IN LOWERCASE LETTERS AND THERE IS AN EXCLAMATION POINT AT THE END. "VITORRI!" APPEARS WITH AN UNDERLINE ON AN ASYMMETRICAL ARC STARTING LOWER ON THE LEFT SIDE OF THE MARK. THE UNDERLINE IS UNEVEN IN THICKNESS.

SEC. 2(F).

**CLASS 29—MEATS AND PROCESSED FOODS**

FOR (BASED ON USE IN COMMERCE) CHEESE (BASED ON INTENT TO USE) CANNED VEGETABLES; MEAT (U.S. CL. 46).

FIRST USE 8-2-2002; IN COMMERCE 8-2-2002.

**CLASS 30—STAPLE FOODS**

FOR (BASED ON INTENT TO USE) PASTA (U.S. CL. 46).

CHRIS WELLS, EXAMINING ATTORNEY

---

SN 85-890,576. BURRUS, DANIEL, HARTLAND, WI. FILED 3-29-2013.

## Daniel Burrus

THE MARK CONSISTS OF STANDARD CHARACTERS WITHOUT CLAIM TO ANY PARTICULAR FONT, STYLE, SIZE, OR COLOR.

OWNER OF U.S. REG. NO. 3,744,517.

THE NAME(S), PORTRAIT(S), AND/OR SIGNATURE(S) SHOWN IN THE MARK IDENTIFIES "DANIEL BURRUS", WHOSE CONSENT(S) TO REGISTER IS MADE OF RECORD.

**CLASS 16—PAPER GOODS AND PRINTED MATTER**

FOR BOOKS IN THE FIELD OF BUSINESS STRATEGY, INNOVATION, AND FUTURISM (U.S. CLS. 2, 5, 22, 23, 29, 37, 38 AND 50).

FIRST USE 1-1-1983; IN COMMERCE 1-1-1983.

**CLASS 41—EDUCATION AND ENTERTAINMENT**

FOR EDUCATIONAL AND ENTERTAINMENT SERVICES, NAMELY, PROVIDING MOTIVATIONAL SPEAKING SERVICES IN THE FIELD OF BUSINESS STRATEGY, INNOVATION, AND FUTURISM; TRAINING SERVICES IN THE FIELD OF BUSINESS STRATEGY, INNOVATION, AND FUTURISM (U.S. CLS. 100, 101 AND 107).

FIRST USE 1-1-1983; IN COMMERCE 1-1-1983.

ELIZABETH JACKSON, EXAMINING ATTORNEY

RECREATION, TOURISM AND TRAVEL; SOUVENIR PROGRAMS CONCERNING RECREATION, TOURISM, AND TRAVEL EVENTS, LOCATIONS, AND PLACES; STICKERS; TRAVEL BOOKS; TRAVEL GUIDES; VOUCHER BOOKS; AND 3D DECALS FOR USE ON ANY SURFACE (U.S. CLS. 2, 5, 22, 23, 29, 37, 38 AND 50).

**CLASS 35—ADVERTISING AND BUSINESS**

FOR PROMOTING RECREATION AND TOURISM IN NORTH CAROLINA (U.S. CLS. 100, 101 AND 102).

DOMINICK J. SALEMI, EXAMINING ATTORNEY

SN 85-890,786. NC DEPARTMENT OF COMMERCE, RALEIGH, NC. FILED 3-29-2013.

SN 85-891,708. GAIJIN ENTERTAINMENT CORPORATION, ALEXANDRIA, VA. FILED 4-1-2013.



NO CLAIM IS MADE TO THE EXCLUSIVE RIGHT TO USE "NORTH CAROLINA" AND THE GEOGRAPHICAL REPRESENTATION OF THE STATE OF NORTH CAROLINA, APART FROM THE MARK AS SHOWN.

THE MARK CONSISTS OF THE TERMS "NORTH CAROLINA" WITH A LEAF IN BETWEEN THE TERMS "NORTH" AND "CAROLINA". THE SHADOW OF THE LEAF FORMS THE SHAPE OF THE STATE OF NORTH CAROLINA INCLUDING THE OUTER BANKS BELOW THE WRITTEN WORD "CAROLINA".

**CLASS 16—PAPER GOODS AND PRINTED MATTER**

FOR PRINTED MATERIALS IN THE FIELD OF TOURISM, NAMELY, ADVERTISING PAMPHLETS; ADVERTISING SIGNS OF PAPER; ADVERTISING SIGNS OF CARDBOARD; AGENDAS; ANNOUNCEMENT CARDS; ATLASES; BANNERS OF PAPER; BINDERS; BOOKMARKS; BOOKS IN THE FIELD OF RECREATIONAL, TOURISM, AND TRAVEL EVENTS, LOCATIONS, AND PLACES; BROCHURES; BUSINESS CARDS; BUSINESS FORMS; BUMPER STICKERS; CALENDARS; CITY DIRECTORIES; CLIP BOARDS; COASTERS MADE OF PAPER; COASTERS MADE OF CARDBOARD; COFFEE TABLE BOOKS FEATURING RECREATION, TOURISM AND TRAVEL; COLORING BOOKS; COMMEMORATIVE BOOKS FEATURING RECREATION, TOURISM AND TRAVEL; COOK BOOKS; COUPONS; COUPON BOOKS; DECALS; DIRECTORIES OF RECREATIONAL, TOURISM AND TRAVEL EVENTS, LOCATIONS, AND PLACES; DOCUMENT HOLDERS; ENTRY TICKETS; ENVELOPES; EVENT PROGRAMS; FABRIC GIFT BAGS; FRAMED ART PRINTS; GIFT BAGS; GUIDE BOOKS FEATURING INFORMATION ABOUT RECREATION, TOURISM, AND TRAVEL EVENTS, LOCATIONS, AND PLACES; INFORMATION AND PROFILE SHEETS; INFORMATIONAL FLYERS FEATURING RECREATION, TOURISM AND TRAVEL; INVITATION CARDS; LEAFLETS ABOUT RECREATIONAL, TOURISM AND TRAVEL EVENTS, LOCATIONS, AND PLACES; LETTERHEAD PAPER; MAGAZINES, MAGAZINE COLUMNS AND MAGAZINE SECTIONS FEATURING ARTICLES PROMOTING RECREATION, TOURISM, AND TRAVEL; MAPS; NEWSLETTERS IN THE FIELD OF RECREATION, TOURISM, AND TRAVEL EVENTS, LOCATIONS, AND PLACES; NOTEBOOKS; PAMPHLETS IN THE FIELD OF RECREATION, TOURISM AND TRAVEL; POSTCARDS; POSTERS; PRINT ADVERTISING BOARDS OF PAPER; PRINT ADVERTISING BOARDS OF CARDBOARD; PRINTED GUIDES FOR RECREATION, TOURISM AND TRAVEL; PRINTED INFORMATIONAL CARDS IN THE FIELD OF RECREATION, TOURISM AND TRAVEL; PRINTED INVITATIONS; PRINTED MATTER, NAMELY, PAPER SIGNS, BOOKS, MANUALS, CURRICULA, NEWSLETTERS, INFORMATIONAL CARDS AND BROCHURES IN THE FIELD OF

**战争雷霆**

OWNER OF U.S. REG. NO. 4,310,168.

THE MARK CONSISTS OF FOUR SIMPLIFIED MANDARIN HIEROGLYPHICS, TRANSLATED AS "WAR THUNDER" AND READING AS "ZHANZHENGLEITING".

THE NON-LATIN CHARACTERS IN THE MARK TRANSLITERATE TO "ZHANZHENGLEITING" AND THIS MEANS "WAR THUNDER" IN ENGLISH.

**CLASS 9—ELECTRICAL AND SCIENTIFIC APPARATUS**

FOR ENTERTAINMENT MULTIMEDIA COMPUTER GAME PROGRAMS AND COMPUTER GAME SOFTWARE, NAMELY, ELECTRONIC GAME PROGRAMS; COMPUTER GAME PROGRAMS; INTERACTIVE MULTIMEDIA GAME PROGRAMS; DOWNLOADABLE ELECTRONIC GAME PROGRAMS; ELECTRONIC GAME SOFTWARE; DOWNLOADABLE COMPUTER GAME SOFTWARE; COMPUTER GAME SOFTWARE CONTAINED ON DIGITAL MEDIA, NAMELY, ON CDS, CD-ROMS, DVDS, BLUE-LASER-READABLE DISCS, AND INTERACTIVE CD ROMS FOR USE WITH PERSONAL COMPUTERS, BLUE-LASER DISC PLAYERS, HOME VIDEO GAME CONSOLES AND USED WITH TELEVISIONS, HAND HELD PORTABLE DEVICES, MOBILE DEVICES, AND MULTIMEDIA DEVICES, AND USED FOR ARCADE-BASED VIDEO GAME CONSOLES; COMPUTER GAME DISCS FEATURING INTERACTIVE VIDEO, COMPUTER GAMES AND INTERACTIVE GAME SOFTWARE; USER DOCUMENTATION SOLD AS A UNIT THEREWITH (U.S. CLS. 21, 23, 26, 36 AND 38).

**CLASS 41—EDUCATION AND ENTERTAINMENT**

FOR ENTERTAINMENT SERVICES, NAMELY, PROVIDING ON-LINE COMPUTER GAMES AND ENTERTAINMENT INFORMATION IN THE FIELD OF GAMES; PROVIDING A WEBSITE FEATURING ELECTRONIC GAME CONTENT, INTERACTIVE GAME CONTENT, AND INFORMATION IN THE FIELDS OF COMPUTER GAMES, VIDEO GAMES, COMPUTER GAMES AND ELECTRONIC GAME ENTERTAINMENT; PROVIDING INFORMATION ON-LINE RELATING TO COMPUTER GAMES AND COMPUTER ENHANCEMENTS FOR GAMES (U.S. CLS. 100, 101 AND 107).

MICHELLE DUBOIS, EXAMINING ATTORNEY

SN 85-891,736. GAIJIN ENTERTAINMENT CORPORATION,  
ALEXANDRIA, VA. FILED 4-1-2013.

戰爭雷霆

OWNER OF U.S. REG. NO. 4,310,168.  
THE MARK CONSISTS OF FOUR TRADITIONAL MANDARIN HIEROGLYPHICS, TRANSLATED INTO "WAR THUNDER" AND READING AS "ZHANZHENGLEITING".  
THE NON-LATIN CHARACTERS IN THE MARK TRANSLITERATE TO "ZHANZHENGLEITING" AND THIS MEANS "WAR THUNDER" IN ENGLISH.

#### CLASS 9—ELECTRICAL AND SCIENTIFIC APPARATUS

FOR ENTERTAINMENT MULTIMEDIA COMPUTER GAME PROGRAMS AND COMPUTER GAME SOFTWARE, NAMELY, ELECTRONIC GAME PROGRAMS; COMPUTER GAME PROGRAMS; INTERACTIVE MULTIMEDIA GAME PROGRAMS; DOWNLOADABLE ELECTRONIC GAME PROGRAMS; ELECTRONIC GAME SOFTWARE; DOWNLOADABLE COMPUTER GAME SOFTWARE; COMPUTER GAME SOFTWARE CONTAINED ON DIGITAL MEDIA, NAMELY, ON CDS, CD-ROMS, DVDS, BLUE-LASER-READABLE DISCS, AND INTERACTIVE CD ROMS FOR USE WITH PERSONAL COMPUTERS, BLUE-LASER DISC PLAYERS, HOME VIDEO GAME CONSOLES AND USED WITH TELEVISIONS, HAND HELD PORTABLE DEVICES, MOBILE DEVICES, AND MULTIMEDIA DEVICES, AND USED FOR ARCADE-BASED VIDEO GAME CONSOLES; COMPUTER GAME DISCS FEATURING INTERACTIVE VIDEO, COMPUTER GAMES AND INTERACTIVE GAME SOFTWARE; USER DOCUMENTATION SOLD AS A UNIT THEREWITH (U.S. CLS. 21, 23, 26, 36 AND 38).

#### CLASS 41—EDUCATION AND ENTERTAINMENT

FOR ENTERTAINMENT SERVICES, NAMELY, PROVIDING ON-LINE COMPUTER GAMES AND ENTERTAINMENT INFORMATION IN THE FIELD OF GAMES; PROVIDING A WEBSITE FEATURING ELECTRONIC GAME CONTENT, INTERACTIVE GAME CONTENT, AND INFORMATION IN THE FIELDS OF COMPUTER GAMES, VIDEO GAMES, COMPUTER GAMES AND ELECTRONIC GAME ENTERTAINMENT; PROVIDING INFORMATION ON-LINE RELATING TO COMPUTER GAMES AND COMPUTER ENHANCEMENTS FOR GAMES (U.S. CLS. 100, 101 AND 107).

MICHELLE DUBOIS, EXAMINING ATTORNEY

SN 85-896,672. INOFILE LLC, BOISE, ID. FILED 4-5-2013.

KNO2

THE MARK CONSISTS OF STANDARD CHARACTERS WITHOUT CLAIM TO ANY PARTICULAR FONT, STYLE, SIZE, OR COLOR.

#### CLASS 9—ELECTRICAL AND SCIENTIFIC APPARATUS

FOR COMPUTER SOFTWARE FOR SCANNING, CONTROLLING AND MANAGING PATIENT MEDICAL DOCUMENTATION, IMAGES, AND INFORMATION; COMPUTER SOFTWARE FOR INTEGRATION OF MEDICAL DOCUMENTATION, IMAGES, AND INFORMATION FOR USE IN CLINICAL ENVIRONMENTS, NAMELY, MEDICAL CLINICS, PHYSICIANS' OFFICES, HOSPITALS, AND OTHER LOCATIONS OFFERING MEDICAL CARE; SOFTWARE PLATFORM FOR THE MANAGEMENT AND INTEGRATION OF PATIENT INFORMATION IN MEDICAL AND CLINICAL SETTINGS, NAMELY, DATA, DIGITAL INFORMATION, IMAGES, PHOTOGRAPHS, FILM, VIDEO, FORMS, AND OTHER DOCUMENTATION; COMPUTER HARDWARE AND SOFTWARE SYSTEMS FOR DELIVERING SECURE, ENCRYPTED MESSAGES AND DATA REGARDING MEDICAL AND CLINICAL PATIENT INFORMATION FROM NETWORKED DEVICES, WIRELESS DEVICES, MULTIFUNCTION DEVICES, COPIERS, SCANNERS, FAX MACHINES, TABLETS, SMARTPHONES, MOBILE DEVICES, COMPUTERS AND SERVERS INTO HEALTH INFORMATION EXCHANGE NETWORKS (U.S. CLS. 21, 23, 26, 36 AND 38).

#### CLASS 42—SCIENTIFIC AND COMPUTER SERVICES

FOR PROVIDING TEMPORARY ONLINE USE OF NON-DOWNLOADABLE SOFTWARE FOR INTEGRATION OF DOCUMENTATION, IMAGES, AND INFORMATION IN THE HEALTH CARE FIELD (U.S. CLS. 100 AND 101).

MARK T. MULLEN, EXAMINING ATTORNEY

SN 85-897,694. LA VIVRE CORP., HACKENSACK, NJ. FILED 4-8-2013.

VIE MOLÉCULAIRE

THE MARK CONSISTS OF STANDARD CHARACTERS WITHOUT CLAIM TO ANY PARTICULAR FONT, STYLE, SIZE, OR COLOR.

THE ENGLISH TRANSLATION OF "VIE MOLÉCULAIRE" IN THE MARK IS "MOLECULAR LIFE".

#### CLASS 3—COSMETICS AND CLEANING PREPARATIONS

FOR COSMETICS (U.S. CLS. 1, 4, 6, 50, 51 AND 52).

#### CLASS 5—PHARMACEUTICALS

FOR MEDICATED COSMETICS; AND PHARMACEUTICAL PREPARATIONS, NAMELY, PREPARATIONS FOR TREATING ACNE, ALLERGIES, BURNS, DIARRHEA, FUNGAL INFECTIONS, PAIN, GENERIC HYPERTENSION AND DIABETES; AND MEDICATIONS, NAMELY, ACNE MEDICATIONS, ALLERGY MEDICATIONS, BURN RELIEF MEDICATIONS, DIARRHEA MEDICATIONS, FUNGAL MEDICATIONS, PAIN RELIEF MEDICATIONS, GENERIC HYPERTENSION AND DIABETES MEDICATIONS (U.S. CLS. 6, 18, 44, 46, 51 AND 52).

PRISCILLA MILTON, EXAMINING ATTORNEY

SN 85-897,886. NAWI B.V., 7271 LA BORCULO, NETHERLANDS, FILED 4-8-2013.

SN 85-898,696. ABBVIE BIOTECHNOLOGY LTD., HAMILTON, BERMUDA, FILED 4-9-2013.

## NAWI

THE MARK CONSISTS OF STANDARD CHARACTERS WITHOUT CLAIM TO ANY PARTICULAR FONT, STYLE, SIZE, OR COLOR.

PRIORITY CLAIMED UNDER SEC. 44(D) ON ERPN CMNTY TM OFC APPLICATION NO. 11399318, FILED 12-5-2012, REG. NO. 11399318, DATED 5-2-2013, EXPIRES 12-5-2022.

### CLASS 7—MACHINERY

FOR MACHINES AND ROBOTS FOR SLAUGHTERING ANIMALS; MACHINES AND ROBOTS FOR SKIN REMOVAL OF SLAUGHTERED ANIMALS; MACHINES AND ROBOTS FOR DEBONING OF MEAT; MACHINES AND ROBOTS FOR SAWING AND CUTTING MEAT; CONVEYOR BELTS (U.S. CLS. 13, 19, 21, 23, 31, 34 AND 35).

### CLASS 9—ELECTRICAL AND SCIENTIFIC APPARATUS

FOR WEIGHING APPARATUS (U.S. CLS. 21, 23, 26, 36 AND 38).  
PAUL E. FAHRENKOPF, EXAMINING ATTORNEY

---

SN 85-898,689. ABBVIE BIOTECHNOLOGY LTD., HAMILTON, BERMUDA, FILED 4-9-2013.

## HLINK

THE MARK CONSISTS OF STANDARD CHARACTERS WITHOUT CLAIM TO ANY PARTICULAR FONT, STYLE, SIZE, OR COLOR.

### CLASS 41—EDUCATION AND ENTERTAINMENT

FOR EDUCATIONAL SERVICES, NAMELY, CLASSES, SEMINARS AND WORKSHOPS IN THE FIELD OF TREATMENT OPTIONS FOR IMMUNOLOGICAL DISEASES FOR HEALTHCARE PROFESSIONALS AND PATIENTS (U.S. CLS. 100, 101 AND 107).

### CLASS 42—SCIENTIFIC AND COMPUTER SERVICES

FOR NONDOWNLOADABLE COMPUTER SOFTWARE USED FOR COLLECTING, ORGANIZING, MODIFYING, TRANSMITTING, STORING AND SHARING DATA FOR USE BY HEALTHCARE PROFESSIONALS AND PATIENTS IN THE TREATMENT OF IMMUNOLOGICAL DISEASES (U.S. CLS. 100 AND 101).  
PAULA MAHONEY, EXAMINING ATTORNEY

## HUMIRALINK

THE MARK CONSISTS OF STANDARD CHARACTERS WITHOUT CLAIM TO ANY PARTICULAR FONT, STYLE, SIZE, OR COLOR.

OWNER OF U.S. REG. NOS. 2,725,934, 3,784,305 AND 3,785,794.

### CLASS 41—EDUCATION AND ENTERTAINMENT

FOR EDUCATIONAL SERVICES, NAMELY, CLASSES, SEMINARS AND WORKSHOPS IN THE FIELD OF TREATMENT OPTIONS FOR IMMUNOLOGICAL DISEASES FOR HEALTHCARE PROFESSIONALS AND PATIENTS (U.S. CLS. 100, 101 AND 107).

### CLASS 42—SCIENTIFIC AND COMPUTER SERVICES

FOR NONDOWNLOADABLE COMPUTER SOFTWARE USED FOR COLLECTING, ORGANIZING, MODIFYING, TRANSMITTING, STORING AND SHARING DATA FOR USE BY HEALTHCARE PROFESSIONALS AND PATIENTS IN THE TREATMENT OF IMMUNOLOGICAL DISEASES (U.S. CLS. 100 AND 101).  
PAULA MAHONEY, EXAMINING ATTORNEY

---

SN 85-898,934. GATEWAY REHABILITATION CENTER, PITTSBURGH, PA. FILED 4-9-2013.

## IMPROVING OUTCOMES. INSPIRING INNOVATION. BUILDING EXPERTISE.

THE MARK CONSISTS OF STANDARD CHARACTERS WITHOUT CLAIM TO ANY PARTICULAR FONT, STYLE, SIZE, OR COLOR.

### CLASS 41—EDUCATION AND ENTERTAINMENT

FOR EDUCATIONAL SERVICES, NAMELY, CONDUCTING TRAINING IN THE FIELDS OF DRUG, ALCOHOL AND NARCOTIC ADDICTION (U.S. CLS. 100, 101 AND 107).

### CLASS 42—SCIENTIFIC AND COMPUTER SERVICES

FOR MEDICAL AND SCIENTIFIC RESEARCH IN THE FIELDS OF DRUG, ALCOHOL AND NARCOTIC ADDICTION (U.S. CLS. 100 AND 101).  
FIRST USE 4-3-2013; IN COMMERCE 4-3-2013.  
ELLEN PERKINS, EXAMINING ATTORNEY

SN 85-898,969. MONIQUE MARVEZ, OCEANSIDE, CA.  
FILED 4-9-2013.

SN 85-900,387. REVEALED ENTERPRISES LLC, SEATTLE,  
WA. FILED 4-10-2013.

## NOT SKINNY; NOT BLONDE

THE MARK CONSISTS OF STANDARD CHARACTERS WITHOUT CLAIM TO ANY PARTICULAR FONT, STYLE, SIZE, OR COLOR.

### CLASS 9—ELECTRICAL AND SCIENTIFIC APPARATUS

FOR DIGITAL MEDIA, NAMELY, PRE-RECORDED DVDS, CDS, AND DOWNLOADABLE AUDIO AND VIDEO RECORDINGS FEATURING COMEDY (U.S. CLS. 21, 23, 26, 36 AND 38).

### CLASS 38—COMMUNICATION

FOR STREAMING AUDIO AND VIDEO RECORDINGS FEATURING COMEDY ON THE INTERNET (U.S. CLS. 100, 101 AND 104).  
COLLEEN DOMBROW, EXAMINING ATTORNEY

SN 85-900,097. PHILCOR T.V. & ELECTRONIC LEASING,  
INC, LAS VEGAS, NV. FILED 4-10-2013.

## energy avenue

THE MARK CONSISTS OF STANDARD CHARACTERS WITHOUT CLAIM TO ANY PARTICULAR FONT, STYLE, SIZE, OR COLOR.

NO CLAIM IS MADE TO THE EXCLUSIVE RIGHT TO USE "ENERGY", APART FROM THE MARK AS SHOWN.

### CLASS 9—ELECTRICAL AND SCIENTIFIC APPARATUS

FOR APPARATUS AND INSTRUMENTS, NAMELY, LIGHTING BALLASTS, ELECTRIC LIGHT DIMMERS, OCCUPANCY SENSORS IN THE NATURE OF ELECTRONIC DEVICES WHICH DETECT THE PRESENCE OF OCCUPANTS AND CONTROL THE LIGHTING SYSTEM ACCORDINGLY, THERMOSTATS, TIMERS, ELECTRICAL WIRE, AND SOLAR PANELS FOR PRODUCTION OF ELECTRICITY; BATTERIES; LED ILLUMINATED EXIT SIGNS; ELECTRIC LED EMERGENCY SIGNS (U.S. CLS. 21, 23, 26, 36 AND 38).

### CLASS 11—ENVIRONMENTAL CONTROL APPARATUS

FOR LIGHTING, NAMELY, LED FIXTURES, LED LAMPS, LED LIGHT FIXTURES THAT ARE IN THE FORM OF TAPE, LED LIGHT FIXTURES THAT ARE ATTACHED TO ROPE, FLUORESCENT ELECTRIC LIGHT BULBS, INDUCTION OVENS, ELECTRIC LIGHTS FOR CHRISTMAS TREES, SOCKETS FOR ELECTRIC LIGHTS, LANDSCAPE LIGHTING INSTALLATIONS, HID LAMPS, LED AUTOMOTIVE LIGHTING HEADLIGHTS FOR VEHICLES, LED PLANT GROW LIGHTS, STAGE AND STUDIO LAMPS, AND THEATRICAL STAGE LIGHTING APPARATUS (U.S. CLS. 13, 21, 23, 31 AND 34).

INGRID C. EULIN, EXAMINING ATTORNEY

## REVEALED

THE MARK CONSISTS OF STANDARD CHARACTERS WITHOUT CLAIM TO ANY PARTICULAR FONT, STYLE, SIZE, OR COLOR.

### CLASS 39—TRANSPORTATION AND STORAGE

FOR ARRANGING AND CONDUCTING TRAVEL TOURS FOR INDIVIDUALS AND GROUPS, NAMELY, ARRANGING TRANSPORTATION, SIGHTSEEING AND EXCURSIONS; TRAVEL TOUR GUIDE SERVICES (U.S. CLS. 100 AND 105).

### CLASS 43—HOTEL AND RESTAURANT SERVICES

FOR ARRANGING AND CONDUCTING TRAVEL SERVICES FOR INDIVIDUALS AND GROUPS, NAMELY, ARRANGING BOOKINGS FOR TEMPORARY LODGING (U.S. CLS. 100 AND 101).

DOUGLAS LEE, EXAMINING ATTORNEY

SN 85-900,655. OUTPACE SYSTEMS, INC., SAN FRANCISCO, CA. FILED 4-10-2013.



THE COLOR(S) BLUE AND MAGENTA IS/ARE CLAIMED AS A FEATURE OF THE MARK.

THE MARK CONSISTS OF THE WORD "OUTPACE" IN SHADES OF BLUE WITH A CURVED RIBBON IN SHADES OF MAGENTA CUTTING THROUGH THE "O" AND EXTENDING ABOVE THE "UTP" PORTION OF THE WORD.

### CLASS 9—ELECTRICAL AND SCIENTIFIC APPARATUS

FOR PHYSICAL MEDIA COMPUTER SOFTWARE FOR PERFORMING AND ANALYZING CUSTOMIZED OPERATIONAL FUNCTIONS, NAMELY, SALES, MARKETING, AND SUPPLY CHAIN MANAGEMENT; DOWNLOADABLE CLOUD COMPUTER SOFTWARE FOR PERFORMING AND ANALYZING CUSTOMIZED OPERATIONAL FUNCTIONS, NAMELY, SALES, MARKETING, AND SUPPLY CHAIN MANAGEMENT; DOWNLOADABLE COMPUTER SOFTWARE FOR PERFORMING AND ANALYZING CUSTOMIZED OPERATIONAL FUNCTIONS, NAMELY, SALES, MARKETING, AND SUPPLY CHAIN MANAGEMENT; COMPUTER APPLICATION SOFTWARE FOR MOBILE PHONES AND HANDHELD COMPUTERS FOR PERFORMING AND ANALYZING CUSTOMIZED OPERATIONAL FUNCTIONS, NAMELY, SALES, MARKETING, AND SUPPLY CHAIN MANAGEMENT (U.S. CLS. 21, 23, 26, 36 AND 38).

**CLASS 35—ADVERTISING AND BUSINESS**

FOR STRATEGIC BUSINESS CONSULTING SERVICES; OPERATIONAL BUSINESS CONSULTING SERVICES; INFORMATION-TECHNOLOGY RELATED BUSINESS CONSULTING SERVICES (U.S. CLS. 100, 101 AND 102).

**CLASS 42—SCIENTIFIC AND COMPUTER SERVICES**

FOR SOFTWARE DESIGN SERVICES FOR BUSINESSES; SOFTWARE DEVELOPMENT SERVICES FOR BUSINESSES; PROVIDING TEMPORARY USE OF ONLINE NON-DOWNLOADABLE CLOUD COMPUTER SOFTWARE FOR PERFORMING AND ANALYZING CUSTOMIZED OPERATIONAL FUNCTIONS, NAMELY, SALES, MARKETING, AND SUPPLY CHAIN MANAGEMENT; PROVIDING TEMPORARY USE OF ONLINE NON-DOWNLOADABLE COMPUTER SOFTWARE FOR PERFORMING AND ANALYZING CUSTOMIZED OPERATIONAL FUNCTIONS, NAMELY, SALES, MARKETING, AND SUPPLY CHAIN MANAGEMENT (U.S. CLS. 100 AND 101).

KATHERINE CHANG, EXAMINING ATTORNEY

SN 85-900,663. OUTPACE SYSTEMS, INC., ATHERTON, CA. FILED 4-10-2013.

# Outpace

THE MARK CONSISTS OF STANDARD CHARACTERS WITHOUT CLAIM TO ANY PARTICULAR FONT, STYLE, SIZE, OR COLOR.

**CLASS 9—ELECTRICAL AND SCIENTIFIC APPARATUS**

FOR PHYSICAL MEDIA COMPUTER SOFTWARE FOR PERFORMING AND ANALYZING CUSTOMIZED OPERATIONAL FUNCTIONS, NAMELY, SALES, MARKETING, AND SUPPLY CHAIN MANAGEMENT; DOWNLOADABLE CLOUD COMPUTER SOFTWARE FOR PERFORMING AND ANALYZING CUSTOMIZED OPERATIONAL FUNCTIONS, NAMELY, SALES, MARKETING, AND SUPPLY CHAIN MANAGEMENT; DOWNLOADABLE COMPUTER SOFTWARE FOR PERFORMING AND ANALYZING CUSTOMIZED OPERATIONAL FUNCTIONS, NAMELY, SALES, MARKETING, AND SUPPLY CHAIN MANAGEMENT; COMPUTER APPLICATION SOFTWARE FOR MOBILE PHONES AND HANDHELD COMPUTERS FOR PERFORMING AND ANALYZING CUSTOMIZED OPERATIONAL FUNCTIONS, NAMELY, SALES, MARKETING, AND SUPPLY CHAIN MANAGEMENT (U.S. CLS. 21, 23, 26, 36 AND 38).

**CLASS 35—ADVERTISING AND BUSINESS**

FOR STRATEGIC BUSINESS CONSULTING SERVICES; OPERATIONAL BUSINESS CONSULTING SERVICES; INFORMATION-TECHNOLOGY RELATED BUSINESS CONSULTING SERVICES (U.S. CLS. 100, 101 AND 102).

**CLASS 42—SCIENTIFIC AND COMPUTER SERVICES**

FOR SOFTWARE DESIGN SERVICES FOR BUSINESSES; SOFTWARE DEVELOPMENT SERVICES FOR BUSINESSES; PROVIDING TEMPORARY USE OF ONLINE NON-DOWNLOADABLE CLOUD COMPUTER SOFTWARE FOR PERFORMING AND ANALYZING CUSTOMIZED OPERATIONAL FUNCTIONS, NAMELY, SALES, MARKETING, AND SUPPLY CHAIN MANAGEMENT; PROVIDING TEMPORARY USE OF ONLINE NON-DOWNLOADABLE COMPUTER SOFTWARE FOR PERFORMING AND ANALYZING CUSTOMIZED OPERATIONAL FUNCTIONS, NAMELY, SALES, MARKETING, AND SUPPLY CHAIN MANAGEMENT (U.S. CLS. 100 AND 101).

KATHERINE CHANG, EXAMINING ATTORNEY

SN 85-901,329. OBRASCON HUARTE LAIN, S.A., 28046 MADRID, SPAIN, FILED 4-11-2013.



OWNER OF U.S. REG. NOS. 4,132,594 AND 4,144,925. NO CLAIM IS MADE TO THE EXCLUSIVE RIGHT TO USE "ASPHALT", APART FROM THE MARK AS SHOWN.

THE COLOR(S) BLUE, YELLOW, RED, OCHRE, BEIGE AND WHITE IS/ARE CLAIMED AS A FEATURE OF THE MARK.

THE MARK CONSISTS OF THE LETTERS "OHL" APPEARING IN BLUE ABOVE A BLUE LINE, BENEATH WHICH APPEARS THE WORDS "COMMUNITY ASPHALT" IN BLUE. TO THE LEFT OF THE LITERAL BLUE ELEMENTS APPEARS A SQUARE IMAGE OF A SIDE VIEW OF A FACE FORMED FROM A MOSAIC TILE-LIKE DESIGN WITHIN WHICH THE OUTLINE OF THE FACE, OUTLINE OF THE EYE, EYEBROW, NOSE AND MOUTH APPEAR IN BLUE TILE, THE EYE AND ACCENTS AROUND THE EYEBROW, NOSE AND MOUTH APPEAR IN RED TILE, THE INTERIOR OF THE FACE AND LIP APPEAR IN BEIGE AND OCHRE TILE, WITH THE FACE FADING TO YELLOW COLORED TILE TOWARDS THE LEFT OF THE IMAGE, AND WITH YELLOW COLORED TILE APPEARING IN THE BACKGROUND OF THE FACE TO THE RIGHT OF THE FACE. THE SPACE BETWEEN THE TILES THROUGHOUT THE IMAGE, AS WELL AS THE INTERIOR OF THE EYE APPEARS IN WHITE.

**CLASS 36—INSURANCE AND FINANCIAL**

FOR INSURANCE, NAMELY, INSURANCE ADMINISTRATION, INSURANCE UNDERWRITING IN THE FIELD OF LIFE, HEALTH, ACCIDENT AND FIRE, INSURANCE BROKERAGE SERVICES; FINANCIAL AFFAIRS AND MONETARY AFFAIRS, NAMELY, FINANCIAL INFORMATION, MANAGEMENT AND ANALYSIS SERVICES; BANKING; REAL ESTATE AFFAIRS, NAMELY, REAL ESTATE LISTING SERVICES, REAL ESTATE MANAGEMENT SERVICES, REAL ESTATE CONSULTATION (U.S. CLS. 100, 101 AND 102).

**CLASS 37—CONSTRUCTION AND REPAIR**

FOR BUILDING CONSTRUCTION; BUILDING REPAIR; INSTALLATION OF BUILDING INSULATION; CONSTRUCTION AND CONSTRUCTION MANAGEMENT OF TUNNELS AND UNDERGROUND STRUCTURES; CONSTRUCTION OF AIRPORTS AND HARBORS; ROAD AND STREET CONSTRUCTION; LEASING AND RENTAL OF CONSTRUCTION EQUIPMENT (U.S. CLS. 100, 103 AND 106).



**CLASS 42—SCIENTIFIC AND COMPUTER SERVICES**

FOR SCIENTIFIC AND TECHNOLOGICAL SERVICES AND RESEARCH AND DESIGN RELATING THERETO, NAMELY, ARCHITECTURAL DESIGN, CONSULTING SERVICES IN THE FIELD OF ARCHITECTURAL DESIGN, CONSULTING IN THE FIELDS OF ENGINEERING AND ARCHITECTURE, CONSTRUCTION DRAFTING, GEOLOGICAL SURVEYS AND RESEARCH, TECHNOLOGY CONSULTATION AND RESEARCH IN THE FIELD OF ENGINEERING AND GEOLOGY, TECHNOLOGY CONSULTATION BY EXPERTS IN THE FIELD OF ARCHITECTURE, ENGINEERING AND GEOLOGY; DESIGN AND DEVELOPMENT OF COMPUTER HARDWARE AND SOFTWARE IN THE FIELD OF ARCHITECTURE, ENGINEERING, CONSTRUCTION AND GEOLOGY (U.S. CLS. 100 AND 101).

LAURIE MAYES, EXAMINING ATTORNEY

**CLASS 42—SCIENTIFIC AND COMPUTER SERVICES**

FOR SCIENTIFIC AND TECHNOLOGICAL SERVICES AND RESEARCH AND DESIGN RELATING THERETO, NAMELY, ARCHITECTURAL DESIGN, CONSULTING SERVICES IN THE FIELD OF ARCHITECTURAL DESIGN, CONSULTING IN THE FIELDS OF ENGINEERING AND ARCHITECTURE, CONSTRUCTION DRAFTING, GEOLOGICAL SURVEYS AND RESEARCH, TECHNOLOGY CONSULTATION AND RESEARCH IN THE FIELD OF ENGINEERING AND GEOLOGY, TECHNOLOGY CONSULTATION BY EXPERTS IN THE FIELD OF ARCHITECTURE, ENGINEERING AND GEOLOGY; DESIGN AND DEVELOPMENT OF COMPUTER HARDWARE AND SOFTWARE IN THE FIELD OF ARCHITECTURE, ENGINEERING, CONSTRUCTION AND GEOLOGY (U.S. CLS. 100 AND 101).

LAURIE MAYES, EXAMINING ATTORNEY

SN 85-901,372. OBRASCON HUARTE LAIN, S.A., 28046 MADRID, SPAIN, FILED 4-11-2013.



OWNER OF U.S. REG. NOS. 4,132,594 AND 4,144,925. NO CLAIM IS MADE TO THE EXCLUSIVE RIGHT TO USE "CANADA", APART FROM THE MARK AS SHOWN.

THE COLOR(S) BLUE, YELLOW, RED, OCHRE, BEIGE AND WHITE IS/ARE CLAIMED AS A FEATURE OF THE MARK.

THE MARK CONSISTS OF THE LETTERS "OHL CANADA" IN BLUE. TO THE LEFT OF THE LITERAL BLUE ELEMENTS APPEARS A SQUARE IMAGE OF A SIDE VIEW OF A FACE FORMED FROM A MOSAIC TILE-LIKE DESIGN WITHIN WHICH THE OUTLINE OF THE FACE, OUTLINE OF THE EYE, EYEBROW, NOSE AND MOUTH APPEAR IN BLUE TILE, THE EYE AND ACCENTS AROUND THE EYEBROW, NOSE AND MOUTH APPEAR IN RED TILE, THE INTERIOR OF THE FACE AND LIP APPEAR IN BEIGE AND OCHRE TILE, WITH THE FACE FADING TO YELLOW COLORED TILE TOWARDS THE LEFT OF THE IMAGE, AND WITH YELLOW COLORED TILE APPEARING IN THE BACKGROUND OF THE FACE TO THE RIGHT OF THE FACE. THE SPACE BETWEEN THE TILES THROUGHOUT THE IMAGE, AS WELL AS THE INTERIOR OF THE EYE APPEARS IN WHITE.

**CLASS 36—INSURANCE AND FINANCIAL**

FOR INSURANCE, NAMELY, INSURANCE ADMINISTRATION, INSURANCE UNDERWRITING IN THE FIELD OF LIFE, HEALTH, ACCIDENT AND FIRE, INSURANCE BROKERAGE SERVICES; FINANCIAL AFFAIRS AND MONETARY AFFAIRS, NAMELY, FINANCIAL INFORMATION, MANAGEMENT AND ANALYSIS SERVICES; BANKING; REAL ESTATE AFFAIRS, NAMELY, REAL ESTATE LISTING SERVICES, REAL ESTATE MANAGEMENT SERVICES, REAL ESTATE CONSULTATION (U.S. CLS. 100, 101 AND 102).

**CLASS 37—CONSTRUCTION AND REPAIR**

FOR BUILDING CONSTRUCTION; BUILDING REPAIR; INSTALLATION OF BUILDING INSULATION; CONSTRUCTION AND CONSTRUCTION MANAGEMENT OF TUNNELS AND UNDERGROUND STRUCTURES; CONSTRUCTION OF AIRPORTS AND HARBORS; ROAD AND STREET CONSTRUCTION; LEASING AND RENTAL OF CONSTRUCTION EQUIPMENT (U.S. CLS. 100, 103 AND 106).

SN 85-902,418. REFINERY 29, INC., NEW YORK, NY. FILED 4-12-2013.



THE MARK CONSISTS OF CIRCULAR LOGO OF "R29" WITH "REFINERY29".

**CLASS 25—CLOTHING**

FOR CLOTHING, NAMELY, DRESSES, SUITS, SWEATERS, TOPS, PANTS, SHORTS, SKIRTS, JACKETS, OUTERWEAR IN THE NATURE OF JACKETS, COATS AND HATS, HEADWEAR, SCARVES, GLOVES, SOCKS, SLEEPWEAR, LINGERIE, FOOTWEAR, BLAZERS, SHIRTS, T-SHIRTS, POLO SHIRTS, SWEATSHIRTS, SWIMWEAR, BELTS, TIES, AND UNDERWEAR (U.S. CLS. 22 AND 39).

**CLASS 35—ADVERTISING AND BUSINESS**

FOR COMPUTERIZED ON-LINE RETAIL STORE SERVICES IN THE FIELD OF FASHION, BEAUTY, SHOPPING, AND STYLE, FEATURING LUXURY AND FASHION CLOTHING, APPAREL, FOOTWEAR, CLOTHING AND FASHION ACCESSORIES, HANDBAGS, JEWELRY, COSMETICS, AND RELATED GOODS; MARKETING, ADVERTISING, AND PROMOTING THE RETAIL GOODS AND SERVICES OF OTHERS THROUGH THE INTERNET AND WIRELESS ELECTRONIC DEVICES (U.S. CLS. 100, 101 AND 102).

**CLASS 38—COMMUNICATION**

FOR PROVIDING ONLINE ELECTRONIC BULLETIN BOARDS FOR TRANSMISSION OF MESSAGES AMONG COMPUTER USERS CONCERNING FASHION, BEAUTY, SHOPPING, AND STYLE (U.S. CLS. 100, 101 AND 104).

**CLASS 41—EDUCATION AND ENTERTAINMENT**

FOR ENTERTAINMENT SERVICES, NAMELY, PROVIDING INFORMATION, NEWS AND COMMENTARY IN THE FIELDS OF POPULAR CULTURE, CELEBRITY LIFESTYLES AND EVENTS, AND ENTERTAINMENT NEWS (U.S. CLS. 100, 101 AND 107).

**CLASS 44—MEDICAL, BEAUTY AND AGRICULTURAL SERVICES**

FOR PROVIDING ADVICE, INFORMATION, NEWS AND COMMENTARY ABOUT BEAUTY (U.S. CLS. 100 AND 101).

**CLASS 45—PERSONAL AND LEGAL SERVICES**

FOR PROVIDING ADVICE, INFORMATION, NEWS AND COMMENTARY IN THE FIELD OF FASHION AND STYLE; PROVIDING INFORMATION, NEWS AND COMMENTARY ABOUT PERSONAL SHOPPING (U.S. CLS. 100 AND 101).

ARETHA SOMERVILLE, EXAMINING ATTORNEY

---

SN 85-902,428. REFINERY 29, INC., NEW YORK, NY. FILED 4-12-2013.



THE MARK CONSISTS OF CIRCULAR LOGO OF "R29".

**CLASS 25—CLOTHING**

FOR CLOTHING, NAMELY, DRESSES, SUITS, SWEATERS, TOPS, PANTS, SHORTS, SKIRTS, JACKETS, OUTERWEAR IN THE NATURE OF JACKETS, COATS AND HATS, HEADWEAR, SCARVES, GLOVES, SOCKS, SLEEPWEAR, LINGERIE, FOOTWEAR, BLAZERS, SHIRTS, T-SHIRTS, POLO SHIRTS, SWEATSHIRTS, SWIMWEAR, BELTS, TIES, AND UNDERWEAR (U.S. CLS. 22 AND 39).

**CLASS 35—ADVERTISING AND BUSINESS**

FOR COMPUTERIZED ON-LINE RETAIL STORE SERVICES IN THE FIELD OF FASHION, BEAUTY, SHOPPING, AND STYLE, FEATURING LUXURY AND FASHION CLOTHING, APPAREL, FOOTWEAR, CLOTHING AND FASHION ACCESSORIES, HANDBAGS, JEWELRY, COSMETICS, AND RELATED GOODS; MARKETING, ADVERTISING, AND PROMOTING THE RETAIL GOODS AND SERVICES OF OTHERS THROUGH THE INTERNET AND WIRELESS ELECTRONIC DEVICES (U.S. CLS. 100, 101 AND 102).

**CLASS 38—COMMUNICATION**

FOR PROVIDING ONLINE ELECTRONIC BULLETIN BOARDS FOR TRANSMISSION OF MESSAGES AMONG COMPUTER USERS CONCERNING FASHION, BEAUTY, SHOPPING, AND STYLE (U.S. CLS. 100, 101 AND 104).

**CLASS 41—EDUCATION AND ENTERTAINMENT**

FOR ENTERTAINMENT SERVICES, NAMELY, PROVIDING INFORMATION, NEWS AND COMMENTARY IN THE FIELDS OF POPULAR CULTURE, CELEBRITY LIFESTYLES AND EVENTS, AND ENTERTAINMENT NEWS (U.S. CLS. 100, 101 AND 107).

**CLASS 44—MEDICAL, BEAUTY AND AGRICULTURAL SERVICES**

FOR PROVIDING ADVICE, INFORMATION, NEWS AND COMMENTARY ABOUT BEAUTY (U.S. CLS. 100 AND 101).

**CLASS 45—PERSONAL AND LEGAL SERVICES**

FOR PROVIDING ADVICE, INFORMATION, NEWS AND COMMENTARY IN THE FIELD OF FASHION AND STYLE; PROVIDING INFORMATION, NEWS AND COMMENTARY ABOUT PERSONAL SHOPPING (U.S. CLS. 100 AND 101).

ARETHA SOMERVILLE, EXAMINING ATTORNEY

---

SN 85-902,430. REFINERY 29, INC., NEW YORK, NY. FILED 4-12-2013.



THE MARK CONSISTS OF CIRCULAR LOGO OF "R29".

**CLASS 25—CLOTHING**

FOR CLOTHING, NAMELY, DRESSES, SUITS, SWEATERS, TOPS, PANTS, SHORTS, SKIRTS, JACKETS, OUTERWEAR IN THE NATURE OF JACKETS, COATS AND HATS, HEADWEAR, SCARVES, GLOVES, SOCKS, SLEEPWEAR, LINGERIE, FOOTWEAR, BLAZERS, SHIRTS, T-SHIRTS, POLO SHIRTS, SWEATSHIRTS, SWIMWEAR, BELTS, TIES AND UNDERWEAR (U.S. CLS. 22 AND 39).

**CLASS 35—ADVERTISING AND BUSINESS**

FOR COMPUTERIZED ON-LINE RETAIL STORE SERVICES IN THE FIELD OF FASHION, BEAUTY, SHOPPING, AND STYLE, FEATURING LUXURY AND FASHION CLOTHING, APPAREL, FOOTWEAR, CLOTHING AND FASHION ACCESSORIES, HANDBAGS, JEWELRY, COSMETICS, AND RELATED GOODS; MARKETING, ADVERTISING, AND PROMOTING THE RETAIL GOODS AND SERVICES OF OTHERS THROUGH THE INTERNET AND WIRELESS ELECTRONIC DEVICES (U.S. CLS. 100, 101 AND 102).

**CLASS 38—COMMUNICATION**

FOR PROVIDING ONLINE ELECTRONIC BULLETIN BOARDS FOR TRANSMISSION OF MESSAGES AMONG COMPUTER USERS CONCERNING FASHION, BEAUTY, SHOPPING, AND STYLE (U.S. CLS. 100, 101 AND 104).

**CLASS 41—EDUCATION AND ENTERTAINMENT**

FOR ENTERTAINMENT SERVICES, NAMELY, PROVIDING INFORMATION, NEWS AND COMMENTARY IN THE FIELDS OF POPULAR CULTURE, CELEBRITY LIFESTYLES AND EVENTS, AND ENTERTAINMENT NEWS (U.S. CLS. 100, 101 AND 107).

**CLASS 44—MEDICAL, BEAUTY AND AGRICULTURAL SERVICES**

FOR PROVIDING ADVICE, INFORMATION, NEWS AND COMMENTARY ABOUT BEAUTY (U.S. CLS. 100 AND 101).

**CLASS 45—PERSONAL AND LEGAL SERVICES**

FOR PROVIDING ADVICE, INFORMATION, NEWS AND COMMENTARY IN THE FIELD OF FASHION AND STYLE; PROVIDING INFORMATION, NEWS AND COMMENTARY ABOUT PERSONAL SHOPPING (U.S. CLS. 100 AND 101).

ARETHA SOMERVILLE, EXAMINING ATTORNEY

SN 85-902,645. AERODESIGNS, INC., CAMBRIDGE, MA. FILED 4-12-2013.

# AEROPOD

THE MARK CONSISTS OF STANDARD CHARACTERS WITHOUT CLAIM TO ANY PARTICULAR FONT, STYLE, SIZE, OR COLOR.

**CLASS 5—PHARMACEUTICALS**

FOR VITAMINS, MINERALS, CAFFEINE FOR BOOSTING ENERGY NAMELY CAFFEINE PREPARATIONS FOR STIMULATIVE USE, NUTRITIONAL SUPPLEMENTS, NUTRITIONAL SUPPLEMENTS FOR BOOSTING ENERGY, DIETARY SUPPLEMENTS, DIETARY SUPPLEMENTS FOR BOOSTING ENERGY, NUTRACEUTICALS FOR USE AS A DIETARY SUPPLEMENT, ALL IN POWDER FORM SOLD WITH AN AEROSOLIZING DELIVERY APPARATUS; VITAMINS, MINERALS, CAFFEINE FOR BOOSTING ENERGY NAMELY CAFFEINE PREPARATIONS FOR STIMULATIVE USE, NUTRITIONAL SUPPLEMENTS, NUTRITIONAL SUPPLEMENTS FOR BOOSTING ENERGY, DIETARY SUPPLEMENTS, DIETARY SUPPLEMENTS FOR BOOSTING ENERGY, NUTRACEUTICALS AND NUTRACEUTICALS FOR USE AS A DIETARY SUPPLEMENT, ALL IN POWDER CARTRIDGE FORM FOR USE WITH AN AEROSOLIZING DELIVERY APPARATUS (U.S. CLS. 6, 18, 44, 46, 51 AND 52).

**CLASS 10—MEDICAL APPARATUS**

FOR AEROSOL DISPENSER FOR MEDICAL PURPOSES SOLD EMPTY (U.S. CLS. 26, 39 AND 44).

**CLASS 21—HOUSEWARES AND GLASS**

FOR AEROSOL DISPENSERS, NOT FOR MEDICAL OR THERAPEUTIC USE, FOR USE WITH FOOD AND BEVERAGE POWDER CARTRIDGE; AEROSOL DISPENSERS SOLD EMPTY, NOT FOR MEDICAL OR THERAPEUTIC USE (U.S. CLS. 2, 13, 23, 29, 30, 33, 40 AND 50).

**CLASS 29—MEATS AND PROCESSED FOODS**

FOR PATE, CAVIAR, COCOA BUTTER FOR FOOD PURPOSES, MEAT, FISH, POULTRY, GAME, CRUSTACEANS, MEAT EXTRACTS, PROCESSED AND DRIED FRUITS, PROCESSED AND DRIED VEGETABLES, DAIRY PRODUCTS EXCLUDING ICE CREAM, ICE MILK AND FROZEN YOGURT, ALL IN POWDER FORM CONTAINED IN AN AEROSOLIZING DELIVERY APPARATUS AND IN POWDER FORM FOR USE WITH AN AEROSOLIZING DELIVERY APPARATUS (U.S. CL. 46).

**CLASS 30—STAPLE FOODS**

FOR COFFEE, TEA, COCOA-BASED BEVERAGES, CHOCOLATE AND FLAVORED CHOCOLATE, WHITE CHOCOLATE, CANDY, SPICES, SUGAR, COOKIES, BISCUITS, PIZZA, BAKERY GOODS, MILK PRODUCTS NAMELY ICE CREAM, ICE MILK AND FROZEN YOGURT, FOOD FLAVORINGS, COFFEE ESSENCES, AND BEVERAGE FLAVORINGS, ALL IN POWDER FORM CONTAINED IN AN AEROSOLIZING DELIVERY APPARATUS OR IN POWDER CARTRIDGE FORM FOR USE WITH AN AEROSOLIZING DELIVERY APPARATUS (U.S. CL. 46).

**CLASS 32—LIGHT BEVERAGES**

FOR ENERGY DRINKS, FRUIT BEVERAGES, CARBONATED BEVERAGES, VEGETABLE BEVERAGES, BEVERAGE ESSENCES, IN POWDER FORM CONTAINED IN AN AEROSOLIZING DELIVERY APPARATUS OR IN CARTRIDGE FORM FOR USE WITH AN AEROSOLIZING DELIVERY APPARATUS (U.S. CLS. 45, 46 AND 48).

WILLIAM P. SHANAHAN, EXAMINING ATTORNEY

SN 85-903,128. YOUNG CHAMPIONS OF AMERICA, INC., SCOTTSDALE, AZ. FILED 4-12-2013.



THE MARK CONSISTS OF STYLIZED TORCH WITH A DOWNWARD FACING ARROW IN THE CENTER SURROUNDED BY TWO CURVED SYMBOLS ON EITHER SIDE FACING OUTWARD.

**CLASS 18—LEATHER GOODS**

FOR SPORTS BAGS (U.S. CLS. 1, 2, 3, 22 AND 41). FIRST USE 12-31-1995; IN COMMERCE 12-31-1995.

**CLASS 25—CLOTHING**

FOR MARTIAL ARTS, CHEERLEADING, DANCE AND SOCCER APPAREL AND ACCESSORIES, NAMELY, UNIFORMS, T-SHIRTS, SHORTS, SWEATSHIRTS, VESTS, SKIRTS, PANTS, SWEATPANTS, SOCKS, AND HEADBANDS (U.S. CLS. 22 AND 39).

FIRST USE 12-31-1995; IN COMMERCE 12-31-1995.

**CLASS 41—EDUCATION AND ENTERTAINMENT**

FOR INSTRUCTION AND ENTERTAINMENT SERVICES, NAMELY, ORGANIZING, OPERATING, AND CONDUCTING CLASSES, CAMPS, COMPETITIONS AND EVENTS IN THE FIELDS OF MARTIAL ARTS, CHEERLEADING, DANCE AND SOCCER (U.S. CLS. 100, 101 AND 107).

FIRST USE 12-31-1995; IN COMMERCE 12-31-1995.  
SUSAN STIGLITZ, EXAMINING ATTORNEY

SN 85-904,927. NIKE, INC., BEAVERTON, OR. FILED 4-15-2013.

**HYPERVENOM**

SN 85-903,286. CISCO TECHNOLOGY, INC., SAN JOSE, CA. FILED 4-12-2013.

**SMARTNET**

THE MARK CONSISTS OF STANDARD CHARACTERS WITHOUT CLAIM TO ANY PARTICULAR FONT, STYLE, SIZE, OR COLOR.

OWNER OF U.S. REG. NO. 2,689,619.

**CLASS 37—CONSTRUCTION AND REPAIR**

FOR INSTALLATION, REPAIR, AND UPDATING OF COMPUTER NETWORKING AND TELECOMMUNICATIONS HARDWARE (U.S. CLS. 100, 103 AND 106).

FIRST USE 8-15-2000; IN COMMERCE 8-15-2000.

**CLASS 42—SCIENTIFIC AND COMPUTER SERVICES**

FOR TECHNICAL CUSTOMER SUPPORT SERVICES, NAMELY, TROUBLESHOOTING OF COMPUTER SOFTWARE PROBLEMS; TECHNICAL SUPPORT SERVICES, NAMELY, TROUBLESHOOTING IN THE NATURE OF DIAGNOSING COMPUTER HARDWARE PROBLEMS; TECHNICAL CUSTOMER SUPPORT SERVICES, NAMELY, TROUBLESHOOTING IN THE NATURE OF DIAGNOSING COMPUTER NETWORKING EQUIPMENT AND TELECOMMUNICATIONS HARDWARE PROBLEMS; UPDATING OF COMPUTER SOFTWARE; PROVIDING AN INTERNET WEBSITE PORTAL THAT FEATURES INFORMATION IN THE FIELDS OF INFORMATION TECHNOLOGY, COMPUTER NETWORKING AND TELECOMMUNICATIONS TECHNOLOGY; PROVIDING AN INTERNET WEBSITE PORTAL IN THE FIELDS OF TECHNOLOGY AND SOFTWARE DEVELOPMENT THAT ENABLES USERS TO OBTAIN INFORMATION ABOUT SOFTWARE RELEASES, SOFTWARE BUG REPORTS AND REPAIR INFORMATION, AND PROVIDES TEMPORARY USE OF TROUBLESHOOTING TOOLS IN THE NATURE OF ONLINE, NON-DOWNLOADABLE DIAGNOSTIC SOFTWARE CUSTOMIZED FOR USERS' COMPUTER NETWORKING AND TELECOMMUNICATIONS EQUIPMENT; PROVIDING A WEBSITE FEATURING NON-DOWNLOADABLE VIDEOS IN THE FIELDS OF INFORMATION TECHNOLOGY, COMPUTER NETWORKING AND TELECOMMUNICATIONS TECHNOLOGY; COMPUTER SERVICES, NAMELY, CREATING AN ON-LINE COMMUNITY FOR REGISTERED USERS TO PARTICIPATE IN DISCUSSIONS, GET FEEDBACK FROM THEIR PEERS AND FORM VIRTUAL COMMUNITIES IN THE FIELDS OF INFORMATION TECHNOLOGY, COMPUTER NETWORKING AND TELECOMMUNICATIONS TECHNOLOGY (U.S. CLS. 100 AND 101).

FIRST USE 9-0-1991; IN COMMERCE 9-0-1991.  
STEVEN PEREZ, EXAMINING ATTORNEY

OWNER OF U.S. REG. NO. 2,969,824.  
THE MARK CONSISTS OF "HYPERVENOM" IN A STYLIZED FORMAT.

**CLASS 18—LEATHER GOODS**

FOR BAGS, NAMELY, ALL PURPOSE SPORTS BAGS, TOTE BAGS, DUFFLE BAGS, MESSENGER BAGS, BACKPACKS, PURSES, UMBRELLAS, LUGGAGE AND WALLETS, BRIEFCASE-TYPE PORTFOLIOS, COSMETIC AND TOILETRY CASES SOLD EMPTY (U.S. CLS. 1, 2, 3, 22 AND 41).

**CLASS 25—CLOTHING**

FOR CLOTHING, NAMELY, PANTS, SHORTS, SHIRTS, T-SHIRTS, PULLOVERS, SWEAT SHIRTS, SWEAT PANTS, UNDERWEAR, SPORTS BRAS, DRESSES, SKIRTS, SWEATERS, JACKETS, COATS, SOCKS, SWEATBANDS, GLOVES, BELTS, HOSIERY, HEADBANDS, SCARVES, COATS, VESTS, JERSEYS; FOOTWEAR; HEADWEAR (U.S. CLS. 22 AND 39).

**CLASS 28—TOYS AND SPORTING GOODS**

FOR SPORTS EQUIPMENT, NAMELY, SOCCER BALLS, SHIN GUARDS FOR ATHLETIC USE, PROTECTIVE PADDING FOR PLAYING SOCCER; BAGS SPECIALLY ADAPTED FOR CARRYING SPORTS EQUIPMENT AND SPORTS BALLS (U.S. CLS. 22, 23, 38 AND 50).

JANET LEE, EXAMINING ATTORNEY

SN 85-905,255. ROYAL CARIBBEAN CRUISES LTD., MIAMI, FL. FILED 4-16-2013.

**Two70**

THE MARK CONSISTS OF STANDARD CHARACTERS WITHOUT CLAIM TO ANY PARTICULAR FONT, STYLE, SIZE, OR COLOR.

**CLASS 41—EDUCATION AND ENTERTAINMENT**

FOR ENTERTAINMENT SERVICES PROVIDED AT A DEDICATED ENTERTAINMENT VENUE ABOARD A CRUISE SHIP FOR ACROBATIC SHOWS, PERFORMANCE ART, LIGHT SHOWS, DIGITAL SCENERY, MUSICAL PERFORMANCES, COMEDY PERFORMANCES, AND TALENT CONTESTS (U.S. CLS. 100, 101 AND 107).

**CLASS 43—HOTEL AND RESTAURANT SERVICES**

FOR PROVIDING FOOD AND DRINK ABOARD A CRUISE SHIP (U.S. CLS. 100 AND 101).  
BILL DAWE, EXAMINING ATTORNEY

SN 85-905,269. ROYAL CARIBBEAN CRUISES LTD., MIAMI, FL. FILED 4-16-2013.

# SeaPlex

THE MARK CONSISTS OF STANDARD CHARACTERS WITHOUT CLAIM TO ANY PARTICULAR FONT, STYLE, SIZE, OR COLOR.

**CLASS 41—EDUCATION AND ENTERTAINMENT**

FOR PROVIDING RECREATIONAL FACILITIES ABOARD A CRUISE SHIP IN THE NATURE OF A VENUE FEATURING A CIRCUS SCHOOL, A FLYING TRAPEZE, A BASKETBALL COURT, A ROLLER SKATING RINK, BUMPER CARS, AND MUSIC PROVIDED FROM A FLOATING DJ BOOTH (U.S. CLS. 100, 101 AND 107).

**CLASS 43—HOTEL AND RESTAURANT SERVICES**

FOR PROVIDING FOOD AND DRINK ABOARD A CRUISE SHIP (U.S. CLS. 100 AND 101).  
BILL DAWE, EXAMINING ATTORNEY

SN 85-905,820. AMERICAN COLLEGE FOR ADVANCEMENT IN MEDICINE, IRVINE, CA. FILED 4-16-2013.



OWNER OF U.S. REG. NO. 4,260,048.  
THE MARK CONSISTS OF A SQUARE CONTAINING AN ENCIRCLED ROD OF ASCLEPIUS, TO THE RIGHT OF THE SQUARE IS THE WORDING "ACAM AMERICAN COLLEGES FOR ADVANCEMENT IN MEDICINE".

SEC. 2(F) AS TO "AMERICAN COLLEGES FOR ADVANCEMENT IN MEDICINE".

**CLASS 16—PAPER GOODS AND PRINTED MATTER**

FOR PUBLICATIONS, NAMELY, MAGAZINES AND NEWSLETTERS IN THE FIELD OF ALTERNATIVE AND INTEGRATIVE MEDICINE (U.S. CLS. 2, 5, 22, 23, 29, 37, 38 AND 50).

FIRST USE 6-9-2009; IN COMMERCE 1-1-2010.

**CLASS 44—MEDICAL, BEAUTY AND AGRICULTURAL SERVICES**

FOR PROVIDING MEDICAL INFORMATION IN THE FIELD OF ALTERNATIVE AND INTEGRATIVE MEDICINE (U.S. CLS. 100 AND 101).

FIRST USE 6-9-2009; IN COMMERCE 1-1-2010.  
TEJBIR SINGH, EXAMINING ATTORNEY

SN 85-907,369. IGUASU TRADING U.S.A. INC., LOS ANGELES, CA. FILED 4-17-2013.



OWNER OF U.S. REG. NO. 3,229,327.  
NO CLAIM IS MADE TO THE EXCLUSIVE RIGHT TO USE "FOOTWEAR", APART FROM THE MARK AS SHOWN.

THE MARK CONSISTS OF A SHIELD WITH A LION IN THE CENTER WITH THE WORDS "VLADO FOOTWEAR" APPEARING BELOW THE SHIELD.

**CLASS 18—LEATHER GOODS**

FOR BACKPACKS, BOOK BAGS, SPORTS BAGS, BUM BAGS, WALLETS AND HANDBAGS (U.S. CLS. 1, 2, 3, 22 AND 41).

FIRST USE 3-1-2003; IN COMMERCE 3-1-2003.

**CLASS 25—CLOTHING**

FOR CLOTHING, NAMELY, FOOTWEAR, HATS, SHIRTS, PANTS, AND JACKETS; APPAREL, NAMELY, HEADWEAR, RAINWEAR, LOUNGEWEAR, TOPS AND BOTTOMS, TANK TOPS, CROP-TOPS, T-SHIRTS, NECKTIES, ASCOTS, SWEATSHIRTS, SWEAT PANTS, SWEAT SUITS, CARDIGANS, SWEATERS, COATS, BLAZERS, SPORT COATS, SLACKS, BLOUSES, JERSEYS, TIES, VESTS, PULLOVERS, WORKOUT SUITS, UNDERSHIRTS, JEANS, LEGGINGS, LONG JOHNS, SKORTS, SHORTS, ROMPERS, TROUSERS, JUMPSUITS, OVERALLS, SKIRTS, DRESSES, JUMPERS, SWIMWEAR, UNITARDS, LEOTARDS, TIGHTS, SLEEPWEAR, PAJAMAS, NIGHTSHIRTS, ROBES, BATH ROBES, NIGHTGOWNS, SLEEP SHORTS, PONCHOS, SLIPPERS, SLIPPER SOCKS, SOCKS, HOSIERY, BANDANAS, SCARVES, SHAWLS, NECKERCHIEFS, SUSPENDERS, DRESSING GOWNS, APRONS, MUFFLERS, CAPS, VISORS, HEADBANDS, GLOVES, BELTS, LINGERIE, BASEBALL CAPS, AND BEANIES; WOMEN'S UNDERWEAR, NAMELY, BRAS, PANTIES AND THONGS; MEN'S UNDERWEAR, NAMELY, BOXER SHORTS AND BRIEFS; ATHLETIC SHOES; BELTS FOR CLOTHING; LEATHER BELTS; FABRIC BELTS; WAIST BELTS AND BELTS OF TEXTILES (U.S. CLS. 22 AND 39).

FIRST USE 3-1-2003; IN COMMERCE 3-1-2003.

SHAUNIA CARLYLE, EXAMINING ATTORNEY

SN 85-907,987. IGUASU TRADING U.S.A. INC., LOS ANGELES, CA. FILED 4-18-2013.



OWNER OF U.S. REG. NO. 3,229,327.  
NO CLAIM IS MADE TO THE EXCLUSIVE RIGHT TO USE "FOOTWEAR", APART FROM THE MARK AS SHOWN.

THE MARK CONSISTS OF THE WORD "VLADO" APPEARING ABOVE THE WORD "FOOTWEAR" WITH TWO LIONS, ONE ON EACH SIDE OF THE WORD "VLADO" FACING EACH OTHER.

#### CLASS 18—LEATHER GOODS

FOR BACKPACKS, BOOK BAGS, SPORTS BAGS, BUM BAGS, WALLETS AND HANDBAGS (U.S. CLS. 1, 2, 3, 22 AND 41).

FIRST USE 9-1-2009; IN COMMERCE 9-1-2009.

#### CLASS 25—CLOTHING

FOR CLOTHING, NAMELY, FOOTWEAR, HATS, SHIRTS, PANTS, AND JACKETS; APPAREL, NAMELY, HEADWEAR, RAINWEAR, LOUNGEWEAR, TOPS AND BOTTOMS, TANK TOPS, CROP-TOPS, T-SHIRTS, NECKTIES, ASCOTS, SWEATSHIRTS, SWEAT PANTS, SWEAT SUITS, CARDIGANS, SWEATERS, COATS, BLAZERS, SPORT COATS, SLACKS, BLOUSES, JERSEYS, TIES, VESTS, PULLOVERS, WORKOUT SUITS, UNDERSHIRTS, JEANS, LEGGINGS, LONG JOHNS, SKORTS, SHORTS, ROMPERS, TROUSERS, JUMPSUITS, OVERALLS, SKIRTS, DRESSES, JUMPERS, SWIMWEAR, UNITARDS, LEOTARDS, TIGHTS, SLEEPWEAR, PAJAMAS, NIGHTSHIRTS, ROBES, BATH ROBES, NIGHTGOWNS, SLEEP SHORTS, PONCHOS, SLIPPERS, SLIPPER SOCKS, SOCKS, HOSIERY, BANDANNAS, SCARVES, SHAWLS, NECKERCHIEFS, SUSPENDERS, DRESSING GOWNS, APRONS, MUFFLERS, CAPS, VISORS, HEADBANDS, GLOVES, BELTS, LINGERIE, BASEBALL CAPS, AND BEANIES; WOMEN'S UNDERWEAR, NAMELY, BRAS, PANTIES AND THONGS; MEN'S UNDERWEAR, NAMELY, BOXER SHORTS AND BRIEFS; ATHLETIC SHOES; BELTS FOR CLOTHING; LEATHER BELTS; FABRIC BELTS; WAIST BELTS AND BELTS OF TEXTILES (U.S. CLS. 22 AND 39).

FIRST USE 9-1-2009; IN COMMERCE 9-1-2009.  
SHAUNIA CARLYLE, EXAMINING ATTORNEY

SN 85-908,516. NAGAKI SEIKI CO., LTD., OSAKA, JAPAN, FILED 4-18-2013.

eiki

THE MARK CONSISTS OF STANDARD CHARACTERS WITHOUT CLAIM TO ANY PARTICULAR FONT, STYLE, SIZE, OR COLOR.

THE WORDING "EIKI" HAS NO MEANING IN A FOREIGN LANGUAGE.

#### CLASS 8—HAND TOOLS

FOR HAND TOOLS, NAMELY, STRETCHERS FOR WIRE AND CABLE; HAND TOOLS, NAMELY, PULLERS; HAND TOOLS, NAMELY, WIRE AND CABLE PULLING GRIPS; RATCHET SPANNERS; HAND TOOLS, NAMELY, INSULATED STICK TOOLS FOR GRIPPING AND OPERATING ELECTRIC WIRES AND CABLES; WIRE STRIPPERS; HAND TOOLS, NAMELY, HAND HELD WIRE CUTTERS AND CABLE CUTTERS (U.S. CLS. 23, 28 AND 44).

#### CLASS 9—ELECTRICAL AND SCIENTIFIC APPARATUS

FOR TENSIMETERS; ANALOG AND DIGITAL TENSIMETERS; MANOMETERS (U.S. CLS. 21, 23, 26, 36 AND 38).

ZACHARY BELLO, EXAMINING ATTORNEY

SN 85-909,134. ZAKARIAN, GEOFFREY, TAMPA, FL. FILED 4-19-2013.

## THE PERFECT PANTRY

THE MARK CONSISTS OF STANDARD CHARACTERS WITHOUT CLAIM TO ANY PARTICULAR FONT, STYLE, SIZE, OR COLOR.

#### CLASS 29—MEATS AND PROCESSED FOODS

FOR EDIBLE OILS; COOKING OIL (U.S. CL. 46).

#### CLASS 30—STAPLE FOODS

FOR SEASONINGS; SPICES (U.S. CL. 46).  
KAREN BRACEY, EXAMINING ATTORNEY

SN 85-909,438. CHEROKEE INC., SHERMAN OAKS, CA. FILED 4-19-2013.

FAB LAB

THE MARK CONSISTS OF STANDARD CHARACTERS WITHOUT CLAIM TO ANY PARTICULAR FONT, STYLE, SIZE, OR COLOR.

#### CLASS 25—CLOTHING

FOR CLOTHING, NAMELY, PANTS, SLACKS, JEANS, SHORTS, SKIRTS, SHIRTS, BLOUSES, SWEATERS, T-SHIRTS, TANK TOPS, DRESSES, VESTS, SOCKS, HOSIERY, JACKETS, COATS, SCARVES, BELTS, UNDERWEAR, SLIPS, CAMISOLES, BRAS, NIGHTGOWNS, PAJAMAS, ROBES; HEADGEAR, NAMELY, HATS AND CAPS; FOOTWEAR (U.S. CLS. 22 AND 39).

**CLASS 42—SCIENTIFIC AND COMPUTER SERVICES**

FOR DESIGN SERVICES FOR OTHERS, NAMELY, FASHION AND CLOTHING DESIGN; CUSTOM DESIGN OF WEARABLE APPAREL BASED ON PERSONAL SELECTIONS MADE BY THE CUSTOMER (U.S. CLS. 100 AND 101).

JOHN DALIER, EXAMINING ATTORNEY

---

SN 85-909,517. TRAVELWITS, LLC, PITTSBURGH, PA. FILED 4-19-2013.

# TRAVELWITS

THE MARK CONSISTS OF STANDARD CHARACTERS WITHOUT CLAIM TO ANY PARTICULAR FONT, STYLE, SIZE, OR COLOR.

**CLASS 39—TRANSPORTATION AND STORAGE**

FOR TRAVEL AGENCY SERVICES, NAMELY, MAKING RESERVATIONS AND BOOKINGS FOR TRANSPORTATION; PROVIDING INFORMATION CONCERNING TRAVEL, PROVIDING TRAVEL NEWS, MAPS, CITY DIRECTORIES AND LISTINGS FOR USE BY TRAVELERS OVER COMPUTER NETWORKS AND GLOBAL COMMUNICATION NETWORKS (U.S. CLS. 100 AND 105).

**CLASS 43—HOTEL AND RESTAURANT SERVICES**

FOR TRAVEL AGENCY SERVICES, NAMELY, MAKING RESERVATIONS AND BOOKINGS FOR TEMPORARY LODGING; TRAVEL AGENCY SERVICES, NAMELY, MAKING RESERVATIONS AND BOOKINGS FOR RESTAURANTS AND MEALS (U.S. CLS. 100 AND 101).

JESSICA FATHY, EXAMINING ATTORNEY

---

SN 85-909,879. CREATA MACAO COMMERCIAL OFFSHORE LIMITED, 6 ANDAR 0, MACAO, FILED 4-19-2013.

# DRAC ATTACK

THE MARK CONSISTS OF STANDARD CHARACTERS WITHOUT CLAIM TO ANY PARTICULAR FONT, STYLE, SIZE, OR COLOR.

**CLASS 9—ELECTRICAL AND SCIENTIFIC APPARATUS**

FOR INTERACTIVE ENTERTAINMENT SOFTWARE, NAMELY, INTERACTIVE VIDEO GAME PROGRAMS, INTERACTIVE MULTIMEDIA COMPUTER GAME PROGRAMS, COMPUTER GAME SOFTWARE, COMPUTER GAME CARTRIDGES, AND COMPUTER GAME DISCS; DOWNLOADABLE SOFTWARE FOR USE IN PLAYING COMPUTER GAMES; COMPUTER GAME SOFTWARE FOR USE WITH COMMUNICATION DEVICES AND MOBILE TELEPHONES; PRE-RECORDED AUDIO AND VIDEO TAPES FEATURING MUSIC; LASER DISCS, VIDEO DISCS, PHONOGRAPH RECORDS, COMPACT DISCS, PRE-RECORDED CD-ROMS, ALL FEATURING GAMES, MOTION PICTURE FILMS, AND MUSIC; VIDEO GAME SOFTWARE; DOWNLOADABLE COMPUTER GAME SOFTWARE; COMPUTER GAME SOFTWARE FOR HOME VIDEO GAME CONSOLES AND HAND HELD UNITS FOR PLAYING VIDEO GAMES; DOWNLOADABLE VIDEO GAME SOFTWARE FOR MOBILE DEVICES, COMPUTER TABLETS, PERSONAL DIGITAL ASSISTANTS, ELECTRONIC ORGANIZERS, ELECTRONIC NOTEPADS, HANDHELD COMPUTERS, A PORTABLE AND HAND-HELD DIGITAL ELECTRONIC DEVICES AND WIRELESS ELECTRONIC DEVICES; COMPUTER APPLICATION SOFTWARE FOR HAND HELD ELECTRONIC DEVICES INCLUDING MOBILE PHONES, PORTABLE MEDIA PLAYERS, HAND HELD COMPUTERS FOR USE IN COMPUTER GAMES; INTERACTIVE ENTERTAINMENT SOFTWARE IN THE NATURE OF COMPUTER AND VIDEO GAMES ON CD-ROM; PRE-RECORDED MEDIA, NAMELY, DVDS FEATURING ANIMATED ENTERTAINMENT FOR CHILDREN AND TEENS; CALCULATORS; DISPOSABLE CAMERAS; EYEGLASS CASES; RADIOS AND RADIOS INCORPORATING CLOCKS; COMPUTER MOUSE; DECORATIVE MAGNETS; TELEPHONES; COMPUTER GAME CARTRIDGES; COMPUTER GAME CARTRIDGES, CASSETTES, AND INTERACTIVE ENTERTAINMENT SOFTWARE IN THE NATURE OF COMPUTER AND VIDEO GAMES ON CD-ROM, SOFTWARE, PROGRAMS, TAPES AND DISCS; HEADPHONES; INTERACTIVE MULTIMEDIA COMPUTER GAME PROGRAMS; BICYCLE HELMETS; COMPUTER MOUSE PADS; SUNGLASSES; PRE-RECORDED COMPUTER STORYTELLING SOFTWARE; AUDIO AND VIDEO CASSETTES FEATURING GAMES AND STORYTELLING; MUSICAL AUDIO AND VIDEO RECORDINGS; SOUND RECORDINGS FEATURING GAMES AND STORYTELLING; SCREENSAVER PROGRAMS; DOWNLOADABLE MUSIC AND VIDEO FILES FOR COMPUTER AND VIDEO GAMES; BATTERIES; LED LIT DISPLAY BOXES FOR USE AS ADVERTISING DISPLAYS; COLLECTABLE BLANK USB FLASH DRIVES IN THE FORM OF TOY CARS, TOY FIGURES AND FIGURINES; RADIO FREQUENCY IDENTIFICATION (RFID) READERS; RADIO FREQUENCY IDENTIFICATION (RFID) CREDENTIALS, NAMELY, CARDS AND TAGS, AND READERS FOR RADIO FREQUENCY IDENTIFICATION CREDENTIALS; INTERACTIVE VIDEO GAME PROGRAMS; CELL PHONE COVERS; DECORATIVE ORNAMENTS FOR CELLULAR TELEPHONES; DOWNLOADABLE MOTION PICTURES, TELEVISION SHOWS AND ANIMATED FILMS FEATURING CHILDREN'S ENTERTAINMENT; BARCODE DECODERS; COMPUTER STORAGE DEVICES, NAMELY, HIGH-SPEED STORAGE SUBSYSTEMS FOR STORAGE AND BACKUP OF ELECTRONIC DATA EITHER LOCALLY OR VIA A TELECOMMUNICATIONS NETWORK; SELF-ADHESIVE LABELS BEARING DATA IN CODE FORM OR CONTAINING EMBEDDED DATA; COMPUTER STORAGE DEVICES, NAMELY, BLANK FLASH DRIVES; EXTERNAL COMPUTER HARD DRIVES (U.S. CLS. 21, 23, 26, 36 AND 38).

**CLASS 28—TOYS AND SPORTING GOODS**

FOR INTERACTIVE VIRTUAL REALITY VIDEO GAME HARDWARE FOR USE WITH AN EXTERNAL MONITOR AND SOFTWARE; COMPUTER AND VIDEO GAME APPARATUS, NAMELY, VIDEO GAME MACHINES FOR USE WITH TELEVISIONS; GAMING MACHINES; COMPUTER GAME JOYSTICKS; REMOTE CONTROL APPARATUS FOR COMPUTER AND VIDEO GAMES; REMOTE CONTROLLERS FOR COMPUTER AND VIDEO GAMES; REMOTE CONTROLS FOR OPERATING REMOTE CONTROLLED TOYS; TOYS, GAMES AND PLAYTHINGS, NAMELY, TOY VEHICLES AND ACCESSORIES FOR USE THEREWITH; TOY ACTION FIGURES AND ACCESSORIES FOR USE THEREWITH; TOY PLAY SETS FOR USE IN CONNECTION WITH TOY ACTION FIGURES AND TOY VEHICLES; JIGSAW PUZZLES; BOARD GAMES; PARLOUR GAMES; ACTION SKILL GAMES; CARD GAMES; ROLE-PLAYING GAMES; HAND-HELD UNITS FOR PLAYING ELECTRONIC GAMES OTHER THAN THOSE ADAPTED FOR USE WITH AN EXTERNAL DISPLAY SCREEN; TOY VEHICLE PLAY SETS AND ACCESSORIES THEREFOR; REMOTE CONTROLLED TOY VEHICLES AND ACCESSORIES THEREFOR; REMOTE CONTROLLED TOY VEHICLES AND PARTS THEREFOR; REMOTE CONTROLLED TOY VEHICLE PLAY SETS AND ACCESSORIES THEREFOR; INDEPENDENT HAND HELD UNITS FOR PLAYING ELECTRONIC GAMES AND HANDHELD DEVICES ADAPTED FOR USE WITH AN EXTERNAL DISPLAY SCREEN OR MONITOR; PLAYING CARDS; TOY FIGURINES; ACTION TOY FIGURES; ACTION FIGURES AND ACCESSORIES THEREFOR; PARTY FAVORS IN THE NATURE OF SMALL TOYS, SQUEEZE TOYS, STUFFED TOYS, TALKING TOYS, TOY VEHICLES, TOY FIGURES, TOY BANKS, TOY TRUCKS, WIND-UP TOYS, PLUSH TOYS; PROTECTIVE CARRYING CASES AND HOLDERS SPECIALLY ADAPTED FOR COLLECTABLE TOY FIGURES, ARCADE GAME MACHINES; PUZZLES; COSTUME MASKS; CHRISTMAS TREE ORNAMENTS AND DECORATIONS; COLLECTABLE TOY FIGURES; COLLECTABLE TOY FIGURES HAVING RADIO FREQUENCY IDENTIFICATION (RFID) CHIPS OR TAGS; ACTION FIGURES HAVING RFID CHIPS OR TAGS; PLAY SETS FOR COLLECTABLE TOY FIGURES, PROTECTIVE CARRYING CASES SPECIALLY ADAPTED FOR HANDHELD VIDEO GAMES; PLASTIC PARTY HATS; BALLOONS; HAND HELD UNITS FOR PLAYING VIDEO GAMES OTHER THAN THOSE ADAPTED FOR USE WITH AN EXTERNAL DISPLAY SCREEN OR MONITOR; HANDHELD UNIT FOR PLAYING ELECTRONIC VIDEO GAMES; STAND ALONE VIDEO GAME MACHINES; ARCADE GAMES; COIN-OPERATED VIDEO GAMES; ELECTRIC ACTION TOYS; CARD GAMES UTILIZING RFID CHIPS OR TAGS WITHIN THE CARDS FOR PLAYING ELECTRONIC GAMES OTHER THAN THOSE ADAPTED FOR USE WITH AN EXTERNAL DISPLAY SCREEN OR MONITOR; AMUSEMENT PARK RIDES; TOY CANDY DISPENSERS; AMUSEMENT GAME MACHINES; ARCADE CRANE GAME MACHINES; BASEBALL BATS; BASEBALLS; BASEBALL MITTS; BASKETBALLS; BASKETBALL HOOPS; BATH TOYS; INFLATABLE BATH TOYS; BATTERY OPERATED ACTION TOYS; HANDBALLS; BEACH BALLS; BEAN BAG DOLLS; BOBBLE HEAD DOLLS; TRADING CARD GAMES; CHESS GAMES; CHECKER SETS; CHRISTMAS STOCKINGS; TOY CONSTRUCTION SETS; CONSTRUCTION TOYS; EGG DECORATING KITS; FOOTBALLS; AMUSEMENT DEVICES, NAMELY, BOUNCE HOUSES IN THE NATURE OF AN AIR INFLATED CUSHION IN AN AIR INFLATED STRUCTURE; INFLATABLE POOLS FOR RECREATIONAL USE; INFLATABLE TOYS; KITES; KALEIDOSCOPIES; PACHINKOS; PET TOYS; PINBALL GAMES; PIÑATAS; RADIO CONTROLLED TOY VEHICLES; RIDEABLE TOY VEHICLES; SKATEBOARDS; SNOW GLOBES; SOCCER BALLS; SWIM FINS; SWIM FLOATS FOR RECREATIONAL USE; PADDLE BOARDS; WATER TOYS; WATER SQUIRTING TOYS; YO-YOS; GAMING HEADSETS FOR USE IN PLAYING VIDEO GAMES; GAME CONTROLLERS FOR COMPUTER GAMES; CONFETTI; PAPER PARTY HATS (U.S. CLS. 22, 23, 38 AND 50).

**CLASS 41—EDUCATION AND ENTERTAINMENT**

FOR ENTERTAINMENT SERVICES, NAMELY, AN ON-GOING ANIMATED TELEVISION SERIES; EDUCATIONAL SERVICES, NAMELY, CONDUCTING ONLINE EXHIBITIONS AND DISPLAYS IN THE FIELD OF TOYS, GAMES AND PLAYTHINGS; EDUCATIONAL AND ENTERTAINMENT SERVICES, NAMELY, LIVE SHOW PERFORMANCES AND EDUCATIONAL EXHIBITIONS IN THE NATURE OF PERSONAL APPEARANCES AND CONCERTS BY CHARACTERS REGARDING COMPUTER GAMES AND VIDEO GAMES; ENTERTAINMENT SERVICES, NAMELY, PROVIDING ON-LINE INTERACTIVE GAMES; ENTERTAINMENT SERVICES, NAMELY, PROVIDING VIRTUAL ENVIRONMENTS IN WHICH USERS CAN INTERACT FOR RECREATIONAL, LEISURE OR ENTERTAINMENT PURPOSES; ENTERTAINMENT SERVICES, NAMELY, PROVIDING ON-LINE, NON-DOWNLOADABLE VIRTUAL CUSTOMIZABLE WORLDS FOR USE IN VIRTUAL ENVIRONMENTS CREATED FOR ENTERTAINMENT PURPOSES; ENTERTAINMENT SERVICES, NAMELY, ORGANIZATION OF SOCIAL GAMING AND AUGMENTED REALITY GAMING SERVICES; PROVIDING A WEBSITE FEATURING NON-DOWNLOADABLE PUBLICATIONS, NAMELY, CHILDREN BOOKS CONTAINING CHILDREN'S STORIES AND FICTIONAL CHARACTERS; ENTERTAINMENT SERVICES, NAMELY, PROVIDING A WEBSITE FEATURING GAMES AND PUZZLES; ENTERTAINMENT SERVICES, NAMELY, PROVIDING ONLINE NEWS AND INFORMATION IN THE FIELD OF COMPUTER GAMES AND COMPUTER ENHANCEMENTS FOR GAMES; ENTERTAINMENT SERVICES, NAMELY, PROVIDING ONLINE AUGMENTED REALITY GAMES; ENTERTAINMENT SERVICES, NAMELY, CONDUCTING CONTESTS ONLINE; ENTERTAINMENT SERVICES, NAMELY, PROVIDING A WEBSITE FOR ORGANIZING, PLANNING AND EXECUTING EVENTS BETWEEN COMPUTER GAME PLAYERS AND INTEREST GROUPS; ENTERTAINMENT SERVICES, NAMELY, PROVIDING VIRTUAL ENVIRONMENTS IN WHICH USERS CAN INTERACT THROUGH SOCIAL GAMES FOR RECREATIONAL, LEISURE OR ENTERTAINMENT; ENTERTAINMENT SERVICES, NAMELY THE PROVISION OF ON-GOING MOVIES AND TELEVISION SHOWS IN THE FIELD OF CHILDREN'S STORIES AND FICTIONAL CHARACTERS DELIVERED VIA AND BY TELEVISION, CABLE, SATELLITE, AUDIO AND VIDEO MEDIA AND ELECTRONIC MEANS; ENTERTAINMENT SERVICES IN THE NATURE OF AN AMUSEMENT PARK RIDE; AMUSEMENT PARK AND THEME PARK SERVICES; ENTERTAINMENT SERVICES IN THE NATURE OF AN AMUSEMENT PARK ATTRACTION, NAMELY, A THEMED AREA; ONLINE ELECTRONIC PUBLISHING OF BOOKS, MAGAZINES, COMIC BOOKS, GRAPHIC NOVELS AND PERIODICALS; MULTIMEDIA PUBLISHING OF GAMES; PROVIDING ON-LINE PUBLICATIONS IN THE NATURE OF GAME BOOKS; PUBLISHING OF BOOKS, MAGAZINES, COMIC BOOKS, GRAPHIC NOVELS AND PERIODICALS; ON-LINE JOURNALS, NAMELY, BLOGS FEATURING PERSONAL INFORMATION AND OPINIONS; PROVIDING INFORMATION RELATING TO SPORTING AND CULTURAL ACTIVITIES, CONTESTS AND GAMES, MOVIE SCHEDULES AND MOVIE THEATERS; SPECIAL EVENT PLANNING FOR SOCIAL ENTERTAINMENT PURPOSES; ENTERTAINMENT SERVICES, NAMELY, A MULTIMEDIA PROGRAM SERIES FEATURING COMEDY, ACTION AND ADVENTURE DISTRIBUTED VIA VARIOUS PLATFORMS ACROSS MULTIPLE FORMS OF TRANSMISSION MEDIA; ENTERTAINMENT SERVICES, NAMELY, PROVIDING ONLINE COMPUTER GAMES; ENTERTAINMENT SERVICES IN THE NATURE OF ORGANIZING AND CONDUCTING CONTESTS AND ORGANIZATION OF GAMES (U.S. CLS. 100, 101 AND 107).

JASON BLAIR, EXAMINING ATTORNEY



SN 85-910,925. VASCOR, LTD., GEORGETOWN, KY. FILED 4-22-2013.

# VASCOR

THE MARK CONSISTS OF STANDARD CHARACTERS WITHOUT CLAIM TO ANY PARTICULAR FONT, STYLE, SIZE, OR COLOR.

## CLASS 35—ADVERTISING AND BUSINESS

FOR SUPPLY CHAIN, LOGISTICS, AND REVERSE LOGISTICS SERVICES, NAMELY, COMPUTERIZED TRACKING OF RAW MATERIALS, AUTOMOBILE PARTS, FINISHED VEHICLES, AND OTHER FREIGHT FOR OTHERS FOR BUSINESS ADMINISTRATION PURPOSES; INFORMATION MANAGEMENT SERVICES FOR BUSINESS ADMINISTRATION PURPOSES, NAMELY, SHIPMENT PROCESSING, PREPARING SHIPPING DOCUMENTS AND INVOICES, INVENTORY MANAGEMENT, PRODUCTION PLANNING, TRACKING, PACKAGES AND FREIGHT, OVER COMPUTER NETWORKS, INTRANETS, AND THE INTERNET; BUSINESS MANAGEMENT SERVICES, NAMELY, MANAGING LOGISTICS, REVERSE LOGISTICS, SUPPLY CHAIN SERVICES, SUPPLY CHAIN VISIBILITY AND SYNCHRONIZATION, SUPPLY AND DEMAND FORECASTING AND PRODUCT DISTRIBUTION PROCESSES FOR OTHERS; AND BUSINESS CONSULTING SERVICES RELATING TO PRODUCT DISTRIBUTION, OPERATIONS MANAGEMENT SERVICES, LOGISTICS, REVERSE LOGISTICS, SUPPLY CHAIN, AND PRODUCTION SYSTEMS AND DISTRIBUTION SOLUTIONS (U.S. CLS. 100, 101 AND 102).

FIRST USE 2-26-1987; IN COMMERCE 2-26-1987.

## CLASS 39—TRANSPORTATION AND STORAGE

FOR SUPPLY CHAIN, LOGISTICS, AND REVERSE LOGISTICS SERVICES, NAMELY, PICK-UP, STORAGE, TRANSPORTATION, AND DELIVERY OF RAW MATERIALS, AUTOMOBILE PARTS, FINISHED VEHICLES, AND OTHER FREIGHT FOR OTHERS BY AIR, RAIL, SHIP OR TRUCK; WAREHOUSING SERVICES, NAMELY, STORAGE, DISTRIBUTION, PICK-UP, AND PACKING FOR SHIPMENT OF RAW MATERIALS, AUTOMOBILE PARTS AND OTHER FREIGHT FOR OTHERS; FREIGHT FORWARDING SERVICES; AND TRANSPORTATION OF GOODS OF OTHERS BY AIR, RAIL, SHIP, OR TRUCK (U.S. CLS. 100 AND 105).

FIRST USE 2-26-1987; IN COMMERCE 2-26-1987.  
LIEF MARTIN, EXAMINING ATTORNEY

SN 85-912,558. TRANSMITIVE, LLC, NEW YORK, NY. FILED 4-23-2013.

# SIGNL

THE MARK CONSISTS OF STANDARD CHARACTERS WITHOUT CLAIM TO ANY PARTICULAR FONT, STYLE, SIZE, OR COLOR.

## CLASS 9—ELECTRICAL AND SCIENTIFIC APPARATUS

FOR DOWNLOADABLE MOBILE APPLICATION SOFTWARE FOR DATA ANALYSIS; SOFTWARE TO ENABLE UPLOADING, POSTING, SHOWING, DISPLAYING, TAGGING, BLOGGING, SHARING OR OTHERWISE PROVIDING ELECTRONIC MEDIA OR INFORMATION OVER THE INTERNET OR OTHER COMMUNICATIONS NETWORK (U.S. CLS. 21, 23, 26, 36 AND 38).

FIRST USE 4-23-2013; IN COMMERCE 4-23-2013.

## CLASS 42—SCIENTIFIC AND COMPUTER SERVICES

FOR DATA AGGREGATION SERVICES, NAMELY, AGGREGATION OF DATA REGARDING BUSINESS INTELLIGENCE, COMPETITIVE ANALYSIS, SALES-TARGET ANALYSIS, EARLY-STAGE BUSINESSES AND EARLY-STAGE TECHNOLOGIES; PROVIDING A WEBSITE FEATURING NON-DOWNLOADABLE SOFTWARE USED FOR COMPILING AND MANIPULATING INFORMATION FOR DATA ANALYSIS; PROVIDING ON-LINE DOWNLOADABLE SOFTWARE USED FOR COMPILING AND MANIPULATING INFORMATION FOR DATA ANALYSIS; SOFTWARE AS A SERVICE (SAAS) SERVICES FEATURING SOFTWARE FOR USE IN DATA ANALYSIS; APPLICATION SERVICE PROVIDER (ASP) FEATURING SOFTWARE TO ENABLE UPLOADING, POSTING, SHOWING, DISPLAYING, TAGGING, BLOGGING, SHARING OR OTHERWISE PROVIDING ELECTRONIC MEDIA OR INFORMATION OVER THE INTERNET OR OTHER COMMUNICATIONS NETWORKS (U.S. CLS. 100 AND 101).

FIRST USE 4-23-2013; IN COMMERCE 4-23-2013.  
NAPOLEON SHARMA, EXAMINING ATTORNEY

SN 85-912,830. ZIOTA TECHNOLOGY, INC., SAINT-HUBERT, QUEBEC, CANADA, FILED 4-23-2013.

# ONE MAN ONE SCAN

THE MARK CONSISTS OF STANDARD CHARACTERS WITHOUT CLAIM TO ANY PARTICULAR FONT, STYLE, SIZE, OR COLOR.

## CLASS 9—ELECTRICAL AND SCIENTIFIC APPARATUS

FOR TEST EQUIPMENT AND ACCESSORIES, NAMELY, COMPUTER OPERATING SOFTWARE, A COMPUTER SOFTWARE NETWORK MANAGER, MULTIPLE PORTABLE TEST BOX UNITS, ELECTRIC INTERFACE CABLES USED FOR THE INSTALLATION AND MAINTENANCE OF WIRING AND ELECTRICAL SUBSYSTEMS IN TRANSPORT VEHICLES AND EQUIPMENT PLATFORMS, NAMELY, ELECTRICAL HARNESSES AND NON-ELECTRONIC COMPONENTS IN THE NATURE OF ELECTRIC SWITCHES, ELECTRIC RELAYS, ELECTRICAL CONTROLS FOR MOTORS FOR TESTING THE INTEGRITY OF THEIR CONDUCTORS, SHIELDING, AND GROUND (U.S. CLS. 21, 23, 26, 36 AND 38).

**CLASS 37—CONSTRUCTION AND REPAIR**

FOR CONSULTING SERVICES IN THE FIELD OF TURNKEY AUTOMATED SOLUTIONS FOR THE INSTALLATION AND MAINTENANCE OF WIRING AND ELECTRICAL SUB-SYSTEMS IN TRANSPORT VEHICLES AND EQUIPMENT PLATFORMS, NAMELY, PROVIDING MAINTENANCE PROCESSES, AUTOMATED TEST PROGRAMS AND PACKAGES OF INTERFACES CABLES REQUIRED TO VALIDATE THE INTEGRITY OF ELECTRICAL HARNESSSES AND NON-ELECTRONIC COMPONENTS IN THE NATURE OF SWITCHES, RELAYS, ELECTRICAL MOTORS FOR TESTING THE INTEGRITY OF THEIR CONDUCTORS, SHIELDING, AND GROUND (U.S. CLS. 100, 103 AND 106).

NATALIE KENEALY, EXAMINING ATTORNEY

SN 85-913,912. SILVER AND SAGE, LLC, SCOTTSDALE, AZ. FILED 4-24-2013.



NO CLAIM IS MADE TO THE EXCLUSIVE RIGHT TO USE "SILVER" AND "LLC", APART FROM THE MARK AS SHOWN.

THE MARK CONSISTS OF THE WORDS "SILVER & SAGE LLC" AND THREE SAGE LEAVES IN A CIRCULAR BACKGROUND.

**CLASS 14—JEWELRY**

FOR BRACELETS; BROACHES; JEWELRY; JEWELRY MADE IN WHOLE OR SIGNIFICANT PART OF SILVER; JEWELRY, NAMELY, AMULETS; JEWELRY, NAMELY, STONE PENDANTS; WOMEN'S JEWELRY; ALL OF MADE OF SILVER (U.S. CLS. 2, 27, 28 AND 50).

FIRST USE 3-28-2011; IN COMMERCE 3-28-2011.

**CLASS 35—ADVERTISING AND BUSINESS**

FOR ON-LINE WHOLESALE STORE SERVICES FEATURING JEWELRY INCLUDING SILVER JEWELRY; RETAIL JEWELRY STORES INCLUDING SILVER JEWELRY; VENDING IN THE FIELD OF JEWELRY INCLUDING SILVER JEWELRY; WHOLESALE STORE SERVICES FEATURING JEWELRY INCLUDING SILVER JEWELRY (U.S. CLS. 100, 101 AND 102).

FIRST USE 3-28-2011; IN COMMERCE 3-28-2011.

BERNICE MIDDLETON, EXAMINING ATTORNEY

SN 85-912,832. ZIOTA TECHNOLOGY, INC., SAINT-HUBERT, QUÉBEC, CANADA, FILED 4-23-2013.

ONE MAN FULL SCAN

THE MARK CONSISTS OF STANDARD CHARACTERS WITHOUT CLAIM TO ANY PARTICULAR FONT, STYLE, SIZE, OR COLOR.

**CLASS 9—ELECTRICAL AND SCIENTIFIC APPARATUS**

FOR TEST EQUIPMENT AND ACCESSORIES, NAMELY, COMPUTER OPERATING SOFTWARE, A COMPUTER NETWORK MANAGER, MULTIPLE PORTABLE TEST BOX UNITS, ELECTRIC INTERFACE CABLES USED FOR THE INSTALLATION AND MAINTENANCE OF WIRING AND ELECTRICAL SUBSYSTEMS IN TRANSPORT VEHICLES AND EQUIPMENT PLATFORMS, NAMELY, ELECTRICAL HARNESSSES AND NON-ELECTRONIC COMPONENTS IN THE NATURE OF ELECTRIC SWITCHES, ELECTRIC RELAYS, ELECTRICAL CONTROLS FOR MOTORS FOR TESTING THE INTEGRITY OF THEIR CONDUCTORS, SHIELDING, AND GROUND (U.S. CLS. 21, 23, 26, 36 AND 38).

**CLASS 37—CONSTRUCTION AND REPAIR**

FOR CONSULTING SERVICES IN THE FIELD OF TURNKEY AUTOMATED SOLUTIONS FOR THE INSTALLATION AND MAINTENANCE OF WIRING AND ELECTRICAL SUB-SYSTEMS IN TRANSPORT VEHICLES AND EQUIPMENT PLATFORMS, NAMELY, PROVIDING MAINTENANCE PROCESSES, AUTOMATED TEST PROGRAMS AND PACKAGES OF INTERFACES CABLES REQUIRED TO VALIDATE THE INTEGRITY OF ELECTRICAL HARNESSSES AND NON-ELECTRONIC COMPONENTS IN THE NATURE OF SWITCHES, RELAYS, ELECTRICAL MOTORS FOR TESTING THE INTEGRITY OF THEIR CONDUCTORS, SHIELDING, AND GROUND (U.S. CLS. 100, 103 AND 106).

NATALIE KENEALY, EXAMINING ATTORNEY

SN 85-914,677. SAFEWAY INC., PLEASANTON, CA. FILED 4-25-2013.



OWNER OF U.S. REG. NOS. 3,232,276, 3,753,482 AND OTHERS.

THE COLOR(S) GREEN, WHITE, RED AND ORANGE IS/ARE CLAIMED AS A FEATURE OF THE MARK.

THE MARK CONSISTS OF THE STYLIZED WORDING "EATING RIGHT FOR PROTEIN SEEKERS", WITH THE WORDS "EATING RIGHT" APPEARING IN WHITE ON AN INCOMPLETE GREEN SHADED CIRCLE, THE WORD "FOR" APPEARING IN RED ON A SMALL ORANGE SHADED CIRCLE, AND THE WORDS "PROTEIN SEEKERS" APPEARING IN WHITE ON A LARGE RED SHADED CIRCLE, WITH THE INCOMPLETE GREEN SHADED CIRCLE OVERLAPPING THE RED SHADED CIRCLE, THE ORANGE SHADED CIRCLE APPEARING WITHIN THE AREA OF THE RED SHADED CIRCLE AND OVERLAPPING THE INCOMPLETE GREEN SHADED CIRCLE, AND WITH THE CIRCLE ELEMENTS ARRANGED DIAGONALLY. THE GRAY IN THE DRAWING REPRESENTS BACKGROUND AND IS NOT PART OF THE MARK.

**CLASS 5—PHARMACEUTICALS**

FOR NUTRITIONAL SUPPLEMENTS FORMED AND PACKAGED AS BARS; NUTRITIONAL SUPPLEMENT ENERGY BARS; NUTRITIONAL SUPPLEMENT SHAKES; PROTEIN SUPPLEMENT SHAKES; FRUIT-BASED MEAL REPLACEMENT BARS FOR MEDICAL PURPOSES; NUTRITIONAL SUPPLEMENT MEAL REPLACEMENT BARS FOR BOOSTING ENERGY; CHOCOLATE-BASED MEAL REPLACEMENT BARS FOR MEDICAL PURPOSES; CHOCOLATE-BASED MEAL REPLACEMENT SHAKES FOR WEIGHT LOSS PURPOSES (U.S. CLS. 6, 18, 44, 46, 51 AND 52).

**CLASS 29—MEATS AND PROCESSED FOODS**

FOR FRUIT-BASED MEAL REPLACEMENT BARS; FRUIT-BASED MEAL REPLACEMENT BARS FOR BOOSTING ENERGY; MEAL REPLACEMENT BEVERAGES IN THE NATURE OF MILK SHAKES NOT FOR MEDICAL PURPOSES (U.S. CL. 46).

**CLASS 30—STAPLE FOODS**

FOR CEREAL BARS; CEREAL-BASED ENERGY BARS; GRANOLA-BASED SNACK BARS; CHOCOLATE-BASED MEAL REPLACEMENT BARS; PROCESSED CEREAL-BASED FOOD TO BE USED AS A BREAKFAST FOOD, SNACK FOOD, OR INGREDIENT FOR MAKING OTHER FOODS; PACKAGED COOKIES (U.S. CL. 46).

**CLASS 32—LIGHT BEVERAGES**

FOR REFRIGERATED NON-ALCOHOLIC BEVERAGES CONTAINING FRUIT JUICES (U.S. CLS. 45, 46 AND 48).  
CYNTHIA TRIPI, EXAMINING ATTORNEY

**CLASS 30—STAPLE FOODS**

FOR CEREAL BARS; CEREAL-BASED ENERGY BARS; GRANOLA-BASED SNACK BARS; CHOCOLATE-BASED MEAL REPLACEMENT BARS; PROCESSED CEREAL-BASED FOOD TO BE USED AS A BREAKFAST FOOD, SNACK FOOD, OR INGREDIENT FOR MAKING OTHER FOODS; PACKAGED COOKIES (U.S. CL. 46).

**CLASS 32—LIGHT BEVERAGES**

FOR REFRIGERATED NON-ALCOHOLIC BEVERAGES CONTAINING FRUIT JUICES (U.S. CLS. 45, 46 AND 48).  
CYNTHIA TRIPI, EXAMINING ATTORNEY

SN 85-915,653. CINBA GROUP, LLC DBA LIFETRENDS, AUSTIN, TX. FILED 4-26-2013.

SN 85-914,688. SAFEWAY INC., PLEASANTON, CA. FILED 4-25-2013.

EATING RIGHT FOR PROTEIN  
SEEKERS

THE MARK CONSISTS OF STANDARD CHARACTERS WITHOUT CLAIM TO ANY PARTICULAR FONT, STYLE, SIZE, OR COLOR.

OWNER OF U.S. REG. NOS. 3,232,276, 3,753,482 AND OTHERS.

**CLASS 5—PHARMACEUTICALS**

FOR NUTRITIONAL SUPPLEMENTS FORMED AND PACKAGED AS BARS; NUTRITIONAL SUPPLEMENT ENERGY BARS; NUTRITIONAL SUPPLEMENT SHAKES; PROTEIN SUPPLEMENT SHAKES; FRUIT-BASED MEAL REPLACEMENT BARS FOR MEDICAL PURPOSES; NUTRITIONAL SUPPLEMENT MEAL REPLACEMENT BARS FOR BOOSTING ENERGY; CHOCOLATE-BASED MEAL REPLACEMENT BARS FOR MEDICAL PURPOSES; CHOCOLATE-BASED MEAL REPLACEMENT SHAKES FOR WEIGHT LOSS PURPOSES (U.S. CLS. 6, 18, 44, 46, 51 AND 52).

**CLASS 29—MEATS AND PROCESSED FOODS**

FOR FRUIT-BASED MEAL REPLACEMENT BARS; FRUIT-BASED MEAL REPLACEMENT BARS FOR BOOSTING ENERGY; MEAL REPLACEMENT BEVERAGES IN THE NATURE OF MILK SHAKES NOT FOR MEDICAL PURPOSES (U.S. CL. 46).

LIFETRENDS

THE MARK CONSISTS OF STANDARD CHARACTERS WITHOUT CLAIM TO ANY PARTICULAR FONT, STYLE, SIZE, OR COLOR.

**CLASS 35—ADVERTISING AND BUSINESS**

FOR ABSTRACTING SERVICES IN THE NATURE OF EXTRACTING AND SUMMARIZING INFORMATION FROM INSURANCE RECORDS; ANALYZING AND COMPILING DATA MEASURING THE PERFORMANCE OF FINANCIAL MARKETS; COMPILING FINANCIAL MARKET INFORMATION FOR BUSINESS PURPOSES; PREPARING FINANCIAL REPORTS FOR OTHERS; PROVIDING AN ON-LINE COMPUTER WEB SITE THAT PROVIDES STATISTICAL ANALYSIS AND REPORTING AND RELATED REFERENCE INFORMATION FOR BUSINESS PURPOSES IN THE FIELD OF INSURANCE; DATA COMPILING AND ANALYZING IN THE FIELD OF INSURANCE (U.S. CLS. 100, 101 AND 102).

FIRST USE 3-25-2011; IN COMMERCE 3-25-2011.

**CLASS 36—INSURANCE AND FINANCIAL**

FOR FINANCIAL ANALYSES; FINANCIAL ANALYSES AND CONSULTATION; FINANCIAL ANALYSES AND RESEARCH SERVICES; FINANCIAL ANALYSIS, NAMELY, COMPILING AND ANALYZING STATISTICS, DATA AND OTHER SOURCES OF INFORMATION FOR FINANCIAL PURPOSES; FINANCIAL CONSULTANCY; FINANCIAL CONSULTANCY AND INSURANCE CONSULTANCY; FINANCIAL CONSULTATION; FINANCIAL CONSULTATION IN THE FIELD OF INSURANCE; FINANCIAL CONSULTING; FINANCIAL INFORMATION PROVIDED BY ELECTRONIC MEANS; FINANCIAL INFORMATION PROCESSING; FINANCIAL INFORMATION AND ADVISORY SERVICES; FINANCIAL INFORMATION AND EVALUATIONS FINANCIAL INFORMATION PROVIDED BY ELECTRONIC MEANS IN THE FIELD OF INSURANCE; FINANCIAL RESEARCH FINANCIAL RESEARCH AND INFORMATION SERVICES; FINANCIAL SERVICES, NAMELY, PROVIDING AN INVESTMENT OPTION AVAILABLE FOR ANNUITY AND VARIABLE LIFE INSURANCE PRODUCTS; INSURANCE AND FINANCIAL INFORMATION AND CONSULTANCY SERVICES; PROVIDING FINANCIAL INFORMATION; CONSULTING AND INFORMATION CONCERNING INSURANCE; INSURANCE CONSULTANCY; INSURANCE CONSULTATION; INSURANCE CONSULTING IN THE FIELD OF LIFE INSURANCE; INSURANCE INFORMATION; INSURANCE INFORMATION AND CONSULTANCY; INSURANCE PREMIUM RATE COMPUTING; PROVIDING INFORMATION IN INSURANCE MATTERS (U.S. CLS. 100, 101 AND 102).

FIRST USE 3-25-2011; IN COMMERCE 3-25-2011.  
BARBARA GAYNOR, EXAMINING ATTORNEY

**CLASS 11—ENVIRONMENTAL CONTROL APPARATUS**

FOR LIGHTING, NAMELY, LED FIXTURES, LED LAMPS, LED LIGHT FIXTURES THAT ARE IN THE FORM OF TAPE, LED LIGHT FIXTURES THAT ARE ATTACHED TO ROPE, FLUORESCENT ELECTRIC LIGHT BULBS, INDUCTION OVENS, ELECTRIC LIGHTS FOR CHRISTMAS TREES, SOCKETS FOR ELECTRIC LIGHTS, LANDSCAPE LIGHTING INSTALLATIONS, HID LAMPS, LED AUTOMOTIVE LIGHTING HEADLIGHTS FOR VEHICLES, LED PLANT GROW LIGHTS, STAGE AND STUDIO LAMPS, AND THEATRICAL STAGE LIGHTING APPARATUS (U.S. CLS. 13, 21, 23, 31 AND 34).

INGRID C. EULIN, EXAMINING ATTORNEY

SN 85-918,213. ADVENTURE CO., LTD, FUKUOKA, JAPAN,  
FILED 4-29-2013.

# ZAKANAKA

THE MARK CONSISTS OF STANDARD CHARACTERS WITHOUT CLAIM TO ANY PARTICULAR FONT, STYLE, SIZE, OR COLOR.

**CLASS 6—METAL GOODS**

FOR METAL CANS, METAL HANGERS FOR PLANTS, METAL HOOKS, METAL BOXES, BASKETS OF COMMON METALS, AND METAL TUBS (U.S. CLS. 2, 12, 13, 14, 23, 25 AND 50).

FIRST USE 10-7-2013; IN COMMERCE 10-7-2013.

**CLASS 16—PAPER GOODS AND PRINTED MATTER**

FOR CALENDAR COVERS; NOTEBOOK COVERS; STORAGE CONTAINERS AND BOXES MADE OF PAPER OR CARDBOARD; BAGS MADE OF PAPER (U.S. CLS. 2, 5, 22, 23, 29, 37, 38 AND 50).

FIRST USE 10-7-2013; IN COMMERCE 10-7-2013.

**CLASS 18—LEATHER GOODS**

FOR LEATHER AND IMITATION LEATHER BAGS; ALL PURPOSE CARRYING BAGS MADE OF STRAW; SHOPPING BAGS MADE OF TEXTILES AND CORN FIBER; PURSES, CLUTCHES, COSMETIC BAGS SOLD EMPTY AND POUCHES OF TEXTILE, LEATHER AND IMITATION LEATHER; CARRY-ON BAGS, BOSTON BAGS, LUGGAGE AND TRUNKS, SUITCASES; CARRY-ALL BAGS; UMBRELLAS; PARASOLS; TOTE BAGS, SHOULDER BAGS; ATHLETIC BAGS; BACKPACKS; ALL-PURPOSE CARRYING BAGS; KEY CASES; WALLET (U.S. CLS. 1, 2, 3, 22 AND 41).

FIRST USE 10-7-2013; IN COMMERCE 10-7-2013.

**CLASS 20—FURNITURE AND ARTICLES NOT OTHERWISE CLASSIFIED**

FOR FURNITURE; MIRRORS; CUSHIONS; FILING CABINETS; PLASTIC AND WOOD BOXES; NON-METAL STORAGE BOXES; SHOE, COAT AND HAT RACKS; MAGAZINE, NEWSPAPER AND BOOK RACKS AND DISPLAY STANDS; CLOTHES HANGERS; TISSUE BOX COVERS MADE OF TEXTILE, PLASTIC AND WOOD; ACCENT PILLOWS; BED PILLOWS; MIRROR FRAMES; PERSONAL COMPACT MIRRORS (U.S. CLS. 2, 13, 22, 25, 32 AND 50).

FIRST USE 10-7-2013; IN COMMERCE 10-7-2013.

SN 85-918,195. PHILCOR T.V. & ELECTRONIC LEASING,  
INC, LAS VEGAS, NV. FILED 4-29-2013.



NO CLAIM IS MADE TO THE EXCLUSIVE RIGHT TO USE "ENERGY" AND "POWERED BY", APART FROM THE MARK AS SHOWN.

THE STIPPLING IS FOR SHADING PURPOSES ONLY.

THE MARK CONSISTS OF THE TEXT "ENERGY AVENUE, POWER BY SAVINGS" IN AIRBUS SPECIAL FONT. A ROAD STRETCHES FROM BOTH ENDS OF THE WORD "ENERGY" AND RUNS BEHIND IT FADING OFF IN THE DISTANCE ENDING AT THE WORD "AVENUE". A CART WITH A LIGHT BULB IN IT SHINNING SITS AT THE END OF THE WORDS "ENERGY AVENUE" AND BELOW THAT READS "POWERED BY SAVINGS".

**CLASS 9—ELECTRICAL AND SCIENTIFIC APPARATUS**

FOR APPARATUS AND INSTRUMENTS, NAMELY, LIGHTING BALLASTS, ELECTRIC LIGHT DIMMERS, OCCUPANCY SENSORS IN THE NATURE OF ELECTRONIC DEVICES WHICH DETECT THE PRESENCE OF OCCUPANTS AND CONTROL THE LIGHTING SYSTEM ACCORDINGLY, THERMOSTATS, TIMERS, ELECTRICAL WIRE, AND SOLAR PANELS FOR PRODUCTION OF ELECTRICITY; BATTERIES; LED ILLUMINATED EXIT SIGNS; ELECTRIC LED EMERGENCY SIGNS (U.S. CLS. 21, 23, 26, 36 AND 38).

**CLASS 21—HOUSEWARES AND GLASS**

FOR TOILET PAPER AND PAPER TOWEL RACKS, DISPENSERS AND HOLDERS; DECORATIVE CLOTHES PINS; CONTAINERS FOR HOUSEHOLD OR KITCHEN USE; LAUNDRY HAMPERS FOR HOUSEHOLD USE; WASTE PAPER BASKETS SOLD EMPTY, PICNIC BASKETS, FLOWER BASKETS, LAUNDRY BASKETS AND PLANT BASKETS, ALL OF WHICH ARE NOT MADE OF METAL; COASTERS NOT OF PAPER AND NOT OF TABLE LINEN; POTS FOR PLANTS; DECORATIVE JUGS; WATERING CANS; NON-METAL STORAGE BASKETS FOR DOMESTIC USE (U.S. CLS. 2, 13, 23, 29, 30, 33, 40 AND 50).

FIRST USE 10-7-2013; IN COMMERCE 10-7-2013.

**CLASS 24—FABRICS**

FOR TEXTILES AND TEXTILE GOODS, NAMELY, QUILTS, CUSHION COVERS, TABLE CLOTHS, DUVET COVERS, BED COVERS; WALL HANGINGS OF TEXTILE; HANDKERCHIEFS; BED BLANKETS, BABY BLANKETS, BLANKETS FOR OUTDOOR USE, CHILDREN'S BLANKETS, LAP BLANKETS AND TRAVELING BLANKETS; TEXTILE PLACE MATS; TEXTILE COASTERS; CURTAINS; TOWELS OF TEXTILE; OVEN MITTS AND POT HOLDERS; CURTAINS (U.S. CLS. 42 AND 50).

FIRST USE 10-7-2013; IN COMMERCE 10-7-2013.

**CLASS 25—CLOTHING**

FOR CLOTHING FOR WOMEN AND CHILDREN, NAMELY, PONCHOS, CAPES, BOLEROS, STOLES, HAND AND EAR MUFFLERS, MITTENS, GLOVES, SCARVES, HATS, CAPS, COATS, JACKETS, SHIRTS, SLOUSES, DRESSES, PANTS, SHORTS, SWEATERS, SWEAT SHIRTS, SWEAT PANTS, SKIRTS, RAINWEAR, PAJAMAS, CAMISOLES, T-SHIRTS, APRONS, UNDERWEAR, BRAS, SLIPS, LINGERIE, SHOES, SNEAKERS, BOOTS, SLIPPERS, SANDALS, SOCKS, TIGHTS, LEGGINGS, STOCKINGS, PANTY HOSE, SLIPS AND PETTI-COATS, LEG WARMERS, BELTS FOR CLOTHING, VESTS, SANITARY SHORTS; WEARABLE BLANKETS IN THE NATURE OF BLANKETS WITH SLEEVES (U.S. CLS. 22 AND 39).

FIRST USE 10-7-2013; IN COMMERCE 10-7-2013.

**CLASS 27—FLOOR COVERINGS**

FOR BATH MATS, KITCHEN FLOOR MATS, DOOR MATS, FLOOR MATS, BEACH MATS, CARPETS, RUGS (U.S. CLS. 19, 20, 37, 42 AND 50).

FIRST USE 10-7-2013; IN COMMERCE 10-7-2013.

**CLASS 35—ADVERTISING AND BUSINESS**

FOR ONLINE RETAIL STORE SERVICES, RETAIL STORE SERVICES AND WHOLESALE STORE SERVICES, ALL FEATURING METAL CANS, BOXES AND RACKS, ACCESSORIES, GIFTS, BAGS, LUGGAGE, CASES, FURNITURE, HOUSEHOLD FURNISHINGS, STORAGE BOXES, HOUSEHOLD GOODS, TEXTILE GOODS, BEDDING, TOWELS, DECORATIVE GARDEN SUPPLIES, CLOTHING FOR WOMEN AND CHILDREN, UNDERWEAR, FOOTWEAR, HEADGEAR, CARPETS, MIRRORS, WALL HANGINGS, SUNGLASSES, EYEGLASSES AND TOYS (U.S. CLS. 100, 101 AND 102).

FIRST USE 10-7-2013; IN COMMERCE 10-7-2013.

WON TEAK OH, EXAMINING ATTORNEY

SN 85-919,396. LUNT CAPITAL MANAGEMENT, INC., SALT LAKE CITY, UT. FILED 4-30-2013.

LUNT CAPITAL HIGH BETA LOW  
VOLATILITY ROTATION INDEX

THE MARK CONSISTS OF STANDARD CHARACTERS WITHOUT CLAIM TO ANY PARTICULAR FONT, STYLE, SIZE, OR COLOR.

NO CLAIM IS MADE TO THE EXCLUSIVE RIGHT TO USE "CAPITAL HIGH BETA LOW VOLATILITY ROTATION INDEX", APART FROM THE MARK AS SHOWN.

**CLASS 35—ADVERTISING AND BUSINESS**

FOR PROVIDING AND UPDATING A FINANCIAL INDEX OF SECURITIES VALUES AND CLASSIFICATION, ANALYSIS, AND REPORTING THEREOF; PROVIDING FINANCIAL INDICES BASED ON SELECTED GROUPS OF SECURITIES AND INDICES (U.S. CLS. 100, 101 AND 102).

FIRST USE 7-31-2012; IN COMMERCE 7-31-2012.

**CLASS 36—INSURANCE AND FINANCIAL**

FOR FINANCIAL SERVICES, NAMELY, PROVIDING FINANCIAL AND INVESTMENT SERVICES BASED ON AN INDEX THAT MEASURES MARKETPLACE RISK IN SELECTED FINANCIAL MARKETS; PROVIDING FINANCIAL AND INVESTMENT INFORMATION SERVICES IN THE NATURE OF A FINANCIAL INDEX; PROVIDING CONSULTATION IN THE FIELD OF INVESTING; PROVIDING FINANCIAL ANALYSIS AND MANAGEMENT; PERFORMING FINANCIAL RESEARCH AND ANALYSIS FOR OTHERS (U.S. CLS. 100, 101 AND 102).

FIRST USE 7-31-2012; IN COMMERCE 7-31-2012.

MICHAEL ENGEL, EXAMINING ATTORNEY

SN 85-920,260. DSM IP ASSETS B.V., HEERLEN, NETHERLANDS, FILED 5-1-2013.



PRIORITY CLAIMED UNDER SEC. 44(D) ON BENELUX APPLICATION NO. 1260296, FILED 12-21-2012, REG. NO. 0930769, DATED 12-28-2012, EXPIRES 12-21-2022.

OWNER OF U.S. REG. NOS. 3,744,692, 3,930,068 AND OTHERS.

NO CLAIM IS MADE TO THE EXCLUSIVE RIGHT TO USE "OMEGA", APART FROM THE MARK AS SHOWN.

THE MARK CONSISTS OF THE STYLIZED WORDING "LIFE'S OMEGA" SURROUNDED BY THE DEPICTION OF A RECTANGLE HAVING TWO ROUNDED CORNERS IN THE UPPER LEFT AND LOWER RIGHT AND THE APOSTROPHE APPEARING AS THE DEPICTION OF A STYLIZED LEAF.

**CLASS 5—PHARMACEUTICALS**

FOR (BASED ON 44(E)) FOOD SUPPLEMENTS, WHETHER OR NOT DIETETIC; DIETETIC SUBSTANCES FOR MEDICAL USE, NAMELY, DIETARY SUPPLEMENTS, DIETARY SUPPLEMENT DRINKS; INGREDIENTS FOR DIETETIC FOODS FOR MEDICAL USE, NAMELY, FOOD ADDITIVES FOR USE AS NUTRITIONAL SUPPLEMENTS; FOOD FOR BABIES; FOOD FOR ILL PEOPLE FOR MEDICAL USE, NAMELY, NUTRITIONAL SUPPLEMENTS, NUTRITIONALLY FORTIFIED BEVERAGES; VITAMINS AND VITAMIN PREPARATIONS; MEDICINAL OILS; VITAMIN OILS FOR HUMAN CONSUMPTION, ALL THE FOREGOING CONTAINING OMEGA FATTY ACIDS (U.S. CLS. 6, 18, 44, 46, 51 AND 52).

**CLASS 29—MEATS AND PROCESSED FOODS**

FOR (BASED ON INTENT TO USE) MEAT, FISH, POULTRY AND GAME; MEAT EXTRACTS; PRESERVED, FROZEN, DRIED AND COOKED FRUITS AND VÉGETABLES, JELLIES, JAMS, COMPOTES; EGGS, MILK; MILK PRODUCTS EXCLUDING ICE CREAM, ICE MILK AND FROZEN YOGURT; EDIBLE OILS AND FATS; ALGAE OIL, VEGETABLE OIL AND COOKING OIL; SOUPS, SOUP EXTRACTS; DAIRY PRODUCTS EXCLUDING ICE CREAM, ICE MILK AND FROZEN YOGURT; DAIRY-BASED BEVERAGES; SOY-BASED BEVERAGES USED AS A MILK SUBSTITUTE; POTATO CHIPS, PROTEIN FOR HUMAN CONSUMPTION, NAMELY, PROTEIN MILK, FORMED TEXTURED VEGETABLE PROTEIN FOR USE AS A MEAT SUBSTITUTE, ALL THE FOREGOING CONTAINING OMEGA FATTY ACIDS (U.S. CL. 46).

**CLASS 32—LIGHT BEVERAGES**

FOR (BASED ON INTENT TO USE) BEER; NON-ALCOHOLIC BEVERAGES, NAMELY, NON-ALCOHOLIC BEVERAGES CONTAINING FRUIT JUICES, NON-ALCOHOLIC CARBONATED BEVERAGES; FRUIT DRINKS AND FRUIT JUICES; SYRUPS FOR MAKING BEVERAGES; PREPARATIONS FOR MAKING BEVERAGES, NAMELY, NON-ALCOHOLIC SPORT DRINKS, NON-ALCOHOLIC ENERGY DRINKS, FLAVORED WATERS AND FRUIT DRINKS; NON-ALCOHOLIC SPORT DRINKS; NON-ALCOHOLIC ENERGY DRINKS; SOY-BASED BEVERAGES NOT BEING MILK SUBSTITUTES, ALL THE FOREGOING CONTAINING OMEGA FATTY ACIDS (U.S. CLS. 45, 46 AND 48).

MICHAEL TANNER, EXAMINING ATTORNEY

**CLASS 9—ELECTRICAL AND SCIENTIFIC APPARATUS**

FOR PHYSICAL MEDIA COMPUTER SOFTWARE FOR PERFORMING AND ANALYZING CUSTOMIZED OPERATIONAL FUNCTIONS, NAMELY, SALES, MARKETING, AND SUPPLY CHAIN MANAGEMENT; DOWNLOADABLE CLOUD COMPUTER SOFTWARE FOR PERFORMING AND ANALYZING CUSTOMIZED OPERATIONAL FUNCTIONS, NAMELY, SALES, MARKETING, AND SUPPLY CHAIN MANAGEMENT; DOWNLOADABLE COMPUTER SOFTWARE FOR PERFORMING AND ANALYZING CUSTOMIZED OPERATIONAL FUNCTIONS, NAMELY, SALES, MARKETING, AND SUPPLY CHAIN MANAGEMENT; COMPUTER APPLICATION SOFTWARE FOR MOBILE PHONES AND HANDHELD COMPUTERS FOR PERFORMING AND ANALYZING CUSTOMIZED OPERATIONAL FUNCTIONS, NAMELY, SALES, MARKETING, AND SUPPLY CHAIN MANAGEMENT (U.S. CLS. 21, 23, 26, 36 AND 38).

**CLASS 35—ADVERTISING AND BUSINESS**

FOR STRATEGIC BUSINESS CONSULTING SERVICES; OPERATIONAL BUSINESS CONSULTING SERVICES; INFORMATION-TECHNOLOGY RELATED BUSINESS CONSULTING SERVICES (U.S. CLS. 100, 101 AND 102).

**CLASS 42—SCIENTIFIC AND COMPUTER SERVICES**

FOR SOFTWARE DESIGN SERVICES FOR BUSINESSES; SOFTWARE DEVELOPMENT SERVICES FOR BUSINESSES; PROVIDING TEMPORARY USE OF ONLINE NON-DOWNLOADABLE CLOUD COMPUTER SOFTWARE FOR PERFORMING AND ANALYZING CUSTOMIZED OPERATIONAL FUNCTIONS, NAMELY, SALES, MARKETING, AND SUPPLY CHAIN MANAGEMENT; PROVIDING TEMPORARY USE OF ONLINE NON-DOWNLOADABLE COMPUTER SOFTWARE FOR PERFORMING AND ANALYZING CUSTOMIZED OPERATIONAL FUNCTIONS, NAMELY, SALES, MARKETING, AND SUPPLY CHAIN MANAGEMENT (U.S. CLS. 100 AND 101).

KATHERINE CHANG, EXAMINING ATTORNEY

SN 85-920,912. OUTPACE SYSTEMS, INC., ATHERTON, CA. FILED 5-1-2013.

SN 85-920,917. OUTPACE SYSTEMS, INC., ATHERTON, CA. FILED 5-1-2013.

**BizAgile**

**Profit Engines**

THE MARK CONSISTS OF STANDARD CHARACTERS WITHOUT CLAIM TO ANY PARTICULAR FONT, STYLE, SIZE, OR COLOR.

THE MARK CONSISTS OF STANDARD CHARACTERS WITHOUT CLAIM TO ANY PARTICULAR FONT, STYLE, SIZE, OR COLOR.

**CLASS 9—ELECTRICAL AND SCIENTIFIC APPARATUS**

FOR PHYSICAL MEDIA COMPUTER SOFTWARE FOR PERFORMING AND ANALYZING CUSTOMIZED OPERATIONAL FUNCTIONS, NAMELY, SALES, MARKETING, AND SUPPLY CHAIN MANAGEMENT; DOWNLOADABLE CLOUD COMPUTER SOFTWARE FOR PERFORMING AND ANALYZING CUSTOMIZED OPERATIONAL FUNCTIONS, NAMELY, SALES, MARKETING, AND SUPPLY CHAIN MANAGEMENT; DOWNLOADABLE COMPUTER SOFTWARE FOR PERFORMING AND ANALYZING CUSTOMIZED OPERATIONAL FUNCTIONS, NAMELY, SALES, MARKETING, AND SUPPLY CHAIN MANAGEMENT; COMPUTER APPLICATION SOFTWARE FOR MOBILE PHONES AND HANDHELD COMPUTERS FOR PERFORMING AND ANALYZING CUSTOMIZED OPERATIONAL FUNCTIONS, NAMELY, SALES, MARKETING, AND SUPPLY CHAIN MANAGEMENT (U.S. CLS. 21, 23, 26, 36 AND 38).

**CLASS 35—ADVERTISING AND BUSINESS**

FOR STRATEGIC BUSINESS CONSULTING SERVICES; OPERATIONAL BUSINESS CONSULTING SERVICES; INFORMATION-TECHNOLOGY RELATED BUSINESS CONSULTING SERVICES (U.S. CLS. 100, 101 AND 102).

**CLASS 42—SCIENTIFIC AND COMPUTER SERVICES**

FOR SOFTWARE DESIGN SERVICES FOR BUSINESSES; SOFTWARE DEVELOPMENT SERVICES FOR BUSINESSES; PROVIDING TEMPORARY USE OF ONLINE NON-DOWNLOADABLE CLOUD COMPUTER SOFTWARE FOR PERFORMING AND ANALYZING CUSTOMIZED OPERATIONAL FUNCTIONS, NAMELY, SALES, MARKETING, AND SUPPLY CHAIN MANAGEMENT; PROVIDING TEMPORARY USE OF ONLINE NON-DOWNLOADABLE COMPUTER SOFTWARE FOR PERFORMING AND ANALYZING CUSTOMIZED OPERATIONAL FUNCTIONS, NAMELY, SALES, MARKETING, AND SUPPLY CHAIN MANAGEMENT (U.S. CLS. 100 AND 101).

KATHERINE CHANG, EXAMINING ATTORNEY

SN 85-921,191. VCFO HOLDINGS, INC., AUSTIN, TX. FILED 5-2-2013.

**VTALENT**

THE MARK CONSISTS OF STANDARD CHARACTERS WITHOUT CLAIM TO ANY PARTICULAR FONT, STYLE, SIZE, OR COLOR.

**CLASS 35—ADVERTISING AND BUSINESS**

FOR STAFFING, CAREER, JOB, PERSONNEL PLACEMENT AND RECRUITING SERVICES; PROJECT SUPPORT, NAMELY, EMPLOYMENT STAFFING SERVICES; EMPLOYMENT STAFFING CONSULTING SERVICES; PROVIDING JOB PLACEMENT OF OUTSOURCED FINANCIAL, INFORMATION, AND MANAGEMENT CONSULTANTS TO OTHERS (U.S. CLS. 100, 101 AND 102).

**CLASS 36—INSURANCE AND FINANCIAL**

FOR OUTSOURCE SERVICE PROVIDER IN THE FIELD OF FINANCE (U.S. CLS. 100, 101 AND 102).

ELIZABETH CHANG, EXAMINING ATTORNEY

SN 85-921,846. WAL-MART STORES, INC., BENTONVILLE, AR. FILED 5-2-2013.

WALMART MONEYCENTER EXPRESS

THE MARK CONSISTS OF STANDARD CHARACTERS WITHOUT CLAIM TO ANY PARTICULAR FONT, STYLE, SIZE, OR COLOR.

OWNER OF U.S. REG. NOS. 2,952,586 AND 3,240,238.

NO CLAIM IS MADE TO THE EXCLUSIVE RIGHT TO USE "MONEYCENTER EXPRESS", APART FROM THE MARK AS SHOWN.

**CLASS 35—ADVERTISING AND BUSINESS**

FOR ISSUING SHOPPING CARDS IN THE NATURE OF GIFT CERTIFICATES WHICH MAY BE REDEEMED FOR GOODS OR SERVICES (U.S. CLS. 100, 101 AND 102).

FIRST USE 4-10-2005; IN COMMERCE 4-10-2005.

**CLASS 36—INSURANCE AND FINANCIAL**

FOR PRE-PAID CREDIT, DEBIT AND GIFT CARD TRANSACTION PROCESSING SERVICES; MONEY ORDER SERVICES; MONEY TRANSFER SERVICES AND AUTOMATED TELLER MACHINE SERVICES (U.S. CLS. 100, 101 AND 102).

FIRST USE 4-10-2005; IN COMMERCE 4-10-2005.

JESSICA FATHY, EXAMINING ATTORNEY

SN 85-922,236. SKYLAB MOBILESYSTEMS LTD., HONG KONG, HONG KONG, FILED 5-3-2013.

**SKY DRONE**

NO CLAIM IS MADE TO THE EXCLUSIVE RIGHT TO USE "SKY DRONE", APART FROM THE MARK AS SHOWN.

THE COLOR(S) BLUE IS/ARE CLAIMED AS A FEATURE OF THE MARK.

THE MARK CONSISTS OF THE WORDS, "SKY DRONE", IN A LARGE STYLIZED LIGHT BLUE FONT, SEPARATED BY A STYLISTIC DARK BLUE DESIGN OF AN AIRCRAFT.

**CLASS 9—ELECTRICAL AND SCIENTIFIC APPARATUS**

FOR CINEMATOGRAPHIC CAMERAS; CINEMATOGRAPHIC MACHINES AND APPARATUS; COMPUTER SOFTWARE PLATFORMS FOR AUTO PILOTING AND REMOTE CONTROLLING AERIAL VEHICLES; DAY AND NIGHT VISION SYSTEMS PRIMARILY COMPRISING DAY AND NIGHT SENSORS, DAY AND NIGHT CAMERAS, POWER SOURCES, COMMUNICATION MEANS, MONITORS AND OPERATING SOFTWARE; REMOTE VIDEO MONITORING SYSTEM CONSISTING PRIMARILY OF A CAMERA AND VIDEO MONITOR FOR RECORDING AND TRANSMITTING IMAGES TO A REMOTE LOCATION; SOUND RECORDING APPARATUS AND INSTRUMENTS; SURVEYING INSTRUMENTS (U.S. CLS. 21, 23, 26, 36 AND 38).

**CLASS 12—VEHICLES**

FOR UNMANNED AERIAL VEHICLES (UAVS) (U.S. CLS. 19, 21, 23, 31, 35 AND 44).

MARK SPARACINO, EXAMINING ATTORNEY

SN 85-924,713. SOAR NO MORE, LLC, NAMPA, ID. FILED 5-6-2013.

## SOAR NO MORE

THE MARK CONSISTS OF STANDARD CHARACTERS WITHOUT CLAIM TO ANY PARTICULAR FONT, STYLE, SIZE, OR COLOR.

### CLASS 25—CLOTHING

FOR HATS; SHIRTS (U.S. CLS. 22 AND 39),  
FIRST USE 5-31-2009; IN COMMERCE 5-31-2009.

### CLASS 28—TOYS AND SPORTING GOODS

FOR GAME STRAPS USED IN BIRD HUNTING; HUNTING DECOY BAGS; HUNTING GAME CALLS; WILD GAME HUNTING DECOYS (U.S. CLS. 22, 23, 38 AND 50).

JONATHAN FALK, EXAMINING ATTORNEY

SN 85-925,040. RED BOOK CONNECT, LLC, KENNESAW, GA. FILED 5-7-2013.

## SOFTWARE AT YOUR SERVICE

THE MARK CONSISTS OF STANDARD CHARACTERS WITHOUT CLAIM TO ANY PARTICULAR FONT, STYLE, SIZE, OR COLOR.

NO CLAIM IS MADE TO THE EXCLUSIVE RIGHT TO USE "SOFTWARE", APART FROM THE MARK AS SHOWN.

### CLASS 9—ELECTRICAL AND SCIENTIFIC APPARATUS

FOR DOWNLOADABLE COMPUTER SOFTWARE THAT PROVIDES A SUITE OF APPLICATIONS FOR HIRING, TRAINING, SCHEDULING, OVERALL SHIFT MANAGEMENT, CASH, INVENTORY AND ASSET MANAGEMENT, FOOD COST MANAGEMENT, DASHBOARD ALERTS, CUSTOMER LOYALTY PROGRAMS, FORECASTING, ANALYTICS AND BUSINESS INTELLIGENCE FOR USE IN THE HOSPITALITY INDUSTRY (U.S. CLS. 21, 23, 26, 36 AND 38).

### CLASS 16—PAPER GOODS AND PRINTED MATTER

FOR PRINTED MATERIALS, NAMELY, LOG BOOKS, DESKTOP PLANNERS, PERSONAL DAY PLANNERS, WAIT-LIST NOTE PADS, LOG BOOKS FOR KEEPING TRACK OF TIPS TO BE SHARED, TRAINER'S LOG BOOKS, EMPLOYEE HISTORY LOG BOOKS, CAR RENTAL LOG BOOKS, CALL-AHEAD SEATING LOG BOOKS, DEPOSIT LOG BOOKS, RESERVATION LOG BOOKS, TRI-FOLD NOTE CARDS FOR RECORDING INFORMATION AND NOTE-KEEPING, AND BOOKS IN THE FIELD OF TIME MANAGEMENT FOR USE BY THE HOSPITALITY INDUSTRY AS WELL AS OTHER BUSINESSES (U.S. CLS. 2, 5, 22, 23, 29, 37, 38 AND 50).

### CLASS 42—SCIENTIFIC AND COMPUTER SERVICES

FOR PROVIDING ON-LINE NON-DOWNLOADABLE SOFTWARE THAT PROVIDES A SUITE OF APPLICATIONS FOR HIRING, TRAINING, SCHEDULING, OVERALL SHIFT MANAGEMENT, CASH, INVENTORY AND ASSET MANAGEMENT, FOOD COST MANAGEMENT, DASHBOARD ALERTS, CUSTOMER LOYALTY PROGRAMS, FORECASTING, ANALYTICS AND BUSINESS INTELLIGENCE FOR USE IN THE HOSPITALITY INDUSTRY (U.S. CLS. 100 AND 101).

NANCY CLARKE, EXAMINING ATTORNEY

SN 85-925,627. TRABUCCO FISHING DIFFUSION S.R.L., BIANCONESEFONTEVIVO PR, ITALY, FILED 5-7-2013.



OWNER OF ITALY REG. NO. 1016648, DATED 8-2-2006, EXPIRES 8-2-2016.

OWNER OF U.S. REG. NO. 3,366,068.

THE MARK CONSISTS OF THE STYLIZED WORDING "S FORCE", HAVING THE WORDING "FORCE" IN THE CENTER OF A LARGE LETTER "S".

### CLASS 25—CLOTHING

FOR CLOTHING FOR FISHING, NAMELY, SHIRTS, WIND RESISTANT JACKETS, VESTS, RAINCOATS, BOOTS, WADERS, FISHING HATS (U.S. CLS. 22 AND 39).

### CLASS 28—TOYS AND SPORTING GOODS

FOR FISHING TACKLE, FLOATS FOR FISHING, FISHING RODS, FISHING HOOKS, FISHING REELS, ARTIFICIAL FISHING BAIT, FISHING REELS (U.S. CLS. 22, 23, 38 AND 50).

KAELIE KUNG, EXAMINING ATTORNEY

SN 85-926,597. INSYNC LITIGATION SUPPORT, LLC, NEW YORK, NY. FILED 5-8-2013.

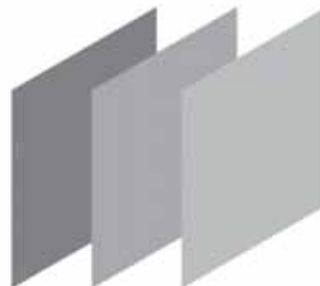

THE MARK CONSISTS OF THREE PARALLEL OVERLAPPING QUADRILATERALS OF VARYING SHADES.



**CLASS 35—ADVERTISING AND BUSINESS**

FOR LEGAL RECORDS MANAGEMENT SERVICES; CLERICAL SERVICES; STENOGRAPHIC TRANSCRIPTION SERVICES (U.S. CLS. 100, 101 AND 102).

**CLASS 45—PERSONAL AND LEGAL SERVICES**

FOR LITIGATION SUPPORT SERVICES; COURT REPORTING; PROCESS SERVING; PRIVATE INVESTIGATION SERVICES FOR LITIGATION PURPOSES, NONE OF THE AFORESAID INVESTIGATION SERVICES OFFERED IN CONNECTION WITH PRE-EMPLOYMENT BACKGROUND SCREENING, IN THE FIELD OF RETAIL STORE OPERATIONS, OR THE MONITORING OF DRIVING RECORDS FOR VIOLATIONS; LITIGATION CONSULTANCY; PUBLIC DOCUMENT FILING SERVICES; PUBLIC RECORD INVESTIGATION SERVICES FOR LITIGATION PURPOSES, NONE OF THE AFORESAID INVESTIGATION SERVICES OFFERED IN CONNECTION WITH PRE-EMPLOYMENT BACKGROUND SCREENING, IN THE FIELD OF RETAIL STORE OPERATIONS, OR THE MONITORING OF DRIVING RECORDS FOR VIOLATIONS (U.S. CLS. 100 AND 101).

BARBARA GAYNOR, EXAMINING ATTORNEY

SN 85-930,129. IOLO TECHNOLOGIES, LLC, LOS ANGELES, CA. FILED 5-13-2013.

**INFECTICIDE PRO**

THE MARK CONSISTS OF STANDARD CHARACTERS WITHOUT CLAIM TO ANY PARTICULAR FONT, STYLE, SIZE, OR COLOR.

**CLASS 9—ELECTRICAL AND SCIENTIFIC APPARATUS**

FOR COMPUTER SOFTWARE FOR DETECTION AND REMOVAL OF MALICIOUS SOFTWARE AND VIRUSES (U.S. CLS. 21, 23, 26, 36 AND 38).

**CLASS 42—SCIENTIFIC AND COMPUTER SERVICES**

FOR COMPUTER SERVICES FOR THE DETECTION AND REMOVAL OF MALICIOUS SOFTWARE AND VIRUSES; PROVIDING TEMPORARY USE OF ON-LINE NON-DOWNLOADABLE SOFTWARE FOR DETECTION AND REMOVAL OF MALICIOUS SOFTWARE AND VIRUSES (U.S. CLS. 100 AND 101).

CHRIS WELLS, EXAMINING ATTORNEY

SN 85-930,830. FUJITSU LIMITED, KANAGAWA 211-8588, JAPAN, FILED 5-13-2013.

**EngineeringBLADE**

THE MARK CONSISTS OF STANDARD CHARACTERS WITHOUT CLAIM TO ANY PARTICULAR FONT, STYLE, SIZE, OR COLOR.

OWNER OF JAPAN REG. NO. 5384471, DATED 1-21-2011, EXPIRES 1-21-2021.

OWNER OF JAPAN REG. NO. 5393245, DATED 2-25-2011, EXPIRES 2-25-2021.

OWNER OF U.S. REG. NO. 4,054,229.

**CLASS 9—ELECTRICAL AND SCIENTIFIC APPARATUS**

FOR COMPUTER SERVER; COMPUTER HARDWARE FOR DATA STORAGE; COMPUTER HARDWARE; COMPUTER SOFTWARE FOR USE IN CIRCUIT DESIGN AND PRINTED CIRCUIT BOARD DESIGN (U.S. CLS. 21, 23, 26, 36 AND 38).

**CLASS 42—SCIENTIFIC AND COMPUTER SERVICES**

FOR COMPUTER PROGRAMMING SERVICES; COMPUTER RENTAL SERVICES; SERVER HOSTING; RENTAL OF WEB SERVERS; INSTALLATION AND MAINTENANCE OF COMPUTER SOFTWARE PROGRAMS; DESIGN, DEVELOPMENT, PREPARATION AND UPDATING OF COMPUTER SOFTWARE PROGRAMS; COMPUTER SYSTEM CONSULTING AND ADVISORY SERVICES; NON-DOWNLOADABLE SOFTWARE APPLICATIONS PROVIDED THROUGH A WEBSITE FOR USE IN CIRCUIT DESIGN AND PRINTED CIRCUIT BOARD DESIGN; OPERATING CLOUD COMPUTING SYSTEMS, NAMELY, CLOUD COMPUTING FEATURING SOFTWARE FOR USE IN CIRCUIT DESIGN AND PRINTED CIRCUIT BOARD DESIGN (U.S. CLS. 100 AND 101).

DAWN FELDMAN, EXAMINING ATTORNEY

SN 85-931,225. PRINCE AGRI PRODUCTS, INC., QUINCY, IL. FILED 5-14-2013.

**OMNIMATE**

THE MARK CONSISTS OF STANDARD CHARACTERS WITHOUT CLAIM TO ANY PARTICULAR FONT, STYLE, SIZE, OR COLOR.

**CLASS 1—CHEMICALS**

FOR FOOD ADDITIVES, NAMELY, CHEMICAL ADDITIVES FOR USE IN THE MANUFACTURE OF ANIMAL FODDER (U.S. CLS. 1, 5, 6, 10, 26 AND 46).

**CLASS 5—PHARMACEUTICALS**

FOR FEED SUPPLEMENTS FOR LIVESTOCK AND COMPANION ANIMALS; MOLD INHIBITING CHEMICALS AND FORMULATIONS FOR TREATING LIVESTOCK FEED, GRAIN, AND FORAGES; NON-MEDICATED NUTRITIONAL ADDITIVES FOR LIVESTOCK FEED FOR USE AS NUTRITIONAL SUPPLEMENTS; MINERAL SUPPLEMENTS; CHEMICALS, ENZYMES, FOOD AND BEVERAGE MANUFACTURING BYPRODUCTS, PLANT PROTEIN, OILS, SILICA-BASED POWDERS, AND SOLUBLES FOR USE AS DIETARY SUPPLEMENTS (U.S. CLS. 6, 18, 44, 46, 51 AND 52).

TAMARA FRAZIER, EXAMINING ATTORNEY

SN 85-932,866. OCEANEERING AS, 4068 STAVANGER, NORWAY, FILED 5-15-2013.

# GTO

THE MARK CONSISTS OF STANDARD CHARACTERS WITHOUT CLAIM TO ANY PARTICULAR FONT, STYLE, SIZE, OR COLOR.  
OWNER OF U.S. REG. NO. 2,965,632.

## CLASS 7—MACHINERY

FOR DREDGING MACHINES; MACHINES AND MACHINE TOOLS, NAMELY, SLURRY PUMPS AND PUMPS FOR PUMPING OF SEDIMENT-WATER MIXTURES, SEDIMENT DISINTEGRATION TOOLS, NAMELY, CUTTER HEADS FOR THE DISINTEGRATION OF SEDIMENT, DRILLS AND HYDRAULIC POWER OPERATED HAMMERS; HYDRAULIC APPARATUS COMPRISED OF DREDGES, PIPELINE SYSTEMS COMPRISED OF SUCTION HEADS AND PIPELINES FOR SEDIMENT TRANSPORT AND REMOVAL, SUCTION HEADS AND EJECTOR PUMPS FOR HANDLING, DISINTEGRATION, EXCAVATION, SHIFTING OR REMOVAL OF SOLID MATERIAL AND SEDIMENT IN WATER, AND TRANSPORT OF SEDIMENT BY WATER THROUGH PIPELINES AND IN FLUMES, AND CRAWLERS FOR HANDLING, DISINTEGRATION, EVACUATION, SHIFTING AND REMOVAL OF SOLID MATERIAL AND SEDIMENT IN WATER (U.S. CLS. 13, 19, 21, 23, 31, 34 AND 35).  
FIRST USE 7-12-2005; IN COMMERCE 7-12-2005.

## CLASS 12—VEHICLES

FOR UNDERWATER VEHICLES, NAMELY, REMOTE OPERATED VEHICLES (ROV), AUTONOMOUS UNDERSEA VEHICLES (AUV), AND CRAWLERS USED FOR DREDGING AND HANDLING, DISINTEGRATION, EVACUATION, SHIFTING AND REMOVAL OF SOLID MATERIAL AND SEDIMENT IN WATER AND TRANSPORT OF SEDIMENT THROUGH PIPELINES AND FLUMES (U.S. CLS. 19, 21, 23, 31, 35 AND 44).  
FIRST USE 7-12-2005; IN COMMERCE 7-12-2005.

## CLASS 37—CONSTRUCTION AND REPAIR

FOR UNDERWATER DREDGING; DREDGING (U.S. CLS. 100, 103 AND 106).  
FIRST USE 7-12-2005; IN COMMERCE 7-12-2005.  
PAUL E. FAHRENKOPF, EXAMINING ATTORNEY

SN 85-933,954. SOLAR SISTER, INC, BRISTOL, RI. FILED 5-16-2013.

# LIGHT. HOPE. OPPORTUNITY

THE MARK CONSISTS OF STANDARD CHARACTERS WITHOUT CLAIM TO ANY PARTICULAR FONT, STYLE, SIZE, OR COLOR.

## CLASS 35—ADVERTISING AND BUSINESS

FOR CHARITABLE SERVICES, NAMELY, ORGANIZING AND DEVELOPING PROGRAMS TO EMPOWER WOMEN AND CREATE A NETWORK OF WOMEN ENTREPRENEURS TO DISTRIBUTE CLEAN ENERGY PRODUCTS IN RURAL COMMUNITIES OF DEVELOPING COUNTRIES (U.S. CLS. 100, 101 AND 102).  
FIRST USE 10-5-2009; IN COMMERCE 10-5-2009.

## CLASS 36—INSURANCE AND FINANCIAL

FOR CHARITABLE FUNDRAISING SERVICES, NAMELY, RAISING FUNDS FOR PROGRAMS AIMED AT CREATING BUSINESS OPPORTUNITIES FOR WOMEN WHILE ALSO PROMOTING USE OF CLEAN ENERGY PRODUCTS IN DEVELOPING COUNTRIES (U.S. CLS. 100, 101 AND 102).

FIRST USE 10-5-2009; IN COMMERCE 10-5-2009.  
DOMINIC FATHY, EXAMINING ATTORNEY

SN 85-933,963. LAYERED INNOVATIONS, INC., OMAHA, NE. FILED 5-16-2013.

## LAYEREDi MOBILITY CLOUD

THE MARK CONSISTS OF STANDARD CHARACTERS WITHOUT CLAIM TO ANY PARTICULAR FONT, STYLE, SIZE, OR COLOR.

NO CLAIM IS MADE TO THE EXCLUSIVE RIGHT TO USE "MOBILITY CLOUD", APART FROM THE MARK AS SHOWN.

## CLASS 9—ELECTRICAL AND SCIENTIFIC APPARATUS

FOR HANDHELD AND MOBILE DIGITAL ELECTRONIC DEVICES, NAMELY, TELECOMMUNICATION TERMINAL FOR THE SENDING AND RECEIVING OF TELEPHONE CALLS, FAXES, ELECTRONIC MAIL, VIDEO, AND OTHER DIGITAL DATA; HANDHELD COMPUTERS, PERSONAL DIGITAL ASSISTANTS, ELECTRONIC PERSONAL ORGANIZERS, ELECTRONIC NOTEPADS IN THE NATURE OF ELECTRONIC TOUCH NOTEBOOK COMPUTERS; TELEPHONES; MOBILE CELLULAR TELEPHONES; COMPUTER SOFTWARE AND FIRMWARE FOR GAMES OF CHANCE ON ANY COMPUTERIZED PLATFORM, NAMELY, DEDICATED GAMING CONSOLES, VIDEO BASED SLOT MACHINES, REEL BASED SLOT MACHINES, AND VIDEO LOTTERY TERMINALS; VIDEOPHONES; CAMERAS; PRERECORDED COMPUTER PROGRAMS FOR PERSONAL INFORMATION MANAGEMENT; DATABASE MANAGEMENT SOFTWARE FOR COMPUTING, DATA STORAGE AND TELECOMMUNICATIONS, TELEPHONY MANAGEMENT SOFTWARE, CHARACTER RECOGNITION SOFTWARE, ELECTRONIC MAIL AND MESSAGING SOFTWARE, PAGING SOFTWARE, DATABASE SYNCHRONIZATION SOFTWARE; COMPUTER PROGRAMS FOR ACCESSING, BROWSING AND SEARCHING ONLINE DATABASES; COMPUTER SOFTWARE AND FIRMWARE, NAMELY, OPERATING SYSTEM PROGRAMS, DATA SYNCHRONIZATION PROGRAMS, AND APPLICATION DEVELOPMENT TOOL PROGRAMS FOR PERSONAL AND HANDHELD COMPUTERS; ELECTRONIC HANDHELD UNITS, NAMELY, PERSONAL COMMUNICATORS FOR THE WIRELESS RECEIPT AND TRANSMISSION OF DATA THAT ENABLE THE USER TO KEEP TRACK OF OR MANAGE PERSONAL AND ENTERPRISE INFORMATION; ELECTRONIC COMMUNICATION DEVICES FOR THE WIRELESS RECEIPT AND TRANSMISSION OF DATA WHICH CAN BE WORN AS EYEWEAR, HEADGEAR AND WRIST WEAR, NAMELY, PEDOMETERS, SMARTPHONES, MP3 PLAYERS, PERSONAL DIGITAL ASSISTANTS, AND MULTIFUNCTIONAL ELECTRONIC DEVICES FOR DISPLAYING, MEASURING, AND UPLOADING TO THE INTERNET INFORMATION INCLUDING TIME, DATE, DISTANCE, SPEED, STEPS TAKEN, CALORIES BURNED, ACTIVITY LEVEL, BODY AND HEART RATES, GLOBAL POSITIONING, NAVIGATIONAL INFORMATION, WEATHER INFORMATION, THE TEMPERATURE, WIND SPEED, DIRECTION, DISTANCE, CALORIES BURNED, ALTITUDE, HOURS SLEPT, QUALITY OF SLEEP, AND SILENT WAKE ALARM; SOFTWARE FOR THE REDIRECTION OF MESSAGES, INTERNET E-MAIL, VIDEO

AND OTHER DATA TO ONE OR MORE ELECTRONIC HANDHELD DEVICES FROM A DATA STORE ON OR ASSOCIATED WITH A PERSONAL COMPUTER OR A SERVER; SOFTWARE FOR THE SYNCHRONIZATION OF DATA BETWEEN A REMOTE STATION OR DEVICE AND A FIXED OR REMOTE STATION, DEVICE OR SERVER; COMPUTER HARDWARE AND SOFTWARE FOR PROVIDING INTEGRATED TELEPHONE COMMUNICATION WITH COMPUTERIZED GLOBAL INFORMATION NETWORKS; COMPUTER HARDWARE AND SOFTWARE FOR SETTING UP AND CONFIGURING LOCAL OR WIDE AREA NETWORKS FOR USE IN DATA CENTERS AND MEGA-SCALE COMPUTING ENVIRONMENTS; COMPUTER HARDWARE AND SOFTWARE RELATING TO FILE SYSTEM ACCESS AND DATA STORAGE FOR USE IN NETWORK COMPUTING IN CONNECTION WITH DATA ACCESS, SHARING, REPLICATION, MODIFYING, DISTRIBUTION, WAREHOUSING, MANAGEMENT AND PROTECTION; COMPUTER SOFTWARE PLATFORMS FOR GRID AND UTILITY COMPUTING AND FOR OPERATING DISTRIBUTED APPLICATIONS AND NETWORKS OF COMPUTERS; TELECOMMUNICATION SYSTEMS AND NETWORKS FOR TRANSMITTING AND RECEIVING VIDEO, DATA AND VOICE SIGNALS OVER WIRELESS COMMUNICATION NETWORKS OR SYSTEMS, NAMELY, MOBILE AND ACCESS COMPUTER AND MOBILE TELEPHONE TERMINALS, BASE TRANSCIVER STATIONS AND WIRELESS RADIO PARTS THEREFOR, TRANSMISSION CIRCUITS, INTEGRATED CIRCUITS, COMPUTER HARDWARE, MULTIPLEXERS, DIGITAL SIGNAL PROCESSORS, RADIO FREQUENCY SIGNAL PROCESSORS, MOBILE SWITCHING CIRCUITS, AIR TRAFFIC ELECTRICAL CONTROLLERS, MOBILITY ELECTRICAL CONTROLLERS, ACCESS ELECTRICAL CONTROLLERS, REMOTE PORT ELECTRICAL CONTROLLERS, RADIO PORTS, ANTENNAS, ELECTRONIC RADIO COMPONENTS, SOFTWARE FOR TELECOMMUNICATIONS APPLICATIONS, AND MOBILE CORE NETWORKS COMPRISING DATA TRANSCIVERS, WIRELESS NETWORKS AND GATEWAYS FOR COLLECTION, TRANSMISSION AND MANAGEMENT OF DATA, VOICE AND VIDEO (U.S. CLS. 21, 23, 26, 36 AND 38).

#### **CLASS 42—SCIENTIFIC AND COMPUTER SERVICES**

FOR SCIENTIFIC AND TECHNOLOGICAL SERVICES AND RESEARCH AND DESIGN RELATING THERETO, NAMELY, RESEARCH AND DEVELOPMENT OF COMPUTER SOFTWARE, MIDDLEWARE AND COMMUNICATION SOFTWARE, AND RESEARCH AND DEVELOPMENT OF SYSTEM ARCHITECTURE AND SYSTEM HARDWARE IN THE FIELD OF INFORMATION AND COMMUNICATION TECHNOLOGY; DESIGN AND DEVELOPMENT OF COMPUTER HARDWARE, MIDDLEWARE AND SOFTWARE; DESIGN AND DEVELOPMENT OF COMMUNICATIONS SOFTWARE; RENTAL OF COMPUTER SOFTWARE AND HARDWARE; UPDATING OF COMPUTER SOFTWARE AND COMMUNICATIONS SOFTWARE, PARTICULARLY FOR MOBILE DEVICES AND MOBILE SOFTWARE MONITORING; COMPUTER SOFTWARE AND MIDDLEWARE CONSULTANCY SERVICES; COMPUTER PROGRAMMING FOR OTHERS, PARTICULARLY FOR THE INTEGRATION OF MOBILE PLATFORMS; DESIGN OF MOBILE NETWORKS AND MOBILE SOFTWARE INSTALLATIONS FOR OTHERS, NAMELY, INSTALLATION OF COMPUTER SOFTWARE AND MIDDLEWARE; PROVIDING TEMPORARY USE OF ON-LINE DOWNLOADABLE COMPUTER SOFTWARE FOR USE IN MANAGEMENT OF A DATABASE, COMPUTER SEARCH ENGINE, SOFTWARE APPLICATIONS FOR INFORMATION RETRIEVAL AND DELIVERY; PROVIDING TEMPORARY USE OF ON-LINE NON-DOWNLOADABLE COMPUTER SOFTWARE FOR AUTOMATIC UPDATING OF AN ADDRESS BOOK, A PERSONAL PLANNER, A DATE REMINDER, A TRAVEL PLANNER, ALUMNI AND PROFESSIONAL GROUP LINKS AND BUSINESS AND SOCIAL NETWORKING FOR A CONSUMER'S BUSINESS AND PERSONAL USE; CROSS-PLATFORM CONVERSION OF DIGITAL CONTENT INTO OTHER FORMS OF DIGITAL CONTENT; DATA ENCRYPTION SERVICES; COMPUTER NETWORK SECURITY SERVICES, NAMELY, COMPILING INFORMATION ABOUT POTENTIAL SECURITY THREADS, DEVELOPING SOFTWARE FOR SCANNING

AND CLEANING VIRUS FOR HANDHELD DEVICES AND COMPUTER SYSTEMS; COMPUTER SECURITY SYSTEM CONSULTATION SERVICES; PROVIDING ELECTRONIC VERIFICATION OF ON-LINE ORDERS OF DIGITAL CONTENT AND GENERATING ELECTRONIC PERMISSION CODES WHICH THEN ALLOW USERS TO ACCESS SAID DIGITAL CONTENT; CREATING AND MAINTAINING WEB SITES FOR OTHERS; PROVIDING DATA CENTERS FOR OTHERS IN THE FORM OF DEDICATED AND VIRTUAL COMPUTER SERVERS, NETWORK SERVERS AND DATA STORAGE; PROVIDING SEARCH ENGINES FOR THE INTERNET; COMPUTER SERVICES, NAMELY, CREATING AN ON-LINE COMMUNITY AND SOCIAL NETWORKING FOR REGISTERED USERS TO PARTICIPATE IN COMPETITIONS, SHOWCASE THEIR SKILLS, GET FEEDBACK FROM THEIR PEERS, JOIN DISCUSSION, SHARE INFORMATION, FORM VIRTUAL COMMUNITIES, ENGAGE IN SOCIAL NETWORKING AND IMPROVE THEIR TALENT; COMPUTER SERVICES, NAMELY, DESIGNING, MANAGING AND MONITORING WEBSITES FOR OTHERS FEATURING ON-LINE FORUMS FOR DISCUSSION; COMPUTER PROGRAMMING SERVICES FOR OTHERS; APPLICATION SERVICE PROVIDER, NAMELY, HOSTING COMPUTER SOFTWARE APPLICATIONS FOR OTHERS FOR MOBILE COMMUNICATIONS; HOSTING OF DIGITAL CONTENT ON THE INTERNET; HOSTING THE WEBSITES OF OTHERS ON A COMPUTER SERVER FOR A GLOBAL COMPUTER NETWORK; COMPUTER SERVICES, NAMELY, CREATING COMPUTER NETWORK-BASED INDEXES OF INFORMATION AVAILABLE ON COMPUTER NETWORKS; PROVIDING CUSTOMIZED COMPUTER SEARCHING SERVICES, NAMELY, SEARCHING AND RETRIEVING INFORMATION AT THE CUSTOMER'S SPECIFIC REQUEST VIA MOBILE DEVICES AND THE GLOBAL COMMUNICATION NETWORKS IN THE FIELD OF INFORMATION TECHNOLOGY; CONSULTING SERVICES IN THE FIELD OF DESIGN, SELECTION, IMPLEMENTATION AND USE OF COMPUTER HARDWARE AND SOFTWARE SYSTEMS FOR OTHERS; INSTALLATION, MAINTENANCE AND REPAIR OF COMPUTER SOFTWARE; ENGINEERING SERVICES, NAMELY, TECHNICAL PROJECT PLANNING SERVICES RELATED TO TELECOMMUNICATIONS EQUIPMENT; PROVIDING CUSTOMIZED COMPUTER SEARCHING SERVICES, NAMELY, SEARCHING AND RETRIEVING INFORMATION AT THE CUSTOMER'S SPECIFIC REQUEST IN THE FIELD OF WIRELESS AND MOBILE COMMUNICATIONS; PROVIDING A WEBSITE FEATURING ON-LINE NON-DOWNLOADABLE SOFTWARE THAT ENABLES USERS TO UPLOAD, DOWNLOAD, STREAM, POST, DISPLAY BLOG, LINK, SHARE AUDIO AND VIDEO CONTENT, PHOTOGRAPHIC IMAGES, TEXT, GRAPHICS AND DATA; COMPUTER SERVICES, NAMELY, MANAGING BUSINESS, PERSONAL AND SOCIAL NETWORKING WEB SITES AMONG DIFFERENT SERVICE AND APPLICATION PLATFORMS OF OTHERS; COMPUTER SERVICES FOR INTEGRATING DIFFERENT SOFTWARE SERVICE AND APPLICATION PLATFORMS IN SOCIAL, BUSINESS, PERSONAL AND COMMUNITY NETWORKING; RESEARCH AND DEVELOPMENT IN THE FIELD OF BUSINESS, PERSONAL AND SOCIAL NETWORKING; PROVISION OF INFORMATION, MANAGEMENT, CONSULTANCY AND ADVISORY SERVICES IN THE FIELD OF INFORMATION AND COMMUNICATION TECHNOLOGY IN THE FORMS OF EXHIBITION PROGRAMS, RESEARCH DISCUSSIONS, TECHNICAL DISCUSSIONS AND TECHNICAL ACTIVITIES; PLATFORM AS A SERVICE (PAAS) FEATURING COMPUTER SOFTWARE PLATFORMS FOR THE MANAGEMENT OF DATA USED IN MARKETING AUTOMATION AND ORGANIZATIONAL COMMUNICATIONS; PLATFORM AS A SERVICE (PAAS) FEATURING COMPUTER SOFTWARE PLATFORMS FOR CAPTURING, STORING, MANIPULATING AND MANAGING USER DATA FROM WEB, MOBILE WEB, NATIVE MOBILE APPS, AND SOCIAL MEDIA CHANNELS; PROVIDING TEMPORARY USE OF ON-LINE NON-DOWNLOADABLE SOFTWARE FOR NON-TECHNICAL USERS TO CREATE WEB PAGES CONTAINING VIDEO, AUDIO, IMAGES, USER INPUT FORMS, SOCIAL MEDIA LINKS AND HYPERLINKS THAT ARE AUTOMATICALLY OPTIMIZED FOR SMARTPHONE DEVICES AND TABLETS; PROVIDING TEMPORARY USE OF ON-LINE NON-DOWNLOADABLE SOFTWARE FOR SENDING SMS (SHORT MESSAGE SERVICE) MESSAGES USING SHORT CODES OR 10-DIGIT PHONE NUMBERS FOR USERS TO OPT-INTO

SMS COMMUNICATIONS FROM MOBILE PHONE DEVICES, CAPTURE OPT-IN PHONE NUMBERS AND STORE IN A DATABASE FOR FUTURE USE, BROADCAST SMS MESSAGES TO OPT-IN LIST, TRACK PERFORMANCE OF SMS ACTIVITY, TRACK PERFORMANCE OF LINKS IN SMS MESSAGES, QUEUE PROCESSING OF SENT MESSAGES TO ACCOMMODATE A LARGE AMOUNT OF PHONE NUMBERS, AND ASSOCIATE A SMS ACTIVITY WITH A BROADER MARKETING CAMPAIGN OR BUSINESS INITIATIVE; PROVIDING TEMPORARY USE OF ON-LINE NON-DOWNLOADABLE SOFTWARE FOR CREATING QR CODES AND LINKING QR CODES TO MOBILE OPTIMIZED CONTENT, MODIFYING THE CONTENT TO WHICH THE QR CODES LINK AFTER THE CREATION OF THE ORIGINAL QR CODE, CREATING INDIVIDUAL QR CODES IN BULK FROM AN EXTERNAL LIST OF RECORDS SUCH AS AN SPREADSHEET OR DATABASE, ASSOCIATING QR CODES WITH BROADER CAMPAIGNS OR INITIATIVES, TRACKING PERFORMANCE OF QR CODES, TRACKING THE TYPES OF MOBILE PHONE OPERATING SYSTEMS ACCESSING THE QR CODES, AND TRACKING THE BROWSERS ACCESSING THE QR CODES; PROVIDING TEMPORARY USE OF WEB-BASED SOFTWARE APPLICATIONS FOR CREATING DIGITAL COUPONS; APPLICATION PROGRAMMING INTERFACE (API) FOR INTEGRATION OF CUSTOMER LOYALTY COMPUTER SOFTWARE FOR DELIVERING DIGITAL VOUCHERS AND COUPONS WITH ON-LINE, WEB-BASED SOFTWARE FOR CREATING DIGITAL COUPONS; PROVIDING TEMPORARY USE OF ON-LINE NON-DOWNLOADABLE SOFTWARE FOR CREATING, ORGANIZING AND MANAGING DIGITAL MARKETING CAMPAIGNS ACCESSED BY QR CODE, SMS, NEAR FIELD COMMUNICATION (NFC) TECHNOLOGY-ENABLED READERS OR DEVICES, IMAGE RECOGNITION, AUGMENTED REALITY, ELECTRONIC MAIL, PUSH NOTIFICATIONS, OR SOCIAL NETWORKS; PROVIDING TEMPORARY USE OF ON-LINE NON-DOWNLOADABLE SOFTWARE FOR CREATING, ORGANIZING, AND DISTRIBUTING TRAINING MESSAGES AND OTHER COMMUNICATIONS THROUGH VIDEO, AUDIO, IMAGES, TEXT COPY AND DISTRIBUTED BY SMS, EMAIL, PUSH NOTIFICATIONS, AND SOCIAL MEDIA (U.S. CLS. 100 AND 101).

CHRISIE B. KING, EXAMINING ATTORNEY

SN 85-934,074. SKADADDLE MEDIA, SAUSALITO, CA. FILED 5-16-2013.

## A DAY WELL LIVED

THE MARK CONSISTS OF STANDARD CHARACTERS WITHOUT CLAIM TO ANY PARTICULAR FONT, STYLE, SIZE, OR COLOR.

### CLASS 35—ADVERTISING AND BUSINESS

FOR ON-LINE RETAIL STORE SERVICES FEATURING CLOTHING, CAPS, PERSONAL ACCESSORIES, BAGS, BOOKS, PRINTS, POSTERS, CALENDARS, NOTEBOOKS, SPORTS BOTTLES, MUGS, HOUSEWARES, AND AUDIO AND VISUAL RECORDINGS (U.S. CLS. 100, 101 AND 102).

### CLASS 41—EDUCATION AND ENTERTAINMENT

FOR EDUCATIONAL AND ENTERTAINMENT SERVICES, NAMELY, PROVIDING ON-LINE PUBLICATIONS IN THE NATURE OF BLOGS, NEWSLETTERS, AND ARTICLES IN THE FIELDS OF PERSONAL GROWTH, INSPIRATION, MOTIVATION, AND SELF-FULFILLMENT (U.S. CLS. 100, 101 AND 107).

### CLASS 45—PERSONAL AND LEGAL SERVICES

FOR PROVIDING A WEB SITE FEATURING PHOTOGRAPHIC, AUDIO, VIDEO, AND PROSE CONTENT IN THE FIELDS OF PERSONAL GROWTH, INSPIRATION, MOTIVATION, AND SELF-FULFILLMENT (U.S. CLS. 100 AND 101).

KEVIN D'INALLO, EXAMINING ATTORNEY

SN 85-934,123. DELTA AIR LINES, INC., ATLANTA, GA. FILED 5-16-2013.

## ENDEAVOR AIR

THE MARK CONSISTS OF STANDARD CHARACTERS WITHOUT CLAIM TO ANY PARTICULAR FONT, STYLE, SIZE, OR COLOR.

NO CLAIM IS MADE TO THE EXCLUSIVE RIGHT TO USE "AIR", APART FROM THE MARK AS SHOWN.

### CLASS 35—ADVERTISING AND BUSINESS

FOR ENHANCED AND EXPEDITED CUSTOMER SERVICE RESPONSES FOR ELITE PASSENGERS (U.S. CLS. 100, 101 AND 102).

### CLASS 39—TRANSPORTATION AND STORAGE

FOR AIR TRANSPORTATION SERVICES; AIR TRANSPORTATION SERVICES FEATURING A FREQUENT FLYER BONUS AWARD PROGRAM, TRANSIT LOUNGE FACILITIES FOR PASSENGER RELAXATION, A SPECIALIZED PRIORITY AIRLINE SERVICE WITH RESERVATION SERVICES, ENHANCED AIRPORT TICKETING PROCESSING, EXPEDITED CALL WAITING PROCEDURES, PRIORITY CHECK-IN, PRIORITY LOBBY CHECK-IN, DEDICATED SERVICE CENTER AND CLUB LANES FOR ELITE PASSENGERS, EXPEDITED GATE HANDLING AND AIRCRAFT BOARDING SERVICES, ENHANCED SEATING ACCOMMODATIONS, ENHANCED PERSONAL SPACE INCLUDING SPECIALIZED ENTERTAINMENT, COMPUTER CONNECTIONS, ENHANCED MEAL SERVICES AND VOUCHER VALUES FOR ELITE PASSENGERS, PRIORITY BAGGAGE DELIVERY (U.S. CLS. 100 AND 105).

### CLASS 45—PERSONAL AND LEGAL SERVICES

FOR SPECIALIZED PRIORITY AND EXPEDITED PASSENGER SECURITY SCREENING (U.S. CLS. 100 AND 101).

DAVID C. REIHNER, EXAMINING ATTORNEY

SN 85-934,238. PASSAGE POINT LLC, NEW YORK, NY.  
FILED 5-16-2013.

## Integrated Infrasolutions

THE MARK CONSISTS OF STANDARD CHARACTERS WITHOUT CLAIM TO ANY PARTICULAR FONT, STYLE, SIZE, OR COLOR.

### CLASS 35—ADVERTISING AND BUSINESS

FOR BUSINESS ADVICE AND INFORMATION RELATING TO INFRASTRUCTURE LOANS, FINANCE AND CAPITAL SOURCING; ADVISORY SERVICES FOR PREPARING AND CARRYING OUT COMMERCIAL TRANSACTIONS; PROVIDING BUSINESS RISK MANAGEMENT SERVICES FOR USE IN PROJECT PLANNING AND MANAGEMENT; PROJECT MANAGEMENT SERVICES FOR OTHERS FOR BUSINESS PURPOSES IN THE FIELDS OF PRIVATE FINANCING OF ENERGY AND INFRASTRUCTURE PROJECTS (U.S. CLS. 100, 101 AND 102).

### CLASS 36—INSURANCE AND FINANCIAL

FOR BUSINESS FINANCE PROCUREMENT SERVICES; PROVIDING INFORMATION AND RESEARCH IN THE FIELD OF FINANCE AND FINANCIAL INVESTMENTS; FINANCIAL ADVISORY AND CONSULTANCY SERVICES, NAMELY, ADVICE AND CONSULTATION FOR CREDIT VALUATION AND MANAGEMENT CONSULTATION, FINANCING FOR PRIVATE EQUITY CAPITAL STRUCTURING, VENTURE CAPITAL STRUCTURING (U.S. CLS. 100, 101 AND 102).

### CLASS 45—PERSONAL AND LEGAL SERVICES

FOR INVESTIGATION OF ASSETS, CREDIT RATINGS, VALUATION, AND FISCAL ASSESSMENTS FOR SECURITY OR SURVEILLANCE PURPOSES (U.S. CLS. 100 AND 101).  
PAULA MAHONEY, EXAMINING ATTORNEY

SN 85-934,380. EYELIGN PRODUCTS, LLC, COOKEVILLE, TN. FILED 5-16-2013.

## EYELIGN

THE MARK CONSISTS OF STANDARD CHARACTERS WITHOUT CLAIM TO ANY PARTICULAR FONT, STYLE, SIZE, OR COLOR.

### CLASS 10—MEDICAL APPARATUS

FOR MEDICAL APPARATUS, NAMELY, APPARATUS FOR MONITORING AND ANALYZING EYE MOVEMENT FOR USE IN TRACKING AND MEASURING EYE CONDITIONS, POSITIONING AND MOVEMENTS (U.S. CLS. 26, 39 AND 44).

### CLASS 44—MEDICAL, BEAUTY AND AGRICULTURAL SERVICES

FOR OPTOMETRY AND OPHTHALMOLOGY SERVICES, NAMELY, TRACKING AND MEASURING EYE CONDITIONS, POSITIONING AND MOVEMENTS; MEDICAL SERVICES, NAMELY, DIAGNOSIS AND EVALUATION OF EYE MOVEMENT AND ALIGNMENT DISORDERS, NAMELY, STRABISMUS, AMBLYOPIA, VESTIBULAR DYSFUNCTIONS; MEDICAL SERVICES, NAMELY, REAL TIME DYNAMIC VISION TREATMENT, NEURO-REHABILITATION AND THERAPY FOR EYE MOVEMENT AND ALIGNMENT DISORDERS; MEDICAL SERVICES, NAMELY, PREDICATIVE ANALYSIS FOR EYE MOVEMENT AND ALIGNMENT DISORDERS (U.S. CLS. 100 AND 101).  
KATHERINE CHANG, EXAMINING ATTORNEY

SN 85-938,452. SR SYSTEMS, LLC, TUSCALOOSA, AL. FILED 5-21-2013.

## GOT BOLTS?

THE MARK CONSISTS OF STANDARD CHARACTERS WITHOUT CLAIM TO ANY PARTICULAR FONT, STYLE, SIZE, OR COLOR.

NO CLAIM IS MADE TO THE EXCLUSIVE RIGHT TO USE "BOLTS", APART FROM THE MARK AS SHOWN.

### CLASS 6—METAL GOODS

FOR METAL BUILDING MATERIALS AND HARDWARE, NAMELY, STUDS, BEAMS, BRACKETS, BRACES, FLANGES, EXTRUDED TUBES, U-SHAPED CHANNELS, GUSSETS, REINFORCING MESH, FOUNDATION BOLTS, ANCHOR BOLTS, THREADED FASTENERS, BOLTS, NUTS, NAILS, RIVETS, SCREWS, FASTENERS TO HOLD REINFORCING MESH TO WINDOWS; METAL WALL PANELS; DOORS AND WINDOWS OF METAL; STORM SHELTERS MADE PRIMARILY OF METAL; STORM SHELTER KITS CONSISTING PRIMARILY OF METAL PANELS AND DOORS (U.S. CLS. 2, 12, 13, 14, 23, 25 AND 50).

### CLASS 19—NON-METALLIC BUILDING MATERIALS

FOR WATER PROOFING SEAM TAPE FOR BUILDING APPLICATIONS; WATERPROOFING MEMBRANES FOR ROOFING, FLOORS AND WALLS; NON-METAL WINDOWS, DOORS AND WALL PANELS; STORM SHELTERS MADE PRIMARILY OF WOOD; STORM SHELTER KITS CONSISTING PRIMARILY OF WOOD PANELS AND DOORS (U.S. CLS. 1, 12, 33 AND 50).  
NORA BUCHANAN WILL, EXAMINING ATTORNEY

SN 85-938,462. SR SYSTEMS, LLC, TUSCALOOSA, AL. FILED 5-21-2013.

## WHEN NAILS ARE NOT ENOUGH

THE MARK CONSISTS OF STANDARD CHARACTERS WITHOUT CLAIM TO ANY PARTICULAR FONT, STYLE, SIZE, OR COLOR.

**CLASS 6—METAL GOODS**

FOR METAL BUILDING MATERIALS AND HARDWARE, NAMELY, STUDS, BEAMS, BRACKETS, BRACES, FLANGES, EXTRUDED TUBES, U-SHAPED CHANNELS, GUSSETS, REINFORCING MESH, FOUNDATION BOLTS, ANCHOR BOLTS, THREADED FASTENERS, BOLTS, NUTS, NAILS, RIVETS, SCREWS, FASTENERS TO HOLD REINFORCING MESH TO WINDOWS; METAL WALL PANELS; DOORS AND WINDOWS OF METAL; STORM SHELTERS MADE PRIMARILY OF METAL; STORM SHELTER KITS CONSISTING PRIMARILY OF METAL PANELS AND DOORS (U.S. CLS. 2, 12, 13, 14, 23, 25 AND 50).

**CLASS 19—NON-METALLIC BUILDING MATERIALS**

FOR WATER PROOFING SEAM TAPE FOR BUILDING APPLICATIONS; WATERPROOFING MEMBRANES FOR ROOFING, FLOORS AND WALLS; NON-METAL WINDOWS, DOORS AND WALL PANELS; STORM SHELTERS MADE PRIMARILY OF WOOD; STORM SHELTER KITS CONSISTING PRIMARILY OF WOOD PANELS AND DOORS (U.S. CLS. 1, 12, 33 AND 50).  
NORA BUCHANAN WILL, EXAMINING ATTORNEY

SN 85-938,877. TUBESTART INC., SANTA MONICA, CA.  
FILED 5-21-2013.

# TUBESTART

THE MARK CONSISTS OF STANDARD CHARACTERS WITHOUT CLAIM TO ANY PARTICULAR FONT, STYLE, SIZE, OR COLOR.

**CLASS 9—ELECTRICAL AND SCIENTIFIC APPARATUS**

FOR COMPUTER SOFTWARE PLATFORM FOR PEOPLE TO RAISE MONEY AND CREATE FUNDING CAMPAIGNS FOR AUDIOVISUAL WORKS, PROJECTS, AND ONLINE CONTENT CHANNELS, AND FOR SOCIAL NETWORKING; COMPUTER E-COMMERCE SOFTWARE THAT ALLOWS USERS, SUPPORTERS, AND CREATORS OF AUDIOVISUAL WORKS, PROJECTS, AND ONLINE CONTENT CHANNELS TO CONNECT AND TO PERFORM ELECTRONIC BUSINESS TRANSACTIONS VIA A GLOBAL COMPUTER NETWORK; DIGITAL AUDIOVISUAL WORKS DOWNLOADABLE FROM THE INTERNET (U.S. CLS. 21, 23, 26, 36 AND 38).

**CLASS 35—ADVERTISING AND BUSINESS**

FOR ADVERTISING, MARKETING, PROMOTION, BUSINESS NETWORKING, AND COMMERCIAL INFORMATION SERVICES RELATED TO THE FUNDING OF AUDIOVISUAL WORKS, PROJECTS, AND ONLINE CONTENT CHANNELS TO RAISE MONEY FOR SUCH WORKS, PROJECTS, AND ONLINE CONTENT CHANNELS, VIA THE INTERNET (U.S. CLS. 100, 101 AND 102).

**CLASS 36—INSURANCE AND FINANCIAL**

FOR PROVIDING A WEBSITE AT WHICH PEOPLE CAN OBTAIN FINANCIAL AND MONETARY INFORMATION ABOUT HOW TO RAISE MONEY, OBTAIN FINANCIAL PLEDGES, AND CREATE FUNDRAISING PLANS FOR AUDIOVISUAL WORKS, PROJECTS, AND ONLINE CONTENT CHANNELS; ONLINE BUSINESS FUNDRAISING SERVICES; PROVIDING FUNDRAISING SERVICES FOR OTHERS VIA A GLOBAL COMPUTER NETWORK; FINANCIAL SERVICES, NAMELY, BUSINESS FUNDRAISING PROVIDED OVER A COMPUTER NETWORK SUCH AS THE INTERNET (U.S. CLS. 100, 101 AND 102).

**CLASS 38—COMMUNICATION**

FOR ONLINE MESSAGING AND BULLETIN BOARD SERVICES (U.S. CLS. 100, 101 AND 104).

**CLASS 41—EDUCATION AND ENTERTAINMENT**

FOR ENTERTAINMENT AND EDUCATION SERVICES, NAMELY, A SERIES OF ONLINE LECTURES AND TUTORIALS FEATURING EDUCATIONAL INFORMATION AND GUIDELINES CONCERNING HOW TO RAISE MONEY FOR AUDIOVISUAL WORKS, PROJECTS, AND ONLINE CONTENT CHANNELS; CONSULTING SERVICES IN THE FIELD OF AUDIOVISUAL PRODUCTIONS; PROVIDING A WEBSITE FEATURING INFORMATION IN THE FIELD OF ENTERTAINMENT; PROVIDING A WEBSITE FEATURING BLOGS AND NON-DOWNLOADABLE ARTICLES, NEWSLETTERS, GUIDES, GUIDELINES, PRESENTATIONS, AND POSTS IN THE FIELDS OF RAISING MONEY AND OBTAINING FINANCIAL PLEDGES FOR AUDIOVISUAL WORKS, PROJECTS, AND ONLINE CONTENT CHANNELS, AND ADVERTISING, MARKETING, PROMOTION, AND DISPLAY OF AUDIOVISUAL WORKS, PROJECTS, AND ONLINE CONTENT CHANNELS; ENTERTAINMENT SERVICES, NAMELY, PRODUCTION OF AUDIOVISUAL WORKS AND CREATIVE PROJECTS FOR INCLUSION IN ONLINE CONTENT CHANNELS (U.S. CLS. 100, 101 AND 107).

**CLASS 42—SCIENTIFIC AND COMPUTER SERVICES**

FOR COMPUTER SERVICES, NAMELY, CREATING AN ONLINE PLATFORM FOR PRESALE AND FUNDRAISING FOR AUDIOVISUAL WORKS, PROJECTS, AND ONLINE CONTENT CHANNELS; HOSTING AN ONLINE COMMUNITY WEBSITE FEATURING PEOPLE RAISING MONEY AND SEEKING PLEDGES FOR AUDIOVISUAL WORKS, PROJECTS, AND ONLINE CONTENT CHANNELS; PROVIDING A WEBSITE FEATURING TECHNOLOGY THAT ENABLES PEOPLE TO OFFER GOODS AND SERVICES FOR PRESALE AND OBTAIN PLEDGES TO PURCHASE GOODS AND SERVICES OFFERED BY OTHERS; PROVIDING A WEBSITE FEATURING TECHNOLOGY THAT ENABLES PEOPLE TO RAISE MONEY FOR AUDIOVISUAL WORKS, PROJECTS, AND ONLINE CONTENT CHANNELS; PROVIDING A WEB SITE FEATURING TECHNOLOGY THAT ENABLES PEOPLE TO OFFER GOODS AND SERVICES FOR PRESALE AND FOR USERS, SUPPORTERS, AND OTHERS TO PLEDGE TO PURCHASE GOODS AND SERVICES OFFERED BY OTHERS; COMPUTER SERVICES IN THE NATURE OF CUSTOMIZED WEB PAGES FEATURING PERSONAL AND BUSINESS INFORMATION, FOR PURPOSES OF PEOPLE RAISING MONEY AND OBTAINING FINANCIAL PLEDGES RELATED TO AUDIOVISUAL WORKS, PROJECTS, AND ONLINE CONTENT CHANNELS, AND FOR THE PURCHASE OF GOODS AND SERVICES OF OTHERS; COMPUTER SERVICES, NAMELY, CREATING AN ONLINE COMMUNITY FOR CREATORS OF AUDIOVISUAL WORKS, SUPPORTERS, USERS, AND OTHERS TO PARTICIPATE IN DISCUSSIONS, EXCHANGE IDEAS, OBTAIN FEEDBACK, FORM VIRTUAL COMMUNITIES, AND ENGAGE IN SOCIAL NETWORKING SERVICES IN THE FIELD OF AUDIOVISUAL WORKS, PROJECTS AND ONLINE CONTENT CHANNELS, FOR PURPOSES OF RAISING MONEY AND OBTAINING FINANCIAL PLEDGES RELATED TO AUDIOVISUAL WORKS, PRO-

JECTS, AND ONLINE CONTENT CHANNELS; COMPUTER SOFTWARE CONSULTING AND ADVISORY SERVICES RELATED TO PEOPLE RAISING MONEY AND OBTAINING FINANCIAL PLEDGES RELATED TO AUDIOVISUAL WORKS, PROJECTS, AND ONLINE CONTENT CHANNELS; PROVIDING A WEBSITE FEATURING NON-DOWNLOADABLE SOFTWARE THAT ASSISTS THE CREATORS OF AUDIOVISUAL WORKS, PROJECTS, AND CONTENT CHANNELS, TO OBTAIN FLEXIBLE FUNDING FROM A VARIETY OF INDIVIDUALS FOR AUDIOVISUAL WORKS, PROJECTS, AND ONLINE CONTENT CHANNELS; PROVIDING AN INTERACTIVE WEBSITE FEATURING TECHNOLOGY THAT ALLOWS PEOPLE TO ORGANIZE AND CONDUCT FUNDRAISING ACTIVITIES TO RAISE MONEY, AND THAT ALLOWS INTERESTED PEOPLE TO MAKE FINANCIAL PLEDGES RELATED TO AUDIOVISUAL WORKS, PROJECTS, AND ONLINE CONTENT CHANNELS; DEVELOPING AND HOSTING A SERVER ON A GLOBAL COMPUTER NETWORK FOR THE PURPOSE OF FACILITATING E-COMMERCE VIA SUCH A SERVER (U.S. CLS. 100 AND 101).

#### **CLASS 45—PERSONAL AND LEGAL SERVICES**

FOR INTERNET-BASED SOCIAL NETWORKING SERVICES; COMPUTER SOFTWARE LICENSING (U.S. CLS. 100 AND 101).

SIDDHARTH JAGANNATHAN, EXAMINING ATTORNEY

---

SN 85-938,881, TUBESTART INC., SANTA MONICA, CA.  
FILED 5-21-2013.

DISCOVER AND GET DISCOVERED

THE MARK CONSISTS OF STANDARD CHARACTERS WITHOUT CLAIM TO ANY PARTICULAR FONT, STYLE, SIZE, OR COLOR.

#### **CLASS 9—ELECTRICAL AND SCIENTIFIC APPARATUS**

FOR COMPUTER SOFTWARE PLATFORM FOR PEOPLE TO RAISE MONEY AND CREATE FUNDING CAMPAIGNS FOR AUDIOVISUAL WORKS, PROJECTS, AND ONLINE CONTENT CHANNELS, AND FOR SOCIAL NETWORKING; COMPUTER E-COMMERCE SOFTWARE THAT ALLOWS USERS, SUPPORTERS, AND CREATORS OF AUDIOVISUAL WORKS, PROJECTS, AND ONLINE CONTENT CHANNELS TO CONNECT AND TO PERFORM ELECTRONIC BUSINESS TRANSACTIONS VIA A GLOBAL COMPUTER NETWORK; DIGITAL AUDIOVISUAL WORKS DOWNLOADABLE FROM THE INTERNET (U.S. CLS. 21, 23, 26, 36 AND 38).

#### **CLASS 35—ADVERTISING AND BUSINESS**

FOR ADVERTISING, MARKETING, PROMOTION, BUSINESS NETWORKING, AND COMMERCIAL INFORMATION SERVICES RELATED TO THE FUNDING OF AUDIOVISUAL WORKS, PROJECTS, AND ONLINE CONTENT CHANNELS TO RAISE MONEY FOR SUCH WORKS, PROJECTS, AND ONLINE CONTENT CHANNELS, VIA THE INTERNET (U.S. CLS. 100, 101 AND 102).

#### **CLASS 36—INSURANCE AND FINANCIAL**

FOR PROVIDING A WEBSITE AT WHICH PEOPLE CAN OBTAIN FINANCIAL AND MONETARY INFORMATION ABOUT HOW TO RAISE MONEY, OBTAIN FINANCIAL PLEDGES, AND CREATE FUNDRAISING PLANS FOR AUDIOVISUAL WORKS, PROJECTS, AND ONLINE CONTENT CHANNELS; ONLINE BUSINESS FUNDRAISING SERVICES; PROVIDING FUNDRAISING SERVICES FOR OTHERS VIA A GLOBAL COMPUTER NETWORK; FINANCIAL SERVICES, NAMELY, BUSINESS FUNDRAISING PROVIDED OVER A COMPUTER NETWORK SUCH AS THE INTERNET (U.S. CLS. 100, 101 AND 102).

#### **CLASS 38—COMMUNICATION**

FOR ONLINE MESSAGING AND BULLETIN BOARD SERVICES (U.S. CLS. 100, 101 AND 104).

#### **CLASS 41—EDUCATION AND ENTERTAINMENT**

FOR ENTERTAINMENT AND EDUCATION SERVICES, NAMELY, A SERIES OF ONLINE LECTURES AND TUTORIALS FEATURING EDUCATIONAL INFORMATION AND GUIDELINES CONCERNING HOW TO RAISE MONEY FOR AUDIOVISUAL WORKS, PROJECTS, AND ONLINE CONTENT CHANNELS; CONSULTING SERVICES IN THE FIELD OF AUDIOVISUAL PRODUCTIONS; PROVIDING A WEBSITE FEATURING INFORMATION IN THE FIELD OF ENTERTAINMENT; PROVIDING A WEBSITE FEATURING BLOGS AND NON-DOWNLOADABLE ARTICLES, NEWSLETTERS, GUIDES, GUIDELINES, PRESENTATIONS, AND POSTS IN THE FIELDS OF RAISING MONEY AND OBTAINING FINANCIAL PLEDGES FOR AUDIOVISUAL WORKS, PROJECTS, AND ONLINE CONTENT CHANNELS, AND ADVERTISING, MARKETING, PROMOTION, AND DISPLAY OF AUDIOVISUAL WORKS, PROJECTS, AND ONLINE CONTENT CHANNELS; ENTERTAINMENT SERVICES, NAMELY, PRODUCTION OF AUDIOVISUAL WORKS AND CREATIVE PROJECTS FOR INCLUSION IN ONLINE CONTENT CHANNELS (U.S. CLS. 100, 101 AND 107).

#### **CLASS 42—SCIENTIFIC AND COMPUTER SERVICES**

FOR COMPUTER SERVICES, NAMELY, CREATING AN ONLINE PLATFORM FOR PRESALE AND FUNDRAISING FOR AUDIOVISUAL WORKS, PROJECTS, AND ONLINE CONTENT CHANNELS; HOSTING AN ONLINE COMMUNITY WEBSITE FEATURING PEOPLE RAISING MONEY AND SEEKING PLEDGES FOR AUDIOVISUAL WORKS, PROJECTS, AND ONLINE CONTENT CHANNELS; PROVIDING A WEBSITE FEATURING TECHNOLOGY THAT ENABLES PEOPLE TO OFFER GOODS AND SERVICES FOR PRESALE AND OBTAIN PLEDGES TO PURCHASE GOODS AND SERVICES OFFERED BY OTHERS; PROVIDING A WEBSITE FEATURING TECHNOLOGY THAT ENABLES PEOPLE TO RAISE MONEY FOR AUDIOVISUAL WORKS, PROJECTS, AND ONLINE CONTENT CHANNELS; PROVIDING A WEB SITE FEATURING TECHNOLOGY THAT ENABLES PEOPLE TO OFFER GOODS AND SERVICES FOR PRESALE AND FOR USERS, SUPPORTERS, AND OTHERS TO PLEDGE TO PURCHASE GOODS AND SERVICES OFFERED BY OTHERS; COMPUTER SERVICES IN THE NATURE OF CUSTOMIZED WEB PAGES FEATURING PERSONAL AND BUSINESS INFORMATION, FOR PURPOSES OF PEOPLE RAISING MONEY AND OBTAINING FINANCIAL PLEDGES RELATED TO AUDIOVISUAL WORKS, PROJECTS, AND ONLINE CONTENT CHANNELS, AND FOR THE PURCHASE OF GOODS AND SERVICES OF OTHERS; COMPUTER SERVICES, NAMELY, CREATING AN ONLINE COMMUNITY FOR CREATORS OF AUDIOVISUAL WORKS, SUPPORTERS, USERS, AND OTHERS TO PARTICIPATE IN DISCUSSIONS, EXCHANGE IDEAS, OBTAIN FEEDBACK, FORM VIRTUAL COMMUNITIES, AND ENGAGE IN SOCIAL NETWORKING SERVICES IN THE FIELD OF AUDIOVISUAL WORKS, PROJECTS AND ONLINE CONTENT CHANNELS, FOR PURPOSES OF RAISING MONEY AND OBTAINING FINANCIAL PLEDGES RELATED TO AUDIOVISUAL WORKS, PRO-

JECTS, AND ONLINE CONTENT CHANNELS; COMPUTER SOFTWARE CONSULTING AND ADVISORY SERVICES RELATED TO PEOPLE RAISING MONEY AND OBTAINING FINANCIAL PLEDGES RELATED TO AUDIOVISUAL WORKS, PROJECTS, AND ONLINE CONTENT CHANNELS; PROVIDING A WEBSITE FEATURING NON-DOWNLOADABLE SOFTWARE THAT ASSISTS THE CREATORS OF AUDIOVISUAL WORKS, PROJECTS, AND CONTENT CHANNELS, TO OBTAIN FLEXIBLE FUNDING FROM A VARIETY OF INDIVIDUALS FOR AUDIOVISUAL WORKS, PROJECTS, AND ONLINE CONTENT CHANNELS; PROVIDING AN INTERACTIVE WEBSITE FEATURING TECHNOLOGY THAT ALLOWS PEOPLE TO ORGANIZE AND CONDUCT FUNDRAISING ACTIVITIES TO RAISE MONEY, AND THAT ALLOWS INTERESTED PEOPLE TO MAKE FINANCIAL PLEDGES RELATED TO AUDIOVISUAL WORKS, PROJECTS, AND ONLINE CONTENT CHANNELS; DEVELOPING AND HOSTING A SERVER ON A GLOBAL COMPUTER NETWORK FOR THE PURPOSE OF FACILITATING E-COMMERCE VIA SUCH A SERVER (U.S. CLS. 100 AND 101).

SN 85-938,982. APPSURDITY INC., REDWOOD SHORES, CA. FILED 5-22-2013.



#### CLASS 45—PERSONAL AND LEGAL SERVICES

FOR INTERNET-BASED SOCIAL NETWORKING SERVICES; COMPUTER SOFTWARE LICENSING (U.S. CLS. 100 AND 101).

SIDDHARTH JAGANNATHAN, EXAMINING ATTORNEY

THE MARK CONSISTS OF THE DESIGN OF A STYLIZED LETTER "D" WITH TWO SOUND WAVES EMANATING TO THE TOP LEFT OF THE MARK, ALL ABOVE THE WORD "DUBBLER" WITH THE WORDS "BE HEARD" UNDERNEATH AND TO THE RIGHT.

#### CLASS 9—ELECTRICAL AND SCIENTIFIC APPARATUS

FOR CINEMATOGRAPHIC CAMERAS; COMMUNICATIONS SERVERS; COMPUTER OPERATING RECORDED PROGRAMS; COMPUTER OPERATING SOFTWARE; COMPUTER PERIPHERAL DEVICES; COMPUTERS; INTEGRATED CIRCUIT MODULES; PORTABLE TELEPHONES; VIDEO DISKS AND VIDEO TAPES WITH RECORDED ANIMATED CARTOONS; VIDEO RECEIVERS (U.S. CLS. 21, 23, 26, 36 AND 38).

FIRST USE 12-4-2012; IN COMMERCE 12-4-2012.

SN 85-938,929. AUTOSPLICE, INC., SAN DIEGO, CA. FILED 5-21-2013.

# AUTOSPLICE

THE MARK CONSISTS OF STANDARD CHARACTERS WITHOUT CLAIM TO ANY PARTICULAR FONT, STYLE, SIZE, OR COLOR.

OWNER OF U.S. REG. NO. 1,021,907.

#### CLASS 38—COMMUNICATION

FOR COMMUNICATIONS BY COMPUTER TERMINALS; COMPUTER-AIDED TRANSMISSION OF MESSAGES AND IMAGES; NEWS AGENCIES, NAMELY, THE TRANSMISSION OF NEWS ITEMS TO NEWS REPORTING ORGANIZATIONS; PROVIDING ACCESS TO DATABASES; PROVIDING ON-LINE CHAT ROOMS FOR SOCIAL NETWORKING; PROVIDING ON-LINE FORUMS FOR TRANSMISSION OF MESSAGES AMONG COMPUTER USERS; PROVIDING TELECOMMUNICATIONS CONNECTIONS TO A GLOBAL COMPUTER NETWORK; PROVIDING USER ACCESS TO A GLOBAL COMPUTER NETWORK; SATELLITE TRANSMISSION; TELECONFERENCING SERVICES (U.S. CLS. 100, 101 AND 104).

FIRST USE 12-4-2012; IN COMMERCE 12-4-2012.

#### CLASS 7—MACHINERY

FOR ELECTRONIC WIRE, CABLE, AND ELECTRONIC COMPONENT CRIMPING, SPLICING AND INSERTION MACHINES (U.S. CLS. 13, 19, 21, 23, 31, 34 AND 35).

FIRST USE 1-2-1969; IN COMMERCE 1-2-1969.

#### CLASS 41—EDUCATION AND ENTERTAINMENT

FOR ARRANGING AND CONDUCTING EDUCATIONAL CONFERENCES; BOOKMOBILE SERVICES; EDUCATIONAL COUNSELING SERVICES TO ASSIST STUDENTS IN PLANNING AND PREPARING FOR FURTHER EDUCATION; EDUCATIONAL EXAMINATION SERVICES; ENTERTAINMENT EVENT BOOKING AGENCIES; ENTERTAINMENT IN THE NATURE OF COMPETITIONS IN THE FIELD OF SPORTS AND MOVIES; ENTERTAINMENT SERVICES, NAMELY, PROVIDING ON-LINE COMPUTER GAMES; INSTRUCTION IN THE FIELD OF COMPUTER PROGRAMS AND COMPUTER TRAINING; LANGUAGE INSTRUCTION; MODELING FOR ARTISTS; ON-LINE PUBLICATION OF MAGAZINES, BOOKS, AND NEWSPAPERS IN THE FIELD OF NETWORK SERVICES AND COMPUTER TECHNOLOGY; PROVIDING EDUCATIONAL ASSESSMENT SERVICES; PUBLICATION OF TEXTS, BOOKS, JOURNALS (U.S. CLS. 100, 101 AND 107).

FIRST USE 12-4-2012; IN COMMERCE 12-4-2012.

#### CLASS 9—ELECTRICAL AND SCIENTIFIC APPARATUS

FOR CONNECTORS FOR ELECTRONIC CIRCUITS; ELECTRONIC COMPONENTS IN THE NATURE OF ELECTRONIC CIRCUIT INTERCONNECTION PRODUCTS, NAMELY, TERMINALS, CONNECTORS ELECTRONIC HOUSING MODULES, CRIMPING ENDS, RFI SHIELD CLIPS, SHAPE MEMORY ALLOY ACTUATORS, PCB PINS, AND PCB CONNECTORS (U.S. CLS. 21, 23, 26, 36 AND 38).

FIRST USE 1-2-1969; IN COMMERCE 1-2-1969.  
DAVID HOFFMAN, EXAMINING ATTORNEY



**CLASS 42—SCIENTIFIC AND COMPUTER SERVICES**

FOR AUTHENTICATING WORKS OF ART; COMPUTER PROGRAMMING; CONSULTING IN THE FIELDS OF ENGINEERING AND ARCHITECTURE; CONVERSION OF DATA OR DOCUMENTS FROM PHYSICAL TO ELECTRONIC MEDIA; COSMETICS RESEARCH; DRESS DESIGNING; MATERIAL TESTING; PROVISION OF SEARCH ENGINES FOR THE INTERNET; SCIENTIFIC RESEARCH AND DEVELOPMENT (U.S. CLS. 100 AND 101).

FIRST USE 12-4-2012; IN COMMERCE 12-4-2012.  
SUNG IN, EXAMINING ATTORNEY

SN 85-940,654. THE CRIMSON CUP, INC., COLUMBUS, OH.  
FILED 5-23-2013.

**FRIEND 2 FARMER**

THE MARK CONSISTS OF STANDARD CHARACTERS WITHOUT CLAIM TO ANY PARTICULAR FONT, STYLE, SIZE, OR COLOR.

**CLASS 35—ADVERTISING AND BUSINESS**

FOR PROMOTING PUBLIC AWARENESS OF, AND THE NEED TO SUPPORT, INTERNATIONAL FAIR TRADE PRACTICES, SUSTAINABLE AGRICULTURE, SUSTAINABLE ECONOMIES, VOLUNTEERISM IN DEVELOPING COUNTRIES, MICRO CREDIT LENDING, AND ECONOMIC DEVELOPMENT IN DEVELOPING COUNTRIES; CHARITABLE SERVICES, NAMELY, PROMOTING PUBLIC AWARENESS IN THE FIELDS OF FARM-TO-CAFETERIA FOOD AND AGRICULTURAL PROGRAMS, GARDENING, FAIR TRADE, ORGANIC AND SUSTAINABLE FOOD PRACTICES, FARMWORKERS' RIGHTS, AND RELATIONSHIPS WITH LOCAL FARMERS; PROMOTING PUBLIC AWARENESS OF AND SUPPORT FOR FAIR TRADE AND FAIR TRADE PRACTICES, NAMELY, AGRICULTURAL AND ENVIRONMENTAL PRACTICES, COFFEE CULTIVATION, PRICE TRANSPARENCY, FARMING AND COMMUNITY ORIENTED INFRASTRUCTURE; PROVIDING AND DISSEMINATING INFORMATION IN THE FIELD OF FAIR TRADE AND FAIR TRADE PRACTICES VIA A GLOBAL COMPUTER NETWORK; CHARITABLE SERVICES, NAMELY, DEVELOPING, ORGANIZING AND CONDUCTING VOLUNTEER PROGRAMS AND COMMUNITY SERVICE PROJECTS; PHILANTHROPIC SERVICES CONCERNING THE BUSINESS-RELATED ADMINISTRATIVE SUPPORT AND FACILITATION OF VOLUNTEERISM, NAMELY, BUSINESS ADMINISTRATION AND OFFICE WORK; PROVIDING ON-LINE INFORMATION AND INTERACTIVE DATA BASES IN THE FIELDS OF INTERNATIONAL FAIR TRADE PRACTICES, SUSTAINABLE ECONOMIES, VOLUNTEERISM, AND ECONOMIC DEVELOPMENT AND ADMINISTRATIVE COORDINATION OF ORGANIZATIONS PROVIDING HUMANITARIAN RELIEF IN DEVELOPING COUNTRIES (U.S. CLS. 100, 101 AND 102).

**CLASS 41—EDUCATION AND ENTERTAINMENT**

FOR CHARITABLE SERVICES, NAMELY, TRAINING IN THE FIELDS OF FARM-TO-CAFETERIA FOOD AND AGRICULTURAL PROGRAMS, GARDENING, FAIR TRADE, ORGANIC AND SUSTAINABLE FOOD PRACTICES, FARMWORKERS' RIGHTS, AND RELATIONSHIPS WITH LOCAL FARMERS (U.S. CLS. 100, 101 AND 107).

SANI KHOURI, EXAMINING ATTORNEY

SN 85-942,130. THE URBAN FOOD INITIATIVE, INC., WABAN, MA. FILED 5-24-2013.

**DAILY TABLE**

THE MARK CONSISTS OF STANDARD CHARACTERS WITHOUT CLAIM TO ANY PARTICULAR FONT, STYLE, SIZE, OR COLOR.

**CLASS 35—ADVERTISING AND BUSINESS**

FOR CHARITABLE SERVICES, NAMELY, COORDINATION OF THE PROCUREMENT AND DISTRIBUTION OF FOOD DONATIONS FROM OTHERS TO ORGANIZATIONS PROVIDING FOOD TO NEEDY PEOPLE; PROCUREMENT OF FOOD FOR OTHERS; WHOLESALE FOOD DISTRIBUTORSHIP SERVICES; RETAIL STORE SERVICES FOR FOOD; AND PROMOTING PUBLIC AWARENESS OF HUNGER AND NUTRITION (U.S. CLS. 100, 101 AND 102).

**CLASS 43—HOTEL AND RESTAURANT SERVICES**

FOR CHARITABLE SERVICES, NAMELY, PROVIDING FOOD TO NEEDY PERSONS; AND RESTAURANT SERVICES (U.S. CLS. 100 AND 101).

KATHERINE STOIDES, EXAMINING ATTORNEY

SN 85-942,578. OPUS SOLUTIONS, LLC, BEAVERTON, OR.  
FILED 5-24-2013.

**OPUS EVENTS AGENCY**

THE MARK CONSISTS OF STANDARD CHARACTERS WITHOUT CLAIM TO ANY PARTICULAR FONT, STYLE, SIZE, OR COLOR.

NO CLAIM IS MADE TO THE EXCLUSIVE RIGHT TO USE "EVENTS AGENCY", APART FROM THE MARK AS SHOWN.

**CLASS 35—ADVERTISING AND BUSINESS**

FOR CREATIVE MARKETING DESIGN SERVICES, MARKETING, ADVERTISING AND PROMOTIONAL SERVICES; CORPORATE EVENT AND TRADE SHOW DESIGN, PLANNING AND MANAGEMENT SERVICES; CORPORATE EVENT AND TRADE SHOW DESIGN, PLANNING AND MANAGEMENT SERVICES IN SUPPORT OF BUSINESS CONFERENCES, INTERNAL COMPANY EVENTS AND OUTINGS, CORPORATE SPONSORED EVENTS, AND CORPORATE PRODUCT LAUNCHES; CREATIVE MARKETING DESIGN; MARKETING AND PROMOTIONAL SERVICES TO SUPPORT MARKETING AND ADVERTISING BY OTHERS AT AIRPORTS; DESIGNING AND MANAGING SPONSORSHIP AND MARKETING PROGRAMS FOR OTHERS; DESIGNING AND MANAGING SPONSORSHIP AND MARKETING PROGRAMS AT AIRPORTS FOR OTHERS (U.S. CLS. 100, 101 AND 102).

**CLASS 42—SCIENTIFIC AND COMPUTER SERVICES**

FOR PROVIDING ON-LINE NON-DOWNLOADABLE SOFTWARE IN THE FIELD OF TRADE SHOW AND CORPORATE EVENTS PLANNING AND MANAGEMENT THAT INCLUDES ONE OR MORE OF A WEBSITE, CALENDAR, AND SCHEDULE TO SUPPORT PLANNING AND MANAGEMENT OF A TRADE SHOW OR EVENT; PROVIDING COMPUTER PROGRAMMING SERVICES TO CUSTOMIZE THE AFOREMENTIONED ON-LINE NON-DOWNLOADABLE SOFTWARE (U.S. CLS. 100 AND 101).

DEZMONA MIZELLE, EXAMINING ATTORNEY

SN 85-942,581. OPUS SOLUTIONS, LLC, BEAVERTON, OR. FILED 5-24-2013.

OPUS AGENCY

THE MARK CONSISTS OF STANDARD CHARACTERS WITHOUT CLAIM TO ANY PARTICULAR FONT, STYLE, SIZE, OR COLOR.

NO CLAIM IS MADE TO THE EXCLUSIVE RIGHT TO USE "AGENCY", APART FROM THE MARK AS SHOWN.

**CLASS 35—ADVERTISING AND BUSINESS**

FOR CREATIVE MARKETING DESIGN SERVICES, MARKETING, ADVERTISING AND PROMOTIONAL SERVICES; CORPORATE EVENT AND TRADE SHOW DESIGN, PLANNING AND MANAGEMENT SERVICES; CORPORATE EVENT AND TRADE SHOW DESIGN, PLANNING AND MANAGEMENT SERVICES IN SUPPORT OF BUSINESS CONFERENCES, INTERNAL COMPANY EVENTS AND OUTINGS, CORPORATE SPONSORED EVENTS, AND CORPORATE PRODUCT LAUNCHES; CREATIVE MARKETING DESIGN; MARKETING AND PROMOTIONAL SERVICES TO SUPPORT MARKETING AND ADVERTISING BY OTHERS AT AIRPORTS; DESIGNING AND MANAGING SPONSORSHIP AND MARKETING PROGRAMS FOR OTHERS; DESIGNING AND MANAGING SPONSORSHIP AND MARKETING PROGRAMS AT AIRPORTS FOR OTHERS (U.S. CLS. 100, 101 AND 102).

**CLASS 42—SCIENTIFIC AND COMPUTER SERVICES**

FOR PROVIDING ON-LINE NON-DOWNLOADABLE SOFTWARE IN THE FIELD OF TRADE SHOW AND CORPORATE EVENTS PLANNING AND MANAGEMENT THAT INCLUDES ONE OR MORE OF A WEBSITE, CALENDAR, AND SCHEDULE TO SUPPORT PLANNING AND MANAGEMENT OF A TRADE SHOW OR EVENT; PROVIDING COMPUTER PROGRAMMING SERVICES TO CUSTOMIZE THE AFOREMENTIONED ON-LINE NON-DOWNLOADABLE SOFTWARE (U.S. CLS. 100 AND 101).

DEZMONA MIZELLE, EXAMINING ATTORNEY

SN 85-943,854. GUANGZHOU GUAN TONG ENTERPRISES LIMITED, GUANGZHOU, CHINA, FILED 5-28-2013.



THE COLOR(S) BLUE, RED AND BLACK IS/ARE CLAIMED AS A FEATURE OF THE MARK.

THE MARK CONSISTS OF THE STYLIZED LETTER "U" IN THE COLOR BLUE AND THE STYLIZED LETTER "P" IN THE COLOR RED AND THE LETTERS "EX" IN THE COLOR BLACK SITUATED TO THE RIGHT OF AND UNDER THE TOP PORTION OF THE STYLIZED LETTER "P". THE MARK APPEARS ON A TRANSPARENT BACKGROUND AND NO OTHER COLORS ARE CLAIMED AS A FEATURE OF THE MARK.

**CLASS 11—ENVIRONMENTAL CONTROL APPARATUS**

FOR PIPES BEING PARTS OF SANITARY FACILITIES; HYDRANTS; HEATING INSTALLATIONS, NAMELY, HOT WATER HEATING INSTALLATIONS; PIPE LINE COCKS IN THE NATURE OF SPIGOTS; PRESSURE WATER TANKS, NAMELY, WATER PURIFICATION TANK; THERMOSTATIC VALVES (U.S. CLS. 13, 21, 23, 31 AND 34).

FIRST USE 3-12-2010; IN COMMERCE 2-18-2013.

**CLASS 19—NON-METALLIC BUILDING MATERIALS**

FOR PLASTIC WATER CONDUITS FOR ROOFS AND BALCONIES (U.S. CLS. 1, 12, 33 AND 50).

FIRST USE 3-12-2010; IN COMMERCE 2-18-2013.

LEE-ANNE BERNIS, EXAMINING ATTORNEY

SN 85-945,127. QUEST NUTRITION, LLC, MARINA DEL REY, CA. FILED 5-29-2013.

Pursue Greatness

THE MARK CONSISTS OF STANDARD CHARACTERS WITHOUT CLAIM TO ANY PARTICULAR FONT, STYLE, SIZE, OR COLOR.

OWNER OF U.S. REG. NOS. 3,703,003, 3,703,004 AND 4,290,313.

**CLASS 5—PHARMACEUTICALS**

FOR DIETARY SUPPLEMENTS, NAME, PROTEIN-BASED, NUTRIENT-DENSE SNACK BARS (U.S. CLS. 6, 18, 44, 46, 51 AND 52).

**CLASS 30—STAPLE FOODS**

FOR CHOCOLATES AND CHOCOLATE BASED READY TO EAT CANDIES AND SNACKS; HIGH PROTEIN, LOW CARBOHYDRATE CEREAL BARS AND SNACKS, NAMELY, CEREAL SNACK BARS AND GRAIN-BASED CHIPS (U.S. CL. 46).

SHANNON TWOHIG, EXAMINING ATTORNEY

SN 85-945,575. CANARYFLOW INC., SAN JOSE, CA. FILED 5-29-2013.

SN 85-946,240. SAKURAI, YUSUKE, BROOKLYN, NY. FILED 5-30-2013.

## CANARYFLOW

THE MARK CONSISTS OF STANDARD CHARACTERS WITHOUT CLAIM TO ANY PARTICULAR FONT, STYLE, SIZE, OR COLOR.

### CLASS 9—ELECTRICAL AND SCIENTIFIC APPARATUS

FOR DOWNLOADABLE COMPUTER SOFTWARE FOR MOBILE DEVICES, NAMELY, SOFTWARE FOR THE COLLECTING, TRACKING, MANAGING, DISTRIBUTING, ACHIEVING, COLLABORATING, EDITING, AND SHARING OF HOMEWORK, FILES, AND ASSIGNMENTS IN THE FIELD OF K-12 EDUCATION; DOWNLOADABLE COMPUTER SOFTWARE FOR MOBILE DEVICES, NAMELY, SOFTWARE FOR THE DISPLAYING, RECEIVING, READING, INTERACTING AND STORING OF INFORMATION FOR STUDENTS, PARENTS, TEACHERS, STAFF, AND COLLEAGUES IN THE FIELD OF K-12 EDUCATION; DOWNLOADABLE COMPUTER SOFTWARE FOR MOBILE DEVICES, NAMELY, SOFTWARE TO ENABLE SCHOOL DISTRICTS, SCHOOLS, ADMINISTRATORS AND TEACHERS TO RECORD, ACCESS, REPORT, AND MANAGE THEIR STUDENT INFORMATION AND PERFORMANCE DATA, AND ALLOWS STUDENTS AND PARENTS TO ACCESS SUCH INFORMATION AND DATA (U.S. CLS. 21, 23, 26, 36 AND 38).

### CLASS 42—SCIENTIFIC AND COMPUTER SERVICES

FOR SOFTWARE AS A SERVICE (SAAS) FEATURING ONLINE NON-DOWNLOADABLE SOFTWARE FOR THE COLLECTING, TRACKING, MANAGING, DISTRIBUTING, ACHIEVING, COLLABORATING, EDITING, AND SHARING OF HOMEWORK, FILES, AND ASSIGNMENTS IN THE FIELD OF K-12 EDUCATION; PROVIDING ONLINE NON-DOWNLOADABLE SOFTWARE FOR THE DISPLAYING, RECEIVING, READING, INTERACTING AND STORING OF INFORMATION FOR STUDENTS, PARENTS, TEACHERS, STAFF, AND COLLEAGUES IN THE FIELD OF K-12 EDUCATION; PROVIDING A WEB-BASED STUDENT INFORMATION SYSTEM IN THE NATURE OF NON-DOWNLOADABLE SOFTWARE THAT ENABLES SCHOOL DISTRICTS, SCHOOLS, ADMINISTRATORS AND TEACHERS TO RECORD, ACCESS, REPORT, AND MANAGE THEIR STUDENT INFORMATION AND PERFORMANCE DATA, AND ALLOWS STUDENTS AND PARENTS TO ACCESS SUCH INFORMATION AND DATA; SOFTWARE AS A SERVICE (SAAS) FEATURING SOFTWARE FOR PROJECT MANAGEMENT, ASSET MANAGEMENT, FILE MANAGEMENT, COLLABORATIVE WORKFLOW, FILE SHARING AND FILE TRANSFER IN THE FIELDS OF EDUCATION VIA COMPUTER NETWORKS, WIRELESS NETWORKS OR GLOBAL COMMUNICATION NETWORKS; COMPUTER SOFTWARE SERVICES, NAMELY, PROVIDING ONLINE, NON-DOWNLOADABLE SOFTWARE AND APPLICATIONS FOR PROJECT MANAGEMENT, ASSET MANAGEMENT, FILE MANAGEMENT, COLLABORATIVE WORKFLOW, FILE SHARING AND FILE TRANSFER RELATING TO EDUCATION VIA COMPUTER NETWORKS, WIRELESS NETWORKS OR GLOBAL COMMUNICATION NETWORKS (U.S. CLS. 100 AND 101).  
HEATHER BIDDULPH, EXAMINING ATTORNEY

## SIRÈNE LOUVETEAU

THE MARK CONSISTS OF STANDARD CHARACTERS WITHOUT CLAIM TO ANY PARTICULAR FONT, STYLE, SIZE, OR COLOR.

THE NAME(S), PORTRAIT(S), AND/OR SIGNATURE(S) SHOWN IN THE MARK IDENTIFIES THE NICKNAME AND SIGNATURE OF YUSUKE SAKURAI, WHOSE CONSENT(S) TO REGISTER IS MADE OF RECORD.

THE ENGLISH TRANSLATION OF "SIRÈNE LOUVETEAU" IN THE MARK IS "MERMAID WOLF CUB".

### CLASS 25—CLOTHING

FOR CLOTHING, NAMELY, COATS, CLOAKS, CAPES, BLAZERS, JACKETS, VESTS, DRESSES, SKIRTS, PANTS, TROUSERS, JEANS, LEGGINGS, SWEATPANTS, SWEATSHIRTS, HOODIES, POLO SHIRTS, SHORTS, SWEATERS, PULLOVERS, SHIRTS, BLOUSES, SHRUGS, TUNICS, T-SHIRTS, HALTER TOPS, TANK TOPS, CAMISOLES, WRAPS, SCARVES, UNDERPANTS, CORSETS, BRASSIERES, GIRDLES, UNDERWEAR, SLEEPWEAR, STOCKINGS, SOCKS, HOSIERY, GARTER BELTS, BATHING SUITS; FOOTWEAR AND HEADWEAR (U.S. CLS. 22 AND 39).

### CLASS 28—TOYS AND SPORTING GOODS

FOR COLLECTIBLE TOY FIGURES, AND ARTICLES OF TOY CLOTHING, NAMELY, TOY WIGS, AND TOY JEWELRY FOR THE TOY FIGURES (U.S. CLS. 22, 23, 38 AND 50).

GILBERT SWIFT, EXAMINING ATTORNEY

SN 85-946,663. DELTA AIR LINES, INC., ATLANTA, GA. FILED 5-30-2013.



NO CLAIM IS MADE TO THE EXCLUSIVE RIGHT TO USE "AIR", APART FROM THE MARK AS SHOWN.

THE COLOR(S) RED AND BLACK IS/ARE CLAIMED AS A FEATURE OF THE MARK.

THE MARK CONSISTS OF THE WORDS "ENDEAVOR AIR" IN BLACK AND TWO CURVED LINES IN RED.

### CLASS 35—ADVERTISING AND BUSINESS

FOR ENHANCED AND EXPEDITED CUSTOMER SERVICE RESPONSES FOR ELITE PASSENGERS (U.S. CLS. 100, 101 AND 102).

**CLASS 39—TRANSPORTATION AND STORAGE**

FOR AIR TRANSPORTATION SERVICES; AIR TRANSPORTATION SERVICES FEATURING A FREQUENT FLYER BONUS AWARD PROGRAM, TRANSIT LOUNGE FACILITIES FOR PASSENGER RELAXATION, A SPECIALIZED PRIORITY AIRLINE SERVICE WITH RESERVATION SERVICES, ENHANCED AIRPORT TICKETING PROCESSING, EXPEDITED CALL WAITING PROCEDURES, PRIORITY CHECK-IN, PRIORITY LOBBY CHECK-IN, DEDICATED SERVICE CENTER AND CLUB LANES FOR ELITE PASSENGERS, EXPEDITED GATE HANDLING AND AIRCRAFT BOARDING SERVICES, ENHANCED SEATING ACCOMMODATIONS, ENHANCED PERSONAL SPACE INCLUDING SPECIALIZED ENTERTAINMENT, COMPUTER CONNECTIONS, ENHANCED MEAL SERVICES AND VOUCHER VALUES FOR ELITE PASSENGERS, PRIORITY BAGGAGE DELIVERY (U.S. CLS. 100 AND 105).

**CLASS 45—PERSONAL AND LEGAL SERVICES**

FOR SPECIALIZED PRIORITY AND EXPEDITED PASSENGER SECURITY SCREENING (U.S. CLS. 100 AND 101).

DAVID C. REIHNER, EXAMINING ATTORNEY

SN 85-946,680. DELTA AIR LINES, INC., ATLANTA, GA. FILED 5-30-2013.



NO CLAIM IS MADE TO THE EXCLUSIVE RIGHT TO USE "AIR", APART FROM THE MARK AS SHOWN.

THE COLOR(S) RED AND BLACK IS/ARE CLAIMED AS A FEATURE OF THE MARK.

THE MARK CONSISTS OF THE WORDS "ENDEAVOR AIR" IN BLACK AND A CURVED LINE IN RED.

**CLASS 35—ADVERTISING AND BUSINESS**

FOR ENHANCED AND EXPEDITED CUSTOMER SERVICE RESPONSES FOR ELITE PASSENGERS (U.S. CLS. 100, 101 AND 102).

**CLASS 39—TRANSPORTATION AND STORAGE**

FOR AIR TRANSPORTATION SERVICES; AIR TRANSPORTATION SERVICES FEATURING A FREQUENT FLYER BONUS AWARD PROGRAM, TRANSIT LOUNGE FACILITIES FOR PASSENGER RELAXATION, A SPECIALIZED PRIORITY AIRLINE SERVICE WITH RESERVATION SERVICES, ENHANCED AIRPORT TICKETING PROCESSING, EXPEDITED CALL WAITING PROCEDURES, PRIORITY CHECK-IN, PRIORITY LOBBY CHECK-IN, DEDICATED SERVICE CENTER AND CLUB LANES FOR ELITE PASSENGERS, EXPEDITED GATE HANDLING AND AIRCRAFT BOARDING SERVICES, ENHANCED SEATING ACCOMMODATIONS, ENHANCED PERSONAL SPACE INCLUDING SPECIALIZED ENTERTAINMENT, COMPUTER CONNECTIONS, ENHANCED MEAL SERVICES AND VOUCHER VALUES FOR ELITE PASSENGERS, PRIORITY BAGGAGE DELIVERY (U.S. CLS. 100 AND 105).

**CLASS 45—PERSONAL AND LEGAL SERVICES**

FOR SPECIALIZED PRIORITY AND EXPEDITED PASSENGER SECURITY SCREENING (U.S. CLS. 100 AND 101).

DAVID C. REIHNER, EXAMINING ATTORNEY

SN 85-947,793. WESTERN SAW, INC., OXNARD, CA. FILED 5-31-2013.



OWNER OF U.S. REG. NOS. 2,190,490 AND 3,915,371. NO CLAIM IS MADE TO THE EXCLUSIVE RIGHT TO USE "SAW", APART FROM THE MARK AS SHOWN.

THE MARK CONSISTS OF THE WORDS "WESTERN SAW" SUPERIMPOSED OVER A SAW BLADE THAT HAS ON ITS FACE AN IMAGE REPRESENTING THE CONTINENTS OF THE WESTERN HEMISPHERE. COLOR IS NOT A FEATURE OF THE MARK.

**CLASS 7—MACHINERY**

FOR CIRCULAR SAW BLADES FOR POWER-OPERATED SAWS, CORES AND BARRELS FOR DIAMOND SAW BLADES, ELECTRONIC WELDING MACHINES AND REPLACEMENT PARTS THEREFOR; MACHINES FOR THE MANUFACTURE OF SAW CUTTING BLADES AND REPLACEMENT PARTS THEREFOR (U.S. CLS. 13, 19, 21, 23, 31, 34 AND 35).

FIRST USE 1-1-2010; IN COMMERCE 1-1-2010.

**CLASS 40—MATERIAL TREATMENT**

FOR TECHNICAL CONSULTATION IN THE FIELD OF POWER-OPERATED CUTTING, LASER, WELDING AND CLADING EQUIPMENT (U.S. CLS. 100, 103 AND 106).

FIRST USE 1-1-2010; IN COMMERCE 1-1-2010. GISELLE AGOSTO, EXAMINING ATTORNEY

SN 85-949,178. FEDERAL HOUSING FINANCE AGENCY, WASHINGTON, DC. FILED 6-3-2013.

# HARP

THE MARK CONSISTS OF STANDARD CHARACTERS WITHOUT CLAIM TO ANY PARTICULAR FONT, STYLE, SIZE, OR COLOR.

**CLASS 35—ADVERTISING AND BUSINESS**

FOR ADVERTISING SERVICES; BUSINESS INFORMATION; DISSEMINATION OF ADVERTISING MATTER; PUBLICITY; ADVERTISING MATTER, NAMELY, THE DISSEMINATION OF ADVERTISING MATERIAL RELATED TO FINANCIAL AND REAL ESTATE SERVICES IN THE FIELD OF MORTGAGE LOANS AND MORTGAGE-BASED OR MORTGAGE-RELATED SECURITIES; BUSINESS ADMINISTRATION SERVICES RELATING TO THE DRAWING UP AND DEVELOPMENT OF STANDARD RULES AND QUALIFICATIONS FOR FINANCIAL AND REAL ESTATE PROGRAMS RELATED TO MORTGAGE LOANS AND MORTGAGE-BASED OR MORTGAGE-RELATED SECURITIES (U.S. CLS. 100, 101 AND 102).

FIRST USE 4-1-2009; IN COMMERCE 4-1-2009.

**CLASS 36—INSURANCE AND FINANCIAL**

FOR PROVIDING FINANCIAL INFORMATION RELATED TO THE QUALIFICATIONS, CRITERIA AND CONDITIONS RELATED TO MORTGAGE LOANS AND MORTGAGE-BASED OR MORTGAGE-RELATED SECURITIES; AND PROVIDING EDUCATIONAL INFORMATION IN THE FIELD OF MORTGAGE LOANS AND MORTGAGE-BASED OR MORTGAGE-RELATED SECURITIES (U.S. CLS. 100, 101 AND 102).

FIRST USE 4-1-2009; IN COMMERCE 4-1-2009.

**CLASS 41—EDUCATION AND ENTERTAINMENT**

FOR ARRANGING AND CONDUCTING OF WORKSHOPS, SEMINARS, SYMPOSIUMS, MEETINGS, AND OTHER TRAINING IN THE FIELD OF MORTGAGE LOANS AND MORTGAGE-BASED OR MORTGAGE-RELATED SECURITIES; PROVIDING COURSES IN THE FIELD OF MORTGAGE LOANS AND MORTGAGE-BASED OR MORTGAGE-RELATED SECURITIES (U.S. CLS. 100, 101 AND 107).

FIRST USE 4-1-2009; IN COMMERCE 4-1-2009.  
BRIDGETT SMITH, EXAMINING ATTORNEY

SN 85-950,677. TACTICAL ELECTRONICS AND MILITARY SUPPLY, L.L.C., BROKEN ARROW, OK. FILED 6-4-2013.



SN 85-949,475. PARTSPROS, INC., FORMERLY ZBRA.COM, INC., LAFAYETTE, LA. FILED 6-3-2013.

LATCHWELL

THE MARK CONSISTS OF STANDARD CHARACTERS WITHOUT CLAIM TO ANY PARTICULAR FONT, STYLE, SIZE, OR COLOR.

**CLASS 6—METAL GOODS**

FOR METAL HANDLES FOR AUTOMOBILE DOORS AND TRUCK TAILGATES; NON-ELECTRICAL CABLES AND WIRES OF COMMON METAL; METAL TRUCK TAILGATE CABLES (U.S. CLS. 2, 12, 13, 14, 23, 25 AND 50).

FIRST USE 1-16-2013; IN COMMERCE 1-16-2013.

**CLASS 12—VEHICLES**

FOR AUTOMOBILE PARTS, NAMELY, INTERIOR AUTOMOBILE DOOR HANDLES, EXTERIOR AUTOMOBILE DOOR HANDLES, TRUCK TAILGATE HANDLES, PLASTIC TAILGATE HANDLE BEZELS (U.S. CLS. 19, 21, 23, 31, 35 AND 44).

FIRST USE 1-16-2013; IN COMMERCE 1-16-2013.  
KATINA MISTER, EXAMINING ATTORNEY

THE MARK CONSISTS OF A CIRCULAR DESIGN WITH AN OUTLINED CIRCLE ON THE OUTER EDGE. INSIDE THAT EDGE IS A BLACK CIRCLE WITH A DRIP OR SPOON LIKE SHAPE EMANATING FROM THE TOP OF THE BLACK CIRCLE. INSIDE THAT IS A WHITE OUTLINE OF THE BLACK CIRCLE AND SPOON SHAPE. A BLACK INNER C LIKE SHAPE IS CREATED, WITH THE C ROTATED 90 DEGREES COUNTER CLOCKWISE.

**CLASS 9—ELECTRICAL AND SCIENTIFIC APPARATUS**

FOR CAMERAS; SURVEILLANCE SYSTEMS PRIMARILY COMPRISED OF CAMERAS TRANSMITTING VIDEO WIRELESSLY TO A MONITOR FOR VIEWING AND RECORDING; UNMANNED AERIAL SYSTEMS PRIMARILY COMPRISED OF CAMERAS FOR REMOTE INSPECTIONS; EXPLOSIVE ORDNANCE DISPOSAL EQUIPMENT, NAMELY, TOOLS TO DISARM EXPLOSIVE DEVICES IN THE NATURE OF EXPLOSIVE CONTAINMENT VESSELS (U.S. CLS. 21, 23, 26, 36 AND 38).

FIRST USE 3-1-2003; IN COMMERCE 3-1-2003.

**CLASS 41—EDUCATION AND ENTERTAINMENT**

FOR MILITARY AND LAW ENFORCEMENT TRAINING; EXPLOSIVE ORDNANCE TRAINING (U.S. CLS. 100, 101 AND 107).

FIRST USE 3-1-2003; IN COMMERCE 3-1-2003.

**CLASS 42—SCIENTIFIC AND COMPUTER SERVICES**

FOR RESEARCH AND NEW PRODUCT DEVELOPMENT IN THE TACTICAL, MILITARY, LAW ENFORCEMENT AND OIL AND GAS INDUSTRIES (U.S. CLS. 100 AND 101).

FIRST USE 3-1-2003; IN COMMERCE 3-1-2003.  
EVIN L. KOZAK, EXAMINING ATTORNEY

SN 85-950,779. THE JUICE SPOT, LLC, MIAMI, FL. FILED 6-4-2013.



NO CLAIM IS MADE TO THE EXCLUSIVE RIGHT TO USE "JUICE", APART FROM THE MARK AS SHOWN.

THE COLOR(S) BLUE-GRAY, GREEN, YELLOW AND WHITE IS/ARE CLAIMED AS A FEATURE OF THE MARK.

THE MARK CONSISTS OF THE WORDS "THE JUICE SPOT" INSIDE OF A CIRCLE OF VARYING THICKNESS, BOTH APPEARING IN BLUE-GRAY AND WHITE, THE WORDS "IT'S A LIFESTYLE" APPEARING IN BLUE-GRAY AND THREE CIRCULAR DROPLETS IN WHICH ONE OF THEM APPEARS TO BE SPLASHING ONTO THE SURFACE OF A LIQUID OUTLINING HALF OF THE INNER PART OF THE CIRCLE AND APPEARING IN GREEN, YELLOW AND WHITE.

#### CLASS 32—LIGHT BEVERAGES

FOR FRUIT JUICES; VEGETABLE JUICES; FRUIT AND VEGETABLE JUICES; FRUIT JUICES CONTAINING NUTRITIONAL SUPPLEMENTS; VEGETABLE JUICES CONTAINING NUTRITIONAL SUPPLEMENTS; FRUIT AND VEGETABLE JUICES CONTAINING NUTRITIONAL SUPPLEMENTS (U.S. CLS. 45, 46 AND 48).

#### CLASS 43—HOTEL AND RESTAURANT SERVICES

FOR RESTAURANT SERVICES (U.S. CLS. 100 AND 101).  
KHANH LE, EXAMINING ATTORNEY

SN 85-950,855. THE JUICE SPOT, LLC, MIAMI, FL. FILED 6-4-2013.

# The Juice Spot

THE MARK CONSISTS OF STANDARD CHARACTERS WITHOUT CLAIM TO ANY PARTICULAR FONT, STYLE, SIZE, OR COLOR.

NO CLAIM IS MADE TO THE EXCLUSIVE RIGHT TO USE "JUICE", APART FROM THE MARK AS SHOWN.

#### CLASS 25—CLOTHING

FOR HATS AND T-SHIRTS (U.S. CLS. 22 AND 39).

#### CLASS 32—LIGHT BEVERAGES

FOR FRUIT JUICES; VEGETABLE JUICES; FRUIT AND VEGETABLE JUICES; FRUIT JUICES CONTAINING NUTRITIONAL SUPPLEMENTS; VEGETABLE JUICES CONTAINING NUTRITIONAL SUPPLEMENTS; FRUIT AND VEGETABLE JUICES CONTAINING NUTRITIONAL SUPPLEMENTS (U.S. CLS. 45, 46 AND 48).

#### CLASS 43—HOTEL AND RESTAURANT SERVICES

FOR RESTAURANT SERVICES (U.S. CLS. 100 AND 101).  
KHANH LE, EXAMINING ATTORNEY

SN 85-951,043. MANDUKA LLC, EL SEGUNDO, CA. FILED 6-5-2013.



OWNER OF U.S. REG. NO. 3,749,312.  
THE MARK CONSISTS OF A DRAWING OF A FROG INSIDE A CIRCLE.

#### CLASS 3—COSMETICS AND CLEANING PREPARATIONS

FOR YOGA MAT CLEANING PREPARATIONS (U.S. CLS. 1, 4, 6, 50, 51 AND 52).  
FIRST USE 0-0-2009; IN COMMERCE 0-0-2009.

#### CLASS 18—LEATHER GOODS

FOR LUGGAGE, HANDBAGS, AND TOTE BAGS (U.S. CLS. 1, 2, 3, 22 AND 41).  
FIRST USE 7-0-2012; IN COMMERCE 7-0-2012.

#### CLASS 24—FABRICS

FOR TOWELS FOR USE AS PERSONAL EXERCISE MATS, TOWELS AND BLANKETS FOR USE DURING YOGA PRACTICE (U.S. CLS. 42 AND 50).  
FIRST USE 0-0-2009; IN COMMERCE 0-0-2009.

#### CLASS 25—CLOTHING

FOR CLOTHING, NAMELY, TEES AND TANKS (U.S. CLS. 22 AND 39).  
FIRST USE 0-0-2011; IN COMMERCE 0-0-2011.

**CLASS 28—TOYS AND SPORTING GOODS**

FOR YOGA MATS, PERSONAL EXERCISE MATS, COTTON YOGA RUGS FOR USE AS PERSONAL EXERCISE MATS, BAGS SPECIALLY FITTED FOR CARRYING YOGA MATS, BLOCKS FOR USE IN THE PRACTICE OF YOGA, STRAPS FOR USE IN THE PRACTICE OF YOGA, BOLSTERS FOR USE IN THE PRACTICE OF YOGA, YOGA KITS COMPRISED PRIMARILY OF COMBINATIONS OF PERSONAL EXERCISE MATS, BAGS SPECIFICALLY FITTED FOR CARRYING YOGA MATS, TOWELS, BLANKETS, BOLSTERS, WATER BOTTLES, BLOCKS, OR STRAPS SOLD AS A UNIT (U.S. CLS. 22, 23, 38 AND 50).

FIRST USE 1-0-2006; IN COMMERCE 1-0-2006.

**CLASS 35—ADVERTISING AND BUSINESS**

FOR MAIL ORDER SERVICES AND ONLINE RETAIL STORE SERVICES FEATURING EXERCISE EQUIPMENT AND ACCESSORIES, APPAREL AND EQUIPMENT AND ACCESSORIES FOR USE IN THE PRACTICE OF YOGA (U.S. CLS. 100, 101 AND 102).

FIRST USE 1-0-2006; IN COMMERCE 1-0-2006.  
ALICIA COLLINS, EXAMINING ATTORNEY

---

SN 85-951,333. FIRST CALIFORNIA MORTGAGE COMPANY, PETALUMA, CA. FILED 6-5-2013.

**MSAA MORTGAGE SERVICES  
ACROSS AMERICA**

THE MARK CONSISTS OF STANDARD CHARACTERS WITHOUT CLAIM TO ANY PARTICULAR FONT, STYLE, SIZE, OR COLOR.

NO CLAIM IS MADE TO THE EXCLUSIVE RIGHT TO USE "MORTGAGE SERVICES" AND "AMERICA", APART FROM THE MARK AS SHOWN.

**CLASS 36—INSURANCE AND FINANCIAL**

FOR MORTGAGE BANKING SERVICES, NAMELY, ORIGINATION, ACQUISITION, SERVICING, SECURITIZATION AND BROKERAGE OF MORTGAGE LOANS; PROVIDING MORTGAGE BANKING, MORTGAGE BROKERAGE, MORTGAGE LENDING, AND MORTGAGE SERVICING SERVICES VIA A GLOBAL COMPUTER NETWORK (U.S. CLS. 100, 101 AND 102).

**CLASS 42—SCIENTIFIC AND COMPUTER SERVICES**

FOR PROVIDING ONLINE NON-DOWNLOADABLE SOFTWARE IN THE FIELDS OF MORTGAGE BANKING, MORTGAGE BROKERAGE, MORTGAGE LENDING AND MORTGAGE SERVICING SERVICES FOR FACILITATING, EXPEDITING, AND TRACKING LOAN APPLICATIONS, LOAN ORIGINATION, AND LOAN PROCESSING; AND APPLICATION SERVICE PROVIDER SERVICES FEATURING SOFTWARE IN THE FIELDS OF MORTGAGE BANKING, MORTGAGE BROKERAGE, MORTGAGE LENDING AND MORTGAGE SERVICING SERVICES FOR FACILITATING, EXPEDITING, AND TRACKING LOAN APPLICATIONS, LOAN ORIGINATION, AND LOAN PROCESSING (U.S. CLS. 100 AND 101).

SOPHIA S. KIM, EXAMINING ATTORNEY

SN 85-951,334. FIRST CALIFORNIA MORTGAGE COMPANY, PETALUMA, CA. FILED 6-5-2013.

**MORTGAGE SERVICES ACROSS  
AMERICA**

THE MARK CONSISTS OF STANDARD CHARACTERS WITHOUT CLAIM TO ANY PARTICULAR FONT, STYLE, SIZE, OR COLOR.

NO CLAIM IS MADE TO THE EXCLUSIVE RIGHT TO USE "MORTGAGE SERVICES" AND "AMERICA", APART FROM THE MARK AS SHOWN.

**CLASS 36—INSURANCE AND FINANCIAL**

FOR MORTGAGE BANKING SERVICES, NAMELY, ORIGINATION, ACQUISITION, SERVICING, SECURITIZATION AND BROKERAGE OF MORTGAGE LOANS; PROVIDING MORTGAGE BANKING, MORTGAGE BROKERAGE, MORTGAGE LENDING, AND MORTGAGE SERVICING SERVICES VIA A GLOBAL COMPUTER NETWORK (U.S. CLS. 100, 101 AND 102).

**CLASS 42—SCIENTIFIC AND COMPUTER SERVICES**

FOR PROVIDING ONLINE NON-DOWNLOADABLE SOFTWARE IN THE FIELDS OF MORTGAGE BANKING, MORTGAGE BROKERAGE, MORTGAGE LENDING AND MORTGAGE SERVICING SERVICES FOR FACILITATING, EXPEDITING, AND TRACKING LOAN APPLICATIONS, LOAN ORIGINATION, AND LOAN PROCESSING; AND APPLICATION SERVICE PROVIDER SERVICES FEATURING SOFTWARE IN THE FIELDS OF MORTGAGE BANKING, MORTGAGE BROKERAGE, MORTGAGE LENDING AND MORTGAGE SERVICING SERVICES FOR FACILITATING, EXPEDITING, AND TRACKING LOAN APPLICATIONS, LOAN ORIGINATION, AND LOAN PROCESSING (U.S. CLS. 100 AND 101).

SOPHIA S. KIM, EXAMINING ATTORNEY

---

SN 85-953,644. WEALTH2K, INC., BOSTON, MA. FILED 6-7-2013.

**SOCIAL SECURITY WISE**

THE MARK CONSISTS OF STANDARD CHARACTERS WITHOUT CLAIM TO ANY PARTICULAR FONT, STYLE, SIZE, OR COLOR.

NO CLAIM IS MADE TO THE EXCLUSIVE RIGHT TO USE "SOCIAL SECURITY", APART FROM THE MARK AS SHOWN.

**CLASS 9—ELECTRICAL AND SCIENTIFIC APPARATUS**

FOR DOWNLOADABLE EDUCATIONAL MATERIALS IN THE FIELD OF FINANCIAL PLANNING; DOWNLOADABLE BROCHURES AND MULTIMEDIA MATERIALS IN THE NATURE OF CDS IN THE FIELD OF FINANCIAL PLANNING; DOWNLOADABLE INFORMATIONAL MATERIALS REGARDING SOCIAL SECURITY INCOME AND RETIREMENT BENEFITS (U.S. CLS. 21, 23, 26, 36 AND 38).

**CLASS 36—INSURANCE AND FINANCIAL**

FOR PROVIDING A PERSONALIZED WEBSITE TO FINANCIAL ADVISORS FEATURING NON-DOWNLOADABLE VIDEOS IN THE FIELD OF FINANCIAL PLANNING; PROVIDING INFORMATION REGARDING SOCIAL SECURITY RETIREMENT INCOME BENEFITS TO FINANCIAL ADVISORS VIA A PERSONALIZED WEBSITE FOR USE IN PROVIDING SAID INFORMATION TO CUSTOMERS; PROVIDING A WEBSITE FEATURING FINANCIAL NEWS AND INFORMATION TO FINANCIAL ADVISORS FOR USE IN PROVIDING TO CUSTOMERS FINANCIAL NEWS AND INFORMATION REGARDING SOCIAL SECURITY RETIREMENT INCOME BENEFITS (U.S. CLS. 100, 101 AND 102).

**CLASS 41—EDUCATION AND ENTERTAINMENT**

FOR PROVIDING NON-DOWNLOADABLE EDUCATIONAL MATERIALS IN THE FIELD OF FINANCIAL PLANNING; PROVIDING NON-DOWNLOADABLE EDUCATIONAL MATERIALS IN THE FIELD OF SOCIAL SECURITY INCOME AND RETIREMENT BENEFITS (U.S. CLS. 100, 101 AND 107).

FIRST USE 5-31-2013; IN COMMERCE 5-31-2013.  
DOMINICK J. SALEMI, EXAMINING ATTORNEY

SN 85-955,633. THERMO FISHER SCIENTIFIC (ASHEVILLE) LLC, ASHEVILLE, NC. FILED 6-10-2013.

# VERSACAL

THE MARK CONSISTS OF STANDARD CHARACTERS WITHOUT CLAIM TO ANY PARTICULAR FONT, STYLE, SIZE, OR COLOR.

**CLASS 9—ELECTRICAL AND SCIENTIFIC APPARATUS**

FOR HEATED BATH CIRCULATORS FOR LABORATORY USE (U.S. CLS. 21, 23, 26, 36 AND 38).

**CLASS 11—ENVIRONMENTAL CONTROL APPARATUS**

FOR HEATED BATH CIRCULATORS FOR INDUSTRIAL USE (U.S. CLS. 13, 21, 23, 31 AND 34).  
DAWN FELDMAN, EXAMINING ATTORNEY

SN 85-956,251. TOWNSEND, CATHERINE ALICE, LOS ANGELES, CA. FILED 6-11-2013.

# The Love Detective

THE MARK CONSISTS OF STANDARD CHARACTERS WITHOUT CLAIM TO ANY PARTICULAR FONT, STYLE, SIZE, OR COLOR.

NO CLAIM IS MADE TO THE EXCLUSIVE RIGHT TO USE "DETECTIVE", APART FROM THE MARK AS SHOWN.

THE NAME(S), PORTRAIT(S), AND/OR SIGNATURE(S) SHOWN IN THE MARK IDENTIFIES CATHERINE TOWNSEND, WHOSE CONSENT(S) TO REGISTER IS MADE OF RECORD.

**CLASS 41—EDUCATION AND ENTERTAINMENT**

FOR CUSTOM WRITING SERVICES FOR NON-ADVERTISING PURPOSES; ON-LINE JOURNALS, NAMELY, BLOGS FEATURING LOVE AND DETECTIVE FEATURES; WRITING OF ARTICLES FOR JOURNALS OTHER THAN FOR ADVERTISING OR PUBLICITY; WRITING OF ARTICLES FOR PERIODICALS OTHER THAN FOR ADVERTISING OR PUBLICITY; WRITING OF TEXTS; WRITING OF TEXTS OTHER THAN PUBLICITY TEXTS (U.S. CLS. 100, 101 AND 107).  
FIRST USE 2-1-2008; IN COMMERCE 2-24-2008.

**CLASS 45—PERSONAL AND LEGAL SERVICES**

FOR BACKGROUND INVESTIGATION AND RESEARCH SERVICES; DETECTIVE INVESTIGATIONS; INVESTIGATING INTO MISSING PERSONS; INVESTIGATION OF ASSETS, CREDIT REPORTS, FISCAL ASSESSMENTS, AND COLLECTION REPORTS FOR SECURITY OR AUTHENTICATION PURPOSES; MISSING PERSONS INVESTIGATION; ON-LINE IDENTITY RELIABILITY INVESTIGATION IN THE FIELD OF ON-LINE DATING AND CLAIMS MADE ABOUT AGE, GENDER; PERSONAL BACKGROUND INVESTIGATIONS; PRE-EMPLOYMENT BACKGROUND INVESTIGATION SERVICES; PRIVATE INVESTIGATION (U.S. CLS. 100 AND 101).

FIRST USE 2-1-2008; IN COMMERCE 5-1-2011.  
TIMOTHY FINNEGAN, EXAMINING ATTORNEY

SN 85-956,494. PRODUCCIONES MARITZA CASIANO, AKA PMC, CAROLINA, PUERTO RICO, FILED 6-11-2013.



NO CLAIM IS MADE TO THE EXCLUSIVE RIGHT TO USE "WEAR & ACCESSORIES", APART FROM THE MARK AS SHOWN.

THE MARK CONSISTS OF A SILHOUETTE COMPOSED OF FEMININE AND MASCULINE FEATURES THAT TOGETHER FORM THE SHAPE OF A CROSS. THEIR BODIES ARE COVERED BY THE LETTER "J" AND "C", WHICH STANDS FOR "JESUS CHRIST". BELOW THE DESIGN IS THE WORDING "JESUS CHRIST" AND THE WORDING "WEAR & ACCESSORIES".

**CLASS 14—JEWELRY**

FOR BRACELETS; CHARMS FOR COLLAR JEWELRY AND BRACELET; JEWELRY AND IMITATION JEWELRY; JEWELRY, NAMELY, STONE PENDANTS; LEATHER JEWELRY AND ACCESSORY BOXES; STAINLESS STEEL JEWELRY BRACELETS (U.S. CLS. 2, 27, 28 AND 50).



**CLASS 18—LEATHER GOODS**

SN 85-957,182. AHHSURE, LLC, MINNEAPOLIS, MN. FILED 6-11-2013.

FOR CLOTHING FOR DOMESTIC PETS; LEATHER AND IMITATION LEATHER BAGS; LEATHER AND IMITATION LEATHER SPORT BAGS AND GENERAL PURPOSE TROLLEY BAGS; LEATHER HANDBAGS (U.S. CLS. 1, 2, 3, 22 AND 41).

**CLASS 25—CLOTHING**

FOR BATHING SUITS FOR MEN; BELTS; CAPS; JEANS; MEN'S AND WOMEN'S JACKETS, COATS, TROUSERS, VESTS; POLO SHIRTS; SUSPENDER BELTS FOR MEN; T-SHIRTS FOR MEN AND WOMEN; TOPS; WOMEN'S CLOTHING, NAMELY, SHIRTS, DRESSES, SKIRTS, BLOUSES (U.S. CLS. 22 AND 39).  
COLLEEN DOMBROW, EXAMINING ATTORNEY

**AHHSURE**

THE MARK CONSISTS OF THE WORD "AHHSURE" IN ALL CAPITAL LETTERS, WITH THE LETTERS "SURE" IN BOLD FONT.

**CLASS 9—ELECTRICAL AND SCIENTIFIC APPARATUS**

SN 85-956,733. CONTACT SOLUTIONS, LLC, RESTON, VA. FILED 6-11-2013.

FOR DOWNLOADABLE SOFTWARE IN THE NATURE OF MOBILE APPLICATIONS FOR VIEWING AND BUYING EXTENDED WARRANTY PLANS; DOWNLOADABLE SOFTWARE IN THE NATURE OF MOBILE APPLICATIONS FOR MATCHING PURCHASERS AND POTENTIAL PURCHASERS OF EXTENDED WARRANTY PLANS, WITH PARTICULAR PROVIDERS OF EXTENDED WARRANTY PLANS; DOWNLOADABLE SOFTWARE IN THE NATURE OF MOBILE APPLICATIONS THAT PROVIDE INFORMATION ON WARRANTIES, PRICES, AND WARRANTIES CARRIERS; DOWNLOADABLE SOFTWARE IN THE NATURE OF MOBILE APPLICATIONS FOR VIEWING AND PURCHASING WARRANTIES, STORING WARRANTY INFORMATION AND NOTIFICATION OF WARRANTY DURATION; DOWNLOADABLE SOFTWARE IN THE NATURE OF MOBILE APPLICATIONS FOR MATCHING PURCHASERS AND POTENTIAL PURCHASERS OF EXTENDED WARRANTY PLANS FOR GENERAL MERCHANDISE AND SERVICES, INCLUDING HOME, AUTO, CONSUMER ELECTRONICS, JEWELRY, CREDIT CARD, AND SMARTPHONES, WITH PARTICULAR CARRIERS OF EXTENDED WARRANTY PLANS (U.S. CLS. 21, 23, 26, 36 AND 38).

**APP2AGENT**

THE MARK CONSISTS OF STANDARD CHARACTERS WITHOUT CLAIM TO ANY PARTICULAR FONT, STYLE, SIZE, OR COLOR.

**CLASS 9—ELECTRICAL AND SCIENTIFIC APPARATUS**

**CLASS 35—ADVERTISING AND BUSINESS**

FOR COMPUTER SOFTWARE THAT ENABLES COMMUNICATIONS VIA E-MAIL, TEXT MESSAGES, TRANSMISSION OF VOICE, VIDEO, DATA AND ELECTRONIC FILES THROUGH AUTOMATED AND AGENT-ASSISTED INTERACTIONS BETWEEN USERS AND AN ENTERPRISE (U.S. CLS. 21, 23, 26, 36 AND 38).

FOR ADVERTISING AND BUSINESS SERVICES, NAMELY, ADVERTISING, MARKETING AND PROMOTIONAL SERVICES FOR THE WARRANTY INSURANCE INDUSTRY; PUBLICITY AND SALES PROMOTION SERVICES FOR THE WARRANTY INSURANCE INDUSTRIES; MATCHING POTENTIAL PURCHASERS OF WARRANTIES WITH PARTICULAR PROVIDERS OF SUCH SERVICES; ADMINISTRATION OF DISCOUNT PROGRAMS ENABLING PARTICIPANTS TO OBTAIN DISCOUNTS ON WARRANTY PURCHASES (U.S. CLS. 100, 101 AND 102).

TARAH HARDY, EXAMINING ATTORNEY

**CLASS 42—SCIENTIFIC AND COMPUTER SERVICES**

SN 85-958,596. SPANISH BROADCASTING SYSTEM, INC. MIAMI, FL. FILED 6-13-2013.

FOR PLATFORM AS A SERVICE (PAAS) FEATURING COMPUTER SOFTWARE PLATFORMS FOR COMMUNICATIONS VIA E-MAIL, TEXT MESSAGES, TRANSMISSION OF VOICE, VIDEO, DATA AND ELECTRONIC FILES THROUGH AUTOMATED AND AGENT-ASSISTED INTERACTIONS BETWEEN USERS AND AN ENTERPRISE; DESIGN AND IMPLEMENTATION OF SOFTWARE AND COMPUTER TECHNOLOGY SOLUTIONS FOR COMMUNICATIONS VIA EMAIL, TEXT MESSAGES, TRANSMISSION OF VOICE, VIDEO, DATA AND ELECTRONIC FILES THROUGH AUTOMATED AND AGENT-ASSISTED INTERACTIONS BETWEEN USERS AND AN ENTERPRISE (U.S. CLS. 100 AND 101).  
ANTHONY RINKER, EXAMINING ATTORNEY

**BACHATA BOYZ**

THE MARK CONSISTS OF STANDARD CHARACTERS WITHOUT CLAIM TO ANY PARTICULAR FONT, STYLE, SIZE, OR COLOR.

NO CLAIM IS MADE TO THE EXCLUSIVE RIGHT TO USE "BACHATA", APART FROM THE MARK AS SHOWN.

**CLASS 9—ELECTRICAL AND SCIENTIFIC APPARATUS**

FOR DIGITAL MEDIA, NAMELY, PRE-RECORDED VIDEO DVDS AND AUDIO CDS FEATURING MUSICAL PERFORMANCES BY A MUSICAL GROUP (U.S. CLS. 21, 23, 26, 36 AND 38).

**CLASS 41—EDUCATION AND ENTERTAINMENT**

FOR ENTERTAINMENT, NAMELY, LIVE PERFORMANCES BY A MUSICAL GROUP (U.S. CLS. 100, 101 AND 107).

DAVID ALESKOW, EXAMINING ATTORNEY

SN 85-959,727. FLAME VENTIURES, LLC, LOS ANGELES, CA. FILED 6-14-2013.

# YOGA THIN

THE MARK CONSISTS OF STANDARD CHARACTERS WITHOUT CLAIM TO ANY PARTICULAR FONT, STYLE, SIZE, OR COLOR.

NO CLAIM IS MADE TO THE EXCLUSIVE RIGHT TO USE "YOGA", APART FROM THE MARK AS SHOWN.

**CLASS 9—ELECTRICAL AND SCIENTIFIC APPARATUS**

FOR PRERECORDED VIDEO TAPES AND DVDS FEATURING YOGA INSTRUCTION AND INSTRUCTION IN HEALTH, FITNESS, EXERCISE, AND WEIGHT CONTROL (U.S. CLS. 21, 23, 26, 36 AND 38).

**CLASS 25—CLOTHING**

FOR CLOTHING AND APPAREL, NAMELY, YOGA SHIRTS, JACKETS, PANTS, LEGGINGS, SOCKS, SCARVES, HATS AND CAPS (U.S. CLS. 22 AND 39).

TIMOTHY FINNEGAN, EXAMINING ATTORNEY

SN 85-960,557. SEAN BROIHIER AND ASSOCIATES, LLC, SANTA MONICA, CA. FILED 6-14-2013.

# PIXEL

THE MARK CONSISTS OF STANDARD CHARACTERS WITHOUT CLAIM TO ANY PARTICULAR FONT, STYLE, SIZE, OR COLOR.

**CLASS 9—ELECTRICAL AND SCIENTIFIC APPARATUS**

FOR DOWNLOADABLE IMAGE FILES CONTAINING PHOTOGRAPHS, VISUAL ART, AND ARTISTIC IMAGES; PRE-RECORDED DIGITAL MEDIA FEATURING PHOTOGRAPHS, VISUAL ART, AND ARTISTIC IMAGES; ELECTRONIC AND COMPUTER MEDIA USED TO ARCHIVE, DISPLAY, AND RETRIEVE DOWNLOADABLE IMAGES, NAMELY, MEDIA PLAYERS, DIGITAL MEDIA SERVICES, DIGITAL MEDIA STREAMING DEVICES, PRE-RECORDED DIGITAL MEDIA FEATURING PHOTOGRAPHS, VISUAL ART, AND ARTISTIC IMAGES; ACCESSORIES FOR HANDHELD MOBILE DIGITAL ELECTRONIC DEVICES, NAMELY, MOBILE PHONES, PERSONAL DIGITAL ASSISTANTS, AND TABLET COMPUTERS, NAMELY, COVERS AND STANDS SPECIALLY ADAPTED THEREFOR (U.S. CLS. 21, 23, 26, 36 AND 38).

**CLASS 16—PAPER GOODS AND PRINTED MATTER**

FOR PRINT PRODUCTS, NAMELY, ART PRINTS ON CANVAS, FRAMED ART PRINTS, ART PRINTS, ACRYLIC ART PRINTS, ART PRINTS ON METAL, POSTERS, CALENDARS, AND GREETING CARDS (U.S. CLS. 2, 5, 22, 23, 29, 37, 38 AND 50).

**CLASS 35—ADVERTISING AND BUSINESS**

FOR ONLINE RETAIL STORE SERVICES FEATURING PRINT PRODUCTS, NAMELY, ART PRINTS ON CANVAS, FRAMED ART PRINTS, ART PRINTS, ACRYLIC ART PRINTS, ART PRINTS ON METAL, POSTERS, AND GREETING CARDS; ADVERTISING SERVICES, NAMELY, PROMOTING THE ARTWORK OF OTHER ARTISTS; PROMOTING VISUAL ARTS EVENTS BY MEANS OF PROVIDING AN ONLINE EVENTS CALENDAR, AND INFORMATION ABOUT ART, ARTISTS, AND ART EVENTS VIA AN INTERNET WEBSITE, ALL FOR PROMOTIONAL PURPOSES; ONLINE BUSINESS NETWORKING SERVICES FOR ARTISTS; ONLINE ADVERTISING AND MARKETING IN THE FIELD OF ARTWORK (U.S. CLS. 100, 101 AND 102).

**CLASS 38—COMMUNICATION**

FOR COMPUTER-AIDED TRANSMISSION OF IMAGES, NAMELY, TRANSMISSION OF ELECTRONIC IMAGES OF ART PRINTS ON CANVAS, FRAMED ART PRINTS, ART PRINTS, ACRYLIC ART PRINTS, ART PRINTS ON METAL, POSTERS, AND OF GREETING CARDS OVER GLOBAL AND NON-GLOBAL COMPUTER NETWORKS (U.S. CLS. 100, 101 AND 104).

**CLASS 40—MATERIAL TREATMENT**

FOR ONLINE PHOTOGRAPHIC AND IMAGE PROCESSING SERVICES, NAMELY, PHOTOGRAPHIC PRINTING, REPRODUCTION AND RETOUCHING; DIGITAL PRINTING, NAMELY, TRANSFERRING PHOTOGRAPHIC AND DIGITAL IMAGES FROM UPLOADED DIGITAL IMAGES TO IMPRINTABLE SURFACES, NAMELY, ONTO CANVAS, FRAMED ART PRINTS, ART PRINTS, ACRYLIC ART PRINTS, ART PRINTS ON METAL, POSTERS, CALENDARS, AND GREETING CARDS (U.S. CLS. 100, 103 AND 106).

**CLASS 45—PERSONAL AND LEGAL SERVICES**

FOR STOCK PHOTOGRAPHY SERVICES, NAMELY, SELLING AND LICENSING REPRODUCTION RIGHTS OF IMAGES AND OTHER GRAPHIC REPRESENTATIONS AND DIGITAL CONTENT TO OTHERS (U.S. CLS. 100 AND 101).

KEVIN CORWIN, EXAMINING ATTORNEY

SN 85-960,570. SEAN BROIHIER AND ASSOCIATES, LLC,  
SANTA MONICA, CA. FILED 6-14-2013.

# PIXELS

THE MARK CONSISTS OF STANDARD CHARACTERS WITHOUT CLAIM TO ANY PARTICULAR FONT, STYLE, SIZE, OR COLOR.

## CLASS 9—ELECTRICAL AND SCIENTIFIC APPARATUS

FOR DOWNLOADABLE IMAGE FILES CONTAINING PHOTOGRAPHS, VISUAL ART, AND ARTISTIC IMAGES; PRE-RECORDED DIGITAL MEDIA FEATURING PHOTOGRAPHS, VISUAL ART, AND ARTISTIC IMAGES; ELECTRONIC AND COMPUTER MEDIA USED TO ARCHIVE, DISPLAY, AND RETRIEVE DOWNLOADABLE IMAGES, NAMELY, MEDIA PLAYERS, DIGITAL MEDIA SERVICES, DIGITAL MEDIA STREAMING DEVICES, PRE-RECORDED DIGITAL MEDIA FEATURING PHOTOGRAPHS, VISUAL ART, AND ARTISTIC IMAGES; ACCESSORIES FOR HANDHELD MOBILE DIGITAL ELECTRONIC DEVICES, NAMELY, MOBILE PHONES, PERSONAL DIGITAL ASSISTANTS, AND TABLET COMPUTERS, NAMELY, COVERS AND STANDS SPECIALLY ADAPTED THEREFOR (U.S. CLS. 21, 23, 26, 36 AND 38).

FIRST USE 6-15-2013; IN COMMERCE 6-15-2013.

## CLASS 16—PAPER GOODS AND PRINTED MATTER

FOR PRINT PRODUCTS, NAMELY, ART PRINTS ON CANVAS, FRAMED ART PRINTS, ART PRINTS, ACRYLIC ART PRINTS, ART PRINTS ON METAL, POSTERS, CALENDARS, AND GREETING CARDS (U.S. CLS. 2, 5, 22, 23, 29, 37, 38 AND 50).

FIRST USE 6-15-2013; IN COMMERCE 6-15-2013.

## CLASS 35—ADVERTISING AND BUSINESS

FOR ONLINE RETAIL STORE SERVICES FEATURING PRINT PRODUCTS, NAMELY, ART PRINTS ON CANVAS, FRAMED ART PRINTS, ART PRINTS, ACRYLIC ART PRINTS, ART PRINTS ON METAL, POSTERS, AND GREETING CARDS; ADVERTISING SERVICES, NAMELY, PROMOTING THE ARTWORK OF OTHER ARTISTS; PROMOTING VISUAL ARTS EVENTS BY MEANS OF PROVIDING AN ONLINE EVENTS CALENDAR, AND INFORMATION ABOUT ART, ARTISTS, AND ART EVENTS VIA AN INTERNET WEBSITE, ALL FOR PROMOTIONAL PURPOSES; ONLINE BUSINESS NETWORKING SERVICES FOR ARTISTS; ONLINE ADVERTISING AND MARKETING IN THE FIELD OF ARTWORK (U.S. CLS. 100, 101 AND 102).

FIRST USE 6-15-2013; IN COMMERCE 6-15-2013.

## CLASS 38—COMMUNICATION

FOR COMPUTER-AIDED TRANSMISSION OF IMAGES, NAMELY, TRANSMISSION OF ELECTRONIC IMAGES OF ART PRINTS ON CANVAS, FRAMED ART PRINTS, ART PRINTS, ACRYLIC ART PRINTS, ART PRINTS ON METAL, POSTERS, AND OF GREETING CARDS OVER GLOBAL AND NON-GLOBAL COMPUTER NETWORKS (U.S. CLS. 100, 101 AND 104).

FIRST USE 6-15-2013; IN COMMERCE 6-15-2013.

## CLASS 40—MATERIAL TREATMENT

FOR ONLINE PHOTOGRAPHIC AND IMAGE PROCESSING SERVICES, NAMELY, PHOTOGRAPHIC PRINTING, REPRODUCTION AND RETOUCHING; DIGITAL PRINTING, NAMELY, TRANSFERRING PHOTOGRAPHIC AND DIGITAL IMAGES FROM UPLOADED DIGITAL IMAGES TO IMPRINTABLE SURFACES, NAMELY, ONTO CANVAS, FRAMED ART PRINTS, ART PRINTS, ACRYLIC ART PRINTS, ART PRINTS ON METAL, POSTERS, CALENDARS, AND GREETING CARDS (U.S. CLS. 100, 103 AND 106).

FIRST USE 6-15-2013; IN COMMERCE 6-15-2013.

## CLASS 45—PERSONAL AND LEGAL SERVICES

FOR STOCK PHOTOGRAPHY SERVICES, NAMELY, SELLING AND LICENSING REPRODUCTION RIGHTS OF IMAGES AND OTHER GRAPHIC REPRESENTATIONS AND DIGITAL CONTENT TO OTHERS (U.S. CLS. 100 AND 101).

FIRST USE 6-15-2013; IN COMMERCE 6-15-2013.

KEVIN CORWIN, EXAMINING ATTORNEY

SN 85-960,581. SEAN BROIHIER AND ASSOCIATES, LLC,  
SANTA MONICA, CA. FILED 6-14-2013.

# PIXELS.COM

THE MARK CONSISTS OF STANDARD CHARACTERS WITHOUT CLAIM TO ANY PARTICULAR FONT, STYLE, SIZE, OR COLOR.

## CLASS 9—ELECTRICAL AND SCIENTIFIC APPARATUS

FOR DOWNLOADABLE IMAGE FILES CONTAINING PHOTOGRAPHS, VISUAL ART, AND ARTISTIC IMAGES; PRE-RECORDED DIGITAL MEDIA FEATURING PHOTOGRAPHS, VISUAL ART, AND ARTISTIC IMAGES; ELECTRONIC AND COMPUTER MEDIA USED TO ARCHIVE, DISPLAY, AND RETRIEVE DOWNLOADABLE IMAGES, NAMELY, MEDIA PLAYERS, DIGITAL MEDIA SERVICES, DIGITAL MEDIA STREAMING DEVICES, PRE-RECORDED DIGITAL MEDIA FEATURING PHOTOGRAPHS, VISUAL ART, AND ARTISTIC IMAGES; ACCESSORIES FOR HANDHELD MOBILE DIGITAL ELECTRONIC DEVICES, NAMELY, MOBILE PHONES, PERSONAL DIGITAL ASSISTANTS, AND TABLET COMPUTERS, NAMELY, COVERS AND STANDS SPECIALLY ADAPTED THEREFOR (U.S. CLS. 21, 23, 26, 36 AND 38).

FIRST USE 6-15-2013; IN COMMERCE 6-15-2013.

## CLASS 16—PAPER GOODS AND PRINTED MATTER

FOR PRINT PRODUCTS, NAMELY, ART PRINTS ON CANVAS, FRAMED ART PRINTS, ART PRINTS, ACRYLIC ART PRINTS, ART PRINTS ON METAL, POSTERS, CALENDARS, AND GREETING CARDS (U.S. CLS. 2, 5, 22, 23, 29, 37, 38 AND 50).

FIRST USE 6-15-2013; IN COMMERCE 6-15-2013.

**CLASS 35—ADVERTISING AND BUSINESS**

FOR ONLINE RETAIL STORE SERVICES FEATURING PRINT PRODUCTS, NAMELY, ART PRINTS ON CANVAS, FRAMED ART PRINTS, ART PRINTS, ACRYLIC ART PRINTS, ART PRINTS ON METAL, POSTERS, AND GREETING CARDS; ADVERTISING SERVICES, NAMELY, PROMOTING THE ARTWORK OF OTHER ARTISTS; PROMOTING VISUAL ARTS EVENTS BY MEANS OF PROVIDING AN ONLINE EVENTS CALENDAR, AND INFORMATION ABOUT ART, ARTISTS, AND ART EVENTS VIA AN INTERNET WEBSITE, ALL FOR PROMOTIONAL PURPOSES; ONLINE BUSINESS NETWORKING SERVICES FOR ARTISTS; ONLINE ADVERTISING AND MARKETING IN THE FIELD OF ARTWORK (U.S. CLS. 100, 101 AND 102).  
FIRST USE 6-15-2013; IN COMMERCE 6-15-2013.

SN 85-962,480. GREENHEART INTERNATIONAL, CHICAGO, IL. FILED 6-18-2013.

**CLASS 38—COMMUNICATION**

FOR COMPUTER-AIDED TRANSMISSION OF IMAGES, NAMELY, TRANSMISSION OF ELECTRONIC IMAGES OF ART PRINTS ON CANVAS, FRAMED ART PRINTS, ART PRINTS, ACRYLIC ART PRINTS, ART PRINTS ON METAL, POSTERS, AND OF GREETING CARDS OVER GLOBAL AND NON-GLOBAL COMPUTER NETWORKS (U.S. CLS. 100, 101 AND 104).  
FIRST USE 6-15-2013; IN COMMERCE 6-15-2013.



THE MARK CONSISTS OF THE LETTERS "CCI" ABOVE AN IMAGE THAT IS TO REPRESENT THE GLOBE. THE IMAGE INCLUDES TWO ARROWS. THE WORD "GREENHEART" APPEARS BELOW WITH AN IMAGE OF A HEART TO THE LEFT.

**CLASS 40—MATERIAL TREATMENT**

FOR ONLINE PHOTOGRAPHIC AND IMAGE PROCESSING SERVICES, NAMELY, PHOTOGRAPHIC PRINTING, REPRODUCTION AND RETOUCHING; DIGITAL PRINTING, NAMELY, TRANSFERRING PHOTOGRAPHIC AND DIGITAL IMAGES FROM UPLOADED DIGITAL IMAGES TO IMPRINTABLE SURFACES, NAMELY, ONTO CANVAS, FRAMED ART PRINTS, ART PRINTS, ACRYLIC ART PRINTS, ART PRINTS ON METAL, POSTERS, CALENDARS, AND GREETING CARDS (U.S. CLS. 100, 103 AND 106).  
FIRST USE 6-15-2013; IN COMMERCE 6-15-2013.

**CLASS 39—TRANSPORTATION AND STORAGE**

FOR ARRANGING AND COORDINATING TRAVEL ARRANGEMENTS FOR INDIVIDUALS AND GROUPS; TRAVEL GUIDE AND TRAVEL INFORMATION SERVICES (U.S. CLS. 100 AND 105).  
FIRST USE 1-0-2013; IN COMMERCE 1-0-2013.

**CLASS 45—PERSONAL AND LEGAL SERVICES**

FOR STOCK PHOTOGRAPHY SERVICES, NAMELY, SELLING AND LICENSING REPRODUCTION RIGHTS OF IMAGES AND OTHER GRAPHIC REPRESENTATIONS AND DIGITAL CONTENT TO OTHERS (U.S. CLS. 100 AND 101).  
FIRST USE 6-15-2013; IN COMMERCE 6-15-2013.  
KEVIN CORWIN, EXAMINING ATTORNEY

**CLASS 41—EDUCATION AND ENTERTAINMENT**

FOR ENTERTAINMENT SERVICES, NAMELY, ORGANIZATION OF SPORTS AND CULTURAL ACTIVITIES, ORGANIZATION OF SPORTS COMPETITIONS AND GAMES FOR FOREIGN AND CULTURAL EXCHANGE STUDENTS AND VOLUNTEERS; PROVIDING SPORTS FACILITIES; EDUCATIONAL SERVICES, NAMELY, CONDUCTING SEMINARS AND CONFERENCES IN THE FIELD OF NUTRITION, MEDITATION AND MUSIC; DEVELOPING INTERNATIONAL EXCHANGE PROGRAMS FOR STUDENTS, INDIVIDUALS AND GROUPS; ORGANIZING AND HOSTING EVENTS AND VOLUNTEER PROGRAMS FOR CULTURAL PURPOSES, NAMELY, CULTURAL IMMERSION AND LANGUAGE PROGRAMS; EDUCATIONAL SERVICES, NAMELY, CONDUCTING SEMINARS, WORKSHOPS AND CONFERENCES IN THE FIELD OF FOREIGN LANGUAGE SKILLS; WORK-BASED LEARNING PROGRAMS, NAMELY, OFFERING INTERNSHIPS TO INTERNATIONAL STUDENTS TO BECOME AN INTERN OR TRAINEE WITHIN THE UNITED STATES (U.S. CLS. 100, 101 AND 107).  
FIRST USE 1-0-2013; IN COMMERCE 1-0-2013.  
KAMAL PREET, EXAMINING ATTORNEY

SN 85-962,628. STATE AND FEDERAL COMMUNICATIONS, INC., AKRON, OH. FILED 6-18-2013.



NO CLAIM IS MADE TO THE EXCLUSIVE RIGHT TO USE "STATE & FEDERAL COMMUNICATIONS", "COMPLIANCE" AND "GUIDANCE", APART FROM THE MARK AS SHOWN.

THE MARK CONSISTS OF RECTANGULAR SHAPED FLAG WITH WAVING STRIPES, STARS ON A DARK BACKGROUND, THE WORDS "STATE & FEDERAL" WITH THE WORD "COMMUNICATIONS" (ALL CAPITAL LETTERS) ON THE LEFT, THE NUMBER "20" BETWEEN THE TEXT AND THE STARS, UNDERNEATH ARE THE WORDS "THE COMPLIANCE STANDARD", UNDERNEATH ARE THE WORDS "EXPERIENCE GUIDANCE SOLUTIONS" WITH A STAR BETWEEN EACH WORD, ALL ON A BACKGROUND WITH STARS.

**CLASS 35—ADVERTISING AND BUSINESS**

FOR RESEARCH AND BUSINESS CONSULTING IN THE FIELD OF GOVERNMENTAL AFFAIRS (U.S. CLS. 100, 101 AND 102).

FIRST USE 4-29-2013; IN COMMERCE 4-29-2013.

**CLASS 45—PERSONAL AND LEGAL SERVICES**

FOR TRACKING AND MONITORING FEDERAL, STATE AND MUNICIPAL REGULATORY REQUIREMENTS IN THE FIELD OF LOBBYING REGISTRATION, REPORTING, AND ETHICS LAWS FOR REGULATORY COMPLIANCE PURPOSES; REGULATORY COMPLIANCE CONSULTING IN THE FIELD OF FEDERAL, STATE AND MUNICIPAL LOBBYING REGISTRATION, REPORTING, AND ETHICS LAWS (U.S. CLS. 100 AND 101).

FIRST USE 4-29-2013; IN COMMERCE 4-29-2013.  
RONALD AIKENS, EXAMINING ATTORNEY

SN 85-963,213. MEASUREMENT INCORPORATED, DURHAM, NC. FILED 6-18-2013.

**PROJECT ESSAY GRADE**

THE MARK CONSISTS OF STANDARD CHARACTERS WITHOUT CLAIM TO ANY PARTICULAR FONT, STYLE, SIZE, OR COLOR.  
SEC. 2(F).

**CLASS 41—EDUCATION AND ENTERTAINMENT**

FOR EDUCATIONAL SERVICES IN THE FIELD OF WRITING ASSESSMENT AND IMPROVEMENT, NAMELY, PROVIDING BUSINESSES, SCHOOLS, GOVERNMENTAL AGENCIES AND INDIVIDUALS WITH TESTING FOR THE EVALUATION OF WRITING COMMUNICATION SKILLS; COMPUTER SERVICES, NAMELY, PROVIDING COMPUTERIZED TESTING IN THE NATURE OF EDUCATIONAL TESTING SERVICES FOR THE EVALUATION OF WRITING COMMUNICATION SKILLS (U.S. CLS. 100, 101 AND 107).

FIRST USE 0-0-2004; IN COMMERCE 0-0-2004.

**CLASS 42—SCIENTIFIC AND COMPUTER SERVICES**

FOR PROVIDING NON-DOWNLOADABLE SOFTWARE THAT ANALYZES AND SCORES WRITTEN MATERIALS IN THE FIELD OF WRITING ASSESSMENT; COMPUTER SERVICES, NAMELY, ACTING AS AN APPLICATION SERVICE PROVIDER IN THE FIELD OF WRITING ASSESSMENT TO HOST COMPUTER APPLICATION SOFTWARE FOR THE PURPOSE OF ANALYZING TEXTUAL MATERIAL (U.S. CLS. 100 AND 101).

FIRST USE 0-0-2004; IN COMMERCE 0-0-2004.  
RONALD DELGIZZI, EXAMINING ATTORNEY

SN 85-963,261. MEASUREMENT INCORPORATED, DURHAM, NC. FILED 6-18-2013.

**PEG WRITING**

THE MARK CONSISTS OF STANDARD CHARACTERS WITHOUT CLAIM TO ANY PARTICULAR FONT, STYLE, SIZE, OR COLOR.

NO CLAIM IS MADE TO THE EXCLUSIVE RIGHT TO USE "WRITING", APART FROM THE MARK AS SHOWN.

**CLASS 41—EDUCATION AND ENTERTAINMENT**

FOR EDUCATIONAL SERVICES IN THE FIELD OF WRITING ASSESSMENT AND IMPROVEMENT, NAMELY, PROVIDING BUSINESSES, SCHOOLS, GOVERNMENTAL AGENCIES AND INDIVIDUALS WITH TESTING FOR THE EVALUATION OF WRITING COMMUNICATION SKILLS; COMPUTER SERVICES, NAMELY, PROVIDING COMPUTERIZED TESTING IN THE NATURE OF EDUCATIONAL TESTING SERVICES FOR THE EVALUATION OF WRITING COMMUNICATION SKILLS (U.S. CLS. 100, 101 AND 107).

FIRST USE 2-15-2013; IN COMMERCE 2-15-2013.

**CLASS 42—SCIENTIFIC AND COMPUTER SERVICES**

FOR PROVIDING A WEBSITE FEATURING ON-LINE NON-DOWNLOADABLE SOFTWARE THAT ENABLES USERS TO ORGANIZE AND PRACTICE WRITING, ANALYZE AND STORE WRITTEN MATERIALS AND SCORES, AND OBTAIN GUIDANCE IN THE FIELD OF WRITING ASSESSMENT AND IMPROVEMENT; COMPUTER SERVICES, NAMELY, ACTING AS AN APPLICATION SERVICE PROVIDER IN THE FIELD OF WRITING ASSESSMENT TO HOST COMPUTER APPLICATION SOFTWARE FOR THE PURPOSE OF EVALUATING WRITING COMMUNICATION SKILLS (U.S. CLS. 100 AND 101).

FIRST USE 2-15-2013; IN COMMERCE 2-15-2013.  
RONALD DELGIZZI, EXAMINING ATTORNEY

SN 85-963,278. MEASUREMENT INCORPORATED, DURHAM, NC. FILED 6-18-2013.



THE MARK CONSISTS OF THE LETTERS "PEG"; THE FIRST TWO LETTERS "P" AND "E" APPEAR IN BLOCK FORM, WHILE THE LETTER "G" ON THE END IS A STYLIZED DESIGN WHICH RESEMBLES THE UNIVERSAL POWER BUTTON (ROTATED 90 DEGREES) AS FOUND ON ELECTRONIC DEVICES, SUCH AS COMPUTERS.

#### CLASS 41—EDUCATION AND ENTERTAINMENT

FOR EDUCATIONAL SERVICES IN THE FIELD OF WRITING ASSESSMENT AND IMPROVEMENT, NAMELY, PROVIDING BUSINESSES, SCHOOLS, GOVERNMENTAL AGENCIES AND INDIVIDUALS WITH TESTING FOR THE EVALUATION OF WRITING COMMUNICATION SKILLS; COMPUTER SERVICES, NAMELY, PROVIDING COMPUTERIZED TESTING IN THE NATURE OF EDUCATIONAL TESTING SERVICES FOR THE EVALUATION OF WRITING COMMUNICATION SKILLS (U.S. CLS. 100, 101 AND 107).

FIRST USE 2-15-2013; IN COMMERCE 2-15-2013.

#### CLASS 42—SCIENTIFIC AND COMPUTER SERVICES

FOR PROVIDING NON-DOWNLOADABLE SOFTWARE THAT ANALYZES AND SCORES WRITTEN MATERIALS IN THE FIELD OF WRITING ASSESSMENT; COMPUTER SERVICES, NAMELY, ACTING AS AN APPLICATION SERVICE PROVIDER IN THE FIELD OF WRITING ASSESSMENT TO HOST COMPUTER APPLICATION SOFTWARE FOR THE PURPOSE OF ANALYZING TEXTUAL MATERIAL (U.S. CLS. 100 AND 101).

FIRST USE 2-15-2013; IN COMMERCE 2-15-2013.  
RONALD DELGIZZI, EXAMINING ATTORNEY

SN 85-963,306. MEASUREMENT INCORPORATED, DURHAM, NC. FILED 6-18-2013.

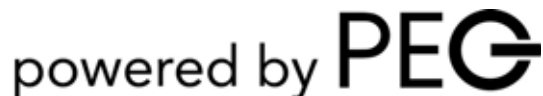

THE MARK CONSISTS OF A LOWER CASE FORM OF THE WORDS "POWERED BY" FOLLOWED BY AN UPPER CASE FORM OF THE LETTERS "PEG." THE LETTERS "P" AND "E" IN "PEG" APPEAR IN BLOCK FORM WHILE THE LETTER "G" ON THE END IS A STYLIZED DESIGN WHICH RESEMBLES THE UNIVERSAL POWER BUTTON (ROTATED 90 DEGREES) AS FOUND ON ELECTRONIC DEVICES, SUCH AS COMPUTERS.

#### CLASS 41—EDUCATION AND ENTERTAINMENT

FOR EDUCATIONAL SERVICES IN THE FIELD OF WRITING ASSESSMENT AND IMPROVEMENT, NAMELY, PROVIDING BUSINESSES, SCHOOLS, GOVERNMENTAL AGENCIES AND INDIVIDUALS WITH TESTING FOR THE EVALUATION OF WRITING COMMUNICATION SKILLS; COMPUTER SERVICES, NAMELY, PROVIDING COMPUTERIZED TESTING IN THE NATURE OF EDUCATIONAL TESTING SERVICES FOR THE EVALUATION OF WRITING COMMUNICATION SKILLS (U.S. CLS. 100, 101 AND 107).

FIRST USE 5-23-2013; IN COMMERCE 5-23-2013.

#### CLASS 42—SCIENTIFIC AND COMPUTER SERVICES

FOR PROVIDING NON-DOWNLOADABLE SOFTWARE THAT ANALYZES AND SCORES WRITTEN MATERIALS IN THE FIELD OF WRITING ASSESSMENT; COMPUTER SERVICES, NAMELY, ACTING AS AN APPLICATION SERVICE PROVIDER IN THE FIELD OF WRITING ASSESSMENT TO HOST COMPUTER APPLICATION SOFTWARE FOR THE PURPOSE OF ANALYZING TEXTUAL MATERIAL (U.S. CLS. 100 AND 101).

FIRST USE 5-23-2013; IN COMMERCE 5-23-2013.  
RONALD DELGIZZI, EXAMINING ATTORNEY

SN 85-963,340. MEASUREMENT INCORPORATED, DURHAM, NC. FILED 6-18-2013.



THE MARK CONSISTS OF STANDARD CHARACTERS WITHOUT CLAIM TO ANY PARTICULAR FONT, STYLE, SIZE, OR COLOR.

#### CLASS 41—EDUCATION AND ENTERTAINMENT

FOR EDUCATIONAL SERVICES IN THE FIELD OF WRITING ASSESSMENT AND IMPROVEMENT, NAMELY, PROVIDING BUSINESSES, SCHOOLS, GOVERNMENTAL AGENCIES AND INDIVIDUALS WITH TESTING FOR THE EVALUATION OF WRITING COMMUNICATION SKILLS; COMPUTER SERVICES, NAMELY, PROVIDING COMPUTERIZED TESTING IN THE NATURE OF EDUCATIONAL TESTING SERVICES FOR THE EVALUATION OF WRITING COMMUNICATION SKILLS (U.S. CLS. 100, 101 AND 107).

FIRST USE 0-0-2004; IN COMMERCE 0-0-2004.

#### CLASS 42—SCIENTIFIC AND COMPUTER SERVICES

FOR PROVIDING NON-DOWNLOADABLE SOFTWARE THAT ANALYZES AND SCORES WRITTEN MATERIALS IN THE FIELD OF WRITING ASSESSMENT; COMPUTER SERVICES, NAMELY, ACTING AS AN APPLICATION SERVICE PROVIDER IN THE FIELD OF WRITING ASSESSMENT TO HOST COMPUTER APPLICATION SOFTWARE FOR THE PURPOSE OF ANALYZING TEXTUAL MATERIAL (U.S. CLS. 100 AND 101).

FIRST USE 0-0-2004; IN COMMERCE 0-0-2004.  
RONALD DELGIZZI, EXAMINING ATTORNEY

SN 85-963,741. GREENHEART INTERNATIONAL, CHICAGO, IL. FILED 6-19-2013.

SN 85-964,680. GRUPO AEROMEXICO, S.A.B DE C.V., MEXICO D. F., MEXICO, FILED 6-19-2013.



THE MARK CONSISTS OF AN IMAGE OF A HEART WITH THE WORD "GREENHEART" BELOW.

#### CLASS 35—ADVERTISING AND BUSINESS

FOR PROMOTION SERVICES, NAMELY, CARRYING OUT PROMOTIONAL CAMPAIGNS FOR COMMERCIAL PURPOSES AND PROMOTION OF GOODS AND SERVICES FOR THIRD PARTIES BY DISTRIBUTION OF PRINTED AND AUDIOVISUAL MATERIAL RELATED TO TOURISM, STUDENT EXCHANGE PROGRAMS, CULTURAL IMMERSION PROGRAMS, FOREIGN LANGUAGE PROGRAMS, STUDENT INTERNSHIPS, NUTRITION, MEDITATION AND MUSIC; ONLINE RETAIL STORE SERVICES FEATURING GENERAL MERCHANDISE THAT ARE FAIR TRADE AND ECO-FRIENDLY (U.S. CLS. 100, 101 AND 102).  
FIRST USE 10-0-2007; IN COMMERCE 10-0-2007.

#### CLASS 39—TRANSPORTATION AND STORAGE

FOR ARRANGING AND COORDINATING TRAVEL ARRANGEMENTS FOR INDIVIDUALS AND GROUPS; TRAVEL GUIDE AND TRAVEL INFORMATION SERVICES (U.S. CLS. 100 AND 105).  
FIRST USE 10-0-2008; IN COMMERCE 10-0-2008.

#### CLASS 41—EDUCATION AND ENTERTAINMENT

FOR ENTERTAINMENT SERVICES, NAMELY, ORGANIZATION OF SPORTS AND CULTURAL ACTIVITIES, ORGANIZATION OF SPORTS COMPETITIONS AND GAMES FOR FOREIGN AND CULTURAL EXCHANGE STUDENTS AND VOLUNTEERS; PROVIDING SPORTS FACILITIES; EDUCATIONAL SERVICES, NAMELY, CONDUCTING SEMINARS AND CONFERENCES IN THE FIELD OF NUTRITION, MEDITATION AND MUSIC; DEVELOPING INTERNATIONAL EXCHANGE PROGRAMS FOR STUDENTS, INDIVIDUALS AND GROUPS; ORGANIZING AND HOSTING EVENTS AND VOLUNTEER PROGRAMS FOR CULTURAL PURPOSES, NAMELY, CULTURAL IMMERSION AND LANGUAGE PROGRAMS; EDUCATIONAL SERVICES, NAMELY, CONDUCTING SEMINARS, WORKSHOPS AND CONFERENCES IN THE FIELD OF FOREIGN LANGUAGE SKILLS; WORK-BASED LEARNING PROGRAMS, NAMELY, OFFERING INTERNSHIPS TO INTERNATIONAL STUDENTS TO BECOME AN INTERN OR TRAINEE WITHIN THE UNITED STATES (U.S. CLS. 100, 101 AND 107).  
FIRST USE 10-0-2004; IN COMMERCE 10-0-2004.  
KAMAL PREET, EXAMINING ATTORNEY



PRIORITY CLAIMED UNDER SEC. 44(D) ON MEXICO APPLICATION NO. 1378375, FILED 5-30-2013, REG. NO. 1398885, DATED 9-24-2013, EXPIRES 5-30-2023.

PRIORITY CLAIMED UNDER SEC. 44(D) ON MEXICO APPLICATION NO. 1378373, FILED 5-30-2013, REG. NO. 1394939, DATED 8-30-2013, EXPIRES 5-30-2023.

PRIORITY CLAIMED UNDER SEC. 44(D) ON MEXICO APPLICATION NO. 1378372, FILED 5-30-2013, REG. NO. 1392139, DATED 8-22-2013, EXPIRES 5-30-2023.

OWNER OF U.S. REG. NOS. 1,712,266, 2,293,104 AND OTHERS.

NO CLAIM IS MADE TO THE EXCLUSIVE RIGHT TO USE "EXPRESS", APART FROM THE MARK AS SHOWN.

THE COLOR(S) DARK BLUE, LIGHT BLUE AND RED IS/ARE CLAIMED AS A FEATURE OF THE MARK.

THE MARK CONSISTS OF AN EAGLE WARRIOR HEAD IN DARK BLUE FOLLOWED BY THE WORD "AEROMEXICO" IN DARK BLUE LETTERS; THE WORD "EXPRESS" IN LIGHT BLUE IS LOCATED TO THE RIGHT AND UNDER THE WORD "AEROMEXICO"; A RED CURVED WAVY LINE APPEARS UNDER THE WORDING "AEROMEXICO EXPRESS".

THE WORDING "AEROMEXICO" HAS NO MEANING IN A FOREIGN LANGUAGE.

#### CLASS 16—PAPER GOODS AND PRINTED MATTER

FOR PRINTED MATTER, NAMELY, PRINTED AIRLINE TICKETS, FOLDERS, BLANK AND PARTIALLY PRINTED BUSINESS FORMS; PUBLICATIONS, NAMELY, PRINTED TIMETABLES, MAGAZINES, NEWSPAPERS, BULLETINS, CATALOGS AND MANUALS, BOOKS AND BROCHURES ALL FEATURING INFORMATION ABOUT THE AIRLINE AND TRAVEL INDUSTRY; WRITING PAPER AND PAPER NOTE TABLETS WITH LETTERHEAD; WRITING PAPER; OFFICE SUPPLIES, NAMELY, PENS, PENCIL CASES, PENCILS, NOTEPADS, NOTEBOOKS, ERASERS, FOLDERS FOR DOCUMENTS, CARDBOARD; PAPER BOXES; DECALS; CALENDARS; NOTEBOOKS; POSTERS; PAPER NAPKINS; MAPS; PAPER SIGNBOARDS; CARDBOARD SIGNBOARDS; PAPER POUCHES FOR PACKAGING (U.S. CLS. 2, 5, 22, 23, 29, 37, 38 AND 50).

#### CLASS 35—ADVERTISING AND BUSINESS

FOR ADVERTISING AND BUSINESS MANAGEMENT SERVICES, NAMELY, ADVERTISING AND PUBLICITY SERVICES; ADMINISTRATION OF A PROGRAM FOR ENABLING PARTICIPANTS TO OBTAIN DISCOUNTS ON GOODS AND SERVICES THROUGH PAYMENT OF A MEMBERSHIP FEE; PROMOTING THE SALE OF GOODS AND SERVICES OF OTHERS BY ADMINISTERING DISCOUNT GROUP PURCHASING PROGRAMS, NAMELY, NEGOTIATING AGREEMENTS WITH PROVIDERS OF GOODS AND SERVICES TO ENABLE PARTICIPANT MEMBERS TO OBTAIN DISCOUNTS IN THE PURCHASE OF GOODS AND SERVICES THROUGH USE OF DISCOUNT MEMBERSHIP (U.S. CLS. 100, 101 AND 102).

**CLASS 39—TRANSPORTATION AND STORAGE**

FOR TRANSPORTATION SERVICES, NAMELY, TRANSPORTATION OF PASSENGERS AND GOODS BY AIR; AIR TRANSPORTATION SERVICES FEATURING A FREQUENT FLYER BONUS PROGRAM OF BONUS AWARDS FOR FREQUENT TRAVELERS; TRANSPORTATION OF CARGO AND FREIGHT BY AIR; AIR CARGO STORAGE AND HANDLING SERVICES; PACKING OF GOODS FOR TRANSPORTATION BY AIR, TRUCK, TRAIN, AND SHIP; PARCEL DELIVERY BY AIR, TRUCK, CAR, TRAIN, AND SHIP; AIRCRAFT CHARTERING SERVICES; TRAVEL SERVICES, NAMELY, ARRANGING TRAVEL TOURS AND CRUISES; TRAVEL AGENCY AND BOOKING SERVICES, NAMELY, MAKING RESERVATIONS AND BOOKINGS FOR TRANSPORTATION; ONLINE TRAVEL AGENCY AND BOOKING SERVICES, NAMELY, MAKING RESERVATIONS AND BOOKINGS FOR TRANSPORTATION VIA THE INTERNET; TRAVEL INFORMATION SERVICES; CONSULTING SERVICES RELATED TO AIR TRANSPORTATION AND TRAVEL, NAMELY, TRANSPORTATION CONSULTING SERVICES (U.S. CLS. 100 AND 105).

MICHAEL TANNER, EXAMINING ATTORNEY

SN 85-964,699. GRUPO AEROMEXICO, S.A.B DE C.V., MEXICO D. F., MEXICO, FILED 6-19-2013.

**AEROMEXICO EXPRESS**

THE MARK CONSISTS OF STANDARD CHARACTERS WITHOUT CLAIM TO ANY PARTICULAR FONT, STYLE, SIZE, OR COLOR.

PRIORITY CLAIMED UNDER SEC. 44(D) ON MEXICO APPLICATION NO. 1378376, FILED 5-30-2013, REG. NO. 1390976, DATED 8-19-2013, EXPIRES 5-30-2023.

PRIORITY CLAIMED UNDER SEC. 44(D) ON MEXICO APPLICATION NO. 1378377, FILED 5-30-2013, REG. NO. 1401337, DATED 9-27-2013, EXPIRES 5-30-2023.

PRIORITY CLAIMED UNDER SEC. 44(D) ON MEXICO APPLICATION NO. 1378378, FILED 5-30-2013, REG. NO. 1400464, DATED 9-26-2013, EXPIRES 5-30-2023.

OWNER OF U.S. REG. NOS. 1,712,266, 2,293,104 AND OTHERS.

NO CLAIM IS MADE TO THE EXCLUSIVE RIGHT TO USE "EXPRESS", APART FROM THE MARK AS SHOWN.

THE WORDING "AEROMEXICO" HAS NO MEANING IN A FOREIGN LANGUAGE.

**CLASS 16—PAPER GOODS AND PRINTED MATTER**

FOR PRINTED MATTER, NAMELY, PRINTED AIRLINE TICKETS, FOLDERS, BLANK AND PARTIALLY PRINTED BUSINESS FORMS; PUBLICATIONS, NAMELY, PRINTED TIMETABLES, MAGAZINES, NEWSPAPERS, BULLETINS, CATALOGS AND MANUALS, BOOKS AND BROCHURES ALL FEATURING INFORMATION ABOUT THE AIRLINE AND TRAVEL INDUSTRY; WRITING PAPER AND PAPER NOTE TABLETS WITH LETTERHEAD; WRITING PAPER; OFFICE SUPPLIES, NAMELY, PENS, PENCIL CASES, PENCILS, NOTEPADS, NOTEBOOKS, ERASERS, FOLDERS FOR DOCUMENTS, CARDBOARD; PAPER BOXES; DECALS; CALENDARS; NOTEBOOKS; POSTERS; PAPER NAPKINS; MAPS; PAPER SIGNBOARDS; CARDBOARD SIGNBOARDS; PAPER POUCHES FOR PACKAGING (U.S. CLS. 2, 5, 22, 23, 29, 37, 38 AND 50).

**CLASS 35—ADVERTISING AND BUSINESS**

FOR ADVERTISING AND BUSINESS MANAGEMENT SERVICES, NAMELY, ADVERTISING AND PUBLICITY SERVICES; ADMINISTRATION OF A PROGRAM FOR ENABLING PARTICIPANTS TO OBTAIN DISCOUNTS ON GOODS AND SERVICES THROUGH PAYMENT OF A MEMBERSHIP FEE; PROMOTING THE SALE OF GOODS AND SERVICES OF OTHERS BY ADMINISTERING DISCOUNT GROUP PURCHASING PROGRAMS, NAMELY, NEGOTIATING AGREEMENTS WITH PROVIDERS OF GOODS AND SERVICES TO ENABLE PARTICIPANT MEMBERS TO OBTAIN DISCOUNTS IN THE PURCHASE OF GOODS AND SERVICES THROUGH USE OF DISCOUNT MEMBERSHIP (U.S. CLS. 100, 101 AND 102).

**CLASS 39—TRANSPORTATION AND STORAGE**

FOR TRANSPORTATION SERVICES, NAMELY, TRANSPORTATION OF PASSENGERS AND GOODS BY AIR; AIR TRANSPORTATION SERVICES FEATURING A FREQUENT FLYER BONUS PROGRAM OF BONUS AWARDS FOR FREQUENT TRAVELERS; TRANSPORTATION OF CARGO AND FREIGHT BY AIR; AIR CARGO STORAGE AND HANDLING SERVICES; PACKING OF GOODS FOR TRANSPORTATION BY AIR, TRUCK, TRAIN, AND SHIP; PARCEL DELIVERY BY AIR, TRUCK, CAR, TRAIN, AND SHIP; AIRCRAFT CHARTERING SERVICES; TRAVEL SERVICES, NAMELY, ARRANGING TRAVEL TOURS AND CRUISES; TRAVEL AGENCY AND BOOKING SERVICES, NAMELY, MAKING RESERVATIONS AND BOOKINGS FOR TRANSPORTATION; ONLINE TRAVEL AGENCY AND BOOKING SERVICES, NAMELY, MAKING RESERVATIONS AND BOOKINGS FOR TRANSPORTATION VIA THE INTERNET; TRAVEL INFORMATION SERVICES; CONSULTING SERVICES RELATED TO AIR TRANSPORTATION AND TRAVEL, NAMELY, TRANSPORTATION CONSULTING SERVICES (U.S. CLS. 100 AND 105).

MICHAEL TANNER, EXAMINING ATTORNEY

SN 85-964,914. SPARTANBURG COUNTY PUBLIC LIBRARIES, SPARTANBURG, SC. FILED 6-20-2013.



THE MARK CONSISTS OF A DRAWING OF A BUILDING WITH A FLAT ROOF AND FOUR GOTHIC ARCHES ACROSS THE LOWER LEVEL.

**CLASS 16—PAPER GOODS AND PRINTED MATTER**

FOR FICTION AND NON-FICTION BOOKS ON VARIETY OF TOPICS; MAPS (U.S. CLS. 2, 5, 22, 23, 29, 37, 38 AND 50).

FIRST USE 10-27-2012; IN COMMERCE 10-27-2012.

**CLASS 41—EDUCATION AND ENTERTAINMENT**

FOR PUBLISHING OF BOOKS; PUBLISHING OF ILLUSTRATIONS; (BASED ON INTENT TO USE) PUBLISHING OF E-BOOKS, AUDIO BOOKS, MUSIC AND PAMPHLETS (U.S. CLS. 100, 101 AND 107).

FIRST USE 10-27-2012; IN COMMERCE 10-27-2012.

CORY BOONE, EXAMINING ATTORNEY



SN 85-965,759. LECARINGTON INT'L, LLC, RAMSEY, NJ.  
FILED 6-20-2013.

# LECARINGTON

THE MARK CONSISTS OF STANDARD CHARACTERS WITHOUT CLAIM TO ANY PARTICULAR FONT, STYLE, SIZE, OR COLOR.

## CLASS 14—JEWELRY

FOR JEWELRY (U.S. CLS. 2, 27, 28 AND 50).

## CLASS 18—LEATHER GOODS

FOR HANDBAGS, WALLETS, DIAPER BAGS, LUGGAGE, TOTE BAGS, BUSINESS CASES, TOILETRY CASES SOLD EMPTY, ANIMAL CARRIERS, UMBRELLAS, CASES FOR BUSINESS CARDS, KEY CASES, CHANGE PURSES (U.S. CLS. 1, 2, 3, 22 AND 41).

## CLASS 25—CLOTHING

FOR MEN'S, WOMEN'S AND CHILDREN'S CLOTHING, NAMELY, DRESSES, SKIRTS, BLOUSES, PANTS, JACKETS, BLAZERS, COATS, RAINCOATS, CAPES, PONCHOS, SCARVES, HATS, GLOVES, SWEATERS, BELTS, HOSIERY, BATHING SUITS, HALTER TOPS, SOCKS, JEANS, WARM UP SUITS, SWEATSHIRTS, SWEATPANTS, LEGGINGS, SHORTS, SLACKS, SPORT COATS, SPORT SHIRTS, SUITS, T-SHIRTS, TUXEDOS, VESTS, TIES; UNDERGARMENTS FOR MEN, WOMEN AND CHILDREN, NAMELY, BOXER SHORTS, BRAS, BUSTIERS, CAMISOLES, NIGHTGOWNS, NIGHTSHIRTS, PAJAMAS, PANTIES, UNDERSHIRTS, UNDERWEAR; FOOTWEAR AND HEADWEAR; BELTS, LEATHER CUFFS (U.S. CLS. 22 AND 39).  
SCOTT BIBB, EXAMINING ATTORNEY

SN 85-965,919. MAK GRILLS, LLC, DALLAS, OR. FILED 6-20-2013.

# MAK GRILLS MOBILE

THE MARK CONSISTS OF STANDARD CHARACTERS WITHOUT CLAIM TO ANY PARTICULAR FONT, STYLE, SIZE, OR COLOR.

OWNER OF U.S. REG. NO. 3,723,659.  
NO CLAIM IS MADE TO THE EXCLUSIVE RIGHT TO USE "GRILLS MOBILE", APART FROM THE MARK AS SHOWN.

## CLASS 9—ELECTRICAL AND SCIENTIFIC APPARATUS

FOR TRANSCEIVERS FOR COMMUNICATION WITH SENSORS AND CONTROLS OF BARBEQUE GRILLS AND BARBEQUE SMOKERS (U.S. CLS. 21, 23, 26, 36 AND 38).

FIRST USE 5-21-2013; IN COMMERCE 5-21-2013.

## CLASS 42—SCIENTIFIC AND COMPUTER SERVICES

FOR PROVIDING TEMPORARY USE OF NON-DOWNLOADABLE COMPUTER SOFTWARE FOR REMOTE MONITORING AND CONTROL OF BARBEQUE GRILLS AND BARBEQUE SMOKERS; PROVIDING A WEBSITE FEATURING TECHNOLOGY ENABLING USERS TO REMOTELY MONITOR AND CONTROL BARBEQUE GRILLS AND BARBEQUE SMOKERS (U.S. CLS. 100 AND 101).

FIRST USE 5-21-2013; IN COMMERCE 5-21-2013.  
DANNEAN HETZEL, EXAMINING ATTORNEY

SN 85-966,092. U.S. VENTURE, INC., APPLETON, WI. FILED 6-21-2013.

# THRIVE

THE MARK CONSISTS OF STANDARD CHARACTERS WITHOUT CLAIM TO ANY PARTICULAR FONT, STYLE, SIZE, OR COLOR.

## CLASS 1—CHEMICALS

FOR COOLANTS; CHEMICALS FOR CONCRETE CONSTRUCTION, NAMELY, CONCRETE FORM RELEASE AGENTS; CHEMICALS, NAMELY, DRAWING FLUIDS, STAMPING FLUIDS AND QUENCHING FLUIDS FOR INDUSTRIAL METAL WORKING; TRANSMISSION FLUIDS (U.S. CLS. 1, 5, 6, 10, 26 AND 46).

## CLASS 2—PAINTS

FOR ANTI-RUST OILS AND GREASES (U.S. CLS. 6, 11 AND 16).

## CLASS 4—LUBRICANTS AND FUELS

FOR ALL PURPOSE LUBRICANTS; ALL PURPOSE PENETRATING OILS; AUTOMOBILE LUBRICANTS; STAMPING OILS FOR INDUSTRIAL METAL WORKING; INDUSTRIAL LUBRICANTS; GEAR OILS; SYNTHETIC GEAR OILS; BAR AND CHAIN OILS FOR CHAIN SAWS AND TWO-CYCLE ENGINES; TWO-CYCLE ENGINE OILS; MAINTENANCE OILS FOR USE IN MACHINES AND COMPRESSORS; INDUSTRIAL PROCESS OILS; INDUSTRIAL OILS, NAMELY, VACUUM PUMP OILS; INDUSTRIAL OILS, NAMELY, ROCK DRILLING OILS; MOTOR OILS FOR GASOLINE AND DIESEL ENGINES; NON-DETERGENT MOTOR OILS; SYNTHETIC MOTOR OILS; HYDRAULIC OILS FOR AUTOMOTIVE AND INDUSTRIAL APPLICATIONS; AUTOMOTIVE AND TRUCK GREASES; GENERAL PURPOSE GREASES; GREASES FOR MACHINES; INDUSTRIAL GREASES; LUBRICATING GREASES; CUTTING OILS FOR INDUSTRIAL METAL WORKING; INDUSTRIAL OILS, NAMELY, NEAT OILS; INDUSTRIAL OILS, NAMELY, TURBINE OILS; INDUSTRIAL OILS, NAMELY, SPINDLE OILS; INDUSTRIAL OILS, NAMELY, HEAT TRANSFER OILS; INDUSTRIAL OILS, NAMELY, WAY OILS; INDUSTRIAL OILS, NAMELY, QUENCH OILS; INDUSTRIAL OILS, NAMELY, COMPRESSOR OILS; INDUSTRIAL OILS, NAMELY, PLUNGER OILS; INDUSTRIAL LUBRICANTS, NAMELY, TOGGLE LUBRICANTS; INDUSTRIAL LUBRICANTS, NAMELY, DIE RELEASE LUBRICANTS (U.S. CLS. 1, 6 AND 15).

LINDSEY BEN, EXAMINING ATTORNEY

SN 85-966,985. MCLAUGHLIN, SUSAN HARTMAN, SAN FRANCISCO, CA. AND D'ORLEANS, PAUL, NEW YORK, NY. FILED 6-21-2013.

# MotoTintype

THE MARK CONSISTS OF STANDARD CHARACTERS WITHOUT CLAIM TO ANY PARTICULAR FONT, STYLE, SIZE, OR COLOR.

## CLASS 25—CLOTHING

FOR A-SHIRTS; BASEBALL CAPS AND HATS; BELTS; BELTS FOR CLOTHING; BELTS MADE OUT OF CLOTH; BODY SHIRTS; BOMBER JACKETS; BOOTS; BOOTS FOR MOTORCYCLING; CAMOUFLAGE PANTS; CAMOUFLAGE SHIRTS; CARGO PANTS; CLOTHING FOR ATHLETIC USE, NAMELY, PADDED PANTS; CLOTHING, NAMELY, KHAKIS; COATS; COATS FOR MEN AND WOMEN; COATS MADE OF COTTON; COATS OF DENIM; DENIM JACKETS; DENIMS; DRESS SHIRTS; DUST COATS; EYESHADES; FINISHED TEXTILE LININGS FOR GARMENTS; FUR COATS; FUR COATS AND JACKETS; FUR HATS; FUR JACKETS; GLOVES AS CLOTHING; HAT BANDS; HATS; HATS FOR INFANTS, BABIES, TODDLERS AND CHILDREN; HEADBANDS FOR CLOTHING; HEAVY COATS; HEAVY JACKETS; HOODED SWEAT SHIRTS; HUNTING PANTS; JACKET LINERS; JACKETS; JACKETS AND SOCKS; JERSEYS; JOGGING PANTS; KNIT SHIRTS; KNITTED CAPS; KNITTED GLOVES; KNITTED UNDERWEAR; LACE BOOTS; LEATHER BELTS; LEATHER COATS; LEATHER JACKETS; LEATHER PANTS; LEATHER SHOES; LIGHT-REFLECTING COATS; LIGHT-REFLECTING JACKETS; LINGERIE; LONG JACKETS; LONG-SLEEVED SHIRTS; LOUNGE PANTS; MEN'S AND WOMEN'S JACKETS, COATS, TROUSERS, VESTS; MEN'S DRESS SOCKS; MEN'S SOCKS; MORNING COATS; MOTORCYCLE JACKETS; MOTORCYCLIST BOOTS; OUTER JACKETS; OVER COATS; OVER SHIRTS; PADDED JACKETS; PADDING JACKETS; PIQUE SHIRTS; POLO KNIT TOPS; RAIN COATS; RAIN HATS; RAIN JACKETS; RAIN-PROOF JACKETS; REVERSIBLE JACKETS; RIDING COATS; RIDING SHOES; SCARVES; SCIENTIFIC AND TECHNOLOGICAL APPAREL, NAMELY, SHIRTS, PANTS, JACKETS, FOOTWEAR, HATS AND CAPS, SCARVES, UNIFORMS; SHELL JACKETS; SHIRT YOKES; SHIRTS; SHIRTS AND SHORT-SLEEVED SHIRTS; SHIRTS FOR INFANTS, BABIES, TODDLERS AND CHILDREN; SHIRTS FOR SUITS; SHOES; SHORT-SLEEVED OR LONG-SLEEVED T-SHIRTS; SHORT-SLEEVED SHIRTS; SLEEP SHIRTS; SLEEPING GARMENTS; SLEEVED OR SLEEVELESS JACKETS; SMALL HATS; SMOKING JACKETS; SOCKS; SPORT COATS; SPORTS JACKETS; SPORTS SHIRTS; SPORTS SHIRTS WITH SHORT SLEEVES; SUEDE JACKETS; SUIT COATS; SWEAT JACKETS; SWEAT PANTS; SWEAT SHIRTS; T-SHIRTS; TEE SHIRTS; THERMAL SOCKS; TIES; TOP COATS; TOPS; TRACK JACKETS; TRAVEL CLOTHING CONTAINED IN A PACKAGE COMPRISING REVERSIBLE JACKETS, PANTS, SKIRTS, TOPS AND A BELT OR SCARF; TRENCH COATS; UNDER GARMENTS; WATERPROOF JACKETS AND PANTS; WEARABLE GARMENTS AND CLOTHING, NAMELY, SHIRTS; WIND COATS; WIND PANTS; WIND RESISTANT JACKETS; WIND-JACKETS; WOMEN'S HATS AND HOODS; WOOLEN SOCKS; WOOLLY HATS; AND, WOVEN OR KNITTED UNDERWEAR (U.S. CLS. 22 AND 39).

FIRST USE 10-7-2012; IN COMMERCE 10-7-2012.

## CLASS 41—EDUCATION AND ENTERTAINMENT

FOR ARRANGING, ORGANIZING, CONDUCTING, AND HOSTING SOCIAL ENTERTAINMENT EVENTS FEATURING PHOTOGRAPHS AND IMAGES OF VINTAGE MOTORCYCLES AND MOTORCYCLE HISTORY; PUBLISHING BOOKS AND MAGAZINES FEATURING PHOTOGRAPHS AND IMAGES OF VINTAGE MOTORCYCLES AND MOTORCYCLE HISTORY; BOOK AND REVIEW PUBLISHING; BOOK PUBLISHING; CONDUCTING ENTERTAINMENT EXHIBITIONS IN THE NATURE OF SHOWS FEATURING PHOTOGRAPHS AND IMAGES OF VINTAGE MOTORCYCLES AND DISPLAYS ABOUT MOTORCYCLE HISTORY; RESEARCH IN THE FIELD OF EDUCATION; EDUCATIONAL SERVICES, NAMELY, DEVELOPING TRAINING COURSES FOR OTHERS; EDUCATIONAL SERVICES, NAMELY, CONDUCTING TRAINING COURSES IN THE FIELD OF PHOTOGRAPHS AND IMAGES OF VINTAGE MOTORCYCLES AND DISTRIBUTING TRAINING MATERIALS IN CONNECTION THEREWITH FOR OTHERS; EDUCATIONAL SERVICES, NAMELY, DEVELOPING, ARRANGING, AND CONDUCTING EDUCATIONAL CONFERENCES AND PROGRAMS AND PROVIDING COURSES OF INSTRUCTION IN THE FIELD OF PHOTOGRAPHS AND IMAGES FEATURING VINTAGE MOTORCYCLES, MOTORCYCLES, MOTORCYCLE HISTORY, MOTORCYCLE RIDERS, MOTORCYCLE RACERS, MOTORCYCLE EVENTS, MOTORCYCLE BOOKS, MOTORCYCLE MOVIES, MOTORCYCLE DESIGNERS, AND MOTORCYCLE ARTISTS; ENTERTAINMENT AND EDUCATION SERVICES IN THE NATURE OF A SERIES OF SHORT SHOWS FEATURING PHOTOGRAPHS AND IMAGES OF VINTAGE MOTORCYCLES, MOTORCYCLES, MOTORCYCLE HISTORY, MOTORCYCLE RIDERS, MOTORCYCLE RACERS, MOTORCYCLE EVENTS, MOTORCYCLE BOOKS, MOTORCYCLE MOVIES, MOTORCYCLE DESIGNERS, AND MOTORCYCLE ARTISTS, ACCESSIBLE BY MEANS OF WEB-BASED APPLICATIONS, MOBILE PHONE APPLICATIONS AND COMPUTER NETWORKS, WHICH MAY INCLUDE VIDEO, TEXT, PHOTOS, IMAGES AND ILLUSTRATIONS OR HYPERTEXT; ENTERTAINMENT AND EDUCATIONAL SERVICES IN THE NATURE OF ON-LINE COMPETITIONS IN THE FIELD OF ENTERTAINMENT, EDUCATION, CULTURE, SPORTS, AND OTHER NON-BUSINESS AND NON-COMMERCIAL FIELDS; ENTERTAINMENT SERVICES, NAMELY, PROVIDING ON-LINE REVIEWS OF PHOTOGRAPHS AND IMAGES OF VINTAGE MOTORCYCLES, MOTORCYCLES, MOTORCYCLE RIDERS, MOTORCYCLE RACERS, MOTORCYCLE EVENTS, MOTORCYCLE DESIGNERS, AND MOTORCYCLE ARTISTS; ENTERTAINMENT SERVICES, NAMELY, PROVIDING ON-LINE REVIEWS OF MOTORCYCLE BOOKS, MOTORCYCLE MOVIES, MOTORCYCLE HISTORY BOOKS, MOTORCYCLE HISTORY MAGAZINES, AND MOTORCYCLE HISTORY JOURNALS; ENTERTAINMENT SERVICES, NAMELY, PROVIDING VIDEO PODCASTS IN THE FIELD OF PHOTOGRAPHS AND IMAGES OF VINTAGE MOTORCYCLES, AND MOTORCYCLE HISTORY; ENTERTAINMENT SERVICES, NAMELY, PROVIDING WEBCASTS IN THE FIELD OF PHOTOGRAPHS AND IMAGES OF VINTAGE MOTORCYCLES, AND MOTORCYCLE HISTORY; MULTIMEDIA PUBLISHING OF BOOKS, MAGAZINES, JOURNALS, SOFTWARE, GAMES, MUSIC, AND ELECTRONIC PUBLICATIONS FEATURING PHOTOGRAPHS AND IMAGES OF VINTAGE MOTORCYCLES; DIGITAL IMAGING SERVICES, NAMELY, PRODUCTION OF DVDS, VIDEOTAPES AND TELEVISION PROGRAMS FEATURING PHOTOGRAPHS AND IMAGES OF VINTAGE MOTORCYCLES; PRODUCTION OF PHOTOGRAPHS AND IMAGES FOR OTHERS FOR USE IN DVDS, TELEVISION PROGRAMS AND ON WEB SITES; PROVIDING ON-LINE PUBLICATIONS IN THE NATURE OF AN E-BOOK IN THE FIELD OF PHOTOGRAPHS AND IMAGES OF VINTAGE MOTORCYCLES, MOTORCYCLES, MOTORCYCLE HISTORY, MOTORCYCLE RIDERS, MOTORCYCLE RACERS, MOTORCYCLE EVENTS, MOTORCYCLE BOOKS, MOTORCYCLE MOVIES, MOTORCYCLE DESIGNERS, AND MOTORCYCLE ARTISTS; TELEVISION, VIDEO AND MOVIE FILMING SERVICES FEATURING PHOTOGRAPHS AND IMAGES OF VINTAGE MOTORCYCLES (U.S. CLS. 100, 101 AND 107).

FIRST USE 10-7-2012; IN COMMERCE 10-7-2012.

JOHN KELLY, EXAMINING ATTORNEY

SN 85-968,068. MARKO DEMOLITION & CRUSHING, LLC,  
GENOA, OH. FILED 6-24-2013.

SN 85-969,594. PASSAGE POINT LLC, NEW YORK, NY.  
FILED 6-25-2013.

# MARKO

THE MARK CONSISTS OF STANDARD CHARACTERS WITHOUT CLAIM TO ANY PARTICULAR FONT, STYLE, SIZE, OR COLOR.

## CLASS 37—CONSTRUCTION AND REPAIR

FOR BUILDING DEMOLITION; EXCAVATION SERVICES (U.S. CLS. 100, 103 AND 106).  
FIRST USE 5-17-2013; IN COMMERCE 5-17-2013.

## CLASS 39—TRANSPORTATION AND STORAGE

FOR TRUCKING SERVICES, NAMELY, HAULING OF BUILDING DEMOLITION RUBBLE (U.S. CLS. 100 AND 105).  
FIRST USE 5-17-2013; IN COMMERCE 5-17-2013.

## CLASS 40—MATERIAL TREATMENT

FOR RECYCLING (U.S. CLS. 100, 103 AND 106).  
FIRST USE 5-17-2013; IN COMMERCE 5-17-2013.  
FRANK LATTUCA, EXAMINING ATTORNEY

SN 85-968,843. MORAN ENVIRONMENTAL RECOVERY,  
LLC, RANDOLPH, MA. FILED 6-25-2013.

THE MARK CONSISTS OF "WRI" OVER A SINGLE, HORIZONTAL WAVE TAPERING FROM LEFT TO RIGHT.

## CLASS 37—CONSTRUCTION AND REPAIR

FOR WASTE DISPOSAL FOR OTHERS; MEDICAL WASTE DISPOSAL; STORAGE TANK CLEANING (U.S. CLS. 100, 103 AND 106).  
FIRST USE 0-0-2012; IN COMMERCE 0-0-2012.

## CLASS 40—MATERIAL TREATMENT

FOR WASTE DISPOSAL, NAMELY, INDUSTRIAL TOXIC WASTE DISPOSAL; RECYCLING SERVICES; WATER TREATMENT SERVICES; AND WASTE TREATMENT SERVICES (U.S. CLS. 100, 103 AND 106).  
FIRST USE 0-0-2012; IN COMMERCE 0-0-2012.  
INGRID C. EULIN, EXAMINING ATTORNEY

# Passage Point

THE MARK CONSISTS OF STANDARD CHARACTERS WITHOUT CLAIM TO ANY PARTICULAR FONT, STYLE, SIZE, OR COLOR.

## CLASS 35—ADVERTISING AND BUSINESS

FOR BUSINESS ADVICE AND INFORMATION RELATING TO INFRASTRUCTURE LOANS, FINANCE AND CAPITAL SOURCING; ADVISORY SERVICES FOR PREPARING AND CARRYING OUT COMMERCIAL TRANSACTIONS; PROVIDING BUSINESS RISK MANAGEMENT SERVICES FOR USE IN PROJECT PLANNING AND MANAGEMENT; PROJECT MANAGEMENT SERVICES FOR OTHERS FOR BUSINESS PURPOSES IN THE FIELDS OF PRIVATE FINANCING OF ENERGY AND INFRASTRUCTURE PROJECTS (U.S. CLS. 100, 101 AND 102).

## CLASS 36—INSURANCE AND FINANCIAL

FOR BUSINESS FINANCE PROCUREMENT SERVICES; PROVIDING INFORMATION AND RESEARCH IN THE FIELD OF FINANCE AND FINANCIAL INVESTMENTS; FINANCIAL ADVISORY AND CONSULTANCY SERVICES, NAMELY, ADVICE AND CONSULTATION FOR CREDIT VALUATION AND MANAGEMENT CONSULTATION, FINANCING FOR PRIVATE EQUITY CAPITAL STRUCTURING, VENTURE CAPITAL STRUCTURING (U.S. CLS. 100, 101 AND 102).

## CLASS 45—PERSONAL AND LEGAL SERVICES

FOR INVESTIGATION OF ASSETS, CREDIT RATINGS, VALUATION, AND FISCAL ASSESSMENTS FOR SECURITY OR SURVEILLANCE PURPOSES (U.S. CLS. 100 AND 101).  
PAULA MAHONEY, EXAMINING ATTORNEY

SN 85-970,164. ADVANCE MAGAZINE PUBLISHERS INC.,  
NEW YORK, NY. FILED 6-26-2013.

# CONVERSATIONS

THE MARK CONSISTS OF STANDARD CHARACTERS WITHOUT CLAIM TO ANY PARTICULAR FONT, STYLE, SIZE, OR COLOR.

## CLASS 9—ELECTRICAL AND SCIENTIFIC APPARATUS

FOR DOWNLOADABLE VIDEO RECORDINGS FEATURING ACTORS, MOVIE AND TELEVISION AND MEDIA PERSONALITIES (U.S. CLS. 21, 23, 26, 36 AND 38).

**CLASS 38—COMMUNICATION**

FOR BROADCASTING OF VIDEO AND AUDIO PROGRAMMING OVER THE INTERNET; VIDEO STREAMING SERVICES VIA THE INTERNET, FEATURING INDEPENDENT FILMS AND MOVIES, INTERVIEWS, BEHIND THE SCENES FOOTAGE (U.S. CLS. 100, 101 AND 104).

**CLASS 41—EDUCATION AND ENTERTAINMENT**

FOR PROVIDING A WEBSITE FEATURING NON-DOWNLOADABLE VIDEOS IN THE FIELD OF INTERVIEWS WITH FAMOUS PEOPLE, CELEBRITIES; ENTERTAINMENT SERVICES, NAMELY, PROVIDING A WEB SITE FEATURING PHOTOGRAPHIC, VIDEO AND AUDIO PRESENTATIONS FEATURING INFORMATION ABOUT FAMOUS PEOPLE, CELEBRITIES (U.S. CLS. 100, 101 AND 107).

LINDA ORNDORFF, EXAMINING ATTORNEY

SN 85-970,267. HOME PRODUCTS INTERNATIONAL - NORTH AMERICA, INC., CHICAGO, IL. FILED 6-26-2013.

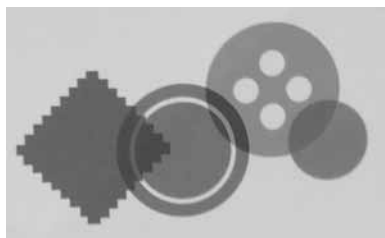

THE MARK CONSISTS OF THE DESIGNS OF A SQUARE PIECE OF FABRIC, A CIRCLE WITHIN A CIRCLE, A BUTTON, AND A CIRCLE. THE RECTANGLE IS NOT A FEATURE OF THE MARK.

**CLASS 6—METAL GOODS**

FOR METAL CLIPS FOR HANGING GARMENTS (U.S. CLS. 2, 12, 13, 14, 23, 25 AND 50).

**CLASS 12—VEHICLES**

FOR CARTS WITH DRAWERS MADE OF FABRIC; PLASTIC CARTS WITH DRAWERS MADE OF PLASTIC; WOOD CART WITH FABRIC DRAWERS; AND PLASTIC STORAGE CART (U.S. CLS. 19, 21, 23, 31, 35 AND 44).

**CLASS 16—PAPER GOODS AND PRINTED MATTER**

FOR DISPOSABLE PAPER CRAFT COVER PAD FOR USE ON TOP OF IRONING BOARDS (U.S. CLS. 2, 5, 22, 23, 29, 37, 38 AND 50).

**CLASS 18—LEATHER GOODS**

FOR TOTE ORGANIZER BAGS; FABRIC SHOPPING TOTE BAGS (U.S. CLS. 1, 2, 3, 22 AND 41).

**CLASS 20—FURNITURE AND ARTICLES NOT OTHERWISE CLASSIFIED**

FOR HANGING ORGANIZERS MADE OF FABRIC; STORAGE BOXES MADE OF FABRIC; ZIPPERED STORAGE BAG MADE OF FABRIC; AND NON-METAL CLIPS FOR HANGING GARMENTS (U.S. CLS. 2, 13, 22, 25, 32 AND 50).

**CLASS 21—HOUSEWARES AND GLASS**

FOR CRAFT SUPPLY CADDY WITH HANDLE AND UTILITY BINS; PLASTIC STORAGE CONTAINER BOX WITH LID FOR DOMESTIC USE; WOODEN CLOTHES PINS (U.S. CLS. 2, 13, 23, 29, 30, 33, 40 AND 50).

DOMINIC FATHY, EXAMINING ATTORNEY

SN 85-970,808. GELLER & COMPANY, LLC, NEW YORK, NY. FILED 6-26-2013.

## ENRICHING WEALTH AND WELL-BEING

THE MARK CONSISTS OF STANDARD CHARACTERS WITHOUT CLAIM TO ANY PARTICULAR FONT, STYLE, SIZE, OR COLOR.

**CLASS 35—ADVERTISING AND BUSINESS**

FOR PREPARING FINANCIAL REPORTS FOR BUSINESSES, INDIVIDUALS AND FAMILIES; ACCOUNTING SERVICES FOR BUSINESSES, INDIVIDUALS AND FAMILIES; PROVIDE OUTSOURCED FINANCIAL SERVICES FOR BUSINESSES, INDIVIDUALS AND FAMILIES (U.S. CLS. 100, 101 AND 102).

FIRST USE 11-13-2013; IN COMMERCE 11-13-2013.

**CLASS 36—INSURANCE AND FINANCIAL**

FOR FINANCIAL SERVICES, NAMELY, WEALTH MANAGEMENT, FINANCIAL PLANNING, STRATEGIC FINANCIAL CONSULTING FOR BUSINESSES, INDIVIDUALS AND FAMILIES (U.S. CLS. 100, 101 AND 102).

FIRST USE 11-13-2013; IN COMMERCE 11-13-2013.

DOMINICK J. SALEMI, EXAMINING ATTORNEY

SN 85-971,004. QUALCOMM INCORPORATED, SAN DIEGO, CA. FILED 6-26-2013.

## QUALCOMM TOQ

THE MARK CONSISTS OF STANDARD CHARACTERS WITHOUT CLAIM TO ANY PARTICULAR FONT, STYLE, SIZE, OR COLOR.

OWNER OF U.S. REG. NOS. 1,622,128, 3,720,881 AND OTHERS.

**CLASS 9—ELECTRICAL AND SCIENTIFIC APPARATUS**

FOR PORTABLE ELECTRONIC DEVICES FOR TRANSMITTING AND REVIEWING TEXT, DATA, IMAGE, AND AUDIO FILES; HANDS FREE DEVICES FOR MOBILE PHONES; BATTERY CHARGERS (U.S. CLS. 21, 23, 26, 36 AND 38).

**CLASS 14—JEWELRY**

FOR SMART WATCHES; A WRISTWATCH FEATURING A PERSONAL COMMUNICATION HUB (U.S. CLS. 2, 27, 28 AND 50).

KATINA MISTER, EXAMINING ATTORNEY



SN 85-971,007. QUALCOMM INCORPORATED, SAN DIEGO, CA. FILED 6-26-2013.

TOQQ

THE MARK CONSISTS OF STANDARD CHARACTERS WITHOUT CLAIM TO ANY PARTICULAR FONT, STYLE, SIZE, OR COLOR.

**CLASS 9—ELECTRICAL AND SCIENTIFIC APPARATUS**

FOR PORTABLE ELECTRONIC DEVICES FOR TRANSMITTING AND REVIEWING TEXT, DATA, IMAGE, AND AUDIO FILES; HANDS FREE DEVICES FOR MOBILE PHONES; BATTERY CHARGERS (U.S. CLS. 21, 23, 26, 36 AND 38).

**CLASS 14—JEWELRY**

FOR SMART WATCHES; A WRISTWATCH FEATURING A PERSONAL COMMUNICATION HUB (U.S. CLS. 2, 27, 28 AND 50).

KATINA MISTER, EXAMINING ATTORNEY



SN 85-971,757. THE MOORINGS, INC., NAPLES, FL. FILED 6-27-2013.

MOORINGS PARK AT GORDON RIVER

THE MARK CONSISTS OF STANDARD CHARACTERS WITHOUT CLAIM TO ANY PARTICULAR FONT, STYLE, SIZE, OR COLOR.

OWNER OF U.S. REG. NO. 3,464,127.

NO CLAIM IS MADE TO THE EXCLUSIVE RIGHT TO USE "GORDON RIVER", APART FROM THE MARK AS SHOWN.

**CLASS 41—EDUCATION AND ENTERTAINMENT**

FOR PROVIDING EXERCISE FACILITIES AND INSTRUCTION SERVICES IN CONNECTION THEREWITH; EDUCATIONAL SERVICES, NAMELY, PROVIDING FACILITIES FOR EDUCATIONAL CLASSES, SEMINARS, CLINICS, WORKSHOPS, TUTORIALS AND CONVENTIONS; EDUCATIONAL SERVICES, NAMELY, PROVIDING CLASSES, SEMINARS, WORKSHOPS IN THE FIELDS OF ARTS AND CRAFTS, CULINARY ARTS, ART, HISTORY, SCIENCE, COMPUTERS, FINANCE, TAX, ACCOUNTING, LOW IMPACT EXERCISES, AEROBICS, HEALTH CARE AND LIFE MANAGEMENT, CALLIGRAPHY, GOLFING, YACHTING, BOATING, BIKING AND PROVIDING COURSES OF INSTRUCTION AT THE GRADUATE LEVEL; PROVIDING FACILITIES FOR RECREATIONAL ACTIVITIES; RECREATIONAL SERVICES, NAMELY, YOGA, BIKING, YACHTING, WALKING, AEROBICS, GOLFING, BINGO AND EXERCISE INSTRUCTION; PROVIDING SPECIAL PROGRAMS DESIGNED FOR OLDER ADULTS AND RETIREES IN THE NATURE OF EDUCATIONAL CLASSES, LECTURES AND SEMINARS FOR OLDER ADULTS AND RETIREES IN THE FIELDS OF HEALTH CARE AND LIFE MANAGEMENT, CALLIGRAPHY, SCIENCE, HISTORY, COMPUTERS, ACCOUNTING, TAX, FINANCE, ART, CULINARY ARTS, GOLFING, YACHTING, BOATING, BIKING, EXERCISE; EDUCATIONAL AND ENTERTAINMENT SERVICES, NAMELY, PROVIDING EDUCATIONAL, POLITICAL AND MOTIVATIONAL SPEAKERS AND TUTORIAL SERVICES IN THE FIELDS OF ARTS AND CRAFTS, CULINARY ARTS, ART, HISTORY, SCIENCE, COMPUTERS, FINANCE, TAX, ACCOUNTING, LOW IMPACT EXERCISES, AEROBICS, HEALTH CARE AND LIFE MANAGEMENT, CALLIGRAPHY, GOLFING, YACHTING, BOATING, BIKING, YOGA, WALKING, AND EXERCISE AT THE ADULT CONTINUING EDUCATION LEVEL; PROVIDING FACILITIES FOR THE SCREENING AND VIEWING OF MOVIES AND VIDEOS; MOVIE THEATER SERVICES; PROVIDING INFORMATION ON THE SUBJECT OF, OR CONDUCTING, THEATRICAL PERFORMANCES FOR OTHERS; AND PROVIDING INFORMATION ABOUT THE NEEDS AND AVAILABILITY OF ALL THE PRECEDING SERVICES (U.S. CLS. 100, 101 AND 107).

**CLASS 43—HOTEL AND RESTAURANT SERVICES**

FOR PROVIDING ASSISTED LIVING FACILITIES AND RETIREMENT HOME SERVICES; PROVIDING INDEPENDENT LIVING FACILITIES; PROVIDING INDEPENDENT LIVING, ASSISTED LIVING AND LONG TERM CARE FACILITIES AND SERVICES, NAMELY, ELDER CARE SERVICES; HOME CARE AND ADULT CARE IN THE NATURE OF MEAL PLANNING AND PREPARATION; PROVIDING COMMUNITY CENTERS FOR SOCIAL GATHERINGS AND MEETINGS; AND PROVIDING INFORMATION REGARDING THE NEED AND AVAILABILITY OF ALL THE PRECEDING SERVICES (U.S. CLS. 100 AND 101).

**CLASS 44—MEDICAL, BEAUTY AND AGRICULTURAL SERVICES**

FOR BEAUTY SALON SERVICES; HEALTH SPA SERVICES, NAMELY, COSMETIC BODY CARE SERVICES; MEDICAL SPA SERVICES, NAMELY, MINIMALLY AND NON-INVASIVE COSMETIC AND BODY FITNESS THERAPIES; NURSING SERVICES; NURSING ASSESSMENTS, NAMELY, HOME HEALTH CARE SERVICES AND PROVIDING HOME NURSING AID SERVICES IN THE NATURE OF INCONTINENCE CARE, MEDICATION MANAGEMENT, ASSISTANCE WITH OR ADMINISTRATION OF MEDICATIONS; NURSING HOME SERVICES; PROVIDING NURSING SERVICES AND LIFE CARE RETIREMENT MEDICAL SERVICES, NAMELY, ROUTINE DRESSING CHANGE, WOUND CARE, NOTIFICATION OF THE PHYSICIAN OF ANY CHANGE IN RESIDENT STATUS, PHYSICIAN ON CALL, NURSING CARE, LICENSED NURSING CARE, HOME NURSING AID SERVICES, AQUA THERAPY, IV THERAPY, CARDIAC REHABILITATION AND BEAUTY SALONS; PHYSICAL THERAPY; OCCUPATIONAL THERAPY; SPEECH THERAPY; MEDICAL ALERT AS-

SISTANCE, NAMELY, REMINDING CLIENTS OF MEDICAL INFORMATION, NAMELY, MEDICINAL DOSAGE, ALLERGIC SENSITIVITY AND PRESCRIPTION REFILLS, AND MEDICAL ASSISTANCE SERVICES PROVIDED VIA TELECOMMUNICATION AND GLOBAL COMPUTER NETWORKS FOR INDIVIDUALS WITH HEALTH PROBLEMS THROUGH THE USE OF WEARABLE MEDICAL DEVICES WITH AUTOMATED ALERT AND MONITORING CAPACITY; PROVIDING NURSING, PHYSICIAN, DENTAL AND PODIATRY SERVICES; PROVIDING PHYSICAL AND MENTAL REHABILITATION FACILITIES; AMBULANT MEDICAL CARE; AND PROVIDING INFORMATION REGARDING THE NEED AND AVAILABILITY OF ALL THE PRECEDING SERVICES (U.S. CLS. 100 AND 101).

#### **CLASS 45—PERSONAL AND LEGAL SERVICES**

FOR PERSONAL CARE ASSISTANCE OF ACTIVITIES OF DAILY LIVING, NAMELY, ASSISTANCE WITH AMBULATION, HOME MANAGEMENT IN THE NATURE OF COORDINATION OF NECESSARY SERVICES AND PERSONAL CARE FOR OLDER INDIVIDUALS, PERSONAL CARE, BATHING, DRESSING, GROOMING, ALL FOR PHYSICALLY CHALLENGED PERSONS; SOCIAL SERVICE, NAMELY, COMPANIONSHIP SERVICES ALL FOR PHYSICALLY CHALLENGED PERSONS; PROVIDING INFORMATION REGARDING THE NEED AND AVAILABILITY OF ALL OF THE PRECEDING (U.S. CLS. 100 AND 101).

ANNE FARRELL, EXAMINING ATTORNEY

#### **CLASS 41—EDUCATION AND ENTERTAINMENT**

FOR PROVIDING EXERCISE FACILITIES AND INSTRUCTION SERVICES IN CONNECTION THEREWITH; EDUCATIONAL SERVICES, NAMELY, PROVIDING FACILITIES FOR EDUCATIONAL CLASSES, SEMINARS, CLINICS, WORKSHOPS, TUTORIALS AND CONVENTIONS; EDUCATIONAL SERVICES, NAMELY, PROVIDING CLASSES, SEMINARS, WORKSHOPS IN THE FIELDS OF ARTS AND CRAFTS, CULINARY ARTS, ART, HISTORY, SCIENCE, COMPUTERS, FINANCE, TAX, ACCOUNTING, LOW IMPACT EXERCISES, AEROBICS, HEALTH CARE AND LIFE MANAGEMENT, CALLIGRAPHY, GOLFING, YACHTING, BOATING, BIKING AND PROVIDING COURSES OF INSTRUCTION AT THE GRADUATE LEVEL; PROVIDING FACILITIES FOR RECREATIONAL ACTIVITIES; RECREATIONAL SERVICES, NAMELY, YOGA, BIKING, YACHTING, WALKING, AEROBICS, GOLFING, BINGO AND EXERCISE INSTRUCTION; PROVIDING SPECIAL PROGRAMS DESIGNED FOR OLDER ADULTS AND RETIREES IN THE NATURE OF EDUCATIONAL CLASSES, LECTURES AND SEMINARS FOR OLDER ADULTS AND RETIREES IN THE FIELDS OF HEALTH CARE AND LIFE MANAGEMENT, CALLIGRAPHY, SCIENCE, HISTORY, COMPUTERS, ACCOUNTING, TAX, FINANCE, ART, CULINARY ARTS, GOLFING, YACHTING, BOATING, BIKING, EXERCISE; EDUCATIONAL AND ENTERTAINMENT SERVICES, NAMELY, PROVIDING EDUCATIONAL, POLITICAL AND MOTIVATIONAL SPEAKERS AND TUTORIAL SERVICES IN THE FIELDS OF ARTS AND CRAFTS, CULINARY ARTS, ART, HISTORY, SCIENCE, COMPUTERS, FINANCE, TAX, ACCOUNTING, LOW IMPACT EXERCISES, AEROBICS, HEALTH CARE AND LIFE MANAGEMENT, CALLIGRAPHY, GOLFING, YACHTING, BOATING, BIKING, YOGA, WALKING, AND EXERCISE AT THE ADULT CONTINUING EDUCATION LEVEL; PROVIDING FACILITIES FOR THE SCREENING AND VIEWING OF MOVIES AND VIDEOS; MOVIE THEATER SERVICES; PROVIDING INFORMATION ON THE SUBJECT OF, OR CONDUCTING, THEATRICAL PERFORMANCES FOR OTHERS; AND PROVIDING INFORMATION ABOUT THE NEEDS AND AVAILABILITY OF ALL THE PRECEDING SERVICES (U.S. CLS. 100, 101 AND 107).

SN 85-971,766. THE MOORINGS, INC., NAPLES, FL. FILED 6-27-2013.

#### **CLASS 43—HOTEL AND RESTAURANT SERVICES**

FOR PROVIDING ASSISTED LIVING FACILITIES AND RETIREMENT HOME SERVICES; PROVIDING INDEPENDENT LIVING FACILITIES; PROVIDING INDEPENDENT LIVING, ASSISTED LIVING AND LONG TERM CARE FACILITIES AND SERVICES, NAMELY, ELDER CARE SERVICES; HOME CARE AND ADULT CARE IN THE NATURE OF MEAL PLANNING AND PREPARATION; PROVIDING COMMUNITY CENTERS FOR SOCIAL GATHERINGS AND MEETINGS; AND PROVIDING INFORMATION REGARDING THE NEED AND AVAILABILITY OF ALL THE PRECEDING SERVICES (U.S. CLS. 100 AND 101).

#### **CLASS 44—MEDICAL, BEAUTY AND AGRICULTURAL SERVICES**

FOR BEAUTY SALON SERVICES; HEALTH SPA SERVICES, NAMELY, COSMETIC BODY CARE SERVICES; MEDICAL SPA SERVICES, NAMELY, MINIMALLY AND NON-INVASIVE COSMETIC AND BODY FITNESS THERAPIES; NURSING SERVICES; NURSING ASSESSMENTS, NAMELY, HOME HEALTH CARE SERVICES AND PROVIDING HOME NURSING AID SERVICES IN THE NATURE OF INCONTINENCE CARE, MEDICATION MANAGEMENT, ASSISTANCE WITH OR ADMINISTRATION OF MEDICATIONS; NURSING HOME SERVICES; PROVIDING NURSING SERVICES AND LIFE CARE RETIREMENT MEDICAL SERVICES, NAMELY, ROUTINE DRESSING CHANGE, WOUND CARE, NOTIFICATION OF THE PHYSICIAN OF ANY CHANGE IN RESIDENT STATUS, PHYSICIAN ON CALL, NURSING CARE, LICENSED NURSING CARE, HOME NURSING AID SERVICES, AQUA THERAPY, IV THERAPY, CARDIAC REHABILITATION AND BEAUTY SALONS; PHYSICAL THERAPY; OCCUPATIONAL THERAPY; SPEECH THERAPY; MEDICAL ALERT AS-



OWNER OF U.S. REG. NO. 3,464,127.

NO CLAIM IS MADE TO THE EXCLUSIVE RIGHT TO USE "CENTER FOR HEALTHY LIVING", APART FROM THE MARK AS SHOWN.

THE MARK CONSISTS OF AN ORCHID DESIGN CENTERED OVER THE WORDS "MOORINGS PARK" IN STYLIZED LETTERING, WITH THE WORDS "THE CENTER FOR HEALTHY LIVING" IN STYLIZED LETTERING, CENTERED IN THE BOTTOM RIGHT.

SISTANCE, NAMELY, REMINDING CLIENTS OF MEDICAL INFORMATION, NAMELY, MEDICINAL DOSAGE, ALLERGIC SENSITIVITY AND PRESCRIPTION REFILLS, AND MEDICAL ASSISTANCE SERVICES PROVIDED VIA TELECOMMUNICATION AND GLOBAL COMPUTER NETWORKS FOR INDIVIDUALS WITH HEALTH PROBLEMS THROUGH THE USE OF WEARABLE MEDICAL DEVICES WITH AUTOMATED ALERT AND MONITORING CAPACITY; PROVIDING NURSING, PHYSICIAN, DENTAL AND PODIATRY SERVICES; PROVIDING PHYSICAL AND MENTAL REHABILITATION FACILITIES; AMBULANT MEDICAL CARE; AND PROVIDING INFORMATION REGARDING THE NEED AND AVAILABILITY OF ALL THE PRECEDING SERVICES (U.S. CLS. 100 AND 101).

#### **CLASS 45—PERSONAL AND LEGAL SERVICES**

FOR PERSONAL CARE ASSISTANCE OF ACTIVITIES OF DAILY LIVING, NAMELY, ASSISTANCE WITH AMBULATION, HOME MANAGEMENT IN THE NATURE OF COORDINATION OF NECESSARY SERVICES AND PERSONAL CARE FOR OLDER INDIVIDUALS, PERSONAL CARE, BATHING, DRESSING, GROOMING, ALL FOR PHYSICALLY CHALLENGED PERSONS; SOCIAL SERVICE, NAMELY, COMPANIONSHIP SERVICES ALL FOR PHYSICALLY CHALLENGED PERSONS; PROVIDING INFORMATION REGARDING THE NEED AND AVAILABILITY OF ALL OF THE PRECEDING (U.S. CLS. 100 AND 101).

ANNE FARRELL, EXAMINING ATTORNEY

SN 85-979,634. FLS ENERGY, INC., ASHEVILLE, NC. FILED 7-25-2012.



NO CLAIM IS MADE TO THE EXCLUSIVE RIGHT TO USE "ENERGY", APART FROM THE MARK AS SHOWN.

THE MARK CONSISTS OF THE WORDING "FLS ENERGY" BELOW A CIRCLE FORMED FROM THE BASES OF TRIANGLES AND CROSSED BY TWO WAVY LINES REPRESENTING A STYLIZED DRAWING OF THE SUN WITH RAYS.

#### **CLASS 36—INSURANCE AND FINANCIAL**

FOR FINANCING RENEWABLE ENERGY PROJECTS (U.S. CLS. 100, 101 AND 102).

FIRST USE 6-25-2008; IN COMMERCE 6-25-2008.

#### **CLASS 39—TRANSPORTATION AND STORAGE**

FOR DISTRIBUTION OF ENERGY PRODUCED BY SOLAR THERMAL AND PHOTOVOLTAIC SYSTEMS (U.S. CLS. 100 AND 105).

#### **CLASS 40—MATERIAL TREATMENT**

FOR GENERATING ELECTRICITY, NAMELY, GENERATING RENEWABLE ELECTRICITY PRODUCED BY SOLAR THERMAL AND PHOTOVOLTAIC SYSTEMS (U.S. CLS. 100, 103 AND 106).

LIEF MARTIN, EXAMINING ATTORNEY

SN 85-980,239. MEDCOM, INC., CYPRESS, CA. FILED 3-22-2013.



OWNER OF U.S. REG. NOS. 976,838, 3,054,134 AND OTHERS.

THE MARK CONSISTS OF THE STYLIZED WORD "MEDCOM" WITH THE LETTER "O" DEPICTED WITH A STYLIZED GLOBE DESIGN.

#### **CLASS 9—ELECTRICAL AND SCIENTIFIC APPARATUS**

FOR DVDS AND AUDIO VISUAL RECORDINGS FOR USE IN THE FIELDS OF HEALTHCARE EDUCATION AND MEDICAL EDUCATION; DOWNLOADABLE ELECTRONIC PUBLICATIONS, NAMELY, BOOKS IN THE NATURE OF COURSE CATALOGS IN THE FIELDS OF HEALTH EDUCATION AND MEDICAL EDUCATION (U.S. CLS. 21, 23, 26, 36 AND 38).

FIRST USE 0-0-2001; IN COMMERCE 0-0-2001.

#### **CLASS 35—ADVERTISING AND BUSINESS**

FOR ONLINE RETAIL STORE SERVICES AND WEB BASED CATALOG SERVICES EACH FEATURING DVDS, BOOKS, AND INSTRUCTIONAL VIDEO RECORDINGS IN THE FIELD OF HEALTH EDUCATION AND MEDICAL EDUCATION (U.S. CLS. 100, 101 AND 102).

FIRST USE 0-0-2001; IN COMMERCE 0-0-2001.

#### **CLASS 38—COMMUNICATION**

FOR STREAMING OF AUDIO-VISUAL MATERIAL ON THE INTERNET IN THE FIELDS OF HEALTHCARE EDUCATION AND MEDICAL EDUCATION (U.S. CLS. 100, 101 AND 104).

FIRST USE 12-1-2004; IN COMMERCE 12-1-2004.

#### **CLASS 41—EDUCATION AND ENTERTAINMENT**

FOR EDUCATIONAL SERVICES, NAMELY, PROVIDING ONLINE INSTRUCTION IN THE FIELDS OF MEDICINE AND HEALTHCARE VIA AN ONLINE WEBSITE; PROVIDING CONTINUING MEDICAL EDUCATIONAL COURSES; EDUCATIONAL TESTING IN THE FIELDS OF HEALTHCARE AND MEDICINE; PROVIDING INFORMATION ABOUT HEALTHCARE EDUCATION AND MEDICAL EDUCATION; PROVIDING A WEBSITE AND ONLINE PROFILE PAGES FEATURING NON-DOWNLOADABLE PHOTOGRAPHS AND INFORMATION ABOUT INSTRUCTION AND INSTRUCTIONAL VIDEOS IN THE FIELD OF MEDICINE AND HEALTHCARE, AND OTHER INFORMATION ABOUT EDUCATION IN THE FIELDS OF MEDICINE AND HEALTHCARE; PROVIDING A WEB BASED ONLINE PORTAL FEATURING NON-DOWNLOADABLE INSTRUCTIONAL VIDEOS AND EDUCATIONAL TESTS IN THE FIELDS OF MEDICINE AND HEALTHCARE; AND PROVIDING ONLINE NON-DOWNLOADABLE INSTRUCTIONAL VIDEOS IN THE FIELD OF HEALTH EDUCATION AND MEDICAL EDUCATION; PROVIDING A WEB BASED ONLINE PORTAL FEATURING STANDARDIZED TESTING FOR CONTINUING MEDICAL EDUCATIONAL COURSES IN THE FIELDS OF HEALTHCARE AND MEDICINE; PROVIDING A WEBSITE FEATURING INFORMATION ABOUT CONTINUING MEDICAL EDUCATION COURSES AND REQUIREMENTS IN THE FIELD OF MEDICINE AND HEALTHCARE (U.S. CLS. 100, 101 AND 107).

FIRST USE 0-0-2001; IN COMMERCE 0-0-2001.

**CLASS 42—SCIENTIFIC AND COMPUTER SERVICES**

FOR PROVIDING TEMPORARY USE OF ONLINE NON-DOWNLOADABLE EDUCATIONAL SOFTWARE ON A WEBSITE FOR USE IN TRAINING, TESTING, TRACKING, AND RECORD KEEPING FOR CONTINUING MEDICAL EDUCATIONAL COURSES IN THE FIELD OF HEALTHCARE AND MEDICINE; PROVIDING AN INTERACTIVE WEBSITE FEATURING TECHNOLOGY THAT ENABLES USERS TO TRACK AND MANAGE CONTINUED MEDICAL EDUCATIONAL COURSE REQUIREMENTS AND TEST RESULTS AND TO RECEIVE PROGRESS REPORTS ON THE SAME (U.S. CLS. 100 AND 101).

FIRST USE 0-0-2001; IN COMMERCE 0-0-2001.

**CLASS 44—MEDICAL, BEAUTY AND AGRICULTURAL SERVICES**

FOR PROVIDING NON-DOWNLOADABLE INSTRUCTIONAL VIDEOS IN THE FIELD OF MEDICINE, MEDICAL INFORMATION AND HEALTHCARE SERVICES VIA A WEBSITE (U.S. CLS. 100 AND 101).

FIRST USE 12-1-2004; IN COMMERCE 12-1-2004.

**CLASS 45—PERSONAL AND LEGAL SERVICES**

FOR SOCIAL NETWORKING SERVICES IN THE FIELDS OF MEDICINE AND HEALTHCARE PROVIDER EDUCATION AND CONTINUING EDUCATION PROGRAMS FOR MEDICAL AND HEALTH CARE PROVIDERS (U.S. CLS. 100 AND 101).

FIRST USE 1-20-2010; IN COMMERCE 1-20-2010.

GENE MACIOL, EXAMINING ATTORNEY

SN 85-980,476. FOOTLIFE, LLC, LATROBE, PA. FILED 5-7-2013.

# FOOTLIFE

THE MARK CONSISTS OF STANDARD CHARACTERS WITHOUT CLAIM TO ANY PARTICULAR FONT, STYLE, SIZE, OR COLOR.

**CLASS 10—MEDICAL APPARATUS**

FOR SHOE INSERTS, NAMELY, ARCH SUPPORTS FOR BOOTS OR SHOES; ORTHOPEDIC ACCOMMODATIVE SHOES; ORTHOTIC DEVICES, NAMELY, ORTHOTIC INSERTS FOR FOOTWEAR, ORTHOTICS FOR THE FOOT; ORTHOPEDIC FOOTWEAR, ORTHOPEDIC DEVICES FOR THERAPEUTIC USE, ORTHOPEDIC SOLES AND SUPPORTS; FOOT DEVICES AND FOOT RELATED ITEMS, NAMELY, ORTHOPEDIC FOOT CUSHIONS, FOOT MASSAGE APPARATUSES, ORTHOPEDIC DEVICES TO STRETCH AND EXERCISE THE TOES AND FEET, THERAPEUTIC DEVICES AND APPARATUSES, NAMELY, FORCE AND MOTION SENSING APPARATUSES AND ASSISTED EXERCISE DEVICES FOR THE REHABILITATION OF FEET AFFECTED BY NEUROMUSCULAR DISEASES, DISORDERS, OR INJURIES FOR HOME OR CLINICAL USE; CUSTOM FOOT DEVICES AND RELATED ITEMS, NAMELY, ORTHOPEDIC ACCOMMODATIVE SHOES, ORTHOTIC INSERTS FOR FOOTWEAR, ORTHOTICS FOR THE FOOT, ORTHOPEDIC DEVICES FOR THERAPEUTIC USE, ORTHOPEDIC SOLES AND SUPPORTS (U.S. CLS. 26, 39 AND 44).

**CLASS 35—ADVERTISING AND BUSINESS**

FOR ADVERTISING SERVICES FOR OTHERS; WEBSITE SERVICES, NAMELY, ADVERTISING AND MARKETING FOR OTHERS; WEBSITE SERVICES, NAMELY, ADVERTISING AND PROMOTING FOOTWEAR PRODUCTS, DEVELOPING ADVERTISING CAMPAIGNS PROVIDED VIA A WEBSITE; WEBSITE FEATURING CONSUMER INFORMATION AND CONTENT REGARDING FEET, MOBILITY, AMBULATION AND FOOT-HEALTH FOR PURPOSES OF ASSISTING CONSUMERS TO SELECT AND PURCHASE PRODUCTS RELATED TO THOSE PURPOSES; FOOT, MOBILITY AND AMBULATION ASSESSMENT, NAMELY, DIAGNOSTIC FOOT TESTING, MONITORING AND REPORTING SERVICES FOR PURPOSES OF PROVIDING CONSUMERS WITH INFORMATION TO ASSIST IN SELECTING PRODUCTS RELATED TO A PARTICULAR NEED; EVALUATION SERVICES, NAMELY, FUNCTIONAL ASSESSMENT PROGRAM FOR CUSTOMERS FOR PURPOSES OF EVALUATING FOOTWEAR AND ORTHOTIC DEVICES FOR PURPOSES OF ASSISTING CONSUMERS IN MAKING A MORE INFORMED PURCHASING DECISION; RETAIL STORE AND ONLINE RETAIL STORE SERVICES FEATURING, FOOT-RELATED ITEMS, CLOTHING, FOOTWEAR AND GLASSWARE; ENDORSEMENT SERVICES, NAMELY, PROMOTING THE GOODS AND SERVICES OF OTHERS; SPONSORSHIP SERVICES, NAMELY, PROMOTING THE GOODS AND SERVICES BY ARRANGING FOR BUSINESSES TO AFFILIATE THEIR GOODS AND SERVICES WITH THE GOODS AND SERVICES OF THIRD PARTIES BY MEANS OF SPONSORSHIP RELATIONSHIPS; PROMOTIONAL SPONSORSHIP OF EDUCATIONAL SEMINARS, SYMPOSIUMS AND CONFERENCES IN THE FIELD OF ORTHOTICS, ORTHOPEDICS AND FOOT CARE, PROMOTIONAL SPONSORSHIP OF SPORTING EVENTS; PROMOTIONAL SPONSORSHIP OF FOOT-RELATED EVENTS AND SPORTING EVENTS; PROMOTING THE GOODS AND SERVICES OF OTHERS BY ARRANGING FOR SPONSORS TO AFFILIATE THEIR GOODS AND SERVICES WITH AN AWARDS PROGRAM, A SPORTS COMPETITION AND SPORTING ACTIVITIES (U.S. CLS. 100, 101 AND 102).

**CLASS 40—MATERIAL TREATMENT**

FOR CUSTOM FOOTWEAR SERVICES, NAMELY, CUSTOM MANUFACTURE OF ORTHOTICS AND DEVICES FOR USE IN CONJUNCTION WITH SHOES AND BOOTS, CUSTOM MANUFACTURE OF ORTHOTICS AND ORTHOPEDIC DEVICES, CUSTOM MANUFACTURE OF PROSTHESIS FOR THE FEET (U.S. CLS. 100, 103 AND 106).

**CLASS 44—MEDICAL, BEAUTY AND AGRICULTURAL SERVICES**

FOR PROVIDING INFORMATION RELATED TO FOOT-HEALTH, MOBILITY AND AMBULATION; HEALTH CONSULTING SERVICES REGARDING FEET, MOBILITY AND AMBULATION; PODIATRY SERVICES; FOOT, MOBILITY AND AMBULATION ASSESSMENT, NAMELY, DIAGNOSTIC FOOT TESTING, MONITORING AND REPORTING SERVICES FOR FOOT-HEALTH RELATED PURPOSES; PROVIDING INDIVIDUALIZED FOOT-HEALTH REPORTS RELATING TO CONDITION, STRUCTURAL, MOBILITY AND AMBULATION ISSUES OF THE FOOT; WEBSITE SERVICES, NAMELY, PROVIDING HEALTH RELATED SUBJECT MATTER RELATED TO FEET, MOBILITY AND AMBULATION; HEALTH CONSULTATION SERVICES RELATING TO FOOT-HEALTH, MOBILITY, AMBULATION, AND FOOT CARE (U.S. CLS. 100 AND 101).

JEFFREY LOOK, EXAMINING ATTORNEY



SN 85-980,599. MORTGAGE CADENCE, LLC, DENVER, CO.  
FILED 3-20-2013.

SN 86-000,340. PLÁSTICOS TÉCNICOS MEXICANOS, S.A. DE  
C.V., MONTERREY, NUEVO LEON, MEXICO, FILED 7-2-  
2013.

# PRELUDE

THE MARK CONSISTS OF STANDARD CHARACTERS WITHOUT CLAIM TO ANY PARTICULAR FONT, STYLE, SIZE, OR COLOR.

## CLASS 9—ELECTRICAL AND SCIENTIFIC APPARATUS

FOR COMPUTER SOFTWARE THAT PROVIDES PROVIDES MORTGAGE LOAN LENDERS AND ORIGINATORS A CUSTOMIZABLE POINT-OF-SALE INTERFACE BETWEEN THE LENDER AND THE CUSTOMER WHICH INCLUDES CONTENT MANAGEMENT AND DATA TRACKING FEATURES INCLUDING LOAN STATUS AND MANAGEMENT OF SENT AND RECEIVED DOCUMENTS AND PROVIDES ACCURATE LOAN-LEVEL PRICING AND FEE CALCULATIONS ENABLING AUTOMATIC PROVIDING OF A FULL 3-DAY DISCLOSURE PACKAGE FROM THE LENDERS AND ORIGINATORS; COMPUTER SOFTWARE THAT PROVIDES MORTGAGE CUSTOMERS WITH SECURE DETAILED MORTGAGE PRODUCT AND PRICING RECOMMENDATIONS AND FILTERING, COMPETITIVE RATES, CLOSING COSTS AND A PRE-QUALIFICATION AND APPLICATION PROCESS INCLUDING DOCUMENT UPLOAD, ELECTRONIC PRE-APPLICATION DISCLOSURES, MORTGAGE CALCULATORS, AND REAL-TIME STATUS UPDATES, IN RESPONSE TO STARTING THE MORTGAGE APPLICATION PROCESS (U.S. CLS. 21, 23, 26, 36 AND 38).

## CLASS 42—SCIENTIFIC AND COMPUTER SERVICES

FOR SOFTWARE AS A SERVICE (SAAS) SERVICES, NAMELY, HOSTING SOFTWARE THAT PROVIDES MORTGAGE LOAN LENDERS AND ORIGINATORS A CUSTOMIZABLE POINT-OF-SALE INTERFACE BETWEEN THE LENDER AND THE CUSTOMER WHICH INCLUDES CONTENT MANAGEMENT AND DATA TRACKING FEATURES INCLUDING LOAN STATUS AND MANAGEMENT OF SENT AND RECEIVED DOCUMENTS AND PROVIDES ACCURATE LOAN-LEVEL PRICING AND FEE CALCULATIONS ENABLING AUTOMATIC PROVIDING OF A FULL 3-DAY DISCLOSURE PACKAGE FROM THE LENDERS AND ORIGINATORS; SOFTWARE AS A SERVICE (SAAS) SERVICES, NAMELY, HOSTING SOFTWARE THAT PROVIDES MORTGAGE CUSTOMERS WITH SECURE DETAILED MORTGAGE PRODUCT AND PRICING RECOMMENDATIONS AND FILTERING, COMPETITIVE RATES, CLOSING COSTS AND A PRE-QUALIFICATION AND APPLICATION PROCESS INCLUDING DOCUMENT UPLOAD, ELECTRONIC PRE-APPLICATION DISCLOSURES, MORTGAGE CALCULATORS, AND REAL-TIME STATUS UPDATES, IN RESPONSE TO STARTING THE MORTGAGE APPLICATION PROCESS (U.S. CLS. 100 AND 101).

MARY ROSSMAN, EXAMINING ATTORNEY



THE MARK CONSISTS OF THE LETTERS "PTM" IN STYLIZED FORM.

## CLASS 20—FURNITURE AND ARTICLES NOT OTHERWISE CLASSIFIED

FOR LOADING PALLETS, NOT OF METAL; BOXES OR CRATES OF PLASTIC MATERIALS; PLASTIC BOXES FOR SODAS; PLASTIC BEER BOXES; DISPLAY CASES FOR MERCHANDISE; DISPLAY RACKS; DISPLAY STANDS; FURNITURE, NAMELY, MERCHANDISE DISPLAY UNITS; POINT OF PURCHASE DISPLAYS; PLASTIC STORAGE CONTAINERS FOR COMMERCIAL OR INDUSTRIAL USE; SHELVES FOR STORAGE; DISPLAY BOARDS (U.S. CLS. 2, 13, 22, 25, 32 AND 50).

## CLASS 21—HOUSEWARES AND GLASS

FOR NON-ELECTRIC PORTABLE COOLERS (U.S. CLS. 2, 13, 23, 29, 30, 33, 40 AND 50).  
AMEEN IMAM, EXAMINING ATTORNEY

---

SN 86-001,194. COCOA CORPORATION, CHICAGO, IL.  
FILED 7-2-2013.



THE MARK CONSISTS OF THE WORD "COCOA" WRITTEN IN A STYLIZED FONT WITH A \* SYMBOL IN THE FIRST "O".

## CLASS 1—CHEMICALS

FOR FERTILIZERS; ORGANIC FERTILIZERS (U.S. CLS. 1, 5, 6, 10, 26 AND 46).

## CLASS 37—CONSTRUCTION AND REPAIR

FOR COLLECTION OF ORGANIC WASTE MATERIALS FOR RECYCLING; SOLID WASTE LANDFILL SERVICES; WASTE DISPOSAL FOR OTHERS (U.S. CLS. 100, 103 AND 106).

TIMOTHY FINNEGAN, EXAMINING ATTORNEY

SN 86-003,069. THANK YOUR BODY, LLC, PLEASANT GROVE, UT. FILED 7-5-2013.

## Thank Your Body

THE MARK CONSISTS OF STANDARD CHARACTERS WITHOUT CLAIM TO ANY PARTICULAR FONT, STYLE, SIZE, OR COLOR.

### CLASS 9—ELECTRICAL AND SCIENTIFIC APPARATUS

FOR DOWNLOADABLE ARTICLES, VIDEO TAPES, AND ELECTRONIC BOOKS, ALL IN THE FIELD OF HEALTHY LIVING (U.S. CLS. 21, 23, 26, 36 AND 38).  
FIRST USE 11-1-2009; IN COMMERCE 10-16-2011.

### CLASS 41—EDUCATION AND ENTERTAINMENT

FOR EDUCATION SERVICES, NAMELY, PROVIDING ONLINE NON-DOWNLOADABLE ARTICLES, VIDEO TAPES, AND ELECTRONIC BOOKS, AND LIVE AND ONLINE CLASSES AND WORKSHOPS, ALL IN THE FIELD OF HEALTHY LIVING (U.S. CLS. 100, 101 AND 107).

FIRST USE 11-1-2009; IN COMMERCE 10-16-2011.  
ALEX KEAM, EXAMINING ATTORNEY

SN 86-004,715. WAN YUAN TEXTILES CO., LTD, TAIPEI, TAIWAN, FILED 7-8-2013.



THE MARK CONSISTS OF A STYLIZED CIRCLE DESIGN HAVING A MOUNTAIN PEAK DESIGN WITHIN THE LEFT HALF OF THE STYLIZED CIRCLE AND A CITYSCAPE DESIGN IN THE RIGHT HALF OF THE STYLIZED CIRCLE AND THE WORDING "OUTERBORO" BENEATH THE STYLIZED CIRCLE.

### CLASS 25—CLOTHING

FOR BATHING TRUNKS; BELTS; CLOTHING, NAMELY, PULLOVERS, SHIRTS, TEE-SHIRTS, TROUSERS; CLOTHING FOR BICYCLE COMMUTING, NAMELY, PANTS, SHIRTS, JACKETS, SHORTS; GLOVES; HATS; KNITWEAR, NAMELY, SWEATERS, GLOVES, SCARVES; CLOTHING MADE OF LINEN, NAMELY, LINEN PANTS AND SHIRTS; NECKTIES; PANTS; OUTER WEAR, NAMELY, PARKAS, COATS, JACKETS; SOCKS; UNDERPANTS; UNDERWEAR; ANTI-SWEAT UNDERWEAR; VESTS; WATERPROOF JACKETS (U.S. CLS. 22 AND 39).

### CLASS 35—ADVERTISING AND BUSINESS

FOR ACCOUNTING; ADMINISTRATIVE PROCESSING OF PURCHASE ORDERS; ADVERTISING; DEMONSTRATION OF GOOD; ORGANIZATION OF EXHIBITIONS FOR COMMERCIAL OR ADVERTISING PURPOSES; ORGANIZATION OF FASHION SHOWS FOR PROMOTIONAL PURPOSES; IMPORT-EXPORT AGENCIES; INVOICING; MARKETING; ON-LINE ADVERTISING ON A COMPUTER NETWORK; OUTDOOR ADVERTISING; PRESENTATION OF GOODS ON COMMUNICATION MEDIA, FOR RETAIL PURPOSES; PUBLIC RELATIONS; PUBLICATION OF PUBLICITY TEXTS; ONLINE RETAIL STORE SERVICES FOR CLOTHING (U.S. CLS. 100, 101 AND 102).

CAROLYN CATALDO, EXAMINING ATTORNEY

SN 86-007,056. WEAREPANEL, INC., BURBANK, CA. FILED 7-10-2013.

## WEESPIN

THE MARK CONSISTS OF STANDARD CHARACTERS WITHOUT CLAIM TO ANY PARTICULAR FONT, STYLE, SIZE, OR COLOR.

### CLASS 9—ELECTRICAL AND SCIENTIFIC APPARATUS

FOR DOWNLOADABLE COMPUTER SOFTWARE FOR STREAMING, BROADCASTING, TRANSMITTING AND REPRODUCING MUSIC (U.S. CLS. 21, 23, 26, 36 AND 38).

### CLASS 35—ADVERTISING AND BUSINESS

FOR ONLINE RETAIL STORE SERVICES FEATURING DOWNLOADABLE/DIGITAL MUSIC (U.S. CLS. 100, 101 AND 102).

### CLASS 41—EDUCATION AND ENTERTAINMENT

FOR ENTERTAINMENT SERVICES, NAMELY, PROVIDING NON-DOWNLOADABLE PLAYBACK OF MUSIC VIA GLOBAL COMMUNICATIONS NETWORKS; PROVIDING NON-DOWNLOADABLE PRERECORDED MUSIC, INFORMATION IN THE FIELD OF MUSIC, AND COMMENTARY AND ARTICLES ABOUT MUSIC VIA A GLOBAL COMPUTER NETWORK; PROVIDING AN INTERNET WEBSITE PORTAL IN THE FIELD OF MUSIC (U.S. CLS. 100, 101 AND 107).

### CLASS 42—SCIENTIFIC AND COMPUTER SERVICES

FOR NON-DOWNLOADABLE COMPUTER SOFTWARE FOR STREAMING, BROADCASTING, TRANSMITTING AND REPRODUCING MUSIC; NON-DOWNLOADABLE DIGITAL MUSIC DATABASES FEATURING TECHNOLOGY THAT INTEGRATES AN INDIVIDUAL'S DIGITAL MUSIC COLLECTIONS AND PLAYLISTS WITH THIRD PARTY DIGITAL MUSIC PURCHASE SERVICE (U.S. CLS. 100 AND 101).

### CLASS 45—PERSONAL AND LEGAL SERVICES

FOR ONLINE SOCIAL NETWORKING SERVICES (U.S. CLS. 100 AND 101).  
MICHELLE DUBOIS, EXAMINING ATTORNEY

SN 86-007,734. FIELD, ERIN, SPRINGFIELD, MA. FILED 7-11-2013.

**BECOMING CATHOLIC...AGAIN**

THE MARK CONSISTS OF STANDARD CHARACTERS WITHOUT CLAIM TO ANY PARTICULAR FONT, STYLE, SIZE, OR COLOR.

NO CLAIM IS MADE TO THE EXCLUSIVE RIGHT TO USE "CATHOLIC", APART FROM THE MARK AS SHOWN.

**CLASS 16—PAPER GOODS AND PRINTED MATTER**

FOR SERIES OF NON-FICTION BOOKS IN THE FIELD OF PERSONAL PERSPECTIVE ON CATHOLICISM (U.S. CLS. 2, 5, 22, 23, 29, 37, 38 AND 50).  
FIRST USE 2-1-2012; IN COMMERCE 2-1-2012.

**CLASS 41—EDUCATION AND ENTERTAINMENT**

FOR ON-LINE JOURNALS, NAMELY, BLOGS FEATURING PERSONAL PERSPECTIVE ON CATHOLICISM (U.S. CLS. 100, 101 AND 107).  
FIRST USE 2-1-2012; IN COMMERCE 2-1-2012.  
JOHN HWANG, EXAMINING ATTORNEY

SN 86-007,993. DOW JONES TRADEMARK HOLDINGS LLC, NEW YORK, NY. FILED 7-11-2013.

**DJX**

THE MARK CONSISTS OF STANDARD CHARACTERS WITHOUT CLAIM TO ANY PARTICULAR FONT, STYLE, SIZE, OR COLOR.

**CLASS 9—ELECTRICAL AND SCIENTIFIC APPARATUS**

FOR DOWNLOADABLE, ELECTRONIC PUBLICATIONS IN THE NATURE OF PERIODICALS, NEWSPAPERS, NEWSLETTERS, JOURNALS, PROMOTIONAL MATERIALS, AND INFORMATIONAL WORKSHEETS IN THE FIELDS OF CURRENT EVENTS NEWS AND INFORMATION, FINANCIAL NEWS AND INFORMATION, BUSINESS NEWS AND INFORMATION, EDUCATIONAL NEWS AND INFORMATION, COMPANY NEWS AND INFORMATION, TECHNOLOGY NEWS AND INFORMATION, AND ENTERTAINMENT NEWS AND INFORMATION PROVIDED ON-LINE FROM DATABASES OR VIA THE INTERNET; COMPUTER SOFTWARE FOR PROVIDING, DOWNLOADING, ACCESSING, AND OBTAINING FINANCIAL INFORMATION; COMPUTER SOFTWARE FOR SEARCHING, ACCESSING, MANAGING AND INTEGRATING GLOBAL NEWS, BUSINESS INFORMATION AND FINANCIAL INFORMATION ONLINE BY SECURE WIDE OR LOCAL AREA NETWORK USERS; DOWNLOADABLE PUBLICATIONS IN THE NATURE OF PERIODICALS, NEWSPAPERS, NEWSLETTERS, JOURNALS, PROMOTIONAL MATERIALS, AND INFORMATIONAL WORKSHEETS IN THE FIELDS OF CURRENT EVENTS NEWS AND INFORMATION, FINANCIAL NEWS AND INFORMATION, BUSINESS NEWS AND INFORMATION, EDUCATIONAL NEWS AND INFORMATION, COMPANY NEWS AND INFORMATION, TECHNOLOGY NEWS AND INFORMATION, AND ENTERTAINMENT NEWS AND INFORMATION; DOWNLOADABLE SOFTWARE IN THE NATURE OF AN APPLICATION FOR MOBILE AND STATIONARY ELECTRONIC DEVICES FOR OBTAINING NEWS, INFORMATION, COMMENTARY, AND TEXTUAL, AUDIO, AND VISUAL CONTENT OF THE TYPE FOUND IN GENERAL INTEREST PUBLICATIONS; MOBILE MEDIA DEVICE SOFTWARE APPLICATIONS FOR USE IN DATABASE MANAGEMENT, USE IN ELECTRONIC STORAGE OF DATA, AND USE ON MOBILE DEVICES; PROVIDING DOWNLOADABLE SOFTWARE FOR SEARCHING DATABASES CONTAINING GLOBAL CURRENT EVENTS NEWS (U.S. CLS. 21, 23, 26, 36 AND 38).

**CLASS 35—ADVERTISING AND BUSINESS**

FOR BUSINESS INFORMATION SERVICES; BUSINESS SERVICES PROVIDED ON-LINE VIA COMPUTER DATABASES AND A GLOBAL COMPUTER NETWORK, NAMELY, STATISTICAL INFORMATION SERVICES, BUSINESS INVESTIGATION SERVICES AND BUSINESS RESEARCH SERVICES; PROVIDING SEARCHABLE ON-LINE ELECTRONIC DATABASES CONTAINING A WIDE RANGE OF BUSINESS INFORMATION; PROVIDING INFORMATION AND NEWS IN THE FIELD OF BUSINESS VIA ELECTRONIC MEANS, NAMELY, NEWSPAPERS, REPORTS, BLOGS, AND MAGAZINES; PROVIDING NEWS VIA THE INTERNET AND ON-LINE ELECTRONIC COMMUNICATIONS NETWORKS IN THE FIELD OF BUSINESS; PROVIDING NEWS AND INFORMATION SERVICES VIA MOBILE AND STATIONARY DEVICES IN THE FIELD OF BUSINESS; PROVIDING RESEARCH AND INFORMATION ON PRIVATE EQUITY INVESTMENTS, ENTREPRENEURSHIP, VENTURE-BACKED COMPANIES, FINANCING FOR ENTREPRENEURIAL BUSINESS, AND INDUSTRY TRENDS; ELECTRONIC NEWS RETRIEVAL SERVICES, NAMELY, CLIPPING SERVICES SPECIALIZING IN BUSINESS AND GENERAL NEWS; BUSINESS INFORMATION SERVICES, NAMELY, PROVIDING OF CUSTOMIZED FINANCIAL REPORTS AND GENERAL NEWS AND INFORMATION VIA ELECTRONIC MEANS; CUSTOMIZED BUSINESS INFORMATION SERVICES WHICH PROVIDE TEXT FROM NEWSPAPERS, WIRE SERVICES AND TRADE PUBLICATIONS BY ELECTRONIC MEANS; BUSINESS INFORMATION SERVICES, NAMELY, COMPANY NEWS, COMPANY ANALYSIS AND PROFILE INFORMATION, EARNINGS STATEMENTS, ESTIMATES AND GUIDELINES, ANALYST PRESENTATIONS AND RECOMMENDATIONS, PRESS RELEASES AND SECURITIES FILINGS, BUSINESS INVESTIGATION, BUSINESS MANAGEMENT, ECONOMIC FORECASTING, BUSINESS RESEARCH AND STATISTICAL INFORMATION; PROVIDING PROFESSIONALS WITH PROPRIETARY AND THIRD PARTY BUSINESS NEWS AND BUSINESS RELATED CONTENT VIA ON-LINE DATABASES; PROVISION OF BUSINESS NEWS;

PROVIDING SEARCHABLE DATABASES FEATURING BUSINESS INFORMATION; ELECTRONIC NEWS RETRIEVAL SERVICES, NAMELY, PROVIDING BUSINESS NEWS VIA CUSTOMIZABLE E-MAILS (U.S. CLS. 100, 101 AND 102).

#### **CLASS 38—COMMUNICATION**

FOR PROVIDING ACCESS OVER A GLOBAL COMPUTER NETWORK TO AN INTERACTIVE COMPUTER DATABASE CONSISTING OF COMPREHENSIVE INFORMATION ON CURRENT EVENTS NEWS AND BUSINESS NEWS (U.S. CLS. 100, 101 AND 104).

#### **CLASS 41—EDUCATION AND ENTERTAINMENT**

FOR PROVIDING SEARCHABLE DATABASES FEATURING GLOBAL CURRENT EVENTS NEWS; PUBLISHING OF ELECTRONIC PUBLICATIONS; PUBLISHING OF ELECTRONIC AND ONLINE NEWSPAPERS AND MAGAZINES; NEWS REPORTERS SERVICES NAMELY, PROVIDING NEWS, OPINION, COMMENTARY AND INFORMATION SERVICES VIA THE WEB AND MOBILE TECHNOLOGY IN THE FIELD OF CURRENT EVENTS RELATING TO GENERAL NEWS, ECONOMICS, BUSINESS, MARKETS, FINANCE, INVESTING, SPORTS, EDUCATION, AND TECHNOLOGY; PROVISION OF NEWS AND COMMENTARY IN THE FIELD OF CURRENT EVENT NEWS VIA ONLINE DATABASES; NEWS REPORTING SERVICES IN THE NATURE OF CURRENT EVENT REPORTING; NEWS AGENCY SERVICES, NAMELY, GATHERING AND DISSEMINATION OF NEWS; PROVIDING NEWS AND INFORMATION VIA THE INTERNET AND ON-LINE ELECTRONIC COMMUNICATIONS NETWORKS IN THE FIELD OF CURRENT EVENT NEWS; PROVIDING NEWS AND INFORMATION SERVICES TO MOBILE AND STATIONARY DEVICES IN THE FIELD OF CURRENT EVENT NEWS; PROVIDING ON-LINE ELECTRONIC DATABASES CONTAINING GLOBAL CURRENT EVENTS NEWS; CUSTOMIZABLE NEWS REPORT SERVICES SPECIALIZING IN BUSINESS AND GENERAL NEWS; ELECTRONIC NEWS RETRIEVAL SERVICES, NAMELY, PROVIDING CURRENT EVENT, GENERAL NEWS VIA CUSTOMIZABLE E-MAILS (U.S. CLS. 100, 101 AND 107).

#### **CLASS 42—SCIENTIFIC AND COMPUTER SERVICES**

FOR PROVIDING TEMPORARY USE OF NON-DOWNLOADABLE SOFTWARE FOR SEARCHING ON-LINE ELECTRONIC DATABASES CONTAINING GLOBAL CURRENT EVENTS NEWS, VIA A GLOBAL COMPUTER NETWORK; COMPUTERIZED INFORMATION RETRIEVAL SERVICES, NAMELY, PUBLIC DOCUMENT RETRIEVAL AND DOCUMENT RETRIEVAL FROM PROPRIETARY DATABASES (U.S. CLS. 100 AND 101).  
RICHARD WHITE, EXAMINING ATTORNEY

SN 86-008,494. NICOMA BLOODSTOCK, INC., LEXINGTON, KY. FILED 7-12-2013.

# NICOMA

THE MARK CONSISTS OF STANDARD CHARACTERS WITHOUT CLAIM TO ANY PARTICULAR FONT, STYLE, SIZE, OR COLOR.

#### **CLASS 36—INSURANCE AND FINANCIAL**

FOR EQUINE APPRAISALS; CONSULTING SERVICES IN THE FIELD OF HORSE APPRAISALS (U.S. CLS. 100, 101 AND 102).  
FIRST USE 12-31-1979; IN COMMERCE 12-31-1979.

#### **CLASS 41—EDUCATION AND ENTERTAINMENT**

FOR CONSULTING SERVICES IN THE FIELD OF THOROUGHBRED RACING (U.S. CLS. 100, 101 AND 107).  
FIRST USE 12-31-1979; IN COMMERCE 12-31-1979.

#### **CLASS 44—MEDICAL, BEAUTY AND AGRICULTURAL SERVICES**

FOR CONSULTING SERVICES IN THE FIELD OF EQUINE MATING ADVICE AND MATING PLANNING (U.S. CLS. 100 AND 101).  
FIRST USE 12-31-1979; IN COMMERCE 12-31-1979.

#### **CLASS 45—PERSONAL AND LEGAL SERVICES**

FOR EXPERT WITNESS SERVICES IN LEGAL MATTERS IN THE FIELD OF THOROUGHBRED RACING AND EQUINE CONCERNS (U.S. CLS. 100 AND 101).  
FIRST USE 12-31-1979; IN COMMERCE 12-31-1979.  
THEODORE MCBRIDE, EXAMINING ATTORNEY

SN 86-008,501. RED DISTRIBUTION, LLC, NEW YORK, NY. AND SHARECAUSEMEDIA, LLC, NEW YORK, NY. FILED 7-12-2013.

## How YouCare

THE MARK CONSISTS OF STANDARD CHARACTERS WITHOUT CLAIM TO ANY PARTICULAR FONT, STYLE, SIZE, OR COLOR.

#### **CLASS 35—ADVERTISING AND BUSINESS**

FOR PROVIDING AN INTERNET WEBSITE FEATURING NEWS AND INFORMATION ON THE TOPIC OF PROMOTION OF SOCIAL AWARENESS AND ACTION REGARDING GLOBAL ISSUES FACING HUMANITY BY UP-AND-COMING AND ESTABLISHED MUSICAL RECORDING ARTISTS; PROVIDING MARKETING AND ADVERTISING SERVICES, NAMELY, PROVIDING CAUSE MARKETING AND CROSS-PROMOTIONAL SERVICES CONNECTING MUSICAL ARTISTS AND CHARITABLE ORGANIZATIONS; PROMOTING THE CHARITABLE SERVICES OF OTHERS, NAMELY, PROVIDING INDIVIDUALS WITH INFORMATION ABOUT VARIOUS CHARITIES FOR THE PURPOSE OF MAKING DONATIONS TO CHARITIES (U.S. CLS. 100, 101 AND 102).

#### **CLASS 38—COMMUNICATION**

FOR BROADCASTING OF ORIGINAL AUDIO AND AUDIOVISUAL PROGRAMMING OVER THE INTERNET FEATURING LIVE MUSICAL PERFORMANCES AND INTERVIEWS WITH MUSICAL ARTISTS THAT SUPPORT AND ARE ACTIVE IN CREATING SOCIAL CHANGE (U.S. CLS. 100, 101 AND 104).

**CLASS 41—EDUCATION AND ENTERTAINMENT**

FOR PROVIDING AN INTERNET WEBSITE FEATURING ENTERTAINMENT NEWS AND INFORMATION ABOUT UP-AND-COMING AND ESTABLISHED MUSICAL RECORDING ARTISTS WHO AMPLIFY SOCIAL AWARENESS AND ACTION AROUND GLOBAL ISSUES FACING HUMANITY; ENTERTAINMENT SERVICES, NAMELY, THE PROVISION OF CONTINUING ORIGINAL AUDIO AND AUDIOVISUAL PROGRAMS, SEGMENTS AND SHOWS FEATURING LIVE MUSICAL PERFORMANCES AND INTERVIEWS WITH MUSICAL ARTISTS THAT SUPPORT AND ARE ACTIVE IN CREATING SOCIAL CHANGE, DELIVERED VIA THE INTERNET (U.S. CLS. 100, 101 AND 107).

LINDA LAVACHE, EXAMINING ATTORNEY

SN 86-009,041. FEDOROV, ANDREY, NEW YORK, NY. FILED 7-12-2013.

# RAIDIX

THE MARK CONSISTS OF STANDARD CHARACTERS WITHOUT CLAIM TO ANY PARTICULAR FONT, STYLE, SIZE, OR COLOR.

**CLASS 9—ELECTRICAL AND SCIENTIFIC APPARATUS**

FOR COMPUTER SOFTWARE FOR DATA AND MEDIA STORAGE, MANAGEMENT, INTEGRATION, SECURITY, AND BACK-UP, AND FOR SUPPORTING MULTIPLE PROCESSORS AND MEMORY SYSTEMS; DATA STORAGE APPLIANCES, NAMELY, HIGH-SPEED STORAGE SUBSYSTEMS FOR STORAGE AND BACKUP OF ELECTRONIC DATA EITHER LOCALLY OR VIA A TELECOMMUNICATIONS NETWORK; SOFTWARE FOR MANAGING AND MONITORING COMPUTER DISC DRIVES AND STORAGE DEVICES USING A COMPUTER NETWORK (U.S. CLS. 21, 23, 26, 36 AND 38).

FIRST USE 9-0-2012; IN COMMERCE 9-0-2012.

**CLASS 42—SCIENTIFIC AND COMPUTER SERVICES**

FOR TECHNICAL SUPPORT SERVICES, NAMELY, TROUBLESHOOTING OF COMPUTER SOFTWARE PROBLEMS; COMPUTER AND INFORMATION TECHNOLOGY CONSULTING SERVICES (U.S. CLS. 100 AND 101).

FIRST USE 9-0-2012; IN COMMERCE 9-0-2012.

**CLASS 45—PERSONAL AND LEGAL SERVICES**

FOR LICENSING OF COMPUTER SOFTWARE (U.S. CLS. 100 AND 101).

FIRST USE 9-0-2012; IN COMMERCE 9-0-2012.

ELI HELLMAN, EXAMINING ATTORNEY

SN 86-008,652. RCP INTEGRITY SERVICES, INC., HOUSTON, TX. FILED 7-12-2013.

## RCP Integrity Services

THE MARK CONSISTS OF STANDARD CHARACTERS WITHOUT CLAIM TO ANY PARTICULAR FONT, STYLE, SIZE, OR COLOR.

NO CLAIM IS MADE TO THE EXCLUSIVE RIGHT TO USE "INTEGRITY SERVICES", APART FROM THE MARK AS SHOWN.

**CLASS 37—CONSTRUCTION AND REPAIR**

FOR CONSTRUCTION OF CATHODIC PROTECTION AND CORROSION CONTROL SYSTEMS AND FACILITIES FOR PIPELINES; INSTALLATION AND MAINTENANCE OF CATHODIC PROTECTION AND CORROSION CONTROL SYSTEMS AND FACILITIES FOR PIPELINES; PIPELINE CONSTRUCTION; PIPELINE CONSTRUCTION AND MAINTENANCE; PIPELINE MAINTENANCE (U.S. CLS. 100, 103 AND 106).

FIRST USE 1-1-2013; IN COMMERCE 1-1-2013.

**CLASS 42—SCIENTIFIC AND COMPUTER SERVICES**

FOR CONSULTING IN THE FIELD OF MECHANICAL, PIPELINE AND CORROSION ENGINEERING; ENGINEERING SERVICES IN THE FIELD OF MECHANICAL, PIPELINE AND CORROSION; ENGINEERING SERVICES, NAMELY, ENGINEERING FOR THE ENERGY AND OIL AND GAS INDUSTRIES, NAMELY, INSPECTION OF PIPELINES, FACILITIES, AND TERMINAL OPERATIONS; PIPELINE INSPECTION SERVICES; TECHNOLOGY CONSULTATION IN THE FIELD OF ENERGY AND OIL AND GAS INDUSTRIES, NAMELY, PIPELINES, FACILITIES, AND TERMINAL OPERATIONS (U.S. CLS. 100 AND 101).

FIRST USE 1-1-2013; IN COMMERCE 1-1-2013.

CHARLOTTE CORWIN, EXAMINING ATTORNEY

SN 86-011,928. OVERSEE.NET, LOS ANGELES, CA. FILED 7-16-2013.

# TRAFFICMATCH

THE MARK CONSISTS OF STANDARD CHARACTERS WITHOUT CLAIM TO ANY PARTICULAR FONT, STYLE, SIZE, OR COLOR.

**CLASS 35—ADVERTISING AND BUSINESS**

FOR ONLINE MARKETING AND ADVERTISING SERVICES; DOMAIN MONETIZATION SERVICES FOR MONETIZING WEB TRAFFIC VISITING UNDEVELOPED DOMAINS (U.S. CLS. 100, 101 AND 102).

FIRST USE 6-18-2013; IN COMMERCE 6-18-2013.

**CLASS 38—COMMUNICATION**

FOR COMMUNICATION SERVICES, NAMELY, COMMUNICATING REQUESTS FROM THIRD PARTIES DIRECTLY TO THE WEB SITES OF OTHERS FOR MONETIZING DOMAIN NAMES (U.S. CLS. 100, 101 AND 104).

FIRST USE 6-18-2013; IN COMMERCE 6-18-2013.

**CLASS 42—SCIENTIFIC AND COMPUTER SERVICES**

FOR COMPUTER SERVICES, NAMELY, ANALYZING INTERNET TRAFFIC FOR THE PURPOSE OF OPTIMIZING THE DESTINATION TO WHICH INTERNET TRAFFIC IS SENT, ON A NUMBER OF FACTORS INCLUDING GEOGRAPHIC LOCATION, TOPICAL CATEGORY, KEYWORD INFORMATION AND DEVICE TYPE (U.S. CLS. 100 AND 101).

FIRST USE 6-18-2013; IN COMMERCE 6-18-2013.  
DOMINICK J. SALEMI, EXAMINING ATTORNEY

---

SN 86-012,207. UPWARDLY GLOBAL, SAN FRANCISCO, CA. FILED 7-17-2013.

**UPWARDLY GLOBAL**

THE MARK CONSISTS OF STANDARD CHARACTERS WITHOUT CLAIM TO ANY PARTICULAR FONT, STYLE, SIZE, OR COLOR.

NO CLAIM IS MADE TO THE EXCLUSIVE RIGHT TO USE "GLOBAL", APART FROM THE MARK AS SHOWN.

**CLASS 35—ADVERTISING AND BUSINESS**

FOR PROVIDING CAREER NETWORKING SERVICES AND CAREER PLACEMENT SERVICES; PROVIDING INFORMATION IN THE FIELDS OF EMPLOYMENT, RECRUITMENT, JOB RESOURCES, JOB LISTINGS, AND LISTINGS OF POTENTIAL EMPLOYERS AND PLACES OF EMPLOYMENT; EMPLOYMENT RECRUITING AND PLACEMENT SERVICES FEATURING SOURCING OF CANDIDATES AND REFERRING CANDIDATES TO EMPLOYERS FOR EMPLOYMENT POSITIONS; PROVIDING ONLINE EMPLOYMENT INFORMATION FEATURING JOB LISTINGS AND AN ONLINE SEARCHABLE DATABASE OF RESUMES OF PROSPECTIVE EMPLOYEES AND JOB CANDIDATES; AND PROVIDING ONLINE CAREER NETWORKING SERVICES AND CAREER PLACEMENT SERVICES (U.S. CLS. 100, 101 AND 102).

FIRST USE 6-0-2002; IN COMMERCE 6-0-2002.

**CLASS 41—EDUCATION AND ENTERTAINMENT**

FOR TRAINING SERVICES IN THE FIELDS OF JOB SEARCHING AND CAREER NETWORKING; EDUCATIONAL SERVICES, NAMELY, ARRANGING OR CONDUCTING MOCK EMPLOYMENT INTERVIEWS TO ENABLE EMPLOYEES OF EMPLOYERS TO DEVELOP COMMUNICATION AND INTERPERSONAL SKILLS FEATURING CULTURAL AWARENESS TRAINING AND MENTOR TRAINING, AND TO ENABLE EMPLOYMENT SEEKERS AND JOB CANDIDATES TO DEVELOP BETTER COMMUNICATION AND INTERPERSONAL SKILLS; AND PROVIDING ONLINE JOB SEARCH TRAINING (U.S. CLS. 100, 101 AND 107).

FIRST USE 3-0-2013; IN COMMERCE 3-0-2013.  
JOHN DWYER, EXAMINING ATTORNEY

SN 86-012,568. COTTON ON CLOTHING PTY LTD, NORTH GEELONG, VIC., AUSTRALIA, FILED 7-17-2013.

**FREE BY COTTON ON**

THE MARK CONSISTS OF STANDARD CHARACTERS WITHOUT CLAIM TO ANY PARTICULAR FONT, STYLE, SIZE, OR COLOR.

PRIORITY CLAIMED UNDER SEC. 44(D) ON AUSTRALIA APPLICATION NO. 1535770, FILED 1-17-2013, REG. NO. 1535770, DATED 8-29-2013, EXPIRES 1-17-2023.

OWNER OF U.S. REG. NOS. 3,616,131 AND 4,385,867.  
NO CLAIM IS MADE TO THE EXCLUSIVE RIGHT TO USE "COTTON", APART FROM THE MARK AS SHOWN.

**CLASS 25—CLOTHING**

FOR CLOTHING, NAMELY, TOPS, KNIT SHIRTS, POLO SHIRTS, SHIRTS, JUMPERS, T-SHIRTS, SWEAT SHIRTS, BLOUSES, BLAZERS, SWEATERS, JACKETS, VESTS, COATS, PONCHOS, DRESSES, SKIRTS, TROUSERS, PANTS, OVERALLS, JEANS AND DENIM TROUSERS, SHORTS, CAMISOLES, LINGERIE, SLEEPWEAR, UNDERWEAR, SWIM WEAR, GLOVES, TIES, SCARVES, HEADSCARVES, SHAWLS, LEATHER BELTS, FABRIC BELTS, SOCKS, HOSIERY, ALL MADE IN WHOLE OR SUBSTANTIAL PART OF COTTON; HEADGEAR, NAMELY, HATS, CAPS, BEANIES, ALL MADE IN WHOLE OR SUBSTANTIAL PART OF COTTON; FOOTWEAR, ATHLETIC FOOTWEAR, BEACH FOOTWEAR, SLIPPERS, BOOTS, SANDALS, ALL MADE IN WHOLE OR SUBSTANTIAL PART OF COTTON (U.S. CLS. 22 AND 39).

**CLASS 35—ADVERTISING AND BUSINESS**

FOR ADVERTISING SERVICES; ADVERTISING BY MAIL ORDER; ADVERTISING SERVICES PROVIDED OVER THE INTERNET; DIRECT MAIL ADVERTISING; FASHION SHOW EXHIBITIONS FOR COMMERCIAL PURPOSES; ONLINE ADVERTISING ON A COMPUTER NETWORK; PROVIDING INFORMATION, INCLUDING ONLINE, ABOUT ADVERTISING, BUSINESS MANAGEMENT AND ADMINISTRATION AND OFFICE FUNCTIONS; ONLINE PROMOTION ON A COMPUTER NETWORK; RETAIL AND WHOLESALE STORE SERVICES, ON-LINE RETAIL AND WHOLESALE STORE SERVICES, CATALOGUE ORDERING SERVICES, AND MAIL ORDER SERVICES FEATURING CLOTHING, NAMELY, TOPS, KNIT SHIRTS, POLO SHIRTS, SHIRTS, JUMPERS, T-SHIRTS, SWEAT SHIRTS, BLOUSES, BLAZERS, SWEATERS, JACKETS, VESTS, COATS, PONCHOS, DRESSES, SKIRTS, TROUSERS, PANTS, OVERALLS, JEANS AND DENIM TROUSERS, SHORTS, CAMISOLES, LINGERIE, SLEEPWEAR, UNDERWEAR, SWIM WEAR, GLOVES, TIES, SCARVES, HEADSCARVES, SHAWLS, LEATHER BELTS, FABRIC BELTS, SOCKS, HOSIERY, ALL MADE IN WHOLE OR SUBSTANTIAL PART OF COTTON, HEADGEAR, NAMELY, HATS, CAPS, BEANIES, ALL MADE IN WHOLE OR SUBSTANTIAL PART OF COTTON, FOOTWEAR, ATHLETIC FOOTWEAR, BEACH FOOTWEAR, SLIPPERS, BOOTS, SANDALS, ALL MADE IN WHOLE OR SUBSTANTIAL PART OF COTTON, EYEWEAR, SUNGLASSES, ELECTRONIC, PHOTOGRAPHIC AND CINEMATOGRAPHIC EQUIPMENT AND INSTRUMENTS, CALCULATORS, CLOCK RADIOS, ELECTRONIC DISPLAY PANELS, DIGITAL PHOTO FRAMES, THERMOMETERS, SCALES AND WEIGHING APPARATUS, CASES, COVERS AND ACCESSORIES FOR DIGITAL AUDIO AND VIDEO PLAYERS, MULTIMEDIA DEVICES AND MOBILE PHONES, JEWELLERY, CUSTOM JEWELLERY, WATCHES, CLOCKS, BAGS, HANDBAGS, TOTE BAGS, TRAVEL BAGS, COSMETIC BAGS, CLUTCHES, PURSES, WALLETS, UMBRELLAS; DEPARTMENT STORE RETAILING; PROMOTION OF THE GOODS OF OTHERS ON COMMUNICATION MEDIA; RETAIL CLOTHING SHOP SERVICES, INCLUDING BUT NOT LIMITED TO COTTON CLOTHING (U.S. CLS. 100, 101 AND 102).

JOHN WILKE, EXAMINING ATTORNEY

SN 86-013,671. BROWARD COUNTY BOARD OF COUNTY COMMISSIONERS, FORT LAUDERDALE, FL. FILED S.R. 7-18-2013; AM. P.R. 9-17-2013.

## South Florida's Powerhouse Port

THE MARK CONSISTS OF STANDARD CHARACTERS WITHOUT CLAIM TO ANY PARTICULAR FONT, STYLE, SIZE, OR COLOR.

NO CLAIM IS MADE TO THE EXCLUSIVE RIGHT TO USE "SOUTH FLORIDA'S" OR "PORT", APART FROM THE MARK AS SHOWN.

### CLASS 35—ADVERTISING AND BUSINESS

FOR BUSINESS OPERATION OF PORT FACILITIES FOR OTHERS; CRUISE SHIP TERMINAL SERVICES, NAMELY, SHIP CHANDLING (U.S. CLS. 100, 101 AND 102).

FIRST USE 10-0-2012; IN COMMERCE 10-0-2012.

### CLASS 36—INSURANCE AND FINANCIAL

FOR LEASING OF OFFICE SPACE IN A FOREIGN TRADE ZONE (U.S. CLS. 100, 101 AND 102).

FIRST USE 10-0-2012; IN COMMERCE 10-0-2012.

### CLASS 37—CONSTRUCTION AND REPAIR

FOR MAINTENANCE AND REPAIR OF MARINE AND INLAND PORT FACILITIES (U.S. CLS. 100, 103 AND 106).

FIRST USE 10-0-2012; IN COMMERCE 10-0-2012.

### CLASS 39—TRANSPORTATION AND STORAGE

FOR MARINE TERMINAL SERVICES, NAMELY, CARGO HANDLING, CARGO UNLOADING, CARGO STORAGE SERVICES, SHIP PILOTING, FREIGHT SHIP TRANSPORT, LEASING OF DOCKAGE FACILITIES IN FOREIGN TRADE ZONE; CRUISE SHIP TERMINAL SERVICES, NAMELY, LOADING AND UNLOADING OF PASSENGERS AND CARGO (U.S. CLS. 100 AND 105).

FIRST USE 10-0-2012; IN COMMERCE 10-0-2012.

HANNO RITTNER, EXAMINING ATTORNEY

SN 86-013,834. THE TREADSTONE GROUP, INC., DENVER, NC. FILED 7-18-2013.

## TM SHERIFF

THE MARK CONSISTS OF STANDARD CHARACTERS WITHOUT CLAIM TO ANY PARTICULAR FONT, STYLE, SIZE, OR COLOR.

NO CLAIM IS MADE TO THE EXCLUSIVE RIGHT TO USE "TM", APART FROM THE MARK AS SHOWN.

### CLASS 35—ADVERTISING AND BUSINESS

FOR NEGOTIATION AND SETTLEMENT OF COMMERCIAL TRANSACTIONS FOR THIRD PARTIES, NAMELY, INTELLECTUAL PROPERTY ACQUISITION SERVICES IN THE NATURE OF NEGOTIATION AND ACQUISITION OF INTELLECTUAL PROPERTY AND DOMAIN NAMES ON BEHALF OF OTHERS (U.S. CLS. 100, 101 AND 102).

FIRST USE 6-15-2004; IN COMMERCE 6-15-2004.

### CLASS 45—PERSONAL AND LEGAL SERVICES

FOR INTELLECTUAL PROPERTY WATCH SERVICES, NAMELY, INVESTIGATING THE UNAUTHORIZED USE OF AN OWNER'S INTELLECTUAL PROPERTY TO MINIMIZE THE UNAUTHORIZED USE OF SUCH INTELLECTUAL PROPERTY; EXPERT WITNESS SERVICES IN LEGAL MATTERS AND LITIGATION SUPPORT SERVICES IN THE FIELD OF INTELLECTUAL PROPERTY; INTELLECTUAL PROPERTY CONSULTATION; LEGAL SUPPORT SERVICES, NAMELY, INTELLECTUAL PROPERTY DUE DILIGENCE SERVICES, NAMELY, CONDUCTING OWNERSHIP RESEARCH ON THE BUSINESSES AND INTELLECTUAL PROPERTY OF OTHERS (U.S. CLS. 100 AND 101).

FIRST USE 6-15-2004; IN COMMERCE 6-15-2004.

TRACY FLETCHER, EXAMINING ATTORNEY

SN 86-014,359. CANBY TELEPHONE ASSOCIATION, CANBY, OR. FILED 7-18-2013.

## EZVIDEO

THE MARK CONSISTS OF STANDARD CHARACTERS WITHOUT CLAIM TO ANY PARTICULAR FONT, STYLE, SIZE, OR COLOR.

### CLASS 38—COMMUNICATION

FOR INTERNET PROTOCOL TELEVISION (IPTV) TRANSMISSION SERVICES; PRIVATE INTERNET PROTOCOL (IP) BROADCASTING OF TELEVISION PROGRAMMING DISTRIBUTED VIA IP RECEIVERS SUCH AS SET-TOP-BOXES (U.S. CLS. 100, 101 AND 104).

FIRST USE 6-30-2013; IN COMMERCE 6-30-2013.

### CLASS 41—EDUCATION AND ENTERTAINMENT

FOR PROVIDING ENTERTAINMENT SERVICES IN THE NATURE OF ONGOING INTERNET PROTOCOL TELEVISION (IPTV) TELEVISION PROGRAMMING IN THE FIELDS OF NEWS, WEATHER, INDIVIDUAL AND FAMILY ENTERTAINMENT, SPORTS, PRODUCT AND SERVICE INFORMATION, PUBLIC SERVICE ANNOUNCEMENTS, TALK SHOWS, MOVIES, REALITY SHOWS, GAME SHOWS, EDUCATION, DOCUMENTARIES, DEBATES, POLITICS, SCIENCE, BUSINESS AND FINANCE (U.S. CLS. 100, 101 AND 107).

FIRST USE 6-30-2013; IN COMMERCE 6-30-2013.

BILL DAWE, EXAMINING ATTORNEY

SN 86-014,691. PARMENTER REALTY & INVESTMENT COMPANY, MIAMI, FL. FILED 7-19-2013.

# PARMENTER

THE MARK CONSISTS OF STANDARD CHARACTERS WITHOUT CLAIM TO ANY PARTICULAR FONT, STYLE, SIZE, OR COLOR.  
SEC. 2(F).

## CLASS 36—INSURANCE AND FINANCIAL

FOR FINANCIAL DUE DILIGENCE SERVICES IN THE FIELD OF REAL ESTATE; FINANCIAL INVESTMENT IN THE FIELD OF REAL ESTATE; FINANCING OF REAL ESTATE DEVELOPMENT PROJECTS; LEASE OF REAL ESTATE; LEASING OF REAL ESTATE; REAL ESTATE BROKERAGE; REAL ESTATE CONSULTANCY; REAL ESTATE CONSULTATION; REAL ESTATE FINANCING SERVICES; REAL ESTATE FUNDS INVESTMENT SERVICES; REAL ESTATE INVESTMENT SERVICES; REAL ESTATE INVESTMENT SERVICES IN THE NATURE OF PURCHASING AND SELLING OF REAL ESTATE FOR OTHERS; REAL ESTATE MANAGEMENT CONSULTATION; REAL ESTATE MANAGEMENT SERVICES; REAL ESTATE SERVICE, NAMELY, RENTAL PROPERTY MANAGEMENT (U.S. CLS. 100, 101 AND 102).

FIRST USE 10-26-1989; IN COMMERCE 10-26-1989.

## CLASS 37—CONSTRUCTION AND REPAIR

FOR REAL ESTATE DEVELOPMENT; REAL ESTATE DEVELOPMENT AND CONSTRUCTION OF COMMERCIAL, RESIDENTIAL AND HOTEL PROPERTY (U.S. CLS. 100, 103 AND 106).

FIRST USE 10-26-1989; IN COMMERCE 10-26-1989.  
CURTIS FRENCH, EXAMINING ATTORNEY

SN 86-014,697. PARMENTER REALTY & INVESTMENT COMPANY, MIAMI, FL. FILED 7-19-2013.

# PARMENTER REALTY PARTNERS

THE MARK CONSISTS OF STANDARD CHARACTERS WITHOUT CLAIM TO ANY PARTICULAR FONT, STYLE, SIZE, OR COLOR.

NO CLAIM IS MADE TO THE EXCLUSIVE RIGHT TO USE "REALTY PARTNERS", APART FROM THE MARK AS SHOWN.

SEC. 2(F) AS TO "PARMENTER".

## CLASS 36—INSURANCE AND FINANCIAL

FOR FINANCIAL DUE DILIGENCE SERVICES IN THE FIELD OF REAL ESTATE; FINANCIAL INVESTMENT IN THE FIELD OF REAL ESTATE; FINANCING OF REAL ESTATE DEVELOPMENT PROJECTS; LEASE OF REAL ESTATE; LEASING OF REAL ESTATE; REAL ESTATE BROKERAGE; REAL ESTATE CONSULTANCY; REAL ESTATE CONSULTATION; REAL ESTATE FINANCING SERVICES; REAL ESTATE FUNDS INVESTMENT SERVICES; REAL ESTATE INVESTMENT SERVICES; REAL ESTATE INVESTMENT SERVICES IN THE NATURE OF PURCHASING AND SELLING OF REAL ESTATE FOR OTHERS; REAL ESTATE MANAGEMENT CONSULTATION; REAL ESTATE MANAGEMENT SERVICES; REAL ESTATE SERVICE, NAMELY, RENTAL PROPERTY MANAGEMENT (U.S. CLS. 100, 101 AND 102).

FIRST USE 1-14-2003; IN COMMERCE 1-14-2003.

## CLASS 37—CONSTRUCTION AND REPAIR

FOR REAL ESTATE DEVELOPMENT; REAL ESTATE DEVELOPMENT AND CONSTRUCTION OF COMMERCIAL, RESIDENTIAL AND HOTEL PROPERTY (U.S. CLS. 100, 103 AND 106).

FIRST USE 1-14-2003; IN COMMERCE 1-14-2003.  
CURTIS FRENCH, EXAMINING ATTORNEY

SN 86-014,738. WELLNESS BEGINS HERE LTD., 101 SAI YEUNG CHOI ST., HONG KONG, FILED 7-19-2013.

# KENZAI

THE MARK CONSISTS OF STANDARD CHARACTERS WITHOUT CLAIM TO ANY PARTICULAR FONT, STYLE, SIZE, OR COLOR.

THE ENGLISH TRANSLATION OF THE JAPANESE WORD "KENZAI" IS "SUSTAINABLE WELLNESS"

## CLASS 9—ELECTRICAL AND SCIENTIFIC APPARATUS

FOR AUDIO AND VIDEO RECORDINGS FEATURING INFORMATION AND INSTRUCTION ON FITNESS, NUTRITION, SPORTS AND EXERCISE; DOWNLOADABLE PODCASTS IN THE FIELDS OF FITNESS, NUTRITION, SPORTS AND EXERCISE; DOWNLOADABLE VIDEO RECORDINGS FEATURING FITNESS, NUTRITION, SPORTS AND EXERCISE INSTRUCTION VIA THE INTERNET AND WIRELESS DEVICES; COMPUTER SOFTWARE THAT ALLOWS USERS TO TRACK AND UTILIZE RESULTS OF FITNESS WORKOUTS; COMPUTER APPLICATION SOFTWARE FOR MOBILE PHONE IN THE FIELDS OF FITNESS, NUTRITION, SPORTS AND EXERCISE; APPLICATION PROGRAMMING INTERFACE (API) COMPUTER SOFTWARE WHICH FACILITATES ONLINE SERVICES FOR SOCIAL NETWORKING AND FOR ALLOWING DATA RETRIEVAL, UPLOAD, DOWNLOAD, ACCESS AND MANAGEMENT; COMPUTER SOFTWARE TO ENABLE UPLOADING, DOWNLOADING, ACCESSING, POSTING, DISPLAYING, TAGGING, BLOGGING, STREAMING, LINKING, SHARING OR OTHERWISE PROVIDING ELECTRONIC MEDIA OR INFORMATION VIA COMPUTER AND COMMUNICATION NETWORKS (U.S. CLS. 21, 23, 26, 36 AND 38).



**CLASS 16—PAPER GOODS AND PRINTED MATTER**

FOR PAPER GOODS AND PRINTED MATTER, NAMELY, NEWSLETTERS, WRITTEN ARTICLES, HANDOUTS AND WORKSHEETS IN THE FIELDS OF FITNESS, NUTRITION, SPORTS AND EXERCISE; PRINTED INSTRUCTIONAL, EDUCATIONAL, AND TEACHING MATERIALS IN THE FIELDS OF FITNESS, NUTRITION, SPORTS AND EXERCISE; POSTERS (U.S. CLS. 2, 5, 22, 23, 29, 37, 38 AND 50).

**CLASS 41—EDUCATION AND ENTERTAINMENT**

FOR ENTERTAINMENT SERVICES, NAMELY, AN ON-GOING SERIES FEATURING FITNESS, NUTRITION, SPORTS AND EXERCISE PROVIDED THROUGH THE INTERNET; PROVIDING INFORMATION IN THE FIELDS OF FITNESS, SPORTS AND EXERCISE VIA A WEBSITE; ONLINE PUBLICATION OF JOURNALS IN THE FIELDS OF FITNESS, NUTRITION, SPORTS AND EXERCISE; ENTERTAINMENT SERVICES, NAMELY, PROVIDING PODCASTS IN THE FIELDS OF FITNESS, NUTRITION, SPORTS AND EXERCISE; EDUCATIONAL SERVICES, NAMELY, CONDUCTING LECTURES, SEMINARS AND WORKSHOPS IN THE FIELDS OF FITNESS, NUTRITION, SPORTS AND EXERCISE; FITNESS TRAINING; ON-LINE JOURNALS, NAMELY, BLOGS IN THE FIELDS OF FITNESS, NUTRITION, SPORTS AND EXERCISE (U.S. CLS. 100, 101 AND 107).  
KATHERINE STOIDES, EXAMINING ATTORNEY

SN 86-014,749. YE, LIAN YOU, ROSLYN, NY. FILED 7-19-2013.



NO CLAIM IS MADE TO THE EXCLUSIVE RIGHT TO USE "FOOD" AND THE NON-LATIN CHARACTERS THAT TRANSLITERATE TO "SHI PHING", APART FROM THE MARK AS SHOWN.

THE MARK CONSISTS OF A BRUSH STROKE DESIGN WHICH CONTAINS TWO LARGE CHINESE CHARACTERS THAT TRANSLITERATE TO "RI WANG" AND BENEATH THEM THERE ARE ENGLISH WORDS READING "RI WANG FOOD". IN BETWEEN THEM TO THE RIGHT, THERE IS A VERTICALLY ARRANGED RECTANGLE CONTAINING TWO SMALL CHINESE CHARACTERS TRANSLITERATING TO "SHI PHING".

THE WORDING "RI WANG" HAS NO MEANING IN A FOREIGN LANGUAGE.

THE NON-LATIN CHARACTERS IN THE MARK TRANSLITERATE TO "RI WANG" AND THIS HAS NO MEANING IN A FOREIGN LANGUAGE AND TO "SHI PHING" WHICH MEANS "FOOD" IN ENGLISH.

**CLASS 29—MEATS AND PROCESSED FOODS**

FOR FOOD, NAMELY, FISH BALLS STUFFED WITH PORK FILLINGS, PORK BALLS STUFFED WITH PORK FILLINGS OR FISH FILLINGS, BEEF BALLS STUFFED WITH PORK FILLINGS, CHICKEN BALLS STUFFED WITH PORK FILLINGS, CUTTLEFISH BALLS, FISH ROLLS STUFFED WITH FISH OR PORK FILLINGS; SHRIMP BALLS STUFFED WITH PORK FILLINGS (U.S. CL. 46).

FIRST USE 3-30-2012; IN COMMERCE 3-30-2012.

**CLASS 30—STAPLE FOODS**

FOR FROZEN DUMPLINGS MADE WITH PORK, CHICKEN, BEEF AND VEGETABLES; MINI BUNS STUFFED WITH PORK; STEAMED BUNS STUFFED WITH PORK; STEAMED BUNS STUFFED WITH CHICKEN; STEAMED DIM SUM CONSISTING PRIMARILY OF A DOUGH WRAPPER ALSO CONTAINING MEAT AND/OR SEAFOOD; WONTONS; DUMPLINGS; FISH DUMPLINGS; AND SHRIMP DUMPLINGS (U.S. CL. 46).

FIRST USE 3-30-2012; IN COMMERCE 3-30-2012.  
KATHERINE STOIDES, EXAMINING ATTORNEY

SN 86-014,814. AMERICA'S WORKFORCE MEDICAL ASSURANCE COMPANY, LLC, PASCAGOULA, MS. FILED 7-19-2013.

# AWMAC

THE MARK CONSISTS OF STANDARD CHARACTERS WITHOUT CLAIM TO ANY PARTICULAR FONT, STYLE, SIZE, OR COLOR.

**CLASS 35—ADVERTISING AND BUSINESS**

FOR PROMOTION AND MARKETING OF MEDICAL SERVICES TO EMPLOYERS THROUGH CONTRACTS WITH PREFERRED PROVIDER NETWORKS AND OTHER MEDICAL SERVICE DELIVERY FIRMS SUCH AS HEALTHCARE FACILITIES AND MEDICAL PROVIDERS (U.S. CLS. 100, 101 AND 102).

FIRST USE 1-1-2013; IN COMMERCE 1-1-2013.

**CLASS 44—MEDICAL, BEAUTY AND AGRICULTURAL SERVICES**

FOR HEALTH CARE SERVICES OFFERED THROUGH A NETWORK OF HEALTH CARE PROVIDERS ON A CONTRACT BASIS TO EMPLOYERS THROUGH CONTRACTS WITH PREFERRED PROVIDER NETWORKS AND OTHER MEDICAL SERVICE DELIVERY FIRMS SUCH AS HEALTHCARE FACILITIES AND MEDICAL PROVIDERS (U.S. CLS. 100 AND 101).

FIRST USE 1-1-2013; IN COMMERCE 1-1-2013.  
JOANNA FIORELLI, EXAMINING ATTORNEY

SN 86-014,872. RAIN BIRD CORPORATION, AZUSA, CA. FILED 7-19-2013.

# CLIMATEMINDER

THE MARK CONSISTS OF STANDARD CHARACTERS WITHOUT CLAIM TO ANY PARTICULAR FONT, STYLE, SIZE, OR COLOR.

**CLASS 9—ELECTRICAL AND SCIENTIFIC APPARATUS**

FOR COMPUTER SOFTWARE AND HARDWARE FOR CONTROLLING, MONITORING AND/OR ANALYZING IRRIGATION SYSTEMS, ENVIRONMENTAL DATA, AND GROWING CONDITIONS; WIRELESS REMOTE CONTROLS AND THEIR COMPONENTS FOR CONTROLLING, MONITORING, AND ANALYZING IRRIGATION SYSTEMS AND GROWING ENVIRONMENTS; SENSORS FOR IRRIGATION SYSTEMS; SOLAR PANELS; SOLAR BATTERIES AND BATTERY CHARGERS; WIRELESS NETWORK REPEATERS; ENVIRONMENTAL MONITORING SYSTEM COMPRISED OF COMPUTER HARDWARE, SENSORS, ELECTRONIC DATA RELAYS FOR SENSORS, ELECTRIC CONTROLLERS, TRANSMITTERS, TRANSCEIVERS, WIRELESS COMMUNICATION DEVICES BEING RADIOS, MODEMS, POWER SUPPLIES, AND SOLAR PANELS, FOR USE WITH IRRIGATION SYSTEMS AND COMPONENT OPERATING SYSTEM COMPUTER SOFTWARE THEREFOR (U.S. CLS. 21, 23, 26, 36 AND 38).

FIRST USE 0-0-2009; IN COMMERCE 3-23-2011.

**CLASS 42—SCIENTIFIC AND COMPUTER SERVICES**

FOR PROVIDING A WEBSITE FEATURING TECHNOLOGY THAT ENABLES USERS TO MONITOR, CONTROL, AND ANALYZE IRRIGATION AND IRRIGATION SYSTEMS, TO MONITOR AND ANALYZE ENVIRONMENTAL DATA AND CONDITIONS, TO PREPARE REPORTS ON IRRIGATION AND IRRIGATION SYSTEMS DATA AND/OR ENVIRONMENTAL DATA AND CONDITIONS, TO STORE AND MAINTAIN IRRIGATION AND ENVIRONMENTAL DATA; PROVIDING ONLINE, NON-DOWNLOADABLE SOFTWARE FOR MONITORING, CONTROLLING AND ANALYZING IRRIGATION AND IRRIGATION SYSTEMS AND ENVIRONMENTAL CONDITIONS AND GROWING ENVIRONMENTS, FOR MONITORING AND ANALYZING ENVIRONMENTAL DATA AND CONDITIONS, FOR GENERATING AND PROVIDING ALERTS AND NOTIFICATIONS CONCERNING IRRIGATION SYSTEMS AND ENVIRONMENTAL AND GROWING CONDITIONS, FOR PREPARING REPORTS ON IRRIGATION, IRRIGATION SYSTEMS, AND/OR ENVIRONMENTAL DATA AND CONDITIONS, FOR STORING AND MAINTAINING IRRIGATION AND ENVIRONMENTAL DATA (U.S. CLS. 100 AND 101).

FIRST USE 0-0-2009; IN COMMERCE 3-23-2011.  
COLLEEN KEARNEY, EXAMINING ATTORNEY

SN 86-015,092. SAMSUNG INFORMATION SYSTEMS AMERICA, INC., SAN JOSE, CA. FILED 7-19-2013.

**STAFF**

THE MARK CONSISTS OF STANDARD CHARACTERS WITHOUT CLAIM TO ANY PARTICULAR FONT, STYLE, SIZE, OR COLOR.

**CLASS 9—ELECTRICAL AND SCIENTIFIC APPARATUS**

FOR COMPUTER SOFTWARE FOR USE IN CREATING PERSONAL AND PROFESSIONAL LIFESTYLE PERFORMANCE ASSESSMENTS AND SKILL ENHANCEMENT PROGRAMS AND ADVICE BASED ON PRINCIPLES OF EMOTIONAL HAPPINESS BY MEANS OF THE USERS' PERSONAL PREFERENCES SOCIAL NETWORK (U.S. CLS. 21, 23, 26, 36 AND 38).

**CLASS 35—ADVERTISING AND BUSINESS**

FOR COMPUTER SERVICES, NAMELY, CONDUCTING ON-LINE PROFESSIONAL LIFESTYLE PERFORMANCE ASSESSMENTS AND ADVICE CONCERNING SUCH ASSESSMENTS, BOTH OF THE FOREGOING FOR BUSINESS PURPOSES, BASED ON PRINCIPLES OF EMOTIONAL HAPPINESS, BY MEANS OF THE USERS' INPUTTED PREFERENCES AND SOCIAL NETWORK; PROVIDING AS WEBSITE FEATURING BUSINESS INFORMATION IN THE NATURE OF COMPANY PROFILES AND DEMOGRAPHIC DATA FOR USE BY PROSPECTIVE EMPLOYEES (U.S. CLS. 100, 101 AND 102).

**CLASS 38—COMMUNICATION**

FOR ELECTRONIC BULLETIN BOARD SERVICES (U.S. CLS. 100, 101 AND 104).

**CLASS 45—PERSONAL AND LEGAL SERVICES**

FOR COMPUTER SERVICES, NAMELY, CONDUCTING ON-LINE PERSONAL LIFESTYLE PERFORMANCE ASSESSMENTS AND ADVICE CONCERNING SUCH ASSESSMENTS BASED ON PRINCIPLES OF EMOTIONAL HAPPINESS, BY MEANS OF THE USERS' INPUTTED PREFERENCES AND SOCIAL NETWORK (U.S. CLS. 100 AND 101).

SUSAN RICHARDS, EXAMINING ATTORNEY

SN 86-015,194. GERBER SCIENTIFIC INTERNATIONAL, INC., TOLLAND, CT. FILED 7-19-2013.

**PARAGON**

THE MARK CONSISTS OF STANDARD CHARACTERS WITHOUT CLAIM TO ANY PARTICULAR FONT, STYLE, SIZE, OR COLOR.  
OWNER OF U.S. REG. NOS. 2,612,417, 2,671,493 AND OTHERS.

**CLASS 7—MACHINERY**

FOR MACHINES FOR MARKING, NESTING, CUTTING, DRILLING, AND NOTCHING TEXTILES, FIBERS, AND FABRICS (U.S. CLS. 13, 19, 21, 23, 31, 34 AND 35).

**CLASS 9—ELECTRICAL AND SCIENTIFIC APPARATUS**

FOR COMPUTER SOFTWARE FOR CONTROLLING MACHINES FOR MARKING, NESTING, CUTTING, DRILLING, AND NOTCHING TEXTILES, FIBERS, AND FABRICS; COMPUTER SOFTWARE FOR CONTROLLING THE OPERATION OF NESTING USED IN THE CUTTING OF FABRICS AND OTHER MATERIALS; COMPUTER SOFTWARE FOR PATTERN DESIGN, GRADING, AND MARKING FOR USE WITH TEXTILE, FIBER, AND FABRIC CUTTING MACHINES (U.S. CLS. 21, 23, 26, 36 AND 38).

SUSAN RICHARDS, EXAMINING ATTORNEY

SN 86-015,624. DAVID SARGENT, MADISON, WI. FILED 7-20-2013.

# Sargent Arms

THE MARK CONSISTS OF STANDARD CHARACTERS WITHOUT CLAIM TO ANY PARTICULAR FONT, STYLE, SIZE, OR COLOR.

NO CLAIM IS MADE TO THE EXCLUSIVE RIGHT TO USE "ARMS" IN INTERNATIONAL CLASS 13, APART FROM THE MARK AS SHOWN.

### CLASS 13—FIREARMS

FOR FIREARMS (U.S. CLS. 2 AND 9).

### CLASS 25—CLOTHING

FOR ATHLETIC SHIRTS (U.S. CLS. 22 AND 39). AMY KERTGATE, EXAMINING ATTORNEY

SN 86-015,800. PRIVATE LABEL, NORTH MIAMI, FL. FILED 7-22-2013.

# CHEERLEADERS BAR & GRILL

THE MARK CONSISTS OF STANDARD CHARACTERS WITHOUT CLAIM TO ANY PARTICULAR FONT, STYLE, SIZE, OR COLOR.

NO CLAIM IS MADE TO THE EXCLUSIVE RIGHT TO USE "BAR & GRILL", APART FROM THE MARK AS SHOWN.

### CLASS 25—CLOTHING

FOR CLOTHING, FOR WOMEN, MEN AND CHILDREN, NAMELY, SHIRTS, LONG-SLEEVED SHIRTS, T-SHIRTS, UNDER SHIRTS, NIGHT SHIRTS, RUGBY SHIRTS, POLO SHIRTS, CARDIGANS, JERSEYS, UNIFORMS, SCRUBS NOT FOR MEDICAL PURPOSES, SMOCKS, DRESS SHIRTS, PANTS, TROUSERS, SLACKS, JEANS, CULOTTES, CARGO PANTS, STRETCH PANTS, DENIM JEANS, OVERALLS, COVERALLS, JUMPERS, JUMP SUITS, SHORTS, BOXER SHORTS, TOPS, STRETCH TOPS, TUBE TOPS, CROP TOPS, TANK TOPS, TANKINIS, HALTER TOPS, SWEAT SHIRTS, HOODED SWEAT SHIRTS, SWEAT JACKETS, SWEAT SHORTS, SWEAT PANTS, WRAPS, WARM-UP SUITS, JOGGING SUITS, TRACK SUITS, PLAY SUITS, BLOUSES, SKIRTS, DRESSES, GOWNS, SWEATERS, VESTS, FLEECE VESTS, PULLOVERS, SNOW SUITS, PARKAS, CAPES, ANORAKS, PONCHOS, CLOAKS, SHRUGS, SHAWLS, PASHMINAS, JACKETS, DINNER JACKETS, REVERSIBLE JACKETS, WIND-RESISTANT JACKETS, SHELL JACKETS, SPORTS JACKETS, GOLF AND SKI JACKETS, JEAN JACKETS, COATS, HEAVY COATS, OVER COATS, TOP COATS, PETTICOATS, BLAZERS, SUITS, TUXEDOS, CUMMERBUNDS, CUFFS, COLLARS, REMOVABLE COLLARS, COLLAR PROTECTORS, TURTLENECKS, CLOTH SKI BIBS, SWIMWEAR, BEACHWEAR, TENNIS WEAR, SURF WEAR, SKI WEAR, LAYETTES, INFANT WEAR, INFANTS SLEEPERS, BOOTIES, BABY BIBS NOT OF PAPER, CAPS, SWIM CAPS, BERETS, BEANIES, HATS, VISORS, HEADBANDS, WRIST BANDS, SWEAT BANDS, HEADWEAR, EAR MUFFS, APRONS, SCARVES, BANDANAS, BELTS, SUSPENDERS, NECKWEAR, TIES, NECKERCHIEFS, POCKET SQUARES, ASCOTS, UNDERWEAR, BRIEFS, SWIM AND BATHING TRUNKS, BRAS, SPORTS BRAS, PANTIES, THONGS, G-STRINGS, SOCKS, LOUNGEWEAR, ROBES, UNDERCLOTHES, PAJAMAS, SLEEPWEAR, NIGHT GOWNS, NIGHTIES, LINGERIE, CAMISOLES, NEGLIGEEES, CHEMISES, CHEMISETTES, SLIPS, SARONGS, LEG WARMERS, HOSIERY, PANTYHOSE, BODY STOCKINGS, KNEE HIGHS, LEGGINGS, TIGHTS, LEOTARDS, BODY SUITS, UNITARDS, BODY SHAPERS, GLOVES, MITTENS, RAIN SLICKERS, RAINWEAR, FOOTWEAR, SHOES, MULES, SNEAKERS, BOOTS, GALOSHES, SANDALS, FLIP-FLOPS, AND SLIPPERS, SPORTS WEAR, NAMELY, T-SHIRTS, SHORTS, SWEATERS, HATS, PANTS, SKIRTS, JACKETS, SNEAKERS, SPORTS BRAS (U.S. CLS. 22 AND 39). FIRST USE 4-6-2010; IN COMMERCE 7-26-2012.

### CLASS 43—HOTEL AND RESTAURANT SERVICES

FOR RESTAURANT AND BAR SERVICES; FOOD CATERING; AND CARRY OUT RESTAURANT SERVICES (U.S. CLS. 100 AND 101).

FIRST USE 4-6-2010; IN COMMERCE 7-26-2012. STEVEN JACKSON, EXAMINING ATTORNEY

SN 86-016,373. AFINIA LLC, CHANHASSEN, MN. FILED 7-22-2013.

# AFINIA

THE MARK CONSISTS OF STANDARD CHARACTERS WITHOUT CLAIM TO ANY PARTICULAR FONT, STYLE, SIZE, OR COLOR.

### CLASS 2—PAINTS

FOR FILLED INK CARTRIDGES FOR PRINTERS (U.S. CLS. 6, 11 AND 16). FIRST USE 4-30-2013; IN COMMERCE 4-30-2013.

**CLASS 9—ELECTRICAL AND SCIENTIFIC APPARATUS**

FOR THREE-DIMENSIONAL (3D) PRINTERS, AND COMPUTER SOFTWARE FOR OPERATING THE 3D PRINTERS (U.S. CLS. 21, 23, 26, 36 AND 38).  
FIRST USE 6-30-2012; IN COMMERCE 6-30-2012.

**CLASS 16—PAPER GOODS AND PRINTED MATTER**

FOR LABEL PRINTING MACHINES (U.S. CLS. 2, 5, 22, 23, 29, 37, 38 AND 50).  
FIRST USE 4-30-2013; IN COMMERCE 4-30-2013.

**CLASS 17—RUBBER GOODS**

FOR PLASTIC FILAMENTS FOR USE IN 3D PRINTING, NAMELY, PLASTIC IN THE FORM OF FILAMENTS FOR FURTHER MANUFACTURE USING THREE DIMENSIONAL PRINTERS (U.S. CLS. 1, 5, 12, 13, 35 AND 50).  
FIRST USE 7-22-2013; IN COMMERCE 7-22-2013.  
TEJBIR SINGH, EXAMINING ATTORNEY

SN 86-017,783. CHICAGO STOOL & CHAIR INC., DBA EHEMCO, ELGIN, IL. FILED 7-23-2013.



THE MARK CONSISTS OF THE LITERAL ELEMENT "EHEMCO" POSITIONED IN THE MIDDLE OF A HORIZONTAL OVAL WITH SHADED TOP AND BOTTOM BORDERS AND CLIPPED SIDES.

**CLASS 20—FURNITURE AND ARTICLES NOT OTHERWISE CLASSIFIED**

FOR SHELVES, STORAGE RACKS, TABLE AND CHAIRS SOLD AS SETS, SIDE TABLES, NON-METAL STEP STOOLS, BREAD BOXES, LAZY SUSANS, STOOLS AND CHAIRS, ACCENT FURNITURE (U.S. CLS. 2, 13, 22, 25, 32 AND 50).

**CLASS 35—ADVERTISING AND BUSINESS**

FOR ONLINE RETAIL STORE SERVICES FEATURING FURNITURE (U.S. CLS. 100, 101 AND 102).  
JENNIFER MARTIN, EXAMINING ATTORNEY

SN 86-018,546. D:FLOURED LLC, DBA NUFLOURS LLC, SEATTLE, WA. FILED 7-24-2013.

**NUFLOURS**

THE MARK CONSISTS OF STANDARD CHARACTERS WITHOUT CLAIM TO ANY PARTICULAR FONT, STYLE, SIZE, OR COLOR.

**CLASS 30—STAPLE FOODS**

FOR PIES; ROLLS; BREAD; TARTS; GRAIN-BASED FOOD BARS ALSO CONTAINING FRUIT; CAKES; PASTRIES; PASTRIES WITH FRUIT; TEA CAKES; COOKIES (U.S. CL. 46).  
FIRST USE 7-23-2013; IN COMMERCE 7-23-2013.

**CLASS 35—ADVERTISING AND BUSINESS**

FOR RETAIL BAKERY SHOPS (U.S. CLS. 100, 101 AND 102).  
FIRST USE 7-23-2013; IN COMMERCE 7-23-2013.  
JOHN GARTNER, EXAMINING ATTORNEY

SN 86-018,946. THE EDUCATION CENTER, LLC, GREENSBORO, NC. FILED 7-24-2013.



OWNER OF U.S. REG. NOS. 1,954,722 AND 2,099,569.  
THE MARK CONSISTS OF A DRAWING OF A MAILBOX ATOP GRASS.

**CLASS 16—PAPER GOODS AND PRINTED MATTER**

FOR PRINTED INSTRUCTIONAL AND EDUCATIONAL MATERIALS FEATURING TEACHING IDEAS, LITERATURE-BASED ACTIVITIES, ART ACTIVITIES, GAMES, MANIPULATIVES, BULLETIN BOARD SUGGESTIONS, ACTIVITY CARDS, TEACHER RESOURCE BOOKS AND REPRODUCIBLES (U.S. CLS. 2, 5, 22, 23, 29, 37, 38 AND 50).

**CLASS 41—EDUCATION AND ENTERTAINMENT**

FOR PROVIDING ONLINE EDUCATIONAL INFORMATION IN THE FIELD OF EARLY CHILDHOOD EDUCATION; PROVIDING ONLINE PUBLICATIONS IN THE NATURE OF EDUCATION RESOURCE MATERIALS FOR USE IN TEACHING, NAMELY, LITERATURE BASED ACTIVITIES, ART ACTIVITIES, GAMES, MANIPULATIVES, BULLETIN BOARD SUGGESTIONS, ACTIVITY CARDS, TEACHER RESOURCE BOOKS (U.S. CLS. 100, 101 AND 107).

**CLASS 42—SCIENTIFIC AND COMPUTER SERVICES**

FOR COMPUTER SERVICES, NAMELY, HOSTING AN INTERACTIVE WEBSITE THAT ALLOWS USER TO ACCESS EDUCATIONAL RESOURCE MATERIALS FOR USE IN TEACHING, NAMELY, LITERATURE BASED ACTIVITIES, ART ACTIVITIES, GAMES, MANIPULATIVES, BULLETIN BOARD SUGGESTIONS, ACTIVITY CARDS, TEACHER RESOURCE BOOKS (U.S. CLS. 100 AND 101).  
LINDA ORNDORFF, EXAMINING ATTORNEY

SN 86-018,975. SACRAMENTO DESIGN NETWORK, INC., FOLSOM, CA. FILED 7-24-2013.



NO CLAIM IS MADE TO THE EXCLUSIVE RIGHT TO USE "WINERY WEB DESIGN", APART FROM THE MARK AS SHOWN.

THE MARK CONSISTS OF A WINE GLASS WITH AN OPEN RIM, CURVED STEM AND NO BASE; THE WINE WITHIN THE WINE GLASS CONTAINS SYMBOLS TO REPRESENT A COMPUTER MOUSE WITH LEFT AND RIGHT CLICK BUTTONS AND A CENTERED SCROLL WHEEL; A SYMBOL OF POURING WINE IS LOCATED ABOVE THE BUTTON ON THE LEFT AND A SYMBOL OF A WAVE WITH TWO SPLASHES IS LOCATED ABOVE THE BUTTON ON THE RIGHT; INCLUDED WITH THE LOGO ARE THE WORDS "WINERY", WHICH IS IN A CURSIVE FONT AND THE WORDS, "WEB DESIGN", WHICH ARE IN A STYLIZED FONT.

**CLASS 35—ADVERTISING AND BUSINESS**

FOR ADVERTISING AND MARKETING SERVICES PROVIDED BY MEANS OF INDIRECT METHODS OF MARKETING COMMUNICATIONS, NAMELY, SOCIAL MEDIA, SEARCH ENGINE MARKETING, INQUIRY MARKETING, INTERNET MARKETING, MOBILE MARKETING, BLOGGING AND OTHER FORMS OF PASSIVE, SHARABLE OR VIRAL COMMUNICATIONS CHANNELS (U.S. CLS. 100, 101 AND 102).

**CLASS 42—SCIENTIFIC AND COMPUTER SERVICES**

FOR COMPUTER SERVICES, NAMELY, DESIGNING AND IMPLEMENTING WEB SITES FOR OTHERS; COMPUTER SERVICES, NAMELY, SEARCH ENGINE OPTIMIZATION (U.S. CLS. 100 AND 101).  
CURTIS FRENCH, EXAMINING ATTORNEY

SN 86-019,183. DELAVENTE INTERNATIONAL LIMITED, HONG KONG, CHINA. FILED 7-24-2013.



THE MARK CONSISTS OF THE STYLIZED WORDS "CERRO QREEN".  
THE ENGLISH TRANSLATION OF THE WORD "CERRO" IN THE MARK IS "HILL".

**CLASS 3—COSMETICS AND CLEANING PREPARATIONS**

FOR PERFUMERY; ESSENTIAL OILS; COSMETICS; HAIR LOTIONS; SOAPS; MAKE-UP REMOVING PREPARATIONS; LIPSTICKS; BEAUTY MASKS; MAKE-UP; POWDER FOR MAKE-UP; MAKE-UP FOR THE FACE, FOR THE EYES, FOR THE SKIN; MASCARA; EYEBROW PENCILS; EYELID SHADOW; COMPACTS CONTAINING MAKE-UP (U.S. CLS. 1, 4, 6, 50, 51 AND 52).

**CLASS 18—LEATHER GOODS**

FOR TRUNKS IN THE NATURE OF LUGGAGE; LUGGAGE; BAGS FOR MAKE-UP, SOLD EMPTY; VANITY CASES, NOT FITTED; COSMETIC PURSES SOLD EMPTY (U.S. CLS. 1, 2, 3, 22 AND 41).

**CLASS 21—HOUSEWARES AND GLASS**

FOR TOILET SPONGES; TOILETRY SPONGES; HAIR BRUSHES; COSMETIC BRUSHES; APPLICATOR STICKS FOR APPLYING MAKE-UP; SMALL TOILET UTENSILS, NAMELY, TOOTH BRUSHES, TOILET PAPER HOLDERS; COSMETIC BRUSHES; COSMETIC UTENSILS, NAMELY, EYEBROW BRUSH, POWDER PUFF; MAKE-UP BRUSHES; LIP BRUSHES (U.S. CLS. 2, 13, 23, 29, 30, 33, 40 AND 50).  
NATALIE KENEALY, EXAMINING ATTORNEY

SN 86-019,399. PICMIX LLC, LEWES, DE. FILED 7-25-2013.



THE COLOR(S) CYAN, WHITE, BLACK, PURPLE AND GREY IS/ARE CLAIMED AS A FEATURE OF THE MARK.  
THE MARK CONSISTS OF A SQUARE WITH ROUNDED CORNERS PRESENTED AS A CAMERA WITH LIGHT GREY AND WHITE STRIPED BACKGROUND ON THE TOP AND MIDDLE SECTIONS OF THE SQUARE AND DARK GREY AND BLACK WITH WHITE HIGHLIGHTS ON THE BOTTOM OF THE SQUARE. A SMALL GREY SQUARE WINDOW WITH PURPLE, GREY AND BLACK CONCENTRIC CIRCLES APPEARS IN THE TOP RIGHT CORNER SYMBOLIZING THE CAMERA FLASH. A STYLIZED "P" APPEARS IN THE CENTER OF THE CAMERA DESIGN REPRESENTING THE CAMERA LENS. THE "P" IS CYAN WITH WHITE HIGHLIGHTS AND CONCENTRIC CIRCLES IN THE COLORS WHITE, GREY, CYAN, PURPLE AND BLACK WITH WHITE HIGHLIGHTS. THE WORDING "PICMIX" APPEARS AT THE BOTTOM RIGHT SIDE OF THE MARK IN LIGHT GREY WITH WHITE HIGHLIGHTS.

**CLASS 9—ELECTRICAL AND SCIENTIFIC APPARATUS**

FOR DIGITAL PHOTO FRAMES FOR DISPLAYING UPLOADED PICTURES FOR SOCIAL PHOTO SHARING; DOWNLOADABLE MOBILE APPLICATIONS FOR SOCIAL PHOTO SHARING WHICH ALLOWS USERS TO SELECT FRAMES ONLINE, UPLOAD PHOTOS, CREATE PHOTO COMBINATIONS ON SELECT FRAMES AND ADD TEXT CAPTIONS (U.S. CLS. 21, 23, 26, 36 AND 38).  
FIRST USE 3-0-2012; IN COMMERCE 3-0-2012.

**CLASS 45—PERSONAL AND LEGAL SERVICES**

FOR ONLINE SOCIAL NETWORKING SERVICES IN THE FIELD OF PHOTO SHARING, PHOTO MIXING SERVICES AND ADDING TEXT CAPTIONS TO PHOTOS AND/OR FRAMES (U.S. CLS. 100 AND 101).  
FIRST USE 3-0-2012; IN COMMERCE 3-0-2012.  
TAMARA FRAZIER, EXAMINING ATTORNEY

---

SN 86-019,981. MESO SCALE DIAGNOSTICS, LLC, ROCKVILLE, MD. FILED 7-25-2013.



THE MARK CONSISTS OF A STYLIZED CAPITAL LETTER "U" EMBEDDED IN A CIRCLE, WITH A HYPHEN NEXT TO IT AND THE WORD "PLEX" IN CAPITAL LETTERS.

**CLASS 1—CHEMICALS**

FOR BIOLOGICAL ASSAYS AND KITS, NAMELY, SELF-ASSEMBLED ARRAYS FOR SIMULTANEOUS, MULTIPLE DETECTION OF BIOLOGICAL ANALYTES AND FOR USE IN THE FIELDS OF BIOLOGICAL AND DIAGNOSTIC TESTING FOR INDUSTRIAL, SCIENTIFIC AND/OR RESEARCH USE (U.S. CLS. 1, 5, 6, 10, 26 AND 46).

**CLASS 5—PHARMACEUTICALS**

FOR BIOLOGICAL ASSAYS AND KITS, NAMELY, SELF-ASSEMBLED ARRAYS FOR SIMULTANEOUS, MULTIPLE DETECTION OF BIOLOGICAL ANALYTES AND FOR USE IN THE FIELDS OF BIOLOGICAL AND DIAGNOSTIC TESTING FOR MEDICAL AND/OR VETERINARY USE (U.S. CLS. 6, 18, 44, 46, 51 AND 52).

**CLASS 9—ELECTRICAL AND SCIENTIFIC APPARATUS**

FOR MULTI-WELL PLATES THAT CAN BE USED IN CHEMICAL OR BIOLOGICAL ANALYSIS USING ELECTROCHEMILUMINESCENCE FOR SCIENTIFIC, LABORATORY OR MEDICAL RESEARCH USE (U.S. CLS. 21, 23, 26, 36 AND 38).  
APRIL ROACH, EXAMINING ATTORNEY

SN 86-020,007. MESO SCALE DIAGNOSTICS, LLC, ROCKVILLE, MD. FILED 7-25-2013.



THE MARK CONSISTS OF A STYLIZED CAPITAL LETTER "V" EMBEDDED IN A CIRCLE, WITH A HYPHEN NEXT TO IT AND THE WORD "PLEX" IN CAPITAL LETTERS.

**CLASS 1—CHEMICALS**

FOR BIOLOGICAL ASSAYS AND KITS, NAMELY, SELF-ASSEMBLED ARRAYS FOR SIMULTANEOUS, MULTIPLE DETECTION OF BIOLOGICAL ANALYTES AND FOR USE IN THE FIELDS OF BIOLOGICAL AND DIAGNOSTIC TESTING FOR INDUSTRIAL, SCIENTIFIC AND/OR RESEARCH USE (U.S. CLS. 1, 5, 6, 10, 26 AND 46).

**CLASS 5—PHARMACEUTICALS**

FOR BIOLOGICAL ASSAYS AND KITS, NAMELY, SELF-ASSEMBLED ARRAYS FOR SIMULTANEOUS, MULTIPLE DETECTION OF BIOLOGICAL ANALYTES AND FOR USE IN THE FIELDS OF BIOLOGICAL AND DIAGNOSTIC TESTING FOR MEDICAL AND/OR VETERINARY USE (U.S. CLS. 6, 18, 44, 46, 51 AND 52).

**CLASS 9—ELECTRICAL AND SCIENTIFIC APPARATUS**

FOR MULTI-WELL PLATES THAT CAN BE USED IN CHEMICAL OR BIOLOGICAL ANALYSIS USING ELECTROCHEMILUMINESCENCE FOR SCIENTIFIC, LABORATORY OR MEDICAL RESEARCH USE (U.S. CLS. 21, 23, 26, 36 AND 38).  
APRIL ROACH, EXAMINING ATTORNEY

---

SN 86-020,141. TETZCHNER, JON S. VON, GLOUCESTER, MA. FILED 7-25-2013.

THE MARK CONSISTS OF STANDARD CHARACTERS WITHOUT CLAIM TO ANY PARTICULAR FONT, STYLE, SIZE, OR COLOR.

**CLASS 9—ELECTRICAL AND SCIENTIFIC APPARATUS**

FOR COMPUTER OPERATING SOFTWARE, COMPUTER BROWSING SOFTWARE, NAMELY, SOFTWARE FOR BROWSING THE GLOBAL COMPUTER NETWORK AND PRIVATE NETWORKS, COMPUTER SEARCH ENGINE SOFTWARE, COMPUTER SOFTWARE FOR PROVIDING ACCESS TO THE INTERNET, COMPUTER HARDWARE, COMPUTERS, DESKTOP COMPUTERS, LAPTOP COMPUTERS, TABLET COMPUTERS, MOBILE PHONES, HAND HELD PERSONAL DIGITAL ASSISTANTS(PDAS); HAND HELD PERSONAL COMPUTERS (U.S. CLS. 21, 23, 26, 36 AND 38).

**CLASS 42—SCIENTIFIC AND COMPUTER SERVICES**

FOR COMPUTER SERVICES, NAMELY, CREATING ON-LINE VIRTUAL COMMUNITIES FOR REGISTERED USERS TO ORGANIZE GROUPS AND EVENTS, PARTICIPATE IN DISCUSSIONS, AND ENGAGE IN SOCIAL, BUSINESS AND COMMUNITY NETWORKING; COMPUTER SERVICES, NAMELY, HOSTING ELECTRONIC FACILITIES FOR OTHERS FOR ORGANIZING AND CONDUCTING MEETINGS, EVENTS AND INTERACTIVE DISCUSSIONS VIA COMMUNICATION NETWORKS; APPLICATION SERVICE PROVIDER (ASP) SERVICES, NAMELY, HOSTING COMPUTER SOFTWARE APPLICATIONS OF OTHERS; APPLICATION SERVICE PROVIDER (ASP) FEATURING SOFTWARE THAT ENABLES USERS TO SHARE CALENDARS IN ORDER TO ALLOW MULTIPLE PARTICIPANTS TO SHARE EVENT SCHEDULES FOR SOCIAL NETWORKING PURPOSES AND FOR USE IN COMPRESSION OF DATA FILES; TECHNICAL SUPPORT SERVICES, NAMELY, TROUBLESHOOTING IN THE NATURE OF DIAGNOSING COMPUTER HARDWARE AND SOFTWARE PROBLEMS AND REPAIR OF SOFTWARE PROBLEMS; COMPUTER SERVICES, NAMELY, CREATING COMPUTER NETWORK BASED INDICES OF INFORMATION, SITES AND OTHER RESOURCES AVAILABLE ON COMPUTER NETWORKS; PROVIDING TEMPORARY USE OF NON-DOWNLOADABLE SOFTWARE APPLICATIONS FOR CREATING A VIRTUAL COMMUNITY AND FOR TRANSMISSION OF AUDIO, VIDEO, PHOTOGRAPHIC IMAGES, TEXT, GRAPHICS AND DATA FOR SOCIAL NETWORKING PURPOSES; APPLICATION SERVICE PROVIDER (ASP) FEATURING ELECTRONIC MAIL SOFTWARE; COMPUTER SERVICES IN THE NATURE OF CUSTOMIZED WEB PAGES FEATURING USER-DEFINED OR SPECIFIED INFORMATION, PERSONAL PROFILES, AUDIO, VIDEO, PHOTOGRAPHIC IMAGES, TEXT, GRAPHICS AND DATA (U.S. CLS. 100 AND 101).

KELLEY WELLS, EXAMINING ATTORNEY

SN 86-020,728. HEXIS CYBER SOLUTIONS, INC., HANOVER, MD. FILED 7-26-2013.

**HEXIS CYBER SOLUTIONS**

THE MARK CONSISTS OF STANDARD CHARACTERS WITHOUT CLAIM TO ANY PARTICULAR FONT, STYLE, SIZE, OR COLOR.

NO CLAIM IS MADE TO THE EXCLUSIVE RIGHT TO USE "CYBER SOLUTIONS", APART FROM THE MARK AS SHOWN.

**CLASS 9—ELECTRICAL AND SCIENTIFIC APPARATUS**

FOR COMPUTER SOFTWARE AND COMPUTER HARDWARE FOR TESTING AND EVALUATING COMPUTERS, COMPUTER NETWORKS AND INFORMATION TECHNOLOGY SYSTEMS FOR SECURITY VULNERABILITY AND RISK RELATING TO HACKING, CYBER-ATTACKS, COMPUTER CRIMES AND COMPUTER VIRUSES; COMPUTER SOFTWARE AND COMPUTER HARDWARE FOR CYBER-SECURITY, CYBER-DEFENSE, INFORMATION SECURITY AND ASSURANCE, DATA SECURITY, COMPUTER SECURITY, NETWORK SECURITY AND PREVENTION OF HACKING, CYBER-ATTACKS, COMPUTER CRIMES AND COMPUTER VIRUSES; COMPUTER SOFTWARE AND COMPUTER HARDWARE FOR MONITORING, DETECTING, INSPECTING, PROCESSING, ANALYZING, MITIGATING AND REMEDIATING COMPUTERS, COMPUTER NETWORKS AND INFORMATION TECHNOLOGY SYSTEMS FOR HACKING, CYBER-ATTACKS, COMPUTER CRIMES AND COMPUTER VIRUSES; COMPUTER SOFTWARE AND COMPUTER HARDWARE FOR RISK MITIGATION AND REMEDIATION, INTEGRITY AND THREAT ANALYSIS, CYBER EVENT DATA ANALYSIS, DIGITAL DATA INTELLIGENCE GATHERING AND ANALYSIS AND DISPATCH OF SECURITY COUNTERMEASURES RELATING TO HACKING, CYBER-ATTACKS, COMPUTER CRIMES AND COMPUTER VIRUSES; COMPUTER SOFTWARE AND COMPUTER HARDWARE FOR DATA WAREHOUSING, DATA ANALYSIS, THREAT DETECTION, MEASUREMENT AND EVALUATION OF SECURITY PROCESS EFFECTIVENESS AND SECURITY MANAGEMENT CONTROLS RELATING TO COMPUTER SECURITY, NETWORK SECURITY AND INFORMATION TECHNOLOGY SYSTEMS SECURITY; COMPUTER SOFTWARE FOR SECURITY INFORMATION AND EVENT MANAGEMENT AND DEFENSE AGAINST HACKING, CYBER-ATTACKS, COMPUTER CRIMES AND COMPUTER VIRUSES, NAMELY, MONITORING COMPUTER, NETWORK AND INFORMATION TECHNOLOGY SYSTEM ACTIVITY AND IDENTIFYING, INVESTIGATING AND RESPONDING TO INFORMATION SECURITY THREATS; COMPUTER PROGRAMS FOR COLLECTING, STORING AND MANAGING NETWORK/ENTERPRISE LOG RECORDS AND CALL DETAIL RECORD RETENTION AND RETRIEVAL RELATING TO COMPUTER AND NETWORK SECURITY (U.S. CLS. 21, 23, 26, 36 AND 38).

SN 86-020,541. TOBIN, J MARK, GREENWOOD VILLAGE, CO. FILED 7-26-2013.

**ENERGEN LODGING**

THE MARK CONSISTS OF STANDARD CHARACTERS WITHOUT CLAIM TO ANY PARTICULAR FONT, STYLE, SIZE, OR COLOR.

NO CLAIM IS MADE TO THE EXCLUSIVE RIGHT TO USE "LODGING", APART FROM THE MARK AS SHOWN.

**CLASS 37—CONSTRUCTION AND REPAIR**

FOR REAL ESTATE DEVELOPMENT AND CONSTRUCTION OF COMMERCIAL, RESIDENTIAL AND HOTEL PROPERTY (U.S. CLS. 100, 103 AND 106).

**CLASS 43—HOTEL AND RESTAURANT SERVICES**

FOR RESORT LODGING SERVICES; HOTEL SERVICES (U.S. CLS. 100 AND 101).

SUSAN RICHARDS, EXAMINING ATTORNEY

**CLASS 42—SCIENTIFIC AND COMPUTER SERVICES**

FOR COMPUTER SECURITY CONSULTANCY IN THE FIELD OF SCANNING AND PENETRATION TESTING OF COMPUTERS AND NETWORKS TO ASSESS INFORMATION SECURITY VULNERABILITY; UPDATING AND MAINTAINING COMPUTER SOFTWARE RELATING TO COMPUTER SECURITY, NETWORK SECURITY, INFORMATION TECHNOLOGY SECURITY AND DATA SECURITY, AND PREVENTION OF COMPUTER RISKS, INCLUDING HACKING, CYBER-ATTACKS, COMPUTER CRIMES AND COMPUTER VIRUSES; CONSULTATION IN THE FIELDS OF COMPUTER SECURITY, NETWORK SECURITY, INFORMATION TECHNOLOGY SECURITY AND DATA SECURITY; AND PROVIDING INFORMATION IN THE FIELD OF COMPUTER SECURITY, NETWORK SECURITY, INFORMATION TECHNOLOGY SECURITY AND DATA SECURITY; DESIGN AND DEVELOPMENT OF COMPUTER SOFTWARE (U.S. CLS. 100 AND 101).

**CLASS 45—PERSONAL AND LEGAL SERVICES**

FOR MONITORING OF COMPUTER SYSTEMS AND NETWORKS FOR SECURITY PURPOSES (U.S. CLS. 100 AND 101).

BARBARA GAYNOR, EXAMINING ATTORNEY

**CLASS 9—ELECTRICAL AND SCIENTIFIC APPARATUS**

FOR COMPUTER SOFTWARE AND COMPUTER HARDWARE FOR TESTING AND EVALUATING COMPUTERS, COMPUTER NETWORKS AND INFORMATION TECHNOLOGY SYSTEMS FOR SECURITY VULNERABILITY AND RISK RELATING TO HACKING, CYBER-ATTACKS, COMPUTER CRIMES AND COMPUTER VIRUSES; COMPUTER SOFTWARE AND COMPUTER HARDWARE FOR CYBER-SECURITY, CYBER-DEFENSE, INFORMATION SECURITY AND ASSURANCE, DATA SECURITY, COMPUTER SECURITY, NETWORK SECURITY AND PREVENTION OF HACKING, CYBER-ATTACKS, COMPUTER CRIMES AND COMPUTER VIRUSES; COMPUTER SOFTWARE AND COMPUTER HARDWARE FOR MONITORING, DETECTING, INSPECTING, PROCESSING, ANALYZING, MITIGATING AND REMEDIATING COMPUTERS, COMPUTER NETWORKS AND INFORMATION TECHNOLOGY SYSTEMS FOR HACKING, CYBER-ATTACKS, COMPUTER CRIMES AND COMPUTER VIRUSES; COMPUTER SOFTWARE AND COMPUTER HARDWARE FOR RISK MITIGATION AND REMEDIATION, INTEGRITY AND THREAT ANALYSIS, CYBER EVENT DATA ANALYSIS, DIGITAL DATA INTELLIGENCE GATHERING AND ANALYSIS AND DISPATCH OF SECURITY COUNTERMEASURES RELATING TO HACKING, CYBER-ATTACKS, COMPUTER CRIMES AND COMPUTER VIRUSES; COMPUTER SOFTWARE AND COMPUTER HARDWARE FOR DATA WAREHOUSING, DATA ANALYSIS, THREAT DETECTION, MEASUREMENT AND EVALUATION OF SECURITY PROCESS EFFECTIVENESS AND SECURITY MANAGEMENT CONTROLS RELATING TO COMPUTER SECURITY, NETWORK SECURITY AND INFORMATION TECHNOLOGY SYSTEMS SECURITY; COMPUTER SOFTWARE FOR SECURITY INFORMATION AND EVENT MANAGEMENT AND DEFENSE AGAINST HACKING, CYBER-ATTACKS, COMPUTER CRIMES AND COMPUTER VIRUSES, NAMELY, MONITORING COMPUTER, NETWORK AND INFORMATION TECHNOLOGY SYSTEM ACTIVITY AND IDENTIFYING, INVESTIGATING AND RESPONDING TO INFORMATION SECURITY THREATS; COMPUTER PROGRAMS FOR COLLECTING, STORING AND MANAGING NETWORK/ENTERPRISE LOG RECORDS AND CALL DETAIL RECORD RETENTION AND RETRIEVAL RELATING TO COMPUTER AND NETWORK SECURITY (U.S. CLS. 21, 23, 26, 36 AND 38).

SN 86-020,743. HEXIS CYBER SOLUTIONS, INC., HANOVER, MD. FILED 7-26-2013.



NO CLAIM IS MADE TO THE EXCLUSIVE RIGHT TO USE "CYBER SOLUTIONS", APART FROM THE MARK AS SHOWN.

THE MARK CONSISTS OF THE WORD "HEXIS" IN STYLIZED LETTERS, BELOW WHICH ARE THE WORDS "CYBER SOLUTIONS" IN STYLIZED LETTERING, AND TO THE LEFT OF THE WORDS IS A DESIGN OF A SMALLER THREE DIMENSIONAL CUBE WITHIN A LARGER THREE DIMENSIONAL CUBE.

**CLASS 42—SCIENTIFIC AND COMPUTER SERVICES**

FOR COMPUTER SECURITY CONSULTANCY IN THE FIELD OF SCANNING AND PENETRATION TESTING OF COMPUTERS AND NETWORKS TO ASSESS INFORMATION SECURITY VULNERABILITY; UPDATING AND MAINTAINING COMPUTER SOFTWARE RELATING TO COMPUTER SECURITY, NETWORK SECURITY, INFORMATION TECHNOLOGY SECURITY AND DATA SECURITY, AND PREVENTION OF COMPUTER RISKS, INCLUDING HACKING, CYBER-ATTACKS, COMPUTER CRIMES AND COMPUTER VIRUSES; CONSULTATION IN THE FIELDS OF COMPUTER SECURITY, NETWORK SECURITY, INFORMATION TECHNOLOGY SECURITY AND DATA SECURITY; AND PROVIDING INFORMATION IN THE FIELD OF COMPUTER SECURITY, NETWORK SECURITY, INFORMATION TECHNOLOGY SECURITY AND DATA SECURITY; DESIGN AND DEVELOPMENT OF COMPUTER SOFTWARE (U.S. CLS. 100 AND 101).

**CLASS 45—PERSONAL AND LEGAL SERVICES**

FOR MONITORING OF COMPUTER SYSTEMS AND NETWORKS FOR SECURITY PURPOSES (U.S. CLS. 100 AND 101).

BARBARA GAYNOR, EXAMINING ATTORNEY



SN 86-021,038. NIMLOK COMPANY, NILES, IL. FILED 7-26-2013.

n·spire

THE MARK CONSISTS OF STANDARD CHARACTERS WITHOUT CLAIM TO ANY PARTICULAR FONT, STYLE, SIZE, OR COLOR.

#### CLASS 35—ADVERTISING AND BUSINESS

FOR CONSULTATION SERVICES, NAMELY, CREATIVE AND STRATEGIC CONSULTATION REGARDING DEVELOPMENT AND PRODUCTION OF MARKETING CAMPAIGNS FOR OTHERS; CREATIVE MARKETING DESIGN SERVICES; DESIGN OF ADVERTISING MATERIALS FOR OTHERS; PREPARATION OF CUSTOMIZED PROMOTIONAL AND MERCHANDISING MATERIALS FOR OTHERS; SPECIAL EVENT PLANNING FOR BUSINESS PURPOSES; ORGANIZING AND CONDUCTING BUSINESS CONFERENCES (U.S. CLS. 100, 101 AND 102).

#### CLASS 42—SCIENTIFIC AND COMPUTER SERVICES

FOR CUSTOM DESIGN AND DEVELOPMENT OF TRADE SHOW DISPLAYS, TRADE SHOW BOOTHS, RETAIL DISPLAYS, EVENT BOOTHS AND DISPLAYS AND CONFERENCE BOOTHS AND DISPLAYS.; WEBSITE DESIGN AND DEVELOPMENT FOR OTHERS; WEBSITE DESIGN CONSULTANCY (U.S. CLS. 100 AND 101).

JENNIFER WILLISTON, EXAMINING ATTORNEY

SN 86-021,207. TIMELESS VETERINARY SYSTEMS INC., CHARLOTTETOWN, PEI, CANADA, FILED 7-26-2013.

TIMELESS VET DRUG INDEX

THE MARK CONSISTS OF STANDARD CHARACTERS WITHOUT CLAIM TO ANY PARTICULAR FONT, STYLE, SIZE, OR COLOR.

NO CLAIM IS MADE TO THE EXCLUSIVE RIGHT TO USE "VET DRUG INDEX", APART FROM THE MARK AS SHOWN.

#### CLASS 9—ELECTRICAL AND SCIENTIFIC APPARATUS

FOR VETERINARY DRUG FORMULARY SOFTWARE APPLICATION FOR COMPUTERS, TABLETS AND SMARTPHONES, NAMELY, SOFTWARE FOR USE IN PROVIDING DRUG INFORMATION, DRUG FORMULAS, USES AND METHODS OF PREPARATION (U.S. CLS. 21, 23, 26, 36 AND 38).

FIRST USE 7-19-2013; IN COMMERCE 7-19-2013.

#### CLASS 42—SCIENTIFIC AND COMPUTER SERVICES

FOR PROVIDING TEMPORARY USE OF NON-DOWNLOADABLE VETERINARY DRUG FORMULARY SOFTWARE FOR PROVIDING DRUG INFORMATION, DRUG FORMULAS, USES AND METHODS OF PREPARATION AND PROVIDING TEMPORARY USE OF NON-DOWNLOADABLE WEB BASED APPLICATIONS FOR PROVIDING DRUG INFORMATION, DRUG FORMULAS, USES AND METHODS OF PREPARATION (U.S. CLS. 100 AND 101).

FIRST USE 7-19-2013; IN COMMERCE 7-19-2013.  
KAMAL PREET, EXAMINING ATTORNEY

SN 86-021,262. TIMELESS VETERINARY SYSTEMS INC., CHARLOTTETOWN, PEI, CANADA, FILED 7-26-2013.



NO CLAIM IS MADE TO THE EXCLUSIVE RIGHT TO USE "RX" AND "VET DRUG INDEX", APART FROM THE MARK AS SHOWN.

THE COLOR(S) GREEN, BLACK AND WHITE IS/ARE CLAIMED AS A FEATURE OF THE MARK.

THE MARK CONSISTS OF THE WORDING "TIMELESS VET DRUG INDEX" IN BLACK ALL CAPITAL LETTERS, WITH THE WORD "TIMELESS" IN LARGER LETTERS AND APPEARING ABOVE THE WORDING "VET DRUG INDEX", WITH ALL OF THESE WORDS APPEARING TO THE RIGHT OF A GREEN RECTANGLE, THE LEFT UPPER CORNER OF WHICH IS ROUNDED, CONTAINING THE LETTERING "RX" IN WHITE. THE COLOR GREEN APPEARS IN THE RECTANGLE, THE COLOR BLACK APPEARS IN THE WORDING "TIMELESS VET DRUG INDEX" AND THE COLOR WHITE APPEARS IN THE LETTERING "RX".

#### CLASS 9—ELECTRICAL AND SCIENTIFIC APPARATUS

FOR VETERINARY DRUG FORMULARY SOFTWARE APPLICATION FOR COMPUTERS, TABLETS AND SMARTPHONES, NAMELY, SOFTWARE FOR USE IN PROVIDING DRUG INFORMATION, DRUG FORMULAS, USES AND METHODS OF PREPARATION (U.S. CLS. 21, 23, 26, 36 AND 38).

FIRST USE 7-19-2013; IN COMMERCE 7-19-2013.

#### CLASS 42—SCIENTIFIC AND COMPUTER SERVICES

FOR PROVIDING TEMPORARY USE OF NON-DOWNLOADABLE VETERINARY DRUG FORMULARY SOFTWARE FOR PROVIDING DRUG INFORMATION, DRUG FORMULAS, USES AND METHODS OF PREPARATION AND PROVIDING TEMPORARY USE OF NON-DOWNLOADABLE WEB BASED APPLICATIONS FOR PROVIDING DRUG INFORMATION, DRUG FORMULAS, USES AND METHODS OF PREPARATION (U.S. CLS. 100 AND 101).

FIRST USE 7-19-2013; IN COMMERCE 7-19-2013.  
KAMAL PREET, EXAMINING ATTORNEY

SN 86-021,730. BUNTIN, CHANTE S, AKA CHANTE S BUTIN MD, INC., APTOS, CA. FILED 7-27-2013.

**SXM SYMPTOM MANAGEMENT**  
Pain Medicine, Palliative Care and  
Hospice  
Life's Path

THE MARK CONSISTS OF STANDARD CHARACTERS WITHOUT CLAIM TO ANY PARTICULAR FONT, STYLE, SIZE, OR COLOR.

OWNER OF U.S. REG. NOS. 4,051,796 AND 4,191,023.

NO CLAIM IS MADE TO THE EXCLUSIVE RIGHT TO USE "SYMPTOM MANAGEMENT PAIN MEDICINE, PALLIATIVE CARE AND HOSPICE", APART FROM THE MARK AS SHOWN.

THE WORDING "SXM" HAS NO MEANING IN A FOREIGN LANGUAGE.

**CLASS 16—PAPER GOODS AND PRINTED MATTER**

FOR (BASED ON INTENT TO USE) EDUCATIONAL PUBLICATIONS, NAMELY, TRAINING MANUALS AND PRINTED INSTRUCTIONAL, EDUCATIONAL, AND TEACHING MATERIALS IN THE FIELD OF MEDICINE, NAMELY, PAIN MEDICINE, PALLIATIVE CARE, ANESTHESIA AND/OR HOSPICE (U.S. CLS. 2, 5, 22, 23, 29, 37, 38 AND 50).

**CLASS 35—ADVERTISING AND BUSINESS**

FOR (BASED ON INTENT TO USE) MEDICAL COST MANAGEMENT; PHYSICIAN REFERRALS (U.S. CLS. 100, 101 AND 102).

**CLASS 38—COMMUNICATION**

FOR (BASED ON INTENT TO USE) PROVIDING A WEB SITE FOR SYNCHRONOUS AND ASYNCHRONOUS COMMUNICATION AND FOR CONNECTION OF PHYSICIANS WITH THEIR PATIENTS REGARDLESS OF MEDICAL ORGANIZATION OR GEOGRAPHIC LOCATION (U.S. CLS. 100, 101 AND 104).

**CLASS 41—EDUCATION AND ENTERTAINMENT**

FOR (BASED ON INTENT TO USE) EDUCATION SERVICES, NAMELY, PROVIDING LECTURES, CONFERENCES, PRESENTATIONS, LECTURES, HAND-OUTS, MANUALS, VIDEOS, BOOKS, AND/OR ON-LINE INFORMATION IN THE FIELD OF MEDICINE, NAMELY, PAIN MEDICINE, PALLIATIVE CARE, ANESTHESIA AND/OR HOSPICE; MEDICAL TRAINING AND TEACHING (U.S. CLS. 100, 101 AND 107).

**CLASS 42—SCIENTIFIC AND COMPUTER SERVICES**

FOR (BASED ON INTENT TO USE) SCIENTIFIC RESEARCH FOR MEDICAL PURPOSES IN THE FIELD OF PAIN MEDICINE, PALLIATIVE CARE, ANESTHESIA AND/OR HOSPICE (U.S. CLS. 100 AND 101).

**CLASS 44—MEDICAL, BEAUTY AND AGRICULTURAL SERVICES**

FOR (BASED ON USE IN COMMERCE) PHYSICIAN SERVICES; PROVIDING MEDICAL ADVICE IN THE FIELD OF PAIN MEDICINE, PALLIATIVE CARE, ANESTHESIA AND/OR HOSPICE (BASED ON INTENT TO USE) DRUG, ALCOHOL AND DNA SCREENING FOR MEDICAL PURPOSES; MEDICAL CONSULTATIONS; MEDICAL COUNSELING; MEDICAL INFORMATION; MEDICAL SCREENING; MEDICAL SERVICES; MEDICAL TESTING FOR DIAGNOSTIC OR TREATMENT PURPOSES; MEDICAL TESTING OF URINE, BLOOD, HAIR FOLLICLES AND BREATH; PROVIDING AN INTERNET-BASED DATABASE OF PATIENT MEDICAL INFORMATION WHERE PATIENTS CAN INQUIRE ABOUT MEDICAL ISSUES AND PROCEDURES FROM OTHER PATIENTS AND CAN RELAY INFORMATION ABOUT THEIR MEDICAL EXPERIENCES FOR SUPPORT AND COMMUNITY; PROVIDING INFORMATION TO PATIENTS IN THE FIELD OF ADMINISTERING MEDICATIONS; PROVIDING MEDICAL INFORMATION, CONSULTANCY AND ADVISORY SERVICES; PROVIDING ON-LINE MEDICAL RECORD ANALYSIS SERVICES DESIGNED TO PROVIDE PATIENTS WITH CUSTOM TAILORED INFORMATION ABOUT THE RANGE OF POSSIBLE DIAGNOSES AND THERAPIES ASSOCIATED WITH A DEFINED SET OF SYMPTOMS; PROVISION OF HEALTH CARE AND MEDICAL SERVICES BY HEALTH CARE PROFESSIONALS VIA THE INTERNET OR TELECOMMUNICATION NETWORKS (U.S. CLS. 100 AND 101).

FIRST USE 7-1-2009; IN COMMERCE 2-17-2010.

BRENDAN REGAN, EXAMINING ATTORNEY

SN 86-022,451. TRIUNE SOFTWARE, INC., DBA TRIUNE GROUP, BEAVERCREEK, OH. FILED 7-29-2013.

**KMaaS**

THE MARK CONSISTS OF STANDARD CHARACTERS WITHOUT CLAIM TO ANY PARTICULAR FONT, STYLE, SIZE, OR COLOR.

**CLASS 35—ADVERTISING AND BUSINESS**

FOR BUSINESS KNOWLEDGE MANAGEMENT SERVICES (U.S. CLS. 100, 101 AND 102).

FIRST USE 7-29-2013; IN COMMERCE 7-29-2013.

**CLASS 42—SCIENTIFIC AND COMPUTER SERVICES**

FOR COMPUTER SERVICES, NAMELY, ACTING AS AN APPLICATION SERVICE PROVIDER IN THE FIELD OF KNOWLEDGE MANAGEMENT TO HOST COMPUTER APPLICATION SOFTWARE FOR THE PURPOSE OF COLLABORATION (U.S. CLS. 100 AND 101).

FIRST USE 7-29-2013; IN COMMERCE 7-29-2013.

B. PARADEWELAI, EXAMINING ATTORNEY

SN 86-023,036. PROSOURCE, INC., CINCINNATI, OH. FILED 7-30-2013.

SN 86-023,635. FOX 40 INTERNATIONAL INC., HAMILTON, ON, CANADA, FILED 7-30-2013.



OWNER OF U.S. REG. NO. 3,288,796.  
THE MARK CONSISTS OF A BALL OVER THE "PRO" IN THE WORDS "PROSOURCE".

#### CLASS 35—ADVERTISING AND BUSINESS

FOR LEASING, HIRE AND RENTAL OF COPIERS, PRINTERS, SCANNERS AND OTHER OFFICE MACHINES; PHOTOCOPYING SERVICES; CONSULTANT AND ADVISORY SERVICES RELATING TO THE LEASING, HIRING AND RENTAL OF COPIERS, PRINTERS, SCANNERS AND OTHER OFFICE MACHINES; DOCUMENT CREATION SERVICES, NAMELY, ORGANIZATION OF INFORMATION FROM SEARCHES FOR PREPARATION OF DOCUMENTS; SERVICES IN THE MANAGEMENT OF DOCUMENT AND IMAGE PROCESSING AND PRODUCTION; TECHNICAL ADVISORY AND CONSULTING SERVICES IN THE FIELD OF PRINT COST ANALYSES; TECHNICAL ADVISORY AND CONSULTING SERVICES IN THE FIELD OF MANAGING OFFICE FUNCTIONS IN THE NATURE OF PRINTING (U.S. CLS. 100, 101 AND 102).

FIRST USE 12-1-2012; IN COMMERCE 12-1-2012.

#### CLASS 37—CONSTRUCTION AND REPAIR

FOR INSTALLATION, MAINTENANCE AND REPAIR OF OFFICE MACHINE AND APPARATUS; INSTALLATION, MAINTENANCE AND REPAIR OF COPYING APPARATUS, PRINTERS, SCANNERS, FACSIMILE TRANSMITTING AND RECEIVING APPARATUS, DOCUMENT HANDLING APPARATUS, AND MULTIFUNCTIONAL DEVICES COMPOSED OF TWO OR MORE OF A COPIER, A PRINTER, A FACSIMILE MACHINE AND A SCANNER; CONSULTING SERVICES IN THE FIELD OF INSTALLATION, MAINTENANCE AND REPAIR OF COMPUTER HARDWARE IN THE AREA PRINTING (U.S. CLS. 100, 103 AND 106).

FIRST USE 9-1-2005; IN COMMERCE 9-1-2005.

#### CLASS 41—EDUCATION AND ENTERTAINMENT

FOR EDUCATION, NAMELY, TRAINING IN THE FIELD OF PRINTING AND PRINTER OPERATION (U.S. CLS. 100, 101 AND 107).

FIRST USE 12-1-2012; IN COMMERCE 12-1-2012.

#### CLASS 42—SCIENTIFIC AND COMPUTER SERVICES

FOR COMPUTER SOFTWARE CONSULTING SERVICES IN THE AREA OF PRINTING; CONSULTING SERVICES IN THE FIELD OF DESIGN, SELECTION, IMPLEMENTATION AND USE OF COMPUTER HARDWARE SYSTEMS FOR OTHERS IN THE AREA OF PRINTING; DESIGN AND DEVELOPMENT OF COMPUTER HARDWARE AND SOFTWARE IN THE FIELD OF PRINTING; TECHNOLOGICAL ADVISORY AND CONSULTING SERVICES IN DATA CONVERSION OF ELECTRONIC FILES AND IN COMPUTER NETWORK INTEGRATION AND MANAGEMENT (U.S. CLS. 100 AND 101).

FIRST USE 12-1-2012; IN COMMERCE 12-1-2012.  
NATALIE POLZER, EXAMINING ATTORNEY

#### FOX 40 MARINE SAFETY

THE MARK CONSISTS OF STANDARD CHARACTERS WITHOUT CLAIM TO ANY PARTICULAR FONT, STYLE, SIZE, OR COLOR.

OWNER OF U.S. REG. NOS. 1,526,597, 3,315,113 AND OTHERS.

NO CLAIM IS MADE TO THE EXCLUSIVE RIGHT TO USE "MARINE SAFETY", APART FROM THE MARK AS SHOWN.

#### CLASS 9—ELECTRICAL AND SCIENTIFIC APPARATUS

FOR SIGNALING EQUIPMENT, NAMELY, WHISTLES; SAFETY EQUIPMENT, NAMELY, BAILERS FOR REMOVING WATER FROM WATER CRAFT; SAFETY PRODUCTS, NAMELY, FLOATING SAFETY ROPES FOR USE IN MARINE AND AQUATIC ENVIRONMENTS; SAFETY APPARATUS, NAMELY, SAFETY ROPE WITH ATTACHED FLOTATION DEVICE; SAFETY EQUIPMENT, NAMELY, RESCUE THROW ROPES FOR WATER RESCUE; FIRE EXTINGUISHERS (U.S. CLS. 21, 23, 26, 36 AND 38).

FIRST USE 12-31-2008; IN COMMERCE 12-31-2008.

#### CLASS 11—ENVIRONMENTAL CONTROL APPARATUS

FOR MARINE FLASHLIGHTS (U.S. CLS. 13, 21, 23, 31 AND 34).

FIRST USE 12-31-2008; IN COMMERCE 12-31-2008.

GRETCHEN ULRICH, EXAMINING ATTORNEY

SN 86-023,780. VPT, INC., BLACKSBURG, VA. FILED 7-30-2013.

#### POWER YOUR CRITICAL MISSION TODAY

THE MARK CONSISTS OF STANDARD CHARACTERS WITHOUT CLAIM TO ANY PARTICULAR FONT, STYLE, SIZE, OR COLOR.

#### CLASS 35—ADVERTISING AND BUSINESS

FOR CATALOG AND ON-LINE RETAIL STORE SERVICES FEATURING PRODUCTS DIRECTED TO THE AVIONICS, MILITARY AND SPACE POWER SYSTEMS, NAMELY, POWER CONVERTERS, ELECTROMAGNETIC INTERFERENCE FILTERS AND SUPPRESSORS, ACCESSORY POWER-RELATED PRODUCTS, NAMELY, INRUSH CURRENT LIMITERS, THERMAL PADS, PRE-CONDITIONING MODULES AND HIGH VOLTAGE BUS CONVERTERS (U.S. CLS. 100, 101 AND 102).

FIRST USE 12-31-2001; IN COMMERCE 12-31-2001.

#### CLASS 40—MATERIAL TREATMENT

FOR ASSEMBLY OF CUSTOM AVIONICS, MILITARY AND SPACE POWER SYSTEMS OF OTHERS (U.S. CLS. 100, 103 AND 106).

FIRST USE 12-31-2001; IN COMMERCE 12-31-2001.

**CLASS 42—SCIENTIFIC AND COMPUTER SERVICES**

FOR CUSTOM ENGINEERING SERVICES AND TESTING SERVICES, NAMELY, THE DESIGN AND TESTING OF CUSTOM AVIONICS, MILITARY AND SPACE POWER SYSTEMS (U.S. CLS. 100 AND 101).

FIRST USE 12-31-2001; IN COMMERCE 12-31-2001.

LESLIE RICHARDS, EXAMINING ATTORNEY

SN 86-023,870. MITCHELL BLACK, LLC, CHICAGO, IL. FILED 7-30-2013.



THE MARK CONSISTS OF A CREST OR COAT OF ARMS WITH THE LETTERS "MB" IN STYLIZED FORM IN THE CENTER.

**CLASS 4—LUBRICANTS AND FUELS**

FOR CANDLES (U.S. CLS. 1, 6 AND 15).

**CLASS 11—ENVIRONMENTAL CONTROL APPARATUS**

FOR CANDLE LANTERNS, LAMP SHADES (U.S. CLS. 13, 21, 23, 31 AND 34).

**CLASS 16—PAPER GOODS AND PRINTED MATTER**

FOR ART PICTURES, FRAMED ART PICTURES, STATIONERY, GREETING CARDS (U.S. CLS. 2, 5, 22, 23, 29, 37, 38 AND 50).

**CLASS 20—FURNITURE AND ARTICLES NOT OTHERWISE CLASSIFIED**

FOR ART PICTURE FRAMES; MIRRORS (U.S. CLS. 2, 13, 22, 25, 32 AND 50).

**CLASS 21—HOUSEWARES AND GLASS**

FOR DISHWARE, CUPS, SAUCERS, SERVING TRAYS, CAKE STANDS, VASES, PICNIC BASKETS SOLD EMPTY, FITTED PICNIC BASKETS, ICE BUCKETS, GLASS STORAGE JARS, CERAMIC STORAGE JARS, FIGURINES OF CRYSTAL, FIGURINES OF GLASS, FIGURINES OF PORCELAIN, COASTERS OF CORK (U.S. CLS. 2, 13, 23, 29, 30, 33, 40 AND 50).

**CLASS 24—FABRICS**

FOR COASTERS OF TEXTILE (U.S. CLS. 42 AND 50).

**CLASS 28—TOYS AND SPORTING GOODS**

FOR CHRISTMAS TREE ORNAMENTS (U.S. CLS. 22, 23, 38 AND 50).

TINA L. SNAPP, EXAMINING ATTORNEY

SN 86-023,894. POLIQUIN, YVES, MONTREAL QC, CANADA, FILED 7-30-2013.

# SHOWZOOM

THE MARK CONSISTS OF STANDARD CHARACTERS WITHOUT CLAIM TO ANY PARTICULAR FONT, STYLE, SIZE, OR COLOR.

**CLASS 9—ELECTRICAL AND SCIENTIFIC APPARATUS**

FOR MOTION CONTROL CAMERA MOUNTING SYSTEM, COMPRISING RACKS, TRACKS, CAMERA MOUNTS, STEPPER MOTORS AND CONTROL BOX (U.S. CLS. 21, 23, 26, 36 AND 38).

**CLASS 41—EDUCATION AND ENTERTAINMENT**

FOR VIDEO PRODUCTION SERVICES (U.S. CLS. 100, 101 AND 107).

ALISON POLLACK, EXAMINING ATTORNEY

SN 86-024,113. BIONIC LABS INC., NEW YORK, NY. FILED 7-30-2013.

# BIONIC IDENTITY

THE MARK CONSISTS OF STANDARD CHARACTERS WITHOUT CLAIM TO ANY PARTICULAR FONT, STYLE, SIZE, OR COLOR.

NO CLAIM IS MADE TO THE EXCLUSIVE RIGHT TO USE "IDENTITY", APART FROM THE MARK AS SHOWN.

**CLASS 9—ELECTRICAL AND SCIENTIFIC APPARATUS**

FOR COMPUTER SOFTWARE AND COMPUTER HARDWARE FOR USE IN SECURE AUTHENTICATION, DATA ENCRYPTION AND DECRYPTION, AND IDENTITY MANAGEMENT FOR THE PURPOSE OF PROTECTING AGAINST IDENTIFY THEFT AND FRAUD; COMPUTER APPLICATION SOFTWARE FOR MOBILE DEVICES AND COMPUTERS FOR UPLOADING, DOWNLOADING, STORING, TRANSFERRING, SHARING, ORGANIZING, MANAGING, AND AUTHENTICATING VARIOUS FORMS OF PERSONALLY IDENTIFIABLE INFORMATION FOR THE PURPOSE OF PROTECTING AGAINST IDENTITY THEFT AND FRAUD (U.S. CLS. 21, 23, 26, 36 AND 38).

**CLASS 42—SCIENTIFIC AND COMPUTER SERVICES**

FOR SOFTWARE AS A SERVICE (SAAS) SERVICES FEATURING SOFTWARE FOR IDENTITY VERIFICATION, USER AUTHENTICATION, IDENTITY MANAGEMENT, DATA CONTROL SERVICES, ACCESS CONTROL SERVICES, AUTHORIZATION AND PROVISIONING, IDENTITY THEFT AND FRAUD PROTECTION (U.S. CLS. 100 AND 101).

SN 86-024,391. CANARY LLC, DENVER, CO. FILED 7-31-2013.

# CANARY

THE MARK CONSISTS OF STANDARD CHARACTERS WITHOUT CLAIM TO ANY PARTICULAR FONT, STYLE, SIZE, OR COLOR.

OWNER OF U.S. REG. NO. 3,776,217.

**CLASS 45—PERSONAL AND LEGAL SERVICES**

FOR PROVIDING SECURE AUTHENTICATION OF PERSONAL IDENTIFICATION INFORMATION TO INDIVIDUALS FOR THE PURPOSE OF PROTECTING AGAINST IDENTITY THEFT AND FRAUD; PROVIDING AUTHENTICATED PERSONAL IDENTIFICATION INFORMATION TO OTHERS FOR THE PURPOSE OF PROTECTING AGAINST IDENTITY THEFT AND FRAUD (U.S. CLS. 100 AND 101).

KAREN SEVERSON, EXAMINING ATTORNEY

**CLASS 37—CONSTRUCTION AND REPAIR**

FOR PROVIDING OILFIELD SERVICES, NAMELY RENTAL OF OIL WELL DRILLING TOOLS, OIL WELL CASING, TUBING, DRILL PIPE INSTALLATION AND REPAIR OF OIL FIELD EQUIPMENT (U.S. CLS. 100, 103 AND 106).

FIRST USE 1-15-2013; IN COMMERCE 1-15-2013.

**CLASS 40—MATERIAL TREATMENT**

FOR PROVIDING OILFIELD SERVICES, NAMELY OIL AND GAS WELL TREATMENT AND OIL WELL PROSPECTING IN THE NATURE OF PERFORATION AND SPILL TREATMENT (U.S. CLS. 100, 103 AND 106).

FIRST USE 1-15-2013; IN COMMERCE 1-15-2013.

WON TEAK OH, EXAMINING ATTORNEY

SN 86-024,375. SEARS HOMETOWN AND OUTLET STORES, INC., HOFFMAN ESTATES, IL. FILED 7-31-2013.

# BLACK FOUR DAY

THE MARK CONSISTS OF STANDARD CHARACTERS WITHOUT CLAIM TO ANY PARTICULAR FONT, STYLE, SIZE, OR COLOR.

**CLASS 35—ADVERTISING AND BUSINESS**

FOR RETAIL AND ON-LINE RETAIL STORE SERVICES FEATURING HOME APPLIANCES, HARDWARE, TOOLS, LAWN AND GARDEN EQUIPMENT (U.S. CLS. 100, 101 AND 102).

**CLASS 36—INSURANCE AND FINANCIAL**

FOR EXTENDED WARRANTY SERVICES, NAMELY, SERVICE CONTRACTS (U.S. CLS. 100, 101 AND 102).

**CLASS 37—CONSTRUCTION AND REPAIR**

FOR INSTALLATION OF HOME APPLIANCES, HARDWARE, TOOLS, LAWN AND GARDEN EQUIPMENT (U.S. CLS. 100, 103 AND 106).

**CLASS 39—TRANSPORTATION AND STORAGE**

FOR HOME DELIVERY OF HOME APPLIANCES, HARDWARE, TOOLS, LAWN AND GARDEN EQUIPMENT (U.S. CLS. 100 AND 105).

CAROLYN CATALDO, EXAMINING ATTORNEY

SN 86-025,317. KABUSHIKI KAISHA SMART EDUCATION, DBA SMARTEDUCATION, LTD., TOKYO, JAPAN, FILED 7-31-2013.

# Gocco

THE MARK CONSISTS OF STANDARD CHARACTERS WITHOUT CLAIM TO ANY PARTICULAR FONT, STYLE, SIZE, OR COLOR.

THE ENGLISH TRANSLATION OF THE WORD "GOCCO" IN THE MARK IS "MAKE BELIEVE PLAY".

**CLASS 9—ELECTRICAL AND SCIENTIFIC APPARATUS**

FOR DOWNLOADABLE COMPUTER SOFTWARE FOR DRAWING PICTURES, SAVING THE PROCESS OF DRAWING PICTURES AS VIDEO, PLAYING BACK THE PROCESS OF DRAWING PICTURES, AND ENABLING TRANSMISSION OF VIDEOS AND PICTURES; COMPUTER PROGRAMS FOR DRAWING IMAGES AND ANIMATING PROCESS; VIDEO AND COMPUTER GAME PROGRAMS; ELECTRONIC GAME PROGRAMS; ANIMAL DRAWING GAME PROGRAMS (U.S. CLS. 21, 23, 26, 36 AND 38).

**CLASS 41—EDUCATION AND ENTERTAINMENT**

FOR ENTERTAINMENT SERVICES, NAMELY, PROVIDING ONLINE VIDEO GAMES, PROVIDING ONLINE COMPUTER GAMES AND PROVIDING ONLINE ELECTRONIC GAMES; ON-LINE JOURNALS, NAMELY, BLOGS FEATURING PERSONAL PROFILES FOR SOCIAL NETWORKING (U.S. CLS. 100, 101 AND 107).

**CLASS 42—SCIENTIFIC AND COMPUTER SERVICES**

FOR APPLICATION SERVICE PROVIDER (ASP) FEATURING SOFTWARE TO ENABLE UPLOADING, POSTING, SHOWING, DISPLAYING, TAGGING, BLOGGING, SHARING THE VIDEOS AND PICTURES OVER THE INTERNET; PROVIDING A WEBSITE FEATURING TECHNOLOGIES THAT ENABLES INTERNET USERS TO SHARE VIDEOS AND PICTURES (U.S. CLS. 100 AND 101).

**CLASS 45—PERSONAL AND LEGAL SERVICES**

FOR ONLINE SOCIAL NETWORKING SERVICES; ONLINE SOCIAL NETWORK SERVICES IN THE FIELD OF DRAWING PICTURES (U.S. CLS. 100 AND 101).  
BRIDGETT SMITH, EXAMINING ATTORNEY

SN 86-026,060. FISCHER, KURT H., DBA THE INTERNATIONAL FOOD & BEVERAGE FORUM, MENDOCINO, CA. FILED 8-1-2013.

The International Food &  
Beverage Forum Hall of  
Fame Society

THE MARK CONSISTS OF STANDARD CHARACTERS WITHOUT CLAIM TO ANY PARTICULAR FONT, STYLE, SIZE, OR COLOR.

OWNER OF U.S. REG. NO. 2,876,568.

NO CLAIM IS MADE TO THE EXCLUSIVE RIGHT TO USE "HALL OF FAME SOCIETY", APART FROM THE MARK AS SHOWN.  
SEC. 2(F).

**CLASS 35—ADVERTISING AND BUSINESS**

FOR ASSOCIATION SERVICES, NAMELY, PROMOTING THE INTERESTS OF THE EDUCATION OF HOSPITALITY PROFESSIONALS (U.S. CLS. 100, 101 AND 102).  
FIRST USE 4-3-2003; IN COMMERCE 4-3-2003.

**CLASS 36—INSURANCE AND FINANCIAL**

FOR CHARITABLE FUNDRAISING SERVICES, NAMELY, PROVIDING FUNDRAISING ACTIVITIES TO SUPPORT EDUCATIONAL SCHOLARSHIPS FOR HOSPITALITY PROFESSIONALS (U.S. CLS. 100, 101 AND 102).

FIRST USE 4-3-2003; IN COMMERCE 4-3-2003.

HELENE LIWINSKI, EXAMINING ATTORNEY

SN 86-026,262. TONDEVOLD, BRIAN WADE, REGINA, SASKATCHEWAN, CANADA, AND STEWART, JARED CHARLES, REGINA, SASKATCHEWAN, CANADA, FILED 8-1-2013.

LONDON JACKS AUTHENTIC  
BRITISH FISH & CHIPS

THE MARK CONSISTS OF STANDARD CHARACTERS WITHOUT CLAIM TO ANY PARTICULAR FONT, STYLE, SIZE, OR COLOR.

NO CLAIM IS MADE TO THE EXCLUSIVE RIGHT TO USE "AUTHENTIC BRITISH FISH & CHIPS" IN INTERNATIONAL CLASS 43, APART FROM THE MARK AS SHOWN.

**CLASS 25—CLOTHING**

FOR BOARD SHORTS; HEADGEAR, NAMELY, HATS AND CAPS; HOODED SWEAT SHIRTS; SHIRTS; SWEAT SHIRTS; T-SHIRTS (U.S. CLS. 22 AND 39).

**CLASS 43—HOTEL AND RESTAURANT SERVICES**

FOR RESTAURANT SERVICES (U.S. CLS. 100 AND 101).

FRED CARL, EXAMINING ATTORNEY

SN 86-026,562. SYLVESTER'S FINE FOODS, INC., NORTHAMPTON, MA. FILED 8-1-2013.



NO CLAIM IS MADE TO THE EXCLUSIVE RIGHT TO USE "BAKERY" AND "RESTAURANT" AND "CAFE" AND "TAKEOUT", APART FROM THE MARK AS SHOWN.

THE MARK CONSISTS OF THE WORD "SYLVESTER'S" WHERE BOTH THE FIRST AND LAST LETTER ARE LARGER THAN THE REST OF THE WORD. UNDERNEATH ARE THE TERMS "BAKERY", "RESTAURANT", "CAFE" "TAKEOUT", EACH SEPARATED BY A DIAMOND DESIGN. ABOVE THE TERM "SYLVESTER'S" ARE THREE PICTURES IN INDIVIDUAL, OUTLINED BOXES, WITH THE LEFT MOST PICTURE DEPICTING A DESIGN OF AN EGG ON A CHECKERBOARD PATTERN, THE MIDDLE PICTURE DEPICTING THE DESIGN OF A SUN, AND THE RIGHT MOST PICTURE DEPICTING THE DESIGN OF A FILLED CAULDRON WITH STEAM LINES BETWEEN DESIGNS OF VEGETABLES.

**CLASS 29—MEATS AND PROCESSED FOODS**

FOR SOUPS; PREPARATIONS FOR MAKING SOUPS; TURKEY SAUSAGES; CORNED BEEF HASH (U.S. CL. 46).

**CLASS 30—STAPLE FOODS**

FOR BAKERY DESSERTS; BAKERY GOODS; BAKERY PRODUCTS; BAKERY PRODUCTS, NAMELY, SWEET BAKERY PRODUCTS; BAKERY GOODS, NAMELY, COOKIES, BROWNIES, BREADS, GLUTEN-FREE BREADS; GRAHAM CRACKERS; CHOCOLATE-COVERED GRAHAM CRACKERS; CARAMEL-COVERED GRAHAM CRACKERS; SALSA; MANGO SALSA; MAPLE SYRUP; COFFEE; COFFEE BASED BEVERAGES; ROASTED COFFEE BEANS; GROUND COFFEE BEANS; SALAD DRESSINGS (U.S. CL. 46).

**CLASS 43—HOTEL AND RESTAURANT SERVICES**

FOR RESTAURANT SERVICES; RESTAURANT SERVICES, INCLUDING SIT-DOWN SERVICE OF FOOD AND TAKE-OUT RESTAURANT SERVICES; RESTAURANT SERVICES, NAMELY, PROVIDING FOOD AND BEVERAGES FOR CONSUMPTION ON AND OFF THE PREMISES; CAFE SERVICES; TAKE-OUT RESTAURANT SERVICES; BAR SERVICES (U.S. CLS. 100 AND 101).

FIRST USE 12-31-2002; IN COMMERCE 12-31-2002.

SETH A. RAPPAPORT, EXAMINING ATTORNEY

SN 86-027,239. GRASSROOTS ALLIANCE, INC., WEST NEWTON, MA. FILED 8-2-2013.



NO CLAIM IS MADE TO THE EXCLUSIVE RIGHT TO USE "HOOP", APART FROM THE MARK AS SHOWN.

THE MARK CONSISTS OF A BASKETBALL WITH ROOTS EXTENDING INTO THE GROUND WITH THE WORDS "HOOP" AND "ROOTZ" ACROSS THE PART OF THE ROOT THAT IS ABOVE GROUND.

**CLASS 25—CLOTHING**

FOR T-SHIRTS (U.S. CLS. 22 AND 39).  
FIRST USE 9-1-2012; IN COMMERCE 9-1-2012.

**CLASS 41—EDUCATION AND ENTERTAINMENT**

FOR BASKETBALL CAMPS; ORGANIZING, ARRANGING, AND CONDUCTING BASKETBALL EVENTS (U.S. CLS. 100, 101 AND 107).

FIRST USE 9-1-2012; IN COMMERCE 9-1-2012.  
KIMBERLY PERRY, EXAMINING ATTORNEY

SN 86-027,258. PETE'S PREMADE PALEO, SAN DIEGO, CA. FILED 8-2-2013.

**PETE'S PALEO**

bringing fine dining to your cave

NO CLAIM IS MADE TO THE EXCLUSIVE RIGHT TO USE "PALEO", APART FROM THE MARK AS SHOWN.

THE STIPPLING IS FOR SHADING PURPOSES ONLY.

THE NAME IN THE MARK IDENTIFIES A LIVING INDIVIDUAL WHOSE CONSENT IS OF RECORD.

THE MARK CONSISTS OF A CIRCLE IMAGE OF A FIELD WITH A CAVE IN THE TOP RIGHT AND A WINDMILL WITH A SKY BACKGROUND WITH A CLOUD. WITH THE NAME "PETE'S PALEO" DIRECTLY BELOW, THEN THE TAG LINE "BRINGING FINE DINING TO YOUR CAVE" BELOW THAT.

**CLASS 25—CLOTHING**

FOR T-SHIRTS (U.S. CLS. 22 AND 39).  
FIRST USE 3-1-2013; IN COMMERCE 3-1-2013.

**CLASS 29—MEATS AND PROCESSED FOODS**

FOR READY-TO-EAT MEALS CONSISTING PRIMARILY OF MEATS, VEGETABLES, AND FRUITS (U.S. CL. 46).

FIRST USE 3-1-2013; IN COMMERCE 3-1-2013.

**CLASS 30—STAPLE FOODS**

FOR SALAD DRESSING; SAUCES (U.S. CL. 46).  
FIRST USE 3-1-2013; IN COMMERCE 3-1-2013.  
JOHN E. MICHOS, EXAMINING ATTORNEY

SN 86-027,370. CHRISTIAN, SHAWN, OJAI, CA. FILED 8-2-2013.

**ADDICTS ANONYMOUS**

THE MARK CONSISTS OF STANDARD CHARACTERS WITHOUT CLAIM TO ANY PARTICULAR FONT, STYLE, SIZE, OR COLOR.

**CLASS 25—CLOTHING**

FOR HATS, T-SHIRTS, HOODED SWEATSHIRTS, SWEATSHIRTS, SWEAT PANTS, SHORTS, TANK TOPS, POLO SHIRTS (U.S. CLS. 22 AND 39).

**CLASS 41—EDUCATION AND ENTERTAINMENT**

FOR ENTERTAINMENT SERVICES, NAMELY, AN ONGOING TELEVISION SERIES FEATURING COMEDY DISTRIBUTED VIA TELEVISION, THE INTERNET, CABLE AND SATELLITE (U.S. CLS. 100, 101 AND 107).  
DAWN HAN, EXAMINING ATTORNEY

SN 86-027,922. ANASTASYA USKOV, DBA VLOGMAKER LLC, TRACY, CA. FILED 8-2-2013.

**Vlogmaker**

THE MARK CONSISTS OF STANDARD CHARACTERS WITHOUT CLAIM TO ANY PARTICULAR FONT, STYLE, SIZE, OR COLOR.

**CLASS 38—COMMUNICATION**

FOR TELECOMMUNICATION SERVICES, NAMELY, TRANSMISSION OF MESSAGES VIA THE INTERNET USING VIDEO, AUDIO AND TEXT CHAT IN THE FIELD OF VIDEO SHARING AND DISCOVERY (U.S. CLS. 100, 101 AND 104).

**CLASS 41—EDUCATION AND ENTERTAINMENT**

FOR PROVIDING A WEB SITE FEATURING USER COMPILED VIDEOS ON A WIDE VARIETY OF TOPICS AND SUBJECTS RELATING TO ENTERTAINMENT (U.S. CLS. 100, 101 AND 107).

**CLASS 42—SCIENTIFIC AND COMPUTER SERVICES**

FOR PROVIDING A WEBSITE WITH TECHNOLOGY CAPABLE OF PROVIDING AN ONLINE VIDEO COMPOSITION AND PUBLISHING PROGRAM THAT GIVES COMPUTER USERS THE ABILITY TO COMPILE, COLLECT AND SHARE SYNDICATED VIDEOS (U.S. CLS. 100 AND 101).

ZACHARY BELLO, EXAMINING ATTORNEY

SN 86-028,666. HEXIS CYBER SOLUTIONS, INC., HANOVER, MD. FILED 8-5-2013.



THE MARK CONSISTS OF THE DESIGN OF A HAWK'S HEAD.

**CLASS 9—ELECTRICAL AND SCIENTIFIC APPARATUS**

FOR COMPUTER SOFTWARE AND COMPUTER HARDWARE FOR TESTING AND EVALUATING COMPUTERS, COMPUTER NETWORKS AND INFORMATION TECHNOLOGY SYSTEMS FOR SECURITY VULNERABILITY AND RISK RELATING TO HACKING, CYBER-ATTACKS, COMPUTER CRIMES AND COMPUTER VIRUSES; COMPUTER SOFTWARE AND COMPUTER HARDWARE FOR CYBER-SECURITY, CYBER-DEFENSE, INFORMATION SECURITY AND ASSURANCE, DATA SECURITY, COMPUTER SECURITY, NETWORK SECURITY AND PREVENTION OF HACKING, CYBER-ATTACKS, COMPUTER CRIMES AND COMPUTER VIRUSES; COMPUTER SOFTWARE AND COMPUTER HARDWARE FOR MONITORING, DETECTING, INSPECTING, PROCESSING, ANALYZING, MITIGATING AND REMEDIATING COMPUTERS, COMPUTER NETWORKS AND INFORMATION TECHNOLOGY SYSTEMS FOR HACKING, CYBER-ATTACKS, COMPUTER CRIMES AND COMPUTER VIRUSES; COMPUTER SOFTWARE AND COMPUTER HARDWARE FOR RISK MITIGATION AND REMEDIATION, INTEGRITY AND THREAT ANALYSIS, CYBER EVENT DATA ANALYSIS, DIGITAL DATA INTELLIGENCE GATHERING AND ANALYSIS AND DISPATCH OF SECURITY COUNTERMEASURES RELATING TO HACKING, CYBER-ATTACKS, COMPUTER CRIMES AND COMPUTER VIRUSES; COMPUTER SOFTWARE AND COMPUTER HARDWARE FOR DATA WAREHOUSING, DATA ANALYSIS, THREAT DETECTION, MEASUREMENT AND EVALUATION OF SECURITY PROCESS EFFECTIVENESS AND SECURITY MANAGEMENT CONTROLS RELATING TO COMPUTER SECURITY, NETWORK SECURITY AND INFORMATION TECHNOLOGY SYSTEMS SECURITY; COMPUTER SOFTWARE FOR SECURITY INFORMATION AND EVENT MANAGEMENT AND DEFENSE AGAINST HACKING, CYBER-ATTACKS, COMPUTER CRIMES AND COMPUTER VIRUSES, NAMELY, MONITORING COMPUTER, NETWORK AND INFORMATION TECHNOLOGY SYSTEM ACTIVITY AND IDENTIFYING, INVESTIGATING AND

RESPONDING TO INFORMATION SECURITY THREATS; COMPUTER PROGRAMS FOR COLLECTING, STORING AND MANAGING NETWORK/ENTERPRISE LOG RECORDS AND CALL DETAIL RECORD RETENTION AND RETRIEVAL RELATING TO COMPUTER AND NETWORK SECURITY (U.S. CLS. 21, 23, 26, 36 AND 38).

**CLASS 42—SCIENTIFIC AND COMPUTER SERVICES**

FOR COMPUTER SECURITY CONSULTANCY IN THE FIELD OF SCANNING AND PENETRATION TESTING OF COMPUTERS AND NETWORKS TO ASSESS INFORMATION SECURITY VULNERABILITY; UPDATING AND MAINTAINING COMPUTER SOFTWARE RELATING TO COMPUTER SECURITY, NETWORK SECURITY, INFORMATION TECHNOLOGY SECURITY AND DATA SECURITY, AND PREVENTION OF COMPUTER RISKS, INCLUDING HACKING, CYBER-ATTACKS, COMPUTER CRIMES AND COMPUTER VIRUSES; CONSULTATION IN THE FIELD OF COMPUTER SECURITY, NETWORK SECURITY, INFORMATION TECHNOLOGY SECURITY AND DATA SECURITY; AND PROVIDING INFORMATION IN THE FIELD OF COMPUTER SECURITY, NETWORK SECURITY, INFORMATION TECHNOLOGY SECURITY AND DATA SECURITY (U.S. CLS. 100 AND 101).

**CLASS 45—PERSONAL AND LEGAL SERVICES**

FOR MONITORING OF COMPUTER SYSTEMS AND NETWORKS FOR SECURITY PURPOSES (U.S. CLS. 100 AND 101).

BARBARA GAYNOR, EXAMINING ATTORNEY

SN 86-028,834. VERAX FILMS, LLC, BIRMINGHAM, AL. FILED 8-5-2013.

**BIG LEAGUE DREAMS**

THE MARK CONSISTS OF STANDARD CHARACTERS WITHOUT CLAIM TO ANY PARTICULAR FONT, STYLE, SIZE, OR COLOR.

**CLASS 9—ELECTRICAL AND SCIENTIFIC APPARATUS**

FOR MOTION PICTURE FILMS ABOUT SPORTS (U.S. CLS. 21, 23, 26, 36 AND 38).

**CLASS 41—EDUCATION AND ENTERTAINMENT**

FOR MOTION PICTURE FILM PRODUCTION; PRODUCTION OF TELEVISION PROGRAMS (U.S. CLS. 100, 101 AND 107).

KEVIN MITTLER, EXAMINING ATTORNEY



SN 86-028,922. LESSA, SELENA, MIAMI, FL. FILED 8-5-2013.

SN 86-029,116. NATASHA MOSTERT, LONDON, ENGLAND, FILED 8-5-2013.

# TOYCAKES

THE MARK CONSISTS OF STANDARD CHARACTERS WITHOUT CLAIM TO ANY PARTICULAR FONT, STYLE, SIZE, OR COLOR.

## CLASS 21—HOUSEWARES AND GLASS

FOR CAKE MOLDS; CAKE PANS; CAKE TINS; CAKE RESTS; CAKE PLATES (U.S. CLS. 2, 13, 23, 29, 30, 33, 40 AND 50).

## CLASS 30—STAPLE FOODS

FOR CAKES; CANDY CAKE DECORATIONS; CAKE FROSTING; CAKE ICING; CUPCAKES; EDIBLE CAKE DECORATIONS (U.S. CL. 46).  
NELSON SNYDER, EXAMINING ATTORNEY

---

SN 86-029,013. PERRY, SHAWN F D, WINNIPEG, CANADA, FILED 8-5-2013.

# NAIL

THE MARK CONSISTS OF THE WORD "NAIL", THE LETTER "I" IN WHICH IS A NAIL POINTING DOWN.

## CLASS 14—JEWELRY

FOR JEWELRY FOR MEN, WOMEN AND CHILDREN, NECKLACES, CHOKERS, EARRINGS, TOE RINGS, RINGS, BRACELETS, CUFFLINKS, TIE CLIPS, ANKLETS, WRIST WATCHES, POCKET WATCHES, LAPEL PINS, BROOCHES, DOG TAGS FOR WEAR BY HUMANS FOR DECORATIVE PURPOSES, BANGLES, BELLY CHAINS, PENDANTS (U.S. CLS. 2, 27, 28 AND 50).

## CLASS 18—LEATHER GOODS

FOR HANDBAGS, PURSES, WALLETS, BOOK BAGS, SPORTS BAGS, BACK PACKS, UMBRELLAS, BRIEF-CASE, ATTACHE CASE, LUGGAGE, SUITCASE, TOTE BAGS (U.S. CLS. 1, 2, 3, 22 AND 41).  
BRENDAN REGAN, EXAMINING ATTORNEY

# PORTABLE MAGIC

THE MARK CONSISTS OF STANDARD CHARACTERS WITHOUT CLAIM TO ANY PARTICULAR FONT, STYLE, SIZE, OR COLOR.

PRIORITY CLAIMED UNDER SEC. 44(D) ON ERPNTY TM OFC APPLICATION NO. 011584166, FILED 2-19-2013, REG. NO. 011584166, DATED 7-17-2013, EXPIRES 2-19-2023.

## CLASS 9—ELECTRICAL AND SCIENTIFIC APPARATUS

FOR DOWNLOADABLE ELECTRONIC PUBLICATIONS IN THE NATURE OF NOVELS; DOWNLOADABLE ELECTRONIC PUBLICATIONS IN THE NATURE OF BOOKS AND SHORT STORIES IN THE FIELDS OF MYSTERY, ADVENTURE, THRILLER, PARANORMAL, FANTASY, OCCULT AND SCIENCE FICTION; DOWNLOADABLE E-NOVELS PROVIDED VIA A BOOK-ON-DEMAND SERVICE; DOWNLOADABLE ELECTRONIC BOOKS AND SHORT STORIES IN THE FIELDS OF MYSTERY, ADVENTURE, THRILLER, PARANORMAL, FANTASY, OCCULT AND SCIENCE FICTION PROVIDED VIA A BOOK-ON-DEMAND SERVICE (U.S. CLS. 21, 23, 26, 36 AND 38).

## CLASS 16—PAPER GOODS AND PRINTED MATTER

FOR FICTION BOOKS IN THE FIELDS OF MYSTERY, ADVENTURE, THRILLER, PARANORMAL, FANTASY, OCCULT, AND SCIENCE FICTION; NOVELS; BOOKS IN THE FIELDS OF MYSTERY, ADVENTURE, THRILLER, PARANORMAL, FANTASY, OCCULT, AND SCIENCE FICTION; SERIES OF FICTION WORKS, NAMELY, NOVELS AND BOOKS; PRINTED MATERIALS PROVIDED VIA A BOOK-ON-DEMAND PRINTING SERVICE, NAMELY, FICTION BOOKS, NOVELS, SERIES OF FICTION BOOKS, AND BOOKS IN THE FIELDS OF MYSTERY, ADVENTURE, THRILLER, PARANORMAL, FANTASY, OCCULT, AND SCIENCE FICTION (U.S. CLS. 2, 5, 22, 23, 29, 37, 38 AND 50).  
STEVEN JACKSON, EXAMINING ATTORNEY

---

SN 86-029,527. CROTTY, SHANNON, CHIPPEWA FALLS, WI. FILED 8-6-2013.

# POLKA DOT POWERHOUSE

THE MARK CONSISTS OF STANDARD CHARACTERS WITHOUT CLAIM TO ANY PARTICULAR FONT, STYLE, SIZE, OR COLOR.

**CLASS 35—ADVERTISING AND BUSINESS**

FOR PROVIDING BUSINESS NETWORKING SERVICES; PROVIDING ON-LINE BUSINESS NETWORKING SERVICES; ARRANGING AND CONDUCTING BUSINESS MEETINGS AND CONFERENCES IN THE FIELD OF BUSINESS, BUSINESS NETWORKING, BUSINESS MANAGEMENT, BUSINESS MARKETING, FINANCE, FITNESS, AND FASHION; SPECIAL EVENT PLANNING FOR BUSINESS PURPOSES; PROVIDING ON-LINE DATABASE IN THE FIELD OF BUSINESS AND BUSINESS NETWORKING (U.S. CLS. 100, 101 AND 102).

FIRST USE 8-4-2012; IN COMMERCE 8-4-2012.

**CLASS 41—EDUCATION AND ENTERTAINMENT**

FOR SOCIAL CLUB SERVICES, NAMELY, ARRANGING, ORGANIZING, AND HOSTING SOCIAL EVENTS, GET-TOGETHERS, AND PARTIES FOR CLUB MEMBERS; ARRANGING AND CONDUCTING BUSINESS SEMINARS, WORKSHOPS, CLASSES IN THE FIELD OF BUSINESS, BUSINESS NETWORKING, BUSINESS MANAGEMENT, BUSINESS MARKETING, FINANCE, FITNESS, AND FASHION; EDUCATIONAL AND ENTERTAINMENT SERVICES, NAMELY, PROVIDING MOTIVATIONAL AND EDUCATIONAL SPEAKERS; ENTERTAINMENT SERVICES, NAMELY, CONDUCTING PARTIES; ARRANGING AND CONDUCTING SPECIAL EVENTS FOR SOCIAL ENTERTAINMENT; ON-LINE JOURNALS, NAMELY, BLOGS FEATURING INFORMATION IN THE FIELD OF BUSINESS; PROVIDING NON-DOWNLOADABLE ON-LINE GUIDES AND RESOURCES, NAMELY, GUIDES, BOOKS, PAMPHLETS IN THE FIELD OF BUSINESS, BUSINESS NETWORKING, BUSINESS MANAGEMENT, BUSINESS MARKETING, FINANCE, FITNESS, AND FASHION; PROVIDING NON-DOWNLOADABLE ON-LINE SUPPORT MATERIAL, NAMELY, VIDEOS, CLASSES, MEMBER DIRECTORY IN THE FIELD OF BUSINESS AND BUSINESS NETWORKING; PERSONAL AND BUSINESS COACHING IN THE FIELD OF CAREER DEVELOPMENT, LEADERSHIP DEVELOPMENT, AND EXECUTIVE COACHING (U.S. CLS. 100, 101 AND 107).

FIRST USE 8-4-2012; IN COMMERCE 8-4-2012.

**CLASS 45—PERSONAL AND LEGAL SERVICES**

FOR PROVIDING PERSONAL NETWORKING SERVICES; PROVIDING ON-LINE PERSONAL NETWORKING SERVICES; PROVIDING A SOCIAL NETWORKING WEBSITE FOR ENTERTAINMENT PURPOSES; ON-LINE SOCIAL NETWORKING SERVICES (U.S. CLS. 100 AND 101).

FIRST USE 8-4-2012; IN COMMERCE 8-4-2012.  
PARKER HOWARD, EXAMINING ATTORNEY

SN 86-029,718. GOMPERS HABILITATION CENTER, PHOENIX, AZ. FILED 8-6-2013.

## TANDEM DOCUMENT PROFESSIONALS

THE MARK CONSISTS OF STANDARD CHARACTERS WITHOUT CLAIM TO ANY PARTICULAR FONT, STYLE, SIZE, OR COLOR.

NO CLAIM IS MADE TO THE EXCLUSIVE RIGHT TO USE "DOCUMENT PROFESSIONALS", APART FROM THE MARK AS SHOWN.

**CLASS 35—ADVERTISING AND BUSINESS**

FOR COPYING OF DOCUMENTS; DOCUMENT REPRODUCTION; PHOTOCOPYING SERVICES (U.S. CLS. 100, 101 AND 102).

**CLASS 42—SCIENTIFIC AND COMPUTER SERVICES**

FOR DIGITIZATION OF DOCUMENTS; ELECTRONIC SCANNING OF PHOTOGRAPHIC IMAGES (U.S. CLS. 100 AND 101).

BERYL GARDNER, EXAMINING ATTORNEY

SN 86-029,829. STATLIFE, TUBIANA, CAMPUS CANCER, FRANCE, FILED 8-6-2013.



OWNER OF ERPN CMNTY TM OFC REG. NO. 007515687, DATED 9-25-2009, EXPIRES 12-19-2018.

THE COLOR(S) ORANGE, LIGHT BLUE AND RED IS/ARE CLAIMED AS A FEATURE OF THE MARK.

THE MARK CONSISTS OF A STYLIZED HUMAN FIGURE IN ORANGE, SUPERIMPOSED OVER LIGHT BLUE CIRCLES OF VARIOUS SIZES ARRANGED IN A DIAMOND PATTERN, ALL TO THE LEFT OF THE WORD "EPIDEMIO" IN RED.

THE WORDING "EPIDEMIO" HAS NO MEANING IN A FOREIGN LANGUAGE.

**CLASS 9—ELECTRICAL AND SCIENTIFIC APPARATUS**

FOR MEDICAL AND PARAMEDICAL COMPUTER SOFTWARE FOR EPIDEMIOLOGY, PREVENTION OR PREDICTION OF DISEASES; EDUCATIONAL COMPUTER SOFTWARE FEATURING INSTRUCTION IN THE FIELD OF EPIDEMIOLOGY, PREVENTION OR PREDICTION OF DISEASES; COMPUTER GAME SOFTWARE; COMPUTER SOFTWARE RECORDED ON COMPUTER MEDIA FOR EPIDEMIOLOGY, PREVENTION OR PREDICTION OF DISEASES; COMPUTER PERIPHERAL DEVICES; DETECTORS, NAMELY, BIO-CHIPS AND GENOTYPING INSTRUMENTS; ELECTRIC WIRES; ELECTRIC RELAYS; DATA PROCESSING EQUIPMENT AND COMPUTERS; INTERFACES FOR COMPUTERS; SCIENTIFIC RESEARCH APPARATUS AND INSTRUMENTS, ALL FOR LABORATORY USE, NAMELY, BIOCHIPS AND GENOTYPING INSTRUMENTS; APPARATUS FOR RECORDING, TRANSMISSION, REPRODUCTION OR PROCESSING OF SOUND OR IMAGES; BLANK MAGNETIC DATA CARRIERS; COMPACT DISCS IN THE NATURE OF BLANK CD-ROMS, DVDS AND CDS, BLANK RECORDING DISCS AND BLANK OPTICAL DISCS; OPTICAL FIBERS; INTEGRATED CIRCUIT CARDS; BLANK SMART CARDS WITH MICROPROCESSORS; ENCODED SMART CARDS WITH MICROPROCESSORS CONTAINING PROGRAMMING USED FOR MEDICAL PREVENTION OR PREDICTION; FIBRE-OPTIC CABLES; DISC DRIVES FOR COMPUTERS; DATA-PROCESSING APPARATUS (U.S. CLS. 21, 23, 26, 36 AND 38).

**CLASS 38—COMMUNICATION**

FOR PROVIDING ACCESS TO GLOBAL COMPUTER NETWORKS; PROVIDING ACCESS TO MEDICAL RECORDS VIA COMPUTER OR TELECOMMUNICATIONS NETWORKS; PROVIDING MULTIPLE-USER ACCESS TO A GLOBAL COMPUTER INFORMATION NETWORK FOR INFORMATION RELATING TO THE PREVENTION OF DISEASES, THE PREDICTION OF DISEASE RISK AND THE PREDICTION OF RISK FACTORS; RENTAL OF ACCESS TIME TO GLOBAL COMPUTER NETWORKS; PROVIDING INTERNET CHAT ROOMS; COMMUNICATIONS BY COMPUTER TERMINALS OR BY FIBER OPTIC NETWORKS; PROVIDING TELECOMMUNICATIONS CONNECTIONS TO A GLOBAL COMPUTER NETWORK; RENTAL OF TELECOMMUNICATIONS EQUIPMENT AND APPARATUS; VOICE MAIL SERVICES; COMPUTER-AIDED TRANSMISSION OF MESSAGES AND IMAGES; TELECOMMUNICATION ROUTING AND JUNCTION SERVICES; ELECTRONIC BULLETIN BOARD SERVICES (U.S. CLS. 100, 101 AND 104).

**CLASS 42—SCIENTIFIC AND COMPUTER SERVICES**

FOR CREATING AND DESIGNING OF WEBSITES FOR OTHERS; DESIGN AND DEVELOPMENT OF COMPUTER HARDWARE AND SOFTWARE; ENGINEERING SERVICES RELATING TO ASSESSMENT, ESTIMATION, RESEARCH AND REPORTING IN THE FIELDS OF SCIENCE AND TECHNOLOGY; SCIENTIFIC AND MEDICAL PROJECT STUDIES, NAMELY, CONDUCTING CLINICAL TRIALS FOR OTHERS AND CONDUCTING OF FEASIBILITY STUDIES; COMPUTER PROGRAMMING; COMPUTER AND SOFTWARE CONSULTANCY; CONVERSION OF DATA AND OF COMPUTER PROGRAMS IN THE FIELD OF SCIENCE FROM PHYSICAL TO ELECTRONIC MEDIA; CONVERSION OF DATA OR DOCUMENTS FROM PHYSICAL TO ELECTRONIC MEDIA; COMPUTER SOFTWARE DESIGN; INSTALLATION, MAINTENANCE, UPDATING AND RENTAL OF COMPUTER SOFTWARE; SCIENTIFIC SERVICES RELATING TO THE PREVENTION OF DISEASES, THE PREDICTION OF DISEASE RISK AND THE PREDICTION OF RISK FACTORS, NAMELY, SCIENTIFIC RESEARCH, SCIENTIFIC LABORATORY SERVICES, GENETIC TESTING FOR SCIENTIFIC RESEARCH PURPOSES, DNA SCREENING FOR SCIENTIFIC RESEARCH PURPOSES, CONDUCTING CLINICAL TRIALS FOR OTHERS, PROVIDING MEDICAL TESTING SERVICES AND INFORMATION IN THE FIELD OF CANCER RESEARCH AND DISEASE CLASSIFICATION; HOSTING OF COMPUTER WEBSITES; RENTAL OF WEB SERVERS; COMPUTER RENTAL (U.S. CLS. 100 AND 101).

KATHERINE CONNOLLY, EXAMINING ATTORNEY

SN 86-030,240. G.S. PIZZA, INC., DBA GRAND STAND PIZZA, FRANKLIN PARK, IL. FILED 8-6-2013.

**Grand Stand Pizza**

THE MARK CONSISTS OF STANDARD CHARACTERS WITHOUT CLAIM TO ANY PARTICULAR FONT, STYLE, SIZE, OR COLOR.

NO CLAIM IS MADE TO THE EXCLUSIVE RIGHT TO USE "PIZZA", APART FROM THE MARK AS SHOWN.

**CLASS 30—STAPLE FOODS**

FOR ITALIAN ICE; PIZZA (U.S. CL. 46).  
FIRST USE 1-1-1982; IN COMMERCE 6-1-2013.

**CLASS 39—TRANSPORTATION AND STORAGE**

FOR PIZZA DELIVERY (U.S. CLS. 100 AND 105).  
FIRST USE 1-1-1982; IN COMMERCE 6-1-2013.  
ASMAT KHAN, EXAMINING ATTORNEY

SN 86-030,332. RICARDO FARIAS CHATSIU, GLIFADA, GREECE, FILED 8-6-2013.

**ANCIENT GREEK HERITAGE**

THE MARK CONSISTS OF STANDARD CHARACTERS WITHOUT CLAIM TO ANY PARTICULAR FONT, STYLE, SIZE, OR COLOR.

NO CLAIM IS MADE TO THE EXCLUSIVE RIGHT TO USE "GREEK", APART FROM THE MARK AS SHOWN.

**CLASS 29—MEATS AND PROCESSED FOODS**

FOR CANNED PROCESSED OLIVES; OLIVE OIL; OLIVE PASTES; PROCESSED STUFFED OLIVES (U.S. CL. 46).

FIRST USE 6-1-2012; IN COMMERCE 12-1-2012.

**CLASS 30—STAPLE FOODS**

FOR EDIBLE SPICES; HONEY; MUSTARD; SEA SALT FOR COOKING; VINEGAR (U.S. CL. 46).

FIRST USE 6-1-2012; IN COMMERCE 12-1-2012.

**CLASS 33—WINES AND SPIRITS**

FOR GRAPE WINE; WINES (U.S. CLS. 47 AND 49).  
FIRST USE 6-1-2012; IN COMMERCE 12-1-2012.

LAURA GOLDEN, EXAMINING ATTORNEY

SN 86-030,454. ALCOHOOT LLC, NEW YORK, NY. FILED 8-6-2013.

**ALCOHOOT**

THE MARK CONSISTS OF STANDARD CHARACTERS WITHOUT CLAIM TO ANY PARTICULAR FONT, STYLE, SIZE, OR COLOR.

**CLASS 9—ELECTRICAL AND SCIENTIFIC APPARATUS**

FOR DOWNLOADABLE COMPUTER APPLICATION SOFTWARE FOR SMART PHONES FOR THE ESTIMATION OF BLOOD ALCOHOL CONTENT OF INDIVIDUALS (U.S. CLS. 21, 23, 26, 36 AND 38).

**CLASS 10—MEDICAL APPARATUS**

FOR ALCOHOL BREATH TESTING UNITS FOR THE DETECTION AND CALCULATION OF BLOOD ALCOHOL CONCENTRATIONS OF INDIVIDUALS (U.S. CLS. 26, 39 AND 44).

CURTIS FRENCH, EXAMINING ATTORNEY

SN 86-031,013. LIQUID WEB, INC., LANSING, MI. FILED 8-7-2013.

## Storm on Demand

THE MARK CONSISTS OF STANDARD CHARACTERS WITHOUT CLAIM TO ANY PARTICULAR FONT, STYLE, SIZE, OR COLOR.

OWNER OF U.S. REG. NO. 3,808,362.

NO CLAIM IS MADE TO THE EXCLUSIVE RIGHT TO USE "ON DEMAND", APART FROM THE MARK AS SHOWN.

### CLASS 38—COMMUNICATION

FOR PROVIDING ACCESS TO HOSTED OPERATING SYSTEMS AND COMPUTER APPLICATIONS THROUGH THE INTERNET (U.S. CLS. 100, 101 AND 104).

FIRST USE 11-0-2009; IN COMMERCE 11-0-2009.

### CLASS 42—SCIENTIFIC AND COMPUTER SERVICES

FOR COMPUTER SERVICES, NAMELY, ACTING AS AN APPLICATION SERVICES PROVIDER FOR THIRD PARTIES FEATURING REMOTE HOSTING OF OPERATING SYSTEMS AND COMPUTER APPLICATIONS; COMPUTER SERVICES, NAMELY, PROVIDING A VIRTUAL COMPUTING ENVIRONMENT ACCESSIBLE VIA THE INTERNET FOR REGISTERED USERS FOR THE PURPOSE OF COMPUTING COMPUTER SERVICE CAPACITY; RENTAL OF COMPUTING AND DATA STORAGE FACILITIES OF VARIABLE CAPACITY, NAMELY, DATABASE SERVERS, TO THIRD PARTIES; SOFTWARE, NON-DOWNLOADABLE, ACCESSIBLE OVER A GLOBAL COMPUTER NETWORK, FOR MANAGING COMPUTER APPLICATIONS (U.S. CLS. 100 AND 101).

FIRST USE 8-25-2009; IN COMMERCE 8-25-2009.  
APRIL ROACH, EXAMINING ATTORNEY

SN 86-031,014. NATHAN SPORTS INC., SHARON HILL, PA. FILED 8-7-2013.

## SPEEDLOCK

THE MARK CONSISTS OF STANDARD CHARACTERS WITHOUT CLAIM TO ANY PARTICULAR FONT, STYLE, SIZE, OR COLOR.

### CLASS 20—FURNITURE AND ARTICLES NOT OTHERWISE CLASSIFIED

FOR CAPS FOR WATER BOTTLES SOLD AS A FEATURE OF SUCH BOTTLES, NAMELY, NON-METALLIC BOTTLE CAPS (U.S. CLS. 2, 13, 22, 25, 32 AND 50).

### CLASS 21—HOUSEWARES AND GLASS

FOR PORTABLE NUTRITION DISPENSERS USED FOR BODY NUTRITION BY ENDURANCE ATHLETES AND OUTDOOR ENTHUSIASTS, NAMELY, PERSONAL DISPENSERS FOR NUTRITIONAL FLUIDS AND NUTRITIONAL VITAMINS FOR DOMESTIC USE; WATER BOTTLES SOLD EMPTY; PERSONAL FLUID HYDRATION SYSTEMS COMPRISING A FLUID RESERVOIR, A DELIVERY TUBE, A MOUTHPIECE AND A CARRYING PACK (U.S. CLS. 2, 13, 23, 29, 30, 33, 40 AND 50).

JAMES STEIN, EXAMINING ATTORNEY

SN 86-031,167. FAST GIRL SKATES LLC, SEATTLE, WA. FILED 8-7-2013.

## FAST GIRL SKATES

THE MARK CONSISTS OF STANDARD CHARACTERS WITHOUT CLAIM TO ANY PARTICULAR FONT, STYLE, SIZE, OR COLOR.

NO CLAIM IS MADE TO THE EXCLUSIVE RIGHT TO USE "GIRL SKATES", APART FROM THE MARK AS SHOWN.

### CLASS 25—CLOTHING

FOR CLOTHING, NAMELY, SHIRTS, T-SHIRTS, TANK TOPS, JACKETS, SHORTS, PANTS, SOCKS, HATS, BANDANAS (U.S. CLS. 22 AND 39).

### CLASS 35—ADVERTISING AND BUSINESS

FOR RETAIL AND ON-LINE RETAIL STORE SERVICES FEATURING ROLLER SKATES, ROLLER SKATING ACCESSORIES, ROLLER DERBY EQUIPMENT AND ACCESSORIES, ROLLER DERBY APPAREL (U.S. CLS. 100, 101 AND 102).

FIRST USE 3-17-2007; IN COMMERCE 3-17-2007.  
TRACY WHITTAKER-BROWN, EXAMINING ATTORNEY

SN 86-031,181. ARTSCAPE, INC., PORTLAND, OR. FILED 8-7-2013.

## ARTSCAPE

THE MARK CONSISTS OF STANDARD CHARACTERS WITHOUT CLAIM TO ANY PARTICULAR FONT, STYLE, SIZE, OR COLOR.

### CLASS 17—RUBBER GOODS

FOR WINDOW COVERINGS, NAMELY, WINDOW FILM IN THE NATURE OF LAMINATED PLASTIC FILM FOR USE ON WINDOWS (U.S. CLS. 1, 5, 12, 13, 35 AND 50).

FIRST USE 4-15-1998; IN COMMERCE 4-5-1999.

**CLASS 20—FURNITURE AND ARTICLES NOT OTHERWISE CLASSIFIED**

FOR WINDOW COVERINGS, NAMELY, WINDOW FILM IN THE NATURE OF VINYL APPLIQUES FOR ATTACHMENT TO WINDOWS, MIRRORS, AND OTHER SOLID SURFACES (U.S. CLS. 2, 13, 22, 25, 32 AND 50).  
 FIRST USE 4-15-1998; IN COMMERCE 4-5-1999.  
 CATHERINE TARCU, EXAMINING ATTORNEY

**CLASS 25—CLOTHING**

FOR CLOTHING, NAMELY, MEN'S, WOMEN'S AND CHILDREN'S CLOTHING, NAMELY, FLEECE TOPS AND BOTTOMS, HEADWEAR, T-SHIRTS, SWEAT-SHIRTS, SHORTS, TANK TOPS, SWEATERS, PANTS, JACKETS, TURTLENECKS, JUMPSUITS, GOLF SHIRTS, WOVEN SHIRTS, KNIT SHIRTS, JERSEYS, WRISTBANDS, WARM UP SUITS, SWIMWEAR, WIND RESISTANT JACKETS, GLOVES, MITTENS, KNIT HATS, CAPS, SCARVES, HEADBANDS, AND UNDERWEAR; CLOTHING, NAMELY, SLEEPWEAR, NAMELY, ROBES, NIGHT SHIRTS AND PAJAMAS (U.S. CLS. 22 AND 39).

SN 86-031,212. FAST GIRL SKATES LLC, SEATTLE, WA. FILED 8-7-2013.

**CLASS 45—PERSONAL AND LEGAL SERVICES**

FOR INTERNET-BASED SOCIAL NETWORKING SERVICES; ONLINE SEARCHABLE DATABASES IN THE FIELD OF SOCIAL NETWORKING (U.S. CLS. 100 AND 101).  
 DAVID TOOLEY, EXAMINING ATTORNEY

**FAST GIRL U**

THE MARK CONSISTS OF STANDARD CHARACTERS WITHOUT CLAIM TO ANY PARTICULAR FONT, STYLE, SIZE, OR COLOR.  
 NO CLAIM IS MADE TO THE EXCLUSIVE RIGHT TO USE "GIRL", APART FROM THE MARK AS SHOWN.

SN 86-031,329. QUEST AFTER IT, LLC, PITTSBURGH, PA. FILED 8-7-2013.

**CLASS 25—CLOTHING**

FOR CLOTHING, NAMELY, SHIRTS, T-SHIRTS, TANK TOPS, JACKETS, SHORTS, PANTS, SOCKS, HATS, BANDANAS (U.S. CLS. 22 AND 39).

**QUEST AFTER IT**

**CLASS 41—EDUCATION AND ENTERTAINMENT**

FOR ORGANIZING, ARRANGING, AND CONDUCTING ROLLER DERBY TRAINING EVENTS, PROGRAMS, AND CAMPS; PROVIDING CLASSES, SEMINARS, WORKSHOPS, AND TRAINING FOR INSTRUCTORS, REFEREES, PARTICIPANTS, AND OTHER INDIVIDUALS IN THE FIELD OF ROLLER DERBY (U.S. CLS. 100, 101 AND 107).  
 TRACY WHITTAKER-BROWN, EXAMINING ATTORNEY

THE MARK CONSISTS OF STANDARD CHARACTERS WITHOUT CLAIM TO ANY PARTICULAR FONT, STYLE, SIZE, OR COLOR.

**CLASS 35—ADVERTISING AND BUSINESS**

FOR ADVERTISING, MARKETING AND INFORMATION DISTRIBUTION SERVICES PROVIDED BY MEANS OF INDIRECT METHODS OF MARKETING COMMUNICATIONS, NAMELY, SOCIAL MEDIA, INTERNET MARKETING, MOBILE MARKETING, BLOGGING AND OTHER FORMS OF PASSIVE, SHARABLE OR VIRAL COMMUNICATIONS CHANNELS; ONLINE SERVICES FOR PROMOTING AND CONNECTING SOCIAL NETWORK USERS WITH RETAILERS FOR THE PURPOSE OF FACILITATING PURCHASES; PROVIDING ONLINE COMPUTER DATABASES AND ONLINE SEARCHABLE DATABASES IN THE FIELD OF THIRD PARTY ADVERTISEMENTS; RETAIL STORE SERVICES AND ON-LINE RETAIL STORE SERVICES FEATURING A WIDE VARIETY OF CONSUMER GOODS OF OTHERS (U.S. CLS. 100, 101 AND 102).

SN 86-031,234. QUEST AFTER IT, LLC, PITTSBURGH, PA. FILED 8-7-2013.



THE MARK CONSISTS OF AN IMAGE OF A THREE-PRONGED CROWN OVER A GEOMETRIC DEPICTION OF A MOUNTAIN.

**CLASS 45—PERSONAL AND LEGAL SERVICES**

FOR INTERNET-BASED SOCIAL NETWORKING SERVICES; ONLINE SEARCHABLE DATABASES IN THE FIELD OF SOCIAL NETWORKING (U.S. CLS. 100 AND 101).  
 DAVID TOOLEY, EXAMINING ATTORNEY

SN 86-031,791. DRUM EXCHANGE, BROOKLYN, NY.  
FILED 8-7-2013.

We are music.

THE MARK CONSISTS OF STANDARD CHARACTERS WITHOUT CLAIM TO ANY PARTICULAR FONT, STYLE, SIZE, OR COLOR.

NO CLAIM IS MADE TO THE EXCLUSIVE RIGHT TO USE "MUSIC", APART FROM THE MARK AS SHOWN.

#### CLASS 35—ADVERTISING AND BUSINESS

FOR ON-LINE RETAIL STORE SERVICES FEATURING USED MUSICAL EQUIPMENT (U.S. CLS. 100, 101 AND 102).

#### CLASS 41—EDUCATION AND ENTERTAINMENT

FOR PROVIDING EDUCATION COURSES IN THE FIELD OF MUSICAL INSTRUMENTS OFFERED THROUGH ONLINE, NON-DOWNLOADABLE VIDEOS AND INSTRUCTOR ASSISTANCE (U.S. CLS. 100, 101 AND 107).

ELISSA GARBER KON, EXAMINING ATTORNEY

SN 86-031,816. ROCHESTER INSTITUTE OF TECHNOLOGY,  
ROCHESTER, NY. FILED 8-7-2013.

MAGIC SPELL STUDIOS

THE MARK CONSISTS OF STANDARD CHARACTERS WITHOUT CLAIM TO ANY PARTICULAR FONT, STYLE, SIZE, OR COLOR.

NO CLAIM IS MADE TO THE EXCLUSIVE RIGHT TO USE "STUDIOS", APART FROM THE MARK AS SHOWN.

#### CLASS 9—ELECTRICAL AND SCIENTIFIC APPARATUS

FOR COMPUTER AND ELECTRONIC GAME SOFTWARE; SOFTWARE FOR PRODUCING 3D MODELING; CHILDREN'S EDUCATIONAL SOFTWARE; EDUCATIONAL SOFTWARE FEATURING INSTRUCTION IN THE FIELDS OF SCIENCE, TECHNOLOGY, ENGINEERING, MATH, MEDICINE, AND LANGUAGE AND LIBERAL ARTS; COMPUTER HARDWARE FOR USE IN THE FIELDS OF SCIENCE, TECHNOLOGY, ENGINEERING, MATH, MEDICINE, AND LANGUAGE AND LIBERAL ARTS (U.S. CLS. 21, 23, 26, 36 AND 38).

#### CLASS 35—ADVERTISING AND BUSINESS

FOR BUSINESS CONSULTATION SERVICES, NAMELY, BUSINESS ASSISTANCE IN AREAS OF TECHNOLOGY COMMERCIALIZATION, PLANNING AND STRATEGIC MARKETING (U.S. CLS. 100, 101 AND 102).

#### CLASS 41—EDUCATION AND ENTERTAINMENT

FOR DEVELOPMENT, CREATION, PRODUCTION AND POST-PRODUCTION SERVICES OF MULTIMEDIA ENTERTAINMENT CONTENT AND SOUND AND IMAGE RECORDINGS; PROVIDING TEMPORARY USE OF ON-LINE NON-DOWNLOADABLE COMPUTER AND ELECTRONIC GAME SOFTWARE (U.S. CLS. 100, 101 AND 107).

#### CLASS 42—SCIENTIFIC AND COMPUTER SERVICES

FOR DESIGN, DEVELOPMENT, UPDATING AND MAINTENANCE OF COMPUTER SOFTWARE APPLICATIONS, COMPUTER AND VIDEO GAME SOFTWARE APPLICATIONS, AND VIRTUAL REALITY, MODELING AND SIMULATION SOFTWARE APPLICATIONS; PROVIDING TEMPORARY USE OF ON-LINE NON-DOWNLOADABLE COMPUTER AND ELECTRONIC GAME SOFTWARE AND APPLICATIONS; PROVIDING TEMPORARY USE OF ON-LINE NON-DOWNLOADABLE SOFTWARE FOR PRODUCING 3D MODELING; PROVIDING TEMPORARY USE OF ON-LINE NON-DOWNLOADABLE CHILDREN'S EDUCATIONAL SOFTWARE; PROVIDING TEMPORARY USE OF ON-LINE NON-DOWNLOADABLE EDUCATIONAL SOFTWARE FEATURING INSTRUCTION IN THE FIELDS OF SCIENCE, TECHNOLOGY, ENGINEERING, MATH, MEDICINE, AND LANGUAGE AND LIBERAL ARTS (U.S. CLS. 100 AND 101).

COURTNEY ALVAREZ, EXAMINING ATTORNEY

SN 86-032,273. KOUADIO, FRANCIS, JACKSONVILLE, FL.  
FILED 8-8-2013.

hesed

THE MARK CONSISTS OF STANDARD CHARACTERS WITHOUT CLAIM TO ANY PARTICULAR FONT, STYLE, SIZE, OR COLOR.

THE ENGLISH TRANSLATION OF THE HEBREW WORD "HESED" IN THE MARK IS "LOVING KINDNESS".

#### CLASS 25—CLOTHING

FOR SPORT SHOES; SPORT OVER UNIFORMS; JERSEYS; T-SHIRTS; TRIATHLON CLOTHING, NAMELY, TRIATHLON TIGHTS, TRIATHLON SHORTS, TRIATHLON SINGLET, TRIATHLON SHIRTS, TRIATHLON SUITS; TURTLE NECK SHIRTS; SWEATSHIRTS; SPORTS SHIRTS WITH SHORT SLEEVES; SPORTS SHIRTS; RUGBY SHIRTS; POLO SHIRTS; MOISTURE-WICKING SPORTS SHIRTS; LONG-SLEEVED SHIRTS; HOODED SWEATSHIRTS; GOLF SHIRTS; GOLF PANTS SHIRTS AND SKIRTS; CLOTHING FOR ATHLETIC USE, NAMELY, PADDED SHIRTS, A-SHIRTS, ATHLETIC SHIRTS; ATHLETIC APPAREL, NAMELY, SHIRTS, PANTS, JACKETS, FOOTWEAR, HATS AND CAPS, ATHLETIC UNIFORMS; APPAREL FOR DANCERS, NAMELY, TEE SHIRTS, SWEATSHIRTS, PANTS, LEGGINGS, SHORTS AND JACKETS; COMPRESSION GARMENTS FOR ATHLETIC OR OTHER NON-MEDICAL USE, NAMELY, SOCKS, STOCKINGS, LEGGINGS, JERSEYS, VESTS, TROUSERS; CYCLISTS' JERSEYS; SLEEVELESS JERSEYS; SPORTS JERSEYS; SPORTS JERSEYS AND BREECHES FOR SPORTS; VOLLEYBALL JERSEYS; SOCCER SHOES; KARATE SUITS; FIGHT SHORTS FOR MIXED MARTIAL ARTS OR GRAPPLING; MARTIAL ARTS UNIFORMS; MIXED MARTIAL ARTS SUITS (U.S. CLS. 22 AND 39).

**CLASS 28—TOYS AND SPORTING GOODS**

FOR GAME EQUIPMENT SET SOLD AS A UNIT COMPRISED PRIMARILY OF A PLAYING BOARD AND PLAYING CARDS AND ALSO INCLUDING RULES OF PLAY, DRY ERASE BOARDS AND ERASERS, MARKERS, A TIMER AND T-SHIRTS; BODY LIMB COMPRESSION SLEEVES FOR USE IN SOCCER AND OTHER SPORTS; SOCCER BALL KNEE PADS; TROLLEY BAGS SPECIALLY ADAPTED FOR SPORT EQUIPMENT; KARATE GLOVES; KARATE HEAD GUARDS; KARATE TARGET PADS; KARATE KICK PADS; MARTIAL ARTS TRAINING EQUIPMENT; SPORTS EQUIPMENT FOR BOXING, MARTIAL ARTS, AND THE LIKE, NAMELY, PROTECTIVE BRAS; SPORTS EQUIPMENT FOR BOXING, MARTIAL ARTS, AND THE LIKE, NAMELY, AN APPARATUS TO SUPPORT A MOVING HEAVY BAG; SPORTS EQUIPMENT FOR BOXING AND MARTIAL ARTS, NAMELY, BOXING GLOVES, BOXING BAGS, PUNCHING MITTS, BELLY PROTECTORS, GROIN PROTECTORS AND SHIN GUARDS; SPORTS EQUIPMENT FOR BOXING AND MARTIAL ARTS, NAMELY, BOXING GLOVES, MIXED MARTIAL ARTS GLOVES, PUNCHING MITTS, AND SHIN GUARDS; BAGS SPECIALLY ADAPTED FOR SPORTS EQUIPMENT; SPORT BALLS (U.S. CLS. 22, 23, 38 AND 50).  
WILLIAM P. SHANAHAN, EXAMINING ATTORNEY

SN 86-032,733. PROHEADER INC., CITY OF INDUSTRY, CA. FILED 8-8-2013.



NO CLAIM IS MADE TO THE EXCLUSIVE RIGHT TO USE "PROHEADER PERFORMANCE PRODUCTS", APART FROM THE MARK AS SHOWN.

THE COLOR(S) WHITE, YELLOW, BLACK, SILVER AND RED IS/ARE CLAIMED AS A FEATURE OF THE MARK.

THE MARK CONSISTS OF THE WORDING "PROHEADER" IN WHITE STYLIZED FONT ABOVE THE YELLOW-COLORED WORDS "PERFORMANCE PRODUCTS" ALL DISPLAYED WITHIN A BLACK-COLORED GEOMETRIC SHAPE RESEMBLING A BADGE SURROUNDED BY WHITE, SILVER AND RED OUTLINES AROUND THE SAME.

**CLASS 7—MACHINERY**

FOR AUTOMOTIVE PARTS, NAMELY, AIR FILTERS FOR MOTORS AND ENGINES, AIR COMPRESSORS FOR VEHICLES, ALTERNATORS FOR LAND VEHICLES, DISTRIBUTORS FOR VEHICLES, FUEL FILTERS, FUEL PUMPS FOR LAND VEHICLES, VEHICLE ENGINE PARTS IN THE NATURE OF ROCKER ARMS, WATER PUMPS FOR LAND VEHICLES, CRANK SHAFTS FOR VEHICLE MOTORS AND ENGINES, CYLINDER HEADS FOR ENGINES AND CONNECTING RODS FOR MOTORS AND ENGINES (U.S. CLS. 13, 19, 21, 23, 31, 34 AND 35).  
FIRST USE 9-30-2010; IN COMMERCE 9-30-2010.

**CLASS 12—VEHICLES**

FOR AUTOMOTIVE PARTS, NAMELY, STEERING AND SUSPENSION SYSTEMS AND PARTS FOR STEERING AND SUSPENSION SYSTEMS FOR VEHICLES IN THE NATURE OF UPPER BALL JOINTS, LOWER BALL JOINTS, BALL JOINTS WITH CONTROL ARMS, BUSHING KITS, INNER TIE ROD ENDS, OUTER TIE ROD ENDS, SLEEVES, IDLER ARMS, CENTER LINKS, STABILIZER KITS, INNER SOCKETS AND PITMAN ARMS AND STEERING WHEELS FOR VEHICLES (U.S. CLS. 19, 21, 23, 31, 35 AND 44).  
FIRST USE 9-30-2010; IN COMMERCE 9-30-2010.

DAVID YONTEF, EXAMINING ATTORNEY

**LET'S EAT HEALTHY**

THE MARK CONSISTS OF STANDARD CHARACTERS WITHOUT CLAIM TO ANY PARTICULAR FONT, STYLE, SIZE, OR COLOR.

**CLASS 29—MEATS AND PROCESSED FOODS**

FOR DRIED BEANS (U.S. CL. 46).

**CLASS 30—STAPLE FOODS**

FOR RICE, GRANOLA, BAKING MIXES, NAMELY, BROWNIE MIXES, COOKIE MIXES, PANCAKE MIXES, MUFFIN MIXES, MIXES FOR BAKING BATTERS, MIXES FOR BAKERY GOODS (U.S. CL. 46).

**CLASS 31—NATURAL AGRICULTURAL PRODUCTS**

FOR UNPROCESSED CEREALS, ANCIENT GRAINS, NAMELY, UNPROCESSED GRAINS AND UNPROCESSED QUINOA (U.S. CLS. 1 AND 46).  
MEREDITH MARESCA, EXAMINING ATTORNEY

SN 86-032,851. FOUR PAWS DOG WALKING, INC., DBA WOOF'S 'N WHISKERS, BROOKLYN, NY. FILED 8-8-2013.

**Woofs 'n Whiskers**

THE MARK CONSISTS OF STANDARD CHARACTERS WITHOUT CLAIM TO ANY PARTICULAR FONT, STYLE, SIZE, OR COLOR.

**CLASS 43—HOTEL AND RESTAURANT SERVICES**

FOR KENNEL SERVICES, NAMELY, BOARDING FOR PETS; PET BOARDING SERVICES; PET DAY CARE SERVICES; PET HOTEL SERVICES (U.S. CLS. 100 AND 101).  
FIRST USE 10-26-1995; IN COMMERCE 10-26-1995.

**CLASS 44—MEDICAL, BEAUTY AND AGRICULTURAL SERVICES**

FOR ANIMAL GROOMING; ANIMAL GROOMING SERVICES; DOG GROOMING SERVICES; PET CARE SERVICES, NAMELY, DOG WALKING, DOG BATHING AND NON-MEDICATED PET GROOMING; PROVIDING SELF-SERVICE PET GROOMING FACILITIES; PROVIDING SELF-SERVICE PET WASHING FACILITIES (U.S. CLS. 100 AND 101).

FIRST USE 10-26-1995; IN COMMERCE 10-26-1995.

**CLASS 45—PERSONAL AND LEGAL SERVICES**

FOR PET SITTING (U.S. CLS. 100 AND 101).  
FIRST USE 10-26-1995; IN COMMERCE 10-26-1995.  
WON TEAK OH, EXAMINING ATTORNEY

---

SN 86-032,874. IGI HEALTH HOLDINGS LLC, PISCATAWAY, NJ. FILED 8-8-2013.

**CLASS 42—SCIENTIFIC AND COMPUTER SERVICES**

FOR SOFTWARE SERVICES, NAMELY, HOSTING SOFTWARE FOR USE BY OTHERS FOR GATHERING PATIENT MEDICAL DATA AND REPORTING DATA TO INSURANCE COMPANIES, AND PROVISION OF SUCH SOFTWARE FOR USE BY THIRD PARTIES; SOFTWARE SERVICES, NAMELY, HOSTING SOFTWARE FOR USE BY OTHERS FOR MONITORING PATIENT HEALTHCARE TREATMENT, AND PROVISION OF SUCH SOFTWARE FOR USE BY THIRD PARTIES; SOFTWARE SERVICES, NAMELY, HOSTING SOFTWARE FOR USE BY OTHERS FOR CONTROLLING AND MANAGING PATIENT MEDICAL INFORMATION, AND PROVISION OF SUCH SOFTWARE FOR USE BY THIRD PARTIES; SOFTWARE SERVICES, NAMELY, HOSTING SOFTWARE FOR USE BY OTHERS FOR PROVIDING PATIENT ALERTS TO MEDICAL PROVIDERS, AND PROVISION OF SUCH SOFTWARE FOR USE BY THIRD PARTIES; SOFTWARE SERVICES, NAMELY, HOSTING SOFTWARE FOR USE BY OTHERS FOR PROVIDING ANALYTICS TO MEDICAL CARE PROVIDERS BASED ON PATIENT DATA, AND PROVISION OF SUCH SOFTWARE FOR USE BY THIRD PARTIES; SOFTWARE SERVICES, NAMELY, HOSTING SOFTWARE FOR USE BY OTHERS FOR MEDICAL INSURANCE COVERAGE MANAGEMENT, AND PROVISION OF SUCH SOFTWARE FOR USE BY THIRD PARTIES; SOFTWARE SERVICES, NAMELY, HOSTING SOFTWARE FOR USE BY OTHERS FOR ASSISTING MEDICAL CARE PROVIDERS WITH THE INSURANCE REIMBURSEMENT PROCESS, AND PROVISION OF SUCH SOFTWARE FOR USE BY THIRD PARTIES (U.S. CLS. 100 AND 101).  
DOMINICK J. SALEMI, EXAMINING ATTORNEY

---

SN 86-033,254. 1010 TECHNOLOGIES LLC, EL CAJON, CA. FILED 8-9-2013.

**HEALTHCARE ENHANCED CONNECTIVITY**

THE MARK CONSISTS OF STANDARD CHARACTERS WITHOUT CLAIM TO ANY PARTICULAR FONT, STYLE, SIZE, OR COLOR.

NO CLAIM IS MADE TO THE EXCLUSIVE RIGHT TO USE "HEALTHCARE" AND "CONNECTIVITY", APART FROM THE MARK AS SHOWN.

**CLASS 9—ELECTRICAL AND SCIENTIFIC APPARATUS**

FOR COMPUTER SOFTWARE FOR GATHERING PATIENT MEDICAL DATA AND REPORTING DATA TO INSURANCE COMPANIES; COMPUTER SOFTWARE FOR MONITORING PATIENT HEALTHCARE TREATMENT; COMPUTER SOFTWARE FOR CONTROLLING AND MANAGING PATIENT MEDICAL INFORMATION; COMPUTER SOFTWARE FOR PROVIDING PATIENT ALERTS TO MEDICAL PROVIDERS; COMPUTER SOFTWARE FOR PROVIDING ANALYTICS TO MEDICAL CARE PROVIDERS BASED ON PATIENT DATA; COMPUTER SOFTWARE FOR MEDICAL INSURANCE COVERAGE MANAGEMENT; COMPUTER SOFTWARE FOR ASSISTING MEDICAL CARE PROVIDERS WITH THE INSURANCE REIMBURSEMENT PROCESS (U.S. CLS. 21, 23, 26, 36 AND 38).

**1010 TECHNOLOGIES**

THE MARK CONSISTS OF STANDARD CHARACTERS WITHOUT CLAIM TO ANY PARTICULAR FONT, STYLE, SIZE, OR COLOR.

NO CLAIM IS MADE TO THE EXCLUSIVE RIGHT TO USE "TECHNOLOGIES", APART FROM THE MARK AS SHOWN.

**CLASS 9—ELECTRICAL AND SCIENTIFIC APPARATUS**

FOR COMPUTER APPLICATION SOFTWARE FOR MOBILE PHONES, PORTABLE MEDIA PLAYERS, HANDHELD COMPUTERS, NAMELY, SOFTWARE FOR CREATING MULTIMEDIA PRESENTATIONS, CREATING AND SHARING NOTES AND STORES; COMPUTER PROGRAM FOR AUTHORIZING AND RUNNING HYPERMEDIA APPLICATIONS (U.S. CLS. 21, 23, 26, 36 AND 38).

**CLASS 42—SCIENTIFIC AND COMPUTER SERVICES**

FOR DESIGN AND DEVELOPMENT OF COMPUTER HARDWARE AND SOFTWARE; CONSULTANCY IN THE FIELD OF SOFTWARE DESIGN (U.S. CLS. 100 AND 101).

FIRST USE 6-1-2013; IN COMMERCE 6-1-2013.  
JAMES MACFARLANE, EXAMINING ATTORNEY



SN 86-033,378. BUENAVISTA INVESTMENT HOLDING LLC,  
MIAMI, FL. FILED 8-9-2013.

**GAVANNA**

THE MARK CONSISTS OF THE WORDS "GAVANNA" IS  
STYLIZED LETTERS.

**CLASS 41—EDUCATION AND ENTERTAINMENT**

FOR ENTERTAINMENT SERVICES, NAMELY, NIGHT CLUBS, DANCE CLUBS, BOOKING OF ENTERTAINMENT HALLS; CONDUCTING PARTIES, SPECIAL EVENT PLANNING FOR SOCIAL ENTERTAINMENT PURPOSES, PARTY PLANNING; BOOKING OF NIGHT CLUBS, DANCE CLUBS AND ENTERTAINMENT HALLS (U.S. CLS. 100, 101 AND 107).

FIRST USE 6-0-2010; IN COMMERCE 2-14-2012.

**CLASS 43—HOTEL AND RESTAURANT SERVICES**

FOR PREPARATION OF FOOD AND DRINK; PROVIDING OF FOOD AND DRINK (U.S. CLS. 100 AND 101).

FIRST USE 6-0-2010; IN COMMERCE 2-14-2012.  
ESTHER BELENKER, EXAMINING ATTORNEY

SN 86-033,397. TAB PRODUCTS CO., LLC, MAYVILLE, WI.  
FILED 8-9-2013.

**TAB**

THE MARK CONSISTS OF STANDARD CHARACTERS WITHOUT CLAIM TO ANY PARTICULAR FONT, STYLE, SIZE, OR COLOR.

OWNER OF U.S. REG. NOS. 1,222,541, 1,588,560 AND 4,179,343.

**CLASS 16—PAPER GOODS AND PRINTED MATTER**

FOR FILE FOLDERS; HANGING FOLDERS; ENVELOPES; BLANK OR PARTIALLY-PRINTED PAPER LABELS; PRINTED PAPER LABELS; INDEX DIVIDERS (U.S. CLS. 2, 5, 22, 23, 29, 37, 38 AND 50).

FIRST USE 5-0-1967; IN COMMERCE 5-0-1967.

**CLASS 20—FURNITURE AND ARTICLES NOT OTHERWISE CLASSIFIED**

FOR SHELVING, NAMELY, SHELVES FOR STORAGE AND ORGANIZATION; MOVING-AISLE FILING AND STORAGE SHELVING; FILING CABINETS (U.S. CLS. 2, 13, 22, 25, 32 AND 50).

FIRST USE 5-0-1979; IN COMMERCE 5-0-1979.

**CLASS 35—ADVERTISING AND BUSINESS**

FOR CONSULTING SERVICES IN THE FIELD OF BUSINESS RECORDS MANAGEMENT; BUSINESS RECORDS MANAGEMENT SERVICES (U.S. CLS. 100, 101 AND 102).

FIRST USE 6-0-1954; IN COMMERCE 6-0-1954.

**CLASS 39—TRANSPORTATION AND STORAGE**

FOR ELECTRONIC STORAGE OF FILES AND DOCUMENTS; STORAGE SERVICES FOR ARCHIVING DATABASES, IMAGES AND OTHER ELECTRONIC DATA (U.S. CLS. 100 AND 105).

FIRST USE 12-0-1988; IN COMMERCE 12-0-1988.  
CARYN GLASSER, EXAMINING ATTORNEY

SN 86-033,401. TAB PRODUCTS CO., LLC, MAYVILLE, WI.  
FILED 8-9-2013.



THE MARK CONSISTS OF A STYLIZED REPRESENTATION OF A LEAPING HUMAN FIGURE ON A SOLID, SQUARE BACKGROUND.

**CLASS 9—ELECTRICAL AND SCIENTIFIC APPARATUS**

FOR RECORDS MANAGEMENT SOFTWARE; LABEL PRINTING SOFTWARE (U.S. CLS. 21, 23, 26, 36 AND 38).

FIRST USE 10-0-1988; IN COMMERCE 10-0-1988.

**CLASS 16—PAPER GOODS AND PRINTED MATTER**

FOR FILE FOLDERS; HANGING FOLDERS; ENVELOPES; BLANK OR PARTIALLY-PRINTED PAPER LABELS; PRINTED PAPER LABELS; INDEX DIVIDERS (U.S. CLS. 2, 5, 22, 23, 29, 37, 38 AND 50).

FIRST USE 10-0-1988; IN COMMERCE 10-0-1988.

**CLASS 20—FURNITURE AND ARTICLES NOT OTHERWISE CLASSIFIED**

FOR SHELVING, NAMELY, SHELVES FOR STORAGE AND ORGANIZATION; MOVING-AISLE FILING AND STORAGE SHELVING; FILING CABINETS (U.S. CLS. 2, 13, 22, 25, 32 AND 50).

FIRST USE 10-0-1988; IN COMMERCE 10-0-1988.

**CLASS 35—ADVERTISING AND BUSINESS**

FOR CONSULTING SERVICES IN THE FIELD OF BUSINESS RECORDS MANAGEMENT; BUSINESS RECORDS MANAGEMENT SERVICES (U.S. CLS. 100, 101 AND 102).

FIRST USE 10-0-1988; IN COMMERCE 10-0-1988.

**CLASS 39—TRANSPORTATION AND STORAGE**

FOR ELECTRONIC STORAGE OF FILES AND DOCUMENTS; STORAGE SERVICES FOR ARCHIVING DATABASES, IMAGES AND OTHER ELECTRONIC DATA (U.S. CLS. 100 AND 105).

FIRST USE 10-0-1988; IN COMMERCE 10-0-1988.  
CARYN GLASSER, EXAMINING ATTORNEY

SN 86-034,559. KANE, GEOFFREY P., BRATTLEBORO, VT.  
FILED 8-10-2013.

**The Two Pillars of Recovery**

THE MARK CONSISTS OF STANDARD CHARACTERS WITHOUT CLAIM TO ANY PARTICULAR FONT, STYLE, SIZE, OR COLOR.

**CLASS 9—ELECTRICAL AND SCIENTIFIC APPARATUS**

FOR DIGITAL MATERIALS, NAMELY, DOWNLOADABLE ELECTRONIC PUBLICATIONS IN THE NATURE OF DOWNLOADABLE ELECTRONIC NEWSLETTERS, DOWNLOADABLE ELECTRONIC ARTICLES AND DOWNLOADABLE CHECKLISTS IN THE FIELD OF AND PROMOTING PERSONAL DEVELOPMENT; DIGITAL MEDIA, NAMELY, PRE-RECORDED DVDS, DOWNLOADABLE AUDIO AND VIDEO RECORDINGS, AND CDS IN THE FIELD OF AND PROMOTING PERSONAL DEVELOPMENT (U.S. CLS. 21, 23, 26, 36 AND 38).

**CLASS 16—PAPER GOODS AND PRINTED MATTER**

FOR PRINTED MATERIALS, NAMELY, CURRICULA IN THE FIELD OF PERSONAL DEVELOPMENT; PRINTED MATERIALS, NAMELY, WRITTEN ARTICLES IN THE FIELD OF PERSONAL DEVELOPMENT; PRINTED MATTER, NAMELY, PAPER SIGNS, BOOKS, MANUALS, CURRICULUM, NEWSLETTERS, INFORMATIONAL CARDS AND BROCHURES IN THE FIELD OF PERSONAL DEVELOPMENT (U.S. CLS. 2, 5, 22, 23, 29, 37, 38 AND 50).

**CLASS 41—EDUCATION AND ENTERTAINMENT**

FOR EDUCATION SERVICES, NAMELY, PROVIDING ON-LINE AND FACE-TO-FACE CLASSES, SEMINARS AND WORKSHOPS IN THE FIELD OF PERSONAL DEVELOPMENT; ON-LINE JOURNALS, NAMELY, BLOGS FEATURING INFORMATION ON PERSONAL DEVELOPMENT; PROVIDING GROUP COACHING IN THE FIELD OF PERSONAL DEVELOPMENT; PROVIDING DIGITAL MATERIALS, NAMELY, PROVIDING ONLINE ELECTRONIC PUBLICATIONS IN THE NATURE OF ONLINE ELECTRONIC NEWSLETTERS, ONLINE ELECTRONIC ARTICLES AND ONLINE CHECKLISTS IN THE FIELD OF AND PROMOTING PERSONAL DEVELOPMENT (U.S. CLS. 100, 101 AND 107).

KATHERINE CHANG, EXAMINING ATTORNEY

SN 86-033,863. COMMIT MEDIA, LLC, NEW YORK, NY.  
FILED 8-9-2013.

**CAUSE ENTERTAINMENT**

THE MARK CONSISTS OF STANDARD CHARACTERS WITHOUT CLAIM TO ANY PARTICULAR FONT, STYLE, SIZE, OR COLOR.

NO CLAIM IS MADE TO THE EXCLUSIVE RIGHT TO USE "ENTERTAINMENT", APART FROM THE MARK AS SHOWN.

**CLASS 35—ADVERTISING AND BUSINESS**

FOR BUSINESS MANAGEMENT CONSULTING, STRATEGIC PLANNING AND BUSINESS ADVISORY SERVICES PROVIDED TO BUSINESSES AND NON-PROFIT CORPORATIONS; ADVISORY AND CONSULTING SERVICES IN THE FIELD OF MARKETING RELATING TO THE ACTIVITIES OF CHARITABLE ORGANIZATIONS, ADVERTISING, AND BRAND AWARENESS; ADVISORY AND CONSULTING SERVICES IN THE FIELD OF ENGAGING CELEBRITIES FOR THE PROMOTION OF PUBLIC AWARENESS OF CHARITABLE AND SOCIAL ISSUES AND THE ACTIVITIES OF CHARITABLE ORGANIZATIONS; MARKETING CONSULTANCY; PUBLIC RELATIONS SERVICES, NAMELY, PUBLIC RELATIONS MARKETING SERVICES IN THE NATURE OF PROMOTING THE GOODS AND SERVICES OF OTHERS (U.S. CLS. 100, 101 AND 102).

**CLASS 36—INSURANCE AND FINANCIAL**

FOR PHILANTHROPY CONSULTATION RELATING TO CHARITABLE FUNDRAISING (U.S. CLS. 100, 101 AND 102).

SN 86-034,670. ROBERT J. SMITH CHFC AEP CLU CLTC,  
SCOTTSDALE, AZ. FILED 8-11-2013.

**CLASS 41—EDUCATION AND ENTERTAINMENT**

FOR ENTERTAINMENT SERVICES, NAMELY, MULTIMEDIA PRODUCTION SERVICES; ENTERTAINMENT SERVICES IN THE NATURE OF DEVELOPMENT, CREATION, PRODUCTION AND POST-PRODUCTION SERVICES OF MULTIMEDIA ENTERTAINMENT CONTENT; ADVISORY AND CONSULTING SERVICES IN THE FIELD OF MEDIA PRODUCTION (U.S. CLS. 100, 101 AND 107).

WILLIAM JACKSON, EXAMINING ATTORNEY

**TODAY'S PHILANTHROPIST**

THE MARK CONSISTS OF STANDARD CHARACTERS WITHOUT CLAIM TO ANY PARTICULAR FONT, STYLE, SIZE, OR COLOR.

NO CLAIM IS MADE TO THE EXCLUSIVE RIGHT TO USE "PHILANTHROPIST", APART FROM THE MARK AS SHOWN.

SN 86-035,442. PREMIERE LOCK COMPANY, LLC, DBA WESLOCK, TULSA, OK. FILED 8-12-2013.

**CLASS 16—PAPER GOODS AND PRINTED MATTER**

FOR GENERAL FEATURE MAGAZINE IN THE FIELD OF PHILANTHROPY (U.S. CLS. 2, 5, 22, 23, 29, 37, 38 AND 50).

**PREMIERE ESSENTIALS**

THE MARK CONSISTS OF STANDARD CHARACTERS WITHOUT CLAIM TO ANY PARTICULAR FONT, STYLE, SIZE, OR COLOR.

**CLASS 41—EDUCATION AND ENTERTAINMENT**

FOR PROVIDING ON-LINE MAGAZINES IN THE FIELD OF PHILANTHROPY (U.S. CLS. 100, 101 AND 107).

RAUL CORDOVA, EXAMINING ATTORNEY

**CLASS 6—METAL GOODS**

FOR METAL HARDWARE FOR USE IN RESIDENTIAL AND COMMERCIAL BUILDINGS, NAMELY, DOOR LOCKS, FACEPLATES, DOOR HINGES, CABINET PULLS, KNOBS, CABINET HINGES, ROLLER CATCHES, DOOR CATCHES, POCKET DOOR HARDWARE, DOOR KICK PLATES, DOOR GUARDS, DOOR LATCH BOLTS, SPRING STOPS, BASEBOARD BUMPERS, SWITCH PLATES, HOUSE NUMBERS, MAIL SLOTS, DOOR KNOCKERS, AND COAT HOOKS; METAL ROBE HOOKS (U.S. CLS. 2, 12, 13, 14, 23, 25 AND 50).

SN 86-035,008. ALTOUR INTERNATIONAL, INC., NEW YORK, NY. FILED 8-12-2013.

**CLASS 21—HOUSEWARES AND GLASS**

FOR BATHROOM HARDWARE AND ACCESSORIES, NAMELY, TOILET PAPER HOLDERS, TOWEL BARS, TOWEL RINGS, SOAP HOLDERS (U.S. CLS. 2, 13, 23, 29, 30, 33, 40 AND 50).

ERNEST SHOSH, EXAMINING ATTORNEY

**Billion Dollar Leverage.  
Personalized Service.**

SN 86-035,476. IGENITY, INC., LANSING, MI. FILED 8-12-2013.

THE MARK CONSISTS OF STANDARD CHARACTERS WITHOUT CLAIM TO ANY PARTICULAR FONT, STYLE, SIZE, OR COLOR.

NO CLAIM IS MADE TO THE EXCLUSIVE RIGHT TO USE "PERSONALIZED SERVICE.", APART FROM THE MARK AS SHOWN.

**TRU-POLLED**

**CLASS 35—ADVERTISING AND BUSINESS**

FOR PROVIDING TRAVEL MANAGEMENT SERVICES; BUSINESS MEETING PLANNING (U.S. CLS. 100, 101 AND 102).

FIRST USE 8-4-2013; IN COMMERCE 8-4-2013.

THE MARK CONSISTS OF STANDARD CHARACTERS WITHOUT CLAIM TO ANY PARTICULAR FONT, STYLE, SIZE, OR COLOR.

**CLASS 42—SCIENTIFIC AND COMPUTER SERVICES**

FOR SCIENTIFIC RESEARCH IN THE FIELD OF GENETICS, NAMELY, RESEARCH SERVICES FOCUSING ON IDENTIFYING THOSE CATTLE WHICH ARE HORNED, HETEROZYGOUS POLLED OR HOMOZYGOUS POLLED, FOR HEALTH AND LIFESTYLE MANAGEMENT, STOCK SEED MANAGEMENT, PASTURE MANAGEMENT (U.S. CLS. 100 AND 101).

FIRST USE 1-1-2005; IN COMMERCE 1-1-2005.

**CLASS 39—TRANSPORTATION AND STORAGE**

FOR ARRANGING TRAVEL TOURS AND TRAVEL AGENCY SERVICES, NAMELY MAKING RESERVATIONS AND BOOKING FOR TRANSPORTATION; COORDINATING TRAVEL ARRANGEMENTS FOR INDIVIDUALS AND FOR GROUPS; LIMOUSINE SERVICES; ARRANGING OF CRUISES; ARRANGING OF RENTAL CARS (U.S. CLS. 100 AND 105).

FIRST USE 8-4-2013; IN COMMERCE 8-4-2013.

**CLASS 44—MEDICAL, BEAUTY AND AGRICULTURAL SERVICES**

FOR VETERINARY SERVICES FOCUSING ON IDENTIFYING THOSE CATTLE WHICH ARE HORNED, HETEROZYGOUS POLLED OR HOMOZYGOUS POLLED, FOR HEALTH AND LIFESTYLE MANAGEMENT, STOCK SEED MANAGEMENT, PASTURE MANAGEMENT (U.S. CLS. 100 AND 101).

FIRST USE 1-1-2005; IN COMMERCE 1-1-2005.

**CLASS 43—HOTEL AND RESTAURANT SERVICES**

FOR TRAVEL AGENCY SERVICES, NAMELY MAKING RESERVATIONS AND BOOKINGS FOR TEMPORARY LODGING, RESTAURANTS AND MEALS (U.S. CLS. 100 AND 101).

FIRST USE 8-4-2013; IN COMMERCE 8-4-2013.  
FONG HSU, EXAMINING ATTORNEY

MARLENE BELL, EXAMINING ATTORNEY

SN 86-035,488. FULFILL FITNESS, LLC, NEW YORK, NY. FILED 8-12-2013.

SN 86-035,922. MOJALINK INC., PORTLAND, OR. FILED 8-12-2013.

## FULFILL FITNESS

THE MARK CONSISTS OF STANDARD CHARACTERS WITHOUT CLAIM TO ANY PARTICULAR FONT, STYLE, SIZE, OR COLOR.

NO CLAIM IS MADE TO THE EXCLUSIVE RIGHT TO USE "FITNESS", APART FROM THE MARK AS SHOWN.

### CLASS 41—EDUCATION AND ENTERTAINMENT

FOR CONSULTING SERVICES IN THE FIELDS OF FITNESS AND EXERCISE (U.S. CLS. 100, 101 AND 107). FIRST USE 6-13-2013; IN COMMERCE 6-13-2013.

### CLASS 44—MEDICAL, BEAUTY AND AGRICULTURAL SERVICES

FOR CONSULTING SERVICES IN THE FIELDS OF HEALTH AND NUTRITION (U.S. CLS. 100 AND 101). FIRST USE 6-13-2013; IN COMMERCE 6-13-2013. MARLENE BELL, EXAMINING ATTORNEY

---

SN 86-035,906. XAVIER, BRAD, LOS ANGELES, CA. FILED 8-12-2013.

## STONETOWN

THE MARK CONSISTS OF STANDARD CHARACTERS WITHOUT CLAIM TO ANY PARTICULAR FONT, STYLE, SIZE, OR COLOR.

### CLASS 25—CLOTHING

FOR FLIP FLOPS; HATS; HOODED SWEATSHIRTS; JACKETS; PAJAMAS; PANTS; SHIRTS; SWEATSHIRTS; T-SHIRTS (U.S. CLS. 22 AND 39). FIRST USE 6-1-2013; IN COMMERCE 6-1-2013.

### CLASS 41—EDUCATION AND ENTERTAINMENT

FOR ENTERTAINMENT IN THE NATURE OF AN ANIMATED ONGOING SERIES DISTRIBUTED VIA VARIOUS PLATFORMS ACROSS MULTIPLE FORMS OF TRANSMISSION MEDIA (U.S. CLS. 100, 101 AND 107). FIRST USE 4-20-2012; IN COMMERCE 4-20-2012. BRENDAN REGAN, EXAMINING ATTORNEY

## MOJA

THE MARK CONSISTS OF STANDARD CHARACTERS WITHOUT CLAIM TO ANY PARTICULAR FONT, STYLE, SIZE, OR COLOR.

OWNER OF U.S. REG. NO. 3,902,524. THE ENGLISH TRANSLATION OF "MOJA" IN THE MARK IS "ONE".

### CLASS 35—ADVERTISING AND BUSINESS

FOR ONLINE PROFESSIONAL NETWORKING SERVICES (U.S. CLS. 100, 101 AND 102). FIRST USE 8-1-2008; IN COMMERCE 8-1-2008.

### CLASS 36—INSURANCE AND FINANCIAL

FOR CHARITABLE FUNDRAISING SERVICES (U.S. CLS. 100, 101 AND 102). FIRST USE 8-1-2008; IN COMMERCE 10-1-2011.

### CLASS 42—SCIENTIFIC AND COMPUTER SERVICES

FOR PROVIDING AN ONLINE NETWORK SERVICE THAT ENABLES USERS TO SHARE DATA IN THE FIELDS OF CHARITABLE, SOCIAL ENTERPRISE INITIATIVES AND PROJECTS FOR INDIVIDUALS, GOVERNMENT, NONPROFIT AND FOR-PROFIT ORGANIZATIONS (U.S. CLS. 100 AND 101). FIRST USE 8-1-2008; IN COMMERCE 8-1-2008.

### CLASS 45—PERSONAL AND LEGAL SERVICES

FOR ONLINE SOCIAL NETWORKING SERVICES WITHIN GLOBAL COMMUNICATION NETWORKS; PROVIDING INFORMATION IN THE FIELD OF SOCIAL NETWORKING SERVICES, NAMELY, CONNECTING FOR-PROFIT, CHARITABLE, PHILANTHROPIC, HUMANITARIAN, AND PUBLIC AND COMMUNITY SERVICE USERS AND ORGANIZATIONS WITH OPPORTUNITIES FOR COLLABORATIVE SOCIAL NETWORKING (U.S. CLS. 100 AND 101). FIRST USE 8-1-2008; IN COMMERCE 8-1-2008. BRENDAN REGAN, EXAMINING ATTORNEY

---

SN 86-035,938. OLIVER H. WESSLING, BOCA RATON, FL. FILED 8-13-2013.

## get2Clouds

THE MARK CONSISTS OF STANDARD CHARACTERS WITHOUT CLAIM TO ANY PARTICULAR FONT, STYLE, SIZE, OR COLOR.

**CLASS 9—ELECTRICAL AND SCIENTIFIC APPARATUS**

FOR COMPUTER SOFTWARE, NAMELY, TRANSFER AND MEDIA MANAGERS FOR THE EASY AND SECURE TRANSMISSION OF DIGITAL GOODS, NAMELY DATA, MESSAGES, VOICE, GRAPHICS, IMAGES, AUDIO AND VIDEO VIA TELECOMMUNICATIONS NETWORKS, WIRELESS NETWORKS, WIRELESS COMMUNICATION AND THE INTERNET (U.S. CLS. 21, 23, 26, 36 AND 38).

FIRST USE 9-1-2011; IN COMMERCE 9-1-2011.

**CLASS 38—COMMUNICATION**

FOR TELECOMMUNICATION SERVICES, NAMELY, ELECTRONIC TRANSMISSION OF DATA, MESSAGES, VOICE, GRAPHICS, IMAGES, AUDIO AND VIDEO BY MEANS OF TELECOMMUNICATIONS NETWORKS, WIRELESS NETWORKS, WIRELESS COMMUNICATION AND THE INTERNET (U.S. CLS. 100, 101 AND 104).

FIRST USE 9-1-2011; IN COMMERCE 9-1-2011.

**CLASS 42—SCIENTIFIC AND COMPUTER SERVICES**

FOR DESIGN AND DEVELOPMENT SERVICES OF COMPUTER SOFTWARE, NAMELY, DESIGN AND DEVELOPMENT OF COMPUTER SOFTWARE FOR TRANSFER AND MEDIA MANAGERS FOR THE EASY AND SECURE TRANSMISSION OF DIGITAL GOODS, NAMELY, DATA, MESSAGES, VOICE, GRAPHICS, IMAGES, AUDIO AND VIDEO VIA TELECOMMUNICATIONS NETWORKS, WIRELESS NETWORKS, WIRELESS COMMUNICATION AND THE INTERNET (U.S. CLS. 100 AND 101).

FIRST USE 9-1-2011; IN COMMERCE 9-1-2011.  
KRISTIN DAHLING, EXAMINING ATTORNEY

SN 86-036,131. SHE'S THE B.O.S.S., BALTIMORE, MD.  
FILED 8-13-2013.



NO CLAIM IS MADE TO THE EXCLUSIVE RIGHT TO USE "ROM. 12: 9-13", APART FROM THE MARK AS SHOWN.

THE COLOR(S) BLUE, DARK BLUE, GREY, GREEN, ORANGE, PINK, AND BLACK IS/ARE CLAIMED AS A FEATURE OF THE MARK.

THE MARK CONSISTS OF THE HIGHLY STYLIZED LETTERS "TZ" IN DARK BLUE WITH PARTIAL GREY OUTLINING AND THE BLACK WORDING "ROM. 12:9-13" IN SMALL STYLIZED PRINT TO THE RIGHT OF THE LETTER "Z" IN "TZ". THE WORDING IS SURROUNDED BY A HEART DESIGN SEPARATED INTO SIX SECTIONS. THE SECTIONS OF THE HEART, STARTING FROM THE TOP AND GOING CLOCKWISE, APPEAR IN THE FOLLOWING COLORS: A BLUE SECTION WITH PARTIAL BLACK OUTLINING, A PINK SECTION, A BLUE SECTION WITH

PARTIAL BLACK OUTLINING, A SECTION IN GREEN, ORANGE, PINK BLUE AND PINK FROM TOP TO BOTTOM, A BLUE SECTION AND A GREEN SECTION. UNDERNEATH THE HEART DESIGN THE WORDING "SHE'S" APPEARS OVER THE WORDING "THE B.O.S.S." WITH THE TERM "SHE'S" IN THE COLOR BLUE WITH PARTIAL BLACK OUTLINING, THE TERM "THE" IN THE COLOR GREEN WITH PARTIAL BLACK OUTLINING, AND THE TERM "B.O.S.S." IN THE COLOR PINK WITH PARTIAL BLACK OUTLINING.

**CLASS 3—COSMETICS AND CLEANING PREPARATIONS**

FOR COMPACTS CONTAINING MAKE-UP; COSMETIC PREPARATIONS FOR EYE LASHES; COSMETICS AND MAKE-UP; EYE CREAM; EYE GELS; EYE LINER; EYE LOTIONS; EYE MAKE-UP; EYE MAKE-UP REMOVER; EYE PENCILS; EYE SHADOW; EYE SHADOWS; EYE-SHADOW; EYES MAKE-UP; EYES PENCILS; FACIAL MAKE-UP; FACIAL MAKE-UP, NAMELY, PRIMER, FOUNDATION, POWDER, MASCARA; FOUNDATION MAKE-UP; HAIR MASCARA; LIPSTICK; LIPSTICK CASES; LIPSTICK HOLDERS; LIPSTICKS; MAKE UP FOUNDATIONS; MAKE UP REMOVING PREPARATIONS; MAKE-UP; MAKE-UP FOR THE FACE AND BODY; MAKE-UP FOUNDATIONS; MAKE-UP KITS COMPRISED OF LIPSTICK, LIP GLOSS, LIP BALM; MAKE-UP PENCILS; MAKE-UP POWDER; MAKE-UP PREPARATIONS; MAKE-UP PREPARATIONS FOR THE FACE AND BODY; MAKE-UP PRIMER; MAKE-UP REMOVER; MAKE-UP REMOVING LOTIONS; MAKE-UP REMOVING MILK, GEL, LOTIONS AND CREAMS; MAKE-UP REMOVING MILKS; MAKE-UP REMOVING PREPARATIONS; MAKE-UP SETS; MASCARA; MASCARAS; NATURAL MINERAL MAKE-UP; POWDER FOR MAKE-UP (U.S. CLS. 1, 4, 6, 50, 51 AND 52).

**CLASS 18—LEATHER GOODS**

FOR BACKPACKS, BOOK BAGS, SPORTS BAGS, BUM BAGS, WALLETS AND HANDBAGS; EVENING HANDBAGS; FASHION HANDBAGS; FITTED PROTECTIVE COVERS FOR HANDBAGS, BRIEFCASES, VALISES, SUITCASES, AND BRIEFCASE-LIKE PORTFOLIOS; GENTLEMEN'S HANDBAGS; HANDBAG FRAMES; HANDBAGS; HANDBAGS FOR LADIES; HANDBAGS FOR MEN; HANDBAGS, PURSES AND WALLETS; INTERCHANGEABLE DECORATIVE COVERS FOR ACCESSORIZATION PURPOSES THAT ARE SPECIALLY ADAPTED TO HANDBAGS; LEATHER HANDBAGS; STRAPS FOR HANDBAGS (U.S. CLS. 1, 2, 3, 22 AND 41).

**CLASS 25—CLOTHING**

FOR APPAREL FOR DANCERS, NAMELY, TEE SHIRTS, SWEATSHIRTS, PANTS, LEGGINGS, SHORTS AND JACKETS; ATHLETIC APPAREL, NAMELY, SHIRTS, PANTS, JACKETS, FOOTWEAR, HATS AND CAPS, ATHLETIC UNIFORMS; ATHLETIC SHIRTS; BODY SHIRTS; BUTTON DOWN SHIRTS; CAMOUFLAGE SHIRTS; CLOTHING FOR ATHLETIC USE, NAMELY, PADDED SHIRTS; CLOTHING FOR BABIES, TODDLERS AND CHILDREN, TREATED WITH FIRE AND HEAT RETARDANTS, NAMELY, PAJAMAS, JACKETS, SHIRTS, PANTS, JUMPERS; CLOTHING SHIELDS, NAMELY, PADS APPLIED TO THE UNDERARMS OF SHIRTS, BLOUSES AND SWEATERS; COLLARED SHIRTS; DRESS SHIRTS; GOLF PANTS, SHIRTS AND SKIRTS; GOLF SHIRTS; HOODED SWEAT SHIRTS; KNIT SHIRTS; LEATHER SHIRTS; LONG-SLEEVED SHIRTS; MATERNITY CLOTHING, NAMELY, SHIRTS, PANTS, SHORTS; MOISTURE-WICKING SPORTS SHIRTS; NIGHT SHIRTS; OPEN-NECKED SHIRTS; OVER SHIRTS; PIQUE SHIRTS; POLO SHIRTS; RAMIE SHIRTS; RUGBY SHIRTS; SHIRT FRONTS; SHIRT INSERTS, NAMELY, DICKIES; SHIRTS; SHIRTS AND SHORT-SLEEVED SHIRTS; SHIRTS AND SLIPS; SHIRTS FOR INFANTS, BABIES, TODDLERS AND CHILDREN; SHIRTS FOR SUITS; SHORT-SLEEVED OR LONG-SLEEVED T-SHIRTS; SHORT-SLEEVED SHIRTS; SLEEP SHIRTS; SLEEVES WORN SEPARATE AND APART FROM BLOUSES, SHIRTS AND OTHER TOPS; SNAP CROTCH SHIRTS FOR INFANTS AND TODDLERS;

SPORT SHIRTS; SPORTS SHIRTS; SPORTS SHIRTS WITH SHORT SLEEVES; SUN PROTECTIVE CLOTHING, NAMELY, SHIRTS, PANTS; SWEAT SHIRTS; T-SHIRTS; T-SHIRTS FOR INFANTS, BABIES, TODDLERS, CHILDREN, ADULTS; TEE SHIRTS; TRIATHLON CLOTHING, NAMELY, TRIATHLON TIGHTS, TRIATHLON SHORTS, TRIATHLON SINGLETS, TRIATHLON SHIRTS, TRIATHLON SUITS; TURTLE NECK SHIRTS; WEARABLE GARMENTS AND CLOTHING, NAMELY, SHIRTS; WIND SHIRTS; WOMEN'S CLOTHING, NAMELY, SHIRTS, DRESSES, SKIRTS, BLOUSES; YOGA SHIRTS (U.S. CLS. 22 AND 39).

JEFFERY COWARD, EXAMINING ATTORNEY

SN 86-036,140. SSKM CORPORATION, WILMINGTON, DE. FILED 8-13-2013.



#### CLASS 9—ELECTRICAL AND SCIENTIFIC APPARATUS

FOR COMPUTER APPLICATION SOFTWARE FOR MOBILE PHONES, NAMELY, SOFTWARE FOR FACILITATION OF IDENTIFICATION OF BUSINESS BRANDS AND SERVICES; COMPUTER E-COMMERCE SOFTWARE TO ALLOW USERS TO PERFORM ELECTRONIC BUSINESS TRANSACTIONS VIA A GLOBAL COMPUTER NETWORK (U.S. CLS. 21, 23, 26, 36 AND 38).

FIRST USE 7-12-2013; IN COMMERCE 7-12-2013.

#### CLASS 35—ADVERTISING AND BUSINESS

FOR ADVERTISING SERVICES, NAMELY, PROMOTING AND MARKETING THE GOODS AND SERVICES OF OTHERS IN THE FIELD OF CONSUMER GOODS AND SERVICES VIA PRINT AND ELECTRONIC MEDIA; ADVERTISING SERVICES, NAMELY, PROMOTING AND MARKETING THE GOODS AND SERVICES OF OTHERS THROUGH ALL PUBLIC COMMUNICATION MEANS; ADVERTISING, MARKETING AND PROMOTION SERVICES; PROMOTING AND MARKETING THE GOODS AND SERVICES OF OTHERS BY DISTRIBUTING ADVERTISING MATERIAL, COUPONS AND DISCOUNT OFFERS VIA TEXT MESSAGES (U.S. CLS. 100, 101 AND 102).

FIRST USE 7-12-2013; IN COMMERCE 7-12-2013.

JEFFERY COWARD, EXAMINING ATTORNEY

SN 86-036,253. DJ NETWORKS, INC., NEW YORK, NY. FILED 8-13-2013.

# FASHION LAB

THE MARK CONSISTS OF STANDARD CHARACTERS WITHOUT CLAIM TO ANY PARTICULAR FONT, STYLE, SIZE, OR COLOR.

NO CLAIM IS MADE TO THE EXCLUSIVE RIGHT TO USE "FASHION", APART FROM THE MARK AS SHOWN.

#### CLASS 25—CLOTHING

FOR BATHING SUITS; FOOTWEAR; JACKETS; PANTS; SHIRTS; SLEEPWEAR (U.S. CLS. 22 AND 39).

FIRST USE 5-31-2007; IN COMMERCE 5-31-2007.

#### CLASS 35—ADVERTISING AND BUSINESS

FOR ON-LINE RETAIL STORE SERVICES FEATURING WOMEN'S CLOTHING, NAMELY, SHIRTS, PANTS, SLEEPWEAR, OUTERWEAR, NAMELY, JACKETS, BATHING SUITS, FOOTWEAR, BAGS, AND SUNGLASSES (U.S. CLS. 100, 101 AND 102).

FIRST USE 5-31-2007; IN COMMERCE 5-31-2007.

CAITLIN WATTS-FITZGERALD, EXAMINING ATTORNEY

SN 86-036,347. JASON WESTFALL, PASO ROBLES, CA. FILED 8-13-2013.



THE COLOR(S) RED AND DARK RED IS/ARE CLAIMED AS A FEATURE OF THE MARK.

THE MARK CONSISTS OF THE WORDS "THE WINE LINE" APPEARING INSIDE AN OVAL WITH A WINE GLASS LYING ON ITS SIDE AT THE TOP RIGHT OF THE OVAL AND A WINE GLASS LYING ON ITS SIDE AT THE BOTTOM LEFT OF THE OVAL. THE WORD "THE" APPEARS AT THE TOP LEFT OF THE WORDS "WINE LINE" IN A SMALLER FONT THAN THE WORDS "WINE LINE". THE WORDS "THE WINE LINE" AND THE OVAL AND WINE GLASS DESIGN ALL APPEAR IN THE COLOR RED WITH DARK RED OUTLINING AND HIGHLIGHTS. THE COLOR WHITE APPEARING IN THE MARK REPRESENTS TRANSPARENT BACKGROUND AREAS AND IS NOT BEING CLAIMED AS A FEATURE OF THE MARK.

SEC. 2(F) AS TO "THE WINE LINE" FOR CLASS 39.

#### CLASS 25—CLOTHING

FOR (BASED ON INTENT TO USE) CLOTHING, NAMELY, T-SHIRTS, SWEATSHIRTS, HOODIES, SHORTS, AND HATS (U.S. CLS. 22 AND 39).

#### CLASS 39—TRANSPORTATION AND STORAGE

FOR (BASED ON USE IN COMMERCE) ARRANGING TRAVEL TOURS OF VINEYARDS AND WINERIES; ARRANGING PASSENGER RESERVATIONS AND BOOKINGS FOR TRAVEL TOURS, VINEYARD TOURS AND WINERY TOURS; ARRANGING RESERVATIONS AND BOOKINGS FOR GROUND TRANSPORTATION FOR TRAVEL TOURS, VINEYARD TOURS AND WINERY TOURS; TRANSPORTATION OF PASSENGERS BY GROUND TRANSPORTATION (U.S. CLS. 100 AND 105).

FIRST USE 8-1-2008; IN COMMERCE 8-1-2008.

JEFFERY COWARD, EXAMINING ATTORNEY

SN 86-036,547. BDTRONIC GMBH, 97990 WEIKERSHEIM, FED REP GERMANY, FILED 8-13-2013.



The logo for bdtronic consists of the word "bdtronic" in a bold, lowercase, sans-serif font. To the right of the text is a square icon with a stylized 'D' shape inside, formed by a solid line on the right and bottom, and a broken line on the top and left.

THE MARK CONSISTS OF THE WORDING, "BDTRONIC", APPEARING IN LOWER CASE LETTERS, FOLLOWED AT RIGHT BY THE DESIGN OF A POLYGON MADE WITH BROKEN LINES IN TWO PLACES AT TOP.

#### CLASS 8—HAND TOOLS

FOR INLINE STATIC AND DYNAMIC MIXING MACHINES USED FOR MIXING AND DISPENSING ADHESIVES, SEALANTS, AND THE LIKE (U.S. CLS. 23, 28 AND 44).

FIRST USE 9-21-2012; IN COMMERCE 9-21-2012.

#### CLASS 11—ENVIRONMENTAL CONTROL APPARATUS

FOR MELTING FURNACES FOR MELTING HOT MELT GLUE AND ADHESIVES, INFRARED RADIATION UNITS FOR CURING ADHESIVES FOR USE IN AUTOMATED MANUFACTURING PROCESS; AND INFRARED RADIATION UNITS FOR CURING ADHESIVES FOR USE IN AUTOMATED MANUFACTURING PROCESS, NAMELY, THERMAL SPOT CURING SYSTEMS (U.S. CLS. 13, 21, 23, 31 AND 34).

FIRST USE 9-21-2012; IN COMMERCE 9-21-2012.

#### CLASS 37—CONSTRUCTION AND REPAIR

FOR REPAIR OR MAINTENANCE OF PLASTIC PROCESSING MACHINES AND APPARATUS; PUMP REPAIR OR MAINTENANCE; TECHNICAL SUPPORT SERVICES, NAMELY, TECHNICAL CONSULTATION IN THE FIELD OF APPLICATION OF SPRAY-ON INSULATION AND PROTECTIVE COATINGS; APPLICATION OF COATINGS FOR OTHERS, NAMELY, APPLYING PLASTIC RESINS TO SEAL ELECTRONIC DEVICES AND ELECTRIC MOTORS (U.S. CLS. 100, 103 AND 106).

FIRST USE 9-21-2012; IN COMMERCE 9-21-2012.  
ELI HELLMAN, EXAMINING ATTORNEY

SN 86-037,653. THE LONDON METAL EXCHANGE, LONDON, UNITED KINGDOM, FILED 8-14-2013.



The logo for LMEsword consists of the word "LMEsword" in a serif font. The "LME" is in a larger, bold font, and "sword" is in a smaller font. The 's' in "sword" is stylized with a long, thin tail that extends to the right.

THE MARK CONSISTS OF STANDARD CHARACTERS WITHOUT CLAIM TO ANY PARTICULAR FONT, STYLE, SIZE, OR COLOR.

OWNER OF U.S. REG. NOS. 2,161,156, 2,745,483 AND 2,875,963.

#### CLASS 36—INSURANCE AND FINANCIAL

FOR FINANCIAL CLEARING HOUSE SERVICES (U.S. CLS. 100, 101 AND 102).

FIRST USE 4-0-2010; IN COMMERCE 4-0-2010.

#### CLASS 38—COMMUNICATION

FOR ELECTRONIC TRANSMISSION OF DATA AND DOCUMENTS NAMELY, WARRANT TITLES AND SECURITIES TITLES (U.S. CLS. 100, 101 AND 104).

FIRST USE 4-0-2010; IN COMMERCE 4-0-2010.

#### CLASS 39—TRANSPORTATION AND STORAGE

FOR STORAGE OF WARRANTS AND SECURITIES DOCUMENTATION (U.S. CLS. 100 AND 105).

FIRST USE 4-0-2010; IN COMMERCE 4-0-2010.  
ANDREA BUTLER, EXAMINING ATTORNEY

SN 86-037,685. FREMANTLEMEDIA OPERATIONS B.V., 1217 GP HILVERSUM, NETHERLANDS, FILED 8-14-2013.

### SHOWCASE SHOWDOWN

THE MARK CONSISTS OF STANDARD CHARACTERS WITHOUT CLAIM TO ANY PARTICULAR FONT, STYLE, SIZE, OR COLOR.

OWNER OF U.S. REG. NO. 3,039,601.

#### CLASS 9—ELECTRICAL AND SCIENTIFIC APPARATUS

FOR COMPUTER GAME SOFTWARE; DECORATIVE MAGNETS; DOWNLOADABLE COMPUTER GAME PROGRAMS; DOWNLOADABLE COMPUTER GRAPHICS; DOWNLOADABLE IMAGE FILE CONTAINING ARTWORK, TEXT, AUDIO, VIDEO, GAMES AND INTERNET WEB LINKS RELATING TO A GAME SHOW; ELECTRONIC DIARIES; ELECTRONIC DAY PLANNERS; ELECTRONIC GAME SOFTWARE FOR CELLULAR TELEPHONES; INTERACTIVE VIDEO GAME PROGRAMS; MAGNETIC CODED GIFT CARDS; MOBILE TELEPHONES; PRE-PAID TELEPHONE CALLING CARDS, MAGNETICALLY ENCODED; PRE-RECORDED ELECTRONIC AND DIGITAL MEDIA FEATURING A GAME SHOW; VIDEO GAME SOFTWARE; DIGITAL PHOTO FRAMES FOR DISPLAYING DIGITAL PHOTOS; PRE-RECORDED AUDIO AND VIDEO MEDIA, NAMELY, VIDEO CASSETTES, DIGITAL VIDEO DISCS, DIGITAL VERSATILE DISCS, DOWNLOADABLE AUDIO AND VIDEO RECORDINGS, DVDS AND HIGH DEFINITION DIGITAL DISCS FEATURING GAME SHOWS; DOWNLOADABLE ELECTRONIC NEWSLETTERS IN THE FIELD OF GAME SHOWS; DOWNLOADABLE ELECTRONIC PUBLICATIONS IN THE NATURE OF MAGAZINES AND BOOKS IN THE FIELD OF GAME SHOWS (U.S. CLS. 21, 23, 26, 36 AND 38).

#### CLASS 28—TOYS AND SPORTING GOODS

FOR GAMING MACHINES, NAMELY, DEVICES WHICH ACCEPT A WAGER; GAMING MACHINES, NAMELY, SLOT MACHINES AND VIDEO LOTTERY TERMINALS (U.S. CLS. 22, 23, 38 AND 50).

SIMON TENG, EXAMINING ATTORNEY

SN 86-037,837. IWEAR SHOES LLC, SAN JUAN, PUERTO RICO, FILED 8-14-2013.

SN 86-037,978. G S INVERSIONES HIPICAS LLC, WESTON, FL. FILED 8-14-2013.

## HECTIK BY NATALIA

THE MARK CONSISTS OF STANDARD CHARACTERS WITHOUT CLAIM TO ANY PARTICULAR FONT, STYLE, SIZE, OR COLOR.

### CLASS 14—JEWELRY

FOR BRACELETS, CASES FOR WATCHES AND CLOCKS, ALARM CLOCKS, FIGURES OF PRECIOUS METAL, ALLOYS OF PRECIOUS METAL, JEWELRY BROOCHES, CLOCKS AND WATCHES, JEWELRY AMULETS, CLOCKS, ANKLE BRACELETS, PERSONAL CHARMS JEWELRY, CHARMS FOR COLLAR JEWELRY AND BRACELET, DRESS WATCHES, BODY JEWELRY, HAIR JEWELRY IN THE NATURE OF JEWELRY FOR USE IN THE HAIR, GEMSTONES, GEMSTONE JEWELRY, EAR CLIPS, EARRINGS, IMITATION JEWELRY, JEWELRY NECKLACES, CHRONOSCOPES, JEWELRY, JEWELRY CHAINS, JEWELRY RINGS, JEWELRY BOXES OF PRECIOUS METAL, JEWELRY ORGANIZERS, JEWELRY WATCHES, SHOE ORNAMENTS OF PRECIOUS METAL, PRECIOUS GEMSTONES (U.S. CLS. 2, 27, 28 AND 50).

### CLASS 18—LEATHER GOODS

FOR FLIGHT BAGS, GENTLEMEN'S HANDBAGS, BARREL BAGS, BRIEFCASES AND ATTACHE CASES, BUSINESS CARD CASES, BEACH BAGS, BELT BAGS, ALL-PURPOSE SPORT BAGS, ALL-PURPOSE ATHLETIC BAGS, COSMETIC BAGS SOLD EMPTY, COIN PURSES, DIAPER BAGS, CARRY-ALL BAGS, BACKPACKS, BOOKBAGS, SPORT BAGS, BUM BAGS, WALLETS AND HANDBAGS, BACKPACKS WITH ROLLING WHEELS, KEY CASES MEN'S CLUTCH BAGS, LUGGAGE, LUGGAGE TAGS, VALISES, TOTE BAGS ROLL BAGS, SPORT BAGS, PURSES AND WALLETS, TRAVEL BAGS, SCHOOLBAGS, SCHOOL CHILDREN'S BACKPACKS (U.S. CLS. 1, 2, 3, 22 AND 41).

### CLASS 25—CLOTHING

FOR BATHING SUITS, BATHROBES, BATHING SUITS FOR MEN, BATHING COSTUMES FOR WOMEN, GLOVES, BEACHWEAR, HATS, GLOVES FOR APPAREL, HAT BANDS, BEACH SHOES, BRIEFS, BELTS FOR CLOTHING, GOLF PANTS, SHIRTS AND SKIRTS, ATHLETIC SHOES, CYCLING SHOES, CYCLING SHORTS, CLOTHING, COLLARS, FABRIC BELTS, DRESS PANTS, DRESS SUITS, DRESSES, DRESS SHIRTS, DENIM PANTS, KNIT SKIRTS, BLAZERS, KNIT DRESSES, GYM PANTS, CAPRIS, BODY SUITS, CAPRI PANTS, MEN'S SUITS, MEN'S DRESS SOCKS, MEN'S SOCKS (U.S. CLS. 22 AND 39).

C. DIONNE CLYBURN, EXAMINING ATTORNEY

## GELFENSTEIN FARM

THE MARK CONSISTS OF STANDARD CHARACTERS WITHOUT CLAIM TO ANY PARTICULAR FONT, STYLE, SIZE, OR COLOR.

NO CLAIM IS MADE TO THE EXCLUSIVE RIGHT TO USE "FARM", APART FROM THE MARK AS SHOWN.

### CLASS 41—EDUCATION AND ENTERTAINMENT

FOR ENTERTAINMENT IN THE NATURE OF HORSE RACES; HORSE TRAINING; ORGANIZATION OF HORSE RACES (U.S. CLS. 100, 101 AND 107).  
FIRST USE 10-2-2012; IN COMMERCE 10-2-2012.

### CLASS 44—MEDICAL, BEAUTY AND AGRICULTURAL SERVICES

FOR HORSE BREEDING AND STUD SERVICES; HORSE FARMS (U.S. CLS. 100 AND 101).  
FIRST USE 10-2-2012; IN COMMERCE 10-2-2012.  
KAREN SEVERSON, EXAMINING ATTORNEY

SN 86-038,008. COPPERFIELD, DAVID, NEW YORK, NY. FILED 8-14-2013.



THE MARK CONSISTS OF A BACKWARDS LETTER "D" AND THE LETTER "C" SURROUNDED BY A BROKEN INNER CIRCLE AND A BROKEN OUTER CIRCLE.

### CLASS 16—PAPER GOODS AND PRINTED MATTER

FOR PAPER GOODS, NAMELY, CALENDARS, NOTEBOOKS, POSTERS AND STICKERS; PHOTOGRAPH ALBUMS, AUTOGRAPH BOOKS, BINDERS, BOOK-ENDS, DIARIES; SERIES OF BOOKS IN THE FIELD OF MAGIC; BLANK JOURNAL BOOKS; PAPER AND CARDBOARD ARTICLES, NAMELY, PAPER PARTY FAVORS, PAPER PARTY BAGS, PRINTED INVITATIONS, TRADING CARDS; OFFICE SUPPLIES, NAMELY, BALL POINT PENS, ENVELOPES, STAPLERS; SCHOOL SUPPLIES, NAMELY, COLOR PENCILS, ERASERS, NOTE PAPER, PEN OR PENCIL HOLDERS, PENCILS, PENCIL SHARPENERS, PEN AND PENCIL CASES, PENS, WRITING PAPER, WRITING IMPLEMENTS (U.S. CLS. 2, 5, 22, 23, 29, 37, 38 AND 50).



**CLASS 25—CLOTHING**

FOR MEN'S, WOMEN'S AND KID'S APPAREL, NAMELY, CREWNECK SHIRTS; KNIT SHIRTS; PIQUE SHIRTS; POLO SHIRTS, SINGLETTS; SKIRTS; JEANS; SHORTS; TROUSERS; DRESS SUITS; DRESSES; CULOTTES; SWEATERS; BLOUSES; JACKETS; BLAZERS; BATHROBES; COATS; OVERCOATS; RAINCOATS; CAPES; STORM COATS; TRENCH COATS; RAIN WEAR; RAIN SLICKERS; GLOVES; MITTENS; SCARVES; TIES; SOCKS; UNDERWEAR; HATS; PAJAMAS; NEGLIGEEES; HOSIERY; UNDERWEAR; BOOTS; SHOES; ATHLETIC SHOES; SLIPPERS; FLIP FLOPS; MOCCASINS; FISHING WADERS; OVERSHOES; RUBBERS; BELTS; SWIMSUITS; SWIM TRUNKS; BATHING SUITS; BREECHES; CAPS; MUFFLERS; PONCHOS; BANDANAS; RASH GUARDS; WRISTBANDS, BEACHWEAR; BIKINIS; BOARD SHORTS; BOXER SHORTS; CAMISOLES; CARGO PANTS; DENIM JACKETS; DENIM PANTS; FLEECE PULLOVERS; FLEECE SHORTS; LEG WARMERS; LEGGINGS; LOUNGE PANTS; LOUNGEWEAR; SWEATPANTS; SWEATSUITS; SWEATSHIRTS; SWEAT SHORTS; SOCKS; WAISTCOATS; BOLEROS; CARDIGANS; CAPRI PANTS; V-NECK SWEATERS; TURTLENECK SWEATERS; TUXEDOS; BRAS; SPORTS BRAS; BUSTIERS; CORSETS; GIRDLES; CHEMISES; FOUNDATION GARMENTS; VESTS; BODY SUITS; INFANT AND TODDLER WEAR, NAMELY, SHIRTS, TROUSERS, CLOTH BIBS, JUMPERS, OVERALL SLEEPWEAR, PAJAMAS, NIGHT SHIRTS, NIGHT GOWNS, ROMPERS, ONE-PIECE GARMENTS AND SHOES AND BOOTS; SKI WEAR; WIND COATS; WIND PANTS; TENNIS WEAR; NECKWEAR; EXERCISE SUITS, NAMELY, JOGGING SUITS; EXERCISE TOPS AND BOTTOMS; STOCKINGS; LINGERIE; SLIPS; SLEEPWEAR; NIGHTWEAR; UNDERCLOTHES; UNDERGARMENTS; SUSPENDERS; SCARVES AND SHAWLS; CUMMERBUNDS AND SASHES; TIES AND BOW TIES; SANDALS; CAPS; HEADSCARVES; SNOWSUITS; OVERALLS; SHORTALLS; ROMPERS; APRONS, WARM-UP SUITS; SLACKS; WETSUITS; HOODED PARKAS; VOLLEY SHORTS; SKI BOARD AND SNOWBOARD WEAR, NAMELY, SKI PANTS, SKI SUITS, SKI TROUSERS, SKI JACKETS, SNOWBOARD PANTS, SNOWBOARD TROUSERS AND SNOWBOARD JACKETS; EAR MUFFS; SARONGS; TUNICS; KIMONOS; BOOTS FOR SPORTS, NAMELY, SKATEBOARDING BOOTS, SNOW BOOTS, SNOWBOARD BOOTS, SKI BOOTS AND SURFBOARD BOOTS. GYMNASTIC FOOTWEAR, NAMELY, SNEAKERS, SLIPPERS AND ATHLETIC SHOES; FLEECE SWEAT TOPS; FLEECE SWEAT PANTS; BEACH COATS; PAREOS; SPORTS JERSEYS; VISORS; WATERPROOF JACKETS; SWEATBANDS; SKULL CAPS; TRAINING SHOES; DRESS SHOES; CLOTH BIBS; HALLOWEEN COSTUMES (U.S. CLS. 22 AND 39).

**CLASS 28—TOYS AND SPORTING GOODS**

FOR MAGIC KITS COMPRISED OF MAGIC TRICKS AND ACCESSORIES; MAGIC TRICKS; MAGIC PRODUCTS COMPRISED OF MAGIC TRICKS; MAGIC GAMES; PLAYING CARDS; BOARD GAMES; CARD GAMES; MANIPULATIVE GAMES, PARLOR GAME, ROLE-PLAYING GAMES, VIDEO PARLOR COMPUTER GAME MACHINES; TARGET GAMES; COIN OPERATED AND NON-COIN OPERATED VIDEO GAME MACHINES, JIGSAW PUZZLES, MANIPULATIVE PUZZLES, ACTION SKILL GAMES; TOYS, NAMELY, ACTION FIGURES AND ACCESSORIES THEREOF; STUFFED TOY ANIMALS; BABY MULTIPLE ACTIVITY TOYS; BALLOONS; BATH TOYS; RIDE-ON TOYS; TOY CARS; TOY VEHICLES; TOY BANKS; TOY TRUCKS; DISC TOSS TOYS, DOLLS; DOLL HOUSE FURNISHINGS; STUFFED TOYS; CHECKER SETS; CHESS SETS; CHILDREN'S PLAY COSMETICS; CHILD'S MULTIPLE ACTIVITY TOYS; TOY BLOCKS; TOYS, NAMELY PLASTIC AND RUBBER FIGURINES, CHRISTMAS TREE ORNAMENTS, CHRISTMAS STOCKINGS; MARIONETTE PUPPETS; WIND-UP TOYS; BASEBALLS; BEAN BAG DOLLS; COLLECTABLE TOY FIGURES; SQUEEZE TOYS; TALKING TOYS; TEDDY BEARS (U.S. CLS. 22, 23, 38 AND 50).

**CLASS 41—EDUCATION AND ENTERTAINMENT**

FOR ENTERTAINMENT SERVICES, NAMELY, LIVE, TELEVISED AND INTERNET MAGIC PERFORMANCES, COMPETITIONS AND GAMES; PROVIDING ONLINE PUBLICATIONS IN THE NATURE OF BOOKS, MAGAZINES, MANUALS AND NEWSLETTERS ON THE SUBJECT OF MAGIC TRICKS AND ILLUSIONS; PROVIDING A WEBSITE FEATURING EDUCATION AND ENTERTAINMENT INFORMATION ABOUT MAGIC TRICKS AND ILLUSIONS; ENTERTAINMENT SERVICES, NAMELY, PROVIDING NON-DOWNLOADABLE INTERACTIVE GAMES AND ELECTRONIC GAMES; AMUSEMENT PARK AND THEME PARK SERVICES; ENTERTAINMENT SERVICES IN THE NATURE OF A LIVE AMUSEMENT PARK SHOW AND PERFORMANCES BY COSTUMED CHARACTERS; MOTION PICTURE THEATERS; AND PROVIDING INFORMATION VIA THE INTERNET IN THE FIELDS OF GAMES, MUSIC, ACTIVITIES AND MOVIES FOR CHILDREN; ENTERTAINMENT SERVICES, NAMELY, PROVIDING ONLINE VIDEO GAMES (U.S. CLS. 100, 101 AND 107).

JOANNA DUKOVIC, EXAMINING ATTORNEY

SN 86-038,456, JIMERSON II, ANDREW, SUWANEE, GA.  
FILED 8-15-2013.

# J. Curves

THE MARK CONSISTS OF STANDARD CHARACTERS WITHOUT CLAIM TO ANY PARTICULAR FONT, STYLE, SIZE, OR COLOR.

THE NAME "J. CURVES" IDENTIFIES A LIVING INDIVIDUAL WHOSE CONSENT IS OF RECORD.

**CLASS 25—CLOTHING**

FOR DRESSES; HATS; JEANS; LONG-SLEEVED SHIRTS; PANTS; SCRUBS NOT FOR MEDICAL PURPOSES; SHORTS; SKIRTS; T-SHIRTS; TANK TOPS; UNDERWEAR (U.S. CLS. 22 AND 39).

**CLASS 44—MEDICAL, BEAUTY AND AGRICULTURAL SERVICES**

FOR PLASTIC SURGERY SERVICES (U.S. CLS. 100 AND 101).

EMILY CARLSEN, EXAMINING ATTORNEY

SN 86-038,527, PALMER, DEBBRA L., PORTLAND, OR.  
FILED 8-15-2013.

# Writers write. Poets pote.

THE MARK CONSISTS OF STANDARD CHARACTERS WITHOUT CLAIM TO ANY PARTICULAR FONT, STYLE, SIZE, OR COLOR.

**CLASS 25—CLOTHING**

FOR HOODED SWEATSHIRTS; SHORT-SLEEVED AND LONG-SLEEVED T-SHIRTS (U.S. CLS. 22 AND 39).

SN 86-038,669. STONEHOUSE SIGNS, INC., ARVADA, CO. FILED 8-15-2013.

**CLASS 35—ADVERTISING AND BUSINESS**

FOR ON-LINE RETAIL STORE SERVICES FEATURING HOODED SWEATSHIRTS, SHORT SLEEVED T-SHIRTS AND LONG-SLEEVED T-SHIRTS (U.S. CLS. 100, 101 AND 102).

KAMAL PREET, EXAMINING ATTORNEY

**KID THOUGHTS!**

THE MARK CONSISTS OF STANDARD CHARACTERS WITHOUT CLAIM TO ANY PARTICULAR FONT, STYLE, SIZE, OR COLOR.

NO CLAIM IS MADE TO THE EXCLUSIVE RIGHT TO USE "KID", APART FROM THE MARK AS SHOWN.

SN 86-038,585. RUDDERLESS BREWING COMPANY, TIGARD, OR. FILED 8-15-2013.

**Rudderless Brewing Company****CLASS 16—PAPER GOODS AND PRINTED MATTER**

FOR DRY ERASE BOARDS (U.S. CLS. 2, 5, 22, 23, 29, 37, 38 AND 50).

FIRST USE 9-11-2013; IN COMMERCE 9-11-2013.

THE MARK CONSISTS OF STANDARD CHARACTERS WITHOUT CLAIM TO ANY PARTICULAR FONT, STYLE, SIZE, OR COLOR.

NO CLAIM IS MADE TO THE EXCLUSIVE RIGHT TO USE "BREWING COMPANY", APART FROM THE MARK AS SHOWN.

**CLASS 42—SCIENTIFIC AND COMPUTER SERVICES**

FOR GRAPHIC DESIGN SERVICES; CUSTOM DESIGN OF DRY ERASE BOARDS (U.S. CLS. 100 AND 101).

FIRST USE 7-18-2013; IN COMMERCE 7-18-2013.

ELLEN B. AWRICH, EXAMINING ATTORNEY

**CLASS 25—CLOTHING**

FOR SWEATSHIRTS; T-SHIRTS (U.S. CLS. 22 AND 39).

SN 86-038,731. ZOYO, LLC, CHANDLER, AZ. FILED 8-15-2013.

**CLASS 32—LIGHT BEVERAGES**

FOR BEER (U.S. CLS. 45, 46 AND 48).

CHERYL CLAYTON, EXAMINING ATTORNEY

SN 86-038,605. JIMERSON II, ANDREW, SUWANEE, GA. FILED 8-15-2013.

**Dr. Curves**

THE MARK CONSISTS OF STANDARD CHARACTERS WITHOUT CLAIM TO ANY PARTICULAR FONT, STYLE, SIZE, OR COLOR.

THE NAME "DR. CURVES" IDENTIFIES A LIVING INDIVIDUAL WHOSE CONSENT IS OF RECORD.

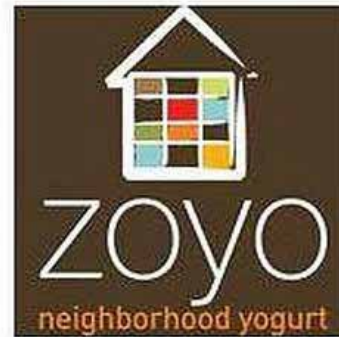

OWNER OF U.S. REG. NOS. 3,901,601 AND 3,954,094. NO CLAIM IS MADE TO THE EXCLUSIVE RIGHT TO USE "NEIGHBORHOOD YOGURT", APART FROM THE MARK AS SHOWN.

THE COLOR(S) LIGHT BROWN, LIGHT BLUE, LIGHT GREEN, YELLOW, BROWN, WHITE, RED, GREEN, AND ORANGE IS/ARE CLAIMED AS A FEATURE OF THE MARK.

THE MARK CONSISTS OF A BROWN SUBSTANTIALLY SQUARE BACKGROUND ON WHICH APPEARS A STYLIZED WHITE-OUTLINED HOUSE WITH AN INVERTED V-SHAPED BROWN ROOF IN THE TOP CENTER POSITION. INSIDE THE HOUSE ARE TWELVE SUBSTANTIALLY RECTANGULAR ROOMS FORMED BY TWO WHITE COLUMNS AND THREE WHITE ROWS. THE COLORING OF EACH ROOM, TOP TO BOTTOM, IS LIGHT BROWN, BROWN, GREEN, AND LIGHT BLUE IN THE FIRST COLUMN; BROWN, RED, ORANGE, AND BROWN IN THE SECOND COLUMN; AND LIGHT GREEN, LIGHT BLUE, BROWN AND YELLOW IN THE THIRD COLUMN. BELOW THE HOUSE IN WHITE LETTERING IS THE WORD "ZOYO" AND THEREBENEATH IN ORANGE LETTERING THE WORDS "NEIGHBORHOOD YOGURT".

**CLASS 25—CLOTHING**

FOR DRESSES; HATS; JEANS; LONG-SLEEVED SHIRTS; PANTS; SCRUBS NOT FOR MEDICAL PURPOSES; SHORTS; SKIRTS; T-SHIRTS; TANK TOPS; UNDERWEAR (U.S. CLS. 22 AND 39).

**CLASS 44—MEDICAL, BEAUTY AND AGRICULTURAL SERVICES**

FOR PLASTIC SURGERY SERVICES (U.S. CLS. 100 AND 101).

EMILY CARLSEN, EXAMINING ATTORNEY

**CLASS 30—STAPLE FOODS**

FOR FROZEN YOGURT (U.S. CL. 46).  
FIRST USE 4-30-2010; IN COMMERCE 4-30-2010.

SN 86-038,838. MARABELLA, SANTO D., FLEETWOOD, PA.  
FILED 8-15-2013.

**CLASS 35—ADVERTISING AND BUSINESS**

FOR RETAIL STORES FEATURING FROZEN YOGURT AND FROZEN YOGURT TOPPINGS; AND FRANCHISE SERVICES, NAMELY, OFFERING TECHNICAL AND BUSINESS MANAGEMENT ASSISTANCE IN THE ESTABLISHMENT AND OPERATION OF RETAIL STORES FEATURING FROZEN YOGURT (U.S. CLS. 100, 101 AND 102).

FIRST USE 1-1-2010; IN COMMERCE 1-1-2010.  
BRENDAN REGAN, EXAMINING ATTORNEY

**The Practical Prof**

THE MARK CONSISTS OF STANDARD CHARACTERS WITHOUT CLAIM TO ANY PARTICULAR FONT, STYLE, SIZE, OR COLOR.

**CLASS 9—ELECTRICAL AND SCIENTIFIC APPARATUS**

FOR PROVIDING WRITTEN EDUCATIONAL, TRAINING AND MOTIVATIONAL MATERIALS IN THE FIELD OF MANAGEMENT, LEADERSHIP, EMPLOYEE DEVELOPMENT, PRODUCTIVITY AND EFFECTIVENESS IN ELECTRONIC FORM AS BOOKS, ARTICLES, EDITORIAL COLUMNS, MANUALS, HANDBOOKS AND CURRICULA TO BUSINESS AND NOT-FOR-PROFIT ORGANIZATION EMPLOYERS, EMPLOYEES AND VOLUNTEER (U.S. CLS. 21, 23, 26, 36 AND 38).

FIRST USE 7-24-2012; IN COMMERCE 7-24-2012.

**CLASS 16—PAPER GOODS AND PRINTED MATTER**

FOR PROVIDING WRITTEN EDUCATIONAL, TRAINING AND MOTIVATIONAL MATERIALS IN THE FIELD OF MANAGEMENT, LEADERSHIP, EMPLOYEE DEVELOPMENT, PRODUCTIVITY AND EFFECTIVENESS IN PRINTED FORM AS BOOKS, ARTICLES, EDITORIAL COLUMNS, MANUALS, HANDBOOKS AND CURRICULA TO BUSINESS AND NOT-FOR-PROFIT ORGANIZATION EMPLOYERS, EMPLOYEES AND VOLUNTEERS (U.S. CLS. 2, 5, 22, 23, 29, 37, 38 AND 50).

FIRST USE 7-24-2012; IN COMMERCE 7-24-2012.

**CLASS 35—ADVERTISING AND BUSINESS**

FOR PROVIDING LIVE AND ON-LINE CONSULTING IN THE FIELD OF MANAGEMENT OF BUSINESS INFORMATION, BUSINESS CONSULTATION IN THE FIELD OF BUSINESS LEADERSHIP, EMPLOYEE DEVELOPMENT, PRODUCTIVITY AND EFFECTIVENESS TO BUSINESS AND NOT-FOR-PROFIT ORGANIZATION EMPLOYERS, EMPLOYEES AND VOLUNTEERS (U.S. CLS. 100, 101 AND 102).

FIRST USE 4-7-2013; IN COMMERCE 4-7-2013.

**CLASS 41—EDUCATION AND ENTERTAINMENT**

FOR EDUCATIONAL SERVICES, NAMELY, PROVIDING LIVE, ON-LINE, AND RECORDED WORKSHOPS, SEMINARS, CLASSES, RETREATS IN THE FIELD OF MANAGEMENT, LEADERSHIP, EMPLOYEE DEVELOPMENT, PRODUCTIVITY AND EFFECTIVENESS BY PERSONAL APPEARANCE, RADIO, SATELLITE, AUDIO, COMPUTER, TELEVISION, VIDEO, AND FILM TO BUSINESS AND NOT-FOR-PROFIT ORGANIZATION EMPLOYERS, EMPLOYEES AND VOLUNTEERS; EDUCATIONAL SERVICES, NAMELY, PROVIDING WRITTEN EDUCATIONAL, TRAINING IN THE FIELD OF MANAGEMENT, LEADERSHIP, EMPLOYEE DEVELOPMENT, PRODUCTIVITY AND EFFECTIVENESS TO BUSINESS AND NOT-FOR-PROFIT ORGANIZATION EMPLOYERS, EMPLOYEES AND VOLUNTEERS (U.S. CLS. 100, 101 AND 107).

FIRST USE 7-24-2012; IN COMMERCE 7-24-2012.  
FLORENTINA BLANDU, EXAMINING ATTORNEY

SN 86-038,737. MEREDITH COLLEGE, RALEIGH, NC.  
FILED 8-15-2013.

**MEREDITH COLLEGE GOING STRONG**

THE MARK CONSISTS OF STANDARD CHARACTERS WITHOUT CLAIM TO ANY PARTICULAR FONT, STYLE, SIZE, OR COLOR.

OWNER OF U.S. REG. NOS. 3,480,180, 3,566,762 AND OTHERS.

NO CLAIM IS MADE TO THE EXCLUSIVE RIGHT TO USE "COLLEGE", APART FROM THE MARK AS SHOWN.

**CLASS 16—PAPER GOODS AND PRINTED MATTER**

FOR EDUCATIONAL AND TEACHING PUBLICATIONS, NAMELY, REPORTS, MANUALS, GUIDES, AND PROGRAMS REGARDING UNIVERSITY-LEVEL COURSES, UNIVERSITY PROGRAMS, AND UNIVERSITY EVENTS; NOTEBOOKS, PENS, NOTE PAPER, ENVELOPES, DECALS, POSTCARDS, STATIONERY (U.S. CLS. 2, 5, 22, 23, 29, 37, 38 AND 50).

**CLASS 25—CLOTHING**

FOR CLOTHING, NAMELY, HATS, SWEATERS, T-SHIRTS, JACKETS, SWEATSHIRTS AND SWEATPANTS, SHORTS AND PANTS ALL FOR PROMOTING ACTIVITIES OF, SHOWING SUPPORT FOR, AND SHOWING AFFILIATION WITH A UNIVERSITY (U.S. CLS. 22 AND 39).

**CLASS 41—EDUCATION AND ENTERTAINMENT**

FOR EDUCATIONAL SERVICES, NAMELY, PROVIDING COURSES OF INSTRUCTION AT THE COLLEGE, GRADUATE AND DOCTORAL LEVELS AND DISTRIBUTING COURSE MATERIALS IN CONNECTION THEREWITH; AND ORGANIZING AND CONDUCTING CULTURAL EVENTS, NAMELY, THEATER PRODUCTIONS AND ART EXHIBITS (U.S. CLS. 100, 101 AND 107).

BRENDAN REGAN, EXAMINING ATTORNEY

SN 86-038,896. SOOTHE, LLC, LAS VEGAS, NV. FILED 8-15-2013.

# SOOTHE

THE MARK CONSISTS OF STANDARD CHARACTERS WITHOUT CLAIM TO ANY PARTICULAR FONT, STYLE, SIZE, OR COLOR.

#### CLASS 4—LUBRICANTS AND FUELS

FOR CANDLES (U.S. CLS. 1, 6 AND 15).  
FIRST USE 2-16-1999; IN COMMERCE 3-2-2001.

#### CLASS 20—FURNITURE AND ARTICLES NOT OTHERWISE CLASSIFIED

FOR MESSAGE TABLES (U.S. CLS. 2, 13, 22, 25, 32 AND 50).  
FIRST USE 2-16-1999; IN COMMERCE 3-2-2001.

#### CLASS 44—MEDICAL, BEAUTY AND AGRICULTURAL SERVICES

FOR MESSAGE AND MESSAGE THERAPY SERVICES (U.S. CLS. 100 AND 101).  
FIRST USE 2-16-1999; IN COMMERCE 3-2-2001.  
ROBIN CHOSID, EXAMINING ATTORNEY

SN 86-038,971. BARRACUDA NETWORKS, INC., CAMPBELL, CA. FILED 8-15-2013.

# SIGNNOW

THE MARK CONSISTS OF STANDARD CHARACTERS WITHOUT CLAIM TO ANY PARTICULAR FONT, STYLE, SIZE, OR COLOR.  
OWNER OF U.S. REG. NO. 4,129,826.

#### CLASS 9—ELECTRICAL AND SCIENTIFIC APPARATUS

FOR DOWNLOADABLE MOBILE APPLICATIONS FOR ELECTRONIC AUTHENTICATION OF DOCUMENTS; DOWNLOADABLE MOBILE APPLICATIONS TO CAPTURE ELECTRONIC SIGNATURES; DOWNLOADABLE MOBILE APPLICATIONS TO FACILITATE THE ASSIGNMENT OF AN ELECTRONIC SIGNATURE TO A DOCUMENT OR FILE (U.S. CLS. 21, 23, 26, 36 AND 38).  
FIRST USE 12-12-2011; IN COMMERCE 12-12-2011.

#### CLASS 39—TRANSPORTATION AND STORAGE

FOR ELECTRONIC STORAGE OF FILES AND DOCUMENTS; PROVIDING A WEBSITE FOR THE ELECTRONIC STORAGE OF FILES AND DOCUMENTS (U.S. CLS. 100 AND 105).  
FIRST USE 4-6-2011; IN COMMERCE 4-6-2011.

#### CLASS 42—SCIENTIFIC AND COMPUTER SERVICES

FOR PROVIDING AN INTERACTIVE WEBSITE FEATURING TECHNOLOGY THAT ALLOWS USERS TO SAVE ELECTRONIC SIGNATURES; FILE-SHARING SERVICES, NAMELY, PROVIDING A WEBSITE FEATURING TECHNOLOGY ENABLING USERS TO UPLOAD AND DOWNLOAD ELECTRONIC FILES; ELECTRONIC DOCUMENT AND E-MAIL AUTHENTICATION SERVICES; PROVIDING AN INTERACTIVE WEBSITE FEATURING NON-DOWNLOADABLE SOFTWARE FOR LANGUAGE TRANSLATION; PROVIDING A WEBSITE FEATURING NON-DOWNLOADABLE SOFTWARE THAT ALLOWS USERS TO CREATE DOCUMENT TEMPLATES; PROVIDING AN INTERACTIVE WEBSITE FEATURING TECHNOLOGY THAT ALLOWS USERS TO NOTARIZE DOCUMENTS (U.S. CLS. 100 AND 101).

FIRST USE 4-6-2011; IN COMMERCE 4-6-2011.  
CAROLINE WOOD, EXAMINING ATTORNEY

SN 86-038,996. BARRACUDA NETWORKS, INC., CAMPBELL, CA. FILED 8-15-2013.



THE MARK CONSISTS OF THE LETTER "S" WITH SQUARE BACKGROUND.

#### CLASS 9—ELECTRICAL AND SCIENTIFIC APPARATUS

FOR DOWNLOADABLE MOBILE APPLICATIONS FOR ELECTRONIC AUTHENTICATION OF DOCUMENTS; DOWNLOADABLE MOBILE APPLICATIONS TO CAPTURE ELECTRONIC SIGNATURES; DOWNLOADABLE MOBILE APPLICATIONS TO FACILITATE THE ASSIGNMENT OF AN ELECTRONIC SIGNATURE TO A DOCUMENT OR FILE (U.S. CLS. 21, 23, 26, 36 AND 38).  
FIRST USE 1-29-2013; IN COMMERCE 1-29-2013.

#### CLASS 39—TRANSPORTATION AND STORAGE

FOR ELECTRONIC STORAGE OF FILES AND DOCUMENTS; PROVIDING A WEBSITE FOR THE ELECTRONIC STORAGE OF FILES AND DOCUMENTS (U.S. CLS. 100 AND 105).  
FIRST USE 1-29-2013; IN COMMERCE 1-29-2013.

**CLASS 42—SCIENTIFIC AND COMPUTER SERVICES**

FOR PROVIDING AN INTERACTIVE WEBSITE FEATURING TECHNOLOGY THAT ALLOWS USERS TO SAVE ELECTRONIC SIGNATURES; FILE-SHARING SERVICES, NAMELY, PROVIDING A WEBSITE FEATURING TECHNOLOGY ENABLING USERS TO UPLOAD AND DOWNLOAD ELECTRONIC FILES; ELECTRONIC DOCUMENT AND E-MAIL AUTHENTICATION SERVICES; PROVIDING AN INTERACTIVE WEBSITE FEATURING NON-DOWNLOADABLE SOFTWARE FOR LANGUAGE TRANSLATION; PROVIDING A WEBSITE FEATURING NON-DOWNLOADABLE SOFTWARE THAT ALLOWS USERS TO CREATE DOCUMENT TEMPLATES; PROVIDING AN INTERACTIVE WEBSITE FEATURING TECHNOLOGY THAT ALLOWS USERS TO NOTARIZE DOCUMENTS (U.S. CLS. 100 AND 101).

FIRST USE 1-29-2013; IN COMMERCE 1-29-2013.  
CAROLINE WOOD, EXAMINING ATTORNEY

SN 86-039,157. NEWCOMER FUNERAL SERVICE GROUP, INC., TOPEKA, KS. FILED 8-15-2013.



THE MARK CONSISTS OF THE WORD "ARACREMATIION" IN ALL CAPITAL LETTERS, WITH A DEPICTION OF A MULTIPLE TIERED FLOWER CENTERED ABOVE THE WORD.

**CLASS 35—ADVERTISING AND BUSINESS**

FOR RETAIL SERVICES, NAMELY, GIFT SHOPS FEATURING CREMATION AND MEMORIAL PRODUCTS, INCLUDING, CREMATION URNS, CREMATION KEEPSAKE JEWELRY, AND CREMATION SERVICE PLANNING KITS, WHICH PRIMARILY INCLUDE CANDLES, REGISTER BOOKS, SERVICE PLANNING CHECKLISTS, AND OBITUARY WRITING GUIDELINES (U.S. CLS. 100, 101 AND 102).

**CLASS 36—INSURANCE AND FINANCIAL**

FOR PRE-PAID FUNERAL AND CREMATION EXPENSES SERVICES (U.S. CLS. 100, 101 AND 102).

**CLASS 45—PERSONAL AND LEGAL SERVICES**

FOR FUNERAL SERVICES ACCOMPANYING CREMATION; FUNERAL SERVICES AND FUNERAL ARRANGEMENT SERVICES; SERVICES OF PREARRANGING FUNERAL OR CREMATION PLANS; FUNERAL AND CREMATION PLANNING SERVICES; CREMATION SERVICES (U.S. CLS. 100 AND 101).  
JULIE VEPPUMTHARA, EXAMINING ATTORNEY

SN 86-039,095. NEWCOMER FUNERAL SERVICE GROUP, INC., TOPEKA, KS. FILED 8-15-2013.

AraCremation

THE MARK CONSISTS OF STANDARD CHARACTERS WITHOUT CLAIM TO ANY PARTICULAR FONT, STYLE, SIZE, OR COLOR.

**CLASS 35—ADVERTISING AND BUSINESS**

FOR RETAIL SERVICES, NAMELY, GIFT SHOPS FEATURING CREMATION AND MEMORIAL PRODUCTS, INCLUDING, CREMATION URNS, CREMATION KEEPSAKE JEWELRY, AND CREMATION SERVICE PLANNING KITS, WHICH PRIMARILY INCLUDE CANDLES, REGISTER BOOKS, SERVICE PLANNING CHECKLISTS, AND OBITUARY WRITING GUIDELINES (U.S. CLS. 100, 101 AND 102).

**CLASS 36—INSURANCE AND FINANCIAL**

FOR PRE-PAID FUNERAL AND CREMATION EXPENSES SERVICES (U.S. CLS. 100, 101 AND 102).

**CLASS 45—PERSONAL AND LEGAL SERVICES**

FOR FUNERAL SERVICES ACCOMPANYING CREMATION; FUNERAL SERVICES AND FUNERAL ARRANGEMENT SERVICES; SERVICES OF PREARRANGING FUNERAL OR CREMATION PLANS; FUNERAL AND CREMATION PLANNING SERVICES; CREMATION SERVICES (U.S. CLS. 100 AND 101).  
JULIE VEPPUMTHARA, EXAMINING ATTORNEY

SN 86-039,635. CHALLENGEFINDER LLC, SAN FRANCISCO, CA. FILED 8-15-2013.

Challenge Finder

THE MARK CONSISTS OF STANDARD CHARACTERS WITHOUT CLAIM TO ANY PARTICULAR FONT, STYLE, SIZE, OR COLOR.

NO CLAIM IS MADE TO THE EXCLUSIVE RIGHT TO USE "CHALLENGE", APART FROM THE MARK AS SHOWN.

**CLASS 35—ADVERTISING AND BUSINESS**

FOR COLLECTION AND SYSTEMATISATION OF INFORMATION INTO COMPUTER DATABASES; ORGANIZING OF BUSINESS COMPETITIONS; PROMOTING TECHNICAL AND SCIENTIFIC INVESTIGATION, RESEARCH AND EXPERIMENTATION IN THE FIELD OF SCIENTIFIC DISCOVERY THROUGH SUPPORT OF EDUCATIONAL INSTITUTIONS AND SCIENTIFIC ORGANIZATIONS (U.S. CLS. 100, 101 AND 102).

**CLASS 41—EDUCATION AND ENTERTAINMENT**

FOR ENTERTAINMENT AND EDUCATIONAL SERVICES IN THE NATURE OF COMPETITIONS IN THE FIELD OF ENTERTAINMENT, EDUCATION, CULTURE, SPORTS, AND OTHER NON-BUSINESS AND NON-COMMERCIAL FIELDS; ENTERTAINMENT SERVICES, NAMELY, ARRANGING AND CONDUCTING OF COMPETITIONS FOR SOLVING SCIENCE AND TECHNOLOGY PROBLEMS (U.S. CLS. 100, 101 AND 107).

**CLASS 42—SCIENTIFIC AND COMPUTER SERVICES**

FOR PROVIDING AN ON-LINE SEARCHABLE DATABASE IN THE FIELD OF TECHNICAL CHALLENGES AND COMPETITIONS FOR SCIENTIFIC RESEARCH PURPOSES (U.S. CLS. 100 AND 101).

SAMUAL PAQUIN, EXAMINING ATTORNEY

SN 86-039,822. CIXI HAIPLE ELECTRICAL APPLIANCE CO., LTD., ZHEJIANG PROVINCE, CHINA, FILED 8-16-2013.

**CLASS 9—ELECTRICAL AND SCIENTIFIC APPARATUS**

FOR AUDIO-RECEIVERS AND VIDEO-RECEIVERS; BATTERIES, ELECTRIC; DATA PROCESSING EQUIPMENT, NAMELY, COUPLERS; EARPHONES; ELECTRIC CONNECTIONS AND CONNECTORS; ELECTRICAL PLUGS AND SOCKETS; HORNS FOR LOUDSPEAKERS; LOUDSPEAKERS; PORTABLE MEDIA PLAYERS; REMOTE CONTROLS FOR TELEVISIONS; SOUND TRANSMITTING APPARATUS; STANDS SPECIALLY ADAPTED FOR STEREO AND AUDIO SPEAKERS; TELEVISIONS (U.S. CLS. 21, 23, 26, 36 AND 38).

**CLASS 20—FURNITURE AND ARTICLES NOT OTHERWISE CLASSIFIED**

FOR FURNITURE; FURNITURE FRAMES; FURNITURE OF METAL; HARDWARE, NAMELY, NON-METAL BRACKETS FOR GENERAL USE; NON-METAL SHELF BRACKETS; OFFICE FURNITURE; SOFAS; STANDS FOR CALCULATING MACHINES; TEA TABLES; TELEVISION STANDS (U.S. CLS. 2, 13, 22, 25, 32 AND 50).

JOHN KELLY, EXAMINING ATTORNEY

SN 86-039,927. AFINIX LIFE SCIENCES INC., EDMONTON, AB, CANADA, FILED 8-16-2013.

THE MARK CONSISTS OF STANDARD CHARACTERS WITHOUT CLAIM TO ANY PARTICULAR FONT, STYLE, SIZE, OR COLOR.

PRIORITY CLAIMED UNDER SEC. 44(D) ON CANADA APPLICATION NO. 1,615,228, FILED 2-22-2013.

NO CLAIM IS MADE TO THE EXCLUSIVE RIGHT TO USE "LIFE SCIENCES", APART FROM THE MARK AS SHOWN.

**CLASS 5—PHARMACEUTICALS**

FOR NUTRITIONAL AND HERBAL SUPPLEMENTS FOR GENERAL HEALTH AND WELL BEING; NUTRITIONAL AND HERBAL SUPPLEMENTS FOR TREATMENT OF MENOPAUSAL SYMPTOMS, PERIMENOPAUSAL SYMPTOMS, MENSTRUAL DISORDERS, PREMENSTRUAL SYMPTOMS, ANDROPAUSAL SYMPTOMS, LIBIDINAL DYSFUNCTION, SEXUAL DYSFUNCTION, FATIGUE, STRESS, DEPRESSION, ANXIETY, MOOD DISORDERS, SLEEP DISORDERS, INSOMNIA, BONE AND JOINT PAIN, RHEUMATOID ARTHRITIS, OSTEOARTHRITIS, LIVER DAMAGE, LIVER DISEASE, OBESITY, HYPERTENSION, HYPERLIPIDEMIA, CARDIOVASCULAR DISEASE, HYPERGLYCEMIA, DIABETES, INFECTIOUS DISEASE, OR CANCER; PHARMACEUTICAL PREPARATIONS CONTAINING BOTANICAL EXTRACTS FOR TREATMENT OF MENOPAUSAL SYMPTOMS, PERIMENOPAUSAL SYMPTOMS, MENSTRUAL DISORDERS, PREMENSTRUAL SYMPTOMS, ANDROPAUSAL SYMPTOMS, LIBIDINAL DYSFUNCTION, SEXUAL DYSFUNCTION, FATIGUE, STRESS, DEPRESSION, ANXIETY, MOOD DISORDERS, SLEEP DISORDERS, INSOMNIA, BONE AND JOINT PAIN, RHEUMATOID ARTHRITIS, OSTEOARTHRITIS, LIVER DAMAGE, LIVER DISEASE, OBESITY, HYPERTENSION, HYPERLIPIDEMIA, CARDIOVASCULAR DISEASE, HYPERGLYCEMIA, DIABETES, INFECTIOUS DISEASE, OR CANCER (U.S. CLS. 6, 18, 44, 46, 51 AND 52).

**CLASS 35—ADVERTISING AND BUSINESS**

FOR REGULATORY SERVICES, NAMELY, PREPARING APPLICATIONS AND DOCUMENTS FOR SUBMISSION TO REGULATORY BODIES IN RELATION TO NATURAL HEALTH PRODUCTS AND PHARMACEUTICALS FOR OTHERS; BUSINESS ADVISORY AND CONSULTING SERVICES REGARDING RESEARCH AND DEVELOPMENT, FORMULATION DEVELOPMENT, QUALITY CONTROL, CLINICAL EVALUATION, REGULATORY REGISTRATION, MANUFACTURE, MARKETING, AND SALES IN THE FIELD OF NATURAL HEALTH PRODUCTS AND PHARMACEUTICALS (U.S. CLS. 100, 101 AND 102).

JEFF DEFORD, EXAMINING ATTORNEY

SN 86-040,069. SACHER & SILVER, INC., DBA SILVER LINING OPTICIANS, NEW YORK, NY. FILED 8-16-2013.

OWNER OF U.S. REG. NO. 3,840,006.  
NO CLAIM IS MADE TO THE EXCLUSIVE RIGHT TO USE "NYC OPTICIANS", APART FROM THE MARK AS SHOWN.

THE MARK CONSISTS OF A STYLIZED SCRIPT "SILVER" ABOVE A STYLIZED SCRIPT "LINING" WITH THE LETTER L OVERLAPPING IN BOTH WORDS, ALL ABOVE A HORIZONTAL LINE WITH A BREAK IN THE MIDDLE FOR A SCRIPT "NYC" WITH "OPTICIANS" BELOW AND A HORIZONTAL LINE BELOW THE TEXT.

#### CLASS 9—ELECTRICAL AND SCIENTIFIC APPARATUS

FOR EYEWEAR, NAMELY, EYEGLASSES, SUNGLASSES, AND FRAMES (U.S. CLS. 21, 23, 26, 36 AND 38).

FIRST USE 2-1-2005; IN COMMERCE 2-1-2005.

#### CLASS 35—ADVERTISING AND BUSINESS

FOR ON-LINE RETAIL STORE SERVICES FEATURING OPTICAL PRODUCTS, NAMELY, EYEGLASSES, SUNGLASSES, AND FRAMES; ON-LINE WHOLESALE STORE SERVICES FEATURING OPTICAL PRODUCTS, NAMELY, EYEGLASSES, SUNGLASSES, AND FRAMES; RETAIL STORE SERVICES FEATURING OPTICAL PRODUCTS, NAMELY, EYEGLASSES, SUNGLASSES, AND FRAMES; WHOLESALE STORE SERVICES FEATURING OPTICAL PRODUCTS, NAMELY, EYEGLASSES, SUNGLASSES, AND FRAMES (U.S. CLS. 100, 101 AND 102).

FIRST USE 2-1-2005; IN COMMERCE 2-1-2005.

#### CLASS 44—MEDICAL, BEAUTY AND AGRICULTURAL SERVICES

FOR OPTICIAN SERVICES (U.S. CLS. 100 AND 101).  
FIRST USE 2-1-2005; IN COMMERCE 2-1-2005.  
JENNIFER MARTIN, EXAMINING ATTORNEY

---

SN 86-040,093. BATTERIES & BANDS, INC., SANDY, UT.  
FILED 8-16-2013.

**PRECISION TIME**  
THE WATCH EXPERTS

OWNER OF U.S. REG. NO. 3,239,077.

NO CLAIM IS MADE TO THE EXCLUSIVE RIGHT TO USE "THE WATCH EXPERTS", APART FROM THE MARK AS SHOWN.

THE MARK CONSISTS OF THE WORDS "PRECISION" AND "TIME" WITH A STYLIZED WATCH FACE IN BETWEEN, AND THE PHRASE "THE WATCH EXPERTS" ON THE LINE BELOW.

#### CLASS 35—ADVERTISING AND BUSINESS

FOR RETAIL STORE SERVICES FEATURING WATCHES, CLOCKS, WATCH BANDS, WATCH CASES, WATCH STRAPS, WATCH BATTERIES, AND OTHER WATCH ACCESSORIES; ONLINE RETAIL STORE SERVICES FEATURING WATCHES, WATCH BANDS, WATCH CASES, WATCH STRAPS, WATCH BATTERIES, AND OTHER WATCH ACCESSORIES (U.S. CLS. 100, 101 AND 102).

FIRST USE 7-22-2013; IN COMMERCE 7-22-2013.

#### CLASS 37—CONSTRUCTION AND REPAIR

FOR REPAIR, RESTORATION, AND MAINTENANCE OF WATCHES AND CLOCKS (U.S. CLS. 100, 103 AND 106).

FIRST USE 7-22-2013; IN COMMERCE 7-22-2013.  
JAMES LOVELACE, EXAMINING ATTORNEY

SN 86-040,157. MARVIN ENGINEERING CO., INC., INGLEWOOD, CA. FILED 8-16-2013.

## THE MARVIN GROUP

THE MARK CONSISTS OF STANDARD CHARACTERS WITHOUT CLAIM TO ANY PARTICULAR FONT, STYLE, SIZE, OR COLOR.

NO CLAIM IS MADE TO THE EXCLUSIVE RIGHT TO USE "GROUP", APART FROM THE MARK AS SHOWN.

#### CLASS 40—MATERIAL TREATMENT

FOR CUSTOM MANUFACTURING AND PRODUCTION IN THE NATURE OF CUSTOM BUILDING AND ASSEMBLY OF PRODUCTS FOR THE AEROSPACE AND DEFENSE INDUSTRIES, NAMELY, AIRBORNE ARMAMENT, MACHINED COMPONENTS AND ASSEMBLIES, TEST AND MEASUREMENT INSTRUMENTATION, GROUND VEHICLES, EQUIPMENT TRAILERS, ENVIRONMENTAL SYSTEMS AND WEAPONS INTEGRATION (U.S. CLS. 100, 103 AND 106).

FIRST USE 8-0-2000; IN COMMERCE 8-0-2000.

#### CLASS 42—SCIENTIFIC AND COMPUTER SERVICES

FOR ENGINEERING DESIGN OF PRODUCTS FOR THE AEROSPACE AND DEFENSE INDUSTRIES, NAMELY, AIRBORNE ARMAMENT, MACHINED COMPONENTS AND ASSEMBLIES, TEST AND MEASUREMENT INSTRUMENTATION, GROUND VEHICLES, EQUIPMENT TRAILERS, ENVIRONMENTAL SYSTEMS AND WEAPONS INTEGRATION (U.S. CLS. 100 AND 101).

FIRST USE 8-0-2000; IN COMMERCE 8-0-2000.

MARY CRAWFORD, EXAMINING ATTORNEY

---

SN 86-040,330. LOVE & PROMISE JEWELERS CO., INC., AKA L&P JEWELERS, CHICAGO, IL. FILED 8-16-2013.

 **ROSADOS BOX**

THE COLOR(S) RED, PINK, AND BLACK IS/ARE CLAIMED AS A FEATURE OF THE MARK.

THE MARK CONSISTS OF A RED, PINK, AND BLACK ROSE DESIGN APPEARING INSIDE A PINK SQUARE WITH ROUNDED CORNERS. TO THE RIGHT OF THE DESIGN APPEARS THE WORDING "ROSADOS BOX" WITH "ROSADOS" APPEARING IN RED, AND "BOX" APPEARING IN BLACK.

THE ENGLISH TRANSLATION OF "ROSADOS" IN THE MARK IS "ROSY".

#### CLASS 14—JEWELRY

FOR DIAMOND JEWELRY; GEMSTONE JEWELRY; JEWELRY; JEWELRY MADE IN WHOLE OR SIGNIFICANT PART OF GOLD, PLATINUM, PALLADIUM OR SILVER; RINGS; RINGS BEING JEWELRY; WOMEN'S JEWELRY (U.S. CLS. 2, 27, 28 AND 50).

FIRST USE 12-13-2011; IN COMMERCE 2-28-2013.

**CLASS 35—ADVERTISING AND BUSINESS**

FOR ON-LINE WHOLESALE AND RETAIL STORE SERVICES FEATURING JEWELRY; RETAIL JEWELRY STORES (U.S. CLS. 100, 101 AND 102).  
FIRST USE 12-13-2011; IN COMMERCE 2-28-2013.  
KATHERINE E. HALMEN, EXAMINING ATTORNEY

---

SN 86-040,493. IMRAN HOLDINGS, LLC, GASTONIA, NC.  
FILED 8-16-2013.



NO CLAIM IS MADE TO THE EXCLUSIVE RIGHT TO USE "COLLECTIONS", APART FROM THE MARK AS SHOWN.

THE MARK CONSISTS OF A CROWN, POSITIONED ABOVE THE WORD "HIGHBORN" IN A LARGE FONT SIZE, WHICH IS POSITIONED ABOVE THE WORD "COLLECTIONS" IN A SMALL FONT SIZE.

**CLASS 9—ELECTRICAL AND SCIENTIFIC APPARATUS**

FOR BAGS AND CASES SPECIALLY ADAPTED FOR HOLDING OR CARRYING PORTABLE TELEPHONES AND TELEPHONE EQUIPMENT AND ACCESSORIES; CASES FOR MOBILE PHONES; CELLULAR PHONE ACCESSORY CHARMS; DEVICES FOR HANDS-FREE USE OF MOBILE PHONES; HANDS FREE DEVICES FOR MOBILE-PHONES; HEADSETS FOR CELLULAR OR MOBILE PHONES; KEYBOARDS FOR MOBILE PHONES; MOBILE PHONE STRAPS; MOBILE TELEPHONE ACCESSORIES, NAMELY, BELT CLIPS (U.S. CLS. 21, 23, 26, 36 AND 38).

**CLASS 25—CLOTHING**

FOR ATHLETIC APPAREL, NAMELY, SHIRTS, PANTS, JACKETS, FOOTWEAR, HATS AND CAPS, ATHLETIC UNIFORMS; HATS; HOODED SWEAT SHIRTS; JACKETS; PANTS; SHIRTS; SHOES; SHORT-SLEEVED OR LONG-SLEEVED T-SHIRTS; SPORTS CAPS AND HATS; SWEAT SHIRTS; T-SHIRTS (U.S. CLS. 22 AND 39).

ANN E. SAPPENFIELD, EXAMINING ATTORNEY

---

SN 86-040,544. AGILEX FLAVOR & FRAGRANCES, INC.,  
PISCATAWAY, NJ. FILED 8-16-2013.

**FLAVORDNA**

THE MARK CONSISTS OF STANDARD CHARACTERS WITHOUT CLAIM TO ANY PARTICULAR FONT, STYLE, SIZE, OR COLOR.

**CLASS 35—ADVERTISING AND BUSINESS**

FOR BUSINESS CONSULTATION AND MARKETING CONSULTATION SERVICES IN THE FIELD OF FRAGRANCES DEVELOPMENT AND USAGE (U.S. CLS. 100, 101 AND 102).

**CLASS 42—SCIENTIFIC AND COMPUTER SERVICES**

FOR PROVIDING ONLINE NON-DOWNLOADABLE SOFTWARE FOR USE IN DETERMINING APPROPRIATE FRAGRANCES FOR USE IN THE MANUFACTURE OF PRODUCTS (U.S. CLS. 100 AND 101).  
CAROLINE WOOD, EXAMINING ATTORNEY

---

SN 86-040,546. AGILEX FLAVOR & FRAGRANCES, INC.,  
PISCATAWAY, NJ. FILED 8-16-2013.

**AIRCAREDNA**

THE MARK CONSISTS OF STANDARD CHARACTERS WITHOUT CLAIM TO ANY PARTICULAR FONT, STYLE, SIZE, OR COLOR.

**CLASS 35—ADVERTISING AND BUSINESS**

FOR BUSINESS CONSULTATION AND MARKETING CONSULTATION SERVICES IN THE FIELD OF FRAGRANCES DEVELOPMENT AND USAGE (U.S. CLS. 100, 101 AND 102).

**CLASS 42—SCIENTIFIC AND COMPUTER SERVICES**

FOR PROVIDING ONLINE NON-DOWNLOADABLE SOFTWARE FOR USE IN DETERMINING APPROPRIATE FRAGRANCES FOR USE IN THE MANUFACTURE OF PRODUCTS (U.S. CLS. 100 AND 101).  
CAROLINE WOOD, EXAMINING ATTORNEY

---

SN 86-040,548. AGILEX FLAVOR & FRAGRANCES, INC.,  
PISCATAWAY, NJ. FILED 8-16-2013.

**PERSONALCAREDNA**

THE MARK CONSISTS OF STANDARD CHARACTERS WITHOUT CLAIM TO ANY PARTICULAR FONT, STYLE, SIZE, OR COLOR.

**CLASS 35—ADVERTISING AND BUSINESS**

FOR BUSINESS CONSULTATION AND MARKETING CONSULTATION SERVICES IN THE FIELD OF FRAGRANCES DEVELOPMENT AND USAGE (U.S. CLS. 100, 101 AND 102).



**CLASS 42—SCIENTIFIC AND COMPUTER SERVICES**

FOR PROVIDING ONLINE NON-DOWNLOADABLE SOFTWARE FOR USE IN DETERMINING APPROPRIATE FRAGRANCES FOR USE IN THE MANUFACTURE OF PRODUCTS (U.S. CLS. 100 AND 101).

CAROLINE WOOD, EXAMINING ATTORNEY

SN 86-040,550. AGILEX FLAVOR & FRAGRANCES, INC., PISCATAWAY, NJ. FILED 8-16-2013.

**HEMECAREDNA**

THE MARK CONSISTS OF STANDARD CHARACTERS WITHOUT CLAIM TO ANY PARTICULAR FONT, STYLE, SIZE, OR COLOR.

**CLASS 35—ADVERTISING AND BUSINESS**

FOR BUSINESS CONSULTATION AND MARKETING CONSULTATION SERVICES IN THE FIELD OF FRAGRANCES DEVELOPMENT AND USAGE (U.S. CLS. 100, 101 AND 102).

**CLASS 42—SCIENTIFIC AND COMPUTER SERVICES**

FOR PROVIDING ONLINE NON-DOWNLOADABLE SOFTWARE FOR USE IN DETERMINING APPROPRIATE FRAGRANCES FOR USE IN THE MANUFACTURE OF PRODUCTS (U.S. CLS. 100 AND 101).

CAROLINE WOOD, EXAMINING ATTORNEY

SN 86-040,659. FITNESS EXPERIENCE, LLC, LOS ANGELES, CA. FILED 8-16-2013.

**Now Lets Get Fit**

THE MARK CONSISTS OF STANDARD CHARACTERS WITHOUT CLAIM TO ANY PARTICULAR FONT, STYLE, SIZE, OR COLOR.

NO CLAIM IS MADE TO THE EXCLUSIVE RIGHT TO USE "FIT" FOR INTERNATIONAL CLASS 41, APART FROM THE MARK AS SHOWN.

**CLASS 21—HOUSEWARES AND GLASS**

FOR ALUMINUM WATER BOTTLES SOLD EMPTY; BOTTLES, SOLD EMPTY; WATER BOTTLES SOLD EMPTY (U.S. CLS. 2, 13, 23, 29, 30, 33, 40 AND 50).

**CLASS 25—CLOTHING**

FOR ATHLETIC APPAREL, NAMELY, SHIRTS, PANTS, JACKETS, FOOTWEAR, HATS AND CAPS, ATHLETIC UNIFORMS; ATHLETIC PANTS; ATHLETIC SHIRTS; BODY SHIRTS; CLOTHING FOR ATHLETIC USE, NAMELY, PADDED PANTS; CLOTHING FOR ATHLETIC USE, NAMELY, PADDED SHIRTS; CLOTHING FOR ATHLETIC USE, NAMELY, PADDED SHORTS; COMBINATIONS; JOGGING PANTS; PANTS; SHORTS; SPORT SHIRTS; SWEAT SHIRTS; T-SHIRTS; TIES; TOPS (U.S. CLS. 22 AND 39).

**CLASS 41—EDUCATION AND ENTERTAINMENT**

FOR ARRANGING FOR TICKET RESERVATIONS FOR SHOWS AND OTHER ENTERTAINMENT EVENTS; CONDUCTING FITNESS CLASSES; EDUCATION SERVICES, NAMELY, PROVIDING PANEL DISCUSSIONS IN THE FIELD OF SPORTS AND FITNESS; ENTERTAINMENT SERVICES, NAMELY, ORGANIZING AND CONDUCTING AN ARRAY OF ATHLETIC EVENTS RENDERED LIVE AND RECORDED FOR THE PURPOSE OF DISTRIBUTION THROUGH BROADCAST MEDIA; ENTERTAINMENT SERVICES, NAMELY, PARTICIPATION IN SPORTS AND FITNESS EVENTS; ORGANIZATION OF DANCING EVENTS; ORGANIZING AND CONDUCTING A RUNNING EVENT THE PROCEEDS OF WHICH ARE DONATED TO CHARITY; ORGANIZING COMMUNITY SPORTING AND CULTURAL EVENTS; ORGANIZING SPORTING EVENTS, NAMELY, FITNESS, FOOTBALL AND DANCE; PERSONAL FITNESS TRAINING SERVICES AND CONSULTANCY; PERSONAL FITNESS TRAINING SERVICES FEATURING AEROBIC AND ANAEROBIC ACTIVITIES COMBINED WITH RESISTANCE AND FLEXIBILITY TRAINING; PHYSICAL FITNESS CONDITIONING CLASSES; PHYSICAL FITNESS CONSULTATION; PHYSICAL FITNESS INSTRUCTION; PHYSICAL FITNESS STUDIO SERVICES, NAMELY, PROVIDING EXERCISE CLASSES, BODY SCULPTING CLASSES, AND GROUP FITNESS CLASSES; PHYSICAL FITNESS STUDIO SERVICES, NAMELY, PROVIDING GROUP EXERCISE INSTRUCTION, EQUIPMENT, AND FACILITIES; PHYSICAL FITNESS TRAINING OF INDIVIDUALS AND GROUPS; PHYSICAL FITNESS TRAINING SERVICES; PROVIDING A WEB SITE FEATURING INFORMATION ON EXERCISE AND FITNESS; PROVIDING A WEBSITE FEATURING INFORMATION ON EXERCISE AND FITNESS; PROVIDING AN INTERACTIVE WEBSITE FEATURING INFORMATION AND LINKS RELATING TO FITNESS; PROVIDING AN INTERNET WEBSITE PORTAL IN THE FIELD OF ENTERTAINMENT, CULTURAL AND SPORTING EVENTS; PROVIDING AN ON-LINE COMPUTER DATABASE FEATURING INFORMATION REGARDING EXERCISE AND FITNESS; PROVIDING INFORMATION RELATING TO SPORTS AND SPORTING EVENTS (U.S. CLS. 100, 101 AND 107).

KIMBERLY PARKS, EXAMINING ATTORNEY

SN 86-040,681. LYNCH FAMILY VINEYARDS, LLC, CALISTOGA, CA. FILED 8-16-2013.

**RUBY FOX**

THE MARK CONSISTS OF STANDARD CHARACTERS WITHOUT CLAIM TO ANY PARTICULAR FONT, STYLE, SIZE, OR COLOR.

THE NAME(S), PORTRAIT(S), AND/OR SIGNATURE(S) SHOWN IN THE MARK DOES NOT IDENTIFY A PARTICULAR LIVING INDIVIDUAL.

**CLASS 33—WINES AND SPIRITS**

FOR WINE (U.S. CLS. 47 AND 49).

**CLASS 35—ADVERTISING AND BUSINESS**

FOR ADMINISTERING A WINE CLUB BY MEANS OF SELECTING WINES AND ARRANGING PERIODIC SHIPMENT TO CLUB MEMBERS (U.S. CLS. 100, 101 AND 102).

CIMMERIAN COLEMAN, EXAMINING ATTORNEY

SN 86-040,828. CLOUD MALL LIMITED, WANCHAI, HONG KONG, FILED 8-17-2013.

SN 86-040,964. INTERLOCKEN LLC, NEW YORK, NY. FILED 8-18-2013.

THE MARK CONSISTS OF THE WORD "CLOUDMALL" WRITTEN IN STYLIZED FORM WITH AN IMAGE OF A CLOUD WITH A HALF OF A SHOPPING BAG IN FRONT, PLACED AS THE LETTER "O" IN THE WORD "CLOUD" AND THE LEFT STEM OF THE LETTER "M" IN THE WORD "MALL" SHOWN AS THE LOWER STEM OF THE LETTER "D" IN THE WORD "CLOUD".

**CLASS 16—PAPER GOODS AND PRINTED MATTER**

FOR INFLIGHT MAGAZINES; MAGAZINES FEATURING ENTERTAINMENT AND TRAVEL (U.S. CLS. 2, 5, 22, 23, 29, 37, 38 AND 50).

**CLASS 35—ADVERTISING AND BUSINESS**

FOR RETAIL STORE, ONLINE RETAIL STORE AND CATALOG ORDERING SERVICES FEATURING WINE, ALCOHOLIC BEVERAGES, BEAUTY PRODUCTS, CONSUMER ELECTRONIC DEVICES AND GADGETS, FOOD AND BEVERAGES, CLOTHING AND APPAREL, LAMPS, PAINTINGS, PICTURE FRAMES, LUGGAGE, HANDBAGS, JEWELRY, BOOKS, TOYS, RELAXATION AND MASSAGE EQUIPMENT, NUTRITIONAL PRODUCTS, COSMETICS, BODY AND HAIR CARE PRODUCTS, CONSUMER ELECTRONIC ACCESSORIES, PHONES, TABLET COMPUTERS AND COMPUTER ACCESSORIES, BACKPACKS, CAMPING EQUIPMENT, BOOTS, HIKING ACCESSORIES (U.S. CLS. 100, 101 AND 102).  
SAMUEL E. SHARPER JR., EXAMINING ATTORNEY

SN 86-040,899. GRDJICH, DANICA L, CHICAGO, IL. FILED 8-17-2013.

Shoe Shag, ShoeShag,

THE MARK CONSISTS OF STANDARD CHARACTERS WITHOUT CLAIM TO ANY PARTICULAR FONT, STYLE, SIZE, OR COLOR.

NO CLAIM IS MADE TO THE EXCLUSIVE RIGHT TO USE "SHOE", APART FROM THE MARK AS SHOWN.

**CLASS 18—LEATHER GOODS**

FOR SHOE BAGS FOR TRAVEL (U.S. CLS. 1, 2, 3, 22 AND 41).

**CLASS 25—CLOTHING**

FOR SHOE ACCESSORIES, NAMELY, FITTED DECORATIVE COVERS FOR SHOES (U.S. CLS. 22 AND 39).  
RONALD MCMORROW, EXAMINING ATTORNEY

THE MARK CONSISTS OF STANDARD CHARACTERS WITHOUT CLAIM TO ANY PARTICULAR FONT, STYLE, SIZE, OR COLOR.

**CLASS 16—PAPER GOODS AND PRINTED MATTER**

FOR POSTERS (U.S. CLS. 2, 5, 22, 23, 29, 37, 38 AND 50).

**CLASS 25—CLOTHING**

FOR BASEBALL CAPS AND HATS; HEADBANDS; HOODED SWEATSHIRTS; JACKETS; PONCHOS; SHIRTS; SWEAT SHIRTS; SWEATBANDS; T-SHIRTS (U.S. CLS. 22 AND 39).

**CLASS 41—EDUCATION AND ENTERTAINMENT**

FOR ENTERTAINMENT IN THE NATURE OF LIVE MUSIC FESTIVALS AND PERFORMING ARTS FESTIVALS; ORGANIZING, ARRANGING, AND CONDUCTING CONCERTS AND OTHER LIVE MUSIC AND PERFORMING ARTS EVENTS (U.S. CLS. 100, 101 AND 107).

TRICIA SONNEBORN, EXAMINING ATTORNEY

SN 86-040,965. INTERLOCKEN LLC, NEW YORK, NY. FILED 8-18-2013.

LOCKN' FESTIVAL

THE MARK CONSISTS OF STANDARD CHARACTERS WITHOUT CLAIM TO ANY PARTICULAR FONT, STYLE, SIZE, OR COLOR.

NO CLAIM IS MADE TO THE EXCLUSIVE RIGHT TO USE "FESTIVAL" FOR INTERNATIONAL CLASS 041, APART FROM THE MARK AS SHOWN.

**CLASS 16—PAPER GOODS AND PRINTED MATTER**

FOR POSTERS (U.S. CLS. 2, 5, 22, 23, 29, 37, 38 AND 50).

**CLASS 25—CLOTHING**

FOR BASEBALL CAPS AND HATS; HEADBANDS; HOODED SWEATSHIRTS; JACKETS; PONCHOS; SHIRTS; SWEAT SHIRTS; SWEATBANDS; T-SHIRTS (U.S. CLS. 22 AND 39).

**CLASS 41—EDUCATION AND ENTERTAINMENT**

FOR ENTERTAINMENT IN THE NATURE OF LIVE MUSIC FESTIVALS AND PERFORMING ARTS FESTIVALS; ORGANIZING, ARRANGING, AND CONDUCTING CONCERTS AND OTHER LIVE MUSIC AND PERFORMING ARTS EVENTS (U.S. CLS. 100, 101 AND 107).

TRICIA SONNEBORN, EXAMINING ATTORNEY

SN 86-040,966. INTERLOCKEN LLC, NEW YORK, NY. FILED 8-18-2013.



THE MARK CONSISTS OF AN INFINITY SYMBOL WITH DOUBLE LINE AND A BREAK ON THE RIGHT SIDE.

**CLASS 16—PAPER GOODS AND PRINTED MATTER**

FOR POSTERS (U.S. CLS. 2, 5, 22, 23, 29, 37, 38 AND 50).

**CLASS 25—CLOTHING**

FOR BASEBALL CAPS AND HATS; HEADBANDS; HOODED SWEATSHIRTS; JACKETS; PONCHOS; SHIRTS; SWEAT SHIRTS; SWEATBANDS; T-SHIRTS (U.S. CLS. 22 AND 39).

**CLASS 41—EDUCATION AND ENTERTAINMENT**

FOR ENTERTAINMENT IN THE NATURE OF LIVE MUSIC FESTIVALS AND PERFORMING ARTS FESTIVALS; ORGANIZING, ARRANGING, AND CONDUCTING CONCERTS AND OTHER LIVE MUSIC AND PERFORMING ARTS EVENTS (U.S. CLS. 100, 101 AND 107).

TRICIA SONNEBORN, EXAMINING ATTORNEY

SN 86-041,171. MEDLARS LLC, SAN ANTONIO, TX. FILED 8-19-2013.

# MEDLARS

THE MARK CONSISTS OF STANDARD CHARACTERS WITHOUT CLAIM TO ANY PARTICULAR FONT, STYLE, SIZE, OR COLOR.

**CLASS 14—JEWELRY**

FOR JEWELRY (U.S. CLS. 2, 27, 28 AND 50). FIRST USE 12-31-1975; IN COMMERCE 12-31-1975.

**CLASS 35—ADVERTISING AND BUSINESS**

FOR RETAIL STORE SERVICES FEATURING JEWELRY (U.S. CLS. 100, 101 AND 102). FIRST USE 12-31-1975; IN COMMERCE 12-31-1975.

**CLASS 40—MATERIAL TREATMENT**

FOR CASTING AND CUSTOM MANUFACTURE OF JEWELRY (U.S. CLS. 100, 103 AND 106). FIRST USE 12-31-1975; IN COMMERCE 12-31-1975.

**CLASS 42—SCIENTIFIC AND COMPUTER SERVICES**

FOR CUSTOM DESIGN OF JEWELRY (U.S. CLS. 100 AND 101). FIRST USE 12-31-1975; IN COMMERCE 12-31-1975. STEVEN R. FINE, EXAMINING ATTORNEY

SN 86-041,194. UNITED TRADEMARK HOLDINGS, INC., BEVERLY HILLS, CA. FILED 8-19-2013.

## Once Upon a Zombie

THE MARK CONSISTS OF STANDARD CHARACTERS WITHOUT CLAIM TO ANY PARTICULAR FONT, STYLE, SIZE, OR COLOR.

OWNER OF U.S. REG. NO. 4,403,514.

**CLASS 14—JEWELRY**

FOR BRACELETS FOR KIDS (U.S. CLS. 2, 27, 28 AND 50).

**CLASS 16—PAPER GOODS AND PRINTED MATTER**

FOR STICKERS; ALBUMS FOR PHOTOGRAPHS, COINS, AND STAMPS; CHILDREN'S ACTIVITY BOOKS; PHOTO CARDS (U.S. CLS. 2, 5, 22, 23, 29, 37, 38 AND 50).

**CLASS 28—TOYS AND SPORTING GOODS**

FOR TRADING CARD GAMES (U.S. CLS. 22, 23, 38 AND 50). CIMMERIAN COLEMAN, EXAMINING ATTORNEY

SN 86-041,195. ORACLE GIFTS LIMITED, SAN PO KONG, KOWLOON, HONG KONG, FILED 8-19-2013.

# ENFILL

THE MARK CONSISTS OF STANDARD CHARACTERS WITHOUT CLAIM TO ANY PARTICULAR FONT, STYLE, SIZE, OR COLOR.

**CLASS 9—ELECTRICAL AND SCIENTIFIC APPARATUS**

FOR DVD CASES; EARPHONE ACCESSORIES, NAMELY, EARPHONE CUSHIONS, EARPHONE PADS, CORD MANAGEMENT SYSTEMS, EARPHONE CASES, AND EARPHONE EXTENSION CORDS; EYE COVERS FOR PROTECTIVE PURPOSES; EYEGGLASS CASES; EYEWEAR ACCESSORIES, NAMELY, STRAPS, NECK CORDS AND HEAD STRAPS WHICH RESTRAIN EYEWEAR FROM MOVEMENT ON A WEARER; KEYBOARD COVERS; KEYBOARDS FOR MOBILE PHONES; LOUDSPEAKERS, HEADPHONES, MICROPHONES AND CD PLAYERS; MOBILE PHONE STRAPS; MOBILE TELEPHONE ACCESSORIES, NAMELY, BELT CLIPS; MOUSEPADS; MUSIC HEADPHONES; PLASTIC CASE USED AS A SECURITY DEVICE FOR PROTECTING AND SECURING DVDS AND OTHER MAGNETIC AND ELECTRONIC MEDIA FROM THEFT; PLASTIC CASES SPECIALLY ADAPTED HOLDING COMPACT DISCS AND BLANK DVDS; PROTECTIVE CARRYING CASES FOR PORTABLE MUSIC PLAYERS; PROTECTIVE CARRYING CASES SPECIALLY ADAPTED FOR PERSONAL DIGITAL ASSISTANTS (PDA); PROTECTIVE CASES FOR SMARTPHONES; PROTECTIVE COVERS AND CASES FOR CELL PHONES, LAPTOPS AND PORTABLE MEDIA PLAYERS; PROTECTIVE COVERS AND CASES FOR TABLET COMPUTERS; PROTECTIVE COVERS FOR ELECTRONIC READING DEVICES; PROTECTIVE COVERS FOR SMARTPHONES; STRAPS FOR MOBILE PHONES; BAGS FOR CAMERAS AND PHOTOGRAPHIC EQUIPMENT; CAMERA CASES; CASES FOR TELEPHONES; EARPHONES; EARPHONES AND HEADPHONES; HEADPHONES; HEADPHONES INCLUDING ATTACHED LANYARD; HEADSETS FOR CELLULAR OR MOBILE PHONES; HEADSETS FOR MOBILE TELEPHONES; NOTEBOOK COMPUTER CARRYING CASES; BAGS AND CASES SPECIALLY ADAPTED FOR HOLDING OR CARRYING PORTABLE TELEPHONES AND TELEPHONE EQUIPMENT AND ACCESSORIES; BATTERY CHARGE DEVICES; BATTERY CHARGERS; BATTERY PACKS; CARRYING CASES FOR CELL PHONES; CARRYING CASES FOR MOBILE COMPUTERS; CARRYING CASES SPECIALLY ADAPTED FOR POCKET CALCULATORS AND CELLPHONES; CARRYING CASES, HOLDERS, PROTECTIVE CASES AND STANDS FEATURING POWER SUPPLY CONNECTORS, ADAPTORS, SPEAKERS AND BATTERY CHARGING DEVICES, SPECIALLY ADAPTED FOR USE WITH HANDHELD DIGITAL ELECTRONIC DEVICES, NAMELY, CELL PHONES, MP3 PLAYERS AND CASES FOR CELL PHONES, LAPTOPS, PERSONAL DIGITAL ASSISTANTS AND PORTABLE MEDIA PLAYERS EXCLUDING GAMING APPARATUS; CASES FOR DISKETTES AND COMPACT DISKS; CASES FOR ELECTRONIC DIARIES; CASES FOR MOBILE PHONES; CASES FOR MUSIC, AUDIO AND RELATED ELECTRONIC EQUIPMENT, NAMELY, CASES FOR AUDIO TUNERS, AUDIO RECEIVERS, AMPLIFIERS, TAPE PLAYERS, COMPACT DISC PLAYERS, MP3 CONTROLLERS/PLAYERS, AUDIO MIXERS, AUDIO SPEAKERS IN THE NATURE OF MUSIC STUDIO MONITORS, MICROPHONES, AUDIO SPEAKERS, COMPACT DISCS, AUDIO TAPES, PORTABLE COMPUTERS, ANTENNAS, PHONOGRAPHIC RECORD PLAYERS, AUDIO RECORDING EQUIPMENT, AND THE CABLES ASSOCIATED WITH ALL OF THE FOREGOING EQUIPMENT; CD CASES; CELL PHONE BATTERY CHARGERS; CELL PHONE CASES; CELL PHONE COVERS; CELL PHONE STRAPS; CELLULAR PHONE ACCESSORY CHARGES; CHARGERS FOR BATTERIES (U.S. CLS. 21, 23, 26, 36 AND 38).

FIRST USE 8-5-2013; IN COMMERCE 8-15-2013.

**CLASS 14—JEWELRY**

FOR BANGLE BRACELETS; BANGLES; BRACELETS; BRACELETS MADE OF RUBBER SILICON, METALS AND/OR PLASTIC; CASES FOR WATCHES AND CLOCKS; CASKETS FOR CLOCKS AND JEWELS; CHARITY BRACELETS; CHARMS; CHARMS FOR COLLAR JEWELRY AND BRACELET; CHARMS IN PRECIOUS METALS OR COATED THEREWITH; CHILDREN'S JEWELRY; CHOKERS; CLIP EARRINGS; CLOCK AND WATCHMAKING PENDULUMS; CLOCK CABINETS; CLOCK CASES; COSTUME JEWELRY; CUFF LINKS; CUFF LINKS AND TIE CLIPS; CUFF LINKS OF PRECIOUS METAL; CUFFLINKS; CUFF-LINKS; EAR

CLIPS; EAR STUDS; EARRINGS; EQUINE NECKLACES; FANCY KEYRINGS OF PRECIOUS METALS; FIGURES OF PRECIOUS METAL; FIGURINES OF PRECIOUS METAL; GEMSTONE JEWELRY; IMITATION JEWELRY; JEWEL CASES OF PRECIOUS METAL; JEWEL CHAINS; JEWEL PENDANTS; JEWELLERY; JEWELRY AND IMITATION JEWELLERY; JEWELLERY AND PRECIOUS STONES; JEWELLERY AND WATCHES; JEWELLERY CASES; JEWELLERY CASES OF PRECIOUS METAL; JEWELLERY CHAIN OF PRECIOUS METAL FOR BRACELETS; JEWELLERY CHAINS; JEWELLERY, INCLUDING IMITATION JEWELLERY AND PLASTIC JEWELLERY; JEWELRY; JEWELRY AND IMITATION JEWELRY; JEWELRY CASES; JEWELRY CHAINS; JEWELRY CLIPS FOR ADAPTING PIERCED EARRINGS TO CLIP-ON EARRINGS; JEWELRY FOR THE HEAD; JEWELRY ORGANIZER CASES; JEWELRY, NAMELY, ARM CUFFS; JEWELS; KEY CHAINS OF PRECIOUS METAL; KEY HOLDERS OF PRECIOUS METALS; KEY RINGS OF PRECIOUS METALS; NECKLACES; NECKLACES MADE OF STONES, RUBBER SILICON, METALS AND/OR PLASTIC; NYLON ANKLE BRACELETS; NYLON BRACELETS; ORNAMENTAL BUTTON COVERS BEING JEWELRY; ORNAMENTAL LAPEL PINS; ORNAMENTAL PINS; ORNAMENTAL PINS MADE OF PRECIOUS METAL; ORNAMENTS OF PRECIOUS METAL IN THE NATURE OF JEWELRY; PENDANTS; PLASTIC BRACELETS IN THE NATURE OF JEWELRY; PRECIOUS GEMSTONES; PRECIOUS JEWELS; PRECIOUS METALS AND ALLOYS THEREOF; PRECIOUS METALS AND THEIR ALLOYS; PRECIOUS STONES; PRECIOUS STONES AND WATCHES; REAL AND IMITATION JEWELLERY; RINGS; RINGS BEING JEWELRY; RINGS MADE IN WHOLE OR SIGNIFICANT PART OF SILICONE, RUBBER, METAL, STONE AND/OR PLASTIC; RUBBER OR SILICON WRISTBANDS IN THE NATURE OF A BRACELET; STRAPS FOR WRISTWATCHES; WATCH BRACELETS; WATCH CASES; WATCH CHAINS; WATCH POUCHES; WATCH STRAPS; WATCH STRAPS MADE OF METAL OR LEATHER OR PLASTIC; WATCHBANDS; WATCHES AND STRAPS FOR WATCHES; WATCHES, CLOCKS, JEWELLERY AND IMITATION JEWELLERY; WATCHES, CLOCKS, JEWELRY AND IMITATION JEWELRY; WATCHSTRAPS; WEDDING BANDS; WEDDING RINGS; WOMEN'S JEWELRY; WOMEN'S WATCHES; WRIST WATCHES; HAIR JEWELRY IN THE NATURE OF JEWELRY FOR USE IN THE HAIR; KEY CHAINS AS JEWELLERY; NECK CHAINS; SLAP BRACELETS; SLAP-BAND BRACELETS; SLIDES FOR BOLO TIES (U.S. CLS. 2, 27, 28 AND 50).

FIRST USE 8-5-2013; IN COMMERCE 8-15-2013.

**CLASS 18—LEATHER GOODS**

FOR ALL-PURPOSE CARRYING BAGS; ALL-PURPOSE LEATHER STRAPS; ALL-PURPOSE REUSABLE CARRYING BAGS; ATTACHE CASES; ATTACHE CASES MADE OF LEATHER; ATTACHE CASES MADE OF IMITATION LEATHER; BABY BACKPACKS; BABY CARRIER COVERS SPECIALLY ADAPTED FOR BABY CARRIERS WORN ON THE BODY; BABY CARRIERS WORN ON THE BODY; BABY CARRYING BAGS; BACK FRAMES FOR CARRYING CHILDREN; BACKPACK STRAPS; BACKPACKS, BOOK BAGS, SPORTS BAGS, BUM BAGS, WALLETS AND HANDBAGS; BAGGAGE TAGS; BAGS FOR CARRYING BABIES' ACCESSORIES; BAGS FOR UMBRELLAS; BEACH BAGS; BUSINESS CARD CASES; BUSINESS CARD HOLDERS IN THE NATURE OF CARD CASES; BUSINESS CASES; CARD WALLETS; CARRIERS FOR SUITS, SHIRTS AND DRESSES; CARRYING CASES; CARRYING CASES FOR DOCUMENTS; CARRY-ALL BAGS; CARRY-ON BAGS; CASES FOR KEYS; CASES OF IMITATION LEATHER; CREDIT CARD CASES; CREDIT CARD CASES AND HOLDERS; CREDIT CARD HOLDERS; FASHION HANDBAGS; GARMENT BAGS FOR TRAVEL; HANDBAGS; HANDBAGS FOR LADIES; HANDBAGS FOR MEN; HANDBAGS, PURSES AND WALLETS; IMITATION LEATHER KEY CHAINS; IMITATION LEATHER SOLD IN BULK; INTERCHANGEABLE DECORATIVE COVERS FOR ACCESSORIZATION PURPOSES THAT ARE SPECIALLY ADAPTED TO HANDBAGS; JEWELRY POUCHES; KEY BAGS; KEY CASES; KEY CASES OF LEATHER OR IMITATION LEATHER; KEY WALLETS; KEYCASES; KEY-CASES; KEY-CASES OF LEATHER AND SKINS; KIT BAGS; KNITTED BAGS, NOT OF PRECIOUS METALS; KNITTING POUCHES, NAMELY,

FUNCTIONAL SACKS FOR HOLDING AND CARRYING YARN WHILE KNITTING; LUGGAGE LABEL HOLDERS; LUGGAGE TAGS; MAKE-UP BAGS SOLD EMPTY; MEN'S CLUTCH BAGS; MESH SHOPPING BAGS; MESSENGER BAGS; MULTI-PURPOSE PURSES; NAME CARD CASES; OVERNIGHT BAGS; OVERNIGHT CASES; OVERNIGHT SUITCASES; PLASTIC LUGGAGE LABELS; POCHETTES; POCKET WALLETS; POUCHES FOR HOLDING KEYS; POUCHES FOR HOLDING MAKE-UP, KEYS AND OTHER PERSONAL ITEMS; POUCHES MADE FROM IMITATION LEATHER; POUCHES MADE OUT OF CLOTH; POUCHES OF LEATHER; POUCHES OF TEXTILE; PURSES; PURSES AND WALLETS; PURSES NOT MADE OF PRECIOUS METAL; PURSES, NOT OF PRECIOUS METAL; ROLL BAGS; SADDLE COVERS; SADDLE HORN BAGS; SADDLEBAGS; SADDLERY; SADDLERY, NAMELY, HORN BAGS; SADDLES; SATCHELS; SCHOOL BAGS; SCHOOL BOOK BAGS; SCHOOL KNAPSACKS; SCHOOL SATCHELS; SCHOOLBAGS; SHOE BAGS FOR TRAVEL; SHOULDER BAGS; SHOULDER STRAPS; SMALL BACKPACKS; SMALL BAGS FOR MEN; SMALL CLUTCH PURSES; SMALL PURSES; SMALL SUITCASES; SOUVENIR BAGS; STRAPS FOR HANDBAGS; STRAPS FOR LUGGAGE; SUIT BAGS; SUIT CARRIERS; SUITCASES; TOTE BAGS; TRAIN CASES; TRAVEL BAGGAGE; TRAVEL BAGS; TRAVEL CASES; TRAVELING BAGS; TRAVELLING TRUNKS; TRUNKS; TRUNKS AND SUITCASES; UMBRELLA BASES; UMBRELLA COVERS; WAIST BAGS; WAIST PACKS; WALLET CHAINS; WALLETS; WALLETS AND WALLET INSERTS; WALLETS INCLUDING CARD HOLDERS; WALLETS MADE OF LEATHER OR OTHER MATERIALS; WALLETS WITH CARD COMPARTMENTS; WALLETS, NOT OF PRECIOUS METAL; WRIST MOUNTED CARRYALL BAGS; WRIST MOUNTED PURSES; WRIST OR ANKLE MOUNTED WALLETS; WRISTLET BAGS; CLUTCH BAGS; CLUTCH PURSES; CLUTCHES; COIN HOLDERS IN THE NATURE OF WALLETS; COIN PURSES; COIN PURSES NOT MADE OF PRECIOUS METAL; COIN PURSES, NOT OF PRECIOUS METALS; COSMETIC BAGS SOLD EMPTY; COSMETIC CARRYING CASES SOLD EMPTY; COSMETIC CASES SOLD EMPTY; STRAPS FOR CARRYING CASES (U.S. CLS. 1, 2, 3, 22 AND 41).

FIRST USE 8-5-2013; IN COMMERCE 8-15-2013.  
ZACHARY CROMER, EXAMINING ATTORNEY

SN 86-041,215. MOUNTAIN SHEEP LTD., HELSINKI, FINLAND, FILED 8-19-2013.

Kinghunt

THE MARK CONSISTS OF STANDARD CHARACTERS WITHOUT CLAIM TO ANY PARTICULAR FONT, STYLE, SIZE, OR COLOR.

## CLASS 9—ELECTRICAL AND SCIENTIFIC APPARATUS

FOR VIDEO GAMES FOR MOBILE DEVICES, PERSONAL COMPUTERS, CONSOLES, TABLETS; COMPUTER GAME SOFTWARE FOR COMMUNICATION DEVICES; COMPUTER GAME SOFTWARE AND COMPUTER GAME PROGRAMS ENABLING USERS TO PLAY GAMES WITH MOBILE PHONES AND PERSONAL DIGITAL ASSISTANTS; COMPUTER APPLICATION SOFTWARE FOR MOBILE PHONES, NAMELY, GAMES; COMPUTER SOFTWARE AND COMPUTER SOFTWARE PROGRAMS FOR USE IN ENABLING USERS WITH COMMUNICATION DEVICES TO SIMULTANEOUSLY ACCESS DATABASES AND GLOBAL COMPUTER NETWORKS; SOFTWARE ENABLING TRANSFER OF DATA BETWEEN MOBILE COMMUNICATION APPARATUS; COMPUTER GAME SOFTWARE; COMPUTER GAME PROGRAMS; DOWNLOADABLE SOFTWARE FOR USE AS A COMPUTER GAME; DOWNLOADABLE ELECTRONIC GAME PROGRAMS; PROTECTIVE CARRYING CASES SPECIALLY ADAPTED FOR PHONES AND HANDHELD COMPUTERS (U.S. CLS. 21, 23, 26, 36 AND 38).

## CLASS 28—TOYS AND SPORTING GOODS

FOR ACTION FIGURES; ELECTRONIC GAMES NOT INCLUDED IN OTHER CLASSES, NAMELY, ARCADE TYPE ELECTRONIC VIDEO GAMES; ELECTRONIC ACTION TOYS; FANTASY CHARACTER TOYS; PLASTIC CHARACTER TOYS; PLAYING PIECES IN THE NATURE OF MINIATURE ACTION FIGURES AND TOY MODEL VEHICLES FOR USE WITH TABLE TOP HOBBY BATTLE GAMES IN THE NATURE OF BATTLE, WAR AND SKIRMISH GAMES, AND FANTASY GAMES; TOY ACTION FIGURES AND ACCESSORIES THEREFOR (U.S. CLS. 22, 23, 38 AND 50).

## CLASS 41—EDUCATION AND ENTERTAINMENT

FOR ENTERTAINMENT SERVICES, NAMELY, PROVIDING ONLINE COMPUTER GAMES PROVIDED VIA NETWORK BETWEEN COMMUNICATIONS NETWORKS AND COMPUTERS; PROVIDING ON-LINE COMPUTER GAMES; PROVIDING ONLINE GAME SERVICES, NAMELY, PROVIDING ONLINE COMPUTER GAMES VIA A GLOBAL COMPUTER INFORMATION NETWORK; PROVIDING TEMPORARY NON-DOWNLOADABLE USE OF INTERACTIVE GAME SOFTWARE AND VIDEO GAME SOFTWARE FROM DATABASES ON WEB SITES, A GLOBAL COMPUTER INFORMATION NETWORK, AND FROM MOBILE AND CELLULAR PHONES AND PERSONAL DIGITAL ASSISTANTS (U.S. CLS. 100, 101 AND 107).

CURTIS FRENCH, EXAMINING ATTORNEY

SN 86-041,219. BRILLIANT ENERGY, LLC, HOUSTON, TX, FILED 8-19-2013.



NO CLAIM IS MADE TO THE EXCLUSIVE RIGHT TO USE "ENERGY" AND "ELECTRICITY PROVIDER", APART FROM THE MARK AS SHOWN.

THE COLOR(S) BLUE, ORANGE, YELLOW, AND BLACK IS/ARE CLAIMED AS A FEATURE OF THE MARK.

THE MARK CONSISTS OF THE WORD "BRILLIANT" IN BLUE STYLIZED FONT ABOVE THE WORD "ENERGY" IN

BLACK STYLIZED FONT ABOVE THE WORDING "ELECTRICITY PROVIDER", ALSO IN BLACK STYLIZED FONT. A CURVED BLUE LINE APPEARS BETWEEN THE WORDING "ENERGY" AND "ELECTRICITY PROVIDER". A SHADED ORANGE AND YELLOW CIRCLE APPEARS BEHIND THE LEFT PORTION OF THE WORDS "BRILLIANT" AND "ENERGY", WITH THE CENTER OF THE CIRCLE IN YELLOW AND SHADING OUTWARD TOWARD THE OUTER PORTION OF THE CIRCLE IN ORANGE.

#### CLASS 35—ADVERTISING AND BUSINESS

FOR RETAIL ENERGY PROVIDER SERVICES THAT ALLOW CUSTOMERS TO PURCHASE RETAIL ELECTRIC SERVICE AS PART OF A COMPETITIVE RETAIL ENERGY MARKET (U.S. CLS. 100, 101 AND 102).  
FIRST USE 4-28-2010; IN COMMERCE 4-28-2010.

#### CLASS 39—TRANSPORTATION AND STORAGE

FOR PUBLIC UTILITY SERVICES IN THE NATURE OF ELECTRICITY DISTRIBUTION (U.S. CLS. 100 AND 105).  
FIRST USE 4-28-2010; IN COMMERCE 4-28-2010.  
KAREN SEVERSON, EXAMINING ATTORNEY

SN 86-041,238. 8 INLANDS WEAR, MURRIETA, CA. FILED 8-19-2013.

## 8 Inlands wear

THE MARK CONSISTS OF STANDARD CHARACTERS WITHOUT CLAIM TO ANY PARTICULAR FONT, STYLE, SIZE, OR COLOR.  
NO CLAIM IS MADE TO THE EXCLUSIVE RIGHT TO USE "WEAR", APART FROM THE MARK AS SHOWN.

#### CLASS 16—PAPER GOODS AND PRINTED MATTER

FOR DECALS (U.S. CLS. 2, 5, 22, 23, 29, 37, 38 AND 50).

#### CLASS 25—CLOTHING

FOR BEANIES; HATS; SWEATSHIRTS; T-SHIRTS (U.S. CLS. 22 AND 39).  
RUSS HERMAN, EXAMINING ATTORNEY

SN 86-041,356. JUNO DERMATOLOGY, LLC, PALM BEACH GARDENS, FL. FILED 8-19-2013.

## Juno Dermatology

THE MARK CONSISTS OF STANDARD CHARACTERS WITHOUT CLAIM TO ANY PARTICULAR FONT, STYLE, SIZE, OR COLOR.  
NO CLAIM IS MADE TO THE EXCLUSIVE RIGHT TO USE "DERMATOLOGY", APART FROM THE MARK AS SHOWN.

#### CLASS 5—PHARMACEUTICALS

FOR MEDICATED SKIN CARE PREPARATIONS (U.S. CLS. 6, 18, 44, 46, 51 AND 52).  
FIRST USE 5-18-2012; IN COMMERCE 6-10-2013.

#### CLASS 44—MEDICAL, BEAUTY AND AGRICULTURAL SERVICES

FOR MEDICAL SERVICES IN THE FIELD OF DERMATOLOGY (U.S. CLS. 100 AND 101).  
FIRST USE 5-18-2012; IN COMMERCE 6-10-2013.  
RICHARD WHITE, EXAMINING ATTORNEY

SN 86-041,367. CUTHBERTSON, SAMME A., PLAINFIELD, IL. FILED 8-19-2013.

## VisionQuest Graphics

THE MARK CONSISTS OF STANDARD CHARACTERS WITHOUT CLAIM TO ANY PARTICULAR FONT, STYLE, SIZE, OR COLOR.  
NO CLAIM IS MADE TO THE EXCLUSIVE RIGHT TO USE "GRAPHICS", APART FROM THE MARK AS SHOWN.

#### CLASS 41—EDUCATION AND ENTERTAINMENT

FOR PHOTOGRAPHY SERVICES (U.S. CLS. 100, 101 AND 107).

#### CLASS 42—SCIENTIFIC AND COMPUTER SERVICES

FOR GRAPHIC DESIGN SERVICES; WEB SITE DESIGN (U.S. CLS. 100 AND 101).  
ESTHER BELENKER, EXAMINING ATTORNEY

SN 86-041,565. WASTE CASKET, LLC, AVON LAKE, OH. FILED 8-19-2013.

## Waste Casket, LLC

THE MARK CONSISTS OF STANDARD CHARACTERS WITHOUT CLAIM TO ANY PARTICULAR FONT, STYLE, SIZE, OR COLOR.  
NO CLAIM IS MADE TO THE EXCLUSIVE RIGHT TO USE "LLC", APART FROM THE MARK AS SHOWN.

**CLASS 9—ELECTRICAL AND SCIENTIFIC APPARATUS**

FOR MUSICAL SOUND RECORDINGS; MUSICAL VIDEO RECORDINGS; PRERECORDED AUDIO AND AUDIO/VISUAL MEDIA, NAMELY, PRERECORDED COMPACT DISCS, AUDIO CASSETTES, VIDEOCASSETTES, DVDS AND PHONOGRAPH RECORDS FEATURING MUSIC; PRERECORDED AUDIO AND AUDIO/VISUAL MEDIA IN DIGITAL FORMATS, NAMELY, MUSICAL DATA IN DIGITAL FORM DOWNLOADABLE FROM A GLOBAL COMPUTER NETWORK; MOTION PICTURE FILMS FEATURING A MUSICAL ARTIST; MULTIMEDIA SOFTWARE RECORDED ON CD-ROM AND IN DIGITAL FORM FEATURING A MUSICAL ARTIST (U.S. CLS. 21, 23, 26, 36 AND 38).

**CLASS 41—EDUCATION AND ENTERTAINMENT**

FOR ENTERTAINMENT SERVICES, NAMELY, LIVE PERFORMANCES, LIVE PERSONAL APPEARANCES, AND LIVE TELEVISION AND LIVE RADIO PERFORMANCES BY A MUSICAL ARTIST; ENTERTAINMENT, NAMELY, PRODUCTION OF LIVE MUSIC THEATRICAL SHOWS, LIVE MUSICAL SHOWS, CONCERTS, MUSIC VIDEOS, MULTIMEDIA MUSIC VIDEOS AND RADIO AND TELEVISION PROGRAMS; AUDIO AND VIDEO RECORDING SERVICES; PRODUCTION OF VIDEO AND AUDIO RECORDINGS ON DVDS, COMPACT DISCS AND IN DIGITAL FORMAT, FEATURING MUSIC; ENTERTAINMENT SERVICES, NAMELY, PROVIDING NON-DOWNLOADABLE PRERECORDED MUSIC AND VIDEOS FEATURING MUSIC ONLINE VIA A GLOBAL COMPUTER NETWORK; PROVIDING A WEBSITE FEATURING INFORMATION ON A MUSICAL ARTIST, NAMELY, PERFORMANCES, APPEARANCES AND BIOGRAPHICAL INFORMATION ONLINE VIA A GLOBAL COMPUTER NETWORK (U.S. CLS. 100, 101 AND 107).

IRA J. GOODSAD, EXAMINING ATTORNEY

SN 86-041,572. ASSOCIATED MANUFACTURERS LTD., KINGSTON 5, JAMAICA, FILED 8-19-2013.



THE COLOR(S) BROWN, BLACK, RED, WHITE, TURQUOISE, AND GOLD IS/ARE CLAIMED AS A FEATURE OF THE MARK.

THE MARK CONSISTS OF A WOMAN WITH BLACK HAIR, BLACK EYES, BROWN SKIN, RED LIPS, AND WHITE TEETH WEARING A RED DRESS WITH WHITE TRIM AROUND THE NECKLINE AND A BROWN HAT STANDING BEHIND A JERK PAN. THE JERK PAN IN FRONT OF THE WOMAN HAS FOUR PIECES OF BROWN MEAT COOKING ON TOP OF IT, IS TURQUOISE IN COLOR, AND HAS FOUR GOLD LEGS.

**CLASS 30—STAPLE FOODS**

FOR SAUCES; SEASONINGS; SPICES (U.S. CL. 46). FIRST USE 7-0-1998; IN COMMERCE 7-0-1998.

**CLASS 35—ADVERTISING AND BUSINESS**

FOR WHOLESALE FOOD DISTRIBUTORSHIP SERVICES (U.S. CLS. 100, 101 AND 102). FIRST USE 7-0-1998; IN COMMERCE 7-0-1998. ROSELLE HERRERA, EXAMINING ATTORNEY

SN 86-041,601. TIMED EXERCISE FRANCHISING, LLC, GROVETOWN, GA. FILED 8-19-2013.

**Quik 30 Fitness**

THE MARK CONSISTS OF STANDARD CHARACTERS WITHOUT CLAIM TO ANY PARTICULAR FONT, STYLE, SIZE, OR COLOR.

NO CLAIM IS MADE TO THE EXCLUSIVE RIGHT TO USE "FITNESS", APART FROM THE MARK AS SHOWN.

**CLASS 18—LEATHER GOODS**

FOR GYM BAGS (U.S. CLS. 1, 2, 3, 22 AND 41).

**CLASS 25—CLOTHING**

FOR WEARABLE GARMENTS AND CLOTHING, NAMELY, SHIRTS (U.S. CLS. 22 AND 39).

**CLASS 41—EDUCATION AND ENTERTAINMENT**

FOR PHYSICAL FITNESS TRAINING SERVICES (U.S. CLS. 100, 101 AND 107). BRITTANY ESTELL, EXAMINING ATTORNEY

SN 86-041,628. MICROBIOLOGICS, INC., ST. CLOUD, MN. FILED 8-19-2013.

**MICROBIOLOGICS**

THE MARK CONSISTS OF STANDARD CHARACTERS WITHOUT CLAIM TO ANY PARTICULAR FONT, STYLE, SIZE, OR COLOR.

OWNER OF U.S. REG. NO. 3,271,896.

**CLASS 1—CHEMICALS**

FOR DIAGNOSTIC PREPARATIONS FOR SCIENTIFIC OR RESEARCH USE; REAGENTS FOR SCIENTIFIC OR MEDICAL RESEARCH USE; DIAGNOSTIC REAGENTS FOR CLINICAL OR MEDICAL LABORATORY USE; DIAGNOSTIC REAGENTS FOR SCIENTIFIC USE; DIAGNOSTIC REAGENTS FOR IN VITRO USE IN BIOCHEMISTRY, CLINICAL CHEMISTRY AND MICROBIOLOGY; RESEARCH REAGENTS FOR INDUSTRIAL USE, NAMELY, FOR FOOD TESTING, WATER TESTING AND PHARMACEUTICAL TESTING; TEST PARTICLES FOR BIO-DETECTION SYSTEMS, BIOLOGICAL ANALOGUES AND MICROSCOPIC CARRIER BEADS WITH CHEMICALLY ATTACHED DNA FRAGMENTS FOR USE IN TESTING THE OPERATION OF EQUIPMENT USED FOR ANALYZING AIR FOR THE PRESENCE OF HARMFUL BIOLOGICAL SUBSTANCES; DIAGNOSTIC REAGENTS CONTAINING LYOPHILIZED MICROORGANISMS, AND REAGENTS CONTAINING LYOPHILIZED MICROORGANISMS ALL FOR IN-VITRO USE AND FOR USE IN BIOCHEMISTRY, CLINICAL CHEMISTRY AND MICROBIOLOGY (U.S. CLS. 1, 5, 6, 10, 26 AND 46).

FIRST USE 2-15-1984; IN COMMERCE 2-15-1984.

**CLASS 5—PHARMACEUTICALS**

FOR CULTURE MEDIA FOR CULTIVATING MICROORGANISM CELLS; CULTURE MEDIA FOR USE IN FOR USE IN MEDICAL LABORATORIES; DIAGNOSTIC REAGENTS AND CONTRAST MEDIA FOR MEDICAL USE (U.S. CLS. 6, 18, 44, 46, 51 AND 52).

FIRST USE 2-15-1984; IN COMMERCE 2-15-1984.  
GEOFFREY FOSDICK, EXAMINING ATTORNEY

**CLASS 41—EDUCATION AND ENTERTAINMENT**

FOR EDUCATION SERVICES, NAMELY, PROVIDING ON-LINE READ-ALONG, ANIMATED AND INTERACTIVE ELECTRONIC BOOKS IN THE FIELD OF DEVELOPING AND ENHANCING READING, VOCABULARY, GRAMMAR AND WORD RECOGNITION SKILLS; EDUCATIONAL AND ENTERTAINMENT SERVICES, NAMELY, PROVIDING ON-LINE INTERACTIVE CHILDREN'S STORIES; ELECTRONIC PUBLISHING SERVICES, NAMELY, PUBLICATION OF TEXT AND GRAPHIC WORKS OF OTHERS ON WEB-BASED APPLICATIONS, MOBILE APPLICATIONS AND COMPUTER NETWORKS FEATURING E-BOOKS THAT INCLUDE READ-ALONG, ANIMATED, INTERACTIVE AND OTHER MULTI-MEDIA CONTENT ORIENTED TOWARDS CHILDREN OF ALL AGES; PROVIDING A WEBSITE FEATURING NON-DOWNLOADABLE PUBLICATIONS IN THE NATURE OF E-BOOKS IN THE FIELD OF ENTERTAINMENT AND EDUCATION ORIENTED TOWARDS CHILDREN OF ALL AGES; PROVIDING ON-LINE PUBLICATIONS IN THE NATURE OF E-BOOKS IN THE FIELD OF ENTERTAINMENT AND EDUCATION ORIENTED TOWARDS CHILDREN OF ALL AGES.; PROVIDING ONLINE NON-DOWNLOADABLE E-BOOKS IN THE FIELD OF ENTERTAINMENT AND EDUCATION ORIENTED TOWARDS CHILDREN OF ALL AGES; PROVIDING ONLINE NON-DOWNLOADABLE ELECTRONIC BOOKS IN THE FIELD OF ENTERTAINMENT AND EDUCATION ORIENTED TOWARDS CHILDREN OF ALL AGES (U.S. CLS. 100, 101 AND 107).

FIRST USE 5-2-2012; IN COMMERCE 5-25-2012.

**CLASS 42—SCIENTIFIC AND COMPUTER SERVICES**

FOR COMPUTER SOFTWARE DEVELOPMENT IN THE FIELD OF MOBILE APPLICATIONS; PROVIDING A WEB-BASED SERVICE FEATURING TECHNOLOGY THAT ENABLES USERS TO MANAGE THE PRODUCTION AND PUBLICATION OF ELECTRONIC BOOKS (E-BOOKS) AND RELATED DIGITAL CONTENT AND OFFER THEM FOR SALE TO THE GENERAL PUBLIC (U.S. CLS. 100 AND 101).

FIRST USE 5-2-2012; IN COMMERCE 5-25-2012.  
AMY HELLA, EXAMINING ATTORNEY

SN 86-041,781. SPEARHEAD GLOBAL, INC., BEAR, DE. FILED 8-19-2013.

SN 86-041,861. VELOCITY THEATRE COMPANY, LLC, BRONX, NY. FILED 8-19-2013.

**SMARTKIDZCLUB**

**Kat Bond**

THE MARK CONSISTS OF STANDARD CHARACTERS WITHOUT CLAIM TO ANY PARTICULAR FONT, STYLE, SIZE, OR COLOR.

THE NAME "KAT BOND" IDENTIFIES THE NICKNAME OF "KATHARYN BOND", A LIVING INDIVIDUAL WHOSE CONSENT IS OF RECORD.

THE MARK CONSISTS OF STANDARD CHARACTERS WITHOUT CLAIM TO ANY PARTICULAR FONT, STYLE, SIZE, OR COLOR.

**CLASS 35—ADVERTISING AND BUSINESS**

FOR ON-LINE RETAIL STORE SERVICES FEATURING DOWNLOADABLE ELECTRONIC BOOKS; ON-LINE RETAIL STORE SERVICES FEATURING READ-ALONG, ANIMATED AND INTERACTIVE E-BOOKS ORIENTED TOWARDS CHILDREN OF ALL AGES (U.S. CLS. 100, 101 AND 102).

FIRST USE 5-2-2012; IN COMMERCE 5-25-2012.

**CLASS 25—CLOTHING**

FOR BLOUSES; DRESSES; HOODED SWEAT SHIRTS; JACKETS; PANTS; SHIRTS; SHORTS; SKIRTS; SLEEPWEAR; SPORTS BRA; SWEATSHIRTS; T-SHIRTS; TANK TOPS; UNDERGARMENTS (U.S. CLS. 22 AND 39).

**CLASS 35—ADVERTISING AND BUSINESS**

FOR ON-LINE RETAIL STORE SERVICES FEATURING A WIDE VARIETY OF CONSUMER APPAREL GOODS OF OTHERS (U.S. CLS. 100, 101 AND 102).

COLLEEN DOMBROW, EXAMINING ATTORNEY



SN 86-042,238. SHAW, BETH JUNE, LOS ANGELES, CA.  
FILED 8-19-2013.



OWNER OF U.S. REG. NOS. 1,921,647 AND 3,061,591.  
THE MARK CONSISTS OF THE WORD "YOGAFIT" AND THE DESIGN OF A STYLIZED HUMAN FIGURE SET WITHIN A CIRCLE, THE STYLIZED HUMAN FIGURE AND THE CIRCLE ARE CENTERED ABOVE THE WORD "YOGAFIT".

### CLASS 3—COSMETICS AND CLEANING PREPARATIONS

FOR NON-MEDICATED SKIN CARE PRODUCTS AND FACIAL AND BODY TREATMENTS, NAMELY, FACIAL CREAMS, FACIAL LOTIONS, FACIAL CLEANSERS, FACIAL MASKS, FACIAL EXFOLIATING CREAMS OR LIQUIDS, HAND CREAMS, TONERS, AND BATH AND BODY LOTIONS, BODY CLEANSERS AND BODY MASKS (U.S. CLS. 1, 4, 6, 50, 51 AND 52).

### CLASS 5—PHARMACEUTICALS

FOR NUTRITIONAL SUPPLEMENTS FOR HUMANS, NAMELY, DIETARY FOOD SUPPLEMENTS, HERBAL SUPPLEMENTS, NUTRITIONAL SUPPLEMENTS, VITAMIN AND MINERAL SUPPLEMENTS AND NATURAL FOOD SUPPLEMENTS USED FOR WEIGHT LOSS, HEALTHY LIVING AND ENERGY, IN THE FORM OF PILLS, CAPSULES, VITAMINS, NUTRITIONAL BARS, DROPS, POWDERS AND TABLETS (U.S. CLS. 6, 18, 44, 46, 51 AND 52).

TEJBIR SINGH, EXAMINING ATTORNEY

SN 86-042,266. MU LAMBDA LABS INCORPORATED, FORT WORTH, TX. FILED 8-19-2013.



THE COLOR(S) RED, WHITE, BLUE, AND BLACK IS/ARE CLAIMED AS A FEATURE OF THE MARK.

THE MARK CONSISTS OF A BLACK OUTLINED CIRCLE WITH A DIAGONAL GRADIENT OF RED, WHITE AND BLUE. INSIDE THE CIRCLE ARE THE GREEK CHARACTERS MU AND LAMBDA, BOTH WHITE WITH A BLACK OUTLINE. THE CHARACTER LAMBDA THAT EXTENDS OUTSIDE OF THE CIRCLE IS BLACK.

### CLASS 9—ELECTRICAL AND SCIENTIFIC APPARATUS

FOR ANTENNA PARAMETER MEASURING APPARATUS; APPARATUS AND INSTRUMENTS FOR CONVEYING, DISTRIBUTING, TRANSFORMING, STORING, REGULATING OR CONTROLLING ELECTRIC CURRENT; AUDIO ELECTRONIC COMPONENTS, NAMELY, SURROUND SOUND SYSTEMS; AUTOMATED SELF CONTAINED ELECTRONIC SURVEILLANCE DEVICES THAT CAN BE DEPLOYED TO GATHER EVIDENCE OR INTELLIGENCE IN REMOTE LOCATIONS; AUTOMOTIVE MEASURING INSTRUMENTS, NAMELY, WATER TEMPERATURE GAUGES, AIR FUEL/RATIO GAUGES, BOOST GAUGES, VACUUM GAUGES AND EXHAUST GAS TEMPERATURE GAUGES; CARRYING CASES SPECIALLY ADAPTED FOR ELECTRONIC EQUIPMENT, NAMELY, TEST INSTRUMENTS; CARRYING CASES, HOLDERS, PROTECTIVE CASES AND STANDS FEATURING POWER SUPPLY CONNECTORS, ADAPTORS, SPEAKERS AND BATTERY CHARGING DEVICES, SPECIALLY ADAPTED FOR USE WITH HANDHELD DIGITAL ELECTRONIC DEVICES, NAMELY, TEST INSTRUMENTS; CONSUMER ELECTRONIC PRODUCTS, NAMELY, AUDIO AMPLIFIERS, AUDIO SPEAKERS, AUDIO RECEIVERS, ELECTRICAL AUDIO AND SPEAKER CABLES AND CONNECTORS, AUDIO DECODERS, VIDEO DECODERS, SPEAKERS, POWER CONVERSION DEVICES, POWER CONVERTERS, AND POWER INVERTERS; DERIVED-UNIT MEASURING MACHINES AND APPARATUS; DESIGN LIBRARIES, NAMELY, DOWNLOADABLE ELECTRONIC DATA FILES FOR USE IN INTEGRATED CIRCUIT AND SEMICONDUCTOR DESIGN; ELECTRIC AND ELECTRONIC CIRCUITS; ELECTRIC NAVIGATIONAL INSTRUMENTS; ELECTRIC OR ELECTRONIC SENSORS FOR ELECTRIC CURRENT, VOLTAGE, PRESSURE, ACCELERATION, TEMPERATURE, HUMIDITY.; ELECTROMAGNETIC APPARATUS USED TO GENERATE OR MEASURE MAGNETIC FIELDS; ELECTRONIC AND OPTICAL COMMUNICATIONS INSTRUMENTS AND COMPONENTS, NAMELY, CABLE TELEVISION TRANSMITTERS; ELECTRONIC AND OPTICAL COMMUNICATIONS INSTRUMENTS AND COMPONENTS, NAMELY, COMMUNICATION LINK TESTERS FOR TESTING COMMUNICATION LINKS; ELECTRONIC AND OPTICAL COMMUNICATIONS INSTRUMENTS AND COMPONENTS, NAMELY, DIGITAL TRANSMITTERS; ELECTRONIC AND OPTICAL COMMUNICATIONS INSTRUMENTS AND COMPONENTS, NAMELY, OPTICAL DATA LINKS; ELECTRONIC AND OPTICAL COMMUNICATIONS INSTRUMENTS AND COMPONENTS, NAMELY, OPTICAL RECEIVERS; ELECTRONIC AND OPTICAL COMMUNICATIONS INSTRUMENTS AND COMPONENTS, NAMELY, OPTICAL TRANSCEIVERS; ELECTRONIC AND OPTICAL COMMUNICATIONS INSTRUMENTS AND COMPONENTS, NAMELY, OPTICAL TRANSMITTERS; ELECTRONIC APPARATUS AND INSTRUMENTS FOR CONTROLLING, ADJUSTING AND TESTING OF DRIVES AND MOTORS; ELECTRONIC APPARATUS FOR TESTING THE ELECTRICAL CONDUCTIVITY OF WIRE, CABLE, RESISTOR; ELECTRONIC APPARATUS FOR THE REMOTE CONTROL OF INDUSTRIAL OPERATIONS; ELECTRONIC APPARATUS, NAMELY, MOTION DETECTORS; ELECTRONIC CABLES; ELECTRONIC CIRCUIT BOARD; ELECTRONIC CIRCUIT CARDS; ELECTRONIC CIRCUITS; ELECTRONIC CIRCUITS FOR ERROR CORRECTION; ELECTRONIC CODING UNITS; ELECTRONIC COMBINERS FOR CONNECTING ANTENNAS AND RECEIVERS; ELECTRONIC COMMUNICATIONS SYSTEMS COMPRISED OF COMPUTER HARDWARE AND SOFTWARE FOR THE TRANSMISSION OF DATA BETWEEN TWO POINTS; ELECTRONIC COMPONENTS FOR COMPUTERS; ELECTRONIC COMPONENTS IN THE NATURE OF INFRARED DETECTORS FOR USE IN FURTHER MANUFACTURE; ELECTRONIC COMPUTERS; ELECTRONIC CONTROL GEARS (ECGS) FOR LED LAMPS AND LIGHT FIXTURES; ELECTRONIC CONTROL SYSTEMS FOR MACHINES; ELECTRONIC

CONTROLLERS FOR USE WITH POWER CONVERTERS; ELECTRONIC CONTROLLERS USED TO REDUCE POWER CONSUMPTION; ELECTRONIC DATA LOGGERS; ELECTRONIC DETECTORS FOR OBSERVING AND MEASURING THE INFRARED SPECTRUM, NAMELY, INFRARED DETECTORS; ELECTRONIC DEVICE FOR MONITORING AND OPTIMIZING PHOTOVOLTAIC ARRAYS; ELECTRONIC DEVICES FOR READING, ENCODING AND PROGRAMMING TRANSPONDER KEYS; ELECTRONIC DEVICES USED TO LOCATE LOST ARTICLES EMPLOYING THE GLOBAL POSITIONING SYSTEM OR CELLULAR COMMUNICATION NETWORKS; ELECTRONIC DEVICES USED TO LOCATED LOST OBJECTS EMPLOYING RADIO FREQUENCY; ELECTRONIC DEVICES, NAMELY, ENERGY METERS FOR TRACKING AND MONITORING ENERGY USAGE; ELECTRONIC DEVICES, NAMELY, ENERGY SUBMETERS FOR TRACKING AND MONITORING ENERGY USAGE; ELECTRONIC DEVICES, NAMELY, HANDHELDS FOR EXCHANGING DATA IN ENERGY METERS OR SUBMETERS; ELECTRONIC DEVICES, NAMELY, RADIO FREQUENCY REPEATERS USED IN LONG RANGE COMMUNICATION FOR TRACKING AND MONITORING ENERGY USAGE; ELECTRONIC ENCRYPTION UNITS; ELECTRONIC EQUIPMENT, NAMELY, TRANSFORMERS, BALUNS, CABLES USED IN CONNECTION WITH COMPUTERS, COMPUTER PERIPHERAL DEVICES, TELEVISIONS, AUDIO-VIDEO EQUIPMENT, CLOSED-CIRCUIT TV EQUIPMENT AND TELECOMMUNICATION EQUIPMENT; ELECTRONIC INDICATOR BOARDS; ELECTRONIC INDICATOR PANELS; ELECTRONIC INSTRUMENTS FOR USE IN REMOTE INSPECTION AND MEASUREMENT OF INDUSTRIAL COMPONENTS USING REMOTE VISUAL DEVICES; ELECTRONIC INSTRUMENTS, NAMELY, LOGIC ANALYZERS; ELECTRONIC INTEGRATED CIRCUITS; ELECTRONIC INTERCONNECTERS FOR AUDIO AND VIDEO SIGNALS; ELECTRONIC LCD DISPLAY UNIT WITH MULTI-NETWORKING (TCP/IP) CAPABILITIES; ELECTRONIC MAGNETOSTRICTIVE EQUIPMENT, NAMELY, A WAVE GENERATOR, WAVE SENSOR AND WAVE ANALYZER; ELECTRONIC MEMORIES; ELECTRONIC MEMORY CARD READERS; ELECTRONIC MONITORS AND MONITOR MODULES FOR MONITORING ELECTRIC CURRENT AND ELECTRICAL SIGNALS; ELECTRONIC NAVIGATIONAL AND POSITIONING APPARATUS AND INSTRUMENTS; ELECTRONIC PLOTTERS; ELECTRONIC POWER SUPPLIES FOR DRIVING ELECTRIC MOTORS; ELECTRONIC PRODUCTS FOR THE GENERATION, MEASUREMENT, AND ANALYSIS OF AUDIO SIGNALS, NAMELY, AUDIO ANALYZERS; ELECTRONIC PRODUCTS FOR THE MANIPULATION OF THE FREQUENCY, TIME, AND AMPLITUDE CHARACTERISTICS OF AUDIO SIGNALS, NAMELY, AUDIO PROCESSORS; ELECTRONIC RECORDERS FOR STORING AND ARCHIVING INFORMATION RELATED TO POWER SYSTEM FAULTS; ELECTRONIC REGULATING AND CONTROL DEVICES FOR THE OPERATION OF LIGHT EMITTING DIODES; ELECTRONIC SCALERS FOR AUDIO AND VIDEO SIGNALS; ELECTRONIC SECURITY AND SURVEILLANCE DEVICES, NAMELY, ELECTRONIC SECURITY TAGS AND LABELS, ACOUSTIC TAGS, MAGNETIC TAGS; ELECTRONIC SEMI-CONDUCTORS; ELECTRONIC SOUND MIXING, PROCESSING AND SYNTHESIZING APPARATUS; ELECTRONIC SWITCHERS FOR AUDIO AND VIDEO SIGNALS; ELECTRONIC TAGS FOR GOODS; ELECTRONIC TEST AND MEASUREMENT DEVICES FOR USE IN THE FIELDS OF NETWORKS AND TELECOMMUNICATIONS, NAMELY, INSTRUMENTATION USED TO TEST AND CERTIFY NEW AND EXISTING DATA AND VOICE COMMUNICATION CABLE AND COAXIAL CABLE; ELECTRONIC TESTING EQUIPMENT, NAMELY, SOUND LEVEL METERS; ELECTRONIC TESTING EQUIPMENT, NAMELY, TELECOMMUNICATION LINE INTEGRITY TESTING APPARATUS; ELECTRONIC TIMERS; ELECTRONIC TRANSMITTERS AND RECEIVERS FOR TELEMETRY, COMMUNICATIONS; ELECTRONIC VIDEO SURVEILLANCE PRODUCTS, NAMELY, ELECTRONIC COMPONENTS OF SECURITY SYSTEMS; ELECTRONIC-BASED INSTRUMENTS FOR MEASURING ENVIRONMENTAL PARAMETERS INCLUDING HUMIDITY, MOLD, BACTERIA, AIR QUALITY AND WATER QUALITY; ELECTRONICAL SENSORS FOR MEASURING SOLAR RADIATION; ENCODING AND DECODING APPARATUS AND INSTRUMENTS; ENVIRONMENTAL MONITORING SYSTEM COMPRISED OF METERS AND

SENSORS THAT MEASURE PRESSURE, HUMIDITY, TEMPERATURE AND INCLUDES ALARM AND REPORTING FUNCTIONS; GRAVITY MEASURING INSTRUMENTS; HEAT SINKS FOR USE IN ELECTRONIC COMPONENTS; HOURGLASSES; INPUT DEVICES FOR COMPUTER HARDWARE AND ELECTRONIC INSTRUMENTS, NAMELY, JOG WHEELS; INSTRUMENTS AND APPARATUS FOR CONTROLLING ELECTRIC CURRENT, NAMELY, ELECTRICAL CONTROLLERS FOR MAGNETIC BEARING CONTROL; INSTRUMENTS FOR DETECTING AND MEASURING TWO-DIMENSIONAL DISTRIBUTION OF FORCE AND PRESSURE; INSTRUMENTS FOR MEASURING LENGTH; INTEGRATED BATTERY BACKUP SYSTEMS COMPRISING A BATTERY, AN ELECTRONIC MEASUREMENT APPARATUS FOR USE IN THE MEASUREMENT OF BATTERY HEALTH AND PERFORMANCE, AND A REMOTE COMPUTER SOFTWARE PROGRAM THAT USES THE FOREGOING DATA TO TREND, PREDICT, AND STORE DATA RELATED TO THE HEALTH OF THE BATTERY; LABELS CARRYING MAGNETICALLY, OPTICALLY, OR ELECTRONICALLY RECORDED OR ENCODED INFORMATION; LASER DOPPLER FOR MEASURING PURPOSES; LASER MEASURING SYSTEMS; LASERS FOR MEASURING PURPOSES; MEASURING APPARATUS FOR TEMPERATURE AND HUMIDITY LEVELS IN GASES AND SOLID SUBSTANCES; MEASURING APPARATUS, NAMELY, CLAMP METERS FOR MEASURING ELECTRICITY; MEASURING APPARATUS, NAMELY, LASER DISTANCE METERS; MEASURING APPARATUS, NAMELY, RAIN GAUGES; MEASURING INSTRUMENTATION AND APPARATUS, NAMELY, DIGITIZERS; METEOROLOGICAL INSTRUMENTS; MICROSENSORS FOR MEASUREMENT OF PRESSURE, ACCELERATION, FORCE AND FLOW, NAMELY, SILICON PIEZORESISTIVE PRESSURE SENSORS; NAVIGATIONAL INSTRUMENTS FOR VEHICLES; OCCUPANCY SENSORS, NAMELY, ELECTRONIC DEVICES WHICH DETECT THE PRESENCE OF OCCUPANTS AND CONTROL THE LIGHTING SYSTEM ACCORDINGLY; OPTICAL COMMUNICATIONS SYSTEMS COMPRISED OF OPTICAL AND ELECTRONIC HARDWARE AND COMPUTER SOFTWARE FOR THE TRANSMISSION OF DATA BETWEEN TWO POINTS; PANEL METERS, NAMELY, AN ELECTRONIC INSTRUMENT THAT DISPLAYS AN INPUT SIGNAL IN EITHER A DIGITAL OR ANALOG FORM; PORTABLE AND HANDHELD DIGITAL ELECTRONIC DEVICES FOR RECORDING, ORGANIZING, TRANSMITTING, MANIPULATING, AND REVIEWING TEXT, DATA, IMAGE, AND AUDIO FILES; PORTABLE ELECTRONIC RECORDER FOR MEASURING AND RECORDING MULTIPLE VOLTAGE, CURRENT AND THERMOCOUPLE READINGS FROM VARIOUS TRANSDUCERS; PORTABLE HANDHELD ELECTRONIC DIGITAL VIDEO MESSENGERS FOR RECORDING, STORAGE, TRANSMISSION OR REPRODUCTION OF VISUAL, AUDIO AND DATA CONTENT; POWER SUPPLY CONNECTORS AND ADAPTORS FOR USE WITH PORTABLE ELECTRONIC DEVICES; PRECISION INSTRUMENTS FOR MANIPULATION AND POSITIONING OF MICROSCOPIC OBJECTS; PRESSURE MEASURING APPARATUS; PRINTED ELECTRONIC CIRCUITS FOR APPARATUS AND CARDS BEARING INTEGRATED CIRCUITS; RADIATION SHIELDS FOR ELECTRONIC PRODUCTS; RADIATION-MEASURING INSTRUMENTS; RECEIVERS OF ELECTRONIC SIGNALS; REMOTE SENSORS FOR USE IN MEASURING THERMAL AND INFRARED RADIATION ENERGY WAVES; RESISTANCE MEASURING INSTRUMENTS; SCIENTIFIC MEASURING INSTRUMENTS, NAMELY, CONDUCTIVITY METERS; SEISMOLOGICAL INSTRUMENTS; SIGNAL SPLITTERS FOR ELECTRONIC APPARATUS; SOUND RECORDING AND SOUND REPRODUCING APPARATUS AND INSTRUMENTS; SOUND RECORDING APPARATUS AND INSTRUMENTS; SPECIALTY HOLSTERS ADAPTED FOR CARRYING PERSONAL ELECTRONIC DEVICES, NAMELY, ELECTRONIC TEST INSTRUMENTS; STANDS FOR HANDHELD DIGITAL ELECTRONIC DEVICES, NAMELY, ELECTRONIC TEST INSTRUMENTS; STANDS FOR PERSONAL DIGITAL ELECTRONIC DEVICES, NAMELY, ELECTRONIC TEST INSTRUMENTS; TESTING AND MEASURING EQUIPMENT FOR USE IN TESTING THE PERFORMANCE AND EFFICIENCY OF POWER PLANT EQUIPMENT; TOOL MEASURING INSTRUMENTS; TRANSMITTERS OF ELECTRONIC SIGNALS; ULTRASONIC INSTRUMENTATION FOR TESTING MACHINES; USER INTERFACES, NAMELY, BUTTONS, KEYBOARDS, TOUCHSCREEN AND VIDEO

DISPLAY FOR ELECTROTECHNICAL AND ELECTRONIC DEVICES; WEIGHING APPARATUS AND INSTRUMENTS; WIRE DIAMETER MEASURING DEVICES; WIRELESS CONTROLLERS TO MONITOR AND CONTROL THE FUNCTIONING OF OTHER ELECTRONIC DEVICES; WIRELESS DIGITAL ELECTRONIC APPARATUS TO SECURE AND PROTECT DATA AND IMAGES ON ALL FORMS OF WIRELESS EQUIPMENT INCLUDING MOBILE TELECOMMUNICATIONS EQUIPMENT USING AN AUTOMATIC SYNCHRONIZATION PROCESS AND ALARM NOTIFICATION OF THE LOSS OR THEFT OF THE WIRELESS EQUIPMENT INCLUDING MOBILE TELECOMMUNICATIONS EQUIPMENT (U.S. CLS. 21, 23, 26, 36 AND 38).

### CLASS 35—ADVERTISING AND BUSINESS

FOR BUSINESS CONSULTING SERVICES IN THE FIELDS OF ENERGY MEASUREMENT TO IMPROVE ENERGY EFFICIENCY WITHIN RESIDENTIAL, COMMERCIAL, INDUSTRIAL AND INSTITUTIONAL FACILITIES (U.S. CLS. 100, 101 AND 102).

JORDAN BAKER, EXAMINING ATTORNEY

SN 86-042,270. MU LAMBDA LABS INCORPORATED, FORT WORTH, TX. FILED 8-19-2013.



THE MARK CONSISTS OF A CIRCLE DESIGN AND WITHIN THE CIRCLE ARE THE GREEK CHARACTERS MU AND LAMBDA. THE CHARACTER LAMBDA EXTENDS OUTSIDE THE CIRCLE IN THE UPPER AND LOWER PORTIONS OF THE CIRCLE.

### CLASS 9—ELECTRICAL AND SCIENTIFIC APPARATUS

FOR ANTENNA PARAMETER MEASURING APPARATUS; APPARATUS AND INSTRUMENTS FOR CONVEYING, DISTRIBUTING, TRANSFORMING, STORING, REGULATING OR CONTROLLING ELECTRIC CURRENT; AUDIO ELECTRONIC COMPONENTS, NAMELY, SURROUND SOUND SYSTEMS; AUTOMATED SELF CONTAINED ELECTRONIC SURVEILLANCE DEVICES THAT CAN BE DEPLOYED TO GATHER EVIDENCE OR INTELLIGENCE IN REMOTE LOCATIONS; AUTOMOTIVE MEASURING INSTRUMENTS, NAMELY, WATER TEMPERATURE GAUGES, AIR FUEL/RATIO GAUGES, BOOST GAUGES, VACUUM GAUGES AND EXHAUST GAS TEMPERATURE GAUGES; CARRYING CASES SPECIALLY ADAPTED FOR ELECTRONIC EQUIPMENT, NAMELY, TEST INSTRUMENTS; CARRYING CASES, HOLDERS, PROTECTIVE CASES AND STANDS FEATURING POWER SUPPLY CONNECTORS, ADAPTORS, SPEAKERS AND BATTERY CHARGING DEVICES, SPECIALLY ADAPTED FOR USE WITH HANDHELD DIGITAL ELECTRONIC DEVICES, NAMELY, TEST INSTRUMENTS; CONSUMER ELECTRONIC PRODUCTS, NAMELY, AUDIO AMPLIFIERS, AUDIO SPEAKERS, AUDIO RECEIVERS, ELECTRICAL AUDIO AND SPEAKER CABLES AND CONNECTORS, AUDIO DECODERS, VIDEO DECODERS, SPEAKERS, POWER CONVERSION DEVICES, POWER CONVERTERS, AND

POWER INVERTERS; DERIVED-UNIT MEASURING MACHINES AND APPARATUS; DESIGN LIBRARIES, NAMELY, DOWNLOADABLE ELECTRONIC DATA FILES FOR USE IN INTEGRATED CIRCUIT AND SEMICONDUCTOR DESIGN; ELECTRIC AND ELECTRONIC CIRCUITS; ELECTRIC NAVIGATIONAL INSTRUMENTS; ELECTRIC OR ELECTRONIC SENSORS FOR ELECTRIC CURRENT, VOLTAGE, PRESSURE, ACCELERATION, TEMPERATURE, HUMIDITY; ELECTROMAGNETIC APPARATUS USED TO GENERATE OR MEASURE MAGNETIC FIELDS; ELECTRONIC AND OPTICAL COMMUNICATIONS INSTRUMENTS AND COMPONENTS, NAMELY, CABLE TELEVISION TRANSMITTERS; ELECTRONIC AND OPTICAL COMMUNICATIONS INSTRUMENTS AND COMPONENTS, NAMELY, COMMUNICATION LINK TESTERS FOR TESTING COMMUNICATION LINKS; ELECTRONIC AND OPTICAL COMMUNICATIONS INSTRUMENTS AND COMPONENTS, NAMELY, DIGITAL TRANSMITTERS; ELECTRONIC AND OPTICAL COMMUNICATIONS INSTRUMENTS AND COMPONENTS, NAMELY, OPTICAL DATA LINKS; ELECTRONIC AND OPTICAL COMMUNICATIONS INSTRUMENTS AND COMPONENTS, NAMELY, OPTICAL RECEIVERS; ELECTRONIC AND OPTICAL COMMUNICATIONS INSTRUMENTS AND COMPONENTS, NAMELY, OPTICAL TRANSCIEVERS; ELECTRONIC AND OPTICAL COMMUNICATIONS INSTRUMENTS AND COMPONENTS, NAMELY, OPTICAL TRANSMITTERS; ELECTRONIC APPARATUS AND INSTRUMENTS FOR CONTROLLING, ADJUSTING AND TESTING OF DRIVES AND MOTORS; ELECTRONIC APPARATUS FOR TESTING THE ELECTRICAL CONDUCTIVITY OF WIRE, CABLE, RESISTOR; ELECTRONIC APPARATUS FOR THE REMOTE CONTROL OF INDUSTRIAL OPERATIONS; ELECTRONIC APPARATUS, NAMELY, MOTION DETECTORS; ELECTRONIC CABLES; ELECTRONIC CIRCUIT BOARD; ELECTRONIC CIRCUIT CARDS; ELECTRONIC CIRCUITS; ELECTRONIC CIRCUITS FOR ERROR CORRECTION; ELECTRONIC CODING UNITS; ELECTRONIC COMBINERS FOR CONNECTING ANTENNAS AND RECEIVERS; ELECTRONIC COMMUNICATIONS SYSTEMS COMPRISED OF COMPUTER HARDWARE AND SOFTWARE FOR THE TRANSMISSION OF DATA BETWEEN TWO POINTS; ELECTRONIC COMPONENTS FOR COMPUTERS; ELECTRONIC COMPONENTS IN THE NATURE OF INFRARED DETECTORS FOR USE IN FURTHER MANUFACTURE; ELECTRONIC COMPUTERS; ELECTRONIC CONTROL GEARS (ECGS) FOR LED LAMPS AND LIGHT FIXTURES; ELECTRONIC CONTROL SYSTEMS FOR MACHINES; ELECTRONIC CONTROLLERS FOR USE WITH POWER CONVERTERS; ELECTRONIC CONTROLLERS USED TO REDUCE POWER CONSUMPTION; ELECTRONIC DATA LOGGERS; ELECTRONIC DETECTORS FOR OBSERVING AND MEASURING THE INFRARED SPECTRUM, NAMELY, INFRARED DETECTORS; ELECTRONIC DEVICE FOR MONITORING AND OPTIMIZING PHOTOVOLTAIC ARRAYS; ELECTRONIC DEVICES FOR READING, ENCODING AND PROGRAMMING TRANSPONDER KEYS; ELECTRONIC DEVICES USED TO LOCATE LOST ARTICLES EMPLOYING THE GLOBAL POSITIONING SYSTEM OR CELLULAR COMMUNICATION NETWORKS; ELECTRONIC DEVICES USED TO LOCATED LOST OBJECTS EMPLOYING RADIO FREQUENCY; ELECTRONIC DEVICES, NAMELY, ENERGY METERS FOR TRACKING AND MONITORING ENERGY USAGE; ELECTRONIC DEVICES, NAMELY, ENERGY SUBMETERS FOR TRACKING AND MONITORING ENERGY USAGE; ELECTRONIC DEVICES, NAMELY, HANDHELDS FOR EXCHANGING DATA IN ENERGY METERS OR SUBMETERS; ELECTRONIC DEVICES, NAMELY, RADIO FREQUENCY REPEATERS USED IN LONG RANGE COMMUNICATION FOR TRACKING AND MONITORING ENERGY USAGE; ELECTRONIC ENCRYPTION UNITS; ELECTRONIC EQUIPMENT, NAMELY, TRANSFORMERS, BALUNS, CABLES USED IN CONNECTION WITH COMPUTERS, COMPUTER PERIPHERAL DEVICES, TELEVISIONS, AUDIO-VIDEO EQUIPMENT, CLOSED-CIRCUIT TV EQUIPMENT AND TELECOMMUNICATION EQUIPMENT; ELECTRONIC INDICATOR BOARDS; ELECTRONIC INDICATOR PANELS; ELECTRONIC INSTRUMENTS FOR USE IN REMOTE INSPECTION AND MEASUREMENT OF INDUSTRIAL COMPONENTS USING REMOTE VISUAL DEVICES; ELECTRONIC INSTRUMENTS, NAMELY, LOGIC ANALYZERS; ELECTRONIC INTEGRATED CIRCUITS; ELECTRONIC INTERCONNECTERS FOR AUDIO AND VIDEO SIG-

NALS; ELECTRONIC LCD DISPLAY UNIT WITH MULTI-NETWORKING (TCP/IP) CAPABILITIES; ELECTRONIC MAGNETOSTRICTIVE EQUIPMENT, NAMELY, A WAVE GENERATOR, WAVE SENSOR AND WAVE ANALYZER; ELECTRONIC MEMORIES; ELECTRONIC MEMORY CARD READERS; ELECTRONIC MONITORS AND MONITOR MODULES FOR MONITORING ELECTRIC CURRENT AND ELECTRICAL SIGNALS; ELECTRONIC NAVIGATIONAL AND POSITIONING APPARATUS AND INSTRUMENTS; ELECTRONIC PLOTTERS; ELECTRONIC POWER SUPPLIES FOR DRIVING ELECTRIC MOTORS; ELECTRONIC PRODUCTS FOR THE GENERATION, MEASUREMENT, AND ANALYSIS OF AUDIO SIGNALS, NAMELY, AUDIO ANALYZERS; ELECTRONIC PRODUCTS FOR THE MANIPULATION OF THE FREQUENCY, TIME, AND AMPLITUDE CHARACTERISTICS OF AUDIO SIGNALS, NAMELY, AUDIO PROCESSORS; ELECTRONIC RECORDERS FOR STORING AND ARCHIVING INFORMATION RELATED TO POWER SYSTEM FAULTS; ELECTRONIC REGULATING AND CONTROL DEVICES FOR THE OPERATION OF LIGHT EMITTING DIODES; ELECTRONIC SCALERS FOR AUDIO AND VIDEO SIGNALS; ELECTRONIC SECURITY AND SURVEILLANCE DEVICES, NAMELY, ELECTRONIC SECURITY TAGS AND LABELS, ACOUSTIC TAGS, MAGNETIC TAGS; ELECTRONIC SEMI-CONDUCTORS; ELECTRONIC SOUND MIXING, PROCESSING AND SYNTHESIZING APPARATUS; ELECTRONIC SWITCHERS FOR AUDIO AND VIDEO SIGNALS; ELECTRONIC TAGS FOR GOODS; ELECTRONIC TEST AND MEASUREMENT DEVICES FOR USE IN THE FIELDS OF NETWORKS AND TELECOMMUNICATIONS, NAMELY, INSTRUMENTATION USED TO TEST AND CERTIFY NEW AND EXISTING DATA AND VOICE COMMUNICATION CABLE AND COAXIAL CABLE; ELECTRONIC TESTING EQUIPMENT, NAMELY, SOUND LEVEL METERS; ELECTRONIC TESTING EQUIPMENT, NAMELY, TELECOMMUNICATION LINE INTEGRITY TESTING APPARATUS; ELECTRONIC TIMERS; ELECTRONIC TRANSMITTERS AND RECEIVERS FOR TELEMETRY, COMMUNICATIONS; ELECTRONIC VIDEO SURVEILLANCE PRODUCTS, NAMELY, ELECTRONIC COMPONENTS OF SECURITY SYSTEMS; ELECTRONIC-BASED INSTRUMENTS FOR MEASURING ENVIRONMENTAL PARAMETERS INCLUDING HUMIDITY, MOLD, BACTERIA, AIR QUALITY AND WATER QUALITY; ELECTRONICAL SENSORS FOR MEASURING SOLAR RADIATION; ENCODING AND DECODING APPARATUS AND INSTRUMENTS; ENVIRONMENTAL MONITORING SYSTEM COMPRISED OF METERS AND SENSORS THAT MEASURE PRESSURE, HUMIDITY, TEMPERATURE AND INCLUDES ALARM AND REPORTING FUNCTIONS; GRAVITY MEASURING INSTRUMENTS; HEAT SINKS FOR USE IN ELECTRONIC COMPONENTS; HOURGLASSES; INPUT DEVICES FOR COMPUTER HARDWARE AND ELECTRONIC INSTRUMENTS, NAMELY, JOG WHEELS; INSTRUMENTS AND APPARATUS FOR CONTROLLING ELECTRIC CURRENT, NAMELY, ELECTRICAL CONTROLLERS FOR MAGNETIC BEARING CONTROL; INSTRUMENTS FOR DETECTING AND MEASURING TWO-DIMENSIONAL DISTRIBUTION OF FORCE AND PRESSURE; INSTRUMENTS FOR MEASURING LENGTH; INTEGRATED BATTERY BACKUP SYSTEMS COMPRISING A BATTERY, AN ELECTRONIC MEASUREMENT APPARATUS FOR USE IN THE MEASUREMENT OF BATTERY HEALTH AND PERFORMANCE, AND A REMOTE COMPUTER SOFTWARE PROGRAM THAT USES THE FOREGOING DATA TO TREND, PREDICT, AND STORE DATA RELATED TO THE HEALTH OF THE BATTERY; LABELS CARRYING MAGNETICALLY, OPTICALLY, OR ELECTRONICALLY RECORDED OR ENCODED INFORMATION; LASER DOPPLER FOR MEASURING PURPOSES; LASER MEASURING SYSTEMS; LASERS FOR MEASURING PURPOSES; MEASURING APPARATUS FOR TEMPERATURE AND HUMIDITY LEVELS IN GASES AND SOLID SUBSTANCES; MEASURING APPARATUS, NAMELY, CLAMP METERS FOR MEASURING ELECTRICITY; MEASURING APPARATUS, NAMELY, LASER DISTANCE METERS; MEASURING APPARATUS, NAMELY, RAIN GAUGES; MEASURING INSTRUMENTATION AND APPARATUS, NAMELY, DIGITIZERS; METEOROLOGICAL INSTRUMENTS; MICROSENSORS FOR MEASUREMENT OF PRESSURE, ACCELERATION, FORCE AND FLOW, NAMELY, SILICON PIEZORESISTIVE PRESSURE SENSORS; NAVIGATIONAL INSTRUMENTS FOR VEHICLES; OCCUPANCY SENSORS, NAMELY, ELECTRONIC DEVICES WHICH

DETECT THE PRESENCE OF OCCUPANTS AND CONTROL THE LIGHTING SYSTEM ACCORDINGLY; OPTICAL COMMUNICATIONS SYSTEMS COMPRISED OF OPTICAL AND ELECTRONIC HARDWARE AND COMPUTER SOFTWARE FOR THE TRANSMISSION OF DATA BETWEEN TWO POINTS; PANEL METERS, NAMELY, AN ELECTRONIC INSTRUMENT THAT DISPLAYS AN INPUT SIGNAL IN EITHER A DIGITAL OR ANALOG FORM; PORTABLE AND HANDHELD DIGITAL ELECTRONIC DEVICES FOR RECORDING, ORGANIZING, TRANSMITTING, MANIPULATING, AND REVIEWING TEXT, DATA, IMAGE, AND AUDIO FILES; PORTABLE ELECTRONIC RECORDER FOR MEASURING AND RECORDING MULTIPLE VOLTAGE, CURRENT AND THERMOCOUPLE READINGS FROM VARIOUS TRANSDUCERS; PORTABLE HANDHELD ELECTRONIC DIGITAL VIDEO MESSENGERS FOR RECORDING, STORAGE, TRANSMISSION OR REPRODUCTION OF VISUAL, AUDIO AND DATA CONTENT; POWER SUPPLY CONNECTORS AND ADAPTORS FOR USE WITH PORTABLE ELECTRONIC DEVICES; PRECISION INSTRUMENTS FOR MANIPULATION AND POSITIONING OF MICROSCOPIC OBJECTS; PRESSURE MEASURING APPARATUS; PRINTED ELECTRONIC CIRCUITS FOR APPARATUS AND CARDS BEARING INTEGRATED CIRCUITS; RADIATION SHIELDS FOR ELECTRONIC PRODUCTS; RADIATION-MEASURING INSTRUMENTS; RECEIVERS OF ELECTRONIC SIGNALS; REMOTE SENSORS FOR USE IN MEASURING THERMAL AND INFRARED RADIATION ENERGY WAVES; RESISTANCE MEASURING INSTRUMENTS; SCIENTIFIC MEASURING INSTRUMENTS, NAMELY, CONDUCTIVITY METERS; SEISMOLOGICAL INSTRUMENTS; SIGNAL SPLITTERS FOR ELECTRONIC APPARATUS; SOUND RECORDING AND SOUND REPRODUCING APPARATUS AND INSTRUMENTS; SOUND RECORDING APPARATUS AND INSTRUMENTS; SPECIALTY HOLSTERS ADAPTED FOR CARRYING PERSONAL ELECTRONIC DEVICES, NAMELY, ELECTRONIC TEST INSTRUMENTS; STANDS FOR HANDHELD DIGITAL ELECTRONIC DEVICES, NAMELY, ELECTRONIC TEST INSTRUMENTS; STANDS FOR PERSONAL DIGITAL ELECTRONIC DEVICES, NAMELY, ELECTRONIC TEST INSTRUMENTS; TESTING AND MEASURING EQUIPMENT FOR USE IN TESTING THE PERFORMANCE AND EFFICIENCY OF POWER PLANT EQUIPMENT; TOOL MEASURING INSTRUMENTS; TRANSMITTERS OF ELECTRONIC SIGNALS; ULTRASONIC INSTRUMENTATION FOR TESTING MACHINES; USER INTERFACES, NAMELY, BUTTONS, KEYBOARDS, TOUCHSCREEN AND VIDEO DISPLAY FOR ELECTROTECHNICAL AND ELECTRONIC DEVICES; WEIGHING APPARATUS AND INSTRUMENTS; WIRE DIAMETER MEASURING DEVICES; WIRELESS CONTROLLERS TO MONITOR AND CONTROL THE FUNCTIONING OF OTHER ELECTRONIC DEVICES; WIRELESS DIGITAL ELECTRONIC APPARATUS TO SECURE AND PROTECT DATA AND IMAGES ON ALL FORMS OF WIRELESS EQUIPMENT INCLUDING MOBILE TELECOMMUNICATIONS EQUIPMENT USING AN AUTOMATIC SYNCHRONIZATION PROCESS AND ALARM NOTIFICATION OF THE LOSS OR THEFT OF THE WIRELESS EQUIPMENT INCLUDING MOBILE TELECOMMUNICATIONS EQUIPMENT (U.S. CLS. 21, 23, 26, 36 AND 38).

### CLASS 35—ADVERTISING AND BUSINESS

FOR BUSINESS CONSULTING SERVICES IN THE FIELDS OF ENERGY MEASUREMENT TO IMPROVE ENERGY EFFICIENCY WITHIN RESIDENTIAL, COMMERCIAL, INDUSTRIAL AND INSTITUTIONAL FACILITIES (U.S. CLS. 100, 101 AND 102).

JORDAN BAKER, EXAMINING ATTORNEY

SN 86-042,271. MU LAMBDA LABS INCORPORATED, FORT WORTH, TX. FILED 8-19-2013.



NO CLAIM IS MADE TO THE EXCLUSIVE RIGHT TO USE "LABS INC." AND "EXCELLENCE IN ELECTRONIC INSTRUMENTS", APART FROM THE MARK AS SHOWN. THE COLOR(S) RED, WHITE, BLUE, AND BLACK IS/ARE CLAIMED AS A FEATURE OF THE MARK.

THE MARK CONSISTS OF A BLACK OUTLINED CIRCLE WITH A DIAGONAL GRADIENT OF RED, WHITE AND BLUE. INSIDE THE CIRCLE ARE THE GREEK CHARACTERS MU AND LAMBDA, BOTH WHITE WITH A BLACK OUTLINE. THE PORTION OF THE CHARACTER LAMBDA THAT EXTENDS OUTSIDE OF THE CIRCLE IS BLACK. THERE IS A HORIZONTAL BLACK LINE RUNNING ON EITHER SIDE OF THE CIRCLE AT IT'S CENTER. ON THE LEFT HAND SIDE THE WORDS "MU LAMBDA LABS INC." IS WRITTEN IN BLACK FONT ABOVE THE LINE AND ON THE RIGHT OF THE CIRCLE THE WORDS "EXCELLENCE IN ELECTRONIC" IS WRITTEN ABOVE THE LINE AND "INSTRUMENTS" IS WRITTEN UNDER IT IN THE SAME BLACK FONT.

#### CLASS 9—ELECTRICAL AND SCIENTIFIC APPARATUS

FOR ANTENNA PARAMETER MEASURING APPARATUS; APPARATUS AND INSTRUMENTS FOR CONVEYING, DISTRIBUTING, TRANSFORMING, STORING, REGULATING OR CONTROLLING ELECTRIC CURRENT; AUDIO ELECTRONIC COMPONENTS, NAMELY, SURROUND SOUND SYSTEMS; AUTOMATED SELF CONTAINED ELECTRONIC SURVEILLANCE DEVICES THAT CAN BE DEPLOYED TO GATHER EVIDENCE OR INTELLIGENCE IN REMOTE LOCATIONS; AUTOMOTIVE MEASURING INSTRUMENTS, NAMELY, WATER TEMPERATURE GAUGES, AIR FUEL/RATIO GAUGES, BOOST GAUGES, VACUUM GAUGES AND EXHAUST GAS TEMPERATURE GAUGES; CARRYING CASES SPECIALLY ADAPTED FOR ELECTRONIC EQUIPMENT, NAMELY, TEST INSTRUMENTS; CARRYING CASES, HOLDERS, PROTECTIVE CASES AND STANDS FEATURING POWER SUPPLY CONNECTORS, ADAPTORS, SPEAKERS AND BATTERY CHARGING DEVICES, SPECIALLY ADAPTED FOR USE WITH HANDHELD DIGITAL ELECTRONIC DEVICES, NAMELY, TEST INSTRUMENTS; CONSUMER ELECTRONIC PRODUCTS, NAMELY, AUDIO AMPLIFIERS, AUDIO SPEAKERS, AUDIO RECEIVERS, ELECTRICAL AUDIO AND SPEAKER CABLES AND CONNECTORS, AUDIO DECODERS, VIDEO DECODERS, SPEAKERS, POWER CONVERSION DEVICES, POWER CONVERTERS, AND POWER INVERTERS; DERIVED-UNIT MEASURING MACHINES AND APPARATUS; DESIGN LIBRARIES, NAMELY, DOWNLOADABLE ELECTRONIC DATA FILES FOR USE IN INTEGRATED CIRCUIT AND SEMICONDUCTOR DESIGN; ELECTRIC AND ELECTRONIC CIRCUITS; ELECTRIC NAVIGATIONAL INSTRUMENTS; ELECTRIC OR ELECTRONIC SENSORS FOR ELECTRIC CURRENT, VOLTAGE, PRESSURE, ACCELERATION, TEMPERATURE, HUMIDITY; ELECTROMAGNETIC APPARATUS USED TO GENERATE OR MEASURE MAGNETIC FIELDS; ELECTRONIC AND OPTICAL COMMUNICATIONS INSTRUMENTS AND COMPONENTS, NAMELY, CABLE TELEVISION TRANSMITTERS; ELECTRONIC AND OPTICAL COMMUNICATIONS INSTRUMENTS AND COMPONENTS, NAMELY, COMMUNICATION LINK TESTERS FOR TESTING COMMUNICATION LINKS; ELECTRONIC AND OPTICAL COMMUNICATIONS INSTRUMENTS AND COMPONENTS, NAMELY, DIGITAL TRANSMITTERS; ELECTRONIC AND OPTICAL COMMUNICATIONS INSTRUMENTS AND COMPONENTS, NAMELY, OPTICAL DATA LINKS; ELECTRONIC AND OPTICAL COMMUNICATIONS INSTRUMENTS AND COMPONENTS, NAMELY, OPTICAL RECEIVERS; ELECTRONIC AND OPTICAL COMMUNICATIONS INSTRUMENTS AND

COMPONENTS, NAMELY, OPTICAL TRANSCIVERS; ELECTRONIC AND OPTICAL COMMUNICATIONS INSTRUMENTS AND COMPONENTS, NAMELY, OPTICAL TRANSMITTERS; ELECTRONIC APPARATUS AND INSTRUMENTS FOR CONTROLLING, ADJUSTING AND TESTING OF DRIVES AND MOTORS; ELECTRONIC APPARATUS FOR TESTING THE ELECTRICAL CONDUCTIVITY OF WIRE, CABLE, RESISTOR; ELECTRONIC APPARATUS FOR THE REMOTE CONTROL OF INDUSTRIAL OPERATIONS; ELECTRONIC APPARATUS, NAMELY, MOTION DETECTORS; ELECTRONIC CABLES; ELECTRONIC CIRCUIT BOARD; ELECTRONIC CIRCUIT CARDS; ELECTRONIC CIRCUITS; ELECTRONIC CIRCUITS FOR ERROR CORRECTION; ELECTRONIC CODING UNITS; ELECTRONIC COMBINERS FOR CONNECTING ANTENNAS AND RECEIVERS; ELECTRONIC COMMUNICATIONS SYSTEMS COMPRISED OF COMPUTER HARDWARE AND SOFTWARE FOR THE TRANSMISSION OF DATA BETWEEN TWO POINTS; ELECTRONIC COMPONENTS FOR COMPUTERS; ELECTRONIC COMPONENTS IN THE NATURE OF INFRARED DETECTORS FOR USE IN FURTHER MANUFACTURE; ELECTRONIC COMPUTERS; ELECTRONIC CONTROL GEARS (ECGS) FOR LED LAMPS AND LIGHT FIXTURES; ELECTRONIC CONTROL SYSTEMS FOR MACHINES; ELECTRONIC CONTROLLERS FOR USE WITH POWER CONVERTERS; ELECTRONIC CONTROLLERS USED TO REDUCE POWER CONSUMPTION; ELECTRONIC DATA LOGGERS; ELECTRONIC DETECTORS FOR OBSERVING AND MEASURING THE INFRARED SPECTRUM, NAMELY, INFRARED DETECTORS; ELECTRONIC DEVICE FOR MONITORING AND OPTIMIZING PHOTOVOLTAIC ARRAYS; ELECTRONIC DEVICES FOR READING, ENCODING AND PROGRAMMING TRANSPONDER KEYS; ELECTRONIC DEVICES USED TO LOCATE LOST ARTICLES EMPLOYING THE GLOBAL POSITIONING SYSTEM OR CELLULAR COMMUNICATION NETWORKS; ELECTRONIC DEVICES USED TO LOCATED LOST OBJECTS EMPLOYING RADIO FREQUENCY; ELECTRONIC DEVICES, NAMELY, ENERGY METERS FOR TRACKING AND MONITORING ENERGY USAGE; ELECTRONIC DEVICES, NAMELY, ENERGY SUBMETERS FOR TRACKING AND MONITORING ENERGY USAGE; ELECTRONIC DEVICES, NAMELY, HANDHELDS FOR EXCHANGING DATA IN ENERGY METERS OR SUBMETERS; ELECTRONIC DEVICES, NAMELY, RADIO FREQUENCY REPEATERS USED IN LONG RANGE COMMUNICATION FOR TRACKING AND MONITORING ENERGY USAGE; ELECTRONIC ENCRYPTION UNITS; ELECTRONIC EQUIPMENT, NAMELY, TRANSFORMERS, BALUNS, CABLES USED IN CONNECTION WITH COMPUTERS, COMPUTER PERIPHERAL DEVICES, TELEVISIONS, AUDIO-VIDEO EQUIPMENT, CLOSED-CIRCUIT TV EQUIPMENT AND TELECOMMUNICATION EQUIPMENT; ELECTRONIC INDICATOR BOARDS; ELECTRONIC INDICATOR PANELS; ELECTRONIC INSTRUMENTS FOR USE IN REMOTE INSPECTION AND MEASUREMENT OF INDUSTRIAL COMPONENTS USING REMOTE VISUAL DEVICES; ELECTRONIC INSTRUMENTS, NAMELY, LOGIC ANALYZERS; ELECTRONIC INTEGRATED CIRCUITS; ELECTRONIC INTERCONNECTERS FOR AUDIO AND VIDEO SIGNALS; ELECTRONIC LCD DISPLAY UNIT WITH MULTI-NETWORKING (TCP/IP) CAPABILITIES; ELECTRONIC MAGNETOSTRICTIVE EQUIPMENT, NAMELY, A WAVE GENERATOR, WAVE SENSOR AND WAVE ANALYZER; ELECTRONIC MEMORIES; ELECTRONIC MEMORY CARD READERS; ELECTRONIC MONITORS AND MONITOR MODULES FOR MONITORING ELECTRIC CURRENT AND ELECTRICAL SIGNALS; ELECTRONIC NAVIGATIONAL AND POSITIONING APPARATUS AND INSTRUMENTS; ELECTRONIC PLOTTERS; ELECTRONIC POWER SUPPLIES FOR DRIVING ELECTRIC MOTORS; ELECTRONIC PRODUCTS FOR THE GENERATION, MEASUREMENT, AND ANALYSIS OF AUDIO SIGNALS, NAMELY, AUDIO ANALYZERS; ELECTRONIC PRODUCTS FOR THE MANIPULATION OF THE FREQUENCY, TIME, AND AMPLITUDE CHARACTERISTICS OF AUDIO SIGNALS, NAMELY, AUDIO PROCESSORS; ELECTRONIC RECORDERS FOR STORING AND ARCHIVING INFORMATION RELATED TO POWER SYSTEM FAULTS; ELECTRONIC REGULATING AND CONTROL DEVICES FOR THE OPERATION OF LIGHT EMITTING DIODES; ELECTRONIC SCALERS FOR AUDIO AND VIDEO SIGNALS; ELECTRONIC SECURITY AND SURVEILLANCE DEVICES, NAMELY, ELECTRONIC SE-

CURITY TAGS AND LABELS, ACOUSTIC TAGS, MAGNETIC TAGS; ELECTRONIC SEMI-CONDUCTORS; ELECTRONIC SOUND MIXING, PROCESSING AND SYNTHESIZING APPARATUS; ELECTRONIC SWITCHERS FOR AUDIO AND VIDEO SIGNALS; ELECTRONIC TAGS FOR GOODS; ELECTRONIC TEST AND MEASUREMENT DEVICES FOR USE IN THE FIELDS OF NETWORKS AND TELECOMMUNICATIONS, NAMELY, INSTRUMENTATION USED TO TEST AND CERTIFY NEW AND EXISTING DATA AND VOICE COMMUNICATION CABLE AND COAXIAL CABLE; ELECTRONIC TESTING EQUIPMENT, NAMELY, SOUND LEVEL METERS; ELECTRONIC TESTING EQUIPMENT, NAMELY, TELECOMMUNICATION LINE INTEGRITY TESTING APPARATUS; ELECTRONIC TIMERS; ELECTRONIC TRANSMITTERS AND RECEIVERS FOR TELEMTRY, COMMUNICATIONS; ELECTRONIC VIDEO SURVEILLANCE PRODUCTS, NAMELY, ELECTRONIC COMPONENTS OF SECURITY SYSTEMS; ELECTRONIC-BASED INSTRUMENTS FOR MEASURING ENVIRONMENTAL PARAMETERS INCLUDING HUMIDITY, MOLD, BACTERIA, AIR QUALITY AND WATER QUALITY; ELECTRONICAL SENSORS FOR MEASURING SOLAR RADIATION; ENCODING AND DECODING APPARATUS AND INSTRUMENTS; ENVIRONMENTAL MONITORING SYSTEM COMPRISED OF METERS AND SENSORS THAT MEASURE PRESSURE, HUMIDITY, TEMPERATURE AND INCLUDES ALARM AND REPORTING FUNCTIONS; GRAVITY MEASURING INSTRUMENTS; HEAT SINKS FOR USE IN ELECTRONIC COMPONENTS; HOURGLASSES; INPUT DEVICES FOR COMPUTER HARDWARE AND ELECTRONIC INSTRUMENTS, NAMELY, JOG WHEELS; INSTRUMENTS AND APPARATUS FOR CONTROLLING ELECTRIC CURRENT, NAMELY, ELECTRICAL CONTROLLERS FOR MAGNETIC BEARING CONTROL; INSTRUMENTS FOR DETECTING AND MEASURING TWO-DIMENSIONAL DISTRIBUTION OF FORCE AND PRESSURE; INSTRUMENTS FOR MEASURING LENGTH; INTEGRATED BATTERY BACKUP SYSTEMS COMPRISING A BATTERY, AN ELECTRONIC MEASUREMENT APPARATUS FOR USE IN THE MEASUREMENT OF BATTERY HEALTH AND PERFORMANCE, AND A REMOTE COMPUTER SOFTWARE PROGRAM THAT USES THE FOREGOING DATA TO TREND, PREDICT, AND STORE DATA RELATED TO THE HEALTH OF THE BATTERY; LABELS CARRYING MAGNETICALLY, OPTICALLY, OR ELECTRONICALLY RECORDED OR ENCODED INFORMATION; LASER DOPPLER FOR MEASURING PURPOSES; LASER MEASURING SYSTEMS; LASERS FOR MEASURING PURPOSES; MEASURING APPARATUS FOR TEMPERATURE AND HUMIDITY LEVELS IN GASES AND SOLID SUBSTANCES; MEASURING APPARATUS, NAMELY, CLAMP METERS FOR MEASURING ELECTRICITY; MEASURING APPARATUS, NAMELY, LASER DISTANCE METERS; MEASURING APPARATUS, NAMELY, RAIN GAUGES; MEASURING INSTRUMENTATION AND APPARATUS, NAMELY, DIGITIZERS; METEOROLOGICAL INSTRUMENTS; MICROSENSORS FOR MEASUREMENT OF PRESSURE, ACCELERATION, FORCE AND FLOW, NAMELY, SILICON PIEZORESISTIVE PRESSURE SENSORS; NAVIGATIONAL INSTRUMENTS FOR VEHICLES; OCCUPANCY SENSORS, NAMELY, ELECTRONIC DEVICES WHICH DETECT THE PRESENCE OF OCCUPANTS AND CONTROL THE LIGHTING SYSTEM ACCORDINGLY; OPTICAL COMMUNICATIONS SYSTEMS COMPRISED OF OPTICAL AND ELECTRONIC HARDWARE AND COMPUTER SOFTWARE FOR THE TRANSMISSION OF DATA BETWEEN TWO POINTS; PANEL METERS, NAMELY, AN ELECTRONIC INSTRUMENT THAT DISPLAYS AN INPUT SIGNAL IN EITHER A DIGITAL OR ANALOG FORM; PORTABLE AND HANDHELD DIGITAL ELECTRONIC DEVICES FOR RECORDING, ORGANIZING, TRANSMITTING, MANIPULATING, AND REVIEWING TEXT, DATA, IMAGE, AND AUDIO FILES; PORTABLE ELECTRONIC RECORDER FOR MEASURING AND RECORDING MULTIPLE VOLTAGE, CURRENT AND THERMOCOUPLE READINGS FROM VARIOUS TRANSDUCERS; PORTABLE HANDHELD ELECTRONIC DIGITAL VIDEO MESSAGERS FOR RECORDING, STORAGE, TRANSMISSION OR REPRODUCTION OF VISUAL, AUDIO AND DATA CONTENT; POWER SUPPLY CONNECTORS AND ADAPTORS FOR USE WITH PORTABLE ELECTRONIC DEVICES; PRECISION INSTRUMENTS FOR MANIPULATION AND POSITIONING OF MICROSCOPIC OBJECTS; PRESSURE MEASURING APPARATUS; PRINTED ELECTRONIC CIRCUITS FOR APPARATUS AND CARDS BEARING

INTEGRATED CIRCUITS; RADIATION SHIELDS FOR ELECTRONIC PRODUCTS; RADIATION-MEASURING INSTRUMENTS; RECEIVERS OF ELECTRONIC SIGNALS; REMOTE SENSORS FOR USE IN MEASURING THERMAL AND INFRARED RADIATION ENERGY WAVES; RESISTANCE MEASURING INSTRUMENTS; SCIENTIFIC MEASURING INSTRUMENTS, NAMELY, CONDUCTIVITY METERS; SEISMOLOGICAL INSTRUMENTS; SIGNAL SPLITTERS FOR ELECTRONIC APPARATUS; SOUND RECORDING AND SOUND REPRODUCING APPARATUS AND INSTRUMENTS; SOUND RECORDING APPARATUS AND INSTRUMENTS; SPECIALTY HOLSTERS ADAPTED FOR CARRYING PERSONAL ELECTRONIC DEVICES, NAMELY, ELECTRONIC TEST INSTRUMENTS; STANDS FOR HANDHELD DIGITAL ELECTRONIC DEVICES, NAMELY, ELECTRONIC TEST INSTRUMENTS; STANDS FOR PERSONAL DIGITAL ELECTRONIC DEVICES, NAMELY, ELECTRONIC TEST INSTRUMENTS; TESTING AND MEASURING EQUIPMENT FOR USE IN TESTING THE PERFORMANCE AND EFFICIENCY OF POWER PLANT EQUIPMENT; TOOL MEASURING INSTRUMENTS; TRANSMITTERS OF ELECTRONIC SIGNALS; ULTRASONIC INSTRUMENTATION FOR TESTING MACHINES; USER INTERFACES, NAMELY, BUTTONS, KEYBOARDS, TOUCHSCREEN AND VIDEO DISPLAY FOR ELECTROTECHNICAL AND ELECTRONIC DEVICES; WEIGHING APPARATUS AND INSTRUMENTS; WIRE DIAMETER MEASURING DEVICES; WIRELESS CONTROLLERS TO MONITOR AND CONTROL THE FUNCTIONING OF OTHER ELECTRONIC DEVICES; WIRELESS DIGITAL ELECTRONIC APPARATUS TO SECURE AND PROTECT DATA AND IMAGES ON ALL FORMS OF WIRELESS EQUIPMENT INCLUDING MOBILE TELECOMMUNICATIONS EQUIPMENT USING AN AUTOMATIC SYNCHRONIZATION PROCESS AND ALARM NOTIFICATION OF THE LOSS OR THEFT OF THE WIRELESS EQUIPMENT INCLUDING MOBILE TELECOMMUNICATIONS EQUIPMENT (U.S. CLS. 21, 23, 26, 36 AND 38).

#### CLASS 35—ADVERTISING AND BUSINESS

FOR BUSINESS CONSULTING SERVICES IN THE FIELDS OF ENERGY MEASUREMENT TO IMPROVE ENERGY EFFICIENCY WITHIN RESIDENTIAL, COMMERCIAL, INDUSTRIAL AND INSTITUTIONAL FACILITIES (U.S. CLS. 100, 101 AND 102).

JORDAN BAKER, EXAMINING ATTORNEY

SN 86-042,285. DFUZE ENTERTAINMENT MEDIA, LLC, NEW YORK, NY. FILED 8-19-2013.

## Ghost Sniffers

THE MARK CONSISTS OF STANDARD CHARACTERS WITHOUT CLAIM TO ANY PARTICULAR FONT, STYLE, SIZE, OR COLOR.

NO CLAIM IS MADE TO THE EXCLUSIVE RIGHT TO USE "GHOST", APART FROM THE MARK AS SHOWN.

#### CLASS 35—ADVERTISING AND BUSINESS

FOR PRODUCT MERCHANDISING (U.S. CLS. 100, 101 AND 102).

#### CLASS 38—COMMUNICATION

FOR BROADCAST OF CABLE TELEVISION PROGRAMMES; BROADCASTING OF TELEVISION PROGRAMMES; TELEVISION BROADCASTING (U.S. CLS. 100, 101 AND 104).

REBECCA GILBERT, EXAMINING ATTORNEY

SN 86-042,303. ROTA LLC, HOUSTON, TX. FILED 8-20-2013.

MARK SPARACINO, EXAMINING ATTORNEY

## ROTA CYCLING

THE MARK CONSISTS OF STANDARD CHARACTERS WITHOUT CLAIM TO ANY PARTICULAR FONT, STYLE, SIZE, OR COLOR.

NO CLAIM IS MADE TO THE EXCLUSIVE RIGHT TO USE "CYCLING", APART FROM THE MARK AS SHOWN.

### CLASS 25—CLOTHING

FOR ATHLETIC FOOTWEAR; ATHLETIC PANTS; ATHLETIC SHIRTS; ATHLETIC SHORTS; ATHLETIC SKIRTS; ATHLETIC TIGHTS; BANDANAS; BELTS; BODY SUITS; CAPS; CLOTHING, NAMELY, ARM WARMERS; COATS; DRESSES; EAR MUFFS; FOOTWEAR; GLOVES; HATS; HEADBANDS; HEADWEAR; JACKETS; JERSEYS; JUMPERS; LEG WARMERS; LEGGINGS; LEOTARDS; MITTENS; PANTS; SANDALS; SHAWLS; SHIRTS; SHOES; SHORTS; SHOULDER WRAPS; SKIRTS; SKULLIES; SOCKS; SPORTS BRA; SWEATERS; SWEAT-PANTS; SWEATSHIRTS; T-SHIRTS; TANK TOPS; TIGHTS; TOQUES; UNDERWEAR; VESTS; VISORS; WARM-UP SUITS (U.S. CLS. 22 AND 39).

### CLASS 41—EDUCATION AND ENTERTAINMENT

FOR PHYSICAL FITNESS STUDIO SERVICES, NAMELY, PROVIDING GROUP EXERCISE INSTRUCTION, EQUIPMENT, AND FACILITIES (U.S. CLS. 100, 101 AND 107).

JOANNA DUKOVIC, EXAMINING ATTORNEY

SN 86-042,755. CHERYL A. POSEY, NORTH TIPP CITY, OH. FILED 8-20-2013.

## SPEAKING YOUR BEST

THE MARK CONSISTS OF STANDARD CHARACTERS WITHOUT CLAIM TO ANY PARTICULAR FONT, STYLE, SIZE, OR COLOR.

### CLASS 9—ELECTRICAL AND SCIENTIFIC APPARATUS

FOR PRE-RECORDED DOWNLOADABLE MP3 RECORDINGS, AUDIO CD'S, AND DVD'S FOR SELF-STUDY FEATURING SOUND RECORDINGS OF THE CORRECT PRONUNCIATION OF AMERICAN ENGLISH VOWELS, CONSONANTS, WORDS, AND SENTENCES ONLINE (U.S. CLS. 21, 23, 26, 36 AND 38).

FIRST USE 4-25-2006; IN COMMERCE 4-25-2006.

### CLASS 41—EDUCATION AND ENTERTAINMENT

FOR EDUCATIONAL SERVICES, NAMELY, CONDUCTING LANGUAGE COURSES FOR THE PURPOSE OF ACCENT REDUCTION AND COURSE MATERIALS DISTRIBUTED THEREWITH, PROVIDING A WEBSITE FEATURING INFORMATION ON LANGUAGE STUDY AND ACCENT REDUCTION (U.S. CLS. 100, 101 AND 107).

FIRST USE 4-25-2006; IN COMMERCE 4-25-2006.

SN 86-042,809. REALANALOGICS, INC., STATELINE, NV. FILED 8-20-2013.

## House Science

THE MARK CONSISTS OF STANDARD CHARACTERS WITHOUT CLAIM TO ANY PARTICULAR FONT, STYLE, SIZE, OR COLOR.

NO CLAIM IS MADE TO THE EXCLUSIVE RIGHT TO USE "HOUSE", APART FROM THE MARK AS SHOWN.

### CLASS 9—ELECTRICAL AND SCIENTIFIC APPARATUS

FOR SOFTWARE FOR REAL ESTATE INFORMATION, NAMELY, SOFTWARE FOR SEARCHING, RETRIEVING, VIEWING AND PROVIDING INFORMATION RELATED TO REAL ESTATE MARKETS, TRENDS, PROPERTIES, LISTINGS, PRICING, OPEN HOUSES, AGENTS AND BROKERS (U.S. CLS. 21, 23, 26, 36 AND 38).

### CLASS 36—INSURANCE AND FINANCIAL

FOR PROVIDING INFORMATION IN THE FIELD OF REAL ESTATE VIA THE INTERNET (U.S. CLS. 100, 101 AND 102).

BRENDAN MCCAULEY, EXAMINING ATTORNEY

SN 86-042,851. REALANALOGICS, INC., STATELINE, NV. FILED 8-20-2013.

## iDealHomeAnalyzer

THE MARK CONSISTS OF STANDARD CHARACTERS WITHOUT CLAIM TO ANY PARTICULAR FONT, STYLE, SIZE, OR COLOR.

### CLASS 9—ELECTRICAL AND SCIENTIFIC APPARATUS

FOR SOFTWARE FOR REAL ESTATE INFORMATION, NAMELY, SOFTWARE FOR SEARCHING, RETRIEVING, VIEWING AND PROVIDING INFORMATION RELATED TO REAL ESTATE MARKETS, TRENDS, PROPERTIES, LISTINGS, PRICING, OPEN HOUSES, AGENTS AND BROKERS (U.S. CLS. 21, 23, 26, 36 AND 38).

### CLASS 36—INSURANCE AND FINANCIAL

FOR PROVIDING INFORMATION IN THE FIELD OF REAL ESTATE VIA THE INTERNET (U.S. CLS. 100, 101 AND 102).

BRENDAN MCCAULEY, EXAMINING ATTORNEY

SN 86-042,862. IDEALEASE, INC., AKA IDEALEASE OF NORTH AMERICA, INC., NORTH BARRINGTON, IL. FILED 8-20-2013.

SN 86-043,118. THE HOUSING PROJECT'S FILM PROJECT, LLC, RIDGEWOOD, NJ. FILED 8-20-2013.

## IDEALEASE

THE MARK CONSISTS OF STANDARD CHARACTERS WITHOUT CLAIM TO ANY PARTICULAR FONT, STYLE, SIZE, OR COLOR.

OWNER OF U.S. REG. NO. 2,149,514.

### CLASS 37—CONSTRUCTION AND REPAIR

FOR MOTOR VEHICLE MAINTENANCE AND REPAIR (U.S. CLS. 100, 103 AND 106).

FIRST USE 8-12-2013; IN COMMERCE 8-12-2013.

### CLASS 39—TRANSPORTATION AND STORAGE

FOR LEASING OF MOTOR VEHICLES; RENTAL OF MOTOR VEHICLES (U.S. CLS. 100 AND 105).

FIRST USE 8-12-2013; IN COMMERCE 8-12-2013.

TIMOTHY O. SCHIMPF, EXAMINING ATTORNEY

SN 86-042,986. ALLY BURGUIERES ART, LLC, DBA COCOALLY, NEW ORLEANS, LA. FILED 8-20-2013.

## Cocoally

THE MARK CONSISTS OF STANDARD CHARACTERS WITHOUT CLAIM TO ANY PARTICULAR FONT, STYLE, SIZE, OR COLOR.

### CLASS 18—LEATHER GOODS

FOR DOG APPAREL; HANDBAGS, PURSES AND WALLETS (U.S. CLS. 1, 2, 3, 22 AND 41).

FIRST USE 1-15-2013; IN COMMERCE 1-15-2013.

### CLASS 25—CLOTHING

FOR CHILDREN'S AND INFANT'S APPAREL, NAMELY, JUMPERS, OVERALL SLEEPWEAR, PAJAMAS, ROMPERS AND ONE-PIECE GARMENTS; SCARVES; SWEATSHIRTS FOR BABIES, ADULTS, AND CHILDREN; T-SHIRTS FOR BABIES, ADULTS, AND CHILDREN (U.S. CLS. 22 AND 39).

FIRST USE 1-15-2013; IN COMMERCE 1-15-2013.

AMY ALFIERI, EXAMINING ATTORNEY

## CATS FOR SURE

THE MARK CONSISTS OF STANDARD CHARACTERS WITHOUT CLAIM TO ANY PARTICULAR FONT, STYLE, SIZE, OR COLOR.

NO CLAIM IS MADE TO THE EXCLUSIVE RIGHT TO USE "CATS", APART FROM THE MARK AS SHOWN.

### CLASS 5—PHARMACEUTICALS

FOR DIETARY PET SUPPLEMENTS IN THE FORM OF PET TREATS; DIETARY SUPPLEMENTS FOR PETS (U.S. CLS. 6, 18, 44, 46, 51 AND 52).

### CLASS 31—NATURAL AGRICULTURAL PRODUCTS

FOR CAT FOOD; CAT TREATS; PET BEVERAGES; PET FOOD; PET TREATS (U.S. CLS. 1 AND 46).

DAVID COLLIER, EXAMINING ATTORNEY

SN 86-043,119. ROYAL SOUTH, LLC, WINTERVILLE, NC. FILED 8-20-2013.

## ROYAL SOUTH

THE MARK CONSISTS OF STANDARD CHARACTERS WITHOUT CLAIM TO ANY PARTICULAR FONT, STYLE, SIZE, OR COLOR.

### CLASS 9—ELECTRICAL AND SCIENTIFIC APPARATUS

FOR EYEGLASS STRAPS, HOLDERS, AND RETAINERS (U.S. CLS. 21, 23, 26, 36 AND 38).

### CLASS 21—HOUSEWARES AND GLASS

FOR INSULATED CONTAINERS FOR BEVERAGE CANS AND BOTTLES FOR HOUSEHOLD USE (U.S. CLS. 2, 13, 23, 29, 30, 33, 40 AND 50).

### CLASS 25—CLOTHING

FOR CLOTHING AND APPAREL, NAMELY, SHIRTS, SWEATERS, JACKETS, COATS, SHORTS, PANTS, BOXERS, TIES, BOW TIES, HATS, AND VISORS (U.S. CLS. 22 AND 39).

SHANNON TWOHIG, EXAMINING ATTORNEY



SN 86-043,126. W.K. KELLOGG FOUNDATION, BATTLE CREEK, MI. FILED 8-20-2013.



OWNER OF U.S. REG. NOS. 4,272,998, 4,276,685 AND OTHERS.

NO CLAIM IS MADE TO THE EXCLUSIVE RIGHT TO USE "FOUNDATION", APART FROM THE MARK AS SHOWN.

THE NAME "W.K. KELLOGG" DOES NOT IDENTIFY A LIVING INDIVIDUAL.

THE MARK CONSISTS OF A SQUARE WITH THE LETTERS "WK" STACKED ON TOP OF THE LETTERS "KF", THE "K'S" FORMING A VERTICAL LINE WITHIN THE SQUARE; TO THE RIGHT OF THE SQUARE, THE STACKED LETTERS AND WORDS "W.K.", "KELLOGG", AND "FOUNDATION".

#### **CLASS 16—PAPER GOODS AND PRINTED MATTER**

FOR PRINTED PUBLICATIONS, NAMELY, BOOKS, BOOKLETS, PAMPHLETS, BROCHURES, REPORTS, WORK BOOKS AND WHITE PAPERS IN THE FIELDS OF HEALTH, FAMILY ECONOMIC SECURITY, EARLY CHILDHOOD EDUCATION AND HIGHER EDUCATION, PHILANTHROPY, VOLUNTEERISM, COMMUNITY DEVELOPMENT, CHILD DEVELOPMENT, HEALTH AND WELFARE, RACIAL INEQUITY, RACIAL HEALING, JUVENILE JUSTICE, AND ECONOMIC SUCCESS (U.S. CLS. 2, 5, 22, 23, 29, 37, 38 AND 50).

FIRST USE 11-7-2011; IN COMMERCE 11-7-2011.

#### **CLASS 35—ADVERTISING AND BUSINESS**

FOR CHARITABLE SERVICES, NAMELY, ORGANIZING AND CONDUCTING VOLUNTEER OUTREACH PROGRAMS DESIGNED TO PROMOTE RACIAL HEALING, ADDRESS RACIAL INEQUITY, AND BRIDGE RACIAL GAPS IN THE AREAS OF EDUCATION, HEALTH, JUVENILE JUSTICE, ECONOMIC SUCCESS, AND THE MEDIA; CHARITABLE SERVICES, NAMELY, ORGANIZING AND CONDUCTING VOLUNTEER PROGRAMS AND COMMUNITY SERVICES PROGRAMS DESIGNED TO PROMOTE RACIAL HEALING, ADDRESS RACIAL INEQUITY, AND BRIDGE RACIAL GAPS IN THE AREAS OF EDUCATION, HEALTH, JUVENILE JUSTICE, ECONOMIC SUCCESS, AND THE MEDIA (U.S. CLS. 100, 101 AND 102).

FIRST USE 11-7-2011; IN COMMERCE 11-7-2011.

#### **CLASS 36—INSURANCE AND FINANCIAL**

FOR PROVIDING GRANTS, EDUCATIONAL SCHOLARSHIPS AND FINANCING AND LOAN SERVICES FOR RESEARCH AND PROGRAMS IN THE FIELD OF HEALTH, FAMILY ECONOMIC SECURITY, EARLY CHILDHOOD EDUCATION AND HIGHER EDUCATION, PHILANTHROPY AND VOLUNTEERISM, COMMUNITY DEVELOPMENT, CHILD DEVELOPMENT, HEALTH AND WELFARE; PROVIDING GRANTS TO NONPROFIT ORGANIZATIONS INVOLVED IN CIVIC ENGAGEMENT; PROVIDING GRANTS, EDUCATIONAL SCHOLARSHIPS AND FINANCING AND LOAN SERVICES FOR RESEARCH AND PROGRAMS IN THE FIELD OF FOOD SYSTEMS, NAMELY, FOOD SAFETY, QUALITY, DISTRIBUTION, AND HEALTHFUL EATING FOR THE HEALTH, DEVELOPMENT AND WELFARE OF IMPOVERISHED AND UNDERPRIVILEGED CHILDREN, FAMILIES, AND COMMUNITIES; CHARITABLE FUNDRAISING SERVICES FOR OTHERS, NAMELY, RAISING FUNDS FOR PROGRAMS FOR FAMILY ECONOMIC SECURITY, EARLY CHILDHOOD EDUCATION AND HIGHER EDUCATION, PHILANTHROPY AND VOLUNTEERISM, COMMUNITY DEVELOPMENT, CHILD DEVELOPMENT, HEALTH AND WELFARE; CHARITABLE FUND RAISING SERVICES FOR RESEARCH PROGRAMS IN THE FIELD OF FOOD SYSTEMS, NAMELY, FOOD SAFETY, QUALITY, DISTRIBUTION, AND HEALTHFUL EATING FOR THE HEALTH, DEVELOPMENT AND WELFARE OF IMPOVERISHED AND UNDERPRIVILEGED CHILDREN, FAMILIES, AND COMMUNITIES; CHARITABLE FUNDRAISING SERVICES, NAMELY, RAISING FUNDS FOR PROGRAMS DESIGNED TO PROMOTE RACIAL HEALING, ADDRESS RACIAL INEQUITY, AND BRIDGE RACIAL GAPS IN THE AREAS OF EDUCATION, HEALTH, JUVENILE JUSTICE, ECONOMIC SUCCESS, AND THE MEDIA; PROVIDING GRANTS, EDUCATIONAL SCHOLARSHIPS AND FINANCING AND LOAN SERVICES FOR RESEARCH AND EDUCATIONAL PROGRAMS, NAMELY, EDUCATIONAL AND CAREER COUNSELING AND GUIDANCE, FOR OUT OF SCHOOL YOUTHS, THAT PROVIDE ALTERNATIVES TO HIGH SCHOOL DIPLOMAS AND ASSOCIATES DEGREES (U.S. CLS. 100, 101 AND 102).

FIRST USE 11-7-2011; IN COMMERCE 11-7-2011.

#### **CLASS 41—EDUCATION AND ENTERTAINMENT**

FOR ARRANGING AND CONDUCTING EDUCATIONAL CONFERENCES, SEMINARS AND WORKSHOPS IN THE FIELD OF HEALTH, FAMILY ECONOMIC SECURITY, EARLY CHILDHOOD EDUCATION AND HIGHER EDUCATION, PHILANTHROPY AND VOLUNTEERISM, COMMUNITY DEVELOPMENT, CHILD DEVELOPMENT, HEALTH AND WELFARE; ARRANGING AND CONDUCTING EDUCATIONAL CONFERENCES, SEMINARS AND WORKSHOPS IN THE FIELD OF FOOD SYSTEMS, NAMELY, FOOD SAFETY, QUALITY, DISTRIBUTION, AND HEALTHFUL EATING FOR THE HEALTH, DEVELOPMENT AND WELFARE OF IMPOVERISHED AND UNDERPRIVILEGED CHILDREN, FAMILIES, AND COMMUNITIES; ARRANGING AND CONDUCTING EDUCATIONAL CONFERENCES TO PROMOTE RACIAL HEALING, ADDRESS RACIAL INEQUITY, AND BRIDGE RACIAL GAPS IN THE AREAS OF EDUCATION, HEALTH, JUVENILE JUSTICE, ECONOMIC SUCCESS, AND THE MEDIA; EDUCATIONAL PROGRAMS, NAMELY, EDUCATIONAL AND CAREER COUNSELING AND GUIDANCE, FOR OUT OF SCHOOL YOUTHS, THAT PROVIDE ALTERNATIVES TO HIGH SCHOOL DIPLOMAS AND ASSOCIATES DEGREES; PROVIDING ON-LINE EDUCATIONAL PUBLICATIONS IN THE NATURE OF JOURNALS, NEWSLETTERS, CURRICULUM GUIDES IN THE FIELD OF ISSUES RELATING TO OUT OF SCHOOL YOUTHS SEEKING ALTERNATIVES TO HIGH SCHOOL DIPLOMAS AND ASSOCIATES DEGREES FOR ASSISTING COMMUNITY BASED ORGANIZATIONS AND SOCIAL ENTERPRISES FOR SUPPORTING OUT OF SCHOOL YOUTHS IN THE PROCESS OF SECURING ENTRY LEVEL EMPLOYMENT (U.S. CLS. 100, 101 AND 107).

FIRST USE 11-7-2011; IN COMMERCE 11-7-2011.  
DAVID COLLIER, EXAMINING ATTORNEY

SN 86-043,157. DIABETES CARE PHARMACY INC, DBA DIABETES CARE PARTNERS, WEST COVINA, CA. FILED 8-20-2013.

### DIABETES CARE PARTNERS

THE MARK CONSISTS OF STANDARD CHARACTERS WITHOUT CLAIM TO ANY PARTICULAR FONT, STYLE, SIZE, OR COLOR.

OWNER OF U.S. REG. NO. 3,002,957.

NO CLAIM IS MADE TO THE EXCLUSIVE RIGHT TO USE "DIABETES CARE", APART FROM THE MARK AS SHOWN.

### CLASS 35—ADVERTISING AND BUSINESS

FOR MAIL ORDER PHARMACY SERVICES; RETAIL PHARMACY SERVICES (U.S. CLS. 100, 101 AND 102).

### CLASS 44—MEDICAL, BEAUTY AND AGRICULTURAL SERVICES

FOR DIETITIAN SERVICES; PROVIDING INFORMATION IN THE FIELD OF DIABETES (U.S. CLS. 100 AND 101).

BRIAN PINO, EXAMINING ATTORNEY

SN 86-043,165. BRIANA A. AGUILA, LA PUENTE, CA. FILED 8-20-2013.

### BECAUSE THE BEAUTIFUL GAME ISN'T ALWAYS PERFECT

THE MARK CONSISTS OF STANDARD CHARACTERS WITHOUT CLAIM TO ANY PARTICULAR FONT, STYLE, SIZE, OR COLOR.

### CLASS 16—PAPER GOODS AND PRINTED MATTER

FOR STICKERS (U.S. CLS. 2, 5, 22, 23, 29, 37, 38 AND 50).

### CLASS 25—CLOTHING

FOR CLOTHING, NAMELY, T-SHIRTS, PANTS, SHORTS, DRESSES, COATS AND SOCKS (U.S. CLS. 22 AND 39).

DAVID COLLIER, EXAMINING ATTORNEY

SN 86-043,245. AMERICAN K-9 DETECTION SERVICES, LLC, LAKE MARY, FL. FILED 8-20-2013.

# AMK9

THE MARK CONSISTS OF STANDARD CHARACTERS WITHOUT CLAIM TO ANY PARTICULAR FONT, STYLE, SIZE, OR COLOR.

OWNER OF U.S. REG. NO. 3,625,574.

### CLASS 37—CONSTRUCTION AND REPAIR

FOR PEST CONTROL SERVICES, NAMELY, BED BUG DETECTION SERVICES USING TEAMS OF CANINE AND HUMAN HANDLERS (U.S. CLS. 100, 103 AND 106). FIRST USE 10-3-2003; IN COMMERCE 10-3-2003.

### CLASS 42—SCIENTIFIC AND COMPUTER SERVICES

FOR TESTING, AND ANALYSIS IN THE FIELD OF CANINE HANDLING TO EVALUATE THE KNOWLEDGE SKILLS AND ABILITIES OF CANINE HANDLERS FOR THE PURPOSE OF CERTIFICATION OF CANINES AND PATROL TEAMS TO OPERATE IN THE FIELDS OF NARCOTICS DETECTION, BED BUG DETECTION, HUMAN REMAINS DETECTION, MINE DETECTION, AND EXPLOSIVES DETECTION FOR USE IN SPECIAL ASSIGNMENTS AND FOR PUBLIC SAFETY PURPOSES (U.S. CLS. 100 AND 101).

FIRST USE 10-8-2003; IN COMMERCE 10-8-2003.

### CLASS 45—PERSONAL AND LEGAL SERVICES

FOR NARCOTICS DETECTION, HUMAN REMAINS DETECTION, MINE DETECTION, AND EXPLOSIVES DETECTION SERVICES USING TEAMS OF CANINE AND HUMAN HANDLERS FOR THE PROTECTION OF PROPERTY AND INDIVIDUALS (U.S. CLS. 100 AND 101).

FIRST USE 10-8-2003; IN COMMERCE 10-8-2003.

TARAH HARDY, EXAMINING ATTORNEY

SN 86-043,275. WINDWOOD FARM, LLC, DBA WINDWOOD EQUESTRIAN, PELHAM, AL. FILED 8-20-2013.

## Windwood Equestrian

THE MARK CONSISTS OF STANDARD CHARACTERS WITHOUT CLAIM TO ANY PARTICULAR FONT, STYLE, SIZE, OR COLOR.

NO CLAIM IS MADE TO THE EXCLUSIVE RIGHT TO USE "EQUESTRIAN", APART FROM THE MARK AS SHOWN.

### CLASS 41—EDUCATION AND ENTERTAINMENT

FOR HORSE SHOWING; HORSE TRAINING (U.S. CLS. 100, 101 AND 107).

FIRST USE 12-2-2005; IN COMMERCE 12-2-2005.

### CLASS 43—HOTEL AND RESTAURANT SERVICES

FOR BOARDING FOR HORSES; PROVIDING HORSE STABLE FACILITIES (U.S. CLS. 100 AND 101).

FIRST USE 12-2-2005; IN COMMERCE 12-2-2005.

KHANH LE, EXAMINING ATTORNEY

SN 86-043,307. A. ARENZ TRAVEL PLANNER ASSOCIATES, INC., MEADOW VISTA, CA. FILED 8-20-2013.

**AATPA**

THE MARK CONSISTS OF STANDARD CHARACTERS WITHOUT CLAIM TO ANY PARTICULAR FONT, STYLE, SIZE, OR COLOR.

**CLASS 39—TRANSPORTATION AND STORAGE**

FOR WHOLESALE AND RETAIL VACATION PACKAGE PLANNING SERVICES, NAMELY, THE ARRANGING AND PROVIDING OF TRAVEL VACATION PACKAGES FOR OTHERS INCLUDING ONE OR MORE OF TRANSPORTATION, TRAVEL TOURS, SIGHTSEEING TRAVEL TOURS, AND EXCURSION ARRANGEMENT FOR INDIVIDUALS OR GROUPS OF INDIVIDUALS; WHOLESALE AND RETAIL TRAVEL AGENCY SERVICES, NAMELY, THE ARRANGING, MAKING OF RESERVATIONS, AND BOOKING OF RESERVATIONS FOR TRANSPORTATION, TRAVEL TOURS, SIGHTSEEING TRAVEL TOURS, AND EXCURSION ARRANGEMENT FOR INDIVIDUALS OR GROUPS OF INDIVIDUALS (U.S. CLS. 100 AND 105).  
FIRST USE 1-3-2002; IN COMMERCE 1-3-2002.

**CLASS 43—HOTEL AND RESTAURANT SERVICES**

FOR WHOLESALE AND RETAIL VACATION PACKAGE PLANNING SERVICES FOR OTHERS, NAMELY, MAKING RESERVATIONS AND BOOKING FOR TEMPORARY LODGING; WHOLESALE AND RETAIL TRAVEL AGENCY SERVICES, NAMELY, MAKING RESERVATIONS AND BOOKING FOR TEMPORARY LODGING (U.S. CLS. 100 AND 101).  
FIRST USE 1-3-2002; IN COMMERCE 1-3-2002.  
BRIAN PINO, EXAMINING ATTORNEY

SN 86-043,378. CON SURFBOARD HOLDINGS, INC., DBA CON SURFBOARDS, SAN DIEGO, CA. FILED 8-20-2013.



OWNER OF U.S. REG. NOS. 3,216,780 AND 3,216,781.  
THE MARK CONSISTS OF A STYLIZED SHOWING OF THE TERM "CON". THE LETTER "C" WRAPS AROUND THE LETTER "O", WHICH IN TURN ENCOMPASSES THE LETTER "N".

**CLASS 16—PAPER GOODS AND PRINTED MATTER**

FOR STICKERS; DECALS (U.S. CLS. 2, 5, 22, 23, 29, 37, 38 AND 50).  
FIRST USE 6-1-1959; IN COMMERCE 6-1-1962.

**CLASS 25—CLOTHING**

FOR T-SHIRTS; SHORT AND LONG SLEEVED T-SHIRTS (U.S. CLS. 22 AND 39).  
FIRST USE 6-1-1959; IN COMMERCE 5-1-1962.

**CLASS 28—TOYS AND SPORTING GOODS**

FOR SURFBOARDS; SURFBOARD FINS (U.S. CLS. 22, 23, 38 AND 50).  
FIRST USE 6-1-1959; IN COMMERCE 5-1-1962.  
NICHOLAS ALTREE, EXAMINING ATTORNEY

SN 86-043,382. BOTTLE LOGIC BREWING, LLC, ANAHEIM, CA. FILED 8-20-2013.



NO CLAIM IS MADE TO THE EXCLUSIVE RIGHT TO USE "EST. 2013" AND "BREWING", APART FROM THE MARK AS SHOWN.

THE MARK CONSISTS OF THE WORD "EST." FOLLOWED BY AN OUTLINE OF A BEER BOTTLE INSIDE AN OUTLINE OF A LIGHT-BULB WITH BOLTS ON EACH SIDE AND FOLLOWED BY THE WORD "2013", WITH THE WORDS "BOTTLE LOGIC" CENTERED UNDERNEATH, AND THEN UNDERNEATH THAT, THE WORD "BREWING".

**CLASS 32—LIGHT BEVERAGES**

FOR BEER, NAMELY, ALCOHOLIC BEER, LAGER, ALE, STOUT, PORTER, DRAFT AND MICRO-BREW (U.S. CLS. 45, 46 AND 48).

**CLASS 43—HOTEL AND RESTAURANT SERVICES**

FOR BAR, TASTING ROOM, AND RESTAURANT SERVICES (U.S. CLS. 100 AND 101).  
NICHOLAS ALTREE, EXAMINING ATTORNEY

SN 86-043,385. CON SURFBOARD HOLDINGS, INC., DBA  
CON SURFBOARDS, SAN DIEGO, CA. FILED 8-20-2013.



OWNER OF U.S. REG. NOS. 3,216,780 AND 3,216,781.  
THE MARK CONSISTS OF A STYLIZED SHOWING OF  
THE TERM "CON". THE LETTER "C" WRAPS AROUND  
THE LETTER "O", WHICH IN TURN ENCOMPASSES THE  
LETTER "N".

#### **CLASS 9—ELECTRICAL AND SCIENTIFIC APPARATUS**

FOR EYEWEAR, NAMELY, SUNGLASSES AND GOG-  
GLES FOR SPORTS; COMPUTER CARRYING CASES;  
PRE-RECORDED VIDEO TAPES, DVD'S, AND DIGITAL  
MULTIMEDIA FILES FEATURING SURFING AND  
OTHER SPORTS; EYEGLASSES; ACCESSORIES FOR  
EYEGLASSES, NAMELY, EYEGLASS CASES, EYE-  
GLASS RIMS AND FRAMES, REPLACEMENT PARTS  
FOR EYEGLASSES, EYEGLASS CHAINS AND CORDS;  
SUNGLASSES; ACCESSORIES FOR SUNGLASSES,  
NAMELY, SUNGLASS RIMS AND FRAMES, SUNGLASS  
CASES, SUNGLASS CHAINS AND CORDS (U.S. CLS. 21,  
23, 26, 36 AND 38).

#### **CLASS 16—PAPER GOODS AND PRINTED MATTER**

FOR BOOKS FEATURING THE SUBJECTS OF  
SPORTS, FASHION, AND ENTERTAINMENT, BOOK  
COVERS, AND CALENDARS (U.S. CLS. 2, 5, 22, 23, 29,  
37, 38 AND 50).

#### **CLASS 18—LEATHER GOODS**

FOR LEATHER AND IMITATIONS OF LEATHER,  
AND GOODS MADE OF LEATHER AND IMITATION  
LEATHER, NAMELY, SHOULDER STRAPS AND LUG-  
GAGE LABELS; BAGS, NAMELY, LEATHER AND IMI-  
TATION LEATHER BAGS, SPORTS BAGS, GYM BAGS,  
ATHLETICS BAGS, BEACH BAGS, ALL-PURPOSE CAR-  
RYING BAGS, HANDBAGS, SCHOOL BAGS, CARRY-ON  
BAGS, CLUTCH BAGS, DRAWSTRING BAGS, DUFFEL  
BAGS, TOTE BAGS, ROLL BAGS, SHOULDER BAGS,  
OVERNIGHT BAGS, GARMENT BAGS FOR TRAVEL,  
SHAVING BAGS SOLD EMPTY, TOILETRY BAGS SOLD  
EMPTY, TRAVEL BAGS, SLING BAGS, HIKING BAGS,  
KIT BAGS, MESSENGER BAGS, KNITTED BAGS, NOT  
OF PRECIOUS METAL, BELT BAGS, WAIST BAGS, HIP  
BAGS, BUM BAGS, DIAPER BAGS, BAGS FOR CARRY-  
ING BABIES' ACCESSORIES, BAGS SOLD EMPTY FOR  
ATTACHMENT TO BACKPACKS, SOUVENIR BAGS,  
WHEELED BAGS, AND WRISTLET BAGS; BACKPACKS,  
RUCKSACKS; TRUNKS; POUCHES, NAMELY, DRAW-  
STRING POUCHES, LEATHER POUCHES, IMITATION  
LEATHER POUCHES, CLOTH POUCHES, TEXTILE  
POUCHES, FELT POUCHES, JEWELRY POUCHES,  
POUCHES SOLD EMPTY FOR ATTACHMENT TO  
BACKPACKS, POUCHES FOR HOLDING KEYS, MAKE-  
UP AND OTHER PERSONAL ITEMS, AND WEARABLE  
STRAP-ON POUCHES, AND KEY CASES; PURSES,  
WALLETS, KEY CASES; COSMETICS BAGS, PURSES  
AND CASES, ALL SOLD EMPTY; UMBRELLAS, PARA-  
SOLS AND WALKING STICKS; REPLACEMENT PARTS  
FOR ALL OF THE FOREGOING; ACCESSORIES FOR  
BAGS, BACKPACKS, RUCKSACKS, UMBRELLAS AND  
PARASOLS, NAMELY, WATERPROOF COVERS; AC-  
CESSORIES FOR LUGGAGE, NAMELY, STRAPS AND  
TAGS (U.S. CLS. 1, 2, 3, 22 AND 41).

#### **CLASS 25—CLOTHING**

FOR FOOTWEAR; HEADWEAR; HATS; WETSUITS;  
SWIMWEAR; BOARD SHORTS; SWEATSHIRTS;  
HOODED SHIRTS; JACKETS; COATS; SHORTS; WALK  
SHORTS; LONG PANTS; JEANS; DENIMS; RASH  
GUARDS; LOUNGWEAR; BRACES/SUSPENDERS  
AND GAITERS; BRIEFS; BELTS; SOCKS; GLOVES;  
SURFBOARD BOOTS; SANDALS; THONG FOOTWEAR;  
SURF HOODS; BOOTS FOR SPORTS; SURF WEAR (U.S.  
CLS. 22 AND 39).

#### **CLASS 28—TOYS AND SPORTING GOODS**

FOR SURFBOARDS AND OTHER WATER SPORTS  
APPARATUS, NAMELY, BODY BOARDS, PADDLE-  
BOARDS, WAKE BOARDS, KITE BOARDS, WATER  
SKIS, SKIM BOARDS AND SAIL-BOARD; BAGS ESPE-  
CIALLY DESIGNED FOR SURFBOARDS AND OTHER  
WATER SPORTS APPARATUS; SURFBOARD STORAGE  
RACKS AND SURFBOARD DISPLAY RACKS, DECK  
GRIPS FOR SPORTS EQUIPMENT BOARDS, NAMELY,  
SURFBOARDS AND PADDLE SURFBOARDS; PADDLE  
SURFBOARDS; SWIMMING FLIPPERS AND BODY  
BOARDING FLIPPERS; GLOVES FOR WATERSPORTS,  
NAMELY, SURFING GLOVES, BODYBOARDING  
GLOVES, AND PADDLING GLOVES; ACCESSORIES  
FOR SURFBOARDS AND OTHER WATER SPORTS  
APPARATUS, NAMELY, LEASHES FOR SURFBOARDS,  
LEASHES FOR FINS, PADDLES FOR USE WITH SURF-  
BOARDS, SURFBOARD TRACTION PADS, FINS FOR  
BODY BOARDS, SURFBOARD WAX, PADDLE BOARD  
WAX AND SKIM BOARD WAX (U.S. CLS. 22, 23, 38 AND  
50).

NICHOLAS ALTREE, EXAMINING ATTORNEY

SN 86-043,603. PETTY, BRIAN, MIDLAND, TX. FILED 8-21-2013.



NO CLAIM IS MADE TO THE EXCLUSIVE RIGHT TO USE THE PICTORIAL REPRESENTATION OF THE STATE OF TEXAS, APART FROM THE MARK AS SHOWN.

THE MARK CONSISTS OF A TEXAS SHAPE SOLID WITH THE EXCEPTION OF A VERTICAL LINE AND HORIZONTAL LINE WHICH INTERSECT AT THE PHYSICAL LOCATION OF MIDLAND, TX.

**CLASS 13—FIREARMS**

FOR FIREARM ATTACHMENTS, NAMELY, MOUNTS FOR ATTACHING ACCESSORIES TO A FIREARM; FIREARMS (U.S. CLS. 2 AND 9).  
FIRST USE 5-20-2013; IN COMMERCE 5-20-2013.

**CLASS 40—MATERIAL TREATMENT**

FOR ENGRAVING; MACHINE SHOP SERVICES, NAMELY, MACHINING PARTS FOR OTHERS; PROTOTYPE FABRICATION OF NEW PRODUCTS FOR OTHERS (U.S. CLS. 100, 103 AND 106).  
FIRST USE 5-20-2013; IN COMMERCE 5-20-2013.  
COURTNEY ALVAREZ, EXAMINING ATTORNEY

SN 86-043,738. EROTAS ENTERPRISES, LLC, EXCELSIOR, MN. FILED 8-21-2013.



NO CLAIM IS MADE TO THE EXCLUSIVE RIGHT TO USE "LEMON", APART FROM THE MARK AS SHOWN.

THE MARK CONSISTS OF THE TERM "LEMON" WRITTEN WITH A LINE UNDERNEATH, A DESIGN OF A LEMON ON A VINE WITH LEAVES UNDERNEATH, AND THE TERM "& VINE" WITH LINES OVER AND ABOVE IT APPEARING UNDERNEATH THE DESIGN. THE WORDING AND IMAGES APPEAR ON A DARK BACKGROUND AND WITH AN INNER LIGHT FRAME.

**CLASS 29—MEATS AND PROCESSED FOODS**

FOR JAMS; PICKLES; PRESERVED FRUITS AND VEGETABLES; PROCESSED OILS AND FATS; CHILI; FROZEN, PREPARED OR PACKAGED GREEK ENTREES CONSISTING PRIMARILY OF MEAT, FISH, POULTRY, VEGETABLES OR CHEESE; FROZEN, PREPARED OR PACKAGED GREEK APPETIZERS CONSISTING PRIMARILY OF MEAT, FISH, POULTRY, VEGETABLES OR CHEESE; SOUPS (U.S. CL. 46).

**CLASS 30—STAPLE FOODS**

FOR SALAD DRESSINGS; BARBEQUE SAUCE; SAUCES; SPICE RUBS; SPICES; WINE VINEGAR; ICE CREAM; FROZEN, PREPARED OR PACKAGED GREEK ENTREES CONSISTING PRIMARILY OF PASTA OR RICE; PREPARED OR PACKAGED GREEK APPETIZERS CONSISTING PRIMARILY OF PASTA OR RICE; RICE AND SEASONING MIX COMBINED IN UNITARY PACKAGES (U.S. CL. 46).  
INGRID C. EULIN, EXAMINING ATTORNEY

SN 86-043,935. CARLTON, CHELON, BEDFORD, NY. FILED 8-21-2013.

Lischer and Fein

THE MARK CONSISTS OF STANDARD CHARACTERS WITHOUT CLAIM TO ANY PARTICULAR FONT, STYLE, SIZE, OR COLOR.

**CLASS 30—STAPLE FOODS**

FOR PASTRIES, COOKIES, BREADS, SWEET BREADS, CHOCOLATE CONFECTIONS, CARAMELS, FUDGE, PASTRIES, DESSERT MIXES FOR BAKERY GOODS, CINNAMON ROLLS, SWEET ROLLS, SWEET BREADS, CAKES, TARTS AND PIES THAT CONTAIN THE SPICE CINNAMON (U.S. CL. 46).

**CLASS 35—ADVERTISING AND BUSINESS**

FOR RETAIL BAKERY SHOPS (U.S. CLS. 100, 101 AND 102).  
REBECCA SMITH, EXAMINING ATTORNEY

SN 86-043,946. CROSSPULSE, OAKLAND, CA. FILED 8-21-2013.

CROSSPULSE

THE MARK CONSISTS OF STANDARD CHARACTERS WITHOUT CLAIM TO ANY PARTICULAR FONT, STYLE, SIZE, OR COLOR.

**CLASS 9—ELECTRICAL AND SCIENTIFIC APPARATUS**

FOR AUDIO AND VIDEO RECORDINGS FEATURING MUSIC AND ARTISTIC PERFORMANCES; DOWNLOADABLE MP3 FILES AND MP3 RECORDINGS FEATURING MUSIC AND ARTISTIC PERFORMANCES; MUSICAL RECORDINGS; PRE-RECORDED CDS, VIDEO TAPES, LASER DISKS AND DVDS FEATURING MUSIC AND ARTISTIC PERFORMANCES (U.S. CLS. 21, 23, 26, 36 AND 38).

FIRST USE 12-31-1994; IN COMMERCE 12-31-1994.

**CLASS 41—EDUCATION AND ENTERTAINMENT**

FOR ARRANGING AND CONDUCTING OF CONCERTS; EDUCATION SERVICES, NAMELY, PROVIDING CLASSES, SEMINARS, AND WORKSHOPS IN THE FIELD OF MUSIC AND DANCE; ORGANIZATION OF EXHIBITIONS FOR CULTURAL OR EDUCATIONAL PURPOSES; ORGANIZING COMMUNITY FESTIVALS FEATURING PRIMARILY MUSIC AND DANCE PERFORMANCES AND ALSO PROVIDING MUSIC AND DANCE WORKSHOPS AND TRAINING (U.S. CLS. 100, 101 AND 107).

FIRST USE 12-31-1985; IN COMMERCE 12-31-1994.  
JAMES LOVELACE, EXAMINING ATTORNEY

---

SN 86-044,024. VIZUP LLC, CAMBRIDGE, MA. FILED 8-21-2013.

vizup

THE MARK CONSISTS OF STANDARD CHARACTERS WITHOUT CLAIM TO ANY PARTICULAR FONT, STYLE, SIZE, OR COLOR.

**CLASS 9—ELECTRICAL AND SCIENTIFIC APPARATUS**

FOR COMPUTER SOFTWARE FOR 3D MODEL OPTIMIZATION AND VISUALIZATION; COMPUTER SOFTWARE FOR POINT CLOUD DATA TRIANGULATION, OPTIMIZATION AND VISUALIZATION; DOWNLOADABLE 3D MODEL AND POINT CLOUD DATA FILES CONTAINING LEVEL OF DETAIL AND MULTI-RESOLUTION REPRESENTATIONS (U.S. CLS. 21, 23, 26, 36 AND 38).

FIRST USE 9-3-2002; IN COMMERCE 9-3-2002.

**CLASS 42—SCIENTIFIC AND COMPUTER SERVICES**

FOR PROVIDING VIRTUAL COMPUTER SYSTEMS AND VIRTUAL COMPUTER ENVIRONMENTS THROUGH CLOUD COMPUTING WHICH ALLOW THE USER TO OPTIMIZE AND REPAIR 3D MODELS, PRODUCE LEVEL OF DETAIL AND MULTI-RESOLUTION REPRESENTATIONS ONLINE; PROVIDING A SECURE ELECTRONIC ONLINE SYSTEM FEATURING TECHNOLOGY WHICH ALLOWS USERS TO REPAIR, DECIMATE, OPTIMIZE AND VISUALIZE 3D MODELS; PROVIDING A WEBSITE FEATURING ONLINE NON-DOWNLOADABLE SOFTWARE TOOLS FOR POLYGON AND POINT CLOUD REDUCTION, 3D OPTIMIZATION AND VISUALIZATION (U.S. CLS. 100 AND 101).

FIRST USE 7-17-2013; IN COMMERCE 7-17-2013.  
KATHERINE STOIDES, EXAMINING ATTORNEY

SN 86-044,081. THE WALLACE BARNES COMPANY, BRISTOL, CT. FILED 8-21-2013.

N-STRUTS

THE MARK CONSISTS OF STANDARD CHARACTERS WITHOUT CLAIM TO ANY PARTICULAR FONT, STYLE, SIZE, OR COLOR.

**CLASS 6—METAL GOODS**

FOR METAL HARDWARE, NAMELY, GAS STRUTS, METAL GAS SPRINGS FOR USE IN LAND VEHICLES, MARINE VEHICLES, RAIL VEHICLES, AIRCRAFT, CONSUMER PRODUCTS, AND INDUSTRIAL EQUIPMENT (U.S. CLS. 2, 12, 13, 14, 23, 25 AND 50).

**CLASS 7—MACHINERY**

FOR MACHINE PARTS, NAMELY, GAS SPRINGS, GAS SHOCKS, DAMPERS; SHOCK ABSORBERS FOR MACHINES (U.S. CLS. 13, 19, 21, 23, 31, 34 AND 35).

ANNE E. GUSTASON, EXAMINING ATTORNEY

---

SN 86-044,314. BLEUFLAMME LLC, SAN FRANCISCO, CA. FILED 8-21-2013.

ORIGINAL STITCH

THE MARK CONSISTS OF STANDARD CHARACTERS WITHOUT CLAIM TO ANY PARTICULAR FONT, STYLE, SIZE, OR COLOR.

**CLASS 25—CLOTHING**

FOR CLOTHING, NAMELY, SHIRTS (U.S. CLS. 22 AND 39).

**CLASS 40—MATERIAL TREATMENT**

FOR TAILORING SERVICES, NAMELY, CUSTOM CONSTRUCTION AND TAILORING OF CLOTHING; TAILORING SERVICES, NAMELY, CUSTOM CONSTRUCTION AND TAILORING OF CLOTHING AVAILABLE THROUGH AN ON-LINE STORE (U.S. CLS. 100, 103 AND 106).

JORDAN BAKER, EXAMINING ATTORNEY

SN 86-044,353. BLEUFLAMME LLC, SAN FRANCISCO, CA. FILED 8-21-2013.

SN 86-044,478. NUSUN ENTERTAINMENT LLC, WOODLAND HILLS, CA. FILED 8-21-2013.



NuSun Entertainment

THE MARK CONSISTS OF THREE OVERLAPPING CIRCULAR FIGURES OF EQUAL HEIGHT, THE LEFT-MOST BEING A CLOSED CIRCLE, THE CENTER AND RIGHT TOGETHER REMINISCENT OF A HORIZONTALLY-ORIENTED LETTER "S".

THE MARK CONSISTS OF STANDARD CHARACTERS WITHOUT CLAIM TO ANY PARTICULAR FONT, STYLE, SIZE, OR COLOR.

NO CLAIM IS MADE TO THE EXCLUSIVE RIGHT TO USE "ENTERTAINMENT", APART FROM THE MARK AS SHOWN.

**CLASS 25—CLOTHING**

FOR CLOTHING, NAMELY, SHIRTS (U.S. CLS. 22 AND 39).

**CLASS 9—ELECTRICAL AND SCIENTIFIC APPARATUS**

FOR DIGITAL MUSIC DOWNLOADABLE FROM THE INTERNET AND PRE-RECORDED CDS FEATURING MUSIC (U.S. CLS. 21, 23, 26, 36 AND 38).

**CLASS 40—MATERIAL TREATMENT**

FOR TAILORING SERVICES, NAMELY, CUSTOM CONSTRUCTION AND TAILORING OF CLOTHING; TAILORING SERVICES, NAMELY, CUSTOM CONSTRUCTION AND TAILORING OF CLOTHING AVAILABLE THROUGH AN ON-LINE STORE (U.S. CLS. 100, 103 AND 106).

JORDAN BAKER, EXAMINING ATTORNEY

**CLASS 35—ADVERTISING AND BUSINESS**

FOR ARTIST MANAGEMENT, TALENT AGENCY SERVICES; CONSULTING SERVICES IN THE FIELD OF MANAGING INTELLECTUAL PROPERTIES (U.S. CLS. 100, 101 AND 102).

**CLASS 41—EDUCATION AND ENTERTAINMENT**

FOR MUSIC PUBLISHING SERVICES; PRODUCTION OF LIVE MUSIC EVENTS BY THIRD PARTIES (U.S. CLS. 100, 101 AND 107).

GIANCARLO CASTRO, EXAMINING ATTORNEY

SN 86-044,393. EMERGE MEDICAL INC., DENVER, CO. FILED 8-21-2013.

SOLUTION HOLE

SN 86-044,535. TRUECAR, INC., SANTA MONICA, CA. FILED 8-21-2013.

THE MARK CONSISTS OF STANDARD CHARACTERS WITHOUT CLAIM TO ANY PARTICULAR FONT, STYLE, SIZE, OR COLOR.

TRUEDISCOUNT

**CLASS 10—MEDICAL APPARATUS**

FOR SURGICAL AND MEDICAL IMPLANTS, NAMELY, BONE SCREWS, BONE PLATES, AND SURGICAL INSTRUMENTS THEREFOR (U.S. CLS. 26, 39 AND 44).

**CLASS 40—MATERIAL TREATMENT**

FOR TREATMENT OF HUMAN BONE FOR SURGICAL IMPLANTS (U.S. CLS. 100, 103 AND 106).

ALISON POLLACK, EXAMINING ATTORNEY

THE MARK CONSISTS OF STANDARD CHARACTERS WITHOUT CLAIM TO ANY PARTICULAR FONT, STYLE, SIZE, OR COLOR.

OWNER OF U.S. REG. NOS. 3,759,175, 4,436,580 AND OTHERS.

**CLASS 35—ADVERTISING AND BUSINESS**

FOR PROVIDING MOTORIZED VEHICLE PURCHASE ADVISORY AND CONSULTING SERVICES; PROVIDING MOTORIZED VEHICLE VALUE ADVISORY AND PRICE EVALUATION SERVICES; PROVIDING INFORMATION VIA A GLOBAL COMPUTER NETWORK CONCERNING THE PRICE AND VALUE OF MOTORIZED VEHICLES; PROVIDING CONSUMER PRODUCT INFORMATION FOR THE PURPOSE OF SELECTING MOTOR VEHICLES TO MEET THE CONSUMER'S SPECIFICATIONS; STATISTICAL ANALYSIS OF NATIONAL AND REGIONAL MOTORIZED VEHICLE PRICE DATA; PROVIDING MOTORIZED VEHICLE PRICE REPORTS THAT INCLUDE A STATISTICAL ANALYSIS OF PRICE FOR A PARTICULAR VEHICLE BASED ON ACTUAL PURCHASE DATA; MARKETING AND ADVERTISING SERVICES FOR SELLERS OF NEW AND USED MOTORIZED VEHICLES, MOTORIZED VEHICLE PARTS AND ACCESSORIES, AND MOTORIZED VEHICLE REPAIR, CUSTOMIZATION AND RESTORATION SERVICES; PROVIDING CONSUMER PRODUCT INFORMATION VIA A GLOBAL COMPUTER NETWORK BASED ON MOTORIZED VEHICLE SPECIFICATIONS; PROVIDING CONSUMER PRODUCT INFORMATION VIA A GLOBAL COMPUTER NETWORK BASED ON THE GAS MILEAGE AND FUEL EFFICIENCY OF MOTORIZED VEHICLES; PROVIDING CONSUMER PRODUCT INFORMATION VIA A GLOBAL COMPUTER NETWORK IN CONNECTION WITH THE GAS MILEAGE AND FUEL EFFICIENCY OF MOTORIZED VEHICLES; PRICE DATA COMPILING AND STATISTICAL ANALYSIS CONCERNING MOTORIZED VEHICLE INSURANCE; PROVIDING CONSUMER PRODUCT INFORMATION, NAMELY, MOTORIZED VEHICLE INSURANCE PRICE REPORTS BASED ON STATISTICAL ANALYSIS OF MARKET DATA; MARKETING AND ADVERTISING SERVICES OF MOTORIZED VEHICLE INSURANCE FOR OTHERS; PROVIDING MOTORIZED VEHICLE PURCHASE AND LEASE FINANCING EVALUATION SERVICES FOR CONSUMERS; PROVIDING CONSUMER INFORMATION VIA A GLOBAL COMPUTER NETWORK IN CONNECTION WITH THE FINANCING OF MOTORIZED VEHICLE PURCHASES AND LEASES; STATISTICAL ANALYSIS OF MOTORIZED VEHICLE PURCHASE AND LEASE FINANCING DATA; PROVIDING CONSUMER INFORMATION IN THE NATURE OF MOTORIZED VEHICLE PURCHASE AND LEASE FINANCING REPORTS BASED ON STATISTICAL ANALYSIS OF MARKET DATA; MARKETING AND ADVERTISING SERVICES OF MOTORIZED VEHICLE LEASES AND MOTORIZED VEHICLE FINANCING FOR OTHERS (U.S. CLS. 100, 101 AND 102).

**CLASS 42—SCIENTIFIC AND COMPUTER SERVICES**

FOR PROVIDING A WEB SITE FEATURING TEMPORARY USE OF NON-DOWNLOADABLE SOFTWARE ALLOWING WEBSITE USERS TO SEARCH FOR, RESEARCH, PURCHASE AND SELL MOTORIZED VEHICLES; PROVIDING A WEB SITE FEATURING TEMPORARY USE OF NON-DOWNLOADABLE SOFTWARE ALLOWING WEBSITE USERS TO RESEARCH MOTORIZED VEHICLE SPECIFICATIONS; PROVIDING A WEBSITE FEATURING TEMPORARY USE OF NON-DOWNLOADABLE SOFTWARE ALLOWING WEBSITE USERS TO RESEARCH MOTORIZED VEHICLE GAS MILEAGE AND FUEL EFFICIENCY INFORMATION (U.S. CLS. 100 AND 101).

Laura Kovalsky, Examining Attorney

SN 86-044,699. EGO TECH USA INC, WALNUT, CA. FILED 8-22-2013.

**WONDER VAPE**

THE MARK CONSISTS OF STANDARD CHARACTERS WITHOUT CLAIM TO ANY PARTICULAR FONT, STYLE, SIZE, OR COLOR.

NO CLAIM IS MADE TO THE EXCLUSIVE RIGHT TO USE "VAPE", APART FROM THE MARK AS SHOWN.

**CLASS 11—ENVIRONMENTAL CONTROL APPARATUS**

FOR ELECTRIC VAPORIZERS (U.S. CLS. 13, 21, 23, 31 AND 34).

FIRST USE 6-11-2013; IN COMMERCE 6-11-2013.

**CLASS 34—SMOKERS' ARTICLES**

FOR ELECTRONIC CIGARETTES; ELECTRONIC CIGARETTE LIGHTERS; CARTOMIZERS, NAMELY, COMBINATION ELECTRONIC CIGARETTE REFILL CARTRIDGES SOLD EMPTY AND ATOMIZERS, SOLD AS A COMPONENT OF ELECTRONIC CIGARETTES (U.S. CLS. 2, 8, 9 AND 17).

FIRST USE 6-11-2013; IN COMMERCE 6-11-2013.

Natalie Polzer, Examining Attorney

SN 86-044,760. SS GENERAL TRADING, INC., DBA U.S.A. REGIONAL TRADE CENTER, DUBLIN, OH. FILED 8-22-2013.

NO CLAIM IS MADE TO THE EXCLUSIVE RIGHT TO USE "U.S.A.", APART FROM THE MARK AS SHOWN.

THE MARK CONSISTS OF A STYLIZED "U.S.A." INCLUDING A SHOOTING FIVE-POINTED STAR AND THE WORDING "RTC".

**CLASS 35—ADVERTISING AND BUSINESS**

FOR ARRANGING AND CONDUCTING SPECIAL EVENTS FOR BUSINESS PURPOSES; ARRANGING SUBSCRIPTIONS TO TELECOMMUNICATION SERVICES; BUSINESS SERVICES, NAMELY, OPERATING TELEPRESENCE ENVIRONMENTS OF OTHERS; SERVICES FOR PROVISION OF FOREIGN TRADE INFORMATION (U.S. CLS. 100, 101 AND 102).

FIRST USE 12-31-2011; IN COMMERCE 12-31-2011.

**CLASS 36—INSURANCE AND FINANCIAL**

FOR ARRANGING OF LEASES AND RENTAL AGREEMENTS FOR REAL ESTATE; RENTAL OF SPACE IN MARKETPLACES FOR SELLERS OF GOODS AND/OR SERVICES (U.S. CLS. 100, 101 AND 102).

FIRST USE 12-31-2011; IN COMMERCE 12-31-2011.

Kimberly Frye, Examining Attorney



SN 86-044,762. LITTLE LEAF STUDIOS, WINCHESTER, MA.  
FILED 8-22-2013.

SN 86-044,873. O2 ENVIRONMENTAL, MAHON, CORK,  
IRELAND, FILED 8-22-2013.

## Little Leaf Studios

## BlueTech

THE MARK CONSISTS OF STANDARD CHARACTERS WITHOUT CLAIM TO ANY PARTICULAR FONT, STYLE, SIZE, OR COLOR.

NO CLAIM IS MADE TO THE EXCLUSIVE RIGHT TO USE "STUDIOS", APART FROM THE MARK AS SHOWN.

### CLASS 41—EDUCATION AND ENTERTAINMENT

FOR PHOTOGRAPHY SERVICES (U.S. CLS. 100, 101 AND 107).

FIRST USE 10-30-2007; IN COMMERCE 1-3-2008.

### CLASS 42—SCIENTIFIC AND COMPUTER SERVICES

FOR GRAPHIC DESIGN (U.S. CLS. 100 AND 101).

FIRST USE 10-30-2007; IN COMMERCE 1-3-2008.  
KIMBERLY FRYE, EXAMINING ATTORNEY

THE MARK CONSISTS OF STANDARD CHARACTERS WITHOUT CLAIM TO ANY PARTICULAR FONT, STYLE, SIZE, OR COLOR.

OWNER OF U.S. REG. NOS. 3,916,356 AND 3,916,607.

### CLASS 9—ELECTRICAL AND SCIENTIFIC APPARATUS

FOR ELECTRONIC DATABASE IN THE FIELD OF EMERGING WATER TECHNOLOGIES RECORDED ON COMPUTER MEDIA (U.S. CLS. 21, 23, 26, 36 AND 38).

FIRST USE 3-10-2010; IN COMMERCE 3-10-2010.

### CLASS 35—ADVERTISING AND BUSINESS

FOR BUSINESS CONSULTING SERVICES IN THE FIELD OF GLOBAL WATER MARKETS (U.S. CLS. 100, 101 AND 102).

FIRST USE 3-10-2010; IN COMMERCE 3-10-2010.  
DAVID I, EXAMINING ATTORNEY

SN 86-044,870. CEDAR RAPIDS DEVELOPMENT GROUP,  
LLC, CEDAR RAPIDS, IA. FILED 8-22-2013.

SN 86-044,886. Z&H HOSPITALITY L.L.C., MINNEAPOLIS,  
MN. FILED 8-22-2013.

## CEDAR CROSSING CASINO

## AGRA CULTURE

THE MARK CONSISTS OF STANDARD CHARACTERS WITHOUT CLAIM TO ANY PARTICULAR FONT, STYLE, SIZE, OR COLOR.

NO CLAIM IS MADE TO THE EXCLUSIVE RIGHT TO USE "CASINO", APART FROM THE MARK AS SHOWN.

### CLASS 41—EDUCATION AND ENTERTAINMENT

FOR CASINOS (U.S. CLS. 100, 101 AND 107).

### CLASS 43—HOTEL AND RESTAURANT SERVICES

FOR RESTAURANT SERVICES (U.S. CLS. 100 AND 101).

KRISTIN DAHLING, EXAMINING ATTORNEY

THE MARK CONSISTS OF STANDARD CHARACTERS WITHOUT CLAIM TO ANY PARTICULAR FONT, STYLE, SIZE, OR COLOR.

### CLASS 35—ADVERTISING AND BUSINESS

FOR RESTAURANT FRANCHISING, NAMELY, OFFERING BUSINESS MANAGEMENT ASSISTANCE IN THE ESTABLISHMENT AND OPERATION OF RESTAURANTS (U.S. CLS. 100, 101 AND 102).

### CLASS 43—HOTEL AND RESTAURANT SERVICES

FOR RESTAURANT AND TAKE-OUT RESTAURANT SERVICES (U.S. CLS. 100 AND 101).

SAIMA MAKHDOOM, EXAMINING ATTORNEY

SN 86-044,932. CLARK, SUNDARA, GARBERVILLE, CA.  
FILED 8-22-2013.

SN 86-045,497. KHALIPA, INC., DBA NORCAL CROSSFIT,  
SAN JOSE, CA 95129, CA. FILED 8-22-2013.

## Vixen Kitchen

THE MARK CONSISTS OF STANDARD CHARACTERS WITHOUT CLAIM TO ANY PARTICULAR FONT, STYLE, SIZE, OR COLOR.

NO CLAIM IS MADE TO THE EXCLUSIVE RIGHT TO USE "KITCHEN", APART FROM THE MARK AS SHOWN.

### CLASS 29—MEATS AND PROCESSED FOODS

FOR CANDIED NUTS (U.S. CL. 46).  
FIRST USE 5-17-2013; IN COMMERCE 5-17-2013.

### CLASS 30—STAPLE FOODS

FOR FROZEN CASHEW-BASED DESSERTS (U.S. CL. 46).  
FIRST USE 5-17-2013; IN COMMERCE 5-17-2013.  
CHRISTOPHER LAW, EXAMINING ATTORNEY

SN 86-045,009. DN LIGHTING CO., LTD., HIRATSUKA,  
KANAGAWA PR, JAPAN, FILED 8-22-2013.

## DN LIGHTING CO., LTD.

THE MARK CONSISTS OF STANDARD CHARACTERS WITHOUT CLAIM TO ANY PARTICULAR FONT, STYLE, SIZE, OR COLOR.

NO CLAIM IS MADE TO THE EXCLUSIVE RIGHT TO USE "LIGHTING CO., LTD.", APART FROM THE MARK AS SHOWN.

### CLASS 35—ADVERTISING AND BUSINESS

FOR SERVICES RELATING TO LIGHTING RELATED GOODS, NAMELY, WHOLESALE DISTRIBUTORSHIPS FEATURING LIGHTING GOODS (U.S. CLS. 100, 101 AND 102).

### CLASS 40—MATERIAL TREATMENT

FOR SERVICES RELATING TO LIGHTING RELATED GOODS, NAMELY, MANUFACTURING OF LIGHTING GOODS TO THE ORDER AND SPECIFICATION OF OTHERS (U.S. CLS. 100, 103 AND 106).  
ROSELLE HERRERA, EXAMINING ATTORNEY

The logo for "GO MAT" features the word "GO" in a large, bold, black, sans-serif font above the word "MAT" in a similar but slightly smaller font. Both words are slanted to the right, giving the logo a dynamic, energetic feel.

NO CLAIM IS MADE TO THE EXCLUSIVE RIGHT TO USE "MAT" AS TO CLASSES 27 AND 28 ONLY., APART FROM THE MARK AS SHOWN.

THE MARK CONSISTS OF ANGLED TEXT READING "GO MAT".

### CLASS 16—PAPER GOODS AND PRINTED MATTER

FOR PRINTED PAMPHLETS, BROCHURES, MANUALS, BOOKS, BOOKLETS, LEAFLETS, INFORMATIONAL FLYERS, INFORMATIONAL SHEETS AND NEWSLETTERS, ADHESIVE BACKED STICKERS, AND KITS COMPRISING ONE OR MORE OF THE FOREGOING MATERIALS IN THE FIELD OF EXERCISE, FITNESS, HEALTH, AND PERSONAL MOTIVATION; STICKERS; STICKERS AND STICKER ALBUMS; STICKERS AND TRANSFERS (U.S. CLS. 2, 5, 22, 23, 29, 37, 38 AND 50).

### CLASS 27—FLOOR COVERINGS

FOR ANTI-FATIGUE FLOOR MAT; ANTI-FATIGUE FLOOR MATS MADE PRIMARILY OF FOAM AND/OR RUBBER; ANTI-SLIP FLOOR MATS MADE PRIMARILY OF FOAM AND/OR RUBBER; ANTI-STATIC MATS FOR NON-SAFETY USE; BEACH MATS; CARPETS, RUGS, MATS AND MATTING, LINOLEUM FOR COVERING EXISTING FLOORS; FLOOR MAT SYSTEMS COMPRISED PRIMARILY OF FLOOR MATS MADE OF FOAM AND/OR RUBBER; FLOOR MATS; FLOOR MATS FEATURING LOGOS MADE PRIMARILY OF FOAM AND/OR RUBBER; GYMNASIUM EXERCISE MATS; GYMNASIUM MATS; PERSONAL SITTING MATS; RUBBER MATS (U.S. CLS. 19, 20, 37, 42 AND 50).

### CLASS 28—TOYS AND SPORTING GOODS

FOR FITNESS EQUIPMENT, NAMELY, STRAPS USED FOR YOGA AND OTHER FITNESS ACTIVITIES AND FOR CARRYING A YOGA MAT; MEDITATION MATS; PERSONAL EXERCISE MATS; YOGA ACCESSORIES, NAMELY, YOGA MAT CARRYING APPARATUS COMPRISING A CENTRAL WINDING CORE AFFIXED TO REMOVABLE END CAPS; YOGA MATS (U.S. CLS. 22, 23, 38 AND 50).  
NANCY CLARKE, EXAMINING ATTORNEY

SN 86-045,627. MONSTER ENERGY COMPANY, CORONA, CA. FILED 8-22-2013.

SN 86-046,181. RECOLOGY INC., SAN FRANCISCO, CA. FILED 8-23-2013.

## PEACE LOVE TEA

THE MARK CONSISTS OF STANDARD CHARACTERS WITHOUT CLAIM TO ANY PARTICULAR FONT, STYLE, SIZE, OR COLOR.

OWNER OF U.S. REG. NO. 3,838,986.  
NO CLAIM IS MADE TO THE EXCLUSIVE RIGHT TO USE "TEA", APART FROM THE MARK AS SHOWN.

### CLASS 30—STAPLE FOODS

FOR READY TO DRINK TEA, ICED TEA AND TEA BASED BEVERAGES; READY TO DRINK FLAVORED TEA, ICED TEA AND TEA BASED BEVERAGES (U.S. CL. 46).

### CLASS 32—LIGHT BEVERAGES

FOR NON-ALCOHOLIC BEVERAGES WITH TEA FLAVOR; NON-ALCOHOLIC BEVERAGES CONTAINING FRUIT JUICES; NON-ALCOHOLIC BEVERAGES WITH TEA FLAVOR AND CONTAINING FRUIT JUICES (U.S. CLS. 45, 46 AND 48).

ZHALEH DELANEY, EXAMINING ATTORNEY



SN 86-045,725. GOODSNITCH, LLC, WILMINGTON, DE. FILED 8-22-2013.

**Goodsnitch**

THE MARK CONSISTS OF THE TERM "GOODSNITCH" HAVING A SEMICIRCLE UNDER THE DOUBLE "OO" WHICH ARE CONNECTED BY A LINE TO FORM A SMILEY FACE.

### CLASS 9—ELECTRICAL AND SCIENTIFIC APPARATUS

FOR COMPUTER SOFTWARE PLATFORM WHICH ALLOWS USERS TO UPLOAD, POST, SHARE, REVIEW AND RATE THIRD PARTY GOODS AND SERVICES (U.S. CLS. 21, 23, 26, 36 AND 38).

### CLASS 42—SCIENTIFIC AND COMPUTER SERVICES

FOR PLATFORM AS A SERVICE (PAAS) FEATURING A COMPUTER SOFTWARE PLATFORM WHICH ALLOWS USERS TO UPLOAD, POST, SHARE, REVIEW AND RATE THIRD PARTY GOODS AND SERVICES (U.S. CLS. 100 AND 101).

RENEE MCCRAY, EXAMINING ATTORNEY

OWNER OF U.S. REG. NO. 3,955,290.  
NO CLAIM IS MADE TO THE EXCLUSIVE RIGHT TO USE "REDUCE", "REUSE", AND "RECYCLE", APART FROM THE MARK AS SHOWN.

THE MARK CONSISTS OF THE WORDS "REDUCE REUSE RECYCLE RECOLOGIZE!" EACH OF WHICH IS SEPARATED BY A LEAF DESIGN AND ALL OF WHICH SURROUND A REPRESENTATION OF THE PLANET EARTH WITH VARIOUS LEAF DESIGNS SCATTERED OVER THE PLANET DESIGN.

### CLASS 37—CONSTRUCTION AND REPAIR

FOR SOLID WASTE MANAGEMENT, NAMELY, WASTE DISPOSAL; WASTE DISPOSAL FOR OTHERS; CONSULTING SERVICES RELATED TO WASTE DISPOSAL; COLLECTION OF TRASH; REFUSE CLEAN-UP; COLLECTION OF FOOD WASTE AND ORGANIC WASTE FOR PURPOSES OF CONVERTING IT TO COMPOST, SOIL AMENDMENT, PLANT FOOD, SOIL CONDITIONERS, PLANTING AND POTTING SOIL, TOPSOIL, PLANTER MIX AND MULCH (U.S. CLS. 100, 103 AND 106).

### CLASS 39—TRANSPORTATION AND STORAGE

FOR SOLID WASTE MANAGEMENT, NAMELY, WASTE COLLECTION IN THE NATURE OF TRANSPORTING WASTE; CONSULTING SERVICES RELATED TO WASTE COLLECTION IN THE NATURE OF TRANSPORTING WASTE; GARBAGE COLLECTION AND TRANSPORT BY TRUCK; RENTAL OF DUMPSTERS (U.S. CLS. 100 AND 105).

**CLASS 40—MATERIAL TREATMENT**

FOR WASTE MANAGEMENT; SOLID WASTE MANAGEMENT INCLUDING COMPOSTING AND RECYCLING; RECYCLING AND WASTE TREATMENT; CONSULTATION IN THE FIELD OF WASTE TREATMENT; CONSULTATION IN THE FIELD OF RECYCLING; RECYCLING AND WASTE TREATMENT SERVICES; SORTING OF WASTE AND RECYCLABLE MATERIAL; TREATMENT OF WASTE MATERIALS TO CONVERT THEM INTO PLANT FOOD PRODUCTS; CONSULTATION WITH REGARD TO TREATMENT OF WASTE MATERIALS; WASTE TREATMENT SERVICES AND PROVIDING TECHNICAL CONSULTATION IN CONNECTION THEREWITH; RECYCLING; WASTE-TO-ENERGY GENERATION SERVICES; RESOURCE RECOVERY AND RECLAMATION SERVICES, NAMELY, SORTING PLASTICS, PAPER, CARDBOARD, GLASS AND METAL; RECYCLING OF WASTE AND TRASH; CONSULTING SERVICES RELATED TO WASTE TREATMENT; MATERIAL TREATMENT SERVICES IN CONNECTION WITH WASTE PROCESSING, RECYCLING AND RECYCLING OF ORGANIC MATERIALS, LEAVES, LOGS, GRASS, BRUSH, CLEAN WOOD WASTE, WOOD, TIMBER, TREE TRIMMINGS, VEGETABLE WASTE, VEGETATION, PLANTS, ORGANIC WASTE, PLANT MATERIAL, TREES, FLOWER BEDDING, YARD WASTE, MIXED YARD WASTE, PRE-CONSUMER FOOD WASTE, POST-CONSUMER FOOD WASTE, ORGANIC LEFTOVER FROM FOOD PROCESSING AND ORGANIC PRODUCTS; MATERIAL TREATMENT SERVICES IN CONNECTION WITH AEROBIC DECOMPOSITION AND DECAYING OF ORGANIC MATERIALS, NAMELY, GRINDING AND MIXING OF ORGANIC MATERIALS, LOGS, LEAVES, GRASS, BRUSH, CLEAN WOOD WASTE, WOOD, TIMBER, TREE TRIMMINGS, VEGETABLE WASTE, VEGETATION, PLANTS, ORGANIC WASTE, PLANT MATERIAL, TREES, FLOWER BEDDING, YARD WASTE, MIXED YARD WASTE, PRE-CONSUMER FOOD WASTE, POST-CONSUMER FOOD WASTE, ORGANIC LEFTOVER FROM FOOD PROCESSING AND ORGANIC PRODUCTS; RECYCLING FOR OTHERS, CUSTOM PRODUCTION FOR OTHERS OF COMPOST, SOIL AMENDMENTS, PLANT FOOD, SOIL CONDITIONERS, PLANTING AND POTTING SOIL, TOPSOIL, PLANTER MIX AND MULCH FROM RECYCLED ORGANIC MATERIALS, NAMELY, LEAVES, LOGS, GRASS, BRUSH, CLEAN WOOD WASTE, WOOD, TIMBER, TREE TRIMMINGS, VEGETABLE (U.S. CLS. 100, 103 AND 106).  
INGRID C. EULIN, EXAMINING ATTORNEY

SN 86-046,261. SPEEDO INTERNATIONAL LIMITED, LONDON, UNITED KINGDOM, FILED 8-23-2013.



THE MARK CONSISTS OF A STYLIZED LETTER "C" COMPRISED OF THREE COMPONENTS WITH THE TOP COMPONENT BEING A THICK PORTION, THE SIDE COMPONENT BEING A THINNER PORTION AND THE BOTTOM COMPONENT BEING THE THINNEST PORTION.

**CLASS 9—ELECTRICAL AND SCIENTIFIC APPARATUS**

FOR COMPUTER APPLICATION SOFTWARE FOR USE IN RESEARCHING, TRAINING, TRACKING, GOAL SETTING AND SOCIAL NETWORKING IN THE FIELD OF SWIMMING, HEALTH AND FITNESS; DOWNLOADABLE COMPUTER SOFTWARE FOR USE IN RESEARCHING, TRAINING, TRACKING, GOAL SETTING AND SOCIAL NETWORKING IN THE FIELD OF SWIMMING, HEALTH AND FITNESS; DOWNLOADABLE MOBILE APPLICATIONS FOR USE IN RESEARCHING, TRAINING, TRACKING, GOAL SETTING AND SOCIAL NETWORKING IN THE FIELD OF SWIMMING, HEALTH AND FITNESS (U.S. CLS. 21, 23, 26, 36 AND 38).  
FIRST USE 6-0-2011; IN COMMERCE 6-0-2011.

**CLASS 35—ADVERTISING AND BUSINESS**

FOR PROVIDING AN ONLINE DIRECTORY INFORMATION SERVICE FEATURING INFORMATION REGARDING, AND IN THE NATURE OF, TRAINING FOR SWIMMING AND AQUATIC EVENTS AND SOCIAL NETWORKING FOR SWIMMERS (U.S. CLS. 100, 101 AND 102).  
FIRST USE 6-0-2011; IN COMMERCE 6-0-2011.

**CLASS 38—COMMUNICATION**

FOR PROVIDING ONLINE CHAT ROOMS FOR REGISTERED USERS FOR TRANSMISSION OF MESSAGES CONCERNING TRAINING AND COMPETING IN AQUATIC EVENTS AND SOCIAL NETWORKING FOR SWIMMERS (U.S. CLS. 100, 101 AND 104).  
FIRST USE 6-0-2011; IN COMMERCE 6-0-2011.  
JENNIFER WILLISTON, EXAMINING ATTORNEY

SN 86-046,578. FREELIFE INTERNATIONAL HOLDINGS, LLC, PHOENIX, AZ. FILED 8-23-2013.

**TAIFIT**

THE MARK CONSISTS OF STANDARD CHARACTERS WITHOUT CLAIM TO ANY PARTICULAR FONT, STYLE, SIZE, OR COLOR.

**CLASS 5—PHARMACEUTICALS**

FOR DIETARY AND NUTRITIONAL SUPPLEMENTS; DIETARY SUPPLEMENTAL DRINKS; DIETARY SUPPLEMENT BEVERAGES FOR ENERGY, HYDRATION AND RE-HYDRATION (U.S. CLS. 6, 18, 44, 46, 51 AND 52).  
FIRST USE 8-23-2013; IN COMMERCE 8-23-2013.

**CLASS 32—LIGHT BEVERAGES**

FOR ENERGY DRINKS; SPORTS DRINKS, NAMELY, HYDRATION DRINKS; SPORTS DRINKS, NAMELY, PHYSICAL ACTIVITY RECOVERY DRINKS; SPORTS DRINKS, NAMELY, ENERGY, PERFORMANCE AND RECOVERY DRINKS; POWDERS USED IN THE PREPARATION OF SPORTS DRINKS; POWDERS USED IN THE PREPARATION OF HYDRATION DRINKS; POWDERS USED IN THE PREPARATION OF ENERGY DRINKS; POWDERS USED IN THE PREPARATION OF ISOTONIC SPORTS DRINKS AND SPORTS BEVERAGES (U.S. CLS. 45, 46 AND 48).  
FIRST USE 8-23-2013; IN COMMERCE 8-23-2013.  
JEFF DEFORD, EXAMINING ATTORNEY

SN 86-046,593. FREELIFE INTERNATIONAL HOLDINGS, LLC, PHOENIX, AZ. FILED 8-23-2013.

# HYDRAZONE

THE MARK CONSISTS OF STANDARD CHARACTERS WITHOUT CLAIM TO ANY PARTICULAR FONT, STYLE, SIZE, OR COLOR.

## CLASS 5—PHARMACEUTICALS

FOR DIETARY AND NUTRITIONAL SUPPLEMENTS; DIETARY SUPPLEMENTAL DRINKS; DIETARY SUPPLEMENT BEVERAGES FOR ENERGY, HYDRATION AND RE-HYDRATION (U.S. CLS. 6, 18, 44, 46, 51 AND 52).

FIRST USE 8-23-2013; IN COMMERCE 8-23-2013.

## CLASS 32—LIGHT BEVERAGES

FOR ENERGY DRINKS; SPORTS DRINKS, NAMELY, HYDRATION DRINKS; SPORTS DRINKS, NAMELY, PHYSICAL ACTIVITY RECOVERY DRINKS; SPORTS DRINKS, NAMELY, ENERGY, PERFORMANCE AND RECOVERY DRINKS; POWDERS USED IN THE PREPARATION OF SPORTS DRINKS; POWDERS USED IN THE PREPARATION OF HYDRATION DRINKS; POWDERS USED IN THE PREPARATION OF ENERGY DRINKS; POWDERS USED IN THE PREPARATION OF ISOTONIC SPORTS DRINKS AND SPORTS BEVERAGES (U.S. CLS. 45, 46 AND 48).

FIRST USE 8-23-2013; IN COMMERCE 8-23-2013.

JEFF DEFORD, EXAMINING ATTORNEY

SN 86-046,825. USA PADEL, HOUSTON, TX. FILED 8-23-2013.



NO CLAIM IS MADE TO THE EXCLUSIVE RIGHT TO USE "USA PADEL", APART FROM THE MARK AS SHOWN.

THE MARK CONSISTS OF A PADEL RACQUET, WITH A SWOOSH FOLLOWED BY A TENNIS BALL. IN THE SWOOSH THE NAME "PADEL" IS WRITTEN IN ALL CAPITAL LETTERS. JUST ABOVE THAT "USA" IS WRITTEN IN BIG CAPITAL LETTERS AS WELL.

## CLASS 35—ADVERTISING AND BUSINESS

FOR ON-LINE RETAIL STORE SERVICES FEATURING PADEL COURTS, PADEL RACQUETS, CLOTHES, SHOES, GRIPS, BALLS, AND ACCESSORIES RELATED TO THE SPORT OF PADEL; RETAIL SERVICES BY DIRECT SOLICITATION BY SALES AGENTS IN THE FIELD OF PADEL COURTS, PADEL RACQUETS, CLOTHES, SHOES, GRIPS, BALLS, AND ACCESSORIES RELATED TO THE SPORT OF PADEL; RETAIL STORE SERVICES FEATURING PADEL COURTS, PADEL RACQUETS, CLOTHES, SHOES, GRIPS, BALLS, AND ACCESSORIES RELATED TO THE SPORT OF PADEL (U.S. CLS. 100, 101 AND 102).

FIRST USE 5-5-2007; IN COMMERCE 5-5-2007.

## CLASS 37—CONSTRUCTION AND REPAIR

FOR INSTALLATION OF PADEL COURTS (U.S. CLS. 100, 103 AND 106).

FIRST USE 5-5-2007; IN COMMERCE 5-5-2007.  
SIDDHARTH JAGANNATHAN, EXAMINING ATTORNEY

SN 86-047,039. HEER, DAIN, HOUSTON, TX. FILED 8-23-2013.

## THE AWARENESS REVOLUTION

THE MARK CONSISTS OF STANDARD CHARACTERS WITHOUT CLAIM TO ANY PARTICULAR FONT, STYLE, SIZE, OR COLOR.

NO CLAIM IS MADE TO THE EXCLUSIVE RIGHT TO USE "AWARENESS", APART FROM THE MARK AS SHOWN.

## CLASS 9—ELECTRICAL AND SCIENTIFIC APPARATUS

FOR DIGITAL MEDIA, NAMELY, PRE-RECORDED DVDS, DOWNLOADABLE AUDIO AND VIDEO RECORDINGS, AND CDS FEATURING AND PROMOTING PERSONAL AWARENESS (U.S. CLS. 21, 23, 26, 36 AND 38).

## CLASS 16—PAPER GOODS AND PRINTED MATTER

FOR BOOKS AND PAMPHLETS IN THE FIELD OF PERSONAL AWARENESS (U.S. CLS. 2, 5, 22, 23, 29, 37, 38 AND 50).

## CLASS 38—COMMUNICATION

FOR STREAMING OF AUDIO, VISUAL AND AUDIO-VISUAL MATERIAL VIA A GLOBAL COMPUTER NETWORK (U.S. CLS. 100, 101 AND 104).

## CLASS 41—EDUCATION AND ENTERTAINMENT

FOR EDUCATIONAL SERVICES, NAMELY, CONDUCTING SEMINARS, LECTURES, TELESEMINARS, TELECLASSES, AND WORKSHOPS IN PERSONAL AWARENESS; PROVIDING A WEBSITE FEATURING BLOGS AND NON-DOWNLOADABLE PUBLICATIONS IN THE NATURE OF ARTICLES IN THE FIELD OF PERSONAL AWARENESS; EDUCATION AND ENTERTAINMENT SERVICES, NAMELY, PRODUCTION AND DISTRIBUTION OF ONGOING TELEVISION PROGRAMS IN THE FIELD OF PERSONAL AWARENESS (U.S. CLS. 100, 101 AND 107).

DEIRDRE ROBERTSON, EXAMINING ATTORNEY

SN 86-047,219. ERIN EDWARDS, TULSA, OK. FILED 8-24-2013.

## THE VINTAGE PEARL

THE MARK CONSISTS OF STANDARD CHARACTERS WITHOUT CLAIM TO ANY PARTICULAR FONT, STYLE, SIZE, OR COLOR.

OWNER OF U.S. REG. NO. 4,288,714.

### CLASS 25—CLOTHING

FOR CLOTHING ITEMS, NAMELY, T-SHIRTS, BLOUSES, APRONS, HATS, SWEATSHIRTS, DRESSES, SKIRTS, JACKETS (U.S. CLS. 22 AND 39).

FIRST USE 6-15-2006; IN COMMERCE 11-22-2006.

### CLASS 35—ADVERTISING AND BUSINESS

FOR RETAIL CLOTHING STORE (U.S. CLS. 100, 101 AND 102).

FIRST USE 6-15-2006; IN COMMERCE 11-22-2006.

SUSAN RICHARDS, EXAMINING ATTORNEY

SN 86-047,369. MEDIA3 TECHNOLOGIES, LLC, AKA MEDIA3THREE MEDIA3.COM MEDIA3.NET, PEMBROKE, MA. FILED 8-25-2013.

# media3

THE MARK CONSISTS OF STANDARD CHARACTERS WITHOUT CLAIM TO ANY PARTICULAR FONT, STYLE, SIZE, OR COLOR.

OWNER OF U.S. REG. NO. 4,388,015.

### CLASS 9—ELECTRICAL AND SCIENTIFIC APPARATUS

FOR COMPUTER TELEPHONY SOFTWARE; DIGITAL TELEPHONE PLATFORMS AND SOFTWARE (U.S. CLS. 21, 23, 26, 36 AND 38).

### CLASS 38—COMMUNICATION

FOR (BASED ON USE IN COMMERCE) ELECTRONIC MAIL AND MESSAGING SERVICES; ELECTRONIC TRANSMISSION OF MESSAGES AND DATA (BASED ON INTENT TO USE) AUTOMATED TELEPHONE VOICE MESSAGE SERVICES; BROADCAST COMMUNICATION SERVICES, NAMELY, TRANSMITTING E-MAILS, FAXES, TEXT MESSAGES AND TELEPHONE VOICE MESSAGES TO DESIGNATED RECIPIENTS FOR OTHERS; TELECOMMUNICATION SERVICES IN THE NATURE OF PROVIDING TELEPHONE SERVICES WITH VARIOUS TELEPHONE FEATURES, NAMELY, A DEDICATED TOLL-FREE NUMBER, VOICEMAIL, MULTIPLE MAILBOX EXTENSIONS, TELEPHONE MESSAGE NOTIFICATION, FAX CAPABILITIES, DETAILED CALL REPORTS, CALL WAITING, CALL IDENTIFICATION, CALL FORWARDING, AND MESSAGE WAITING; TELECOMMUNICATION SERVICES, NAMELY, LOCAL AND LONG DISTANCE TRANSMISSION OF VOICE, DATA, GRAPHICS BY MEANS OF TELEPHONE, TELEGRAPHIC, CABLE, AND SATELLITE TRANSMISSIONS; TELECOMMUNICATION SERVICES, NAMELY, PROVIDING ADVANCED CALLING FEATURES, NAMELY, CHANGING ONE'S CALLER ID, RECORDING CALLS, CHANGING THE SOUND OF ONE'S VOICE OVER THE PHONE, AND STRAIGHT-TO-VOICEMAIL CALLS; TELECOMMUNICATION SERVICES, NAMELY, PROVIDING ADVANCED CALLING FEATURES, NAMELY, PROVIDING THE ABILITY TO RECORD VOICE MEMOS AFTER A TELEPHONE CALL BY LEAVING A MESSAGE THAT WILL BE RECORDED SEPARATELY AND SAVED ONLINE AS A FILE WHICH CAN THEN BE EMAILED, SHARED OR KEPT PRIVATE BASED ON THE USER SETTINGS; TELECOMMUNICATIONS RESELLER SERVICES FOR BUSINESSES, NAMELY, PROVIDING LONG DISTANCE TELECOMMUNICATION SERVICES, VOICE TELECOMMUNICATION SERVICES, LOCAL TELEPHONE SERVICE, AND INTERNET ACCESS SERVICES; TELEPHONE COMMUNICATION SERVICES; TELEPHONE VOICE MESSAGING SERVICES (U.S. CLS. 100, 101 AND 104).

FIRST USE 6-1-1995, THE MARK WAS FIRST USED ANYWHERE IN A DIFFERENT FORM OTHER THAN THAT SOUGHT TO BE REGISTERED AT LEAST AS EARLY AS 06/01/1995.; IN COMMERCE 6-1-1995, THE MARK WAS FIRST USED IN COMMERCE IN A DIFFERENT FORM OTHER THAN THAT SOUGHT TO BE REGISTERED AT LEAST AS EARLY AS 06/01/1995..

RONALD MCMORROW, EXAMINING ATTORNEY

SN 86-047,892. LUTHERAN SOCIAL MINISTRIES OF NEW JERSEY, INC., BURLINGTON, NJ. FILED 8-26-2013.

## Lutheran Crossings Enhanced Living

THE MARK CONSISTS OF STANDARD CHARACTERS WITHOUT CLAIM TO ANY PARTICULAR FONT, STYLE, SIZE, OR COLOR.

NO CLAIM IS MADE TO THE EXCLUSIVE RIGHT TO USE "LUTHERAN" AND "ENHANCED LIVING", APART FROM THE MARK AS SHOWN.

**CLASS 43—HOTEL AND RESTAURANT SERVICES**

FOR ARRANGING TEMPORARY HOUSING ACCOMMODATIONS; CHARITABLE SERVICES, NAMELY, PROVIDING SAFE AND AFFORDABLE HOUSING TO THOSE IN NEED; PROVIDING ASSISTANCE TO SENIOR CITIZENS SEEKING TO DETERMINE ASSISTED LIVING FACILITIES APPROPRIATE FOR THEIR NEEDS; PROVIDING ASSISTED LIVING FACILITIES; PROVIDING ELDER CARE; PROVIDING INDEPENDENT LIVING RESIDENCES AND LIVING FACILITIES; RENTAL OF ROOMS AS TEMPORARY LIVING ACCOMMODATIONS; RETIREMENT HOMES (U.S. CLS. 100 AND 101).

**CLASS 44—MEDICAL, BEAUTY AND AGRICULTURAL SERVICES**

FOR CHARITABLE SERVICES, NAMELY, PROVIDING HEALTH CARE SERVICES IN THE NATURE OF REHABILITATION AND PATIENT CARE TO THE SICK AND ELDERLY; HEALTH CARE SERVICES FOR TREATING THE SICK AND ELDERLY; HEALTH COUNSELING; MENTAL HEALTH SERVICES; MENTAL HEALTH THERAPY SERVICES; NURSING CARE; NURSING HOMES; PSYCHOLOGICAL ASSESSMENT SERVICES; PSYCHOLOGICAL COUNSELING; REHABILITATION PATIENT CARE SERVICES; REHABILITATION PATIENT CARE SERVICES WHICH INCLUDES INPATIENT AND OUTPATIENT CARE (U.S. CLS. 100 AND 101).

**CLASS 45—PERSONAL AND LEGAL SERVICES**

FOR PERSONAL CARE ASSISTANCE OF ACTIVITIES OF DAILY LIVING, SUCH AS BATHING, GROOMING AND PERSONAL MOBILITY FOR MENTALLY OR PHYSICALLY CHALLENGED PEOPLE; PROVIDING PERSONAL SUPPORT SERVICES FOR CAREGIVERS, PARTNERS, WIVES AND HUSBANDS OF THE CHRONICALLY ILL AND/OR DISABLED, NAMELY, COMPANIONSHIP AND EMOTIONAL SUPPORT; PROVIDING PERSONAL SUPPORT SERVICES FOR FAMILIES OF PATIENTS WITH LIFE THREATENING DISORDERS, NAMELY, COMPANIONSHIP, HELP WITH MEDICAL FORMS, EMOTIONAL COUNSELING AND EMOTIONAL SUPPORT; PROVIDING PERSONAL SUPPORT SERVICES FOR PATIENTS AND FAMILIES OF PATIENTS, NAMELY, EMOTIONAL COUNSELING AND EMOTIONAL SUPPORT (U.S. CLS. 100 AND 101).  
GEOFFREY FOSDICK, EXAMINING ATTORNEY

SN 86-048,071. DEAN COASTAL LLC, SAN ANTONIO, TX. FILED 8-26-2013.



THE MARK CONSISTS OF THE LITERAL ELEMENTS "BAYTEK" WRITTEN IN STYLIZED FORM WHEREIN WAVE LINES LIKE A FISH TAIL ARE PLACED TOWARDS LEFT OF MARK.

**CLASS 25—CLOTHING**

FOR CLOTHING, NAMELY, HATS, T-SHIRTS, HOODED SWEATSHIRTS; HEADWEAR; SWIM CAPS; SWIM SUITS; SWIM WEAR (U.S. CLS. 22 AND 39).

**CLASS 28—TOYS AND SPORTING GOODS**

FOR FISHING RODS; SWIM FINNS; SWIM BOARDS FOR RECREATIONAL USE; SWIM FLOATS FOR RECREATIONAL USE; FLOATS FOR RECREATIONAL USE, NAMELY, ARM FLOATS, FOAM FLOATS (U.S. CLS. 22, 23, 38 AND 50).

PAUL CROWLEY, EXAMINING ATTORNEY

SN 86-048,162. WORD OF FAITH INTERNATIONAL CHRISTIAN CENTER, SOUTHFIELD, MI. FILED 8-26-2013.

# FAITH REPUBLIC

THE MARK CONSISTS OF STANDARD CHARACTERS WITHOUT CLAIM TO ANY PARTICULAR FONT, STYLE, SIZE, OR COLOR.

**CLASS 9—ELECTRICAL AND SCIENTIFIC APPARATUS**

FOR AUDIO AND VISUAL PERFORMANCES BY A MUSICAL GROUP RECORDED ON AUDIO CASSETTES, CDS, AND DVDS (U.S. CLS. 21, 23, 26, 36 AND 38).

**CLASS 41—EDUCATION AND ENTERTAINMENT**

FOR ENTERTAINMENT IN THE NATURE OF LIVE AUDIO PERFORMANCES BY A MUSICAL GROUP; ENTERTAINMENT SERVICES IN THE NATURE OF LIVE MUSICAL PERFORMANCES; ENTERTAINMENT SERVICES IN THE NATURE OF LIVE MUSICAL PERFORMANCES; LIVE PERFORMANCES BY A MUSICAL GROUP (U.S. CLS. 100, 101 AND 107).

GISELLE AGOSTO, EXAMINING ATTORNEY

SN 86-048,486. ARCSOFT, INC., FREMONT, CA. FILED 8-26-2013.

# ARCLINK

THE MARK CONSISTS OF STANDARD CHARACTERS WITHOUT CLAIM TO ANY PARTICULAR FONT, STYLE, SIZE, OR COLOR.

**CLASS 9—ELECTRICAL AND SCIENTIFIC APPARATUS**

FOR COMPUTER SOFTWARE FOR CONNECTING, ACCESSING, CONTROLLING, AND OTHERWISE USING A COMPUTING OR ELECTRONIC DEVICE FROM ANOTHER COMPUTING DEVICE; COMPUTER SOFTWARE FOR DATA BACKUP, SYNCHRONIZATION AND RECOVERY (U.S. CLS. 21, 23, 26, 36 AND 38).

**CLASS 42—SCIENTIFIC AND COMPUTER SERVICES**

FOR PROVIDING ON-LINE NON-DOWNLOADABLE SOFTWARE FOR CONNECTING, ACCESSING, CONTROLLING, AND OTHERWISE USING A COMPUTING OR ELECTRONIC DEVICE FROM ANOTHER COMPUTING DEVICE; PROVIDING ON-LINE NON-DOWNLOADABLE SOFTWARE FOR DATA BACKUP, SYNCHRONIZATION AND RECOVERY; REMOTE BACKUP SERVICES FOR COMPUTERS AND ELECTRONIC DEVICES; WEBSITE HOSTING AND WEBSITE BUILDING SERVICE, NAMELY, WEBSITE CREATION AND DESIGN FOR OTHERS; ON-LINE NON-DOWNLOADABLE SOFTWARE FOR MANAGING ACCOUNT INFORMATION (U.S. CLS. 100 AND 101).

WILLIAM ROSSMAN, EXAMINING ATTORNEY

**CLASS 3—COSMETICS AND CLEANING PREPARATIONS**

FOR COSMETIC PREPARATIONS FOR THE CARE OF MOUTH AND TEETH, NAMELY, ORAL MISTS; BREATH FRESHENERS; TOOTHPASTE; COSMETIC TOOTH WHITENING PREPARATIONS (U.S. CLS. 1, 4, 6, 50, 51 AND 52).

**CLASS 21—HOUSEWARES AND GLASS**

FOR DENTAL FLOSSERS (U.S. CLS. 2, 13, 23, 29, 30, 33, 40 AND 50).

HEATHER THOMPSON, EXAMINING ATTORNEY

SN 86-050,461. VALENT BIOSCIENCES CORPORATION, LIBERTYVILLE, IL. FILED 8-28-2013.



NO CLAIM IS MADE TO THE EXCLUSIVE RIGHT TO USE "BIORATIONAL WINDOW TARGETED APPLICATION", APART FROM THE MARK AS SHOWN.

THE COLOR(S) GREEN, BLACK, WHITE, RED, YELLOW, GREY, AND BLUE IS/ARE CLAIMED AS A FEATURE OF THE MARK.

THE MARK CONSISTS OF THE WORD "BIORATIONAL", IN GREEN, ABOVE THE WORD "WINDOW", WHICH IS BLACK. INSIDE THE LETTER "O" IN "WINDOW", THERE IS A DART BOARD. THE DART BOARD HAS FIVE CIRCULAR CONCENTRIC RINGS. THE OUTERMOST RING IS WHITE, THE SECOND RING IS BLUE, THE THIRD IS WHITE, THE FOURTH IS RED, AND THE CENTER IS YELLOW. TWO GREY DARTS, WITH RED TIPS, ARE STUCK IN THE CENTER. ONE DART POINTS UP TO THE LEFT, AND THE OTHER POINTS UP TO THE RIGHT. BOTH DARTS CASTS SHADOWS ACROSS THE LOWER RIGHT QUARTER OF THE RINGS. THE WORDS "TARGETED APPLICATION" IN GREY APPEAR BELOW AND TO THE RIGHT OF THE WORD "WINDOW".

**CLASS 1—CHEMICALS**

FOR PLANT GROWTH REGULATORS FOR AGRICULTURAL USE (U.S. CLS. 1, 5, 6, 10, 26 AND 46).

**CLASS 5—PHARMACEUTICALS**

FOR INSECTICIDES (U.S. CLS. 6, 18, 44, 46, 51 AND 52).

MORGAN WYNNE, EXAMINING ATTORNEY

SN 86-051,056. JOHNSON & JOHNSON, NEW BRUNSWICK, NJ. FILED 8-29-2013.

**POWER TO YOUR MOUTH**

THE MARK CONSISTS OF STANDARD CHARACTERS WITHOUT CLAIM TO ANY PARTICULAR FONT, STYLE, SIZE, OR COLOR.

OWNER OF U.S. REG. NO. 4,355,608.

SN 86-052,084. FIELD, PATRICIA, NEW YORK, NY. FILED 8-30-2013.

**PATRICIA FIELD**

THE MARK CONSISTS OF STANDARD CHARACTERS WITHOUT CLAIM TO ANY PARTICULAR FONT, STYLE, SIZE, OR COLOR.

THE NAME(S), PORTRAIT(S), AND/OR SIGNATURE(S) SHOWN IN THE MARK IDENTIFIES "PATRICIA FIELD", WHOSE CONSENT(S) TO REGISTER IS MADE OF RECORD.

**CLASS 9—ELECTRICAL AND SCIENTIFIC APPARATUS**

FOR GLASSES, NAMELY, EYEWEAR; SUNGLASSES; EYEGASSES; READING GLASSES (U.S. CLS. 21, 23, 26, 36 AND 38).

FIRST USE 1-1-2003; IN COMMERCE 1-1-2003.

**CLASS 14—JEWELRY**

FOR JEWELRY, NAMELY, RINGS, ANKLE BRACELETS, BRACELETS, NECKLACES, EARRINGS, COSTUME JEWELRY, BEADS FOR USE IN THE MANUFACTURE OF JEWELRY, BODY-PIERCING RINGS, BODY-PIERCING STUDS, BROOCHES, CHARMS, CLIP EARRINGS, WEDDING BANDS, CUFFLINKS, DIAMONDS, IDENTIFICATION BRACELETS, JEWELRY CHAINS, JEWELRY PINS, AMULETS, CROSSES, LAPEL PINS, MEDALLIONS, PEARLS, AND PENDANTS; POCKET WATCHES; CLOCKS; WATCHES; NON-MONETARY COINS; COLLECTIBLE COINS; JEWELRY CASES MADE OF PRECIOUS METAL; PRECIOUS METALS AND THEIR ALLOYS, NAMELY, GOLD, SILVER AND PLATINUM; JEWELRY MADE FROM SEMI-PRECIOUS AND PRECIOUS STONES AND METALS (U.S. CLS. 2, 27, 28 AND 50).

FIRST USE 1-1-2003; IN COMMERCE 1-1-2003.

**CLASS 18—LEATHER GOODS**

FOR BAGS, NAMELY, HANDBAGS, POCKETBOOKS, PURSES, BOOK BAGS, BACKPACKS, TRAVELING BAGS, TOTE BAGS, ALL-PURPOSE SPORT BAGS, BEACH BAGS, CARRY-ON BAGS, CHANGE PURSES, COSMETIC BAGS SOLD EMPTY, FANNY PACKS, DIAPER BAGS, SUITCASES, BRIEFCASES, OVERNIGHT BAGS, GYM BAGS; UMBRELLAS; PARASOLS; WALLETS; LUGGAGE; LEATHER BAGS; LEATHER KEY CHAINS (U.S. CLS. 1, 2, 3, 22 AND 41).

FIRST USE 1-1-1995; IN COMMERCE 1-1-1995.



**CLASS 25—CLOTHING**

FOR CLOTHING, NAMELY, SHIRTS, PANTS, UNDERWEAR, BRAS, JACKETS, SHORTS, TANK TOPS, SWEAT SHIRTS, SWEAT PANTS, SKIRTS, SOCKS AND FOOTWEAR (U.S. CLS. 22 AND 39).

FIRST USE 6-12-1982; IN COMMERCE 6-12-1982.  
MATTHEW GALAN, EXAMINING ATTORNEY

ELISSA GARBER KON, EXAMINING ATTORNEY

SN 86-053,330. YAANA TECHNOLOGIES LLC, MILPITAS, CA. FILED 8-31-2013.

SN 86-052,259. BREW BEARD & BOXERS COMPANY, FORT LAUDERDALE, FL. FILED 8-30-2013.

**BREWS, BEARDS & BOXERS**

THE MARK CONSISTS OF STANDARD CHARACTERS WITHOUT CLAIM TO ANY PARTICULAR FONT, STYLE, SIZE, OR COLOR.

NO CLAIM IS MADE TO THE EXCLUSIVE RIGHT TO USE "BEARDS" AND "BOXERS", APART FROM THE MARK AS SHOWN.

THE MARK CONSISTS OF STANDARD CHARACTERS WITHOUT CLAIM TO ANY PARTICULAR FONT, STYLE, SIZE, OR COLOR.

NO CLAIM IS MADE TO THE EXCLUSIVE RIGHT TO USE "TECHNOLOGIES", APART FROM THE MARK AS SHOWN.

THE ENGLISH TRANSLATION OF THE WORD "YAA-NA" IN THE MARK IS "PATH FORWARD".

**CLASS 3—COSMETICS AND CLEANING PREPARATIONS**

FOR SHAVING PREPARATIONS (U.S. CLS. 1, 4, 6, 50, 51 AND 52).

**CLASS 38—COMMUNICATION**

FOR MESSAGE COLLECTION AND TRANSMISSION (U.S. CLS. 100, 101 AND 104).

FIRST USE 10-20-2007; IN COMMERCE 10-20-2007.

**CLASS 25—CLOTHING**

FOR MEN'S UNDERWEAR (U.S. CLS. 22 AND 39).  
LINDA POWELL, EXAMINING ATTORNEY

**CLASS 39—TRANSPORTATION AND STORAGE**

FOR STORAGE SERVICES FOR ARCHIVING DATABASES, IMAGES AND OTHER ELECTRONIC DATA (U.S. CLS. 100 AND 105).

FIRST USE 10-20-2007; IN COMMERCE 10-20-2007.

SN 86-052,769. SCHOENFELD, MELODY, PASADENA, CA. FILED 8-30-2013.



THE MARK CONSISTS OF AN ANT HOLDING A KETTLEBELL OVERHEAD WITH THE STYLIZED TEXT "ANT STRONG" IN THE CENTER OF THE KETTLEBELL AND THE STYLIZED TEXT "WWW.FLAWLESSFITNESS.COM" UNDER THE IMAGE.

**CLASS 42—SCIENTIFIC AND COMPUTER SERVICES**

FOR DATA AUTOMATION AND COLLECTION SERVICE USING PROPRIETARY SOFTWARE TO EVALUATE, ANALYZE AND COLLECT SERVICE DATA (U.S. CLS. 100 AND 101).

FIRST USE 10-20-2007; IN COMMERCE 10-20-2007.

**CLASS 45—PERSONAL AND LEGAL SERVICES**

FOR COMPUTERIZED SECURITY SERVICES, NAMELY, ELECTRONICALLY MONITORING, DETECTING AND REPORTING ON SUSPICIOUS AND ABNORMAL PATTERNS OF POINT OF SALE ACTIVITY INDICATING THEFT, FRAUD, OR OTHER CRIMINAL ACTIVITY (U.S. CLS. 100 AND 101).

FIRST USE 10-20-2007; IN COMMERCE 10-20-2007.

WARREN L. OLANDRIA, EXAMINING ATTORNEY

**CLASS 25—CLOTHING**

FOR SHIRTS; SHORTS; SOCKS; SWEAT PANTS; SWEAT SHIRTS; T-SHIRTS; YOGA PANTS (U.S. CLS. 22 AND 39).

FIRST USE 1-1-2009; IN COMMERCE 1-1-2009.

SN 86-053,362. YAANA TECHNOLOGIES LLC, MILPITAS, CA. FILED 8-31-2013.

**CLASS 41—EDUCATION AND ENTERTAINMENT**

FOR PERSONAL FITNESS TRAINING SERVICES AND CONSULTANCY (U.S. CLS. 100, 101 AND 107).

FIRST USE 1-1-2009; IN COMMERCE 1-1-2009.

NO CLAIM IS MADE TO THE EXCLUSIVE RIGHT TO USE "TECHNOLOGIES", APART FROM THE MARK AS SHOWN.

THE COLOR(S) MAROON, GOLD, AND WHITE IS/ARE CLAIMED AS A FEATURE OF THE MARK.

THE MARK CONSISTS OF THE WORD "YAANA" IN THE COLOR MAROON ABOVE THE WORD "TECHNOLOGIES" IN THE COLOR WHITE WHICH IS WITHIN A RECTANGLE WITH ROUNDED EDGES IN THE COLOR GOLD WITH A STYLIZED ELLIPTICAL SWIRL TO THE LEFT OF THE WORD "YAANA" WITH THE LEFT HALF OF THE SWIRL IN MAROON AND THE RIGHT PART OF THE SWIRL IN GOLD.

THE ENGLISH TRANSLATION OF THE WORD "YAA-NA" IN THE MARK IS "PATH FORWARD".

#### CLASS 38—COMMUNICATION

FOR MESSAGE COLLECTION AND TRANSMISSION (U.S. CLS. 100, 101 AND 104).  
FIRST USE 10-20-2007; IN COMMERCE 10-20-2007.

#### CLASS 39—TRANSPORTATION AND STORAGE

FOR STORAGE SERVICES FOR ARCHIVING DATABASES, IMAGES AND OTHER ELECTRONIC DATA (U.S. CLS. 100 AND 105).  
FIRST USE 10-20-2007; IN COMMERCE 10-20-2007.

#### CLASS 42—SCIENTIFIC AND COMPUTER SERVICES

FOR DATA AUTOMATION AND COLLECTION SERVICE USING PROPRIETARY SOFTWARE TO EVALUATE, ANALYZE AND COLLECT SERVICE DATA (U.S. CLS. 100 AND 101).  
FIRST USE 10-20-2007; IN COMMERCE 10-20-2007.

#### CLASS 45—PERSONAL AND LEGAL SERVICES

FOR COMPUTERIZED SECURITY SERVICES, NAMELY, ELECTRONICALLY MONITORING, DETECTING AND REPORTING ON SUSPICIOUS AND ABNORMAL PATTERNS OF POINT OF SALE ACTIVITY INDICATING THEFT, FRAUD, OR OTHER CRIMINAL ACTIVITY (U.S. CLS. 100 AND 101).  
FIRST USE 10-20-2007; IN COMMERCE 10-20-2007.  
WARREN L. OLANDRIA, EXAMINING ATTORNEY

SN 86-054,722. ZYNGA INC., SAN FRANCISCO, CA. FILED 9-3-2013.



PRIORITY CLAIMED UNDER SEC. 44(D) ON INDIA APPLICATION NO. 2503897, FILED 3-28-2013.

OWNER OF U.S. REG. NO. 4,161,430.  
THE MARK CONSISTS OF THE STYLIZED WORD "SCRAMBLE", IN WHICH THE LETTERS "S" AND "M" BOTH INCLUDE ARROWS, FOLLOWED BY THE STYLIZED WORDS "WITH FRIENDS" IN A SPEECH BUBBLE.

#### CLASS 9—ELECTRICAL AND SCIENTIFIC APPARATUS

FOR COMPUTER GAME SOFTWARE; COMPUTER GAME PROGRAMS; ELECTRONIC GAME PROGRAMS; INTERACTIVE VIDEO GAME PROGRAMS (U.S. CLS. 21, 23, 26, 36 AND 38).  
FIRST USE 1-4-2012; IN COMMERCE 1-4-2012.

#### CLASS 41—EDUCATION AND ENTERTAINMENT

FOR COMPUTER AND ELECTRONIC GAMES PROVIDED ONLINE AND ENHANCEMENTS WITHIN ONLINE COMPUTER AND ELECTRONIC GAMES; VIRTUAL ENVIRONMENTS IN WHICH USERS CAN INTERACT THROUGH SOCIAL GAMES FOR RECREATIONAL, LEISURE OR ENTERTAINMENT PURPOSES (U.S. CLS. 100, 101 AND 107).

FIRST USE 1-4-2012; IN COMMERCE 1-4-2012.  
JAMES A. RAUEN, EXAMINING ATTORNEY

SN 86-055,398. CLOCKWORK IP, LLC, SARASOTA, FL. FILED 9-4-2013.

#### HOME COMFORT COLLECTION

THE MARK CONSISTS OF STANDARD CHARACTERS WITHOUT CLAIM TO ANY PARTICULAR FONT, STYLE, SIZE, OR COLOR.

NO CLAIM IS MADE TO THE EXCLUSIVE RIGHT TO USE "HOME", APART FROM THE MARK AS SHOWN.

#### CLASS 36—INSURANCE AND FINANCIAL

FOR PREPAID SERVICE PLANS FOR HEATING, VENTILATING, AND AIR CONDITIONING SYSTEMS, AND ROOFING SERVICE SYSTEMS (U.S. CLS. 100, 101 AND 102).

#### CLASS 37—CONSTRUCTION AND REPAIR

FOR REPAIR, MAINTENANCE, AND INSTALLATION SERVICES IN THE FIELD OF PLUMBING, HEATING, VENTILATION, AND AIR CONDITIONING, AND ROOFING SERVICES (U.S. CLS. 100, 103 AND 106).  
ELIZABETH CHANG, EXAMINING ATTORNEY

SN 86-058,055. FEDERAL HOUSING FINANCE AGENCY, WASHINGTON, DC. FILED S.R. 9-6-2013; AM. P.R. 9-26-2013.



THE COLOR(S) RED, GRAY, BLUE, BLACK AND WHITE IS/ARE CLAIMED AS A FEATURE OF THE MARK.

THE MARK CONSISTS OF A RED, GRAY AND BLUE VERSION OF A ROAD SIGN DIVIDED INTO THREE SECTIONS BY TWO THICK WHITE LINES. THE TOP THIRD OF THE MARK IS RED, IN THE SHAPE OF A HOUSE, INCORPORATES A HORIZONTAL RECTANGULAR CHIMNEY ON THE RIGHT, AND CONTAINS A FIVE

ANGLED STAR IN THE CENTER IN THE COLOR WHITE. THE MIDDLE THIRD OF THE MARK IS GRAY, IN A RECTANGULAR SHAPE, AND CONTAINS THE CAPITAL LETTERS "H A R P", WHICH ARE CENTERED IN THIS PORTION OF THE LOGO DEPICTED IN THE COLOR WHITE. THE LOWER THIRD OF THE MARK IS BLUE AND IN THE SHAPE OF A HALF CIRCLE. THIS SECTION IS DIVIDED INTO FOUR SUBSECTIONS BY THREE THICK, WHITE, VERTICAL LINES. THE PHRASE "YOUR BEST ROUTE TO A BETTER MORTGAGE" IS LOCATED BELOW THE MARK DEPICTED IN THE COLOR BLACK.

#### CLASS 35—ADVERTISING AND BUSINESS

FOR ADVERTISING SERVICES; BUSINESS INFORMATION; DISSEMINATION OF ADVERTISING MATTER; PUBLICITY; ADVERTISING MATTER, NAMELY, THE DISSEMINATION OF ADVERTISING MATERIAL RELATED TO FINANCIAL AND REAL ESTATE SERVICES IN THE FIELD OF MORTGAGE LOANS AND MORTGAGE-BASED OR MORTGAGE-RELATED SECURITIES; BUSINESS ADMINISTRATION SERVICES RELATING TO THE DRAWING UP AND DEVELOPMENT OF STANDARD RULES AND QUALIFICATIONS FOR FINANCIAL AND REAL ESTATE PROGRAMS RELATED TO MORTGAGE LOANS AND MORTGAGE-BASED OR MORTGAGE-RELATED SECURITIES (U.S. CLS. 100, 101 AND 102).

FIRST USE 9-2-2013; IN COMMERCE 9-2-2013.

#### CLASS 36—INSURANCE AND FINANCIAL

FOR PROVIDING FINANCIAL INFORMATION RELATED TO THE QUALIFICATIONS, CRITERIA AND CONDITIONS RELATED TO MORTGAGE LOANS AND MORTGAGE-BASED OR MORTGAGE-RELATED SECURITIES; AND PROVIDING EDUCATIONAL INFORMATION IN THE FIELD OF MORTGAGE LOANS AND MORTGAGE-BASED OR MORTGAGE-RELATED SECURITIES (U.S. CLS. 100, 101 AND 102).

FIRST USE 9-2-2013; IN COMMERCE 9-2-2013.

#### CLASS 41—EDUCATION AND ENTERTAINMENT

FOR ARRANGING AND CONDUCTING OF WORKSHOPS, SEMINARS, SYMPOSIUMS, MEETINGS, AND OTHER TRAINING IN THE FIELD OF MORTGAGE LOANS AND MORTGAGE-BASED OR MORTGAGE-RELATED SECURITIES; PROVIDING COURSES IN THE FIELD OF MORTGAGE LOANS AND MORTGAGE-BASED OR MORTGAGE-RELATED SECURITIES (U.S. CLS. 100, 101 AND 107).

FIRST USE 9-2-2013; IN COMMERCE 9-2-2013.  
BRIDGETT SMITH, EXAMINING ATTORNEY

SN 86-058,527. B-N-K VENTURES, INC, CORAL SPRINGS, FL. FILED 9-7-2013.



NO CLAIM IS MADE TO THE EXCLUSIVE RIGHT TO USE "FROZEN YOGURT", APART FROM THE MARK AS SHOWN.

THE COLOR(S) BLACK, RED, GREEN, PINK, AND WHITE IS/ARE CLAIMED AS A FEATURE OF THE MARK.

THE MARK CONSISTS OF THE STYLIZED WORD "COWBERRY" WITH A DRAWING RESEMBLING THE CARTOON OF A COW. THE WORDS "FROZEN YOGURT" APPEAR BELOW THE WORD "COWBERRY". THE LETTERS "COW" APPEAR BETWEEN A DRAWING OF A SCOOP OF FROZEN YOGURT IN THE COLOR PINK AND

A DRAWING OF A CHERRY FRUIT IN THE COLOR RED ABOVE THE SCOOP. THE DRAWING OF A SPOON IN THE COLOR GREEN APPEARS STANDING ON THE SCOOP. BELOW THE WORD "COW" APPEARS A DRAWING OF A CUP WITH WHITE AND BLACK MARKINGS RESEMBLING A COW'S MARKS IN THE COLORS WHITE AND BLACK. THE LETTERS "COW" ARE IN THE COLOR BLACK AND THE LETTERS "BERRY" ARE IN THE COLOR RED. THE DRAWING OF THE COW IS BLACK, WHITE, AND PINK. THE WORDS "FROZEN YOGURT" ARE IN THE COLOR GREEN.

#### CLASS 30—STAPLE FOODS

FOR FROZEN YOGURT; FROZEN YOGURT MIXES (U.S. CL. 46).

#### CLASS 35—ADVERTISING AND BUSINESS

FOR SELF-SERVE FROZEN YOGURT SHOP SERVICES (U.S. CLS. 100, 101 AND 102).

CHRISTINE MARTIN, EXAMINING ATTORNEY

SN 86-059,481. ON YOUR OWN LLC, SAN FRANCISCO, CA. FILED 9-9-2013.



THE MARK CONSISTS OF THE WORD "ON" IN STYLIZED FORM OVER THE WORD "YOUR" IN STYLIZED FORM OVER THE WORD "OWN" IN STYLIZED FORM AND WHERE THE WORDS ARE LEFT-JUSTIFIED. TO THE RIGHT OF THE WORDS "ON YOUR OWN" IS THE SILHOUETTE OF A FEMALE WHICH FEATURES A SKIRT AND WHOSE UPHELD HAND HOLDS A WHISK.

#### CLASS 16—PAPER GOODS AND PRINTED MATTER

FOR BOOKS IN THE FIELD OF HEALTHY LIVING AND LIFESTYLE WELLNESS; COOK BOOKS; RECIPE BOOKS (U.S. CLS. 2, 5, 22, 23, 29, 37, 38 AND 50).

#### CLASS 21—HOUSEWARES AND GLASS

FOR COOKING POTS AND PANS; COOKING SPOONS; DISHES AND PLATES; HOUSEHOLD UTENSILS, NAMELY, POT AND PAN SCRAPERS, ROLLING PINS, SPATULAS, TURNERS, WHISKS, KITCHEN TONGS, GRATERS, SIEVES, SKIMMERS; RECIPE BOXES; SERVING SPOONS; SERVINGWARE FOR SERVING FOOD AND DRINKS; UTENSILS FOR BARBECUES, NAMELY, FORKS, TONGS, TURNERS (U.S. CLS. 2, 13, 23, 29, 30, 33, 40 AND 50).

**CLASS 43—HOTEL AND RESTAURANT SERVICES**

FOR PROVIDING A WEBSITE FEATURING INFORMATION IN THE FIELD OF RECIPES AND COOKING; PROVIDING AN ONLINE COMPUTER DATABASE TO CONSUMERS FEATURING INFORMATION ABOUT RECIPES, INGREDIENTS AND COOKING INFORMATION (U.S. CLS. 100 AND 101).

**CLASS 44—MEDICAL, BEAUTY AND AGRICULTURAL SERVICES**

FOR PROVIDING A WEBSITE FEATURING INFORMATION REGARDING HEALTHY LIVING AND LIFESTYLE WELLNESS (U.S. CLS. 100 AND 101).  
KEVIN DINALLO, EXAMINING ATTORNEY

---

SN 86-059,552. ON YOUR OWN LLC, SAN FRANCISCO, CA. FILED 9-9-2013.

**ON YOUR OWN**

THE MARK CONSISTS OF STANDARD CHARACTERS WITHOUT CLAIM TO ANY PARTICULAR FONT, STYLE, SIZE, OR COLOR.

**CLASS 16—PAPER GOODS AND PRINTED MATTER**

FOR BOOKS IN THE FIELD OF HEALTHY LIVING AND LIFESTYLE WELLNESS; COOK BOOKS; RECIPE BOOKS (U.S. CLS. 2, 5, 22, 23, 29, 37, 38 AND 50).

**CLASS 21—HOUSEWARES AND GLASS**

FOR COOKING POTS AND PANS; COOKING SPOONS; DISHES AND PLATES; HOUSEHOLD UTENSILS, NAMELY, POT AND PAN SCRAPERS, ROLLING PINS, SPATULAS, TURNERS, WHISKS, KITCHEN TONGS, GRATERS, SIEVES, SKIMMERS; RECIPE BOXES; SERVING SPOONS; SERVINGWARE FOR SERVING FOOD AND DRINKS; UTENSILS FOR BARBECUES, NAMELY, FORKS, TONGS, TURNERS (U.S. CLS. 2, 13, 23, 29, 30, 33, 40 AND 50).

**CLASS 43—HOTEL AND RESTAURANT SERVICES**

FOR PROVIDING A WEBSITE FEATURING INFORMATION IN THE FIELD OF RECIPES AND COOKING; PROVIDING AN ONLINE COMPUTER DATABASE TO CONSUMERS FEATURING INFORMATION ABOUT RECIPES, INGREDIENTS AND COOKING INFORMATION (U.S. CLS. 100 AND 101).

**CLASS 44—MEDICAL, BEAUTY AND AGRICULTURAL SERVICES**

FOR PROVIDING A WEBSITE FEATURING INFORMATION REGARDING HEALTHY LIVING AND LIFESTYLE WELLNESS (U.S. CLS. 100 AND 101).  
KEVIN DINALLO, EXAMINING ATTORNEY

SN 86-060,199. WHITEWAVE SERVICES, INC., BROOMFIELD, CO. FILED 9-10-2013.

**SMART PACKS**

THE MARK CONSISTS OF STANDARD CHARACTERS WITHOUT CLAIM TO ANY PARTICULAR FONT, STYLE, SIZE, OR COLOR.

NO CLAIM IS MADE TO THE EXCLUSIVE RIGHT TO USE "PACKS", APART FROM THE MARK AS SHOWN.

**CLASS 29—MEATS AND PROCESSED FOODS**

FOR CHEESE AND CRACKER COMBINATIONS; PEANUT BUTTER AND CRACKER COMBINATIONS (U.S. CL. 46).

**CLASS 30—STAPLE FOODS**

FOR CRACKERS, GRAHAM CRACKERS, CRACKER SANDWICHES (U.S. CL. 46).  
SUSAN STIGLITZ, EXAMINING ATTORNEY

---

SN 86-060,599. LIGHTLAB IMAGING, INC., WESTFORD, MA. FILED 9-10-2013.

**ILUMIEN OPTIS**

THE MARK CONSISTS OF STANDARD CHARACTERS WITHOUT CLAIM TO ANY PARTICULAR FONT, STYLE, SIZE, OR COLOR.

OWNER OF U.S. REG. NOS. 4,258,470 AND 4,389,443.

**CLASS 9—ELECTRICAL AND SCIENTIFIC APPARATUS**

FOR OPTICAL COHERENCE TOMOGRAPHY SOFTWARE FOR MEDICAL IMAGING; COMPUTER SOFTWARE FOR USE IN MEDICAL DIAGNOSIS, NAMELY, FOR USE IN MEASUREMENT AND ASSESSMENT OF MEASURED PHYSIOLOGICAL VARIABLES (U.S. CLS. 21, 23, 26, 36 AND 38).

**CLASS 10—MEDICAL APPARATUS**

FOR CATHETERS USED IN MEDICAL IMAGING; COMPUTER MONITORS USED IN DIRECT ASSOCIATION WITH MEDICAL DIAGNOSTIC APPARATUS FOR USE IN MEDICAL DIAGNOSTICS AND ASSOCIATED SOFTWARE FOR ANALYZING MEDICAL DIAGNOSTIC DATA. ALL SOLD AS A UNIT; INTRAVASCULAR PRESSURE SENSORS AND GUIDEWIRES (U.S. CLS. 26, 39 AND 44).

ELLEN BURNS, EXAMINING ATTORNEY

SN 86-060,607. LIGHTLAB IMAGING, INC., WESTFORD, MA. FILED 9-10-2013.

ELLEN BURNS, EXAMINING ATTORNEY

# ILUMIEN

THE MARK CONSISTS OF STANDARD CHARACTERS WITHOUT CLAIM TO ANY PARTICULAR FONT, STYLE, SIZE, OR COLOR.

OWNER OF U.S. REG. NO. 4,258,470.

## CLASS 9—ELECTRICAL AND SCIENTIFIC APPARATUS

FOR OPTICAL COHERENCE TOMOGRAPHY SOFTWARE FOR MEDICAL IMAGING; COMPUTER SOFTWARE FOR USE IN MEDICAL DIAGNOSIS, NAMELY, FOR USE IN MEASUREMENT AND ASSESSMENT OF MEASURED PHYSIOLOGICAL VARIABLES (U.S. CLS. 21, 23, 26, 36 AND 38).

## CLASS 10—MEDICAL APPARATUS

FOR CATHETERS USED IN MEDICAL IMAGING; OPTICAL COHERENCE COMPUTED TOMOGRAPHY APPARATUS FOR MEDICAL IMAGING INCORPORATING COMPUTER DISPLAYS AND COMPUTER MONITORS AND CONTROLLERS THEREFOR USED DURING MEDICAL IMAGING OF AN INDIVIDUAL; COMPUTER MONITORS USED IN DIRECT ASSOCIATION WITH MEDICAL DIAGNOSTIC APPARATUS FOR USE IN MEDICAL DIAGNOSTICS AND ASSOCIATED SOFTWARE FOR ANALYZING MEDICAL DIAGNOSTIC DATA, ALL SOLD AS A UNIT; INTRAVASCULAR PRESSURE SENSORS AND GUIDEWIRES (U.S. CLS. 26, 39 AND 44).

ELLEN BURNS, EXAMINING ATTORNEY

SN 86-060,611. LIGHTLAB IMAGING, INC., WESTFORD, MA. FILED 9-10-2013.

# OPTIS

THE MARK CONSISTS OF STANDARD CHARACTERS WITHOUT CLAIM TO ANY PARTICULAR FONT, STYLE, SIZE, OR COLOR.

OWNER OF U.S. REG. NO. 4,389,443.

## CLASS 9—ELECTRICAL AND SCIENTIFIC APPARATUS

FOR OPTICAL COHERENCE TOMOGRAPHY SOFTWARE FOR MEDICAL IMAGING; COMPUTER SOFTWARE FOR USE IN MEDICAL DIAGNOSIS, NAMELY, FOR USE IN MEASUREMENT AND ASSESSMENT OF MEASURED PHYSIOLOGICAL VARIABLES (U.S. CLS. 21, 23, 26, 36 AND 38).

## CLASS 10—MEDICAL APPARATUS

FOR COMPUTER MONITORS USED IN DIRECT ASSOCIATION WITH MEDICAL DIAGNOSTIC APPARATUS FOR USE IN MEDICAL DIAGNOSTICS AND ASSOCIATED SOFTWARE FOR ANALYZING MEDICAL DIAGNOSTIC DATA, ALL SOLD AS A UNIT; INTRAVASCULAR PRESSURE SENSORS AND GUIDEWIRES (U.S. CLS. 26, 39 AND 44).

SN 86-060,612. COALITION OF INDEPENDENT MUSIC STORES, LLC, BIRMINGHAM, AL. FILED 9-10-2013.

# THINK INDIE

OWNER OF U.S. REG. NOS. 3,711,666, 3,713,033 AND OTHERS.

THE STIPPLING IS A FEATURE OF THE MARK. THE MARK CONSISTS OF THE WORDS "THINK INDIE" IN A STYLIZED FONT THAT IS DISTRESSED AND LEANING TO THE RIGHT.

## CLASS 9—ELECTRICAL AND SCIENTIFIC APPARATUS

FOR AUDIO AND VIDEO RECORDINGS FEATURING MUSIC AND MUSICAL PERFORMANCES; AUDIO RECORDINGS FEATURING MUSIC; DIGITAL MEDIA, NAMELY, DVDS AND CDS FEATURING MUSIC AND MUSICAL PERFORMANCES; DVDS FEATURING MUSIC AND MUSICAL PERFORMANCES; MUSICAL SOUND RECORDINGS; MUSICAL VIDEO RECORDINGS; PHONOGRAPH RECORD SLEEVES; PHONOGRAPH RECORDS FEATURING MUSIC; PRE-RECORDED CDS FEATURING MUSIC; PRE-RECORDED DIGITAL MEDIA FEATURING MUSIC; SOUND RECORDINGS FEATURING MUSIC (U.S. CLS. 21, 23, 26, 36 AND 38).

FIRST USE 6-1-2013; IN COMMERCE 6-1-2013.

## CLASS 35—ADVERTISING AND BUSINESS

FOR ADVERTISING AND PUBLICITY SERVICES, NAMELY, PROMOTING THE GOODS, SERVICES, BRAND IDENTITY AND COMMERCIAL INFORMATION AND NEWS OF THIRD PARTIES THROUGH PRINT, AUDIO, VIDEO, DIGITAL AND ON-LINE MEDIUM; ASSOCIATION SERVICES, NAMELY, PROMOTING THE INTERESTS OF MUSICIANS AND MUSIC LABELS; PROMOTING THE GOODS AND SERVICES OF OTHERS VIA A GLOBAL COMPUTER NETWORK (U.S. CLS. 100, 101 AND 102).

FIRST USE 6-1-2013; IN COMMERCE 6-1-2013.

ADA HAN, EXAMINING ATTORNEY

SN 86-061,238. HASHTAG ART, INC., NEW YORK, NY. FILED 9-11-2013.

# HYPERACTIVATE

THE MARK CONSISTS OF STANDARD CHARACTERS WITHOUT CLAIM TO ANY PARTICULAR FONT, STYLE, SIZE, OR COLOR.

**CLASS 35—ADVERTISING AND BUSINESS**

FOR ADVERTISING AND MARKETING CONSULTANCY; PROVIDING MARKETING CONSULTING IN THE FIELD OF SOCIAL MEDIA; SOCIAL MEDIA STRATEGY AND MARKETING CONSULTANCY FOCUSING ON HELPING CLIENTS CREATE AND EXTEND THEIR PRODUCT AND BRAND STRATEGIES BY BUILDING VIRALLY ENGAGING MARKETING SOLUTIONS; ADVERTISING AND MARKETING SERVICES PROVIDED BY MEANS OF INDIRECT METHODS OF MARKETING COMMUNICATIONS, NAMELY, SOCIAL MEDIA, SEARCH ENGINE MARKETING, INQUIRY MARKETING, INTERNET MARKETING, MOBILE MARKETING, BLOGGING AND OTHER FORMS OF PASSIVE, SHARABLE OR VIRAL COMMUNICATIONS CHANNELS; ADVERTISING AGENCIES; ORGANIZING EXHIBITIONS FOR COMMERCIAL OR ADVERTISING PURPOSES; ON-LINE ADVERTISING ON COMPUTER NETWORKS; ORGANIZATION OF TRADE FAIRS FOR COMMERCIAL OR ADVERTISING PURPOSES, OUT-DOOR ADVERTISING (U.S. CLS. 100, 101 AND 102).

FIRST USE 11-6-2012; IN COMMERCE 11-6-2012.

**CLASS 42—SCIENTIFIC AND COMPUTER SERVICES**

FOR SOFTWARE AS A SERVICE (SAAS) SERVICES FEATURING SOFTWARE FOR CREATING SOCIAL MEDIA AND INTERNET MARKETING CAMPAIGNS; SOFTWARE AS A SERVICE (SAAS) SERVICES FEATURING SOFTWARE FOR ACTIVATING USERS ON SOCIAL MEDIA; SOFTWARE AS A SERVICE (SAAS) SERVICES FEATURING SOFTWARE FOR INTEGRATING SOCIAL MEDIA INTO EXISTING MARKETING CAMPAIGN; SOFTWARE AS A SERVICE (SAAS) SERVICES FEATURING SOFTWARE FOR SEARCHING, FILTERING, DISPLAYING, REVIEWING, ANALYZING, CURATING, INTEGRATING, AND UTILIZING DATA FROM THIRD-PARTY SOCIAL MEDIA PLATFORMS FOR MARKETING PURPOSES AND INTEGRATING SOCIAL MEDIA CONTENT INTO MARKETING CAMPAIGNS; PROVIDING TECHNOLOGY CONSULTING IN THE FIELD OF SOCIAL MEDIA; COMPUTER SOFTWARE CONSULTING; CONSULTING SERVICES IN THE FIELD OF SOFTWARE AS A SERVICE (SAAS); DESIGN, DEVELOPMENT, AND CONSULTING SERVICES RELATED THERETO IN THE FIELD OF SOCIAL MEDIA AND INTERNET MARKETING (U.S. CLS. 100 AND 101).

FIRST USE 11-6-2012; IN COMMERCE 11-6-2012.

JORDAN BAKER, EXAMINING ATTORNEY

**CLASS 36—INSURANCE AND FINANCIAL**

FOR FINANCIAL AFFAIRS AND MONETARY AFFAIRS, NAMELY, FINANCIAL INFORMATION, MANAGEMENT AND ANALYSIS SERVICES; INSURANCE UNDERWRITING IN THE FIELDS OF HEALTH, DENTAL, EVACUATION, REPATRIATION, LIFE, ACCIDENTAL DEATH AND DISMEMBERMENT, VISION, DISABILITY, AND TRAVEL; FINANCIAL SERVICES, NAMELY, PROVIDING EMERGENCY FINANCIAL FUNDS FOR UNFORESEEN EXPENSES DURING TRAVELING INCLUDING BUT NOT LIMITED TO PAYMENT OF RANSOM; INSURANCE CLAIMS ADMINISTRATION; ADMINISTRATION OF EMPLOYEE BENEFIT PLANS CONCERNING HEALTH INSURANCE (U.S. CLS. 100, 101 AND 102).

**CLASS 39—TRANSPORTATION AND STORAGE**

FOR TRANSPORT OF PERSONS AND GOODS; PACKAGING AND STORAGE OF GOODS; TRAVEL ARRANGEMENT; TRAVEL ASSISTANCE SERVICES, NAMELY, ARRANGING FOR THE EMERGENCY REPLACEMENT OF AIRLINE TICKETS; TRANSPORTATION, STORAGE AND DELIVERY OF MEDICAL EQUIPMENT, SUPPLIES AND SERVICES; ORGANIZING AND PLANNING OF EMERGENCY EVACUATION AND REPATRIATION SERVICES; RESCUE SERVICES; BOOKING OF SEATS FOR TRAVEL; ARRANGING THE ESCORT OF TRAVELERS; MEDICAL TRANSPORT SERVICES; ARRANGING FOR TRAVEL VISAS, PASSPORTS AND TRAVEL DOCUMENTS (U.S. CLS. 100 AND 105).

**CLASS 44—MEDICAL, BEAUTY AND AGRICULTURAL SERVICES**

FOR MEDICAL SERVICES; HYGIENIC AND BEAUTY CARE FOR HUMAN BEINGS; HEALTH AND WELLNESS ASSESSMENT SERVICES, NAMELY, PROVIDING AN ONLINE INTERACTIVE HEALTH AND WELLNESS QUESTIONNAIRE TO BE USED TO EVALUATE AN INDIVIDUAL'S HEALTH HABITS AND LIFESTYLE, AND TO RECOMMEND IMPROVEMENTS; HEALTH AND WELLNESS COUNSELING AND CONSULTING SERVICES; HEALTH COACHING SERVICES, NAMELY, SELF-DIRECTED, ONLINE INTERACTIVE NUTRITIONAL, PHYSICAL ACTIVITY, SLEEP HABITS AND STRESS MANAGEMENT PROGRAMS; PSYCHOLOGICAL COUNSELING (U.S. CLS. 100 AND 101).

AMY HELLA, EXAMINING ATTORNEY

SN 86-061,869. PERLATO LLC, LAKEWOOD, NJ. FILED 9-11-2013.

SN 86-061,559. CIGNA INTELLECTUAL PROPERTY, INC., WILMINGTON, DE. FILED 9-12-2013.

# Perlato

## PROTECTN' GO

THE MARK CONSISTS OF STANDARD CHARACTERS WITHOUT CLAIM TO ANY PARTICULAR FONT, STYLE, SIZE, OR COLOR.

THE ENGLISH TRANSLATION OF "PERLATO" IN THE MARK IS "PEARLED".

**CLASS 11—ENVIRONMENTAL CONTROL APPARATUS**

FOR BATHTUBS; FAUCETS (U.S. CLS. 13, 21, 23, 31 AND 34).

THE MARK CONSISTS OF STANDARD CHARACTERS WITHOUT CLAIM TO ANY PARTICULAR FONT, STYLE, SIZE, OR COLOR.

**CLASS 20—FURNITURE AND ARTICLES NOT OTHERWISE CLASSIFIED**

FOR BATHROOM VANITIES (U.S. CLS. 2, 13, 22, 25, 32 AND 50).  
ZACHARY BELLO, EXAMINING ATTORNEY



SN 86-062,104, PANDORA MEDIA, INC., OAKLAND, CA. FILED 9-11-2013.



THE COLOR(S) BLUE, LIGHT BLUE, WHITE, DARK BLUE AND BLACK IS/ARE CLAIMED AS A FEATURE OF THE MARK.

THE MARK CONSISTS OF A COLLAGE OF BLUE AND LIGHT BLUE CIRCLES WITH TRANSPARENT RINGS OF LIGHT BLUE AND WHITE ON A DARK BLUE AND BLACK BACKGROUND.

**CLASS 9—ELECTRICAL AND SCIENTIFIC APPARATUS**

FOR COMPUTER SOFTWARE FOR STREAMING, BROADCASTING, TRANSMITTING AND REPRODUCING MUSIC AND COMEDY; DOWNLOADABLE COMPUTER SOFTWARE FOR STREAMING, BROADCASTING, TRANSMITTING AND REPRODUCING MUSIC AND COMEDY (U.S. CLS. 21, 23, 26, 36 AND 38).

**CLASS 38—COMMUNICATION**

FOR STREAMING OF MUSIC AND COMEDY OF OTHERS OVER A GLOBAL COMPUTER NETWORK; BROADCASTING SERVICES INCLUDING RADIO AND INTERNET BASED BROADCASTING; BROADCASTING SERVICES, NAMELY DIGITAL AUDIO BROADCASTING SERVICES PROVIDED VIA A GLOBAL COMMUNICATIONS NETWORK; INTERNET RADIO BROADCASTING SERVICES; INTERNET RADIO BROADCASTING SERVICES IN THE FIELDS OF MUSIC AND COMEDY (U.S. CLS. 100, 101 AND 104).

**CLASS 41—EDUCATION AND ENTERTAINMENT**

FOR PROVIDING MUSIC REVIEWS AND INFORMATION IN THE FIELD OF MUSIC OVER A GLOBAL COMPUTER NETWORK; ENTERTAINMENT SERVICES, NAMELY, PROVIDING NON-DOWNLOADABLE PLAYBACK OF MUSIC VIA GLOBAL COMMUNICATIONS NETWORKS; ENTERTAINMENT SERVICES, NAMELY, PROVIDING NONDOWNLOADABLE PRERECORDED MUSIC, INFORMATION IN THE FIELD OF MUSIC, AND COMMENTARY AND ARTICLES ABOUT MUSIC, ALL ON-LINE VIA A GLOBAL COMPUTER NETWORK; PROVIDING AN INTERNET WEBSITE PORTAL IN THE FIELD OF MUSIC; ENTERTAINMENT SERVICES, NAMELY, PROVIDING NON-DOWNLOADABLE COMEDY PERFORMANCES, COMEDY VIDEOS, RELATED FILM CLIPS, PHOTOGRAPHS, AND OTHER MULTIMEDIA MATERIALS FEATURING COMEDY BY MEANS OF AUDIO AND VIDEO TRANSMISSION OVER THE INTERNET AND OTHER COMMUNICATIONS NETWORKS; ENTERTAINMENT SERVICES, NAMELY, PROVIDING INFORMATION IN THE FIELD OF COMEDY OVER A GLOBAL COMPUTER NETWORK AND OTHER COMMUNICATIONS NETWORKS; ENTERTAINMENT SERVICES, NAMELY, PROVIDING ONLINE REVIEWS OF COMEDY PERFORMANCES; ENTERTAINMENT SERVICES, NAMELY, PROFILING OF COMEDY TASTES BY PROVIDING VIDEO CLIPS OF COMEDY ROUTINES OVER A GLOBAL COMPUTER NETWORK WHERE USERS MAKE SELECTIONS OF PREFERRED CLIPS; ENTERTAINMENT SERVICES, NAMELY, MAKING RECOMMENDATIONS OF COMEDY ROUTINES BASED ON USER SELECTION OF VIDEO CLIPS OF COMEDY ROUTINES; ARRANGING AND CONDUCTING OF CONCERTS; ENTERTAINMENT, NAMELY, LIVE MUSIC SHOWS AND COMEDY SHOWS (U.S. CLS. 100, 101 AND 107).

**CLASS 42—SCIENTIFIC AND COMPUTER SERVICES**

FOR PROVIDING A WEB SITE FEATURING TECHNOLOGY THAT ALLOWS USERS TO INPUT THEIR SELECTIONS OF MUSIC CLIPS AND COMEDY VIDEOS, SO THAT PROFILING CAN BE COMPLETED AND RECOMMENDATIONS PROVIDED FOR OTHER MUSIC AND COMEDY SELECTIONS; PROVIDING TEMPORARY ACCESS TO NON-DOWNLOADABLE SOFTWARE FOR PROFILING MUSICAL AND COMEDY TASTES BASED ON CONSUMER SELECTION OF MUSIC CLIPS AND COMEDY VIDEOS PLAYED OVER A GLOBAL COMPUTER NETWORK, AND RECOMMENDING OTHER MUSIC AND COMEDY TO CONSUMERS BASED ON SUCH SELECTIONS (U.S. CLS. 100 AND 101).  
CHERYL CLAYTON, EXAMINING ATTORNEY



SN 86-062,382, TIDMAN, SPENSER, LARMOR-PLAGE, UNITED KINGDOM, FILED 9-12-2013.

**DRIVE YOUR BUSINESS THROUGH THE CLOUD**

THE MARK CONSISTS OF STANDARD CHARACTERS WITHOUT CLAIM TO ANY PARTICULAR FONT, STYLE, SIZE, OR COLOR.

**CLASS 9—ELECTRICAL AND SCIENTIFIC APPARATUS**

FOR COMPUTER SOFTWARE FOR USE IN CUSTOMER RELATIONSHIP MANAGEMENT (CRM); DOWNLOADABLE COMPUTER SOFTWARE FOR MARKETING STRATEGY DEVELOPMENT; DOWNLOADABLE COMPUTER SOFTWARE FOR DEVELOPMENT, MANAGEMENT, AND ADMINISTRATION OF MARKETING PROGRAM COMPONENTS; DOWNLOADABLE COMPUTER SOFTWARE FOR SALES LEAD GENERATION, LEAD CAPTURE, SALES INTEGRATION, AND ANALYTICS, TRACKING, AND REPORTING; DOWNLOADABLE COMPUTER SOFTWARE FOR CREATING, EDITING, AND PROVIDING MARKETING PRESENTATIONS, MATERIALS, AND VISUAL AIDS; COMPUTER SOFTWARE FOR DATABASE MANAGEMENT (U.S. CLS. 21, 23, 26, 36 AND 38).

**CLASS 42—SCIENTIFIC AND COMPUTER SERVICES**

FOR SOFTWARE AS A SERVICE (SAAS) SERVICES FEATURING SOFTWARE FOR REAL-TIME ERP OR ENTERPRISE RESOURCE PLANNING AND CRM OR CUSTOMER RELATIONSHIP MANAGEMENT DATA INTEGRATION AND DATA MANAGEMENT AND STORAGE; SOFTWARE AS A SERVICE (SAAS) SERVICES FEATURING SOFTWARE FOR USE IN CUSTOMER RELATIONSHIP MANAGEMENT (CRM); SOFTWARE AS A SERVICE (SAAS) SERVICES FEATURING SOFTWARE FOR MARKETING STRATEGY DEVELOPMENT; SOFTWARE AS A SERVICE (SAAS) SERVICES FEATURING SOFTWARE FOR DEVELOPMENT, MANAGEMENT, AND ADMINISTRATION OF MARKETING PROGRAM COMPONENTS; SOFTWARE AS A SERVICE (SAAS) SERVICES FEATURING SOFTWARE FOR SALES LEAD GENERATION, SALES INTEGRATION, AND ANALYTICS, TRACKING, AND REPORTING; SOFTWARE AS A SERVICE (SAAS) SERVICES FEATURING SOFTWARE FOR CREATING, EDITING, AND PROVIDING MARKETING PRESENTATIONS, MATERIALS, AND VISUAL AIDS; SOFTWARE AS A SERVICE (SAAS) SERVICES FEATURING SOFTWARE FOR COLLABORATION AND COMMUNICATION BETWEEN SALES REPRESENTATIVES AND THEIR CUSTOMERS; SOFTWARE AS A SERVICE (SAAS) SERVICES FEATURING SOFTWARE FOR DATABASE MANAGEMENT REPRESENTATIVES AND THEIR CUSTOMERS; SOFTWARE AS A SERVICE (SAAS) SERVICES FEATURING SOFTWARE FOR DATABASE MANAGEMENT (U.S. CLS. 100 AND 101).

SUSAN RICHARDS, EXAMINING ATTORNEY

SN 86-062,516. JOHNSON & JOHNSON, NEW BRUNSWICK, NJ. FILED 9-12-2013.

**PILLARS OF CARE**

THE MARK CONSISTS OF STANDARD CHARACTERS WITHOUT CLAIM TO ANY PARTICULAR FONT, STYLE, SIZE, OR COLOR.

**CLASS 35—ADVERTISING AND BUSINESS**

FOR PROVIDING PATIENT ASSISTANCE PROGRAM REFERRALS TO HEALTHCARE PROVIDERS AND MEDICAL PATIENTS; ADMINISTERING A DISCOUNT PRESCRIPTION DRUG SAVINGS PROGRAM (U.S. CLS. 100, 101 AND 102).

**CLASS 36—INSURANCE AND FINANCIAL**

FOR INSURANCE INFORMATION SERVICES, NAMELY, PROVIDING ASSISTANCE TO HEALTHCARE PROVIDERS AND PATIENTS, NAMELY, RESEARCHING MEDICAL PATIENT INSURANCE INFORMATION FOR HEALTHCARE PROVIDERS AND PATIENTS FOR PURPOSES OF DETERMINING EXISTING MEDICAL INSURANCE BENEFITS AND IDENTIFYING THE PROCESS FOR APPEALING THE DENIAL OF MEDICAL INSURANCE COVERAGE FOR PHARMACEUTICALS, PROVIDING INSURANCE BENEFIT SUMMARIES CONCERNING INSURANCE COVERAGE FOR PHARMACEUTICALS, INSURANCE VERIFICATION AND PRIOR AUTHORIZATION SERVICES (U.S. CLS. 100, 101 AND 102).

**CLASS 44—MEDICAL, BEAUTY AND AGRICULTURAL SERVICES**

FOR PROVIDING PERSONALIZED MEDICAL PRESCRIPTION REFILL REMINDERS; NURSING SERVICES (U.S. CLS. 100 AND 101).

HEATHER THOMPSON, EXAMINING ATTORNEY

SN 86-062,580. J&G LELAND ENTERPRISES, LELAND, MI. FILED 9-12-2013.



THE MARK CONSISTS OF THE TEXT "45TH" WITH A CURVED LINE THROUGH IT, WITH THE LETTER "N" AT THE END OF THE LINE.

**CLASS 14—JEWELRY**

FOR BRACELETS; EARRINGS; NECKLACES (U.S. CLS. 2, 27, 28 AND 50).

**CLASS 25—CLOTHING**

FOR HATS; JACKETS; POLO SHIRTS; SCARVES; SHIRTS; SHORTS; SWEATSHIRTS; T-SHIRTS (U.S. CLS. 22 AND 39).

JUSTINE D. PARKER, EXAMINING ATTORNEY

SN 86-062,581. MATTHEW ALTON OLSON, DBA MATTYO HOLDINGS INC., MISSOULA, MT. FILED 9-12-2013.

**Montality**

THE MARK CONSISTS OF STANDARD CHARACTERS WITHOUT CLAIM TO ANY PARTICULAR FONT, STYLE, SIZE, OR COLOR.



**CLASS 9—ELECTRICAL AND SCIENTIFIC APPARATUS**

FOR DOWNLOADABLE MULTIMEDIA FILE CONTAINING ARTWORK, TEXT, AUDIO, VIDEO, GAMES, AND INTERNET WEB LINKS RELATING TO MONTANA; DOWNLOADABLE MULTIMEDIA FILE CONTAINING VIDEO RELATING TO MONTANA (U.S. CLS. 21, 23, 26, 36 AND 38).

**CLASS 38—COMMUNICATION**

FOR PODCASTING SERVICES; TELECOMMUNICATION SERVICES, NAMELY, TRANSMISSION OF PODCASTS (U.S. CLS. 100, 101 AND 104).  
JUSTINE D. PARKER, EXAMINING ATTORNEY

**CLASS 25—CLOTHING**

FOR GLOVES AND BICYCLE GLOVES (U.S. CLS. 22 AND 39).

**CLASS 28—TOYS AND SPORTING GOODS**

FOR GLOVES FOR SPORTS, NAMELY, BASEBALL BATTING GLOVES, FOOTBALL GLOVES, ROCK CLIMBING GLOVES, GOALKEEPERS' GLOVES, GOLF GLOVES, TENNIS GLOVES, WATERSKI GLOVES, WINDSURFING GLOVES, WORK-OUT GLOVES, COMPETITIVE LUMBERJACKING GLOVES AND WEIGHTLIFTING GLOVES (U.S. CLS. 22, 23, 38 AND 50).  
JACLYN KIDWELL WALKER, EXAMINING ATTORNEY

SN 86-062,677. NORTH ATLANTIC IMPORTS, LLC, SPRING LAKE, MI. FILED 9-12-2013.

# RINGTONS

THE MARK CONSISTS OF STANDARD CHARACTERS WITHOUT CLAIM TO ANY PARTICULAR FONT, STYLE, SIZE, OR COLOR.

**CLASS 21—HOUSEWARES AND GLASS**

FOR BEVERAGE GLASSWARE; PORCELAIN MUGS, CUPS, SAUCERS, PLATES AND DISHES; EARTHENWARE MUGS, CUPS, SAUCERS, PLATES AND DISHES; COASTERS NOT OF PAPER AND NOT BEING TABLE; MEAL TRAYS; SERVING TRAYS NOT OF PRECIOUS METAL; COFFEE POTS NOT OF PRECIOUS METAL; HAND OPERATED COFFEE GRINDERS; NON ELECTRIC COFFEE MAKERS; DOMESTIC COFFEE MEASURES; NON ELECTRIC COFFEE PERCOLATORS; COFFEE SERVERS NOT OF PRECIOUS METAL; COFFEE SERVICES NOT OF PRECIOUS METAL; COFFEE CUPS; TEAPOTS NOT OF PRECIOUS METAL; COFFEE CUPS; TEAPOTS NOT OF PRECIOUS METAL; TEA STRAINERS TEA SERVICES NOT OF PRECIOUS METAL (U.S. CLS. 2, 13, 23, 29, 30, 33, 40 AND 50).

**CLASS 30—STAPLE FOODS**

FOR COFFEE, TEA, COCOA, SUGAR, RICE, SAGO, TAPIOCA; CEREAL BASED SNACK FOOD; BREAD, BISCUITS, COOKIES, CAKES AND DANISH PASTRIES; CANDY, CHOCOLATE AND FROZEN CONFECTIONS (U.S. CL. 46).  
CURTIS FRENCH, EXAMINING ATTORNEY

SN 86-062,839. APOLLO MARKETING LLC, ROME, GA. FILED 9-12-2013.

# MO-JO

THE MARK CONSISTS OF STANDARD CHARACTERS WITHOUT CLAIM TO ANY PARTICULAR FONT, STYLE, SIZE, OR COLOR.

SN 86-063,297. TORRY COURTE, POWELL RIVER, B.C., CANADA, FILED 9-12-2013.

# RENTDAY

THE MARK CONSISTS OF STANDARD CHARACTERS WITHOUT CLAIM TO ANY PARTICULAR FONT, STYLE, SIZE, OR COLOR.

**CLASS 35—ADVERTISING AND BUSINESS**

FOR PROVIDING A SEARCHABLE ONLINE ADVERTISING WEBSITE AND INFORMATIONAL GUIDE FEATURING THE GOODS AND SERVICES OF OTHER VENDORS VIA THE INTERNET IN THE FIELD OF RESIDENTIAL AND COMMERCIAL REAL ESTATE; PROVIDING AN INTERACTIVE REAL ESTATE WEBSITE WHICH PROMOTES HOUSING AND APARTMENT PROPERTIES THROUGH OFFERING PROSPECTIVE TENANTS VIDEO WALK THROUGHS, PROPERTY DESCRIPTIONS, TEXT, PRICE, LOCATION, MAPS AND OTHER INFORMATION THAT WOULD BE INFLUENTIAL TO A PROSPECTIVE TENANT IN MAKING A RENTAL DECISION; REAL ESTATE MARKETING SERVICES, NAMELY, ON-LINE SERVICES FEATURING TOURS OF RESIDENTIAL AND COMMERCIAL REAL ESTATE (U.S. CLS. 100, 101 AND 102).

**CLASS 36—INSURANCE AND FINANCIAL**

FOR PROVIDING A DATABASE OF INFORMATION ABOUT RESIDENTIAL REAL ESTATE LISTINGS IN DIFFERENT NEIGHBORHOODS AND COMMUNITIES; PROVIDING AN INTERNET WEBSITE PORTAL OFFERING INFORMATION IN THE FIELDS OF REAL ESTATE CONCERNING THE PURCHASE AND SALE OF NEW AND RESALE HOMES AND CONDOS; PROVIDING REAL ESTATE LISTINGS AND REAL ESTATE INFORMATION VIA THE INTERNET (U.S. CLS. 100, 101 AND 102).

SUE LAWRENCE, EXAMINING ATTORNEY

SN 86-063,773. CHURCH & DWIGHT CO., INC., EWING, NJ.  
FILED 9-13-2013.

**ARM & HAMMER HEALTHY HOME  
SOLUTIONS**

THE MARK CONSISTS OF STANDARD CHARACTERS WITHOUT CLAIM TO ANY PARTICULAR FONT, STYLE, SIZE, OR COLOR.

OWNER OF U.S. REG. NOS. 1,461,631, 2,924,295 AND OTHERS.

NO CLAIM IS MADE TO THE EXCLUSIVE RIGHT TO USE "HEALTHY HOME SOLUTIONS", APART FROM THE MARK AS SHOWN.

**CLASS 3—COSMETICS AND CLEANING PREPARATIONS**

FOR CARPET CLEANING PREPARATIONS AND FLOOR CLEANING PREPARATIONS (U.S. CLS. 1, 4, 6, 50, 51 AND 52).

**CLASS 5—PHARMACEUTICALS**

FOR CAT LITTER DEODORIZERS AND CARPET DEODORIZERS (U.S. CLS. 6, 18, 44, 46, 51 AND 52).

**CLASS 16—PAPER GOODS AND PRINTED MATTER**

FOR DISPOSABLE HOUSEBREAKING PADS FOR PETS (U.S. CLS. 2, 5, 22, 23, 29, 37, 38 AND 50).

**CLASS 27—FLOOR COVERINGS**

FOR DISPOSABLE ABSORBENT PADS FOR PROTECTING FLOORS AND CARPETS (U.S. CLS. 19, 20, 37, 42 AND 50).

**CLASS 31—NATURAL AGRICULTURAL PRODUCTS**

FOR CAT LITTER (U.S. CLS. 1 AND 46).  
WENDY GOODMAN, EXAMINING ATTORNEY

SN 86-063,806. PIVOTAL SOFTWARE, INC., PALO ALTO, CA. FILED 9-13-2013.



NO CLAIM IS MADE TO THE EXCLUSIVE RIGHT TO USE "IO", APART FROM THE MARK AS SHOWN.

THE MARK CONSISTS OF THE WORD "SPRING" FOLLOWED BY A TILTED SQUARE WITH THE LETTERS "I" AND "O" AND WITH A LEAF DESIGN OVER THE LETTER "O".

**CLASS 9—ELECTRICAL AND SCIENTIFIC APPARATUS**

FOR COMPUTER SOFTWARE FOR DEVELOPMENT, DEPLOYMENT, AND EXECUTION OF COMPUTER SYSTEMS, APPLICATIONS, AND APPLICATION PROGRAMMING INTERFACES (APIS) (U.S. CLS. 21, 23, 26, 36 AND 38).

**CLASS 42—SCIENTIFIC AND COMPUTER SERVICES**

FOR DEVELOPMENT OF STANDARDS FOR DEVELOPMENT, DEPLOYMENT, AND EXECUTION OF COMPUTER SYSTEMS, APPLICATIONS, AND APPLICATION PROGRAMMING INTERFACES (APIS); SOFTWARE AS A SERVICE (SAAS) SERVICES FEATURING SOFTWARE FOR DEVELOPMENT, DEPLOYMENT, AND EXECUTION OF COMPUTER SYSTEMS, APPLICATIONS, AND APIS; PLATFORM AS A SERVICE (PAAS) FEATURING COMPUTER SOFTWARE PLATFORMS FOR DEVELOPMENT, DEPLOYMENT, AND EXECUTION OF COMPUTER SYSTEMS, APPLICATIONS AND APIS (U.S. CLS. 100 AND 101).

ZACHARY BELLO, EXAMINING ATTORNEY

SN 86-063,872. VG INNOVATIONS, LLC, ST. PETERSBURG, FL. FILED 9-13-2013.

**SiJoin**

THE MARK CONSISTS OF STANDARD CHARACTERS WITHOUT CLAIM TO ANY PARTICULAR FONT, STYLE, SIZE, OR COLOR.

**CLASS 5—PHARMACEUTICALS**

FOR BIOLOGICAL BONE TISSUE INTENDED FOR SUBSEQUENT IMPLANTATION; SURGICAL IMPLANTS COMPRISING LIVING BONE TISSUE; IMPLANTS FOR USE IN THE SACROILIAC JOINT COMPOSED OF LIVING AUTOGRAFT MATERIAL, LIVING ALLOGRAFT MATERIAL, OR LIVING ALLOGRAFT AND AUTOGRAFT MATERIAL AND OTHER LIVING BIOCOMPATIBLE MATERIALS (U.S. CLS. 6, 18, 44, 46, 51 AND 52).

FIRST USE 1-29-2013; IN COMMERCE 1-29-2013.

**CLASS 10—MEDICAL APPARATUS**

FOR BONE IMPLANTS COMPOSED OF ARTIFICIAL MATERIALS; SACROILIAC JOINT IMPLANTS COMPRISING NATURAL, NON-LIVING MATERIALS; MEDICAL DEVICES AND APPARATUS, NAMELY, SURGICAL IMPLANTS COMPRISED PRIMARILY OF ARTIFICIAL MATERIAL AND INCORPORATING PROCESSED BONE TISSUE FOR USE IN SURGERY; MEDICAL DEVICES, NAMELY, SACROILIAC JOINT IMPLANTS COMPOSED OF ARTIFICIAL MATERIALS INCORPORATING ALLOGRAFT MATERIALS, ALLOGRAFT MATERIAL, OR ALLOGRAFT AND AUTOGRAFT MATERIAL AND OTHER BIOCOMPATIBLE MATERIALS (U.S. CLS. 26, 39 AND 44).

FIRST USE 1-29-2013; IN COMMERCE 1-29-2013.

**CLASS 44—MEDICAL, BEAUTY AND AGRICULTURAL SERVICES**

FOR MEDICAL SERVICES IN THE FIELD OF SURGERY ON THE SACROILIAC JOINT (U.S. CLS. 100 AND 101).

FIRST USE 1-29-2013; IN COMMERCE 1-29-2013.  
LANA PHAM, EXAMINING ATTORNEY

SN 86-063,946. BANK OF AMERICA CORPORATION, CHARLOTTE, NC. FILED 9-13-2013.

SN 86-063,985. SEQUENTIA, LLC, ELYRIA, OH. FILED 9-13-2013.

# OCTAVE

CONNECTING YOU WITH CARE

THE MARK CONSISTS OF STANDARD CHARACTERS WITHOUT CLAIM TO ANY PARTICULAR FONT, STYLE, SIZE, OR COLOR.

THE MARK CONSISTS OF STANDARD CHARACTERS WITHOUT CLAIM TO ANY PARTICULAR FONT, STYLE, SIZE, OR COLOR.

## CLASS 35—ADVERTISING AND BUSINESS

FOR PROMOTING THE SALE OF CREDIT CARD ACCOUNTS AND PROMOTING THE USE OF CREDIT CARD SERVICES THROUGH THE ADMINISTRATION OF A REWARDS PROGRAM; PROMOTING THE SALE OF GOODS AND SERVICES OF OTHERS THROUGH THE ADMINISTRATION OF A REWARDS PROGRAM FOR CREDIT CARD USE (U.S. CLS. 100, 101 AND 102).

## CLASS 35—ADVERTISING AND BUSINESS

FOR PROVIDING A SEARCHABLE ONLINE ADVERTISING WEBSITE AND INFORMATIONAL GUIDE FEATURING THE GOODS AND SERVICES OF OTHER VENDORS VIA THE INTERNET IN THE FIELD OF HEALTH CARE FACILITIES, EXTENDED CARE FACILITIES, AND LONG-TERM CARE MANAGEMENT SERVICES (U.S. CLS. 100, 101 AND 102).

## CLASS 36—INSURANCE AND FINANCIAL

FOR BANKING AND FINANCIAL SERVICES, NAMELY, CREDIT CARD SERVICES (U.S. CLS. 100, 101 AND 102).  
CHRISTOPHER REAMS, EXAMINING ATTORNEY

## CLASS 44—MEDICAL, BEAUTY AND AGRICULTURAL SERVICES

FOR INTERNET-BASED HEALTH CARE INFORMATION SERVICES (U.S. CLS. 100 AND 101).  
MARCIE MILONE, EXAMINING ATTORNEY

SN 86-063,982. BE 1 ENTREPRENEUR, LLC, EDGEWATER, NJ. FILED 9-13-2013.

SN 86-063,987. FISCHER, ANDREA M, DALLAS, TX. FILED 9-13-2013.

# CEO NEXT DOOR

yournewsroom.com

THE MARK CONSISTS OF STANDARD CHARACTERS WITHOUT CLAIM TO ANY PARTICULAR FONT, STYLE, SIZE, OR COLOR.

THE MARK CONSISTS OF STANDARD CHARACTERS WITHOUT CLAIM TO ANY PARTICULAR FONT, STYLE, SIZE, OR COLOR.

## CLASS 9—ELECTRICAL AND SCIENTIFIC APPARATUS

FOR DIGITAL MEDIA, NAMELY, CD'S, DOWNLOADABLE AUDIO FILES, AND DOWNLOADABLE BOOKS, WORKBOOKS, AND MAGAZINES FEATURING SMALL BUSINESS MANAGEMENT AND THE PROFESSIONAL DEVELOPMENT OF SMALL BUSINESS PERSONNEL; ELECTRONIC PUBLICATIONS, NAMELY, MAGAZINES FEATURING SMALL BUSINESS MANAGEMENT AND THE PROFESSIONAL DEVELOPMENT OF SMALL BUSINESS PERSONNEL RECORDED ON COMPUTER MEDIA (U.S. CLS. 21, 23, 26, 36 AND 38).

## CLASS 35—ADVERTISING AND BUSINESS

FOR COPY WRITING FOR ADVERTISING AND PROMOTIONAL PURPOSES; CUSTOM WRITING SERVICES COMPRISING PUBLIC RELATIONS AND MARKETING MATERIALS FOR THE AUDIO, VIDEO AND TECHNOLOGY INDUSTRIES; WRITING OF GRANT PROPOSALS FOR NON-PROFIT ORGANIZATIONS, EDUCATIONAL INSTITUTIONS AND OTHER COMMUNITY ORGANIZATIONS; WRITING OF PUBLICITY TEXTS (U.S. CLS. 100, 101 AND 102).

## CLASS 41—EDUCATION AND ENTERTAINMENT

FOR EDUCATION SERVICES, NAMELY, PROVIDING LIVE AND ON-LINE MENTORING, TUTORING, CLASSES, SEMINARS, CONFERENCES, AND WORKSHOPS IN THE FIELD OF SMALL BUSINESS MANAGEMENT AND THE PROFESSIONAL DEVELOPMENT OF SMALL BUSINESS PERSONNEL; ON-LINE JOURNALS, NAMELY, BLOGS FEATURING SMALL BUSINESS MANAGEMENT AND THE PROFESSIONAL DEVELOPMENT OF SMALL BUSINESS PERSONNEL; TRAINING SERVICES IN THE FIELD OF SMALL BUSINESS MANAGEMENT AND THE PROFESSIONAL DEVELOPMENT OF SMALL BUSINESS PERSONNEL (U.S. CLS. 100, 101 AND 107).

## CLASS 41—EDUCATION AND ENTERTAINMENT

FOR COPY EDITING; CUSTOM WRITING SERVICES FOR NON-ADVERTISING PURPOSES; EDITORIAL CONSULTATION; EDITORIAL REPORTING SERVICES; PUBLICATION AND EDITING OF PRINTED MATTER; PUBLICATION OF THE EDITORIAL CONTENT OF SITES ACCESSIBLE VIA A GLOBAL COMPUTER NETWORK; SPEECH WRITING FOR NON-ADVERTISING PURPOSES; WRITING OF ARTICLES FOR JOURNALS OTHER THAN FOR ADVERTISING OR PUBLICITY; WRITING OF ARTICLES FOR PERIODICALS OTHER THAN FOR ADVERTISING OR PUBLICITY; WRITING OF ARTICLES FOR PROFESSIONAL JOURNALS OTHER THAN FOR ADVERTISING OR PUBLICITY; WRITING OF TEXTS OTHER THAN PUBLICITY TEXTS (U.S. CLS. 100, 101 AND 107).

MARCIE MILONE, EXAMINING ATTORNEY

MARCIE MILONE, EXAMINING ATTORNEY

SN 86-064.005. PIVOTAL SOFTWARE, INC., PALO ALTO, CA. FILED 9-13-2013.

SN 86-064.025. THE JOHN AND MARY R. MARKLE FOUNDATION, INC., NEW YORK, NY. FILED 9-13-2013.

## PIVOTAL ONE

THE MARK CONSISTS OF STANDARD CHARACTERS WITHOUT CLAIM TO ANY PARTICULAR FONT, STYLE, SIZE, OR COLOR.

OWNER OF U.S. REG. NOS. 3,378,168, 3,463,766 AND 3,463,767.

### CLASS 9—ELECTRICAL AND SCIENTIFIC APPARATUS

FOR COMPUTER SOFTWARE FOR COMPUTER SYSTEM AND APPLICATION DEVELOPMENT, DEPLOYMENT AND MANAGEMENT; COMPUTER SOFTWARE FOR THE COLLECTION, ANALYSIS AND STORAGE OF INFORMATION AND DATA (U.S. CLS. 21, 23, 26, 36 AND 38).

### CLASS 42—SCIENTIFIC AND COMPUTER SERVICES

FOR PLATFORM AS A SERVICE (PAAS) FEATURING COMPUTER SOFTWARE PLATFORMS FOR A VIRTUAL COMPUTING ENVIRONMENT ACCESSIBLE VIA THE INTERNET FOR THE PURPOSE OF APPLICATION DEVELOPMENT, DEPLOYMENT AND MANAGEMENT; PAAS SERVICES FEATURING COMPUTER PLATFORMS FOR THE COLLECTION, ANALYSIS AND STORAGE OF INFORMATION AND DATA; PAAS SERVICES FEATURING COMPUTER SOFTWARE PLATFORMS FOR COMPUTER SYSTEM AND APPLICATION DEVELOPMENT, DEPLOYMENT AND MANAGEMENT (U.S. CLS. 100 AND 101).

ZACHARY BELLO, EXAMINING ATTORNEY

SN 86-064.022. FRESH MATTERS, LLC, FEDERAL WAY, WA. FILED 9-13-2013.

## apple'tude

THE MARK CONSISTS OF STANDARD CHARACTERS WITHOUT CLAIM TO ANY PARTICULAR FONT, STYLE, SIZE, OR COLOR.

OWNER OF U.S. REG. NO. 4,226,461.

### CLASS 29—MEATS AND PROCESSED FOODS

FOR APPLESAUCE; COMPOTES; FRUIT PUREES (U.S. CL. 46).

### CLASS 30—STAPLE FOODS

FOR FROZEN JUICE BARS (U.S. CL. 46).

### CLASS 32—LIGHT BEVERAGES

FOR AERATED FRUIT JUICES; APPLE JUICE BEVERAGES; FRUIT BEVERAGES; FRUIT DRINKS; FRUIT JUICE; NON-ALCOHOLIC CIDER; NON-ALCOHOLIC FRUIT JUICE BEVERAGES (U.S. CLS. 45, 46 AND 48).

FIRST USE 6-19-2012; IN COMMERCE 6-19-2012.  
SHAUNIA CARLYLE, EXAMINING ATTORNEY

## MARKLE

THE MARK CONSISTS OF STANDARD CHARACTERS WITHOUT CLAIM TO ANY PARTICULAR FONT, STYLE, SIZE, OR COLOR.

OWNER OF U.S. REG. NOS. 3,377,211 AND 4,026,695.  
SEC. 2(F).

### CLASS 9—ELECTRICAL AND SCIENTIFIC APPARATUS

FOR DOWNLOADABLE ELECTRONIC PUBLICATIONS IN THE NATURE OF WHITE PAPERS AND RESEARCH AND BUSINESS REPORTS CONCERNING USES OF NEW INFORMATION AND COMMUNICATION TECHNOLOGIES IN AREAS OF CRITICAL PUBLIC INTEREST AND LEVERAGING TECHNOLOGY AND ADVANCING PUBLIC AND PRIVATE LEADERSHIP AND INDIVIDUAL ACTION (U.S. CLS. 21, 23, 26, 36 AND 38).

FIRST USE 8-31-2010; IN COMMERCE 8-31-2010.

### CLASS 16—PAPER GOODS AND PRINTED MATTER

FOR PRINTED MATERIALS, NAMELY, WHITE PAPERS AND RESEARCH AND BUSINESS REPORTS CONCERNING USES OF NEW INFORMATION AND COMMUNICATION TECHNOLOGIES IN AREAS OF CRITICAL PUBLIC INTEREST AND ADVANCING PUBLIC AND PRIVATE LEADERSHIP AND INDIVIDUAL ACTION (U.S. CLS. 2, 5, 22, 23, 29, 37, 38 AND 50).

FIRST USE 7-15-2013; IN COMMERCE 7-15-2013.

### CLASS 35—ADVERTISING AND BUSINESS

FOR PROMOTING PUBLIC AWARENESS OF THE NEED FOR DISCUSSION, POLICY DEVELOPMENT, AND/OR PERSONAL ENGAGEMENT IN THE FIELDS OF HEALTH AND MEDICINE, INFORMATION TECHNOLOGY AND INFORMATION TECHNOLOGY INFRASTRUCTURE, AND ECONOMIC AND NATIONAL SECURITY, AND FOR DEVELOPING OPPORTUNITIES IN THE FIELDS OF TECHNOLOGY, THE ECONOMY, ECONOMIC AND NATIONAL SECURITY, HEALTHCARE, AND MOBILITY; PROMOTING PUBLIC AWARENESS OF THE NEED FOR DEVELOPING OPPORTUNITY FOR MORE AMERICANS BY LEVERAGING TECHNOLOGY AND ADVANCING PUBLIC AND PRIVATE LEADERSHIP AND INDIVIDUAL ACTION (U.S. CLS. 100, 101 AND 102).

FIRST USE 1-10-2011; IN COMMERCE 1-10-2011.

**CLASS 41—EDUCATION AND ENTERTAINMENT**

FOR ORGANIZATION OF WORKING GROUPS COMPOSED OF INFORMATION TECHNOLOGY EXPERTS, HEALTHCARE PROFESSIONALS, POLICYMAKERS, AND REPRESENTATIVES OF PUBLIC AND PRIVATE SECTOR ENTITIES IN THE FIELDS OF HEALTH AND MEDICINE, INFORMATION TECHNOLOGY, INFORMATION TECHNOLOGY INFRASTRUCTURE, AND ECONOMIC AND NATIONAL SECURITY; ORGANIZATION OF WORKING GROUPS COMPOSED OF INFORMATION TECHNOLOGY EXPERTS, HEALTHCARE PROFESSIONALS, POLICYMAKERS, AND REPRESENTATIVES OF PUBLIC AND PRIVATE SECTOR ENTITIES TO, AMONG OTHER THINGS, DEVELOP OPPORTUNITIES IN THE FIELDS OF TECHNOLOGY, THE ECONOMY, AND ECONOMIC AND NATIONAL SECURITY, HEALTHCARE, AND MOBILITY, AND TO DEVELOP OPPORTUNITY FOR MORE AMERICANS BY LEVERAGING TECHNOLOGY AND ADVANCING PUBLIC AND PRIVATE LEADERSHIP AND INDIVIDUAL ACTION; ON-LINE JOURNALS, NAMELY, BLOGS FEATURING NEWS AND COMMENTARY IN THE FIELDS OF HEALTH AND MEDICINE, INFORMATION TECHNOLOGY AND INFORMATION TECHNOLOGY INFRASTRUCTURE, AND ECONOMIC AND NATIONAL SECURITY AND ON THE SUBJECT OF CREATING OPPORTUNITY FOR MORE AMERICANS BY LEVERAGING TECHNOLOGY AND ADVANCING PUBLIC AND PRIVATE LEADERSHIP AND INDIVIDUAL ACTION (U.S. CLS. 100, 101 AND 107).

FIRST USE 1-10-2011; IN COMMERCE 1-10-2011.  
AMY C. KEAN, EXAMINING ATTORNEY

SN 86-064,035. FRESH MATTERS, LLC, FEDERAL WAY, WA. FILED 9-13-2013.

**gala'tude**

THE MARK CONSISTS OF STANDARD CHARACTERS WITHOUT CLAIM TO ANY PARTICULAR FONT, STYLE, SIZE, OR COLOR.

OWNER OF U.S. REG. NO. 4,226,461.

**CLASS 29—MEATS AND PROCESSED FOODS**

FOR APPLESAUCE; COMPOTES; FRUIT PUREES (U.S. CL. 46).

**CLASS 30—STAPLE FOODS**

FOR FROZEN JUICE BARS (U.S. CL. 46).

**CLASS 32—LIGHT BEVERAGES**

FOR AERATED FRUIT JUICES; APPLE JUICE BEVERAGES; FRUIT BEVERAGES; FRUIT DRINKS; FRUIT JUICE; NON-ALCOHOLIC CIDER; NON-ALCOHOLIC FRUIT JUICE BEVERAGES (U.S. CLS. 45, 46 AND 48).

FIRST USE 6-19-2012; IN COMMERCE 6-19-2012.  
SHAUNIA CARLYLE, EXAMINING ATTORNEY

SN 86-064,029. FRESH MATTERS, LLC, FEDERAL WAY, WA. FILED 9-13-2013.

**fuji'tude**

THE MARK CONSISTS OF STANDARD CHARACTERS WITHOUT CLAIM TO ANY PARTICULAR FONT, STYLE, SIZE, OR COLOR.

OWNER OF U.S. REG. NO. 4,226,461.

**CLASS 29—MEATS AND PROCESSED FOODS**

FOR APPLESAUCE; COMPOTES; FRUIT PUREES (U.S. CL. 46).

**CLASS 30—STAPLE FOODS**

FOR FROZEN JUICE BARS (U.S. CL. 46).

**CLASS 32—LIGHT BEVERAGES**

FOR AERATED FRUIT JUICES; APPLE JUICE BEVERAGES; FRUIT BEVERAGES; FRUIT DRINKS; FRUIT JUICE; NON-ALCOHOLIC CIDER; NON-ALCOHOLIC FRUIT JUICE BEVERAGES (U.S. CLS. 45, 46 AND 48).

FIRST USE 6-19-2012; IN COMMERCE 6-19-2012.  
SHAUNIA CARLYLE, EXAMINING ATTORNEY

SN 86-064,043. FRESH MATTERS, LLC, FEDERAL WAY, WA. FILED 9-13-2013.

**honey'tude**

THE MARK CONSISTS OF STANDARD CHARACTERS WITHOUT CLAIM TO ANY PARTICULAR FONT, STYLE, SIZE, OR COLOR.

OWNER OF U.S. REG. NO. 4,226,461.

**CLASS 29—MEATS AND PROCESSED FOODS**

FOR APPLESAUCE; COMPOTES; FRUIT PUREES (U.S. CL. 46).

**CLASS 30—STAPLE FOODS**

FOR FROZEN JUICE BARS (U.S. CL. 46).

**CLASS 32—LIGHT BEVERAGES**

FOR AERATED FRUIT JUICES; APPLE JUICE BEVERAGES; FRUIT BEVERAGES; FRUIT DRINKS; FRUIT JUICE; NON-ALCOHOLIC CIDER; NON-ALCOHOLIC FRUIT JUICE BEVERAGES (U.S. CLS. 45, 46 AND 48).

FIRST USE 6-19-2012; IN COMMERCE 6-19-2012.  
SHAUNIA CARLYLE, EXAMINING ATTORNEY

SN 86-064,048. FRESH MATTERS, LLC, FEDERAL WAY, WA. FILED 9-13-2013.

SN 86-064,059. FRESH MATTERS, LLC, FEDERAL WAY, WA. FILED 9-13-2013.

# granny'tude

# pinky'tude

THE MARK CONSISTS OF STANDARD CHARACTERS WITHOUT CLAIM TO ANY PARTICULAR FONT, STYLE, SIZE, OR COLOR.

OWNER OF U.S. REG. NO. 4,226,461.

THE MARK CONSISTS OF STANDARD CHARACTERS WITHOUT CLAIM TO ANY PARTICULAR FONT, STYLE, SIZE, OR COLOR.

OWNER OF U.S. REG. NO. 4,226,461.

## CLASS 29—MEATS AND PROCESSED FOODS

FOR APPLESAUCE; COMPOTES; FRUIT PUREES (U.S. CL. 46).

## CLASS 29—MEATS AND PROCESSED FOODS

FOR APPLESAUCE; COMPOTES; FRUIT PUREES (U.S. CL. 46).

## CLASS 30—STAPLE FOODS

FOR FROZEN JUICE BARS (U.S. CL. 46).

## CLASS 30—STAPLE FOODS

FOR FROZEN JUICE BARS (U.S. CL. 46).

## CLASS 32—LIGHT BEVERAGES

FOR AERATED FRUIT JUICES; APPLE JUICE BEVERAGES; FRUIT BEVERAGES; FRUIT DRINKS; FRUIT JUICE; NON-ALCOHOLIC CIDER; NON-ALCOHOLIC FRUIT JUICE BEVERAGES (U.S. CLS. 45, 46 AND 48).

FIRST USE 6-19-2012; IN COMMERCE 6-19-2012.  
SHAUNIA CARLYLE, EXAMINING ATTORNEY

## CLASS 32—LIGHT BEVERAGES

FOR AERATED FRUIT JUICES; APPLE JUICE BEVERAGES; FRUIT BEVERAGES; FRUIT DRINKS; FRUIT JUICE; NON-ALCOHOLIC CIDER; NON-ALCOHOLIC FRUIT JUICE BEVERAGES (U.S. CLS. 45, 46 AND 48).

FIRST USE 6-19-2012; IN COMMERCE 6-19-2012.  
SHAUNIA CARLYLE, EXAMINING ATTORNEY

SN 86-064,051. KW INTELLECTUAL PROPERTIES, INC., POLK CITY, FL. FILED 9-13-2013.

SN 86-064,060. FRESH CUT LAWN CARE, INC., EGG HARBOR TOWNSHIP, NJ. FILED 9-13-2013.

# SPARK U

# FRESH CUT

THE MARK CONSISTS OF STANDARD CHARACTERS WITHOUT CLAIM TO ANY PARTICULAR FONT, STYLE, SIZE, OR COLOR.

## CLASS 25—CLOTHING

FOR CAPS; HATS; SHIRTS; SWEAT SHIRTS; T-SHIRTS (U.S. CLS. 22 AND 39).

THE MARK CONSISTS OF STANDARD CHARACTERS WITHOUT CLAIM TO ANY PARTICULAR FONT, STYLE, SIZE, OR COLOR.

## CLASS 37—CONSTRUCTION AND REPAIR

FOR CONSTRUCTION OF DRIVEWAYS, PATIOS, POOL DECKS, PLANTERS, WALLS; CONSTRUCTION, MAINTENANCE AND RENOVATION OF PROPERTY; INSTALLATION AND MAINTENANCE OF IRRIGATION SYSTEMS; SNOW REMOVAL SERVICES (U.S. CLS. 100, 103 AND 106).

FIRST USE 1-1-1986; IN COMMERCE 1-1-1986.

## CLASS 41—EDUCATION AND ENTERTAINMENT

FOR ACADEMIC ENRICHMENT PROGRAMS IN THE FIELD(S) OF MATH, SCIENCE, CIVICS, HISTORY, AND AVIATION; EDUCATION SERVICES, NAMELY, PROVIDING SEMINARS, WORKSHOPS, LECTURES AND CLASSES IN THE FIELD OF CREATIVITY AND INNOVATION, PERSONAL ASSESSMENT, MEASUREMENT AND IMPROVEMENT, PERSONAL AND PROFESSIONAL DEVELOPMENT, PERSONAL GROWTH AND MOTIVATION (U.S. CLS. 100, 101 AND 107).

SUI DUONG, EXAMINING ATTORNEY

## CLASS 44—MEDICAL, BEAUTY AND AGRICULTURAL SERVICES

FOR LANDSCAPE GARDENING; LANDSCAPE GARDENING DESIGN FOR OTHERS; LAWN CARE (U.S. CLS. 100 AND 101).

FIRST USE 1-1-1986; IN COMMERCE 1-1-1986.  
SUI DUONG, EXAMINING ATTORNEY

SN 86-064,065. FRESH MATTERS, LLC, FEDERAL WAY, WA. FILED 9-13-2013.

SN 86-064,092. FRESH MATTERS, LLC, FEDERAL WAY, WA. FILED 9-13-2013.

fruititude

THE MARK CONSISTS OF STANDARD CHARACTERS WITHOUT CLAIM TO ANY PARTICULAR FONT, STYLE, SIZE, OR COLOR.  
OWNER OF U.S. REG. NO. 4,226,461.

**CLASS 29—MEATS AND PROCESSED FOODS**

FOR APPLESAUCE; COMPOTES; FRUIT PUREES (U.S. CL. 46).

**CLASS 30—STAPLE FOODS**

FOR FROZEN JUICE BARS (U.S. CL. 46).

**CLASS 32—LIGHT BEVERAGES**

FOR AERATED FRUIT JUICES; APPLE JUICE BEVERAGES; FRUIT BEVERAGES; FRUIT DRINKS; FRUIT JUICE; NON-ALCOHOLIC CIDER; NON-ALCOHOLIC FRUIT JUICE BEVERAGES (U.S. CLS. 45, 46 AND 48).  
SHAUNIA CARLYLE, EXAMINING ATTORNEY

SN 86-064,085. FRESH MATTERS, LLC, FEDERAL WAY, WA. FILED 9-13-2013.

'tude

OWNER OF U.S. REG. NO. 4,226,461.  
THE MARK CONSISTS OF THE WORD "TUDE" IN STYLIZED FORM PRECEDED BY AN APOSTROPHE AND SUPERIMPOSED OVER AN IMAGE OF A FRUIT.

**CLASS 29—MEATS AND PROCESSED FOODS**

FOR APPLESAUCE; COMPOTES; FRUIT PUREES (U.S. CL. 46).

**CLASS 30—STAPLE FOODS**

FOR FROZEN JUICE BARS (U.S. CL. 46).

**CLASS 32—LIGHT BEVERAGES**

FOR AERATED FRUIT JUICES; APPLE JUICE BEVERAGES; FRUIT BEVERAGES; FRUIT DRINKS; FRUIT JUICE; NON-ALCOHOLIC CIDER; NON-ALCOHOLIC FRUIT JUICE BEVERAGES (U.S. CLS. 45, 46 AND 48).  
FIRST USE 6-19-2012; IN COMMERCE 6-19-2012.  
SHAUNIA CARLYLE, EXAMINING ATTORNEY

POSITIVELY GOOD

THE MARK CONSISTS OF STANDARD CHARACTERS WITHOUT CLAIM TO ANY PARTICULAR FONT, STYLE, SIZE, OR COLOR.  
OWNER OF U.S. REG. NO. 4,222,939.

**CLASS 29—MEATS AND PROCESSED FOODS**

FOR APPLESAUCE; COMPOTES; FRUIT PUREES (U.S. CL. 46).

**CLASS 30—STAPLE FOODS**

FOR FROZEN JUICE BARS (U.S. CL. 46).  
SHAUNIA CARLYLE, EXAMINING ATTORNEY

SN 86-064,119. SIOUX FALLS CONSTRUCTION COMPANY, SIOUX FALLS, SD. FILED 9-13-2013.

JOURNEY

THE MARK CONSISTS OF THE WORD "JOURNEY" WHICH APPEARS BESIDE AND BENEATH AN ARCH.

**CLASS 37—CONSTRUCTION AND REPAIR**

FOR BUILDING CONSTRUCTION SERVICES; PRE-CONSTRUCTION SERVICES, NAMELY, PRELIMINARY BUDGETING AND ESTIMATING SERVICES; GENERAL CONTRACTING SERVICES IN THE FIELD OF COMMERCIAL BUILDING CONSTRUCTION; CONSTRUCTION MANAGEMENT; CONSTRUCTION SUPERVISION; STRUCTURAL AND SITE CONCRETE WORK AND STRUCTURAL STEEL ERECTION, NAMELY, CONCRETE CONSTRUCTION, PRE-CAST CONCRETE ERECTION WORK, AND STEEL STRUCTURE CONSTRUCTION WORKS; CONSTRUCTION OF COMMERCIAL, EDUCATIONAL, INSTITUTIONAL, INDUSTRIAL, RETAIL AND MEDICAL BUILDINGS; RENOVATION AND REPAIR SERVICES FOR BUILDINGS; REAL ESTATE DEVELOPMENT; LAND DEVELOPMENT SERVICES, NAMELY, PLANNING AND REAL ESTATE DEVELOPMENT OF RESIDENTIAL AND COMMERCIAL COMMUNITIES; BUILDING INSPECTION, NAMELY, INSPECTING STRUCTURAL, MECHANICAL, ELECTRICAL SYSTEMS OF BUILDINGS AND COMMERCIAL, INDUSTRIAL AND INSTITUTIONAL FACILITIES (U.S. CLS. 100, 103 AND 106).

**CLASS 42—SCIENTIFIC AND COMPUTER SERVICES**

FOR CONSULTING WITH ARCHITECTS, ENGINEERS AND OWNERS TO ASSIST IN THE DEVELOPMENT OF CONSTRUCTION DESIGN DOCUMENTS; DESIGN-BUILD SERVICES, NAMELY, THE DESIGN OF BUILDINGS; AND CONSULTING SERVICES IN THE DESIGN AND DEVELOPMENT OF PREVENTIVE MAINTENANCE PROGRAMS FOR THE STRUCTURAL, MECHANICAL, ELECTRICAL SYSTEMS OF BUILDINGS AND COMMERCIAL, INDUSTRIAL AND INSTITUTIONAL FACILITIES (U.S. CLS. 100 AND 101).

ELLEN BURNS, EXAMINING ATTORNEY

SN 86-064,422. MIHALTIAN, PETER MICHAEL, WESTERVILLE, OH. FILED 9-13-2013.

SN 86-064,353. KRAYZELBURG, LENNY, LOS ANGELES, CA. FILED 9-13-2013.

# TALAJC

## SWIMRIGHT

THE MARK CONSISTS OF STANDARD CHARACTERS WITHOUT CLAIM TO ANY PARTICULAR FONT, STYLE, SIZE, OR COLOR.

THE MARK CONSISTS OF STANDARD CHARACTERS WITHOUT CLAIM TO ANY PARTICULAR FONT, STYLE, SIZE, OR COLOR.

### CLASS 14—JEWELRY

FOR CHARMS; JEWELRY; NECKLACES (U.S. CLS. 2, 27, 28 AND 50).

### CLASS 5—PHARMACEUTICALS

FOR DISPOSABLE SWIM DIAPERS FOR CHILDREN AND INFANTS (U.S. CLS. 6, 18, 44, 46, 51 AND 52).

### CLASS 25—CLOTHING

FOR BASEBALL CAPS AND HATS; SHIRTS (U.S. CLS. 22 AND 39).  
THEODORE MCBRIDE, EXAMINING ATTORNEY

### CLASS 25—CLOTHING

FOR SWIMMING CAPS, SWIMMING TRUNKS, BATHING SUITS, BIKINIS, WETSUITS, SWIM SUITS, SHORTS, SHIRTS, HATS, JACKETS, SWEATSHIRTS, WATER-RESISTANT SHOES; FLIP FLOPS; RASH GUARDS; PANTS, COATS, INFANTWEAR, SWEAT PANTS, SWEAT SHIRTS, SKIRTS, BLOUSES, SHAWLS, COVERUPS, VESTS, UNDERWEAR, BELTS, HATS, GLOVES, PAJAMAS (U.S. CLS. 22 AND 39).  
CHRISTINA SOBRAL, EXAMINING ATTORNEY

SN 86-064,802. PACIFIC AXIS, INC., DBA MOTIV, SANTA CRUZ, CA. FILED 9-14-2013.

SN 86-064,398. MIHALTIAN, PETER MICHAEL, WESTERVILLE, OH. FILED 9-13-2013.

# Motiv

TAKE ANOTHER LOOK AT JESUS  
CHRIST

THE MARK CONSISTS OF STANDARD CHARACTERS WITHOUT CLAIM TO ANY PARTICULAR FONT, STYLE, SIZE, OR COLOR.

THE MARK CONSISTS OF STANDARD CHARACTERS WITHOUT CLAIM TO ANY PARTICULAR FONT, STYLE, SIZE, OR COLOR.

### CLASS 41—EDUCATION AND ENTERTAINMENT

FOR DANCE CLUB SERVICES; NIGHT CLUBS (U.S. CLS. 100, 101 AND 107).  
FIRST USE 7-25-2008; IN COMMERCE 7-25-2008.

### CLASS 14—JEWELRY

FOR CHARMS; JEWELRY; NECKLACES (U.S. CLS. 2, 27, 28 AND 50).

### CLASS 43—HOTEL AND RESTAURANT SERVICES

### CLASS 25—CLOTHING

FOR BASEBALL CAPS AND HATS; SHIRTS (U.S. CLS. 22 AND 39).  
THEODORE MCBRIDE, EXAMINING ATTORNEY

FOR RESTAURANT AND BAR SERVICES (U.S. CLS. 100 AND 101).  
FIRST USE 7-25-2008; IN COMMERCE 7-25-2008.  
DAVID MURRAY, EXAMINING ATTORNEY



SN 86-064,807. PACIFIC AXIS, INC., DBA MOTIV, SANTA CRUZ, CA. FILED 9-14-2013.



THE MARK CONSISTS OF A SQUARE CONTAINING AN "M" SHAPE, WITH THE WORD "MOTIV" UNDER THE "M". THE "M" IS SURROUNDED BY THE SQUARE, AND THE WORD "MOTIV" APPEARS IN A RECTANGLE BELOW IT. ABOVE THE "M" A CLEAR RECTANGLE APPEARS.

**CLASS 41—EDUCATION AND ENTERTAINMENT**

FOR DANCE CLUB SERVICES; NIGHT CLUBS (U.S. CLS. 100, 101 AND 107).  
FIRST USE 7-25-2008; IN COMMERCE 7-25-2008.

**CLASS 43—HOTEL AND RESTAURANT SERVICES**

FOR RESTAURANT AND BAR SERVICES (U.S. CLS. 100 AND 101).  
FIRST USE 7-25-2008; IN COMMERCE 7-25-2008.  
DAVID MURRAY, EXAMINING ATTORNEY

SN 86-065,103. EDUBAY L.L.C., MARSHALL, MN. AND CAPPS JOSEPH JOHN, MARSHALL, MN. FILED 9-16-2013.

Edubay

THE MARK CONSISTS OF STANDARD CHARACTERS WITHOUT CLAIM TO ANY PARTICULAR FONT, STYLE, SIZE, OR COLOR.

**CLASS 38—COMMUNICATION**

FOR COMPUTER SERVICES, NAMELY, PROVIDING ON-LINE FACILITIES FOR REAL-TIME INTERACTION WITH OTHER COMPUTER USERS CONCERNING TOPICS OF EDUCATION (U.S. CLS. 100, 101 AND 104).

**CLASS 41—EDUCATION AND ENTERTAINMENT**

FOR PROVIDING A WEB SITE FEATURING THE RATINGS, REVIEWS AND RECOMMENDATIONS OF USERS ON EVENTS AND ACTIVITIES IN THE FIELD OF ENTERTAINMENT AND EDUCATION; PROVIDING A WEB SITE THAT FEATURES INFORMATION ABOUT ONLINE HIGHER EDUCATION RESOURCES; PROVIDING CLASSROOM INSTRUCTION AT THE COLLEGE LEVEL USING PEDAGOGICAL PRINCIPLES; PROVIDING COURSES OF INSTRUCTION AT THE COLLEGE LEVEL; PROVIDING COURSES OF INSTRUCTION AT THE COLLEGE LEVEL FOR ENGLISH AS A SECOND LANGUAGE LEARNING; PROVIDING EDUCATION COURSES IN THE FIELD OF ENGLISH AS A SECOND LANGUAGE OFFERED THROUGH ONLINE, NON-DOWNLOADABLE VIDEOS AND INSTRUCTOR ASSISTANCE; PROVIDING EDUCATION IN THE FIELD OF ENGLISH AS A SECOND LANGUAGE RENDERED THROUGH VIDEO CONFERENCE; PROVIDING EDUCATIONAL MENTORING SERVICES AND PROGRAMS IN THE FIELD OF ENGLISH AS A SECOND LANGUAGE; PROVIDING INFORMATION ABOUT EDUCATION; PROVIDING INFORMATION ABOUT ONLINE EDUCATION (U.S. CLS. 100, 101 AND 107).  
GILBERT SWIFT, EXAMINING ATTORNEY

SN 86-065,254. NASH RANCHO HILLS, LLC, SAN DIEGO, CA. FILED 9-16-2013.

RANCHO SIENNA

THE MARK CONSISTS OF STANDARD CHARACTERS WITHOUT CLAIM TO ANY PARTICULAR FONT, STYLE, SIZE, OR COLOR.

**CLASS 35—ADVERTISING AND BUSINESS**

FOR HOMEOWNER ASSOCIATION SERVICES, NAMELY, PROMOTING THE INTERESTS OF HOMEOWNERS IN A SPECIFIC COMMUNITY; ONLINE INFORMATION SERVICES IN THE FIELD OF REAL ESTATE, NAMELY, REAL ESTATE SALES MANAGEMENT; PROVIDING WEBSITES IN THE FIELD OF REAL ESTATE, NAMELY, REAL ESTATE SALES MANAGEMENT (U.S. CLS. 100, 101 AND 102).

**CLASS 36—INSURANCE AND FINANCIAL**

FOR REAL ESTATE MANAGEMENT; ONLINE INFORMATION SERVICES IN THE FIELD OF REAL ESTATE; PROVIDING WEBSITES IN THE FIELD OF REAL ESTATE; ONLINE INFORMATION ABOUT LEASING OF HOUSES IN PLANNED COMMUNITIES AND DEVELOPMENTS AND REAL ESTATE MANAGEMENT OF PLANNED COMMUNITIES AND DEVELOPMENTS (U.S. CLS. 100, 101 AND 102).

**CLASS 37—CONSTRUCTION AND REPAIR**

FOR REAL ESTATE DEVELOPMENT; LAND DEVELOPMENT SERVICES, NAMELY, PLANNING AND LAYING OUT OF RESIDENTIAL AND COMMERCIAL DEVELOPMENTS; MASTER PLAN COMMUNITY SERVICES, NAMELY, PLANNING AND LAYING OUT OF RESIDENTIAL AND COMMERCIAL DEVELOPMENTS; ONLINE INFORMATION SERVICES IN THE FIELD OF REAL ESTATE DEVELOPMENT; REAL ESTATE DEVELOPMENT; LAND DEVELOPMENT SERVICES, NAMELY, PLANNING AND LAYING OUT OF RESIDENTIAL AND/OR COMMERCIAL COMMUNITIES; MASTER PLAN COMMUNITY SERVICES, NAMELY, PLANNING, DEVELOPING, AND CONSTRUCTION OF MASTER PLAN COMMUNITIES; CONSTRUCTION PLANNING; CONSTRUCTION MANAGEMENT; ONLINE INFORMATION SERVICES IN THE FIELDS OF REAL ESTATE DEVELOPMENT, NAMELY, THE DEVELOPMENT OF PLANNED COMMUNITIES, AND RESIDENTIAL AND/OR COMMERCIAL DEVELOPMENTS; PROVIDING MAINTENANCE OF RECREATIONAL AREAS, POOL FACILITIES, SPA FACILITIES, COUNTRY CLUB FACILITIES, PHYSICAL FITNESS FACILITIES, CLUB ROOM FACILITIES, TENNIS COURT FACILITIES; STREET MAINTENANCE; COMMERCIAL AND RESIDENTIAL WASTE DISPOSAL SERVICES FOR OTHERS; BUILDING CONSTRUCTION, REPAIR, MAINTENANCE, AND RENOVATION SERVICES, CONSTRUCTION AND MAINTENANCE OF ROADS AND OTHER INFRASTRUCTURE (U.S. CLS. 100, 103 AND 106).

ERNEST SHOSHO, EXAMINING ATTORNEY

SN 86-065,339. ABENGOA BIOENERGY NEW TECHNOLOGIES, LLC, CHESTERFIELD, MO. FILED 9-16-2013.

Science. Solutions.  
Service.

THE MARK CONSISTS OF STANDARD CHARACTERS WITHOUT CLAIM TO ANY PARTICULAR FONT, STYLE, SIZE, OR COLOR.

**CLASS 4—LUBRICANTS AND FUELS**

FOR ETHANOL FUELS (U.S. CLS. 1, 6 AND 15).

**CLASS 31—NATURAL AGRICULTURAL PRODUCTS**

FOR CATTLE FEED (U.S. CLS. 1 AND 46).  
VERNA BETH RIRIE, EXAMINING ATTORNEY

SN 86-065,307. AVX NORTHWEST, INC., DBA ATHLETIC SOUND, CENTRALIA, WA. FILED 9-16-2013.

ATHLETICSOUND

THE MARK CONSISTS OF STANDARD CHARACTERS WITHOUT CLAIM TO ANY PARTICULAR FONT, STYLE, SIZE, OR COLOR.

**CLASS 9—ELECTRICAL AND SCIENTIFIC APPARATUS**

FOR SOUND SYSTEMS COMPRISING REMOTE CONTROLS, AMPLIFIERS, LOUDSPEAKERS AND COMPONENTS THEREFOR (U.S. CLS. 21, 23, 26, 36 AND 38).  
FIRST USE 4-8-2009; IN COMMERCE 8-6-2009.

**CLASS 37—CONSTRUCTION AND REPAIR**

FOR INSTALLATION, MAINTENANCE AND REPAIR OF SOUND SYSTEMS (U.S. CLS. 100, 103 AND 106).  
FIRST USE 4-8-2009; IN COMMERCE 8-6-2009.

**CLASS 42—SCIENTIFIC AND COMPUTER SERVICES**

FOR DESIGN, DEVELOPMENT, AND CONSULTING SERVICES RELATED THERETO IN THE FIELD OF SOUND SYSTEMS (U.S. CLS. 100 AND 101).  
FIRST USE 4-8-2009; IN COMMERCE 8-6-2009.  
DOMINICK J. SALEMI, EXAMINING ATTORNEY

SN 86-065,358. LEINWEBER GMBH & CO. KG, 32051 HERFORD, FED REP GERMANY, FILED 9-16-2013.

BRAX

THE MARK CONSISTS OF STANDARD CHARACTERS WITHOUT CLAIM TO ANY PARTICULAR FONT, STYLE, SIZE, OR COLOR.

OWNER OF U.S. REG. NO. 3,275,437.  
THE WORDING "BRAX" HAS NO MEANING IN A FOREIGN LANGUAGE.

**CLASS 18—LEATHER GOODS**

FOR ALL-PURPOSE CARRYING BAGS; BACKPACKS; BRIEFCASES; CASES FOR KEYS; COSMETIC BAGS SOLD EMPTY; CREDIT CARD CASES AND HOLDERS; HANDBAGS; LUGGAGE AND TRUNKS; TOILETRY BAGS SOLD EMPTY; UMBRELLAS AND PARASOLS (U.S. CLS. 1, 2, 3, 22 AND 41).

**CLASS 25—CLOTHING**

FOR BLOUSES; FLEECE PULLOVERS; FLEECE SHORTS; FLEECE TOPS; FLEECE VESTS; GLOVES; GOLF CAPS; GOLF PANTS, SHIRTS AND SKIRTS; GOLF SHIRTS; GOLF SHOES; GOLF SHORTS; GOLF TROUSERS; JEANS; MEN'S AND WOMEN'S JACKETS, COATS, TROUSERS, VESTS; POLO SHIRTS; PULLOVERS; RAINWEAR; SHIRTS; SHOES; SKIRTS AND DRESSES; SWEATSHIRTS; T-SHIRTS; TREKKING JACKETS; TREKKING TROUSERS; TUQUES (U.S. CLS. 22 AND 39).  
BARBARA BROWN, EXAMINING ATTORNEY

SN 86-065,359. WORLDRELAY, INC., AUSTIN, TX. FILED 9-16-2013.

# WORLDRELAY

THE MARK CONSISTS OF STANDARD CHARACTERS WITHOUT CLAIM TO ANY PARTICULAR FONT, STYLE, SIZE, OR COLOR.

## CLASS 9—ELECTRICAL AND SCIENTIFIC APPARATUS

FOR COMPUTER APPLICATION SOFTWARE FOR STREAMING MEDIA PLAYERS, TELEVISIONS, SMARTPHONES, COMPUTERS, AND TABLET COMPUTERS, NAMELY, SOFTWARE FOR STREAMING AUDIO-VISUAL MEDIA CONTENT, AND FOR TELECOMMUNICATIONS SERVICES (U.S. CLS. 21, 23, 26, 36 AND 38).

## CLASS 35—ADVERTISING AND BUSINESS

FOR COMPUTERIZED ON-LINE RETAIL STORE SERVICES IN THE FIELD OF ENTERTAINMENT AND EDUCATIONAL CONTENT, NAMELY, SUBSCRIPTIONS TO RADIO AND TELEVISION PROGRAMMING AND TELECOMMUNICATIONS SERVICES (U.S. CLS. 100, 101 AND 102).

## CLASS 38—COMMUNICATION

FOR AUDIO AND VIDEO BROADCASTING SERVICES OVER THE INTERNET (U.S. CLS. 100, 101 AND 104).  
VERNA BETH RIRIE, EXAMINING ATTORNEY

SN 86-065,369. LEINWEBER GMBH & CO. KG, 32051 HERFORD, FED REP GERMANY, FILED 9-16-2013.

OWNER OF U.S. REG. NO. 3,340,351.  
THE MARK CONSISTS OF A STYLIZED LETTER "X".

## CLASS 18—LEATHER GOODS

FOR ALL-PURPOSE CARRYING BAGS; BACKPACKS; BRIEFCASES; CASES FOR KEYS; COSMETIC BAGS SOLD EMPTY; CREDIT CARD CASES AND HOLDERS; HANDBAGS; LUGGAGE AND TRUNKS; TOILETRY BAGS SOLD EMPTY; UMBRELLAS AND PARASOLS (U.S. CLS. 1, 2, 3, 22 AND 41).

## CLASS 25—CLOTHING

FOR BLOUSES; FLEECE PULLOVERS; FLEECE SHORTS; FLEECE TOPS; FLEECE VESTS; GLOVES; GOLF CAPS; GOLF PANTS, SHIRTS AND SKIRTS; GOLF SHIRTS; GOLF SHOES; GOLF SHORTS; GOLF TROUSERS; JEANS; MEN'S AND WOMEN'S JACKETS, COATS, TROUSERS, VESTS; POLO SHIRTS; PULL-OVERS; RAINWEAR; SHIRTS; SHOES; SKIRTS AND DRESSES; SWEATSHIRTS; T-SHIRTS; TREKKING JACKETS; TREKKING TROUSERS; TUQUES (U.S. CLS. 22 AND 39).

BARBARA BROWN, EXAMINING ATTORNEY

SN 86-065,439. GALLAGHER BASSETT SERVICES, INC., ITASCA, IL. FILED 9-16-2013.

# GO BEYOND

THE MARK CONSISTS OF STANDARD CHARACTERS WITHOUT CLAIM TO ANY PARTICULAR FONT, STYLE, SIZE, OR COLOR.

## CLASS 35—ADVERTISING AND BUSINESS

FOR CUSTOMIZED RISK MANAGEMENT CONSULTATION SERVICES, NAMELY, ASSESSMENT RISK EVALUATION, HAZARD SURVEYS, LOSS ANALYSIS, OSHA AND STATE COMPLIANCE AUDITS, PROPERTY AND LIABILITY ASSESSMENT, ERGONOMIC RISK EVALUATION, SAFETY PROGRAM EVALUATIONS AND UNDERWRITING OF RISK EXPOSURE AND CREATION OF RISK CONTROL PROGRAMS; MANAGED CARE SERVICES, NAMELY, HEALTH CARE COST CONTAINMENT, UTILIZATION REVIEW AND PRE-CERTIFICATION SERVICES; COMPUTERIZED DATABASE MANAGEMENT AND ELECTRONIC PROCESSING OF HEALTH CARE INFORMATION; ADMINISTRATION OF INSURANCE PROVIDER NETWORKS; ESTABLISHMENT OF INSURANCE PROVIDER NETWORKS; PREPARING BUSINESS REPORTS FROM THE INSURANCE CLAIMS INFORMATION (U.S. CLS. 100, 101 AND 102).

## CLASS 36—INSURANCE AND FINANCIAL

FOR PROVIDING INSURANCE SERVICES IN THE FIELD OF RISK MANAGEMENT SOLUTIONS, NAMELY, CLAIMS ADMINISTRATION, CLAIMS PROCESSING, CLAIMS STATUS INFORMATION, AND UNDERWRITING RISK ASSESSMENTS; PROVIDING ONLINE INSURANCE INFORMATION AND INSURANCE SERVICES IN THE FIELD OF HEALTH CARE, NAMELY, CLAIMS ADMINISTRATION, CLAIMS PROCESSING, CLAIMS STATUS INFORMATION, AND MEMBER ELIGIBILITY AND ENROLLMENT INFORMATION; ADMINISTRATION OF PREFERRED PROVIDER PLANS IN THE FIELD OF HEALTHCARE ADMINISTRATION OF MANAGED CARE HEALTH INSURANCE SERVICES; INFORMATION MANAGEMENT SERVICES IN THE FIELD OF INSURANCE CLAIM ADJUSTING, NAMELY, PROVIDING AN ON-LINE COMPUTER DATABASE FEATURING INSURANCE INFORMATION FOR INSURANCE CLAIM ADJUSTMENT AND FOR ACCESSING INSURANCE CLAIMS; PROVIDING ONLINE INFORMATION IN THE FIELD OF HEALTH CARE INSURANCE (U.S. CLS. 100, 101 AND 102).

TINA MAI, EXAMINING ATTORNEY

SN 86-065,451. AMERICAN FARMER BRANDS LLC,  
BROOKLYN, NY. FILED 9-16-2013.

## AMERICAN FARMER

THE MARK CONSISTS OF STANDARD CHARACTERS  
WITHOUT CLAIM TO ANY PARTICULAR FONT, STYLE,  
SIZE, OR COLOR.

OWNER OF U.S. REG. NO. 4,191,775.

### CLASS 1—CHEMICALS

FOR FERTILIZERS; PLANT FOOD; PLANTING SOIL  
(U.S. CLS. 1, 5, 6, 10, 26 AND 46).

### CLASS 31—NATURAL AGRICULTURAL PRODUCTS

FOR AGRICULTURAL SEEDS; LIVE PLANTS; PET  
FOOD (U.S. CLS. 1 AND 46).  
SCOTT BIBB, EXAMINING ATTORNEY

---

SN 86-065,466. GALLAGHER BASSETT SERVICES, INC.,  
ITASCA, IL. FILED 9-16-2013.

## GB FLEXWORKS

THE MARK CONSISTS OF STANDARD CHARACTERS  
WITHOUT CLAIM TO ANY PARTICULAR FONT, STYLE,  
SIZE, OR COLOR.

### CLASS 35—ADVERTISING AND BUSINESS

FOR CUSTOMIZED BUSINESS CONSULTATION REGARDING SELECTION OF WORKERS COMPENSATION SPECIALTY PROVIDER NETWORKS AND WORKERS COMPENSATION SPECIALTY PROVIDER CLAIMS ADMINISTRATION TO EMPLOYERS IN ACCORDANCE WITH STATE WORKER'S COMPENSATION LAWS AND ADMINISTRATIVE RULES FOR THE TREATMENT, DIAGNOSTIC TESTING AND SPECIALIST CARE OF WORKERS; COST ASSESSMENT, NAMELY, WORKER'S COMPENSATION ASSESSMENT EVALUATION; PROVIDING BUSINESS DATA ANALYSIS OF WORKERS COMPENSATION MEDICAL PROVIDERS AND TREATMENT PLANS; PREPARE BUSINESS AND FINANCIAL REPORTS FOR OTHERS RELATING TO WORKERS COMPENSATION INSURANCE CLAIMS FROM INFORMATION OBTAINED OVER A GLOBAL COMMUNICATIONS NETWORK (U.S. CLS. 100, 101 AND 102).

FIRST USE 6-17-2013; IN COMMERCE 6-25-2013.

### CLASS 36—INSURANCE AND FINANCIAL

FOR CUSTOMIZED FINANCIAL CONSULTATION REGARDING INSURANCE UNDERWRITING SERVICES FOR WORKERS COMPENSATION INSURANCE TO MINIMIZE MEDICAL AND ADMINISTRATIVE COSTS AND INCREASE QUALIFIED CARE AND TREATMENT OF INJURED WORKERS; INSURANCE SERVICES IN THE FIELD OF WORKERS COMPENSATION ADMINISTRATION SOLUTIONS, NAMELY, WORKERS COMPENSATION INSURANCE CLAIMS ADMINISTRATION, WORKERS COMPENSATION INSURANCE CLAIMS PROCESSING, PROVIDING WORKERS COMPENSATION INSURANCE CLAIM STATUS INFORMATION AND PROVIDING WORKERS COMPENSATION INSURANCE UNDERWRITING SERVICES TO EMPLOYERS; WORKERS COMPENSATION INSURANCE ADMINISTRATION THROUGH A NETWORK OF SPECIALTY INSURANCE PROVIDERS; PROVIDING ON-LINE INSURANCE INFORMATION; INFORMATION MANAGEMENT SERVICES IN THE FIELD OF WORKERS COMPENSATION INSURANCE CLAIM ADJUSTING, NAMELY, PROVIDING AN ON-LINE COMPUTER DATABASE IN THE FIELD OF INSURANCE INFORMATION REGARDING WORKERS COMPENSATION INSURANCE CLAIMS ADJUSTMENTS AND ACCESSING INSURANCE CLAIMS INFORMATION; PROVIDING WORKERS COMPENSATION INSURANCE CLAIMS INFORMATION OVER A GLOBAL COMMUNICATIONS NETWORK (U.S. CLS. 100, 101 AND 102).

FIRST USE 6-17-2013; IN COMMERCE 6-25-2013.

### CLASS 42—SCIENTIFIC AND COMPUTER SERVICES

FOR PROVIDING A WEBSITE FEATURING NON-DOWNLOADABLE SOFTWARE FOR MANAGING WORKERS COMPENSATION INSURANCE CLAIMS INFORMATION IN THE FIELD OF WORKERS COMPENSATION BUSINESS AND FINANCIAL INSURANCE RISK MANAGEMENT; PROVIDING TEMPORARY USE OF ON-LINE NON-DOWNLOADABLE COMPUTER SOFTWARE FOR PROCESSING, FILING AND MANAGING WORKERS COMPENSATION INSURANCE CLAIMS INFORMATION (U.S. CLS. 100 AND 101).

FIRST USE 6-17-2013; IN COMMERCE 6-25-2013.  
TINA MAI, EXAMINING ATTORNEY

---

SN 86-065,522. VELVET SLIPPER LLC, HOUSTON, TX.  
FILED 9-16-2013.

## VELVET SLIPPER DIVINE

THE MARK CONSISTS OF STANDARD CHARACTERS  
WITHOUT CLAIM TO ANY PARTICULAR FONT, STYLE,  
SIZE, OR COLOR.

### CLASS 35—ADVERTISING AND BUSINESS

FOR EVENT PLANNING AND MANAGEMENT FOR MARKETING, BRANDING, PROMOTING OR ADVERTISING THE GOODS AND SERVICES OF OTHERS; RETAIL STORE SERVICES FEATURING A WIDE VARIETY OF CONSUMER GOODS OF OTHERS; RETAIL STORE SERVICES FEATURING WOMEN'S CLOTHING, JEWELRY AND SHOES; SPECIAL EVENT PLANNING FOR BUSINESS PURPOSES; SPECIAL EVENT PLANNING FOR COMMERCIAL, PROMOTIONAL OR ADVERTISING PURPOSES (U.S. CLS. 100, 101 AND 102).

### CLASS 38—COMMUNICATION

FOR INTERNET RADIO SERVICES, NAMELY, TRANSMISSION OF AUDIO MATERIAL VIA THE INTERNET (U.S. CLS. 100, 101 AND 104).

**CLASS 41—EDUCATION AND ENTERTAINMENT**

FOR CONSULTATION IN THE FIELD OF SPECIAL EVENT PLANNING FOR SOCIAL ENTERTAINMENT PURPOSES; SPECIAL EVENT PLANNING FOR SOCIAL ENTERTAINMENT PURPOSES (U.S. CLS. 100, 101 AND 107).

BERYL GARDNER, EXAMINING ATTORNEY

SN 86-065,531. TKS SOLUTIONS, LLC, MT KISCO, NY. FILED 9-16-2013.

## Ingenious Initiatives

THE MARK CONSISTS OF STANDARD CHARACTERS WITHOUT CLAIM TO ANY PARTICULAR FONT, STYLE, SIZE, OR COLOR.

**CLASS 9—ELECTRICAL AND SCIENTIFIC APPARATUS**

FOR COMPUTER SOFTWARE FOR ACCOUNTING FOR HEDGE FUND BACK-OFFICES, FUND ADMINISTRATORS, INVESTMENT MANAGEMENT COMPANIES, PRIVATE EQUITY PARTNERSHIPS, AND FAMILY OFFICE WEALTH MANAGEMENT (U.S. CLS. 21, 23, 26, 36 AND 38).

**CLASS 42—SCIENTIFIC AND COMPUTER SERVICES**

FOR DESIGN, DEVELOPMENT, AND IMPLEMENTATION OF SOFTWARE FOR ACCOUNTING FOR HEDGE FUND BACK-OFFICES, FUND ADMINISTRATORS, INVESTMENT MANAGEMENT COMPANIES, PRIVATE EQUITY PARTNERSHIPS, AND FAMILY OFFICE WEALTH MANAGEMENT (U.S. CLS. 100 AND 101).

HOWARD B. LEVINE, EXAMINING ATTORNEY

SN 86-065,615. SYSTEM OF STRENGTH, GRANDVIEW HEIGHTS, OH. FILED 9-16-2013.

# SOS

THE MARK CONSISTS OF STANDARD CHARACTERS WITHOUT CLAIM TO ANY PARTICULAR FONT, STYLE, SIZE, OR COLOR.

**CLASS 35—ADVERTISING AND BUSINESS**

FOR ON-LINE RETAIL STORE SERVICES FEATURING APPAREL, NUTRITIONAL SUPPLEMENTS, AND FITNESS ACCESSORIES; PROVIDING ASSISTANCE, FITNESS EVALUATION AND CONSULTATION TO CORPORATE CLIENTS TO HELP THEIR EMPLOYEES MAKE HEALTH, WELLNESS AND NUTRITIONAL CHANGES IN THEIR DAILY LIVING TO INCREASE PRODUCTIVITY AND LOWER HEALTH CARE COSTS (U.S. CLS. 100, 101 AND 102).

FIRST USE 1-1-2013; IN COMMERCE 1-1-2013.

**CLASS 41—EDUCATION AND ENTERTAINMENT**

FOR CONDUCTING FITNESS CLASSES; CONSULTING SERVICES IN THE FIELDS OF FITNESS AND EXERCISE; PHYSICAL FITNESS INSTRUCTION; PROVIDING A WEB SITE FEATURING INFORMATION ON EXERCISE AND FITNESS; PROVIDING EDUCATION COURSES IN THE FIELD OF FITNESS OFFERED THROUGH ONLINE, NON-DOWNLOADABLE VIDEOS AND INSTRUCTOR ASSISTANCE (U.S. CLS. 100, 101 AND 107).

FIRST USE 1-1-2013; IN COMMERCE 1-1-2013.

SANI KHOURI, EXAMINING ATTORNEY

SN 86-065,684. SYSTEM OF STRENGTH, GRANDVIEW HEIGHTS, OH. FILED 9-16-2013.

## SYSTEM OF STRENGTH

THE MARK CONSISTS OF STANDARD CHARACTERS WITHOUT CLAIM TO ANY PARTICULAR FONT, STYLE, SIZE, OR COLOR.

**CLASS 35—ADVERTISING AND BUSINESS**

FOR ON-LINE RETAIL STORE SERVICES FEATURING APPAREL, NUTRITIONAL SUPPLEMENTS, AND FITNESS ACCESSORIES; PROVIDING ASSISTANCE, FITNESS EVALUATION AND CONSULTATION TO CORPORATE CLIENTS TO HELP THEIR EMPLOYEES MAKE HEALTH, WELLNESS AND NUTRITIONAL CHANGES IN THEIR DAILY LIVING TO INCREASE PRODUCTIVITY AND LOWER HEALTH CARE COSTS (U.S. CLS. 100, 101 AND 102).

FIRST USE 1-1-2013; IN COMMERCE 1-1-2013.

**CLASS 41—EDUCATION AND ENTERTAINMENT**

FOR CONDUCTING FITNESS CLASSES; CONSULTING SERVICES IN THE FIELDS OF FITNESS AND EXERCISE; PHYSICAL FITNESS INSTRUCTION; PROVIDING A WEB SITE FEATURING INFORMATION ON EXERCISE AND FITNESS; PROVIDING EDUCATION COURSES IN THE FIELD OF FITNESS OFFERED THROUGH ONLINE, NON-DOWNLOADABLE VIDEOS AND INSTRUCTOR ASSISTANCE (U.S. CLS. 100, 101 AND 107).

FIRST USE 1-1-2013; IN COMMERCE 1-1-2013.

SANI KHOURI, EXAMINING ATTORNEY

SN 86-065,802. PIVOTAL SOFTWARE, INC., PALO ALTO, CA. FILED 9-16-2013.

# RABBITMQ

THE MARK CONSISTS OF STANDARD CHARACTERS WITHOUT CLAIM TO ANY PARTICULAR FONT, STYLE, SIZE, OR COLOR.

**CLASS 9—ELECTRICAL AND SCIENTIFIC APPARATUS**

FOR COMPUTER SOFTWARE FOR QUEUING AND TRANSMITTING ELECTRONIC MESSAGES; COMPUTER SOFTWARE FOR USE IN THE TRANSMISSION OF BINARY AND TEXT DATA VIA COMPUTER NETWORKS (U.S. CLS. 21, 23, 26, 36 AND 38).  
FIRST USE 12-0-2007; IN COMMERCE 12-0-2007.

**CLASS 42—SCIENTIFIC AND COMPUTER SERVICES**

FOR PROVIDING TEMPORARY USE OF NON-DOWNLOADABLE SOFTWARE FOR QUEUING AND TRANSMITTING ELECTRONIC MESSAGES; PROVIDING TEMPORARY USE OF NON-DOWNLOADABLE SOFTWARE FOR USE IN THE TRANSMISSION OF BINARY AND TEXT DATA VIA COMPUTER NETWORKS (U.S. CLS. 100 AND 101).  
FIRST USE 12-0-2007; IN COMMERCE 12-0-2007.  
ZACHARY BELLO, EXAMINING ATTORNEY

SN 86-065,991. MIHALTIAN, PETER MICHAEL, WESTERVILLE, OH. FILED 9-16-2013.



THE MARK CONSISTS OF THE STYLIZED WORD "TALAJC" WHEREIN THE "T" IS IN THE SHAPE OF A THREE DIMENSIONAL CROSS WITH A CRESCENT SHAPED HALO THAT ENCIRCLES THE UPPER PORTION OF THE CROSS AND WHEREIN THE WORDS ARE IN AN UPWARD SLANTING ANGLE.

**CLASS 14—JEWELRY**

FOR CHARMS; JEWELRY; NECKLACES (U.S. CLS. 2, 27, 28 AND 50).

**CLASS 25—CLOTHING**

FOR BASEBALL CAPS AND HATS; SHIRTS (U.S. CLS. 22 AND 39).  
THEODORE MCBRIDE, EXAMINING ATTORNEY

SN 86-065,958. WRIGHT, RONALD, PEBBLE BEACH, CA. FILED 9-16-2013.

SN 86-066,016. DULCE DOMUM, LLC, NORWALK, CT. FILED 9-16-2013.

SWAMP BUCKETT



NO CLAIM IS MADE TO THE EXCLUSIVE RIGHT TO USE "SAN FRANCISCO COTTAGES AND GARDENS", APART FROM THE MARK AS SHOWN.

THE MARK CONSISTS OF STYLIZED CHARACTERS "SFC&G" AND THE WORDING "SAN FRANCISCO COTTAGES & GARDENS".

THE MARK CONSISTS OF STANDARD CHARACTERS WITHOUT CLAIM TO ANY PARTICULAR FONT, STYLE, SIZE, OR COLOR.

**CLASS 9—ELECTRICAL AND SCIENTIFIC APPARATUS**

FOR DIGITAL MEDIA, NAMELY, RECORD ALBUMS, CDS AND MP3S FEATURING MUSIC (U.S. CLS. 21, 23, 26, 36 AND 38).

**CLASS 9—ELECTRICAL AND SCIENTIFIC APPARATUS**

FOR DOWNLOADABLE ELECTRONIC PUBLICATIONS IN THE NATURE OF GENERAL FEATURE MAGAZINES (U.S. CLS. 21, 23, 26, 36 AND 38).

**CLASS 25—CLOTHING**

FOR T-SHIRTS (U.S. CLS. 22 AND 39).

**CLASS 16—PAPER GOODS AND PRINTED MATTER**

FOR GENERAL FEATURE MAGAZINES (U.S. CLS. 2, 5, 22, 23, 29, 37, 38 AND 50).

**CLASS 41—EDUCATION AND ENTERTAINMENT**

FOR ENTERTAINMENT SERVICES IN THE NATURE OF LIVE MUSICAL PERFORMANCES (U.S. CLS. 100, 101 AND 107).  
SHAUNIA CARLYLE, EXAMINING ATTORNEY

**CLASS 41—EDUCATION AND ENTERTAINMENT**

FOR PROVIDING ON-LINE NON-DOWNLOADABLE GENERAL FEATURE MAGAZINES (U.S. CLS. 100, 101 AND 107).  
LINDA POWELL, EXAMINING ATTORNEY

SN 86-066,027. ODOBESCU GHENADIE, DBA ODOBESCU GHENADIE, MONTREAL, CANADA, FILED 9-16-2013.

SN 86-066,199. NAVERA, INC., SAN FRANCISCO, CA. FILED 9-16-2013.

born to be strong

THE MARK CONSISTS OF STANDARD CHARACTERS WITHOUT CLAIM TO ANY PARTICULAR FONT, STYLE, SIZE, OR COLOR.

**CLASS 32—LIGHT BEVERAGES**

FOR BEERS; NON-ALCOHOLIC COCKTAIL BASES; NON-ALCOHOLIC COCKTAIL MIXES; NON-ALCOHOLIC COCKTAILS; NON-ALCOHOLIC COCKTAILS, NAMELY, MOCKTAILS (U.S. CLS. 45, 46 AND 48).

**CLASS 33—WINES AND SPIRITS**

FOR ALCOHOLIC COCKTAIL MIXES; ALCOHOLIC FRUIT COCKTAIL DRINKS; BRANDY; CACHACA; CHINESE SPIRIT OF SORGHUM (GAOLIAN-JIOU); COGNAC; DISTILLED SPIRITS; DISTILLED SPIRITS OF RICE (AWAMORI); GIN; GRAPE WINE; KOREAN DISTILLED SPIRITS (SOJU); PORT WINES; PREPARED ALCOHOLIC COCKTAIL; RUM; SHOCHU (SPIRITS); SPIRITS; SPIRITS AND LIQUEURS; TEQUILA; VODKA; WHISKY (U.S. CLS. 47 AND 49).

JESSICA FATHY, EXAMINING ATTORNEY

SN 86-066,191. FULLER, PAUL C. HOLLISTER, CA. FILED 9-16-2013.

Astropreneur

THE MARK CONSISTS OF STANDARD CHARACTERS WITHOUT CLAIM TO ANY PARTICULAR FONT, STYLE, SIZE, OR COLOR.

**CLASS 9—ELECTRICAL AND SCIENTIFIC APPARATUS**

FOR COMPUTER GAME PROGRAMMES DOWNLOADABLE VIA THE INTERNET; COMPUTER GAME SOFTWARE; COMPUTER GAME SOFTWARE FOR PERSONAL COMPUTERS AND HOME VIDEO GAME CONSOLES; COMPUTER GAME SOFTWARE FOR USE ON MOBILE AND CELLULAR PHONES; DOWNLOADABLE COMPUTER GAME SOFTWARE VIA A GLOBAL COMPUTER NETWORK AND WIRELESS DEVICES (U.S. CLS. 21, 23, 26, 36 AND 38).

**CLASS 35—ADVERTISING AND BUSINESS**

FOR ASSISTANCE, ADVICE AND CONSULTANCY WITH REGARD TO BUSINESS PLANNING, BUSINESS ANALYSIS, BUSINESS MANAGEMENT AND BUSINESS ORGANIZATION RELATING TO PURCHASING FUNCTIONS; ASSISTANCE, ADVISORY SERVICES AND CONSULTANCY WITH REGARD TO BUSINESS PLANNING, BUSINESS ANALYSIS, BUSINESS MANAGEMENT, AND BUSINESS ORGANIZATION; BRAND IMAGERY CONSULTING SERVICES; BUSINESS ADMINISTRATION CONSULTANCY (U.S. CLS. 100, 101 AND 102).

TOBY BULLOFF, EXAMINING ATTORNEY

HARVEY

THE MARK CONSISTS OF STANDARD CHARACTERS WITHOUT CLAIM TO ANY PARTICULAR FONT, STYLE, SIZE, OR COLOR.

**CLASS 36—INSURANCE AND FINANCIAL**

FOR BUSINESS SERVICES FOR EMPLOYERS, NAMELY, PROVIDING INFORMATION ON EMPLOYEE BENEFITS PLANS CONCERNING INSURANCE AND FINANCE, EMPLOYEE BENEFITS PLAN ENROLLMENT SUPPORT SERVICES; PROVIDING A WEBSITE FEATURING INFORMATION AND ONLINE VIDEOS IN THE FIELD OF INSURANCE AND EMPLOYEE BENEFITS; PROVIDING ONLINE INFORMATION AND ONLINE VIDEOS ABOUT EMPLOYEE BENEFIT PLAN PRODUCTS VIA A WEBSITE (U.S. CLS. 100, 101 AND 102).

**CLASS 41—EDUCATION AND ENTERTAINMENT**

FOR EDUCATIONAL SERVICES, NAMELY, PROVIDING ONLINE ANIMATION-BASED EDUCATION MODULES AND VIDEOS FEATURING PRODUCT INFORMATION FOR EMPLOYEES IN THE FIELD OF INSURANCE AND EMPLOYEE BENEFITS VIA A WEBSITE (U.S. CLS. 100, 101 AND 107).

**CLASS 42—SCIENTIFIC AND COMPUTER SERVICES**

FOR COMPUTER SERVICES, NAMELY, PROVIDING SEARCH PLATFORMS TO ALLOW USERS TO INPUT PERSONAL USER EXPERIENCE AND PRODUCT INFORMATION IN A WAY THAT MORE EFFECTIVELY ENGAGES AND EDUCATES EMPLOYEES ON AVAILABLE EMPLOYEE BENEFITS; SOFTWARE AS A SERVICE (SAAS) SERVICES FEATURING SOFTWARE FOR PRODUCT SPECIFIC INFORMATION, SEGMENTATION BASED PRODUCT EDUCATION, QUOTE AND PRICING, DECISION SUPPORT AND GENERAL ENROLLMENT PROCESS SUPPORT IN THE FIELD OF INSURANCE AND EMPLOYEE BENEFITS (U.S. CLS. 100 AND 101).

JONATHAN FALK, EXAMINING ATTORNEY

SN 86-066,323. MARY RAGER, OSTEEEN, FL. FILED 9-17-2013.

Shiba Love!

THE MARK CONSISTS OF STANDARD CHARACTERS WITHOUT CLAIM TO ANY PARTICULAR FONT, STYLE, SIZE, OR COLOR.

**CLASS 16—PAPER GOODS AND PRINTED MATTER**

FOR 3D DECALS FOR USE ON ANY SURFACE; ADDRESS BOOKS AND DIARIES; ADDRESS LABELS; ADDRESS STAMPS; BALL POINT PENS; BIBLES; BLANK CARDS; BLANK NOTE CARDS; BOOKMARKS; BUMPER STICKERS; CALENDARS AND DIARIES; CARDS BEARING UNIVERSAL GREETINGS; CORRESPONDENCE CARDS; DECALS; FABRIC GIFT BAGS; FELT-TIP PENS; GEL ROLLER PENS; HOLIDAY CARDS; MAGNETIC BUMPER STICKERS; PAPER GIFT BAGS; PENS; PHOTOGRAPHS; PICTORIAL PRINTS; PICTURE BOOKS; PICTURE CARDS; PICTURES; POCKET CALENDARS; POSTCARDS AND GREETING CARDS; POSTCARDS AND PICTURE POSTCARDS; STICKERS; STICKERS AND TRANSFERS; WALL CALENDARS; WRITING IMPLEMENTS (U.S. CLS. 2, 5, 22, 23, 29, 37, 38 AND 50).

FIRST USE 6-12-2013; IN COMMERCE 9-15-2013.

**CLASS 18—LEATHER GOODS**

FOR ALL PURPOSE SPORT BAGS; ALL-PURPOSE ATHLETIC BAGS; ALL-PURPOSE CARRYING BAGS; ALL-PURPOSE REUSABLE CARRYING BAGS; ANIMAL HARNESSSES; ANIMAL LEASHES; BACKPACKS FOR PETS; BACKPACKS, BOOK BAGS, SPORTS BAGS, BUM BAGS, WALLETS AND HANDBAGS; CARRY-ALL BAGS; CLOTHING FOR ANIMALS; CLOTHING FOR DOMESTIC PETS; COLLARS FOR ANIMALS; COLLARS FOR PETS; DOG APPAREL; DOG CLOTHING; DOG COATS; DOG COLLARS; DOG COLLARS AND LEADS; DOG LEASHES; DOG PARKAS; GARMENTS FOR PETS; LEADS FOR ANIMALS; LEASHES FOR ANIMALS; PET CLOTHING; PET COLLAR ACCESSORIES, NAMELY, BELLS, SILENCERS, SAFETY LIGHTS AND BLINKERS, PENDANTS AND CHARMS; PET PRODUCTS, NAMELY, PET RESTRAINING DEVICES CONSISTING OF LEASHES, COLLARS, HARNESSSES, RESTRAINING STRAPS, AND LEASHES WITH LOCKING DEVICES (U.S. CLS. 1, 2, 3, 22 AND 41).

FIRST USE 6-12-2013; IN COMMERCE 9-15-2013.

**CLASS 21—HOUSEWARES AND GLASS**

FOR BOWLS; COFFEE CUPS, TEA CUPS AND MUGS; DISHWARE; PET BRUSHES; PET FEEDING AND DRINKING BOWLS; PET FEEDING DISHES; PET TREAT JARS (U.S. CLS. 2, 13, 23, 29, 30, 33, 40 AND 50).

FIRST USE 6-12-2013; IN COMMERCE 9-15-2013.

**CLASS 24—FABRICS**

FOR BABY BEDDING, NAMELY, BUNDLE BAGS, SWADDLING BLANKETS, CRIB BUMPERS, FITTED CRIB SHEETS, CRIB SKIRTS, CRIB BLANKETS, AND DIAPER CHANGING PAD COVERS NOT OF PAPER; BED LINEN AND TABLE LINEN; CHILDREN'S BED SHEETS, PILLOW CASES, AND BLANKETS; HAND TOWELS; HOUSEHOLD LINEN, INCLUDING FACE TOWELS; KITCHEN LINENS; KITCHEN TOWELS; LINEN FOR HOUSEHOLD PURPOSES; PET BLANKETS; TOWELS; WASHCLOTHS (U.S. CLS. 42 AND 50).

FIRST USE 6-12-2013; IN COMMERCE 9-15-2013.

**CLASS 25—CLOTHING**

FOR ATHLETIC APPAREL, NAMELY, SHIRTS, PANTS, JACKETS, FOOTWEAR, HATS AND CAPS, ATHLETIC UNIFORMS; BABY TOPS; BASEBALL CAPS; BEACHWEAR; BEANIES; BIBS NOT OF PAPER; BODY SHIRTS; CAP VISORS; CHILDREN'S AND INFANT'S APPAREL, NAMELY, JUMPERS, OVERALL SLEEPWEAR, PAJAMAS, ROMPERS AND ONE-PIECE GARMENTS; CHILDREN'S AND INFANTS' APPAREL TREATED WITH FIRE AND HEAT RETARDANTS, NAMELY, JUMPERS, OVERALL SLEEPWEAR, PAJAMAS, ROMPERS AND ONE-PIECE GARMENTS; CHILDREN'S AND INFANTS' CLOTH BIBS; CHILDREN'S HEADWEAR; COLLARED SHIRTS; GOLF SHIRTS; HALTER TOPS; HAT BANDS; HEAD SWEATBANDS; HEADWEAR; HEADBANDS; HOODED SWEATSHIRTS; INFANT WEAR; KNIT SHIRTS; ONE-PIECE GARMENTS FOR CHILDREN; PAJAMAS; POLO SHIRTS; SHIRTS AND SHORT-SLEEVED SHIRTS; SHORTS; SLEEPWEAR; SWEAT SUITS; SWIM WEAR; UNDERGARMENTS (U.S. CLS. 22 AND 39).

FIRST USE 6-12-2013; IN COMMERCE 9-11-2013.

SHARON MEIER, EXAMINING ATTORNEY

SN 86-066,388. WRASCAL, INC., SAN JOSE, CA. FILED 9-17-2013.

# Wrascal

THE MARK CONSISTS OF STANDARD CHARACTERS WITHOUT CLAIM TO ANY PARTICULAR FONT, STYLE, SIZE, OR COLOR.

**CLASS 18—LEATHER GOODS**

FOR HANDBAGS; LUGGAGE; POUCHES AND BAGS SOLD EMPTY FOR ATTACHMENT TO BACKPACKS (U.S. CLS. 1, 2, 3, 22 AND 41).

**CLASS 25—CLOTHING**

FOR HATS; JACKETS; T-SHIRTS (U.S. CLS. 22 AND 39).

SUZANNE BLANE, EXAMINING ATTORNEY

SN 86-066,444. LEARNING THROUGH ART, INC., CINCINNATI, OH. FILED 9-17-2013.

## BOOKS ALIVE! FOR KIDS

THE MARK CONSISTS OF STANDARD CHARACTERS WITHOUT CLAIM TO ANY PARTICULAR FONT, STYLE, SIZE, OR COLOR.

OWNER OF U.S. REG. NO. 2,736,314.

**CLASS 9—ELECTRICAL AND SCIENTIFIC APPARATUS**

FOR VIDEO AND/OR SOUND RECORDINGS FEATURING PERFORMANCES RELATED TO ENHANCED CREATIVE THINKING, WRITING, READING, ART, AND MUSIC (U.S. CLS. 21, 23, 26, 36 AND 38).

FIRST USE 0-0-2007; IN COMMERCE 0-0-2007.



**CLASS 16—PAPER GOODS AND PRINTED MATTER**

FOR STORY BOOKS; PRINTED INSTRUCTIONAL, EDUCATIONAL, AND TEACHING MATERIALS IN THE FIELDS OF ENHANCED CREATIVE THINKING, WRITING, READING, ART, AND MUSIC; PRINTED MENUS; PRINTED INVITATIONS; ARTS AND CRAFTS SUPPLIES; KITS OF INSTRUCTIONAL, EDUCATIONAL, AND TEACHING MATERIALS IN THE FIELDS OF ENHANCED CREATIVE THINKING, WRITING, READING, ART, AND MUSIC COMPRISING BOOKS, PRINTED STUDY GUIDES, PRINTED FACT SHEETS, PRINTED VOCABULARY SHEETS, ARTS AND CRAFTS SUPPLIES, VIDEO RECORDINGS, AND PRINTED DISCUSSION MATERIALS; KITS OF PARTY-THEMED EDUCATIONAL MATERIALS COMPRISING BOOKS, PRINTED PARTY-THEMED PLANNERS, PRINTED MENUS, PRINTED INVITATIONS, ARTS AND CRAFTS SUPPLIES, MUSIC RECORDINGS, AND PRINTED THANK YOU NOTES; KITS OF HOLIDAY-THEMED EDUCATIONAL MATERIALS COMPRISING BOOKS, PRINTED HOLIDAY-THEMED PLANNERS, PRINTED HOLIDAY-THEMED MENUS, PRINTED VOCABULARY SHEETS, ARTS AND CRAFTS SUPPLIES (U.S. CLS. 2, 5, 22, 23, 29, 37, 38 AND 50).

FIRST USE 0-0-1998; IN COMMERCE 0-0-1998.

**CLASS 41—EDUCATION AND ENTERTAINMENT**

FOR TELEVISION PROGRAMS FEATURING CONTENT RELATED TO ENHANCED CREATIVE THINKING, WRITING, READING, ART, AND MUSIC; PARTY PLANNING SERVICES (U.S. CLS. 100, 101 AND 107).

FIRST USE 0-0-2007; IN COMMERCE 0-0-2007.  
ZACHARY BELLO, EXAMINING ATTORNEY

SN 86-066,529. FUEL THE BRAIN, LLC, BELVIDERE, NC. FILED 9-17-2013.

**FUEL THE BRAIN**

THE MARK CONSISTS OF STANDARD CHARACTERS WITHOUT CLAIM TO ANY PARTICULAR FONT, STYLE, SIZE, OR COLOR.

**CLASS 9—ELECTRICAL AND SCIENTIFIC APPARATUS**

FOR DOWNLOADABLE COMPUTER GAME SOFTWARE VIA A GLOBAL COMPUTER NETWORK AND WIRELESS DEVICES (U.S. CLS. 21, 23, 26, 36 AND 38).

**CLASS 41—EDUCATION AND ENTERTAINMENT**

FOR ENTERTAINMENT SERVICES, NAMELY, PROVIDING ON-LINE COMPUTER GAMES (U.S. CLS. 100, 101 AND 107).

FIRST USE 2-0-2009; IN COMMERCE 2-0-2009.  
MORGAN WYNNE, EXAMINING ATTORNEY

SN 86-066,527. PORT O'CONNOR OFFSHORE ASSOCIATION, HOUSTON, TX. FILED 9-17-2013.

**POCO BUENO**

THE MARK CONSISTS OF STANDARD CHARACTERS WITHOUT CLAIM TO ANY PARTICULAR FONT, STYLE, SIZE, OR COLOR.

OWNER OF U.S. REG. NO. 1,225,436.  
THE ENGLISH TRANSLATION OF "POCO BUENO" IN THE MARK IS "LITTLE GOOD ONE".

**CLASS 21—HOUSEWARES AND GLASS**

FOR INSULATING SLEEVE HOLDER FOR BOTTLES; INSULATING SLEEVE HOLDERS FOR BEVERAGE CANS (U.S. CLS. 2, 13, 23, 29, 30, 33, 40 AND 50).

FIRST USE 7-31-1985; IN COMMERCE 7-31-1985.

**CLASS 25—CLOTHING**

FOR CAPS; T-SHIRTS (U.S. CLS. 22 AND 39).  
FIRST USE 6-30-1969; IN COMMERCE 6-30-1969.  
STEPHANIE ALI, EXAMINING ATTORNEY

SN 86-066,534. FINNDI, YARMOUTH, ME. FILED 9-17-2013.

**FINNDI**

THE MARK CONSISTS OF STANDARD CHARACTERS WITHOUT CLAIM TO ANY PARTICULAR FONT, STYLE, SIZE, OR COLOR.

THE WORDING "FINNDI" HAS NO MEANING IN A FOREIGN LANGUAGE.

**CLASS 9—ELECTRICAL AND SCIENTIFIC APPARATUS**

FOR COMPUTER APPLICATION SOFTWARE FOR MOBILE PHONES, HANDHELD COMPUTERS, LAPTOP COMPUTERS, DESKTOP COMPUTERS, AND ENTERPRISE COMPUTERS, NAMELY, SOFTWARE FOR DATABASE MANAGEMENT, ELECTRONIC STORAGE OF DATA, AND DATA CONTENT MANAGEMENT AND REFINEMENT; COMPUTER SEARCH ENGINE SOFTWARE; COMPUTER SOFTWARE FOR CREATING SEARCHABLE DATABASES OF INFORMATION AND DATA (U.S. CLS. 21, 23, 26, 36 AND 38).

**CLASS 35—ADVERTISING AND BUSINESS**

FOR BUSINESS CONSULTATION; BUSINESS MANAGEMENT AND CONSULTATION IN THE FIELD OF BEST PRACTICE IN THE AREA OF BUSINESS DATA COLLECTION, AGGREGATION, ANALYSIS, MANAGEMENT, AND REFINEMENT; CONSULTATION SERVICES IN THE FIELD OF COMPANY, BUSINESS SECTOR AND INDUSTRY DATA AND RESEARCH; DATA PROCESSING SERVICES; SYSTEMATIZATION OF DATA IN COMPUTER DATABASES (U.S. CLS. 100, 101 AND 102).

FIRST USE 1-1-2013; IN COMMERCE 1-22-2013.

**CLASS 42—SCIENTIFIC AND COMPUTER SERVICES**

FOR COMPUTER SERVICES, NAMELY, SEARCH ENGINE OPTIMIZATION; CONSULTING IN THE FIELD OF IT PROJECT MANAGEMENT; DATA MINING; DESIGN, DEVELOPMENT AND IMPLEMENTATION OF SOFTWARE; DESIGN, DEVELOPMENT, AND IMPLEMENTATION OF SOFTWARE FOR DATA CONTENT MANAGEMENT AND ENTERPRISE SEARCHING; TECHNOLOGY CONSULTATION IN THE FIELD OF DATA CONTENT MANAGEMENT AND ENTERPRISE SEARCH FUNCTIONS (U.S. CLS. 100 AND 101).

FIRST USE 1-1-2013; IN COMMERCE 1-22-2013.  
ARETHA SOMERVILLE, EXAMINING ATTORNEY



SN 86-066,577. NEXT STEP REALTY, LLC, NEW YORK, NY. FILED 9-17-2013.



THE MARK CONSISTS OF THE SILHOUETTE OF A GIRAFFE.

**CLASS 35—ADVERTISING AND BUSINESS**

FOR CONNECTING QUALIFIED SERVICE PROVIDERS WITH CONSUMERS; MATCHING CONSUMERS WITH PROFESSIONALS IN THE FIELD OF REAL ESTATE (U.S. CLS. 100, 101 AND 102).

FIRST USE 7-20-2010; IN COMMERCE 7-20-2010.

**CLASS 36—INSURANCE AND FINANCIAL**

FOR REAL ESTATE AGENCIES; REAL ESTATE BROKERAGE (U.S. CLS. 100, 101 AND 102).

FIRST USE 7-20-2010; IN COMMERCE 7-20-2010.  
CURTIS FRENCH, EXAMINING ATTORNEY



SN 86-066,804. TRIMBLE NAVIGATION LIMITED, SUNNYVALE, CA. FILED 9-17-2013.

**RTX**

THE MARK CONSISTS OF STANDARD CHARACTERS WITHOUT CLAIM TO ANY PARTICULAR FONT, STYLE, SIZE, OR COLOR.

**CLASS 9—ELECTRICAL AND SCIENTIFIC APPARATUS**

FOR GLOBAL NAVIGATION SATELLITE SYSTEM (GNSS) RECEIVERS; COMPUTER APPLICATION SOFTWARE FOR USE IN PROCESSING AND VISUALIZING DATA DERIVED FROM GLOBAL POSITIONING SYSTEMS (GPS) AND GLOBAL NAVIGATION SATELLITE SYSTEMS (GNSS), FOR USE IN NAVIGATION AND POSITIONING OF AGRICULTURAL AND CONSTRUCTION MACHINERY, AND FOR ASSET MANAGEMENT OF AGRICULTURAL AND CONSTRUCTION MACHINERY; DOWNLOADABLE MOBILE APPLICATIONS FOR USE IN PROCESSING AND VISUALIZING DATA DERIVED FROM GLOBAL POSITIONING SYSTEMS (GPS) AND GLOBAL NAVIGATION SATELLITE SYSTEMS (GNSS), FOR USE IN NAVIGATION AND POSITIONING OF AGRICULTURAL AND CONSTRUCTION MACHINERY, AND FOR ASSET MANAGEMENT OF AGRICULTURAL AND CONSTRUCTION MACHINERY; COMPUTER APPLICATION SOFTWARE FOR USE IN PROCESSING AND VISUALIZING DATA DERIVED FROM GLOBAL POSITIONING SYSTEMS (GPS), GLOBAL NAVIGATION SATELLITE SYSTEMS (GNSS), WEATHER STATIONS, SEISMIC SENSORS AND RADIO BEACON TRANSMITTERS, FOR USE IN THE FIELDS OF CARTOGRAPHY, EARTH SCIENCE, GEODESY, GEOINFORMATICS, GEOLOGY, METEOROLOGY, NAVIGATION, SEARCH AND RESCUE, SEISMOLOGY AND SURVEYING; DOWNLOADABLE MOBILE APPLICATIONS FOR USE IN PROCESSING AND VISUALIZING DATA DERIVED FROM GLOBAL POSITIONING SYSTEMS (GPS), GLOBAL NAVIGATION SATELLITE SYSTEMS (GNSS), WEATHER STATIONS, SEISMIC SENSORS AND RADIO BEACON TRANSMITTERS, FOR USE IN THE FIELDS OF CARTOGRAPHY, EARTH SCIENCE, GEODESY, GEOINFORMATICS, GEOLOGY, METEOROLOGY, NAVIGATION, SEARCH AND RESCUE, SEISMOLOGY AND SURVEYING (U.S. CLS. 21, 23, 26, 36 AND 38).

**CLASS 38—COMMUNICATION**

FOR GLOBAL NAVIGATION SATELLITE SYSTEM (GNSS) SATELLITE SIGNAL TRANSMISSION AND RECEIVING SERVICES FOR PURPOSES OF NAVIGATION AND POSITIONING OF AGRICULTURAL AND CONSTRUCTION MACHINERY, FOR MAPPING, FOR GEOGRAPHIC INFORMATION SYSTEM (GIS) APPLICATIONS, AND FOR ASSET MANAGEMENT OF AGRICULTURAL AND CONSTRUCTION MACHINERY; PROVIDING ACCESS TO A REAL-TIME KINEMATIC (RTK) BASE STATION NETWORK FOR USE IN TRANSMISSION OF SATELLITE SIGNALS, FOR USE IN NAVIGATION AND COURSE-CORRECTION OF AGRICULTURAL AND CONSTRUCTION MACHINERY, FOR MAPPING, FOR GEOGRAPHIC INFORMATION SYSTEM (GIS) APPLICATIONS, AND FOR ASSET MANAGEMENT OF AGRICULTURAL AND CONSTRUCTION MACHINERY (U.S. CLS. 100, 101 AND 104).

KEVIN MITTLER, EXAMINING ATTORNEY



SN 86-066,835. RAWPO IP ASSETS, LLC, BROOKLYN, NY. FILED 9-17-2013.

**RAWSTACHE**

THE MARK CONSISTS OF STANDARD CHARACTERS WITHOUT CLAIM TO ANY PARTICULAR FONT, STYLE, SIZE, OR COLOR.

**CLASS 5—PHARMACEUTICALS**

FOR DIETARY SUPPLEMENTAL DRINKS IN THE NATURE OF VITAMIN AND MINERAL BEVERAGES; ELECTROLYTE DRINKS FOR MEDICAL PURPOSES; HERBAL DRINKS USED TO AID IN SLEEP AND RELAXATION; DIETARY AND NUTRITIONAL SUPPLEMENTS; DIETARY SUPPLEMENTS FOR HUMAN CONSUMPTION; DIETARY SUPPLEMENTAL DRINKS; DIETARY SUPPLEMENTAL DRINKS IN THE NATURE OF VITAMIN AND MINERAL BEVERAGES (U.S. CLS. 6, 18, 44, 46, 51 AND 52).

SN 86-066,887. ASCEND, INC., NEW YORK, NY. FILED 9-17-2013.

NAAMBA

THE MARK CONSISTS OF STANDARD CHARACTERS WITHOUT CLAIM TO ANY PARTICULAR FONT, STYLE, SIZE, OR COLOR.

**CLASS 32—LIGHT BEVERAGES**

FOR FRUIT DRINKS; FRUIT DRINKS AND FRUIT JUICES; VEGETABLE DRINKS; FRUIT AND VEGETABLE DRINKS COMPRISED PRIMARILY OF FRUIT AND VEGETABLE JUICE BLENDS WITH ADDITIONAL NATURAL INGREDIENTS SUCH AS COCONUT WATER, NUTS, SEEDS, ROOTS, FLOWERS, TREE SYRUP AND NECTAR (U.S. CLS. 45, 46 AND 48).  
MARCIE MILONE, EXAMINING ATTORNEY

**CLASS 16—PAPER GOODS AND PRINTED MATTER**

FOR TRADE JOURNALS IN THE FIELD OF MASTERS OF BUSINESS ADMINISTRATION (U.S. CLS. 2, 5, 22, 23, 29, 37, 38 AND 50).  
FIRST USE 1-1-2011; IN COMMERCE 1-1-2011.

SN 86-066,838. MICHAELS, JENNIFER, KENWOOD, CA. FILED 9-17-2013.

**CLASS 35—ADVERTISING AND BUSINESS**

FOR PROVIDING AN ONLINE DIRECTORY INFORMATION SERVICE FEATURING INFORMATION REGARDING VENDORS FOR PERSONS WITH MASTERS OF BUSINESS ADMINISTRATION, CAREER INFORMATION, JOB PLACEMENT AND JOB SEEKING INFORMATION FOR BUSINESS PERSONS (U.S. CLS. 100, 101 AND 102).  
FIRST USE 1-1-2011; IN COMMERCE 1-1-2011.

Jungle Jenny

**CLASS 41—EDUCATION AND ENTERTAINMENT**

FOR EDUCATION SERVICES, NAMELY, PROVIDING CLASSES, SEMINARS, CONFERENCES AND WORKSHOPS IN THE FIELD OF BUSINESS ADMINISTRATION; PUBLICATION OF ELECTRONIC MAGAZINES (U.S. CLS. 100, 101 AND 107).  
FIRST USE 1-1-2011; IN COMMERCE 1-1-2011.  
MARY ROSSMAN, EXAMINING ATTORNEY

THE MARK CONSISTS OF STANDARD CHARACTERS WITHOUT CLAIM TO ANY PARTICULAR FONT, STYLE, SIZE, OR COLOR.

THE NAME "JUNGLE JENNY" IDENTIFIES A LIVING INDIVIDUAL WHOSE CONSENT IS OF RECORD.

SN 86-066,895. ASCEND, INC., NEW YORK, NY. FILED 9-17-2013.

**CLASS 16—PAPER GOODS AND PRINTED MATTER**

FOR CHILDREN'S BOOKS; COMIC BOOKS (U.S. CLS. 2, 5, 22, 23, 29, 37, 38 AND 50).



**CLASS 41—EDUCATION AND ENTERTAINMENT**

FOR ENTERTAINMENT SERVICES IN THE NATURE OF DEVELOPMENT, CREATION, PRODUCTION AND POST-PRODUCTION SERVICES OF MULTIMEDIA ENTERTAINMENT CONTENT; ENTERTAINMENT SERVICES, NAMELY, PERSONAL APPEARANCES BY A TELEVISION HOST AND EDUCATIONAL SPEAKER; MULTIMEDIA ENTERTAINMENT SERVICES IN THE NATURE OF RECORDING, PRODUCTION AND POST-PRODUCTION SERVICES IN THE FIELDS OF MUSIC, VIDEO, AND FILMS; PROVIDING A WEBSITE FEATURING BLOGS AND NON-DOWNLOADABLE PUBLICATIONS IN THE NATURE OF ARTICLES, VIDEOS, AND PHOTOGRAPHS IN THE FIELD(S) OF ENTERTAINMENT AND EDUCATION (U.S. CLS. 100, 101 AND 107).

FIRST USE 10-0-2008; IN COMMERCE 10-0-2008.  
MARCIE MILONE, EXAMINING ATTORNEY

NO CLAIM IS MADE TO THE EXCLUSIVE RIGHT TO USE "NATIONAL ASSOCIATION OF ASIAN MBAS", APART FROM THE MARK AS SHOWN.

THE MARK CONSISTS OF THE LETTERING "NAAMBA" OVER THE WORDING "NATIONAL ASSOCIATION OF ASIAN MBAS" IN A RECTANGULAR DESIGN WITH A DOG-EARED RIGHT UPPER CORNER.

**CLASS 16—PAPER GOODS AND PRINTED MATTER**

FOR TRADE JOURNALS IN THE FIELD OF MASTERS OF BUSINESS ADMINISTRATION (U.S. CLS. 2, 5, 22, 23, 29, 37, 38 AND 50).  
FIRST USE 1-1-2011; IN COMMERCE 1-1-2011.

**CLASS 35—ADVERTISING AND BUSINESS**

FOR PROVIDING AN ONLINE DIRECTORY INFORMATION SERVICE FEATURING INFORMATION REGARDING VENDORS FOR PERSONS WITH MASTERS OF BUSINESS ADMINISTRATION, CAREER INFORMATION, JOB PLACEMENT AND JOB SEEKING INFORMATION FOR BUSINESS PERSONS (U.S. CLS. 100, 101 AND 102).

FIRST USE 1-1-2011; IN COMMERCE 1-1-2011.

**CLASS 41—EDUCATION AND ENTERTAINMENT**

FOR EDUCATION SERVICES, NAMELY, PROVIDING CLASSES, SEMINARS, CONFERENCES AND WORKSHOPS IN THE FIELD OF BUSINESS ADMINISTRATION; PUBLICATION OF ELECTRONIC MAGAZINES (U.S. CLS. 100, 101 AND 107).

FIRST USE 1-1-2011; IN COMMERCE 1-1-2011.  
MARY ROSSMAN, EXAMINING ATTORNEY

**CLASS 43—HOTEL AND RESTAURANT SERVICES**

FOR ARRANGING TEMPORARY HOUSING ACCOMMODATIONS; BOOKING OF CAMPGROUND ACCOMMODATION; CONSULTING SERVICES IN THE FIELD OF HOSPITALITY; PROVIDING TRAVEL LODGING INFORMATION SERVICES AND TRAVEL LODGING BOOKING AGENCY SERVICES FOR TRAVELERS; TRAVEL AGENCY SERVICES, NAMELY, MAKING RESERVATIONS AND BOOKING FOR TEMPORARY LODGING; VACATION CLUB SERVICES, NAMELY, MAKING RESERVATIONS AND BOOKINGS FOR TEMPORARY LODGING (U.S. CLS. 100 AND 101).

FIRST USE 7-15-2012; IN COMMERCE 7-15-2012.  
NICHOLAS ALTREE, EXAMINING ATTORNEY

SN 86-067,044. ANTOCI, LENA MARIE, ALHAMBRA, CA. FILED 9-17-2013.

SN 86-066,953. BLUEGREEN CORPORATION, BOCA RATON, FL. FILED 9-17-2013.

WE BELIEVE IN THE POWER OF  
VACATION

THE MARK CONSISTS OF STANDARD CHARACTERS WITHOUT CLAIM TO ANY PARTICULAR FONT, STYLE, SIZE, OR COLOR.

**CLASS 36—INSURANCE AND FINANCIAL**

FOR REAL ESTATE SERVICES, NAMELY, RENTAL OF VACATION HOMES, CONDOMINIUMS, CABINS, AND VILLAS; REAL ESTATE TIME-SHARE EXCHANGE SERVICES; REAL ESTATE OWNERSHIP EXCHANGE SERVICES, NAMELY, VACATION REAL ESTATE TIME SHARING, REAL ESTATE MANAGEMENT AND LEASING SERVICES; PROVIDING FINANCIAL INFORMATION RELATED TO SALES OF REAL ESTATE TIMESHARE AND VACATION PROPERTIES FOR THE PURPOSE OF FEE BASED LENDER FUNDING AND REPORTING, VIA A WEBSITE PORTAL AVAILABLE TO REGISTERED USERS; VACATION CLUB SERVICES, NAMELY, REAL ESTATE TIME SHARING SERVICES; VACATION REAL ESTATE TIMESHARE SERVICES FEATURING INCENTIVE AWARD PROGRAM; CONSULTING SERVICES FOR RESORT PROPERTIES, NAMELY, CONSULTING IN THE FIELD OF LEASING AND MANAGEMENT OF RESORT AND TIMESHARE PROPERTIES; MANAGEMENT OF RESORT AND TIME-SHARE PROPERTIES; MORTGAGE LOAN FINANCING AND OTHER FINANCING SERVICES (U.S. CLS. 100, 101 AND 102).

FIRST USE 7-15-2012; IN COMMERCE 7-15-2012.

**CLASS 39—TRANSPORTATION AND STORAGE**

FOR VACATION CLUB SERVICES, NAMELY, MAKING RESERVATIONS, AND BOOKING FOR TRANSPORTATION; TRAVEL AGENCY SERVICES, NAMELY, MAKING RESERVATIONS, AND BOOKING FOR TRANSPORTATION; TRAVEL CLUB SERVICES (U.S. CLS. 100 AND 105).

FIRST USE 7-15-2012; IN COMMERCE 7-15-2012.

life listens

THE MARK CONSISTS OF STANDARD CHARACTERS WITHOUT CLAIM TO ANY PARTICULAR FONT, STYLE, SIZE, OR COLOR.

**CLASS 41—EDUCATION AND ENTERTAINMENT**

FOR LIFE COACHING SERVICES IN THE FIELD OF PERSONAL DEVELOPMENT (U.S. CLS. 100, 101 AND 107).

**CLASS 44—MEDICAL, BEAUTY AND AGRICULTURAL SERVICES**

FOR PROVIDING IN-PERSON ENERGY HEALING SERVICES (U.S. CLS. 100 AND 101).

SKYE YOUNG, EXAMINING ATTORNEY

SN 86-067,191. MBLP PROPERTIES, LLC, BRECKSVILLE, OH. FILED 9-17-2013.

OLD WORLD FLAVORS FOR NEW  
WORLD CHEFS

THE MARK CONSISTS OF STANDARD CHARACTERS WITHOUT CLAIM TO ANY PARTICULAR FONT, STYLE, SIZE, OR COLOR.

**CLASS 29—MEATS AND PROCESSED FOODS**

FOR JELLIES, JAMS; MEAT AND MEAT EXTRACTS; POTATO PANCAKES; PREPARED MEAT; SOUPS; STEWS (U.S. CL. 46).

**CLASS 30—STAPLE FOODS**

FOR BAKERY DESSERTS; BAKERY GOODS; BAKERY PRODUCTS; BARBEQUE SAUCE; BREAD; BREAD CRUMBS; COATINGS FOR FOODS MADE OF BREADING; DUMPLINGS; GRAVIES; MIXES FOR MAKING BATTERS FOR FRIED FOODS; NOODLE-BASED PREPARED MEALS; PIEROGIES; SAUCES; SPICES (U.S. CL. 46).

DAVID MURRAY, EXAMINING ATTORNEY

SN 86-067,405. VILLA GROUP HOTEL AND RESORTS, S.A. DE C.V., LAGUNA BEACH, CA. FILED 9-17-2013.

**Villa del Palmar**

THE MARK CONSISTS OF STANDARD CHARACTERS WITHOUT CLAIM TO ANY PARTICULAR FONT, STYLE, SIZE, OR COLOR.

THE ENGLISH TRANSLATION OF THE WORD "VILLA DEL PALMAR" IN THE MARK IS "VILLA OF PALM GROVE".

SN 86-067,193. IMMUNE DEFICIENCY FOUNDATION, TOWSON, MD. FILED 9-17-2013.



THE MARK CONSISTS OF THE OVERLAPPING STYLIZED LETTERS "IDF".

**CLASS 35—ADVERTISING AND BUSINESS**

FOR PROMOTING PUBLIC AWARENESS OF PRIMARY IMMUNE DEFICIENCY DISEASE BY DISTRIBUTING PRINTED MATERIALS (U.S. CLS. 100, 101 AND 102).

FIRST USE 6-10-2013; IN COMMERCE 6-26-2013.

**CLASS 41—EDUCATION AND ENTERTAINMENT**

FOR EDUCATION SERVICES, NAMELY, PROVIDING EDUCATIONAL PROGRAMS, PUBLIC POLICY PROGRAMS AND EDUCATIONAL PEER SUPPORT PROGRAMS ALL IN THE FIELD OF PRIMARY IMMUNE DEFICIENCY DISEASE AND ITS DIAGNOSIS AND TREATMENT, AND DISTRIBUTING PRINTED COURSE MATERIALS IN CONNECTION THEREWITH (U.S. CLS. 100, 101 AND 107).

FIRST USE 6-26-2013; IN COMMERCE 6-26-2013.

**CLASS 42—SCIENTIFIC AND COMPUTER SERVICES**

FOR MEDICAL RESEARCH IN THE FIELD OF PRIMARY IMMUNE DEFICIENCY DISEASE AND ITS DIAGNOSIS AND TREATMENT (U.S. CLS. 100 AND 101).

FIRST USE 6-26-2013; IN COMMERCE 6-26-2013.

**CLASS 44—MEDICAL, BEAUTY AND AGRICULTURAL SERVICES**

FOR PROVIDING A DATABASE AND ONLINE RESOURCE CENTER IN THE NATURE OF A WEBSITE, ALL IN THE FIELD OF PRIMARY IMMUNE DEFICIENCY DISEASE (U.S. CLS. 100 AND 101).

FIRST USE 6-26-2013; IN COMMERCE 6-26-2013.  
INGA ERVIN, EXAMINING ATTORNEY

**CLASS 36—INSURANCE AND FINANCIAL**

FOR REAL ESTATE TIME-SHARING; VACATION REAL ESTATE TIMESHARE SERVICES (U.S. CLS. 100, 101 AND 102).

FIRST USE 12-1-1999; IN COMMERCE 12-1-1999.

**CLASS 43—HOTEL AND RESTAURANT SERVICES**

FOR HOTEL ACCOMMODATION SERVICES; HOTEL AND MOTEL SERVICES; HOTEL AND RESTAURANT SERVICES; HOTEL SERVICES; HOTEL SERVICES FOR PREFERRED CUSTOMERS; HOTEL, BAR AND RESTAURANT SERVICES; HOTEL, MOTEL, RESTAURANT, BAR AND CATERING SERVICES; HOTEL, RESTAURANT AND BAR SERVICES; HOTEL, RESTAURANT AND CATERING SERVICES; HOTELS; MAKING HOTEL RESERVATIONS FOR OTHERS; PROVIDING HOTEL ACCOMMODATION; RESERVATION OF HOTEL ROOMS FOR TRAVELERS; RESORT HOTEL SERVICES; RESORT LODGING SERVICES; RESTAURANT AND HOTEL SERVICES (U.S. CLS. 100 AND 101).

FIRST USE 12-1-1999; IN COMMERCE 12-1-1999.

**CLASS 44—MEDICAL, BEAUTY AND AGRICULTURAL SERVICES**

FOR HEALTH SPA SERVICES FOR HEALTH AND WELLNESS OF THE BODY AND SPIRIT OFFERED AT A HEALTH RESORT (U.S. CLS. 100 AND 101).

FIRST USE 12-1-1999; IN COMMERCE 12-1-1999.  
BARNEY CHARLON, EXAMINING ATTORNEY

SN 86-067,479. KIDNECTED WORLD, DRAPER, UT. FILED 9-17-2013.

**CALL FOR WONDER**

THE MARK CONSISTS OF STANDARD CHARACTERS WITHOUT CLAIM TO ANY PARTICULAR FONT, STYLE, SIZE, OR COLOR.

**CLASS 9—ELECTRICAL AND SCIENTIFIC APPARATUS**

FOR DOWNLOADABLE MOBILE APPLICATIONS FOR VIEWING AND SHARING INSPIRATIONAL, MOTIVATIONAL, AND EDUCATIONAL STORIES AND IMAGES (U.S. CLS. 21, 23, 26, 36 AND 38).

**CLASS 42—SCIENTIFIC AND COMPUTER SERVICES**

FOR PROVIDING A WEBSITE FEATURING TECHNOLOGY THAT ENABLES USERS TO VIEW AND SHARE INSPIRATIONAL, MOTIVATIONAL, AND EDUCATIONAL STORIES AND IMAGES (U.S. CLS. 100 AND 101).

GINA FINK, EXAMINING ATTORNEY

**CLASS 36—INSURANCE AND FINANCIAL**

FOR FINANCIAL AND INSURANCE SERVICES FOR CREDIT UNIONS, NAMELY INDIRECT LENDING SERVICES, CONSULTING AND INFORMATION CONCERNING INSURANCE, AND INSURANCE BROKERAGE SERVICES (U.S. CLS. 100, 101 AND 102).

FIRST USE 9-11-2013; IN COMMERCE 9-11-2013.  
ELLEN BURNS, EXAMINING ATTORNEY

SN 86-067,487. RAMSEY, DIANA R., AKA DIANA R. RAMSEY, WOODBRIDGE, VA. FILED 9-17-2013.

SN 86-067,632. TARGIT A/S, HJORRING, DENMARK, FILED 9-18-2013.

**SistersWithBeauty**

THE MARK CONSISTS OF STANDARD CHARACTERS WITHOUT CLAIM TO ANY PARTICULAR FONT, STYLE, SIZE, OR COLOR.

OWNER OF U.S. REG. NO. 4,098,881.

**CLASS 35—ADVERTISING AND BUSINESS**

FOR ON-LINE RETAIL STORE SERVICES FEATURING CLOTHING, JEWELRY, HANDBAGS AND HAIR ACCESSORIES, NAMELY, HAIR CLIPS (U.S. CLS. 100, 101 AND 102).

FIRST USE 6-20-2011; IN COMMERCE 6-20-2011.

**CLASS 44—MEDICAL, BEAUTY AND AGRICULTURAL SERVICES**

FOR BEAUTY CONSULTATION SERVICES (U.S. CLS. 100 AND 101).

FIRST USE 6-20-2011; IN COMMERCE 6-20-2011.  
HEATHER BIDDULPH, EXAMINING ATTORNEY

SN 86-067,542. SOUTH CAROLINA FINANCIAL SOLUTIONS, LLC, NORTH CHARLESTON, SC. FILED 9-18-2013.

**OUR SOLUTIONS. YOUR SUCCESS.**

THE MARK CONSISTS OF STANDARD CHARACTERS WITHOUT CLAIM TO ANY PARTICULAR FONT, STYLE, SIZE, OR COLOR.

**CLASS 35—ADVERTISING AND BUSINESS**

FOR BUSINESS SERVICES FOR CREDIT UNIONS, NAMELY KNOWLEDGE MANAGEMENT CONSULTING SERVICES, BUSINESS CONSULTING SERVICES IN THE FIELD OF EMPLOYEE RECRUITING, ACQUISITION, DEVELOPMENT, ASSESSMENT, AND RETENTION, BUSINESS CONSULTING SERVICES IN THE FIELD OF EMPLOYEE BENEFITS, AND BUSINESS ADMINISTRATION OF PRE-PAID LEGAL SERVICES (U.S. CLS. 100, 101 AND 102).

FIRST USE 9-11-2013; IN COMMERCE 9-11-2013.

**COURAGE TO ACT**

THE MARK CONSISTS OF STANDARD CHARACTERS WITHOUT CLAIM TO ANY PARTICULAR FONT, STYLE, SIZE, OR COLOR.

**CLASS 9—ELECTRICAL AND SCIENTIFIC APPARATUS**

FOR COMPUTER SOFTWARE FOR ANALYSIS AND ORGANIZATION OF STATISTICAL DATA (U.S. CLS. 21, 23, 26, 36 AND 38).

FIRST USE 3-31-2013; IN COMMERCE 3-31-2013.

**CLASS 42—SCIENTIFIC AND COMPUTER SERVICES**

FOR DEVELOPMENT, MAINTENANCE, REPAIR, INSTALLATION AND IMPLEMENTATION OF COMPUTER SOFTWARE FOR ANALYSIS AND ORGANIZATION OF STATISTICAL DATA (U.S. CLS. 100 AND 101).

FIRST USE 3-31-2013; IN COMMERCE 3-31-2013.  
RUDY R. SINGLETON, EXAMINING ATTORNEY

SN 86-067,683. PRICE PFISTER, INC., LAKE FOREST, CA. FILED 9-18-2013.

**ARTERRA**

THE MARK CONSISTS OF STANDARD CHARACTERS WITHOUT CLAIM TO ANY PARTICULAR FONT, STYLE, SIZE, OR COLOR.

**CLASS 6—METAL GOODS**

FOR METAL ROBE HOOKS (U.S. CLS. 2, 12, 13, 14, 23, 25 AND 50).

**CLASS 11—ENVIRONMENTAL CONTROL APPARATUS**

FOR PLUMBING PRODUCTS, NAMELY, FAUCETS, FAUCET FILTERS, SHOWERHEADS, HAND-HELD SHOWER HEADS, FAUCET HANDLES, SHOWER ARMS, SPOUTS, VALVES, LEVERS, POP-UP DRAINS (U.S. CLS. 13, 21, 23, 31 AND 34).

**CLASS 19—NON-METALLIC BUILDING MATERIALS**

FOR NON-METAL FINISH TRIM, NAMELY SHOWER TRIM AND DIVERTER TRIM (U.S. CLS. 1, 12, 33 AND 50).

SN 86-067,710. GEM OF CHAMPIONS LLC, DAPHNE, AL. FILED 9-18-2013.

**CLASS 21—HOUSEWARES AND GLASS**

FOR BATHROOM ACCESSORIES, NAMELY TOWEL BARS, TOWEL RINGS, TOILET TISSUE HOLDERS, SOAP DISHES AND TOOTHBRUSH-TUMBLER HOLDERS (U.S. CLS. 2, 13, 23, 29, 30, 33, 40 AND 50).  
ROBIN CHOSID, EXAMINING ATTORNEY

Gem of Champions

SN 86-067,704. MOVING ISLAND TRANSIT INC., BRANTFORD, ON, CANADA, FILED 9-18-2013.

THE MARK CONSISTS OF STANDARD CHARACTERS WITHOUT CLAIM TO ANY PARTICULAR FONT, STYLE, SIZE, OR COLOR.

**CLASS 25—CLOTHING**

FOR LEOTARDS; SHIRTS; SPORTS BRA; UNIFORMS (U.S. CLS. 22 AND 39).  
FIRST USE 4-4-2011; IN COMMERCE 4-4-2011.

**CLASS 41—EDUCATION AND ENTERTAINMENT**

FOR ENTERTAINMENT SERVICES, NAMELY, CHEERLEADING; GYMNASIAC INSTRUCTION; INSTRUCTION IN THE FIELD OF STUNT AND PYRAMID BUILDING (U.S. CLS. 100, 101 AND 107).  
FIRST USE 4-4-2011; IN COMMERCE 4-4-2011.  
LINDA ESTRADA, EXAMINING ATTORNEY

THE MARK CONSISTS OF THE LETTERS "MITI" IN STYLIZED FORM; THE LETTERS "MITI" ARE ENCASED WITHIN A THIN OUTLINE FORMING A SQUARE.

SN 86-067,712. TILTskill, INC., AUSTIN, TX. FILED 9-18-2013.

**CLASS 5—PHARMACEUTICALS**

FOR DENTAL IMPRESSION MATERIALS (U.S. CLS. 6, 18, 44, 46, 51 AND 52).

**CLASS 10—MEDICAL APPARATUS**

FOR DENTAL IMPRESSION TRAYS; DENTAL PROSTHESES (U.S. CLS. 26, 39 AND 44).

**CLASS 40—MATERIAL TREATMENT**

FOR DENTAL LABORATORIES (U.S. CLS. 100, 103 AND 106).

TILTskill

**CLASS 41—EDUCATION AND ENTERTAINMENT**

FOR EDUCATIONAL SERVICES, NAMELY, CONDUCTING CLASSES AND WORKSHOPS IN THE FIELDS OF CLINICAL DENTISTRY AND DISTRIBUTION OF TRAINING MATERIALS IN CONNECTION THEREWITH (U.S. CLS. 100, 101 AND 107).  
LINDA ESTRADA, EXAMINING ATTORNEY

THE MARK CONSISTS OF STANDARD CHARACTERS WITHOUT CLAIM TO ANY PARTICULAR FONT, STYLE, SIZE, OR COLOR.

**CLASS 41—EDUCATION AND ENTERTAINMENT**

FOR EDUCATION SERVICES, NAMELY, ONE-ON-ONE MENTORING IN THE FIELDS OF PROFESSIONAL SKILLS, TRADE SKILLS AND REPAIRS, ACADEMICS, LIFE SKILLS, HOBBIES AND INTERESTS; EDUCATION SERVICES, NAMELY, PROVIDING LIVE AND ON-LINE COURSES IN THE FIELD OF PROFESSIONAL SKILLS, TRADE SKILLS AND REPAIRS, ACADEMICS, LIFE SKILLS, HOBBIES AND INTERESTS; EDUCATION SERVICES, NAMELY, PROVIDING NON-DOWNLOADABLE WEBINARS IN THE FIELD OF PROFESSIONAL SKILLS, TRADE SKILLS AND REPAIRS, ACADEMICS, LIFE SKILLS, HOBBIES AND INTERESTS; EDUCATIONAL SERVICES, NAMELY, CONDUCTING INFORMAL ON-LINE PROGRAMS IN THE FIELDS OF PROFESSIONAL SKILLS, TRADE SKILLS AND REPAIRS, ACADEMICS, LIFE SKILLS, HOBBIES AND INTERESTS, AND PRINTABLE MATERIALS DISTRIBUTED THEREWITH; EDUCATIONAL SERVICES, NAMELY, CONDUCTING PROGRAMS IN THE FIELD OF PROFESSIONAL SKILLS, TRADE SKILLS AND REPAIRS, ACADEMICS, LIFE SKILLS, HOBBIES AND INTERESTS; EDUCATIONAL SERVICES, NAMELY, CONDUCTING ONE-ON-ONE AND ONE-TO-MANY TUTORING SESSIONS, CLASSES, SEMINARS, CONFERENCES, AND WORKSHOPS IN THE FIELD OF PROFESSIONAL SKILLS, TRADE SKILLS AND REPAIRS, ACADEMICS, LIFE SKILLS, HOBBIES AND INTERESTS; PROVIDING EDUCATION COURSES IN THE FIELD OF PROFESSIONAL SKILLS, TRADE SKILLS AND REPAIRS, ACADEMICS, LIFE SKILLS, HOBBIES AND INTERESTS OFFERED THROUGH ONLINE, NON-DOWNLOADABLE VIDEOS AND INSTRUCTOR ASSISTANCE; PROVIDING EDUCATION IN THE FIELD OF PROFESSIONAL SKILLS, TRADE SKILLS AND REPAIRS, ACADEMICS, LIFE SKILLS, HOBBIES AND INTERESTS RENDERED THROUGH VIDEO CONFERENCE; PROVIDING ON-LINE TRAINING COURSES IN THE FIELD OF PROFESSIONAL SKILLS, TRADE SKILLS AND REPAIRS, ACADEMICS, LIFE SKILLS, HOBBIES AND INTERESTS (U.S. CLS. 100, 101 AND 107).

**CLASS 42—SCIENTIFIC AND COMPUTER SERVICES**

FOR APPLICATION SERVICE PROVIDER (ASP) FEATURING SOFTWARE FOR USE BY OTHERS IN CREATING, PUBLISHING, DELIVERING, BEING PAID FOR, AND ORGANIZING DIGITAL CONTENT ONLINE IN THE FIELD OF PROVIDING OR TAKING TRAINING OR FOR ENABLING OR FACILITATING THE UPLOADING, DOWNLOADING, STREAMING, POSTING, DISPLAYING, BLOGGING, LINKING, SHARING OR OTHERWISE PROVIDING ELECTRONIC MEDIA OR INFORMATION OVER COMMUNICATION NETWORKS; COMPUTER SERVICES, NAMELY, CREATING AN ON-LINE COMMUNITY FOR REGISTERED USERS TO PROVIDE OR TAKE TRAINING, PARTICIPATE IN DISCUSSIONS, GET FEEDBACK FROM THEIR PEERS, FORM VIRTUAL COMMUNITIES, ORGANIZE GROUPS AND EVENTS, AND ENGAGE IN SOCIAL, BUSINESS, AND COMMUNITY NETWORKING; COMPUTER SERVICES, NAMELY, CREATING AN ON-LINE VIRTUAL ENVIRONMENT FOR PROVIDING OR TAKING COURSES; COMPUTER SERVICES, NAMELY, HOSTING AN INTERACTIVE WEB SITE THAT ALLOWS USERS TO CREATE, PUBLISH, DELIVER, BE PAID FOR, AND ORGANIZE DIGITAL CONTENT ONLINE IN THE FIELD OF PROVIDING OR TAKING TRAINING OR THAT ENABLES OR FACILITATES THE UPLOADING, DOWNLOADING, STREAMING, POSTING, DISPLAYING, BLOGGING, LINKING, SHARING OR OTHERWISE PROVIDING ELECTRONIC MEDIA OR INFORMATION OVER COMMUNICATION NETWORKS; COMPUTER SERVICES, NAMELY, HOSTING ON-LINE WEB FACILITIES FOR OTHERS FOR ORGANIZING AND CONDUCTING ONLINE MEETINGS, GATHERINGS, AND INTERACTIVE DISCUSSIONS; CREATING AN ON-LINE COMMUNITY FOR TEACHERS AND LEARNERS FOR THE PURPOSE OF PARTICIPATING IN EDUCATION AND TRAINING; HOSTING AN ON-LINE COMMUNITY WEB SITE FEATURING EDUCATION AND TRAINING CONTENT; HOSTING ON-LINE WEB FACILITIES FOR OTHERS FOR CREATING, PUBLISHING, DELIVERING, BEING PAID FOR, AND ORGANIZING DIGITAL CONTENT

ONLINE; PROVIDING A WEB SITE FEATURING TECHNOLOGY THAT ENABLES USERS TO SHARE, BOOKMARK, INDEX, STORE, COLLECT AND SHOWCASE CONTENT, ARTICLES, IMAGES, CALENDARS, PRODUCTS, PROJECTS, AND OTHER INFORMATION RESOURCES IN ELECTRONIC FORM IN THE NATURE AND FIELD OF EDUCATION AND TRAINING; PROVIDING A WEBSITE FEATURING NON-DOWNLOADABLE SOFTWARE FOR CREATING, PUBLISHING, DELIVERING, BEING PAID FOR, AND ORGANIZING DIGITAL CONTENT ONLINE; PROVIDING A WEBSITE THAT GIVES COMPUTER USERS THE ABILITY TO CREATE, PUBLISH, DELIVER, BE PAID FOR, AND ORGANIZE DIGITAL CONTENT ONLINE IN THE FIELD OF PROVIDING OR TAKING TRAINING OR THAT ENABLES OR FACILITATES THE UPLOADING, DOWNLOADING, STREAMING, POSTING, DISPLAYING, BLOGGING, LINKING, SHARING OR OTHERWISE PROVIDING ELECTRONIC MEDIA OR INFORMATION OVER COMMUNICATION NETWORKS; PROVIDING AN INTERACTIVE WEBSITE FEATURING TECHNOLOGY THAT ALLOWS USERS TO UPLOAD, DOWNLOAD, SHARE AND SELL CUSTOM AND BRANDED DIGITAL PUBLICATIONS; PROVIDING AN INTERACTIVE WEBSITE FEATURING TECHNOLOGY THAT ALLOWS USERS TO CREATE, PUBLISH, DELIVER, BE PAID FOR, AND ORGANIZE DIGITAL CONTENT ONLINE IN THE FIELD OF PROVIDING OR TAKING TRAINING OR THAT ENABLES OR FACILITATES THE UPLOADING, DOWNLOADING, STREAMING, POSTING, DISPLAYING, BLOGGING, LINKING, SHARING OR OTHERWISE PROVIDING ELECTRONIC MEDIA OR INFORMATION OVER COMMUNICATION NETWORKS; PROVIDING ON-LINE NON-DOWNLOADABLE SOFTWARE FOR CREATING, PUBLISHING, DELIVERING, BEING PAID FOR, AND ORGANIZING DIGITAL CONTENT ONLINE; PROVIDING TEMPORARY USE OF A WEB-BASED SOFTWARE APPLICATION FOR CREATING, PUBLISHING, DELIVERING, BEING PAID FOR, AND ORGANIZING DIGITAL CONTENT ONLINE; PROVIDING TEMPORARY USE OF ON-LINE NON-DOWNLOADABLE SOFTWARE AND APPLICATIONS FOR CREATING, PUBLISHING, DELIVERING, BEING PAID FOR, AND ORGANIZING DIGITAL CONTENT ONLINE; SOFTWARE AS A SERVICE (SAAS) SERVICES FEATURING SOFTWARE FOR CREATING, PUBLISHING, DELIVERING, BEING PAID FOR, AND ORGANIZING DIGITAL CONTENT ONLINE IN THE FIELD OF PROVIDING OR TAKING TRAINING OR FOR ENABLING OR FACILITATING THE UPLOADING, DOWNLOADING, STREAMING, POSTING, DISPLAYING, BLOGGING, LINKING, SHARING OR OTHERWISE PROVIDING ELECTRONIC MEDIA OR INFORMATION OVER COMMUNICATION NETWORKS (U.S. CLS. 100 AND 101).

SUSAN RICHARDS, EXAMINING ATTORNEY

SN 86-067,731. LIFESCAPE LLC, HARTLAND, VT. FILED 9-18-2013.

# LifeScape

THE MARK CONSISTS OF STANDARD CHARACTERS WITHOUT CLAIM TO ANY PARTICULAR FONT, STYLE, SIZE, OR COLOR.

**CLASS 41—EDUCATION AND ENTERTAINMENT**

FOR INTERACTIVE ONLINE WEB JOURNALS FEATURING PERSONAL, CORPORATE, INSTITUTIONAL AND/OR THIRD-PARTY INFORMATION, CONTENT AND MEDIA (U.S. CLS. 100, 101 AND 107).



**CLASS 42—SCIENTIFIC AND COMPUTER SERVICES**

SN 86-067,806. BALOS FOODS LLC, DORAL, FL. FILED 9-18-2013.

FOR PROVIDING AN ONLINE NON-DOWNLOADABLE INTERNET-BASED SYSTEM APPLICATION FEATURING TECHNOLOGY ENABLING USERS TO UPLOAD, ORGANIZE AND SHARE PERSONAL, CORPORATE, INSTITUTIONAL AND/OR THIRD-PARTY INFORMATION, CONTENT AND MEDIA, AND TO CREATE AND SHARE PERSONAL HISTORIES (U.S. CLS. 100 AND 101).



**CLASS 45—PERSONAL AND LEGAL SERVICES**

FOR ONLINE SOCIAL NETWORKING SERVICES IN THE FIELD OF SHARED INTERESTS AND PERSONAL, CORPORATE, INSTITUTIONAL OR THIRD-PARTY INFORMATION, CONTENT AND MEDIA PROVIDED VIA A WEBSITE (U.S. CLS. 100 AND 101).  
ARETHA SOMERVILLE, EXAMINING ATTORNEY

THE COLOR(S) WHITE, BLUE, YELLOW AND RED IS/ARE CLAIMED AS A FEATURE OF THE MARK.

THE MARK CONSISTS OF THE LITERAL ELEMENT "DANY" WRITTEN IN STYLIZED FORM IN COLOR BLUE FILLED IN COLOR WHITE, PLACED OVER THE IMAGE OF A RED CIRCLE OUTLINED IN WHITE, ALL OVER ON A YELLOW CIRCLE AND A BLUE CIRCLE DEFLECTED TO THE LEFT.

THE WORDING "DANY" HAS NO MEANING IN A FOREIGN LANGUAGE.

SN 86-067,798. BUCKS HILL MANAGEMENT, LLC, AIKEN, SC. FILED 9-18-2013.

**TREASURES & TRADITIONS**

**CLASS 29—MEATS AND PROCESSED FOODS**

FOR CHEESE; DRIED BEAN; FROZEN FRUITS; FROZEN VEGETABLES; PROCESSED BEANS; PROCESSED EDIBLE SEEDS; FRUITS CONSERVES; PICKLED VEGETABLES; MIXES FOR MAKING BROTHS (U.S. CL. 46).

**CLASS 30—STAPLE FOODS**

FOR BAKERY PRODUCTS; BROWN SUGAR, NAMELY DULCE DE PANELA; COOKIES, CRACKERS, FROZEN CONFECTIONS; CORN MEAL, NAMELY TORTILLAS, PUPUSAS, AND TAMALES; SAUCES; CHOW MEIN NOODLES; COFFEE ROASTED AND POWDERED (U.S. CL. 46).

MARIA-VICTORIA SUAREZ, EXAMINING ATTORNEY

THE MARK CONSISTS OF STANDARD CHARACTERS WITHOUT CLAIM TO ANY PARTICULAR FONT, STYLE, SIZE, OR COLOR.

**CLASS 36—INSURANCE AND FINANCIAL**

FOR CHARITABLE FUNDRAISING SERVICES BY MEANS OF ORGANIZING AND CONDUCTING AUCTIONS FEATURING FIREARMS, FIREARMS WITH CUSTOM AND STANDARD ENGRAVINGS, AND HUNTING EQUIPMENT, SHOOTING EQUIPMENT, AND HUNTING, SHOOTING AND FISHING ART AND MEMORABILIA, AND BOOKS; CHARITABLE FUNDRAISING TO SUPPORT WILDLIFE AND HABITAT CONSERVATION AND EDUCATION REGARDING HUNTING'S ROLE IN CONSERVATION (U.S. CLS. 100, 101 AND 102).

FIRST USE 5-1-2007; IN COMMERCE 5-1-2007.

SN 86-067,820. ROCHE DIAGNOSTICS GMBH, 68305 MANNHEIM, FED REP GERMANY, FILED 9-18-2013.

**ACCU-CHEK MOBILE**

THE MARK CONSISTS OF STANDARD CHARACTERS WITHOUT CLAIM TO ANY PARTICULAR FONT, STYLE, SIZE, OR COLOR.

OWNER OF U.S. REG. NOS. 1,277,867, 2,403,536 AND 2,651,417.

NO CLAIM IS MADE TO THE EXCLUSIVE RIGHT TO USE "MOBILE", APART FROM THE MARK AS SHOWN.

**CLASS 41—EDUCATION AND ENTERTAINMENT**

FOR ENTERTAINMENT IN THE NATURE OF ONGOING TELEVISION PROGRAMS IN THE FIELD OF APPRAISAL AND AUCTION OF ANTIQUE, COLLECTIBLE AND HISTORIC FIREARMS, HUNTING EQUIPMENT, SHOOTING EQUIPMENT, FISHING EQUIPMENT, ARCHERY EQUIPMENT, HUNTING, SHOOTING AND FISHING ART AND MEMORABILIA, AND BOOKS (U.S. CLS. 100, 101 AND 107).

JOHN KELLY, EXAMINING ATTORNEY

**CLASS 5—PHARMACEUTICALS**

FOR TEST STRIPS AND TEST TAPES CONTAINED IN CASSETTES FOR THE DETECTION OF GLUCOSE IN BODY FLUIDS FOR MEDICAL DIAGNOSTIC USE (U.S. CLS. 6, 18, 44, 46, 51 AND 52).

**CLASS 10—MEDICAL APPARATUS**

FOR INSTRUMENTS, DEVICES AND APPARATUS FOR MEDICAL PURPOSES, NAMELY, BLOOD GLUCOSE METERS, LANCET DEVICES AND LANCETS, INSULIN PUMPS AND ACCESSORIES THEREFOR, NAMELY, DISPOSABLE INFUSION SETS, CATHETERS, PEN NEEDLES, SYRINGES AND PATACHES; AND BLOOD GLUCOSE METER KITS CONSISTING OF A BLOOD GLUCOSE METER, TEST STRIPS AND TEST TAPES CONTAINED IN CASSETTES, LANCETS AND LANCET DEVICE, ALL FOR MEDICAL DIAGNOSTIC USE (U.S. CLS. 26, 39 AND 44).

**CLASS 44—MEDICAL, BEAUTY AND AGRICULTURAL SERVICES**

FOR SERVICES RELATED TO THE FIELD OF DIABETES FOR PROFESSIONALS AND PATIENTS, NAMELY, MEDICAL CONSULTATION, DOCUMENTATION IN THE NATURE OF MAINTAINING FILES AND RECORDS CONCERNING THE MEDICAL CONDITION OF INDIVIDUALS, AND PROVIDING INFORMATION ABOUT DIABETES VIA A WEBSITE ON THE INTERNET (U.S. CLS. 100 AND 101).

HEATHER BIDDULPH, EXAMINING ATTORNEY

SN 86-067,865. IDEA NUOVA, INC., NEW YORK, NY. FILED 9-18-2013.

IN GLOBAL  
LIVING MODERN

THE MARK CONSISTS OF STANDARD CHARACTERS WITHOUT CLAIM TO ANY PARTICULAR FONT, STYLE, SIZE, OR COLOR.

OWNER OF U.S. REG. NO. 4,031,907.

**CLASS 20—FURNITURE AND ARTICLES NOT OTHERWISE CLASSIFIED**

FOR PILLOWS (U.S. CLS. 2, 13, 22, 25, 32 AND 50).

**CLASS 24—FABRICS**

FOR BLANKET THROWS; COMFORTERS; PILLOW SHAMS (U.S. CLS. 42 AND 50).

**CLASS 27—FLOOR COVERINGS**

FOR AREA RUGS (U.S. CLS. 19, 20, 37, 42 AND 50).  
KIM SAITO, EXAMINING ATTORNEY

SN 86-067,912. GABRIEL FIGUEREDO, ANCASTER, ON, CANADA, FILED 9-18-2013.

MEEK  
IMMORTALS

THE MARK CONSISTS OF THE WORDS "MEEK IMMORTALS" IN STYLIZED FORM WITH THE LETTERS "EEK" ABOVE THE LETTERS "MMORTALS" - THE LETTER "M" AND THE LETTER "I" ARE SET TO THE LEFT AND ARE THE COMBINED HEIGHT OF "EEK" AND "MMORTALS".

**CLASS 9—ELECTRICAL AND SCIENTIFIC APPARATUS**

FOR AUDIO AND VIDEO RECORDINGS FEATURING MUSIC AND ARTISTIC PERFORMANCES; AUDIO BOOKS IN THE FIELD OF MUSIC; CHILDREN'S EDUCATIONAL MUSIC CDS AND DVDS; COMPACT DISCS FEATURING MUSIC; DIGITAL MUSIC DOWNLOADABLE FROM THE INTERNET; DOWNLOADABLE ELECTRONIC BOOKS IN THE FIELD OF MUSIC; DOWNLOADABLE FILMS AND MOVIES FEATURING MUSIC PROVIDED VIA A VIDEO-ON-DEMAND SERVICE; DOWNLOADABLE MUSIC FILES; DOWNLOADABLE RING TONES, GRAPHICS AND MUSIC VIA A GLOBAL COMPUTER NETWORK AND WIRELESS DEVICES; DOWNLOADABLE VIDEO RECORDINGS FEATURING MUSIC; MOTION PICTURE FILMS ABOUT MUSIC; VIDEO RECORDINGS FEATURING MUSIC (U.S. CLS. 21, 23, 26, 36 AND 38).

**CLASS 16—PAPER GOODS AND PRINTED MATTER**

FOR BALL POINT PENS; BOOKS IN THE FIELD OF MUSIC, COMPILATIONS OF QUOTES, BIBLE REFERENCES; CHILDREN'S ACTIVITY BOOKS; FELT PENS; FOUNTAIN PENS; MOUNTED POSTERS; POSTERS; PRINTED MUSIC BOOKS; PRINTED PERIODICALS IN THE FIELD OF MOVIES; PRINTED PERIODICALS IN THE FIELD OF MUSIC (U.S. CLS. 2, 5, 22, 23, 29, 37, 38 AND 50).

**CLASS 21—HOUSEWARES AND GLASS**

FOR BEER MUGS; COFFEE MUGS; MUGS (U.S. CLS. 2, 13, 23, 29, 30, 33, 40 AND 50).

**CLASS 25—CLOTHING**

FOR JACKETS; PANTS; SHORTS; SWEATERS; T-SHIRTS (U.S. CLS. 22 AND 39).

SCOTT BIBB, EXAMINING ATTORNEY

SN 86-067,924. SKINNY NUTRITIONAL CORP, DBA SKINNY NUTRITIONAL CORP., RADNOR, PA. FILED 9-18-2013.

Skinny Shake

THE MARK CONSISTS OF STANDARD CHARACTERS WITHOUT CLAIM TO ANY PARTICULAR FONT, STYLE, SIZE, OR COLOR.

OWNER OF U.S. REG. NOS. 2,557,075, 3,886,580 AND OTHERS.

NO CLAIM IS MADE TO THE EXCLUSIVE RIGHT TO USE "SHAKE", APART FROM THE MARK AS SHOWN.

**CLASS 5—PHARMACEUTICALS**

FOR CHOCOLATE-BASED MEAL REPLACEMENT SHAKES FOR WEIGHT LOSS PURPOSES; DIETARY AND NUTRITIONAL SUPPLEMENTS; DIETARY AND NUTRITIONAL SUPPLEMENTS USED FOR WEIGHT LOSS; LIQUID PROTEIN SUPPLEMENTS; NUTRITIONALLY FORTIFIED BEVERAGES; PROTEIN SUPPLEMENT SHAKES; PROTEIN SUPPLEMENT SHAKES FOR WEIGHT GAIN PURPOSES (U.S. CLS. 6, 18, 44, 46, 51 AND 52).

**CLASS 32—LIGHT BEVERAGES**

FOR BEAUTY BEVERAGES, NAMELY, FRUIT JUICES AND ENERGY DRINKS CONTAINING NUTRITIONAL SUPPLEMENTS; COCONUT-BASED BEVERAGES NOT BEING MILK SUBSTITUTES; COCONUT-BASED NON-ALCOHOLIC BEVERAGES NOT BEING MILK SUBSTITUTES; OAT-BASED BEVERAGES WITH FRUIT JUICE NOT FOR FOOD PURPOSES; SHERBET BEVERAGES; SMOOTHIES; SORBETS IN THE FORM OF BEVERAGES; WHEY BEVERAGES (U.S. CLS. 45, 46 AND 48).

JERI J. FICKES, EXAMINING ATTORNEY

**CLASS 35—ADVERTISING AND BUSINESS**

FOR REAL ESTATE ADVERTISING SERVICES; REAL ESTATE MARKETING ANALYSIS; REAL ESTATE MARKETING SERVICES; REAL ESTATE MARKETING SERVICES, NAMELY, ON-LINE SERVICES FEATURING THE PROMOTION OF RESIDENTIAL NEW CONSTRUCTION, WHICH ALSO CONTAINS BACK OFFICE SOLUTIONS FOR BUILDERS; REAL ESTATE MARKETING SERVICES, NAMELY, ON-LINE SERVICES FEATURING TOURS OF RESIDENTIAL AND COMMERCIAL REAL ESTATE; REAL ESTATE SALES MANAGEMENT (U.S. CLS. 100, 101 AND 102).

MORGAN WYNNE, EXAMINING ATTORNEY

SN 86-068,008. GOODWOOD, INC., EL MONTE, CA. FILED 9-18-2013.

CANA

THE MARK CONSISTS OF STANDARD CHARACTERS WITHOUT CLAIM TO ANY PARTICULAR FONT, STYLE, SIZE, OR COLOR.

OWNER OF U.S. REG. NO. 4,112,891.

THE WORDING "CANA" HAS NO MEANING IN A FOREIGN LANGUAGE.

**CLASS 5—PHARMACEUTICALS**

FOR DIETARY FOOD SUPPLEMENTS; ENZYME FOOD SUPPLEMENTS; FOOD FOR ENTERAL FEEDING; FOOD SUPPLEMENTS; FOOD SUPPLEMENTS, NAMELY, ANTI-OXIDANTS; GLUCOSE FOR USE AS AN ADDITIVE TO FOODS FOR MEDICAL PURPOSES; HEALTH FOOD SUPPLEMENTS; MINERAL FOOD SUPPLEMENTS; VITAMIN AND MINERAL SUPPLEMENTS FOR USE AS INGREDIENTS IN THE FOOD AND PHARMACEUTICAL INDUSTRY (U.S. CLS. 6, 18, 44, 46, 51 AND 52).

**CLASS 9—ELECTRICAL AND SCIENTIFIC APPARATUS**

FOR DVD MACHINES; LIQUID CRYSTAL DISPLAY (LCD) TELEVISIONS; TELEVISION MONITORS; TELEVISIONS; TELEVISIONS AND MONITORS; TV MONITORS; VCD MACHINES (U.S. CLS. 21, 23, 26, 36 AND 38).

**CLASS 25—CLOTHING**

FOR JACKETS; JEANS; JEGGINGS, NAMELY, PANTS THAT ARE PARTIALLY JEANS AND PARTIALLY LEGGINGS; JERSEYS; TRAVEL CLOTHING CONTAINED IN A PACKAGE COMPRISING REVERSIBLE JACKETS, PANTS, SKIRTS, TOPS AND A BELT OR SCARF; WEARABLE GARMENTS AND CLOTHING, NAMELY, SHIRTS; WOMEN'S CLOTHING, NAMELY, SHIRTS, DRESSES, SKIRTS, BLOUSES (U.S. CLS. 22 AND 39).

FIRST USE 3-1-2006; IN COMMERCE 5-1-2006.

**CLASS 27—FLOOR COVERINGS**

FOR CARPET TILES FOR COVERING FLOORS; CARPETS, RUGS, MATS AND MATTING, LINOLEUM FOR COVERING EXISTING FLOORS; CHAIR MATS; COVERINGS FOR EXISTING FLOORS; FLOOR COVERINGS; FLOOR MATS; FLOOR MATS IN THE NATURE OF NON-SLIP PADS FOR USE UNDER APPARATUS TO PREVENT SLIPPAGE; PROTECTIVE FLOOR COVERINGS; VINYL FLOOR COVERINGS (U.S. CLS. 19, 20, 37, 42 AND 50).

FIRST USE 5-10-2010; IN COMMERCE 5-30-2010.

SN 86-068,052. MAKERSQR INC., PALO ALTO, CA. FILED 9-18-2013.



THE MARK CONSISTS OF A SQUARE INCLUDING TWENTY FIVE SMALLER SQUARES AND THE WORD "MAKERSQR" IN STYLIZED LETTERS, ALL OF WHICH ARE SUPERIMPOSED ON A PARTIAL SQUARE WHICH APPEARS AS TWO TRIANGLES AT THE LOWER RIGHT CORNER OF THE LARGER SQUARE.

**CLASS 9—ELECTRICAL AND SCIENTIFIC APPARATUS**

FOR COMPUTER PROGRAMS, DOWNLOADABLE COMPUTER PROGRAMS AND MOBILE DEVICE SOFTWARE FOR USE IN CONNECTING RESEARCHERS AND EXPERTS, FOR CONNECTING BUYERS AND SELLERS, FOR CREATING, COLLABORATING ON AND PUBLISHING PROJECTS, FOR PARTICIPATING IN DISCUSSIONS, FOR GETTING FEEDBACK, FOR ENGAGING IN SOCIAL, BUSINESS AND COMMUNITY NETWORKING SERVICES, AND FOR UPLOADING, DISPLAYING, SHARING, AND TRANSMITTING INFORMATION, MESSAGES, COMMENTS, MULTIMEDIA CONTENT, IMAGES, ILLUSTRATIONS, VIDEOS, PODCASTS, WEBCASTS, AND OTHER USER GENERATED CONTENT (U.S. CLS. 21, 23, 26, 36 AND 38).

**CLASS 42—SCIENTIFIC AND COMPUTER SERVICES**

FOR HOSTING AN INTERACTIVE ONLINE PLATFORM FOR USE IN CONNECTING RESEARCHERS AND EXPERTS, FOR CONNECTING BUYERS AND SELLERS, FOR CREATING, COLLABORATING ON AND PUBLISHING PROJECTS, FOR PARTICIPATING IN DISCUSSIONS, FOR GETTING FEEDBACK, FOR ENGAGING IN SOCIAL, BUSINESS AND COMMUNITY NETWORKING SERVICES, AND FOR UPLOADING, DISPLAYING, SHARING, AND TRANSMITTING INFORMATION, MESSAGES, COMMENTS, MULTIMEDIA CONTENT, IMAGES, ILLUSTRATIONS, VIDEOS, PODCASTS, WEBCASTS, AND OTHER USER GENERATED CONTENT (U.S. CLS. 100 AND 101).

SKYE YOUNG, EXAMINING ATTORNEY

SN 86-068,060. GUTT UP, LLC, LOS ANGELES, CA. FILED 9-18-2013.

SN 86-068,158. JOSEPH KRAUSE, MATAWAN, NJ. FILED 9-18-2013.

## MAKE EM SAY UGHH

THE MARK CONSISTS OF STANDARD CHARACTERS WITHOUT CLAIM TO ANY PARTICULAR FONT, STYLE, SIZE, OR COLOR.

### CLASS 25—CLOTHING

FOR BASEBALL CAPS AND HATS; HATS; LONG-SLEEVED SHIRTS; PANTS; SHIRTS AND SHORT-SLEEVED SHIRTS; SHORTS; SWEAT SHIRTS; SWEATERS; T-SHIRTS (U.S. CLS. 22 AND 39).

### CLASS 29—MEATS AND PROCESSED FOODS

FOR POTATO CHIPS (U.S. CL. 46).

### CLASS 30—STAPLE FOODS

FOR CANDY BARS; COOKIES AND CRACKERS; CORN-BASED CHIPS (U.S. CL. 46).

### CLASS 32—LIGHT BEVERAGES

FOR BOTTLED WATER; ENERGY DRINKS; SOFT DRINKS (U.S. CLS. 45, 46 AND 48); SKYE YOUNG, EXAMINING ATTORNEY

SN 86-068,064. BLAZKI, S.A. DE C.V., LOS CABOS, BC, MEXICO, FILED 9-18-2013.

## PUEBLO BONITO

THE MARK CONSISTS OF STANDARD CHARACTERS WITHOUT CLAIM TO ANY PARTICULAR FONT, STYLE, SIZE, OR COLOR.

THE ENGLISH TRANSLATION OF "PUEBLO BONITO" IN THE MARK IS "BEAUTIFUL TOWN".

### CLASS 35—ADVERTISING AND BUSINESS

FOR ADMINISTRATIVE HOTEL MANAGEMENT; ADVERTISEMENT AND PUBLICITY SERVICES BY TELEVISION, INTERNET, RADIO, MAIL, ETC (U.S. CLS. 100, 101 AND 102).

FIRST USE 12-10-1985; IN COMMERCE 0-0-1986.

### CLASS 43—HOTEL AND RESTAURANT SERVICES

FOR HOTEL ACCOMMODATION SERVICES (U.S. CLS. 100 AND 101).

FIRST USE 12-10-1985; IN COMMERCE 0-0-1986. SKYE YOUNG, EXAMINING ATTORNEY

## THE BEAK THAT IS UNIQUE

THE MARK CONSISTS OF STANDARD CHARACTERS WITHOUT CLAIM TO ANY PARTICULAR FONT, STYLE, SIZE, OR COLOR.

### CLASS 9—ELECTRICAL AND SCIENTIFIC APPARATUS

FOR SAFETY HELMET (U.S. CLS. 21, 23, 26, 36 AND 38).

### CLASS 25—CLOTHING

FOR BASEBALL CAP (U.S. CLS. 22 AND 39). ALICIA COLLINS, EXAMINING ATTORNEY

SN 86-068,185. NICONOVUM USA, INC., WINSTON-SALEM, NC. FILED 9-18-2013.

## EVERY VICTORY COUNTS

THE MARK CONSISTS OF STANDARD CHARACTERS WITHOUT CLAIM TO ANY PARTICULAR FONT, STYLE, SIZE, OR COLOR.

### CLASS 5—PHARMACEUTICALS

FOR PHARMACEUTICAL PREPARATIONS FOR HUMAN USE, NAMELY PREPARATIONS FOR SUPPRESSING, REDUCING, OR ELIMINATING SMOKING AND THE URGE TO SMOKE; PHARMACEUTICAL PREPARATIONS IN TABLET OR LOZENGE FORM FOR SUPPRESSING, REDUCING, OR ELIMINATING SMOKING AND THE URGE TO SMOKE; CHEWING GUM FOR MEDICAL PURPOSES; DIRECT COMPRESSED MEDICATED NICOTINE CHEWING GUM (U.S. CLS. 6, 18, 44, 46, 51 AND 52).

### CLASS 44—MEDICAL, BEAUTY AND AGRICULTURAL SERVICES

FOR SMOKING CESSATION SUPPORT SERVICES; ANTI-SMOKING THERAPY; ADVICE AND COUNSELING SERVICES RELATING TO OVERCOMING DRUG ADDICTION AND/OR DEPENDENCY, PARTICULARLY WITH RESPECT TO NICOTINE ADDICTION AND/OR DEPENDENCY (U.S. CLS. 100 AND 101).

LANA PHAM, EXAMINING ATTORNEY

SN 86-068,323. VAN ET TEN, SUSAN, WEST NEWBURY, MA.  
FILED 9-18-2013.

SN 86-068,412. OPAL HOLDINGS LTD, WARKWORTH  
AUCKLAND, NEW ZEALAND, FILED 9-18-2013.

educate, encourage, empower



THE MARK CONSISTS OF STANDARD CHARACTERS WITHOUT CLAIM TO ANY PARTICULAR FONT, STYLE, SIZE, OR COLOR.

THE STIPPLING IS FOR SHADING PURPOSES ONLY. THE MARK CONSISTS OF A STYLIZED ABSTRACT TREE WITH THE WORD "OYESS!".

**CLASS 41—EDUCATION AND ENTERTAINMENT**

FOR EDUCATIONAL AND ENTERTAINMENT SERVICES FOR CHILDREN, NAMELY, PROVIDING INTERACTIVE PLAY AREAS, INSTRUCTIONAL CLASSES IN THE FIELD OF ANTI-BULLYING AND SOCIAL GATHERINGS FOR CHILDREN (U.S. CLS. 100, 101 AND 107).  
FIRST USE 1-1-2002; IN COMMERCE 1-1-2011.

**CLASS 3—COSMETICS AND CLEANING PREPARATIONS**

FOR BODY LOTIONS; COSMETICS (U.S. CLS. 1, 4, 6, 50, 51 AND 52).

**CLASS 44—MEDICAL, BEAUTY AND AGRICULTURAL SERVICES**

FOR INFORMATION IN THE FIELD OF PARENTING CONCERNING THE HEALTH OF CHILDREN (U.S. CLS. 100 AND 101).  
FIRST USE 1-1-2002; IN COMMERCE 1-1-2011.  
DEZMONA MIZELLE, EXAMINING ATTORNEY

**CLASS 5—PHARMACEUTICALS**

FOR NUTRITIONAL SUPPLEMENTS (U.S. CLS. 6, 18, 44, 46, 51 AND 52).  
AMY C. KEAN, EXAMINING ATTORNEY

SN 86-068,374. COPT CC HOLDING, LLC, COLUMBIA, MD.  
FILED 9-18-2013.

SN 86-068,433. INTERUNIVERSALISM INC., SHERMAN OAKS, CA. FILED 9-18-2013.

CANTON CROSSING

Erfan Halgheh

THE MARK CONSISTS OF STANDARD CHARACTERS WITHOUT CLAIM TO ANY PARTICULAR FONT, STYLE, SIZE, OR COLOR.

THE MARK CONSISTS OF STANDARD CHARACTERS WITHOUT CLAIM TO ANY PARTICULAR FONT, STYLE, SIZE, OR COLOR.

OWNER OF U.S. REG. NO. 3,315,303.  
SEC. 2(F) AS TO "CANTON".

THE ENGLISH TRANSLATION OF "ERFAN" AND "HALGHEH" IN THE MARK IS "MYSTICISM" AND "RING".

**CLASS 36—INSURANCE AND FINANCIAL**

FOR REAL ESTATE SERVICES, NAMELY, RENTAL, BROKERAGE, LEASING AND MANAGEMENT OF COMMERCIAL PROPERTY, OFFICES AND OFFICE SPACE (U.S. CLS. 100, 101 AND 102).  
FIRST USE 3-1-2004; IN COMMERCE 3-1-2004.

**CLASS 41—EDUCATION AND ENTERTAINMENT**

FOR EDUCATION SERVICES, NAMELY, PROVIDING CLASSES, SEMINARS, AND WORKSHOPS IN THE FIELDS OF HEALTH AND WELLNESS (U.S. CLS. 100, 101 AND 107).  
FIRST USE 3-1-2012; IN COMMERCE 3-1-2012.

**CLASS 37—CONSTRUCTION AND REPAIR**

FOR REAL ESTATE DEVELOPMENT SERVICES (U.S. CLS. 100, 103 AND 106).  
FIRST USE 3-1-2004; IN COMMERCE 3-1-2004.  
LANA PHAM, EXAMINING ATTORNEY

**CLASS 45—PERSONAL AND LEGAL SERVICES**

FOR SPIRITUAL THERAPY SERVICES FOR HEALTH AND WELLNESS (U.S. CLS. 100 AND 101).  
FIRST USE 3-1-2012; IN COMMERCE 3-1-2012.  
ZACHARY BELLO, EXAMINING ATTORNEY

SN 86-068,450. COPT CC HOLDING, LLC, COLUMBIA, MD.  
FILED 9-18-2013.

SN 86-068,498. ABSIST LLC, JACKSON, MS. FILED 9-18-2013.



OWNER OF U.S. REG. NO. 3,315,303.  
THE MARK CONSISTS OF THE LETTERS "CC" IN A CIRCLE THE TOP HALF OF WHICH IS WHITE AND THE BOTTOM HALF OF WHICH IS SHADED, FOLLOWED BY THE WORD "CANTON" ABOVE THE WORD "CROSSING", BOTH OF WHICH ARE SHADED, ALL ON A CONTRASTING BACKGROUND.

SEC. 2(F) AS TO "CANTON".

**CLASS 36—INSURANCE AND FINANCIAL**

FOR REAL ESTATE SERVICES, NAMELY, RENTAL, BROKERAGE, LEASING AND MANAGEMENT OF COMMERCIAL PROPERTY, OFFICES AND OFFICE SPACE (U.S. CLS. 100, 101 AND 102).

FIRST USE 0-0-2010; IN COMMERCE 0-0-2010.

**CLASS 37—CONSTRUCTION AND REPAIR**

FOR REAL ESTATE DEVELOPMENT SERVICES (U.S. CLS. 100, 103 AND 106).

FIRST USE 0-0-2010; IN COMMERCE 0-0-2010.  
LANA PHAM, EXAMINING ATTORNEY

SN 86-068,452. STORMBREAKER BREWING, LLC, PORTLAND, OR. FILED 9-18-2013.

**STORMBREAKER BREWING**

THE MARK CONSISTS OF STANDARD CHARACTERS WITHOUT CLAIM TO ANY PARTICULAR FONT, STYLE, SIZE, OR COLOR.

NO CLAIM IS MADE TO THE EXCLUSIVE RIGHT TO USE "BREWING", APART FROM THE MARK AS SHOWN.

**CLASS 32—LIGHT BEVERAGES**

FOR BEERS (U.S. CLS. 45, 46 AND 48).

**CLASS 43—HOTEL AND RESTAURANT SERVICES**

FOR BREWPUB SERVICES; BAR SERVICES; TAVERN SERVICES; AND RESTAURANT SERVICES (U.S. CLS. 100 AND 101).

AISHA CLARKE, EXAMINING ATTORNEY

**IMAGICENTER**

THE MARK CONSISTS OF STANDARD CHARACTERS WITHOUT CLAIM TO ANY PARTICULAR FONT, STYLE, SIZE, OR COLOR.

**CLASS 42—SCIENTIFIC AND COMPUTER SERVICES**

FOR MEDICAL AND SCIENTIFIC RESEARCH IN THE FIELD OF MEDICAL IMAGING (U.S. CLS. 100 AND 101).

**CLASS 44—MEDICAL, BEAUTY AND AGRICULTURAL SERVICES**

FOR MEDICAL IMAGING SERVICES (U.S. CLS. 100 AND 101).

AISHA CLARKE, EXAMINING ATTORNEY

SN 86-068,533. DAVENPORT, STEPHEN, LAS VEGAS, NV.  
FILED 9-18-2013.

**Stevie D**

THE MARK CONSISTS OF STANDARD CHARACTERS WITHOUT CLAIM TO ANY PARTICULAR FONT, STYLE, SIZE, OR COLOR.

**CLASS 14—JEWELRY**

FOR JEWELRY (U.S. CLS. 2, 27, 28 AND 50).

**CLASS 18—LEATHER GOODS**

FOR HANDBAGS; PURSES (U.S. CLS. 1, 2, 3, 22 AND 41).

**CLASS 25—CLOTHING**

FOR SHIRTS; T-SHIRTS; TOPS (U.S. CLS. 22 AND 39).

**CLASS 35—ADVERTISING AND BUSINESS**

FOR ON-LINE RETAIL STORE SERVICES FEATURING CLOTHING AND ACCESSORIES; WHOLESALE STORE SERVICES FEATURING CLOTHING AND ACCESSORIES (U.S. CLS. 100, 101 AND 102).

RONALD MCMORROW, EXAMINING ATTORNEY

SN 86-068,551. ELPHAME, BEVERLY, MA. FILED 9-18-2013.

# Elphame

THE MARK CONSISTS OF STANDARD CHARACTERS WITHOUT CLAIM TO ANY PARTICULAR FONT, STYLE, SIZE, OR COLOR.

**CLASS 14—JEWELRY**

FOR JEWELRY (U.S. CLS. 2, 27, 28 AND 50).

**CLASS 25—CLOTHING**

FOR GLOVES; HATS; SCARVES (U.S. CLS. 22 AND 39).  
JAMES MACFARLANE, EXAMINING ATTORNEY

**CLASS 42—SCIENTIFIC AND COMPUTER SERVICES**

FOR DATA DECODING SERVICES; COMPUTER SECURITY CONSULTANCY IN THE FIELD OF ELECTRONIC DATA AND INFORMATION; COMPUTER SERVICES, NAMELY, PROVIDING VIRTUAL AND NON-VIRTUAL APPLICATION SERVERS, WEB SERVERS, FILE SERVERS, CO-LOCATION SERVERS, LOAD BALANCING SERVERS, REDUNDANCY SERVERS, MEDIA SERVERS AND DATABASE SERVERS OF VARIABLE CAPACITY TO THIRD PARTY COMPUTING AND DATA STORAGE FACILITIES; COMPUTER SERVICES, NAMELY, REMOTE AND ON-SITE MANAGEMENT OF ELECTRONIC MESSAGING SYSTEMS FOR OTHERS; REMOTE COMPUTER BACKUP SERVICES; PROVIDING TEMPORARY USE OF ON-LINE NON-DOWNLOADABLE COMPUTER SOFTWARE FOR USE IN ELECTRONIC STORAGE OF DATA AND INFORMATION; COMPUTER VIRUS PROTECTION SERVICES; PROVIDING VIRTUAL COMPUTER SYSTEMS AND VIRTUAL COMPUTER ENVIRONMENTS THROUGH CLOUD COMPUTING; COMPUTER SERVICES, NAMELY, PROVIDING SPAM FILTERING SERVICES TO PROTECT WEBSITES AND ONLINE APPLICATIONS FROM RECEIVING UNSOLICITED MESSAGES; COMPUTER SERVICES, NAMELY, ON-LINE SCANNING, DETECTING, QUARANTINING AND ELIMINATING OF VIRUSES, WORMS, TROJANS, SPYWARE, ADWARE, MALWARE AND UNAUTHORIZED DATA AND PROGRAMS ON COMPUTERS AND ELECTRONIC DEVICES (U.S. CLS. 100 AND 101).

FIRST USE 1-25-2005; IN COMMERCE 1-25-2005.  
CAROLINE WOOD, EXAMINING ATTORNEY

SN 86-068,595. BARRACUDA NETWORKS, INC., CAMPBELL, CA. FILED 9-18-2013.

RECLAIM YOUR NETWORK

THE MARK CONSISTS OF STANDARD CHARACTERS WITHOUT CLAIM TO ANY PARTICULAR FONT, STYLE, SIZE, OR COLOR.

**CLASS 9—ELECTRICAL AND SCIENTIFIC APPARATUS**

FOR MESSAGING AND NETWORK SECURITY APPLIANCES COMPRISING COMPUTER HARDWARE AND SOFTWARE FOR SEARCHING, DETECTING, BLOCKING, FILTERING, TAGGING, COMPILING, INDEXING, ANALYZING, SECURING, REMOVING AND REPORTING ON UNDESIRABLE CONTENT OVER AND IN INFORMATION NETWORKS, GLOBAL INFORMATION NETWORKS, INDIVIDUAL WORKSTATIONS, PERSONAL COMPUTERS, SOFTWARE, ELECTRONIC MAIL, AND WORKGROUP COMMUNICATIONS (U.S. CLS. 21, 23, 26, 36 AND 38).

FIRST USE 1-25-2005; IN COMMERCE 1-25-2005.

SN 86-068,617. DIRECT COMMERCE, INC., SAN FRANCISCO, CA. FILED 9-18-2013.

# Buru.com

THE MARK CONSISTS OF STANDARD CHARACTERS WITHOUT CLAIM TO ANY PARTICULAR FONT, STYLE, SIZE, OR COLOR.

**CLASS 9—ELECTRICAL AND SCIENTIFIC APPARATUS**

FOR COMPUTER SOFTWARE THAT PROVIDES WEB-BASED ACCESS TO APPLICATIONS AND SERVICES THROUGH A WEB OPERATING SYSTEM OR PORTAL INTERFACE (U.S. CLS. 21, 23, 26, 36 AND 38).

**CLASS 36—INSURANCE AND FINANCIAL**

FOR PROVIDING AN INTERNET WEBSITE PORTAL IN THE FIELD OF FINANCIAL TRANSACTION AND PAYMENT PROCESSING SERVICES (U.S. CLS. 100, 101 AND 102).

SHAVELL MCPHERSON, EXAMINING ATTORNEY

SN 86-068,638. SOULATES, LLC, STUDIO CITY, CA. FILED 9-18-2013.

SN 86-068,670. DATAFORCE, INC., LOUISVILLE, CO. FILED 9-18-2013.

## SOULATES

THE MARK CONSISTS OF STANDARD CHARACTERS WITHOUT CLAIM TO ANY PARTICULAR FONT, STYLE, SIZE, OR COLOR.

### CLASS 9—ELECTRICAL AND SCIENTIFIC APPARATUS

FOR DOWNLOADABLE MP3 FILES AND MP3 RECORDINGS FEATURING PILATES INSTRUCTION, PHYSICAL FITNESS INSTRUCTION AND ENERGY HEALING INSTRUCTION; DIGITAL MEDIA, NAMELY, DVDS, DOWNLOADABLE AUDIO AND VIDEO RECORDS FEATURING PILATES INSTRUCTION, PHYSICAL FITNESS INSTRUCTION AND ENERGY HEALING INSTRUCTION (U.S. CLS. 21, 23, 26, 36 AND 38).

### CLASS 41—EDUCATION AND ENTERTAINMENT

FOR PROVIDING PHYSICAL FITNESS TRAINING SERVICES; PROVIDING FITNESS AND EXERCISE STUDIO SERVICES, NAMELY, PILATES INSTRUCTION AND TRAINING; PROVIDING A WEB SITE FEATURING INFORMATION ON EXERCISE AND FITNESS; PROVIDING A WEB SITE FEATURING NON-DOWNLOADABLE INSTRUCTIONAL VIDEOS IN THE FIELD OF PHYSICAL FITNESS AND PILATES (U.S. CLS. 100, 101 AND 107).

### CLASS 44—MEDICAL, BEAUTY AND AGRICULTURAL SERVICES

FOR REIKI HEALING SERVICES; PROVIDING IN-PERSON ENERGY HEALING SERVICES (U.S. CLS. 100 AND 101).  
JASON TURNER, EXAMINING ATTORNEY

SN 86-068,641. BOOKER, RICHARD, PINECREST, FL. FILED 9-18-2013.

## Nine Mile

THE MARK CONSISTS OF STANDARD CHARACTERS WITHOUT CLAIM TO ANY PARTICULAR FONT, STYLE, SIZE, OR COLOR.

### CLASS 25—CLOTHING

FOR POLO SHIRTS; SPORT SHIRTS; SWEAT SHIRTS; T-SHIRTS (U.S. CLS. 22 AND 39).

### CLASS 34—SMOKERS' ARTICLES

FOR TOBACCO, CIGARS AND CIGARETTES (U.S. CLS. 2, 8, 9 AND 17).  
MORGAN WYNNE, EXAMINING ATTORNEY

## SCANDOUT

THE MARK CONSISTS OF STANDARD CHARACTERS WITHOUT CLAIM TO ANY PARTICULAR FONT, STYLE, SIZE, OR COLOR.

### CLASS 9—ELECTRICAL AND SCIENTIFIC APPARATUS

FOR COMPUTER SOFTWARE FOR AUTOMATING SALES, NAMELY, ALLOWING SALES FORCE PERSONNEL OR SHOPPERS TO GATHER, STORE, INDEX AND TRANSFER ITEMS IN A SHOPPING LIST OR VIRTUAL SHOPPING CART TO A POINT OF SALE OR INVENTORY SYSTEM (U.S. CLS. 21, 23, 26, 36 AND 38).

### CLASS 42—SCIENTIFIC AND COMPUTER SERVICES

FOR PROVIDING TEMPORARY USE OF ON-LINE NON-DOWNLOADABLE SOFTWARE AND APPLICATIONS FOR ALLOWING SALES FORCE PERSONNEL OR SHOPPERS TO GATHER, STORE, INDEX AND TRANSFER ITEMS IN A SHOPPING LIST OR VIRTUAL SHOPPING CART TO A POINT OF SALE OR INVENTORY SYSTEM (U.S. CLS. 100 AND 101).  
NORA BUCHANAN WILL, EXAMINING ATTORNEY

SN 86-068,699. A PRO SPEAKER LLC, POMPANO BEACH, FL. FILED 9-18-2013.

## be who u are

THE MARK CONSISTS OF STANDARD CHARACTERS WITHOUT CLAIM TO ANY PARTICULAR FONT, STYLE, SIZE, OR COLOR.

### CLASS 14—JEWELRY

FOR ANKLE BRACELETS; BANGLE BRACELETS; BRACELETS; BRACELETS OF PRECIOUS METAL; CHARITY BRACELETS; CHARMS FOR COLLAR JEWELRY AND BRACELET; IDENTIFICATION BRACELETS; JEWELLERY CHAIN OF PRECIOUS METAL FOR BRACELETS; JEWELRY, NAMELY, BRACELETS, WRISTBANDS AND NECKLACES THAT ALSO PROVIDES NOTIFICATION TO THE WEARER OF A PENDING MEDICAL RELATED TASK; NYLON ANKLE BRACELETS; NYLON BRACELETS; PLASTIC BRACELETS IN THE NATURE OF JEWELRY; RUBBER OR SILICONE WRISTBANDS IN THE NATURE OF A BRACELET; SLAP BRACELETS; SLAPBAND BRACELETS; STAINLESS STEEL JEWELRY BRACELETS; WATCH BRACELETS (U.S. CLS. 2, 27, 28 AND 50).

### CLASS 41—EDUCATION AND ENTERTAINMENT

FOR EDUCATIONAL AND ENTERTAINMENT SERVICES, NAMELY, PROVIDING MOTIVATIONAL SPEAKING SERVICES IN THE FIELD OF PERSONAL DEVELOPMENT (U.S. CLS. 100, 101 AND 107).



KYLE PEETE, EXAMINING ATTORNEY

SN 86-068,765. CAPSOVISION, INC., SARATOGA, CA. FILED 9-18-2013.

SN 86-068,762. CAPSOVISION, INC., SARATOGA, CA. FILED 9-18-2013.



OWNER OF U.S. REG. NOS. 3,994,399, 3,998,663 AND 3,998,670.

THE COLOR(S) BLUE, GREEN, AND BLACK IS/ARE CLAIMED AS A FEATURE OF THE MARK.

THE MARK CONSISTS OF STYLIZED "CAPSOVISION" IN BLACK, A STYLIZED PHRASE "EMPOWERING THROUGH INNOVATION" IN BLACK, "CAPSOVISION" APPEARING ABOVE "EMPOWERING THROUGH INNOVATION", "CAPSOVISION" APPEARING DISTINGUISHABLY LARGER IN FONT SIZE THAN "EMPOWERING THROUGH INNOVATION", FOUR MOONS CRESCENTS ABOVE "CAPSOVISION" AND EACH MOON CRESCENT DISPLACED FROM THE OTHERS AND WITH A DISTINCT SIZE AND SEPARATED FROM EACH OTHER BY SPACE AND THE LARGEST MOON CRESCENT AND THE SMALLEST MOON CRESCENT BOTH APPEARING IN A DARKER BLUE THAN THE MOON CRESCENT WITH A SIZE BETWEEN THE LARGEST AND THE SMALLEST MOON CRESCENT APPEARING IN A LIGHTER BLUE AND A GREEN MOON CRESCENT WITH A SIZE LARGER THAN THE SMALLEST MOON CRESCENT AND SMALLER THAN THE OTHER MOON CRESCENTS. THE COLOR WHITE REPRESENTS TRANSPARENT AREAS AND IS NOT PART OF THE MARK.

**CLASS 9—ELECTRICAL AND SCIENTIFIC APPARATUS**

FOR COMPUTER DOCKING STATIONS FOR USE WITH INGESTIBLE DIAGNOSTIC CAMERAS; COMPUTER WORKSTATIONS CONSISTING OF CENTRAL PROCESSING UNITS, MONITORS, KEYBOARDS, AND MICE FOR USE WITH INGESTIBLE DIAGNOSTIC CAMERAS; COMPUTER NETWORKING HARDWARE FOR USE WITH INGESTIBLE DIAGNOSTIC CAMERAS; COMPUTER SOFTWARE FOR IMAGING AND IMAGE ANALYSIS FOR USE WITH INGESTIBLE DIAGNOSTIC CAMERAS AND COMPUTER DOCKING STATIONS AND WORKSTATIONS (U.S. CLS. 21, 23, 26, 36 AND 38).

**CLASS 10—MEDICAL APPARATUS**

FOR INGESTIBLE DIAGNOSTIC CAMERAS FOR MEDICAL PURPOSES (U.S. CLS. 26, 39 AND 44).

**CLASS 42—SCIENTIFIC AND COMPUTER SERVICES**

FOR RESEARCH AND DEVELOPMENT IN THE FIELD OF INGESTIBLE DIAGNOSTIC CAMERAS FOR MEDICAL PURPOSES (U.S. CLS. 100 AND 101). CAROL SPILS, EXAMINING ATTORNEY

OWNER OF U.S. REG. NOS. 3,994,399, 3,998,663 AND 3,998,670.

NO CLAIM IS MADE TO THE EXCLUSIVE RIGHT TO USE "CAM", APART FROM THE MARK AS SHOWN.

THE COLOR(S) BLACK, BLUE, GREEN, AND WHITE IS/ARE CLAIMED AS A FEATURE OF THE MARK.

THE MARK CONSISTS OF THE WORDING "CAPSO CAM" WITH "CAPSO" IN STYLIZED LETTERS IN BLACK AND "CAM" IN BLOCK CAPITALIZED LETTERS WITH A DESIGN APPEARING AS A BLUE CIRCLE INTO WHICH THE LETTERS "CAM" APPEAR IN WHITE AND A BLUE INNER AND A BLUE, GREEN AND WHITE OUTER RING CIRCLING THE OUTER PART OF THE CIRCLE WITH THE LETTERS "CAM" AND THE BLUE INNER RING SEPARATED FROM THE CIRCLE WITH A WHITE RING AND THE OUTER BLUE, GREEN AND WHITE RING SEPARATED FROM THE CIRCLE AND THE INNER BLUE RING WITH A WHITE RING, THE INNER BLUE RING HAVING TWO SEMICIRCLES EACH WITH A DIFFERENT SHADE OF BLUE AND SEPARATED FROM EACH OTHER WITH WHITE SPACE AND THE BLUE OF EACH SEMICIRCLE FADING IN COLOR TOWARD THE EDGES OF EACH OF THE SEMICIRCLES TOWARD THE WHITE SPACES AND THE OUTER BLUE, GREEN AND WHITE OUTER RING WITH HALF THEREOF IN BLUE AND SEPARATED FROM THE GREEN BY WHITE AND THE REMAINING PORTION OF THE OUTER BLUE, GREEN, AND WHITE OUTER RING BEING WHITE, THE BLUE AND GREEN EACH FADING AT OUTER EDGES AND NEAR THE WHITE.

**CLASS 9—ELECTRICAL AND SCIENTIFIC APPARATUS**

FOR COMPUTER SOFTWARE FOR IMAGING AND IMAGE ANALYSIS FOR USE WITH INGESTIBLE DIAGNOSTIC CAMERAS (U.S. CLS. 21, 23, 26, 36 AND 38).

**CLASS 10—MEDICAL APPARATUS**

FOR INGESTIBLE DIAGNOSTIC CAMERAS FOR MEDICAL DIAGNOSTIC USE (U.S. CLS. 26, 39 AND 44). CAROL SPILS, EXAMINING ATTORNEY

SN 86-068,842. CYL-TEC, INC., AURORA, IL. FILED 9-19-2013.



THE MARK CONSISTS OF STANDARD CHARACTERS WITHOUT CLAIM TO ANY PARTICULAR FONT, STYLE, SIZE, OR COLOR.

**CLASS 6—METAL GOODS**

FOR METAL FLUID STORAGE TANKS, NAMELY TANKS FOR STORAGE OF CARBON DIOXIDE FOR BEVERAGE OR CRYOGENIC LIQUIDS; TANKS FOR COMPRESSED GAS STORAGE FOR TRANSPORT OF LIQUIDS OR GASSES; METAL CYLINDERS FOR STORAGE OF COMPRESSED GASSES AND LIQUIDS (U.S. CLS. 2, 12, 13, 14, 23, 25 AND 50).

FIRST USE 10-1-1999; IN COMMERCE 10-1-1999.

**CLASS 9—ELECTRICAL AND SCIENTIFIC APPARATUS**

FOR ELECTRICAL APPARATUS; NAMELY SCIENTIFIC, MEASURING, SIGNALLING AND CHECKING APPARATUS AND INSTRUMENTS, NAMELY, FLOW TRANSMITTERS, PRESSURE TRANSMITTERS, PRESSURE SENSORS, LEVEL TRANSMITTERS, LEVEL SWITCHES, TEMPERATURE TRANSMITTERS, ANALYTICAL TRANSMITTERS, CONDUCTIVITY SENSORS, CONDUCTIVITY TRANSMITTERS, CAPACITANCE SENSORS, CAPACITANCE TRANSMITTERS (U.S. CLS. 21, 23, 26, 36 AND 38).

FIRST USE 10-1-1999; IN COMMERCE 10-1-1999.  
JANET LEE, EXAMINING ATTORNEY

SN 86-068,932. TAMAE ISHII, NEW YORK, NY. FILED 9-19-2013.

---

**Privé Pet**

THE MARK CONSISTS OF STANDARD CHARACTERS WITHOUT CLAIM TO ANY PARTICULAR FONT, STYLE, SIZE, OR COLOR.

NO CLAIM IS MADE TO THE EXCLUSIVE RIGHT TO USE "PET", APART FROM THE MARK AS SHOWN.

THE ENGLISH TRANSLATION OF "PRIVÉ" IN THE MARK IS "PRIVATE".

**CLASS 18—LEATHER GOODS**

FOR ANIMAL CARRIERS; CARRY-ALL BAGS; CLOTHING FOR DOMESTIC PETS; COLLARS FOR PETS; DUFFEL BAGS FOR TRAVEL; GARMENTS FOR PETS; PET CLOTHING (U.S. CLS. 1, 2, 3, 22 AND 41).

FIRST USE 1-1-2011; IN COMMERCE 5-1-2013.

**CLASS 21—HOUSEWARES AND GLASS**

FOR CAT LITTER BOXES; CAT LITTER PANS; DISPOSABLE LINER PADS FOR ANIMAL LITTER BOXES; LITTER BOXES FOR PETS; PET FEEDING AND DRINKING BOWLS; PET LITTER BOXES (U.S. CLS. 2, 13, 23, 29, 30, 33, 40 AND 50).

FIRST USE 1-1-2011; IN COMMERCE 5-1-2013.  
ELLEN BURNS, EXAMINING ATTORNEY

SN 86-068,945. NYANSA, INC., PALO ALTO, CA. FILED 9-19-2013.

**NYANSA**

THE MARK CONSISTS OF STANDARD CHARACTERS WITHOUT CLAIM TO ANY PARTICULAR FONT, STYLE, SIZE, OR COLOR.

**CLASS 9—ELECTRICAL AND SCIENTIFIC APPARATUS**

FOR COMPUTER PROGRAMS, DOWNLOADABLE COMPUTER PROGRAMS AND MOBILE DEVICE SOFTWARE FOR ANALYZING NETWORKS TO DIAGNOSE AND OPTIMIZE APPLICATION AND NETWORK PERFORMANCE, COMPLIANCE MONITORING, AND SECURITY (U.S. CLS. 21, 23, 26, 36 AND 38).

**CLASS 42—SCIENTIFIC AND COMPUTER SERVICES**

FOR COMPUTER SERVICES, NAMELY SOFTWARE AS A SERVICE (SAAS) FEATURING COMPUTER PROGRAMS FOR ANALYZING NETWORKS TO DIAGNOSE AND OPTIMIZE APPLICATION AND NETWORK PERFORMANCE, COMPLIANCE MONITORING, AND SECURITY (U.S. CLS. 100 AND 101).

AISHA CLARKE, EXAMINING ATTORNEY

SN 86-068,952. CROWE, JESSICA, PICKENS, SC. FILED 9-19-2013.

---

**ROPE LIFE**

THE MARK CONSISTS OF STANDARD CHARACTERS WITHOUT CLAIM TO ANY PARTICULAR FONT, STYLE, SIZE, OR COLOR.

**CLASS 16—PAPER GOODS AND PRINTED MATTER**

FOR BUMPER STICKERS; DECALS; STICKERS (U.S. CLS. 2, 5, 22, 23, 29, 37, 38 AND 50).

**CLASS 25—CLOTHING**

FOR GLOVES; HATS; HOODED SWEATSHIRTS; JACKETS; LONG-SLEEVED SHIRTS; SHIRTS; SHIRTS AND SHORT-SLEEVED SHIRTS; SHORT-SLEEVED OR LONG-SLEEVED T-SHIRTS; SWEATSHIRTS; T-SHIRTS (U.S. CLS. 22 AND 39).

ELLEN BURNS, EXAMINING ATTORNEY

SN 86-068,975. TACKLEWEBS INC., MIAMI, FL. FILED 9-19-2013.

# TACKLEWEBS

THE MARK CONSISTS OF STANDARD CHARACTERS WITHOUT CLAIM TO ANY PARTICULAR FONT, STYLE, SIZE, OR COLOR.

**CLASS 12—VEHICLES**

FOR DECK BAGS ADAPTED FOR USE ON KAYAKS (U.S. CLS. 19, 21, 23, 31, 35 AND 44).  
FIRST USE 8-16-2010; IN COMMERCE 8-16-2010.

**CLASS 22—CORDAGE AND FIBERS**

FOR MESH BAGS FOR STORAGE (U.S. CLS. 1, 2, 7, 19, 22, 42 AND 50).  
FIRST USE 8-16-2010; IN COMMERCE 8-16-2010.

**CLASS 28—TOYS AND SPORTING GOODS**

FOR FISHING TACKLE BAGS; SPORTSMAN'S FISHING BAGS (U.S. CLS. 22, 23, 38 AND 50).  
FIRST USE 8-16-2010; IN COMMERCE 8-16-2010.  
CYNTHIA TRIPI, EXAMINING ATTORNEY

---

SN 86-069,239. CHIRPIFY, INC., PORTLAND, OR. FILED 9-19-2013.

# CHIRPIFY

THE MARK CONSISTS OF STANDARD CHARACTERS WITHOUT CLAIM TO ANY PARTICULAR FONT, STYLE, SIZE, OR COLOR.

**CLASS 35—ADVERTISING AND BUSINESS**

FOR BUSINESS CONSULTING SERVICES, NAMELY MARKETING CAMPAIGN STRATEGY, PLANNING, DESIGN AND EXECUTION; BUSINESS CONSULTING SERVICES, NAMELY SOCIAL MEDIA MARKETING CAMPAIGN STRATEGY, PLANNING, DESIGN AND EXECUTION (U.S. CLS. 100, 101 AND 102).  
FIRST USE 11-21-2011; IN COMMERCE 11-21-2011.

**CLASS 42—SCIENTIFIC AND COMPUTER SERVICES**

FOR PROVIDING ON-LINE NON-DOWNLOADABLE SOFTWARE FOR CAPTURING DATA AND PROCESSING PAYMENT TRANSACTIONS; PROVIDING ON-LINE NON-DOWNLOADABLE SOFTWARE FOR CAPTURING DATA AND PROCESSING PAYMENT TRANSACTIONS ACROSS SOCIAL MEDIA PLATFORMS; PROVIDING ON-LINE NON-DOWNLOADABLE SOFTWARE FOR DESIGNING AND LAUNCHING SOCIAL MARKETING CAMPAIGNS; PROVIDING ON-LINE NON-DOWNLOADABLE SOFTWARE FOR ACCESSING, EXPORTING, AND VIEWING CONSUMER, MARKETING AND ADVERTISING CAMPAIGN DATA; APPLICATION SERVICE PROVIDER FEATURING APPLICATION PROGRAMMING INTERFACE (API) SOFTWARE FOR CAPTURING DATA AND PROCESSING PAYMENT TRANSACTIONS (U.S. CLS. 100 AND 101).  
FIRST USE 11-21-2011; IN COMMERCE 11-21-2011.  
HEATHER BIDDULPH, EXAMINING ATTORNEY

---

SN 86-069,256. CARBON GLACIER DISTILLERY, LLC, WILKESON, WA. FILED 9-19-2013.

# Moose Shine

THE MARK CONSISTS OF STANDARD CHARACTERS WITHOUT CLAIM TO ANY PARTICULAR FONT, STYLE, SIZE, OR COLOR.

**CLASS 25—CLOTHING**

FOR WEARABLE GARMENTS AND CLOTHING, NAMELY, SHIRTS (U.S. CLS. 22 AND 39).  
FIRST USE 2-21-2013; IN COMMERCE 2-21-2013.

**CLASS 33—WINES AND SPIRITS**

FOR DISTILLED SPIRITS (U.S. CLS. 47 AND 49).  
FIRST USE 1-29-2013; IN COMMERCE 2-21-2013.  
SUNG IN, EXAMINING ATTORNEY

---

SN 86-069,317. KBD CONCEPTS LLC, MADERA, CA. FILED 9-19-2013.



THE MARK CONSISTS OF THE STYLIZED LETTERS "KBD" MOLDED TOGETHER.

**CLASS 25—CLOTHING**

FOR WEARABLE GARMENTS AND CLOTHING, NAMELY, SHIRTS (U.S. CLS. 22 AND 39).

**CLASS 37—CONSTRUCTION AND REPAIR**

FOR INSTALLATION OF AUDIO EQUIPMENT IN AUTOMOBILES (U.S. CLS. 100, 103 AND 106).  
LINDSEY BEN, EXAMINING ATTORNEY

SN 86-069,348. RESTAURANT BUSINESS STRATEGIES, LLC, BEVERLY HILLS, CA. FILED 9-19-2013.

## GOT DEGREES IN PIZZA

THE MARK CONSISTS OF STANDARD CHARACTERS WITHOUT CLAIM TO ANY PARTICULAR FONT, STYLE, SIZE, OR COLOR.

NO CLAIM IS MADE TO THE EXCLUSIVE RIGHT TO USE "PIZZA", APART FROM THE MARK AS SHOWN.

### CLASS 30—STAPLE FOODS

FOR BAKERY DESSERTS; BAKERY GOODS; BAKERY PRODUCTS; BREAD; BREAD ROLLS; BREAD STICKS; FRESH PIZZA; FROZEN DOUGH FOR USE AS PIZZA, BREAD OR OTHER BREAD-TYPE PRODUCTS; KITS COMPRISED OF INGREDIENTS FOR PREPARING PIZZA; PITA BREAD; PIZZA; PIZZA CRUST; PIZZA CRUST MIXES; PIZZA DOUGH; PIZZA SAUCE; ROLLS (U.S. CL. 46).

### CLASS 43—HOTEL AND RESTAURANT SERVICES

FOR BAR SERVICES; PREPARATION OF FOOD AND BEVERAGES; PROVIDING OF FOOD AND DRINK; RESTAURANT AND CAFE SERVICES; RESTAURANT AND CATERING SERVICES; RESTAURANT SERVICES; RESTAURANT SERVICES FEATURING BAKERY, CREPES, AND PIZZA; RESTAURANT SERVICES, INCLUDING SIT-DOWN SERVICE OF FOOD AND TAKE-OUT RESTAURANT SERVICES; SERVING FOOD AND DRINKS (U.S. CLS. 100 AND 101).

WILLIAM ROSSMAN, EXAMINING ATTORNEY

SN 86-069,373. TV BAND SERVICE, LLC, WILMINGTON, NC. FILED 9-19-2013.

## URCAST

THE MARK CONSISTS OF STANDARD CHARACTERS WITHOUT CLAIM TO ANY PARTICULAR FONT, STYLE, SIZE, OR COLOR.

### CLASS 9—ELECTRICAL AND SCIENTIFIC APPARATUS

FOR COMPUTER NETWORKING AND TELECOMMUNICATIONS HARDWARE AND SOFTWARE; COMPUTER NETWORKING AND TELECOMMUNICATIONS HARDWARE AND SOFTWARE, NAMELY, COMPUTER HARDWARE AND SOFTWARE FOR DISTRIBUTING, TRANSMITTING, STREAMING, BROADCASTING, DISPLAYING, FORMATTING, AND TRANSFERRING VIDEOS, TEXT, DATA, IMAGES AND OTHER DIGITAL WORKS OVER THE INTERNET, COMPUTER NETWORKS, DIGITAL CABLE NETWORKS, DIGITAL TELEVISION NETWORKS, AND OTHER COMMUNICATION NETWORKS; COMPUTER SOFTWARE FOR USE IN THE SELECTION AND INDEXING OF VIDEOS, TEXT, DATA, IMAGES AND OTHER DIGITAL WORKS; COMPUTER SOFTWARE FOR USE IN THE SELECTION, INDEXING, DELIVERY, DISTRIBUTION AND TRANSMISSION OF VIDEOS, TEXT, DATA, IMAGES AND OTHER DIGITAL WORKS OVER THE INTERNET, COMPUTER NETWORKS, DIGITAL CABLE NETWORKS, DIGITAL TELEVISION NETWORKS, AND OTHER COMMUNICATION NETWORKS; SOFTWARE APPLICATIONS FOR PERSONAL COMPUTERS, SMART PHONES, TABLET COMPUTERS, AND OTHER MOBILE DEVICES, NAMELY, SOFTWARE FOR RECEIVING, DOWNLOADING, STREAMING, AND DISPLAYING VIDEOS, TEXT, DATA, IMAGES AND OTHER DIGITAL WORKS; COMPUTER HARDWARE AND SOFTWARE FOR UPLOAD, STORAGE, RETRIEVAL, DOWNLOAD, TRANSMISSION, INDEXING, AND DELIVERY OF DIGITAL CONTENT; COMPUTER HARDWARE AND SOFTWARE FOR PROVIDING SECURE ACCESS TO PRIVATE COMPUTER NETWORKS; COMPUTER HARDWARE, NAMELY, WIRED AND WIRELESS NETWORK GATEWAYS (U.S. CLS. 21, 23, 26, 36 AND 38).

### CLASS 38—COMMUNICATION

FOR TELECOMMUNICATIONS SERVICES, NAMELY, ELECTRONIC TRANSMISSION OF DATA, MESSAGES AND INFORMATION; TELECOMMUNICATIONS SERVICES, NAMELY, ELECTRONIC TRANSMISSION OF VIDEOS, TEXT, DATA, IMAGES AND OTHER DIGITAL CONTENT TO OTHERS OVER THE INTERNET, COMPUTER NETWORKS, DIGITAL CABLE NETWORKS, DIGITAL TELEVISION NETWORKS, AND OTHER COMMUNICATION NETWORKS; DELIVERY OF DIGITAL DATA AND MULTIMEDIA CONTENT OVER COMPUTER NETWORKS, DIGITAL CABLE NETWORKS, DIGITAL TELEVISION NETWORKS, AND OTHER COMMUNICATION NETWORKS; PROVIDING MULTIPLE USER ACCESS TO LOCAL COMPUTER INFORMATION NETWORKS (U.S. CLS. 100, 101 AND 104).

NAKIA HENRY, EXAMINING ATTORNEY

SN 86-069,393. RETAIL ROYALTY COMPANY, LAS VEGAS, NV. FILED 9-19-2013.

## QUICK FIXES

THE MARK CONSISTS OF STANDARD CHARACTERS WITHOUT CLAIM TO ANY PARTICULAR FONT, STYLE, SIZE, OR COLOR.

OWNER OF U.S. REG. NOS. 3,703,194 AND 4,078,158.

### CLASS 25—CLOTHING

FOR LINGERIE ACCESSORIES, NAMELY, REMOVABLE BREAST ENHANCER PADS USED IN A BRA; SELF-ADHESIVE NIPPLE COVERS FOR BREASTS, SELF-ADHESIVE BRA CUPS (U.S. CLS. 22 AND 39).

FIRST USE 7-0-2013; IN COMMERCE 7-0-2013.

**CLASS 26—FANCY GOODS**

FOR BODY AND CLOTHING TAPE, NAMELY, ADHESIVE TAPE TO KEEP CLOTHING IN PLACE; BRA STRAP POSITIONING DEVICE, NAMELY, BRA STRAP POSITIONING CLIP (U.S. CLS. 37, 39, 40, 42 AND 50).  
FIRST USE 7-0-2013; IN COMMERCE 7-0-2013.  
AMY C. KEAN, EXAMINING ATTORNEY

CORY BOONE, EXAMINING ATTORNEY

SN 86-069,663. OUTSKI, LLC, TUCSON, AZ. FILED 9-19-2013.

SN 86-069,413. XOS TECHNOLOGIES, INC., DBA XOS DIGITAL, LAKE MARY, FL. FILED 9-19-2013.

**THUNDERCLOUD**

THE MARK CONSISTS OF STANDARD CHARACTERS WITHOUT CLAIM TO ANY PARTICULAR FONT, STYLE, SIZE, OR COLOR.

**CLASS 9—ELECTRICAL AND SCIENTIFIC APPARATUS**

FOR COMPUTER SOFTWARE PRODUCTS, NAMELY, DOWNLOADABLE COMPUTER APPLICATION SOFTWARE HOSTED VIA A WEB NETWORK OR CLOUD BASED PLATFORM FOR USE IN PROFESSIONAL, COLLEGIATE AND AMATEUR SPORTS TO CAPTURE, EDIT, ANALYZE, ARCHIVE AND VIEW VIDEO, AUDIO, DATA AND MULTI-MEDIA CONTENT FOR SCOUTING, RECRUITING AND INSTRUCTING; COMPUTER APPLICATION SOFTWARE FOR DATA MANAGEMENT TO ACCESS, MANAGE AND UTILIZE ATHLETE RELATED VIDEO, AUDIO AND DATA AND OTHER INFORMATION (U.S. CLS. 21, 23, 26, 36 AND 38).

**CLASS 38—COMMUNICATION**

FOR ELECTRONIC STORAGE OF VIDEO, PHOTOGRAPHS, AUDIO, DATA AND MULTI-MEDIA CONTENT; STORAGE SERVICES OF ARCHIVING VIDEO, AUDIO, ELECTRONIC DATA AND CONSULTATION IN CONNECTION THEREWITH (U.S. CLS. 100, 101 AND 104).

HEATHER SAPP, EXAMINING ATTORNEY

SN 86-069,612. CANEDO, GUILLERMO, MIAMI, FL. FILED 9-19-2013.

**the source of all goodness**

THE MARK CONSISTS OF STANDARD CHARACTERS WITHOUT CLAIM TO ANY PARTICULAR FONT, STYLE, SIZE, OR COLOR.

**CLASS 5—PHARMACEUTICALS**

FOR VITAMIN AND MINERAL SUPPLEMENTS (U.S. CLS. 6, 18, 44, 46, 51 AND 52).

**CLASS 32—LIGHT BEVERAGES**

FOR FRUIT JUICES; VEGETABLE JUICES (U.S. CLS. 45, 46 AND 48).

**OUTSKI**

THE MARK CONSISTS OF STANDARD CHARACTERS WITHOUT CLAIM TO ANY PARTICULAR FONT, STYLE, SIZE, OR COLOR.

**CLASS 36—INSURANCE AND FINANCIAL**

FOR ADMINISTRATION OF TRAVEL SAVINGS ACCOUNTS; CORPORATE SAVINGS ACCOUNT SERVICES; FINANCIAL SERVICES, NAMELY, SAVINGS PROGRAMS FOR TRAVEL; ISSUING PREPAID DEBIT CARDS; ON-LINE PREPAID CARD SERVICES; AND SAVINGS ACCOUNT SERVICES (U.S. CLS. 100, 101 AND 102).

**CLASS 39—TRANSPORTATION AND STORAGE**

FOR BOOKING OF TRAVEL TICKETS; COORDINATING TRAVEL ARRANGEMENTS FOR INDIVIDUALS AND FOR GROUPS; AND ON-LINE TRANSPORTATION RESERVATION AND TRAVEL TICKET RESERVATION SERVICES (U.S. CLS. 100 AND 105).

**CLASS 42—SCIENTIFIC AND COMPUTER SERVICES**

FOR COMPUTER SERVICES, NAMELY, CREATING AN ON-LINE COMMUNITY FOR REGISTERED USERS TO PLAN AND BOOK TRAVEL; AND PROVIDING A WEB SITE FEATURING TECHNOLOGY THAT ENABLES INTERNET USERS TO BOOK TRAVEL (U.S. CLS. 100 AND 101).

JEFFREY LOOK, EXAMINING ATTORNEY

SN 86-069,676. POLLY PARKER PRESS, LLC, SOUTH CARVER, MA. FILED 9-19-2013.

**NORBERT**

THE MARK CONSISTS OF STANDARD CHARACTERS WITHOUT CLAIM TO ANY PARTICULAR FONT, STYLE, SIZE, OR COLOR.

**CLASS 16—PAPER GOODS AND PRINTED MATTER**

FOR ART PICTURES; ART PRINTS; ART PRINTS COMPRISED OF DIGITAL ILLUSTRATIONS ORIGINATING FROM PHOTOGRAPHS; ART PRINTS ON CANVAS; ARTS AND CRAFT PAINT KITS; BLANK CARDS; BLANK JOURNAL BOOKS; BLANK JOURNALS; BLANK NOTE CARDS; BLANK WRITING JOURNALS; BOOK MARKS; CALENDARS; CHILDREN'S BOOKS; CHILDREN'S ARTS AND CRAFTS PAPER KITS; CHRISTMAS CARDS; FRAMED ART PICTURES; FRAMED ART PRINTS; GIFT BAGS; GREETING CARDS; PAPER BAGS; POSTERS; SCHOOL SUPPLY KITS CONTAINING VARIOUS COMBINATIONS OF SELECTED SCHOOL SUPPLIES, NAMELY, WRITING INSTRUMENTS, PENS, PENCILS, MECHANICAL PENCILS, ERASERS, MARKERS, CRAYONS, HIGHLIGHTER PENS, FOLDERS, NOTEBOOKS, PAPER, PROTRACTORS, PAPER CLIPS, PENCIL SHARPENERS, WRITING GRIPS, GLUE AND BOOK MARKS (U.S. CLS. 2, 5, 22, 23, 29, 37, 38 AND 50).

**CLASS 25—CLOTHING**

FOR CHILDREN'S AND INFANT'S APPAREL, NAMELY, JUMPERS, OVERALL SLEEPWEAR, PAJAMAS, ROMPERS AND ONE-PIECE GARMENTS; CHILDREN'S AND INFANTS' CLOTH BIBS; COSTUMES FOR USE IN CHILDREN'S DRESS UP PLAY; HATS; HATS FOR INFANTS, BABIES, TODDLERS AND CHILDREN; HOODED SWEATSHIRTS FOR CHILDREN; INFANT AND TODDLER ONE PIECE CLOTHING; JACKETS; JERSEYS; SHIRTS FOR INFANTS, BABIES, TODDLERS AND CHILDREN; SHORT-SLEEVED OR LONG-SLEEVED T-SHIRTS; SWEATSHIRTS FOR CHILDREN; T-SHIRTS; T-SHIRTS FOR CHILDREN; TOPS; WEARABLE GARMENTS AND CLOTHING, NAMELY, SHIRTS; WOMEN'S CLOTHING, NAMELY, SHIRTS, DRESSES, SKIRTS, BLOUSES (U.S. CLS. 22 AND 39).

**CLASS 28—TOYS AND SPORTING GOODS**

FOR PLUSH TOYS; STUFFED AND PLUSH TOYS; STUFFED DOLLS AND ANIMALS; STUFFED PUPPETS; STUFFED TOY ANIMALS; STUFFED TOYS; TOY ANIMALS; TOY ANIMALS AND ACCESSORIES THEREFOR; TOYS, NAMELY, BEAN BAG ANIMALS; TOYS, NAMELY, PUPPETS AND ACCESSORIES THEREFOR (U.S. CLS. 22, 23, 38 AND 50).

MELISSA VALLILLO, EXAMINING ATTORNEY

SN 86-069,680. AL KENIG, FORT LEE, NJ. FILED 9-19-2013.

**MATTESEELITE**

THE MARK CONSISTS OF STANDARD CHARACTERS WITHOUT CLAIM TO ANY PARTICULAR FONT, STYLE, SIZE, OR COLOR.

**CLASS 3—COSMETICS AND CLEANING PREPARATIONS**

FOR ADHESIVES FOR FALSE EYELASHES, HAIR AND NAILS; COSMETIC PENCILS; COSMETICS AND MAKE-UP; EYEBROW COSMETICS; GLITTER FOR COSMETIC PURPOSES; HAIR CONDITIONERS; HAIR GEL; HAIR SHAMPOOS AND CONDITIONERS; MAKE-UP KITS COMPRISED OF EYESHADOW; NAIL PAINT (U.S. CLS. 1, 4, 6, 50, 51 AND 52).

**CLASS 8—HAND TOOLS**

FOR ELECTRIC HAIR CURLING IRONS; ELECTRIC HAIR STRAIGHTENING IRONS; ELECTRIC HAND-HELD HAIR STYLING IRONS (U.S. CLS. 23, 28 AND 44).

**CLASS 11—ENVIRONMENTAL CONTROL APPARATUS**

FOR ELECTRIC HAIR DRYERS; HAIR DRYER DIFFUSERS (U.S. CLS. 13, 21, 23, 31 AND 34).

CHRISTINA SOBRAL, EXAMINING ATTORNEY

SN 86-069,686. YAKIMA PRODUCTS, INC., BEAVERTON, OR. FILED 9-19-2013.

**TAKE MORE FRIENDS**

THE MARK CONSISTS OF STANDARD CHARACTERS WITHOUT CLAIM TO ANY PARTICULAR FONT, STYLE, SIZE, OR COLOR.

**CLASS 12—VEHICLES**

FOR ALL-PURPOSE AUTOMOBILE RACKS AND RELATED EQUIPMENT, NAMELY, AUTOMOBILE RACKS FOR CARRYING ALL TYPES OF SPORTS EQUIPMENT, INCLUDING BICYCLES, SKIS, SAILBOARDS, SURFBOARDS, CANOES, KAYAKS, RAFTS AND SMALL BOATS; AUTOMOBILE RACKS FOR CARRYING LUGGAGE, MERCHANDISE, HOME FURNISHINGS, LUMBER, EQUIPMENT AND TOOLS; PARTS, FITTINGS AND COMPONENT PARTS FOR AUTOMOBILE RACKS, NAMELY, CROSS BARS, FOOT BRACES, MOUNTING PADS, ROOF PADS, BRACKETS, FAIRINGS, HITCHES, STRAPS, ANTI-THEFT LOCKS AND SECURITY CABLES; CARGO BOXES AND BASKETS, REMOVABLE CARGO BAGS AND NETS, ALL BEING SPECIALLY ADAPTED FOR USE IN CONNECTION WITH AUTOMOBILE CARGO RACKS (U.S. CLS. 19, 21, 23, 31, 35 AND 44).

FIRST USE 8-1-2012; IN COMMERCE 8-1-2012.

**CLASS 35—ADVERTISING AND BUSINESS**

FOR RETAIL STORE, ONLINE RETAIL STORE, AND CATALOG ORDERING SERVICES, ALL FEATURING AUTOMOBILE RACKS AND RELATED PARTS AND EQUIPMENT (U.S. CLS. 100, 101 AND 102).

FIRST USE 8-1-2012; IN COMMERCE 8-1-2012.

REGINA DRUMMOND, EXAMINING ATTORNEY

SN 86-069,690. NATIONAL STRENGTH AND CONDITIONING ASSOCIATION, COLORADO SPRINGS, CO. FILED 9-19-2013.



OWNER OF U.S. REG. NOS. 2,264,315, 2,561,457 AND 2,837,834.

THE MARK CONSISTS OF THE LETTERS "NSCA" LOCATED TO THE RIGHT OF THE LEFT PORTION OF A BARBELL.

#### **CLASS 16—PAPER GOODS AND PRINTED MATTER**

FOR PRINTED MATERIALS, NAMELY, WORKBOOKS, HANDBOOKS, BOOKLETS, MANUALS, GUIDES AND PRINTED EDUCATIONAL MATERIALS ALL IN THE FIELD OF PHYSICAL TRAINING AND CONDITIONING (U.S. CLS. 2, 5, 22, 23, 29, 37, 38 AND 50).

FIRST USE 1-1-2001, THE MARK WAS FIRST USED ANYWHERE IN A DIFFERENT FORM OTHER THAN THAT SOUGHT TO BE REGISTERED AT LEAST AS EARLY AS 02/01/1978; IN COMMERCE 1-1-2001, THE MARK WAS FIRST USED IN COMMERCE IN A DIFFERENT FORM OTHER THAN THAT SOUGHT TO BE REGISTERED AT LEAST AS EARLY AS 02/01/1978.

#### **CLASS 25—CLOTHING**

FOR CLOTHING, NAMELY, SHIRTS, T-SHIRTS, POLO SHIRTS, GOLF SHIRTS, SHORTS, PANTS, JACKETS AND HATS (U.S. CLS. 22 AND 39).

FIRST USE 1-1-2001, THE MARK WAS FIRST USED ANYWHERE IN A DIFFERENT FORM OTHER THAN THAT SOUGHT TO BE REGISTERED AT LEAST AS EARLY AS 02/01/1978; IN COMMERCE 1-1-2001, THE MARK WAS FIRST USED IN COMMERCE IN A DIFFERENT FORM OTHER THAN THAT SOUGHT TO BE REGISTERED AT LEAST AS EARLY AS 02/01/1978.

MICHAEL KEATING, EXAMINING ATTORNEY

SN 86-069,705. OUTSKI, LLC, TUCSON, AZ. FILED 9-19-2013.

**401(PLAY)**

THE MARK CONSISTS OF STANDARD CHARACTERS WITHOUT CLAIM TO ANY PARTICULAR FONT, STYLE, SIZE, OR COLOR.

#### **CLASS 36—INSURANCE AND FINANCIAL**

FOR ADMINISTRATION OF TRAVEL SAVINGS ACCOUNTS; CORPORATE SAVINGS ACCOUNT SERVICES; ELECTRONIC FUNDS TRANSFER; FINANCIAL SERVICES, NAMELY, SAVINGS PROGRAMS FOR TRAVEL; FINANCIAL SERVICES, NAMELY, ELECTRONIC REMOTE CHECK DEPOSIT SERVICES; SAVINGS PROGRAMS FOR TRAVEL; ISSUING PREPAID DEBIT CARDS; ON-LINE PREPAID CARD SERVICES; AND SAVINGS ACCOUNT SERVICES (U.S. CLS. 100, 101 AND 102).

#### **CLASS 39—TRANSPORTATION AND STORAGE**

FOR BOOKING OF TRAVEL TICKETS; COORDINATING TRAVEL ARRANGEMENTS FOR INDIVIDUALS AND FOR GROUPS; AND ON-LINE TRANSPORTATION RESERVATION AND TRAVEL TICKET RESERVATION SERVICES (U.S. CLS. 100 AND 105).

JEFFREY LOOK, EXAMINING ATTORNEY

SN 86-069,715. STRATEGIC FINANCIAL LITERACY, INC., TUCSON, AZ. FILED 9-19-2013.

#### **STRATEGIC VALUE CREATION**

THE MARK CONSISTS OF STANDARD CHARACTERS WITHOUT CLAIM TO ANY PARTICULAR FONT, STYLE, SIZE, OR COLOR.

#### **CLASS 9—ELECTRICAL AND SCIENTIFIC APPARATUS**

FOR DOWNLOADABLE ELECTRONIC PUBLICATIONS, NAMELY, BOOKS, WRITTEN ARTICLES, NEWSLETTERS, HANDOUTS AND WORKSHEETS IN THE FIELD OF FINANCE, FINANCIAL DECISION-MAKING, AND MANAGEMENT; AUDIO BOOKS IN THE FIELD OF FINANCE, FINANCIAL DECISION-MAKING, AND MANAGEMENT; AUDIO BOOKS IN THE FIELD OF FINANCE, FINANCIAL DECISION-MAKING AND MANAGEMENT RECORDED ON COMPUTER MEDIA (U.S. CLS. 21, 23, 26, 36 AND 38).

#### **CLASS 16—PAPER GOODS AND PRINTED MATTER**

FOR PRINTED EDUCATIONAL MATERIALS IN THE FIELD OF FINANCE, FINANCIAL DECISION-MAKING, AND FINANCIAL MANAGEMENT; PRINTED PUBLICATIONS, NAMELY, BOOKS, WRITTEN ARTICLES, NEWSLETTERS, HANDOUTS, AND WORKSHEETS IN THE FIELD OF FINANCE, FINANCIAL-DECISION MAKING AND MANAGEMENT (U.S. CLS. 2, 5, 22, 23, 29, 37, 38 AND 50).

#### **CLASS 41—EDUCATION AND ENTERTAINMENT**

FOR EDUCATION SERVICES, NAMELY, PROVIDING CLASSES, SEMINARS, WORKSHOPS IN THE FIELD OF FINANCIAL DECISION-MAKING AND MANAGEMENT; PROFESSIONAL COACHING SERVICES IN THE FIELD OF FINANCIAL DECISION-MAKING AND MANAGEMENT; NON-DOWNLOADABLE ELECTRONIC PUBLICATIONS, NAMELY, BOOKS, WRITTEN ARTICLES, NEWSLETTERS, HANDOUTS AND WORKSHEETS IN THE FIELD OF FINANCE, FINANCIAL DECISION-MAKING, AND MANAGEMENT (U.S. CLS. 100, 101 AND 107).

AMY C. KEAN, EXAMINING ATTORNEY

SN 86-069,721. ROY, JASON, MISSOURI CITY, TX. FILED 9-19-2013.

SN 86-069,722. OUTSKI, LLC, TUCSON, AZ. FILED 9-19-2013.

# (P)LAYAWAY

## ZERO 2 A HUNDRED

THE MARK CONSISTS OF STANDARD CHARACTERS WITHOUT CLAIM TO ANY PARTICULAR FONT, STYLE, SIZE, OR COLOR.

### CLASS 25—CLOTHING

FOR ATHLETIC SHORTS; BLOUSES; CAPS; COATS; DRESSES; FOOTWEAR; GOLF SHIRTS; HATS; HEADWEAR; HOODED PULLOVERS; HOODED SWEAT SHIRTS; JACKETS; JEANS; KNIT SHIRTS; KNITTED CAPS; PANTS; POLO SHIRTS; SHIRTS; SHORT-SLEEVED SHIRTS; SHORTS; SKIRTS; SKULL CAPS; SLEEVED OR SLEEVELESS JACKETS; SOCKS; SPORTS SHIRTS; SWEAT SHIRTS; SWEATERS; SWEATPANTS; T-SHIRTS; TANK TOPS (U.S. CLS. 22 AND 39).

### CLASS 36—INSURANCE AND FINANCIAL

FOR CHARITABLE FOUNDATION SERVICES, NAMELY, PROVIDING FINANCIAL SUPPORT TO CHILDREN, YOUNG ADULTS AND ADULTS FOR EXPENSES RELATED TO NECK, SPINAL OR BRAIN TRAUMA INJURIES; CHARITABLE FOUNDATION SERVICES, NAMELY, PROVIDING FUNDRAISING ACTIVITIES TO SUPPORT MEDICAL RESEARCH AND PROCEDURES FOR THOSE IN NEED; CHARITABLE FUNDRAISING (U.S. CLS. 100, 101 AND 102).

### CLASS 41—EDUCATION AND ENTERTAINMENT

FOR CONDUCTING WORKSHOPS AND SEMINARS IN MOTIVATIONAL THINKING, AFFIRMATIVE THINKING, POSITIVE THINKING, SELF-AWARENESS, SELF-IMPROVEMENT, AFFIRMATIONS, INSPIRATIONS, INTUITION, SETTING AND ACHIEVING PERSONAL GOALS, SETTING AND ACHIEVING CAREER AND PROFESSIONAL GOALS, PROBLEM SOLVING, SELF-CONFIDENCE, SELF-HELP, DEALING WITH THE PAST, LIFESTYLE ASSESSMENT, INTERPERSONAL RELATIONSHIPS, EMOTIONAL GROWTH, SPIRITUAL GROWTH, RELIGIOUS GROWTH, PERSONAL GROWTH, PERSONAL DEVELOPMENT; EDUCATIONAL AND ENTERTAINMENT SERVICES, NAMELY, PROVIDING MOTIVATIONAL SPEAKING SERVICES IN THE FIELD OF MOTIVATIONAL THINKING, AFFIRMATIVE THINKING, POSITIVE THINKING, SELF-AWARENESS, SELF-IMPROVEMENT, AFFIRMATIONS, INSPIRATIONS, INTUITION, SETTING AND ACHIEVING PERSONAL GOALS, SETTING AND ACHIEVING CAREER AND PROFESSIONAL GOALS, PROBLEM SOLVING, SELF-CONFIDENCE, SELF-HELP, DEALING WITH THE PAST, LIFESTYLE ASSESSMENT, INTERPERSONAL RELATIONSHIPS, EMOTIONAL GROWTH, SPIRITUAL GROWTH, RELIGIOUS GROWTH, PERSONAL GROWTH, PERSONAL DEVELOPMENT (U.S. CLS. 100, 101 AND 107).

CHRISTINA SOBRAL, EXAMINING ATTORNEY

THE MARK CONSISTS OF STANDARD CHARACTERS WITHOUT CLAIM TO ANY PARTICULAR FONT, STYLE, SIZE, OR COLOR.

### CLASS 36—INSURANCE AND FINANCIAL

FOR ADMINISTRATION OF TRAVEL SAVINGS ACCOUNTS; FINANCIAL SERVICES, NAMELY, SAVINGS PROGRAMS FOR TRAVEL; AND SAVINGS PROGRAMS FOR TRAVEL (U.S. CLS. 100, 101 AND 102).

### CLASS 39—TRANSPORTATION AND STORAGE

FOR BOOKING OF TRAVEL TICKETS UNDER A PAYMENT PROGRAM; COORDINATING TRAVEL ARRANGEMENTS FOR INDIVIDUALS AND FOR GROUPS; AND ON-LINE TRANSPORTATION RESERVATION AND TRAVEL TICKET RESERVATION SERVICES UNDER A PAYMENT PROGRAM (U.S. CLS. 100 AND 105).

JEFFREY LOOK, EXAMINING ATTORNEY

---

SN 86-069,732. CYC SEED COMPANY LLC, CASA GRANDE, AZ. FILED 9-19-2013.

# Coat-Right

THE MARK CONSISTS OF STANDARD CHARACTERS WITHOUT CLAIM TO ANY PARTICULAR FONT, STYLE, SIZE, OR COLOR.

### CLASS 1—CHEMICALS

FOR CHEMICALS FOR USE IN AGRICULTURE, HORTICULTURE AND FORESTRY EXCEPT FUNGICIDES, HERBICIDES, INSECTICIDES AND PARASITICIDES (U.S. CLS. 1, 5, 6, 10, 26 AND 46).

FIRST USE 5-1-2013; IN COMMERCE 7-1-2013.

### CLASS 31—NATURAL AGRICULTURAL PRODUCTS

FOR AGRICULTURAL SEEDS (U.S. CLS. 1 AND 46).  
FIRST USE 5-1-2013; IN COMMERCE 7-1-2013.  
MARCIE MILONE, EXAMINING ATTORNEY



SN 86-069,743. STRATEGIC FINANCIAL LITERACY, INC., TUCSON, AZ. FILED 9-19-2013.

## VALUE CREATION GPS

THE MARK CONSISTS OF STANDARD CHARACTERS WITHOUT CLAIM TO ANY PARTICULAR FONT, STYLE, SIZE, OR COLOR.

### CLASS 9—ELECTRICAL AND SCIENTIFIC APPARATUS

FOR DOWNLOADABLE ELECTRONIC PUBLICATIONS, NAMELY, BOOKS, WRITTEN ARTICLES, NEWSLETTERS, HANDOUTS AND WORKSHEETS IN THE FIELD OF FINANCE, FINANCIAL DECISION-MAKING, AND MANAGEMENT; AUDIO BOOKS IN THE FIELD OF FINANCE, FINANCIAL DECISION-MAKING, AND MANAGEMENT; AUDIO BOOKS IN THE FIELD OF FINANCE, FINANCIAL DECISION-MAKING AND MANAGEMENT RECORDED ON COMPUTER MEDIA (U.S. CLS. 21, 23, 26, 36 AND 38).

### CLASS 16—PAPER GOODS AND PRINTED MATTER

FOR PRINTED EDUCATIONAL MATERIALS IN THE FIELD OF FINANCE, FINANCIAL DECISION-MAKING, AND FINANCIAL MANAGEMENT; PRINTED PUBLICATIONS, NAMELY, BOOKS, WRITTEN ARTICLES, NEWSLETTERS, HANDOUTS, AND WORKSHEETS IN THE FIELD OF FINANCE, FINANCIAL-DECISION MAKING AND MANAGEMENT (U.S. CLS. 2, 5, 22, 23, 29, 37, 38 AND 50).

### CLASS 41—EDUCATION AND ENTERTAINMENT

FOR EDUCATION SERVICES, NAMELY, PROVIDING CLASSES, SEMINARS, WORKSHOPS IN THE FIELD OF FINANCIAL DECISION-MAKING AND MANAGEMENT; PROFESSIONAL COACHING SERVICES IN THE FIELD OF FINANCIAL DECISION-MAKING AND MANAGEMENT; NON-DOWNLOADABLE ELECTRONIC PUBLICATIONS, NAMELY, BOOKS, WRITTEN ARTICLES, NEWSLETTERS, HANDOUTS AND WORKSHEETS IN THE FIELD OF FINANCE, FINANCIAL DECISION-MAKING, AND MANAGEMENT (U.S. CLS. 100, 101 AND 107).  
AMY C. KEAN, EXAMINING ATTORNEY

SN 86-069,751. PARAMOUNT PICTURES CORPORATION, HOLLYWOOD, CA. FILED 9-19-2013.

## CRASH TEST

THE MARK CONSISTS OF STANDARD CHARACTERS WITHOUT CLAIM TO ANY PARTICULAR FONT, STYLE, SIZE, OR COLOR.

### CLASS 9—ELECTRICAL AND SCIENTIFIC APPARATUS

FOR DIGITAL MEDIA, NAMELY, PRE-RECORDED DIGITAL VIDEO DISCS, DIGITAL VERSATILE DISCS, DOWNLOADABLE AUDIO AND VIDEO RECORDINGS, DVDS, AND HIGH DEFINITION DIGITAL DISCS FEATURING MOTION PICTURES AND TELEVISION SERIES IN THE FIELD OF COMEDY (U.S. CLS. 21, 23, 26, 36 AND 38).

### CLASS 41—EDUCATION AND ENTERTAINMENT

FOR ENTERTAINMENT SERVICES, NAMELY, TELEVISION PROGRAMS AND EPISODIC MOTION PICTURE SERIES IN THE FIELD OF COMEDY PROVIDED VIA THE INTERNET, TELEVISION, AND VIDEO-ON-DEMAND; PROVIDING ONLINE INFORMATION IN THE FIELD OF ENTERTAINMENT CONCERNING TELEVISION PROGRAMS AND MOTION PICTURES IN THE FIELD OF COMEDY (U.S. CLS. 100, 101 AND 107).  
AHSEN KHAN, EXAMINING ATTORNEY

SN 86-069,770. ADAPTIVE SPECTRUM AND SIGNAL ALIGNMENT, INC., REDWOOD CITY, CA. FILED 9-19-2013.

## RAPIDE

THE MARK CONSISTS OF STANDARD CHARACTERS WITHOUT CLAIM TO ANY PARTICULAR FONT, STYLE, SIZE, OR COLOR.

OWNER OF U.S. REG. NO. 3,353,557.  
THE ENGLISH TRANSLATION OF "RAPIDE" IN THE MARK IS "RAPID".

### CLASS 38—COMMUNICATION

FOR CONSULTATION SERVICES TO PROVIDERS AND END-USERS IN THE FIELD OF BROADBAND ACCESS AND LOCAL AREA NETWORK SYSTEMS (U.S. CLS. 100, 101 AND 104).

### CLASS 42—SCIENTIFIC AND COMPUTER SERVICES

FOR TECHNICAL SUPPORT, NAMELY, MONITORING, TESTING AND REPORTING ON THE PERFORMANCE AND EFFICIENCY OF BROADBAND ACCESS AND LOCAL AREA NETWORK SYSTEMS OF OTHERS (U.S. CLS. 100 AND 101).  
MORGAN WYNNE, EXAMINING ATTORNEY

SN 86-069,786. BEATS MUSIC, LLC, SAN FRANCISCO, CA. FILED 9-19-2013.

## JUST FOR YOU

THE MARK CONSISTS OF STANDARD CHARACTERS WITHOUT CLAIM TO ANY PARTICULAR FONT, STYLE, SIZE, OR COLOR.

**CLASS 9—ELECTRICAL AND SCIENTIFIC APPARATUS**

FOR AUDIO RECORDINGS FEATURING MUSIC; VIDEO RECORDINGS FEATURING MUSIC; DOWNLOADABLE AUDIO AND VIDEO RECORDINGS FEATURING MUSIC; MUSIC PERFORMANCES, AND MUSIC VIDEOS; PRERECORDED MUSIC, NAMELY, DIGITAL DOWNLOADS; USER INTERFACE FOR TELEVISION AND VIDEO ON DEMAND COMMUNICATIONS EQUIPMENT; COMPUTER SOFTWARE FOR USE IN THE DELIVERY, DISTRIBUTION AND TRANSMISSION OF DIGITAL MUSIC AND ENTERTAINMENT-RELATED AUDIO, VIDEO, TEXT AND MULTIMEDIA CONTENT; COMPUTER SOFTWARE FOR ENABLING TRANSMISSION, STORAGE, SHARING, COLLECTION, EDITING, ORGANIZING AND MODIFYING AUDIO, VIDEO, MESSAGES, IMAGES AND OTHER DATA FOR USE IN SOCIAL NETWORKING, ONLINE CHATS AND INTERACTIVE GAMING, FOR USE IN CREATING SOCIAL NETWORKING DATABASES AND FOR USE IN SOCIAL NETWORKING DATABASE MANAGEMENT; COMPUTER SOFTWARE FOR CREATING SEARCHABLE DATABASES OF INFORMATION AND DATA FOR PEER-TO-PEER SOCIAL NETWORKING DATABASES; GIFT CARDS, NAMELY, MAGNETICALLY ENCODED GIFT CARDS (U.S. CLS. 21, 23, 26, 36 AND 38).

**CLASS 35—ADVERTISING AND BUSINESS**

FOR GIFT CARDS, NAMELY, NON-MAGNETICALLY ENCODED GIFT CARDS; PRINTED GIFT CERTIFICATES; NON-MAGNETICALLY ENCODED PREPAID PURCHASE CARDS FOR ALLOWING USERS TO TRANSFER FINANCIAL VALUE ON-LINE VIA ELECTRONIC COMMUNICATION NETWORKS, LOCAL AND GLOBAL COMPUTER NETWORKS AND WIRELESS COMMUNICATION DEVICES; NON-MAGNETICALLY ENCODED PREPAID PURCHASE CARDS FOR THE ONLINE PURCHASE OF MUSIC, VIDEOS, SPORTS, NEWS AND ENTERTAINMENT CONTENT VIA ELECTRONIC COMMUNICATION NETWORKS, LOCAL AND GLOBAL COMPUTER NETWORKS AND WIRELESS COMMUNICATION DEVICES (U.S. CLS. 100, 101 AND 102).

**CLASS 38—COMMUNICATION**

FOR AUDIO AND AUDIOVISUAL BROADCASTING AND TRANSMISSION OF DATA AND OF INFORMATION VIA ELECTRONIC COMMUNICATION NETWORKS, LOCAL AND GLOBAL COMPUTER NETWORKS AND WIRELESS COMMUNICATION NETWORKS; STREAMING OF AUDIO AND AUDIOVISUAL CONTENT VIA ELECTRONIC COMMUNICATION NETWORKS, LOCAL AND GLOBAL COMPUTER NETWORKS AND WIRELESS COMMUNICATION NETWORKS; WEBCASTING SERVICES; PROVIDING ON-LINE CHAT ROOMS AND DISCUSSION FORUMS FOR TRANSMISSION OF MESSAGES, AUDIO, VIDEO, AND DIGITAL PICTURES AMONG USERS IN THE FIELD OF GENERAL INTEREST; TELECOMMUNICATIONS ON THE INTERNET, NAMELY, AUDIO AND VIDEO TRANSMISSION; STREAMING OF MUSIC, FILMS, TELEVISION PROGRAMS, CURRENT EVENTS NEWS, ENTERTAINMENT NEWS, AND SPORTS PROGRAMS TO USERS ONLINE VIA A COMMUNICATION NETWORK (U.S. CLS. 100, 101 AND 104).

**CLASS 41—EDUCATION AND ENTERTAINMENT**

FOR ENTERTAINMENT SERVICES, NAMELY, PROVIDING ONLINE RADIO AND TELEVISION PROGRAMS FEATURING MUSIC AND ENTERTAINMENT, CURRENT EVENT NEWS, ENTERTAINMENT NEWS, ENTERTAINMENT-RELATED PROGRAMS IN THE NATURE OF VIDEOS OF MUSICAL PERFORMANCES, AND ONLINE COMPUTER GAMES, ALL DELIVERED TO USERS VIA A COMMUNICATION NETWORK; PROVIDING AN ONLINE DATABASE VIA A COMMUNICATION NETWORK FEATURING MUSIC, FILM, TELEVISION PROGRAMS, CURRENT EVENT NEWS, ENTERTAINMENT NEWS, SPORTS, ENTERTAINMENT-RELATED PROGRAMS AND GAMES; MUSIC PRODUCTION; PROVIDING ONLINE COMPUTER GAMES; RENTAL OF FILMS, VIDEO AND COMPUTER GAMES AND MUSIC RECORDINGS VIA A COMMUNICATION NETWORK (U.S. CLS. 100, 101 AND 107).

**CLASS 42—SCIENTIFIC AND COMPUTER SERVICES**

FOR PROVIDING AN INTERACTIVE ONLINE NETWORK WEBSITE, VIA ELECTRONIC COMMUNICATION NETWORKS, LOCAL AND GLOBAL COMPUTER NETWORKS AND WIRELESS COMMUNICATION DEVICES, FEATURING TECHNOLOGY TO ENABLE USERS TO PROGRAM AUDIO, VIDEO, MOVIES, TEXT AND OTHER MULTIMEDIA CONTENT; PROVIDING A WEBSITE FEATURING NON-DOWNLOADABLE SOFTWARE TO ENABLE USERS TO PROGRAM AUDIO, VIDEO, MOVIES, TEXT AND OTHER MULTIMEDIA CONTENT IN THE FIELD OF MUSIC, VIDEO, ONLINE RADIO, ENTERTAINMENT AND CULTURAL EVENTS; PROVIDING SEARCH ENGINES AND SEARCH PLATFORMS FOR OBTAINING DATA AND CONTENT VIA ELECTRONIC COMMUNICATION NETWORKS, LOCAL AND GLOBAL COMPUTER NETWORKS AND WIRELESS COMMUNICATION DEVICES; COMPUTER SERVICES, NAMELY, CREATING COMPUTER NETWORK-BASED INDEXES OF INFORMATION, WEBSITES AND RESOURCES AVAILABLE ON ELECTRONIC COMMUNICATION NETWORKS, LOCAL AND GLOBAL COMPUTER NETWORKS AND WIRELESS COMMUNICATION DEVICES; SEARCHING, BROWSING AND RETRIEVING INFORMATION, SITES, AND OTHER RESOURCES AVAILABLE ON ELECTRONIC COMMUNICATION NETWORKS, LOCAL AND GLOBAL COMPUTER NETWORKS AND WIRELESS COMMUNICATION DEVICES (U.S. CLS. 100 AND 101).

DAVID TAYLOR, EXAMINING ATTORNEY

SN 86-069,839. ASIANCY ICON LLC, LOS ANGELES, CA.  
FILED 9-19-2013.

**YASKY**

THE MARK CONSISTS OF STANDARD CHARACTERS WITHOUT CLAIM TO ANY PARTICULAR FONT, STYLE, SIZE, OR COLOR.

**CLASS 32—LIGHT BEVERAGES**

FOR BEER, ALE AND LAGER; BEER, ALE AND PORTER; BEER, ALE, LAGER, STOUT AND PORTER; BEER, ALE, LAGER, STOUT, PORTER, SHANDY; BEER-BASED COCKTAILS; BEER-BASED COOLERS; BEERS; BLACK BEER; BREWED MALT-BASED ALCOHOLIC BEVERAGE IN THE NATURE OF A BEER; COFFEE-FLAVORED BEER; FLAVORED BEERS; MALT BEER (U.S. CLS. 45, 46 AND 48).

**CLASS 33—WINES AND SPIRITS**

FOR ALCOHOLIC MIXED BEVERAGES EXCEPT BEERS; BLENDED SPIRITS; CHINESE SPIRIT OF SORGHUM (GAOLIAN-JIOU); DISTILLED SPIRITS; DISTILLED SPIRITS OF RICE (AWAMORI); KOREAN DISTILLED SPIRITS (SOJU); LIQUOR; SHOCHU (SPIRITS); SPIRITS; SPIRITS AND LIQUEURS (U.S. CLS. 47 AND 49).

JILLIAN CANTOR, EXAMINING ATTORNEY

SN 86-069,925. GLOBAL MEDIA GROUP LLC, FORT LAUDERDALE, FL. FILED 9-19-2013.

**SLIMFY**

SN 86-069,858. NEWSPEAK MEDIA, LLC, LOS ANGELES, CA. FILED 9-19-2013.

**Boomer Reinvention**

THE MARK CONSISTS OF STANDARD CHARACTERS WITHOUT CLAIM TO ANY PARTICULAR FONT, STYLE, SIZE, OR COLOR.

**CLASS 41—EDUCATION AND ENTERTAINMENT**

FOR BUSINESS EDUCATION AND TRAINING SERVICES, NAMELY, DEVELOPING AND FACILITATING CUSTOMIZED LEADERSHIP AND EXECUTIVE DEVELOPMENT PROGRAMS, PROVIDING EXECUTIVE COACHING SERVICES, AND PROVIDING BUSINESS EDUCATION PROGRAMS TO EMPLOYEES AND EXECUTIVES (U.S. CLS. 100, 101 AND 107).

**CLASS 45—PERSONAL AND LEGAL SERVICES**

FOR COUNSELING IN THE FIELD OF PERSONAL DEVELOPMENT, NAMELY, SELF-IMPROVEMENT, SELF-FULFILLMENT, AND INTERPERSONAL COMMUNICATION (U.S. CLS. 100 AND 101).

CHRISTINA SOBRAL, EXAMINING ATTORNEY

THE MARK CONSISTS OF STANDARD CHARACTERS WITHOUT CLAIM TO ANY PARTICULAR FONT, STYLE, SIZE, OR COLOR.

**CLASS 5—PHARMACEUTICALS**

FOR DIETARY AND NUTRITIONAL SUPPLEMENTS, CONTAINING NATURAL INGREDIENTS, USED FOR WEIGHT LOSS AND/OR TOXIN ELIMINATION (U.S. CLS. 6, 18, 44, 46, 51 AND 52).

**CLASS 44—MEDICAL, BEAUTY AND AGRICULTURAL SERVICES**

FOR PROVIDING A WEBSITE FEATURING INFORMATION AND ADVICE IN THE FIELDS OF DIET, WEIGHT MANAGEMENT, AND LIFESTYLE WELLNESS, AND/OR PROVIDING WEIGHT AND HEALTH ASSESSMENT SERVICES (U.S. CLS. 100 AND 101).

SOPHIA S. KIM, EXAMINING ATTORNEY

SN 86-069,932. GLOBAL MEDIA GROUP LLC, FORT LAUDERDALE, FL. FILED 9-20-2013.

**Slimfy**

SN 86-069,889. MOSI-OA-TUNYA, LLC, ATLANTA, GA. FILED 9-19-2013.

**DON'T CROSS ME, I'M FIT**

THE MARK CONSISTS OF STANDARD CHARACTERS WITHOUT CLAIM TO ANY PARTICULAR FONT, STYLE, SIZE, OR COLOR.

**CLASS 16—PAPER GOODS AND PRINTED MATTER**

FOR BUMPER STICKERS (U.S. CLS. 2, 5, 22, 23, 29, 38 AND 50).

**CLASS 25—CLOTHING**

FOR T-SHIRTS (U.S. CLS. 22 AND 39).  
SANI KHOURI, EXAMINING ATTORNEY

THE MARK CONSISTS OF STYLIZED WORD "SLIMFY".

**CLASS 5—PHARMACEUTICALS**

FOR DIETARY AND NUTRITIONAL SUPPLEMENTS, CONTAINING NATURAL INGREDIENTS, USED FOR WEIGHT LOSS AND/OR TOXIN ELIMINATION (U.S. CLS. 6, 18, 44, 46, 51 AND 52).

**CLASS 44—MEDICAL, BEAUTY AND AGRICULTURAL SERVICES**

FOR PROVIDING A WEBSITE FEATURING INFORMATION AND ADVICE IN THE FIELDS OF DIET, WEIGHT MANAGEMENT, AND LIFESTYLE WELLNESS, AND/OR PROVIDING WEIGHT AND HEALTH ASSESSMENT SERVICES (U.S. CLS. 100 AND 101).

SOPHIA S. KIM, EXAMINING ATTORNEY

SN 86-070,046. GREAT LAKES COMNET, EAST LANSING, MI. FILED 9-20-2013.

## Simplifying a Complex World

THE MARK CONSISTS OF STANDARD CHARACTERS WITHOUT CLAIM TO ANY PARTICULAR FONT, STYLE, SIZE, OR COLOR.

### CLASS 38—COMMUNICATION

FOR PROVIDING PRIVATE AND SECURE REAL TIME ELECTRONIC COMMUNICATION OVER A COMPUTER NETWORK; TELECOMMUNICATIONS SERVICES, NAMELY, PROVIDING FIBER OPTIC NETWORK SERVICES; VOICE OVER INTERNET PROTOCOL (VOIP) SERVICES (U.S. CLS. 100, 101 AND 104).  
FIRST USE 8-31-2013; IN COMMERCE 8-31-2013.

### CLASS 39—TRANSPORTATION AND STORAGE

FOR ELECTRONIC STORAGE OF DATA (U.S. CLS. 100 AND 105).  
FIRST USE 8-31-2013; IN COMMERCE 8-31-2013.

### CLASS 42—SCIENTIFIC AND COMPUTER SERVICES

FOR COMPUTER SERVICES, NAMELY, REMOTE AND ON-SITE MANAGEMENT OF CLOUD COMPUTING SYSTEMS AND APPLICATIONS FOR OTHERS; CONSULTING SERVICES IN THE FIELD OF CLOUD COMPUTING; HOSTING THE SOFTWARE, WEBSITES AND OTHER COMPUTER APPLICATIONS OF OTHERS ON A VIRTUAL PRIVATE SERVER; PLANNING, DESIGN AND IMPLEMENTATION OF VIRTUALIZATION TECHNOLOGIES FOR ENTERPRISES AND BUSINESSES; TECHNICAL SUPPORT, NAMELY, MONITORING OF NETWORK SYSTEMS (U.S. CLS. 100 AND 101).  
FIRST USE 8-31-2013; IN COMMERCE 8-31-2013.  
TOBY BULLOFF, EXAMINING ATTORNEY

SN 86-070,072. CADILLAC JACK, INC., DULUTH, GA. FILED 9-20-2013.

## BUFF BEACH

THE MARK CONSISTS OF STANDARD CHARACTERS WITHOUT CLAIM TO ANY PARTICULAR FONT, STYLE, SIZE, OR COLOR.

### CLASS 9—ELECTRICAL AND SCIENTIFIC APPARATUS

FOR COMPUTER GAME SOFTWARE FOR GAMING MACHINES INCLUDING SLOT MACHINES OR VIDEO LOTTERY TERMINALS; GAMING SOFTWARE THAT GENERATES OR DISPLAYS WAGER OUTCOMES OF GAMING MACHINES (U.S. CLS. 21, 23, 26, 36 AND 38).

### CLASS 28—TOYS AND SPORTING GOODS

FOR GAMING MACHINES THAT GENERATE OR DISPLAY WAGER OUTCOMES; RECONFIGURABLE CASINO AND LOTTERY GAMING EQUIPMENT, NAMELY, GAMING MACHINES AND OPERATIONAL COMPUTER GAME SOFTWARE THEREFOR SOLD AS A UNIT (U.S. CLS. 22, 23, 38 AND 50).  
APRIL ROACH, EXAMINING ATTORNEY

SN 86-070,077. CADILLAC JACK, INC., DULUTH, GA. FILED 9-20-2013.

## ELEMENTAL GEMS

THE MARK CONSISTS OF STANDARD CHARACTERS WITHOUT CLAIM TO ANY PARTICULAR FONT, STYLE, SIZE, OR COLOR.

### CLASS 9—ELECTRICAL AND SCIENTIFIC APPARATUS

FOR COMPUTER GAME SOFTWARE FOR GAMING MACHINES INCLUDING SLOT MACHINES OR VIDEO LOTTERY TERMINALS; GAMING SOFTWARE THAT GENERATES OR DISPLAYS WAGER OUTCOMES OF GAMING MACHINES (U.S. CLS. 21, 23, 26, 36 AND 38).

### CLASS 28—TOYS AND SPORTING GOODS

FOR GAMING MACHINES THAT GENERATE OR DISPLAY WAGER OUTCOMES; RECONFIGURABLE CASINO AND LOTTERY GAMING EQUIPMENT, NAMELY, GAMING MACHINES AND OPERATIONAL COMPUTER GAME SOFTWARE THEREFOR SOLD AS A UNIT (U.S. CLS. 22, 23, 38 AND 50).  
APRIL ROACH, EXAMINING ATTORNEY

SN 86-070,140. NAMCO BANDAI GAMES INC., TOKYO, JAPAN, FILED 9-20-2013.

## WHERE'S THE ANIMAL?

THE MARK CONSISTS OF STANDARD CHARACTERS WITHOUT CLAIM TO ANY PARTICULAR FONT, STYLE, SIZE, OR COLOR.

### CLASS 16—PAPER GOODS AND PRINTED MATTER

FOR COLLECTABLE TRADING CARDS; TRADING CARDS (U.S. CLS. 2, 5, 22, 23, 29, 37, 38 AND 50).

### CLASS 28—TOYS AND SPORTING GOODS

FOR ARCADE GAME MACHINES; ARCADE GAMES; ARCADE-TYPE ELECTRONIC VIDEO GAMES; COIN-OPERATED AMUSEMENT MACHINES; COIN-OPERATED VIDEO GAMES; GAME CARDS; PLAYING CARDS; TRADING CARD GAMES (U.S. CLS. 22, 23, 38 AND 50).  
DOMINICK J. SALEMI, EXAMINING ATTORNEY

FEB 11, 2014

U.S. PATENT AND TRADEMARK OFFICE

TM 413

SN 86-070,180. SPENCER, DAVE, HILLSBOROUGH, CA.  
FILED 9-20-2013.

## NEW PRAGMATIST

THE MARK CONSISTS OF STANDARD CHARACTERS WITHOUT CLAIM TO ANY PARTICULAR FONT, STYLE, SIZE, OR COLOR.

### CLASS 16—PAPER GOODS AND PRINTED MATTER

FOR PRINTED PUBLICATIONS, NAMELY, BOOKS AND NEWSLETTERS IN THE FIELD OF POLITICS (U.S. CLS. 2, 5, 22, 23, 29, 37, 38 AND 50).

### CLASS 41—EDUCATION AND ENTERTAINMENT

FOR ELECTRONIC PUBLICATIONS, NAMELY, ONLINE NEWSLETTERS AND BLOG IN THE FIELD OF POLITICS (U.S. CLS. 100, 101 AND 107).  
KAPIL BHANOT, EXAMINING ATTORNEY

SN 86-070,188. ANIMOTO INC., SAN FRANCISCO, CA.  
FILED 9-20-2013.



THE MARK CONSISTS OF FOUR FANNED OUT TRIANGLES CONNECTED AT A SINGLE POINT, WHERE THE SECOND TRIANGLE FROM THE BOTTOM IS SLIGHTLY LONGER THAN THE OTHER THREE.

### CLASS 9—ELECTRICAL AND SCIENTIFIC APPARATUS

FOR DOWNLOADABLE SOFTWARE VIA A GLOBAL COMPUTER NETWORK, WIRELESS DEVICE, MOBILE PHONE, SMART PHONE, OR TABLET DEVICE FOR PROVIDING USERS OF THE SOFTWARE WITH THE MEANS TO CREATE SLIDESHOWS AND VIDEOS USING DIGITAL MEDIA SUCH AS PHOTOGRAPHS, MUSIC AND VIDEO (U.S. CLS. 21, 23, 26, 36 AND 38).  
FIRST USE 1-14-2013; IN COMMERCE 1-14-2013.

### CLASS 42—SCIENTIFIC AND COMPUTER SERVICES

FOR PROVIDING ON-LINE NON-DOWNLOADABLE SOFTWARE FOR PROVIDING USERS OF GLOBAL COMPUTER NETWORKS WITH THE MEANS TO CREATE SLIDESHOWS AND VIDEOS USING DIGITAL MEDIA SUCH AS PHOTOGRAPHS, MUSIC AND VIDEO (U.S. CLS. 100 AND 101).  
FIRST USE 1-14-2013; IN COMMERCE 1-14-2013.  
KAREN SEVERSON, EXAMINING ATTORNEY

SN 86-070,295. LIVE LIFE 360, SANDY, UT. FILED 9-20-2013.

## Live Life 360

THE MARK CONSISTS OF STANDARD CHARACTERS WITHOUT CLAIM TO ANY PARTICULAR FONT, STYLE, SIZE, OR COLOR.

### CLASS 3—COSMETICS AND CLEANING PREPARATIONS

FOR NON-MEDICATED SKIN CARE PREPARATIONS, NAMELY, FACIAL AND BODY CLEANSERS, MOISTURIZERS, WRINKLE TREATMENT SERUM, SCRUBS, LOTIONS, GELS, MASKS, TONERS, ESSENTIAL OILS (U.S. CLS. 1, 4, 6, 50, 51 AND 52).

### CLASS 5—PHARMACEUTICALS

FOR DIETARY AND NUTRITIONAL SUPPLEMENTS (U.S. CLS. 6, 18, 44, 46, 51 AND 52).  
DOMINICK J. SALEMI, EXAMINING ATTORNEY

SN 86-070,306. ENDGAME, INC., ATLANTA, GA. FILED 9-20-2013.

## SENSE. DISCOVER. ACT.

THE MARK CONSISTS OF STANDARD CHARACTERS WITHOUT CLAIM TO ANY PARTICULAR FONT, STYLE, SIZE, OR COLOR.

### CLASS 9—ELECTRICAL AND SCIENTIFIC APPARATUS

FOR SOFTWARE FOR USE IN CYBER AND NETWORK SECURITY MANAGEMENT; SOFTWARE FOR USE IN DATA ANALYTICS AND VISUALIZATION (U.S. CLS. 21, 23, 26, 36 AND 38).

**CLASS 42—SCIENTIFIC AND COMPUTER SERVICES**

FOR PROVIDING NON-DOWNLOADABLE SOFTWARE FOR USE IN CYBER AND NETWORK SECURITY MANAGEMENT; PROVIDING NON-DOWNLOADABLE SOFTWARE FOR USE IN DATA ANALYTICS AND VISUALIZATION; PROVIDING ADVICE AND CONSULTING SERVICES IN THE FIELDS OF CYBER AND NETWORK SECURITY MANAGEMENT (U.S. CLS. 100 AND 101).

DOMINICK J. SALEMI, EXAMINING ATTORNEY

SN 86-070,308. ENDGAME, INC., ATLANTA, GA. FILED 9-20-2013.

**PATTERN OF LIFE**

THE MARK CONSISTS OF STANDARD CHARACTERS WITHOUT CLAIM TO ANY PARTICULAR FONT, STYLE, SIZE, OR COLOR.

**CLASS 9—ELECTRICAL AND SCIENTIFIC APPARATUS**

FOR SOFTWARE FOR USE IN CYBER AND NETWORK SECURITY MANAGEMENT; SOFTWARE FOR USE IN DATA ANALYTICS AND VISUALIZATION (U.S. CLS. 21, 23, 26, 36 AND 38).

**CLASS 42—SCIENTIFIC AND COMPUTER SERVICES**

FOR PROVIDING NON-DOWNLOADABLE SOFTWARE FOR USE IN CYBER AND NETWORK SECURITY MANAGEMENT; PROVIDING NON-DOWNLOADABLE SOFTWARE FOR USE IN DATA ANALYTICS AND VISUALIZATION; PROVIDING ADVICE AND CONSULTING SERVICES IN THE FIELDS OF CYBER AND NETWORK SECURITY MANAGEMENT (U.S. CLS. 100 AND 101).

DOMINICK J. SALEMI, EXAMINING ATTORNEY

SN 86-070,403. CRUCIFIX WORLD LLC, THORNTON, CO. FILED 9-20-2013.

**Cruce Signati**

THE MARK CONSISTS OF STANDARD CHARACTERS WITHOUT CLAIM TO ANY PARTICULAR FONT, STYLE, SIZE, OR COLOR.

THE ENGLISH TRANSLATION OF "CRUCE SIGNATI" IN THE MARK IS "SIGNED" OR "MARKED WITH A CROSS".

**CLASS 14—JEWELRY**

FOR WRIST WATCHES (U.S. CLS. 2, 27, 28 AND 50).

**CLASS 25—CLOTHING**

FOR ATHLETIC APPAREL, NAMELY, SHIRTS, PANTS, JACKETS, FOOTWEAR, HATS AND CAPS, ATHLETIC UNIFORMS; COLLARED SHIRTS; DRESS SHIRTS; GOLF SHIRTS; HATS; HOODED SWEAT SHIRTS; JACKETS; LONG-SLEEVED SHIRTS; SHORT-SLEEVED OR LONG-SLEEVED T-SHIRTS; SPORT SHIRTS; SWEAT SHIRTS; WEARABLE GARMENTS AND CLOTHING, NAMELY, SHIRTS (U.S. CLS. 22 AND 39).

SCOTT BIBB, EXAMINING ATTORNEY

SN 86-070,412. ARTCORE AESTHETICS LLC, GREENWICH, CT. FILED 9-20-2013.

**ARTCORE AESTHETICS**

THE MARK CONSISTS OF STANDARD CHARACTERS WITHOUT CLAIM TO ANY PARTICULAR FONT, STYLE, SIZE, OR COLOR.

**CLASS 25—CLOTHING**

FOR DRESSES; TEE SHIRTS (U.S. CLS. 22 AND 39). FIRST USE 4-17-2013; IN COMMERCE 4-17-2013.

**CLASS 42—SCIENTIFIC AND COMPUTER SERVICES**

FOR COMMERCIAL ART DESIGN; GRAPHIC ARTS DESIGN (U.S. CLS. 100 AND 101).

FIRST USE 7-19-2013; IN COMMERCE 7-19-2013. ROSELLE HERRERA, EXAMINING ATTORNEY

SN 86-070,455. BIONIC BRIDE, LLC, CORPUS CHRISTI, TX. FILED 9-20-2013.

**THE BIONIC BRIDE**

THE MARK CONSISTS OF STANDARD CHARACTERS WITHOUT CLAIM TO ANY PARTICULAR FONT, STYLE, SIZE, OR COLOR.

**CLASS 35—ADVERTISING AND BUSINESS**

FOR PROMOTING PUBLIC AWARENESS IN THE FIELD OF HEART HEALTH AND HEART DISEASE (U.S. CLS. 100, 101 AND 102).

**CLASS 41—EDUCATION AND ENTERTAINMENT**

FOR PROVIDING MOTIVATIONAL SPEAKING SERVICES IN THE FIELD OF HEART HEALTH AND HEART DISEASE (U.S. CLS. 100, 101 AND 107).

JACQUELINE ABRAMS, EXAMINING ATTORNEY

SN 86-070,466. PATRICK C. HO, HILTON, NY. FILED 9-20-2013.



THE MARK CONSISTS OF THE LETTER "B" IN STYLIZED SCRIPT AND WITHIN A CIRCLE AND WITH A DIAMOND AT THE BOTTOM RIGHT CORNER OF THE "B".

**CLASS 9—ELECTRICAL AND SCIENTIFIC APPARATUS**

FOR EYEWEAR, NAMELY, SUNGLASSES, EYEGLASSES AND OPHTHALMIC FRAMES AND CASES THEREFOR, AND DECORATIVE CHARMS FOR EYEWEAR (U.S. CLS. 21, 23, 26, 36 AND 38).

**CLASS 35—ADVERTISING AND BUSINESS**

FOR ON-LINE RETAIL STORE SERVICES FEATURING EYEGGLASS FRAMES AND LENSES, EYEGLASSES, SUNGLASSES, CONTACT LENSES, CONTACT SOLUTIONS, AND OPTICAL ACCESSORIES; RETAIL STORE SERVICES FEATURING EYEGGLASS FRAMES AND LENSES, EYEGLASSES, SUNGLASSES, CONTACT LENSES, CONTACT SOLUTIONS, AND OPTICAL ACCESSORIES (U.S. CLS. 100, 101 AND 102).  
ANGELA DUONG, EXAMINING ATTORNEY

**CLASS 42—SCIENTIFIC AND COMPUTER SERVICES**

FOR PLATFORM AS A SERVICE (PAAS) FEATURING COMPUTER SOFTWARE PLATFORMS FOR BROADCAST PAYOUT AND CONTENT MANAGEMENT SERVICES, NAMELY, BROADCAST PAYOUT AUTOMATION SOFTWARE WITH INTEGRATED GRAPHIC PRODUCTION AND DELIVERY, LIVE EVENT MANAGEMENT AND PRE-RECORDED ASSET MANAGEMENT FOR ENABLING THE SECURE AND QUALITY TRANSPORT OF INDUSTRY STANDARD BROADCAST STREAMS AT LOW LATENCY ACROSS WIDE AREA IP NETWORKS, AND FOR MANAGING VIDEO/AUDIO BROWSING, METADATA MANAGEMENT, LIVE SIGNAL MANAGEMENT AND ROUTING THROUGH SECURE WEB BASED TOOLS; SOFTWARE AS A SERVICE (SAAS) SERVICES FEATURING SOFTWARE FOR BROADCAST PAYOUT AND CONTENT MANAGEMENT SERVICES, NAMELY, BROADCAST PAYOUT AUTOMATION SOFTWARE WITH INTEGRATED GRAPHIC PRODUCTION AND DELIVERY, LIVE EVENT MANAGEMENT AND PRE-RECORDED ASSET MANAGEMENT FOR ENABLING THE SECURE AND QUALITY TRANSPORT OF INDUSTRY STANDARD BROADCAST STREAMS AT LOW LATENCY ACROSS WIDE AREA IP NETWORKS, AND FOR MANAGING VIDEO/AUDIO BROWSING, METADATA MANAGEMENT, LIVE SIGNAL MANAGEMENT AND ROUTING THROUGH SECURE WEB BASED TOOLS (U.S. CLS. 100 AND 101).

FIRST USE 8-28-2013; IN COMMERCE 9-12-2013.  
ANNE MADDEN, EXAMINING ATTORNEY

SN 86-070,632. WD PARTNERS, INC., DUBLIN, OH. FILED 9-20-2013.



THE MARK CONSISTS OF STANDARD CHARACTERS WITHOUT CLAIM TO ANY PARTICULAR FONT, STYLE, SIZE, OR COLOR.

OWNER OF U.S. REG. NOS. 3,296,872 AND 3,338,476.

**CLASS 35—ADVERTISING AND BUSINESS**

FOR MARKETING AND BUSINESS CONSULTING SERVICES, NAMELY, BRAND AND BUSINESS ASSESSMENTS AND DEVELOPMENT, COMPETITIVE ANALYSIS AND POSITIONING, BRAND AND CONCEPT GROWTH STRATEGIES FOR THE CUSTOM DESIGN AND BRANDING OF MULTI-UNIT RESTAURANTS AND RETAIL FACILITIES (U.S. CLS. 100, 101 AND 102).  
FIRST USE 9-1-2000; IN COMMERCE 9-1-2000.

**CLASS 37—CONSTRUCTION AND REPAIR**

FOR CONSTRUCTION SERVICES, NAMELY, PLANNING, LAYING OUT AND CONSTRUCTION PROGRAM MANAGEMENT OF CUSTOM CONSTRUCTION AND BUILDING RENOVATION OF MULTI-UNIT RESTAURANT AND RETAIL FACILITIES (U.S. CLS. 100, 103 AND 106).  
FIRST USE 9-1-2000; IN COMMERCE 9-1-2000.

SN 86-070,569. DELUXE ENTERTAINMENT SERVICES GROUP INC., BURBANK, CA. FILED 9-20-2013.



THE MARK CONSISTS OF STANDARD CHARACTERS WITHOUT CLAIM TO ANY PARTICULAR FONT, STYLE, SIZE, OR COLOR.

**CLASS 9—ELECTRICAL AND SCIENTIFIC APPARATUS**

FOR COMPUTER HARDWARE (U.S. CLS. 21, 23, 26, 36 AND 38).

**CLASS 42—SCIENTIFIC AND COMPUTER SERVICES**

FOR ARCHITECTURAL SERVICES, NAMELY, DESIGN OF MULTI-UNIT RESTAURANT AND RETAIL FACILITIES AND SITE ADAPT DEVELOPMENT; DESIGN SERVICES, NAMELY, GRAPHICS AND SIGNAGE DESIGN, FIXTURE DESIGN, AND DESIGN FOR OTHERS IN THE FIELD OF ENVIRONMENTAL ENGINEERING FOR THE CUSTOM DESIGN OF MULTI-UNIT RESTAURANTS AND RETAIL FACILITIES; ENGINEERING SERVICES, NAMELY, STRUCTURAL ENGINEERING AND CIVIL ENGINEERING SERVICES; SURVEYING SERVICES, NAMELY, BOUNDARY AND TOPOGRAPHIC SURVEYING (U.S. CLS. 100 AND 101).

FIRST USE 9-1-2000; IN COMMERCE 9-1-2000.

HEATHER THOMPSON, EXAMINING ATTORNEY

**CLASS 21—HOUSEWARES AND GLASS**

FOR MAKE-UP BRUSHES (U.S. CLS. 2, 13, 23, 29, 30, 33, 40 AND 50).

**CLASS 44—MEDICAL, BEAUTY AND AGRICULTURAL SERVICES**

FOR CONSULTATION SERVICES IN THE FIELD OF MAKE-UP, NAMELY, ON-LINE MAKEUP CONSULTATION SERVICES AND IN-PERSON MAKEUP CONSULTATION AND APPLICATION SERVICES; MAKE-UP APPLICATION SERVICES; PROVIDING ON-SITE BEAUTY SERVICES, NAMELY, HAIR STYLING AND MAKE-UP APPLICATION SERVICES; SERVICES OF A MAKE-UP ARTIST (U.S. CLS. 100 AND 101).

MORGAN WYNNE, EXAMINING ATTORNEY

SN 86-070,686. MANISCALCO, ERICA, BELLMORE, NY. FILED 9-20-2013.



SN 86-070,699. WILLIAM R. CATES, INC., LAUREL, MD. FILED 9-20-2013.

# Referral Fitness

THE COLOR(S) PINK, BLACK, WHITE, YELLOW IS/ARE CLAIMED AS A FEATURE OF THE MARK.

THE MARK CONSISTS OF A WHITE SKELETON HEAD OUTLINED IN BLACK WITH A PINK HEART ON THE CHEEK, BLACK EYES AND EYELASHES, BLACK NOSTRILS AND BLACK STITCHED MOUTH, WEARING A PINK CROWN OUTLINED IN BLACK WITH YELLOW BALLS AT THE TIP. BALLS ARE OUTLINED IN BLACK. LETTERS "PB" ON THE CROWN IN BLACK. 2 CRISS-CROSSED WHITE BONES OUTLINED IN BLACK BEHIND THE HEAD. WORD "PRINCESS" TO THE LEFT OF THE HEAD AND WORD "BONES" TO THE RIGHT OF THE HEAD. WORDS ARE PINK AND OUTLINED IN BLACK.

**CLASS 3—COSMETICS AND CLEANING PREPARATIONS**

FOR COMPACTS CONTAINING MAKE-UP; COSMETICS AND MAKE-UP; EYE MAKE-UP; EYES MAKE-UP; FACIAL MAKE-UP; FACIAL MAKE-UP, NAMELY, BLUSH, FOUNDATION, LIP GLOSS, EYELINER, MASCARA, LIPSTICK, PRIMER, EYESHADOW; FOUNDATION MAKE-UP; MAKE UP FOUNDATIONS; MAKE-UP; MAKE-UP FOR THE FACE AND BODY; MAKE-UP FOUNDATIONS; MAKE-UP KITS COMPRISED OF BLUSH, FOUNDATION, LIP GLOSS, EYELINER, MASCARA, LIPSTICK, PRIMER, EYESHADOW; MAKE-UP PENCILS; MAKE-UP POWDER; MAKE-UP PREPARATIONS; MAKE-UP PREPARATIONS FOR THE FACE AND BODY; MAKE-UP SETS; NATURAL MINERAL MAKE-UP; POWDER FOR MAKE-UP (U.S. CLS. 1, 4, 6, 50, 51 AND 52).

**CLASS 16—PAPER GOODS AND PRINTED MATTER**

FOR AIRBRUSH MAKE-UP STENCILS (U.S. CLS. 2, 5, 22, 23, 29, 37, 38 AND 50).

**CLASS 18—LEATHER GOODS**

FOR MAKE-UP BAGS SOLD EMPTY; POUCHES FOR HOLDING MAKE-UP, KEYS AND OTHER PERSONAL ITEMS (U.S. CLS. 1, 2, 3, 22 AND 41).

THE MARK CONSISTS OF STANDARD CHARACTERS WITHOUT CLAIM TO ANY PARTICULAR FONT, STYLE, SIZE, OR COLOR.

NO CLAIM IS MADE TO THE EXCLUSIVE RIGHT TO USE "REFERRAL", APART FROM THE MARK AS SHOWN.

**CLASS 9—ELECTRICAL AND SCIENTIFIC APPARATUS**

FOR DIGITAL MEDIA, NAMELY, PRE-RECORDED VIDEOS, DIGITAL VIDEO DISCS, DIGITAL VERSATILE DISCS, DOWNLOADABLE AUDIO AND VIDEO RECORDINGS, DVD'S AND HIGH DEFINITION DIGITAL DISKS FEATURING INFORMATION ON HOW TO OBTAIN BUSINESS REFERRALS (U.S. CLS. 21, 23, 26, 36 AND 38).

FIRST USE 6-27-2013; IN COMMERCE 6-27-2013.

**CLASS 16—PAPER GOODS AND PRINTED MATTER**

FOR EDUCATIONAL PUBLICATIONS, NAMELY, WORKBOOKS IN THE FIELD OF HOW TO OBTAIN BUSINESS REFERRALS (U.S. CLS. 2, 5, 22, 23, 29, 37, 38 AND 50).

FIRST USE 6-27-2013; IN COMMERCE 6-27-2013.

**CLASS 41—EDUCATION AND ENTERTAINMENT**

FOR EDUCATION SERVICES, NAMELY, PROVIDING CLASSES, SEMINARS AND WORKSHOPS IN THE FIELD OF HOW TO OBTAIN BUSINESS REFERRALS AND DISTRIBUTION OF COURSE MATERIAL IN CONNECTION THEREWITH (U.S. CLS. 100, 101 AND 107).

FIRST USE 6-27-2013; IN COMMERCE 6-27-2013.  
VERNA BETH RIRIE, EXAMINING ATTORNEY



SN 86-070,743. INTERNATIONAL TRUCK INTELLECTUAL PROPERTY COMPANY, LLC, LISLE, IL. FILED 9-20-2013.

SN 86-070,774. INTERNATIONAL TRUCK INTELLECTUAL PROPERTY COMPANY, LLC, LISLE, IL. FILED 9-20-2013.

## CONTINENTAL BEST MIXER WORLDWIDE

THE MARK CONSISTS OF STANDARD CHARACTERS WITHOUT CLAIM TO ANY PARTICULAR FONT, STYLE, SIZE, OR COLOR.

OWNER OF U.S. REG. NO. 3,967,273.

NO CLAIM IS MADE TO THE EXCLUSIVE RIGHT TO USE "BEST MIXER WORLDWIDE", APART FROM THE MARK AS SHOWN.

### CLASS 12—VEHICLES

FOR CONCRETE MIXING TRUCKS AND STRUCTURAL PARTS THEREFOR (U.S. CLS. 19, 21, 23, 31, 35 AND 44).

### CLASS 35—ADVERTISING AND BUSINESS

FOR RETAIL STORE SERVICES FEATURING TRUCKS, SPECIFICALLY TRUCKS WITH CONCRETE OR CEMENT MIXER BODIES AND PARTS AND ACCESSORIES THEREFOR (U.S. CLS. 100, 101 AND 102).  
KATHERINE E. HALMEN, EXAMINING ATTORNEY

## CBMW MIXER

THE MARK CONSISTS OF STANDARD CHARACTERS WITHOUT CLAIM TO ANY PARTICULAR FONT, STYLE, SIZE, OR COLOR.

NO CLAIM IS MADE TO THE EXCLUSIVE RIGHT TO USE "MIXER", APART FROM THE MARK AS SHOWN.

### CLASS 12—VEHICLES

FOR CONCRETE MIXING TRUCKS AND STRUCTURAL PARTS THEREFOR (U.S. CLS. 19, 21, 23, 31, 35 AND 44).

### CLASS 35—ADVERTISING AND BUSINESS

FOR RETAIL STORE SERVICES FEATURING TRUCKS, SPECIFICALLY TRUCKS WITH CONCRETE OR CEMENT MIXER BODIES AND PARTS AND ACCESSORIES THEREFOR (U.S. CLS. 100, 101 AND 102).  
KATHERINE E. HALMEN, EXAMINING ATTORNEY

SN 86-070,786. DRAGONSTEEL ENTERTAINMENT, LLC, AMERICAN FORK, UT. FILED 9-20-2013.

SN 86-070,762. RNB LICENSING, LLC, MANHATTAN BEACH, CA. FILED 9-20-2013.

## ROCK CONCERT BAR

THE MARK CONSISTS OF STANDARD CHARACTERS WITHOUT CLAIM TO ANY PARTICULAR FONT, STYLE, SIZE, OR COLOR.

### CLASS 21—HOUSEWARES AND GLASS

FOR DRINKING GLASSES; DRINKING STEINS; MUGS; SHOT GLASSES (U.S. CLS. 2, 13, 23, 29, 30, 33, 40 AND 50).

### CLASS 25—CLOTHING

FOR CAPS; SHIRTS; SWEAT SHIRTS (U.S. CLS. 22 AND 39).

### CLASS 32—LIGHT BEVERAGES

FOR BEER (U.S. CLS. 45, 46 AND 48).  
DAVID TAYLOR, EXAMINING ATTORNEY

## MISTBORN

THE MARK CONSISTS OF STANDARD CHARACTERS WITHOUT CLAIM TO ANY PARTICULAR FONT, STYLE, SIZE, OR COLOR.

### CLASS 9—ELECTRICAL AND SCIENTIFIC APPARATUS

FOR DOWNLOADABLE SERIES OF FICTION BOOKS (U.S. CLS. 21, 23, 26, 36 AND 38).

### CLASS 14—JEWELRY

FOR COSTUME JEWELRY (U.S. CLS. 2, 27, 28 AND 50).

### CLASS 16—PAPER GOODS AND PRINTED MATTER

FOR SERIES OF FICTION WORKS, NAMELY, NOVELS AND BOOKS (U.S. CLS. 2, 5, 22, 23, 29, 37, 38 AND 50).

### CLASS 25—CLOTHING

FOR WEARABLE GARMENTS AND CLOTHING, NAMELY, SHIRTS (U.S. CLS. 22 AND 39).  
JOHN SCHUYLER YARD, EXAMINING ATTORNEY

SN 86-070,803. ACCOMPANI, INC., LOS ALTOS, CA. FILED 9-20-2013.

SN 86-070,822. DRAGONSTEEL ENTERTAINMENT, LLC, AMERICAN FORK, UT. FILED 9-20-2013.

## ACCOMPANI

THE MARK CONSISTS OF STANDARD CHARACTERS WITHOUT CLAIM TO ANY PARTICULAR FONT, STYLE, SIZE, OR COLOR.

### CLASS 9—ELECTRICAL AND SCIENTIFIC APPARATUS

FOR DOWNLOADABLE SOFTWARE FOR CREATING, CAPTURING, ORGANIZING, DISPLAYING, SEARCHING, SYNCHRONIZING AND STORING INFORMATION BETWEEN MULTIPLE DEVICES AND PLATFORMS, AND TO ORGANIZE AND INTEGRATE INFORMATION AND TO CREATE FOLLOW UP LISTS TO PROVIDE REMINDERS FROM ELECTRONIC CORRESPONDENCE, CALENDARS, CONTACTS, SEARCH, NEWS SOURCES, VIDEO CONTENT SERVICES AND SOCIAL MEDIA PLATFORMS; DOWNLOADABLE SOFTWARE IN THE NATURE OF A MOBILE APPLICATION FOR CREATING, CAPTURING, ORGANIZING, DISPLAYING, SEARCHING, SYNCHRONIZING AND STORING INFORMATION BETWEEN MULTIPLE DEVICES AND PLATFORMS, AND TO ORGANIZE AND INTEGRATE INFORMATION AND TO CREATE FOLLOW UP LISTS TO PROVIDE REMINDERS FROM ELECTRONIC CORRESPONDENCE, CALENDARS, CONTACTS, SEARCH, NEWS SOURCES, VIDEO CONTENT SERVICES AND SOCIAL MEDIA PLATFORMS (U.S. CLS. 21, 23, 26, 36 AND 38).

### CLASS 42—SCIENTIFIC AND COMPUTER SERVICES

FOR SOFTWARE AS A SERVICE SERVICES FEATURING SOFTWARE FOR CREATING, CAPTURING, ORGANIZING, DISPLAYING, SEARCHING, SYNCHRONIZING AND STORING INFORMATION BETWEEN MULTIPLE DEVICES AND PLATFORMS, AND TO ORGANIZE AND INTEGRATE INFORMATION AND TO CREATE FOLLOW UP LISTS TO PROVIDE REMINDERS FROM ELECTRONIC CORRESPONDENCE, CALENDARS, CONTACTS, SEARCH, NEWS SOURCES, VIDEO CONTENT SERVICES AND SOCIAL MEDIA PLATFORMS; CLOUD COMPUTING FEATURING SOFTWARE FOR CREATING, CAPTURING, ORGANIZING, DISPLAYING, SEARCHING, SYNCHRONIZING AND STORING INFORMATION BETWEEN MULTIPLE DEVICES AND PLATFORMS, AND TO ORGANIZE AND INTEGRATE INFORMATION AND TO CREATE FOLLOW UP LISTS TO PROVIDE REMINDERS FROM ELECTRONIC CORRESPONDENCE, CALENDARS, CONTACTS, SEARCH, NEWS SOURCES, VIDEO CONTENT SERVICES AND SOCIAL MEDIA PLATFORMS (U.S. CLS. 100 AND 101).

BRENDAN REGAN, EXAMINING ATTORNEY

## STEELHEART

THE MARK CONSISTS OF STANDARD CHARACTERS WITHOUT CLAIM TO ANY PARTICULAR FONT, STYLE, SIZE, OR COLOR.

### CLASS 9—ELECTRICAL AND SCIENTIFIC APPARATUS

FOR DOWNLOADABLE SERIES OF FICTION BOOKS (U.S. CLS. 21, 23, 26, 36 AND 38).

### CLASS 16—PAPER GOODS AND PRINTED MATTER

FOR SERIES OF FICTION WORKS, NAMELY, NOVELS AND BOOKS (U.S. CLS. 2, 5, 22, 23, 29, 37, 38 AND 50).

JOHN SCHUYLER YARD, EXAMINING ATTORNEY

SN 86-070,922. TEC SOLUTIONS, INC., BURLINGAME, CA. FILED 9-20-2013.

## BONAFEYED

THE MARK CONSISTS OF STANDARD CHARACTERS WITHOUT CLAIM TO ANY PARTICULAR FONT, STYLE, SIZE, OR COLOR.

### CLASS 9—ELECTRICAL AND SCIENTIFIC APPARATUS

FOR SOFTWARE FOR DATA PROTECTION IN THE FORM OF ENCRYPTION, AND DIGITAL RIGHTS MANAGEMENT (DRM) TO CONTROL ACCESS TO DATA AND OTHER ELECTRONIC INFORMATION (U.S. CLS. 21, 23, 26, 36 AND 38).

### CLASS 42—SCIENTIFIC AND COMPUTER SERVICES

FOR PROVIDING ON-LINE NON-DOWNLOADABLE SOFTWARE FOR USER MANAGEMENT OF THEIR CONTENTS DIGITAL RIGHTS, AND STORING AND DISPENSING NECESSARY KEYS TO ACCESS PROTECTED CONTENTS (U.S. CLS. 100 AND 101).

STEVEN JACKSON, EXAMINING ATTORNEY

SN 86-070,951. WAVECONNEX, INC., MOUNTAIN VIEW, CA. FILED 9-20-2013.

# KEYSSA

THE MARK CONSISTS OF STANDARD CHARACTERS WITHOUT CLAIM TO ANY PARTICULAR FONT, STYLE, SIZE, OR COLOR.

THE WORDING "KEYSSA" HAS NO MEANING IN A FOREIGN LANGUAGE.

## CLASS 9—ELECTRICAL AND SCIENTIFIC APPARATUS

FOR CABLES FOR ELECTRICAL OR OPTICAL SIGNAL TRANSMISSION; COMMUNICATIONS SOFTWARE FOR CONNECTING MOBILE DEVICES, CELL PHONES, COMPUTER NETWORK USERS, GLOBAL COMPUTER NETWORKS, POINT-OF-SALE (POS) TERMINALS, BANKING TERMINALS, SERVERS, TELEVISIONS, SET-TOP CABLE BOXES, GAMING CONSOLES, AUTOMOBILES, COMPUTER PERIPHERALS, COMPUTER DOCKING STATIONS, HANDS FREE DEVICES FOR MOBILE-PHONES AND COMPUTER STORAGE DEVICES, NAMELY, HIGH-SPEED STORAGE SUBSYSTEMS FOR STORAGE AND BACKUP OF ELECTRONIC DATA EITHER LOCALLY OR VIA A TELECOMMUNICATIONS NETWORK AND CONSUMER ELECTRONIC DEVICES; COMPUTER CABLES; COMPUTER DOCKING STATIONS; COMPUTER EQUIPMENT, NAMELY, WIRELESS CARDS; COMPUTER HARDWARE FOR WIRELESS CONTENT DELIVERY; COMPUTER HARDWARE, NAMELY, WIRELESS NETWORK EXTENDERS; COMPUTER HARDWARE, NAMELY, WIRELESS NETWORK REPEATERS; COMPUTER MONITORS; COMPUTER SOFTWARE AND FIRMWARE FOR WIRELESS AND CONTACTLESS CONTENT DELIVERY AND FOR OPERATING NEAR FIELD COMMUNICATION (NFC), RADIO FREQUENCY AND CELLULAR COMMUNICATIONS NETWORKS; COMPUTER SOFTWARE AND HARDWARE FOR WIRELESS AND CONTACTLESS CONTENT DELIVERY AND FOR OPERATING NEAR FIELD COMMUNICATION (NFC), RADIO FREQUENCY AND CELLULAR COMMUNICATIONS NETWORKS; COMPUTER SOFTWARE FOR WIRELESS CONTENT DELIVERY; CONNECTION CABLES; CONNECTORS FOR ELECTRONIC CIRCUITS; DATA SYNCHRONIZATION CABLES; ELECTRONIC DEVICES FOR LOCATING AND TRACKING MOBILE DEVICES AND USERS WEARING MOBILE DEVICES USING WIRELESS AND CONTACTLESS COMMUNICATIONS, NEAR FIELD COMMUNICATION (NFC), RADIO FREQUENCY AND CELLULAR COMMUNICATIONS NETWORKS; ELECTRONIC DOCKING STATIONS; INTEGRATED CIRCUIT MODULES; INTEGRATED CIRCUITS; INTEGRATED CIRCUITS AND INTEGRATED CIRCUIT CORES FOR USE IN WIRELESS COMMUNICATIONS AND WIRELESS COMMUNICATION EQUIPMENT AND APPARATI AND DIGITAL SIGNAL PROCESSORS (DSP); INTEROPERABLE COMMUNICATION SYSTEM DESIGNED TO PROVIDE RADIO, STREAMING VIDEO, WIRELESS INTERNET, AND VOIP PHONE; NEAR FIELD COMMUNICATION (NFC) TECHNOLOGY-ENABLED DEVICES, NAMELY, SEMICONDUCTOR CHIPS AND CIRCUITS, NFC TECHNOLOGY-ENABLED SENDERS AND READERS; NEAR FIELD COMMUNICATION (NFC) TECHNOLOGY-ENABLED READERS; POWER CONNECTORS; ROUND PLUG CONNECTORS; SEMICONDUCTOR CHIPS; SEMICONDUCTOR DEVICES; TELECOMMUNICATIONS AND DATA NETWORKING HARDWARE, NAMELY, DEVICES FOR TRANSPORTING AND AGGREGATING VOICE, DATA, AND VIDEO COMMUNICATIONS ACROSS MULTIPLE NETWORK INFRASTRUCTURES AND COMMUNICATIONS PROTOCOLS; VERY LARGE SCALE INTEGRATION (VLSI) SEMICONDUCTOR INTEGRATED CIRCUITS; WIRELESS COMMUNICATION DEVICE FEATURING VOICE, DATA AND IMAGE TRANSMISSION INCLUDING VOICE, TEXT AND PICTURE MESSAGING, A VIDEO AND STILL IMAGE CAMERA, ALSO FUNCTIONAL TO

PURCHASE MUSIC, GAMES, VIDEO AND SOFTWARE APPLICATIONS OVER THE AIR FOR DOWNLOADING TO THE DEVICE; WIRELESS COMMUNICATION DEVICES FOR TRANSMITTING IMAGES TAKEN BY A CAMERA; WIRELESS COMMUNICATION DEVICES FOR VOICE, DATA OR IMAGE TRANSMISSION; WIRELESS DISTRIBUTION SYSTEM COMPRISING WAVEGUIDES (U.S. CLS. 21, 23, 26, 36 AND 38).

## CLASS 42—SCIENTIFIC AND COMPUTER SERVICES

FOR COMPUTER HARDWARE AND SOFTWARE DESIGN; DESIGN AND DEVELOPMENT OF COMPUTER HARDWARE AND SOFTWARE; DESIGN AND DEVELOPMENT OF COMPUTER SOFTWARE; DESIGN AND DEVELOPMENT OF SOFTWARE AND HARDWARE FOR DIGITAL SIGNAL PROCESSING; DESIGN AND DEVELOPMENT OF SOFTWARE AND HARDWARE FOR SIGNAL AMPLIFICATION AND TRANSMISSION; DESIGN AND DEVELOPMENT OF SOFTWARE AND HARDWARE FOR INTEGRATED CIRCUITS AND SEMICONDUCTOR CHIPS FOR USE IN WIRELESS AND CONTACTLESS COMMUNICATIONS, WIRELESS COMMUNICATION EQUIPMENT AND APPARATI, NEAR FIELD COMMUNICATION (NFC) TECHNOLOGY-ENABLED DEVICES AND DIGITAL SIGNAL PROCESSORS (DSP), AND FOR THE TRANSMISSION, TRANSFER AND EXCHANGE OF DATA AND VIDEO BY AND BETWEEN MOBILE DEVICES, CELL PHONES, COMPUTER NETWORK USERS, GLOBAL COMPUTER NETWORKS, POINT-OF-SALE (POS) TERMINALS, BANKING TERMINALS, SERVERS, TELEVISIONS, SET-TOP CABLE BOXES, GAMING CONSOLES, AUTOMOBILES, COMPUTER PERIPHERALS, COMPUTER DOCKING STATIONS, HANDS FREE DEVICES FOR MOBILE-PHONES AND COMPUTER STORAGE DEVICES; DESIGN AND DEVELOPMENT OF WIRELESS COMMUNICATION SYSTEMS FOR TRANSMISSION AND RECEPTION OF VOICE, DATA AND VIDEO; DESIGN AND DEVELOPMENT OF WIRELESS COMPUTER NETWORKS; DESIGN FOR OTHERS OF INTEGRATED CIRCUITS AND INTEGRATED CIRCUIT CORES FOR USE IN WIRELESS COMMUNICATIONS AND WIRELESS COMMUNICATION EQUIPMENT AND APPARATI AND DIGITAL SIGNAL PROCESSORS (DSP); DESIGN OF COMPUTER HARDWARE, INTEGRATED CIRCUITS, COMMUNICATIONS HARDWARE AND SOFTWARE AND COMPUTER NETWORKS FOR OTHERS; DESIGN, DEVELOPMENT, AND CONSULTING SERVICES RELATED THERETO IN THE FIELD OF WIRELESS AND CONTACTLESS COMMUNICATIONS, NEAR FIELD COMMUNICATIONS (NFC), SEMICONDUCTOR CHIPS AND DEVICES AND TELECOMMUNICATIONS AND DATA NETWORKING HARDWARE; DESIGN, DEVELOPMENT, AND IMPLEMENTATION OF SOFTWARE FOR THE TRANSMISSION, TRANSFER AND EXCHANGE OF DATA AND VIDEO BY AND BETWEEN MOBILE DEVICES, CELL PHONES, COMPUTER NETWORK USERS, GLOBAL COMPUTER NETWORKS, POINT-OF-SALE (POS) TERMINALS, BANKING TERMINALS, SERVERS, TELEVISIONS, SET-TOP CABLE BOXES, GAMING CONSOLES, AUTOMOBILES, COMPUTER PERIPHERALS, COMPUTER DOCKING STATIONS, HANDS FREE DEVICES FOR MOBILE-PHONES AND COMPUTER STORAGE DEVICES; DESIGN, DEVELOPMENT, INSTALLATION AND MAINTENANCE OF COMPUTER SOFTWARE; DESIGN, MAINTENANCE, DEVELOPMENT AND UPDATING OF COMPUTER SOFTWARE; TESTING, ANALYSIS AND EVALUATION OF THE GOODS OF OTHERS FOR THE PURPOSE OF CERTIFICATION; TESTING, ANALYSIS AND EVALUATION OF THE SERVICES OF OTHERS FOR THE PURPOSE OF CERTIFICATION (U.S. CLS. 100 AND 101).

MARCIE MILONE, EXAMINING ATTORNEY

SN 86-071,014. MATT ALBERTSEN, OROVILLE, CA. AND MELISSA WINNAMAN, OROVILLE, CA. FILED 9-20-2013.

DAVID TAYLOR, EXAMINING ATTORNEY

## BABE IN THE WOODZ

THE MARK CONSISTS OF STANDARD CHARACTERS WITHOUT CLAIM TO ANY PARTICULAR FONT, STYLE, SIZE, OR COLOR.

### CLASS 3—COSMETICS AND CLEANING PREPARATIONS

FOR COSMETICS; LIP BALM; NON-MEDICATED TOILETRIES (U.S. CLS. 1, 4, 6, 50, 51 AND 52).

### CLASS 5—PHARMACEUTICALS

FOR INSECT REPELLENTS (U.S. CLS. 6, 18, 44, 46, 51 AND 52).

WANDA KAY PRICE, EXAMINING ATTORNEY

SN 86-071,064. STREAMFRAME CORPORATION, NEW YORK, NY. FILED 9-20-2013.

## STREAMFRAME

THE MARK CONSISTS OF STANDARD CHARACTERS WITHOUT CLAIM TO ANY PARTICULAR FONT, STYLE, SIZE, OR COLOR.

### CLASS 9—ELECTRICAL AND SCIENTIFIC APPARATUS

FOR BUSINESS MANAGEMENT SOFTWARE PROVIDING COLLECTION, PROCESSING AND DISTRIBUTION OF WORKFLOW DATA FOR PRODUCTION AND PROJECT MANAGEMENT TO MANAGERS, STAFF, FREELANCERS, CLIENTS, AND INVESTORS; BUSINESS MANAGEMENT SOFTWARE PROVIDING REAL-TIME DATA AND ACCOUNTABILITY TO CENTRALLY-LOCATED OR GLOBALLY-DISTRIBUTED TEAMS REGARDING TASKS, DELIVERABLES, MILESTONES, HUMAN RESOURCES, AND FINANCIAL INFORMATION; BUSINESS MANAGEMENT SOFTWARE ENABLING COMMUNICATION OF DATA BY CENTRALLY-LOCATED OR GLOBALLY-DISTRIBUTED TEAMS (U.S. CLS. 21, 23, 26, 36 AND 38).

### CLASS 42—SCIENTIFIC AND COMPUTER SERVICES

FOR APPLICATION SERVICE PROVIDER FEATURING SCALABLE WEB-BASED BUSINESS MANAGEMENT SOFTWARE FOR USE IN PROJECT MANAGEMENT WITH TASK-BASED AND DELIVERABLE-ORIENTED WORKFLOWS ENABLING FEEDBACK AND COLLABORATION AND PROVIDING TEAM ACCESS TO MILESTONES, SCHEDULES, BUDGETS, ASSET MANAGEMENT, RESOURCE ALLOCATION, COMPLIANCE, APPROVALS, FINANCIAL ACCOUNTABILITY, AND HUMAN RESOURCE INTEGRATION; CONSULTING SERVICES FOR OTHERS IN THE FIELD OF DESIGN, PLANNING, AND IMPLEMENTATION OF COMPUTERIZED PROJECT MANAGEMENT SYSTEMS (U.S. CLS. 100 AND 101).

SN 86-071,093. FLOMO PLASTICS INDUSTRIAL CO., LTD., TAINAN, TAIWAN, FILED 9-20-2013.

## FLOMO

THE MARK CONSISTS OF STANDARD CHARACTERS WITHOUT CLAIM TO ANY PARTICULAR FONT, STYLE, SIZE, OR COLOR.

OWNER OF U.S. REG. NOS. 1,477,610, 1,673,552 AND 3,637,928.

### CLASS 16—PAPER GOODS AND PRINTED MATTER

FOR STATIONERY LETTER SETS CONSISTING OF PENCILS, RULERS, ERASERS, PENCIL SHARPENERS, WRITING PAPER AND ENVELOPES, PENCIL CASES, TAPE DISPENSERS; BALL PEN SETS CONSISTING OF BALL POINT PENS AND NOTEBOOKS; FABRIC GIFT BAGS, PAPER GIFT BAGS; CHRISTMAS CARDS AND STATIONERY; RAFFIA RIBBON, NAMELY, PAPER GIFT WRAPPING RIBBONS; SHREDS, NAMELY, SHREDDED PAPER; PAPER GIFT WRAP, CELLOPHANE GIFT WRAP; GIFT BOXES; PAPER GIFT TAGS; PAPER TABLECLOTHS AND PAPER TABLE SKIRTS; CHRISTMAS PAPER BANNERS; CHRISTMAS PACKAGING ACCESSORIES, NAMELY, CELLOPHANE BAGS AND CELLOPHANE WRAP PAPER; PAPER PARTY PLATES, PARTY CUPS, NAPKINS, PRINTED PAPER SIGNS, PAPER FOR USE IN MAKING SIGNS, PAPER BANNERS, DECORATIVE DECALS FOR WINDOWS, HOLDERS FOR PAPER GIFT CARDS, PAPER PARTY FAVORS, PAPER WALL PLAQUES (U.S. CLS. 2, 5, 22, 23, 29, 37, 38 AND 50).

FIRST USE 1-1-1975; IN COMMERCE 5-1-1980.

### CLASS 26—FANCY GOODS

FOR ORNAMENTAL GIFT BOWS FOR DECORATION AND GIFT WRAPPING, POLYPROPYLENE (PP) CURLY SWIRL RIBBONS, POLYPROPYLENE GIFT WRAPPING RIBBONS, FABRIC RIBBONS, POLYPROPYLENE GIFT BAGS, POLYETHYLENE GIFT BAGS, GARLANDS; ARTIFICIAL FLORAL ACCESSORIES, NAMELY, FLOWER PICKS, LONG STEM FLOWERS, ARTIFICIAL ROSES, GARLANDS, GREEN LEAVES, FLOWER BUSHES, WREATHS ALL ARTIFICIAL GOODS; POLYPROPYLENE GIFT WRAPPING RIBBONS, ELASTIC STRETCH TIE RIBBONS FOR PACKAGING, WIRE EDGE RIBBONS AND BOWS (U.S. CLS. 37, 39, 40, 42 AND 50).

FIRST USE 3-0-1992; IN COMMERCE 3-0-1992.

### CLASS 28—TOYS AND SPORTING GOODS

FOR CHRISTMAS TREE DECORATIONS, CHRISTMAS TREE ORNAMENTS; PLUSH ANIMALS AND PLUSH TOYS; CHRISTMAS STOCKINGS; PARTY BLOW-OUTS (HORNS), PAPER PARTY HATS, PLASTIC PARTY HATS (U.S. CLS. 22, 23, 38 AND 50).

FIRST USE 1-19-1991; IN COMMERCE 1-19-1991.  
RON FAIRBANKS, EXAMINING ATTORNEY

SN 86-071,146. GUNN, RAINE, MAGNOLIA, TX. FILED 9-21-2013.



NO CLAIM IS MADE TO THE EXCLUSIVE RIGHT TO USE "BOARDS", APART FROM THE MARK AS SHOWN.

THE MARK CONSISTS OF THE STYLIZED TEXT "RATLECAN" WRITTEN ABOVE THE STYLIZED TEXT "BOARDS". THERE IS AN IMAGE OF A PAINT CAN NOZZLE DRAWN ON THE SIDE WITH A FLAME DRAWN AT THE TOP AND A STYLIZED CIRCLE DRAWN IN THE MIDDLE.

#### CLASS 25—CLOTHING

FOR BEANIES; HATS; HOODED SWEAT SHIRTS; SHIRTS; SWEAT SHIRTS; T-SHIRTS (U.S. CLS. 22 AND 39).

#### CLASS 28—TOYS AND SPORTING GOODS

FOR SKATEBOARDS; SURFBOARDS (U.S. CLS. 22, 23, 38 AND 50).  
DAVID C. REIHNER, EXAMINING ATTORNEY

SN 86-071,159. GRUBHUB SEAMLESS INC., NEW YORK, NY. FILED 9-21-2013.



OWNER OF U.S. REG. NOS. 3,830,311, 4,368,564 AND OTHERS.

THE COLOR(S) RED AND WHITE IS/ARE CLAIMED AS A FEATURE OF THE MARK.

THE MARK CONSISTS OF THE STYLIZED WORD "GRUBHUB" IN THE COLOR RED TO THE RIGHT OF THE WORD "SEAMLESS", WHICH APPEARS IN THE COLOR WHITE WITHIN A RED BONE-LIKE RECTANGULAR SHAPE.

#### CLASS 9—ELECTRICAL AND SCIENTIFIC APPARATUS

FOR DOWNLOADABLE SOFTWARE IN THE NATURE OF MOBILE APPLICATIONS, NAMELY, SOFTWARE FOR USE IN FACILITATING THE ADVERTISING AND MARKETING OF RESTAURANTS TO CONSUMERS, FOR ACCESSING RESTAURANT MENUS, FOR PLACING RESTAURANT ORDERS, FOR MONITORING THE STATUS AND/OR LOCATION OF RESTAURANT ORDERS, AND FOR ASSISTING RESTAURANT DELIVERY OPERATORS WITH MAPPING, PLANNING, AND TRACKING THEIR ORDERS, TRIPS, AND FINANCES (U.S. CLS. 21, 23, 26, 36 AND 38).

#### CLASS 35—ADVERTISING AND BUSINESS

FOR COMPUTERIZED ONLINE ORDERING SERVICES IN THE FIELD OF RESTAURANTS AND FOOD; ELECTRONIC PROCESSING OF RESTAURANT AND FOOD ORDERS FOR OTHERS; ONLINE ORDERING SERVICES FEATURING RESTAURANTS TAKE-OUT AND FOOD; ONLINE ORDERING SERVICES IN THE FIELD OF RESTAURANT TAKE-OUT AND DELIVERY; PROMOTING AND MARKETING THE GOODS AND SERVICES OF OTHERS IN THE FIELD OF RESTAURANTS AND FOOD; ADMINISTRATION OF PROGRAMS FOR ENABLING PARTICIPANTS TO OBTAIN DISCOUNTS ON PRODUCTS AND SERVICES IN THE FIELD OF RESTAURANTS AND FOOD; ADVERTISING SERVICES VIA THE INTERNET; PROVIDING CONSUMER INFORMATION, NAMELY, RATINGS AND REVIEWS OF RESTAURANTS AND COMPILATIONS OF RATINGS AND REVIEWS OF RESTAURANTS; ON-LINE ADVERTISING AND MARKETING SERVICES FOR RESTAURANTS, NAMELY, SOCIAL MEDIA, INTERNET AND MOBILE MARKETING; ON-LINE ADVERTISING AND MARKETING SERVICES FOR RESTAURANTS, NAMELY, SOCIAL MEDIA, INTERNET AND MOBILE MARKETING; PROVIDING CONSUMER INFORMATION IN THE FIELD OF RESTAURANTS AND FOOD; PROVIDING CONSUMER INFORMATION VIA A GLOBAL COMPUTER NETWORK IN THE FIELD OF RESTAURANTS AND FOOD; ADVERTISING SERVICES VIA THE INTERNET; PROVIDING CONSUMER INFORMATION, NAMELY, RATINGS AND REVIEWS OF RESTAURANTS AND COMPILATIONS OF RATINGS AND REVIEWS OF RESTAURANTS; CUSTOMER SERVICE, NAMELY RESPONDING TO CUSTOMER INQUIRIES FOR OTHERS IN THE FIELD OF RESTAURANT DELIVERY AND CARRY-OUT (U.S. CLS. 100, 101 AND 102).

#### CLASS 41—EDUCATION AND ENTERTAINMENT

FOR BLOGS FEATURING NEWS, INFORMATION AND COMMENTARY IN THE FIELD OF DINING, RESTAURANTS AND FOOD; PROVIDING RECOGNITION AND INCENTIVES BY THE WAY OF AWARDS AND CONTESTS TO DEMONSTRATE EXCELLENCE IN THE FIELDS OF RESTAURANTS AND FOOD (U.S. CLS. 100, 101 AND 107).

#### CLASS 42—SCIENTIFIC AND COMPUTER SERVICES

FOR PROVIDING WEBSITES FEATURING TEMPORARY USE OF NON-DOWNLOADABLE SOFTWARE, NAMELY, SOFTWARE FOR USE IN FACILITATING THE ADVERTISING AND MARKETING OF RESTAURANTS TO CONSUMERS, FOR ACCESSING RESTAURANT MENUS, FOR PLACING RESTAURANT ORDERS, FOR MONITORING THE STATUS AND/OR LOCATION OF RESTAURANT ORDERS, AND FOR RESTAURANTS TO MANAGE CUSTOMER ORDER INFORMATION; PROVIDING ONLINE NON-DOWNLOADABLE SOFTWARE WHICH ALLOWS MEMBER RESTAURANTS TO MANAGE CUSTOMER ORDER INFORMATION USING MOBILE DEVICES; COMPUTER SOFTWARE DESIGN AND DEVELOPMENT IN THE FIELDS OF RESTAURANT DELIVERY/CARRYOUT, CUSTOMER SERVICE AND MOBILE APPLICATIONS, SPECIFICALLY DESIGN AND DEVELOPMENT OF SOFTWARE THAT RETRIEVES ORDERS, INDICATES ORDER STATUSES, DISPLAYS A SELECTED ORDER, CHANGES ORDER STATUS OF A SELECTED ORDER, AND COMMUNICATES ORDER STATUS UPDATES TO CUSTOMERS OR A RESTAURANT SERVER WHERE SOFTWARE ADOPTS ON MOBILE APPLIANCES TO MONITOR THE POINT-OF-SALE SYSTEM FOR UPDATES TO MENU INFORMATION, AND TO TRANSMIT UPDATED MENU INFORMATION TO RESTAURANT SERVERS COUPLED TO A DATABASE STORING MENUS; PROVIDING ONLINE NON-DOWNLOADABLE SOFTWARE WHICH ALLOWS MEMBER RESTAURANTS TO MANAGE CUSTOMER ORDER INFORMATION USING MOBILE DEVICES (U.S. CLS. 100 AND 101).

TEJBIR SINGH, EXAMINING ATTORNEY

SN 86-071,223. SHANDONG FUTASTE CO.,LTD, QINGDAO CITY, CHINA, FILED 9-22-2013.

SN 86-071,224. ATGAMES DIGITAL MEDIA INC., PACIFIC PALISADES, CA. FILED 9-22-2013.

# Supar

THE MARK CONSISTS OF FIVE ENGLISH LETTERS "S", "U", "P", "A", "R", THE FIVE ENGLISH LETTERS ARE ALL BLACK, THE BACKGROUND IS WHITE.

## CLASS 1—CHEMICALS

FOR AMYL ALCOHOL (PENTANOL); ARTIFICIAL SWEETENERS; BENZYL ALCOHOL; ENZYMES FOR USE IN THE PROCESSING OF SUGAR CANE; GLUCOSE FOR THE FOOD INDUSTRY; LACTOSE FOR THE FOOD INDUSTRY; LACTOSE TO BE USED IN THE MANUFACTURE OF FOODSTUFFS; LECITHIN FOR THE FOOD INDUSTRY; METHYL ALCOHOL (METHANOL); PROTEIN IN RAW MATERIAL FORM FOR SCIENTIFIC AND MEDICAL RESEARCH (U.S. CLS. 1, 5, 6, 10, 26 AND 46).

FIRST USE 3-22-2013; IN COMMERCE 3-22-2013.

## CLASS 5—PHARMACEUTICALS

FOR AIR PURIFYING PREPARATIONS; CANDY FOR MEDICAL PURPOSES; DIET PILLS; DIETARY FIBER TO AID DIGESTION; DIETARY SUPPLEMENTS; GINSENG FOR MEDICINAL USE; MEDICATED CANDIES; PHARMACEUTICAL PREPARATIONS, NAMELY, A BLOOD CLOTTING AID AND DELIVERY SYSTEM FOR USE IN HUMAN AND VETERINARY MEDICINE; SANITARY STERILIZING PREPARATIONS; VETERINARY PREPARATIONS, NAMELY, ANTIOXIDANTS (U.S. CLS. 6, 18, 44, 46, 51 AND 52).

FIRST USE 3-22-2013; IN COMMERCE 3-22-2013.

## CLASS 29—MEATS AND PROCESSED FOODS

FOR ALBUMEN FOR CULINARY PURPOSES; BEVERAGES HAVING A MILK BASE; DRIED VEGETABLES; EDIBLE BIRD'S NESTS; EGGS; FRUIT JELLIES; FRUIT SALADS; MEAT; PRESERVED FRUITS; TINNED FRUITS (U.S. CL. 46).

FIRST USE 3-22-2013; IN COMMERCE 3-22-2013.

## CLASS 30—STAPLE FOODS

FOR CEREAL BASED SNACK FOOD; COFFEE FLAVORED SYRUP USED IN MAKING FOOD BEVERAGES; CONDIMENT, NAMELY, PEPPER SAUCE; CONFECTIONERIES, NAMELY, SNACK FOODS, NAMELY, CHOCOLATE; FARINACEOUS FOOD PASTES FOR HUMAN CONSUMPTION; GOLDEN SYRUP; ICE CREAM; MOLASSES; NATURAL SWEETENER; TEA-BASED BEVERAGES (U.S. CL. 46).

FIRST USE 3-22-2013; IN COMMERCE 3-22-2013.

## CLASS 32—LIGHT BEVERAGES

FOR BEER; FRUIT JUICE; NON-ALCOHOLIC FRUIT EXTRACTS USED IN THE PREPARATION OF BEVERAGES; NON-ALCOHOLIC FRUIT JUICE BEVERAGES; PREPARATIONS FOR MAKING BEVERAGES, NAMELY, FRUIT DRINKS; SYRUP FOR MAKING LEMONADE; SYRUPS FOR MAKING BEVERAGES; SYRUPS FOR MAKING SOFT DRINKS; TOMATO JUICE; VEGETABLE JUICES (U.S. CLS. 45, 46 AND 48).

FIRST USE 3-22-2013; IN COMMERCE 3-22-2013.  
JENNIFER MARTIN, EXAMINING ATTORNEY

# Zooti

THE MARK CONSISTS OF STANDARD CHARACTERS WITHOUT CLAIM TO ANY PARTICULAR FONT, STYLE, SIZE, OR COLOR.

## CLASS 35—ADVERTISING AND BUSINESS

FOR ON-LINE RETAIL STORE SERVICES FEATURING DOWNLOADABLE ELECTRONIC BOOKS; ON-LINE RETAIL STORE SERVICES FEATURING DOWNLOADABLE PRE-RECORDED MUSIC AND VIDEO; ON-LINE WHOLESALE AND RETAIL STORE SERVICES FEATURING DOWNLOADABLE SOUND, MUSIC, IMAGE, VIDEO AND GAME FILES (U.S. CLS. 100, 101 AND 102).

## CLASS 41—EDUCATION AND ENTERTAINMENT

FOR ENTERTAINMENT SERVICES, NAMELY, PROVIDING ONLINE COMPUTER GAMES THAT HELP MAINTAIN AN ACTIVE BRAIN AND THUS IMPROVE MEMORY, SPEED OF PROCESSING, AND THAT PROVIDE A VARIETY OF COGNITIVE BENEFITS THAT POSITIVELY IMPACT QUALITY OF LIFE; ENTERTAINMENT SERVICES, NAMELY, PROVIDING ONLINE ELECTRONIC GAMES; ENTERTAINMENT SERVICES, NAMELY, PROVIDING ONLINE VIDEO GAMES; ENTERTAINMENT SERVICES, NAMELY, PROVIDING TEMPORARY USE OF NON-DOWNLOADABLE COMPUTER GAMES; ENTERTAINMENT SERVICES, NAMELY, PROVIDING TEMPORARY USE OF NON-DOWNLOADABLE COMPUTER LEARNING GAMES; ENTERTAINMENT SERVICES, NAMELY, PROVIDING TEMPORARY USE OF NON-DOWNLOADABLE ELECTRONIC GAMES; ENTERTAINMENT SERVICES, NAMELY, PROVIDING TEMPORARY USE OF NON-DOWNLOADABLE INTERACTIVE GAMES; ENTERTAINMENT SERVICES, NAMELY, PROVIDING TEMPORARY USE OF NON-DOWNLOADABLE VIDEO GAMES; MULTIMEDIA PUBLISHING OF BOOKS, MAGAZINES, JOURNALS, SOFTWARE, GAMES, MUSIC, AND ELECTRONIC PUBLICATIONS (U.S. CLS. 100, 101 AND 107).

JENNIFER MARTIN, EXAMINING ATTORNEY

SN 86-071,344. HAN, ALLEN, MOUNTAIN VIEW, CA. FILED 9-22-2013.

# TEFORIA

THE MARK CONSISTS OF STANDARD CHARACTERS WITHOUT CLAIM TO ANY PARTICULAR FONT, STYLE, SIZE, OR COLOR.

## CLASS 11—ENVIRONMENTAL CONTROL APPARATUS

FOR ELECTRIC APPLIANCES FOR DOMESTIC USE; NAMELY, TEA AND COFFEE MAKERS (U.S. CLS. 13, 21, 23, 31 AND 34).

**CLASS 35—ADVERTISING AND BUSINESS**

FOR ON-LINE RETAIL STORE SERVICES FEATURING TEAS, COFFEE, TEA ACCESSORIES, ELECTRIC AND NON-ELECTRIC APPLIANCES, HOUSEWARES, GLASSWARE, AND GIFTWARE (U.S. CLS. 100, 101 AND 102).

KHANH LE, EXAMINING ATTORNEY

SN 86-071,478. ZION INTERNATIONAL, LLC, JEFFERSONVILLE, PA. FILED 9-23-2013.

**CLASS 44—MEDICAL, BEAUTY AND AGRICULTURAL SERVICES**

FOR WILDLIFE MANAGEMENT CONSULTING SERVICES, NAMELY, AGRICULTURAL ADVICE IN THE NATURE OF RECOMMENDATIONS FOR SEED PLANTING, SOIL SAMPLING, HERBICIDES AND SOIL FERTILITY AND PLANTING, SEEDING, GROWING, FERTILIZING, LIMING AND PRUNING OF WILDLIFE FORAGE AND CROPS FOR OTHERS (U.S. CLS. 100 AND 101).

FIRST USE 4-10-2004; IN COMMERCE 8-8-2006.  
KAPIL BHANOT, EXAMINING ATTORNEY

**YOUR SECRET INDULGENCE**

THE MARK CONSISTS OF STANDARD CHARACTERS WITHOUT CLAIM TO ANY PARTICULAR FONT, STYLE, SIZE, OR COLOR.

**CLASS 3—COSMETICS AND CLEANING PREPARATIONS**

FOR BODY LOTIONS; MAKE-UP; MASSAGE OILS; AND PERFUME (U.S. CLS. 1, 4, 6, 50, 51 AND 52).

**CLASS 10—MEDICAL APPARATUS**

FOR ADULT SEXUAL STIMULATION AIDS, NAMELY VIBRATORS, DILDO SEX TOYS, ANAL SEX TOYS, COCK RINGS, AND ORAL SEX TOYS (U.S. CLS. 26, 39 AND 44).

**CLASS 25—CLOTHING**

FOR CLOTHING ITEMS, NAMELY, BLINDFOLDS WORN OVER THE EYES; CLOTHING ITEMS, NAMELY, GAGS WORN OVER THE MOUTH; COSTUMES FOR ROLE-PLAYING GAMES; LINGERIE; SLEEPWEAR; T-SHIRTS; DRESSES; SKIRTS; PANTS; JEANS; WOMEN'S TOPS, NAMELY, BLOUSES, TANK TOPS, CAMISOLES, AND TUNICS; SWEATERS; PULLOVERS; COATS; JACKETS; AND SWIMWEAR (U.S. CLS. 22 AND 39).

APRIL ROACH, EXAMINING ATTORNEY

SN 86-071,563. SNAVELY, JASON R., DBA DROP-TINE WILDLIFE CONSULTING, BLOOMSBURG, PA. FILED 9-23-2013.

**DROP-TINE**

THE MARK CONSISTS OF STANDARD CHARACTERS WITHOUT CLAIM TO ANY PARTICULAR FONT, STYLE, SIZE, OR COLOR.

**CLASS 42—SCIENTIFIC AND COMPUTER SERVICES**

FOR WILDLIFE MANAGEMENT CONSULTING SERVICES, NAMELY, LAND USE PLANNING IN THE NATURE OF ADVICE FOR CREATING AND MAINTAINING WILDLIFE HABITATS (U.S. CLS. 100 AND 101).

FIRST USE 4-10-2004; IN COMMERCE 8-8-2006.

SN 86-071,568. SNAVELY, JASON R., DBA DROP-TINE WILDLIFE CONSULTING, BLOOMSBURG, PA. FILED 9-23-2013.



THE MARK CONSISTS OF THE IMAGE OF A DEER FROM THE BASE OF THE NECK TO THE TIP OF THE ANTLERS. THERE IS FOLIAGE SURROUNDING THE BASE OF THE IMAGE OF THE DEER, WITH AN OUTLINE OF A CRESCENT MOON TO THE LEFT OF THE IMAGE OF THE DEER AND FOLIAGE.

**CLASS 42—SCIENTIFIC AND COMPUTER SERVICES**

FOR WILDLIFE MANAGEMENT CONSULTING SERVICES, NAMELY, LAND USE PLANNING IN THE NATURE OF ADVICE FOR CREATING AND MAINTAINING WILDLIFE HABITATS (U.S. CLS. 100 AND 101).

FIRST USE 4-10-2004; IN COMMERCE 8-8-2006.

**CLASS 44—MEDICAL, BEAUTY AND AGRICULTURAL SERVICES**

FOR WILDLIFE MANAGEMENT CONSULTING SERVICES, NAMELY, AGRICULTURAL ADVICE IN THE NATURE OF RECOMMENDATIONS FOR SEED PLANTING, SOIL SAMPLING, HERBICIDES AND SOIL FERTILITY AND PLANTING, SEEDING, GROWING, FERTILIZING, LIMING AND PRUNING OF WILDLIFE FORAGE AND CROPS FOR OTHERS (U.S. CLS. 100 AND 101).

FIRST USE 4-10-2004; IN COMMERCE 8-8-2006.  
KAPIL BHANOT, EXAMINING ATTORNEY

SN 86-071,580. JOHNSON & JOHNSON, NEW BRUNSWICK, NJ. FILED 9-23-2013.

## SINUS SKETCHER

THE MARK CONSISTS OF STANDARD CHARACTERS WITHOUT CLAIM TO ANY PARTICULAR FONT, STYLE, SIZE, OR COLOR.

NO CLAIM IS MADE TO THE EXCLUSIVE RIGHT TO USE "SINUS", APART FROM THE MARK AS SHOWN.

### CLASS 5—PHARMACEUTICALS

FOR PHARMACEUTICAL PREPARATIONS FOR THE TREATMENT OF CONGESTION, COUGHS, COLDS, AND ALLERGIES (U.S. CLS. 6, 18, 44, 46, 51 AND 52).

### CLASS 41—EDUCATION AND ENTERTAINMENT

FOR ENTERTAINMENT SERVICES, NAMELY, CONDUCTING CONTESTS (U.S. CLS. 100, 101 AND 107).

### CLASS 44—MEDICAL, BEAUTY AND AGRICULTURAL SERVICES

FOR PROVIDING MEDICAL INFORMATION RELATING TO THE TREATMENT OF CONGESTION, COUGHS, COLDS, AND ALLERGIES (U.S. CLS. 100 AND 101).

HEATHER THOMPSON, EXAMINING ATTORNEY

---

SN 86-071,663. ONETASTE INCORPORATED, SAN FRANCISCO, CA. FILED 9-23-2013.

## POWERED BY ORGASM

THE MARK CONSISTS OF STANDARD CHARACTERS WITHOUT CLAIM TO ANY PARTICULAR FONT, STYLE, SIZE, OR COLOR.

### CLASS 6—METAL GOODS

FOR METAL KEY CHAINS (U.S. CLS. 2, 12, 13, 14, 23, 25 AND 50).

### CLASS 9—ELECTRICAL AND SCIENTIFIC APPARATUS

FOR CELL PHONE COVERS; FLASH MEMORY CARD (U.S. CLS. 21, 23, 26, 36 AND 38).

FIRST USE 1-1-2013; IN COMMERCE 1-1-2013.

### CLASS 16—PAPER GOODS AND PRINTED MATTER

FOR (BASED ON USE IN COMMERCE) STICKERS(BASED ON INTENT TO USE) BUMPER STICKERS; BUSINESS CARDS; GREETING CARDS; POSTERS; PRINTED PAMPHLETS, BROCHURES, MANUALS, BOOKS, BOOKLETS, LEAFLETS, INFORMATIONAL FLYERS, INFORMATIONAL SHEETS AND NEWSLETTERS, ADHESIVE BACKED STICKERS, AND KITS COMPRISING ONE OR MORE OF THE FOREGOING MATERIALS IN THE FIELD OF HUMAN SEXUALITY, RELATIONSHIPS, COMMUNICATION, BODY-BASED AWARENESS AND LIVING; STATIONERY (U.S. CLS. 2, 5, 22, 23, 29, 37, 38 AND 50).

FIRST USE 1-1-2013; IN COMMERCE 1-1-2013.

### CLASS 18—LEATHER GOODS

FOR TOTE BAGS (U.S. CLS. 1, 2, 3, 22 AND 41).

FIRST USE 1-1-2013; IN COMMERCE 1-1-2013.

### CLASS 20—FURNITURE AND ARTICLES NOT OTHERWISE CLASSIFIED

FOR (BASED ON USE IN COMMERCE) NON-METAL AND NON-LEATHER KEY CHAINS(BASED ON INTENT TO USE) PILLOWS (U.S. CLS. 2, 13, 22, 25, 32 AND 50).

FIRST USE 1-1-2013; IN COMMERCE 1-1-2013.

### CLASS 21—HOUSEWARES AND GLASS

FOR MUGS (U.S. CLS. 2, 13, 23, 29, 30, 33, 40 AND 50).

### CLASS 25—CLOTHING

FOR (BASED ON USE IN COMMERCE) T-SHIRTS FOR MEN AND WOMEN(BASED ON INTENT TO USE) HATS; JACKETS; MEN'S UNDERWEAR; SOCKS; SWEAT-SHIRTS; WOMEN'S UNDERWEAR (U.S. CLS. 22 AND 39).

FIRST USE 1-1-2013; IN COMMERCE 1-1-2013.

### CLASS 32—LIGHT BEVERAGES

FOR BOTTLED WATER; ENERGY DRINKS (U.S. CLS. 45, 46 AND 48).

### CLASS 41—EDUCATION AND ENTERTAINMENT

FOR (BASED ON USE IN COMMERCE) EDUCATIONAL SERVICES, NAMELY, CONDUCTING CLASSES, SEMINARS, CONFERENCES, WORKSHOPS, LECTURES, DISCUSSION GROUPS IN THE FIELD OF HUMAN SEXUALITY, RELATIONSHIPS, COMMUNICATION, BODY-BASED AWARENESS AND LIVING AND DISTRIBUTION OF TRAINING MATERIAL IN CONNECTION THEREWITH(BASED ON INTENT TO USE) CONTINUING EDUCATION SERVICES, NAMELY, PROVIDING LIVE AND ON-LINE CONTINUING PROFESSIONAL EDUCATION SEMINARS IN THE FIELD OF SEX EDUCATION; PROVIDING ON-LINE NON-DOWNLOADABLE NEWSPAPERS (U.S. CLS. 100, 101 AND 107).

FIRST USE 1-1-2013; IN COMMERCE 1-1-2013.

### CLASS 42—SCIENTIFIC AND COMPUTER SERVICES

FOR COMPUTER SERVICES, NAMELY, CREATING AN ON-LINE COMMUNITY FOR REGISTERED USERS TO PARTICIPATE IN DISCUSSIONS, GET FEEDBACK FROM THEIR PEERS, FORM VIRTUAL COMMUNITIES, AND ENGAGE IN SOCIAL NETWORKING SERVICES IN THE FIELD OF HUMAN SEXUALITY, RELATIONSHIPS, COMMUNICATION, BODY-BASED AWARENESS AND LIVING; CREATING AN ON-LINE COMMUNITY FOR SEX EDUCATION; HOSTING AN ON-LINE COMMUNITY WEB SITE FEATURING VIDEOS AND EDUCATIONAL MATERIALS THAT USERS MAY ACCESS VIA A MONTHLY SUBSCRIPTION (U.S. CLS. 100 AND 101).



ELI HELLMAN, EXAMINING ATTORNEY

SN 86-071,906. FIRST BUSINESS FINANCIAL SERVICES, INC., MADISON, WI. FILED 9-23-2013.

## FBIZ Advantage

THE MARK CONSISTS OF STANDARD CHARACTERS WITHOUT CLAIM TO ANY PARTICULAR FONT, STYLE, SIZE, OR COLOR.

NO CLAIM IS MADE TO THE EXCLUSIVE RIGHT TO USE "ADVANTAGE", APART FROM THE MARK AS SHOWN.

### CLASS 35—ADVERTISING AND BUSINESS

FOR PROVIDING AN ON-LINE SEARCHABLE DATABASE FEATURING BUSINESS INFORMATION AND BUSINESS CONTACTS; PROVIDING BUSINESS INFORMATION IN THE FIELD OF FINANCE, MANAGEMENT, SALES AND MARKETING AND INFORMATION TECHNOLOGY (U.S. CLS. 100, 101 AND 102).

FIRST USE 2-28-2013; IN COMMERCE 3-25-2013.

### CLASS 36—INSURANCE AND FINANCIAL

FOR PROVIDING AN ON-LINE SEARCHABLE DATABASE FEATURING FINANCIAL INFORMATION ABOUT CASH MANAGEMENT, COMMERCIAL REAL ESTATE, BUSINESS CAPITAL AND FINANCING SOURCES (U.S. CLS. 100, 101 AND 102).

FIRST USE 2-28-2013; IN COMMERCE 3-25-2013.

DAVID MURRAY, EXAMINING ATTORNEY

SN 86-071,991. FOODHANDLER, INC., CREVE COEUR, MO. FILED 9-23-2013.

## ONESAFE

THE MARK CONSISTS OF STANDARD CHARACTERS WITHOUT CLAIM TO ANY PARTICULAR FONT, STYLE, SIZE, OR COLOR.

### CLASS 9—ELECTRICAL AND SCIENTIFIC APPARATUS

FOR CLEAN ROOM SAFETY GLOVES FOR USE IN CLEAN ROOMS; DISPENSERS FOR CLEAN ROOM SAFETY GLOVES AND SINGLE USE CLEAN ROOM SAFETY GLOVES, DISPOSABLE PLASTIC GLOVES FOR LABORATORY USE, DISPOSABLE LATEX GLOVES FOR LABORATORY USE; PROTECTIVE GLOVES FOR INDUSTRIAL USE (U.S. CLS. 21, 23, 26, 36 AND 38).

### CLASS 10—MEDICAL APPARATUS

FOR GLOVES FOR SURGICAL PURPOSES; GLOVES FOR MEDICAL PURPOSES; GLOVES FOR DENTAL PURPOSES; GLOVES FOR VETERINARY PURPOSES; DISPENSERS FOR GLOVES FOR SURGICAL, MEDICAL, DENTAL, AND VETERINARY PURPOSES; DISPOSABLE MEDICAL PRODUCTS, NAMELY POWDERED AND POWDER FREE LATEX, NITRILE AND VINYL EXAMINATION GLOVES AND DISPENSERS THEREFOR (U.S. CLS. 26, 39 AND 44).

### CLASS 21—HOUSEWARES AND GLASS

FOR DISPOSABLE GLOVES FOR USE IN CATERING, CLEANING AND FOOD PREPARATION; SINGLE USE DISPOSABLE GLOVES FOR USE IN CATERING, CLEANING AND FOOD PREPARATION; DOMESTIC GLOVES, NAMELY, HOUSEHOLD GLOVES FOR GENERAL USE AND FOR FOOD PREPARATION; SINGLE USE DOMESTIC GLOVES, NAMELY, HOUSEHOLD GLOVES FOR GENERAL USE AND FOR FOOD PREPARATION; GLOVES FOR CLEANING, NAMELY, HOUSEHOLD GLOVES FOR GENERAL USE; SINGLE USE GLOVES FOR CLEANING, NAMELY, HOUSEHOLD GLOVES FOR GENERAL USE; GLOVES FOR THE PROTECTION OF ARTICLES HANDLED BY THE WEARER IN THE NATURE OF WORK GLOVES; SINGLE USE DISPOSABLE GLOVES FOR THE PROTECTION OF ARTICLES HANDLED BY THE WEARER IN THE NATURE OF WORK GLOVES; GLOVES FOR WASHING THE HOME, NAMELY, HOUSEHOLD GLOVES FOR GENERAL USE; GLOVES FOR WASHING THE HOME, NAMELY, SINGLE USE DISPOSABLE HOUSEHOLD GLOVES FOR GENERAL USE; DISPENSERS FOR HOUSEHOLD AND WORK GLOVES FOR CATERING, DOMESTIC OR WASHING PURPOSES; DISPOSABLE GLOVES FOR USE IN THE FOOD SERVICE INDUSTRY; DISPOSABLE SANITARY GLOVES AND DISPENSERS THEREFOR (U.S. CLS. 2, 13, 23, 29, 30, 33, 40 AND 50).

ANTHONY RINKER, EXAMINING ATTORNEY

SN 86-072,018. PROSCI, INC., LOVELAND, CO. FILED 9-23-2013.

## MANAGE CHANGE MAXIMIZE PERFORMANCE

THE MARK CONSISTS OF STANDARD CHARACTERS WITHOUT CLAIM TO ANY PARTICULAR FONT, STYLE, SIZE, OR COLOR.

### CLASS 9—ELECTRICAL AND SCIENTIFIC APPARATUS

FOR DOWNLOADABLE ELECTRONIC PUBLICATIONS, NAMELY, TEMPLATES, ASSESSMENTS, WORKSHEETS, REPORTS, ARTICLES, AND GUIDELINES CONTAINED ON ELECTRONIC DOCUMENTS, ALL IN THE FIELDS OF BUSINESS ORGANIZATION AND MANAGEMENT (U.S. CLS. 21, 23, 26, 36 AND 38).

### CLASS 16—PAPER GOODS AND PRINTED MATTER

FOR PAPER PUBLICATIONS, NAMELY, SCORECARDS, TEMPLATES, WORKSHEETS, ASSESSMENTS, CHECKLISTS, PRINTED GUIDELINES, WORKBOOKS, ARTICLES, BOOKS, READY-TO-USE PRINTED PRESENTATIONS IN THE FIELDS OF BUSINESS ORGANIZATION AND MANAGEMENT (U.S. CLS. 2, 5, 22, 23, 29, 37, 38 AND 50).

**CLASS 35—ADVERTISING AND BUSINESS**

FOR PROVIDING RESEARCH AND ANALYSIS IN THE FIELDS OF BUSINESS ORGANIZATION AND MANAGEMENT; PROVIDING INFORMATION IN THE FIELDS OF BUSINESS ORGANIZATION AND MANAGEMENT; BUSINESS MANAGEMENT CONSULTATION SERVICES (U.S. CLS. 100, 101 AND 102).

**CLASS 41—EDUCATION AND ENTERTAINMENT**

FOR EDUCATIONAL SERVICES, NAMELY, ARRANGING AND CONDUCTING WORKSHOPS, PRESENTATIONS, CONFERENCES, WEBINARS, SEMINARS, RETREATS, TRAINING, AND TUTORIALS IN THE FIELDS OF BUSINESS ORGANIZATION AND MANAGEMENT; NON-DOWNLOADABLE ELECTRONIC PUBLICATIONS, NAMELY, TEMPLATES, ASSESSMENTS, WORKSHEETS, REPORTS, AND ARTICLES IN THE FIELDS OF BUSINESS ORGANIZATION AND MANAGEMENT (U.S. CLS. 100, 101 AND 107).  
ROBERT STRUCK, EXAMINING ATTORNEY

SN 86-072,108. MCS INDUSTRIES, INC., EASTON, PA. FILED 9-23-2013.

**SECOND STORY**

THE MARK CONSISTS OF STANDARD CHARACTERS WITHOUT CLAIM TO ANY PARTICULAR FONT, STYLE, SIZE, OR COLOR.

**CLASS 14—JEWELRY**

FOR CLOCKS (U.S. CLS. 2, 27, 28 AND 50).

**CLASS 20—FURNITURE AND ARTICLES NOT OTHERWISE CLASSIFIED**

FOR BULLETIN BOARDS; DISPLAY CASES; FURNITURE FOR DISPLAYING GOODS; MIRRORS; PICTURE FRAMES; SHELVES; SHELVING AND COMPONENT PARTS THEREOF, NAMELY, SHELVES AND BRACKETS SOLD AS A UNIT (U.S. CLS. 2, 13, 22, 25, 32 AND 50).  
KYLE PEETE, EXAMINING ATTORNEY

SN 86-072,213. LAHTI, MARIA R. DBA CHURCH OF SPIRITS FRANCHISE HOLDINGS, LLC, DESTIN, FL. AND LAHTI, RAYMOND M. DBA CHURCH OF SPIRITS FRANCHISE HOLDINGS, LLC, DESTIN, FL. FILED 9-23-2013.

**Church of Spirits**

THE MARK CONSISTS OF STANDARD CHARACTERS WITHOUT CLAIM TO ANY PARTICULAR FONT, STYLE, SIZE, OR COLOR.

**CLASS 35—ADVERTISING AND BUSINESS**

FOR RETAIL GIFT SHOPS (U.S. CLS. 100, 101 AND 102).

**CLASS 43—HOTEL AND RESTAURANT SERVICES**

FOR BAR SERVICES; RESTAURANT SERVICES (U.S. CLS. 100 AND 101).  
SIDDHARTH JAGANNATHAN, EXAMINING ATTORNEY

SN 86-072,462. TIMELESS VISONZ, LLC, BEVERLY HILLS, CA. FILED 9-23-2013.

**D'INK**

THE MARK CONSISTS OF STANDARD CHARACTERS WITHOUT CLAIM TO ANY PARTICULAR FONT, STYLE, SIZE, OR COLOR.

**CLASS 9—ELECTRICAL AND SCIENTIFIC APPARATUS**

FOR INTERACTIVE MOBILE APPLICATION THAT ALLOWS USERS TO SUBMIT IMAGES AND TO OBTAIN RENDERINGS OF POTENTIAL RESULTS OF LASER TATTOO REMOVAL, ESTIMATED COST AND NUMBER OF TREATMENTS REQUIRED FOR LASER TATTOO REMOVAL, AND TO LOCATE PROFESSIONAL PROVIDERS OF LASER TATTOO REMOVAL SERVICES (U.S. CLS. 21, 23, 26, 36 AND 38).

**CLASS 44—MEDICAL, BEAUTY AND AGRICULTURAL SERVICES**

FOR LASER TATTOO REMOVAL SERVICES (U.S. CLS. 100 AND 101).  
ROBERT STRUCK, EXAMINING ATTORNEY

SN 86-072,494. DANNY EXPORT, LLC, MIAMI, FL. FILED 9-23-2013.

**DEPLUS**

THE MARK CONSISTS OF THE LETTERS "DEPLUS".

**CLASS 7—MACHINERY**

FOR CLOTHES WASHING MACHINES; DISHWASHING MACHINES (U.S. CLS. 13, 19, 21, 23, 31, 34 AND 35).  
FIRST USE 6-21-2013; IN COMMERCE 6-21-2013.

**CLASS 9—ELECTRICAL AND SCIENTIFIC APPARATUS**

FOR AUDIO AMPLIFIERS; BRACKETS SPECIALLY ADAPTED FOR SETTING UP FLAT SCREEN TV SETS; COMPACT DISC PLAYERS; COMPUTER PRINTERS; DESKTOP COMPUTERS; LAPTOP COMPUTERS; RADIOS; STEREO RECEIVERS; TELEVISIONS (U.S. CLS. 21, 23, 26, 36 AND 38).  
FIRST USE 6-17-2013; IN COMMERCE 6-17-2013.

**CLASS 11—ENVIRONMENTAL CONTROL APPARATUS**

FOR AIR CONDITIONERS; CLOTHES DRYERS; ELECTRIC FANS; ELECTRIC STOVES; FREEZERS; GAS STOVES; MICROWAVE OVENS; REFRIGERATORS (U.S. CLS. 13, 21, 23, 31 AND 34).

FIRST USE 6-15-2013; IN COMMERCE 6-15-2013.  
GIANCARLO CASTRO, EXAMINING ATTORNEY

**CLASS 41—EDUCATION AND ENTERTAINMENT**

FOR BUSINESS TRAINING IN THE FIELDS OF LEADERSHIP DEVELOPMENT AND EXECUTIVE COACHING; PERSONAL COACHING SERVICES IN THE FIELD OF BUSINESS LEADERSHIP DEVELOPMENT AND EXECUTIVE COACHING; CONDUCTING WORKSHOPS AND SEMINARS IN THE FIELDS OF BUSINESS, LEADERSHIP AND BUSINESS MANAGEMENT STRATEGY (U.S. CLS. 100, 101 AND 107).

FIRST USE 6-30-2009; IN COMMERCE 6-30-2009.  
GIANCARLO CASTRO, EXAMINING ATTORNEY

SN 86-072,542. PACIFIC INTERNATIONAL LINES (PRIVATE) LIMITED, SINGAPORE, SINGAPORE, FILED 9-23-2013.

SN 86-072,499. LUBE CENTER DISTRIBUTING, INC., OLD TOWN, FL. FILED 9-23-2013.

**CRASH A RAMA**

THE MARK CONSISTS OF STANDARD CHARACTERS WITHOUT CLAIM TO ANY PARTICULAR FONT, STYLE, SIZE, OR COLOR.

**CLASS 25—CLOTHING**

FOR T-SHIRTS (U.S. CLS. 22 AND 39).  
FIRST USE 0-0-1998; IN COMMERCE 0-0-1998.

**CLASS 41—EDUCATION AND ENTERTAINMENT**

FOR ENTERTAINMENT IN THE NATURE OF AUTOMOBILE RACES (U.S. CLS. 100, 101 AND 107).  
FIRST USE 1-1-1998; IN COMMERCE 1-1-1998.  
GIANCARLO CASTRO, EXAMINING ATTORNEY

OWNER OF U.S. REG. NOS. 3,443,781, 3,629,277 AND OTHERS.

THE MARK CONSISTS OF WAVY STRIPES FOLLOWED BY THE LETTERS "P," "I" AND "L".

**CLASS 6—METAL GOODS**

FOR INDUSTRIAL AND TRANSPORT PACKAGING CONTAINERS OF METAL; CONTAINERS OF METAL FOR STORAGE AND TRANSPORTATION OF GOODS; METAL CONTAINER CLOSURES, METAL ALLOY CONTAINERS, AND METALLIC AND ALUMINUM GOODS AND/OR MATERIALS USED AS CONTAINERS FOR THE STORAGE AND TRANSPORTATION OF GOODS; CONTAINERS ALL MADE WHOLLY OR PRINCIPALLY OF METAL AND FOR USE IN THE STORAGE OR CARRIAGE OF GOODS; METAL STRUCTURES, NAMELY, FLATRACKS (U.S. CLS. 2, 12, 13, 14, 23, 25 AND 50).  
FIRST USE 0-0-1989; IN COMMERCE 1-0-2012.

SN 86-072,500. RUBEN CONSULTING GROUP, LTD., SAN FRANCISCO, CA. FILED 9-23-2013.

**TANGLE DOCTOR**

THE MARK CONSISTS OF STANDARD CHARACTERS WITHOUT CLAIM TO ANY PARTICULAR FONT, STYLE, SIZE, OR COLOR.

**CLASS 35—ADVERTISING AND BUSINESS**

FOR BUSINESS CONSULTATION (U.S. CLS. 100, 101 AND 102).  
FIRST USE 6-30-2009; IN COMMERCE 6-30-2009.

**CLASS 35—ADVERTISING AND BUSINESS**

FOR INFORMATION-MANAGEMENT SERVICES, NAMELY, BOOKING AND SCHEDULING OF FREIGHT TRANSPORT AND DELIVERY BY GROUND, AIR CARRIER AND BY WATER, AND TRACKING PACKAGES AND FREIGHT ON-LINE FROM A COMPUTER DATABASE OR THE GLOBAL COMMUNICATIONS NETWORK (U.S. CLS. 100, 101 AND 102).  
FIRST USE 0-0-1989; IN COMMERCE 1-0-2012.

**CLASS 39—TRANSPORTATION AND STORAGE**

FOR TRANSPORTATION SERVICES BY WATER, NAMELY, FREIGHT-SHIP TRANSPORT, TRANSPORT BY BOAT; PACKING AND PACKAGING OF GOODS FOR TRANSPORTATION; SHIP-BROKERAGES SERVICES; FREIGHT-SHIP TRANSPORT AND FREIGHT-FORWARDING SERVICES; TRANSPORT BY WATER OF FREIGHT, NAMELY, TRANSPORT BY FREIGHT SHIP AND TRANSPORT BY BOAT (U.S. CLS. 100 AND 105).  
FIRST USE 0-0-1989; IN COMMERCE 1-0-2012.

JOHN HWANG, EXAMINING ATTORNEY

SN 86-073,131. INNOVATIVE XERCISE SOLUTIONS, LLC, BLOOMFIELD HILLS, MI. FILED 9-24-2013.



THE MARK CONSISTS OF A FIRST LETTER "C", A SECOND LETTER "C", AND FIVE CIRCULAR BALLS; THE FIRST LETTER "C" AND THE SECOND LETTER "C" EACH BEING A SOLID BLACK LETTER, THE FIVE CIRCULAR BALLS EACH HAVING A SOLID BLACK COLOR; THE FIRST LETTER "C" AND THE SECOND LETTER "C" BEING TILTED COUNTERCLOCKWISE ABOUT 45 DEGREES FROM A FACING RELATIONSHIP TO ONE ANOTHER SUCH THAT A LOWER END OF THE FIRST LETTER "C" IS DISPOSED PROXIMATE TO AN UPPER END OF THE SECOND LETTER "C" AND A GAP IS DISPOSED THERE BETWEEN, THE FIVE CIRCULAR BALLS BEING DISPOSED PROXIMATE TO ONE ANOTHER BETWEEN AN UPPER END OF THE FIRST LETTER "C" AND A LOWER END OF THE SECOND LETTER "C" AND THROUGH THE GAP.

#### CLASS 9—ELECTRICAL AND SCIENTIFIC APPARATUS

FOR DIGITAL MEDIA, NAMELY, PRE-RECORDED DVDS, AND DOWNLOADABLE AUDIO AND VIDEO RECORDINGS FEATURING EXERCISE WORKOUTS AND PHYSICAL FITNESS INSTRUCTION (U.S. CLS. 21, 23, 26, 36 AND 38).

#### CLASS 28—TOYS AND SPORTING GOODS

FOR EXERCISE EQUIPMENT, NAMELY, FREE-STANDING EXERCISE BARS (U.S. CLS. 22, 23, 38 AND 50).

#### CLASS 41—EDUCATION AND ENTERTAINMENT

FOR EDUCATIONAL SERVICES, NAMELY, PROVIDING A WEBSITE FEATURING ON-LINE INSTRUCTION IN THE FIELD OF PHYSICAL EXERCISE AND WELLNESS (U.S. CLS. 100, 101 AND 107).

THEODORE MCBRIDE, EXAMINING ATTORNEY

SN 86-073,761. GUTT UP, LLC, LOS ANGELES, CA. FILED 9-24-2013.

THE MARK CONSISTS OF THE WORDING "MAKE 'EM SAY UGHH!" IN A STYLIZED DIAGONAL FONT.

#### CLASS 25—CLOTHING

FOR BASEBALL CAPS AND HATS; HATS; LONG-SLEEVED SHIRTS; PANTS; SHIRTS AND SHORT-SLEEVED SHIRTS; SHORTS; SWEATERS; SWEAT-SHIRTS; T-SHIRTS (U.S. CLS. 22 AND 39).

#### CLASS 29—MEATS AND PROCESSED FOODS

FOR POTATO CHIPS (U.S. CL. 46).

#### CLASS 30—STAPLE FOODS

FOR CANDY BARS; COOKIES AND CRACKERS; CORN-BASED CHIPS (U.S. CL. 46).

#### CLASS 32—LIGHT BEVERAGES

FOR BOTTLED WATER; ENERGY DRINKS; SOFT DRINKS (U.S. CLS. 45, 46 AND 48).  
SKYE YOUNG, EXAMINING ATTORNEY

SN 86-073,809. BRYANT, KATHERINE, ATLANTA, GA. FILED 9-24-2013.



THE MARK CONSISTS OF THE WORD "ODDLY" IN CURSIVE NEXT TO A SMILEY FACE HOLDING A CARD WITH THE WORD "ME" ON IT.

#### CLASS 35—ADVERTISING AND BUSINESS

FOR ADVERTISING AND MARKETING SERVICES PROVIDED BY MEANS OF INDIRECT METHODS OF MARKETING COMMUNICATIONS, NAMELY, SOCIAL MEDIA, SEARCH ENGINE MARKETING, INQUIRY MARKETING, INTERNET MARKETING, MOBILE MARKETING, BLOGGING AND OTHER FORMS OF PASSIVE, SHARABLE OR VIRAL COMMUNICATIONS CHANNELS (U.S. CLS. 100, 101 AND 102).

#### CLASS 42—SCIENTIFIC AND COMPUTER SERVICES

FOR COMPUTER SERVICES, NAMELY, CREATING AN ON-LINE COMMUNITY FOR REGISTERED USERS TO RATE AND COMMENT ON CONSUMER PRODUCTS (U.S. CLS. 100 AND 101).

#### CLASS 45—PERSONAL AND LEGAL SERVICES

FOR ON-LINE SOCIAL NETWORKING SERVICES (U.S. CLS. 100 AND 101).  
TEJBIR SINGH, EXAMINING ATTORNEY

SN 86-073,810. DRUM EXCHANGE, BROOKLYN, NY. FILED 9-24-2013.



NO CLAIM IS MADE TO THE EXCLUSIVE RIGHT TO USE "DRUM EXCHANGE", APART FROM THE MARK AS SHOWN.

THE COLOR(S) RED, WHITE AND BLACK IS/ARE CLAIMED AS A FEATURE OF THE MARK.

THE MARK CONSISTS OF THE STYLIZED WORDING "DRUM EXCHANGE" IN BLACK WITH A WHITE BORDER AROUND THE WORDS, AGAINST A BLACK BACKGROUND. THE "X" IS OVERSIZED IN RED WITH A NORTHWEST FACING ARROW ATTACHED TO ITS UPPER LEFT LIMB AND A SOUTHEAST FACING ARROW ATTACHED TO ITS LOWER RIGHT LIMB.

**CLASS 35—ADVERTISING AND BUSINESS**

FOR ON-LINE RETAIL STORE SERVICES FEATURING USED MUSICAL EQUIPMENT (U.S. CLS. 100, 101 AND 102).

**CLASS 41—EDUCATION AND ENTERTAINMENT**

FOR PROVIDING EDUCATION COURSES IN THE FIELD OF MUSICAL INSTRUCTION OFFERED THROUGH ONLINE, NON-DOWNLOADABLE VIDEOS AND INSTRUCTOR ASSISTANCE (U.S. CLS. 100, 101 AND 107).

ELISSA GARBER KON, EXAMINING ATTORNEY

---

SN 86-073,832. SURECRITIC INC, SEATTLE, WA. FILED 9-24-2013.

**SureCritic**

THE MARK CONSISTS OF STANDARD CHARACTERS WITHOUT CLAIM TO ANY PARTICULAR FONT, STYLE, SIZE, OR COLOR.

OWNER OF U.S. REG. NO. 4,098,949.

**CLASS 35—ADVERTISING AND BUSINESS**

FOR PROVIDING A WEB SITE FEATURING THE RATINGS, REVIEWS AND RECOMMENDATIONS ON PRODUCTS AND SERVICES FOR COMMERCIAL PURPOSES POSTED BY USERS (U.S. CLS. 100, 101 AND 102).  
FIRST USE 2-1-2011; IN COMMERCE 2-1-2011.

**CLASS 42—SCIENTIFIC AND COMPUTER SERVICES**

FOR PROVIDING A WEB SITE FEATURING TECHNOLOGY THAT ENABLES USERS TO PRESENT PRODUCTS, SERVICES, AND PROPOSALS TO OTHERS FOR COMMENT, AND GATHER FEEDBACK FROM THOSE OTHERS ABOUT THOSE PRODUCTS, SERVICES, AND PROPOSALS (U.S. CLS. 100 AND 101).

FIRST USE 2-2-2011; IN COMMERCE 2-2-2011.  
WENDY JUN, EXAMINING ATTORNEY

SN 86-074,364. NAMCO BANDAI GAMES INC., TOKYO, JAPAN, FILED 9-25-2013.

**NAMCO ANTHOLOGY**

THE MARK CONSISTS OF STANDARD CHARACTERS WITHOUT CLAIM TO ANY PARTICULAR FONT, STYLE, SIZE, OR COLOR.

OWNER OF U.S. REG. NOS. 1,131,225, 1,906,185 AND OTHERS.

**CLASS 9—ELECTRICAL AND SCIENTIFIC APPARATUS**

FOR COMPUTER GAME PROGRAMS; COMPUTER GAME SOFTWARE; DOWNLOADABLE COMPUTER GAME PROGRAMS; DOWNLOADABLE COMPUTER GAME SOFTWARE VIA A GLOBAL COMPUTER NETWORK AND WIRELESS DEVICES; VIDEO GAME SOFTWARE (U.S. CLS. 21, 23, 26, 36 AND 38).

**CLASS 41—EDUCATION AND ENTERTAINMENT**

FOR ENTERTAINMENT SERVICES, NAMELY, PROVIDING A COMPUTER GAME THAT MAY BE ACCESSED NETWORK-WIDE BY NETWORK USERS VIA MOBILE PHONES AND COMPUTERS; PROVIDING COMPUTER GAMES VIA NETWORK BETWEEN COMMUNICATIONS NETWORKS AND COMPUTERS (U.S. CLS. 100, 101 AND 107).

DOMINICK J. SALEMI, EXAMINING ATTORNEY

---

SN 86-074,629. E. & J. GALLO WINERY, MODESTO, CA. FILED 9-25-2013.

**ALL THE BEST**

THE MARK CONSISTS OF STANDARD CHARACTERS WITHOUT CLAIM TO ANY PARTICULAR FONT, STYLE, SIZE, OR COLOR.

**CLASS 33—WINES AND SPIRITS**

FOR ALCOHOLIC BEVERAGES EXCEPT BEERS (U.S. CLS. 47 AND 49).  
FIRST USE 11-25-2013; IN COMMERCE 11-25-2013.

**CLASS 35—ADVERTISING AND BUSINESS**

FOR BUSINESS INFORMATION SERVICES AND ON-LINE RETAIL STORE SERVICES FEATURING ALCOHOLIC BEVERAGES (U.S. CLS. 100, 101 AND 102).  
FIRST USE 11-25-2013; IN COMMERCE 11-25-2013.  
ROBIN CHOSID, EXAMINING ATTORNEY

SN 86-074,782. IDEOPIA, INC., CINCINNATI, OH. FILED 9-25-2013.

# Ideopia

THE MARK CONSISTS OF STANDARD CHARACTERS WITHOUT CLAIM TO ANY PARTICULAR FONT, STYLE, SIZE, OR COLOR.

## CLASS 35—ADVERTISING AND BUSINESS

FOR ADVERTISING AND MARKETING SERVICES PROVIDED BY MEANS OF INDIRECT METHODS OF MARKETING COMMUNICATIONS, NAMELY, SOCIAL MEDIA, SEARCH ENGINE MARKETING, INQUIRY MARKETING, INTERNET MARKETING, MOBILE MARKETING, BLOGGING AND OTHER FORMS OF PASSIVE, SHARABLE OR VIRAL COMMUNICATIONS CHANNELS; ADVERTISING AND PUBLICITY SERVICES, NAMELY, PROMOTING THE GOODS, SERVICES, BRAND IDENTITY AND COMMERCIAL INFORMATION AND NEWS OF THIRD PARTIES THROUGH PRINT, AUDIO, VIDEO, DIGITAL AND ON-LINE MEDIUM (U.S. CLS. 100, 101 AND 102).  
FIRST USE 4-19-2002; IN COMMERCE 4-19-2002.

## CLASS 42—SCIENTIFIC AND COMPUTER SERVICES

FOR PLANNING, DESIGN, DEVELOPMENT, MAINTENANCE AND OPTIMIZATION OF ONLINE WEBSITES FOR THIRD PARTIES (U.S. CLS. 100 AND 101).  
FIRST USE 4-19-2002; IN COMMERCE 4-19-2002.  
LINDA QUIGLEY, EXAMINING ATTORNEY

SN 86-074,824. COPPERFIELD, DAVID, NEW YORK, NY. FILED 9-25-2013.

# REDSAFE

THE MARK CONSISTS OF STANDARD CHARACTERS WITHOUT CLAIM TO ANY PARTICULAR FONT, STYLE, SIZE, OR COLOR.

## CLASS 36—INSURANCE AND FINANCIAL

FOR CHARITABLE FUNDRAISING; FINANCIAL SPONSORSHIP OF FUNDRAISING EVENTS (U.S. CLS. 100, 101 AND 102).

## CLASS 41—EDUCATION AND ENTERTAINMENT

FOR CHARITABLE SERVICES, NAMELY, PROVIDING EDUCATIONAL MATERIALS IN THE NATURE OF BOOKS TO THOSE IN NEED (U.S. CLS. 100, 101 AND 107).

## CLASS 43—HOTEL AND RESTAURANT SERVICES

FOR CHARITABLE SERVICES, NAMELY, PROVIDING FOOD AND WATER TO THOSE IN NEED (U.S. CLS. 100 AND 101).  
JOANNA DUKOVIC, EXAMINING ATTORNEY

SN 86-075,256. JL BEERS, INC., FARGO, ND. FILED 9-26-2013.

# AMERICAN GEEZERS

THE MARK CONSISTS OF STANDARD CHARACTERS WITHOUT CLAIM TO ANY PARTICULAR FONT, STYLE, SIZE, OR COLOR.

NO CLAIM IS MADE TO THE EXCLUSIVE RIGHT TO USE "AMERICAN", APART FROM THE MARK AS SHOWN.

## CLASS 37—CONSTRUCTION AND REPAIR

FOR RESTORATION IN THE FIELD OF AUTOMOBILES (U.S. CLS. 100, 103 AND 106).

## CLASS 43—HOTEL AND RESTAURANT SERVICES

FOR RESTAURANT AND BAR SERVICES (U.S. CLS. 100 AND 101).  
NANCY CLARKE, EXAMINING ATTORNEY

SN 86-075,700. LEICA BIOSYSTEMS RICHMOND, INC., RICHMOND, IL. FILED 9-26-2013.

# AFFIRMSEAL

THE MARK CONSISTS OF STANDARD CHARACTERS WITHOUT CLAIM TO ANY PARTICULAR FONT, STYLE, SIZE, OR COLOR.

## CLASS 1—CHEMICALS

FOR PREFILLED CONTAINERS CONTAINING CHEMICALS IN THE NATURE OF PRESERVATIVE PREPARATIONS FOR COLLECTION, PRESERVATION AND STORAGE OF BIOLOGICAL SPECIMENS FOR LABORATORY USE (U.S. CLS. 1, 5, 6, 10, 26 AND 46).  
FIRST USE 8-2-2013; IN COMMERCE 8-2-2013.

## CLASS 5—PHARMACEUTICALS

FOR PREFILLED CONTAINERS CONTAINING CHEMICALS IN THE NATURE OF PRESERVATIVE PREPARATIONS FOR COLLECTION, PRESERVATION AND STORAGE OF BIOLOGICAL SPECIMENS FOR CLINICAL MEDICAL USE (U.S. CLS. 6, 18, 44, 46, 51 AND 52).  
FIRST USE 8-2-2013; IN COMMERCE 8-2-2013.  
BRIN ANDERSON, EXAMINING ATTORNEY

SN 86-076,098. PARAMOUNT PICTURES CORPORATION, HOLLYWOOD, CA. FILED 9-26-2013.

# MEAN GIRLS

THE MARK CONSISTS OF STANDARD CHARACTERS WITHOUT CLAIM TO ANY PARTICULAR FONT, STYLE, SIZE, OR COLOR.

OWNER OF U.S. REG. NOS. 3,758,991 AND 4,093,935.

**CLASS 9—ELECTRICAL AND SCIENTIFIC APPARATUS**

FOR DOWNLOADABLE ELECTRONIC GAME PROGRAMS FOR USE ON PERSONAL COMPUTERS, MOBILE PHONES, TABLET COMPUTERS, AND OTHER ELECTRONIC DEVICES; INTERACTIVE VIDEO GAME PROGRAMS; COMPUTER GAME PROGRAMS (U.S. CLS. 21, 23, 26, 36 AND 38).  
FIRST USE 2-27-2009; IN COMMERCE 2-27-2009.

SN 86-076,587. D.K. WILSON, BEVERLY HILLS, CA. FILED 9-27-2013.



THE MARK CONSISTS OF THE BLOCK LETTERS "W" AND "A" WITH THE NUMBER "1" IN THE CENTER OF THE LETTER "A".

**CLASS 41—EDUCATION AND ENTERTAINMENT**

FOR ENTERTAINMENT SERVICES IN THE NATURE OF A SERIES OF MOTION PICTURES IN THE FIELDS OF COMEDY AND DRAMA FOR THEATRICAL RELEASE AND FOR DISTRIBUTION VIA TELEVISION, CABLE TELEVISION AND THE INTERNET; PROVIDING WEBSITES FEATURING NON-DOWNLOADABLE IMAGES, AUDIO, VIDEO, TEXT, GRAPHICS AND RELATED INFORMATION IN THE FIELD OF MOTION PICTURES; PROVIDING TEMPORARY USE OF INTERACTIVE, MULTIPLAYER AND SINGLE PLAYER GAMES PLAYED VIA COMPUTER OR COMMUNICATION NETWORKS; PROVIDING NON-DOWNLOADABLE COMPUTER GAMES AND VIDEO GAMES (U.S. CLS. 100, 101 AND 107).  
FIRST USE 4-30-2004; IN COMMERCE 4-30-2004.  
AHSEN KHAN, EXAMINING ATTORNEY

**CLASS 18—LEATHER GOODS**

FOR SPORTS AND ATHLETIC BAGS; BACKPACKS (U.S. CLS. 1, 2, 3, 22 AND 41).

**CLASS 25—CLOTHING**

FOR SPORTSWEAR FOR MEN, WOMEN AND CHILDREN, NAMELY, T-SHIRTS, WIND SUITS, TUNICS, PANTS, TOPS, TANK-TOPS, SHIRTS, SHORTS, SKIRTS, ATHLETIC UNIFORMS, POLO SHIRTS, SPORTS BRAS, ATHLETIC JERSEYS, PARKAS AND SOCKS, SWEAT-PANTS, SWEATSHIRTS, PULLOVER, AND JACKETS (U.S. CLS. 22 AND 39).  
LEIGH CAROLINE CASE, EXAMINING ATTORNEY

SN 86-076,123. BREATHOMETER, INC., BURLINGAME, CA. FILED 9-26-2013.

**BACK TO ZERO**

THE MARK CONSISTS OF STANDARD CHARACTERS WITHOUT CLAIM TO ANY PARTICULAR FONT, STYLE, SIZE, OR COLOR.

SN 86-077,000. FOODHANDLER, INC., CREVE COEUR, MO. FILED 9-27-2013.

**SURETOUCH**

THE MARK CONSISTS OF STANDARD CHARACTERS WITHOUT CLAIM TO ANY PARTICULAR FONT, STYLE, SIZE, OR COLOR.

**CLASS 9—ELECTRICAL AND SCIENTIFIC APPARATUS**

FOR COMPUTER SOFTWARE FOR A PORTABLE BREATH DETECTION APPARATUS THAT MEASURES THE ALCOHOLIC CONTENT OF INDIVIDUALS, AND DETECTS HALITOSIS, DIABETES, ALLERGENS, PATHOGENS, AND ASTHMA IN INDIVIDUALS (U.S. CLS. 21, 23, 26, 36 AND 38).

**CLASS 9—ELECTRICAL AND SCIENTIFIC APPARATUS**

FOR PROTECTIVE GLOVES FOR INDUSTRIAL USE; MESH SAFETY GLOVES; PROTECTIVE WORK GLOVES; CLEAN ROOM SAFETY GLOVES FOR USE IN CLEAN ROOMS; DISPOSABLE PLASTIC GLOVES FOR LABORATORY USE, DISPOSABLE LATEX GLOVES FOR LABORATORY USE (U.S. CLS. 21, 23, 26, 36 AND 38).

**CLASS 10—MEDICAL APPARATUS**

FOR BREATH TESTING UNITS, NAMELY, PORTABLE BREATH DETECTION APPARATUS THAT MEASURES THE ALCOHOLIC CONTENT OF INDIVIDUALS, AND DETECTS HALITOSIS, DIABETES, ALLERGENS, PATHOGENS, AND ASTHMA IN INDIVIDUALS (U.S. CLS. 26, 39 AND 44).  
MARTHA SANTOMARTINO, EXAMINING ATTORNEY

**CLASS 21—HOUSEWARES AND GLASS**

FOR GENERAL PURPOSE RUBBER AND PLASTIC GLOVES FOR DOMESTIC USE; GENERAL WORK CLOTHING, NAMELY, GENERAL WORK GLOVES, NAMELY, COTTON GLOVES, COTTON AND LEATHER GLOVES AND LEATHER GLOVES; LATEX GLOVES, RUBBER GLOVES, VINYL GLOVES AND POLYVINYL CHLORIDE GLOVES, NITRILE GLOVES, POLY GLOVES; DISPOSABLE GLOVES FOR USE IN CATERING, CLEANING AND FOOD PREPARATION; SINGLE USE DISPOSABLE GLOVES FOR USE IN CATERING, CLEANING AND FOOD PREPARATION; DOMESTIC GLOVES, NAMELY, HOUSEHOLD GLOVES FOR GENERAL USE AND FOR FOOD PREPARATION; SINGLE USE DOMESTIC GLOVES, NAMELY, HOUSEHOLD GLOVES FOR GENERAL USE AND FOR FOOD PREPARATION; GLOVES FOR CLEANING, NAMELY, HOUSEHOLD GLOVES FOR GENERAL USE; SINGLE USE GLOVES FOR CLEANING, NAMELY, HOUSEHOLD GLOVES FOR GENERAL USE; GLOVES FOR THE PROTECTION OF ARTICLES HANDLED BY THE WEARER IN THE NATURE OF WORK GLOVES; SINGLE USE DISPOSABLE GLOVES FOR THE PROTECTION OF ARTICLES HANDLED BY THE WEARER IN THE NATURE OF WORK GLOVES; GLOVES FOR WASHING THE HOME, NAMELY, HOUSEHOLD GLOVES FOR GENERAL USE; GLOVES FOR WASHING THE HOME, NAMELY, SINGLE USE DISPOSABLE HOUSEHOLD GLOVES FOR GENERAL USE; DISPOSABLE GLOVES FOR USE IN THE FOOD SERVICE INDUSTRY; DISPOSABLE SANITARY GLOVES AND DISPENSERS THEREFOR (U.S. CLS. 2, 13, 23, 29, 30, 33, 40 AND 50).

ANTHONY RINKER, EXAMINING ATTORNEY

SN 86-077,165. PROX MANAGEMENT, LLC, DBA INNOVA PERFORMANCE PRODUCTS, MILFORD CENTER, OH. FILED 9-27-2013.

**Innova Performance Products**

THE MARK CONSISTS OF STANDARD CHARACTERS WITHOUT CLAIM TO ANY PARTICULAR FONT, STYLE, SIZE, OR COLOR.

NO CLAIM IS MADE TO THE EXCLUSIVE RIGHT TO USE "PRODUCTS", APART FROM THE MARK AS SHOWN.

**CLASS 1—CHEMICALS**

FOR CHEMICAL PREPARATIONS FOR USE IN AGRICULTURE, HORTICULTURE AND FORESTRY, NAMELY, CHEMICAL PREPARATIONS FOR THE TREATMENT OF SEEDS; FERTILIZERS FOR AGRICULTURAL USE; NUTRITIVE ADDITIVE TO ENHANCE THE BIOLOGICAL ACTIVITY OF WATER, SOIL, SEEDS AND PLANTS FOR PURPOSES OF FERTILIZATION AND BIOREMEDIATION OF POLLUTANTS; PLANT GROWTH REGULATORS FOR AGRICULTURAL USE; SEED COATING APPLIED TO CORN, SOYBEANS, WHEAT AND ALFALFA SEEDS TO IMPROVE STANDS, SEEDLING HEALTH AND YIELD (U.S. CLS. 1, 5, 6, 10, 26 AND 46).

FIRST USE 5-2-2013; IN COMMERCE 5-2-2013.

**CLASS 5—PHARMACEUTICALS**

FOR FUNGICIDES FOR AGRICULTURAL USE; HERBICIDE FOR AGRICULTURAL USE; HERBICIDES FOR AGRICULTURAL USE; INSECTICIDE FOR AGRICULTURAL USE; INSECTICIDES FOR AGRICULTURAL USE; PESTICIDES FOR AGRICULTURAL USE; WEED KILLERS FOR AGRICULTURAL USE (U.S. CLS. 6, 18, 44, 46, 51 AND 52).

FIRST USE 5-2-2013; IN COMMERCE 5-2-2013.  
MARLENE BELL, EXAMINING ATTORNEY

SN 86-077,456. 5D I.P., L.L.C., EUNICE, LA. FILED 9-27-2013.



THE MARK CONSISTS OF THE LETTER "O", THE LETTER "H" AND THE LETTER "N" IN STYLIZED FONT ENCLOSED WITHIN A CIRCLE, WITH THE LETTER "O" ON THE LEFT SIDE OF THE CIRCLE, THE LETTER "H" SLIGHTLY STEPPED DOWN TO THE RIGHT OF THE LETTER "O", AND THE LETTER "N" SLIGHTLY STEPPED DOWN TO THE RIGHT OF THE LETTER "H".

**CLASS 7—MACHINERY**

FOR DRILLING MACHINES AND PARTS THEREFOR; OILFIELD EQUIPMENT, NAMELY A WELLBORE ATTACHMENT USED TO RETRIEVE METAL OBJECTS ENTERING THE WELLBORE (U.S. CLS. 13, 19, 21, 23, 31, 34 AND 35).

FIRST USE 9-1-2013; IN COMMERCE 9-1-2013.

**CLASS 9—ELECTRICAL AND SCIENTIFIC APPARATUS**

FOR MAGNETS FOR INDUSTRIAL PURPOSES; MAGNETS FOR USE IN OILFIELD DRILLING, COMPLETION AND PRODUCTION EQUIPMENT; MAGNETS USED IN OIL AND GAS DRILLING; MAGNETS FOR USE IN OIL AND GAS DRILLING, COMPLETION AND PRODUCTION OPERATIONS (U.S. CLS. 21, 23, 26, 36 AND 38).

FIRST USE 9-1-2013; IN COMMERCE 9-1-2013.  
SHARON MEIER, EXAMINING ATTORNEY

SN 86-077,712. HHL AMERICA, INC., DOVER, DE. FILED 9-29-2013.

**SWISS WIN**

THE MARK CONSISTS OF STANDARD CHARACTERS WITHOUT CLAIM TO ANY PARTICULAR FONT, STYLE, SIZE, OR COLOR.

NO CLAIM IS MADE TO THE EXCLUSIVE RIGHT TO USE "SWISS", APART FROM THE MARK AS SHOWN.



**CLASS 9—ELECTRICAL AND SCIENTIFIC APPARATUS**

FOR BACKPACKS ESPECIALLY ADAPTED FOR HOLDING LAPTOPS AND NOTEBOOK COMPUTERS; CARRYING CASES FOR MOBILE COMPUTERS; CARRYING CASES SPECIALLY ADAPTED FOR ELECTRONIC EQUIPMENT, NAMELY, LAPTOPS, MOBILE PHONES, ELECTRONIC BOOK READERS, AND RELATED ELECTRONIC ACCESSORIES, NAMELY, CHARGERS, BATTERIES, PROTECTIVE COVERS, CABLES, MICE, MOUSE PADS, HARD DRIVES, HEADPHONES, HEADSETS, SPEAKERS, MICROPHONES; EYEGLASSES; LAPTOP CARRYING CASES; NEOPRENE LAPTOP COVERS; SUNGLASSES; VINYL COVERS SPECIALLY ADAPTED FOR CELL PHONES, MP3 PLAYERS, LAPTOPS, COMPUTERS, PORTABLE SATELLITE RADIOS, PERSONAL DIGITAL ASSISTANTS, REMOTE CONTROLS, AND TELEVISION SATELLITE RECORDERS; WHEELED BACKPACKS ESPECIALLY ADAPTED FOR HOLDING LAPTOPS (U.S. CLS. 21, 23, 26, 36 AND 38).

**CLASS 18—LEATHER GOODS**

FOR BACKPACKS; BOOK BAGS; BUM BAGS; HANDBAGS; LUGGAGE; SPORT BAGS; WALLETS (U.S. CLS. 1, 2, 3, 22 AND 41).  
KIMBERLY CLARKE, EXAMINING ATTORNEY

SN 86-077,905. URBAN OUTFITTERS, INC., PHILADELPHIA, PA. FILED 9-30-2013.

**DEVON YARD**

THE MARK CONSISTS OF STANDARD CHARACTERS WITHOUT CLAIM TO ANY PARTICULAR FONT, STYLE, SIZE, OR COLOR.

**CLASS 36—INSURANCE AND FINANCIAL**

FOR SHOPPING CENTER SERVICES, NAMELY, RENTAL OF SHOPPING CENTER SPACE; LEASING OF SHOPPING CENTER SPACE (U.S. CLS. 100, 101 AND 102).

**CLASS 37—CONSTRUCTION AND REPAIR**

FOR REAL ESTATE DEVELOPMENT SERVICES; CONSTRUCTION OF BUILDINGS (U.S. CLS. 100, 103 AND 106).  
EVIN L. KOZAK, EXAMINING ATTORNEY

SN 86-078,136. CAFETERIA GROUP LLC, NEW YORK, NY. FILED 9-30-2013.

**CAFETERIA**

THE MARK CONSISTS OF STANDARD CHARACTERS WITHOUT CLAIM TO ANY PARTICULAR FONT, STYLE, SIZE, OR COLOR.  
OWNER OF U.S. REG. NOS. 2,353,649 AND 3,856,615.

**CLASS 21—HOUSEWARES AND GLASS**

FOR WATER BOTTLES, SOLD EMPTY (U.S. CLS. 2, 13, 23, 29, 30, 33, 40 AND 50).  
FIRST USE 7-31-2008; IN COMMERCE 7-31-2008.

**CLASS 25—CLOTHING**

FOR T-SHIRTS, SHIRTS, CAPS, APRONS, FOOTWEAR (U.S. CLS. 22 AND 39).  
FIRST USE 12-31-1999; IN COMMERCE 12-31-1999.

**CLASS 32—LIGHT BEVERAGES**

FOR ENERGY DRINKS (U.S. CLS. 45, 46 AND 48).  
FIRST USE 7-31-2005; IN COMMERCE 7-31-2005.  
FRED CARL, EXAMINING ATTORNEY

SN 86-079,501. SELECT JEWELRY, INC., LONG ISLAND CITY, NY. FILED 10-1-2013.

**MODERN PRINCESS**

THE MARK CONSISTS OF STANDARD CHARACTERS WITHOUT CLAIM TO ANY PARTICULAR FONT, STYLE, SIZE, OR COLOR.

**CLASS 14—JEWELRY**

FOR JEWELRY, NAMELY, WEDDING BANDS, RINGS, BRACELETS, PENDANTS, EARRINGS, NECKLACES, BROOCHES AND PINS (U.S. CLS. 2, 27, 28 AND 50).

**CLASS 35—ADVERTISING AND BUSINESS**

FOR RETAIL STORE SERVICES AND RETAIL ONLINE SERVICES FEATURING JEWELRY, INCLUDING RINGS, WATCHES, BRACELETS, PENDANTS, EARRINGS, NECKLACES, BROOCHES AND PINS (U.S. CLS. 100, 101 AND 102).  
PRISCILLA MILTON, EXAMINING ATTORNEY

SN 86-079,884. LEVEL 3 COMMUNICATIONS, LLC, BROOMFIELD, CO. FILED 10-1-2013.

**CONNECTING AND PROTECTING THE NETWORKED WORLD**

THE MARK CONSISTS OF STANDARD CHARACTERS WITHOUT CLAIM TO ANY PARTICULAR FONT, STYLE, SIZE, OR COLOR.

**CLASS 35—ADVERTISING AND BUSINESS**

FOR BUSINESS CONSULTATION IN THE FIELD OF TELECOMMUNICATIONS AND WIDE AREA NETWORKS (WAN) MANAGEMENT (U.S. CLS. 100, 101 AND 102).

**CLASS 38—COMMUNICATION**

FOR TELECOMMUNICATIONS GATEWAY SERVICES; ELECTRONIC STREAMING, TRANSMISSION AND DELIVERY OF AUDIO AND VIDEO MESSAGES AND IMAGES ON THE INTERNET OR AN INTRANET; TELEVISION TRANSMISSION SERVICES AND SATELLITE TRANSMISSION SERVICES; PROVIDING COMPUTER NETWORK ACCESS SERVICES TO OTHERS, NAMELY, ETHERNET SERVICES, MANAGED ROUTER SERVICES AND VIRTUAL PRIVATE NETWORKS (VPN); PROVIDING VIDEO, VOICE AND DATA TRANSMISSION SERVICES USING AN INTEGRATED ACCESS DEVICE, NAMELY, TELECOMMUNICATION HARDWARE AND EQUIPMENT; PROVIDING FACILITIES, EQUIPMENT AND VOICE, DATA, GRAPHICS, IMAGES, AUDIO AND VIDEO TRANSPORT-BASED COMMUNICATION SERVICES; PROVIDING FACILITIES, EQUIPMENT AND VOICE, DATA, GRAPHICS, IMAGES, AUDIO AND VIDEO TRANSPORT-BASED COMMUNICATION SERVICES (U.S. CLS. 100, 101 AND 104).

SN 86-080,231. QUOTABELLE, INC., FAIRFAX, VA. FILED 10-1-2013.

# QUOTABELLE

**CLASS 39—TRANSPORTATION AND STORAGE**

FOR ELECTRONIC STORAGE OF MEDIA CONTENT (U.S. CLS. 100 AND 105).  
SUSAN RICHARDS, EXAMINING ATTORNEY

SN 86-079,950. FERGUSON ENTERPRISES, INC., NEWPORT NEWS, VA. FILED 10-1-2013.



THE COLOR(S) LIGHT BLUE IS/ARE CLAIMED AS A FEATURE OF THE MARK.

THE MARK CONSISTS OF A STYLIZED CAPITAL LETTER "M" IN LIGHT BLUE.

**CLASS 11—ENVIRONMENTAL CONTROL APPARATUS**

FOR PLUMBING SUPPLIES, NAMELY, WATER DISPENSERS, FAUCET HOLE COVERS, AIR GAPS; PLUMBING FITTINGS, NAMELY, AERATORS, FLUSH LEVERS, SINK STRAINERS, DRAINS, DRAIN EXTENSIONS, TRAPS, STOPS, SUPPLY TUBES AND SPOUTS; SHOWERHEADS AND COMPONENTS THEREOF; TUB SPOUTS; TUB PARTS, NAMELY, TUB OVERFLOWS, SHOWER CONTROL FITTINGS, NAMELY, ESCUTCHEONS AND SHOWER FAUCET EXTENSIONS (U.S. CLS. 13, 21, 23, 31 AND 34).  
FIRST USE 6-0-2012; IN COMMERCE 6-0-2012.

**CLASS 21—HOUSEWARES AND GLASS**

FOR SOAP DISPENSERS; DRAIN STOPPERS FOR SINKS AND DRAINS (U.S. CLS. 2, 13, 23, 29, 30, 33, 40 AND 50).  
FIRST USE 6-0-2012; IN COMMERCE 6-0-2012.  
WILLIAM P. SHANAHAN, EXAMINING ATTORNEY

THE MARK CONSISTS OF STANDARD CHARACTERS WITHOUT CLAIM TO ANY PARTICULAR FONT, STYLE, SIZE, OR COLOR.

**CLASS 9—ELECTRICAL AND SCIENTIFIC APPARATUS**

FOR COMPUTER SOFTWARE FOR WIRELESS CONTENT DELIVERY; COMPUTER SOFTWARE FOR TELLING STORIES ABOUT FAMOUS PEOPLE; COMPUTER SOFTWARE FOR ACCESSING, STORING, RETRIEVING, SHARING AND MAINTAINING QUOTATIONS FROM FAMOUS PEOPLE; COMPUTER SOFTWARE FOR CREATING SEARCHABLE DATABASES OF INFORMATION AND DATA; COMPUTER APPLICATION SOFTWARE FOR MOBILE PHONES AND TABLETS, NAMELY, SOFTWARE FOR TELLING STORIES ABOUT AND PROVIDING QUOTATIONS FROM FAMOUS PEOPLE; DOWNLOADABLE MOBILE APPLICATIONS FOR PROVIDING QUOTATIONS FROM AND TELLING STORIES ABOUT FAMOUS PEOPLE; DOWNLOADABLE COMPUTER SOFTWARE FOR PROVIDING QUOTATIONS FROM AND TELLING STORIES ABOUT FAMOUS PEOPLE; ELECTRONIC DATABASE IN THE FIELD OF QUOTATIONS FROM FAMOUS PEOPLE (U.S. CLS. 21, 23, 26, 36 AND 38).

**CLASS 41—EDUCATION AND ENTERTAINMENT**

FOR EDUCATIONAL SERVICES, NAMELY, PROVIDING AN ON-LINE COMPUTER DATABASE FEATURING INFORMATION REGARDING QUOTATIONS FROM AND STORIES ABOUT FAMOUS PEOPLE (U.S. CLS. 100, 101 AND 107).

**CLASS 42—SCIENTIFIC AND COMPUTER SERVICES**

FOR COMPUTER SOFTWARE DESIGN AND DEVELOPMENT; COMPUTER SOFTWARE DEVELOPMENT IN THE FIELD OF MOBILE APPLICATIONS; PROVIDING A WEBSITE FEATURING ON-LINE NON-DOWNLOADABLE SOFTWARE FOR PROVIDING QUOTATIONS FROM AND TELLING STORIES ABOUT FAMOUS PEOPLE; PLATFORM AS A SERVICE (PAAS) FEATURING COMPUTER SOFTWARE PROGRAMS TO MANAGE CONTENT CREATORS AND CONTENT CREATION IN THE FORM OF TEXT, IMAGES, VIDEOS, SOUND AND THE LIKE BASED ON CONSUMER DEMAND FOR SPECIFIC INFORMATION (U.S. CLS. 100 AND 101).  
DAVID MURRAY, EXAMINING ATTORNEY

SN 86-080,686. OMM TRAINING, LLC, PELHAM MANOR, NY. FILED 10-2-2013.

**OMM**

THE MARK CONSISTS OF STANDARD CHARACTERS WITHOUT CLAIM TO ANY PARTICULAR FONT, STYLE, SIZE, OR COLOR.

**CLASS 9—ELECTRICAL AND SCIENTIFIC APPARATUS**

FOR COMPUTER APPLICATION SOFTWARE FOR MOBILE PHONES, DESKTOP COMPUTERS, PORTABLE MEDIA PLAYERS, AND HAND HELD COMPUTERS, NAMELY, SOFTWARE FOR MEDITATION, MINDFULNESS, STRESS RELIEF, IMPROVED DECISION MAKING, IMPROVED LEADERSHIP, AND INCREASED RESILIENCE (U.S. CLS. 21, 23, 26, 36 AND 38).

**CLASS 35—ADVERTISING AND BUSINESS**

FOR BUSINESS MANAGEMENT CONSULTING SERVICES IN THE FIELD OF USING SELF-EMPOWERMENT AND MEDITATIVE TECHNIQUES TO IMPROVE BUSINESS PERFORMANCE AND PRODUCTIVITY (U.S. CLS. 100, 101 AND 102).

**CLASS 41—EDUCATION AND ENTERTAINMENT**

FOR BUSINESS EDUCATION AND TRAINING SERVICES, NAMELY, DEVELOPING AND FACILITATING CUSTOMIZED LEADERSHIP AND EXECUTIVE DEVELOPMENT PROGRAMS, PROVIDING EXECUTIVE COACHING SERVICES, AND PROVIDING BUSINESS EDUCATION PROGRAMS TO EMPLOYEES AND EXECUTIVES; LEADERSHIP DEVELOPMENT TRAINING IN THE FIELD OF USING SELF EMPOWERMENT AND MEDITATIVE TECHNIQUES TO IMPROVE BUSINESS PERFORMANCE AND PRODUCTIVITY; MEDITATION TRAINING; PERSONAL COACHING SERVICES IN THE FIELD OF PERSONAL DEVELOPMENT, NAMELY, SELF-IMPROVEMENT, SELF-FULFILLMENT, AND INTERPERSONAL COMMUNICATION (U.S. CLS. 100, 101 AND 107).

NICHOLAS COLEMAN, EXAMINING ATTORNEY

SN 86-081,471. THE PILLSBURY COMPANY, LLC, MINNEAPOLIS, MN. FILED 10-3-2013.



OWNER OF U.S. REG. NOS. 669,633, 1,671,946 AND OTHERS.

THE MARK CONSISTS OF A DOUGH LIKE FIGURE WITH HIS LEFT ARM RAISED, WEARING A CHEF'S HAT AND NECK SCARF HOLDING A CIRCULAR SIGN WITH THE WORD "PILLSBURY" ENCLOSED IN A DOTTED BORDER. THE CIRCLE ON THE CHEF'S HAT CONTAINS ILLEGIBLE WRITING.

**CLASS 29—MEATS AND PROCESSED FOODS**

FOR FROZEN PACKAGED MEAL CONSISTING OF EGGS, MEAT, VEGETABLES AND CHEESE SAUCE (U.S. CL. 46).  
FIRST USE 7-18-2011; IN COMMERCE 7-18-2011.

**CLASS 30—STAPLE FOODS**

FOR BISCUIT SANDWICHES; DOUGH (U.S. CL. 46).  
FIRST USE 7-18-2011; IN COMMERCE 7-18-2011.  
KAREN SEVERSON, EXAMINING ATTORNEY

SN 86-081,970. PROVIMI NORTH AMERICA, INC., BROOKVILLE, OH. FILED 10-3-2013.

**NURTURE PROFESSIONAL**

THE MARK CONSISTS OF STANDARD CHARACTERS WITHOUT CLAIM TO ANY PARTICULAR FONT, STYLE, SIZE, OR COLOR.

NO CLAIM IS MADE TO THE EXCLUSIVE RIGHT TO USE "PROFESSIONAL", APART FROM THE MARK AS SHOWN.

**CLASS 5—PHARMACEUTICALS**

FOR NON-MEDICATED ANIMAL FEED SUPPLEMENTS FOR LIVESTOCK (U.S. CLS. 6, 18, 44, 46, 51 AND 52).

**CLASS 31—NATURAL AGRICULTURAL PRODUCTS**

FOR ANIMAL FEED FOR LIVESTOCK (U.S. CLS. 1 AND 46).  
ANGELA M. MICHELI, EXAMINING ATTORNEY

SN 86-083,162. WEST CORPORATION, OMAHA, NE. FILED 10-4-2013.

**INFORMED RESPONSE**

THE MARK CONSISTS OF STANDARD CHARACTERS WITHOUT CLAIM TO ANY PARTICULAR FONT, STYLE, SIZE, OR COLOR.

**CLASS 9—ELECTRICAL AND SCIENTIFIC APPARATUS**

FOR COMPUTER SOFTWARE FOR DATABASE MANAGEMENT FOR USE WITH AN INFORMATION MANAGEMENT SYSTEM; COMPUTER SOFTWARE FOR PROVIDING EMERGENCY SUPPORT INFORMATION VIA TELEPHONE AND COMMUNICATIONS DEVICES FROM CALLERS TO EMERGENCY MANAGEMENT SYSTEM PERSONNEL; COMPUTER SOFTWARE FOR MANAGEMENT AND HANDLING OF 911 EMERGENCY CALLS, NAMELY, SOFTWARE FOR COMPUTER SERVERS HOSTING EMERGENCY COMMUNICATION DATABASES, AND SOFTWARE FOR CLIENT PC-BASED WORKSTATIONS FROM WHICH EMERGENCY COMMUNICATION DATA IS ACCESSED; TELECOMMUNICATIONS PRODUCTS FOR AUTOMATIC NUMBER AND LOCATION IDENTIFICATION SYSTEMS TO PERFORM ENHANCED EMERGENCY CALL FUNCTIONS, NAMELY, MULTIPLEXERS AND ELECTRICAL CONTROLLERS; COMPUTER SOFTWARE FOR USE IN THE FIELD OF PUBLIC SAFETY ANSWERING SYSTEMS TO CONTROL AUTOMATIC NUMBER AND LOCATION IDENTIFICATION MICROPROCESSORS, AND TO COLLECT, DISPLAY AND STORE INCOMING CALL INFORMATION, MANAGE RECORDS OF INCOMING CALLS, AND AID IN DISPATCHING EMERGENCY PERSONNEL; AUTOMATIC NUMBER AND LOCATION IDENTIFICATION SYSTEMS TO PERFORM ENHANCED EMERGENCY CALL FUNCTIONS COMPRISED OF DISPLAY MONITORS, COMPUTER PROGRAMS TO CONTROL AUTOMATIC NUMBER AND LOCATION IDENTIFICATION MICROPROCESSORS, AND TO COLLECT, DISPLAY AND STORE INCOMING CALL INFORMATION, ALTERNATE MICROPROCESSOR CONTROL CARDS, MULTIPLEXERS, ELECTRICAL CONTROLLERS, COMPUTER TERMINALS, KEY PADS, AND PRINTERS (U.S. CLS. 21, 23, 26, 36 AND 38).

**CLASS 38—COMMUNICATION**

FOR COMMUNICATION SERVICES, NAMELY, ELECTRONIC COMMUNICATION AND INFORMATION SYSTEMS THAT FACILITATE ACCESS TO AND USE OF EMERGENCY INFORMATION BY EMERGENCY ADMINISTRATION PERSONNEL, PUBLIC SERVICE ACCESS PROVIDERS, PUBLIC SAFETY AGENCIES, AND COMMERCIAL FIRMS PROVIDING EMERGENCY SERVICES; TELECOMMUNICATION SERVICES, NAMELY, PROVIDING ACCESS TO AND USE OF DATABASES OF EMERGENCY INFORMATION BY EMERGENCY ADMINISTRATION PERSONNEL AND PUBLIC SERVICES ACCESS PROVIDERS; TELECOMMUNICATIONS SERVICES, NAMELY, PROVIDING ACCESS TO, USE OF AND ROUTING OF EMERGENCY ADMINISTRATION PERSONNEL AND PUBLIC SERVICES ACCESS PROVIDERS BY PROVIDING TELEPHONE, WIRELESS, FACSIMILE AND DATA COMMUNICATIONS MESSAGING SERVICES; COMMUNICATION SERVICES, NAMELY, EMERGENCY BROADCASTING SERVICES, NAMELY, TRANSMITTING WARNINGS VIA RADIO, TELEVISION, COMPUTER TERMINALS FOR IDENTIFYING AND NOTIFYING A DESIGNATED POPULATION OF AN IMPENDING SITUATION; COMMUNICATION SERVICES, NAMELY, ELECTRONIC COMMUNICATION AND INFORMATION SYSTEMS THAT FACILITATE THE SENDING, STORING AND RECEIVING VOICE MESSAGES OVER TELECOMMUNICATIONS NETWORKS AND GLOBAL COMPUTER NETWORKS, NAMELY, PROVIDING ELECTRONIC MESSAGING SERVICES; COMMUNICATION SERVICES, NAMELY, PROVIDING ACCESS TO A DATABASE OF EMERGENCY SUPPORT INFORMATION; COMMUNICATION SERVICES, NAMELY, ELECTRONIC COMMUNICATION SYSTEMS CONSISTING OF LOCAL AND GLOBAL TELECOMMUNICATIONS AND COMPUTER NETWORKS THAT FACILITATE ACCESS TO EMERGENCY INFORMATION DATABASES; TELECOMMUNICATIONS SERVICES, NAMELY, A NATIONWIDE COMPREHENSIVE SERVICE CONSISTING OF LOCAL AND GLOBAL NETWORKS FOR WIRELESS LONG DISTANCE PROVIDERS, LOCAL TELEPHONE COMPANIES, SATELLITE COMMUNICATIONS COMPANIES, ALTERNATIVE AND COMPETITIVE LOCAL EXCHANGE CARRIERS, AND OTHER TELECOMMUNICATIONS PROVIDERS TO INTERCONNECT AND INTEGRATE DISPARATE SYSTEMS AND TRADI-

TIONAL TELECOMMUNICATIONS PROVIDERS TO PROVIDE AUTOMATED CALL ROUTING FOR ACCESS TO EMERGENCY SUPPORT PUBLIC SAFETY ANSWERING POINTS; TELECOMMUNICATIONS SERVICES, NAMELY, A PRIVATE INFORMATION AND NOTIFICATION SYSTEM FOR COMMUNICATING CRITICAL EMERGENCY INFORMATION ABOUT SUBSCRIBERS TO PUBLIC SAFETY ANSWERING POINTS AND TO RESPONDING FIELD UNITS AND TO NOTIFY SUBSCRIBER DESIGNATED CONTACTS (U.S. CLS. 100, 101 AND 104).

**CLASS 42—SCIENTIFIC AND COMPUTER SERVICES**

FOR COMPUTER SERVICES, NAMELY, PROVIDING ON-LINE DATABASES OF NAMES, ADDRESSES, PHONE NUMBERS AND UPDATABLE BY ELECTRONIC MEANS FOR STORING, UPDATING AND RETRIEVING INFORMATION USEFUL TO PROVIDERS OF EMERGENCY SERVICES; COMPUTER SERVICES, NAMELY, PROVIDING INDIVIDUAL DATABASES TO THE GENERAL PUBLIC TO ACCESS AND INPUT PERSONALIZED EMERGENCY INFORMATION AND PREFERENCES WHICH MAY BE USEFUL TO PROVIDERS OF EMERGENCY SERVICES SUCH AS FAMILY INFORMATION, EMERGENCY CONTACT INFORMATION, MEDICAL CONDITIONS, SECURITY ASSESS CODES, LANGUAGE LIMITATIONS, CLERGY AND RELIGIOUS PREFERENCES, FAMILY NOTIFICATION INSTRUCTIONS, PERSONNEL INFORMATION, MEDICAL TREATMENT PREFERENCES, MEDICAL SERVICE PROVIDER PREFERENCES; EMERGENCY RESPONSE SERVICES, NAMELY, MONITORING TELEPHONE CALLS IN ORDER TO PROVIDE INFORMATION AND ASSISTANCE IN EMERGENCY AND NON-EMERGENCY SITUATIONS, AND NOTIFYING EMERGENCY FACILITIES AND DESIGNATED THIRD PARTIES (U.S. CLS. 100 AND 101).

MARIA-VICTORIA SUAREZ, EXAMINING ATTORNEY

SN 86-083,883. JOHNSON & JOHNSON, NEW BRUNSWICK, NJ. FILED 10-7-2013.

**PODER A TU BOCA**

THE MARK CONSISTS OF STANDARD CHARACTERS WITHOUT CLAIM TO ANY PARTICULAR FONT, STYLE, SIZE, OR COLOR.

OWNER OF U.S. REG. NO. 4,355,608.

THE ENGLISH TRANSLATION OF "PODER A TU BOCA" IN THE MARK IS "POWER TO YOUR MOUTH".

**CLASS 3—COSMETICS AND CLEANING PREPARATIONS**

FOR NON-MEDICATED MOUTHWASH; COSMETIC PREPARATIONS FOR THE CARE OF MOUTH AND TEETH, NAMELY, ORAL MISTS; BREATH FRESHENERS; TOOTHPASTE; COSMETIC TOOTH WHITENING PREPARATIONS (U.S. CLS. 1, 4, 6, 50, 51 AND 52).

**CLASS 5—PHARMACEUTICALS**

FOR MEDICATED MOUTHWASH; FLUORIDE MOUTHWASH (U.S. CLS. 6, 18, 44, 46, 51 AND 52).

**CLASS 21—HOUSEWARES AND GLASS**

FOR DENTAL FLOSS; DENTAL FLOSSERS (U.S. CLS. 2, 13, 23, 29, 30, 33, 40 AND 50).

HEATHER THOMPSON, EXAMINING ATTORNEY

SN 86-084,114. TRUECAR, INC., SANTA MONICA, CA.  
FILED 10-7-2013.

# TRUEBOOK

THE MARK CONSISTS OF STANDARD CHARACTERS WITHOUT CLAIM TO ANY PARTICULAR FONT, STYLE, SIZE, OR COLOR.  
OWNER OF U.S. REG. NOS. 3,759,175, 4,436,580 AND OTHERS.

## CLASS 35—ADVERTISING AND BUSINESS

FOR PROVIDING MOTORIZED VEHICLE PURCHASE ADVISORY AND CONSULTING SERVICES; PROVIDING MOTORIZED VEHICLE VALUE ADVISORY AND PRICE EVALUATION SERVICES; PROVIDING INFORMATION VIA A GLOBAL COMPUTER NETWORK CONCERNING THE PRICE AND VALUE OF MOTORIZED VEHICLES; PROVIDING CONSUMER PRODUCT INFORMATION FOR THE PURPOSE OF SELECTING MOTOR VEHICLES TO MEET THE CONSUMER'S SPECIFICATIONS; STATISTICAL ANALYSIS OF NATIONAL AND REGIONAL MOTORIZED VEHICLE PRICE DATA; PROVIDING MOTORIZED VEHICLE PRICE REPORTS THAT INCLUDE A STATISTICAL ANALYSIS OF PRICE FOR A PARTICULAR VEHICLE BASED ON ACTUAL PURCHASE DATA; MARKETING AND ADVERTISING SERVICES FOR SELLERS OF NEW AND USED MOTORIZED VEHICLES, MOTORIZED VEHICLE PARTS AND ACCESSORIES, AND MOTORIZED VEHICLE REPAIR, CUSTOMIZATION AND RESTORATION SERVICES; PROVIDING CONSUMER PRODUCT INFORMATION VIA A GLOBAL COMPUTER NETWORK BASED ON MOTORIZED VEHICLE SPECIFICATIONS; PROVIDING CONSUMER PRODUCT INFORMATION VIA A GLOBAL COMPUTER NETWORK BASED ON THE GAS MILEAGE AND FUEL EFFICIENCY OF MOTORIZED VEHICLES; PROVIDING CONSUMER PRODUCT INFORMATION VIA A GLOBAL COMPUTER NETWORK IN CONNECTION WITH THE GAS MILEAGE AND FUEL EFFICIENCY OF MOTORIZED VEHICLES; PRICE DATA COMPILING AND STATISTICAL ANALYSIS CONCERNING MOTORIZED VEHICLE INSURANCE; PROVIDING CONSUMER PRODUCT INFORMATION, NAMELY, MOTORIZED VEHICLE INSURANCE PRICE REPORTS BASED ON STATISTICAL ANALYSIS OF MARKET DATA; MARKETING AND ADVERTISING SERVICES OF MOTORIZED VEHICLE INSURANCE FOR OTHERS; PROVIDING MOTORIZED VEHICLE PURCHASE AND LEASE FINANCING EVALUATION SERVICES FOR CONSUMERS; PROVIDING CONSUMER INFORMATION VIA A GLOBAL COMPUTER NETWORK IN CONNECTION WITH THE FINANCING OF MOTORIZED VEHICLE PURCHASES AND LEASES; STATISTICAL ANALYSIS OF MOTORIZED VEHICLE PURCHASE AND LEASE FINANCING DATA; PROVIDING CONSUMER INFORMATION IN THE NATURE OF MOTORIZED VEHICLE PURCHASE AND LEASE FINANCING REPORTS BASED ON STATISTICAL ANALYSIS OF MARKET DATA; MARKETING AND ADVERTISING SERVICES OF MOTORIZED VEHICLE LEASES AND MOTORIZED VEHICLE FINANCING FOR OTHERS (U.S. CLS. 100, 101 AND 102).

## CLASS 42—SCIENTIFIC AND COMPUTER SERVICES

FOR PROVIDING A WEBSITE FEATURING TEMPORARY USE OF NON-DOWNLOADABLE SOFTWARE ALLOWING WEBSITE USERS TO SEARCH FOR, RESEARCH, PURCHASE AND SELL MOTORIZED VEHICLES; PROVIDING A WEB SITE FEATURING TEMPORARY USE OF NON-DOWNLOADABLE SOFTWARE ALLOWING WEBSITE USERS TO RESEARCH MOTORIZED VEHICLE SPECIFICATIONS; PROVIDING A WEBSITE FEATURING TEMPORARY USE OF NON-DOWNLOADABLE SOFTWARE ALLOWING WEBSITE USERS TO RESEARCH MOTORIZED VEHICLE GAS MILEAGE AND FUEL EFFICIENCY INFORMATION (U.S. CLS. 100 AND 101).

LAURA KOVALSKY, EXAMINING ATTORNEY

SN 86-084,151. GOLDEN SUN, INC., DBA NEWHALL LABORATORIES, INC., STAMFORD, CT. FILED 10-7-2013.

# El Secreto De La Belleza Latina

THE MARK CONSISTS OF STANDARD CHARACTERS WITHOUT CLAIM TO ANY PARTICULAR FONT, STYLE, SIZE, OR COLOR.

NO CLAIM IS MADE TO THE EXCLUSIVE RIGHT TO USE "LATINA", APART FROM THE MARK AS SHOWN.

THE ENGLISH TRANSLATION OF "EL SECRETO DE LA BELLEZA LATINA" IN THE MARK IS "THE SECRET OF LATIN BEAUTY".

## CLASS 3—COSMETICS AND CLEANING PREPARATIONS

FOR HAIR SHAMPOO; HAIR CONDITIONER; BODY LOTIONS; LIQUID BODY SOAP; BAR SOAP; HAIR STYLING AIDS, NAMELY, STYLING GELS, STYLING MOUSSE, HAIR WAX POMADES, HAIR GEL POMADES, AND HAIR SPRAYS; HAIR TREATMENTS, NAMELY, CONDITIONING TREATMENTS, HOT OILS, AND CONDITIONING HAIRDRESSINGS; SKIN CREAM; SKIN MOISTURIZER; FACIAL CLEANSER; FACIAL SCRUB; TONING GEL; BATH GEL; SHOWER GEL; FOAMING BATH GEL; FOOT SCRUBS; FOOT MOISTURIZERS; AND FOOT EXFOLIATING LOTIONS (U.S. CLS. 1, 4, 6, 50, 51 AND 52).

## CLASS 5—PHARMACEUTICALS

FOR TOPICAL CREAMS AND OINTMENTS FOR THE RELIEF OF ACHES AND PAIN (U.S. CLS. 6, 18, 44, 46, 51 AND 52).

MICHELE SWAIN, EXAMINING ATTORNEY

SN 86-086,042. PURDUE RESEARCH FOUNDATION, WEST LAFAYETTE, IN. FILED 10-8-2013.

# SMARTER AGRICULTURE

THE MARK CONSISTS OF STANDARD CHARACTERS WITHOUT CLAIM TO ANY PARTICULAR FONT, STYLE, SIZE, OR COLOR.

NO CLAIM IS MADE TO THE EXCLUSIVE RIGHT TO USE "AGRICULTURE", APART FROM THE MARK AS SHOWN.

SN 86-086,545. CHOBANI, INC., NORWICH, NY. FILED 10-9-2013.

### CLASS 9—ELECTRICAL AND SCIENTIFIC APPARATUS

FOR SOFTWARE FOR USE IN TRACKING, MANAGING, ANALYZING AND COMMUNICATING DATA IN THE FIELD OF AGRICULTURE; MOBILE APPLICATION FOR USE IN TRACKING, MANAGING, ANALYZING AND COMMUNICATING DATA IN THE FIELD OF AGRICULTURE (U.S. CLS. 21, 23, 26, 36 AND 38).

### CLASS 41—EDUCATION AND ENTERTAINMENT

FOR EDUCATIONAL SERVICES, NAMELY, PROVIDING COURSES OF INSTRUCTION AT THE COLLEGE LEVEL IN THE FIELD OF AGRICULTURE, NAMELY, COURSES RELATED TO THE COLLECTION, ANALYSIS, DOCUMENTATION AND USE OF AGRICULTURAL DATA, AND DISTRIBUTION OF COURSE MATERIALS IN CONNECTION THEREWITH; EDUCATIONAL SERVICES, NAMELY, CONDUCTING SEMINARS, CONFERENCES, CLASSES AND WORKSHOPS IN THE FIELD OF AGRICULTURE, NAMELY, COURSES RELATED TO THE COLLECTION, ANALYSIS, DOCUMENTATION AND USE OF AGRICULTURAL DATA, AND DISTRIBUTION OF COURSE MATERIALS IN CONNECTION THEREWITH (U.S. CLS. 100, 101 AND 107).

### CLASS 42—SCIENTIFIC AND COMPUTER SERVICES

FOR PROVIDING A WEBSITE FEATURING AGRICULTURAL DATA AND INFORMATION REGARDING AGRICULTURAL RESEARCH; PROVIDING NON-DOWNLOADABLE SOFTWARE FOR USE IN TRACKING, MANAGING, ANALYZING AND COMMUNICATING DATA IN THE FIELD OF AGRICULTURE; COLLECTION AND ANALYSIS OF AGRICULTURAL DATA FOR RESEARCH PURPOSES (U.S. CLS. 100 AND 101).

ANTHONY RINKER, EXAMINING ATTORNEY

SN 86-086,329. WING ENTERPRISES, INC., SPRINGVILLE, UT. FILED 10-8-2013.

## KICKSTAND

THE MARK CONSISTS OF STANDARD CHARACTERS WITHOUT CLAIM TO ANY PARTICULAR FONT, STYLE, SIZE, OR COLOR.

### CLASS 6—METAL GOODS

FOR METAL LADDERS (U.S. CLS. 2, 12, 13, 14, 23, 25 AND 50).

### CLASS 20—FURNITURE AND ARTICLES NOT OTHERWISE CLASSIFIED

FOR NON-METAL LADDERS (U.S. CLS. 2, 13, 22, 25, 32 AND 50).  
JOHN KELLY, EXAMINING ATTORNEY

## HOW MATTERS

THE MARK CONSISTS OF STANDARD CHARACTERS WITHOUT CLAIM TO ANY PARTICULAR FONT, STYLE, SIZE, OR COLOR.

### CLASS 30—STAPLE FOODS

FOR FROZEN CONFECTIONS; FROZEN YOGURT; FROZEN YOGURT CONFECTIONS (U.S. CL. 46).

### CLASS 43—HOTEL AND RESTAURANT SERVICES

FOR RESTAURANT SERVICES; CAFÉ SERVICES (U.S. CLS. 100 AND 101).  
NAKIA HENRY, EXAMINING ATTORNEY

SN 86-086,829. AHN BEAUTY, LLC, BELLPORT, NY. FILED 10-9-2013.



THE COLOR(S) BLACK, WHITE AND RED IS/ARE CLAIMED AS A FEATURE OF THE MARK.

THE MARK CONSISTS OF THE WORDING "LOVE + HALO" IN THE COLOR WHITE, UNDER A RED HEART AND WHITE HALO, ALL ON A BLACK RECTANGULAR BACKGROUND.

### CLASS 3—COSMETICS AND CLEANING PREPARATIONS

FOR FRAGRANCES, NAMELY, PERFUMES, COLOGNES, EAU DE TOILETTE, PERFUMED BATH GELS, PERFUMED BODY LOTIONS, PERFUMED BODY POWDERS; SOAPS; COSMETICS, FOUNDATION; SKINCARE PREPARATIONS, NAMELY, FACE AND BODY MOISTURIZERS, FACIAL CLEANSERS, EYE CREAMS AND GELS, SKIN CREAMS AND LOTIONS; HAIR SHAMPOOS AND CONDITIONERS, HAIR SPRAY, HAIR GELS (U.S. CLS. 1, 4, 6, 50, 51 AND 52).

### CLASS 8—HAND TOOLS

FOR ELECTRIC IRONS FOR STYLING HAIR (U.S. CLS. 23, 28 AND 44).

### CLASS 11—ENVIRONMENTAL CONTROL APPARATUS

FOR HAIR DRYERS (U.S. CLS. 13, 21, 23, 31 AND 34).  
WANDA KAY PRICE, EXAMINING ATTORNEY

SN 86-087,158. FLOWER, ELIZABETH RAMSEY, VAIL, CO.  
FILED 10-9-2013.

## amazing life beer

THE MARK CONSISTS OF STANDARD CHARACTERS WITHOUT CLAIM TO ANY PARTICULAR FONT, STYLE, SIZE, OR COLOR.

NO CLAIM IS MADE TO THE EXCLUSIVE RIGHT TO USE "BEER", APART FROM THE MARK AS SHOWN.

### CLASS 25—CLOTHING

FOR ATHLETIC APPAREL, NAMELY, SHIRTS, PANTS, JACKETS, FOOTWEAR, HATS AND CAPS, ATHLETIC UNIFORMS (U.S. CLS. 22 AND 39).

### CLASS 32—LIGHT BEVERAGES

FOR BEER (U.S. CLS. 45, 46 AND 48).  
MATTHEW MCDOWELL, EXAMINING ATTORNEY

SN 86-088,040. FROMM INTERNATIONAL, INC., MT. PROSPECT, IL. FILED 10-10-2013.

## DIANE

THE MARK CONSISTS OF STANDARD CHARACTERS WITHOUT CLAIM TO ANY PARTICULAR FONT, STYLE, SIZE, OR COLOR.

OWNER OF U.S. REG. NO. 949,766.

### CLASS 8—HAND TOOLS

FOR BLADES AND BRUSHES FOR ELECTRIC HAIR CLIPPERS AND TRIMMERS; BLADES FOR SHEARS; CALLUS CUTTERS; ELECTRIC HAIR STRAIGHTENER; ELECTRIC RAZORS AND ELECTRIC HAIR CLIPPERS; FLAT IRONS; HAIR CLIPPERS; HAIR CUTTING SCISSORS; HAIR TRIMMERS; HAND-OPERATED SHEARS; MANICURE IMPLEMENTS, NAMELY, NAIL CLIPPERS, NAIL FILES, NAIL BUFFERS, CUTICLE PUSHERS; PEDICURE IMPLEMENTS, NAMELY, NAIL CLIPPERS, NAIL FILES, NAIL BUFFERS, CUTICLE PUSHERS, FOOT CARE IMPLEMENTS, NAMELY, FOOT SCRAPPERS; RAZOR BLADES; RAZOR STROPS; RAZORS; SHAVING BLADES; SHEARS; TWEEZERS (U.S. CLS. 23, 28 AND 44).

FIRST USE 5-0-1967; IN COMMERCE 5-0-1967.

### CLASS 11—ENVIRONMENTAL CONTROL APPARATUS

FOR ELECTRIC HAIR DRYERS (U.S. CLS. 13, 21, 23, 31 AND 34).  
FIRST USE 1-0-2010; IN COMMERCE 1-0-2010.

### CLASS 16—PAPER GOODS AND PRINTED MATTER

FOR APPOINTMENT BOOKS (U.S. CLS. 2, 5, 22, 23, 29, 37, 38 AND 50).  
FIRST USE 7-0-2013; IN COMMERCE 7-0-2013.

### CLASS 20—FURNITURE AND ARTICLES NOT OTHERWISE CLASSIFIED

FOR HAND-HELD MIRRORS; MANNEQUINS; MIRRORS; MIRRORS ENHANCED BY ELECTRIC LIGHTS (U.S. CLS. 2, 13, 22, 25, 32 AND 50).

FIRST USE 1-0-2006; IN COMMERCE 1-0-2006.

### CLASS 21—HOUSEWARES AND GLASS

FOR COMB CASES; COMBS; DISPOSABLE LATEX GLOVES FOR GENERAL USE; EMPTY SPRAY BOTTLES; FACIAL SPONGES FOR APPLYING MAKE-UP; HAIR PICKS; HAIRBRUSHES; MAKE-UP BRUSHES (U.S. CLS. 2, 13, 23, 29, 30, 33, 40 AND 50).

FIRST USE 8-0-1964; IN COMMERCE 8-0-1964.

### CLASS 25—CLOTHING

FOR APRONS; CAPES; GOWNS (U.S. CLS. 22 AND 39).  
FIRST USE 9-4-1945; IN COMMERCE 9-4-1945.

### CLASS 26—FANCY GOODS

FOR BOBBY PINS; ELECTRIC HAIR ROLLERS; HAIR ACCESSORIES, NAMELY, CLAW CLIPS; HAIR CLAMPS; HAIR CLIPS; HAIR COLORING CAPS; HAIR COLORING FOILS; HAIR FROSTING CAPS; HAIR NETS; HAIR PINS; HAIR RODS; NON-ELECTRIC HAIR ROLLERS; RUBBER BANDS FOR HAIR; WIG CAPS (U.S. CLS. 37, 39, 40, 42 AND 50).

FIRST USE 5-0-1967; IN COMMERCE 5-0-1967.

JERI J. FICKES, EXAMINING ATTORNEY

SN 86-088,201. NICOTINE SOLUTIONS INC., ANN ARBOR, MI. FILED 10-10-2013.

## VAPE MONKEY

THE MARK CONSISTS OF STANDARD CHARACTERS WITHOUT CLAIM TO ANY PARTICULAR FONT, STYLE, SIZE, OR COLOR.

NO CLAIM IS MADE TO THE EXCLUSIVE RIGHT TO USE "VAPE", APART FROM THE MARK AS SHOWN.

### CLASS 30—STAPLE FOODS

FOR CARTRIDGES SOLD FILLED WITH CHEMICAL FLAVORINGS IN LIQUID FORM FOR ELECTRONIC CIGARETTES; CHEMICAL FLAVORINGS IN LIQUID FORM USED TO REFILL ELECTRONIC CIGARETTE CARTRIDGES; ELECTRONIC CIGARETTE LIQUID (E-LIQUID) COMPRISED OF FLAVORINGS IN LIQUID FORM USED TO REFILL ELECTRONIC CIGARETTE CARTRIDGES (U.S. CL. 46).

FIRST USE 10-24-2010; IN COMMERCE 10-24-2010.

### CLASS 34—SMOKERS' ARTICLES

FOR CARTOMIZERS, NAMELY, COMBINATION ELECTRONIC CIGARETTE REFILL CARTRIDGES SOLD EMPTY AND ATOMIZERS, SOLD AS A COMPONENT OF ELECTRONIC CIGARETTES; ELECTRONIC CIGARETTE REFILL CARTRIDGES SOLD EMPTY; ELECTRONIC CIGARETTES (U.S. CLS. 2, 8, 9 AND 17).

FIRST USE 10-24-2010; IN COMMERCE 10-24-2010.

LINDSEY BEN, EXAMINING ATTORNEY

SN 86-088,315. VITAL PHARMACEUTICALS, INC., WESTON, FL. FILED 10-10-2013.

SN 86-088,992. TIDMAN, SPENCER, LARMOR-PLAGE, FRANCE, FILED 10-11-2013.

## STRONG ATHLETE

THE MARK CONSISTS OF STANDARD CHARACTERS WITHOUT CLAIM TO ANY PARTICULAR FONT, STYLE, SIZE, OR COLOR.

NO CLAIM IS MADE TO THE EXCLUSIVE RIGHT TO USE "ATHLETE", APART FROM THE MARK AS SHOWN.

### CLASS 5—PHARMACEUTICALS

FOR DIETARY AND NUTRITIONAL SUPPLEMENTS; DIETARY SUPPLEMENTS; NUTRITIONAL SUPPLEMENTS (U.S. CLS. 6, 18, 44, 46, 51 AND 52).

### CLASS 32—LIGHT BEVERAGES

FOR ENERGY DRINKS; ISOTONIC BEVERAGES; ISOTONIC DRINKS (U.S. CLS. 45, 46 AND 48).  
CHARLES L. JENKINS, EXAMINING ATTORNEY

SN 86-088,414. NICOTINE SOLUTIONS INC., ANN ARBOR, MI. FILED 10-10-2013.



THE MARK CONSISTS OF A MONKEY FACE WITH ELECTRONIC CIGARETTE IN MOUTH.

### CLASS 30—STAPLE FOODS

FOR CARTRIDGES SOLD FILLED WITH CHEMICAL FLAVORINGS IN LIQUID FORM FOR ELECTRONIC CIGARETTES; CHEMICAL FLAVORINGS IN LIQUID FORM USED TO REFILL ELECTRONIC CIGARETTE CARTRIDGES; ELECTRONIC CIGARETTE LIQUID (E-LIQUID) COMPRISED OF FLAVORINGS IN LIQUID FORM USED TO REFILL ELECTRONIC CIGARETTE CARTRIDGES (U.S. CL. 46).  
FIRST USE 8-0-2011; IN COMMERCE 8-0-2011.

### CLASS 34—SMOKERS' ARTICLES

FOR CARTOMIZERS, NAMELY, COMBINATION ELECTRONIC CIGARETTE REFILL CARTRIDGES SOLD EMPTY AND ATOMIZERS, SOLD AS A COMPONENT OF ELECTRONIC CIGARETTES; ELECTRONIC CIGARETTE REFILL CARTRIDGES SOLD EMPTY; ELECTRONIC CIGARETTES (U.S. CLS. 2, 8, 9 AND 17).  
FIRST USE 8-0-2011; IN COMMERCE 8-0-2011.  
LINDSEY BEN, EXAMINING ATTORNEY

## SALESTRATUS

THE MARK CONSISTS OF STANDARD CHARACTERS WITHOUT CLAIM TO ANY PARTICULAR FONT, STYLE, SIZE, OR COLOR.

### CLASS 9—ELECTRICAL AND SCIENTIFIC APPARATUS

FOR COMPUTER SOFTWARE FOR USE IN CUSTOMER RELATIONSHIP MANAGEMENT (CRM); DOWNLOADABLE COMPUTER SOFTWARE FOR MARKETING STRATEGY DEVELOPMENT; DOWNLOADABLE COMPUTER SOFTWARE FOR DEVELOPMENT, MANAGEMENT, AND ADMINISTRATION OF MARKETING PROGRAM COMPONENTS; DOWNLOADABLE COMPUTER SOFTWARE FOR SALES LEAD GENERATION, LEAD CAPTURE, SALES INTEGRATION, AND ANALYTICS, TRACKING, AND REPORTING; DOWNLOADABLE COMPUTER SOFTWARE FOR CREATING, EDITING, AND PROVIDING MARKETING PRESENTATIONS, MATERIALS, AND VISUAL AIDS; COMPUTER SOFTWARE FOR DATABASE MANAGEMENT (U.S. CLS. 21, 23, 26, 36 AND 38).

### CLASS 42—SCIENTIFIC AND COMPUTER SERVICES

FOR SOFTWARE AS A SERVICE (SAAS) SERVICES FEATURING SOFTWARE FOR REAL-TIME ERP OR ENTERPRISE RESOURCE PLANNING AND CRM OR CUSTOMER RELATIONSHIP MANAGEMENT DATA INTEGRATION AND DATA MANAGEMENT AND STORAGE; SOFTWARE AS A SERVICE (SAAS) SERVICES FEATURING SOFTWARE FOR USE IN CUSTOMER RELATIONSHIP MANAGEMENT (CRM); SOFTWARE AS A SERVICE (SAAS) SERVICES FEATURING SOFTWARE FOR MARKETING STRATEGY DEVELOPMENT; SOFTWARE AS A SERVICE (SAAS) SERVICES FEATURING SOFTWARE FOR DEVELOPMENT, MANAGEMENT, AND ADMINISTRATION OF MARKETING PROGRAM COMPONENTS; SOFTWARE AS A SERVICE (SAAS) SERVICES FEATURING SOFTWARE FOR SALES LEAD GENERATION, SALES INTEGRATION, AND ANALYTICS, TRACKING, AND REPORTING; SOFTWARE AS A SERVICE (SAAS) SERVICES FEATURING SOFTWARE FOR CREATING, EDITING, AND PROVIDING MARKETING PRESENTATIONS, MATERIALS, AND VISUAL AIDS; SOFTWARE AS A SERVICE (SAAS) SERVICES FEATURING SOFTWARE FOR COLLABORATION AND COMMUNICATION BETWEEN SALES REPRESENTATIVES AND THEIR CUSTOMERS; SOFTWARE AS A SERVICE (SAAS) SERVICES FEATURING SOFTWARE FOR DATABASE MANAGEMENT (U.S. CLS. 100 AND 101).  
SUSAN RICHARDS, EXAMINING ATTORNEY

SN 86-089,142. ORA INVESTMENTS LLC, MIAMI, FL. FILED 10-11-2013.

## VARANDA

THE MARK CONSISTS OF STANDARD CHARACTERS WITHOUT CLAIM TO ANY PARTICULAR FONT, STYLE, SIZE, OR COLOR.



**CLASS 29—MEATS AND PROCESSED FOODS**

FOR BACON; BACON BITS; BACON RINDS; BEEF; BEEF BOUILLON; BEEF JERKY; BEEF PATTIES; BEEF SLICES; BEEF STEW; BEEF STOCK; BEEF TALLOW; BOTTLED COOKED MEAT; CABBAGE ROLLS STUFFED WITH MEAT; CANADIAN BACON; CANNED COOKED MEAT; CHOW MEIN; CORNED BEEF; CORNED BEEF HASH; DRIED BEEF; DRIED MEAT; EDIBLE DECORATIONS FOR MEATS; EDIBLE OILS AND FATS; FISH AND MEAT PRESERVES; EXTRACTS OF MEAT; FISH AND MEAT PRESERVES; FLAKES OF DRIED FISH MEAT (KEZURI-BUSHI); FRANKFURTERS; FRESH MEAT; FRIED MEAT; GRILLED MEAT MARINATED IN SOY SAUCE; HAMBURGER; HEAD CHEESE; HOT DOGS; LUNCHEON MEATS; MARRANITAS, NAMELY, GREEN PLANTAIN SHAPED INTO BALLS FILLED WITH FRIED POTATOES, CHICKEN, BEEF OR SHRIMP; MEAT; MEAT AND MEAT EXTRACTS; MEAT BOILED DOWN IN SOY SAUCE (TSUKUDANI MEAT); MEAT EXTRACT; MEAT EXTRACTS; MEAT JELLIES; MEAT JUICES; MEAT PASTE; MEAT PRESERVES; MEAT SUBSTITUTES; MEAT, FISH, FRUIT AND VEGETABLE JELLIES; MEAT, FISH, FRUIT AND VEGETABLE PRESERVES; MEAT, FISH, POULTRY AND GAME PRESERVES; MEAT, FROZEN; MEAT, FRUIT AND VEGETABLE JELLIES, JAMS; MEAT, FRUIT AND VEGETABLE JELLIES, JAMS, EGGS; MEAT, POULTRY AND GAME; MEAT-BASED MOUSSE; MEAT-BASED SNACK FOODS; MEAT-BASED SPREADS; NUT MEATS; PACKAGED MEATS; POTTED MEATS; PREPARED BEEF; PREPARED ENTREES CONSISTING PRIMARILY OF LOBSTER MEAT DIPPED IN BATTER AND FRIED; PREPARED MEALS CONSISTING PRIMARILY OF MEAT SUBSTITUTES; PREPARED MEAT; PRESERVED MEATS AND SAUSAGES; PROCESSED MEAT; PROCESSED MEAT, NAMELY, KIDNEYS; REFRIGERATED FOOD PACKAGE COMBINATIONS CONSISTING PRIMARILY OF MEAT, CHEESE OR PROCESSED VEGETABLES FOR PURPOSES OF CREATING A SANDWICH; RIBS; ROAST BEEF; SALTED MEAT; SLICED MEAT; TINNED MEAT; TINNED MEAT, FISH, VEGETABLES AND FRUITS; TURKEY BACON; VEGETABLE-BASED MEAT SUBSTITUTES; VIETNAMESE COOKED MEATS, NAMELY, HAM (JAMBON); VIETNAMESE COOKED MEATS, NAMELY, PORK HOT DOGS (CHA LUA); WIENERS (U.S. CL. 46).

**CLASS 35—ADVERTISING AND BUSINESS**

FOR ADVERTISING, MARKETING AND PROMOTING THE GOODS AND SERVICES OF OTHERS USING KIOSKS; FOOD KIOSK SERVICES; MOBILE FOOD KIOSK SERVICES; PROVIDING ADVERTISING SPACE ON BILLBOARDS AND IN KIOSKS; RETAIL AND ON-LINE GROCERY STORE SERVICES FEATURING HOME DELIVERY SERVICE; RETAIL STORE SERVICES FEATURING FOOD AND FOOD RELATED ITEMS (U.S. CLS. 100, 101 AND 102).

**CLASS 43—HOTEL AND RESTAURANT SERVICES**

FOR AGENCY SERVICES FOR RESERVATION OF RESTAURANTS; BAR AND RESTAURANT SERVICES; CAFE AND RESTAURANT SERVICES; CAFE-RESTAURANTS; CAFETERIA AND RESTAURANT SERVICES; CONSULTING IN THE FIELD OF RESTAURANT MENU DEVELOPMENT; DELICATESSEN SERVICES; FAST-FOOD RESTAURANT SERVICES; FAST-FOOD RESTAURANTS; FAST-FOOD RESTAURANTS AND SNACK-BARS; FROZEN YOGURT SHOP SERVICES IN THE NATURE OF A RESTAURANT; HOTEL AND RESTAURANT SERVICES; HOTEL, BAR AND RESTAURANT SERVICES; ICE CREAM SHOP SERVICES IN THE NATURE OF A RESTAURANT; MAKING RESERVATIONS AND BOOKINGS FOR RESTAURANTS AND MEALS; PROVIDING INFORMATION AND ADVICE ON HOTELS AND RESTAURANTS TO TOURISTS AND

BUSINESS TRAVELERS; PROVIDING ON-LINE REVIEWS OF RESTAURANTS AND HOTELS; PROVIDING PROGRESSIVE DINNER EVENTS WHERE PARTICIPANTS SAMPLE MEALS AND DRINKS AT A SERIES OF RESTAURANTS; PROVIDING REVIEWS OF RESTAURANTS; PROVIDING REVIEWS OF RESTAURANTS AND BARS; RESERVATION OF RESTAURANTS; RESTAURANT AND CAFE SERVICES; RESTAURANT AND CATERING SERVICES; RESTAURANT AND HOTEL SERVICES; RESTAURANT INFORMATION SERVICES; RESTAURANT RESERVATION SERVICES; RESTAURANT SERVICES (U.S. CLS. 100 AND 101).

DARRYL SPRUILL, EXAMINING ATTORNEY

SN 86-089,454. STONYFIELD FARM, INC., LONDONDERY, NH. FILED 10-11-2013.



OWNER OF U.S. REG. NOS. 4,042,063, 4,062,634 AND OTHERS.

NO CLAIM IS MADE TO THE EXCLUSIVE RIGHT TO USE "ORGANIC", APART FROM THE MARK AS SHOWN.

THE MARK CONSISTS OF A CURVED QUADRILATERAL SHAPE WITH ROUNDED EDGES AND THREE NOTCHES INWARD ON THE LEFT AND RIGHT SIDE OF THE SHAPE, WITHIN WHICH ARE THE WORDS "STONYFIELD" IN A LARGE, STYLIZED FONT, AND THE WORD "ORGANIC" IN STYLIZED FONT POSITIONED UNDERNEATH THE "F".

**CLASS 5—PHARMACEUTICALS**

FOR ORGANIC BABY FOOD (U.S. CLS. 6, 18, 44, 46, 51 AND 52).

**CLASS 29—MEATS AND PROCESSED FOODS**

FOR ORGANIC DAIRY PRODUCTS EXCLUDING ICE CREAM, ICE MILK AND FROZEN YOGURT; ORGANIC YOGURT (U.S. CL. 46).

FIRST USE 8-15-2013; IN COMMERCE 8-15-2013.

**CLASS 30—STAPLE FOODS**

FOR ORGANIC FROZEN YOGURT (U.S. CL. 46).  
MELISSA VALLILLO, EXAMINING ATTORNEY

SN 86-090,855. TOMMY BAHAMA GROUP, INC., ATLANTA, GA. FILED 10-14-2013.

# Relaxology

THE MARK CONSISTS OF STANDARD CHARACTERS WITHOUT CLAIM TO ANY PARTICULAR FONT, STYLE, SIZE, OR COLOR.

**CLASS 25—CLOTHING**

FOR SHOES (U.S. CLS. 22 AND 39).

**CLASS 35—ADVERTISING AND BUSINESS**

FOR RETAIL STORE SERVICES FEATURING SHOES (U.S. CLS. 100, 101 AND 102).  
SHAILA LEWIS, EXAMINING ATTORNEY

**CLASS 44—MEDICAL, BEAUTY AND AGRICULTURAL SERVICES**

FOR PROVIDING MEDICAL INFORMATION RELATING TO THE TREATMENT OF CONGESTION, COUGHS, COLDS, AND ALLERGIES (U.S. CLS. 100 AND 101).  
HEATHER THOMPSON, EXAMINING ATTORNEY

SN 86-091,191. MAGIC-FLIGHT GENERAL MANUFACTURING, INC., RANCHO SANTA FE, CA. FILED 10-14-2013.

SN 86-091,581. REPUBLIC CHEMICAL INDUSTRIES, INC., QUEZON CITY, PHILIPPINES, FILED 10-15-2013.

# MUAD'DIB

THE MARK CONSISTS OF STANDARD CHARACTERS WITHOUT CLAIM TO ANY PARTICULAR FONT, STYLE, SIZE, OR COLOR.

**CLASS 11—ENVIRONMENTAL CONTROL APPARATUS**

FOR HAND-HELD ELECTRICAL VAPORIZERS FOR THE VAPORIZATION OF ORGANIC MATERIALS, NAMELY, HEATING THE MATERIALS TO A TEMPERATURE WHERE THE PSYCHOACTIVE INGREDIENTS EVAPORATE WITHOUT CAUSING COMBUSTION TO AVOID IRRITATING RESPIRATORY TOXINS (U.S. CLS. 13, 21, 23, 31 AND 34).

**CLASS 34—SMOKERS' ARTICLES**

FOR SMOKER'S ARTICLES, NAMELY, HAND-HELD ELECTRICAL VAPORIZERS FOR THE VAPORIZATION OF TOBACCO, NAMELY, HEATING THE TOBACCO TO A TEMPERATURE WHERE THE PSYCHOACTIVE INGREDIENTS EVAPORATE WITHOUT CAUSING COMBUSTION TO AVOID IRRITATING RESPIRATORY TOXINS (U.S. CLS. 2, 8, 9 AND 17).  
PATRICIA EVANKO, EXAMINING ATTORNEY

SN 86-091,412. JOHNSON & JOHNSON, NEW BRUNSWICK, NJ. FILED 10-15-2013.



THE COLOR(S) RED, WHITE AND BLACK IS/ARE CLAIMED AS A FEATURE OF THE MARK.

THE MARK CONSISTS OF A RECTANGLE WITH THE WORDS "OPEN UP" IN WHITE INSIDE A RED ARROW POINTING TOWARD THE TERM "& SHARE" IN BLACK ON A WHITE BACKGROUND.

**CLASS 5—PHARMACEUTICALS**

FOR PHARMACEUTICAL PREPARATIONS FOR THE TREATMENT OF CONGESTION, COUGHS, COLDS, AND ALLERGIES (U.S. CLS. 6, 18, 44, 46, 51 AND 52).

**CLASS 41—EDUCATION AND ENTERTAINMENT**

FOR ENTERTAINMENT SERVICES, NAMELY, CONDUCTING CONTESTS (U.S. CLS. 100, 101 AND 107).



NO CLAIM IS MADE TO THE EXCLUSIVE RIGHT TO USE "BOND", APART FROM THE MARK AS SHOWN.  
THE MARK CONSISTS OF THE WORDS "MIGHTY BOND" SURROUNDED BY A SHADED RECTANGULAR BORDER.

**CLASS 1—CHEMICALS**

FOR ADHESIVES USED IN INDUSTRY (U.S. CLS. 1, 5, 6, 10, 26 AND 46).

**CLASS 16—PAPER GOODS AND PRINTED MATTER**

FOR ADHESIVES FOR STATIONERY AND HOUSEHOLD PURPOSES (U.S. CLS. 2, 5, 22, 23, 29, 37, 38 AND 50).  
DONALD JOHNSON, EXAMINING ATTORNEY

SN 86-092,011. PROVIMI NORTH AMERICA, INC., BROOKVILLE, OH. FILED 10-15-2013.

# NeoTec

THE MARK CONSISTS OF STANDARD CHARACTERS WITHOUT CLAIM TO ANY PARTICULAR FONT, STYLE, SIZE, OR COLOR.

**CLASS 5—PHARMACEUTICALS**

FOR NON-MEDICATED ANIMAL FEED SUPPLEMENTS; NON-MEDICATED ADDITIVES FOR ANIMAL FEED FOR USE AS NUTRITIONAL SUPPLEMENTS (U.S. CLS. 6, 18, 44, 46, 51 AND 52).

**CLASS 31—NATURAL AGRICULTURAL PRODUCTS**

FOR ANIMAL FEED (U.S. CLS. 1 AND 46).  
ANGELA M. MICHELI, EXAMINING ATTORNEY

SN 86-092,020. PROVIMI NORTH AMERICA, INC., BROOKVILLE, OH. FILED 10-15-2013.

SN 86-092,515. MORRISON MANAGEMENT SPECIALISTS, INC., ATLANTA, GA. FILED 10-16-2013.

# NeoTec5g

THE MARK CONSISTS OF STANDARD CHARACTERS WITHOUT CLAIM TO ANY PARTICULAR FONT, STYLE, SIZE, OR COLOR.

## CLASS 5—PHARMACEUTICALS

FOR NON-MEDICATED ANIMAL FEED SUPPLEMENTS; NON-MEDICATED ADDITIVES FOR ANIMAL FEED FOR USE AS NUTRITIONAL SUPPLEMENTS (U.S. CLS. 6, 18, 44, 46, 51 AND 52).

## CLASS 31—NATURAL AGRICULTURAL PRODUCTS

FOR ANIMAL FEED (U.S. CLS. 1 AND 46).  
ANGELA M. MICHELI, EXAMINING ATTORNEY

SN 86-092,033. BASE CULTURE, LLC, TAMPA, FL. FILED 10-15-2013.

# SIMPLE. NATURAL. PRIMAL.

THE MARK CONSISTS OF STANDARD CHARACTERS WITHOUT CLAIM TO ANY PARTICULAR FONT, STYLE, SIZE, OR COLOR.

NO CLAIM IS MADE TO THE EXCLUSIVE RIGHT TO USE "NATURAL", APART FROM THE MARK AS SHOWN.

## CLASS 29—MEATS AND PROCESSED FOODS

FOR ALMOND BUTTER; ALMOND FLOUR; FRUIT-AND NUT-BASED FOOD BARS; PACKAGED MEALS CONSISTING PRIMARILY OF MEAT, FISH, POULTRY, FRUIT OR VEGETABLES; TODDLER MEALS, NAMELY, PACKAGED ENTREES CONSISTING PRIMARILY OF MEAT, FISH, POULTRY, FRUIT OR VEGETABLES; ALL THE ABOVE GOODS MADE IN WHOLE OR SUBSTANTIAL PART OF NATURAL INGREDIENTS (U.S. CL. 46).

## CLASS 30—STAPLE FOODS

FOR BAKED GOODS, NAMELY, COOKIES, BROWNIES, MUFFINS, AND BREADS; GRANOLA; VANILLA EXTRACT; FLOUR; ALL THE ABOVE GOODS MADE IN WHOLE OR SUBSTANTIAL PART OF NATURAL INGREDIENTS (U.S. CL. 46).

## CLASS 35—ADVERTISING AND BUSINESS

FOR RETAIL STORE SERVICES ACCESSIBLE ONLINE AND BY TELEPHONE FEATURING NATURAL FOOD (U.S. CLS. 100, 101 AND 102).  
PRISCILLA MILTON, EXAMINING ATTORNEY

# MORRISON HEALTHCARE

THE MARK CONSISTS OF STANDARD CHARACTERS WITHOUT CLAIM TO ANY PARTICULAR FONT, STYLE, SIZE, OR COLOR.

OWNER OF U.S. REG. NOS. 2,909,530, 2,909,532 AND OTHERS.

NO CLAIM IS MADE TO THE EXCLUSIVE RIGHT TO USE "HEALTHCARE", APART FROM THE MARK AS SHOWN.

SEC. 2(F).

## CLASS 43—HOTEL AND RESTAURANT SERVICES

FOR CONTRACT FOOD SERVICES; FOOD PREPARATION SERVICES, ALL IN THE FIELD OF HEALTH CARE (U.S. CLS. 100 AND 101).

FIRST USE 8-1-2013, THE MARK WAS FIRST USED ANYWHERE IN A DIFFERENT FORM OTHER THAN THAT SOUGHT TO BE REGISTERED AT LEAST AS EARLY AS 06/30/1999; IN COMMERCE 8-1-2013, THE MARK WAS FIRST USED IN COMMERCE IN A DIFFERENT FORM OTHER THAN THAT SOUGHT TO BE REGISTERED AT LEAST AS EARLY AS 06/30/1999.

## CLASS 44—MEDICAL, BEAUTY AND AGRICULTURAL SERVICES

FOR NUTRITION COUNSELING SERVICES, IN THE FIELD OF HEALTH CARE (U.S. CLS. 100 AND 101).

FIRST USE 8-1-2013, THE MARK WAS FIRST USED ANYWHERE IN A DIFFERENT FORM OTHER THAN THAT SOUGHT TO BE REGISTERED AT LEAST AS EARLY AS 06/30/1999; IN COMMERCE 8-1-2013, THE MARK WAS FIRST USED IN COMMERCE IN A DIFFERENT FORM OTHER THAN THAT SOUGHT TO BE REGISTERED AT LEAST AS EARLY AS 06/30/1999.

LEIGH CAROLINE CASE, EXAMINING ATTORNEY

SN 86-092,713. SUPERMAX HEALTHCARE, INC., AURORA, IL. FILED 10-16-2013.

# AURELIA ZERO

THE MARK CONSISTS OF STANDARD CHARACTERS WITHOUT CLAIM TO ANY PARTICULAR FONT, STYLE, SIZE, OR COLOR.

OWNER OF U.S. REG. NOS. 3,000,179 AND 3,037,301.

## CLASS 9—ELECTRICAL AND SCIENTIFIC APPARATUS

FOR PROTECTIVE GLOVES FOR INDUSTRIAL USE; PROTECTIVE WORK GLOVES (U.S. CLS. 21, 23, 26, 36 AND 38).

## CLASS 10—MEDICAL APPARATUS

FOR DENTAL GLOVES; GLOVES FOR MEDICAL PURPOSES; GLOVES FOR MEDICAL USE; MEDICAL GLOVES; PROTECTIVE GLOVES FOR MEDICAL USE (U.S. CLS. 26, 39 AND 44).

JULIE GUTTADAURO, EXAMINING ATTORNEY

SN 86-093,668. UNITED TRADEMARK HOLDINGS, INC.,  
BEVERLY HILLS, CA. FILED 10-17-2013.

## fairy tale high

THE MARK CONSISTS OF STANDARD CHARACTERS WITHOUT CLAIM TO ANY PARTICULAR FONT, STYLE, SIZE, OR COLOR.

### CLASS 16—PAPER GOODS AND PRINTED MATTER

FOR (BASED ON INTENT TO USE) STATIONERY COMPRISING STATIONERY TYPE PORTFOLIOS, NOTEBOOKS, COMPOSITION BOOKS, BINDERS, DIARIES, JOURNALS, WRITING INSTRUMENTS, PENS, PENCILS, CRAYONS, STICKERS, STAMPERS, LOCKER CALENDARS, STICKY NOTES, MEMO PADS, LIST PADS AND STATIONERY SETS (U.S. CLS. 2, 5, 22, 23, 29, 37, 38 AND 50).

### CLASS 18—LEATHER GOODS

FOR (BASED ON INTENT TO USE) WALLETS, COSMETIC BAGS SOLD EMPTY, VANITY BAGS SOLD EMPTY, BELT BAGS, COIN PURSES AND WRISTLETS, PLUSH BAGS, NAMELY, PLUSH ALL PURPOSE CARRYING BAGS, ROLLER LUGGAGE, SLING BAGS, TRAVEL ACCESSORIES, NAMELY, TOILETRY CASES SOLD EMPTY AND TRAVEL KITS IN THE NATURE OF TRAVEL CASES (U.S. CLS. 1, 2, 3, 22 AND 41).

### CLASS 25—CLOTHING

FOR (BASED ON USE IN COMMERCE) 2 PIECE SETS COMPRISED OF SHIRTS AND PANTS, SPORTSWEAR, NAMELY, SHIRTS, SLEEPWEAR, UNDERWEAR, SOCKS AND JOGGING SUITS (U.S. CLS. 22 AND 39).  
FIRST USE 6-0-2013; IN COMMERCE 6-0-2013.  
CIMMERIAN COLEMAN, EXAMINING ATTORNEY

SN 86-093,873. BLUEGREEN CORPORATION, BOCA RATON, FL. FILED 10-17-2013.

## POWER OF VACATION

THE MARK CONSISTS OF STANDARD CHARACTERS WITHOUT CLAIM TO ANY PARTICULAR FONT, STYLE, SIZE, OR COLOR.

### CLASS 36—INSURANCE AND FINANCIAL

FOR REAL ESTATE SERVICES, NAMELY, RENTAL OF VACATION HOMES, CONDOMINIUMS, CABINS, AND VILLAS; REAL ESTATE TIME-SHARE EXCHANGE SERVICES; REAL ESTATE OWNERSHIP EXCHANGE SERVICES; NAMELY, VACATION REAL ESTATE TIME SHARING, REAL ESTATE MANAGEMENT AND LEASING SERVICES; PROVIDING FINANCIAL INFORMATION RELATED TO SALES OF REAL ESTATE TIMESHARE AND VACATION PROPERTIES FOR THE PURPOSE OF FEE BASED LENDER FUNDING AND REPORTING, VIA A WEBSITE PORTAL AVAILABLE TO REGISTERED USERS; VACATION CLUB SERVICES, NAMELY, REAL ESTATE TIME SHARING SERVICES; VACATION REAL ESTATE TIMESHARE SERVICES FEATURING INCENTIVE AWARD PROGRAM; CONSULTING SERVICES FOR RESORT PROPERTIES, NAMELY, CONSULTING IN THE FIELD OF LEASING AND MANAGEMENT OF RESORT AND TIMESHARE PROPERTIES; MANAGEMENT OF RESORT AND TIME-SHARE PROPERTIES; MORTGAGE LOAN FINANCING AND OTHER FINANCING SERVICES (U.S. CLS. 100, 101 AND 102).

### CLASS 39—TRANSPORTATION AND STORAGE

FOR VACATION CLUB SERVICES, NAMELY, MAKING RESERVATIONS, AND BOOKING FOR TRANSPORTATION; TRAVEL AGENCY SERVICES, NAMELY, MAKING RESERVATIONS, AND BOOKING FOR TRANSPORTATION; TRAVEL CLUB SERVICES (U.S. CLS. 100 AND 105).

### CLASS 43—HOTEL AND RESTAURANT SERVICES

FOR ARRANGING TEMPORARY HOUSING ACCOMMODATIONS; BOOKING OF CAMPGROUND ACCOMMODATION; CONSULTING SERVICES IN THE FIELD OF HOSPITALITY; PROVIDING TRAVEL LODGING INFORMATION SERVICES AND TRAVEL LODGING BOOKING AGENCY SERVICES FOR TRAVELERS; TRAVEL AGENCY SERVICES, NAMELY, MAKING RESERVATIONS AND BOOKING FOR TEMPORARY LODGING; VACATION CLUB SERVICES, NAMELY, MAKING RESERVATIONS AND BOOKINGS FOR TEMPORARY LODGING (U.S. CLS. 100 AND 101).

NICHOLAS ALTREE, EXAMINING ATTORNEY

SN 86-094,058. MEIJER, INC., GRAND RAPIDS, MI. FILED 10-17-2013.

## Dream Gallery

THE MARK CONSISTS OF STANDARD CHARACTERS WITHOUT CLAIM TO ANY PARTICULAR FONT, STYLE, SIZE, OR COLOR.

### CLASS 25—CLOTHING

FOR COSTUMES FOR USE IN CHILDREN'S DRESS UP PLAY; COSTUMES FOR USE IN ROLE-PLAYING GAMES (U.S. CLS. 22 AND 39).

### CLASS 28—TOYS AND SPORTING GOODS

FOR ROLE PLAYING GAMES; ROLE PLAYING TOYS IN THE NATURE OF PLAY SETS FOR CHILDREN TO IMITATE REAL LIFE OCCUPATIONS; TOYS, NAMELY, CHILDREN'S DRESS-UP ACCESSORIES (U.S. CLS. 22, 23, 38 AND 50).

RAMONA ORTIGA, EXAMINING ATTORNEY

SN 86-094,450. CADILLAC JACK, INC., DULUTH, GA.  
FILED 10-17-2013.

SN 86-094,471. CADILLAC JACK, INC., DULUTH, GA.  
FILED 10-17-2013.

## THUNDER BEAR

THE MARK CONSISTS OF STANDARD CHARACTERS WITHOUT CLAIM TO ANY PARTICULAR FONT, STYLE, SIZE, OR COLOR.

### CLASS 9—ELECTRICAL AND SCIENTIFIC APPARATUS

FOR COMPUTER GAME SOFTWARE FOR GAMING MACHINES INCLUDING SLOT MACHINES OR VIDEO LOTTERY TERMINALS; GAMING SOFTWARE THAT GENERATES OR DISPLAYS WAGER OUTCOMES OF GAMING MACHINES (U.S. CLS. 21, 23, 26, 36 AND 38).

### CLASS 28—TOYS AND SPORTING GOODS

FOR GAMING MACHINES THAT GENERATE OR DISPLAY WAGER OUTCOMES; RECONFIGURABLE CASINO AND LOTTERY GAMING EQUIPMENT, NAMELY, GAMING MACHINES AND OPERATIONAL COMPUTER GAME SOFTWARE THEREFOR SOLD AS A UNIT (U.S. CLS. 22, 23, 38 AND 50).  
APRIL ROACH, EXAMINING ATTORNEY

## DIAMOND LION

THE MARK CONSISTS OF STANDARD CHARACTERS WITHOUT CLAIM TO ANY PARTICULAR FONT, STYLE, SIZE, OR COLOR.

### CLASS 9—ELECTRICAL AND SCIENTIFIC APPARATUS

FOR COMPUTER GAME SOFTWARE FOR GAMING MACHINES INCLUDING SLOT MACHINES OR VIDEO LOTTERY TERMINALS; GAMING SOFTWARE THAT GENERATES OR DISPLAYS WAGER OUTCOMES OF GAMING MACHINES (U.S. CLS. 21, 23, 26, 36 AND 38).

### CLASS 28—TOYS AND SPORTING GOODS

FOR GAMING MACHINES THAT GENERATE OR DISPLAY WAGER OUTCOMES; RECONFIGURABLE CASINO AND LOTTERY GAMING EQUIPMENT, NAMELY, GAMING MACHINES AND OPERATIONAL COMPUTER GAME SOFTWARE THEREFOR SOLD AS A UNIT (U.S. CLS. 22, 23, 38 AND 50).  
APRIL ROACH, EXAMINING ATTORNEY

SN 86-094,463. CADILLAC JACK, INC., DULUTH, GA.  
FILED 10-17-2013.

SN 86-095,357. PRESTIGE PRESCHOOLS OPERATIONS LLC,  
GLENDALE, CA. FILED 10-18-2013.

## LION STORM

THE MARK CONSISTS OF STANDARD CHARACTERS WITHOUT CLAIM TO ANY PARTICULAR FONT, STYLE, SIZE, OR COLOR.

### CLASS 9—ELECTRICAL AND SCIENTIFIC APPARATUS

FOR COMPUTER GAME SOFTWARE FOR GAMING MACHINES INCLUDING SLOT MACHINES OR VIDEO LOTTERY TERMINALS; GAMING SOFTWARE THAT GENERATES OR DISPLAYS WAGER OUTCOMES OF GAMING MACHINES (U.S. CLS. 21, 23, 26, 36 AND 38).

### CLASS 28—TOYS AND SPORTING GOODS

FOR GAMING MACHINES THAT GENERATE OR DISPLAY WAGER OUTCOMES; RECONFIGURABLE CASINO AND LOTTERY GAMING EQUIPMENT, NAMELY, GAMING MACHINES AND OPERATIONAL COMPUTER GAME SOFTWARE THEREFOR SOLD AS A UNIT (U.S. CLS. 22, 23, 38 AND 50).  
APRIL ROACH, EXAMINING ATTORNEY

## PRESTIGE PRESCHOOL ACADEMY

THE MARK CONSISTS OF STANDARD CHARACTERS WITHOUT CLAIM TO ANY PARTICULAR FONT, STYLE, SIZE, OR COLOR.

NO CLAIM IS MADE TO THE EXCLUSIVE RIGHT TO USE "PRESCHOOL ACADEMY", APART FROM THE MARK AS SHOWN.

### CLASS 41—EDUCATION AND ENTERTAINMENT

FOR EDUCATION SERVICES, NAMELY, PROVIDING PRE-KINDERGARTEN CLASSROOM INSTRUCTION; EDUCATIONAL SERVICES, NAMELY, PROVIDING PRE-KINDERGARTEN CLASSROOM INSTRUCTION VIA THE INTERNET; PROVIDING AFTER SCHOOL EDUCATIONAL PROGRAMS FOR CHILDREN IN PRE-KINDERGARTEN AND PLAY FACILITIES FOR CHILDREN (U.S. CLS. 100, 101 AND 107).

### CLASS 43—HOTEL AND RESTAURANT SERVICES

FOR CHILD CARE SERVICES (U.S. CLS. 100 AND 101).  
JUSTINE D. PARKER, EXAMINING ATTORNEY

SN 86-095,938. GOLDEN KRUST PATTIES, INC., BRONX, NY. FILED 10-18-2013.

# JERKTOPIA

THE MARK CONSISTS OF STANDARD CHARACTERS WITHOUT CLAIM TO ANY PARTICULAR FONT, STYLE, SIZE, OR COLOR.

## CLASS 35—ADVERTISING AND BUSINESS

FOR FRANCHISE SERVICES, NAMELY, OFFERING BUSINESS MANAGEMENT ASSISTANCE IN THE ESTABLISHMENT AND OPERATION OF RESTAURANTS (U.S. CLS. 100, 101 AND 102).

## CLASS 43—HOTEL AND RESTAURANT SERVICES

FOR FAST-FOOD RESTAURANT SERVICES; RESTAURANT SERVICES (U.S. CLS. 100 AND 101).  
ROBIN MITTLER, EXAMINING ATTORNEY

SN 86-096,965. TRAVEL CADDY, INC., DBA TRAVELON, ELK GROVE VILLAGE, IL. FILED 10-21-2013.



THE MARK CONSISTS OF A LETTER "T" DESIGN.

## CLASS 9—ELECTRICAL AND SCIENTIFIC APPARATUS

FOR COMPUTER CARRYING CASES AND BAGS; CONVERTERS; ADAPTER PLUGS; POWER ADAPTERS; BATTERY CHARGERS; SURGE PROTECTORS; WEIGHING APPARATUS AND INSTRUMENTS; MULTI-FUNCTION ELECTRONIC DEVICE COMPRISING A TEMPERATURE GAUGE AND CLOCK (U.S. CLS. 21, 23, 26, 36 AND 38).

FIRST USE 3-0-2012; IN COMMERCE 3-0-2012.

## CLASS 18—LEATHER GOODS

FOR HOUSE MARK FOR GARMENT BAGS FOR TRAVEL, WHEELED LUGGAGE AND BAGS, CARRYING CASES, ALL-PURPOSE CARRYING BAGS, SPORTS BAGS, BOOK BAGS, DUFFLE BAGS, TOTE BAGS, TOILETRY BAGS AND CASES SOLD EMPTY, WAIST PACKS, BACKPACKS, MESSENGER BAGS, HAND BAGS, PURSES, WALLETS, DOCUMENT CASES, POUCHES OF TEXTILE, FABRIC, OR LEATHER, VINYL POUCHES SOLD EMPTY FOR HOLDING MAKE-UP, PHONES, ELECTRONICS, KEYS AND OTHER PERSONAL ITEMS, BRIEFCASES, NON-MOTORIZED COLLAPSIBLE LUGGAGE CARTS, TRAVEL ORGANIZERS, NAMELY, TRAVEL BAGS, TRAVEL ACCESSORIES, NAMELY, LUGGAGE TAGS, STRAPS FOR LUGGAGE, SHOULDER STRAPS; LAUNDRY BAGS FOR TRAVEL; SHOE BAGS FOR TRAVEL; UMBRELLAS AND THEIR PARTS (U.S. CLS. 1, 2, 3, 22 AND 41).

FIRST USE 3-0-2012; IN COMMERCE 3-0-2012.

SUI DUONG, EXAMINING ATTORNEY

SN 86-097,500. PERFORMANCE FABRICS, INC., GRAND RAPIDS, MI. FILED 10-22-2013.

# WorkDNA

THE MARK CONSISTS OF STANDARD CHARACTERS WITHOUT CLAIM TO ANY PARTICULAR FONT, STYLE, SIZE, OR COLOR.

## CLASS 9—ELECTRICAL AND SCIENTIFIC APPARATUS

FOR PROTECTIVE GLOVES FOR INDUSTRIAL USE (U.S. CLS. 21, 23, 26, 36 AND 38).

## CLASS 21—HOUSEWARES AND GLASS

FOR LIGHT DUTY UTILITY GLOVES (U.S. CLS. 2, 13, 23, 29, 30, 33, 40 AND 50).

TRACY WHITTAKER-BROWN, EXAMINING ATTORNEY

SN 86-098,491. KING TECHNOLOGY INC., HOPKINS, MN. FILED 10-22-2013.



THE MARK CONSISTS OF A CURVED-SHAPED SMILE WITH EACH END OF THE SMILE CONNECTING CURVE-SHAPE CHEEK.

## CLASS 1—CHEMICALS

FOR WATER PURIFICATION CHEMICALS CONTAINED IN DISPENSERS (U.S. CLS. 1, 5, 6, 10, 26 AND 46).

**CLASS 5—PHARMACEUTICALS**

FOR ALGAEICIDES AND BACTERICIDES FOR SWIMMING POOL (U.S. CLS. 6, 18, 44, 46, 51 AND 52).

**CLASS 9—ELECTRICAL AND SCIENTIFIC APPARATUS**

FOR SWIMMING POOL EQUIPMENT, NAMELY, AUTOMATIC VALVES FOR DISPENSING WATER PURIFICATION MATERIALS, NAMELY, WATER PURIFICATION CHEMICALS AND WATER PURIFICATION PARTICLES IN SWIMMING POOLS (U.S. CLS. 21, 23, 26, 36 AND 38).

**CLASS 11—ENVIRONMENTAL CONTROL APPARATUS**

FOR SWIMMING POOL EQUIPMENT, NAMELY, HAND-OPERATED PLUMBING VALVES FOR DISPENSING WATER PURIFICATION MATERIALS, NAMELY, WATER PURIFICATION CHEMICALS AND WATER PURIFICATION PARTICLES IN SWIMMING POOLS; SWIMMING POOL EQUIPMENT, NAMELY, SWIMMING POOL WATER CLEANING AND FILTERING UNITS (U.S. CLS. 13, 21, 23, 31 AND 34).

HANNO RITTNER, EXAMINING ATTORNEY

**CLASS 11—ENVIRONMENTAL CONTROL APPARATUS**

FOR SWIMMING POOL EQUIPMENT, NAMELY, HAND-OPERATED PLUMBING VALVES FOR DISPENSING WATER PURIFICATION MATERIALS, NAMELY, WATER PURIFICATION CHEMICALS AND WATER PURIFICATION PARTICLES IN SWIMMING POOLS; SWIMMING POOL EQUIPMENT, NAMELY, SWIMMING POOL WATER CLEANING AND FILTERING UNITS (U.S. CLS. 13, 21, 23, 31 AND 34).

HANNO RITTNER, EXAMINING ATTORNEY

SN 86-098,554. KING TECHNOLOGY INC., HOPKINS, MN. FILED 10-22-2013.

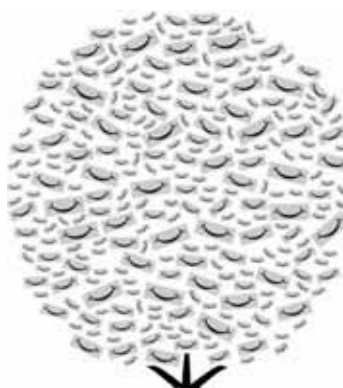

THE MARK CONSISTS OF A DRAWING OF A CIRCULAR-SHAPED BUSH WITH A PARTIAL VIEW OF THE BUSH TRUNK AND WITH A PLURALITY OF RECTANGULAR-SHAPED LEAVES EACH HAVING A DRAWING OF A SMILE THEREON.

**CLASS 1—CHEMICALS**

FOR WATER PURIFICATION CHEMICALS CONTAINED IN DISPENSERS (U.S. CLS. 1, 5, 6, 10, 26 AND 46).

**CLASS 5—PHARMACEUTICALS**

FOR ALGAEICIDES AND BACTERICIDES FOR SWIMMING POOL (U.S. CLS. 6, 18, 44, 46, 51 AND 52).

**CLASS 9—ELECTRICAL AND SCIENTIFIC APPARATUS**

FOR SWIMMING POOL EQUIPMENT, NAMELY, AUTOMATIC VALVES FOR DISPENSING WATER PURIFICATION MATERIALS, NAMELY, WATER PURIFICATION CHEMICALS AND WATER PURIFICATION PARTICLES IN SWIMMING POOLS (U.S. CLS. 21, 23, 26, 36 AND 38).

**CLASS 11—ENVIRONMENTAL CONTROL APPARATUS**

FOR SWIMMING POOL EQUIPMENT, NAMELY, HAND-OPERATED PLUMBING VALVES FOR DISPENSING WATER PURIFICATION MATERIALS, NAMELY, WATER PURIFICATION CHEMICALS AND WATER PURIFICATION PARTICLES IN SWIMMING POOLS; SWIMMING POOL EQUIPMENT, NAMELY, SWIMMING POOL WATER CLEANING AND FILTERING UNITS (U.S. CLS. 13, 21, 23, 31 AND 34).

HANNO RITTNER, EXAMINING ATTORNEY

SN 86-098,534. KING TECHNOLOGY INC., HOPKINS, MN. FILED 10-22-2013.



THE MARK CONSISTS OF A CARTOON DRAWING OF A PAIR OF FROG EYES EXTENDING FROM THE FOREHEAD OF A FROG.

**CLASS 1—CHEMICALS**

FOR WATER PURIFICATION CHEMICALS CONTAINED IN DISPENSERS (U.S. CLS. 1, 5, 6, 10, 26 AND 46).

**CLASS 5—PHARMACEUTICALS**

FOR ALGAEICIDES AND BACTERICIDES FOR SWIMMING POOL (U.S. CLS. 6, 18, 44, 46, 51 AND 52).

**CLASS 9—ELECTRICAL AND SCIENTIFIC APPARATUS**

FOR SWIMMING POOL EQUIPMENT, NAMELY, AUTOMATIC VALVES FOR DISPENSING WATER PURIFICATION MATERIALS, NAMELY, WATER PURIFICATION CHEMICALS AND WATER PURIFICATION PARTICLES IN SWIMMING POOLS (U.S. CLS. 21, 23, 26, 36 AND 38).

SN 86-098,580. KING TECHNOLOGY INC., HOPKINS, MN.  
FILED 10-22-2013.

SN 86-098,838. MED-EL ELEKTROMEDIZINISCHE GERÄTE  
GES.M.B.H., INNSBRUCK, AUSTRIA, FILED 10-23-2013.

# AUDIOKEY



THE MARK CONSISTS OF A DRAWING OF A TREE HAVING A CANOPY PORTION LOCATED AT THE TIP PORTION OF THE TREE TRUNK AND A PAIR OF BRANCHES EXTENDING FROM THE MIDWAY PORTION OF THE TREE TRUNK, THE CANOPY AND THE PAIR OF BRANCHES EACH HAVING A PLURALITY OF DIFFERENT SIZE LEAVES WITH EACH OF THE LEAVES COMPRISING A CARTOON DRAWING OF A PAIR OF FROG EYES EXTENDING FROM THE FOREHEAD OF A FROG.

## CLASS 1—CHEMICALS

FOR WATER PURIFICATION CHEMICALS CONTAINED IN DISPENSERS (U.S. CLS. 1, 5, 6, 10, 26 AND 46).

## CLASS 5—PHARMACEUTICALS

FOR ALGAECIDES AND BACTERICIDES FOR SWIMMING POOL (U.S. CLS. 6, 18, 44, 46, 51 AND 52).

## CLASS 9—ELECTRICAL AND SCIENTIFIC APPARATUS

FOR SWIMMING POOL EQUIPMENT, NAMELY, AUTOMATIC VALVES FOR DISPENSING WATER PURIFICATION MATERIALS, NAMELY, WATER PURIFICATION CHEMICALS AND WATER PURIFICATION PARTICLES IN SWIMMING POOLS (U.S. CLS. 21, 23, 26, 36 AND 38).

## CLASS 11—ENVIRONMENTAL CONTROL APPARATUS

FOR SWIMMING POOL EQUIPMENT, NAMELY, HAND-OPERATED PLUMBING VALVES FOR DISPENSING WATER PURIFICATION MATERIALS, NAMELY, WATER PURIFICATION CHEMICALS AND WATER PURIFICATION PARTICLES IN SWIMMING POOLS; SWIMMING POOL EQUIPMENT, NAMELY, SWIMMING POOL WATER CLEANING AND FILTERING UNITS (U.S. CLS. 13, 21, 23, 31 AND 34).

HANNO RITTNER, EXAMINING ATTORNEY

THE MARK CONSISTS OF STANDARD CHARACTERS WITHOUT CLAIM TO ANY PARTICULAR FONT, STYLE, SIZE, OR COLOR.

## CLASS 9—ELECTRICAL AND SCIENTIFIC APPARATUS

FOR SOFTWARE FOR PROGRAMMING SPEECH PROCESSORS FOR ARTIFICIAL COCHLEAR IMPLANTS AND IMPLANT SYSTEMS, SKULL MOUNTED HEARING IMPLANT SYSTEMS, AUDITORY BRAINSTEM SYSTEMS AND COMBINED ELECTRIC ACOUSTIC STIMULATION SYSTEMS; SOFTWARE FOR PROGRAMMING ARTIFICIAL IMPLANT SYSTEMS; SOFTWARE FOR ARTIFICIAL IMPLANT AND STIMULATION PARAMETER IDENTIFICATION AND TELEMETRY; SOFTWARE FOR DETERMINATION AND ANALYSIS OF INFORMATION ON PHYSIOLOGICAL REACTIONS OF THE STIMULATED HEARING NERVES; SOFTWARE FOR PROVIDING DATA TRANSFER OVER WIRELESS AND WIRED CONNECTIONS FROM AND TO HEARING IMPLANT SYSTEMS (U.S. CLS. 21, 23, 26, 36 AND 38).

## CLASS 10—MEDICAL APPARATUS

FOR HEARING PROSTHESES SYSTEMS; SURGICAL IMPLANT SYSTEMS COMPRISING ARTIFICIAL MATERIAL; HEARING IMPLANT SYSTEMS, NAMELY, COCHLEAR IMPLANT SYSTEMS, SKULL MOUNTED HEARING IMPLANT SYSTEMS AND AUDITORY BRAINSTEM IMPLANT SYSTEMS; ELECTRODES FOR MEDICAL PURPOSES; IMPLANT ELECTRODE SYSTEMS FOR MEDICAL USE; PARTIALLY AND FULLY IMPLANTABLE HEARING AID SYSTEMS; COMBINED ELECTRIC-ACOUSTIC STIMULATION SYSTEMS (U.S. CLS. 26, 39 AND 44).

DAVID BROOKSHIRE, EXAMINING ATTORNEY

SN 86-098,916. ROLEX WATCH U.S.A., INC., NEW YORK, NY, FILED 10-23-2013.

## ROLEX AWARDS FOR ENTERPRISE

THE MARK CONSISTS OF STANDARD CHARACTERS WITHOUT CLAIM TO ANY PARTICULAR FONT, STYLE, SIZE, OR COLOR.

OWNER OF U.S. REG. NO. 3,260,453.

NO CLAIM IS MADE TO THE EXCLUSIVE RIGHT TO USE "AWARDS", APART FROM THE MARK AS SHOWN.

## CLASS 16—PAPER GOODS AND PRINTED MATTER

FOR BOOKS AND MAGAZINES PERTAINING TO THE ADVANCEMENT OF HUMAN KNOWLEDGE AND WELL-BEING IN THE FIELDS OF SCIENCE AND MEDICINE, TECHNOLOGY AND INNOVATION, EXPLORATION AND DISCOVERY, THE ENVIRONMENT AND CULTURAL STUDIES (U.S. CLS. 2, 5, 22, 23, 29, 37, 38 AND 50).

FIRST USE 9-27-2000; IN COMMERCE 9-27-2000.



**CLASS 41—EDUCATION AND ENTERTAINMENT**

FOR PROVIDING RECOGNITION AND INCENTIVES BY WAY OF AWARDS TO RECOGNIZE AND SUPPORT PIONEERING ACHIEVEMENT IN THE ADVANCEMENT OF HUMAN KNOWLEDGE AND WELL-BEING (U.S. CLS. 100, 101 AND 107).

FIRST USE 9-27-2000; IN COMMERCE 9-27-2000.  
SIDDHARTH JAGANNATHAN, EXAMINING ATTORNEY

SN 86-099,476. PREMIER HOMECARE OPTIONS, LLC, WALDORF, MD. FILED 10-23-2013.

CAREHOMEDIN

THE MARK CONSISTS OF STANDARD CHARACTERS WITHOUT CLAIM TO ANY PARTICULAR FONT, STYLE, SIZE, OR COLOR.

**CLASS 35—ADVERTISING AND BUSINESS**

FOR ON-LINE BUSINESS DIRECTORIES FEATURING CONSUMER AND TRADE INFORMATION IN THE FIELD OF SENIOR AND ELDERLY CARE; PROVIDING ON-LINE WEB DIRECTORY SERVICES FEATURING HYPERLINKS TO THE WEBSITES OF OTHERS (U.S. CLS. 100, 101 AND 102).

FIRST USE 10-21-2013; IN COMMERCE 10-21-2013.

**CLASS 45—PERSONAL AND LEGAL SERVICES**

FOR ON-LINE SOCIAL NETWORKING SERVICES; ONLINE SOCIAL NETWORKING SERVICES IN THE FIELD OF SENIOR AND ELDERLY CARE (U.S. CLS. 100 AND 101).

FIRST USE 10-21-2013; IN COMMERCE 10-21-2013.  
CURTIS FRENCH, EXAMINING ATTORNEY

SN 86-102,066. AMERICAN PISTACHIO GROWERS, FRESNO, CA. FILED 10-25-2013.

The POWER of  
PISTACHIOS

OWNER OF U.S. REG. NOS. 4,314,942, 4,397,865 AND OTHERS.

THE COLOR(S) DARK AND LIGHT GREEN IS/ARE CLAIMED AS A FEATURE OF THE MARK.

THE MARK CONSISTS OF THE WORD "THE" IN DARK GREEN IN UPPER AND LOWER CASE SCRIPT, PRECEDING THE WORD "POWER" CAPITALIZED WITH DARK GREEN AT THE TOP OF THE LETTERS TRANSITIONING TO LIGHT GREEN AT THE BOTTOM OF THE LETTERS, FOLLOWED BY THE WORD "OF" IN LOWER CASE SCRIPT, ALL OVER THE CAPITALIZED WORD "PISTACHIOS" WITH LIGHT GREEN AT THE TOP OF THE LETTERS AND TRANSITIONING TO DARK GREEN AT THE BOTTOM.

**CLASS 29—MEATS AND PROCESSED FOODS**

FOR PROCESSED NUTS; ROASTED NUTS; SEASONED NUTS; SHELLED NUTS (U.S. CL. 46).  
FIRST USE 8-11-2011; IN COMMERCE 9-13-2011.

**CLASS 35—ADVERTISING AND BUSINESS**

FOR ASSOCIATION SERVICES, NAMELY, PROMOTING THE INTERESTS OF PISTACHIO GROWERS, PACKERS, PROCESSORS, AND PRODUCERS THROUGH COMMERCIAL ADVERTISEMENTS IN THE FORM OF TELEVISION, PRINT, FILM, MOTION PICTURE, AND ELECTRONIC MEDIA; CONDUCTING MARKETING PROGRAMS FOR OTHERS TO PROMOTE THE PISTACHIO INDUSTRY VIA DISTRIBUTION OF PROMOTIONAL ITEMS; PRODUCT DEMONSTRATION AND BUSINESS MERCHANDISING DISPLAY SERVICES; BUSINESS CONSULTING SERVICES FOR THE PISTACHIO INDUSTRY; AND DISTRIBUTION OF PRINTED ADVERTISING MATERIAL (U.S. CLS. 100, 101 AND 102).

FIRST USE 7-21-2011; IN COMMERCE 7-21-2011.  
ZACHARY CROMER, EXAMINING ATTORNEY

SN 86-102,083. SHADOW PUPPET, INC., SAN FRANCISCO, CA. FILED 10-25-2013.

Shadow Puppet

THE MARK CONSISTS OF STANDARD CHARACTERS WITHOUT CLAIM TO ANY PARTICULAR FONT, STYLE, SIZE, OR COLOR.

**CLASS 9—ELECTRICAL AND SCIENTIFIC APPARATUS**

FOR DOWNLOADABLE SOFTWARE APPLICATION USED TO ENABLE ORAL COMMUNICATIONS OVER VISUAL MEDIA, THROUGH RECORDING AUDIO SYNCHRONIZED WITH PHOTOGRAPHIC IMAGES AND VIDEO (U.S. CLS. 21, 23, 26, 36 AND 38).

FIRST USE 9-24-2013; IN COMMERCE 9-24-2013.

**CLASS 42—SCIENTIFIC AND COMPUTER SERVICES**

FOR SOFTWARE AS SERVICE FEATURING SOFTWARE USED TO ENABLE ORAL COMMUNICATIONS OVER VISUAL MEDIA, THROUGH RECORDING AUDIO SYNCHRONIZED WITH PHOTOGRAPHIC IMAGES AND VIDEO (U.S. CLS. 100 AND 101).

FIRST USE 9-24-2013; IN COMMERCE 9-24-2013.  
AHSEN KHAN, EXAMINING ATTORNEY

SN 86-102,097. AMERICAN PISTACHIO GROWERS, FRESNO, CA. FILED 10-25-2013.

THE POWER OF PISTACHIOS

THE MARK CONSISTS OF STANDARD CHARACTERS WITHOUT CLAIM TO ANY PARTICULAR FONT, STYLE, SIZE, OR COLOR.

OWNER OF U.S. REG. NOS. 4,314,942, 4,397,865 AND OTHERS.

**CLASS 29—MEATS AND PROCESSED FOODS**

FOR PROCESSED NUTS; ROASTED NUTS; SEASONED NUTS; SHELLED NUTS (U.S. CL. 46).  
FIRST USE 8-11-2011; IN COMMERCE 9-13-2011.

**CLASS 35—ADVERTISING AND BUSINESS**

FOR ASSOCIATION SERVICES, NAMELY, PROMOTING THE INTERESTS OF PISTACHIO GROWERS, PACKERS, PROCESSORS, AND PRODUCERS THROUGH COMMERCIAL ADVERTISEMENTS IN THE FORM OF TELEVISION, PRINT, FILM, MOTION PICTURE, AND ELECTRONIC MEDIA; CONDUCTING MARKETING PROGRAMS FOR OTHERS TO PROMOTE THE PISTACHIO INDUSTRY VIA DISTRIBUTION OF PROMOTIONAL ITEMS; PRODUCT DEMONSTRATION AND BUSINESS MERCHANDISING DISPLAY SERVICES; BUSINESS CONSULTING SERVICES FOR THE PISTACHIO INDUSTRY; AND DISTRIBUTION OF PRINTED ADVERTISING MATERIAL (U.S. CLS. 100, 101 AND 102).

FIRST USE 7-21-2011; IN COMMERCE 7-21-2011.  
ZACHARY CROMER, EXAMINING ATTORNEY

SN 86-104,219. DANISH PASTRY HOLDING, LLC, HOLLYWOOD, FL. FILED 10-29-2013.



NO CLAIM IS MADE TO THE EXCLUSIVE RIGHT TO USE "DANISH PASTRY CO." AND "ORIGINAL RECIPE FROM DENMARK", APART FROM THE MARK AS SHOWN.

THE MARK CONSISTS OF THE LITERAL ELEMENTS "DANISH PASTRY CO." WITH AN OPEN CROWN ON TOP OF DANISH KRINGLE AND SURROUNDED BY A DOTTED LINE ON EACH SIDE OF THE KRINGLE. ON THE BOTTOM ARE THE LITERAL ELEMENTS "ORIGINAL RECIPE FROM DENMARK".

**CLASS 30—STAPLE FOODS**

FOR BAKERY GOODS; DANISH BREAD; DANISH PASTRIES; PASTRIES (U.S. CL. 46).  
FIRST USE 1-1-2013; IN COMMERCE 2-23-2013.

**CLASS 35—ADVERTISING AND BUSINESS**

FOR ONLINE RETAIL BAKERY SHOPS; RETAIL SHOPS FEATURING BAKED GOODS (U.S. CLS. 100, 101 AND 102).  
FIRST USE 1-1-2013; IN COMMERCE 2-23-2013.

**CLASS 43—HOTEL AND RESTAURANT SERVICES**

FOR CATERING SERVICES (U.S. CLS. 100 AND 101).  
FIRST USE 1-1-2013; IN COMMERCE 2-23-2013.  
SKYE YOUNG, EXAMINING ATTORNEY

SN 86-105,308. SANOFI, 75008 PARIS, FRANCE, FILED 10-30-2013.

**TIXUMIA**

THE MARK CONSISTS OF STANDARD CHARACTERS WITHOUT CLAIM TO ANY PARTICULAR FONT, STYLE, SIZE, OR COLOR.

OWNER OF U.S. REG. NO. 4,144,605.

**CLASS 5—PHARMACEUTICALS**

FOR PHARMACEUTICAL PREPARATIONS FOR THE PREVENTION AND TREATMENT OF DIABETES (U.S. CLS. 6, 18, 44, 46, 51 AND 52).

**CLASS 10—MEDICAL APPARATUS**

FOR INJECTOR PENS FOR PHARMACEUTICAL PRODUCTS (U.S. CLS. 26, 39 AND 44).  
THEODORE MCBRIDE, EXAMINING ATTORNEY

SN 86-106,363. HASBRO, INC., PAWTUCKET, RI. FILED 10-31-2013.



OWNER OF U.S. REG. NOS. 2,455,261, 4,412,057 AND OTHERS.

THE MARK CONSISTS OF THE NUMBER "4" PAIRED WITH HALF OF A ROBOT HELMET WITH THE WORDS "TRANSFORMERS AGE OF EXTINCTION" BELOW.

**CLASS 9—ELECTRICAL AND SCIENTIFIC APPARATUS**

FOR INTERACTIVE ENTERTAINMENT SOFTWARE, NAMELY, COMPUTER GAME SOFTWARE, COMPUTER GAME PROGRAMS, COMPUTER GAME CARTRIDGES, COMPUTER GAME DISCS; INTERACTIVE MULTIMEDIA COMPUTER GAME PROGRAMS; DOWNLOADABLE GAME SOFTWARE FOR USE IN CONNECTION WITH COMPUTERS, COMMUNICATION DEVICES AND MOBILE TELEPHONES; PRE-RECORDED LASER AND VIDEO DISC FEATURING AN ANIMATED CARTOON SERIES (U.S. CLS. 21, 23, 26, 36 AND 38).

**CLASS 28—TOYS AND SPORTING GOODS**

FOR TOY VEHICLES AND ACCESSORIES FOR USE THEREWITH; TOY ACTION FIGURES AND ACCESSORIES FOR USE THEREWITH; TOY ACTION FIGURES, TOY VEHICLES AND TOY ROBOTS CONVERTIBLE INTO OTHER VISUAL TOY FORMS (U.S. CLS. 22, 23, 38 AND 50).

**CLASS 41—EDUCATION AND ENTERTAINMENT**

FOR ENTERTAINMENT SERVICES, NAMELY, PRODUCTION AND DISTRIBUTION OF MOTION PICTURES, ONGOING TELEVISION PROGRAMS AND TELEVISION GAME SHOWS, AND AN ANIMATED TELEVISION SERIES; EDUCATIONAL AND ENTERTAINMENT SERVICES, NAMELY, ONGOING PROGRAMS IN THE FIELD OF CHILDREN'S ENTERTAINMENT ACCESSIBLE BY TELEVISION, SATELLITE, RADIO, AUDIO, VIDEO, ELECTRONIC MEDIA AND COMPUTER NETWORKS; PROVIDING NEWS AND INFORMATION IN THE FIELD OF CHILDREN'S EDUCATIONAL ACTIVITIES AND ENTERTAINMENT; ENTERTAINMENT SERVICES, NAMELY, PROVIDING ONLINE COMPUTER GAMES AND INTERACTIVE MULTIPLAYER ONLINE GAMES VIA GLOBAL NETWORKS; FAN CLUB SERVICES; ENTERTAINMENT SERVICES IN THE NATURE OF COMPETITIONS IN THE FIELD OF ENTERTAINMENT TRIVIA; PROVIDING COMPUTER DATABASES, INFORMATION AND WEBSITES, ALL FEATURING AUDIO ENTERTAINMENT, VISUAL ENTERTAINMENT AND AUDIOVISUAL ENTERTAINMENT IN THE FIELD OF EDUCATION AND ENTERTAINMENT VIA GLOBAL COMPUTER NETWORKS; ENTERTAINMENT SERVICES, NAMELY, THE PRODUCTION OF DVDS AND SOUNDTRACK ALBUMS (U.S. CLS. 100, 101 AND 107).  
MICHAEL WEBSTER, EXAMINING ATTORNEY

---

SN 86-107,038. PROXIMO SPIRITS, INC., JERSEY CITY, NJ. FILED 10-31-2013.

**TINCUP**

THE MARK CONSISTS OF STANDARD CHARACTERS WITHOUT CLAIM TO ANY PARTICULAR FONT, STYLE, SIZE, OR COLOR.

**CLASS 32—LIGHT BEVERAGES**

FOR NON-ALCOHOLIC COCKTAIL MIXES (U.S. CLS. 45, 46 AND 48).

**CLASS 33—WINES AND SPIRITS**

FOR ALCOHOLIC BEVERAGES, NAMELY, WHISKEY (U.S. CLS. 47 AND 49).  
SUI DUONG, EXAMINING ATTORNEY

---

SN 86-108,441. SUBCO FOODS, INC., WEST CHICAGO, IL. FILED 11-1-2013.



OWNER OF U.S. REG. NO. 1,775,408.  
THE MARK CONSISTS OF THE STYLIZED WORDING "ORCHARD PARK" ABOVE WHICH APPEARS THE DEPICTION OF A TREE AND BELOW WHICH APPEARS AN ARCH-SHAPED UNDERSCORE.

**CLASS 3—COSMETICS AND CLEANING PREPARATIONS**

FOR MOUTHWASH (U.S. CLS. 1, 4, 6, 50, 51 AND 52).  
FIRST USE 2-21-2013; IN COMMERCE 2-21-2013.

**CLASS 29—MEATS AND PROCESSED FOODS**

FOR COFFEE CREAMER; DIP MIXES; PISTACHIO-BASED INSTANT PIE FILLINGS (U.S. CL. 46).  
FIRST USE 6-6-2007; IN COMMERCE 6-6-2007.

**CLASS 30—STAPLE FOODS**

FOR PANCAKE SYRUP; BREAKFAST SYRUP; FLAVORED AND SWEETENED GELATINS; FLAVORED, SWEETENED GELATIN DESSERTS; DESSERT PUDDINGS; INSTANT DESSERT PUDDINGS; INSTANT PUDDING MIXES; COCOA MIXES; INSTANT CAPPUCINO; CAPPUCINO MIXES; SALAD DRESSING MIXES (U.S. CL. 46).  
FIRST USE 6-14-2010; IN COMMERCE 6-14-2010.

**CLASS 32—LIGHT BEVERAGES**

FOR POWDERS USED IN THE PREPARATION OF FRUIT-FLAVORED BEVERAGES; POWDERS USED IN THE PREPARATION OF SOFT DRINKS OR TEA-FLAVORED BEVERAGES; POWDERS USED IN THE PREPARATION OF FRUIT-BASED BEVERAGES; NON-ALCOHOLIC COCKTAIL MIXES (U.S. CLS. 45, 46 AND 48).  
FIRST USE 6-8-2011; IN COMMERCE 6-8-2011.  
JOHN SCHUYLER YARD, EXAMINING ATTORNEY

---

SN 86-109,233. ACXIOM CORPORATION, LITTLE ROCK, AR. FILED 11-4-2013.

**Acxiom Data Safe Haven**

THE MARK CONSISTS OF STANDARD CHARACTERS WITHOUT CLAIM TO ANY PARTICULAR FONT, STYLE, SIZE, OR COLOR.

OWNER OF U.S. REG. NOS. 1,907,571, 4,358,531 AND OTHERS.

NO CLAIM IS MADE TO THE EXCLUSIVE RIGHT TO USE "DATA", APART FROM THE MARK AS SHOWN.

**CLASS 35—ADVERTISING AND BUSINESS**

FOR BUSINESS INFORMATION SERVICES, NAMELY, MODIFYING AND AUGMENTING BUSINESS CUSTOMER DATA OF OTHERS TO MEET DATA PRIVACY PROTECTION AND REGULATORY COMPLIANCE REQUIREMENTS (U.S. CLS. 100, 101 AND 102).

**CLASS 42—SCIENTIFIC AND COMPUTER SERVICES**

FOR APPLICATION SERVICE PROVIDER SERVICES, NAMELY, MAINTAINING SOFTWARE APPLICATIONS ACCESSIBLE BY OTHERS OVER A NETWORK TO PROVIDE CONSUMER DATA PRIVACY PROTECTION, CONSUMER DATA HYGIENE, CONSUMER DATA MATCHING, AND TO CONNECT CONSUMER MARKETING DATA AND CONSUMER MARKETING DATA ANALYSIS RESULTS TO SOFTWARE APPLICATIONS OF OTHERS BY MEANS OF AN APPLICATION PROGRAMMING INTERFACE (API) (U.S. CLS. 100 AND 101).

HEATHER THOMPSON, EXAMINING ATTORNEY

SN 86-109,254. ACXIOM CORPORATION, LITTLE ROCK, AR. FILED 11-4-2013.

# My Data Safe Haven

THE MARK CONSISTS OF STANDARD CHARACTERS WITHOUT CLAIM TO ANY PARTICULAR FONT, STYLE, SIZE, OR COLOR.

NO CLAIM IS MADE TO THE EXCLUSIVE RIGHT TO USE "DATA", APART FROM THE MARK AS SHOWN.

## CLASS 35—ADVERTISING AND BUSINESS

FOR BUSINESS INFORMATION SERVICES, NAMELY, MODIFYING AND AUGMENTING BUSINESS CUSTOMER DATA OF OTHERS TO MEET DATA PRIVACY PROTECTION AND REGULATORY COMPLIANCE REQUIREMENTS (U.S. CLS. 100, 101 AND 102).

## CLASS 42—SCIENTIFIC AND COMPUTER SERVICES

FOR APPLICATION SERVICE PROVIDER SERVICES, NAMELY, MAINTAINING SOFTWARE APPLICATIONS ACCESSIBLE BY OTHERS OVER A NETWORK TO PROVIDE CONSUMER DATA PRIVACY PROTECTION, CONSUMER DATA HYGIENE, CONSUMER DATA MATCHING, AND TO CONNECT CONSUMER MARKETING DATA AND CONSUMER MARKETING DATA ANALYSIS RESULTS TO SOFTWARE APPLICATIONS OF OTHERS BY MEANS OF AN APPLICATION PROGRAMMING INTERFACE (API) (U.S. CLS. 100 AND 101).

HEATHER THOMPSON, EXAMINING ATTORNEY

## CLASS 42—SCIENTIFIC AND COMPUTER SERVICES

FOR APPLICATION SERVICE PROVIDER SERVICES, NAMELY, MAINTAINING SOFTWARE APPLICATIONS ACCESSIBLE BY OTHERS OVER A NETWORK TO PROVIDE CONSUMER DATA PRIVACY PROTECTION, CONSUMER DATA HYGIENE, CONSUMER DATA MATCHING, AND TO CONNECT CONSUMER MARKETING DATA AND CONSUMER MARKETING DATA ANALYSIS RESULTS TO SOFTWARE APPLICATIONS OF OTHERS BY MEANS OF AN APPLICATION PROGRAMMING INTERFACE (API) (U.S. CLS. 100 AND 101).

HEATHER THOMPSON, EXAMINING ATTORNEY

SN 86-109,455. AFFIRM, INC., SAN FRANCISCO, CA. FILED 11-4-2013.



THE MARK CONSISTS OF A STYLIZED UPPER CASE LETTER "A" HAVING AN ANGLED LEFT LINE, A VERTICAL RIGHT LINE AND NO HORIZONTAL LINE, THE STYLIZED LETTER IS COMPLETELY WITHIN A CIRCLE.

## CLASS 9—ELECTRICAL AND SCIENTIFIC APPARATUS

FOR COMPUTER SOFTWARE FOR TRANSACTION AUTHORIZATION AND CREDIT AUTHORIZATION (U.S. CLS. 21, 23, 26, 36 AND 38).

## CLASS 36—INSURANCE AND FINANCIAL

FOR COMPUTERIZED FINANCIAL TRANSACTION AUTHORIZATION, NAMELY, PROVIDING SECURE COMMERCIAL TRANSACTIONS AND PAYMENT OPTIONS; COMPUTERIZED FINANCIAL TRANSACTION AUTHORIZATION, NAMELY, PROVIDING SECURE COMMERCIAL TRANSACTIONS AND PAYMENT OPTIONS USING A MOBILE DEVICE AT A POINT OF SALE; BANKING SERVICES; FINANCIAL SERVICES, NAMELY, DEBT SETTLEMENT; ELECTRONIC FUNDS TRANSFER SERVICES; DEBT SETTLEMENT SERVICES; BILL PAYMENT SERVICES; PROVIDING FINANCIAL INFORMATION (U.S. CLS. 100, 101 AND 102).

MARCIE MILONE, EXAMINING ATTORNEY

SN 86-109,256. ACXIOM CORPORATION, LITTLE ROCK, AR. FILED 11-4-2013.

# Data Safe Haven

THE MARK CONSISTS OF STANDARD CHARACTERS WITHOUT CLAIM TO ANY PARTICULAR FONT, STYLE, SIZE, OR COLOR.

NO CLAIM IS MADE TO THE EXCLUSIVE RIGHT TO USE "DATA", APART FROM THE MARK AS SHOWN.

## CLASS 35—ADVERTISING AND BUSINESS

FOR BUSINESS INFORMATION SERVICES, NAMELY, MODIFYING AND AUGMENTING BUSINESS CUSTOMER DATA OF OTHERS TO MEET DATA PRIVACY PROTECTION AND REGULATORY COMPLIANCE REQUIREMENTS (U.S. CLS. 100, 101 AND 102).

SN 86-111,203. SKECHERS U.S.A., INC. II, MANHATTAN BEACH, CA. FILED 11-5-2013.

## BRANDBLACK

THE MARK CONSISTS OF STANDARD CHARACTERS WITHOUT CLAIM TO ANY PARTICULAR FONT, STYLE, SIZE, OR COLOR.

### CLASS 3—COSMETICS AND CLEANING PREPARATIONS

FOR COSMETIC PREPARATIONS; TOILET PREPARATIONS, NAMELY, PERFUMES, COLOGNES, SCENTED BODY SPRAYS, AFTERSHAVE, AFTERSHAVE BALM, PERSONAL DEODORANTS AND ANTI-PERSPIRANTS; BODY CLEANSING PRODUCTS, NAMELY, BATH GEL, SHOWER GEL, HAIR SHAMPOO, HAIR CONDITIONERS, BODY SCRUBS, BODY CREAM, SKIN CLEANSING CREAM, SKIN CLEANSING LOTION, SOAP, LIQUID SOAP FOR HANDS, FACE AND BODY, HAND AND BODY LOTIONS; SUN PROTECTION PRODUCTS, NAMELY, SUNTAN LOTIONS; PRODUCTS FOR TANNING WITHOUT SUN, NAMELY, SELF-TANNING LOTIONS AND SKIN GELS FOR ACCELERATING, ENHANCING OR EXTENDING TAN; LIP BALM; LIP GLOSS; FOOT DEODORANT SPRAY (U.S. CLS. 1, 4, 6, 50, 51 AND 52).

### CLASS 9—ELECTRICAL AND SCIENTIFIC APPARATUS

FOR EYEWEAR, NAMELY, EYEGASSES, SUNGLASSES, SUNGLASS FRAMES, CASES FOR EYEWEAR, PARTS AND ACCESSORIES FOR EYEWEAR, NAMELY, STRAPS, NECK CORDS, AND HEAD STRAPS WHICH RESTRAIN EYEWEAR FROM MOVEMENT ON A WEARER; GOGGLES FOR SPORTS, SWIM GOGGLES, SKI GOGGLES, SNOW GOGGLES; HEADPHONES, PORTABLE MUSIC PLAYERS, AND PEDOMETERS; EAR PLUGS FOR SWIMMING PURPOSES (U.S. CLS. 21, 23, 26, 36 AND 38).

### CLASS 14—JEWELRY

FOR TIMEPIECES OF ALL TYPES, NAMELY, WATCHES, WRIST WATCHES, STOPWATCHES, AND CHRONOGRAPHS; AND JEWELRY (U.S. CLS. 2, 27, 28 AND 50).

### CLASS 16—PAPER GOODS AND PRINTED MATTER

FOR DECALS, POSTERS, NAMELY, POSTERS DEPICTING ATHLETES; PHOTOGRAPHS; PRINTED CARDS, NAMELY, GREETING CARDS, NOTE CARDS, BUSINESS CARDS; PENS, BINDERS, STUDENT PLANNERS, AND PORTFOLIO COVERS (U.S. CLS. 2, 5, 22, 23, 29, 37, 38 AND 50).

### CLASS 18—LEATHER GOODS

FOR ALL-PURPOSE SPORTS BAGS, TOTE BAGS, TRAVEL BAGS, WAIST PACKS, BACKPACKS, BOOK-BAGS, POUCHES FOR CARRYING SCHOOL MATERIALS, FANNYPACKS, HAND BAGS, SHOULDER BAGS, BEACH BAGS, OVERNIGHT BAGS, TRUNKS, SUITCASES, TRAVELLING BAGS, DUFFLE BAGS, WALLET, KEY CASES, PURSES, PARASOLS, AND UMBRELLAS (U.S. CLS. 1, 2, 3, 22 AND 41).

### CLASS 25—CLOTHING

FOR APPAREL, NAMELY, TOPS, SHIRTS, BLOUSES, T-SHIRTS, SWEAT SHIRTS, SPORTS JERSEYS, SWEATERS, BOTTOMS, TROUSERS, PANTS, SWEAT PANTS, SHORTS, JACKETS, COATS, OVERCOATS, PULLOVERS, JUMPERS, DRESSES, SKIRTS, BEACHWEAR, SWIMSUITS, UNDERWEAR, LINGERIE, HEADWEAR, HATS, CAPS, BEANIES, VISORS, TIES, SOCKS, BELTS, GLOVES, SCARVES AND WRISTBANDS (U.S. CLS. 22 AND 39).

### CLASS 28—TOYS AND SPORTING GOODS

FOR SPORTS BALLS OF EVERY KIND, RACKETS FOR TENNIS, SQUASH OR SHUTTLECOCK, ICE AND ROLLER SKATES, RACKET COVERS, GOLF CLUBS, GOLF BALLS, GOLF GLOVES, GOLF CLUB GRIPS, GOLF BAGS, GOLF TEES, HEAD COVERS FOR GOLF CLUBS, GOLF BALL MARKERS, BASEBALL AND SOFTBALL BATS, MITTS; NOSE CLIPS FOR SWIMMING PURPOSES, KICKBOARDS, AND BUOYS FOR RECREATIONAL USE (U.S. CLS. 22, 23, 38 AND 50).

### CLASS 35—ADVERTISING AND BUSINESS

FOR RETAIL STORE, ON-LINE RETAIL STORE, AND MAIL ORDER CATALOG SERVICES FEATURING FOOTWEAR AND APPAREL (U.S. CLS. 100, 101 AND 102).

### CLASS 41—EDUCATION AND ENTERTAINMENT

FOR ORGANIZING AND CONDUCTING SPORTS AND ATHLETIC COMPETITIONS, TOURNAMENTS, EXHIBITIONS AND EVENTS IN THE FIELDS OF BASEBALL, BASKETBALL, DIVING, GOLF, TENNIS, TRACK AND FIELD, SOCCER, SWIMMING; ATHLETIC TRAINING SERVICES (U.S. CLS. 100, 101 AND 107).

AISHA CLARKE, EXAMINING ATTORNEY

SN 86-112,657. WATERS TECHNOLOGIES CORPORATION, WILMINGTON, DE. FILED 11-7-2013.

## VICAM

THE MARK CONSISTS OF STANDARD CHARACTERS WITHOUT CLAIM TO ANY PARTICULAR FONT, STYLE, SIZE, OR COLOR.

### CLASS 1—CHEMICALS

FOR KITS COMPRISING REAGENTS NOT FOR MEDICAL USE, CHEMICALLY-TREATED TEST STRIPS AND HOLDERS FOR TEST STRIPS FOR THE DETECTION OF MYCOTOXINS BY ANTIBODY AFFINITY REACTIONS IN GRAIN, FEED, AND FOOD PRODUCTS; ASSAY KITS COMPRISING AN AFFINITY COLUMN AND CHEMICAL REAGENTS FOR TESTING FOR MYCOTOXIN CONTAMINATION IN GRAIN, FEED, AND FOOD PRODUCTS; AFFINITY COLUMNS, COMPRISING MONOCLONAL ANTIBODIES, FOR PURIFYING SAMPLES FOR SUBSEQUENT LIQUID-CHROMATOGRAPHY AND MASS-SPECTROMETRY TESTING FOR MYCOTOXIN CONTAMINATION IN GRAIN, FEED, AND FOOD PRODUCTS; KITS COMPRISING MONOCLONAL ANTIBODIES, BUFFERS AND REAGENTS FOR USE IN THE DETECTION OF MYCOTOXIN CONTAMINATION (U.S. CLS. 1, 5, 6, 10, 26 AND 46).

FIRST USE 12-31-1987; IN COMMERCE 12-31-1987.

**CLASS 9—ELECTRICAL AND SCIENTIFIC APPARATUS**

FOR ELECTRONIC DETECTORS FOR INDICATING THE PRESENCE OR ABSENCE OF TOXINS IN THE FIELDS OF AGRICULTURE AND FOOD PROCESSING; MEASURING DEVICES, NAMELY, FLUOROMETERS; LATERAL FLOW READERS (U.S. CLS. 21, 23, 26, 36 AND 38).

FIRST USE 12-31-1987; IN COMMERCE 12-31-1987.  
FLORENTINA BLANDU, EXAMINING ATTORNEY

**CLASS 42—SCIENTIFIC AND COMPUTER SERVICES**

FOR PROVIDING A WEBSITE THAT GIVES USERS THE ABILITY TO PURCHASE DOWNLOADABLE MUSIC; PROVIDING A WEB SITE FEATURING TECHNOLOGY THAT ENABLES THE PURCHASE OF MUSIC (U.S. CLS. 100 AND 101).

RONALD MCMORROW, EXAMINING ATTORNEY

SN 86-112,982. SPANISH BROADCASTING SYSTEM, INC., COCONUT GROVE, FL. FILED 11-7-2013.

SN 86-113,005. SPANISH BROADCASTING SYSTEM, INC., COCONUT GROVE, FL. FILED 11-7-2013.

**La Maquina Del Tiempo****Radioactivo**

THE MARK CONSISTS OF STANDARD CHARACTERS WITHOUT CLAIM TO ANY PARTICULAR FONT, STYLE, SIZE, OR COLOR.

THE ENGLISH TRANSLATION OF THE WORDS "LA MAQUINA DEL TIEMPO" IS "THE TIME MACHINE".

THE MARK CONSISTS OF STANDARD CHARACTERS WITHOUT CLAIM TO ANY PARTICULAR FONT, STYLE, SIZE, OR COLOR.

THE ENGLISH TRANSLATION OF "RADIOACTIVO" IS "RADIOACTIVE".

**CLASS 41—EDUCATION AND ENTERTAINMENT**

FOR PROVIDING A WEBSITE FEATURING INFORMATION IN THE FIELD OF HISTORIC MUSIC (U.S. CLS. 100, 101 AND 107).

**CLASS 38—COMMUNICATION**

FOR STREAMING OF RADIO AND AUDIO MATERIAL ON THE INTERNET; COMMUNICATIONS SERVICES, NAMELY, TRANSMITTING STREAMED RADIO, SOUND AND AUDIO-VISUAL RECORDINGS VIA THE INTERNET; STREAMING OF VIDEO MATERIAL ON THE INTERNET; RADIO BROADCASTING SERVICES; SPANISH LANGUAGE RADIO BROADCASTING (U.S. CLS. 100, 101 AND 104).

**CLASS 42—SCIENTIFIC AND COMPUTER SERVICES**

FOR PROVIDING A WEBSITE FEATURING TECHNOLOGY THAT ENABLES USERS TO BROWSE, ACCESS AND SEARCH HISTORIC MUSIC CONTENT BY DATE AND TIMELINE; HOSTING OF DIGITAL MUSIC, VIDEO AND ENTERTAINMENT CONTENT ON THE INTERNET (U.S. CLS. 100 AND 101).

RONALD MCMORROW, EXAMINING ATTORNEY

**CLASS 42—SCIENTIFIC AND COMPUTER SERVICES**

FOR HOSTING OF DIGITAL MUSIC, VIDEO AND ENTERTAINMENT CONTENT ON THE INTERNET (U.S. CLS. 100 AND 101).

RONALD MCMORROW, EXAMINING ATTORNEY

SN 86-112,997. SPANISH BROADCASTING SYSTEM, INC., COCONUT GROVE, FL. FILED 11-7-2013.

SN 86-114,048. MARTIN, AUGUST D., ALBUQUERQUE, NM. FILED 11-8-2013.

**MusicaMania****LOVETOWN**

THE MARK CONSISTS OF STANDARD CHARACTERS WITHOUT CLAIM TO ANY PARTICULAR FONT, STYLE, SIZE, OR COLOR.

**CLASS 35—ADVERTISING AND BUSINESS**

FOR ON-LINE RETAIL STORE SERVICES FEATURING DOWNLOADABLE PRE-RECORDED MUSIC AND VIDEO; PROVIDING AN ON-LINE SEARCHABLE DATABASE FEATURING MUSIC OFFERED FOR SALE (U.S. CLS. 100, 101 AND 102).

THE MARK CONSISTS OF STANDARD CHARACTERS WITHOUT CLAIM TO ANY PARTICULAR FONT, STYLE, SIZE, OR COLOR.

**CLASS 25—CLOTHING**

FOR BASEBALL CAPS AND HATS; HATS; HEAD WRAPS; HEADWEAR; HOODED SWEATSHIRTS; JACKETS; JERSEYS; PANTS; SHIRTS; SWEATSHIRTS; T-SHIRTS (U.S. CLS. 22 AND 39).

**CLASS 41—EDUCATION AND ENTERTAINMENT**

FOR ENTERTAINMENT SERVICES IN THE NATURE OF LIVE MUSICAL PERFORMANCES; ENTERTAINMENT SERVICES IN THE NATURE OF PRESENTING LIVE MUSICAL PERFORMANCES; ENTERTAINMENT SERVICES IN THE NATURE OF PROVIDING A WEB SITE FEATURING INFORMATION RELATING TO LIVE MUSICAL PERFORMANCES, MUSICAL RECORDINGS, AND RELATED MERCHANDISE; ENTERTAINMENT, NAMELY, LIVE PERFORMANCES BY A MUSICAL BAND (U.S. CLS. 100, 101 AND 107).

ESTHER BELENKER, EXAMINING ATTORNEY

SN 86-114,358. GENERAL ELECTRIC COMPANY, SCHE-  
NECTADY, NY. FILED 11-8-2013.



OWNER OF U.S. REG. NOS. 320,304, 1,017,947 AND OTHERS.

THE MARK CONSISTS OF STYLIZED LETTERS "GE" INSIDE A CIRCLE WITH FOUR CURLICUES SURROUNDED BY WORDS "GENERAL" AND "ELECTRIC".

**CLASS 7—MACHINERY**

FOR CLOTHES WASHING MACHINES; DISH WASHING MACHINES (U.S. CLS. 13, 19, 21, 23, 31, 34 AND 35).  
FIRST USE 10-1-2013; IN COMMERCE 10-1-2013.

**CLASS 11—ENVIRONMENTAL CONTROL APPARATUS**

FOR BAKING OVENS; CLOTHES DRYERS; CONVECTION OVENS; COOKING OVENS; ELECTRIC COOKING OVENS; ELECTRIC COOKING STOVES; ELECTRIC RANGES; GAS COOKING OVENS; GAS RANGES; GAS STOVES; MICROWAVE OVENS FOR HOUSEHOLD PURPOSES; REFRIGERATORS (U.S. CLS. 13, 21, 23, 31 AND 34).

FIRST USE 10-1-2013; IN COMMERCE 10-1-2013.  
KATHERINE STOIDES, EXAMINING ATTORNEY

SN 86-114,400. PANDORA MEDIA, INC., OAKLAND, CA.  
FILED 11-8-2013.



OWNER OF U.S. REG. NOS. 4,396,690 AND 4,396,691.  
THE COLOR(S) BLUE IS/ARE CLAIMED AS A FEATURE OF THE MARK.

THE MARK CONSISTS OF THE A BLUE LETTER "P" IN A CUSTOM FONT.

**CLASS 9—ELECTRICAL AND SCIENTIFIC APPARATUS**

FOR DOWNLOADABLE COMPUTER SOFTWARE FOR STREAMING, BROADCASTING, TRANSMITTING AND REPRODUCING MUSIC AND COMEDY (U.S. CLS. 21, 23, 26, 36 AND 38).

FIRST USE 9-18-2013; IN COMMERCE 9-18-2013.

**CLASS 38—COMMUNICATION**

FOR STREAMING OF MUSIC AND COMEDY OF OTHERS OVER A GLOBAL COMPUTER NETWORK; BROADCASTING SERVICES, NAMELY, DIGITAL AUDIO BROADCASTING SERVICES PROVIDED VIA A GLOBAL COMMUNICATIONS NETWORK; INTERNET RADIO BROADCASTING SERVICES (U.S. CLS. 100, 101 AND 104).

FIRST USE 9-18-2013; IN COMMERCE 9-18-2013.

**CLASS 41—EDUCATION AND ENTERTAINMENT**

FOR PROVIDING MUSIC REVIEWS AND INFORMATION IN THE FIELD OF MUSIC OVER A GLOBAL COMPUTER NETWORK; ENTERTAINMENT SERVICES, NAMELY, PROVIDING NON-DOWNLOADABLE PRE-RECORDED MUSIC, INFORMATION IN THE FIELD OF MUSIC, AND COMMENTARY AND ARTICLES ABOUT MUSIC, ALL ON-LINE VIA A GLOBAL COMPUTER NETWORK; PROVIDING AN INTERNET WEBSITE PORTAL IN THE FIELD OF MUSIC; ENTERTAINMENT SERVICES, NAMELY, PROVIDING NON-DOWNLOADABLE COMEDY PERFORMANCES, COMEDY VIDEOS, RELATED FILM CLIPS, PHOTOGRAPHS, AND OTHER MULTIMEDIA MATERIALS FEATURING COMEDY BY MEANS OF AUDIO AND VIDEO TRANSMISSION OVER THE INTERNET AND OTHER COMMUNICATIONS NETWORKS; ENTERTAINMENT SERVICES, NAMELY, PROVIDING INFORMATION IN THE FIELD OF COMEDY OVER A GLOBAL COMPUTER NETWORK AND OTHER COMMUNICATIONS NETWORKS; ENTERTAINMENT SERVICES, NAMELY, PROVIDING ONLINE REVIEWS OF COMEDY PERFORMANCES; ENTERTAINMENT SERVICES, NAMELY, PROFILING OF COMEDY TASTES BY PROVIDING VIDEO CLIPS OF COMEDY ROUTINES OVER A GLOBAL COMPUTER NETWORK WHERE USERS MAKE SELECTIONS OF PREFERRED CLIPS; ENTERTAINMENT SERVICES, NAMELY, MAKING RECOMMENDATIONS OF COMEDY ROUTINES BASED ON USER SELECTION OF VIDEO CLIPS OF COMEDY ROUTINES; ARRANGING AND CONDUCTING OF CONCERTS; ENTERTAINMENT, NAMELY, LIVE MUSIC SHOWS AND COMEDY SHOWS (U.S. CLS. 100, 101 AND 107).

FIRST USE 9-18-2013; IN COMMERCE 9-18-2013.

**CLASS 42—SCIENTIFIC AND COMPUTER SERVICES**

FOR PROVIDING A WEB SITE FEATURING TECHNOLOGY THAT ALLOWS USERS TO INPUT THEIR SELECTIONS OF MUSIC CLIPS AND COMEDY VIDEOS, SO THAT PROFILING CAN BE COMPLETED AND RECOMMENDATIONS PROVIDED FOR OTHER MUSIC AND COMEDY SELECTIONS; PROVIDING TEMPORARY ACCESS TO NON-DOWNLOADABLE SOFTWARE FOR PROFILING MUSICAL AND COMEDY TASTES BASED ON CONSUMER SELECTION OF MUSIC CLIPS AND COMEDY VIDEOS PLAYED OVER A GLOBAL COMPUTER NETWORK, AND RECOMMENDING OTHER MUSIC AND COMEDY TO CONSUMERS BASED ON SUCH SELECTIONS (U.S. CLS. 100 AND 101).

FIRST USE 9-18-2013; IN COMMERCE 9-18-2013.  
CHERYL CLAYTON, EXAMINING ATTORNEY

SN 86-114,402. PANDORA MEDIA, INC., OAKLAND, CA.  
FILED 11-8-2013.



OWNER OF U.S. REG. NOS. 4,396,690 AND 4,396,691.  
THE MARK CONSISTS OF THE LETTER "P" IN A  
CUSTOM FONT, ON A SQUARE WITH ROUNDED EDGES  
THAT ARE SHADED SO THE SQUARE APPEARS THREE  
DIMENSIONAL.

#### **CLASS 9—ELECTRICAL AND SCIENTIFIC APPARATUS**

FOR DOWNLOADABLE COMPUTER SOFTWARE FOR  
STREAMING, BROADCASTING, TRANSMITTING AND  
REPRODUCING MUSIC AND COMEDY (U.S. CLS. 21,  
23, 26, 36 AND 38).

FIRST USE 9-18-2013; IN COMMERCE 9-18-2013.

#### **CLASS 38—COMMUNICATION**

FOR STREAMING OF MUSIC AND COMEDY OF  
OTHERS OVER A GLOBAL COMPUTER NETWORK;  
BROADCASTING SERVICES, NAMELY, DIGITAL  
AUDIO BROADCASTING SERVICES PROVIDED VIA A  
GLOBAL COMMUNICATIONS NETWORK; INTERNET  
RADIO BROADCASTING SERVICES (U.S. CLS. 100, 101  
AND 104).

FIRST USE 9-18-2013; IN COMMERCE 9-18-2013.

#### **CLASS 41—EDUCATION AND ENTERTAIN- MENT**

FOR PROVIDING MUSIC REVIEWS AND INFORMA-  
TION IN THE FIELD OF MUSIC OVER A GLOBAL  
COMPUTER NETWORK; ENTERTAINMENT SERVICES,  
NAMELY, PROVIDING NON-DOWNLOADABLE PRE-  
RECORDED MUSIC, INFORMATION IN THE FIELD  
OF MUSIC, AND COMMENTARY AND ARTICLES  
ABOUT MUSIC, ALL ON-LINE VIA A GLOBAL COM-  
PUTER NETWORK; PROVIDING AN INTERNET WEB-  
SITE PORTAL IN THE FIELD OF MUSIC;  
ENTERTAINMENT SERVICES, NAMELY, PROVIDING  
NON-DOWNLOADABLE COMEDY PERFORMANCES,  
COMEDY VIDEOS, RELATED FILM CLIPS, PHOTO-  
GRAPHS, AND OTHER MULTIMEDIA MATERIALS  
FEATURING COMEDY BY MEANS OF AUDIO AND  
VIDEO TRANSMISSION OVER THE INTERNET AND  
OTHER COMMUNICATIONS NETWORKS; ENTER-  
TAINMENT SERVICES, NAMELY, PROVIDING INFOR-  
MATION IN THE FIELD OF COMEDY OVER A GLOBAL  
COMPUTER NETWORK AND OTHER COMMUNICA-  
TIONS NETWORKS; ENTERTAINMENT SERVICES,  
NAMELY, PROVIDING ONLINE REVIEWS OF COME-  
DY PERFORMANCES; ENTERTAINMENT SERVICES,  
NAMELY, PROFILING OF COMEDY TASTES BY PRO-  
VIDING VIDEO CLIPS OF COMEDY ROUTINES OVER  
A GLOBAL COMPUTER NETWORK WHERE USERS  
MAKE SELECTIONS OF PREFERRED CLIPS; ENTER-  
TAINMENT SERVICES, NAMELY, MAKING RECOM-  
MENDATIONS OF COMEDY ROUTINES BASED ON  
USER SELECTION OF VIDEO CLIPS OF COMEDY  
ROUTINES; ARRANGING AND CONDUCTING OF  
CONCERTS; ENTERTAINMENT, NAMELY, LIVE MU-  
SIC SHOWS AND COMEDY SHOWS (U.S. CLS. 100, 101  
AND 107).

FIRST USE 9-18-2013; IN COMMERCE 9-18-2013.

#### **CLASS 42—SCIENTIFIC AND COMPUTER SERVICES**

FOR PROVIDING A WEB SITE FEATURING TECH-  
NOLOGY THAT ALLOWS USERS TO INPUT THEIR  
SELECTIONS OF MUSIC CLIPS AND COMEDY VIDEOS,  
SO THAT PROFILING CAN BE COMPLETED AND  
RECOMMENDATIONS PROVIDED FOR OTHER MUSIC  
AND COMEDY SELECTIONS; PROVIDING TEMPOR-  
ARY ACCESS TO NON-DOWNLOADABLE SOFTWARE  
FOR PROFILING MUSICAL AND COMEDY TASTES  
BASED ON CONSUMER SELECTION OF MUSIC CLIPS  
AND COMEDY VIDEOS PLAYED OVER A GLOBAL  
COMPUTER NETWORK, AND RECOMMENDING  
OTHER MUSIC AND COMEDY TO CONSUMERS  
BASED ON SUCH SELECTIONS (U.S. CLS. 100 AND 101).

FIRST USE 9-18-2013; IN COMMERCE 9-18-2013.

CHERYL CLAYTON, EXAMINING ATTORNEY

SN 86-114,745. MICROBIAL DISINFECTING SOLUTIONS,  
INC., DBA FIRST TEAM CLEAN, KNOXVILLE, TN.  
FILED 11-10-2013.

#### **For The Health Of The Game**

THE MARK CONSISTS OF STANDARD CHARACTERS  
WITHOUT CLAIM TO ANY PARTICULAR FONT, STYLE,  
SIZE, OR COLOR.

#### **CLASS 3—COSMETICS AND CLEANING PRE- PARATIONS**

FOR LAUNDRY DETERGENT, NAMELY, A DETER-  
GENT HAVING ANTI-MICROBIAL PROPERTIES FOR  
WASHING FABRIC PRODUCTS AND UNIFORMS USED  
IN ATHLETIC PROGRAMS (U.S. CLS. 1, 4, 6, 50, 51 AND  
52).



**CLASS 5—PHARMACEUTICALS**

FOR DISINFECTING SPRAYS FOR SPORTS EQUIPMENT; ANTI-BACTERIAL AND DEODORIZING AIR SPRAYS; MOLD INHIBITOR IN SPRAY FORM, NAMELY, ANTIMICROBIAL PREPARATIONS FOR INHIBITING MOLD; DISINFECTING SPRAY FOR FIELD TURF; LAUNDRY ADDITIVE IN THE NATURE OF AN ANTIMICROBIAL PREPARATION FOR TREATING AND PRE-TREATING BACTERIA; ANTI-SEPTIC WIPES; ANTI-SEPTIC OINTMENTS; ANTI-BACTERIAL HAND SANITIZER GEL (U.S. CLS. 6, 18, 44, 46, 51 AND 52).

MARCIE MILONE, EXAMINING ATTORNEY

SN 86-115,015. FASTENAL IP COMPANY, WINONA, MN.  
FILED 11-11-2013.

## FASTENAL PERFORMANCE ANCHORING SYSTEMS

THE MARK CONSISTS OF STANDARD CHARACTERS WITHOUT CLAIM TO ANY PARTICULAR FONT, STYLE, SIZE, OR COLOR.

OWNER OF U.S. REG. NOS. 3,211,071, 3,549,765 AND 3,722,293.

NO CLAIM IS MADE TO THE EXCLUSIVE RIGHT TO USE "ANCHORING SYSTEMS", APART FROM THE MARK AS SHOWN.

**CLASS 1—CHEMICALS**

FOR EPOXY GLUE FOR GENERAL BONDING AND REPAIR PURPOSES (U.S. CLS. 1, 5, 6, 10, 26 AND 46).

**CLASS 8—HAND TOOLS**

FOR MANUALLY-OPERATED EPOXY ADHESIVE DISPENSING GUNS AND NOZZLES AND BITS FOR SAME; HAND TOOLS, NAMELY, SETTING TOOLS FOR DROP ANCHORS (U.S. CLS. 23, 28 AND 44).

APRIL REEVES, EXAMINING ATTORNEY

SN 86-115,020. HOMER TLC, INC., WILMINGTON, DE.  
FILED 11-11-2013.

## CONNECT UP

THE MARK CONSISTS OF STANDARD CHARACTERS WITHOUT CLAIM TO ANY PARTICULAR FONT, STYLE, SIZE, OR COLOR.

**CLASS 9—ELECTRICAL AND SCIENTIFIC APPARATUS**

FOR HOME AND OFFICE AUTOMATION SYSTEMS COMPRISING WIRELESS AND WIRED CONTROLLERS, CONTROLLED DEVICES, AND SOFTWARE FOR LIGHTING, HVAC, SECURITY, SAFETY AND OTHER HOME AND OFFICE MONITORING AND CONTROL APPLICATIONS; FIRE ALARMS, ALARM CENTRAL UNITS, ANTI-INTRUSION ALARMS, BURGLAR ALARMS, PERSONAL HEALTH AND SECURITY ALARMS, SMOKE ALARMS, AND GAS ALARMS; SPRINKLER SYSTEMS FOR FIRE PROTECTION; ENVIRONMENTAL SENSORS AND DETECTORS FOR DETECTING SMOKE, GAS, PRESSURE AND MOVEMENT; KEYPADS AND CONTROL PANELS FOR SECURITY SYSTEMS, FIRE ALARMS, ALARM CENTRAL UNITS, ANTI-INTRUSION ALARMS, BURGLAR ALARMS, PERSONAL HEALTH AND SECURITY ALARMS, SMOKE AND GAS ALARMS, HOME SURVEILLANCE SYSTEMS, LIGHTING CONTROLS, HOME AUTOMATION DEVICES AND SPRINKLER SYSTEMS FOR FIRE PROTECTION; COMPUTER SOFTWARE USED TO OPERATE, MANAGE AND MONITOR SECURITY SYSTEMS, FIRE ALARMS, ALARM CENTRAL UNITS, ANTI-INTRUSION ALARMS, BURGLAR ALARMS, PERSONAL HEALTH AND SECURITY ALARMS, SMOKE AND GAS ALARMS, HOME SURVEILLANCE SYSTEMS, LIGHTING CONTROLS AND HOME AUTOMATION DEVICES; COMPUTER SOFTWARE USED TO TRACK HEALTH CONDITIONS AND ENVIRONMENTAL CONDITIONS, AND USED TO TRANSMIT ELECTRONIC MESSAGES AND DATA VIA COMMUNICATIONS NETWORKS; HOME AND OFFICE AUTOMATION SYSTEMS COMPRISING WIRELESS AND WIRED CONTROLLERS, CONTROLLED DEVICES, AND SOFTWARE FOR LIGHTING, HVAC, SECURITY, SAFETY; ELECTRICAL CONTROLLERS AND SWITCHES FOR USE WITH SPRINKLER SYSTEMS, HOME AUTOMATION AND LIGHTING; MOTION SENSITIVE SECURITY LIGHTS; ELECTRIC AND ELECTRONIC VIDEO SURVEILLANCE INSTALLATIONS; CAMERAS, INCLUDING VIDEO, TELEVISION AND SURVEILLANCE CAMERAS; VIDEO AND TELEVISION MONITORS; MOUNTING DEVICES FOR CAMERAS AND MONITORS (U.S. CLS. 21, 23, 26, 36 AND 38).

**CLASS 10—MEDICAL APPARATUS**

FOR HEART MONITORS; BLOOD PRESSURE MONITORS (U.S. CLS. 26, 39 AND 44).

**CLASS 35—ADVERTISING AND BUSINESS**

FOR RETAIL STORE SERVICES, ONLINE RETAIL STORE SERVICES AND MAIL ORDER SERVICES FEATURING TELECOMMUNICATIONS SYSTEMS FOR HOME SECURITY AND AUTOMATION APPLICATIONS; RETAIL STORE SERVICES, ONLINE RETAIL STORE SERVICES AND MAIL ORDER SERVICES FEATURING INTEGRATED BUILDING SYSTEMS COMBINING SECURITY, LIGHTING, CLIMATE CONTROL, AUTOMATION, PERSONAL HEALTH AND SECURITY ALARMS AND OTHER FUNCTIONS; PROVIDING INFORMATION ON HOME AND OFFICE AUTOMATION PRODUCTS AND SERVICES (U.S. CLS. 100, 101 AND 102).

**CLASS 37—CONSTRUCTION AND REPAIR**

FOR INSTALLATION OF HOME AND OFFICE AUTOMATION SYSTEMS COMPRISING WIRELESS AND WIRED CONTROLLERS, CONTROLLED DEVICES AND SOFTWARE FOR LIGHTING, HVAC, SECURITY, SAFETY AND OTHER HOME AND OFFICE MONITORING, PERSONAL HEALTH AND SECURITY ALARMS, AND CONTROL APPLICATIONS (U.S. CLS. 100, 103 AND 106).

**CLASS 45—PERSONAL AND LEGAL SERVICES**

SN 86-116,453. THINKTHIN, LLC, VENTURA, CA. FILED 11-12-2013.

FOR ELECTRONIC MONITORING SERVICES FOR SECURITY PURPOSES IN THE FIELD OF INTEGRATED BUILDING SYSTEMS COMBINING HAZARD DETECTION, HAZARD ALARM, SECURITY, LIGHTING, CLIMATE CONTROL, AUTOMATION, PERSONAL HEALTH AND SECURITY ALARMS, AND OTHER FUNCTIONS (U.S. CLS. 100 AND 101).

BRIAN NEVILLE, EXAMINING ATTORNEY

---

SN 86-115,212. BONNIER ACTIVE MEDIA, INC., WINTER PARK, FL. FILED 11-11-2013.

**OUTDOOR LIFE**

THE MARK CONSISTS OF STANDARD CHARACTERS WITHOUT CLAIM TO ANY PARTICULAR FONT, STYLE, SIZE, OR COLOR.

NO CLAIM IS MADE TO THE EXCLUSIVE RIGHT TO USE "OUTDOOR", APART FROM THE MARK AS SHOWN.

**CLASS 20—FURNITURE AND ARTICLES NOT OTHERWISE CLASSIFIED**

FOR CAMPING TABLES, CHAIRS, COTS AND PILLOWS; INFLATABLE AIR MATTRESS FOR USE WHEN CAMPING; SLEEPING BAGS FOR CAMPING; FOAM MATTRESS AND SLEEPING BAG PADS FOR CAMPING USE (U.S. CLS. 2, 13, 22, 25, 32 AND 50).

**CLASS 22—CORDAGE AND FIBERS**

FOR TENTS; TENTS FOR MOUNTAINEERING OR CAMPING, CANVAS CANOPIES FOR CAMPING (U.S. CLS. 1, 2, 7, 19, 22, 42 AND 50).

ELLEN PERKINS, EXAMINING ATTORNEY

---

SN 86-116,056. KURION, INC., OAK RIDGE, TN. FILED 11-12-2013.

**MDS**

THE MARK CONSISTS OF STANDARD CHARACTERS WITHOUT CLAIM TO ANY PARTICULAR FONT, STYLE, SIZE, OR COLOR.

**CLASS 11—ENVIRONMENTAL CONTROL APPARATUS**

FOR HAZARDOUS WASTE PROCESSING SYSTEM PRIMARILY COMPRISING MACHINES USING DETRIATION PROCESSING TO REMOVE TRITIUM FROM LIGHT WATER (U.S. CLS. 13, 21, 23, 31 AND 34).

**CLASS 40—MATERIAL TREATMENT**

FOR HAZARDOUS WASTE MANAGEMENT, NAMELY, REMOVAL OF TRITIUM FROM LIGHT WATER (U.S. CLS. 100, 103 AND 106).

STEVEN R. FINE, EXAMINING ATTORNEY

**THINKTHIN PROTEIN**

THE MARK CONSISTS OF STANDARD CHARACTERS WITHOUT CLAIM TO ANY PARTICULAR FONT, STYLE, SIZE, OR COLOR.

OWNER OF U.S. REG. NOS. 3,238,772, 4,054,067 AND OTHERS.

NO CLAIM IS MADE TO THE EXCLUSIVE RIGHT TO USE "PROTEIN", APART FROM THE MARK AS SHOWN.

**CLASS 5—PHARMACEUTICALS**

FOR DIETARY DRINK MIX FOR USE AS A MEAL REPLACEMENT FOR WEIGHT LOSS PURPOSES; DIETARY SUPPLEMENTAL DRINKS; DIETARY SUPPLEMENTAL DRINKS IN THE NATURE OF VITAMIN AND MINERAL BEVERAGES; DIETARY SUPPLEMENTS IN THE NATURE OF WEIGHT LOSS POWDERS; ENERGY BOOSTING BARS FOR USE AS A MEAL REPLACEMENT FOR WEIGHT LOSS PURPOSES; DIETARY SUPPLEMENT DRINK MIXES; MEAL REPLACEMENT BARS, MEAL REPLACEMENT DRINKS AND MEAL REPLACEMENT SNACKS FOR WEIGHT LOSS PURPOSES; NUTRITIONAL AND DIETARY SUPPLEMENTS FORMED AND PACKAGED AS BARS; NUTRITIONAL DRINKS, NUTRITIONAL ENERGY BARS AND NUTRITIONAL FOOD BARS USED AS A MEAL REPLACEMENT FOR WEIGHT LOSS PURPOSES; SOY PROTEIN FOR USE AS A NUTRITIONAL SUPPLEMENT IN VARIOUS POWDERED AND READY-TO-DRINK BEVERAGES; VEGAN PROTEIN FOR USE AS A NUTRITIONAL SUPPLEMENT IN READY-TO-DRINK BEVERAGES; ALL THE FOREGOING CONTAINING PROTEIN (U.S. CLS. 6, 18, 44, 46, 51 AND 52).

**CLASS 29—MEATS AND PROCESSED FOODS**

FOR NUT AND SEED-BASED SNACK BARS; NUT-BASED SNACK FOODS; NUT-BASED SNACK FOODS, NAMELY, NUT CLUSTERS; NUT-BASED SNACK FOODS, NAMELY, NUT CRISPS; FROZEN ENTREES CONSISTING PRIMARILY OF MEAT, FISH, POULTRY OR VEGETABLES; ALL THE FOREGOING CONTAINING PROTEIN (U.S. CL. 46).

**CLASS 30—STAPLE FOODS**

FOR CEREAL-BASED SNACK FOODS; FROZEN ENTREES CONSISTING PRIMARILY OF PASTA OR RICE; ALL THE FOREGOING CONTAINING PROTEIN (U.S. CL. 46).

ANTHONY RINKER, EXAMINING ATTORNEY

SN 86-117,441. BLUEGREEN CORPORATION, BOCA RATON, FL. FILED 11-13-2013.



OWNER OF U.S. REG. NO. 4,332,646.  
 THE COLOR(S) BLUE, GREEN, ORANGE AND GREY IS/ARE CLAIMED AS A FEATURE OF THE MARK.  
 THE MARK CONSISTS OF THREE CIRCLES IN THE COLORS BLUE, GREEN AND ORANGE WITH THE GREEN CIRCLE APPEARING TO THE RIGHT OF THE BLUE CIRCLE AND THE ORANGE CIRCLE APPEARING TO THE RIGHT OF THE GREEN CIRCLE. TO THE RIGHT OF THE ORANGE CIRCLE, THE WORD "BLUEGREENVACATIONS" APPEARS IN GREY.

**CLASS 36—INSURANCE AND FINANCIAL**

FOR VACATION CLUB SERVICES, NAMELY, REAL ESTATE TIME SHARING SERVICES; VACATION REAL ESTATE TIME-SHARING SERVICES (U.S. CLS. 100, 101 AND 102).  
 FIRST USE 5-0-2011; IN COMMERCE 5-0-2011.

**CLASS 43—HOTEL AND RESTAURANT SERVICES**

FOR VACATION CLUB SERVICES, NAMELY, MAKING RESERVATIONS AND BOOKINGS FOR TEMPORARY LODGING; TRAVEL AGENCY SERVICES, NAMELY, MAKING RESERVATIONS AND BOOKINGS FOR TEMPORARY LODGING (U.S. CLS. 100 AND 101).  
 FIRST USE 5-0-2011; IN COMMERCE 5-0-2011.  
 NICHOLAS ALTREE, EXAMINING ATTORNEY

SN 86-117,509. BLUEGREEN CORPORATION, BOCA RATON, FL. FILED 11-13-2013.



OWNER OF U.S. REG. NO. 4,332,646.  
 THE COLOR(S) BLUE, GREEN, ORANGE AND GREY IS/ARE CLAIMED AS A FEATURE OF THE MARK.  
 THE MARK CONSISTS OF THREE CIRCLES IN THE COLORS BLUE, GREEN AND ORANGE WITH THE GREEN CIRCLE APPEARING TO THE RIGHT OF THE BLUE CIRCLE AND THE ORANGE CIRCLE APPEARING TO THE RIGHT OF THE GREEN CIRCLE. UNDER THE CIRCLES, THE WORD "BLUEGREENVACATIONS" APPEARS IN GREY.

**CLASS 36—INSURANCE AND FINANCIAL**

FOR VACATION CLUB SERVICES, NAMELY, REAL ESTATE TIME SHARING SERVICES; VACATION REAL ESTATE TIME-SHARING SERVICES (U.S. CLS. 100, 101 AND 102).  
 FIRST USE 5-0-2011; IN COMMERCE 5-0-2011.

**CLASS 43—HOTEL AND RESTAURANT SERVICES**

FOR VACATION CLUB SERVICES, NAMELY, MAKING RESERVATIONS AND BOOKINGS FOR TEMPORARY LODGING; TRAVEL AGENCY SERVICES, NAMELY, MAKING RESERVATIONS AND BOOKINGS FOR TEMPORARY LODGING (U.S. CLS. 100 AND 101).  
 FIRST USE 5-0-2011; IN COMMERCE 5-0-2011.  
 NICHOLAS ALTREE, EXAMINING ATTORNEY

SN 86-117,917. CHARTER COMMUNICATIONS HOLDING COMPANY L.L.C., ST. LOUIS, MO. FILED 11-13-2013.



OWNER OF U.S. REG. NOS. 2,461,485, 2,509,312 AND 3,899,216.  
 NO CLAIM IS MADE TO THE EXCLUSIVE RIGHT TO USE "VOICE", APART FROM THE MARK AS SHOWN.  
 THE MARK CONSISTS OF THE WORDS "CHARTER SPECTRUM" BELOW WHICH IS THE WORD "VOICE" AND TO THE RIGHT OF WHICH IS A TRIANGULAR ARROW POINT.

**CLASS 38—COMMUNICATION**

FOR TELECOMMUNICATIONS, NAMELY, THE ELECTRONIC TRANSMISSION OF DATA, SOUND, TEXT, IMAGES AND VIDEO BY MEANS OF FIBER OPTICS, COAXIAL CABLE, SATELLITE, TRANSMISSION MEDIA, AND VIA WIRELESS DEVICES. CABLE TELEVISION COMMUNICATIONS SERVICES, NAMELY, THE INTERACTIVE DISTRIBUTION AND TRANSMISSION OF ANALOG AND DIGITAL FORMAT TELEVISION PROGRAMS, VIDEO, AUDIO, MUSIC, PROGRAM LISTINGS AND DATA VIA CABLE NETWORKS, SATELLITE, COMPUTERS, THE GLOBAL COMPUTER NETWORK, FIBER OPTICS NETWORKS, WIRELESS NETWORKS AND DEVICES THAT ENABLE COMMUNICATIONS; PAY-PER-VIEW TELEVISION AND VIDEO TRANSMISSION SERVICES; VIDEO-ON-DEMAND TELEVISION TRANSMISSION SERVICES; AND INTERACTIVE TELEVISION BROADCASTING AND TRANSMISSION SERVICES PROVIDING ACCESS TO INFORMATION FROM THIRD-PARTY SOURCES AND THE GLOBAL COMPUTER NETWORK; PROVIDING BROADBAND INTERNET ACCESS; PROVIDING BROADBAND INTERNET ACCESS SERVICES TO END USERS; PROVIDING MULTIPLE-USER ACCESS TO A GLOBAL COMPUTER NETWORK, AND PROVIDING VIRTUAL PRIVATE NETWORK (VPN) SERVICES; PROVIDING COMMUNICATIONS CONNECTIONS TO LOCAL AND WIDE AREA COMPUTER AND TELEPHONE NETWORK SYSTEMS, AND PROVIDING ELECTRONIC MAIL SERVICES, TELEPHONE SERVICES, NAMELY, LOCAL AND LONG-DISTANCE DOMESTIC AND INTERNATIONAL TELEPHONE SERVICES, VOICE OVER INTERNET PROTOCOL COMMUNICATIONS SERVICES, LOCAL AND LONG DISTANCE TRANSMISSION OF VOICE, SOUND, DATA, TEXT, IMAGES AND GRAPHICS BY MEANS OF PREPAID TELEPHONE CALLING CARDS; VIDEO AND VOICE CONFERENCING AND TRANSMISSION SERVICES; ELECTRONIC MESSAGING AND CALL FORWARDING SERVICES; PAGING SERVICES; ELECTRONIC MAIL SERVICES; ELECTRONIC TRANSMISSION OF DATA, SOUND, IMAGES AND VIDEO TO SUPPORT DISTANCE EDUCATION NETWORKS (U.S. CLS. 100, 101 AND 104).

**CLASS 39—TRANSPORTATION AND STORAGE**

FOR COMPUTER SERVICES, NAMELY, PROVIDING ELECTRONIC DATA STORAGE, BACKUP AND ARCHIVING SERVICES; PROVIDING ONLINE DATA STORAGE, NAMELY, ELECTRONIC STORAGE AND RETRIEVAL OF ELECTRONIC DIGITAL CONTENT AND DATA TRANSMITTED AND RETRIEVED VIA THE INTERNET; ELECTRONIC STORAGE OF MESSAGES AND DATA USING ENCRYPTION AND DECRYPTION METHODS; STORAGE SERVICES FOR ARCHIVING DATABASES, IMAGES AND OTHER ELECTRONIC DATA RETRIEVED AND TRANSMITTED OVER THE INTERNET; TECHNICAL SUPPORT SERVICES, NAMELY, PROVIDING COMPUTER FACILITIES AND SUPPORT FOR STORAGE AND RETRIEVAL OF DIGITAL DATA TRANSMITTED AND RETRIEVED VIA THE INTERNET (U.S. CLS. 100 AND 105).

**CLASS 42—SCIENTIFIC AND COMPUTER SERVICES**

FOR TECHNICAL SUPPORT SERVICES, NAMELY, TROUBLESHOOTING OF COMPUTER HARDWARE, ELECTRONIC EQUIPMENT AND SOFTWARE THAT ACCESSES THE INTERNET AND GLOBAL COMPUTER NETWORKS VIA TELEPHONE, ELECTRONIC MAIL, FIBER AND COAXIAL CABLE (U.S. CLS. 100 AND 101).  
LINDA M. KING, EXAMINING ATTORNEY

**CLASS 38—COMMUNICATION**

FOR TELECOMMUNICATIONS, NAMELY, THE ELECTRONIC TRANSMISSION OF DATA, SOUND, TEXT, IMAGES AND VIDEO BY MEANS OF FIBER OPTICS, COAXIAL CABLE, SATELLITE, TRANSMISSION MEDIA, AND VIA WIRELESS DEVICES. CABLE TELEVISION COMMUNICATIONS SERVICES, NAMELY, THE INTERACTIVE DISTRIBUTION AND TRANSMISSION OF ANALOG AND DIGITAL FORMAT TELEVISION PROGRAMS, VIDEO, AUDIO, MUSIC, PROGRAM LISTINGS AND DATA VIA CABLE NETWORKS, SATELLITE, COMPUTERS, THE GLOBAL COMPUTER NETWORK, FIBER OPTICS NETWORKS, WIRELESS NETWORKS AND DEVICES THAT ENABLE COMMUNICATIONS; PAY-PER-VIEW TELEVISION AND VIDEO TRANSMISSION SERVICES; VIDEO-ON-DEMAND TELEVISION TRANSMISSION SERVICES; AND INTERACTIVE TELEVISION BROADCASTING AND TRANSMISSION SERVICES PROVIDING ACCESS TO INFORMATION FROM THIRD-PARTY SOURCES AND THE GLOBAL COMPUTER NETWORK; PROVIDING BROADBAND INTERNET ACCESS; PROVIDING BROADBAND INTERNET ACCESS SERVICES TO END USERS; PROVIDING MULTIPLE-USER ACCESS TO A GLOBAL COMPUTER NETWORK, AND PROVIDING VIRTUAL PRIVATE NETWORK (VPN) SERVICES; PROVIDING COMMUNICATIONS CONNECTIONS TO LOCAL AND WIDE AREA COMPUTER AND TELEPHONE NETWORK SYSTEMS, AND PROVIDING ELECTRONIC MAIL SERVICES. TELEPHONE SERVICES, NAMELY, LOCAL AND LONG-DISTANCE DOMESTIC AND INTERNATIONAL TELEPHONE SERVICES, VOICE OVER INTERNET PROTOCOL COMMUNICATIONS SERVICES, LOCAL AND LONG DISTANCE TRANSMISSION OF VOICE, SOUND, DATA, TEXT, IMAGES AND GRAPHICS BY MEANS OF PREPAID TELEPHONE CALLING CARDS; VIDEO AND VOICE CONFERENCING AND TRANSMISSION SERVICES; ELECTRONIC MESSAGING AND CALL FORWARDING SERVICES; PAGING SERVICES; ELECTRONIC MAIL SERVICES; ELECTRONIC TRANSMISSION OF DATA, SOUND, IMAGES AND VIDEO TO SUPPORT DISTANCE EDUCATION NETWORKS (U.S. CLS. 100, 101 AND 104).

SN 86-117,926. CHARTER COMMUNICATIONS HOLDING COMPANY L.L.C., ST. LOUIS, MO. FILED 11-13-2013.

**CLASS 39—TRANSPORTATION AND STORAGE**

FOR COMPUTER SERVICES, NAMELY, PROVIDING ELECTRONIC DATA STORAGE, BACKUP AND ARCHIVING SERVICES; PROVIDING ONLINE DATA STORAGE, NAMELY, ELECTRONIC STORAGE AND RETRIEVAL OF ELECTRONIC DIGITAL CONTENT AND DATA TRANSMITTED AND RETRIEVED VIA THE INTERNET; ELECTRONIC STORAGE OF MESSAGES AND DATA USING ENCRYPTION AND DECRYPTION METHODS; STORAGE SERVICES FOR ARCHIVING DATABASES, IMAGES AND OTHER ELECTRONIC DATA RETRIEVED AND TRANSMITTED OVER THE INTERNET; TECHNICAL SUPPORT SERVICES, NAMELY, PROVIDING COMPUTER FACILITIES AND SUPPORT FOR STORAGE AND RETRIEVAL OF DIGITAL DATA TRANSMITTED AND RETRIEVED VIA THE INTERNET (U.S. CLS. 100 AND 105).

**CLASS 42—SCIENTIFIC AND COMPUTER SERVICES**

FOR TECHNICAL SUPPORT SERVICES, NAMELY, TROUBLESHOOTING OF COMPUTER HARDWARE, ELECTRONIC EQUIPMENT AND SOFTWARE THAT ACCESSES THE INTERNET AND GLOBAL COMPUTER NETWORKS VIA TELEPHONE, ELECTRONIC MAIL, FIBER AND COAXIAL CABLE (U.S. CLS. 100 AND 101).  
LINDA M. KING, EXAMINING ATTORNEY

OWNER OF U.S. REG. NOS. 2,461,485, 3,899,216 AND OTHERS.

NO CLAIM IS MADE TO THE EXCLUSIVE RIGHT TO USE "TV INTERNET", APART FROM THE MARK AS SHOWN.

THE MARK CONSISTS OF THE WORDS "CHARTER SPECTRUM" BELOW WHICH APPEAR THE WORDS "TV/INTERNET", AND TO THE RIGHT OF WHICH IS A TRIANGULAR ARROW POINT.

SN 86-117,930. CHARTER COMMUNICATIONS HOLDING COMPANY L.L.C., ST. LOUIS, MO. FILED 11-13-2013.



OWNER OF U.S. REG. NOS. 2,461,485, 3,899,216 AND OTHERS.

NO CLAIM IS MADE TO THE EXCLUSIVE RIGHT TO USE "INTERNET VOICE", APART FROM THE MARK AS SHOWN.

THE MARK CONSISTS OF THE WORDS "CHARTER SPECTRUM", BELOW WHICH ARE THE WORDS "INTERNET/VOICE", AND TO THE RIGHT OF WHICH IS A TRIANGULAR ARROW POINT.

### CLASS 38—COMMUNICATION

FOR TELECOMMUNICATIONS, NAMELY, THE ELECTRONIC TRANSMISSION OF DATA, SOUND, TEXT, IMAGES AND VIDEO BY MEANS OF FIBER OPTICS, COAXIAL CABLE, SATELLITE, TRANSMISSION MEDIA, AND VIA WIRELESS DEVICES; CABLE TELEVISION COMMUNICATIONS SERVICES, NAMELY, THE INTERACTIVE DISTRIBUTION AND TRANSMISSION OF ANALOG AND DIGITAL FORMAT TELEVISION PROGRAMS, VIDEO, AUDIO, MUSIC, PROGRAM LISTINGS AND DATA VIA CABLE NETWORKS, SATELLITE, COMPUTERS, THE GLOBAL COMPUTER NETWORK, FIBER OPTICS NETWORKS, WIRELESS NETWORKS AND DEVICES THAT ENABLE COMMUNICATIONS; PAY-PER-VIEW TELEVISION AND VIDEO TRANSMISSION SERVICES; VIDEO-ON-DEMAND TELEVISION TRANSMISSION SERVICES; AND INTERACTIVE TELEVISION BROADCASTING AND TRANSMISSION SERVICES PROVIDING ACCESS TO INFORMATION FROM THIRD-PARTY SOURCES AND THE GLOBAL COMPUTER NETWORK; PROVIDING BROADBAND INTERNET ACCESS; PROVIDING BROADBAND INTERNET ACCESS SERVICES TO END USERS; PROVIDING MULTIPLE-USER ACCESS TO A GLOBAL COMPUTER NETWORK, AND PROVIDING VIRTUAL PRIVATE NETWORK (VPN) SERVICES; PROVIDING COMMUNICATIONS CONNECTIONS TO LOCAL AND WIDE AREA COMPUTER AND TELEPHONE NETWORK SYSTEMS, AND PROVIDING ELECTRONIC MAIL SERVICES, TELEPHONE SERVICES, NAMELY, LOCAL AND LONG-DISTANCE DOMESTIC AND INTERNATIONAL TELEPHONE SERVICES, VOICE OVER INTERNET PROTOCOL COMMUNICATIONS SERVICES, LOCAL AND LONG DISTANCE TRANSMISSION OF VOICE, SOUND, DATA, TEXT, IMAGES AND GRAPHICS BY MEANS OF PREPAID TELEPHONE CALLING CARDS; VIDEO AND VOICE CONFERENCING AND TRANSMISSION SERVICES; ELECTRONIC MESSAGING AND CALL FORWARDING SERVICES; PAGING SERVICES; ELECTRONIC MAIL SERVICES; ELECTRONIC TRANSMISSION OF DATA, SOUND, IMAGES AND VIDEO TO SUPPORT DISTANCE EDUCATION NETWORKS (U.S. CLS. 100, 101 AND 104).

### CLASS 39—TRANSPORTATION AND STORAGE

FOR COMPUTER SERVICES, NAMELY, PROVIDING ELECTRONIC DATA STORAGE, BACKUP AND ARCHIVING SERVICES; PROVIDING ONLINE DATA STORAGE, NAMELY, ELECTRONIC STORAGE AND RETRIEVAL OF ELECTRONIC DIGITAL CONTENT AND DATA TRANSMITTED AND RETRIEVED VIA THE INTERNET; ELECTRONIC STORAGE OF MESSAGES AND DATA USING ENCRYPTION AND DECRYPTION METHODS; STORAGE SERVICES FOR ARCHIVING DATABASES, IMAGES AND OTHER ELECTRONIC DATA RETRIEVED AND TRANSMITTED OVER THE INTERNET; TECHNICAL SUPPORT SERVICES, NAMELY, PROVIDING COMPUTER FACILITIES AND SUPPORT FOR STORAGE AND RETRIEVAL OF DIGITAL DATA TRANSMITTED AND RETRIEVED VIA THE INTERNET (U.S. CLS. 100 AND 105).

### CLASS 42—SCIENTIFIC AND COMPUTER SERVICES

FOR TECHNICAL SUPPORT SERVICES, NAMELY, TROUBLESHOOTING OF COMPUTER HARDWARE, ELECTRONIC EQUIPMENT AND SOFTWARE THAT ACCESSES THE INTERNET AND GLOBAL COMPUTER NETWORKS VIA TELEPHONE, ELECTRONIC MAIL, FIBER AND COAXIAL CABLE (U.S. CLS. 100 AND 101).  
LINDA M. KING, EXAMINING ATTORNEY

SN 86-118,047. INDIAN MOTORCYCLE INTERNATIONAL, LLC, MEDINA, MN. FILED 11-13-2013.



OWNER OF U.S. REG. NOS. 4,198,942, 4,325,612 AND OTHERS.

THE MARK CONSISTS OF THE STYLIZED WORDS "INDIAN MOTORCYCLE" LOCATED WITHIN AN INDIAN HEADADDRESS DESIGN.

### CLASS 6—METAL GOODS

FOR NON-LUMINOUS AND NON-MECHANICAL METAL SIGNS (U.S. CLS. 2, 12, 13, 14, 23, 25 AND 50).

### CLASS 9—ELECTRICAL AND SCIENTIFIC APPARATUS

FOR LUMINOUS SIGNS (U.S. CLS. 21, 23, 26, 36 AND 38).

### CLASS 11—ENVIRONMENTAL CONTROL APPARATUS

FOR LAMPS (U.S. CLS. 13, 21, 23, 31 AND 34).

### CLASS 14—JEWELRY

FOR JEWELRY, CLOCKS, COLLECTIBLE COINS (U.S. CLS. 2, 27, 28 AND 50).

### CLASS 16—PAPER GOODS AND PRINTED MATTER

FOR CHECK BOOKS, ART PRINTS AND SIGNS ON CANVAS AND PAPER (U.S. CLS. 2, 5, 22, 23, 29, 37, 38 AND 50).

### CLASS 20—FURNITURE AND ARTICLES NOT OTHERWISE CLASSIFIED

FOR TABLE TOPS (U.S. CLS. 2, 13, 22, 25, 32 AND 50).

### CLASS 21—HOUSEWARES AND GLASS

FOR DECORATIVE STAINED GLASS SIGNS (U.S. CLS. 2, 13, 23, 29, 30, 33, 40 AND 50).

### CLASS 24—FABRICS

FOR CLOTH AND FABRIC FLAGS (U.S. CLS. 42 AND 50).

**CLASS 28—TOYS AND SPORTING GOODS**

FOR TOY MODEL TRAIN SETS; TOY FIGURINES (U.S. CLS. 22, 23, 38 AND 50).  
KATHY DE JONGE, EXAMINING ATTORNEY

SN 86-119,204. UNITED NATIONS FOUNDATION, INC., WASHINGTON, DC. FILED 11-14-2013.

# FP2020

THE MARK CONSISTS OF STANDARD CHARACTERS WITHOUT CLAIM TO ANY PARTICULAR FONT, STYLE, SIZE, OR COLOR.

**CLASS 35—ADVERTISING AND BUSINESS**

FOR PROMOTING PUBLIC AWARENESS OF THE NEED FOR ACCESSIBILITY OF CONTRACEPTIVES AND EFFECTIVE MEANS OF VOLUNTARY FERTILITY CONTROL FOR WOMEN AND GIRLS IN THE DEVELOPING WORLD; PROMOTING PUBLIC POLICIES THAT PROTECT REPRODUCTIVE RIGHTS OF WOMEN AND GIRLS IN THE DEVELOPING WORLD; PROMOTING THE ACCESSIBILITY OF CONTRACEPTION AND EFFECTIVE MEANS OF VOLUNTARY FERTILITY CONTROL; PROMOTING COLLABORATION WITHIN THE RESEARCH AND DEVELOPMENT COMMUNITY TO ACHIEVE ADVANCES IN THE FIELD OF CONTRACEPTION; PROMOTING COLLABORATION AMONG GOVERNMENTS, CIVIL SOCIETY, MULTI-LATERAL ORGANIZATIONS, DONORS, THE PRIVATE SECTOR AND THE RESEARCH AND DEVELOPMENT COMMUNITY TO ENABLE THE USE OF CONTRACEPTIVES BY WOMEN AND GIRLS IN THE DEVELOPING WORLD (U.S. CLS. 100, 101 AND 102).

FIRST USE 6-1-2013; IN COMMERCE 6-1-2013.

**CLASS 41—EDUCATION AND ENTERTAINMENT**

FOR OPERATING EDUCATIONAL AWARENESS PROGRAMS AND CONDUCTING EDUCATIONAL LECTURES, CONFERENCES AND EXHIBITS IN THE FIELDS OF REPRODUCTIVE AND SEXUAL HEALTH, VOLUNTARY FERTILITY CONTROL, AND CONTRACEPTION (U.S. CLS. 100, 101 AND 107).

FIRST USE 6-1-2013; IN COMMERCE 6-1-2013.  
NELSON SNYDER, EXAMINING ATTORNEY

SN 86-119,877. HOMER TLC, INC., WILMINGTON, DE. FILED 11-15-2013.



OWNER OF U.S. REG. NOS. 1,188,191, 4,438,588 AND OTHERS.

NO CLAIM IS MADE TO THE EXCLUSIVE RIGHT TO USE "HOME", APART FROM THE MARK AS SHOWN.

THE MARK CONSISTS OF A HOUSE SHAPE COMPRISED OF HOME APPLIANCES, TOOLS AND ACCESSORIES. AT THE CENTER OF THE HOUSE IS A BOX WITH THE SLANTED STYLIZED TEXT "THE HOME DEPOT". THE CHIMNEY OF THE HOUSE IS COMPRISED OF A BUCKET. ON THE BUCKET IS THE SHADED SQUARE WITH THE SLANTED STYLIZED TEXT "THE HOME DEPOT" INSIDE.

**CLASS 21—HOUSEWARES AND GLASS**

FOR BUCKETS (U.S. CLS. 2, 13, 23, 29, 30, 33, 40 AND 50).

**CLASS 35—ADVERTISING AND BUSINESS**

FOR RETAIL STORE SERVICES FEATURING HOME IMPROVEMENT GOODS AND SERVICES (U.S. CLS. 100, 101 AND 102).

LINDA M. KING, EXAMINING ATTORNEY

SN 86-120,131. CONSILIENT RESTAURANTS HOLDINGS, LLC, DALLAS, TX. FILED 11-15-2013.

# EYE GLASS

THE MARK CONSISTS OF STANDARD CHARACTERS WITHOUT CLAIM TO ANY PARTICULAR FONT, STYLE, SIZE, OR COLOR.

**CLASS 35—ADVERTISING AND BUSINESS**

FOR RETAIL STORE SERVICES FEATURING A WIDE VARIETY OF THIRD PARTY CONSUMER GOODS OF OTHERS RELATED TO MOVIES AND FILM (U.S. CLS. 100, 101 AND 102).

**CLASS 41—EDUCATION AND ENTERTAINMENT**

FOR MOVIE THEATERS (U.S. CLS. 100, 101 AND 107).

**CLASS 43—HOTEL AND RESTAURANT SERVICES**

FOR BAR AND RESTAURANT SERVICES (U.S. CLS. 100 AND 101).

BRIAN PINO, EXAMINING ATTORNEY

SN 86-120,228. DECISION INSIGHT INFORMATION GROUP S.A.R.L., LUXEMBOURG, LUXEMBOURG, FILED 11-15-2013.

# ROOF CONDITION INTELLIGENCE

THE MARK CONSISTS OF STANDARD CHARACTERS WITHOUT CLAIM TO ANY PARTICULAR FONT, STYLE, SIZE, OR COLOR.

NO CLAIM IS MADE TO THE EXCLUSIVE RIGHT TO USE "ROOF CONDITION", APART FROM THE MARK AS SHOWN.

SN 86-120,730. CONSILIENT RESTAURANTS HOLDINGS, LLC, DALLAS, TX. FILED 11-16-2013.

#### CLASS 36—INSURANCE AND FINANCIAL

FOR INSURANCE SERVICES, NAMELY, RISK ASSESSMENT FOR ROOFS; INSURANCE SERVICES, NAMELY, VALUATION FOR INSURANCE UNDERWRITING AND REPLACEMENT COSTS FOR ROOFS; INSURANCE SERVICES, NAMELY, COLLECTING, MAINTAINING, AND PROVIDING INFORMATION ABOUT ROOFS AND ROOF CONDITIONS FOR USE BY THE INSURANCE INDUSTRY, PROPERTY OWNERS, PROPERTY BUYERS, LENDERS, APPRAISERS, AND GOVERNMENTAL ENTITIES (U.S. CLS. 100, 101 AND 102).

#### CLASS 42—SCIENTIFIC AND COMPUTER SERVICES

FOR SOFTWARE AS A SERVICE PROVIDING TEMPORARY USE OF ON-LINE NON-DOWNLOADABLE SOFTWARE AND APPLICATIONS FOR COLLECTING, MAINTAINING, AND PROVIDING PROPERTY VALUATION INFORMATION, FINANCIAL VALUATION INFORMATION, INSURANCE RISK INFORMATION, AND RISK ASSESSMENT INFORMATION ABOUT ROOFS, INCLUDING ENABLING THE USER TO DOWNLOAD THE DATA OUTPUT (U.S. CLS. 100 AND 101).

TRACY CROSS, EXAMINING ATTORNEY

SN 86-120,264. HOUSE OF SPEAKEASY FOUNDATION, NEW YORK, NY. FILED 11-15-2013.

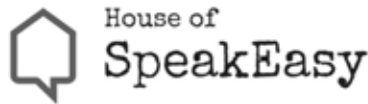

THE MARK CONSISTS OF A SPEECH BUBBLE SHAPED LIKE A HOUSE WITH THE WORDS "HOUSE OF SPEAKEASY" PRINTED ON THE RIGHT.

#### CLASS 35—ADVERTISING AND BUSINESS

FOR PROMOTIONAL SERVICES IN THE NATURE OF ALLOWING WRITERS TO LINK TO RESOURCES AVAILABLE ON A WEBSITE FOR THEIR OWN MARKETING PURPOSES; ONLINE BOOKSTORE FEATURING WORKS OF ART BY FEATURED WRITERS, INCLUDING E-BOOKS, DOWNLOADABLE MUSIC, MOVIES, SCREENPLAYS, BOOKS AND OTHER PUBLISHED MATERIALS BY AUTHORS AND RELATED GOODS (U.S. CLS. 100, 101 AND 102).

#### CLASS 41—EDUCATION AND ENTERTAINMENT

FOR ENTERTAINMENT SERVICES IN THE NATURE OF CABARET STYLE EVENTS DEDICATED TO SUPPORTING AND PROMOTING THE ART OF WRITING, FEATURING PUBLISHED WRITERS, INCLUDING JOURNALISTS, POETS, SONG-WRITERS, AND COMEDIANS; ONLINE NOTEBOOK IN THE NATURE OF A SUBSCRIPTION BASED NEWSLETTER FOCUSED ON SUPPORTING AND PROMOTING THE ART OF WRITING AND PUBLISHED AUTHORS; PROVIDING A WEBSITE FEATURING ENTERTAINMENT INFORMATION AND RECOMMENDATIONS FOR EVENTS, PODCASTS AND VIDEOS, ALL IN THE FIELD OF ART, DEDICATED TO SUPPORTING AND PROMOTING THE ART OF WRITING AND PUBLISHED WRITERS (U.S. CLS. 100, 101 AND 107).

KRISTIN DAHLING, EXAMINING ATTORNEY

## TRUSTED SOURCES

THE MARK CONSISTS OF STANDARD CHARACTERS WITHOUT CLAIM TO ANY PARTICULAR FONT, STYLE, SIZE, OR COLOR.

#### CLASS 35—ADVERTISING AND BUSINESS

FOR RETAIL STORE SERVICES FEATURING A WIDE VARIETY OF THIRD PARTY CONSUMER GOODS OF OTHERS (U.S. CLS. 100, 101 AND 102).

#### CLASS 43—HOTEL AND RESTAURANT SERVICES

FOR RESTAURANT AND BAR SERVICES (U.S. CLS. 100 AND 101).  
BRIAN PINO, EXAMINING ATTORNEY

SN 86-121,217. MORRISON MANAGEMENT SPECIALISTS, INC., ATLANTA, GA. FILED 11-18-2013.



OWNER OF U.S. REG. NOS. 1,006,514, 2,909,530 AND OTHERS.

NO CLAIM IS MADE TO THE EXCLUSIVE RIGHT TO USE "HEALTHCARE", APART FROM THE MARK AS SHOWN.

THE MARK CONSISTS OF THE WORD "MORRISON" IN BOLD LOWER CASE LETTERS OVER THE WORD "HEALTHCARE" IN LOWER CASE LETTERS, BOTH TO THE LEFT OF A PARTIAL HEART CONSISTING OF A PARTIAL CIRCLE FACING LEFT, AND 3 PARTIAL CONCENTRIC CIRCLES FACING RIGHT.

#### CLASS 43—HOTEL AND RESTAURANT SERVICES

FOR CONTRACT FOOD SERVICES; FOOD PREPARATION SERVICES, ALL IN THE FIELD OF HEALTH CARE (U.S. CLS. 100 AND 101).

#### CLASS 44—MEDICAL, BEAUTY AND AGRICULTURAL SERVICES

FOR NUTRITION COUNSELING SERVICES IN THE FIELD OF HEALTH CARE (U.S. CLS. 100 AND 101).  
LEIGH CAROLINE CASE, EXAMINING ATTORNEY

SN 86-121,556. WD PARTNERS, INC., DUBLIN, OH. FILED 11-18-2013.

### WE ARE THINKERS THAT DO

THE MARK CONSISTS OF STANDARD CHARACTERS WITHOUT CLAIM TO ANY PARTICULAR FONT, STYLE, SIZE, OR COLOR.

#### CLASS 35—ADVERTISING AND BUSINESS

FOR MARKETING AND BUSINESS CONSULTING SERVICES, NAMELY, BRAND AND BUSINESS ASSESSMENTS AND DEVELOPMENT, COMPETITIVE ANALYSIS AND POSITIONING, BRAND AND CONCEPT GROWTH STRATEGIES FOR THE CUSTOM DESIGN AND BRANDING OF MULTI-UNIT RESTAURANTS AND RETAIL FACILITIES (U.S. CLS. 100, 101 AND 102).  
FIRST USE 12-0-2012; IN COMMERCE 12-0-2012.

#### CLASS 37—CONSTRUCTION AND REPAIR

FOR CONSTRUCTION SERVICES, NAMELY, PLANNING, LAYING OUT AND CONSTRUCTION PROGRAM MANAGEMENT OF CUSTOM CONSTRUCTION AND BUILDING RENOVATION OF MULTI-UNIT RESTAURANT AND RETAIL FACILITIES (U.S. CLS. 100, 103 AND 106).  
FIRST USE 12-0-2012; IN COMMERCE 12-0-2012.

#### CLASS 42—SCIENTIFIC AND COMPUTER SERVICES

FOR ARCHITECTURAL SERVICES, NAMELY, DESIGN OF MULTI-UNIT RESTAURANT AND RETAIL FACILITIES AND SITE ADAPT DEVELOPMENT; DESIGN SERVICES, NAMELY, GRAPHICS AND SIGNAGE DESIGN, FIXTURE DESIGN, AND DESIGN FOR OTHERS IN THE FIELD OF ENVIRONMENTAL ENGINEERING FOR THE CUSTOM DESIGN OF MULTI-UNIT RESTAURANTS AND RETAIL FACILITIES; ENGINEERING SERVICES, NAMELY, STRUCTURAL ENGINEERING AND CIVIL ENGINEERING SERVICES; SURVEYING SERVICES, NAMELY, BOUNDARY AND TOPOGRAPHIC SURVEYING (U.S. CLS. 100 AND 101).  
FIRST USE 12-0-2012; IN COMMERCE 12-0-2012.  
HEATHER THOMPSON, EXAMINING ATTORNEY

SN 86-121,576. AMERICAN CITY BUSINESS JOURNALS INC., CHARLOTTE, NC. FILED 11-18-2013.



NO CLAIM IS MADE TO THE EXCLUSIVE RIGHT TO USE "PITTSBURGH BUSINESS", APART FROM THE MARK AS SHOWN.

THE COLOR(S) RED AND WHITE IS/ARE CLAIMED AS A FEATURE OF THE MARK.

THE MARK CONSISTS OF THE WORDS "PITTSBURGH BUSINESS TIMES" IN A WHITE FONT ON A RED BACKGROUND WITH WHITE STRIPES. THE RECTANGULAR SHAPE OF THE BACKGROUND IS NOT CLAIMED AS A FEATURE OF THE MARK.

#### CLASS 16—PAPER GOODS AND PRINTED MATTER

FOR MAGAZINES, NEWSPAPERS, JOURNALS ALL ON THE SUBJECT OF BUSINESS (U.S. CLS. 2, 5, 22, 23, 29, 37, 38 AND 50).

FIRST USE 11-15-2013; IN COMMERCE 11-15-2013.

#### CLASS 41—EDUCATION AND ENTERTAINMENT

FOR PROVIDING ON-LINE NON-DOWNLOADABLE PUBLICATIONS IN THE NATURE OF MAGAZINES, NEWSLETTERS, NEWSPAPERS AND JOURNALS ALL ON THE SUBJECT OF BUSINESS; NON-DOWNLOADABLE ELECTRONIC PUBLICATIONS IN THE NATURE OF MAGAZINES, NEWSLETTERS, NEWSPAPERS AND JOURNALS ALL ON THE SUBJECT OF BUSINESS (U.S. CLS. 100, 101 AND 107).

FIRST USE 11-15-2013; IN COMMERCE 11-15-2013.

ZHALEH DELANEY, EXAMINING ATTORNEY

SN 86-121,579. AMERICAN CITY BUSINESS JOURNALS INC., CHARLOTTE, NC. FILED 11-18-2013.



NO CLAIM IS MADE TO THE EXCLUSIVE RIGHT TO USE "ST. LOUIS BUSINESS JOURNAL", APART FROM THE MARK AS SHOWN.

THE COLOR(S) RED AND WHITE IS/ARE CLAIMED AS A FEATURE OF THE MARK.

THE MARK CONSISTS OF THE WORDS "ST. LOUIS BUSINESS JOURNAL" IN A WHITE FONT ON A RED BACKGROUND WITH WHITE STRIPES. THE RECTANGULAR SHAPE OF THE BACKGROUND IS NOT CLAIMED AS A FEATURE OF THE MARK.

#### CLASS 16—PAPER GOODS AND PRINTED MATTER

FOR MAGAZINES, NEWSPAPERS, JOURNALS ALL ON THE SUBJECT OF BUSINESS (U.S. CLS. 2, 5, 22, 23, 29, 37, 38 AND 50).

FIRST USE 9-27-2013; IN COMMERCE 9-27-2013.

#### CLASS 41—EDUCATION AND ENTERTAINMENT

FOR PROVIDING ON-LINE NON-DOWNLOADABLE PUBLICATIONS IN THE NATURE OF MAGAZINES, NEWSLETTERS, NEWSPAPERS AND JOURNALS ALL ON THE SUBJECT OF BUSINESS; NON-DOWNLOADABLE ELECTRONIC PUBLICATIONS IN THE NATURE OF MAGAZINES, NEWSLETTERS, NEWSPAPERS AND JOURNALS ALL ON THE SUBJECT OF BUSINESS (U.S. CLS. 100, 101 AND 107).

FIRST USE 9-27-2013; IN COMMERCE 9-27-2013.

ZHALEH DELANEY, EXAMINING ATTORNEY



SN 86-122,687. DOSKOCIL MANUFACTURING COMPANY, INC., ARLINGTON, TX. FILED 11-19-2013.

## Pop & Go

THE MARK CONSISTS OF STANDARD CHARACTERS WITHOUT CLAIM TO ANY PARTICULAR FONT, STYLE, SIZE, OR COLOR.

OWNER OF U.S. REG. NO. 3,395,286.

### CLASS 12—VEHICLES

FOR PET BARRIER TO BE USED IN VEHICLES (U.S. CLS. 19, 21, 23, 31, 35 AND 44).

### CLASS 20—FURNITURE AND ARTICLES NOT OTHERWISE CLASSIFIED

FOR PORTABLE PET KENNELS; PET CARRIERS (U.S. CLS. 2, 13, 22, 25, 32 AND 50).

PAULA MAHONEY, EXAMINING ATTORNEY

SN 86-124,195. EDGENUITY INC., SCOTTSDALE, AZ. FILED 11-20-2013.

## EDGENUITY WHERE LEARNING CLICKS

THE MARK CONSISTS OF STANDARD CHARACTERS WITHOUT CLAIM TO ANY PARTICULAR FONT, STYLE, SIZE, OR COLOR.

### CLASS 9—ELECTRICAL AND SCIENTIFIC APPARATUS

FOR EDUCATIONAL SOFTWARE AND DOWNLOADABLE EDUCATIONAL SOFTWARE FEATURING COURSEWORK AND INTERACTIVE VIDEO AND AUDIO INSTRUCTION FOR GRADES K-12 EDUCATION, SPECIAL EDUCATION, ENGLISH AS A SECOND LANGUAGE, HIGHER EDUCATION, TECHNICAL, INDUSTRIAL, AND OCCUPATIONAL EDUCATION OR CERTIFICATION, AND CONTINUING OR PROFESSIONAL EDUCATION AND CERTIFICATION; COMPUTER SOFTWARE AND DOWNLOADABLE COMPUTER SOFTWARE FOR EDUCATIONAL PURPOSES, NAMELY, SOFTWARE THAT ALLOWS EDUCATIONAL INSTRUCTORS TO CREATE, CONDUCT, AND DELIVER CUSTOMIZED CURRICULA AND INTERACTIVE LESSONS AND COURSEWORK, GRADE TESTS AND REPORTS, PROVIDE FEEDBACK AND DELIVER PROGRESS AND GRADING REPORTS TO STUDENTS, PREPARE ACADEMIC CALENDARS, AND ARRANGE AND CONDUCT LIVE VIRTUAL EDUCATION SESSIONS; COMPUTER SOFTWARE AND DOWNLOADABLE COMPUTER SOFTWARE FOR DISTRIBUTING, INSTALLING, OPERATING, AND CUSTOMIZING INTERACTIVE EDUCATIONAL SOFTWARE; COMPUTER HARDWARE; COMPUTER SERVERS; INTERNET SERVERS; NETWORK SERVERS; COMPUTER NETWORKING HARDWARE (U.S. CLS. 21, 23, 26, 36 AND 38).

FIRST USE 3-1-2013; IN COMMERCE 3-1-2013.

### CLASS 41—EDUCATION AND ENTERTAINMENT

FOR EDUCATIONAL SERVICES, NAMELY, DEVELOPMENT AND DISSEMINATION OF EDUCATIONAL CURRICULA IN THE FIELDS OF GRADES K-12 EDUCATION, SPECIAL EDUCATION, ENGLISH AS A SECOND LANGUAGE, HIGHER EDUCATION, TECHNICAL, INDUSTRIAL, AND OCCUPATIONAL EDUCATION OR CERTIFICATION, AND CONTINUING OR PROFESSIONAL EDUCATION AND CERTIFICATION; EDUCATIONAL SERVICES, NAMELY, PROVIDING ON-LINE INTERACTIVE COURSES IN THE FIELDS OF K-12 EDUCATION, SPECIAL EDUCATION, ENGLISH AS A SECOND LANGUAGE, HIGHER EDUCATION, TECHNICAL, INDUSTRIAL, AND OCCUPATIONAL EDUCATION OR CERTIFICATION, AND CONTINUING OR PROFESSIONAL EDUCATION AND CERTIFICATION; RESEARCH IN THE FIELDS OF EDUCATION; CONSULTING IN THE FIELD OF EDUCATION RELATING THE DEVELOPMENT OF EDUCATIONAL CURRICULA AND COURSES (U.S. CLS. 100, 101 AND 107).

FIRST USE 2-6-2013; IN COMMERCE 2-6-2013.

### CLASS 42—SCIENTIFIC AND COMPUTER SERVICES

FOR SOFTWARE AS A SERVICE (SAAS) SERVICES FEATURING SOFTWARE USED FOR PROVIDING COURSEWORK AND INTERACTIVE VIDEO, AUDIO, AND WRITTEN INSTRUCTION FOR GRADES K-12 EDUCATION, SPECIAL EDUCATION, ENGLISH AS A SECOND LANGUAGE, HIGHER EDUCATION, TECHNICAL, INDUSTRIAL, AND OCCUPATIONAL EDUCATION OR CERTIFICATION, AND CONTINUING OR PROFESSIONAL EDUCATION AND CERTIFICATION; SOFTWARE AS A SERVICE (SAAS) FEATURING COMPUTER SOFTWARE FOR EDUCATIONAL PURPOSES, NAMELY, SOFTWARE THAT ALLOWS EDUCATIONAL INSTRUCTORS TO CREATE, CONDUCT, AND DELIVER CUSTOMIZED CURRICULA AND INTERACTIVE LESSONS AND COURSEWORK, GRADE TESTS AND REPORTS, PROVIDE FEEDBACK AND DELIVER PROGRESS AND GRADING REPORTS TO STUDENTS, PREPARE ACADEMIC CALENDARS, AND ARRANGE AND CONDUCT LIVE VIRTUAL EDUCATION SESSIONS; RESEARCH IN THE FIELD OF EDUCATIONAL SOFTWARE AND SOFTWARE AS IT RELATES TO INTERACTIVE LEARNING; DESIGN, INSTALLATION, MAINTENANCE, AND DEVELOPMENT OF COMPUTER SOFTWARE; TECHNICAL SUPPORT SERVICES, NAMELY, INSTALLATION, ADMINISTRATION, AND TROUBLESHOOTING OF COMPUTER SOFTWARE, WEB, AND DATABASE APPLICATIONS; EDUCATIONAL SOFTWARE CONSULTING (U.S. CLS. 100 AND 101).

FIRST USE 2-6-2013; IN COMMERCE 2-6-2013.

AHSEN KHAN, EXAMINING ATTORNEY

SN 86-124,435. GAMESYS LIMITED, LONDON, UNITED KINGDOM, FILED 11-20-2013.

## TREASURES FROM THE GODS

THE MARK CONSISTS OF STANDARD CHARACTERS WITHOUT CLAIM TO ANY PARTICULAR FONT, STYLE, SIZE, OR COLOR.

**CLASS 9—ELECTRICAL AND SCIENTIFIC APPARATUS**

FOR COMPUTER GAME SOFTWARE; COMPUTER GAME SOFTWARE FEATURING CARD GAMES, SLOT GAMES, VIDEO GAMES, GAMING, GAMBLING, CASINO, BINGO, INSTANT WIN, LOTTERY AND BETTING ACTIVITIES; COMPUTER HARDWARE RELATING TO GAMES, CARD GAMES, SLOT GAMES, VIDEO GAMES, GAMING, GAMBLING, CASINO, BINGO, INSTANT WIN, LOTTERY AND BETTING ACTIVITIES; COMPUTER SOFTWARE TO ENABLE SEARCHING, BROWSING AND RETRIEVING INFORMATION, WEBSITES, AND OTHER RESOURCES AVAILABLE ON GLOBAL COMPUTER NETWORKS FOR OTHERS; DOWNLOADABLE ONLINE GAME SOFTWARE AND GAME RELATED APPLICATIONS, NAMELY, DOWNLOADABLE COMPUTER GAME PROGRAMS AND DOWNLOADABLE ELECTRONIC GAME PROGRAMS; INTERACTIVE VIDEO GAME PROGRAMS; COMPUTER SOFTWARE TO ENABLE UPLOADING, POSTING, SHOWING, DISPLAYING, TAGGING, BLOGGING, SHARING OR OTHERWISE PROVIDING ELECTRONIC MEDIA AND INFORMATION IN THE FIELDS OF VIRTUAL COMMUNITIES, ELECTRONIC GAMING, ENTERTAINMENT, AND GENERAL INTEREST VIA THE INTERNET OR OTHER COMMUNICATIONS NETWORKS; DOWNLOADABLE ELECTRONIC PUBLICATIONS, NAMELY, MAGAZINES, MANUALS, NEWSLETTERS, ARTICLES, AND MANUALS FEATURING GAMING; ELECTRONIC PUBLICATIONS, NAMELY, DOWNLOADABLE NEWSLETTERS PROVIDED BY ELECTRONIC MAIL IN THE FIELDS OF GAMES, GAMING, GAMBLING, CASINOS, BINGO, INSTANT WIN GAMES, SLOTS, POKER, LOTTERY, AND BETTING; COMPUTER SOFTWARE FOR CONDUCTING AND ADMINISTRATION OF ON-LINE GAMES, GAMBLING AND COMPETITIONS (U.S. CLS. 21, 23, 26, 36 AND 38).

**CLASS 28—TOYS AND SPORTING GOODS**

FOR GAMES AND PLAYTHINGS, NAMELY, SLOT MACHINES; SCRATCH CARD LOTTERY GAMES; PLAYING CARDS; ELECTRONIC OR ELECTROTECHNICAL GAMING APPARATUS, NAMELY, GAMING MACHINES; MACHINES FOR PLAYING GAMES OF CHANCE; GAMES INVOLVING GAMBLING, NAMELY, SLOT MACHINES AND GAMING MACHINES; SLOT MACHINES OPERATED BY COINS, TOKENS, BANKNOTES, TICKETS OR BY MEANS OF ELECTRONIC, MAGNETIC OR BIOMETRIC STORAGE MEDIA (U.S. CLS. 22, 23, 38 AND 50).

**CLASS 38—COMMUNICATION**

FOR TELECOMMUNICATION SERVICES, NAMELY, ELECTRONIC TRANSMISSION OF STREAMED AND DOWNLOADABLE AUDIO, VIDEO AND GAME FILES VIA COMPUTER AND ELECTRONIC COMMUNICATIONS NETWORKS; PROVIDING ON-LINE CHAT ROOMS AND BULLETIN BOARDS FOR THE TRANSMISSION OF MESSAGES AMONG COMPUTER USERS CONCERNING ENTERTAINMENT, MUSIC, CONCERTS, VIDEOS, RADIO, TELEVISION, FILM, NEWS, SPORTS, GAMES AND CULTURAL EVENTS; WEBCASTING SERVICES; DELIVERY OF MESSAGES BY ELECTRONIC TRANSMISSION; PROVIDING CONNECTIVITY SERVICES AND ACCESS TO ELECTRONIC TELECOMMUNICATIONS NETWORKS FOR TRANSMISSION OR RECEPTION OF AUDIO, VIDEO, GAME OR MULTIMEDIA CONTENT; PROVIDING ACCESS TO COMPUTER DATABASES; PROVIDING ON-LINE FACILITIES, VIA A GLOBAL COMPUTER NETWORK AND OTHER COMPUTER AND ELECTRONIC COMMUNICATION NETWORKS FOR REAL-TIME INTERACTION WITH OTHER COMPUTER USERS TO ENABLE USERS TO ACCESS MULTIMEDIA CONTENT; PROVIDING ACCESS TO DATABASES IN THE FIELD OF COMPUTER GAMES, GAMING AND SOCIAL NETWORKING (U.S. CLS. 100, 101 AND 104).

**CLASS 41—EDUCATION AND ENTERTAINMENT**

FOR CASINO SERVICES; BETTING SERVICES; GAMBLING SERVICES; PROVIDING OFF TRACK BETTING FACILITIES; ORGANIZATION OF GAMING COMPETITIONS; LOTTERY SERVICES; BINGO SERVICES, NAMELY, LOTTERY AND GAMBLING SERVICES; SLOT MACHINE SERVICES, NAMELY, PROVIDING SLOT MACHINE PARLORS; ELECTRONIC GAME, GAMING QUIZ AND GAMBLING COMPETITION SERVICES PROVIDED BY MEANS OF THE INTERNET OR ON-LINE FROM A COMPUTER NETWORK OR DATABASE, MOBILE TELEPHONE AND TELEVISION; PROVISION OF ONLINE NON-DOWNLOADABLE ELECTRONIC PUBLICATIONS, NAMELY, BOOKS AND NEWSLETTERS IN THE FIELD OF GAMES AND GAMBLING; ENTERTAINMENT SERVICES, NAMELY, PROVIDING ONLINE COMPUTER GAMES, ENHANCEMENTS WITHIN ONLINE COMPUTER GAMES, AND GAME APPLICATIONS WITHIN ONLINE COMPUTER GAMES; PROVISION OF TRAINING IN THE USE AND OPERATION OF COMPUTER GAME SOFTWARE DEVELOPMENT TOOLS; ENTERTAINMENT SERVICES, NAMELY, PROVIDING ON-LINE REVIEWS OF COMPUTER GAMES FOR ENTERTAINMENT PURPOSES AND PROVIDING INFORMATION IN THE FIELD OF COMPUTER GAMES; ENTERTAINMENT SERVICES, NAMELY, PROVIDING VIRTUAL ENVIRONMENTS IN WHICH USERS CAN INTERACT THROUGH SOCIAL GAMES FOR RECREATIONAL, LEISURE OR ENTERTAINMENT PURPOSES; CONSULTANCY SERVICES RELATING TO ON-LINE GAMING, NAMELY, GAMING SERVICES CONSULTING IN THE NATURE OF CASINO GAMING; CONSULTANCY, INFORMATION AND ADVISORY SERVICES RELATING TO ALL THE AFORESAID SERVICES (U.S. CLS. 100, 101 AND 107).

TIMOTHY O. SCHIMPF, EXAMINING ATTORNEY

---

SN 86-124.444. GAMESYS LIMITED, LONDON, UNITED KINGDOM, FILED 11-20-2013.

**THE GREAT WINDINI**

THE MARK CONSISTS OF STANDARD CHARACTERS WITHOUT CLAIM TO ANY PARTICULAR FONT, STYLE, SIZE, OR COLOR.

**CLASS 9—ELECTRICAL AND SCIENTIFIC APPARATUS**

FOR COMPUTER GAME SOFTWARE; COMPUTER GAME SOFTWARE FEATURING CARD GAMES, SLOT GAMES, VIDEO GAMES, GAMING, GAMBLING, CASINO, BINGO, INSTANT WIN, LOTTERY AND BETTING ACTIVITIES; COMPUTER HARDWARE RELATING TO GAMES, CARD GAMES, SLOT GAMES, VIDEO GAMES, GAMING, GAMBLING, CASINO, BINGO, INSTANT WIN, LOTTERY AND BETTING ACTIVITIES; COMPUTER SOFTWARE TO ENABLE SEARCHING, BROWSING AND RETRIEVING INFORMATION, WEBSITES, AND OTHER RESOURCES AVAILABLE ON GLOBAL COMPUTER NETWORKS FOR OTHERS; DOWNLOADABLE ONLINE GAME SOFTWARE AND GAME RELATED APPLICATIONS, NAMELY, DOWNLOADABLE COMPUTER GAME PROGRAMS AND DOWNLOADABLE ELECTRONIC GAME PROGRAMS; INTERACTIVE VIDEO GAME PROGRAMS; COMPUTER SOFTWARE TO ENABLE UPLOADING, POSTING, SHOWING, DISPLAYING, TAGGING, BLOGGING, SHARING OR OTHERWISE PROVIDING ELECTRONIC MEDIA AND INFORMATION IN THE FIELDS OF VIRTUAL COMMUNITIES, ELECTRONIC GAMING, ENTERTAINMENT, AND GENERAL INTEREST VIA THE INTERNET OR OTHER COMMUNICATIONS NETWORKS; DOWNLOADABLE ELECTRONIC PUBLICATIONS, NAMELY, MAGAZINES, MANUALS, NEWSLETTERS, ARTICLES, AND MANUALS FEATURING GAMING; ELECTRONIC PUBLICATIONS, NAMELY, DOWNLOADABLE NEWSLETTERS PROVIDED BY ELECTRONIC MAIL IN THE FIELDS OF GAMES, GAMING, GAMBLING, CASINOS, BINGO, INSTANT WIN GAMES, SLOTS, POKER, LOTTERY, AND BETTING; COMPUTER SOFTWARE FOR CONDUCTING AND ADMINISTRATION OF ON-LINE GAMES, GAMBLING AND COMPETITIONS (U.S. CLS. 21, 23, 26, 36 AND 38).

**CLASS 28—TOYS AND SPORTING GOODS**

FOR GAMES AND PLAYTHINGS, NAMELY, SLOT MACHINES; SCRATCH CARD LOTTERY GAMES; ELECTRONIC OR ELECTROTECHNICAL GAMING APPARATUS, NAMELY, GAMING MACHINES; MACHINES FOR PLAYING GAMES OF CHANCE; GAMES INVOLVING GAMBLING, NAMELY, SLOT MACHINES AND GAMING MACHINES; SLOT MACHINES OPERATED BY COINS, TOKENS, BANKNOTES, TICKETS OR BY MEANS OF ELECTRONIC, MAGNETIC OR BIOMETRIC STORAGE MEDIA (U.S. CLS. 22, 23, 38 AND 30).

**CLASS 38—COMMUNICATION**

FOR TELECOMMUNICATION SERVICES, NAMELY, ELECTRONIC TRANSMISSION OF STREAMED AND DOWNLOADABLE AUDIO, VIDEO AND GAME FILES VIA COMPUTER AND ELECTRONIC COMMUNICATIONS NETWORKS; PROVIDING ON-LINE CHAT ROOMS AND BULLETIN BOARDS FOR THE TRANSMISSION OF MESSAGES AMONG COMPUTER USERS CONCERNING ENTERTAINMENT, MUSIC, CONCERTS, VIDEOS, RADIO, TELEVISION, FILM, NEWS, SPORTS, GAMES AND CULTURAL EVENTS; WEBCASTING SERVICES; DELIVERY OF MESSAGES BY ELECTRONIC TRANSMISSION; PROVIDING CONNECTIVITY SERVICES AND ACCESS TO ELECTRONIC TELECOMMUNICATIONS NETWORKS FOR TRANSMISSION OR RECEPTION OF AUDIO, VIDEO, GAME OR MULTIMEDIA CONTENT; PROVIDING ACCESS TO COMPUTER DATABASES; PROVIDING ON-LINE FACILITIES, VIA A GLOBAL COMPUTER NETWORK AND OTHER COMPUTER AND ELECTRONIC COMMUNICATION NETWORKS FOR REAL-TIME INTERACTION WITH OTHER COMPUTER USERS TO ENABLE USERS TO ACCESS MULTIMEDIA CONTENT; PROVIDING ACCESS TO DATABASES IN THE FIELD OF COMPUTER GAMES, GAMING AND SOCIAL NETWORKING (U.S. CLS. 100, 101 AND 104).

**CLASS 41—EDUCATION AND ENTERTAINMENT**

FOR CASINO SERVICES; BETTING SERVICES; GAMBLING SERVICES; PROVIDING OFF TRACK BETTING FACILITIES; ORGANIZATION OF GAMING COMPETITIONS; LOTTERY SERVICES; BINGO SERVICES, NAMELY, LOTTERY AND GAMBLING SERVICES; SLOT MACHINE SERVICES, NAMELY, PROVIDING SLOT MACHINE PARLORS; ELECTRONIC GAME, GAMING QUIZ AND GAMBLING COMPETITION SERVICES PROVIDED BY MEANS OF THE INTERNET OR ON-LINE FROM A COMPUTER NETWORK OR DATABASE, MOBILE TELEPHONE AND TELEVISION; PROVISION OF ONLINE NON-DOWNLOADABLE ELECTRONIC PUBLICATIONS, NAMELY, BOOKS AND NEWSLETTERS IN THE FIELD OF GAMES AND GAMBLING; ENTERTAINMENT SERVICES, NAMELY, PROVIDING ONLINE COMPUTER GAMES, ENHANCEMENTS WITHIN ONLINE COMPUTER GAMES, AND GAME APPLICATIONS WITHIN ONLINE COMPUTER GAMES; PROVISION OF TRAINING IN THE USE AND OPERATION OF COMPUTER GAME SOFTWARE DEVELOPMENT TOOLS; ENTERTAINMENT SERVICES, NAMELY, PROVIDING ON-LINE REVIEWS OF COMPUTER GAMES FOR ENTERTAINMENT PURPOSES AND PROVIDING INFORMATION IN THE FIELD OF COMPUTER GAMES; ENTERTAINMENT SERVICES, NAMELY, PROVIDING VIRTUAL ENVIRONMENTS IN WHICH USERS CAN INTERACT THROUGH SOCIAL GAMES FOR RECREATIONAL, LEISURE OR ENTERTAINMENT PURPOSES; CONSULTANCY SERVICES RELATING TO ON-LINE GAMING, NAMELY, GAMING SERVICES CONSULTING IN THE NATURE OF CASINO GAMING; CONSULTANCY, INFORMATION AND ADVISORY SERVICES RELATING TO ALL THE AFORESAID SERVICES (U.S. CLS. 100, 101 AND 107).

TIMOTHY O. SCHIMPF, EXAMINING ATTORNEY

SN 86-124.446. GAMESYS LIMITED, LONDON, UNITED KINGDOM, FILED 11-20-2013.

**JIN'S JUNGLE**

THE MARK CONSISTS OF STANDARD CHARACTERS WITHOUT CLAIM TO ANY PARTICULAR FONT, STYLE, SIZE, OR COLOR.

**CLASS 9—ELECTRICAL AND SCIENTIFIC APPARATUS**

FOR COMPUTER GAME SOFTWARE; COMPUTER GAME SOFTWARE FEATURING CARD GAMES, SLOT GAMES, VIDEO GAMES, GAMING, GAMBLING, CASINO, BINGO, INSTANT WIN, LOTTERY AND BETTING ACTIVITIES; COMPUTER HARDWARE RELATING TO GAMES, CARD GAMES, SLOT GAMES, VIDEO GAMES, GAMING, GAMBLING, CASINO, BINGO, INSTANT WIN, LOTTERY AND BETTING ACTIVITIES; COMPUTER SOFTWARE TO ENABLE SEARCHING, BROWSING AND RETRIEVING INFORMATION, WEBSITES, AND OTHER RESOURCES AVAILABLE ON GLOBAL COMPUTER NETWORKS FOR OTHERS; DOWNLOADABLE ONLINE GAME SOFTWARE AND GAME RELATED APPLICATIONS, NAMELY, DOWNLOADABLE COMPUTER GAME PROGRAMS AND DOWNLOADABLE ELECTRONIC GAME PROGRAMS; INTERACTIVE VIDEO GAME PROGRAMS; COMPUTER SOFTWARE TO ENABLE UPLOADING, POSTING, SHOWING, DISPLAYING, TAGGING, BLOGGING, SHARING OR OTHERWISE PROVIDING ELECTRONIC MEDIA AND INFORMATION IN THE FIELDS OF VIRTUAL COMMUNITIES, ELECTRONIC GAMING, ENTERTAINMENT, AND GENERAL INTEREST VIA THE INTERNET OR OTHER COMMUNICATIONS NETWORKS; DOWNLOADABLE ELECTRONIC PUBLICATIONS, NAMELY, MAGAZINES, MANUALS, NEWSLETTERS, ARTICLES, AND MANUALS FEATURING GAMING; ELECTRONIC PUBLICATIONS, NAMELY, DOWNLOADABLE NEWSLETTERS PROVIDED BY ELECTRONIC MAIL IN THE FIELDS OF GAMES, GAMING, GAMBLING, CASINOS, BINGO, INSTANT WIN GAMES, SLOTS, POKER, LOTTERY, AND BETTING; COMPUTER SOFTWARE FOR CONDUCTING AND ADMINISTRATION OF ON-LINE GAMES, GAMBLING AND COMPETITIONS (U.S. CLS. 21, 23, 26, 36 AND 38).

**CLASS 28—TOYS AND SPORTING GOODS**

FOR GAMES AND PLAYTHINGS, NAMELY, SLOT MACHINES; SCRATCH CARD LOTTERY GAMES; PLAYING CARDS; ELECTRONIC OR ELECTROTECHNICAL GAMING APPARATUS, NAMELY, GAMING MACHINES; MACHINES FOR PLAYING GAMES OF CHANCE; GAMES INVOLVING GAMBLING, NAMELY, SLOT MACHINES AND GAMING MACHINES; SLOT MACHINES OPERATED BY COINS, TOKENS, BANKNOTES, TICKETS OR BY MEANS OF ELECTRONIC, MAGNETIC OR BIOMETRIC STORAGE MEDIA (U.S. CLS. 22, 23, 38 AND 50).

**CLASS 38—COMMUNICATION**

FOR TELECOMMUNICATION SERVICES, NAMELY, ELECTRONIC TRANSMISSION OF STREAMED AND DOWNLOADABLE AUDIO, VIDEO AND GAME FILES VIA COMPUTER AND ELECTRONIC COMMUNICATIONS NETWORKS; PROVIDING ON-LINE CHAT ROOMS AND BULLETIN BOARDS FOR THE TRANSMISSION OF MESSAGES AMONG COMPUTER USERS CONCERNING ENTERTAINMENT, MUSIC, CONCERTS, VIDEOS, RADIO, TELEVISION, FILM, NEWS, SPORTS, GAMES AND CULTURAL EVENTS; WEBCASTING SERVICES; DELIVERY OF MESSAGES BY ELECTRONIC TRANSMISSION; PROVIDING CONNECTIVITY SERVICES AND ACCESS TO ELECTRONIC TELECOMMUNICATIONS NETWORKS FOR TRANSMISSION OR RECEPTION OF AUDIO, VIDEO, GAME OR MULTIMEDIA CONTENT; PROVIDING ACCESS TO COMPUTER DATABASES; PROVIDING ON-LINE FACILITIES, VIA A GLOBAL COMPUTER NETWORK AND OTHER COMPUTER AND ELECTRONIC COMMUNICATION NETWORKS FOR REAL-TIME INTERACTION WITH OTHER COMPUTER USERS TO ENABLE USERS TO ACCESS MULTIMEDIA CONTENT; PROVIDING ACCESS TO DATABASES IN THE FIELD OF COMPUTER GAMES, GAMING AND SOCIAL NETWORKING (U.S. CLS. 100, 101 AND 104).

**CLASS 41—EDUCATION AND ENTERTAINMENT**

FOR CASINO SERVICES; BETTING SERVICES; GAMBLING SERVICES; PROVIDING OFF TRACK BETTING FACILITIES; ORGANIZATION OF GAMING COMPETITIONS; LOTTERY SERVICES; BINGO SERVICES, NAMELY, LOTTERY AND GAMBLING SERVICES; SLOT MACHINE SERVICES, NAMELY, PROVIDING SLOT MACHINE PARLORS; ELECTRONIC GAME, GAMING QUIZ AND GAMBLING COMPETITION SERVICES PROVIDED BY MEANS OF THE INTERNET OR ON-LINE FROM A COMPUTER NETWORK OR DATABASE, MOBILE TELEPHONE AND TELEVISION; PROVISION OF ONLINE NON-DOWNLOADABLE ELECTRONIC PUBLICATIONS, NAMELY, BOOKS AND NEWSLETTERS IN THE FIELD OF GAMES AND GAMBLING; ENTERTAINMENT SERVICES, NAMELY, PROVIDING ONLINE COMPUTER GAMES, ENHANCEMENTS WITHIN ONLINE COMPUTER GAMES, AND GAME APPLICATIONS WITHIN ONLINE COMPUTER GAMES; PROVISION OF TRAINING IN THE USE AND OPERATION OF COMPUTER GAME SOFTWARE DEVELOPMENT TOOLS; ENTERTAINMENT SERVICES, NAMELY, PROVIDING ON-LINE REVIEWS OF COMPUTER GAMES FOR ENTERTAINMENT PURPOSES AND PROVIDING INFORMATION IN THE FIELD OF COMPUTER GAMES; ENTERTAINMENT SERVICES, NAMELY, PROVIDING VIRTUAL ENVIRONMENTS IN WHICH USERS CAN INTERACT THROUGH SOCIAL GAMES FOR RECREATIONAL, LEISURE OR ENTERTAINMENT PURPOSES; CONSULTANCY SERVICES RELATING TO ON-LINE GAMING, NAMELY, GAMING SERVICES CONSULTING IN THE NATURE OF CASINO GAMING; CONSULTANCY, INFORMATION AND ADVISORY SERVICES RELATING TO ALL THE AFORESAID SERVICES (U.S. CLS. 100, 101 AND 107).

TIMOTHY O. SCHIMPF, EXAMINING ATTORNEY

---

SN 86-124.448. GAMESYS LIMITED, LONDON, UNITED KINGDOM, FILED 11-20-2013.

**PARADISE PARTY**

THE MARK CONSISTS OF STANDARD CHARACTERS WITHOUT CLAIM TO ANY PARTICULAR FONT, STYLE, SIZE, OR COLOR.

**CLASS 9—ELECTRICAL AND SCIENTIFIC APPARATUS**

FOR COMPUTER GAME SOFTWARE; COMPUTER GAME SOFTWARE FEATURING CARD GAMES, SLOT GAMES, VIDEO GAMES, GAMING, GAMBLING, CASINO, BINGO, INSTANT WIN, LOTTERY AND BETTING ACTIVITIES; COMPUTER HARDWARE RELATING TO GAMES, CARD GAMES, SLOT GAMES, VIDEO GAMES, GAMING, GAMBLING, CASINO, BINGO, INSTANT WIN, LOTTERY AND BETTING ACTIVITIES; COMPUTER SOFTWARE TO ENABLE SEARCHING, BROWSING AND RETRIEVING INFORMATION, WEBSITES, AND OTHER RESOURCES AVAILABLE ON GLOBAL COMPUTER NETWORKS FOR OTHERS; DOWNLOADABLE ONLINE GAME SOFTWARE AND GAME RELATED APPLICATIONS, NAMELY, DOWNLOADABLE COMPUTER GAME PROGRAMS AND DOWNLOADABLE ELECTRONIC GAME PROGRAMS; INTERACTIVE VIDEO GAME PROGRAMS; COMPUTER SOFTWARE TO ENABLE UPLOADING, POSTING, SHOWING, DISPLAYING, TAGGING, BLOGGING, SHARING OR OTHERWISE PROVIDING ELECTRONIC MEDIA AND INFORMATION IN THE FIELDS OF VIRTUAL COMMUNITIES, ELECTRONIC GAMING, ENTERTAINMENT, AND GENERAL INTEREST VIA THE INTERNET OR OTHER COMMUNICATIONS NETWORKS; DOWNLOADABLE ELECTRONIC PUBLICATIONS, NAMELY, MAGAZINES, MANUALS, NEWSLETTERS, ARTICLES, AND MANUALS FEATURING GAMING; ELECTRONIC PUBLICATIONS, NAMELY, DOWNLOADABLE NEWSLETTERS PROVIDED BY ELECTRONIC MAIL IN THE FIELDS OF GAMES, GAMING, GAMBLING, CASINOS, BINGO, INSTANT WIN GAMES, SLOTS, POKER, LOTTERY, AND BETTING; COMPUTER SOFTWARE FOR CONDUCTING AND ADMINISTRATION OF ON-LINE GAMES, GAMBLING AND COMPETITIONS (U.S. CLS. 21, 23, 26, 36 AND 38).

**CLASS 28—TOYS AND SPORTING GOODS**

FOR GAMES AND PLAYTHINGS, NAMELY, SLOT MACHINES; SCRATCH CARD LOTTERY GAMES; PLAYING CARDS; ELECTRONIC OR ELECTROTECHNICAL GAMING APPARATUS, NAMELY, GAMING MACHINES; MACHINES FOR PLAYING GAMES OF CHANCE; GAMES INVOLVING GAMBLING, NAMELY, SLOT MACHINES AND GAMING MACHINES; SLOT MACHINES OPERATED BY COINS, TOKENS, BANKNOTES, TICKETS OR BY MEANS OF ELECTRONIC, MAGNETIC OR BIOMETRIC STORAGE MEDIA (U.S. CLS. 22, 23, 38 AND 50).

**CLASS 38—COMMUNICATION**

FOR TELECOMMUNICATION SERVICES, NAMELY, ELECTRONIC TRANSMISSION OF STREAMED AND DOWNLOADABLE AUDIO, VIDEO AND GAME FILES VIA COMPUTER AND ELECTRONIC COMMUNICATIONS NETWORKS; PROVIDING ON-LINE CHAT ROOMS AND BULLETIN BOARDS FOR THE TRANSMISSION OF MESSAGES AMONG COMPUTER USERS CONCERNING ENTERTAINMENT, MUSIC, CONCERTS, VIDEOS, RADIO, TELEVISION, FILM, NEWS, SPORTS, GAMES AND CULTURAL EVENTS; WEBCASTING SERVICES; DELIVERY OF MESSAGES BY ELECTRONIC TRANSMISSION; PROVIDING CONNECTIVITY SERVICES AND ACCESS TO ELECTRONIC TELECOMMUNICATIONS NETWORKS FOR TRANSMISSION OR RECEPTION OF AUDIO, VIDEO, GAME OR MULTIMEDIA CONTENT; PROVIDING ACCESS TO COMPUTER DATABASES; PROVIDING ON-LINE FACILITIES, VIA A GLOBAL COMPUTER NETWORK AND OTHER COMPUTER AND ELECTRONIC COMMUNICATION NETWORKS FOR REAL-TIME INTERACTION WITH OTHER COMPUTER USERS TO ENABLE USERS TO ACCESS MULTIMEDIA CONTENT; PROVIDING ACCESS TO DATABASES IN THE FIELD OF COMPUTER GAMES, GAMING AND SOCIAL NETWORKING (U.S. CLS. 100, 101 AND 104).

**CLASS 41—EDUCATION AND ENTERTAINMENT**

FOR CASINO SERVICES; BETTING SERVICES; GAMBLING SERVICES; PROVIDING OFF TRACK BETTING FACILITIES; ORGANIZATION OF GAMING COMPETITIONS; LOTTERY SERVICES; BINGO SERVICES, NAMELY, LOTTERY AND GAMBLING SERVICES; SLOT MACHINE SERVICES, NAMELY, PROVIDING SLOT MACHINE PARLORS; ELECTRONIC GAME, GAMING QUIZ AND GAMBLING COMPETITION SERVICES PROVIDED BY MEANS OF THE INTERNET OR ON-LINE FROM A COMPUTER NETWORK OR DATABASE, MOBILE TELEPHONE AND TELEVISION; PROVISION OF ONLINE NON-DOWNLOADABLE ELECTRONIC PUBLICATIONS, NAMELY, BOOKS AND NEWSLETTERS IN THE FIELD OF GAMES AND GAMBLING; ENTERTAINMENT SERVICES, NAMELY, PROVIDING ONLINE COMPUTER GAMES, ENHANCEMENTS WITHIN ONLINE COMPUTER GAMES, AND GAME APPLICATIONS WITHIN ONLINE COMPUTER GAMES; PROVISION OF TRAINING IN THE USE AND OPERATION OF COMPUTER GAME SOFTWARE DEVELOPMENT TOOLS; ENTERTAINMENT SERVICES, NAMELY, PROVIDING ON-LINE REVIEWS OF COMPUTER GAMES FOR ENTERTAINMENT PURPOSES AND PROVIDING INFORMATION IN THE FIELD OF COMPUTER GAMES; ENTERTAINMENT SERVICES, NAMELY, PROVIDING VIRTUAL ENVIRONMENTS IN WHICH USERS CAN INTERACT THROUGH SOCIAL GAMES FOR RECREATIONAL, LEISURE OR ENTERTAINMENT PURPOSES; CONSULTANCY SERVICES RELATING TO ON-LINE GAMING, NAMELY, GAMING SERVICES CONSULTING IN THE NATURE OF CASINO GAMING; CONSULTANCY, INFORMATION AND ADVISORY SERVICES RELATING TO ALL THE AFORESAID SERVICES (U.S. CLS. 100, 101 AND 107).

TIMOTHY O. SCHIMPF, EXAMINING ATTORNEY

---

SN 86-124,451. GAMESYS LIMITED, LONDON, UNITED KINGDOM, FILED 11-20-2013.

**TIKI'S CATCH OF THE DAY**

THE MARK CONSISTS OF STANDARD CHARACTERS WITHOUT CLAIM TO ANY PARTICULAR FONT, STYLE, SIZE, OR COLOR.

OWNER OF U.S. REG. NO. 4,290,748.

**CLASS 9—ELECTRICAL AND SCIENTIFIC APPARATUS**

FOR COMPUTER GAME SOFTWARE; COMPUTER GAME SOFTWARE FEATURING CARD GAMES, SLOT GAMES, VIDEO GAMES, GAMING, GAMBLING, CASINO, BINGO, INSTANT WIN, LOTTERY AND BETTING ACTIVITIES; COMPUTER HARDWARE RELATING TO GAMES, CARD GAMES, SLOT GAMES, VIDEO GAMES, GAMING, GAMBLING, CASINO, BINGO, INSTANT WIN, LOTTERY AND BETTING ACTIVITIES; COMPUTER SOFTWARE TO ENABLE SEARCHING, BROWSING AND RETRIEVING INFORMATION, WEBSITES, AND OTHER RESOURCES AVAILABLE ON GLOBAL COMPUTER NETWORKS FOR OTHERS; DOWNLOADABLE ONLINE GAME SOFTWARE AND GAME RELATED APPLICATIONS, NAMELY, DOWNLOADABLE COMPUTER GAME PROGRAMS AND DOWNLOADABLE ELECTRONIC GAME PROGRAMS; INTERACTIVE VIDEO GAME PROGRAMS; COMPUTER SOFTWARE TO ENABLE UPLOADING, POSTING, SHOWING, DISPLAYING, TAGGING, BLOGGING, SHARING OR OTHERWISE PROVIDING ELECTRONIC MEDIA AND INFORMATION IN THE FIELDS OF VIRTUAL COMMUNITIES, ELECTRONIC GAMING, ENTERTAINMENT, AND GENERAL INTEREST VIA THE INTERNET OR OTHER COMMUNICATIONS NETWORKS; DOWNLOADABLE ELECTRONIC PUBLICATIONS, NAMELY, MAGAZINES, MANUALS, NEWSLETTERS, ARTICLES, AND MANUALS FEATURING GAMING; ELECTRONIC PUBLICATIONS, NAMELY, DOWNLOADABLE NEWSLETTERS PROVIDED BY ELECTRONIC MAIL IN THE FIELDS OF GAMES, GAMING, GAMBLING, CASINOS, BINGO, INSTANT WIN GAMES, SLOTS, POKER, LOTTERY, AND BETTING; COMPUTER SOFTWARE FOR CONDUCTING AND ADMINISTRATION OF ON-LINE GAMES, GAMBLING AND COMPETITIONS (U.S. CLS. 21, 23, 26, 36 AND 38).

**CLASS 28—TOYS AND SPORTING GOODS**

FOR GAMES AND PLAYTHINGS, NAMELY, SLOT MACHINES; SCRATCH CARD LOTTERY GAMES; PLAYING CARDS; ELECTRONIC OR ELECTROTECHNICAL GAMING APPARATUS, NAMELY, GAMING MACHINES; MACHINES FOR PLAYING GAMES OF CHANCE; GAMES INVOLVING GAMBLING, NAMELY, SLOT MACHINES AND GAMING MACHINES; SLOT MACHINES OPERATED BY COINS, TOKENS, BANKNOTES, TICKETS OR BY MEANS OF ELECTRONIC, MAGNETIC OR BIOMETRIC STORAGE MEDIA (U.S. CLS. 22, 23, 38 AND 50).

**CLASS 38—COMMUNICATION**

FOR TELECOMMUNICATION SERVICES, NAMELY, ELECTRONIC TRANSMISSION OF STREAMED AND DOWNLOADABLE AUDIO, VIDEO AND GAME FILES VIA COMPUTER AND ELECTRONIC COMMUNICATIONS NETWORKS; PROVIDING ON-LINE CHAT ROOMS AND BULLETIN BOARDS FOR THE TRANSMISSION OF MESSAGES AMONG COMPUTER USERS CONCERNING ENTERTAINMENT, MUSIC, CONCERTS, VIDEOS, RADIO, TELEVISION, FILM, NEWS, SPORTS, GAMES AND CULTURAL EVENTS; WEBCASTING SERVICES; DELIVERY OF MESSAGES BY ELECTRONIC TRANSMISSION; PROVIDING CONNECTIVITY SERVICES AND ACCESS TO ELECTRONIC TELECOMMUNICATIONS NETWORKS FOR TRANSMISSION OR RECEPTION OF AUDIO, VIDEO, GAME OR MULTIMEDIA CONTENT; PROVIDING ACCESS TO COMPUTER DATABASES; PROVIDING ON-LINE FACILITIES, VIA A GLOBAL COMPUTER NETWORK AND OTHER COMPUTER AND ELECTRONIC COMMUNICATION NETWORKS FOR REAL-TIME INTERACTION WITH OTHER COMPUTER USERS TO ENABLE USERS TO ACCESS MULTIMEDIA CONTENT; PROVIDING ACCESS TO DATABASES IN THE FIELD OF COMPUTER GAMES, GAMING AND SOCIAL NETWORKING (U.S. CLS. 100, 101 AND 104).

**CLASS 41—EDUCATION AND ENTERTAINMENT**

FOR CASINO SERVICES; BETTING SERVICES; GAMBLING SERVICES; PROVIDING OFF TRACK BETTING FACILITIES; ORGANIZATION OF GAMING COMPETITIONS; LOTTERY SERVICES; BINGO SERVICES, NAMELY, LOTTERY AND GAMBLING SERVICES; SLOT MACHINE SERVICES, NAMELY, PROVIDING SLOT MACHINE PARLORS; ELECTRONIC GAME, GAMING QUIZ AND GAMBLING COMPETITION SERVICES PROVIDED BY MEANS OF THE INTERNET OR ON-LINE FROM A COMPUTER NETWORK OR DATABASE, MOBILE TELEPHONE AND TELEVISION; PROVISION OF ONLINE NON-DOWNLOADABLE ELECTRONIC PUBLICATIONS, NAMELY, BOOKS AND NEWSLETTERS IN THE FIELD OF GAMES AND GAMBLING; ENTERTAINMENT SERVICES, NAMELY, PROVIDING ONLINE COMPUTER GAMES, ENHANCEMENTS WITHIN ONLINE COMPUTER GAMES, AND GAME APPLICATIONS WITHIN ONLINE COMPUTER GAMES; PROVISION OF TRAINING IN THE USE AND OPERATION OF COMPUTER GAME SOFTWARE DEVELOPMENT TOOLS; ENTERTAINMENT SERVICES, NAMELY, PROVIDING ON-LINE REVIEWS OF COMPUTER GAMES FOR ENTERTAINMENT PURPOSES AND PROVIDING INFORMATION IN THE FIELD OF COMPUTER GAMES; ENTERTAINMENT SERVICES, NAMELY, PROVIDING VIRTUAL ENVIRONMENTS IN WHICH USERS CAN INTERACT THROUGH SOCIAL GAMES FOR RECREATIONAL, LEISURE OR ENTERTAINMENT PURPOSES; CONSULTANCY SERVICES RELATING TO ON-LINE GAMING, NAMELY, GAMING SERVICES CONSULTING IN THE NATURE OF CASINO GAMING; CONSULTANCY, INFORMATION AND ADVISORY SERVICES RELATING TO ALL THE AFORESAID SERVICES (U.S. CLS. 100, 101 AND 107).

TIMOTHY O. SCHIMPF, EXAMINING ATTORNEY

SN 86-125,530. POINT6, LLC, STEAMBOAT SPRINGS, CO. FILED 11-21-2013.



OWNER OF U.S. REG. NOS. 3,486,094 AND 3,895,545. THE MARK CONSISTS OF THE WORD "POINT" FOLLOWED BY A STYLIZED NUMBER "6".

**CLASS 25—CLOTHING**

FOR CLOTHING COMPRISED OF AT LEAST 30% WOOL BY COMPOSITION, NAMELY, SHIRTS, PANTS, T-SHIRTS, SHORTS, SWEATERS, SWEATSHIRTS, UNDERGARMENTS, UNDERSHIRTS, THERMAL UNDERWEAR, NECK GAITERS, HEADWEAR, BEANIES, CAPS, BASEBALL CAPS, SKI HATS, GLOVES, SCARVES, ATHLETIC SHIRTS, ATHLETIC PANTS, ATHLETIC SHORTS, JOGGING SUITS, SWEAT SUITS, AND FOOTWEAR, NOT MARKETED THROUGH MASS MERCHANDISERS EXCEPT THROUGH SPECIALTY SECTIONS OR BOUTIQUES DEDICATED TO SPECIFIC BRANDS OR TO ACTIVE OUTDOOR WEAR AND LOCATED WITHIN A MASS MERCHANDISER STORE (U.S. CLS. 22 AND 39).

**CLASS 35—ADVERTISING AND BUSINESS**

FOR RETAIL APPAREL STORES AND ON-LINE RETAIL STORE SERVICES FEATURING APPAREL COMPRISED OF AT LEAST 30% WOOL BY COMPOSITION (U.S. CLS. 100, 101 AND 102).

JACLYN KIDWELL WALKER, EXAMINING ATTORNEY

SN 86-129,927. PAYCHEX OF NEW YORK, LLC, ROCHESTER, NY. FILED 11-26-2013.

PAYCHEX ACCOUNTING ONLINE

THE MARK CONSISTS OF STANDARD CHARACTERS WITHOUT CLAIM TO ANY PARTICULAR FONT, STYLE, SIZE, OR COLOR.

OWNER OF U.S. REG. NOS. 1,121,151, 3,021,275 AND OTHERS.

NO CLAIM IS MADE TO THE EXCLUSIVE RIGHT TO USE "ACCOUNTING ONLINE", APART FROM THE MARK AS SHOWN.

#### CLASS 35—ADVERTISING AND BUSINESS

FOR ACCOUNTING SERVICES; BUSINESS MANAGEMENT IN THE FIELD OF ACCOUNTING; COMPUTERIZED ACCOUNTING SERVICES (U.S. CLS. 100, 101 AND 102).

#### CLASS 42—SCIENTIFIC AND COMPUTER SERVICES

FOR PROVIDING A WEBSITE FEATURING NON-DOWNLOADABLE SOFTWARE FOR USE IN THE FIELDS OF ACCOUNTING AND BUSINESS MANAGEMENT; SOFTWARE AS A SERVICE (SAAS) SERVICES FEATURING SOFTWARE FOR ACCOUNTING (U.S. CLS. 100 AND 101).

TRACY WHITTAKER-BROWN, EXAMINING ATTORNEY

SN 86-130,401. BBY SOLUTIONS, INC., RICHFIELD, MN. FILED 11-27-2013.

GEEK SQUAD SOLUTION CENTRAL

THE MARK CONSISTS OF STANDARD CHARACTERS WITHOUT CLAIM TO ANY PARTICULAR FONT, STYLE, SIZE, OR COLOR.

OWNER OF U.S. REG. NOS. 1,943,643, 3,457,884 AND OTHERS.

NO CLAIM IS MADE TO THE EXCLUSIVE RIGHT TO USE "SOLUTION", APART FROM THE MARK AS SHOWN.

#### CLASS 41—EDUCATION AND ENTERTAINMENT

FOR EDUCATIONAL SERVICES, NAMELY, CONDUCTING CLASSES, WORKSHOPS, AND SEMINARS IN THE FIELD OF COMPUTERS, COMPUTER SOFTWARE, COMPUTER PERIPHERALS, MOBILE PHONES AND DEVICES, AND CONSUMER ELECTRONIC DEVICES AND COMPUTER-RELATED GOODS (U.S. CLS. 100, 101 AND 107).

FIRST USE 5-0-2012; IN COMMERCE 5-0-2012.

#### CLASS 42—SCIENTIFIC AND COMPUTER SERVICES

FOR CONSULTING SERVICES RELATED TO THE IMPLEMENTATION, USE AND OPERATION OF COMPUTER HARDWARE, COMPUTER SOFTWARE, COMPUTER PERIPHERALS, MOBILE PHONES AND DEVICES, AND CONSUMER ELECTRONIC DEVICES AND COMPUTER-RELATED GOODS (U.S. CLS. 100 AND 101).

FIRST USE 5-0-2012; IN COMMERCE 5-0-2012.

NATALIE KENEALY, EXAMINING ATTORNEY

SN 86-131,799. BARON T. LTD., DBA CARMEL CAR & LIMOUSINE SERVICE, NEW YORK, NY. FILED 11-29-2013.

Need a Ride? Just Carmel  
It!

THE MARK CONSISTS OF STANDARD CHARACTERS WITHOUT CLAIM TO ANY PARTICULAR FONT, STYLE, SIZE, OR COLOR.

OWNER OF U.S. REG. NO. 3,073,155.

#### CLASS 9—ELECTRICAL AND SCIENTIFIC APPARATUS

FOR DOWNLOADABLE COMPUTER SOFTWARE FOR SCHEDULING, RESERVING AND PROVIDING TRANSPORTATION SERVICES, NAMELY, COMPUTER SOFTWARE TO ENABLE SCHEDULING RESERVATIONS FOR TRANSPORTATION OF PERSONS BY CAR AND LIMOUSINE AND FOR DISPATCHING MOTORIZED VEHICLES TO CUSTOMERS FOR THE PURPOSE OF PROVIDING TRANSPORTATION BY CAR AND LIMOUSINE (U.S. CLS. 21, 23, 26, 36 AND 38).

FIRST USE 5-9-2013; IN COMMERCE 5-9-2013.

#### CLASS 42—SCIENTIFIC AND COMPUTER SERVICES

FOR PROVIDING TEMPORARY USE OF ON-LINE NON-DOWNLOADABLE SOFTWARE AND APPLICATIONS FOR PROVIDING TRANSPORTATION RESERVATION SERVICES, PROVIDING A BOOKING SERVICE FOR CUSTOMERS WHO REQUEST TRANSPORTATION SERVICES AND FOR DISPATCHING MOTORIZED VEHICLES TO CUSTOMERS SEEKING TRANSPORTATION (U.S. CLS. 100 AND 101).

FIRST USE 5-9-2013; IN COMMERCE 5-9-2013.

THEODORE MCBRIDE, EXAMINING ATTORNEY

SN 86-132,239. IDEA NUOVA, INC., NEW YORK, NY. FILED 12-1-2013.

YOUNG DIMENSION

THE MARK CONSISTS OF STANDARD CHARACTERS WITHOUT CLAIM TO ANY PARTICULAR FONT, STYLE, SIZE, OR COLOR.

**CLASS 20—FURNITURE AND ARTICLES NOT OTHERWISE CLASSIFIED**

FOR ACCENT PILLOWS; BEAN BAG PILLOWS; FLOOR PILLOWS; SLEEPING BAGS; SLEEPING MATS (U.S. CLS. 2, 13, 22, 25, 32 AND 50).

**CLASS 24—FABRICS**

FOR BED BLANKETS; BED SHEETS; BED THROWS; CHILDREN'S BED SHEETS, PILLOW CASES, AND BLANKETS (U.S. CLS. 42 AND 50).

**CLASS 27—FLOOR COVERINGS**

FOR CARPETS AND RUGS (U.S. CLS. 19, 20, 37, 42 AND 50).

KIM SAITO, EXAMINING ATTORNEY

SN 86-133,628. WHOLESOME INTERNATIONAL LLC, PITTSBURGH, PA. FILED 12-3-2013.

**CHOO LA AH MOOLA AH**

THE MARK CONSISTS OF STANDARD CHARACTERS WITHOUT CLAIM TO ANY PARTICULAR FONT, STYLE, SIZE, OR COLOR.

THE WORDING "CHOO LA AH" HAS NO MEANING IN A FOREIGN LANGUAGE.

**CLASS 9—ELECTRICAL AND SCIENTIFIC APPARATUS**

FOR MAGNETICALLY ENCODED GIFT CARDS (U.S. CLS. 21, 23, 26, 36 AND 38).

**CLASS 16—PAPER GOODS AND PRINTED MATTER**

FOR NON-MAGNETICALLY ENCODED GIFT CARDS (U.S. CLS. 2, 5, 22, 23, 29, 37, 38 AND 50).

MICHAEL TANNER, EXAMINING ATTORNEY

SN 86-136,189. FMC CORPORATION, PHILADELPHIA, PA. FILED 12-5-2013.

**ALL DAY**

THE MARK CONSISTS OF STANDARD CHARACTERS WITHOUT CLAIM TO ANY PARTICULAR FONT, STYLE, SIZE, OR COLOR.

**CLASS 5—PHARMACEUTICALS**

FOR PESTICIDES (U.S. CLS. 6, 18, 44, 46, 51 AND 52).

**CLASS 7—MACHINERY**

FOR AGRICULTURAL MACHINERY, NAMELY, PESTICIDE DISPERSERS (U.S. CLS. 13, 19, 21, 23, 31, 34 AND 35).

VERNA BETH RIRIE, EXAMINING ATTORNEY

SN 86-136,360. SOUTH DAKOTA WHEAT GROWERS ASSOCIATION, DBA WHEAT GROWERS, ABERDEEN, SD. FILED 12-5-2013.

**JRV**

THE MARK CONSISTS OF STANDARD CHARACTERS WITHOUT CLAIM TO ANY PARTICULAR FONT, STYLE, SIZE, OR COLOR.

**CLASS 1—CHEMICALS**

FOR ADJUVANT FOR USE WITH AGRICULTURAL CHEMICALS; FERTILIZERS FOR AGRICULTURAL USE; PLANT GROWTH REGULATORS FOR AGRICULTURAL USE (U.S. CLS. 1, 5, 6, 10, 26 AND 46).

**CLASS 5—PHARMACEUTICALS**

FOR BIOCIDES, GERMICIDES, BACTERICIDES, VIRUCIDES, FUNGICIDES, INSECTICIDES, PESTICIDES AND HERBICIDES (U.S. CLS. 6, 18, 44, 46, 51 AND 52).

**CLASS 31—NATURAL AGRICULTURAL PRODUCTS**

FOR AGRICULTURAL SEEDS; CROP SEEDS; GENETICALLY-MODIFIED AGRICULTURAL SEEDS; SEEDS FOR AGRICULTURAL PURPOSES; SEEDS FOR FRUIT AND VEGETABLES; UNPROCESSED SEEDS FOR AGRICULTURAL USE; VEGETABLE SEEDS FOR PLANTING; WHEAT SEED; WILDLIFE SEED MIXTURES (U.S. CLS. 1 AND 46).

MATTHEW EINSTEIN, EXAMINING ATTORNEY

SN 86-137,499. VIEJAS BAND OF KUMEYAY INDIANS, ALPINE, CA. FILED 12-6-2013.

**VIEJAS**

THE MARK CONSISTS OF STANDARD CHARACTERS WITHOUT CLAIM TO ANY PARTICULAR FONT, STYLE, SIZE, OR COLOR.

OWNER OF U.S. REG. NOS. 2,569,162, 3,106,500 AND OTHERS.

THE ENGLISH TRANSLATION OF "VIEJAS" IN THE MARK IS "OLD" OR "AGED".

**CLASS 9—ELECTRICAL AND SCIENTIFIC APPARATUS**

FOR MAGNETIC CODED CARDS FOR MEMBERSHIP SERVICES (U.S. CLS. 21, 23, 26, 36 AND 38).

FIRST USE 4-0-2006; IN COMMERCE 4-0-2006.



**CLASS 16—PAPER GOODS AND PRINTED MATTER**

FOR PENS; POSTCARDS (U.S. CLS. 2, 5, 22, 23, 29, 37, 38 AND 50).  
FIRST USE 12-0-2004; IN COMMERCE 12-0-2004.

**CLASS 35—ADVERTISING AND BUSINESS**

FOR ADMINISTRATION OF A PROGRAM FOR ENABLING PARTICIPANTS TO OBTAIN DISCOUNTS ON GOODS AND RECEIVE IMPROVED SERVICES (U.S. CLS. 100, 101 AND 102).  
FIRST USE 4-0-2004; IN COMMERCE 5-0-2004.

**CLASS 18—LEATHER GOODS**

FOR UMBRELLAS (U.S. CLS. 1, 2, 3, 22 AND 41).  
FIRST USE 10-0-2012; IN COMMERCE 10-0-2012.

**CLASS 43—HOTEL AND RESTAURANT SERVICES**

FOR HOTEL ACCOMMODATION SERVICES (U.S. CLS. 100 AND 101).  
FIRST USE 3-22-2013; IN COMMERCE 3-22-2013.

**CLASS 21—HOUSEWARES AND GLASS**

FOR BEVERAGE GLASSWARE; MUGS (U.S. CLS. 2, 13, 23, 29, 30, 33, 40 AND 50).  
FIRST USE 12-0-2004; IN COMMERCE 12-0-2004.

**CLASS 45—PERSONAL AND LEGAL SERVICES**

FOR HOTEL CONCIERGE SERVICES (U.S. CLS. 100 AND 101).  
FIRST USE 3-22-2013; IN COMMERCE 3-22-2013.  
KATHY DE JONGE, EXAMINING ATTORNEY

\* \* \* \* \*

## SECTION 2.— INTERNATIONAL CLASSIFICATION

The short titles associated below with the international class numbers are terms designed merely for quick identification and are not an official part of the international classification. The full names of international classes are given in section 6.1 of the trademark rules of practice.

The designation "U.S. Cl." appearing in this section refers to the U.S. class in effect prior to Sep. 1, 1973 rather than the international class which applies to applications filed on or after that date. For adoption of international classification see notice in the OFFICIAL GAZETTE of Jun. 26, 1973 (911 O.G. TM 210).

### Application in one class

#### CLASS 1—CHEMICALS

SN 79-123,176. 5 PRIME GMBH, FED REP GERMANY, FILED 11-27-2012.

#### CLASS 1—(Continued).

SN 79-131,307. VASELIFE INTERNATIONAL B.V., NETHERLANDS, FILED 4-18-2013.

## REALMASTERSCRIPT

THE MARK CONSISTS OF STANDARD CHARACTERS WITHOUT CLAIM TO ANY PARTICULAR FONT, STYLE, SIZE, OR COLOR.

PRIORITY DATE OF 6-29-2012 IS CLAIMED.

OWNER OF INTERNATIONAL REGISTRATION 1142770 DATED 11-27-2012, EXPIRES 11-27-2022.

OWNER OF U.S. REG. NO. 3,627,075.

FOR CHEMICALS AND BIOCHEMICALS FOR INDUSTRIAL AND SCIENTIFIC PURPOSES, NAMELY, NUCLEIC ACIDS, ENZYMES, MOLECULAR PROBES AND BUFFER CHEMICALS USED IN CHEMISTRY; BIOLOGY, BIOCHEMISTRY AND BIOTECHNOLOGY; AND KITS OF CHEMICALS AND BIOCHEMICALS FOR INDUSTRIAL AND SCIENTIFIC PURPOSES CONTAINING THE AFORESAID GOODS (U.S. CLS. 1, 5, 6, 10, 26 AND 46).

LINDA ESTRADA, EXAMINING ATTORNEY



SN 79-130,760. CLARIANT AG, SWITZERLAND, FILED 4-18-2013.

## TIVOGEN

THE MARK CONSISTS OF STANDARD CHARACTERS WITHOUT CLAIM TO ANY PARTICULAR FONT, STYLE, SIZE, OR COLOR.

PRIORITY DATE OF 1-31-2013 IS CLAIMED.

OWNER OF INTERNATIONAL REGISTRATION 1161899 DATED 4-18-2013, EXPIRES 4-18-2023.

FOR CHEMICALS FOR USE IN INDUSTRY AND SCIENCE, CHEMICALS FOR USE IN AGRICULTURE, HORTICULTURE AND FORESTRY, EXCEPT FUNGICIDES, HERBICIDES, INSECTICIDES AND PARASITICIDES; CHEMICAL ADDITIVES FOR THE FORMULATION OF CHEMICAL COMPOSITIONS FOR PLANT PROTECTION (U.S. CLS. 1, 5, 6, 10, 26 AND 46).

HELENE LIWINSKI, EXAMINING ATTORNEY

PRIORITY DATE OF 2-21-2013 IS CLAIMED.

OWNER OF INTERNATIONAL REGISTRATION 1163304 DATED 4-18-2013, EXPIRES 4-18-2023.

THE MARK CONSISTS OF A DESIGN OF TWO FLOWERS TO THE LEFT OF THE TERM "VASELIFE".

FOR PLANT FOOD, PLANTING SOIL, COMPOST, FERTILIZER, FLOWER PRESERVATIVES, GROWING MEDIA FOR PLANTS, SOIL CONDITIONERS FOR DOMESTIC OR HORTICULTURAL USE, SOIL AMENDMENTS, NATURAL MANURE AND ARTIFICIAL MANURE, AND CLEANING AND SHINING PREPARATIONS FOR PLANT LEAVES (U.S. CLS. 1, 5, 6, 10, 26 AND 46).

JANICE L. MCMORROW, EXAMINING ATTORNEY

**CLASS 1—(Continued).**

SN 79-137,878. DYNEA CHEMICALS OY, FINLAND, FILED 9-17-2013.

# PREFERE

THE MARK CONSISTS OF STANDARD CHARACTERS WITHOUT CLAIM TO ANY PARTICULAR FONT, STYLE, SIZE, OR COLOR.

PRIORITY DATE OF 3-21-2013 IS CLAIMED.

OWNER OF INTERNATIONAL REGISTRATION 1180137 DATED 9-17-2013, EXPIRES 9-17-2023.

THE ENGLISH TRANSLATION OF THE FOREIGN WORD(S) IN THE MARK IS: THIS MARK HAS NO MEANING IN ENGLISH.

FOR CHEMICALS USED IN INDUSTRY, SPECIFICALLY FOR ADHESION AND BINDING APPLICATIONS IN WOODWORKING, CONSTRUCTION, METAL FINISHING AND VEHICLE COMPONENT MANUFACTURING INDUSTRY; UNPROCESSED ARTIFICIAL RESINS, SPECIFICALLY USED IN ADHESIVES, BINDERS AND IMPREGNATION AND COATING OF MATERIALS; ADHESIVES USED IN INDUSTRY; UREA-MELAMINE-PHENOL- AND RESORCINOL-FORMALDEHYDE RESINS USED IN INDUSTRY, SPECIFICALLY FOR MANUFACTURING OF WOOD BASED PANELS, FURNITURE, STRUCTURAL BEAMS, VENEERING AND PLYWOOD; CHEMICAL BASED ADHESIVES USED IN INDUSTRY, SPECIFICALLY FOR BUILDING, BOOK-BINDING, LABELLING AND STICKERS, PAPER, PACKAGING PRESSURE-SENSITIVE TAPES AND SHOE APPLICATION PURPOSES; CHEMICAL BASED BINDERS USED IN INDUSTRY, SPECIFICALLY FOR INSULATION MATERIALS, PAPER IMPREGNATION, NON-WOVEN FABRICS, GLASS FIBRE TISSUE, FOUNDRY MOULDS, REFRACTORY GOODS, ABRASIVES AND GRINDING WHEELS, TIRES, BRAKES, FILTERING MEDIA, FLORAL FOAM, INSULATION FOAM, MINING FOAM, BATTERY SEPARATORS, MOULDED COMPOSITES, TEXTILE FELTS FOR HEADLINERS AND ACOUSTIC PARTS (U.S. CLS. 1, 5, 6, 10, 26 AND 46).

DAVID MURRAY, EXAMINING ATTORNEY

**CLASS 1—(Continued).**

SN 85-826,312. MICHAEL SHEENA, SOUTHFIELD, MI. FILED 1-17-2013.

# DriveSmart

THE MARK CONSISTS OF STANDARD CHARACTERS WITHOUT CLAIM TO ANY PARTICULAR FONT, STYLE, SIZE, OR COLOR.

FOR ANTIFREEZE; POWER STEERING FLUID; BRAKE FLUID (U.S. CLS. 1, 5, 6, 10, 26 AND 46).

TINA BROWN, EXAMINING ATTORNEY

SN 85-841,399. CSS TECHNOLOGY, INC., TOLAR, TX. FILED 2-5-2013.

# EN 1

THE MARK CONSISTS OF STANDARD CHARACTERS WITHOUT CLAIM TO ANY PARTICULAR FONT, STYLE, SIZE, OR COLOR.

FOR SOIL STABILIZERS FOR USE IN ROAD CONSTRUCTION (U.S. CLS. 1, 5, 6, 10, 26 AND 46).

FIRST USE 7-0-1989; IN COMMERCE 7-0-1990.

SUSAN BILLHEIMER, EXAMINING ATTORNEY

SN 85-852,580. SMB INTERNATIONAL LLC, WEST LONG BRANCH, NJ. FILED 2-18-2013.

# UNIFIDE

THE MARK CONSISTS OF STANDARD CHARACTERS WITHOUT CLAIM TO ANY PARTICULAR FONT, STYLE, SIZE, OR COLOR.

FOR ANTIFREEZE, GAS LINE ANTIFREEZE; AIR BRAKE ANTIFREEZE; ISO-DRIER ANTIFREEZE; AND WATER REMOVER ADDITIVE FOR GASOLINE; BRAKE FLUID; POWER STEERING FLUID; FUEL INJECTOR CLEANER CHEMICAL ADDITIVES; AUTOMOBILE TIRE INFLATOR SEALERS; CHEMICAL GASOLINE TREATMENT ADDITIVE; CHEMICAL ADDITIVES FOR FUEL INJECTOR AND CARBURETOR CLEANING; CHEMICAL ADDITIVES FOR FUEL INJECTOR CLEANING; OCTANE BOOSTER FUEL CHEMICAL ADDITIVE; CHEMICAL GASOLINE TREATMENT ADDITIVE; CHEMICAL FUEL SYSTEM CLEANER ADDITIVE; AUTOMOTIVE CHEMICAL ADDITIVES, NAMELY, RADIATOR STOP LEAK FLUID; POWER STEERING FLUID; FLUSHING AGENTS FOR AUTOMOBILE RADIATORS; RADIATOR ADDITIVES TO PREVENT RUST; AUTOMOTIVE CHEMICAL ADDITIVES, NAMELY, ENGINE SEALERS; AUTOMOTIVE CHEMICAL ADDITIVES, NAMELY, POWER STEERING SEALERS; AND CHEMICAL ENGINE TREATMENTS, NAMELY, TRANSMISSION SEALERS (U.S. CLS. 1, 5, 6, 10, 26 AND 46).

CIMMERIAN COLEMAN, EXAMINING ATTORNEY

SN 79-138,997. CHEMISCHES LABORATORIUM; DR. KURT RICHTER GMBH, FED REP GERMANY, FILED 9-23-2013.

# Maricol S CLR

THE MARK CONSISTS OF STANDARD CHARACTERS WITHOUT CLAIM TO ANY PARTICULAR FONT, STYLE, SIZE, OR COLOR.

PRIORITY DATE OF 7-1-2013 IS CLAIMED.

OWNER OF INTERNATIONAL REGISTRATION 1183035 DATED 9-23-2013, EXPIRES 9-23-2023.

FOR CHEMICAL PRODUCTS FOR INDUSTRIAL PURPOSES, NAMELY, RAW MATERIALS AND ADDITIVES FOR THE MANUFACTURE OF COSMETIC PRODUCTS (U.S. CLS. 1, 5, 6, 10, 26 AND 46).

KAREN BRACEY, EXAMINING ATTORNEY

**CLASS 1—(Continued).**

SN 85-852,596. SMB INTERNATIONAL LLC, WEST LONG BRANCH, NJ. FILED 2-18-2013.

# PHOENIX

THE MARK CONSISTS OF STANDARD CHARACTERS WITHOUT CLAIM TO ANY PARTICULAR FONT, STYLE, SIZE, OR COLOR.

FOR ANTIFREEZE; GAS LINE ANTIFREEZE; AIR BRAKE ANTIFREEZE; ISO-DRIER ANTIFREEZE; AND WATER REMOVER ADDITIVE FOR GASOLINE; BRAKE FLUID; POWER STEERING FLUID; FUEL INJECTOR CLEANER CHEMICAL ADDITIVES; AUTOMOBILE TIRE INFLATOR SEALERS; CHEMICAL GASOLINE TREATMENT ADDITIVE; CHEMICAL ADDITIVES FOR FUEL INJECTOR AND CARBURETOR CLEANING; CHEMICAL ADDITIVES FOR FUEL INJECTOR CLEANING; OCTANE BOOSTER FUEL CHEMICAL ADDITIVE; CHEMICAL GASOLINE TREATMENT ADDITIVE; CHEMICAL FUEL SYSTEM CLEANER ADDITIVE; AUTOMOTIVE CHEMICAL ADDITIVES, NAMELY, RADIATOR STOP LEAK FLUID; POWER STEERING FLUID; FLUSHING AGENTS FOR AUTOMOBILE RADIATORS; RADIATOR ADDITIVES TO PREVENT RUST; AUTOMOTIVE CHEMICAL ADDITIVES, NAMELY, ENGINE SEALERS; AUTOMOTIVE CHEMICAL ADDITIVES, NAMELY, POWER STEERING SEALERS; AND CHEMICAL ENGINE TREATMENTS, NAMELY, TRANSMISSION SEALERS (U.S. CLS. 1, 5, 6, 10, 26 AND 46).

CIMMERIAN COLEMAN, EXAMINING ATTORNEY

SN 85-927,561. CURTIS, WILLIAM, DBA CONCEPT AG LLC, CAPE GIRARDEAU, MO. FILED 5-9-2013.

# Foliar RX

THE MARK CONSISTS OF STANDARD CHARACTERS WITHOUT CLAIM TO ANY PARTICULAR FONT, STYLE, SIZE, OR COLOR.

NO CLAIM IS MADE TO THE EXCLUSIVE RIGHT TO USE "FOLIAR", APART FROM THE MARK AS SHOWN.

FOR FERTILIZERS (U.S. CLS. 1, 5, 6, 10, 26 AND 46). FIRST USE 3-1-2013; IN COMMERCE 3-1-2013. PAULA MAHONEY, EXAMINING ATTORNEY

**CLASS 1—(Continued).**

SN 85-933,286. DEVMAR PRODUCTS, LLC, NASHVILLE, TN. FILED 5-15-2013.



NO CLAIM IS MADE TO THE EXCLUSIVE RIGHT TO USE "REMOVES GREASE & OIL" "RESTORES FRICTION" "REDUCES SLIPS & FALLS" "ODOR ELIMINATOR" AND "ENHANCES PEST CONTROL", APART FROM THE MARK AS SHOWN.

THE COLOR(S) ORANGE, WHITE AND BLACK IS/ARE CLAIMED AS A FEATURE OF THE MARK.

THE MARK CONSISTS OF THE ORANGE STYLIZED WORDING "SAFETY-SWEEP" TRIMMED IN WHITE AND OUTLINED IN BLACK. BEHIND THE WORDING IS THE DESIGN OF A BLACK SHADED BROOM. BELOW THE WORDING IS THE BLACK STYLIZED WORDING "REMOVES GREASE & OIL RESTORES FRICTION" ALL INSIDE AN ORANGE SHADED RECTANGLE TRIMMED IN WHITE AND OUTLINED IN BLACK. ON THE RIGHT OF THAT RECTANGLE IS THE BLACK STYLIZED WORDING "REDUCES SLIPS & FALLS" OUTLINED IN WHITE. BELOW AND CENTER OF THE MARK IS A STYLIZED PERSON SHADED IN BLACK SLIPPING ON AN ORANGE SPILL BEHIND A WHITE PROHIBITION SYMBOL TRIMMED IN ORANGE AND OUTLINED IN BLACK. ACROSS THE TOP AND BOTTOM OF THE ENTIRE MARK IS A WHITE RECTANGULAR STRIP OUTLINED IN BLACK AND FEATURING DIAGONAL STRIPES OF ORANGE BARS OUTLINED IN BLACK.

FOR CHEMICALS FOR ABSORBING BOTH OIL AND OIL-BASED PRODUCTS (U.S. CLS. 1, 5, 6, 10, 26 AND 46). BERYL GARDNER, EXAMINING ATTORNEY

SN 85-933,719. GE NUTRIENTS, INC., ANAHEIM, CA. FILED 5-16-2013.

# GENALLUMA

THE MARK CONSISTS OF STANDARD CHARACTERS WITHOUT CLAIM TO ANY PARTICULAR FONT, STYLE, SIZE, OR COLOR.

OWNER OF U.S. REG. NO. 3,326,237.

FOR CARALLUMA FIMBRIATA COMPOSITIONS USED AS INGREDIENTS IN THE MANUFACTURE OF DIETARY SUPPLEMENTS (U.S. CLS. 1, 5, 6, 10, 26 AND 46).

SHANNON TWOHIG, EXAMINING ATTORNEY

**CLASS 1—(Continued).**

SN 85-936,207. OPTIMA WORLDWIDE LTD., PRESCOTT, AZ. FILED 5-19-2013.

**Guardian Gel**

THE MARK CONSISTS OF STANDARD CHARACTERS WITHOUT CLAIM TO ANY PARTICULAR FONT, STYLE, SIZE, OR COLOR.

FOR ACTIVE CHEMICAL INGREDIENTS FOR USE IN THE MANUFACTURE OF PHARMACEUTICALS FOR TREATING SEXUALLY TRANSMITTED DISEASES AND INFECTIONS (U.S. CLS. 1, 5, 6, 10, 26 AND 46).

SUSAN RICHARDS, EXAMINING ATTORNEY

SN 85-936,453. TOTAL POWER, INC, SAN DIEGO, CA. FILED 5-20-2013.



NO CLAIM IS MADE TO THE EXCLUSIVE RIGHT TO USE "CERTIFIED ECO-FRIENDLY", APART FROM THE MARK AS SHOWN.

THE MARK CONSISTS OF A DESIGN OF A CIRCULAR SEAL WITH MANY POINTED EDGES AND THE STYLIZED TEXT "CERTIFIED ECO-FRIENDLY" ALL SURROUNDING THE STYLIZED LETTERS "TPX" WITH SMALL AMOUNTS OF VEGETATION GROWING IN THE CENTER.

FOR ECO-FRIENDLY SYNTHETIC FUEL ADDITIVES (U.S. CLS. 1, 5, 6, 10, 26 AND 46).

FIRST USE 6-1-2010; IN COMMERCE 6-1-2010.  
KRISTINA MORRIS, EXAMINING ATTORNEY

SN 85-940,808. MIDTECH R&D, INC., FAIRMONT, MN. FILED 5-23-2013.

**LOCKDOWN**

THE MARK CONSISTS OF STANDARD CHARACTERS WITHOUT CLAIM TO ANY PARTICULAR FONT, STYLE, SIZE, OR COLOR.

FOR ADJUVANT FOR USE WITH AGRICULTURAL CHEMICALS (U.S. CLS. 1, 5, 6, 10, 26 AND 46).

FIRST USE 2-0-2007; IN COMMERCE 2-0-2007.  
SUNG IN, EXAMINING ATTORNEY

**CLASS 1—(Continued).**

SN 85-946,418. IMMUNOCHEMISTRY TECHNOLOGIES, LLC, BLOOMINGTON, MN. FILED 5-30-2013.

**CELLMETRIX**

THE MARK CONSISTS OF STANDARD CHARACTERS WITHOUT CLAIM TO ANY PARTICULAR FONT, STYLE, SIZE, OR COLOR.

FOR DIAGNOSTIC CHEMICAL REAGENTS, DYES AND STAINS FOR LABORATORY USE, NAMELY, FOR BIOMEDICAL, LIFE SCIENCE AND MOLECULAR BIOLOGY RESEARCH (U.S. CLS. 1, 5, 6, 10, 26 AND 46).  
REGINA DRUMMOND, EXAMINING ATTORNEY

SN 85-959,285. MIRUS BIO LLC, MADISON, WI. FILED 6-13-2013.

**TRANSIT-X2**

THE MARK CONSISTS OF STANDARD CHARACTERS WITHOUT CLAIM TO ANY PARTICULAR FONT, STYLE, SIZE, OR COLOR.

OWNER OF U.S. REG. NOS. 2,670,434, 2,783,312 AND 3,023,427.

FOR A TRANSFECTION REAGENT FOR DELIVERING CHEMICALS AND BIOLOGICALS TO CELLS (U.S. CLS. 1, 5, 6, 10, 26 AND 46).

PRISCILLA MILTON, EXAMINING ATTORNEY

SN 86-015,712. ENZO LIFE SCIENCES, INC., FARMINGDALE, NY. FILED 7-21-2013.

**EPIXTRACT**

THE MARK CONSISTS OF STANDARD CHARACTERS WITHOUT CLAIM TO ANY PARTICULAR FONT, STYLE, SIZE, OR COLOR.

FOR DNA AND PROTEIN ISOLATION KITS COMPRISED PRIMARILY OF ASSAYS AND REAGENTS FOR USE IN EPIGENETIC RESEARCH (U.S. CLS. 1, 5, 6, 10, 26 AND 46).

MARK SHINER, EXAMINING ATTORNEY

**CLASS 1—(Continued).**

SN 86-021,907. TRYECO, PORTLAND, OR. FILED 7-29-2013.

**AGRISORB**

THE MARK CONSISTS OF STANDARD CHARACTERS WITHOUT CLAIM TO ANY PARTICULAR FONT, STYLE, SIZE, OR COLOR.

FOR STARCH BASED SUPER-ABSORBENT POLYMER SOIL AMENDMENTS (U.S. CLS. 1, 5, 6, 10, 26 AND 46).  
AMY KERTGATE, EXAMINING ATTORNEY

---

SN 86-041,671. CENTER STAR, INC., SANTA ROSA BEACH, FL. FILED 8-19-2013.

**THERMOPEL**

THE MARK CONSISTS OF STANDARD CHARACTERS WITHOUT CLAIM TO ANY PARTICULAR FONT, STYLE, SIZE, OR COLOR.

OWNER OF U.S. REG. NO. 4,429,690.  
FOR CONCRETE ADDITIVES (U.S. CLS. 1, 5, 6, 10, 26 AND 46).  
BARBARA RUTLAND, EXAMINING ATTORNEY

---

SN 86-042,586. HUNTSMAN PETROCHEMICAL LLC, THE WOODLANDS, TX. FILED 8-20-2013.

**JEFF-FLOW**

THE MARK CONSISTS OF STANDARD CHARACTERS WITHOUT CLAIM TO ANY PARTICULAR FONT, STYLE, SIZE, OR COLOR.

FOR CHEMICALS FOR USE IN THE FIELD OF OIL EXPLORATION AND PRODUCTION (U.S. CLS. 1, 5, 6, 10, 26 AND 46).  
COURTNEY ALVAREZ, EXAMINING ATTORNEY

---

SN 86-042,897. FLEMING, JAMES, BATTLE GROUND, WA. FILED 8-20-2013.

**VegiShield**

THE MARK CONSISTS OF STANDARD CHARACTERS WITHOUT CLAIM TO ANY PARTICULAR FONT, STYLE, SIZE, OR COLOR.

FOR ORGANIC FOOD AND BEVERAGE PRESERVATIVE (U.S. CLS. 1, 5, 6, 10, 26 AND 46).  
ALAIN LAPTER, EXAMINING ATTORNEY

**CLASS 1—(Continued).**

SN 86-042,998. FLORATINE PRODUCTS GROUP, INC., AKA FPG, COLLIERVILLE, TN. FILED 8-20-2013.

**Vita Foam**

THE MARK CONSISTS OF STANDARD CHARACTERS WITHOUT CLAIM TO ANY PARTICULAR FONT, STYLE, SIZE, OR COLOR.

NO CLAIM IS MADE TO THE EXCLUSIVE RIGHT TO USE "FOAM", APART FROM THE MARK AS SHOWN.

FOR CHEMICAL FERTILIZERS; CHEMICALLY CONVERTED COMPOUND FERTILIZERS; CHEMICALS FOR USE IN AGRICULTURE, HORTICULTURE AND FORESTRY EXCEPT FUNGICIDES, HERBICIDES, INSECTICIDES AND PARASITICIDES; COMPLEX FERTILIZER; FERTILIZERS; FERTILIZERS FOR AGRICULTURAL USE; FERTILIZERS FOR DOMESTIC USE; FERTILIZING PREPARATIONS; MIXED FERTILIZERS; NATURAL FERTILIZERS; NON-CHEMICAL BIO-FERTILIZERS; ORGANIC FERTILIZERS; PLANT GROWTH NUTRIENTS; PLANT NUTRIENTS; PLANT NUTRITION PREPARATIONS; PREPARATIONS FOR FORTIFYING PLANTS (U.S. CLS. 1, 5, 6, 10, 26 AND 46).  
JILL PRATER, EXAMINING ATTORNEY

---

SN 86-043,108. DALY, THOMAS, ARLINGTON HEIGHTS, IL. FILED 8-20-2013.

**FRESHAMINE**

THE MARK CONSISTS OF STANDARD CHARACTERS WITHOUT CLAIM TO ANY PARTICULAR FONT, STYLE, SIZE, OR COLOR.

OWNER OF U.S. REG. NOS. 3,124,731 AND 3,525,308.  
FOR CHEMICAL ADDITIVE FOR NEUTRALIZING ACIDS, DISPERSING PIGMENTS AND MINERALS IN COATINGS, PERSONAL CARE, MINING AND INDUSTRIAL APPLICATIONS (U.S. CLS. 1, 5, 6, 10, 26 AND 46).  
FIRST USE 5-5-2011; IN COMMERCE 5-5-2011.  
KEVIN CORWIN, EXAMINING ATTORNEY

---

SN 86-045,145. FUTIRA, LLC, LAGUNA BEACH, CA. FILED 8-22-2013.

**Ventana**

THE MARK CONSISTS OF STANDARD CHARACTERS WITHOUT CLAIM TO ANY PARTICULAR FONT, STYLE, SIZE, OR COLOR.

THE ENGLISH TRANSLATION OF THE WORD "VENTANA" IN THE MARK IS "WINDOW".

FOR CARTRIDGES SOLD FILLED WITH PROPYLENE GLYCOL FOR ELECTRONIC CIGARETTES; CARTRIDGES SOLD FILLED WITH VEGETABLE GLYCERIN FOR ELECTRONIC CIGARETTES (U.S. CLS. 1, 5, 6, 10, 26 AND 46).  
ALEXANDER L. POWERS, EXAMINING ATTORNEY

**CLASS 1—(Continued).**

SN 86-045,998. SUN BULB COMPANY, INC., ARCADIA, FL.  
FILED 8-23-2013.

**ORCHID MOSS**

THE MARK CONSISTS OF STANDARD CHARACTERS WITHOUT CLAIM TO ANY PARTICULAR FONT, STYLE, SIZE, OR COLOR.

OWNER OF U.S. REG. NOS. 1,427,071 AND 2,190,040.  
NO CLAIM IS MADE TO THE EXCLUSIVE RIGHT TO USE "MOSS", APART FROM THE MARK AS SHOWN.  
SEC. 2(F).

FOR POTTING MATERIAL FOR PLANTS (U.S. CLS. 1, 5, 6, 10, 26 AND 46).

FIRST USE 6-11-1996; IN COMMERCE 6-11-1996.  
SUNG IN, EXAMINING ATTORNEY

SN 86-058,235. FUTIRA, LLC, LAGUNA BEACH, CA. FILED  
9-6-2013.

**Vero**

THE MARK CONSISTS OF STANDARD CHARACTERS WITHOUT CLAIM TO ANY PARTICULAR FONT, STYLE, SIZE, OR COLOR.

THE ENGLISH TRANSLATION OF THE WORD "VERO" IN THE MARK IS "TRUE".

FOR CARTRIDGES SOLD FILLED WITH PROPYLENE GLYCOL FOR ELECTRONIC CIGARETTES; CARTRIDGES SOLD FILLED WITH VEGETABLE GLYCERIN FOR ELECTRONIC CIGARETTES (U.S. CLS. 1, 5, 6, 10, 26 AND 46).

ALEXANDER L. POWERS, EXAMINING ATTORNEY

SN 86-063,897. CLEARWATER INTERNTIONAL L.L.C.,  
HOUSTON, TX. FILED 9-13-2013.

**CLEAR-BLOCK**

THE MARK CONSISTS OF STANDARD CHARACTERS WITHOUT CLAIM TO ANY PARTICULAR FONT, STYLE, SIZE, OR COLOR.

FOR CHEMICAL FLUID, NAMELY A TEMPORARY PLUGGING AGENT FOR CONTROLLING FLOW OF FLUID IN HYDROCARBON RECOVERY (U.S. CLS. 1, 5, 6, 10, 26 AND 46).

FIRST USE 12-1-2000; IN COMMERCE 12-1-2000.  
SOPHIA S. KIM, EXAMINING ATTORNEY

**CLASS 1—(Continued).**

SN 86-064,183. NUTRITION TM USA, INC., LOS ANGELES,  
CA. AND MOO YOUNG KANG, LOS ANGELES, CA.  
FILED 9-13-2013.

THE MARK CONSISTS OF THE WORD "ORGMIN" IN STYLIZED FONTS WITH A LEAF-SHAPED FIGURE ON THE UPPER RIGHT OF THE LETTER "R".

FOR FERTILIZERS (U.S. CLS. 1, 5, 6, 10, 26 AND 46).

FIRST USE 8-1-2013; IN COMMERCE 8-1-2013.  
KEVIN MITTLER, EXAMINING ATTORNEY

SN 86-065,312. LIN, CHIH-YUNG, NEW TAIPEI CITY 238,  
TAIWAN, FILED 9-16-2013.

**iSpacer**

THE MARK CONSISTS OF STANDARD CHARACTERS WITHOUT CLAIM TO ANY PARTICULAR FONT, STYLE, SIZE, OR COLOR.

FOR ASSAYS FOR RESEARCH PURPOSES; BIO-CHEMICALS FOR IN VITRO AND IN VIVO SCIENTIFIC USE; BIOLOGICAL PREPARATION FOR USE IN CELL CULTURES OTHER THAN FOR MEDICAL OR VETERINARY USE; BIOLOGICAL TISSUE CULTURES OTHER THAN FOR MEDICAL OR VETERINARY PURPOSES; BIOLOGICAL TISSUE, NAMELY, A SET OF MATCHED FROZEN AND FIXED HUMAN BIOLOGICAL SPECIMENS DERIVED FROM THE DIVISION OF ONE ORIGINAL SPECIMEN FOR USE IN SCIENTIFIC AND MEDICAL RESEARCH; BIOMEDICAL COMPOUNDS, NAMELY, PEPTIDE SUBSTRATES USED IN ANALYZING AND DETECTING CERTAIN TOXINS FOR LABORATORY OR RESEARCH USE; BIOMEDICAL COMPOUNDS, NAMELY, PEPTIDE SUBSTRATES USED IN ANALYZING AND DETECTING CERTAIN TOXINS FOR CLINICAL OR MEDICAL LABORATORY USE; CHEMICAL TEST KITS FOR SCIENTIFIC AND CLINICAL RESEARCH PURPOSES FOR LABORATORY OR RESEARCH USE; DIAGNOSTIC PREPARATIONS FOR SCIENTIFIC OR RESEARCH USE; DIAGNOSTIC PREPARATIONS FOR SCIENTIFIC USE; DIAGNOSTIC PREPARATIONS USED IN SCIENCE; DIAGNOSTIC PREPARATIONS FOR CLINICAL OR MEDICAL LABORATORY USE; DIAGNOSTIC PREPARATIONS FOR SCIENTIFIC OR RESEARCH USE (U.S. CLS. 1, 5, 6, 10, 26 AND 46).

DOMINICK J. SALEMI, EXAMINING ATTORNEY

**CLASS 1—(Continued).**

SN 86-065,544. TWO LITTLE FISHIES, INC., MIAMI GARDENS, FL. FILED 9-16-2013.

**HydroClear**

THE MARK CONSISTS OF STANDARD CHARACTERS WITHOUT CLAIM TO ANY PARTICULAR FONT, STYLE, SIZE, OR COLOR.

FOR ACTIVATED CARBONS FOR FILTERING WATER FOR AQUARIUMS (U.S. CLS. 1, 5, 6, 10, 26 AND 46).

DAVID COLLIER, EXAMINING ATTORNEY



SN 86-066,189. NUTRABERRY LLC, KENMORE, WA. FILED 9-16-2013.

**nutraberriy**

THE MARK CONSISTS OF "NUTRABERRY" IN STYLIZED FONT.

FOR PLANT EXTRACTS, NAMELY FRUIT AND SEED EXTRACTS, USED IN THE MANUFACTURE OF DIETARY AND NUTRITIONAL SUPPLEMENTS, FOOD AND PERSONAL CARE CREAMS, LOTIONS, SERUMS, PREPARATIONS AND COSMETICS (U.S. CLS. 1, 5, 6, 10, 26 AND 46).

FIRST USE 8-13-2011; IN COMMERCE 8-13-2011.  
TOBY BULLOFF, EXAMINING ATTORNEY



SN 86-066,410. BINNO, JOE, HOLLY, MI. FILED 9-17-2013.

**Mom Grows Best!**

THE MARK CONSISTS OF STANDARD CHARACTERS WITHOUT CLAIM TO ANY PARTICULAR FONT, STYLE, SIZE, OR COLOR.

FOR ORGANIC FERTILIZERS (U.S. CLS. 1, 5, 6, 10, 26 AND 46).

ARETHA SOMERVILLE, EXAMINING ATTORNEY

**CLASS 1—(Continued).**

SN 86-066,917. OMNOVA SOLUTIONS INC., FAIRLAWN, OH. FILED 9-17-2013.

**PLIOLITE**

THE MARK CONSISTS OF STANDARD CHARACTERS WITHOUT CLAIM TO ANY PARTICULAR FONT, STYLE, SIZE, OR COLOR.

OWNER OF U.S. REG. NOS. 300,926, 323,370 AND 646,243. FOR SYNTHETIC POLYMERS, IN POWDER FORM OR DISPERSED IN A CARRIER SOLVENT, FOR USE IN THE MANUFACTURE OF MASONRY COATINGS, PAINTS, PRIMERS, AND INTUMESCENT COATINGS, AS WELL AS ADDITIVES TO DRILLING CEMENTS AND FLUIDS (U.S. CLS. 1, 5, 6, 10, 26 AND 46).

FIRST USE 10-8-1932; IN COMMERCE 6-1-2013.  
TRACY CROSS, EXAMINING ATTORNEY



SN 86-067,476. INNOPHOS, INC., CRANBURY, NJ. FILED 9-17-2013.

**L-VIS**

THE MARK CONSISTS OF STANDARD CHARACTERS WITHOUT CLAIM TO ANY PARTICULAR FONT, STYLE, SIZE, OR COLOR.

FOR CHEMICALS FOR USE IN THE MANUFACTURE OF ASPHALT (U.S. CLS. 1, 5, 6, 10, 26 AND 46).

SUZANNE BLANE, EXAMINING ATTORNEY



SN 86-067,878. VALHALLA PARTNERS, LLC, MOUNT DORA, FL. FILED 9-18-2013.

**Green 14**

THE MARK CONSISTS OF STANDARD CHARACTERS WITHOUT CLAIM TO ANY PARTICULAR FONT, STYLE, SIZE, OR COLOR.

NO CLAIM IS MADE TO THE EXCLUSIVE RIGHT TO USE "GREEN", APART FROM THE MARK AS SHOWN.

FOR A PREPARATION OF NATURALLY OCCURRING BACTERIAL STRAINS ENHANCED TO LIQUEFY AND DIGEST WASTE AND CONTROL ODOR IN CESSPOOLS, SEPTIC TANKS, OUTDOOR TOILETS AND WASTEWATER EFFLUENTS (U.S. CLS. 1, 5, 6, 10, 26 AND 46).

DAVID MURRAY, EXAMINING ATTORNEY



**CLASS 1—(Continued).**

SN 86-068,074. INNOVASAN CORPORATION, KNOXVILLE, TN. FILED 9-18-2013.

**Innova-Shield**

THE MARK CONSISTS OF STANDARD CHARACTERS WITHOUT CLAIM TO ANY PARTICULAR FONT, STYLE, SIZE, OR COLOR.

FOR CHEMICAL SOLUTIONS FOR ADDING TO A FLUID WASTE STREAM TO PREVENT LIPID PARTICULATE IN THE WASTE STREAM FROM ADHERING TO COMPONENTS OF A WASTE TREATMENT SYSTEM (U.S. CLS. 1, 5, 6, 10, 26 AND 46).

RICHARD WHITE, EXAMINING ATTORNEY

**CLASS 1—(Continued).**

SN 86-070,806. PIERCE BIOTECHNOLOGY, INC., ROCK-FORD, IL. FILED 9-20-2013.

**TURBOLUC**

THE MARK CONSISTS OF STANDARD CHARACTERS WITHOUT CLAIM TO ANY PARTICULAR FONT, STYLE, SIZE, OR COLOR.

FOR CHEMICAL, BIOCHEMICAL, NUCLEIC ACID AND POLYPEPTIDE REAGENTS FOR SCIENTIFIC, RESEARCH OR SCREENING USE (U.S. CLS. 1, 5, 6, 10, 26 AND 46).

MICHAEL WEBSTER, EXAMINING ATTORNEY

SN 86-069,533. GE NUTRIENTS, INC., ANAHEIM, CA. FILED 9-19-2013.

**ActivAMP**

THE MARK CONSISTS OF STANDARD CHARACTERS WITHOUT CLAIM TO ANY PARTICULAR FONT, STYLE, SIZE, OR COLOR.

FOR GYNOSTEMMA PENTAPHYLLUM COMPOSITIONS USED AS INGREDIENTS IN THE MANUFACTURE OF DIETARY SUPPLEMENTS (U.S. CLS. 1, 5, 6, 10, 26 AND 46).

ANDREA HACK, EXAMINING ATTORNEY

SN 86-070,887. ACCELERGY CORPORATION, HOUSTON, TX. FILED 9-20-2013.

**TERRASYNC**

THE MARK CONSISTS OF STANDARD CHARACTERS WITHOUT CLAIM TO ANY PARTICULAR FONT, STYLE, SIZE, OR COLOR.

FOR FERTILIZERS (U.S. CLS. 1, 5, 6, 10, 26 AND 46).

ANDREA HACK, EXAMINING ATTORNEY

SN 86-071,335. OMNI RESEARCH CORPORATION, DBA BIO-DEX LABORATORIES, PHOENIX, AZ. FILED 9-22-2013.

**SALT PROTECT**

SN 86-070,213. SHEMIN NURSERIES, INC., DANBURY, CT. FILED 9-20-2013.

**CHOICEMELT**

THE MARK CONSISTS OF STANDARD CHARACTERS WITHOUT CLAIM TO ANY PARTICULAR FONT, STYLE, SIZE, OR COLOR.

FOR CHEMICAL PREPARATIONS FOR MELTING SNOW AND ICE (U.S. CLS. 1, 5, 6, 10, 26 AND 46).

LINDA E. BLOHM, EXAMINING ATTORNEY

THE MARK CONSISTS OF STANDARD CHARACTERS WITHOUT CLAIM TO ANY PARTICULAR FONT, STYLE, SIZE, OR COLOR.

OWNER OF U.S. REG. NO. 3,132,665. NO CLAIM IS MADE TO THE EXCLUSIVE RIGHT TO USE "SALT", APART FROM THE MARK AS SHOWN.

FOR WATER TREATMENT CHEMICALS FOR USE IN SWIMMING POOLS AND SPAS (U.S. CLS. 1, 5, 6, 10, 26 AND 46).

FIRST USE 5-30-2006; IN COMMERCE 5-30-2006.

KHANH LE, EXAMINING ATTORNEY

**CLASS 1—(Continued).**

SN 86-071,948. KAZ & ASSOCIATES, LLC., BENICIA, CA. FILED 9-23-2013.

**HARMONY ORGANICS**

THE MARK CONSISTS OF STANDARD CHARACTERS WITHOUT CLAIM TO ANY PARTICULAR FONT, STYLE, SIZE, OR COLOR.

NO CLAIM IS MADE TO THE EXCLUSIVE RIGHT TO USE "ORGANICS", APART FROM THE MARK AS SHOWN. FOR ORGANIC SOIL ENHANCEMENT LIQUIDS AND PREPARATIONS (U.S. CLS. 1, 5, 6, 10, 26 AND 46).

IRA J. GOODSAD, EXAMINING ATTORNEY

**CLASS 1—(Continued).**

SN 86-084,835. DISTRIBUTORS PROCESSING, INC., PORTERVILLE, CA. FILED 10-7-2013.

**Impact MB**

THE MARK CONSISTS OF STANDARD CHARACTERS WITHOUT CLAIM TO ANY PARTICULAR FONT, STYLE, SIZE, OR COLOR.

FOR ORGANIC COMPOST ACTIVATOR TO INCREASE NUTRIENT RETENTION AND MINIMIZE ODOROUS VOLATILIZATION OF FINISHED COMPOST (U.S. CLS. 1, 5, 6, 10, 26 AND 46).

FIRST USE 9-24-2013; IN COMMERCE 9-24-2013.  
JOANNA DUKOVIC, EXAMINING ATTORNEY

SN 86-072,210. NEU SPECIALTY ENGINEERED MATERIALS, LLC, AVON LAKE, OH. FILED 9-23-2013.

**TRANSPIRE**

THE MARK CONSISTS OF STANDARD CHARACTERS WITHOUT CLAIM TO ANY PARTICULAR FONT, STYLE, SIZE, OR COLOR.

FOR PLASTIC COMPOUNDS HAVING RADIOCAPACITY AND OPTICAL TRANSLUCENCY FOR FURTHER USE IN PLASTIC MANUFACTURING (U.S. CLS. 1, 5, 6, 10, 26 AND 46).

SIDDHARTH JAGANNATHAN, EXAMINING ATTORNEY

SN 86-115,587. TGTM HOLDINGS LLC, COLUMBUS, OH. FILED 11-11-2013.

**TRUA-SPHERES**

THE MARK CONSISTS OF STANDARD CHARACTERS WITHOUT CLAIM TO ANY PARTICULAR FONT, STYLE, SIZE, OR COLOR.

FOR BOTANICAL EXTRACTS FOR USE IN MAKING COSMETICS; PLANT EXTRACTS FOR USE IN THE MANUFACTURE OF CREAMS, LOTIONS AND COSMETIC PRODUCTS (U.S. CLS. 1, 5, 6, 10, 26 AND 46).

JEANIE LEE, EXAMINING ATTORNEY

SN 86-072,785. DIVERSEY, INC., STURTEVANT, WI. FILED 9-24-2013.

**NUFIBER**

THE MARK CONSISTS OF STANDARD CHARACTERS WITHOUT CLAIM TO ANY PARTICULAR FONT, STYLE, SIZE, OR COLOR.

FOR CHEMICALS FOR USE IN THE MANUFACTURE AND RECYCLING OF PAPER AND PAPER PRODUCTS (U.S. CLS. 1, 5, 6, 10, 26 AND 46).

NATALIE POLZER, EXAMINING ATTORNEY

SN 86-118,620. ABENGOA BIOENERGY NEW TECHNOLOGIES, LLC, CHESTERFIELD, MO. FILED 11-14-2013.

**ABEZYM**

THE MARK CONSISTS OF STANDARD CHARACTERS WITHOUT CLAIM TO ANY PARTICULAR FONT, STYLE, SIZE, OR COLOR.

FOR ENZYMES FOR THE PRODUCTION OF BIOFUELS AND OTHER PRODUCTS FROM RENEWABLE CARBON FEEDSTOCKS; ENZYMES FOR THE CONVERSION OF CELLULOSIC BIOMASS TO SUGARS, ALCOHOLS, BIOFUELS, AND OTHER PRODUCTS (U.S. CLS. 1, 5, 6, 10, 26 AND 46).

VERNA BETH RIRIE, EXAMINING ATTORNEY

**CLASS 2—PAINTS**

SN 79-132,913. CIN - CORPORAÇÃO INDUSTRIAL; DO NORTE, S.A., PORTUGAL, FILED 5-9-2013.

CIN

THE MARK CONSISTS OF STANDARD CHARACTERS WITHOUT CLAIM TO ANY PARTICULAR FONT, STYLE, SIZE, OR COLOR.

OWNER OF INTERNATIONAL REGISTRATION 0496019 DATED 9-16-1985, EXPIRES 9-16-2015.

OWNER OF U.S. REG. NO. 3,913,307. FOR COLORS, NAMELY, PAINTS, ENAMEL PAINTS; VARNISHES (U.S. CLS. 6, 11 AND 16).

MICHAEL WIENER, EXAMINING ATTORNEY

SN 79-136,608. CIN - CORPORAÇÃO INDUSTRIAL; DO NORTE, S.A., PORTUGAL, FILED 6-6-2013.

CIN COAT

THE MARK CONSISTS OF STANDARD CHARACTERS WITHOUT CLAIM TO ANY PARTICULAR FONT, STYLE, SIZE, OR COLOR.

OWNER OF INTERNATIONAL REGISTRATION 0775344 DATED 2-13-2002, EXPIRES 2-13-2022.

OWNER OF U.S. REG. NO. 3,913,307. NO CLAIM IS MADE TO THE EXCLUSIVE RIGHT TO USE "COAT", APART FROM THE MARK AS SHOWN.

FOR PAINTS, VARNISHES, ENAMEL PAINTS, LACQUERS, SICCATIVES FOR COLOURS AND SICCATIVES FOR USE AS A DRYING AGENT FOR COATINGS AND INKS (U.S. CLS. 6, 11 AND 16).

ANDREW LEASER, EXAMINING ATTORNEY

SN 79-140,236. CIN - CORPORAÇÃO INDUSTRIAL; DO NORTE, S.A., PORTUGAL, FILED 6-6-2013.

C-THANE

THE MARK CONSISTS OF STANDARD CHARACTERS WITHOUT CLAIM TO ANY PARTICULAR FONT, STYLE, SIZE, OR COLOR.

OWNER OF INTERNATIONAL REGISTRATION 0775508 DATED 2-13-2002, EXPIRES 2-13-2022.

FOR PAINTS, VARNISHES, ENAMEL PAINTS, LACQUERS, SICCATIVES FOR COLOURS AND SICCATIVES FOR USE AS A DRYING AGENT FOR COATINGS AND INKS (U.S. CLS. 6, 11 AND 16).

JAMES MACFARLANE, EXAMINING ATTORNEY

**CLASS 2—(Continued).**

SN 79-140,237. CIN - CORPORAÇÃO INDUSTRIAL; DO NORTE, S.A., PORTUGAL, FILED 6-6-2013.

C-POX

THE MARK CONSISTS OF STANDARD CHARACTERS WITHOUT CLAIM TO ANY PARTICULAR FONT, STYLE, SIZE, OR COLOR.

OWNER OF INTERNATIONAL REGISTRATION 0780716 DATED 5-17-2002, EXPIRES 5-17-2022.

FOR PAINTS, VARNISHES, ENAMEL PAINTS, LACQUERS, SICCATIVES FOR COLOURS AND SICCATIVES FOR USE AS A DRYING AGENT FOR COATINGS AND INKS (U.S. CLS. 6, 11 AND 16).

JAMES MACFARLANE, EXAMINING ATTORNEY

SN 79-140,246. CIN - CORPORAÇÃO INDUSTRIAL; DO NORTE, S.A., PORTUGAL, FILED 6-6-2013.

C-CRYL

THE MARK CONSISTS OF STANDARD CHARACTERS WITHOUT CLAIM TO ANY PARTICULAR FONT, STYLE, SIZE, OR COLOR.

OWNER OF INTERNATIONAL REGISTRATION 0823100 DATED 2-10-2004, EXPIRES 2-10-2014.

FOR PAINTS, VARNISHES, ENAMEL PAINTS, LACQUERS, SICCATIVES FOR COLOURS AND SICCATIVES FOR USE AS A DRYING AGENT FOR COATINGS AND INKS (U.S. CLS. 6, 11 AND 16).

JAMES MACFARLANE, EXAMINING ATTORNEY

**CLASS 2—(Continued).**

SN 85-859,198. KAPCI COATINGS COMPANY (SAE), PORT SAID, EGYPT, FILED 2-25-2013.



OWNER OF EGYPT REG. NO. 253413, DATED 10-16-2012, EXPIRES 11-14-2021.

NO CLAIM IS MADE TO THE EXCLUSIVE RIGHT TO USE THE TERM "LATICO" AND THE NON-LATIN CHARACTERS THAT TRANSLITERATE TO "LATICO", APART FROM THE MARK AS SHOWN.

THE COLOR(S) ORANGE, YELLOW, GREEN, BLUE AND PURPLE IS/ARE CLAIMED AS A FEATURE OF THE MARK.

THE MARK CONSISTS OF THE STYLIZED WORD "LATICO" IN THE COLOR BLUE, WITH ARABIC CHARACTERS UNDERNEATH IN THE COLOR BLUE, WITH A CURVED LINE DESIGN IN THE COLORS ORANGE, YELLOW, GREEN, BLUE AND PURPLE.

THE ENGLISH TRANSLATION OF "LATICO" IN THE MARK IS "SHINY".

THE NON-LATIN CHARACTERS IN THE MARK TRANSLITERATE TO "LATICO" AND THIS MEANS "SHINY" IN ENGLISH.

FOR ANTICORROSIVE PAINTS; ANTI-CHIPPING COATINGS, NAMELY, STONE GUARD COATINGS FOR VEHICLE BODIES; AUTOMOBILE UNDERCOATING TO PROTECT UNDERCARRIAGE AGAINST RUST AND TO REDUCE CABIN NOISE; BINDING AGENTS FOR PAINTS; CLEAR AND PIGMENTED COATINGS IN THE NATURE OF PAINT; CLEAR COATING PROTECTANT FOR VEHICLES; COATING COMPOSITIONS IN THE NATURE OF PAINT CONTAINING THERMOSETTING RESINS AND THERMOPLASTIC RESINS USED TO COAT METAL PRODUCTS, FOR INDUSTRIAL APPLICATIONS; COATINGS FOR WOOD AS PAINTS; COATINGS IN THE NATURE OF AUTOMOBILE FINISHING; COLORANTS; COLORANTS, PAINTS AND DYES FOR GENERAL INDUSTRIAL USE; ENAMEL PAINTS; LACQUERS; LACQUERS IN THE NATURE OF A COATING; MIXED PAINTS; OIL PAINTS; PAINT FOR USE IN THE MANUFACTURE OF AUTOMOBILES; PAINT FOR USE IN THE MANUFACTURE OF FURNITURE; PAINT PRIMERS; PAINT SEALERS; PAINT THINNER; PAINT THINNERS; PAINTS; PAINTS AND COATINGS FOR AUTOMOBILES, LUMBER AND BUILDINGS; PAINTS AND LACQUERS; PAINTS, LACQUERS, VARNISHES; POLYURETHANE COATINGS FOR AUTOMOBILE FINISHING, FURNITURE, FLOORS; POLYURETHANE VARNISH; PRIMER; PRIMERS; SICCATIVES FOR COLOURS; SYNTHETIC RESIN PAINTS; TEXTURED ADDITIVES FOR PAINT; THINNERS FOR COLOURS; THINNERS FOR PAINT; TONERS; UNDERCOATING FOR SURFACES TO BE PAINTED; UNDERCOATING FOR VEHICLES CHASSIS; VARNISHES; WATER-BASED PAINTS (U.S. CLS. 6, 11 AND 16).

KRISTIN DAHLING, EXAMINING ATTORNEY

**CLASS 2—(Continued).**

SN 86-020,069. CALIFORNIA PRODUCTS CORPORATION, ANDOVER, MA. FILED 7-25-2013.

### RENUE MOLD AND MILDEW SOLUTIONS

THE MARK CONSISTS OF STANDARD CHARACTERS WITHOUT CLAIM TO ANY PARTICULAR FONT, STYLE, SIZE, OR COLOR.

NO CLAIM IS MADE TO THE EXCLUSIVE RIGHT TO USE "MOLD" OR "MILDEW", APART FROM THE MARK AS SHOWN.

FOR SURFACE COATINGS FOR INTERIOR AND EXTERIOR USE TO PROTECT AGAINST AND TREAT GROWTH OF MOLD, MILDEW, BACTERIA AND FUNGI (U.S. CLS. 6, 11 AND 16).

DAVID HOFFMAN, EXAMINING ATTORNEY

SN 86-027,247. WAZANA BROTHERS INTERNATIONAL, INC., DBA MICRO SOLUTIONS ENTERPRISES, VAN NUYS, CA. FILED 8-2-2013.



**Intelligent  
Re-Engineering**

OWNER OF U.S. REG. NOS. 4,055,517 AND 4,205,138.

NO CLAIM IS MADE TO THE EXCLUSIVE RIGHT TO USE "RE-ENGINEERING", APART FROM THE MARK AS SHOWN.

THE COLOR(S) DARK TEAL, PALE TEAL, LIME GREEN, PALE LIME GREEN, BLUE, PALE BLUE, WHITE IS/ARE CLAIMED AS A FEATURE OF THE MARK.

THE MARK CONSISTS OF THE WORDS "INTELLIGENT RE-ENGINEERING" APPEARING CENTERED BENEATH A DARK TEAL SQUARE WITH ROUNDED EDGES WITH THE IMAGE OF A GEAR INSIDE THE ROUNDED SQUARE AND TO THE LEFT OUTLINED IN WHITE AND COLORED DARK TEAL WITHIN THE WHITE OUTLINE, WITH THE IMAGE OF A LEAF AND COLORED DARK TEAL WITHIN THE WHITE OUTLINE WITH THE IMAGE OF A LEAF IN BLUE, PALE BLUE AND PALE LIME GREEN APPEARING TO THE RIGHT OF THE IMAGE OF THE GEAR, AND WITH THE STEM OF THE LEAF IN PALE LIME GREEN AND LIME GREEN JOINING THE LEAF IMAGE AND THE GEAR IMAGE BY WRAPPING FROM THE BOTTOM OF THE LEAF IMAGE TO THE RIGHT OF THE IMAGE OF THE GEAR AND AROUND AND TO THE LEFT OF THE IMAGE OF THE GEAR AND WITH THE STEM OF THE LEAF IN PALE LIME GREEN AND LIME GREEN.

FOR TONER CARTRIDGES (U.S. CLS. 6, 11 AND 16).

FIRST USE 3-15-2012; IN COMMERCE 3-15-2012.

MATTHEW KLINE, EXAMINING ATTORNEY

**CLASS 2—(Continued).**

SN 86-044,503. NUTEC DIGITAL INK (PTY) LTD, LANS-DOWNE, SOUTH AFRICA, FILED 8-21-2013.



THE MARK CONSISTS OF A SLOTTCH OF INK WITH AN ABSTRACT DIGITAL DESIGN OF LIGHT AND DARK SQUARES

FOR INK FOR PRINTERS AND PHOTOCOPIERS; INKJET PRINTER INK; DRY INKS; ENGRAVING INK; PIGMENTED SOLVENT BASED DIGITAL PRINTING INKS; PIGMENTED UV CURABLE DIGITAL PRINTING INKS; DYE SUBLIMATION INKS; LATEX INKS FOR DIGITAL PRINTING; FILLED INK CARTRIDGES FOR PRINTERS AND PHOTOCOPIERS; FILLED TONER CARTRIDGES FOR PRINTERS AND PHOTOCOPIERS; FILLED INKJET CARTRIDGES; AND PAINT COATINGS (U.S. CLS. 6, 11 AND 16).

ANTHONY RINKER, EXAMINING ATTORNEY

SN 86-044,521. NUTEC DIGITAL INK (PTY) LTD, LANS-DOWNE, SOUTH AFRICA, FILED 8-21-2013.

**nutec**  
DIGITAL INK

NO CLAIM IS MADE TO THE EXCLUSIVE RIGHT TO USE "DIGITAL INK", APART FROM THE MARK AS SHOWN.

THE MARK CONSISTS OF THE WORDS "NUTEC DIGITAL INK".

FOR INK FOR PRINTERS AND PHOTOCOPIERS; INKJET PRINTER INK; DRY INKS; ENGRAVING INK; PIGMENTED SOLVENT BASED DIGITAL PRINTING INKS; PIGMENTED UV CURABLE DIGITAL PRINTING INKS; DYE SUBLIMATION INKS; LATEX INKS FOR DIGITAL PRINTING; FILLED INK CARTRIDGES FOR PRINTERS AND PHOTOCOPIERS; FILLED TONER CARTRIDGES FOR PRINTERS AND PHOTOCOPIERS; FILLED INKJET CARTRIDGES; AND PAINT COATINGS (U.S. CLS. 6, 11 AND 16).

ANTHONY RINKER, EXAMINING ATTORNEY

**CLASS 2—(Continued).**

SN 86-045,942. ODEN, STEVE, MERIDIAN, ID. AND ODEN, MELISSA, MERIDIAN, ID. FILED 8-23-2013.

**VINTAGE CHIC FARM**

THE MARK CONSISTS OF STANDARD CHARACTERS WITHOUT CLAIM TO ANY PARTICULAR FONT, STYLE, SIZE, OR COLOR.

FOR COATINGS USED FOR FURNITURE FINISHING (U.S. CLS. 6, 11 AND 16).

JEFFERY COWARD, EXAMINING ATTORNEY

SN 86-061,000. MATERIALS MODIFICATION INC., FAIRFAX, VA. FILED 9-10-2013.

**NIX-IT**

THE MARK CONSISTS OF STANDARD CHARACTERS WITHOUT CLAIM TO ANY PARTICULAR FONT, STYLE, SIZE, OR COLOR.

FOR PAINT HAVING WATER REPELLANT PROPERTIES; COATING PREPARATIONS HAVING WATER REPELLANT PROPERTIES; WATER REPELLANT PAINT; PAINT HAVING ANTI-FREEZING AND DE-ICING PROPERTIES; PAINT HAVING OIL REPELLANT PROPERTIES (U.S. CLS. 6, 11 AND 16).

RUSS HERMAN, EXAMINING ATTORNEY

SN 86-063,713. CLOVER TECHNOLOGIES GROUP, LLC, OTTAWA, IL. FILED 9-13-2013.

**PRINTLOGIC**

THE MARK CONSISTS OF STANDARD CHARACTERS WITHOUT CLAIM TO ANY PARTICULAR FONT, STYLE, SIZE, OR COLOR.

FOR TONER CARTRIDGES (U.S. CLS. 6, 11 AND 16). FIRST USE 8-25-2010; IN COMMERCE 8-25-2010.

SUNG IN, EXAMINING ATTORNEY

**CLASS 2—(Continued).**

SN 86-063,733. CLOVER TECHNOLOGIES GROUP, LLC, OTTAWA, IL. FILED 9-13-2013.

## PRINTLOGIC

THE MARK CONSISTS OF STANDARD CHARACTERS WITHOUT CLAIM TO ANY PARTICULAR FONT, STYLE, SIZE, OR COLOR.  
FOR INK CARTRIDGES FOR PRINTERS (U.S. CLS. 6, 11 AND 16).  
SUNG IN, EXAMINING ATTORNEY

SN 86-068,202. DIC IMAGING PRODUCTS USA, LLC, OAK CREEK, WI. FILED 9-18-2013.

## ONECURE

THE MARK CONSISTS OF STANDARD CHARACTERS WITHOUT CLAIM TO ANY PARTICULAR FONT, STYLE, SIZE, OR COLOR.  
FOR FLOOR COATINGS; INSTANT CURE COATINGS FOR FLOORS (U.S. CLS. 6, 11 AND 16).  
AISHA CLARKE, EXAMINING ATTORNEY

SN 86-069,546. FIXTURE-FIX, LLC, OYSTER BAY COVE, NY. FILED 9-19-2013.

## PORC-A-FIX

THE MARK CONSISTS OF STANDARD CHARACTERS WITHOUT CLAIM TO ANY PARTICULAR FONT, STYLE, SIZE, OR COLOR.  
FOR PORCELAIN TOUCH-UP KIT COMPRISING LIQUID PORCELAIN, BRUSH TOP APPLICATOR AND FINISHING PAPER (U.S. CLS. 6, 11 AND 16).  
FIRST USE 8-8-1974; IN COMMERCE 8-8-1974.  
NAKIA HENRY, EXAMINING ATTORNEY

**CLASS 2—(Continued).**

SN 86-069,880. RYAN PRICE, KAILUA, HI. FILED 9-19-2013.

## EnduraDry

THE MARK CONSISTS OF STANDARD CHARACTERS WITHOUT CLAIM TO ANY PARTICULAR FONT, STYLE, SIZE, OR COLOR.  
FOR COATING PREPARATIONS HAVING WATER REPELLENT PROPERTIES (U.S. CLS. 6, 11 AND 16).  
BARBARA BROWN, EXAMINING ATTORNEY

SN 86-070,330. ARTISTIC, INC., WAPAKONETA, OH. FILED 9-20-2013.

## GRANIFLEX

THE MARK CONSISTS OF STANDARD CHARACTERS WITHOUT CLAIM TO ANY PARTICULAR FONT, STYLE, SIZE, OR COLOR.  
FOR DECORATIVE COATINGS FOR WOOD, DECKS, AND FLOORING; PROTECTIVE COATING FOR WOOD, DECKS, AND FLOORING (U.S. CLS. 6, 11 AND 16).  
FIRST USE 8-14-2012; IN COMMERCE 8-14-2012.  
RAMONA ORTIGA, EXAMINING ATTORNEY

SN 86-073,150. COLUMBIA INSURANCE COMPANY, OMAHA, NE. FILED 9-24-2013.

## NATURA RENEW

THE MARK CONSISTS OF STANDARD CHARACTERS WITHOUT CLAIM TO ANY PARTICULAR FONT, STYLE, SIZE, OR COLOR.  
OWNER OF U.S. REG. NO. 3,551,709.  
THE ENGLISH TRANSLATION OF "NATURA" IN THE MARK IS "NATURAL".  
FOR INTERIOR AND EXTERIOR PAINTS AND COATINGS IN THE NATURE OF A PAINT (U.S. CLS. 6, 11 AND 16).  
KEVON CHISOLM, EXAMINING ATTORNEY

**CLASS 2—(Continued).**

SN 86-073,248. PPG INDUSTRIES OHIO, INC., CLEVELAND, OH. FILED 9-24-2013.

**SILVERSAN**

THE MARK CONSISTS OF STANDARD CHARACTERS WITHOUT CLAIM TO ANY PARTICULAR FONT, STYLE, SIZE, OR COLOR.

FOR COATING COMPOSITIONS IN THE NATURE OF PAINT AND POWDER FOR INDUSTRIAL APPLICATIONS; THE AFOREMENTIONED TREATED WITH SILVER-IONIC TECHNOLOGY (U.S. CLS. 6, 11 AND 16).  
FIRST USE 10-0-2001; IN COMMERCE 10-0-2001.  
ELI HELLMAN, EXAMINING ATTORNEY

SN 86-074,086. THE VALSPAR CORPORATION, MINNEAPOLIS, MN. FILED 9-25-2013.

**HYDROCHROMA**

THE MARK CONSISTS OF STANDARD CHARACTERS WITHOUT CLAIM TO ANY PARTICULAR FONT, STYLE, SIZE, OR COLOR.

FOR PAINTS (U.S. CLS. 6, 11 AND 16).  
AISHA CLARKE, EXAMINING ATTORNEY

SN 86-074,587. THE VALSPAR CORPORATION, MINNEAPOLIS, MN. FILED 9-25-2013.



THE COLOR(S) RED, ORANGE, YELLOW, GREEN, BLUE, AND PURPLE IS/ARE CLAIMED AS A FEATURE OF THE MARK.

THE MARK CONSISTS OF THE WORD "HYDROCHROMA" COMPRISING THE COLORS RED, ORANGE, YELLOW, GREEN, BLUE, AND PURPLE IN A SPECTRUM OF COLORS FROM LEFT TO RIGHT AND THE FIRST LETTER "O" COMPRISED OF A GREEN RAINDROP.  
FOR PAINTS (U.S. CLS. 6, 11 AND 16).  
AISHA CLARKE, EXAMINING ATTORNEY

**CLASS 2—(Continued).**

SN 86-076,531. HORIZON GROUP USA, INC., WARREN, NJ. FILED 9-27-2013.

**CAMP ANYWHERE**

THE MARK CONSISTS OF STANDARD CHARACTERS WITHOUT CLAIM TO ANY PARTICULAR FONT, STYLE, SIZE, OR COLOR.

FOR PAINTS; FABRIC DYES FOR USE IN TIE-DYING (U.S. CLS. 6, 11 AND 16).  
DEBORAH LOBO, EXAMINING ATTORNEY

SN 86-119,251. FIXTURE-FIX, LLC, OYSTER BAY COVE, NY. FILED 11-14-2013.

**PORC-A-FILLER**

THE MARK CONSISTS OF STANDARD CHARACTERS WITHOUT CLAIM TO ANY PARTICULAR FONT, STYLE, SIZE, OR COLOR.

FOR PORCELAIN REPAIR KIT CONTAINING PUTTY-BASED FILLER, APPLICATOR STICK AND SANDPAPER TO FILL IN CHIPS AND GOUGES IN PORCELAIN (U.S. CLS. 6, 11 AND 16).  
NAKIA HENRY, EXAMINING ATTORNEY

**CLASS 3—COSMETICS AND CLEANING PREPARATIONS**

SN 76-713,552. GLIPTONE MANUFACTURING, INC., RONKONKOMA, NY. FILED 2-22-2013.

**EMERALD CLEAN**

THE MARK CONSISTS OF STANDARD CHARACTERS WITHOUT CLAIM TO ANY PARTICULAR FONT, STYLE, SIZE, OR COLOR.

NO CLAIM IS MADE TO THE EXCLUSIVE RIGHT TO USE "CLEAN", APART FROM THE MARK AS SHOWN.  
FOR LIQUID CLEANER AND DEGREASER FOR AUTOMOBILES (U.S. CLS. 1, 4, 6, 50, 51 AND 52).  
FIRST USE 12-30-1998; IN COMMERCE 12-30-1998.  
KIM SAITO, EXAMINING ATTORNEY

**CLASS 3—(Continued).**

SN 76-714,674. KOONTZ, JOHN M, MARS, PA. FILED 8-2-2013.

**RESTORO**

THE MARK CONSISTS OF STANDARD CHARACTERS WITHOUT CLAIM TO ANY PARTICULAR FONT, STYLE, SIZE, OR COLOR.

FOR CLEANING AND POLISHING COMPOUND FOR CLEANING AND POLISHING METAL, GLASS, FIBER-GLASS, TILE, MARBLE, GRANITE, AND PAINTED SURFACES (U.S. CLS. 1, 4, 6, 50, 51 AND 52).

FIRST USE 3-5-1934; IN COMMERCE 3-5-1934.  
KATHY WANG, EXAMINING ATTORNEY

SN 77-119,862. SEXY HAIR CONCEPTS, LLC, CHATSWORTH, CA. FILED 3-1-2007.

**SEXY SKIN**

THE MARK CONSISTS OF STANDARD CHARACTERS WITHOUT CLAIM TO ANY PARTICULAR FONT, STYLE, SIZE, OR COLOR.

FOR NON-MEDICATED SKIN CARE PREPARATIONS, BODY BUTTER, SKIN MOISTURIZERS (U.S. CLS. 1, 4, 6, 50, 51 AND 52).

ALLISON HOLTZ, EXAMINING ATTORNEY

SN 78-590,656. TANNER, JANELLE HOLDEN, MANHATTAN BEACH, CA. FILED 3-18-2005.

**BABY BLING**

THE MARK CONSISTS OF STANDARD CHARACTERS WITHOUT CLAIM TO ANY PARTICULAR FONT, STYLE, SIZE, OR COLOR.

OWNER OF U.S. REG. NO. 3,005,085.

NO CLAIM IS MADE TO THE EXCLUSIVE RIGHT TO USE "BABY", APART FROM THE MARK AS SHOWN.

FOR CHILDREN'S TOOTHPASTE (U.S. CLS. 1, 4, 6, 50, 51 AND 52).

MICHAEL ENGEL, EXAMINING ATTORNEY

**CLASS 3—(Continued).**

SN 79-132,230. ACQUA DI PARMA S.R.L., ITALY, FILED 1-4-2013.

**ACQUA  
DI  
PARMA**  
*Acqua Nobile*



PRIORITY DATE OF 7-18-2012 IS CLAIMED.  
OWNER OF INTERNATIONAL REGISTRATION 1165726 DATED 1-4-2013, EXPIRES 1-4-2023.

OWNER OF U.S. REG. NOS. 2,079,666, 4,326,358 AND OTHERS.

NO CLAIM IS MADE TO THE EXCLUSIVE RIGHT TO USE "PARMA", APART FROM THE MARK AS SHOWN.

THE MARK CONSISTS OF THE WORDING "ACQUA DI PARMA" IN BLOCK LETTERING, ABOVE THE WORDING "ACQUA NOBILE" IN SCRIPT LETTERING. BENEATH THIS WORDING IS THE DESIGN OF A SHIELD WITH A CLOSED CROWN ON TOP.

THE ENGLISH TRANSLATION OF THE WORD "ACQUA DI PARMA" AND "ACQUA NOBILE" IN THE MARK IS "WATER OF PARMA" AND "WATER NOBLE".

FOR PERFUMERY, NAMELY, PERFUMES, EAU-DE-COLOGNE, TOILET WATER, ESSENTIAL OILS, DEODORANTS FOR PERSONAL USE, SCENTED LOTIONS FOR THE SKIN, SCENTED SKIN SOAPS, BATH SALTS, BATH OILS, SHAMPOOS, BATH GELS, SHOWER GELS; COSMETICS, NAMELY, FACE, BODY AND HAND CREAMS, GELS, MILKS, POWDERS AND LOTIONS, NAMELY, BATH GELS, HAIR GELS; BEAUTY MILKS, COSMETIC MILKS, FACE POWDER, MAKE-UP POWDER, LOTIONS FOR COSMETIC PURPOSES; INCENSE, POTPOURRI (U.S. CLS. 1, 4, 6, 50, 51 AND 52).

RON FAIRBANKS, EXAMINING ATTORNEY

SN 79-133,174. BJÖRN AXÉN INSTITUT AB, SWEDEN, FILED 6-26-2013.

**BJÖRN AXÉN THE LEGACY 1963**

THE MARK CONSISTS OF STANDARD CHARACTERS WITHOUT CLAIM TO ANY PARTICULAR FONT, STYLE, SIZE, OR COLOR.

PRIORITY DATE OF 2-5-2013 IS CLAIMED.

OWNER OF INTERNATIONAL REGISTRATION 1168175 DATED 6-26-2013, EXPIRES 6-26-2023.

NO CLAIM IS MADE TO THE EXCLUSIVE RIGHT TO USE "1963", APART FROM THE MARK AS SHOWN.

THE NAME "BJÖRN AXÉN" DOES NOT IDENTIFY A LIVING INDIVIDUAL.

FOR HAIR CARE PREPARATIONS; SHAMPOOS AND CONDITIONERS; SCALP TREATMENTS, NAMELY, NON-MEDICATED SCALP TREATMENT CREAM; NON-MEDICATED HAIR TREATMENT PREPARATIONS FOR COSMETIC PURPOSES; HAIR STYLING PREPARATIONS; HAIR COLOURING AND HAIR TINTING PREPARATIONS (U.S. CLS. 1, 4, 6, 50, 51 AND 52).

KATHERINE E. HALMEN, EXAMINING ATTORNEY



**CLASS 3—(Continued).**

SN 79-137,426. LVMH FRAGRANCE BRANDS, FRANCE,  
FILED 7-31-2013.

**Ylang**  
***Austral***

PRIORITY DATE OF 2-21-2013 IS CLAIMED.  
OWNER OF INTERNATIONAL REGISTRATION 1178853  
DATED 7-31-2013, EXPIRES 7-31-2023.  
NO CLAIM IS MADE TO THE EXCLUSIVE RIGHT TO  
USE "YLANG", APART FROM THE MARK AS SHOWN.  
FOR PERFUMES, EAUX DE COLOGNE AND TOILET  
WATERS (U.S. CLS. 1, 4, 6, 50, 51 AND 52).  
KRISTINA MORRIS, EXAMINING ATTORNEY

SN 79-137,642. LVMH FRAGRANCE BRANDS, FRANCE,  
FILED 8-30-2013.



PRIORITY DATE OF 7-2-2013 IS CLAIMED.  
OWNER OF INTERNATIONAL REGISTRATION 1179585  
DATED 8-30-2013, EXPIRES 8-30-2023.  
OWNER OF U.S. REG. NOS. 4,079,380, 4,441,951 AND  
OTHERS.

THE COLOR(S) RED, BLACK, WHITE, AND GRAY IS/  
ARE CLAIMED AS A FEATURE OF THE MARK.

THE MARK CONSISTS OF THE STYLIZED BLACK  
WORDING "RÊVE D'ESCAPADE GIVENCHY" ON A  
WHITE RECTANGLE WITH HORIZONTAL RED AND  
GRAY LINES ABOVE AND BELOW THE WORDING. A  
RED AND WHITE FLORAL DESIGN APPEARS BEHIND  
THE WORDING. THE ENTIRE MARK IS ON A WHITE  
RECTANGLE WITH A GRAY BORDER.

THE ENGLISH TRANSLATION OF THE FOREIGN  
WORD(S) IN THE MARK IS: "GETAWAY DREAM GIVEN-  
CHY".

FOR TOILET WATER; PERFUMES (U.S. CLS. 1, 4, 6,  
50, 51 AND 52).

KRISTINA MORRIS, EXAMINING ATTORNEY

**CLASS 3—(Continued).**

SN 79-137,994. LVMH FRAGRANCE BRANDS, FRANCE,  
FILED 7-31-2013.

**Cuir**  
***Blanc***

PRIORITY DATE OF 2-21-2013 IS CLAIMED.  
OWNER OF INTERNATIONAL REGISTRATION 1180450  
DATED 7-31-2013, EXPIRES 7-31-2023.

THE ENGLISH TRANSLATION OF "CUIR BLANC" IN  
THE MARK IS "WHITE LEATHER".

FOR PERFUMES, EAU DE COLOGNE AND TOILET  
WATER (U.S. CLS. 1, 4, 6, 50, 51 AND 52).

KRISTINA MORRIS, EXAMINING ATTORNEY

SN 79-140,646. D-UP CORPORATION, JAPAN, FILED 7-26-  
2013.

**D.U.P**

PRIORITY DATE OF 7-1-2013 IS CLAIMED.  
OWNER OF INTERNATIONAL REGISTRATION 1187318  
DATED 7-26-2013, EXPIRES 7-26-2023.

FOR COSMETICS; FALSE EYELASHES; ADHESIVES  
FOR AFFIXING FALSE EYELASHES; MASCARA; EYE  
LINER; NAIL POLISH; FALSE NAILS; NAIL POLISH  
BASE COAT; COSMETIC PREPARATIONS FOR EYE-  
LASHES; PRE-SHAPED AND CUT DOUBLE-SIDED AD-  
HESIVE EYELID TAPE USED TO CREATE A DOUBLE  
EYELID; NAIL POLISH REMOVERS; ADHESIVES FOR  
ARTIFICIAL NAILS; GEL NAIL POLISH; BALMS  
OTHER THAN FOR MEDICAL PURPOSES; PERFUMES  
(U.S. CLS. 1, 4, 6, 50, 51 AND 52).

SUZANNE BLANE, EXAMINING ATTORNEY

**CLASS 3—(Continued).**

SN 85-019,036. MISSION PRODUCT HOLDINGS, INC., NEW YORK, NY. FILED 4-21-2010.

## ShapeUp Toner

THE MARK CONSISTS OF STANDARD CHARACTERS WITHOUT CLAIM TO ANY PARTICULAR FONT, STYLE, SIZE, OR COLOR.

NO CLAIM IS MADE TO THE EXCLUSIVE RIGHT TO USE "TONER", APART FROM THE MARK AS SHOWN.

FOR NON-MEDICATED SKIN CARE PREPARATIONS; COSMETIC CREAMS AND LOTIONS FOR SKIN CARE; SKIN CLEANSERS AND MOISTURIZERS; SUN SCREEN PREPARATIONS; SUN BLOCK PREPARATIONS; DEODORANTS AND ANTIPERSPIRANTS FOR PERSONAL USE AND BODY CARE; NON-MEDICATED FOOT CREAMS (U.S. CLS. 1, 4, 6, 50, 51 AND 52).

CAROLINE WOOD, EXAMINING ATTORNEY

---

SN 85-037,160. SOUTH PACIFIC DISTRIBUTORS LLC, DBA SOUTH PACIFIC DISTRIBUTORS LLC, HONOLULU, HI. FILED 5-12-2010.

## Vegas Hottie

THE MARK CONSISTS OF STANDARD CHARACTERS WITHOUT CLAIM TO ANY PARTICULAR FONT, STYLE, SIZE, OR COLOR.

FOR NAIL POLISH (U.S. CLS. 1, 4, 6, 50, 51 AND 52).

MICHELLE DUBOIS, EXAMINING ATTORNEY

---

SN 85-091,517. VIGLIOTTI, MALYNDA GRACE, NEW YORK, NY. FILED 7-23-2010.

## BOOM BOOM'S FLASH! WAX

THE MARK CONSISTS OF STANDARD CHARACTERS WITHOUT CLAIM TO ANY PARTICULAR FONT, STYLE, SIZE, OR COLOR.

NO CLAIM IS MADE TO THE EXCLUSIVE RIGHT TO USE "WAX", APART FROM THE MARK AS SHOWN.

FOR DEPILATORY WAX (U.S. CLS. 1, 4, 6, 50, 51 AND 52).

FIRST USE 3-1-2010; IN COMMERCE 3-1-2010.

MICHELLE DUBOIS, EXAMINING ATTORNEY

**CLASS 3—(Continued).**

SN 85-211,257. RWACHSBERG HOLDINGS INC., TORONTO, ONTARIO, CANADA, FILED 1-5-2011.

## WASH WELL

THE MARK CONSISTS OF STANDARD CHARACTERS WITHOUT CLAIM TO ANY PARTICULAR FONT, STYLE, SIZE, OR COLOR.

PRIORITY CLAIMED UNDER SEC. 44(D) ON CANADA APPLICATION NO. 1505688, FILED 11-29-2010.

NO CLAIM IS MADE TO THE EXCLUSIVE RIGHT TO USE "WASH", APART FROM THE MARK AS SHOWN.

FOR PERSONAL CARE PRODUCTS, NAMELY, SHAMPOOS AND HAIR CONDITIONERS; SOAPS FOR PERSONAL USE; NON-MEDICATED SKIN CARE PREPARATIONS; ALL PURPOSE CLEANERS FOR HOUSEHOLD AND INDUSTRIAL USE; CLEANING SOLVENTS, NAMELY, MULTI-SURFACE CLEANERS FOR HOUSEHOLD AND INDUSTRIAL USE (U.S. CLS. 1, 4, 6, 50, 51 AND 52).

KERI CANTONE, EXAMINING ATTORNEY

---

SN 85-583,156. BIOTHERM, MONACO, MONACO, FILED 3-29-2012.

## TOTAL PERFECTOR

THE MARK CONSISTS OF STANDARD CHARACTERS WITHOUT CLAIM TO ANY PARTICULAR FONT, STYLE, SIZE, OR COLOR.

PRIORITY CLAIMED UNDER SEC. 44(D) ON MONACO APPLICATION NO. 30672, FILED 3-12-2012, REG. NO. 12,29007, DATED 3-12-2012, EXPIRES 3-12-2021.

FOR PERFUME, EAU DE TOILETTE; GELS FOR THE EYES; SALTS FOR THE BATH AND THE SHOWER NOT FOR MEDICAL PURPOSE; TOILET SOAPS, BODY DEODORANTS; COSMETICS, NAMELY, CREAMS, MILKS, LOTIONS, GELS AND POWDERS FOR THE FACE, THE BODY AND THE HANDS; NON-MEDICATED SUN CARE PREPARATIONS; MAKE-UP PREPARATIONS; SHAMPOOS; GELS, SPRAYS, MOUSSES AND BALMS FOR HAIR STYLING AND HAIR CARE; HAIR LACQUERS; HAIR COLOURING AND HAIR DECOLORANT PREPARATIONS; PERMANENT WAVING AND CURLING PREPARATIONS; ESSENTIAL OILS FOR PERSONAL USE (U.S. CLS. 1, 4, 6, 50, 51 AND 52).

WILLIAM JACKSON, EXAMINING ATTORNEY

**CLASS 3—(Continued).**

SN 85-758,514. MYBODY, L.L.C., PHOENIX, AZ. FILED 10-19-2012.

# SPALIDAY

THE MARK CONSISTS OF STANDARD CHARACTERS WITHOUT CLAIM TO ANY PARTICULAR FONT, STYLE, SIZE, OR COLOR.

FOR KITS CONTAINING SKIN CLEANSERS, SKIN LOTIONS AND CANDLES (U.S. CLS. 1, 4, 6, 50, 51 AND 52).

FIRST USE 9-9-2011; IN COMMERCE 9-9-2011.  
KIMBERLY PERRY, EXAMINING ATTORNEY

SN 85-772,956. SYLTE SUNDRIES, DBA SEATTLE SUNDRIES, SEATTLE, WA. FILED 11-6-2012.

# Smooch Stick

THE MARK CONSISTS OF STANDARD CHARACTERS WITHOUT CLAIM TO ANY PARTICULAR FONT, STYLE, SIZE, OR COLOR.

NO CLAIM IS MADE TO THE EXCLUSIVE RIGHT TO USE "STICK", APART FROM THE MARK AS SHOWN.

FOR LIP BALM; NON-MEDICATED LIP CARE PREPARATIONS; NON-MEDICATED LIP PROTECTORS (U.S. CLS. 1, 4, 6, 50, 51 AND 52).

JILL PRATER, EXAMINING ATTORNEY

SN 85-795,698. BETTER THAN BRANDS, LLC, IRWINDALE, CA. FILED 12-5-2012.

# LASHPRO

THE MARK CONSISTS OF STANDARD CHARACTERS WITHOUT CLAIM TO ANY PARTICULAR FONT, STYLE, SIZE, OR COLOR.

FOR NON-MEDICATED EYELASH SERUM FOR CONDITIONING AND ENHANCING THE APPEARANCE OF EYELASHES (U.S. CLS. 1, 4, 6, 50, 51 AND 52).

FIRST USE 5-0-2012; IN COMMERCE 5-0-2012.  
NAKIA HENRY, EXAMINING ATTORNEY

**CLASS 3—(Continued).**

SN 85-810,428. AMOREPACIFIC CORPORATION, SEOUL, REPUBLIC OF KOREA, FILED 12-26-2012.

순행 클렌징  
GENTLE CLEANSING

OWNER OF TAIWAN REG. NO. 01598504, DATED 9-16-2013, EXPIRES 9-15-2023.

NO CLAIM IS MADE TO THE EXCLUSIVE RIGHT TO USE THE NON-LATIN CHARACTERS THAT TRANSLITERATE TO "CLEANSING" AND THE WORDING "GENTLE CLEANSING", APART FROM THE MARK AS SHOWN.

THE MARK CONSISTS OF TWO KOREAN WORDS TRANSLITERATED AS "SOONHANG CLEANSING" WRITTEN OVER ENGLISH WORDS "GENTLE CLEANSING".

THE ENGLISH TRANSLATION OF "SOONHANG CLEANSING" IN THE MARK IS "SOOTH MOVEMENT CLEANSING".

THE NON-LATIN CHARACTERS IN THE MARK TRANSLITERATE TO "SOONHANG CLEANSING" AND THIS MEANS "SOOTH MOVEMENT CLEANSING" IN ENGLISH.

FOR COSMETICS, NAMELY, MAKE UP FOUNDATION, LIPSTICK, EYE SHADOW, MASCARA, EYE LINER, BLUSHER, HAIR SHAMPOO AND SOLID POWDER FOR COMPACTS; COSMETIC PREPARATIONS FOR SKIN CARE, NAMELY, SKIN LOTIONS; COSMETICS FOR CLEANSING, NAMELY, COSMETIC CLEANSING CREAMS, COSMETIC CLEANSING LOTION, COSMETIC CLEANSING OIL, MAKE-UP REMOVING LOTIONS, SKIN CLEANSERS; DENTIFRICES, NAMELY, TOOTH PASTES AND TOOTH GELS; COSMETICS FOR PET, NAMELY, SHAMPOO FOR PETS (U.S. CLS. 1, 4, 6, 50, 51 AND 52).

STEPHANIE ALI, EXAMINING ATTORNEY

SN 85-831,774. FOR LIFE PRODUCTS, INC., MIRAMAR, FL. FILED 1-24-2013.

# SHINE BOOSTER

THE MARK CONSISTS OF STANDARD CHARACTERS WITHOUT CLAIM TO ANY PARTICULAR FONT, STYLE, SIZE, OR COLOR.

NO CLAIM IS MADE TO THE EXCLUSIVE RIGHT TO USE "SHINE", APART FROM THE MARK AS SHOWN.

FOR HOUSEHOLD CLEANING PRODUCTS, NAMELY, FLOOR CLEANERS, FLOOR WAX AND FLOOR POLISH (U.S. CLS. 1, 4, 6, 50, 51 AND 52).

TIMOTHY FINNEGAN, EXAMINING ATTORNEY

**CLASS 3—(Continued).**

SN 85-839,911. NUCERITY INTERNATIONAL, INC., HOUSTON, TX. FILED 2-4-2013.

**NUCERITY PURE BODY SILK**

THE MARK CONSISTS OF STANDARD CHARACTERS WITHOUT CLAIM TO ANY PARTICULAR FONT, STYLE, SIZE, OR COLOR.

OWNER OF U.S. REG. NOS. 3,931,580 AND 4,222,763. NO CLAIM IS MADE TO THE EXCLUSIVE RIGHT TO USE "BODY", APART FROM THE MARK AS SHOWN. FOR COSMETICS (U.S. CLS. 1, 4, 6, 50, 51 AND 52). DAVID TOOLEY, EXAMINING ATTORNEY

SN 85-840,360. AMOREPACIFIC CORPORATION, SEOUL, REPUBLIC OF KOREA, FILED 2-4-2013.

**BIO MELASOLV**

THE MARK CONSISTS OF STANDARD CHARACTERS WITHOUT CLAIM TO ANY PARTICULAR FONT, STYLE, SIZE, OR COLOR.

OWNER OF HONG KONG REG. NO. 302517354, DATED 5-2-2013, EXPIRES 5-2-2023.

FOR COSMETICS, NAMELY MAKE UP FOUNDATION, LIPSTICK, EYE SHADOW, MASCARA, EYE LINER, BLUSHER, HAIR SHAMPOO AND SOLID POWDER FOR COMPACTS; COSMETIC PREPARATIONS FOR SKIN CARE, NAMELY SKIN LOTIONS; DENTIFRICES, NAMELY TOOTH PASTES AND TOOTH GELS; COSMETICS FOR PET, NAMELY SHAMPOO FOR PETS (U.S. CLS. 1, 4, 6, 50, 51 AND 52).

SHANNON TWOHIG, EXAMINING ATTORNEY

SN 85-869,119. DEVA CONCEPTS LLC, NEW YORK, NY. FILED 3-6-2013.

**EMBRACE YOUR CURLS**

THE MARK CONSISTS OF STANDARD CHARACTERS WITHOUT CLAIM TO ANY PARTICULAR FONT, STYLE, SIZE, OR COLOR.

NO CLAIM IS MADE TO THE EXCLUSIVE RIGHT TO USE "CURLS", APART FROM THE MARK AS SHOWN.

FOR FULL LINE OF HAIR CARE PRODUCTS, NAMELY, HAIR CARE PREPARATIONS, HAIR CLEANING PREPARATIONS, HAIR STYLING PREPARATIONS, HAIR DRESSINGS, SHAMPOO, CONDITIONERS, HAIR SPRAY, HAIR GEL, MOUSSE, DYES, RINSES, BLEACH, RELAXERS, LIGHTENERS, AND STRAIGHTENERS (U.S. CLS. 1, 4, 6, 50, 51 AND 52).

FIRST USE 1-1-2009; IN COMMERCE 1-1-2009. IRA J. GOODSaid, EXAMINING ATTORNEY

**CLASS 3—(Continued).**

SN 85-875,354. CELEB LLC, FORT LAUDERDALE, FL. FILED 3-13-2013.

**CELEBSWAG**

THE MARK CONSISTS OF STANDARD CHARACTERS WITHOUT CLAIM TO ANY PARTICULAR FONT, STYLE, SIZE, OR COLOR.

FOR HAIR CARE CREAMS; HAIR CARE PREPARATIONS; HAIR GEL; HAIR LOTION; HAIR MOUSSE; HAIR POMADES; HAIR SHAMPOOS AND CONDITIONERS; HAIR SPRAYS; HAIR TONIC (U.S. CLS. 1, 4, 6, 50, 51 AND 52).

MATTHEW KLINE, EXAMINING ATTORNEY

SN 85-875,503. BARE ESSENTUALS BEAUTY, INC., SAN FRANCISCO, CA. FILED 3-13-2013.

**SHOW SOME SKIN**

THE MARK CONSISTS OF STANDARD CHARACTERS WITHOUT CLAIM TO ANY PARTICULAR FONT, STYLE, SIZE, OR COLOR.

NO CLAIM IS MADE TO THE EXCLUSIVE RIGHT TO USE "SKIN", APART FROM THE MARK AS SHOWN.

FOR COSMETICS (U.S. CLS. 1, 4, 6, 50, 51 AND 52). SHANNON TWOHIG, EXAMINING ATTORNEY

SN 85-877,422. BENEDICT III, MILNER, TAMPA, FL. FILED 3-15-2013.

**REGREENCE**

THE MARK CONSISTS OF STANDARD CHARACTERS WITHOUT CLAIM TO ANY PARTICULAR FONT, STYLE, SIZE, OR COLOR.

FOR SKIN CARE PREPARATIONS; SKIN CARE PRODUCTS, NAMELY, LOTIONS, SKIN CREAMS, FACIAL SKIN CLEANSERS AND MOISTURIZERS (U.S. CLS. 1, 4, 6, 50, 51 AND 52).

MICHAEL WIENER, EXAMINING ATTORNEY

**CLASS 3—(Continued).**

SN 85-886,810. CONOPCO, INC., ENGLEWOOD CLIFFS, NJ. FILED 3-26-2013.

**CLASS 3—(Continued).**

SN 85-886,816. CONOPCO, INC., ENGLEWOOD CLIFFS, NJ. FILED 3-26-2013.



**CEASE FIRE**

OWNER OF U.S. REG. NOS. 3,181,731, 4,317,182 AND OTHERS.

NO CLAIM IS MADE TO THE EXCLUSIVE RIGHT TO USE "DRY OIL", APART FROM THE MARK AS SHOWN.

THE COLOR(S) BLUE AND GOLD IS/ARE CLAIMED AS A FEATURE OF THE MARK.

THE MARK CONSISTS OF THE WORD "DOVE" IN STYLIZED BLUE LETTERING ABOVE A GOLD DOVE DESIGN WHICH APPEARS ABOVE THE WORDS "PURE CARE DRY OIL" IN STYLIZED BLUE LETTERING.

FOR SOAPS; PERFUMERY; ESSENTIAL OILS; PERSONAL DEODORANTS AND ANTIPERSPIRANTS; HAIR CARE PRODUCTS, NAMELY, HAIR COLORANTS, HAIR DYES, HAIR LOTIONS, HAIR WAVING PREPARATIONS, SHAMPOOS, CONDITIONERS, HAIR SPRAYS, HAIR POWDER, HAIR DRESSINGS, HAIR LACQUERS, HAIR MOUSSES, HAIR GLAZES, HAIR GELS, HAIR MOISTURIZERS; HAIR LIQUID, NAMELY, LIQUID MOISTURIZING TREATMENTS FOR HAIR, HAIR MOISTURIZERS; NON-MEDICATED HAIR PRESERVATION TREATMENTS, NAMELY, HAIR SPRAY, HAIR OILS, HAIR TONIC, HAIR CREAMS, HAIR DESICCATING TREATMENTS, NON-MEDICATED PREPARATIONS FOR THE BATH AND/OR SHOWER; NON-MEDICATED TOILET PREPARATIONS, NAMELY, OILS, CREAMS AND LOTIONS FOR THE SKIN; NON-MEDICATED SKIN CARE PREPARATIONS, NAMELY, LOTIONS FOR THE SKIN; COSMETICS (U.S. CLS. 1, 4, 6, 50, 51 AND 52).

HENRY S. ZAK, EXAMINING ATTORNEY

SN 85-887,236. DISNEY ENTERPRISES, INC., BURBANK, CA. FILED 3-26-2013.

THE MARK CONSISTS OF STANDARD CHARACTERS WITHOUT CLAIM TO ANY PARTICULAR FONT, STYLE, SIZE, OR COLOR.

FOR SOAPS; PERFUMERY; ESSENTIAL OILS; DEODORANTS AND ANTIPERSPIRANTS; HAIR CARE PREPARATIONS; HAIR COLORANTS, HAIR DYES, HAIR LOTIONS, HAIR WAVING PREPARATIONS, SHAMPOOS, CONDITIONERS, HAIR SPRAYS, HAIR POWDER, HAIR DRESSINGS, HAIR LACQUERS, HAIR MOUSSES, HAIR GLAZES, HAIR GELS, HAIR MOISTURIZERS, HAIR LIQUID, HAIR PRESERVATION TREATMENTS, IN THE NATURE OF HAIR CONDITIONERS, HAIR OILS, HAIR TONIC, HAIR CREAMS, HAIR DESICCATING TREATMENTS, NAMELY, NOURISHING CREAMS, OILS AND SHEEN SPRAY, HAIR OILS, HAIR TONIC, HAIR CREAMS, NON-MEDICATED PREPARATIONS FOR THE BATH AND SHOWER; NON-MEDICATED TOILET PREPARATIONS, NAMELY, OILS, CREAMS AND LOTIONS FOR THE SKIN; NON-MEDICATED SKIN CARE PREPARATIONS; COSMETICS (U.S. CLS. 1, 4, 6, 50, 51 AND 52).

HENRY S. ZAK, EXAMINING ATTORNEY

**OLIVIA POPE**

THE MARK CONSISTS OF STANDARD CHARACTERS WITHOUT CLAIM TO ANY PARTICULAR FONT, STYLE, SIZE, OR COLOR.

THE NAME(S), PORTRAIT(S), AND/OR SIGNATURE(S) SHOWN IN THE MARK DOES NOT IDENTIFY A PARTICULAR LIVING INDIVIDUAL.

FOR COSMETICS; DENTIFRICES; NON-MEDICATED TOILETRIES; FRAGRANCES; PERFUMES (U.S. CLS. 1, 4, 6, 50, 51 AND 52).

DORITT L. CARROLL, EXAMINING ATTORNEY

**CLASS 3—(Continued).**

SN 85-895,799. AMOREPACIFIC CORPORATION, SEOUL, REPUBLIC OF KOREA, FILED 4-4-2013.

**AMOREPACIFIC CC CUSHION**

THE MARK CONSISTS OF STANDARD CHARACTERS WITHOUT CLAIM TO ANY PARTICULAR FONT, STYLE, SIZE, OR COLOR.

PRIORITY CLAIMED UNDER SEC. 44(D) ON REPUBLIC OF KOREA APPLICATION NO. 40-2012-0074, FILED 11-28-2012, REG. NO. 40-1005747, DATED 11-7-2013, EXPIRES 11-7-2023.

OWNER OF U.S. REG. NOS. 4,266,459, 4,310,136 AND OTHERS.

NO CLAIM IS MADE TO THE EXCLUSIVE RIGHT TO USE "CC", APART FROM THE MARK AS SHOWN.

FOR COSMETICS, NAMELY, COSMETICS FOR MAKEUP, COSMETICS FOR BATH, LIPSTICK, EYE LINER AND HAIR SHAMPOO; COSMETIC PREPARATIONS FOR SKIN CARE, NAMELY, BALMS OTHER THAN FOR MEDICAL PURPOSES; DENTIFRICES, NAMELY, TOOTH PASTES AND TOOTH GELS; COSMETICS FOR PET, NAMELY, SHAMPOO FOR PETS (U.S. CLS. 1, 4, 6, 50, 51 AND 52).

SHANNON TWOHIG, EXAMINING ATTORNEY

---

SN 85-896,149. ELEVEN/11 BEAUTY, INC., PALM HARBOR, FL. FILED 4-5-2013.

**rePear by Andrew Ashton**

THE MARK CONSISTS OF STANDARD CHARACTERS WITHOUT CLAIM TO ANY PARTICULAR FONT, STYLE, SIZE, OR COLOR.

THE NAME(S), PORTRAIT(S), AND/OR SIGNATURE(S) SHOWN IN THE MARK IDENTIFIES "ANDREW ASHTON", WHOSE CONSENT(S) TO REGISTER IS MADE OF RECORD.

FOR HAIR CARE PREPARATIONS (U.S. CLS. 1, 4, 6, 50, 51 AND 52).

FIRST USE 6-1-2011; IN COMMERCE 1-1-2012.

JOANNA DUKOVIC, EXAMINING ATTORNEY

**CLASS 3—(Continued).**

SN 85-896,885. CONOPCO, INC., ENGLEWOOD CLIFFS, NJ. FILED 4-5-2013.

**AXE HARMONY**

THE MARK CONSISTS OF STANDARD CHARACTERS WITHOUT CLAIM TO ANY PARTICULAR FONT, STYLE, SIZE, OR COLOR.

OWNER OF U.S. REG. NOS. 3,180,934, 3,624,747 AND OTHERS.

FOR BODY CLEANING WASHES, BEAUTY BARS FOR CLEANSING AND NOURISHING THE SKIN; SKIN MOISTURIZERS, DEODORANT AND ANTIPERSPIRANT; HAIR CARE PRODUCTS NAMELY, SHAMPOO, CONDITIONER, HAIR SPRAY, STYLING CREAM AND MOUSSE, ANTI-FRIZZ CREAM AND MOUSSE; FACIAL SKIN TONER, FACIAL CLEANSERS (U.S. CLS. 1, 4, 6, 50, 51 AND 52).

HENRY S. ZAK, EXAMINING ATTORNEY

---

SN 85-902,377. THE SUN PRODUCTS CORPORATION, WILTON, CT. FILED 4-12-2013.

**LAVENDER BLOOM**

THE MARK CONSISTS OF STANDARD CHARACTERS WITHOUT CLAIM TO ANY PARTICULAR FONT, STYLE, SIZE, OR COLOR.

NO CLAIM IS MADE TO THE EXCLUSIVE RIGHT TO USE "LAVENDER", APART FROM THE MARK AS SHOWN.

FOR FABRIC SOFTENERS FOR LAUNDRY USE; LAUNDRY DETERGENT (U.S. CLS. 1, 4, 6, 50, 51 AND 52).

NAPOLEON SHARMA, EXAMINING ATTORNEY

---

SN 85-904,760. CHANG HOON YIE, ANYANG-SI, GYEONG-GI-DO, REPUBLIC OF KOREA, FILED 4-15-2013.



THE COLOR(S) TURQUOISE, BLACK, AND WHITE IS/ ARE CLAIMED AS A FEATURE OF THE MARK.

THE MARK CONSISTS OF A MODIFIED ELLIPSE SHAPE IN TURQUOISE, EACH OF THE UPPER AND LOWER PORTIONS OF THE MODIFIED ELLIPSE IS PROTRUDED FROM THE SURFACE, CREATING AN ELONGATED STEP

**CLASS 3—(Continued).**

THROUGHOUT EACH OF THE UPPER AND LOWER PORTIONS, WITH WHITE DOTS FORMING THE SAME SHAPE OF THE MODIFIED ELLIPSE AND LOCATED IN THE INSIDE PERIPHERY OF THE MODIFIED ELLIPSE, WHEREIN THE WORD "OSILKIN" IN BLACK WITH STYLIZED "K" IS POSITIONED APPROXIMATELY AT THE CENTER OF THE MODIFIED ELLIPSE AND THE WORD "HOLIDAY SPIRIT" IS ARCHED IN BLACK AND LOCATED ABOVE THE WORD "OSILKIN" AND INSIDE THE MODIFIED ELLIPSE.

THE WORD(S) "OSILKIN" HAS NO MEANING IN A FOREIGN LANGUAGE.

FOR AROMATICS FOR HOUSEHOLD PURPOSES, NAMELY, ESSENTIAL OILS, CANDLES MADE WITH COCONUT WAX, PALM WAX, SOY WAX; FRAGRANCES FOR HOUSEHOLD PURPOSES; AIR FRAGRANCING PREPARATIONS; BASES FOR FLOWER PERFUMES, NAMELY, FLOWER ESSENCES FOR COSMETIC PURPOSES; VANILLA PERFUMERY; PEPPERMINT OIL PERFUMERY; SCENTED WOOD; PERFUMERY; INCENSE; SYNTHETIC MUSK; SYNTHETIC PERFUMERY; FUMIGATION PREPARATIONS PERFUMES NOT FOR MEDICAL PURPOSES (U.S. CLS. 1, 4, 6, 50, 51 AND 52).

THOMAS MANOR, EXAMINING ATTORNEY

---

SN 85-914,938. ALBERTO-CULVER USA, INC., MELROSE PARK, IL. FILED 4-25-2013.

**COLOR ASSURE**

THE MARK CONSISTS OF STANDARD CHARACTERS WITHOUT CLAIM TO ANY PARTICULAR FONT, STYLE, SIZE, OR COLOR.

NO CLAIM IS MADE TO THE EXCLUSIVE RIGHT TO USE "COLOR", APART FROM THE MARK AS SHOWN.

FOR SOAPS; PERFUMERY; ESSENTIAL OILS; DEODORANTS AND ANTIPERSPIRANTS; HAIR CARE PREPARATIONS, HAIR COLORANTS, HAIR DYES, HAIR LOTIONS, HAIR WAVING PREPARATIONS, SHAMPOOS, CONDITIONERS, HAIR SPRAYS, HAIR-WASHING POWDER, COSMETIC HAIR DRESSING PREPARATIONS, HAIR DRESSINGS FOR MEN, HAIR DRESSINGS FOR WOMEN, HAIR LACQUERS, HAIR MOUSSES, HAIR GLAZES, HAIR GELS, HAIR MOISTURIZERS, LIQUID HAIR STYLING PREPARATIONS, HAIR PRESERVATION TREATMENTS IN THE NATURE OF HAIR CONDITIONERS, NON-MEDICATED PREPARATIONS FOR BATH, NON-MEDICATED PREPARATIONS FOR SHOWER; SKIN CARE PREPARATIONS; COSMETICS (U.S. CLS. 1, 4, 6, 50, 51 AND 52).

FIRST USE 1-0-2006; IN COMMERCE 1-0-2006.  
PAULA MAHONEY, EXAMINING ATTORNEY

**CLASS 3—(Continued).**

SN 85-916,029. TOUCHDOWN MARKETING, MIAMI, FL. FILED 4-26-2013.



NO CLAIM IS MADE TO THE EXCLUSIVE RIGHT TO USE "FRENCH", APART FROM THE MARK AS SHOWN.

THE MARK CONSISTS OF A STYLIZED VERSION OF THE WORDS "SO FRENCH".

FOR COSMETICS, NAMELY, PERFUMES, COLOGNE, AND EAU DE TOILETTES MADE IN FRANCE (U.S. CLS. 1, 4, 6, 50, 51 AND 52).

FIRST USE 3-13-2013; IN COMMERCE 3-13-2013.  
KAMAL PREET, EXAMINING ATTORNEY

---

SN 85-917,376. KUSIN & KUSIN, LTD, DALLAS, TX. FILED 4-29-2013.

**PET YOUR PET FRESH**

THE MARK CONSISTS OF STANDARD CHARACTERS WITHOUT CLAIM TO ANY PARTICULAR FONT, STYLE, SIZE, OR COLOR.

FOR REUSABLE HAND MITT IMPREGNATED WITH PET DEODORIZING FRAGRANCES FOR NEUTRALIZING PET ODORS (U.S. CLS. 1, 4, 6, 50, 51 AND 52).

CHRISTINE MARTIN, EXAMINING ATTORNEY

**CLASS 3—(Continued).**

SN 85-920,288. ALBERTO-CULVER USA, INC., MELROSE PARK, IL. FILED 5-1-2013.



NO CLAIM IS MADE TO THE EXCLUSIVE RIGHT TO USE "COLOR" OR "SULFATE-FREE SYSTEM", APART FROM THE MARK AS SHOWN.

THE MARK CONSISTS OF THE TERMS "COLOR ASSURE" CENTERED ABOVE THE TERMS "SULFATE-FREE SYSTEM". THE WORDING IS SET AGAINST A SHADED RECTANGLE.

FOR SOAPS; PERFUMERY; ESSENTIAL OILS; DEODORANTS AND ANTIPERSPIRANTS; HAIR CARE PREPARATIONS; HAIR COLORANTS, HAIR DYES, HAIR LOTIONS, HAIR WAVING PREPARATIONS, SHAMPOOS, CONDITIONERS, HAIR SPRAYS, HAIR-WASHING POWDER, COSMETIC HAIR DRESSING PREPARATIONS, HAIR DRESSINGS FOR MEN, HAIR DRESSINGS FOR WOMEN, HAIR LACQUERS, HAIR MOUSSES, HAIR GLAZES, HAIR GELS, HAIR MOISTURIZERS, LIQUID HAIR STYLING PREPARATIONS, HAIR PRESERVATION TREATMENTS IN THE NATURE OF HAIR CONDITIONERS, HAIR DESICCATING TREATMENTS, NAMELY, HAIR OILS, HAIR TONIC, HAIR CREAMS FOR THE PURPOSE OF REMOVING EXCESS OIL FROM THE HAIR, NON-MEDICATED PREPARATIONS FOR BATH, NON-MEDICATED PREPARATIONS FOR SHOWER; SKIN CARE PREPARATIONS; COSMETICS (U.S. CLS. 1, 4, 6, 50, 51 AND 52).  
PAULA MAHONEY, EXAMINING ATTORNEY

SN 85-923,969. HAKON INNOVATIONS, SANTA BARBARA, CA. FILED 5-6-2013.

## No Smell The Diaper

THE MARK CONSISTS OF STANDARD CHARACTERS WITHOUT CLAIM TO ANY PARTICULAR FONT, STYLE, SIZE, OR COLOR.

FOR SCENTED PATCH-LIKE DEVICE IN THE NATURE OF A COVER FOR THE NOSE TO BLOCK OFFENSIVE ODORS (U.S. CLS. 1, 4, 6, 50, 51 AND 52).  
SUSAN RICHARDS, EXAMINING ATTORNEY

**CLASS 3—(Continued).**

SN 85-934,413. PACIFIC WORLD CORPORATION, ALISO VIEJO, CA. FILED 5-16-2013.

## FRENCH EXPRESS

THE MARK CONSISTS OF STANDARD CHARACTERS WITHOUT CLAIM TO ANY PARTICULAR FONT, STYLE, SIZE, OR COLOR.

OWNER OF U.S. REG. NOS. 2,865,754, 3,411,152 AND OTHERS.

NO CLAIM IS MADE TO THE EXCLUSIVE RIGHT TO USE "FRENCH", APART FROM THE MARK AS SHOWN.  
FOR ARTIFICIAL FINGERNAILS (U.S. CLS. 1, 4, 6, 50, 51 AND 52).

RONALD DELGIZZI, EXAMINING ATTORNEY

SN 85-939,241. LANCOME PARFUMS ET BEAUTE & CIE, PARIS, FRANCE, FILED 5-22-2013.

## PHOTO SMOOTH TECHNOLOGY

THE MARK CONSISTS OF STANDARD CHARACTERS WITHOUT CLAIM TO ANY PARTICULAR FONT, STYLE, SIZE, OR COLOR.

PRIORITY CLAIMED UNDER SEC. 44(D) ON ERP N CMNTY TM OFC APPLICATION NO. 011766417, FILED 4-24-2013.

NO CLAIM IS MADE TO THE EXCLUSIVE RIGHT TO USE "TECHNOLOGY", APART FROM THE MARK AS SHOWN.

FOR PERFUME, EAU DE TOILETTE; GELS, SALTS FOR THE BATH AND THE SHOWER NOT FOR MEDICAL PURPOSE; TOILET SOAPS, BODY DEODORANTS; COSMETICS, NAMELY, CREAMS, MILKS, LOTIONS, GELS AND POWDERS FOR THE FACE, THE BODY AND THE HANDS; NON-MEDICATED SUN CARE PREPARATIONS; MAKE-UP PREPARATIONS; SHAMPOOS; GELS, SPRAYS, MOUSSES AND BALMS FOR HAIR STYLING AND HAIR CARE; HAIR LACQUERS; HAIR COLOURING AND HAIR DECOLORANT PREPARATIONS; PERMANENT WAVING AND CURLING PREPARATIONS; ESSENTIAL OILS FOR PERSONAL USE (U.S. CLS. 1, 4, 6, 50, 51 AND 52).  
LUCY ARANT, EXAMINING ATTORNEY



**CLASS 3—(Continued).**

SN 85-944,709. RAZAC PRODUCTS INC., NEWARK, NJ. FILED 5-29-2013.

# TERRA CAPELLI

THE MARK CONSISTS OF STANDARD CHARACTERS WITHOUT CLAIM TO ANY PARTICULAR FONT, STYLE, SIZE, OR COLOR.

NO CLAIM IS MADE TO THE EXCLUSIVE RIGHT TO USE "CAPELLI", APART FROM THE MARK AS SHOWN.

THE ENGLISH TRANSLATION OF "TERRA CAPELLI" IN THE MARK IS "EARTH HAIR".

FOR HAND AND BODY LOTIONS, SHAMPOO, HAIR AND SCALP CONDITIONERS, HAIR STYLING PREPARATIONS, HAIR SPRAY, HOT OIL TREATMENT FOR HAIR AND CONDITIONING CREME HAIR RELAXER (U.S. CLS. 1, 4, 6, 50, 51 AND 52).  
CAROLINE WOOD, EXAMINING ATTORNEY

**CLASS 3—(Continued).**

SN 85-949,068. REN LIMITED, LONDON, UNITED KINGDOM, FILED 6-3-2013.

# ACQUA DI SIRENA

THE MARK CONSISTS OF STANDARD CHARACTERS WITHOUT CLAIM TO ANY PARTICULAR FONT, STYLE, SIZE, OR COLOR.

THE ENGLISH TRANSLATION OF "ACQUA DI SIRENA" IN THE MARK IS "WATER MERMAID".

FOR COSMETICS; COSMETIC PREPARATIONS FOR SKINCARE AND BODYCARE; ESSENTIAL OILS; PERFUMERY; SCENTED WATERS; TOILET WATERS; EAU DE COLOGNE; SCENTED BODY SPRAYS; ANTI-PERSPIRANTS; DEODORANTS FOR PERSONAL USE; COSMETIC PREPARATIONS FOR BATH AND SHOWER; PREPARATIONS FOR BATHING AND SHOWERING, NAMELY, FOAMS, CREAMS, GELS, OILS, LOTIONS, MILKS, SCRUBS, EXFOLIATORS, SALTS OR PEARLS; SOAPS AND CLEANSERS IN SOLID, LIQUID, GEL OR CREAM FORM FOR BODYCARE AND SKINCARE; FRAGRANCED, SCENTED OR PERFUMED BODY LOTIONS AND CREAMS (U.S. CLS. 1, 4, 6, 50, 51 AND 52).  
MORGAN WYNNE, EXAMINING ATTORNEY

SN 85-944,822. TERRA FIRMA COSMETICS, OLYMPIA, WA. FILED 5-29-2013.

# Terra Firma Cosmetics

THE MARK CONSISTS OF STANDARD CHARACTERS WITHOUT CLAIM TO ANY PARTICULAR FONT, STYLE, SIZE, OR COLOR.

NO CLAIM IS MADE TO THE EXCLUSIVE RIGHT TO USE "COSMETICS", APART FROM THE MARK AS SHOWN.

FOR COSMETICS (U.S. CLS. 1, 4, 6, 50, 51 AND 52).  
HENRY S. ZAK, EXAMINING ATTORNEY

SN 85-960,414. CALVIN KLEIN TRADEMARK TRUST, NEW YORK, NY. FILED 6-14-2013.

# CK ONE WET

THE MARK CONSISTS OF STANDARD CHARACTERS WITHOUT CLAIM TO ANY PARTICULAR FONT, STYLE, SIZE, OR COLOR.

OWNER OF U.S. REG. NOS. 1,946,318, 3,916,700 AND OTHERS.

FOR EAU DE TOILETTE, SKIN MOISTURIZER, BODY MASSAGE OIL, BODY WASH, SOAP, PERSONAL DEODORANT, TALC OILS FOR HAIR CONDITIONING, SHAMPOO, HAIR GEL (U.S. CLS. 1, 4, 6, 50, 51 AND 52).  
ANNE E. GUSTASON, EXAMINING ATTORNEY

**CLASS 3—(Continued).**

SN 85-963,626. SHULTON, INC., CINCINNATI, OH. FILED 6-19-2013.



THE MARK CONSISTS OF THE WORDING "OLD SPICE RE FRESH" INSIDE OF A HEXAGON-SHAPED DESIGN. THE BORDER OF THE HEXAGON SHAPE FEATURES STITCHING LINES LIKE THAT FOUND ON CLOTHING OR PATCHES. THE WORD "REFRESH" IS SPLIT INTO "RE" AND "FRESH" BY DESIGNS OF TWO ARROWS SPIRALING IN A CIRCLE. AND THERE ARE HORIZONTAL LINES ABOVE AND BELOW THIS WORDING.

FOR BODY SPRAYS (U.S. CLS. 1, 4, 6, 50, 51 AND 52).  
CORY BOONE, EXAMINING ATTORNEY

SN 85-964,264. ENRIQUE IGLESIAS, MIAMI, FL. FILED 6-19-2013.

ENRIQUE IGLESIAS

THE MARK CONSISTS OF STANDARD CHARACTERS WITHOUT CLAIM TO ANY PARTICULAR FONT, STYLE, SIZE, OR COLOR.

PRIORITY CLAIMED UNDER SEC. 44(D) ON ERP N CMNTY TM OFC APPLICATION NO. 011675394, FILED 3-21-2013, REG. NO. 011675394, DATED 8-19-2013, EXPIRES 3-21-2023.

THE NAME "ENRIQUE IGLESIAS" IDENTIFIES A LIVING INDIVIDUAL WHOSE CONSENT IS OF RECORD.

FOR MEN'S FRAGRANCE PRODUCTS, NAMELY, COLOGNES; WOMEN'S FRAGRANCE PRODUCTS, NAMELY, EAU DE TOILETTE, COLOGNES, AND PERFUMES; BATH AND BODY PRODUCTS, NAMELY, FRAGRANCED AFTER SHAVE LOTIONS AND BALMS, FRAGRANCED DEODORANTS AND ANTIPERSPIRANTS, FRAGRANCED BODY WASH, FRAGRANCED BODY SPRAY, FRAGRANCED SOAPS, FRAGRANCED SHOWER GELS AND ESSENTIAL OILS (U.S. CLS. 1, 4, 6, 50, 51 AND 52).

JILL PRATER, EXAMINING ATTORNEY

**CLASS 3—(Continued).**

SN 85-968,797. THE PROCTER & GAMBLE COMPANY, CINCINNATI, OH. FILED 6-25-2013.

HYDRASMOOTHING PRIMER

THE MARK CONSISTS OF STANDARD CHARACTERS WITHOUT CLAIM TO ANY PARTICULAR FONT, STYLE, SIZE, OR COLOR.

NO CLAIM IS MADE TO THE EXCLUSIVE RIGHT TO USE "PRIMER", APART FROM THE MARK AS SHOWN.

FOR NON-MEDICATED SKIN CARE PREPARATIONS (U.S. CLS. 1, 4, 6, 50, 51 AND 52).

JORDAN BAKER, EXAMINING ATTORNEY

SN 86-000,799. DNA COSMETICS LLC, BRONX, NY. FILED 7-2-2013.



NO CLAIM IS MADE TO THE EXCLUSIVE RIGHT TO USE "NEW YORK", APART FROM THE MARK AS SHOWN.

THE MARK CONSISTS OF THE STYLIZED WORD "SHADÉ" WITH THE WORDS "NEW YORK" APPEARING UNDER THE "HAD" PORTION OF "SHADÉ". ABOVE THE TERM "SHADÉ" IS A DESIGN OF A BOW WITH TWO HORIZONTAL STRAPS EXTENDING FROM EACH SIDE OF THE BOW.

THE ENGLISH TRANSLATION OF "SHADÉ" IN THE MARK IS "SHADE".

FOR BLUSH; EYE LINER; EYE SHADOWS; EYELINER; FACIAL CONCEALER; FOUNDATION; FRAGRANCES; HAIR CONDITIONER; HAIR DYES; LIP GLOSS; LIP STAINS; LIPSTICK; MASCARAS; NAIL POLISH; SHAMPOOS (U.S. CLS. 1, 4, 6, 50, 51 AND 52).

PAULA MAHONEY, EXAMINING ATTORNEY

**CLASS 3—(Continued).**

SN 86-019,959. GABRIELLE STUDIO, INC., NEW YORK, NY. FILED 7-25-2013.

DONNA KARAN LIQUID CASHMERE

THE MARK CONSISTS OF STANDARD CHARACTERS WITHOUT CLAIM TO ANY PARTICULAR FONT, STYLE, SIZE, OR COLOR.

OWNER OF U.S. REG. NOS. 2,375,843, 3,011,483 AND OTHERS.

NO CLAIM IS MADE TO THE EXCLUSIVE RIGHT TO USE "LIQUID", APART FROM THE MARK AS SHOWN.

THE NAME(S), PORTRAIT(S), AND/OR SIGNATURE(S) SHOWN IN THE MARK IDENTIFIES "DONNA KARAN", WHOSE CONSENT(S) TO REGISTER IS MADE OF RECORD.

FOR FRAGRANCES FOR PERSONAL USE; NON-MEDICATED SKIN CARE PREPARATIONS (U.S. CLS. 1, 4, 6, 50, 51 AND 52).

LINDA ESTRADA, EXAMINING ATTORNEY

SN 86-021,048. COTY B.V., HAARLEM, NETHERLANDS, FILED 7-26-2013.

**JOOP!**

THE MARK CONSISTS OF STANDARD CHARACTERS WITHOUT CLAIM TO ANY PARTICULAR FONT, STYLE, SIZE, OR COLOR.

OWNER OF U.S. REG. NO. 3,847,924.

FOR PERFUMERY, EAU DE TOILETTE, SHOWER GEL; BODY LOTION (U.S. CLS. 1, 4, 6, 50, 51 AND 52).

FIRST USE 3-0-1988; IN COMMERCE 10-0-1991.

EVELYN BRADLEY, EXAMINING ATTORNEY

SN 86-024,506. L'OREAL, PARIS, FRANCE, FILED 7-31-2013.

**5 sec  
Blur**

THE MARK CONSISTS OF THE LITERAL ELEMENT "5 SEC BLUR" WITH A DESIGN OF A PARTIAL CLOCK FACE SET ABOVE AND TO THE RIGHT OF THE "C" IN "SEC".

FOR NON-MEDICATED SKINCARE PREPARATIONS (U.S. CLS. 1, 4, 6, 50, 51 AND 52).

ROGER T. MCDORMAN, EXAMINING ATTORNEY

**CLASS 3—(Continued).**

SN 86-025,901. BELLAH BRANDS INCORPORATED, LOS ANGELES, CA. FILED 8-1-2013.

WILD ESSENCE HALLE BERRY

THE MARK CONSISTS OF STANDARD CHARACTERS WITHOUT CLAIM TO ANY PARTICULAR FONT, STYLE, SIZE, OR COLOR.

OWNER OF U.S. REG. NOS. 3,677,810, 3,978,494 AND 4,262,177.

NO CLAIM IS MADE TO THE EXCLUSIVE RIGHT TO USE "ESSENCE", APART FROM THE MARK AS SHOWN.

THE NAME(S), PORTRAIT(S), AND/OR SIGNATURE(S) SHOWN IN THE MARK IDENTIFIES "HALLE BERRY", WHOSE CONSENT(S) TO REGISTER IS MADE OF RECORD.

FOR PERFUMERY (U.S. CLS. 1, 4, 6, 50, 51 AND 52).

WILLIAM BRECKENFELD, EXAMINING ATTORNEY

SN 86-028,185. PURITY INTERNATIONAL, LLC, OSWEGO, IL. FILED 8-4-2013.



NO CLAIM IS MADE TO THE EXCLUSIVE RIGHT TO USE "INTERNATIONAL", APART FROM THE MARK AS SHOWN.

THE COLOR(S) GREEN, BROWN, AND BLACK IS/ARE CLAIMED AS A FEATURE OF THE MARK.

THE MARK CONSISTS OF A GREEN MOROCCAN ARGAN SEED WITH GREEN LEAVES ON A BROWN BRANCH. THE LETTER "P" IS ENCLOSED IN THE ARGAN SEED TO BEGIN THE WORDS "PURITY INTERNATIONAL" WITH TWO DROPLETS EXTENDING FROM THE BOTTOM OF THE "Y". ALL OF THE LETTERING EXCEPT THE INITIAL "P", AS WELL AS THE DROPLETS, ARE IN BLACK; THE COLOR WHITE REPRESENTS TRANSPARENT BACKGROUND AND IS NOT CLAIMED AS A FEATURE OF THE MARK.

FOR ARGAN OIL FOR COSMETIC PURPOSES (U.S. CLS. 1, 4, 6, 50, 51 AND 52).

LAURA GOLDEN, EXAMINING ATTORNEY

**CLASS 3—(Continued).**

SN 86-030,622. GOLDSTEIN, MELISSA, MILLWOOD, NY. FILED 8-6-2013.

## MESS HALL

THE MARK CONSISTS OF STANDARD CHARACTERS WITHOUT CLAIM TO ANY PARTICULAR FONT, STYLE, SIZE, OR COLOR.

FOR BODY WASH; BEAUTY BARS FOR CLEANSING AND NOURISHING THE SKIN; SKIN MOISTURIZERS; FACIAL CLEANSERS; FACIAL WIPES IN THE NATURE OF PRE-MOISTENED COSMETIC WIPES, DEODORANT AND ANTIPERSPIRANT; BODY AND FACE MOISTURIZERS; NON-MEDICATED ACNE TREATMENT PREPARATIONS; NON-MEDICATED FOOT CREAM, LOTIONS AND SOAKS IN INTERNATIONAL CLASS 003 (U.S. CLS. 1, 4, 6, 50, 51 AND 52).

KIMBERLY PERRY, EXAMINING ATTORNEY

SN 86-031,069. R. A. MARKETING LIMITED, LONDON, UNITED KINGDOM, FILED 8-7-2013.

## VISITOR

THE MARK CONSISTS OF STANDARD CHARACTERS WITHOUT CLAIM TO ANY PARTICULAR FONT, STYLE, SIZE, OR COLOR.

PRIORITY CLAIMED UNDER SEC. 44(D) ON UNITED KINGDOM APPLICATION NO. 2651299, FILED 2-7-2013, REG. NO. 2651299, DATED 7-5-2013, EXPIRES 2-7-2023.

FOR SOAPS, NON-MEDICATED TOILETRIES, COSMETICS, HAIR CARE PREPARATIONS, SKIN CARE PREPARATIONS, BATH LOTIONS, DEODORANTS FOR BODY CARE, SKIN CLEANSERS, SKIN MOISTURIZERS, PERFUMERY, LAUNDRY DETERGENTS, GELS FOR USE ON THE HAIR, NON-MEDICATED TOILET PREPARATIONS, DENTIFRICES, SHAMPOOS, NAIL CARE PREPARATIONS, ANTIPERSPIRANTS, DEPILATORY PREPARATIONS, SHAVING SOAPS, COSMETIC PREPARATIONS FOR TANNING THE SKIN, EAU DE COLOGNE, DISINFECTANT SOAPS, DEODORANT SOAPS, STAIN REMOVERS, TOILET WATERS, SHAVING PREPARATIONS, HAIR WAVING PREPARATIONS, HAIR SETTING PREPARATIONS, CLEANING PREPARATIONS, COSMETIC PREPARATIONS FOR THE SHOWER, PRE-SHAVING AND AFTER-SHAVING LOTIONS, SKIN CREAMS, WASHING PREPARATIONS, BATHROOM PREPARATIONS IN THE NATURE OF NON-MEDICATED TOILETRIES, BODY POWDER, TOILET ARTICLES IN THE NATURE OF NON-MEDICATED TOILETRIES, BODY CARE PRODUCTS IN THE NATURE OF COSMETICS, BEAUTY CARE PRODUCTS IN THE NATURE OF COSMETICS, HAIR AND BEARD

**CLASS 3—(Continued).**

COLORING PREPARATIONS, COLORING TINTS AND LOTIONS, HAIR BLEACHING PREPARATIONS, COSMETIC PREPARATIONS FOR THE CARE OF THE BODY, EMERY BOARDS, EMERY PAPER, EMERY CLOTH, ALL FOR NAIL GROOMING, ANTIPERSPIRANT SOAPS, BATH SALTS, NOT FOR MEDICAL PURPOSES, CLEANSING MILK FOR TOILET PURPOSES, COSMETIC ESSENTIAL OILS, EYE MAKEUP, EYEBROW COSMETICS, EYEBROW PENCILS, HAIR COLORANTS, HAIR DYES, HAIR LOTIONS, LOTIONS FOR COSMETIC PURPOSES, MAKEUP, MAKEUP POWDER, MAKEUP PREPARATIONS, MAKEUP REMOVING PREPARATIONS, BEAUTY MASKS, MEDICATED SOAP, NAIL POLISH, NAIL VARNISH, OILS FOR COSMETIC PURPOSES, OILS FOR PERFUMES AND SCENTS, PERFUMES, SHAVING PREPARATIONS, SHAVING SOAP, SUN TANNING PREPARATIONS, TALCUM POWDER, TISSUES IMPREGNATED WITH COSMETIC LOTIONS, NON-MEDICATED TOILETRIES, NAIL VARNISH, NAIL VARNISH REMOVING PREPARATIONS (U.S. CLS. 1, 4, 6, 50, 51 AND 52).

KATHERINE CHANG, EXAMINING ATTORNEY

SN 86-032,309. KATIE REICHEL, EAST ISLIP, NY. FILED 8-8-2013.

## Surf Scrub

THE MARK CONSISTS OF STANDARD CHARACTERS WITHOUT CLAIM TO ANY PARTICULAR FONT, STYLE, SIZE, OR COLOR.

NO CLAIM IS MADE TO THE EXCLUSIVE RIGHT TO USE "SCRUB", APART FROM THE MARK AS SHOWN.

FOR BODY SCRUB (U.S. CLS. 1, 4, 6, 50, 51 AND 52). ANTHONY RINKER, EXAMINING ATTORNEY

SN 86-032,923. WOODS JOHN, SOUTH MOLTON, DEVON, UNITED KINGDOM, FILED 8-8-2013.

## Harly Wax

THE MARK CONSISTS OF STANDARD CHARACTERS WITHOUT CLAIM TO ANY PARTICULAR FONT, STYLE, SIZE, OR COLOR.

NO CLAIM IS MADE TO THE EXCLUSIVE RIGHT TO USE "WAX", APART FROM THE MARK AS SHOWN.

FOR CARNAUBA WAX FOR AUTOMOTIVE USE (U.S. CLS. 1, 4, 6, 50, 51 AND 52).

FIRST USE 6-15-1956; IN COMMERCE 6-15-1956. WON TEAK OH, EXAMINING ATTORNEY

**CLASS 3—(Continued).**

SN 86-033,550. DANNIE SHAY / M.D., LLC, CHARLESTON, SC. FILED 8-9-2013.

**CLASS 3—(Continued).**

SN 86-033,692. DEVOTED CREATIONS, INC., OLDSMAR, FL. FILED 8-9-2013.

**DANNIESHAY M.D.**

**Diamond Status**

THE MARK CONSISTS OF STANDARD CHARACTERS WITHOUT CLAIM TO ANY PARTICULAR FONT, STYLE, SIZE, OR COLOR.

NO CLAIM IS MADE TO THE EXCLUSIVE RIGHT TO USE "M.D.", APART FROM THE MARK AS SHOWN.

THE NAME "DANNIESHAY" DOES NOT IDENTIFY A LIVING INDIVIDUAL.

FOR ANTI-AGING CREAMS; BODY AND BEAUTY CARE COSMETICS; COSMETIC CREAMS FOR SKIN CARE; COSMETIC PREPARATIONS FOR SKIN CARE; COSMETIC PREPARATIONS FOR THE HAIR AND SCALP; COSMETIC SUN-PROTECTING PREPARATIONS; COSMETICS; NON-MEDICATED SKIN CARE CREAMS AND LOTIONS (U.S. CLS. 1, 4, 6, 50, 51 AND 52).

TEJBIR SINGH, EXAMINING ATTORNEY

THE MARK CONSISTS OF STANDARD CHARACTERS WITHOUT CLAIM TO ANY PARTICULAR FONT, STYLE, SIZE, OR COLOR.

FOR COSMETIC SUN-TANNING PREPARATIONS; COSMETIC TANNING PREPARATIONS; INDOOR SUN TANNING PREPARATIONS; SELF-TANNING PREPARATIONS; SKIN GELS FOR ACCELERATING, ENHANCING OR EXTENDING TANS; SUN TAN GEL; SUN TAN LOTION; SUN TAN OIL; SUN-TANNING OILS; SUN-TANNING OILS AND LOTIONS; SUN-TANNING PREPARATIONS; SUNTAN CREAMS; TANNING AND AFTER-SUN MILKS, GELS AND OILS; TANNING CREAMS; TANNING GELS; TANNING MILKS; TANNING OILS (U.S. CLS. 1, 4, 6, 50, 51 AND 52).

SUSAN RICHARDS, EXAMINING ATTORNEY

SN 86-033,683. DEVOTED CREATIONS, INC., OLDSMAR, FL. FILED 8-9-2013.

SN 86-033,735. DEVOTED CREATIONS, INC., OLDSMAR, FL. FILED 8-9-2013.

**Black Secret**

**owl tan u**

THE MARK CONSISTS OF STANDARD CHARACTERS WITHOUT CLAIM TO ANY PARTICULAR FONT, STYLE, SIZE, OR COLOR.

FOR COSMETIC SUN-TANNING PREPARATIONS; COSMETIC TANNING PREPARATIONS; INDOOR SUN TANNING PREPARATIONS; SELF-TANNING PREPARATIONS; SKIN GELS FOR ACCELERATING, ENHANCING OR EXTENDING TANS; SUN TAN GEL; SUN TAN LOTION; SUN TAN OIL; SUN-TANNING OILS; SUN-TANNING OILS AND LOTIONS; SUN-TANNING PREPARATIONS; SUNTAN CREAMS; TANNING AND AFTER-SUN MILKS, GELS AND OILS; TANNING CREAMS; TANNING GELS; TANNING MILKS; TANNING OILS (U.S. CLS. 1, 4, 6, 50, 51 AND 52).

SUSAN RICHARDS, EXAMINING ATTORNEY

THE MARK CONSISTS OF STANDARD CHARACTERS WITHOUT CLAIM TO ANY PARTICULAR FONT, STYLE, SIZE, OR COLOR.

NO CLAIM IS MADE TO THE EXCLUSIVE RIGHT TO USE "TAN", APART FROM THE MARK AS SHOWN.

FOR COSMETIC SUN-TANNING PREPARATIONS; COSMETIC TANNING PREPARATIONS; INDOOR SUN TANNING PREPARATIONS; SELF-TANNING PREPARATIONS; SKIN GELS FOR ACCELERATING, ENHANCING OR EXTENDING TANS; SUN TAN GEL; SUN TAN LOTION; SUN TAN OIL; SUN-TANNING OILS; SUN-TANNING OILS AND LOTIONS; SUN-TANNING PREPARATIONS; SUNTAN CREAMS; TANNING AND AFTER-SUN MILKS, GELS AND OILS; TANNING CREAMS; TANNING GELS; TANNING MILKS; TANNING OILS (U.S. CLS. 1, 4, 6, 50, 51 AND 52).

SUSAN RICHARDS, EXAMINING ATTORNEY

**CLASS 3—(Continued).**

SN 86-033,741. DEVOTED CREATIONS, INC., OLDSMAR, FL. FILED 8-9-2013.

## so naughty nude

THE MARK CONSISTS OF STANDARD CHARACTERS WITHOUT CLAIM TO ANY PARTICULAR FONT, STYLE, SIZE, OR COLOR.

NO CLAIM IS MADE TO THE EXCLUSIVE RIGHT TO USE "NUDE", APART FROM THE MARK AS SHOWN.

FOR COSMETIC SUN-TANNING PREPARATIONS; COSMETIC TANNING PREPARATIONS; INDOOR SUN TANNING PREPARATIONS; SELF-TANNING PREPARATIONS; SKIN GELS FOR ACCELERATING, ENHANCING OR EXTENDING TANS; SUN TAN GEL; SUN TAN LOTION; SUN TAN OIL; SUN-TANNING OILS; SUN-TANNING OILS AND LOTIONS; SUN-TANNING PREPARATIONS; SUNTAN CREAMS; TANNING AND AFTER-SUN MILKS, GELS AND OILS; TANNING CREAMS; TANNING GELS; TANNING MILKS; TANNING OILS (U.S. CLS. 1, 4, 6, 50, 51 AND 52).  
SUSAN RICHARDS, EXAMINING ATTORNEY

SN 86-035,517. BRYANT NEVITT, WINCHESTER, CA. FILED 8-12-2013.

## LIQUID LUCK

THE MARK CONSISTS OF STANDARD CHARACTERS WITHOUT CLAIM TO ANY PARTICULAR FONT, STYLE, SIZE, OR COLOR.

NO CLAIM IS MADE TO THE EXCLUSIVE RIGHT TO USE "LIQUID", APART FROM THE MARK AS SHOWN.

FOR COLOGNE; COLOGNES; PERFUMES AND COSMETICS; EAU DE COLOGNES; EAU DE PERFUME; EAU DE TOILETTE AND EAU DE COLOGNE; LIQUID PERFUMES; PERFUMES AND COLOGNES (U.S. CLS. 1, 4, 6, 50, 51 AND 52).  
MARLENE BELL, EXAMINING ATTORNEY

SN 86-035,742. EDWARD BESS, NEW YORK, NY. FILED 8-12-2013.

## HAIR HERO

THE MARK CONSISTS OF STANDARD CHARACTERS WITHOUT CLAIM TO ANY PARTICULAR FONT, STYLE, SIZE, OR COLOR.

NO CLAIM IS MADE TO THE EXCLUSIVE RIGHT TO USE "HAIR", APART FROM THE MARK AS SHOWN.

FOR HAIR CARE PREPARATIONS; HAIR CONDITIONERS; HAIR SHAMPOO; HAIR STYLING PREPARATIONS (U.S. CLS. 1, 4, 6, 50, 51 AND 52).  
FIRST USE 1-1-2013; IN COMMERCE 1-1-2013.  
EDWARD NELSON, EXAMINING ATTORNEY

**CLASS 3—(Continued).**

SN 86-036,447. ONCOR CORP., DBA DANNE MONTAGUE-KING CO., CERRITOS, CA. FILED 8-13-2013.

## FIBROMAX C

THE MARK CONSISTS OF STANDARD CHARACTERS WITHOUT CLAIM TO ANY PARTICULAR FONT, STYLE, SIZE, OR COLOR.

NO CLAIM IS MADE TO THE EXCLUSIVE RIGHT TO USE "C", APART FROM THE MARK AS SHOWN.

FOR COSMETIC PREPARATIONS FOR SKIN RENEWAL; NON-MEDICATED SKIN CARE PREPARATIONS, NAMELY, SKIN CARE CREAMS, LOTIONS AND POWDERS; ALL OF THE FOREGOING CONTAINING VITAMIN C (U.S. CLS. 1, 4, 6, 50, 51 AND 52).  
JOHN E. MICHOS, EXAMINING ATTORNEY

SN 86-038,078. BOB SMITH INDUSTRIES, ATASCADERO, CA. FILED 8-14-2013.

## INSTA-CLEAN

THE MARK CONSISTS OF STANDARD CHARACTERS WITHOUT CLAIM TO ANY PARTICULAR FONT, STYLE, SIZE, OR COLOR.

FOR AN ALL-PURPOSE CLEANER ESPECIALLY FOR GUM RESIDUE LEFT BY LABELS AND STICKERS (U.S. CLS. 1, 4, 6, 50, 51 AND 52).

PAUL E. FAHRENKOPF, EXAMINING ATTORNEY

SN 86-038,962. SBR SPORTS, INC., SANTA ANA, CA. FILED 8-15-2013.

## DERMASPORT skincare

NO CLAIM IS MADE TO THE EXCLUSIVE RIGHT TO USE "SKINCARE", APART FROM THE MARK AS SHOWN.

THE MARK CONSISTS OF THE STYLIZED WORDING "DERMASPORT SKINCARE" WITH THE TERM "SKINCARE" APPEARING IN LOWER CASE AND WITH "DERMASPORT" STACKED ON TOP OF AND ALIGNED ON THE LEFT WITH "SKINCARE".

FOR COSMETIC CREAMS FOR SKIN CARE; NON-MEDICATED CLEANSERS FOR PERSONAL USE, NAMELY, FACIAL CLEANSERS; NON-MEDICATED SKIN CARE PREPARATIONS, NAMELY, TONERS (U.S. CLS. 1, 4, 6, 50, 51 AND 52).

JERI J. FICKES, EXAMINING ATTORNEY

**CLASS 3—(Continued).**

SN 86-041,224. BUBBLE FARM SOAP COMPANY, ALAMEDA, CA. FILED 8-19-2013.

**Bubble Farm Soap Company**

THE MARK CONSISTS OF STANDARD CHARACTERS WITHOUT CLAIM TO ANY PARTICULAR FONT, STYLE, SIZE, OR COLOR.

NO CLAIM IS MADE TO THE EXCLUSIVE RIGHT TO USE "SOAP COMPANY", APART FROM THE MARK AS SHOWN.

FOR BATH SALTS; NON-MEDICATED HERBAL BODY CARE PRODUCTS, NAMELY, BODY OILS, SALVES, AND LIP BALMS; SOAPS (U.S. CLS. 1, 4, 6, 50, 51 AND 52).

FIRST USE 9-7-2010; IN COMMERCE 9-7-2010.  
RUSS HERMAN, EXAMINING ATTORNEY

**CLASS 3—(Continued).**

SN 86-043,745. ABNER COLON, TAMPA, FL. AND ALLEGRA AKULLIAN, CLEARWATER, FL. FILED 8-21-2013.



"A. ASHTON" IDENTIFIES THE STAGE NAME OF ALLEGRA AKULLIAN A LIVING INDIVIDUAL WHOSE CONSENT IS OF RECORD.

THE MARK CONSISTS OF THE NAME "A. ASHTON" BELOW A SNOWFLAKE DESIGN THAT IS FORMED BY 4 LINES IN A CRISS-CROSS PATTERN.

FOR COLOGNES, PERFUMES AND COSMETICS (U.S. CLS. 1, 4, 6, 50, 51 AND 52).

JENNIFER WILLISTON, EXAMINING ATTORNEY

SN 86-042,475. L'OREAL, PARIS, FRANCE, FILED 8-20-2013.

**MISS MANGA**

THE MARK CONSISTS OF STANDARD CHARACTERS WITHOUT CLAIM TO ANY PARTICULAR FONT, STYLE, SIZE, OR COLOR.

OWNER OF U.S. REG. NO. 4,374,750.  
FOR COSMETICS (U.S. CLS. 1, 4, 6, 50, 51 AND 52).  
ROGER T. MCDORMAN, EXAMINING ATTORNEY

SN 86-043,752. VOODOO RIDE, LLC, CHICAGO, IL. FILED 8-21-2013.

SN 86-042,863. SUN & SKIN CARE RESEARCH, LLC, COCOA, FL. FILED 8-20-2013.

**OCEAN POTION PROTECT AND RENEW**

THE MARK CONSISTS OF STANDARD CHARACTERS WITHOUT CLAIM TO ANY PARTICULAR FONT, STYLE, SIZE, OR COLOR.

OWNER OF U.S. REG. NOS. 276,609, 2,724,181 AND 2,865,642.

NO CLAIM IS MADE TO THE EXCLUSIVE RIGHT TO USE "PROTECT AND RENEW", APART FROM THE MARK AS SHOWN.

FOR SKIN CARE AND BATH PRODUCTS, NAMELY, SUN BLOCK LOTIONS AND SPRAYS, SUNSCREEN LOTIONS AND SPRAYS, SELF-TANNING LOTIONS AND SPRAYS, MOISTURIZING LOTIONS AND SPRAYS, AFTER-SUN LOTIONS AND SPRAYS, BODY MASK LOTIONS AND SPRAYS, SKIN LOTIONS AND SPRAYS, HAIR LOTIONS AND SPRAYS, FACIAL LOTIONS AND SPRAYS, BODY LOTIONS AND SPRAYS, MOISTURIZERS AND TONERS, AFTER-BATH LOTIONS AND SPRAYS (U.S. CLS. 1, 4, 6, 50, 51 AND 52).

GINA HAYES, EXAMINING ATTORNEY

**VOODOO RIDE**

THE MARK CONSISTS OF STANDARD CHARACTERS WITHOUT CLAIM TO ANY PARTICULAR FONT, STYLE, SIZE, OR COLOR.

OWNER OF U.S. REG. NO. 3,481,113.

FOR AUTOMOTIVE SURFACE CARE PRODUCTS, NAMELY, AUTOMOBILE CLEANERS, AUTOMOBILE POLISHES AND WAXES (U.S. CLS. 1, 4, 6, 50, 51 AND 52).

FIRST USE 1-7-2008; IN COMMERCE 1-7-2008.

NAKIA HENRY, EXAMINING ATTORNEY

**CLASS 3—(Continued).**

SN 86-044,019. DIRTY KNEES SOAP CO., LLC, LENGBY, MN. FILED 8-21-2013.

## Dirty Knees Soap Co.

THE MARK CONSISTS OF STANDARD CHARACTERS WITHOUT CLAIM TO ANY PARTICULAR FONT, STYLE, SIZE, OR COLOR.

NO CLAIM IS MADE TO THE EXCLUSIVE RIGHT TO USE "SOAP CO.", APART FROM THE MARK AS SHOWN.

FOR SOAPS FOR BODY CARE; SOAPS FOR BABIES; BATH SOAPS; PET SHAMPOOS; FACE AND BODY LOTIONS; LIP BALM; BAR SOAP; HANDMADE SOAP BARS; NATURAL SOAP BARS; SOAPS FOR BODY CARE, SOAPS FOR HOUSEHOLD USE; BODY BUTTER; SOAPS FOR PERSONAL USE; FOOT SCRUBS; BODY SCRUB; HAND SOAPS; SHOWER GEL; BATH GEL; BATH SALTS; BATH FIZZIES; BATH MILKS; BATH OILS; BATH SOAPS IN LIQUID, SOLID OR GEL FORM; LIQUID SOAPS; FRAGRANCED BODY CARE PREPARATIONS, NAMELY, BODY LOTION, SHOWER GEL, BATH SOAPS IN LIQUID, SOLID, OR GEL FORM, SHAMPOO, CONDITIONER, NON-MEDICATED LIP BALM, SOAP, BODY POLISH, BODY AND FOOT SCRUB, SHAVING CREAM, AFTER-SHAVE; AROMATIC BODY CARE PRODUCTS, NAMELY, BODY LOTION, SHOWER GEL, CUTICLE CREAM, SHAMPOO, CONDITIONER, NON-MEDICATED LIP BALM, SOAP, BODY POLISH, BODY AND FOOT SCRUB AND NON-MEDICATED FOOT CREAM; EYE LOTIONS; MASSAGE LOTIONS; GIFT BASKETS CONTAINING NON-MEDICATED BATH PREPARATIONS AND COSMETIC PREPARATIONS; MINERAL SALT IN THE NATURE OF BATH SALTS NOT FOR MEDICAL PURPOSES; SHAMPOO; CONDITIONER; HAIR GELS; HAIR CARE CREAMS; HAIR SPRAYS (U.S. CLS. 1, 4, 6, 50, 51 AND 52).

FIRST USE 1-1-2010; IN COMMERCE 1-1-2010.

KATHERINE STOIDES, EXAMINING ATTORNEY

**CLASS 3—(Continued).**

SN 86-047,366. SMITH-BECKFORD, ROBERTA, ATLANTA, GA. FILED 8-25-2013.

## Natural District

THE MARK CONSISTS OF STANDARD CHARACTERS WITHOUT CLAIM TO ANY PARTICULAR FONT, STYLE, SIZE, OR COLOR.

FOR 3-IN-1 HAIR CONDITIONERS; 3-IN-1 HAIR SHAMPOOS; 3-IN-1 ORGANIC SOAP BARS FOR USE AS SOAP, SHAMPOO AND CONDITIONER; AFTER SHAVE LOTIONS; AFTER SUN CREAMS; AFTER-SHAVE; AFTER-SHAVE BALMS; AFTER-SHAVE CREAMS; AFTER-SHAVE EMULSIONS; AFTER-SHAVE GEL; AFTER-SHAVE LIQUID; AFTER-SHAVE LOTIONS; AFTER-SUN GELS; AFTER-SUN LOTIONS; AFTER-SHAVE MOISTURISING CREAM; ALL PURPOSE CLEANING PREPARATION WITH DEODORIZING PROPERTIES; ALL PURPOSE CLEANING PREPARATIONS; ALL-PURPOSE CLEANERS; ALMOND SOAPS; ALOE VERA GEL FOR COSMETIC PURPOSES; ARGAN OIL FOR COSMETIC PURPOSES; AROMATIC ESSENTIAL OILS; BABY BUBBLE BATH; BABY HAIR CONDITIONER; BABY HAND SOAP; BABY LOTION; BABY OIL; BABY OILS; BABY SHAMPOO; BAR SOAP; BATH LOTION; BATH OIL; BATH OILS; BATH OILS FOR COSMETIC PURPOSES; BATH SOAPS; BATH SOAPS IN LIQUID, SOLID OR GEL FORM; BEAUTY BALM CREAMS; BEAUTY CREAMS; BEAUTY CREAMS FOR BODY CARE; BEAUTY GELS; BEAUTY LOTIONS; BEAUTY MASKS; BEAUTY SERUMS; BODY CREAM; BODY CREAMS; BODY LOTION; BODY LOTIONS; BODY OIL; BODY OILS; BODY SPLASH; BODY SPRAY USED AS A PERSONAL DEODORANT AND AS FRAGRANCE; BODY SPRAYS; BODY SPRAYS, NAMELY, WATER IN ATOMIZED CONTAINERS USED TO PRODUCE A COOLING EFFECT; BODY WASH; BUBBLE BATH (U.S. CLS. 1, 4, 6, 50, 51 AND 52).

RONALD MCMORROW, EXAMINING ATTORNEY

SN 86-047,259. THE DANCING BEE APIARIES, LLC, BOLIVAR, TN. FILED 8-25-2013.

## naughty bear

THE MARK CONSISTS OF STANDARD CHARACTERS WITHOUT CLAIM TO ANY PARTICULAR FONT, STYLE, SIZE, OR COLOR.

NO CLAIM IS MADE TO THE EXCLUSIVE RIGHT TO USE "BEAR", APART FROM THE MARK AS SHOWN.

FOR BEAUTY SOAP; BODY AND BEAUTY CARE COSMETICS (U.S. CLS. 1, 4, 6, 50, 51 AND 52).

FIRST USE 5-28-2012; IN COMMERCE 5-28-2013.

KATHLEEN M. VANSTON, EXAMINING ATTORNEY

SN 86-047,416. ECOSOLVE AMERICAS INC, WINDSOR, CANADA, FILED 8-26-2013.

## EZ STRIP

THE MARK CONSISTS OF STANDARD CHARACTERS WITHOUT CLAIM TO ANY PARTICULAR FONT, STYLE, SIZE, OR COLOR.

NO CLAIM IS MADE TO THE EXCLUSIVE RIGHT TO USE "STRIP", APART FROM THE MARK AS SHOWN.

FOR PAINT REMOVERS; PAINT AND COATING REMOVERS AND CLEANERS; ALL-PURPOSE CLEANERS; VARNISH REMOVERS; STAIN REMOVERS (U.S. CLS. 1, 4, 6, 50, 51 AND 52).

JOHN WILKE, EXAMINING ATTORNEY



**CLASS 3—(Continued).**

SN 86-047,465. ANTIGUA-SOLIVEY, RAFAEL HERIBERTO, SANTO DOMINGO, DOMINICAN REP. FILED 8-26-2013.



THE NAME(S), PORTRAIT(S), AND/OR SIGNATURE(S) SHOWN IN THE MARK IDENTIFIES A LIVING INDIVIDUAL, WHOSE CONSENT(S) TO REGISTER IS MADE OF RECORD.

THE MARK CONSISTS OF THE WORDS "ACTION! BY RAFAEL ANTIGUA" IN STYLIZED FORM.

FOR COSMETICS; ESSENTIAL OILS; HAIR LOTIONS; PERFUME; SOAPS FOR BODY AND FACE (U.S. CLS. 1, 4, 6, 50, 51 AND 52).

ANTHONY RINKER, EXAMINING ATTORNEY

SN 86-052,296. USKO, INC., EL SEGUNDO, CA. FILED 8-30-2013.



THE MARK CONSISTS OF A HORIZONTAL STYLIZED NUMBER NINE WITH A PUPIL IN THE MIDDLE.

FOR LIPSTICKS; LIP GLOSS; LIP LINERS; LIP BALMS; EYE SHADOWS; EYE LINING PENCILS; LIQUID EYE LINERS; EYE MAKEUP; MASCARA; EYEBROW PENCILS; ARTIFICIAL EYELASHES; BLUSHERS; SKIN BRONZERS; COTTON STICKS FOR COSMETIC PURPOSES; FOUNDATION MAKEUP; PRESSED FACE POWDER; LOOSE FACE POWDER; MAKEUP REMOVER; CONCEALERS; EYE MAKEUP PALETTES; LIP PALETTES COMPRISED OF LIP CREAM, GLOSS, LINER, POLISH AND STAIN; MAKE-UP SETS; MULTI-USE COLORED FACE AND BODY CREAMS; POWDERS AND GELS FOR USE ON FACE; NAIL POLISH; NAIL ENAMEL; NAIL POLISH REMOVER; NON-MEDICATED SKIN CARE PRODUCTS, NAMELY, CLEANSERS, EXFOLIATORS, TONERS, EYE CREAMS, WIPES IMPREGNATED WITH SKIN CLEANSER; MOISTURIZING SPRITZERS FOR SKIN; TINTED SKIN MOISTURIZERS; FRAGRANCES FOR PERSONAL USE; HAIR CARE PREPARATIONS; NAIL CARE PREPARATIONS; NON-MEDICATED TOILETRIES AND PERFUMERY (U.S. CLS. 1, 4, 6, 50, 51 AND 52).

KATHLEEN M. VANSTON, EXAMINING ATTORNEY

**CLASS 3—(Continued).**

SN 86-057,912. SUN & SKIN CARE RESEARCH, LLC, COCOA, FL. FILED 9-6-2013.

**XTREME TANNING XCELERATOR**

THE MARK CONSISTS OF STANDARD CHARACTERS WITHOUT CLAIM TO ANY PARTICULAR FONT, STYLE, SIZE, OR COLOR.

NO CLAIM IS MADE TO THE EXCLUSIVE RIGHT TO USE "TANNING", APART FROM THE MARK AS SHOWN,

FOR SKIN CARE AND BATH PRODUCTS, NAMELY, SUN BLOCK LOTIONS AND SPRAYS, SUNSCREEN LOTIONS AND SPRAYS, SELF-TANNING LOTIONS AND SPRAYS, MOISTURIZING LOTIONS AND SPRAYS, AFTER-SUN LOTIONS AND SPRAYS, BODY MASK LOTIONS AND SPRAYS, SKIN LOTIONS AND SPRAYS, HAIR LOTIONS AND SPRAYS, FACIAL LOTIONS AND SPRAYS, BODY LOTIONS AND SPRAYS, MOISTURIZERS AND TONERS, AFTER-BATH LOTIONS AND SPRAYS (U.S. CLS. 1, 4, 6, 50, 51 AND 52).

GINA HAYES, EXAMINING ATTORNEY

SN 86-059,174. THE PROCTER & GAMVBLE COMPANY, CINCINNATI, OH. FILED 9-9-2013.

**SMOOTHINATOR!**

THE MARK CONSISTS OF STANDARD CHARACTERS WITHOUT CLAIM TO ANY PARTICULAR FONT, STYLE, SIZE, OR COLOR.

FOR NON-MEDICATED SKIN CARE PREPARATIONS (U.S. CLS. 1, 4, 6, 50, 51 AND 52).

JULIE VEPPIUMTHARA, EXAMINING ATTORNEY

SN 86-059,979. JOHNSON & JOHNSON, NEW BRUNSWICK, NJ. FILED 9-10-2013.

**PRIMER CUIDADO**

THE MARK CONSISTS OF STANDARD CHARACTERS WITHOUT CLAIM TO ANY PARTICULAR FONT, STYLE, SIZE, OR COLOR.

OWNER OF U.S. REG. NO. 3,345,099.

THE ENGLISH TRANSLATION OF "PRIMER CUIDADO" IN THE MARK IS "FIRST TOUCH".

FOR COSMETIC PREPARATIONS FOR THE CARE AND CLEANSING OF SKIN AND HAIR (U.S. CLS. 1, 4, 6, 50, 51 AND 52).

HEATHER THOMPSON, EXAMINING ATTORNEY

**CLASS 3—(Continued).**

SN 86-060,317. MINEFF, MICHAEL, CORPUS CHRISTI, TX. FILED 9-10-2013.

## Nature's Zero

THE MARK CONSISTS OF STANDARD CHARACTERS WITHOUT CLAIM TO ANY PARTICULAR FONT, STYLE, SIZE, OR COLOR.

FOR HAIR GEL; HAIR WAX; STYLING CLAY FOR HAIR (U.S. CLS. 1, 4, 6, 50, 51 AND 52).  
SHARON MEIER, EXAMINING ATTORNEY

**CLASS 3—(Continued).**

SN 86-063,907. TRI-COASTAL DESIGN GROUP, INC., WHARTON, NJ. FILED 9-13-2013.

## ROCKING WILD RASPBERRY

THE MARK CONSISTS OF STANDARD CHARACTERS WITHOUT CLAIM TO ANY PARTICULAR FONT, STYLE, SIZE, OR COLOR.

OWNER OF U.S. REG. NO. 4,430,345.  
NO CLAIM IS MADE TO THE EXCLUSIVE RIGHT TO USE "RASPBERRY", APART FROM THE MARK AS SHOWN.

FOR BATH GEL; BATH SALTS; BATH SOAPS; BODY CREAM; BODY LOTION; BODY OIL; BODY SCRUB; BODY SPRAYS; BUBBLE BATH; DUSTING POWDER; FOOT SCRUBS; LIP BALM; LIP GLOSS; LIQUID SOAP; NAIL POLISH; REEDS AND SCENTED OILS SOLD AS A UNIT FOR USE IN ROOM SCENT DIFFUSERS (U.S. CLS. 1, 4, 6, 50, 51 AND 52).

JULIE GUTTADAURO, EXAMINING ATTORNEY

SN 86-063,299. BRETON ENTERPRISES, INC., HUNTINGTON, NY. FILED 9-12-2013.

## FLEUR DE FRANCE

THE MARK CONSISTS OF STANDARD CHARACTERS WITHOUT CLAIM TO ANY PARTICULAR FONT, STYLE, SIZE, OR COLOR.

NO CLAIM IS MADE TO THE EXCLUSIVE RIGHT TO USE "FRANCE", APART FROM THE MARK AS SHOWN.

THE ENGLISH TRANSLATION OF "FLEUR DE FRANCE" IN THE MARK IS "FLOWER OF FRANCE".

FOR ALMOND SOAPS; BAR SOAP; BATH GEL; BATH GELS; BATH LOTION; BATH SOAPS; BATH SOAPS IN LIQUID, SOLID OR GEL FORM; BATHING LOTIONS; BEAUTY GELS; BEAUTY LOTIONS; BEAUTY SOAP; BODY CREAM; BODY CREAM SOAP; BODY LOTION; BODY LOTIONS; BODY SCRUB; BODY WASH; COLOGNE; COLOGNE WATER; COSMETIC SOAPS; CREAM SOAPS; EAU DE COLOGNE; EAU DE PARFUM; EAU DE PERFUME; EAU DE TOILETTE; EAU-DE-COLOGNE; EAUX DE COLOGNE; FACE AND BODY LOTIONS; FACIAL LOTION; HAIR CARE LOTIONS; HAIR GEL; HAIR LOTION; HAIR SHAMPOO; HAND LOTIONS; HAND SOAPS; LIP BALM; LIP CREAM; LIP GLOSS; LIQUID BATH SOAPS; LIQUID SOAP; LIQUID SOAPS; LOTIONS FOR FACE AND BODY CARE; PERFUME; PERFUMED SOAP; PERFUMED SOAPS; SHAMPOO-CONDITIONERS; SHAMPOOS; SHOWER AND BATH FOAM; SHOWER AND BATH GEL; SHOWER GEL; SKIN LOTION; SKIN MOISTURIZING GEL; SKIN SOAP; SOAPS FOR BODY CARE; SOAPS FOR PERSONAL USE; TOILET SOAP (U.S. CLS. 1, 4, 6, 50, 51 AND 52).

DOMINICK J. SALEMI, EXAMINING ATTORNEY

SN 86-064,252. CAMUTO CONSULTING, INC., DBA CAMUTO GROUP, GREENWICH, CT. FILED 9-13-2013.

## VINCE CAMUTO BELLE

THE MARK CONSISTS OF STANDARD CHARACTERS WITHOUT CLAIM TO ANY PARTICULAR FONT, STYLE, SIZE, OR COLOR.

OWNER OF U.S. REG. NOS. 4,176,547, 4,396,115 AND OTHERS.

THE NAME(S), PORTRAIT(S), AND/OR SIGNATURE(S) SHOWN IN THE MARK IDENTIFIES "VINCE CAMUTO", WHOSE CONSENT(S) TO REGISTER IS MADE OF RECORD.

THE ENGLISH TRANSLATION OF "BELLE" IN THE MARK IS "BEAUTIFUL".

FOR FRAGRANCED BODY CARE PREPARATIONS, NAMELY, BODY LOTIONS AND SPRAYS; FRAGRANCES FOR PERSONAL USE; PERFUMES AND COLOGNES (U.S. CLS. 1, 4, 6, 50, 51 AND 52).

ALLISON HOLTZ, EXAMINING ATTORNEY

**CLASS 3—(Continued).**

SN 86-064,280. CAMUTO CONSULTING, INC., DBA CAMUTO GROUP, GREENWICH, CT. FILED 9-13-2013.

**VINCE CAMUTO BELLA**

THE MARK CONSISTS OF STANDARD CHARACTERS WITHOUT CLAIM TO ANY PARTICULAR FONT, STYLE, SIZE, OR COLOR.

THE NAME(S), PORTRAIT(S), AND/OR SIGNATURE(S) SHOWN IN THE MARK IDENTIFIES "VINCE CAMUTO", WHOSE CONSENT(S) TO REGISTER IS MADE OF RECORD.

THE ENGLISH TRANSLATION OF "BELLA" IN THE MARK IS "BEAUTIFUL".

FOR FRAGRANCED BODY CARE PREPARATIONS, NAMELY, BODY LOTIONS AND SPRAYS; FRAGRANCES FOR PERSONAL USE; PERFUMES AND COLOGNES (U.S. CLS. 1, 4, 6, 50, 51 AND 52).

ALLISON HOLTZ, EXAMINING ATTORNEY

SN 86-064,308. CAMUTO CONSULTING, INC., DBA CAMUTO GROUP, GREENWICH, CT. FILED 9-13-2013.

**VINCE CAMUTO DU JOUR**

THE MARK CONSISTS OF STANDARD CHARACTERS WITHOUT CLAIM TO ANY PARTICULAR FONT, STYLE, SIZE, OR COLOR.

OWNER OF U.S. REG. NOS. 4,176,547, 4,195,426 AND 4,396,115.

THE NAME(S), PORTRAIT(S), AND/OR SIGNATURE(S) SHOWN IN THE MARK IDENTIFIES "VINCE CAMUTO", WHOSE CONSENT(S) TO REGISTER IS MADE OF RECORD.

THE ENGLISH TRANSLATION OF "DU JOUR" IN THE MARK IS "OF THE DAY".

FOR FRAGRANCED BODY CARE PREPARATIONS, NAMELY, BODY LOTIONS AND SPRAYS; FRAGRANCES FOR PERSONAL USE; PERFUMES AND COLOGNES (U.S. CLS. 1, 4, 6, 50, 51 AND 52).

ALLISON HOLTZ, EXAMINING ATTORNEY

SN 86-064,448. SPARTAN BRANDS, INC., NEW YORK, NY. FILED 9-13-2013.

**SEAL AWAY**

THE MARK CONSISTS OF STANDARD CHARACTERS WITHOUT CLAIM TO ANY PARTICULAR FONT, STYLE, SIZE, OR COLOR.

FOR HAIR CARE PREPARATIONS, NAMELY, SHAMPOOS AND CONDITIONERS (U.S. CLS. 1, 4, 6, 50, 51 AND 52).

DOUGLAS LEE, EXAMINING ATTORNEY

**CLASS 3—(Continued).**

SN 86-064,679. CORE NUTRITION LLC, BEVERLY HILLS, CA. FILED 9-13-2013.

**CORE NATURAL**

THE MARK CONSISTS OF STANDARD CHARACTERS WITHOUT CLAIM TO ANY PARTICULAR FONT, STYLE, SIZE, OR COLOR.

OWNER OF U.S. REG. NO. 4,301,383.

NO CLAIM IS MADE TO THE EXCLUSIVE RIGHT TO USE "NATURAL", APART FROM THE MARK AS SHOWN.

FOR COSMETICS (U.S. CLS. 1, 4, 6, 50, 51 AND 52).

ELIZABETH HUGHITT, EXAMINING ATTORNEY

SN 86-065,270. TOMMY BAHAMA GROUP, INC., ATLANTA, GA. FILED 9-16-2013.

**Tommy Bahama Compass**

THE MARK CONSISTS OF STANDARD CHARACTERS WITHOUT CLAIM TO ANY PARTICULAR FONT, STYLE, SIZE, OR COLOR.

OWNER OF U.S. REG. NO. 3,075,649.

THE NAME(S), PORTRAIT(S), AND/OR SIGNATURE(S) SHOWN IN THE MARK DOES NOT IDENTIFY A PARTICULAR LIVING INDIVIDUAL.

FOR EAU DE COLOGNES; FRAGRANCED BODY CARE PREPARATIONS, NAMELY, LOTIONS, SOAPS, BATH AND SHOWER GELS, BODY MISTS, DEODORANTS FOR PERSONAL HYGIENE, AFTER-SHAVE BALMS; FRAGRANCES (U.S. CLS. 1, 4, 6, 50, 51 AND 52).

SHAILA LEWIS, EXAMINING ATTORNEY

SN 86-065,279. TOMMY BAHAMA GROUP, INC., ATLANTA, GA. FILED 9-16-2013.

**COMPASS**

THE MARK CONSISTS OF STANDARD CHARACTERS WITHOUT CLAIM TO ANY PARTICULAR FONT, STYLE, SIZE, OR COLOR.

FOR EAU DE COLOGNES; FRAGRANCED BODY CARE PREPARATIONS, NAMELY, LOTIONS, SOAPS, BATH AND SHOWER GELS, BODY MISTS, DEODORANTS FOR PERSONAL HYGIENE, AFTER-SHAVE BALMS; FRAGRANCES (U.S. CLS. 1, 4, 6, 50, 51 AND 52).

SHAILA LEWIS, EXAMINING ATTORNEY

**CLASS 3—(Continued).**

SN 86-065,291. CHRIS CASSIDY, PALM BEACH, FL. FILED 9-16-2013.

## AdvanceMint, Mints With a Purpose

THE MARK CONSISTS OF STANDARD CHARACTERS WITHOUT CLAIM TO ANY PARTICULAR FONT, STYLE, SIZE, OR COLOR.

FOR BREATH FRESHENER (U.S. CLS. 1, 4, 6, 50, 51 AND 52).

FIRST USE 1-1-2013; IN COMMERCE 8-26-2013.

DOMINICK J. SALEMI, EXAMINING ATTORNEY

**CLASS 3—(Continued).**

SN 86-065,692. ECOLOGY LLC, ST. LOUIS, MO. FILED 9-16-2013.

## SPIN-CREDIBLE

THE MARK CONSISTS OF STANDARD CHARACTERS WITHOUT CLAIM TO ANY PARTICULAR FONT, STYLE, SIZE, OR COLOR.

FOR LAUNDRY DETERGENT (U.S. CLS. 1, 4, 6, 50, 51 AND 52).

JENNIFER WILLISTON, EXAMINING ATTORNEY

SN 86-065,444. FRUITZEN, LLC, CEDAR RAPIDS, IA. FILED 9-16-2013.

## BOONIES

THE MARK CONSISTS OF STANDARD CHARACTERS WITHOUT CLAIM TO ANY PARTICULAR FONT, STYLE, SIZE, OR COLOR.

FOR LIP BALM (U.S. CLS. 1, 4, 6, 50, 51 AND 52).

FIRST USE 8-5-2013; IN COMMERCE 8-5-2013.

AMY ALFIERI, EXAMINING ATTORNEY

SN 86-066,219. BLISSFUL CENTANY INTERNATIONAL LIMITED, EBENE, MAURITIUS, FILED 9-16-2013.

## ELIORA

THE MARK CONSISTS OF STANDARD CHARACTERS WITHOUT CLAIM TO ANY PARTICULAR FONT, STYLE, SIZE, OR COLOR.

THE WORDING "ELIORA" HAS NO MEANING IN A FOREIGN LANGUAGE.

FOR ADHESIVES FOR AFFIXING FALSE EYELASHES; ANTIPERSPIRANT SOAP; ARTIFICIAL EYELASHES; BAR SOAP; BEAUTY MASKS; BLEACHING PREPARATIONS FOR COSMETIC PURPOSES; BLEACHING PREPARATIONS FOR LAUNDRY USE; BREATH FRESHENING SPRAYS; CLEANING PREPARATIONS; COSMETIC CREAMS; COSMETIC PREPARATIONS FOR BATH AND SHOWER; COSMETIC PREPARATIONS FOR SLIMMING PURPOSES; COSMETICS; COTTON STICKS FOR COSMETIC PURPOSES; DENTAL BLEACHING GELS; DENTIFRICES; DEODORANT SOAP; DISINFECTANT SOAP; DRY SHAMPOOS; EAU DE COLOGNE; EYEBROW COSMETICS; EYEBROW PENCILS; EYELASH TINT; FALSE EYELASHES; FALSE NAILS; HAIR COLORANTS; HAIR LOTIONS; HAIR SPRAY; HAND SOAPS; LIP GLOSS; LIPSTICKS; MAKE-UP KITS COMPRISED OF EYEBROW PENCILS, COSMETIC PREPARATIONS FOR EYELASHES, ADHESIVES FOR AFFIXING FALSE EYELASHES, FALSE EYELASHES, LIP GLOSSES, LIPSTICKS, COSMETIC CREAMS, MAKE-UP POWDER, MAKE-UP REMOVING PREPARATIONS, MASCARA, NAIL ART STICKERS, NAIL CARE PREPARATIONS, NAIL POLISH, FALSE NAILS; NON-MEDICATED MOUTH WASHES; NON-MEDICATED TOILETRIES; PERFUMERY; PERFUMES; PREPARATION FOR CLEANING DENTURES; SHAMPOOS; SKIN WHITENING CREAMS; SOAPS FOR HANDS AND FACE, BODY CARE; TALCUM POWDER; TOOTHPASTE; WASHING PREPARATIONS AND LAUNDRY BLEACH (U.S. CLS. 1, 4, 6, 50, 51 AND 52).

JONATHAN FALK, EXAMINING ATTORNEY

SN 86-065,548. SANTO CAROLLO, OLDSMAR, FL. FILED 9-16-2013.

## Strivitox

THE MARK CONSISTS OF STANDARD CHARACTERS WITHOUT CLAIM TO ANY PARTICULAR FONT, STYLE, SIZE, OR COLOR.

FOR AGE RETARDANT GEL; AGE RETARDANT LOTION; ANTI-AGING CREAM; ANTI-AGING CREAMS (U.S. CLS. 1, 4, 6, 50, 51 AND 52).

FIRST USE 9-25-2006; IN COMMERCE 10-23-2006.

DAVID COLLIER, EXAMINING ATTORNEY

**CLASS 3—(Continued).**

SN 86-066,345. JEREZ, JOSE, BRONX, NY. FILED 9-17-2013.

**D'GLAMOUR**

THE MARK CONSISTS OF STANDARD CHARACTERS WITHOUT CLAIM TO ANY PARTICULAR FONT, STYLE, SIZE, OR COLOR.

FOR ALL PURPOSE CLEANING PREPARATIONS; ALL PURPOSE CLEANING PREPARATION WITH DEODORIZING PROPERTIES; AUTOMOBILE, TIRE, GLASS AND WHEEL CLEANING PREPARATIONS; AUTOMOTIVE CLEANING PREPARATIONS; HOUSEHOLD CLEANING PREPARATIONS; AUTOMOBILE POLISHES; FRAGRANCES AND PERFUMERY; FRAGRANCES FOR AUTOMOBILES; FRAGRANCES FOR PERSONAL USE; ROOM FRAGRANCES; PERFUMES; BODY SPRAYS; BEAUTY SOAPS; PERFUMED SOAPS (U.S. CLS. 1, 4, 6, 50, 51 AND 52).

KYLE PEETE, EXAMINING ATTORNEY

SN 86-066,710. HERING, JERRY, PORTLAND, OR. FILED 9-17-2013.

**21st Century Longevity**

THE MARK CONSISTS OF STANDARD CHARACTERS WITHOUT CLAIM TO ANY PARTICULAR FONT, STYLE, SIZE, OR COLOR.

FOR COSMETICS (U.S. CLS. 1, 4, 6, 50, 51 AND 52).

MAUREEN DALL, EXAMINING ATTORNEY

SN 86-066,737. DOTERRA HOLDINGS, LLC, OREM, UT. FILED 9-17-2013.

**clarycalm**

THE MARK CONSISTS OF STANDARD CHARACTERS WITHOUT CLAIM TO ANY PARTICULAR FONT, STYLE, SIZE, OR COLOR.

FOR AROMATIC ESSENTIAL OILS; ESSENTIAL OILS; ESSENTIAL OILS FOR AROMATHERAPY USE; ESSENTIAL OILS FOR PERSONAL USE; LAVENDER OIL; NATURAL ESSENTIAL OILS (U.S. CLS. 1, 4, 6, 50, 51 AND 52).

FIRST USE 8-31-2013; IN COMMERCE 8-31-2013.

CAROL SPILS, EXAMINING ATTORNEY

**CLASS 3—(Continued).**

SN 86-067,732. VISION SOLUTIONS II, LLC, ORLANDO, FL. FILED 9-18-2013.

**BUFF LES**

THE MARK CONSISTS OF STANDARD CHARACTERS WITHOUT CLAIM TO ANY PARTICULAR FONT, STYLE, SIZE, OR COLOR.

FOR CLEANER FOR USE ON PAINT AND CHROME SURFACES (U.S. CLS. 1, 4, 6, 50, 51 AND 52).

FIRST USE 1-1-2010; IN COMMERCE 1-1-2010.

CHRISTOPHER REAMS, EXAMINING ATTORNEY

SN 86-067,823. ZOYA COMPANY, BEDFORD, OH. FILED 9-18-2013.

**MIA**

THE MARK CONSISTS OF STANDARD CHARACTERS WITHOUT CLAIM TO ANY PARTICULAR FONT, STYLE, SIZE, OR COLOR.

FOR NAIL POLISH COLOR (U.S. CLS. 1, 4, 6, 50, 51 AND 52).

FIRST USE 3-31-2009; IN COMMERCE 3-31-2009.

TINA L. SNAPP, EXAMINING ATTORNEY

SN 86-067,849. ZOYA COMPANY, BEDFORD, OH. FILED 9-18-2013.

**ARIZONA**

THE MARK CONSISTS OF STANDARD CHARACTERS WITHOUT CLAIM TO ANY PARTICULAR FONT, STYLE, SIZE, OR COLOR.

FOR NAIL POLISH COLOR (U.S. CLS. 1, 4, 6, 50, 51 AND 52).

FIRST USE 3-23-2012; IN COMMERCE 3-23-2012.

TINA L. SNAPP, EXAMINING ATTORNEY

**CLASS 3—(Continued).**

SN 86-067,856. ZOYA COMPANY, BEDFORD, OH. FILED 9-18-2013.

**PIPPA**

THE MARK CONSISTS OF STANDARD CHARACTERS WITHOUT CLAIM TO ANY PARTICULAR FONT, STYLE, SIZE, OR COLOR.  
FOR NAIL POLISH COLOR (U.S. CLS. 1, 4, 6, 50, 51 AND 52).  
FIRST USE 3-31-2009; IN COMMERCE 3-31-2009.  
TINA L. SNAPP, EXAMINING ATTORNEY

**CLASS 3—(Continued).**

SN 86-068,881. PERFORMANCE INDUSTRIES MANUFACTURING INC., SALT LAKE CITY, UT. FILED 9-19-2013.

**VORTEX HYDRO-NYX**

THE MARK CONSISTS OF STANDARD CHARACTERS WITHOUT CLAIM TO ANY PARTICULAR FONT, STYLE, SIZE, OR COLOR.  
FOR HAND CLEANERS (U.S. CLS. 1, 4, 6, 50, 51 AND 52).  
KEVIN CORWIN, EXAMINING ATTORNEY

SN 86-067,866. ZOYA COMPANY, BEDFORD, OH. FILED 9-18-2013.

**PURITY**

THE MARK CONSISTS OF STANDARD CHARACTERS WITHOUT CLAIM TO ANY PARTICULAR FONT, STYLE, SIZE, OR COLOR.  
FOR NAIL POLISH COLOR (U.S. CLS. 1, 4, 6, 50, 51 AND 52).  
FIRST USE 3-31-2009; IN COMMERCE 3-31-2009.  
TINA L. SNAPP, EXAMINING ATTORNEY

SN 86-068,966. RENEGADE BRANDS LLC, CLEVELAND, OH. FILED 9-19-2013.

**MAKE YOUR IMPACT**

THE MARK CONSISTS OF STANDARD CHARACTERS WITHOUT CLAIM TO ANY PARTICULAR FONT, STYLE, SIZE, OR COLOR.  
FOR LAUNDRY DETERGENT (U.S. CLS. 1, 4, 6, 50, 51 AND 52).  
ELLEN BURNS, EXAMINING ATTORNEY

SN 86-068,384. SPARKLEHEARTS, LLC, HUNTINGTON BEACH, CA. FILED 9-18-2013.

**Honestly Phresh**

THE MARK CONSISTS OF STANDARD CHARACTERS WITHOUT CLAIM TO ANY PARTICULAR FONT, STYLE, SIZE, OR COLOR.  
FOR DEODORANT FOR PERSONAL USE (U.S. CLS. 1, 4, 6, 50, 51 AND 52).  
FIRST USE 9-20-2013; IN COMMERCE 9-20-2013.  
MARY ROSSMAN, EXAMINING ATTORNEY

SN 86-069,044. HADNOTT, E RENEE, LOS ANGELES, CA. FILED 9-19-2013.

**DivinityDerm**

THE MARK CONSISTS OF STANDARD CHARACTERS WITHOUT CLAIM TO ANY PARTICULAR FONT, STYLE, SIZE, OR COLOR.  
FOR NON-MEDICATED SKIN CARE PREPARATIONS (U.S. CLS. 1, 4, 6, 50, 51 AND 52).  
TAMARA FRAZIER, EXAMINING ATTORNEY

**CLASS 3—(Continued).**

SN 86-069,559. JACK BLACK, L.L.C., CARROLLTON, TX. FILED 9-19-2013.

**DEEP DIVE**

THE MARK CONSISTS OF STANDARD CHARACTERS WITHOUT CLAIM TO ANY PARTICULAR FONT, STYLE, SIZE, OR COLOR.  
FOR FACIAL CLEANSERS; BEAUTY MASKS; FACIAL MASKS (U.S. CLS. 1, 4, 6, 50, 51 AND 52).  
MARIA-VICTORIA SUAREZ, EXAMINING ATTORNEY

**CLASS 3—(Continued).**

SN 86-070,028. ZOYA COMPANY, BEDFORD, OH. FILED 9-20-2013.

**HEIDI**

THE MARK CONSISTS OF STANDARD CHARACTERS WITHOUT CLAIM TO ANY PARTICULAR FONT, STYLE, SIZE, OR COLOR.  
FOR NAIL POLISH COLOR (U.S. CLS. 1, 4, 6, 50, 51 AND 52).  
FIRST USE 4-1-2009; IN COMMERCE 4-1-2009.  
TINA L. SNAPP, EXAMINING ATTORNEY

SN 86-069,567. JACK BLACK, L.L.C., CARROLLTON, TX. FILED 9-19-2013.

**COOL CTRL**

THE MARK CONSISTS OF STANDARD CHARACTERS WITHOUT CLAIM TO ANY PARTICULAR FONT, STYLE, SIZE, OR COLOR.  
FOR DEODORANTS AND ANTIPERSPIRANTS, AND EXCLUDING SKIN CARE PREPARATIONS FOR THE TREATMENT OF ACNE (U.S. CLS. 1, 4, 6, 50, 51 AND 52).  
MARIA-VICTORIA SUAREZ, EXAMINING ATTORNEY

SN 86-070,035. ZOYA COMPANY, BEDFORD, OH. FILED 9-20-2013.

**CHARLA**

THE MARK CONSISTS OF STANDARD CHARACTERS WITHOUT CLAIM TO ANY PARTICULAR FONT, STYLE, SIZE, OR COLOR.  
FOR NAIL POLISH COLOR (U.S. CLS. 1, 4, 6, 50, 51 AND 52).  
FIRST USE 3-23-2010; IN COMMERCE 3-23-2010.  
CAITLIN WATTS-FITZGERALD, EXAMINING ATTORNEY

SN 86-070,027. ZOYA COMPANY, BEDFORD, OH. FILED 9-20-2013.

**ANJA**

THE MARK CONSISTS OF STANDARD CHARACTERS WITHOUT CLAIM TO ANY PARTICULAR FONT, STYLE, SIZE, OR COLOR.  
FOR NAIL POLISH COLOR (U.S. CLS. 1, 4, 6, 50, 51 AND 52).  
FIRST USE 3-3-2011; IN COMMERCE 3-3-2011.  
TINA L. SNAPP, EXAMINING ATTORNEY

SN 86-070,037. ZOYA COMPANY, BEDFORD, OH. FILED 9-20-2013.

**ZIV**

THE MARK CONSISTS OF STANDARD CHARACTERS WITHOUT CLAIM TO ANY PARTICULAR FONT, STYLE, SIZE, OR COLOR.  
FOR NAIL POLISH COLOR (U.S. CLS. 1, 4, 6, 50, 51 AND 52).  
FIRST USE 10-9-2012; IN COMMERCE 10-9-2012.  
CAITLIN WATTS-FITZGERALD, EXAMINING ATTORNEY

**CLASS 3—(Continued).**

SN 86-070,282. WILSON, RICHARD, BROOKLYN, NY.  
FILED 9-20-2013.



THE STIPPLING IS FOR SHADING PURPOSES ONLY.  
THE MARK CONSISTS OF A SMILING CARTOON  
GLOVE NAMED MR. DOOTS.  
FOR BABY WIPES (U.S. CLS. 1, 4, 6, 50, 51 AND 52).  
FIRST USE 2-20-2013; IN COMMERCE 8-12-2013.  
BRIN ANDERSON, EXAMINING ATTORNEY

SN 86-070,889. BEAUTY PLUS GLOBAL, INC., ONTARIO,  
CA. FILED 9-20-2013.



THE STIPPLING IS FOR SHADING PURPOSES ONLY.  
THE MARK CONSISTS OF THE STYLIZED LETTERS "BP  
BEAUTYPLUS" WITH LETTERS "BP" INSIDE A SWIRLING  
CIRCLE FOLLOWED BY THE WORDS "BEAUTYPLUS".  
FOR COSMETICS (U.S. CLS. 1, 4, 6, 50, 51 AND 52).  
FIRST USE 7-1-2013; IN COMMERCE 8-1-2013.  
MORGAN WYNNE, EXAMINING ATTORNEY

SN 86-071,571. CELLQUEST INC, LARGO, FL. FILED 9-23-  
2013.

## Musa Visage

THE MARK CONSISTS OF STANDARD CHARACTERS  
WITHOUT CLAIM TO ANY PARTICULAR FONT, STYLE,  
SIZE, OR COLOR.  
FOR ANTI-AGING CREAM; ANTI-AGING MOISTUR-  
IZER; NON-MEDICATED ANTI-AGING SERUM (U.S.  
CLS. 1, 4, 6, 50, 51 AND 52).  
KAPIL BHANOT, EXAMINING ATTORNEY

**CLASS 3—(Continued).**

SN 86-072,065. COTY US LLC, NEW YORK, NY. FILED 9-23-  
2013.

## DAREDEVIL

THE MARK CONSISTS OF STANDARD CHARACTERS  
WITHOUT CLAIM TO ANY PARTICULAR FONT, STYLE,  
SIZE, OR COLOR.  
FOR PERFUMERY (U.S. CLS. 1, 4, 6, 50, 51 AND 52).  
ALEX KEAM, EXAMINING ATTORNEY

SN 86-072,240. INSPIRED BEAUTY BRANDS, INC., GREAT  
NECK, NY. FILED 9-23-2013.

## WHO SAYS SILVER HAIR ISN'T SEXY?

THE MARK CONSISTS OF STANDARD CHARACTERS  
WITHOUT CLAIM TO ANY PARTICULAR FONT, STYLE,  
SIZE, OR COLOR.  
FOR HAIR CARE PRODUCTS, NAMELY, SHAMPOOS,  
CONDITIONERS AND HAIR FIXATIVES (U.S. CLS. 1, 4,  
6, 50, 51 AND 52).  
SETH A. RAPPAPORT, EXAMINING ATTORNEY

SN 86-073,622. FANTASMA TOYS, INC., NEW YORK, NY.  
FILED 9-24-2013.

## TIDY TUSHIE

THE MARK CONSISTS OF STANDARD CHARACTERS  
WITHOUT CLAIM TO ANY PARTICULAR FONT, STYLE,  
SIZE, OR COLOR.  
FOR BABY WIPES (U.S. CLS. 1, 4, 6, 50, 51 AND 52).  
RUSS HERMAN, EXAMINING ATTORNEY



**CLASS 3—(Continued).**

SN 86-074,095. PERFECT IMAGE LLC, RENO, NV. FILED 9-25-2013.

# Revitaboost

THE MARK CONSISTS OF STANDARD CHARACTERS WITHOUT CLAIM TO ANY PARTICULAR FONT, STYLE, SIZE, OR COLOR.

FOR NON-MEDICATED SKIN CARE PREPARATIONS, NAMELY, PEELS, EXFOLIATORS, SKIN PEELS, CHEMICAL PEELS, FACIAL PEELS (U.S. CLS. 1, 4, 6, 50, 51 AND 52).

FIRST USE 9-1-2013; IN COMMERCE 9-1-2013.  
AMY C. KEAN, EXAMINING ATTORNEY

**CLASS 3—(Continued).**

SN 86-077,047. REVLON CONSUMER PRODUCTS CORPORATION, NEW YORK, NY. FILED 9-27-2013.

# THE ELECTRIC CHROME COLLECTION

THE MARK CONSISTS OF STANDARD CHARACTERS WITHOUT CLAIM TO ANY PARTICULAR FONT, STYLE, SIZE, OR COLOR.

NO CLAIM IS MADE TO THE EXCLUSIVE RIGHT TO USE "COLLECTION", APART FROM THE MARK AS SHOWN.

FOR COSMETICS AND MAKE-UP (U.S. CLS. 1, 4, 6, 50, 51 AND 52).

DEIRDRE ROBERTSON, EXAMINING ATTORNEY

SN 86-075,367. THE PILLSBURY COMPANY, LLC, MINNEAPOLIS, MN. FILED 9-26-2013.



OWNER OF U.S. REG. NOS. 1,671,945, 1,830,866 AND OTHERS.

THE MARK CONSISTS OF A DOUGH LIKE FIGURE WITH ONE ARM RAISED, WEARING A CHEF'S HAT AND NECK SCARF. THE CIRCLE ON THE CHEF'S HAT CONTAINS ILLEGIBLE WRITING.

FOR LIP BALM (U.S. CLS. 1, 4, 6, 50, 51 AND 52).  
FIRST USE 6-30-2007; IN COMMERCE 6-30-2007.  
KAREN SEVERSON, EXAMINING ATTORNEY

SN 86-077,100. REVLON CONSUMER PRODUCTS CORPORATION, NEW YORK, NY. FILED 9-27-2013.

# ALMAY TONEMIMIC

THE MARK CONSISTS OF STANDARD CHARACTERS WITHOUT CLAIM TO ANY PARTICULAR FONT, STYLE, SIZE, OR COLOR.

OWNER OF U.S. REG. NOS. 980,494, 3,143,514 AND OTHERS.

FOR COSMETICS AND MAKE-UP (U.S. CLS. 1, 4, 6, 50, 51 AND 52).

DEIRDRE ROBERTSON, EXAMINING ATTORNEY

SN 86-079,081. IT COSMETICS, LLC, JERSEY CITY, NJ. FILED 9-30-2013.

## Clinically Proven. Skin Loving. Problem Solutions.

THE MARK CONSISTS OF STANDARD CHARACTERS WITHOUT CLAIM TO ANY PARTICULAR FONT, STYLE, SIZE, OR COLOR.

NO CLAIM IS MADE TO THE EXCLUSIVE RIGHT TO USE "CLINICALLY PROVEN", APART FROM THE MARK AS SHOWN.

FOR BODY LOTION; BODY LOTIONS; BODY OIL; BODY OILS; BODY POWDER; COLORING PREPARATIONS FOR COSMETIC PURPOSES; COSMETIC OILS; COSMETIC PREPARATIONS FOR BODY CARE; COSMETIC SUN-PROTECTING PREPARATIONS; COSMETICS; COSMETICS AND COSMETIC PREPARATIONS; COSMETICS AND MAKE-UP; ESSENTIAL OILS; FACE AND BODY CREAMS; FACE AND BODY LOTIONS; FACE CREAMS; FACE CREAMS FOR COSMETIC USE; FACE OILS; FACIAL LOTION; FACIAL MOISTURIZER WITH SPF; FACIAL OILS; FRAGRANCES FOR PERSONAL USE; HAIR CARE PREPARATIONS; LOTIONS FOR FACE AND BODY CARE; MAKE-UP; MAKE-UP FOR THE FACE AND BODY; NON-MEDICATED SKIN CARE CREAMS AND LOTIONS; NON-MEDICATED SKIN CARE PREPARATIONS; NON-MEDICATED SKIN CREAMS; SKIN CREAM; SKIN CREAMS (U.S. CLS. 1, 4, 6, 50, 51 AND 52).

JENNIFER RICHARDSON, EXAMINING ATTORNEY

SN 86-076,601. HORIZON GROUP USA, INC., WARREN, NJ. FILED 9-27-2013.

# CAMP ANYWHERE

THE MARK CONSISTS OF STANDARD CHARACTERS WITHOUT CLAIM TO ANY PARTICULAR FONT, STYLE, SIZE, OR COLOR.

FOR FACE PAINT (U.S. CLS. 1, 4, 6, 50, 51 AND 52).  
DEBORAH LOBO, EXAMINING ATTORNEY

**CLASS 3—(Continued).**

SN 86-080,396. AUSTRALIAN GOLD, LLC, INDIANAPOLIS, IN. FILED 10-2-2013.

**COLOR PERFECTING COMPLEX**

THE MARK CONSISTS OF STANDARD CHARACTERS WITHOUT CLAIM TO ANY PARTICULAR FONT, STYLE, SIZE, OR COLOR.

OWNER OF U.S. REG. NOS. 3,848,703, 4,176,522 AND OTHERS.

NO CLAIM IS MADE TO THE EXCLUSIVE RIGHT TO USE "COMPLEX", APART FROM THE MARK AS SHOWN. FOR INDOOR AND OUTDOOR NON-MEDICATED SKIN TANNING PREPARATIONS (U.S. CLS. 1, 4, 6, 50, 51 AND 52).

JEFFERY COWARD, EXAMINING ATTORNEY

**CLASS 3—(Continued).**

SN 86-081,384. IT COSMETICS, LLC, JERSEY CITY, NJ. FILED 10-2-2013.

**BYE BYE FOUNDATION**

THE MARK CONSISTS OF STANDARD CHARACTERS WITHOUT CLAIM TO ANY PARTICULAR FONT, STYLE, SIZE, OR COLOR.

OWNER OF U.S. REG. NOS. 3,644,712, 3,833,838 AND OTHERS.

NO CLAIM IS MADE TO THE EXCLUSIVE RIGHT TO USE "FOUNDATION", APART FROM THE MARK AS SHOWN.

FOR BODY LOTION; BODY LOTIONS; BODY OIL; BODY OILS; BODY POWDER; COLORING PREPARATIONS FOR COSMETIC PURPOSES; COSMETIC OILS; COSMETIC PREPARATIONS FOR BODY CARE; COSMETIC SUN-PROTECTING PREPARATIONS; COSMETICS; COSMETICS AND COSMETIC PREPARATIONS; COSMETICS AND MAKE-UP; ESSENTIAL OILS; FACE AND BODY CREAMS; FACE AND BODY LOTIONS; FACE CREAMS; FACE CREAMS FOR COSMETIC USE; FACE OILS; FACIAL LOTION; FACIAL MOISTURIZER WITH SPF; FACIAL OILS; FRAGRANCES FOR PERSONAL USE; HAIR CARE PREPARATIONS; LOTIONS FOR FACE AND BODY CARE; MAKE-UP; MAKE-UP FOR THE FACE AND BODY; NON-MEDICATED SKIN CARE CREAMS AND LOTIONS; NON-MEDICATED SKIN CARE PREPARATIONS; NON-MEDICATED SKIN CREAMS; SKIN CREAM; SKIN CREAMS (U.S. CLS. 1, 4, 6, 50, 51 AND 52).

JENNIFER RICHARDSON, EXAMINING ATTORNEY

SN 86-081,191. SPARTAN BRANDS, INC., NEW YORK, NY. FILED 10-2-2013.

**CITRSLICK**

THE MARK CONSISTS OF STANDARD CHARACTERS WITHOUT CLAIM TO ANY PARTICULAR FONT, STYLE, SIZE, OR COLOR.

FOR BODY WASH AND SHAVE GEL (U.S. CLS. 1, 4, 6, 50, 51 AND 52).

DOUGLAS LEE, EXAMINING ATTORNEY

SN 86-082,241. GOLDEN SUN, INC., DBA NEWHALL LABORATORIES, INC., STAMFORD, NY. FILED 10-3-2013.

**Pure & Natural**

THE MARK CONSISTS OF STANDARD CHARACTERS WITHOUT CLAIM TO ANY PARTICULAR FONT, STYLE, SIZE, OR COLOR.

OWNER OF U.S. REG. NOS. 2,064,273, 3,881,777 AND OTHERS.

SEC. 2(F). FOR HAIR SHAMPOO; HAIR CONDITIONER; LOTIONS FOR SKIN, BODY, FACE AND HAIR; BAR SOAP; BODY WASH; LIQUID BODY SOAP; LIQUID HAND SOAP; HAIR STYLING GEL; SKIN CREAM; SKIN MOISTURIZER; FACIAL CLEANSER; FACIAL SCRUB; TONING GEL; BATH GEL; SHOWER GEL; FOAMING BATH GEL; AND DEODORANT (U.S. CLS. 1, 4, 6, 50, 51 AND 52).

MICHELE SWAIN, EXAMINING ATTORNEY

**CLASS 3—(Continued).**

SN 86-084,623. REVLOX CONSUMER PRODUCTS CORPORATION, NEW YORK, NY. FILED 10-7-2013.

REVLOX PHOTOREADY EYE ART

THE MARK CONSISTS OF STANDARD CHARACTERS WITHOUT CLAIM TO ANY PARTICULAR FONT, STYLE, SIZE, OR COLOR.

OWNER OF U.S. REG. NOS. 3,791,046, 3,880,036 AND OTHERS.

NO CLAIM IS MADE TO THE EXCLUSIVE RIGHT TO USE "EYE", APART FROM THE MARK AS SHOWN.

FOR COSMETICS AND MAKE-UP (U.S. CLS. 1, 4, 6, 50, 51 AND 52).

DEIRDRE ROBERTSON, EXAMINING ATTORNEY

SN 86-084,629. REVLOX CONSUMER PRODUCTS CORPORATION, NEW YORK, NY. FILED 10-7-2013.

REVLOX PHOTOREADY ARTISTE

THE MARK CONSISTS OF STANDARD CHARACTERS WITHOUT CLAIM TO ANY PARTICULAR FONT, STYLE, SIZE, OR COLOR.

OWNER OF U.S. REG. NOS. 3,791,046, 3,880,036 AND OTHERS.

FOR COSMETICS AND MAKE-UP (U.S. CLS. 1, 4, 6, 50, 51 AND 52).

DEIRDRE ROBERTSON, EXAMINING ATTORNEY

SN 86-085,691. DOLLAR SHAVE CLUB, INC., VENICE, CA. FILED 10-8-2013.

LITTLE BIG CLOUD

THE MARK CONSISTS OF STANDARD CHARACTERS WITHOUT CLAIM TO ANY PARTICULAR FONT, STYLE, SIZE, OR COLOR.

FOR SKIN, FACE, HAND, FEET, AND BODY MOISTURIZERS (U.S. CLS. 1, 4, 6, 50, 51 AND 52).

ESTHER A. BORSUK, EXAMINING ATTORNEY

**CLASS 3—(Continued).**

SN 86-086,112. TARGET BRANDS, INC., MINNEAPOLIS, MN. FILED 10-8-2013.

MERONA

THE MARK CONSISTS OF STANDARD CHARACTERS WITHOUT CLAIM TO ANY PARTICULAR FONT, STYLE, SIZE, OR COLOR.

OWNER OF U.S. REG. NOS. 2,099,493, 2,896,145 AND OTHERS.

FOR COSMETICS; PERSONAL CARE PRODUCTS, NAMELY, PERFUME, COLOGNE, FRAGRANCES, AFTERSHAVE GELS, AFTERSHAVE LOTION, ANTI-PERSPIRANT, COSMETIC SKIN AND FACE ASTRINGENTS, BATH BEADS, BATH FLAKES, BATH OIL, BATH SALTS, BATH FOAM, BODY GLITTER, NON-MEDICATED SKIN CARE PREPARATION IN THE NATURE OF BODY MIST, BODY OIL, BODY LOTION, BODY SCRUB, BODY WASH, BUBBLE BATH, BODY CREAM, FACE CREAM, ESSENTIAL OILS FOR PERSONAL USE, EXFOLIATING PREPARATIONS FOR THE SKIN, EYE GELS, EYE BEAUTY MASKS, FACIAL MASKS, FACIAL SCRUB, NON-MEDICATED FOOT SOAKS, SKIN TONERS FOR THE FACE, FRAGRANT BODY SPLASH, FRAGRANT BODY MIST, HAIR CONDITIONERS, HAIR GLITTER, HAIR RINSES, HAIR SHAMPOO, HAIR SPRAY, HAIR STYLING GEL, HAIR STYLING MOUSSE, HAND LOTION, FACE LOTION, LIP BALM, MASSAGE CREAM, MASSAGE LOTION, MASSAGE OIL, NAIL POLISH, NAIL POLISH REMOVER, NON-MEDICATED FACE CLEANSER, COSMETIC BLOTTING PAPER IN THE NATURE OF OIL BLOTTING SHEETS FOR THE SKIN, BODY POWDER, SHAVING CREAM, SHAVING GEL, SHOWER CREAM, SHOWER GEL, SKIN BRONZING CREAM, BODY SOAP, FACE SOAP, HAND SOAP, SUN BLOCK FOR THE BODY, SUN BLOCK FOR THE FACE, SUNTAN LOTION FOR THE BODY, SUNTAN LOTION FOR THE FACE, SUNLESS TANNING LOTION, TALCUM POWDER; POTPOURRI, INCENSE, SACHETS (U.S. CLS. 1, 4, 6, 50, 51 AND 52).

MEREDITH MARESCA, EXAMINING ATTORNEY

SN 86-086,237. GOLDEN SUN, INC., STAMFORD, CT. FILED 10-8-2013.

L.A. LOOKS

THE MARK CONSISTS OF STANDARD CHARACTERS WITHOUT CLAIM TO ANY PARTICULAR FONT, STYLE, SIZE, OR COLOR.

OWNER OF U.S. REG. NOS. 1,698,676, 3,210,950 AND 3,211,480.

FOR HAIR CARE AND HAIR STYLING PRODUCTS, NAMELY, STYLING GELS, HAIR SPRAYS AND MOUSSE (U.S. CLS. 1, 4, 6, 50, 51 AND 52).

FIRST USE 9-30-1987; IN COMMERCE 9-30-1987.

MICHELE SWAIN, EXAMINING ATTORNEY

**CLASS 3—(Continued).**

SN 86-087,178. REVLON CONSUMER PRODUCTS CORPORATION, NEW YORK, NY. FILED 10-9-2013.

## REVLON COLORSTAY SKINNY

THE MARK CONSISTS OF STANDARD CHARACTERS WITHOUT CLAIM TO ANY PARTICULAR FONT, STYLE, SIZE, OR COLOR.

OWNER OF U.S. REG. NOS. 2,103,818, 3,035,671 AND OTHERS.

FOR COSMETICS AND MAKE-UP (U.S. CLS. 1, 4, 6, 50, 51 AND 52).

DEIRDRE ROBERTSON, EXAMINING ATTORNEY

SN 86-087,522. HIGH RIDGE BRANDS CO., STAMFORD, CT. FILED 10-9-2013.

## CLIMASHIELD

THE MARK CONSISTS OF STANDARD CHARACTERS WITHOUT CLAIM TO ANY PARTICULAR FONT, STYLE, SIZE, OR COLOR.

FOR HAIR STYLING PREPARATIONS, NAMELY, SCULPTING SPRAY GEL, PROTECTIVE AND REVITALIZING HAIR CURLING PREPARATIONS, PROTECTIVE STYLING MOUSSE, HAIR GEL AND HAIR SPRAY (U.S. CLS. 1, 4, 6, 50, 51 AND 52).

FIRST USE 12-15-2012; IN COMMERCE 12-15-2012.

WENDY GOODMAN, EXAMINING ATTORNEY

SN 86-087,609. CELEB LLC, FORT LAUDERDALE, FL. FILED 10-9-2013.

## COLOR SURVIVAL

THE MARK CONSISTS OF STANDARD CHARACTERS WITHOUT CLAIM TO ANY PARTICULAR FONT, STYLE, SIZE, OR COLOR.

NO CLAIM IS MADE TO THE EXCLUSIVE RIGHT TO USE "COLOR", APART FROM THE MARK AS SHOWN.

FOR BLEACHING PREPARATIONS FOR THE HAIR; COLOR-REMOVING PREPARATIONS FOR HAIR; HAIR BLEACH; HAIR CARE CREAMS; HAIR CARE PREPARATIONS; HAIR COLOR; HAIR DYE; HAIR GEL; HAIR LOTION; HAIR MOUSSE; HAIR POMADES; HAIR RELAXERS; HAIR SHAMPOOS AND CONDITIONERS; HAIR SPRAYS; HAIR STRAIGHTENING PREPARATIONS; HAIR STYLING PREPARATIONS; HAIR TONIC; PERMANENT WAVE PREPARATIONS (U.S. CLS. 1, 4, 6, 50, 51 AND 52).

GINA HAYES, EXAMINING ATTORNEY

**CLASS 3—(Continued).**

SN 86-090,848. DOTERRA HOLDINGS, LLC, OREM, UT. FILED 10-14-2013.

## Salubelle

THE MARK CONSISTS OF STANDARD CHARACTERS WITHOUT CLAIM TO ANY PARTICULAR FONT, STYLE, SIZE, OR COLOR.

FOR AROMATIC ESSENTIAL OILS; COSMETIC OILS FOR THE EPIDERMIS; ESSENTIAL OILS; ESSENTIAL OILS FOR AROMATHERAPY USE; ESSENTIAL OILS FOR PERSONAL USE; LAVENDER OIL; NATURAL ESSENTIAL OILS; OILS FOR COSMETIC PURPOSES; ROSE OIL FOR COSMETIC PURPOSES (U.S. CLS. 1, 4, 6, 50, 51 AND 52).

CAROL SPILS, EXAMINING ATTORNEY

SN 86-092,776. REVLON CONSUMER PRODUCTS CORPORATION, NEW YORK, NY. FILED 10-16-2013.

## REVLON COLORSTAY GEL ENVY

THE MARK CONSISTS OF STANDARD CHARACTERS WITHOUT CLAIM TO ANY PARTICULAR FONT, STYLE, SIZE, OR COLOR.

OWNER OF U.S. REG. NOS. 2,103,818, 3,035,671 AND OTHERS.

NO CLAIM IS MADE TO THE EXCLUSIVE RIGHT TO USE "GEL", APART FROM THE MARK AS SHOWN.

FOR COSMETICS (U.S. CLS. 1, 4, 6, 50, 51 AND 52).

DEIRDRE ROBERTSON, EXAMINING ATTORNEY

SN 86-093,223. KATE SOMERVILLE SKINCARE, LLC, WEST HOLLYWOOD, CA. FILED 10-16-2013.

## DERMALQUENCH CLEAR

THE MARK CONSISTS OF STANDARD CHARACTERS WITHOUT CLAIM TO ANY PARTICULAR FONT, STYLE, SIZE, OR COLOR.

OWNER OF U.S. REG. NOS. 4,181,899 AND 4,429,219.

NO CLAIM IS MADE TO THE EXCLUSIVE RIGHT TO USE "CLEAR", APART FROM THE MARK AS SHOWN.

FOR NON-MEDICATED TOPICAL SKIN CARE TREATMENT INTENDED TO MANAGE ACNE, MOISTURIZE, AND PROVIDE ANTI-AGING BENEFITS (U.S. CLS. 1, 4, 6, 50, 51 AND 52).

CAITLIN WATTS-FITZGERALD, EXAMINING ATTORNEY

**CLASS 3—(Continued).**

SN 86-093,994. TUPPERWARE PRODUCTS S.A., FRIBOURG, SWITZERLAND, FILED 10-17-2013.



NO CLAIM IS MADE TO THE EXCLUSIVE RIGHT TO USE "JUST FOR TEENS", APART FROM THE MARK AS SHOWN.

THE MARK CONSISTS OF THREE STARS AND A CYLINDER WITH THE TERMS "JUST 4 TEENS" INSIDE. FOR COSMETICS; NON-MEDICATED SKIN CARE PREPARATIONS (U.S. CLS. 1, 4, 6, 50, 51 AND 52). TOBY BULLOFF, EXAMINING ATTORNEY

SN 86-094,903. TUPPERWARE PRODUCTS S.A., FRIBOURG, SWITZERLAND, FILED 10-18-2013.

sensual  
fever

OWNER OF U.S. REG. NO. 3,669,896.  
THE MARK CONSISTS OF THE STYLIZED STYLIZED WORDS "SENSUAL FEVER".  
FOR NON-MEDICATED SKIN CARE PREPARATIONS; PERFUMERY (U.S. CLS. 1, 4, 6, 50, 51 AND 52).  
TOBY BULLOFF, EXAMINING ATTORNEY

**CLASS 3—(Continued).**

SN 86-096,631. SPARTAN BRANDS, INC., NEW YORK, NY. FILED 10-21-2013.

**MIX N' FIX**

THE MARK CONSISTS OF STANDARD CHARACTERS WITHOUT CLAIM TO ANY PARTICULAR FONT, STYLE, SIZE, OR COLOR.

FOR HAIR CARE PREPARATIONS, NAMELY, HAIR RELAXERS, HAIR DRESSINGS AND HAIR CONDITIONERS (U.S. CLS. 1, 4, 6, 50, 51 AND 52).  
DOUGLAS LEE, EXAMINING ATTORNEY

SN 86-096,672. SPARTAN BRANDS, INC., NEW YORK, NY. FILED 10-21-2013.

**BLEND N' MEND**

THE MARK CONSISTS OF STANDARD CHARACTERS WITHOUT CLAIM TO ANY PARTICULAR FONT, STYLE, SIZE, OR COLOR.

FOR HAIR CARE PREPARATIONS, NAMELY, HAIR RELAXERS, HAIR DRESSINGS AND HAIR CONDITIONERS (U.S. CLS. 1, 4, 6, 50, 51 AND 52).  
DOUGLAS LEE, EXAMINING ATTORNEY

SN 86-097,519. HIGH RIDGE BRANDS CO., STAMFORD, CT. FILED 10-22-2013.

**ACTIVE BOTANICALS**

THE MARK CONSISTS OF STANDARD CHARACTERS WITHOUT CLAIM TO ANY PARTICULAR FONT, STYLE, SIZE, OR COLOR.

NO CLAIM IS MADE TO THE EXCLUSIVE RIGHT TO USE "BOTANICALS", APART FROM THE MARK AS SHOWN.

FOR PERFUMERY, TOILET ARTICLES AND COSMETICS, NAMELY, HAIR SHAMPOOS, HAIR CONDITIONERS, BODY WASHES, HAIR SPRAYS, HAIR MOUSSE AND HAIR GEL; NON-MEDICATED HAIR TREATMENT PREPARATIONS FOR COSMETIC PURPOSES, NAMELY, DEEP CONDITIONERS; BODY SCRUBS; SOAPS; BAR SOAPS; BODY LOTIONS; FACIAL CLEANSERS; FACIAL SCRUBS; FACIAL MOISTURIZERS; BABY SHAMPOO; BABY BODY WASH; NON-MEDICATED DIAPER RASH OINTMENTS AND LOTIONS; NON-MEDICATED DIAPER RASH CREAM; ALL OF THE AFOREMENTIONED GOODS ARE MADE IN PART FROM BOTANICALS (U.S. CLS. 1, 4, 6, 50, 51 AND 52).

WENDY GOODMAN, EXAMINING ATTORNEY

**CLASS 3—(Continued).**

SN 86-103,139. JACK BLACK, L.L.C., CARROLLTON, TX.  
FILED 10-28-2013.

MR. T

THE MARK CONSISTS OF STANDARD CHARACTERS WITHOUT CLAIM TO ANY PARTICULAR FONT, STYLE, SIZE, OR COLOR.

FOR SKIN CARE PREPARATIONS AND TREATMENTS, NAMELY, MATTIFYING GELS, MATTIFYING CREAMS, MATTIFYING LOTIONS, OIL CONTROL LOTIONS, OIL CONTROL GELS, OIL CONTROL CREAMS; SKIN OIL ABSORBERS, NAMELY, CREAMS, LOTIONS, GELS, SERUMS, TONERS, EMULSIONS, FOAMS, MASKS, FLUIDS, POWDERS (U.S. CLS. 1, 4, 6, 50, 51 AND 52).

MARIA-VICTORIA SUAREZ, EXAMINING ATTORNEY

SN 86-104,383. ORGANIC TO GREEN, INC., PACIFIC PALISADES, CA. FILED 10-29-2013.

ORGANIC TO GREEN

THE MARK CONSISTS OF STANDARD CHARACTERS WITHOUT CLAIM TO ANY PARTICULAR FONT, STYLE, SIZE, OR COLOR.

FOR ORGANIC BEAUTY CREAMS FOR BODY CARE; ORGANIC BODY SCRUB; ORGANIC BUBBLE BATH; ORGANIC COSMETIC PREPARATIONS FOR BATH AND SHOWER; ORGANIC COSMETIC SUNSCREEN PREPARATIONS; ORGANIC FACE AND BODY BEAUTY CREAMS; ORGANIC FACIAL SCRUBS; ORGANIC HAIR SHAMPOOS AND CONDITIONERS; ORGANIC LIQUID SOAPS (U.S. CLS. 1, 4, 6, 50, 51 AND 52).  
FIRST USE 1-0-2009; IN COMMERCE 1-0-2009.

KIM MONINGHOFF, EXAMINING ATTORNEY

**CLASS 3—(Continued).**

SN 86-104,934. PAULA'S CHOICE, LLC, RENTON, WA.  
FILED 10-29-2013.

PC4  
MEN

NO CLAIM IS MADE TO THE EXCLUSIVE RIGHT TO USE "MEN", APART FROM THE MARK AS SHOWN.

THE MARK CONSISTS OF THE LETTERS "PC" AND THE NUMBER "4" ATOP THE WORD "MEN".

FOR SKIN CARE PREPARATIONS, NAMELY, AFTER SHAVE CREAMS, LOTIONS AND GELS, AFTER SHAVE HEALING LOTIONS, EYE CREAMS AND GELS, FACE CREAMS, GELS AND LOTIONS, FACIAL EXFOLIATING SCRUBS, FACIAL MOISTURIZERS, FACIAL SOAPS, FACIAL GEL AND CREAM CLEANSERS FACIAL TONERS, NON-MEDICATED ANTI-WRINKLE CREAMS, LOTIONS AND GELS, NON-MEDICATED SKIN RENEWAL CREAMS, DARK SPOT TREATMENTS, SHAVING FOAMS, CREAMS, LOTIONS AND GELS, SKIN BRONZING CREAMS, LOTIONS AND GELS, AND BLEMISH TOUCH STICK; SUNSCREEN CREAMS AND LOTIONS; LIP BALMS WITH SPF; FACIAL MOISTURIZERS WITH SPF; SPF SUN BLOCK SPRAYS AND TOWELETTES; SHAMPOOS; HAIR CONDITIONERS; HAIR SPRAYS AND HAIR GELS; ANTI-PERSPIRANT DEODORANTS; AFTERSHAVE AND AFTERSHAVE PREPARATIONS (U.S. CLS. 1, 4, 6, 50, 51 AND 52).

PATRICIA EVANKO, EXAMINING ATTORNEY

SN 86-105,012. SHIPMAN ASSOCIATES, INC., DBA THE-BALM, SAN FRANCISCO, CA. FILED 10-29-2013.

MEET MATT(E) HUGHES

THE MARK CONSISTS OF STANDARD CHARACTERS WITHOUT CLAIM TO ANY PARTICULAR FONT, STYLE, SIZE, OR COLOR.

OWNER OF U.S. REG. NOS. 4,097,028 AND 4,318,783.  
THE NAME(S), PORTRAIT(S), AND/OR SIGNATURE(S) SHOWN IN THE MARK DOES NOT IDENTIFY A PARTICULAR LIVING INDIVIDUAL.

FOR COSMETICS; COSMETICS AND MAKE-UP; FACIAL MAKE-UP; LIPSTICK; MAKE-UP (U.S. CLS. 1, 4, 6, 50, 51 AND 52).

VIVIAN MICZNIK FIRST, EXAMINING ATTORNEY

**CLASS 3—(Continued).**

SN 86-110,997. JACQUI & DAVID, INC., DORAL, FL. FILED 11-5-2013.



NO CLAIM IS MADE TO THE EXCLUSIVE RIGHT TO USE "SPRAY", APART FROM THE MARK AS SHOWN.

THE MARK CONSISTS OF THE WORDS "JACQUI & DAVID'S" IN STYLIZED FONT ABOVE THE WORD "LOVE" IN STYLIZED FONT ABOVE THE WORD "SPRAY" IN STYLIZED FONT ABOVE A STYLIZED HEART.

FOR BODY SPRAYS; BODY SPRAY USED AS A FRAGRANCE; BODY MIST; PERFUMES AND COLOGNES; NON-MEDICATED SKIN CARE CREAM AND LOTIONS; NON-MEDICATED SKIN CARE PREPARATION; BODY CREAMS; BODY BUTTER; BODY LOTIONS; BODY SCRUBS; BODY WASHES; PERFUMING SACHETS; FRAGRANCED BODY CARE PREPARATIONS, NAMELY, BODY SCRUBS (U.S. CLS. 1, 4, 6, 50, 51 AND 52).

RONALD DELGIZZI, EXAMINING ATTORNEY

SN 86-112,704. HENKEL AG & CO. KGAA, DUESSELDORF, FED REP GERMANY, FILED 11-7-2013.

# RELAXERTEC

THE MARK CONSISTS OF STANDARD CHARACTERS WITHOUT CLAIM TO ANY PARTICULAR FONT, STYLE, SIZE, OR COLOR.

FOR HAIR CARE PREPARATIONS; HAIR CLEANING PREPARATIONS; HAIR COLORING PREPARATIONS; HAIR STRAIGHTENING PREPARATIONS; HAIR STYLING PREPARATIONS; HAIR WAVING PREPARATIONS (U.S. CLS. 1, 4, 6, 50, 51 AND 52).

PATRICIA EVANKO, EXAMINING ATTORNEY

**CLASS 3—(Continued).**

SN 86-113,551. HENKEL AG & CO. KGAA, DUESSELDORF, FED REP GERMANY, FILED 11-8-2013.

# LADINE

THE MARK CONSISTS OF STANDARD CHARACTERS WITHOUT CLAIM TO ANY PARTICULAR FONT, STYLE, SIZE, OR COLOR.

FOR HAIR CARE PREPARATIONS; HAIR CLEANING PREPARATIONS; HAIR COLORING PREPARATIONS; HAIR STRAIGHTENING PREPARATIONS; HAIR STYLING PREPARATIONS; HAIR WAVING PREPARATIONS (U.S. CLS. 1, 4, 6, 50, 51 AND 52).

PATRICIA EVANKO, EXAMINING ATTORNEY

SN 86-117,215. 3D INTERNATIONAL LLC, SANTA CLARITA, CA. FILED 11-13-2013.

# 3D

THE MARK CONSISTS OF STANDARD CHARACTERS WITHOUT CLAIM TO ANY PARTICULAR FONT, STYLE, SIZE, OR COLOR.

FOR DEGREASING PREPARATIONS NOT USED IN MANUFACTURING PROCESSES FOR USE ON ENGINES, TIRES, WHEELS, MACHINERY, TOOLS AND FLOORS; SOAPS AND DETERGENTS FOR AUTOMOBILE FINISHED SURFACES; CARPET SHAMPOO; CARPET CLEANER WITH DEODORIZER; UPHOLSTERY CLEANERS FOR AUTOMOBILE CARPETING AND UPHOLSTERY; PREPARATIONS FOR CLEANING, PROTECTING AND PRESERVING VEHICLE SURFACES, NAMELY, VINYL TOPS, CARPETS, UPHOLSTERY, MAGNESIUM WIRE WHEELS AND CHROME SPOKES; GLASS CLEANERS; GUM REMOVER; ADHESIVE REMOVER; TAR REMOVER; AUTOMOBILE INTERIOR AND EXTERIOR DRESSINGS IN THE NATURE OF WIPE-ON PASTES AND AEROSOL SPRAYS USED FOR PROTECTING, CLEANING, RESTORING AND BEAUTIFYING RUBBER, VINYL, AND LEATHER SURFACES; AUTOMOBILE WAX FOR CLEANING, GLAZING, SEALING AND SHINING PAINT, GLASS, METAL, LEATHER, VINYL, PLASTIC, AND WOOD SURFACES; AND GENERAL PURPOSE CLEANING, POLISHING, AND ABRASIVE LIQUIDS AND POWDERS (U.S. CLS. 1, 4, 6, 50, 51 AND 52).

FIRST USE 9-30-1994; IN COMMERCE 9-30-1994.

RUDY R. SINGLETON, EXAMINING ATTORNEY

**CLASS 3—(Continued).**

SN 86-118,290. SPARTAN BRANDS, INC., NEW YORK, NY.  
FILED 11-13-2013.

**CITRACTIVE**

THE MARK CONSISTS OF STANDARD CHARACTERS WITHOUT CLAIM TO ANY PARTICULAR FONT, STYLE, SIZE, OR COLOR.

FOR HAIR CARE PREPARATIONS, NAMELY, SHAMPOOS AND CONDITIONERS, HAIR CREAM, HAIR GEL, HAIR SPRAY; NON-MEDICATED SKIN CARE PREPARATIONS, NAMELY, HAND LOTIONS, FACE AND BODY LOTIONS, SKIN LOTIONS, BODY CREAM, HAND CREAM, SKIN SOAP, BODY WASH FOR HUMANS, FACIAL CLEANSERS, SKIN CLEANSERS, BODY SCRUBS AND FACIAL SCRUBS (U.S. CLS. 1, 4, 6, 50, 51 AND 52).

DOUGLAS LEE, EXAMINING ATTORNEY

**CLASS 3—(Continued).**

SN 86-120,823. CELEB LLC, FORT LAUDERDALE, FL.  
FILED 11-16-2013.

**HAIR PRODUCT JUNKIE**

THE MARK CONSISTS OF STANDARD CHARACTERS WITHOUT CLAIM TO ANY PARTICULAR FONT, STYLE, SIZE, OR COLOR.

NO CLAIM IS MADE TO THE EXCLUSIVE RIGHT TO USE "HAIR PRODUCT", APART FROM THE MARK AS SHOWN.

FOR BLEACHING PREPARATIONS FOR THE HAIR; COLOR-REMOVING PREPARATIONS FOR HAIR; HAIR BLEACH; HAIR CARE CREAMS; HAIR CARE PREPARATIONS; HAIR COLOR; HAIR DYE; HAIR GEL; HAIR LOTION; HAIR MOUSSE; HAIR POMADES; HAIR RELAXERS; HAIR SHAMPOOS AND CONDITIONERS; HAIR SPRAYS; HAIR STRAIGHTENING PREPARATIONS; HAIR STYLING PREPARATIONS; HAIR TONIC; PERMANENT WAVE PREPARATIONS (U.S. CLS. 1, 4, 6, 50, 51 AND 52).

GINA HAYES, EXAMINING ATTORNEY

SN 86-121,603. HENKEL AG & CO. KGAA, DUESSELDORF,  
FED REP GERMANY, FILED 11-18-2013.

**GLISS**

THE MARK CONSISTS OF STANDARD CHARACTERS WITHOUT CLAIM TO ANY PARTICULAR FONT, STYLE, SIZE, OR COLOR.

OWNER OF U.S. REG. NO. 3,249,822.

FOR HAIR CARE PREPARATIONS; HAIR COLORING PREPARATIONS; HAIR STYLING PREPARATIONS (U.S. CLS. 1, 4, 6, 50, 51 AND 52).

PATRICIA EVANKO, EXAMINING ATTORNEY

SN 86-120,153. TRI-COASTAL DESIGN GROUP, INC.,  
WHARTON, NJ. FILED 11-15-2013.

**SUMMER BLOSSOM**

THE MARK CONSISTS OF STANDARD CHARACTERS WITHOUT CLAIM TO ANY PARTICULAR FONT, STYLE, SIZE, OR COLOR.

OWNER OF U.S. REG. NOS. 4,400,999 AND 4,437,737.

FOR BATH GEL; BATH SALTS; BATH SOAPS; BODY CREAM; BODY LOTION; BODY OIL; BODY SCRUB; BODY SPRAYS; BUBBLE BATH; DUSTING POWDER; FOOT SCRUBS; LIP BALM; LIP GLOSS; LIQUID SOAP (U.S. CLS. 1, 4, 6, 50, 51 AND 52).

JULIE GUTTADAURO, EXAMINING ATTORNEY

SN 86-129,276. DOLLAR SHAVE CLUB, INC., VENICE, CA.  
FILED 11-26-2013.

**BIG CLOUD**

THE MARK CONSISTS OF STANDARD CHARACTERS WITHOUT CLAIM TO ANY PARTICULAR FONT, STYLE, SIZE, OR COLOR.

FOR SKIN, FACE, HAND, FEET, AND BODY MOISTURIZERS (U.S. CLS. 1, 4, 6, 50, 51 AND 52).

ESTHER A. BORSUK, EXAMINING ATTORNEY



**CLASS 3—(Continued).**

SN 86-136,114. HENKEL AG & CO. KGAA, DUESSELDORF, AZ. FILED 12-5-2013.

# DIADEM

THE MARK CONSISTS OF STANDARD CHARACTERS WITHOUT CLAIM TO ANY PARTICULAR FONT, STYLE, SIZE, OR COLOR.

OWNER OF ERPN CMNTY TM OFC REG. NO. 1618412, DATED 11-12-2001, EXPIRES 4-19-2020.

FOR HAIR CARE PREPARATIONS; HAIR COLORING PREPARATIONS; HAIR STYLING PREPARATIONS (U.S. CLS. 1, 4, 6, 50, 51 AND 52).

PATRICIA EVANKO, EXAMINING ATTORNEY

**CLASS 4—(Continued).**

SN 85-848,086. DYM ENERGY INC., CELINA, TX. FILED 2-12-2013.

# dym energy, inc., DYME, DYM ENERGY CORP.

THE MARK CONSISTS OF STANDARD CHARACTERS WITHOUT CLAIM TO ANY PARTICULAR FONT, STYLE, SIZE, OR COLOR.

NO CLAIM IS MADE TO THE EXCLUSIVE RIGHT TO USE "ENERGY INC." AND "ENERGY CORP.", APART FROM THE MARK AS SHOWN.

FOR CRUDE OIL; NATURAL GAS (U.S. CLS. 1, 6 AND 15).

RONALD MCMORROW, EXAMINING ATTORNEY

SN 86-138,448. COTY US LLC, NEW YORK, NY. FILED 12-9-2013.

# CONTAGIOUS

THE MARK CONSISTS OF STANDARD CHARACTERS WITHOUT CLAIM TO ANY PARTICULAR FONT, STYLE, SIZE, OR COLOR.

FOR PERFUMERY, COSMETICS, ESSENTIAL OILS (U.S. CLS. 1, 4, 6, 50, 51 AND 52).

ALEX KEAM, EXAMINING ATTORNEY

SN 85-852,028. SHORT, BONNIE J. DBA CONTEMPO FLAME, PORTLAND, OR. AND CAVALERI, ALYSSA S. DBA CONTEMPO FLAME, PORTLAND, OR. FILED 2-16-2013.

# Contempo Flame

THE MARK CONSISTS OF STANDARD CHARACTERS WITHOUT CLAIM TO ANY PARTICULAR FONT, STYLE, SIZE, OR COLOR.

OWNER OF U.S. REG. NO. 4,438,402.

NO CLAIM IS MADE TO THE EXCLUSIVE RIGHT TO USE "FLAME", APART FROM THE MARK AS SHOWN.

FOR ALCOHOL AND MIXED ALCOHOL FUEL; ETHANOL FUELS; FOSSIL FUEL SUBSTITUTES, NAMELY, BIOFUELS; FUELS; FUELS FROM BIOLOGICAL SOURCES; FUELS WITH AN ALCOHOLIC BASE; RENEWABLE FUELS; SOLID FUELS (U.S. CLS. 1, 6 AND 15).

FIRST USE 3-1-2012; IN COMMERCE 3-1-2012.

SKYE YOUNG, EXAMINING ATTORNEY

**CLASS 4—LUBRICANTS AND FUELS**

SN 76-713,555. GLIPTONE MANUFACTURING, INC., ROKKOMA, NY. FILED 2-22-2013.

# BODY LUBE

THE MARK CONSISTS OF STANDARD CHARACTERS WITHOUT CLAIM TO ANY PARTICULAR FONT, STYLE, SIZE, OR COLOR.

NO CLAIM IS MADE TO THE EXCLUSIVE RIGHT TO USE "LUBE", APART FROM THE MARK AS SHOWN.

FOR ALL PURPOSE SPRAY LUBRICANTS; ALL-PURPOSE SPRAY LUBRICANT THAT CONTAINS A GLOSS ENHANCER (U.S. CLS. 1, 6 AND 15).

FIRST USE 9-1-2012; IN COMMERCE 9-1-2012.

KIM SAITO, EXAMINING ATTORNEY

SN 86-020,940. TYSHKEVYCH, OLEKSII, KHERSON, UKRAINE, FILED 7-26-2013.

# kazmunaygaz

THE MARK CONSISTS OF STANDARD CHARACTERS WITHOUT CLAIM TO ANY PARTICULAR FONT, STYLE, SIZE, OR COLOR.

FOR CRUDE OIL, NATURAL GAS, COAL GAS (U.S. CLS. 1, 6 AND 15).

ANTHONY RINKER, EXAMINING ATTORNEY

**CLASS 4—(Continued).**

SN 86-039,883. ESPINOSA, STEVEN D, YUCAIPA, CA. FILED 8-16-2013.

**Craftsman Candlelight**

THE MARK CONSISTS OF STANDARD CHARACTERS WITHOUT CLAIM TO ANY PARTICULAR FONT, STYLE, SIZE, OR COLOR.

NO CLAIM IS MADE TO THE EXCLUSIVE RIGHT TO USE "CANDLELIGHT", APART FROM THE MARK AS SHOWN.

FOR CANDLES (U.S. CLS. 1, 6 AND 15).  
ANDREW LEASER, EXAMINING ATTORNEY

SN 86-040,091. POMA HOLDING COMPANY, INC., BLOOMINGTON, CA. FILED 8-16-2013.

**PRIME PERFORMANCE**

THE MARK CONSISTS OF STANDARD CHARACTERS WITHOUT CLAIM TO ANY PARTICULAR FONT, STYLE, SIZE, OR COLOR.

NO CLAIM IS MADE TO THE EXCLUSIVE RIGHT TO USE "PERFORMANCE", APART FROM THE MARK AS SHOWN.

FOR AUTOMOBILE LUBRICANTS; AUTOMOTIVE ENGINE OILS; AUTOMOTIVE GREASES; AUTOMOTIVE LUBRICANTS; DIESEL OIL; ENGINE OILS; GEAR OILS; HEAVY OILS; HYDRAULIC OILS; INDUSTRIAL AND VEHICULAR LUBRICANTS; LUBRICATING OILS FOR MOTOR VEHICLE ENGINES; MOTOR OILS (U.S. CLS. 1, 6 AND 15).

JAMES LOVELACE, EXAMINING ATTORNEY

SN 86-043,432. WATERS, JESSICA M, ENCINITAS, CA. AND PUDA, JUSTIN J, ENCINITAS, CA. AND WATERS, HWEI-FEN L, OCEANSIDE, CA. FILED 8-20-2013.



THE MARK COMPRISES THE WORDING "EARTHLITE" WITH A STYLIZED FLAME IN A CIRCLE TO THE LEFT.

FOR AROMATHERAPY FRAGRANCE CANDLES; CANDLE-MAKING KITS; CANDLES; CANDLES CONTAINING INSECT REPELLENT; CANDLES FOR LIGHTING; SCENTED CANDLES; TEA LIGHT CANDLES; VOTIVE CANDLES; WAX FOR MAKING CANDLES (U.S. CLS. 1, 6 AND 15).

FIRST USE 4-24-2013; IN COMMERCE 6-21-2013.  
KAPIL BHANOT, EXAMINING ATTORNEY

**CLASS 4—(Continued).**

SN 86-062,165. CANDLE LAMP COMPANY, LLC, DBA STERNOCANDLELAMP, CORONA, CA. FILED 9-11-2013.

**ECOCHOICE**

THE MARK CONSISTS OF STANDARD CHARACTERS WITHOUT CLAIM TO ANY PARTICULAR FONT, STYLE, SIZE, OR COLOR.

FOR TABLE LIGHTING PRODUCTS, NAMELY, CANDLES; LIGHTING FUEL; WAX CARTRIDGES FOR USE AS A FUEL IN LIGHTING FIXTURES; CHAFING DISH FUEL; LIQUID AND SOLID FUEL PRIMARILY COMPOSED OF ALCOHOL FOR WARMING FOOD (U.S. CLS. 1, 6 AND 15).

SUSAN RICHARDS, EXAMINING ATTORNEY

SN 86-063,758. OEMETA CHEMISCHE WERKE GMBH, D-25436 UETERSEN, FED REP GERMANY, FILED 9-13-2013.

**OEMETA THE COO!ANT COMPANY**

THE MARK CONSISTS OF STANDARD CHARACTERS WITHOUT CLAIM TO ANY PARTICULAR FONT, STYLE, SIZE, OR COLOR.

OWNER OF U.S. REG. NO. 2,592,593.

NO CLAIM IS MADE TO THE EXCLUSIVE RIGHT TO USE "THE COOLANT COMPANY", APART FROM THE MARK AS SHOWN.

FOR INDUSTRIAL OILS AND GREASES; INDUSTRIAL LUBRICANTS; METAL PROCESSING FLUIDS, NAMELY, MULTI-PURPOSE HYDRAULIC, SPINDLE, LUBRICATING, AND INDUSTRIAL OILS; AND COOLING LUBRICANTS AND OILS, NAMELY, WATER SOLUBLE COOLING LUBRICANTS AND OILS, GRINDING FLUIDS, DRILLING OILS, GRINDING OILS, AND CUTTING OILS (U.S. CLS. 1, 6 AND 15).

DARRYL SPRUILL, EXAMINING ATTORNEY

SN 86-065,768. AMERICAN REFINING GROUP, INC., WEST CONSHOHOCKEN, PA. FILED 9-16-2013.



THE MARK CONSISTS OF STANDARD CHARACTERS WITHOUT CLAIM TO ANY PARTICULAR FONT, STYLE, SIZE, OR COLOR.

FOR INDUSTRIAL LUBRICANTS; PARAFFIN WAX; CHEMICALS FOR USE IN INDUSTRY, NAMELY, WAX EMULSIONS (U.S. CLS. 1, 6 AND 15).

WANDA KAY PRICE, EXAMINING ATTORNEY

**CLASS 4—(Continued).**

SN 86-071,135. RAMIREZ, MARIAN I, VALINDA, CA. AND RAMIREZ, MARIA J, BALDWIN PARK, CA. FILED 9-21-2013.

**CANDLES BY THREE**

THE MARK CONSISTS OF STANDARD CHARACTERS WITHOUT CLAIM TO ANY PARTICULAR FONT, STYLE, SIZE, OR COLOR.

FOR CANDLES; PERFUMED CANDLES; SCENTED CANDLES (U.S. CLS. 1, 6 AND 15).

JAMES A. RAUEN, EXAMINING ATTORNEY

SN 86-072,211. FIREPOINT PRODUCTS, INC., ORLANDO, FL. FILED 9-23-2013.



THE MARK CONSISTS OF AN FIREFLY OUTLINE WITH THE STYLIZED TEXT "FIRE" AND "FLY" WRITTEN ON EACH WING. "FIRE" IS ON THE LEFT WING, AND "FLY" IS ON THE RIGHT WING.

FOR SOLID FIRE STARTERS (U.S. CLS. 1, 6 AND 15). SIDDHARTH JAGANNATHAN, EXAMINING ATTORNEY

SN 86-086,191. EXXON MOBIL CORPORATION, IRVING, TX. FILED 10-8-2013.

**MOBILTRANS**

THE MARK CONSISTS OF STANDARD CHARACTERS WITHOUT CLAIM TO ANY PARTICULAR FONT, STYLE, SIZE, OR COLOR.

OWNER OF U.S. REG. NOS. 337,002, 1,588,477 AND OTHERS.

FOR LUBRICATING OILS AND GREASES (U.S. CLS. 1, 6 AND 15).

FIRST USE 12-31-1986; IN COMMERCE 12-31-1986.

SOPHIA S. KIM, EXAMINING ATTORNEY

**CLASS 4—(Continued).**

SN 86-088,415. FASTENAL IP COMPANY, WINONA, MN. FILED 10-10-2013.

**FMT**

THE MARK CONSISTS OF STANDARD CHARACTERS WITHOUT CLAIM TO ANY PARTICULAR FONT, STYLE, SIZE, OR COLOR.

OWNER OF U.S. REG. NOS. 4,084,023 AND 4,365,335.

FOR INDUSTRIAL AND VEHICULAR LUBRICANTS, NAMELY, OILS AND GREASES; CUTTING FLUIDS, NAMELY, WAY OIL; ALL-PURPOSE LUBRICANTS, NAMELY, OILS AND GREASES; CUTTING AND DRILLING LUBRICANTS, NAMELY, OILS AND GREASES (U.S. CLS. 1, 6 AND 15).

APRIL REEVES, EXAMINING ATTORNEY

SN 86-092,279. MARTIN OPERATING PARTNERSHIP L.P., DBA MARTIN LUBRICANTS, KILGORE, TX. FILED 10-15-2013.

**TRUE-FLO**

THE MARK CONSISTS OF STANDARD CHARACTERS WITHOUT CLAIM TO ANY PARTICULAR FONT, STYLE, SIZE, OR COLOR.

OWNER OF U.S. REG. NO. 2,724,890.

FOR HYDRAULIC OILS (U.S. CLS. 1, 6 AND 15).

FIRST USE 0-0-2000; IN COMMERCE 0-0-2000.

SAIMA MAKHDOOM, EXAMINING ATTORNEY

SN 86-113,289. GREAT AMERICAN OPPORTUNITIES, INC., NASHVILLE, TN. FILED 11-8-2013.

**TAYLOR'S CANDLE VILLAGE**

THE MARK CONSISTS OF STANDARD CHARACTERS WITHOUT CLAIM TO ANY PARTICULAR FONT, STYLE, SIZE, OR COLOR.

NO CLAIM IS MADE TO THE EXCLUSIVE RIGHT TO USE "CANDLE", APART FROM THE MARK AS SHOWN.

THE NAME(S), PORTRAIT(S), AND/OR SIGNATURE(S) SHOWN IN THE MARK DOES NOT IDENTIFY A PARTICULAR LIVING INDIVIDUAL.

FOR CANDLES (U.S. CLS. 1, 6 AND 15).

NELSON SNYDER, EXAMINING ATTORNEY

**CLASS 5—PHARMACEUTICALS**

SN 76-714,366. MEAD JOHNSON & COMPANY, LLC, GLENVIEW, IL. FILED 6-11-2013.

**PHENYL-FREE**

THE MARK CONSISTS OF STANDARD CHARACTERS WITHOUT CLAIM TO ANY PARTICULAR FONT, STYLE, SIZE, OR COLOR.

OWNER OF U.S. REG. NO. 1,260,352.  
SEC. 2(F).

FOR DIETETIC FOODS, NAMELY, POWDERED MILK SUBSTITUTE ADAPTED FOR MEDICAL USE BY INFANTS AND CHILDREN WITH PHENYLKETONURIA AND WHICH DOES NOT CONTAIN PHENYLALANINE (U.S. CLS. 6, 18, 44, 46, 51 AND 52).

FIRST USE 11-21-1978; IN COMMERCE 11-21-1978.  
ROGER T. MCDORMAN, EXAMINING ATTORNEY

SN 77-728,487. ENZYMEDICA, PORT CHARLOTTE, FL. FILED 5-4-2009.

**Vital Life Nutrition**

THE MARK CONSISTS OF STANDARD CHARACTERS WITHOUT CLAIM TO ANY PARTICULAR FONT, STYLE, SIZE, OR COLOR.

NO CLAIM IS MADE TO THE EXCLUSIVE RIGHT TO USE "NUTRITION", APART FROM THE MARK AS SHOWN.

FOR DIETARY AND NUTRITIONAL SUPPLEMENTS (U.S. CLS. 6, 18, 44, 46, 51 AND 52).

MARK SHINER, EXAMINING ATTORNEY

SN 78-699,958. 1590520 ONTARIO LIMITED, OTTAWA, CANADA, FILED 8-24-2005.

**THE FUEL**

THE MARK CONSISTS OF STANDARD CHARACTERS WITHOUT CLAIM TO ANY PARTICULAR FONT, STYLE, SIZE, OR COLOR.

PRIORITY CLAIMED UNDER SEC. 44(D) ON CANADA APPLICATION NO. 1269697, FILED 8-23-2005.

FOR NUTRITIONALLY FORTIFIED WATER (U.S. CLS. 6, 18, 44, 46, 51 AND 52).

GRETTA YAO, EXAMINING ATTORNEY

**CLASS 5—(Continued).**

SN 79-128,350. BASILEA PHARMACEUTICA AG, BASEL, SWITZERLAND, FILED 3-13-2013.

**KAREEJ**

THE MARK CONSISTS OF STANDARD CHARACTERS WITHOUT CLAIM TO ANY PARTICULAR FONT, STYLE, SIZE, OR COLOR.

OWNER OF INTERNATIONAL REGISTRATION 1155659 DATED 3-13-2013, EXPIRES 3-13-2023.

FOR PHARMACEUTICAL PREPARATIONS AND SUBSTANCES FOR THE TREATMENT OF INFECTIOUS DISEASES, FOR THE TREATMENT OF DERMATOLOGICAL DISORDERS, FOR THE TREATMENT OF ONCOLOGICAL DISEASES, FOR THE TREATMENT OF GASTROINTESTINAL DISEASES, FOR THE TREATMENT OF NEUROLOGICAL DISEASES, FOR THE TREATMENT OF CARDIOVASCULAR DISEASES, AND FOR THE TREATMENT OF GYNECOLOGICAL DISEASES (U.S. CLS. 6, 18, 44, 46, 51 AND 52).

APRIL ROACH, EXAMINING ATTORNEY

SN 79-132,014. ISIGNY - SAINTE MERE, FRANCE, FILED 4-22-2013.



PRIORITY DATE OF 3-26-2013 IS CLAIMED.

OWNER OF INTERNATIONAL REGISTRATION 1165183 DATED 4-22-2013, EXPIRES 4-22-2023.

OWNER OF U.S. REG. NOS. 2,718,501, 3,119,060 AND 3,302,745.

NO CLAIM IS MADE TO THE EXCLUSIVE RIGHT TO USE "ISIGNY", APART FROM THE MARK AS SHOWN.

THE COLOR(S) BLUE, BROWN AND WHITE IS/ARE CLAIMED AS A FEATURE OF THE MARK.

THE MARK CONSISTS OF THE STYLIZED WORDING "ISIGNY STE MÈRE" IN BLUE AND WHITE LETTERING WITH A BLUE AND WHITE DESIGN OF A DAIRY MAID RIDING A DONKEY CARRYING MILK CANS IN A CRATE WITH A BROWN AND WHITE TREE AND FENCE DESIGN IN THE BACKGROUND. THE COLOR BROWN ALSO APPEARS IN THE CURVED LINES ABOVE AND BELOW THE WORDING IN THE MARK. THE COLOR BLUE ALSO APPEARS IN A CURVED LINE LOCATED BELOW THE BROWN CURVED LINE UNDER THE WORDING IN THE MARK.

THE ENGLISH TRANSLATION OF "STE MÈRE" IS "HOLY MOTHER".

FOR FOOD FOR BABIES; HUMAN BREAST MILKS AND POWDERED MILKS FOR BABIES; LACTEAL FLOUR FOR BABIES; MEDICATED OILS AND POWDERS FOR BABIES (U.S. CLS. 6, 18, 44, 46, 51 AND 52).

NATALIE POLZER, EXAMINING ATTORNEY

**CLASS 5—(Continued).**

SN 85-252,627. THE NUTRACEUTICAL MEDICINE COMPANY INC., DUNCAN, BC, CANADA, FILED 2-26-2011.

# IMMUNE7

THE MARK CONSISTS OF STANDARD CHARACTERS WITHOUT CLAIM TO ANY PARTICULAR FONT, STYLE, SIZE, OR COLOR.

PRIORITY CLAIMED UNDER SEC. 44(D) ON CANADA APPLICATION NO. 1515724, FILED 2-17-2011, REG. NO. TMA864447, DATED 11-6-2013, EXPIRES 11-6-2028.

FOR NUTRACEUTICALS, NAMELY, AN IMMUNE SUPPORT NUTRITIONAL SUPPLEMENT IN CAPSULE, TABLET OR POWDER FORM CONTAINING PLANT EXTRACTS (U.S. CLS. 6, 18, 44, 46, 51 AND 52).

ANNE E. GUSTASON, EXAMINING ATTORNEY

**CLASS 5—(Continued).**

SN 85-570,613. SIX DIMENSIONS, INC., MAYFIELD, KY. FILED 3-15-2012.

# THINCICLE

THE MARK CONSISTS OF STANDARD CHARACTERS WITHOUT CLAIM TO ANY PARTICULAR FONT, STYLE, SIZE, OR COLOR.

FOR NUTRITIONAL SUPPLEMENTS IN THE FORM OF FROZEN ICE POPS (U.S. CLS. 6, 18, 44, 46, 51 AND 52).

AMY KERTGATE, EXAMINING ATTORNEY

SN 85-276,075. PROTEOTECH INC., KIRKLAND, WA. FILED 3-24-2011.

# Cognitive Advantage

THE MARK CONSISTS OF STANDARD CHARACTERS WITHOUT CLAIM TO ANY PARTICULAR FONT, STYLE, SIZE, OR COLOR.

FOR DIETARY AND NUTRITIONAL SUPPLEMENTS (U.S. CLS. 6, 18, 44, 46, 51 AND 52).

MAYUR VAGHANI, EXAMINING ATTORNEY

SN 85-672,135. FERRARI, RAYMOND JOHN, DBA PAIUTE INVESTMENTS, AUBURN, CA. FILED 7-9-2012.

# Grains4Life

# ZEN RELIEF BALM

THE MARK CONSISTS OF STANDARD CHARACTERS WITHOUT CLAIM TO ANY PARTICULAR FONT, STYLE, SIZE, OR COLOR.

OWNER OF U.S. REG. NO. 3,730,990.

NO CLAIM IS MADE TO THE EXCLUSIVE RIGHT TO USE "RELIEF BALM", APART FROM THE MARK AS SHOWN.

FOR PHARMACEUTICAL PREPARATIONS, NAMELY, TOPICAL ANALGESICS FOR ACHEs AND PAINS DUE TO SPORTS INJURIES, ARTHRITIS, AND MUSCLE PAINS (U.S. CLS. 6, 18, 44, 46, 51 AND 52).

DARRYL SPRUILL, EXAMINING ATTORNEY

THE MARK CONSISTS OF STANDARD CHARACTERS WITHOUT CLAIM TO ANY PARTICULAR FONT, STYLE, SIZE, OR COLOR.

FOR WHEAT-FREE AND GLUTEN-FREE PASTA, PIZZA, BREAD, COOKIES, BUNS, CRACKERS, AND MUFFINS FOR THE TREATMENT OF SPECIAL MEDICAL AND HEALTH CONDITIONS (U.S. CLS. 6, 18, 44, 46, 51 AND 52).

CORY BOONE, EXAMINING ATTORNEY

**CLASS 5—(Continued).**

SN 85-690,477. INDUS BIOTECH PRIVATE LIMITED, MAHARASHTRA, INDIA, FILED 7-30-2012.



NO CLAIM IS MADE TO THE EXCLUSIVE RIGHT TO USE "BIOTECH" AND "SCIENCE SAFETY EFFICACY", APART FROM THE MARK AS SHOWN.

THE COLOR(S) GREEN, BLACK AND GRAY IS/ARE CLAIMED AS A FEATURE OF THE MARK.

THE MARK CONSISTS OF THE FOLLOWING: THE WORDING "INDUS" IN BLACK, THE WORDING "BIOTECH" IN GREEN AND "SCIENCE" "SAFETY" AND "EFFICACY" IN GRAY WITH A GRAY BULLET POINT BETWEEN "SCIENCE" AND "SAFETY" AND BETWEEN "SAFETY" AND "EFFICACY", AND A DESIGN CONSISTING OF A SERIES OF GREEN OVALS IN A CURVED LINE APPEARS TO THE LEFT OF THE WORDING.

FOR DIETETIC SUBSTANCES ADAPTED FOR MEDICAL USE, NAMELY, DIETARY SUPPLEMENTS, NUTRITIONAL SUPPLEMENTS, MEDICAL FOOD IN THE NATURE OF ENERGY DRINKS, BISCUITS, CHOCOLATES, POWDERS, PASTA, CRACKER, FOOD SUPPLEMENTS FOR CHRONIC DISEASES IN THE NATURE OF DIABETES, HYPERTENSION, AUTOIMMUNE DISEASES, CANCERS, RESPIRATORY DISEASES, RENAL DISORDERS, LIFESTYLE DISEASES IN THE NATURE OF HEART DISEASE, OSTEOPOROSIS, OBESITY, INFECTIOUS DISEASES AND ALLERGIES, AND VETERINARY DISEASES (U.S. CLS. 6, 18, 44, 46, 51 AND 52).

FIRST USE 12-6-2007; IN COMMERCE 12-6-2007.  
APRIL ROACH, EXAMINING ATTORNEY

SN 85-690,494. INDUS BIOTECH PRIVATE LIMITED, MAHARASHTRA, INDIA, FILED 7-30-2012.



NO CLAIM IS MADE TO THE EXCLUSIVE RIGHT TO USE "BIOTECH", APART FROM THE MARK AS SHOWN.

THE COLOR(S) GREEN, BLACK AND GRAY IS/ARE CLAIMED AS A FEATURE OF THE MARK.

THE MARK CONSISTS OF THE WORDING "INDUS" IN BLACK, "BIOTECH" IN GREEN AND "KINDER & GENTLER" IN GRAY. THE WORDING "KINDER & GENTLER" APPEARS UNDERNEATH THE WORDING "INDUS BIOTECH". A DESIGN CONSISTING OF A SERIES OF GREEN OVALS IN A CURVED LINE APPEARS TO THE LEFT OF THE WORDING.

FOR DIETETIC SUBSTANCES ADAPTED FOR MEDICAL USE, NAMELY, DIETARY SUPPLEMENTS, NUTRITIONAL SUPPLEMENTS, MEDICAL FOOD IN THE NATURE OF ENERGY DRINKS, BISCUITS, CHOCOLATES, POWDERS, PASTA, CRACKER, FOOD SUPPLEMENTS FOR CHRONIC DISEASES IN THE NATURE OF DIABETES, HYPERTENSION, AUTOIMMUNE DISEASES, CANCERS, RESPIRATORY DISEASES, RENAL DISORDERS, LIFESTYLE DISEASES IN THE NATURE OF HEART DISEASE, OSTEOPOROSIS, OBESITY, INFECTIOUS DISEASES AND ALLERGIES, AND VETERINARY DISEASES (U.S. CLS. 6, 18, 44, 46, 51 AND 52).

FIRST USE 11-19-2007; IN COMMERCE 11-19-2007.  
APRIL ROACH, EXAMINING ATTORNEY

**CLASS 5—(Continued).**

SN 85-700,891. OLEOSEA SA, 1700 FRIBOURG, SWITZERLAND, FILED 8-10-2012.

## VITALSEA

THE MARK CONSISTS OF STANDARD CHARACTERS WITHOUT CLAIM TO ANY PARTICULAR FONT, STYLE, SIZE, OR COLOR.

FOR FOOD SUPPLEMENTS FOR MEDICAL AND DIETETIC PURPOSES CONTAINING KRILL OIL AND FISH GELATIN; HEALTH FOOD SUPPLEMENTS CONTAINING KRILL OIL AND FISH GELATIN; VITAMIN AND MINERAL FOOD SUPPLEMENTS CONTAINING KRILL OIL AND FISH GELATIN; NUTRITIONAL, DIETARY AND HERBAL SUPPLEMENTS CONTAINING KRILL OIL AND FISH GELATIN; THERMAL WATER FOR MEDICAL PURPOSES; HERBS FOR MEDICINAL PURPOSES CONTAINING KRILL OIL AND FISH GELATIN; VITAMIN PREPARATIONS CONTAINING KRILL OIL AND FISH GELATIN; FOOD SUPPLEMENTS IN THE FORM OF OIL-BASED CAPSULES CONTAINING KRILL OIL AND FISH GELATIN (U.S. CLS. 6, 18, 44, 46, 51 AND 52).

LEE-ANNE BERNS, EXAMINING ATTORNEY

SN 85-732,537. NOVARTIS AG, BASEL, SWITZERLAND, FILED 9-19-2012.

## TREZILENT

THE MARK CONSISTS OF STANDARD CHARACTERS WITHOUT CLAIM TO ANY PARTICULAR FONT, STYLE, SIZE, OR COLOR.

PRIORITY CLAIMED UNDER SEC. 44(D) ON SWITZERLAND APPLICATION NO. 61131/2012, FILED 9-19-2012, REG. NO. 634383, DATED 9-17-2012, EXPIRES 9-17-2022.

FOR (BASED ON INTENT TO USE) ANTI-INFLAMMATORIES; ANTIBACTERIAL PHARMACEUTICALS; ANTIBIOTICS; ANTIFUNGAL PREPARATIONS; ANTIVIRALS; CARDIOVASCULAR PHARMACEUTICALS; PHARMACEUTICAL PREPARATIONS ACTING ON THE CENTRAL NERVOUS SYSTEM; PHARMACEUTICAL PREPARATIONS AND SUBSTANCES FOR THE TREATMENT OF GASTRO-INTESTINAL DISEASES; PHARMACEUTICAL PREPARATIONS FOR THE TREATMENT AND PREVENTION OF DISEASES AND DISORDERS OF THE AUTOIMMUNE SYSTEM, THE METABOLIC SYSTEM, THE MUSCULO-SKELETAL SYSTEM AND THE GENITOURINARY SYSTEM; PHARMACEUTICAL PREPARATIONS FOR USE IN HEMATOLOGY AND IN TISSUE AND ORGAN TRANSPLANTATION; PHARMACEUTICAL PREPARATIONS FOR THE TREATMENT OF EYE DISEASES AND CONDITIONS; PHARMACEUTICAL PREPARATIONS FOR THE TREATMENT OF HEART RHYTHM DISORDERS; PHARMACEUTICAL PREPARATIONS FOR THE TREATMENT OF IMMUNE SYSTEM RELATED DISEASES AND DISORDERS; PHARMACEUTICAL PREPARATIONS FOR THE TREATMENT OF KIDNEY DISEASES; PHARMACEUTICAL PREPARATIONS FOR TREATING DIABETES; PHARMACEUTICAL PREPARATIONS FOR USE IN DERMATOLOGY; PHARMACEUTICAL PRODUCTS FOR OPHTHALMOLOGICAL USE; PHARMACEUTICAL PRODUCTS FOR THE PREVENTION AND TREATMENT OF CANCER; PHARMACEUTICAL PRODUCTS FOR THE TREATMENT OF BONE DISEASES; PHARMACEUTICAL PRODUCTS FOR

**CLASS 5—(Continued).**

TREATING RESPIRATORY DISEASES; PHARMACEUTICAL PRODUCTS FOR TREATING RESPIRATORY DISEASES AND ASTHMA; PHARMACEUTICALS, NAMELY, ANTI-INFECTIVES(BASED ON 44(D) PRIORITY APPLICATION) ANTI-INFLAMMATORIES; ANTI-BACTERIAL PHARMACEUTICALS; ANTIBIOTICS; ANTIFUNGAL PREPARATIONS; ANTIVIRALS; CARDIOVASCULAR PHARMACEUTICALS; PHARMACEUTICAL PREPARATIONS ACTING ON THE CENTRAL NERVOUS SYSTEM; PHARMACEUTICAL PREPARATIONS AND SUBSTANCES FOR THE TREATMENT OF GASTRO-INTESTINAL DISEASES; PHARMACEUTICAL PREPARATIONS FOR THE TREATMENT AND PREVENTION OF DISEASES AND DISORDERS OF THE AUTOIMMUNE SYSTEM, THE METABOLIC SYSTEM, THE MUSCULO-SKELETAL SYSTEM AND THE GENITOURINARY SYSTEM; PHARMACEUTICAL PREPARATIONS FOR USE IN HEMATOLOGY AND IN TISSUE AND ORGAN TRANSPLANTATION; PHARMACEUTICAL PREPARATIONS FOR THE TREATMENT OF EYE DISEASES AND CONDITIONS; PHARMACEUTICAL PREPARATIONS FOR THE TREATMENT OF HEART RHYTHM DISORDERS; PHARMACEUTICAL PREPARATIONS FOR THE TREATMENT OF IMMUNE SYSTEM RELATED DISEASES AND DISORDERS; PHARMACEUTICAL PREPARATIONS FOR THE TREATMENT OF KIDNEY DISEASES; PHARMACEUTICAL PREPARATIONS FOR TREATING DIABETES; PHARMACEUTICAL PREPARATIONS FOR USE IN DERMATOLOGY; PHARMACEUTICAL PRODUCTS FOR OPHTHALMOLOGICAL USE; PHARMACEUTICAL PRODUCTS FOR THE PREVENTION AND TREATMENT OF CANCER; PHARMACEUTICAL PRODUCTS FOR THE TREATMENT OF BONE DISEASES; PHARMACEUTICAL PRODUCTS FOR TREATING RESPIRATORY DISEASES; PHARMACEUTICAL PRODUCTS FOR TREATING RESPIRATORY DISEASES AND ASTHMA; PHARMACEUTICALS, NAMELY, ANTI-INFECTIVES (U.S. CLS. 6, 18, 44, 46, 51 AND 52).

DOMINIC J. FERRAIUOLO, EXAMINING ATTORNEY

SN 85-763,419. VINTEK NUTRITION, LLC, SIOUX FALLS, SD. FILED 10-25-2012.



OWNER OF U.S. REG. NO. 4,220,603.

NO CLAIM IS MADE TO THE EXCLUSIVE RIGHT TO USE "NUTRITION, LLC", APART FROM THE MARK AS SHOWN.

THE COLOR(S) DARK BLUE AND GREEN IS/ARE CLAIMED AS A FEATURE OF THE MARK.

THE MARK CONSISTS OF A DNA DOUBLE HELIX FRAMED BY THE SHAPE OF A LEAF WITH FOUR WAVEY LEAF-LIKE DESIGNS APPEARING VERTICALLY AND FOUR HORIZONTAL BARS IN BETWEEN, ALL ALTERNATING DARK BLUE AND GREEN. TO THE RIGHT OF THE DESIGN IS THE WORD "VINTEK" IN DARK BLUE AND THE WORDING "NUTRITION, LLC" IN GREEN.

FOR DIETARY SUPPLEMENTS FOR HUMAN CONSUMPTION; DIETARY SUPPLEMENTS FOR PETS; DIETARY SUPPLEMENTS FOR DIABETIC DOGS; FOOD SUPPLEMENTS FOR HEALTHY SKIN AND COAT FOR DOGS; NUTRACEUTICALS FOR USE AS A DIETARY SUPPLEMENT FOR DIABETIC HUMANS; NUTRITIONAL SUPPLEMENT FOR ELIMINATING TOXINS FROM THE BODY; NUTRITIONAL SUPPLEMENTS FOR BOOSTING ENERGY IN DOGS (U.S. CLS. 6, 18, 44, 46, 51 AND 52).

FIRST USE 8-26-2011; IN COMMERCE 8-26-2011.

NORA BUCHANAN WILL, EXAMINING ATTORNEY

**CLASS 5—(Continued).**

SN 85-808,243. AMERICAN BIOTECH LABS, LLC, ALPINE, UT. FILED 12-20-2012.

**AMERICAN BIOTECH LABS**

THE MARK CONSISTS OF STANDARD CHARACTERS WITHOUT CLAIM TO ANY PARTICULAR FONT, STYLE, SIZE, OR COLOR.

OWNER OF U.S. REG. NOS. 3,143,731, 3,207,478 AND OTHERS.

NO CLAIM IS MADE TO THE EXCLUSIVE RIGHT TO USE "LABS", APART FROM THE MARK AS SHOWN.

SEC. 2(F).

FOR NATURAL ANTIMICROBIAL PREPARATIONS FOR INTERNAL AND EXTERNAL USE FOR INHIBITING GROWTH OF MICROBES (U.S. CLS. 6, 18, 44, 46, 51 AND 52).

FIRST USE 12-23-2002; IN COMMERCE 1-20-2003.

JESSICA A. POWERS, EXAMINING ATTORNEY

SN 85-843,213. NOVARTIS AG, BASEL, SWITZERLAND, FILED 2-7-2013.

**FILREVVY**

THE MARK CONSISTS OF STANDARD CHARACTERS WITHOUT CLAIM TO ANY PARTICULAR FONT, STYLE, SIZE, OR COLOR.

FOR PHARMACEUTICAL PREPARATIONS FOR THE PREVENTION AND TREATMENT OF DISORDERS OF THE NERVOUS SYSTEM, THE IMMUNE SYSTEM, THE CARDIOVASCULAR SYSTEM, THE RESPIRATORY SYSTEM, THE MUSCULOSKELETAL SYSTEM AND THE GENITOURINARY SYSTEM; PHARMACEUTICAL PREPARATIONS FOR THE TREATMENT OF INFLAMMATORY DISORDERS; PHARMACEUTICAL PREPARATIONS FOR USE IN DERMATOLOGY, HEMATOLOGY AND ONCOLOGY; PHARMACEUTICAL PREPARATIONS FOR USE IN TRANSPLANTATION; PHARMACEUTICAL PREPARATIONS FOR USE IN OPHTHALMOLOGY; PHARMACEUTICAL PREPARATIONS FOR USE IN THE GASTROENTEROLOGICAL AREAS AND FOR THE PREVENTION AND TREATMENT OF OCULAR DISORDERS OR DISEASES; PHARMACEUTICAL PREPARATIONS, NAMELY, ANTI-INFECTIVES; PHARMACEUTICAL PREPARATIONS FOR TREATING BACTERIAL-BASED DISEASES; PHARMACEUTICAL PREPARATIONS, NAMELY, ANTIVIRALS, ANTIBIOTICS AND ANTIFUNGALS (U.S. CLS. 6, 18, 44, 46, 51 AND 52).

CHARLES L. JENKINS, EXAMINING ATTORNEY

**CLASS 5—(Continued).**

SN 85-844,775. NORDIC GROUP B.V., HOOFDDORP, NETHERLANDS, FILED 2-8-2013.

# NORDIC

THE MARK CONSISTS OF STANDARD CHARACTERS WITHOUT CLAIM TO ANY PARTICULAR FONT, STYLE, SIZE, OR COLOR.

OWNER OF ERPN CMNTY TM OFC REG. NO. 002745354, DATED 6-29-2006, EXPIRES 6-26-2022.

FOR PHARMACEUTICAL PREPARATIONS FOR THE TREATMENT OF GASTROINTESTINAL DISEASES, CARDIOVASCULAR DISEASES, PAIN TREATMENT, ANTI-INFECTIOUS DISEASES, RESPIRATORY DISEASES, DIABETES, ALLERGIC REACTIONS, MENIERE'S DISEASE, DISEASES ASSOCIATED WITH THE IMMUNE SYSTEM AND PHARMACEUTICAL PREPARATIONS FOR USE IN GYNECOLOGY AND OBSTETRICS, FOR USE IN HAEMATOLOGY AND FOR USE IN ONCOLOGY (U.S. CLS. 6, 18, 44, 46, 51 AND 52).

DAVID TOOLEY, EXAMINING ATTORNEY

**CLASS 5—(Continued).**

SN 85-850,957. JOHNSON & JOHNSON, NEW BRUNSWICK, NJ, FILED 2-15-2013.

# OPEN UP

THE MARK CONSISTS OF STANDARD CHARACTERS WITHOUT CLAIM TO ANY PARTICULAR FONT, STYLE, SIZE, OR COLOR.

FOR PHARMACEUTICAL PREPARATIONS FOR THE TREATMENT OF CONGESTION, COUGHS, COLDS, AND ALLERGIES (U.S. CLS. 6, 18, 44, 46, 51 AND 52).

FIRST USE 10-4-2013; IN COMMERCE 10-4-2013.

TASHIA BUNCH, EXAMINING ATTORNEY

SN 85-852,932. REGENERATION WORLDWIDE COMPANY INC., PANAMA CITY, PANAMA, FILED 2-18-2013.

SN 85-844,789. NORDIC GROUP B.V., HOOFDDORP, NETHERLANDS, FILED 2-8-2013.

# NORDIC



OWNER OF ERPN CMNTY TM OFC REG. NO. 002745271, DATED 5-16-2006, EXPIRES 6-26-2022.

THE COLOR(S) BLACK AND GREEN IS/ARE CLAIMED AS A FEATURE OF THE MARK.

THE MARK CONSISTS OF THE TERM "NORDIC" IN BLACK WITH A GREEN RECTANGULAR SHAPE TO THE RIGHT OF THE TERM.

FOR PHARMACEUTICAL PREPARATIONS FOR THE TREATMENT OF GASTROINTESTINAL DISEASES, CARDIOVASCULAR DISEASES, PAIN TREATMENT, ANTI-INFECTIOUS DISEASES, RESPIRATORY DISEASES, DIABETES, ALLERGIC REACTIONS, MENIERE'S DISEASE, DISEASES ASSOCIATED WITH THE IMMUNE SYSTEM AND PHARMACEUTICAL PREPARATIONS FOR USE IN GYNECOLOGY AND OBSTETRICS, FOR USE IN HAEMATOLOGY AND FOR USE IN ONCOLOGY (U.S. CLS. 6, 18, 44, 46, 51 AND 52).

DAVID TOOLEY, EXAMINING ATTORNEY

# REHEALTH

THE MARK CONSISTS OF STANDARD CHARACTERS WITHOUT CLAIM TO ANY PARTICULAR FONT, STYLE, SIZE, OR COLOR.

FOR ADHESIVE TISSUE IN THE NATURE OF MEDICAL ADHESIVES FOR BINDING INTERNAL TISSUE; BIOLOGICAL PREPARATIONS FOR THE TREATMENT OF INFECTIOUS, AUTO-IMMUNE, CELL-PROLIFERATIVE, INFLAMMATORY, METABOLIC, CARDIOVASCULAR, RESPIRATORY, NEUROLOGICAL, JOINT DISORDERS, AND MUSCULOSKELETAL DISORDERS AND DISEASES; BIOLOGICAL PREPARATIONS FOR MEDICAL USE FOR THE TREATMENT OF INFECTIOUS, AUTO-IMMUNE, CELL-PROLIFERATIVE, INFLAMMATORY, METABOLIC, CARDIOVASCULAR, RESPIRATORY, NEUROLOGICAL, JOINT DISORDERS, AND MUSCULOSKELETAL DISORDERS AND DISEASES; STEM CELLS FOR MEDICAL OR VETERINARY USE; STEM CELLS FOR MEDICAL USE; CULTURED CELLS FOR MEDICAL USE; CELLS FOR MEDICAL OR CLINICAL USE; MEDICATED DERMATOLOGICAL PREPARATIONS FOR BODY AND BEAUTY CARE; GENE THERAPY PRODUCTS, NAMELY, GENETICALLY ENGINEERED TISSUES FOR TRANSPLANT PURPOSES; LIVE TISSUE FOR SURGICAL TRANSPLANTATIONS OF BLOOD PLASMA AND BLOOD PRODUCTS FOR MEDICAL USE; BLOOD PLASMA; BLOOD FOR MEDICAL PURPOSES (U.S. CLS. 6, 18, 44, 46, 51 AND 52).

AMY KERTGATE, EXAMINING ATTORNEY



**CLASS 5—(Continued).**

SN 85-853,680. RESTORES SCIENCE HEALTH SUPPLEMENTS, LLC, BIG SPRING, TX. FILED 2-19-2013.

**CLASS 5—(Continued).**

SN 85-860,004. NOVARTIS AG, BASEL, SWITZERLAND, FILED 2-26-2013.

# ProsCure

THE MARK CONSISTS OF STANDARD CHARACTERS WITHOUT CLAIM TO ANY PARTICULAR FONT, STYLE, SIZE, OR COLOR.

FOR DIETARY AND NUTRITIONAL SUPPLEMENTS; SUPPOSITORIES (U.S. CLS. 6, 18, 44, 46, 51 AND 52).  
FIRST USE 2-18-2013; IN COMMERCE 2-18-2013.  
SHAILA LEWIS, EXAMINING ATTORNEY

# XIRPLENI

---

SN 85-855,967. MAX ZELLER SOHNE AKTIENGESELLSCHAFT, ROMANSHORN, SWITZERLAND, FILED 2-21-2013.

# PETZELL

THE MARK CONSISTS OF STANDARD CHARACTERS WITHOUT CLAIM TO ANY PARTICULAR FONT, STYLE, SIZE, OR COLOR.

FOR ALLERGY CAPSULES; ALLERGY MEDICATIONS; ALLERGY RELIEF MEDICATION; ALLERGY TABLETS; DIETARY SUPPLEMENTS; PLANT EXTRACTS FOR MEDICAL, VETERINARY AND PHARMACEUTICAL PURPOSES (U.S. CLS. 6, 18, 44, 46, 51 AND 52).

MICHAEL ENGEL, EXAMINING ATTORNEY

THE MARK CONSISTS OF STANDARD CHARACTERS WITHOUT CLAIM TO ANY PARTICULAR FONT, STYLE, SIZE, OR COLOR.

FOR PHARMACEUTICAL PREPARATIONS FOR HUMAN USE FOR THE PREVENTION AND TREATMENT OF DISORDERS OF THE NERVOUS SYSTEM, THE IMMUNE SYSTEM, THE CARDIOVASCULAR SYSTEM, THE RESPIRATORY SYSTEM, THE MUSCULOSKELETAL SYSTEM AND THE GENITOURINARY SYSTEM; PHARMACEUTICAL PREPARATIONS FOR HUMAN USE FOR THE TREATMENT OF INFLAMMATORY DISORDERS; PHARMACEUTICAL PREPARATIONS FOR HUMAN USE FOR USE IN DERMATOLOGY, HEMATOLOGY AND ONCOLOGY; PHARMACEUTICAL PREPARATIONS FOR HUMAN USE FOR USE IN TRANSPLANTATION; PHARMACEUTICAL PREPARATIONS FOR HUMAN USE FOR USE IN OPHTHALMOLOGY; PHARMACEUTICAL PREPARATIONS FOR HUMAN USE FOR USE IN THE GASTROENTEROLOGICAL AREAS AND FOR THE PREVENTION AND TREATMENT OF OCULAR DISORDERS OR DISEASES; PHARMACEUTICAL PREPARATIONS FOR HUMAN USE, NAMELY, ANTI-INFECTIVES; PHARMACEUTICAL PREPARATIONS FOR TREATING BACTERIAL-BASED DISEASES; PHARMACEUTICAL PREPARATIONS FOR HUMAN USE, NAMELY, ANTIVIRALS, ANTIBIOTICS AND ANTIFUNGALS (U.S. CLS. 6, 18, 44, 46, 51 AND 52).

RON FAIRBANKS, EXAMINING ATTORNEY

**CLASS 5—(Continued).**

SN 85-860,007. NOVARTIS AG, BASEL, SWITZERLAND, FILED 2-26-2013.

# ZIRPLENI

THE MARK CONSISTS OF STANDARD CHARACTERS WITHOUT CLAIM TO ANY PARTICULAR FONT, STYLE, SIZE, OR COLOR.

FOR PHARMACEUTICAL PREPARATIONS FOR HUMAN USE FOR THE PREVENTION AND TREATMENT OF DISORDERS OF THE NERVOUS SYSTEM, THE IMMUNE SYSTEM, THE CARDIOVASCULAR SYSTEM, THE RESPIRATORY SYSTEM, THE MUSCULOSKELETAL SYSTEM AND THE GENITOURINARY SYSTEM; PHARMACEUTICAL PREPARATIONS FOR HUMAN USE FOR THE TREATMENT OF INFLAMMATORY DISORDERS; PHARMACEUTICAL PREPARATIONS FOR HUMAN USE FOR USE IN DERMATOLOGY, HEMATOLOGY AND ONCOLOGY; PHARMACEUTICAL PREPARATIONS FOR HUMAN USE FOR USE IN TRANSPLANTATION; PHARMACEUTICAL PREPARATIONS FOR HUMAN USE FOR USE IN OPHTHALMOLOGY; PHARMACEUTICAL PREPARATIONS FOR HUMAN USE FOR USE IN THE GASTROENTEROLOGICAL AREAS AND FOR THE PREVENTION AND TREATMENT OF OCULAR DISORDERS OR DISEASES; PHARMACEUTICAL PREPARATIONS FOR HUMAN USE, NAMELY, ANTI-INFECTIVES; PHARMACEUTICAL PREPARATIONS FOR TREATING BACTERIAL-BASED DISEASES; PHARMACEUTICAL PREPARATIONS FOR HUMAN USE, NAMELY, ANTIVIRALS, ANTIBIOTICS AND ANTIFUNGALS (U.S. CLS. 6, 18, 44, 46, 51 AND 52).

RON FAIRBANKS, EXAMINING ATTORNEY

SN 85-860,549. BATH & BODY WORKS BRAND MANAGEMENT, INC., REYNOLDSBURG, OH. FILED 2-26-2013.



THE MARK CONSISTS OF A CONFIGURATION OF A BOTTLE DESIGN, IN THE SHAPE OF A TRAPEZOID WITH FOUR SIDES, ROUNDED CORNERS, AND WITH THE TOP NARROWER THAN THE BOTTOM. THE CAP ON THE TOP OF THE BOTTLE IS NOT CLAIMED AS A FEATURE OF THE MARK.

SEC. 2(F).

FOR ANTIBACTERIAL ALCOHOL SKIN SANITIZER GEL; HAND-SANITIZING PREPARATIONS (U.S. CLS. 6, 18, 44, 46, 51 AND 52).

FIRST USE 7-0-2008; IN COMMERCE 7-0-2008.

MICHAEL ENGEL, EXAMINING ATTORNEY

**CLASS 5—(Continued).**

SN 85-860,906. CASPIA MANAGEMENT LTD IRELAND, DUBLIN, IRELAND, FILED 2-26-2013.

# PREFUNC

THE MARK CONSISTS OF STANDARD CHARACTERS WITHOUT CLAIM TO ANY PARTICULAR FONT, STYLE, SIZE, OR COLOR.

FOR DIETARY AND NUTRITIONAL SUPPLEMENTS (U.S. CLS. 6, 18, 44, 46, 51 AND 52).

FIRST USE 12-26-2012; IN COMMERCE 12-26-2012.

MARK SHINER, EXAMINING ATTORNEY

SN 85-864,154. ELI LILLY AND COMPANY, INDIANAPOLIS, IN. FILED 3-1-2013.

# ZINLISTIQ

THE MARK CONSISTS OF STANDARD CHARACTERS WITHOUT CLAIM TO ANY PARTICULAR FONT, STYLE, SIZE, OR COLOR.

FOR PHARMACEUTICAL PREPARATIONS FOR THE TREATMENT OF ALCOHOL USE DISORDERS, ALZHEIMER'S ANXIETY DISORDERS, ATHEROSCLEROSIS, AUTOIMMUNE DISEASES AND DISORDERS, BLOOD DISORDERS, BONE AND SKELETAL DISEASES AND DISORDERS; PHARMACEUTICAL PREPARATIONS FOR THE TREATMENT OF CANCER, CARDIOVASCULAR DISEASES, CENTRAL NERVOUS SYSTEM DISEASES AND DISORDERS, CHOLESTEROL DISORDERS, CYSTIC FIBROSIS, DEMENTIA, DERMATOLOGICAL DISEASES AND DISORDERS; PHARMACEUTICAL PREPARATIONS FOR THE TREATMENT OF DIABETES, DYSLIPIDEMIA, ENDOCRINE DISEASES AND DISORDERS, GASTROINTESTINAL DISEASES AND DISORDERS, HORMONAL DISEASES AND DISORDERS; PHARMACEUTICAL PREPARATIONS FOR THE TREATMENT OF INFLAMMATION AND INFLAMMATORY DISEASES AND DISORDERS, KIDNEY DISEASES AND DISORDERS, LIVER DISEASES AND DISORDERS, METABOLIC DISEASES AND DISORDERS, MIGRAINES; PHARMACEUTICAL PREPARATIONS FOR THE TREATMENT OF MUSCLE DISEASES AND DISORDERS, NEURODEGENERATIVE DISEASES AND DISORDERS, NEUROLOGICAL DISORDERS, PAIN, PANCREATIC DISEASES AND DISORDERS, PSYCHIATRIC DISORDERS; PHARMACEUTICAL PREPARATIONS FOR THE TREATMENT OF REPRODUCTIVE SYSTEM DISEASES AND DISORDERS, SLEEP DISORDERS AND UROLOGICAL DISORDERS; ANTIDEPRESSANTS (U.S. CLS. 6, 18, 44, 46, 51 AND 52).

BERYL GARDNER, EXAMINING ATTORNEY

**CLASS 5—(Continued).**

SN 85-866,109. ELI LILLY AND COMPANY, INDIANAPOLIS, IN. FILED 3-4-2013.

# ENTUZITY

THE MARK CONSISTS OF STANDARD CHARACTERS WITHOUT CLAIM TO ANY PARTICULAR FONT, STYLE, SIZE, OR COLOR.

FOR PHARMACEUTICAL PREPARATIONS FOR THE TREATMENT OF ALCOHOL USE DISORDERS, ALZHEIMER'S, ANXIETY DISORDERS, ATHEROSCLEROSIS, AUTOIMMUNE DISEASES AND DISORDERS, BLOOD DISORDERS AND BONE AND SKELETAL DISEASES AND DISORDERS; PHARMACEUTICAL PREPARATIONS FOR THE TREATMENT OF CANCER, CARDIOVASCULAR DISEASES, CENTRAL NERVOUS SYSTEM DISEASES AND DISORDERS, CHOLESTEROL DISORDERS, CYSTIC FIBROSIS, DEMENTIA AND DERMATOLOGICAL DISEASES AND DISORDERS; PHARMACEUTICAL PREPARATIONS FOR THE TREATMENT OF DIABETES, DYSLIPIDEMIA, ENDOCRINE DISEASES AND DISORDERS, GASTROINTESTINAL DISEASES AND DISORDERS AND HORMONAL DISEASES AND DISORDERS; PHARMACEUTICAL PREPARATIONS FOR THE TREATMENT OF INFLAMMATION AND INFLAMMATORY DISEASES AND DISORDERS, KIDNEY DISEASES AND DISORDERS, LIVER DISEASES AND DISORDERS, METABOLIC DISEASES AND DISORDERS AND MIGRAINES; PHARMACEUTICAL PREPARATIONS FOR THE TREATMENT OF MUSCLE DISEASES AND DISORDERS, NEURODEGENERATIVE DISEASES AND DISORDERS, NEUROLOGICAL DISORDERS, PAIN, PANCREATIC DISEASES AND DISORDERS AND PSYCHIATRIC DISORDERS; PHARMACEUTICAL PREPARATIONS FOR THE TREATMENT OF REPRODUCTIVE SYSTEM DISEASES AND DISORDERS, SLEEP DISORDERS AND UROLOGICAL DISORDERS; ANTIDEPRESSANTS (U.S. CLS. 6, 18, 44, 46, 51 AND 52).

BERYL GARDNER, EXAMINING ATTORNEY

SN 85-870,338. ANSUN BIOPHARMA, INC., SAN DIEGO, CA. FILED 3-7-2013.

# ANSUN BIOPHARMA

THE MARK CONSISTS OF STANDARD CHARACTERS WITHOUT CLAIM TO ANY PARTICULAR FONT, STYLE, SIZE, OR COLOR.

NO CLAIM IS MADE TO THE EXCLUSIVE RIGHT TO USE "BIOPHARMA", APART FROM THE MARK AS SHOWN.

FOR PHARMACEUTICAL PREPARATIONS FOR THE TREATMENT OF ALLERGIES, CANCER, CARDIOVASCULAR DISORDERS, DERMATOLOGICAL DISORDERS, DIABETES, ENDOCRINE DISORDERS, GASTROINTESTINAL DISORDERS, HYPERTENSION, IMMUNOLOGICAL DISORDERS, INFECTIOUS DISEASES, INFLAMMATION, INFLAMMATORY DISEASES, MIGRAINES, OBESITY, PAIN, RENAL DISORDERS, RESPIRATORY DISEASES, SEPSIS, STROKE, VIRAL DISORDERS (U.S. CLS. 6, 18, 44, 46, 51 AND 52).

JANET LEE, EXAMINING ATTORNEY

**CLASS 5—(Continued).**

SN 85-870,539. INSTASHIELD, INC., MIAMI, FL. FILED 3-8-2013.



THE MARK CONSISTS OF THE WORD "COUNTER" TO THE LEFT OF AND SLIGHTLY ABOVE THE WORD "ACT", WHICH IS SUPERIMPOSED OVER AN OVAL SHAPE, WITH AN OVAL BORDER AND POSITIONED ABOVE AN OVAL SHADOW OF ITSELF.

FOR ALL PURPOSE DISINFECTANTS (U.S. CLS. 6, 18, 44, 46, 51 AND 52).

NAKWAMA ANKRAH, EXAMINING ATTORNEY

SN 85-879,640. NOVARTIS AG, BASEL, SWITZERLAND, FILED 3-19-2013.

# CERPLENZI

THE MARK CONSISTS OF STANDARD CHARACTERS WITHOUT CLAIM TO ANY PARTICULAR FONT, STYLE, SIZE, OR COLOR.

FOR PHARMACEUTICAL PREPARATIONS FOR HUMAN USE FOR THE PREVENTION AND TREATMENT OF DISORDERS OF THE NERVOUS SYSTEM, THE IMMUNE SYSTEM, THE CARDIOVASCULAR SYSTEM, THE RESPIRATORY SYSTEM, THE MUSCULOSKELETAL SYSTEM AND THE GENITOURINARY SYSTEM; PHARMACEUTICAL PREPARATIONS FOR HUMAN USE FOR THE TREATMENT OF INFLAMMATORY DISORDERS; PHARMACEUTICAL PREPARATIONS FOR HUMAN USE FOR USE IN DERMATOLOGY, HEMATOLOGY AND ONCOLOGY; PHARMACEUTICAL PREPARATIONS FOR HUMAN USE FOR USE IN TRANSPLANTATION; PHARMACEUTICAL PREPARATIONS FOR HUMAN USE FOR USE IN OPHTHALMOLOGY; PHARMACEUTICAL PREPARATIONS FOR HUMAN USE FOR USE IN THE GASTROENTEROLOGICAL AREAS AND FOR THE PREVENTION AND TREATMENT OF OCULAR DISORDERS OR DISEASES; PHARMACEUTICAL PREPARATIONS FOR HUMAN USE, NAMELY, ANTI-INFECTIVES; PHARMACEUTICAL PREPARATIONS FOR TREATING BACTERIAL-BASED DISEASES; PHARMACEUTICAL PREPARATIONS FOR HUMAN USE, NAMELY, ANTIVIRALS, ANTIBIOTICS AND ANTIFUNGALS (U.S. CLS. 6, 18, 44, 46, 51 AND 52).

RON FAIRBANKS, EXAMINING ATTORNEY

**CLASS 5—(Continued).**

SN 85-884,135. DURVET, INC., BLUE SPRINGS, MO. FILED 3-22-2013.

# CAT VAX 3

THE MARK CONSISTS OF STANDARD CHARACTERS WITHOUT CLAIM TO ANY PARTICULAR FONT, STYLE, SIZE, OR COLOR.

NO CLAIM IS MADE TO THE EXCLUSIVE RIGHT TO USE "CAT VAX", APART FROM THE MARK AS SHOWN.

FOR VETERINARY MEDICATIONS, NAMELY, VACCINES (U.S. CLS. 6, 18, 44, 46, 51 AND 52).

FIRST USE 3-15-2013; IN COMMERCE 3-15-2013.  
ERNEST SHOSHO, EXAMINING ATTORNEY

SN 85-908,557. KELLY, ANGELA M, MANHATTAN BEACH, CA. FILED 4-18-2013.

# Nutrivation Powered by Nutrition Driven by Innovation

THE MARK CONSISTS OF STANDARD CHARACTERS WITHOUT CLAIM TO ANY PARTICULAR FONT, STYLE, SIZE, OR COLOR.

FOR DIETARY AND NUTRITIONAL SUPPLEMENTS (U.S. CLS. 6, 18, 44, 46, 51 AND 52).

PAM WILLIS, EXAMINING ATTORNEY

SN 85-930,305. TOTAL NUTRITION, INC., FARMINGDALE, NY. FILED 5-13-2013.

# TNVITAMINS

THE MARK CONSISTS OF STANDARD CHARACTERS WITHOUT CLAIM TO ANY PARTICULAR FONT, STYLE, SIZE, OR COLOR.

FOR DIETARY AND NUTRITIONAL SUPPLEMENTS CONTAINING VITAMINS; DIETARY SUPPLEMENTS FOR PETS CONTAINING VITAMINS; HERBAL SUPPLEMENTS CONTAINING VITAMINS; VITAMIN AND MINERAL SUPPLEMENTS CONTAINING VITAMINS; VITAMIN OILS FOR HUMAN CONSUMPTION (U.S. CLS. 6, 18, 44, 46, 51 AND 52).

FIRST USE 9-1-2005; IN COMMERCE 9-1-2005.  
B. PARADEWELAI, EXAMINING ATTORNEY

**CLASS 5—(Continued).**

SN 85-930,916. ALLERGEN RESEARCH CORPORATION, MENLO PARK, CA. FILED 5-13-2013.



NO CLAIM IS MADE TO THE EXCLUSIVE RIGHT TO USE "ALLERGEN RESEARCH CORPORATION", APART FROM THE MARK AS SHOWN.

THE MARK CONSISTS OF ONE CURVED LINE APPEARING BETWEEN THE WORDS "ARC" IN THE LOWER LEFT HAND CORNER AND "ALLERGEN RESEARCH CORPORATION" STACKED VERTICALLY IN THE UPPER RIGHT HAND CORNER.

FOR ORAL IMMUNOTHERAPY PRODUCTS, NAMELY, PHARMACEUTICAL PREPARATIONS FOR THE TREATMENT OF FOOD ALLERGIES, AND FOR THE DIAGNOSIS AND VERIFICATION OF FOOD ALLERGIES (U.S. CLS. 6, 18, 44, 46, 51 AND 52).

CHRISTOPHER LAW, EXAMINING ATTORNEY

SN 85-950,373. INVADO PHARMACEUTICALS, LLC, CHICAGO, IL. FILED 6-4-2013.

# NeutraGel

THE MARK CONSISTS OF STANDARD CHARACTERS WITHOUT CLAIM TO ANY PARTICULAR FONT, STYLE, SIZE, OR COLOR.

FOR PHARMACEUTICAL PREPARATIONS FOR THE TREATMENT OF ORAL INJURY, ORAL TRAUMA, ORAL INFLAMMATION OR ORAL PAIN (U.S. CLS. 6, 18, 44, 46, 51 AND 52).

JONATHAN FALK, EXAMINING ATTORNEY

SN 85-953,206. BWISE, LLC, DBA BWISE, LLC, RICHMOND, VA. FILED 6-6-2013.



THE COLOR(S) ORANGE, GREEN, YELLOW AND BROWN IS/ARE CLAIMED AS A FEATURE OF THE MARK.

THE MARK CONSISTS OF LOWER CASE "B", "W" SHAPED AS A BUTTERFLY, UPPERCASE LETTERS "I", "S", AND "E". THE "B" IS ORANGE, THE BUTTERFLY ("W") IS BROWN, GREEN, YELLOW, AND ORANGE. THE "I", "S", AND "E" ARE BROWN.

FOR VITAMIN ENRICHED SPARKLING WATER; VITAMIN ENRICHED WATER (U.S. CLS. 6, 18, 44, 46, 51 AND 52).

NELSON SNYDER, EXAMINING ATTORNEY

**CLASS 5—(Continued).**

SN 85-953,455. HENRY THAYER COMPANY, WESTPORT, CT. FILED 6-7-2013.



THE MARK CONSISTS OF A HAND HOLDING A LOZENGE, A CAPITAL LETTER "T" APPEARS ON THE LOZENGE.

FOR THROAT LOZENGES (U.S. CLS. 6, 18, 44, 46, 51 AND 52).

FIRST USE 2-0-1895; IN COMMERCE 9-14-2012.  
RONALD MCMORROW, EXAMINING ATTORNEY

SN 85-970,170. GRENADE (UK) LTD, COVENTRY, WARWICKSHIRE, UNITED KINGDOM, FILED 6-26-2013.

# HYDRA 6

THE MARK CONSISTS OF STANDARD CHARACTERS WITHOUT CLAIM TO ANY PARTICULAR FONT, STYLE, SIZE, OR COLOR.

PRIORITY CLAIMED UNDER SEC. 44(D) ON ERPNTY TM OFC APPLICATION NO. 11927531, FILED 6-24-2013, REG. NO. 011927531, DATED 11-15-2013, EXPIRES 6-24-2023.

FOR DIETARY, HERBAL, AND NUTRITIONAL SUPPLEMENTS; PROTEIN DIETARY SUPPLEMENTS IN POWDER FORM; PROTEIN DIETARY SUPPLEMENT DRINK MIXES FOR SPORTS ENHANCEMENT, PERFORMANCE ENHANCEMENT, MUSCLE BUILDING PURPOSES, WEIGHT MANAGEMENT, WEIGHT LOSS, AND WEIGHT GAIN; NUTRITIONAL SUPPLEMENT DRINKS AND SHAKES; DIETARY FOOD SUPPLEMENTS; DIETARY SUPPLEMENT DRINK MIXES FOR USE AS A MEAL REPLACEMENT; DIETARY SUPPLEMENT DRINK MIXES FOR USE AS A MEAL REPLACEMENT, SPORTS ENHANCEMENT, PERFORMANCE ENHANCEMENT, MUSCLE BUILDING PURPOSES, WEIGHT MANAGEMENT, WEIGHT LOSS, AND WEIGHT GAIN; NUTRITIONAL AND DIETARY SUPPLEMENTS, NAMELY, VITAMINS, MINERALS, AND ANTI OXIDANTS; NUTRITIONAL SUPPLEMENT MEAL REPLACEMENT BARS FOR SPORTS ENHANCEMENT, PERFORMANCE ENHANCEMENT, MUSCLE BUILDING PURPOSES, WEIGHT MANAGEMENT, WEIGHT LOSS, AND WEIGHT GAIN; NUTRITIONAL, FOOD, AND DIETARY SUPPLEMENTS FOR SPORTS ENHANCEMENT AND PERFORMANCE ENHANCEMENT; NUTRITIONAL SUPPLEMENTS AND DIETARY SUPPLEMENTS IN TABLET AND CAPSULE FORM, NAMELY, THERMOGENICS, AND VITAMIN PREPARATIONS; NUTRITIONAL SUPPLEMENTS AND DIETARY SUPPLEMENTS IN TABLET AND CAPSULE FORM FOR WEIGHT LOSS (U.S. CLS. 6, 18, 44, 46, 51 AND 52).

ELIZABETH CHANG, EXAMINING ATTORNEY

**CLASS 5—(Continued).**

SN 86-012,671. LIFE FOODS LLC, HOUSTON, TX. FILED 7-17-2013.

# KOLÉ

THE MARK CONSISTS OF STANDARD CHARACTERS WITHOUT CLAIM TO ANY PARTICULAR FONT, STYLE, SIZE, OR COLOR.

THE ENGLISH TRANSLATION OF "KOLÉ" IN THE MARK IS "CLOSE TOGETHER" WHEN USED IN THE FRENCH CREOLE PHRASE KOLÉ SÈRE.

FOR DIETARY SUPPLEMENT BEVERAGE FOR AIDING SLEEP, IMPROVING COGNITION, OR ENHANCING VITALITY OR MOOD.; DIETARY SUPPLEMENTAL DRINKS IN THE NATURE OF VITAMIN AND MINERAL BEVERAGES; NUTRITIONALLY FORTIFIED BEVERAGES (U.S. CLS. 6, 18, 44, 46, 51 AND 52).

DEZMONA MIZELLE, EXAMINING ATTORNEY

SN 86-014,581. NATIONAL CONCESSIONS GROUP, INC., DENVER, CO. FILED 7-19-2013.



THE MARK CONSISTS OF THE LITERAL ELEMENTS "O.PENVAPE" WRITTEN IN STYLIZED FORM, CONSISTING OF THREE SMALL AND THREE LARGE STYLIZED CIRCLES ON THE LEFT HAND SIDE OF THE LITERAL ELEMENTS. THE LETTER "O" OF THE WORD "O.PENVAPE" IS DEPICTED BY THE IMAGE OF THE BIG CIRCLE IN THE MIDDLE.

FOR TOBACCO-FREE CIGARETTES FOR MEDICAL PURPOSES (U.S. CLS. 6, 18, 44, 46, 51 AND 52).

FIRST USE 10-31-2012; IN COMMERCE 10-31-2012.  
LAURIE KAUFMAN, EXAMINING ATTORNEY

SN 86-014,584. NATIONAL CONCESSIONS GROUP, INC., DENVER, CO. FILED 7-19-2013.

# O.PENVAPE

THE MARK CONSISTS OF STANDARD CHARACTERS WITHOUT CLAIM TO ANY PARTICULAR FONT, STYLE, SIZE, OR COLOR.

FOR TOBACCO-FREE CIGARETTES FOR MEDICAL PURPOSES (U.S. CLS. 6, 18, 44, 46, 51 AND 52).  
FIRST USE 10-31-2012; IN COMMERCE 10-31-2012.  
LAURIE KAUFMAN, EXAMINING ATTORNEY

**CLASS 5—(Continued).**

SN 86-020,418. MEN'S HEALTH FORMULAS LLC, ENCINO, CA. FILED 7-25-2013.

**TESTOSTEREN**

THE MARK CONSISTS OF STANDARD CHARACTERS WITHOUT CLAIM TO ANY PARTICULAR FONT, STYLE, SIZE, OR COLOR.

FOR VITAMIN SUPPLEMENTS (U.S. CLS. 6, 18, 44, 46, 51 AND 52).

FIRST USE 6-6-2013; IN COMMERCE 6-6-2013.

VIVIAN MICZNIK FIRST, EXAMINING ATTORNEY

---

SN 86-020,560. ETUDE SUPPLEMENTS LLC, EDGEFIELD, SC. FILED 7-26-2013.

**Practice Fuel**

THE MARK CONSISTS OF STANDARD CHARACTERS WITHOUT CLAIM TO ANY PARTICULAR FONT, STYLE, SIZE, OR COLOR.

NO CLAIM IS MADE TO THE EXCLUSIVE RIGHT TO USE "FUEL", APART FROM THE MARK AS SHOWN.

FOR NUTRITIONAL SUPPLEMENTS (U.S. CLS. 6, 18, 44, 46, 51 AND 52).

LUCY ARANT, EXAMINING ATTORNEY

---

SN 86-020,667. TRYGG PHARMA, INC., ARLINGTON, VA. FILED 7-26-2013.

**OMTRYG**

THE MARK CONSISTS OF STANDARD CHARACTERS WITHOUT CLAIM TO ANY PARTICULAR FONT, STYLE, SIZE, OR COLOR.

FOR PHARMACEUTICAL PREPARATIONS FOR THE TREATMENT OF CARDIOVASCULAR CONDITIONS (U.S. CLS. 6, 18, 44, 46, 51 AND 52).

DEBORAH MEINERS, EXAMINING ATTORNEY

**CLASS 5—(Continued).**

SN 86-022,505. BIO HUMA NETICS, INC., GILBERT, AZ. FILED 7-29-2013.

**PRO-MAX**

THE MARK CONSISTS OF STANDARD CHARACTERS WITHOUT CLAIM TO ANY PARTICULAR FONT, STYLE, SIZE, OR COLOR.

FOR FUNGICIDE FOR TURF AND ORNAMENTAL USE; FUNGICIDES; FUNGICIDES FOR AGRICULTURAL USE; FUNGICIDES FOR TURF USE; NEMATOCIDES (U.S. CLS. 6, 18, 44, 46, 51 AND 52).

FIRST USE 5-8-2003; IN COMMERCE 5-8-2003.

SUSAN RICHARDS, EXAMINING ATTORNEY

---

SN 86-033,584. S1 BIOPHARMA, INC., JERSEY CITY, NJ. FILED 8-9-2013.

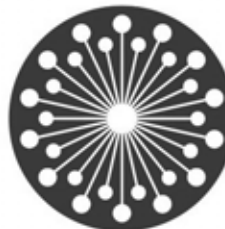

THE MARK CONSISTS OF A CIRCULAR SHAPE FORMED BY LINES WITH CIRCULAR END POINTS, RADIATING FROM A CENTRAL CIRCLE. ALL THE FOREGOING APPEARS ON A CIRCULAR BACKGROUND AND DEPICTS A STYLIZED SCHEMATIC OF THE CENTRAL NERVOUS SYSTEM, WITH BRAIN AT CENTER, RADIAL AXONS, AND DISTAL SYNAPSES.

FOR PHARMACEUTICAL PREPARATIONS FOR THE TREATMENT OF PSYCHIATRIC, COGNITIVE, AND SEXUAL DISORDERS AND DYSFUNCTIONS (U.S. CLS. 6, 18, 44, 46, 51 AND 52).

CHRISTINE MARTIN, EXAMINING ATTORNEY

**CLASS 5—(Continued).**

SN 86-033,915. ASPEN TRANSDERMAL SOLUTIONS, LLC, ASPEN, CO. FILED 8-9-2013.

# Peak Patches

THE MARK CONSISTS OF STANDARD CHARACTERS WITHOUT CLAIM TO ANY PARTICULAR FONT, STYLE, SIZE, OR COLOR.

NO CLAIM IS MADE TO THE EXCLUSIVE RIGHT TO USE "PATCHES", APART FROM THE MARK AS SHOWN.

FOR TRANSDERMAL PATCHES FOR USE IN THE TREATMENT OF ENERGY DEFICIENCY, CAFFEINE, STRESS, HANGOVERS, AND SLEEP DISORDERS (U.S. CLS. 6, 18, 44, 46, 51 AND 52).

FIRST USE 1-25-2013; IN COMMERCE 7-31-2013.  
ARETHA SOMERVILLE, EXAMINING ATTORNEY

**CLASS 5—(Continued).**

SN 86-034,958. MAGEDOFF, ROBERT, BOCA RATON, FL. FILED 8-12-2013.

# Tinnitus Away

THE MARK CONSISTS OF STANDARD CHARACTERS WITHOUT CLAIM TO ANY PARTICULAR FONT, STYLE, SIZE, OR COLOR.

NO CLAIM IS MADE TO THE EXCLUSIVE RIGHT TO USE "TINNITUS", APART FROM THE MARK AS SHOWN.

FOR VITAMINS, NAMELY, A NUTRACEUTICAL FORMULA FOR PEOPLE WHO HAVE TINNITUS (U.S. CLS. 6, 18, 44, 46, 51 AND 52).

RAUL CORDOVA, EXAMINING ATTORNEY

SN 86-034,701. USA EVERGREEN MEDICINE GROUP, SALT LAKE CITY, UT. FILED 8-12-2013.



THE MARK CONSISTS OF THE WORDING "GOODOO" WITH A CURVED LINE AROUND THE WORDING AND TWO STYLIZED FLOWER ON TOP OF THE WORDING.

FOR DIETARY SUPPLEMENTS FOR ANIMALS; DIETETIC FOODS, NAMELY, PASTA, CRACKERS ADAPTED FOR MEDICAL USE; FOOD FOR BABIES; MEDICINAL DRINKS; MINERAL FOOD SUPPLEMENTS; NUTRITIONAL SUPPLEMENTS; NUTRITIONAL SUPPLEMENTS FOR BOOSTING ENERGY, PROMOTING HEALTHY SKIN; NUTRITIONALLY FORTIFIED BEVERAGES; PROPOLIS DIETARY SUPPLEMENTS; PROTEIN DIETARY SUPPLEMENTS (U.S. CLS. 6, 18, 44, 46, 51 AND 52).

FIRST USE 7-2-2012; IN COMMERCE 7-2-2012.  
DANNEAN HETZEL, EXAMINING ATTORNEY

SN 86-035,949. CAO LING, YUEYANG, HUNAN, CHINA, FILED 8-13-2013.



THE MARK CONSISTS OF THE WORDING "DU AI" WITH A DOT BETWEEN "DU" AND "AI". A STYLIZED PARTIAL DESIGN OF A HEART IS ABOVE THE LETTER "I".

FOR BIOCIDES; DEPURATIVES FOR THE BODY; MEDICAL LUBRICANT, NAMELY, VAGINAL LUBRICANTS; MEDICATED MASSAGE OILS; MEDICATED SUN CARE PREPARATIONS; MEDICINAL OILS; NUTRITIONAL SUPPLEMENTS; PERSONAL SEXUAL LUBRICANTS; PHARMACEUTICAL PREPARATIONS, NAMELY, AN ANALGESIC FOR HUMAN CONSUMPTION TAKEN ORALLY; SALINE WASH FOR MEDICAL PURPOSES (U.S. CLS. 6, 18, 44, 46, 51 AND 52).

FIRST USE 1-21-2012; IN COMMERCE 1-21-2012.  
DANNEAN HETZEL, EXAMINING ATTORNEY

**CLASS 5—(Continued).**

SN 86-036,252. KOOL-DOWN, INC., SOUTH DAYTONA, FL. FILED 8-13-2013.

**Bio-Kool**

THE MARK CONSISTS OF STANDARD CHARACTERS WITHOUT CLAIM TO ANY PARTICULAR FONT, STYLE, SIZE, OR COLOR.

FOR BURN RELIEF MEDICATION (U.S. CLS. 6, 18, 44, 46, 51 AND 52).

FIRST USE 2-1-2009; IN COMMERCE 2-1-2009.  
DAWN FELDMAN, EXAMINING ATTORNEY



SN 86-037,013. INTEGRA LABS, LLC., SAN DIEGO, CA. FILED 8-13-2013.

**RDS**

THE MARK CONSISTS OF STANDARD CHARACTERS WITHOUT CLAIM TO ANY PARTICULAR FONT, STYLE, SIZE, OR COLOR.

FOR DIETARY SUPPLEMENTAL DRINKS IN THE NATURE OF VITAMIN AND MINERAL BEVERAGES (U.S. CLS. 6, 18, 44, 46, 51 AND 52).

DORITT L. CARROLL, EXAMINING ATTORNEY



SN 86-037,576. FIRST QUALITY PRODUCTS, INC., GREAT NECK, NY. FILED 8-14-2013.

**BODYCURVE**

THE MARK CONSISTS OF STANDARD CHARACTERS WITHOUT CLAIM TO ANY PARTICULAR FONT, STYLE, SIZE, OR COLOR.

OWNER OF U.S. REG. NO. 4,444,292.  
FOR FEMININE HYGIENE PADS AND PANTILINERS (U.S. CLS. 6, 18, 44, 46, 51 AND 52).

TASHIA BUNCH, EXAMINING ATTORNEY

**CLASS 5—(Continued).**

SN 86-038,760. FIRST QUALITY PRODUCTS, INC., GREAT NECK, NY. FILED 8-15-2013.

**BODYCURVE**

THE MARK CONSISTS OF STANDARD CHARACTERS WITHOUT CLAIM TO ANY PARTICULAR FONT, STYLE, SIZE, OR COLOR.

OWNER OF U.S. REG. NO. 4,444,292.  
FOR DISPOSABLE BABY DIAPERS AND YOUTH TRAINING PANTS; PROTECTIVE TRAINING UNDERWEAR AND BRIEFS; PROTECTIVE INCONTINENCE UNDERWEAR AND BRIEFS (U.S. CLS. 6, 18, 44, 46, 51 AND 52).

TASHIA BUNCH, EXAMINING ATTORNEY



SN 86-039,326. FIA BIOMED GMBH, D-48282 EMSDETTEN, FED REP GERMANY, FILED 8-15-2013.



THE MARK CONSISTS OF A STYLIZED INTERCONNECTED REPRESENTATION OF THE STYLIZED LETTERS "FIA" WITH THE STYLIZED LETTERS "F" AND "I" FORMING AN ARCH CONTOUR CONTAINING A REPRESENTATION OF THE LETTER "A" THEREIN WITH THE ARCH CONTOUR HAVING A POINTED EXTENSION EXTENDING FROM A TOP PORTION OF THE ARCH CONTOUR.

FOR DIAGNOSTIC REAGENTS FOR MEDICINAL USE; CONTROL SOLUTIONS FOR MEDICAL USE USED FOR QUALITY CHECKS ON BLOOD GLUCOSE MONITORS; TEST STRIPS FOR MEASURING BLOOD GLUCOSE LEVELS; MEDICAL DIAGNOSTIC TEST STRIPS FOR USE IN THE FIELD OF DIABETES (U.S. CLS. 6, 18, 44, 46, 51 AND 52).

LEE-ANNE BERNS, EXAMINING ATTORNEY



**CLASS 5—(Continued).**

SN 86-040,054. WTFN, INC., CHATSWORTH, CA. FILED 8-16-2013.

**SPANK ME**

THE MARK CONSISTS OF STANDARD CHARACTERS WITHOUT CLAIM TO ANY PARTICULAR FONT, STYLE, SIZE, OR COLOR.

FOR SKIN AND BODY PREPARATION, NAMELY, NON-MEDICATED SKIN CREAMS, OILS, BALMS AND MISTS FOR ENHANCING SEXUAL AROUSAL; SKIN AND BODY PREPARATION, NAMELY, MEDICATED SKIN CREAMS, OILS, BALMS AND MISTS FOR ENHANCING SEXUAL AROUSAL (U.S. CLS. 6, 18, 44, 46, 51 AND 52).

SEAN CROWLEY, EXAMINING ATTORNEY

SN 86-040,070. WTFN, INC., CHATSWORTH, CA. FILED 8-16-2013.

**TOUCH MYSELF**

THE MARK CONSISTS OF STANDARD CHARACTERS WITHOUT CLAIM TO ANY PARTICULAR FONT, STYLE, SIZE, OR COLOR.

FOR SKIN AND BODY PREPARATION, NAMELY, NON-MEDICATED SKIN CREAMS, OILS, BALMS AND MISTS FOR ENHANCING SEXUAL AROUSAL; SKIN AND BODY PREPARATION, NAMELY, MEDICATED SKIN CREAMS, OILS, BALMS AND MISTS FOR ENHANCING SEXUAL AROUSAL (U.S. CLS. 6, 18, 44, 46, 51 AND 52).

SEAN CROWLEY, EXAMINING ATTORNEY

SN 86-040,685. GUGLIEMELLI, DINO, VALENCIA, CA. FILED 8-16-2013.

**ACUQUIRE ACNECARE**

THE MARK CONSISTS OF STANDARD CHARACTERS WITHOUT CLAIM TO ANY PARTICULAR FONT, STYLE, SIZE, OR COLOR.

NO CLAIM IS MADE TO THE EXCLUSIVE RIGHT TO USE "ACNECARE", APART FROM THE MARK AS SHOWN. FOR ACNE TREATMENT PREPARATIONS (U.S. CLS. 6, 18, 44, 46, 51 AND 52).

JORDAN BAKER, EXAMINING ATTORNEY

**CLASS 5—(Continued).**

SN 86-041,186. BAYER HEALTHCARE ANIMAL HEALTH INC., PITTSBURGH, PA. FILED 8-19-2013.

**ANTHELBAN**

THE MARK CONSISTS OF STANDARD CHARACTERS WITHOUT CLAIM TO ANY PARTICULAR FONT, STYLE, SIZE, OR COLOR.

FOR PARASITICIDAL PREPARATION (U.S. CLS. 6, 18, 44, 46, 51 AND 52).

MARY ROSSMAN, EXAMINING ATTORNEY

SN 86-041,254. RECKITT & COLMAN (OVERSEAS) LIMITED, HULL, ENGLAND, FILED 8-19-2013.

**LYSI-PRO**

THE MARK CONSISTS OF STANDARD CHARACTERS WITHOUT CLAIM TO ANY PARTICULAR FONT, STYLE, SIZE, OR COLOR.

FOR PHARMACEUTICAL PREPARATIONS AND SUBSTANCES, NAMELY, ANALGESIC, ANTI-INFLAMMATORY AND ANTI-PYRETIC PREPARATIONS; PREPARATIONS FOR THE RELIEF OF SYMPTOMS OF COLDS, INFLUENZA AND ALLERGIES (U.S. CLS. 6, 18, 44, 46, 51 AND 52).

SHAVELL MCPHERSON, EXAMINING ATTORNEY

SN 86-041,939. OMNI HERBALS, LLC, ENCINO, CA. FILED 8-19-2013.

**Raspberry Ketone Blast**

THE MARK CONSISTS OF STANDARD CHARACTERS WITHOUT CLAIM TO ANY PARTICULAR FONT, STYLE, SIZE, OR COLOR.

NO CLAIM IS MADE TO THE EXCLUSIVE RIGHT TO USE "RASPBERRY KETONE", APART FROM THE MARK AS SHOWN.

FOR DIETARY AND NUTRITIONAL SUPPLEMENTS CONTAINING RASPBERRY KETONES; DIETARY AND NUTRITIONAL SUPPLEMENTS USED FOR WEIGHT LOSS CONTAINING RASPBERRY KETONES; HERBAL SUPPLEMENTS CONTAINING RASPBERRY KETONES; HERBAL SUPPLEMENTS FOR WEIGHT LOSS CONTAINING RASPBERRY KETONES; NUTRACEUTICALS FOR USE AS A DIETARY SUPPLEMENT CONTAINING RASPBERRY KETONES; NUTRACEUTICALS FOR USE AS A DIETARY SUPPLEMENT FOR WEIGHT LOSS CONTAINING RASPBERRY KETONES; WEIGHT MANAGEMENT SUPPLEMENTS CONTAINING RASPBERRY KETONES (U.S. CLS. 6, 18, 44, 46, 51 AND 52).

FIRST USE 9-4-2012; IN COMMERCE 9-4-2012.

ANGELA M. MICHELI, EXAMINING ATTORNEY

**CLASS 5—(Continued).**

SN 86-042,026. KROMASOL EJECUTIVA INTERNACIONAL, S.A. DE C.V., ZAPOPAN, JALISCO, MEXICO, FILED 8-19-2013.

# ANDROMEDA

THE MARK CONSISTS OF STANDARD CHARACTERS WITHOUT CLAIM TO ANY PARTICULAR FONT, STYLE, SIZE, OR COLOR.

FOR NUTRITIONAL SUPPLEMENTS, DIETARY SUPPLEMENTS; LIQUID AND POWDER NUTRITIONAL SUPPLEMENTS; LIQUID PROTEIN, FIBER, VITAMIN AND MINERAL SUPPLEMENTS (U.S. CLS. 6, 18, 44, 46, 51 AND 52).

TINA BROWN, EXAMINING ATTORNEY

**CLASS 5—(Continued).**

SN 86-043,590. ROTAM AGROCHEM INTERNATIONAL CO. LTD., CHAI WAN, HONG KONG, FILED 8-21-2013.

# TOPEKA

THE MARK CONSISTS OF STANDARD CHARACTERS WITHOUT CLAIM TO ANY PARTICULAR FONT, STYLE, SIZE, OR COLOR.

FOR VETERINARY PREPARATIONS, NAMELY, CHEMICAL REAGENTS FOR VETERINARY PURPOSES; VETERINARY PREPARATIONS, NAMELY, ANTIBIOTICS, PAIN RELIEF MEDICATION, ANTIOXIDANTS, VACCINES, ANIMAL FEED FEATURING TRACE ELEMENTS FOR PREVENTING AND DESTROYING ECTOPARASITES AND ENDOPARASITES AND OTHER INFECTIOUS DISEASES IN FARM ANIMALS AND COMPANION ANIMALS; VETERINARY PREPARATIONS IN THE FORM OF FOOD SUPPLEMENTS FOR ANIMALS, NAMELY, VITAMINS, MINERALS, FIBRES, PROTEIN, CARBOHYDRATES FOR THE TREATMENT OF PARASITES IN LIVESTOCK AND COMPANION ANIMALS; VETERINARY PREPARATIONS IN THE FORM OF ANIMAL FOOD SUPPLEMENTS; VETERINARY PREPARATIONS IN THE FORM OF VITAMIN SUPPLEMENTS FOR ANIMALS; VETERINARY PREPARATIONS IN THE FORM OF VETERINARY HEALTH FOOD SUPPLEMENTS; VETERINARY PREPARATIONS IN THE FORM OF NUTRITIONAL SUPPLEMENTS FOR ANIMALS; NON-MEDICATED FOOD ADDITIVES IN THE NATURE OF DIETARY SUPPLEMENTS FOR ANIMALS; PESTICIDES, INSECTICIDES, HERBICIDES, FUNGICIDES, PARASITICIDES, PREPARATIONS FOR DESTROYING VERMIN (U.S. CLS. 6, 18, 44, 46, 51 AND 52).

KRISTIN DAHLING, EXAMINING ATTORNEY

SN 86-043,012. NUTRI-HEALTH SUPPLEMENTS, L.L.C., COTTONWOOD, AZ. FILED 8-20-2013.



OWNER OF U.S. REG. NOS. 3,267,559 AND 4,084,658. THE MARK CONSISTS OF THE WORDS "SEDONA PRO" AND THE DESIGN OF A PILL AS BACKGROUND.

FOR DIETARY AND NUTRITIONAL SUPPLEMENTS (U.S. CLS. 6, 18, 44, 46, 51 AND 52).

FIRST USE 7-15-2013; IN COMMERCE 7-15-2013.

TINA MAI, EXAMINING ATTORNEY

SN 86-043,671. PLATINUM NATURALS, LTD., RICHMOND HILL, ONTARIO, CANADA, FILED 8-21-2013.

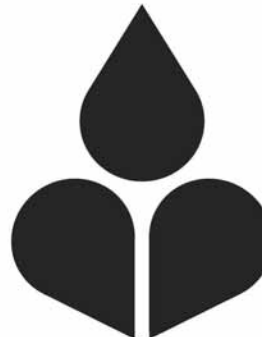

THE MARK CONSISTS OF THREE SOLID TEARDROPS SET IN A TRIANGULAR CONFIGURATION.

FOR VITAMINS; VITAMIN AND MINERAL SUPPLEMENTS; NUTRITIONAL SUPPLEMENTS; MEDICINAL HERBS AND MEDICINAL HERB EXTRACTS (U.S. CLS. 6, 18, 44, 46, 51 AND 52).

DAVID MURRAY, EXAMINING ATTORNEY

**CLASS 5—(Continued).**

SN 86-045,392. NATURAL ORGANICS INC., MELVILLE, NY.  
FILED 8-22-2013.

**CLASS 5—(Continued).**

SN 86-047,467. NEURO LOGICAL NUTRITION, CARY, NC.  
FILED 8-26-2013.

## SPIRU-TEIN PLUS

THE MARK CONSISTS OF STANDARD CHARACTERS WITHOUT CLAIM TO ANY PARTICULAR FONT, STYLE, SIZE, OR COLOR.

OWNER OF U.S. REG. NOS. 1,406,439, 3,106,318 AND OTHERS.

FOR DIETARY DRINK MIX FOR USE AS A MEAL REPLACEMENT (U.S. CLS. 6, 18, 44, 46, 51 AND 52).

FIRST USE 6-20-2001; IN COMMERCE 6-20-2001.  
GINA FINK, EXAMINING ATTORNEY

## Learning Leverage

THE MARK CONSISTS OF STANDARD CHARACTERS WITHOUT CLAIM TO ANY PARTICULAR FONT, STYLE, SIZE, OR COLOR.

NO CLAIM IS MADE TO THE EXCLUSIVE RIGHT TO USE "LEARNING", APART FROM THE MARK AS SHOWN. FOR NUTRITIONAL SUPPLEMENTS FOR LEARNING AND BRAIN DEVELOPMENT (U.S. CLS. 6, 18, 44, 46, 51 AND 52).

ANTHONY RINKER, EXAMINING ATTORNEY

SN 86-045,927. REYES AVILA, LLC, BOSTON, MA. FILED 8-23-2013.

## NOVOANDINA

THE MARK CONSISTS OF STANDARD CHARACTERS WITHOUT CLAIM TO ANY PARTICULAR FONT, STYLE, SIZE, OR COLOR.

THE ENGLISH TRANSLATION OF THE WORD "NOVOANDINA" IN THE MARK IS "NEW ANDEAN".

FOR HERB TEAS FOR MEDICINAL PURPOSES, MEDICINAL TEA, DIETARY SUPPLEMENTS (U.S. CLS. 6, 18, 44, 46, 51 AND 52).

KELLY BOULTON, EXAMINING ATTORNEY

SN 86-047,525. NUTRI-HEALTH SUPPLEMENTS, L.L.C., COTTONWOOD, AZ. FILED 8-26-2013.

SN 86-046,820. NATROL, INC., CHATSWORTH, CA. FILED 8-23-2013.

## TRUBONE COMPLETE

## A Healthy Family

THE MARK CONSISTS OF STANDARD CHARACTERS WITHOUT CLAIM TO ANY PARTICULAR FONT, STYLE, SIZE, OR COLOR.

FOR DIETARY SUPPLEMENTS (U.S. CLS. 6, 18, 44, 46, 51 AND 52).

PARKER HOWARD, EXAMINING ATTORNEY

THE MARK CONSISTS OF STANDARD CHARACTERS WITHOUT CLAIM TO ANY PARTICULAR FONT, STYLE, SIZE, OR COLOR.

NO CLAIM IS MADE TO THE EXCLUSIVE RIGHT TO USE "COMPLETE", APART FROM THE MARK AS SHOWN. FOR DIETARY AND NUTRITIONAL SUPPLEMENTS (U.S. CLS. 6, 18, 44, 46, 51 AND 52).

FIRST USE 1-25-2013; IN COMMERCE 1-25-2013.  
TINA MAI, EXAMINING ATTORNEY

**CLASS 5—(Continued).**

SN 86-049,880. JAREAR DRUGSTORE, LLC, AMMAN, JORDAN, FILED 8-28-2013.

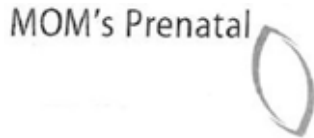

NO CLAIM IS MADE TO THE EXCLUSIVE RIGHT TO USE "PRENATAL", APART FROM THE MARK AS SHOWN. THE MARK CONSISTS OF THE TEXT "MOM'S PRENATAL" NEXT TO A GRAPHIC DESIGN OF A LEAF.

FOR CHEMICAL REAGENTS FOR MEDICAL OR VETERINARY PURPOSES; HEALTH FOOD SUPPLEMENTS; HERBAL SUPPLEMENTS; HERBAL SUPPLEMENTS FOR REDUCING SYMPTOMS OF MORNING SICKNESS AND IMPROVING NOURISHMENT DURING PREGNANCY; HORMONES FOR MEDICAL PURPOSES; MEDICAMENTS FOR REDUCING SYMPTOMS OF MORNING SICKNESS AND IMPROVING NOURISHMENT DURING PREGNANCY; MEDICINAL PREPARATIONS FOR REDUCING SYMPTOMS OF MORNING SICKNESS AND IMPROVING NOURISHMENT DURING PREGNANCY; MINERAL SUPPLEMENTS; NUTRACEUTICALS FOR USE AS A DIETARY SUPPLEMENT FOR REDUCING SYMPTOMS OF MORNING SICKNESS AND IMPROVING NOURISHMENT DURING PREGNANCY; NUTRITIONAL SUPPLEMENTS FOR REDUCING SYMPTOMS OF MORNING SICKNESS AND IMPROVING NOURISHMENT DURING PREGNANCY; PHARMACEUTICAL PREPARATIONS FOR REDUCING SYMPTOMS OF MORNING SICKNESS AND IMPROVING NOURISHMENT DURING PREGNANCY; PLANT EXTRACTS FOR MEDICAL, VETERINARY AND PHARMACEUTICAL PURPOSES; VITAMIN AND MINERAL SUPPLEMENTS (U.S. CLS. 6, 18, 44, 46, 51 AND 52).

FIRST USE 6-15-2013; IN COMMERCE 6-15-2013.  
SUSAN RICHARDS, EXAMINING ATTORNEY

SN 86-051,325. THE HEALTH NETWORK INC, DBA XOOMA WORLDWIDE, HAMPTON, VA. FILED 8-29-2013.



NO CLAIM IS MADE TO THE EXCLUSIVE RIGHT TO USE "CHOCOLATE" AND "MIX", APART FROM THE MARK AS SHOWN.

THE MARK CONSISTS OF THE WORDS "CHOCOLATE FIX MIX" IN STYLIZED LETTERING.

FOR CHOCOLATE POWDER IN THE NATURE OF A DIETARY FOOD SUPPLEMENT (U.S. CLS. 6, 18, 44, 46, 51 AND 52).

FIRST USE 9-9-2013; IN COMMERCE 9-27-2013.  
SUSAN RICHARDS, EXAMINING ATTORNEY

**CLASS 5—(Continued).**

SN 86-058,387. ANNAKIE, DAVID, NEW YORK, NY. FILED 9-6-2013.

# Washout

THE MARK CONSISTS OF STANDARD CHARACTERS WITHOUT CLAIM TO ANY PARTICULAR FONT, STYLE, SIZE, OR COLOR.

FOR DIETARY AND NUTRITIONAL SUPPLEMENTS (U.S. CLS. 6, 18, 44, 46, 51 AND 52).  
SUE LAWRENCE, EXAMINING ATTORNEY

SN 86-058,855. SIMILASAN AG, JONEN, SWITZERLAND, FILED 9-9-2013.



THE COLOR(S) GRAY, GREEN AND WHITE IS/ARE CLAIMED AS A FEATURE OF THE MARK.

THE MARK CONSISTS OF A GRAY SWISS CROSS WITH A GREEN LEAF IN THE UPPER RIGHT HAND QUADRANT FORMED BY THE CROSS, ALL ON A WHITE BACKGROUND.

FOR FULL LINE OF HOMEOPATHIC PHARMACEUTICAL PREPARATIONS (U.S. CLS. 6, 18, 44, 46, 51 AND 52).

JASON TURNER, EXAMINING ATTORNEY

**CLASS 5—(Continued).**

SN 86-061,253. DISCGENICS, INC., SALT LAKE CITY, UT. FILED 9-11-2013.

**DISCGENICS**

THE MARK CONSISTS OF STANDARD CHARACTERS WITHOUT CLAIM TO ANY PARTICULAR FONT, STYLE, SIZE, OR COLOR.

FOR STEM CELLS FOR MEDICAL PURPOSES; BIOLOGICAL TISSUES, NAMELY, STEM CELLS FOR MEDICAL USE; BIOLOGICAL IMPLANTS, NAMELY, BIOLOGICAL IMPLANTS COMPRISING OR DERIVED FROM STEM CELLS OR PROGENITOR CELLS; IMPLANTABLE, INJECTABLE AND OTHER BIOLOGICAL-USE PREPARATIONS COMPRISING OR DERIVED FROM STEM CELLS OR PROGENITOR CELLS FOR MEDICAL PURPOSES (U.S. CLS. 6, 18, 44, 46, 51 AND 52).  
PAUL E. FAHRENKOPF, EXAMINING ATTORNEY

SN 86-061,953. GREEN-LINE DIETARY SUPPLEMENTS AND COSMETICS, CORP., LUTZ, FL. FILED 9-11-2013.

**GREEN-LINE**

THE MARK CONSISTS OF STANDARD CHARACTERS WITHOUT CLAIM TO ANY PARTICULAR FONT, STYLE, SIZE, OR COLOR.

FOR DIETARY AND NUTRITIONAL SUPPLEMENTS (U.S. CLS. 6, 18, 44, 46, 51 AND 52).  
ELI HELLMAN, EXAMINING ATTORNEY

SN 86-062,704. TAMBRANDS, INC., CINCINNATI, OH. FILED 9-12-2013.



THE MARK CONSISTS OF A TAMPON WRAPPED BY A MEASURING TAPE CONTAINING THE WORDING "SLENDERFIT".

FOR TAMPONS (U.S. CLS. 6, 18, 44, 46, 51 AND 52).  
EDWARD NELSON, EXAMINING ATTORNEY

**CLASS 5—(Continued).**

SN 86-063,307. GERMANO, WAYNE, EL PASO, TX. FILED 9-12-2013.

**THE NEW COVER FOR PEOPLE OF COLOR**

THE MARK CONSISTS OF STANDARD CHARACTERS WITHOUT CLAIM TO ANY PARTICULAR FONT, STYLE, SIZE, OR COLOR.

FOR ADHESIVE BANDAGES (U.S. CLS. 6, 18, 44, 46, 51 AND 52).  
SHARON MEIER, EXAMINING ATTORNEY

SN 86-065,143. DOW AGROSCIENCES LLC, INDIANAPOLIS, IN. FILED 9-16-2013.

**PERFECTMATCH**

THE MARK CONSISTS OF STANDARD CHARACTERS WITHOUT CLAIM TO ANY PARTICULAR FONT, STYLE, SIZE, OR COLOR.

FOR PESTICIDES AND PREPARATIONS FOR DESTROYING VERMIN, NAMELY, HERBICIDES, INSECTICIDES AND FUNGICIDES FOR AGRICULTURE, HORTICULTURE, FORESTRY, TURF AND ORNAMENTAL, COMMERCIAL, INDUSTRIAL AND DOMESTIC USE (U.S. CLS. 6, 18, 44, 46, 51 AND 52).  
DOUGLAS LEE, EXAMINING ATTORNEY

SN 86-065,150. MERCK SHARP & DOHME CORP., WHITEHOUSE STATION, NJ. FILED 9-16-2013.

**EQLYMIA**

THE MARK CONSISTS OF STANDARD CHARACTERS WITHOUT CLAIM TO ANY PARTICULAR FONT, STYLE, SIZE, OR COLOR.

FOR PHARMACEUTICAL PREPARATIONS FOR TREATING DIABETES (U.S. CLS. 6, 18, 44, 46, 51 AND 52).  
DOMINIC FATHY, EXAMINING ATTORNEY

**CLASS 5—(Continued).**

SN 86-065,267. ASPEN VETERINARY RESOURCES, LTD., GREELEY, CO. FILED 9-16-2013.

**IMUNO-VAX**

THE MARK CONSISTS OF STANDARD CHARACTERS WITHOUT CLAIM TO ANY PARTICULAR FONT, STYLE, SIZE, OR COLOR.

FOR VETERINARY VACCINES FOR COMPANION ANIMALS AND LIVESTOCK (U.S. CLS. 6, 18, 44, 46, 51 AND 52).

FIRST USE 6-6-2002; IN COMMERCE 6-6-2002.  
RENEE MCCRAY, EXAMINING ATTORNEY

**CLASS 5—(Continued).**

SN 86-065,323. GREAT HEALTHWORKS, INC., HOLLYWOOD, FL. FILED 9-16-2013.

**FocusWorks**

THE MARK CONSISTS OF STANDARD CHARACTERS WITHOUT CLAIM TO ANY PARTICULAR FONT, STYLE, SIZE, OR COLOR.

FOR NUTRITIONAL SUPPLEMENTS FOR IMPROVING MENTAL ALERTNESS (U.S. CLS. 6, 18, 44, 46, 51 AND 52).

JORDAN BAKER, EXAMINING ATTORNEY

SN 86-065,435. FMC CORPORATION, PHILADELPHIA, PA. FILED 9-16-2013.

**STANZA****DigestWorks**

THE MARK CONSISTS OF STANDARD CHARACTERS WITHOUT CLAIM TO ANY PARTICULAR FONT, STYLE, SIZE, OR COLOR.

FOR NUTRITIONAL SUPPLEMENTS FOR PROMOTING DIGESTIVE HEALTH; PROBIOTICS (U.S. CLS. 6, 18, 44, 46, 51 AND 52).

JORDAN BAKER, EXAMINING ATTORNEY

THE MARK CONSISTS OF STANDARD CHARACTERS WITHOUT CLAIM TO ANY PARTICULAR FONT, STYLE, SIZE, OR COLOR.

FOR PREPARATIONS FOR THE DESTRUCTION OF VERMIN AND WEEDS; PESTICIDES; HERBICIDES; AND FUNGICIDES (U.S. CLS. 6, 18, 44, 46, 51 AND 52).

VERNA BETH RIRIE, EXAMINING ATTORNEY

SN 86-065,547. VELIUS, LLC., GREAT NECK, NY. FILED 9-16-2013.

**Bruiseguard**

SN 86-065,322. GREAT HEALTHWORKS, INC., HOLLYWOOD, FL. FILED 9-16-2013.

**HeartWorks**

THE MARK CONSISTS OF STANDARD CHARACTERS WITHOUT CLAIM TO ANY PARTICULAR FONT, STYLE, SIZE, OR COLOR.

FOR NUTRITIONAL SUPPLEMENTS FOR HEART HEALTH (U.S. CLS. 6, 18, 44, 46, 51 AND 52).

JORDAN BAKER, EXAMINING ATTORNEY

THE MARK CONSISTS OF STANDARD CHARACTERS WITHOUT CLAIM TO ANY PARTICULAR FONT, STYLE, SIZE, OR COLOR.

FOR NON-PRESCRIPTION MEDICINES AND PHARMACEUTICAL PREPARATIONS FOR THE TREATMENT OF BRUISES AND REDUCTION OF COLOR OF BRUISES.; NON-PRESCRIPTION MEDICINES AND PHARMACEUTICAL PREPARATIONS, NAMELY, TABLETS FOR THE TREATMENT OF BRUISES AND REDUCTION OF COLOR OF BRUISES (U.S. CLS. 6, 18, 44, 46, 51 AND 52).

FIRST USE 2-10-2009; IN COMMERCE 2-10-2009.  
CHRISTINA SOBRAL, EXAMINING ATTORNEY

**CLASS 5—(Continued).**

SN 86-065,587. HERO NUTRITIONALS, INC., SAN CLEMENTE, CA. FILED 9-16-2013.

PURE LOVE DESERVES PURE  
NUTRITION

THE MARK CONSISTS OF STANDARD CHARACTERS WITHOUT CLAIM TO ANY PARTICULAR FONT, STYLE, SIZE, OR COLOR.

FOR DIETARY AND NUTRITIONAL SUPPLEMENTS (U.S. CLS. 6, 18, 44, 46, 51 AND 52).

FIRST USE 9-1-2013; IN COMMERCE 9-1-2013.  
DAVID COLLIER, EXAMINING ATTORNEY

---

SN 86-065,671. GENESIS BUSINESS VENTURES LLC, CORONADO, CA. FILED 9-16-2013.

ENSPIRA

THE MARK CONSISTS OF STANDARD CHARACTERS WITHOUT CLAIM TO ANY PARTICULAR FONT, STYLE, SIZE, OR COLOR.

FOR NUTRITIONAL SUPPLEMENTS SPECIFICALLY FORMULATED FOR USE BY BARIATRIC PATIENTS BEFORE AND AFTER WEIGHT LOSS SURGERY (U.S. CLS. 6, 18, 44, 46, 51 AND 52).

FIRST USE 12-31-2009; IN COMMERCE 12-31-2009.  
JAMES A. RAUEN, EXAMINING ATTORNEY

---

SN 86-065,963. TENKOZ, INC., ALPHARETTA, GA. FILED 9-16-2013.

TUBRIX

THE MARK CONSISTS OF STANDARD CHARACTERS WITHOUT CLAIM TO ANY PARTICULAR FONT, STYLE, SIZE, OR COLOR.

FOR PESTICIDES AND PREPARATIONS FOR DESTROYING VERMIN, NAMELY HERBICIDES, INSECTICIDES, FUNGICIDES AND MITICIDES FOR AGRICULTURE, HORTICULTURE, FORESTRY, TURF AND ORNAMENTAL, COMMERCIAL, INDUSTRIAL AND DOMESTIC USE (U.S. CLS. 6, 18, 44, 46, 51 AND 52).  
SANJEEV VOHRA, EXAMINING ATTORNEY

**CLASS 5—(Continued).**

SN 86-066,113. NUTRIFUSION, LLC, HILTON HEAD, SC. FILED 9-16-2013.

GrandFusion

THE MARK CONSISTS OF STANDARD CHARACTERS WITHOUT CLAIM TO ANY PARTICULAR FONT, STYLE, SIZE, OR COLOR.

FOR VITAMIN AND MINERAL SUPPLEMENTS; VITAMIN AND MINERAL SUPPLEMENTS FOR USE AS INGREDIENTS IN THE FOOD INDUSTRY; VITAMIN AND MINERAL SUPPLEMENTS FOR USE AS INGREDIENTS IN FINISHED FOOD PRODUCTS; POWDERED NUTRITIONAL SUPPLEMENT CONCENTRATE; VITAMIN AND MINERAL SUPPLEMENTS FOR USE AS INGREDIENTS IN FINISHED FOOD PRODUCTS, NAMELY, BREADS, MUFFINS, COOKIES, ENERGY BARS, SALAD DRESSINGS, SOUPS, YOGURTS, AND BEVERAGES (U.S. CLS. 6, 18, 44, 46, 51 AND 52).

FIRST USE 1-0-2011; IN COMMERCE 1-0-2011.  
HEATHER THOMPSON, EXAMINING ATTORNEY

---

SN 86-066,186. TOADALLY GONE, LLC, BOCA RATON, FL. FILED 9-16-2013.

Toadally Gone

THE MARK CONSISTS OF STANDARD CHARACTERS WITHOUT CLAIM TO ANY PARTICULAR FONT, STYLE, SIZE, OR COLOR.

FOR PESTICIDES (U.S. CLS. 6, 18, 44, 46, 51 AND 52).  
GEORGE LORENZO, EXAMINING ATTORNEY

---

SN 86-066,297. SPIELBERG, MAX, LOS ANGELES, CA. FILED 9-16-2013.

PERFECT NUTRITION, MADE  
WITH LOVE

THE MARK CONSISTS OF STANDARD CHARACTERS WITHOUT CLAIM TO ANY PARTICULAR FONT, STYLE, SIZE, OR COLOR.

FOR DIETARY AND NUTRITIONAL SUPPLEMENTS (U.S. CLS. 6, 18, 44, 46, 51 AND 52).

JAMES LOVELACE, EXAMINING ATTORNEY

**CLASS 5—(Continued).**

SN 86-066,334. P & K INC OF CENTRAL FL, MELBOURNE, FL. FILED 9-17-2013.

# VEDARX

THE MARK CONSISTS OF STANDARD CHARACTERS WITHOUT CLAIM TO ANY PARTICULAR FONT, STYLE, SIZE, OR COLOR.

FOR DIETARY AND NUTRITIONAL SUPPLEMENTS; HERBAL SUPPLEMENTS; MEDICINAL HERBAL PREPARATIONS (U.S. CLS. 6, 18, 44, 46, 51 AND 52).  
ELLEN BURNS, EXAMINING ATTORNEY

---

SN 86-066,422. NATURE'S INNOVATION, INC., BUFORD, GA. FILED 9-17-2013.

# VEN-RX

THE MARK CONSISTS OF STANDARD CHARACTERS WITHOUT CLAIM TO ANY PARTICULAR FONT, STYLE, SIZE, OR COLOR.

FOR ALL NATURAL TOPICAL APPLICATION FOR PAIN RELIEF (U.S. CLS. 6, 18, 44, 46, 51 AND 52).  
ANN E. SAPPENFIELD, EXAMINING ATTORNEY

---

SN 86-066,428. NATURE'S INNOVATION, INC., BUFORD, GA. FILED 9-17-2013.

# TAG-X

THE MARK CONSISTS OF STANDARD CHARACTERS WITHOUT CLAIM TO ANY PARTICULAR FONT, STYLE, SIZE, OR COLOR.

FOR ALL NATURAL APPLICATION FOR THE REMOVAL OF SKIN TAGS (U.S. CLS. 6, 18, 44, 46, 51 AND 52).

ANN E. SAPPENFIELD, EXAMINING ATTORNEY

**CLASS 5—(Continued).**

SN 86-066,447. NATURE'S INNOVATION, INC., BUFORD, GA. FILED 9-17-2013.

 The logo for VenRx features the word "VenRx" in a bold, sans-serif font. The "V" is capitalized and larger than the other letters. The "EN" is in lowercase. The "R" is in uppercase and has a horizontal line extending from its base to the right. The "X" is in lowercase and has a horizontal line extending from its base to the right, which is slightly longer than the one under the "R".

THE MARK CONSISTS OF THE LOGO FOR "VENRX". THE "V" IS CAPITALIZED; THE "EN" IS LOWER CASE WITH THE "E" STARTING FROM WITHIN THE "V." THE LOWER PART OF THE "V" EXTENDS BELOW THE "EN". THE "R" IN "RX" IS IN CAPITALS AND THE "X" IS LOWERCASE. THE RIGHT LOWER LINE OF THE "R" BECOMES THE FIRST DIAGONAL OF THE "X" AND THE "X" EXTENDS BENEATH THE "R." THERE IS A HORIZONTAL LINE RUNNING FROM THE LOWER TIP OF THE "V" TO THE "X" THAT SERVES AS A BORDER FOR THE LOGO.

FOR ALL NATURAL TOPICAL APPLICATION FOR PAIN RELIEF (U.S. CLS. 6, 18, 44, 46, 51 AND 52).  
ANN E. SAPPENFIELD, EXAMINING ATTORNEY

---

SN 86-066,497. NUTRIFUSION, LLC, HILTON HEAD, SC. FILED 9-17-2013.



THE MARK CONSISTS OF THE OUTLINE OF AN APPLE HAVING A HEART-SHAPED INTERIOR ENCLOSING THE OUTLINE OF A CLUSTER OF BROCCOLI.

FOR VITAMIN AND MINERAL SUPPLEMENTS; VITAMIN AND MINERAL SUPPLEMENTS FOR USE AS INGREDIENTS IN THE FOOD INDUSTRY; VITAMIN AND MINERAL SUPPLEMENTS FOR USE AS INGREDIENTS IN FINISHED FOOD PRODUCTS; VITAMIN AND MINERAL SUPPLEMENTS FOR USE AS INGREDIENTS IN FINISHED FOOD PRODUCTS, NAMELY, BREADS, MUFFINS, COOKIES, ENERGY BARS, SALAD DRESSINGS, SOUPS, YOGURTS, AND BEVERAGES; POWDERED NUTRITIONAL SUPPLEMENT CONCENTRATE (U.S. CLS. 6, 18, 44, 46, 51 AND 52).

FIRST USE 1-0-2011; IN COMMERCE 1-0-2011.

HEATHER THOMPSON, EXAMINING ATTORNEY



**CLASS 5—(Continued).**

SN 86-066,643. METAGENICS, INC., ALISO VIEJO, CA. FILED 9-17-2013.

# Attencia

THE MARK CONSISTS OF STANDARD CHARACTERS WITHOUT CLAIM TO ANY PARTICULAR FONT, STYLE, SIZE, OR COLOR.  
FOR DIETARY SUPPLEMENTS (U.S. CLS. 6, 18, 44, 46, 51 AND 52).  
KATHERINE M. DUBRAY, EXAMINING ATTORNEY

**CLASS 5—(Continued).**

SN 86-066,850. BIO-VET, INC., BLUE MOUNDS, WI. FILED 9-17-2013.

# QuadriCal

THE MARK CONSISTS OF STANDARD CHARACTERS WITHOUT CLAIM TO ANY PARTICULAR FONT, STYLE, SIZE, OR COLOR.  
FOR ANIMAL FEED SUPPLEMENTS (U.S. CLS. 6, 18, 44, 46, 51 AND 52).  
FIRST USE 9-12-2013; IN COMMERCE 9-12-2013.  
AISHA CLARKE, EXAMINING ATTORNEY

SN 86-066,820. GLOBAL QUALITY HEALTH INC., YORK-TOWN HEIGHTS, NY. FILED 9-17-2013.

# CLOUD 9

THE MARK CONSISTS OF STANDARD CHARACTERS WITHOUT CLAIM TO ANY PARTICULAR FONT, STYLE, SIZE, OR COLOR.  
FOR NUTRITIONAL AND DIETARY SUPPLEMENTS (U.S. CLS. 6, 18, 44, 46, 51 AND 52).  
FIRST USE 9-3-2013; IN COMMERCE 9-3-2013.  
JEANIE LEE, EXAMINING ATTORNEY

SN 86-066,913. TRU RX LLC, EAGLE, ID. FILED 9-17-2013.

# PETLOCK

THE MARK CONSISTS OF STANDARD CHARACTERS WITHOUT CLAIM TO ANY PARTICULAR FONT, STYLE, SIZE, OR COLOR.  
FOR PREPARATIONS TO TREAT OR PREVENT FLEAS AND TICKS ON PETS (U.S. CLS. 6, 18, 44, 46, 51 AND 52).  
TRACY CROSS, EXAMINING ATTORNEY

SN 86-066,841. TEVA WOMEN'S HEALTH, INC., WOOD-CLIFF LAKE, NJ. FILED 9-17-2013.

# AFTERA

THE MARK CONSISTS OF STANDARD CHARACTERS WITHOUT CLAIM TO ANY PARTICULAR FONT, STYLE, SIZE, OR COLOR.  
FOR EMERGENCY CONTRACEPTIVE TABLETS (U.S. CLS. 6, 18, 44, 46, 51 AND 52).  
AISHA CLARKE, EXAMINING ATTORNEY

SN 86-067,003. X GYM ULTIMATE NUTRITION LLC, SAMMAMISH, WA. FILED 9-17-2013.

# BioSparx

THE MARK CONSISTS OF STANDARD CHARACTERS WITHOUT CLAIM TO ANY PARTICULAR FONT, STYLE, SIZE, OR COLOR.  
FOR DIETARY AND NUTRITIONAL SUPPLEMENTS; LIQUID NUTRITIONAL SUPPLEMENT; NUTRITIONAL AND DIETARY SUPPLEMENTS FORMED AND PACKAGED AS BARS; NUTRITIONAL SUPPLEMENT ENERGY BARS (U.S. CLS. 6, 18, 44, 46, 51 AND 52).  
FIRST USE 10-1-2011; IN COMMERCE 10-1-2011.  
TINA BROWN, EXAMINING ATTORNEY

**CLASS 5—(Continued).**

SN 86-067,343. GENETICALLY ENHANCED ANABOLIC RESEARCH, INC., HOLBROOK, NY. FILED 9-17-2013.

**PRE SHOCK**

THE MARK CONSISTS OF STANDARD CHARACTERS WITHOUT CLAIM TO ANY PARTICULAR FONT, STYLE, SIZE, OR COLOR.  
FOR DIETARY AND NUTRITIONAL SUPPLEMENTS (U.S. CLS. 6, 18, 44, 46, 51 AND 52).  
JILLIAN CANTOR, EXAMINING ATTORNEY

SN 86-067,455. TOP SECRET NUTRITION, LLC, MIRAMAR, FL. FILED 9-17-2013.

**WHAT DAY IS IT? PUMP DAY!**

THE MARK CONSISTS OF STANDARD CHARACTERS WITHOUT CLAIM TO ANY PARTICULAR FONT, STYLE, SIZE, OR COLOR.  
FOR DIETARY AND NUTRITIONAL SUPPLEMENTS (U.S. CLS. 6, 18, 44, 46, 51 AND 52).  
BARBARA RUTLAND, EXAMINING ATTORNEY

SN 86-067,551. RICH VITALITY, LLC, PAW PAW, MI. FILED 9-18-2013.

**RICH VITALITY**

THE MARK CONSISTS OF STANDARD CHARACTERS WITHOUT CLAIM TO ANY PARTICULAR FONT, STYLE, SIZE, OR COLOR.  
FOR NUTRITIONAL SUPPLEMENTS IN THE FORM OF POWDER; PROTEIN SUPPLEMENT SHAKES; PROTEIN SUPPLEMENTS; VEGAN LIQUID PROTEIN SUPPLEMENTS; NUTRITIONAL SUPPLEMENTS FOR BOOSTING ENERGY; NUTRITIONAL SUPPLEMENT SHAKES; PROTEIN SUPPLEMENT SHAKES; VITAMIN AND MINERAL SUPPLEMENTS (U.S. CLS. 6, 18, 44, 46, 51 AND 52).  
FIRST USE 7-2-2012; IN COMMERCE 7-2-2012.  
MATTHEW MCDOWELL, EXAMINING ATTORNEY

**CLASS 5—(Continued).**

SN 86-067,602. VITA NEUROSCIENCES, LLC, RALEIGH, NC. FILED 9-18-2013.

**MIGRAVITA**

THE MARK CONSISTS OF STANDARD CHARACTERS WITHOUT CLAIM TO ANY PARTICULAR FONT, STYLE, SIZE, OR COLOR.  
FOR VITAMINS; DIETARY AND NUTRITIONAL SUPPLEMENTS (U.S. CLS. 6, 18, 44, 46, 51 AND 52).  
MARCIE MILONE, EXAMINING ATTORNEY

SN 86-067,624. STACOR BIOSCIENCES, LLC, ROCKVILLE, MD. FILED 9-18-2013.

**PRONERVA**

THE MARK CONSISTS OF STANDARD CHARACTERS WITHOUT CLAIM TO ANY PARTICULAR FONT, STYLE, SIZE, OR COLOR.  
FOR NUTRITIONAL SUPPLEMENTS (U.S. CLS. 6, 18, 44, 46, 51 AND 52).  
ALICIA COLLINS, EXAMINING ATTORNEY

SN 86-067,795. ADVANCED PROTEIN SYSTEMS, LLC, DBA APS BIOGROUP, PHOENIX, AZ. FILED 9-18-2013.

**IMMULOX**

THE MARK CONSISTS OF STANDARD CHARACTERS WITHOUT CLAIM TO ANY PARTICULAR FONT, STYLE, SIZE, OR COLOR.  
FOR DIETARY SUPPLEMENTS FOR ENHANCING IMMUNITY EXTRACTED FROM BOVINE COLOSTRUM (U.S. CLS. 6, 18, 44, 46, 51 AND 52).  
FIRST USE 1-13-2005; IN COMMERCE 1-19-2005.  
MARY ROSSMAN, EXAMINING ATTORNEY

**CLASS 5—(Continued).**

SN 86-067,991. MAXIMUM HUMAN PERFORMANCE, LLC,  
FAIRFIELD, NJ. FILED 9-18-2013.

**CLASS 5—(Continued).**

SN 86-068,389. QUINCY BIOSCIENCE, LLC, MADISON, WI.  
FILED 9-18-2013.

# Secret Sauce

# SUGAR RIVER SUPPLEMENTS

THE MARK CONSISTS OF STANDARD CHARACTERS  
WITHOUT CLAIM TO ANY PARTICULAR FONT, STYLE,  
SIZE, OR COLOR.  
FOR DIETARY AND NUTRITIONAL SUPPLEMENTS  
(U.S. CLS. 6, 18, 44, 46, 51 AND 52).  
JEANIE LEE, EXAMINING ATTORNEY

THE MARK CONSISTS OF STANDARD CHARACTERS  
WITHOUT CLAIM TO ANY PARTICULAR FONT, STYLE,  
SIZE, OR COLOR.  
NO CLAIM IS MADE TO THE EXCLUSIVE RIGHT TO  
USE "SUPPLEMENTS", APART FROM THE MARK AS  
SHOWN.  
FOR DIETARY SUPPLEMENTS (U.S. CLS. 6, 18, 44, 46,  
51 AND 52).  
NICHOLAS ALTREE, EXAMINING ATTORNEY

SN 86-068,083. F. H. G. CORPORATION, SPRING HILL, TN.  
FILED 9-18-2013.

SN 86-068,477. METAMUNE, INC., DBA METAMUNE, INC.,  
SEATTLE, WA. FILED 9-18-2013.

# CLOCK

# Bodymune

THE MARK CONSISTS OF STANDARD CHARACTERS  
WITHOUT CLAIM TO ANY PARTICULAR FONT, STYLE,  
SIZE, OR COLOR.  
FOR DIETARY SUPPLEMENTS (U.S. CLS. 6, 18, 44, 46,  
51 AND 52).  
LINDA POWELL, EXAMINING ATTORNEY

THE MARK CONSISTS OF STANDARD CHARACTERS  
WITHOUT CLAIM TO ANY PARTICULAR FONT, STYLE,  
SIZE, OR COLOR.  
FOR DIETARY AND NUTRITIONAL SUPPLEMENTS;  
DIETARY SUPPLEMENTS (U.S. CLS. 6, 18, 44, 46, 51  
AND 52).  
FIRST USE 6-15-2010; IN COMMERCE 3-1-2012.  
TINA L. SNAPP, EXAMINING ATTORNEY

SN 86-068,352. DENALI BIOTECHNOLOGIES, INC.,  
HOMER, AK. FILED 9-18-2013.

SN 86-068,550. STANKZ LLC, SARATOGA SPRINGS, NY.  
FILED 9-18-2013.

# THE WILD BLUE WONDER

# STANKZ

THE MARK CONSISTS OF STANDARD CHARACTERS  
WITHOUT CLAIM TO ANY PARTICULAR FONT, STYLE,  
SIZE, OR COLOR.  
FOR NUTRITIONAL SUPPLEMENTS (U.S. CLS. 6, 18,  
44, 46, 51 AND 52).  
TINA BROWN, EXAMINING ATTORNEY

THE MARK CONSISTS OF STANDARD CHARACTERS  
WITHOUT CLAIM TO ANY PARTICULAR FONT, STYLE,  
SIZE, OR COLOR.  
FOR SHOE DEODORIZERS (U.S. CLS. 6, 18, 44, 46, 51  
AND 52).  
REGINA DRUMMOND, EXAMINING ATTORNEY

**CLASS 5—(Continued).**

SN 86-068,901. GLAXOSMITHKLINE LLC, WILMINGTON, DE. FILED 9-19-2013.

**SPONSORSHIP TO QUIT**

THE MARK CONSISTS OF STANDARD CHARACTERS WITHOUT CLAIM TO ANY PARTICULAR FONT, STYLE, SIZE, OR COLOR.  
OWNER OF U.S. REG. NOS. 3,973,418 AND 3,973,419.  
FOR SMOKING CESSATION PREPARATIONS (U.S. CLS. 6, 18, 44, 46, 51 AND 52).  
NATALIE POLZER, EXAMINING ATTORNEY

SN 86-069,232. NEWTON-EVERETT, LLC, SCOTTSDALE, AZ. FILED 9-19-2013.

**CHOLEST-RITE**

THE MARK CONSISTS OF STANDARD CHARACTERS WITHOUT CLAIM TO ANY PARTICULAR FONT, STYLE, SIZE, OR COLOR.  
FOR DIETARY SUPPLEMENTS (U.S. CLS. 6, 18, 44, 46, 51 AND 52).  
FIRST USE 7-13-2011; IN COMMERCE 7-13-2011.  
TRACY FLETCHER, EXAMINING ATTORNEY

SN 86-069,248. NEWTON-EVERETT, LLC, SCOTTSDALE, AZ. FILED 9-19-2013.

**CLEANSE-RITE**

THE MARK CONSISTS OF STANDARD CHARACTERS WITHOUT CLAIM TO ANY PARTICULAR FONT, STYLE, SIZE, OR COLOR.  
FOR DIETARY SUPPLEMENTS (U.S. CLS. 6, 18, 44, 46, 51 AND 52).  
FIRST USE 4-23-2008; IN COMMERCE 4-23-2008.  
TRACY FLETCHER, EXAMINING ATTORNEY

**CLASS 5—(Continued).**

SN 86-069,273. NEWTON-EVERETT, LLC, SCOTTSDALE, AZ. FILED 9-19-2013.

**DETOX-RITE**

THE MARK CONSISTS OF STANDARD CHARACTERS WITHOUT CLAIM TO ANY PARTICULAR FONT, STYLE, SIZE, OR COLOR.  
FOR DIETARY SUPPLEMENTS (U.S. CLS. 6, 18, 44, 46, 51 AND 52).  
FIRST USE 7-26-2011; IN COMMERCE 7-26-2011.  
TRACY FLETCHER, EXAMINING ATTORNEY

SN 86-069,292. NEWTON-EVERETT, LLC, SCOTTSDALE, AZ. FILED 9-19-2013.

**ENERGEX**

THE MARK CONSISTS OF STANDARD CHARACTERS WITHOUT CLAIM TO ANY PARTICULAR FONT, STYLE, SIZE, OR COLOR.  
FOR DIETARY SUPPLEMENTS (U.S. CLS. 6, 18, 44, 46, 51 AND 52).  
FIRST USE 7-26-2011; IN COMMERCE 7-26-2011.  
TRACY FLETCHER, EXAMINING ATTORNEY

SN 86-069,748. KROMASOL EJECUTIVA INTERNACIONAL, S.A. DE C.V., ZAPOPAN, JALISCO, MEXICO, FILED 9-19-2013.

**KROMASOL**

THE MARK CONSISTS OF THE TERM "KROMASOL" IN STYLIZED LETTERING.  
FOR DIETARY AND NUTRITIONAL SUPPLEMENTS; DIETARY SUPPLEMENTAL DRINKS IN THE NATURE OF VITAMIN AND MINERAL BEVERAGES; LIQUID AND POWDER NUTRITIONAL SUPPLEMENTS; LIQUID PROTEIN, FIBER, VITAMIN AND MINERAL SUPPLEMENTS (U.S. CLS. 6, 18, 44, 46, 51 AND 52).  
FIRST USE 4-18-2013; IN COMMERCE 4-18-2013.  
TINA BROWN, EXAMINING ATTORNEY

**CLASS 5—(Continued).**

SN 86-069,919. LAZCANO TORRES, MARIO, HOUSTON, TX.  
FILED 9-19-2013.

# ESBELTEX

THE MARK CONSISTS OF STANDARD CHARACTERS WITHOUT CLAIM TO ANY PARTICULAR FONT, STYLE, SIZE, OR COLOR.

FOR DIETARY AND NUTRITIONAL SUPPLEMENTS; DIETARY AND NUTRITIONAL SUPPLEMENTS FOR ENDURANCE SPORTS; DIETARY AND NUTRITIONAL SUPPLEMENTS USED FOR WEIGHT LOSS (U.S. CLS. 6, 18, 44, 46, 51 AND 52).

SOPHIA S. KIM, EXAMINING ATTORNEY

**CLASS 5—(Continued).**

SN 86-069,975. NEWTON-EVERETT, LLC, SCOTTSDALE, AZ. FILED 9-20-2013.

# XANTHADRENE

THE MARK CONSISTS OF STANDARD CHARACTERS WITHOUT CLAIM TO ANY PARTICULAR FONT, STYLE, SIZE, OR COLOR.

FOR DIETARY AND NUTRITIONAL SUPPLEMENTS USED FOR WEIGHT LOSS; WEIGHT MANAGEMENT SUPPLEMENTS; HERBAL SUPPLEMENTS (U.S. CLS. 6, 18, 44, 46, 51 AND 52).

FIRST USE 3-5-2008; IN COMMERCE 3-5-2008.

TRACY FLETCHER, EXAMINING ATTORNEY

SN 86-069,970. NEWTON-EVERETT, LLC, SCOTTSDALE, AZ. FILED 9-20-2013.

# FIRSTBIOTIC

THE MARK CONSISTS OF STANDARD CHARACTERS WITHOUT CLAIM TO ANY PARTICULAR FONT, STYLE, SIZE, OR COLOR.

FOR DIETARY AND NUTRITIONAL SUPPLEMENTS; NUTRITIONAL SUPPLEMENTS, NAMELY, PROBIOTIC COMPOSITIONS (U.S. CLS. 6, 18, 44, 46, 51 AND 52).

FIRST USE 1-10-2012; IN COMMERCE 1-10-2012.

TRACY FLETCHER, EXAMINING ATTORNEY

SN 86-069,976. NEWTON-EVERETT, LLC, SCOTTSDALE, AZ. FILED 9-20-2013.

# LIVEROL

THE MARK CONSISTS OF STANDARD CHARACTERS WITHOUT CLAIM TO ANY PARTICULAR FONT, STYLE, SIZE, OR COLOR.

FOR DIETARY AND NUTRITIONAL SUPPLEMENTS (U.S. CLS. 6, 18, 44, 46, 51 AND 52).

FIRST USE 7-7-2011; IN COMMERCE 7-7-2011.

TRACY FLETCHER, EXAMINING ATTORNEY

SN 86-069,972. NEWTON-EVERETT, LLC, SCOTTSDALE, AZ. FILED 9-20-2013.

# WELLSTRA

THE MARK CONSISTS OF STANDARD CHARACTERS WITHOUT CLAIM TO ANY PARTICULAR FONT, STYLE, SIZE, OR COLOR.

FOR DIETARY AND NUTRITIONAL SUPPLEMENTS (U.S. CLS. 6, 18, 44, 46, 51 AND 52).

FIRST USE 11-2-2011; IN COMMERCE 11-2-2011.

TRACY FLETCHER, EXAMINING ATTORNEY

SN 86-069,977. NEWTON-EVERETT, LLC, SCOTTSDALE, AZ. FILED 9-20-2013.

# PRESSURIL

THE MARK CONSISTS OF STANDARD CHARACTERS WITHOUT CLAIM TO ANY PARTICULAR FONT, STYLE, SIZE, OR COLOR.

FOR DIETARY AND NUTRITIONAL SUPPLEMENTS (U.S. CLS. 6, 18, 44, 46, 51 AND 52).

FIRST USE 6-27-2011; IN COMMERCE 6-27-2011.

TRACY FLETCHER, EXAMINING ATTORNEY

**CLASS 5—(Continued).**

SN 86-069,981. NEWTON-EVERETT, LLC, SCOTTSDALE, AZ. FILED 9-20-2013.

**PRODRENE**

THE MARK CONSISTS OF STANDARD CHARACTERS WITHOUT CLAIM TO ANY PARTICULAR FONT, STYLE, SIZE, OR COLOR.  
FOR WHEY PROTEIN SUPPLEMENTS (U.S. CLS. 6, 18, 44, 46, 51 AND 52).  
FIRST USE 10-12-2007; IN COMMERCE 10-12-2007.  
JULIE WATSON, EXAMINING ATTORNEY

**CLASS 5—(Continued).**

SN 86-070,332. PAULSON,ROBERT, EAST MORICHES, NY. FILED 9-20-2013.

**Nu Normal**

THE MARK CONSISTS OF STANDARD CHARACTERS WITHOUT CLAIM TO ANY PARTICULAR FONT, STYLE, SIZE, OR COLOR.  
FOR WHEAT-FREE AND GLUTEN-FREE FOOD FOR THE TREATMENT OF SPECIAL MEDICAL AND HEALTH CONDITIONS (U.S. CLS. 6, 18, 44, 46, 51 AND 52).  
SUZANNE BLANE, EXAMINING ATTORNEY

SN 86-069,984. NEWTON-EVERETT, LLC, SCOTTSDALE, AZ. FILED 9-20-2013.

**RETENIX**

THE MARK CONSISTS OF STANDARD CHARACTERS WITHOUT CLAIM TO ANY PARTICULAR FONT, STYLE, SIZE, OR COLOR.  
FOR DIETARY AND NUTRITIONAL SUPPLEMENTS (U.S. CLS. 6, 18, 44, 46, 51 AND 52).  
FIRST USE 1-10-2012; IN COMMERCE 1-10-2012.  
JULIE WATSON, EXAMINING ATTORNEY

SN 86-070,464. SANOFI-AVENTIS NETHERLANDS B.V., 2803 PE GOUDA, NETHERLANDS, FILED 9-20-2013.

**TING**

THE MARK CONSISTS OF STANDARD CHARACTERS WITHOUT CLAIM TO ANY PARTICULAR FONT, STYLE, SIZE, OR COLOR.  
OWNER OF U.S. REG. NO. 993,663.  
FOR ANTIFUNGAL PREPARATIONS (U.S. CLS. 6, 18, 44, 46, 51 AND 52).  
FIRST USE 0-0-1992; IN COMMERCE 0-0-1992.  
BRENDAN MCCAULEY, EXAMINING ATTORNEY

SN 86-069,986. NEWTON-EVERETT, LLC, SCOTTSDALE, AZ. FILED 9-20-2013.

**SLENDERSOL**

THE MARK CONSISTS OF STANDARD CHARACTERS WITHOUT CLAIM TO ANY PARTICULAR FONT, STYLE, SIZE, OR COLOR.  
FOR DIETARY AND NUTRITIONAL SUPPLEMENTS (U.S. CLS. 6, 18, 44, 46, 51 AND 52).  
FIRST USE 1-10-2012; IN COMMERCE 1-10-2012.  
JULIE WATSON, EXAMINING ATTORNEY

SN 86-070,976. ANNAKIE, DAVID, NEW YORK, NY. FILED 9-20-2013.

**Bio-Granate**

THE MARK CONSISTS OF STANDARD CHARACTERS WITHOUT CLAIM TO ANY PARTICULAR FONT, STYLE, SIZE, OR COLOR.  
FOR DIETARY AND NUTRITIONAL SUPPLEMENTS; LIQUID VITAMIN SUPPLEMENTS (U.S. CLS. 6, 18, 44, 46, 51 AND 52).  
ARETHA SOMERVILLE, EXAMINING ATTORNEY

**CLASS 5—(Continued).**

SN 86-071,005. AVANIR PHARMACEUTICALS, INC., ALISO VIEJO, CA. FILED 9-20-2013.

# PROMTIVA

THE MARK CONSISTS OF STANDARD CHARACTERS WITHOUT CLAIM TO ANY PARTICULAR FONT, STYLE, SIZE, OR COLOR.

FOR PHARMACEUTICAL PREPARATIONS AND SUBSTANCES FOR THE TREATMENT AND/OR ALLEVIATION OF MIGRAINE; ANTIMIGRAINE TRIPTANS; SUMATRIPTAN (U.S. CLS. 6, 18, 44, 46, 51 AND 52).

KATINA MISTER, EXAMINING ATTORNEY

**CLASS 5—(Continued).**

SN 86-071,019. AVANIR PHARMACEUTICALS, INC., ALISO VIEJO, CA. FILED 9-20-2013.

# SPELIFA

THE MARK CONSISTS OF STANDARD CHARACTERS WITHOUT CLAIM TO ANY PARTICULAR FONT, STYLE, SIZE, OR COLOR.

FOR PHARMACEUTICAL PREPARATIONS AND SUBSTANCES FOR THE TREATMENT AND/OR ALLEVIATION OF MIGRAINE; ANTIMIGRAINE TRIPTANS; SUMATRIPTAN (U.S. CLS. 6, 18, 44, 46, 51 AND 52).

KATINA MISTER, EXAMINING ATTORNEY

SN 86-071,009. AVANIR PHARMACEUTICALS, INC., ALISO VIEJO, CA. FILED 9-20-2013.

# ONZETRA

THE MARK CONSISTS OF STANDARD CHARACTERS WITHOUT CLAIM TO ANY PARTICULAR FONT, STYLE, SIZE, OR COLOR.

FOR PHARMACEUTICAL PREPARATIONS AND SUBSTANCES FOR THE TREATMENT AND/OR ALLEVIATION OF MIGRAINE; ANTIMIGRAINE TRIPTANS; SUMATRIPTAN (U.S. CLS. 6, 18, 44, 46, 51 AND 52).

KATINA MISTER, EXAMINING ATTORNEY

SN 86-071,133. SERGIO ALEJANDRO VACA CONTRERAS, CIUDAD GUZMÁN, MEXICO, FILED 9-21-2013.

# Chiaswiss

THE MARK CONSISTS OF STANDARD CHARACTERS WITHOUT CLAIM TO ANY PARTICULAR FONT, STYLE, SIZE, OR COLOR.

FOR DIETARY AND NUTRITIONAL SUPPLEMENTS CONTAINING CHIA (U.S. CLS. 6, 18, 44, 46, 51 AND 52).

JAMES A. RAUEN, EXAMINING ATTORNEY

SN 86-071,016. AVANIR PHARMACEUTICALS, INC., ALISO VIEJO, CA. FILED 9-20-2013.

# ZOREXIA

THE MARK CONSISTS OF STANDARD CHARACTERS WITHOUT CLAIM TO ANY PARTICULAR FONT, STYLE, SIZE, OR COLOR.

FOR PHARMACEUTICAL PREPARATIONS AND SUBSTANCES FOR THE TREATMENT AND/OR ALLEVIATION OF MIGRAINE; ANTIMIGRAINE TRIPTANS; SUMATRIPTAN (U.S. CLS. 6, 18, 44, 46, 51 AND 52).

KATINA MISTER, EXAMINING ATTORNEY

SN 86-071,302. MID-CONTINENTAL DENTAL SUPPLY CO. LTD., HEADINGLEY, MANITOBA, CANADA, FILED 9-22-2013.

# OnePro

THE MARK CONSISTS OF STANDARD CHARACTERS WITHOUT CLAIM TO ANY PARTICULAR FONT, STYLE, SIZE, OR COLOR.

FOR DIETARY AND NUTRITIONAL SUPPLEMENTS; MULTI-VITAMIN PREPARATIONS; NUTRITIONAL SUPPLEMENTS; VITAMIN AND MINERAL SUPPLEMENTS (U.S. CLS. 6, 18, 44, 46, 51 AND 52).

LUCY ARANT, EXAMINING ATTORNEY

**CLASS 5—(Continued).**

SN 86-071,657. IDEAZ,LLC, PITTSBURGH, PA. FILED 9-23-2013.

# MUSTGO

THE MARK CONSISTS OF STANDARD CHARACTERS WITHOUT CLAIM TO ANY PARTICULAR FONT, STYLE, SIZE, OR COLOR.

FOR BIOSTATIC ANTIMICROBIAL PREPARATIONS FOR TREATING BACTERIA, MOLD, MILDEW, ALGAE AND YEAST AND FOR INHIBITING GROWTH OF THOSE ORGANISMS (U.S. CLS. 6, 18, 44, 46, 51 AND 52).  
FIRST USE 9-20-2013; IN COMMERCE 9-20-2013.

VIVIAN MICZNIK FIRST, EXAMINING ATTORNEY

SN 86-072,414. BARRINGTON MOORE INC., ALAMOGORDO, NM. FILED 9-23-2013.

# CHUNK

THE MARK CONSISTS OF STANDARD CHARACTERS WITHOUT CLAIM TO ANY PARTICULAR FONT, STYLE, SIZE, OR COLOR.

FOR BABY DIAPERS (U.S. CLS. 6, 18, 44, 46, 51 AND 52).

FIRST USE 2-1-2013; IN COMMERCE 2-1-2013.  
ALLISON HOLTZ, EXAMINING ATTORNEY

SN 86-072,547. BIO HEALTH SOLUTIONS, INC., LAS VEGAS, NV. FILED 9-23-2013.



THE COLOR(S) GREEN, AQUA, BLUE, AND WHITE IS/ARE CLAIMED AS A FEATURE OF THE MARK.

THE MARK CONSISTS OF THE WORDS "FOR MOTION" IN LOWERCASE LETTERS AND SET BELOW THE WORD "ORTHOBREX" WHICH HAS LARGER LETTERING WITH THE FIRST "O" AND THE "B" IN "ORTHOBREX" CAPITALIZED AND THE REMAINING LETTERS IN LOWERCASE, ALL IN WHITE AND CENTERED AGAINST THREE FREE FORM OVERLAPPING OVALS, ONE OF WHICH IS GREEN, ONE OF WHICH IS BLUE AND ONE OF WHICH IS AQUA, AND WHERE THE AQUA OVERLAPS THE GREEN CREATES A DARKER GREEN COLOR, AND WHERE THE AQUA OVERLAPS THE BLUE CREATES A DARKER BLUE COLOR, AND ALL OF WHICH IS SET AGAINST A WHITE BACKGROUND.

FOR ANIMAL FEED ADDITIVE FOR USE AS A NUTRITIONAL SUPPLEMENT FOR MEDICAL PURPOSES; ANIMAL FEED SUPPLEMENTS; NUTRACEUTICALS FOR USE AS A DIETARY SUPPLEMENT FOR SUPPORTING HEALTHY JOINTS IN CATS AND DOGS (U.S. CLS. 6, 18, 44, 46, 51 AND 52).

FRANK LATTUCA, EXAMINING ATTORNEY

**CLASS 5—(Continued).**

SN 86-072,865. BKK PHARMACEUTICALS, LLC, WILMINGTON, DE. FILED 9-24-2013.

# REVDERMX

THE MARK CONSISTS OF STANDARD CHARACTERS WITHOUT CLAIM TO ANY PARTICULAR FONT, STYLE, SIZE, OR COLOR.

FOR DIETARY SUPPLEMENTS (U.S. CLS. 6, 18, 44, 46, 51 AND 52).

DEZMONA MIZELLE, EXAMINING ATTORNEY

SN 86-074,691. NOVARTIS AG, BASEL, SWITZERLAND, FILED 9-25-2013.

# XTORO

THE MARK CONSISTS OF STANDARD CHARACTERS WITHOUT CLAIM TO ANY PARTICULAR FONT, STYLE, SIZE, OR COLOR.

THE WORDING "XTORO" HAS NO MEANING IN A FOREIGN LANGUAGE.

FOR OTIC PREPARATIONS (U.S. CLS. 6, 18, 44, 46, 51 AND 52).

BARBARA A. GOLD, EXAMINING ATTORNEY

SN 86-076,931. GLAXO GROUP LIMITED, BRENTFORD, MIDDLESEX, UNITED KINGDOM, FILED 9-27-2013.

# POSIVENT

THE MARK CONSISTS OF STANDARD CHARACTERS WITHOUT CLAIM TO ANY PARTICULAR FONT, STYLE, SIZE, OR COLOR.

OWNER OF UNITED KINGDOM REG. NO. 2573181, DATED 2-23-2011, EXPIRES 2-23-2021.

THE WORDING "POSIVENT" HAS NO MEANING IN A FOREIGN LANGUAGE.

FOR PHARMACEUTICAL PREPARATIONS AND SUBSTANCES FOR THE TREATMENT OF DAMAGED SKIN AND TISSUE; PHARMACEUTICAL PREPARATIONS AND SUBSTANCES FOR THE TREATMENT OF INFECTIOUS DISEASES, BLOOD DISORDERS, PAIN, INFLAMMATION, SEPSIS, ALOPECIA, OBESITY AND COGNITIVE DISORDERS; PHARMACEUTICAL PREPARATIONS AND SUBSTANCES FOR THE TREATMENT OF VIRAL, METABOLIC, ENDOCRINE, MUSCULOSKELETAL, CARDIOVASCULAR, CARDIOPULMONARY, GENITOURINARY, SEXUAL DYSFUNCTION, ONCOLOGICAL, HEPATOLOGICAL, OPHTHALMIC, RESPIRATORY, NEUROLOGICAL, GASTROINTESTINAL, HORMONAL, DERMATOLOGICAL, PSYCHIATRIC AND IMMUNE SYSTEM RELATED DISEASES AND DISORDERS; VACCINES (U.S. CLS. 6, 18, 44, 46, 51 AND 52).

JEFF DEFORD, EXAMINING ATTORNEY



**CLASS 5—(Continued).**

SN 86-077,247. TOP SECRET NUTRITION, LLC, MIRAMAR, FL. FILED 9-27-2013.

# TEST IGNITER

THE MARK CONSISTS OF STANDARD CHARACTERS WITHOUT CLAIM TO ANY PARTICULAR FONT, STYLE, SIZE, OR COLOR.

FOR DIETARY AND NUTRITIONAL SUPPLEMENTS; NUTRITIONAL AND DIETARY SUPPLEMENTS FORMED AND PACKAGED AS BARS; NUTRITIONALLY FORTIFIED BEVERAGES (U.S. CLS. 6, 18, 44, 46, 51 AND 52).

BARBARA RUTLAND, EXAMINING ATTORNEY

**CLASS 5—(Continued).**

SN 86-078,055. ADVANCED PROTEIN SYSTEMS, LLC, DBA APS BIOGROUP, PHOENIX, AZ. FILED 9-30-2013.

# INFOPROTEIN

THE MARK CONSISTS OF STANDARD CHARACTERS WITHOUT CLAIM TO ANY PARTICULAR FONT, STYLE, SIZE, OR COLOR.

FOR DIETARY SUPPLEMENTS FOR ENHANCED IMMUNITY EXTRACTED FROM BOVINE COLOSTRUM CONTAINING PROTEIN (U.S. CLS. 6, 18, 44, 46, 51 AND 52).

FIRST USE 1-13-2005; IN COMMERCE 1-19-2005.  
MARY ROSSMAN, EXAMINING ATTORNEY

SN 86-077,273. TOP SECRET NUTRITION, LLC, MIRAMAR, FL. FILED 9-27-2013.

# CREAVAR IGNITER

THE MARK CONSISTS OF STANDARD CHARACTERS WITHOUT CLAIM TO ANY PARTICULAR FONT, STYLE, SIZE, OR COLOR.

FOR DIETARY AND NUTRITIONAL SUPPLEMENTS; NUTRITIONAL AND DIETARY SUPPLEMENTS FORMED AND PACKAGED AS BARS; NUTRITIONALLY FORTIFIED BEVERAGES (U.S. CLS. 6, 18, 44, 46, 51 AND 52).

BARBARA RUTLAND, EXAMINING ATTORNEY

SN 86-080,311. SUMMERS, ERIC V, PONTE VEDRA BEACH, FL. FILED 10-2-2013.

# Dr FeelGood The Original Practicing Herbal Doctor

THE MARK CONSISTS OF STANDARD CHARACTERS WITHOUT CLAIM TO ANY PARTICULAR FONT, STYLE, SIZE, OR COLOR.

NO CLAIM IS MADE TO THE EXCLUSIVE RIGHT TO USE "THE ORIGINAL" OR "HERBAL", APART FROM THE MARK AS SHOWN.

FOR DIETARY AND NUTRITIONAL SUPPLEMENTS (U.S. CLS. 6, 18, 44, 46, 51 AND 52).  
WILLIAM JACKSON, EXAMINING ATTORNEY

SN 86-077,794. GREAT HEALTHWORKS, INC., HOLLYWOOD, FL. FILED 9-29-2013.

# BackWorks

THE MARK CONSISTS OF STANDARD CHARACTERS WITHOUT CLAIM TO ANY PARTICULAR FONT, STYLE, SIZE, OR COLOR.

FOR NUTRITIONAL SUPPLEMENTS FOR PROMOTING BACK HEALTH (U.S. CLS. 6, 18, 44, 46, 51 AND 52).  
JORDAN BAKER, EXAMINING ATTORNEY

SN 86-085,225. PHARMAFREAK HOLDINGS INC., TORONTO, ONTARIO, CANADA, FILED 10-8-2013.

# SEX GOD

THE MARK CONSISTS OF STANDARD CHARACTERS WITHOUT CLAIM TO ANY PARTICULAR FONT, STYLE, SIZE, OR COLOR.

NO CLAIM IS MADE TO THE EXCLUSIVE RIGHT TO USE "SEX", APART FROM THE MARK AS SHOWN.

FOR DIETARY SUPPLEMENTS FOR ENHANCED SEXUAL PLEASURE AND PERFORMANCE IN CAPSULE, CAPLET, TABLET, LIQUID BEVERAGES AND POWDER FORM (U.S. CLS. 6, 18, 44, 46, 51 AND 52).

FIRST USE 9-0-2011; IN COMMERCE 9-0-2011.  
MICHAEL SOUDERS, EXAMINING ATTORNEY

**CLASS 5—(Continued).**

SN 86-087,163. MERCK SHARP & DOHME CORP., WHITEHOUSE STATION, NJ. FILED 10-9-2013.

# LEKEYA

THE MARK CONSISTS OF STANDARD CHARACTERS WITHOUT CLAIM TO ANY PARTICULAR FONT, STYLE, SIZE, OR COLOR.

FOR PHARMACEUTICAL PREPARATIONS FOR THE TREATMENT OF METABOLIC DISEASES (U.S. CLS. 6, 18, 44, 46, 51 AND 52).

DOMINIC FATHY, EXAMINING ATTORNEY

---

SN 86-087,167. MERCK SHARP & DOHME CORP., WHITEHOUSE STATION, NJ. FILED 10-9-2013.

# LESEVRA

THE MARK CONSISTS OF STANDARD CHARACTERS WITHOUT CLAIM TO ANY PARTICULAR FONT, STYLE, SIZE, OR COLOR.

FOR PHARMACEUTICAL PREPARATIONS FOR THE TREATMENT OF METABOLIC DISEASES (U.S. CLS. 6, 18, 44, 46, 51 AND 52).

DOMINIC FATHY, EXAMINING ATTORNEY

---

SN 86-087,499. THE BUGARIE GROUP, HALLANDALE, FL. FILED 10-9-2013.

# ULTIMATE GIRL

THE MARK CONSISTS OF STANDARD CHARACTERS WITHOUT CLAIM TO ANY PARTICULAR FONT, STYLE, SIZE, OR COLOR.

OWNER OF U.S. REG. NOS. 4,239,496, 4,315,141 AND OTHERS.

NO CLAIM IS MADE TO THE EXCLUSIVE RIGHT TO USE "GIRL", APART FROM THE MARK AS SHOWN.

FOR DIETARY SUPPLEMENTAL DRINKS IN THE NATURE OF VITAMIN AND MINERAL BEVERAGES; NUTRACEUTICALS FOR USE AS A DIETARY SUPPLEMENT; MEAL REPLACEMENT BARS AND DRINKS ADAPTED FOR MEDICAL USE, NUTRITIONAL SUPPLEMENT SHAKES; POWDERED NUTRITIONAL SUPPLEMENT DRINK MIX, DIETARY AND NUTRITIONAL SUPPLEMENTS, VITAMINS, AND NUTRITIONAL SUPPLEMENT ENERGY BARS (U.S. CLS. 6, 18, 44, 46, 51 AND 52).

SHAVELL MCPHERSON, EXAMINING ATTORNEY

**CLASS 5—(Continued).**

SN 86-087,712. MERCK KGAA, D 64293 DARMSTADT, FED REP GERMANY, FILED 10-9-2013.

# MOVECTRO

THE MARK CONSISTS OF STANDARD CHARACTERS WITHOUT CLAIM TO ANY PARTICULAR FONT, STYLE, SIZE, OR COLOR.

FOR PHARMACEUTICAL PREPARATIONS, NAMELY, PREPARATIONS FOR THE TREATMENT OF INFERTILITY, METABOLIC, GENETIC AND PULMONARY DISEASES AND DISORDERS (U.S. CLS. 6, 18, 44, 46, 51 AND 52).

TOBY BULLOFF, EXAMINING ATTORNEY

---

SN 86-087,825. MERCK SHARP & DOHME CORP., WHITEHOUSE STATION, NJ. FILED 10-10-2013.

# LONVIACT

THE MARK CONSISTS OF STANDARD CHARACTERS WITHOUT CLAIM TO ANY PARTICULAR FONT, STYLE, SIZE, OR COLOR.

FOR PHARMACEUTICAL PREPARATIONS FOR THE TREATMENT OF METABOLIC DISEASES (U.S. CLS. 6, 18, 44, 46, 51 AND 52).

DOMINIC FATHY, EXAMINING ATTORNEY

---

SN 86-087,826. MERCK SHARP & DOHME CORP., WHITEHOUSE STATION, NJ. FILED 10-10-2013.

# LONVULET

THE MARK CONSISTS OF STANDARD CHARACTERS WITHOUT CLAIM TO ANY PARTICULAR FONT, STYLE, SIZE, OR COLOR.

FOR PHARMACEUTICAL PREPARATIONS FOR THE TREATMENT OF METABOLIC DISEASES (U.S. CLS. 6, 18, 44, 46, 51 AND 52).

DOMINIC FATHY, EXAMINING ATTORNEY

**CLASS 5—(Continued).**

SN 86-088,498. UNITED INDUSTRIES CORPORATION, EARTH CITY, MO. FILED 10-10-2013.

# Cutter

THE MARK CONSISTS OF STANDARD CHARACTERS WITHOUT CLAIM TO ANY PARTICULAR FONT, STYLE, SIZE, OR COLOR.

OWNER OF U.S. REG. NOS. 1,341,985, 4,276,942 AND OTHERS.

FOR INSECT BITE RELIEF MEDICATION (U.S. CLS. 6, 18, 44, 46, 51 AND 52).

FIRST USE 11-27-2006; IN COMMERCE 11-27-2006.  
KATHLEEN KOLACZ, EXAMINING ATTORNEY

SN 86-088,506. UNITED INDUSTRIES CORPORATION, EARTH CITY, MO. FILED 10-10-2013.

# Bite MD

THE MARK CONSISTS OF STANDARD CHARACTERS WITHOUT CLAIM TO ANY PARTICULAR FONT, STYLE, SIZE, OR COLOR.

NO CLAIM IS MADE TO THE EXCLUSIVE RIGHT TO USE "BITE", APART FROM THE MARK AS SHOWN.

FOR INSECT BITE RELIEF MEDICATION (U.S. CLS. 6, 18, 44, 46, 51 AND 52).

FIRST USE 11-27-2006; IN COMMERCE 11-27-2006.  
KATHLEEN KOLACZ, EXAMINING ATTORNEY

SN 86-088,686. TOP SECRET NUTRITION, LLC, MIRAMAR, FL. FILED 10-10-2013.

# VITALITY SUPPORT

THE MARK CONSISTS OF STANDARD CHARACTERS WITHOUT CLAIM TO ANY PARTICULAR FONT, STYLE, SIZE, OR COLOR.

FOR DIETARY AND NUTRITIONAL SUPPLEMENTS; DIETARY SUPPLEMENTAL DRINKS IN THE NATURE OF VITAMIN AND MINERAL BEVERAGES; NUTRITIONAL AND DIETARY SUPPLEMENTS FORMED AND PACKAGED AS BARS; NUTRITIONALLY FORTIFIED BEVERAGES (U.S. CLS. 6, 18, 44, 46, 51 AND 52).  
BARBARA RUTLAND, EXAMINING ATTORNEY

**CLASS 5—(Continued).**

SN 86-089,417. BLUE EARTH ENTERPRISES, INC., SANTA CLARITA, CA. FILED 10-11-2013.



THE MARK CONSISTS OF A STYLIZED DRAWING OF VITRUVIAN MAN WEARING A LEAF PLACED WITHIN THE SMALLER OF TWO CONCENTRIC CIRCLES AND THE WORDING "WHOLE LIFE" AROUND THE TOP HEMISPHERE BETWEEN THE SMALLER AND LARGER CIRCLES.

FOR VITAMIN AND MINERAL SUPPLEMENTS; VITAMIN SUPPLEMENTS; VITAMINS (U.S. CLS. 6, 18, 44, 46, 51 AND 52).

PARKER HOWARD, EXAMINING ATTORNEY

SN 86-091,852. INDUS BIOTECH PRIVATE LIMITED, MAHARASHTRA, INDIA, FILED 10-15-2013.

# ALLEVIAC

THE MARK CONSISTS OF STANDARD CHARACTERS WITHOUT CLAIM TO ANY PARTICULAR FONT, STYLE, SIZE, OR COLOR.

FOR PHARMACEUTICAL PREPARATIONS FOR THE PREVENTION AND TREATMENT OF MIGRAINE AND OTHER HEADACHE DISORDERS (U.S. CLS. 6, 18, 44, 46, 51 AND 52).

RAUL CORDOVA, EXAMINING ATTORNEY

SN 86-093,124. FARNAM COMPANIES, INC., PHOENIX, AZ. FILED 10-16-2013.

# DUOCARE

THE MARK CONSISTS OF STANDARD CHARACTERS WITHOUT CLAIM TO ANY PARTICULAR FONT, STYLE, SIZE, OR COLOR.

FOR ANTIPARASITIC PREPARATION FOR ANIMALS, NAMELY, HORSES (U.S. CLS. 6, 18, 44, 46, 51 AND 52).  
MARIA-VICTORIA SUAREZ, EXAMINING ATTORNEY

**CLASS 5—(Continued).**

SN 86-093,927. VALAREZO SANCHEZ, MERCEDES LORENA, GUAYAQUIL, ECUADOR, FILED 10-17-2013.



NO CLAIM IS MADE TO THE EXCLUSIVE RIGHT TO USE "JARABE PARA LA TOS CON MIEL Y EUCALIPTO", APART FROM THE MARK AS SHOWN.

THE COLOR(S) GREEN, YELLOW, RED, BLUE, AND BLACK IS/ARE CLAIMED AS A FEATURE OF THE MARK.

THE MARK CONSISTS OF WORD "EUCAMIEL" IN GREEN, YELLOW, AND BLUE FONT WITH THE WORDS "JARABE PARA LA TOS CON MIEL Y EUCALIPTO" UNDERNEATH IN RED. ABOVE THE "E" IN "EUCAMIEL" IS A BLACK AND WHITE BEE WITH BLUE WINGS.

THE ENGLISH TRANSLATION OF "JARABE PARA LA TOS CON MIEL Y EUCALIPTO" IN THE MARK IS "COUGH SYRUP WITH HONEY AND EUCALYPTUS".

FOR VITAMIN AND MINERAL SUPPLEMENTS FEATURING HONEY AND EUCALYPTUS (U.S. CLS. 6, 18, 44, 46, 51 AND 52).

APRIL REEVES, EXAMINING ATTORNEY

---

SN 86-094,022. GENESIS BUSINESS VENTURES LLC, CORONADO, CA. FILED 10-17-2013.

## VITA-ALEPH

THE MARK CONSISTS OF STANDARD CHARACTERS WITHOUT CLAIM TO ANY PARTICULAR FONT, STYLE, SIZE, OR COLOR.

FOR NUTRITIONAL SUPPLEMENTS (U.S. CLS. 6, 18, 44, 46, 51 AND 52).

JAMES A. RAUEN, EXAMINING ATTORNEY

---

SN 86-094,373. MAXIMUM HUMAN PERFORMANCE, LLC, FAIRFIELD, NJ. FILED 10-17-2013.

## GP6

THE MARK CONSISTS OF STANDARD CHARACTERS WITHOUT CLAIM TO ANY PARTICULAR FONT, STYLE, SIZE, OR COLOR.

FOR DIETARY AND NUTRITIONAL SUPPLEMENTS (U.S. CLS. 6, 18, 44, 46, 51 AND 52).

JEANIE LEE, EXAMINING ATTORNEY

**CLASS 5—(Continued).**

SN 86-097,592. SANOFI, 75008 PARIS, FRANCE, FILED 10-22-2013.

## VEDI

THE MARK CONSISTS OF STANDARD CHARACTERS WITHOUT CLAIM TO ANY PARTICULAR FONT, STYLE, SIZE, OR COLOR.

FOR PHARMACEUTICALS, PREPARATIONS AND MEDICATIONS FOR PREVENTION AND TREATMENT OF CARDIOVASCULAR AND CEREBROVASCULAR DISEASES AND DISORDERS; ACETYLSALICYLIC ACID; PAIN RELIEF MEDICATION; ANTI-THROMBOTIC PHARMACEUTICALS, PREPARATIONS AND MEDICATIONS; PHARMACEUTICALS, PREPARATIONS AND MEDICATIONS FOR INHIBITING PLATELET ACTIVATION AND AGGREGATION; PHARMACEUTICALS, PREPARATIONS AND MEDICATIONS FOR SUPPRESSING GASTRIC ACID; PHARMACEUTICALS, PREPARATIONS AND MEDICATIONS FOR PREVENTION AND TREATMENT OF GASTROINTESTINAL DISEASES AND DISORDERS (U.S. CLS. 6, 18, 44, 46, 51 AND 52).

THEODORE MCBRIDE, EXAMINING ATTORNEY

---

SN 86-097,619. SANOFI, 75008 PARIS, FRANCE, FILED 10-22-2013.

## ALIRIDUC

THE MARK CONSISTS OF STANDARD CHARACTERS WITHOUT CLAIM TO ANY PARTICULAR FONT, STYLE, SIZE, OR COLOR.

FOR CARDIOVASCULAR PHARMACEUTICALS (U.S. CLS. 6, 18, 44, 46, 51 AND 52).

THEODORE MCBRIDE, EXAMINING ATTORNEY

**CLASS 5—(Continued).**

SN 86-101,458. PFIZER INC., NEW YORK, NY. FILED 10-25-2013.

# FASAILLA

THE MARK CONSISTS OF STANDARD CHARACTERS WITHOUT CLAIM TO ANY PARTICULAR FONT, STYLE, SIZE, OR COLOR.

FOR PHARMACEUTICAL PREPARATIONS FOR THE TREATMENT OF CARDIOVASCULAR, CENTRAL NERVOUS SYSTEM, ENDOCRINE, GASTROINTESTINAL, GENETIC IMMUNOLOGICAL, INFECTIOUS, INFLAMMATORY, MENOPAUSAL, METABOLIC, AUTOIMMUNE, MUSCULOSKELETAL, NEUROLOGICAL, OPHTHALMOLOGICAL, PSYCHIATRIC, RESPIRATORY, UROGENITAL, UROLOGICAL AND VIRAL DISEASES AND DISORDERS; PHARMACEUTICAL PREPARATIONS FOR THE TREATMENT OF ERECTILE DYSFUNCTION, SEXUAL DYSFUNCTION, CANCER, PAIN AND DIABETES; PHARMACEUTICAL PREPARATIONS FOR USE IN HEMATOLOGY; PHARMACEUTICAL PREPARATIONS, NAMELY, ANTIFUNGAL PREPARATIONS, DERMATOLOGICAL PREPARATIONS, SMOKING CESSATION PREPARATIONS, AND TISSUE REPAIR PREPARATIONS; VACCINES FOR HUMAN USE (U.S. CLS. 6, 18, 44, 46, 51 AND 52).  
JAMES GRIFFIN, EXAMINING ATTORNEY

**CLASS 5—(Continued).**

SN 86-106,705. MYOS CORPORATION, CEDAR KNOLLS, NJ. FILED 10-31-2013.

# MYOS

THE MARK CONSISTS OF STANDARD CHARACTERS WITHOUT CLAIM TO ANY PARTICULAR FONT, STYLE, SIZE, OR COLOR.

OWNER OF U.S. REG. NO. 3,917,650.  
THE WORDING "MYOS" HAS NO MEANING IN A FOREIGN LANGUAGE.  
FOR DIETARY AND NUTRITIONAL SUPPLEMENTS (U.S. CLS. 6, 18, 44, 46, 51 AND 52).  
ESTHER BELENKER, EXAMINING ATTORNEY

SN 86-107,956. MENPER DISTRIBUTORS, INC., MIAMI, FL. FILED 11-1-2013.

# ABEJAS Y VIBORAS

THE MARK CONSISTS OF STANDARD CHARACTERS WITHOUT CLAIM TO ANY PARTICULAR FONT, STYLE, SIZE, OR COLOR.

THE ENGLISH TRANSLATION OF THE WORDS "ABEJAS Y VIBORAS" IN THE MARK IS "BEES AND VIPERS".  
FOR EXTERNAL USE PAIN RELIEVER PREPARATION, OINTMENT AND LIQUID LINIMENT (U.S. CLS. 6, 18, 44, 46, 51 AND 52).  
FIRST USE 10-28-2013; IN COMMERCE 10-28-2013.  
KHANH LE, EXAMINING ATTORNEY

SN 86-109,720. MAXIMUM HUMAN PERFORMANCE, LLC, FAIRFIELD, NJ. FILED 11-4-2013.

# Low T, Not Me

THE MARK CONSISTS OF STANDARD CHARACTERS WITHOUT CLAIM TO ANY PARTICULAR FONT, STYLE, SIZE, OR COLOR.

FOR DIETARY AND NUTRITIONAL SUPPLEMENTS (U.S. CLS. 6, 18, 44, 46, 51 AND 52).  
JEANIE LEE, EXAMINING ATTORNEY

SN 86-101,460. PFIZER INC., NEW YORK, NY. FILED 10-25-2013.

# POVELLYS

THE MARK CONSISTS OF STANDARD CHARACTERS WITHOUT CLAIM TO ANY PARTICULAR FONT, STYLE, SIZE, OR COLOR.

FOR PHARMACEUTICAL PREPARATIONS FOR THE TREATMENT OF CARDIOVASCULAR, CENTRAL NERVOUS SYSTEM, ENDOCRINE, GASTROINTESTINAL, GENETIC IMMUNOLOGICAL, INFECTIOUS, INFLAMMATORY, MENOPAUSAL, METABOLIC, AUTOIMMUNE, MUSCULOSKELETAL, NEUROLOGICAL, OPHTHALMOLOGICAL, PSYCHIATRIC, RESPIRATORY, UROGENITAL, UROLOGICAL AND VIRAL DISEASES AND DISORDERS; PHARMACEUTICAL PREPARATIONS FOR THE TREATMENT OF ERECTILE DYSFUNCTION, SEXUAL DYSFUNCTION, CANCER, PAIN AND DIABETES; PHARMACEUTICAL PREPARATIONS FOR USE IN HEMATOLOGY; PHARMACEUTICAL PREPARATIONS, NAMELY, ANTIFUNGAL PREPARATIONS, DERMATOLOGICAL PREPARATIONS, SMOKING CESSATION PREPARATIONS, AND TISSUE REPAIR PREPARATIONS; VACCINES FOR HUMAN USE (U.S. CLS. 6, 18, 44, 46, 51 AND 52).  
JAMES GRIFFIN, EXAMINING ATTORNEY

**CLASS 5—(Continued).**

SN 86-115,998. MUNDY, FORD, RIDGELAND, MS. FILED 11-12-2013.

**DURADRIN**

THE MARK CONSISTS OF STANDARD CHARACTERS WITHOUT CLAIM TO ANY PARTICULAR FONT, STYLE, SIZE, OR COLOR.

FOR PHARMACEUTICAL PREPARATIONS IN A CAPLET, CAPSULE, SOFTGEL, TABLET, NASAL, OR INJECTION FORM FOR THE TREATMENT AND RELIEF OF MIGRAINES, TENSION HEADACHES, CLUSTER HEADACHES, HANGOVERS, OR PAIN; ANALGESICS; VASOCONSTRICTORS (U.S. CLS. 6, 18, 44, 46, 51 AND 52).

ROSELLE HERRERA, EXAMINING ATTORNEY

SN 86-115,999. MUNDY, FORD, MADISON, MS. FILED 11-12-2013.

**MIGRALAM**

THE MARK CONSISTS OF STANDARD CHARACTERS WITHOUT CLAIM TO ANY PARTICULAR FONT, STYLE, SIZE, OR COLOR.

FOR PHARMACEUTICAL PREPARATIONS IN A CAPLET, CAPSULE, SOFTGEL, TABLET, NASAL, OR INJECTION FORM FOR THE TREATMENT AND RELIEF OF MIGRAINES, TENSION HEADACHES, CLUSTER HEADACHES, HANGOVERS, OR PAIN; ANALGESICS; VASOCONSTRICTORS (U.S. CLS. 6, 18, 44, 46, 51 AND 52).

ROSELLE HERRERA, EXAMINING ATTORNEY

SN 86-117,422. SANOFI, PARIS, FRANCE, FILED 11-13-2013.

**FARUPIVI**

THE MARK CONSISTS OF STANDARD CHARACTERS WITHOUT CLAIM TO ANY PARTICULAR FONT, STYLE, SIZE, OR COLOR.

PRIORITY CLAIMED UNDER SEC. 44(D) ON ERP CMNTY TM OFC APPLICATION NO. 11842432, FILED 5-24-2013, REG. NO. 11842432, DATED 10-16-2013, EXPIRES 5-24-2023.

OWNER OF U.S. REG. NO. 3,838,029.

FOR PHARMACEUTICAL PRODUCTS FOR THE TREATMENT OF AUTOIMMUNE DISEASES, INFLAMMATORY DISEASES, RHEUMATOID ARTHRITIS AND ANKYLOSING SPONDYLARTHROSIS (U.S. CLS. 6, 18, 44, 46, 51 AND 52).

THEODORE MCBRIDE, EXAMINING ATTORNEY

**CLASS 5—(Continued).**

SN 86-117,851. IDEAL LIVING VENTURES, LTD., 88 QUEENSWAY, HONG KONG, FILED 11-13-2013.

**100% Male**

THE MARK CONSISTS OF STANDARD CHARACTERS WITHOUT CLAIM TO ANY PARTICULAR FONT, STYLE, SIZE, OR COLOR.

NO CLAIM IS MADE TO THE EXCLUSIVE RIGHT TO USE "MALE", APART FROM THE MARK AS SHOWN. FOR DIETARY AND NUTRITIONAL SUPPLEMENTS (U.S. CLS. 6, 18, 44, 46, 51 AND 52).

WANDA KAY PRICE, EXAMINING ATTORNEY

SN 86-119,318. ELORAC, INC., VERNON HILLS, IL. FILED 11-14-2013.

**vectrin**

THE MARK CONSISTS OF STANDARD CHARACTERS WITHOUT CLAIM TO ANY PARTICULAR FONT, STYLE, SIZE, OR COLOR.

FOR PHARMACEUTICAL PREPARATION FOR SKIN CARE (U.S. CLS. 6, 18, 44, 46, 51 AND 52).

CHRISTOPHER REAMS, EXAMINING ATTORNEY

SN 86-125,784. TRU RX LLC, EAGLE, ID. FILED 11-21-2013.

**TRIPLE GUARD**

THE MARK CONSISTS OF STANDARD CHARACTERS WITHOUT CLAIM TO ANY PARTICULAR FONT, STYLE, SIZE, OR COLOR.

FOR PREPARATIONS TO TREAT OR PREVENT FLEAS, FLEA EGGS AND FLEA LARVAE, LICE, MOSQUITOS AND TICKS ON PETS (U.S. CLS. 6, 18, 44, 46, 51 AND 52).

TRACY CROSS, EXAMINING ATTORNEY

**CLASS 5—(Continued).**

SN 86-127,519. STEVENS, NATHAN, WEST ORANGE, NJ. FILED 11-23-2013.

# T-DRIVE

THE MARK CONSISTS OF STANDARD CHARACTERS WITHOUT CLAIM TO ANY PARTICULAR FONT, STYLE, SIZE, OR COLOR.

FOR PHARMACEUTICAL PREPARATIONS, NAMELY, OVER THE COUNTER HERBAL PREPARATIONS TO SUPPORT TESTOSTERONE LEVELS AND MALE ENHANCEMENT (U.S. CLS. 6, 18, 44, 46, 51 AND 52).

ALICIA COLLINS, EXAMINING ATTORNEY

---

SN 86-128,033. AMGEN INC., THOUSAND OAKS, CA. FILED 11-25-2013.

# SOLYMBIC

THE MARK CONSISTS OF STANDARD CHARACTERS WITHOUT CLAIM TO ANY PARTICULAR FONT, STYLE, SIZE, OR COLOR.

FOR PHARMACEUTICAL PREPARATIONS FOR THE TREATMENT OF DISEASES ASSOCIATED WITH CHOLESTEROL RELATED DISORDERS (U.S. CLS. 6, 18, 44, 46, 51 AND 52).

DARRYL SPRUILL, EXAMINING ATTORNEY

---

SN 86-129,277. GLAXOSMITHKLINE LLC, WILMINGTON, DE. FILED 11-26-2013.

# PIMTARGA

THE MARK CONSISTS OF STANDARD CHARACTERS WITHOUT CLAIM TO ANY PARTICULAR FONT, STYLE, SIZE, OR COLOR.

FOR PHARMACEUTICAL PREPARATIONS AND SUBSTANCES FOR THE TREATMENT OF DAMAGED SKIN AND TISSUE; PHARMACEUTICAL PREPARATIONS AND SUBSTANCES FOR THE TREATMENT OF INFECTIOUS DISEASES, BLOOD DISORDERS, PAIN, INFLAMMATION, SEPSIS, ALOPECIA, OBESITY AND COGNITIVE DISORDERS; PHARMACEUTICAL PREPARATIONS AND SUBSTANCES FOR THE TREATMENT OF VIRAL, METABOLIC, ENDOCRINE, MUSCULOSKELETAL, CARDIOVASCULAR, CARDIOPULMONARY, GENITOURINARY, SEXUAL DYSFUNCTION, ONCOLOGICAL, HEPATOLOGICAL, OPHTHALMIC, RESPIRATORY, NEUROLOGICAL, GASTROINTESTINAL, HORMONAL, DERMATOLOGICAL, PSYCHIATRIC AND IMMUNE SYSTEM RELATED DISEASES AND DISORDERS; VACCINES (U.S. CLS. 6, 18, 44, 46, 51 AND 52).

NATALIE POLZER, EXAMINING ATTORNEY

**CLASS 5—(Continued).**

SN 86-132,122. GENESIS BUSINESS VENTURES LLC, CORONADO, CA. FILED 11-30-2013.

# VITALEPH

THE MARK CONSISTS OF STANDARD CHARACTERS WITHOUT CLAIM TO ANY PARTICULAR FONT, STYLE, SIZE, OR COLOR.

FOR NUTRITIONAL SUPPLEMENTS (U.S. CLS. 6, 18, 44, 46, 51 AND 52).

FIRST USE 11-26-2013; IN COMMERCE 11-29-2013.

JAMES A. RAUEN, EXAMINING ATTORNEY

---

SN 86-138,359. TEVA WOMEN'S HEALTH, INC., WOODCLIFF LAKE, NJ. FILED 12-9-2013.

# LO SEASONIQUE

THE MARK CONSISTS OF STANDARD CHARACTERS WITHOUT CLAIM TO ANY PARTICULAR FONT, STYLE, SIZE, OR COLOR.

FOR PHARMACEUTICALS, NAMELY, ORAL CONTRACEPTIVES (U.S. CLS. 6, 18, 44, 46, 51 AND 52).

AISHA CLARKE, EXAMINING ATTORNEY

---

SN 86-138,443. TEVA WOMEN'S HEALTH, INC., WOODCLIFF LAKE, PA. FILED 12-9-2013.



THE MARK CONSISTS OF "SEASONIQUE" WITH FOUR DOTS IN THE UPPER RIGHT CORNER ABOVE "SEASONIQUE".

FOR PHARMACEUTICALS, NAMELY, ORAL CONTRACEPTIVES (U.S. CLS. 6, 18, 44, 46, 51 AND 52).

AISHA CLARKE, EXAMINING ATTORNEY

**CLASS 5—(Continued).**

SN 86-138,445. TEVA WOMEN'S HEALTH, INC., WOODCLIFF LAKE, PA. FILED 12-9-2013.



THE MARK CONSISTS OF "LO SEASONIQUE" WITH FOUR DOTS IN THE UPPER RIGHT HAND CORNER ABOVE "SEASONIQUE".  
FOR PHARMACEUTICALS, NAMELY, ORAL CONTRACEPTIVES (U.S. CLS. 6, 18, 44, 46, 51 AND 52).  
AISHA CLARKE, EXAMINING ATTORNEY

**CLASS 6—METAL GOODS**

SN 79-121,525. MOLLIFICIO BORTOLUSSI S.R.L., ITALY, FILED 8-8-2012.



VIGNETINOX

PRIORITY DATE OF 5-7-2012 IS CLAIMED.  
OWNER OF INTERNATIONAL REGISTRATION 1138658 DATED 8-8-2012, EXPIRES 8-8-2022.

NO CLAIM IS MADE TO THE EXCLUSIVE RIGHT TO USE "INOX", APART FROM THE MARK AS SHOWN.

THE MARK CONSISTS OF TWO CONCENTRIC CIRCLES WITH THE WORDS "VIGNETI INOX" WRITTEN BETWEEN THE CIRCLES WITH TWO SMALLER CIRCLES BETWEEN THE WORDS, AND INSIDE THE INNER CIRCLE IS A DESIGN OF A CLUSTER OF GRAPES WITH A GRAPE LEAF HANGING ON A BRANCH, AND THE WORD "VIGNETINOX" APPEARS BELOW.

THE ENGLISH TRANSLATION OF "VIGNETI INOX" IN THE MARK IS "VINYARD STAINLESS STEEL".

FOR COMMON METALS AND THEIR ALLOYS MADE IN SIGNIFICANT PART OF STAINLESS STEEL; METAL BUILDING MATERIALS, NAMELY, WIRES, RODS AND NETS, ALL MADE IN SIGNIFICANT PART OF STAINLESS STEEL; TRANSPORTABLE BUILDINGS OF MADE IN SIGNIFICANT PART OF STAINLESS STEEL; MATERIALS OF METAL FOR RAILWAY TRACKS MADE IN SIGNIFICANT PART OF STAINLESS STEEL; NON-ELECTRIC CABLES AND WIRES OF COMMON METAL MADE IN SIGNIFICANT PART OF STAINLESS STEEL; IRONMONGERY, NAMELY, METAL CLASPS MADE IN SIGNIFICANT PART OF STAINLESS STEEL CLIPS AND STRETCHERS; SMALL ITEMS OF METAL HARDWARE, NAMELY, NUTS, PULLEYS, SPRINGS, WASHERS AND BRACKETS, PIPES AND TUBES OF METAL ALL MADE IN SIGNIFICANT PART OF STAINLESS STEEL (U.S. CLS. 2, 12, 13, 14, 23, 25 AND 50).

JOHN WILKE, EXAMINING ATTORNEY

**CLASS 6—(Continued).**

SN 79-124,685. AMAG ROLLING GMBH, AUSTRIA, FILED 12-7-2012.

AMAG TOPFORM

THE MARK CONSISTS OF STANDARD CHARACTERS WITHOUT CLAIM TO ANY PARTICULAR FONT, STYLE, SIZE, OR COLOR.

PRIORITY DATE OF 8-22-2012 IS CLAIMED.  
OWNER OF INTERNATIONAL REGISTRATION 1146344 DATED 12-7-2012, EXPIRES 12-7-2022.

OWNER OF U.S. REG. NOS. 3,818,590, 4,110,734 AND OTHERS.

FOR COMMON METALS AND THEIR ALLOYS IN THE FORM OF FLAT ROLLED COILS, SHEETS AND PLATES (U.S. CLS. 2, 12, 13, 14, 23, 25 AND 50).

YAT SYE, LEE, EXAMINING ATTORNEY

SN 79-130,831. REDAELLI TECNA S.P.A., ITALY, FILED 3-15-2013.

FLEXMINE

THE MARK CONSISTS OF STANDARD CHARACTERS WITHOUT CLAIM TO ANY PARTICULAR FONT, STYLE, SIZE, OR COLOR.

PRIORITY DATE OF 1-15-2013 IS CLAIMED.  
OWNER OF INTERNATIONAL REGISTRATION 1162052 DATED 3-15-2013, EXPIRES 3-15-2023.

FOR NON-ELECTRIC CABLES OF METALS, METAL ROPES AND NON-ELECTRIC WIRES, STEEL CORDS, NAMELY, TO BE USED FOR TIRES, METAL COMPONENTS TO BE USED FOR HOOKING, INSTALLATION AND CONTROL OF CABLES AND WIRE ROPES, NAMELY, STEEL CARABINERS, PRETENSIONERS, SPRINGS, HOOKS, BOLT SNAPS OF METAL, ANCHORS (U.S. CLS. 2, 12, 13, 14, 23, 25 AND 50).

CHRISTINE MARTIN, EXAMINING ATTORNEY

SN 79-139,844. AUSVAT PTY LTD, AUSTRALIA, FILED 9-18-2013.

ivat

THE MARK CONSISTS OF STANDARD CHARACTERS WITHOUT CLAIM TO ANY PARTICULAR FONT, STYLE, SIZE, OR COLOR.

PRIORITY DATE OF 7-1-2013 IS CLAIMED.  
OWNER OF INTERNATIONAL REGISTRATION 1185141 DATED 9-18-2013, EXPIRES 9-18-2023.

FOR VATS OF METAL, METAL STORAGE TANKS, METAL STORAGE TANKS FOR WINE (U.S. CLS. 2, 12, 13, 14, 23, 25 AND 50).

LINDA LAVACHE, EXAMINING ATTORNEY



**CLASS 6—(Continued).**

SN 79-140,381. SANDVIK INTELLECTUAL PROPERTY AB, SWEDEN, FILED 9-20-2013.

# SAXON

THE MARK CONSISTS OF STANDARD CHARACTERS WITHOUT CLAIM TO ANY PARTICULAR FONT, STYLE, SIZE, OR COLOR.

OWNER OF INTERNATIONAL REGISTRATION 1186561 DATED 9-20-2013, EXPIRES 9-20-2023.

FOR STEEL FOR MAKING CUTTING DIES, DIE CUTTING KNIVES, SAW BLADES, STEEL RULES AND DIE CUTTING RULES (U.S. CLS. 2, 12, 13, 14, 23, 25 AND 50).

KERI CANTONE, EXAMINING ATTORNEY

**CLASS 6—(Continued).**

SN 85-840,746. HANDI-FOIL CORPORATION, WHEELING, IL. FILED 2-5-2013.

# iCATERING

THE MARK CONSISTS OF STANDARD CHARACTERS WITHOUT CLAIM TO ANY PARTICULAR FONT, STYLE, SIZE, OR COLOR.

FOR ALUMINUM FOIL AND ALUMINUM FOIL ROLLS (U.S. CLS. 2, 12, 13, 14, 23, 25 AND 50).

STEVEN R. FINE, EXAMINING ATTORNEY

SN 85-792,823. UNION CORPORATION, OSAKA, JAPAN, FILED 12-3-2012.

# UNION

THE MARK CONSISTS OF STANDARD CHARACTERS WITHOUT CLAIM TO ANY PARTICULAR FONT, STYLE, SIZE, OR COLOR.

OWNER OF JAPAN REG. NO. 147362, DATED 11-2-1922, EXPIRES 11-2-2022.

FOR DOOR HANDLES OF METAL; FURNITURE FITTINGS OF METAL; KNOBS OF METAL; METAL HINGES; METAL HOUSE NUMBERS; DOOR FITTINGS OF METAL; DOOR STOPPERS OF METAL; DOOR KNOCKERS OF METAL (U.S. CLS. 2, 12, 13, 14, 23, 25 AND 50).

JENNIFER WILLISTON, EXAMINING ATTORNEY

SN 85-844,748. AEGIS TECHNOLOGIES, INC., WAYNE, PA. FILED 2-8-2013.

# BRANCHLET

THE MARK CONSISTS OF STANDARD CHARACTERS WITHOUT CLAIM TO ANY PARTICULAR FONT, STYLE, SIZE, OR COLOR.

FOR METAL THREADED OR GROOVED BRANCH PIPE CONNECTION FITTINGS FOR USE IN THE FIRE SPRINKLER INDUSTRY (U.S. CLS. 2, 12, 13, 14, 23, 25 AND 50).

STEVEN JACKSON, EXAMINING ATTORNEY

SN 85-840,743. HANDI-FOIL CORPORATION, WHEELING, IL. FILED 2-5-2013.

# iCATER

THE MARK CONSISTS OF STANDARD CHARACTERS WITHOUT CLAIM TO ANY PARTICULAR FONT, STYLE, SIZE, OR COLOR.

FOR ALUMINUM FOIL AND ALUMINUM FOIL ROLLS (U.S. CLS. 2, 12, 13, 14, 23, 25 AND 50).

STEVEN R. FINE, EXAMINING ATTORNEY

SN 85-900,259. ECOPACT, LLC, PHOENIX, AZ. FILED 4-10-2013.

# THE PALLETTRUTH.ORG

THE MARK CONSISTS OF STANDARD CHARACTERS WITHOUT CLAIM TO ANY PARTICULAR FONT, STYLE, SIZE, OR COLOR.

OWNER OF U.S. REG. NO. 4,407,161.

FOR METAL PALLETS (U.S. CLS. 2, 12, 13, 14, 23, 25 AND 50).

LEE-ANNE BERNS, EXAMINING ATTORNEY

**CLASS 6—(Continued).**

SN 85-905,605. HIQUAL ENGINEERED STRUCTURES LTD., WINNIPEG MANITOBA, CANADA, FILED 4-16-2013.

**FASTCOVER**

THE MARK CONSISTS OF STANDARD CHARACTERS WITHOUT CLAIM TO ANY PARTICULAR FONT, STYLE, SIZE, OR COLOR.

PRIORITY CLAIMED UNDER SEC. 44(D) ON CANADA APPLICATION NO. 1599722, FILED 10-25-2012, REG. NO. TMA863942, DATED 10-30-2013, EXPIRES 10-30-2028.

FOR PORTABLE METAL-FRAMED, FABRIC COVERED BUILDINGS FOR USE IN ASSOCIATION WITH VEHICLE STORAGE, INDUSTRIAL STORAGE, COMMERCIAL WAREHOUSING, RECREATIONAL FACILITIES, LIVESTOCK FACILITIES, AGRICULTURAL BUILDINGS; SEMI-PERMANENT PORTABLE, METAL-FRAMED FABRIC COVERED BUILDINGS FOR USE IN ASSOCIATION WITH VEHICLE STORAGE, INDUSTRIAL STORAGE, COMMERCIAL WAREHOUSING, RECREATIONAL FACILITIES, LIVESTOCK FACILITIES, AGRICULTURAL BUILDINGS; PERMANENT, NON-PORTABLE PREFABRICATED FABRIC COVERED BUILDINGS MADE SUBSTANTIALLY OF METAL FOR USE IN ASSOCIATION WITH VEHICLE STORAGE, INDUSTRIAL STORAGE, COMMERCIAL WAREHOUSING, RECREATIONAL FACILITIES, LIVESTOCK FACILITIES, AGRICULTURAL BUILDINGS (U.S. CLS. 2, 12, 13, 14, 23, 25 AND 50).

SCOTT BIBB, EXAMINING ATTORNEY

SN 85-906,928. DECOR GRATES INCORPORATED, MARKHAM, ONTARIO, CANADA, FILED 4-17-2013.

**ORIENTAL**

THE MARK CONSISTS OF STANDARD CHARACTERS WITHOUT CLAIM TO ANY PARTICULAR FONT, STYLE, SIZE, OR COLOR.

SEC. 2(F).

FOR METAL VENT COVERS FOR HVAC DUCTS (U.S. CLS. 2, 12, 13, 14, 23, 25 AND 50).

FIRST USE 12-0-2004; IN COMMERCE 12-0-2004.  
SHAUNIA CARLYLE, EXAMINING ATTORNEY

**CLASS 6—(Continued).**

SN 85-907,125. CRS HOLDINGS, INC., WILMINGTON, DE. FILED 4-17-2013.

**CUSTOM 475**

THE MARK CONSISTS OF STANDARD CHARACTERS WITHOUT CLAIM TO ANY PARTICULAR FONT, STYLE, SIZE, OR COLOR.

OWNER OF U.S. REG. NOS. 891,899, 2,277,806 AND OTHERS.

NO CLAIM IS MADE TO THE EXCLUSIVE RIGHT TO USE "CUSTOM", APART FROM THE MARK AS SHOWN.

FOR STEEL IN THE FORM OF WIRE, ROD, BAR, STRIP, BILLET, AND OTHER SHAPES (U.S. CLS. 2, 12, 13, 14, 23, 25 AND 50).

MARGARET POWER, EXAMINING ATTORNEY

SN 85-927,537. DECOR GRATES INCORPORATED, MARKHAM, ONTARIO, CANADA, FILED 5-9-2013.

**GOTHIC**

THE MARK CONSISTS OF STANDARD CHARACTERS WITHOUT CLAIM TO ANY PARTICULAR FONT, STYLE, SIZE, OR COLOR.

SEC. 2(F).

FOR METAL VENT COVERS FOR HVAC DUCTS (U.S. CLS. 2, 12, 13, 14, 23, 25 AND 50).

FIRST USE 6-0-2007; IN COMMERCE 6-0-2007.

SHAUNIA CARLYLE, EXAMINING ATTORNEY

SN 85-936,808. JUPITER ALUMINUM CORPORATION, SCHILLER PARK, IL. FILED 5-20-2013.



THE MARK CONSISTS OF A CIRCULAR BORDER CONTAINING THE GREEK SYMBOL FOR "JUPITER" ALONG WITH THE WORD "JUPITER" IN STYLIZED FONT.

FOR ALUMINIUM SHEETS AND COILS (U.S. CLS. 2, 12, 13, 14, 23, 25 AND 50).

FIRST USE 9-1-1993; IN COMMERCE 9-1-1993.

STEVEN PEREZ, EXAMINING ATTORNEY

**CLASS 6—(Continued).**

SN 85-937,862. ELLWOOD GROUP INVESTMENT CORP., WILMINGTON, DE. FILED 5-21-2013.



THE MARK CONSISTS OF "ECF" IN BLOCK LETTERS HAVING A DIAMOND IN THE MIDDLE OF THE "C" AND A LINE THROUGH THE TOP PORTION OF THE LETTERS.

FOR GOODS MADE FROM METALS AND METAL ALLOYS, NAMELY, DIE FORGING PARTS IN THE NATURE OF SHAFTS, BLOCKS, LARGE ECCENTRICS, SMOOTH FORGED BILLET, ROUGH TURNED BAR, HOLLOW AND DISC FORGINGS, STEELS FOR PLASTIC MOLDS, FORGING DIE BLOCKS, AND CUSTOM FORGINGS (U.S. CLS. 2, 12, 13, 14, 23, 25 AND 50).

FIRST USE 1-1-1986; IN COMMERCE 1-1-1986.  
SUSAN RICHARDS, EXAMINING ATTORNEY

**CLASS 6—(Continued).**

SN 86-017,958. KDF FLUID TREATMENT INC., THREE RIVERS, MI. FILED 7-23-2013.

THE MARK CONSISTS OF STANDARD CHARACTERS WITHOUT CLAIM TO ANY PARTICULAR FONT, STYLE, SIZE, OR COLOR.

OWNER OF U.S. REG. NO. 1,586,491.

FOR COPPER/ZINC ALLOY PARTICLES FOR USE IN FLUID TREATMENT UNITS (U.S. CLS. 2, 12, 13, 14, 23, 25 AND 50).

FIRST USE 12-16-1983; IN COMMERCE 8-22-1986.

ROGER T. MCDORMAN, EXAMINING ATTORNEY

SN 85-937,920. ELLWOOD GROUP INVESTMENT CORP., WILMINGTON, DE. FILED 5-21-2013.

THE MARK CONSISTS OF STANDARD CHARACTERS WITHOUT CLAIM TO ANY PARTICULAR FONT, STYLE, SIZE, OR COLOR.

FOR COMMON METAL ALLOY FOR USE IN CONSUMABLE TOOLING FOR PIPE CASTING (U.S. CLS. 2, 12, 13, 14, 23, 25 AND 50).

FIRST USE 1-13-2004; IN COMMERCE 1-13-2004.  
SUSAN RICHARDS, EXAMINING ATTORNEY



SN 86-015,230. DURATECH PLASTICS CORPORATION, CARLSTADT, NJ. FILED 7-19-2013.

THE MARK CONSISTS OF STANDARD CHARACTERS WITHOUT CLAIM TO ANY PARTICULAR FONT, STYLE, SIZE, OR COLOR.

NO CLAIM IS MADE TO THE EXCLUSIVE RIGHT TO USE "BAG", APART FROM THE MARK AS SHOWN.

FOR FIXED DISPENSERS OF METAL FOR PLASTIC BAGS FOR USE IN GROCERY STORES FOR FOOD PURCHASE AND STORAGE (U.S. CLS. 2, 12, 13, 14, 23, 25 AND 50).

MARILYN IZZI, EXAMINING ATTORNEY

THE MARK CONSISTS OF THE TERM "YUXING" WITH THE NON-LATIN CHINESE CHARACTERS FOR ABOVE THE LETTERS "ING" IN THE WORD PORTION OF THE MARK.

THE NON-LATIN CHARACTERS IN THE MARK TRANSLITERATE TO "YUXING" AND THIS MEANS "UNIVERSE STAR" IN ENGLISH.

FOR BINDING SCREWS OF METAL FOR CABLES; BOLTS OF METAL; MECHANICAL FASTENING ELEMENTS OF METAL; METAL FASTENERS, NAMELY, BOLTS, NAILS, RIVETS, SCREWS; METAL HARDWARE, NAMELY, NUTS; METAL HOOKS; METAL NUTS; METAL THREADED FASTENERS; SCREWS OF METAL (U.S. CLS. 2, 12, 13, 14, 23, 25 AND 50).

FIRST USE 6-15-2013; IN COMMERCE 6-23-2013.

JOHN DALIER, EXAMINING ATTORNEY

**CLASS 6—(Continued).**

SN 86-030,816. VAN MERKSTEIJN INTERNATIONAL BV, ALMELO, NETHERLANDS, FILED 8-7-2013.



NO CLAIM IS MADE TO THE EXCLUSIVE RIGHT TO USE "USA", APART FROM THE MARK AS SHOWN.

THE MARK CONSISTS OF A IMAGE OF FOUR DIAGONALLY STACKED BARS ABOVE AN FIVE-SIDED BOX TO THE LEFT OF THE WORD "VAN" READING VERTICAL TO THE LEFT OF THE WORD "MERKSTEIJN" WITH A BAR ABOVE THE "I" AND "J" AND WITH THE ABBREVIATION "USA" BELOW THE "M".

FOR WELDED WIRE REINFORCEMENT MATERIALS FOR BUILDING, NAMELY, MESH FOR PRECAST AND CAST-IN-PLACE USES; MESH REINFORCEMENT MATERIALS FOR BUILDING, NAMELY, WIRE MESH FOR PRECAST AND CAST-IN-PLACE USES (U.S. CLS. 2, 12, 13, 14, 23, 25 AND 50).

FIRST USE 2-10-2011; IN COMMERCE 2-10-2011.  
ALEX KEAM, EXAMINING ATTORNEY

SN 86-032,910. MISSION RUBBER COMPANY LLC, CORONA, CA. FILED 8-8-2013.

**THE MISSION SUMO**

THE MARK CONSISTS OF STANDARD CHARACTERS WITHOUT CLAIM TO ANY PARTICULAR FONT, STYLE, SIZE, OR COLOR.

FOR COLLAPSIBLE METAL PIPE COUPLINGS (U.S. CLS. 2, 12, 13, 14, 23, 25 AND 50).

ELI HELLMAN, EXAMINING ATTORNEY

SN 86-033,628. TILE REDI, LLC, CORAL SPRINGS, FL. FILED 8-9-2013.

**GREAT GRATES!**

THE MARK CONSISTS OF STANDARD CHARACTERS WITHOUT CLAIM TO ANY PARTICULAR FONT, STYLE, SIZE, OR COLOR.

FOR METALLIC CONSTRUCTION MATERIALS, NAMELY, SHOWER DRAIN GRATES (U.S. CLS. 2, 12, 13, 14, 23, 25 AND 50).

FIRST USE 1-0-2013; IN COMMERCE 1-0-2013.  
PARKER HOWARD, EXAMINING ATTORNEY

**CLASS 6—(Continued).**

SN 86-039,802. KORBEL, BRADLEY, CALIFON, NJ. FILED 8-16-2013.

**We sweat so you can swim.**

THE MARK CONSISTS OF STANDARD CHARACTERS WITHOUT CLAIM TO ANY PARTICULAR FONT, STYLE, SIZE, OR COLOR.

FOR STEEL WALL PANELS, AND STEEL STEP LADDERS AND STEP STOOLS, FOR USE IN IN-GROUND VINYL LINER SWIMMING POOLS (U.S. CLS. 2, 12, 13, 14, 23, 25 AND 50).

DAVID ELTON, EXAMINING ATTORNEY

SN 86-040,256. SELA PRODUCTS, LLC, EDMOND, OK. FILED 8-16-2013.



OWNER OF U.S. REG. NO. 4,151,810.

THE MARK CONSISTS OF THE WORDS "MOUNT-WERKZ" THE WORD "WERKZ" IS IN A BOLD FONT.

FOR METAL MOUNTING BRACKETS FOR SPEAKERS, METAL WALL AND CEILING TELEVISION AND TELEVISION DISPLAY MOUNTS (U.S. CLS. 2, 12, 13, 14, 23, 25 AND 50).

FIRST USE 7-0-2010; IN COMMERCE 7-0-2010.  
JEFF DEFORD, EXAMINING ATTORNEY

SN 86-063,301. BOCARISA HOLDING LIMITED, LIMASSOL, CYPRUS, FILED 9-12-2013.

**CANADOIL**

THE MARK CONSISTS OF STANDARD CHARACTERS WITHOUT CLAIM TO ANY PARTICULAR FONT, STYLE, SIZE, OR COLOR.

FOR METAL JUNCTIONS FOR PIPES, BRANCHING PIPES OF METAL, METAL PIPES AND FITTINGS THEREFOR, METAL TUBES, METAL FLANGES, METAL CASTINGS, METAL RODS FOR WELDING, ELBOWS FOR ASSEMBLING WITH PIPES OR ITS PARTS ALL MADE OF METALS, IRONS AND STEELS, ALLOYED IRON, BRANCHING TUBES OF METAL FOR PIPELINES, CLAD STEEL PLATES AND SHEETS, STEEL PIPES AND TUBES, STEEL PLATES AND SHEETS (U.S. CLS. 2, 12, 13, 14, 23, 25 AND 50).

FIRST USE 0-0-1984; IN COMMERCE 0-0-1984.  
ERNEST SHOSHO, EXAMINING ATTORNEY

**CLASS 6—(Continued).**

SN 86-063,323. BOCARISA HOLDING LIMITED, LIMASSOL, CYPRUS, FILED 9-12-2013.

**TUBEND**

THE MARK CONSISTS OF STANDARD CHARACTERS WITHOUT CLAIM TO ANY PARTICULAR FONT, STYLE, SIZE, OR COLOR.

FOR METAL JUNCTIONS FOR PIPES, BRANCHING PIPES OF METAL, METAL PIPES AND FITTINGS THEREFOR, METAL TUBES, METAL FLANGES, METAL CASTINGS, METAL RODS FOR WELDING, ELBOWS FOR ASSEMBLING WITH PIPES OR ITS PARTS ALL MADE OF METALS, IRONS AND STEELS, ALLOYED IRON, BRANCHING TUBES OF METAL FOR PIPELINES, CLAD STEEL PLATES AND SHEETS, STEEL PIPES AND TUBES, STEEL PLATES AND SHEETS (U.S. CLS. 2, 12, 13, 14, 23, 25 AND 50).

ERNEST SHOSHO, EXAMINING ATTORNEY

SN 86-065,271. RAYNOR MFG. CO., DIXON, IL. FILED 9-16-2013.

**OPTIFINISH**

THE MARK CONSISTS OF STANDARD CHARACTERS WITHOUT CLAIM TO ANY PARTICULAR FONT, STYLE, SIZE, OR COLOR.

FOR GARAGE DOOR PANELS MADE FROM METAL WITH CUSTOMIZED COLOR DESIGN COATING ON OUTSIDE PANEL SURFACE (U.S. CLS. 2, 12, 13, 14, 23, 25 AND 50).

REBECCA SMITH, EXAMINING ATTORNEY

SN 86-065,416. NORTH COUNTRY WIND BELLS, INC., ROUND POND, ME. FILED 9-16-2013.

**MEMORABELL**

THE MARK CONSISTS OF STANDARD CHARACTERS WITHOUT CLAIM TO ANY PARTICULAR FONT, STYLE, SIZE, OR COLOR.

FOR METAL BELLS (U.S. CLS. 2, 12, 13, 14, 23, 25 AND 50).

FIRST USE 9-4-2013; IN COMMERCE 9-4-2013.  
NANCY CLARKE, EXAMINING ATTORNEY

**CLASS 6—(Continued).**

SN 86-067,268. LULABOP LLC, SEATTLE, WA. FILED 9-17-2013.

**LULABINER**

THE MARK CONSISTS OF STANDARD CHARACTERS WITHOUT CLAIM TO ANY PARTICULAR FONT, STYLE, SIZE, OR COLOR.

FOR METAL CLIP FOR HANGING BELONGINGS (U.S. CLS. 2, 12, 13, 14, 23, 25 AND 50).

SUNG IN, EXAMINING ATTORNEY

SN 86-067,966. VANDERGEEST INC., BARRIE, ONTARIO, CANADA, FILED 9-18-2013.

**Guard it Right  Save a Life**

THE MARK CONSISTS OF A DESIGN OF A CHECK MARK INSIDE OF A BOX WITH THE STYLIZED TEXT "GUARD IT RIGHT" TO THE LEFT OF THE DESIGN AND THE STYLIZED TEXT "SAVE A LIFE" TO THE RIGHT OF THE DESIGN.

FOR METAL GUARD BARRIERS FOR ROTATING EQUIPMENT (U.S. CLS. 2, 12, 13, 14, 23, 25 AND 50).

ANGELA DUONG, EXAMINING ATTORNEY

SN 86-069,307. TIE ME DOWN LLC, PALMETTO, GA. FILED 9-19-2013.



THE MARK CONSISTS OF THE STYLIZED LETTERS "TMD" WITH THE STYLIZED TEXT "TIEMEDOWN" BENEATH THAT WITH A DESIGN OF A TIE DOWN WITH A ROPE WRAPPED AROUND "TIEMEDOWN" CONNECTED TO THE TIE DOWN.

FOR METAL STRAPPING OR TIE DOWNS (U.S. CLS. 2, 12, 13, 14, 23, 25 AND 50).

HEATHER THOMPSON, EXAMINING ATTORNEY

**CLASS 6—(Continued).**

SN 86-069,329. NETBRAZE, MT. ORAB, OH. FILED 9-19-2013.

**LoLo**

THE MARK CONSISTS OF STANDARD CHARACTERS WITHOUT CLAIM TO ANY PARTICULAR FONT, STYLE, SIZE, OR COLOR.

FOR LOW FUMING BRONZE BRAZING ALLOY USED FOR METAL JOINING (U.S. CLS. 2, 12, 13, 14, 23, 25 AND 50).

GINA FINK, EXAMINING ATTORNEY

**CLASS 6—(Continued).**

SN 86-070,508. BRIAN BICKEL, DES MOINES, IA. FILED 9-20-2013.

**FLYING FURNACE**

THE MARK CONSISTS OF STANDARD CHARACTERS WITHOUT CLAIM TO ANY PARTICULAR FONT, STYLE, SIZE, OR COLOR.

FOR SCULPTURES OF METAL (U.S. CLS. 2, 12, 13, 14, 23, 25 AND 50).

HEATHER SAPP, EXAMINING ATTORNEY

SN 86-069,641. NEW FASTENERS ARE HERE LTD., DES-PLAINES, IL. FILED 9-19-2013.

**BLACK LUSTER**

THE MARK CONSISTS OF STANDARD CHARACTERS WITHOUT CLAIM TO ANY PARTICULAR FONT, STYLE, SIZE, OR COLOR.

SEC. 2(F).

FOR METAL FASTENERS, NAMELY, ACORN NUTS, WING NUTS, HEX NUTS, LOCKING HEX NUTS, CAP SCREWS, BOLTS, TAP BOLTS, WASHERS, PUSH CAPS, PAD LOCKABLE BENT PINS (U.S. CLS. 2, 12, 13, 14, 23, 25 AND 50).

FIRST USE 6-0-2005; IN COMMERCE 6-0-2005.

CIMMERIAN COLEMAN, EXAMINING ATTORNEY

SN 86-072,471. COMPACT CONTAINER SYSTEMS LLC, SAVANNAH, GA. FILED 9-23-2013.

**FOLDX**

THE COLOR(S) GREEN AND BLUE IS/ARE CLAIMED AS A FEATURE OF THE MARK.

THE MARK CONSISTS OF THE LETTERS "FOLDX" WHERE THE LETTERS "FOLD" ARE IN GREEN AND THE "X" IS IN BLUE.

FOR CONTAINERS OF METAL FOR TRANSPORT (U.S. CLS. 2, 12, 13, 14, 23, 25 AND 50).

RONALD MCMORROW, EXAMINING ATTORNEY

SN 86-069,806. KORBEL, BRADLEY, CALIFON, NJ. FILED 9-19-2013.

**Zamtastic Pools**

THE MARK CONSISTS OF STANDARD CHARACTERS WITHOUT CLAIM TO ANY PARTICULAR FONT, STYLE, SIZE, OR COLOR.

NO CLAIM IS MADE TO THE EXCLUSIVE RIGHT TO USE "POOLS", APART FROM THE MARK AS SHOWN.

FOR STEEL WALL IN-GROUND SWIMMING POOL WALLS (U.S. CLS. 2, 12, 13, 14, 23, 25 AND 50).

FIRST USE 8-10-2013; IN COMMERCE 8-12-2013.

DAVID ELTON, EXAMINING ATTORNEY

SN 86-080,146. PARAMOUNT PICTURES CORPORATION, HOLLYWOOD, CA. FILED 10-1-2013.

**JACK RYAN: SHADOW RECRUIT**

THE MARK CONSISTS OF STANDARD CHARACTERS WITHOUT CLAIM TO ANY PARTICULAR FONT, STYLE, SIZE, OR COLOR.

THE NAME(S), PORTRAIT(S), AND/OR SIGNATURE(S) SHOWN IN THE MARK DOES NOT IDENTIFY A PARTICULAR LIVING INDIVIDUAL.

FOR BUSTS OF NON-PRECIOUS METAL; FIGURES OF COMMON METAL; KEY FOBS OF COMMON METAL; METAL KEY CHAINS (U.S. CLS. 2, 12, 13, 14, 23, 25 AND 50).

AHSEN KHAN, EXAMINING ATTORNEY

**CLASS 6—(Continued).**

SN 86-085,976. JEWELRY FOR A CAUSE, LLC, COS COB, CT.  
FILED 10-8-2013.

# SHREDS

THE MARK CONSISTS OF STANDARD CHARACTERS  
WITHOUT CLAIM TO ANY PARTICULAR FONT, STYLE,  
SIZE, OR COLOR.

FOR WORKS OF ART OF COMMON METAL (U.S.  
CLS. 2, 12, 13, 14, 23, 25 AND 50).

WENDY JUN, EXAMINING ATTORNEY

SN 86-085,987. JEWELRY FOR A CAUSE, LLC, COS COB, CT.  
FILED 10-8-2013.

# DESTROYED. NEVER TO DESTROY AGAIN.

THE MARK CONSISTS OF STANDARD CHARACTERS  
WITHOUT CLAIM TO ANY PARTICULAR FONT, STYLE,  
SIZE, OR COLOR.

FOR WORKS OF ART OF COMMON METAL (U.S.  
CLS. 2, 12, 13, 14, 23, 25 AND 50).

WENDY JUN, EXAMINING ATTORNEY

SN 86-086,700. THE WALLACE BARNES COMPANY, BRIS-  
TOL, CT. FILED 10-9-2013.

# NITRO-LOCK

THE MARK CONSISTS OF STANDARD CHARACTERS  
WITHOUT CLAIM TO ANY PARTICULAR FONT, STYLE,  
SIZE, OR COLOR.

FOR METAL LOCK RING FOR WORK ROLL CHOCKS  
(U.S. CLS. 2, 12, 13, 14, 23, 25 AND 50).

ANNE E. GUSTASON, EXAMINING ATTORNEY

**CLASS 6—(Continued).**

SN 86-088,221. ILLINOIS TOOL WORKS INC., DBA ITW  
POWERTRAIN FASTENING, LEXINGTON, KY. FILED  
10-10-2013.



OWNER OF U.S. REG. NO. 3,267,391.  
THE MARK CONSISTS OF SHAPE OF A BARBELL.  
FOR METAL BOLTS; METAL SCREWS (U.S. CLS. 2, 12,  
13, 14, 23, 25 AND 50).

FIRST USE 7-0-2006; IN COMMERCE 7-0-2006.

ANN E. SAPPENFIELD, EXAMINING ATTORNEY

SN 86-090,467. NUCOR CORPORATION, CHARLOTTE, NC.  
FILED 10-14-2013.

# NUPOST

THE MARK CONSISTS OF STANDARD CHARACTERS  
WITHOUT CLAIM TO ANY PARTICULAR FONT, STYLE,  
SIZE, OR COLOR.

FOR METAL FENCE POSTS (U.S. CLS. 2, 12, 13, 14, 23,  
25 AND 50).

STEVEN PEREZ, EXAMINING ATTORNEY

SN 86-091,895. KEVIN FRIESTH, FORT DODGE, IA. FILED  
10-15-2013.

# REAP

THE MARK CONSISTS OF STANDARD CHARACTERS  
WITHOUT CLAIM TO ANY PARTICULAR FONT, STYLE,  
SIZE, OR COLOR.

FOR BASE ALUMINUM, NAMELY, ALUMINUM AL-  
LOYS (U.S. CLS. 2, 12, 13, 14, 23, 25 AND 50).

RENEE MCCRAY, EXAMINING ATTORNEY

**CLASS 6—(Continued).**

SN 86-103,439. UNITED STATES STEEL CORPORATION, PITTSBURGH, PA. FILED 10-28-2013.

# USS-PATRIOT EBM

THE MARK CONSISTS OF STANDARD CHARACTERS WITHOUT CLAIM TO ANY PARTICULAR FONT, STYLE, SIZE, OR COLOR.

NO CLAIM IS MADE TO THE EXCLUSIVE RIGHT TO USE "EBM", APART FROM THE MARK AS SHOWN.

FOR STEEL PIPES AND TUBES (U.S. CLS. 2, 12, 13, 14, 23, 25 AND 50).

KARANENDRA S. CHHINA, EXAMINING ATTORNEY

---

SN 86-115,000. HUBBELL INCORPORATED, SHELTON, CT. FILED 11-11-2013.

# WEEB

THE MARK CONSISTS OF STANDARD CHARACTERS WITHOUT CLAIM TO ANY PARTICULAR FONT, STYLE, SIZE, OR COLOR.

FOR METAL HARDWARE, NAMELY, WASHERS (U.S. CLS. 2, 12, 13, 14, 23, 25 AND 50).

FIRST USE 0-0-2006; IN COMMERCE 0-0-2006.

EVIN L. KOZAK, EXAMINING ATTORNEY

**CLASS 7—MACHINERY**

SN 78-664,347. ROLLER BEARING COMPANY OF AMERICA, INC., OXFORD, CT. FILED 7-6-2005.

# 1630

THE MARK CONSISTS OF STANDARD CHARACTERS WITHOUT CLAIM TO ANY PARTICULAR FONT, STYLE, SIZE, OR COLOR.

SEC. 2(F).

FOR THIN SECTION ROLLER BEARINGS (U.S. CLS. 13, 19, 21, 23, 31, 34 AND 35).

FIRST USE 0-0-1946; IN COMMERCE 0-0-1946.

DORITT L. CARROLL, EXAMINING ATTORNEY

**CLASS 7—(Continued).**

SN 79-123,242. KSB AKTIENGESELLSCHAFT, FED REP GERMANY, FILED 8-30-2012.

# MegaCPK

THE MARK CONSISTS OF STANDARD CHARACTERS WITHOUT CLAIM TO ANY PARTICULAR FONT, STYLE, SIZE, OR COLOR.

OWNER OF INTERNATIONAL REGISTRATION 1142915 DATED 8-30-2012, EXPIRES 8-30-2022.

FOR MACHINES, NAMELY, PUMPS FOR MACHINES, AND PUMPS AS PARTS OF MACHINES, MOTORS AND ENGINES; INSTALLATIONS FOR TRANSPORT, REGULATION, TREATMENT, AND FILLING OF LIQUID MEDIA, NAMELY, AGITATORS FOR CIRCULATING LIQUID MEDIA, PACKAGING MACHINES IN THE NATURE OF LIQUID CONTAINER FILLERS, INDUSTRIAL MIXER FOR MIXING LIQUIDS IN THE PHARMACEUTICAL AND CHEMICAL INDUSTRIES, CONVEYORS, DIFFUSERS USED IN MACHINES FOR WASTEWATER AND CLEAN WATER TREATMENT, FILLING MACHINES AND PARTS THEREOF; PUMPS, NAMELY, HIGH TEMPERATURE PUMPS, PUMPS FOR THERMAL OIL, ELECTRIC PUMPS, ELECTRIC WATER PUMPS, WASTEWATER PUMPS, ELECTRIC PRESSURE BOOSTING PUMPS, SLURRY PUMPS, DRAINAGE PUMPS, SEWAGE LIFTING PUMPS, CIRCULATING PUMPS FOR COOLING AND HEATING FLUID, SEWAGE PUMPS, SUBMERSIBLE PUMPS, CENTRIFUGAL PUMPS, FLUE GAS SCRUBBER PUMPS, BOILER FEED PUMPS, CONDENSATE PUMPS, REVERSE OSMOSIS PUMPS, WATER PUMPS FOR WELLS, ELECTRIC CORROSION-RESISTANT PUMPS, ELECTRIC HERMETICALLY-SEALED PUMPS, ELECTRIC DESALINATION PLANT PUMPS, ELECTRIC IRRIGATION PUMPS, ELECTRIC MAGNETIC DRIVE PUMPS, ELECTRIC EXPLOSION-PROOF PUMPS, AND ELECTRIC OIL AND CHEMICAL PUMPS FOR HANDLING AGGRESSIVE, TOXIC, EXPLOSIVE, VALUABLE, INFLAMMABLE, MALODOROUS, AND HARMFUL LIQUIDS; ELECTRIC PUMPS FOR CRUDE OIL TRANSPORT AND PETROCHEMICAL APPLICATIONS, AND ELECTRIC MULTI-STAGE WATER PUMPS FOR GARDEN SPRINKLING, IRRIGATION SYSTEMS, RAIN WATER UTILIZATION, DOMESTIC, AND MUNICIPAL WATER SUPPLY AND AGRICULTURE; CANNED PUMPS AS PARTS OF MACHINES, NAMELY, PUMPS WITH INTEGRATED MOTORS; MOTORS AND ENGINES, NOT FOR USE IN LAND VEHICLES; UNITS CONSISTING OF ELECTRIC PUMPS AND ELECTRIC MOTORS, FOR USE IN THE HANDLING OF PURE, AGGRESSIVE, CLEAN, AND CONTAMINATED LIQUIDS FOR USE IN SEWAGE TREATMENT, POWER PLANT, DESALINATION PLANT, CONSTRUCTION SITE, AGRICULTURE, INDUSTRIAL, CHEMICAL, PETROCHEMICAL, PHARMACEUTICAL, FOOD PROCESSING, FOOD PACKING, AND SPRINKLER SYSTEM APPLICATIONS; PARTS OF MACHINES, INSTALLATIONS AND PUMPS, NAMELY, PUMP IMPELLERS, PUMP CASINGS, BEARINGS, BLADES, SHAFTS FOR PUMPS, BASE PLATES, STATORS, AND ROTORS; MACHINE FOUNDATIONS; MACHINE TOOL HOLDERS; BEARING BRACKETS FOR MACHINES; MOUNTING ACCESSORY AND FITTING SETS FOR MACHINES, INSTALLATIONS AND PUMPS COMPRISED PRIMARILY OF JOINTS FOR CONNECTING SLIDING STRIPS, MACHINE BEARING RINGS, MACHINE SPLIT RINGS, MECHANICAL SEALS, METAL AND NON-METAL NUTS, METAL AND NON-METAL SCREWS, METAL AND NON-METAL BOLTS, METAL AND NON-METAL EXPANDING SLEEVES FOR AFFIXING SCREWS, AND METAL AND NON-METAL THREADED FASTENERS; PARTS OF MACHINES, NAMELY, REGULATING AND CONTROL APPARATUS COMPRISED OF PUMP MONITORING GAUGES, FLOW REGULATORS, PRESSURE REGULATORS, PUMP AND MOTOR CONTROLLERS, AND PUMP CONTROL



**CLASS 7—(Continued).**

VALVES; VALVES BEING PARTS OF MACHINES, NAMELY, BALL VALVES, DIAPHRAGM VALVES, SLIDE GATE VALVES, BUTTERFLY VALVES, SAMPLE AND BLEED VALVES, BYPASS VALVES; ACTUATORS FOR MOTORS WITH ELECTRONIC CONTROL, NAMELY, LINEAR ACTUATORS, HYDRAULIC VALVE ACTUATORS, PNEUMATIC VALVE ACTUATORS, HYDRAULIC LINEAR ACTUATORS IN THE NATURE OF ELECTRO-HYDRAULIC VALVE ACTUATORS, PNEUMATIC LINEAR ACTUATORS IN THE NATURE OF DIAPHRAGM ACTUATORS (U.S. CLS. 13, 19, 21, 23, 31, 34 AND 35).

JAY BESCH, EXAMINING ATTORNEY

SN 79-128,271. STEINEL NORMALIEN AG, FED REP GERMANY, FILED 2-15-2013.

**STEINEL**

PRIORITY DATE OF 8-16-2012 IS CLAIMED.  
OWNER OF INTERNATIONAL REGISTRATION 1155458  
DATED 2-15-2013, EXPIRES 2-15-2023.  
SEC. 2(F).

FOR MACHINE TOOLS, IN PARTICULAR FOR DRILLING, COUNTERBORING, GRATING, PRECISION BORING, THREAD CUTTING, MILLING, LATHING, SAWING AND RIVETING AND APPERTAINING TO MECHANICAL TOOLS AND APPLIANCES, NAMELY, WORKPIECE HOLDING DEVICES AND WORKPIECE CLAMPING DEVICES; POWER OPERATED PRESSES, NAMELY, MANUAL TOGGLE PRESSES, PUNCHING AND BENDING PRESSES; INSERTED TOOLS AND APPLIANCES FOR THE AFORESAID PRESSES, NAMELY, COLUMNAR MOUNTS OF STEEL OR GREY IRON, GUIDING, CUTTING AND SPRING ELEMENTS, NAMELY, CUTTING PUNCHES, CUTTING BUSHES, PUNCH GUIDE BUSHES, MOUNTING SLEEVES AND PLATES FOR CUTTING PUNCHES; MACHINE PARTS, NAMELY, COIL SPRINGS, PLATE SPRINGS, RUBBER AND PLASTIC SPRINGS, SPRING-LOADED PRESSURE PIECES AND SAW BLADES (U.S. CLS. 13, 19, 21, 23, 31, 34 AND 35).

KRISTINA MORRIS, EXAMINING ATTORNEY

**CLASS 7—(Continued).**

SN 79-129,813. HANGZHOU WANXING REDUCER CO., LTD., CHINA, FILED 2-1-2013.



OWNER OF INTERNATIONAL REGISTRATION 1159406  
DATED 2-1-2013, EXPIRES 2-1-2023.

THE MARK CONSISTS OF A FOUR POINTED STAR WITH A RECTANGULAR ZIG-ZAG DESIGN INSIDE IT, THAT IS PLACED ABOVE THE TERM "WANXING" AND TWO CHINESE CHARACTERS, WHICH ARE PLACED TO THE RIGHT THE TERM.

THE ENGLISH TRANSLATION OF THE FOREIGN WORD(S) IN THE MARK IS: THE FIRST CHINESE CHARACTER "WAN" MEANS "TEN THOUSAND", THE SECOND CHINESE "XING" MEANS "HAPPY", THE FULL CHINESE CHARACTERS "WAN XING" AND CHARACTERS "WANXING" HAVE NO MEANING.

THE TRANSLITERATION OF THE NON-LATIN CHARACTERS IN THE MARK IS: THE FIRST CHARACTER READS "WAN", THE SECOND CHARACTER READS "XING", THE FULL CHINESE CHARACTERS READS "WAN XING".

FOR SPEED REDUCER BEING A POWER TRANSMISSION DEVICE FOR ENGINES USED IN CAR SYSTEM; SPEED GOVERNORS FOR MACHINES, ENGINES AND MOTORS; SHAFT COUPLINGS FOR MACHINES; CHAINWHEEL BEING PARTS OF MACHINES, NAMELY, ENGINES USED IN CAR SYSTEM; RACK AND PINION JACKS, NAMELY, POWER JACKS; MACHINE WHEELWORK; DYNAMOS (U.S. CLS. 13, 19, 21, 23, 31, 34 AND 35).

KAMAL PREET, EXAMINING ATTORNEY

SN 79-132,320. RUAN MENGZHU, CHINA, FILED 6-5-2013.



OWNER OF INTERNATIONAL REGISTRATION 1165949  
DATED 6-5-2013, EXPIRES 6-5-2023.

THE MARK CONSISTS OF THE STYLIZED LETTERS "JEMA" INSIDE A RECTANGLE.

THE LATIN LETTERS "JEMA" APPEARING IN THE TRADEMARK HAVE NO SIGNIFICANCE IN THE RELEVANT TRADE OR INDUSTRY, OR ANY GEOGRAPHICAL SIGNIFICANCE, OR ANY MEANING IN A FOREIGN LANGUAGE.

FOR STITCHING MACHINES; HEMMING MACHINES; IRONING MACHINES FOR CLOTHING; SEWING MACHINES; PACKING SEWING MACHINES; OVERLOCK SEWING MACHINES; BUTTON LOCKING MACHINES; FLAT SEWING MACHINES; EDGE SEWING MACHINES; FABRIC CUTTING MACHINES; CLOTH FEEDING MACHINES; BEDPLATES FOR INDUSTRIAL SEWING MACHINES (U.S. CLS. 13, 19, 21, 23, 31, 34 AND 35).

SAMUAL PAQUIN, EXAMINING ATTORNEY

**CLASS 7—(Continued).**

SN 79-134,210. ZHEJIANG AUARITA; PNEUMATIC TOOLS L.L.C., CHINA, FILED 5-29-2013.



OWNER OF INTERNATIONAL REGISTRATION 1170841 DATED 5-29-2013, EXPIRES 5-29-2023.

OWNER OF U.S. REG. NO. 3,643,879.

THE MARK CONSISTS OF A HIGHLY STYLIZED AND SEGMENTED LETTER "A".

FOR MOULDS AS PARTS OF MACHINES FOR PROCESSING PLASTICS; HAND-HELD TOOLS, OTHER THAN HAND-OPERATED, NAMELY, POWER DRILLS; WIND-POWERED METALWORKING MACHINE TOOLS; VALVES BEING PARTS OF MACHINES; SPRAY-PAINT GUNS; SPRAY-PAINT MACHINES; WELDING MACHINES, ELECTRIC; PRESSURE WASHING MACHINES (U.S. CLS. 13, 19, 21, 23, 31, 34 AND 35).

TASNEEM HUSSAIN, EXAMINING ATTORNEY

SN 79-139,343. COMPACT POWER PLANT PRODUCTS GMBH, AUSTRIA, FILED 9-19-2013.

# RESONABTOR

THE MARK CONSISTS OF STANDARD CHARACTERS WITHOUT CLAIM TO ANY PARTICULAR FONT, STYLE, SIZE, OR COLOR.

PRIORITY DATE OF 3-28-2013 IS CLAIMED.

OWNER OF INTERNATIONAL REGISTRATION 1183920 DATED 9-19-2013, EXPIRES 9-19-2023.

FOR SILENCERS FOR USE IN EXHAUST DUCTS OF GAS TURBINE POWER PLANTS (U.S. CLS. 13, 19, 21, 23, 31, 34 AND 35).

DARRYL SPRUILL, EXAMINING ATTORNEY

SN 85-368,204. WHITE KNIGHT FLUID HANDLING, INC., KAMAS, UT. FILED 7-11-2011.



OWNER OF U.S. REG. NO. 4,321,592.

THE MARK CONSISTS OF THE LETTERS "W" AND "K" INTERSECTING WITH ONE ANOTHER WITHIN A SHADED CIRCLE TO THE LEFT OF THE WORDING "WHITE KNIGHT" THE WORDING "WHITE" ABOVE THE WORDING "KNIGHT".

FOR PNEUMATICALLY POWERED LIQUID PUMPS FOR USE IN PUMPING CAUSTIC FLUIDS USING PRESSURIZED AIR OR GAS (U.S. CLS. 13, 19, 21, 23, 31, 34 AND 35).

MARC LEIPZIG, EXAMINING ATTORNEY

**CLASS 7—(Continued).**

SN 85-734,242. HARDWARE LABS PERFORMANCE SYSTEMS, INC., QUEZON CITY, PHILIPPINES, FILED 9-20-2012.

# masiv

THE MARK CONSISTS OF STANDARD CHARACTERS WITHOUT CLAIM TO ANY PARTICULAR FONT, STYLE, SIZE, OR COLOR.

FOR COOLING RADIATORS FOR MOTORS AND ENGINES; RADIATORS FOR MOTORS AND ENGINES; RADIATORS FOR MOTORS AND ENGINES; RADIATORS FOR VEHICLES (U.S. CLS. 13, 19, 21, 23, 31, 34 AND 35).

FIRST USE 3-1-2006; IN COMMERCE 5-1-2009.

FRED CARL, EXAMINING ATTORNEY

SN 85-754,470. SMITH INTERNATIONAL, INC., HOUSTON, TX. FILED 10-15-2012.

# VCL

THE MARK CONSISTS OF STANDARD CHARACTERS WITHOUT CLAIM TO ANY PARTICULAR FONT, STYLE, SIZE, OR COLOR.

FOR POWER DRIVEN DRILL BITS FOR USE IN OIL AND GAS DRILLING (U.S. CLS. 13, 19, 21, 23, 31, 34 AND 35).

ERIN FALK, EXAMINING ATTORNEY

SN 85-826,536. K-TEC, INC., OREM, UT. FILED 1-18-2013.

# SIGNATURE SERIES

THE MARK CONSISTS OF STANDARD CHARACTERS WITHOUT CLAIM TO ANY PARTICULAR FONT, STYLE, SIZE, OR COLOR.

NO CLAIM IS MADE TO THE EXCLUSIVE RIGHT TO USE "SERIES", APART FROM THE MARK AS SHOWN.

FOR ELECTRIC FOOD BLENDERS FOR USE IN THE FIELD OF FOOD AND DRINK PREPARATION (U.S. CLS. 13, 19, 21, 23, 31, 34 AND 35).

FIRST USE 3-28-2013; IN COMMERCE 3-28-2013.

JOHN DWYER, EXAMINING ATTORNEY

**CLASS 7—(Continued).**

SN 85-835,920. STAHL'S INC., ROSEVILLE, MI. FILED 1-29-2013.

**COUNTERCADDIE**

THE MARK CONSISTS OF STANDARD CHARACTERS WITHOUT CLAIM TO ANY PARTICULAR FONT, STYLE, SIZE, OR COLOR.

FOR STANDS FOR MACHINES; STANDS FOR HEAT TRANSFER PRESSES (U.S. CLS. 13, 19, 21, 23, 31, 34 AND 35).

MARIA-VICTORIA SUAREZ, EXAMINING ATTORNEY

SN 85-860,617. AMP INDÚSTRIA E COMÉRCIO DE PEÇAS AUTOMOTIVAS LTDA., SAO PAULO/SP, BRAZIL, FILED 2-26-2013.

**URBA BROSOL**

THE MARK CONSISTS OF STANDARD CHARACTERS WITHOUT CLAIM TO ANY PARTICULAR FONT, STYLE, SIZE, OR COLOR.

THE NAME(S), PORTRAIT(S), AND/OR SIGNATURE(S) SHOWN IN THE MARK DOES NOT IDENTIFY A PARTICULAR LIVING INDIVIDUAL.

THE WORDING "URBA BROSOL" HAS NO MEANING IN A FOREIGN LANGUAGE.

FOR MUFFLERS FOR MOTORS AND ENGINES; OIL-WATER SEPARATORS FOR PNEUMATIC CONTROLS BEING PART OF MACHINES; DRAIN COCKS BEING PARTS OF MACHINES; ALTERNATORS; ANTI-POLLUTION DEVICES FOR MOTORS AND ENGINES; SELF-OILING BEARINGS; PUMP DIAPHRAGMS; PARTS OF MACHINES, ENGINES OR MOTORS, NAMELY, PUMPS; GEAR BOXES OTHER THAN FOR LAND VEHICLES; CARBURETORS; FEEDERS FOR CARBURETOR IN THE NATURE OF AUTOMOTIVE PARTS; UNIVERSAL JOINTS, NOT FOR LAND VEHICLES; CARDAN JOINTS FOR MACHINES; FUEL CONVERSION APPARATUS FOR INTERNAL COMBUSTION ENGINES; FUEL ECONOMISERS FOR MOTORS AND ENGINES; COMPRESSED AIR PUMPS; CATALYTIC CONVERTERS; DYNAMO BELTS; PARTS OF MACHINES OR ENGINES, NAMELY, FUEL FILTERS AND OIL FILTERS; FORGE BELLOWS; PARTS OF ENGINES, NAMELY, JOINTS, NOT BEING PARTS OF LAND VEHICLES; PARTS OF ENGINES, NAMELY, SEALING JOINTS, NOT BEING PARTS OF LAND VEHICLES; LUBRICATING PUMPS; PARTS OF MACHINES, NAMELY, LUBRICATORS; PARTS OF MACHINES, NAMELY, GREASE BOXES; CONTROL MECHANISMS FOR MACHINES, ENGINES OR MOTORS; PISTONS FOR ENGINES; BALL VALVES BEING PARTS OF MACHINES; SPARK PLUGS FOR INTERNAL COMBUSTION ENGINES; SPEED GOVERNORS FOR MACHINES, ENGINES AND MOTORS; FANS FOR MOTORS AND ENGINES; PUMP DIAPHRAGMS; GLOW PLUGS FOR DIESEL ENGINES; CLUTCHES FOR MACHINES; FILTERS FOR CLEANING, COOLING AIR, FOR ENGINES; PART OF MACHINE AND ENGINE, NAMELY, RING LUBRICATION; PART OF MACHINE, NAMELY, PISTON RING; CENTRIFUGAL PUMPS; CENTRIFUGAL PUMP FLOW IN THE NATURE OF AUTOMOTIVE PARTS AND HOUSEHOLD APPLIANCES; PUMP WITH TIMER MACHINES OR ENGINES, NOT FOR LAND VEHICLES; WATER

**CLASS 7—(Continued).**

PUMP FOR LAND VEHICLES; FUEL INJECTION PUMP FOR ENGINES, NOT FOR LAND VEHICLES; PUMP FOR OIL APPLICATION AND FLUID IN THE NATURE OF AUTOMOTIVE PARTS; ELECTRIC PUMPS FOR SWIMMING POOLS; IMMERSION PNEUMATIC PUMP; PART OF MACHINE AND VEHICLE, NAMELY, COMPRESSOR; CATALYTIC CONVERTER, EXCEPT FOR VEHICLES; CUP FOR BRAKES, NAMELY ROCKER; PART OF MACHINE, NAMELY, DIAPHRAGM; PART OF ENGINE, NAMELY, GASKET; PART OF MACHINE, NAMELY, STARTER MOTORS; COOLING DEVICE, NAMELY, RADIATOR FOR MOTORS AND MACHINES; ELECTROMAGNETIC VALVE OF WATER INLET IN WASHING MACHINES, BEING PART OF THE MACHINE; VALVE FOR HYDRAULIC PUMP; CRANKSHAFT; PUMP FOR APPLICATION OF OIL AND FLUID IN THE NATURE OF AUTOMOTIVE PARTS; ENGINE HEAD; PRESSURE ASSEMBLY USED IN WASHERS AND WASHING MACHINES; PLATINUM-POINT FOR ENGINES (U.S. CLS. 13, 19, 21, 23, 31, 34 AND 35).

DAWN FELDMAN, EXAMINING ATTORNEY

SN 85-861,193. SUNRISE GLOBAL MARKETING LLC, MOORESVILLE, NC. FILED 2-27-2013.

**SMART CUT**

THE MARK CONSISTS OF STANDARD CHARACTERS WITHOUT CLAIM TO ANY PARTICULAR FONT, STYLE, SIZE, OR COLOR.

NO CLAIM IS MADE TO THE EXCLUSIVE RIGHT TO USE "SMART", APART FROM THE MARK AS SHOWN.

FOR ELECTRONIC CONTROLLER FOR GOVERNING THE ELECTRICAL OUTPUT OF A BATTERY DURING MOWING OPERATION, SOLD AS AN INTEGRAL COMPONENT OF LAWN MOWERS (U.S. CLS. 13, 19, 21, 23, 31, 34 AND 35).

KIMBERLY PARKS, EXAMINING ATTORNEY

SN 85-875,810. TRU-TRAC ROLLERS (PTY) LIMITED, CENTURION, SOUTH AFRICA, FILED 3-14-2013.

**TRU-TRAC**

THE MARK CONSISTS OF STANDARD CHARACTERS WITHOUT CLAIM TO ANY PARTICULAR FONT, STYLE, SIZE, OR COLOR.

OWNER OF AUSTRALIA REG. NO. 811302, DATED 10-22-1999, EXPIRES 10-22-2019.

FOR ROLLERS AND IDLERS FOR CONVEYORS AND CONVEYOR BELTS, TROUGH AND VEE BELT ROLLER ASSEMBLIES; FLAT BELT ROLLER ASSEMBLIES, TRAINING IDLERS AND GUIDE DEVICES IN THE NATURE OF ROLLERS AND IDLERS FOR GUIDING AND ALIGNING CONVEYORS AND CONVEYOR BELTS; BELT CLEANERS AND SCRAPERS FOR CONVEYORS AND CONVEYOR BELTS; AND PARTS AND ACCESSORIES THEREFOR, NAMELY, ROLLER BEARINGS, ROLLER DRUMS, SCRAPER BLADES, TENSIONING SPRINGS AND SCRAPER MOUNTS (U.S. CLS. 13, 19, 21, 23, 31, 34 AND 35).

CIMMERIAN COLEMAN, EXAMINING ATTORNEY

**CLASS 7—(Continued).**

SN 85-920,881. SOUTHWEST BEST BUYS, LLC, MARBLE FALLS, TX. FILED 5-1-2013.

## Smokehouse Chef

THE MARK CONSISTS OF STANDARD CHARACTERS WITHOUT CLAIM TO ANY PARTICULAR FONT, STYLE, SIZE, OR COLOR.

FOR ELECTRIC MEAT GRINDERS; SAUSAGE MACHINES (U.S. CLS. 13, 19, 21, 23, 31, 34 AND 35).

FIRST USE 6-1-2012; IN COMMERCE 6-1-2012.

ZACHARY R. SPARER, EXAMINING ATTORNEY

**CLASS 7—(Continued).**

SN 86-011,980. DIXIE ELECTRIC LTD., CONCORD, ONTARIO, CANADA, FILED 7-16-2013.



NO CLAIM IS MADE TO THE EXCLUSIVE RIGHT TO USE "SELECT", APART FROM THE MARK AS SHOWN.

THE MARK CONSISTS OF THE LETTERS "SPS" OVER THE WORDS "SELECT POWER SOURCE", WHICH ARE SURROUNDED BY RECTANGLES.

FOR STARTERS AND ALTERNATORS FOR MOTOR VEHICLES (U.S. CLS. 13, 19, 21, 23, 31, 34 AND 35).

JULIE GUTTADAURO, EXAMINING ATTORNEY

SN 85-924,981. VERMEER MANUFACTURING COMPANY, PELLA, IA. FILED 5-7-2013.

## EQUIPPED TO DO MORE

THE MARK CONSISTS OF STANDARD CHARACTERS WITHOUT CLAIM TO ANY PARTICULAR FONT, STYLE, SIZE, OR COLOR.

FOR POWER-OPERATED AGRICULTURAL EQUIPMENT, NAMELY, HAY BALERS, MOWERS AND CONDITIONERS, HAY RAKES, BALE MOVERS, HAY TEDDERS; MATERIAL REDUCING MACHINES, NAMELY, BRUSH CHIPPERS, STUMP CUTTERS, WHOLE TREE CHIPPERS, HORIZONTAL GRINDERS, TUB GRINDERS, TROMMEL SCREENS, COMPOST TURNERS, CONCRETE CUTTERS; EARTH MOVING AND EARTH BORING MACHINES, NAMELY, PEDESTRIAN TRENCHERS, UTILITY TRENCHERS, TRACK TRENCHERS, VIBRATORY PLOWS, MINI SKID STEERS, PILE DRIVE MACHINES, GUIDED BORING MACHINES, UNDERGROUND BORING MACHINES, HORIZONTAL DIRECTIONAL DRILLING MACHINES, MUD MIXING MACHINES FOR USE IN DRILLING APPLICATIONS, PNEUMATIC PIERCING TOOLS (U.S. CLS. 13, 19, 21, 23, 31, 34 AND 35).

TIMOTHY FINNEGAN, EXAMINING ATTORNEY

SN 86-015,045. SMART GLOBAL PRODUCTS, LLC, ALPHARETTA, GA. FILED 7-19-2013.

## Buckhead

SN 85-962,530. AXON LLC, RALEIGH, NC. FILED 6-18-2013.

## LANZARA

THE MARK CONSISTS OF STANDARD CHARACTERS WITHOUT CLAIM TO ANY PARTICULAR FONT, STYLE, SIZE, OR COLOR.

THE ENGLISH TRANSLATION OF "LANZARA" IN THE MARK IS "TO THROW" OR "TO LAUNCH".

FOR PACKAGING MACHINES; PACKAGING MACHINES FOR HEAT SHRINK SLEEVE AND TAMPER EVIDENT APPLICATIONS (U.S. CLS. 13, 19, 21, 23, 31, 34 AND 35).

LINDA ESTRADA, EXAMINING ATTORNEY

THE MARK CONSISTS OF STANDARD CHARACTERS WITHOUT CLAIM TO ANY PARTICULAR FONT, STYLE, SIZE, OR COLOR.

FOR AIR POWERED TOOLS, NAMELY, IMPACT WRENCHES, RATCHET WRENCHES, DRILLS, HAMMERS AND SCREWDRIVERS; POWER TOOLS, NAMELY, CIRCULAR SAWS, AUGERS, DRILLS, ROUTERS, NAIL HAMMERS, AND STAPLERS; COMPRESSORS FOR MACHINES AND AIR COMPRESSORS FOR POWER TOOLS; EMERGENCY POWER GENERATORS, WATER PUMPS FOR MOVING SEMI-TRASH, PUMPS FOR SPRAYING MACHINES; FASTENERS, NAMELY, POWER-OPERATED SCREWDRIVERS AND POWER-DRIVEN WRENCHES; ELECTRIC AND/OR AIR-OPERATED POWER TOOLS, NAMELY, SANDERS, AND IMPACT AND RATCHET WRENCHES, HAND-HELD GRINDERS, BANDSAWS; GAS OPERATED POWER GENERATORS (U.S. CLS. 13, 19, 21, 23, 31, 34 AND 35).

JOHN DWYER, EXAMINING ATTORNEY

**CLASS 7—(Continued).**

SN 86-017,088. ROBOMAID AUSTRALIA PTY LTD, BANK-SMEADOW, AUSTRALIA, FILED 7-23-2013.

**CLASS 7—(Continued).**

SN 86-022,059. WEATHERFORD/LAMB, INC., HOUSTON, TX. FILED 7-29-2013.

# ROBOMAID

# SeaShield

THE MARK CONSISTS OF STANDARD CHARACTERS WITHOUT CLAIM TO ANY PARTICULAR FONT, STYLE, SIZE, OR COLOR.

FOR SUCTION CLEANING MACHINES, NAMELY, VACUUM CLEANERS; INDUSTRIAL CLEANING MACHINES, NAMELY, INDUSTRIAL VACUUM CLEANERS; INDUSTRIAL FLOOR CLEANING MACHINES, NAMELY, INDUSTRIAL VACUUM CLEANERS; VACUUM CLEANER BAGS; VACUUM CLEANER HOSES; VACUUM CLEANERS; ROBOTIC VACUUM CLEANERS; DOMESTIC VACUUM CLEANERS; ELECTRIC VACUUM CLEANERS; HOUSEHOLD VACUUM CLEANERS; WET VACUUM CLEANERS; INDUSTRIAL VACUUM MACHINES FOR CLEANING; VACUUM CLEANER BAGS OF CARDBOARD; VACUUM CLEANER BAGS OF PAPER; ROBOTIC CLEANING MACHINES, NAMELY, ROBOTIC SWIMMING POOL CLEANING MACHINES; INDUSTRIAL ROBOTIC POLISHING MACHINES FOR FLOORS; PORTABLE ELECTRIC VACUUM CLEANERS; PORTABLE ELECTRIC UPHOLSTERY CLEANERS UTILIZING A VACUUM; INDUSTRIAL ROBOTS; FLOOR BUFFERS; VACUUM CLEANERS (U.S. CLS. 13, 19, 21, 23, 31, 34 AND 35).

DAVID MURRAY, EXAMINING ATTORNEY

THE MARK CONSISTS OF STANDARD CHARACTERS WITHOUT CLAIM TO ANY PARTICULAR FONT, STYLE, SIZE, OR COLOR.

FOR POWER OPERATED DOWNHOLE TOOLS, NAMELY, A ROTATING CONTROL DEVICE POWERED BY AN ELECTRO-HYDRAULIC UNIT USED WHEN DRILLING IN OFFSHORE ENVIRONMENTS TO CREATE A PRESSURE-TIGHT BARRIER IN THE WELLBORE ANNULUS IN DEFENSE OF POTENTIAL DRILLING HAZARDS SUCH AS KICKS AND SHALLOW GAS (U.S. CLS. 13, 19, 21, 23, 31, 34 AND 35).

FIRST USE 5-31-2010; IN COMMERCE 5-31-2010.  
FRANK LATTUCA, EXAMINING ATTORNEY

SN 86-024,741. ADCO MANUFACTURING, SANGER, CA. FILED 7-31-2013.

SN 86-018,414. NORTH AMERICAN ROTARY INSTRUMENTS, INC., ST. PAUL, MN. FILED 7-24-2013.

# CONCENTRIX

# Hobbi-Bits

THE MARK CONSISTS OF STANDARD CHARACTERS WITHOUT CLAIM TO ANY PARTICULAR FONT, STYLE, SIZE, OR COLOR.

FOR BITS FOR POWER ROTARY TOOLS FOR THE HOBBY INDUSTRY (U.S. CLS. 13, 19, 21, 23, 31, 34 AND 35).

FIRST USE 6-1-2013; IN COMMERCE 6-1-2013.  
JASON BLAIR, EXAMINING ATTORNEY

THE MARK CONSISTS OF STANDARD CHARACTERS WITHOUT CLAIM TO ANY PARTICULAR FONT, STYLE, SIZE, OR COLOR.

FOR AUTOMATED WRAPPER IN-FEED MACHINE; CARTON SEALING MACHINES; CARTONING MACHINES; PACKAGING MACHINES; PACKAGING MACHINES AND PARTS THEREOF; PACKAGING MACHINES FOR FOOD; PACKING MACHINES (U.S. CLS. 13, 19, 21, 23, 31, 34 AND 35).

FIRST USE 5-13-2013; IN COMMERCE 7-15-2013.  
KAREN K. BUSH, EXAMINING ATTORNEY

**CLASS 7—(Continued).**

SN 86-037,389. MECCO PARTNERS, LLC, CRANBERRY TWP., PA. FILED 8-14-2013.

## EtherMark/IP

THE MARK CONSISTS OF STANDARD CHARACTERS WITHOUT CLAIM TO ANY PARTICULAR FONT, STYLE, SIZE, OR COLOR.

FOR LASER MARKING MACHINES FOR ETCHING AND ENGRAVING PART NUMBERS, SERIALS NUMBER, LOGOS AND BAR CODES DIRECTLY ON THE SURFACE OF METALS, PLASTICS, CERAMICS, WOOD AND GLASS FOR THE PURPOSE OF PRODUCT IDENTIFICATION AND TRACEABILITY; ELECTROMECHANICAL MARKING MACHINES, NAMELY, DOT PEEN MARKING SYSTEM FOR INDENT MARKING PART NUMBERS, SERIALS NUMBER, LOGOS AND BAR CODES DIRECTLY ON THE SURFACE OF METALS, PLASTICS, CERAMICS AND WOOD FOR THE PURPOSE OF PRODUCT IDENTIFICATION AND TRACEABILITY (U.S. CLS. 13, 19, 21, 23, 31, 34 AND 35).

FIRST USE 8-13-2013; IN COMMERCE 8-13-2013.  
MATTHEW KLINE, EXAMINING ATTORNEY

---

SN 86-037,451. MECCO PARTNERS, LLC, CRANBERRY TWP., PA. FILED 8-14-2013.

## ProfiMark

THE MARK CONSISTS OF STANDARD CHARACTERS WITHOUT CLAIM TO ANY PARTICULAR FONT, STYLE, SIZE, OR COLOR.

FOR LASER MARKING MACHINES FOR ETCHING AND ENGRAVING PART NUMBERS, SERIALS NUMBER, LOGOS AND BAR CODES DIRECTLY ON THE SURFACE OF METALS, PLASTICS, CERAMICS, WOOD AND GLASS FOR THE PURPOSE OF PRODUCT IDENTIFICATION AND TRACEABILITY; ELECTROMECHANICAL MARKING MACHINES, NAMELY, DOT PEEN MARKING SYSTEM FOR INDENT MARKING PART NUMBERS, SERIALS NUMBER, LOGOS AND BAR CODES DIRECTLY ON THE SURFACE OF METALS, PLASTICS, CERAMICS AND WOOD FOR THE PURPOSE OF PRODUCT IDENTIFICATION AND TRACEABILITY (U.S. CLS. 13, 19, 21, 23, 31, 34 AND 35).

FIRST USE 8-13-2013; IN COMMERCE 8-13-2013.  
MATTHEW KLINE, EXAMINING ATTORNEY

**CLASS 7—(Continued).**

SN 86-037,463. MECCO PARTNERS, LLC, CRANBERRY TWP., PA. FILED 8-14-2013.



**ProfiMark**  
PROFINET for Marking Devices

NO CLAIM IS MADE TO THE EXCLUSIVE RIGHT TO USE "MARKING DEVICES", APART FROM THE MARK AS SHOWN.

THE COLOR(S) BLUE AND GRAY IS/ARE CLAIMED AS A FEATURE OF THE MARK.

THE MARK CONSISTS OF THE WORD "PROFIMARK" IN LARGE BLUE LETTERS PLACED ABOVE "PROFINET FOR MARKING DEVICES" IN GRAY; A CURVED BLUE LINE IS PLACED UNDERNEATH AND TO THE LEFT THE LARGE BLUE "P" IN "PROFIMARK".

FOR LASER MARKING MACHINES FOR ETCHING AND ENGRAVING PART NUMBERS, SERIALS NUMBER, LOGOS AND BAR CODES DIRECTLY ON THE SURFACE OF METALS, PLASTICS, CERAMICS, WOOD AND GLASS FOR THE PURPOSE OF PRODUCT IDENTIFICATION AND TRACEABILITY; ELECTROMECHANICAL MARKING MACHINES, NAMELY, DOT PEEN MARKING SYSTEM FOR INDENT MARKING PART NUMBERS, SERIALS NUMBER, LOGOS AND BAR CODES DIRECTLY ON THE SURFACE OF METALS, PLASTICS, CERAMICS AND WOOD FOR THE PURPOSE OF PRODUCT IDENTIFICATION AND TRACEABILITY (U.S. CLS. 13, 19, 21, 23, 31, 34 AND 35).

FIRST USE 8-13-2013; IN COMMERCE 8-13-2013.  
MATTHEW KLINE, EXAMINING ATTORNEY

---

SN 86-037,812. FINISHING BRANDS HOLDINGS INC., MINNEAPOLIS, MN. FILED 8-14-2013.



**PLUS**

THE MARK CONSISTS OF THE WORD "PLUS" WITH A PLUS SIGN SUPERIMPOSED ON THE "P".

FOR SPRAY GUN FOR AUTOMOTIVE PAINTING FOR INDUSTRIAL AND PROFESSIONAL PURPOSES (U.S. CLS. 13, 19, 21, 23, 31, 34 AND 35).

FIRST USE 5-18-2001; IN COMMERCE 5-18-2001.  
REBECCA POVARCHUK, EXAMINING ATTORNEY

**CLASS 7—(Continued).**

SN 86-038,847. AUBURN GEAR, INC., AUBURN, IN. FILED 8-15-2013.

POWER WHEEL E-TRAC DRIVE  
SYSTEM

THE MARK CONSISTS OF STANDARD CHARACTERS WITHOUT CLAIM TO ANY PARTICULAR FONT, STYLE, SIZE, OR COLOR.

OWNER OF U.S. REG. NO. 2,114,998.

NO CLAIM IS MADE TO THE EXCLUSIVE RIGHT TO USE "DRIVE SYSTEM", APART FROM THE MARK AS SHOWN.

SEC. 2(F) AS TO "POWER WHEEL".

FOR ELECTRICALLY POWERED DRIVE SYSTEMS, COMPRISED IN PART OF A PLANETARY GEAR DRIVE, AN ELECTRIC MOTOR AND CONTROLLER, FOR USE IN MOBILE OFF HIGHWAY EQUIPMENT (U.S. CLS. 13, 19, 21, 23, 31, 34 AND 35).

FIRST USE 10-8-2012; IN COMMERCE 10-8-2012.

JOHN DWYER, EXAMINING ATTORNEY

**CLASS 7—(Continued).**

SN 86-042,105. EURO-PRO OPERATING LLC, NEWTON, MA. FILED 8-19-2013.

MASTER PREP FLIP

THE MARK CONSISTS OF STANDARD CHARACTERS WITHOUT CLAIM TO ANY PARTICULAR FONT, STYLE, SIZE, OR COLOR.

OWNER OF U.S. REG. NO. 3,911,722.

FOR BEVERAGE PROCESSING MACHINES; ELECTRIC EGG BEATERS; ELECTRIC FOOD BLENDERS; ELECTRIC FOOD CHOPPERS; ELECTRIC FOOD GRINDERS; ELECTRIC FOOD PROCESSORS; ELECTRIC FOOD SLICERS; ELECTRIC FRUIT PEELERS; ELECTRIC FRUIT PRESSES FOR HOUSEHOLD USE; ELECTRIC GRATERS; ELECTRIC JUICERS; ELECTRIC MEAT GRINDERS; ELECTRIC MIXERS FOR HOUSEHOLD PURPOSES; ELECTRIC PASTA MAKERS FOR DOMESTIC USE; ELECTRIC VEGETABLE PEELERS; ELECTRIC WHISKS FOR HOUSEHOLD PURPOSES; ELECTRICAL COFFEE GRINDERS; JUICE EXTRACTORS (U.S. CLS. 13, 19, 21, 23, 31, 34 AND 35).

DAVID H. STINE, EXAMINING ATTORNEY

SN 86-042,126. EURO-PRO OPERATING LLC, NEWTON, MA. FILED 8-19-2013.

SN 86-041,854. MICROCENTRIC CORPORATION, PLAINVIEW, NY. FILED 8-19-2013.

RAPID CHANGE

THE MARK CONSISTS OF STANDARD CHARACTERS WITHOUT CLAIM TO ANY PARTICULAR FONT, STYLE, SIZE, OR COLOR.

NO CLAIM IS MADE TO THE EXCLUSIVE RIGHT TO USE "CHANGE", APART FROM THE MARK AS SHOWN.

FOR MACHINE TOOLS, NAMELY, COLLET CHUCKS, MACHINE CHUCKS, DRILL CHUCKS, HYDRAULIC VALVE ACTUATORS, LINEAR ACTUATORS AND PNEUMATIC VALVE ACTUATORS (U.S. CLS. 13, 19, 21, 23, 31, 34 AND 35).

DAVID TOOLEY, EXAMINING ATTORNEY

NINJA FLIP

THE MARK CONSISTS OF STANDARD CHARACTERS WITHOUT CLAIM TO ANY PARTICULAR FONT, STYLE, SIZE, OR COLOR.

OWNER OF U.S. REG. NOS. 3,794,590, 4,085,289 AND 4,119,051.

FOR BEVERAGE PROCESSING MACHINES; ELECTRIC COFFEE GRINDERS; ELECTRIC EGG BEATERS; ELECTRIC FOOD BLENDERS; ELECTRIC FOOD CHOPPERS; ELECTRIC FOOD GRINDERS; ELECTRIC FOOD PROCESSORS; ELECTRIC FOOD SLICERS; ELECTRIC FRUIT PEELERS; ELECTRIC FRUIT PRESSES FOR HOUSEHOLD USE; ELECTRIC GRATERS; ELECTRIC JUICERS; ELECTRIC MEAT GRINDERS; ELECTRIC MIXERS FOR HOUSEHOLD PURPOSES; ELECTRIC PASTA MAKERS FOR DOMESTIC USE; ELECTRIC VEGETABLE PEELERS; ELECTRIC WHISKS FOR HOUSEHOLD PURPOSES; JUICE EXTRACTORS (U.S. CLS. 13, 19, 21, 23, 31, 34 AND 35).

DAVID H. STINE, EXAMINING ATTORNEY

**CLASS 7—(Continued).**

SN 86-042,847. SMITH, RICHARD, ROCHESTER, IN. FILED 8-20-2013.



NO CLAIM IS MADE TO THE EXCLUSIVE RIGHT TO USE "PERFORMANCE", APART FROM THE MARK AS SHOWN.

THE MARK CONSISTS OF THE STYLIZED TEXT "SMT PERFORMANCE" INSIDE AN OVAL SHAPE.

FOR VEHICLE ENGINE PARTS, NAMELY, ROCKER ARMS (U.S. CLS. 13, 19, 21, 23, 31, 34 AND 35).

FIRST USE 10-15-2010; IN COMMERCE 10-15-2010.

CHRISTOPHER BUONGIORNO, EXAMINING ATTORNEY

**CLASS 7—(Continued).**

SN 86-060,042. WEATHERFORD/LAMB, INC., HOUSTON, TX. FILED 9-10-2013.

## TerraForm

THE MARK CONSISTS OF STANDARD CHARACTERS WITHOUT CLAIM TO ANY PARTICULAR FONT, STYLE, SIZE, OR COLOR.

FOR OIL FIELD EQUIPMENT, NAMELY, HYDRAULIC POWERED MACHINE THAT PROVIDES LONG TERM ZONAL ISOLATION BY DEPLOYING A PROPRIETARY SEAL AGAINST THE WELLBORE THAT PREVENTS RESERVOIR DAMAGE AND ACCOMMODATES LARGE WASH OUTS FOR OIL AND GAS PRODUCTION (U.S. CLS. 13, 19, 21, 23, 31, 34 AND 35).

FIRST USE 1-5-2013; IN COMMERCE 1-5-2013.

ELIZABETH CHANG, EXAMINING ATTORNEY

SN 86-043,682. CLASSONE EQUIPMENT, INC., DECATUR, GA. FILED 8-21-2013.

## SOLSTICE

THE MARK CONSISTS OF STANDARD CHARACTERS WITHOUT CLAIM TO ANY PARTICULAR FONT, STYLE, SIZE, OR COLOR.

FOR AUTOMATED MACHINES FOR PROCESSING SEMICONDUCTOR WAFERS AND OTHER SUBSTRATES FOR MICROELECTRONIC DEVICES (U.S. CLS. 13, 19, 21, 23, 31, 34 AND 35).

B. PARADEWELAI, EXAMINING ATTORNEY

SN 86-062,084. SHAREWELL HDD DRILLING PRODUCTS LLC, SPRING, TX. FILED 9-11-2013.

## THUNDERBOLT

THE MARK CONSISTS OF STANDARD CHARACTERS WITHOUT CLAIM TO ANY PARTICULAR FONT, STYLE, SIZE, OR COLOR.

FOR MECHANIZED EARTH AUGERS OVER 2,000 POUNDS IN GROSS WEIGHT (U.S. CLS. 13, 19, 21, 23, 31, 34 AND 35).

JULIE GUTTADAURO, EXAMINING ATTORNEY

SN 86-046,023. LEE, KAI SING, PORTAGE, MI. FILED 8-23-2013.

## Lawn & Snow Shark

THE MARK CONSISTS OF STANDARD CHARACTERS WITHOUT CLAIM TO ANY PARTICULAR FONT, STYLE, SIZE, OR COLOR.

NO CLAIM IS MADE TO THE EXCLUSIVE RIGHT TO USE "LAWN & SNOW", APART FROM THE MARK AS SHOWN.

FOR A LAWN MOWER IN THE SUMMER THAT CAN BE CONVERTED TO BECOME A SNOW BLOWER IN THE WINTER (U.S. CLS. 13, 19, 21, 23, 31, 34 AND 35).

JEFF DEFORD, EXAMINING ATTORNEY

SN 86-062,901. J. H. FENNER & CO. LIMITED, EAST YORKSHIRE, UNITED KINGDOM, FILED 9-12-2013.

## NovaFlex

THE MARK CONSISTS OF STANDARD CHARACTERS WITHOUT CLAIM TO ANY PARTICULAR FONT, STYLE, SIZE, OR COLOR.

FOR CONVEYOR BELTS CONSTRUCTED PRIMARILY WITH DUAL CRIMPED REINFORCING FABRIC WEAVES (U.S. CLS. 13, 19, 21, 23, 31, 34 AND 35).

PAUL CROWLEY, EXAMINING ATTORNEY



**CLASS 7—(Continued).**

SN 86-065,109. LI XIAOXIA, JIANGSU, CHINA, FILED 9-16-2013.

# NEVA

THE MARK CONSISTS OF STANDARD CHARACTERS WITHOUT CLAIM TO ANY PARTICULAR FONT, STYLE, SIZE, OR COLOR.

THE WORDING "NEVA" HAS NO MEANING IN A FOREIGN LANGUAGE.

FOR ELECTRIC DOOR OPENERS AND CLOSERS; HYDRAULIC CONTROLS FOR MACHINES, MOTORS AND ENGINES; HYDRAULIC DOOR OPENERS; HYDRAULIC ENGINES AND MOTORS; HYDRAULIC EXCAVATORS; HYDRAULIC POWER UNITS; PNEUMATIC PUMPS; PNEUMATIC TUBE CONVEYORS; PUMPS AS PARTS OF MACHINES, MOTORS AND ENGINES; VALVES BEING PARTS OF MACHINES (U.S. CLS. 13, 19, 21, 23, 31, 34 AND 35).

KATHERINE CONNOLLY, EXAMINING ATTORNEY

**CLASS 7—(Continued).**

SN 86-068,729. MAMIROBOT CO., LTD., HA-NAM CITY, GYOUNG-GI, REPUBLIC OF KOREA, FILED 9-18-2013.

# MAMI

THE MARK CONSISTS OF STANDARD CHARACTERS WITHOUT CLAIM TO ANY PARTICULAR FONT, STYLE, SIZE, OR COLOR.

FOR COMMERCIAL AND INDUSTRIAL VACUUM CLEANERS; DUST FILTERS AND BAGS FOR VACUUM CLEANERS; ELECTRIC BRUSHES BEING PARTS OF MACHINES; ELECTRIC VACUUM CLEANERS; ELECTRIC VACUUM CLEANERS AND THEIR COMPONENTS; ROBOTIC VACUUM CLEANERS; VACUUM CLEANERS; VACUUM CLEANERS FOR HOUSEHOLD PURPOSES; VACUUM CLEANERS FOR INDUSTRIAL PURPOSES (U.S. CLS. 13, 19, 21, 23, 31, 34 AND 35).

SAIMA MAKHDOOM, EXAMINING ATTORNEY

SN 86-066,653. SUMMIT ESP, LLC, TULSA, OK. FILED 9-17-2013.

# TIGER SHARK

THE MARK CONSISTS OF STANDARD CHARACTERS WITHOUT CLAIM TO ANY PARTICULAR FONT, STYLE, SIZE, OR COLOR.

FOR CENTRIFUGAL PUMPS (U.S. CLS. 13, 19, 21, 23, 31, 34 AND 35).

JENNIFER BUTTON, EXAMINING ATTORNEY

SN 86-069,128. CARDONICK, INC., TA ADVANCED SERVICES, BENSLEM, PA. FILED 9-19-2013.

# STUFFNCUP

THE MARK CONSISTS OF STANDARD CHARACTERS WITHOUT CLAIM TO ANY PARTICULAR FONT, STYLE, SIZE, OR COLOR.

FOR AUTOMATIC VENDING MACHINES (U.S. CLS. 13, 19, 21, 23, 31, 34 AND 35).

HEATHER SAPP, EXAMINING ATTORNEY

SN 86-067,758. WOODWARD, INC., FORT COLLINS, CO. FILED 9-18-2013.

# VARISTROKE

THE MARK CONSISTS OF STANDARD CHARACTERS WITHOUT CLAIM TO ANY PARTICULAR FONT, STYLE, SIZE, OR COLOR.

FOR LINEAR ELECTRO-HYDRAULIC ACTUATORS (U.S. CLS. 13, 19, 21, 23, 31, 34 AND 35).

FIRST USE 12-1-2012; IN COMMERCE 12-1-2012.

CHRISTOPHER REAMS, EXAMINING ATTORNEY

SN 86-070,136. LENORE PERRY, LEO, IN. FILED 9-20-2013.

Are we proud of how it all  
started? Just a little bit.

THE MARK CONSISTS OF STANDARD CHARACTERS WITHOUT CLAIM TO ANY PARTICULAR FONT, STYLE, SIZE, OR COLOR.

FOR GROOVING, BORING, AND CUTTING TOOLS FOR USE IN METAL-WORKING MACHINE TOOLS, AND TOOL HOLDERS THEREFOR (U.S. CLS. 13, 19, 21, 23, 31, 34 AND 35).

TEJBIR SINGH, EXAMINING ATTORNEY

**CLASS 7—(Continued).**

SN 86-070,149. LENORE PERRY, LEO, IN. FILED 9-20-2013.

More tools than you can  
shake a lathe at.

THE MARK CONSISTS OF STANDARD CHARACTERS WITHOUT CLAIM TO ANY PARTICULAR FONT, STYLE, SIZE, OR COLOR.

FOR GROOVING, BORING, AND CUTTING TOOLS FOR USE IN METAL-WORKING MACHINE TOOLS, AND TOOL HOLDERS THEREFOR (U.S. CLS. 13, 19, 21, 23, 31, 34 AND 35).

TEJBIR SINGH, EXAMINING ATTORNEY

SN 86-070,816. LENORE PERRY, LEO, IN. FILED 9-20-2013.



THE COLOR(S) BLUE AND WHITE IS/ARE CLAIMED AS A FEATURE OF THE MARK.

THE MARK CONSISTS OF THE WORDS "MORE TOOLS THAN YOU CAN SHAKE A LATHE AT" IN SIX LINES. THE WORDS APPEAR IN WHITE ON A BLUE BACKGROUND WITH A WHITE OUTLINE SHAPED TO THE OUTLINE OF THE WORDS. CERTAIN LETTERS IN THE MARK ARE DEPICTED TO LOOK LIKE CUTTING TOOLS. THE FIRST LINE IS THE WORD "MORE" OVER THE WORD "TOOLS" OVER THE WORD "THAN" OVER THE WORDS "YOU CAN" OVER THE WORDS "SHAKE A" OVER THE WORDS "LATHE AT".

FOR GROOVING, BORING, AND CUTTING TOOLS FOR USE IN METAL-WORKING MACHINE TOOLS, AND TOOL HOLDERS THEREFOR (U.S. CLS. 13, 19, 21, 23, 31, 34 AND 35).

TEJBIR SINGH, EXAMINING ATTORNEY

**CLASS 7—(Continued).**

SN 86-071,834. ZHEWANG ZHANG, QINGYUAN, BAODING., CHINA, FILED 9-23-2013.

# OFMAG

THE MARK CONSISTS OF "OFMAG".  
THE WORDING OFMAG HAS NO MEANING IN A FOREIGN LANGUAGE.

FOR CAPSTANS; ELECTRIC JACKS; ELEVATORS AND PARTS OF ELEVATORS; EXCAVATING MACHINES; HOISTS; MECHANICAL AND PNEUMATIC HOISTING APPARATUS; MECHANICAL RAILED LIFTING CONVEYORS; PORTABLE HOIST SYSTEMS; POWER-OPERATED LIFTS FOR MOVING, PARKING AND STORING LAND VEHICLES; ROLLER CONVEYORS (U.S. CLS. 13, 19, 21, 23, 31, 34 AND 35).

FIRST USE 3-12-2010; IN COMMERCE 5-10-2010.  
FLORENTINA BLANDU, EXAMINING ATTORNEY

SN 86-071,947. OXARC, INC., SPOKANE, WA. FILED 9-23-2013.

# ARMORCUT

THE MARK CONSISTS OF STANDARD CHARACTERS WITHOUT CLAIM TO ANY PARTICULAR FONT, STYLE, SIZE, OR COLOR.

FOR ELECTRIC PLASMA CUTTERS (U.S. CLS. 13, 19, 21, 23, 31, 34 AND 35).

EMILY CHUO, EXAMINING ATTORNEY

SN 86-074,630. LENORE PERRY, LEO, IN. FILED 9-25-2013.

# Let's Groove

THE MARK CONSISTS OF STANDARD CHARACTERS WITHOUT CLAIM TO ANY PARTICULAR FONT, STYLE, SIZE, OR COLOR.

FOR GROOVING, BORING, AND CUTTING TOOLS FOR USE IN METAL-WORKING MACHINE TOOLS, AND TOOL HOLDERS THEREFOR (U.S. CLS. 13, 19, 21, 23, 31, 34 AND 35).

TEJBIR SINGH, EXAMINING ATTORNEY

**CLASS 7—(Continued).**

SN 86-086,885. SEARS BRANDS, LLC, HOFFMAN ESTATES, IL. FILED 10-9-2013.

# COMPLETE START

THE MARK CONSISTS OF STANDARD CHARACTERS WITHOUT CLAIM TO ANY PARTICULAR FONT, STYLE, SIZE, OR COLOR.

NO CLAIM IS MADE TO THE EXCLUSIVE RIGHT TO USE "START", APART FROM THE MARK AS SHOWN.

FOR A PUSH BUTTON STARTING SYSTEM SOLD AS AN INTEGRAL COMPONENT OF RIDING MOWERS AND TRACTORS (U.S. CLS. 13, 19, 21, 23, 31, 34 AND 35).  
NAKIA HENRY, EXAMINING ATTORNEY

**CLASS 7—(Continued).**

SN 86-094,964. WHIRLPOOL PROPERTIES, INC., ST. JOSEPH, MI. FILED 10-18-2013.

# INTELLIJET

THE MARK CONSISTS OF STANDARD CHARACTERS WITHOUT CLAIM TO ANY PARTICULAR FONT, STYLE, SIZE, OR COLOR.

FOR COMPONENT CLEANING FEATURE OF DISHWASHERS, NAMELY, SEQUENCING SPRAY JETS, SOLD AS AN INTEGRAL COMPONENT OF DISHWASHERS (U.S. CLS. 13, 19, 21, 23, 31, 34 AND 35).

DAVID COLLIER, EXAMINING ATTORNEY

---

SN 86-091,848. EXCEL INDUSTRIES, INC., HESSTON, KS. FILED 10-15-2013.

# D.R.O.P.S.

THE MARK CONSISTS OF STANDARD CHARACTERS WITHOUT CLAIM TO ANY PARTICULAR FONT, STYLE, SIZE, OR COLOR.

FOR ROLLOVER PROTECTION SYSTEMS FOR RIDING LAWNMOWERS COMPRISING OVERHEAD ROLL BARS FOR PROTECTING THE OPERATOR OF A RIDING LAWNMOWER IN THE EVENT OF A ROLLOVER (U.S. CLS. 13, 19, 21, 23, 31, 34 AND 35).

JOSETTE BEVERLY, EXAMINING ATTORNEY

---

SN 86-108,115. IRWIN INDUSTRIAL TOOL COMPANY, ATLANTA, GA. FILED 11-1-2013.

# LENOX MAX CT

THE MARK CONSISTS OF STANDARD CHARACTERS WITHOUT CLAIM TO ANY PARTICULAR FONT, STYLE, SIZE, OR COLOR.

OWNER OF U.S. REG. NOS. 1,340,125, 2,618,551 AND 3,187,875.

FOR BAND SAW BLADES (U.S. CLS. 13, 19, 21, 23, 31, 34 AND 35).

WENDY GOODMAN, EXAMINING ATTORNEY

---

SN 86-093,791. SHARP KABUSHIKI KAISHA, TA SHARP CORPORATION, OSAKA, JAPAN, FILED 10-17-2013.

# SHARP

THE MARK CONSISTS OF STANDARD CHARACTERS WITHOUT CLAIM TO ANY PARTICULAR FONT, STYLE, SIZE, OR COLOR.

OWNER OF U.S. REG. NOS. 1,059,852, 4,051,172 AND OTHERS.

FOR LOW SPEED JUICING MACHINES FOR HOUSEHOLD USE; ELECTRIC FRUIT PRESSES (U.S. CLS. 13, 19, 21, 23, 31, 34 AND 35).

KARANENDRA S. CHHINA, EXAMINING ATTORNEY

---

SN 86-110,101. WHIRLPOOL PROPERTIES, INC., ST. JOSEPH, MI. FILED 11-5-2013.

# EXACTPULP

THE MARK CONSISTS OF STANDARD CHARACTERS WITHOUT CLAIM TO ANY PARTICULAR FONT, STYLE, SIZE, OR COLOR.

FOR ELECTRIC JUICER WITH A FEATURE THAT ADJUSTS THE AMOUNT OF PULP IN JUICE (U.S. CLS. 13, 19, 21, 23, 31, 34 AND 35).

DAVID COLLIER, EXAMINING ATTORNEY

**CLASS 7—(Continued).**

SN 86-119,469. KEY TECHNOLOGY, INC., WALLA WALLA, WA. FILED 11-14-2013.

VITISORT

THE MARK CONSISTS OF STANDARD CHARACTERS WITHOUT CLAIM TO ANY PARTICULAR FONT, STYLE, SIZE, OR COLOR.  
 FOR SORTING MACHINES FOR GRAPES (U.S. CLS. 13, 19, 21, 23, 31, 34 AND 35).  
 FIRST USE 11-14-2013; IN COMMERCE 11-14-2013.  
 ANTHONY RINKER, EXAMINING ATTORNEY

SN 86-126,380. RAYNOR MFG. CO., DIXON, IL. FILED 11-22-2013.

AIRMAN

THE MARK CONSISTS OF STANDARD CHARACTERS WITHOUT CLAIM TO ANY PARTICULAR FONT, STYLE, SIZE, OR COLOR.  
 FOR GARAGE DOOR OPENER FOR OVERHEAD DOORS (U.S. CLS. 13, 19, 21, 23, 31, 34 AND 35).  
 REBECCA SMITH, EXAMINING ATTORNEY

**CLASS 8—HAND TOOLS**

SN 85-767,936. HERO ENTERPRISES LLC, CRESTED BUTTE, CO. FILED 10-31-2012.



NO CLAIM IS MADE TO THE EXCLUSIVE RIGHT TO USE "KIT", APART FROM THE MARK AS SHOWN.  
 THE MARK CONSISTS OF THE WORD PHRASES "HERO KIT" AND "SAVE THE DAY" LOCATED ABOVE AND BELOW THE IMAGE OF A DOG HEAD WITH A BARREL ATTACHED TO ITS NECK, THE ENTIRE MARK FEATURING A CIRCULAR BORDER.  
 FOR PACKAGED KITS CONTAINING BICYCLE REPAIR HAND TOOLS, BICYCLE CHAINS AND LINKS, CLEAT AND FRAME BOLTS, TIRE GEAR LEVERS, PLASTIC ZIP TIES, DUCT TAPE, GEAR CABLES, TIRE REPAIR PATCHES, TOILET PAPER, PLASTIC PONCHO, ANTIBIOTIC CREAM, BURN GEL, DIPHENHYDRAMINE TABLETS, IBUPROFEN TABLETS, BANDAGES, WASTE BAG, LATEX GLOVES, NON-NEEDLE SYRINGE FOR WOUND CLEANING, AND PRINTED INSTRUCTIONS THERETO (U.S. CLS. 23, 28 AND 44).  
 FIRST USE 6-1-2012; IN COMMERCE 7-6-2012.  
 WILLIAM VERHOSEK, EXAMINING ATTORNEY

SN 85-885,843. RESTORATION HARDWARE, INC., CORTE MADERA, CA. FILED 3-25-2013.

RH

THE MARK CONSISTS OF STANDARD CHARACTERS WITHOUT CLAIM TO ANY PARTICULAR FONT, STYLE, SIZE, OR COLOR.  
 FOR FIREPLACE TOOL SETS SOLD AS A UNIT, NAMELY, POKERS, SHOVELS AND BRUSHES; GARDENING HAND TOOLS, NAMELY, A MANUALLY OPERATED TOOL FOR INJECTING AND TRANSPLANTING SEEDS INTO THE SOIL, PRUNERS, TROWELS, AND WEEDING FORKS (U.S. CLS. 23, 28 AND 44).  
 DAVID C. REIHNER, EXAMINING ATTORNEY

**CLASS 8—(Continued).**

SN 85-968,866. SHULTON, INC., CINCINNATI, OH. FILED 6-25-2013.

# OLD SPICE

THE MARK CONSISTS OF STANDARD CHARACTERS WITHOUT CLAIM TO ANY PARTICULAR FONT, STYLE, SIZE, OR COLOR.

FOR RAZORS; RAZOR BLADES; RAZORS AND RAZOR BLADES SOLD AS A UNIT AS PART OF CARTRIDGES, DISPENSERS, AND/OR HOLDERS FOR THE GOODS (U.S. CLS. 23, 28 AND 44).

CORY BOONE, EXAMINING ATTORNEY

SN 86-019,192. FROST CUTLERY COMPANY LLC, OOLTEWAH, TN. FILED 7-24-2013.

# NIGHT WALKER

THE MARK CONSISTS OF STANDARD CHARACTERS WITHOUT CLAIM TO ANY PARTICULAR FONT, STYLE, SIZE, OR COLOR.

FOR KNIVES (U.S. CLS. 23, 28 AND 44).  
FIRST USE 7-15-2013; IN COMMERCE 7-15-2013.  
ALISON POLLACK, EXAMINING ATTORNEY

SN 86-020,419. DANBEN PTY. LTD.; AS TRUSTEE FOR THE TERRA FIRMA TRUST, YOKINE SOUTH WA, AUSTRALIA, FILED 7-25-2013.



NO CLAIM IS MADE TO THE EXCLUSIVE RIGHT TO USE "SATAY" AND "CHEF", APART FROM THE MARK AS SHOWN.

THE MARK CONSISTS OF A LOGO OF AN OUTER CIRCLE CONTAINING THE WORDS "SATAY CHEF" AT THE BOTTOM IN STYLIZED LETTERS AND A SHADED INNER CIRCLE CONTAINING A STYLIZED IMAGE OF A PALM TREE, WITH THE WORD "SKEWERITE" IN LARGE LETTERS APPEARING TO THE RIGHT OF THE LOGO; THE LETTER "S" IN "SKEWERITE" IS LARGER THAN THE OTHER LETTERS IN THE WORD; BOTH THE LOGO AND WORD "SKEWERITE" APPEAR ON A BACKGROUND OF FIVE SKEWERS.

FOR FOOD PREPARATION UTENSIL, NAMELY, A NON-ELECTRIC APPARATUS USED FOR CUTTING FOOD INTO UNIFORM-SIZED PORTIONS FOR SKEWERS, KEBABS, SATAYS, SHASLICKS, AND YAKITORI; NON-ELECTRIC FOOD PREPARATION UTENSILS USED FOR CUTTING FOOD (U.S. CLS. 23, 28 AND 44).

KATHY WANG, EXAMINING ATTORNEY

**CLASS 8—(Continued).**

SN 86-031,659. ARBORSYSTEMS, INC., OMAHA, NE. FILED 8-7-2013.

# QuikPlug

THE MARK CONSISTS OF STANDARD CHARACTERS WITHOUT CLAIM TO ANY PARTICULAR FONT, STYLE, SIZE, OR COLOR.

FOR A MANUALLY OPERATED PLASTIC TOOL FOR INJECTING TREE TREATMENT CHEMICALS INTO TREES (U.S. CLS. 23, 28 AND 44).

HAI-LY LAM, EXAMINING ATTORNEY

SN 86-036,157. WATERFOWL JUNKIE, INC., WATERTOWN, SD. FILED 8-13-2013.

# BirdHitch

THE MARK CONSISTS OF STANDARD CHARACTERS WITHOUT CLAIM TO ANY PARTICULAR FONT, STYLE, SIZE, OR COLOR.

FOR HAND-OPERATED CUTTING TOOL, NAMELY, A DEVICE FOR CLEANING GAME BIRDS (U.S. CLS. 23, 28 AND 44).

FIRST USE 0-0-2008; IN COMMERCE 0-0-2008.  
BARNEY CHARLON, EXAMINING ATTORNEY

SN 86-037,446. KCD IP, LLC, HOFFMAN ESTATES, IL. FILED 8-14-2013.

# CRAFTSMAN CHROME

THE MARK CONSISTS OF STANDARD CHARACTERS WITHOUT CLAIM TO ANY PARTICULAR FONT, STYLE, SIZE, OR COLOR.

OWNER OF U.S. REG. NOS. 525,092, 4,356,501 AND OTHERS.

NO CLAIM IS MADE TO THE EXCLUSIVE RIGHT TO USE "CHROME", APART FROM THE MARK AS SHOWN.

FOR HAND TOOLS FEATURING CHROME PLATING AND/OR CONTAINING CHROME, NAMELY, SCREWDRIVERS, PLIERS, HAMMERS, RATCHETS, SOCKETS AND WRENCHES (U.S. CLS. 23, 28 AND 44).

SHARON MEIER, EXAMINING ATTORNEY

**CLASS 8—(Continued).**

SN 86-041,068. THE WALL DOCTORX, LLC, WILMINGTON, DE. FILED 8-18-2013.

# got holes

THE MARK CONSISTS OF STANDARD CHARACTERS WITHOUT CLAIM TO ANY PARTICULAR FONT, STYLE, SIZE, OR COLOR.

FOR DRYWALL REPAIR KITS COMPRISED PRIMARILY OF DRYWALL HAWKS, DRYWALL JOINT TAPE AND COMPOUND AND DRYWALL (U.S. CLS. 23, 28 AND 44).

HOWARD B. LEVINE, EXAMINING ATTORNEY

SN 86-047,744. HUTTON, D. PATRICK, ALBUQUERQUE, NM. FILED 8-26-2013.



THE MARK CONSISTS OF THE STYLIZED INITIALS "H" AND "E" CONJOINED AND WITH PORTIONS OF THE LETTERS BREAKING THROUGH A CIRCLE SURROUNDING THE LETTERS.

FOR KNIVES FOR SELF DEFENSE; KNIVES FOR TACTICAL CLOSE QUARTER COMBAT (U.S. CLS. 23, 28 AND 44).

FIRST USE 10-26-2011; IN COMMERCE 10-26-2011.  
BRENDAN MCCAULEY, EXAMINING ATTORNEY

SN 86-054,994. ENE, LLC, CINCINNATI, OH. FILED 9-4-2013.

# LA TILDE

THE MARK CONSISTS OF STANDARD CHARACTERS WITHOUT CLAIM TO ANY PARTICULAR FONT, STYLE, SIZE, OR COLOR.

THE ENGLISH TRANSLATION OF THE WORD "LA" IN THE MARK IS "THE".

FOR RAZOR BLADES; RAZORS (U.S. CLS. 23, 28 AND 44).

SUSAN RICHARDS, EXAMINING ATTORNEY

**CLASS 8—(Continued).**

SN 86-062,719. THE IDEA BOX LLC, KIRKWOOD, NY. FILED 9-12-2013.

# Ez-Pry Hive Tool

THE MARK CONSISTS OF STANDARD CHARACTERS WITHOUT CLAIM TO ANY PARTICULAR FONT, STYLE, SIZE, OR COLOR.

NO CLAIM IS MADE TO THE EXCLUSIVE RIGHT TO USE "HIVE TOOL", APART FROM THE MARK AS SHOWN.

FOR HAND TOOLS, NAMELY, WRECKING BARS, STRIPPING BARS, SMALL BARS AND NAIL PULLERS, SAN ANGELO BARS, TAMPER BARS, WEDGE POINT BARS, PITCH POINT BARS (U.S. CLS. 23, 28 AND 44).

FIRST USE 10-22-2010; IN COMMERCE 11-19-2010.  
ZACHARY R. SPARER, EXAMINING ATTORNEY

SN 86-062,857. BALKAMP, INC., INDIANAPOLIS, IN. FILED 9-12-2013.

THE MARK CONSISTS OF THE WORD "HAMMERHEAD" IN A STYLIZED FONT WITH TRIANGLE SHAPES APPLIED TO THE UPPER LEFT OF THE FIRST "H" AND THE "D".

FOR HAND-OPERATED AUTOMOTIVE REPAIR TOOLS, NAMELY, TIRE REPAIR NEEDLE TOOLS (U.S. CLS. 23, 28 AND 44).

LESLIE RICHARDS, EXAMINING ATTORNEY

SN 86-066,605. SIMPLIFYING COMPLEX SPACES, LLC, SIERRA VISTA, AZ. FILED 9-17-2013.

# COOLDRY

THE MARK CONSISTS OF STANDARD CHARACTERS WITHOUT CLAIM TO ANY PARTICULAR FONT, STYLE, SIZE, OR COLOR.

FOR RAZOR BLADES (U.S. CLS. 23, 28 AND 44).

FIRST USE 9-4-2012; IN COMMERCE 9-4-2012.  
MATTHEW GALAN, EXAMINING ATTORNEY

**CLASS 8—(Continued).**

SN 86-067,037. WORLD TABLEWARE, INC., TOLEDO, OH. FILED 9-17-2013.

# FARMHOUSE

THE MARK CONSISTS OF STANDARD CHARACTERS WITHOUT CLAIM TO ANY PARTICULAR FONT, STYLE, SIZE, OR COLOR.  
FOR FLATWARE, NAMELY, FORKS, KNIVES, AND SPOONS (U.S. CLS. 23, 28 AND 44).  
SKYE YOUNG, EXAMINING ATTORNEY

SN 86-072,138. COYE KNIVES LLC, TULSA, OK. FILED 9-23-2013.

# #doyouevengrindbro

THE MARK CONSISTS OF STANDARD CHARACTERS WITHOUT CLAIM TO ANY PARTICULAR FONT, STYLE, SIZE, OR COLOR.  
FOR HUNTING KNIVES; KNIVES FOR TACTICAL USE; SPORT KNIVES (U.S. CLS. 23, 28 AND 44).  
FIRST USE 7-15-2013; IN COMMERCE 7-15-2013.  
DAVID MURRAY, EXAMINING ATTORNEY

SN 86-121,185. REVLON CONSUMER PRODUCTS CORPORATION, NEW YORK, NY. FILED 11-18-2013.

# REVLON EASY CUTICLE NIPPER

THE MARK CONSISTS OF STANDARD CHARACTERS WITHOUT CLAIM TO ANY PARTICULAR FONT, STYLE, SIZE, OR COLOR.  
OWNER OF U.S. REG. NOS. 3,959,613, 4,254,710 AND OTHERS.  
NO CLAIM IS MADE TO THE EXCLUSIVE RIGHT TO USE "CUTICLE NIPPER", APART FROM THE MARK AS SHOWN.  
FOR MANICURE IMPLEMENTS, NAMELY, CUTICLE NIPPERS (U.S. CLS. 23, 28 AND 44).  
DEIRDRE ROBERTSON, EXAMINING ATTORNEY

**CLASS 9—ELECTRICAL AND SCIENTIFIC APPARATUS**

SN 76-713,306. YAMAHA CORPORATION, SHIZUOKA, JAPAN, FILED 1-23-2013.

# BEAT RE:EDIT

THE MARK CONSISTS OF STANDARD CHARACTERS WITHOUT CLAIM TO ANY PARTICULAR FONT, STYLE, SIZE, OR COLOR.  
NO CLAIM IS MADE TO THE EXCLUSIVE RIGHT TO USE "BEAT", APART FROM THE MARK AS SHOWN.  
FOR AUDIO MIXERS; COMPUTER SOFTWARE FOR REMIXING SOUND OR MUSIC; COMPUTER SOFTWARE FOR RECREATING SOUND OR MUSIC; COMPUTER SOFTWARE FOR REARRANGING SOUND OR MUSIC; COMPUTER SOFTWARE FOR CREATING COMPUTER MUSIC, NAMELY, SOFTWARE FOR EDITING, EXTRACTING, AND CATEGORIZING SOUND FRAGMENTS FOR PURPOSES OF CREATING MUSIC; MULTIMEDIA COMPUTER SOFTWARE FOR INTERCONNECTING PERSONAL COMPUTERS AND MUSICAL INSTRUMENTS TO FACILITATE THE INTEGRATION OF MUSIC, TEXT, AUDIO, GRAPHICS, STILL IMAGES, AND MOVING PICTURES; PRERECORDED MAGNETIC DATA CARRIERS FEATURING SOFTWARE FOR MUSICAL COMPOSITION; ELECTRONIC DEVICES, NAMELY, ELECTRONIC MIXERS AND CONTROLLERS FOR CREATING AND MANIPULATING SOUND AND MUSIC (U.S. CLS. 21, 23, 26, 36 AND 38).  
FIRST USE 11-21-2012; IN COMMERCE 11-21-2012.  
JOHN GARTNER, EXAMINING ATTORNEY

SN 76-713,849. HAYES, EARNEST, CHICAGO, IL. FILED 4-1-2013.



THE COLOR(S) BLACK, WHITE AND GREEN IS/ARE CLAIMED AS A FEATURE OF THE MARK.  
THE MARK CONSISTS OF THE WORDING "A KILLER NAMED STREETS" WHICH APPEARS IN WHITE AND GREEN SHADING ALL AGAINST A BLACK BACKGROUND.  
FOR PRERECORDED DVDS FEATURING DOCUMENTARIES ABOUT THE REALITY OF STREET LIFE (U.S. CLS. 21, 23, 26, 36 AND 38).  
FIRST USE 4-19-2007; IN COMMERCE 4-19-2007.  
DANIEL S. STRINGER, EXAMINING ATTORNEY

**CLASS 9—(Continued).**

SN 76-714,861. WHATS GOOD NOW, INC., SHERMAN OAKS, CA. FILED 9-3-2013.

**CIETY**

THE MARK CONSISTS OF STANDARD CHARACTERS WITHOUT CLAIM TO ANY PARTICULAR FONT, STYLE, SIZE, OR COLOR.

FOR DOWNLOADABLE MOBILE APPLICATIONS FOR SELECTING RESTAURANTS AND NIGHT CLUBS IN PARTICULAR GEOGRAPHIC LOCATIONS WITH REAL-TIME UPDATES (U.S. CLS. 21, 23, 26, 36 AND 38).  
BARNEY CHARLON, EXAMINING ATTORNEY

SN 76-714,962. QINETIQ NORTH AMERICA, INC., RESTON, VA. FILED 9-17-2013.

**WiPPR**

THE MARK CONSISTS OF STANDARD CHARACTERS WITHOUT CLAIM TO ANY PARTICULAR FONT, STYLE, SIZE, OR COLOR.

FOR RADAR BASED WIND SPEED DETECTOR (U.S. CLS. 21, 23, 26, 36 AND 38).  
FIRST USE 8-14-2013; IN COMMERCE 8-14-2013.  
REGINA DRUMMOND, EXAMINING ATTORNEY

**CLASS 9—(Continued).**

SN 77-507,844. SCREENSCAPE NETWORKS INC., CHARLOTTETOWN, P.E.I., CANADA, FILED 6-25-2008.



ScreenMatch

PRIORITY CLAIMED UNDER SEC. 44(D) ON CANADA APPLICATION NO. 1,379,394, FILED 1-15-2008.

OWNER OF CANADA REG. NO. 868517, DATED 1-7-2014, EXPIRES 1-7-2029.

THE MARK CONSISTS OF THE WORDS "SCREEN-MATCH" AND TWO HANDS SHAKING WITHIN A RECTANGLE.

FOR COMPUTER SOFTWARE TO BE USED BY MARKETERS IN COMPARING THE GOALS OF A MARKETING CAMPAIGN WITH THE ATTRIBUTES OF A VENUE'S PROSPECTIVE SCREEN AUDIENCE (U.S. CLS. 21, 23, 26, 36 AND 38).

B. PARADEWELAI, EXAMINING ATTORNEY

SN 77-927,222. NIZDIL, MARK C, MONTROSE, CA. FILED 2-3-2010.

**American Dream**

THE MARK CONSISTS OF STANDARD CHARACTERS WITHOUT CLAIM TO ANY PARTICULAR FONT, STYLE, SIZE, OR COLOR.

FOR COMPUTER GAME SOFTWARE FOR GAMING MACHINES, NAMELY, SLOT MACHINES AND VIDEO LOTTERY TERMINALS (U.S. CLS. 21, 23, 26, 36 AND 38).  
TIMOTHY FINNEGAN, EXAMINING ATTORNEY



**CLASS 9—(Continued).**

SN 79-112,272. MI-ZONE LIMITED, UNITED KINGDOM, FILED 2-28-2012.

**MI-ZONE**

THE MARK CONSISTS OF STANDARD CHARACTERS WITHOUT CLAIM TO ANY PARTICULAR FONT, STYLE, SIZE, OR COLOR.

PRIORITY DATE OF 9-1-2011 IS CLAIMED.

OWNER OF INTERNATIONAL REGISTRATION 1114306 DATED 2-28-2012, EXPIRES 2-28-2022.

FOR COMPUTER SOFTWARE AND FIRMWARE, NAMELY, PROGRAMS FOR USE WITH PERSONAL AND HANDHELD COMPUTERS AND MOBILE TELEPHONES THAT ENABLE THE USER TO KEEP TRACK OF OR MANAGE PERSONAL ITEMS AND INDIVIDUALS; ALL OF THE AFORESAID GOODS FOR THE PURPOSES OF ENABLING THE USER TO KEEP TRACK OF OR MANAGE ITEMS, INDIVIDUALS AND/OR ANIMALS; NONE OF THE AFOREMENTIONED GOODS INCLUDING FITNESS MONITORING DEVICES (U.S. CLS. 21, 23, 26, 36 AND 38).

CHRISTINE MARTIN, EXAMINING ATTORNEY

SN 79-118,112. ZHEJIANG SHUQIMENG ENERGY TECHNOLOGY CO., LTD., ZHEJIANG PROVINCE, CHINA, FILED 2-21-2012.

**SIREAM**

OWNER OF INTERNATIONAL REGISTRATION 1129732 DATED 2-21-2012, EXPIRES 2-21-2022.

THE MARK CONSISTS OF THE STYLIZED WORDING "STREAM".

FOR WEIGHING MACHINES; MECHANICAL SIGNS; MONOCRYSTALLINE SILICON WAFERS; POLYCRYSTALLINE SILICON WAFERS (U.S. CLS. 21, 23, 26, 36 AND 38).

KRISTINA MORRIS, EXAMINING ATTORNEY

**CLASS 9—(Continued).**

SN 79-119,269. FRIEDRICH LÜTZE GMBH, 71384 WEIN-STADT, FED REP GERMANY, FILED 5-24-2012.

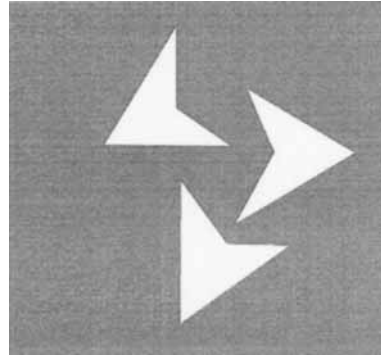

PRIORITY DATE OF 11-24-2011 IS CLAIMED.

OWNER OF INTERNATIONAL REGISTRATION 1132671 DATED 5-24-2012, EXPIRES 5-24-2022.

THE MARK CONSISTS OF A SQUARE HAVING THREE ARROWS POINTING IN THREE DIFFERENT DIRECTIONS WITHIN.

FOR APPARATUS AND INSTRUMENTS FOR CONDUCTING, SWITCHING, TRANSFORMING, ACCUMULATING, REGULATING OR CONTROLLING ELECTRICITY, NAMELY, APPARATUS AND INSTRUMENTS FOR CONVEYING DISTRIBUTING, TRANSFORMING, STORING, REGULATING OR CONTROLLING ELECTRIC CURRENT, DATA ACCESS PORT FOR USE WITH ELECTRICAL CONTROL PANELS FOR CONNECTING MULTIPLE DATA AND ELECTRICAL DEVICES; CONNECTIONS FOR ELECTRICAL LINES; SHEATHS FOR ELECTRIC CABLES; WIRE CONNECTORS, NAMELY, ELECTRICAL CONNECTORS; IDENTIFICATION SHEATHS FOR ELECTRIC WIRES; ELECTRICITY CONDUITS; JUMP START CABLES; ELECTRIC CABLES AND WIRES; ELECTRIC CABLES AND WIRES FOR DATA COMMUNICATION; C-TRACK CABLES, NAMELY, ELECTRIC CABLES FOR ENERGY TRANSMISSION AND SIGNAL TRANSMISSION; ELECTRICAL CONNECTORS, WIRES, CABLES AND ADAPTORS, IN PARTICULAR PLUGS, SOCKETS AND OTHER ELECTRIC CONNECTIONS; ELECTRIC WIRING SYSTEMS, NAMELY, ELECTRIC RELAYS, CIRCUIT BOARDS, ELECTRIC AND ELECTRICAL FRAME CONNECTORS OF CONTROL CABINET CONSTRUCTIONS; VOLTAGE SUPPRESSION DEVICES, NAMELY, ELECTRICAL CONNECTORS, IN PARTICULAR SUPPRESSION MODULES IN THE NATURE OF INSULATED ELECTRIC CONNECTORS, VALVE SUPPRESSORS IN THE NATURE OF AUTOMATIC VALVES AND PRESSURE INDICATING PLUGS FOR VALVES, INTERFACE SUPPRESSORS IN THE NATURE OF ELECTRONIC DISPLAY INTERFACES, MOTOR SUPPRESSORS IN THE NATURE OF ELECTRONIC CONTROLS FOR MOTORS; ELECTRONIC COMPONENTS, NAMELY, DIGITAL TRANSMITTERS, OPTICAL TRANSCIEVERS, OPTICAL TRANSMITTERS; SEMICONDUCTORS; ELECTRIC RELAYS; ELECTRIC SIGNAL CONVERTERS; ELECTRIC AND ELECTRONIC SWITCHING DEVICES AND CONTROL SYSTEMS FOR ENGINEERING AND PLANT CONSTRUCTION, NAMELY, ELECTRIC SWITCHES, ELECTRONIC MOTION SENSITIVE SWITCHES, ELECTRIC CONTROL PANELS, ELECTRICAL CONTROLLING DEVICES; DATA PROCESSING APPARATUS; ELECTRIC SENSORS; INTERFACES FOR COMPUTERS OR INTERFACES FOR DETECTORS (U.S. CLS. 21, 23, 26, 36 AND 38).

MAYUR VAGHANI, EXAMINING ATTORNEY

**CLASS 9—(Continued).**

SN 79-119,280. SAMSUNG ELECTRONICS CO., LTD., REPUBLIC OF KOREA, FILED 3-21-2012.

# S BEAM

THE MARK CONSISTS OF STANDARD CHARACTERS WITHOUT CLAIM TO ANY PARTICULAR FONT, STYLE, SIZE, OR COLOR.

PRIORITY DATE OF 3-19-2012 IS CLAIMED.

OWNER OF INTERNATIONAL REGISTRATION 1132695 DATED 3-21-2012, EXPIRES 3-21-2022.

FOR THREE-DIMENSIONAL (3D) EYEGLASSES; CAMCORDERS; COMPUTER GAME SOFTWARE; COMPUTER NETWORK HUBS, SWITCHES AND ROUTERS; COMPUTER SOFTWARE FOR INSTANT MESSAGING, SENDING AND RECEIVING EMAILS AND CONTACT INFORMATION, SCHEDULE SHARING AND CONTENTS SHARING SERVICE; COMPUTER SOFTWARE FOR MANAGING AND ORGANIZING VARIOUS DIGITAL READING CONTENTS, NAMELY, E-BOOKS, E-NEWSPAPERS, THESIS, AND E-MAGAZINES; COMPUTER SOFTWARE FOR PERSONAL INFORMATION MANAGEMENT; COMPUTER SOFTWARE FOR PURCHASING, DOWNLOADING, PLAYING OR LISTENING TO MUSIC; COMPUTER SOFTWARE FOR PURCHASING, SUBSCRIBING, DOWNLOADING, PLAYING OR LISTENING TO DIGITAL READING CONTENTS, NAMELY, E-BOOKS, E-NEWSPAPERS, THESIS AND E-MAGAZINES AND ELECTRONIC GAMES; COMPUTER SOFTWARE FOR USE IN RECORDING, ORGANIZING, TRANSMITTING, MANIPULATING, AND REVIEWING TEXT, DATA, AUDIO FILES, VIDEO FILES AND ELECTRONIC GAMES IN CONNECTION WITH TV, COMPUTERS, MUSIC PLAYERS, VIDEO PLAYERS, MEDIA PLAYERS, MOBILE PHONES, AND PORTABLE AND HANDHELD DIGITAL ELECTRONIC DEVICES; COMPUTER SOFTWARE FOR USE WITH SATELLITE AND GLOBAL POSITIONING SYSTEM (GPS) NAVIGATION SYSTEMS FOR NAVIGATION, ROUTE AND TRIP PLANNING, AND ELECTRONIC MAPPING; COMPUTER SOFTWARE FOR TRAVEL INFORMATION SYSTEMS THAT PROVIDES TRAVEL ADVICE AND FOR INFORMATION CONCERNING HOTELS, LANDMARKS, MUSEUMS, PUBLIC TRANSPORTATION, RESTAURANTS AND OTHER INFORMATION REGARDING TRAVEL AND TRANSPORT; COMPUTER SOFTWARE FOR VIEWING AND DOWNLOADING ELECTRONIC MAPS; COMPUTER SOFTWARE EMBEDDED ON PORTABLE PHONES AND PORTABLE COMPUTERS THAT ALLOWS USERS TO PLAY AND DOWNLOAD ELECTRONIC GAMES, LISTEN TO AND DOWNLOAD RING TONES AND MUSIC, AND VIEW AND DOWNLOAD SCREEN SAVERS AND WALLPAPERS; COMPUTER SOFTWARE THAT EDITS DAILY ACTIVITIES, ADDRESS BOOKS, CALENDARS, MEMOS, AND MULTIMEDIA CONTENTS STORED IN MOBILE DEVICES; COMPUTER SOFTWARE THAT ENABLES AUTHORIZING, POSTING, UPLOADING, DOWNLOADING, TRANSMITTING, RECEIVING, EDITING, EXTRACTING, ENCODING, DECODING, PLAYING, STORING, ORGANIZING, SHOWING, DISPLAYING, TAGGING, BLOGGING, SHARING AND PROVIDING ELECTRONIC MEDIA OR INFORMATION OVER THE INTERNET OR OTHER COMMUNICATIONS NETWORK; COMPUTER SOFTWARE THAT ENABLES USERS TO PROGRAM AND DISTRIBUTE AUDIO, VIDEO, TEXT AND OTHER MULTIMEDIA CONTENT, NAMELY, MUSIC, CONCERTS, VIDEOS, RADIO, TELEVISION, NEWS, SPORTS, GAMES, CULTURAL EVENTS, AND ENTERTAINMENT-RELATED AND EDUCATIONAL PROGRAMS VIA COMMUNICATION NETWORK; COMPUTER SOFTWARE FOR SUGGESTING THE MOST SUITABLE PEN-INPUT APPLICATIONS FOR THE MOBILE DEVICE; COMPUTERS; DIGITAL PHOTO ALBUMS FOR DISPLAYING DIGITAL PICTURES, VIDEO CLIPS AND MUSIC; DIGITAL CAMERAS; DIGITAL PHOTO FRAMES FOR DISPLAYING DIGITAL PICTURES, VIDEO CLIPS AND MUSIC; DIGITAL SET-TOP BOXES; DOWNLOADABLE DIGITAL IMAGES, NAMELY, PHOTOGRAPHIC OR VIDEO IMAGES IN THE FIELD OF MUSIC, EDUCATION AND ENTERTAINMENT;

**CLASS 9—(Continued).**

DOWNLOADABLE RING TONES FOR MOBILE PHONES; DVD PLAYERS; FACSIMILE MACHINES; HARD DISK DRIVES; INTERNET PROTOCOL (IP) PRIVATE BRANCH EXCHANGE SWITCHBOARDS; INTERNET PROTOCOL (IP) PHONE; KEY PHONE SWITCHBOARDS; INTERCOM KEY TERMINALS FOR CONNECTION TO A TELEPHONE NETWORK; KEY PHONE OPERATING SYSTEM SOFTWARE; LOCAL AREA NETWORK (LAN) SWITCHES; MOBILE PHONE AND TABLET COMPUTER ACCESSORIES, NAMELY, BATTERIES, ELECTRIC BATTERY CHARGERS, DATA COMMUNICATION CABLES, WIRED HEADSETS, WIRELESS HEADSETS, EAR PHONES, CAR CHARGERS, LEATHER CASES FOR MOBILE PHONES AND ELECTRONIC DEVICES, HANDS FREES KITS ADAPTED FOR USE WITH MOBILE PHONES AND TABLET COMPUTERS, FLIP CASE COVERS ADAPTED FOR MOBILE PHONE AND TABLET COMPUTERS, STYLUS FOR PORTABLE ELECTRONIC DEVICES, PHONE HOLDERS, SCREEN PROTECTIVE FILMS, PHONE STRAPS, CELL PHONE, MOBILE PHONE, AND TABLET COMPUTER FACEPLATES OF PLASTIC OR SILICON ADAPTED FOR USE IN ENCASING; REPLACEMENT FRONT PANELS FOR MOBILE PHONES AND PORTABLE COMPUTERS; AUDIO DECKS ADAPTED FOR USE WITH MOBILE PHONE AND TABLET COMPUTERS; HOLDERS ADAPTED FOR MOBILE PHONES; MOBILE PHONE OPERATING SYSTEM SOFTWARE; MOBILE TELEPHONES; COMPUTER MONITORS; MP3 PLAYERS; NETWORK ACCESS SERVER HARDWARE; NETWORK ACCESS SERVER OPERATING SOFTWARE; PERSONAL DIGITAL ASSISTANTS (PDAS); PORTABLE COMPUTERS; PORTABLE MULTIMEDIA PLAYERS; PRINTERS FOR COMPUTERS; SEMICONDUCTORS CHIPS; SMART PHONES; SOFTWARE FOR USE IN NETWORK MANAGEMENT SYSTEM; TABLET COMPUTER OPERATING SYSTEM SOFTWARE; TABLET COMPUTERS; TELEPHONES; TELEPHONES USED AS TERMINAL DEVICES FOR INTERNET PROTOCOL (IP) PRIVATE BRANCH EXCHANGE (PBX); TELEVISION RECEIVERS; BLANK UNIVERSAL SERIAL BUS (USB) FLASH DRIVES; UNIVERSAL SERIAL BUS (USB) FLASH MEMORY CARDS; WIDE AREA NETWORK (WAN) ROUTERS; WIRELESS HEADSETS FOR CELLULAR AND MOBILE PHONES (U.S. CLS. 21, 23, 26, 36 AND 38).

CHRISTOPHER BUONGIORNO, EXAMINING ATTORNEY

**CLASS 9—(Continued).**

SN 79-121,611. AL-ABASSY, ISSAM, AUSTRIA, FILED 6-26-2012.

**CLASS 9—(Continued).**

SN 79-126,675. VALLÉS NAVARRO, ALFREDO, SPAIN, AND VALLÉS NAVARRO, ANDRÉS, BARCELONA, SPAIN, FILED 12-20-2012.



# SCORPIOLENS

PRIORITY DATE OF 1-11-2012 IS CLAIMED.

OWNER OF INTERNATIONAL REGISTRATION 1138919 DATED 6-26-2012, EXPIRES 6-26-2022.

THE COLOR(S) BLUE, WHITE AND YELLOW IS/ARE CLAIMED AS A FEATURE OF THE MARK.

THE MARK CONSISTS OF THE STYLIZED WORDING "ACCUPOWER" WITH "ACCU" IN WHITE AND "POWER" IN YELLOW ALL ON A BLUE RECTANGLE.

FOR ACCUMULATORS AND BATTERIES; ACCUMULATOR BOXES; ACCUMULATOR JARS; BATTERY CASES; BATTERY CHARGE DEVICES; BATTERY CHARGERS; BATTERY CONTROL AND MONITORING DEVICES, NAMELY, BATTERY TESTERS; BATTERIES FOR LIGHTING; BATTERY PACKS; BATTERY PACKS FOR ELECTRIC VEHICLES; BATTERY PERFORMANCE MONITORS; BATTERY TESTERS; CHARGERS FOR ELECTRIC BATTERIES; ELECTRIC ACCUMULATORS; ELECTRIC BATTERIES; ELECTRIC BATTERIES FOR VEHICLES; ELECTRIC CABLES; ELECTRIC CAPACITORS; ELECTRIC CONNECTORS; ELECTRIC CONTACTS; ELECTRIC JUNCTION BOXES; ELECTRIC TRANSFORMERS; ELECTRIC WIRES; ELECTRIC STORAGE BATTERIES, IN PARTICULAR BEING SINGLE BATTERIES AND POWER PACKS; ELECTRICAL ENERGY MANAGEMENT AND STORAGE DEVICES, NAMELY, ELECTRICAL STORAGE BATTERIES; GALVANIC BATTERIES; GRIDS FOR BATTERIES; ELECTRIC CONVERTERS; ELECTRIC INVERTERS; ELECTRICITY REDUCERS, NAMELY, STEP DOWN TRANSFORMERS; FIRE AND EXPLOSION PROTECTION CABINETS FOR BATTERIES AND BATTERY PACKS FOR TRANSPORTATION AND STORAGE OF BATTERIES, NAMELY, PROTECTIVE COVERS SPECIALLY ADAPTED FOR BATTERIES; MEASURING INSTRUMENTS FOR BATTERIES, NAMELY, VOLTMETERS; MEASURING INSTRUMENTS FOR ELECTRIC VEHICLES, NAMELY, AMMETERS; WELDING TRANSFORMERS (U.S. CLS. 21, 23, 26, 36 AND 38).

ROBERT STRUCK, EXAMINING ATTORNEY

THE MARK CONSISTS OF STANDARD CHARACTERS WITHOUT CLAIM TO ANY PARTICULAR FONT, STYLE, SIZE, OR COLOR.

PRIORITY DATE OF 6-25-2012 IS CLAIMED.

OWNER OF INTERNATIONAL REGISTRATION 1151327 DATED 12-20-2012, EXPIRES 12-20-2022.

FOR LENSES FOR PHOTOGRAPHIC AND CINEMATOGRAPHIC CAMERAS, CRANES SPECIALLY DESIGNED TO WORK WITH CAMERAS AS ACCESSORIES, NAMELY, CRANES FOR PHOTOGRAPHIC AND CINEMATOGRAPHIC CAMERAS, STABILIZED HEADS THAT ARE CAMERA MOUNTS AND SUPPORTS FOR PHOTOGRAPHIC AND CINEMATOGRAPHIC CAMERAS, REMOTE HEADS THAT ARE CAMERA MOUNTS AND SUPPORTS FOR PHOTOGRAPHIC AND CINEMATOGRAPHIC CAMERAS, REMOTE CONTROL APPARATUS FOR PHOTOGRAPHIC AND CINEMATOGRAPHIC CAMERAS, ELECTRONIC DOLLIES THAT ARE CAMERA MOUNTS AND SUPPORTS FOR PHOTOGRAPHIC AND CINEMATOGRAPHIC CAMERAS, PHOTOGRAPHIC AND CINEMATOGRAPHIC CAMERAS (U.S. CLS. 21, 23, 26, 36 AND 38).

ANDREW RHIM, EXAMINING ATTORNEY

**CLASS 9—(Continued).**

SN 79-126,689. NEKTOON AG, SWITZERLAND, FILED 12-10-2012.



PRIORITY DATE OF 6-11-2012 IS CLAIMED.  
OWNER OF INTERNATIONAL REGISTRATION 1151355  
DATED 12-10-2012, EXPIRES 12-10-2022.

THE MARK CONSISTS OF A STYLIZED SQUIRREL.  
FOR SOFTWARE FOR RETRIEVING, INPUTTING, COMPILING, INDEXING, ORGANIZING, STORING, SYNCHRONIZING, AUTOMATICALLY UPDATING, AUTOMATICALLY EXTENDING, INSPECTING AND TRANSMITTING DATA, IN PARTICULAR ON INDIVIDUAL WORKSTATIONS, COMPUTERS OR COMPUTER NETWORKS; SOFTWARE FOR COLLECTING, UPDATING, EXTENDING, MANAGING AND BACKING-UP DATA, IN PARTICULAR ON THE INTERNET AND THE WORLD WIDE WEB; COMPUTER SOFTWARE FOR DOWNLOADING WEB PAGE CONTENT FOR USE OFFLINE AND ARCHIVING IN THE NATURE OF WEB-CLIPPING SOFTWARE; COMPUTER SOFTWARE PLATFORMS FOR RETRIEVING, INPUTTING, COMPILING, INDEXING, ORGANIZING, STORING, SYNCHRONIZING, AUTOMATICALLY UPDATING, AUTOMATICALLY EXTENDING, INSPECTING AND TRANSMITTING DATA, IN PARTICULAR ON INDIVIDUAL WORKSTATIONS, COMPUTERS OR COMPUTER NETWORKS; COMPUTER SOFTWARE PLATFORMS FOR DOWNLOADING WEB PAGE CONTENT FOR USE OFFLINE AND ARCHIVING IN THE NATURE OF WEB-CLIPPING SOFTWARE; INTERACTIVE COMPUTER SOFTWARE OF AN EDUCATIONAL NATURE BASED ON USE AND EXPERIENCE IN THE FIELD OF HISTORY, ART, SOCIAL STUDIES, GEOGRAPHY, TRAVELLING, SCIENCE, READING, MATH, LITERATURE, ENGLISH, AND EARLY CHILDHOOD EDUCATION; DOWNLOADABLE ELECTRONIC BOOKS FEATURING CHILDREN'S EDUCATIONAL TOPICS; E-NOTEBOOKS, NAMELY, ELECTRONIC NOTEBOOK COMPUTERS; E-AGENDAS, NAMELY, ELECTRONIC DAY PLANNERS (U.S. CLS. 21, 23, 26, 36 AND 38).

KYLE PEETE, EXAMINING ATTORNEY

**CLASS 9—(Continued).**

SN 79-128,986. BLACKNOISE DEUTSCHLAND GMBH, FED REP GERMANY, FILED 11-6-2012.



OWNER OF INTERNATIONAL REGISTRATION 1157359  
DATED 11-6-2012, EXPIRES 11-6-2022.

OWNER OF U.S. REG. NO. 4,378,125.

THE MARK CONSISTS OF THE LETTERS "NB" WITH THREE CURVED LINES ON EITHER SIDE.

FOR COMPUTERS; DATA-PROCESSING APPARATUS; COMPUTER PERIPHERAL DEVICES; MICROPROCESSORS; INTEGRATED CIRCUITS; COMPUTER MEMORIES; DRIVES FOR COMPUTER, IN PARTICULAR FLOPPY DISK DRIVES, HARD DISK DRIVES OR CD DRIVES; POWER SUPPLIERS FOR COMPUTERS, COMPUTER HARDWARE, COMPUTER PERIPHERALS, COMPUTER EQUIPMENT AND DATA PROCESSORS; KEYBOARDS; COMPUTER MICE; MONITORS; SCANNERS; NOTEBOOK COMPUTERS; PRINTERS; COMPUTER HOUSINGS; BLANK MAGNETIC DATA CARRIERS; COMPUTER GRAPHICS SOFTWARE, CONTROL SOFTWARE FOR COMPUTER FANS; PROJECTION APPARATUS, IN PARTICULAR MOVIE PROJECTORS; VIDEO PROJECTORS; REGULATING AND CONTROL APPARATUS INCLUDED IN THIS CLASS, NAMELY, ELECTRONIC REGULATING AND CONTROL DEVICES FOR THE OPERATION OF LIGHT EMITTING DIODES, AND COMPUTER FANS; ELECTRICAL REGULATORS, NAMELY, VOLTAGE REGULATORS FOR COMPUTERS, COMPUTER HARDWARE, COMPUTER PERIPHERALS, COMPUTER EQUIPMENT AND DATA PROCESSORS; SENSORS, IN PARTICULAR TEMPERATURE SENSORS; REMOTE CONTROL APPARATUS, NAMELY, REMOTE CONTROLS FOR RADIOS AND TELEVISIONS; HOUSINGS FOR ALL THE AFORESAID GOODS; FANS FOR COMPUTERS; FANS FOR CPUS (CENTRAL PROCESSING UNITS); COMPUTER HEAT SINKS; HEAT SINKS FOR COMPUTER HOUSINGS; HEAT SINKS FOR ELECTRONIC COMPONENTS; ELECTRIC CONNECTORS AND POWER CONNECTORS FOR COMPUTERS, COMPUTER HARDWARE, COMPUTER PERIPHERALS, COMPUTER EQUIPMENT AND DATA PROCESSORS (U.S. CLS. 21, 23, 26, 36 AND 38).

KATHERINE M. DUBRAY, EXAMINING ATTORNEY

**CLASS 9—(Continued).**

SN 79-129,712. ALCANTARA S.P.A., ITALY, FILED 3-15-2013.

**ALCANTARA**

THE MARK CONSISTS OF STANDARD CHARACTERS WITHOUT CLAIM TO ANY PARTICULAR FONT, STYLE, SIZE, OR COLOR.

PRIORITY DATE OF 3-12-2013 IS CLAIMED.

OWNER OF INTERNATIONAL REGISTRATION 1159145 DATED 3-15-2013, EXPIRES 3-15-2023.

OWNER OF U.S. REG. NOS. 1,833,839, 2,064,352 AND 3,251,962.

FOR CASES FOR MOBILE PHONES; BAGS AND CASES SPECIALLY ADAPTED FOR HOLDING OR CARRYING MP3 PLAYERS, BAGS AND CASES SPECIALLY ADAPTED FOR HOLDING OR CARRYING COMPUTERS, BAGS AND CASES SPECIALLY ADAPTED FOR HOLDING OR CARRYING PORTABLE COMPUTERS, BAGS AND CASES SPECIALLY ADAPTED FOR HOLDING OR CARRYING TABLET COMPUTERS; BAGS AND CASES SPECIALLY ADAPTED FOR HOLDING OR CARRYING CAMERAS AND VIDEO CAMERAS; MOUSE PADS; BAGS AND CASES SPECIALLY ADAPTED FOR HOLDING OR CARRYING GLOBAL POSITIONING SYSTEM (GPS) DEVICES, BAGS AND CASES SPECIALLY ADAPTED FOR HOLDING OR CARRYING ELECTRONIC ORGANIZERS; CASES FOR SPECTACLES AND SUNGLASSES (U.S. CLS. 21, 23, 26, 36 AND 38).

JOHN KELLY, EXAMINING ATTORNEY

SN 79-131,756. GARVAN S.N.C.; DI MARTELLI ANDREA E GAUDENZI ROBERTO, ITALY, FILED 3-21-2013.



OWNER OF INTERNATIONAL REGISTRATION 1164491 DATED 3-21-2013, EXPIRES 3-21-2023.

NO CLAIM IS MADE TO THE EXCLUSIVE RIGHT TO USE "ARREDAMENTO ACUSTICO", APART FROM THE MARK AS SHOWN.

THE MARK CONSISTS OF A STYLIZED LETTER "G" OVER A RECTANGLE CONTAINING THE TERM "GARVAN" OVER THE TERMS "ARREDAMENTO ACUSTICO".

THE ENGLISH TRANSLATION OF THE FOREIGN WORD(S) IN THE MARK IS "GARVAN ACOUSTIC FURNITURE".

FOR APPARATUS FOR RECORDING, TRANSMISSION OR REPRODUCTION OF SOUND, NAMELY, LOUDSPEAKERS; AUDIO SPEAKERS; SUB-WOOFERS; LOUDSPEAKERS WITH BUILT IN AMPLIFIERS; PUBLIC ADDRESS (PA) AND SOUND SYSTEM ACCESSORIES, NAMELY, SPEAKER STANDS, SPEAKER CABLES, SPEAKER BOXES AND SOUND MIXERS; CABINETS FOR LOUDSPEAKERS; HORNS FOR LOUDSPEAKERS; SOUND SYSTEMS COMPRISING REMOTE CONTROLS, AMPLIFIERS, LOUDSPEAKERS AND COMPONENTS THEREFOR; AMPLIFIER BOXES; SPEAKERS FOR COMPUTERS; AUDIO AMPLIFIERS; STEREO AMPLIFIERS; ACOUSTICAL DIFFUSERS (U.S. CLS. 21, 23, 26, 36 AND 38).

JANICE L. MCMORROW, EXAMINING ATTORNEY

**CLASS 9—(Continued).**

SN 79-132,106. JEOL LTD., JAPAN, FILED 5-24-2013.

**MIXCROSCOPY**

THE MARK CONSISTS OF STANDARD CHARACTERS WITHOUT CLAIM TO ANY PARTICULAR FONT, STYLE, SIZE, OR COLOR.

OWNER OF INTERNATIONAL REGISTRATION 1165344 DATED 5-24-2013, EXPIRES 5-24-2023.

FOR LABORATORY APPARATUS AND INSTRUMENTS, NAMELY, COMBINED ELECTRON AND OPTICAL MICROSCOPES; OPTICAL APPARATUS AND INSTRUMENTS, NAMELY, OPTICAL MICROSCOPES; MEASURING OR TESTING MACHINES AND INSTRUMENTS, NAMELY, REVIEW SYSTEMS FOR ANALYZING OR MEASURING MATERIAL, NAMELY, WAFER DEFECT INSPECTION INSTRUMENTS, PATTERN MEASURING INSTRUMENTS; INDUSTRIAL X-RAY MACHINES AND APPARATUS NOT FOR MEDICAL USE; ELECTRON MICROSCOPES (U.S. CLS. 21, 23, 26, 36 AND 38).

ANNE MADDEN, EXAMINING ATTORNEY

SN 79-132,686. PENCRAZY PTY LTD, AUSTRALIA, FILED 5-28-2013.

**Tapfit**

THE MARK CONSISTS OF STANDARD CHARACTERS WITHOUT CLAIM TO ANY PARTICULAR FONT, STYLE, SIZE, OR COLOR.

PRIORITY DATE OF 4-16-2013 IS CLAIMED.

OWNER OF INTERNATIONAL REGISTRATION 1166858 DATED 5-28-2013, EXPIRES 5-28-2023.

FOR PRERECORDED DVDS FEATURING DANCE AND FITNESS INSTRUCTION (U.S. CLS. 21, 23, 26, 36 AND 38).

BERNICE MIDDLETON, EXAMINING ATTORNEY

SN 79-133,055. PENCRAZY PTY LTD, AUSTRALIA, FILED 5-28-2013.

**tapfun**

THE MARK CONSISTS OF STANDARD CHARACTERS WITHOUT CLAIM TO ANY PARTICULAR FONT, STYLE, SIZE, OR COLOR.

PRIORITY DATE OF 4-16-2013 IS CLAIMED.

OWNER OF INTERNATIONAL REGISTRATION 1167783 DATED 5-28-2013, EXPIRES 5-28-2023.

FOR PRERECORDED DVDS FEATURING DANCE AND FITNESS INSTRUCTION (U.S. CLS. 21, 23, 26, 36 AND 38).

BERNICE MIDDLETON, EXAMINING ATTORNEY

**CLASS 9—(Continued).**

SN 79-134.454. CONTINENTAL AUTOMOTIVE GMBH, FED REP GERMANY, FILED 6-4-2013.

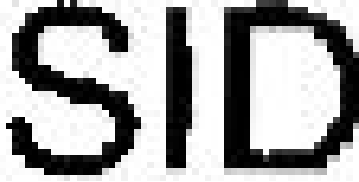

THE MARK CONSISTS OF STANDARD CHARACTERS WITHOUT CLAIM TO ANY PARTICULAR FONT, STYLE, SIZE, OR COLOR.

PRIORITY DATE OF 12-20-2012 IS CLAIMED.

OWNER OF INTERNATIONAL REGISTRATION 1171452 DATED 6-4-2013, EXPIRES 6-4-2023.

FOR MONITORING DEVICES IN THE NATURE OF COMPUTER HARDWARE AND SOFTWARE AND ELECTRONIC SENSORS FOR MONITORING ENGINE PERFORMANCE, AND SYSTEMS CONSISTING THEREOF, NAMELY ELECTRONIC CONTROL SYSTEMS FOR GASOLINE ENGINES FOR LAND VEHICLES, NAMELY ENGINE MANAGEMENT CONTROL UNITS (ECUS), POWERTRAIN CONTROL MODULES (PCMS) AND APPARATUS FOR CONTROLLING PERFORMANCE OF INTERNAL COMBUSTION ENGINES, INCLUDING CONTROL OF AIR-FUEL RATIO, IGNITION TIMING, IDLE SPEED, VALVE TIMING, AND VALVE CONTROL; DIAGNOSTIC DEVICES AND APPARATUS AND SYSTEMS CONSISTING THEREOF, NAMELY COMPUTER HARDWARE AND SOFTWARE FOR DIAGNOSING ELECTRICAL AND MECHANICAL PROBLEMS IN MOTOR VEHICLES (U.S. CLS. 21, 23, 26, 36 AND 38).

COLLEEN KEARNEY, EXAMINING ATTORNEY

SN 79-135.221. XIE LIANG, PANYU DISTRICT; GUANGZHOU, CHINA, FILED 7-29-2013.



OWNER OF INTERNATIONAL REGISTRATION 1173252 DATED 7-29-2013, EXPIRES 7-29-2023.

THE MARK CONSISTS OF A DESIGN OF WHIRLPOOL AND THE WORDING "STVDIODUE" IN STYLIZED LETTERS BELOW THE DESIGN, BOTH IN A SQUARE BACKGROUND.

THE WORDING "STVDIODUE" HAS NO MEANING IN A FOREIGN LANGUAGE.

FOR ACOUSTIC CONDUITS; CABINETS FOR LOUDSPEAKERS; ACOUSTIC MEMBRANES; LOUDSPEAKERS; SOUND TRANSMITTING APPARATUS; HORNS FOR LOUDSPEAKERS; ACOUSTIC COUPLERS (U.S. CLS. 21, 23, 26, 36 AND 38).

DEBORAH LOBO, EXAMINING ATTORNEY

**CLASS 9—(Continued).**

SN 79-135.273. ELMO COMPANY, LIMITED, JAPAN, FILED 3-4-2013.



OWNER OF INTERNATIONAL REGISTRATION 1173335 DATED 3-4-2013, EXPIRES 3-4-2023.

OWNER OF U.S. REG. NOS. 1,721,532, 3,919,105 AND OTHERS.

FOR PRESENTATION ELECTRONIC APPARATUS FOR USE IN CAPTURING AND TRANSMITTING VISUAL IMAGES; VIDEO PROJECTORS; MOVIE PROJECTORS; LCD (LIQUID CRYSTAL DISPLAY) MONITORS; LCD (LIQUID CRYSTAL DISPLAY) PROJECTORS FOR COMPUTERS; AMPLIFIERS; MICROPHONES; LOUDSPEAKERS; TV MONITORS; DIGITAL VIDEO RECORDERS; SOUND MIXERS; DIGITAL VIDEO SIGNAL PROCESSORS; REMOTE CONTROLS FOR VIDEO PROJECTORS, TELEVISIONS, VIDEO MONITORS; DIGITAL VIDEO RECORDERS, DIGITAL AUDIO TAPE RECORDERS, PRESENTATION APPARATUS FOR CAPTURING AND TRANSMITTING VISUAL IMAGES; PROJECTION SCREENS; COMPUTER WHITEBOARDS; TABLET COMPUTERS; DATA PROCESSING APPARATUS; LCD (LIQUID CRYSTAL DISPLAY) TOUCH PANELS FOR COMPUTERS; BLANK FLASH MEMORY CARDS; COMPUTERS; RECORDED COMPUTER SOFTWARE FOR SAVING AND VIEWING DIGITAL IMAGES AND VIDEO; DOWNLOADABLE COMPUTER SOFTWARE FOR SAVING AND VIEWING DIGITAL IMAGES AND VIDEO; COMPUTER PERIPHERAL DEVICES; POWER ADAPTERS; BATTERY PACKS AND BATTERY CHARGERS; CCD (CHARGE-COUPLED DEVICE) CAMERAS, CMOS (COMPLEMENTARY METAL-OXIDE SEMICONDUCTOR) CAMERAS, VIDEO CAMERAS, AND LENSES THEREOF; PORTABLE VIDEO RECORDERS; PORTABLE VIDEO DISC PLAYERS; PORTABLE VIDEO MONITORS; CARRYING CASES, WATERPROOF CASES, HOLDERS, STRAPS, STANDS AND SUPPORTS, ALL SPECIALLY ADAPTED FOR USE WITH PORTABLE VIDEO MONITORS, PORTABLE VIDEO RECORDERS, PORTABLE VIDEO DISC PLAYERS, CCD (CHARGE-COUPLED DEVICE) CAMERAS AND CMOS (COMPLEMENTARY METAL-OXIDE SEMICONDUCTOR) CAMERAS; TILTING HEADS FOR CAMERAS; SURVEILLANCE CAMERAS; COMPACT DISCS FEATURING MUSIC; DOWNLOADABLE MUSIC FILES; EXPOSED CINEMATOGRAPHIC FILMS; EXPOSED SLIDE FILMS; SLIDE FILM MOUNTS; DOWNLOADABLE IMAGE FILE CONTAINING ARTWORK, TEXT, AUDIO, VIDEO, GAMES IN THE FIELDS OF ELEMENTARY EDUCATION; PRE-RECORDED VIDEO DISCS FEATURING MOVIES, MUSIC, GAMES, SPORTS, ENTERTAINMENT AND ELEMENTARY EDUCATION; DOWNLOADABLE ELECTRONIC PUBLICATIONS IN THE NATURE OF BOOKS, MAGAZINES, MANUALS, PAMPHLETS AND BROCHURES IN THE FIELD OF MOVIES, MUSIC, GAMES, SPORTS, ENTERTAINMENT, ELEMENTARY EDUCATION; ELECTRONIC PUBLICATIONS, NAMELY, BOOKS, MAGAZINES, MANUALS, PAMPHLETS AND BROCHURES FEATURING MOVIES, MUSIC, GAMES, SPORTS, ENTERTAINMENT AND ELEMENTARY EDUCATION RECORDED ON COMPUTER MEDIA (U.S. CLS. 21, 23, 26, 36 AND 38).

JASON TURNER, EXAMINING ATTORNEY

**CLASS 9—(Continued).**

SN 79-135,432. ELEMENTAR ANALYSENSYSTEME GMBH,  
FED REP GERMANY, FILED 6-4-2013.

# isoTOC

THE MARK CONSISTS OF STANDARD CHARACTERS WITHOUT CLAIM TO ANY PARTICULAR FONT, STYLE, SIZE, OR COLOR.

OWNER OF INTERNATIONAL REGISTRATION 1173708 DATED 6-4-2013, EXPIRES 6-4-2023.

THE ENGLISH TRANSLATION OF "ISO" IN THE MARK IS "EQUAL". THE WORDING "ISOTOC" HAS NO MEANING IN A FOREIGN LANGUAGE.

FOR SCIENTIFIC AND TECHNICAL APPARATUS, NAMELY, MEASURING APPARATUS FOR CHEMICAL ANALYSIS IN THE NATURE OF MASS SPECTROMETERS AND PARTS AND FITTINGS THEREFOR FOR MEASUREMENT OF THE ISOTOPIC RATIO OF TOTAL ORGANIC CARBON (U.S. CLS. 21, 23, 26, 36 AND 38).

ROBIN MITTLER, EXAMINING ATTORNEY

SN 79-135,433. ELEMENTAR ANALYSENSYSTEME GMBH,  
FED REP GERMANY, FILED 6-4-2013.

# conTEST

THE MARK CONSISTS OF STANDARD CHARACTERS WITHOUT CLAIM TO ANY PARTICULAR FONT, STYLE, SIZE, OR COLOR.

OWNER OF INTERNATIONAL REGISTRATION 1173709 DATED 6-4-2013, EXPIRES 6-4-2023.

FOR SCIENTIFIC AND TECHNICAL APPARATUS, NAMELY, MEASURING APPARATUS FOR CHEMICAL ANALYSIS IN THE NATURE OF MASS SPECTROMETERS AND PARTS AND FITTINGS THEREFOR FOR MEASURING OF CONCENTRATIONS OF THE ELEMENTS SULFUR, CARBON, NITROGEN, OXYGEN AND HYDROGEN IN METALS AND INORGANIC SUBSTANCES (U.S. CLS. 21, 23, 26, 36 AND 38).

ROBIN MITTLER, EXAMINING ATTORNEY

SN 79-138,659. STUDIOCOAST PTY LTD, AUSTRALIA,  
FILED 9-17-2013.

# StudioCoast

THE MARK CONSISTS OF STANDARD CHARACTERS WITHOUT CLAIM TO ANY PARTICULAR FONT, STYLE, SIZE, OR COLOR.

PRIORITY DATE OF 8-15-2013 IS CLAIMED.  
OWNER OF INTERNATIONAL REGISTRATION 1182155 DATED 9-17-2013, EXPIRES 9-17-2023.

FOR COMPUTER SOFTWARE FOR MULTIMEDIA PRESENTATION, LIVE PRODUCTION, BROADCASTING AND ONLINE STREAMING (U.S. CLS. 21, 23, 26, 36 AND 38).

LAURIE MAYES, EXAMINING ATTORNEY

**CLASS 9—(Continued).**

SN 79-138,806. KABUSHIKI KAISHA NIHON MICRONICS,  
JAPAN, AND GUALA TECHNOLOGY CORPORATION,  
JAPAN, FILED 9-13-2013.

# QUANPOWER

THE MARK CONSISTS OF STANDARD CHARACTERS WITHOUT CLAIM TO ANY PARTICULAR FONT, STYLE, SIZE, OR COLOR.

PRIORITY DATE OF 4-22-2013 IS CLAIMED.  
OWNER OF INTERNATIONAL REGISTRATION 1182571 DATED 9-13-2013, EXPIRES 9-13-2023.

FOR ACCUMULATORS, ELECTRIC; BATTERIES; ELECTRICAL CELLS AND BATTERIES (U.S. CLS. 21, 23, 26, 36 AND 38).

DAVID HOFFMAN, EXAMINING ATTORNEY

SN 79-138,807. KABUSHIKI KAISHA NIHON MICRONICS,  
JAPAN, AND GUALA TECHNOLOGY CORPORATION,  
JAPAN, FILED 9-13-2013.

# battenice

THE MARK CONSISTS OF STANDARD CHARACTERS WITHOUT CLAIM TO ANY PARTICULAR FONT, STYLE, SIZE, OR COLOR.

PRIORITY DATE OF 4-22-2013 IS CLAIMED.  
OWNER OF INTERNATIONAL REGISTRATION 1182572 DATED 9-13-2013, EXPIRES 9-13-2023.

FOR ACCUMULATORS, ELECTRIC; BATTERIES; ELECTRICAL CELLS AND BATTERIES (U.S. CLS. 21, 23, 26, 36 AND 38).

DAVID HOFFMAN, EXAMINING ATTORNEY

SN 79-138,939. BOSTON CLUB CO., LTD., JAPAN, FILED 9-19-2013.

# BOSTON CLUB

OWNER OF INTERNATIONAL REGISTRATION 1182871 DATED 9-19-2013, EXPIRES 9-19-2023.

FOR EYEGLASSES; EYEGLASS CASES; EYEGLASS FRAMES; SUNGLASSES (U.S. CLS. 21, 23, 26, 36 AND 38).

DARRYL SPRULL, EXAMINING ATTORNEY

**CLASS 9—(Continued).**

SN 79-139,116. GRANDOTTICA DI CALDERONI ANTONELLO; & C. S.A.S., ITALY, FILED 9-13-2013.



PRIORITY DATE OF 9-2-2013 IS CLAIMED.  
OWNER OF INTERNATIONAL REGISTRATION 1183327  
DATED 9-13-2013, EXPIRES 9-13-2023.

THE MARK CONSISTS OF THE STYLIZED DEVICE OF A PAIR OF GLASSES WITH THE FANCY WORD "KYME" BELOW.

FOR SPECTACLES AND SUNGLASSES, CHAINS FOR SPECTACLES AND SUNGLASSES, CASES FOR SPECTACLES AND SUNGLASSES, FRAMES FOR SPECTACLES AND SUNGLASSES; SAFETY HELMETS (U.S. CLS. 21, 23, 26, 36 AND 38).

DAVID HOFFMAN, EXAMINING ATTORNEY

SN 85-023,147. SCHWEITZER ENGINEERING LABORATORIES, INC., PULLMAN, WA. FILED 4-26-2010.

FOR COMPUTER HARDWARE USED TO MONITOR AND CONTROL ELECTRICAL POWER LINES, OIL, GAS OR PETROCHEMICAL STATIONS OR PIPELINES, HIGHWAY, RAILWAY OR MASS TRANSIT SYSTEMS, MINING EQUIPMENT AND INDUSTRIAL APPLICATIONS, NAMELY, MULTIPLEXERS, TELECOMMUNICATIONS SWITCHES, ETHERNET SWITCHES, ETHERNET REPEATERS, ETHERNET TRANSCEIVERS, FIBER OPTIC TRANSCEIVERS, FIBER OPTIC MULTIPLEXERS, AND FIBER OPTIC SWITCHES; ELECTRONIC AND OPTICAL TELECOMMUNICATIONS INSTRUMENTS FOR USE IN MONITORING AND CONTROLLING ELECTRICAL POWER LINES, OIL, GAS AND PETROCHEMICAL STATIONS AND PIPELINES, HIGHWAY, RAILWAY AND MASS TRANSIT SYSTEMS, MINING EQUIPMENT AND INDUSTRIAL APPLICATIONS, NAMELY, TRANSMITTERS, RECEIVERS, CONVERTERS, SWITCHES, AND MULTIPLEXERS; COMPUTER HARDWARE FOR GENERATION AND DISTRIBUTION OF DIGITAL TIME SIGNALS; TELECOMMUNICATIONS HARDWARE FOR USE IN THE SYNCHRONIZATION OF NETWORKS; COMPUTER HARDWARE FOR USE IN TRANSLATING AND DISTRIBUTING SATELLITE DATA AND TIME DATA (U.S. CLS. 21, 23, 26, 36 AND 38).

KRISTIN DAHLING, EXAMINING ATTORNEY

**CLASS 9—(Continued).**

SN 85-185,582. PINEAPPLE TRADEMARKS PTY LTD, BURLEIGH HEADS, QLD, AUSTRALIA, FILED 11-26-2010.

THE MARK CONSISTS OF STANDARD CHARACTERS WITHOUT CLAIM TO ANY PARTICULAR FONT, STYLE, SIZE, OR COLOR.

PRIORITY CLAIMED UNDER SEC. 44(D) ON AUSTRALIA APPLICATION NO. 1363316, FILED 5-25-2010.

OWNER OF U.S. REG. NO. 3,709,180.

FOR SUNGLASSES, SPECTACLES, SUNGLASSES FRAMES, SPECTACLE FRAMES (U.S. CLS. 21, 23, 26, 36 AND 38).

HAI-LY LAM, EXAMINING ATTORNEY

SN 85-190,901. VINVOX INTERNATIONAL CORP., MONCTON, NEW BRUNSWICK, CANADA, FILED 12-5-2010.

THE MARK CONSISTS OF STANDARD CHARACTERS WITHOUT CLAIM TO ANY PARTICULAR FONT, STYLE, SIZE, OR COLOR.

PRIORITY CLAIMED UNDER SEC. 44(D) ON CANADA APPLICATION NO. 1505568, FILED 11-26-2010, REG. NO. 866796, DATED 12-6-2013, EXPIRES 12-6-2028.

FOR ACCESS DIAGNOSTIC SYSTEM SOFTWARE FOR THE MONITORING AND REMOTE ASSESSMENT OF VEHICLE OPERATING SYSTEMS; WIRELESS SOFTWARE, NAMELY, COMPUTER SOFTWARE FOR ACQUIRING, ORGANIZING, AND ANALYZING DATA FROM IN-VEHICLE COMPUTERS; WIRELESS SOFTWARE, NAMELY, COMPUTER SOFTWARE, NAMELY, SOFTWARE THAT FACILITATES AND PROVIDES DATA TRANSFER AND COMMUNICATION FROM AND BETWEEN VEHICLES AND COMPUTERS, FROM AND BETWEEN DRIVERS, THIRD PARTIES AND COMPUTERS AND GENERAL MOBILE PHONE MANAGEMENT SOFTWARE SERVICES, ALL IN CONNECTION WITH AUTOMOTIVE DIAGNOSTICS, AND AUTOMOTIVE REPAIR, INCLUDING MAINTENANCE SCHEDULE MONITORING AND NOTIFICATION, VEHICLE SERVICE REMINDERS, ALL USING COMPONENTS INTEGRATED INTO A MOTOR VEHICLE, NAMELY, TRANSMITTERS, RECEIVERS, MICROPROCESSORS, SOFTWARE, WIRELESS TELECOMMUNICATION DEVICES, AND ELECTRICAL ARCHITECTURE ALL INTERACTING WITH WIRELESS NETWORKS AND A CUSTOMER SERVICE CENTRE (U.S. CLS. 21, 23, 26, 36 AND 38).

DOUGLAS LEE, EXAMINING ATTORNEY



**CLASS 9—(Continued).**

SN 85-259,229. AINSWORTH GAME TECHNOLOGY LIMITED, NEWINGTON, AUSTRALIA, FILED 3-6-2011.

## MONEY TOWER

THE MARK CONSISTS OF STANDARD CHARACTERS WITHOUT CLAIM TO ANY PARTICULAR FONT, STYLE, SIZE, OR COLOR.

NO CLAIM IS MADE TO THE EXCLUSIVE RIGHT TO USE MONEY, APART FROM THE MARK AS SHOWN.

FOR COMPUTER SOFTWARE AND FIRMWARE FOR GAMES OF CHANCE ON ANY COMPUTERIZED PLATFORM, INCLUDING DEDICATED GAMING CONSOLES, VIDEO BASED SLOT MACHINES, REEL BASED SLOT MACHINES, AND VIDEO LOTTERY TERMINALS (U.S. CLS. 21, 23, 26, 36 AND 38).

JOHN HWANG, EXAMINING ATTORNEY

SN 85-269,723. MARCH NETWORKS CORPORATION, KANATA, ONTARIO, CANADA, FILED 3-17-2011.

## MARCH NETWORKS SEARCHLIGHT

THE MARK CONSISTS OF STANDARD CHARACTERS WITHOUT CLAIM TO ANY PARTICULAR FONT, STYLE, SIZE, OR COLOR.

PRIORITY CLAIMED UNDER SEC. 44(D) ON CANADA APPLICATION NO. 1506867, FILED 12-7-2010, REG. NO. TMA855140, DATED 7-15-2013, EXPIRES 7-15-2028.

OWNER OF U.S. REG. NOS. 3,436,495 AND 3,441,121.

NO CLAIM IS MADE TO THE EXCLUSIVE RIGHT TO USE "NETWORKS", APART FROM THE MARK AS SHOWN.

FOR COMPUTER SOFTWARE, NAMELY, FRAUD DETECTION SOFTWARE, NAMELY, APPLICATION SOFTWARE THAT COMBINES VIDEO ANALYSIS DATA WITH FINANCIAL TRANSACTION DATA FOR THE PURPOSE OF DETECTING AND ELIMINATING FRAUDULENT ACTIVITY; COMPUTER SOFTWARE, NAMELY, ANTI-SKIMMING SOFTWARE; COMPUTER SOFTWARE, NAMELY, APPLICATION SOFTWARE FOR USE IN THE CAPTURE, PROCESSING, COMPRESSION, TRANSMISSION, COMMUNICATION, VIEWING, SEARCHING, MONITORING, MANAGING, ANALYZING, AUTHENTICATING, FILTERING, RE-PURPOSING, EDITING, ANNOTATING, COPYING, PRINTING, PACKAGING, EXPORTING, REPORTING, BROADCASTING, DISTRIBUTION AND STORAGE OF AUDIO, VIDEO, AND RELATED DATA INPUT, AND FOR THE MANAGEMENT, MONITORING, AND ADMINISTRATION OF VIDEO RECORDERS, CAMERAS, VIDEO AND AUDIO STORAGE EQUIPMENT AND VIDEO SURVEILLANCE EQUIPMENT; COMPUTER SOFTWARE, NAMELY, APPLICATION SOFTWARE FOR INTEGRATION AND SYNCHRONIZATION OF BANK MACHINE, AND FINANCIAL TRANSACTION DATA WITH RELATED VIDEO AND AUDIO AND FOR INTEGRATION AND SYNCHRONIZATION OF SURVEILLANCE VIDEO AND AUDIO WITH RELATED DATA; COMPUTER SOFTWARE, NAMELY, VIDEO ANALYTICS SOFTWARE FOR EXTRACTION OF INFORMATION FROM VIDEO DATA, ANALYSIS OF VIDEO DATA, COMPILATION OF REPORTS FOR SECURITY OR BUSINESS INTELLIGENCE; COMPUTER SOFTWARE, NAMELY, VIDEO BASED SOFTWARE INTELLIGENCE TOOLS FOR USE IN THE CAPTURE, PROCESSING, COMPRESSION, TRANSMISSION, COM-

**CLASS 9—(Continued).**

MUNICATION, VIEWING, SEARCHING, MONITORING, MANAGING, ANALYZING, AUTHENTICATING, FILTERING, RE-PURPOSING, EDITING, ANNOTATING, COPYING, PRINTING, PACKAGING, EXPORTING, REPORTING, BROADCASTING, DISTRIBUTION AND STORAGE OF SURVEILLANCE AUDIO, SURVEILLANCE VIDEO AND RELATED DATA INPUT; COMPUTER SOFTWARE, NAMELY, BUSINESS INTELLIGENCE SOFTWARE FOR INTEGRATION AND SYNCHRONIZATION OF BANK MACHINE, AND FINANCIAL TRANSACTION DATA, WITH RELATED VIDEO AND AUDIO AND FOR INTEGRATION AND SYNCHRONIZATION OF SURVEILLANCE VIDEO AND AUDIO WITH RELATED DATA, IN THE FIELD OF BUSINESS; DIGITAL VIDEO RECORDERS; VIDEO RECORDERS, NETWORK VIDEO RECORDERS, AND RELATED PERIPHERALS FOR USE IN THE REAL-TIME CAPTURE, PROCESSING, COMPRESSION, TRANSMISSION, COMMUNICATION, VIEWING, SEARCHING, FILTERING, RE-PURPOSING, EDITING, ANNOTATING, COPYING, PRINTING, PACKAGING, EXPORTING, REPORTING, BROADCASTING, DISTRIBUTION AND STORAGE OF AUDIO, VIDEO AND RELATED DATA INPUT, AND IN DIGITAL MEDIA DISTRIBUTION AND MANAGEMENT (U.S. CLS. 21, 23, 26, 36 AND 38).

KATHERINE CONNOLLY, EXAMINING ATTORNEY

SN 85-286,501. SANEI, AHMAD, LOS ANGELES, CA. FILED 4-5-2011.

## Hollywood Stars

THE MARK CONSISTS OF STANDARD CHARACTERS WITHOUT CLAIM TO ANY PARTICULAR FONT, STYLE, SIZE, OR COLOR.

FOR ELECTRIC HAIR CURLING IRONS; ELECTRIC HAIR STRAIGHTENING IRONS; SPECIALTY HOLSTER FOR CARRYING HAIR CURLING IRONS AND HAIR STRAIGHTENING IRONS (U.S. CLS. 21, 23, 26, 36 AND 38).

FIRST USE 6-24-2006; IN COMMERCE 9-27-2006.  
ELLEN PERKINS, EXAMINING ATTORNEY

SN 85-356,925. FINK, RYAN, VANCOUVER, WA. FILED 6-27-2011.

## HITME

THE MARK CONSISTS OF STANDARD CHARACTERS WITHOUT CLAIM TO ANY PARTICULAR FONT, STYLE, SIZE, OR COLOR.

FOR DOWNLOADABLE SOFTWARE APPLICATIONS FOR MOBILE DEVICES ALLOWING GEOGRAPHIC-PROXIMITY-BASED SOCIAL NETWORKING BETWEEN MOBILE DEVICE USERS WITHIN A LIMITED GEOGRAPHIC PROXIMITY OF ONE ANOTHER (U.S. CLS. 21, 23, 26, 36 AND 38).

LINDA M. KING, EXAMINING ATTORNEY

**CLASS 9—(Continued).**

SN 85-406,809. SPIELO INTERNATIONAL CANADA ULC, MONCTON, NEW BRUNSWICK, CANADA, FILED 8-25-2011.

**CLASS 9—(Continued).**

SN 85-466,123. LG ELECTRONICS INC., SEOUL 150-721, REPUBLIC OF KOREA, FILED 11-7-2011.

**TRIGGER TILES**

THE MARK CONSISTS OF STANDARD CHARACTERS WITHOUT CLAIM TO ANY PARTICULAR FONT, STYLE, SIZE, OR COLOR.

PRIORITY CLAIMED UNDER SEC. 44(D) ON CANADA APPLICATION NO. 1539724, FILED 8-15-2011, REG. NO. TMA865019, DATED 11-14-2013, EXPIRES 11-14-2028.

FOR RECONFIGURABLE CASINO AND LOTTERY GAMING EQUIPMENT, NAMELY, GAMING MACHINES AND OPERATIONAL COMPUTER GAME SOFTWARE THEREFOR (U.S. CLS. 21, 23, 26, 36 AND 38).

AMY KELLY, EXAMINING ATTORNEY

PRIORITY CLAIMED UNDER SEC. 44(D) ON REPUBLIC OF KOREA APPLICATION NO. 402011005915, FILED 10-27-2011, REG. NO. 1008512, DATED 11-21-2013, EXPIRES 11-21-2023.

NO CLAIM IS MADE TO THE EXCLUSIVE RIGHT TO USE "MOTION CLARITY INDEX", APART FROM THE MARK AS SHOWN.

THE MARK CONSISTS OF THE STYLIZED LETTERING "MCI" WITH THE STYLIZED WORDING "MOTION CLARITY INDEX" UNDERNEATH WITH THE "I" IN THE WORDING AS A BOLDED VERTICAL LINE. TO THE RIGHT IS A STYLIZED SHADED QUADRILATERAL CONTAINING TWO STARS ON THE LEFT AND A CURVED BAND ON THE RIGHT.

FOR MOBILE PHONES (U.S. CLS. 21, 23, 26, 36 AND 38).

SCOTT BIBB, EXAMINING ATTORNEY

SN 85-462,331. XOOMCHARGE, INC., SAN JOSE, CA. FILED 11-2-2011.

SN 85-529,584. SAMSUNG ELECTRONICS CO., LTD., SU-WON-SI, GYEONGGI-DO, REPUBLIC OF KOREA, FILED 1-31-2012.

**XoomCharge****SAMSUNG SMART STATION**

THE MARK CONSISTS OF STANDARD CHARACTERS WITHOUT CLAIM TO ANY PARTICULAR FONT, STYLE, SIZE, OR COLOR.

FOR ELECTRICAL APPARATUS, NAMELY, CHARGING STATIONS FOR CHARGING MULTIPLE SMART-PHONES AND ELECTRIC AUTOMOBILES (U.S. CLS. 21, 23, 26, 36 AND 38).

NATALIE POLZER, EXAMINING ATTORNEY

THE MARK CONSISTS OF STANDARD CHARACTERS WITHOUT CLAIM TO ANY PARTICULAR FONT, STYLE, SIZE, OR COLOR.

OWNER OF PHILIPPINES REG. NO. 42012001309, DATED 5-31-2012, EXPIRES 5-31-2022.

NO CLAIM IS MADE TO THE EXCLUSIVE RIGHT TO USE "SMART STATION", APART FROM THE MARK AS SHOWN.

FOR COMPUTER MONITORS; COMPUTERS; COMPUTER PERIPHERALS (U.S. CLS. 21, 23, 26, 36 AND 38).

MORGAN WYNNE, EXAMINING ATTORNEY

**CLASS 9—(Continued).**

SN 85-572,870. HUAWEI TECHNOLOGIES CO., LTD., SHENZHEN, CHINA, FILED 3-19-2012.

**HUAWEI SoftMobile**

THE MARK CONSISTS OF STANDARD CHARACTERS WITHOUT CLAIM TO ANY PARTICULAR FONT, STYLE, SIZE, OR COLOR.

OWNER OF CHINA REG. NO. 10485025, DATED 6-7-2013, EXPIRES 6-6-2023.

OWNER OF U.S. REG. NOS. 2,750,650, 3,854,515 AND OTHERS.

THE WORDING "HUAWEI" HAS NO MEANING IN A FOREIGN LANGUAGE.

FOR TELECOMMUNICATIONS AND DATA NETWORKING HARDWARE, NAMELY, DEVICES FOR TRANSPORTING AND AGGREGATING VOICE, DATA, AND VIDEO COMMUNICATIONS ACROSS MULTIPLE NETWORK INFRASTRUCTURES AND COMMUNICATIONS PROTOCOLS; AUTOMATIC TELEPHONE EXCHANGES; AUTOMATIC TELEPHONE EXCHANGE APPARATUS; BROADBAND WIRELESS EQUIPMENT, NAMELY, TELECOMMUNICATIONS BASE STATION EQUIPMENT FOR CELLULAR AND FIXED NETWORKING AND COMMUNICATIONS APPLICATIONS; ELECTRONIC CONTROLLERS FOR COMMUNICATIONS BASE STATIONS; TELEPHONE CALL ROUTERS; NETWORK ROUTERS; COMPUTER NETWORK HUBS, SWITCHES AND ROUTERS (U.S. CLS. 21, 23, 26, 36 AND 38).

AHSEN KHAN, EXAMINING ATTORNEY

**CLASS 9—(Continued).**

SN 85-660,325. TOPP SHELF MUSIC & ENTERTAINMENT INC, WEST COVINA, CA. FILED 6-25-2012.

**TOPP SHELF MUSIC & ENTERTAINMENT INC**

THE MARK CONSISTS OF STANDARD CHARACTERS WITHOUT CLAIM TO ANY PARTICULAR FONT, STYLE, SIZE, OR COLOR.

NO CLAIM IS MADE TO THE EXCLUSIVE RIGHT TO USE "MUSIC & ENTERTAINMENT INC", APART FROM THE MARK AS SHOWN.

FOR AUDIO AND VIDEO RECORDINGS FEATURING MUSIC AND ARTISTIC PERFORMANCES (U.S. CLS. 21, 23, 26, 36 AND 38).

SUE LAWRENCE, EXAMINING ATTORNEY

SN 85-665,306. UNIVERSAL POWER GROUP, INC., COPPELL, TX. FILED 6-29-2012.

**SAM DIY**

THE MARK CONSISTS OF STANDARD CHARACTERS WITHOUT CLAIM TO ANY PARTICULAR FONT, STYLE, SIZE, OR COLOR.

NO CLAIM IS MADE TO THE EXCLUSIVE RIGHT TO USE "DIY", APART FROM THE MARK AS SHOWN.

FOR BURGLAR ALARMS; ELECTRONIC DOOR ALARMS; ALARM MONITORING SYSTEMS; ANTI-INTRUSION ALARMS; ELECTRONIC COMPONENTS OF SECURITY SYSTEMS; MOTION DETECTORS; SECURITY SYSTEM COMPONENTS, NAMELY, BATTERIES, MOTION SENSORS, CAMERAS, REMOTE CONTROLS, MAGNETIC SENSORS, GLASS BREAK SENSORS, COMPUTER HARDWARE, WIRELESS CONTROL HARDWARE, CONTACT SENSORS, RFID SENSORS, SIRENS, SAFETY LIGHTS, POWER SUPPLIES AND WATER SENSORS; INTRUDER DETECTION SYSTEMS COMPRISED OF BATTERY, MOTION SENSOR, REMOTE CONTROL, GLASS BREAK SENSOR, COMPUTER HARDWARE, MAGNETIC CONTACT SENSOR, RFID SENSOR, SIREN AND POWER SUPPLY; DOWNLOADABLE SOFTWARE FOR MANAGING AND MONITORING A SECURITY SYSTEM; MOTION DETECTOR KITS COMPRISED OF BATTERY, MOTION SENSOR, REMOTE CONTROL, GLASS BREAK SENSOR, COMPUTER HARDWARE, MAGNETIC CONTACT SENSOR, RFID SENSOR, SIREN AND POWER SUPPLY (U.S. CLS. 21, 23, 26, 36 AND 38).

BRIDGETT SMITH, EXAMINING ATTORNEY

SN 85-650,316. 3DMD TECHNOLOGIES, LIMITED, CHOBHAM, SURREY, UNITED KINGDOM, FILED 6-13-2012.

**3DMDVULTUS**

THE MARK CONSISTS OF STANDARD CHARACTERS WITHOUT CLAIM TO ANY PARTICULAR FONT, STYLE, SIZE, OR COLOR.

THE WORDING "VULTUS" HAS NO MEANING IN A FOREIGN LANGUAGE.

FOR COMPUTER SOFTWARE FOR ANALYZING 3D IMAGES OF THE HUMAN FORM (U.S. CLS. 21, 23, 26, 36 AND 38).

FIRST USE 5-0-2006; IN COMMERCE 5-0-2006.  
MATTHEW GALAN, EXAMINING ATTORNEY

**CLASS 9—(Continued).**

SN 85-682,769. QUANTA COMPUTER INC., TAOYUAN HSIEN, TAIWAN, FILED 7-20-2012.

# Tabook

THE MARK CONSISTS OF STANDARD CHARACTERS WITHOUT CLAIM TO ANY PARTICULAR FONT, STYLE, SIZE, OR COLOR.

PRIORITY CLAIMED UNDER SEC. 44(D) ON TAIWAN APPLICATION NO. 101040916, FILED 1-20-2012, REG. NO. 01560117, DATED 1-16-2013, EXPIRES 1-15-2023.

THE WORDING "TABOOK" HAS NO MEANING IN A FOREIGN LANGUAGE.

FOR COMPUTER PERIPHERALS; COMPUTER HARDWARE; COMPUTER OPERATING SOFTWARE; COMPUTER OPERATING PROGRAMS, RECORDED; NETWORK SERVERS; DATA PROCESSING APPARATUS; COMPUTERS; COMPUTER HOSTS FOR DATA STORAGE, NAMELY, COMPUTER HARDWARE FOR HIGH-SPEED PROCESSING AND STORAGE OF DATA USING MULTIPLE CPUS; COMPUTER MONITORS; HANDHELD COMPUTERS; PORTABLE COMPUTERS; NOTEBOOK COMPUTERS; COMPUTER WORKSTATIONS COMPRISING COMPUTER MONITORS, KEYBOARDS, COMPUTER MICE AND CPUS; PERSONAL COMPUTERS; COMPUTER TERMINALS (U.S. CLS. 21, 23, 26, 36 AND 38).

AMY KERTGATE, EXAMINING ATTORNEY

**CLASS 9—(Continued).**

SN 85-687,565. SQUARE ENIX LIMITED, LONDON, UNITED KINGDOM, FILED 7-26-2012.

# AGENT 47

THE MARK CONSISTS OF STANDARD CHARACTERS WITHOUT CLAIM TO ANY PARTICULAR FONT, STYLE, SIZE, OR COLOR.

OWNER OF ERPN CMNTY TM OFC REG. NO. 002909851, DATED 10-23-2003, EXPIRES 10-28-2022.

FOR COMPUTER GAME SOFTWARE; COMPUTER GAMES RECORDED ON COMPUTER DISCS; VIDEO GAME SOFTWARE; VIDEO GAMES RECORDED ON COMPUTER DISCS; ELECTRONIC GAME SOFTWARE FOR MOBILE PHONES; DOWNLOADABLE DATA IN THE NATURE OF DOWNLOADABLE ELECTRONIC GAMES FEATURING INFORMATION ABOUT VIDEO, DISKS AND TAPES PRE-RECORDED WITH COMPUTER GAME SOFTWARE, VIDEO GAME SOFTWARE; DOWNLOADABLE ELECTRONIC PUBLICATIONS, NAMELY, GAME GUIDES HAVING COMPUTER GAMES AS THEIR SUBJECT MATTER (U.S. CLS. 21, 23, 26, 36 AND 38).

JOHN DWYER, EXAMINING ATTORNEY

SN 85-686,402. CAMPBELL, STEVEN I., JACKSON, MS. FILED S.R. 7-25-2012; AM. P.R. 11-27-2013.

# IWEAVE

THE MARK CONSISTS OF STANDARD CHARACTERS WITHOUT CLAIM TO ANY PARTICULAR FONT, STYLE, SIZE, OR COLOR.

FOR COMPUTER APPLICATION SOFTWARE FOR MOBILE PHONES, NAMELY, SOFTWARE FOR HAIR WEAVE ORDERING; COMPUTER HARDWARE AND COMPUTER SOFTWARE PROGRAMS FOR THE INTEGRATION OF TEXT, AUDIO, GRAPHICS, STILL IMAGES AND MOVING PICTURES INTO AN INTERACTIVE DELIVERY FOR MULTIMEDIA APPLICATIONS; COMPUTER SOFTWARE FOR COMPUTER SYSTEM AND APPLICATION DEVELOPMENT, DEPLOYMENT AND MANAGEMENT (U.S. CLS. 21, 23, 26, 36 AND 38).

STEPHANIE ALI, EXAMINING ATTORNEY

SN 85-691,398. ROCHA MIGUEL, DBA PROGRAMAX, LLC, SUGAR LAND, TX. FILED 7-31-2012.

# SPHESYS

THE MARK CONSISTS OF STANDARD CHARACTERS WITHOUT CLAIM TO ANY PARTICULAR FONT, STYLE, SIZE, OR COLOR.

FOR COMPUTER SOFTWARE, NAMELY, COMPUTER SOFTWARE FOR STORING AND MANAGING PAPER DOCUMENTS AND ELECTRONIC DATA; COMPUTER SOFTWARE THAT PROVIDES WEB-BASED ACCESS TO APPLICATIONS AND SERVICES THROUGH AN OPERATING SYSTEM OR PORTAL INTERFACE; COMPUTER SOFTWARE FOR COMPUTER SYSTEM AND APPLICATION DEVELOPMENT, DEPLOYMENT AND MANAGEMENT; COMPUTER SOFTWARE FOR FILE STORAGE MANAGEMENT AND FILE ACCESS (U.S. CLS. 21, 23, 26, 36 AND 38).

FIRST USE 7-1-2012; IN COMMERCE 7-1-2012.

CHRISTOPHER LAW, EXAMINING ATTORNEY

**CLASS 9—(Continued).**

SN 85-691,773. PROFICIO INC., IRVINE, CA. FILED 7-31-2012.

# ProSOC

THE MARK CONSISTS OF STANDARD CHARACTERS WITHOUT CLAIM TO ANY PARTICULAR FONT, STYLE, SIZE, OR COLOR.

FOR COMPUTER HARDWARE AND SOFTWARE SYSTEMS FOR SECURITY OPERATIONS CENTER MANAGEMENT (U.S. CLS. 21, 23, 26, 36 AND 38).  
FIRST USE 0-0-2010; IN COMMERCE 0-0-2010.  
RONALD MCMORROW, EXAMINING ATTORNEY

**CLASS 9—(Continued).**

SN 85-702,866. MUZIK, LLC, MIAMI BEACH, FL. FILED 8-14-2012.

# SMARTWARE

THE MARK CONSISTS OF STANDARD CHARACTERS WITHOUT CLAIM TO ANY PARTICULAR FONT, STYLE, SIZE, OR COLOR.

FOR HEADPHONES; PORTABLE AND INTEGRATED AUDIO EQUIPMENT AND DEVICES, NAMELY, STEREO EAR BUDS, REPLACEMENT EARPHONES AND EAR BUDS, STEREO HEADPHONES EQUIPPED WITH MICROPHONES, HEADSETS AND HANDS-FREE HEADSETS FOR CELLULAR TELEPHONES, MOBILE TELEPHONES OR COMPUTERS, AUDIO AND POWER CONNECTOR CABLES AND ADAPTERS AND ADAPTER PLUGS AND REPLACEMENT PARTS THEREFOR, EXTENSION CORDS AND RECHARGING ELECTRIC CORDS, HEADSETS FOR USE WITH CELLULAR PHONES, MOBILE PHONES, TELEPHONES AND COMPUTERS, AND PORTABLE AND HANDHELD ELECTRONIC DEVICES FOR RECORDING, ORGANIZING, TRANSMITTING, MANIPULATING AND LISTENING TO MUSIC AND AUDIO RECORDINGS; COMPUTER SOFTWARE AND MOBILE SOFTWARE APPLICATIONS FOR STREAMING MUSIC (U.S. CLS. 21, 23, 26, 36 AND 38).

CHRISTOPHER BUONGIORNO, EXAMINING ATTORNEY

SN 85-702,885. MUZIK, LLC, MIAMI BEACH, FL. FILED 8-14-2012.

SN 85-697,777. EQUUS AUTOMOTIVE INC., AUBURN HILLS, CO. FILED 8-7-2012.

# CITIZEN OF THE WORLD

THE MARK CONSISTS OF STANDARD CHARACTERS WITHOUT CLAIM TO ANY PARTICULAR FONT, STYLE, SIZE, OR COLOR.

FOR AUDIO AND VIDEO RECORDINGS FEATURING MUSIC AND ARTISTIC PERFORMANCES; AUDIO AND VIDEO RECORDINGS FEATURING MUSIC (U.S. CLS. 21, 23, 26, 36 AND 38).  
ALEX KEAM, EXAMINING ATTORNEY

# SOCIAL SMARTWARE

THE MARK CONSISTS OF STANDARD CHARACTERS WITHOUT CLAIM TO ANY PARTICULAR FONT, STYLE, SIZE, OR COLOR.

NO CLAIM IS MADE TO THE EXCLUSIVE RIGHT TO USE "SOCIAL", APART FROM THE MARK AS SHOWN.

FOR HEADPHONES; PORTABLE AND INTEGRATED AUDIO EQUIPMENT AND DEVICES, NAMELY, STEREO EAR BUDS, REPLACEMENT EARPHONES AND EAR BUDS, STEREO HEADPHONES EQUIPPED WITH MICROPHONES, HEADSETS AND HANDS-FREE HEADSETS FOR CELLULAR TELEPHONES, MOBILE TELEPHONES OR COMPUTERS, AUDIO AND POWER CONNECTOR CABLES AND ADAPTERS AND ADAPTER PLUGS AND REPLACEMENT PARTS THEREFOR, EXTENSION CORDS AND RECHARGING ELECTRIC CORDS, HEADSETS FOR USE WITH CELLULAR PHONES, MOBILE PHONES, TELEPHONES AND COMPUTERS, AND PORTABLE AND HANDHELD ELECTRONIC DEVICES FOR RECORDING, ORGANIZING, TRANSMITTING, MANIPULATING AND LISTENING TO MUSIC AND AUDIO RECORDINGS; COMPUTER SOFTWARE AND MOBILE SOFTWARE APPLICATIONS FOR STREAMING MUSIC (U.S. CLS. 21, 23, 26, 36 AND 38).

CHRISTOPHER BUONGIORNO, EXAMINING ATTORNEY

**CLASS 9—(Continued).**

SN 85-711,079. U.S. MUSIC CORPORATION, BUFFALO GROVE, IL. FILED 8-23-2012.

# BEAST

THE MARK CONSISTS OF STANDARD CHARACTERS WITHOUT CLAIM TO ANY PARTICULAR FONT, STYLE, SIZE, OR COLOR.

FOR AMPLIFIERS (U.S. CLS. 21, 23, 26, 36 AND 38).  
TAMARA FRAZIER, EXAMINING ATTORNEY

---

SN 85-733,682. SIGMA KOKI CO., LTD., HIDAKA-SHI, SAITAMA, JAPAN, FILED 9-20-2012.

## LIGHT SOLUTIONS FOR LIFE

THE MARK CONSISTS OF STANDARD CHARACTERS WITHOUT CLAIM TO ANY PARTICULAR FONT, STYLE, SIZE, OR COLOR.

PRIORITY CLAIMED UNDER SEC. 44(D) ON JAPAN APPLICATION NO. 2012-76093, FILED 9-20-2012, REG. NO. 5562138, DATED 3-1-2013, EXPIRES 3-1-2023.

FOR PHOTOGRAPHIC MACHINES AND APPARATUS, NAMELY, CAMERA LENSES; CINEMATOGRAPHIC MACHINES AND APPARATUS; OPTICAL APPARATUS AND INSTRUMENTS, NAMELY, OPTICAL LENSES, FOCUSING MECHANISMS AND SHUTTERS FOR OPTICAL COMPONENTS, OPTICAL ATTENUATORS, MIRRORS, PRISMS, BEAM-SPLITTERS, MULTI-ELEMENT OPTICS, POLARIZERS CONSISTING OF CALCITE PRISMS, DICHROIC SHEET FILTERS AND QUARTZ WAVE PLATES, AND FILTERS; DISTANCE MEASURING APPARATUS; ELECTRICAL POWER DISTRIBUTION UNITS AND ELECTRIC CONTROL UNITS; ELECTRIC OR MAGNETIC METERS AND TESTERS; ELECTRIC CONDUCTORS; AUTOMATIC SWITCHING APPARATUS AND DEVICES FOR TELECOMMUNICATION; ELECTRONIC MACHINES, AND APPARATUS, NAMELY, OPTO-ELECTRONIC COMPONENTS IN THE NATURE OF LASERS, LASER SCANNERS, LIGHT SOURCES FOR CAMERAS, LIGHT DETECTORS, ELECTRO-OPTICAL AND ACOUSTO-OPTICAL DEVICES USED FOR LIGHT MODULATION AND CONTROL, NAMELY, KERR CELLS, MODULATORS, TUNABLE FILTERS AND Q-SWITCHES (U.S. CLS. 21, 23, 26, 36 AND 38).

SHAVELL MCPHERSON, EXAMINING ATTORNEY

**CLASS 9—(Continued).**

SN 85-752,393. MINEWARE PTY LTD., QUEENSLAND, AUSTRALIA, FILED 10-12-2012.

# ARGUS

THE MARK CONSISTS OF STANDARD CHARACTERS WITHOUT CLAIM TO ANY PARTICULAR FONT, STYLE, SIZE, OR COLOR.

FOR PERFORMANCE MONITORING SOFTWARE FOR MINING SHOVELS; GPS SYSTEMS FOR MONITORING MINING OPERATIONS; COMPUTER SOFTWARE FOR MINING OPERATIONS, NAMELY, COMPUTER SOFTWARE FOR MONITORING SHOVELS, PAYLOAD, OPERATOR PERFORMANCE, PRODUCTION EFFICIENCY, MAINTENANCE AND SAFETY; COMPUTER SOFTWARE FOR REAL TIME MINE PLANNING INFORMATION (U.S. CLS. 21, 23, 26, 36 AND 38).  
FIRST USE 8-1-2010; IN COMMERCE 8-1-2010.

KRISTIN CARLSON, EXAMINING ATTORNEY

---

SN 85-758,859. SOLIMAN, AMR, DBA VISSO ELECTRONICA, SAN DIEGO, CA. FILED 10-19-2012.



NO CLAIM IS MADE TO THE EXCLUSIVE RIGHT TO USE "ELECTRONICA", APART FROM THE MARK AS SHOWN.

THE MARK CONSISTS OF A STYLIZED LETTER "V", THE LETTERS "I", "S", "S", "O", AND THE WORD "ELECTRONICA" BELOW THE TERM "VISSO".

FOR ELECTRONIC EQUIPMENT, NAMELY, TRANSFORMERS, BALUNS, CABLES USED IN CONNECTION WITH COMPUTERS, COMPUTER PERIPHERAL DEVICES, TELEVISIONS, AUDIO-VIDEO EQUIPMENT, CLOSED-CIRCUIT TV EQUIPMENT AND TELECOMMUNICATION EQUIPMENT (U.S. CLS. 21, 23, 26, 36 AND 38).

FIRST USE 3-1-2012; IN COMMERCE 3-1-2012.

TEJBIR SINGH, EXAMINING ATTORNEY

**CLASS 9—(Continued).**

SN 85-761,823. YINHUAN HONG, SHANGHAI, CHINA, FILED 10-24-2012.



THE MARK CONSISTS OF THE WORD "SOUNDWAY" IN WHITE LETTERS WITH THE LETTERS "S" AND "W" IN CAPITAL, SURROUNDED BY A BLACK RECTANGLE.

FOR AUDIO SPEAKERS, BASS SPEAKERS, LOUD SPEAKERS, MICROPHONES, HORNS FOR SPEAKER, CAMERAS, ELECTRO-ACOUSTIC TRANSDUCER ASSEMBLY, DELAY REVERB TO MODIFY SOUND, PICK-UPS, AUDIO CONNECTORS, STEREOS, AMPLIFIERS, EQUALIZERS, CROSSOVERS, SPEAKER HOUSINGS, AND POWER TIMING DEVICES (U.S. CLS. 21, 23, 26, 36 AND 38).

FIRST USE 1-7-2007; IN COMMERCE 1-7-2007.  
TINA L. SNAPP, EXAMINING ATTORNEY

SN 85-785,423. BRUKER NANO, INC., SANTA BARBARA, CA. FILED 11-21-2012.

**NANOLENS**

THE MARK CONSISTS OF STANDARD CHARACTERS WITHOUT CLAIM TO ANY PARTICULAR FONT, STYLE, SIZE, OR COLOR.

FOR METROLOGY INSTRUMENTS, NAMELY, SCANNING PROBE MICROSCOPES AND STYLUS PROFILERS; SOFTWARE FOR OPERATING METROLOGY INSTRUMENTS (U.S. CLS. 21, 23, 26, 36 AND 38).

ESTHER BELENKER, EXAMINING ATTORNEY

**CLASS 9—(Continued).**

SN 85-787,688. B&B EXPORTING LIMITED, HUADU, GUANGZHOU, CHINA, FILED 11-27-2012.



NO CLAIM IS MADE TO THE EXCLUSIVE RIGHT TO USE "IDENTIFICATION WRISTBANDS", APART FROM THE MARK AS SHOWN.

THE MARK CONSISTS OF TWO STYLIZED LETTER "B" FEATURED ADJACENT TO TWO CIRCLE DOTS AND ENCASED INSIDE AN INCOMPLETE RECTANGLE, SYMMETRICALLY SEPARATED BY AN AMPERSAND, WITH A PHRASE "IDENTIFICATION WRISTBANDS" BELOW ALL THE ABOVE.

FOR PRINTERS FOR USE WITH COMPUTERS; BAR CODE READERS; SMART CARDS, NAMELY, INTEGRATED CIRCUIT CARDS; ENCODED IDENTIFICATION BRACELETS, MAGNETIC; COMPUTER PERIPHERAL DEVICES; PROCESSORS, NAMELY, CENTRAL PROCESSING UNITS; DATA PROCESSING EQUIPMENT, NAMELY, SCANNERS; TIME RECORDING APPARATUS; ELECTRONIC TAGS FOR GOODS; PARKING METERS; TIME RECORDING DEVICES, NAMELY, TIME CLOCKS; PUNCHED CARD MACHINES FOR OFFICES; WEIGHING APPARATUS AND INSTRUMENTS; MEASURES; ELECTRONIC NOTICE BOARDS; ELECTRO-DYNAMIC APPARATUS FOR THE REMOTE CONTROL OF SIGNALS; MONITORING APPARATUS, NAMELY, CAMERAS, ALARM MONITORING SYSTEMS, ELECTRONIC MONITORS FOR MONITORING ELECTRONIC CURRENTS, MONITORING DEVICES FOR MONITORING BATTERY PERFORMANCE CHARACTERISTICS, ELECTRONIC DEVICE FOR MONITORING AND OPTIMIZING PHOTOVOLTAIC ARRAYS; CAMERAS FOR PHOTOGRAPHY; SURVEYING APPARATUS AND INSTRUMENTS; MATERIALS FOR ELECTRICITY MAINS, NAMELY, WIRES AND CABLES; PRINTED CIRCUIT BOARDS; EYEPIECES (U.S. CLS. 21, 23, 26, 36 AND 38).

FIRST USE 4-19-2007; IN COMMERCE 3-10-2009.  
DEZMONA MIZELLE, EXAMINING ATTORNEY

SN 85-792,651. THE TIFFEN COMPANY, LLC, HAUPPAUGE, NY. FILED 12-3-2012.

**GEARPROTEX**

THE MARK CONSISTS OF STANDARD CHARACTERS WITHOUT CLAIM TO ANY PARTICULAR FONT, STYLE, SIZE, OR COLOR.

FOR CAMERA BAGS FOR HOLDING PHOTOGRAPHIC EQUIPMENT; CAMERA BAG INSERTS, NAMELY, CAMERA BAG DIVIDERS, POCKETS AND PADDING (U.S. CLS. 21, 23, 26, 36 AND 38).

JOHN KELLY, EXAMINING ATTORNEY

**CLASS 9—(Continued).**

SN 85-793,447. TRANE INTERNATIONAL INC., PISCATAWAY, NJ. FILED 12-3-2012.

# ASIST

THE MARK CONSISTS OF STANDARD CHARACTERS WITHOUT CLAIM TO ANY PARTICULAR FONT, STYLE, SIZE, OR COLOR.

FOR MOBILE SOFTWARE APPLICATION FOR USE BY DEALERS AND INSTALLERS OF RESIDENTIAL AIR CONDITIONING EQUIPMENT, NAMELY, SOFTWARE FOR ORDERING EQUIPMENT, PARTS, AND LITERATURE, FOR TRACKING ORDER STATUS, FOR SEARCHING FOR PRODUCT INFORMATION, FOR COMPLETING WARRANTY REQUIREMENTS, FOR INTERACTIVE PRODUCT SUPPORT AND FOR VIEWING AND PRINTING INVOICES, ALL IN CONNECTION WITH SALES, SERVICE, TRAINING, PRODUCT SUPPORT, WARRANTY CLAIMS, ENERGY USE CALCULATIONS AND ORDER MANAGEMENT IN THE FIELD OF RESIDENTIAL AIR CONDITIONING EQUIPMENT (U.S. CLS. 21, 23, 26, 36 AND 38).

RUDY R. SINGLETON, EXAMINING ATTORNEY

---

SN 85-795,767. ACTV8, INC., BEVERLY HILLS, CA. FILED 12-5-2012.

# TV CRASHERS

THE MARK CONSISTS OF STANDARD CHARACTERS WITHOUT CLAIM TO ANY PARTICULAR FONT, STYLE, SIZE, OR COLOR.

NO CLAIM IS MADE TO THE EXCLUSIVE RIGHT TO USE "TV", APART FROM THE MARK AS SHOWN.

FOR SOFTWARE FOR USE ON A HAND HELD DEVICE FOR SYNCING WITH A TELEVISION SHOW TO PROVIDE SOCIAL INTERACTION AND INFORMATION SHARING (U.S. CLS. 21, 23, 26, 36 AND 38).

RONALD AIKENS, EXAMINING ATTORNEY

---

SN 85-796,882. LOTUS EYE PRODUCTIONS, AKA HOLLY ADAMS, ALBUQUERQUE, NM. FILED 12-6-2012.

# The Man-App

THE MARK CONSISTS OF STANDARD CHARACTERS WITHOUT CLAIM TO ANY PARTICULAR FONT, STYLE, SIZE, OR COLOR.

FOR COMPUTER GAME PROGRAMS (U.S. CLS. 21, 23, 26, 36 AND 38).

FIRST USE 5-1-2012; IN COMMERCE 5-1-2012.

JULIE VEPPUMTHARA, EXAMINING ATTORNEY

**CLASS 9—(Continued).**

SN 85-797,999. UBIQUITOUS ENTERTAINMENT INC., TOKYO, JAPAN, FILED 12-7-2012.

# moon Plate

THE MARK CONSISTS OF STANDARD CHARACTERS WITHOUT CLAIM TO ANY PARTICULAR FONT, STYLE, SIZE, OR COLOR.

PRIORITY CLAIMED UNDER SEC. 44(D) ON JAPAN APPLICATION NO. 2012097675, FILED 12-3-2012, REG. NO. 5576684, DATED 4-19-2013, EXPIRES 4-19-2023.

NO CLAIM IS MADE TO THE EXCLUSIVE RIGHT TO USE "PLATE", APART FROM THE MARK AS SHOWN.

FOR COMPUTER SOFTWARE DEVELOPMENT PROGRAMS FOR PROVIDING FRAMEWORK FOR USE CREATING GAMES AND APPLICATIONS USING LANGUAGE PROCESSORS AND INTERPRETERS; DOWNLOADABLE SPECIALIZED COMPUTER DATABASES FEATURING A FRAMEWORK WHICH ALLOWS PROGRAMMERS TO CREATE CROSS BROWSER COMPLIANT CODE FOR GAMES QUICKLY AND EASILY (U.S. CLS. 21, 23, 26, 36 AND 38).

TRACY FLETCHER, EXAMINING ATTORNEY

---

SN 85-800,420. SAMSUNG ELECTRONICS CO., LTD., SUWON-SI, GYEONGGI-DO, REPUBLIC OF KOREA, FILED 12-12-2012.

# SAMSUNG SAVANNA

THE MARK CONSISTS OF STANDARD CHARACTERS WITHOUT CLAIM TO ANY PARTICULAR FONT, STYLE, SIZE, OR COLOR.

OWNER OF UNITED KINGDOM REG. NO. 008359648, DATED 12-24-2009, EXPIRES 12-8-2019.

OWNER OF U.S. REG. NOS. 2,929,519 AND 2,929,523.

THE ENGLISH TRANSLATION OF "SAMSUNG" IN THE MARK IS "THREE STARS".

FOR MOBILE PHONES; MOBILE TELEPHONE OPERATING SYSTEM SOFTWARES; MP3 PLAYERS; TELEVISIONS; PERSONAL DIGITAL ASSISTANTS (PDAS); NOTEBOOK COMPUTERS; DVD PLAYERS; COMPUTER PRINTERS; COMPUTER MONITORS; SEMICONDUCTORS; HEADSETS FOR MOBILE PHONES; CAMCORDERS; DIGITAL CAMERAS (U.S. CLS. 21, 23, 26, 36 AND 38).

FLORENTINA BLANDU, EXAMINING ATTORNEY



**CLASS 9—(Continued).**

SN 85-805,947. UBIQUITOUS ENTERTAINMENT INC., TOKYO, JAPAN, FILED 12-18-2012.

# MoonBlock

THE MARK CONSISTS OF STANDARD CHARACTERS WITHOUT CLAIM TO ANY PARTICULAR FONT, STYLE, SIZE, OR COLOR.

PRIORITY CLAIMED UNDER SEC. 44(D) ON JAPAN APPLICATION NO. 2012101911, FILED 12-17-2012, REG. NO. 5579220, DATED 5-2-2013, EXPIRES 5-2-2023.

FOR COMPUTER SOFTWARE DEVELOPMENT TOOLS FOR USE CREATING COMPUTER GAME SOFTWARE; COMPUTER SOFTWARE FOR CREATING GAMES AND SOFTWARE APPLICATIONS BY COMBINING INFORMATION SHOWN IN THE FORM OF BLOCKS ON THE USER INTERFACE (U.S. CLS. 21, 23, 26, 36 AND 38).

TRACY FLETCHER, EXAMINING ATTORNEY

**CLASS 9—(Continued).**

SN 85-812,020. SKULLCANDY, INC., PARK CITY, UT, FILED 12-28-2012.



THE MARK CONSISTS OF THE NUMBER "2" WITH A LINE GOING THROUGH IT, INSIDE A CIRCLE.

FOR EARPHONES; HEADPHONES; HEADSETS FOR USE WITH MOBILE DEVICES, NAMELY, MOBILE PHONES, E-READERS, TABLET COMPUTERS, AND DIGITAL MEDIA PLAYERS (U.S. CLS. 21, 23, 26, 36 AND 38).

TARAH HARDY, EXAMINING ATTORNEY

SN 85-807,664. TRUMPET, INC., PHOENIX, AZ. FILED 12-20-2012.

# Trumpet Publisher

THE MARK CONSISTS OF STANDARD CHARACTERS WITHOUT CLAIM TO ANY PARTICULAR FONT, STYLE, SIZE, OR COLOR.

NO CLAIM IS MADE TO THE EXCLUSIVE RIGHT TO USE "PUBLISHER", APART FROM THE MARK AS SHOWN, FOR SOFTWARE THAT RELOCATES, RENAMES, RECLASSIFIES, OR PUBLISHES ELECTRONIC FILES (U.S. CLS. 21, 23, 26, 36 AND 38).

FIRST USE 9-0-2012; IN COMMERCE 9-0-2012.

KELLY TRUSILO, EXAMINING ATTORNEY

SN 85-815,877. OFFLINE MAGAZINE LLC, MINNEAPOLIS, MN. FILED 1-4-2013.

# Offline Magazine

THE MARK CONSISTS OF STANDARD CHARACTERS WITHOUT CLAIM TO ANY PARTICULAR FONT, STYLE, SIZE, OR COLOR.

NO CLAIM IS MADE TO THE EXCLUSIVE RIGHT TO USE "MAGAZINE", APART FROM THE MARK AS SHOWN.

FOR ELECTRONIC PUBLICATIONS, NAMELY, E-ZINES FEATURING MEN'S LIFESTYLE ARTICLES RECORDED ON COMPUTER MEDIA (U.S. CLS. 21, 23, 26, 36 AND 38).

JULIE WATSON, EXAMINING ATTORNEY

**CLASS 9—(Continued).**

SN 85-817,039. TARATECH ENTERPRISE INC., FORT LEE, NJ. FILED 1-7-2013.



THE COLOR(S) BLACK AND MAGENTA IS/ARE CLAIMED AS A FEATURE OF THE MARK.

THE MARK CONSISTS OF A MAGENTA CIRCLE WITH BLACK OUTLINE WITH A "T" IN BLACK ON THE CIRCLE AND ANOTHER UPSIDE DOWN "T" ON THE CIRCLE IN BLACK.

FOR CELL PHONE CASES (U.S. CLS. 21, 23, 26, 36 AND 38).

BRETT J. GOLDEN, EXAMINING ATTORNEY

**CLASS 9—(Continued).**

SN 85-835,934. SNAPPOST, INC., SANTA CRUZ, CA. FILED 1-30-2013.

**INTERNET OF STUFF**

SN 85-833,181. USERSIGHT CORPORATION, BOYNTON BEACH, FL. FILED 1-26-2013.

zombie apocalypse defense  
force

THE MARK CONSISTS OF STANDARD CHARACTERS WITHOUT CLAIM TO ANY PARTICULAR FONT, STYLE, SIZE, OR COLOR.

FOR BULLET-PROOF VESTS AND CLOTHING; PROTECTIVE BODY ARMOR, NAMELY, BALLISTIC, BULLET, BLAST, SLASH AND STAB RESISTANT VESTS; PROTECTIVE LOAD BEARING VESTS REINFORCED WITH BALLISTIC ARMOR FOR HOLDING TACTICAL EQUIPMENT (U.S. CLS. 21, 23, 26, 36 AND 38).

FIRST USE 12-21-2012; IN COMMERCE 12-21-2012.

SUNG IN, EXAMINING ATTORNEY

THE MARK CONSISTS OF STANDARD CHARACTERS WITHOUT CLAIM TO ANY PARTICULAR FONT, STYLE, SIZE, OR COLOR.

FOR SOFTWARE AND SOFTWARE PLATFORM FOR ENABLING SOCIAL NETWORKING FUNCTIONS OF SOFTWARE THAT ENABLES COMMUNICATIONS BY OR CONCERNING PERSONS, ENTITIES AND ORGANIZATIONS IN ASSOCIATION WITH INFORMATION RELATED TO PHYSICAL OBJECTS; SOFTWARE AND SOFTWARE PLATFORM FOR GENERATING, RENDERING, PUBLISHING AND POSTING A WEB PAGE PRESENTING INFORMATION RELATED TO A SPECIFIC PHYSICAL OBJECT; SOFTWARE AND SOFTWARE PLATFORM FOR GENERATING, RENDERING, PUBLISHING AND POSTING A WEB PAGE PRESENTING INFORMATION RELATED TO A PLURALITY OF PHYSICAL OBJECTS ASSOCIATED WITH, POSSESSED BY OR OWNED BY AN INDIVIDUAL, ENTITY OR ORGANIZATION AND ENABLING SOCIAL INTERACTION AND COMMUNICATION; SOFTWARE AND SOFTWARE PLATFORM FOR ENABLING SOCIAL NETWORKING FUNCTIONS OF SOFTWARE THAT ENABLES COMMUNICATIONS BY OR CONCERNING PERSONS, ENTITIES AND ORGANIZATIONS IN ASSOCIATION WITH INFORMATION RELATED TO PHYSICAL OBJECTS; SOFTWARE AND SOFTWARE PLATFORM FOR INDEXING AND CURATING INFORMATION RELATED TO PHYSICAL OBJECTS; SOFTWARE AND SOFTWARE PLATFORM FOR INDEXING AND CURATING INFORMATION DIGITIZED IMAGES OF PHYSICAL OBJECTS; SOFTWARE AND SOFTWARE PLATFORM ENABLING VIDEO CAPTURE AND IMAGE RECOGNITION OF PHYSICAL OBJECTS (U.S. CLS. 21, 23, 26, 36 AND 38).

MICHAEL KEATING, EXAMINING ATTORNEY

**CLASS 9—(Continued).**

SN 85-835,941. SNAPPOST, SANTA CRUZ, CA. FILED 1-30-2013.

**CLASS 9—(Continued).**

SN 85-837,095. MAXTHON INTERNATIONAL LIMITED, ROAD TOWN, TORTOLA., BR.VIRGIN ISLANDS, FILED 1-30-2013.



**Cloud**Browser

# WEB OF STUFF

THE MARK CONSISTS OF STANDARD CHARACTERS WITHOUT CLAIM TO ANY PARTICULAR FONT, STYLE, SIZE, OR COLOR.

FOR SOFTWARE AND SOFTWARE PLATFORM FOR ENABLING SOCIAL NETWORKING FUNCTIONS OF SOFTWARE THAT ENABLES COMMUNICATIONS BY OR CONCERNING PERSONS, ENTITIES AND ORGANIZATIONS IN ASSOCIATION WITH INFORMATION RELATED TO PHYSICAL OBJECTS; SOFTWARE AND SOFTWARE PLATFORM FOR GENERATING, RENDERING, PUBLISHING AND POSTING A WEB PAGE PRESENTING INFORMATION RELATED TO A SPECIFIC PHYSICAL OBJECT; SOFTWARE AND SOFTWARE PLATFORM FOR GENERATING, RENDERING, PUBLISHING AND POSTING A WEB PAGE PRESENTING INFORMATION RELATED TO A PLURALITY OF PHYSICAL OBJECTS ASSOCIATED WITH, POSSESSED BY OR OWNED BY AN INDIVIDUAL, ENTITY OR ORGANIZATION AND ENABLING SOCIAL INTERACTION AND COMMUNICATION; SOFTWARE AND SOFTWARE PLATFORM FOR ENABLING SOCIAL NETWORKING FUNCTIONS OF SOFTWARE THAT ENABLES COMMUNICATIONS BY OR CONCERNING PERSONS, ENTITIES AND ORGANIZATIONS IN ASSOCIATION WITH INFORMATION RELATED TO PHYSICAL OBJECTS; SOFTWARE AND SOFTWARE PLATFORM FOR INDEXING AND CURATING INFORMATION RELATED TO PHYSICAL OBJECTS; SOFTWARE AND SOFTWARE PLATFORM FOR INDEXING AND CURATING INFORMATION DIGITIZED IMAGES OF PHYSICAL OBJECTS; SOFTWARE AND SOFTWARE PLATFORM ENABLING VIDEO CAPTURE AND IMAGE RECOGNITION OF PHYSICAL OBJECTS (U.S. CLS. 21, 23, 26, 36 AND 38).

MICHAEL KEATING, EXAMINING ATTORNEY

NO CLAIM IS MADE TO THE EXCLUSIVE RIGHT TO USE "CLOUD BROWSER", APART FROM THE MARK AS SHOWN.

THE MARK CONSISTS OF STYLISTED "M" WITH CLOUD DEVICE IN A SQUARE. THERE IS STYLISTED WORDING "CLOUD BROWSER" UNDERNEATH.

FOR DATA PROCESSING APPARATUS; COMPUTER MEMORIES; COMPUTER MEMORY HARDWARE; MEMORY CARDS; BLANK HARD COMPUTER DISCS; COMPUTER HARDWARE AND COMPUTER SOFTWARE PROGRAMS FOR THE INTEGRATION OF TEXT, AUDIO, GRAPHICS, STILL IMAGES AND MOVING PICTURES INTO AN INTERACTIVE DELIVERY FOR MULTIMEDIA APPLICATIONS; COMPUTER OPERATING RECORDED PROGRAMS; COMPUTER PROGRAMS AND COMPUTER SOFTWARE FOR ELECTRONICALLY TRADING SECURITIES; COMPUTER PROGRAMS FOR USING THE INTERNET AND THE WORLDWIDE WEB; COMPUTER SOFTWARE FOR USE IN DATABASE MANAGEMENT, USE AS A SPREADSHEET AND WORD PROCESSING; COMPUTER SOFTWARE PROGRAMS RECORDED ON DATA MEDIA DESIGNED FOR USE IN CONSTRUCTION AND AUTOMATED MANUFACTURING FOR USE WITH CAD/CAM HARDWARE; COMMUNICATIONS SOFTWARE FOR CONNECTING COMPUTER NETWORK USERS AND GLOBAL COMPUTER NETWORKS; COMPUTER ANTI-VIRUS SOFTWARE; COMPUTER APPLICATION SOFTWARE FOR MOBILE PHONES, NAMELY, SOFTWARE FOR USE IN DATABASE MANAGEMENT AND ELECTRONIC STORAGE OF DATA; COMPUTER SEARCH ENGINE SOFTWARE; COMPUTER SOFTWARE FOR ACCESSING INFORMATION DIRECTORIES THAT MAY BE DOWNLOADED FROM THE GLOBAL COMPUTER NETWORK; COMPUTER SOFTWARE FOR ADMINISTRATION OF COMPUTER NETWORKS; COMPUTER SOFTWARE FOR PROCESSING DIGITAL IMAGES; COMPUTER SOFTWARE TO AUTOMATE DATA WAREHOUSING; COMPUTER GAME PROGRAMS; BLANK OPTICAL DISCS; BLANK RECORDABLE OPTICAL DISC; OPTICAL DISC DRIVES; NOTEBOOK COMPUTERS; BLANK FLOPPY COMPUTER DISCS; FLOPPY DISC DRIVES; RADIOS; RECONFIGURABLE PROCESSORS FOR USE IN WIRELESS COMMUNICATION HANDSETS AND NETWORK EQUIPMENT IN THE FIELD OF WIDEBAND COMMUNICATIONS; COMMUNICATIONS COMPUTERS; COMMUNICATIONS SERVERS; INTERNET WEB BROWSER SOFTWARE; INTERNET BROWSERS; COMPUTER SOFTWARE, NAMELY, BROWSERS FOR ACCESSING WORLDWIDE COMPUTER NETWORKS AND SECURE PRIVATE COMPUTER NETWORKS; DOWNLOADABLE SOFTWARE IN THE NATURE OF A MOBILE APPLICATION FOR USE IN DATABASE MANAGEMENT, FOR USE AS A SPREADSHEET AND FOR WORD PROCESSING (U.S. CLS. 21, 23, 26, 36 AND 38).

FIRST USE 12-10-2012; IN COMMERCE 12-10-2012.

CHRISTOPHER LAW, EXAMINING ATTORNEY

**CLASS 9—(Continued).**

SN 85-837,773. A & R CAMBRIDGE LIMITED, CAMBRIDGE, UNITED KINGDOM, FILED 1-31-2013.

# AIRDAC

THE MARK CONSISTS OF STANDARD CHARACTERS WITHOUT CLAIM TO ANY PARTICULAR FONT, STYLE, SIZE, OR COLOR.

OWNER OF ERPN CMNTY TM OFC REG. NO. 011451457, DATED 5-20-2013, EXPIRES 12-21-2022.

FOR ELECTRICAL AND ELECTRONIC APPARATUS AND INSTRUMENTS FOR USE IN AUDIO AND AUDIO-VISUAL TECHNOLOGY, NAMELY, AUDIO AMPLIFIERS, PREAMPLIFIERS, POWER AMPLIFIERS, DIGITAL TO ANALOGUE CONVERTERS, WIRELESS DIGITAL TO ANALOGUE CONVERTERS, REMOTE CONTROLLERS, DIGITAL AUDIO PROCESSORS, AUDIO-STREAMING APPARATUS IN THE NATURE OF DIGITAL MEDIA STREAMING DEVICES, WIRELESS TRANSMISSION APPARATUS, WIRELESS RECEIVING APPARATUS (U.S. CLS. 21, 23, 26, 36 AND 38).  
KIMBERLY FRYE, EXAMINING ATTORNEY

**CLASS 9—(Continued).**

SN 85-840,630. BRADFORD NETWORKS, INC., CONCORD, NH. FILED 2-5-2013.

# SMARTEDGE

THE MARK CONSISTS OF STANDARD CHARACTERS WITHOUT CLAIM TO ANY PARTICULAR FONT, STYLE, SIZE, OR COLOR.

FOR COMPUTER SOFTWARE AND HARDWARE FOR NETWORK ACCESS CONTROL SECURITY SYSTEMS FOR USE IN INSTITUTIONAL WORKPLACE ENVIRONMENTS FOR THE PURPOSE OF ENHANCING SECURITY MANAGEMENT IN THE FIELD OF COMPUTER NETWORK SECURITY (U.S. CLS. 21, 23, 26, 36 AND 38).  
LINDA LAVACHE, EXAMINING ATTORNEY

SN 85-840,653. BRADFORD NETWORKS, INC., CONCORD, NH. FILED 2-5-2013.

# THE SMART EDGE

THE MARK CONSISTS OF STANDARD CHARACTERS WITHOUT CLAIM TO ANY PARTICULAR FONT, STYLE, SIZE, OR COLOR.

FOR COMPUTER SOFTWARE AND HARDWARE FOR NETWORK ACCESS CONTROL SECURITY SYSTEMS FOR USE IN INSTITUTIONAL WORKPLACE ENVIRONMENTS FOR THE PURPOSE OF ENHANCING SECURITY MANAGEMENT IN THE FIELD OF COMPUTER NETWORK SECURITY (U.S. CLS. 21, 23, 26, 36 AND 38).  
LINDA LAVACHE, EXAMINING ATTORNEY

SN 85-838,854. RHEMA, NEW HYDE PARK, NY. FILED 2-1-2013.

# RHEMA

THE MARK CONSISTS OF STANDARD CHARACTERS WITHOUT CLAIM TO ANY PARTICULAR FONT, STYLE, SIZE, OR COLOR.

THE ENGLISH TRANSLATION OF "RHEMA" IN THE MARK IS A "SPOKEN WORD".

FOR CARRYING CASES AND ACCESSORIES DESIGNED FOR CONSUMER ELECTRONICS, NAMELY, MOBILE PHONE CASES, PORTABLE COMPUTER CASES, PORTABLE AUDIO PLAYER CASES, AND STORAGE DEVICES FOR COMPUTERS; CONSUMER ELECTRONICS PRODUCTS, NAMELY, PORTABLE AUDIO SPEAKERS, LOUDSPEAKERS, MP3 PLAYERS, RADIOS, ELECTRICAL CABLES, ADAPTERS, HEADPHONES, EARPHONES, AND HANDS-FREE DEVICE FOR MOBILE PHONES, DIGITAL AUDIO PLAYERS, AUDIO SPEAKERS; HOLDERS AND MOUNTS FOR MOBILE PHONES (U.S. CLS. 21, 23, 26, 36 AND 38).  
CAROLINE WOOD, EXAMINING ATTORNEY

SN 85-842,766. TWENTIETH CENTURY FOX FILM CORPORATION, LOS ANGELES, CA. FILED 2-6-2013.

# SLEEPY HOLLOW

THE MARK CONSISTS OF STANDARD CHARACTERS WITHOUT CLAIM TO ANY PARTICULAR FONT, STYLE, SIZE, OR COLOR.

FOR PRE-RECORDED DVDS FEATURING DRAMA; DOWNLOADABLE TELEVISION SHOWS FEATURING DRAMA; DECORATIVE MAGNETS; EYE GLASSES (U.S. CLS. 21, 23, 26, 36 AND 38).  
WILLIAM BRECKENFELD, EXAMINING ATTORNEY

**CLASS 9—(Continued).**

SN 85-845,970. VISOPTICAL, LLC, FENTON, MO. FILED 2-11-2013.

# POPSTAR

THE MARK CONSISTS OF STANDARD CHARACTERS WITHOUT CLAIM TO ANY PARTICULAR FONT, STYLE, SIZE, OR COLOR.

FOR EYEWEAR (U.S. CLS. 21, 23, 26, 36 AND 38).  
MARK SHINER, EXAMINING ATTORNEY

---

SN 85-846,089. WIRELESS DYNAMICS INC., CALGARY, CANADA, FILED 2-11-2013.

# MiPOS

THE MARK CONSISTS OF STANDARD CHARACTERS WITHOUT CLAIM TO ANY PARTICULAR FONT, STYLE, SIZE, OR COLOR.

FOR ELECTRONIC DEVICE, NAMELY, APPARATUS COMPRISED OF COMPUTER HARDWARE AND SOFTWARE FOR READING MAGNETIC STRIP CARDS, SMART CARDS, CONTACTLESS CARDS, ENCODED ELECTRONIC CHIP CARDS, CONTACTLESS ENCODED ELECTRONIC CHIP CARDS, AND NEAR FIELD COMMUNICATION (NFC) MOBILE DEVICES; COMPUTER HARDWARE AND SOFTWARE FOR MANAGING AND PROCESSING ELECTRONIC INFORMATION, NAMELY, CREDIT CARDS, CUSTOMER LOYALTY CARDS, ELECTRONIC COUPONS, AND PAYMENT TRANSACTION INFORMATION; COMPUTER HARDWARE AND SOFTWARE FOR SENDING E-MAIL OR SHORT MESSAGE SERVICE (SMS) RECEIPTS; COMPUTER HARDWARE AND SOFTWARE FOR ACCEPTING COMMANDS AND SENDING RESPONSES TO USER INTERFACE APPLICATIONS ON HOST USER INTERFACE DEVICES; COMPUTER HARDWARE AND SOFTWARE FOR CONNECTING AND INTERACTING WITH CREDIT CARD, PRE-PAID CARD, DEBIT CARD, AND LOYALTY REWARDS CARD PROCESSOR, ISSUER, AND PAYMENT NETWORK BACK END SYSTEMS, SERVERS AND GATEWAYS; MAGNETIC ENCODED CARD READERS, CHIP CARD READERS, AND CONTACTLESS INTEGRATED CHIP CARD READERS FOR USE AS A MAGNETIC STRIPE, CHIP, AND CONTACTLESS CARD POINT OF SALE (POS) PAYMENT ACCEPTANCE DEVICE TO PERFORM PAYMENT TRANSACTIONS VIA FOB, DONGLE, SLEEVE, OR PROTECTIVE CASE FORMATS, VIA PLUG AND PLAY ATTACHMENT TO COMPUTING DEVICES SUCH AS SMART PHONES, MOBILE PHONES, AND TABLET COMPUTERS (U.S. CLS. 21, 23, 26, 36 AND 38).

GINA FINK, EXAMINING ATTORNEY

**CLASS 9—(Continued).**

SN 85-846,698. TWENTIETH CENTURY FOX FILM CORPORATION, LOS ANGELES, CA. FILED 2-11-2013.

# DELIRIUM

THE MARK CONSISTS OF STANDARD CHARACTERS WITHOUT CLAIM TO ANY PARTICULAR FONT, STYLE, SIZE, OR COLOR.

FOR PRE-RECORDED DVDS FEATURING DRAMA; DOWNLOADABLE VIDEO RECORDINGS FEATURING A DRAMATIC TELEVISION PROGRAM; DOWNLOADABLE TELEVISION SHOWS AND VIDEO RECORDINGS FEATURING DRAMA; DOWNLOADABLE RING TONES, GRAPHICS, COMPUTER DESKTOP WALLPAPER, AND GAMES VIA A GLOBAL COMPUTER NETWORK AND WIRELESS DEVICES; COMPUTER SCREEN SAVER SOFTWARE; COMPUTER GAME AND VIDEO GAME SOFTWARE; MOUSEPADS; DECORATIVE MAGNETS; EYE GLASSES; DOWNLOADABLE MOBILE SOFTWARE APPLICATIONS FOR MOBILE COMMUNICATION DEVICES FOR USE IN DISTRIBUTION OF DIGITAL VIDEO, VIDEO FILES, AND VIDEO GAMES (U.S. CLS. 21, 23, 26, 36 AND 38).

THEODORE MCBRIDE, EXAMINING ATTORNEY

---

SN 85-847,001. UMBRA SOFTWARE LTD, HELSINKI, FINLAND, FILED 2-12-2013.

# UMBRA SOFTWARE

THE MARK CONSISTS OF STANDARD CHARACTERS WITHOUT CLAIM TO ANY PARTICULAR FONT, STYLE, SIZE, OR COLOR.

NO CLAIM IS MADE TO THE EXCLUSIVE RIGHT TO USE "SOFTWARE", APART FROM THE MARK AS SHOWN. FOR COMPUTER GAME SOFTWARE DEVELOPMENT TOOL FOR 3D GRAPHIC OPTIMIZATION, MAINLY FOR DEVELOPING COMPUTER GAMES, COMPUTER GAME VISUALIZATIONS AND COMPUTER GAME SIMULATIONS FOR PROFESSIONAL GAME DEVELOPERS VIA COMMERCIAL LICENCE (U.S. CLS. 21, 23, 26, 36 AND 38).

DOMINIC FATHY, EXAMINING ATTORNEY

**CLASS 9—(Continued).**

SN 85-847,327. HANCHETT ENTRY SYSTEMS, INC., PHOENIX, AZ. FILED 2-12-2013.

**SMART STRIKE**

THE MARK CONSISTS OF STANDARD CHARACTERS WITHOUT CLAIM TO ANY PARTICULAR FONT, STYLE, SIZE, OR COLOR.

NO CLAIM IS MADE TO THE EXCLUSIVE RIGHT TO USE "STRIKE", APART FROM THE MARK AS SHOWN.

FOR ELECTRIC DOOR LOCKING SYSTEM COMPRISING AN ELECTRONIC STRIKE CAPABLE OF INTERFACING WITH MOST MANUFACTURED LOCK SETS AND PRODUCTS FOR ACCESS CONTROL, NAMELY, ELECTRONIC CIRCUITRY FOR POWERING THE STRIKE OVER A RANGE OF VOLTAGES WITH MINIMUM ELECTRIC POWER DEMANDS (U.S. CLS. 21, 23, 26, 36 AND 38).

BRIAN NEVILLE, EXAMINING ATTORNEY

SN 85-848,910. BOYD, BRADFORD A, MIRAMAR, FL. FILED 2-13-2013.

**CargoSoft**

THE MARK CONSISTS OF STANDARD CHARACTERS WITHOUT CLAIM TO ANY PARTICULAR FONT, STYLE, SIZE, OR COLOR.

FOR COMPUTER SOFTWARE FOR LOGISTICS MANAGEMENT FOR USE IN THE TRANSPORTATION INDUSTRY (U.S. CLS. 21, 23, 26, 36 AND 38).

KATHERINE M. DUBRAY, EXAMINING ATTORNEY

SN 85-848,952. DUNGEY ENTERPRISES LLC, BELLE PLAINE, MN. FILED 2-13-2013.

**RYAN DUNGEY**

THE MARK CONSISTS OF STANDARD CHARACTERS WITHOUT CLAIM TO ANY PARTICULAR FONT, STYLE, SIZE, OR COLOR.

THE NAME(S), PORTRAIT(S), AND/OR SIGNATURE(S) SHOWN IN THE MARK IDENTIFIES "RYAN DUNGEY", WHOSE CONSENT(S) TO REGISTER IS MADE OF RECORD.

FOR MOTORCYCLE GOGGLES; MOTORCYCLE HELMETS (U.S. CLS. 21, 23, 26, 36 AND 38).

FIRST USE 12-1-2012; IN COMMERCE 12-1-2012.  
SHAUNIA CARLYLE, EXAMINING ATTORNEY

**CLASS 9—(Continued).**

SN 85-850,079. DASHBOARDHOSTING, INC., CORAL SPRINGS, FL. FILED 2-14-2013.

**ISWING**

THE MARK CONSISTS OF STANDARD CHARACTERS WITHOUT CLAIM TO ANY PARTICULAR FONT, STYLE, SIZE, OR COLOR.

FOR COMPUTER SOFTWARE APPLICATION FOR MOBILE PHONES, NAMELY, SOFTWARE THAT ENABLES SECURE INTERPERSONAL COMMUNICATIONS AND EVENTS SCHEDULING AMONG PERSONS INVOLVED IN DATING AND SWINGER LIFESTYLES (U.S. CLS. 21, 23, 26, 36 AND 38).

CHARLES L. JENKINS, EXAMINING ATTORNEY

SN 85-850,717. INNOVYZE, INC., BROOMFIELD, CO. FILED 2-15-2013.

**INFINITY SYSTEM**

THE MARK CONSISTS OF STANDARD CHARACTERS WITHOUT CLAIM TO ANY PARTICULAR FONT, STYLE, SIZE, OR COLOR.

NO CLAIM IS MADE TO THE EXCLUSIVE RIGHT TO USE "SYSTEM", APART FROM THE MARK AS SHOWN.

FOR COMPUTER APPLICATION SOFTWARE FOR MOBILE PHONES, PORTABLE MEDIA PLAYERS, HANDHELD COMPUTERS, LAPTOP COMPUTERS, NAMELY, SOFTWARE FOR ACCESSING, VIEWING, MANAGING REAL-TIME AND HISTORICAL DATA AND AN EVENT MANAGEMENT DATABASE IN THE FIELD OF DRINKING WATER, WASTEWATER, STORMWATER, RIVER AND COMBINED SYSTEMS (U.S. CLS. 21, 23, 26, 36 AND 38).

KIMBERLY PARKS, EXAMINING ATTORNEY

SN 85-851,498. ANKI, INC., SAN FRANCISCO, CA. FILED 2-15-2013.

**ANKI**

THE MARK CONSISTS OF STANDARD CHARACTERS WITHOUT CLAIM TO ANY PARTICULAR FONT, STYLE, SIZE, OR COLOR.

THE ENGLISH TRANSLATION OF THE MARK IS "MEMORIZING".

FOR ROBOTS FOR PERSONAL, EDUCATIONAL, AND HOBBY USE, AND SOFTWARE FOR USE AND CONTROLLING AND OPERATING ROBOTS (U.S. CLS. 21, 23, 26, 36 AND 38).

ANDREW LEASER, EXAMINING ATTORNEY

**CLASS 9—(Continued).**

SN 85-852,273. COOPER, CHARLES, LAFAYETTE, CA. FILED 2-18-2013.

**BOTSEE**

THE MARK CONSISTS OF STANDARD CHARACTERS WITHOUT CLAIM TO ANY PARTICULAR FONT, STYLE, SIZE, OR COLOR.

FOR ROBOTS FOR PERSONAL, EDUCATIONAL AND HOBBY USE AND STRUCTURAL PARTS THEREFOR (U.S. CLS. 21, 23, 26, 36 AND 38).

DAWN FELDMAN, EXAMINING ATTORNEY

**CLASS 9—(Continued).**

SN 85-855,282. CEMBRE S.P.A., 25135 BRESCIA (BS), ITALY, FILED 2-20-2013.

**GENIUSPRO**

THE MARK CONSISTS OF STANDARD CHARACTERS WITHOUT CLAIM TO ANY PARTICULAR FONT, STYLE, SIZE, OR COLOR.

PRIORITY CLAIMED UNDER SEC. 44(D) ON EUROPEAN UNION APPLICATION NO. 11574639, FILED 2-14-2013.

FOR SOFTWARE FOR THERMAL TRANSFER PRINTERS FOR PRINTING MARKERS, TAGS AND LEGENDS FOR ELECTRICAL COMPONENTS USED IN INDUSTRIAL LABELING (U.S. CLS. 21, 23, 26, 36 AND 38).

FIRST USE 8-29-2013; IN COMMERCE 8-29-2013.  
JOHN LINCOSKI, EXAMINING ATTORNEY

SN 85-853,802. SYNC ESSENTIALS, INC., MOUNTAIN VIEW, CA. FILED 2-19-2013.

**TRADE ACCOUNTANT**

THE MARK CONSISTS OF STANDARD CHARACTERS WITHOUT CLAIM TO ANY PARTICULAR FONT, STYLE, SIZE, OR COLOR.

SEC. 2(F).

FOR COMPUTER SOFTWARE FOR USE IN PERSONAL AND BUSINESS FINANCE, NAMELY, SECURITIES PORTFOLIO TRACKING AND MANAGEMENT, AND USER MANUALS SOLD AS A UNIT THEREWITH (U.S. CLS. 21, 23, 26, 36 AND 38).

FIRST USE 1-3-2002; IN COMMERCE 1-3-2002.  
RONALD MCMORROW, EXAMINING ATTORNEY

SN 85-855,762. FUJICELL TECHNO CORPORATION, AKA FUJICELL TECHNO CORPORATION, KAWASAKI, JAPAN, FILED 2-21-2013.

**FUJICELL**

SN 85-854,468. KELLEY JR, CHRISTOPHER, STERLING HEIGHTS, MI. FILED 2-20-2013.

**THE DROP OUT NATION**

THE MARK CONSISTS OF STANDARD CHARACTERS WITHOUT CLAIM TO ANY PARTICULAR FONT, STYLE, SIZE, OR COLOR.

FOR DIGITAL MUSIC DOWNLOADABLE FROM THE INTERNET; DIGITAL MEDIA, NAMELY, CDS, DVDS, HIGH DEFINITION DIGITAL DISCS AND DOWNLOADABLE AUDIO AND VIDEO FILES, FEATURING MUSIC (U.S. CLS. 21, 23, 26, 36 AND 38).

ADA HAN, EXAMINING ATTORNEY

OWNER OF JAPAN REG. NO. 5508546, DATED 7-20-2012, EXPIRES 7-20-2022.

OWNER OF U.S. REG. NO. 4,241,109.

FOR BLANK MAGNETIC DATA CARRIERS AND RECORDING DISCS; BATTERIES; SOLAR BATTERIES; BATTERY CHARGERS FOR DIGITAL CAMERAS; BLANK DIGITAL STORAGE MEDIA; CAMERAS; DIGITAL AUDIO AND VIDEO PLAYERS; COMPUTERS; ELECTRICAL APPARATUS, NAMELY, PHOTOVOLTAIC SOLAR MODULES FOR PRODUCTION OF ELECTRICITY (U.S. CLS. 21, 23, 26, 36 AND 38).

HANNO RITTNER, EXAMINING ATTORNEY

**CLASS 9—(Continued).**

SN 85-856,403. TAEGU CITY, TAEGU CITY, REPUBLIC OF KOREA, FILED 2-21-2013.



THE MARK CONSISTS OF A STYLIZED "O" LIKE BROKEN CONTOUR WHICH INCLUDES A LEFT AND RIGHT SECTION SEPARATED FROM EACH OTHER.

FOR EYEGGLASS FRAMES; EYEGGLASSES; SUNGLASSES; CONTACT LENSES; GLOVES FOR PROTECTION AGAINST ACCIDENTS FOR INDUSTRIAL USE (U.S. CLS. 21, 23, 26, 36 AND 38).

ASMAT KHAN, EXAMINING ATTORNEY

SN 85-857,473. LG ELECTRONICS INC., SEOUL 150-721, REPUBLIC OF KOREA, FILED 2-22-2013.

# Aqua Shield

THE MARK CONSISTS OF STANDARD CHARACTERS WITHOUT CLAIM TO ANY PARTICULAR FONT, STYLE, SIZE, OR COLOR.

PRIORITY CLAIMED UNDER SEC. 44(D) ON REPUBLIC OF KOREA APPLICATION NO. 402013000984, FILED 2-18-2013, REG. NO. 1008510, DATED 11-21-2013, EXPIRES 11-21-2023.

NO CLAIM IS MADE TO THE EXCLUSIVE RIGHT TO USE "AQUA", APART FROM THE MARK AS SHOWN.

FOR MOBILE PHONES (U.S. CLS. 21, 23, 26, 36 AND 38).

CHRIS WELLS, EXAMINING ATTORNEY

**CLASS 9—(Continued).**

SN 85-858,595. NEWSTYLE, SANTA ANA, CA. FILED 2-25-2013.

## TWISTERS READING GLASSES

THE MARK CONSISTS OF STANDARD CHARACTERS WITHOUT CLAIM TO ANY PARTICULAR FONT, STYLE, SIZE, OR COLOR.

NO CLAIM IS MADE TO THE EXCLUSIVE RIGHT TO USE "READING GLASSES", APART FROM THE MARK AS SHOWN.

FOR EYEGGLASSES (U.S. CLS. 21, 23, 26, 36 AND 38).

BERYL GARDNER, EXAMINING ATTORNEY

SN 85-862,815. THAT CORPORATION, MILFORD, MA. FILED 2-28-2013.

# TOTAL CAL

THE MARK CONSISTS OF STANDARD CHARACTERS WITHOUT CLAIM TO ANY PARTICULAR FONT, STYLE, SIZE, OR COLOR.

FOR DIGITAL SIGNAL PROCESSING CHIPS, DIGITAL SIGNAL PROCESSORS, ELECTRONIC BROADCAST SIGNAL PROCESSORS, ELECTRONIC CIRCUITS AND INTEGRATED CIRCUITS; ELECTRONIC CONTROLLERS FOR PROCESSING AND CONTROLLING AUDIO SIGNALS AND FOR MEASURING, ANALYZING AND CONTROLLING AUDIO VOLUME LEVELS; COMPUTER SOFTWARE FOR MEASURING, ANALYZING, CONTROLLING, PROCESSING, ENCODING AND DECODING AUDIO SIGNALS; DIGITAL AUDIO AND VIDEO RECORDERS AND PLAYERS; WIRELESS COMMUNICATION DEVICES FOR VOICE, DATA OR IMAGE TRANSMISSION; AUDIO-RECEIVERS AND VIDEO-RECEIVERS; SOUND AND VIDEO RECORDING AND PLAYBACK MACHINES; TELEVISIONS; TELEPHONES AND MOBILE TELEPHONES; RADIO RECEIVERS AND TRANSMITTERS; AUDIO AND VIDEO TUNERS; SPEAKERS AND HEADPHONES; SET-TOP BOXES; AND COMPUTERS AND COMPUTER HARDWARE (U.S. CLS. 21, 23, 26, 36 AND 38).

AISHA CLARKE, EXAMINING ATTORNEY



**CLASS 9—(Continued).**

SN 85-864,215. THE RIBBON PRINT COMPANY, LLC, HIGHLAND PARK, IL. FILED 3-1-2013.



NO CLAIM IS MADE TO THE EXCLUSIVE RIGHT TO USE "THE RIBBON PRINT COMPANY", APART FROM THE MARK AS SHOWN.

THE COLOR(S) ORANGE, RED, AND YELLOW IS/ARE CLAIMED AS A FEATURE OF THE MARK.

THE MARK CONSISTS OF A STYLIZED DESIGN OF A YELLOW BOW POSITIONED ABOVE THE STYLIZED WORDS "THE RIBBON PRINT COMPANY". THE WORDS "THE" AND COMPANY ARE IN ORANGE. THE WORDS "RIBBON PRINT" ARE IN RED.

FOR COMPUTERS; COMPUTER PRINTERS; CARRYING CASES FOR COMPUTERS AND COMPUTER PRINTERS; COMPUTER PRINTER ACCESSORIES, NAMELY, RIBBON PLATES, RIBBON HOLDERS, AND RIBBON ADAPTORS; WIRELESS COMPUTER MICE; COMPUTER SOFTWARE FOR DESIGNING GRAPHICS AND PRINTING THE SAME ON RIBBONS (U.S. CLS. 21, 23, 26, 36 AND 38).

FIRST USE 0-0-2012; IN COMMERCE 0-0-2012.  
JILL PRATER, EXAMINING ATTORNEY

---

SN 85-864,274. GOOD LIFE LLC, MEDFORD, OR. FILED 3-1-2013.

## Ultimate Dog Silencer

THE MARK CONSISTS OF STANDARD CHARACTERS WITHOUT CLAIM TO ANY PARTICULAR FONT, STYLE, SIZE, OR COLOR.

NO CLAIM IS MADE TO THE EXCLUSIVE RIGHT TO USE "DOG", APART FROM THE MARK AS SHOWN.

SEC. 2(F).

FOR ELECTRONIC DOG BARK CONTROL DEVICES (U.S. CLS. 21, 23, 26, 36 AND 38).

FIRST USE 3-1-2007; IN COMMERCE 3-1-2007.  
JEAN IM, EXAMINING ATTORNEY

**CLASS 9—(Continued).**

SN 85-864,306. GOOD LIFE LLC, MEDFORD, OR. FILED 3-1-2013.

## Dog Silencer Pro

THE MARK CONSISTS OF STANDARD CHARACTERS WITHOUT CLAIM TO ANY PARTICULAR FONT, STYLE, SIZE, OR COLOR.

NO CLAIM IS MADE TO THE EXCLUSIVE RIGHT TO USE "DOG", APART FROM THE MARK AS SHOWN.

SEC. 2(F).

FOR ELECTRONIC DOG BARK CONTROL DEVICES (U.S. CLS. 21, 23, 26, 36 AND 38).

FIRST USE 4-1-2005; IN COMMERCE 4-1-2005.

JEAN IM, EXAMINING ATTORNEY

---

SN 85-864,642. ROCKWELL AUTOMATION, INC., MILWAUKEE, WI. FILED 3-1-2013.

## CELLGUARD

THE MARK CONSISTS OF STANDARD CHARACTERS WITHOUT CLAIM TO ANY PARTICULAR FONT, STYLE, SIZE, OR COLOR.

FOR AUTOMATED SAFETY AND MONITORING SYSTEMS FOR USE IN AN INDUSTRIAL OR MANUFACTURING ENCLOSED WORK ZONE, NAMELY, SOFTWARE, HARDWARE, GATES, SENSING, SCANNING AND COMMUNICATIONS DEVICES THAT INTERFACE WITH THE STANDARD CONTROL SYSTEM TO MONITOR ENVIRONMENTAL CONDITIONS, TO COMMUNICATE SAFETY INFORMATION AND TO CONTROL DEVICES IN A MANNER DESIGNED TO PROTECT WORKERS IN THE ENVIRONMENT (U.S. CLS. 21, 23, 26, 36 AND 38).

PAUL E. FAHRENKOPF, EXAMINING ATTORNEY

**CLASS 9—(Continued).**

SN 85-865,616. INSTITUTIONAL INVESTOR, LLC, NEW YORK, NY. FILED 3-4-2013.

Institutional Investor's  
Alpha

THE MARK CONSISTS OF STANDARD CHARACTERS WITHOUT CLAIM TO ANY PARTICULAR FONT, STYLE, SIZE, OR COLOR.

OWNER OF U.S. REG. NOS. 1,595,305 AND 3,503,906. NO CLAIM IS MADE TO THE EXCLUSIVE RIGHT TO USE "ALPHA", APART FROM THE MARK AS SHOWN. SEC. 2(F) AS TO "INSTITUTIONAL INVESTOR'S".

FOR COMPUTER SOFTWARE FOR USE IN ELECTRONIC STORAGE OF DATA IN THE FIELDS OF FINANCIAL MARKETS AND HEDGE FUND INDUSTRY, MOBILE APPS AND DOWNLOADABLE ELECTRONIC PUBLICATIONS RELATING TO THE FINANCIAL MARKETS AND HEDGE FUND INDUSTRY (U.S. CLS. 21, 23, 26, 36 AND 38).

NORA BUCHANAN WILL, EXAMINING ATTORNEY

**CLASS 9—(Continued).**

SN 85-869,359. TEAMSTUDIO, INC., BEVERLY, MA. FILED 3-7-2013.



THE MARK CONSISTS OF TWO OPPOSING DOTTED ARCS, EACH ARC CONSISTING OF SEVEN DOTS INCREASING IN SIZE.

FOR COMPUTER APPLICATION SOFTWARE FOR COMPUTERS AND MOBILE DEVICES, NAMELY, SOFTWARE FOR THE ELECTRONIC DISTRIBUTION AND STORAGE OF DATA AND PROVIDING FUNCTIONALITY AND ACCESS TO ELECTRONIC DATA (U.S. CLS. 21, 23, 26, 36 AND 38).

FIRST USE 1-27-2013; IN COMMERCE 1-27-2013.

CAROL SPILLS, EXAMINING ATTORNEY

SN 85-867,648. INFRAGISTICS, INC., CRANBURY, NJ. FILED 3-5-2013.

INDIGO STUDIO

THE MARK CONSISTS OF STANDARD CHARACTERS WITHOUT CLAIM TO ANY PARTICULAR FONT, STYLE, SIZE, OR COLOR.

OWNER OF U.S. REG. NO. 4,314,374. NO CLAIM IS MADE TO THE EXCLUSIVE RIGHT TO USE "STUDIO", APART FROM THE MARK AS SHOWN.

FOR COMPUTER SOFTWARE, NAMELY, DESIGN TOOLS FOR PROTOTYPING, STORYBOARDING, AND WIREFRAMING; DESIGN TOOLS FOR CREATING COMPUTER SOFTWARE APPLICATIONS (U.S. CLS. 21, 23, 26, 36 AND 38).

FIRST USE 12-20-2011; IN COMMERCE 11-29-2012.

PRISCILLA MILTON, EXAMINING ATTORNEY

SN 85-870,222. SAMSUNG ELECTRONICS CO., LTD., SUWON-SI, GYEONGGI-DO, REPUBLIC OF KOREA, FILED 3-7-2013.

CHORD

THE MARK CONSISTS OF STANDARD CHARACTERS WITHOUT CLAIM TO ANY PARTICULAR FONT, STYLE, SIZE, OR COLOR.

FOR COMPUTER APPLICATION SOFTWARE FOR MOBILE PHONES, SMARTPHONES AND TABLET COMPUTERS HAVING A CONTENT SHARING FUNCTION, NAMELY, SOFTWARE THAT ALLOWS USERS TO FORM A PEER-TO-PEER CONNECTION WITH OTHER MOBILE DEVICES TO SHARE DATA, INCLUDING, TEXT, IMAGES, MUSIC, AND VIDEO, TO BROADCAST MESSAGES TO OTHER MOBILE DEVICES, AND TO ALLOW THE PLAYING OF MULTI-PLAYER VIDEO GAMES ON MOBILE DEVICES; COMPUTER SOFTWARE DEVELOPMENT TOOLS FOR BUILDING AND DEVELOPING APPLICATION SOFTWARE HAVING CONTENTS SHARING FUNCTION FOR MOBILE PHONES, SMARTPHONES AND TABLET COMPUTERS; COMPUTER SOFTWARE DEVELOPMENT TOOLS (U.S. CLS. 21, 23, 26, 36 AND 38).

HAI-LY LAM, EXAMINING ATTORNEY

**CLASS 9—(Continued).**

SN 85-870,435. HEFEI HUAHENG ELECTRONIC TECHNOLOGY CO., LTD., HEFEI, ANHUI, CHINA, FILED 3-7-2013.



THE MARK CONSISTS OF FOUR CIRCLES WITH IRREGULAR CIRCUMFERENCES THAT HAVE A TRIANGLE-LIKE SHAPE ATTACHED TO THEM. TWO OF THESE CIRCLES ARE STACKED DIRECTLY ABOVE THE REMAINING TWO CIRCLES.

FOR COMPUTER KEYBOARDS; COMPUTER PERIPHERAL EQUIPMENT; COMPUTER-GAMING SOFTWARE; COMPUTERS; DOWNLOADABLE ELECTRONIC PUBLICATIONS IN THE NATURE OF MAGAZINES IN THE FIELD OF JEWELRY AND FASHION; ELECTRIC NAVIGATIONAL INSTRUMENTS; GPS NAVIGATION DEVICE; MP4 PLAYERS; NAVIGATION APPARATUS FOR BOATS; NAVIGATION APPARATUS FOR VEHICLES; NAVIGATIONAL INSTRUMENTS FOR VEHICLES; PC TABLETS; PORTABLE MEDIA PLAYERS; PORTABLE TELEPHONES (U.S. CLS. 21, 23, 26, 36 AND 38).

FIRST USE 3-16-2012; IN COMMERCE 9-21-2012.  
GRETCHEN ULRICH, EXAMINING ATTORNEY

---

SN 85-871,476. MINDAPTIV, LLC, CENTENNIAL, CO. FILED 3-8-2013.

**Xspot**

THE MARK CONSISTS OF STANDARD CHARACTERS WITHOUT CLAIM TO ANY PARTICULAR FONT, STYLE, SIZE, OR COLOR.

FOR COMPUTER HARDWARE AND SOFTWARE USED TOGETHER AS A UNIT TO PROVIDE LOCAL AREA AND DISTRIBUTED COMPUTING RESOURCES, NAMELY, PROCESSORS, STORAGE, AND RAM, WITH ENHANCED SECURITY, AND COLLABORATIVE SHARING BETWEEN MULTIPLE USERS (U.S. CLS. 21, 23, 26, 36 AND 38).

MICHAEL WEBSTER, EXAMINING ATTORNEY

**CLASS 9—(Continued).**

SN 85-872,663. JMIS, LLC, COTTONWOOD HEIGHTS, UT. FILED 3-11-2013.

**RNUMBERS**

THE MARK CONSISTS OF STANDARD CHARACTERS WITHOUT CLAIM TO ANY PARTICULAR FONT, STYLE, SIZE, OR COLOR.

FOR COMPUTER SOFTWARE FOR USE IN MANAGING RESTAURANTS, NAMELY, SOFTWARE FOR USE IN MANAGING CASH, MANAGING FOOD COSTS, CREATING SALES REPORTS, PROVIDING DAILY PREPARATION AND BUILD TO CHARTS, PROVIDING DAILY FOOD TARGETS, LINE BAR SCHEDULING, SERVICE TIME TRACKING, AND BACK OFFICE REPORTING (U.S. CLS. 21, 23, 26, 36 AND 38).

DEBORAH LOBO, EXAMINING ATTORNEY

---

SN 85-872,900. CBS STUDIOS INC., STUDIO CITY, CA. FILED 3-11-2013.

**NCIS: RED**

THE MARK CONSISTS OF STANDARD CHARACTERS WITHOUT CLAIM TO ANY PARTICULAR FONT, STYLE, SIZE, OR COLOR.

OWNER OF U.S. REG. NOS. 3,955,035, 3,961,732 AND 4,055,049.

SEC. 2(F) AS TO "NCIS".

FOR DIGITAL MEDIA, NAMELY, PRE-RECORDED DIGITAL VIDEO DISCS, DIGITAL VERSATILE DISCS, DVDS, DOWNLOADABLE AUDIO AND VIDEO RECORDINGS, AND HIGH DEFINITION DIGITAL DISCS FEATURING DRAMA; DOWNLOADABLE TELEVISION PROGRAMS FEATURING DRAMA PROVIDED VIA A VIDEO-ON-DEMAND SERVICE (U.S. CLS. 21, 23, 26, 36 AND 38).

DAVID H. STINE, EXAMINING ATTORNEY

**CLASS 9—(Continued).**

SN 85-873,541. WORLD WRESTLING ENTERTAINMENT, INC., STAMFORD, CT. FILED 3-12-2013.

**ROCKPOCALYPSE**

THE MARK CONSISTS OF STANDARD CHARACTERS WITHOUT CLAIM TO ANY PARTICULAR FONT, STYLE, SIZE, OR COLOR.

FOR COMPUTER APPLICATION SOFTWARE FOR MOBILE PHONES, PORTABLE MEDIA PLAYERS, HANDHELD COMPUTERS, NAMELY, SOFTWARE FOR SAVING QR CODE DATA, DISPLAYING QR CODE DATA AND QR CODE DATABASE MANAGERMENTS AND DISPLAYING CONTENT ON MOBILE PHONES, PORTABLE MEDIA PLAYERS, HANDHELD COMPUTERS THROUGH USE OF QR CODE; COMPUTER SOFTWARE FOR QR CODE DATABASE MANAGEMENT; VIDEO GAMES FOR MOBILE DEVICES, PERSONAL COMPUTERS, CONSOLES, TABLETS; ELECTRONIC GAME PROGRAMS; DOWNLOADABLE ELECTRONIC GAME PROGRAMS; ELECTRONIC GAME SOFTWARE; COMPUTER GAME PROGRAMS; DOWNLOADABLE COMPUTER GAME PROGRAMS; INTERACTIVE GAME PROGRAMS; INTERACTIVE GAME SOFTWARE; CINEMATOGRAPHIC APPARATUS (U.S. CLS. 21, 23, 26, 36 AND 38).

SALLY SHIH, EXAMINING ATTORNEY

**CLASS 9—(Continued).**

SN 85-875,845. INGENUITY SUN MEDIA LLC, RANDOLPH, NJ. FILED 3-14-2013.



NO CLAIM IS MADE TO THE EXCLUSIVE RIGHT TO USE "SUN MEDIA", APART FROM THE MARK AS SHOWN.

THE MARK CONSISTS OF THE LITERAL ELEMENT "SUN MEDIA TREE" UNDERSCORED WITH A SINGLE LINE; IN THE WORD "TREE" THE "T" IS A STYLIZED REPRESENTATION OF THE DIGITAL SIGNAGE.

FOR SOLAR POWERED DIGITAL SIGNAGE (U.S. CLS. 21, 23, 26, 36 AND 38).

WENDY GOODMAN, EXAMINING ATTORNEY

---

SN 85-874,808. KINESIO CAPTURE LLC., BETHESDA, MD. FILED 3-13-2013.

**Spark Motion**

THE MARK CONSISTS OF STANDARD CHARACTERS WITHOUT CLAIM TO ANY PARTICULAR FONT, STYLE, SIZE, OR COLOR.

NO CLAIM IS MADE TO THE EXCLUSIVE RIGHT TO USE "MOTION", APART FROM THE MARK AS SHOWN.

FOR COMPUTER SOFTWARE FOR USE IN SPORTS TRAINING AND PHYSICAL THERAPY FEATURING INTERACTIVE AUDIO AND VIDEO COMPUTER PROGRAMS FOR ANALYZING MOVEMENT FOR USE IN DEVELOPING A REHABILITATION PROGRAM (U.S. CLS. 21, 23, 26, 36 AND 38).

BERYL GARDNER, EXAMINING ATTORNEY

---

SN 85-877,863. AMERICAN HEALTHCARE PRODUCTS, INC., ALHAMBRA, CA. FILED 3-15-2013.

**SOLUTIONS AT HAND**

THE MARK CONSISTS OF STANDARD CHARACTERS WITHOUT CLAIM TO ANY PARTICULAR FONT, STYLE, SIZE, OR COLOR.

FOR DISPOSABLE PROTECTIVE GLOVES FOR INDUSTRIAL USE, NAMELY, LATEX GLOVES, VINYL GLOVES, NITRILE GLOVES, AND SYNTHETIC GLOVES (U.S. CLS. 21, 23, 26, 36 AND 38).

FIRST USE 1-1-1999; IN COMMERCE 1-1-1999.

ANNE E. GUSTASON, EXAMINING ATTORNEY

**CLASS 9—(Continued).**

SN 85-880,099. TSI INCORPORATED, SHOREVIEW, MN. FILED 3-19-2013.

# CHEMREVEAL

THE MARK CONSISTS OF STANDARD CHARACTERS WITHOUT CLAIM TO ANY PARTICULAR FONT, STYLE, SIZE, OR COLOR.

FOR INSTRUMENTATION EQUIPMENT, NAMELY, LASER SPECTROMETERS AND OPTICAL SPECTROMETERS INCLUDING BUT NOT LIMITED TO LASER-INDUCED BREAKDOWN SPECTROMETERS AND RAMAN SPECTROMETERS AND SOFTWARE FOR THE DETECTION AND ANALYSIS OF THE CHEMICAL COMPOSITION OF MATERIAL AT AN ELEMENTAL AND MOLECULAR LEVEL (U.S. CLS. 21, 23, 26, 36 AND 38).

JAMES LOVELACE, EXAMINING ATTORNEY

**CLASS 9—(Continued).**

SN 85-880,689. SCAN, INC., OREM, UT. FILED 3-20-2013.



NO CLAIM IS MADE TO THE EXCLUSIVE RIGHT TO USE "SCAN", APART FROM THE MARK AS SHOWN.

THE COLOR(S) RED AND WHITE IS/ARE CLAIMED AS A FEATURE OF THE MARK.

THE MARK CONSISTS OF THE WORDING "SCAN" IN WHITE TO THE RIGHTS OF A BROKEN WHITE SQUARE ON A RED TRIANGLE WITH ROUNDED CORNERS.

FOR COMPUTER SOFTWARE FOR SCANNING OR READING A CODE, NAMELY, A QUICK RESPONSE (QR) CODE, BAR CODE, AND RFID TAGS VIA A COMPUTER OR MOBILE DEVICE (U.S. CLS. 21, 23, 26, 36 AND 38).

JANET LEE, EXAMINING ATTORNEY

SN 85-880,532. CIPEX INTERNATIONAL LIMITED, SANTA FE SPRINGS, CA. FILED 3-19-2013.



FOR BAGS FOR CAMERAS AND PHOTOGRAPHIC EQUIPMENT (U.S. CLS. 21, 23, 26, 36 AND 38).

CORY BOONE, EXAMINING ATTORNEY

SN 85-880,758. NICOTERA, AIMEE, GREAT BARRINGTON, MA. FILED 3-20-2013.

# Take 20!

SN 85-880,561. CIPEX INTERNATIONAL LIMITED, SANTA FE SPRINGS, CA. FILED 3-19-2013.

# PRO CLICK

THE MARK CONSISTS OF STANDARD CHARACTERS WITHOUT CLAIM TO ANY PARTICULAR FONT, STYLE, SIZE, OR COLOR.

FOR BAGS FOR CAMERAS AND PHOTOGRAPHIC EQUIPMENT (U.S. CLS. 21, 23, 26, 36 AND 38).

CORY BOONE, EXAMINING ATTORNEY

THE MARK CONSISTS OF STANDARD CHARACTERS WITHOUT CLAIM TO ANY PARTICULAR FONT, STYLE, SIZE, OR COLOR.

NO CLAIM IS MADE TO THE EXCLUSIVE RIGHT TO USE "20", APART FROM THE MARK AS SHOWN.

FOR DVDS FEATURING FITNESS WORKOUTS (U.S. CLS. 21, 23, 26, 36 AND 38).

JULIE GUTTADAURO, EXAMINING ATTORNEY

**CLASS 9—(Continued).**

SN 85-883,852. AVENTURA TECHNOLOGIES, INC., HAUPAUGE, NY. FILED 3-22-2013.

**Aventura Technologies**

THE MARK CONSISTS OF STANDARD CHARACTERS WITHOUT CLAIM TO ANY PARTICULAR FONT, STYLE, SIZE, OR COLOR.

NO CLAIM IS MADE TO THE EXCLUSIVE RIGHT TO USE "TECHNOLOGIES", APART FROM THE MARK AS SHOWN.

THE ENGLISH TRANSLATION OF "AVENTURA" IN THE MARK IS "ADVENTURE".

FOR CAMERA HARDWARE SYSTEMS FOR IP (INTERNET PROTOCOL) VIDEO SURVEILLANCE; CLOSED CIRCUIT TV SYSTEMS FOR SECURITY AND SURVEILLANCE, NAMELY, CAMERAS, SWITCHERS, MONITORS, MICROPHONES, AND RECORDERS; COMPUTER HARDWARE FOR IP VIDEO SURVEILLANCE; DIGITAL VIDEO RECORDING SOFTWARE FOR IP (INTERNET PROTOCOL) VIDEO SURVEILLANCE; ELECTRIC AND ELECTRONIC VIDEO SURVEILLANCE INSTALLATIONS; ELECTRONIC VIDEO SURVEILLANCE PRODUCTS, NAMELY, ELECTRONIC COMPONENTS OF SECURITY SYSTEMS; NETWORK VIDEO RECORDING SOFTWARE FOR IP (INTERNET PROTOCOL) VIDEO SURVEILLANCE (U.S. CLS. 21, 23, 26, 36 AND 38).

FIRST USE 12-1-2000; IN COMMERCE 12-1-2000.  
EDWARD NELSON, EXAMINING ATTORNEY

**CLASS 9—(Continued).**

SN 85-887,987. THE WILL-BURT COMPANY, ORRVILLE, OH. FILED 3-27-2013.



THE MARK CONSISTS OF A CAT DESIGN WITHIN A SHADED SQUARE-LIKE SHAPE.

FOR COMPUTER SOFTWARE, NAMELY, ACCESS CONTROL SOFTWARE FOR RESTRICTED PHYSICAL AREAS (U.S. CLS. 21, 23, 26, 36 AND 38).

DAVID BROOKSHIRE, EXAMINING ATTORNEY

SN 85-888,221. HBP, INC., FALLS CHURCH, VA. FILED 3-27-2013.

SN 85-886,263. KOPIN CORPORATION, WESTBOROUGH, MA. FILED 3-26-2013.

**PEARL**

THE MARK CONSISTS OF STANDARD CHARACTERS WITHOUT CLAIM TO ANY PARTICULAR FONT, STYLE, SIZE, OR COLOR.

FOR DISPLAY MODULES IN THE NATURE OF LCDS, COMPRISING MICRO-DISPLAY, BACKLIGHT AND OPTICS, SOLD AS COMPONENTS TO MANUFACTURERS OF NEAR-TO EYE VIEWING DEVICES (U.S. CLS. 21, 23, 26, 36 AND 38).

JAMES STEIN, EXAMINING ATTORNEY



NO CLAIM IS MADE TO THE EXCLUSIVE RIGHT TO USE "CONTENT KEY", APART FROM THE MARK AS SHOWN.

THE MARK CONSISTS OF THE WORDING "CONTENT-KEY" WITH SOUND WAVES ABOVE THE FIRST "T" IN "CONTENT".

FOR DOWNLOADABLE SOFTWARE APPLICATIONS FOR USE IN DIGITAL RIGHTS MANAGEMENT (U.S. CLS. 21, 23, 26, 36 AND 38).

FIRST USE 1-0-2013; IN COMMERCE 1-0-2013.  
ALLISON HOLTZ, EXAMINING ATTORNEY

**CLASS 9—(Continued).**

SN 85-893,647. STILWELL & ASSOCIATES OF THE USA, INC., CHESAPEAKE, VA. FILED 4-3-2013.

**TK PRO**

THE MARK CONSISTS OF STANDARD CHARACTERS WITHOUT CLAIM TO ANY PARTICULAR FONT, STYLE, SIZE, OR COLOR.

NO CLAIM IS MADE TO THE EXCLUSIVE RIGHT TO USE "PRO", APART FROM THE MARK AS SHOWN.

FOR COMPUTER SOFTWARE AND HARDWARE FOR CREATING SAFETY PERMITS, NAMELY, LOCKOUT-TAGOUT (LOTO), JOB HAZARD ANALYSIS (JSA) IN ALL THE INDUSTRIAL FIELDS, NAMELY, REFINING, MANUFACTURING, ENERGY/POWER ASSOCIATED WITH OSHA COMPLIANCE; COMPUTER SOFTWARE FOR CREATING SAFETY PERMITS, NAMELY, LOCKOUT-TAGOUT (LOTO), JOB HAZARD ANALYSIS (JSA) IN ALL THE INDUSTRIAL FIELDS, NAMELY, REFINING, MANUFACTURING, ENERGY/POWER ASSOCIATED WITH OSHA COMPLIANCE THAT MAY BE DOWNLOADED FROM A GLOBAL COMPUTER NETWORK (U.S. CLS. 21, 23, 26, 36 AND 38).

WILLIAM BRECKENFELD, EXAMINING ATTORNEY

SN 85-896,687. BONK, RON, LIVERPOOL, NY. AND RITTER, TIM, LEXINGTON, KY. FILED 4-5-2013.

**TRUTH OR DARE**

THE MARK CONSISTS OF STANDARD CHARACTERS WITHOUT CLAIM TO ANY PARTICULAR FONT, STYLE, SIZE, OR COLOR.

SEC. 2(F).

FOR DOWNLOADABLE FILMS AND MOVIES FEATURING HORROR AND/OR THRILLERS, COMEDY, DRAMA, ADVENTURE, ACTION AND/OR ANIMATION PROVIDED VIA A VIDEO-ON-DEMAND SERVICE; MOTION PICTURE FILMS ABOUT HORROR AND/OR THRILLERS, NAMELY HORROR AND/OR THRILLER CINEMA PRODUCTIONS FEATURING COMEDY, DRAMA, ADVENTURE, ACTION AND/OR ANIMATION; MOTION PICTURE FILMS FOR BROADCAST ON TELEVISION FEATURING COMEDY, DRAMA, ADVENTURE, ACTION AND/OR ANIMATION AND VIDEO AND DIGITAL VERSATILE DISCS FEATURING COMEDY, DRAMA, ADVENTURE, ACTION AND/OR ANIMATION (U.S. CLS. 21, 23, 26, 36 AND 38).

FIRST USE 0-0-1986; IN COMMERCE 0-0-1986.

JULIE WATSON, EXAMINING ATTORNEY

**CLASS 9—(Continued).**

SN 85-896,865. BIG TIME HOLDINGS, INC., ROME, GA. FILED 4-5-2013.

**MUD WARRIOR**

THE MARK CONSISTS OF STANDARD CHARACTERS WITHOUT CLAIM TO ANY PARTICULAR FONT, STYLE, SIZE, OR COLOR.

FOR ARTICLES OF PROTECTIVE CLOTHING FOR WEAR BY MOTORCYCLISTS FOR PROTECTION AGAINST ACCIDENT OR INJURY IN THE NATURE OF MOTORCYCLE GLOVES AND ALL-TERRAIN VEHICLE GLOVES (U.S. CLS. 21, 23, 26, 36 AND 38).

MICHAEL KEATING, EXAMINING ATTORNEY

SN 85-896,958. DISNEY ENTERPRISES, INC., BURBANK, CA. FILED 4-5-2013.

**FINDING DORY**

THE MARK CONSISTS OF STANDARD CHARACTERS WITHOUT CLAIM TO ANY PARTICULAR FONT, STYLE, SIZE, OR COLOR.

FOR APPARATUS FOR RECORDING, TRANSMISSION OR REPRODUCTION OF SOUND OR IMAGES; AUDIO BOOKS IN THE NATURE OF NOVELS; AUDIO RECORDINGS FEATURING MUSIC, STORIES, DRAMATIC PERFORMANCES, NON-DRAMATIC PERFORMANCES, LEARNING ACTIVITIES FOR CHILDREN, AND GAMES; DOWNLOADABLE RINGTONES AND SOUND RECORDINGS FEATURING MUSIC AND OTHER SOUNDS, ALL FOR WIRELESS COMMUNICATIONS DEVICES; AUDIO AND VISUAL RECORDINGS FEATURING LIVE-ACTION ENTERTAINMENT, ANIMATED ENTERTAINMENT, MUSIC, STORIES, AND GAMES FOR CHILDREN; MUSICAL RECORDINGS; VIDEO GAME SOFTWARE; COMPUTER GAME SOFTWARE AND COMPUTER GAME PROGRAMS; CONSUMER ELECTRONICS, NAMELY, COMPUTER SOFTWARE FEATURING LEARNING ACTIVITIES FOR CHILDREN, COMPUTER CHIPS, COMPUTER HARDWARE AND PERIPHERAL DEVICES, MOUSE PADS, WRIST AND ARM RESTS FOR USE WITH COMPUTERS, CALCULATORS, ELECTRICAL AND OPTICAL CABLES, ELECTRONIC PERSONAL ORGANIZER, PERSONAL DIGITAL ASSISTANTS, CAMCORDERS, CAMERAS, DIGITAL CAMERAS, OPTICAL AND MAGNETO-OPTICAL DISC PLAYERS AND RECORDERS FOR AUDIO, VIDEO AND COMPUTER DATA, RADIOS, TELEVISION SETS, AUDIO SPEAKERS, HEADPHONES, EARPHONES, WALKIE-TALKIES, TELEPHONES, VIDEOPHONES, HEAD SETS FOR CELLULAR TELEPHONES, ADAPTERS FOR CELLULAR TELEPHONES, BATTERIES FOR CELLULAR TELEPHONES, CASES FOR CELLULAR TELEPHONES, CELL PHONE FACEPLATES, EYEGLASSES, SUNGLASSES, EYEGLASS AND SUNGLASS CASES; BINOCULARS; DECORATIVE MAGNETS, GRADUATED RULERS (U.S. CLS. 21, 23, 26, 36 AND 38).

DORITT L. CARROLL, EXAMINING ATTORNEY

**CLASS 9—(Continued).**

SN 85-897,626. ANALOG DEVICES, INC., NORWOOD, MA. FILED 4-8-2013.



NO CLAIM IS MADE TO THE EXCLUSIVE RIGHT TO USE "AUTOMOTIVE AUDIO BUS", APART FROM THE MARK AS SHOWN.

THE MARK CONSISTS OF THE STYLIZED LETTERS "AB" WITH THE NUMBER "2" SUPERIMPOSED ON TOP ALL TO THE LEFT OF THE STYLIZED WORDS "AUTOMOTIVE AUDIO BUS", WITH A VERTICAL LINE IN BETWEEN "A2B" AND "AUTOMOTIVE".

FOR ELECTRICAL COMPONENTS IN THE NATURE OF SEMICONDUCTOR TRANSCIEVER DEVICES (U.S. CLS. 21, 23, 26, 36 AND 38).

JENNIFER DIXON, EXAMINING ATTORNEY

SN 85-898,778. HARPO, INC., CHICAGO, IL. FILED 4-9-2013.

**SUPER SOUL SUNDAY**

THE MARK CONSISTS OF STANDARD CHARACTERS WITHOUT CLAIM TO ANY PARTICULAR FONT, STYLE, SIZE, OR COLOR.

FOR DVD AND VIDEO RECORDINGS, SOLD INDIVIDUALLY OR AS A COLLECTION, FEATURING EPISODES FROM A TELEVISION SERIES IN THE FIELDS OF GENERAL INTEREST, HUMAN BEHAVIOR, RELATIONSHIPS, RELIGION, FAITH, SPIRITUALITY, WELLNESS AND CONSCIOUS LIVING, PERSONAL FULFILLMENT, PERSONAL GROWTH AND MOTIVATION (U.S. CLS. 21, 23, 26, 36 AND 38).

JOHN SCHUYLER YARD, EXAMINING ATTORNEY

SN 85-901,427. BARK BOOKS, AKA BARKBOOKS, IRVINE, CA. FILED 4-11-2013.

**BARKBOOKS**

THE MARK CONSISTS OF STANDARD CHARACTERS WITHOUT CLAIM TO ANY PARTICULAR FONT, STYLE, SIZE, OR COLOR.

FOR DOWNLOADABLE ELECTRONIC PUBLICATIONS IN THE NATURE OF BOOKS IN THE FIELD OF OF FICTION AND NON-FICTION ON A VARIETY OF TOPICS; DOWNLOADABLE ELECTRONIC PUBLICATIONS, NAMELY, WORKS OF FICTION AND NON-FICTION ON A VARIETY OF TOPICS WHICH ARE SHORTER THAN BOOK LENGTH; AUDIOBOOKS IN THE FIELDS OF FICTION AND NON-FICTION ON A VARIETY OF TOPICS; DOWNLOADABLE SOFTWARE IN THE NATURE OF MOBILE APPLICATIONS FOR READING, VIEWING, LISTENING TO OR INTERACTING WITH ELECTRONIC, DIGITAL, AUDIO, VIDEO OR MULTIMEDIA BOOKS; ELECTRONIC GAME SOFTWARE FOR WIRELESS DEVICES (U.S. CLS. 21, 23, 26, 36 AND 38).

FIRST USE 3-29-2013; IN COMMERCE 3-29-2013.  
CAROLYN CATALDO, EXAMINING ATTORNEY

**CLASS 9—(Continued).**

SN 85-905,686. COZYBIT, INC., DBA COZYBIT, SAN FRANCISCO, CA. FILED 4-16-2013.

**MESHBOARD**

THE MARK CONSISTS OF STANDARD CHARACTERS WITHOUT CLAIM TO ANY PARTICULAR FONT, STYLE, SIZE, OR COLOR.

FOR COMMUNICATIONS SOFTWARE FOR CONNECTING MOBILE PHONE DEVICES; COMPUTER APPLICATION SOFTWARE FOR MOBILE PHONES, NAMELY, SOFTWARE FOR THE COLLECTION, EDITING, ORGANIZING, MODIFYING, BOOK MARKING, TRANSMISSION, STORAGE AND SHARING OF DATA AND INFORMATION (U.S. CLS. 21, 23, 26, 36 AND 38).

CHRISTINA SOBRAL, EXAMINING ATTORNEY

SN 85-905,737. COZYBIT, INC., DBA COZYBIT, SAN FRANCISCO, CA. FILED 4-16-2013.

**MESHBRICK**

THE MARK CONSISTS OF STANDARD CHARACTERS WITHOUT CLAIM TO ANY PARTICULAR FONT, STYLE, SIZE, OR COLOR.

FOR COMMUNICATIONS SOFTWARE FOR CONNECTING MOBILE PHONE DEVICES; COMPUTER APPLICATION SOFTWARE FOR MOBILE PHONES, NAMELY, ELECTRONIC GAME SOFTWARE (U.S. CLS. 21, 23, 26, 36 AND 38).

CHRISTINA SOBRAL, EXAMINING ATTORNEY

SN 85-905,749. COZYBIT, INC., DBA COZYBIT, SAN FRANCISCO, CA. FILED 4-16-2013.

**MESHMOB**

THE MARK CONSISTS OF STANDARD CHARACTERS WITHOUT CLAIM TO ANY PARTICULAR FONT, STYLE, SIZE, OR COLOR.

FOR COMMUNICATIONS SOFTWARE FOR CONNECTING MOBILE PHONE DEVICES; COMPUTER APPLICATION SOFTWARE FOR MOBILE PHONES, NAMELY, SOFTWARE FOR CREATING VISUAL DIRECTORIES, ENABLING ELECTRONIC MESSAGING AND EXCHANGING CONTACT INFORMATION; COMPUTER APPLICATION SOFTWARE FOR MOBILE PHONES, NAMELY, SOFTWARE FOR THE COLLECTION, EDITING, ORGANIZING, MODIFYING, BOOK MARKING, TRANSMISSION, STORAGE AND SHARING OF DATA AND INFORMATION (U.S. CLS. 21, 23, 26, 36 AND 38).

CHRISTINA SOBRAL, EXAMINING ATTORNEY



**CLASS 9—(Continued).**

SN 85-909,461. RADWIN, LTD., TEL AVIV, ISRAEL, FILED 4-19-2013.

**FIBERINMOTION**

THE MARK CONSISTS OF STANDARD CHARACTERS WITHOUT CLAIM TO ANY PARTICULAR FONT, STYLE, SIZE, OR COLOR.

FOR WIRELESS CONNECTIVITY PRODUCTS, NAMELY, OUTDOOR TELECOMMUNICATIONS BASE STATIONS THAT DELIVER DATA FROM A SINGLE OUTDOOR BASE STATION UNIT, SUBSCRIBER UNITS WITH INTEGRATED OR CONNECTORIZED ANTENNAS FOR FIXED AND NOMADIC APPLICATIONS, RADIOS, ANTENNAS, AND SOFTWARE FOR EFFECTIVE COMMUNICATIONS OVER THE SUB-6 GHZ SPECTRUM IN LICENSED AND UNLICENSED BANDS (U.S. CLS. 21, 23, 26, 36 AND 38).

STEVEN JACKSON, EXAMINING ATTORNEY

---

SN 85-909,616. RADWIN, LTD., TEL AVIV, ISRAEL, FILED 4-19-2013.

**FIBERCLASS WIRELESS**

THE MARK CONSISTS OF STANDARD CHARACTERS WITHOUT CLAIM TO ANY PARTICULAR FONT, STYLE, SIZE, OR COLOR.

NO CLAIM IS MADE TO THE EXCLUSIVE RIGHT TO USE "WIRELESS", APART FROM THE MARK AS SHOWN.

FOR WIRELESS CONNECTIVITY PRODUCTS, NAMELY, OUTDOOR TELECOMMUNICATIONS BASE STATIONS THAT DELIVER DATA FROM A SINGLE OUTDOOR BASE STATION UNIT, SUBSCRIBER UNITS WITH INTEGRATED OR CONNECTORIZED ANTENNAS FOR FIXED AND NOMADIC APPLICATIONS, RADIOS, ANTENNAS, AND SOFTWARE FOR EFFECTIVE COMMUNICATIONS OVER THE SUB-6 GHZ SPECTRUM IN LICENSED AND UNLICENSED BANDS (U.S. CLS. 21, 23, 26, 36 AND 38).

STEVEN JACKSON, EXAMINING ATTORNEY

---

SN 85-912,987. ESPEY MFG. & ELECTRONICS CORP., SARATOGA SPRINGS, NY. FILED 4-24-2013.

**MAC STICK**

THE MARK CONSISTS OF STANDARD CHARACTERS WITHOUT CLAIM TO ANY PARTICULAR FONT, STYLE, SIZE, OR COLOR.

FOR POWER INVERTERS; POWER INVERTERS FOR USE IN VEHICLES TO POWER ELECTRONIC ACCESSORIES (U.S. CLS. 21, 23, 26, 36 AND 38).

TEJBIR SINGH, EXAMINING ATTORNEY

**CLASS 9—(Continued).**

SN 85-924,246. INVISITRACK, INC., ANNAPOLIS, MD. FILED 5-6-2013.

**polte**

THE MARK CONSISTS OF STANDARD CHARACTERS WITHOUT CLAIM TO ANY PARTICULAR FONT, STYLE, SIZE, OR COLOR.

FOR LOCATING AND TRACKING SYSTEMS, COMPRISING ELECTRONIC TRANSMITTERS, RECEIVERS, COMPUTER HARDWARE AND FIRMWARE, AND COMPUTER SOFTWARE, ALL FOR USE IN INDOOR AND OUTDOOR LOCATING AND TRACKING OF PERSONS, VEHICLES, OBJECTS AND ANIMALS (U.S. CLS. 21, 23, 26, 36 AND 38).

ELIZABETH KAJUBI, EXAMINING ATTORNEY

---

SN 85-924,722. ANKI, INC., SAN FRANCISCO, CA. FILED 5-6-2013.

**anki**

THE MARK CONSISTS OF THE WORD "ANKI" IN STYLIZED LETTERING.

THE ENGLISH TRANSLATION OF THE MARK IS "MEMORIZING".

FOR ROBOTS FOR PERSONAL, EDUCATIONAL, AND HOBBY USE, AND SOFTWARE FOR USE AND CONTROLLING AND OPERATING ROBOTS (U.S. CLS. 21, 23, 26, 36 AND 38).

ANDREW LEASER, EXAMINING ATTORNEY

**CLASS 9—(Continued).**

SN 85-926,254. TEAMSTUDIO, INC., BEVERLY, MA. FILED 5-8-2013.



THE MARK CONSISTS OF A STYLIZED ELECTRICAL PLUG DESIGN WITH THREE CURVED LINES, INCREASING IN LENGTH, EMANATING FROM THE PLUG.

FOR COMPUTER APPLICATION SOFTWARE FOR COMPUTERS AND MOBILE DEVICES, NAMELY, SOFTWARE FOR THE ELECTRONIC DISTRIBUTION AND STORAGE OF DATA AND PROVIDING FUNCTIONALITY AND ACCESS TO ELECTRONIC DATA (U.S. CLS. 21, 23, 26, 36 AND 38).

FIRST USE 5-3-2013; IN COMMERCE 5-3-2013.  
CAROL SPILS, EXAMINING ATTORNEY

SN 85-930,921. ANKI, INC., SAN FRANCISCO, CA. FILED 5-13-2013.

# ANKIDRIVE

THE MARK CONSISTS OF STANDARD CHARACTERS WITHOUT CLAIM TO ANY PARTICULAR FONT, STYLE, SIZE, OR COLOR.

THE ENGLISH TRANSLATION OF THE WORD "ANKI" IN THE MARK IS "MEMORIZING".

FOR ROBOTS FOR PERSONAL, EDUCATIONAL, AND HOBBY USE, AND SOFTWARE FOR USE AND CONTROLLING AND OPERATING ROBOTS (U.S. CLS. 21, 23, 26, 36 AND 38).

ANDREW LEASER, EXAMINING ATTORNEY

**CLASS 9—(Continued).**

SN 85-933,590. PLAIN LLC, CARBONDALE, PA. FILED 5-16-2013.

# BARLEY

THE MARK CONSISTS OF STANDARD CHARACTERS WITHOUT CLAIM TO ANY PARTICULAR FONT, STYLE, SIZE, OR COLOR.

FOR COMPUTER SOFTWARE THAT PROVIDES WEB-BASED ACCESS TO APPLICATIONS AND SERVICES THROUGH A WEB OPERATING SYSTEM OR PORTAL INTERFACE (U.S. CLS. 21, 23, 26, 36 AND 38).

FIRST USE 2-12-2013; IN COMMERCE 5-1-2013.  
TOBY BULLOFF, EXAMINING ATTORNEY

SN 85-938,101. KENNETH MOBLEY BRICE, ATLANTA, GA. FILED 5-21-2013.

# LEE BRICE

THE MARK CONSISTS OF STANDARD CHARACTERS WITHOUT CLAIM TO ANY PARTICULAR FONT, STYLE, SIZE, OR COLOR.

THE NAME(S), PORTRAIT(S), AND/OR SIGNATURE(S) SHOWN IN THE MARK IDENTIFIES KENNETH MOBLEY BRICE, PROFESSIONALLY KNOWN AS "LEE BRICE", WHOSE CONSENT(S) TO REGISTER IS MADE OF RECORD.

FOR SOUND RECORDINGS AND AUDIOVISUAL RECORDINGS FEATURING MUSIC AND MUSIC ENTERTAINMENT (U.S. CLS. 21, 23, 26, 36 AND 38).

FIRST USE 6-8-2010; IN COMMERCE 6-8-2010.  
ALICIA COLLINS, EXAMINING ATTORNEY

SN 85-944,442. SPI/SEMICON, FULLERTON, CA. FILED 5-28-2013.

# SEMICON

THE MARK CONSISTS OF STANDARD CHARACTERS WITHOUT CLAIM TO ANY PARTICULAR FONT, STYLE, SIZE, OR COLOR.

SEC. 2(F).

FOR PACKAGING TRAYS, BOXES, COVERS, CUSHIONS, TUBES, AND END PLUGS ESPECIALLY ADAPTED FOR SHIPPING AND STORAGE OF SEMICONDUCTOR WAFERS AND EQUIPMENT (U.S. CLS. 21, 23, 26, 36 AND 38).

FIRST USE 10-23-1970; IN COMMERCE 10-23-1970.  
PAULA MAHONEY, EXAMINING ATTORNEY

**CLASS 9—(Continued).**

SN 85-945,313. INTERNATIONAL GAMING PROJECTS LIMITED, VALLETTA VLT, MALTA, FILED 5-29-2013.



OWNER OF U.S. REG. NO. 4,255,537.  
NO CLAIM IS MADE TO THE EXCLUSIVE RIGHT TO USE "CASH", APART FROM THE MARK AS SHOWN.

THE COLOR(S) PURPLE, BLACK AND WHITE IS/ARE CLAIMED AS A FEATURE OF THE MARK.

THE MARK CONSISTS OF THE WORD "ORTIZ" IN PURPLE LETTERS OUTLINED IN BLACK AND THE WORD "CASH" TO THE RIGHT IN WHITE LETTERS, OUTLINED IN BLACK INSIDE A PURPLE OVAL ALSO OUTLINED IN BLACK.

FOR SOFTWARE FOR DATA PROCESSING, PLAYING AND OPERATING BINGO GAMES, MANAGING COMMUNICATION TO THE SLOT MACHINES AND CASHIER DESKS AND DATA PROCESSING EQUIPMENT; NETWORK MANAGEMENT CONTROL APPARATUS, NAMELY, COMPUTER SOFTWARE, COMPUTER NETWORK ADAPTERS, NETWORK ROUTERS, GATEWAY ROUTERS IN THE NATURE OF COMPUTER CONTROL HARDWARE, VPN (VIRTUAL PRIVATE NETWORK) HARDWARE, COMPUTER SOFTWARE IN THE NATURE OF A WIRELESS ACCESS POINT (WAP) DEVICE; FINANCIAL MANAGEMENT SOFTWARE (U.S. CLS. 21, 23, 26, 36 AND 38).

ZACHARY BELLO, EXAMINING ATTORNEY

**CLASS 9—(Continued).**

SN 85-947,018. LI YING, SHENZHEN, GUANGDONG, CHINA, AND DU ZEHAI, SHENZHEN, GUANGDONG, CHINA, FILED 5-31-2013.



THE MARK CONSISTS OF THE WORDING "WEIZE", TWO CHINESE CHARACTERS WHICH ARE PRONOUNCED "WEIZE", WHICH HAS NO MEANING IN A FOREIGN LANGUAGE, AND A DESIGN OF A PARTIALLY SHADED CIRCLE WITH THREE STARS.

THE WORDING "WEIZE" HAS NO MEANING IN A FOREIGN LANGUAGE.

THE NON-LATIN CHARACTERS IN THE MARK TRANSLITERATE TO "WEIZE" AND THIS HAS NO MEANING IN A FOREIGN LANGUAGE.

FOR CASES FOR PHOTOGRAPHIC APPARATUS; CHARGERS FOR ELECTRIC BATTERIES; COMPUTER PERIPHERAL DEVICES; ELECTRIC LIGHT DIMMERS; ELECTRIC SWITCHES; ELECTRONIC ANTI-THEFT SYSTEM COMPRISED OF A BAR CODE SCANNER THAT ALLOWS MANUFACTURERS TO TEMPORARILY DISABLE ELECTRONIC GOODS DURING THE MANUFACTURING PROCESS AND ALLOWS RETAILERS TO ENABLE SUCH GOODS UPON RECEIVING THE PURCHASE PRICE FOR THE GOODS; ELECTRONIC MONITORS AND MONITOR MODULES FOR MONITORING ELECTRIC CURRENT AND ELECTRICAL SIGNALS; ELECTRONIC MONITORS FOR MONITORING FLOWMETERS; PARTS FOR ANTI-THEFT AUTOMOTIVE ALARMS, NAMELY, ELECTRONIC SENSORS, REMOTE CONTROL TRANSMITTERS AND RECEIVERS FOR REMOTELY OPERATING LAND VEHICLES; PORTABLE TELEPHONES; TRANSMITTERS OF ELECTRONIC SIGNALS; VIDEO SCREENS (U.S. CLS. 21, 23, 26, 36 AND 38).

FIRST USE 6-12-2012; IN COMMERCE 12-17-2012.

ANNE MADDEN, EXAMINING ATTORNEY

**CLASS 9—(Continued).**

SN 85-948,809. VANAIA LLC, NEW YORK, NY. FILED 6-3-2013.

# VANAIA

THE MARK CONSISTS OF STANDARD CHARACTERS WITHOUT CLAIM TO ANY PARTICULAR FONT, STYLE, SIZE, OR COLOR.

THE WORD "VANAIA" IS A SYNONYM FOR "VANAJA". "VANAJA" IS A HINDI FEMALE NAME FOR A "DAUGHTER OF THE FOREST".

FOR COMPUTER SOFTWARE FOR CAPTURING, SCANNING, ORGANIZING, SEARCHING, INDEXING, STORING, RECOGNIZING, SHARING, TRANSMITTING, MANIPULATING, EDITING AND DISPLAYING DIGITAL FILES AND DOCUMENTS FOR INTERACTIVE RESPONSE SYSTEM (IRS); COMPUTER SOFTWARE FOR MANAGING SURVEYS AND QUESTIONNAIRES FOR USE IN THE FIELD OF ELECTIONS, BALLOTING AND VOTING; COMPUTER SOFTWARE FOR MANAGING DAILY ACTIVITIES, RESOURCES, RESERVATIONS, CUSTOMERS, CALENDAR AND ADDRESS BOOK; COMPUTER SOFTWARE FOR BOOKING OF SERVICES, FOR MAKING RESERVATIONS, FOR SCHEDULING AND FOR RESOURCE ALLOCATION AND OPTIMIZATION, AND THAT MAY ALL BE DOWNLOADED FROM A GLOBAL COMPUTER NETWORK (U.S. CLS. 21, 23, 26, 36 AND 38).

KATHERINE STOIDES, EXAMINING ATTORNEY

---

SN 85-949,690. VERTO MEDICAL SOLUTIONS, LLC, DBA YURBUDS, ST. LOUIS, MO. FILED 6-3-2013.

# YURFIT

THE MARK CONSISTS OF STANDARD CHARACTERS WITHOUT CLAIM TO ANY PARTICULAR FONT, STYLE, SIZE, OR COLOR.

FOR WEARABLE ELECTRONIC DEVICES INCORPORATING A MICROPROCESSOR FOR MONITORING AND REPORTING NUTRITION, HEALTH, FITNESS AND ACTIVITY DATA, FOR RECREATION, FITNESS AND TRAINING PURPOSES (U.S. CLS. 21, 23, 26, 36 AND 38).

JOHN SCHUYLER YARD, EXAMINING ATTORNEY

**CLASS 9—(Continued).**

SN 85-949,698. VERTO MEDICAL SOLUTIONS, LLC, DBA YURBUDS, ST. LOUIS, MO. FILED 6-4-2013.

# GO

THE MARK CONSISTS OF STANDARD CHARACTERS WITHOUT CLAIM TO ANY PARTICULAR FONT, STYLE, SIZE, OR COLOR.

FOR WEARABLE ELECTRONIC DEVICES INCORPORATING A MICROPROCESSOR FOR MONITORING AND REPORTING NUTRITION, HEALTH, FITNESS AND ACTIVITY DATA, FOR RECREATION, FITNESS AND TRAINING PURPOSES (U.S. CLS. 21, 23, 26, 36 AND 38).

JOHN SCHUYLER YARD, EXAMINING ATTORNEY

---

SN 85-949,701. VERTO MEDICAL SOLUTIONS, LLC, DBA YURBUDS, ST. LOUIS, MO. FILED 6-4-2013.

# GO BAND

THE MARK CONSISTS OF STANDARD CHARACTERS WITHOUT CLAIM TO ANY PARTICULAR FONT, STYLE, SIZE, OR COLOR.

NO CLAIM IS MADE TO THE EXCLUSIVE RIGHT TO USE "BAND", APART FROM THE MARK AS SHOWN.

FOR WEARABLE ELECTRONIC DEVICES INCORPORATING A MICROPROCESSOR FOR MONITORING AND REPORTING NUTRITION, HEALTH, FITNESS AND ACTIVITY DATA, FOR RECREATION, FITNESS AND TRAINING PURPOSES (U.S. CLS. 21, 23, 26, 36 AND 38).

JOHN SCHUYLER YARD, EXAMINING ATTORNEY

---

SN 85-950,318. MITSUBISHI ELECTRIC CORPORATION, TOKYO, JAPAN, FILED 6-4-2013.

# i-GCB

THE MARK CONSISTS OF STANDARD CHARACTERS WITHOUT CLAIM TO ANY PARTICULAR FONT, STYLE, SIZE, OR COLOR.

FOR GAS CIRCUIT BREAKERS (U.S. CLS. 21, 23, 26, 36 AND 38).

REGINA DRUMMOND, EXAMINING ATTORNEY

**CLASS 9—(Continued).**

SN 85-950,650. DIAMOND DATA SYSTEMS, INC., DBA PREMIER DATA SYSTEMS, RICHARDSON, TX. FILED 6-4-2013.

**CLASS 9—(Continued).**

SN 85-955,352. PAUL FRANK INDUSTRIES LLC, LOS ANGELES, CA. FILED 6-10-2013.



NO CLAIM IS MADE TO THE EXCLUSIVE RIGHT TO USE "UNIFORM", APART FROM THE MARK AS SHOWN.

THE COLOR(S) BLUE, WHITE AND BLACK IS/ARE CLAIMED AS A FEATURE OF THE MARK.

THE MARK CONSISTS OF FIVE BLUE AND WHITE SHADED QUADRILATERALS, ONE HORIZONTAL AND ON THE TOP, THREE VERTICAL IN THE MIDDLE, AND ONE HORIZONTAL ON THE BOTTOM, FASHIONED TO LOOK LIKE A "T", "U", AND AN "S". THE ONE ON TOP IS A TRAPEZOID WITH ONE SLANTED SIDE AND ONE STRAIGHT SIDE. THE ONE ON BOTTOM IS A 180 DEGREE ROTATION OF THIS SAME TRAPEZOID. THE THREE QUADRILATERALS IN THE MIDDLE OF THE SHAPE ARE OF DIFFERENT SIZES. THE ONE THAT IS THE FARTHEST UP IS ON THE LEFT AND IS THE SAME SIZE AS THE ONE THAT IS ON THE BOTTOM RIGHT. THE MIDDLE ONE CONNECTS THE BOTTOM AND TOP TRAPEZOID. TO THE RIGHT OF THE QUADRILATERALS APPEARS THE UPPERCASE BLACK WORDING "THE UNIFORM SOLUTION". THE WORDS "THE UNIFORM" ARE ON TOP OF THE WORD "SOLUTION" AND THE WORDS "UNIFORM SOLUTION" ARE IN BOLDFACE.

FOR ELECTRONIC EQUIPMENT FOR POINT-OF-SALES (POS) SYSTEMS, NAMELY, COMPUTER OPERATING SOFTWARE FOR POINT-OF-SALES SYSTEMS (U.S. CLS. 21, 23, 26, 36 AND 38).

FIRST USE 10-3-2012; IN COMMERCE 10-3-2012.  
EDWARD FENNESSY, EXAMINING ATTORNEY

OWNER OF U.S. REG. NOS. 2,325,420, 3,240,161 AND OTHERS.

THE COLOR(S) BLACK, BEIGE, RED AND PINK IS/ARE CLAIMED AS A FEATURE OF THE MARK.

THE MARK CONSISTS OF A BEIGE WIDE MOUTH SMILING MONKEY WITH A BLACK OUTLINE AROUND THE HEAD AND EARS, BLACK EYES, A BLACK NOSE, AND A RED MOUTH WITH A PINK TONGUE.

FOR VIDEO GAME CARTRIDGES, CASSETTES, DISCS AND TAPES; COMPUTER GAME PROGRAMS, CARTRIDGES AND DISCS; DOWNLOADABLE COMPUTER GAME PROGRAMS; INTERACTIVE GAME PROGRAMS; INTERACTIVE GAME SOFTWARE; VIDEO GAMES FOR MOBILE DEVICES, PERSONAL COMPUTERS, CONSOLES, AND TABLETS; DOWNLOADABLE ELECTRONIC GAME PROGRAMS; ELECTRONIC GAME SOFTWARE; CINEMATOGRAPHIC APPARATUS; PROTECTIVE CARRYING CASES SPECIFICALLY ADAPTED FOR WIRELESS TELEPHONES, MP3 PLAYERS, DIGITAL CAMERAS, PERSONAL DIGITAL ASSISTANTS AND HANDHELD COMPUTERS; CAMERAS; DIGITAL CAMERAS; PRERECORDED DVDS FEATURING ANIMATED ENTERTAINMENT FOR CHILDREN AND MUSIC; DOWNLOADABLE AUDIO AND VIDEO RECORDINGS FEATURING MUSIC AND CHILDREN'S ANIMATED ENTERTAINMENT; EYEWEAR, NAMELY, SUNGLASSES, EYEGASSES AND OPHTHALMIC FRAMES AND CASES THEREFORE; AND EYEWEAR ACCESSORIES, NAMELY, STRAPS, NECK CORDS AND HEAD STRAPS WHICH RESTRAIN EYEWEAR FROM MOVEMENT ON A WEARER (U.S. CLS. 21, 23, 26, 36 AND 38).

MATTHEW MCDOWELL, EXAMINING ATTORNEY

**CLASS 9—(Continued).**

SN 85-956,451. BAY VALLEY PARTS, INC, FREMONT, CA.  
FILED 6-11-2013.



NO CLAIM IS MADE TO THE EXCLUSIVE RIGHT TO USE "PARTS", APART FROM THE MARK AS SHOWN.

THE MARK CONSISTS OF A POWER SUPPLY SIGN INSIDE A SQUARE AND THE TEXT "BAY VALLEY PARTS" CENTERED BELOW.

FOR BATTERY PACKS FOR LAPTOPS; POWER ADAPTERS (U.S. CLS. 21, 23, 26, 36 AND 38).

FIRST USE 4-1-2012; IN COMMERCE 4-1-2012.

FLORENTINA BLANDU, EXAMINING ATTORNEY

SN 85-957,347. HOMETOWN GAMES LLC, MAYNARD, MA.  
FILED 6-12-2013.

## HomeTown Games

THE MARK CONSISTS OF STANDARD CHARACTERS WITHOUT CLAIM TO ANY PARTICULAR FONT, STYLE, SIZE, OR COLOR.

NO CLAIM IS MADE TO THE EXCLUSIVE RIGHT TO USE "GAMES", APART FROM THE MARK AS SHOWN.

FOR COMPUTER GAME SOFTWARE (U.S. CLS. 21, 23, 26, 36 AND 38).

HEATHER SAPP, EXAMINING ATTORNEY

**CLASS 9—(Continued).**

SN 85-957,495. C & L ENTERPRISES, INC. OF GREENVILLE,  
DBA SACREDSHEETMUSIC.COM, PICKENS, SC. FILED  
6-12-2013.

## iObserveU

THE MARK CONSISTS OF STANDARD CHARACTERS WITHOUT CLAIM TO ANY PARTICULAR FONT, STYLE, SIZE, OR COLOR.

FOR MOBILE SOFTWARE APPLICATION FOR TABLET COMPUTERS TO EVALUATE TEACHERS AND TEACHER CANDIDATES; TEACHER CANDIDATES ARE DEFINED AS COLLEGE OR UNIVERSITY STUDENTS THAT ARE PURSUING AN EDUCATION DEGREE THAT WOULD ULTIMATELY LEAD TO TEACHER CERTIFICATION (U.S. CLS. 21, 23, 26, 36 AND 38).

FIRST USE 8-5-2012; IN COMMERCE 8-25-2012.

DAVID HOFFMAN, EXAMINING ATTORNEY

SN 85-958,320. DREAMBOX LEARNING, INC., BELLEVUE,  
WA. FILED 6-12-2013.

## DREAMBOX LEARNING

THE MARK CONSISTS OF STANDARD CHARACTERS WITHOUT CLAIM TO ANY PARTICULAR FONT, STYLE, SIZE, OR COLOR.

OWNER OF U.S. REG. NOS. 3,534,834, 4,264,245 AND OTHERS.

NO CLAIM IS MADE TO THE EXCLUSIVE RIGHT TO USE "LEARNING", APART FROM THE MARK AS SHOWN.

FOR CHILDREN'S EDUCATIONAL SOFTWARE AND COMPUTER GAME SOFTWARE FEATURING INSTRUCTION AT THE PRE-SCHOOL, PRIMARY, SECONDARY, COLLEGE, GRADUATE AND POST-GRADUATE LEVEL AND FOR GENERATING PROGRESS REPORTS RELATED THERETO; EDUCATIONAL SOFTWARE AND COMPUTER GAME SOFTWARE BOTH FEATURING MATHEMATICS INSTRUCTION FOR THE PRE-SCHOOL, PRIMARY, SECONDARY, COLLEGE, GRADUATE AND POST-GRADUATE LEVEL AND FOR GENERATING PROGRESS REPORTS RELATED THERETO; COMPUTER SOFTWARE FOR MOBILE PHONES, MOBILE COMPUTERS, MOBILE PERSONAL DIGITAL ASSISTANTS, PORTABLE MEDIA PLAYERS, MOBILE DIGITAL BOOK READERS AND TABLET COMPUTERS FOR CREATING, MODIFYING AND VIEWING EDUCATIONAL AND INSTRUCTIONAL LESSONS PLANS; COMPUTER SOFTWARE FOR MOBILE PHONES, MOBILE COMPUTERS, MOBILE PERSONAL DIGITAL ASSISTANTS, PORTABLE MEDIA PLAYERS, MOBILE DIGITAL BOOK READERS AND TABLET COMPUTERS FOR DOWNLOADING, CREATING, MODIFYING AND VIEWING EDUCATIONAL AND INSTRUCTIONAL MULTIMEDIA INFORMATION AND VIDEOS; COMPUTER SOFTWARE FOR ALIGNING EDUCATIONAL AND INSTRUCTIONAL OBJECTIVES AND LESSONS WITH STATE CURRICULUM STANDARDS, ANALYZING STATE MANDATED SCHOOL ASSESSMENTS, BENCHMARKING STUDENT PROGRESS ASSESSMENTS AND TRANSMITTING AND SHARING ELECTRONIC LESSON PLANS; COMPUTER SOFTWARE FOR PREDICTING FUTURE EDUCATIONAL PERFORMANCE OF STUDENTS (U.S. CLS. 21, 23, 26, 36 AND 38).

DAVID YONTEF, EXAMINING ATTORNEY

**CLASS 9—(Continued).**

SN 85-958,330. DREAMBOX LEARNING, INC., BELLEVUE, WA. FILED 6-12-2013.



OWNER OF U.S. REG. NOS. 4,264,245 AND 4,264,280.  
THE MARK CONSISTS OF A LOWERCASE LETTER "D" IN STYLIZED FONT.

FOR CHILDREN'S EDUCATIONAL SOFTWARE AND COMPUTER GAME SOFTWARE FEATURING INSTRUCTION AT THE PRE-SCHOOL, PRIMARY, SECONDARY, COLLEGE, GRADUATE AND POST-GRADUATE LEVEL AND FOR GENERATING PROGRESS REPORTS RELATED THERETO; EDUCATIONAL SOFTWARE AND COMPUTER GAME SOFTWARE BOTH FEATURING MATHEMATICS INSTRUCTION FOR THE PRE-SCHOOL, PRIMARY, SECONDARY, COLLEGE, GRADUATE AND POST-GRADUATE LEVEL AND FOR GENERATING PROGRESS REPORTS RELATED THERETO; COMPUTER SOFTWARE FOR MOBILE PHONES, MOBILE COMPUTERS, MOBILE PERSONAL DIGITAL ASSISTANTS, PORTABLE MEDIA PLAYERS, MOBILE DIGITAL BOOK READERS AND TABLET COMPUTERS FOR CREATING, MODIFYING AND VIEWING EDUCATIONAL AND INSTRUCTIONAL LESSONS PLANS; COMPUTER SOFTWARE FOR MOBILE PHONES, MOBILE COMPUTERS, MOBILE PERSONAL DIGITAL ASSISTANTS, PORTABLE MEDIA PLAYERS, MOBILE DIGITAL BOOK READERS AND TABLET COMPUTERS FOR DOWNLOADING, CREATING, MODIFYING AND VIEWING EDUCATIONAL AND INSTRUCTIONAL MULTIMEDIA INFORMATION AND VIDEOS; DOWNLOADABLE VIDEO RECORDINGS FEATURING EDUCATIONAL INSTRUCTION IN THE FIELD OF MATHEMATICS AND INFORMATION ABOUT EDUCATION; COMPUTER SOFTWARE FOR ALIGNING EDUCATIONAL AND INSTRUCTIONAL OBJECTIVES AND LESSONS WITH STATE CURRICULUM STANDARDS, ANALYZING STATE MANDATED SCHOOL ASSESSMENTS, BENCHMARKING STUDENT PROGRESS ASSESSMENTS AND TRANSMITTING AND SHARING ELECTRONIC LESSON PLANS; COMPUTER SOFTWARE FOR PREDICTING FUTURE EDUCATIONAL PERFORMANCE OF STUDENTS (U.S. CLS. 21, 23, 26, 36 AND 38).  
DAVID YONTEF, EXAMINING ATTORNEY

**CLASS 9—(Continued).**

SN 86-001,790. HEWLETT-PACKARD DEVELOPMENT COMPANY, L.P., HOUSTON, TX. FILED 7-3-2013.

# ENVY ROVE

THE MARK CONSISTS OF STANDARD CHARACTERS WITHOUT CLAIM TO ANY PARTICULAR FONT, STYLE, SIZE, OR COLOR.

OWNER OF U.S. REG. NO. 3,641,673.  
FOR COMPUTERS, PERSONAL COMPUTERS, ALL-IN-ONE COMPUTERS (U.S. CLS. 21, 23, 26, 36 AND 38).  
ROSELLE HERRERA, EXAMINING ATTORNEY

SN 86-004,687. IMERSER TECHNOLOGIES INC, TORONTO, CANADA, FILED 7-8-2013.



THE COLOR(S) RED AND WHITE IS/ARE CLAIMED AS A FEATURE OF THE MARK.

THE MARK CONSISTS OF THE RED, STYLIZED LETTER "I" WITH A RED, CURVED LINE COMING OFF THE BASE OF THE LETTER; IMMEDIATELY TO THE RIGHT OF THE LETTER "I" APPEARS THE WHITE, STYLIZED TERM "MERSER" THAT INCLUDES A HORIZONTAL LINE RUNNING THROUGH ALL OF THE LETTERS EXCEPT THE LETTER "S"; AN OUTLINE OF AN EXPLOSION APPEARS BEHIND THE LETTER "S"; THE COLOR BLACK IS NOT CLAIMED AS PART OF THE MARK AND SERVES AS ONLY BACKGROUND COLOR AND FOR TRANSPARENCY PURPOSES.

FOR INTERACTIVE COMPUTER HARDWARE, COMPUTER PERIPHERALS, AND COMPUTER OPERATING SOFTWARE, FOR USE IN DISPLAYING BUSINESS MARKETING AND INFORMATION AT TRADE SHOWS AND CORPORATE EVENTS (U.S. CLS. 21, 23, 26, 36 AND 38).

FIRST USE 6-30-2012; IN COMMERCE 6-30-2012.  
CHRISTOPHER BUONGIORNO, EXAMINING ATTORNEY

**CLASS 9—(Continued).**

SN 86-006,306. DANFOSS A/S, DK- 6430 NORDORG, DENMARK, FILED 7-10-2013.

# QLX

THE MARK CONSISTS OF STANDARD CHARACTERS WITHOUT CLAIM TO ANY PARTICULAR FONT, STYLE, SIZE, OR COLOR.

PRIORITY CLAIMED UNDER SEC. 44(D) ON ERPN CMNTY TM OFC APPLICATION NO. 011955382, FILED 7-4-2013, REG. NO. 011955382, DATED 11-28-2013, EXPIRES 7-4-2023.

FOR INVERTERS; PHOTOVOLTAIC INVERTERS; INVERTERS FOR TRANSFORMING SOLAR ENERGY TO ELECTRICITY; PHOTOVOLTAIC INSTALLATION APPARATUS, NAMELY, SOLAR MODULES FOR PRODUCTION OF ELECTRICITY, SOLAR THERMAL AND ELECTRICAL RECEIVERS, TRACKING MECHANISMS AND CONCENTRATING OPTICS, AND CONTROL ALGORITHMS (U.S. CLS. 21, 23, 26, 36 AND 38).

MARLENE BELL, EXAMINING ATTORNEY

---

SN 86-007,438. CSAM MARKETING, INC., SOMERVILLE, NJ, FILED 7-11-2013.

## CLASS COMPETE

THE MARK CONSISTS OF STANDARD CHARACTERS WITHOUT CLAIM TO ANY PARTICULAR FONT, STYLE, SIZE, OR COLOR.

FOR COMPUTER SOFTWARE, NAMELY, EDUCATIONAL COMPUTER SOFTWARE FOR THE PURPOSE OF CONTENT TRANSMISSION, DATABASE MANAGEMENT, DATA ANALYTICS, INFORMATION SHARING AND ANALYSIS, IN THE FIELD EDUCATION, TESTING ADMINISTRATION, SCORING AND ASSESSING PERFORMANCE ON GRADE SCHOOL AND HIGH SCHOOL EDUCATIONAL TASKS (U.S. CLS. 21, 23, 26, 36 AND 38).

FIRST USE 12-5-2013; IN COMMERCE 12-5-2013.  
INGRID C. EULIN, EXAMINING ATTORNEY

---

SN 86-008,754. OMAR COLON, CHARLESTON, SC. AND JAMES NELSON, MARIETTA, GA. FILED 7-12-2013.

## POETRY THIEVES

THE MARK CONSISTS OF STANDARD CHARACTERS WITHOUT CLAIM TO ANY PARTICULAR FONT, STYLE, SIZE, OR COLOR.

FOR DIGITAL MUSIC DOWNLOADABLE FROM THE INTERNET; MUSICAL SOUND RECORDINGS; PRE-RECORDED CDS FEATURING MUSIC; PRE-RECORDED ELECTRONIC AND DIGITAL MEDIA FEATURING MUSIC (U.S. CLS. 21, 23, 26, 36 AND 38).

INGRID C. EULIN, EXAMINING ATTORNEY

**CLASS 9—(Continued).**

SN 86-008,798. MIND PLUS SP. Z.O.O, KRAKOW, POLAND, FILED 7-12-2013.

# MIND PLUS

THE MARK CONSISTS OF STANDARD CHARACTERS WITHOUT CLAIM TO ANY PARTICULAR FONT, STYLE, SIZE, OR COLOR.

NO CLAIM IS MADE TO THE EXCLUSIVE RIGHT TO USE "MIND", APART FROM THE MARK AS SHOWN.

FOR BRAIN MACHINE INTERFACE PRODUCTS, NAMELY, BRAIN MACHINE INTERFACE (BMI) SENSORS AND HEADSETS COMPRISED OF BRAIN MACHINE INTERFACE (BMI) SENSORS FOR MEASURING HUMAN HEAD BIO-SIGNALS FOR EDUCATION, COMPUTER GAMING, AND SCIENTIFIC PURPOSES; COMPUTER SOFTWARE FOR USE IN THE INTERPRETATION OF NEURO AND BRAIN-SCANS (U.S. CLS. 21, 23, 26, 36 AND 38).

RENEE MCCRAY, EXAMINING ATTORNEY

---

SN 86-009,900. ELECOM CO., LTD., OSAKA-SHI, OSAKA, JAPAN, FILED 7-15-2013.

# ELECOM

THE MARK CONSISTS OF THE WORDING "ELECOM" IN STYLIZED FONT.

FOR COMPUTER ELECTRONIC PRODUCTS, NAMELY, COMPUTER MICE, MOUSE PADS, WRIST RESTS FOR USE WITH COMPUTERS, MEMORY CARDS, READING AND WRITING DEVICES FOR MEMORY CARDS, NAMELY, MEMORY CARD READERS AND WRITERS, SPEAKERS FOR HANDHELD DEVICES, HEADPHONES, EARPHONES, HEAD SETS FOR TELEPHONE, MOBILE PHONE, PORTABLE MUSIC PLAYER, TELEVISION, VIDEO CAMERA, AND FOR USE WITH COMPUTERS; MICROPHONES, SMARTPHONE STANDS AND TOUCH PENS FOR SMARTPHONES; COMPUTER APPLICATION SOFTWARE FOR SMART PHONES, MOBILE PHONES AND HAND HELD DEVICES, NAMELY, SOFTWARE DOWNLOADS FOR SCHEDULING, TEXT EDITING, WEB CONFERENCING, DATA MANAGEMENT, QR CODE READERS, INPUTTING HANDWRITTEN CHARACTERS, WEB BROWSING, CAMERA PRESETS, ALARMS, CREATING AVATARS, MAKING AND ARRANGING LABELS AND CARDS, TAKING, SHARING, EDITING, TRANSMITTING, AND ARRANGING PHOTOS AND PLAYING



**CLASS 9—(Continued).**

MUSIC, WALLPAPER ACCESSORIES, REALLY SIMPLE SYNDICATION (RSS) FEEDS, DIARY CUSTOMIZATION, SCRAPBOOKING AND LINKING TO SOCIAL NETWORKING SERVICES (SNS); CARRYING CASES FOR CONSUMER ELECTRONIC EQUIPMENT, NAMELY, LAPTOP PERSONAL COMPUTERS, TABLET PCS, CELL PHONES, SMARTPHONES, PORTABLE DIGITAL AUDIO PLAYERS, DIGITAL CAMERAS, OPTICAL, MAGNETO-OPTICAL OR MAGNETIC DISCS, TELEPHONES, ELECTRONIC DICTIONARIES, MEMORY CARDS, HARD DISC DRIVES FOR COMPUTERS, PORTABLE CD/DVD DRIVES AND COMPUTER MICE; COVERS FOR TABLET PCS, LAPTOP PERSONAL COMPUTERS AND PRINTERS FOR COMPUTERS; BAGS FOR TABLET PC AND LAPTOP PERSONAL COMPUTERS; PROTECTIVE FILMS FOR LCD DISPLAYS; ELECTRIC BATTERIES; LIGHT-EMITTING DIODE LIGHTS; ALL OF THE FOREGOING BEING FOR SALE DIRECTLY TO CONSUMERS AND NOT SOLD AS PARTS TO ORIGINAL EQUIPMENT MANUFACTURERS (U.S. CLS. 21, 23, 26, 36 AND 38).

FIRST USE 10-0-1997; IN COMMERCE 0-0-2006.  
JENNIFER MARTIN, EXAMINING ATTORNEY

---

SN 86-011,568. TOPSONIC INC., EL MONTE, CA. FILED 7-16-2013.

# TOPZONE

THE MARK CONSISTS OF STANDARD CHARACTERS WITHOUT CLAIM TO ANY PARTICULAR FONT, STYLE, SIZE, OR COLOR.

FOR ANTENNA; ANTENNAS FOR RADIO, FOR TELEVISION; AUDIO SPEAKERS; AUDIO-VIDEO RECEIVERS; CABLE CONNECTORS; CABLE TELEVISION CONVERTERS; CAR CASSETTE PLAYERS; CD CASES; CD PLAYERS; CD STORAGE RACKS; COAXIAL CABLES; COMPACT DISK PLAYERS; COMPUTER CABLES; CONNECTION CABLES; DEVICES FOR HANDS-FREE USE OF MOBILE PHONES; DVD-PLAYERS; EAR PHONES; ELECTRIC CABLES; ELECTRIC CORDS; ELECTRIC OUTLETS; ELECTRIC OUTLET COVERS; ELECTRIC WIRE AND CABLE; ELECTRICAL CORDS; EXTENSION CORDS; HEADPHONES; MICROPHONES; MODULAR TELEPHONE OUTLETS; CELL PHONE BATTERY CHARGERS, MP3 PLAYERS; PERSONAL HEADPHONES FOR USE WITH SOUND TRANSMITTING SYSTEMS; PERSONAL STEREO; PLUG CONNECTORS; PLUG-IN CONNECTORS; POWER CABLES; REMOTE CONTROLS FOR TELEVISION, VCR, DVD, CD; ELECTRICAL SPEAKER WIRES; STEREO CABLES; TELECOMMUNICATION CABLES; VIDEO PHONES; ELECTRONIC LED SIGNS; EXTENSION CABLES; PLUG ADAPTORS (U.S. CLS. 21, 23, 26, 36 AND 38).

FIRST USE 8-1-2004; IN COMMERCE 8-1-2004.  
KATHLEEN M. VANSTON, EXAMINING ATTORNEY

**CLASS 9—(Continued).**

SN 86-011,591. FUHU HOLDINGS, INC., EL SEGUNDO, CA. FILED 7-16-2013.

# REFLECT MONITOR

THE MARK CONSISTS OF STANDARD CHARACTERS WITHOUT CLAIM TO ANY PARTICULAR FONT, STYLE, SIZE, OR COLOR.

NO CLAIM IS MADE TO THE EXCLUSIVE RIGHT TO USE "MONITOR", APART FROM THE MARK AS SHOWN.

FOR COMPUTER SOFTWARE FOR USE IN PERSONAL COMPUTERS AND HANDHELD ELECTRONIC DEVICES, NAMELY, COMPUTER SOFTWARE FOR USE IN REAL TIME MONITORING AND RECORDING OF INTERNET USAGE AND COMPUTER ACTIVITY ACROSS GLOBAL COMPUTER NETWORKS, WIRELESS NETWORKS, AND ELECTRONIC COMMUNICATIONS NETWORKS; REMOTE MONITORING SOFTWARE (U.S. CLS. 21, 23, 26, 36 AND 38).

DOMINICK J. SALEMI, EXAMINING ATTORNEY

---

SN 86-012,708. EXELIS INC., MCLEAN, VA. FILED 7-17-2013.

# XWAN

THE MARK CONSISTS OF STANDARD CHARACTERS WITHOUT CLAIM TO ANY PARTICULAR FONT, STYLE, SIZE, OR COLOR.

FOR COMPUTER NETWORKING HARDWARE; SOFTWARE FOR SETTING UP, CONFIGURING, OPERATING AND ADMINISTERING LOCAL AND WIDE AREA NETWORKS; COMPUTER SERVERS, COMPUTER STORAGE DEVICES, NAMELY, HIGH-SPEED STORAGE SUBSYSTEMS FOR STORAGE AND BACKUP OF ELECTRONIC DATA EITHER LOCALLY OR VIA A TELECOMMUNICATIONS NETWORK AND COMPUTER SOFTWARE FOR INTERCONNECTING, MANAGING AND OPERATING LOCAL AND WIDE AREA NETWORKS UTILIZING A DATA CENTER PROTOCOL ACROSS THE NETWORKS FOR EFFICIENT TRANSMISSION OF DATA, VOICE, AUDIO, VIDEO AND DISTRIBUTED STORAGE (U.S. CLS. 21, 23, 26, 36 AND 38).

MATTHEW KLINE, EXAMINING ATTORNEY

**CLASS 9—(Continued).**

SN 86-012,944. DJ INVENTIONS, LLC, HOUSTON, TX. FILED 7-17-2013.

**CRYPTOBUS**

THE MARK CONSISTS OF STANDARD CHARACTERS WITHOUT CLAIM TO ANY PARTICULAR FONT, STYLE, SIZE, OR COLOR.

FOR DOWNLOADABLE COMPUTER SOFTWARE FOR SOFTWARE APPLICATIONS THAT REQUIRE SECURITY ENCRYPTION FOR COMMUNICATION BETWEEN ANY REMOTE AUTOMATION DEVICE SUCH AS INDUSTRIAL CONTROLLERS OR UTILITY METERS WITH STANDARD COMMUNICATION PORTS AND DATA CENTERS (U.S. CLS. 21, 23, 26, 36 AND 38).

FIRST USE 3-1-2013; IN COMMERCE 3-1-2013.  
DAVID I, EXAMINING ATTORNEY

**CLASS 9—(Continued).**

SN 86-016,509. MUELLER INTERNATIONAL, LLC, ATLANTA, GA. FILED 7-22-2013.

**ASSETLOGICS**

THE MARK CONSISTS OF STANDARD CHARACTERS WITHOUT CLAIM TO ANY PARTICULAR FONT, STYLE, SIZE, OR COLOR.

OWNER OF U.S. REG. NOS. 4,342,722 AND 4,342,723.

FOR LEAK DETECTORS FOR WATER PIPES AND WATER INFRASTRUCTURE; AND SOFTWARE FOR USE IN DETECTING LEAKS IN WATER PIPES AND WATER INFRASTRUCTURE; SENSORS FOR MEASURING PIPE WALL INTEGRITY; PIPE WALL INTEGRITY MONITORS; MEASURING APPARATUS AND INSTRUMENTS, NAMELY, SENSORS FOR MEASURING PIPE WALL INTEGRITY TO DETECT POTENTIAL FAILURE; SCIENTIFIC SURVEYING AND CHECKING APPARATUS AND INSTRUMENTS, NAMELY, AN INSPECTION DEVICE USED IN PIPES TO DETECT PIPE WALL DEFECTS; SOFTWARE FOR USE IN ASSESSING THE INTEGRITY AND CONDITION OF PIPE WALLS; SOFTWARE FOR USE IN DETECTING THE PRESENCE OF LEAKS IN WATER PIPES AND WATER INFRASTRUCTURE; SOFTWARE FOR USE IN DETECTING THE LOCATION OF LEAKS IN WATER PIPES AND WATER INFRASTRUCTURE (U.S. CLS. 21, 23, 26, 36 AND 38).

SUSAN RICHARDS, EXAMINING ATTORNEY

SN 86-016,141. BENEFITFOCUS.COM, INC., CHARLESTON, SC. FILED 7-22-2013.

**HR INTOUCH**

THE MARK CONSISTS OF STANDARD CHARACTERS WITHOUT CLAIM TO ANY PARTICULAR FONT, STYLE, SIZE, OR COLOR.

OWNER OF U.S. REG. NOS. 3,461,016, 4,261,142 AND 4,261,146.

NO CLAIM IS MADE TO THE EXCLUSIVE RIGHT TO USE "HR", APART FROM THE MARK AS SHOWN.

FOR DOWNLOADABLE MOBILE APPLICATION FOR RESEARCH OF EMPLOYEE BENEFITS, QUOTATION OF RATES AND FEES, COMPARISON OF BENEFITS AND POLICIES, PURCHASE AND ENROLLMENT IN BENEFITS PROGRAMS AND ELECTRONIC DISPLAY OF INFORMATION ABOUT ENROLLED BENEFITS (U.S. CLS. 21, 23, 26, 36 AND 38).

DOMINICK J. SALEMI, EXAMINING ATTORNEY

SN 86-016,515. MUELLER INTERNATIONAL, LLC, ATLANTA, GA. FILED 7-22-2013.

**ENVIROSTAT**

THE MARK CONSISTS OF STANDARD CHARACTERS WITHOUT CLAIM TO ANY PARTICULAR FONT, STYLE, SIZE, OR COLOR.

FOR LEAK DETECTORS FOR WATER PIPES AND WATER INFRASTRUCTURE; AND SOFTWARE FOR USE IN DETECTING LEAKS IN WATER PIPES AND WATER INFRASTRUCTURE; SENSORS FOR MEASURING PIPE WALL INTEGRITY; PIPE WALL INTEGRITY MONITORS; MEASURING APPARATUS AND INSTRUMENTS, NAMELY, SENSORS FOR MEASURING PIPE WALL INTEGRITY TO DETECT POTENTIAL FAILURE; SCIENTIFIC SURVEYING AND CHECKING APPARATUS AND INSTRUMENTS, NAMELY, AN INSPECTION DEVICE USED IN PIPES TO DETECT PIPE WALL DEFECTS; SOFTWARE FOR USE IN ASSESSING THE INTEGRITY AND CONDITION OF PIPE WALLS; SOFTWARE FOR USE IN DETECTING THE PRESENCE OF LEAKS IN WATER PIPES AND WATER INFRASTRUCTURE; SOFTWARE FOR USE IN DETECTING THE LOCATION OF LEAKS IN WATER PIPES AND WATER INFRASTRUCTURE (U.S. CLS. 21, 23, 26, 36 AND 38).

SUSAN RICHARDS, EXAMINING ATTORNEY

**CLASS 9—(Continued).**

SN 86-017,239. OCEANEERING INTERNATIONAL, INC., HOUSTON, TX. FILED 7-23-2013.

**OCEANEERING**

THE MARK CONSISTS OF STANDARD CHARACTERS WITHOUT CLAIM TO ANY PARTICULAR FONT, STYLE, SIZE, OR COLOR.

OWNER OF U.S. REG. NOS. 983,504, 3,329,445 AND OTHERS.

FOR ELECTRICAL AND ELECTRONIC CONTROLS, NAMELY, ELECTRIC CONTROLLERS FOR HYDRAULIC DRILLING MACHINES AND ELECTRIC CONTROLLERS FOR MACHINES IN THE PRODUCTION OF OIL AND GAS; ELECTRIC CONTROLLERS FOR BLOWOUT PREVENTERS; ELECTRONIC AND ELECTRICAL CIRCUIT BOARDS FOR CONTROLLING AND MONITORING SOLENOIDS AND ACCOMPANYING COMPUTER SOFTWARE FOR CONTROLLING AND MONITORING SOLENOIDS SOLD AS A UNIT; ELECTROMECHANICAL CONTROLS IN THE NATURE OF SWITCHES FOR USE IN BLOW OUT PREVENTER CONTROLS; CAMERAS; CONTROL UNITS FOR CAMERAS; REMOTE CONTROLS FOR CAMERAS; VIDEO TRANSMITTER AND CONVERTER APPARATUS, NAMELY, FIBER-OPTICS TRANSMITTER AND VIDEO SIGNAL CONVERTER; TELEPHONES (U.S. CLS. 21, 23, 26, 36 AND 38).

FIRST USE 10-25-2010; IN COMMERCE 10-25-2010.  
DAVID C. REIHNER, EXAMINING ATTORNEY

SN 86-017,747. VIA, INC., FORMERLY VIALANGUAGE, INC., PORTLAND, OR. FILED 7-23-2013.



OWNER OF U.S. REG. NOS. 2,540,404 AND 4,201,807.  
THE COLOR(S) WHITE AND ORANGE IS/ARE CLAIMED AS A FEATURE OF THE MARK.

THE MARK CONSISTS OF ORANGE CIRCLE WITH WHITE LETTERS "VIA" IN CENTER. FONT IS SUCH THAT THE MARK IS IDENTICAL WHEN TURNED UPSIDE DOWN.

FOR COMPUTER SOFTWARE AND COMPUTER HARDWARE FOR USE IN LANGUAGE LOCALIZATION, BY MEANS OF LANGUAGE TRANSLATION, SUBTITLING, DUBBING, CLOSED CAPTIONING AND TELETEXT FOR FEATURE FILMS, TELEVISION PROGRAMS, VIDEOS AND DIGITAL MEDIA IN GENERAL (U.S. CLS. 21, 23, 26, 36 AND 38).

FIRST USE 11-23-2011; IN COMMERCE 3-5-2012.  
RONALD AIKENS, EXAMINING ATTORNEY

**CLASS 9—(Continued).**

SN 86-017,856. SOFTWARE IN THE PUBLIC INTEREST, INC., ALBANY, NY. FILED 7-23-2013.

**MINGW**

THE MARK CONSISTS OF STANDARD CHARACTERS WITHOUT CLAIM TO ANY PARTICULAR FONT, STYLE, SIZE, OR COLOR.

FOR COMPUTER SOFTWARE FOR ACHIEVING COMPATIBILITY WITH COMPUTER OPERATING SYSTEM ENVIRONMENTS AND APPLICATIONS (U.S. CLS. 21, 23, 26, 36 AND 38).

FIRST USE 7-1-1998; IN COMMERCE 2-3-2000.  
CHERYL CLAYTON, EXAMINING ATTORNEY

SN 86-020,701. ALEX BROWN INC., WASHINGTON, DC. FILED 7-26-2013.

**EYNACK**

THE MARK CONSISTS OF STANDARD CHARACTERS WITHOUT CLAIM TO ANY PARTICULAR FONT, STYLE, SIZE, OR COLOR.

FOR EYE GLASSES; SUNGLASSES (U.S. CLS. 21, 23, 26, 36 AND 38).

FIRST USE 9-20-2012; IN COMMERCE 9-20-2012.  
JULIE GUTTADAURO, EXAMINING ATTORNEY

SN 86-020,825. KOBO INC., TORONTO, ONTARIO, CANADA, FILED 7-26-2013.

**KOBO AURA**

THE MARK CONSISTS OF STANDARD CHARACTERS WITHOUT CLAIM TO ANY PARTICULAR FONT, STYLE, SIZE, OR COLOR.

PRIORITY CLAIMED UNDER SEC. 44(D) ON CANADA APPLICATION NO. 1632888, FILED 6-27-2013.

OWNER OF U.S. REG. NOS. 4,355,823, 4,359,524 AND OTHERS.

FOR PORTABLE ELECTRONIC DEVICE FOR READING, DISPLAYING, RECEIVING, PURCHASING, SHARING, LENDING, ACCESSING AND STORING DOWNLOADABLE ELECTRONIC PUBLICATIONS, NAMELY, BOOKS, JOURNALS, NEWSPAPERS, MAGAZINES, MULTIMEDIA PRESENTATIONS, AS WELL AS TEXT, IMAGES, SOUND, AND DIGITAL WEBSITE CONTENT, ALL THROUGH WIRED AND WIRELESS INTERNET ACCESS, AND RELATED ACCESSORIES THEREFORE, NAMELY, COVERS, CASES, ADAPTERS, AND POWER CORDS (U.S. CLS. 21, 23, 26, 36 AND 38).

FIRST USE 4-25-2013; IN COMMERCE 4-25-2013.  
BERNICE MIDDLETON, EXAMINING ATTORNEY

**CLASS 9—(Continued).**

SN 86-021,258. SHENZHEN YICHAO TECHNOLOGY CO., LTD, BAO'AN DIST. SHENZHEN, CHINA, FILED 7-26-2013.

# Obillion

THE MARK CONSISTS OF STYLIZED LETTERING "OBILLION".

FOR COMPUTER MOUSE; ELECTRONIC POCKET TRANSLATORS; NOTEBOOK COMPUTERS; ELECTRONIC DOWNLOADABLE PUBLICATIONS IN THE NATURE OF MAGAZINES IN THE FIELD OF COMPUTER GAMES; LAPTOP COMPUTERS; PORTABLE TELEPHONES; SATELLITE NAVIGATIONAL APPARATUS; COMPUTERS; COMPUTER GAMING SOFTWARE, RECORDED; COMPUTER GAME PROGRAMS; PHOTOGRAPHIC CAMERAS; DATA PROCESSING EQUIPMENT, NAMELY, SCANNERS; FACSIMILE MACHINES; NAVIGATIONAL INSTRUMENTS FOR VEHICLES (U.S. CLS. 21, 23, 26, 36 AND 38).

FIRST USE 5-1-2012; IN COMMERCE 7-1-2012.  
KAMAL PREET, EXAMINING ATTORNEY

**CLASS 9—(Continued).**

SN 86-023,411. DEKKA TECHNOLOGIES, LLC, HOUMA, LA. FILED 7-30-2013.

# Striker

THE MARK CONSISTS OF STANDARD CHARACTERS WITHOUT CLAIM TO ANY PARTICULAR FONT, STYLE, SIZE, OR COLOR.

FOR ELECTRONIC WEAPONS RECOIL SIMULATORS FOR TRAINING IN THE USE OF RIFLES, SHOTGUNS AND HANDGUNS (U.S. CLS. 21, 23, 26, 36 AND 38).

MATTHEW PAPPAS, EXAMINING ATTORNEY

SN 86-022,164. THE BEST OF ORGANIC LLC, WEST BLOOMFIELD, MI. FILED 7-29-2013.

# PALEO 101

THE MARK CONSISTS OF STANDARD CHARACTERS WITHOUT CLAIM TO ANY PARTICULAR FONT, STYLE, SIZE, OR COLOR.

NO CLAIM IS MADE TO THE EXCLUSIVE RIGHT TO USE "PALEO", APART FROM THE MARK AS SHOWN.

FOR DIGITAL MEDIA, NAMELY, DOWNLOADABLE E-BOOKS, E-BOOKS RECORDED ON COMPUTER MEDIA, DIGITAL VIDEO DISCS, DIGITAL VERSATILE DISCS, AND DOWNLOADABLE AUDIO AND VIDEO RECORDINGS FEATURING DIET, WEIGHT LOSS, DIET PLANNING AND LIFESTYLE WELLNESS (U.S. CLS. 21, 23, 26, 36 AND 38).

MARK SPARACINO, EXAMINING ATTORNEY

SN 86-028,322. ACCOUNTREX, LLC, WILMINGTON, DE. FILED 8-5-2013.

# AccounTrex

THE MARK CONSISTS OF STANDARD CHARACTERS WITHOUT CLAIM TO ANY PARTICULAR FONT, STYLE, SIZE, OR COLOR.

FOR COMPUTER SOFTWARE PLATFORMS FOR SECURITIES PORTFOLIO MANAGEMENT (U.S. CLS. 21, 23, 26, 36 AND 38).

FIRST USE 1-5-2013; IN COMMERCE 1-5-2013.  
LEIGH CAROLINE CASE, EXAMINING ATTORNEY

SN 86-022,661. MAJORPLANET STUDIOS, LLC, SAN FRANCISCO, CA. FILED 7-29-2013.

# PUBLISH ONCE. BE EVERYWHERE.

THE MARK CONSISTS OF STANDARD CHARACTERS WITHOUT CLAIM TO ANY PARTICULAR FONT, STYLE, SIZE, OR COLOR.

FOR COMPUTER SOFTWARE FOR USE AS A PUBLISHING TOOL FOR MULTIMEDIA STORYTELLING (U.S. CLS. 21, 23, 26, 36 AND 38).

FIRST USE 6-10-2013; IN COMMERCE 6-10-2013.  
CAROLINE WOOD, EXAMINING ATTORNEY

SN 86-028,997. ILLINOIS STUDENT ASSISTANCE COMMISSION, AN AGENCY OF THE STATE OF ILLINOIS, DEERFIELD, IL. FILED 8-5-2013.

# B4 College Alerts

THE MARK CONSISTS OF STANDARD CHARACTERS WITHOUT CLAIM TO ANY PARTICULAR FONT, STYLE, SIZE, OR COLOR.

NO CLAIM IS MADE TO THE EXCLUSIVE RIGHT TO USE "COLLEGE ALERTS", APART FROM THE MARK AS SHOWN.

FOR DOWNLOADABLE MOBILE APPLICATIONS FOR PROVIDING STUDENTS, FAMILIES, AND OTHER USERS WITH CUSTOMIZED INFORMATION CONCERNING EDUCATIONAL SERVICES, POSTSECONDARY PLANNING AND ENROLLMENT, AND FINANCIAL AID THROUGH ELECTRONIC MEANS (U.S. CLS. 21, 23, 26, 36 AND 38).

FIRST USE 4-1-2013; IN COMMERCE 4-1-2013.  
BRENDAN REGAN, EXAMINING ATTORNEY

**CLASS 9—(Continued).**

SN 86-029,415. STAY AWAY FROM MY CAKE LLC, MOUNTAIN VIEW, CA. FILED 8-6-2013.

# PURPLE DEVIL

THE MARK CONSISTS OF STANDARD CHARACTERS WITHOUT CLAIM TO ANY PARTICULAR FONT, STYLE, SIZE, OR COLOR.

OWNER OF U.S. REG. NO. 4,423,966.  
FOR DOWNLOADABLE MOTION PICTURES AND TELEVISION SHOWS IN THE FIELD OF ANIMATION ADAPTED FROM A COMIC STRIP; MOTION PICTURE FILMS IN THE FIELD OF ANIMATION ADAPTED FROM A COMIC STRIP (U.S. CLS. 21, 23, 26, 36 AND 38).  
FIRST USE 7-8-2011; IN COMMERCE 7-8-2011.  
SALLY SHIH, EXAMINING ATTORNEY

SN 86-029,555. GLOBAL MARINE NETWORKS, LLC, MARYVILLE, TN. FILED 8-6-2013.

# STARPILOT

THE MARK CONSISTS OF STANDARD CHARACTERS WITHOUT CLAIM TO ANY PARTICULAR FONT, STYLE, SIZE, OR COLOR.

FOR SOFTWARE FOR USE IN CELESTIAL NAVIGATION AND PILOTING (U.S. CLS. 21, 23, 26, 36 AND 38).  
FIRST USE 11-0-1999; IN COMMERCE 11-0-1999.  
ESTHER A. BORSUK, EXAMINING ATTORNEY

SN 86-029,745. ADAM REED HERSCHMAN, LOS ANGELES, CA. AND CHASE FRANKLIN REED HERSCHMAN, LOS ANGELES, CA. FILED 8-6-2013.

# STREAMR

THE MARK CONSISTS OF STANDARD CHARACTERS WITHOUT CLAIM TO ANY PARTICULAR FONT, STYLE, SIZE, OR COLOR.

FOR COMPUTER APPLICATION SOFTWARE, NAMELY, A MOBILE APPLICATION ENABLING USERS TO EASILY COMBINE THEIR VARIOUS SOCIAL MEDIA FEEDS, EMAIL ACCOUNTS, AND DAILY WEB CONTENT IN A SINGLE VIEW (U.S. CLS. 21, 23, 26, 36 AND 38).  
DAVID HOFFMAN, EXAMINING ATTORNEY

**CLASS 9—(Continued).**

SN 86-029,999. S&C ELECTRIC COMPANY, CHICAGO, IL. FILED 8-6-2013.

# VISI-GAP

THE MARK CONSISTS OF STANDARD CHARACTERS WITHOUT CLAIM TO ANY PARTICULAR FONT, STYLE, SIZE, OR COLOR.

FOR ELECTRICAL SWITCHES, ELECTRIC CIRCUIT FAULT INTERRUPTERS (U.S. CLS. 21, 23, 26, 36 AND 38).  
FRED CARL, EXAMINING ATTORNEY

SN 86-030,041. FLYCOM, BOCA RATON, FL. FILED 8-6-2013.

# Flypay

THE MARK CONSISTS OF STANDARD CHARACTERS WITHOUT CLAIM TO ANY PARTICULAR FONT, STYLE, SIZE, OR COLOR.

FOR MOBILE APPLICATION SOFTWARE FOR MOBILE DEVICES FOR THE PURPOSE OF PROVIDING PREPAID AIRTIME REFILLS FOR PHONE USAGE (U.S. CLS. 21, 23, 26, 36 AND 38).  
REBECCA SMITH, EXAMINING ATTORNEY

SN 86-030,072. SIMON & SCHUSTER, INC., NEW YORK, NY. FILED 8-6-2013.

# SIMON 451

THE MARK CONSISTS OF STANDARD CHARACTERS WITHOUT CLAIM TO ANY PARTICULAR FONT, STYLE, SIZE, OR COLOR.

OWNER OF U.S. REG. NOS. 2,270,980, 2,664,657 AND OTHERS.  
FOR FICTION AUDIO BOOKS ON A VARIETY OF SUBJECTS; NON-FICTION DOWNLOADABLE ELECTRONIC BOOKS ON A VARIETY OF SUBJECTS; DOWNLOADABLE ELECTRONIC PUBLICATIONS IN THE FIELD OF SCIENCE FICTION BOOKS (U.S. CLS. 21, 23, 26, 36 AND 38).  
JENNY PARK, EXAMINING ATTORNEY

**CLASS 9—(Continued).**

SN 86-030,568. CURB THE CHAOS LLC, EXTON, PA. FILED 8-6-2013.

**CURB THE CHAOS**

THE MARK CONSISTS OF STANDARD CHARACTERS WITHOUT CLAIM TO ANY PARTICULAR FONT, STYLE, SIZE, OR COLOR.

FOR PRE-RECORDED VIDEO TAPES AND CASSETTES, DVDS, CDS, AND AUDIO AND VIDEO FILES FEATURING SELF-HELP, GOAL ASSESSMENT, LIFE COACHING, AND INSTRUCTION RELATED THERETO, AND PRINTED INSTRUCTIONAL MATERIALS DISTRIBUTED IN CONNECTION THEREWITH, ALL SOLD AS A UNIT; COMPUTER SOFTWARE, NAMELY, AN APPLICATION OR PRE-RECORDED AUDIO AND VIDEO FILES FEATURING SELF-HELP, GOAL ASSESSMENT, AND LIFE COACHING (U.S. CLS. 21, 23, 26, 36 AND 38).

JOSETTE BEVERLY, EXAMINING ATTORNEY

SN 86-032,089. AVEN, INC., ANN ARBOR, MI. FILED 8-8-2013.

**MIGHTY SCOPE**

THE MARK CONSISTS OF STANDARD CHARACTERS WITHOUT CLAIM TO ANY PARTICULAR FONT, STYLE, SIZE, OR COLOR.

NO CLAIM IS MADE TO THE EXCLUSIVE RIGHT TO USE "SCOPE", APART FROM THE MARK AS SHOWN.

FOR DIGITAL MICROSCOPES (U.S. CLS. 21, 23, 26, 36 AND 38).

FIRST USE 9-26-2008; IN COMMERCE 9-29-2008.  
CHERYL CLAYTON, EXAMINING ATTORNEY

SN 86-032,939. ANTONIO VILLARD LLC, TUCSON, AZ. FILED 8-8-2013.

**It's A Boy Electronic Cigar**

THE MARK CONSISTS OF STANDARD CHARACTERS WITHOUT CLAIM TO ANY PARTICULAR FONT, STYLE, SIZE, OR COLOR.

NO CLAIM IS MADE TO THE EXCLUSIVE RIGHT TO USE "ELECTRONIC CIGAR", APART FROM THE MARK AS SHOWN.

FOR ELECTRONIC CIGAR BATTERIES (U.S. CLS. 21, 23, 26, 36 AND 38).

EDWARD FENNESSY, EXAMINING ATTORNEY

**CLASS 9—(Continued).**

SN 86-032,958. ANTONIO VILLARD LLC, TUCSON, AZ. FILED 8-8-2013.

**It's A Girl Electronic Cigar**

THE MARK CONSISTS OF STANDARD CHARACTERS WITHOUT CLAIM TO ANY PARTICULAR FONT, STYLE, SIZE, OR COLOR.

NO CLAIM IS MADE TO THE EXCLUSIVE RIGHT TO USE "ELECTRONIC CIGAR", APART FROM THE MARK AS SHOWN.

FOR ELECTRONIC CIGAR BATTERIES (U.S. CLS. 21, 23, 26, 36 AND 38).

EDWARD FENNESSY, EXAMINING ATTORNEY

SN 86-033,221. UROVO TECHNOLOGY CORPORATION LIMITED, SHENZHEN CITY, CHINA, FILED 8-9-2013.

**UROVO**

THE MARK CONSISTS OF THE WORD "UROVO" IN STYLIZED LETTERS.

THE WORDING "UROVO" HAS NO MEANING IN A FOREIGN LANGUAGE.

FOR DATA PROCESSING APPARATUS; COMPUTERS; BAR CODE READERS; COMPUTER PERIPHERAL DEVICES; COMPUTER OPERATING SOFTWARE; COMPUTER GAME SOFTWARE; SCANNERS; LAPTOP COMPUTERS; PORTABLE TELEPHONES; CHARGERS FOR ELECTRIC BATTERIES; SMART CARD READERS; CHIP CARD READERS; EMBEDDED SOFTWARE AND SYSTEM SOFTWARE FOR USE IN OPERATING SMARTPHONES, LAPTOPS, PDAS, AND TABLETS (U.S. CLS. 21, 23, 26, 36 AND 38).

FIRST USE 4-8-2013; IN COMMERCE 4-8-2013.  
ALICIA COLLINS, EXAMINING ATTORNEY

SN 86-033,272. C AND D BRUCE ENTERPRISES, LLC, JOHNSTOWN, CO. FILED 8-9-2013.

**EARVIEW MIRROR**

THE MARK CONSISTS OF STANDARD CHARACTERS WITHOUT CLAIM TO ANY PARTICULAR FONT, STYLE, SIZE, OR COLOR.

NO CLAIM IS MADE TO THE EXCLUSIVE RIGHT TO USE "MIRROR", APART FROM THE MARK AS SHOWN.

FOR INSPECTION MIRRORS, NAMELY, HANDS-FREE MIRRORS USED FOR INSPECTION (U.S. CLS. 21, 23, 26, 36 AND 38).

KATHY DE JONGE, EXAMINING ATTORNEY

**CLASS 9—(Continued).**

SN 86-033,307. VDO360, LLC, EDGEWATER, MD. FILED 8-9-2013.

**VDO360**

THE MARK CONSISTS OF STANDARD CHARACTERS WITHOUT CLAIM TO ANY PARTICULAR FONT, STYLE, SIZE, OR COLOR.

FOR CAMERAS THAT CONNECT TO COMPUTING DEVICES, NAMELY, COMPUTERS, LAP TOP COMPUTERS, TABLET COMPUTERS, AND SMARTPHONES NOT FOR USE IN CONNECTION WITH SYSTEMS INTEGRAL TO THE OPERATION OF VEHICLES OR FOR USE IN CONNECTION WITH TRACKING, MANAGING FLEETS, DIAGNOSTICS, REPAIR, OR SERVING OF VEHICLES (U.S. CLS. 21, 23, 26, 36 AND 38).

FIRST USE 9-0-2012; IN COMMERCE 11-0-2012.  
DAVID ALESKOW, EXAMINING ATTORNEY

**CLASS 9—(Continued).**

SN 86-035,130. DIGITAL OUTDOOR LLC, MIAMI, FL. FILED 8-12-2013.



NO CLAIM IS MADE TO THE EXCLUSIVE RIGHT TO USE "OUTDOOR", APART FROM THE MARK AS SHOWN. THE COLOR(S) DARK BLUE, LIGHT PURPLE, ORANGE, AND GOLD IS/ARE CLAIMED AS A FEATURE OF THE MARK.

THE MARK CONSISTS OF THE WORDS "LIGHTKING OUTDOOR" IN A DARK BLUE FONT TO THE RIGHT OF A STYLIZED DESIGN OF AN LED LIGHT BULB COMPRISED OF SEVEN GEOMETRIC SHAPES IN DARK BLUE, LIGHT PURPLE, ORANGE, AND GOLD.

FOR LED SIGNS, ELECTRONIC SIGNS, DIGITAL BILLBOARDS, DIGITAL SIGNS, ELECTRONIC BILLBOARDS, ELECTRONIC MESSAGE CENTERS (EMCS) (U.S. CLS. 21, 23, 26, 36 AND 38).

FIRST USE 7-1-2012; IN COMMERCE 7-1-2012.  
CAITLIN WATTS-FITZGERALD, EXAMINING ATTORNEY

SN 86-035,088. DIGITAL OUTDOOR LLC, MIAMI, FL. FILED 8-12-2013.

**LIGHTKING OUTDOOR**

THE MARK CONSISTS OF STANDARD CHARACTERS WITHOUT CLAIM TO ANY PARTICULAR FONT, STYLE, SIZE, OR COLOR.

NO CLAIM IS MADE TO THE EXCLUSIVE RIGHT TO USE "OUTDOOR", APART FROM THE MARK AS SHOWN.

FOR LED SIGNS, ELECTRONIC SIGNS, DIGITAL BILLBOARDS, DIGITAL SIGNS, ELECTRONIC BILLBOARDS, ELECTRONIC MESSAGE CENTERS (EMCS) (U.S. CLS. 21, 23, 26, 36 AND 38).

FIRST USE 7-1-2012; IN COMMERCE 7-1-2012.  
CAITLIN WATTS-FITZGERALD, EXAMINING ATTORNEY

SN 86-035,430. ZIP PRODUCTIONS LLC, NEWHALL, CA. FILED 8-12-2013.

**MISS ERIN'S MAGICAL DANCE CLASS**

THE MARK CONSISTS OF STANDARD CHARACTERS WITHOUT CLAIM TO ANY PARTICULAR FONT, STYLE, SIZE, OR COLOR.

NO CLAIM IS MADE TO THE EXCLUSIVE RIGHT TO USE "DANCE CLASS", APART FROM THE MARK AS SHOWN.

FOR DIGITAL MEDIA, NAMELY, PRE-RECORDED DVDS, DOWNLOADABLE AUDIO AND VIDEO RECORDINGS, AND HIGH DEFINITION DIGITAL DISCS IN THE FIELD OF ENTERTAINMENT AND EDUCATION FEATURING MUSICAL DANCE PERFORMANCES AND SONGS; DOWNLOADABLE MP3 FILES, MP3 RECORDINGS, ON-LINE DISCUSSION BOARD POSTS, WEBCASTS, WEBINARS AND PODCASTS IN THE FIELD OF ENTERTAINMENT AND EDUCATION FEATURING MUSICAL DANCE PERFORMANCES AND SONGS (U.S. CLS. 21, 23, 26, 36 AND 38).

GIANCARLO CASTRO, EXAMINING ATTORNEY

**CLASS 9—(Continued).**

SN 86-036,288. CA, INC., ISLANDIA, NY. FILED 8-13-2013.

**CA ACCESSMINDER**

THE MARK CONSISTS OF STANDARD CHARACTERS WITHOUT CLAIM TO ANY PARTICULAR FONT, STYLE, SIZE, OR COLOR.

PRIORITY CLAIMED UNDER SEC. 44(D) ON ERPN CMNTY TM OFC APPLICATION NO. 012015707, FILED 7-25-2013.

OWNER OF U.S. REG. NOS. 2,396,840, 3,399,671 AND OTHERS.

FOR DOWNLOADABLE COMPUTER SOFTWARE FOR SECURING, MANAGING AND TRACKING ACCESS TO DIGITAL RESOURCES, NAMELY, WEB PORTALS, WEBSITES, APPLICATIONS, WEB SERVICES, AND APPLICATION PROGRAMMING INTERFACES (APIS) (U.S. CLS. 21, 23, 26, 36 AND 38).

CHRISTINE MARTIN, EXAMINING ATTORNEY

**CLASS 9—(Continued).**

SN 86-036,413. COMMSCOPE, INC. OF NORTH CAROLINA, HICKORY, NC. FILED 8-13-2013.

**CSOLUTIONS**

THE MARK CONSISTS OF STANDARD CHARACTERS WITHOUT CLAIM TO ANY PARTICULAR FONT, STYLE, SIZE, OR COLOR.

FOR COMPUTER APPLICATION SOFTWARE FOR MOBILE PHONES AND TABLET COMPUTERS FOR PROVIDING PRODUCT INFORMATION FOR COMMUNICATIONS INFRASTRUCTURE PRODUCTS, NAMELY, COMMUNICATIONS CABLES, CABLE CONNECTORS, AND ANTENNAS UTILIZED IN THE COMMUNICATIONS AND DATA TRANSFER INDUSTRY (U.S. CLS. 21, 23, 26, 36 AND 38).

FIRST USE 10-24-2011; IN COMMERCE 10-24-2011.

SIMON TENG, EXAMINING ATTORNEY

SN 86-036,414. HECKTECH, INC., DBA HECKLER DESIGN, TEMPE, AZ. FILED 8-13-2013.

**WINDFALL**

THE MARK CONSISTS OF STANDARD CHARACTERS WITHOUT CLAIM TO ANY PARTICULAR FONT, STYLE, SIZE, OR COLOR.

FOR COMPUTER HOLDERS, NAMELY, CARRYING CASES FOR TABLET AND MOBILE COMPUTERS; COMPUTER ENCLOSURES, NAMELY, PROTECTIVE COVERS, SECURITY ENCLOSURES AND CASES FOR TABLET AND MOBILE COMPUTERS; POINT-OF-SALE TERMINALS (U.S. CLS. 21, 23, 26, 36 AND 38).

FIRST USE 5-0-2012; IN COMMERCE 6-0-2012.

JESSICA A. POWERS, EXAMINING ATTORNEY

SN 86-036,392. COMMSCOPE, INC. OF NORTH CAROLINA, HICKORY, NC. FILED 8-13-2013.

**CCATALOG**

SN 86-036,695. TREEFROG DEVELOPMENTS, INC., SAN DIEGO, CA. FILED 8-13-2013.

THE MARK CONSISTS OF STANDARD CHARACTERS WITHOUT CLAIM TO ANY PARTICULAR FONT, STYLE, SIZE, OR COLOR.

FOR COMPUTER APPLICATION SOFTWARE FOR MOBILE PHONES AND TABLET COMPUTERS FOR PROVIDING PRODUCT INFORMATION FOR COMMUNICATIONS INFRASTRUCTURE PRODUCTS, NAMELY, COMMUNICATIONS CABLES, CABLE CONNECTORS, AND ANTENNAS UTILIZED IN THE COMMUNICATIONS AND DATA TRANSFER INDUSTRY (U.S. CLS. 21, 23, 26, 36 AND 38).

FIRST USE 10-11-2011; IN COMMERCE 10-11-2011.

SIMON TENG, EXAMINING ATTORNEY

**LIFEPROOF**

OWNER OF U.S. REG. NOS. 4,057,201, 4,301,438 AND 4,360,963.

THE MARK CONSISTS OF FOUR BOXES WITH ROUNDED CORNERS ON THE UPPER LEFT AND BOTTOM RIGHT POSITIONS AND POINTED CORNERS ON



**CLASS 9—(Continued).**

THE UPPER RIGHT AND BOTTOM LEFT POSITIONS. THE FOUR BOXES ARE IN A ROW WITH THREE RAIN DROPS IN THE FIRST BOX, A DIRT SPLATTER IN THE SECOND BOX, A SIX-PRONGED SNOWFLAKE IN THE THIRD BOX, AND A CELL PHONE WITH AN IMPACT EXPLOSIVE DESIGN ON THE BOTTOM LEFT CORNER OF THE CELL PHONE IN THE FOURTH BOX. THE WORD "LIFEPROOF" APPEARS IN UPPER CASE LETTERS BELOW THE FOUR BOXES ALIGNED WITH THE RIGHT EDGE OF THE FOURTH BOX.

FOR PROTECTIVE CASES, CARRYING CASES, CASINGS, AND COVERS FOR PORTABLE ELECTRONIC DEVICES, NAMELY, CELL PHONES, PORTABLE MEDIA PLAYERS, ELECTRONIC TABLETS, ELECTRONIC BOOK READERS, AND LAPTOP COMPUTERS; CASES AND HOLSTERS SPECIALLY ADAPTED FOR HOLDING OR CARRYING MOBILE ELECTRONIC DEVICES, NAMELY, MOBILE PHONES, ELECTRONIC TABLETS, ELECTRONIC BOOK READERS; ACCESSORIES SPECIALLY ADAPTED FOR MOBILE ELECTRONIC DEVICES, NAMELY, BELT CLIPS, SHOULDER STRAPS, AND HAND STRAPS (U.S. CLS. 21, 23, 26, 36 AND 38).

FIRST USE 5-27-2011; IN COMMERCE 5-27-2011.  
CURTIS FRENCH, EXAMINING ATTORNEY

**CLASS 9—(Continued).**

SN 86-037,613. JASON NEWSTED, SAN FRANCISCO, CA. FILED 8-14-2013.

**CHOPHOUSE RECORDS**

SN 86-036,934. MEDITE, INC., ORLANDO, FL. FILED 8-13-2013.

# TES Valida

THE MARK CONSISTS OF STANDARD CHARACTERS WITHOUT CLAIM TO ANY PARTICULAR FONT, STYLE, SIZE, OR COLOR.

NO CLAIM IS MADE TO THE EXCLUSIVE RIGHT TO USE "TES", APART FROM THE MARK AS SHOWN.

THE ENGLISH TRANSLATION OF "VALIDA" IN THE MARK IS "VALID".

FOR LABORATORY EQUIPMENT IN THE NATURE OF A SYSTEM COMPRISING A THERMAL UNIT, COOLING UNIT, AND DISPENSER UNIT USED IN HISTOLOGY LABORATORIES FOR PRODUCING PARAFFIN BLOCKS (U.S. CLS. 21, 23, 26, 36 AND 38).

FIRST USE 7-5-2012; IN COMMERCE 7-5-2012.  
MICHAEL SOUDERS, EXAMINING ATTORNEY

THE MARK CONSISTS OF STANDARD CHARACTERS WITHOUT CLAIM TO ANY PARTICULAR FONT, STYLE, SIZE, OR COLOR.

NO CLAIM IS MADE TO THE EXCLUSIVE RIGHT TO USE "RECORDS", APART FROM THE MARK AS SHOWN.

FOR (BASED ON USE IN COMMERCE) MUSICAL SOUND RECORDINGS; (BASED ON INTENT TO USE) AUDIO-VISUAL RECORDINGS FEATURING MUSIC; CASES FOR HOLDING COMPACT DISCS, DVDS, AND OTHER ELECTRONIC MEDIA; COMPUTER GAMES, NAMELY, COMPUTER GAME CARTRIDGES, CASSETTES, TAPES, DISCS, PROGRAMS AND SOFTWARE; COMPUTER STORAGE DEVICES, NAMELY, FLASH DRIVES SOLD BLANK; COMPUTER STORAGE DEVICES WITH PRE-RECORDED MUSIC CONTENT; DECORATIVE MAGNETS; DOWNLOADABLE ELECTRONIC PUBLICATIONS IN THE NATURE OF BOOKS, BOOKLETS, MAGAZINES, JOURNALS, BROCHURES, PAMPHLETS, NEWSLETTERS, SONGBOOKS AND ELECTRONIC TABLATURE MUSIC SHEETS, ALL IN THE FIELD OF MUSIC, AND SUBJECT MATTERS GENERALLY RELATED TO ENTERTAINMENT; DIGITAL MUSIC DOWNLOADABLE FROM THE INTERNET AND MOBILE DEVICES; DIGITAL VIDEO AND AUDIO RECORDINGS DOWNLOADABLE FROM THE INTERNET AND MOBILE DEVICES FEATURING MUSIC AND MUSICAL ENTERTAINMENT PERFORMANCES; ELECTRONIC GAME PROGRAMS; EYEGLASSES AND EYEGLASS CASES; HEADPHONES AND EARPHONES; LOUDSPEAKERS; MOUSE PADS; MUSICAL VIDEO RECORDINGS; FITTED SKINS AND COVERS FOR PORTABLE ELECTRONIC DEVICES, NAMELY, CELL PHONES, PDAS, LAPTOPS, MUSIC PLAYERS, E-BOOK READERS, TABLET COMPUTERS, GPS UNITS, COMPUTER ACCESSORIES AND PERIPHERALS, CAMERAS, CAMCORDERS, HEADPHONES AND SPEAKERS (U.S. CLS. 21, 23, 26, 36 AND 38).

FIRST USE 4-0-1992; IN COMMERCE 4-0-1992.  
REBECCA GILBERT, EXAMINING ATTORNEY

**CLASS 9—(Continued).**

SN 86-037,851. APONTE, CLAUDIA P., BOCA RATON, FL. FILED 8-14-2013.



THE COLOR(S) SILVER AND BROWN IS/ARE CLAIMED AS A FEATURE OF THE MARK.

THE MARK CONSISTS OF THE STYLIZED WORDING "NATNICS" ALL IN SHINY SILVER CAPITAL MODELED LETTERS AND ON THE TOP OF THE LETTER "T" IS A DESIGN OF A CUTTING TOOL COMPOSED OF A BODY WITH SILVER COLOR WITH THREE CERAMIC BROWN INSERTS.

FOR ELECTRONIC EQUIPMENT FOR POINT-OF-SALES (POS) SYSTEMS, NAMELY, POINT-OF-SALE TERMINALS, BAR CODE READERS, OPTICAL READERS, ADVERTISEMENT DISPLAY MONITORS, KEYBOARDS, PRINTERS, SCANNERS, RADIO TRANSMITTERS, RADIO RECEIVERS, COMPUTER HARDWARE, AND COMPUTER OPERATING SOFTWARE (U.S. CLS. 21, 23, 26, 36 AND 38).

FIRST USE 11-1-2007; IN COMMERCE 5-14-2009.

DOMINIC J. FERRAIUOLO, EXAMINING ATTORNEY

---

SN 86-038,090. SPACEMUX, INC., PACIFIC PALISADES, CA. FILED 8-14-2013.



THE MARK CONSISTS OF STANDARD CHARACTERS WITHOUT CLAIM TO ANY PARTICULAR FONT, STYLE, SIZE, OR COLOR.

FOR WIRELESS NETWORKING PRODUCTS, NAMELY, TELECOMMUNICATIONS BASE STATION EQUIPMENT FOR CELLULAR AND FIXED NETWORKING AND COMMUNICATIONS APPLICATIONS; COMPUTER NETWORKING HARDWARE; WIRELESS COMMUNICATION DEVICES FOR VOICE, DATA OR IMAGE TRANSMISSION; WIRELESS TRANSMITTERS AND RECEIVERS, NAMELY, WIRELESS ARRAYS; TELECOMMUNICATION SWITCHES, NAMELY, WIRELESS SWITCHES (U.S. CLS. 21, 23, 26, 36 AND 38).

SKYE YOUNG, EXAMINING ATTORNEY

**CLASS 9—(Continued).**

SN 86-038,797. PERRY, KEVIN, DBA THE KNVERLFT GROUP, VALLEY STREAM, NY. FILED 8-15-2013.



THE MARK CONSISTS OF STANDARD CHARACTERS WITHOUT CLAIM TO ANY PARTICULAR FONT, STYLE, SIZE, OR COLOR.

THE WORDING "KNVERLFT KIC" HAS NO MEANING IN A FOREIGN LANGUAGE.

FOR ELECTRONIC DEVICES USED TO LOCATE LOST ARTICLES EMPLOYING THE GLOBAL POSITIONING SYSTEM OR CELLULAR COMMUNICATION NETWORKS; ELECTRONIC TRANSMITTERS AND RECEIVERS USED TO LOCATE LOST CHILDREN AND PETS (U.S. CLS. 21, 23, 26, 36 AND 38).

BRIAN PINO, EXAMINING ATTORNEY

---

SN 86-038,798. ELEMENT CASE, INC., SAN CARLOS, CA. FILED 8-15-2013.



THE MARK CONSISTS OF STANDARD CHARACTERS WITHOUT CLAIM TO ANY PARTICULAR FONT, STYLE, SIZE, OR COLOR.

FOR CARRYING CASES SPECIALLY ADAPTED FOR ELECTRONIC EQUIPMENT, NAMELY, CELL PHONES, SMARTPHONES, TABLETS, AND COMPUTERS (U.S. CLS. 21, 23, 26, 36 AND 38).

FIRST USE 2-21-2013; IN COMMERCE 2-21-2013.

BRIN ANDERSON, EXAMINING ATTORNEY

---

SN 86-038,932. STRATUS ANALYTICS, LLC., GREENWICH, CT. FILED 8-15-2013.



THE MARK CONSISTS OF STANDARD CHARACTERS WITHOUT CLAIM TO ANY PARTICULAR FONT, STYLE, SIZE, OR COLOR.

FOR ANALYTICAL SOFTWARE FOR USE BY COMMERCIAL AIRLINES IN ANALYZING AND EVALUATING THE ACQUISITION, FINANCING, AND DISPOSITION OF AIRCRAFT (U.S. CLS. 21, 23, 26, 36 AND 38).

LAURA GOLDEN, EXAMINING ATTORNEY

**CLASS 9—(Continued).**

SN 86-038,968. STRATUS ANALYTICS, LLC., GREENWICH, CT. FILED 8-15-2013.

# SKLL

THE MARK CONSISTS OF STANDARD CHARACTERS WITHOUT CLAIM TO ANY PARTICULAR FONT, STYLE, SIZE, OR COLOR.

NO CLAIM IS MADE TO THE EXCLUSIVE RIGHT TO USE "SKLL", APART FROM THE MARK AS SHOWN. FOR ANALYTICAL SOFTWARE FOR USE BY COMMERCIAL AIRLINES IN EVALUATING WHETHER AIRCRAFT SHOULD BE LEASED OR PURCHASED (U.S. CLS. 21, 23, 26, 36 AND 38).

LAURA GOLDEN, EXAMINING ATTORNEY

SN 86-038,975. BLACK-I TECHNOLOGIES, MIAMI, FL. FILED 8-15-2013.

# spytection software

THE MARK CONSISTS OF STANDARD CHARACTERS WITHOUT CLAIM TO ANY PARTICULAR FONT, STYLE, SIZE, OR COLOR.

NO CLAIM IS MADE TO THE EXCLUSIVE RIGHT TO USE "SOFTWARE", APART FROM THE MARK AS SHOWN.

FOR COMPUTER APPLICATION SOFTWARE FOR MOBILE PHONES, TABLETS, LAPTOPS AND DESKTOPS, NAMELY, COMPUTER SECURITY SOFTWARE TO DETECT MALICIOUS ACCESS TO DEVICE HARDWARE (U.S. CLS. 21, 23, 26, 36 AND 38).

FIRST USE 7-21-2013; IN COMMERCE 7-21-2013.  
SALLY SHIH, EXAMINING ATTORNEY

SN 86-039,508. IRWIN, LLOYD, ROSEBURG, OR. FILED 8-15-2013.

# PROPANE PAL

THE MARK CONSISTS OF STANDARD CHARACTERS WITHOUT CLAIM TO ANY PARTICULAR FONT, STYLE, SIZE, OR COLOR.

NO CLAIM IS MADE TO THE EXCLUSIVE RIGHT TO USE "PROPANE", APART FROM THE MARK AS SHOWN. FOR PROPANE WEIGHING SCALE (U.S. CLS. 21, 23, 26, 36 AND 38).

FIRST USE 8-0-2013; IN COMMERCE 8-0-2013.  
PATRICIA EVANKO, EXAMINING ATTORNEY

**CLASS 9—(Continued).**

SN 86-039,868. WESTON, PAT, CAMERON PARK, CA. FILED 8-16-2013.

# SPEEDBEE PRODUCTS

THE MARK CONSISTS OF STANDARD CHARACTERS WITHOUT CLAIM TO ANY PARTICULAR FONT, STYLE, SIZE, OR COLOR.

NO CLAIM IS MADE TO THE EXCLUSIVE RIGHT TO USE "PRODUCTS", APART FROM THE MARK AS SHOWN.

FOR REMOTE MONITORING AND CONTROL APPARATUS FOR MONITORING, CONTROLLING, AND TRACKING THE SPEED OF MODEL TRAINS, CARS, AND OTHER TOY HOBBY VEHICLES (U.S. CLS. 21, 23, 26, 36 AND 38).

KIMBERLY FRYE, EXAMINING ATTORNEY

SN 86-040,633. LEE, MICHAEL, CLIFTON, VA. FILED 8-16-2013.

# Financial Management Made Easy

THE MARK CONSISTS OF STANDARD CHARACTERS WITHOUT CLAIM TO ANY PARTICULAR FONT, STYLE, SIZE, OR COLOR.

NO CLAIM IS MADE TO THE EXCLUSIVE RIGHT TO USE "FINANCIAL MANAGEMENT", APART FROM THE MARK AS SHOWN.

FOR VIDEO RECORDINGS TEACHING FINANCIAL MANAGEMENT (U.S. CLS. 21, 23, 26, 36 AND 38).

MARK SHINER, EXAMINING ATTORNEY

SN 86-040,771. BLUE GEM SUNGLASSES, INC., CARPINTERIA, CA. FILED 8-16-2013.

# BG DL

THE MARK CONSISTS OF STANDARD CHARACTERS WITHOUT CLAIM TO ANY PARTICULAR FONT, STYLE, SIZE, OR COLOR.

OWNER OF U.S. REG. NO. 4,164,466. FOR SUNGLASSES (U.S. CLS. 21, 23, 26, 36 AND 38).

FIRST USE 4-30-2013; IN COMMERCE 4-30-2013.  
KATHERINE CHANG, EXAMINING ATTORNEY

**CLASS 9—(Continued).**

SN 86-040,858. WILSON, GLENN, HOUSTON, TX. FILED 8-17-2013.

# KVChess

THE MARK CONSISTS OF STANDARD CHARACTERS WITHOUT CLAIM TO ANY PARTICULAR FONT, STYLE, SIZE, OR COLOR.

OWNER OF U.S. REG. NO. 4,376,190.  
FOR GAME SOFTWARE (U.S. CLS. 21, 23, 26, 36 AND 38).

FIRST USE 8-10-2013; IN COMMERCE 8-10-2013.  
KAPIL BHANOT, EXAMINING ATTORNEY

---

SN 86-040,945. GEORGE BROOKS ARMSTEAD, DERRY, NH. FILED 8-18-2013.

# EFFEN BRILLIANT

THE MARK CONSISTS OF STANDARD CHARACTERS WITHOUT CLAIM TO ANY PARTICULAR FONT, STYLE, SIZE, OR COLOR.

THE ENGLISH TRANSLATION OF THE WORD "EFFEN" IN THE MARK IS "PLAIN".

FOR FLASHING AND STEADY SAFETY LIGHTS (U.S. CLS. 21, 23, 26, 36 AND 38).

DAVID TAYLOR, EXAMINING ATTORNEY

---

SN 86-041,024. ROY GOLDSBERRY JR. AKA GOLDIE FACIQO, CHESAPEAKE, VA. FILED 8-18-2013.

# Faciqo

THE MARK CONSISTS OF STANDARD CHARACTERS WITHOUT CLAIM TO ANY PARTICULAR FONT, STYLE, SIZE, OR COLOR.

FOR AUDIO AND VIDEO RECORDINGS FEATURING MUSIC AND ARTISTIC PERFORMANCES (U.S. CLS. 21, 23, 26, 36 AND 38).

MICHAEL KEATING, EXAMINING ATTORNEY

**CLASS 9—(Continued).**

SN 86-041,139. EASTERN BRILLIANT TRADING CO., LIMITED, HONG KONG, HONG KONG, FILED 8-19-2013.

# CASELAND

THE MARK CONSISTS OF STANDARD CHARACTERS WITHOUT CLAIM TO ANY PARTICULAR FONT, STYLE, SIZE, OR COLOR.

FOR CELL PHONE BATTERY CHARGERS; COMPUTER STYLUS; CARRYING CASES FOR CELL PHONES; CELLULAR PHONE ACCESSORY CHARMS; CELLULAR PHONE ACCESSORIES IN THE NATURE OF BELT CLIPS; CELL PHONE BACKPLATES; CELL PHONE COVERS; CELL PHONE FACEPLATES; CELL PHONE STRAPS; HEAD-CLIP CELL PHONE HOLDERS; CLEAR PROTECTIVE COVERS SPECIALLY ADAPTED FOR PERSONAL ELECTRONIC DEVICES, NAMELY, CELL PHONES, MP3 PLAYERS, PERSONAL DIGITAL ASSISTANTS; PROTECTIVE COVERS AND CASES FOR CELL PHONES AND PORTABLE MEDIA PLAYERS; STANDS FOR HANDHELD DIGITAL ELECTRONIC DEVICES, NAMELY, CELL PHONES, MP3 PLAYERS, PERSONAL DIGITAL ASSISTANTS (U.S. CLS. 21, 23, 26, 36 AND 38).

VIVIAN MICZNIK FIRST, EXAMINING ATTORNEY

---

SN 86-041,198. JENNINGS, WILBUR, LOS ANGELES, CA. FILED 8-19-2013.

# YOGA ZEN ELEVATION

THE MARK CONSISTS OF STANDARD CHARACTERS WITHOUT CLAIM TO ANY PARTICULAR FONT, STYLE, SIZE, OR COLOR.

NO CLAIM IS MADE TO THE EXCLUSIVE RIGHT TO USE "YOGA ZEN", APART FROM THE MARK AS SHOWN.

FOR DIGITAL MEDIA, NAMELY, PRE-RECORDED DVDS, DOWNLOADABLE AUDIO AND VIDEO RECORDINGS, AND CDS FEATURING AND PROMOTING FITNESS AND YOGA (U.S. CLS. 21, 23, 26, 36 AND 38).

KAMAL PREET, EXAMINING ATTORNEY

**CLASS 9—(Continued).**

SN 86-041,540. BOSTON ENGINEERING CORPORATION, WALTHAM, MA. FILED 8-19-2013.

**IMAGINE THE IMPACT**

THE MARK CONSISTS OF STANDARD CHARACTERS WITHOUT CLAIM TO ANY PARTICULAR FONT, STYLE, SIZE, OR COLOR.

FOR EMBEDDED COMPUTER HARDWARE AND SOFTWARE FOR USE BY OTHERS FOR DEVELOPING ELECTRONICS, ELECTRONIC DEVICES AND PROTOTYPES; ELECTRONIC APPARATUS AND INSTRUMENTS FOR CONTROLLING, ADJUSTING AND TESTING OF DRIVES AND MOTORS; ELECTRONIC MOTOR CONTROL TECHNOLOGY EVALUATION KIT COMPRISED OF COMPUTER HARDWARE AND SOFTWARE FOR USE BY OTHERS IN MODELING AND IMPLEMENTATION OF MOTOR CONTROL ALGORITHMS (U.S. CLS. 21, 23, 26, 36 AND 38).

HANNO RITTRER, EXAMINING ATTORNEY

SN 86-041,722. SKALE, RICHARD, ST. LOUIS, MO. FILED 8-19-2013.

**UPSKALE**

THE MARK CONSISTS OF STANDARD CHARACTERS WITHOUT CLAIM TO ANY PARTICULAR FONT, STYLE, SIZE, OR COLOR.

SEC. 2(F).  
FOR EYEWEAR, NAMELY, SUNGLASSES, EYEGLASSES AND OPHTHALMIC FRAMES AND CASES THEREFOR (U.S. CLS. 21, 23, 26, 36 AND 38).

FIRST USE 11-0-2001; IN COMMERCE 11-0-2001.  
CORY BOONE, EXAMINING ATTORNEY

SN 86-041,803. VISUAL ECHOES, INC., LAKE ZURICH, IL. FILED 8-19-2013.

**BETTER BEAMER**

THE MARK CONSISTS OF STANDARD CHARACTERS WITHOUT CLAIM TO ANY PARTICULAR FONT, STYLE, SIZE, OR COLOR.

FOR PHOTOGRAPHIC FLASH EXTENDER, NAMELY, LENS ATTACHED TO CAMERA FLASHES DESIGNED TO FOCUS AND CONCENTRATE THE OUTPUT OF THE FLASH (U.S. CLS. 21, 23, 26, 36 AND 38).

FIRST USE 1-31-1998; IN COMMERCE 1-31-1998.  
CHRISTINE MARTIN, EXAMINING ATTORNEY

**CLASS 9—(Continued).**

SN 86-041,866. KING WIRE INC., NORTH CHICAGO, IL. FILED 8-19-2013.

**EZ SLIDE**

THE MARK CONSISTS OF STANDARD CHARACTERS WITHOUT CLAIM TO ANY PARTICULAR FONT, STYLE, SIZE, OR COLOR.

FOR ELECTRICAL WIRING, NAMELY, ALUMINUM BUILDING WIRE (U.S. CLS. 21, 23, 26, 36 AND 38).

JILLIAN CANTOR, EXAMINING ATTORNEY

SN 86-042,208. JOHNSON & JOHNSON, NEW BRUNSWICK, NJ. FILED 8-19-2013.

**ACUVUE CLEAR**

THE MARK CONSISTS OF STANDARD CHARACTERS WITHOUT CLAIM TO ANY PARTICULAR FONT, STYLE, SIZE, OR COLOR.

OWNER OF U.S. REG. NOS. 1,458,177, 3,331,060 AND OTHERS.

NO CLAIM IS MADE TO THE EXCLUSIVE RIGHT TO USE "CLEAR", APART FROM THE MARK AS SHOWN.

FOR CONTACT LENSES (U.S. CLS. 21, 23, 26, 36 AND 38).

HEATHER THOMPSON, EXAMINING ATTORNEY

SN 86-042,249. GLAM HOUSE, INC., LOS ANGELES, CA. FILED 8-19-2013.

**GLAM GIRLS**

THE MARK CONSISTS OF STANDARD CHARACTERS WITHOUT CLAIM TO ANY PARTICULAR FONT, STYLE, SIZE, OR COLOR.

OWNER OF U.S. REG. NO. 3,279,718.  
NO CLAIM IS MADE TO THE EXCLUSIVE RIGHT TO USE "GIRLS", APART FROM THE MARK AS SHOWN.

FOR SUNGLASSES (U.S. CLS. 21, 23, 26, 36 AND 38).  
MARC LEIPZIG, EXAMINING ATTORNEY

**CLASS 9—(Continued).**

SN 86-042,358. PROTECTIVE ENCLOSURES COMPANY, LLC, ALTAMONTE SPRINGS, FL. FILED 8-20-2013.

**THE TV SHIELD**

THE MARK CONSISTS OF STANDARD CHARACTERS WITHOUT CLAIM TO ANY PARTICULAR FONT, STYLE, SIZE, OR COLOR.

OWNER OF U.S. REG. NO. 4,333,553.  
NO CLAIM IS MADE TO THE EXCLUSIVE RIGHT TO USE "TV", APART FROM THE MARK AS SHOWN.  
SEC. 2(F).

FOR SPECIALLY ADAPTED WEATHERPROOF ENCLOSURES FOR FLAT SCREEN TELEVISIONS THAT COMPLETELY ENCLOSE AND PROTECT THE TELEVISION (U.S. CLS. 21, 23, 26, 36 AND 38).

FIRST USE 2-0-2003; IN COMMERCE 2-0-2003.  
FONG HSU, EXAMINING ATTORNEY

SN 86-042,362. PROTECTIVE ENCLOSURES COMPANY, LLC, ALTAMONTE SPRINGS, FL. FILED 8-20-2013.

**THE DISPLAY SHIELD**

THE MARK CONSISTS OF STANDARD CHARACTERS WITHOUT CLAIM TO ANY PARTICULAR FONT, STYLE, SIZE, OR COLOR.

NO CLAIM IS MADE TO THE EXCLUSIVE RIGHT TO USE "DISPLAY", APART FROM THE MARK AS SHOWN.  
SEC. 2(F).

FOR SPECIALLY ADAPTED WEATHERPROOF AND TAMPER-RESISTANT ENCLOSURES FOR FLAT SCREEN TELEVISIONS, FLAT PANEL DISPLAYS AND DIGITAL SIGNAGE THAT COMPLETELY ENCLOSE AND PROTECT THE TELEVISION, FLAT PANEL DISPLAY AND DIGITAL SIGNAGE (U.S. CLS. 21, 23, 26, 36 AND 38).

FIRST USE 2-0-2003; IN COMMERCE 2-0-2003.  
FONG HSU, EXAMINING ATTORNEY

SN 86-042,371. JENNINGS, WILBUR, LOS ANGELES, CA. FILED 8-20-2013.

**CARDIO ZEN ELEVATION**

THE MARK CONSISTS OF STANDARD CHARACTERS WITHOUT CLAIM TO ANY PARTICULAR FONT, STYLE, SIZE, OR COLOR.

NO CLAIM IS MADE TO THE EXCLUSIVE RIGHT TO USE "CARDIO ZEN", APART FROM THE MARK AS SHOWN.

FOR DIGITAL MEDIA, NAMELY, PRE-RECORDED DVDS, DOWNLOADABLE AUDIO AND VIDEO RECORDINGS, AND CDS FEATURING AND PROMOTING FITNESS AND YOGA (U.S. CLS. 21, 23, 26, 36 AND 38).

KAMAL PREET, EXAMINING ATTORNEY

**CLASS 9—(Continued).**

SN 86-042,662. HAPPY HOUR NINJA, POTOMAC, MD. FILED 8-20-2013.

**Because it's 4 o'clock  
somewhere!**

THE MARK CONSISTS OF STANDARD CHARACTERS WITHOUT CLAIM TO ANY PARTICULAR FONT, STYLE, SIZE, OR COLOR.

FOR DOWNLOADABLE MOBILE APPLICATIONS FOR LOCATING HAPPY HOURS AT BARS AND RESTAURANTS; DOWNLOADABLE SOFTWARE IN THE NATURE OF A MOBILE APPLICATION FOR LOCATING HAPPY HOURS AT BARS AND RESTAURANTS (U.S. CLS. 21, 23, 26, 36 AND 38).

ANDREW RHIM, EXAMINING ATTORNEY

SN 86-043,006. SELECT MIX, INC., LAS VEGAS, NV. FILED 8-20-2013.

**SELECT MIX DIGITAL**

THE MARK CONSISTS OF STANDARD CHARACTERS WITHOUT CLAIM TO ANY PARTICULAR FONT, STYLE, SIZE, OR COLOR.

OWNER OF U.S. REG. NO. 2,934,936.  
NO CLAIM IS MADE TO THE EXCLUSIVE RIGHT TO USE "DIGITAL", APART FROM THE MARK AS SHOWN.  
SEC. 2(F) AS TO "SELECT MIX".

FOR MUSICAL SOUND RECORDINGS (U.S. CLS. 21, 23, 26, 36 AND 38).

FIRST USE 1-0-2013; IN COMMERCE 1-0-2013.  
JILL PRATER, EXAMINING ATTORNEY

SN 86-043,251. ACENDA, INC., SAN DIEGO, CA. FILED 8-20-2013.

**ACENDA**

THE MARK CONSISTS OF STANDARD CHARACTERS WITHOUT CLAIM TO ANY PARTICULAR FONT, STYLE, SIZE, OR COLOR.

THE ENGLISH TRANSLATION OF THE WORD "ACENDA" IN THE MARK IS "LIGHT".

FOR COMPUTER E-COMMERCE SOFTWARE TO ALLOW USERS TO PERFORM ELECTRONIC BUSINESS TRANSACTIONS VIA A GLOBAL COMPUTER NETWORK (U.S. CLS. 21, 23, 26, 36 AND 38).

ELIZABETH JACKSON, EXAMINING ATTORNEY

**CLASS 9—(Continued).**

SN 86-043,354. SERVER TECHNOLOGY, INC., RENO, NV. FILED 8-20-2013.

**SERVER TECHNOLOGY**

THE MARK CONSISTS OF STANDARD CHARACTERS WITHOUT CLAIM TO ANY PARTICULAR FONT, STYLE, SIZE, OR COLOR.

OWNER OF U.S. REG. NOS. 3,305,028, 4,241,253 AND 4,241,257.

NO CLAIM IS MADE TO THE EXCLUSIVE RIGHT TO USE "TECHNOLOGY", APART FROM THE MARK AS SHOWN.

SEC. 2(F).  
FOR ELECTRICAL POWER DISTRIBUTION UNITS FOR DATA CENTER EQUIPMENT CABINETS (U.S. CLS. 21, 23, 26, 36 AND 38).

FIRST USE 0-0-1984; IN COMMERCE 0-0-1984.  
TINA BROWN, EXAMINING ATTORNEY

**CLASS 9—(Continued).**

SN 86-044,008. SOFT COMPUTER CONSULTANTS, INC., DBA SCC SOFT COMPUTER, CLEARWATER, FL. FILED 8-21-2013.

**SCC's Outreach Information Systems Suite**

THE MARK CONSISTS OF STANDARD CHARACTERS WITHOUT CLAIM TO ANY PARTICULAR FONT, STYLE, SIZE, OR COLOR.

OWNER OF U.S. REG. NOS. 2,892,837 AND 3,273,266.

NO CLAIM IS MADE TO THE EXCLUSIVE RIGHT TO USE "OUTREACH INFORMATION SYSTEMS SUITE", APART FROM THE MARK AS SHOWN.

FOR COMPUTER SOFTWARE FOR APPLICATION AND DATABASE INTEGRATION FOR USE IN OUTREACH SOLUTIONS, NAMELY, WEB OUTREACH, BILLING AND COLLECTIONS, MEDICAL NECESSITY CHECKING, AND COURIER TRACKING/CUSTOMER RELATION MANAGEMENT (U.S. CLS. 21, 23, 26, 36 AND 38).

KATHERINE STOIDES, EXAMINING ATTORNEY

SN 86-044,217. PIECEMAKER TECHNOLOGIES INC., PITTSBURGH, PA. FILED 8-21-2013.

**PIECE-IT!**

THE MARK CONSISTS OF STANDARD CHARACTERS WITHOUT CLAIM TO ANY PARTICULAR FONT, STYLE, SIZE, OR COLOR.

FOR OPERATING SOFTWARE FOR PRINTERS, INCLUDING THREE DIMENSIONAL (3D) PRINTERS (U.S. CLS. 21, 23, 26, 36 AND 38).

CHRISTINA SOBRAL, EXAMINING ATTORNEY

SN 86-043,668. EPIC TECH, LLC, PIEDMONT, SC. FILED 8-21-2013.

**DRILLING FOR DOLLARS**

THE MARK CONSISTS OF STANDARD CHARACTERS WITHOUT CLAIM TO ANY PARTICULAR FONT, STYLE, SIZE, OR COLOR.

NO CLAIM IS MADE TO THE EXCLUSIVE RIGHT TO USE "DRILLING", APART FROM THE MARK AS SHOWN.

FOR SOFTWARE, NAMELY, SOFTWARE FOR RUNNING AND OPERATING ELECTRONIC SLOT AND BINGO MACHINES, ELECTRONIC CASINO GAME MACHINES, ELECTRONIC SKILL-BASED GAME MACHINES, AND ELECTRONIC SWEEPSTAKES GAME MACHINES (U.S. CLS. 21, 23, 26, 36 AND 38).

ANDREW RHIM, EXAMINING ATTORNEY

SN 86-044,266. WATERS TECHNOLOGIES CORPORATION, WILMINGTON, MA. FILED 8-21-2013.

**TREFOIL**

THE MARK CONSISTS OF STANDARD CHARACTERS WITHOUT CLAIM TO ANY PARTICULAR FONT, STYLE, SIZE, OR COLOR.

FOR CHROMATOGRAPHY COLUMNS FOR LABORATORY USE (U.S. CLS. 21, 23, 26, 36 AND 38).

FLORENTINA BLANDU, EXAMINING ATTORNEY

**CLASS 9—(Continued).**

SN 86-044,297. MY COLLEGE HUSTLE LLC, WASHINGTON, DC. FILED 8-21-2013.

**CLASS 9—(Continued).**

SN 86-044,480. JENCON SOLUTIONS, LLC, HOUSTON, TX. FILED 8-21-2013.

**MY COLLEGE HUSTLE**

THE MARK CONSISTS OF STANDARD CHARACTERS WITHOUT CLAIM TO ANY PARTICULAR FONT, STYLE, SIZE, OR COLOR.

NO CLAIM IS MADE TO THE EXCLUSIVE RIGHT TO USE "COLLEGE", APART FROM THE MARK AS SHOWN.

FOR DOWNLOADABLE SOFTWARE FOR MOBILE DEVICES THAT ALLOWS COLLEGE STUDENTS TO BUY, SELL, AND TRADE GOODS AND SERVICES TO THE GENERAL PUBLIC (U.S. CLS. 21, 23, 26, 36 AND 38).

KHANH LE, EXAMINING ATTORNEY

SN 86-044,303. MY COLLEGE HUSTLE LLC, WASHINGTON, DC. FILED 8-21-2013.



NO CLAIM IS MADE TO THE EXCLUSIVE RIGHT TO USE "COLLEGE", APART FROM THE MARK AS SHOWN.

THE MARK CONSISTS OF REAR PORTRAIT OF A BOY WITH SHOULDER-LENGTH HAIR WEARING LONG-SLEEVED SHIRT/SWEATER; THE BOY IS WEARING A BACKPACK; ON THE FRONT OF THE BACKPACK, STYLIZED LETTERS "MCH" ARE PRINTED; THE BACKPACK IS PARTIALLY OPEN AND THERE IS CASH SPILLING OUT OF THE BACKPACK; THE BOY'S HEAD IS TURNED SIDWAYS, FACING THE LEFT SIDE; WITH HIS LEFT HAND HE IS HOLDING/REMOVING HER SUNGLASSES AND WITH HIS RIGHT HAND, HE IS GIVING THE THUMBS UP; HE IS WEARING A BASEBALL CAP WORN BACKWARDS; THE FOREGOING IS AGAINST THE BACKGROUND OF COLLEGE RULED SHEET PAPER; ALL OF THE FOREGOING IS ENCLOSED WITHIN A CIRCLE; OUTSIDE OF THE CIRCLE, TO THE RIGHT IS THE PHRASE "MY COLLEGE HUSTLE" WHICH IS IN STYLIZED FONT; SOME OF THE CASH FROM THE BACKPACK SPILLS OUTSIDE OF THE CIRCLE ONTO THE LETTERS "M" AND "Y"; 3 BILLS OF CASH TOUCHES THE TOP OF THE LETTER "M"; 1 BILL RESTS ABOVE THE LETTER "M"; ANOTHER 2 BILLS SIT ON TOP OF THE LETTER "M".

FOR DOWNLOADABLE SOFTWARE IN THE NATURE OF A MOBILE APPLICATION FOR FOR USE BY COLLEGE STUDENTS THAT ALLOWS THEM TO BUY, SELL, AND TRADE GOODS AND SERVICES TO THE GENERAL PUBLIC (U.S. CLS. 21, 23, 26, 36 AND 38).

KHANH LE, EXAMINING ATTORNEY



NO CLAIM IS MADE TO THE EXCLUSIVE RIGHT TO USE "SOLUTIONS, LLC", APART FROM THE MARK AS SHOWN.

THE MARK CONSISTS OF THE TEXT "JENCON", IN WHICH THE "O" IS A DIVING HELMET AND THERE IS A BOOK IS LEANING AGAINST THE SECOND "N", AND BELOW IS THE TEXT "SOLUTIONS, LLC".

FOR DOWNLOADABLE ELECTRONIC BOOKS IN THE FIELD OF COMMERCIAL DIVING AND ABOUT UNDERWATER COMMERCIAL DIVING SERVICES (U.S. CLS. 21, 23, 26, 36 AND 38).

ASMAT KHAN, EXAMINING ATTORNEY



**CLASS 9—(Continued).**

SN 86-044,668. LYONS, MARK J, SYDNEY, AUSTRALIA,  
FILED 8-22-2013.



NO CLAIM IS MADE TO THE EXCLUSIVE RIGHT TO USE "IT", APART FROM THE MARK AS SHOWN.

THE COLOR(S) BLACK, GOLD AND WHITE IS/ARE CLAIMED AS A FEATURE OF THE MARK.

THE MARK CONSISTS OF A BLACK STAR SHAPED DESIGN OUTLINED IN BLACK AND SHADES OF GOLD, WITH THE LETTERS "IT" IN WHITE COLOR IN THE CENTRE OF THE STAR SHAPED DESIGN. LOCATED CENTRALLY UNDERNEATH THE STAR SHAPED DESIGN ARE THE BLACK COLOR LETTERS AND WORDS "APP-STAR" WHICH ARE POSITIONED BETWEEN THE TWO POINTS OF THE STAR.

FOR COMPUTER APPLICATION SOFTWARE FOR MOBILE PHONES, NAMELY, SOFTWARE FOR MOBILE SMART PHONES FOR AUDIO VISUAL DISPLAYS, STREAMING OF VIDEOS, MUSIC, AND MOBILE APPLICATIONS, AND IDENTITY AND PERSONAL INFORMATION SECURITY; COMPUTER HARDWARE AND COMPUTER SOFTWARE PROGRAMS FOR THE INTEGRATION OF TEXT, AUDIO, GRAPHICS, STILL IMAGES AND MOVING PICTURES INTO AN INTERACTIVE DELIVERY FOR MULTIMEDIA APPLICATIONS; COMPUTER SOFTWARE FOR APPLICATION AND DATABASE INTEGRATION; COMPUTER SOFTWARE THAT PROVIDES WEB-BASED ACCESS TO APPLICATIONS AND SERVICES THROUGH A WEB OPERATING SYSTEM OR PORTAL INTERFACE; COMPUTER SOFTWARE TO ENHANCE THE AUDIO-VISUAL CAPABILITIES OF MULTIMEDIA APPLICATIONS, NAMELY, FOR THE INTEGRATION OF TEXT, AUDIO, GRAPHICS, STILL IMAGES AND MOVING PICTURES; COMPUTER SOFTWARE, NAMELY, SOFTWARE DEVELOPMENT TOOLS FOR THE CREATION OF MOBILE INTERNET APPLICATIONS AND CLIENT INTERFACES; DOWNLOADABLE GRAPHICS FOR MOBILE PHONES; DOWNLOADABLE MOBILE APPLICATIONS FOR SMARTPHONES, MEDIA PLAYERS, HANDHELD COMPUTERS FOR AUDIO VISUAL DISPLAYS, STREAMING OF VIDEOS, MUSIC, AND MOBILE APPLICATIONS, AND IDENTITY AND PERSONAL INFORMATION SECURITY; MOBILE COMPUTING AND OPERATING PLATFORMS CONSISTING OF DATA TRANSCEIVERS, WIRELESS NETWORKS AND GATEWAYS FOR COLLECTION AND MANAGEMENT OF DATA (U.S. CLS. 21, 23, 26, 36 AND 38).

TINA MAI, EXAMINING ATTORNEY

**CLASS 9—(Continued).**

SN 86-044,701. PHONO SOLAR TECHNOLOGY CO., LTD,  
210032 NANJING, CHINA, FILED 8-22-2013.

**Phonocube**

THE MARK CONSISTS OF THE STYLIZED WORD "PHONOCUBE" WITH THE LETTERS "CUBE" ON A RECTANGULAR BACKGROUND.

FOR APPARATUS AND INSTRUMENTS FOR CONVEYING, DISTRIBUTING, TRANSFORMING, STORING, REGULATING OR CONTROLLING ELECTRIC CURRENT; BATTERY BOXES; COMMUTATORS; ELECTRIC ACCUMULATORS; ELECTRIC CONTROL PANELS; ELECTRICAL DISTRIBUTION BOXES; ELECTRICITY DISTRIBUTION CONSOLES; INDUSTRIAL AUTOMATION CONTROLS; INVERTERS; PHOTOVOLTAIC CELLS ALSO INCLUDING A SOLAR THERMAL COLLECTOR SOLD AS A UNIT (U.S. CLS. 21, 23, 26, 36 AND 38).

SHANNON TWOHIG, EXAMINING ATTORNEY

SN 86-044,733. HANDY APPS PTE LTD, SINGAPORE,  
SINGAPORE, FILED 8-22-2013.

**VIDEO LOCKER**

THE MARK CONSISTS OF STANDARD CHARACTERS WITHOUT CLAIM TO ANY PARTICULAR FONT, STYLE, SIZE, OR COLOR.

NO CLAIM IS MADE TO THE EXCLUSIVE RIGHT TO USE "VIDEO", APART FROM THE MARK AS SHOWN.

FOR MOBILE SOFTWARE APPLICATION FOR SMART PHONES, HANDHELD DEVICES AND TABLET COMPUTERS THAT PROVIDES SECURE ACCESS TO VIDEO FILES STORED ON THAT DEVICE (U.S. CLS. 21, 23, 26, 36 AND 38).

FIRST USE 7-19-2012; IN COMMERCE 7-19-2012.

MATTHEW EINSTEIN, EXAMINING ATTORNEY

**CLASS 9—(Continued).**

SN 86-044,753. 4CABLE TV INC, CONWAY, SC. FILED 8-22-2013.

## PowerMiser

THE MARK CONSISTS OF STANDARD CHARACTERS WITHOUT CLAIM TO ANY PARTICULAR FONT, STYLE, SIZE, OR COLOR.

FOR POWER BOOSTER AMPLIFIER FOR REDUCING THE POWER REQUIREMENTS OF CABLE TELEVISION AMPLIFIERS (U.S. CLS. 21, 23, 26, 36 AND 38).

FIRST USE 7-21-2009; IN COMMERCE 7-21-2009.  
JEAN IM, EXAMINING ATTORNEY

---

SN 86-045,058. REVCO INDUSTRIES, INC., NORWALK, CA. FILED 8-22-2013.

## MAXIMUS

THE MARK CONSISTS OF STANDARD CHARACTERS WITHOUT CLAIM TO ANY PARTICULAR FONT, STYLE, SIZE, OR COLOR.

FOR PROTECTIVE GLOVES FOR INDUSTRIAL USE; PROTECTIVE WORK GLOVES; PROTECTIVE WORK GLOVES FOR WELDING (U.S. CLS. 21, 23, 26, 36 AND 38).

CHRISTOPHER LAW, EXAMINING ATTORNEY

---

SN 86-045,123. CONTROL-TEC LLC, ALLEN PARK, MI. FILED 8-22-2013.

## CT-600

THE MARK CONSISTS OF STANDARD CHARACTERS WITHOUT CLAIM TO ANY PARTICULAR FONT, STYLE, SIZE, OR COLOR.

OWNER OF U.S. REG. NOS. 4,107,084, 4,133,155 AND 4,406,398.

FOR ELECTRONIC DATA RECORDERS FOR USE IN VEHICLES THAT ALLOW COMMUNICATION BETWEEN A COMPUTER AND A VEHICLE (U.S. CLS. 21, 23, 26, 36 AND 38).

JENNIFER MARTIN, EXAMINING ATTORNEY

**CLASS 9—(Continued).**

SN 86-045,915. YULONG COMPUTER TELECOMMUNICATION SCIENTIFIC (SHENZHEN) CO., LTD., SHENZHEN, GD, CHINA, FILED 8-23-2013.

## Coolpad flo

THE MARK CONSISTS OF STANDARD CHARACTERS WITHOUT CLAIM TO ANY PARTICULAR FONT, STYLE, SIZE, OR COLOR.

OWNER OF U.S. REG. NOS. 3,527,661, 4,358,836 AND OTHERS.

THE WORDING "FLO" HAS NO MEANING IN A FOREIGN LANGUAGE.

FOR AUTOMATIC TELEPHONE EXCHANGES; BAGS AND CASES SPECIALLY ADAPTED FOR HOLDING OR CARRYING PORTABLE TELEPHONES AND TELEPHONE EQUIPMENT AND ACCESSORIES; BATTERIES; CAMERAS; CASES FOR TELEPHONES; CELLULAR TELEPHONES; COMMUNICATIONS COMPUTERS; COMPUTER ANTI-VIRUS SOFTWARE; COMPUTER APPLICATION SOFTWARE FOR MOBILE PHONES, NAMELY, SOFTWARE FOR USE IN DATABASE MANAGEMENT; COMPUTER GAME PROGRAMS; COMPUTER HARDWARE AND PERIPHERALS; COMPUTER HARDWARE FOR TELECOMMUNICATIONS; COMPUTER OPERATING SOFTWARE; COMPUTER SOFTWARE TO ENABLE THE TRANSMISSION OF PHOTOGRAPHS TO MOBILE TELEPHONES; CORDLESS TELEPHONES; DIGITAL TELEPHONE PLATFORMS AND SOFTWARE; DIGITAL TELEPHONES; DOWNLOADABLE COMPUTER GAME PROGRAMS; ELECTRONIC GAME SOFTWARE FOR CELLULAR TELEPHONES; FIXED LOCATION TELEPHONES; GLOBAL POSITIONING SYSTEM (GPS); GPS NAVIGATION DEVICE; HEADSETS FOR MOBILE TELEPHONES; IN-CAR TELEPHONE HANDSET CRADLES; MOBILE TELEPHONE BATTERIES; MOBILE TELEPHONES; NOTEBOOK COMPUTERS; PHOTOGRAPHIC CAMERAS; PORTABLE TELECOMMUNICATION INSTANT MESSAGING DEVICES; PORTABLE TELEPHONES; RADIO TELEPHONES; SATELLITE TELEPHONES; TABLET COMPUTER; TELEPHONE APPARATUS; TELEPHONE RECORDERS; TELEPHONE SETS WITH SCREEN AND KEYBOARD; TELEPHONES; VIDEO SCREENS; VIDEO TELEPHONES (U.S. CLS. 21, 23, 26, 36 AND 38).

KELLY BOULTON, EXAMINING ATTORNEY

---

SN 86-046,022. CANNED BANANAS, NEW YORK, NY. FILED 8-23-2013.

## Farkle Tower

THE MARK CONSISTS OF STANDARD CHARACTERS WITHOUT CLAIM TO ANY PARTICULAR FONT, STYLE, SIZE, OR COLOR.

NO CLAIM IS MADE TO THE EXCLUSIVE RIGHT TO USE "FARKLE", APART FROM THE MARK AS SHOWN.

FOR COMPUTER GAME SOFTWARE FOR USE ON MOBILE AND CELLULAR PHONES (U.S. CLS. 21, 23, 26, 36 AND 38).

JEFF DEFORD, EXAMINING ATTORNEY

**CLASS 9—(Continued).**

SN 86-046,824. ZHAVEA, INC, ENCINO, CA. FILED 8-23-2013.

**J'OUVERT**

THE MARK CONSISTS OF STANDARD CHARACTERS WITHOUT CLAIM TO ANY PARTICULAR FONT, STYLE, SIZE, OR COLOR.

THE ENGLISH TRANSLATION OF "J'OUVERT" IN THE MARK IS "I OPENED".

FOR AUDIO AND VIDEO RECORDINGS FEATURING MUSIC AND ARTISTIC PERFORMANCES; DIGITAL MEDIA, NAMELY, PRE-RECORDED DVDS, DOWNLOADABLE AUDIO AND VIDEO RECORDINGS, AND CDS FEATURING AND PROMOTING MUSIC AND VIDEOS; DOWNLOADABLE MUSIC FILES; DOWNLOADABLE MUSICAL SOUND RECORDINGS; DOWNLOADABLE VIDEO RECORDINGS FEATURING MUSIC (U.S. CLS. 21, 23, 26, 36 AND 38).

KEVIN CORWIN, EXAMINING ATTORNEY

**CLASS 9—(Continued).**

SN 86-047,020. NEWPORT EXCHANGE HOLDINGS, INC, DBA ONLINE TRADING ACADEMY, IRVINE, CA. FILED 8-23-2013.

**ProActive  
Investor**

OWNER OF U.S. REG. NOS. 3,956,550 AND 3,987,746.  
NO CLAIM IS MADE TO THE EXCLUSIVE RIGHT TO USE "INVESTOR", APART FROM THE MARK AS SHOWN. THE COLOR(S) GREEN AND BLUE IS/ARE CLAIMED AS A FEATURE OF THE MARK.

THE MARK CONSISTS OF THE WORD "PROACTIVE" APPEARING IN VARIEGATED SHADES OF GREEN DIRECTLY ABOVE AND SLIGHTLY TO THE RIGHT OF THE WORD "INVESTOR" WHICH APPEARS IN VARIEGATED SHADES OF BLUE.

FOR PRE-RECORDED CDS AND DVDS FEATURING EDUCATION, INSTRUCTION AND TRAINING IN THE FIELD OF FINANCIAL AND SECURITIES TRAINING (U.S. CLS. 21, 23, 26, 36 AND 38).

FIRST USE 1-11-2009; IN COMMERCE 1-11-2009.

WILLIAM VERHOSEK, EXAMINING ATTORNEY

---

SN 86-047,541. AMPHENOL CORPORATION, WALLINGFORD, CT. FILED 8-26-2013.

**CHAMELEON**

THE MARK CONSISTS OF STANDARD CHARACTERS WITHOUT CLAIM TO ANY PARTICULAR FONT, STYLE, SIZE, OR COLOR.

FOR ELECTRICAL CONNECTORS (U.S. CLS. 21, 23, 26, 36 AND 38).

ALAIN LAPTER, EXAMINING ATTORNEY

---

SN 86-047,742. CLEVERMIND, LLC, ELMHURST, IL. FILED 8-26-2013.

**ProActive Investor****clevermind**

THE MARK CONSISTS OF STANDARD CHARACTERS WITHOUT CLAIM TO ANY PARTICULAR FONT, STYLE, SIZE, OR COLOR.

OWNER OF U.S. REG. NOS. 3,956,550 AND 3,987,746.

NO CLAIM IS MADE TO THE EXCLUSIVE RIGHT TO USE "INVESTOR", APART FROM THE MARK AS SHOWN.

FOR PRE - RECORDED CDS AND DVDS FEATURING EDUCATION, INSTRUCTION AND TRAINING IN THE FIELD OF FINANCIAL AND SECURITIES EDUCATION (U.S. CLS. 21, 23, 26, 36 AND 38).

FIRST USE 1-11-2009; IN COMMERCE 1-11-2009.

WILLIAM VERHOSEK, EXAMINING ATTORNEY

THE MARK CONSISTS OF STANDARD CHARACTERS WITHOUT CLAIM TO ANY PARTICULAR FONT, STYLE, SIZE, OR COLOR.

FOR COMPUTER APPLICATION SOFTWARE FOR MOBILE PHONES AND TABLET COMPUTERS, NAMELY, SOFTWARE FOR PLAYING ELECTRONIC GAMES FOR COGNITIVE IMPROVEMENT, AND SOFTWARE FOR USE IN ENGAGING IN SOCIAL NETWORKING (U.S. CLS. 21, 23, 26, 36 AND 38).

FIRST USE 8-18-2012; IN COMMERCE 1-1-2013.

ANDREW RHIM, EXAMINING ATTORNEY

**CLASS 9—(Continued).**

SN 86-047,757. RIPPLE EFFECTS, INC., SAN FRANCISCO, CA. FILED 8-26-2013.

**Ripple Effects PocketBuddy**

THE MARK CONSISTS OF STANDARD CHARACTERS WITHOUT CLAIM TO ANY PARTICULAR FONT, STYLE, SIZE, OR COLOR.

OWNER OF U.S. REG. NO. 3,191,697.

FOR COMPUTER APPLICATION SOFTWARE FOR MOBILE PHONES, NAMELY, SOFTWARE FOR PROVIDING CONFIDENTIAL EMOTIONAL SUPPORT, MOTIVATIONAL COUNSELING AND COGNITIVE, BEHAVIORAL AND EMOTIONAL SKILL BUILDING FOR A HOST OF LIFE ISSUES FACING SERVICE MEMBERS AND THEIR FAMILIES (U.S. CLS. 21, 23, 26, 36 AND 38).

JAMES LOVELACE, EXAMINING ATTORNEY

---

SN 86-047,867. GEOSYS SA, CEDEX, FRANCE, FILED 8-26-2013.

**CROPTICAL**

THE MARK CONSISTS OF STANDARD CHARACTERS WITHOUT CLAIM TO ANY PARTICULAR FONT, STYLE, SIZE, OR COLOR.

FOR DOWNLOADABLE SOFTWARE IN THE NATURE OF A MOBILE APPLICATION FOR PROVIDING THOSE IN THE AGRICULTURAL INDUSTRY WITH INFORMATION REGARDING THE HEALTH AND GROWTH OF THEIR CROPS, THE HISTORY OF THEIR FIELDS' PERFORMANCE, AND INFORMATION FOR BENCHMARKING THE PERFORMANCE OF THEIR FIELDS AGAINST NEIGHBORHOOD FIELDS (U.S. CLS. 21, 23, 26, 36 AND 38).

AMEEN IMAM, EXAMINING ATTORNEY

---

SN 86-048,043. ARMPOCKET ENTERPRISES, LLC, MIRAMAR, FL. FILED 8-26-2013.

**NIGHTHAWK**

THE MARK CONSISTS OF STANDARD CHARACTERS WITHOUT CLAIM TO ANY PARTICULAR FONT, STYLE, SIZE, OR COLOR.

FOR ARMBANDS DESIGNED FOR AND HOLDERS FOR CELLULAR PHONES AND PORTABLE AND HANDHELD DIGITAL ELECTRONIC DEVICES; ARMBANDS WITH INTEGRATED FLASHLIGHT DESIGNED FOR AND HOLDERS FOR CELLULAR PHONES AND PORTABLE AND HANDHELD DIGITAL ELECTRONIC DEVICES (U.S. CLS. 21, 23, 26, 36 AND 38).

FIRST USE 1-16-2013; IN COMMERCE 1-16-2013.

MORGAN WYNNE, EXAMINING ATTORNEY

**CLASS 9—(Continued).**

SN 86-048,639. THE CONSUMER GROUP LLC, BOCA RATON, FL. FILED 8-27-2013.

**Air It**

THE MARK CONSISTS OF STANDARD CHARACTERS WITHOUT CLAIM TO ANY PARTICULAR FONT, STYLE, SIZE, OR COLOR.

NO CLAIM IS MADE TO THE EXCLUSIVE RIGHT TO USE "AIR", APART FROM THE MARK AS SHOWN.

FOR AIR COMPRESSORS SOLD AS A FEATURE OF BATTERY JUMP STARTERS (U.S. CLS. 21, 23, 26, 36 AND 38).

FIRST USE 6-1-2013; IN COMMERCE 6-1-2013.

JAMES MACFARLANE, EXAMINING ATTORNEY

---

SN 86-049,609. BARKING MUFFIN GAMES, LLC, EMERYVILLE, CA. FILED 8-27-2013.



NO CLAIM IS MADE TO THE EXCLUSIVE RIGHT TO USE "GAMES", APART FROM THE MARK AS SHOWN.

THE MARK CONSISTS OF A STYLIZED MUFFIN CHARACTERIZED WITH DOG EARS, EYES, NOSE, MOUTH AND A WAGGING TAIL ABOVE THE WORDS "BARKING MUFFIN" POSITIONED AT A SLIGHT ANGLE ALL INSIDE A BORDER ENCOMPASSING THE WORDING AND DESIGN WITH THE WORD "GAMES" APPEARING BELOW THE WORD "MUFFIN" AND INSIDE AN OBLONG CARRIER EXTENDING HORIZONTALLY FROM THE BORDER.

FOR COMPUTER GAME PROGRAMMES DOWNLOADABLE VIA THE INTERNET (U.S. CLS. 21, 23, 26, 36 AND 38).

JEFF DEFORD, EXAMINING ATTORNEY

**CLASS 9—(Continued).**

SN 86-051,386. TRIFECTA MULTIMEDIA, DBA TRIFECTA CLINICAL, LOS ANGELES, CA. FILED 8-29-2013.

# SiteReady

THE MARK CONSISTS OF STANDARD CHARACTERS WITHOUT CLAIM TO ANY PARTICULAR FONT, STYLE, SIZE, OR COLOR.

FOR COMPUTER SOFTWARE FOR USE IN THE DISTRIBUTION, TRACKING AND COLLECTION OF DOCUMENTS RELATED TO CLINICAL STUDY START-UPS IN THE FIELD OF PHARMACEUTICALS AND MEDICAL DEVICES (U.S. CLS. 21, 23, 26, 36 AND 38).  
SUSAN RICHARDS, EXAMINING ATTORNEY

**CLASS 9—(Continued).**

SN 86-052,526. ASSOCIATION OF POSTCONSUMER PLASTIC RECYCLERS, WASHINGTON, DC. FILED 8-30-2013.

# APR Design

THE MARK CONSISTS OF STANDARD CHARACTERS WITHOUT CLAIM TO ANY PARTICULAR FONT, STYLE, SIZE, OR COLOR.

OWNER OF U.S. REG. NOS. 2,524,100 AND 4,202,639.  
NO CLAIM IS MADE TO THE EXCLUSIVE RIGHT TO USE "DESIGN", APART FROM THE MARK AS SHOWN.

FOR DOWNLOADABLE TECHNICAL DOCUMENTS FOR USE BY PACKAGING DESIGNERS, BOTTLE INNOVATORS, PLASTIC BOTTLE DESIGNERS, FABRICATORS, AND PACKAGING DECISION-MAKERS TO ADDRESS FITNESS OF PURPOSE FOR PLASTICS RECYCLING BY SPECIFYING THE CRITERIA FOR DESIGNING AND MANUFACTURING PLASTIC MATERIAL TO BE COMPATIBLE WITH THE BROADEST RANGE OF PLASTIC RECYCLING OPERATIONS AND TECHNOLOGIES (U.S. CLS. 21, 23, 26, 36 AND 38).  
DAVID TOOLEY, EXAMINING ATTORNEY

SN 86-052,268. TELECOMMUNICATION SYSTEMS, INC., ANNAPOLIS, MD. FILED 8-30-2013.



THE COLOR(S) YELLOW AND BLUE IS/ARE CLAIMED AS A FEATURE OF THE MARK.

THE MARK CONSISTS OF A STYLIZED "V" THAT FORMS PART OF AN EKG GRAPH, WITH THE MARK APPEARING IN YELLOW ON THE LEFT SIDE AND CHANGING TO BLUE ON THE RIGHT SIDE.

FOR SOFTWARE FOR ENABLING ACCESS TO TELEHEALTHCARE SERVICES BY USERS OF MOBILE AND WEB-ENABLED DEVICES; SOFTWARE THAT ENABLES HEALTH PRACTITIONERS, CARE GIVERS AND FAMILY MEMBERS TO LOCATE THROUGH MOBILE AND WEB-ENABLED DEVICES PATIENTS AND FAMILY MEMBERS RECEIVING CARE BASED ON THE LOCATION OF THESE PATIENTS AND FAMILY MEMBERS (U.S. CLS. 21, 23, 26, 36 AND 38).  
FRED CARL, EXAMINING ATTORNEY

SN 86-052,672. BROTHER INDUSTRIES, LTD., NAGOYA-SHI, JAPAN, FILED 8-30-2013.



OWNER OF U.S. REG. NOS. 3,717,358 AND 3,724,252.  
THE COLOR(S) RED, BLUE, GREEN AND YELLOW IS/ARE CLAIMED AS A FEATURE OF THE MARK.

THE MARK CONSISTS OF A DESIGN DEPICTING A BOX WITH RED, BLUE, GREEN AND YELLOW SIDES AND AN OPEN RED LID. THE COLOR WHITE REPRESENTS BACKGROUND, OUTLINING AND/OR TRANSPARENT AREAS AND IS NOT PART OF THE MARK.

FOR COMPUTER SOFTWARE AND MEDIA PRE-RECORDED WITH COMPUTER SOFTWARE USED FOR OPERATING AND PROGRAMMING PRINTERS, SCANNERS, COPYING MACHINES, FACSIMILE MACHINES, AND MULTIFUNCTION ELECTRONIC DEVICES FOR USE IN COPYING, PRINTING, SCANNING, VIDEO CAPTURING AND/OR TRANSMITTING DOCUMENTS AND IMAGES; ONLINE DOWNLOADABLE COMPUTER PROGRAMS FOR CREATING PHOTOGRAPH PROJECTS AND PRINTABLE DOWNLOAD MATERIALS, AND CREATING ARTS, CRAFTS AND STATIONERY MATERIALS FOR PHOTOGRAPH RESTORATION; PRINTERS; MULTIFUNCTION ELECTRONIC DEVICES FOR USE IN COPYING, PRINTING, SCANNING, VIDEO CAPTURING AND/OR TRANSMITTING DOCUMENTS AND IMAGES (U.S. CLS. 21, 23, 26, 36 AND 38).

FIRST USE 11-30-2007; IN COMMERCE 11-30-2007.  
INGRID C. EULIN, EXAMINING ATTORNEY

**CLASS 9—(Continued).**

SN 86-053,389. SS DIGITAL MEDIA, LLC, IRVINE, CA. FILED 8-31-2013.



THE MARK CONSISTS OF AN OUTLINE OF A MOBILE DEVICE SEPARATED INTO FOUR PARTS, WITH THE LOWER LEFT PART STYLED AS A LETTER "T".

FOR COMPUTER APPLICATION SOFTWARE FOR SMARTPHONES, TABLETS, MULTIMEDIA DEVICES, AND COMPUTING DEVICES, NAMELY, SOFTWARE FOR DOWNLOADING, MANAGING, DESIGNING, MODIFYING, AND EXPORTING GRAPHICAL USER INTERFACES; DOWNLOADABLE GRAPHICS FOR MOBILE PHONES; GRAPHICAL USER INTERFACE SOFTWARE (U.S. CLS. 21, 23, 26, 36 AND 38).

RAMONA ORTIGA, EXAMINING ATTORNEY

SN 86-054,833. HAPPY HOUR NINJA, LLC, DBA CLINK, POTOMAC, MD. FILED 9-3-2013.



THE COLOR(S) MERLOT AND WHITE IS/ARE CLAIMED AS A FEATURE OF THE MARK.

THE MARK CONSISTS OF THE WORD "CLINK" APPEARING DIAGONALLY IN STYLIZED WHITE LETTERS ADJACENT TO A WHITE WINE GLASS ON A SQUARE MERLOT BACKGROUND.

FOR DOWNLOADABLE MOBILE APPLICATIONS FOR THE GEO-LOCATION OF HAPPY HOURS AND EACH BAR OR RESTAURANT'S SPECIALS; DOWNLOADABLE SOFTWARE IN THE NATURE OF A MOBILE APPLICATION FOR THE GEO-LOCATION OF HAPPY HOURS AND EACH BAR OR RESTAURANT'S SPECIALS (U.S. CLS. 21, 23, 26, 36 AND 38).

RONALD MCMORROW, EXAMINING ATTORNEY

**CLASS 9—(Continued).**

SN 86-055,603. WARNER BROS. ENTERTAINMENT INC., BURBANK, CA. FILED 9-4-2013.

## POTTERMORE

THE MARK CONSISTS OF STANDARD CHARACTERS WITHOUT CLAIM TO ANY PARTICULAR FONT, STYLE, SIZE, OR COLOR.

OWNER OF U.S. REG. NO. 4,376,701.

FOR PRERECORDED AUDIO TAPES, AUDIO-VIDEO TAPES, AUDIO VIDEO CASSETTES, AUDIO VIDEO DISCS, AND DIGITAL VERSATILE DISCS FEATURING COMEDY, DRAMA, ACTION AND ADVENTURE; DOWNLOADABLE AUDIO RECORDINGS FEATURING COMEDY, DRAMA, ACTION AND ADVENTURE; DOWNLOADABLE AUDIO-VIDEO RECORDINGS FEATURING COMEDY, DRAMA, ACTION AND ADVENTURE; HAND-HELD CALCULATORS; CD ROM COMPUTER GAME DISCS; INTERACTIVE VIDEO GAME PROGRAMS; INTERACTIVE MULTIMEDIA GAME PROGRAMS; VIDEO GAME CARTRIDGES AND CASSETTES; ELECTRONIC DIARIES; MOUSE PADS; COMPUTER PROGRAMS, NAMELY, SOFTWARE LINKING DIGITIZED VIDEO AND AUDIO MEDIA TO A GLOBAL COMPUTER INFORMATION NETWORK; CELLULAR TELEPHONE ACCESSORIES, NAMELY, HANDS-FREE ACCESSORIES, CELLULAR TELEPHONE COVERS AND CELLULAR TELEPHONE FACE COVERS; ENCODED MAGNETIC CARDS, NAMELY, PHONE CARDS, CREDIT CARDS, CASH CARDS, DEBIT CARDS AND MAGNETIC KEY CARDS; DOWNLOADABLE TELEPHONES RING TONES FOR WIRELESS PHONES; DOWNLOADABLE SCREENSAVERS SOFTWARE FOR COMPUTERS (U.S. CLS. 21, 23, 26, 36 AND 38).

JUSTINE D. PARKER, EXAMINING ATTORNEY

SN 86-056,055. HEIRLOOM AUDIO PRODUCTIONS, LLC, THOMSON, IL. FILED 9-4-2013.

## The Extraordinary Adventures of G.A. Henty

THE MARK CONSISTS OF STANDARD CHARACTERS WITHOUT CLAIM TO ANY PARTICULAR FONT, STYLE, SIZE, OR COLOR.

FOR DIGITAL MEDIA, NAMELY, PRE-RECORDED DVDS, DOWNLOADABLE AUDIO AND VIDEO RECORDINGS, AND CDS FEATURING AND PROMOTING MORAL AND EDUCATIONAL THEMES BY MEANS OF CHILDREN'S ADVENTURES (U.S. CLS. 21, 23, 26, 36 AND 38).

FIRST USE 11-1-2012; IN COMMERCE 9-1-2013.

AMY ALFIERI, EXAMINING ATTORNEY

**CLASS 9—(Continued).**

SN 86-056,700. WEATHERFORD/LAMB, INC., HOUSTON, TX. FILED 9-5-2013.

**nThermal**

THE MARK CONSISTS OF STANDARD CHARACTERS WITHOUT CLAIM TO ANY PARTICULAR FONT, STYLE, SIZE, OR COLOR.

FOR COMPUTER HARDWARE AND SOFTWARE TOOLS TO PROVIDE DOWNHOLE DATA FOR OIL-FIELD APPLICATIONS, NAMELY, WELL OPERATION, STORAGE, PERFORMANCE, SANDFACE MEASUREMENT, AND PRODUCTION, TO THE OPERATOR DURING DRILLING (U.S. CLS. 21, 23, 26, 36 AND 38).

ELIZABETH CHANG, EXAMINING ATTORNEY

**CLASS 9—(Continued).**

SN 86-059,301. THE MOBILE APE, INC., BELLEVUE, WA. FILED 9-9-2013.

**THE MOBILE APE**

THE MARK CONSISTS OF STANDARD CHARACTERS WITHOUT CLAIM TO ANY PARTICULAR FONT, STYLE, SIZE, OR COLOR.

NO CLAIM IS MADE TO THE EXCLUSIVE RIGHT TO USE "MOBILE", APART FROM THE MARK AS SHOWN.

FOR COMPUTER HARDWARE; SOFTWARE USED FOR MOBILE AND CLOUD COMMUNICATIONS; ELECTRONIC SENSORS USED IN WEARABLE DEVICES AND APPAREL FOR USE IN SENSING EXTERNAL, INTERNAL AND PHYSICAL CONDITIONS (U.S. CLS. 21, 23, 26, 36 AND 38).

SUSAN RICHARDS, EXAMINING ATTORNEY

SN 86-056,793. WEATHERFORD/LAMB, INC., HOUSTON, TX. FILED 9-5-2013.

**nWaves**

THE MARK CONSISTS OF STANDARD CHARACTERS WITHOUT CLAIM TO ANY PARTICULAR FONT, STYLE, SIZE, OR COLOR.

FOR SENSOR TECHNOLOGY, NAMELY, SENSORS HOUSED IN TUBING OR CASING AND CONVEYED DOWNHOLE FOR SEISMIC MONITORING IN THE OIL AND GAS INDUSTRY (U.S. CLS. 21, 23, 26, 36 AND 38).

ELIZABETH CHANG, EXAMINING ATTORNEY

SN 86-059,669. RADIO TOOLBOX, LLC, WATAUGA, TX. FILED 9-9-2013.

**Steamcast**

THE MARK CONSISTS OF STANDARD CHARACTERS WITHOUT CLAIM TO ANY PARTICULAR FONT, STYLE, SIZE, OR COLOR.

FOR DOWNLOADABLE COMPUTER SOFTWARE FOR USE IN TRANSMITTING AND PLAYING AUDIO OR VIDEO STREAMING TRANSMISSIONS OF MUSIC, PERFORMANCES AND OTHER EVENTS VIA A GLOBAL COMPUTER NETWORK (U.S. CLS. 21, 23, 26, 36 AND 38).

FIRST USE 8-7-2004; IN COMMERCE 9-1-2004.

LINDA QUIGLEY, EXAMINING ATTORNEY

SN 86-057,222. CIENA CORPORATION, HANOVER, MD. FILED 9-5-2013.

**THE MUX**

THE MARK CONSISTS OF STANDARD CHARACTERS WITHOUT CLAIM TO ANY PARTICULAR FONT, STYLE, SIZE, OR COLOR.

FOR MOBILE APPLICATION THAT BRINGS TOGETHER THE TELECOM AND TECHNOLOGY RSS FEEDS FROM ACROSS INDUSTRIES AND ALLOWS A USER TO CUSTOMIZE FEEDS, SAVE AND SHARE ARTICLES (U.S. CLS. 21, 23, 26, 36 AND 38).

WANDA KAY PRICE, EXAMINING ATTORNEY

SN 86-059,950. ENE, LLC, CINCINNATI, OH. FILED 9-10-2013.

**LA TILDE**

THE MARK CONSISTS OF STANDARD CHARACTERS WITHOUT CLAIM TO ANY PARTICULAR FONT, STYLE, SIZE, OR COLOR.

THE ENGLISH TRANSLATION OF THE WORD "LA" IN THE MARK IS "THE".

FOR EYE GLASSES; EYEGLASSES; EYEWEAR; SUNGLASSES (U.S. CLS. 21, 23, 26, 36 AND 38).

FIRST USE 8-1-2012; IN COMMERCE 8-1-2012.

SUSAN RICHARDS, EXAMINING ATTORNEY

**CLASS 9—(Continued).**

SN 86-060,428. MIND CURES, LLC, E.QUOGUE, NY. FILED 9-10-2013.

create meditate elevate

THE MARK CONSISTS OF STANDARD CHARACTERS WITHOUT CLAIM TO ANY PARTICULAR FONT, STYLE, SIZE, OR COLOR.

FOR DIGITAL MATERIALS, NAMELY, AUDIO FILES FEATURING HYPNOSIS INCLUDING MEDITATION; DOWNLOADABLE MOBILE APPLICATIONS FOR CREATING AUDIO FILES RELATING TO HYPNOSIS AND MEDITATION (U.S. CLS. 21, 23, 26, 36 AND 38).

FIRST USE 7-4-2013; IN COMMERCE 7-4-2013.  
SUSAN RICHARDS, EXAMINING ATTORNEY

SN 86-060,441. MIND CURES, LLC, E.QUOGUE, NY. FILED 9-10-2013.

self help hero

THE MARK CONSISTS OF STANDARD CHARACTERS WITHOUT CLAIM TO ANY PARTICULAR FONT, STYLE, SIZE, OR COLOR.

NO CLAIM IS MADE TO THE EXCLUSIVE RIGHT TO USE "SELF HELP", APART FROM THE MARK AS SHOWN.

FOR DOWNLOADABLE MOBILE APPLICATIONS FOR CREATING AUDIO FILES IN THE FIELD OF SELF HELP (U.S. CLS. 21, 23, 26, 36 AND 38).

SUSAN RICHARDS, EXAMINING ATTORNEY

SN 86-060,985. ITIZEN, LLC, MINNEAPOLIS, MN. FILED 9-10-2013.

Kidizen

THE MARK CONSISTS OF STANDARD CHARACTERS WITHOUT CLAIM TO ANY PARTICULAR FONT, STYLE, SIZE, OR COLOR.

FOR DOWNLOADABLE SOFTWARE IN THE NATURE OF A MOBILE APPLICATION FOR USE AS A MARKET-PLACE PLATFORM ALLOWING USERS TO POST, DISPLAY, ORGANIZE, BROWSE, DISCUSS, BUY AND SELL CHILDREN'S APPAREL AND ACCESSORIES (U.S. CLS. 21, 23, 26, 36 AND 38).

STEVEN PEREZ, EXAMINING ATTORNEY

**CLASS 9—(Continued).**

SN 86-061,508. JLAB, LLC, FRISCO, TX. FILED 9-11-2013.

Shaker

THE MARK CONSISTS OF STANDARD CHARACTERS WITHOUT CLAIM TO ANY PARTICULAR FONT, STYLE, SIZE, OR COLOR.

FOR AUDIO SPEAKERS, NAMELY, WIRELESS PORTABLE SPEAKERS (U.S. CLS. 21, 23, 26, 36 AND 38).

FIRST USE 3-1-2013; IN COMMERCE 3-1-2013.  
KATHLEEN LORENZO, EXAMINING ATTORNEY

SN 86-061,799. VOXX INTERNATIONAL CORPORATION, HAUPPAUGE, NY. FILED 9-11-2013.

SIZZLESTICK

THE MARK CONSISTS OF STANDARD CHARACTERS WITHOUT CLAIM TO ANY PARTICULAR FONT, STYLE, SIZE, OR COLOR.

FOR A POWER BANK BATTERY CHARGER DEVICE THAT STORES ENERGY INTO A SECONDARY CELL OR RECHARGEABLE BATTERY USED TO RECHARGE PORTABLE ELECTRONIC DEVICES (U.S. CLS. 21, 23, 26, 36 AND 38).

SUSAN RICHARDS, EXAMINING ATTORNEY

SN 86-061,843. FASETTO, LLC, SCOTTSDALE, AZ. FILED 9-11-2013.



THE MARK CONSISTS OF A CUBE WITH SQUARE PIECES ON THE RIGHT SIDE OF IT MISSING WITH THE WORD "FASETTO" TO THE RIGHT OF IT WITH THE "O" HAVING A WHITE SILHOUETTE OF A CLOUD WITHIN IT AND THE WORDS "THE WAY YOU SHARE" UNDER "FASETTO".

FOR COMPUTER SOFTWARE FOR FILE SHARING AND APPLICATION SHARING; ELECTRIC SECURITY TOKEN IN THE NATURE OF FOB-LIKE DEVICE USED BY AN AUTHORIZED USER OF A COMPUTER SYSTEM TO FACILITATE AUTHENTICATION (U.S. CLS. 21, 23, 26, 36 AND 38).

ROBIN CHOSID, EXAMINING ATTORNEY



**CLASS 9—(Continued).**

SN 86-061,962. CORERO NETWORK SECURITY, INC., HUDSON, MA. FILED 9-11-2013.

## SMARTWALL

THE MARK CONSISTS OF STANDARD CHARACTERS WITHOUT CLAIM TO ANY PARTICULAR FONT, STYLE, SIZE, OR COLOR.

FOR COMPUTER HARDWARE FOR MONITORING NETWORK TRAFFIC FOR THE PURPOSE OF DETERMINING WHETHER TO ALLOW IT TO PASS TO THE NEXT DEVICE IN A NETWORK; COMPUTER SOFTWARE FOR MONITORING NETWORK TRAFFIC FOR THE PURPOSE OF DETERMINING WHETHER TO ALLOW IT TO PASS TO THE NEXT DEVICE IN A NETWORK (U.S. CLS. 21, 23, 26, 36 AND 38).

JENNIFER WILLISTON, EXAMINING ATTORNEY

SN 86-062,184. WARNER BROS. ENTERTAINMENT INC., BURBANK, CA. FILED 9-11-2013.

## FANTASTIC BEASTS

THE MARK CONSISTS OF STANDARD CHARACTERS WITHOUT CLAIM TO ANY PARTICULAR FONT, STYLE, SIZE, OR COLOR.

FOR MOTION PICTURE FILMS FEATURING COMEDY, DRAMA, ACTION, ADVENTURE AND/OR ANIMATION, AND MOTION PICTURE FILMS FOR BROADCAST ON TELEVISION FEATURING COMEDY, DRAMA, ACTION, ADVENTURE AND/OR ANIMATION; DOWNLOADABLE LIVE-ACTION, COMEDY, DRAMA, ANIMATED AND REALITY TELEVISION SERIES; AUDIO TAPES, AUDIO-VIDEO TAPES, AUDIO VIDEO CASSETTES, AUDIO VIDEO DISCS, AND DIGITAL VERSATILE DISCS FEATURING MUSIC, COMEDY, DRAMA, ACTION, ADVENTURE, AND/OR ANIMATION; STEREO HEADPHONES; BATTERIES; CORDLESS TELEPHONES; AUDIO CASSETTE AND CD PLAYERS; CD ROM COMPUTER GAME DISCS; TELEPHONE AND/OR RADIO PAGERS; SHORT MOTION PICTURE FILM CASSETTES FEATURING COMEDY, DRAMA, ACTION, ADVENTURE AND/OR ANIMATION TO BE USED WITH HAND-HELD VIEWERS OR PROJECTORS; VIDEO CASSETTE RECORDERS AND PLAYERS, COMPACT DISC PLAYERS, DIGITAL AUDIO TAPE RECORDERS AND PLAYERS; RADIOS; MOUSE PADS; EYEGLASSES, SUNGLASSES AND CASES THEREFORE; VIDEO AND COMPUTER GAME PROGRAMS; VIDEO GAME CARTRIDGES AND CASSETTES; COMPUTER AND VIDEO GAMES WHICH ARE DESIGNED FOR HARDWARE PLATFORMS, NAMELY, GAME CONSOLES AND PERSONAL COMPUTERS; CD-ROM COMPUTER GAME DISCS AND COMPUTER PROGRAMS, NAMELY, SOFTWARE LINKING DIGITIZED VIDEO AND AUDIO MEDIA TO A GLOBAL COMPUTER INFORMATION NETWORK; DOWNLOADABLE VIDEO GAME SOFTWARE; DOWN-

**CLASS 9—(Continued).**

LOADABLE COMPUTER GAME SOFTWARE; DOWNLOADABLE MOBILE GAME SOFTWARE; DOWNLOADABLE PUBLICATIONS IN THE NATURE OF FICTION BOOKS AND AUDIO BOOKS FEATURING CHARACTERS FROM ANIMATED, ACTION ADVENTURE, COMEDY AND/OR DRAMA FEATURES, COMIC BOOKS, CHILDREN'S BOOKS, STRATEGY GUIDES IN THE FIELD OF BOARD GAMES, VIDEO GAMES AND COMPUTER GAMES, COLORING BOOKS, GRAPHIC NOVELS, AND MAGAZINES FEATURING CHARACTERS FROM ANIMATED, ACTION ADVENTURE, COMEDY AND/OR DRAMA FEATURES; COMPUTER GAME SOFTWARE FOR GAMING MACHINES, NAMELY, SLOT MACHINES; CELLULAR TELEPHONE ACCESSORIES, NAMELY, HANDS-FREE ACCESSORIES, CELLULAR TELEPHONE COVERS AND CELLULAR TELEPHONE FACE COVERS; ENCODED MAGNETIC CARDS, NAMELY, PHONE CARDS, CREDIT CARDS, CASH CARDS, DEBIT CARDS AND MAGNETIC KEY CARDS; AND DECORATIVE MAGNETS (U.S. CLS. 21, 23, 26, 36 AND 38).

JUSTINE D. PARKER, EXAMINING ATTORNEY

SN 86-062,185. WARNER BROS. ENTERTAINMENT INC., BURBANK, CA. FILED 9-11-2013.

## KENILWORTHY WHISP

THE MARK CONSISTS OF STANDARD CHARACTERS WITHOUT CLAIM TO ANY PARTICULAR FONT, STYLE, SIZE, OR COLOR.

FOR MOTION PICTURE FILMS FEATURING COMEDY, DRAMA, ACTION, ADVENTURE AND/OR ANIMATION, AND MOTION PICTURE FILMS FOR BROADCAST ON TELEVISION FEATURING COMEDY, DRAMA, ACTION, ADVENTURE AND/OR ANIMATION; DOWNLOADABLE LIVE-ACTION, COMEDY, DRAMA, ANIMATED AND REALITY TELEVISION SERIES; AUDIO TAPES, AUDIO-VIDEO TAPES, AUDIO VIDEO CASSETTES, AUDIO VIDEO DISCS, AND DIGITAL VERSATILE DISCS FEATURING MUSIC, COMEDY, DRAMA, ACTION, ADVENTURE, AND/OR ANIMATION; STEREO HEADPHONES; BATTERIES; CORDLESS TELEPHONES; AUDIO CASSETTE AND CD PLAYERS; CD ROM COMPUTER GAME DISCS; TELEPHONE AND/OR RADIO PAGERS; SHORT MOTION PICTURE FILM CASSETTES FEATURING COMEDY, DRAMA, ACTION, ADVENTURE AND/OR ANIMATION TO BE USED WITH HAND-HELD VIEWERS OR PROJECTORS; VIDEO CASSETTE RECORDERS AND PLAYERS, COMPACT DISC PLAYERS, DIGITAL AUDIO TAPE RECORDERS AND PLAYERS; RADIOS; MOUSE PADS; EYEGLASSES, SUNGLASSES AND CASES THEREFORE; VIDEO AND COMPUTER GAME PROGRAMS; VIDEO GAME CARTRIDGES AND CASSETTES; COMPUTER AND VIDEO GAMES WHICH ARE DESIGNED FOR HARDWARE PLATFORMS, NAMELY, GAME CONSOLES AND PERSONAL COMPUTERS; CD-ROM COMPUTER GAME DISCS AND COMPUTER PROGRAMS, NAMELY, SOFTWARE LINKING DIGITIZED VIDEO AND AUDIO MEDIA TO A GLOBAL COMPUTER INFORMATION NETWORK; DOWNLOADABLE VIDEO GAME SOFTWARE; DOWN-

**CLASS 9—(Continued).**

LOADABLE COMPUTER GAME SOFTWARE; DOWNLOADABLE MOBILE GAME SOFTWARE; DOWNLOADABLE PUBLICATIONS IN THE NATURE OF FICTION BOOKS AND AUDIO BOOKS FEATURING CHARACTERS FROM ANIMATED, ACTION ADVENTURE, COMEDY AND/OR DRAMA FEATURES, COMIC BOOKS, CHILDREN'S BOOKS, STRATEGY GUIDES IN THE FIELD OF BOARD GAMES, VIDEO GAMES AND COMPUTER GAMES, COLORING BOOKS, GRAPHIC NOVELS, AND MAGAZINES FEATURING CHARACTERS FROM ANIMATED, ACTION ADVENTURE, COMEDY AND/OR DRAMA FEATURES; COMPUTER GAME SOFTWARE FOR GAMING MACHINES, NAMELY, SLOT MACHINES; CELLULAR TELEPHONE ACCESSORIES, NAMELY, HANDS-FREE ACCESSORIES, CELLULAR TELEPHONE COVERS AND CELLULAR TELEPHONE FACE COVERS; ENCODED MAGNETIC CARDS, NAMELY, PHONE CARDS, CREDIT CARDS, CASH CARDS, DEBIT CARDS AND MAGNETIC KEY CARDS; AND DECORATIVE MAGNETS (U.S. CLS. 21, 23, 26, 36 AND 38).

JUSTINE D. PARKER, EXAMINING ATTORNEY

**CLASS 9—(Continued).**

LOADABLE COMPUTER GAME SOFTWARE; DOWNLOADABLE MOBILE GAME SOFTWARE; DOWNLOADABLE PUBLICATIONS IN THE NATURE OF FICTION BOOKS AND AUDIO BOOKS FEATURING CHARACTERS FROM ANIMATED, ACTION ADVENTURE, COMEDY AND/OR DRAMA FEATURES, COMIC BOOKS, CHILDREN'S BOOKS, STRATEGY GUIDES IN THE FIELD OF BOARD GAMES, VIDEO GAMES AND COMPUTER GAMES, COLORING BOOKS, GRAPHIC NOVELS, AND MAGAZINES FEATURING CHARACTERS FROM ANIMATED, ACTION ADVENTURE, COMEDY AND/OR DRAMA FEATURES; COMPUTER GAME SOFTWARE FOR GAMING MACHINES, NAMELY, SLOT MACHINES; CELLULAR TELEPHONE ACCESSORIES, NAMELY, HANDS-FREE ACCESSORIES, CELLULAR TELEPHONE COVERS AND CELLULAR TELEPHONE FACE COVERS; ENCODED MAGNETIC CARDS, NAMELY, PHONE CARDS, CREDIT CARDS, CASH CARDS, DEBIT CARDS AND MAGNETIC KEY CARDS; AND DECORATIVE MAGNETS (U.S. CLS. 21, 23, 26, 36 AND 38).

JUSTINE D. PARKER, EXAMINING ATTORNEY

SN 86-062,196. WARNER BROS. ENTERTAINMENT INC., BURBANK, CA. FILED 9-11-2013.

FANTASTIC BEASTS & WHERE  
TO FIND THEM

THE MARK CONSISTS OF STANDARD CHARACTERS WITHOUT CLAIM TO ANY PARTICULAR FONT, STYLE, SIZE, OR COLOR.

FOR MOTION PICTURE FILMS FEATURING COMEDY, DRAMA, ACTION, ADVENTURE AND/OR ANIMATION, AND MOTION PICTURE FILMS FOR BROADCAST ON TELEVISION FEATURING COMEDY, DRAMA, ACTION, ADVENTURE AND/OR ANIMATION; DOWNLOADABLE LIVE-ACTION, COMEDY, DRAMA, ANIMATED AND REALITY TELEVISION SERIES; AUDIO TAPES, AUDIO-VIDEO TAPES, AUDIO VIDEO CASSETTES, AUDIO VIDEO DISCS, AND DIGITAL VERSATILE DISCS FEATURING MUSIC, COMEDY, DRAMA, ACTION, ADVENTURE, AND/OR ANIMATION; STEREO HEADPHONES; BATTERIES; CORDLESS TELEPHONES; AUDIO CASSETTE AND CD PLAYERS; CD ROM COMPUTER GAME DISCS; TELEPHONE AND/OR RADIO PAGERS; SHORT MOTION PICTURE FILM CASSETTES FEATURING COMEDY, DRAMA, ACTION, ADVENTURE AND/OR ANIMATION TO BE USED WITH HAND-HELD VIEWERS OR PROJECTORS; VIDEO CASSETTE RECORDERS AND PLAYERS, COMPACT DISC PLAYERS, DIGITAL AUDIO TAPE RECORDERS AND PLAYERS; RADIOS; MOUSE PADS; EYEGLASSES, SUNGLASSES AND CASES THEREFORE; VIDEO AND COMPUTER GAME PROGRAMS; VIDEO GAME CARTRIDGES AND CASSETTES; COMPUTER AND VIDEO GAMES WHICH ARE DESIGNED FOR HARDWARE PLATFORMS, NAMELY, GAME CONSOLES AND PERSONAL COMPUTERS; CD-ROM COMPUTER GAME DISCS AND COMPUTER PROGRAMS, NAMELY, SOFTWARE LINKING DIGITIZED VIDEO AND AUDIO MEDIA TO A GLOBAL COMPUTER INFORMATION NETWORK; DOWNLOADABLE VIDEO GAME SOFTWARE; DOWN-

SN 86-062,199. GROUNDWORK RENEWABLES, INC., MONTEREY, CA. FILED 9-11-2013.

# GroundWork

THE MARK CONSISTS OF STANDARD CHARACTERS WITHOUT CLAIM TO ANY PARTICULAR FONT, STYLE, SIZE, OR COLOR.

FOR METEOROLOGICAL INSTRUMENTS, NAMELY, CUSTOM TERRESTRIAL, OBSERVATIONAL, METEOROLOGICAL STATION MEASURING WEATHER, INCLUDING BUT NOT LIMITED TO IRRADIANCE, AMBIENT TEMPERATURE, WIND SPEED AND DIRECTION, AND BAROMETRIC PRESSURE (U.S. CLS. 21, 23, 26, 36 AND 38).

FIRST USE 10-19-2009; IN COMMERCE 10-19-2009.  
WENDY JUN, EXAMINING ATTORNEY

SN 86-062,225. GROUNDWORK RENEWABLES, INC., MONTEREY, CA. FILED 9-11-2013.



THE COLOR(S) BROWN AND GREEN IS/ARE CLAIMED AS A FEATURE OF THE MARK.

THE MARK CONSISTS OF A STYLIZED VERSION OF THE WORD "GROUNDWORK". THE "G" IS BROWN AND STYLIZED WHEREIN THE BOTTOM OF THE "G" IS AN

**CLASS 9—(Continued).**

ARROW AND THE STRAIGHT PART OF THE "G" IS AN ELECTRICAL CORD WITH A LEAF STYLIZED TO LOOK LIKE A PLANT. THE ELECTRICAL CORD WITH PLANT ALSO SERVES AS THE "R" WITH THE LEAF STYLED TO LOOK LIKE THE ARM COMING OFF THE STRAIGHT PORTION OF A LOWER CASE "R". THE "G" AND THE ELECTRICAL CORD PLANT COMPRISING OF THE "R" AND PART OF "G" ARE BROWN. THE REMAINDER OF THE WORD "GROUNDWORK" IS GREEN WITH AN UPPER CASE "W".

FOR METEOROLOGICAL INSTRUMENTS, NAMELY, CUSTOM TERRESTRIAL, OBSERVATIONAL, METEOROLOGICAL STATION MEASURING WEATHER, INCLUDING BUT NOT LIMITED TO IRRADIANCE, AMBIENT TEMPERATURE, WIND SPEED AND DIRECTION, AND BAROMETRIC PRESSURE (U.S. CLS. 21, 23, 26, 36 AND 38).

FIRST USE 10-19-2009; IN COMMERCE 10-19-2009.  
WENDY JUN, EXAMINING ATTORNEY

**CLASS 9—(Continued).**

LOADABLE COMPUTER GAME SOFTWARE; DOWNLOADABLE MOBILE GAME SOFTWARE; DOWNLOADABLE PUBLICATIONS IN THE NATURE OF FICTION BOOKS AND AUDIO BOOKS FEATURING CHARACTERS FROM ANIMATED, ACTION ADVENTURE, COMEDY AND/OR DRAMA FEATURES, COMIC BOOKS, CHILDREN'S BOOKS, STRATEGY GUIDES IN THE FIELD OF BOARD GAMES, VIDEO GAMES AND COMPUTER GAMES, COLORING BOOKS, GRAPHIC NOVELS, AND MAGAZINES FEATURING CHARACTERS FROM ANIMATED, ACTION ADVENTURE, COMEDY AND/OR DRAMA FEATURES; COMPUTER GAME SOFTWARE FOR GAMING MACHINES, NAMELY, SLOT MACHINES; CELLULAR TELEPHONE ACCESSORIES, NAMELY, HANDS-FREE ACCESSORIES, CELLULAR TELEPHONE COVERS AND CELLULAR TELEPHONE FACE COVERS; ENCODED MAGNETIC CARDS, NAMELY, PHONE CARDS, CREDIT CARDS, CASH CARDS, DEBIT CARDS AND MAGNETIC KEY CARDS; AND DECORATIVE MAGNETS (U.S. CLS. 21, 23, 26, 36 AND 38).

JUSTINE D. PARKER, EXAMINING ATTORNEY

---

SN 86-062,495. WARNER BROS. ENTERTAINMENT INC.,  
BURBANK, CA. FILED 9-12-2013.

FANTASTIC BEASTS AND WHERE  
TO FIND THEM

---

SN 86-062,860. THE BAUEN GROUP, LLC, HOUSTON, TX.  
FILED 9-12-2013.

THE MARK CONSISTS OF STANDARD CHARACTERS WITHOUT CLAIM TO ANY PARTICULAR FONT, STYLE, SIZE, OR COLOR.

FOR MOTION PICTURE FILMS FEATURING COMEDY, DRAMA, ACTION, ADVENTURE AND/OR ANIMATION, AND MOTION PICTURE FILMS FOR BROADCAST ON TELEVISION FEATURING COMEDY, DRAMA, ACTION, ADVENTURE AND/OR ANIMATION; DOWNLOADABLE LIVE-ACTION, COMEDY, DRAMA, ANIMATED AND REALITY TELEVISION SERIES; AUDIO TAPES, AUDIO-VIDEO TAPES, AUDIO VIDEO CASSETTES, AUDIO VIDEO DISCS, AND DIGITAL VERSATILE DISCS FEATURING MUSIC, COMEDY, DRAMA, ACTION, ADVENTURE, AND/OR ANIMATION; STEREO HEADPHONES; BATTERIES; CORDLESS TELEPHONES; AUDIO CASSETTE AND CD PLAYERS; CD ROM COMPUTER GAME DISCS; TELEPHONE AND/OR RADIO PAGERS; SHORT MOTION PICTURE FILM CASSETTES FEATURING COMEDY, DRAMA, ACTION, ADVENTURE AND/OR ANIMATION TO BE USED WITH HAND-HELD VIEWERS OR PROJECTORS; VIDEO CASSETTE RECORDERS AND PLAYERS, COMPACT DISC PLAYERS, DIGITAL AUDIO TAPE RECORDERS AND PLAYERS; RADIOS; MOUSE PADS; EYEGLASSES, SUNGLASSES AND CASES THEREFORE; VIDEO AND COMPUTER GAME PROGRAMS; VIDEO GAME CARTRIDGES AND CASSETTES; COMPUTER AND VIDEO GAMES WHICH ARE DESIGNED FOR HARDWARE PLATFORMS, NAMELY, GAME CONSOLES AND PERSONAL COMPUTERS; CD-ROM COMPUTER GAME DISCS AND COMPUTER PROGRAMS, NAMELY, SOFTWARE LINKING DIGITIZED VIDEO AND AUDIO MEDIA TO A GLOBAL COMPUTER INFORMATION NETWORK; DOWNLOADABLE VIDEO GAME SOFTWARE; DOWN-

PROOVONGO

THE MARK CONSISTS OF STANDARD CHARACTERS WITHOUT CLAIM TO ANY PARTICULAR FONT, STYLE, SIZE, OR COLOR.

FOR COMPUTER SOFTWARE IN THE FIELD OF DOCUMENT MANAGEMENT, WORK FLOW MANAGEMENT AND TASK MANAGEMENT; COMPUTER SOFTWARE ALLOWING USERS TO ELECTRONICALLY APPROVE DOCUMENTS IN WORKFLOW QUEUES; SOFTWARE USED IN THE FIELDS OF DOCUMENT WORKFLOW, AUTOMATED COLLABORATION AND TASK MANAGEMENT (U.S. CLS. 21, 23, 26, 36 AND 38).  
LESLIE RICHARDS, EXAMINING ATTORNEY

**CLASS 9—(Continued).**

SN 86-063,156. DATAGRAVITY, INC., NASHUA, NH. FILED 9-12-2013.

**DISCOVERYPOINT**

THE MARK CONSISTS OF STANDARD CHARACTERS WITHOUT CLAIM TO ANY PARTICULAR FONT, STYLE, SIZE, OR COLOR.

FOR COMPUTER STORAGE DEVICES, NAMELY, EXTERNALLY CONNECTED SOLID STATE AND ROTATING MEDIA DISK DRIVES; SOFTWARE FOR MANAGING DATA STORAGE SYSTEMS, RECOVERY OF LOST DATA AND DATABASE ANALYTICS FOR USE IN COMPUTER DATA CENTERS; DOWNLOADABLE SOFTWARE FOR CONNECTING STORAGE DEVICES TO BUSINESS APPLICATIONS IN ORDER TO INTEGRATE THE OPERATION OF SERVERS WITH STORAGE USED IN COMPUTER DATA CENTERS; SOFTWARE USED AS A DATABASE AND COMPUTER DATA RECOVERY MANAGEMENT CONSOLE ON MOBILE DEVICES; SOFTWARE FOR DEVELOPING A DISASTER RECOVERY PLAN FOR COMPUTER DATA, BOTH LOCALLY AND GEOGRAPHICALLY REMOTE, FOR USE IN COMPUTER DATA CENTERS (U.S. CLS. 21, 23, 26, 36 AND 38).

RUDY R. SINGLETON, EXAMINING ATTORNEY

SN 86-063,322. HUNTER INDUSTRIES, INC., SAN MARCOS, CA. FILED 9-12-2013.

**ACTIVASSIGN**

THE MARK CONSISTS OF STANDARD CHARACTERS WITHOUT CLAIM TO ANY PARTICULAR FONT, STYLE, SIZE, OR COLOR.

FOR ELECTRONIC MODULES USED TO ASSIGN A NUMBER OR OTHER MEANS OF IDENTIFICATION TO DESIGNATE A LIGHT OR GROUP OF LIGHTS FOR LIGHTING CONTROL PURPOSES; OUTDOOR LIGHTING CONTROLLERS USED IN CONNECTION WITH MOBILE ELECTRONIC DEVICES, COMPUTERS, MOBILE PHONES, AND PDAS (U.S. CLS. 21, 23, 26, 36 AND 38).

RONALD DELGIZZI, EXAMINING ATTORNEY

**CLASS 9—(Continued).**

SN 86-063,629. WHELEN ENGINEERING COMPANY, INC., CHESTER, CT. FILED 9-13-2013.

**CENCOM**

THE MARK CONSISTS OF STANDARD CHARACTERS WITHOUT CLAIM TO ANY PARTICULAR FONT, STYLE, SIZE, OR COLOR.

OWNER OF U.S. REG. NO. 2,821,664.  
FOR PROGRAMMABLE CONTROLLER AND SIREN FOR OPERATING VEHICULAR WARNING LIGHTS, PUBLIC ADDRESS SPEAKERS, AND RADIOS (U.S. CLS. 21, 23, 26, 36 AND 38).

FIRST USE 9-14-1992; IN COMMERCE 9-14-1992.  
ZACHARY R. SPARER, EXAMINING ATTORNEY

SN 86-063,647. :SYPRIS ELECTRONICS, LLC, TAMPA, FL. FILED 9-13-2013.

**KEYSTONE**

THE MARK CONSISTS OF STANDARD CHARACTERS WITHOUT CLAIM TO ANY PARTICULAR FONT, STYLE, SIZE, OR COLOR.

FOR DEVICE FOR LOADING CRYPTOGRAPHIC KEYS INTO ENCRYPTION EQUIPMENT, NAMELY, AN ELECTRONIC KEY FILL DEVICE CAPABLE OF RECEIVING, STORING AND TRANSFERRING CRYPTOGRAPHIC KEYS AND STORING USER PROFILES FOR USE BY MILITARY AND GOVERNMENT PERSONNEL IN COMMUNICATIONS SECURITY APPLICATIONS (U.S. CLS. 21, 23, 26, 36 AND 38).

RENEE MCCRAY, EXAMINING ATTORNEY

SN 86-063,678. BEGO, HARRY, DBA TEXYZ, UTRECHT, NETHERLANDS, FILED 9-13-2013.

**TExtract**

THE MARK CONSISTS OF STANDARD CHARACTERS WITHOUT CLAIM TO ANY PARTICULAR FONT, STYLE, SIZE, OR COLOR.

FOR COMPUTER SOFTWARE FOR CREATING BACK-OF-BOOK INDEXES (U.S. CLS. 21, 23, 26, 36 AND 38).

FIRST USE 1-1-1992; IN COMMERCE 1-1-1995.  
FLORENTINA BLANDU, EXAMINING ATTORNEY

**CLASS 9—(Continued).**

SN 86-063,788. KORG U.S.A., INC., MELVILLE, NY. FILED 9-13-2013.

**TRITON TAKTILE**

THE MARK CONSISTS OF STANDARD CHARACTERS WITHOUT CLAIM TO ANY PARTICULAR FONT, STYLE, SIZE, OR COLOR.

FOR USB MUSICAL INSTRUMENT DIGITAL INTERFACE (MIDI) CONTROLLER (U.S. CLS. 21, 23, 26, 36 AND 38).

DARRYL SPRULL, EXAMINING ATTORNEY

**CLASS 9—(Continued).**

SN 86-063,844. VOXX INTERNATIONAL CORPORATION, HAUPPAUGE, NY. FILED 9-13-2013.

**AUDIOVOX MOBILE TV**

THE MARK CONSISTS OF STANDARD CHARACTERS WITHOUT CLAIM TO ANY PARTICULAR FONT, STYLE, SIZE, OR COLOR.

OWNER OF U.S. REG. NOS. 1,234,338, 1,432,756 AND 3,274,427.

NO CLAIM IS MADE TO THE EXCLUSIVE RIGHT TO USE "MOBILE TV", APART FROM THE MARK AS SHOWN.

FOR PORTABLE TELEVISIONS (U.S. CLS. 21, 23, 26, 36 AND 38).

SUSAN RICHARDS, EXAMINING ATTORNEY

SN 86-063,859. DIRECT COMPUTER RESOURCES, INC., FRANKLIN LAKES, NJ. FILED 9-13-2013.

**DATAVANTAGE DME**

THE MARK CONSISTS OF STANDARD CHARACTERS WITHOUT CLAIM TO ANY PARTICULAR FONT, STYLE, SIZE, OR COLOR.

OWNER OF U.S. REG. NOS. 2,274,154, 2,797,997 AND 3,665,694.

FOR COMPUTER SOFTWARE FOR THE IMPLEMENTATION OF DATA PRIVACY AND DATA PROTECTION BY ENCRYPTION, MASKING, DE-IDENTIFICATION AND SUBSTITUTION OF DATA (U.S. CLS. 21, 23, 26, 36 AND 38).

SOPHIA S. KIM, EXAMINING ATTORNEY

SN 86-063,901. KOTHARI LEADERSHIP ENTERPRISES, LLC, NEWPORT BEACH, CA. FILED 9-13-2013.

**FEEDFORWARD**

THE MARK CONSISTS OF STANDARD CHARACTERS WITHOUT CLAIM TO ANY PARTICULAR FONT, STYLE, SIZE, OR COLOR.

FOR COMPUTER SOFTWARE, NAMELY, SOFTWARE THAT PROVIDES FEEDBACK FROM THIRD PARTIES OR CONTENT FROM THE INTERNET TO HELP IMPROVE THE PERFORMANCE, EXECUTION AND RESULTS OF PEOPLE IN THE FIELDS OF BUSINESS MANAGEMENT, PERSONAL MANAGEMENT AND TIME MANAGEMENT (U.S. CLS. 21, 23, 26, 36 AND 38).

SOPHIA S. KIM, EXAMINING ATTORNEY

SN 86-063,807. SHENZHEN YIWEIKE E-COMMERCE CO., LTD, SHENZHEN, GUANGDONG, CHINA, FILED 9-13-2013.

**evikoo**

THE MARK CONSISTS OF THE WORDING "EVIKOO".

FOR ANTI-THEFT LOCKS SPECIALLY ADAPTED TO PERSONAL ELECTRONIC DEVICES, NAMELY, LAPTOPS, PC TABLETS; CAMCORDERS; CHARGERS FOR ELECTRIC BATTERIES; COMPUTER PERIPHERAL DEVICES; DATA PROCESSING EQUIPMENT, NAMELY, COUPLERS; EARPHONES AND HEADPHONES; ELECTRONIC ANTI-THEFT SYSTEM COMPRISED OF A BAR CODE SCANNER THAT ALLOWS MANUFACTURERS TO TEMPORARILY DISABLE ELECTRONIC GOODS DURING THE MANUFACTURING PROCESS AND ALLOWS RETAILERS TO ENABLE SUCH GOODS UPON RECEIVING THE PURCHASE PRICE FOR THE GOODS; ELECTRONIC APPARATUS FOR THE REMOTE CONTROL OF INDUSTRIAL OPERATIONS; REMOTE CONTROL TELEMETERING MACHINES AND APPARATUS; SATELLITE NAVIGATIONAL SYSTEM, NAMELY, A GLOBAL POSITIONING SYSTEM (GPS); SCANNERS; SOLAR BATTERIES (U.S. CLS. 21, 23, 26, 36 AND 38).

FIRST USE 1-14-2012; IN COMMERCE 10-21-2012.

KEVIN MITTLER, EXAMINING ATTORNEY

**CLASS 9—(Continued).**

SN 86-063,991. SALISBURY, JAMES M., CHARLTON, MA. AND DIAZ, ALEXANDER, CHARLTON, MA. FILED 9-13-2013.

# XFINDER

THE MARK CONSISTS OF STANDARD CHARACTERS WITHOUT CLAIM TO ANY PARTICULAR FONT, STYLE, SIZE, OR COLOR.

FOR ELECTRONIC DEVICES FOR LOCATING AND TRACKING LOST ARTICLES, PEOPLE, AND PETS USING RADIO FREQUENCY (U.S. CLS. 21, 23, 26, 36 AND 38).

TRACY FLETCHER, EXAMINING ATTORNEY

---

SN 86-063,996. DATAGRAVITY, INC., NASHUA, NH. FILED 9-13-2013.

# DISCOVERY

THE MARK CONSISTS OF STANDARD CHARACTERS WITHOUT CLAIM TO ANY PARTICULAR FONT, STYLE, SIZE, OR COLOR.

FOR COMPUTER STORAGE DEVICES, NAMELY, EXTERNALLY CONNECTED SOLID STATE AND ROTATING MEDIA DISK DRIVES; SOFTWARE FOR MANAGING DATA STORAGE SYSTEMS, RECOVERY OF LOST DATA AND DATABASE ANALYTICS FOR USE IN COMPUTER DATA CENTERS; DOWNLOADABLE SOFTWARE FOR CONNECTING STORAGE DEVICES TO BUSINESS APPLICATIONS IN ORDER TO INTEGRATE THE OPERATION OF SERVERS WITH STORAGE USED IN COMPUTER DATA CENTERS; SOFTWARE USED AS A DATABASE AND COMPUTER DATA RECOVERY MANAGEMENT CONSOLE ON MOBILE DEVICES; SOFTWARE FOR DEVELOPING A DISASTER RECOVERY PLAN FOR COMPUTER DATA, BOTH LOCALLY AND GEOGRAPHICALLY REMOTE, FOR USE IN COMPUTER DATA CENTERS (U.S. CLS. 21, 23, 26, 36 AND 38).

RUDY R. SINGLETON, EXAMINING ATTORNEY

**CLASS 9—(Continued).**

SN 86-064,082. SOMNIQ, INC., MENLO PARK, CA. FILED 9-13-2013.

# empathy interface

NO CLAIM IS MADE TO THE EXCLUSIVE RIGHT TO USE "INTERFACE", APART FROM THE MARK AS SHOWN.

THE MARK CONSISTS OF THE WORD "EMPATHY", FOLLOWED BY A SPIRAL DESIGN, FOLLOWED BY THE WORD "INTERFACE".

FOR PORTABLE DIGITAL ELECTRONIC DEVICES FOR CAPTURING, RECORDING, STORING, ORGANIZING, TRANSMITTING AND REVIEWING DATA, IMAGES AND AUDIO FILES AND PROVIDING FEEDBACK TO THE USER THEREON IN THE FORM OF LIGHT, SOUND AND VIBRATION (U.S. CLS. 21, 23, 26, 36 AND 38).

ROSELLE HERRERA, EXAMINING ATTORNEY

---

SN 86-064,131. HACKSURFER, LLC, GLENELG, MD. FILED 9-13-2013.

# CYBERFACT

THE MARK CONSISTS OF STANDARD CHARACTERS WITHOUT CLAIM TO ANY PARTICULAR FONT, STYLE, SIZE, OR COLOR.

FOR DOWNLOADABLE SOFTWARE IN THE NATURE OF A MOBILE APPLICATION FOR PROVIDING INFORMATION, DATA AND STATISTICS IN THE FIELDS OF COMPUTER SECURITY, CYBER-SECURITY, AND INTRUSION PROTECTION (U.S. CLS. 21, 23, 26, 36 AND 38).

BARBARA RUTLAND, EXAMINING ATTORNEY

**CLASS 9—(Continued).**

SN 86-064,361. DATAGRAVITY, INC., NASHUA, NH. FILED 9-13-2013.

**CONTENT IN CONTEXT**

THE MARK CONSISTS OF STANDARD CHARACTERS WITHOUT CLAIM TO ANY PARTICULAR FONT, STYLE, SIZE, OR COLOR.

FOR COMPUTER STORAGE DEVICES, NAMELY, EXTERNALLY CONNECTED SOLID STATE AND ROTATING MEDIA DISK DRIVES; SOFTWARE FOR MANAGING DATA STORAGE SYSTEMS, RECOVERY OF LOST DATA AND DATABASE ANALYTICS FOR USE IN COMPUTER DATA CENTERS; DOWNLOADABLE SOFTWARE FOR CONNECTING STORAGE DEVICES TO BUSINESS APPLICATIONS IN ORDER TO INTEGRATE THE OPERATION OF SERVERS WITH STORAGE USED IN COMPUTER DATA CENTERS; SOFTWARE USED AS A DATABASE AND COMPUTER DATA RECOVERY MANAGEMENT CONSOLE ON MOBILE DEVICES; SOFTWARE FOR DEVELOPING A DISASTER RECOVERY PLAN FOR COMPUTER DATA, BOTH LOCALLY AND GEOGRAPHICALLY REMOTE, FOR USE IN COMPUTER DATA CENTERS (U.S. CLS. 21, 23, 26, 36 AND 38).

RUDY R. SINGLETON, EXAMINING ATTORNEY

---

SN 86-064,561. PLEX, INC., SAN JOSE, CA. FILED 9-13-2013.

**PLEX**

THE MARK CONSISTS OF STANDARD CHARACTERS WITHOUT CLAIM TO ANY PARTICULAR FONT, STYLE, SIZE, OR COLOR.

FOR DOWNLOADABLE COMPUTER SOFTWARE IN THE FIELD OF DIGITAL MEDIA MANAGEMENT FOR USE IN PLAYING, ORGANIZING, INDEXING, SEARCHING, AND TRANSCODING DIGITAL VIDEO, AUDIO AND IMAGES (U.S. CLS. 21, 23, 26, 36 AND 38). FIRST USE 8-9-2008; IN COMMERCE 8-9-2008.

ROBIN CHOSID, EXAMINING ATTORNEY

**CLASS 9—(Continued).**

SN 86-064,786. PRO RIDERS, INC., DAYTON, TX. FILED 9-14-2013.

**Ridaz Gotta Ride**

THE MARK CONSISTS OF STANDARD CHARACTERS WITHOUT CLAIM TO ANY PARTICULAR FONT, STYLE, SIZE, OR COLOR.

FOR COMPUTER GAME SOFTWARE FOR USE WITH PERSONAL COMPUTERS, HOME VIDEO GAME CONSOLES USED WITH TELEVISIONS AND ARCADE-BASED VIDEO GAME CONSOLES; COMPUTER PROGRAMS FOR VIDEO AND COMPUTER GAMES; DOWNLOADABLE COMPUTER GAME PROGRAMS; DOWNLOADABLE COMPUTER GAME SOFTWARE VIA A GLOBAL COMPUTER NETWORK AND WIRELESS DEVICES; DOWNLOADABLE COMPUTER PROGRAMS FEATURING POSITIONABLE GAME PIECE FIGURES FOR USE IN THE FIELD OF COMPUTER GAMES; DOWNLOADABLE ELECTRONIC GAME PROGRAMS; DOWNLOADABLE ELECTRONIC GAME SOFTWARE FOR USE ON MOBILE AND CELLULAR PHONES, TABLETS, HAND HELD COMPUTERS; ELECTRONIC GAME PROGRAMS; ELECTRONIC GAME SOFTWARE; ELECTRONIC GAME SOFTWARE FOR CELLULAR TELEPHONES; ELECTRONIC GAME SOFTWARE FOR HANDHELD ELECTRONIC DEVICES; ELECTRONIC GAME SOFTWARE FOR WIRELESS DEVICES; GAME SOFTWARE; INTERACTIVE GAME PROGRAMS; INTERACTIVE GAME SOFTWARE; INTERACTIVE MULTIMEDIA COMPUTER GAME PROGRAMS; INTERACTIVE VIDEO GAME PROGRAMS; RECORDED COMPUTER GAME PROGRAMS; VIDEO AND COMPUTER GAME PROGRAMS; VIRTUAL REALITY GAME SOFTWARE (U.S. CLS. 21, 23, 26, 36 AND 38).

RONALD DELGIZZI, EXAMINING ATTORNEY

---

SN 86-064,815. LOTTERY GENIE, JACKSON, NJ. FILED 9-14-2013.

**LOTTERY-GENIE**

THE MARK CONSISTS OF STANDARD CHARACTERS WITHOUT CLAIM TO ANY PARTICULAR FONT, STYLE, SIZE, OR COLOR.

FOR COMPUTER GAME SOFTWARE FOR GAMING MACHINES, NAMELY, SLOT MACHINES AND VIDEO LOTTERY TERMINALS; DOWNLOADABLE COMPUTER PROGRAMS SOFTWARE FOR CALCULATIONS OF LOTTERY NUMBERS (U.S. CLS. 21, 23, 26, 36 AND 38).

AMY C. KEAN, EXAMINING ATTORNEY

**CLASS 9—(Continued).**

SN 86-064,916. OSBORNE, TERRY, WORCESTER, MA. FILED 9-14-2013.

# Inopia

THE MARK CONSISTS OF STANDARD CHARACTERS WITHOUT CLAIM TO ANY PARTICULAR FONT, STYLE, SIZE, OR COLOR.

FOR AUDIO AND VIDEO RECORDINGS FEATURING MUSIC AND ARTISTIC PERFORMANCES; AUDIO RECORDINGS FEATURING INOPIA; COMPACT DISCS FEATURING MUSIC (U.S. CLS. 21, 23, 26, 36 AND 38). FIRST USE 3-1-1997; IN COMMERCE 3-1-1997.

MICHAEL WIENER, EXAMINING ATTORNEY

SN 86-064,928. NEAR DEATH LLC, DBA BEFOREPLAY LLC, BOULDER, CO. FILED 9-14-2013.

# BeForeplay

THE MARK CONSISTS OF STANDARD CHARACTERS WITHOUT CLAIM TO ANY PARTICULAR FONT, STYLE, SIZE, OR COLOR.

FOR COMPUTER APPLICATION SOFTWARE FOR MOBILE PHONES, TABLET COMPUTERS, AND OTHER MOBILE COMPUTING DEVICES, NAMELY, SOFTWARE FOR FACILITATING INFORMATION EXCHANGE BETWEEN PROSPECTIVE SEXUAL PARTNERS (U.S. CLS. 21, 23, 26, 36 AND 38).

MARYNELLE WILSON, EXAMINING ATTORNEY

SN 86-065,114. AINSWORTH GAME TECHNOLOGY LIMITED, NEWINGTON, AUSTRALIA, FILED 9-16-2013.

# SUGAR AND SPICE

THE MARK CONSISTS OF STANDARD CHARACTERS WITHOUT CLAIM TO ANY PARTICULAR FONT, STYLE, SIZE, OR COLOR.

FOR COMPUTER SOFTWARE AND FIRMWARE FOR GAMES OF CHANCE ON ANY COMPUTERIZED PLATFORM, INCLUDING DEDICATED GAMING CONSOLES, VIDEO BASED SLOT MACHINES, REEL BASED SLOT MACHINES, AND VIDEO LOTTERY TERMINALS (U.S. CLS. 21, 23, 26, 36 AND 38).

JEFFREY LOOK, EXAMINING ATTORNEY

**CLASS 9—(Continued).**

SN 86-065,115. AINSWORTH GAME TECHNOLOGY LIMITED, NEWINGTON, AUSTRALIA, FILED 9-16-2013.

# ACTION DRAGONS

THE MARK CONSISTS OF STANDARD CHARACTERS WITHOUT CLAIM TO ANY PARTICULAR FONT, STYLE, SIZE, OR COLOR.

FOR COMPUTER SOFTWARE AND FIRMWARE FOR GAMES OF CHANCE ON ANY COMPUTERIZED PLATFORM, INCLUDING DEDICATED GAMING CONSOLES, VIDEO BASED SLOT MACHINES, REEL BASED SLOT MACHINES, AND VIDEO LOTTERY TERMINALS (U.S. CLS. 21, 23, 26, 36 AND 38).

JEFFREY LOOK, EXAMINING ATTORNEY

SN 86-065,164. SPECULATIVE PRODUCT DESIGN, LLC, DBA SPECK PRODUCTS, MOUNTAIN VIEW, CA. FILED 9-16-2013.

# TrueTap

THE MARK CONSISTS OF STANDARD CHARACTERS WITHOUT CLAIM TO ANY PARTICULAR FONT, STYLE, SIZE, OR COLOR.

FOR PROTECTIVE CARRYING CASES FOR PORTABLE ELECTRONIC LISTENING DEVICES AND MUSIC PLAYERS, NAMELY, MP3 PLAYERS, AND FOR PORTABLE COMPUTERS, GLOBAL POSITIONING SYSTEMS (GPS DEVICES), MOBILE AND CELLULAR TELEPHONES, PORTABLE MEDIA PLAYERS, AND PERSONAL DIGITAL ASSISTANTS (U.S. CLS. 21, 23, 26, 36 AND 38).

KYLE PEETE, EXAMINING ATTORNEY

SN 86-065,167. SPECULATIVE PRODUCT DESIGN, LLC, DBA SPECK PRODUCTS, MOUNTAIN VIEW, CA. FILED 9-16-2013.

# LONG LIVE THE MACHINES

THE MARK CONSISTS OF STANDARD CHARACTERS WITHOUT CLAIM TO ANY PARTICULAR FONT, STYLE, SIZE, OR COLOR.

FOR PROTECTIVE CARRYING CASES FOR PORTABLE ELECTRONIC LISTENING DEVICES AND MUSIC PLAYERS, NAMELY, MP3 PLAYERS, AND FOR PORTABLE COMPUTERS, GLOBAL POSITIONING SYSTEMS (GPS DEVICES), MOBILE AND CELLULAR TELEPHONES, PORTABLE MEDIA PLAYERS, AND PERSONAL DIGITAL ASSISTANTS (U.S. CLS. 21, 23, 26, 36 AND 38).

KYLE PEETE, EXAMINING ATTORNEY



**CLASS 9—(Continued).**

SN 86-065,177. JAMES L KRAFT, BOCA RATON, FL. FILED 9-16-2013.

**CLASS 9—(Continued).**

SN 86-065,287. NAMCO BANDAI GAMES INC., TOKYO, JAPAN, FILED 9-16-2013.

# FALLPhone

THE MARK CONSISTS OF STANDARD CHARACTERS WITHOUT CLAIM TO ANY PARTICULAR FONT, STYLE, SIZE, OR COLOR.  
FOR CELLULAR PHONES; CELLULAR TELEPHONES (U.S. CLS. 21, 23, 26, 36 AND 38).  
BARBARA RUTLAND, EXAMINING ATTORNEY

# TALES OF ZESTIRIA

THE MARK CONSISTS OF STANDARD CHARACTERS WITHOUT CLAIM TO ANY PARTICULAR FONT, STYLE, SIZE, OR COLOR.  
FOR COMPUTER GAME PROGRAMS; COMPUTER GAME SOFTWARE; DOWNLOADABLE COMPUTER GAME PROGRAMS; DOWNLOADABLE COMPUTER GAME SOFTWARE VIA A GLOBAL COMPUTER NETWORK AND WIRELESS DEVICES; VIDEO GAME SOFTWARE (U.S. CLS. 21, 23, 26, 36 AND 38).  
DOMINICK J. SALEMI, EXAMINING ATTORNEY

SN 86-065,209. RENTAL XPRESS, LLC, CORPUS CHRISTI, TX. FILED 9-16-2013.

# FLI

THE MARK CONSISTS OF STANDARD CHARACTERS WITHOUT CLAIM TO ANY PARTICULAR FONT, STYLE, SIZE, OR COLOR.  
FOR ALARM SYSTEM FOR MONITORING LIQUIDS IN TANKS AND VESSELS (U.S. CLS. 21, 23, 26, 36 AND 38).  
FIRST USE 5-1-2012; IN COMMERCE 5-1-2012.  
HEATHER SAPP, EXAMINING ATTORNEY

SN 86-065,313. HALO2CLOUD LLC, GLASTONBURY, CT. FILED 9-16-2013.

SN 86-065,247. NAMCO BANDAI GAMES INC., TOKYO, JAPAN, FILED 9-16-2013.

# DREAM CHARGER

# SAMURAI-GHOST

THE MARK CONSISTS OF STANDARD CHARACTERS WITHOUT CLAIM TO ANY PARTICULAR FONT, STYLE, SIZE, OR COLOR.  
OWNER OF U.S. REG. NO. 3,527,942.  
FOR COMPUTER GAME CARTRIDGES; COMPUTER GAME PROGRAMS (U.S. CLS. 21, 23, 26, 36 AND 38).  
DOMINICK J. SALEMI, EXAMINING ATTORNEY

THE MARK CONSISTS OF STANDARD CHARACTERS WITHOUT CLAIM TO ANY PARTICULAR FONT, STYLE, SIZE, OR COLOR.  
NO CLAIM IS MADE TO THE EXCLUSIVE RIGHT TO USE "CHARGER", APART FROM THE MARK AS SHOWN.  
FOR PORTABLE POWER CHARGERS FOR CHARGING PORTABLE ELECTRONIC DEVICES (U.S. CLS. 21, 23, 26, 36 AND 38).  
KEVIN CORWIN, EXAMINING ATTORNEY

**CLASS 9—(Continued).**

SN 86-065,382. PROTHERX, INC., JACKSON, TN. FILED 9-16-2013.



THE MARK CONSISTS OF A CIRCULAR GRAPHIC RESEMBLING AN "O" WITH HUMAN FIGURE IN CENTER.

FOR PRE-RECORDED VIDEO DISCS, VIDEO RECORDING AND VIDEO TAPES FEATURING PHYSICAL FITNESS AND EXERCISE ROUTINES (U.S. CLS. 21, 23, 26, 36 AND 38).

FIRST USE 3-14-2013; IN COMMERCE 3-14-2013.  
KEVIN CORWIN, EXAMINING ATTORNEY

**CLASS 9—(Continued).**

SN 86-065,420. CHARLES D. CORRY, CHICAGO, IL. FILED 9-16-2013.

spander

THE MARK CONSISTS OF STANDARD CHARACTERS WITHOUT CLAIM TO ANY PARTICULAR FONT, STYLE, SIZE, OR COLOR.

FOR CARRYING CASES, HOLDERS, PROTECTIVE CASES AND STANDS FEATURING POWER SUPPLY CONNECTORS, ADAPTORS, SPEAKERS AND BATTERY CHARGING DEVICES, SPECIALLY ADAPTED FOR USE WITH HANDHELD DIGITAL ELECTRONIC DEVICES, NAMELY, CELL PHONES, SMART PHONES, TABLET COMPUTERS; CASES FOR MOBILE PHONES; CELL PHONE BATTERY CHARGERS; CELL PHONE CASES; CELL PHONE COVERS; PROTECTIVE CASES FOR SMARTPHONES; PROTECTIVE COVERS AND CASES FOR CELL PHONES, LAPTOPS AND PORTABLE MEDIA PLAYERS; PROTECTIVE COVERS FOR SMARTPHONES (U.S. CLS. 21, 23, 26, 36 AND 38).

AMY ALFIERI, EXAMINING ATTORNEY

SN 86-065,481. KLIQUE INC., PRESTO, PA. FILED 9-16-2013.

SN 86-065,394. HEIDECHE, MARK JOSEPH, DOWNERS GROVE, IL. FILED 9-16-2013.

EU

THE MARK CONSISTS OF STANDARD CHARACTERS WITHOUT CLAIM TO ANY PARTICULAR FONT, STYLE, SIZE, OR COLOR.

OWNER OF U.S. REG. NO. 3,291,744.  
FOR AUDIO AND VIDEO RECORDINGS FEATURING MUSIC AND ARTISTIC PERFORMANCES; DOWNLOADABLE MUSIC FILES; DOWNLOADABLE VIDEO RECORDINGS FEATURING MUSIC (U.S. CLS. 21, 23, 26, 36 AND 38).

FIRST USE 3-1-2007; IN COMMERCE 3-1-2007.  
AMY ALFIERI, EXAMINING ATTORNEY

k

THE MARK CONSISTS OF A STYLIZED LOWERCASE LETTER "K".

FOR DOWNLOADABLE SOFTWARE APPLICATION USED FOR SOCIAL MEDIA, NAMELY, ALLOWING USERS TO SHARE INFORMATION WITH ONE ANOTHER (U.S. CLS. 21, 23, 26, 36 AND 38).

JAMES MACFARLANE, EXAMINING ATTORNEY

**CLASS 9—(Continued).**

SN 86-065,488. KLIQUE INC., PRESTO, PA. FILED 9-16-2013.



THE MARK CONSISTS OF A STYLIZED LOWERCASE LETTER "K" INSIDE A SQUARE WITH ROUNDED CORNERS.

FOR DOWNLOADABLE SOFTWARE APPLICATION USED FOR SOCIAL MEDIA, NAMELY, ALLOWING USERS TO SHARE INFORMATION WITH ONE ANOTHER (U.S. CLS. 21, 23, 26, 36 AND 38).

JAMES MACFARLANE, EXAMINING ATTORNEY

**CLASS 9—(Continued).**

SN 86-065,558. ADVANCED ELECTRONIC DESIGN, INC., NORTH ATTLEBORO, MA. FILED 9-16-2013.

**Patrol PC**

THE MARK CONSISTS OF STANDARD CHARACTERS WITHOUT CLAIM TO ANY PARTICULAR FONT, STYLE, SIZE, OR COLOR.

NO CLAIM IS MADE TO THE EXCLUSIVE RIGHT TO USE "PC", APART FROM THE MARK AS SHOWN.

FOR CALCULATING MACHINES; CAR NAVIGATION COMPUTERS; CASH REGISTERS (U.S. CLS. 21, 23, 26, 36 AND 38).

FIRST USE 1-1-2010; IN COMMERCE 1-1-2010.

HENRY S. ZAK, EXAMINING ATTORNEY

SN 86-065,492. TORA HOLDINGS, INC., BURLINGAME, CA. FILED 9-16-2013.

**TORA BLOCX**

THE MARK CONSISTS OF STANDARD CHARACTERS WITHOUT CLAIM TO ANY PARTICULAR FONT, STYLE, SIZE, OR COLOR.

OWNER OF U.S. REG. NOS. 3,261,003, 3,567,651 AND OTHERS.

FOR COMPUTER SOFTWARE FOR USE IN BUYING AND SELLING EQUITIES, FUTURES, STOCKS, BONDS AND OTHER SECURITIES; COMPUTER SOFTWARE FOR USE IN MANAGING AND TRACKING THE BUYING AND SELLING OF EQUITIES, FUTURES, STOCKS, BONDS AND OTHER SECURITIES; DOWNLOADABLE COMPUTER SOFTWARE PROVIDING A BLOCK CROSSING UTILITY FOR CLEARED DERIVATIVES (U.S. CLS. 21, 23, 26, 36 AND 38).

THEODORE MCBRIDE, EXAMINING ATTORNEY

SN 86-065,566. DIGITAL GLOBAL SYSTEMS, LLC, BELTSVILLE, MD. FILED 9-16-2013.

**PARIIS**

THE MARK CONSISTS OF STANDARD CHARACTERS WITHOUT CLAIM TO ANY PARTICULAR FONT, STYLE, SIZE, OR COLOR.

FOR COMPUTER HARDWARE AND SOFTWARE FOR RADIO FREQUENCY SPECTRUM ANALYSIS, RADIO FREQUENCY SPECTRUM MANAGEMENT AND RADIO FREQUENCY SIGNAL OPTIMIZATION; ELECTRONIC DEVICES FOR ANALYZING AND MANAGING RADIO FREQUENCY SPECTRUM AND OPTIMIZING RADIO FREQUENCY SIGNALS (U.S. CLS. 21, 23, 26, 36 AND 38).

ALEXANDER L. POWERS, EXAMINING ATTORNEY

**CLASS 9—(Continued).**

SN 86-065,569. ZIZZCO PRODUCTS LLC, BRONX, NY. FILED 9-16-2013.



THE MARK CONSISTS OF A CIRCLE CONTAINING THE LETTER "Z" FOLLOWED BY THE STYLIZED WORD "ZIZZCO".

THE WORDING "ZIZZCO" HAS NO MEANING IN A FOREIGN LANGUAGE.

FOR WIRELESS, CELLULAR AND MOBILE PHONE CARRYING CASES; WIRELESS, CELLULAR AND MOBILE PHONE CHARGERS; BATTERY CHARGERS; WIRELESS, CELLULAR AND MOBILE PHONE HEADSETS; WIRELESS, CELLULAR AND MOBILE PHONE SCREEN PROTECTORS; DISPLAY SCREEN PROTECTORS FOR ELECTRONIC DEVICES, NAMELY, HANDHELD COMPUTERS; PROTECTIVE COVERS AND CASES FOR TABLET COMPUTERS; PROTECTIVE COVERS FOR WIRELESS, CELLULAR AND MOBILE PHONES (U.S. CLS. 21, 23, 26, 36 AND 38).

HENRY S. ZAK, EXAMINING ATTORNEY

SN 86-065,588. FUELBOX, INC., SANTA BARBARA, CA. FILED 9-16-2013.



THE COLOR(S) YELLOW AND BLACK IS/ARE CLAIMED AS A FEATURE OF THE MARK.

THE MARK CONSISTS OF A BLACK STYLIZED LIGHTNING BOLT DESIGN WITHIN A YELLOW CIRCLE HAVING A BLACK BORDER.

FOR ELECTRICAL POWER SUPPLIES, NAMELY, CHARGERS, RECHARGERS, POWER SUPPLY CONNECTORS, POWER ADAPTORS, CABLES, CONNECTORS; SOFTWARE APPLICATIONS FOR LOCATING AND NAVIGATING BETWEEN A PORTABLE ELECTRONIC DEVICE AND ELECTRICAL POWER SUPPLIES FOR PORTABLE ELECTRONIC DEVICES, NAMELY, NOTEBOOK COMPUTERS, NETBOOK COMPUTERS, TABLET COMPUTERS, MEDIA TABLETS, SMART PHONES, MOBILE PHONES, CELLULAR PHONES, PERSONAL DIGITAL ASSISTANT DEVICES (PDA'S), PRINTERS, CAMERAS, HANDHELD COMPUTERS AND DIGITAL ELECTRONIC DEVICES, AND PORTABLE ELECTRONIC BUSINESS EQUIPMENT; SURGE PROTECTOR SUPPLIES, NAMELY, CHARGERS, RECHARGERS, POWER SUPPLY CONNECTORS, POWER ADAPTORS, CABLES, CONNECTORS; SURGE PROTECTORS (U.S. CLS. 21, 23, 26, 36 AND 38).

FIRST USE 1-1-2013; IN COMMERCE 1-1-2013.

MARYNELLE WILSON, EXAMINING ATTORNEY

**CLASS 9—(Continued).**

SN 86-065,602. PLEX, INC., SAN JOSE, CA. FILED 9-16-2013.



THE MARK CONSISTS OF THE STYLIZED WORDING "PLEX".

FOR DOWNLOADABLE COMPUTER SOFTWARE IN THE FIELD OF DIGITAL MEDIA MANAGEMENT FOR USE IN PLAYING, ORGANIZING, INDEXING, SEARCHING, AND TRANSCODING DIGITAL VIDEO, AUDIO AND IMAGES (U.S. CLS. 21, 23, 26, 36 AND 38).

FIRST USE 8-9-2008; IN COMMERCE 8-9-2008.

ROBIN CHOSID, EXAMINING ATTORNEY

SN 86-065,667. WOLO MANUFACTURING CORP., DEER PARK, NY. FILED 9-16-2013.

## B-SEEN

THE MARK CONSISTS OF STANDARD CHARACTERS WITHOUT CLAIM TO ANY PARTICULAR FONT, STYLE, SIZE, OR COLOR.

FOR EMERGENCY WARNING LIGHTS FOR VEHICLES (U.S. CLS. 21, 23, 26, 36 AND 38).

FIRST USE 7-20-2010; IN COMMERCE 7-20-2010.

RUDY R. SINGLETON, EXAMINING ATTORNEY

SN 86-065,675. ERIC WAGNER, DBA TCPWAVE INC., PRINCETON, NJ. FILED 9-16-2013.

## SharkCage

THE MARK CONSISTS OF STANDARD CHARACTERS WITHOUT CLAIM TO ANY PARTICULAR FONT, STYLE, SIZE, OR COLOR.

FOR COMPUTER HARDWARE AND SOFTWARE FOR SETTING UP AND CONFIGURING LOCAL AREA NETWORKS; COMPUTER HARDWARE AND SOFTWARE FOR SETTING UP AND CONFIGURING WIDE AREA NETWORKS; COMPUTER HARDWARE AND SOFTWARE USED FOR THE CONTROL OF VOICE CONTROLLED INFORMATION AND COMMUNICATION DEVICES; COMPUTER HARDWARE, NAMELY, FIREWALLS; COMPUTER PROGRAM FOR THE COMPILATION OF CREDIT REPORTING DATA; COMPUTER SOFTWARE DEVELOPMENT TOOLS (U.S. CLS. 21, 23, 26, 36 AND 38).

JAMES A. RAUEN, EXAMINING ATTORNEY

**CLASS 9—(Continued).**

SN 86-065,685. Z2LIVE, INC., SEATTLE, WA. FILED 9-16-2013.

**CLASS 9—(Continued).**

SN 86-065,828. GARMIN INTERNATIONAL, INC., OLATHE, KS. FILED 9-16-2013.

## SHADOWSLAYER

THE MARK CONSISTS OF STANDARD CHARACTERS WITHOUT CLAIM TO ANY PARTICULAR FONT, STYLE, SIZE, OR COLOR.

FOR COMPUTER GAME SOFTWARE; COMPUTER GAME SOFTWARE DOWNLOADABLE FROM A GLOBAL COMPUTER NETWORK; COMPUTER GAME SOFTWARE FOR USE ON MOBILE AND CELLULAR PHONES (U.S. CLS. 21, 23, 26, 36 AND 38).

DAVID COLLIER, EXAMINING ATTORNEY

## G1000H

---

SN 86-065,816. JAZE LABS, INC., BOSTON, MA. FILED 9-16-2013.

## JAZE

THE MARK CONSISTS OF STANDARD CHARACTERS WITHOUT CLAIM TO ANY PARTICULAR FONT, STYLE, SIZE, OR COLOR.

FOR SOFTWARE FOR MOBILE COMMUNICATIONS DEVICES THAT PROVIDES THE ABILITY TO REMOTELY CHECK THE STATUS OF MOTOR VEHICLE OPERATING SYSTEMS, PROVIDES AUTOMOTIVE DIAGNOSTIC INFORMATION AND PROVIDES USERS WITH REPAIR SHOP INFORMATION; COMPUTER HARDWARE FOR AUTOMOTIVE DIAGNOSTICS AND COMMUNICATIONS REGARDING THE STATUS AND SAFETY OF AN AUTOMOBILE AND ENABLES USERS TO OBTAIN ROADSIDE AND EMERGENCY ASSISTANCE (U.S. CLS. 21, 23, 26, 36 AND 38).

LAURA FIONDA, EXAMINING ATTORNEY

THE MARK CONSISTS OF STANDARD CHARACTERS WITHOUT CLAIM TO ANY PARTICULAR FONT, STYLE, SIZE, OR COLOR.

OWNER OF U.S. REG. NOS. 2,973,152, 3,467,319 AND 3,807,526.

FOR NAVIGATION AND COMMUNICATION SYSTEMS IN THE FIELD OF AVIONICS, NAMELY, GPS RECEIVERS, COMMUNICATION TRANSCEIVERS, TRANSPONDERS, AUDIO PANELS COMPRISING HARDWARE AND SOFTWARE FOR CONTROLLING TRANSMISSION AND RECEPTION OF RADIO SIGNALS, WEATHER RADAR, TERRAIN AWARENESS AND WARNING SYSTEMS (TAWS) COMPRISING HARDWARE AND SOFTWARE FOR DETERMINING WHEN A TERRAIN HAZARD EXISTS AND FOR OUTPUTTING CORRESPONDING ALERTS TO AN AIRCRAFT PILOT OR CREW, AUTOMATIC FLIGHT CONTROL SYSTEMS (AFCS) COMPRISING HARDWARE AND SOFTWARE FOR AUTOMATICALLY CONTROLLING FLIGHT OF AN AIRCRAFT, ATTITUDE HEADING AND REFERENCE SYSTEMS (AHRS) COMPRISING HARDWARE AND SOFTWARE FOR PROVIDING AIRCRAFT ATTITUDE AND HEADING INFORMATION FOR USE BY A PILOT, FLIGHT CREW OR OTHER AVIONICS, PRIMARY FLIGHT DISPLAYS (PFDS) COMPRISING HARDWARE AND SOFTWARE FOR DISPLAYING NAVIGATION AND FLIGHT INFORMATION AND FOR CONTROLLING AVIONICS INSTRUMENTS, AND MULTI-FUNCTION FLIGHT DISPLAYS (MFDS) COMPRISING HARDWARE AND SOFTWARE FOR DISPLAYING NAVIGATION AND FLIGHT INFORMATION AND FOR CONTROLLING AVIONICS INSTRUMENTS (U.S. CLS. 21, 23, 26, 36 AND 38).

FIRST USE 12-0-2010; IN COMMERCE 12-0-2010.

SUI DUONG, EXAMINING ATTORNEY

**CLASS 9—(Continued).**

SN 86-066,332. NIE YUAN, CHANGSHA, HUNAN, CHINA, FILED 9-17-2013.



THE MARK CONSISTS OF STYLIZED LETTERS "OKSOBUY".

THE WORDING "OKSOBUY" HAS NO MEANING IN A FOREIGN LANGUAGE.

FOR AMMETERS; CAPACITORS; CHARGERS FOR ELECTRIC BATTERIES; COMPUTER CURSOR CONTROL DEVICES, NAMELY, COMPUTER MOUSE; COMPUTER MOUSE; COMPUTER MOUSE, NAMELY, TOUCHPADS; DATA PROCESSING EQUIPMENT, NAMELY, COUPLERS; DIFFUSERS FOR USE IN PHOTOGRAPHY; LENSES FOR CAMERAS; LENSES FOR MICROSCOPES; LENSES FOR PHOTOGRAPHIC APPARATUS; MAGNIFYING LENSES; MAGNIFYING PEEPHOLES FOR DOORS; MEDIA PLAYERS; PINNEZ MOUNTINGS; PORTABLE MEDIA PLAYERS; TELEPHONE TRANSMITTERS (U.S. CLS. 21, 23, 26, 36 AND 38).

FIRST USE 10-8-2010; IN COMMERCE 10-8-2010.

DAVID TAYLOR, EXAMINING ATTORNEY

SN 86-066,338. SHENZHEN FEST TECHNOLOGY CO.,LTD, BAO'AN,SHENZHEN, CHINA, FILED 9-17-2013.



THE MARK CONSISTS OF STYLIZED LETTERS "EFEST" AND A FIRE DESIGN UNDER THE LETTERS.

THE WORDING "EFEST" HAS NO MEANING IN A FOREIGN LANGUAGE.

FOR BATTERIES; BATTERIES AND BATTERY CHARGERS; BATTERY CHARGERS; BURGLAR ALARMS; COMPUTER NETWORKING HARDWARE; ELECTRIC CONNECTIONS AND CONNECTORS; ELECTRIC CONTACTS; ELECTRICAL CONNECTORS; ELECTRICAL PLUGS AND SOCKETS; JUNCTION BOXES; NETWORK ACCESS SERVER HARDWARE; THEFT ALARMS (U.S. CLS. 21, 23, 26, 36 AND 38).

FIRST USE 6-13-2010; IN COMMERCE 6-13-2010.

KATHERINE STOIDES, EXAMINING ATTORNEY

**CLASS 9—(Continued).**

SN 86-066,356. SHENZHEN XINKECHUANG ELECTRONIC TECHNOLOGY CO., LTD., SHENZHEN, CHINA, FILED 9-17-2013.



THE MARK CONSISTS OF WORDS "FEELYMOS" IN A DESIGNED STYLE.

FOR BATTERIES, ELECTRIC; BLANK USB FLASH DRIVES; CELL PHONE STRAPS; COMPUTER-GAMING SOFTWARE; DATA PROCESSING EQUIPMENT, NAMELY, COUPLERS; DIGITAL BOOK READERS; ELECTRIC INSTALLATIONS FOR THE REMOTE CONTROL OF INDUSTRIAL OPERATIONS; ELECTRONIC APPARATUS FOR THE REMOTE CONTROL OF INDUSTRIAL OPERATIONS; ELECTRONIC DEVICES FOR ASSISTING CARE GIVING FOR SENIORS OR PEOPLE NEEDING ASSISTANCE COMPRISED OF SENSORS FOR DETERMINING STATUS OF PERSON AND APPARATUS FOR SENDING ELECTRONIC ALERTS TO CARE GIVERS; ELECTRONIC TEST AND MEASUREMENT DEVICES FOR USE IN THE FIELDS OF NETWORKS AND TELECOMMUNICATIONS, NAMELY, INSTRUMENTATION USED TO TEST AND CERTIFY NEW AND EXISTING DATA AND VOICE COMMUNICATION CABLE AND COAXIAL CABLE; ELECTROPHORESIS APPARATUS NOT FOR MEDICAL PURPOSES; INTEGRATED BOILER CONTROL SYSTEMS CONSISTING OF ELECTRONIC FLAME SAFEGUARD AND MODULATING CONTROLS; MEASURING DEVICES, NAMELY, FLUOROMETERS; PHOTOGRAPHIC CAMERAS; PORTABLE TELEPHONES; PROJECTION SCREENS FOR MOVIE FILMS; PROTECTIVE COVERS AND CASES FOR CELL PHONES, LAPTOPS AND PORTABLE MEDIA PLAYERS; REMOTE CONTROL TELEMETERING MACHINES AND APPARATUS; RIDING HELMETS; SURVEYING MACHINES AND INSTRUMENTS; TELEPHONE APPARATUS; TELEVISION APPARATUS FOR PROJECTION PURPOSES; VIDEO SCREENS (U.S. CLS. 21, 23, 26, 36 AND 38).

FIRST USE 5-1-2010; IN COMMERCE 10-1-2010.

DONALD JOHNSON, EXAMINING ATTORNEY

**CLASS 9—(Continued).**

SN 86-066,379. ANDY MAPPLE, WINTER GARDEN, FL. FILED 9-17-2013.



THE MARK CONSISTS OF ZIG ZAG LINES FOR FLOTATION VESTS (U.S. CLS. 21, 23, 26, 36 AND 38).  
FIRST USE 1-31-2012; IN COMMERCE 1-31-2012.  
LINDA POWELL, EXAMINING ATTORNEY

SN 86-066,441. CHARLES ELECTRONICS, LLC, MT. CARROLL, IL. FILED 9-17-2013.

**SKIPSHOOTER**

THE MARK CONSISTS OF STANDARD CHARACTERS WITHOUT CLAIM TO ANY PARTICULAR FONT, STYLE, SIZE, OR COLOR.  
FOR ANTENNAS (U.S. CLS. 21, 23, 26, 36 AND 38).  
FIRST USE 12-31-1967; IN COMMERCE 12-31-1967.  
WILLIAM ROSSMAN, EXAMINING ATTORNEY

SN 86-066,523. MODERNIZING MEDICINE, INC., BOCA RATON, FL. FILED 9-17-2013.

**MODMED**

THE MARK CONSISTS OF STANDARD CHARACTERS WITHOUT CLAIM TO ANY PARTICULAR FONT, STYLE, SIZE, OR COLOR.  
FOR COMPUTER SOFTWARE FOR PATIENT RECORDS AND BILLING, SCHEDULING, MEDICAL DECISION MAKING, CREATING PATIENT TREATMENT SCHEDULES, DATA PORTAL AND ORDERING AND MANAGING PRESCRIPTIONS AND TESTS, FOR USE BY HEALTHCARE AND MEDICAL ORGANIZATIONS AND PROVIDERS (U.S. CLS. 21, 23, 26, 36 AND 38).  
MORGAN WYNNE, EXAMINING ATTORNEY

**CLASS 9—(Continued).**

SN 86-066,533. DIGITAL INNOVATIONS LLC, ARLINGTON HEIGHTS, IL. FILED 9-17-2013.

**SOUND DR**

THE MARK CONSISTS OF STANDARD CHARACTERS WITHOUT CLAIM TO ANY PARTICULAR FONT, STYLE, SIZE, OR COLOR.  
FOR SPEAKER/AMPLIFIER DEVICES USING INDUCTION TECHNOLOGY TO AMPLIFY SOUND FROM A CELLULAR TELEPHONE WHEN THE TELEPHONE IS PLACED NEAR THE DEVICE (U.S. CLS. 21, 23, 26, 36 AND 38).  
APRIL ROACH, EXAMINING ATTORNEY

SN 86-066,582. FU, QIANG, HOUSTON, TX. FILED 9-17-2013.

**C&J**

THE MARK CONSISTS OF STANDARD CHARACTERS WITHOUT CLAIM TO ANY PARTICULAR FONT, STYLE, SIZE, OR COLOR.  
FOR ADJUSTABLE SMARTPHONE AND PC TABLET STABILIZERS AND MOUNTS; ANTI-THEFT LOCKS SPECIALLY ADAPTED TO PERSONAL ELECTRONIC DEVICES, NAMELY, PC TABLETS, LAPTOPS; COMPUTER CURSOR CONTROL DEVICES, NAMELY, DIGITIZER TABLETS; ELECTRONIC CHARGING DEVICES FOR TABLET PCS THAT ALSO INCLUDE FEATURES TO SECURE AND DISINFECT THE TABLET PCS; ELECTRONIC DEVICE TO CHARGE AND SECURE TABLET PCS; ELECTRONIC WRITING TABLETS; PC TABLET MOUNTS; PC TABLET STABILIZERS; PC TABLETS; PROTECTIVE COVERS AND CASES FOR TABLET COMPUTERS; STABILIZERS FOR PC TABLETS WITH PROTECTIVE CASES; TABLET COMPUTER (U.S. CLS. 21, 23, 26, 36 AND 38).  
MORGAN WYNNE, EXAMINING ATTORNEY

**CLASS 9—(Continued).**

SN 86-066,613. FREEVISION TECHNOLOGIES CO., LTD., SHANGHAI, CHINA, FILED 9-17-2013.

# FREEVISION

THE MARK CONSISTS OF STANDARD CHARACTERS WITHOUT CLAIM TO ANY PARTICULAR FONT, STYLE, SIZE, OR COLOR.

FOR MAGNETICALLY ENCODED IDENTITY CARDS; ENCODED INTEGRATED CIRCUIT SMART CARDS CONTAINING PROGRAMMING FOR GUARD SYSTEMS FOR ENABLING OF ACCESS OR ENTRANCE CONTROL; ELECTRONIC TAGS FOR GOODS; TIME CLOCKS, NAMELY TIME RECORDING DEVICES; AUTOMATED TELLER MACHINES, NAMELY ATMS; CARD READERS FOR MAGNETICALLY ENCODED CARDS (U.S. CLS. 21, 23, 26, 36 AND 38).

FIRST USE 9-1-2013; IN COMMERCE 9-1-2013.  
LAURIE MAYES, EXAMINING ATTORNEY

**CLASS 9—(Continued).**

SN 86-066,671. AUDIVERO, LLC, NORMAN, OK. FILED 9-17-2013.



THE MARK CONSISTS OF A SPHERE WEARING HEADPHONES. ANTENNAS ARE POSITIONED ON THE RIGHT UPPER SIDE OF THE HEADPHONES.

FOR DOWNLOADABLE SOFTWARE IN THE NATURE OF A MOBILE APPLICATION FOR STREAMING AUDIO TO A USER'S MOBILE DEVICE (U.S. CLS. 21, 23, 26, 36 AND 38).

FIRST USE 1-15-2013; IN COMMERCE 1-15-2013.  
BARBARA BROWN, EXAMINING ATTORNEY

SN 86-066,747. GOODNIGHT FAMILY, LLC, RYE, NY. FILED 9-17-2013.

# COMPUTERVISION

THE MARK CONSISTS OF STANDARD CHARACTERS WITHOUT CLAIM TO ANY PARTICULAR FONT, STYLE, SIZE, OR COLOR.

FOR CONTACT LENSES; CONTAINERS FOR CONTACT LENSES; EYEGLASS CHAINS AND CORDS; EYEGLASS LENSES; EYEWEAR, NAMELY, SUNGLASSES, EYEGLASSES AND OPHTHALMIC FRAMES AND CASES THEREFOR; SUNGLASS LENSES (U.S. CLS. 21, 23, 26, 36 AND 38).

JOHN GARTNER, EXAMINING ATTORNEY

SN 86-066,635. AUDIVERO, LLC, NORMAN, OK. FILED 9-17-2013.

# AUDIVERO

SN 86-066,818. HEALTHMYNE, INC., MADISON, WI. FILED 9-17-2013.

# Healthmyne

THE MARK CONSISTS OF STANDARD CHARACTERS WITHOUT CLAIM TO ANY PARTICULAR FONT, STYLE, SIZE, OR COLOR.

FOR DOWNLOADABLE SOFTWARE IN THE NATURE OF A MOBILE APPLICATION FOR STREAMING AUDIO TO A USER'S MOBILE DEVICE (U.S. CLS. 21, 23, 26, 36 AND 38).

FIRST USE 1-15-2013; IN COMMERCE 1-15-2013.  
BARBARA BROWN, EXAMINING ATTORNEY

THE MARK CONSISTS OF STANDARD CHARACTERS WITHOUT CLAIM TO ANY PARTICULAR FONT, STYLE, SIZE, OR COLOR.

FOR COMPUTER SOFTWARE FOR USE IN DISPLAY, STORAGE, RETRIEVAL, ANALYSIS AND DISTRIBUTION OF MEDICAL IMAGES AND MEDICAL INFORMATION (U.S. CLS. 21, 23, 26, 36 AND 38).

JEANIE LEE, EXAMINING ATTORNEY



**CLASS 9—(Continued).**

SN 86-066,889. SOL VOLTAICS AB, LUND, SWEDEN, FILED 9-17-2013.

# SolInk

THE MARK CONSISTS OF STANDARD CHARACTERS WITHOUT CLAIM TO ANY PARTICULAR FONT, STYLE, SIZE, OR COLOR.  
FOR PHOTOVOLTAIC CELLS; PHOTOVOLTAIC CELLS AND MODULES (U.S. CLS. 21, 23, 26, 36 AND 38).  
TRACY CROSS, EXAMINING ATTORNEY

SN 86-066,964. DISRUPTIVE TECHNOLOGY PARTNERS, LLC, CHICAGO, IL. FILED 9-17-2013.

# MARKER

THE MARK CONSISTS OF STANDARD CHARACTERS WITHOUT CLAIM TO ANY PARTICULAR FONT, STYLE, SIZE, OR COLOR.  
FOR COMPUTER SOFTWARE FOR EVENT PLANNING AND MANAGEMENT, FUNDRAISING AND CHARITABLE GIVING EVENTS AND ACTIVITIES PLANNING AND MANAGEMENT, AND ELECTRONIC FUNDS TRANSFER AND PAYMENT SERVICES; COMPUTER SOFTWARE FOR SOCIAL, ENTERTAINMENT, AND PHILANTHROPIC EVENT PLANNING AND MANAGEMENT (U.S. CLS. 21, 23, 26, 36 AND 38).  
FIRST USE 4-0-2013; IN COMMERCE 8-12-2013.  
JENNIFER WILLISTON, EXAMINING ATTORNEY

SN 86-067,001. BEEONICS INC, CONCORD, MA. FILED 9-17-2013.

# Beeonics

THE MARK CONSISTS OF STANDARD CHARACTERS WITHOUT CLAIM TO ANY PARTICULAR FONT, STYLE, SIZE, OR COLOR.  
FOR COMPUTER SOFTWARE DEVELOPMENT TOOLS (U.S. CLS. 21, 23, 26, 36 AND 38).  
FIRST USE 11-17-2011; IN COMMERCE 11-17-2011.  
KATINA MISTER, EXAMINING ATTORNEY

**CLASS 9—(Continued).**

SN 86-067,095. BABY-TECH INNOVATIONS, INC., DBA INFANTTECH, MONTEBELLO, CA. FILED 9-17-2013.

# Always in View

THE MARK CONSISTS OF STANDARD CHARACTERS WITHOUT CLAIM TO ANY PARTICULAR FONT, STYLE, SIZE, OR COLOR.  
FOR BABY MONITORS FOR PLACEMENT IN VEHICLES TO TRANSMIT WHAT IS TAKING PLACE WITHIN THE VEHICLE TO BE VIEWED BY OTHERS (U.S. CLS. 21, 23, 26, 36 AND 38).  
FIRST USE 8-1-2013; IN COMMERCE 9-1-2013.  
SUSAN RICHARDS, EXAMINING ATTORNEY

SN 86-067,101. VARIAN MEDICAL SYSTEMS, INC., PALO ALTO, CA. FILED 9-17-2013.

# TRUST-RATED

THE MARK CONSISTS OF STANDARD CHARACTERS WITHOUT CLAIM TO ANY PARTICULAR FONT, STYLE, SIZE, OR COLOR.  
FOR SOFTWARE FOR USE IN CARGO SECURITY SCREENING (U.S. CLS. 21, 23, 26, 36 AND 38).  
JASON TURNER, EXAMINING ATTORNEY

SN 86-067,157. ANKA, DARRYL, ALTADENA, CA. FILED 9-17-2013.



THE COLOR(S) BLUE, LIGHT BLUE AND WHITE IS/ARE CLAIMED AS A FEATURE OF THE MARK.  
THE MARK CONSISTS OF A STYLIZED TRIANGLE WITH LIGHT BLUE FADING TO WHITE BORDERS, WITH A BLUE SWIRL DESIGN IN THE CENTER.  
FOR DIGITAL MEDIA, NAMELY, DVDS AND CDS FEATURING METAPHYSICS (U.S. CLS. 21, 23, 26, 36 AND 38).  
FIRST USE 1-0-2008; IN COMMERCE 1-0-2008.  
ELLEN BURNS, EXAMINING ATTORNEY

**CLASS 9—(Continued).**

SN 86-067,177. MACPHUN SOFTWARE, AKA MACPHUN, DEL MAR, CA. FILED 9-17-2013.

CleanPics

THE MARK CONSISTS OF STANDARD CHARACTERS WITHOUT CLAIM TO ANY PARTICULAR FONT, STYLE, SIZE, OR COLOR.

FOR COMPUTER PROGRAMS FOR EDITING IMAGES, SOUND AND VIDEO; SOFTWARE FOR EDITING PHOTOS (U.S. CLS. 21, 23, 26, 36 AND 38).

FIRST USE 9-4-2013; IN COMMERCE 9-4-2013.  
ANDREA K. NADELMAN, EXAMINING ATTORNEY

**CLASS 9—(Continued).**

SN 86-067,276. SYFER TECHNOLOGY LIMITED, ARMINGHALL, NORWICH, UNITED KINGDOM, FILED 9-17-2013.

SYFER

THE MARK CONSISTS OF STANDARD CHARACTERS WITHOUT CLAIM TO ANY PARTICULAR FONT, STYLE, SIZE, OR COLOR.

OWNER OF ERPN CMNTY TM OFC REG. NO. 011203049, DATED 1-30-2013, EXPIRES 9-20-2022.

OWNER OF U.S. REG. NO. 2,301,374.

FOR ELECTRICAL AND ELECTRONIC COMPONENTS FOR COMPUTERS, COMPUTER DISPLAYS, LIQUID CRYSTAL DISPLAYS, TELECOMMUNICATION APPARATUS, AEROSPACE TESTING FOR TESTING ELECTRICAL SYSTEMS, ELECTRIC POWER SUPPLIES; CERAMIC MULTI-LAYER COMPONENTS, NAMELY, CERAMIC CAPACITORS; CAPACITORS; FILTERS, NAMELY, SUPPRESSION FILTERS; ELECTRONIC COMPONENTS, NAMELY, VARISTORS AND ELECTRONIC CAPACITORS; INTEGRATED PASSIVE COMPONENTS; EMI CHIPS AND HIGH CURRENT EMI FOR CERAMIC AND ELECTRIC CAPACITORS, LOW INDUCTANCE CHIPS FOR ELECTRIC AND CERAMIC CAPACITORS; SAFETY CHIP CAPACITORS, STACKED CAPACITORS FOR SWITCHED MODE POWER SUPPLIES AND CAPACITORS ARRAYS; MULTI-LAYER CERAMIC CAPACITORS; PARTS AND FITTINGS FOR ALL THE AFORESAID GOODS, NAMELY, CAPACITORS AND COMPONENTS FOR CAPACITORS (U.S. CLS. 21, 23, 26, 36 AND 38).

FIRST USE 8-0-1987; IN COMMERCE 8-0-1987.  
LEIGH CAROLINE CASE, EXAMINING ATTORNEY

SN 86-067,190. WILLIAM C. BURGESS, DBA AIRBLOOM AMPLIFIERS, MORAGA, CA. FILED 9-17-2013.

"The sound of the future  
is the sound of the  
past....improved!"

THE MARK CONSISTS OF STANDARD CHARACTERS WITHOUT CLAIM TO ANY PARTICULAR FONT, STYLE, SIZE, OR COLOR.

FOR GUITAR AMPLIFIERS (U.S. CLS. 21, 23, 26, 36 AND 38).

NANCY CLARKE, EXAMINING ATTORNEY

SN 86-067,290. PERFORMANCE INDUSTRIES, LLC, MT CLEMENS, MI. FILED 9-17-2013.



THE MARK CONSISTS OF THE STYLIZED WORD "KLIPSTAND" WITH A SIDE VIEW STAND DESIGN AS THE LETTER "K".

FOR BELT CLIPS AND PORTABLE TABLE TOP SUPPORTS FOR SMARTPHONES (U.S. CLS. 21, 23, 26, 36 AND 38).

EUGENIA MARTIN, EXAMINING ATTORNEY

**CLASS 9—(Continued).**

SN 86-067,324. BIOTIX INC., SAN DIEGO, CA. FILED 9-17-2013.

**CLASS 9—(Continued).**

SN 86-067,539. CHANG-AN CHOU, TAIPEI, TAIWAN, FILED 9-18-2013.

# CHEM-RESIN

THE MARK CONSISTS OF STANDARD CHARACTERS WITHOUT CLAIM TO ANY PARTICULAR FONT, STYLE, SIZE, OR COLOR.

OWNER OF U.S. REG. NO. 4,028,403.  
FOR LABORATORY EQUIPMENT, NAMELY, PIPETTE TIPS (U.S. CLS. 21, 23, 26, 36 AND 38).  
TIMOTHY FINNEGAN, EXAMINING ATTORNEY



SN 86-067,407. MARTINEAU, ROBERT, BEVERLY HILLS, FL. FILED 9-17-2013.

# iRing

# Total Recall

THE MARK CONSISTS OF STANDARD CHARACTERS WITHOUT CLAIM TO ANY PARTICULAR FONT, STYLE, SIZE, OR COLOR.

FOR COMPUTER APPLICATION SOFTWARE FOR COMPUTING AND COMMUNICATION DEVICES, NAMELY, SOFTWARE FOR VOICE-BASED USER INTERFACES; COMPUTER HARDWARE AND SOFTWARE USED FOR THE CONTROL OF VOICE CONTROLLED INFORMATION AND COMMUNICATION DEVICES (U.S. CLS. 21, 23, 26, 36 AND 38).  
NICHOLAS COLEMAN, EXAMINING ATTORNEY



SN 86-067,447. ONGUARD INDUSTRIES, LLC, HAVRE DE GRACE, MD. FILED 9-17-2013.

# DURAPRO

THE MARK CONSISTS OF STANDARD CHARACTERS WITHOUT CLAIM TO ANY PARTICULAR FONT, STYLE, SIZE, OR COLOR.

FOR PROTECTIVE FOOTWEAR (U.S. CLS. 21, 23, 26, 36 AND 38).  
SUZANNE BLANE, EXAMINING ATTORNEY

THE MARK CONSISTS OF STANDARD CHARACTERS WITHOUT CLAIM TO ANY PARTICULAR FONT, STYLE, SIZE, OR COLOR.

FOR COMPUTER SOFTWARE FOR CONTROLLING AND MANAGING PATIENT MEDICAL INFORMATION; COMPUTER SOFTWARE THAT PROVIDES WEB-BASED ACCESS TO APPLICATIONS AND SERVICES THROUGH A WEB OPERATING SYSTEM OR PORTAL INTERFACE; COMPUTER HARDWARE AND SOFTWARE, FOR USE WITH MEDICAL PATIENT MONITORING EQUIPMENT, FOR RECEIVING, PROCESSING, TRANSMITTING AND DISPLAYING DATA; COMPUTER SOFTWARE FOR COMMUNICATING WITH USERS OF HAND-HELD COMPUTERS; COMPUTER SOFTWARE FOR COMMUNICATING PURPOSES BETWEEN MICROCOMPUTERS; COMPUTER SOFTWARE FOR USE IN MEDICAL DECISION SUPPORT SYSTEMS; ACCELERATION SENSORS; MOTION DETECTORS; PEDOMETERS; ACOUSTIC SOUND ALARMS; ELECTRONIC MONITORING DEVICES FOR DETECTING, STORING, AND MONITORING DAILY ACTIVITY AND PHYSIOLOGICAL CONDITIONS; ELECTRONIC HEART RATE RECORDERS OTHER THAN FOR MEDICAL USE; ELECTRONIC TEMPERATURE MONITORS OTHER THAN FOR MEDICAL USE; SENSORS FOR THE DETERMINATION OF TEMPERATURES, POSITIONS AND DISTANCES; SENSORS FOR DETERMINING POSITION, VELOCITY, ACCELERATION AND TEMPERATURE; COMPUTER SOFTWARE FOR MEDICAL CLINICIANS TO ELECTRONICALLY MANAGE AND PROCESS PATIENT HEALTH DATA AND INSTRUCTIONAL USER GUIDES SOLD AS A UNIT (U.S. CLS. 21, 23, 26, 36 AND 38).  
FIRST USE 7-15-2013; IN COMMERCE 7-15-2013.  
ROSELLE HERRERA, EXAMINING ATTORNEY

**CLASS 9—(Continued).**

SN 86-067,545. CHANG-AN CHOU, TAIPEI, TAIWAN, FILED 9-18-2013.

# iRhythm

THE MARK CONSISTS OF STANDARD CHARACTERS WITHOUT CLAIM TO ANY PARTICULAR FONT, STYLE, SIZE, OR COLOR.

FOR COMPUTER SOFTWARE FOR CONTROLLING AND MANAGING PATIENT MEDICAL INFORMATION; COMPUTER SOFTWARE THAT PROVIDES WEB-BASED ACCESS TO APPLICATIONS AND SERVICES THROUGH A WEB OPERATING SYSTEM OR PORTAL INTERFACE; COMPUTER HARDWARE AND SOFTWARE, FOR USE WITH MEDICAL PATIENT MONITORING EQUIPMENT, FOR RECEIVING, PROCESSING, TRANSMITTING AND DISPLAYING DATA; COMPUTER SOFTWARE FOR COMMUNICATING WITH USERS OF HAND-HELD COMPUTERS; COMPUTER SOFTWARE FOR COMMUNICATING PURPOSES BETWEEN MICROCOMPUTERS; COMPUTER SOFTWARE FOR USE IN MEDICAL DECISION SUPPORT SYSTEMS; ACCELERATION SENSORS; MOTION DETECTORS; PEDOMETERS; ACOUSTIC SOUND ALARMS; ELECTRONIC MONITORING DEVICES FOR DETECTING, STORING, AND MONITORING DAILY ACTIVITY AND PHYSIOLOGICAL CONDITIONS; ELECTRONIC HEART RATE RECORDERS OTHER THAN FOR MEDICAL USE; ELECTRONIC TEMPERATURE MONITORS OTHER THAN FOR MEDICAL USE; SENSORS FOR THE DETERMINATION OF TEMPERATURES, POSITIONS AND DISTANCES; SENSORS FOR DETERMINING POSITION, VELOCITY, ACCELERATION AND TEMPERATURE; COMPUTER SOFTWARE FOR MEDICAL CLINICIANS TO ELECTRONICALLY MANAGE AND PROCESS PATIENT HEALTH DATA AND INSTRUCTIONAL USER GUIDES SOLD AS A UNIT (U.S. CLS. 21, 23, 26, 36 AND 38).  
FIRST USE 7-15-2013; IN COMMERCE 7-15-2013.  
ROSELLE HERRERA, EXAMINING ATTORNEY

SN 86-067,642. LSI CORPORATION, SAN JOSE, CA. FILED 9-18-2013.

# STREAMSIGHT

THE MARK CONSISTS OF STANDARD CHARACTERS WITHOUT CLAIM TO ANY PARTICULAR FONT, STYLE, SIZE, OR COLOR.

FOR COMPUTER HARDWARE AND SOFTWARE FOR USE IN NETWORK MANAGEMENT (U.S. CLS. 21, 23, 26, 36 AND 38).

DAVID TAYLOR, EXAMINING ATTORNEY

**CLASS 9—(Continued).**

SN 86-067,790. QUASI STELLAR ALPHA INC., SAN FRANCISCO, CA. FILED 9-18-2013.

# QUATRIX

THE MARK CONSISTS OF THE TERM "QUATRIX" IN STYLIZED FONT.

FOR MOBILE PHONES; SMARTPHONES; ACCESSORIES FOR MOBILE PHONES, NAMELY, CASES, COVERS, HEADSETS, AND BATTERIES (U.S. CLS. 21, 23, 26, 36 AND 38).

EUGENIA MARTIN, EXAMINING ATTORNEY

SN 86-067,811. QUASI STELLAR ALPHA INC., SAN FRANCISCO, CA. FILED 9-18-2013.

# QSDX

THE MARK CONSISTS OF THE LETTERS "QS" AND THE GREEK LETTER ALPHA IN STYLIZED FONT.

FOR MOBILE PHONES; SMARTPHONES; ACCESSORIES FOR MOBILE PHONES, NAMELY, CASES, COVERS, HEADSETS, AND BATTERIES (U.S. CLS. 21, 23, 26, 36 AND 38).

EUGENIA MARTIN, EXAMINING ATTORNEY

SN 86-067,814. QUASI STELLAR ALPHA INC., SAN FRANCISCO, CA. FILED 9-18-2013.



THE MARK CONSISTS OF THE LETTERS "QS" AND THE GREEK LETTER ALPHA IN STYLIZED FONT AND ARRANGED IN THE OVERALL SHAPE OF A BOX.

FOR MOBILE PHONES; SMARTPHONES; ACCESSORIES FOR MOBILE PHONES, NAMELY, CASES, COVERS, HEADSETS, AND BATTERIES (U.S. CLS. 21, 23, 26, 36 AND 38).

EUGENIA MARTIN, EXAMINING ATTORNEY

**CLASS 9—(Continued).**

SN 86-067,826. QUASI STELLAR ALPHA INC., SAN FRANCISCO, CA. FILED 9-18-2013.

# QSALPHA

THE MARK CONSISTS OF STANDARD CHARACTERS WITHOUT CLAIM TO ANY PARTICULAR FONT, STYLE, SIZE, OR COLOR.

FOR MOBILE PHONES; SMARTPHONES; ACCESSORIES FOR MOBILE PHONES, NAMELY, CASES, COVERS, HEADSETS, AND BATTERIES (U.S. CLS. 21, 23, 26, 36 AND 38).

EUGENIA MARTIN, EXAMINING ATTORNEY

SN 86-067,968. NEW ANGLE SOLUTIONS AB, UPPSALA, SWEDEN, FILED 9-18-2013.

# GadgetMe

THE MARK CONSISTS OF STANDARD CHARACTERS WITHOUT CLAIM TO ANY PARTICULAR FONT, STYLE, SIZE, OR COLOR.

FOR BLANK USB FLASH DRIVES; CELL PHONE CASES; ELECTRONIC PENS; PROTECTIVE COVERS AND CASES FOR CELL PHONES, LAPTOPS AND PORTABLE MEDIA PLAYERS; SCALES (U.S. CLS. 21, 26, 36 AND 38).

FIRST USE 5-1-2012; IN COMMERCE 5-1-2012.  
ANGELA DUONG, EXAMINING ATTORNEY

SN 86-068,015. PENCIL LABS, INC., BOSTON, MA. FILED 9-18-2013.

# HAPS

THE MARK CONSISTS OF STANDARD CHARACTERS WITHOUT CLAIM TO ANY PARTICULAR FONT, STYLE, SIZE, OR COLOR.

FOR COMPUTER APPLICATION SOFTWARE FOR MOBILE PHONES, NAMELY, SOFTWARE FOR SOCIAL NETWORKING, PLANNING, SCHEDULING, CALENDARING, MESSAGING, ARRANGING MEETINGS AND SOCIAL EVENTS, SHARING, POSTING AND MATCHING IDEAS, COMMON INTERESTS AND PLANS, COORDINATING OF PLANS, MEETING TIMES AND PLACES, AND EVENTS; COMPUTER APPLICATION SOFTWARE FOR MOBILE PHONES, PORTABLE MEDIA PLAYERS, HANDHELD COMPUTERS, NAMELY, SOFTWARE FOR CONNECTING AND MATCHING USERS WITH THIRD PARTY RETAIL SERVICES BY MAKING USE OF NATURAL LANGUAGE PROCESSING (NLP) AND CONTENT AND GEOLOCATION MATCHING FOR ENHANCED INTERACTIVE EXPERIENCES; COMPUTER SOFTWARE FOR ACCESSING INFORMATION DIRECTORIES THAT MAY BE DOWNLOADED FROM THE GLOBAL COM-

**CLASS 9—(Continued).**

PUTER NETWORK; COMPUTER SOFTWARE FOR COMMUNICATING WITH USERS OF HAND-HELD COMPUTERS; COMPUTER SOFTWARE FOR SOCIAL NETWORKING, PLANNING, SCHEDULING, CALENDARING, MESSAGING, ARRANGING MEETINGS AND SOCIAL EVENTS, SHARING, POSTING AND MATCHING IDEAS, COMMON INTERESTS AND PLANS, COORDINATING OF PLANS, MEETING TIMES AND PLACES, AND EVENTS; COMPUTER SOFTWARE FOR INTEGRATION WITH CONNECTING AND MATCHING USERS WITH THIRD PARTY RETAIL SERVICES BY MAKING USE OF NATURAL LANGUAGE PROCESSING (NLP) AND CONTENT AND GEOLOCATION MATCHING FOR ENHANCED INTERACTIVE EXPERIENCES; COMPUTER SOFTWARE THAT PROVIDES WEB-BASED ACCESS TO APPLICATIONS AND SERVICES THROUGH A WEB OPERATING SYSTEM OR PORTAL INTERFACE; DOWNLOADABLE CLOUD COMPUTER SOFTWARE FOR SOCIAL NETWORKING, PLANNING, SCHEDULING, CALENDARING, MESSAGING, ARRANGING MEETINGS AND SOCIAL EVENTS, SHARING, POSTING AND MATCHING IDEAS, COMMON INTERESTS AND PLANS, COORDINATING OF PLANS, MEETING TIMES AND PLACES, AND EVENTS, CONNECTING AND MATCHING USERS WITH THIRD PARTY RETAIL SERVICES BY MAKING USE OF NATURAL LANGUAGE PROCESSING (NLP) AND CONTENT AND GEOLOCATION MATCHING FOR ENHANCED INTERACTIVE EXPERIENCES; DOWNLOADABLE COMPUTER SOFTWARE FOR SOCIAL NETWORKING, PLANNING, SCHEDULING, CALENDARING, MESSAGING, ARRANGING MEETINGS AND SOCIAL EVENTS, SHARING, POSTING AND MATCHING IDEAS, COMMON INTERESTS AND PLANS, COORDINATING OF PLANS, MEETING TIMES AND PLACES, AND EVENTS, CONNECTING AND MATCHING USERS WITH THIRD PARTY RETAIL SERVICES BY MAKING USE OF NATURAL LANGUAGE PROCESSING (NLP) AND CONTENT AND GEOLOCATION MATCHING FOR ENHANCED INTERACTIVE EXPERIENCES; DOWNLOADABLE GEOGRAPHIC INFORMATION SYSTEM (GIS) SOFTWARE; DOWNLOADABLE MOBILE APPLICATIONS FOR SOCIAL NETWORKING, PLANNING, SCHEDULING, CALENDARING, MESSAGING, ARRANGING MEETINGS AND SOCIAL EVENTS, SHARING, POSTING AND MATCHING IDEAS, COMMON INTERESTS AND PLANS, COORDINATING OF PLANS, MEETING TIMES AND PLACES, AND EVENTS, CONNECTING AND MATCHING USERS WITH THIRD PARTY RETAIL SERVICES BY MAKING USE OF NATURAL LANGUAGE PROCESSING (NLP) AND CONTENT AND GEOLOCATION MATCHING FOR ENHANCED INTERACTIVE EXPERIENCES; DOWNLOADABLE SOFTWARE FOR SOCIAL NETWORKING, PLANNING, SCHEDULING, CALENDARING, MESSAGING, ARRANGING MEETINGS AND SOCIAL EVENTS, SHARING, POSTING AND MATCHING IDEAS, COMMON INTERESTS AND PLANS, COORDINATING OF PLANS, MEETING TIMES AND PLACES, AND EVENTS, CONNECTING AND MATCHING USERS WITH THIRD PARTY RETAIL SERVICES BY MAKING USE OF NATURAL LANGUAGE PROCESSING (NLP) AND CONTENT AND GEOLOCATION MATCHING FOR ENHANCED INTERACTIVE EXPERIENCES; DOWNLOADABLE SOFTWARE IN THE NATURE OF A MOBILE APPLICATION FOR SOCIAL NETWORKING, PLANNING, SCHEDULING, CALENDARING, MESSAGING, ARRANGING MEETINGS AND SOCIAL EVENTS, SHARING, POSTING AND MATCHING IDEAS, COMMON INTERESTS AND PLANS, COORDINATING OF PLANS, MEETING TIMES AND PLACES, AND EVENTS, CONNECTING AND MATCHING USERS WITH THIRD PARTY RETAIL SERVICES BY MAKING USE OF NATURAL LANGUAGE PROCESSING (NLP) AND CONTENT AND GEOLOCATION MATCHING FOR ENHANCED INTERACTIVE EXPERIENCES (U.S. CLS. 21, 23, 26, 36 AND 38).

CAROL SPILS, EXAMINING ATTORNEY

**CLASS 9—(Continued).**

SN 86-068,173. JACOB HURLEY, NEW YORK, NY. FILED 9-18-2013.

# buskr

THE MARK CONSISTS OF STANDARD CHARACTERS WITHOUT CLAIM TO ANY PARTICULAR FONT, STYLE, SIZE, OR COLOR.

FOR DOWNLOADABLE SOFTWARE IN THE NATURE OF A MOBILE APPLICATION FOR USING GEOLOCATION SERVICES TO DISCOVER, LOCATE, INTERFACE WITH, AND PURCHASE MEDIA FROM INDEPENDENT ARTISTS, PERFORMERS, AND MUSICIANS (U.S. CLS. 21, 23, 26, 36 AND 38).

ESTHER BELENKER, EXAMINING ATTORNEY

SN 86-068,187. FUSION UNLIMITED, LLC, IRVINE, CA. FILED 9-18-2013.

# VISSLA

THE MARK CONSISTS OF STANDARD CHARACTERS WITHOUT CLAIM TO ANY PARTICULAR FONT, STYLE, SIZE, OR COLOR.

FOR SUNGLASSES; EYEGLASS FRAMES; EYEGLASS CASES; PROTECTIVE COVERS AND CASES FOR CELL PHONES, TABLET COMPUTERS, LAPTOP COMPUTERS, AND MP3 PLAYERS (U.S. CLS. 21, 23, 26, 36 AND 38).

AISHA CLARKE, EXAMINING ATTORNEY

SN 86-068,216. COLORS IN OPTICS, LTD., NEW YORK, NY. FILED 9-18-2013.

# ATHLIX

THE MARK CONSISTS OF STANDARD CHARACTERS WITHOUT CLAIM TO ANY PARTICULAR FONT, STYLE, SIZE, OR COLOR.

FOR EYEWEAR, SUNGLASSES AND OPHTHALMIC FRAMES (U.S. CLS. 21, 23, 26, 36 AND 38).

RUDY R. SINGLETON, EXAMINING ATTORNEY

**CLASS 9—(Continued).**

SN 86-068,286. CHRISTOPHER E. CARPENTER, PALM BEACH, FL. FILED 9-18-2013.

# THE UP SHOT

THE MARK CONSISTS OF STANDARD CHARACTERS WITHOUT CLAIM TO ANY PARTICULAR FONT, STYLE, SIZE, OR COLOR.

FOR DOWNLOADABLE ELECTRONIC NEWSLETTERS IN THE FIELD OF REAL ESTATE AND PERSONAL INVESTING (U.S. CLS. 21, 23, 26, 36 AND 38).

FIRST USE 8-31-2013; IN COMMERCE 8-31-2013.

NANCY CLARKE, EXAMINING ATTORNEY

SN 86-068,306. WHOLE LOGIC, INC., VIOLA, ID. FILED 9-18-2013.

# WHOLELOGIC

THE MARK CONSISTS OF STANDARD CHARACTERS WITHOUT CLAIM TO ANY PARTICULAR FONT, STYLE, SIZE, OR COLOR.

FOR COMPUTER APPLICATION SOFTWARE FOR MOBILE PHONES AND DEVICES, NAMELY, SOFTWARE FOR CALCULATING AND REFERENCING PHARMACEUTICAL QUANTITIES IN THE FIELD OF CLINICAL VETERINARY PRACTICE; ELECTRONIC CLINICIANS TRAINING SIMULATORS; MEDICAL DIAGNOSTIC SIMULATORS FOR USE AS TEACHING AIDS FOR HUMAN AND VETERINARY HEALTH SCIENCES (U.S. CLS. 21, 23, 26, 36 AND 38).

FIRST USE 11-1-2007; IN COMMERCE 11-1-2007.

ALLISON SCHRODY, EXAMINING ATTORNEY

SN 86-068,318. SPELLBOOK STUDIO, LLC, SPRINGFIELD, MO. FILED 9-18-2013.

# THE INFINITE BLACK

THE MARK CONSISTS OF STANDARD CHARACTERS WITHOUT CLAIM TO ANY PARTICULAR FONT, STYLE, SIZE, OR COLOR.

FOR VIDEO GAMES FOR MOBILE DEVICES, PERSONAL COMPUTERS, CONSOLES AND TABLETS; ELECTRONIC GAME PROGRAMS; DOWNLOADABLE ELECTRONIC GAME PROGRAMS; ELECTRONIC GAME SOFTWARE; COMPUTER GAME PROGRAMS; DOWNLOADABLE COMPUTER GAME PROGRAMS; INTERACTIVE GAME PROGRAMS; AND INTERACTIVE GAME SOFTWARE (U.S. CLS. 21, 23, 26, 36 AND 38).

FIRST USE 8-30-2011; IN COMMERCE 8-30-2011.

KELLY TRUSILO, EXAMINING ATTORNEY

**CLASS 9—(Continued).**

SN 86-068,342. SPELLBOOK STUDIO, LLC, SPRINGFIELD, MO. FILED 9-18-2013.

DIRE

THE MARK CONSISTS OF STANDARD CHARACTERS WITHOUT CLAIM TO ANY PARTICULAR FONT, STYLE, SIZE, OR COLOR.

FOR VIDEO GAMES FOR MOBILE DEVICES, PERSONAL COMPUTERS, CONSOLES AND TABLETS; ELECTRONIC GAME PROGRAMS; DOWNLOADABLE ELECTRONIC GAME PROGRAMS; ELECTRONIC GAME SOFTWARE; COMPUTER GAME PROGRAMS; DOWNLOADABLE COMPUTER GAME PROGRAMS; INTERACTIVE GAME PROGRAMS; AND INTERACTIVE GAME SOFTWARE (U.S. CLS. 21, 23, 26, 36 AND 38).

KELLY TRUSILO, EXAMINING ATTORNEY

**CLASS 9—(Continued).**

SN 86-068,489. STUDENTSCENE, INC., SAN DIEGO, CA. FILED 9-18-2013.

S

THE MARK CONSISTS OF THE LOWER CASE LETTER "S" IN SCRIPT.

FOR DOWNLOADABLE SOFTWARE IN THE NATURE OF A MOBILE APPLICATION FOR USERS TO CREATE, UPLOAD, SHARE, DISCUSS, AND READ ABOUT EVENTS AND ACTIVITIES, ADVERTISE GOODS AND SERVICES FOR SALE, ASK AND ANSWER QUESTIONS, AND COMMUNICATE REGARDING RANKINGS, RATINGS, REVIEWS, REFERRALS, AND RECOMMENDATIONS RELATING TO BUSINESS ORGANIZATIONS AND SERVICE PROVIDERS (U.S. CLS. 21, 23, 26, 36 AND 38).

RENEE MCCRAY, EXAMINING ATTORNEY

SN 86-068,488. DRAFTPEDIA, LLC, ENCINO, CA. FILED 9-18-2013.

SPORTSDB

THE MARK CONSISTS OF STANDARD CHARACTERS WITHOUT CLAIM TO ANY PARTICULAR FONT, STYLE, SIZE, OR COLOR.

FOR COMPUTER APPLICATION SOFTWARE FOR MOBILE PHONES, NAMELY, SOFTWARE FOR ACCESSING ELECTRONIC MEDIA, DATA FILES, DATABASES, AND INFORMATION, ALL IN THE FIELD OF SPORTS; DOWNLOADABLE SOFTWARE FOR ACCESSING ELECTRONIC MEDIA, DATA FILES, DATABASES, AND INFORMATION, ALL IN THE FIELD OF SPORTS (U.S. CLS. 21, 23, 26, 36 AND 38).

AISHA CLARKE, EXAMINING ATTORNEY

SN 86-068,644. 3D25D, LLC, EVERGREEN, CO. FILED 9-18-2013.

3D25D

THE MARK CONSISTS OF THE CHARACTERS "3D25D". THE "D"S ARE CAPITALIZED. THE "3D" CHARACTERS APPEAR WITH A DROP SHADOW. THE "2" CHARACTER IS LARGER AND ROTATED CLOCKWISE SEVERAL DEGREES. IT APPEARS THREE-DIMENSIONAL AND IS RENDERED IN HALFTONES. THE "5D" CHARACTERS APPEAR WITH A DROP SHADOW. THE MARK CONSISTS OF THE CHARACTERS "3D25D". THE "D"S ARE CAPITALIZED. THE "3D" CHARACTERS APPEAR WITH A DROP SHADOW. THE "2" CHARACTER IS LARGER AND ROTATED CLOCKWISE SEVERAL DEGREES. IT APPEARS THREE-DIMENSIONAL AND IS RENDERED IN HALFTONES. THE "5D" CHARACTERS APPEAR WITH A DROP SHADOW. THREE CONCENTRIC OVALS APPEAR BELOW THE CHARACTER PORTION OF THE MARK. THEY ARE CENTERED UNDER THE "2" CHARACTER. THE WEIGHT OF THE STROKES FORMING THE OVALS VARIES. THE INNER OVAL HAS THE THINNEST STROKE, AND ALL OVALS ARE THINNEST IN THE FRONT. THE OUTER OVAL HAS THE THICKEST STROKE. THE STROKE OF THE INTERSTITIAL OVAL IS IN BETWEEN THE WEIGHTS

**CLASS 9—(Continued).**

OF THE INNER AND OUTER OVAL STROKES. THREE CONCENTRIC OVALS APPEAR BELOW THE CHARACTER PORTION OF THE MARK. THEY ARE CENTERED UNDER THE "2" CHARACTER. THE WEIGHT OF THE STROKES FORMING THE OVALS VARIES. THE INNER OVAL HAS THE THINNEST STROKE, AND ALL OVALS ARE THINNEST IN THE FRONT. THE OUTER OVAL HAS THE THICKEST STROKE. THE STROKE OF THE INTERSTITIAL OVAL IS IN BETWEEN THE WEIGHTS OF THE INNER AND OUTER OVAL STROKES.

FOR COMPUTER GAME SOFTWARE FOR PERSONAL COMPUTERS AND HOME VIDEO GAME CONSOLES; COMPUTER PROGRAMS FOR VIDEO AND COMPUTER GAMES; INTERACTIVE VIDEO GAME PROGRAMS; VIDEO AND COMPUTER GAME PROGRAMS; VIDEO GAME SOFTWARE (U.S. CLS. 21, 23, 26, 36 AND 38).

JASON TURNER, EXAMINING ATTORNEY

---

SN 86-068,763. CAPSOVISION, INC., SARATOGA, CA. FILED 9-18-2013.



OWNER OF U.S. REG. NOS. 3,994,399, 3,998,663 AND 3,998,670.

THE COLOR(S) BLACK, RED, BLUE, GREEN AND YELLOW IS/ARE CLAIMED AS A FEATURE OF THE MARK.

THE MARK CONSISTS OF THE WORD "CAPSOVIEW" WITH "VIEW" APPEARING STYLIZED AND EACH LETTER OF THE WORD "VIEW" HAVING EACH LETTER APPEAR IN A RECTANGULAR BLOCK WITH THE LETTER "V" APPEARING AT THE TOP LEFT AND THE LETTER "I" APPEARING TO THE RIGHT OF THE LETTER "V" AND THE LETTER "W" APPEARING UNDER THE LETTER "V" AND THE LETTER "E" APPEARING BELOW THE LETTER "I" AND TO THE RIGHT OF THE LETTER "W" AND EACH LETTER APPEARING IN A DISTINCT COLORED BLOCK WITH THE LETTER "V" APPEARING IN CAPITAL LETTER IN A RED COLORED BLOCK AND THE LETTER "I" APPEARING IN CAPITAL LETTER IN A GREEN COLORED BLOCK AND THE LETTER "W" APPEARING IN CAPITAL LETTER IN A BLUE COLORED BLOCK AND THE LETTER "E" APPEARING IN CAPITAL LETTER IN A YELLOW COLORED BLOCK. THE COLOR WHITE REPRESENTS TRANSPARENT AREAS AND IS NOT PART OF THE MARK.

FOR COMPUTER DOCKING STATIONS FOR USE WITH INGESTIBLE DIAGNOSTIC CAMERAS; COMPUTER WORKSTATIONS CONSISTING OF CENTRAL PROCESSING UNITS, MONITORS, KEYBOARDS, AND MICE FOR USE WITH INGESTIBLE DIAGNOSTIC CAMERAS; COMPUTER NETWORKING HARDWARE FOR USE WITH INGESTIBLE DIAGNOSTIC CAMERAS; COMPUTER SOFTWARE FOR IMAGING AND IMAGE ANALYSIS FOR USE WITH INGESTIBLE DIAGNOSTIC CAMERAS AND COMPUTER DOCKING STATIONS AND WORKSTATIONS (U.S. CLS. 21, 23, 26, 36 AND 38).

CAROL SPILS, EXAMINING ATTORNEY

**CLASS 9—(Continued).**

SN 86-068,772. RELATIONAL ANALYTICS LLC, SHAKER HEIGHTS, OH. FILED 9-18-2013.

# CLINALYTIC

THE MARK CONSISTS OF STANDARD CHARACTERS WITHOUT CLAIM TO ANY PARTICULAR FONT, STYLE, SIZE, OR COLOR.

FOR COMPUTER SOFTWARE FOR RECORDING, ANALYZING AND MANAGING PATIENT HEALTH INFORMATION (U.S. CLS. 21, 23, 26, 36 AND 38).

ROBERT C. CLARK JR., EXAMINING ATTORNEY

---

SN 86-068,785. CERNER INNOVATION, INC., KANSAS CITY, KS. FILED 9-18-2013.

# CARETRACKER

THE MARK CONSISTS OF STANDARD CHARACTERS WITHOUT CLAIM TO ANY PARTICULAR FONT, STYLE, SIZE, OR COLOR.

OWNER OF U.S. REG. NO. 3,381,941.

FOR COMPUTER HARDWARE AND COMPUTER SOFTWARE PROGRAMS FOR ELECTRONICALLY COLLECTING INFORMATION ABOUT THE TREATMENT AND STATUS OF RESIDENTS IN LONG-TERM CARE AND EXTENDED CARE HEALTH CARE FACILITIES, HOME CARE AND REHABILITATIVE-TYPE FACILITIES AND PREPARING REPORTS CONTAINING THE INFORMATION (U.S. CLS. 21, 23, 26, 36 AND 38).

ROBIN CHOSID, EXAMINING ATTORNEY

---

SN 86-068,875. SECURE INTERNATIONAL TECHNOLOGIES, ROCKVILLE, MD. FILED 9-19-2013.

# ZXT SAFE

THE MARK CONSISTS OF STANDARD CHARACTERS WITHOUT CLAIM TO ANY PARTICULAR FONT, STYLE, SIZE, OR COLOR.

FOR DOWNLOADABLE MOBILE APPLICATIONS FOR LIMITING CERTAIN CELL PHONE FUNCTIONS BASED ON A SPEED OVER DISTANCE RATIO; DOWNLOADABLE SOFTWARE FOR LIMITING CERTAIN CELL PHONE FUNCTIONS BASED ON A SPEED OVER DISTANCE RATIO (U.S. CLS. 21, 23, 26, 36 AND 38).

KEVIN CORWIN, EXAMINING ATTORNEY



**CLASS 9—(Continued).**

SN 86-068,900. RAILWAY EQUIPMENT COMPANY, INC., DELANO, MN. FILED 9-19-2013.

# IHAB

THE MARK CONSISTS OF STANDARD CHARACTERS WITHOUT CLAIM TO ANY PARTICULAR FONT, STYLE, SIZE, OR COLOR.

FOR SNOWMELTER MONITORING AND CONTROL SYSTEM UNITS COMPOSED PRIMARILY OF ADVANCED ELECTRONIC CONTROL MODULES, WIRELESS COMMUNICATIONS INTERFACE TRANSMITTERS, AND EMBEDDED SOFTWARE FOR USE IN OBTAINING AND DISPLAYING DATA ON EMBEDDED WEB PAGES WHICH CAN BE ACCESSED REMOTELY, SOLD AS A COMPONENT OF SNOWMELTERS (U.S. CLS. 21, 23, 26, 36 AND 38).

RUDY R. SINGLETON, EXAMINING ATTORNEY

---

SN 86-068,921. VITEC SA, CHÂTILLON, FRANCE, FILED 9-19-2013.

# PROXSYS

THE MARK CONSISTS OF STANDARD CHARACTERS WITHOUT CLAIM TO ANY PARTICULAR FONT, STYLE, SIZE, OR COLOR.

FOR COMPUTER HARDWARE AND SOFTWARE AND RELATED COMPONENTS, NAMELY, HARDWARE AND SOFTWARE FOR VIDEO MONITORING, CAPTURE, PLAYOUT, AND INDEXING, IN THE DATABASE STORAGE FIELD FOR STORING AND MANAGING DIGITAL MEDIA (U.S. CLS. 21, 23, 26, 36 AND 38).

FIRST USE 8-12-2004; IN COMMERCE 4-17-2005.

SUZANNE BLANE, EXAMINING ATTORNEY

---

SN 86-069,060. 2ADVANSZ LLC, PARAMUS, NJ. FILED 9-19-2013.

THE MARK CONSISTS OF THE TEXT "TABOO" WITH DROP SHADOW WITH SHINE FEATURES. THE TEXT "TYKE" WITH A LITTLE HAIR ABOVE THE "E". THE BACKGROUND HAS A PILL SHAPE WITH CRACKS.

FOR COMPUTER APPLICATION SOFTWARE FOR MOBILE PHONES, NAMELY, SOFTWARE FOR USE IN GAMING (U.S. CLS. 21, 23, 26, 36 AND 38).

SCOTT BIBB, EXAMINING ATTORNEY

**CLASS 9—(Continued).**

SN 86-069,091. CODI, INC., HARRISBURG, PA. FILED 9-19-2013.

# CODI

OWNER OF U.S. REG. NOS. 1,950,702, 3,641,620 AND OTHERS.

FOR CASES FOR CARRYING COMPUTERS; AND COMPUTER PERIPHERALS, NAMELY POWER ADAPTERS, MICE, USB PORTS AND MEMORY DRIVES (U.S. CLS. 21, 23, 26, 36 AND 38).

FIRST USE 2-1-2007; IN COMMERCE 2-1-2007.

BARBARA BROWN, EXAMINING ATTORNEY

---

SN 86-069,138. BARKEEP MOBILE, LLC, CLEVELAND, OH. FILED 9-19-2013.

# BARKEEP4U

THE MARK CONSISTS OF STANDARD CHARACTERS WITHOUT CLAIM TO ANY PARTICULAR FONT, STYLE, SIZE, OR COLOR.

FOR COMPUTER APPLICATION SOFTWARE FOR MOBILE PHONES, PORTABLE MEDIA PLAYERS, HANDHELD COMPUTERS, NAMELY, SOFTWARE FOR MAKING RESTAURANT AND BAR RESERVATIONS, PROVIDING REVIEWS, RATINGS AND RECOMMENDATIONS OR BARS AND RESTAURANTS; SOFTWARE FOR MAKING RESTAURANT AND BAR RESERVATIONS (U.S. CLS. 21, 23, 26, 36 AND 38).

RAMONA ORTIGA, EXAMINING ATTORNEY

**CLASS 9—(Continued).**

SN 86-069,161. OCZ TECHNOLOGY GROUP, INC., SAN JOSE, CA. FILED 9-19-2013.



THE MARK CONSISTS OF THE LETTERS "ZD" AND "XL" IN UPPERCASE STYLIZED FONT; WHEREIN THE "ZD" AND "XL" ARE SPACED APART AND IN THAT SPACE A DOWNWARD ARCHING ARROW IS POINTING TOWARDS THE RIGHT UNDERNEATH THE LETTERS "XL".

FOR COMPUTER MEMORY HARDWARE; COMPUTER SOFTWARE AND HARDWARE FOR MEMORY STORAGE; COMPUTER STORAGE DEVICES, NAMELY, BLANK FLASH DRIVES; SOLID STATE MASS STORAGE DEVICES IN THE NATURE OF A NONVOLATILE STORAGE MEDIUM THAT EMPLOYS INTEGRATED CIRCUITS; ELECTRONIC DATA STORAGE, NAMELY, BLANK ELECTRONIC STORAGE MEDIA (U.S. CLS. 21, 23, 26, 36 AND 38).

FIRST USE 5-7-2013; IN COMMERCE 5-7-2013.  
SUZANNE BLANE, EXAMINING ATTORNEY

SN 86-069,304. HEADS INNOVATION, LLC, TRENTON, NJ. FILED 9-19-2013.

# HEADS

THE MARK CONSISTS OF STANDARD CHARACTERS WITHOUT CLAIM TO ANY PARTICULAR FONT, STYLE, SIZE, OR COLOR.

FOR APPARATUS FOR RECORDING, TRANSMISSION OR REPRODUCTION OF SOUND; APPARATUS FOR TRANSMITTING AND REPRODUCING SOUND OR IMAGES; AUDIO HEADPHONES; DIGITAL MEDIA RECEIVERS; EARPHONE ACCESSORIES, NAMELY, EARPHONE CUSHIONS, EARPHONE PADS, CORD MANAGEMENT SYSTEMS, EARPHONE CASES, AND EARPHONE EXTENSION CORDS; EARPHONES; EARPHONES AND HEADPHONES; ELECTRONIC PRODUCTS FOR THE GENERATION, MEASUREMENT, AND ANALYSIS OF AUDIO SIGNALS, NAMELY, AUDIO ANALYZERS; ELECTRONIC PRODUCTS FOR THE MANIPULATION OF THE FREQUENCY, TIME, AND AMPLITUDE CHARACTERISTICS OF AUDIO SIGNALS, NAMELY, AUDIO PROCESSORS; ELECTRONIC SOUND MIXING, PROCESSING AND SYNTHESIZING APPARATUS; HEADPHONES; HEADPHONES INCLUDING ATTACHED LANYARD; HEADSETS FOR USE WITH COMPUTERS; MUSIC HEADPHONES; PERSONAL HEADPHONES FOR SOUND TRANSMITTING APPARATUS; PERSONAL HEADPHONES FOR USE WITH SOUND TRANSMITTING SYSTEMS; SOFTWARE TO CONTROL AND IMPROVE AUDIO EQUIPMENT SOUND QUALITY; STEREO HEADPHONES (U.S. CLS. 21, 23, 26, 36 AND 38).

HEATHER THOMPSON, EXAMINING ATTORNEY

**CLASS 9—(Continued).**

SN 86-069,325. ECONIFY LLC, SAN FRANCISCO, CA. FILED 9-19-2013.

# ENTHOOSE

THE MARK CONSISTS OF STANDARD CHARACTERS WITHOUT CLAIM TO ANY PARTICULAR FONT, STYLE, SIZE, OR COLOR.

FOR COMPUTER APPLICATION SOFTWARE FOR MOBILE DEVICES DEDICATED TO SPECIFIC HUMAN INTERESTS AND THE TRANSMISSION OF INFORMATION, MESSAGES, PHOTOS, AND DOCUMENTS CONCERNING ACTIVITIES AND EVENTS RELATED TO THOSE INTERESTS (U.S. CLS. 21, 23, 26, 36 AND 38).

GINA FINK, EXAMINING ATTORNEY

SN 86-069,360. ELECTRO-OPTICS TECHNOLOGY, INCORPORATED, TRAVERSE CITY, MI. FILED 9-19-2013.

THE MARK CONSISTS OF THE LETTERS EOT IN A STYLIZED FORMAT.

FOR MAGNETO-OPTIC DEVICES FOR ROTATING THE POLARIZATION OF LIGHT; PHOTODETECTORS, NAMELY, DEVICES USED FOR THE DETECTION OF LASER LIGHT OR ELECTROMAGNETIC ENERGY; LASER EQUIPMENT, NAMELY FIBER OPTIC COLLIMATORS FOR LASER BEAM DELIVERY (U.S. CLS. 21, 23, 26, 36 AND 38).

FIRST USE 0-0-1998; IN COMMERCE 0-0-1998.  
THEODORE MCBRIDE, EXAMINING ATTORNEY

SN 86-069,372. GORDON \* HOWARD ASSOCIATES, INC., LITTLETON, CO. FILED 9-19-2013.

OWNER OF U.S. REG. NOS. 2,989,184, 3,363,102 AND OTHERS.

THE COLOR(S) BLACK, GRAY, AND YELLOW IS/ARE CLAIMED AS A FEATURE OF THE MARK.

THE MARK CONSISTS OF THE WORD "ELITE" IN DARK GRAY CURSIVE SCRIPT, UNDERLINED IN YEL-

**CLASS 9—(Continued).**

LOW; THE WORD "PRO" IN LIGHT GRAY BLOCK LETTERS APPEARING BENEATH THE WORD "ELITE"; AND THE WORD "PASSTIME" IN BLACK STYLIZED CHARACTERS, SITUATED TO THE UPPER LEFT OF THE WORD "ELITE". THE LETTER "I" IN THE WORD "PASSTIME" IS YELLOW AND CREATES THE NEEDLE ON A YELLOW SPEDOMETER THAT FORMS A SEMI-CIRCLE OVER THE WORD "PASSTIME". THE END OF WHICH FLOWS INTO THE CURSIVE SCRIPT OF THE LETTER "E" IN THE WORD "ELITE".

FOR VEHICLE LOCATING, TRACKING, SECURITY, PAYMENT AND RECOVERY SYSTEMS, COMPRISED OF COMPUTER HARDWARE AND SOFTWARE, STARTER INTERRUPT CIRCUITRY, GPS UNIT, AND RADIO TELECOMMUNICATIONS EQUIPMENT, ALL FOR USE IN CONNECTION WITH VEHICLE LOCATING, VEHICLE TRACKING, VEHICLE ANTI-THEFT, VEHICLE PAYMENT MANAGEMENT, AND REMOTELY PREVENTING IGNITION OF VEHICLES FOR WHICH PAYMENTS ARE DELINQUENT; WIRELESS TRANSCEIVERS WITH COLLECTION AND DISPLAY TECHNOLOGY FOR LOCATING, TRACKING AND MONITORING VEHICLES, AND INSTRUCTION MANUALS USED IN CONNECTION THEREWITH (U.S. CLS. 21, 23, 26, 36 AND 38).

FIRST USE 8-17-2012; IN COMMERCE 8-15-2013.  
SOPHIA S. KIM, EXAMINING ATTORNEY

SN 86-069,385. GORDON \* HOWARD ASSOCIATES, INC., LITTLETON, CO. FILED 9-19-2013.



OWNER OF U.S. REG. NOS. 2,989,184, 3,363,102 AND OTHERS.

THE COLOR(S) BLACK, GRAY, YELLOW, AND WHITE IS/ARE CLAIMED AS A FEATURE OF THE MARK.

THE MARK CONSISTS OF THE WORD "ELITE" IN GRAY CURSIVE SCRIPT, UNDERLINED IN YELLOW; THE WORD "PLUS" IN WHITE BLOCK LETTERS OUTLINED IN GRAY APPEARING BENEATH THE WORD "ELITE"; AND THE WORD "PASSTIME" IN BLACK STYLIZED CHARACTERS, SITUATED TO THE UPPER LEFT OF THE WORD "ELITE". THE LETTER "I" IN THE WORD "PASSTIME" IS YELLOW AND CREATES THE NEEDLE ON A YELLOW SPEDOMETER THAT FORMS A SEMI-CIRCLE OVER THE WORD "PASSTIME". THE END OF WHICH FLOWS INTO THE CURSIVE SCRIPT OF THE LETTER "E" IN THE WORD "ELITE".

FOR VEHICLE LOCATING, TRACKING, SECURITY, PAYMENT AND RECOVERY SYSTEMS, COMPRISED OF COMPUTER HARDWARE AND SOFTWARE, STARTER INTERRUPT CIRCUITRY, GPS UNIT, AND RADIO TELECOMMUNICATIONS EQUIPMENT, ALL FOR USE IN CONNECTION WITH VEHICLE LOCATING, VEHICLE TRACKING, VEHICLE ANTI-THEFT, VEHICLE PAYMENT MANAGEMENT, AND REMOTELY PREVENTING IGNITION OF VEHICLES FOR WHICH PAYMENTS ARE DELINQUENT; WIRELESS TRANSCEIVERS WITH COLLECTION AND DISPLAY TECHNOLOGY FOR LOCATING, TRACKING AND MONITORING VEHICLES, AND INSTRUCTION MANUALS USED IN CONNECTION THEREWITH (U.S. CLS. 21, 23, 26, 36 AND 38).

FIRST USE 8-17-2012; IN COMMERCE 8-15-2013.  
SOPHIA S. KIM, EXAMINING ATTORNEY

**CLASS 9—(Continued).**

SN 86-069,391. GORDON \* HOWARD ASSOCIATES, INC., LITTLETON, CO. FILED 9-19-2013.



OWNER OF U.S. REG. NOS. 2,989,184, 3,363,102 AND OTHERS.

NO CLAIM IS MADE TO THE EXCLUSIVE RIGHT TO USE "GPS", APART FROM THE MARK AS SHOWN.

THE COLOR(S) BLACK, ORANGE AND WHITE IS/ARE CLAIMED AS A FEATURE OF THE MARK.

THE MARK CONSISTS OF THE WORD "PASSTIME" IN BLACK STYLIZED CHARACTERS WITH A WHITE LINE RUNNING THROUGH THE BOTTOM PORTION OF THE LETTERS "P", "A", "S", AND "S" AND A WHITE LINE RUNNING THROUGH THE TOP PORTION OF THE LETTERS "T", "I", "M", AND "E". THE LETTER "I" IN THE WORD "PASSTIME" IS ORANGE AND CREATES THE NEEDLE ON AN ORANGE SPEDOMETER THAT FORMS A SEMI-CIRCLE OVER THE WORD "PASSTIME". THE LETTERS "GPS" APPEAR IN WHITE BLOCK LETTERS SURROUNDED BY AN ORANGE CIRCULAR BACKGROUND TO THE LOWER RIGHT OF THE WORD "PASSTIME".

FOR VEHICLE LOCATING, TRACKING, SECURITY, PAYMENT AND RECOVERY SYSTEMS, COMPRISED OF COMPUTER HARDWARE AND SOFTWARE, STARTER INTERRUPT CIRCUITRY, GPS UNIT, AND RADIO TELECOMMUNICATIONS EQUIPMENT, ALL FOR USE IN CONNECTION WITH VEHICLE LOCATING, VEHICLE TRACKING, VEHICLE ANTI-THEFT, VEHICLE PAYMENT MANAGEMENT, AND REMOTELY PREVENTING IGNITION OF VEHICLES FOR WHICH PAYMENTS ARE DELINQUENT; WIRELESS TRANSCEIVERS WITH COLLECTION AND DISPLAY TECHNOLOGY FOR LOCATING, TRACKING AND MONITORING VEHICLES, AND INSTRUCTION MANUALS USED IN CONNECTION THEREWITH (U.S. CLS. 21, 23, 26, 36 AND 38).

FIRST USE 8-17-2012; IN COMMERCE 8-15-2013.  
SOPHIA S. KIM, EXAMINING ATTORNEY

SN 86-069,456. ERIC LAM, LOS ANGELES, CA. FILED 9-19-2013.



THE MARK CONSISTS OF AN UPSIDE-DOWN TRIANGLE.

FOR DOWNLOADABLE MP3 FILES AND MP3 RECORDINGS FEATURING MUSIC; DOWNLOADABLE MUSIC FILES; PRE-RECORDED CDS FEATURING MUSIC (U.S. CLS. 21, 23, 26, 36 AND 38).

FIRST USE 5-1-2013; IN COMMERCE 5-1-2013.  
REGINA DRUMMOND, EXAMINING ATTORNEY

**CLASS 9—(Continued).**

SN 86-069,496. DEL BOCA, ADRIAN, M.D., P.A., MIAMI, FL.  
FILED 9-19-2013.



OWNER OF U.S. REG. NOS. 3,233,114, 4,451,240 AND OTHERS.

THE MARK CONSISTS OF AN IMAGE OF A WOMAN'S PREGNANT BODY. BENEATH THE DESIGN IS THE WORD "AGNES".

FOR COMPUTER SOFTWARE FOR AUTOMATING THE CLINICAL AND ADMINISTRATIVE FUNCTIONS OF PHYSICIAN OFFICES (U.S. CLS. 21, 23, 26, 36 AND 38).

ALEXANDER L. POWERS, EXAMINING ATTORNEY

SN 86-069,580. PEARSON, BRENT, LOS ANGELES, CA.  
FILED 9-19-2013.

## FUTURE EYES

THE MARK CONSISTS OF STANDARD CHARACTERS WITHOUT CLAIM TO ANY PARTICULAR FONT, STYLE, SIZE, OR COLOR.

NO CLAIM IS MADE TO THE EXCLUSIVE RIGHT TO USE "EYES", APART FROM THE MARK AS SHOWN.

FOR EYE GLASSES (U.S. CLS. 21, 23, 26, 36 AND 38).

FIRST USE 12-0-2011; IN COMMERCE 12-0-2011.

COURTNEY ALVAREZ, EXAMINING ATTORNEY

SN 86-069,807. SCHMIEDER, JOSHUA, WAYLAND, NY.  
FILED 9-19-2013.

## printapix

THE MARK CONSISTS OF STANDARD CHARACTERS WITHOUT CLAIM TO ANY PARTICULAR FONT, STYLE, SIZE, OR COLOR.

FOR COMPUTER APPLICATION SOFTWARE FOR SMARTPHONES, TABLETS, NAMELY, SOFTWARE FOR USERS TO PRINT PICTURES DIRECTLY FROM THEIR DEVICE (U.S. CLS. 21, 23, 26, 36 AND 38).

TINA L. SNAPP, EXAMINING ATTORNEY

**CLASS 9—(Continued).**

SN 86-069,818. MORIAH MUSE, LOS ANGELES, CA. FILED  
9-19-2013.

## GagEase

THE MARK CONSISTS OF STANDARD CHARACTERS WITHOUT CLAIM TO ANY PARTICULAR FONT, STYLE, SIZE, OR COLOR.

FOR PROTECTIVE FACE MASKS NOT FOR MEDICAL PURPOSES (U.S. CLS. 21, 23, 26, 36 AND 38).

LYNDSEY KUYKENDALL, EXAMINING ATTORNEY

SN 86-069,941. LEAP FORWARD GAMING, INC., RENO, NV.  
FILED 9-20-2013.

## TCG

THE MARK CONSISTS OF STANDARD CHARACTERS WITHOUT CLAIM TO ANY PARTICULAR FONT, STYLE, SIZE, OR COLOR.

FOR COMPUTER GAME SOFTWARE FOR GAMING MACHINES INCLUDING SLOT MACHINES OR VIDEO LOTTERY TERMINALS; COMPUTER GAME SOFTWARE FOR GAMING MACHINES, NAMELY, SLOT MACHINES AND VIDEO LOTTERY TERMINALS; COMPUTER SOFTWARE AND FIRMWARE FOR GAMES OF CHANCE ON ANY COMPUTERIZED PLATFORM, INCLUDING DEDICATED GAMING CONSOLES, VIDEO BASED SLOT MACHINES, REEL BASED SLOT MACHINES, AND VIDEO LOTTERY TERMINALS; DOWNLOADABLE COMPUTER GAME PROGRAMS; DOWNLOADABLE ELECTRONIC GAME PROGRAMS; DOWNLOADABLE ELECTRONIC GAME SOFTWARE FOR USE ON GAMING MACHINES; DOWNLOADABLE MULTIMEDIA FILE CONTAINING ARTWORK, TEXT, AUDIO, VIDEO, GAMES, AND INTERNET WEB LINKS RELATING TO GAMING MACHINES; GAMES THAT ACCEPT VIRTUAL OR MONETARY WAGERS SOLD AS A FEATURE OF GAME SOFTWARE; GAMING SOFTWARE THAT GENERATES OR DISPLAYS WAGER OUTCOMES OF GAMING MACHINES; INTERACTIVE GAME PROGRAMS; INTERACTIVE GAME SOFTWARE; INTERACTIVE MULTIMEDIA COMPUTER GAME PROGRAMS; INTERACTIVE VIDEO GAME PROGRAMS (U.S. CLS. 21, 23, 26, 36 AND 38).

KAREN BRACEY, EXAMINING ATTORNEY

**CLASS 9—(Continued).**

SN 86-069,996. ID AMERICA INC., NEW YORK, NY. FILED 9-20-2013.

**CROSSLINK**

THE MARK CONSISTS OF STANDARD CHARACTERS WITHOUT CLAIM TO ANY PARTICULAR FONT, STYLE, SIZE, OR COLOR.

FOR CELL PHONE BATTERY CHARGERS; USB CABLES FOR CELLPHONES; BATTERY CHARGING DEVICE SPECIALLY ADAPTED FOR USE WITH CELL PHONES, MP3 PLAYERS, PERSONAL DIGITAL ASSISTANTS (U.S. CLS. 21, 23, 26, 36 AND 38).

JULIE GUTTADAURO, EXAMINING ATTORNEY

---

SN 86-070,039. G. B. & SMITH, NIMES, FRANCE, FILED 9-20-2013.

**360View**

THE MARK CONSISTS OF STANDARD CHARACTERS WITHOUT CLAIM TO ANY PARTICULAR FONT, STYLE, SIZE, OR COLOR.

FOR COMPUTER SOFTWARE FOR USE IN IMPLEMENTING AND MANAGING COMPUTER FILE PERMISSION AND ACCESS LEVELS BY PROVIDING A COMPREHENSIVE GRAPHICAL USER INTERFACE FOR USE THEREOF (U.S. CLS. 21, 23, 26, 36 AND 38).

FIRST USE 5-15-2007; IN COMMERCE 5-15-2007.  
TOBY BULLOFF, EXAMINING ATTORNEY

---

SN 86-070,058. 3E COMPANY ENVIRONMENTAL, ECOLOGICAL AND ENGINEERING, CARLSBAD, CA. FILED 9-20-2013.

**ISDSGEN**

THE MARK CONSISTS OF STANDARD CHARACTERS WITHOUT CLAIM TO ANY PARTICULAR FONT, STYLE, SIZE, OR COLOR.

FOR COMPUTER SOFTWARE FOR CREATING DATABASES OF INTERNATIONAL CHEMICAL REGULATORY INFORMATION, FOR CREATING CHEMICAL HAZARD COMMUNICATIONS, FOR CREATING MATERIAL SAFETY DATA SHEETS, FOR CREATING AND DISTRIBUTING MATERIAL SAFETY DATA SHEETS AND LABELS BEARING MATERIAL SAFETY DATA SHEETS INFORMATION, FOR CHEMICAL INVENTORY MANAGEMENT, TRACKING AND REPORTING; AND FOR GENERATING CHEMICAL INVENTORY REPORTS (U.S. CLS. 21, 23, 26, 36 AND 38).

RONALD DELGIZZI, EXAMINING ATTORNEY

**CLASS 9—(Continued).**

SN 86-070,113. NORDAL, CURT B., HEMET, CA. FILED 9-20-2013.

**White Trash Topia**

THE MARK CONSISTS OF STANDARD CHARACTERS WITHOUT CLAIM TO ANY PARTICULAR FONT, STYLE, SIZE, OR COLOR.

FOR COMPUTER APPLICATION SOFTWARE FOR MOBILE PHONES, TABLETS, AND DESKTOP COMPUTERS, NAMELY, SOFTWARE FOR GAMING; COMPUTER GAME SOFTWARE (U.S. CLS. 21, 23, 26, 36 AND 38).

REBECCA GILBERT, EXAMINING ATTORNEY

---

SN 86-070,200. RAMLOLL, RAMESHSHARMA, NEW ROCHELLE, NY. FILED 9-20-2013.

**REZMELA**

THE MARK CONSISTS OF STANDARD CHARACTERS WITHOUT CLAIM TO ANY PARTICULAR FONT, STYLE, SIZE, OR COLOR.

FOR COMPUTER SOFTWARE, NAMELY, AN APPLICATION WHICH ALLOWS NON-PROGRAMMERS AND TEACHERS TO CREATE RAPIDLY VIRTUAL REALITY ENVIRONMENTS FOR TRAINING PURPOSES (U.S. CLS. 21, 23, 26, 36 AND 38).

FIRST USE 9-9-2013; IN COMMERCE 9-10-2013.  
SETH A. RAPPAPORT, EXAMINING ATTORNEY

---

SN 86-070,248. W-DOOR LTD., SHEUNG WAN, HONG KONG, FILED 9-20-2013.

**MIWA**

THE MARK CONSISTS OF THE STYLIZED TEXT "MIWA".

FOR COMPUTER GAME SOFTWARE FOR USE WITH PERSONAL COMPUTERS, HOME VIDEO GAME CONSOLES USED WITH TELEVISIONS AND ARCADE-BASED VIDEO GAME CONSOLES (U.S. CLS. 21, 23, 26, 36 AND 38).

JAMES GRIFFIN, EXAMINING ATTORNEY

**CLASS 9—(Continued).**

SN 86-070,291. JAMMIT, INC., HOLLYWOOD, CA. FILED 9-20-2013.

**SONGTOUCH**

THE MARK CONSISTS OF STANDARD CHARACTERS WITHOUT CLAIM TO ANY PARTICULAR FONT, STYLE, SIZE, OR COLOR.

FOR COMPUTER APPLICATION SOFTWARE FOR MOBILE PHONES, NAMELY, SOFTWARE FOR TEACHING, LEARNING, MIXING, OR ANALYSIS OF MUSIC; COMPUTER APPLICATION SOFTWARE FOR TEACHING, LEARNING, MIXING, OR ANALYSIS OF MUSIC, NAMELY, SOFTWARE FOR TEACHING, LEARNING, MIXING, OR ANALYSIS OF MULTI-TRACK MUSIC; COMPUTER HARDWARE AND SOFTWARE FOR PROCESSING DIGITAL MUSIC FILES; COMPUTER HARDWARE AND SOFTWARE SYSTEMS FOR TEACHING, LEARNING, MIXING, OR ANALYSIS OF MUSIC; COMPUTER SOFTWARE DEVELOPMENT TOOLS; COMPUTER SOFTWARE FEATURING MUSICAL SOUND RECORDINGS AND MUSICAL VIDEO RECORDINGS; COMPUTER SOFTWARE FOR CREATING AND EDITING MUSIC AND SOUNDS; COMPUTER SOFTWARE FOR TEACHING, LEARNING, MIXING, OR ANALYSIS OF MUSIC; COMPUTER SOFTWARE FOR TEACHING, LEARNING, MIXING, OR ANALYSIS OF MUSIC THAT MAY BE DOWNLOADED FROM A GLOBAL COMPUTER NETWORK; COMPUTER SOFTWARE PLATFORMS FOR TEACHING, LEARNING, MIXING, OR ANALYSIS OF MUSIC; DOWNLOADABLE CLOUD COMPUTER SOFTWARE FOR TEACHING, LEARNING, MIXING, OR ANALYSIS OF MUSIC; TEACHING, LEARNING, MIXING, OR ANALYSIS OF MUSIC; DOWNLOADABLE COMPUTER GAME SOFTWARE VIA A GLOBAL COMPUTER NETWORK AND WIRELESS DEVICES; DOWNLOADABLE COMPUTER SOFTWARE FOR TEACHING, LEARNING, MIXING, OR ANALYSIS OF MULTI-TRACK MUSIC; DOWNLOADABLE SOFTWARE FOR PROVIDING A VARIABLE RATE TIME REFERENCE TO ASSIST IN EMULATING AN ORIGINAL WORK; EDUCATIONAL SOFTWARE FEATURING INSTRUCTION IN INSTRUCTION IN THE USE OF SOFTWARE TOOLS FOR TEACHING, LEARNING, MIXING, OR ANALYSIS OF MUSIC (U.S. CLS. 21, 23, 26, 36 AND 38).  
DOMINICK J. SALEMI, EXAMINING ATTORNEY

SN 86-070,334. INVINCEA, INC., FAIRFAX, VA. FILED 9-20-2013.

**FreeSpace**

THE MARK CONSISTS OF STANDARD CHARACTERS WITHOUT CLAIM TO ANY PARTICULAR FONT, STYLE, SIZE, OR COLOR.

FOR COMPUTER SYSTEM, NAMELY, SECURITY SOFTWARE AND HARDWARE THAT DETECT AND TERMINATE SECURITY THREATS IN BROWSERS AND DOCUMENTS ON COMPUTER WORKSTATIONS AND ENTERPRISE NETWORKS, AND MONITOR THE SAME TO PREVENT FURTHER INCIDENTS OF DESKTOP AND NETWORK INTRUSION (U.S. CLS. 21, 23, 26, 36 AND 38).

SUZANNE BLANE, EXAMINING ATTORNEY

**CLASS 9—(Continued).**

SN 86-070,430. JASON ADAMS, LOGANDALE, NV. FILED 9-20-2013.

**TO THE END**

THE MARK CONSISTS OF STANDARD CHARACTERS WITHOUT CLAIM TO ANY PARTICULAR FONT, STYLE, SIZE, OR COLOR.

FOR SUNGLASSES (U.S. CLS. 21, 23, 26, 36 AND 38).  
FIRST USE 7-1-2013; IN COMMERCE 9-1-2013.  
KAELIE KUNG, EXAMINING ATTORNEY

SN 86-070,483. WANG, KUO HSIN, CITY OF INDUSTRY, CA. FILED 9-20-2013.

**JOYANCE**

THE MARK CONSISTS OF STANDARD CHARACTERS WITHOUT CLAIM TO ANY PARTICULAR FONT, STYLE, SIZE, OR COLOR.

FOR COMPUTER HARDWARE (U.S. CLS. 21, 23, 26, 36 AND 38).  
FIRST USE 7-1-2013; IN COMMERCE 7-1-2013.  
HEATHER SAPP, EXAMINING ATTORNEY

SN 86-070,489. VLT, INC., ANDOVER, MA. FILED 9-20-2013.

**VERSACORE**

THE MARK CONSISTS OF STANDARD CHARACTERS WITHOUT CLAIM TO ANY PARTICULAR FONT, STYLE, SIZE, OR COLOR.

FOR ELECTRONIC SWITCHING POWER CONVERTERS, MODULES AND ACCESSORIES, NAMELY, HIGH-FREQUENCY SWITCHING POWER CONVERTERS AND SWITCHING POWER CONVERTER CIRCUITRY, AND EVALUATION BOARDS FOR POWER CONVERTER CIRCUITRY (U.S. CLS. 21, 23, 26, 36 AND 38).

KARANENDRA S. CHHINA, EXAMINING ATTORNEY

**CLASS 9—(Continued).**

SN 86-070,607. TRUBEND SYSTEMS, INC., CLAREMORE, OK. FILED 9-20-2013.

**EuroBend**

THE MARK CONSISTS OF THE STYLIZED WORD "EUROBEND" WITH STRAIGHT LINES SHOWN ABOVE THE LETTERS "URO" AND ABOVE THE LETTERS "END" IN THE STYLIZED MARK.

FOR DIGITAL MEASUREMENT SYSTEM FOR MEASURING BEND ANGLES IN PIPE (U.S. CLS. 21, 23, 26, 36 AND 38).

FIRST USE 2-1-2013; IN COMMERCE 2-1-2013.

ALEXANDER L. POWERS, EXAMINING ATTORNEY

**CLASS 9—(Continued).**

SN 86-070,917. LUXEL CORPORATION, FRIDAY HARBOR, WA. FILED 9-20-2013.

**LEX HT**

THE MARK CONSISTS OF STANDARD CHARACTERS WITHOUT CLAIM TO ANY PARTICULAR FONT, STYLE, SIZE, OR COLOR.

FOR DETECTOR WINDOWS, NAMELY, ELECTRONIC DISPLAY INTERFACES FOR HIGH TEMPERATURE X-RAY ELEMENTS (U.S. CLS. 21, 23, 26, 36 AND 38).

FIRST USE 11-1-2009; IN COMMERCE 11-1-2009.

NATALIE POLZER, EXAMINING ATTORNEY

SN 86-070,724. OLEKSHI TEBENKO, KYIV, UKRAINE, FILED 9-20-2013.

**MindSticks**

THE MARK CONSISTS OF STANDARD CHARACTERS WITHOUT CLAIM TO ANY PARTICULAR FONT, STYLE, SIZE, OR COLOR.

FOR CINEMATOGRAPHIC MACHINES AND APPARATUS; COMPUTER GAME PROGRAMS; COMPUTER GAME SOFTWARE; DOWNLOADABLE COMPUTER GAME PROGRAMS; DOWNLOADABLE SOFTWARE FOR GAME PROGRAMS; DOWNLOADABLE SOFTWARE IN THE NATURE OF A MOBILE APPLICATION FOR GAME PROGRAMS; INTERACTIVE GAME PROGRAMS; INTERACTIVE GAME SOFTWARE; INTERACTIVE VIDEO GAME PROGRAMS; VIDEO GAME SOFTWARE (U.S. CLS. 21, 23, 26, 36 AND 38).

FIRST USE 3-5-2013; IN COMMERCE 6-17-2013.

LINDA MICKLEBURGH, EXAMINING ATTORNEY

SN 86-070,920. BALDWIN, JUSTIN, PORTLAND, OR. FILED 9-20-2013.

**Monsters Ate My Birthday  
Cake**

THE MARK CONSISTS OF STANDARD CHARACTERS WITHOUT CLAIM TO ANY PARTICULAR FONT, STYLE, SIZE, OR COLOR.

FOR VIDEO GAME SOFTWARE FOR MOBILE PHONES AND DESKTOP COMPUTERS (U.S. CLS. 21, 23, 26, 36 AND 38).

BARBARA A. GOLD, EXAMINING ATTORNEY

SN 86-070,881. GOOD LIFE LLC, MEDFORD, OR. FILED 9-20-2013.

**OnGuard**

THE MARK CONSISTS OF STANDARD CHARACTERS WITHOUT CLAIM TO ANY PARTICULAR FONT, STYLE, SIZE, OR COLOR.

FOR HANDHELD ELECTRONIC DOG REPELLER (U.S. CLS. 21, 23, 26, 36 AND 38).

MORGAN WYNNE, EXAMINING ATTORNEY

SN 86-070,952. LUXEL CORPORATION, FRIDAY HARBOR, WA. FILED 9-20-2013.

**LEX**

THE MARK CONSISTS OF STANDARD CHARACTERS WITHOUT CLAIM TO ANY PARTICULAR FONT, STYLE, SIZE, OR COLOR.

FOR DETECTOR WINDOWS, NAMELY, ELECTRONIC DISPLAY INTERFACES FOR X-RAY LIGHT ELEMENTS (U.S. CLS. 21, 23, 26, 36 AND 38).

FIRST USE 5-1-2009; IN COMMERCE 5-1-2009.

NATALIE POLZER, EXAMINING ATTORNEY

**CLASS 9—(Continued).**

SN 86-070,975. LINDBERGH, CARL, CORONA, CA. FILED 9-20-2013.

# Bunnyman

THE MARK CONSISTS OF STANDARD CHARACTERS WITHOUT CLAIM TO ANY PARTICULAR FONT, STYLE, SIZE, OR COLOR.

FOR MOTION PICTURE FILMS ABOUT HORROR (U.S. CLS. 21, 23, 26, 36 AND 38).

FIRST USE 9-18-2009; IN COMMERCE 9-18-2009.  
BRENDAN REGAN, EXAMINING ATTORNEY

SN 86-071,098. HEADS INNOVATION, LLC, TRENTON, NJ. FILED 9-20-2013.

HARMONIC ENGINEERING ARTS  
DEFINES SONICS

THE MARK CONSISTS OF STANDARD CHARACTERS WITHOUT CLAIM TO ANY PARTICULAR FONT, STYLE, SIZE, OR COLOR.

FOR APPARATUS FOR RECORDING, TRANSMISSION OR REPRODUCTION OF SOUND; APPARATUS FOR TRANSMITTING AND REPRODUCING SOUND OR IMAGES; AUDIO HEADPHONES; DIGITAL MEDIA RECEIVERS; EARPHONE ACCESSORIES, NAMELY, EARPHONE CUSHIONS, EARPHONE PADS, CORD MANAGEMENT SYSTEMS, EARPHONE CASES, AND EARPHONE EXTENSION CORDS; EARPHONES; EARPHONES AND HEADPHONES; ELECTRONIC PRODUCTS FOR THE GENERATION, MEASUREMENT, AND ANALYSIS OF AUDIO SIGNALS, NAMELY, AUDIO ANALYZERS; ELECTRONIC PRODUCTS FOR THE MANIPULATION OF THE FREQUENCY, TIME, AND AMPLITUDE CHARACTERISTICS OF AUDIO SIGNALS, NAMELY, AUDIO PROCESSORS; ELECTRONIC SOUND MIXING, PROCESSING AND SYNTHESIZING APPARATUS; HEADPHONES; HEADPHONES INCLUDING ATTACHED LANYARD; HEADSETS FOR USE WITH COMPUTERS; MUSIC HEADPHONES; PERSONAL HEADPHONES FOR SOUND TRANSMITTING APPARATUSES; PERSONAL HEADPHONES FOR USE WITH SOUND TRANSMITTING SYSTEMS; SOFTWARE TO CONTROL AND IMPROVE AUDIO EQUIPMENT SOUND QUALITY; STEREO HEADPHONES (U.S. CLS. 21, 23, 26, 36 AND 38).

HEATHER THOMPSON, EXAMINING ATTORNEY

**CLASS 9—(Continued).**

SN 86-071,120. XIAO, JIA, WUHAN, CHINA, FILED 9-21-2013.

# QIBOX

THE MARK CONSISTS OF STANDARD CHARACTERS WITHOUT CLAIM TO ANY PARTICULAR FONT, STYLE, SIZE, OR COLOR.

FOR BATTERIES AND BATTERY CHARGERS; BATTERY CABLES; BATTERY CASES; BATTERY CHARGE DEVICES; BATTERY PACKS; RENEWABLE BATTERY SYSTEM TO PROVIDE BACKUP POWER; CARRYING CASES, HOLDERS, PROTECTIVE CASES FOR USE WITH HANDHELD DIGITAL ELECTRONIC DEVICES, NAMELY CELL PHONES, MP3 PLAYERS, PERSONAL DIGITAL ASSISTANTS, LAPTOP COMPUTERS AND TABLETS (U.S. CLS. 21, 23, 26, 36 AND 38).

DOUGLAS LEE, EXAMINING ATTORNEY

SN 86-071,121. TIME SUCK MEDIA, LLC., SAN FRANCISCO, CA. FILED 9-21-2013.

# U SUCK

THE MARK CONSISTS OF STANDARD CHARACTERS WITHOUT CLAIM TO ANY PARTICULAR FONT, STYLE, SIZE, OR COLOR.

FOR COMPUTER GAME SOFTWARE; DOWNLOADABLE COMPUTER GAME PROGRAMS (U.S. CLS. 21, 23, 26, 36 AND 38).

DOUGLAS LEE, EXAMINING ATTORNEY

SN 86-071,346. CAO GADGETS LLC, DBA CAO GADGETS LLC, ALISO VIEJO, CA. FILED 9-22-2013.

# Kumostat

THE MARK CONSISTS OF STANDARD CHARACTERS WITHOUT CLAIM TO ANY PARTICULAR FONT, STYLE, SIZE, OR COLOR.

FOR CLIMATE CONTROL SYSTEMS CONSISTING OF DIGITAL THERMOSTATS FOR COOLING EQUIPMENT, AND A PROGRAMMABLE LOGIC CONTROLLER (PLC) WITH INPUT AND OUTPUT FEATURES FOR TEMPERATURE AND HUMIDITY, WHICH WORKS WITH A REMOTE DIGITAL READ OUT CONTROLLER; CLIMATE CONTROL SYSTEMS CONSISTING OF DIGITAL THERMOSTATS, AIR CONDITIONING, HEATING, VENTILATION AND DRYING CONTROL DEVICES; DECORATIVE DIALS FOR THERMOSTATS NOT FOR MEDICAL USE; THERMOSTATS (U.S. CLS. 21, 23, 26, 36 AND 38).

KRISTIN DAHLING, EXAMINING ATTORNEY



**CLASS 9—(Continued).**

SN 86-071,492. MOZILLA FOUNDATION, MOUNTAIN VIEW, CA. FILED 9-23-2013.

**CLASS 9—(Continued).**

SN 86-071,493. MOZILLA FOUNDATION, MOUNTAIN VIEW, CA. FILED 9-23-2013.

**FIREFOX**



THE MARK CONSISTS OF STANDARD CHARACTERS WITHOUT CLAIM TO ANY PARTICULAR FONT, STYLE, SIZE, OR COLOR.

OWNER OF U.S. REG. NOS. 2,974,321 AND 3,408,321.  
FOR MOBILE PHONES; HANDHELD MOBILE DIGITAL ELECTRONIC DEVICES FOR THE SENDING AND RECEIVING OF TELEPHONE CALLS, ELECTRONIC MAIL, AND OTHER DIGITAL DATA, FOR USE AS A DIGITAL FORMAT AUDIO PLAYER, AND FOR USE AS A HANDHELD COMPUTER, PERSONAL DIGITAL ASSISTANT, ELECTRONIC ORGANIZER, ELECTRONIC NOTEPAD, AND CAMERA; OPERATING SYSTEM SOFTWARE; SOFTWARE FOR USE IN DEVELOPING, EXECUTING, AND RUNNING OTHER SOFTWARE ON MOBILE COMMUNICATION DEVICES, COMPUTERS, COMPUTER NETWORKS, AND GLOBAL COMMUNICATION NETWORKS; GRAPHICAL USER INTERFACE SOFTWARE; APPLICATION DEVELOPMENT TOOL SOFTWARE; SOFTWARE FOR ACCESSING, ORGANIZING, AND MANAGING MULTIPLE SOFTWARE APPLICATIONS, SOLD AS AN INTEGRAL COMPONENT OF COMPUTER OPERATING SYSTEM AND GRAPHICAL USER INTERFACE SOFTWARE (U.S. CLS. 21, 23, 26, 36 AND 38).

Laurie Kaufman, Examining Attorney

OWNER OF U.S. REG. NOS. 2,974,321 AND 3,408,321.  
THE COLOR(S) ORANGE, YELLOW, BLACK, WHITE, AND BLUE IS/ARE CLAIMED AS A FEATURE OF THE MARK.

THE MARK CONSISTS OF AN ORANGE FOX WITH A YELLOW TAIL, BLACK NOSE, AND WHITE MOUTH SUPERIMPOSED ON A BLUE WORLD DESIGN.

FOR MOBILE PHONES; HANDHELD MOBILE DIGITAL ELECTRONIC DEVICES FOR THE SENDING AND RECEIVING OF TELEPHONE CALLS, ELECTRONIC MAIL, AND OTHER DIGITAL DATA, FOR USE AS A DIGITAL FORMAT AUDIO PLAYER, AND FOR USE AS A HANDHELD COMPUTER, PERSONAL DIGITAL ASSISTANT, ELECTRONIC ORGANIZER, ELECTRONIC NOTEPAD, AND CAMERA; OPERATING SYSTEM SOFTWARE; SOFTWARE FOR USE IN DEVELOPING, EXECUTING, AND RUNNING OTHER SOFTWARE ON MOBILE COMMUNICATION DEVICES, COMPUTERS, COMPUTER NETWORKS, AND GLOBAL COMMUNICATION NETWORKS; GRAPHICAL USER INTERFACE SOFTWARE; APPLICATION DEVELOPMENT TOOL SOFTWARE; SOFTWARE FOR ACCESSING, ORGANIZING, AND MANAGING MULTIPLE SOFTWARE APPLICATIONS, SOLD AS AN INTEGRAL COMPONENT OF COMPUTER OPERATING SYSTEM AND GRAPHICAL USER INTERFACE SOFTWARE (U.S. CLS. 21, 23, 26, 36 AND 38).

Laurie Kaufman, Examining Attorney

**CLASS 9—(Continued).**

SN 86-071,704. STRATEGIC POLYMER SCIENCES, INC., STATE COLLEGE, PA. FILED 9-23-2013.

**NOVASENTIS**

THE MARK CONSISTS OF STANDARD CHARACTERS WITHOUT CLAIM TO ANY PARTICULAR FONT, STYLE, SIZE, OR COLOR.

FOR APPARATUS AND INSTRUMENTS FOR CONDUCTING, SWITCHING, TRANSFORMING, ACCUMULATING, REGULATING OR CONTROLLING ELECTRICITY, NAMELY, ELECTRIC ACTUATORS FOR USE IN MOTION CONTROL; ELECTRIC ACTUATORS FEATURING HAPTIC TECHNOLOGY; ELECTRIC ACTUATORS FOR PRODUCING TACTILE AND FORCE OUTPUT; ELECTRIC LINEAR TRANSDUCERS; ELECTRICAL TRANSDUCERS FOR USE IN MOTION CONTROL; ELECTRIC SENSORS FOR SENSING MOTION AND PRESSURE; ELECTRIC ACTUATORS FEATURING ACOUSTIC TECHNOLOGY; ELECTRIC ACTUATORS FEATURING CAPACITIVE TECHNOLOGY (U.S. CLS. 21, 23, 26, 36 AND 38).

JULIE GUTTADAURO, EXAMINING ATTORNEY

SN 86-072,094. NEWPORT CORPORATION, IRVINE, CA. FILED 9-23-2013.

**TALON**

THE MARK CONSISTS OF STANDARD CHARACTERS WITHOUT CLAIM TO ANY PARTICULAR FONT, STYLE, SIZE, OR COLOR.

FOR LASERS NOT FOR MEDICAL USE (U.S. CLS. 21, 23, 26, 36 AND 38).

THEODORE MCBRIDE, EXAMINING ATTORNEY

SN 86-072,113. NEWPORT CORPORATION, IRVINE, CA. FILED 9-23-2013.

**ASCEND**

THE MARK CONSISTS OF STANDARD CHARACTERS WITHOUT CLAIM TO ANY PARTICULAR FONT, STYLE, SIZE, OR COLOR.

FOR LASERS NOT FOR MEDICAL USE (U.S. CLS. 21, 23, 26, 36 AND 38).

THEODORE MCBRIDE, EXAMINING ATTORNEY

**CLASS 9—(Continued).**

SN 86-072,152. RAD AND REFINED INC., LOS ANGELES, CA. FILED 9-23-2013.

**Rad Bands**

THE MARK CONSISTS OF STANDARD CHARACTERS WITHOUT CLAIM TO ANY PARTICULAR FONT, STYLE, SIZE, OR COLOR.

FOR EYEWEAR, NAMELY, SUNGLASSES AND EYEGLASSES (U.S. CLS. 21, 23, 26, 36 AND 38).

FIRST USE 6-15-2013; IN COMMERCE 6-15-2013.

SUNG IN, EXAMINING ATTORNEY

SN 86-072,160. ODIN PHARMACY INNOVATIONS, LLC, MATTAPOISETT, MA. FILED 9-23-2013.

**APPAGRAPHIA**

THE MARK CONSISTS OF STANDARD CHARACTERS WITHOUT CLAIM TO ANY PARTICULAR FONT, STYLE, SIZE, OR COLOR.

FOR SOFTWARE APPLICATION FOR COMPUTERS, LAPTOPS, TABLETS AND MOBILE DEVICES THAT PROMOTES AND ASSISTS PATIENT COMPLIANCE AND ADHERENCE TO MEDICATION REGIMENS, PROVIDES RESOURCE LINKS FOR HEALTHCARE MANAGEMENT AND PERMITS ANONYMOUS SHARING AND COMPARISON OF PATIENT COMPLIANCE AND ADHERENCE TO MEDICATION REGIMENS (U.S. CLS. 21, 23, 26, 36 AND 38).

SETH A. RAPPAPORT, EXAMINING ATTORNEY

SN 86-072,168. WINTERS, ADAM, ROBBINS, TN. FILED 9-23-2013.



THE COLOR(S) ORANGE AND BLUE IS/ARE CLAIMED AS A FEATURE OF THE MARK.

THE MARK CONSISTS OF THE STYLIZED WORD "SHIHEY" IN ORANGE FONT. THERE IS A BLUE LINE EXTENDING FROM THE BOTTOM OF THE "P" AND "Y".

FOR COMPUTER APPLICATION SOFTWARE FOR MOBILE PHONES, NAMELY, SOFTWARE FOR CONNECTING PEOPLE WITH NEAREST LOCAL SHIPPER (U.S. CLS. 21, 23, 26, 36 AND 38).

DAVID COLLIER, EXAMINING ATTORNEY

**CLASS 9—(Continued).**

SN 86-072,220. TRANSWESTERN COMMERCIAL SERVICES, L.L.C., SOUTH HOUSTON, TX. FILED 9-23-2013.

# TRANScend

THE MARK CONSISTS OF THE WORD "TRANSCEND" AND AN IMAGE OF THE CONTINENTS WITHIN THE LETTER "D" IN THE WORD "TRANSCEND".

FOR COMPUTER SOFTWARE FOR COMMERCIAL REAL ESTATE USING REAL-TIME GEOGRAPHY, PHOTOGRAPHY AND VIDEO DISPLAY TO AGGREGATE MULTIPLE TYPES OF COMMERCIAL REAL ESTATE INFORMATION USING A SINGLE OBJECT MODEL (U.S. CLS. 21, 23, 26, 36 AND 38).

ANDREW LEASER, EXAMINING ATTORNEY

SN 86-072,298. ASIA VITAL COMPONENTS CO., LTD., NEW TAIPEI CITY 242, TAIWAN, FILED 9-23-2013.

# LAVII

THE MARK CONSISTS OF THE WORD "LAVII" WITH STYLIZED LETTERS "A" AND "V".

THE WORDING "LAVII" HAS NO MEANING IN A FOREIGN LANGUAGE.

FOR COMPUTER KEYBOARDS; COMPUTER STYLUS; BAGS FOR PORTABLE COMPUTERS; BAGS FOR NOTEBOOK COMPUTERS; BAGS FOR TABLET COMPUTERS; HEADPHONES; LOUDSPEAKERS; MICROPHONES; LITHIUM ION BATTERIES; BATTERIES AND BATTERY CHARGERS; CHARGING WIRES FOR VEHICLES; POWER CABLES; DATA SYNCHRONIZATION CABLES; COMPUTER CABLES; COMPUTER NETWORK ADAPTERS, SWITCHES, ROUTERS AND HUBS; ELECTRIC CONNECTORS; BAGS AND CASES SPECIALLY ADAPTED FOR HOLDING OR CARRYING PORTABLE TELEPHONES AND TELEPHONE EQUIPMENT AND ACCESSORIES; ELECTRIC TRANSFORMERS; ELECTRONIC DETECTORS FOR OBSERVING AND MEASURING THE INFRARED SPECTRUM, NAMELY, INFRARED DETECTORS; PHOTOVOLTAIC INSTALLATION APPARATUS, NAMELY, SOLAR MODULES FOR PRODUCTION OF ELECTRICITY, SOLAR THERMAL AND ELECTRIC RECEIVERS, TRACKING MECHANISMS AND CONCENTRATING OPTICS, AND CONTROL ALGORITHMS; AND SOLAR PANELS FOR PRODUCTION OF ELECTRICITY (U.S. CLS. 21, 23, 26, 36 AND 38).

JORDAN BAKER, EXAMINING ATTORNEY

**CLASS 9—(Continued).**

SN 86-072,316. KAUFMAN, CAROLINE, BEVERLY HILLS, CA. FILED 9-23-2013.

## MOVIES TO YOUR MOUTH

THE MARK CONSISTS OF STANDARD CHARACTERS WITHOUT CLAIM TO ANY PARTICULAR FONT, STYLE, SIZE, OR COLOR.

FOR SOUND RECORDINGS FEATURING MUSIC AND ENTERTAINMENT, NAMELY, CELEBRITY COMMENTARY (U.S. CLS. 21, 23, 26, 36 AND 38).

ANDREA HACK, EXAMINING ATTORNEY

SN 86-072,372. HANSCOMB, NEA, DBA APPROPO SOFTWARE, LLC, SAN FRANCISCO, CA. FILED 9-23-2013.

# Sayin' It

THE MARK CONSISTS OF STANDARD CHARACTERS WITHOUT CLAIM TO ANY PARTICULAR FONT, STYLE, SIZE, OR COLOR.

FOR CHILDREN'S EDUCATIONAL SOFTWARE; COMPUTER APPLICATION SOFTWARE FOR MOBILE PHONES, NAMELY, SOFTWARE FOR VOICE-ACTIVATED EDUCATIONAL APP FOR CHILDREN.; COMPUTER APPLICATION SOFTWARE FOR CHILDREN, NAMELY, SOFTWARE FOR VOICE-ACTIVATED EDUCATIONAL GAMING; COMPUTER GAME SOFTWARE; COMPUTER GAME SOFTWARE FOR USE ON MOBILE AND CELLULAR PHONES; EDUCATIONAL SOFTWARE FEATURING INSTRUCTION IN SPEECH THERAPY; ELECTRONIC GAME SOFTWARE; ELECTRONIC GAME SOFTWARE FOR CELLULAR TELEPHONES; ELECTRONIC GAME SOFTWARE FOR HANDHELD ELECTRONIC DEVICES; ELECTRONIC GAME SOFTWARE FOR WIRELESS DEVICES; GAME SOFTWARE; INTERACTIVE GAME SOFTWARE (U.S. CLS. 21, 23, 26, 36 AND 38).

ANTHONY RINKER, EXAMINING ATTORNEY

SN 86-072,435. AUDYSSEY LABORATORIES, INC., LOS ANGELES, CA. FILED 9-23-2013.

# BrandFit

THE MARK CONSISTS OF STANDARD CHARACTERS WITHOUT CLAIM TO ANY PARTICULAR FONT, STYLE, SIZE, OR COLOR.

FOR SOFTWARE FOR AUDIO AND VOICE PROCESSING (U.S. CLS. 21, 23, 26, 36 AND 38).

RONALD MCMORROW, EXAMINING ATTORNEY

**CLASS 9—(Continued).**

SN 86-072,440. SUSTAINABLE POWER SYSTEMS LLC, BOULDER, CO. FILED 9-23-2013.

SunStore

THE MARK CONSISTS OF STANDARD CHARACTERS WITHOUT CLAIM TO ANY PARTICULAR FONT, STYLE, SIZE, OR COLOR.  
FOR PHOTOVOLTAIC INVERTERS (U.S. CLS. 21, 23, 26, 36 AND 38).  
JOHN WILKE, EXAMINING ATTORNEY

**CLASS 9—(Continued).**

SN 86-072,478. AUDYSSEY LABORATORIES, INC., LOS ANGELES, CA. FILED 9-23-2013.

FullVoice

THE MARK CONSISTS OF STANDARD CHARACTERS WITHOUT CLAIM TO ANY PARTICULAR FONT, STYLE, SIZE, OR COLOR.  
FOR SOFTWARE FOR AUDIO AND VOICE PROCESSING (U.S. CLS. 21, 23, 26, 36 AND 38).  
RONALD MCMORROW, EXAMINING ATTORNEY

SN 86-072,447. AUDYSSEY LABORATORIES, INC., LOS ANGELES, CA. FILED 9-23-2013.

Quietype

THE MARK CONSISTS OF STANDARD CHARACTERS WITHOUT CLAIM TO ANY PARTICULAR FONT, STYLE, SIZE, OR COLOR.  
FOR SOFTWARE FOR AUDIO AND VOICE PROCESSING (U.S. CLS. 21, 23, 26, 36 AND 38).  
RONALD MCMORROW, EXAMINING ATTORNEY

SN 86-072,679. SPECULATIVE PRODUCT DESIGN, LLC, DBA SPECK PRODUCTS, MOUNTAIN VIEW, CA. FILED 9-24-2013.



The Long Live Promise

SN 86-072,469. AUDYSSEY LABORATORIES, INC., LOS ANGELES, CA. FILED 9-23-2013.

RoomFit

THE MARK CONSISTS OF STANDARD CHARACTERS WITHOUT CLAIM TO ANY PARTICULAR FONT, STYLE, SIZE, OR COLOR.  
FOR SOFTWARE FOR AUDIO AND VOICE PROCESSING (U.S. CLS. 21, 23, 26, 36 AND 38).  
RONALD MCMORROW, EXAMINING ATTORNEY

THE MARK CONSISTS OF A HAND GRIPPING A CELL PHONE IN A CIRCLE WITH A LINE BEFORE AND AFTER THE CIRCLE. UNDERNEATH THE HAND LOGO APPEARS THE WORDS "THE LONG LIVE PROMISE".  
FOR PROTECTIVE CARRYING CASES FOR PORTABLE ELECTRONIC LISTENING DEVICES AND MUSIC PLAYERS, NAMELY, MP3 PLAYERS, AND FOR PORTABLE COMPUTERS, GLOBAL POSITIONING SYSTEMS (GPS DEVICES), MOBILE AND CELLULAR TELEPHONES, PORTABLE MEDIA PLAYERS, AND PERSONAL DIGITAL ASSISTANTS (U.S. CLS. 21, 23, 26, 36 AND 38).  
FIRST USE 9-1-2013; IN COMMERCE 9-16-2013.  
KYLE PEETE, EXAMINING ATTORNEY

**CLASS 9—(Continued).**

SN 86-072,680. SPECULATIVE PRODUCT DESIGN, LLC, DBA SPECK PRODUCTS, MOUNTAIN VIEW, CA. FILED 9-24-2013.

**STYLEBOOK**

THE MARK CONSISTS OF STANDARD CHARACTERS WITHOUT CLAIM TO ANY PARTICULAR FONT, STYLE, SIZE, OR COLOR.

FOR PROTECTIVE CARRYING CASES FOR PORTABLE ELECTRONIC LISTENING DEVICES AND MUSIC PLAYERS, NAMELY, MP3 PLAYERS, AND FOR PORTABLE COMPUTERS, GLOBAL POSITIONING SYSTEMS (GPS DEVICES), MOBILE AND CELLULAR TELEPHONES, PORTABLE MEDIA PLAYERS, AND PERSONAL DIGITAL ASSISTANTS (U.S. CLS. 21, 23, 26, 36 AND 38).

KYLE PEETE, EXAMINING ATTORNEY

**CLASS 9—(Continued).**

SN 86-073,302. US AMEXS, LLC., WILMINGTON, DE. FILED 9-24-2013.

**DREAMSKY**

THE MARK CONSISTS OF STANDARD CHARACTERS WITHOUT CLAIM TO ANY PARTICULAR FONT, STYLE, SIZE, OR COLOR.

FOR ADAPTER PLUGS; ADAPTERS; AUDIO AMPLIFIERS; AUDIO CABLES; AUDIO HEADPHONES; AUDIO SPEAKERS; BATTERIES AND BATTERY CHARGERS; BLANK CD-ROMS FOR SOUND OR VIDEO RECORDING; BLANK RECORDABLE CD-RS AND DVD-RS; CAMERAS; CARRYING CASES FOR CELL PHONES; CD-ROM WRITERS; CELLULAR PHONES; COAXIAL CABLES; COMBINATION VIDEO PLAYERS AND RECORDERS; COMPONENT VIDEO CABLES; COMPUTER CABLES; COMPUTER PERIPHERALS; CONNECTING ELECTRICAL CABLES; CONNECTION CABLES; DIGITAL AUDIO AND VIDEO RECORDERS AND PLAYERS; DIGITAL VIDEO RECORDERS; ELECTRIC CABLES; ELECTRIC WIRE AND CABLE; ELECTRIC WIRES AND CABLES; ELECTRONIC BOOK READER; ELECTRONIC VIDEO SURVEILLANCE PRODUCTS, NAMELY, ELECTRONIC COMPONENTS OF SECURITY SYSTEMS; GPS NAVIGATION DEVICE; HEADMOUNTED VIDEO DISPLAYS; MOUNTING RACKS FOR COMPUTER HARDWARE; MOUNTING RACKS FOR TELECOMMUNICATIONS HARDWARE; PC TABLET MOUNTS; SMARTPHONE MOUNTS; VIDEO AND COMPUTER GAME PROGRAMS; VIDEO GAME CARTRIDGES AND DISCS; VIDEO GAME DISCS (U.S. CLS. 21, 23, 26, 36 AND 38).

FIRST USE 9-3-2013; IN COMMERCE 9-3-2013.  
RONALD DELGIZZI, EXAMINING ATTORNEY

SN 86-073,453. HUBBELL INCORPORATED, SHELTON, CT. FILED 9-24-2013.

SN 86-073,102. ROTHSCHILD DOWNES, INC., DENVER, CO. FILED 9-24-2013.

**TCTrac**



THE MARK CONSISTS OF STANDARD CHARACTERS WITHOUT CLAIM TO ANY PARTICULAR FONT, STYLE, SIZE, OR COLOR.

FOR REAL-TIME COMPUTER SOFTWARE FOR TRACKING RETAIL TENANT DESIGN AND CONSTRUCTION ACTIVITY FOR MULTI-TENANT PROJECTS (U.S. CLS. 21, 23, 26, 36 AND 38).

FIRST USE 0-0-2011; IN COMMERCE 0-0-2011.  
SETH A. RAPPAPORT, EXAMINING ATTORNEY

OWNER OF U.S. REG. NOS. 1,334,057, 1,748,239 AND 1,751,136.

THE MARK CONSISTS OF THE WORDS "DUAL" AND "LITE" SEPARATED WITH A VERTICAL LINE BETWEEN THE WORDS WITHIN A HIGHLY STYLIZED BATTERY DESIGN.

FOR BATTERIES (U.S. CLS. 21, 23, 26, 36 AND 38).  
EVIN L. KOZAK, EXAMINING ATTORNEY

**CLASS 9—(Continued).**

SN 86-073,582. FUHU HOLDINGS, INC., EL SEGUNDO, CA. FILED 9-24-2013.

**STANDTIVITY**

THE MARK CONSISTS OF STANDARD CHARACTERS WITHOUT CLAIM TO ANY PARTICULAR FONT, STYLE, SIZE, OR COLOR.

FOR STANDS SPECIALLY ADAPTED FOR HANDHELD MOBILE DIGITAL ELECTRONIC DEVICES, NAMELY, COMPUTERS, TABLET COMPUTERS, ELECTRONIC BOOK READERS, DIGITAL AUDIO AND VIDEO PLAYERS, ELECTRONIC PERSONAL ORGANIZERS, PERSONAL DIGITAL ASSISTANTS, ELECTRONIC CALENDARS, AND GLOBAL POSITIONING SYSTEM (GPS) DEVICES (U.S. CLS. 21, 23, 26, 36 AND 38).

JEAN IM, EXAMINING ATTORNEY

SN 86-074,384. FU, QIANG, HOUSTON, TX. FILED 9-25-2013.

**ValuePad**

THE MARK CONSISTS OF STANDARD CHARACTERS WITHOUT CLAIM TO ANY PARTICULAR FONT, STYLE, SIZE, OR COLOR.

FOR ADJUSTABLE SMARTPHONE AND PC TABLET STABILIZERS AND MOUNTS; ANTI-THEFT LOCKS SPECIALLY ADAPTED TO PERSONAL ELECTRONIC DEVICES, NAMELY, TABLETS, PC TABLETS, LAPTOP COMPUTERS, MOBILE INTERNET DEVICES; COMPUTER CURSOR CONTROL DEVICES, NAMELY, DIGITIZER TABLETS; DISPLAY SCREEN FILTERS ADAPTED FOR USE WITH TABLETS, PC TABLETS, LAPTOP COMPUTERS, MOBILE INTERNET DEVICES; ELECTRONIC CHARGING DEVICES FOR TABLET PCS THAT ALSO INCLUDE FEATURES TO SECURE AND DISINFECT THE TABLET PCS; ELECTRONIC DEVICE TO CHARGE AND SECURE TABLET PCS; ELECTRONIC WRITING TABLETS; PC TABLET MOUNTS; PC TABLET STABILIZERS; PC TABLETS; PROTECTIVE COVERS AND CASES FOR TABLET COMPUTERS; PROTECTIVE DISPLAY SCREEN COVERS ADAPTED FOR USE WITH TABLETS, PC TABLETS, LAPTOP COMPUTERS, MOBILE INTERNET DEVICES; STABILIZERS FOR PC TABLETS WITH PROTECTIVE CASES; TABLET COMPUTER (U.S. CLS. 21, 23, 26, 36 AND 38).

MORGAN WYNNE, EXAMINING ATTORNEY

**CLASS 9—(Continued).**

SN 86-074,545. CHEVONNE AND THE FUZZ, LLC, POMPTON LAKES, NJ. FILED 9-25-2013.

**CHEVONNE AND THE FUZZ**

THE MARK CONSISTS OF STANDARD CHARACTERS WITHOUT CLAIM TO ANY PARTICULAR FONT, STYLE, SIZE, OR COLOR.

FOR AUDIO RECORDINGS FEATURING MUSIC BY A BAND; DIGITAL MATERIALS, NAMELY, CD'S AND DOWNLOADABLE AUDIO FILES FEATURING MUSIC BY A BAND (U.S. CLS. 21, 23, 26, 36 AND 38).

FIRST USE 9-17-2013; IN COMMERCE 9-17-2013.  
AMY ALFIERI, EXAMINING ATTORNEY

SN 86-075,081. CITRIX ONLINE LLC, GOLETA, CA. FILED 9-26-2013.

**TALKBOARD**

THE MARK CONSISTS OF STANDARD CHARACTERS WITHOUT CLAIM TO ANY PARTICULAR FONT, STYLE, SIZE, OR COLOR.

FOR COMPUTER SOFTWARE AND DOWNLOADABLE MOBILE APPLICATION SOFTWARE FOR FACILITATING COLLABORATION BETWEEN REMOTE USERS; COMPUTER SOFTWARE AND DOWNLOADABLE MOBILE APPLICATION SOFTWARE FOR CREATING, SHARING AND EXCHANGING GRAPHICS, DRAWINGS, SKETCHES, ILLUSTRATIONS, NOTES AND INFORMATION (U.S. CLS. 21, 23, 26, 36 AND 38).

FIRST USE 8-29-2013; IN COMMERCE 8-29-2013.  
KATHERINE CHANG, EXAMINING ATTORNEY

SN 86-076,461. SASSHAYE RECORDS, MCKINNEY, TX. FILED 9-27-2013.

**SASSHAYE**  
RECORDS



NO CLAIM IS MADE TO THE EXCLUSIVE RIGHT TO USE "RECORDS", APART FROM THE MARK AS SHOWN. THE LIKENESS IN THE MARK IDENTIFIES KIMMIE SWAN, A LIVING INDIVIDUAL WHOSE CONSENT IS OF RECORD.

THE MARK CONSISTS OF THE WORDING "SASSHAYE RECORDS" AND A SILHOUETTE OF THE LIKENESS OF THE SINGER KIMMIE SWAN WEARING EARRINGS AND SINGING INTO A MICROPHONE. A HORIZONTAL LINE SEPARATES THE WORDS "SASSHAYE" AND "RECORDS" AND THE SILHOUETTE OF KIMMIE SWAN FORMS THE "Y" IN THE WORD "SASSHAYE".

FOR DIGITAL MATERIALS, NAMELY, CDS, DVDS, AND DOWNLOADABLE AUDIO FILES FEATURING MUSIC (U.S. CLS. 21, 23, 26, 36 AND 38).

FIRST USE 1-12-2012; IN COMMERCE 1-12-2012.  
DAVID ELTON, EXAMINING ATTORNEY

**CLASS 9—(Continued).**

SN 86-076,984. PEAK ALARM COMPANY, INC., SALT LAKE CITY, UT. FILED 9-27-2013.



NO CLAIM IS MADE TO THE EXCLUSIVE RIGHT TO USE "ALARM", APART FROM THE MARK AS SHOWN. THE COLOR(S) RED, WHITE AND BLACK IS/ARE CLAIMED AS A FEATURE OF THE MARK.

THE MARK CONSISTS OF THE RED LETTERS "PEAK" IMMEDIATELY FOLLOWED BY THE BLACK LETTERS "ALARM" WITH A BADGE DESIGN IMMEDIATELY ABOVE THE BLACK LETTERS "ALARM" THAT CONSISTS OF A LEFT SIDE THAT IS RED WITH THE WHITE LETTERS "PEAK", A MIDDLE ROUNDED TRAPEZOIDAL SHAPE OUTLINED IN BLACK WITH BLACK AND WHITE MOUNTAIN PEAKS AND WHITE SKY INSIDE THE SHAPE AND A LEFT SIDE THAT IS READ WITH THE WHITE LETTERS "ALARM". ALL OUTLINED IN BLACK. THE BACKGROUND OF THE MARK IS TRANSPARENT.

FOR ALARM MONITORING SYSTEMS (U.S. CLS. 21, 23, 26, 36 AND 38). FIRST USE 1-1-1976; IN COMMERCE 1-1-1976. MORGAN WYNNE, EXAMINING ATTORNEY

**CLASS 9—(Continued).**

SN 86-077,946. SHELTERED WINGS, INC., MIDDLETON, WI. FILED 9-30-2013.

TRIUMPH

THE MARK CONSISTS OF STANDARD CHARACTERS WITHOUT CLAIM TO ANY PARTICULAR FONT, STYLE, SIZE, OR COLOR.

OWNER OF U.S. REG. NO. 2,835,907. FOR RIFLESCOPES (U.S. CLS. 21, 23, 26, 36 AND 38). KATHLEEN LORENZO, EXAMINING ATTORNEY

SN 86-078,164. SAMSUNG ELECTRONICS CO., LTD., GYEONGGI-DO, REPUBLIC OF KOREA, FILED 9-30-2013.

SAMSUNG GALAXY ROUND

THE MARK CONSISTS OF STANDARD CHARACTERS WITHOUT CLAIM TO ANY PARTICULAR FONT, STYLE, SIZE, OR COLOR.

OWNER OF U.S. REG. NOS. 4,020,438, 4,354,880 AND OTHERS.

FOR COMPUTER SOFTWARE FOR ENCODING AND DECODING OF VOICE AND AUDIO SIGNALS; ANALOG AND DIGITAL SOUND ENHANCING SOFTWARE FOR PROCESSING, RECORDING, CAPTURING, RECEIVING, TRANSMITTING, RENDERING AND STORING VOICE AND AUDIO SIGNALS, FILES AND SOUNDS; AUDIO AMPLIFIERS; AUDIO SPEAKERS; BLANK UNIVERSAL SERIAL BUS (USB) FLASH MEMORY DRIVE; BUILT-IN WIRELESS AUDIO AND VIDEO RECEIVERS AND ELECTRONIC DOCKING STATIONS FOR USE WITH ELECTRONIC BOOK READERS, TABLET COMPUTERS, MP3 PLAYERS, MP4 PLAYERS, MOBILE PHONES AND SMART PHONES; CAMCORDERS; COMPUTER AND MOBILE DEVICE SOFTWARE TO PERSONALIZE WIDGETS AND MOBILE APPLICATIONS; COMPUTER APPLICATION SOFTWARE FOR MOBILE PHONES, PORTABLE MEDIA PLAYERS AND HANDHELD COMPUTERS, NAMELY, SOFTWARE FOR USE IN VOICE RECOGNITION; COMPUTER GAME SOFTWARE; COMPUTER MONITORS; COMPUTER NETWORK HUBS, SWITCHES AND ROUTERS; COMPUTER SOFTWARE EMBEDDED ON PORTABLE PHONES AND/OR PORTABLE COMPUTERS THAT ALLOWS USERS TO PLAY AND DOWNLOAD ELECTRONIC GAMES, LISTEN TO AND DOWNLOAD RING TONES AND MUSIC, AND VIEW AND DOWNLOAD SCREEN SAVERS AND WALLPAPERS; COMPUTER SOFTWARE FOR CONTROLLING HOME APPLIANCES; COMPUTER SOFTWARE FOR INSTANT MESSAGING, SENDING AND RECEIVING EMAILS AND CONTACT INFORMATION, SCHEDULE SHARING AND CONTENTS SHARING; COMPUTER SOFTWARE FOR MANAGING AND ORGANIZING VARIOUS DIGITAL READING CONTENTS, NAMELY, DIGITAL ELECTRONIC-BOOKS, DIGITAL ELECTRONIC-NEWSPAPERS, THESIS, AND DIGITAL ELECTRONIC-MAGAZINES; COMPUTER SOFTWARE FOR PERSONAL INFORMATION MANAGEMENT; COMPUTER SOFTWARE FOR PLAYING, SHARING AND MANAGING MULTIMEDIA FILES; COMPUTER SOFTWARE FOR PURCHASING, DOWNLOADING, PLAYING OR LISTENING TO MUSIC; COMPUTER SOFTWARE FOR PURCHASING, SUBSCRIBING, DOWNLOADING, PLAYING OR LISTENING TO DIGITAL READING CONTENTS, NAMELY, DIGI-

SN 86-077,447. APPLE INC., CUPERTINO, CA. FILED 9-27-2013.



PRIORITY CLAIMED UNDER SEC. 44(D) ON JAMAICA APPLICATION NO. 063154, FILED 8-7-2013.

THE COLOR(S) BLACK AND WHITE IS/ARE CLAIMED AS A FEATURE OF THE MARK.

THE MARK CONSISTS OF WHITE SQUARE WITH ROUNDED EDGES CONTAINING AN IMAGE OF A BLACK LINE GRAPH.

FOR COMPUTER SOFTWARE, FOR RECORDING, EDITING, MANAGING, AND SHARING AUDIO CONTENT, FOR USE IN CONNECTION WITH HANDHELD MOBILE DIGITAL ELECTRONIC DEVICES, MOBILE PHONES, DIGITAL AUDIO AND VIDEO PLAYERS, HANDHELD COMPUTERS, HANDHELD COMPUTERS, AND TABLET COMPUTERS (U.S. CLS. 21, 23, 26, 36 AND 38).

FIRST USE 9-18-2013; IN COMMERCE 9-18-2013. STEPHANIE ALI, EXAMINING ATTORNEY

**CLASS 9—(Continued).**

TAL ELECTRONIC-BOOKS, DIGITAL ELECTRONICS-NEWSPAPERS, THESIS AND DIGITAL ELECTRONIC-MAGAZINES AND ELECTRONIC GAMES; COMPUTER SOFTWARE FOR TRAVEL INFORMATION SYSTEMS FOR THE PROVISION OR RENDERING OF TRAVEL ADVICE AND FOR INFORMATION CONCERNING HOTELS, LANDMARKS, MUSEUMS, PUBLIC TRANSPORTATION, RESTAURANTS AND OTHER INFORMATION REGARDING TRAVEL AND TRANSPORT; COMPUTER SOFTWARE FOR USE IN RECORDING, ORGANIZING, TRANSMITTING, MANIPULATING, AND REVIEWING TEXT, AUDIO FILES, VIDEO FILES AND COMPUTER GAME PROGRAMS IN CONNECTION WITH TELEVISIONS, COMPUTERS, MUSIC PLAYERS, VIDEO PLAYERS, MEDIA PLAYERS AND MOBILE PHONES; COMPUTER SOFTWARE FOR USE IN SEARCHING FOR, BROWSING, AND PURCHASING SOFTWARE ON AN ELECTRONIC DATABASE; COMPUTER SOFTWARE FOR USE WITH SATELLITE AND GLOBAL POSITIONING SYSTEM (GPS) NAVIGATION SYSTEMS FOR NAVIGATION, ROUTE AND TRIP PLANNING, AND ELECTRONIC MAPPING; COMPUTER SOFTWARE SUGGESTING THE MOST SUITABLE PEN-INPUT APPLICATIONS FOR THE MOBILE DEVICE; COMPUTER SOFTWARE TO ACCESS INTERNET AND VARIOUS APPLICATIONS; COMPUTER SOFTWARE TO BE USED FOR VIEWING AND DOWNLOADING ELECTRONIC MAPS; COMPUTER SOFTWARE TO EDIT DAILY ACTIVITIES, ADDRESS BOOK, CALENDAR, MEMOS, AND MULTIMEDIA CONTENTS STORED IN MOBILE DEVICES; COMPUTER SOFTWARE TO ENABLE AUTHORING, POSTING, UPLOADING, DOWNLOADING, TRANSMITTING, RECEIVING, EDITING, EXTRACTING, ENCODING, DECODING, PLAYING, STORING, ORGANIZING, SHOWING, DISPLAYING, TAGGING, BLOGGING AND/OR SHARING ELECTRONIC MEDIA AND INFORMATION OVER THE INTERNET, LOCAL AREA NETWORK OR TELECOMMUNICATION NETWORK; COMPUTER SOFTWARE TO ENABLE USERS TO PROGRAM AND DISTRIBUTE AUDIO, VIDEO, TEXT AND OTHER MULTIMEDIA CONTENT, NAMELY, MUSIC, CONCERTS, VIDEOS, RADIO, TELEVISION, NEWS, SPORTS, GAMES, CULTURAL EVENTS, AND ENTERTAINMENT-RELATED AND EDUCATIONAL PROGRAMS VIA COMMUNICATION NETWORK; COMPUTER SOFTWARE TO RECEIVE, TRANSPORT, ENCODE, DECODE, DECRYPT, ENCRYPT, TRANSMIT, MULTIPLEX, DE-MULTIPLEX, AND MANIPULATE VIDEO, AUDIO AND TEXT IN DIGITAL FORMAT TO DELIVER TELEVISION AND OTHER VIDEO PROGRAMMING TO APPROPRIATE VIDEO DEVICES FOR DISTRIBUTION OF TELEVISION PROGRAMMING FOR VIEWING ON TELEVISION SETS AND COMPUTER MONITORS; COMPUTER SOFTWARE USED TO ENHANCE AND OPTIMIZE AUDIO AND VIDEO SOUND; COMPUTERS; DIGITAL CAMERAS; DIGITAL PHOTO ALBUMS FOR DISPLAYING DIGITAL PICTURES, VIDEO CLIPS AND MUSIC; DIGITAL PHOTO FRAMES FOR DISPLAYING DIGITAL PICTURES, VIDEO CLIPS AND MUSIC; DIGITAL SET-TOP BOXES, NAMELY, DIGITAL MEDIA RECEIVERS AND DECODERS, CABLE TELEVISION CONVERTERS, ETHERNET STREAMING MEDIA CONVERTERS; DOWNLOADABLE DIGITAL IMAGES, NAMELY, PHOTOGRAPHIC OR VIDEO IMAGES IN THE FIELD OF ARCHITECTURE, BALLET DANCERS, COSTUMES, MUSICAL INSTRUMENTS, SET DESIGNS, COMMUNICATION EQUIPMENT, SOUND WAVES, POLITICAL FIGURES, POVERTY, MOUNTAINS, LAKES, ROCK STRATA, SOLDIERS, HISTORICAL FIGURES AND PLACES, COURTHOUSES, LAWYERS, COURT SCENES, JUDGES, CRIMINALS, MANUSCRIPTS, BOOKS, BOOK COVER ART, ORCHESTRAS, ROCK BANDS, SINGERS, GUITAR PLAYERS, GUITARS, PHILOSOPHERS, PRINTING PRESSES, NEWSPAPERS, NEWSROOMS, LABORATORIES, SCIENCE LABS, SPACE, PLANETS, GALAXIES, THE MOON, PLANTS, SPACE ALIENS, SPACE SHIPS, SCIENCE FICTION CREATURES, CARS AND COMPUTERS; DOWNLOADABLE RING TONES FOR MOBILE PHONES AND TABLET COMPUTERS; DVD PLAYERS; ELECTRONIC WHITEBOARDS; FACSIMILE MACHINES; HARD DISK DRIVES; INTERCOM KEY PHONE TERMINALS FOR CONNECTION TO A TELEPHONE NETWORK; INTERNET PROTOCOL PHONES; INTERNET PROTOCOL PRIVATE BRANCH EXCHANGE (PBX) SWITCHBOARDS; KEY PHONE OPERATING SYSTEM SOFTWARE; KEY PHONE SWITCH BOARDS;

**CLASS 9—(Continued).**

LOCAL AREA NETWORK (LAN) SWITCHES; MOBILE PHONE AND TABLET COMPUTER ACCESSORIES, NAMELY, BATTERIES, ELECTRIC BATTERY CHARGERS, DATA COMMUNICATION CABLES, HEADSETS, EAR PHONES, BATTERY CHARGERS FOR USE IN A CAR, LEATHER CASES ADAPTED FOR MOBILE PHONES AND TABLET COMPUTERS, FLIP COVERS FOR MOBILE PHONES AND TABLET COMPUTERS, HANDS FREES KITS AND SNAP ON CASES ADAPTED FOR MOBILE PHONES AND TABLET COMPUTERS, STYLUS, AUDIO DOCKING STATIONS, SCREEN PROTECTIVE FILMS ADAPTED FOR MOBILE PHONES AND TABLET COMPUTERS AND PORTABLE SPEAKERS; MOBILE PHONE OPERATING SYSTEM SOFTWARE; MOBILE TELEPHONES; MP3 PLAYERS; NETWORK ACCESS SERVER HARDWARE; NETWORK ACCESS SERVER OPERATING SOFTWARE; OPTICAL DISK DRIVES; OPTICAL DISK PLAYERS; PERSONAL DIGITAL ASSISTANTS (PDAS); PORTABLE COMPUTERS; PORTABLE MEDIA PLAYER; PRINTERS FOR COMPUTERS; SEMICONDUCTORS CHIPS; SMART PHONES; STEREO AUDIO SPEAKERS; STYLUS FOR PORTABLE ELECTRONIC DEVICES; TABLET COMPUTER OPERATING SYSTEM SOFTWARE; TABLET COMPUTERS; TELEPHONES; TELEPHONES USED AS TERMINAL DEVICES FOR INTERNET PROTOCOL (IP) PRIVATE BRANCH EXCHANGE (PBX); TELEVISION RECEIVERS; 3D GLASSES; WIDE AREA NETWORK(-WAN) ROUTERS (U.S. CLS. 21, 23, 26, 36 AND 38).  
KATINA MISTER, EXAMINING ATTORNEY

SN 86-078,583. INDUSTRIAL TOYBOX LLC, PASADENA, CA. FILED 9-30-2013.



THE MARK CONSISTS OF A STYLIZED LETTER "M" WITH A FIVE-POINTED STAR BELOW THE MIDDLE LEG OF THE "M." THE WORDS "MIDNIGHT" AND "STAR" APPEAR CENTERED BELOW THE STAR ON SEPARATE LINES.

FOR COMPUTER GAME SOFTWARE FOR USE ON MOBILE AND CELLULAR PHONES, COMPUTER GAME SOFTWARE FOR USE WITH PERSONAL COMPUTERS, HOME VIDEO GAME CONSOLES USED WITH TELEVISIONS AND ARCADE-BASED VIDEO GAME CONSOLES; DOWNLOADABLE ELECTRONIC PUBLICATIONS IN THE NATURE OF COMIC BOOKS AND GRAPHIC NOVELS; INTERACTIVE VIDEO GAME PROGRAMS (U.S. CLS. 21, 23, 26, 36 AND 38).

KATHERINE CHANG, EXAMINING ATTORNEY



**CLASS 9—(Continued).**

SN 86-078,652. EVEREADY BATTERY COMPANY, INC., ST. LOUIS, MO. FILED 9-30-2013.



OWNER OF U.S. REG. NOS. 1,502,902, 4,436,250 AND OTHERS.  
 THE MARK CONSISTS OF A BUNNY BEATING A DRUM BEARING THE WORD "ENERGIZER".  
 FOR BATTERIES; BATTERY CHARGERS (U.S. CLS. 21, 23, 26, 36 AND 38).  
 KELLY BOULTON, EXAMINING ATTORNEY

**CLASS 9—(Continued).**

SN 86-079,268. G. B. & SMITH, NIMES, FRANCE, FILED 10-1-2013.

# 365View

THE MARK CONSISTS OF STANDARD CHARACTERS WITHOUT CLAIM TO ANY PARTICULAR FONT, STYLE, SIZE, OR COLOR.  
 FOR COMPUTER SOFTWARE FOR USE IN IMPLEMENTING AND MANAGING COMPUTER FILE PERMISSION AND ACCESS LEVELS BY PROVIDING A COMPREHENSIVE GRAPHICAL USER INTERFACE FOR USE THEREOF (U.S. CLS. 21, 23, 26, 36 AND 38).  
 TOBY BULLOFF, EXAMINING ATTORNEY

SN 86-079,422. SHELTERED WINGS, INC., MIDDLETON, WI. FILED 10-1-2013.

# RADIAN

THE MARK CONSISTS OF STANDARD CHARACTERS WITHOUT CLAIM TO ANY PARTICULAR FONT, STYLE, SIZE, OR COLOR.  
 OWNER OF U.S. REG. NO. 3,369,180.  
 FOR BINOCULARS (U.S. CLS. 21, 23, 26, 36 AND 38).  
 FIRST USE 10-1-2013; IN COMMERCE 10-1-2013.  
 KATHLEEN LORENZO, EXAMINING ATTORNEY

SN 86-078,861. VIGILANT SOLUTIONS, INC., MINNEAPOLIS, MN. FILED 9-30-2013.



OWNER OF U.S. REG. NO. 3,277,807.  
 NO CLAIM IS MADE TO THE EXCLUSIVE RIGHT TO USE "CAM", APART FROM THE MARK AS SHOWN.  
 THE MARK CONSISTS OF THE TERM "CAM" ABOVE THE TERM "SMARTZ" WITH AN OVAL DESIGN CONNECTING THE TWO TERMS. THE COLORS BLACK, WHITE AND/OR GRAY REPRESENT BACKGROUND, OUTLINING, SHADING AND/OR TRANSPARENT AREAS AND ARE NOT PART OF THE MARK.  
 FOR COMPUTER HARDWARE AND SOFTWARE IN THE FIELD OF SECURITY, NAMELY, CLOSED CIRCUIT TELEVISION AND RELATED SOFTWARE FOR REAL-TIME DETECTION, TRACKING, AND CLASSIFICATION OF OBJECTS (U.S. CLS. 21, 23, 26, 36 AND 38).  
 FIRST USE 4-3-2007; IN COMMERCE 4-3-2007.  
 DARRYL SPRUILL, EXAMINING ATTORNEY

SN 86-079,623. HARMAN INTERNATIONAL INDUSTRIES, INCORPORATED, NORTHRIDGE, CA. FILED 10-1-2013.



THE MARK CONSISTS OF A STYLIZED WAVEFORM DESIGN.  
 FOR SOFTWARE FOR OPTIMIZATION OF AUDIO SIGNALS AND AUDIO OUTPUT; COMPUTER HARDWARE FOR DIGITAL SIGNAL PROCESSING (U.S. CLS. 21, 23, 26, 36 AND 38).  
 HENRY S. ZAK, EXAMINING ATTORNEY

**CLASS 9—(Continued).**

SN 86-079,786. DISNEY ENTERPRISES, INC., BURBANK, CA. FILED 10-1-2013.



THE MARK CONSISTS OF STYLIZED LETTERS "DMG" AND WORD "NASHVILLE" WITH AN IMAGE OF A STAR OVER THE LETTERS "H" AND "V". THE LETTER "G" AND WORD "NASHVILLE" APPEAR OVER AN IRREGULAR HORIZONTAL DESIGN.

FOR MUSICAL SOUND RECORDINGS (U.S. CLS. 21, 23, 26, 36 AND 38).  
KATHERINE STOIDES, EXAMINING ATTORNEY

SN 86-079,809. GOODNIGHT FAMILY, LLC, RYE, NY. FILED 10-1-2013.

## COMPUTERVIZ

THE MARK CONSISTS OF STANDARD CHARACTERS WITHOUT CLAIM TO ANY PARTICULAR FONT, STYLE, SIZE, OR COLOR.

FOR CONTACT LENSES; CONTAINERS FOR CONTACT LENSES; EYEGLASS CHAINS AND CORDS; EYEGLASS LENSES; EYEWEAR, NAMELY, SUNGLASSES, EYEGLASSES AND OPHTHALMIC FRAMES AND CASES THEREFOR; SUNGLASS LENSES (U.S. CLS. 21, 23, 26, 36 AND 38).

JOHN GARTNER, EXAMINING ATTORNEY

SN 86-079,861. HARMAN INTERNATIONAL INDUSTRIES, INCORPORATED, NORTHRIDGE, CA. FILED 10-1-2013.



THE MARK CONSISTS OF THE WORDS "SIGNAL DOCTOR" AND A STYLIZED WAVEFORM DESIGN.

FOR SOFTWARE FOR OPTIMIZATION OF AUDIO SIGNALS AND AUDIO OUTPUT; COMPUTER HARDWARE FOR DIGITAL SIGNAL PROCESSING (U.S. CLS. 21, 23, 26, 36 AND 38).

HENRY S. ZAK, EXAMINING ATTORNEY

**CLASS 9—(Continued).**

SN 86-079,929. GRAYBAR SERVICES, INC., GLENDALE HEIGHTS, IL. FILED 10-1-2013.

## GRAYBAR GBID

THE MARK CONSISTS OF STANDARD CHARACTERS WITHOUT CLAIM TO ANY PARTICULAR FONT, STYLE, SIZE, OR COLOR.

OWNER OF U.S. REG. NOS. 835,653, 2,940,043 AND OTHERS.

FOR SOFTWARE FOR USE IN THE ELECTRICAL, DATA, AND COMMUNICATIONS INDUSTRIES FOR CONTRACT BIDDING, JOB ACCOUNTING, AND MANAGEMENT OF MATERIALS (U.S. CLS. 21, 23, 26, 36 AND 38).

COLLEEN DOMBROW, EXAMINING ATTORNEY

SN 86-079,933. GRAYBAR SERVICES, INC., GLENDALE HEIGHTS, IL. FILED 10-1-2013.

## GBID

THE MARK CONSISTS OF STANDARD CHARACTERS WITHOUT CLAIM TO ANY PARTICULAR FONT, STYLE, SIZE, OR COLOR.

FOR SOFTWARE FOR USE IN THE ELECTRICAL, DATA, AND COMMUNICATIONS INDUSTRIES FOR CONTRACT BIDDING, JOB ACCOUNTING, AND MANAGEMENT OF MATERIALS (U.S. CLS. 21, 23, 26, 36 AND 38).

COLLEEN DOMBROW, EXAMINING ATTORNEY

SN 86-079,982. PARAMOUNT PICTURES CORPORATION, HOLLYWOOD, CA. FILED 10-1-2013.

## JACK RYAN: SHADOW RECRUIT

THE MARK CONSISTS OF STANDARD CHARACTERS WITHOUT CLAIM TO ANY PARTICULAR FONT, STYLE, SIZE, OR COLOR.

THE NAME(S), PORTRAIT(S), AND/OR SIGNATURE(S) SHOWN IN THE MARK DOES NOT IDENTIFY A PARTICULAR LIVING INDIVIDUAL.

FOR CASES FOR EYEGLASSES AND SUNGLASSES; DECORATIVE MAGNETS; PROTECTIVE COVERS AND CASES FOR CELL PHONES, LAPTOPS AND PORTABLE MEDIA PLAYERS; PROTECTIVE COVERS AND CASES FOR TABLET COMPUTERS; SUNGLASSES (U.S. CLS. 21, 23, 26, 36 AND 38).

AHSEN KHAN, EXAMINING ATTORNEY

**CLASS 9—(Continued).**

SN 86-080,155. BEBE STUDIO, INC., LOS ANGELES, CA. FILED 10-1-2013.



OWNER OF U.S. REG. NOS. 2,289,914 AND 3,509,651.  
THE MARK CONSISTS OF THE STYLIZED NUMBER "2" AND THE STYLIZED LETTER "B" ON ONE LINE, FOLLOWED BY THE STYLIZED "BEBE" IN LOWERCASE ON THE LINE BELOW IT.

THE ENGLISH TRANSLATION OF THE WORD "BEBE" IN THE MARK IS "QUEEN OF HEARTS IN A PERSIAN DECK OF CARDS".

FOR EYEGLASS FRAMES; EYEWEAR; EYEWEAR ACCESSORIES, NAMELY, STRAPS, NECK CORDS AND HEAD STRAPS WHICH RESTRAIN EYEWEAR FROM MOVEMENT ON A WEARER; EYEWEAR CASES; EYEWEAR, NAMELY, SUNGLASSES, EYEGLASSES AND OPHTHALMIC FRAMES AND CASES THEREFOR (U.S. CLS. 21, 23, 26, 36 AND 38).

FIRST USE 7-1-2013; IN COMMERCE 7-1-2013.

KATHLEEN LORENZO, EXAMINING ATTORNEY

---

SN 86-080,180. APPLE INC., CUPERTINO, CA. FILED 10-1-2013.



PRIORITY CLAIMED UNDER SEC. 44(D) ON JAMAICA APPLICATION NO. 62302, FILED 4-3-2013.

OWNER OF U.S. REG. NOS. 3,268,180, 3,470,983 AND 3,886,204.

THE COLOR(S) BLUE, LIGHT BLUE, RED, WHITE IS/ARE CLAIMED AS A FEATURE OF THE MARK.

THE MARK CONSISTS OF A WHITE SQUARE WITH ROUNDED EDGES IN WHICH APPEARS A STYLIZED COMPASS COMPOSED OF A BLUE AND LIGHT BLUE CIRCLE, WHITE DEGREE MARKS, AND A STYLIZED NEEDLE WITH WHITE ON THE BOTTOM HALF AND RED ON THE TOP HALF.

FOR INTERNET BROWSER SOFTWARE; DOWNLOADABLE INTERNET BROWSER SOFTWARE (U.S. CLS. 21, 23, 26, 36 AND 38).

FIRST USE 6-10-2013; IN COMMERCE 9-18-2013.

STEPHANIE ALI, EXAMINING ATTORNEY

**CLASS 9—(Continued).**

SN 86-080,667. OMM TRAINING, LLC, PELHAM MANOR, NY. FILED 10-2-2013.



THE MARK CONSISTS OF A STYLIZED CARTOON DESIGN OF A MAN'S HEAD, WITH HIS EYES CLOSED AND SMILING, APPARENTLY IN MEDITATION; THE COLOR GRAY, AS IT APPEARS IN THE MARK, REPRESENTS BACKGROUND ONLY AND IS NOT CLAIMED AS A FEATURE OF THE MARK.

FOR COMPUTER APPLICATION SOFTWARE FOR MOBILE PHONES, DESKTOP COMPUTERS, PORTABLE MEDIA PLAYERS, AND HAND HELD COMPUTERS, NAMELY, SOFTWARE FOR MEDITATION, MINDFULNESS, STRESS RELIEF, IMPROVED DECISION MAKING, IMPROVED LEADERSHIP, AND INCREASED RESILIENCE (U.S. CLS. 21, 23, 26, 36 AND 38).

NICHOLAS COLEMAN, EXAMINING ATTORNEY

---

SN 86-081,819. WOLO MANUFACTURING CORP., DEER PARK, NY. FILED 10-3-2013.

**THE COMMISSIONER**

THE MARK CONSISTS OF STANDARD CHARACTERS WITHOUT CLAIM TO ANY PARTICULAR FONT, STYLE, SIZE, OR COLOR.

FOR SIRENS (U.S. CLS. 21, 23, 26, 36 AND 38).

FIRST USE 8-1-2013; IN COMMERCE 8-1-2013.

RUDY R. SINGLETON, EXAMINING ATTORNEY

**CLASS 9—(Continued).**

SN 86-082,470. NUTRSPACE, LLC, GRAND PRAIRIE, TX. FILED 10-3-2013.

**All things health**

THE MARK CONSISTS OF STANDARD CHARACTERS WITHOUT CLAIM TO ANY PARTICULAR FONT, STYLE, SIZE, OR COLOR.

NO CLAIM IS MADE TO THE EXCLUSIVE RIGHT TO USE "HEALTH", APART FROM THE MARK AS SHOWN.

FOR DOWNLOADABLE COMPUTER SOFTWARE FOR MONITORING HEALTH, PROVIDING CONSUMER HEALTH AND HEALTHCARE RESOURCES FOR SEARCHING, LOCATING, RATING, PURCHASING, EVALUATING, LEARNING AND INFERRING USER NEEDS AND PREFERENCES, AND MAKING PROACTIVE AND PERSONALIZED DECISIONS FOR CONSUMERS AND PATIENTS ABOUT A WIDE RANGE OF GOODS, SERVICES AND INFORMATION RELATED TO HEALTH AND GENERAL WELL BEING OVER A GLOBAL COMMUNICATIONS NETWORK AND USING ANY CONNECTED ACCESS MODE IN ANY FORMAT, NAMELY, MOBILE COMMUNICATION DEVICES, DESKTOP INTERNET, EMAIL, VOICE OR SOCIAL MEDIA CHANNELS; COMPUTER SOFTWARE FOR WIRELESS DATA COMMUNICATION FOR RECEIVING, PROCESSING, TRANSMITTING AND DISPLAYING INFORMATION RELATING TO HEALTH AND WELL BEING; COMPUTER SOFTWARE THAT ENABLES USERS TO PRODUCE, SHARE, AND DISCUSS HEALTH-RELATED INFORMATION OVER A GLOBAL COMMUNICATIONS NETWORK AND USING ANY CONNECTED ACCESS MODE IN ANY FORMAT, NAMELY, MOBILE COMMUNICATION DEVICES, DESKTOP INTERNET, EMAIL, VOICE OR SOCIAL MEDIA CHANNELS (U.S. CLS. 21, 23, 26, 36 AND 38).

JUSTINE D. PARKER, EXAMINING ATTORNEY

SN 86-082,865. BLUCARAT LLC, NEW YORK, NY. FILED 10-4-2013.

**BLUCARAT**

THE MARK CONSISTS OF STANDARD CHARACTERS WITHOUT CLAIM TO ANY PARTICULAR FONT, STYLE, SIZE, OR COLOR.

FOR COMPUTER E-COMMERCE SOFTWARE TO ALLOW USERS TO PERFORM ELECTRONIC BUSINESS TRANSACTIONS VIA A GLOBAL COMPUTER NETWORK; DOWNLOADABLE SOFTWARE IN THE NATURE OF COMPUTER SOFTWARE AND MOBILE APPLICATIONS FOR USE IN THE COLLECTION, ORGANIZING, MODIFYING, TRANSMISSION, STORAGE AND SHARING OF INFORMATION; DOWNLOADABLE SOFTWARE IN THE NATURE OF COMPUTER SOFTWARE AND MOBILE APPLICATIONS THAT ALLOW USERS TO CREATE, UPLOAD, BOOKMARK, VIEW, ANNOTATE, AND SHARE INFORMATION AND MULTIMEDIA CONTENT; DOWNLOADABLE SOFTWARE IN THE NATURE OF COMPUTER SOFTWARE AND MOBILE APPLICATIONS THAT FACILITATE SHARING AND DISCOVERING OF INFORMATION AND MEDIA CONTENT VIA LOCAL AND GLOBAL COMPUTER, ELECTRONIC, AND COMMUNICATIONS NETWORKS (U.S. CLS. 21, 23, 26, 36 AND 38).

RONALD MCMORROW, EXAMINING ATTORNEY

**CLASS 9—(Continued).**

SN 86-084,490. SAMSUNG ELECTRONICS CO., LTD., SUWON-CITY GYEONGGI-DO, REPUBLIC OF KOREA, FILED 10-7-2013.

**COASTER**

THE MARK CONSISTS OF STANDARD CHARACTERS WITHOUT CLAIM TO ANY PARTICULAR FONT, STYLE, SIZE, OR COLOR.

FOR COMPUTER HARDWARE; COMPUTER APPLICATION SOFTWARE FOR MOBILE DEVICES TO FACILITATE THE SHARING, CURATING, DISPLAY AND CONTROL OF PRESENTATIONS AND DIGITAL MEDIA (U.S. CLS. 21, 23, 26, 36 AND 38).

KATINA MISTER, EXAMINING ATTORNEY

SN 86-084,757. CNU ONLINE HOLDINGS, LLC, CHICAGO, IL. FILED 10-7-2013.

**CASHNETUSA**

THE MARK CONSISTS OF STANDARD CHARACTERS WITHOUT CLAIM TO ANY PARTICULAR FONT, STYLE, SIZE, OR COLOR.

OWNER OF U.S. REG. NOS. 3,210,976, 3,893,165 AND OTHERS.

FOR DOWNLOADABLE SOFTWARE IN THE NATURE OF A MOBILE APPLICATION FOR USE IN CONDUCTING AND MANAGING CONSUMER FINANCING TRANSACTIONS AND APPLYING FOR AND MANAGING PERSONAL LOANS (U.S. CLS. 21, 23, 26, 36 AND 38).

FIRST USE 5-8-2013; IN COMMERCE 5-8-2013.  
DOUGLAS LEE, EXAMINING ATTORNEY

SN 86-085,800. WHELEN ENGINEERING COMPANY, INC., CHESTER, CT. FILED 10-8-2013.

**AVENGER**

THE MARK CONSISTS OF STANDARD CHARACTERS WITHOUT CLAIM TO ANY PARTICULAR FONT, STYLE, SIZE, OR COLOR.

FOR EMERGENCY WARNING LIGHTS FOR VEHICLES (U.S. CLS. 21, 23, 26, 36 AND 38).

FIRST USE 4-0-2008; IN COMMERCE 4-0-2008.

ZACHARY R. SPARER, EXAMINING ATTORNEY

**CLASS 9—(Continued).**

SN 86-085,826. WHELEN ENGINEERING COMPANY, INC., CHESTER, CT. FILED 10-8-2013.

**FREEDOM**

THE MARK CONSISTS OF STANDARD CHARACTERS WITHOUT CLAIM TO ANY PARTICULAR FONT, STYLE, SIZE, OR COLOR.

FOR ELECTRIC WARNING LIGHTS, NAMELY, LIGHTBARS (U.S. CLS. 21, 23, 26, 36 AND 38). FIRST USE 7-0-2003; IN COMMERCE 7-0-2003. ZACHARY R. SPARER, EXAMINING ATTORNEY

**CLASS 9—(Continued).**

SN 86-088,261. WHELEN ENGINEERING COMPANY, INC., CHESTER, CT. FILED 10-10-2013.

**INDEPENDENCE**

THE MARK CONSISTS OF STANDARD CHARACTERS WITHOUT CLAIM TO ANY PARTICULAR FONT, STYLE, SIZE, OR COLOR.

FOR ELECTRIC WARNING LIGHTS, NAMELY, LIGHTBARS (U.S. CLS. 21, 23, 26, 36 AND 38). ZACHARY R. SPARER, EXAMINING ATTORNEY

SN 86-085,831. EXPRESSTECH INTERNATIONAL, LLC, OREM, UT. FILED 10-8-2013.

**THE 7 NON-NEGOTIABLES OF WINNING**

THE MARK CONSISTS OF STANDARD CHARACTERS WITHOUT CLAIM TO ANY PARTICULAR FONT, STYLE, SIZE, OR COLOR.

FOR ELECTRONIC MEDIA PRODUCTS, NAMELY, PRE-RECORDED AUDIOTAPES, VIDEO TAPES, CDS, DVDS, DOWNLOADABLE ELECTRONIC NEWSLETTERS, AND ELECTRONIC PUBLICATIONS, NAMELY, BOOKS, MAGAZINES AND MANUALS RECORDED ON ELECTRONIC MEDIA, ALL IN THE FIELDS OF BUILDING INDIVIDUAL AND BUSINESS ORGANIZATIONAL SKILLS, LEADERSHIP, CULTURE, EFFECTIVENESS AND GROWTH, FOCUSED ON THE PRINCIPLES OF RESPECT, BELIEF, TRUST, LOYALTY, COMMITMENT, COURAGE AND GRATITUDE (U.S. CLS. 21, 23, 26, 36 AND 38). COLLEEN DOMBROW, EXAMINING ATTORNEY

SN 86-085,841. WHELEN ENGINEERING COMPANY, INC., CHESTER, CT. FILED 10-8-2013.

**CANTROL**

THE MARK CONSISTS OF STANDARD CHARACTERS WITHOUT CLAIM TO ANY PARTICULAR FONT, STYLE, SIZE, OR COLOR.

FOR PROGRAMMABLE CONTROLLER AND SIREN FOR OPERATING VEHICULAR WARNING LIGHTS AND PUBLIC ADDRESS SPEAKERS (U.S. CLS. 21, 23, 26, 36 AND 38). FIRST USE 7-15-2010; IN COMMERCE 7-15-2010. ZACHARY R. SPARER, EXAMINING ATTORNEY

SN 86-088,836. GUARDIAN PROSTAR, INC., GRAND JUNCTION, CO. FILED 10-10-2013.

**BLUESTAR GPS**

THE MARK CONSISTS OF STANDARD CHARACTERS WITHOUT CLAIM TO ANY PARTICULAR FONT, STYLE, SIZE, OR COLOR.

NO CLAIM IS MADE TO THE EXCLUSIVE RIGHT TO USE "GPS", APART FROM THE MARK AS SHOWN. FOR GPS TRACKING AND POSITION DETERMINING DEVICES FOR TRACKING AND LOCATING BURIED UTILITY ASSETS BY FIELD CREWS IN THE UTILITY AND PIPELINE INDUSTRY (U.S. CLS. 21, 23, 26, 36 AND 38). MEREDITH MARESCA, EXAMINING ATTORNEY

SN 86-089,892. HARMAN INTERNATIONAL INDUSTRIES, INCORPORATED, NORTHRIDGE, CA. FILED 10-11-2013.

**DARE TO LISTEN**

THE MARK CONSISTS OF STANDARD CHARACTERS WITHOUT CLAIM TO ANY PARTICULAR FONT, STYLE, SIZE, OR COLOR.

FOR APPARATUS FOR RECORDING, TRANSMISSION OR REPRODUCTION OF SOUND OR IMAGES; HEADPHONES, EAR BUDS AND DOCKING STATIONS, AMPLIFIERS, PRE-AMPLIFIERS, TWEETERS, WOOFERS, SUBWOOFERS, RECEIVERS, TUNERS, RADIOS, LOUDSPEAKERS, SPEAKER DRIVERS, DVD-PLAYERS, OPTICAL DISC PLAYERS AND SOUND PROCESSORS (U.S. CLS. 21, 23, 26, 36 AND 38). HENRY S. ZAK, EXAMINING ATTORNEY

**CLASS 9—(Continued).**

SN 86-090,713. EXPRESSTECH INTERNATIONAL, LLC, OREM, UT. FILED 10-14-2013.

7NNs

THE MARK CONSISTS OF STANDARD CHARACTERS WITHOUT CLAIM TO ANY PARTICULAR FONT, STYLE, SIZE, OR COLOR.

FOR ELECTRONIC MEDIA PRODUCTS, NAMELY, PRE-RECORDED AUDIOTAPES, VIDEO TAPES, CDS, DVDS, DOWNLOADABLE ELECTRONIC NEWSLETTERS, AND ELECTRONIC PUBLICATIONS, NAMELY, BOOKS, MAGAZINES AND MANUALS RECORDED ON ELECTRONIC MEDIA, ALL IN THE FIELDS OF BUILDING INDIVIDUAL AND BUSINESS ORGANIZATIONAL SKILLS, LEADERSHIP, CULTURE, EFFECTIVENESS AND GROWTH, FOCUSED ON THE PRINCIPLES OF RESPECT, BELIEF, TRUST, LOYALTY, COMMITMENT, COURAGE AND GRATITUDE (U.S. CLS. 21, 23, 26, 36 AND 38).

COLLEEN DOMBROW, EXAMINING ATTORNEY

**CLASS 9—(Continued).**

SN 86-093,964. APPLE INC., CUPERTINO, CA. FILED 10-17-2013.



PRIORITY CLAIMED UNDER SEC. 44(D) ON JAMAICA APPLICATION NO. 62507, FILED 4-25-2013.

OWNER OF U.S. REG. NO. 3,886,206.

THE COLOR(S) ORANGE AND WHITE IS/ARE CLAIMED AS A FEATURE OF THE MARK.

THE MARK CONSISTS OF AN ORANGE SQUARE WITH ROUNDED CORNERS AND A WHITE STYLIZED DESIGN OF AN OPEN BOOK IN THE CENTER.

FOR COMPUTER SOFTWARE FOR USE IN SEARCHING, BROWSING, REVIEWING, SAMPLING, PLAYING, PURCHASING, DOWNLOADING, STORING, AND ORGANIZING ELECTRONIC PUBLICATIONS (U.S. CLS. 21, 23, 26, 36 AND 38).

STEPHANIE ALI, EXAMINING ATTORNEY

SN 86-094,512. APPLE INC., CUPERTINO, CA. FILED 10-17-2013.



PRIORITY CLAIMED UNDER SEC. 44(D) ON JAMAICA APPLICATION NO. 62503, FILED 4-25-2013.

OWNER OF U.S. REG. NOS. 2,935,038 AND 3,984,462.

THE COLOR(S) PINK, RED, ORANGE AND WHITE IS/ARE CLAIMED AS A FEATURE OF THE MARK.

THE MARK CONSISTS OF A RED, ORANGE, AND PINK SQUARE WITH ROUNDED CORNERS WITH A WHITE STYLIZED DESIGN OF A MUSICAL NOTE IN THE CENTER.

FOR COMPUTER SOFTWARE FOR USE IN REVIEWING, STORING, ORGANIZING, AND PLAYING LIVE AND PRE-RECORDED AUDIO CONTENT (U.S. CLS. 21, 23, 26, 36 AND 38).

FIRST USE 6-10-2013; IN COMMERCE 9-18-2013.

STEPHANIE ALI, EXAMINING ATTORNEY

SN 86-093,441. CASCADE CORPORATION, FAIRVIEW, OR. FILED 10-16-2013.

HFC

THE MARK CONSISTS OF STANDARD CHARACTERS WITHOUT CLAIM TO ANY PARTICULAR FONT, STYLE, SIZE, OR COLOR.

FOR LOAD CLAMPING REGULATOR FOR MATERIALS HANDLING EQUIPMENT, NAMELY, HYDRAULIC REGULATORS FOR FORK LIFT ATTACHMENTS (U.S. CLS. 21, 23, 26, 36 AND 38).

FIRST USE 10-0-2008; IN COMMERCE 10-0-2008.

SUSAN RICHARDS, EXAMINING ATTORNEY

**CLASS 9—(Continued).**

SN 86-094,565. APPLE INC., CUPERTINO, CA. FILED 10-17-2013.



PRIORITY CLAIMED UNDER SEC. 44(D) ON JAMAICA APPLICATION NO. 62508, FILED 4-25-2013.

OWNER OF U.S. REG. NOS. 2,935,038, 3,984,462 AND 4,119,260.

THE COLOR(S) PINK, PURPLE AND WHITE IS/ARE CLAIMED AS A FEATURE OF THE MARK.

THE MARK CONSISTS OF A PURPLE AND PINK SQUARE WITH ROUNDED CORNERS WITH A WHITE STYLIZED MUSICAL NOTE IN THE CENTER SURROUNDED BY A WHITE CIRCLE.

FOR COMPUTER SOFTWARE FOR USE IN SEARCHING, BROWSING, REVIEWING, SAMPLING, PLAYING, PURCHASING AND DOWNLOADING LIVE AND PRE-RECORDED AUDIO AND VIDEO CONTENT (U.S. CLS. 21, 23, 26, 36 AND 38).

FIRST USE 6-10-2013; IN COMMERCE 9-18-2013.  
STEPHANIE ALI, EXAMINING ATTORNEY

**CLASS 9—(Continued).**

SN 86-098,388. POLK AUDIO, INC., BALTIMORE, MD. FILED 10-22-2013.

**POLK HAMPDEN**

THE MARK CONSISTS OF STANDARD CHARACTERS WITHOUT CLAIM TO ANY PARTICULAR FONT, STYLE, SIZE, OR COLOR.

OWNER OF U.S. REG. NOS. 2,163,217, 2,888,137 AND OTHERS.

FOR AUDIO SPEAKERS (U.S. CLS. 21, 23, 26, 36 AND 38).

JENNY PARK, EXAMINING ATTORNEY

SN 86-098,789. NATURALMOTION LTD, OXFORD, UNITED KINGDOM, FILED 10-23-2013.

**Hyper Detail**

THE MARK CONSISTS OF STANDARD CHARACTERS WITHOUT CLAIM TO ANY PARTICULAR FONT, STYLE, SIZE, OR COLOR.

FOR COMPUTER SOFTWARE DEVELOPMENT TOOLS (U.S. CLS. 21, 23, 26, 36 AND 38).

CHRISTINE MARTIN, EXAMINING ATTORNEY

SN 86-097,650. THE CARTOON NETWORK, INC., ATLANTA, GA. FILED 10-22-2013.

**THE AMAZING WORLD OF GUMBALL**

THE MARK CONSISTS OF STANDARD CHARACTERS WITHOUT CLAIM TO ANY PARTICULAR FONT, STYLE, SIZE, OR COLOR.

OWNER OF U.S. REG. NO. 3,982,522.

FOR INTERACTIVE VIDEO GAME PROGRAMS; VIDEO GAME CARTRIDGES AND DISCS; ELECTRONIC GAME PROGRAMS; COMPUTER GAME CARTRIDGES AND DISCS; DOWNLOADABLE PRE-RECORDED VIDEO RECORDINGS FEATURING ENTERTAINMENT FOR CHILDREN; SUNGLASSES AND PROTECTIVE HELMETS FOR SPORTS (U.S. CLS. 21, 23, 26, 36 AND 38).

CHRISTOPHER LAW, EXAMINING ATTORNEY

SN 86-103,869. CERNER INNOVATION, INC., KANSAS CITY, KS. FILED 10-29-2013.

**CareAware Asset Management**

THE MARK CONSISTS OF STANDARD CHARACTERS WITHOUT CLAIM TO ANY PARTICULAR FONT, STYLE, SIZE, OR COLOR.

OWNER OF U.S. REG. NOS. 3,529,177, 4,106,307 AND OTHERS.

NO CLAIM IS MADE TO THE EXCLUSIVE RIGHT TO USE "ASSET MANAGEMENT", APART FROM THE MARK AS SHOWN.

FOR COMPUTER SOFTWARE AND DEVICES FOR USE IN THE HEALTH CARE FIELD, NAMELY, COMPUTER HARDWARE AND DATA ACQUISITION AND INTEGRATION SOFTWARE FOR MANAGING, STORING, ANALYZING, MAINTAINING, PROCESSING, STRUCTURING, REVIEWING, BUILDING, EDITING, DISTRIBUTING, COMMUNICATING, ORGANIZING, SHARING, REFERENCING, MONITORING AND INTEGRATING HEALTH CARE INFORMATION, AND RELATED USER MANUALS SOLD AS A UNIT THEREWITH (U.S. CLS. 21, 23, 26, 36 AND 38).

ROBIN CHOSID, EXAMINING ATTORNEY

**CLASS 9—(Continued).**

SN 86-104,124. CERNER INNOVATION, INC., KANSAS CITY, KS. FILED 10-29-2013.

## CareAware Waveform Management

THE MARK CONSISTS OF STANDARD CHARACTERS WITHOUT CLAIM TO ANY PARTICULAR FONT, STYLE, SIZE, OR COLOR.

OWNER OF U.S. REG. NOS. 3,529,177, 4,106,307 AND OTHERS.

NO CLAIM IS MADE TO THE EXCLUSIVE RIGHT TO USE "MANAGEMENT", APART FROM THE MARK AS SHOWN.

FOR COMPUTER SOFTWARE AND DEVICES FOR USE IN THE HEALTH CARE FIELD, NAMELY, COMPUTER HARDWARE AND DATA ACQUISITION AND INTEGRATION SOFTWARE FOR MANAGING, STORING, ANALYZING, MAINTAINING, PROCESSING, STRUCTURING, REVIEWING, BUILDING, EDITING, DISTRIBUTING, COMMUNICATING, ORGANIZING, SHARING, REFERENCING, MONITORING AND INTEGRATING HEALTH CARE INFORMATION, AND RELATED USER MANUALS SOLD AS A UNIT THEREWITH (U.S. CLS. 21, 23, 26, 36 AND 38).  
ROBIN CHOSID, EXAMINING ATTORNEY

SN 86-105,756. BARON T. LTD., NEW YORK, NY. FILED 10-30-2013.

## Dont' Leave Home Without It

THE MARK CONSISTS OF STANDARD CHARACTERS WITHOUT CLAIM TO ANY PARTICULAR FONT, STYLE, SIZE, OR COLOR.

FOR DOWNLOADABLE COMPUTER SOFTWARE FOR SCHEDULING, RESERVING AND PROVIDING TRANSPORTATION SERVICES, NAMELY, COMPUTER SOFTWARE TO ENABLE SCHEDULING RESERVATIONS FOR TRANSPORTATION OF PERSONS BY CAR AND LIMOUSINE AND FOR DISPATCHING MOTORIZED VEHICLES TO CUSTOMERS FOR THE PURPOSE OF PROVIDING TRANSPORTATION BY CAR AND LIMOUSINE (U.S. CLS. 21, 23, 26, 36 AND 38).  
THEODORE MCBRIDE, EXAMINING ATTORNEY

SN 86-106,897. SPEEDO INTERNATIONAL LIMITED, LONDON, UNITED KINGDOM, FILED 10-31-2013.

## GOGGLE MATRIX

THE MARK CONSISTS OF STANDARD CHARACTERS WITHOUT CLAIM TO ANY PARTICULAR FONT, STYLE, SIZE, OR COLOR.

NO CLAIM IS MADE TO THE EXCLUSIVE RIGHT TO USE "GOGGLE", APART FROM THE MARK AS SHOWN.

FOR SWIM GOGGLES (U.S. CLS. 21, 23, 26, 36 AND 38).

JENNIFER WILLISTON, EXAMINING ATTORNEY

**CLASS 9—(Continued).**

SN 86-107,240. AINSWORTH GAME TECHNOLOGY LIMITED, NEWINGTON, AUSTRALIA, FILED 10-31-2013.

## SHANGHAI NIGHTS

THE MARK CONSISTS OF STANDARD CHARACTERS WITHOUT CLAIM TO ANY PARTICULAR FONT, STYLE, SIZE, OR COLOR.

FOR COMPUTER SOFTWARE AND FIRMWARE FOR GAMES OF CHANCE ON ANY COMPUTERIZED PLATFORM, INCLUDING DEDICATED GAMING CONSOLES, VIDEO BASED SLOT MACHINES, REEL BASED SLOT MACHINES, AND VIDEO LOTTERY TERMINALS (U.S. CLS. 21, 23, 26, 36 AND 38).

JEFFREY LOOK, EXAMINING ATTORNEY

SN 86-107,343. AINSWORTH GAME TECHNOLOGY LIMITED, NEWINGTON, AUSTRALIA, FILED 10-31-2013.

## SUN MONEY

THE MARK CONSISTS OF STANDARD CHARACTERS WITHOUT CLAIM TO ANY PARTICULAR FONT, STYLE, SIZE, OR COLOR.

FOR COMPUTER SOFTWARE AND FIRMWARE FOR GAMES OF CHANCE ON ANY COMPUTERIZED PLATFORM, INCLUDING DEDICATED GAMING CONSOLES, VIDEO BASED SLOT MACHINES, REEL BASED SLOT MACHINES, AND VIDEO LOTTERY TERMINALS (U.S. CLS. 21, 23, 26, 36 AND 38).

JEFFREY LOOK, EXAMINING ATTORNEY

SN 86-108,005. SANDISK ENTERPRISE IP LLC, MILPITAS, CA. FILED 11-1-2013.

## SURESCALE

THE MARK CONSISTS OF STANDARD CHARACTERS WITHOUT CLAIM TO ANY PARTICULAR FONT, STYLE, SIZE, OR COLOR.

FOR BLANK DATA STORAGE DEVICES, NAMELY, NONVOLATILE FLASH MEMORY DRIVES, NONVOLATILE MEMORY DRIVES IN THE NATURE OF COMPUTER MEMORY HARDWARE, SOLID STATE DRIVES AND EMBEDDED MEMORY STORAGE DRIVES; DATA STORAGE DEVICES, NAMELY, PRE-RECORDED FLASH DRIVES AND SOLID STATE DRIVES FEATURING SOFTWARE FOR DATA MANAGEMENT, APPLICATION ACCELERATION, SECURITY AND ENCRYPTION OF DATA (U.S. CLS. 21, 23, 26, 36 AND 38).

JAMES MACFARLANE, EXAMINING ATTORNEY



**CLASS 9—(Continued).**

SN 86-109,571. PYRAMEX SAFETY PRODUCTS, LLC, COLLIERVILLE, TN. FILED 11-4-2013.

V3G

THE MARK CONSISTS OF STANDARD CHARACTERS WITHOUT CLAIM TO ANY PARTICULAR FONT, STYLE, SIZE, OR COLOR.

OWNER OF U.S. REG. NO. 3,021,939. FOR SAFETY GLASSES (U.S. CLS. 21, 23, 26, 36 AND 38).

FIRST USE 3-22-2013; IN COMMERCE 3-22-2013. SHARON MEIER, EXAMINING ATTORNEY

SN 86-110,340. PSYCHO KILLER MUSIC, LLC, WEST PALM BEACH, FL. FILED 11-5-2013.



THE MARK CONSISTS OF A DESIGN OF TWO CROSSED AXES.

FOR MUSICAL SOUND RECORDINGS AND MUSICAL AUDIOVISUAL RECORDINGS FEATURING A MUSICAL ARTIST; DIGITAL MEDIA, NAMELY, DOWNLOADABLE AUDIO FILES AND DOWNLOADABLE AUDIO AND VIDEO FILES FEATURING A MUSICAL ARTIST; DOWNLOADABLE RING TONES AND MUSIC VIA THE INTERNET AND WIRELESS DEVICES; DOWNLOADABLE SOUND RECORDINGS FEATURING A MUSICAL ARTIST (U.S. CLS. 21, 23, 26, 36 AND 38).

FIRST USE 7-5-2013; IN COMMERCE 7-5-2013. TRACY CROSS, EXAMINING ATTORNEY

**CLASS 9—(Continued).**

SN 86-110,743. AOL INC., DULLES, VA. FILED 11-5-2013.



THE COLOR(S) GREEN, WHITE AND GRAY IS/ARE CLAIMED AS A FEATURE OF THE MARK.

THE MARK CONSISTS OF THE LETTER "M" IN THREE DIMENSIONAL FORM IN WHITE WITH GRAY SHADING IN THE CENTER OF A GREEN SQUARE WITH ROUNDED CORNERS.

FOR WIRELESS NAVIGATION SOFTWARE, NAMELY, DOWNLOADABLE SOFTWARE FOR USE IN MOBILE AND CELLULAR COMMUNICATIONS DEVICES TO PERMIT ACCESS TO A GPS NAVIGATION PLATFORM VIA WIRELESS COMMUNICATIONS NETWORKS; DOWNLOADABLE SOFTWARE THAT ALLOWS MOBILE AND CELLULAR COMMUNICATIONS DEVICES TO ACT AS GPS RECEIVERS OVER WIRELESS NETWORKS; DOWNLOADABLE SOFTWARE FOR CUSTOMIZED MAPPING OF LOCATIONS, ELECTRONIC MAP DISPLAY, INTERACTIVE MAPS, DRIVING DIRECTIONS, TRIP PLANNING, TRAVEL PLANNING, BUSINESS FINDING, NAVIGATIONAL INFORMATION, AND DESTINATION INFORMATION (U.S. CLS. 21, 23, 26, 36 AND 38).

FIRST USE 11-14-2013; IN COMMERCE 11-14-2013. LINDA LAVACHE, EXAMINING ATTORNEY

SN 86-111,016. VARIAN MEDICAL SYSTEMS, INC., PALO ALTO, CA. FILED 11-5-2013.

NEXUS

THE MARK CONSISTS OF STANDARD CHARACTERS WITHOUT CLAIM TO ANY PARTICULAR FONT, STYLE, SIZE, OR COLOR.

FOR COMPUTER SOFTWARE AND HARDWARE FOR CAPTURING AND PROCESSING DIGITAL IMAGE DATA (U.S. CLS. 21, 23, 26, 36 AND 38).

JASON TURNER, EXAMINING ATTORNEY

**CLASS 9—(Continued).**

SN 86-111,778. SQUIRRELS LLC, BOLIVAR, OH. FILED 11-6-2013.



THE MARK CONSISTS OF A STYLIZED PARROT HEAD IN THE SHAPE OF A CIRCLE INCLUDING AN OUTLINE OF A RECTANGLE ABOVE THE BEAK AND A TRIANGLE LOCATED AT THE LOWER FRONT OF THE RECTANGLE.

FOR DOWNLOADABLE COMPUTER SOFTWARE, NAMELY, SOFTWARE FOR SHARING COMPUTER SCREENS, AND AUDIO AND VIDEO DATA BETWEEN COMPUTERS AND TELEVISIONS (U.S. CLS. 21, 23, 26, 36 AND 38).

FIRST USE 2-22-2012; IN COMMERCE 2-22-2012.  
DOUGLAS LEE, EXAMINING ATTORNEY

**CLASS 9—(Continued).**

SN 86-115,071. SCRIPPS NETWORKS, LLC, KNOXVILLE, DC. FILED 11-11-2013.

**VACATION HOUSE FOR FREE**

THE MARK CONSISTS OF STANDARD CHARACTERS WITHOUT CLAIM TO ANY PARTICULAR FONT, STYLE, SIZE, OR COLOR.

NO CLAIM IS MADE TO THE EXCLUSIVE RIGHT TO USE "VACATION HOUSE", APART FROM THE MARK AS SHOWN.

FOR PRERECORDED VIDEO DISKS, AUDIO AND VISUAL RECORDINGS, DOWNLOADABLE AUDIO AND VIDEO RECORDINGS, AND DVDS, ALL FEATURING CONTENT IN THE FIELDS OF HOME DESIGN, HOME BUILDING, REAL ESTATE AND RENOVATION; DOWNLOADABLE SOFTWARE APPLICATIONS FOR PROVIDING INFORMATION AND PRE-RECORDED TELEVISION PROGRAMS IN THE FIELDS HOME DESIGN, HOME BUILDING, REAL ESTATE AND RENOVATION (U.S. CLS. 21, 23, 26, 36 AND 38).

MICHAEL WIENER, EXAMINING ATTORNEY

SN 86-115,121. TRAVEL CHANNEL, LLC, THE, CHEVY CHASE, DC. FILED 11-11-2013.

SN 86-114,067. SANOFI, PARIS, FRANCE, FILED 11-8-2013.

**AUCTION ON WHEELS****RENTRACK**

THE MARK CONSISTS OF STANDARD CHARACTERS WITHOUT CLAIM TO ANY PARTICULAR FONT, STYLE, SIZE, OR COLOR.

FOR DOWNLOADABLE SOFTWARE USED FOR DIET MONITORING AND TRACKING FOOD AND MINERAL INTAKE, INTENDED FOR PEOPLE SUFFERING FROM KIDNEY DISEASE (U.S. CLS. 21, 23, 26, 36 AND 38).

THEODORE MCBRIDE, EXAMINING ATTORNEY

THE MARK CONSISTS OF STANDARD CHARACTERS WITHOUT CLAIM TO ANY PARTICULAR FONT, STYLE, SIZE, OR COLOR.

NO CLAIM IS MADE TO THE EXCLUSIVE RIGHT TO USE "AUCTION", APART FROM THE MARK AS SHOWN.

FOR PRERECORDED VIDEO DISKS, AUDIO AND VISUAL RECORDINGS, DOWNLOADABLE AUDIO AND VIDEO RECORDINGS, AND DVDS, ALL FEATURING CONTENT IN THE FIELDS OF TRAVEL, ADVENTURE, CULTURE, AND LIFESTYLES; DOWNLOADABLE SOFTWARE APPLICATIONS FOR PROVIDING INFORMATION AND PRE-RECORDED TELEVISION PROGRAMS IN THE FIELDS OF TRAVEL, ADVENTURE, CULTURE, AND LIFESTYLES (U.S. CLS. 21, 23, 26, 36 AND 38).

KATHERINE CONNOLLY, EXAMINING ATTORNEY

**CLASS 9—(Continued).**

SN 86-119,323. HUBBELL INCORPORATED, SHELTON, CT. FILED 11-14-2013.

**VANTAGE TECHNOLOGY**

THE MARK CONSISTS OF STANDARD CHARACTERS WITHOUT CLAIM TO ANY PARTICULAR FONT, STYLE, SIZE, OR COLOR.

NO CLAIM IS MADE TO THE EXCLUSIVE RIGHT TO USE "TECHNOLOGY", APART FROM THE MARK AS SHOWN.

FOR ELECTRICAL CONNECTORS FOR HAZARDOUS LOCATIONS (U.S. CLS. 21, 23, 26, 36 AND 38).

EVIN L. KOZAK, EXAMINING ATTORNEY



SN 86-120,169. ARNOUSE DIGITAL DEVICES CORP., LAKE SUCCESS, NY. FILED 11-15-2013.

**SKINNYSERVER**

THE MARK CONSISTS OF STANDARD CHARACTERS WITHOUT CLAIM TO ANY PARTICULAR FONT, STYLE, SIZE, OR COLOR.

FOR AD SERVER, NAMELY, A COMPUTER SERVER FOR STORING ADVERTISEMENTS AND DELIVERING ADVERTISEMENTS TO WEBSITES; COMMUNICATIONS SERVERS; COMPUTER NETWORK SERVER; COMPUTER SERVERS; COMPUTER SOFTWARE FOR CONTROLLING AND MANAGING ACCESS SERVER APPLICATIONS; DIGITAL MEDIA SERVERS; INTERNET SERVERS; INTRANET SERVERS; IP VIDEO SERVERS; NETWORK ACCESS SERVER HARDWARE; NETWORK ACCESS SERVER OPERATING SOFTWARE; NETWORK SERVERS (U.S. CLS. 21, 23, 26, 36 AND 38).

FIRST USE 10-30-2013; IN COMMERCE 10-30-2013.

MORGAN WYNNE, EXAMINING ATTORNEY

**CLASS 9—(Continued).**

SN 86-120,385. PROGRESS SOFTWARE CORPORATION, BEDFORD, MA. FILED 11-15-2013.

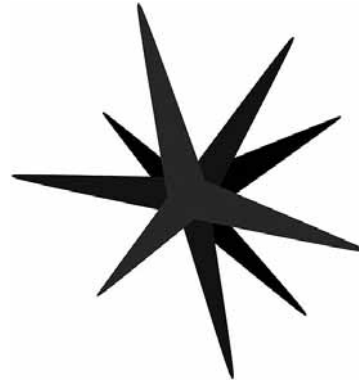

THE MARK CONSISTS OF A STYLIZED SPARK.

FOR DOWNLOADABLE COMPUTER SOFTWARE FOR USE IN THE FIELD OF INFORMATION TECHNOLOGY FOR THE DEVELOPMENT, DEPLOYMENT, INTEGRATION, HOSTING, AND MANAGEMENT OF OTHER COMPUTER PROGRAMS, BUSINESS APPLICATIONS AND DATA WITHIN PUBLIC OR PRIVATE ONLINE ENVIRONMENTS, WHICH MAY BE ON-PREMISE, CLOUD-BASED, OR A COMBINATION THEREOF, AND WHICH ARE ACCESSIBLE VIA LOCAL AREA, WIDE AREA, AND GLOBAL NETWORKS, AND USER GUIDES AND MANUALS FOR SUCH SOFTWARE SOLD THEREWITH (U.S. CLS. 21, 23, 26, 36 AND 38).

FIRST USE 10-5-2013; IN COMMERCE 10-5-2013.

TAMARA FRAZIER, EXAMINING ATTORNEY



SN 86-121,242. TRIPADVISOR LLC, NEWTON, MA. FILED 11-18-2013.

**THE PEOPLE BEHIND THE PLACES**

THE MARK CONSISTS OF STANDARD CHARACTERS WITHOUT CLAIM TO ANY PARTICULAR FONT, STYLE, SIZE, OR COLOR.

OWNER OF U.S. REG. NO. 3,902,859.  
FOR DOWNLOADABLE SOFTWARE IN THE NATURE OF A MOBILE APPLICATION USED TO ACCESS GUIDES AND REVIEWS OF TRAVEL SERVICE PROVIDERS, TRAVEL DESTINATIONS, TOURS, AND LOCAL ATTRACTIONS, AND USED TO ACCESS A SEARCHABLE DATABASE IN THE FIELD OF TRANSPORTATION, TRAVEL, AND TRAVEL PLANNING (U.S. CLS. 21, 23, 26, 36 AND 38).

SKYE YOUNG, EXAMINING ATTORNEY

**CLASS 9—(Continued).**

SN 86-121,418. EVEREADY BATTERY COMPANY, INC., ST. LOUIS, MO. FILED 11-18-2013.

# ENERGIZER

THE MARK CONSISTS OF STANDARD CHARACTERS WITHOUT CLAIM TO ANY PARTICULAR FONT, STYLE, SIZE, OR COLOR.

OWNER OF U.S. REG. NOS. 1,502,902, 4,365,713 AND OTHERS.

FOR WEBCAMS; MICROPHONES; HEADSETS FOR USE WITH COMPUTERS; INTERNET PHONES; COMPUTER KEYBOARDS; PROTECTIVE COVERS FOR COMPUTERS AND LAPTOPS; WRIST RESTS FOR USE WITH COMPUTERS; COMPUTER KEYPADS; PROTECTIVE SLEEVES FOR LAPTOP COMPUTERS; LAPTOP CARRYING CASES; BLANK RECORDABLE CD-RS AND DVD-RS; USB HUBS; CD AND DVD BURNERS; CD AND DVD DRIVES; PORTABLE MEDIA PLAYERS; COMPUTER HARDWARE, NAMELY, WIRELESS NETWORK EXTENDERS; WIRELESS ADAPTERS FOR COMPUTERS (U.S. CLS. 21, 23, 26, 36 AND 38).

KELLY BOULTON, EXAMINING ATTORNEY

---

SN 86-123,749. FIRST TEXAS PRODUCTS, LLC, EL PASO, TX. FILED 11-20-2013.

# G2

THE MARK CONSISTS OF STANDARD CHARACTERS WITHOUT CLAIM TO ANY PARTICULAR FONT, STYLE, SIZE, OR COLOR.

FOR METAL DETECTORS (U.S. CLS. 21, 23, 26, 36 AND 38).

FIRST USE 9-30-2010; IN COMMERCE 9-30-2010.

DAVID ELTON, EXAMINING ATTORNEY

**CLASS 9—(Continued).**

SN 86-124,852. UNIVERSAL CITY STUDIOS LLC, UNIVERSAL CITY, CA. FILED 11-20-2013.

# MINION MISHAP

THE MARK CONSISTS OF STANDARD CHARACTERS WITHOUT CLAIM TO ANY PARTICULAR FONT, STYLE, SIZE, OR COLOR.

FOR DOWNLOADABLE COMPUTER, VIDEO AND ELECTRONIC GAME PROGRAMS AND SOFTWARE VIA A GLOBAL COMPUTER NETWORK AND WIRELESS COMMUNICATION DEVICES; DOWNLOADABLE INTERACTIVE COMPUTER, VIDEO AND ELECTRONIC GAME PROGRAMS AND SOFTWARE VIA A GLOBAL COMPUTER NETWORK AND WIRELESS COMMUNICATION DEVICES; COMPUTER, VIDEO AND ELECTRONIC GAMES, GAME PROGRAMS, SOFTWARE, CARTRIDGES, AND MEMORY CARDS; INTERACTIVE COMPUTER, VIDEO AND ELECTRONIC GAMES, GAME PROGRAMS, SOFTWARE, CARTRIDGES, AND MEMORY CARDS (U.S. CLS. 21, 23, 26, 36 AND 38).

ROBERT C. CLARK JR., EXAMINING ATTORNEY

---

SN 86-131,097. PAYSTR LLC, BAY CITY, MI. FILED 11-27-2013.

# PRICEDROPPR

THE MARK CONSISTS OF STANDARD CHARACTERS WITHOUT CLAIM TO ANY PARTICULAR FONT, STYLE, SIZE, OR COLOR.

FOR PAYMENT PROCESSING CHECK OUT SOFTWARE APPLICATION WHEREBY THE PRICE OF DIGITAL PRODUCTS IS REDUCED OR ELIMINATED IF THE CUSTOMER COMPLETES ENOUGH ADVERTISING OFFERS SUCH AS SURVEYS OR VIEWING PRODUCT ADVERTISING VIDEOS (U.S. CLS. 21, 23, 26, 36 AND 38).

DAVID BROOKSHIRE, EXAMINING ATTORNEY

---

SN 86-131,513. VOXX INTERNATIONAL CORPORATION, HAUPPAUGE, NY. FILED 11-27-2013.

# HERE TO ANYWHERE

THE MARK CONSISTS OF STANDARD CHARACTERS WITHOUT CLAIM TO ANY PARTICULAR FONT, STYLE, SIZE, OR COLOR.

FOR USB CHARGERS FOR USE IN AUTOMOBILES, HOMES AND OFFICES (U.S. CLS. 21, 23, 26, 36 AND 38).

SUSAN RICHARDS, EXAMINING ATTORNEY

**CLASS 9—(Continued).**

SN 86-133,457. NATURALMOTION LTD, OXFORD, UNITED KINGDOM, FILED 12-3-2013.



THE MARK CONSISTS OF A HUMAN-LIKE CARTOON FIGURE HAVING LARGE EYES DRESSED IN A NINJA COSTUME, HOLDING A SIGN THAT SAYS IN CAPITAL LETTERS "CLUMSY NINJA".

FOR COMPUTER GAME PROGRAMS; COMPUTER GAME SOFTWARE; COMPUTER GAME SOFTWARE DOWNLOADABLE FROM A GLOBAL COMPUTER NETWORK; COMPUTER GAME SOFTWARE FOR USE ON MOBILE AND CELLULAR PHONES; COMPUTER PROGRAMS FOR VIDEO AND COMPUTER GAMES; DOWNLOADABLE COMPUTER GAME PROGRAMS; DOWNLOADABLE COMPUTER GAME SOFTWARE VIA A GLOBAL COMPUTER NETWORK AND WIRELESS DEVICES; DOWNLOADABLE ELECTRONIC GAME PROGRAMS; ELECTRONIC GAME SOFTWARE FOR CELLULAR TELEPHONES; ELECTRONIC GAME SOFTWARE FOR HANDHELD ELECTRONIC DEVICES; ELECTRONIC GAME SOFTWARE FOR WIRELESS DEVICES; INTERACTIVE GAME PROGRAMS; INTERACTIVE GAME SOFTWARE; VIDEO AND COMPUTER GAME PROGRAMS (U.S. CLS. 21, 23, 26, 36 AND 38).

FIRST USE 11-22-2013; IN COMMERCE 11-22-2013.  
CHRISTINE MARTIN, EXAMINING ATTORNEY

SN 86-138,384. METAMAKO TECHNOLOGY LP, SIDNEY, AUSTRALIA, FILED 12-9-2013.

**METACONNECT**

THE MARK CONSISTS OF STANDARD CHARACTERS WITHOUT CLAIM TO ANY PARTICULAR FONT, STYLE, SIZE, OR COLOR.

FOR COMPUTER NETWORK SWITCHES (U.S. CLS. 21, 23, 26, 36 AND 38).  
SHAVELL MCPHERSON, EXAMINING ATTORNEY

**CLASS 10—MEDICAL APPARATUS**

SN 76-714,951. HUNTER, ALTON LEE, JR., COLUMBIA, TN, FILED 9-16-2013.

**WHY STRUGGLE**

THE MARK CONSISTS OF STANDARD CHARACTERS WITHOUT CLAIM TO ANY PARTICULAR FONT, STYLE, SIZE, OR COLOR.

FOR ARM POSITIONER DEVICE FOR USE DURING ORTHOPAEDIC SURGICAL PROCEDURES ON AN ARM (U.S. CLS. 26, 39 AND 44).

DAVID BROOKSHIRE, EXAMINING ATTORNEY

SN 79-114,225. MEDI USA LP, WHITSETT, NC. FILED 3-22-2012.

**mediven active**

THE MARK CONSISTS OF STANDARD CHARACTERS WITHOUT CLAIM TO ANY PARTICULAR FONT, STYLE, SIZE, OR COLOR.

OWNER OF INTERNATIONAL REGISTRATION 1119681A DATED 3-22-2012, EXPIRES 3-22-2022.

OWNER OF U.S. REG. NOS. 2,818,660, 3,794,717 AND 3,895,106.

NO CLAIM IS MADE TO THE EXCLUSIVE RIGHT TO USE "ACTIVE", APART FROM THE MARK AS SHOWN.

FOR MEDICAL STOCKINGS FOR ARM AND LEG, NAMELY, COMPRESSION STOCKINGS, ANTI-THROMBOSIS STOCKINGS, SUPPORT STOCKINGS; MEDICAL TIGHTS, NAMELY, COMPRESSION TIGHTS, ANTI-THROMBOSIS TIGHTS, SUPPORT TIGHTS (U.S. CLS. 26, 39 AND 44).

LAURIE KAUFMAN, EXAMINING ATTORNEY

SN 79-128,956. KONINKLIJKE PHILIPS N.V., NETHERLANDS, FILED 4-3-2013.

**INFRACARE**

THE MARK CONSISTS OF STANDARD CHARACTERS WITHOUT CLAIM TO ANY PARTICULAR FONT, STYLE, SIZE, OR COLOR.

OWNER OF INTERNATIONAL REGISTRATION 0846217 DATED 3-17-2005, EXPIRES 3-17-2015.

FOR ULTRAVIOLET AND INFRARED IRRADIATION LAMPS FOR THERAPEUTICAL, CURATIVE AND/OR MEDICINAL PURPOSES; SUNLAMPS AND SUNBEDS FOR MEDICAL USE (U.S. CLS. 26, 39 AND 44).

APRIL ROACH, EXAMINING ATTORNEY

**CLASS 10—(Continued).**

SN 79-129,189. LIGHTNIX, INC., JAPAN, FILED 2-21-2013.

# PINNIX

THE MARK CONSISTS OF STANDARD CHARACTERS WITHOUT CLAIM TO ANY PARTICULAR FONT, STYLE, SIZE, OR COLOR.

PRIORITY DATE OF 1-7-2013 IS CLAIMED.

OWNER OF INTERNATIONAL REGISTRATION 1157890 DATED 2-21-2013, EXPIRES 2-21-2023.

FOR LANCETS; NEEDLES FOR MEDICAL PURPOSES; MEDICAL APPARATUS AND INSTRUMENTS FOR USE IN BLOOD GLUCOSE MEASUREMENT (U.S. CLS. 26, 39 AND 44).

JAMES GRIFFIN, EXAMINING ATTORNEY



SN 79-131,573. CEREDAS, FRANCE, FILED 4-24-2013.

# CEREDAS

THE MARK CONSISTS OF STANDARD CHARACTERS WITHOUT CLAIM TO ANY PARTICULAR FONT, STYLE, SIZE, OR COLOR.

OWNER OF INTERNATIONAL REGISTRATION 1164001 DATED 4-24-2013, EXPIRES 4-24-2023.

FOR SURGICAL, MEDICAL, DENTAL AND VETERINARY APPARATUS AND INSTRUMENTS, NAMELY, MEDICAL DEVICES FOR IMPROVING PULMONARY AND PHONATORY FUNCTIONS, NAMELY, VALVES, UNIVERSAL ADAPTERS FOR VALVES FOR PHONATORY IMPLANTS, TUBES AND CANNULAE, SHOWER PROTECTIONS, HEAT AND MOISTURE EXCHANGERS, DISPOSABLE TRACHEAL PROTECTIONS, ALL THE AFORESAID GOODS INTENDED FOR TRACHEOTOMIZED AND/OR LARYNGECTOMIZED SUBJECTS (U.S. CLS. 26, 39 AND 44).

BERNICE MIDDLETON, EXAMINING ATTORNEY

**CLASS 10—(Continued).**

SN 79-134,745. FUN FACTORY GMBH, FED REP GERMANY, FILED 6-21-2013.

PRIORITY DATE OF 6-14-2013 IS CLAIMED.

OWNER OF INTERNATIONAL REGISTRATION 1172119 DATED 6-21-2013, EXPIRES 6-21-2023.

OWNER OF U.S. REG. NOS. 4,024,736, 4,192,569 AND 4,223,825.

THE COLOR(S) RED, CHAMPAGNE (PANTONE 10136 C), AND WHITE IS/ARE CLAIMED AS A FEATURE OF THE MARK.

THE MARK CONSISTS OF THREE CIRCLES STACKED IN A COLUMN, WITH THE TOP CIRCLE IS RED AND CONTAINS THE WORDING "FUN" IN STYLIZED WHITE LETTERING, THE MIDDLE CIRCLE IN CHAMPAGNE AND CONTAINS A WHITE PLUS SIGN, AND THE BOTTOM CIRCLE IS CAMPAGNE AND CONTAINS A WHITE MINUS SIGN. THE BACKGROUND WHICH APPEARS WHITE AND CHAMPAGNE IS NOT CLAIMED AS A FEATURE OF THE MARK.

FOR DILDOS IN THE NATURE OF ARTIFICIAL PENISES; MASSAGE BALLS IN THE NATURE OF BENWA BALLS (U.S. CLS. 26, 39 AND 44).

MATTHEW MCDOWELL, EXAMINING ATTORNEY

**CLASS 10—(Continued).**

SN 79-137,720. JIANGSU SUYUN MEDICAL MATERIALS CO., LTD., CHINA, FILED 7-16-2013.



OWNER OF INTERNATIONAL REGISTRATION 1179723 DATED 7-16-2013, EXPIRES 7-16-2023.

THE MARK CONSISTS OF THE WORDING "MED-SUYUN" IN STYLIZED FONT AGAINST A PARTIALLY SHADED OVAL.

THE WORDING "MEDSUYUN" HAS NO MEANING IN A FOREIGN LANGUAGE.

FOR CATHETERS; SYRINGES FOR INJECTIONS; INJECTORS FOR MEDICAL PURPOSES; MEDICAL APPARATUS AND INSTRUMENTS FOR SURGERY; MEDICAL APPARATUS AND INSTRUMENTS FOR TREATING CARDIOVASCULAR DISEASE; MEDICAL APPARATUS AND INSTRUMENTS FOR TREATING OSTEOARTHRITIS AND OSTEOPOROSIS; OTOLARYNGOLOGICAL APPARATUS AND INSTRUMENTS, NAMELY, SINUSCOPES, OTOSCOPES, AND LARYNGOSCOPES; BLOOD TRANSFUSION APPARATUS; GALVANIC THERAPEUTIC APPLIANCES, NAMELY, LOW FREQUENCY ELECTRIC THERAPY APPARATUS FOR USE IN THERMAL THERAPY; GALVANIC THERAPEUTIC APPLIANCES, NAMELY, GALVANIC NERVE STIMULATORS; GALVANIC THERAPEUTIC APPLIANCES, NAMELY, ELECTRONIC STIMULATION APPARATUS FOR NERVES, SKIN, AND MUSCLES FOR PHYSICAL THERAPY PURPOSES; ORTHOPEDIC ARTICLES, NAMELY, ORTHOPEDIC BRACES, ORTHOPEDIC JOINT IMPLANTS MADE OF ARTIFICIAL MATERIALS, ORTHOPEDIC SHOE INSERTS, ORTHOPEDIC SUPPORTS, AND ORTHOPEDIC SPLINTS; DISPOSABLE INFUSION SET; VAGINAL DILATORS (U.S. CLS. 26, 39 AND 44).

JOHN KELLY, EXAMINING ATTORNEY

SN 79-140,046. LAERDAL MEDICAL AS, NORWAY, FILED 9-16-2013.

# MAMA-U

THE MARK CONSISTS OF STANDARD CHARACTERS WITHOUT CLAIM TO ANY PARTICULAR FONT, STYLE, SIZE, OR COLOR.

PRIORITY DATE OF 4-19-2013 IS CLAIMED.

OWNER OF INTERNATIONAL REGISTRATION 1185735 DATED 9-16-2013, EXPIRES 9-16-2023.

FOR MEDICAL APPARATUS FOR TRAINING OF HEALTH PERSONNEL IN POSTPARTUM INTERVENTIONS, NAMELY A SIMULATED HUMAN-LIKE UTERUS WITH CERVIX AND VAGINA (U.S. CLS. 26, 39 AND 44).

SHAILA LEWIS, EXAMINING ATTORNEY

**CLASS 10—(Continued).**

SN 85-389,681. INTUITIVE SURGICAL, INC., SUNNYVALE, CA. FILED 8-4-2011.

# FIREFLY

THE MARK CONSISTS OF STANDARD CHARACTERS WITHOUT CLAIM TO ANY PARTICULAR FONT, STYLE, SIZE, OR COLOR.

FOR COMPUTERIZED SURGICAL MANIPULATION SYSTEM COMPRISED OF SURGEON'S CONSOLE, MASTER CONTROL, IMMERSIVE VIDEO DISPLAY, CAMERA IMAGE PROCESSING EQUIPMENT, SURGICAL MANIPULATION SYSTEM SOFTWARE AND INSTRUCTIONAL MANUALS PROVIDED AS A UNIT; MEDICAL APPARATUS, NAMELY, PATIENT-SIDE CART WITH SET-UP ARMS AND MANIPULATOR SLAVE ARMS FOR USE IN COMPUTERIZED SURGICAL MANIPULATION SYSTEMS; MEDICAL APPARATUS, NAMELY, STERILE ADAPTORS TO CONNECT ARMS TO INSTRUMENTS FOR USE IN COMPUTERIZED SURGICAL MANIPULATION SYSTEMS; A FULL LINE OF RESPONSIBLE LIMITED RE-USE TOOLS AND INSTRUMENTS FOR MEDICAL USE, NAMELY, LAPAROSCOPES, ENDOSCOPES, TROCARS, CANNULAS, CUTTERS, CLAMPS, ELEVATORS, GOUGES, KNIVES, SCOPE PREHEATERS, LIGHT SOURCES, CABLES AND COMPONENT PARTS, ELECTROSURGICAL INSTRUMENTS, ELECTROCAUTERY INSTRUMENTS, LASER INSTRUMENTS, ULTRASOUND INSTRUMENTS, LENS CLEANING, SCRUB AND BIOPSY BRUSHES, CLIP APPLIERS AND CLIPS, TACK APPLIERS AND TACKS, APPLICATORS, LIGATURE CARRIERS, NEEDLE HOLDERS, CLAMPS, HEMOSTATS, GRASPERS, CURETTES, INSTRUMENT GUIDES, LIGATURE PASSING AND KNOTTING INSTRUMENTS, NEEDLES, RETRACTORS, SNARES, STYLETS, FORCEPS, DISSECTORS, CALIERS, SCISSORS, SUCTION AND IRRIGATION PROBES, STERILE DRAPES, HEMOSTATS, AMPUTATION HOOKS, OSTEOTOMES, SAWS, RETAINERS, SUTURING APPARATUS, MEASURING TAPES, CHISELS AND CONTRACTORS, FILES, SKIN GRAFT EXPANDERS, LANCETS, MALLETS, PLIERS, HAMMERS, RASPS, SPATULAS, AND STRIPPERS; SURGICAL INSTRUMENTS, NAMELY, SCALPELS, SCALPEL BLADES AND HANDLES, STAPLERS, TACKERS, CLIP APPLIERS, ELECTROCAUTERY TOOLS, FORCEPS, NEEDLE HOLDERS, GUIDES AND DRIVERS, GRASPERS, AND KITENERS (U.S. CLS. 26, 39 AND 44).

SALLY SHIH, EXAMINING ATTORNEY

SN 85-411,312. ANATASOL, LLC, AUSTIN, TX. FILED 8-31-2011.

# Tone the V-Zone

THE MARK CONSISTS OF STANDARD CHARACTERS WITHOUT CLAIM TO ANY PARTICULAR FONT, STYLE, SIZE, OR COLOR.

FOR MEDICAL DEVICES FOR KEGEL EXERCISES, NAMELY, PELVIC FLOOR EXERCISERS FOR USE TO TREAT SYMPTOMS OF URINARY INCONTINENCE AND FOR THERAPEUTIC PURPOSES (U.S. CLS. 26, 39 AND 44).

WILLIAM JACKSON, EXAMINING ATTORNEY

**CLASS 10—(Continued).**

SN 85-422,827. SAMSUNG ELECTRONICS CO., LTD., SUWON-SI, GYEONGGI-DO, REPUBLIC OF KOREA, FILED 9-14-2011.

# XGEO

THE MARK CONSISTS OF STANDARD CHARACTERS WITHOUT CLAIM TO ANY PARTICULAR FONT, STYLE, SIZE, OR COLOR.

OWNER OF REPUBLIC OF KOREA REG. NO. 0936356, DATED 10-5-2012, EXPIRES 10-5-2022.

FOR OBSTETRIC APPARATUS FOR CATTLE; OPHTHALMOMETERS; HOOKS FOR MEDICAL PURPOSES, NAMELY, SURGICAL SKIN HOOKS, PHLEBECTOMY HOOKS, HOOKS FOR SPONDYLOLYSIS; CASTRATING APPARATUS FOR VETERINARY PURPOSES; CASTRATING PINCERS; HEALTH TRUSSES; OPHTHALMOSCOPES; EYE TESTING MACHINES AND APPARATUS; SKIASCOPES; LITHOTOMICAL INSTRUMENTS; FORCEPS ELEVATORS; SPECULUMS; MEDICAL INSTRUMENTS FOR PERCUTANEOUS TRACHEOSTOMY; RIGID AND FLEXIBLE MEDICAL ENDOSCOPES; STATIC ELECTRIC THERAPY APPARATUS; HIGH FREQUENCY ELECTROMAGNETIC THERAPY APPARATUS; DIAPHYSEAL PLUGS; PERIOSTEAL ELEVATORS; PELVIMETERS; INTRAMEDULLARY NAILS; BONE CEMENTATION TOOLS AND EQUIPMENT, NAMELY, BONE FORCEPS, BONE REPAIR COMPOUND FOR USE IN ORTHOPEDIC SURGERY, BONE RETRACTORS, BONE SCRAPERS AND BONE SCREWS; BUCCAL TUBES; MEDICAL STRETCHERS; SURGICAL ELEVATORS; PERIOSTEAL EAR TRUMPETS BEING HEARING AIDS; MEDICAL APPARATUS FOR USE IN SURGICAL OPERATIONS OF FALLOPIAN TUBE; APPARATUS FOR THE TREATMENT OF DEAFNESS, NAMELY, HEARING AIDS; ENDOSCOPIC CAMERAS; ENDOSCOPIC EQUIPMENT; VALVES FOR THE TREATMENT OF HYDROCEPHALUS; ELECTROENCEPHALOGRAPHS; CATHETERS; INTERPUPILLOMETERS; DEVICES FOR MEASURING INTRACRANIAL PRESSURE; STRETCHERS; LANCETS; FORCEPS FOR REPOSITIONING; ANESTHETIC INHALERS BEING SOLD EMPTY; ANESTHETIC DELIVERY APPARATUS; PULSE MEASURING DEVICES; IMMUNE AFFINITY CHROMATOGRAPHY APPARATUS FOR MEDICAL PURPOSES; DISINFECTING ULTRAVIOLET LAMPS HOUSED IN A CONTAINER OR COVER FOR DISINFECTING OBJECTS PLACED THEREIN FOR HOSPITAL USE; CAPILLARY DRAINAGE TUBES; CAPILLARY REAGENT TUBES; CRUTCHES; PHYSIOTHERAPY APPARATUS, NAMELY, EXERCISE MACHINES FOR THERAPEUTIC PURPOSES; INCUBATORS FOR BABIES; ESTHETIC MASSAGE APPARATUS; WHEELED STRETCHERS; SURGICAL HAND TOOLS, NAMELY, RASPS; RADIATION DOSIMETERS FOR ASSESSING THERAPEUTIC DOSES OF RADIATION DELIVERED TO PATIENT; PLATINUM CAUTERIES; PROSTHETIC INSTRUMENTS FOR DENTAL PURPOSES; HEARING AIDS; WALKING AIDS FOR MEDICAL PURPOSES; ABDOMINAL BELTS; ABDOMINAL CORSETS; ABDOMINAL PADS; BONE SCRAPERS; SUTURE MATERIALS; SUTURE NEEDLES; GLASS CONTAINERS FOR CUPPING THERAPY; MEDICAL MATTRESSES FOR CHILDBIRTH; UROLOGICAL APPARATUS AND INSTRUMENTS, NAMELY, IMAGING SYSTEMS; EMERGENCY PELVIC CLAMPS; SUBSTITUTES FOR BONES, CARTILAGE, LIGAMENTS AND TENDONS; BONE RETRACTORS; BONE SETTING MACHINES AND INSTRUMENTS; BONE FORCEPS; OSSIOUS IMPLANTS; ARTIFICIAL BONE PARTS TO BE IMPLANTED IN NATURAL BONES; OBSTETRIC APPARATUS FOR HUMAN PURPOSE; DILATORS FOR OBSTETRICS AND GYNECOLOGY; OXYGEN INHALATORS; ELBOW GUARD FOR EPICONDYLITIS; CAPILLARY TUBES FOR SAMPLES; MEDICAL INSTRUMENTS FOR INTERSTITIAL THERMOTHERAPY OF BIOLOGICAL TISSUE; TONGUE DEPRESSORS; LAVAGE APPARATUS, NAMELY, NETI POT FOR NASAL LAVAGE; MEDICAL AND DENTAL STERILIZERS; RE-

**CLASS 10—(Continued).**

SUSCITATION APPARATUS; BOUGIES; OPERATING TABLES; LIGHTING APPARATUS FOR SURGICAL OPERATIONS; MICROSCOPES FOR OPERATIONS; POST-OPERATIVE PRESSURE GARMENTS; MERCURY ARC LAMP UNITS FOR THERAPEUTIC PURPOSES; SURGICAL VETERINARY APPARATUS AND INSTRUMENTS; OBSTETRICAL APPARATUS FOR VETERINARY PURPOSES; SURGICAL OPERATION INSTRUMENTS AND EQUIPMENT FOR VETERINARY PURPOSES; BLOOD TRANSFUSION APPARATUS; STENTS; ARCH SUPPORTS FOR BOOTS AND SHOES; HEART PACEMAKERS; HEARTBEAT MEASURING APPARATUS; ELECTROCARDIOGRAPHS; AMALGAM CARRIERS; MASSAGE APPARATUS; TONOMETERS; MEDICAL APPARATUS FOR INTRODUCING PHARMACEUTICAL PREPARATIONS INTO THE HUMAN BODY; MEDICAL APPARATUS FOR FACILITATING THE INHALATION OF PHARMACEUTICAL PREPARATIONS; INJECTION DEVICE FOR PHARMACEUTICALS; GYNECOLOGICAL MEDICAL INSTRUMENTS FOR EXAMINING WOMEN'S REPRODUCTIVE ORGANS; SHARP CURETTES; MOXIBUSTION APPARATUS; MEDICAL APPARATUS, NAMELY, THERAPEUTIC DEVICES FOR DELIVERING SPECIFICALLY ENGINEERED PRESSURE AND GAS MIXTURES FOR MEDICAL BENEFIT; FITTED INSTRUMENT CASES FOR USE BY SURGEONS AND DOCTORS; ARTIFICIAL SURGICAL IMPLANTS; SCISSORS FOR SURGERY; SURGICAL MIRRORS; SURGICAL RETRACTORS; SURGICAL AND MEDICAL APPARATUS AND INSTRUMENTS FOR USE IN GENERAL SURGERY, ORTHOPEDIC SURGERY, OPHTHALMIC SURGERY; SURGICAL APPARATUS AND INSTRUMENTS FOR MEDICAL AND DENTAL USE; BLUNT CURETTES; SCALPERS; LASERS FOR SURGICAL AND MEDICAL USE; DRILLING JIGS FOR SURGICAL AND DENTAL APPLICATIONS; PLATINUM CAUTERIES FOR SURGICAL USE; SURGICAL SPLINTS; BONE SUBSTITUTES FOR SURGICAL USE; BOUGIES FOR SURGERY; COMPRESSORS FOR SURGICAL USE; ARTIFICIAL SKIN FOR SURGICAL PURPOSES; ELECTRIC SCALPERS FOR SURGICAL PURPOSES; SURGICAL AMPUTATORS; KNIVES FOR SURGICAL PURPOSES; CUTLERY FOR SURGICAL USE; SURGICAL CLIPS; SAWS FOR SURGICAL PURPOSES; SURGICAL PLIERS; DRESSING FORCEPS FOR SURGICAL USE; URETHRAL SYRINGES; URETHRAL PROBES; CANNULAE FOR ANESTHETICS WITH RECEPTACLES; GASTROSCOPES; THERMAL PACKS FOR FIRST AID PURPOSES; MEDICAL MACHINES AND APPARATUS, NAMELY, X-RAY APPARATUS; CASES FITTED FOR MEDICAL INSTRUMENTS; MEDICAL APPARATUS AND INSTRUMENTS FOR USE IN SURGERY; MEDICAL GUIDEWIRES; TRACTION APPARATUS FOR MEDICAL PURPOSES; ENEMA APPARATUS FOR MEDICAL PURPOSES; STRAIT JACKETS; INSTRUMENT STANDS FOR MEDICAL PURPOSES; INSTRUMENT TABLES FOR MEDICAL PURPOSES; MEDICAL SCREW CONNECTIONS; RADIUM TUBES FOR MEDICAL PURPOSES; LAMPS FOR MEDICAL PURPOSES; LASERS FOR MEDICAL PURPOSES; MASSAGE APPARATUS FOR MEDICAL PURPOSES; HYDROSTATIC BEDS FOR MEDICAL PURPOSES; ARMCHAIRS FOR MEDICAL OR DENTAL PURPOSES; NEEDLES FOR MEDICAL PURPOSES; RADIOLOGICAL APPARATUS FOR MEDICAL PURPOSES; RADIOLOGY SCREENS FOR MEDICAL PURPOSES; DRAINAGE TUBES FOR MEDICAL PURPOSES; BELTS FOR MEDICAL PURPOSES; MEDICAL HEARING INSTRUMENTS AND PARTS OF SUCH DEVICES; ABDOMINAL BELTS FOR MEDICAL PURPOSES; SPLINTS FOR MEDICAL PURPOSES; SPRAYERS FOR CLEANING GUMS AND TEETH USED IN DENTISTS OFFICES DURING DENTAL PROCEDURES; MEDICAL DIAGNOSTIC INSTRUMENTS FOR THE ANALYSIS OF BODY FLUIDS; MEDICAL APPARATUS AND INSTRUMENTS FOR MONITORING OXYMETERY, GAS ANALYSIS, VITAL SIGNS, BLOOD PROPERTIES AND RESPIRATORY EVENTS; QUARTZ LAMPS FOR MEDICAL PURPOSES; DEFIBRILLATORS; BASINS FOR MEDICAL PURPOSES; IRRIGATORS FOR MEDICAL USE; FINGER GUARDS FOR MEDICAL PURPOSES; PROTECTIVE BOOTS FOR MEDICAL PURPOSES; PHYSICAL EXERCISE APPARATUS FOR MEDICAL PURPOSES; AEROSOL DISPENSERS FOR MEDICAL PURPOSES; AIR MATTRESSES FOR MEDICAL PURPOSES; HOT AIR VIBRATORS FOR MEDICAL PURPOSES; THERMOMETERS FOR MEDICAL PURPOSES; TELEMETRY DEVICES FOR MEDICAL



**CLASS 10—(Continued).**

APPLICATIONS; CLIPS FOR USE IN CONTROLLING RINGERS SOLUTION FOR MEDICAL PURPOSES; HAIR PROSTHESES FOR MEDICAL PURPOSES; BABY INCUBATORS FOR MEDICAL PURPOSES; ULTRAVIOLET RAY LAMPS FOR MEDICAL PURPOSES; FILTERS FOR ULTRAVIOLET RAYS, FOR MEDICAL PURPOSES; ELECTRODES FOR MEDICAL USE; ELECTRIC ABDOMINAL BELTS FOR MEDICAL PURPOSES FOR USE IN PROMOTING BLOOD CIRCULATION; CUTTERS FOR MEDICAL PURPOSES; EXCISERS FOR MEDICAL PURPOSES; MEDICAL FLUID INJECTORS; INJECTION NEEDLES FOR MEDICAL USE; SUPPORTERS FOR MEDICAL PURPOSES; DIAGNOSTIC APPARATUS FOR MEDICAL PURPOSES FOR THE DETECTION OF CANCER; DIAGNOSTIC APPARATUS FOR PURPOSES FOR PERIODONTAL DISEASE; FORCEPS; SURGICAL PERFORATORS; KNIVES FOR MEDICAL USE; CORSETS FOR MEDICAL PURPOSES; PROBES FOR MEDICAL PURPOSES; BLOOD TESTING APPARATUS, NAMELY, BLOOD COLLECTING TUBES; VACUUM PUMPS FOR MEDICAL PURPOSES; MEDICAL DEVICES, NAMELY, INFUSION PUMPS FOR DELIVERING MEASURED AMOUNTS OF SOLUTIONS INTO THE BLOODSTREAM OVER TIME; MEDICAL SPIROMETERS; SKIN THICKNESS MEASURING APPARATUS FOR MEDICAL PURPOSES; TWEEZERS FOR MEDICAL PURPOSES; INHALERS FOR MEDICAL PURPOSES, BEING SOLD EMPTY; X-RAYS TUBES FOR MEDICAL PURPOSES; APPARATUS AND INSTALLATIONS FOR THE PRODUCTION OF X-RAYS, FOR MEDICAL PURPOSES; PROTECTION DEVICES AGAINST X-RAYS FOR MEDICAL PURPOSES; X-RAY PHOTOGRAPHS FOR MEDICAL PURPOSES; ROENTGEN APPARATUS FOR MEDICAL PURPOSES; FURNITURE ESPECIALLY MADE FOR MEDICAL PURPOSES; BEDS SPECIALLY MADE FOR MEDICAL PURPOSES; PROSTHETIC SOCKETS USED TO FASTEN PROSTHETIC LIMBS TO THE BODY; ARTIFICIAL LIMBS; ARTIFICIAL EYES; ARTIFICIAL TEETH AND PROTECTIVE CUPS; ARTIFICIAL TEETH AND CAPS; ARTIFICIAL TEETH; SETS OF ARTIFICIAL TEETH; PINS FOR ARTIFICIAL TEETH; MOBILE MONITORING SCANNERS FOR USE IN SPECIFIC BODY PARTS OR SPECIFIC DISEASES; LENSES FOR SURGICAL IMPLANTATION; ARTIFICIAL BONES FOR IMPLANTATION; SUBCUTANEOUS VALVES FOR IMPLANTATION; ARTIFICIAL JOINTS; ARTIFICIAL PNEUMOTHORAX; ENDOPROSTHESES; INTRAOCULAR LENS BIOMETERS; DIALYSIS MACHINES; APPARATUS FOR ARTIFICIAL RESPIRATION; ARTIFICIAL BREASTS; HAIR PROSTHESES; ARTIFICIAL CARTILAGE; ARTIFICIAL LIGAMENT; ARTIFICIAL JAWS; DISPOSABLE SYRINGES; MATERNITY BELTS; CLINICAL THERMOMETERS; CLINICAL THREAD MILLS FOR USE IN MEASURING VITAL FUNCTION BY PATIENTS WALK FOR MEDICAL PURPOSE; APPARATUS FOR CLINICAL DIAGNOSIS; UTERINE SYRINGES; APPARATUS FOR MAGNET THERAPY; AUTOMATIC VACCINATION APPARATUS; ULTRAVIOLET RADIATOR UNITS FOR THERAPEUTIC PURPOSES; MEDICAL APPARATUS AND INSTRUMENTS RELATING TO NEUROVEGETATIVE REACTIVITY; LOW FREQUENCY ELECTRIC THERAPY APPARATUS; INFRARED RADIATOR UNITS FOR THERAPEUTIC PURPOSES; ELECTRIC BONE OPERATING MACHINES; ELECTRIC SCALPERS; ELECTRIC CAUTERIES; ELECTRIC HEARING AIDS; ELECTRIC ACUPUNCTURE INSTRUMENTS; GALVANIC THERAPEUTIC APPLIANCES, NAMELY, LOW FREQUENCY ELECTRIC THERAPY APPARATUS AND STATIC ELECTRIC THERAPY APPARATUS; ORTHOPEDIC SOLES; ORTHOPEDIC BELTS; ORTHOPEDIC FOOTWEAR; PRESCRIPTION TABLE FOR HOSPITAL USE; PHARMACEUTICAL APPARATUS AND INSTRUMENTS, NAMELY, MEDICAL APPARATUS FOR INTRODUCING PHARMACEUTICAL PREPARATIONS INTO THE HUMAN BODY AND INSTRUMENTS AND APPARATUS PROVIDED EMPTY USED FOR THE INHALATION OF PHARMACEUTICALS; MEDICAL INSTRUMENTS FOR CUTTING TISSUE; INJECTION NEEDLES; INJECTION SYRINGES; SYRINGES FOR INJECTIONS; CENTRO-MEDULLARY NAILS; APPARATUS FOR ACUPRESSURE THERAPY; HAEMOSTATS; VIBROMASSAGE APPARATUS; EXAMINING TABLES FOR HOSPITAL USE; VAGINAL SYRINGES; DENTAL EXCAVATORS; HOOKS FOR SPONDYLOLYSIS; DENTAL DRILLS; ORTHOPEDIC APPARATUS FOR TALIPES; HEARING PROTECTORS; HEARING AIDS FOR

**CLASS 10—(Continued).**

THE DEAF; AUDIOMETERS; STETHOSCOPES; BRUSHES FOR CLEANING BODY CAVITIES; APPLIANCES FOR WASHING BODY CAVITIES; PROSTHETIC TISSUES FOR PARIETAL, VISCERAL AND VASCULAR USE; BODY-FAT MONITORS; ULTRASHORT WAVE THERAPY MACHINES AND APPARATUS; ULTRASONIC THERAPY MACHINES AND APPARATUS; VERTEBRAL ORTHOPEDIC APPARATUS; FILLING INSTRUMENTS FOR DENTAL PURPOSES; CAVITY DETECTORS; INSUFFLATORS; FORCEPS FOR DENTAL TECHNICAL PURPOSES; MIRRORS FOR DENTISTS; DENTAL FOUNDATION SUPPORTS; X-RAY APPLIANCES FOR DENTAL AND MEDICAL USE; DENTAL BURRS; BROACH FOR DENTAL PURPOSES; DENTAL INSTRUMENTS, NAMELY, PICKS, BURRS, MIRRORS, ORAL IRRIGATORS, DENTAL ROOT FILES USED IN ROOT CANAL THERAPY PROCEDURES, ROOT CANAL THERAPY INSTRUMENTS USED TO SHAVE THE INSIDE OF A ROOT CANAL, PROPHY ANGLES, HEMOSTATS THAT CLAMP BLOOD VESSELS TO DIMINISH OR HALT BLOOD FLOW, CROWN AND BRIDGE REMOVERS; DENTAL CHAIRS; DENTAL APPARATUS, NAMELY, INTRA-ORAL LIGHT SYSTEMS AND APEX LOCATOR; ELECTRIC DENTAL APPARATUS, NAMELY, ELECTRIC DENTAL DRILL BITS USED IN DENTAL MOTORS TO ENABLE DENTISTS TO CUT OR DRILL TEETH, ELECTRIC DRILLS FOR DENTAL APPLICATIONS, DENTAL OPERATING LAMPS AND ELECTRIC DENTAL APPARATUS NAMELY, X-RAY APPARATUS FOR DENTAL IMAGING; CUTTING AND GRINDING DISCS FOR DENTAL APPLICATIONS; CUT-OFF AND ABRASIVE WHEELS FOR DENTAL PURPOSES; POLYMERISATION APPARATUS FOR DENTAL PURPOSES; TREATMENT BEDS FOR DENTAL PURPOSES; DENTISTS' ARMCHAIRS; THERAPEUTIC BATH APPARATUS AND INSTRUMENTS; SCALERS; ORTHODONTIC MACHINES AND INSTRUMENTS FOR DENTAL PURPOSES; ORTHODONTIC APPLIANCES; PROBES FOR GINGIVAL POCKETS; ACUPUNCTURE EQUIPMENT; BED VIBRATORS; ACUPUNCTURE NEEDLES; INJECTION INSTRUMENTS WITHOUT NEEDLES; CATHETERS; CANNULAE; CARBON ARC LAMP UNITS FOR THERAPEUTIC PURPOSES; HERNIA BANDAGES; ANUS PROLAPSE BANDS; TONGUE SCRAPERS; TROCARS; CORN KNIVES; ARCH SUPPORTS FOR FLAT FEET; DERMATOLOGIC ORTHOPEDIC INSTRUMENTS; HYPODERMIC SYRINGES; HYPOGASTRIC BELTS FOR MEDICAL USE; DISSECTING TABLES; MAGNETIC RESONANCE CT APPARATUS; TONGUE SCRAPERS; HEMATIMETERS FOR DIAGNOSTIC MEDICAL USE; DEVICES FOR MEASURING BLOOD SUGAR; ARTERIAL BLOOD PRESSURE MEASURING APPARATUS; FILTERS FOR BLOOD AND BLOOD COMPONENTS; BLOOD TESTING APPARATUS; APPARATUS FOR BLOOD ANALYSIS; APPARATUS FOR TAKING BLOOD SAMPLES; CAPILLARY TUBES FOR BLOOD; APPARATUS FOR TAKING BLOOD; PATIENT STRETCHERS; TIPS FOR CRUTCHES FOR INVALIDS; INVALIDS' HOISTS; STRETCHERS FOR PATIENT TRANSPORT; PORTABLE OXYGEN SUPPLIERS; THORACOSCOPES; INHALERS FOR MEDICAL PURPOSES; CONTRACEPTIVES APPARATUS; DIAPHRAGMS FOR CONTRACEPTION; INTRA-UTERINE CONTRACEPTIVE DEVICES; CONDOMS; PESSARIES; BANDAGES FOR JOINTS; EAR PICKS; SUSPENSORY BANDAGES; BREAST PUMPS; DRAW-SHEETS FOR SICK BEDS; FIST BANDAGES USED FOR SUPPORT IN BOXING; SUTURES; SOPORIFIC PILLOWS FOR INSOMNIA; TRIANGLE BANDAGES; URINE COLLECTION BAGS; URINE POCKET ADAPTORS FOR COLLECTING URINE SAMPLES; URINE POCKET TAPS FOR COLLECTING URINE SAMPLES; EAR PLUGS FOR SLEEPING; SUTURES FOR SURGICAL OPERATION; NURSING BOTTLES; INCONTINENCE SHEETS; ICE PILLOWS FOR MEDICAL PURPOSES; SURGICAL DRAPES; SURGICAL STERILE SHEETS; SURGICAL SUTURES; SURGICAL SPONGES; SURGICAL THREAD; THERMO-ELECTRIC COMPRESSES FOR SURGERY; CATGUT FOR SURGICAL USE; ELASTIC STOCKINGS FOR SURGICAL PURPOSES; PACIFIERS FOR BABIES; TEATS FOR BABIES; CONTAINERS ESPECIALLY MADE FOR MEDICAL WASTE; AIR PILLOWS FOR MEDICAL PURPOSES; AIR CUSHIONS FOR MEDICAL PURPOSES; EAR PLUGS FOR MEDICAL PURPOSES; FEEDING CUPS FOR MEDICAL PURPOSES; WATER BAGS FOR MEDICAL PURPOSES FOR HOT AND ICE BAGS; SUTURE MATERIALS FOR MEDICAL PURPOSES

**CLASS 10—(Continued).**

POSES; URINALS FOR MEDICAL PURPOSES; DROPPING PIPETTES FOR MEDICAL PURPOSES; MEDICAL COMPRESSION STOCKINGS AND TIGHTS; ICE BAGS FOR MEDICAL PURPOSES; CHAMBER POTS FOR MEDICAL PURPOSES; ELECTRIC BLANKETS FOR MEDICAL PURPOSES; ELECTRIC HEATING CUSHIONS FOR MEDICAL PURPOSES; ELECTRIC HEATING PADS FOR MEDICAL PURPOSES; DROPPERS, DROPPER BOTTLES AND DROP COUNTING PHIALS FOR MEDICAL PURPOSES TO ADMINISTER MEDICATIONS; CUSHIONS FOR MEDICAL PURPOSES; SPITTOONS FOR MEDICAL PURPOSES; ELASTIC STOCKINGS FOR MEDICAL PURPOSES; WEANING TOOLS, NAMELY, CUPS ADAPTED FOR FEEDING BABIES AND CHILDREN; ARTIFICIAL TYMPANIC MEMBRANES; DISPOSABLE TEATS; CATGUT FOR SURGICAL USE; STOCKINGS FOR VARICES FOR MEDICAL PURPOSES; PLASTER BANDAGES FOR ORTHOPEDIC PURPOSES; ORTHOPEDIC KNEE BANDAGES; TEMPLATES FOR ORTHOPEDIC PURPOSES; BABIES' BOTTLES; FEEDING BOTTLE VALVES; FEEDING BOTTLE TEATS; SUPPORTIVE BANDAGES; ELASTIC BANDAGES; SPOONS FOR ADMINISTERING MEDICINE; PADS FOR PREVENTING PRESSURE SORES ON PATIENT BODIES; POUCHES FOR PREVENTING PRESSURE SORES ON PATIENT BODIES; BED PANS; COMMUNE CHAIRS FOR MEDICAL PURPOSES; ELECTRIC MASSAGE APPARATUS FOR HOUSEHOLD USE; CLOTHING ESPECIALLY FOR OPERATING ROOMS, NAMELY, SURGICAL SCRUBS; HORSEHAIR GLOVES FOR MASSAGE; GLOVES FOR MASSAGE; GLOVES FOR MEDICAL PURPOSES; ANESTHETIC MASKS; MASKS FOR MEDICAL PURPOSES; MASKS FOR USE BY MEDICAL PERSONNEL; MASSAGE APPARATUS FOR PERSONAL USE; ARTICLES FOR ORTHOPEDIC PURPOSES SUCH AS ORTHOPEDIC BELTS, ORTHOPEDIC BRACES, ORTHOPEDIC CUSHIONS, ORTHOPEDIC FOOTWEAR, SOLES, AND SUPPORTS, ORTHOPEDIC JOINT IMPLANTS AND ORTHOPEDIC BANDAGES (U.S. CLS. 26, 39 AND 44).

LINDA MICKLEBURGH, EXAMINING ATTORNEY

**CLASS 10—(Continued).**

SN 85-626,743. JRI ORTHOPAEDICS LIMITED, CHAPELTOWN, SHEFFIELD, UNITED KINGDOM, FILED 5-16-2012.



PRIORITY CLAIMED UNDER SEC. 44(D) ON ERPN CMNTY TM OFC APPLICATION NO. 010473486, FILED 12-7-2011, REG. NO. 010473486, DATED 12-11-2013, EXPIRES 12-7-2021.

THE COLOR(S) WHITE AND BLUE IS/ARE CLAIMED AS A FEATURE OF THE MARK.

THE MARK CONSISTS OF A WHITE STYLIZED "A" ON A BLUE CIRCLE AND AN OVAL CONTAINING A DIFFERENT SHADE OF BLUE WITHIN THE SAME BLUE CIRCLE.

FOR ORTHOPEDIC JOINT IMPLANTS MADE FROM ARTIFICIAL MATERIAL; BONE, SHOULDER, KNEE, HIP, JOINT, LEG, FOOT, ARM AND HAND PROSTHESES; ORTHOPEDIC JOINT IMPLANTS AND JOINT PROSTHESES; APPARATUS, ARTICLES AND INSTRUMENTS, ALL FOR ORTHOPEDIC USE, NAMELY, ORTHOPEDIC FIXATION DEVICES USED IN ORTHOPEDIC TRANSPLANT OR IMPLANT SURGERY; SURGICAL INSTRUMENTS; STEMS AND HEADS OF PROSTHESES; CUPS FOR PROSTHESES; STRUCTURAL PARTS AND FITTINGS FOR ALL THE AFORESAID GOODS; SCREWS FOR SECURING PROSTHESES; SYNTHETIC MATERIAL FOR SURGICAL USE FOR COATING ORTHOPEDIC IMPLANTS AND ORTHOPEDIC PROSTHESES; SLEEVES OR THIMBLES OF COATING MATERIAL FOR ORTHOPEDIC PROSTHESES; SUTURE MATERIALS (U.S. CLS. 26, 39 AND 44).

DORITT L. CARROLL, EXAMINING ATTORNEY

SN 85-782,061. CYTOLUMINA TECHNOLOGIES CORP., WALNUT, CA. FILED 11-17-2012.

**CytoTrap**<sup>NANO</sup>  
Cancer Cell Trap

NO CLAIM IS MADE TO THE EXCLUSIVE RIGHT TO USE "NANO" AND "CANCER CELL TRAP", APART FROM THE MARK AS SHOWN.

THE MARK CONSISTS OF THE STYLIZED WORDING "CYTOTRAP NANO CANCER CELL TRAP".

FOR MEDICAL DEVICE FOR DETECTING CANCER (U.S. CLS. 26, 39 AND 44).

CYNTHIA TRIPI, EXAMINING ATTORNEY

**CLASS 10—(Continued).**

SN 85-801,426. B2D MARKETING, LLC, SEATTLE, WA.  
FILED 12-12-2012.



NO CLAIM IS MADE TO THE EXCLUSIVE RIGHT TO USE "BURS", APART FROM THE MARK AS SHOWN. THE MARK CONSISTS OF THE DESIGN OF A FOUR-FINGERED HUMAN FIST AND THE WORDING "MIGHTY BURS".

FOR DENTAL DRILL BITS USED IN DENTAL MOTORS TO ENABLE DENTISTS TO CUT OR DRILL TEETH (U.S. CLS. 26, 39 AND 44).  
FIRST USE 1-1-2012; IN COMMERCE 1-1-2012.  
LESLIE RICHARDS, EXAMINING ATTORNEY

---

SN 85-837,739. B & B MANUFACTURING, LLC, SUMAS, WA.  
FILED 1-31-2013.

**RUMEN-MATE**

THE MARK CONSISTS OF STANDARD CHARACTERS WITHOUT CLAIM TO ANY PARTICULAR FONT, STYLE, SIZE, OR COLOR.

FOR VETERINARY APPARATUS, NAMELY, A TRANSFAUNATION SYSTEM COMPRISED OF A PERFORATED AND RIGID STAINLESS STEEL WAND FOR EXTRACTING LIQUIDS DIRECTLY FROM THE RUMEN OF ANIMALS, A NON-METAL BUCKET FITTED WITH A HAND OPERATED PUMP FOR HOLDING, COLLECTING AND DELIVERING EXTRACTED DIGESTIVE FLUIDS, A RIGID NON-METAL WAND FOR DELIVERING DIGESTIVE LIQUIDS DIRECTLY INTO THE RUMEN OF ANIMALS AND CONNECTIVE TUBING (U.S. CLS. 26, 39 AND 44).

FIRST USE 7-31-2012; IN COMMERCE 8-31-2012.  
GRETCHEN ULRICH, EXAMINING ATTORNEY

---

SN 85-851,696. PEPEX BIOMEDICAL, INC., ST. LOUIS, MO.  
FILED 2-15-2013.

**CCM**

THE MARK CONSISTS OF STANDARD CHARACTERS WITHOUT CLAIM TO ANY PARTICULAR FONT, STYLE, SIZE, OR COLOR.

FOR MEDICAL DEVICES, NAMELY, ENZYMATIC BIOMEDICAL SENSORS AND TESTING DEVICES UTILIZING CONDUCTIVE COMPOSITE MONOFILAMENT FOR MEASURING, MONITORING AND TESTING ENZYME PROPERTIES IN HUMANS AND ANIMALS (U.S. CLS. 26, 39 AND 44).

FIRST USE 8-16-2009; IN COMMERCE 8-16-2009.  
SIMON TENG, EXAMINING ATTORNEY

**CLASS 10—(Continued).**

SN 85-861,596. MASIMO CORPORATION, IRVINE, CA.  
FILED 2-27-2013.

**HSI-6**

THE MARK CONSISTS OF STANDARD CHARACTERS WITHOUT CLAIM TO ANY PARTICULAR FONT, STYLE, SIZE, OR COLOR.

FOR MEDICAL DEVICES, NAMELY, PATIENT MONITORS AND PATIENT SENSORS FOR MONITORING AND MEASURING BRAIN FUNCTION (U.S. CLS. 26, 39 AND 44).  
CARYN GLASSER, EXAMINING ATTORNEY

---

SN 85-861,613. MASIMO CORPORATION, IRVINE, CA.  
FILED 2-27-2013.

**HSI-2**

THE MARK CONSISTS OF STANDARD CHARACTERS WITHOUT CLAIM TO ANY PARTICULAR FONT, STYLE, SIZE, OR COLOR.

FOR MEDICAL DEVICES, NAMELY, PATIENT MONITORS AND PATIENT SENSORS FOR MONITORING AND MEASURING BRAIN FUNCTION (U.S. CLS. 26, 39 AND 44).  
CARYN GLASSER, EXAMINING ATTORNEY

---

SN 85-861,624. MASIMO CORPORATION, IRVINE, CA.  
FILED 2-27-2013.

**HSI-4**

THE MARK CONSISTS OF STANDARD CHARACTERS WITHOUT CLAIM TO ANY PARTICULAR FONT, STYLE, SIZE, OR COLOR.

FOR MEDICAL DEVICES, NAMELY, PATIENT MONITORS AND PATIENT SENSORS FOR MONITORING AND MEASURING BRAIN FUNCTION (U.S. CLS. 26, 39 AND 44).

CARYN GLASSER, EXAMINING ATTORNEY

**CLASS 10—(Continued).**

SN 85-866,468. CR LICENSE, LLC, TUCSON, AZ. FILED 3-4-2013.

**SOLE ENERGIZERS**

THE MARK CONSISTS OF STANDARD CHARACTERS WITHOUT CLAIM TO ANY PARTICULAR FONT, STYLE, SIZE, OR COLOR.

NO CLAIM IS MADE TO THE EXCLUSIVE RIGHT TO USE "SOLE", APART FROM THE MARK AS SHOWN.

FOR FOOT THERAPY DEVICE, WHICH IS MANUALLY OPERATED AND USED TO PROMOTE STRENGTH, FLEXIBILITY AND RANGE OF MOTION OF THE FEET (U.S. CLS. 26, 39 AND 44).

ERNEST SHOSHO, EXAMINING ATTORNEY

SN 85-866,475. CR LICENSE, LLC, TUCSON, AZ. FILED 3-4-2013.



NO CLAIM IS MADE TO THE EXCLUSIVE RIGHT TO USE "SOLE", APART FROM THE MARK AS SHOWN.

THE MARK CONSISTS OF THE WORD "SOLE" WITH A HALF CIRCLE DESIGN AT THE BOTTOM OF THE LETTER "O". BELOW "SOLE" IS THE WORD "ENERGIZERS" WITH A HALF CIRCLE DESIGN DOTTING THE LETTER "I".

FOR FOOT THERAPY DEVICE, WHICH IS MANUALLY OPERATED AND USED TO PROMOTE STRENGTH, FLEXIBILITY AND RANGE OF MOTION OF THE FEET (U.S. CLS. 26, 39 AND 44).

ERNEST SHOSHO, EXAMINING ATTORNEY

SN 85-873,503. SPAN-AMERICA MEDICAL SYSTEMS, INC., GREENVILLE, SC. FILED 3-12-2013.

**SHEER TRANSFER ZONE**

THE MARK CONSISTS OF STANDARD CHARACTERS WITHOUT CLAIM TO ANY PARTICULAR FONT, STYLE, SIZE, OR COLOR.

NO CLAIM IS MADE TO THE EXCLUSIVE RIGHT TO USE "SHEER TRANSFER", APART FROM THE MARK AS SHOWN.

FOR PATIENT SUPPORT SURFACES, NAMELY, MATTRESSES, FOAM MATTRESSES, AIR AND FOAM MATTRESSES, PATIENT POSITIONER CUSHIONS, AND WHEELCHAIR CUSHIONS; AND SEPARATE COVERS FOR ALL THE FOREGOING (U.S. CLS. 26, 39 AND 44).

ANTHONY RINKER, EXAMINING ATTORNEY

**CLASS 10—(Continued).**

SN 85-876,496. ELI LILLY AND COMPANY, INDIANAPOLIS, IN. FILED 3-14-2013.

**WINK**

THE MARK CONSISTS OF STANDARD CHARACTERS WITHOUT CLAIM TO ANY PARTICULAR FONT, STYLE, SIZE, OR COLOR.

FOR MEDICAL DEVICES FOR SUBCUTANEOUS DISPENSING OF DRUGS, NAMELY, A MEDICAL DEVICE FOR DISPENSING MEASURED DRUG DOSAGE, A MEDICAL CASSETTE COMPOSED OF DISPOSABLE NEEDLES, AND A DISPOSABLE CARTRIDGE FOR CONTAINING THE DRUG TO BE DISPENSED; ELECTRONIC MEDICAL DEVICES FOR SUBCUTANEOUS DISPENSING OF MEASURED DRUG DOSAGES; MEDICAL CASSETTES COMPOSED OF NEEDLES FOR DISPENSING MEASURED DRUG DOSAGES (U.S. CLS. 26, 39 AND 44).

BERYL GARDNER, EXAMINING ATTORNEY

SN 85-876,499. ELI LILLY AND COMPANY, INDIANAPOLIS, IN. FILED 3-14-2013.

**WINQ**

THE MARK CONSISTS OF STANDARD CHARACTERS WITHOUT CLAIM TO ANY PARTICULAR FONT, STYLE, SIZE, OR COLOR.

FOR MEDICAL DEVICES FOR SUBCUTANEOUS DISPENSING OF DRUGS, NAMELY, A MEDICAL DEVICE FOR DISPENSING MEASURED DRUG DOSAGE, A MEDICAL CASSETTE COMPOSED OF DISPOSABLE NEEDLES, AND A DISPOSABLE CARTRIDGE FOR CONTAINING THE DRUG TO BE DISPENSED; ELECTRONIC MEDICAL DEVICES FOR SUBCUTANEOUS DISPENSING OF MEASURED DRUG DOSAGES; MEDICAL CASSETTES COMPOSED OF NEEDLES FOR DISPENSING MEASURED DRUG DOSAGES (U.S. CLS. 26, 39 AND 44).

BERYL GARDNER, EXAMINING ATTORNEY

**CLASS 10—(Continued).**

SN 85-885,129. NUNA INTERNATIONAL B.V., ERP, NETHERLANDS, FILED 3-25-2013.



OWNER OF U.S. REG. NOS. 3,420,221 AND 3,603,442.  
THE MARK CONSISTS OF THE WORD "NUNA" IN STYLIZED CHARACTERS.  
THE WORDING "NUNA" HAS NO MEANING IN A FOREIGN LANGUAGE.

FOR BABY NURSING APPLIANCES AND ACCESSORIES, NAMELY, BABY BOTTLE NIPPLES; BABY BOTTLES; NIPPLES FOR BABY BOTTLES; NURSING BOTTLES; PACIFIER CLIPS; PACIFIERS FOR BABIES; BREAST PUMPS; BREAST PUMP EQUIPMENT, NAMELY, BREAST MILK STORAGE BAGS AND BOTTLES, BREAST PUMP MEMBRANES, BREAST SHIELDS, BREAST PUMP VALVES; CUPS SOLD EMPTY ADAPTED TO FEED BABIES AND CHILDREN (U.S. CLS. 26, 39 AND 44).

LINDA POWELL, EXAMINING ATTORNEY

---

SN 85-898,271. CANDELA CORPORATION, WAYLAND, MA. FILED 4-8-2013.

## VBEAM PERFECTA

THE MARK CONSISTS OF STANDARD CHARACTERS WITHOUT CLAIM TO ANY PARTICULAR FONT, STYLE, SIZE, OR COLOR.

OWNER OF U.S. REG. NO. 2,515,791.

THE ENGLISH TRANSLATION OF "PERFECTA" IN THE MARK IS "PERFECT".

FOR MEDICAL AESTHETIC DEVICE, NAMELY, A LASER FOR THE COSMETIC TREATMENT OF A WIDE VARIETY OF SKIN CONDITIONS AND FOR SKIN REJUVENATION (U.S. CLS. 26, 39 AND 44).

FIRST USE 12-31-2005; IN COMMERCE 12-31-2005.

MEREDITH MARESCA, EXAMINING ATTORNEY

---

SN 85-958,990. ACRO ASSOCIATES, INC., CONCORD, CA. FILED 6-13-2013.

## Acro

THE MARK CONSISTS OF STANDARD CHARACTERS WITHOUT CLAIM TO ANY PARTICULAR FONT, STYLE, SIZE, OR COLOR.

FOR SOLENOID AND PNEUMATIC PINCH VALVES USED IN FLUIDIC SYSTEMS FOR BIOPHARMACEUTICAL AND MEDICAL DEVICE APPLICATIONS (U.S. CLS. 26, 39 AND 44).

FIRST USE 6-17-1993; IN COMMERCE 6-17-1993.

DOMINICK J. SALEMI, EXAMINING ATTORNEY

**CLASS 10—(Continued).**

SN 85-959,207. MEDTRONIC, INC., MINNEAPOLIS, MN. FILED 6-13-2013.

## SPRINT QUATTRO MRI

THE MARK CONSISTS OF STANDARD CHARACTERS WITHOUT CLAIM TO ANY PARTICULAR FONT, STYLE, SIZE, OR COLOR.

OWNER OF U.S. REG. NOS. 2,635,937, 2,820,385 AND 3,689,990.

NO CLAIM IS MADE TO THE EXCLUSIVE RIGHT TO USE "MRI", APART FROM THE MARK AS SHOWN.

THE ENGLISH TRANSLATION OF "QUATTRO" IN THE MARK IS "FOUR".

FOR MEDICAL LEADS, NAMELY, PACEMAKER, DEFIBRILLATOR AND PULSE GENERATOR LEADS (U.S. CLS. 26, 39 AND 44).

TOBY BULLOFF, EXAMINING ATTORNEY

---

SN 85-959,232. MEDTRONIC, INC., MINNEAPOLIS, MN. FILED 6-13-2013.

## SPRINT QUATTRO SECURE MRI

THE MARK CONSISTS OF STANDARD CHARACTERS WITHOUT CLAIM TO ANY PARTICULAR FONT, STYLE, SIZE, OR COLOR.

OWNER OF U.S. REG. NOS. 2,635,937, 2,820,385 AND 3,689,990.

NO CLAIM IS MADE TO THE EXCLUSIVE RIGHT TO USE "MRI", APART FROM THE MARK AS SHOWN.

THE ENGLISH TRANSLATION OF "QUATTRO" IN THE MARK IS "FOUR".

FOR MEDICAL LEADS, NAMELY, PACEMAKER, DEFIBRILLATOR AND PULSE GENERATOR LEADS (U.S. CLS. 26, 39 AND 44).

TOBY BULLOFF, EXAMINING ATTORNEY

**CLASS 10—(Continued).**

SN 86-007,715. KYON PHARMA, INC., BOSTON, MA. FILED 7-11-2013.

# KYON

THE MARK CONSISTS OF STANDARD CHARACTERS WITHOUT CLAIM TO ANY PARTICULAR FONT, STYLE, SIZE, OR COLOR.

FOR VETERINARY MEDICAL DEVICES, NAMELY, VETERINARY ORTHOPEDIC IMPLANTS CONSISTING OF ARTIFICIAL MATERIALS, SUPPORTS, AND FIXATION DEVICES, AND PARTS THEREOF USED IN ORTHOPEDIC VETERINARY PROCEDURES; AND INSTRUMENTS DESIGNED TO SUPPORT IMPLEMENTATION OF IMPLANTS, SUPPORTS, AND FIXATION DEVICES USED IN VETERINARY ORTHOPEDIC PROCEDURES (U.S. CLS. 26, 39 AND 44).

FIRST USE 5-0-1999; IN COMMERCE 6-0-1999.  
LINDA ESTRADA, EXAMINING ATTORNEY

SN 86-021,309. HAIDER BIOLOGICS, LLC, SAN DIEGO, CA. FILED 7-27-2013.

haider biologics and a  
design

THE MARK CONSISTS OF STANDARD CHARACTERS WITHOUT CLAIM TO ANY PARTICULAR FONT, STYLE, SIZE, OR COLOR.

NO CLAIM IS MADE TO THE EXCLUSIVE RIGHT TO USE "BIOLOGICS", APART FROM THE MARK AS SHOWN.

FOR MEDICAL APPARATUS AND INSTRUMENTS FOR USE IN OPTICAL COHERENCE TOMOGRAPHY IMAGING; SYNTHETIC BONE SUBSTITUTE, NAMELY, SYNTHETIC FILLER AND EXTENDER MATERIALS TO SERVE AS REPLACEMENT FOR BONE COMPRISED OF HYDROXYAPAPITE AND/OR TRICAICIUM PHOSPHATE; MOUTH GUARD FOR MEDICAL PURPOSES FOR PROTECTING THE AIRWAVES WHILE KEEPING AN ENDOTRACHEAL TUBE IN A SECURE POSITION (U.S. CLS. 26, 39 AND 44).

SETH A. RAPPAPORT, EXAMINING ATTORNEY

**CLASS 10—(Continued).**

SN 86-027,281. MAZIN G. SAMONA, CLAWSON, MI. FILED 8-2-2013.

# MAGIC PEN

THE MARK CONSISTS OF STANDARD CHARACTERS WITHOUT CLAIM TO ANY PARTICULAR FONT, STYLE, SIZE, OR COLOR.

NO CLAIM IS MADE TO THE EXCLUSIVE RIGHT TO USE "PEN", APART FROM THE MARK AS SHOWN.

FOR VAPORIZERS FOR MEDICAL PURPOSES, NAMELY, ELECTRONIC VAPORIZERS FOR PERSONAL USE THAT EMIT VAPOR FOR TREATMENT OF A VARIETY OF MEDICAL CONDITIONS, HANDHELD ELECTRICALLY POWERED VAPORIZERS FOR PRODUCING AN INHALABLE AEROSOL, AND ELECTRICALLY POWERED VAPORIZERS FOR VAPORIZING CONSTITUENTS OF HERBAL AND PLANT MATTER FOR PRODUCING AN INHALABLE AEROSOL; ACCESSORIES FOR VAPORIZERS FOR MEDICAL USE FOR PRODUCING AN INHALABLE AEROSOL, NAMELY, CARTRIDGES FOR HOLDING OILS AND LIQUIDS USED TO PRODUCE THE INHALABLE AEROSOL; AND REPLACEMENT PARTS FOR VAPORIZERS FOR MEDICAL USE, NAMELY, MOUTHPIECES, REPLACEMENT CARTRIDGES FOR VAPORIZABLE MATERIALS, AND VAPORIZER FILTERS FOR MEDICAL USE (U.S. CLS. 26, 39 AND 44).

YAT SYE, LEE, EXAMINING ATTORNEY

SN 86-034,424. AVEDRO, INC., WALTHAM, MA. FILED 8-9-2013.

# KXL II

THE MARK CONSISTS OF STANDARD CHARACTERS WITHOUT CLAIM TO ANY PARTICULAR FONT, STYLE, SIZE, OR COLOR.

OWNER OF U.S. REG. NO. 4,211,179.

FOR MEDICAL INSTRUMENTS FOR TREATING EYE CONDITIONS AND DISEASES; MEDICAL APPARATUS AND DEVICES UTILIZING RADIATION TO TREAT EYE CONDITIONS AND DISEASES; SOFTWARE FOR USE IN TREATMENT OF EYE CONDITIONS AND DISEASES, SOLD AS A COMPONENT OF AN OPHTHALMIC MEDICAL TREATMENT APPARATUS (U.S. CLS. 26, 39 AND 44).

MICHELLE DUBOIS, EXAMINING ATTORNEY

**CLASS 10—(Continued).**

SN 86-034,425. AVEDRO, INC., WALTHAM, MA. FILED 8-9-2013.

**KXL**

THE MARK CONSISTS OF STANDARD CHARACTERS WITHOUT CLAIM TO ANY PARTICULAR FONT, STYLE, SIZE, OR COLOR.

OWNER OF U.S. REG. NO. 4,211,179.  
FOR MEDICAL INSTRUMENTS FOR TREATING EYE CONDITIONS AND DISEASES; MEDICAL APPARATUS AND DEVICES UTILIZING RADIATION TO TREAT EYE CONDITIONS AND DISEASES; SOFTWARE FOR USE IN TREATMENT OF EYE CONDITIONS AND DISEASES, SOLD AS A COMPONENT OF AN OPHTHALMIC MEDICAL TREATMENT APPARATUS (U.S. CLS. 26, 39 AND 44).  
MICHELLE DUBOIS, EXAMINING ATTORNEY

SN 86-038,081. DR. JAMES STOXEN, CHICAGO, IL. FILED 8-14-2013.

**MASSAGE ASSIST**

THE MARK CONSISTS OF STANDARD CHARACTERS WITHOUT CLAIM TO ANY PARTICULAR FONT, STYLE, SIZE, OR COLOR.

NO CLAIM IS MADE TO THE EXCLUSIVE RIGHT TO USE "MASSAGE", APART FROM THE MARK AS SHOWN.  
FOR ELECTRIC MASSAGE APPLIANCES, NAMELY, ELECTRIC VIBRATING MASSAGER (U.S. CLS. 26, 39 AND 44).  
FIRST USE 7-1-2013; IN COMMERCE 7-1-2013.  
PAUL E. FAHRENKOPF, EXAMINING ATTORNEY

SN 86-042,558. E BAG SYSTEMS, LLC, HIGHLAND VILLAGE, TX. FILED 8-20-2013.

**Gotta Go Paks**

THE MARK CONSISTS OF STANDARD CHARACTERS WITHOUT CLAIM TO ANY PARTICULAR FONT, STYLE, SIZE, OR COLOR.

NO CLAIM IS MADE TO THE EXCLUSIVE RIGHT TO USE "PAKS", APART FROM THE MARK AS SHOWN.  
FOR BAGS FOR MEDICAL WASTE (U.S. CLS. 26, 39 AND 44).  
KELLEY WELLS, EXAMINING ATTORNEY

**CLASS 10—(Continued).**

SN 86-042,712. CONVATEC INC., SKILLMAN, NJ. FILED 8-20-2013.

**UNOMETER**

THE MARK CONSISTS OF STANDARD CHARACTERS WITHOUT CLAIM TO ANY PARTICULAR FONT, STYLE, SIZE, OR COLOR.

FOR APPARATUS FOR MEASUREMENT OF ABDOMINAL PRESSURE IN THE HUMAN BODY; URINE METERS AND STRUCTURAL PARTS THEREFOR (U.S. CLS. 26, 39 AND 44).  
DORITT L. CARROLL, EXAMINING ATTORNEY

SN 86-046,397. MACKENZIE, SEKIA, MELBOURNE, FL. FILED 8-23-2013.

**Fancy Bred**

THE MARK CONSISTS OF STANDARD CHARACTERS WITHOUT CLAIM TO ANY PARTICULAR FONT, STYLE, SIZE, OR COLOR.

FOR MEDICAL TREATMENT APPAREL, NAMELY, FASHIONABLE CLOTHING FOR MEDICAL OR THERAPEUTIC USE (U.S. CLS. 26, 39 AND 44).  
MARGERY A. TIERNEY, EXAMINING ATTORNEY

SN 86-054,480. WICKED PINNACLE, LLC, SARASOTA, FL. FILED 9-3-2013.

**GREEN UNTAMED**

THE MARK CONSISTS OF STANDARD CHARACTERS WITHOUT CLAIM TO ANY PARTICULAR FONT, STYLE, SIZE, OR COLOR.

FOR ADULT SEXUAL STIMULATION AIDS, NAMELY, MASSAGE DEVICES FOR MASSAGING OR VIBRATING PORTIONS OF THE BODY, AIDING IN COPULATION AND MASTURBATION (U.S. CLS. 26, 39 AND 44).  
GILBERT SWIFT, EXAMINING ATTORNEY

**CLASS 10—(Continued).**

SN 86-055,528. DX BIOSCIENCES, INC., SAN DIEGO, CA.  
FILED 9-4-2013.

**SKINCENTIALS**

THE MARK CONSISTS OF STANDARD CHARACTERS WITHOUT CLAIM TO ANY PARTICULAR FONT, STYLE, SIZE, OR COLOR.

FOR MEDICAL APPARATUSES AND INSTRUMENTS FOR SOLUBILIZING TISSUE FOR COSMETIC PURPOSES AND THERAPEUTIC PURPOSES (U.S. CLS. 26, 39 AND 44).

JILLIAN CANTOR, EXAMINING ATTORNEY

SN 86-056,784. RENALDO MASSINI JUNIOR, PLANTATION, FL. AND ARTHUR CESAR SASSOLI, PLANTATION, FL.  
FILED 9-5-2013.



THE COLOR(S) GRAY AND YELLOW IS/ARE CLAIMED AS A FEATURE OF THE MARK.

THE MARK CONSISTS OF THE WORDING "ARTHROPEDICS" IN GRAY, AND TWO CURVED LINES IN GRAY AND HALF A BALL IN YELLOW.

FOR BONE REPAIR COMPOUND FOR USE IN ORTHOPEDIC SURGERY; EXTERNAL ORTHOPEDIC DEVICES USING ELECTRICAL SIGNALS TO STIMULATE BONE GROWTH; MEDICAL AND SURGICAL APPARATUS AND INSTRUMENTS, NAMELY, DEVICES USED IN ORTHOPEDIC SURGERY TO POSITION SURGICAL INSTRUMENTS, IMPLANTS AND/OR PATIENTS' LIMBS; MEDICAL AND SURGICAL APPARATUS AND INSTRUMENTS, NAMELY, ORTHOPEDIC FIXATION DEVICE USED IN ORTHOPEDIC TRANSPLANT AND/OR IMPLANT SURGERY; MEDICAL APPARATUS AND INSTRUMENTS FOR USE IN ORTHOPEDIC SURGERY; MEDICAL INSTRUMENTS, NAMELY, ORTHOPEDIC APPARATUS AND INSTRUMENTS; MULTIPLE-POCKETED CARRIER FOR PERSONAL ITEMS SPECIALLY ADAPTED FOR ATTACHMENT TO ORTHOPEDIC WALKERS; ORTHOPEDIC APPARATUS AND INSTRUMENTS FOR DIAGNOSTIC AND THERAPEUTIC USE; ORTHOPEDIC APPARATUS FOR TALIPES; ORTHOPEDIC BELTS; ORTHOPEDIC BRACES; ORTHOPEDIC CAST COOLING SYSTEM COMPRISED OF A MEMBRANE WRAPPED AROUND THE CAST, A VACUUM PUMP AND HOSES TO FACILITATE AIR FLOW TO FACILITATE HEALING AND COMFORT; ORTHOPEDIC CUSHIONS; ORTHOPEDIC CUSHIONS AND PADDING; ORTHOPEDIC DEVICE FOR INJECTING DRUGS INTO JOINT SPACES; ORTHOPEDIC DEVICE TO STRETCH AND EXERCISE THE

**CLASS 10—(Continued).**

TOES AND FEET; ORTHOPEDIC DEVICES FOR DIAGNOSTIC AND THERAPEUTIC USE; ORTHOPEDIC FOOTWEAR; ORTHOPEDIC JOINT IMPLANTS MADE OF ARTIFICIAL MATERIALS; ORTHOPEDIC SEAT CUSHIONS; ORTHOPEDIC SOLES; ORTHOPEDIC SUPPORT BANDAGE, NAMELY, WEARABLE PADS FOR THE HANDS; ORTHOPEDIC SUPPORT BANDAGES; ORTHOPEDIC SUPPORTS; ORTHOPEDIC SURGICAL ASPIRATOR FOR USE IN DIAGNOSIS; ORTHOPEDIC WALKERS; PADDING FOR ORTHOPEDIC CASTS; PLASTER CASTS FOR ORTHOPEDIC PURPOSES; PROTECTIVE SLEEVES USED WITH ORTHOPEDIC BRACING SYSTEMS TO PROTECT SKIN FROM ABRASIONS; SPLINTS; SURGICAL AND MEDICAL APPARATUS AND INSTRUMENTS FOR USE IN ORTHOPEDIC SURGERY; SURGICAL APPARATUS AND INSTRUMENTS FOR USE IN ORTHOPEDIC SURGERY; SURGICAL INSTRUMENTS FOR USE IN ORTHOPEDIC AND SPINAL SURGERY; TEMPLATES FOR ORTHOPEDIC PURPOSES; VERTEBRAL ORTHOPEDIC APPARATUS (U.S. CLS. 26, 39 AND 44).

BARBARA BROWN, EXAMINING ATTORNEY

SN 86-064,263. GOATS IN TREES INC., SAN DIEGO, CA.  
FILED 9-13-2013.

**EarAngels**

THE MARK CONSISTS OF STANDARD CHARACTERS WITHOUT CLAIM TO ANY PARTICULAR FONT, STYLE, SIZE, OR COLOR.

FOR EAR PLUGS FOR NOISE REDUCTION (U.S. CLS. 26, 39 AND 44).

FIRST USE 9-10-2013; IN COMMERCE 9-13-2013.

CURTIS FRENCH, EXAMINING ATTORNEY

SN 86-065,388. ANSELL LIMITED, RICHMOND, AUSTRALIA, FILED 9-16-2013.

**BIOGARD**

THE MARK CONSISTS OF STANDARD CHARACTERS WITHOUT CLAIM TO ANY PARTICULAR FONT, STYLE, SIZE, OR COLOR.

FOR GLOVES FOR MEDICAL PURPOSES; GLOVES FOR MEDICAL USE; GLOVES FOR USE IN HOSPITALS; MEDICAL GLOVES; SURGICAL GLOVES (U.S. CLS. 26, 39 AND 44).

JACQUELINE ABRAMS, EXAMINING ATTORNEY



**CLASS 10—(Continued).**

SN 86-066,188. YOFIMETER LLC, LA JOLLA, CA. FILED 9-16-2013.

# YOFILIFE

THE MARK CONSISTS OF STANDARD CHARACTERS WITHOUT CLAIM TO ANY PARTICULAR FONT, STYLE, SIZE, OR COLOR.

THE ENGLISH TRANSLATION OF "YOFI" IN THE MARK IS "BEAUTIFUL".

FOR BLOOD GLUCOSE METER; CARRYING CASE SPECIFICALLY ADAPTED FOR CARRYING DIABETIC SUPPLIES, NAMELY, BLOOD GLUCOSE METER, TESTING STRIPS AND ALSO INCLUDING INSULIN AND OTHER RELATED APPARATUS; DEVICES FOR MONITORING BLOOD GLUCOSE FOR MEDICAL PURPOSES; INTEGRATED MEDICAL EXAMINATION SYSTEMS COMPRISING MEDICAL DEVICES AND COMPUTER SOFTWARE FOR INFORMATION MANAGEMENT FOR USE IN WEB-BASED PHYSICAL EXAMINATION AND ASSESSMENT OF PATIENTS IN A REMOTE, CLINICAL SETTING (U.S. CLS. 26, 39 AND 44).

TOBY BULLOFF, EXAMINING ATTORNEY

SN 86-066,192. MOBILESLLEEPDOC, LLC, SAN FRANCISCO, CA. FILED 9-16-2013.

# PLEX

THE MARK CONSISTS OF STANDARD CHARACTERS WITHOUT CLAIM TO ANY PARTICULAR FONT, STYLE, SIZE, OR COLOR.

FOR MEDICAL DEVICE, NAMELY, A DEVICE FOR MEASURING RESPIRATORY EVENTS DURING SLEEP; SLEEP DISTURBANCE METERS; MEDICAL APPARATUS AND INSTRUMENTS FOR SLEEP DISORDER DIAGNOSIS (U.S. CLS. 26, 39 AND 44).

TOBY BULLOFF, EXAMINING ATTORNEY

SN 86-066,361. MERCADO, AXEL, HIALEAH, FL. FILED 9-17-2013.

# IN-PRO-MA

THE MARK CONSISTS OF STANDARD CHARACTERS WITHOUT CLAIM TO ANY PARTICULAR FONT, STYLE, SIZE, OR COLOR.

FOR MEDICAL INSTRUMENTS USED TO MEASURE, INVESTIGATE AND REMOVE DEVITALIZED TISSUE FROM WOUNDS AND APPLY OINTMENTS AND CREAMS (U.S. CLS. 26, 39 AND 44).

FIRST USE 10-7-2011; IN COMMERCE 10-7-2011.

NORA BUCHANAN WILL, EXAMINING ATTORNEY

**CLASS 10—(Continued).**

SN 86-066,439. DILLINGHAM, TIMOTHY, MERION STATION, PA. FILED 9-17-2013.

# THE RIGHT FIT, RIGHT NOW

THE MARK CONSISTS OF STANDARD CHARACTERS WITHOUT CLAIM TO ANY PARTICULAR FONT, STYLE, SIZE, OR COLOR.

FOR PROSTHETIC LIMBS, NAMELY, LEGS AND ARMS; ATTACHMENTS AND ACCESSORIES FOR PROSTHETIC LIMBS, NAMELY, CUSHIONS AND LINERS FOR PROSTHETIC LIMBS AND PROSTHETIC SOCKETS USED TO FASTEN PROSTHETIC LIMBS TO THE BODY (U.S. CLS. 26, 39 AND 44).

KEVIN CORWIN, EXAMINING ATTORNEY

SN 86-066,891. PEDIFIX, INC., BREWSTER, NY. FILED 9-17-2013.

# FasciaFix

THE MARK CONSISTS OF STANDARD CHARACTERS WITHOUT CLAIM TO ANY PARTICULAR FONT, STYLE, SIZE, OR COLOR.

FOR SUPPORTS FOR THE FOOT FOR MEDICAL USE IN THE NATURE OF ORTHOPEDIC SUPPORT BANDAGES (U.S. CLS. 26, 39 AND 44).

SAIMA MAKHDOOM, EXAMINING ATTORNEY

SN 86-067,274. AMSINO INTERNATIONAL, INC., POMONA, CA. FILED 9-17-2013.

# AMSure-RTU

OWNER OF U.S. REG. NO. 3,919,171.

THE MARK CONSISTS OF THE WORDING "AMSURE-RTU" IN STYLIZED FONT.

FOR CATHETERS; CATHETERS AND PARTS AND FITTINGS THEREFOR; MEDICAL TUBING FOR UROLOGICAL DEVICES; TUBING FOR USE WITH CATHETERS (U.S. CLS. 26, 39 AND 44).

BERNICE MIDDLETON, EXAMINING ATTORNEY

**CLASS 10—(Continued).**

SN 86-067,354. BAD DRAGON ENTERPRISES, INC., PHOENIX, AZ. FILED 9-17-2013.

## Luka the Otter

THE MARK CONSISTS OF STANDARD CHARACTERS WITHOUT CLAIM TO ANY PARTICULAR FONT, STYLE, SIZE, OR COLOR.

FOR ADULT SEXUAL STIMULATION AIDS, NAMELY, ARTIFICIAL PENISES AND ARTIFICIAL VAGINAS (U.S. CLS. 26, 39 AND 44).

FIRST USE 8-1-2013; IN COMMERCE 8-1-2013.  
CAROL SPILS, EXAMINING ATTORNEY

SN 86-067,927. HOME DIALYSIS PLUS, LTD., SUNNYVALE, CA. FILED 9-18-2013.

## TABLO

THE MARK CONSISTS OF STANDARD CHARACTERS WITHOUT CLAIM TO ANY PARTICULAR FONT, STYLE, SIZE, OR COLOR.

FOR DIALYSIS MACHINES (U.S. CLS. 26, 39 AND 44).  
NORA BUCHANAN WILL, EXAMINING ATTORNEY

SN 86-067,967. ACUMED, LLC, HILLSBORO, OR. FILED 9-18-2013.

## Osteo-Clage

THE MARK CONSISTS OF STANDARD CHARACTERS WITHOUT CLAIM TO ANY PARTICULAR FONT, STYLE, SIZE, OR COLOR.

OWNER OF U.S. REG. NO. 1,803,692.

FOR IMPLANTS CONSISTING OF ARTIFICIAL MATERIALS; MEDICAL, SURGICAL AND ORTHOPAEDIC IMPLANTS MADE OF ARTIFICIAL MATERIALS (U.S. CLS. 26, 39 AND 44).

FIRST USE 2-13-1993; IN COMMERCE 2-13-1993.  
ANGELA DUONG, EXAMINING ATTORNEY

**CLASS 10—(Continued).**

SN 86-068,304. HANDI-CRAFT COMPANY, ST. LOUIS, MO. FILED 9-18-2013.

## BOTTLE CHOICE MATTERS

THE MARK CONSISTS OF STANDARD CHARACTERS WITHOUT CLAIM TO ANY PARTICULAR FONT, STYLE, SIZE, OR COLOR.

FOR BABY BOTTLES (U.S. CLS. 26, 39 AND 44).  
REGINA DRUMMOND, EXAMINING ATTORNEY

SN 86-068,434. INNOVATIVE VISUAL SYSTEMS, LLC, ELMHURST, IL. FILED 9-18-2013.

## DISCOVERY

THE MARK CONSISTS OF STANDARD CHARACTERS WITHOUT CLAIM TO ANY PARTICULAR FONT, STYLE, SIZE, OR COLOR.

FOR MEDICAL EQUIPMENT IN THE FIELD OF OPHTHALMOLOGY, NAMELY, A COMBINATION CORNEAL TOPOGRAPHER AND OCULAR ABERROMETER (U.S. CLS. 26, 39 AND 44).

FIRST USE 1-15-2012; IN COMMERCE 1-15-2012.  
AMY C. KEAN, EXAMINING ATTORNEY

SN 86-068,492. LA LUMIERE LLC, CLEVELAND, OH. FILED 9-18-2013.



THE MARK CONSISTS OF A STYLIZED USE OF THE WORD "ILLUMASK", WHICH INCLUDES THE LETTERS I, L, L, U, A, S, K, SHOWN IN LOWER-CASE LETTERS, AND THE LETTER M IN UPPER-CASE.

FOR PHOTOTHERAPEUTIC LIGHT DELIVERY APPARATUS FOR MEDICAL PURPOSES (U.S. CLS. 26, 39 AND 44).

RENEE MCCRAY, EXAMINING ATTORNEY

**CLASS 10—(Continued).**

SN 86-068,515. TJ CREATIVE, INC., HUNTINGTON BEACH, CA. FILED 9-18-2013.

DEVELOPED BY WOMEN, FOR  
WOMEN

THE MARK CONSISTS OF STANDARD CHARACTERS WITHOUT CLAIM TO ANY PARTICULAR FONT, STYLE, SIZE, OR COLOR.

FOR ADULT SEXUAL STIMULATION AIDS FOR ENHANCEMENT OF SEXUAL PLEASURE AND PERFORMANCE, NAMELY, ARTIFICIAL BODY PART SEX TOY DEVICES, NAMELY, ARTIFICIAL PENISES, ARTIFICIAL PENIS STRAPS AND ARTIFICIAL PENIS HARNESSES FOR USE ALONE OR IN COMBINATION WITH OTHER DEVICES FOR ENHANCEMENT OF SEXUAL PLEASURE AND PERFORMANCE; PROTRUSION DEVICES, NAMELY, VIBRATORS, VIBRATOR STRAPS, VIBRATOR HARNESSES AND ANAL PLUGS FOR USE ALONE OR IN COMBINATION WITH OTHER DEVICES FOR ENHANCEMENT OF SEXUAL PLEASURE AND PERFORMANCE (U.S. CLS. 26, 39 AND 44).

BARBARA A. GOLD, EXAMINING ATTORNEY

SN 86-068,637. GIRDLES AND MORE, INC., MIAMI, FL. FILED 9-18-2013.

PREVENT-VARIC

THE MARK CONSISTS OF STANDARD CHARACTERS WITHOUT CLAIM TO ANY PARTICULAR FONT, STYLE, SIZE, OR COLOR.

FOR ELASTIC STOCKINGS (U.S. CLS. 26, 39 AND 44).  
NAKIA HENRY, EXAMINING ATTORNEY

SN 86-068,761. CAPSOVISION, INC., SARATOGA, CA. FILED 9-18-2013.

CapsoRetrieve

THE MARK CONSISTS OF STANDARD CHARACTERS WITHOUT CLAIM TO ANY PARTICULAR FONT, STYLE, SIZE, OR COLOR.

FOR INGESTIBLE DIAGNOSTIC CAMERAS FOR MEDICAL PURPOSES; COLLECTION AND RETRIEVAL SYSTEM FOR INGESTIBLE DIAGNOSTIC CAMERAS CONSISTING PRIMARILY OF GLOVES, COLLECTION TRAY, WASH BOTTLE, SHIPPING CONTAINER AND DISINFECTANT (U.S. CLS. 26, 39 AND 44).

CAROL SPILS, EXAMINING ATTORNEY

**CLASS 10—(Continued).**

SN 86-068,936. MIKKO VAULT LLC, WESTON, FL. FILED 9-19-2013.

SENSE FLO

THE MARK CONSISTS OF STANDARD CHARACTERS WITHOUT CLAIM TO ANY PARTICULAR FONT, STYLE, SIZE, OR COLOR.

FOR BABY BOTTLE NIPPLES; BABY BOTTLES; CUPS ADAPTED FOR FEEDING BABIES AND CHILDREN; FEEDING BOTTLE VALVES; FEEDING BOTTLES; NIPPLES FOR BABY BOTTLES (U.S. CLS. 26, 39 AND 44).

JEFFREY LOOK, EXAMINING ATTORNEY

SN 86-068,978. MERCK SHARP & DOHME CORP., WHITEHOUSE STATION, NJ. FILED 9-19-2013.

STEDII

THE MARK CONSISTS OF STANDARD CHARACTERS WITHOUT CLAIM TO ANY PARTICULAR FONT, STYLE, SIZE, OR COLOR.

FOR INJECTION DEVICE FOR PHARMACEUTICALS (U.S. CLS. 26, 39 AND 44).

DOMINIC FATHY, EXAMINING ATTORNEY

SN 86-068,983. MERCK SHARP & DOHME CORP., WHITEHOUSE STATION, NJ. FILED 9-19-2013.

TWOSIM

THE MARK CONSISTS OF STANDARD CHARACTERS WITHOUT CLAIM TO ANY PARTICULAR FONT, STYLE, SIZE, OR COLOR.

FOR INJECTION DEVICE FOR PHARMACEUTICALS (U.S. CLS. 26, 39 AND 44).

DOMINIC FATHY, EXAMINING ATTORNEY

**CLASS 10—(Continued).**

SN 86-068,986. MERCK SHARP & DOHME CORP., WHITEHOUSE STATION, NJ. FILED 9-19-2013.

# INTWO

THE MARK CONSISTS OF STANDARD CHARACTERS WITHOUT CLAIM TO ANY PARTICULAR FONT, STYLE, SIZE, OR COLOR.

FOR INJECTION DEVICE FOR PHARMACEUTICALS (U.S. CLS. 26, 39 AND 44).

DOMINIC FATHY, EXAMINING ATTORNEY

---

SN 86-068,989. MERCK SHARP & DOHME CORP., WHITEHOUSE STATION, NJ. FILED 9-19-2013.

# APTII

THE MARK CONSISTS OF STANDARD CHARACTERS WITHOUT CLAIM TO ANY PARTICULAR FONT, STYLE, SIZE, OR COLOR.

FOR INJECTION DEVICE FOR PHARMACEUTICALS (U.S. CLS. 26, 39 AND 44).

DOMINIC FATHY, EXAMINING ATTORNEY

---

SN 86-068,990. MERCK SHARP & DOHME CORP., WHITEHOUSE STATION, NJ. FILED 9-19-2013.

# 2ITIVE

THE MARK CONSISTS OF STANDARD CHARACTERS WITHOUT CLAIM TO ANY PARTICULAR FONT, STYLE, SIZE, OR COLOR.

FOR INJECTION DEVICE FOR PHARMACEUTICALS (U.S. CLS. 26, 39 AND 44).

DOMINIC FATHY, EXAMINING ATTORNEY

**CLASS 10—(Continued).**

SN 86-069,133. TURNER MEDICAL, INC., WILLIMANTIC, CT. FILED 9-19-2013.

# O2HEALTH

THE MARK CONSISTS OF STANDARD CHARACTERS WITHOUT CLAIM TO ANY PARTICULAR FONT, STYLE, SIZE, OR COLOR.

FOR PULSE OXIMETERS (U.S. CLS. 26, 39 AND 44).

THOMAS MANOR, EXAMINING ATTORNEY

---

SN 86-069,673. ARIA-BIO LTD., KFAR VRADIM, 25147, ISRAEL, FILED 9-19-2013.

# ARIA BIO

THE MARK CONSISTS OF STANDARD CHARACTERS WITHOUT CLAIM TO ANY PARTICULAR FONT, STYLE, SIZE, OR COLOR.

FOR DENTAL AND MEDICAL DRILL BITS FOR CUTTING TEETH OR BONE; DENTAL DRILLS; DENTAL FIXTURES, NAMELY, PREFABRICATED PARTS FOR CROWNS, BRIDGES AND PONTICS; DENTAL IMPLANTS; DENTAL INSTRUMENTS FOR USE IN DENTAL SURGERY, PLACING AND REMOVING DENTAL IMPLANTS, DENTAL RESTORATION, CREATING AND PLACING DENTAL PROSTHETICS IN CONNECTION WITH SUCH RESTORATIONS, TAKING DENTAL IMPRESSIONS TO FACILITATE SUCH RESTORATIONS; DENTAL INSTRUMENTS, NAMELY, DENTAL FIXTURES, DENTAL IMPLANTS, IMPRESSION TRANSFERS, DENTAL IMPLANT ANALOGS, HEALING CAPS, HEALING ABUTMENTS, DENTAL ABUTMENTS, DENTAL PROSTHETICS, SCREWS, SURGICAL DRILLS, DENTAL DRILLS, MOTOR SYSTEMS, RATCHET WRENCHES AND DRIVERS FOR PLACING AND REMOVING DENTAL IMPLANTS AND COMPLETING DENTAL RESTORATIONS, MALLETS, DEPTH GAUGES, ABUTMENT GRIPPERS; DENTAL PRODUCTS, NAMELY, PLASTIC MATERIAL FOR FABRICATING COMPLETE AND PARTIAL DENTURE LINERS/RELINES, AND FOR FABRICATING GASKETS FOR OVER DENTURES; DENTAL PROSTHESES; DRILLING JIGS FOR SURGICAL AND DENTAL APPLICATIONS; DRILLS FOR DENTAL APPLICATIONS; DRILLS FOR DENTAL USE; IMPLANTS CONSISTING OF ARTIFICIAL MATERIALS; ORTHODONTIC MACHINES AND INSTRUMENTS; PROSTHETIC INSTRUMENTS FOR DENTAL PURPOSES; SURGICAL APPARATUS AND INSTRUMENTS FOR MEDICAL, DENTAL OR VETERINARY USE; SURGICAL IMPLANTS COMPRISING ARTIFICIAL MATERIAL; SURGICAL IMPLANTS COMPRISING ARTIFICIAL MATERIAL AND ASSOCIATED SURGICAL INSTRUMENT SETS (U.S. CLS. 26, 39 AND 44).

AISHA CLARKE, EXAMINING ATTORNEY

**CLASS 10—(Continued).**

SN 86-071,444. ZION INTERNATIONAL LLC, JEFFERSONVILLE, PA. FILED 9-23-2013.



THE MARK CONSISTS OF A RIBBON FORMED INTO A BOW, WITH THE ENDS OF THE RIBBON CROSSING OVER TO FORM THE SHAPE OF A HEART.

FOR ADULT SEXUAL STIMULATION AIDS, NAMELY VIBRATORS, DILDO SEX TOYS, ANAL SEX TOYS, COCK RINGS, AND ORAL SEX TOYS (U.S. CLS. 26, 39 AND 44).

APRIL ROACH, EXAMINING ATTORNEY

SN 86-072,119. J. H. FENNER & CO. LIMITED, HESSLE, EAST YORKSHIRE, UNITED KINGDOM, FILED 9-23-2013.

## Precishaft

THE MARK CONSISTS OF STANDARD CHARACTERS WITHOUT CLAIM TO ANY PARTICULAR FONT, STYLE, SIZE, OR COLOR.

FOR MEDICAL DEVICES FOR THE ADMINISTRATION OF ENTERAL NUTRITION, NAMELY, TAPERED ENTERAL FEEDING TUBES (U.S. CLS. 26, 39 AND 44).

PAUL CROWLEY, EXAMINING ATTORNEY

SN 86-072,131. LOMA VISTA MEDICAL, INC., BURLINGAME, CA. FILED 9-23-2013.

## TRUE

THE MARK CONSISTS OF STANDARD CHARACTERS WITHOUT CLAIM TO ANY PARTICULAR FONT, STYLE, SIZE, OR COLOR.

FOR MEDICAL DEVICES AND APPARATUS, NAMELY, BALLOON VALVULOPLASTY CATHETERS AND PARTS AND FITTING THEREFOR (U.S. CLS. 26, 39 AND 44).

FIRST USE 1-31-2012; IN COMMERCE 3-21-2012.

MARK SHINER, EXAMINING ATTORNEY

**CLASS 10—(Continued).**

SN 86-072,188. BUMBLE BE HOLDINGS, LLC, LOS ANGELES, CA. FILED 9-23-2013.

## DAZZLEARS

THE MARK CONSISTS OF STANDARD CHARACTERS WITHOUT CLAIM TO ANY PARTICULAR FONT, STYLE, SIZE, OR COLOR.

FOR EAR PLUGS FOR HEARING PROTECTION AND NOISE REDUCTION (U.S. CLS. 26, 39 AND 44).

DAVID COLLIER, EXAMINING ATTORNEY

SN 86-072,779. BAD DRAGON ENTERPRISES, INC., PHOENIX, AZ. FILED 9-24-2013.

## Equiknot

THE MARK CONSISTS OF STANDARD CHARACTERS WITHOUT CLAIM TO ANY PARTICULAR FONT, STYLE, SIZE, OR COLOR.

FOR ADULT SEXUAL STIMULATION AIDS, NAMELY, ARTIFICIAL PENISES, ARTIFICIAL VAGINAS (U.S. CLS. 26, 39 AND 44).

FIRST USE 8-1-2013; IN COMMERCE 8-1-2013.

CAROL SPILS, EXAMINING ATTORNEY

SN 86-088,804. BAD DRAGON ENTERPRISES, INC., PHOENIX, AZ. FILED 10-10-2013.

## Kippy the Caline

THE MARK CONSISTS OF STANDARD CHARACTERS WITHOUT CLAIM TO ANY PARTICULAR FONT, STYLE, SIZE, OR COLOR.

FOR ADULT SEXUAL STIMULATION AIDS, NAMELY, ARTIFICIAL PENISES AND ARTIFICIAL VAGINAS (U.S. CLS. 26, 39 AND 44).

FIRST USE 9-27-2013; IN COMMERCE 9-27-2013.

CAROL SPILS, EXAMINING ATTORNEY

**CLASS 10—(Continued).**

SN 86-092,503. GROUP MEDICAL SUPPLY LLC, PLYMOUTH, MN. FILED 10-16-2013.

## GMS Cold-Pax

THE MARK CONSISTS OF STANDARD CHARACTERS WITHOUT CLAIM TO ANY PARTICULAR FONT, STYLE, SIZE, OR COLOR.

NO CLAIM IS MADE TO THE EXCLUSIVE RIGHT TO USE "COLD PACKS", APART FROM THE MARK AS SHOWN.

FOR CHEMICALLY ACTIVATED HOT AND COLD GEL PACKS FOR MEDICAL PURPOSES; CHEMICALLY ACTIVATED HOT AND/OR COLD COMPRESSES; MEDICAL ICE PACKS; THERAPEUTIC HOT AND COLD COMPRESSION WRAPS; THERAPEUTIC HOT AND COLD THERAPY PACKS; THERMAL PACKS FOR FIRST AID PURPOSES (U.S. CLS. 26, 39 AND 44).

FIRST USE 7-23-2010; IN COMMERCE 7-23-2010.  
JAMES GRIFFIN, EXAMINING ATTORNEY

SN 86-093,076. SS WHITE BURS, INC., LAKEWOOD, NJ. FILED 10-16-2013.

## SS WHITE DENTAL

THE MARK CONSISTS OF STANDARD CHARACTERS WITHOUT CLAIM TO ANY PARTICULAR FONT, STYLE, SIZE, OR COLOR.

OWNER OF U.S. REG. NOS. 138,523, 3,822,625 AND OTHERS.

NO CLAIM IS MADE TO THE EXCLUSIVE RIGHT TO USE "DENTAL", APART FROM THE MARK AS SHOWN.

FOR DENTAL BURS, NAMELY DENTAL DIAMOND POINTS AND CARBIDE BURS, BUR HOLDER BLOCKS, BUR CLEANING BRUSHES, DENTAL GLOVES, AND RUBBER DAMS (U.S. CLS. 26, 39 AND 44).

DORITT L. CARROLL, EXAMINING ATTORNEY

SN 86-099,318. GLOBUS MEDICAL, INC, AUDUBON, PA. FILED 10-23-2013.

## ALTERA

THE MARK CONSISTS OF STANDARD CHARACTERS WITHOUT CLAIM TO ANY PARTICULAR FONT, STYLE, SIZE, OR COLOR.

THE ENGLISH TRANSLATION OF THE WORD "ALTERA" IN THE MARK IS "ALTER" OR "CHANGE".

FOR SPINAL IMPLANTS MADE FROM ARTIFICIAL MATERIALS FOR USE IN SPINE SURGERY (U.S. CLS. 26, 39 AND 44).

ALEX KEAM, EXAMINING ATTORNEY

**CLASS 10—(Continued).**

SN 86-110,590. BAD DRAGON ENTERPRISES, INC., PHOENIX, AZ. FILED 11-5-2013.

## Terra the Amazon Wyvern

THE MARK CONSISTS OF STANDARD CHARACTERS WITHOUT CLAIM TO ANY PARTICULAR FONT, STYLE, SIZE, OR COLOR.

FOR ADULT SEXUAL STIMULATION AIDS, NAMELY, ARTIFICIAL PENISES, ARTIFICIAL VAGINAS (U.S. CLS. 26, 39 AND 44).

FIRST USE 10-20-2013; IN COMMERCE 10-20-2013.  
CAROL SPILS, EXAMINING ATTORNEY

SN 86-110,767. BAD DRAGON ENTERPRISES, INC., PHOENIX, AZ. FILED 11-5-2013.

## The Ice Dragon

THE MARK CONSISTS OF STANDARD CHARACTERS WITHOUT CLAIM TO ANY PARTICULAR FONT, STYLE, SIZE, OR COLOR.

FOR ADULT SEXUAL STIMULATION AIDS, NAMELY, ARTIFICIAL PENISES, ARTIFICIAL VAGINAS (U.S. CLS. 26, 39 AND 44).

FIRST USE 10-1-2013; IN COMMERCE 10-1-2013.  
CAROL SPILS, EXAMINING ATTORNEY

SN 86-112,812. BAD DRAGON ENTERPRISES, INC., PHOENIX, AZ. FILED 11-7-2013.

## Spritz The Seadragon

THE MARK CONSISTS OF STANDARD CHARACTERS WITHOUT CLAIM TO ANY PARTICULAR FONT, STYLE, SIZE, OR COLOR.

FOR ADULT SEXUAL STIMULATION AIDS, NAMELY, ARTIFICIAL PENISES, ARTIFICIAL VAGINAS (U.S. CLS. 26, 39 AND 44).

FIRST USE 10-1-2013; IN COMMERCE 10-1-2013.  
CAROL SPILS, EXAMINING ATTORNEY

**CLASS 10—(Continued).**

SN 86-118,226. BAD DRAGON ENTERPRISES, INC., PHOENIX, AZ. FILED 11-13-2013.

**The Werewolf Were-Able**

THE MARK CONSISTS OF STANDARD CHARACTERS WITHOUT CLAIM TO ANY PARTICULAR FONT, STYLE, SIZE, OR COLOR.

FOR ADULT SEXUAL STIMULATION AIDS, NAMELY, ARTIFICIAL PENISES, ARTIFICIAL VAGINAS (U.S. CLS. 26, 39 AND 44).

FIRST USE 10-20-2013; IN COMMERCE 10-20-2013.  
CAROL SPILS, EXAMINING ATTORNEY

SN 86-118,454. CAROLINA EAR & HEARING CLINIC, PC, RALEIGH, NC. FILED 11-14-2013.

**BREAKING THE SOUND BARRIER**

THE MARK CONSISTS OF STANDARD CHARACTERS WITHOUT CLAIM TO ANY PARTICULAR FONT, STYLE, SIZE, OR COLOR.

OWNER OF U.S. REG. NO. 3,296,539.  
FOR AUDIOLOGICAL AND OTOLOGICAL PRODUCTS, NAMELY, HEARING AIDS, ASSISTIVE LISTENING DEVICES FOR THE HEARING IMPAIRED, PROSTHETIC HEARING DEVICES, COCHLEAR IMPLANT DEVICES; ELECTRONIC EQUIPMENT FOR LOCALLY OR REMOTELY MONITORING AND/OR PROGRAMMING OF AUDIOLOGICAL AND OTOLOGICAL PRODUCTS, NAMELY, HEARING AIDS, ASSISTIVE LISTENING DEVICES FOR THE HEARING IMPAIRED, PROSTHETIC HEARING DEVICES AND COCHLEAR IMPLANT DEVICES (U.S. CLS. 26, 39 AND 44).

JEFFREY LOOK, EXAMINING ATTORNEY

SN 86-118,654. MEDICAL DIAGNOSTIC LABORATORIES, LCC, HAMILTON, NJ. FILED 11-14-2013.



THE COLOR(S) GOLD AND TEAL IS/ARE CLAIMED AS A FEATURE OF THE MARK.

THE MARK CONSISTS OF A 2-D STYLIZED WORD "URODEK" AND A 3-D GRAPHIC OF AN ANTIBODY, "URODEK" IS DEPICTED HORIZONTALLY FROM THE LEFT TO THE RIGHT OF THE MARK, THE LETTERS "U" AND "DEK" OF "URODEK" ARE IN UPPERCASE AND THE LETTERS "RO" OF "URODEK" ARE IN LOWERCASE, THE LETTERS "URO" ARE GOLD IN COLOR AND THE LETTERS "DEK" ARE TEAL IN COLOR, ON TOP OF THE LEFT-HAND SIDE OF THE LETTER "D" OF "URODEK" IS A GRAPHIC REPRESENTATION OF AN ANTIBODY

**CLASS 10—(Continued).**

SHADED TO GIVE IT A 3-D APPEARANCE, THE ANTIBODY CONSISTS OF TWO GOLD BARS AND TWO TEAL BARS, THE GOLD BARS REPRESENT THE HEAVY CHAINS OF AN ANTIBODY AND THE TEAL BARS REPRESENT THE LIGHT CHAINS OF AN ANTIBODY, THE GOLD BARS ARE MIRROR IMAGES OF EACH OTHER, CONSISTING OF OBTUSE ANGLES, THE UPPER LEGS OF EACH ANGLE ARE LONGER THAN THE LOWER LEGS AND ARE ATTACHED TO EACH OTHER, THE LOWER LEGS CREATE A 45 DEGREE ANGLE WITH EACH OTHER, TOGETHER CREATING A GOLD Y-SHAPED GRAPHIC ANGLED TOWARDS THE LEFT-HAND SIDE OF THE LOGO THAT IS ATTACHED TO THE TOP LEFT-HAND CORNER OF THE LETTER "D" OF THE STYLIZED WORD "URODEK", THE TEAL BARS ARE PARALLEL AND ATTACHED TO THE OUTSIDE OF THE LOWER LEGS OF THE GOLD "Y", ONE TEAL BAR ON EACH LOWER LEG. THE COLOR WHITE APPEARS AS A TRANSPARENCY AND IS NOT A PART OF THE MARK.

FOR DIAGNOSTIC APPARATUS FOR THE DETECTION OF CANCER (U.S. CLS. 26, 39 AND 44).  
SKYE YOUNG, EXAMINING ATTORNEY

SN 86-118,660. MEDICAL DIAGNOSTIC LABORATORIES, LCC, HAMILTON, NJ. FILED 11-14-2013.



THE MARK CONSISTS OF A 2-D STYLIZED WORD "URODEK" AND A 3-D GRAPHIC OF AN ANTIBODY, "URODEK" IS DEPICTED HORIZONTALLY FROM THE LEFT TO THE RIGHT OF THE MARK, THE LETTERS "U" AND "DEK" OF "URODEK" ARE IN UPPERCASE AND THE LETTERS "RO" OF "URODEK" ARE IN LOWERCASE, ON TOP OF THE LEFT-HAND SIDE OF THE LETTER "D" OF "URODEK" IS A GRAPHIC REPRESENTATION OF AN ANTIBODY, SHADED TO GIVE IT A 3-D APPEARANCE, THE ANTIBODY CONSISTS OF TWO BARS IN LIGHTER SHADES AND TWO BARS IN DARKER SHADES, THE LIGHTER BARS REPRESENT THE HEAVY CHAINS OF AN ANTIBODY AND THE DARKER BARS REPRESENT THE LIGHT CHAINS OF AN ANTIBODY, THE LIGHTER BARS ARE MIRROR IMAGES OF EACH OTHER, CONSISTING OF OBTUSE ANGLES, THE UPPER LEGS OF EACH ANGLE ARE LONGER THAN THE LOWER LEGS AND ARE ATTACHED TO EACH OTHER, THE LOWER LEGS CREATE A 45 DEGREE ANGLE WITH EACH OTHER, TOGETHER CREATING A Y-SHAPED GRAPHIC ANGLED TOWARDS THE LEFT-HAND SIDE OF THE LOGO THAT IS ATTACHED TO THE TOP LEFT-HAND CORNER OF THE LETTER "D" OF THE STYLIZED WORD "URODEK", THE DARKER BARS ARE PARALLEL AND ATTACHED TO THE OUTSIDE OF THE LOWER LEGS OF THE "Y", ONE DARKER BAR ON EACH LOWER LEG.

FOR MEDICAL DIAGNOSTIC APPARATUS FOR DETECTING CANCER (U.S. CLS. 26, 39 AND 44).  
SKYE YOUNG, EXAMINING ATTORNEY

**CLASS 10—(Continued).**

SN 86-121,775. REVERSE MEDICAL CORPORATION, IRVINE, CA. FILED 11-18-2013.

**REVERSE MEDICAL**

THE MARK CONSISTS OF STANDARD CHARACTERS WITHOUT CLAIM TO ANY PARTICULAR FONT, STYLE, SIZE, OR COLOR.

OWNER OF U.S. REG. NOS. 4,041,221 AND 4,286,531. NO CLAIM IS MADE TO THE EXCLUSIVE RIGHT TO USE "MEDICAL", APART FROM THE MARK AS SHOWN.

FOR MEDICAL DEVICES NAMELY, CATHETERS, EXCLUDING HEMODIALYSIS CATHETERS; MICRO-CATHETERS FOR INTRACRANIAL AND INTRAVASCULAR USE; GUIDE CATHETERS; ANEURYSM BRIDGING DEVICES; VASCULAR RECONSTRUCTION DEVICES; MICRO VASCULAR PLUGS; EMBOLIC DEVICES FOR TREATING VASCULAR ANOMALIES OF THE BODY; VESSEL OCCLUSION DEVICES; AND MECHANICAL THROMBECTOMY DEVICES AND FOREIGN BODY RETRIEVAL DEVICES FOR USE IN BLOOD VESSELS (U.S. CLS. 26, 39 AND 44).

FIRST USE 3-1-2008; IN COMMERCE 3-1-2008.

FLORENTINA BLANDU, EXAMINING ATTORNEY

SN 86-126,485. MILFORD HOLDING COMPANY, WILMINGTON, DE. FILED 11-22-2013.

**ValuGrip**

THE MARK CONSISTS OF STANDARD CHARACTERS WITHOUT CLAIM TO ANY PARTICULAR FONT, STYLE, SIZE, OR COLOR.

FOR DENTAL EXAMINATION GLOVES (U.S. CLS. 26, 39 AND 44).

FIRST USE 4-29-2010; IN COMMERCE 4-29-2010.

ROGER T. MCDORMAN, EXAMINING ATTORNEY

SN 86-136,430. BAD DRAGON ENTERPRISES, INC., PHOENIX, AZ. FILED 12-5-2013.

**Duke's Butt**

THE MARK CONSISTS OF STANDARD CHARACTERS WITHOUT CLAIM TO ANY PARTICULAR FONT, STYLE, SIZE, OR COLOR.

FOR ADULT SEXUAL STIMULATION AIDS, NAMELY, ARTIFICIAL PENISES, ARTIFICIAL VAGINAS (U.S. CLS. 26, 39 AND 44).

FIRST USE 11-15-2013; IN COMMERCE 11-15-2013.

CAROL SPILS, EXAMINING ATTORNEY

**CLASS 10—(Continued).**

SN 86-146,152. CURE CARE, INC., SAN MARCOS, CA. FILED 12-17-2013.

**WTS-2000**

THE MARK CONSISTS OF STANDARD CHARACTERS WITHOUT CLAIM TO ANY PARTICULAR FONT, STYLE, SIZE, OR COLOR.

FOR MEDICAL DEVICES, NAMELY, APPARATUSES AND INSTRUMENTS FOR USE IN TREATING AND HEALING WOUNDS (U.S. CLS. 26, 39 AND 44).

FIRST USE 12-1-2013; IN COMMERCE 12-1-2013.

HANNO RITTNER, EXAMINING ATTORNEY

**CLASS 11—ENVIRONMENTAL CONTROL APPARATUS**

SN 79-131,094. MR. COFFEE CO.,LTD., REPUBLIC OF KOREA, FILED 4-29-2013.



PRIORITY DATE OF 12-13-2012 IS CLAIMED. OWNER OF INTERNATIONAL REGISTRATION 1162709 DATED 4-29-2013, EXPIRES 4-29-2023.

NO CLAIM IS MADE TO THE EXCLUSIVE RIGHT TO USE "SHOP ROASTER" AND "FRESH ROASTING SYSTEM", APART FROM THE MARK AS SHOWN.

THE COLOR(S) BROWN AND WHITE IS/ARE CLAIMED AS A FEATURE OF THE MARK.

THE MARK CONSISTS OF THE TERM "ROASTBOY" IN BROWN TO THE RIGHT OF THE DESIGN OF THE SILHOUETTE OF A MAN IN BROWN BENDING OVER A BROWN AND WHITE COFFEE ROASTER AT THE CENTER OF A CIRCLE WITH A WHITE BACKGROUND. THE OUTER RING OF THE CIRCLE IS BROWN WITH THE WORDING "SHOP ROASTER" IN WHITE ALONG THE TOP ARC, AND THE WORDING "FRESH ROASTING SYSTEM" IN WHITE ALONG THE BOTTOM ARC OF THE CIRCLE. TWO WHITE COFFEE BEANS APPEAR ON EITHER SIDE OF THE CIRCLE SEPARATING THE TERMS.

FOR COFFEE ROASTERS; ROASTERS; ROASTING JACKS; MALT ROASTERS; FRUIT ROASTERS; BREAD BAKING MACHINES; BAKING OVENS FOR HOUSEHOLD PURPOSES; INDUSTRIAL COOKING OVENS; BREAD-MAKING MACHINES; MICROWAVE OVENS FOR INDUSTRIAL PURPOSES; PLATE WARMERS (U.S. CLS. 13, 21, 23, 31 AND 34).

ELLEN PERKINS, EXAMINING ATTORNEY



**CLASS 11—(Continued).**

SN 79-140,644. LINDE AKTIENGESELLSCHAFT, FED REP GERMANY, FILED 7-18-2013.

**SOLVOCARB**

THE MARK CONSISTS OF STANDARD CHARACTERS WITHOUT CLAIM TO ANY PARTICULAR FONT, STYLE, SIZE, OR COLOR.

OWNER OF INTERNATIONAL REGISTRATION 1187315 DATED 7-18-2013, EXPIRES 7-18-2023.

FOR INSTALLATIONS FOR THE TREATMENT OF WASTE WATER, DRINKING WATER AND SERVICE WATER (MAINLY CONSISTING OF SEDIMENTATION, FLOTATION AND PRECIPITATION BEDS, SAND FILTERS, APPARATUS FOR INTRODUCING GASES, CHEMICALS AND ACTIVATED CARBON INTO WATER, WATER STORAGE BASINS, PIPELINES, MEASURING, REGULATING AND MONITORING APPARATUS), DEVICES FOR INTRODUCING CARBON DIOXIDE INTO WASTE WATER, DRINKING WATER AND SERVICE WATER, FILTERS FOR THE AFORESAID EQUIPMENT, APPARATUS AND INSTALLATIONS (U.S. CLS. 13, 21, 23, 31 AND 34).

SUZANNE BLANE, EXAMINING ATTORNEY

**CLASS 11—(Continued).**

SN 85-644,874. GROTE INDUSTRIES, LLC, MADISON, IN, FILED 6-6-2012.

**LIGHTFORM**

THE MARK CONSISTS OF STANDARD CHARACTERS WITHOUT CLAIM TO ANY PARTICULAR FONT, STYLE, SIZE, OR COLOR.

FOR NON-FIXTURE FLEXIBLE LED (LIGHT EMITTING DIODE) LIGHTING ELEMENTS FOR USE BY VEHICLE MANUFACTURERS IN THE TRANSPORTATION INDUSTRY IN THE FORM OF THIN-FILM LIGHTING STRIPS FOR MOTORIZED AND NON-MOTORIZED LAND VEHICLES, AIRCRAFT, AND WATERCRAFT, EXCLUDING ELECTRICAL LIGHTING FIXTURES FOR LAND-BASED BUILDING APPLICATIONS (U.S. CLS. 13, 21, 23, 31 AND 34).

VERNA BETH RIRIE, EXAMINING ATTORNEY

SN 85-256,887. FOXFURY, VISTA, CA. FILED 3-3-2011.

**NOMAD**

THE MARK CONSISTS OF STANDARD CHARACTERS WITHOUT CLAIM TO ANY PARTICULAR FONT, STYLE, SIZE, OR COLOR.

FOR PORTABLE UTILITY LIGHTS (U.S. CLS. 13, 21, 23, 31 AND 34).

FIRST USE 6-0-2008; IN COMMERCE 4-0-2010.

JEAN IM, EXAMINING ATTORNEY

SN 85-769,286. LES PRODUITS NEPTUNE INC., ST-HYACINTHE, QUEBEC, CANADA, FILED 11-1-2012.

**WISTERIA**

THE MARK CONSISTS OF STANDARD CHARACTERS WITHOUT CLAIM TO ANY PARTICULAR FONT, STYLE, SIZE, OR COLOR.

OWNER OF CANADA REG. NO. TMA868,462, DATED 1-7-2014, EXPIRES 1-7-2029.

FOR BATH TUBS, WHIRLPOOL BATHS, AIR BATH TUBS, COMBINATION BATH TUBS, NAMELY, WHIRLPOOL BATHS AND AIR BATH TUBS, SHOWERS ENCLOSURES, MOLDED SHOWER ENCLOSURES, SHOWER BASES, SHOWER DOORS (U.S. CLS. 13, 21, 23, 31 AND 34).

DANNEAN HETZEL, EXAMINING ATTORNEY

SN 85-607,574. SAMSUNG ELECTRONICS CO., LTD., SUWON-SI, GYEONGGI-DO, REPUBLIC OF KOREA, FILED 4-25-2012.

**SIMPLE CLEAN FILTER**

THE MARK CONSISTS OF STANDARD CHARACTERS WITHOUT CLAIM TO ANY PARTICULAR FONT, STYLE, SIZE, OR COLOR.

OWNER OF CANADA REG. NO. TMA864760, DATED 11-12-2013, EXPIRES 11-12-2025.

NO CLAIM IS MADE TO THE EXCLUSIVE RIGHT TO USE "CLEAN FILTER", APART FROM THE MARK AS SHOWN.

FOR MICROWAVE OVENS (U.S. CLS. 13, 21, 23, 31 AND 34).

AHSEN KHAN, EXAMINING ATTORNEY

SN 85-798,102. CONVECTAIR-NMT INC., STE-THÉRÈSE, QC, CANADA, FILED 12-8-2012.

**ADAGIO**

THE MARK CONSISTS OF STANDARD CHARACTERS WITHOUT CLAIM TO ANY PARTICULAR FONT, STYLE, SIZE, OR COLOR.

PRIORITY CLAIMED UNDER SEC. 44(D) ON CANADA APPLICATION NO. 1604370, FILED 11-29-2012, REG. NO. TMA866173, DATED 11-28-2013, EXPIRES 11-28-2028.

FOR (BASED ON 44(D) PRIORITY APPLICATION) ELECTRIC SPACE HEATERS (U.S. CLS. 13, 21, 23, 31 AND 34).

MARGERY A. TIERNEY, EXAMINING ATTORNEY

**CLASS 11—(Continued).**

SN 85-853,144. HICON GROUP CO., LTD., ZHEJIANG, CHINA, FILED 2-19-2013.



OWNER OF U.S. REG. NO. 3,202,266.  
THE MARK CONSISTS OF THE WORD "HICON" IN STYLIZED FONT WITH THE LETTER "H" PARTIALLY FORMED, A DIAMOND FOR THE DOT IN THE LETTER "I" AND ANOTHER DIAMOND IN THE LETTER "O".  
THE WORDING "HICON" HAS NO MEANING IN A FOREIGN LANGUAGE.

FOR AIR CONDITIONING APPARATUS; AIR COOLING APPARATUS; ELECTRIC HEATING FANS; ELECTRIC RADIATORS; FILTERS FOR DRINKING WATER; FREEZERS; ICE MACHINES AND APPARATUS; LIGHT BULBS; REFRIGERATING DISPLAY CABINETS; REFRIGERATORS; WINE COOLERS, NAMELY, REFRIGERATED CABINETS CONTAINING RACKS FOR WINE BOTTLES AND STORAGE SHELVES (U.S. CLS. 13, 21, 23, 31 AND 34).

FIRST USE 3-1-2004; IN COMMERCE 12-8-2004.  
FRANK LATTUCA, EXAMINING ATTORNEY

---

SN 85-856,430. LOTUS PROMOTION LIMITED, NAGANO-KEN, JAPAN, FILED 2-21-2013.



PRIORITY CLAIMED UNDER SEC. 44(D) ON JAPAN APPLICATION NO. 2012-090411, FILED 11-7-2012, REG. NO. 5616502, DATED 9-20-2013, EXPIRES 9-20-2023.

NO CLAIM IS MADE TO THE EXCLUSIVE RIGHT TO USE "SYS", APART FROM THE MARK AS SHOWN.

THE MARK CONSISTS OF A LARGER STYLIZED LETTER "T" TO THE LEFT OF A SMALLER STYLIZED PHRASE "2SYS", WHERE THE NUMBER "2" OVERLAPS WITH THE LOWER RIGHT CORNER OF THE LETTER "T".

FOR CARBONATED WATER MAKING SYSTEM COMPRISED OF CARBONATING AND MIXING EQUIPMENT AND PARTS THEREOF; APPARATUS AND INSTRUMENTS FOR USE IN BEAUTY SALONS OR BARBERS' SHOPS, NOT INCLUDING HAIRDRESSING CHAIRS, NAMELY, APPARATUS FOR ENRICHING WATER WITH CARBON DIOXIDE (CO<sub>2</sub>) (U.S. CLS. 13, 21, 23, 31 AND 34).

PAUL E. FAHRENKOPF, EXAMINING ATTORNEY

**CLASS 11—(Continued).**

SN 85-865,473. GLOBE UNION INDUSTRIAL CORP., TAI-CHUNG, TAIWAN, FILED 3-4-2013.

# BLAZE

THE MARK CONSISTS OF STANDARD CHARACTERS WITHOUT CLAIM TO ANY PARTICULAR FONT, STYLE, SIZE, OR COLOR.

FOR FAUCETS, TOILETS, TOILET BOWLS, LAVATORIES, LAVATORY BOWLS (U.S. CLS. 13, 21, 23, 31 AND 34).

YAT SYE, LEE, EXAMINING ATTORNEY

---

SN 85-874,751. KOHLER CO., KOHLER, WI. FILED 3-13-2013.

# STRIVE

THE MARK CONSISTS OF STANDARD CHARACTERS WITHOUT CLAIM TO ANY PARTICULAR FONT, STYLE, SIZE, OR COLOR.

FOR SINKS (U.S. CLS. 13, 21, 23, 31 AND 34).  
CAROLINE WOOD, EXAMINING ATTORNEY

---

SN 85-879,408. RA BRANDS, L.L.C., MADISON, NC. FILED 3-18-2013.

## REMINGTON OPS OPTIMUM PURSUIT SERIES

THE MARK CONSISTS OF STANDARD CHARACTERS WITHOUT CLAIM TO ANY PARTICULAR FONT, STYLE, SIZE, OR COLOR.

OWNER OF U.S. REG. NOS. 187,871, 1,092,498 AND OTHERS.

NO CLAIM IS MADE TO THE EXCLUSIVE RIGHT TO USE "SERIES", APART FROM THE MARK AS SHOWN.

FOR GAS GRILLS AND GAS-POWERED DEEP FRYERS FOR USE OUTDOORS (U.S. CLS. 13, 21, 23, 31 AND 34).

JESSICA FATHY, EXAMINING ATTORNEY

**CLASS 11—(Continued).**

SN 85-885,846. RESTORATION HARDWARE, INC., CORTE MADERA, CA. FILED 3-25-2013.

RH

THE MARK CONSISTS OF STANDARD CHARACTERS WITHOUT CLAIM TO ANY PARTICULAR FONT, STYLE, SIZE, OR COLOR.

FOR SINKS; BATHTUBS; PLUMBING FITTINGS, NAMELY, FRESH WATER FILLS FOR BATHTUBS; CHANDELIERS; SCONCE LIGHTING FIXTURES; ELECTRIC LANTERNS; CANDLE LANTERNS; ELECTRIC LIGHT DECORATIVE STRINGS; ELECTRIC HOLIDAY LIGHTS; LAMPS; PENDANT LIGHTING FIXTURES; CEILING FANS; LAMP SHADES; BOOK LIGHTS; ELECTRIC CANDLES; ELECTRIC NIGHT LIGHTS; OUTDOOR SOLAR POWERED LIGHTING FIXTURES; ELECTRIC FANS; BATHROOM LIGHTING FIXTURES; PLUMBING FITTINGS, NAMELY, TUB AND SHOWER CONTROL VALVES AND TRIM SET FOR MOUNTING THE CONTROL VALVE SOLD AS A UNIT; FAUCET SETS; HANDHELD SHOWERS; WATER FOUNTAINS; ELECTRIC PATIO HEATERS; GAS PATIO HEATERS; FIREPLACES; PORTABLE FIREPLACES IN THE NATURE OF A FIRE BOWL; DECORATIVE HEAT REGISTERS (U.S. CLS. 13, 21, 23, 31 AND 34).

DAVID C. REIHNER, EXAMINING ATTORNEY

**CLASS 11—(Continued).**

SN 85-899,904. ACTRON ENGINEERING PTY LTD., BELLA VISTA, AUSTRALIA, FILED 4-10-2013.



OWNER OF AUSTRALIA REG. NO. 1507091, DATED 3-21-2013, EXPIRES 8-8-2022.

THE MARK CONSISTS OF A BLACK TRIANGLE WITH THREE WAVE LIKE LINES FLOWING ACROSS THE TRIANGLE.

FOR APPARATUS FOR HEATING, COOLING, REFRIGERATING, VENTILATING AND AIR FILTERING, AIR DEODORISING AND AIR CONDITIONING, NAMELY, SPLIT SYSTEM AND REVERSE CYCLE AIR CONDITIONING UNITS, HEAT PUMPS AND HEATING AND COOLING UNITS FOR INDUSTRIAL, COMMERCIAL AND RESIDENTIAL PURPOSES (U.S. CLS. 13, 21, 23, 31 AND 34).

ANDREW LEASER, EXAMINING ATTORNEY

SN 85-901,575. MANNING LIGHTING INC., SHEBOYGAN, WI. FILED 4-11-2013.

**SOLID STATEMENT**

THE MARK CONSISTS OF STANDARD CHARACTERS WITHOUT CLAIM TO ANY PARTICULAR FONT, STYLE, SIZE, OR COLOR.

FOR ELECTRIC LIGHTING FIXTURES (U.S. CLS. 13, 21, 23, 31 AND 34).

FIRST USE 5-7-2012; IN COMMERCE 5-7-2012.

ELISSA GARBER KON, EXAMINING ATTORNEY

SN 85-899,112. ADVANCED CONSERVATION TECHNOLOGY DISTRIBUTION, INC., COSTA MESA, CA. FILED 4-9-2013.

D'MAND MORE

THE MARK CONSISTS OF STANDARD CHARACTERS WITHOUT CLAIM TO ANY PARTICULAR FONT, STYLE, SIZE, OR COLOR.

OWNER OF U.S. REG. NO. 3,868,452.

FOR WATER AND ENERGY CONSERVATION EQUIPMENT, NAMELY, WATER CIRCULATION SYSTEM FOR CIRCULATION OF WATER IN PIPES COMPRISED OF WATER PUMPS, WATER PIPES AND HOT WATER CONTROLS THEREFOR (U.S. CLS. 13, 21, 23, 31 AND 34).

INGRID C. EULIN, EXAMINING ATTORNEY

SN 85-901,581. MANNING LIGHTING INC., SHEBOYGAN, WI. FILED 4-11-2013.

**DIGITALSPECK**

THE MARK CONSISTS OF STANDARD CHARACTERS WITHOUT CLAIM TO ANY PARTICULAR FONT, STYLE, SIZE, OR COLOR.

FOR ELECTRIC LIGHTING FIXTURES (U.S. CLS. 13, 21, 23, 31 AND 34).

FIRST USE 5-7-2012; IN COMMERCE 5-7-2012.

ELISSA GARBER KON, EXAMINING ATTORNEY

**CLASS 11—(Continued).**

SN 85-903,303. KOHLER CO., KOHLER, WI. FILED 4-12-2013.

**MEDLEY**

THE MARK CONSISTS OF STANDARD CHARACTERS WITHOUT CLAIM TO ANY PARTICULAR FONT, STYLE, SIZE, OR COLOR.

FOR BATHTUB AND SHOWER UNITS (U.S. CLS. 13, 21, 23, 31 AND 34).

CAROLINE WOOD, EXAMINING ATTORNEY

---

SN 85-919,992. CLARCOR AIR FILTRATION PRODUCTS, INC., JEFFERSONVILLE, IN. FILED 5-1-2013.

**PUR AG**

THE MARK CONSISTS OF STANDARD CHARACTERS WITHOUT CLAIM TO ANY PARTICULAR FONT, STYLE, SIZE, OR COLOR.

NO CLAIM IS MADE TO THE EXCLUSIVE RIGHT TO USE "AG", APART FROM THE MARK AS SHOWN.

FOR AIR HANDLER FILTERS, HOUSINGS FOR AIR HANDLER FILTERS, AND AIR FILTRATION SYSTEMS COMPRISED OF AIR HANDLER FILTERS AND HOUSINGS THEREFOR, ALL FOR USE IN AGRICULTURAL APPLICATIONS (U.S. CLS. 13, 21, 23, 31 AND 34).

JULIE WATSON, EXAMINING ATTORNEY

---

SN 85-920,567. KOHLER CO., KOHLER, WI. FILED 5-1-2013.

**SUNSTRUCK**

THE MARK CONSISTS OF STANDARD CHARACTERS WITHOUT CLAIM TO ANY PARTICULAR FONT, STYLE, SIZE, OR COLOR.

FOR BATHTUBS (U.S. CLS. 13, 21, 23, 31 AND 34).

CAROLINE WOOD, EXAMINING ATTORNEY

**CLASS 11—(Continued).**

SN 85-933,497. SECCUA GMBH, STEINGADEN, FED REP GERMANY, FILED 5-16-2013.



OWNER OF U.S. REG. NO. 4,324,969.  
THE COLOR(S) BLUE AND WHITE IS/ARE CLAIMED AS A FEATURE OF THE MARK.

THE MARK CONSISTS OF THE LITERAL ELEMENT "SECCUA" IS WRITTEN IN A STYLIZED FORM IN BLUE COLOR. A BLUE COLOR CIRCLE BROKEN BY WHITE COLOR ALPHABET "S" RUNNING FROM THE TOP OF THE CIRCLE TO THE BOTTOM OF THE CIRCLE HAS BEEN PLACED ABOVE THE LITERAL ELEMENT "SECCUA" AS SHOWN IN THE MARK.

FOR FILTERS MADE OF FIBER FOR WATER FILTRATION; WATER FILTRATION AND PURIFICATION UNITS AND REPLACEMENT CARTRIDGES AND FILTERS THEREFOR; WATER FILTRATION APPARATUS FOR THE DEIONIZATION OF WATER; WATER PURIFICATION AND FILTRATION APPARATUS (U.S. CLS. 13, 21, 23, 31 AND 34).

FIRST USE 9-1-2006; IN COMMERCE 4-20-2009.  
WILLIAM JACKSON, EXAMINING ATTORNEY

---

SN 85-937,262. WILDFIRE, INC., TORRANCE, CA. FILED 5-20-2013.

**VIOSTAR**

THE MARK CONSISTS OF STANDARD CHARACTERS WITHOUT CLAIM TO ANY PARTICULAR FONT, STYLE, SIZE, OR COLOR.

FOR ULTRAVIOLET LIGHTING FIXTURES AND PARTS AND FITTINGS THEREFOR FOR USE IN FILM, TELEVISION, MUSICAL AND THEATRICAL PRODUCTIONS, NIGHTCLUBS, AMUSEMENT PARKS AND ENTERTAINMENT VENUES TO CREATE BLACK LIGHT EFFECTS AND ART (U.S. CLS. 13, 21, 23, 31 AND 34).

KATHRYN COWARD, EXAMINING ATTORNEY

**CLASS 11—(Continued).**

SN 85-947,160. LI YING, SHENZHEN, GUANGDONG, CHINA, AND DU ZEHAI, SHENZHEN, GUANGDONG, CHINA, FILED 5-31-2013.



THE MARK CONSISTS OF THE WORDING "WEIZE", TWO CHINESE CHARACTERS WHICH ARE PRONOUNCED "WEIZE", WHICH HAS NO MEANING IN A FOREIGN LANGUAGE, AND A DESIGN OF A PARTIALLY SHADED CIRCLE WITH THREE STARS.

THE WORDING "WEIZE" HAS NO MEANING IN A FOREIGN LANGUAGE.

THE NON-LATIN CHARACTERS IN THE MARK TRANSLITERATE TO "WEIZE" AND THIS HAS NO MEANING IN A FOREIGN LANGUAGE.

FOR AIR-CONDITIONING APPARATUS; ELECTRIC HOLIDAY LIGHTS; ELECTRIC LAMPS; ELECTRIC LIGHTS FOR CHRISTMAS TREES; ELECTRICAL INDUCTION HEATING APPARATUS FOR HEATING METAL WORK PIECES; FLUORESCENT LAMP TUBES; FLUORESCENT LIGHTING TUBES; LAMPS; LED (LIGHT EMITTING DIODES) LIGHTING FIXTURES FOR USE IN DISPLAY, COMMERCIAL, INDUSTRIAL, RESIDENTIAL, AND ARCHITECTURAL ACCENT LIGHTING APPLICATIONS; LIGHTS FOR VEHICLES; SOLAR COLLECTORS FOR HEATING; WATER PURIFICATION INSTALLATIONS (U.S. CLS. 13, 21, 23, 31 AND 34).

FIRST USE 6-12-2012; IN COMMERCE 12-17-2012.  
ANNE MADDEN, EXAMINING ATTORNEY

SN 85-950,494. MILLER, RICK J., HILLSBORO, KS. FILED 6-4-2013.

## Ricky J Redneck

THE MARK CONSISTS OF STANDARD CHARACTERS WITHOUT CLAIM TO ANY PARTICULAR FONT, STYLE, SIZE, OR COLOR.

THE NAME "RICKY J REDNECK" DOES NOT IDENTIFY A LIVING INDIVIDUAL.

FOR PERSONAL OUTDOOR SOAKING TUBS; WATER AND AIR JETS FOR USE IN PERSONAL OUTDOOR SOAKING TUBS; SUBMERSIBLE SEATS FOR PERSONAL OUTDOOR SOAKING TUBS; PLUMBING FIXTURES, NAMELY, FAUCETS FOR OUTDOOR SOAKING TUBS (U.S. CLS. 13, 21, 23, 31 AND 34).

PATRICIA EVANKO, EXAMINING ATTORNEY

**CLASS 11—(Continued).**

SN 86-002,357. MAXTEC PLASTICS, INC., TAICHUNG CITY 406, TAIWAN, FILED 7-3-2013.

# MAXTEC

THE MARK CONSISTS OF STANDARD CHARACTERS WITHOUT CLAIM TO ANY PARTICULAR FONT, STYLE, SIZE, OR COLOR.

FOR COUNTERTOP TRIPLE FILTRATION WATER TREATMENT UNITS, REVERSE OSMOSIS WATER TREATMENT UNITS, OZONE GENERATOR THAT KILLS MOLD AND MILDEW, ULTRAVIOLET WATER TREATMENT UNITS FOR WATER STERILIZATION, WATER DISTILLING UNITS, BOTTLED WATER TREATMENT UNITS FOR PURIFICATION OF BOTTLED WATER, WATER COOLERS, CHEMICAL WASTE WATER TREATMENT UNITS; FILTER CARTRIDGES, FILTERS, AND FILTER HOUSINGS FOR WATER TREATMENT UNITS (U.S. CLS. 13, 21, 23, 31 AND 34).

FIRST USE 4-30-1997; IN COMMERCE 4-30-1997.  
BARBARA GAYNOR, EXAMINING ATTORNEY

SN 86-020,680. MULTISTACK, LLC, SPARTA, WI. FILED 7-26-2013.

# MAGLEV

THE MARK CONSISTS OF STANDARD CHARACTERS WITHOUT CLAIM TO ANY PARTICULAR FONT, STYLE, SIZE, OR COLOR.

OWNER OF U.S. REG. NO. 3,278,206.

SEC. 2(F).

FOR AIR-CONDITIONING REFRIGERATION UNITS; AIR-CONDITIONING MODULAR REFRIGERATION UNITS; AIR-CONDITIONING SYSTEMS PRIMARILY COMPRISING MOTOR AND COMPRESSOR UNITS, CHILLERS, EVAPORATORS, HEAT-EXCHANGERS, AND CONTROL SYSTEMS (U.S. CLS. 13, 21, 23, 31 AND 34).

FIRST USE 12-2-2005; IN COMMERCE 12-2-2005.

BARBARA RUTLAND, EXAMINING ATTORNEY

SN 86-020,800. UOP LLC, DES PLAINES, IL. FILED 7-26-2013.

# SEPARSIV

THE MARK CONSISTS OF STANDARD CHARACTERS WITHOUT CLAIM TO ANY PARTICULAR FONT, STYLE, SIZE, OR COLOR.

FOR TEMPERATURE-SWING ADSORPTION SYSTEM USED IN THE REMOVAL OF HYDROCARBONS AND WATER FROM NATURAL GAS COMPRISED OF REGENERATION GAS HEATERS, COOLERS AND SEPARATORS, ADSORPTION BEDS, SWITCHING VALVES, AND ELECTRONIC CONTROLS FOR AUTOMATIC CONTROL OF THE SWITCHING VALVES (U.S. CLS. 13, 21, 23, 31 AND 34).

MICHAEL TANNER, EXAMINING ATTORNEY

**CLASS 11—(Continued).**

SN 86-031,229. UOP LLC, DES PLAINES, IL. FILED 8-7-2013.

**SIMULFLOW**

THE MARK CONSISTS OF STANDARD CHARACTERS WITHOUT CLAIM TO ANY PARTICULAR FONT, STYLE, SIZE, OR COLOR.

FOR MASS TRANSFER DEVICES FOR USE IN THE PETROLEUM AND PETROCHEMICAL INDUSTRY, NAMELY, FRACTIONATION TRAYS USED IN THE SEPARATION OF VOLATILE CHEMICALS AND WATER DISTILLATION COLUMNS (U.S. CLS. 13, 21, 23, 31 AND 34).

MICHAEL TANNER, EXAMINING ATTORNEY

**CLASS 11—(Continued).**

SN 86-034,388. VENT-RITE VALVE CORP., RANDOLPH, MA. FILED 8-9-2013.

**VENT-RITE**

THE MARK CONSISTS OF STANDARD CHARACTERS WITHOUT CLAIM TO ANY PARTICULAR FONT, STYLE, SIZE, OR COLOR.

OWNER OF U.S. REG. NO. 3,448,634.

FOR COMPONENT PARTS OF COMMERCIAL AND DOMESTIC BUILDING HEATING SYSTEMS, NAMELY, CONDENSATE PUMP SYSTEMS CONSISTING OF TANKS, PUMPS AND ELECTRICAL CONTROLS SOLD AS A UNIT, VACUUM PUMP SYSTEMS CONSISTING OF VACUUM PUMPS, TANKS AND ELECTRICAL CONTROLS SOLD AS A UNIT AND BOILER FEED SYSTEMS CONSISTING OF TANKS, PUMPS AND ELECTRICAL CONTROLS SOLD AS A UNIT (U.S. CLS. 13, 21, 23, 31 AND 34).

FIRST USE 5-1-1985; IN COMMERCE 5-1-1985.

LUCY ARANT, EXAMINING ATTORNEY

SN 86-031,511. AQUATIC SCIENTIFIC CO. LTD, CHAO CHOU TOWN, TAIWAN, FILED 8-7-2013.



NO CLAIM IS MADE TO THE EXCLUSIVE RIGHT TO USE "WATER SCIENCE", APART FROM THE MARK AS SHOWN.

THE COLOR(S) BLACK AND BLUE IS/ARE CLAIMED AS A FEATURE OF THE MARK.

THE MARK CONSISTS OF NINE INDEPENDENT SQUARES FORMING AN INVERTED PYRAMID WHICH CONSIST OF A BLUE SQUARE FOLLOWED BY THREE BLACK SQUARES AND ONE BLUE SQUARE ON THE TOP LAYER, THEN FOLLOWED BY ONE BLUE SQUARE, ONE BLACK SQUARE AND ONE BLUE SQUARE IN THE LAYER BELOW AND THEN FOLLOWED BY A SINGLE BLUE SQUARE IN THE LAST LAYER. ALL SQUARES JOINED BY SMALL BLACK CIRCLES IN THE INTERNAL BOTTOM CORNERS. THEN FOLLOWED ON THE LEFT HAND SIDE BY THE WORDS "HYDRO GUARD WATER SCIENCES" CAPITALIZED. "HYDRO" IS IN BOLD ABOVE THE WORD "GUARD" AND "WATER SCIENCES" ARE TOGETHER RIGHT BELOW THE WORD "GUARD".

FOR WATER PURIFIERS FOR HOUSEHOLD PURPOSES (U.S. CLS. 13, 21, 23, 31 AND 34).

FIRST USE 5-1-2011; IN COMMERCE 5-1-2011.

MATTHEW KLINE, EXAMINING ATTORNEY

SN 86-035,453. CASUAL CLASSICS FURNITURE GROUP LLC, RANCHO CORDOVA, CA. FILED 8-12-2013.



NO CLAIM IS MADE TO THE EXCLUSIVE RIGHT TO USE "PROFESSIONAL GAS GRILL", APART FROM THE MARK AS SHOWN.

THE COLOR(S) RED, ORANGE AND BLACK IS/ARE CLAIMED AS A FEATURE OF THE MARK.

THE MARK CONSISTS OF THE STYLIZED TEXT "SUNFIRE" IN RED AND OUTLINED IN BLACK, WITH A DESIGN OF AN ORANGE SUN IMAGE OUTLINED IN RED BEHIND THE LETTER "S" IN "SUNFIRE" AND THE STYLIZED TEXT "PROFESSIONAL GAS GRILL" CENTERED BENEATH "SUNFIRE" IN BLACK.

FOR PROPANE AND GAS FIRED BARBECUE (U.S. CLS. 13, 21, 23, 31 AND 34).

SOPHIA S. KIM, EXAMINING ATTORNEY

**CLASS 11—(Continued).**

SN 86-038,333. EMODERNDECOR, DIAMOND BAR, CA.  
FILED 8-14-2013.



THE MARK CONSISTS OF THE WORD "ARIEL" INSIDE AN OFFSET OVAL, WITH TIP OF CAPITAL LETTER A SLIGHTLY COMING OUT OF THE OVAL AND THE LOWER CASE "I" IS DOTTED WITH A STAR.

FOR FAUCETS; KITCHEN SINK SPRAYERS; KITCHEN SINKS; SHOWER HEAD SPRAYERS; SHOWERS AND SHOWER CUBICLES; SINGLE LEVER FIXTURES FOR LAVATORIES AND SINKS; SINKS (U.S. CLS. 13, 21, 23, 31 AND 34).

FIRST USE 1-1-2013; IN COMMERCE 1-1-2013.  
KATINA MISTER, EXAMINING ATTORNEY

SN 86-041,043. EVERGREEN GLOBAL MANAGEMENT INC,  
ATLANTA, GA. FILED 8-18-2013.



THE COLOR(S) DARK BLUE, LIGHT BLUE AND WHITE IS/ARE CLAIMED AS A FEATURE OF THE MARK.

THE MARK CONSISTS OF THE STYLIZED WORDING "TOPDURALED" IN DARK BLUE, WITH WHITE SHADING AROUND THE LETTERS "OPD", IMPOSED OVER A LIGHT BLUE STAR DESIGN.

FOR CULTIVATION LAMPS AND PARTS THEREOF, NAMELY, HIGH PRESSURE SODIUM (HPS), METAL HALIDE, PLASMA, AND LIGHT EMITTING DIODE (LED); LED (LIGHT EMITTING DIODE) LIGHTING FIXTURES; LED (LIGHT EMITTING DIODES) LIGHTING FIXTURES FOR USE IN DISPLAY, COMMERCIAL, INDUSTRIAL, RESIDENTIAL, AND ARCHITECTURAL ACCENT LIGHTING APPLICATIONS; LED AND HID LIGHT FIXTURES; LED CANDLES; LED FLOOD LIGHTS AND LED WORK LIGHTS FOR CONSTRUCTION SETTINGS; LED LANDSCAPE LIGHTS; LED LIGHT APPARATUS THAT CLIPS ON TO A HANDBAG, USED TO ILLUMINATE A HANDBAG; LED LIGHT ASSEMBLIES FOR STREET LIGHTS, SIGNS, COMMERCIAL LIGHTING, AUTOMOBILES, BUILDINGS, AND OTHER ARCHITECTURAL USES; LED LIGHT BULBS; LED LIGHT ENGINES; LED LIGHT MACHINES; LED LIGHT STRIPS FOR DECORATIVE PURPOSES; LED LIGHTING FIXTURES FOR INDOOR AND OUTDOOR LIGHTING APPLICATIONS; LED LIGHTING SYSTEMS, NAMELY, LED MODULES, POWER SUPPLIES, AND WIRING; LED LIGHTS FOR LIGHTING PURPOSES

**CLASS 11—(Continued).**

INCORPORATED INTO KEY CHAINS, SMALL TOYS OR OTHER SIMILAR PERSONAL ITEMS; LED LIGHTS FOR STRINGS, FLOWERS, BRANCHES AND OTHER ORNAMENTAL DECORATIONS; LED LUMINAIRES; LED STROBE LIGHTS TO BE PLACED ON PUBLIC SAFETY VEHICLES; LED UNDERWATER LIGHTS; LIGHT EMITTING DIODE (LED) PLANT GROW LIGHT; LIGHT EMITTING DIODES (LEDS) INCORPORATED INTO METALLIC AND ADHESIVE PLASTIC REFLECTOR FILM FOR ILLUMINATING TRANSPARENT BALLOONS AND SIMILAR PRODUCTS; LUMINAIRES, USING LIGHT EMITTING DIODES (LEDS) AS A LIGHT SOURCE, FOR STREET OR ROADWAY LIGHTING; OPTICAL LENS COVERS THAT IMPROVE LIGHT OUTPUT AND UNIFORMITY AND PROTECT THE LED, SOLD AS A FEATURE OF AN LED LIGHTING SYSTEM; RED LED FLASHLIGHTS FOR ILLUMINATION PURPOSES; TOOLS, COMPONENTS AND SUPPLIES FOR USE IN MAKING SIGNS, NAMELY, FLUORESCENT, HID, LED AND INCANDESCENT BULBS, LAMPS AND FIXTURES (U.S. CLS. 13, 21, 23, 31 AND 34).

JORDAN BAKER, EXAMINING ATTORNEY

SN 86-041,795. LACE TECHNOLOGIES, INC., ADDISON, IL.  
FILED 8-19-2013.

**BOLT BUSTER**

THE MARK CONSISTS OF STANDARD CHARACTERS WITHOUT CLAIM TO ANY PARTICULAR FONT, STYLE, SIZE, OR COLOR.

NO CLAIM IS MADE TO THE EXCLUSIVE RIGHT TO USE "BOLT", APART FROM THE MARK AS SHOWN.

FOR HANDHELD HEAT INDUCTION TOOL FOR REMOVING RUSTED, SEIZED OR STRIPPED NUTS, BOLTS, BEARINGS, GEARS, PINS AND THE LIKE (U.S. CLS. 13, 21, 23, 31 AND 34).

FIRST USE 1-1-2013; IN COMMERCE 1-1-2013.  
KATHRYN COWARD, EXAMINING ATTORNEY

SN 86-044,451. JST PERFORMANCE, INC., DBA RIGID  
INDUSTRIES, GILBERT, AZ. FILED 8-21-2013.

**D-SERIES**

THE MARK CONSISTS OF STANDARD CHARACTERS WITHOUT CLAIM TO ANY PARTICULAR FONT, STYLE, SIZE, OR COLOR.

OWNER OF U.S. REG. NO. 4,263,785.

FOR LIGHT BARS FOR VEHICLES, NAMELY, MARINE-BASED VEHICLES (U.S. CLS. 13, 21, 23, 31 AND 34).

FIRST USE 5-31-2011; IN COMMERCE 5-31-2011.

JOHN E. MICHOS, EXAMINING ATTORNEY

**CLASS 11—(Continued).**

SN 86-047,552. SMITH MOUNTAIN INDUSTRIES, INC., FOREST, VA. FILED 8-26-2013.

**SQUEEZE-UMS**

THE MARK CONSISTS OF STANDARD CHARACTERS WITHOUT CLAIM TO ANY PARTICULAR FONT, STYLE, SIZE, OR COLOR.

FOR AIR FRESHENER DISPENSING UNITS, NAMELY, FIGURINE-SHAPED DISPENSING UNITS HAVING ODOR NEUTRALIZING, ODOR DEODORIZING, FRAGRANCE DISCS AND BEADS CONTAINED THEREIN ALL SOLD AS A UNIT (U.S. CLS. 13, 21, 23, 31 AND 34).

TARAH HARDY, EXAMINING ATTORNEY

**CLASS 11—(Continued).**

SN 86-059,814. JST PERFORMANCE, INC., DBA RIGID INDUSTRIES, GILBERT, AZ. FILED 9-9-2013.

**E-SERIES**

THE MARK CONSISTS OF STANDARD CHARACTERS WITHOUT CLAIM TO ANY PARTICULAR FONT, STYLE, SIZE, OR COLOR.

FOR LED (LIGHT EMITTING DIODE) LIGHT BARS FOR MOTOR VEHICLES (U.S. CLS. 13, 21, 23, 31 AND 34).

FIRST USE 10-1-2009; IN COMMERCE 10-1-2009.  
JOHN E. MICHOS, EXAMINING ATTORNEY

SN 86-048,129. HNO GREENFUELS, INC., TEMECULA, CA. FILED 8-26-2013.

**Making Particulate Matter  
Emissions a Thing of the  
Past**

THE MARK CONSISTS OF STANDARD CHARACTERS WITHOUT CLAIM TO ANY PARTICULAR FONT, STYLE, SIZE, OR COLOR.

FOR HYDROGEN-GENERATION EQUIPMENT AND COMPONENTS, NAMELY, HYDROGEN GENERATORS, HYDROGEN PURIFIERS, HYDROGEN PURIFICATION MEMBRANES, FUEL PROCESSORS, AND STEAM REFORMERS (U.S. CLS. 13, 21, 23, 31 AND 34).

FIRST USE 8-23-2013; IN COMMERCE 8-23-2013.  
JACQUELINE ABRAMS, EXAMINING ATTORNEY

SN 86-061,801. AQUARII, INC., CAMILLUS, NY. FILED 9-11-2013.

**AXCELERON**

THE MARK CONSISTS OF STANDARD CHARACTERS WITHOUT CLAIM TO ANY PARTICULAR FONT, STYLE, SIZE, OR COLOR.

FOR LED (LIGHT EMITTING DIODE) LIGHTING FIXTURES (U.S. CLS. 13, 21, 23, 31 AND 34).

SUSAN RICHARDS, EXAMINING ATTORNEY

SN 86-048,328. OPUS INTERNATIONAL LLC, IRVINE, CA. FILED 8-26-2013.

**AROMA SENSE**

THE MARK CONSISTS OF STANDARD CHARACTERS WITHOUT CLAIM TO ANY PARTICULAR FONT, STYLE, SIZE, OR COLOR.

NO CLAIM IS MADE TO THE EXCLUSIVE RIGHT TO USE "AROMA", APART FROM THE MARK AS SHOWN. FOR SHOWER HEADS; SHOWER HEAD FILTERS (U.S. CLS. 13, 21, 23, 31 AND 34).

FIRST USE 6-1-2013; IN COMMERCE 6-30-2013.  
MIDGE BUTLER, EXAMINING ATTORNEY

SN 86-063,498. DSM&T CO., INC., FONTANA, CA. FILED 9-12-2013.

**FEET RETREAT**

THE MARK CONSISTS OF STANDARD CHARACTERS WITHOUT CLAIM TO ANY PARTICULAR FONT, STYLE, SIZE, OR COLOR.

FOR ELECTRICALLY-HEATED CARPETS (U.S. CLS. 13, 21, 23, 31 AND 34).

DOUGLAS LEE, EXAMINING ATTORNEY



**CLASS 11—(Continued).**

SN 86-065,255. HALO2CLOUD LLC, GLASTONBURY, CT. FILED 9-16-2013.

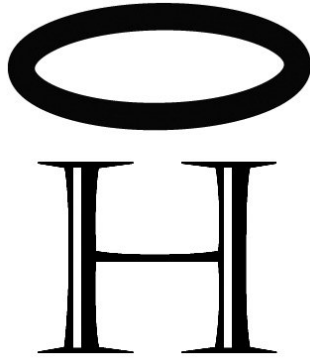

OWNER OF U.S. REG. NOS. 4,244,626 AND 4,250,272.  
THE MARK CONSISTS OF THE CAPITALIZED LETTER "H" WITH A HALO APPEARING ABOVE IT.

FOR FLASHLIGHTS AND RECHARGEABLE FLASHLIGHTS; COMBINATION FLASHLIGHT AND PORTABLE POWER CHARGERS FOR CHARGING PORTABLE ELECTRONIC DEVICES; ELECTRIC LANTERNS; PORTABLE LIGHT EMITTING DIODE (LED) LIGHTING FIXTURES; PORTABLE UTILITY LIGHTS; AND PORTABLE LIGHTS WITH MOTION DETECTION (U.S. CLS. 13, 21, 23, 31 AND 34).

FIRST USE 3-0-2013; IN COMMERCE 3-0-2013.  
KEVIN CORWIN, EXAMINING ATTORNEY

SN 86-065,897. SPINARRI AUTOSKEWERS INC., ST. CLAIR SHORES, MI. FILED 9-16-2013.

**SPINARRI AUTOSKEWERS**

THE MARK CONSISTS OF STANDARD CHARACTERS WITHOUT CLAIM TO ANY PARTICULAR FONT, STYLE, SIZE, OR COLOR.

FOR BARBEQUE EQUIPMENT, NAMELY ROTISERIES AND PARTS THEREFOR (U.S. CLS. 13, 21, 23, 31 AND 34).

FIRST USE 9-7-2013; IN COMMERCE 9-7-2013.  
ELLEN BURNS, EXAMINING ATTORNEY

**CLASS 11—(Continued).**

SN 86-066,591. PACLIGHTS LLC, CHINO HILLS, CA. FILED 9-17-2013.

**PACLIGHTS**

THE MARK CONSISTS OF STANDARD CHARACTERS WITHOUT CLAIM TO ANY PARTICULAR FONT, STYLE, SIZE, OR COLOR.

FOR FLASHLIGHTS; LED LIGHT STRIPS FOR DECORATIVE PURPOSES; LIGHT BULBS; LIGHTING FIXTURES (U.S. CLS. 13, 21, 23, 31 AND 34).

FIRST USE 8-1-2013; IN COMMERCE 8-1-2013.  
NORA BUCHANAN WILL, EXAMINING ATTORNEY

SN 86-067,012. KRAMER, JESSE D, HERMOSA BEACH, CA. FILED 9-17-2013.

**MotorMood**

THE MARK CONSISTS OF STANDARD CHARACTERS WITHOUT CLAIM TO ANY PARTICULAR FONT, STYLE, SIZE, OR COLOR.

FOR LED LIGHT ASSEMBLIES FOR STREET LIGHTS, SIGNS, COMMERCIAL LIGHTING, AUTOMOBILES, BUILDINGS, AND OTHER ARCHITECTURAL USES (U.S. CLS. 13, 21, 23, 31 AND 34).

FIRST USE 6-0-2013; IN COMMERCE 7-0-2013.  
KATHERINE STOIDES, EXAMINING ATTORNEY

SN 86-067,314. REGINA M. GORE, DANBURY, CT. FILED 9-17-2013.

**COOLCUMBERS**

THE MARK CONSISTS OF STANDARD CHARACTERS WITHOUT CLAIM TO ANY PARTICULAR FONT, STYLE, SIZE, OR COLOR.

FOR HAIR DRYERS; COOL AIR HAIR DRYERS FOR BABIES; ELECTRIC FANS; COLD PACKS FOR COOLING THE BODY AND NOT FOR MEDICAL PURPOSES; HAIR DRYERS; HAND-HELD ELECTRIC HAIR DRYERS; MINIBARS (U.S. CLS. 13, 21, 23, 31 AND 34).

TIMOTHY FINNEGAN, EXAMINING ATTORNEY

**CLASS 11—(Continued).**

SN 86-067,775. TOOSHLIGHTS, NEWBURY PARK, CA.  
FILED 9-18-2013.

# Tooshlights

THE MARK CONSISTS OF STANDARD CHARACTERS WITHOUT CLAIM TO ANY PARTICULAR FONT, STYLE, SIZE, OR COLOR.

FOR LED LIGHTING SYSTEMS, NAMELY, LED MODULES, POWER SUPPLIES, AND WIRING (U.S. CLS. 13, 21, 23, 31 AND 34).

MORGAN WYNNE, EXAMINING ATTORNEY

**CLASS 11—(Continued).**

SN 86-073,546. FANTASMA TOYS, INC., NEW YORK, NY.  
FILED 9-24-2013.

# TIDY TUSHIE

THE MARK CONSISTS OF STANDARD CHARACTERS WITHOUT CLAIM TO ANY PARTICULAR FONT, STYLE, SIZE, OR COLOR.

FOR PORTABLE BIDETS (U.S. CLS. 13, 21, 23, 31 AND 34).

RUSS HERMAN, EXAMINING ATTORNEY

SN 86-068,468. MIELE, INC., PRINCETON, NJ. FILED 9-18-2013.

# MTOUCH

THE MARK CONSISTS OF STANDARD CHARACTERS WITHOUT CLAIM TO ANY PARTICULAR FONT, STYLE, SIZE, OR COLOR.

FOR COOKING OVENS; COOKING RANGES; STEAM OVENS; ELECTRIC COFFEE MAKERS (U.S. CLS. 13, 21, 23, 31 AND 34).

KEVIN CORWIN, EXAMINING ATTORNEY

SN 86-070,993. GO GREEN TRADING, INC, LOS ANGELES, CA. FILED 9-20-2013.



THE MARK CONSISTS OF TWO LETTERS "GG". ONE G BACKWARDS AND ONE IS RIGHT WAY FORWARD.  
FOR ELECTRONIC VAPORIZER (U.S. CLS. 13, 21, 23, 31 AND 34).

FIRST USE 6-1-2013; IN COMMERCE 6-1-2013.

RONALD MCMORROW, EXAMINING ATTORNEY

SN 86-078,653. EVEREADY BATTERY COMPANY, INC., ST. LOUIS, MO. FILED 9-30-2013.



OWNER OF U.S. REG. NOS. 1,502,902, 4,436,250 AND OTHERS.

THE MARK CONSISTS OF A BUNNY BEATING A DRUM BEARING THE WORD "ENERGIZER".

FOR FLASHLIGHTS (U.S. CLS. 13, 21, 23, 31 AND 34).

KELLY BOULTON, EXAMINING ATTORNEY

SN 86-082,749. BECKETT CORPORATION, IRVING, TX.  
FILED 10-4-2013.

# Tranquil Accents

THE MARK CONSISTS OF STANDARD CHARACTERS WITHOUT CLAIM TO ANY PARTICULAR FONT, STYLE, SIZE, OR COLOR.

FOR WATER FOUNTAINS, ORNAMENTAL WATER FOUNTAINS, AND OTHER DECORATIVE WATER FOUNTAINS, NAMELY TABLE-TOP FOUNTAINS (U.S. CLS. 13, 21, 23, 31 AND 34).

FIRST USE 9-27-2013; IN COMMERCE 9-27-2013.

TEJBIR SINGH, EXAMINING ATTORNEY

**CLASS 11—(Continued).**

SN 86-082,793. JST PERFORMANCE, INC., DBA RIGID INDUSTRIES, GILBERT, AZ. FILED 10-4-2013.

# RDS-SERIES

THE MARK CONSISTS OF STANDARD CHARACTERS WITHOUT CLAIM TO ANY PARTICULAR FONT, STYLE, SIZE, OR COLOR.

FOR LED (LIGHT EMITTING DIODE) LIGHTING FIXTURES (U.S. CLS. 13, 21, 23, 31 AND 34).  
JOHN E. MICHOS, EXAMINING ATTORNEY

**CLASS 11—(Continued).**

SN 86-106,918. CHRONOMITE LABORATORIES, INC., CITY OF INDUSTRY, CA. FILED 10-31-2013.



OWNER OF U.S. REG. NOS. 1,159,032 AND 1,159,033.  
THE MARK CONSISTS OF THE WORD "CHRONOMITE" WITH A STYLIZED LETTER "C". INSIDE THE "C" IS AN OVAL WITH AN ARROW SHAPE.

FOR WATER HEATERS, AND PARTS THEREFOR (U.S. CLS. 13, 21, 23, 31 AND 34).  
FIRST USE 0-0-1967; IN COMMERCE 0-0-1967.  
AMY HELLA, EXAMINING ATTORNEY

SN 86-095,514. WILDFIRE, INC., TORRANCE, CA. FILED 10-18-2013.

# VIOSTORM PRO

THE MARK CONSISTS OF STANDARD CHARACTERS WITHOUT CLAIM TO ANY PARTICULAR FONT, STYLE, SIZE, OR COLOR.

NO CLAIM IS MADE TO THE EXCLUSIVE RIGHT TO USE "PRO", APART FROM THE MARK AS SHOWN.

FOR ULTRAVIOLET LIGHTING FIXTURES AND PARTS AND FITTINGS THEREFOR FOR USE IN FILM, TELEVISION, MUSICAL AND THEATRICAL PRODUCTIONS, NIGHTCLUBS, AMUSEMENT PARKS AND ENTERTAINMENT VENUES (U.S. CLS. 13, 21, 23, 31 AND 34).  
COLLEEN KEARNEY, EXAMINING ATTORNEY

SN 86-111,158. LLOYDS IP HOLDINGS LLC, POMONA, CA. FILED 11-5-2013.

# QUIET CLEAN

THE MARK CONSISTS OF STANDARD CHARACTERS WITHOUT CLAIM TO ANY PARTICULAR FONT, STYLE, SIZE, OR COLOR.

FOR SPAS IN THE NATURE OF HEATED POOLS, HOT TUBS (U.S. CLS. 13, 21, 23, 31 AND 34).  
WILLIAM ROSSMAN, EXAMINING ATTORNEY

SN 86-100,697. FERGUSON ENTERPRISES, INC., NEWPORT NEWS, VA. FILED 10-24-2013.

# LINCOLN PRODUCTS

THE MARK CONSISTS OF STANDARD CHARACTERS WITHOUT CLAIM TO ANY PARTICULAR FONT, STYLE, SIZE, OR COLOR.

OWNER OF U.S. REG. NOS. 4,193,140, 4,201,024 AND OTHERS.

NO CLAIM IS MADE TO THE EXCLUSIVE RIGHT TO USE "PRODUCTS", APART FROM THE MARK AS SHOWN.

FOR WATER TREATMENT EQUIPMENT, NAMELY, CARTRIDGE FILTRATION UNITS; FAUCETS FOR DRINKING FOUNTAINS (U.S. CLS. 13, 21, 23, 31 AND 34).  
WILLIAM P. SHANAHAN, EXAMINING ATTORNEY

SN 86-128,047. HOMER TLC, INC., WILMINGTON, DE. FILED 11-25-2013.

# ELIZABETHAN CLASSICS

THE MARK CONSISTS OF STANDARD CHARACTERS WITHOUT CLAIM TO ANY PARTICULAR FONT, STYLE, SIZE, OR COLOR.

OWNER OF U.S. REG. NOS. 2,722,881, 3,840,355 AND OTHERS.

SEC. 2(F).  
FOR BATH TUBS AND PLUMBING FIXTURES, NAMELY, FAUCETS AND SHOWERHEADS (U.S. CLS. 13, 21, 23, 31 AND 34).

FIRST USE 4-0-1998; IN COMMERCE 4-0-1998.  
BRIAN NEVILLE, EXAMINING ATTORNEY

**CLASS 12—VEHICLES**

SN 77-678,256. STARCRAFT MARK HOLDING COMPANY, LLC, GOSHEN, IN. FILED 2-25-2009.

# EVERGREEN

THE MARK CONSISTS OF STANDARD CHARACTERS WITHOUT CLAIM TO ANY PARTICULAR FONT, STYLE, SIZE, OR COLOR.

FOR RECREATIONAL VEHICLES, NAMELY, MOTORIZED AND TOWABLE LAND VEHICLES HAVING LIVING QUARTERS THEREIN (U.S. CLS. 19, 21, 23, 31, 35 AND 44).

BRIDGETT SMITH, EXAMINING ATTORNEY

SN 78-743,034. DUB PUBLISHING, INC., CITY OF INDUSTRY, CA. FILED 10-28-2005.

# DUB EDITION

THE MARK CONSISTS OF STANDARD CHARACTERS WITHOUT CLAIM TO ANY PARTICULAR FONT, STYLE, SIZE, OR COLOR.

FOR VEHICLE ACCESSORIES, NAMELY, GRILLES, SPOILERS, RUNNING BOARDS, FENDER FLARES, VANITY MIRRORS, LICENSE PLATE HOLDERS AND FRAMES AND FASTENERS, SEAT COVERS, STEERING WHEEL COVERS, AUTOMOBILE WINDSHIELD SUN SHADES, AND AUTOMOBILE WINDSHIELD SHADE SCREENS (U.S. CLS. 19, 21, 23, 31, 35 AND 44).

JAMES GRIFFIN, EXAMINING ATTORNEY

SN 79-093,977. BIKE ALERT PLC, UNITED KINGDOM, FILED 1-27-2011.

# JT SPROCKETS

THE MARK CONSISTS OF STANDARD CHARACTERS WITHOUT CLAIM TO ANY PARTICULAR FONT, STYLE, SIZE, OR COLOR.

PRIORITY DATE OF 10-25-2010 IS CLAIMED.

OWNER OF INTERNATIONAL REGISTRATION 1068182 DATED 1-27-2011, EXPIRES 1-27-2021.

OWNER OF U.S. REG. NOS. 3,237,531, 3,385,713 AND OTHERS.

NO CLAIM IS MADE TO THE EXCLUSIVE RIGHT TO USE "SPROCKETS", APART FROM THE MARK AS SHOWN.

FOR MOTORCYCLE PARTS, NAMELY, SPROCKETS, DRIVE CHAINS, TRANSMISSION CHAINS, HOUSING COVERS FOR ENGINES, AND GEARS; VEHICLES, NAMELY, MOTORCYCLES; MOTOR VEHICLE ENGINES, NAMELY, ENGINES FOR LAND VEHICLES; SHOCK ABSORBERS AND BRAKES FOR MOTORCYCLES (U.S. CLS. 19, 21, 23, 31, 35 AND 44).

BERNICE MIDDLETON, EXAMINING ATTORNEY

**CLASS 12—(Continued).**

SN 79-129,882. ARCOA, FRANCE, FILED 12-21-2012.

# ARCOA

OWNER OF INTERNATIONAL REGISTRATION 0248237 DATED 10-7-1961, EXPIRES 10-7-2021.

THE MARK CONSISTS OF THE STYLIZED WORD "ARCOA".

FOR MOTORBOATS, SAILBOATS AND ROWBOATS AND FLOATING CRAFT, NAMELY, BOATS (U.S. CLS. 19, 21, 23, 31, 35 AND 44).

JASON TURNER, EXAMINING ATTORNEY

SN 79-130,896. TOPFUN, S.L., SANT FELIU DE CODINES (BARCELONA), SPAIN, FILED 3-4-2013.



# FINNA

OWNER OF INTERNATIONAL REGISTRATION 1162139 DATED 3-4-2013, EXPIRES 3-4-2023.

THE MARK CONSISTS OF THE WORDING "FINNA" AND THE DESIGN OF A STYLIZED "F" APPEARING IN A RECTANGLE WITH ONE ROUNDED SIDE.

THE WORDING "FINNA" HAS NO MEANING IN A FOREIGN LANGUAGE.

FOR BICYCLES; HORNS, PUMPS, INNER TUBES, FRAMES, BRAKES, MUDGUARDS, HANDLEBARS, TIRES, PEDALS, WHEELS, SEATS, AND BICYCLE RACKS FOR VEHICLES, ALL THE FOREGOING FOR BICYCLES (U.S. CLS. 19, 21, 23, 31, 35 AND 44).

KIMBERLY CLARKE, EXAMINING ATTORNEY

**CLASS 12—(Continued).**

SN 79-134,144. ROBERT BOSCH GMBH, FED REP GER-  
MANY, FILED 7-1-2013.

**PPP**

THE MARK CONSISTS OF STANDARD CHARACTERS  
WITHOUT CLAIM TO ANY PARTICULAR FONT, STYLE,  
SIZE, OR COLOR.

PRIORITY DATE OF 6-3-2013 IS CLAIMED.  
OWNER OF INTERNATIONAL REGISTRATION 1170630  
DATED 7-1-2013, EXPIRES 7-1-2023.  
FOR WINDSHIELD WIPER BLADES (U.S. CLS. 19, 21,  
23, 31, 35 AND 44).  
TASNEEM HUSSAIN, EXAMINING ATTORNEY

**CLASS 12—(Continued).**

SN 79-136,875. PRODY PTY LTD, AUSTRALIA, FILED 7-26-  
2013.

**ACADEMY**

THE MARK CONSISTS OF STANDARD CHARACTERS  
WITHOUT CLAIM TO ANY PARTICULAR FONT, STYLE,  
SIZE, OR COLOR.

OWNER OF INTERNATIONAL REGISTRATION 1177522  
DATED 7-26-2013, EXPIRES 7-26-2023.  
FOR BICYCLE BRAKES; BICYCLE CHAINS; BICYCLE  
FRAMES; BICYCLE HANDLE BARS; BICYCLE RIMS;  
BICYCLE SADDLES; BICYCLE SEATS; BICYCLE  
SPOKES; BICYCLE TIRES (TYRES); BICYCLES; COVERS  
FOR BICYCLE SADDLES; HUBS FOR BICYCLES; IN-  
NER TUBES FOR BICYCLES; PEDAL BICYCLES; PED-  
ALS FOR BICYCLES; RACING BICYCLES; RIMS FOR  
WHEELS OF BICYCLES; SADDLE COVERS FOR BI-  
CYCLES OR MOTORCYCLES; SADDLES FOR BI-  
CYCLES OR MOTORCYCLES; STANDS FOR BICYCLES  
(PARTS OF BICYCLES); WHEELS BEING PARTS OF  
BICYCLES (U.S. CLS. 19, 21, 23, 31, 35 AND 44).  
DOUGLAS LEE, EXAMINING ATTORNEY

SN 79-135,500. GOOD WAY AUTOMOBILE PARTS; CO.,  
LTD., CHINA, FILED 8-2-2013.



OWNER OF INTERNATIONAL REGISTRATION 1173879  
DATED 8-2-2013, EXPIRES 8-2-2023.

THE MARK CONSISTS OF A DIAMOND SUPPORTED BY  
A SYMMETRIC ZIG-ZAG LINE WHICH LIES ON TOP OF  
THE TERM "GUOWEI".

THE WORDING "GUOWEI" HAS NO MEANING IN A  
FOREIGN LANGUAGE.  
FOR CARS: CONNECTING RODS FOR LAND VEHI-  
CLES OTHER THAN PARTS OF MOTORS AND EN-  
GINES; DRIVE SHAFTS FOR LAND VEHICLES;  
WINDSCREEN WIPERS; SUSPENSION SPRINGS FOR  
MOTOR CARS (U.S. CLS. 19, 21, 23, 31, 35 AND 44).  
JEFFERY COWARD, EXAMINING ATTORNEY

SN 85-596,551. LESILE DAVID WEAVER, PALM BEACH  
GARDENS, FL. FILED 4-12-2012.

**AirStair Solutions**

THE MARK CONSISTS OF STANDARD CHARACTERS  
WITHOUT CLAIM TO ANY PARTICULAR FONT, STYLE,  
SIZE, OR COLOR.

NO CLAIM IS MADE TO THE EXCLUSIVE RIGHT TO  
USE "AIRSTAIR", APART FROM THE MARK AS SHOWN.  
FOR CHAIR LIFTS (U.S. CLS. 19, 21, 23, 31, 35 AND  
44).  
FIRST USE 2-22-2012; IN COMMERCE 2-22-2012.  
JAMES LOVELACE, EXAMINING ATTORNEY

**CLASS 12—(Continued).**

SN 85-769,824. MANDO CORPORATION, KYUNGKI-DO, REPUBLIC OF KOREA, FILED 11-2-2012.

# MANDO

PRIORITY CLAIMED UNDER SEC. 44(D) ON REPUBLIC OF KOREA APPLICATION NO. 40-2012-0057, FILED 9-13-2012, REG. NO. 400980133, DATED 7-8-2013, EXPIRES 9-13-2022.

OWNER OF REPUBLIC OF KOREA REG. NO. 40-0977181, DATED 6-25-2013, EXPIRES 7-10-2022.

THE MARK CONSISTS OF THE STYLIZED WORD "MANDO".

FOR HORNS FOR MOTOR CARS; ANTI-THEFT DEVICES FOR MOTOR CARS; WHEEL RIMS FOR MOTOR CARS; MOTORCYCLES; PARTS AND ACCESSORIES FOR MOTORCYCLES, NAMELY, MOTORCYCLE WHEEL RIMS, WHEELS FOR MOTORCYCLES, SPOKES FOR MOTORCYCLE WHEELS, MOTORCYCLE STANDS, MOTORCYCLE FRAMES, MOTORCYCLE HANDLE BARS, MOTORCYCLE WHEEL HUBS; TWO-WHEELED MOTOR VEHICLES; AIR BAGS AS SAFETY DEVICES FOR AUTOMOBILES; STEERING WHEELS FOR AUTOMOBILES; REVERSING ALARMS FOR AUTOMOBILES; PARTS AND ACCESSORIES FOR AUTOMOBILES, NAMELY, WHEELS; ELECTRIC CARS; TANDEM BICYCLES; MOPEDS; TOURING BICYCLES; DELIVERY BICYCLES; BICYCLES; BICYCLE WHEEL RIMS; WHEELS FOR BICYCLES, CYCLES; BICYCLE WHEEL SPOKES; FRAMES FOR LUGGAGE CARRIERS FOR BICYCLES; BICYCLE STANDS; BICYCLE FRAMES; BICYCLE HANDLE BARS; PARTS AND ACCESSORIES FOR BICYCLES, NAMELY, HANDLEBARS; SHOCK ABSORBING SPRINGS FOR MOTOR CARS; SPIRAL SPRINGS FOR VEHICLES, NAMELY, SHOCK ABSORBING SPRINGS FOR VEHICLES; SPRING-ASSISTED HYDRAULIC SHOCK ABSORBERS FOR VEHICLES; AIR SPRINGS FOR VEHICLES; SUSPENSION SHOCK ABSORBERS FOR VEHICLES; SHOCK ABSORBING SPRINGS FOR VEHICLES; SUSPENSION SHOCK ABSORBERS FOR VEHICLES; SHOCK ABSORBERS FOR AUTOMOBILES; BRAKES FOR MOTOR CARS; BRAKE LININGS FOR MOTOR CARS; BRAKE SHOES FOR MOTOR CARS; BRAKE SEGMENTS FOR MOTOR CARS; DISK BRAKES FOR VEHICLES; BAND BRAKES FOR VEHICLES; BRAKES FOR VEHICLES; BRAKE FACINGS FOR VEHICLES; BRAKE LININGS FOR VEHICLES; BRAKE SHOES FOR VEHICLES; BRAKE SYSTEMS FOR VEHICLES; BRAKING SYSTEMS FOR VEHICLES AND PARTS THEREOF; BRAKE SEGMENTS FOR VEHICLES; BRAKE SHOES FOR VEHICLES; BLOCK BRAKES FOR VEHICLES; CONICAL BRAKES FOR VEHICLES; NON-SKID DEVICES FOR VEHICLE TIRES, NAMELY, BRAKES FOR VEHICLES; MOTORCYCLE BRAKES; BAND BRAKES FOR LAND VEHICLES; BLOCK BRAKES FOR LAND VEHICLES; BRAKE PADS FOR AUTOMOBILES; BRAKES FOR BICYCLES, MOTORCYCLES; BICYCLE BRAKES; GEARBOXES FOR MOTOR CARS; CRANKCASES FOR COMPONENTS FOR MOTOR CARS OTHER THAN FOR ENGINES; CLUTCH MECHANISMS FOR MOTOR CARS; TORQUE CONVERTERS FOR MOTOR CARS; GEARS FOR MOTORCYCLES; REDUCTION GEARS FOR LAND VEHICLES; GEARS FOR LAND VEHICLES; GEAR BOXES FOR LAND VEHICLES; TRANSMISSION SHAFTS FOR LAND VEHICLES; GEARS FOR VEHICLES; CRANKS FOR CYCLES; WHEEL BEARINGS FOR LAND VEHICLES; AXLES FOR LAND VEHICLES; SHAFT COUPLINGS FOR LAND VEHICLES; AXLE JOURNALS FOR VEHICLES; TRAILER COUPLINGS; ELECTRIC MOTORS FOR MOTOR CARS; MOTORS FOR MOTORCYCLES; ALTERNATING CURRENT AC MOTORS FOR LAND VEHICLES; DRIVING MOTORS FOR LAND VEHICLES; MOTORS FOR LAND VEHICLES; SERVO-MOTORS FOR LAND VEHICLES; ELECTRIC MOTORS FOR LAND VEHICLES; DIRECT CURRENT DC MOTORS FOR LAND VEHICLES (U.S. CLS. 19, 21, 23, 31, 35 AND 44).

DAVID MURRAY, EXAMINING ATTORNEY

**CLASS 12—(Continued).**

SN 85-786,118. HOT SHOT OUTFITTER, LLC, TWIN LAKE, MI. FILED 11-23-2012.

## HOT SHOT OUTFITTER

THE MARK CONSISTS OF STANDARD CHARACTERS WITHOUT CLAIM TO ANY PARTICULAR FONT, STYLE, SIZE, OR COLOR.

NO CLAIM IS MADE TO THE EXCLUSIVE RIGHT TO USE "OUTFITTER", APART FROM THE MARK AS SHOWN.

FOR TRUCK PARTS, NAMELY, A PREMIUM-OUT-FITTED TRUCK CAB (U.S. CLS. 19, 21, 23, 31, 35 AND 44).

FIRST USE 7-2-2012; IN COMMERCE 8-1-2012.

NAAKWAMA ANKRAH, EXAMINING ATTORNEY

SN 85-828,470. KUMHO TIRE CO., INC., SEOUL, REPUBLIC OF KOREA, FILED 1-21-2013.

## EXPERION

THE MARK CONSISTS OF STANDARD CHARACTERS WITHOUT CLAIM TO ANY PARTICULAR FONT, STYLE, SIZE, OR COLOR.

PRIORITY CLAIMED UNDER SEC. 44(D) ON REPUBLIC OF KOREA APPLICATION NO. 40-2013-0001, FILED 1-7-2013, REG. NO. 1011012, DATED 12-4-2013, EXPIRES 12-4-2023.

FOR AUTOMOBILE TIRES (U.S. CLS. 19, 21, 23, 31, 35 AND 44).

KRISTIN DAHLING, EXAMINING ATTORNEY

SN 85-833,464. YATES ELECTROSPACE CORPORATION, ALISO VIEJO, CA. FILED 1-28-2013.

## SILENT ARROW

THE MARK CONSISTS OF STANDARD CHARACTERS WITHOUT CLAIM TO ANY PARTICULAR FONT, STYLE, SIZE, OR COLOR.

NO CLAIM IS MADE TO THE EXCLUSIVE RIGHT TO USE "SILENT", APART FROM THE MARK AS SHOWN.

FOR APPARATUS FOR LOCOMOTION BY AIR, NAMELY, AIRPLANES, AIRCRAFT, AND HYBRID ELECTRIC UNMANNED AERIAL VEHICLES (U.S. CLS. 19, 21, 23, 31, 35 AND 44).

CHRISIE B. KING, EXAMINING ATTORNEY

**CLASS 12—(Continued).**

SN 85-833,911. LEE, KYUNG JOON, GURI-SI, REPUBLIC OF KOREA, FILED 1-28-2013.

**MASTERMARINE**

THE MARK CONSISTS OF STANDARD CHARACTERS WITHOUT CLAIM TO ANY PARTICULAR FONT, STYLE, SIZE, OR COLOR.

OWNER OF REPUBLIC OF KOREA REG. NO. 40-0549984, DATED 6-3-2003, RENEWED AS REG. NO. 0549984, DATED 9-10-2013, EXPIRES 6-3-2023.

FOR BOATS; MOTOR BOATS; YACHTS; FERRY BOATS; CANOES; HYDROPLANE; AMPHIBIOUS AIRPLANES; PARACHUTES; INNER TUBES; AMPHIBIOUS VEHICLES (U.S. CLS. 19, 21, 23, 31, 35 AND 44).

LINDA M. KING, EXAMINING ATTORNEY

---

SN 85-834,247. A-FAB, LLC, LINCOLN, NE. FILED 1-28-2013.



NO CLAIM IS MADE TO THE EXCLUSIVE RIGHT TO USE "SHOCKS", APART FROM THE MARK AS SHOWN. THE MARK CONSISTS OF THE WORD "PRO" OVER THE WORD "SHOCKS" WITHIN AN OVAL.

SEC. 2(F) AS TO "PRO SHOCKS".

FOR SHOCK ABSORBERS FOR AUTOMOBILES, NAMELY, SHOCK ABSORBERS FOR RACE CARS, MUSCLE CARS AND STREET RODS SOLD THROUGH SPECIALTY AND HIGH PERFORMANCE AUTOMOBILE PART DEALERS (U.S. CLS. 19, 21, 23, 31, 35 AND 44).

AMEEN IMAM, EXAMINING ATTORNEY

**CLASS 12—(Continued).**

SN 85-835,151. BAJAJ AUTO LIMITED, PUNE - 411 035, INDIA, FILED 1-29-2013.

**BAJAJ**

OWNER OF INDIA REG. NO. 1208006, DATED 6-20-2003, RENEWED AS REG. NO. 1208006, DATED 6-20-2013, EXPIRES 6-20-2023.

OWNER OF U.S. REG. NO. 1,230,997.

THE MARK CONSISTS OF THE TERM "BAJAJ" IN STYLIZED LETTERS.

FOR TWO-WHEELED MOTORIZED VEHICLES, THREE-WHEELED MOTORIZED VEHICLES, LAND VEHICLES, SCOOTERS, SCOOTERETTES, NAMELY, MOPEDS, MOTORCYCLES AND PARTS THEREOF, NAMELY, FAIRINGS, HANDLE BARS, SUSPENSION SYSTEMS FOR MOTORIZED VEHICLES, FRONT AND REAR FENDERS, FRONT AND REAR TURN SIGNAL INDICATORS, ENGINES FOR LAND VEHICLES, FRONT AND REAR WHEELS, WHEEL RIMS, TIRES, SEATS, HANDLE BAR GRIPS, MIRRORS, NAMELY, REAR VIEW MIRRORS AND SIDE VIEW MIRRORS, SWING ARMS, NAMELY, SUSPENSION STRUTS, FUEL TANK ASSEMBLY, METALLIC TANKS, NAMELY, GAS TANKS AND FUEL TANKS (U.S. CLS. 19, 21, 23, 31, 35 AND 44).

GINA FINK, EXAMINING ATTORNEY

---

SN 85-870,287. CROSS TRAILERS, INC., ELKHART, IN. FILED S.R. 3-7-2013; AM. P.R. 4-23-2013.

**CROSS**

THE MARK CONSISTS OF STANDARD CHARACTERS WITHOUT CLAIM TO ANY PARTICULAR FONT, STYLE, SIZE, OR COLOR.

FOR CARGO TRAILERS (U.S. CLS. 19, 21, 23, 31, 35 AND 44).

FIRST USE 3-1-2013; IN COMMERCE 3-1-2013.

HOWARD B. LEVINE, EXAMINING ATTORNEY

**CLASS 12—(Continued).**

SN 85-882,182. GENERAL MOTORS LLC, DETROIT, MI.  
FILED 3-21-2013.



THE MARK CONSISTS OF A "V" DESIGN WITH A STRIPE OF LINES RUNNING ALONG ITS RIGHT HAND SIDE.

FOR MOTOR LAND VEHICLES, NAMELY, AUTOMOBILES, SPORT UTILITY VEHICLES, TRUCKS, VANS, ENGINES THEREFOR AND STRUCTURAL PARTS THEREOF (U.S. CLS. 19, 21, 23, 31, 35 AND 44).

JANICE L. MCMORROW, EXAMINING ATTORNEY

SN 85-910,396. KOHLER CO., KOHLER, WI. FILED 4-22-2013.

# CONFIDANT

THE MARK CONSISTS OF STANDARD CHARACTERS WITHOUT CLAIM TO ANY PARTICULAR FONT, STYLE, SIZE, OR COLOR.

FOR ENGINES FOR LAND VEHICLES (U.S. CLS. 19, 21, 23, 31, 35 AND 44).

CAROLINE WOOD, EXAMINING ATTORNEY

SN 85-911,043. FORD MOTOR COMPANY, DEARBORN, MI.  
FILED 4-22-2013.

# ESCORT

THE MARK CONSISTS OF STANDARD CHARACTERS WITHOUT CLAIM TO ANY PARTICULAR FONT, STYLE, SIZE, OR COLOR.

FOR MOTOR VEHICLES, NAMELY, LAND MOTOR VEHICLES AND PARTS AND ACCESSORIES THEREOF (U.S. CLS. 19, 21, 23, 31, 35 AND 44).

HEATHER SAPP, EXAMINING ATTORNEY

**CLASS 12—(Continued).**

SN 86-030,523. ODYNE SYSTEMS, LLC, WAUKESHA, WI.  
FILED 8-6-2013.

# ODYNE

THE MARK CONSISTS OF STANDARD CHARACTERS WITHOUT CLAIM TO ANY PARTICULAR FONT, STYLE, SIZE, OR COLOR.

FOR DRIVE SYSTEMS FOR VEHICLES COMPRISED OF POWER TAKE OFFS, ELECTRIC MOTORS, INVERTERS, BATTERIES, CHARGERS, CONVERTERS, AND COOLING SYSTEMS SOLD AS A UNIT (U.S. CLS. 19, 21, 23, 31, 35 AND 44).

FIRST USE 0-0-2009; IN COMMERCE 0-0-2009.

JILLIAN CANTOR, EXAMINING ATTORNEY

SN 86-030,531. ODYNE SYSTEMS, LLC, WAUKESHA, WI.  
FILED 8-6-2013.



THE COLOR(S) ORANGE AND BLUE IS/ARE CLAIMED AS A FEATURE OF THE MARK.

THE MARK CONSISTS OF THE DROP WITH AN ORANGE OUTLINE THAT IS TRANSPARENT IN THE MIDDLE, WITH TWO BLUE LINES EXTENDING UPWARD FROM THE RIGHT SIDE OF THE DROP. THE COLOR WHITE REPRESENTS THE BACKGROUND AND IS NOT CLAIMED AS A FEATURE OF THE MARK.

FOR DRIVE SYSTEMS FOR VEHICLES COMPRISED OF POWER TAKE OFFS, ELECTRIC MOTORS, INVERTERS, BATTERIES, CHARGERS, CONVERTERS, AND COOLING SYSTEMS SOLD AS A UNIT (U.S. CLS. 19, 21, 23, 31, 35 AND 44).

FIRST USE 0-0-2009; IN COMMERCE 0-0-2009.

JILLIAN CANTOR, EXAMINING ATTORNEY



**CLASS 12—(Continued).**

SN 86-030,792. SHENZHEN HAOTING AUTO SALES CO., LTD., GUANGDONG, CHINA, FILED 8-7-2013.



THE MARK CONSISTS OF STYLIZED LETTERS "BLUEWAY".  
FOR AIR-CUSHION VEHICLES; AIRPLANES; BARGES; BOAT CHOCKS; BOAT HULLS; BOAT PARTS, NAMELY, WAKEBOARD TOWERS; BOATS; BOATS AND STRUCTURAL PARTS THEREFOR; ELECTRIC LOCOMOTIVES; LAND VEHICLES, NAMELY, LOW-SPEED ELECTRIC VEHICLES; LAUNCHES; LIGHT RAIL VEHICLES; LOCOMOTIVES; RAIL VEHICLES, NAMELY, PASSENGER CARRIAGES; REMOTELY CONTROLLED LAND VEHICLE; STEAM LOCOMOTIVES; WATER SCOOTERS; WATER VEHICLES, NAMELY, HYDROFOIL BOATS SUPPORTED BY SINGLE OR MULTI HULLS, AND STRUCTURAL PARTS THEREFOR; YACHTS (U.S. CLS. 19, 21, 23, 31, 35 AND 44).  
FIRST USE 10-10-2010; IN COMMERCE 10-10-2010.  
ALEX KEAM, EXAMINING ATTORNEY

SN 86-036,528. PETE'S TIRE BARNS, INC., ORANGE, MA. FILED 8-13-2013.



NO CLAIM IS MADE TO THE EXCLUSIVE RIGHT TO USE "TIRE BARNS, INC.", APART FROM THE MARK AS SHOWN.  
THE NAME, "PETE'S" SHOWN IN THE MARK IDENTIFIES PETER GERRY, WHOSE CONSENT TO REGISTER IS MADE OF RECORD.  
THE MARK CONSISTS OF FOUR HORIZONTAL TIRE TREADS, WITH THE SHADED WORDING, "PETE'S" TO THE RIGHT, WITH A SHADED BAR BELOW CONTAINING THE UNSHADED WORDING, "TIRE BARNS, INC." PRINTED BELOW "PETE'S".  
FOR TIRES (U.S. CLS. 19, 21, 23, 31, 35 AND 44).  
FIRST USE 7-1-2005; IN COMMERCE 7-1-2005.  
ODESSA BIBBINS, EXAMINING ATTORNEY

**CLASS 12—(Continued).**

SN 86-038,064. ROSCO, INC., JAMAICA, NY. FILED 8-14-2013.



THE MARK CONSISTS OF A RECTANGLE WHICH IS INTENDED TO DEPICT A REARVIEW MIRROR. INSIDE THE RECTANGLE IS THE WORD "MOR-VISION", WHEREIN THE "MOR" IS WRITTEN IN SHADOWED LETTERS AGAINST A RECTANGULAR BACKGROUND, WHICH IS INTENDED TO DEPICT A MONITOR, AND THE HYPHEN AND WORD "VISION" ARE WRITTEN IN SLIGHTLY SLANTED FASHION.  
FOR VEHICLE PARTS, NAMELY, A REARVIEW MIRROR INCORPORATING A BACKUP CAMERA SYSTEM WITH THE MONITOR EMBEDDED IN THE MIRROR (U.S. CLS. 19, 21, 23, 31, 35 AND 44).  
TAMARA FRAZIER, EXAMINING ATTORNEY

SN 86-038,185. FEDERAL-MOGUL IGNITION COMPANY, SOUTHFIELD, MI. FILED 8-14-2013.



THE MARK CONSISTS OF A STYLIZED CROSS-SECTIONAL VIEW OF A WIPER BLADE AND A SMALL TEARDROP SHAPE WITHIN A LARGER TEARDROP SHAPE WITH THREE LINES IN THE UPPER-LEFT PORTION.  
FOR WINDSHIELD WIPER BLADES (U.S. CLS. 19, 21, 23, 31, 35 AND 44).  
DAVID ELTON, EXAMINING ATTORNEY

**CLASS 12—(Continued).**

SN 86-038,193. FEDERAL-MOGUL IGNITION COMPANY, SOUTHFIELD, MI. FILED 8-14-2013.



THE MARK CONSISTS OF THREE SUCCESSIVELY LARGER CONNECTED SPHERES WITHIN A TEARDROP SHAPE.  
FOR WINDSHIELD WIPER BLADES (U.S. CLS. 19, 21, 23, 31, 35 AND 44).  
DAVID ELTON, EXAMINING ATTORNEY

SN 86-038,199. FEDERAL-MOGUL IGNITION COMPANY, SOUTHFIELD, MI. FILED 8-14-2013.



THE MARK CONSISTS OF THREE SUCCESSIVELY LARGER CONNECTED SPHERES WITH A PLUS SIGN IN THE LARGEST SPHERE, ALL WITHIN A TEARDROP SHAPE.  
FOR WINDSHIELD WIPER BLADES (U.S. CLS. 19, 21, 23, 31, 35 AND 44).  
DAVID ELTON, EXAMINING ATTORNEY

**CLASS 12—(Continued).**

SN 86-044,559. MY NET WHEELS, INC., COVINA, CA. FILED 8-21-2013.

**FLOATER CAP**

THE MARK CONSISTS OF STANDARD CHARACTERS WITHOUT CLAIM TO ANY PARTICULAR FONT, STYLE, SIZE, OR COLOR.  
NO CLAIM IS MADE TO THE EXCLUSIVE RIGHT TO USE "CAP", APART FROM THE MARK AS SHOWN.  
FOR VEHICLE WHEEL CENTER CAP (U.S. CLS. 19, 21, 23, 31, 35 AND 44).  
ROBIN CHOSID, EXAMINING ATTORNEY

SN 86-044,745. EXCELLENCE MARINE INC., DBA VELOCITY POWERBOATS, TAMPA, FL. FILED 8-22-2013.

**Get to the fish fast!**

THE MARK CONSISTS OF STANDARD CHARACTERS WITHOUT CLAIM TO ANY PARTICULAR FONT, STYLE, SIZE, OR COLOR.  
FOR BOAT ACCESSORIES, NAMELY, PLANING HULLS; BOATS; FISHING BOATS (U.S. CLS. 19, 21, 23, 31, 35 AND 44).  
BRENDAN REGAN, EXAMINING ATTORNEY

SN 86-044,975. TREK BICYCLE CORPORATION, WATERLOO, WI. FILED 8-22-2013.



THE MARK CONSISTS OF ON THE LEFT SIDE OF THE MARK THERE IS ONE DIAMOND SHAPE ON TOP OF ANOTHER DIAMOND SHAPE; ON THE RIGHT SIDE OF MARK THERE IS AN ARROW HEAD POINTING TOWARDS THE TWO DIAMONDS.  
FOR BICYCLES, BICYCLE FRAMES, AND BICYCLE STRUCTURAL PARTS THEREFOR (U.S. CLS. 19, 21, 23, 31, 35 AND 44).  
FIRST USE 8-1-2013; IN COMMERCE 8-1-2013.  
GIANCARLO CASTRO, EXAMINING ATTORNEY

**CLASS 12—(Continued).**

SN 86-048,354. PULSE AEROSPACE, INC., LAKEWOOD, CO.  
FILED 8-26-2013.



The logo for PULSE AEROSPACE features the word "PULSE" in a bold, red, sans-serif font. Below "PULSE" is a stylized grey line that resembles a heartbeat or a pulse. Underneath the line, the word "AEROSPACE" is written in a smaller, grey, sans-serif font.

NO CLAIM IS MADE TO THE EXCLUSIVE RIGHT TO USE "AEROSPACE", APART FROM THE MARK AS SHOWN.

THE COLOR(S) RED, BLACK, AND GREY IS/ARE CLAIMED AS A FEATURE OF THE MARK.

THE MARK CONSISTS OF THE WORD "PULSE" APPEARS IN RED, WITH VARYING DEGREES OF SHADING AND COLOR INTENSITY. BELOW IT IS A STYLIZED LINE IN BLACK AND GREY. BELOW THE LINE IS THE WORD "AEROSPACE" WHICH ALSO APPEARS IN BLACK AND GREY.

FOR UNMANNED AERIAL VEHICLES (UAVS) (U.S. CLS. 19, 21, 23, 31, 35 AND 44).

FIRST USE 6-1-2012; IN COMMERCE 8-6-2012.

DEIRDRE ROBERTSON, EXAMINING ATTORNEY

SN 86-057,196. THOR TECH, INC., JACKSON CENTER, OH.  
FILED 9-5-2013.

**BEARCAT**

THE MARK CONSISTS OF STANDARD CHARACTERS WITHOUT CLAIM TO ANY PARTICULAR FONT, STYLE, SIZE, OR COLOR.

FOR RECREATIONAL VEHICLES, NAMELY, TOWABLE TRAILERS (U.S. CLS. 19, 21, 23, 31, 35 AND 44).

FIRST USE 0-0-1971; IN COMMERCE 0-0-1971.

MAUREEN DALL, EXAMINING ATTORNEY

**CLASS 12—(Continued).**

SN 86-060,015. QINGDAO CARFLEX AUTO PARTS CO., LTD, SHINAN DIST., QINGDAO, CHINA, FILED 9-10-2013.



The logo for CARFLEX features the word "CARFLEX" in a bold, black, sans-serif font. The letters are slightly slanted to the right, giving it a dynamic, forward-moving appearance.

THE MARK CONSISTS OF SEVEN ENGLISH LETTERS "CARFLEX" IN A STYLIZED FONT.

FOR AUTOMOBILE CHASSIS; AUTOMOBILES; BRAKE PADS FOR VEHICLES; BRAKE SEGMENTS FOR MOTOR CARS; CONCRETE MIXING VEHICLES; CONNECTING RODS FOR LAND VEHICLES OTHER THAN PARTS OF MOTORS AND ENGINES; ELECTRIC BICYCLES; ELECTRIC CARS; ELECTRIC LOCOMOTIVES; ELECTRIC MOTORCYCLES; ELECTRIC RAILWAY CARS; ENGINES FOR LAND VEHICLES; FORK LIFT TRUCKS; FUEL LINE HOSES FOR VEHICLES; INNER TUBES; LAND VEHICLES, NAMELY, LOW-SPEED ELECTRIC VEHICLES; MOTOR CARS FOR TRANSPORT ON LAND; MOTOR HOMES; MOTORCYCLES; RAILWAY COUPLINGS; SELF-PROPELLED ELECTRIC VEHICLE; SPOKE CLIPS FOR BICYCLE WHEELS; SPORTS UTILITY VEHICLES; TIRES; VEHICLE PARTS, NAMELY, POWER STEERING HOSES; VEHICLE POWER TRAIN MECHANISM COMPRISED OF CLUTCH, TRANSMISSION, DRIVE SHAFT, AND DIFFERENTIAL; WHEEL HUBS FOR AUTOMOBILES; YACHTS (U.S. CLS. 19, 21, 23, 31, 35 AND 44).

FIRST USE 3-15-2012; IN COMMERCE 3-15-2012.

MARTHA FROMM, EXAMINING ATTORNEY

SN 86-062,413. HU, JAY, SHANGHAI, CHINA, FILED 9-12-2013.

**MEGADURAX**

THE MARK CONSISTS OF STANDARD CHARACTERS WITHOUT CLAIM TO ANY PARTICULAR FONT, STYLE, SIZE, OR COLOR.

FOR TIRES, SOLID, FOR VEHICLE WHEELS; INNER TUBES FOR VEHICLE TIRES; SPARE TIRE COVERS; TIRE REPAIR PATCHES; TIRE PUMPS; TIRE TUBES FOR VEHICLES; TIRES; TUBULAR TYRES; VALVES FOR VEHICLE TIRES (U.S. CLS. 19, 21, 23, 31, 35 AND 44).

KEVIN MITTLER, EXAMINING ATTORNEY

**CLASS 12—(Continued).**

SN 86-063,772. SMITH, JONATHAN, LOS GATOS, CA. FILED 9-13-2013.

# QfactR

THE MARK CONSISTS OF STANDARD CHARACTERS WITHOUT CLAIM TO ANY PARTICULAR FONT, STYLE, SIZE, OR COLOR.

FOR BICYCLE RACKS FOR VEHICLES; BICYCLE TRAILERS (RIYAKAH); BICYCLE WHEELS, RIMS AND STRUCTURAL PARTS THEREFOR; FRAMES FOR BICYCLES (U.S. CLS. 19, 21, 23, 31, 35 AND 44).  
DARRYL SPRUILL, EXAMINING ATTORNEY

**CLASS 12—(Continued).**

SN 86-064,920. CRUISER ACCESSORIES, LLC, MONUMENT, CO. FILED 9-14-2013.

# Live Baseball

THE MARK CONSISTS OF STANDARD CHARACTERS WITHOUT CLAIM TO ANY PARTICULAR FONT, STYLE, SIZE, OR COLOR.

FOR LICENSE PLATE FRAMES (U.S. CLS. 19, 21, 23, 31, 35 AND 44).  
NATALIE KENEALY, EXAMINING ATTORNEY

SN 86-064,543. ETHAN GAS OIL, LLC., HOUSTON, TX. FILED 9-13-2013.

# EGO

THE MARK CONSISTS OF STANDARD CHARACTERS WITHOUT CLAIM TO ANY PARTICULAR FONT, STYLE, SIZE, OR COLOR.

PRIORITY CLAIMED UNDER SEC. 44(D) ON MEXICO APPLICATION NO. 1406714, FILED 8-23-2013.  
FOR RAILCARS; RAILWAY TANK CARS; RAILWAY FREIGHT CARS; RAILWAY CARS (U.S. CLS. 19, 21, 23, 31, 35 AND 44).  
CHERYL CLAYTON, EXAMINING ATTORNEY

SN 86-064,922. CRUISER ACCESSORIES, LLC, MONUMENT, CO. FILED 9-14-2013.

# Live Basketball

THE MARK CONSISTS OF STANDARD CHARACTERS WITHOUT CLAIM TO ANY PARTICULAR FONT, STYLE, SIZE, OR COLOR.

FOR LICENSE PLATE FRAMES (U.S. CLS. 19, 21, 23, 31, 35 AND 44).  
NATALIE KENEALY, EXAMINING ATTORNEY

SN 86-064,606. MACNEIL IP LLC, BOLINGBROOK, IL. FILED 9-13-2013.

# TECHFRAME

THE MARK CONSISTS OF STANDARD CHARACTERS WITHOUT CLAIM TO ANY PARTICULAR FONT, STYLE, SIZE, OR COLOR.

FOR FRAMES FOR LICENSE PLATES (U.S. CLS. 19, 21, 23, 31, 35 AND 44).  
CHERYL CLAYTON, EXAMINING ATTORNEY

SN 86-064,924. CRUISER ACCESSORIES, LLC, MONUMENT, CO. FILED 9-14-2013.

# Live Football

THE MARK CONSISTS OF STANDARD CHARACTERS WITHOUT CLAIM TO ANY PARTICULAR FONT, STYLE, SIZE, OR COLOR.

FOR LICENSE PLATE FRAMES (U.S. CLS. 19, 21, 23, 31, 35 AND 44).  
NATALIE KENEALY, EXAMINING ATTORNEY

**CLASS 12—(Continued).**

SN 86-064,929. CRUISER ACCESSORIES, LLC, MONUMENT, CO. FILED 9-14-2013.

# Live Tennis

THE MARK CONSISTS OF STANDARD CHARACTERS WITHOUT CLAIM TO ANY PARTICULAR FONT, STYLE, SIZE, OR COLOR.  
FOR LICENSE PLATE FRAMES (U.S. CLS. 19, 21, 23, 31, 35 AND 44).  
NATALIE KENEALY, EXAMINING ATTORNEY

---

SN 86-064,930. CRUISER ACCESSORIES, LLC, MONUMENT, CO. FILED 9-14-2013.

# Live Volleyball

THE MARK CONSISTS OF STANDARD CHARACTERS WITHOUT CLAIM TO ANY PARTICULAR FONT, STYLE, SIZE, OR COLOR.  
FOR LICENSE PLATE FRAMES (U.S. CLS. 19, 21, 23, 31, 35 AND 44).  
NATALIE KENEALY, EXAMINING ATTORNEY

---

SN 86-065,709. SROKA, SCOTT, SOUTH PASADENA, FL. FILED 9-16-2013.

# VAMOOSE

THE MARK CONSISTS OF STANDARD CHARACTERS WITHOUT CLAIM TO ANY PARTICULAR FONT, STYLE, SIZE, OR COLOR.  
FOR CAMPING TRAILERS; CARGO TRAILERS (U.S. CLS. 19, 21, 23, 31, 35 AND 44).  
NICHOLAS COLEMAN, EXAMINING ATTORNEY

**CLASS 12—(Continued).**

SN 86-066,618. LUND, INC., BUFORD, GA. FILED 9-17-2013.

# LUND LATITUDE

THE MARK CONSISTS OF STANDARD CHARACTERS WITHOUT CLAIM TO ANY PARTICULAR FONT, STYLE, SIZE, OR COLOR.  
OWNER OF U.S. REG. NOS. 2,073,272, 2,553,224 AND 2,867,223.  
FOR AUTOMOTIVE VEHICLE ACCESSORIES, NAMELY, NERF BARS (U.S. CLS. 19, 21, 23, 31, 35 AND 44).  
RICHARD WHITE, EXAMINING ATTORNEY

---

SN 86-066,927. BOMBARDIER INC., DORVAL, CANADA, FILED 9-17-2013.

# LXi

THE MARK CONSISTS OF STANDARD CHARACTERS WITHOUT CLAIM TO ANY PARTICULAR FONT, STYLE, SIZE, OR COLOR.  
FOR AIRCRAFT (U.S. CLS. 19, 21, 23, 31, 35 AND 44).  
JENNIFER WILLISTON, EXAMINING ATTORNEY

---

SN 86-067,570. GLOBAL CARAVAN TECHNOLOGIES INC., SPEEDWAY, IN. FILED 9-18-2013.

# GCT

THE MARK CONSISTS OF STANDARD CHARACTERS WITHOUT CLAIM TO ANY PARTICULAR FONT, STYLE, SIZE, OR COLOR.  
FOR RECREATIONAL VEHICLES, NAMELY, TRAVEL TRAILERS, 5TH WHEEL TRAILERS AND MOTOR HOMES (U.S. CLS. 19, 21, 23, 31, 35 AND 44).  
WANDA KAY PRICE, EXAMINING ATTORNEY

**CLASS 12—(Continued).**

SN 86-067,740. HIGH END SEATING SOLUTIONS, LLC,  
SANTA ANA, CA. FILED 9-18-2013.

# IST

THE MARK CONSISTS OF STANDARD CHARACTERS  
WITHOUT CLAIM TO ANY PARTICULAR FONT, STYLE,  
SIZE, OR COLOR.  
FOR MOTORCYCLE SEATS AND SEAT CUSHIONS  
(U.S. CLS. 19, 21, 23, 31, 35 AND 44).  
ARETHA SOMERVILLE, EXAMINING ATTORNEY

SN 86-068,404. VIMA USA INC., MONTEREY PARK, CA.  
FILED 9-18-2013.

# VIMA

THE MARK CONSISTS OF STANDARD CHARACTERS  
WITHOUT CLAIM TO ANY PARTICULAR FONT, STYLE,  
SIZE, OR COLOR.  
FOR FORK LIFT TRUCKS (U.S. CLS. 19, 21, 23, 31, 35  
AND 44).  
FIRST USE 12-1-2008; IN COMMERCE 9-1-2013.  
RAMONA ORTIGA, EXAMINING ATTORNEY

SN 86-068,784. TORKLIIFT INTERNATIONAL, INC., SUM-  
NER, WA. FILED 9-18-2013.

# TRANSFORMER

THE MARK CONSISTS OF STANDARD CHARACTERS  
WITHOUT CLAIM TO ANY PARTICULAR FONT, STYLE,  
SIZE, OR COLOR.  
FOR AUTOMOTIVE PARTS, NAMELY TRUCK CAM-  
PER BUMPERS (U.S. CLS. 19, 21, 23, 31, 35 AND 44).  
MARIA-VICTORIA SUAREZ, EXAMINING ATTORNEY

**CLASS 12—(Continued).**

SN 86-069,244. WTD INC., CERRITOS, CA. FILED 9-19-2013.

# WINDFORCE

THE MARK CONSISTS OF STANDARD CHARACTERS  
WITHOUT CLAIM TO ANY PARTICULAR FONT, STYLE,  
SIZE, OR COLOR.  
FOR TIRES; VEHICLE WHEELS (U.S. CLS. 19, 21, 23,  
31, 35 AND 44).  
SCOTT BIBB, EXAMINING ATTORNEY

SN 86-070,761. KARMA MEDICAL PRODUCTS CO., LTD.,  
CHIA-YI, TAIWAN, FILED 9-20-2013.

# EVO LECTUS

THE MARK CONSISTS OF STYLIZED WORDS "EVO" IN  
LARGER FONT AND "LECTUS" IN SMALLER FONT.  
FOR WHEELCHAIRS, ELECTRIC WHEELCHAIRS,  
ELECTRIC SCOOTERS (U.S. CLS. 19, 21, 23, 31, 35 AND  
44).  
DAVID TAYLOR, EXAMINING ATTORNEY

SN 86-072,532. YASUFUSA SORAGA, HIROSHIMA, JAPAN,  
FILED 9-23-2013.

# ZXSPEED

THE MARK CONSISTS OF STANDARD CHARACTERS  
WITHOUT CLAIM TO ANY PARTICULAR FONT, STYLE,  
SIZE, OR COLOR.  
FOR SUSPENSION SYSTEMS FOR AUTOMOBILES  
(U.S. CLS. 19, 21, 23, 31, 35 AND 44).  
TINA MAI, EXAMINING ATTORNEY

**CLASS 12—(Continued).**

SN 86-078,931. SAF-T-CAB, INC., FRESNO, CA. FILED 9-30-2013.

**FRUIT CAB**

THE MARK CONSISTS OF STANDARD CHARACTERS WITHOUT CLAIM TO ANY PARTICULAR FONT, STYLE, SIZE, OR COLOR.

NO CLAIM IS MADE TO THE EXCLUSIVE RIGHT TO USE "CAB", APART FROM THE MARK AS SHOWN.

FOR OPERATOR CABS FOR OFF-HIGHWAY MOBILE EQUIPMENT, NAMELY, TRACTORS (U.S. CLS. 19, 21, 23, 31, 35 AND 44).

FIRST USE 4-1-2008; IN COMMERCE 12-19-2008.  
JOHN WILKE, EXAMINING ATTORNEY

SN 86-106,641. TOYO TIRE & RUBBER CO., LTD., OSAKA, JAPAN, FILED 10-31-2013.

**EXO GRAPPLER**

THE MARK CONSISTS OF STANDARD CHARACTERS WITHOUT CLAIM TO ANY PARTICULAR FONT, STYLE, SIZE, OR COLOR.

OWNER OF U.S. REG. NOS. 3,230,678, 4,052,417 AND OTHERS.

FOR TIRES FOR VEHICLES, INNER TUBES FOR VEHICLE TIRES AND WHEELS FOR VEHICLES (U.S. CLS. 19, 21, 23, 31, 35 AND 44).

ELLEN BURNS, EXAMINING ATTORNEY

SN 86-118,708. TOYO TIRE & RUBBER CO., LTD., OSAKA, JAPAN, FILED 11-14-2013.

**THERMA SPIKE**

THE MARK CONSISTS OF STANDARD CHARACTERS WITHOUT CLAIM TO ANY PARTICULAR FONT, STYLE, SIZE, OR COLOR.

FOR TIRES FOR VEHICLES, AND INNER TUBES FOR VEHICLE TIRES (U.S. CLS. 19, 21, 23, 31, 35 AND 44).

ELLEN BURNS, EXAMINING ATTORNEY

**CLASS 12—(Continued).**

SN 86-120,989. BUDGE INDUSTRIES LLC, LANSDALE, PA. FILED 11-17-2013.

**RUSTEC**

THE MARK CONSISTS OF STANDARD CHARACTERS WITHOUT CLAIM TO ANY PARTICULAR FONT, STYLE, SIZE, OR COLOR.

FOR FITTED AND SEMI-FITTED COVERS FOR BOATS AND VEHICLES, NAMELY, AUTOMOBILES, MOTORCYCLES, BOATS, RECREATIONAL VEHICLES, ALL-TERRAIN VEHICLES, UTILITY VEHICLES, SNOWMOBILES, AND GOLF CARTS (U.S. CLS. 19, 21, 23, 31, 35 AND 44).

KATHY WANG, EXAMINING ATTORNEY

SN 86-127,096. MACNEIL IP LLC, BOLINGBROOK, IL. FILED 11-22-2013.

**PLATESPACER**

THE MARK CONSISTS OF STANDARD CHARACTERS WITHOUT CLAIM TO ANY PARTICULAR FONT, STYLE, SIZE, OR COLOR.

FOR METAL LICENSE PLATE FRAMES FOR LAND VEHICLES (U.S. CLS. 19, 21, 23, 31, 35 AND 44).

CHERYL CLAYTON, EXAMINING ATTORNEY

**CLASS 13—FIREARMS**

SN 85-864,751. ADAPTIVE TACTICAL, LLC, NAMPA, ID. FILED 3-1-2013.



THE MARK CONSISTS OF A STYLIZED REPRESENTATION OF THE UNSHADED WORD "TACTRED" SUPERIMPOSED OVER A SHADED RECTANGULAR SHAPE, THE BOTTOM OF THE RECTANGULAR SHAPE HAVING A SAW-LIKE PATTERN.

FOR FIREARM ACCESSORY, NAMELY, MONOPODS FOR FIREARMS (U.S. CLS. 2 AND 9).

ODESSA BIBBINS, EXAMINING ATTORNEY

**CLASS 13—(Continued).**

SN 85-867,061. VELOCITY MANUFACTURING COMPANY,  
FORT SCOTT, KS. FILED 3-5-2013.

## VELOCITY TACTICS

THE MARK CONSISTS OF STANDARD CHARACTERS WITHOUT CLAIM TO ANY PARTICULAR FONT, STYLE, SIZE, OR COLOR.

FOR BALLISTIC WEAPONS (U.S. CLS. 2 AND 9).  
JENNIFER MARTIN, EXAMINING ATTORNEY

SN 85-890,918. RIVERMAN, LLC, COEUR D' ALENE, ID.  
FILED 3-29-2013.

## MBR MODULAR BREAKDOWN RIFLE

THE MARK CONSISTS OF STANDARD CHARACTERS WITHOUT CLAIM TO ANY PARTICULAR FONT, STYLE, SIZE, OR COLOR.

NO CLAIM IS MADE TO THE EXCLUSIVE RIGHT TO USE "MODULAR BREAKDOWN RIFLE", APART FROM THE MARK AS SHOWN.

FOR FIREARMS, NAMELY, RIFLES AND LONG GUNS; FIREARM PARTS AND ACCESSORIES, NAMELY, BARRELS, RECEIVERS, STOCKS, FLAME SUPPRESSORS IN THE NATURE OF FLASH SUPPRESSORS, AMMUNITION MAGAZINES, SLINGS, FRONT SIGHTS AND REAR SIGHTS (U.S. CLS. 2 AND 9).

AMY KERTGATE, EXAMINING ATTORNEY

**CLASS 13—(Continued).**

SN 86-040,979. ENGBRETSON, KEVIN J, LAKEWOOD, CO.  
FILED 8-18-2013.

Engbretson & Co., Ltd.



Custom Gun & Rifle Maker  
Denver, Colorado  
Established 2013

NO CLAIM IS MADE TO THE EXCLUSIVE RIGHT TO USE "& CO., LTD" OR "CUSTOM GUN & RIFLE MAKER DENVER, COLORADO, ESTABLISHED 2013", APART FROM THE MARK AS SHOWN.

THE NAME(S), PORTRAIT(S), AND/OR SIGNATURE(S) SHOWN IN THE MARK DOES NOT IDENTIFY A PARTICULAR LIVING INDIVIDUAL.

THE MARK CONSISTS OF A DESIGN OF A HELMET ABOVE A SHIELD WITH STYLIZED WORDING ON TOP "ENGBRETSON & CO., LTD." ALL WRITING IN LEIBNIZ-FRAKTUR FONT. INSIDE THE SHIELD ARE 3 FLEUR DE LIS AND A ROSE. THERE IS A VINE DESIGN ON BOTH SIDES OF THE HELMET AND SHIELD. UNDER THE SHIELD IS THE STYLIZED WORDING "CUSTOM GUN & RIFLE MAKER, DENVER COLORADO, ESTABLISHED 2013".

FOR COMPONENT PARTS FOR RIFLES; GUN AND RIFLE CASES; HUNTING RIFLES; RIFLE BARRELS; RIFLE CASES; RIFLE FORE ENDS; RIFLE HAND GRIPS; RIFLE SHEATHS; RIFLE SLINGS; RIFLE STOCKS; RIFLE STRAPS; RIFLES; RIFLES AND PARTS THEREOF; SPORTING RIFLES (U.S. CLS. 2 AND 9).  
JONATHAN FALK, EXAMINING ATTORNEY

SN 86-041,128. SPARKS, LAWRENCE, BUENA PARK, CA.  
FILED 8-19-2013.



NO CLAIM IS MADE TO THE EXCLUSIVE RIGHT TO USE "PEPPER SPRAY", APART FROM THE MARK AS SHOWN.

THE MARK CONSISTS OF THE STYLIZED, STACKED WORDING "PEPPER SPRAY", "MANTRAP" AND "PEPPER-SPRAYMANTRAP@MINDSPRING.COM" APPEARING WITHIN A RECTANGLE WITH ROUNDED CORNERS THAT IS SUPERIMPOSED OVER A DIAMOND CONTAINING STYLIZED DEPICTIONS OF TWO SKULLS AND BARBED WIRE THAT APPEAR ABOVE AND BELOW THE RECTANGLE. THE SHADED SQUARE APPEARING BEHIND THE DIAMOND REPRESENTS BACKGROUND ONLY AND IS NOT PART OF THE MARK.

FOR PEPPER SPRAY (U.S. CLS. 2 AND 9).  
AMY KERTGATE, EXAMINING ATTORNEY



**CLASS 13—(Continued).**

SN 86-046,546. POBOYS SHOOTING SUPPLY, INC., DEFU-  
 NIAK SPRINGS, FL. FILED 8-23-2013.

## PoBoys Tactical

THE MARK CONSISTS OF STANDARD CHARACTERS  
 WITHOUT CLAIM TO ANY PARTICULAR FONT, STYLE,  
 SIZE, OR COLOR.

NO CLAIM IS MADE TO THE EXCLUSIVE RIGHT TO  
 USE "TACTICAL", APART FROM THE MARK AS SHOWN.  
 FOR FIREARMS (U.S. CLS. 2 AND 9).  
 MEREDITH MARESCA, EXAMINING ATTORNEY

SN 86-067,960. GANS INDUSTRIES, LLC, DBA ATOMIC  
 AMMUNITION, PHOENIX, AZ. FILED 9-18-2013.



NO CLAIM IS MADE TO THE EXCLUSIVE RIGHT TO  
 USE "AMMUNITION", APART FROM THE MARK AS  
 SHOWN.

THE MARK CONSISTS OF THE WORDS "ATOMIC  
 AMMUNITION", WHERE THE LETTER "I" IN THE WORD  
 "ATOMIC" IS OCCUPIED BY A PHOTO REPRESENTATION  
 OF A BULLET.

FOR AMMUNITION; AMMUNITION FOR FIREARMS  
 (U.S. CLS. 2 AND 9).  
 FIRST USE 1-0-2012; IN COMMERCE 1-0-2012.  
 DAVID MURRAY, EXAMINING ATTORNEY

SN 86-095,741. RA BRANDS, L.L.C., MADISON, NC. FILED  
 10-18-2013.

## REMINGTON GENERATIONS

THE MARK CONSISTS OF STANDARD CHARACTERS  
 WITHOUT CLAIM TO ANY PARTICULAR FONT, STYLE,  
 SIZE, OR COLOR.

OWNER OF U.S. REG. NOS. 187,871, 1,027,328 AND  
 OTHERS.  
 SEC. 2(F) AS TO "REMINGTON".  
 FOR FIREARMS (U.S. CLS. 2 AND 9).  
 JERI J. FICKES, EXAMINING ATTORNEY

**CLASS 14—JEWELRY**

SN 76-714,444. QUANTUM LIFE INC., DBA LIONETTE,  
 NEW YORK, NY. FILED 6-25-2013.



NO CLAIM IS MADE TO THE EXCLUSIVE RIGHT TO  
 USE "DESIGNS BY", APART FROM THE MARK AS  
 SHOWN.

THE NAME "NOA SADE" IDENTIFIES A LIVING IN-  
 DIVIDUAL WHOSE CONSENT IS OF RECORD.

THE MARK CONSISTS OF THE WORDING "LIONETTE  
 DESIGNS BY NOA SADE" WITH AN ABSTRACT DESIGN  
 OF THE LETTER "L" AND AN INVERTED "L" ARRANGED  
 SYMMETRICALLY WITHIN A CIRCLE ABOVE THE  
 WORDING.

FOR JEWELRY, NAMELY, BRACELETS, EARRINGS,  
 NECKLACES AND RINGS (U.S. CLS. 2, 27, 28 AND 50).  
 FIRST USE 10-12-2009; IN COMMERCE 10-12-2009.  
 BERNICE MIDDLETON, EXAMINING ATTORNEY

SN 85-830,648. NEW ORLEANS HORNETS NBA, LLC,  
 METAIRIE, LA. FILED 1-23-2013.



NO CLAIM IS MADE TO THE EXCLUSIVE RIGHT TO  
 USE "NOLA", APART FROM THE MARK AS SHOWN.

THE MARK CONSISTS OF THE WORDS "NOLA" AND  
 "PELICANS" DEPICTED IN STYLIZED FONTS APPEAR-  
 ING WITH STYLIZED DESIGNS OF A BASKETBALL AND  
 FLEUR-DE-LIS AND ALL CONTAINED WITHIN A STY-  
 LIZED CREST OR SHIELD THAT FEATURES A SEMICIR-  
 CLE.

FOR JEWELRY; COSTUME JEWELRY; BEADED JEW-  
 ELRY; RUBBER OR SILICON WRISTBANDS IN THE  
 NATURE OF A BRACELET. BEADED NECKLACES;  
 BEADS FOR USE IN THE MANUFACTURE OF JEW-  
 ELRY; EARRINGS, NECKLACES, CUFF LINKS, PEN-  
 DANTS, CLOCKS, WATCHES; WATCH BANDS AND  
 WATCH STRAPS, WATCH CASES, WATCH FOBS; JEW-  
 ELRY BOXES, DECORATIVE BOXES MADE OF PRE-  
 CIOUS METAL; TIE CLIPS; MEDALLIONS; NON-  
 MONETARY COINS OF PRECIOUS METAL; PRECIOUS  
 METALS; FIGURES AND FIGURINES OF PRECIOUS  
 METAL; TROPHIES OF PRECIOUS METALS (U.S. CLS.  
 2, 27, 28 AND 50).

ALICE BENMAMAN, EXAMINING ATTORNEY

**CLASS 14—(Continued).**

SN 85-835,727. NATALI, MICHAEL, DANVILLE, CA. FILED 1-29-2013.

# canna coin

THE MARK CONSISTS OF STANDARD CHARACTERS WITHOUT CLAIM TO ANY PARTICULAR FONT, STYLE, SIZE, OR COLOR.

NO CLAIM IS MADE TO THE EXCLUSIVE RIGHT TO USE "COIN", APART FROM THE MARK AS SHOWN.

FOR COMMEMORATIVE COINS (U.S. CLS. 2, 27, 28 AND 50).

FIRST USE 11-12-2012; IN COMMERCE 11-12-2012.

ELLEN PERKINS, EXAMINING ATTORNEY

---

SN 85-838,284. A.V. JEWELRY OF NY LTD., NEW YORK, NY. FILED 2-1-2013.

## SHIMMER COLLECTION

THE MARK CONSISTS OF STANDARD CHARACTERS WITHOUT CLAIM TO ANY PARTICULAR FONT, STYLE, SIZE, OR COLOR.

NO CLAIM IS MADE TO THE EXCLUSIVE RIGHT TO USE "COLLECTION", APART FROM THE MARK AS SHOWN.

FOR JEWELRY, NAMELY, RINGS, BRACELETS, PENDANTS, EARRINGS, NECKLACES, BROOCHES, PINS, CUFFLINKS (U.S. CLS. 2, 27, 28 AND 50).

FIRST USE 8-0-2013; IN COMMERCE 8-0-2013.

EDWARD NELSON, EXAMINING ATTORNEY

---

SN 85-852,025. FAITH ANN KIELY, INC., BROOKLYN, NY. FILED 2-16-2013.

# Aquilum

THE MARK CONSISTS OF STANDARD CHARACTERS WITHOUT CLAIM TO ANY PARTICULAR FONT, STYLE, SIZE, OR COLOR.

FOR FINE JEWELRY, WATCHES, BRACELETS, EARRINGS, RINGS, SILVER AND GOLD BROOCHES, PENDANTS, NECKLACES, POLISHED DIAMONDS, PRECIOUS AND SEMI-PRECIOUS GEMSTONES, WRIST WATCHES, WATCH BRACELETS (U.S. CLS. 2, 27, 28 AND 50).

FIRST USE 3-1-2012; IN COMMERCE 3-1-2012.

JENNIFER WILLISTON, EXAMINING ATTORNEY

**CLASS 14—(Continued).**

SN 85-852,646. CAMPANELLI & PEAR LLC, TROY, MI. FILED 2-18-2013.

# C & P

THE MARK CONSISTS OF STANDARD CHARACTERS WITHOUT CLAIM TO ANY PARTICULAR FONT, STYLE, SIZE, OR COLOR.

FOR JEWELRY AND CUSTOM DESIGNED JEWELRY, NAMELY, RINGS, NECKLACES, PENDANTS, EARRINGS, BRACELETS, BROOCHES, BODY JEWELRY AND HAIR JEWELRY (U.S. CLS. 2, 27, 28 AND 50).

FIRST USE 6-1-2011; IN COMMERCE 6-1-2011.

THEODORE MCBRIDE, EXAMINING ATTORNEY

---

SN 85-894,734. REQUISITE SOLUTIONS INC., CHICAGO, IL. FILED 4-4-2013.

# IMAGINEIT

THE MARK CONSISTS OF STANDARD CHARACTERS WITHOUT CLAIM TO ANY PARTICULAR FONT, STYLE, SIZE, OR COLOR.

OWNER OF U.S. REG. NOS. 2,833,009 AND 3,911,332.

FOR JEWELRY (U.S. CLS. 2, 27, 28 AND 50).

ROBERT STRUCK, EXAMINING ATTORNEY

---

SN 85-904,615. MDMBA CONSULTING, LLC, ENCINITAS, CA. FILED 4-15-2013.

# Owaves

THE MARK CONSISTS OF STANDARD CHARACTERS WITHOUT CLAIM TO ANY PARTICULAR FONT, STYLE, SIZE, OR COLOR.

FOR WEARABLE ACCESSORY DEVICES IN THE HEALTH, WELLNESS AND FITNESS SPACE, NAMELY, MULTIFUNCTIONAL ELECTRONIC WATCHES AND JEWELRY (U.S. CLS. 2, 27, 28 AND 50).

LIEF MARTIN, EXAMINING ATTORNEY

**CLASS 14—(Continued).**

SN 85-909,370. SUTTON CLOCK SHOP, NEW YORK, NY.  
FILED 4-19-2013.

## The Heartbeat of the Home

THE MARK CONSISTS OF STANDARD CHARACTERS WITHOUT CLAIM TO ANY PARTICULAR FONT, STYLE, SIZE, OR COLOR.  
FOR CLOCKS (U.S. CLS. 2, 27, 28 AND 50).  
FIRST USE 4-18-2013; IN COMMERCE 4-18-2013.  
DAVID HOFFMAN, EXAMINING ATTORNEY

**CLASS 14—(Continued).**

SN 86-000,932. ORYX JEWELLERY DMCC, P.O. BOX 184488,  
UNITED ARAB EMIR., FILED 7-2-2013.



SN 85-910,611. QVC, INC., WEST CHESTER, PA. FILED 4-22-2013.

## MASTER CUT

THE MARK CONSISTS OF STANDARD CHARACTERS WITHOUT CLAIM TO ANY PARTICULAR FONT, STYLE, SIZE, OR COLOR.  
NO CLAIM IS MADE TO THE EXCLUSIVE RIGHT TO USE "CUT", APART FROM THE MARK AS SHOWN.  
FOR JEWELRY (U.S. CLS. 2, 27, 28 AND 50).  
GINA FINK, EXAMINING ATTORNEY

OWNER OF UNITED ARAB EMIR. REG. NO. 158951,  
DATED 10-31-2011, EXPIRES 12-19-2020.

THE MARK CONSISTS OF THE STYLIZED WORDING "B360°" WITH THE DEGREE SYMBOL TOUCHING THE ZERO. THE WORDING "B° PROUD" IS UNDER THE FOREMENTIONED WORDING ELEMENTS OF THE MARK.

FOR WATCHES AND JEWELLERY (U.S. CLS. 2, 27, 28 AND 50).

TRACY WHITTAKER-BROWN, EXAMINING ATTORNEY

SN 85-924,253. MONTBLANC-SIMPLO GMBH, HAMBURG,  
FED REP GERMANY, FILED 5-6-2013.

## PREUVES D'AMOUR

THE MARK CONSISTS OF STANDARD CHARACTERS WITHOUT CLAIM TO ANY PARTICULAR FONT, STYLE, SIZE, OR COLOR.

OWNER OF ERPN CMNTY TM OFC REG. NO. 011782182,  
DATED 9-23-2013, EXPIRES 4-30-2023.

THE ENGLISH TRANSLATION OF "PREUVES D'AMOUR" IN THE MARK IS "PROOF OF LOVE".

FOR JEWELRY, NECKLACES (U.S. CLS. 2, 27, 28 AND 50).

IRA J. GOODSaid, EXAMINING ATTORNEY

SN 86-005,189. MILES, AMY R, DBA THE REDHEAD NYC,  
NEW YORK CITY, NY. FILED 7-9-2013.

## The Redhead NYC

THE MARK CONSISTS OF STANDARD CHARACTERS WITHOUT CLAIM TO ANY PARTICULAR FONT, STYLE, SIZE, OR COLOR.

NO CLAIM IS MADE TO THE EXCLUSIVE RIGHT TO USE "NYC", APART FROM THE MARK AS SHOWN.

FOR COSTUME JEWELRY; GEMSTONE JEWELRY; PRECIOUS AND SEMI-PRECIOUS CRYSTAL STONES AND BEADS FOR USE IN JEWELRY (U.S. CLS. 2, 27, 28 AND 50).

FIRST USE 6-15-2013; IN COMMERCE 6-15-2013.

ASMAT KHAN, EXAMINING ATTORNEY

**CLASS 14—(Continued).**

SN 86-006,581. CERRUTI 1881 S.A.S., PARIS, FRANCE,  
FILED 7-10-2013.

**CERRUTI 1881**

THE MARK CONSISTS OF STANDARD CHARACTERS WITHOUT CLAIM TO ANY PARTICULAR FONT, STYLE, SIZE, OR COLOR.

OWNER OF U.S. REG. NO. 3,333,093.

FOR PRECIOUS METALS AND THEIR ALLOYS AND GOODS IN PRECIOUS METALS OR COATED THEREWITH, NAMELY, BODY JEWELRY, JEWELRY CHAINS, BOXES OF PRECIOUS METAL, BROACHES, CHARMS, CUFF LINKS AND TIE PINS, KEY RINGS OF PRECIOUS METALS, RINGS, WATCH FOBS, ORNAMENTAL PINS, ORNAMENTAL LAPEL PINS, HAT ORNAMENTS, SHOE ORNAMENTS, EARRINGS, NECKLACES, BRACELETS, FIGURINES; JEWELRY, PRECIOUS STONES; HOROLOGICAL AND CHRONOMETRICAL INSTRUMENTS (U.S. CLS. 2, 27, 28 AND 50).

MARK SPARACINO, EXAMINING ATTORNEY

---

SN 86-016,861. WORLD DIAMOND IMPORTS, FT. LAUDERDALE, FL. FILED S.R. 7-22-2013; AM. P.R. 12-6-2013.

**JILLIAN'S CUT**

THE MARK CONSISTS OF STANDARD CHARACTERS WITHOUT CLAIM TO ANY PARTICULAR FONT, STYLE, SIZE, OR COLOR.

NO CLAIM IS MADE TO THE EXCLUSIVE RIGHT TO USE "CUT", APART FROM THE MARK AS SHOWN.

FOR ROUND BRILLIANT CUT DIAMONDS THAT DISPLAY HEARTS AND ARROWS (U.S. CLS. 2, 27, 28 AND 50).

FIRST USE 4-25-2003; IN COMMERCE 4-25-2003.

JULIE GUTTADAURO, EXAMINING ATTORNEY

---

SN 86-017,318. MANYI, CHENG, MISSOURI CITY, TX. FILED 7-23-2013.

**SHOWJADE**

THE MARK CONSISTS OF STANDARD CHARACTERS WITHOUT CLAIM TO ANY PARTICULAR FONT, STYLE, SIZE, OR COLOR.

FOR JEWELS, NAMELY, JADE (U.S. CLS. 2, 27, 28 AND 50).

FIRST USE 4-1-2013; IN COMMERCE 6-1-2013.

KHANH LE, EXAMINING ATTORNEY

**CLASS 14—(Continued).**

SN 86-017,328. JD DESIGNS, LLC, SAN FRANCISCO, CA. FILED 7-23-2013.

**BLACK THIRTY ONE**

THE MARK CONSISTS OF STANDARD CHARACTERS WITHOUT CLAIM TO ANY PARTICULAR FONT, STYLE, SIZE, OR COLOR.

FOR JEWELRY, NAMELY, RINGS, AMULETS, PENDANTS, GOLD THREAD NECKLACES AND SILVER LINK NECKLACES, BRACELETS, AND BODY JEWELRY (U.S. CLS. 2, 27, 28 AND 50).

FIRST USE 7-13-2013; IN COMMERCE 7-13-2013.

BILL DAWE, EXAMINING ATTORNEY

---

SN 86-031,301. MARK, PHILLIP EDWARD, ORLANDO, FL. FILED 8-7-2013.



THE MARK CONSISTS OF A CIRCLE WITH THE WORDS "MY CALL TO SERVE" AT THE TOP PORTION OF THE CIRCLE, "D&C 4" AT THE BOTTOM PORTION OF THE CIRCLE AND AN IMAGE OF WHEAT IN THE MIDDLE AND "1830" TO THE RIGHT OF THE WHEAT.

FOR JEWELRY (U.S. CLS. 2, 27, 28 AND 50).

KATHLEEN LORENZO, EXAMINING ATTORNEY

**CLASS 14—(Continued).**

SN 86-033,681. VIEIRA, YVES LEELAND, SUFFOLK, VA.  
FILED 8-9-2013.



NO CLAIM IS MADE TO THE EXCLUSIVE RIGHT TO USE "CREATIONS", APART FROM THE MARK AS SHOWN.

THE NAME(S), PORTRAIT(S), AND/OR SIGNATURE(S) SHOWN IN THE MARK DOES NOT IDENTIFY A PARTICULAR LIVING INDIVIDUAL.

THE MARK CONSISTS OF THE FOLLOWING: A BLACK OVAL WITH A TAN INTERIOR, WITH THREE BLACK LINES ON THE INSIDE OF EACH END OF THE OVAL, AND THE WORDING "LEE" AND "VEE" IN BLACK, FOUR LARGE BLACK BEADS AND THREE SMALLER BLACK BEADS LINKING THE LARGE BEADS, AND THE WORDING "CREATIONS" IN BLACK ALL INSIDE OF THE OVAL.

FOR JEWELRY (U.S. CLS. 2, 27, 28 AND 50).

FIRST USE 12-0-2010; IN COMMERCE 12-0-2010.

APRIL ROACH, EXAMINING ATTORNEY

SN 86-038,626. STACKED NEW YORK, LLC, LONG ISLAND CITY, NY. FILED 8-15-2013.

## Stacked New York

THE MARK CONSISTS OF STANDARD CHARACTERS WITHOUT CLAIM TO ANY PARTICULAR FONT, STYLE, SIZE, OR COLOR.

NO CLAIM IS MADE TO THE EXCLUSIVE RIGHT TO USE "NEW YORK", APART FROM THE MARK AS SHOWN. FOR BANGLE BRACELETS; JEWELRY; RINGS (U.S. CLS. 2, 27, 28 AND 50).

FIRST USE 5-1-2013; IN COMMERCE 5-1-2013.

JANICE KIM, EXAMINING ATTORNEY

**CLASS 14—(Continued).**

SN 86-039,679. CELIA L. CARTER, DBA CICI CARTER, SAGINAW, MI. FILED 8-16-2013.

## THE TAG

THE MARK CONSISTS OF STANDARD CHARACTERS WITHOUT CLAIM TO ANY PARTICULAR FONT, STYLE, SIZE, OR COLOR.

SEC. 2(F).

FOR BRACELETS; BROOCHES; CUFF LINKS; EARRINGS; GEMSTONE JEWELRY; JEWELRY CHAINS; NECKLACES; ORNAMENTAL PINS; PENDANTS (U.S. CLS. 2, 27, 28 AND 50).

FIRST USE 6-0-2002; IN COMMERCE 5-0-2003.

MARY ROSSMAN, EXAMINING ATTORNEY

SN 86-042,237. GLAM HOUSE, INC., LOS ANGELES, CA. FILED 8-19-2013.

## GLAM GIRLS

THE MARK CONSISTS OF STANDARD CHARACTERS WITHOUT CLAIM TO ANY PARTICULAR FONT, STYLE, SIZE, OR COLOR.

OWNER OF U.S. REG. NO. 3,279,718.

NO CLAIM IS MADE TO THE EXCLUSIVE RIGHT TO USE "GIRLS", APART FROM THE MARK AS SHOWN.

FOR JEWELRY AND WATCHES (U.S. CLS. 2, 27, 28 AND 50).

MARC LEIPZIG, EXAMINING ATTORNEY

SN 86-062,497. COLÉOPTÈRE, OAKLAND, CA. FILED 9-12-2013.

## COLÉOPTÈRE

THE MARK CONSISTS OF STANDARD CHARACTERS WITHOUT CLAIM TO ANY PARTICULAR FONT, STYLE, SIZE, OR COLOR.

THE ENGLISH TRANSLATION OF "COLÉOPTÈRE" IN THE MARK IS "BEETLE".

FOR JEWELRY (U.S. CLS. 2, 27, 28 AND 50).

FIRST USE 1-0-2013; IN COMMERCE 1-0-2013.

KEVIN MITTLER, EXAMINING ATTORNEY

**CLASS 14—(Continued).**

SN 86-062,785. SEACHELLE DESIGNS, LLC, DELMAR, MD. FILED 9-12-2013.

**SEACHELLE DESIGNS**

THE MARK CONSISTS OF STANDARD CHARACTERS WITHOUT CLAIM TO ANY PARTICULAR FONT, STYLE, SIZE, OR COLOR.

NO CLAIM IS MADE TO THE EXCLUSIVE RIGHT TO USE "DESIGNS", APART FROM THE MARK AS SHOWN.

FOR BEADS FOR MAKING JEWELRY; JEWELRY (U.S. CLS. 2, 27, 28 AND 50).

FIRST USE 10-0-2012; IN COMMERCE 10-0-2012.  
AHSEN KHAN, EXAMINING ATTORNEY

**CLASS 14—(Continued).**

SN 86-065,193. VDOWNNS, LTD., CHICAGO, IL. FILED 9-16-2013.

**Project Sarcasm**

THE MARK CONSISTS OF STANDARD CHARACTERS WITHOUT CLAIM TO ANY PARTICULAR FONT, STYLE, SIZE, OR COLOR.

FOR CHARMS (U.S. CLS. 2, 27, 28 AND 50).  
FIRST USE 1-1-2013; IN COMMERCE 7-1-2013.  
TRACY FLETCHER, EXAMINING ATTORNEY

SN 86-065,568. BRILLIANT JEWELERS/MJJ INC., NEW YORK, NY. FILED 9-16-2013.

**WITH EVERY TWIST AND TURN  
ROMANCE HAS NO LIMITS**

THE MARK CONSISTS OF STANDARD CHARACTERS WITHOUT CLAIM TO ANY PARTICULAR FONT, STYLE, SIZE, OR COLOR.

FOR JEWELRY (U.S. CLS. 2, 27, 28 AND 50).  
HENRY S. ZAK, EXAMINING ATTORNEY

SN 86-065,137. LEGEND BRIGHT TRADING LIMITED, KOWLOON,, HONG KONG, FILED 9-16-2013.

**JEWELLERY  
THEATRE**

NO CLAIM IS MADE TO THE EXCLUSIVE RIGHT TO USE "JEWELLERY", APART FROM THE MARK AS SHOWN.

THE MARK CONSISTS OF "JEWELLERY THEATRE" AND STYLISHED LETTERS OF "JT" ON THE TOP.

FOR DIAMONDS; BRACELETS OF PRECIOUS METAL; BANGLE BRACELETS; STRAPS FOR WRIST-WATCHES; BROOCHES; PINS BEING JEWELRY; TIE PINS; PEARLS; TIE CLIPS; CUFF LINKS; WORKS OF ART OF PRECIOUS METAL; JEWELLERY; PRECIOUS STONES; SEMI-PRECIOUS STONES; NECKLACES; RINGS; WATCH CASES; WATCH MOVEMENTS; CLOCK CASES; PLATINUM; RHODIUM AND ITS ALLOYS; RUTHENIUM AND ITS ALLOYS; EARRINGS; FIGURINES OF PRECIOUS METAL; WATCH FACES; CLOCK AND WATCH HANDS; CHRONOGRAPHS AS WATCHES; JEWELLERY CHAINS; UNWROUGHT AND SEMI-WROUGHT PRECIOUS STONES AND THEIR IMITATIONS; UNWROUGHT PRECIOUS STONES; JEWELRY CASKETS; KEY CHAINS AS JEWELLERY; ORNAMENTS OF PRECIOUS METAL IN THE NATURE OF JEWELRY; WATCHES (U.S. CLS. 2, 27, 28 AND 50).  
GILBERT SWIFT, EXAMINING ATTORNEY

SN 86-067,329. JOSE DE JESUS ZUÑIGA CANUTO, DISTRICTO FEDERAL, MEXICO, FILED 9-17-2013.



THE MARK CONSISTS OF THE MARK CONSISTS OF "MIGUELITO", TO THE LEFT OF AN ANGEL WITH A BOW AND ARROW IN POSITION TO SHOOT AN ARROW, ALL AGAINST A SHADED BACKGROUND.

FOR BODY JEWELRY; BRACELETS; BRACELETS AND JEWELRY FEATURING ELECTRONIC CHIPS FOR ATTRACTING ENERGY TO THE BODY WHEREIN THE ELECTRONIC CHIPS INCREASE IN POWER IN THE PRESENCE OF ELECTROMAGNETIC FIELDS, FOR THE PURPOSE OF RE-BALANCING THE HUMAN ENERGY FIELD; BRONZE JEWELRY; BROOCHES; CHARMS; CHARMS FOR COLLAR JEWELRY AND BRACELET; CHILDREN'S JEWELRY; COSTUME JEWELRY; HAIR JEWELRY IN THE NATURE OF JEWELRY FOR USE IN THE HAIR; IDENTIFICATION BRACELETS; INEXPENSIVE NON-JEWELRY WATCHES; JEWELRY AND IMITATION JEWELRY; JEWELRY BOXES; JEWELRY BOXES NOT OF METAL; JEWELRY BROOCHES; JEWELRY CASES; JEWELRY CASES NOT OF PRECIOUS METAL; JEWELRY CHAINS; JEWELRY CLIPS FOR ADAPTING PIERCED EARRINGS TO CLIP-ON EARRINGS; JEWELRY FOR ATTACHMENT TO CLOTHING; JEWELRY FOR THE HEAD; JEWELRY IN THE NATURE OF IDENTIFICATION TAGS FOR WEAR

**CLASS 14—(Continued).**

BY HUMANS FOR DECORATIVE PURPOSES; JEWELRY MAKING KITS; JEWELRY ORGANIZER CASES; JEWELRY PINS FOR USE ON HATS; JEWELRY RING HOLDERS; JEWELRY WATCHES; JEWELRY, NAMELY, AMULETS; JEWELRY, NAMELY, ARM CUFFS; JEWELRY, NAMELY, BRACELETS, WRISTBANDS AND NECKLACES THAT ALSO PROVIDES NOTIFICATION TO THE WEARER OF A PENDING MEDICAL RELATED TASK; JEWELRY, NAMELY, COLLAR TIPS OF COMMON METAL; JEWELRY, NAMELY, DOG TAGS FOR WEAR BY HUMANS FOR DECORATIVE PURPOSES; JEWELRY, NAMELY, MAGNETIC NECKLACES; JEWELRY, NAMELY, MAGNETIC PENDANTS; LAPEL PINS; LEATHER JEWELRY AND ACCESSORY BOXES; PASTE JEWELRY; PLASTIC BRACELETS IN THE NATURE OF JEWELRY; PRECIOUS AND SEMI-PRECIOUS CRYSTAL STONES AND BEADS FOR USE IN JEWELRY; STAINLESS STEEL JEWELRY BRACELETS; WATCHES AND JEWELRY; WATCHES, CLOCKS, JEWELRY AND IMITATION JEWELRY; WOMEN'S JEWELRY (U.S. CLS. 2, 27, 28 AND 50).

EUGENIA MARTIN, EXAMINING ATTORNEY

SN 86-067,524. CHEN, HUI, SAN FRANCISCO, CA. FILED 9-18-2013.

# ONE ION

THE MARK CONSISTS OF STANDARD CHARACTERS WITHOUT CLAIM TO ANY PARTICULAR FONT, STYLE, SIZE, OR COLOR.

FOR BRACELETS; BRACELETS; BRACELETS MADE OF RUBBER, SILICONE, CLOTH, LEATHER, STAINLESS STEEL, PREVIOUS METALS OR THEIR ALLOYS OR COATED THEREWITH, PRECIOUS STONES, JEWELRY, OR A COMBINATION THEREOF; BRACELETS OF PRECIOUS METAL; JEWELRY, NAMELY, MAGNETIC NECKLACES; NECKLACES; NECKLACES MADE OF RUBBER, SILICONE, CLOTH, LEATHER, STAINLESS STEEL, PREVIOUS METALS OR THEIR ALLOYS OR COATED THEREWITH, PRECIOUS STONES, JEWELRY, OR A COMBINATION THEREOF; PRECIOUS METALS AND THEIR ALLOYS; RUBBER OR SILICONE WRISTBANDS IN THE NATURE OF A BRACELET (U.S. CLS. 2, 27, 28 AND 50).

MICHAEL WIENER, EXAMINING ATTORNEY

SN 86-067,931. MELISSA JOY MANNING, INC., BERKELEY, CA. FILED 9-18-2013.



OWNER OF U.S. REG. NOS. 3,311,470 AND 3,453,125. THE MARK CONSISTS OF STYLIZED SCRIPT OF LETTERS "M", "J", AND "M".

FOR JEWELRY; JEWELRY BOXES (U.S. CLS. 2, 27, 28 AND 50).

NORA BUCHANAN WILL, EXAMINING ATTORNEY

**CLASS 14—(Continued).**

SN 86-068,010. WATCHSTAR, COLUMBIA, MD. FILED 9-18-2013.

# BlackStar

THE MARK CONSISTS OF STANDARD CHARACTERS WITHOUT CLAIM TO ANY PARTICULAR FONT, STYLE, SIZE, OR COLOR.

FOR CLOCKS; WATCHES (U.S. CLS. 2, 27, 28 AND 50). FIRST USE 7-18-2012; IN COMMERCE 8-2-2012. MORGAN WYNNE, EXAMINING ATTORNEY

SN 86-068,742. GOOLSBY, TINA J, ORMOND BEACH, FL. FILED 9-18-2013.

# Pieces Past

THE MARK CONSISTS OF STANDARD CHARACTERS WITHOUT CLAIM TO ANY PARTICULAR FONT, STYLE, SIZE, OR COLOR.

FOR JEWELRY (U.S. CLS. 2, 27, 28 AND 50). FIRST USE 5-28-2009; IN COMMERCE 5-28-2009. JESSICA FATHY, EXAMINING ATTORNEY

SN 86-069,055. VITAL-AMP, L.L.C., GILBERT, AZ. FILED 9-19-2013.

# VITAL-AMP

THE MARK CONSISTS OF STANDARD CHARACTERS WITHOUT CLAIM TO ANY PARTICULAR FONT, STYLE, SIZE, OR COLOR.

FOR JEWELRY (U.S. CLS. 2, 27, 28 AND 50). JOHN SCHUYLER YARD, EXAMINING ATTORNEY

**CLASS 14—(Continued).**

SN 86-069,912. COLBAUGH PROCESSING, INC., GOLDEN VALLEY, AZ. FILED 9-19-2013.

**FIFTY SHADES OF BLUE**

THE MARK CONSISTS OF STANDARD CHARACTERS WITHOUT CLAIM TO ANY PARTICULAR FONT, STYLE, SIZE, OR COLOR.

FOR JEWELRY, NAMELY, JEWELRY MADE FROM TURQUOISE (U.S. CLS. 2, 27, 28 AND 50).  
SOPHIA S. KIM, EXAMINING ATTORNEY

SN 86-069,974. DI, LI, SHENZHEN, CHINA, FILED 9-20-2013.

**VANTASY**

THE MARK CONSISTS OF STANDARD CHARACTERS WITHOUT CLAIM TO ANY PARTICULAR FONT, STYLE, SIZE, OR COLOR.

FOR WATCHES AND CLOCKS; WATCH BANDS AND STRAPS; POCKET WATCHES (U.S. CLS. 2, 27, 28 AND 50).

FIRST USE 3-19-2013; IN COMMERCE 3-19-2013.  
LINDA POWELL, EXAMINING ATTORNEY

SN 86-070,583. CATERINA JEWELRY, LLC., LOS ANGELES, CA. FILED 9-20-2013.



THE MARK CONSISTS OF THE LETTER "C" AND THE LETTER "J" STYLIZED. THE LETTER "J" IS ADORNED WITH A CROWN.

FOR JEWELRY (U.S. CLS. 2, 27, 28 AND 50).  
LINDA MICKLEBURGH, EXAMINING ATTORNEY

**CLASS 14—(Continued).**

SN 86-071,353. GRUBBS, JERMAINE S., LAS VEGAS, NV. FILED 9-22-2013.

**Count Down**

THE MARK CONSISTS OF STANDARD CHARACTERS WITHOUT CLAIM TO ANY PARTICULAR FONT, STYLE, SIZE, OR COLOR.

FOR JEWELRY (U.S. CLS. 2, 27, 28 AND 50).  
MICHAEL ENGEL, EXAMINING ATTORNEY

SN 86-074,051. EXPRESS, LLC, COLUMBUS, OH. FILED 9-25-2013.

**GLENDALE**

THE MARK CONSISTS OF STANDARD CHARACTERS WITHOUT CLAIM TO ANY PARTICULAR FONT, STYLE, SIZE, OR COLOR.

FOR WATCHES (U.S. CLS. 2, 27, 28 AND 50).  
DAVID ELTON, EXAMINING ATTORNEY

SN 86-074,121. EXPRESS, LLC, COLUMBUS, OH. FILED 9-25-2013.

**TOPANGA**

THE MARK CONSISTS OF STANDARD CHARACTERS WITHOUT CLAIM TO ANY PARTICULAR FONT, STYLE, SIZE, OR COLOR.

FOR WATCHES (U.S. CLS. 2, 27, 28 AND 50).  
DAVID ELTON, EXAMINING ATTORNEY

SN 86-074,129. EXPRESS, LLC, COLUMBUS, OH. FILED 9-25-2013.

**NORFOLK**

THE MARK CONSISTS OF STANDARD CHARACTERS WITHOUT CLAIM TO ANY PARTICULAR FONT, STYLE, SIZE, OR COLOR.

FOR WATCHES (U.S. CLS. 2, 27, 28 AND 50).  
DAVID ELTON, EXAMINING ATTORNEY



**CLASS 14—(Continued).**

SN 86-074,132. EXPRESS, LLC, COLUMBUS, OH. FILED 9-25-2013.

RIVINGTON

THE MARK CONSISTS OF STANDARD CHARACTERS WITHOUT CLAIM TO ANY PARTICULAR FONT, STYLE, SIZE, OR COLOR.

FOR WATCHES (U.S. CLS. 2, 27, 28 AND 50).  
DAVID ELTON, EXAMINING ATTORNEY

SN 86-077,233. JEWELEX NEW YORK, LTD., NEW YORK, NY. FILED 9-27-2013.



NO CLAIM IS MADE TO THE EXCLUSIVE RIGHT TO USE "COLLECTION", APART FROM THE MARK AS SHOWN.

THE MARK CONSISTS OF THE WORDS "LOVEDOVES COLLECTION". ABOVE THE WORD "LOVEDOVES" THERE IS A STYLIZED HEART. SITTING ON THE UPPER LEFT PORTION OF THE HEART IS A DOVE WITH ITS WINGS SPREAD UPRIGHT. IN THE DOVE'S MOUTH IS A TWIG WITH LEAVES.

FOR JEWELRY, NAMELY, GOLD, PLATINUM, TITANIUM AND SILVER JEWELRY; AND GOLD, PLATINUM, TITANIUM AND SILVER JEWELRY WITH PRECIOUS STONES, NAMELY, DIAMONDS, RUBIES, EMERALDS, SAPPHIRES, AND SEMI-PRECIOUS COLORED STONES EMBEDDED THEREIN, AND PEARLS EMBEDDED THEREIN (U.S. CLS. 2, 27, 28 AND 50).

SKYE YOUNG, EXAMINING ATTORNEY

**CLASS 14—(Continued).**

SN 86-080,120. BEBE STUDIO, INC, LOS ANGELES, CA. FILED 10-1-2013.



OWNER OF U.S. REG. NOS. 2,328,170, 2,494,865 AND 3,509,651.

THE MARK CONSISTS OF THE STYLIZED NUMBER "2" AND THE STYLIZED LETTER "B" ON ONE LINE, FOLLOWED BY THE STYLIZED "BEBE" IN LOWERCASE ON THE LINE BELOW IT.

THE ENGLISH TRANSLATION OF THE WORD "BEBE" IN THE MARK IS "QUEEN OF HEARTS IN A PERSIAN DECK OF CARDS".

FOR JEWELRY, NAMELY, EARRINGS, RINGS, NECKLACES, PENDANTS, BODY JEWELRY, AND BRACELETS (U.S. CLS. 2, 27, 28 AND 50).

FIRST USE 6-17-2013; IN COMMERCE 6-17-2013.

KATHLEEN LORENZO, EXAMINING ATTORNEY

SN 86-080,130. PARAMOUNT PICTURES CORPORATION, HOLLYWOOD, CA. FILED 10-1-2013.

JACK RYAN: SHADOW RECRUIT

THE MARK CONSISTS OF STANDARD CHARACTERS WITHOUT CLAIM TO ANY PARTICULAR FONT, STYLE, SIZE, OR COLOR.

THE NAME(S), PORTRAIT(S), AND/OR SIGNATURE(S) SHOWN IN THE MARK DOES NOT IDENTIFY A PARTICULAR LIVING INDIVIDUAL.

FOR CLOCKS AND WATCHES; CUFFLINKS; JEWELRY AND IMITATION JEWELRY; KEY CHAINS OF PRECIOUS METAL; TIE PINS (U.S. CLS. 2, 27, 28 AND 50).

AHSEN KHAN, EXAMINING ATTORNEY

**CLASS 14—(Continued).**

SN 86-080,971. JONES INVESTMENT CO. INC., WILMINGTON, DE. FILED 10-2-2013.

# GLO

THE MARK CONSISTS OF STANDARD CHARACTERS WITHOUT CLAIM TO ANY PARTICULAR FONT, STYLE, SIZE, OR COLOR.

OWNER OF U.S. REG. NOS. 3,731,417, 3,731,419 AND OTHERS.

THE NAME(S), PORTRAIT(S), AND/OR SIGNATURE(S) SHOWN IN THE MARK DOES NOT IDENTIFY A PARTICULAR LIVING INDIVIDUAL.

FOR JEWELRY; WATCHES (U.S. CLS. 2, 27, 28 AND 50).

EDWARD FENNESSY, EXAMINING ATTORNEY

**CLASS 14—(Continued).**

SN 86-084,633. THE BAZAR GROUP, INC., EAST PROVIDENCE, RI. FILED 10-7-2013.

## VOW JEWELRY by Imperial

THE MARK CONSISTS OF STANDARD CHARACTERS WITHOUT CLAIM TO ANY PARTICULAR FONT, STYLE, SIZE, OR COLOR.

OWNER OF U.S. REG. NOS. 500,280, 3,676,005 AND OTHERS.

NO CLAIM IS MADE TO THE EXCLUSIVE RIGHT TO USE "JEWELRY", APART FROM THE MARK AS SHOWN.

FOR JEWELRY; PEARLS (U.S. CLS. 2, 27, 28 AND 50).

JORDAN BAKER, EXAMINING ATTORNEY

SN 86-084,575. THE BAZAR GROUP, INC., EAST PROVIDENCE, RI. FILED 10-7-2013.

## VOW GIFTS by Imperial

THE MARK CONSISTS OF STANDARD CHARACTERS WITHOUT CLAIM TO ANY PARTICULAR FONT, STYLE, SIZE, OR COLOR.

OWNER OF U.S. REG. NOS. 500,280, 3,676,005 AND OTHERS.

NO CLAIM IS MADE TO THE EXCLUSIVE RIGHT TO USE "GIFTS", APART FROM THE MARK AS SHOWN.

FOR JEWELRY; PEARLS (U.S. CLS. 2, 27, 28 AND 50).

JORDAN BAKER, EXAMINING ATTORNEY

SN 86-104,485. D-GENERATION, INC., DAYTONA BEACH, FL. FILED 10-29-2013.

# OCEANWASH

THE MARK CONSISTS OF STANDARD CHARACTERS WITHOUT CLAIM TO ANY PARTICULAR FONT, STYLE, SIZE, OR COLOR.

OWNER OF U.S. REG. NO. 4,425,720.

FOR JEWELRY (U.S. CLS. 2, 27, 28 AND 50).

FIRST USE 10-18-2003; IN COMMERCE 10-18-2003.

RONALD MCMORROW, EXAMINING ATTORNEY

SN 86-084,606. THE BAZAR GROUP, INC., EAST PROVIDENCE, RI. FILED 10-7-2013.

## VOW PEARLS by Imperial

THE MARK CONSISTS OF STANDARD CHARACTERS WITHOUT CLAIM TO ANY PARTICULAR FONT, STYLE, SIZE, OR COLOR.

OWNER OF U.S. REG. NOS. 500,280, 3,676,005 AND OTHERS.

NO CLAIM IS MADE TO THE EXCLUSIVE RIGHT TO USE "PEARLS", APART FROM THE MARK AS SHOWN.

FOR JEWELRY IN WHOLE OR IN SUBSTANTIAL PART OF PEARL; PEARLS (U.S. CLS. 2, 27, 28 AND 50).

JORDAN BAKER, EXAMINING ATTORNEY

SN 86-110,410. PSYCHO KILLER MUSIC, LLC, WEST PALM BEACH, FL. FILED 11-5-2013.



THE MARK CONSISTS OF A DESIGN OF TWO CROSSED AXES.

FOR JEWELRY (U.S. CLS. 2, 27, 28 AND 50).

TRACY CROSS, EXAMINING ATTORNEY

**CLASS 14—(Continued).**

SN 86-116,375. AHMED, RAYAZ, NEW YORK, NY. FILED 11-12-2013.



NO CLAIM IS MADE TO THE EXCLUSIVE RIGHT TO USE "GROUP" AND "SINCE 1955", APART FROM THE MARK AS SHOWN.

THE COLOR(S) GREEN, YELLOW, WHITE, AND BLACK IS/ARE CLAIMED AS A FEATURE OF THE MARK.

THE MARK CONSISTS OF THE DESIGN OF A PARTIAL OVAL OUTLINED IN GREEN ENCOMPASSING THE TERMS "TAKAT" IN GREEN WHICH IS SUPERIMPOSED OVER THE LETTERS "TG" IN YELLOW. BENEATH THE OVAL IS A GREEN BANNER CONTAINING THE TERMS "TAKAT GROUP" IN WHITE. BENEATH THIS ARE THE TERMS "SINCE 1955" IN BLACK.

THE ENGLISH TRANSLATION OF "TAKAT" IN THE MARK IS "HUMAN MALE ADULT" OR "STAMINA", "STRENGTH".

FOR PRECIOUS STONES (U.S. CLS. 2, 27, 28 AND 50).  
FIRST USE 1-1-1955; IN COMMERCE 1-1-1955.  
SUNG IN, EXAMINING ATTORNEY

**CLASS 14—(Continued).**

SN 86-123,075. CHROME HEARTS LLC, HOLLYWOOD, CA. FILED 11-19-2013.

GOD BLESS THE WORLD (AND  
MOST OF THE PEOPLE IN IT)

THE MARK CONSISTS OF STANDARD CHARACTERS WITHOUT CLAIM TO ANY PARTICULAR FONT, STYLE, SIZE, OR COLOR.

OWNER OF U.S. REG. NOS. 3,342,260 AND 3,406,054.  
FOR JEWELRY, NAMELY, PENDANTS, RINGS, EARRINGS, NECKLACES, BRACELETS, PINS AND CUFF LINKS (U.S. CLS. 2, 27, 28 AND 50).  
FIRST USE 12-1-2001; IN COMMERCE 12-1-2001.  
MICHAEL KEATING, EXAMINING ATTORNEY

SN 86-133,392. GORDON, GARRETT, NORTHBROOK, IL. FILED 12-3-2013.

ROCKED PERFORMANCE JEWELRY

THE MARK CONSISTS OF STANDARD CHARACTERS WITHOUT CLAIM TO ANY PARTICULAR FONT, STYLE, SIZE, OR COLOR.

NO CLAIM IS MADE TO THE EXCLUSIVE RIGHT TO USE "JEWELRY", APART FROM THE MARK AS SHOWN.  
FOR BRACELETS; NECKLACES; ANKLE BRACELETS; RUBBER OR SILICONE WRISTBANDS IN THE NATURE OF JEWELRY; JEWELRY (U.S. CLS. 2, 27, 28 AND 50).  
ANDREA HACK, EXAMINING ATTORNEY

SN 86-117,325. STONEY CLOVER LANE, LLC, PALM BEACH, FL. FILED 11-13-2013.

KEN + LIB

THE MARK CONSISTS OF STANDARD CHARACTERS WITHOUT CLAIM TO ANY PARTICULAR FONT, STYLE, SIZE, OR COLOR.

FOR JEWELRY (U.S. CLS. 2, 27, 28 AND 50).  
FIRST USE 8-0-2009; IN COMMERCE 8-0-2009.  
DOMINICK J. SALEMI, EXAMINING ATTORNEY

**CLASS 15—MUSICAL INSTRUMENTS**

SN 85-859,018. KUCHARSKI, GAY, DBA ONO UKULELE, SIMI VALLEY, CA. FILED 2-25-2013.

Ōno Ukulele

THE MARK CONSISTS OF STANDARD CHARACTERS WITHOUT CLAIM TO ANY PARTICULAR FONT, STYLE, SIZE, OR COLOR.

NO CLAIM IS MADE TO THE EXCLUSIVE RIGHT TO USE "UKULELE", APART FROM THE MARK AS SHOWN.  
THE WORD(S) "ŌNO" HAS NO MEANING IN A FOREIGN LANGUAGE.

FOR CAPOS; GUITAR STRAPS; UKULELES (U.S. CLS. 2, 21 AND 36).  
FIRST USE 7-19-2012; IN COMMERCE 7-19-2012.  
KIMBERLY PERRY, EXAMINING ATTORNEY

**CLASS 15—(Continued).**

SN 85-890,632. MARC E. MINARIK, DBA MINARIK GUITARS, GLENDALE, CA. FILED S.R. 3-29-2013; AM. P.R. 12-10-2013.

# MANTA

THE MARK CONSISTS OF STANDARD CHARACTERS WITHOUT CLAIM TO ANY PARTICULAR FONT, STYLE, SIZE, OR COLOR.

FOR MUSICAL INSTRUMENTS, NAMELY, ELECTRIC, ACOUSTIC AND BASS GUITARS AND PIECE PARTS FOR ELECTRIC, ACOUSTIC AND BASS GUITARS, NAMELY, PICKUPS, FRETS, HEAD STOCK, FRET BOARD, INLAYS, BODIES AND NECKS (U.S. CLS. 2, 21 AND 36).

FIRST USE 1-1-2005; IN COMMERCE 1-1-2005.

JORDAN BAKER, EXAMINING ATTORNEY

**CLASS 15—(Continued).**

SN 86-068,260. CHAPUT, REYNALD L., HARBOR CITY, CA. FILED 9-18-2013.

# STA-TUNED

THE MARK CONSISTS OF STANDARD CHARACTERS WITHOUT CLAIM TO ANY PARTICULAR FONT, STYLE, SIZE, OR COLOR.

OWNER OF U.S. REG. NO. 4,265,330.

FOR ACOUSTIC GUITARS; BASS GUITARS; ELECTRIC BASS GUITARS; ELECTRIC GUITARS; GUITAR ACCESSORIES, NAMELY, GUITAR SLIDES; GUITAR BRIDGES; GUITAR PARTS, NAMELY, AN ATTACHABLE DEVICE TO PREVENT ALL STYLE GUITARS AND STRING INSTRUMENTS FROM GOING OUT OF TUNE, A STRING LOCKING DEVICE TO PREVENT MOVEMENT OF THE STRINGS, AND AN ATTACHABLE VIBRATO AND STRING TAILPIECE; GUITAR SADDLES; GUITARS (U.S. CLS. 2, 21 AND 36).

FIRST USE 8-1-2011; IN COMMERCE 2-2-2012.

JEFFREY LOOK, EXAMINING ATTORNEY

---

SN 86-036,595. PEAVEY ELECTRONICS, CORPORATION, MERIDIAN, MS. FILED 8-13-2013.



NO CLAIM IS MADE TO THE EXCLUSIVE RIGHT TO USE "FAST CHORD", APART FROM THE MARK AS SHOWN.

THE MARK CONSISTS OF AN "S" SHAPED LIGHTNING BOLT, OF WHOSE BOTTOM PORTION SEPARATES THE LITERAL ELEMENTS "FAST" AND "CHORD". THE WORD "FAST" IS ITALICIZED.

FOR GUITAR PLAYING ASSISTANCE DEVICE, NAMELY, A SLIDING CLAMP-LIKE STRUCTURE POSITIONED ONTO A GUITAR NECK TO FORM AND SOUND GUITAR CHORDS AND NOTES (U.S. CLS. 2, 21 AND 36).

SIMON TENG, EXAMINING ATTORNEY

---

SN 86-068,790. AUGUST D. MARTIN, ALBUQUERQUE, NM. FILED 9-19-2013.

# ULTIMOUNT

THE MARK CONSISTS OF STANDARD CHARACTERS WITHOUT CLAIM TO ANY PARTICULAR FONT, STYLE, SIZE, OR COLOR.

FOR DRUM PARTS, NAMELY, MOUNTING HARDWARE FOR DRUM COMPONENTS; DRUM PARTS, NAMELY, A STRUCTURAL FRAMEWORK COUPLING THE DRUM HEAD TO THE DRUM SHELL; MUSICAL INSTRUMENT TUNING APPARATUS, NAMELY, A DRUM MOUNT PROVIDING ADJUSTABLE TENSION ON THE DRUM SHELL AND/OR DRUM HEAD; MUSICAL INSTRUMENTS, NAMELY, DRUMS WITH SPECIALIZED MOUNTING HARDWARE PERMITTING UNIMPEDED RESONANCE OF THE DRUM SHELL (U.S. CLS. 2, 21 AND 36).

ESTHER BELENKER, EXAMINING ATTORNEY

**CLASS 15—(Continued).**

SN 86-069,607. JAMES R. MCKENNEY, GRANT'S PASS, OR.  
FILED 9-19-2013.

# Paradigm

THE MARK CONSISTS OF STANDARD CHARACTERS WITHOUT CLAIM TO ANY PARTICULAR FONT, STYLE, SIZE, OR COLOR.

FOR GUITARS OF THE TYPE HAVING A STRING SUPPORTING BRIDGE UPON A SOUND BOX, A STRING MOUNT WITHIN AND AT THE TAIL END OF THE SOUND BOX, A SOUND HOLE WITHIN THE SOUND BOX'S SOUND BOARD AND POSITIONED TAILWARDLY FROM THE BRIDGE, AND STRINGS EXTENDING TAILWARDLY FROM THE BRIDGE AND TOWARD AND THROUGH THE SOUND HOLE FOR ATTACHMENT TO THE STRING MOUNT (U.S. CLS. 2, 21 AND 36).

CORY BOONE, EXAMINING ATTORNEY

SN 86-070,270. JOHN DAVID ENGLISH, III, DBA BLACK OWL GUITARS, NEW BERN, NC. FILED 9-20-2013.

## BLACK OWL GUITARS

THE MARK CONSISTS OF STANDARD CHARACTERS WITHOUT CLAIM TO ANY PARTICULAR FONT, STYLE, SIZE, OR COLOR.

NO CLAIM IS MADE TO THE EXCLUSIVE RIGHT TO USE "GUITARS", APART FROM THE MARK AS SHOWN.

FOR MUSICAL INSTRUMENTS, NAMELY, GUITARS, BANJOS, CANJOS, UKULELES, MANDOLINES, DIDDLE BOWS, DULCIMERS, DRUMS, AND STOMP BOXES (U.S. CLS. 2, 21 AND 36).

FIRST USE 4-29-2011; IN COMMERCE 8-22-2011.  
SHARON MEIER, EXAMINING ATTORNEY

SN 86-110,011. GUITAR CENTER, INC., WESTLAKE VIL-  
LAGE, CA. FILED 11-4-2013.

## RAVENWOOD

THE MARK CONSISTS OF STANDARD CHARACTERS WITHOUT CLAIM TO ANY PARTICULAR FONT, STYLE, SIZE, OR COLOR.

FOR MUSICAL INSTRUMENTS, NAMELY, ACOUSTIC GUITARS, BASSES, MANDOLINS, FOLK INSTRUMENTS AND ALL FRETTED INSTRUMENTS (U.S. CLS. 2, 21 AND 36).

ANGELA DUONG, EXAMINING ATTORNEY

**CLASS 16—PAPER GOODS AND PRINTED MATTER**

SN 76-712,203. ESSELTE CORPORATION, MELVILLE, NY.  
FILED 8-17-2012.

## AMPAD DOUBLE SEAL

THE MARK CONSISTS OF STANDARD CHARACTERS WITHOUT CLAIM TO ANY PARTICULAR FONT, STYLE, SIZE, OR COLOR.

OWNER OF U.S. REG. NOS. 1,027,904, 3,761,975 AND OTHERS.

NO CLAIM IS MADE TO THE EXCLUSIVE RIGHT TO USE "DOUBLE SEAL", APART FROM THE MARK AS SHOWN.

FOR ENVELOPES (U.S. CLS. 2, 5, 22, 23, 29, 37, 38 AND 50).

ELI HELLMAN, EXAMINING ATTORNEY

SN 76-713,894. RIGHTPATH RESOURCES, INC., SUWANEE,  
GA. FILED 4-9-2013.

# FQ

THE MARK CONSISTS OF STANDARD CHARACTERS WITHOUT CLAIM TO ANY PARTICULAR FONT, STYLE, SIZE, OR COLOR.

FOR PRINTED MATERIALS AND PUBLICATIONS, NAMELY, A SERIES OF BOOKS, WORKBOOKS, ASSESSMENTS, QUESTIONNAIRES, EVALUATION FORMS, PAMPHLETS, NEWSLETTERS, REPORTS AND MANUALS, ALL IN THE FIELDS OF FAMILY BUSINESS DEVELOPMENT (U.S. CLS. 2, 5, 22, 23, 29, 37, 38 AND 50).

FIRST USE 2-20-2013; IN COMMERCE 2-20-2013.  
TEJBIR SINGH, EXAMINING ATTORNEY

**CLASS 16—(Continued).**

SN 76-714,676. HALAPIN LEARNING SYSTEMS, INC., TRUMBULL, CT. FILED 8-2-2013.

**CLASS 16—(Continued).**

SN 85-474,447. YUPO CORPORATION, TOKYO, JAPAN, FILED 11-16-2011.

**THINKTRACK**

THE MARK CONSISTS OF STANDARD CHARACTERS WITHOUT CLAIM TO ANY PARTICULAR FONT, STYLE, SIZE, OR COLOR.

FOR TEACHING AIDS IN THE NATURE OF WORKBOOKS FOR ASSISTING STUDENTS IN PROCESSING VISUAL STIMULI INTO SPOKEN WORDS (U.S. CLS. 2, 5, 22, 23, 29, 37, 38 AND 50).

FIRST USE 12-2-1986; IN COMMERCE 2-17-1987.  
KATHERINE CHANG, EXAMINING ATTORNEY

**YUPOJELLY**

SN 85-275,991. LIFEWAY BAPTIST CHURCH, DBA GLOW PUBLICATIONS, ELLETTSVILLE, IN. FILED 3-24-2011.

**Glow in the Dark**

THE MARK CONSISTS OF STANDARD CHARACTERS WITHOUT CLAIM TO ANY PARTICULAR FONT, STYLE, SIZE, OR COLOR.

FOR PUBLICATIONS, NAMELY, BROCHURES, BOOKLETS, AND TEACHING MATERIALS IN THE FIELD OF RELIGION (U.S. CLS. 2, 5, 22, 23, 29, 37, 38 AND 50).

FIRST USE 4-1-2001; IN COMMERCE 4-21-2001.  
ANDREA K. NADELMAN, EXAMINING ATTORNEY

THE MARK CONSISTS OF STANDARD CHARACTERS WITHOUT CLAIM TO ANY PARTICULAR FONT, STYLE, SIZE, OR COLOR.

FOR PAPER AND CARDBOARD; SYNTHETIC PAPER; GOODS MADE FROM PAPER AND CARDBOARD, NAMELY, PAPER GIFT BAGS, PAPER CARDS, BOOK COVERS, MAGAZINE COVERS, PRINTED MAP COVERS, DRAWING TEMPLATES, DRAFTING TEMPLATES, MARKING TEMPLATES, PAPER REPORT COVERS, AND SALES SHEETS; PRINTED MATTER, NAMELY, BROCHURES, BOOKS, MAGAZINES, AND MANUALS FEATURING THE PAPER INDUSTRY AND THE SYNTHETIC PAPER INDUSTRY; PRINTED MATTER, NAMELY, TAGS, SIGNS, LABELS, WINDOW SIGNS, OUTDOOR SIGNS, CROSSWORD PUZZLES, MENU SIGNS, PAPER MENU DISPLAY CARDS, OVERLAY DRAWINGS, POSTERS, POINT OF PURCHASE MATERIALS, BANNERS, EMERGENCY SIGNS, DIRECTIONAL SIGNS, AND INSTRUCTIONAL SIGNS; BOOK-BINDING MATERIAL; PHOTOGRAPHS; STATIONERY; ADHESIVES FOR STATIONERY OR HOUSEHOLD PURPOSES; ARTISTS' MATERIALS, NAMELY, PAINT TRAYS, PAINT ROLLERS, AND PAINT BRUSHES; TYPEWRITERS AND OFFICE REQUISITES, NAMELY, ENVELOPE SEALING MACHINES; PRINTED INSTRUCTIONAL AND TEACHING MATERIAL, NAMELY, TRAINING MANUALS, INSTRUCTIONAL MANUALS, AND TEACHING MANUALS; PLASTIC MATERIALS FOR PACKAGING, NAMELY, PLASTIC CLING FILM FOR PACKAGING; PRINTERS' TYPE; PRINTING BLOCKS (U.S. CLS. 2, 5, 22, 23, 29, 37, 38 AND 50).

REGINA DRUMMOND, EXAMINING ATTORNEY

**CLASS 16—(Continued).**

SN 85-588,653. MATTEL, INC., EL SEGUNDO, CA. FILED 4-4-2012.

ZOMBISAURS

THE MARK CONSISTS OF STANDARD CHARACTERS WITHOUT CLAIM TO ANY PARTICULAR FONT, STYLE, SIZE, OR COLOR.

PRIORITY CLAIMED UNDER SEC. 44(D) ON FED REP GERMANY APPLICATION NO. 302011069092, FILED 12-22-2011, REG. NO. 302011069092, DATED 12-22-2011, EXPIRES 12-31-2021.

FOR PAPER, CARDBOARD AND GOODS MADE FROM THESE MATERIALS, NOT INCLUDED IN OTHER CLASSES, NAMELY, PAPER NAPKINS, TABLE CLOTHS OF PAPER, PAPER PARTY FAVORS, NOTE CARDS, INVITATION CARDS, CREPE PAPER, BANNERS OF PAPER, TEMPORARY TATTOOS, STICKERS, SKETCH DESIGN BOOKS, STICKER BOOKS, POSTCARDS, MEMO PADS, ADHESIVE NOTE PADS, AGENDAS, DECORATIVE PAPER FOR USE IN DECORATING LOCKERS, STICKER ALBUMS, PARTY GOODIE BAGS OF PLASTIC OR PAPER, IRON-ON AND GLUE-ON TRANSFERS, JOURNALS, DIARIES; PRINTED MATTER, NAMELY, COMIC BOOKS, MAGAZINES OF GENERAL INTEREST FOR TEENAGERS AND CHILDREN, SERIES OF FICTION BOOKS; PHOTOGRAPHS; STATIONERY; ADHESIVES FOR STATIONERY OR HOUSEHOLD PURPOSES, NAMELY, ADHESIVE TAPE DISPENSERS, BOTH FOR STATIONERY AND HOUSEHOLD PURPOSES; ARTISTS' MATERIALS, PAINT BRUSHES; OFFICE REQUISITES (EXCEPT FURNITURE), NAMELY, PENS, PENCILS, ERASERS, DRAWING RULERS AND UNGRADUATED RULERS, FOLDERS, NOTEBOOKS, BOOKMARKS, MAGNETIC BOARDS FOR SCHEDULING ACTIVITIES AND APPOINTMENTS, STENCIL SETS CONSISTING OF STENCILS AND COLORED PENCILS, LAP DESKS, GLUE FOR STATIONERY OR HOUSEHOLD USE, BINDERS, DESKTOP ORGANIZERS, MARKERS, PEN AND PENCIL CASES, DOCUMENT PORTFOLIOS; RUBBER STAMPS, DRY ERASE WRITING BOARDS, PAPER CLIPS AND STAPLERS (U.S. CLS. 2, 5, 22, 23, 29, 37, 38 AND 50).

BRIDGETT SMITH, EXAMINING ATTORNEY

**CLASS 16—(Continued).**

SN 85-694,952. PATAGONIA, INC., VENTURA, CA. FILED 8-3-2012.



THE MARK CONSISTS OF THE STYLIZED LETTERS "PB".

FOR BOOKS PRIMARILY IN THE FIELDS OF BIOGRAPHIES, DISCOVERING AND APPRECIATING NATURE, SURFING, ROCK AND MOUNTAIN CLIMBING AND OTHER SPORT/ADVENTURES, THE ENVIRONMENT, AND BUSINESS PRACTICES (U.S. CLS. 2, 5, 22, 23, 29, 37, 38 AND 50).

FIRST USE 0-0-2011; IN COMMERCE 0-0-2011.  
LINDA ESTRADA, EXAMINING ATTORNEY

SN 85-747,266. ADVENTIST HEALTH SYSTEM/SUNBELT, INC., ALTAMONTE SPRINGS, FL. FILED 10-5-2012.

EVERYONE'S FLOCKING TO  
PINK OUT

THE MARK CONSISTS OF STANDARD CHARACTERS WITHOUT CLAIM TO ANY PARTICULAR FONT, STYLE, SIZE, OR COLOR.

FOR PAPER GOODS AND PRINTED MATTER, NAMELY, BOOKS, PAMPHLETS, BOOKLETS, NOTEBOOKS, NEWSPAPERS, BROCHURES, LEAFLETS, MAGAZINES, NEWSLETTERS, BOOKMARKS, TRAINING MANUALS AND PRINTED INSTRUCTIONAL, EDUCATIONAL AND TRAINING MATERIALS IN THE FIELDS OF MEDICINE AND MEDICAL RESEARCH, PHYSICAL AND SPIRITUAL HEALTH, WELLNESS, AGING, NUTRITION, BREAST CANCER AND BREAST CANCER TREATMENT AND PREVENTION INCLUDING MAMMOGRAMS (U.S. CLS. 2, 5, 22, 23, 29, 37, 38 AND 50).

DAVID TOOLEY, EXAMINING ATTORNEY

**CLASS 16—(Continued).**

SN 85-791,596. VAC PAC, INC., BALTIMORE, MD. FILED 11-30-2012.



NO CLAIM IS MADE TO THE EXCLUSIVE RIGHT TO USE "READY TO COOK" AND "WWW.READYTOCOOK.COM", APART FROM THE MARK AS SHOWN.

THE MARK CONSISTS OF A STYLIZED RENDERING OF THE TERM "READY STACKED" ATOP "2COOK" WITH THE NUMBER TWO BEING TILTED ON ITS AXIS STACKED ATOP "WWW.READY2COOK.COM", ALL OF WHICH APPEARS IN FRONT OF A CIRCULAR DESIGN.

FOR PLASTIC BAGS FOR COOKING (U.S. CLS. 2, 5, 22, 23, 29, 37, 38 AND 50).

FIRST USE 7-0-1998; IN COMMERCE 7-0-1998.

PRISCILLA MILTON, EXAMINING ATTORNEY

**CLASS 16—(Continued).**

SN 85-830,655. NEW ORLEANS HORNETS NBA, LLC, METAIRIE, LA. FILED 1-23-2013.



NO CLAIM IS MADE TO THE EXCLUSIVE RIGHT TO USE "NOLA", APART FROM THE MARK AS SHOWN.

THE MARK CONSISTS OF THE WORDS "NOLA" AND "PELICANS" DEPICTED IN STYLIZED FONTS APPEARING WITH STYLIZED DESIGNS OF A BASKETBALL AND FLEUR-DE-LIS AND ALL CONTAINED WITHIN A STYLIZED CREST OR SHIELD THAT FEATURES A SEMICIRCLE.

FOR PUBLICATIONS AND PRINTED MATTER, NAMELY, BASKETBALL TRADING CARDS, TRADING CARDS, STICKERS, DECALS, COMMEMORATIVE BASKETBALL STAMPS, COLLECTIBLE CARDBOARD TRADING DISCS, MEMO BOARDS, CLIPBOARDS, PAPER COASTERS, POST CARDS, PLACE MATS OF PAPER, FACIAL TISSUES, NOTE CARDS, MEMO PADS, NOTE PADS, BALL POINT PENS, CRAYONS, FELT TIP MARKERS, RUBBER BANDS, PENCILS, PEN AND PAPER HOLDERS, DESKTOP DOCUMENT STANDS, SCRAP BOOKS, RUBBER STAMPS, DRAFTING RULERS, PAPER BANNERS AND FLAGS, 3-RING BINDERS, STATIONERY FOLDERS, WIREBOUND NOTEBOOKS, PORTFOLIO NOTEBOOKS, UNMOUNTED AND MOUNTED PHOTOGRAPHS, POSTERS, CALENDARS, BUMPER STICKERS, BOOK COVERS, BOOKMARKS, WRAPPING PAPER, CHILDREN'S ACTIVITY BOOKS, CHILDREN'S COLORING BOOKS; STATISTICAL BOOKS, GUIDE BOOKS, AND REFERENCE BOOKS, ALL IN THE FIELD OF BASKETBALL; MAGAZINES IN THE FIELD OF BASKETBALL, CATALOGS IN THE FIELD OF BASKETBALL, COMMEMORATIVE GAME AND SOUVENIR PROGRAMS RELATED TO BASKETBALL, PAPER PENNANTS, STATIONERY, STATIONERY-TYPE PORTFOLIOS, POST CARDS, INVITATION CARDS, PRINTED CERTIFICATES, GREETING CARDS, CHRISTMAS CARDS, HOLIDAY CARDS, INFORMATIONAL STATISTICAL SHEETS FOR BASKETBALL TOPICS; NEWSLETTERS, BROCHURES, PAMPHLETS, AND GAME SCHEDULES IN THE FIELD OF BASKETBALL; BANK CHECKS, CHECK BOOK COVERS, CHECK BOOK HOLDERS, COMIC BOOKS; NON-MAGNETIC CREDIT CARDS AND TELEPHONE CALLING CARDS NOT MAGNETICALLY ENCODED (U.S. CLS. 2, 5, 22, 23, 29, 37, 38 AND 50).

ALICE BENMAMAN, EXAMINING ATTORNEY

SN 85-808,587. EASTPOINT, LOWESTOFT, UNITED KINGDOM, FILED 12-21-2012.

# SUPERCUT

THE MARK CONSISTS OF STANDARD CHARACTERS WITHOUT CLAIM TO ANY PARTICULAR FONT, STYLE, SIZE, OR COLOR.

PRIORITY CLAIMED UNDER SEC. 44(D) ON ERP CMNTY TM OFC APPLICATION NO. 011422219, FILED 12-13-2012, REG. NO. 011422219, DATED 12-13-2012, EXPIRES 12-13-2022.

FOR OFFICE REQUISITES, NAMELY, STAPLERS; STAPLES; PAPER HOLE PUNCHES; PAPER CUTTERS AND TRIMMERS (U.S. CLS. 2, 5, 22, 23, 29, 37, 38 AND 50).

BRIDGETT SMITH, EXAMINING ATTORNEY



**CLASS 16—(Continued).**

SN 85-831,736. BROWN, DAN, NEW YORK, NY. FILED 1-24-2013.

**ANGELS & DEMONS**

THE MARK CONSISTS OF STANDARD CHARACTERS WITHOUT CLAIM TO ANY PARTICULAR FONT, STYLE, SIZE, OR COLOR.

OWNER OF U.S. REG. NO. 3,720,057.

FOR PUBLICATIONS, NAMELY, MAGAZINES, NEWSLETTERS, AND NEWSPAPER COLUMNS IN THE FIELD OF FICTIONAL SCIENCE AND RELIGION; POSTERS, CALENDARS, STATIONERY ITEMS, NAMELY, PENS, PENCILS, NOTEBOOKS, NOTEPADS, STICKERS, BINDERS, FOLDERS, WRITING PAPER, ENVELOPES, NOTE CARDS AND GREETING CARDS (U.S. CLS. 2, 5, 22, 23, 29, 37, 38 AND 50).

MICHELLE DUBOIS, EXAMINING ATTORNEY



SN 85-835,214. DAVID SCHNEIDER, SWAMPSCOTT, MA. FILED 1-29-2013.

**TIMELESS ARTOGRAPHY**

THE MARK CONSISTS OF STANDARD CHARACTERS WITHOUT CLAIM TO ANY PARTICULAR FONT, STYLE, SIZE, OR COLOR.

NO CLAIM IS MADE TO THE EXCLUSIVE RIGHT TO USE "ARTOGRAPHY", APART FROM THE MARK AS SHOWN.

FOR ART PRINTS COMPRISED OF DIGITAL ILLUSTRATIONS ORIGINATING FROM PHOTOGRAPHS (U.S. CLS. 2, 5, 22, 23, 29, 37, 38 AND 50).

SUSAN STIGLITZ, EXAMINING ATTORNEY

OWNER OF U.S. REG. NOS. 2,687,673, 2,909,346 AND 4,009,915.

THE COLOR(S) MEDIUM BLUE, DARK BLUE AND GREEN IS/ARE CLAIMED AS A FEATURE OF THE MARK.

THE MARK CONSISTS OF INTERLOCKING STYLIZED TRIANGLES IN MEDIUM BLUE, DARK BLUE AND GREEN LOCATED ABOVE THE STYLIZED ACRONYM "SCA" IN DARK BLUE APPEARING ABOVE THE STYLIZED WORDS "CARE OF LIFE" IN DARK BLUE.

FOR PAPER; PRODUCTS MADE OF PAPER FOR WIPING, DRYING, CLEANING AND POLISHING, NAMELY, FACE TOWELS OF PAPER, PAPER HANDKERCHIEFS, PAPER TOWELS, PAPER NAPKINS, HOUSEHOLD AND TOILET PAPER, PAPER IN ROLLS AND PRE-FORMED FOR WIPING CLEANING AND POLISHING, NAMELY, DISPOSABLE WIPES NOT IMPREGNATED WITH CHEMICALS OR COMPOUNDS; PAPER AND PLASTIC BAGS FOR PACKAGING; PROTECTIVE COVERS MADE OF PAPER AND PROTECTIVE COVERS MADE OF PAPER WITH PLASTIC BACK SHEET, NAMELY, BIBS OF PAPER, PAPER TABLE CLOTHS, UNFITTED FURNITURE COVERS OF PAPER; PRINTING PRODUCTS, NAMELY, PRINTING PAPER, FINE PAPER; WRITING PAPER, NEWSPRINT PAPER, PAPER FOR BOOKS, NEWSPAPERS, CATALOGUES, MAGAZINES AND OTHER PRINTED MATTERS (U.S. CLS. 2, 5, 22, 23, 29, 37, 38 AND 50).

MIAH ROSENBERG, EXAMINING ATTORNEY

**CLASS 16—(Continued).**

SN 85-845,799. FIREFIGHTER DECALS AND MORE, VALLEY SPRINGS, CA. FILED 2-11-2013.



NO CLAIM IS MADE TO THE EXCLUSIVE RIGHT TO USE "DECALS", APART FROM THE MARK AS SHOWN.

THE MARK CONSISTS OF AN IMAGE OF A SKULL WITH CROSSED AXES PLACED BETWEEN THE WORDS "FIREFIGHTER" AND "DECALS" WRITTEN IN STYLIZED FORM AS SHOWN IN THE MARK.

FOR DECALS; 3D DECALS FOR USE ON ANY SURFACE; DECORATIVE DECALS FOR VEHICLE WINDOWS; IRON-ON AND PLASTIC TRANSFERS; PAPER DIE CUT SHAPES; STICKERS AND TRANSFERS; HEAT TRANSFER PAPER; STENCILS FOR TRANSFER OF GRAPHIC DESIGN ONTO ANY SURFACE; SILK SCREEN PRINTS (U.S. CLS. 2, 5, 22, 23, 29, 37, 38 AND 50).

FIRST USE 4-4-2012; IN COMMERCE 4-4-2012.  
MARCIE MILONE, EXAMINING ATTORNEY

SN 85-845,893. POLYCHEM CORPORATION, MENTOR, OH. FILED 2-11-2013.

# Econoboard

THE MARK CONSISTS OF STANDARD CHARACTERS WITHOUT CLAIM TO ANY PARTICULAR FONT, STYLE, SIZE, OR COLOR.

FOR PAPER EXTRUDED ANGLE MEMBERS FORMED OF LAMINATED PAPERBOARD AND ADAPTED FOR COMMERCIAL AND INDUSTRIAL USE IN PROTECTING GOODS AND PROVIDING STACKING STRENGTH FOR CONTAINERS AND THE LIKE, PRIMARILY IN THE PACKING, SHIPPING AND WAREHOUSING INDUSTRIES (U.S. CLS. 2, 5, 22, 23, 29, 37, 38 AND 50).

JOHN SCHUYLER YARD, EXAMINING ATTORNEY

**CLASS 16—(Continued).**

SN 85-857,847. BRAVO ZULU STUDIOS, LLC, JULIAN, CA. FILED 2-22-2013.

[www.AnneElizabeth.net](http://www.AnneElizabeth.net)

THE MARK CONSISTS OF STANDARD CHARACTERS WITHOUT CLAIM TO ANY PARTICULAR FONT, STYLE, SIZE, OR COLOR.

"ANNE ELIZABETH" IDENTIFIES THE PSEUDONYM/STAGE NAME/NICKNAME OF "ANNE ELIZABETH DAVIDSON SWEPSTON", A LIVING INDIVIDUAL WHOSE CONSENT IS OF RECORD.

FOR COMIC BOOKS (U.S. CLS. 2, 5, 22, 23, 29, 37, 38 AND 50).

FIRST USE 1-1-2006; IN COMMERCE 10-1-2010.  
NELSON SNYDER, EXAMINING ATTORNEY

SN 85-861,216. PRISON FELLOWSHIP MINISTRIES, LANS-  
DOWNE, VA. FILED 2-27-2013.

# PF

THE MARK CONSISTS OF STANDARD CHARACTERS WITHOUT CLAIM TO ANY PARTICULAR FONT, STYLE, SIZE, OR COLOR.

OWNER OF U.S. REG. NOS. 3,005,478, 3,005,479 AND 3,019,142.

FOR PUBLICATIONS, NAMELY, BROCHURES, BOOKLETS, PAMPHLETS, TEACHING MATERIALS, REPORTS, STUDY GUIDES, WORKBOOKS, NEWSLETTERS, MAGAZINES, NEWSLETTERS, EDUCATIONAL CURRICULA, TRAINING MANUALS ALL RELATING TO THE OPERATION OF AND PARTICIPATION IN A PRISON INMATE PRE-RELEASE VALUES-BASED PROGRAM, LIFE SKILLS TRAINING, JOB PREPARATION, ACADEMIC INSTRUCTION, BIBLE STUDIES, AND PRISONER RE-ENTRY INTO SOCIETY, FAMILY AND SOCIAL RELATIONSHIPS, RELIGIOUS AND COMMUNITY SERVICE, EMPLOYMENT, EVANGELISM, DISCIPLESHIP, AND MINISTRY TO PRISONERS, UNDERPRIVILEGED CHILDREN, AND THE CHILDREN AND FAMILIES OF PRISONERS, PAROLEES, AND VICTIMS OF CRIME; PUBLICATIONS, NAMELY, BROCHURES, BOOKLETS, PAMPHLETS, TEACHING MATERIALS, REPORTS, STUDY GUIDES, WORKBOOKS, MAGAZINES, NEWSLETTERS, EDUCATIONAL CURRICULA, TRAINING MANUALS ALL IN THE FIELDS OF CULTURE, ARTS, COMMUNICATIONS, JOURNALISM, EDUCATION, HISTORY, POLITICAL SCIENCE, LAW, LITERATURE, PHILOSOPHY, CHRISTIANITY, RELIGION, THEOLOGY, SPIRITUALITY, SCIENCE, SOCIAL SCIENCES, PSYCHOLOGY, SOCIAL AND ETHICAL ISSUES, JUSTICE, CRIMINAL JUSTICE, HUMAN RIGHTS, BIOETHICS, INTERPERSONAL RELATIONSHIPS, ETHICS, VALUES, SOCIAL ISSUES, MORALITY, SEXUALITY, CRIME, HEALTH, POLITICS, LEADERSHIP, GOVERNMENT, ECONOMICS, CURRENT EVENTS, BUSINESS, SOCIOLOGY, AND A WIDE VARIETY OF TOPICS OF GENERAL INTEREST FROM A CHRISTIAN WORLDVIEW PERSPECTIVE; POST-CARDS; BOOK COVERS; NOTEBOOKS, NOTE PADS, PAPER BANNERS, PAPER BADGES; PRINTED PAPER SIGNS; PENS; NOTE CARDS; CHRISTMAS CARDS; PAPER GREETING CARDS; PAPER POSTERS; AND STATIONERY (U.S. CLS. 2, 5, 22, 23, 29, 37, 38 AND 50).

FIRST USE 1-0-1977; IN COMMERCE 1-0-1977.  
MICHAEL WIENER, EXAMINING ATTORNEY

**CLASS 16—(Continued).**

SN 85-872,481. MILLER, BRIAN D, DBA LEARNED, LINCOLN, NC. AND MILLER, RACHEL L, DBA LEARNED, LINCOLN, NC. FILED 3-11-2013.

# LearnEd

THE MARK CONSISTS OF STANDARD CHARACTERS WITHOUT CLAIM TO ANY PARTICULAR FONT, STYLE, SIZE, OR COLOR.

FOR EDUCATIONAL KITS SOLD AS A UNIT IN THE FIELD OF SECONDARY LEVEL SCIENCE CONSISTING PRIMARILY OF EDUCATIONAL BOOKS, FLASH CARDS, WORKSHEETS AND NOTEBOOKS; PRINTED INSTRUCTIONAL, EDUCATIONAL, AND TEACHING MATERIALS IN THE FIELD OF SECONDARY LEVEL SCIENCE (U.S. CLS. 2, 5, 22, 23, 29, 37, 38 AND 50).

FIRST USE 8-0-2011; IN COMMERCE 8-0-2011.  
MIAH ROSENBERG, EXAMINING ATTORNEY

---

SN 85-879,827. POLYCHEM CORPORATION, MENTOR, OH. FILED 3-19-2013.

# EDGEARMOR

THE MARK CONSISTS OF STANDARD CHARACTERS WITHOUT CLAIM TO ANY PARTICULAR FONT, STYLE, SIZE, OR COLOR.

FOR PAPER EXTRUDED ANGLE MEMBERS FORMED OF LAMINATED PAPERBOARD AND ADAPTED FOR USE IN PROTECTING GOODS AND PROVIDING STACKING STRENGTH FOR CONTAINERS AND THE LIKE (U.S. CLS. 2, 5, 22, 23, 29, 37, 38 AND 50).

JOHN SCHUYLER YARD, EXAMINING ATTORNEY

---

SN 85-883,045. VEROTIK, INC., LOS ANGELES, CA. FILED 3-21-2013.

# DRUKIJA

THE MARK CONSISTS OF STANDARD CHARACTERS WITHOUT CLAIM TO ANY PARTICULAR FONT, STYLE, SIZE, OR COLOR.

THE WORDING "DRUKIJA" HAS NO MEANING IN A FOREIGN LANGUAGE.

FOR PUBLICATIONS IN THE FORM OF COMIC BOOKS AND COMIC MAGAZINES; PHOTOGRAPHS; LITHOGRAPHS; POSTERS; CALENDARS; GREETING CARDS; STICKERS; PICTURE BOOKS; MAGAZINES FEATURING COMIC BOOKS (U.S. CLS. 2, 5, 22, 23, 29, 37, 38 AND 50).

ANDREA K. NADELMAN, EXAMINING ATTORNEY

**CLASS 16—(Continued).**

SN 85-884,052. BLUE ZONES LLC, MINNEAPOLIS, MN. FILED 3-22-2013.

# Home Makeover Kit

THE MARK CONSISTS OF STANDARD CHARACTERS WITHOUT CLAIM TO ANY PARTICULAR FONT, STYLE, SIZE, OR COLOR.

NO CLAIM IS MADE TO THE EXCLUSIVE RIGHT TO USE "HOME" AND "KIT", APART FROM THE MARK AS SHOWN.

FOR KITS PRIMARILY COMPRISED OF PAPER LABELS, PAPER REMINDER CARDS, PRINTED PAPER SIGNS, REFRIGERATOR MAGNETS, BRACELETS AND MIRROR CLINGS FOR THE HOME IN ORDER TO ASSIST THE RESIDENTS IN IMPROVING THEIR HEALTH AND LONGEVITY (U.S. CLS. 2, 5, 22, 23, 29, 37, 38 AND 50).

FIRST USE 11-1-2012; IN COMMERCE 11-1-2012.  
DAVID MURRAY, EXAMINING ATTORNEY

---

SN 85-887,041. ROOSTER BOY, INC, LOS ANGELES, CA. FILED 3-26-2013.



NO CLAIM IS MADE TO THE EXCLUSIVE RIGHT TO USE "USA", APART FROM THE MARK AS SHOWN.

THE NAME(S), PORTRAIT(S), AND/OR SIGNATURE(S) SHOWN IN THE MARK DOES NOT IDENTIFY A PARTICULAR LIVING INDIVIDUAL.

THE MARK CONSISTS OF A DESIGN OF AN OVAL WITH STYLIZED WORDS "CHARLIE ROCKET"

FOR PICTURE BOOKS; POSTCARDS; POSTERS; STICKERS (U.S. CLS. 2, 5, 22, 23, 29, 37, 38 AND 50).

FIRST USE 7-5-1995; IN COMMERCE 8-9-1995.  
GINA HAYES, EXAMINING ATTORNEY

**CLASS 16—(Continued).**

SN 85-887,233. DISNEY ENTERPRISES, INC., BURBANK, CA. FILED 3-26-2013.

**OLIVIA POPE**

THE MARK CONSISTS OF STANDARD CHARACTERS WITHOUT CLAIM TO ANY PARTICULAR FONT, STYLE, SIZE, OR COLOR.

THE NAME(S), PORTRAIT(S), AND/OR SIGNATURE(S) SHOWN IN THE MARK DOES NOT IDENTIFY A PARTICULAR LIVING INDIVIDUAL.

FOR ADDRESS BOOKS; ALMANACS; APPOINTMENT BOOKS; ART PRINTS; BALL POINT PENS; BINDERS; BOOKENDS; BOOKMARKS; A SERIES OF FICTION BOOKS; BOOKS; MAGAZINES, NEWSLETTERS AND PERIODICALS, FEATURING STORIES, GAMES AND ACTIVITIES FOR CHILDREN; BUMPER STICKERS; CALENDARS; CARDBOARD; COASTERS MADE OF PAPER; DECALS; DECORATIVE PAPER CENTERPIECES; DIARIES; DRY ERASE WRITING BOARDS AND WRITING SURFACES; ENVELOPES; FELT PENS; PAPER GIFT CARDS; GIFT WRAPPING PAPER; GREETING CARDS; GUEST BOOKS; MARKERS; MEMO PADS; NEWSPAPERS; NOTE PAPER; NOTEBOOKS; NOTEBOOK PAPER; PAINTINGS; PAPER FLAGS; PAPER PARTY FAVORS PAPER CAKE DECORATIONS; PAPER PARTY DECORATIONS; PAPER NAPKINS; PAPER PARTY BAGS; PAPERWEIGHTS; PAPER GIFT WRAP BOWS; PAPER PENNANTS; PAPER PLACE MATS; PAPER TABLE CLOTHS; PEN OR PENCIL HOLDERS; PENCILS; PENCIL SHARPENERS; PEN AND PENCIL CASES AND BOXES; PENS; PHOTOGRAPH ALBUMS; PHOTOGRAPHS; PHOTO-ENGRAVINGS; PICTORIAL PRINTS; PICTURE BOOKS; PARTY BAGS OF PLASTIC; PLASTIC PARTY DECORATIONS; PLASTIC SHOPPING BAGS; PORTRAITS; POSTCARDS; POSTERS; PRINTED AWARDS; PRINTED CERTIFICATES; PRINTED INVITATIONS; PRINTED MENUS; RECIPE BOOKS; RUBBER STAMPS; STAPLERS; STATIONERY; STICKERS; TRADING CARDS; WRITING PAPER; WRITING IMPLEMENTS (U.S. CLS. 2, 5, 22, 23, 29, 37, 38 AND 50).

DORITT L. CARROLL, EXAMINING ATTORNEY

SN 85-893,753. GEORGIA-PACIFIC CORRUGATED LLC, ATLANTA, GA. FILED 4-3-2013.



THE MARK CONSISTS OF THE LETTERS "BRP" WITH A TRIANGLE ABOVE "BRP" AND A TRIANGLE POINTING DOWN UNDER "BRP", ALL IN AN ENCLOSED CIRCLE.

FOR CORRUGATED CARDBOARD BOXES (U.S. CLS. 2, 5, 22, 23, 29, 37, 38 AND 50).

SALLY SHIH, EXAMINING ATTORNEY

**CLASS 16—(Continued).**

SN 85-896,971. DISNEY ENTERPRISES, INC., BURBANK, CA. FILED 4-5-2013.

**FINDING DORY**

THE MARK CONSISTS OF STANDARD CHARACTERS WITHOUT CLAIM TO ANY PARTICULAR FONT, STYLE, SIZE, OR COLOR.

FOR ADDRESS BOOKS; ALMANACS; APPOINTMENT BOOKS; ART PRINTS; ARTS AND CRAFT PAINT KITS; AUTOGRAPH BOOKS; BABY BOOKS; BALL POINT PENS; BASEBALL CARDS; BINDERS; BOOKENDS; BOOKMARKS; A SERIES OF FICTION BOOKS; BOOKS; MAGAZINES, NEWSLETTERS AND PERIODICALS, FEATURING STORIES, GAMES AND ACTIVITIES FOR CHILDREN; BUMPER STICKERS; CALENDARS; CARTOON STRIPS; CHRISTMAS CARDS; CHALK; CHILDREN'S ACTIVITY BOOKS; COASTERS MADE OF PAPER; COIN ALBUMS; COLORING BOOKS; PRINTED CHILDREN'S COLORING PAGES; COLOR PENCILS; COMIC BOOKS; COMIC STRIPS; COUPON BOOKS; CRAYONS; DECALS; DECORATIVE PAPER CENTERPIECES; DIARIES; DRAWING RULERS; DRY ERASE WRITING BOARDS AND WRITING SURFACES; ENVELOPES; ERASERS; FELT PENS; FLASH CARDS; PAPER GIFT CARDS; GIFT WRAPPING PAPER; GLOBES; GREETING CARDS; GUEST BOOKS; GENERAL FEATURE MAGAZINES; MAPS; MARKERS; MEMO PADS; MODELING CLAY; NEWSLETTERS AND PRINTED PERIODICALS, FEATURING STORIES, GAMES AND ACTIVITIES FOR CHILDREN; NEWSPAPERS; NOTE PAPER; NOTEBOOKS; NOTEBOOK PAPER; PAINTINGS; PAPER FLAGS; PAPER PARTY FAVORS; PAPER CAKE DECORATIONS; PAPER PARTY DECORATIONS; PAPER NAPKINS; PAPER PARTY BAGS; PAPERWEIGHTS; PAPER GIFT WRAP BOWS; PAPER PENNANTS; PAPER PLACE MATS; PAPER TABLE CLOTHS; PEN OR PENCIL HOLDERS; PENCILS; PENCIL SHARPENERS; PEN AND PENCIL CASES AND BOXES; PENS; PHOTOGRAPH ALBUMS; PHOTOGRAPHS; PHOTO-ENGRAVINGS; PICTORIAL PRINTS; PICTURE BOOKS; PLASTIC PARTY BAGS; PLASTIC SHOPPING BAGS; PORTRAITS; POSTCARDS; POSTERS; PRINTED AWARDS; PRINTED CERTIFICATES; PRINTED INVITATIONS; PRINTED MENUS; RECIPE BOOKS; RUBBER STAMPS; SCORE CARDS; STAMP ALBUMS; STAPLERS; STICKERS; TRADING CARDS; WRITING PAPER; WRITING IMPLEMENTS (U.S. CLS. 2, 5, 22, 23, 29, 37, 38 AND 50).

LEIGH CAROLINE CASE, EXAMINING ATTORNEY

**CLASS 16—(Continued).**

SN 85-897,104. HENDERSON, SUZETTE J., DBA HOW TO BE HAPPY, VANCOUVER, WA. FILED 4-5-2013.



THE MARK CONSISTS OF THE TERMS "ROCK TALKS" IN NARROW ITALIC FONT, ABOVE THE WORDING "TO BE OR NOT TO BE A BULLY THAT IS THE QUESTION" IN BRUSH SCRIPT FONT. TO THE RIGHT OF "ROCK TALKS" APPEARS A STACK OF SEVEN ROCKS, ONE ON TOP OF THE OTHER.

FOR CHILDREN'S INTERACTIVE EDUCATIONAL BOOKS; EDUCATIONAL KITS SOLD AS A UNIT IN THE FIELD OF ANTI-BULLYING CONSISTING PRIMARILY OF EDUCATIONAL BOOKS AND ALSO INCLUDING DVDS AND T-SHIRTS; EDUCATIONAL PUBLICATIONS, NAMELY, EDUCATIONAL LEARNING CARDS, FLASH CARDS, ACTIVITY CARDS, WORKBOOKS, TEXTBOOKS, ACTIVITY BOOKS, STORY BOOKS, PUZZLE BOOKS, PRINTED PUZZLES, TEACHER GUIDES, MANUALS, POSTERS AND EDUCATIONAL BOOKLETS IN THE FIELD OF ANTI-BULLYING (U.S. CLS. 2, 5, 22, 23, 29, 37, 38 AND 50). COLLEEN MULCRONE, EXAMINING ATTORNEY

SN 85-926,590. LEARNING ZONEXPRESS, INC., OWATONNA, MN. FILED 5-8-2013.

**PORTION DISTORTION**

THE MARK CONSISTS OF STANDARD CHARACTERS WITHOUT CLAIM TO ANY PARTICULAR FONT, STYLE, SIZE, OR COLOR.

SEC. 2(F). FOR PRINTED MATERIALS, NAMELY, POSTERS, BOOKS, AND PAMPHLETS IN THE FIELDS OF NUTRITION AND NUTRITION EDUCATION (U.S. CLS. 2, 5, 22, 23, 29, 37, 38 AND 50). FIRST USE 10-31-2005; IN COMMERCE 10-31-2005. TIMOTHY O. SCHIMPF, EXAMINING ATTORNEY

**CLASS 16—(Continued).**

SN 85-927,607. PULSIFER, RICHARD A, HAMPTON, NH. FILED 5-9-2013.

**HELP IS ON THE WAY!!CALL OR TEXT PHONE OR TXT.**

THE MARK CONSISTS OF STANDARD CHARACTERS WITHOUT CLAIM TO ANY PARTICULAR FONT, STYLE, SIZE, OR COLOR.

FOR STICKERS, NAMELY, STICKERS FOR VEHICLES (U.S. CLS. 2, 5, 22, 23, 29, 37, 38 AND 50). PAUL MORENO, EXAMINING ATTORNEY

SN 85-932,751. MAVERICK INTERNATIONAL (PTY) LTD, ATHLONE, SOUTH AFRICA, FILED 5-15-2013.

**MAVERICK SUPERWIPES**

THE MARK CONSISTS OF STANDARD CHARACTERS WITHOUT CLAIM TO ANY PARTICULAR FONT, STYLE, SIZE, OR COLOR.

FOR BAGS OF PLASTIC IN THE FORM OF POUCHES; BAGS OF PLASTIC IN THE FORM OF POUCHES, NAMELY, A STAND-UP POUCH FOR DISPENSING WIPES; BAGS OF PLASTICS IN THE FORM OF POUCHES FOR DISPENSING WIPES (U.S. CLS. 2, 5, 22, 23, 29, 37, 38 AND 50). BRIAN NEVILLE, EXAMINING ATTORNEY

**CLASS 16—(Continued).**

SN 85-935,972. SPECIALTY PAPERS ACQUISITION, LLC, NEW YORK, NY. FILED 5-17-2013.

**EXPERA SPECIALTY SOLUTIONS**

THE MARK CONSISTS OF STANDARD CHARACTERS WITHOUT CLAIM TO ANY PARTICULAR FONT, STYLE, SIZE, OR COLOR.

NO CLAIM IS MADE TO THE EXCLUSIVE RIGHT TO USE "SPECIALTY SOLUTIONS", APART FROM THE MARK AS SHOWN.

FOR PAPERS FOR USE IN THE MANUFACTURE OF MASKING TAPE; PAPERS USED IN THE MANUFACTURE OF RELEASE LINER FOR PRESSURE SENSITIVE ADHESIVE APPLICATIONS; PAPERS WITH BARRIER PROPERTIES AND HIGH-QUALITY PRINTING SURFACES FOR USE IN FLEXIBLE PACKAGING APPLICATIONS; PAPER, NAMELY, INTERLEAVING, GREASE RESISTANT, WAXING AND LAMINATING BASE, AND WRAPPING PAPERS FOR USE IN THE FOOD PROCESSING AND FOOD SERVICE INDUSTRIES; PAPERS USED IN THE MANUFACTURE OF DENTAL AND MEDICAL PRODUCT PACKAGING; ART PAPERS; CRAFT PAPERS; CONSTRUCTION PAPERS; COLORED PAPERS; BASE PAPERS USED AS A RAW MATERIAL IN THE MANUFACTURE OF LAMINATED, CONVERTED AND COATED PAPERS; PAPERS USED IN THE MANUFACTURE OF MULTI-PLY AND SINGLE-PLY BAGS; PAPER, NAMELY, GLASS INTERLEAVER, METAL INTERLEAVER, PAINT MASKING, MOLD RESISTANT, FLAME RESISTANT, CREPED SPECIALTY, SATURATING AND GREASEPROOF PAPERS; AND CARBONIZING PAPERS (U.S. CLS. 2, 5, 22, 23, 29, 37, 38 AND 50).

LINDA ESTRADA, EXAMINING ATTORNEY

SN 85-960,109. CHAFFOLD, RICKIE, HOUSTON, TX. FILED 6-14-2013.

**MORE THAN A RIB**

THE MARK CONSISTS OF STANDARD CHARACTERS WITHOUT CLAIM TO ANY PARTICULAR FONT, STYLE, SIZE, OR COLOR.

FOR A SERIES OF BOOKS, WRITTEN ARTICLES, HANDOUTS AND WORKSHEETS IN THE FIELD OF MOTIVATION (U.S. CLS. 2, 5, 22, 23, 29, 37, 38 AND 50).

FIRST USE 1-20-2013; IN COMMERCE 1-20-2013.

MATTHEW MCDOWELL, EXAMINING ATTORNEY

**CLASS 16—(Continued).**

SN 85-968,731. NCD VIRGINIA LLC, ALEXANDRIA, VA. FILED 6-24-2013.

**Quties**

THE MARK CONSISTS OF STANDARD CHARACTERS WITHOUT CLAIM TO ANY PARTICULAR FONT, STYLE, SIZE, OR COLOR.

FOR BATHROOM TISSUE; BOXES OF PAPER; FACIAL TISSUE; PAPER TOWELS; TOILET PAPER; TOILET TISSUE (U.S. CLS. 2, 5, 22, 23, 29, 37, 38 AND 50).

FIRST USE 5-1-2013; IN COMMERCE 6-24-2013.

KIM MONINGHOFF, EXAMINING ATTORNEY

SN 86-001,836. HIGH SPEED PRODUCTIONS, INC., SAN FRANCISCO, CA. FILED 7-3-2013.

OWNER OF U.S. REG. NOS. 1,447,232, 2,589,385 AND OTHERS.

THE MARK CONSISTS OF THE WORD "THRASHER" IN STYLIZED FORM.

FOR PRINTED PUBLICATIONS, NAMELY, MAGAZINES IN THE FIELD OF SKATEBOARDING, STICKERS, POSTERS, PAPER BANNERS, RAMP PLANS (U.S. CLS. 2, 5, 22, 23, 29, 37, 38 AND 50).

FIRST USE 1-0-1981; IN COMMERCE 1-0-1981.

SHAUNIA CARLYLE, EXAMINING ATTORNEY

SN 86-004,497. SKC ACQUISITION CORP., GETTYSBURG, PA. FILED 7-8-2013.

**SPECTRA-GUARD**

THE MARK CONSISTS OF STANDARD CHARACTERS WITHOUT CLAIM TO ANY PARTICULAR FONT, STYLE, SIZE, OR COLOR.

OWNER OF U.S. REG. NO. 1,912,068.

FOR PACKAGING MATERIALS MADE OF PAPER, NAMELY, MOLDED PULP FORMS IN THE NATURE OF MOLDED PULP PACKAGING CONTAINERS (U.S. CLS. 2, 5, 22, 23, 29, 37, 38 AND 50).

SETH A. RAPPAPORT, EXAMINING ATTORNEY

**CLASS 16—(Continued).**

SN 86-004,514. SKC ACQUISITION CORP., GETTYSBURG, PA. FILED 7-8-2013.

**SPECTRA-KOTE**

THE MARK CONSISTS OF STANDARD CHARACTERS WITHOUT CLAIM TO ANY PARTICULAR FONT, STYLE, SIZE, OR COLOR.

OWNER OF U.S. REG. NO. 828,586.  
FOR PACKAGING MATERIALS MADE OF PAPER, NAMELY, MOLDED PULP FORMS IN THE NATURE OF MOLDED PULP PACKAGING CONTAINERS (U.S. CLS. 2, 5, 22, 23, 29, 37, 38 AND 50).  
SETH A. RAPPAPORT, EXAMINING ATTORNEY

SN 86-009,553. ARHAYAS PRODUCTIONS AMCC-MCEO, L.L.C., SARASOTA, FL. FILED 7-13-2013.

**HYDROACOUSTIC HARMONICS**

THE MARK CONSISTS OF STANDARD CHARACTERS WITHOUT CLAIM TO ANY PARTICULAR FONT, STYLE, SIZE, OR COLOR.

FOR BOOKLETS IN THE FIELD OF PERSONAL AWARENESS, SELF-AWARENESS AND CONSCIOUSNESS STUDIES; EDUCATIONAL KITS SOLD AS A UNIT IN THE FIELD OF PERSONAL AWARENESS, SELF-AWARENESS AND CONSCIOUSNESS STUDIES CONSISTING PRIMARILY OF PRINTED INSTRUCTIONAL MATERIALS AND ALSO INCLUDING AUDIO CDS; EDUCATIONAL KITS SOLD AS A UNIT IN THE FIELD OF PERSONAL AWARENESS, SELF-AWARENESS AND CONSCIOUSNESS STUDIES CONSISTING PRIMARILY OF HANDBOOKS AND ALSO INCLUDING DVDS; EDUCATIONAL PUBLICATIONS, NAMELY, TRAINING MANUALS, HAND-OUTS, BROCHURES, FLASH CARDS, BOOKS, AND ARTICLES IN THE FIELDS OF PERSONAL AWARENESS, SELF-AWARENESS AND CONSCIOUSNESS STUDIES; MANUALS IN THE FIELD OF PERSONAL AWARENESS, SELF-AWARENESS AND CONSCIOUSNESS STUDIES; PAINTINGS; POSTERS; PUBLICATIONS, NAMELY, BROCHURES, BOOKLETS, AND TEACHING MATERIALS IN THE FIELD OF PERSONAL AWARENESS, SELF-AWARENESS AND CONSCIOUSNESS STUDIES (U.S. CLS. 2, 5, 22, 23, 29, 37, 38 AND 50).  
DAWN HAN, EXAMINING ATTORNEY

**CLASS 16—(Continued).**

SN 86-010,992. PASANEN, WAYNE E., NORTH ANDOVER, MA. FILED 7-16-2013.

**OPIOIDEMIC**

THE MARK CONSISTS OF STANDARD CHARACTERS WITHOUT CLAIM TO ANY PARTICULAR FONT, STYLE, SIZE, OR COLOR.

FOR PRINTED MATERIAL, NAMELY, BOOKS, PAMPHLETS AND MAGAZINES RELATED TO OPIOIDS (U.S. CLS. 2, 5, 22, 23, 29, 37, 38 AND 50).  
DOMINICK J. SALEMI, EXAMINING ATTORNEY

SN 86-013,438. NIEFERXIS CREATIVE WORKS, BELLAIRE, TX. FILED 7-18-2013.

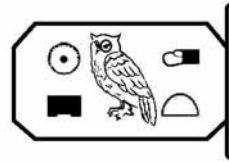

THE MARK CONSISTS OF ELONGATED OCTAGON WITH A VERTICAL BAR ON THE RIGHT SIDE, DISPOSED IN ELONGATED OCTAGON IS AN OWL IN THE CENTER, TO THE UPPER LEFT OF THE OWL IS A CIRCLE AND A SMALL SOLID CIRCLE WITHIN THE CIRCLE, TO THE LOWER LEFT OF THE OWL, IS A INVERTED FOLDER, TO THE UPPER RIGHT OF THE OWL IS A MITT, TO THE LOWER RIGHT OF THE OWL IS AN UPPER SEMI CIRCLE.

FOR PRINTED BOOKS, IN THE FIELD OF HEALTH (U.S. CLS. 2, 5, 22, 23, 29, 37, 38 AND 50).  
FIRST USE 3-1-2010; IN COMMERCE 3-1-2010.  
DAWN FELDMAN, EXAMINING ATTORNEY

SN 86-015,235. DURATECH PLASTICS CORPORATION, CARLSTADT, NJ. FILED 7-19-2013.

**BAG N GO**

THE MARK CONSISTS OF STANDARD CHARACTERS WITHOUT CLAIM TO ANY PARTICULAR FONT, STYLE, SIZE, OR COLOR.

NO CLAIM IS MADE TO THE EXCLUSIVE RIGHT TO USE "BAG", APART FROM THE MARK AS SHOWN.  
FOR PLASTIC BAGS FOR USE IN GROCERY STORES FOR FOOD PURCHASE AND STORAGE (U.S. CLS. 2, 5, 22, 23, 29, 37, 38 AND 50).  
MARILYN IZZI, EXAMINING ATTORNEY

**CLASS 16—(Continued).**

SN 86-016,419. AURAS UNLIMITED PRODUCTIONS, INC., SHERMAN OAKS, CA. FILED 7-22-2013.

# MACGYVER

THE MARK CONSISTS OF STANDARD CHARACTERS WITHOUT CLAIM TO ANY PARTICULAR FONT, STYLE, SIZE, OR COLOR.

FOR BOOKS IN THE FIELD OF A SERIES OF COMIC BOOKS FEATURING THE FICTIONAL MACGYVER LITERARY AND GRAPHIC CHARACTER; CHILDREN'S BOOKS; COMIC BOOKS; COMIC MAGAZINES; COMICS; GRAPHIC NOVELS; PICTURE BOOKS (U.S. CLS. 2, 5, 22, 23, 29, 37, 38 AND 50).

FIRST USE 10-10-2012; IN COMMERCE 10-10-2012.  
JORDAN BAKER, EXAMINING ATTORNEY

**CLASS 16—(Continued).**

SN 86-022,710. STRONGER RELATIONSHIPS, ENCINO, CA. FILED 7-29-2013.



SN 86-016,628. LUGRAND, MICHAEL, ROYAL PALM BEACH, FL. FILED 7-22-2013.



NO CLAIM IS MADE TO THE EXCLUSIVE RIGHT TO USE "DOCUMENTS", APART FROM THE MARK AS SHOWN.

THE COLOR(S) GRAY, BLACK, BLUE, WHITE, TEAL, RED AND TAN IS/ARE CLAIMED AS A FEATURE OF THE MARK.

THE MARK CONSISTS OF A STYLIZED HOUSE THAT DOUBLES AS A FILING CABINET WITH LIFE LIKE FEATURES. THE HOUSE HAS A RED ROOF AND CHIMNEY, A GRAY BODY, TEAL ARMS, WEARING WHITE GLOVES ON ITS HANDS AND HOLDING A TAN FOLDER IN THE RIGHT HAND. THE HOUSE HAS BLACK EYEBROWS AND ITS EYES ARE WHITE, BLUE AND BLACK. THE FILING CABINET HAS GRAY DRAWER PULLS, OUTLINED IN BLACK. ALL OTHER FEATURES ARE ALSO OUTLINED IN BLACK. BELOW THE HOUSE ARE THE WORDS "MY LIFE'S DOCUMENTS" IN BLACK, ABOVE "A HOME FOR YOUR IMPORTANT DOCUMENTS" IN BLACK.

FOR BINDERS (U.S. CLS. 2, 5, 22, 23, 29, 37, 38 AND 50).

HELENE LIWINSKI, EXAMINING ATTORNEY

NO CLAIM IS MADE TO THE EXCLUSIVE RIGHT TO USE "STRONGER RELATIONSHIPS", APART FROM THE MARK AS SHOWN.

THE MARK CONSISTS OF A DIAMOND WITH AN "S" AND AN "R" INSIDE. THE "S" IS VERTICALLY ABOVE THE "R" AND THE BOTTOM OF THE "S" IS INTERLOCKED WITH THE TOP OF THE "R". THE WORD "STRONGER" IS ABOVE THE DIAMOND. THE LETTERS OF THE WORD "STRONGER" CURVE AROUND THE UPPER PORTION OF THE DIAMOND, CONFORMING TO THE CONTOURS OF THE UPPER PORTION OF THE DIAMOND. THE WORD "RELATIONSHIPS" IS BELOW THE DIAMOND. THE LETTERS CURVED AROUND THE LOWER PORTION OF THE DIAMOND, CONFORMING TO THE CONTOURS OF THE LOWER PORTION OF THE DIAMOND.

FOR BOOKS IN THE FIELD OF SELF-HELP (U.S. CLS. 2, 5, 22, 23, 29, 37, 38 AND 50).

DANIEL S. STRINGER, EXAMINING ATTORNEY



**CLASS 16—(Continued).**

SN 86-026,217. INSIGHT UNIVERSITY, DBA INSIGHT UNIVERSITY, SANTA FE, NM. FILED S.R. 8-1-2013; AM. P.R. 11-19-2013.



OWNER OF U.S. REG. NO. 4,031,268.  
NO CLAIM IS MADE TO THE EXCLUSIVE RIGHT TO USE "UNIVERSITY", APART FROM THE MARK AS SHOWN.

THE COLOR(S) BLUE, GREEN, AND DARK GREEN IS/ ARE CLAIMED AS A FEATURE OF THE MARK.  
THE MARK CONSISTS OF THE WORDING "INSIGHT UNIVERSITY" IN BLUE TO THE LEFT OF TREE LOGO IN GREEN AND DARK GREEN.

FOR PRINTED INSTRUCTIONAL, EDUCATIONAL, AND TEACHING MATERIALS IN THE FIELD OF TRANSFORMATIONAL LEADERSHIP; PRINTED MATERIAL, NAMELY, SURVEYS AND ASSESSMENTS IN THE FIELD OF EDUCATOR TRAINING AND PERFORMANCE; PRINTED MATTER, NAMELY, BOOKS, MANUALS, CURRICULUM, NEWSLETTERS, INFORMATIONAL CARDS AND BROCHURES IN THE FIELD OF HIGHER EDUCATION (U.S. CLS. 2, 5, 22, 23, 29, 37, 38 AND 50).

FIRST USE 6-13-2013; IN COMMERCE 6-13-2013.  
AMY KELLY, EXAMINING ATTORNEY

---

SN 86-026,925. ORLASSINO, CHERYL, DBA READING SPECIALISTS OF LONG ISLAND, CENTEREACH, NY. FILED 8-2-2013.

**Blast Off to Reading!**

THE MARK CONSISTS OF STANDARD CHARACTERS WITHOUT CLAIM TO ANY PARTICULAR FONT, STYLE, SIZE, OR COLOR.

FOR EDUCATIONAL PUBLICATIONS, NAMELY, EDUCATIONAL LEARNING CARDS, FLASH CARDS, ACTIVITY CARDS, WORKBOOKS, TEXTBOOKS, ACTIVITY BOOKS, STORY BOOKS, PUZZLE BOOKS, PRINTED PUZZLES, TEACHER GUIDES, MANUALS, POSTERS AND EDUCATIONAL BOOKLETS IN THE FIELD OF LITERACY FOR STUDENTS WHO STRUGGLE TO READ AND THOSE THAT ARE DYSLEXIC (U.S. CLS. 2, 5, 22, 23, 29, 37, 38 AND 50).

FIRST USE 10-23-2012; IN COMMERCE 10-23-2012.  
JAMES LOVELACE, EXAMINING ATTORNEY

**CLASS 16—(Continued).**

SN 86-028,176. WHIPPET CREATIVE WORKS, INC., DBA BOWSIE WOWSIE, MEMPHIS, TN. FILED 8-4-2013.



THE MARK CONSISTS OF THE WORDS "BOWSIE WOWSIE" WITH TWO DOG PAWS LOCATED ABOVE IT. FOR PAPER STATIONERY (U.S. CLS. 2, 5, 22, 23, 29, 37, 38 AND 50).

FIRST USE 1-1-2007; IN COMMERCE 1-1-2007.  
ELIZABETH CHANG, EXAMINING ATTORNEY

---

SN 86-030,492. MASTERSON ART PRODUCTS, INC., PHOENIX, AZ. FILED 8-6-2013.

**Sta-New**

THE MARK CONSISTS OF STANDARD CHARACTERS WITHOUT CLAIM TO ANY PARTICULAR FONT, STYLE, SIZE, OR COLOR.

FOR DRYING RACKS IN THE NATURE OF HOLDING ARTIST'S BRUSHES (U.S. CLS. 2, 5, 22, 23, 29, 37, 38 AND 50).

FIRST USE 1-1-2013; IN COMMERCE 5-1-2013.  
PRISCILLA MILTON, EXAMINING ATTORNEY

---

SN 86-031,848. ROSSLYN JEAN DELMONICO, ABBOTSFORD, B.C., CANADA, FILED 8-7-2013.

**COLOR MY STORY**

THE MARK CONSISTS OF STANDARD CHARACTERS WITHOUT CLAIM TO ANY PARTICULAR FONT, STYLE, SIZE, OR COLOR.

OWNER OF U.S. REG. NO. 4,398,934.  
FOR PRINTED SPEECH AND LANGUAGE THERAPY CARDS TO ENHANCE SPEECH AND LANGUAGE SKILLS; EDUCATIONAL PUBLICATIONS, NAMELY, BOOKS, HAND-OUTS, WORKBOOKS, POSTERS IN THE FIELDS OF SPEECH AND LANGUAGE PATHOLOGY, COGNITIVE THERAPY AND DEVELOPMENT OF NARRATIVE AND SOCIAL LANGUAGE SKILLS (U.S. CLS. 2, 5, 22, 23, 29, 37, 38 AND 50).

FIRST USE 8-1-2007; IN COMMERCE 8-1-2007.  
AMY KELLY, EXAMINING ATTORNEY

**CLASS 16—(Continued).**

SN 86-032,768. ILYSE KOONDEL, DBA GRAFFITI DIPLOMACY, BROOKLYN, NY. FILED 8-8-2013.

**GRAFFITI DIPLOMACY**

THE MARK CONSISTS OF STANDARD CHARACTERS WITHOUT CLAIM TO ANY PARTICULAR FONT, STYLE, SIZE, OR COLOR.

NO CLAIM IS MADE TO THE EXCLUSIVE RIGHT TO USE "GRAFFITI", APART FROM THE MARK AS SHOWN, FOR BOOKS IN THE FIELD OF ART; COLORING BOOKS (U.S. CLS. 2, 5, 22, 23, 29, 37, 38 AND 50).

FIRST USE 1-1-2009; IN COMMERCE 11-30-2009.  
KATHRYN COWARD, EXAMINING ATTORNEY

SN 86-034,516. KAREN MANTYLA, GAINESVILLE, VA. FILED 8-10-2013.

**Quiet Power**

THE MARK CONSISTS OF STANDARD CHARACTERS WITHOUT CLAIM TO ANY PARTICULAR FONT, STYLE, SIZE, OR COLOR.

FOR PRINTED TRAINING MATERIALS IN THE FIELD OF LEADERSHIP AND SUPERVISORY TRAINING (U.S. CLS. 2, 5, 22, 23, 29, 37, 38 AND 50).

FIRST USE 1-1-1994; IN COMMERCE 1-1-1994.  
KATHERINE CHANG, EXAMINING ATTORNEY

SN 86-038,468. BUBBLES GIGGLES AND DOTS, INC., PORTAGE, MI. FILED 8-15-2013.

**IT'S ALL HAPPY**

THE MARK CONSISTS OF STANDARD CHARACTERS WITHOUT CLAIM TO ANY PARTICULAR FONT, STYLE, SIZE, OR COLOR.

FOR GREETING CARDS, STATIONERY; NON-MAGNETICALLY ENCODED GIFT CARDS; NOTE CARDS; POSTCARDS; PRINTED INVITATIONS; PAPER GIFT BAGS; PAPER GIFT TAGS; STICKERS; PAPER BOXES; BOXES OF PAPER OR CARDBOARD; MEMO BLOCKS; MEMO PADS; BLANK JOURNALS (U.S. CLS. 2, 5, 22, 23, 29, 37, 38 AND 50).

BRIAN PINO, EXAMINING ATTORNEY

**CLASS 16—(Continued).**

SN 86-041,664. SCA HYGIENE PRODUCTS AB, GOTEBOG, SWEDEN, FILED 8-19-2013.



THE MARK CONSISTS OF A REPEATING PATTERN OF A LEAF DESIGN.

FOR PAPER HANDKERCHIEFS, PAPER TOWELS, PAPER NAPKINS, PAPER NAPKINS FOR REMOVAL OF MAKEUP, HOUSEHOLD PAPER TOWELS AND TOILET PAPER (U.S. CLS. 2, 5, 22, 23, 29, 37, 38 AND 50).  
BARBARA RUTLAND, EXAMINING ATTORNEY

SN 86-041,969. ELECTRONIC IMAGING MATERIALS, INC., KEENE, NH. FILED 8-19-2013.

**EVERPEEL**

THE MARK CONSISTS OF STANDARD CHARACTERS WITHOUT CLAIM TO ANY PARTICULAR FONT, STYLE, SIZE, OR COLOR.

FOR ADHESIVE LABELS; BLANK OR PARTIALLY PRINTED PAPER LABELS; PRINTED PAPER LABELS (U.S. CLS. 2, 5, 22, 23, 29, 37, 38 AND 50).

ANNE FARRELL, EXAMINING ATTORNEY

SN 86-042,415. ALBERTO CATANHO, ELIZABETH, NJ. FILED 8-20-2013.

**SAVE A LIFE DON'T TEXT AND DRIVE**

THE MARK CONSISTS OF STANDARD CHARACTERS WITHOUT CLAIM TO ANY PARTICULAR FONT, STYLE, SIZE, OR COLOR.

FOR BUMPER STICKERS, PRINTED PAPER SIGNS, ADVERTISING SIGNS OF PAPER, ADVERTISING SIGNS OF CARDBOARD AND POSTERS (U.S. CLS. 2, 5, 22, 23, 29, 37, 38 AND 50).

TAMARA FRAZIER, EXAMINING ATTORNEY

**CLASS 16—(Continued).**

SN 86-042,621. WORLD TRADE CENTERS ASSOCIATION, INC., NEW YORK, NY. FILED 8-20-2013.



OWNER OF U.S. REG. NOS. 1,011,720 AND 4,174,948.  
THE MARK CONSISTS OF THREE CONJOINED OVAL MAPS.

SEC. 2(F).

FOR ADDRESS BOOKS AND DIARIES, ARCHITECTURAL MODELS, ART PRINTS COMPRISED OF DIGITAL ILLUSTRATIONS ORIGINATING FROM PHOTOGRAPHS, ATLASES, BINDERS, BOOKENDS, BOOKLETS IN THE FIELDS OF BUSINESS, BUMPER STICKERS, CALENDARS, CARDS NOT MAGNETICALLY CODED FOR USE IN BUSINESS TRANSACTIONS, COASTERS OF PAPER AND CARDBOARD, COMMEMORATIVE BOOKS AND COFFEE TABLE BOOKS FEATURING HISTORY OF THE WORLD TRADE CENTER ASSOCIATION AND WORLD TRADE CENTERS, DAY PLANNER, DECALS, DICTIONARIES, EVENT PROGRAMS, GLOBES, GUIDE BOOKS FEATURING WORLD TRADE CENTER, FINANCE AND INTERNATIONAL TRADE, GLOBES, GRAPHIC ART PRINTS AND REPRODUCTIONS, GREETING CARDS, MAPS, MEMBERSHIP DIRECTORIES, MOUNTED AND UNMOUNTED PHOTOGRAPHS, PAPER NAME BADGES, PASSPORT HOLDERS, PENS, PENCILS, PHOTOGRAPH ALBUMS, POSTERS, POSTCARDS AND PICTURE POSTCARDS, PUBLICATIONS, NAMELY, NEWS BULLETINS, NEWSLETTERS, NEWSPAPERS, BROCHURES, PAMPHLETS AND MAGAZINES IN THE FIELDS OF BUSINESS, FINANCE AND INTERNATIONAL TRADE, SOUVENIR PROGRAMS CONCERNING WORLD TRADE CENTER, STICKERS (U.S. CLS. 2, 5, 22, 23, 29, 37, 38 AND 50).

RICHARD WHITE, EXAMINING ATTORNEY

**CLASS 16—(Continued).**

SN 86-042,906. PUMPERNICKEL PRESS, LLC, BERRYVILLE, VA. FILED 8-20-2013.



OWNER OF U.S. REG. NO. 3,695,568.  
NO CLAIM IS MADE TO THE EXCLUSIVE RIGHT TO USE "PRESS", APART FROM THE MARK AS SHOWN.  
THE COLOR(S) TEAL BLUE AND WHITE IS/ARE CLAIMED AS A FEATURE OF THE MARK.

THE MARK CONSISTS OF THE STYLIZED WORDING "PINNIE BY PUMPERNICKEL PRESS" IN WHITE INSIDE A TEAL BLUE CIRCLE.

FOR BLANK CARDS; BLANK NOTE CARDS; CHRISTMAS CARDS; GIFT WRAP PAPER; GREETING CARDS; GREETING CARDS HAVING A CHRISTIAN MESSAGE; GREETINGS CARDS AND POSTCARDS; HOLIDAY CARDS; INVITATION CARDS; NOTE CARDS; OCCASION CARDS; PAPER GIFT BAGS; PAPER GIFT CARDS; PAPER GIFT TAGS; PAPER GIFT WRAP; STATIONERY (U.S. CLS. 2, 5, 22, 23, 29, 37, 38 AND 50).

DEBORAH LOBO, EXAMINING ATTORNEY

SN 86-044,619. ELOY RODRIGUEZ, MIAMI, FL. FILED 8-21-2013.



NO CLAIM IS MADE TO THE EXCLUSIVE RIGHT TO USE "REVISTA", APART FROM THE MARK AS SHOWN.

THE COLOR(S) RED, BLACK AND GREEN IS/ARE CLAIMED AS A FEATURE OF THE MARK.

THE MARK CONSISTS OF THE WORDS "LA" IN GREEN STYLIZED FONT WITH BLACK OUTLINE AND SHADING TO THE LEFT OF THE WORD "GUINDA" IN RED STYLIZED FONT WITH BLACK OUTLINE AND SHADING WITH A GREEN STEM AND LEAF ON TOP OF THE "G" IN THE WORD "GUINDA" WITH THE WORDS "UNA REVISTA POLITICAMENTE INCORRECTA" IN GREEN STYLIZED SMALLER FONT BELOW THE "UINDA" IN THE WORD "GUINDA".

THE ENGLISH TRANSLATION OF "LA GUINDA UNA REVISTA POLITICAMENTE INCORRECTA" IN THE MARK IS "CHERRY ON TOP A POLITICALLY INCORRECT MAGAZINE".

FOR MAGAZINES IN THE FIELD OF POLITICAL TOPICS (U.S. CLS. 2, 5, 22, 23, 29, 37, 38 AND 50).

SHAVELL MCPHERSON, EXAMINING ATTORNEY

**CLASS 16—(Continued).**

SN 86-046,351. PENA, JAMES EDWARD, WOODLAND HILLS, CA. FILED 8-23-2013.

# PRAYFIT

THE MARK CONSISTS OF STANDARD CHARACTERS WITHOUT CLAIM TO ANY PARTICULAR FONT, STYLE, SIZE, OR COLOR.

FOR PAPER GOODS AND PRINTED MATTER, NAMELY, A SERIES OF BOOKS IN THE FIELD OF PHYSICAL FITNESS WITH A RELIGIOUS OR SPIRITUAL THEME; DESKTOP PLANNERS; ADDRESS BOOKS; POSTCARDS; NOTEBOOKS; DAY PLANNERS; BINDERS; CLIPBOARDS; POSTERS; CALENDARS; APPOINTMENT BOOKS; GREETING CARDS; FOLDERS; DESK PADS; WRITING PADS; NOTE PADS; STATIONERY FOLDERS; STATIONERY; BOOKMARKS; PENS; PENCILS; ERASERS (U.S. CLS. 2, 5, 22, 23, 29, 37, 38 AND 50).

KATHERINE CONNOLLY, EXAMINING ATTORNEY

SN 86-046,946. FRIEND IN YOUR POCKET, ELMWOOD PARK, NJ. FILED 8-23-2013.



THE COLOR(S) BLACK, WHITE, BLUE, PINK, GRAY, AND BROWN IS/ARE CLAIMED AS A FEATURE OF THE MARK.

THE MARK CONSISTS OF THE WORDING "FRIEND IN YOUR POCKET" WRITTEN IN SEMI CURSIVE DONE IN BLACK FONT WITH WHITE TRACE OUTLINE. THE "Y" IN THE WORD, "YOUR" HAS A BLUE TIP ON THE LEFT SIDE. THESE IMAGES SIT AGAINST A WHITE BACKGROUND WITH A HOT PINK CLOUD TRACED WITH A GRAY OUTLINE. THE OUTLINE HAS FIVE CURVES TRACING THE CLOUD. UNDERNEATH THE WORDS, "FRIEND IN YOUR" IS A WOMAN WITH BROWN SKIN LAYING ON TOP OF THE WORD, "POCKET". SHE IS AN AFRICAN AMERICAN WOMAN LAYING ON HER STOMACH WITH BOTH OF HER LEGS IN THE AIR BEHIND HER; SHOWING THAT SHE IS WEARING A HOT PINK PAIR OF HIGH HEELED PUMPS; SHE IS ALSO WEARING A BLACK TANK TOP STYLE MINI DRESS. THIS WOMAN FIGURE IS WEARING BLACK READING GLASSES WITH HOT PINK FRAMES ON HER FACE WITH HER PINK AND BLACK HAIR PULLED UP IN A PONY TAIL WITH A HOT PINK AND WHITE BOW. SHE ALSO HAS A STUD EARRING IN HER RIGHT EAR AND PINK LIPS. THIS AFRO AMERICAN WOMAN IS HOLDING IN HER LEFT HAND A BLACK RECTANGULAR BOOK WITH WHITE PAPER AND BLACK LINES. HER RIGHT ARM IS BENT 90 DEGREES SUPPORTING HER BODY UNDER HER. SITTING ATTENTIVELY IN FRONT OF THIS AFRICAN AMERICAN WOMAN IS A BLACK COCKERSPANIEL WITH BIG BRIGHT BLACK AND WHITE EYES AND A WHITE TIPPED NOSE; HIS TAIL IS UP RIGHT. FRIEND IN YOUR POCKET" WRITTEN IN SEMI CURSIVE DONE IN BLACK FONT WITH WHITE TRACE OUTLINE. THE "Y" IN THE WORD, "YOUR" HAS A

**CLASS 16—(Continued).**

BLUE TIP ON THE LEFT SIDE. THESE IMAGES SIT AGAINST A WHITE BACKGROUND WITH A HOT PINK CLOUD TRACED WITH A GRAY OUTLINE. THE OUTLINE HAS FIVE CURVES TRACING THE CLOUD. UNDERNEATH THE WORDS, "FRIEND IN YOUR" IS A WOMAN LAYING ON TOP OF THE WORD, "POCKET". SHE IS AN AFRICAN AMERICAN WOMAN LAYING ON HER STOMACH WITH BOTH OF HER LEGS IN THE AIR BEHIND HER; SHOWING THAT SHE IS WEARING A HOT PINK PAIR OF HIGH HEELED PUMPS; SHE IS ALSO WEARING A BLACK TANK TOP STYLE MINI DRESS. THIS WOMAN FIGURE IS WEARING BLACK READING GLASSES WITH HOT PINK FRAMES ON HER FACE WITH HER PINK AND BLACK HAIR PULLED UP IN A PONY TAIL WITH A NOT PINK AND WHITE BOW. SHE ALSO HAS A STUD EARRING IN HER RIGHT EAR. THIS AFRO AMERICAN WOMAN IS HOLDING IN HER LEFT HAND A BLACK RECTANGULAR BOOK WITH WHITE PAPER AND BLACK LINES. HER RIGHT ARM IS BENT 90 DEGREES SUPPORTING HER BODY UNDER HER. SITTING ATTENTIVELY IN FRONT OF THIS AFRICAN AMERICAN WOMAN IS A BLACK COCKERSPANIEL WITH BIG BRIGHT BLACK AND WHITE EYES, WHITE TIPPED NOSE AND PINK COLLAR; HIS TAIL IS UP RIGHT

FOR SERIES OF NON-FICTION BOOKS IN THE FIELD OF INSPIRATION AND MOTIVATION (U.S. CLS. 2, 5, 22, 23, 29, 37, 38 AND 50).

FIRST USE 4-1-2012; IN COMMERCE 4-1-2012.

ALICE BENMAMAN, EXAMINING ATTORNEY

SN 86-055,436. WARNER BROS. ENTERTAINMENT INC., BURBANK, CA. FILED 9-4-2013.

# POTTERMORE

THE MARK CONSISTS OF STANDARD CHARACTERS WITHOUT CLAIM TO ANY PARTICULAR FONT, STYLE, SIZE, OR COLOR.

OWNER OF U.S. REG. NO. 4,376,701.

FOR PRINTED MATTER AND PAPER GOODS, NAMELY, BOOKS FEATURING ACTION, ADVENTURE, AND COMEDY, MAGAZINES FEATURING ACTION, ADVENTURE AND COMEDY, COLORING BOOKS, CHILDREN'S ACTIVITY BOOKS; NOTEBOOKS, DIARIES, NOTE CARDS, STATIONERY, WRITING PAPER, ENVELOPES, GREETING CARDS, PENS, PENCILS AND CASES THEREFOR, ERASERS, CRAYONS, MARKERS, COLORED PENCILS, PAINTING SETS FOR CHILDREN, CHALK AND CHALKBOARDS; POSTERS; BOOK COVERS, BOOK MARKS, CALENDARS (U.S. CLS. 2, 5, 22, 23, 29, 37, 38 AND 50).

JUSTINE D. PARKER, EXAMINING ATTORNEY

**CLASS 16—(Continued).**

SN 86-056,869. NATIONAL TACTICAL OFFICERS ASSOCIATION, DOYLESTOWN, PA. FILED 9-5-2013.



NO CLAIM IS MADE TO THE EXCLUSIVE RIGHT TO USE "PROFESSIONAL JOURNAL OF THE LAW ENFORCEMENT SPECIAL OPERATIONS COMMUNITY", APART FROM THE MARK AS SHOWN.

THE MARK CONSISTS OF "TACTICAL EDGE" BORDERED BY UPPER AND LOWER DOUBLE LINES, "THE" EMBEDDED WITHIN THE UPPER LINE, AND "THE COMPLETE PROFESSIONAL JOURNAL OF THE LAW ENFORCEMENT SPECIAL OPERATIONS COMMUNITY" BELOW THE LOWER LINE.

FOR JOURNALS CONCERNING TACTICAL WEAPONS AND TACTICAL INFORMATION REVIEWED BY LAW ENFORCEMENT OFFICERS FOR LAW ENFORCEMENT OFFICERS (U.S. CLS. 2, 5, 22, 23, 29, 37, 38 AND 50).

FIRST USE 8-1-2012; IN COMMERCE 8-1-2012.  
MICHAEL KEATING, EXAMINING ATTORNEY

**CLASS 16—(Continued).**

SN 86-062,190. WARNER BROS. ENTERTAINMENT INC., BURBANK, CA. FILED 9-11-2013.

**KENILWORTHY WHISP**

SN 86-062,186. WARNER BROS. ENTERTAINMENT INC., BURBANK, CA. FILED 9-11-2013.

**FANTASTIC BEASTS**

THE MARK CONSISTS OF STANDARD CHARACTERS WITHOUT CLAIM TO ANY PARTICULAR FONT, STYLE, SIZE, OR COLOR.

FOR PRINTED MATTER AND PAPER GOODS, NAMELY, BOOKS FEATURING CHARACTERS FROM ANIMATED, ACTION ADVENTURE, COMEDY AND/OR DRAMA FEATURES, COMIC BOOKS, CHILDREN'S BOOKS, MAGAZINES FEATURING CHARACTERS FROM ANIMATED, ACTION ADVENTURE, COMEDY AND/OR DRAMA FEATURES, COLORING BOOKS, CHILDREN'S ACTIVITY BOOK, STRATEGY GUIDES IN THE FIELD OF BOARD GAMES, VIDEO GAMES AND COMPUTER GAMES; STATIONERY, WRITING PAPER, ENVELOPES, NOTEBOOKS, DIARIES, NOTE CARDS, GREETING CARDS, TRADING CARDS; LITHOGRAPHS; PENS, PENCILS, CASES THEREFOR, ERASERS, CRAYONS, MARKERS, COLORED PENCILS, PAINTING SETS FOR CHILDREN, CHALK AND CHALKBOARDS; DECALS, HEAT TRANSFER PAPER; POSTERS; MOUNTED AND/OR UNMOUNTED PHOTOGRAPHS; BOOK COVERS, BOOK MARKS, CALENDARS, GIFT WRAPPING PAPER; PAPER PARTY FAVORS AND PAPER PARTY DECORATIONS—NAMELY, PAPER NAPKINS, PAPER PLACE MATS, CREPE PAPER, PRINTED INVITATIONS, PAPER TABLE CLOTHS, PAPER CAKE DECORATIONS; PRINTED TRANSFERS FOR EMBROIDERY OR FABRIC APPLIQUES; PRINTED PATTERNS FOR COSTUMES, PAJAMAS, SWEATSHIRTS AND T-SHIRTS (U.S. CLS. 2, 5, 22, 23, 29, 37, 38 AND 50).

JUSTINE D. PARKER, EXAMINING ATTORNEY

THE MARK CONSISTS OF STANDARD CHARACTERS WITHOUT CLAIM TO ANY PARTICULAR FONT, STYLE, SIZE, OR COLOR.

FOR PRINTED MATTER AND PAPER GOODS, NAMELY, BOOKS FEATURING CHARACTERS FROM ANIMATED, ACTION ADVENTURE, COMEDY AND/OR DRAMA FEATURES, COMIC BOOKS, CHILDREN'S BOOKS, MAGAZINES FEATURING CHARACTERS FROM ANIMATED, ACTION ADVENTURE, COMEDY AND/OR DRAMA FEATURES, COLORING BOOKS, CHILDREN'S ACTIVITY BOOK, STRATEGY GUIDES IN THE FIELD OF BOARD GAMES, VIDEO GAMES AND COMPUTER GAMES; STATIONERY, WRITING PAPER, ENVELOPES, NOTEBOOKS, DIARIES, NOTE CARDS, GREETING CARDS, TRADING CARDS; LITHOGRAPHS; PENS, PENCILS, CASES THEREFOR, ERASERS, CRAYONS, MARKERS, COLORED PENCILS, PAINTING SETS FOR CHILDREN, CHALK AND CHALKBOARDS; DECALS, HEAT TRANSFER PAPER; POSTERS; MOUNTED AND/OR UNMOUNTED PHOTOGRAPHS; BOOK COVERS, BOOK MARKS, CALENDARS, GIFT WRAPPING PAPER; PAPER PARTY FAVORS AND PAPER PARTY DECORATIONS—NAMELY, PAPER NAPKINS, PAPER PLACE MATS, CREPE PAPER, PRINTED INVITATIONS, PAPER TABLE CLOTHS, PAPER CAKE DECORATIONS; PRINTED TRANSFERS FOR EMBROIDERY OR FABRIC APPLIQUES; PRINTED PATTERNS FOR COSTUMES, PAJAMAS, SWEATSHIRTS AND T-SHIRTS (U.S. CLS. 2, 5, 22, 23, 29, 37, 38 AND 50).

JUSTINE D. PARKER, EXAMINING ATTORNEY

**CLASS 16—(Continued).**

SN 86-062,198. WARNER BROS. ENTERTAINMENT INC.,  
BURBANK, CA. FILED 9-11-2013.

**FANTASTIC BEASTS & WHERE  
TO FIND THEM**

THE MARK CONSISTS OF STANDARD CHARACTERS WITHOUT CLAIM TO ANY PARTICULAR FONT, STYLE, SIZE, OR COLOR.

FOR PRINTED MATTER AND PAPER GOODS, NAMELY, BOOKS FEATURING CHARACTERS FROM ANIMATED, ACTION ADVENTURE, COMEDY AND/OR DRAMA FEATURES, COMIC BOOKS, CHILDREN'S BOOKS, MAGAZINES FEATURING CHARACTERS FROM ANIMATED, ACTION ADVENTURE, COMEDY AND/OR DRAMA FEATURES, COLORING BOOKS, CHILDREN'S ACTIVITY BOOK, STRATEGY GUIDES IN THE FIELD OF BOARD GAMES, VIDEO GAMES AND COMPUTER GAMES; STATIONERY, WRITING PAPER, ENVELOPES, NOTEBOOKS, DIARIES, NOTE CARDS, GREETING CARDS, TRADING CARDS; LITHOGRAPHS; PENS, PENCILS, CASES THEREFOR, ERASERS, CRAYONS, MARKERS, COLORED PENCILS, PAINTING SETS FOR CHILDREN, CHALK AND CHALKBOARDS; DECALS, HEAT TRANSFER PAPER; POSTERS; MOUNTED AND/OR UNMOUNTED PHOTOGRAPHS; BOOK COVERS, BOOK MARKS, CALENDARS, GIFT WRAPPING PAPER; PAPER PARTY FAVORS AND PAPER PARTY DECORATIONS, NAMELY, PAPER NAPKINS, PAPER PLACE MATS, CREPE PAPER, PRINTED INVITATIONS, PAPER TABLE CLOTHS, PAPER CAKE DECORATIONS; PRINTED TRANSFERS FOR EMBROIDERY OR FABRIC APPLIQUES; PRINTED PATTERNS FOR COSTUMES, PAJAMAS, SWEATSHIRTS AND T-SHIRTS (U.S. CLS. 2, 5, 22, 23, 29, 37, 38 AND 50).

JUSTINE D. PARKER, EXAMINING ATTORNEY

**CLASS 16—(Continued).**

SN 86-062,500. WARNER BROS. ENTERTAINMENT INC.,  
BURBANK, CA. FILED 9-12-2013.

**FANTASTIC BEASTS AND WHERE  
TO FIND THEM**

THE MARK CONSISTS OF STANDARD CHARACTERS WITHOUT CLAIM TO ANY PARTICULAR FONT, STYLE, SIZE, OR COLOR.

FOR PRINTED MATTER AND PAPER GOODS, NAMELY, BOOKS FEATURING CHARACTERS FROM ANIMATED, ACTION ADVENTURE, COMEDY AND/OR DRAMA FEATURES, COMIC BOOKS, CHILDREN'S BOOKS, MAGAZINES FEATURING CHARACTERS FROM ANIMATED, ACTION ADVENTURE, COMEDY AND/OR DRAMA FEATURES, COLORING BOOKS, CHILDREN'S ACTIVITY BOOK, STRATEGY GUIDES IN THE FIELD OF BOARD GAMES, VIDEO GAMES AND COMPUTER GAMES; STATIONERY, WRITING PAPER, ENVELOPES, NOTEBOOKS, DIARIES, NOTE CARDS, GREETING CARDS, TRADING CARDS; LITHOGRAPHS; PENS, PENCILS, CASES THEREFOR, ERASERS, CRAYONS, MARKERS, COLORED PENCILS, PAINTING SETS FOR CHILDREN, CHALK AND CHALKBOARDS; DECALS, HEAT TRANSFER PAPER; POSTERS; MOUNTED AND/OR UNMOUNTED PHOTOGRAPHS; BOOK COVERS, BOOK MARKS, CALENDARS, GIFT WRAPPING PAPER; PAPER PARTY FAVORS AND PAPER PARTY DECORATIONS, NAMELY, PAPER NAPKINS, PAPER PLACE MATS, CREPE PAPER, PRINTED INVITATIONS, PAPER TABLE CLOTHS, PAPER CAKE DECORATIONS; PRINTED TRANSFERS FOR EMBROIDERY OR FABRIC APPLIQUES; PRINTED PATTERNS FOR COSTUMES, PAJAMAS, SWEATSHIRTS AND T-SHIRTS (U.S. CLS. 2, 5, 22, 23, 29, 37, 38 AND 50).

JUSTINE D. PARKER, EXAMINING ATTORNEY

SN 86-062,415. HYMAN, MITCH, ALTAMONTE SPRINGS,  
FL. FILED 9-12-2013.

**BUBBA THE REDNECK WEREWOLF**

THE MARK CONSISTS OF STANDARD CHARACTERS WITHOUT CLAIM TO ANY PARTICULAR FONT, STYLE, SIZE, OR COLOR.

FOR COMIC BOOKS (U.S. CLS. 2, 5, 22, 23, 29, 37, 38 AND 50).

FIRST USE 1-31-2002; IN COMMERCE 1-31-2002.  
HOWARD B. LEVINE, EXAMINING ATTORNEY

SN 86-065,711. WARDIE PARKS IV, MEMPHIS, TN. FILED 9-16-2013.

**Graphighte**

THE MARK CONSISTS OF STANDARD CHARACTERS WITHOUT CLAIM TO ANY PARTICULAR FONT, STYLE, SIZE, OR COLOR.

FOR SERIES OF FICTION WORKS, NAMELY, NOVELS AND BOOKS (U.S. CLS. 2, 5, 22, 23, 29, 37, 38 AND 50).

NICHOLAS COLEMAN, EXAMINING ATTORNEY

**CLASS 16—(Continued).**

SN 86-066,342. NHC PUBLISHING PTY LTD, GREENSBOROUGH, AUSTRALIA, FILED 9-17-2013.

# FOUNDR

THE MARK CONSISTS OF STANDARD CHARACTERS WITHOUT CLAIM TO ANY PARTICULAR FONT, STYLE, SIZE, OR COLOR.

FOR MAGAZINES IN THE FIELD OF BUSINESS; DOWNLOADABLE ELECTRONIC BUSINESS MAGAZINES (U.S. CLS. 2, 5, 22, 23, 29, 37, 38 AND 50).

KYLE PEETE, EXAMINING ATTORNEY

**CLASS 16—(Continued).**

SN 86-067,362. JOSE DE JESUS ZUÑIGA CANUTO, DISTRICTO FEDERAL, MEXICO, FILED 9-17-2013.



THE MARK CONSISTS OF THE MARK CONSISTS OF "MIGUELITO", TO THE LEFT OF AN ANGEL WITH A BOW AND ARROW IN POSITION TO SHOOT AN ARROW, ALL AGAINST A SHADED BACKGROUND.

FOR ADVERTISING SIGNS OF PAPER; ART PAPER; ARTISTS' PENS; BALL PENS; BALL POINT PENS; BANNERS OF PAPER; BLACKBOARD ERASERS; BLANK OR PARTIALLY PRINTED PAPER LABELS; BOND PAPER; BOOK-COVER PAPER; BOTTLE WRAPPERS OF CARDBOARD OR PAPER; BOXES OF PAPER; BOXES, CARTONS, STORAGE CONTAINERS, AND PACKAGING CONTAINERS MADE OF PAPER OR CARDBOARD; BUBBLE PENS; BUSINESS CARD PAPER; CALENDAR-FINISHED PAPER; CALENDERED PAPER; CELLOPHANE PAPER; CHALK ERASERS; CHILDREN'S ARTS AND CRAFTS PAPER KITS; COLLAPSIBLE BOXES OF PAPER; COLOR PENCILS; COLOURED PENS; CONTAINERS FOR ICE MADE OF PAPER OR CARDBOARD; CORRUGATED BOARD AND PAPER CONTAINERS; CORRUGATED PAPER; CORRUGATED PAPER PANELS LAMINATED WITH BLEACHED WHITE PAPER PRIMARILY FOR APPLICATION OF PRINTED MEDIA FOR FURTHER USE IN SIGNAGE APPLICATIONS; CORRUGATED PAPER PANELS LAMINATED WITH KRAFT LINERBOARD PRIMARILY FOR LAMINATION WITH DECORATIVE OVERLAYS FOR FURTHER USE IN THE CONSTRUCTION OF WALL PARTITIONS, ROOM DIVIDERS, DESKTOPS AND TABLETOPS; COVERS OF PAPER FOR FLOWER POTS; CRAFT PAPER; DECORATIONS FOR PENCILS; DECORATIVE PAPER BOWS FOR WRAPPING; DECORATIVE PENCIL-TOP ORNAMENTS; DESK STANDS AND HOLDERS FOR PENS, PENCILS, AND INK; DRAWING PAPER; DRAWING PENCILS; DRY ERASE WRITING BOARDS AND WRITING SURFACES; ENVELOPE PAPER; ERASERS; EXTENSIONS AND ATTACHMENTS FOR PENCILS; FELT WRITING PENS; FLUORESCENT PAPER; FOUNTAIN PENS; GIFT WRAPPING PAPER; GROCERY PAPER; ILLUSTRATION PAPER; INK ERASERS; INK PENS; MAGAZINE PAPER; MARKING PENS; MECHANICAL PENCIL SHARPENERS; MECHANICAL PENCILS; PEN AND PENCIL CASES AND BOXES; PEN CLIPS; PENCIL BOXES; PENCIL CASES; PENCIL LEAD HOLDERS; PENCIL LEADS; PENCIL OR PEN BOXES; PENCIL ORNAMENTS; PENCIL POINT PROTECTORS; PENCIL SHARPENERS; PENCILS; PENCILS FOR PAINTING AND DRAWING; PENS FOR MARKING; RETRACTABLE PENCILS; ROLLERBALL PENS; RUBBER ERASERS; SCHOOL SUPPLY KITS CONTAINING VARIOUS COMBINATIONS OF SELECTED SCHOOL SUPPLIES, NAMELY, WRITING INSTRUMENTS, PENS, PENCILS, MECHANICAL PENCILS, ERASERS, MARKERS, CRAYONS, HIGHLIGHTER PENS, FOLDERS, NOTEBOOKS, PAPER, PROTRACTORS, PAPER CLIPS, PENCIL SHARPENERS, WRITING GRIPS, GLUE AND BOOK MARKS; SLATE PENCILS; STANDS FOR PENS AND PENCILS; STEEL PENS; WET ERASE MARKERS (U.S. CLS. 2, 5, 22, 23, 29, 37, 38 AND 50).

EUGENIA MARTIN, EXAMINING ATTORNEY

SN 86-066,843. GO BE SILLY, REDMOND, WA. FILED 9-17-2013.

# Go Be Silly

THE MARK CONSISTS OF STANDARD CHARACTERS WITHOUT CLAIM TO ANY PARTICULAR FONT, STYLE, SIZE, OR COLOR.

FOR CHILDREN'S EDUCATIONAL BOOKS (U.S. CLS. 2, 5, 22, 23, 29, 37, 38 AND 50).

AISHA CLARKE, EXAMINING ATTORNEY

SN 86-066,862. AMERICAN ACADEMY IN BERLIN, NEW YORK, NY. FILED 9-17-2013.

# THE BERLIN JOURNAL

THE MARK CONSISTS OF STANDARD CHARACTERS WITHOUT CLAIM TO ANY PARTICULAR FONT, STYLE, SIZE, OR COLOR.

NO CLAIM IS MADE TO THE EXCLUSIVE RIGHT TO USE "JOURNAL", APART FROM THE MARK AS SHOWN, SEC. 2(F).

FOR MAGAZINES FEATURING SCHOLARLY ARTICLES ON CURRENT EVENTS AND CULTURAL, POLITICAL, ARTISTIC, LEGAL AND HISTORICAL SUBJECTS OF PARTICULAR INTEREST TO GERMANS AND AMERICANS (U.S. CLS. 2, 5, 22, 23, 29, 37, 38 AND 50).

FIRST USE 6-30-1999; IN COMMERCE 6-30-1999.  
PAUL E. FAHRENKOPF, EXAMINING ATTORNEY

**CLASS 16—(Continued).**

SN 86-067,906. JON MARK NYGREN, DBA 29 FACETS LLC, MINNETONKA, MN. FILED 9-18-2013.

WOULD YOU FOLLOW A POLICE  
CAR THAT CLOSE?

THE MARK CONSISTS OF STANDARD CHARACTERS WITHOUT CLAIM TO ANY PARTICULAR FONT, STYLE, SIZE, OR COLOR.

FOR BUMPER STICKERS (U.S. CLS. 2, 5, 22, 23, 29, 37, 38 AND 50).  
TRACY CROSS, EXAMINING ATTORNEY

SN 86-068,040. LEMEROND, TERRENCE J., GREEN BAY, WI. FILED 9-18-2013.

For Your Good Health From  
Terry Naturally

THE MARK CONSISTS OF STANDARD CHARACTERS WITHOUT CLAIM TO ANY PARTICULAR FONT, STYLE, SIZE, OR COLOR.

OWNER OF U.S. REG. NOS. 3,366,334 AND 3,366,335.  
FOR PUBLICATIONS, NAMELY, MAGAZINES, NEWSLETTERS, BOOKLETS AND BOOKS IN THE FIELD OF HEALTH, NUTRITION, FOODS, BEVERAGES, VITAMINS AND DIETARY SUPPLEMENTS (U.S. CLS. 2, 5, 22, 23, 29, 37, 38 AND 50).  
SKYE YOUNG, EXAMINING ATTORNEY

SN 86-068,176. POLO INDUSTRIA E COMERCIO LTDA., SÃO PAULO, BRAZIL, FILED 9-18-2013.



OWNER OF U.S. REG. NO. 3,366,754.  
NO CLAIM IS MADE TO THE EXCLUSIVE RIGHT TO USE "FILMS", APART FROM THE MARK AS SHOWN.

THE MARK CONSISTS OF OF A TILTED OVAL DESIGN WITH A SMALLER OVAL WITHIN AND THE WORD "FILMS" UNDERNEATH ON THE RIGHT SIDE, AND THE WORD "POLO" BELOW IT.

FOR PLASTIC FILM FOR PACKAGING; POLYPROPYLENE FOIL FOR PACKING (U.S. CLS. 2, 5, 22, 23, 29, 37, 38 AND 50).  
NORA BUCHANAN WILL, EXAMINING ATTORNEY

**CLASS 16—(Continued).**

SN 86-068,563. DEVINEY, PATRICK, MAUMEE, OH. FILED 9-18-2013.



THE MARK CONSISTS OF A DESIGN OF A CARTOON TRIANGLE SHAPED LIKE A PIE WITH 2 EYES, ARMS AND LEGS WITH THE STYLIZED TEXT "PIEHOUSE" BENEATH THE DESIGN.

FOR PAINTINGS; POSTCARDS (U.S. CLS. 2, 5, 22, 23, 29, 37, 38 AND 50).  
ALEXANDER L. POWERS, EXAMINING ATTORNEY

SN 86-068,997. TERESE DANA, FRYEBURG, ME. FILED 9-19-2013.

THE FILE FACTOR

THE MARK CONSISTS OF STANDARD CHARACTERS WITHOUT CLAIM TO ANY PARTICULAR FONT, STYLE, SIZE, OR COLOR.

FOR PACKAGED KITS COMPRISING PRINTED INSTRUCTIONAL, EDUCATIONAL, AND TEACHING MATERIALS FOR EDUCATIONAL ACTIVITIES IN THE FIELD OF EMOTIONAL INTELLIGENCE AND SOCIAL SKILLS DEVELOPMENT (U.S. CLS. 2, 5, 22, 23, 29, 37, 38 AND 50).

FIRST USE 3-2-2011; IN COMMERCE 3-2-2011.  
SUZANNE BLANE, EXAMINING ATTORNEY

SN 86-069,327. GORES, TOM, CHICAGO, IL. FILED 9-19-2013.

Sell Your Truth

THE MARK CONSISTS OF STANDARD CHARACTERS WITHOUT CLAIM TO ANY PARTICULAR FONT, STYLE, SIZE, OR COLOR.

FOR BOOKS IN THE FIELD OF BUSINESS; MAGAZINES FEATURING BUSINESS AND LIFESTYLE (U.S. CLS. 2, 5, 22, 23, 29, 37, 38 AND 50).  
GINA FINK, EXAMINING ATTORNEY



**CLASS 16—(Continued).**

SN 86-069,584. GREAT AMERICAN OPPORTUNITIES, INC., NASHVILLE, TN. FILED 9-19-2013.

**REMEMBER THIS!**

THE MARK CONSISTS OF STANDARD CHARACTERS WITHOUT CLAIM TO ANY PARTICULAR FONT, STYLE, SIZE, OR COLOR.

FOR PERSONALIZED PHOTO BOOKS, CALENDARS, AND GREETING CARDS (U.S. CLS. 2, 5, 22, 23, 29, 37, 38 AND 50).

NELSON SNYDER, EXAMINING ATTORNEY

SN 86-069,604. NATHAN MINNEHAN, CHICAGO, IL. FILED 9-19-2013.



THE MARK CONSISTS OF AN OUTLINED CIRCLE WITH A FOUR, UNEVENLY SPACED HORIZONTAL LINES OF UNEVEN WIDTH WITHIN THE BOTTOM HEMISPHERE OF THE CIRCLE AND A VERTICALLY CENTERED LINE THAT ASCENDS FROM THE BOTTOM HEMISPHERE OF THE CIRCLE AND BRANCHES OUT INTO FIVE FANNED LINES BEGINNING AT THE INTERSECTION OF THE LAST HORIZONTAL LINE.

FOR NOTEBOOKS (U.S. CLS. 2, 5, 22, 23, 29, 37, 38 AND 50).

FIRST USE 3-1-2008; IN COMMERCE 6-1-2010.

KATHERINE STOIDES, EXAMINING ATTORNEY

SN 86-069,934. ALLISON, CATHY, SANDY, OR. FILED 9-20-2013.

**A Wicked Twist**

THE MARK CONSISTS OF STANDARD CHARACTERS WITHOUT CLAIM TO ANY PARTICULAR FONT, STYLE, SIZE, OR COLOR.

FOR SERIES OF FICTION BOOKS (U.S. CLS. 2, 5, 22, 23, 29, 37, 38 AND 50).

SETH A. RAPPAPORT, EXAMINING ATTORNEY

**CLASS 16—(Continued).**

SN 86-070,165. DIAZ, PAUL, WALNUT CREEK, CA. FILED 9-20-2013.

My love for you will not  
falter, it will not  
weaken, it will not  
diminish, even with all  
the miles between us.

THE MARK CONSISTS OF STANDARD CHARACTERS WITHOUT CLAIM TO ANY PARTICULAR FONT, STYLE, SIZE, OR COLOR.

FOR ART PRINTS; GREETING CARDS; STICKERS (U.S. CLS. 2, 5, 22, 23, 29, 37, 38 AND 50).

SETH A. RAPPAPORT, EXAMINING ATTORNEY

SN 86-070,205. ALLISON, CATHY, SANDY, OR. FILED 9-20-2013.

**A Wicked Game**

THE MARK CONSISTS OF STANDARD CHARACTERS WITHOUT CLAIM TO ANY PARTICULAR FONT, STYLE, SIZE, OR COLOR.

FOR SERIES OF FICTION BOOKS (U.S. CLS. 2, 5, 22, 23, 29, 37, 38 AND 50).

SETH A. RAPPAPORT, EXAMINING ATTORNEY

SN 86-070,222. SILVER, JILL, SHEPHERDSTOWN, WV. FILED 9-20-2013.

**Adventures in Dentures**

THE MARK CONSISTS OF STANDARD CHARACTERS WITHOUT CLAIM TO ANY PARTICULAR FONT, STYLE, SIZE, OR COLOR.

FOR GREETING CARDS (U.S. CLS. 2, 5, 22, 23, 29, 37, 38 AND 50).

ESTHER A. BORSUK, EXAMINING ATTORNEY

**CLASS 16—(Continued).**

SN 86-070,456. JONES, PAMELA STANTON, TARZANA, CA. FILED 9-20-2013.

**DIVA Certificate**

THE MARK CONSISTS OF STANDARD CHARACTERS WITHOUT CLAIM TO ANY PARTICULAR FONT, STYLE, SIZE, OR COLOR.

FOR COUPONS (U.S. CLS. 2, 5, 22, 23, 29, 37, 38 AND 50).

JACQUELINE ABRAMS, EXAMINING ATTORNEY

---

SN 86-070,520. RTS PACKAGING, LLC, NORCROSS, GA. FILED 9-20-2013.

**RTS**

THE MARK CONSISTS OF STANDARD CHARACTERS WITHOUT CLAIM TO ANY PARTICULAR FONT, STYLE, SIZE, OR COLOR.

OWNER OF U.S. REG. NO. 3,831,050.

FOR PAPERBOARD PARTITIONS; DIECUT PAPERBOARD PACKAGING, NAMELY, INSERTS AND SHIPPING CONTAINERS (U.S. CLS. 2, 5, 22, 23, 29, 37, 38 AND 50).

FIRST USE 9-5-1997; IN COMMERCE 9-5-1997.

THEODORE MCBRIDE, EXAMINING ATTORNEY

---

SN 86-070,536. GOTHE, AXEL, NEW YORK, NY. FILED 9-20-2013.



THE COLOR(S) BLACK AND GREY IS/ARE CLAIMED AS A FEATURE OF THE MARK.

THE MARK CONSISTS OF THE STYLIZED WORD "CONSCIOUS", CONTAINING THE IMAGE OF THE EARTH WITHIN THE FIRST LETTER O IN BLACK AND THE LETTERS U AND S IN BLACK. THE LETTERS C, N, S, C, I, O APPEARING IN A LIGHT TO DARK GREY SCALE. THE STYLIZED WORD "VIBRATIONS" APPEARS BELOW IN LOWER CASE BLACK LETTERS.

FOR GOODS, NAMELY, GREETING CARDS, CALENDARS, POSTERS (U.S. CLS. 2, 5, 22, 23, 29, 37, 38 AND 50).

JANICE L. MCMORROW, EXAMINING ATTORNEY

**CLASS 16—(Continued).**

SN 86-070,805. SCOTT KENNEDY ADRIAN RINGLEVER, EAST LANSING, MI. FILED 9-20-2013.

**Hill No!**

THE MARK CONSISTS OF STANDARD CHARACTERS WITHOUT CLAIM TO ANY PARTICULAR FONT, STYLE, SIZE, OR COLOR.

FOR POLITICAL STICKERS (U.S. CLS. 2, 5, 22, 23, 29, 37, 38 AND 50).

MICHAEL WEBSTER, EXAMINING ATTORNEY

---

SN 86-072,171. VOIP TECH LLC, AUSTIN, TX. FILED 9-23-2013.

**NACHO**

THE MARK CONSISTS OF STANDARD CHARACTERS WITHOUT CLAIM TO ANY PARTICULAR FONT, STYLE, SIZE, OR COLOR.

FOR PRE-PAID TELEPHONE CALLING CARDS, NOT MAGNETICALLY ENCODED (U.S. CLS. 2, 5, 22, 23, 29, 37, 38 AND 50).

FIRST USE 9-16-2013; IN COMMERCE 9-16-2013.

DAVID COLLIER, EXAMINING ATTORNEY

---

SN 86-072,294. CRAYOLA PROPERTIES, INC., EASTON, PA. FILED 9-23-2013.

**TRAYOLA**

THE MARK CONSISTS OF STANDARD CHARACTERS WITHOUT CLAIM TO ANY PARTICULAR FONT, STYLE, SIZE, OR COLOR.

FOR TRAYS FOR MARKERS AND COLORED PENCILS (U.S. CLS. 2, 5, 22, 23, 29, 37, 38 AND 50).

FIRST USE 8-31-2004; IN COMMERCE 8-31-2004.

SIMON TENG, EXAMINING ATTORNEY

**CLASS 16—(Continued).**

SN 86-072,323. KAUFMAN, CAROLINE, BEVERLY HILLS, CA. FILED 9-23-2013.

**MOVIES TO YOUR MOUTH**

THE MARK CONSISTS OF STANDARD CHARACTERS WITHOUT CLAIM TO ANY PARTICULAR FONT, STYLE, SIZE, OR COLOR.

FOR COOK BOOKS; PRINTED RECIPE CARDS (U.S. CLS. 2, 5, 22, 23, 29, 37, 38 AND 50).

ANDREA HACK, EXAMINING ATTORNEY

---

SN 86-072,348. H. W. STEWART, II, STATESVILLE, NC. FILED 9-23-2013.

**WINEAUX**

THE MARK CONSISTS OF STANDARD CHARACTERS WITHOUT CLAIM TO ANY PARTICULAR FONT, STYLE, SIZE, OR COLOR.

OWNER OF U.S. REG. NO. 3,206,251.

FOR NEWSLETTER ABOUT WINE; BROCHURES AND PAMPHLETS ABOUT WINE; INSTRUCTION AND INFORMATION BOOKLETS ON WINE (U.S. CLS. 2, 5, 22, 23, 29, 37, 38 AND 50).

FIRST USE 4-0-2006; IN COMMERCE 4-0-2006.

SALLY SHIH, EXAMINING ATTORNEY

---

SN 86-079,763. CRAYOLA PROPERTIES, INC., EASTON, PA. FILED 10-1-2013.

**CREATE, ERASE, CREATE AGAIN!**

THE MARK CONSISTS OF STANDARD CHARACTERS WITHOUT CLAIM TO ANY PARTICULAR FONT, STYLE, SIZE, OR COLOR.

FOR DRY ERASE WRITING BOARDS AND WRITING SURFACES (U.S. CLS. 2, 5, 22, 23, 29, 37, 38 AND 50).

FIRST USE 4-30-2010; IN COMMERCE 4-30-2010.

SIMON TENG, EXAMINING ATTORNEY

**CLASS 16—(Continued).**

SN 86-079,797. CRAYOLA PROPERTIES, INC., EASTON, PA. FILED 10-1-2013.

**PIP-SQUEAKS SKINNIES**

THE MARK CONSISTS OF STANDARD CHARACTERS WITHOUT CLAIM TO ANY PARTICULAR FONT, STYLE, SIZE, OR COLOR.

OWNER OF U.S. REG. NOS. 4,000,373 AND 4,000,814. FOR MARKERS (U.S. CLS. 2, 5, 22, 23, 29, 37, 38 AND 50).

FIRST USE 8-31-2006; IN COMMERCE 8-31-2006.

SIMON TENG, EXAMINING ATTORNEY

---

SN 86-086,947. LAROSE INDUSTRIES, LLC, RANDOLPH, NJ. FILED 10-9-2013.

**POP COLOR**

THE MARK CONSISTS OF STANDARD CHARACTERS WITHOUT CLAIM TO ANY PARTICULAR FONT, STYLE, SIZE, OR COLOR.

NO CLAIM IS MADE TO THE EXCLUSIVE RIGHT TO USE "COLOR", APART FROM THE MARK AS SHOWN.

FOR CRAYONS, PENS, MARKERS, PAINTS, COLORED PENCILS, PENCIL CASES, PENCIL SHARPENERS, NOTEBOOKS, ART PADS, WRITING PADS, INK PADS, COLORING BOOKS, PUZZLE BOOKS, CHILDREN'S ACTIVITY BOOKS, CHILDREN'S EDUCATIONAL BOOKS, PAINTS, PAINT BRUSHES, RUBBER STAMPS, INK STAMPS, ART PAPER, BLACK AND WHITE POSTERS ON CARDBOARD OR PAPER, POSTERS, DRY ERASE WRITING BOARDS AND WRITING SURFACES, MODELING COMPOUNDS, MODELING CLAY, GLUE FOR STATIONERY OR HOUSEHOLD USE, AND GLITTER GLUE FOR STATIONERY PURPOSES; ACTIVITY KITS COMPRISING CRAYONS, PENS, MARKERS, COLORED PENCILS, PENCIL CASES, PENCIL SHARPENERS, NOTEBOOKS, ART PADS, WRITING PADS, INK PADS, COLORING BOOKS, PUZZLE BOOKS, CHILDREN'S ACTIVITY BOOKS, PAINTS, PAINT BRUSHES, RUBBER STAMPS, INK STAMPS, ART PAPER, BLACK AND WHITE POSTERS ON CARDBOARD OR PAPER, GLUE FOR STATIONERY OR HOUSEHOLD USE, GLITTER GLUE FOR STATIONERY PURPOSES, STICKERS, AND TEMPORARY TATTOO DECALS; ARTS AND CRAFT PAINT KITS; AND MODELING COMPOUNDS AND RELATED ACCESSORIES FOR USE WITH MODELING COMPOUNDS SOLD AS A UNIT (U.S. CLS. 2, 5, 22, 23, 29, 37, 38 AND 50).

TOBY BULLOFF, EXAMINING ATTORNEY

**CLASS 16—(Continued).**

SN 86-089,490. NAMCO BANDAI GAMES INC., TOKYO, JAPAN, FILED 10-11-2013.

**namco**

OWNER OF U.S. REG. NOS. 1,131,225, 1,906,185 AND OTHERS.

THE MARK CONSISTS OF THE STYLIZED WORD "NAMCO" IN LOWER-CASE LETTERS. FOR COLLECTABLE TRADING CARDS; TRADING CARDS (U.S. CLS. 2, 5, 22, 23, 29, 37, 38 AND 50). DOMINICK J. SALEMI, EXAMINING ATTORNEY

SN 86-089,618. LAROSE INDUSTRIES, LLC, RANDOLPH, NJ, FILED 10-11-2013.

**CRA-Z-FUN PAK!**

THE MARK CONSISTS OF STANDARD CHARACTERS WITHOUT CLAIM TO ANY PARTICULAR FONT, STYLE, SIZE, OR COLOR.

OWNER OF U.S. REG. NOS. 4,207,240, 4,298,804 AND OTHERS.

NO CLAIM IS MADE TO THE EXCLUSIVE RIGHT TO USE "PAK", APART FROM THE MARK AS SHOWN.

FOR MODELING COMPOUNDS; MODELING COMPOUNDS AND RELATED ACCESSORIES FOR USE WITH MODELING COMPOUNDS SOLD AS A UNIT (U.S. CLS. 2, 5, 22, 23, 29, 37, 38 AND 50).

TOBY BULLOFF, EXAMINING ATTORNEY

SN 86-090,723. EXPRESSTECH INTERNATIONAL, LLC, OREM, UT, FILED 10-14-2013.

**7NNs**

THE MARK CONSISTS OF STANDARD CHARACTERS WITHOUT CLAIM TO ANY PARTICULAR FONT, STYLE, SIZE, OR COLOR.

FOR PUBLICATIONS, NAMELY, BOOKS, WORKBOOKS, TRAINING MANUALS, FACILITATOR WORKBOOKS AND PRINTED GUIDES, PAPER AND PLASTIC TRANSPARENCIES, PRINTED CHARTS, PRINTED TABLES, DIAGRAMS, HANDOUTS, PRINTED PERIODICALS, AND NEWSLETTERS ALL IN THE FIELDS OF BUILDING INDIVIDUAL AND BUSINESS ORGANIZATIONAL SKILLS, LEADERSHIP, CULTURE, EFFECTIVENESS AND GROWTH, FOCUSED ON THE PRINCIPLES OF RESPECT, BELIEF, TRUST, LOYALTY, COMMITMENT, COURAGE AND GRATITUDE (U.S. CLS. 2, 5, 22, 23, 29, 37, 38 AND 50).

COLLEEN DOMBROW, EXAMINING ATTORNEY

**CLASS 16—(Continued).**

SN 86-095,744. PAUL STANLEY, PINE BROOK, NJ, FILED 10-18-2013.

**PAUL STANLEY**

THE MARK CONSISTS OF STANDARD CHARACTERS WITHOUT CLAIM TO ANY PARTICULAR FONT, STYLE, SIZE, OR COLOR.

THE NAME "PAUL STANLEY" IDENTIFIES A LIVING INDIVIDUAL WHOSE CONSENT IS OF RECORD.

FOR PAINTINGS; GRAPHIC ART REPRODUCTIONS; LITHOGRAPHIC WORKS OF ART (U.S. CLS. 2, 5, 22, 23, 29, 37, 38 AND 50).

FIRST USE 10-5-2005; IN COMMERCE 10-5-2005.

MARYNELLE WILSON, EXAMINING ATTORNEY

SN 86-097,399. HAY HOUSE, INC., CARLSBAD, CA, FILED 10-22-2013.

**I CAN DO IT!**

THE MARK CONSISTS OF STANDARD CHARACTERS WITHOUT CLAIM TO ANY PARTICULAR FONT, STYLE, SIZE, OR COLOR.

OWNER OF U.S. REG. NOS. 2,744,607, 3,197,370 AND OTHERS.

FOR CALENDARS IN FIELD OF INSPIRATIONAL AFFIRMATIONS; SERIES OF CARDS FEATURING INSPIRATIONAL PROSE AND GRAPHICS (U.S. CLS. 2, 5, 22, 23, 29, 37, 38 AND 50).

FIRST USE 1-1-1990; IN COMMERCE 1-1-1990.

ZACHARY CROMER, EXAMINING ATTORNEY

SN 86-097,709. THE CARTOON NETWORK, INC., ATLANTA, GA, FILED 10-22-2013.

**THE AMAZING WORLD OF GUMBALL**

THE MARK CONSISTS OF STANDARD CHARACTERS WITHOUT CLAIM TO ANY PARTICULAR FONT, STYLE, SIZE, OR COLOR.

OWNER OF U.S. REG. NO. 3,982,522.

FOR PAPER PARTY DECORATIONS; CHILDREN'S BOOKS; STATIONERY; WRITING IMPLEMENTS, STICKERS, POSTERS AND CALENDARS (U.S. CLS. 2, 5, 22, 23, 29, 37, 38 AND 50).

CHRISTOPHER LAW, EXAMINING ATTORNEY

**CLASS 16—(Continued).**

SN 86-104,770. D-GENERATION, INC., DAYTONA BEACH, FL. FILED 10-29-2013.

**OCEANWASH**

THE MARK CONSISTS OF STANDARD CHARACTERS WITHOUT CLAIM TO ANY PARTICULAR FONT, STYLE, SIZE, OR COLOR.

OWNER OF U.S. REG. NO. 4,425,720.  
FOR DECALS; GREETING CARDS; STICKERS (U.S. CLS. 2, 5, 22, 23, 29, 37, 38 AND 50).  
FIRST USE 3-6-2008; IN COMMERCE 3-6-2008.  
RONALD MCMORROW, EXAMINING ATTORNEY



SN 86-110,320. KRAMER, DIRK, CROSBY, TX. FILED 11-5-2013.

**DON'T DRONE ME BRO**

THE MARK CONSISTS OF STANDARD CHARACTERS WITHOUT CLAIM TO ANY PARTICULAR FONT, STYLE, SIZE, OR COLOR.

FOR STICKERS (U.S. CLS. 2, 5, 22, 23, 29, 37, 38 AND 50).  
JACLYN KIDWELL WALKER, EXAMINING ATTORNEY



SN 86-116,850. LAROSE INDUSTRIES, LLC, RANDOLPH, NJ. FILED 11-12-2013.

**CRA-Z-FUN SHOP!**

THE MARK CONSISTS OF STANDARD CHARACTERS WITHOUT CLAIM TO ANY PARTICULAR FONT, STYLE, SIZE, OR COLOR.

OWNER OF U.S. REG. NOS. 4,207,240, 4,298,804 AND OTHERS.  
FOR MODELING COMPOUNDS; MODELING COMPOUNDS AND RELATED ACCESSORIES FOR USE WITH MODELING COMPOUNDS SOLD AS A UNIT (U.S. CLS. 2, 5, 22, 23, 29, 37, 38 AND 50).  
TOBY BULLOFF, EXAMINING ATTORNEY

**CLASS 16—(Continued).**

SN 86-116,865. LAROSE INDUSTRIES, LLC, RANDOLPH, NJ. FILED 11-12-2013.

**CRA-Z-RAINBOW FUN!**

THE MARK CONSISTS OF STANDARD CHARACTERS WITHOUT CLAIM TO ANY PARTICULAR FONT, STYLE, SIZE, OR COLOR.

OWNER OF U.S. REG. NOS. 4,207,240, 4,298,804 AND OTHERS.  
FOR MODELING COMPOUNDS; MODELING COMPOUNDS AND RELATED ACCESSORIES FOR USE WITH MODELING COMPOUNDS SOLD AS A UNIT (U.S. CLS. 2, 5, 22, 23, 29, 37, 38 AND 50).  
TOBY BULLOFF, EXAMINING ATTORNEY



SN 86-118,339. TSUKINEKO CO., LTD., TOKYO, JAPAN, FILED 11-13-2013.

**RADIANT NEON**

THE MARK CONSISTS OF STANDARD CHARACTERS WITHOUT CLAIM TO ANY PARTICULAR FONT, STYLE, SIZE, OR COLOR.

NO CLAIM IS MADE TO THE EXCLUSIVE RIGHT TO USE "NEON", APART FROM THE MARK AS SHOWN.  
FOR STAMP PADS AND REFILL INK THEREFOR (U.S. CLS. 2, 5, 22, 23, 29, 37, 38 AND 50).  
SHANNON TWOHIG, EXAMINING ATTORNEY



SN 86-118,691. SPC RESOURCES, INC., HARTSVILLE, SC. FILED 11-14-2013.

**PSC**

THE MARK CONSISTS OF STANDARD CHARACTERS WITHOUT CLAIM TO ANY PARTICULAR FONT, STYLE, SIZE, OR COLOR.

FOR PAPER PRODUCTS, NAMELY, PAPER TUBES AND PAPER CORES (U.S. CLS. 2, 5, 22, 23, 29, 37, 38 AND 50).  
BARNEY CHARLON, EXAMINING ATTORNEY

**CLASS 16—(Continued).**

SN 86-120,421. THE JIM HENSON COMPANY, INC., LOS ANGELES, CA. FILED 11-15-2013.



OWNER OF U.S. REG. NOS. 1,113,706, 2,101,880 AND OTHERS.

THE NAME "JIM HENSON" DOES NOT IDENTIFY A LIVING INDIVIDUAL.

THE MARK CONSISTS OF THE STYLIZED WORDS "JIM HENSON'S ENCHANTED SISTERS" SURROUNDED BY STYLIZED STARS, A LEAF, A FLOWER, A SNOWFLAKE AND A SUN.

FOR A SERIES OF FICTION BOOKS (U.S. CLS. 2, 5, 22, 23, 29, 37, 38 AND 50).

JAMES LOVELACE, EXAMINING ATTORNEY

SN 86-123,417. MARVEL CHARACTERS, INC., BURBANK, CA. FILED 11-19-2013.

**HULK AND THE AGENTS OF  
S.M.A.S.H.**

THE MARK CONSISTS OF STANDARD CHARACTERS WITHOUT CLAIM TO ANY PARTICULAR FONT, STYLE, SIZE, OR COLOR.

OWNER OF U.S. REG. NOS. 890,917, 1,252,880 AND 2,920,699.

FOR COMIC BOOKS; MAGAZINES FEATURING PRINTED STORIES IN ILLUSTRATED FORM AND COMIC BOOK STORIES AND ARTWORK; PRINTED PERIODICALS IN THE FIELD OF COMIC BOOK STORIES AND ARTWORK (U.S. CLS. 2, 5, 22, 23, 29, 37, 38 AND 50).

FIRST USE 10-9-2013; IN COMMERCE 10-9-2013.

JENNIFER WILLISTON, EXAMINING ATTORNEY

**CLASS 16—(Continued).**

SN 86-126,797. FATHEAD LLC, DETROIT, MI. FILED 11-22-2013.

**TOTAL COVERAGE**

THE MARK CONSISTS OF STANDARD CHARACTERS WITHOUT CLAIM TO ANY PARTICULAR FONT, STYLE, SIZE, OR COLOR.

FOR POSTERS; ADHESIVE PLASTIC FILM WITH REMOVABLE PAPER FOR MOUNTING IMAGES FOR DECORATIVE PURPOSES (U.S. CLS. 2, 5, 22, 23, 29, 37, 38 AND 50).

BARBARA BROWN, EXAMINING ATTORNEY

**CLASS 17—RUBBER GOODS**

SN 79-131,191. DORANDA LIMITED, ALBANY 0632, NEW ZEALAND, FILED 4-4-2013.



PRIORITY DATE OF 1-17-2013 IS CLAIMED.  
OWNER OF INTERNATIONAL REGISTRATION 1163054 DATED 4-4-2013, EXPIRES 4-4-2023.

THE MARK CONSISTS OF FOUR RECTANGULAR SHAPES, EACH WITH TWO ROUNDED CORNERS, ARRANGED IN A DIAMOND SHAPE.

FOR PLASTIC SHEETING AND COVERS FOR USE IN AGRICULTURE AND HORTICULTURE FOR SCREENING, SHADING, PROTECTION, HEAT AND LIGHT REFLECTION AND WIND BREAKING; PLASTIC FABRIC SHEETS AND COVERS FOR USE IN AGRICULTURE AND HORTICULTURE FOR SCREENING, SHADING, PROTECTION, HEAT AND LIGHT REFLECTION AND WIND BREAKING (U.S. CLS. 1, 5, 12, 13, 35 AND 50).

LIEF MARTIN, EXAMINING ATTORNEY

**CLASS 17—(Continued).**

SN 85-636,030. BOX PARTNERS LLC, ELGIN, IL. FILED 5-25-2012.

# TAPE LOGIC

THE MARK CONSISTS OF STANDARD CHARACTERS WITHOUT CLAIM TO ANY PARTICULAR FONT, STYLE, SIZE, OR COLOR.

NO CLAIM IS MADE TO THE EXCLUSIVE RIGHT TO USE "TAPE", APART FROM THE MARK AS SHOWN.

FOR TAPE, NAMELY, ADHESIVE TAPE FOR SEALING CARTONS FOR INDUSTRIAL OR COMMERCIAL USE, MASKING TAPE, FILAMENT TAPE, DUCT TAPE, GAFFERS TAPE, ELECTRICAL TAPE; PACKAGING MATERIALS, NAMELY, LOW-DENSITY POLYURETHANE PACKAGING FOAM DISPENSER PACKS; PACKAGING MATERIALS, NAMELY, PACKAGING FOAM IN SHEET FORM (U.S. CLS. 1, 5, 12, 13, 35 AND 50).

MATTHEW GALAN, EXAMINING ATTORNEY

SN 85-775,233. AMAX THREAD CORPORATION, SOUTH EL MONTE, CA. FILED 11-8-2012.

# Amaxfilm

THE MARK CONSISTS OF STANDARD CHARACTERS WITHOUT CLAIM TO ANY PARTICULAR FONT, STYLE, SIZE, OR COLOR.

OWNER OF U.S. REG. NO. 3,672,854.

FOR PALLET CAST WRAP, NAMELY, UNFITTED COVERING WRAPS MADE OF POLYETHYLENE AND OTHER POLYMERS FOR STORING AND TRANSPORTING LUMBER, BUILDING MATERIALS AND OTHER COMMERCIAL AND INDUSTRIAL PRODUCTS (U.S. CLS. 1, 5, 12, 13, 35 AND 50).

TASNEEM HUSSAIN, EXAMINING ATTORNEY

SN 85-842,350. HENRY COMPANY, LLC, EL SEGUNDO, CA. FILED 2-6-2013.

# Metal Clad

THE MARK CONSISTS OF STANDARD CHARACTERS WITHOUT CLAIM TO ANY PARTICULAR FONT, STYLE, SIZE, OR COLOR.

NO CLAIM IS MADE TO THE EXCLUSIVE RIGHT TO USE "METAL", APART FROM THE MARK AS SHOWN.

FOR INSULATING WATER PROOFING MEMBRANES; WATER PROOFING MEMBRANES FOR FOUNDATIONS OF BUILDINGS; WEATHERIZING MEMBRANES AND VAPOR BARRIERS (U.S. CLS. 1, 5, 12, 13, 35 AND 50).

FIRST USE 5-0-2005; IN COMMERCE 5-0-2005.

SHAUNIA CARLYLE, EXAMINING ATTORNEY

**CLASS 17—(Continued).**

SN 85-946,439. DURACOTE CORPORATION, RAVENNA, OH. FILED 5-30-2013.

# FRONTIER

THE MARK CONSISTS OF STANDARD CHARACTERS WITHOUT CLAIM TO ANY PARTICULAR FONT, STYLE, SIZE, OR COLOR.

FOR INSULATING MATERIALS; FIRE BARRIERS COMPRISED OF INORGANIC AND ORGANIC COATINGS TO BE APPLIED TO MATERIALS FOR USE IN MILITARY, AEROSPACE, AUTOMOTIVE, RAIL, ARCHITECTURAL, AND INDUSTRIAL APPLICATIONS TO REDUCE THE FLAMMABILITY OF THE MATERIALS (U.S. CLS. 1, 5, 12, 13, 35 AND 50).

REGINA DRUMMOND, EXAMINING ATTORNEY

SN 86-015,376. NOF CORPORATION, SHIBUYA-KU, TOKYO, JAPAN, FILED 7-19-2013.



THE MARK CONSISTS OF A LARGE CIRCLE CONTAINING TWO SMALLER CIRCLES, ONE CIRCLE CONNECTED TO EACH SIDE OF THE OUTER CIRCLE. THE TWO CIRCLES ARE CONNECTED BY A HORIZONTAL BAR.

FOR PLASTIC FILM CONTAINING ANTIREFLECTIVE AGENTS FOR COMMERCIAL AND INDUSTRIAL USE; PLASTIC FILM FOR USE IN THE MANUFACTURE OF DISPLAYS; PLASTIC FILM FOR USE IN THE MANUFACTURE OF LIQUID CRYSTAL DISPLAY; PLASTIC FILM FOR USE IN THE MANUFACTURE OF FLAT PANEL DISPLAY FOR PERSONAL COMPUTERS, TABLET COMPUTERS, TELEVISIONS, CELLULAR PHONES, CAR NAVIGATION SYSTEMS AND ELECTRIC APPARATUS AND INSTRUMENTS WITH FLAT PANEL DISPLAY SCREENS (U.S. CLS. 1, 5, 12, 13, 35 AND 50).

FIRST USE 11-0-2008; IN COMMERCE 4-0-2009.

KERI CANTONE, EXAMINING ATTORNEY

**CLASS 17—(Continued).**

SN 86-038,810. LIGHTBLOCKS, INC., NASHUA, NH. FILED 8-15-2013.

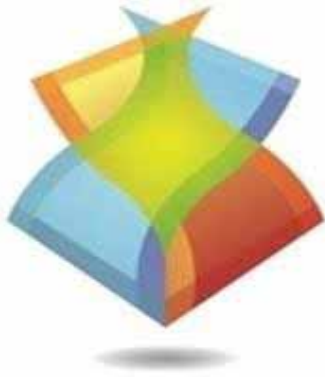

THE COLOR(S) BLUE, GRAY, ORANGE, RED, WHITE AND YELLOW IS/ARE CLAIMED AS A FEATURE OF THE MARK.

THE MARK CONSISTS OF AN INTERTWINED TRIANGULAR DESIGN WITH THE COLORS BLUE, ORANGE, RED, WHITE AND YELLOW; A GRAY SHADOW APPEARS BELOW THE DESIGN.

FOR POLYMER SHEETING FOR USE IN THE MANUFACTURE OF CUSTOM-MADE PRODUCTS, NAMELY, DECORATIVE AND FUNCTIONAL ARCHITECTURAL RESINS (U.S. CLS. 1, 5, 12, 13, 35 AND 50).

FIRST USE 8-1-2013; IN COMMERCE 8-1-2013.

FLORENTINA BLANDU, EXAMINING ATTORNEY

SN 86-044,783. W. L. GORE & ASSOCIATES, INC., NEWARK, DE. FILED 8-22-2013.

**STA-PURE**

THE MARK CONSISTS OF STANDARD CHARACTERS WITHOUT CLAIM TO ANY PARTICULAR FONT, STYLE, SIZE, OR COLOR.

OWNER OF U.S. REG. NOS. 2,432,241, 4,037,354 AND 4,133,883.

FOR FLUOROPOLYMERS, NAMELY, VENTS FOR USE IN DRUG DELIVERY AND PHARMACEUTICAL PACKAGING (U.S. CLS. 1, 5, 12, 13, 35 AND 50).

ALLISON HOLTZ, EXAMINING ATTORNEY

**CLASS 17—(Continued).**

SN 86-066,815. PIPEMEDIC, LLC, TUCSON, AZ. FILED 9-17-2013.

**StifPipe**

THE MARK CONSISTS OF STANDARD CHARACTERS WITHOUT CLAIM TO ANY PARTICULAR FONT, STYLE, SIZE, OR COLOR.

FOR NON-METALLIC FLEXIBLE PIPES (U.S. CLS. 1, 5, 12, 13, 35 AND 50).

FIRST USE 7-12-2011; IN COMMERCE 7-12-2011.

ARETHA SOMERVILLE, EXAMINING ATTORNEY

SN 86-067,450. PIPEMEDIC, LLC, TUCSON, AZ. FILED 9-17-2013.



THE MARK CONSISTS OF A SECTION OF A PIPE THE INSIDE OF WHICH IS PARTIALLY COVERED WITH AN FRP LAMINATE, THE PHRASE PIPEMEDIC AND A CROSS SYMBOL ATTACHED TO THE LETTER "C" IN "PIPEMEDIC".

FOR LAMINATE FOIL CONSISTING PRIMARILY OF PLASTIC WITH OR WITHOUT A METAL LAYER FOR APPLICATION TO A SUBSTRATE (U.S. CLS. 1, 5, 12, 13, 35 AND 50).

FIRST USE 11-11-2008; IN COMMERCE 3-3-2009.

ARETHA SOMERVILLE, EXAMINING ATTORNEY

SN 86-068,562. AGRU/AMERICA, INC., GEORGETOWN, SC. FILED 9-18-2013.

**AGRU TRIDENTLOCK**

THE MARK CONSISTS OF STANDARD CHARACTERS WITHOUT CLAIM TO ANY PARTICULAR FONT, STYLE, SIZE, OR COLOR.

FOR PLASTIC MOUNTING STRIPS SPECIALLY ADAPTED FOR MOUNTING THERMOPLASTIC AND POLYETHYLENE LINERS ONTO CONCRETE WALLS OF LIQUID STORAGE TANKS AND ONTO CONCRETE COLLARS OF SEWAGE AND WASTE LAGOONS (U.S. CLS. 1, 5, 12, 13, 35 AND 50).

SAIMA MAKHDOOM, EXAMINING ATTORNEY



**CLASS 17—(Continued).**

SN 86-074,421. THE VALSPAR CORPORATION, MINNEAPOLIS, MN. FILED 9-25-2013.

**HYDROCHROMA**

THE MARK CONSISTS OF STANDARD CHARACTERS WITHOUT CLAIM TO ANY PARTICULAR FONT, STYLE, SIZE, OR COLOR.  
 FOR ADHESIVE SEALANTS FOR GENERAL USE; CAULKING (U.S. CLS. 1, 5, 12, 13, 35 AND 50).  
 AISHA CLARKE, EXAMINING ATTORNEY

SN 86-074,649. THE VALSPAR CORPORATION, MINNEAPOLIS, MN. FILED 9-25-2013.



THE COLOR(S) RED, ORANGE, YELLOW, GREEN, BLUE, AND PURPLE IS/ARE CLAIMED AS A FEATURE OF THE MARK.  
 THE MARK CONSISTS OF THE WORD "HYDROCHROMA" COMPRISING THE COLORS RED, ORANGE, YELLOW, GREEN, BLUE, AND PURPLE IN A SPECTRUM OF COLORS FROM LEFT TO RIGHT AND THE FIRST LETTER "O" COMPRISED OF A GREEN RAINDROP.  
 FOR ADHESIVE SEALANTS FOR GENERAL USE; CAULKING (U.S. CLS. 1, 5, 12, 13, 35 AND 50).  
 AISHA CLARKE, EXAMINING ATTORNEY

SN 86-105,792. INTERTAPE POLYMER CORP., SARASOTA, FL. FILED 10-30-2013.

**Iron Grip**

THE MARK CONSISTS OF STANDARD CHARACTERS WITHOUT CLAIM TO ANY PARTICULAR FONT, STYLE, SIZE, OR COLOR.  
 FOR DUCT TAPE (U.S. CLS. 1, 5, 12, 13, 35 AND 50).  
 FIRST USE 8-1-2013; IN COMMERCE 8-1-2013.  
 MICHAEL SOUDERS, EXAMINING ATTORNEY

**CLASS 17—(Continued).**

SN 86-110,853. IBCO SRL, ST. MICHAEL, BARBADOS, FILED 11-5-2013.

**RHINOROOF**

THE MARK CONSISTS OF STANDARD CHARACTERS WITHOUT CLAIM TO ANY PARTICULAR FONT, STYLE, SIZE, OR COLOR.  
 FOR FLEXIBLE PLASTIC MEMBRANES FOR CONSTRUCTION APPLICATIONS, NAMELY, ROOFING UNDERLAYMENT (U.S. CLS. 1, 5, 12, 13, 35 AND 50).  
 FIRST USE 3-28-2012; IN COMMERCE 3-28-2012.  
 PAM WILLIS, EXAMINING ATTORNEY

SN 86-114,721. OWENS CORNING INTELLECTUAL CAPITAL, LLC, TOLEDO, OH. FILED 11-10-2013.

**RESHAPING EXPECTATIONS**

THE MARK CONSISTS OF STANDARD CHARACTERS WITHOUT CLAIM TO ANY PARTICULAR FONT, STYLE, SIZE, OR COLOR.  
 FOR INSULATING MATERIALS (U.S. CLS. 1, 5, 12, 13, 35 AND 50).  
 REGINA DRUMMOND, EXAMINING ATTORNEY

SN 86-114,743. OWENS CORNING INTELLECTUAL CAPITAL, LLC, TOLEDO, OH. FILED 11-10-2013.

**UTILICORE**

THE MARK CONSISTS OF STANDARD CHARACTERS WITHOUT CLAIM TO ANY PARTICULAR FONT, STYLE, SIZE, OR COLOR.  
 FOR INSULATING MATERIALS (U.S. CLS. 1, 5, 12, 13, 35 AND 50).  
 REGINA DRUMMOND, EXAMINING ATTORNEY

**CLASS 17—(Continued).**

SN 86-129,372. TOYO INK SC HOLDINGS CO., LTD., TOKYO, JAPAN, FILED 11-26-2013.

# LIOELM

THE MARK CONSISTS OF STANDARD CHARACTERS WITHOUT CLAIM TO ANY PARTICULAR FONT, STYLE, SIZE, OR COLOR.

OWNER OF U.S. REG. NOS. 2,189,768, 3,046,283 AND OTHERS.

FOR PLASTIC FILMS WITH ADHESIVES FOR INDUSTRIAL USE; SYNTHETIC RESIN SHEETS WITH ADHESIVES; PLASTIC TAPE WITH ADHESIVES FOR INDUSTRIAL USE; PLASTICS IN EXTRUDED FORM FOR USE IN MANUFACTURE; ELECTROMAGNETIC SHIELDING MATERIALS; INSULATING MATERIALS (U.S. CLS. 1, 5, 12, 13, 35 AND 50).

FIRST USE 11-10-1989; IN COMMERCE 4-1-2006.  
JAMES MACFARLANE, EXAMINING ATTORNEY

**CLASS 18—LEATHER GOODS**

SN 76-713,510. SKYLAR JACE DESIGNS, LLC, FRISCO, TX, FILED 2-21-2013.

# SKYLAR JACE

THE MARK CONSISTS OF STANDARD CHARACTERS WITHOUT CLAIM TO ANY PARTICULAR FONT, STYLE, SIZE, OR COLOR.

THE NAME(S), PORTRAIT(S), AND/OR SIGNATURE(S) SHOWN IN THE MARK DOES NOT IDENTIFY A PARTICULAR LIVING INDIVIDUAL.

FOR LEATHER AND IMITATION LEATHER GOODS, NAMELY, PURSES, HANDBAGS, KEY HOLDERS AND CARD HOLDERS (U.S. CLS. 1, 2, 3, 22 AND 41).

MICHAEL KEATING, EXAMINING ATTORNEY

SN 76-714,410. LAPLANTE, LYNDA C., ENGLEWOOD, FL, FILED 6-18-2013.

# BORN TO BE LOVED

THE MARK CONSISTS OF STANDARD CHARACTERS WITHOUT CLAIM TO ANY PARTICULAR FONT, STYLE, SIZE, OR COLOR.

FOR PET ATTIRE, NAMELY, PET CLOTHING AND GARMENTS FOR PETS; PET COLLAR ACCESSORIES, NAMELY, BELLS, SILENCES, SAFETY LIGHTS AND BLINKERS, PENDANTS AND CHARMS; PET ACCESSORIES, NAMELY, PET HAIR ORNAMENTS (U.S. CLS. 1, 2, 3, 22 AND 41).

JENNIFER MARTIN, EXAMINING ATTORNEY

**CLASS 18—(Continued).**

SN 76-714,691. CECCHI, MICHAEL D., MADISON, CT, FILED 8-2-2013.



THE MARK CONSISTS OF THE LETTER "S" INSIDE A PENTAGON. THE TOP PORTION OF THE BACKGROUND BEHIND THE "S" IS PARTIALLY SHADED. THE PENTAGON ALSO CONTAINS STRAY SHADED MARKS AND STREAKS INSIDE OF IT.

FOR FLAT, TWO DIMENSIONAL PLAQUES MADE OF LEATHER AND IMITATIONS OF LEATHER, WITH SAID PLAQUES DISPLAYING VARIOUS IMAGES, NAMELY, IMAGES OF SPORTING GOODS, SPORTS PARAPHERNALIA, ANIMALS, VEHICLES, FICTIONAL CHARACTERS, CELEBRITIES, MUSICAL INSTRUMENTS, BUILDINGS, MONUMENTS, BOOKS, FLAGS, AND TROPHIES (U.S. CLS. 1, 2, 3, 22 AND 41).

FIRST USE 4-0-2013; IN COMMERCE 4-0-2013.  
SETH A. RAPPAPORT, EXAMINING ATTORNEY

SN 79-131,430. FURLA S.P.A., ITALY, FILED 12-21-2012.

# FURLA PIPER

THE MARK CONSISTS OF STANDARD CHARACTERS WITHOUT CLAIM TO ANY PARTICULAR FONT, STYLE, SIZE, OR COLOR.

PRIORITY DATE OF 12-18-2012 IS CLAIMED.

OWNER OF INTERNATIONAL REGISTRATION 1163622 DATED 12-21-2012, EXPIRES 12-21-2022.

OWNER OF U.S. REG. NOS. 1,263,380, 2,674,884 AND 4,156,263.

THE NAME(S), PORTRAIT(S), AND/OR SIGNATURE(S) SHOWN IN THE MARK DOES NOT IDENTIFY A PARTICULAR LIVING INDIVIDUAL.

FOR BAGS, NAMELY, HANDBAGS, CLUTCH BAGS, TRAVELLING BAGS OF LEATHER, MESH SHOPPING BAGS, SHOULDER BAGS, LEATHER AND IMITATION OF LEATHER POUCHES, RUCKSACKS, HOLDALLS, REUSABLE SHOPPING BAGS; LEATHER CASES FOR HOLDING PAPER DIARIES SOLD EMPTY, AND LEATHER DOCUMENT CASES; VINTAGE BAGS, NAMELY, HANDBAGS, CLUTCH BAGS, TRAVELLING BAGS OF LEATHER, MESH SHOPPING BAGS, SHOULDER BAGS, LEATHER AND IMITATION OF LEATHER POUCHES, RUCKSACKS, HOLDALLS, REUSABLE SHOPPING BAGS AND HAVERSACKS; WALLETS, PURSES; CREDIT CARD CASES, BUSINESS CARD CASES; LEATHER CASES FOR HOLDING NOTE BOOKS SOLD EMPTY; LUGGAGE, SUITCASES, SUIT CARRIERS FOR TRAVELLING, ATTACHE CASES, TRUNKS; VANITY CASES SOLD EMPTY; MAKE-UP CASES SOLD EMPTY; KEY CASES OF LEATHER; UMBRELLAS, PARASOLS AND WALKING STICKS, SADDLERY (U.S. CLS. 1, 2, 3, 22 AND 41).

BERYL GARDNER, EXAMINING ATTORNEY

**CLASS 18—(Continued).**

SN 79-134,304. DONGHUA(QUANZHOU)UMBRELLA CO.,LTD, CHINA, FILED 7-17-2013.



OWNER OF INTERNATIONAL REGISTRATION 1171062 DATED 7-17-2013, EXPIRES 7-17-2023.

THE MARK CONSISTS OF THE WORDING "DONG HUA" APPEARING BENEATH TWO ASIAN CHARACTERS AND NEXT TO THE STYLIZED DESIGN OF A BEAR.

THE NON-LATIN CHARACTERS IN THE MARK TRANSLITERATE TO "DONGHUA" AND THIS MEANS "EAST ESSENCE" IN ENGLISH.

FOR UMBRELLA RINGS; UMBRELLA OR PARASOL RIBS; UMBRELLA STICKS; FRAMES FOR UMBRELLAS OR PARASOLS; UMBRELLAS; UMBRELLA COVERS; PARASOLS; UMBRELLA HANDLES (U.S. CLS. 1, 2, 3, 22 AND 41).

CHRISTINE MARTIN, EXAMINING ATTORNEY

SN 85-502,496. CELINE LINARTE, BELLFLOWER, CA. FILED 12-22-2011.

FEROSH  
*couture*

OWNER OF U.S. REG. NO. 4,222,245.

NO CLAIM IS MADE TO THE EXCLUSIVE RIGHT TO USE "COUTURE", APART FROM THE MARK AS SHOWN.

FOR ALL-PURPOSE CARRYING BAGS; BACKPACKS, BOOK BAGS, SPORTS BAGS, BUM BAGS, WALLETS AND HANDBAGS; BEACH BAGS; BOOK BAGS; BOSTON BAGS; BUM BAGS; CANVAS SHOPPING BAGS; CARRY-ALL BAGS; CARRY-ON BAGS; CHAIN MESH PURSES; CHANGE PURSES; CHARM BAGS (OMAMORI-IRE); CLUTCH PURSES; CLUTCHES; COIN PURSES; COIN PURSES NOT MADE OF PRECIOUS METAL; COIN PURSES, NOT OF PRECIOUS METALS; COSMETIC BAGS SOLD EMPTY; DOLLY BAGS; DRAWSTRING BAGS; DUFFEL BAGS; DUFFEL BAGS FOR TRAVEL; DUFFLE BAGS; EVENING BAGS; EVENING HANDBAGS; FASHION HANDBAGS; GYM BAGS; HANDBAGS; HANDBAGS FOR LADIES; HANDBAGS, PURSES AND WALLETS; HARD-SIDED AND SOFT-SIDED CARRY-ON BAGS AND GYM BAGS; HIP BAGS; HOBO BAGS; KEY BAGS; KNITTED BAGS, NOT OF PRECIOUS METALS; LEATHER AND IMITATION LEATHER BAGS; LEATHER AND IMITATION LEATHER SPORT BAGS AND GENERAL PURPOSE TROLLEY BAGS; LEATHER BAGS AND WALLETS; LEATHER BAGS, SUITCASES AND WALLETS; LEATHER HANDBAGS; LEATHER PURSES; LEATHER SHOPPING BAGS; MAKE-UP BAGS SOLD EMPTY; MESH SHOPPING BAGS; MESSENGER BAGS; MILI-

**CLASS 18—(Continued).**

TARY DUFFLE BAGS, GARMENT BAGS FOR TRAVEL, TOTE BAGS, SHOULDER BAGS AND BACKPACKS; MINAUDIERES IN THE NATURE OF SMALL CLUTCH PURSES; MULTI-PURPOSE PURSES; MULTI-STRANDED, BEADED CLIP THAT ATTACHES TO THE OUTSIDE OF A WOMEN'S PURSE AS A DECORATIVE ACCESSORY; OVERNIGHT BAGS; PURSE CHARMS; PURSE FRAMES; PURSES; PURSES; PURSES AND WALLETS; REUSABLE SHOPPING BAGS; SACK PACKS, NAMELY, DRAWSTRING BAGS USED AS BACKPACKS; SCHOOL BAGS; SCHOOL BOOK BAGS; SHOPPING BAGS WITH WHEELS ATTACHED; SHOULDER BAGS; SLING BAGS; SMALL CLUTCH PURSES; SMALL PURSES; SOUVENIR BAGS; STRAPS FOR HANDBAGS; TOTE BAGS; TRAVEL BAGS; TRAVELING BAGS; TRAVELLING BAGS; WAIST BAGS; WHEELED MESSENGER BAGS; WHEELED SHOPPING BAGS; WHEELED TOTE BAGS; WINE BAGS WITH HANDLES FOR CARRYING OR HOLDING WINE; WRIST MOUNTED CARRYALL BAGS; WRIST MOUNTED PURSES; WRISTLET BAGS (U.S. CLS. 1, 2, 3, 22 AND 41).

MARK SHINER, EXAMINING ATTORNEY

SN 85-830,662. NEW ORLEANS HORNETS NBA, LLC, METAIRIE, LA. FILED 1-23-2013.



NO CLAIM IS MADE TO THE EXCLUSIVE RIGHT TO USE "NOLA", APART FROM THE MARK AS SHOWN.

THE MARK CONSISTS OF THE WORDS "NOLA" AND "PELICANS" DEPICTED IN STYLIZED FONTS APPEARING WITH STYLIZED DESIGNS OF A BASKETBALL AND FLEUR-DE-LIS AND ALL CONTAINED WITHIN A STYLIZED CREST OR SHIELD THAT FEATURES A SEMICIRCLE.

FOR ATHLETIC BAGS, SHOE BAGS FOR TRAVEL, OVERNIGHT BAGS, UMBRELLAS, BACKPACKS, BABY BACKPACKS, KNAPSACKS, DUFFEL BAGS, TOTE BAGS, BEACH BAGS, BEACH TOTE BAGS, DRAWSTRING POUCHES, LUGGAGE TAGS, PATIO UMBRELLAS, BEACH UMBRELLAS, VALISES, ATTACHÉ CASES, BILLFOLDS, WALLETS, BRIEF-CASES, CANES, BUSINESS CARD CASES, BOOK BAGS, ALL PURPOSE SPORTS BAGS, GOLF UMBRELLAS, GYM BAGS, PURSES, COIN PURSES, FANNY PACKS, WAIST PACKS, COSMETIC CASES SOLD EMPTY, GARMENT BAGS FOR TRAVEL, HANDBAGS, KEY CASES, LEATHER KEY CHAINS, SUITCASES, TOILETRY CASES SOLD EMPTY, TRUNKS FOR TRAVELING AND RUCKSACKS, PET CLOTHING, PET LEASHES, AND PET COLLARS (U.S. CLS. 1, 2, 3, 22 AND 41).

ALICE BENMAMAN, EXAMINING ATTORNEY

**CLASS 18—(Continued).**

SN 85-844,999. JEFFREY J. FORD, FORREST PARK, IL.  
FILED 2-8-2013.

# HY-BO

THE MARK CONSISTS OF STANDARD CHARACTERS WITHOUT CLAIM TO ANY PARTICULAR FONT, STYLE, SIZE, OR COLOR.

THE WORDING "HY-BO" HAS NO MEANING IN A FOREIGN LANGUAGE.

FOR UTILITY BELTS, WORN BY A PET WALKER, CONSISTING OF A NUMBER OF POUCHES FOR PLACEMENT OF DEVICES AND MATERIALS USED WHEN WALKING PETS, NAMELY, DOGS (U.S. CLS. 1, 2, 3, 22 AND 41).

COLLEEN MULCRONE, EXAMINING ATTORNEY

**CLASS 18—(Continued).**

SN 85-871,512. THEORY LLC, NEW YORK, NY. FILED 3-8-2013.

# THEORY

THE MARK CONSISTS OF STANDARD CHARACTERS WITHOUT CLAIM TO ANY PARTICULAR FONT, STYLE, SIZE, OR COLOR.

OWNER OF U.S. REG. NOS. 2,067,427, 3,388,829 AND OTHERS.

FOR WALLETS, PURSES, CLUTCHES, IDENTIFICATION HOLDERS, NAMELY, IDENTIFICATION CARD CASES, LUGGAGE, CARRY-ALL BAGS, WAIST BAGS, FANNY PACKS, KEY CASES, BRIEFCASES, DUFFLE BAGS, ALL-PURPOSE SPORT BAGS, BUSINESS CARD CASES, CREDIT CARD CASES, CHANGE PURSES, ATTACHÉ CASES, BILLFOLDS, COSMETIC BAGS SOLD EMPTY (U.S. CLS. 1, 2, 3, 22 AND 41).

NANCY CLARKE, EXAMINING ATTORNEY

SN 85-849,258. BROSSIE LLC, ATHENS, GA. FILED 2-13-2013.



THE MARK CONSISTS OF AN ABSTRACT DESIGN OF A TURKEY HEAD.

FOR HUNTING GEAR, NAMELY, HUNTING BAGS (U.S. CLS. 1, 2, 3, 22 AND 41).

CHARLES L. JENKINS, EXAMINING ATTORNEY

SN 85-887,237. DISNEY ENTERPRISES, INC., BURBANK, CA. FILED 3-26-2013.

# OLIVIA POPE

THE MARK CONSISTS OF STANDARD CHARACTERS WITHOUT CLAIM TO ANY PARTICULAR FONT, STYLE, SIZE, OR COLOR.

THE NAME(S), PORTRAIT(S), AND/OR SIGNATURE(S) SHOWN IN THE MARK DOES NOT IDENTIFY A PARTICULAR LIVING INDIVIDUAL.

FOR ALL PURPOSE CARRYING BAGS; ALL PURPOSE SPORT BAGS; BABY BACKPACKS; BACKPACKS; BEACH BAGS; BOOK BAGS; CALLING CARD CASES; COIN PURSES; DIAPER BAGS; DUFFEL BAGS; FANNY PACKS; GYM BAGS; HANDBAGS; KNAPSACKS; KEY CASES; LEATHER KEY CHAINS; LUGGAGE TAGS; LUGGAGE; OVERNIGHT BAGS; PURSES; SATCHELS; SHOPPING BAGS MADE OF LEATHER, MESH OR TEXTILE; TOTE BAGS; UMBRELLAS; WAIST PACKS; WALLETS (U.S. CLS. 1, 2, 3, 22 AND 41).

DORITT L. CARROLL, EXAMINING ATTORNEY

**CLASS 18—(Continued).**

SN 85-896,979. DISNEY ENTERPRISES, INC., BURBANK, CA. FILED 4-5-2013.

**FINDING DORY**

THE MARK CONSISTS OF STANDARD CHARACTERS WITHOUT CLAIM TO ANY PARTICULAR FONT, STYLE, SIZE, OR COLOR.

FOR ALL PURPOSE CARRYING BAGS; ALL PURPOSE SPORT BAGS; BABY BACKPACKS; BACKPACKS; BEACH BAGS; BOOK BAGS; CALLING CARD CASES; COIN PURSES; DIAPER BAGS; DUFFEL BAGS; FANNY PACKS; GYM BAGS; HANDBAGS; KNAPSACKS; KEY CASES; LEATHER KEY CHAINS; LUGGAGE TAGS; LUGGAGE; OVERNIGHT BAGS; PURSES; SATCHELS; SHOPPING BAGS MADE OF LEATHER, MESH OR TEXTILE; TOTE BAGS; UMBRELLAS; WAIST PACKS; WALLETS (U.S. CLS. 1, 2, 3, 22 AND 41).

LEIGH CAROLINE CASE, EXAMINING ATTORNEY

---

SN 85-965,748. LECARINGTON INT'L, LLC, RAMSEY, NJ. FILED 6-20-2013.



THE MARK CONSISTS OF THE LETTERS "L", "B" AND "C" IN LARGE STYLIZED LETTERING WITH THE LETTER "B" SUPER IMPOSED OVER THE LETTER "L" AND THE LETTER "C" SUPER IMPOSED OVER THE LETTER "B". A SMALL RECTANGULAR BLOCK IS SUPER IMPOSED WITHIN THE LETTERS "L" AND "B".

FOR HANDBAGS, WALLETS, DIAPER BAGS, LUGGAGE, TOTE BAGS, BUSINESS CASES, TOILETRY CASES SOLD EMPTY, ANIMAL CARRIERS, UMBRELLAS, CASES FOR BUSINESS CARDS, KEY CASES, CHANGE PURSES (U.S. CLS. 1, 2, 3, 22 AND 41).

SCOTT BIBB, EXAMINING ATTORNEY

**CLASS 18—(Continued).**

SN 85-965,762. LECARINGTON INT'L, LLC, RAMSEY, NJ. FILED 6-20-2013.



NO CLAIM IS MADE TO THE EXCLUSIVE RIGHT TO USE "EST 2012", APART FROM THE MARK AS SHOWN.

THE MARK CONSISTS OF TWO DRAGON IMAGES AT EITHER END OF A DESIGN CONTAINING FANCIFUL FLOURISHES WITH THE LETTERS "EST" AND THE YEAR "2012" LOCATED AT THE BOTTOM OF THE MARK.

FOR HANDBAGS, WALLETS, DIAPER BAGS, LUGGAGE, TOTE BAGS, BUSINESS CASES, TOILETRY CASES SOLD EMPTY, ANIMAL CARRIERS, UMBRELLAS, CASES FOR BUSINESS CARDS, KEY CASES, CHANGE PURSES (U.S. CLS. 1, 2, 3, 22 AND 41).

SCOTT BIBB, EXAMINING ATTORNEY

---

SN 86-012,834. SYNCHRONICITY WORLDWIDE INC., CLEVELAND, OH. FILED 7-17-2013.



NO CLAIM IS MADE TO THE EXCLUSIVE RIGHT TO USE "CLE CLEVELAND", APART FROM THE MARK AS SHOWN.

THE MARK CONSISTS OF THE STYLIZED LETTERING "CLE" WHERE THE "L" IS IN THE SHAPE OF A SKYSCRAPER AND THE STYLIZED WORD "CLEVELAND" BELOW "CLE".

FOR ALL-PURPOSE REUSABLE CARRYING BAGS (U.S. CLS. 1, 2, 3, 22 AND 41).

FIRST USE 7-1-2013; IN COMMERCE 7-1-2013.

DAVID ALESKOW, EXAMINING ATTORNEY

**CLASS 18—(Continued).**

SN 86-014,958. MOJAB, MAHTAB, DBA MAHTAB MOJAB, LOS ANGELES, CA. FILED 7-19-2013.



**MAHTAB MOJAB**

THE NAME IDENTIFIES A LIVING INDIVIDUAL WHOSE CONSENT IS OF RECORD.

THE MARK CONSISTS OF BLACK CAPITAL LETTER "M" WITH A THICK BLACK LINE UNDERNEATH AND THE NAME "MAHTAB MOJAB" IN BLACK UNDERNEATH THE LINE.

FOR FASHION HANDBAGS (U.S. CLS. 1, 2, 3, 22 AND 41).

FLORENTINA BLANDU, EXAMINING ATTORNEY

**CLASS 18—(Continued).**

SN 86-030,026. QU NIPU, TEMPLE CITY, CA. FILED 8-6-2013.

**JUMP FROM PAPER**

THE MARK CONSISTS OF STANDARD CHARACTERS WITHOUT CLAIM TO ANY PARTICULAR FONT, STYLE, SIZE, OR COLOR.

FOR HANDBAGS; PURSES AND WALLETS; BACKPACKS; SCHOOL BAGS; MESSENGER BAGS; CLUTCH PURSES; COIN PURSES; EVENING HANDBAGS; SHOULDER BAGS; BRIEFCASES; TOTE BAGS; TRAVELING BAGS; LUGGAGE AND UMBRELLAS (U.S. CLS. 1, 2, 3, 22 AND 41).

FIRST USE 2-11-2010; IN COMMERCE 2-11-2010.  
ESTHER A. BORSUK, EXAMINING ATTORNEY

SN 86-021,674. A-LIST, INC., LOS ANGELES, CA. FILED 7-27-2013.

**KITSON**

THE MARK CONSISTS OF STANDARD CHARACTERS WITHOUT CLAIM TO ANY PARTICULAR FONT, STYLE, SIZE, OR COLOR.

OWNER OF U.S. REG. NOS. 3,217,006 AND 3,413,829.  
SEC. 2(F).

FOR WALLETS; LEATHER BAGS; TOTE BAGS; TRAVEL BAGS; KEY BAGS; COSMETIC BAGS; HANDBAGS; VANITY CASES; SPORTS BAGS; LEATHER SHOPPING BAGS; REUSABLE SHOPPING BAGS; CARRIER BAGS; DIAPER BAGS; LAPTOP BAGS; CLUTCHES; COIN BAGS; PURSES; LEATHER FOR PACKAGING; BAGS FOR PET ARTICLES; CASES OF LEATHER OR LEATHER BOARD; CANVAS BACKPACKS; PARASOLS; IMITATION LEATHER; ANIMAL SKIN; PET CLOTHING; COLLARS FOR ANIMALS; CARRYING BAGS FOR ANIMALS; SLING BAGS FOR CARRYING INFANTS (U.S. CLS. 1, 2, 3, 22 AND 41).

JOHN DALIER, EXAMINING ATTORNEY

SN 86-033,220. SHANGHAI LA CHAPELLE FASHION CO., LTD., SHANGHAI, CHINA, FILED 8-9-2013.

**拉夏贝尔**

THE MARK CONSISTS OF CHINESE CHARACTERS "LA XIA BEI ER".

THE WORDING "LA XIA BEI ER" HAS NO MEANING IN A FOREIGN LANGUAGE.

THE NON-LATIN CHARACTERS IN THE MARK TRANSLITERATE TO LA XIA BEI ER AND THIS HAS NO MEANING IN A FOREIGN LANGUAGE.

FOR ANIMAL SKINS; CANVAS SHOPPING BAGS; HANDBAGS; HAVERSACKS; IMITATION LEATHER; IMITATION LEATHER SOLD IN BULK; LEATHER SHOPPING BAGS; MESH SHOPPING BAGS; PURSES; REUSABLE SHOPPING BAGS; RUCKSACKS; SHOPPING BAGS WITH WHEELS ATTACHED; UMBRELLAS; VALISES (U.S. CLS. 1, 2, 3, 22 AND 41).

FIRST USE 8-8-2011; IN COMMERCE 8-8-2011.  
ERNEST SHOSHO, EXAMINING ATTORNEY

**CLASS 18—(Continued).**

SN 86-040,046. BISSA INTERNATIONAL, LLC, NEW YORK, NY. FILED 8-16-2013.



THE MARK CONSISTS OF A RING WITH THE TEXT "MAGRI" ALONG THE BOTTOM, AND TWO INTER-TWINED SNAKES WRAPPED AROUND THE TOP HALF OF THE RING WITH THE HEADS POINTED OUTWARDLY AT THE TOP FROM OPPOSITE SIDES.

FOR HANDBAGS; LUGGAGE; SHOULDER BAGS; BEACH BAGS; CLUTCH BAGS; ALL-PURPOSE SPORTS BAGS; BOSTON BAGS; ATTACHÉ CASES; SCHOOL BAGS; SCHOOL SATCHELS; TOTE BAGS; TRAVELLING BAGS; LEATHER AND CANVAS SHOPPING BAGS; WAIST BAGS; BOXES OF LEATHER OR LEATHER BOARD; CASES OF LEATHER OR LEATHER BOARD; NOTE CARD CASES; DOCUMENT CASES, BEING FOLDERS, OF LEATHER OR LEATHER BOARD; VANITY CASES, NOT FITTED; POUCHES OF LEATHER FOR PACKAGING; BAGS AS ENVELOPES, POUCHES OF LEATHER FOR PACKAGING; KEY CASES OF LEATHERWARE OR LEATHER BOARD; HAVERSACKS; BACKPACKS; KNAPSACKS; RUCKSACKS; BRIEF-CASES; PURSES; POCKET WALLETS; TRAVELLING TRUNKS; LEATHERWARE TRAVELLING SETS COMPRISED OF LEATHER TRAVELLING BAGS; GARMENT BAGS FOR TRAVEL; SUITCASES; TROLLEY-TYPE SUITCASES; UMBRELLAS; PARASOLS; WALKING STICKS; ALPENSTOCKS; UNWORKED OR SEMI-WORKED LEATHER; IMITATION LEATHER; ANIMAL FUR SKINS; ANIMAL SKIN, NAMELY, MOLESKIN; LEATHER AND IMITATIONS OF LEATHER; ANIMAL SKINS AND HIDES; TRUNKS AND TRAVELLING BAGS; UMBRELLAS AND PARASOLS; WALKING STICKS; WHIPS, HARNESS AND SADDLERY (U.S. CLS. 1, 2, 3, 22 AND 41).

NAAKWAMA ANKRAH, EXAMINING ATTORNEY

SN 86-040,332. TREASURE GARDEN INC., BALDWIN PARK, CA. FILED 8-16-2013.

**TG DESIGNS**

THE MARK CONSISTS OF STANDARD CHARACTERS WITHOUT CLAIM TO ANY PARTICULAR FONT, STYLE, SIZE, OR COLOR.

NO CLAIM IS MADE TO THE EXCLUSIVE RIGHT TO USE "DESIGNS", APART FROM THE MARK AS SHOWN.

FOR PATIO UMBRELLAS AND UMBRELLA BASES (U.S. CLS. 1, 2, 3, 22 AND 41).

FIRST USE 2-0-1999; IN COMMERCE 2-0-1999.

KATHERINE E. HALMEN, EXAMINING ATTORNEY

**CLASS 18—(Continued).**

SN 86-040,347. GOODMAN, SCOTT, DANA POINT, CA. FILED 8-16-2013.

**Headlands Handmade**

THE MARK CONSISTS OF STANDARD CHARACTERS WITHOUT CLAIM TO ANY PARTICULAR FONT, STYLE, SIZE, OR COLOR.

NO CLAIM IS MADE TO THE EXCLUSIVE RIGHT TO USE "HANDMADE", APART FROM THE MARK AS SHOWN.

FOR WALLETS; CLUTCHES; TOILETRY KIT BAGS SOLD EMPTY (U.S. CLS. 1, 2, 3, 22 AND 41).

FIRST USE 11-1-2012; IN COMMERCE 11-1-2012.

MARYNELLE WILSON, EXAMINING ATTORNEY

SN 86-045,891. WINK & WINN GROUP LIMITED, HONG KONG, CHINA, FILED 8-23-2013.

**WINK & WINN**

THE MARK CONSISTS OF STANDARD CHARACTERS WITHOUT CLAIM TO ANY PARTICULAR FONT, STYLE, SIZE, OR COLOR.

FOR HANDBAGS, WALLETS, PURSES, CARRYING CASES, CARRY-ALL BAGS, SPORTS BAGS (U.S. CLS. 1, 2, 3, 22 AND 41).

SUNG IN, EXAMINING ATTORNEY

SN 86-048,301. FLATLINER BAGS, SAN LUIS OBISPO, CA. FILED 8-26-2013.

**Flatliner Bags**

THE MARK CONSISTS OF STANDARD CHARACTERS WITHOUT CLAIM TO ANY PARTICULAR FONT, STYLE, SIZE, OR COLOR.

NO CLAIM IS MADE TO THE EXCLUSIVE RIGHT TO USE "BAGS", APART FROM THE MARK AS SHOWN.

FOR BACKPACKS; BILLFOLDS; CLUTCHES; COIN PURSES; HANDBAGS; MAKE-UP BAGS SOLD EMPTY; MESSENGER BAGS; PURSES; SATCHELS; TOTE BAGS; WALLETS (U.S. CLS. 1, 2, 3, 22 AND 41).

COLLEEN DOMBROW, EXAMINING ATTORNEY

**CLASS 18—(Continued).**

SN 86-058,310. MI BRANDS, LLC, SAN FRANCISCO, CA. FILED 9-6-2013.

# MI

THE MARK CONSISTS OF STANDARD CHARACTERS WITHOUT CLAIM TO ANY PARTICULAR FONT, STYLE, SIZE, OR COLOR.

FOR BABY CARRIERS WORN ON THE BODY; BAGS FOR CARRYING BABIES SPECIALLY ADAPTED FOR BABY CARRIERS WORN ON THE BODY; BACKPACKS SPECIALLY ADAPTED FOR BABY CARRIERS WORN ON THE BODY; BABY SHOULDER BELT CARRIERS WORN ON THE BODY; BAGS FOR CARRYING BABIES' ACCESSORIES; ACCESSORIES FOR BABY CARRIERS WORN ON THE BODY, NAMELY, SUPPORTING BETS SPECIALLY ADAPTED FOR BABY CARRIERS WORN ON THE BODY, BOTTLE HOLDERS SPECIFICALLY ADAPTED FOR BABY CARRIERS WORN ON THE BODY, FANNY PACKS (U.S. CLS. 1, 2, 3, 22 AND 41).

CHERYL CLAYTON, EXAMINING ATTORNEY

SN 86-063,541. GOMEZ-TORRES, MARTA GUADALUPE, LEON, GUANAJUATO, MEXICO, AND COLLADO-LORNTZEN, MARIA ISABEL, LEON, GUANAJUATO, MEXICO, FILED 9-12-2013.

# ARBOL DE VIENTO

THE MARK CONSISTS OF STANDARD CHARACTERS WITHOUT CLAIM TO ANY PARTICULAR FONT, STYLE, SIZE, OR COLOR.

THE ENGLISH TRANSLATION OF "ARBOL DE VIENTO" IN THE MARK IS "TREE OF WIND".

FOR BACKPACKS, BOOK BAGS, SPORTS BAGS, BUM BAGS, WALLETS AND HANDBAGS; PURSES (U.S. CLS. 1, 2, 3, 22 AND 41).

FIRST USE 1-1-2010; IN COMMERCE 6-15-2012.

ARETHA SOMERVILLE, EXAMINING ATTORNEY

SN 86-064,327. KRAYZELBURG, LENNY, LOS ANGELES, CA. FILED 9-13-2013.

# SWIMRIGHT

THE MARK CONSISTS OF STANDARD CHARACTERS WITHOUT CLAIM TO ANY PARTICULAR FONT, STYLE, SIZE, OR COLOR.

FOR SPORTS BAGS, GENERAL PURPOSE BAGS, NAMELY, EQUIPMENT BAGS FOR CARRYING SPORTS EQUIPMENT, QUICK DRY BAGS (U.S. CLS. 1, 2, 3, 22 AND 41).

CHRISTINA SOBRAL, EXAMINING ATTORNEY

**CLASS 18—(Continued).**

SN 86-067,336. KIGER, KELLER, LOS ANGELES, CA. FILED 9-17-2013.

# KELLER KIGER

THE MARK CONSISTS OF STANDARD CHARACTERS WITHOUT CLAIM TO ANY PARTICULAR FONT, STYLE, SIZE, OR COLOR.

THE NAME "KELLER KIGER" IDENTIFIES A LIVING INDIVIDUAL WHOSE CONSENT IS OF RECORD.

FOR BACKPACKS, BOOK BAGS, SPORTS BAGS, BUM BAGS, WALLETS AND HANDBAGS (U.S. CLS. 1, 2, 3, 22 AND 41).

REBECCA POVARCHUK, EXAMINING ATTORNEY

SN 86-068,194. FUSION UNLIMITED, LLC, IRVINE, CA. FILED 9-18-2013.

# VISSLA

THE MARK CONSISTS OF STANDARD CHARACTERS WITHOUT CLAIM TO ANY PARTICULAR FONT, STYLE, SIZE, OR COLOR.

FOR BACKPACKS, DUFFEL BAGS, SUITCASES, SATCHELS, BRIEFCASES, TOTE BAGS, BEACH BAGS, ATHLETIC BAGS, WALLETS, COIN PURSES, CREDIT CARD CASES, FANNY PACKS, KEY CASES, TOILETRY BAGS SOLD EMPTY (U.S. CLS. 1, 2, 3, 22 AND 41).

AISHA CLARKE, EXAMINING ATTORNEY

SN 86-068,884. SERRANO, GERMAN J., MIAMI, FL. FILED 9-19-2013.

# CARD FORTRESS

THE MARK CONSISTS OF STANDARD CHARACTERS WITHOUT CLAIM TO ANY PARTICULAR FONT, STYLE, SIZE, OR COLOR.

NO CLAIM IS MADE TO THE EXCLUSIVE RIGHT TO USE "CARD", APART FROM THE MARK AS SHOWN.

FOR CARD PROTECTION DEVICES, NAMELY, CREDIT CARD AND BUSINESS CARD CASES (U.S. CLS. 1, 2, 3, 22 AND 41).

ANDREW LEASER, EXAMINING ATTORNEY



**CLASS 18—(Continued).**

SN 86-080,001. PARAMOUNT PICTURES CORPORATION, HOLLYWOOD, CA. FILED 10-1-2013.

JACK RYAN: SHADOW RECRUIT

THE MARK CONSISTS OF STANDARD CHARACTERS WITHOUT CLAIM TO ANY PARTICULAR FONT, STYLE, SIZE, OR COLOR.

THE NAME(S), PORTRAIT(S), AND/OR SIGNATURE(S) SHOWN IN THE MARK DOES NOT IDENTIFY A PARTICULAR LIVING INDIVIDUAL.

FOR ALL-PURPOSE CARRYING BAGS; ATHLETIC BAGS; BACKPACKS, BOOK BAGS, SPORTS BAGS, BUM BAGS, WALLETS AND HANDBAGS; CANVAS SHOPPING BAGS; CARRY-ON BAGS; DUFFEL BAGS; GYM BAGS; LEATHER AND IMITATION LEATHER BAGS; TOILETRY BAGS SOLD EMPTY; TOTE BAGS (U.S. CLS. 1, 2, 3, 22 AND 41).

AHSEN KHAN, EXAMINING ATTORNEY

SN 86-080,999. JONES INVESTMENT CO. INC., WILMINGTON, DE. FILED 10-2-2013.

GLO

THE MARK CONSISTS OF STANDARD CHARACTERS WITHOUT CLAIM TO ANY PARTICULAR FONT, STYLE, SIZE, OR COLOR.

OWNER OF U.S. REG. NOS. 3,731,417, 3,731,419 AND OTHERS.

THE NAME(S), PORTRAIT(S), AND/OR SIGNATURE(S) SHOWN IN THE MARK DOES NOT IDENTIFY A PARTICULAR LIVING INDIVIDUAL.

FOR HANDBAGS; WALLETS (U.S. CLS. 1, 2, 3, 22 AND 41).

EDWARD FENNESSY, EXAMINING ATTORNEY

SN 86-087,449. KAVU, INC., SEATTLE, WA. FILED 10-9-2013.

KAVU

THE MARK CONSISTS OF STANDARD CHARACTERS WITHOUT CLAIM TO ANY PARTICULAR FONT, STYLE, SIZE, OR COLOR.

FOR BACKPACKS, BOOK BAGS, SPORTS BAGS, BUM BAGS, WALLETS AND HANDBAGS (U.S. CLS. 1, 2, 3, 22 AND 41).

FIRST USE 2-1-2005; IN COMMERCE 6-1-2005.

KARANENDRA S. CHHINA, EXAMINING ATTORNEY

**CLASS 18—(Continued).**

SN 86-098,132. 24-7 INTERNATIONAL LLC, PINE BROOK, NJ. FILED 10-22-2013.

MONARCH

THE MARK CONSISTS OF STANDARD CHARACTERS WITHOUT CLAIM TO ANY PARTICULAR FONT, STYLE, SIZE, OR COLOR.

OWNER OF U.S. REG. NO. 1,235,291.

FOR TRAVEL BAGS (U.S. CLS. 1, 2, 3, 22 AND 41).

FIRST USE 1-1-1947; IN COMMERCE 1-1-1947.

ROBIN CHOSID, EXAMINING ATTORNEY

SN 86-120,991. BUDGE INDUSTRIES LLC, LANSDALE, PA. FILED 11-17-2013.

RUSTEC

THE MARK CONSISTS OF STANDARD CHARACTERS WITHOUT CLAIM TO ANY PARTICULAR FONT, STYLE, SIZE, OR COLOR.

FOR TOOL BAGS SOLD EMPTY FOR PROTECTING AGAINST CORROSION; ALL-PURPOSE CARRYING BAGS FOR PROTECTING AGAINST CORROSION (U.S. CLS. 1, 2, 3, 22 AND 41).

KATHY WANG, EXAMINING ATTORNEY

SN 86-137,422. O'DONNELL, LAURA MARIE, HERMOSA BEACH, CA. FILED 12-6-2013.



THE MARK CONSISTS OF THE WORD "ZALA". THE MARK IS STYLIZED SUCH THAT THE LETTER "Z" IS LARGER THAN THE OTHER LETTERS IN THE MARK, AND THE LETTERS "ALA" APPEAR ABOVE THE LOWER HORIZONTAL PORTION OF THE LETTER "Z".

FOR PURSES (U.S. CLS. 1, 2, 3, 22 AND 41).

APRIL REEVES, EXAMINING ATTORNEY

**CLASS 19—NON-METALLIC BUILDING MATERIALS**

SN 76-713,298. CONCRETE FORMS LTD., ONTARI, CANADA, FILED 1-25-2013.

**CLASS 19—(Continued).**

SN 79-133,289. SAS PREFABRICADOS DE HORMIGON, S.A., SPAIN, FILED 2-22-2013.



OWNER OF U.S. REG. NOS. 2,960,156 AND 2,971,523.  
NO CLAIM IS MADE TO THE EXCLUSIVE RIGHT TO USE "INSULATED CONCRETE FORMS", APART FROM THE MARK AS SHOWN.

THE MARK CONSISTS OF THE STYLIZED WORDING "LOGIX INSULATED CONCRETE FORMS" ABOVE THE SMALLER WORDING "D-R-V" WHICH IS BETWEEN TWO HORIZONTAL LINES.

FOR EXTERIOR WALL PANELS MADE OF EXPANDED POLYSTYRENE WHICH FORM A WATER AND RAIN BARRIER AND INCREASE THE INSULATION RATING OF THE WALL (U.S. CLS. 1, 12, 33 AND 50).

MICHAEL ENGEL, EXAMINING ATTORNEY



OWNER OF INTERNATIONAL REGISTRATION 1168437 DATED 2-22-2013, EXPIRES 2-22-2023.

THE COLOR(S) DARK GRAY, LIGHT GRAY AND RED IS/ARE CLAIMED AS A FEATURE OF THE MARK.

THE MARK CONSISTS OF A DARK GRAY SQUARE CONTAINING A LIGHT GRAY HALF CIRCLE IN THE BOTTOM PORTION WITH THE LETTERS "SAS" IN RED TRANPOSED OVER THE HALF CIRCLE.

FOR PREFABRICATED BUILDING PARTS OF CONCRETE, NAMELY, PILLARS, BALUSTRADES, FENCE POSTS, SWIMMING POOL COPING, CHIMNEYS, CHIMNEY CAPS AND VENTS, STEPPING STONES, NONMETAL IN-GROUND WATER RUN-OFF BASINS, PAVERS, TILES, WINDOW SILLS, GUTTERS, MOULDINGS, LOUVERS FOR GUIDING LIGHT, WINDOW PANELS, SUPPORT BLOCKS, ARCH TILES, VENTILATION BLOCKS, CORBELS, CONCRETE BASES IN THE NATURE OF CONCRETE BLOCKS AND CONCRETE PILES; BALUSTRADING; COLUMNS AND PEDESTALS NOT OF METAL, NAMELY, PRE-FABRICATED NONMETAL ARCHITECTURAL COLUMNS, BUILDING MATERIALS IN THE NATURE OF CONCRETE PEDESTALS FOR ELEVATING PAVERS; PARTS NOT OF METAL FOR THE CONSTRUCTION OF LARGE WINDOWS AND JALOUSIES, NAMELY, NON-METAL WINDOW CASEMENTS AND SILLS, NON-METAL WINDOW FRAMES; SMALL CEMENT BONDED PARTICLE BOARD FOR TILING AND PAVING; CHIMNEYS, NOT OF METAL; CHIMNEY COWLS, NOT OF METAL; STATIC EXTRACTORS FOR CHIMNEYS NOT OF METAL, NAMELY, NONMETAL CHIMNEY CAPS, NON-METAL CHIMNEY COWLS AND VENTS; NON-METALLIC COVERS FOR SWIMMING POOLS, NAMELY, NON-METALLIC FITTED SWIMMING POOL COVERS; NON-METALLIC MOLDINGS FOR CORNICES, NAMELY, NON-METAL ARCHITECTURAL MOLDINGS; GARGOYLES, NAMELY, STATUES OF STONE, CONCRETE OR MARBLE; PILLARS, PILLAR COVERS AND WALL COVERS, NOT OF METAL, NAMELY, NON-METAL PILLARS FOR BUILDINGS, NON-METAL PILLAR COVERS FOR BUILDINGS, NON-METAL WALL TILES (U.S. CLS. 1, 12, 33 AND 50).

TINA BROWN, EXAMINING ATTORNEY

**CLASS 19—(Continued).**

SN 79-135,848. JINJIANG HENGXIN CERAMICS CO.,LTD, CHINA, FILED 8-7-2013.



OWNER OF INTERNATIONAL REGISTRATION 1174852 DATED 8-7-2013, EXPIRES 8-7-2023.

THE MARK CONSISTS OF A CIRCLE WITH A DISCONNECTED "X" IN IT, AND TWO CHINESE CHARACTERS AND THAT TRANSLITERATE TO "XIN" AND "YUAN" MEANING "PROSPERITY" AND "SOURCE" WITH THE WORD "XINYUAN" WRITTEN IN LATIN CHARACTERS DIRECTLY BELOW.

THE ENGLISH TRANSLATION OF THE NON-LATIN CHARACTERS IN THE MARK IS "PROSPERITY" AND "SOURCE".

THE NON-LATIN CHARACTERS IN THE MARK TRANSLITERATE TO "XIN" AND "YUAN".

FOR BRICKS; CERAMIC WALL TILES AND FLOOR TILES; CERAMIC TILES FOR BUILDING; TILES, NAMELY, GLASS TILES, NATURAL STONE TILES, PAVING TILES; CEMENT BRICKS; CEMENT TILES; TERRAZOS BEING TERRA COTTA BUILDING MATERIAL (U.S. CLS. 1, 12, 33 AND 50).

JACLYN KIDWELL WALKER, EXAMINING ATTORNEY

SN 85-563,873. TOWER IPCO COMPANY LIMITED, DUBLIN 2, IRELAND, FILED 3-8-2012.

# ASPIRE

THE MARK CONSISTS OF STANDARD CHARACTERS WITHOUT CLAIM TO ANY PARTICULAR FONT, STYLE, SIZE, OR COLOR.

FOR VINYL FLOORING (U.S. CLS. 1, 12, 33 AND 50).  
ELI HELLMAN, EXAMINING ATTORNEY

**CLASS 19—(Continued).**

SN 85-826,961. V-T INDUSTRIES, INC., HOLSTEIN, IA, FILED 1-18-2013.

# GENEVA

THE MARK CONSISTS OF STANDARD CHARACTERS WITHOUT CLAIM TO ANY PARTICULAR FONT, STYLE, SIZE, OR COLOR.

FOR BUILDING MATERIALS, NAMELY, NON-METAL COUNTERTOPS AND ALL ASSOCIATED EDGE PROFILES (U.S. CLS. 1, 12, 33 AND 50).

FIRST USE 12-0-2007; IN COMMERCE 12-0-2007.  
MAYUR VAGHANI, EXAMINING ATTORNEY

SN 85-866,153. SIGNAL MOUNTAIN CEMENT COMPANY, BETHLEHEM, PA. FILED 3-4-2013.

## SIGNAL MOUNTAIN CEMENT

THE MARK CONSISTS OF STANDARD CHARACTERS WITHOUT CLAIM TO ANY PARTICULAR FONT, STYLE, SIZE, OR COLOR.

NO CLAIM IS MADE TO THE EXCLUSIVE RIGHT TO USE "CEMENT", APART FROM THE MARK AS SHOWN.

SEC. 2(F).

FOR CEMENT, HYDRAULIC CEMENT, MASONRY CEMENT, MORTAR CEMENT, OIL WELL CEMENT, SLAG CEMENT, BLENDED HYDRAULIC CEMENT AND CEMENT BEING NONMETALLIC CEMENTITIOUS MATERIAL FOR CONSTRUCTION AND BUILDING PURPOSES (U.S. CLS. 1, 12, 33 AND 50).

FIRST USE 9-30-1940; IN COMMERCE 9-30-1940.  
COLLEEN KEARNEY, EXAMINING ATTORNEY

SN 85-931,447. UNILIN FLOORING NC, LLC, CALHOUN, GA. FILED 5-14-2013.

# GRANITE HILLS

THE MARK CONSISTS OF STANDARD CHARACTERS WITHOUT CLAIM TO ANY PARTICULAR FONT, STYLE, SIZE, OR COLOR.

FOR HARDWOOD FLOORING (U.S. CLS. 1, 12, 33 AND 50).

C. DIONNE CLYBURN, EXAMINING ATTORNEY

**CLASS 19—(Continued).**

SN 85-931,469. UNILIN FLOORING NC, LLC, CALHOUN, GA. FILED 5-14-2013.

**GREENVILLE**

THE MARK CONSISTS OF STANDARD CHARACTERS WITHOUT CLAIM TO ANY PARTICULAR FONT, STYLE, SIZE, OR COLOR.

FOR HARDWOOD FLOORING (U.S. CLS. 1, 12, 33 AND 50).

C. DIONNE CLYBURN, EXAMINING ATTORNEY

SN 85-931,492. UNILIN FLOORING NC, LLC, CALHOUN, GA. FILED 5-14-2013.

**DANVILLE**

THE MARK CONSISTS OF STANDARD CHARACTERS WITHOUT CLAIM TO ANY PARTICULAR FONT, STYLE, SIZE, OR COLOR.

FOR HARDWOOD FLOORING (U.S. CLS. 1, 12, 33 AND 50).

C. DIONNE CLYBURN, EXAMINING ATTORNEY

SN 85-966,065. PATERSON, GWAIN, BIRMINGHAM, UNITED KINGDOM, FILED 6-21-2013.



**Thermobar**  
Warm Edge Spacer Tube

OWNER OF ERPN CMNTY TM OFC REG. NO. 009400136, DATED 2-4-2011, EXPIRES 9-24-2020.

OWNER OF U.S. REG. NO. 4,396,544.

NO CLAIM IS MADE TO THE EXCLUSIVE RIGHT TO USE "WARM EDGE SPACER TUBE", APART FROM THE MARK AS SHOWN.

THE COLOR(S) BLACK, GREEN, AND WHITE IS/ARE CLAIMED AS A FEATURE OF THE MARK.

THE MARK CONSISTS OF A ROUNDED SQUARE SHAPE OUTLINED IN BLACK AND COLORED GREEN, WITH THE COLOR WHITE APPEARING IN AN OUTLINE AND A CORNER DESIGN WITH THREE WAVY LINES POINTING TO THE CORNER; THE SQUARE SHAPE APPEARS TO BE FLOATING ABOVE THE GROUND AS A BLACK SHADOW IS UNDERNEATH; UNDER THE DESIGN IS THE WORD "THERMOBAR" WITH "THERMO" IN BLACK AND "BAR" IN GREEN; AND UNDER THIS ARE THE WORDS "WARM EDGE SPACER TUBE" IN BLACK.

FOR NON-METALLIC BUILDING MATERIALS, NAMELY, FOR WINDOWS; NON-METALLIC RIGID PIPES FOR BUILDING (U.S. CLS. 1, 12, 33 AND 50).

KYLE PEETE, EXAMINING ATTORNEY

**CLASS 19—(Continued).**

SN 86-028,515. PUPPY IN MOTION LLC, DBA PUPPY IN MOTION, SAN DIEGO, CA. FILED 8-5-2013.

**Puppy On Board**

THE MARK CONSISTS OF STANDARD CHARACTERS WITHOUT CLAIM TO ANY PARTICULAR FONT, STYLE, SIZE, OR COLOR.

FOR NON-LUMINOUS, NON-MECHANICAL SIGNS NOT OF METAL, NAMELY, PLASTIC NOVELTY SIGNS (U.S. CLS. 1, 12, 33 AND 50).

FIRST USE 4-25-2013; IN COMMERCE 6-25-2013.

CHARLOTTE CORWIN, EXAMINING ATTORNEY

SN 86-028,529. ROYAL LINE, LLC, WANTAGH, NY. FILED 8-5-2013.

**Solar Scapes**

THE MARK CONSISTS OF STANDARD CHARACTERS WITHOUT CLAIM TO ANY PARTICULAR FONT, STYLE, SIZE, OR COLOR.

NO CLAIM IS MADE TO THE EXCLUSIVE RIGHT TO USE "SOLAR", APART FROM THE MARK AS SHOWN.

FOR NON-METAL DECKING (U.S. CLS. 1, 12, 33 AND 50).

LOURDES AYALA, EXAMINING ATTORNEY

SN 86-033,635. TILE REDI, LLC, CORAL SPRINGS, FL. FILED 8-9-2013.

**FINISH IT IN STYLE!**

THE MARK CONSISTS OF STANDARD CHARACTERS WITHOUT CLAIM TO ANY PARTICULAR FONT, STYLE, SIZE, OR COLOR.

FOR NON-METAL FLOOR AND WALL TILES (U.S. CLS. 1, 12, 33 AND 50).

PARKER HOWARD, EXAMINING ATTORNEY

**CLASS 19—(Continued).**

SN 86-033,637. TILE REDI, LLC, CORAL SPRINGS, FL. FILED 8-9-2013.

# Redi Tile

THE MARK CONSISTS OF STANDARD CHARACTERS WITHOUT CLAIM TO ANY PARTICULAR FONT, STYLE, SIZE, OR COLOR.

OWNER OF U.S. REG. NOS. 3,150,380, 3,971,537 AND OTHERS.

NO CLAIM IS MADE TO THE EXCLUSIVE RIGHT TO USE "TILE", APART FROM THE MARK AS SHOWN.

FOR NON-METAL FLOOR AND WALL TILES (U.S. CLS. 1, 12, 33 AND 50).

PARKER HOWARD, EXAMINING ATTORNEY

**CLASS 19—(Continued).**

SN 86-061,986. EMSER TILE LLC, LOS ANGELES, CA. FILED 9-11-2013.

# BAJA

THE MARK CONSISTS OF STANDARD CHARACTERS WITHOUT CLAIM TO ANY PARTICULAR FONT, STYLE, SIZE, OR COLOR.

FOR PORCELAIN TILE (U.S. CLS. 1, 12, 33 AND 50).

FIRST USE 6-0-2013; IN COMMERCE 6-0-2013.

SUSAN RICHARDS, EXAMINING ATTORNEY

SN 86-039,192. FENCESCREEN, INC., LAKE FOREST, CA. FILED 8-15-2013.



NO CLAIM IS MADE TO THE EXCLUSIVE RIGHT TO USE "FENCESCREEN .COM", APART FROM THE MARK AS SHOWN.

THE COLOR(S) BLUE AND GRAY IS/ARE CLAIMED AS A FEATURE OF THE MARK.

THE MARK CONSISTS OF THE STYLIZED LETTERS "FS" IN BLUE APPEARING ABOVE THE STYLIZED WORD "FENCESCREEN" IN GRAY AND BLUE. UNDERNEATH FENCESCREEN IS THE STYLIZED WORD .COM IN GRAY.

FOR NONMETAL WIND PROTECTION SCREENS FOR FENCES; NON-METAL SCREENS FOR FENCES (U.S. CLS. 1, 12, 33 AND 50).

FIRST USE 0-0-2002; IN COMMERCE 0-0-2002.

ELIZABETH KAJUBI, EXAMINING ATTORNEY

SN 86-062,057. AVON PLASTICS, INC., DBA MASTER MARK PLASTICS, ALBANY, MN. FILED 9-11-2013.

ARMADILLO ARMORED AGAINST  
THE ELEMENTS

THE MARK CONSISTS OF STANDARD CHARACTERS WITHOUT CLAIM TO ANY PARTICULAR FONT, STYLE, SIZE, OR COLOR.

OWNER OF U.S. REG. NO. 4,256,341.

FOR COMPOSITE BUILDING MATERIALS, NAMELY, DECKING, BOARDS AND RAILINGS COMPOSED PRIMARILY OF RECYCLED WOOD AND RECYCLED PLASTIC (U.S. CLS. 1, 12, 33 AND 50).

FIRST USE 1-1-2012; IN COMMERCE 1-1-2012.

SUSAN RICHARDS, EXAMINING ATTORNEY

SN 86-044,648. DALTON ENTERPRISES, INC., CHESHIRE, CT. FILED 8-21-2013.

# RE-DRIVE

THE MARK CONSISTS OF STANDARD CHARACTERS WITHOUT CLAIM TO ANY PARTICULAR FONT, STYLE, SIZE, OR COLOR.

FOR BITUMEN-BASED SEALANTS FOR ASPHALT (U.S. CLS. 1, 12, 33 AND 50).

KIMBERLY FRYE, EXAMINING ATTORNEY

SN 86-062,161. AVON PLASTICS, INC., DBA MASTER MARK PLASTICS, ALBANY, MN. FILED 9-11-2013.



ARMORED AGAINST THE ELEMENTS

OWNER OF U.S. REG. NO. 4,256,341.

THE MARK CONSISTS OF THE WORD "ARMADILLO" POSITIONED ABOVE THE WORDS "ARMORED AGAINST THE ELEMENTS" SEPARATED BY A HORIZONTAL LINE WITH THE LETTER "O" IN "ARMADILLO" COMPRISED OF AN ARMADILLO.

FOR COMPOSITE BUILDING MATERIALS, NAMELY, DECKING, BOARDS AND RAILINGS COMPOSED PRIMARILY OF RECYCLED WOOD AND RECYCLED PLASTIC (U.S. CLS. 1, 12, 33 AND 50).

FIRST USE 1-1-2012; IN COMMERCE 1-1-2012.

SUSAN RICHARDS, EXAMINING ATTORNEY

**CLASS 19—(Continued).**

SN 86-067,055. H.B. FULLER CONSTRUCTION PRODUCTS INC., SAINT PAUL, MN. FILED 9-17-2013.

# DESIGNFX

THE MARK CONSISTS OF STANDARD CHARACTERS WITHOUT CLAIM TO ANY PARTICULAR FONT, STYLE, SIZE, OR COLOR.  
OWNER OF U.S. REG. NO. 4,116,303.  
FOR GROUT (U.S. CLS. 1, 12, 33 AND 50).  
SKYE YOUNG, EXAMINING ATTORNEY

**CLASS 19—(Continued).**

SN 86-068,869. OWENS CORNING INTELLECTUAL CAPITAL, LLC, TOLEDO, OH. FILED 9-19-2013.

# DEVONSHIRE

THE MARK CONSISTS OF STANDARD CHARACTERS WITHOUT CLAIM TO ANY PARTICULAR FONT, STYLE, SIZE, OR COLOR.  
FOR NON-METAL SHINGLES (U.S. CLS. 1, 12, 33 AND 50).  
REGINA DRUMMOND, EXAMINING ATTORNEY

SN 86-067,825. LEISURE POOLS INTERNATIONAL LIMITED, NEW BRAUNFELS, TX. FILED 9-18-2013.

# MOROCCAN STYLE

THE MARK CONSISTS OF STANDARD CHARACTERS WITHOUT CLAIM TO ANY PARTICULAR FONT, STYLE, SIZE, OR COLOR.  
OWNER OF U.S. REG. NO. 3,295,854.  
SEC. 2(F).  
FOR NON-METAL SWIMMING POOLS (U.S. CLS. 1, 12, 33 AND 50).  
FIRST USE 1-1-2003; IN COMMERCE 1-1-2003.  
RICHARD WHITE, EXAMINING ATTORNEY

SN 86-069,754. LONE STAR STONE OF TEXAS, INC., WHITNEY, TX 76692, TX. FILED 9-19-2013.

# BUBBA SIZED

THE MARK CONSISTS OF STANDARD CHARACTERS WITHOUT CLAIM TO ANY PARTICULAR FONT, STYLE, SIZE, OR COLOR.  
FOR MANUFACTURED STONE FEATURING BRICK-LIKE INSTALLATION CHARACTERISTICS FOR BUILDING AND CONSTRUCTION (U.S. CLS. 1, 12, 33 AND 50).  
TEJBIR SINGH, EXAMINING ATTORNEY

SN 86-067,983. UA WOOD FLOORS, INC., DOULIOU CITY 640, TAIWAN, FILED 9-18-2013.

# UA+YOU

THE MARK CONSISTS OF THE LETTERS "UA" AND THE WORD "YOU" JOINED BY A "+" SYMBOL.  
FOR NON-METAL FLOORS (U.S. CLS. 1, 12, 33 AND 50).  
FIRST USE 11-1-2011; IN COMMERCE 11-1-2011.  
NORA BUCHANAN WILL, EXAMINING ATTORNEY

SN 86-069,760. LONE STAR STONE OF TEXAS, INC., WHITNEY, TX 76692, TX. FILED 9-19-2013.

# LIBERTY CLASSIC BRICK

THE MARK CONSISTS OF STANDARD CHARACTERS WITHOUT CLAIM TO ANY PARTICULAR FONT, STYLE, SIZE, OR COLOR.  
OWNER OF U.S. REG. NO. 2,825,056.  
NO CLAIM IS MADE TO THE EXCLUSIVE RIGHT TO USE "CLASSIC BRICK", APART FROM THE MARK AS SHOWN.  
FOR MANUFACTURED STONE FEATURING BRICK-LIKE INSTALLATION CHARACTERISTICS FOR BUILDING AND CONSTRUCTION (U.S. CLS. 1, 12, 33 AND 50).  
TEJBIR SINGH, EXAMINING ATTORNEY

**CLASS 19—(Continued).**

SN 86-070,054. AGRU/AMERICA, INC., GEORGETOWN, SC.  
FILED 9-20-2013.

# MINE-LINE

THE MARK CONSISTS OF STANDARD CHARACTERS WITHOUT CLAIM TO ANY PARTICULAR FONT, STYLE, SIZE, OR COLOR.

FOR NON-METAL PIPE COUPLINGS AND JOINTS; NON-METAL PIPE FITTINGS; PIPE FITTINGS COMPRISED PRIMARILY OF PLASTIC; PIPES OF HIGH DENSITY POLYETHYLENE WITH AN ABRASIVE RESISTANT INNER LAYER FOR USE IN SLURRY LINES AND OTHER INSTALLATIONS FOR TRANSPORTING AN ABRASIVE EFFLUENT; RIGID PIPES, NOT OF METAL (U.S. CLS. 1, 12, 33 AND 50).  
SAIMA MAKHDOOM, EXAMINING ATTORNEY

**CLASS 19—(Continued).**

SN 86-071,308. TIMBERWOLF HARDWOODS, LLC, EASTON, MD. FILED 9-22-2013.



OWNER OF U.S. REG. NO. 4,160,082.

THE MARK CONSISTS OF THE LETTERS "TWG" WITH 10 DOTS IN A SEMI-CIRCLE AROUND THE LETTER T.  
FOR BUILDING MATERIALS, NAMELY, HARDWOOD BOARDS (U.S. CLS. 1, 12, 33 AND 50).  
KHANH LE, EXAMINING ATTORNEY

SN 86-070,771. LONE STAR STONE OF TEXAS, INC., WHITNEY, TX 76692, TX. FILED 9-20-2013.



OWNER OF U.S. REG. NO. 2,825,056.

NO CLAIM IS MADE TO THE EXCLUSIVE RIGHT TO USE "CLASSIC BRICK", APART FROM THE MARK AS SHOWN.

THE MARK CONSISTS OF UNDERLINED WORD "LIBERTY": SAID UNDERLYING DIVIDED IN HALF BY "CLASSIC BRICK". FOUR RECTANGLES SEPARATED BY A SQUARE LOCATED ABOVE "LIBERTY".

FOR MANUFACTURED STONE FEATURING BRICK-LIKE INSTALLATION CHARACTERISTICS FOR BUILDING AND CONSTRUCTION (U.S. CLS. 1, 12, 33 AND 50).  
TEJBIR SINGH, EXAMINING ATTORNEY

SN 86-071,606. AGRU/AMERICA, INC., GEORGETOWN, SC. FILED 9-23-2013.

# SURELINE

THE MARK CONSISTS OF STANDARD CHARACTERS WITHOUT CLAIM TO ANY PARTICULAR FONT, STYLE, SIZE, OR COLOR.

FOR RIGID POLYETHYLENE PIPES FOR NATURAL GAS, POTABLE WATER AND SEWAGE LINES, ALL COLOR CODED TO IDENTIFY TYPE OF MATERIAL CARRIED IN PIPE (U.S. CLS. 1, 12, 33 AND 50).

SAIMA MAKHDOOM, EXAMINING ATTORNEY

SN 86-070,870. U.S. SILICA COMPANY, FREDERICK, MD. FILED 9-20-2013.

# TERE-SIL

THE MARK CONSISTS OF STANDARD CHARACTERS WITHOUT CLAIM TO ANY PARTICULAR FONT, STYLE, SIZE, OR COLOR.

FOR GROUND SILICA SAND; SAND (U.S. CLS. 1, 12, 33 AND 50).

MORGAN WYNNE, EXAMINING ATTORNEY

SN 86-086,972. INVISTA NORTH AMERICA S. À R.L., WICHITA, KS. FILED 10-9-2013.

# ARMADYL

THE MARK CONSISTS OF STANDARD CHARACTERS WITHOUT CLAIM TO ANY PARTICULAR FONT, STYLE, SIZE, OR COLOR.

FOR RIGID PIPES, NOT OF METAL (U.S. CLS. 1, 12, 33 AND 50).

TAMARA FRAZIER, EXAMINING ATTORNEY

**CLASS 19—(Continued).**

SN 86-088,902. AVON PLASTICS, INC., DBA MASTER MARK PLASTICS, ALBANY, MN. FILED 10-10-2013.

**ARMADILLO TILE**

THE MARK CONSISTS OF STANDARD CHARACTERS WITHOUT CLAIM TO ANY PARTICULAR FONT, STYLE, SIZE, OR COLOR.

NO CLAIM IS MADE TO THE EXCLUSIVE RIGHT TO USE "TILE", APART FROM THE MARK AS SHOWN.

FOR NON-METAL FLOOR TILES, NON-METAL TILES FOR USE IN ATHLETIC AND RECREATIONAL PLAY SURFACES (U.S. CLS. 1, 12, 33 AND 50).

SUSAN RICHARDS, EXAMINING ATTORNEY

SN 86-093,158. RAYNOR MFG. CO., DIXON, IL. FILED 10-16-2013.

**RAPIDCOIL**

THE MARK CONSISTS OF STANDARD CHARACTERS WITHOUT CLAIM TO ANY PARTICULAR FONT, STYLE, SIZE, OR COLOR.

FOR INDUSTRIAL TRAFFIC IMPACT DOOR MADE PRIMARILY OF FLEXIBLE NON-METAL CURTAIN (U.S. CLS. 1, 12, 33 AND 50).

REBECCA SMITH, EXAMINING ATTORNEY

SN 86-097,712. NORANDEX BUILDING MATERIALS DISTRIBUTION, INC., HUDSON, OH. FILED 10-22-2013.

**NORANDEX**  
**extreme**

OWNER OF U.S. REG. NO. 1,891,085.  
THE MARK CONSISTS OF THE WORD "NORANDEX" AND "EXTREME" STYLIZED.

FOR NON-METAL BUILDING MATERIALS, NAMELY, NON-METAL WINDOWS; NON-METAL WINDOW FRAMES AND CASINGS (U.S. CLS. 1, 12, 33 AND 50).

ANDREA BUTLER, EXAMINING ATTORNEY

**CLASS 19—(Continued).**

SN 86-123,688. DALTON ENTERPRISES, INC., CHESHIRE, CT. FILED 11-20-2013.

**AIRPORT EXTREME**

THE MARK CONSISTS OF STANDARD CHARACTERS WITHOUT CLAIM TO ANY PARTICULAR FONT, STYLE, SIZE, OR COLOR.

OWNER OF U.S. REG. NOS. 1,770,070, 1,776,540 AND 1,778,954.

SEC. 2(F) AS TO "AIRPORT".

FOR BITUMEN-BASED SEALANTS FOR ASPHALT DRIVEWAYS (U.S. CLS. 1, 12, 33 AND 50).

KIMBERLY FRYE, EXAMINING ATTORNEY

SN 86-137,398. OWENS CORNING INTELLECTUAL CAPITAL, LLC, TOLEDO, OH. FILED 12-6-2013.

**TRUBLACK**

THE MARK CONSISTS OF STANDARD CHARACTERS WITHOUT CLAIM TO ANY PARTICULAR FONT, STYLE, SIZE, OR COLOR.

FOR ASPHALT (U.S. CLS. 1, 12, 33 AND 50).

REGINA DRUMMOND, EXAMINING ATTORNEY

**CLASS 20—FURNITURE AND ARTICLES NOT OTHERWISE CLASSIFIED**

SN 79-129,070. OPIUM CO. PTE. LTD, SINGAPORE, FILED 2-7-2013.

**OPIUM**

THE MARK CONSISTS OF STANDARD CHARACTERS WITHOUT CLAIM TO ANY PARTICULAR FONT, STYLE, SIZE, OR COLOR.

OWNER OF INTERNATIONAL REGISTRATION 1157609 DATED 2-7-2013, EXPIRES 2-7-2023.

FOR MODULAR FURNITURE; DISPLAY UNITS; SHELVING AND STORAGE SYSTEMS COMPRISING SHELVES, DISPLAY CASES AND CLOTHES RODS, SOLD AS A UNIT; FITTINGS THEREFOR, NAMELY, SHELVES, BRACKETS, WALL MOUNTINGS, AND SUPPORT ARMS, ALL OF WHICH ARE SOLD AS A UNIT WITH MODULAR FURNITURE, DISPLAY UNITS, AND SHELVING AND STORAGE SYSTEMS COMPRISING SHELVES, DISPLAY CASES AND CLOTHES RODS, SOLD AS A UNIT (U.S. CLS. 2, 13, 22, 25, 32 AND 50).

ALICE BENMAMAN, EXAMINING ATTORNEY



**CLASS 20—(Continued).**

SN 85-580,199. ACTIWIN COMPANY LIMITED, MISSISSAUGA, ONTARIO, CANADA, FILED 3-26-2012.

# SOLWEAVE

THE MARK CONSISTS OF STANDARD CHARACTERS WITHOUT CLAIM TO ANY PARTICULAR FONT, STYLE, SIZE, OR COLOR.

PRIORITY CLAIMED UNDER SEC. 44(D) ON CANADA APPLICATION NO. 1567366, FILED 3-9-2012, REG. NO. TMA855350, DATED 7-16-2013, EXPIRES 7-16-2028.

FOR OUTDOOR FURNITURE AND CUSHIONS (U.S. CLS. 2, 13, 22, 25, 32 AND 50).

WILLIAM P. SHANAHAN, EXAMINING ATTORNEY

---

SN 85-760,790. ARTSANA S.P.A., GRANDATE, COMO, ITALY, FILED 10-23-2012.

# LULLAGO

THE MARK CONSISTS OF STANDARD CHARACTERS WITHOUT CLAIM TO ANY PARTICULAR FONT, STYLE, SIZE, OR COLOR.

PRIORITY CLAIMED UNDER SEC. 44(D) ON ERP CMNTY TM OFC APPLICATION NO. 01182117, FILED 10-19-2012, REG. NO. 011821177, DATED 9-18-2013, EXPIRES 10-19-2022.

FOR COTS, CRADLES, BEDS; BEDROOM FURNITURE FOR INFANTS, BABIES AND CHILDREN (U.S. CLS. 2, 13, 22, 25, 32 AND 50).

ELI HELLMAN, EXAMINING ATTORNEY

---

SN 85-806,056. RAPID RACK INDUSTRIES, INC., CITY OF INDUSTRY, CA. FILED 12-18-2012.

# GORILLA CLAWS

THE MARK CONSISTS OF STANDARD CHARACTERS WITHOUT CLAIM TO ANY PARTICULAR FONT, STYLE, SIZE, OR COLOR.

OWNER OF U.S. REG. NOS. 2,422,507, 4,031,911 AND OTHERS.

FOR STORAGE RACK ACCESSORIES, NAMELY, METAL HOOKS AND METAL WIRE BASKETS SPECIALLY ADAPTED FOR ATTACHMENT TO BOLTLESS METAL STORAGE RACKS (U.S. CLS. 2, 13, 22, 25, 32 AND 50).

KATHLEEN KOLACZ, EXAMINING ATTORNEY

**CLASS 20—(Continued).**

SN 85-832,059. BV FURNITURE, INC., NEW YORK, NY. FILED 1-25-2013.

NO CLAIM IS MADE TO THE EXCLUSIVE RIGHT TO USE "INTERLOCKING FURNITURE", APART FROM THE MARK AS SHOWN.

THE COLOR(S) BLACK AND RED IS/ARE CLAIMED AS A FEATURE OF THE MARK.

THE MARK CONSISTS OF THE LITERAL ELEMENTS "NOTCH & LOCK INTERLOCKING FURNITURE" WRITTEN IN STYLIZED FORM AND CONNECTED WITH EACH OTHER WITH A SMALL LINES WHEREIN THE WORD "NOTCH" IS WRITTEN IN RED COLOR, AND "& LOCK INTERLOCKING FURNITURE" IS WRITTEN IN BLACK COLOR. THE LITERAL ELEMENTS "INTERLOCKING FURNITURE" ARE WRITTEN BELOW ON LEFT SIDE OF THE WORDS "NOTCH & LOCK" AS SHOWN IN THE MARK. THE COLOR WHITE IS EMPLOYED MERELY AS BACKGROUND.

FOR FURNITURE THAT CAN BE ASSEMBLED AND DISASSEMBLED (U.S. CLS. 2, 13, 22, 25, 32 AND 50).

DOMINICK J. SALEMI, EXAMINING ATTORNEY

---

SN 85-852,519. KOHLER CO., KOHLER, WI. FILED 2-18-2013.

# VERDERA

THE MARK CONSISTS OF STANDARD CHARACTERS WITHOUT CLAIM TO ANY PARTICULAR FONT, STYLE, SIZE, OR COLOR.

FOR FURNITURE; MIRRORS; BATHROOM VANITY UNITS; MEDICINE CABINETS; CABINETS; CONSOLE TABLES; CONSOLE TABLE LEGS; BATHROOM VANITIES CONTAINING COUNTERTOPS (U.S. CLS. 2, 13, 22, 25, 32 AND 50).

CAROLINE WOOD, EXAMINING ATTORNEY

---

SN 85-854,603. KOHLER CO., KOHLER, WI. FILED 2-20-2013.

# RECEPTION

THE MARK CONSISTS OF STANDARD CHARACTERS WITHOUT CLAIM TO ANY PARTICULAR FONT, STYLE, SIZE, OR COLOR.

FOR FURNITURE; MIRRORS; BATHROOM VANITY UNITS; MEDICINE CABINETS; CABINETS; CONSOLE TABLES; CONSOLE TABLE LEGS; BATHROOM VANITIES CONTAINING COUNTERTOPS (U.S. CLS. 2, 13, 22, 25, 32 AND 50).

CAROLINE WOOD, EXAMINING ATTORNEY

**CLASS 20—(Continued).**

SN 85-856,374. TAEGU CITY, TAEGU CITY, REPUBLIC OF KOREA, FILED 2-21-2013.



THE MARK CONSISTS OF A STYLIZED "C" LIKE DESIGN HAVING AN UPPER SECTION COMPOSED OF THREE HORIZONTALLY EXTENDING BARS EACH BEING VERTICALLY DISPLACED FROM THE OTHER.

FOR FURNITURE; INDOOR VENETIAN BLINDS; SCULPTURES MADE OF WOOD (U.S. CLS. 2, 13, 22, 25, 32 AND 50).

ASMAT KHAN, EXAMINING ATTORNEY

**CLASS 20—(Continued).**

SN 85-887,246. DISNEY ENTERPRISES, INC., BURBANK, CA. FILED 3-26-2013.

## OLIVIA POPE

THE MARK CONSISTS OF STANDARD CHARACTERS WITHOUT CLAIM TO ANY PARTICULAR FONT, STYLE, SIZE, OR COLOR.

THE NAME(S), PORTRAIT(S), AND/OR SIGNATURE(S) SHOWN IN THE MARK DOES NOT IDENTIFY A PARTICULAR LIVING INDIVIDUAL.

FOR CUSHIONS; DECORATIVE GLITTER; DECORATIVE MOBILES; FIGURINES AND STATUETTES MADE OF PLASTER; FIGURINES AND STATUETTES MADE OF PLASTIC; FIGURINES AND STATUETTES MADE OF WAX; FIGURINES AND STATUETTES MADE OF WOOD; FLAGPOLES; FURNITURE; GIFT PACKAGE DECORATIONS MADE OF PLASTIC; HAND FANS; KEY FOBS NOT OF METAL; MATTRESSES; MIRRORS; NON-CHRISTMAS ORNAMENTS MADE OF PLASTER, PLASTIC, WAX OR WOOD; PARTY ORNAMENTS OF PLASTIC; PICTURE FRAMES; PLASTIC BANNER; PILLOWS; PLASTIC FLAGS; PLASTIC CAKE DECORATIONS; PLASTIC NAME BADGES; PLASTIC NOVELTY LICENSE PLATES; PLASTIC BANNERS; PLASTIC PENNANTS; PLASTIC TISSUE BOX COVERS; SLEEPING BAGS; WIND CHIMES; WINDOW BLINDS (U.S. CLS. 2, 13, 22, 25, 32 AND 50).

DORITT L. CARROLL, EXAMINING ATTORNEY

SN 85-875,459. KOHLER CO., KOHLER, WI. FILED 3-13-2013.

## DIGITAL WOOD

THE MARK CONSISTS OF STANDARD CHARACTERS WITHOUT CLAIM TO ANY PARTICULAR FONT, STYLE, SIZE, OR COLOR.

NO CLAIM IS MADE TO THE EXCLUSIVE RIGHT TO USE "WOOD", APART FROM THE MARK AS SHOWN.

FOR FURNITURE; MIRRORS; BATHROOM VANITY UNITS; MEDICINE CABINETS; CABINETS; CONSOLE TABLES; CONSOLE TABLE LEGS; BATHROOM VANITIES CONTAINING COUNTERTOPS; DECORATIVE GLASS (U.S. CLS. 2, 13, 22, 25, 32 AND 50).

CAROLINE WOOD, EXAMINING ATTORNEY

SN 85-894,520. HNI TECHNOLOGIES, INC., MUSCATINE, IA. FILED 4-3-2013.

## ARTCO-BELL

THE MARK CONSISTS OF STANDARD CHARACTERS WITHOUT CLAIM TO ANY PARTICULAR FONT, STYLE, SIZE, OR COLOR.

FOR FURNITURE; DESKS; COMPUTER KEYBOARD TRAYS; TABLES; CHAIRS; STACK CHAIRS; STOOLS; CAFETERIA SEATING; MUSIC CHAIRS; STORAGE UNITS, NAMELY, SHELVES FOR STORAGE AND STORAGE RACKS; LECTERNS WITH ATTACHED PRIVACY SCREENS (U.S. CLS. 2, 13, 22, 25, 32 AND 50).

FIRST USE 0-0-1961; IN COMMERCE 0-0-1961.

ELISSA GARBER KON, EXAMINING ATTORNEY

**CLASS 20—(Continued).**

SN 85-923,715. CHERRY, JEANNINE B, MABLETON, GA. FILED 5-5-2013.



NO CLAIM IS MADE TO THE EXCLUSIVE RIGHT TO USE "WINE DOOR", APART FROM THE MARK AS SHOWN.

THE COLOR(S) RED, GREEN, BLACK, BROWN, AND WHITE IS/ARE CLAIMED AS A FEATURE OF THE MARK.

THE MARK CONSISTS OF A BROWN LATTICED DOOR WITH BLACK SHADING BETWEEN THE LATTICE, AND A WHITE DOOR KNOB OUTLINED IN BLACK. BESIDE THE DOOR, ARRANGED VERTICALLY, ARE THE WORDS "WINE DOOR" IN RED. BETWEEN THE WORDS IS A GREEN WINE BOTTLE WITH A WHITE LABEL. A BLACK SCROLL ELEMENT IS PLACED BOTH ABOVE AND BELOW THE WORDING.

FOR WINE RACKS (U.S. CLS. 2, 13, 22, 25, 32 AND 50).  
FIRST USE 12-1-2011; IN COMMERCE 12-1-2011.  
JOANNA DUKOVIC, EXAMINING ATTORNEY

SN 85-932,618. LIVING FRESH COLLECTION LLC, POMPA-  
NO BEACH, FL. FILED 5-15-2013.

**DREAMSHADE**

THE MARK CONSISTS OF STANDARD CHARACTERS WITHOUT CLAIM TO ANY PARTICULAR FONT, STYLE, SIZE, OR COLOR.

FOR FURNITURE, NAMELY, SOGI SCREENS; ROOM DIVIDERS, INTERIOR WINDOW COVERINGS, NAMELY, VERTICAL LOUVERS, VENETIAN BLINDS, INTERIOR TEXTILE WINDOW BLINDS, FABRIC WINDOW BLINDS (U.S. CLS. 2, 13, 22, 25, 32 AND 50).

DAVID MURRAY, EXAMINING ATTORNEY

**CLASS 20—(Continued).**

SN 85-941,228. L&P PROPERTY MANAGEMENT COM-  
PANY, SOUTH GATE, CA. FILED 5-23-2013.

**SOMNIGEL**

THE MARK CONSISTS OF STANDARD CHARACTERS WITHOUT CLAIM TO ANY PARTICULAR FONT, STYLE, SIZE, OR COLOR.

FOR MATTRESSES AND OTHER SLEEP COMPONENTS, NAMELY, ELASTIC GEL MATERIAL LOCATED IN THE TOP UPHOLSTERY LAYER OF MATTRESSES, MATTRESS PILLOW-TOPS, AND PILLOWS, SOLD AS AN INTEGRAL COMPONENT OF THE MATTRESSES AND PILLOWS (U.S. CLS. 2, 13, 22, 25, 32 AND 50).

SARA BENJAMIN, EXAMINING ATTORNEY

SN 86-020,313. OMNIA ITALIAN DESIGN, INC., CHINO, CA.  
FILED 7-25-2013.

**SONNO ELEGANTE**

THE MARK CONSISTS OF STANDARD CHARACTERS WITHOUT CLAIM TO ANY PARTICULAR FONT, STYLE, SIZE, OR COLOR.

NO CLAIM IS MADE TO THE EXCLUSIVE RIGHT TO USE "SONNO", APART FROM THE MARK AS SHOWN.

THE ENGLISH TRANSLATION OF "SONNO ELEGANTE" IN THE MARK IS "ELEGANT SLEEP".

FOR SLEEPER SOFAS AND SLEEPER CHAIRS (U.S. CLS. 2, 13, 22, 25, 32 AND 50).

GINA HAYES, EXAMINING ATTORNEY

**CLASS 20—(Continued).**

SN 86-027,103. NATIONAL BOSS HOG ENERGY SERVICES, LLC, HOUSTON, TX. FILED 8-2-2013.

THE MARK CONSISTS OF THE WORD PHRASE "BOSS HOG" IN BOLD CAPITALIZED FORM, WITH THE ELEMENT "BOSS" POSITIONED PROXIMATE AND ABOVE THE ELEMENT "HOG", AND EACH ELEMENT HAVING AN UNDERLINE, WHEREIN THE FONT SIZE OF EACH ELEMENT IS PROPORTIONED SO THAT THE ELEMENT WIDTH IS THE SAME.

FOR OIL AND GAS WELL EQUIPMENT, NAMELY, BRIDGE PLUGS AND FRACTURING PLUGS COMPOSED OF PLASTIC AND SYNTHETIC RUBBER FOR CONTROLLING PRESSURE OR FLUIDS DOWNHOLE (U.S. CLS. 2, 13, 22, 25, 32 AND 50).

FIRST USE 3-1-2012; IN COMMERCE 3-1-2012.

DEIRDRE ROBERTSON, EXAMINING ATTORNEY

SN 86-030,895. GIBSON, AMY LYNNE, RICHMOND, VA. FILED 8-7-2013.

NO CLAIM IS MADE TO THE EXCLUSIVE RIGHT TO USE "REFILL LABELS", APART FROM THE MARK AS SHOWN.

THE MARK CONSISTS OF THE STYLIZED WORDING "REFILL LABELS" WITH AN ABSTRACT LATIN CROSS DESIGN BETWEEN THE TWO WORDS.

FOR REUSABLE PLASTIC PACKAGING CONTAINERS SOLD EMPTY, WITH DECORATIVE LABELS (U.S. CLS. 2, 13, 22, 25, 32 AND 50).

ANDREA K. NADELMAN, EXAMINING ATTORNEY

SN 86-032,037. NIKLES, BRIAN, POINT, TX. FILED 8-8-2013.

THE MARK CONSISTS OF STANDARD CHARACTERS WITHOUT CLAIM TO ANY PARTICULAR FONT, STYLE, SIZE, OR COLOR.

NO CLAIM IS MADE TO THE EXCLUSIVE RIGHT TO USE "SOCK", APART FROM THE MARK AS SHOWN.

FOR DEVICE MADE UP OF NON-METAL TIES FOR FASTENING PAIRS OF SOCKS FOR LAUNDERING (U.S. CLS. 2, 13, 22, 25, 32 AND 50).

KERI CANTONE, EXAMINING ATTORNEY

**CLASS 20—(Continued).**

SN 86-033,464. TILE REDI, LLC, CORAL SPRINGS, FL. FILED 8-9-2013.

ANY WALL, EASY TO INSTALL!

THE MARK CONSISTS OF STANDARD CHARACTERS WITHOUT CLAIM TO ANY PARTICULAR FONT, STYLE, SIZE, OR COLOR.

FOR SHELVES (U.S. CLS. 2, 13, 22, 25, 32 AND 50).

FIRST USE 1-0-2013; IN COMMERCE 1-0-2013.

PARKER HOWARD, EXAMINING ATTORNEY

SN 86-033,472. TILE REDI, LLC, CORAL SPRINGS, FL. FILED 8-9-2013.

IMAGINATION, THE ONLY  
LIMITATION!

THE MARK CONSISTS OF STANDARD CHARACTERS WITHOUT CLAIM TO ANY PARTICULAR FONT, STYLE, SIZE, OR COLOR.

FOR SELF-INSTALL SHELF MAKING KITS (U.S. CLS. 2, 13, 22, 25, 32 AND 50).

FIRST USE 1-0-2013; IN COMMERCE 1-0-2013.

PARKER HOWARD, EXAMINING ATTORNEY

SN 86-033,490. TILE REDI, LLC, CORAL SPRINGS, FL. FILED 8-9-2013.

THE SEAT YOU CAN'T BEAT!

THE MARK CONSISTS OF STANDARD CHARACTERS WITHOUT CLAIM TO ANY PARTICULAR FONT, STYLE, SIZE, OR COLOR.

FOR SHOWER BENCHES FOR SHOWER ENCLOSURES (U.S. CLS. 2, 13, 22, 25, 32 AND 50).

FIRST USE 1-0-2013; IN COMMERCE 1-0-2013.

PARKER HOWARD, EXAMINING ATTORNEY

**CLASS 20—(Continued).**

SN 86-034,438. LANE, PETER, COTO DE CAZA, CA. FILED 8-10-2013.

**MODUWALL**

THE MARK CONSISTS OF STANDARD CHARACTERS WITHOUT CLAIM TO ANY PARTICULAR FONT, STYLE, SIZE, OR COLOR.

FOR ADJUSTABLE, HIGH DENSITY MODULAR SHELVING SYSTEMS COMPRISED OF SHELVES, DRAWERS, CASTERS, CONNECTORS, DIVIDERS, HOOKS, LINERS, POSTS, RECEPTACLES AND RACKS; HIGH DENSITY STORAGE BINS MADE PRIMARILY OF PLASTIC SOLD AS A COMPONENT UNIT OF HIGH DENSITY MOBILE FILING AND STORAGE SHELVING; MOBILE MODULAR STORAGE CABINETS; HIGH DENSITY STORAGE CABINETS AND SHELVING (U.S. CLS. 2, 13, 22, 25, 32 AND 50).

FIRST USE 4-1-2013; IN COMMERCE 4-17-2013.  
HELENE LIWINSKI, EXAMINING ATTORNEY

SN 86-035,431. SEARS BRANDS, LLC, HOFFMAN ESTATES, IL. FILED 8-12-2013.

**ESSENTIAL GARDEN**

THE MARK CONSISTS OF STANDARD CHARACTERS WITHOUT CLAIM TO ANY PARTICULAR FONT, STYLE, SIZE, OR COLOR.

NO CLAIM IS MADE TO THE EXCLUSIVE RIGHT TO USE "GARDEN", APART FROM THE MARK AS SHOWN.

FOR PATIO AND LAWN FURNITURE; PATIO CUSHIONS; PATIO LIGHTS; PATIO DECOR, NAMELY, ARBORS, FOUNTAINS, VASES, CERAMIC POTS, PLANTERS, SUN DIALS AND STATUARY (U.S. CLS. 2, 13, 22, 25, 32 AND 50).

CHERYL CLAYTON, EXAMINING ATTORNEY

SN 86-035,730. WARNER BROS. ENTERTAINMENT INC., BURBANK, CA. FILED 8-12-2013.

**THE THREE BROOMSTICKS**

THE MARK CONSISTS OF STANDARD CHARACTERS WITHOUT CLAIM TO ANY PARTICULAR FONT, STYLE, SIZE, OR COLOR.

FOR SLEEPING BAGS, PLASTIC CAKE DECORATIONS, NON-METAL AND NON-LEATHER KEY CHAINS, CHAIR PADS, DECK CHAIRS, CORKS FOR BOTTLES, PICTURE FRAMES, PILLOWS AND SEAT CUSHIONS, BOOSTER SEATS, INFANT WALKERS, BASSINETS, HIGH CHAIRS, HAND-HELD FLAT AND FOLDING FANS, DECORATIVE MOBILES, AND SOFT-SCULPTURE WALL DECORATIONS (U.S. CLS. 2, 13, 22, 25, 32 AND 50).

JUSTINE D. PARKER, EXAMINING ATTORNEY

**CLASS 20—(Continued).**

SN 86-037,339. DOMBROWSKI, LEON R., HAMMOND, IN. FILED 8-14-2013.

**FLEXQUIK**

THE MARK CONSISTS OF STANDARD CHARACTERS WITHOUT CLAIM TO ANY PARTICULAR FONT, STYLE, SIZE, OR COLOR.

OWNER OF U.S. REG. NOS. 3,229,162 AND 3,254,997.  
FOR DISPLAY STANDS FOR DISPLAYING BANNERS (U.S. CLS. 2, 13, 22, 25, 32 AND 50).

FIRST USE 1-0-2011; IN COMMERCE 1-0-2011.  
MATTHEW GALAN, EXAMINING ATTORNEY

SN 86-037,348. DOMBROWSKI, LEON R., HAMMOND, IN. FILED 8-14-2013.

**BANNERQUIK**

THE MARK CONSISTS OF STANDARD CHARACTERS WITHOUT CLAIM TO ANY PARTICULAR FONT, STYLE, SIZE, OR COLOR.

OWNER OF U.S. REG. NOS. 3,229,162 AND 3,254,997.  
FOR DISPLAY STANDS FOR DISPLAYING BANNERS (U.S. CLS. 2, 13, 22, 25, 32 AND 50).

FIRST USE 12-0-2010; IN COMMERCE 12-0-2010.  
MATTHEW GALAN, EXAMINING ATTORNEY

SN 86-038,302. IMPACT IMAGES INC, TEMECULA, CA. FILED 8-14-2013.

**Impact Air**

THE MARK CONSISTS OF STANDARD CHARACTERS WITHOUT CLAIM TO ANY PARTICULAR FONT, STYLE, SIZE, OR COLOR.

NO CLAIM IS MADE TO THE EXCLUSIVE RIGHT TO USE "AIR", APART FROM THE MARK AS SHOWN.

FOR INFLATABLE PUBLICITY OBJECTS (U.S. CLS. 2, 13, 22, 25, 32 AND 50).

FIRST USE 6-5-2013; IN COMMERCE 6-5-2013.  
COLLEEN MULCRONE, EXAMINING ATTORNEY

**CLASS 20—(Continued).**

SN 86-038,879. ZAMMIT, CALEB P, AUSTIN, TX. FILED 8-15-2013.



THE NAME "CALEB ZAMMIT" IDENTIFIES A LIVING INDIVIDUAL WHOSE CONSENT IS OF RECORD.

THE MARK CONSISTS OF THE TERM "CALEB ZAMMIT" IN A STYLIZED FONT WITHIN A CIRCLE. IN THE CENTER OF THE CIRCLE ARE THE LETTERS "CZ" IN A STYLIZED FONT.

FOR SCULPTURES OF PLASTER AND PLASTIC (U.S. CLS. 2, 13, 22, 25, 32 AND 50).

GIANCARLO CASTRO, EXAMINING ATTORNEY

SN 86-040,045. ALL STRONG INDUSTRY (USA) INC., ONTARIO, CA. FILED 8-16-2013.

## Trim At Home

THE MARK CONSISTS OF STANDARD CHARACTERS WITHOUT CLAIM TO ANY PARTICULAR FONT, STYLE, SIZE, OR COLOR.

NO CLAIM IS MADE TO THE EXCLUSIVE RIGHT TO USE "TRIM", APART FROM THE MARK AS SHOWN.

FOR NON-METAL WINDOW TRIMS; WINDOW FITTINGS, NOT OF METAL; WINDOW BLINDS (U.S. CLS. 2, 13, 22, 25, 32 AND 50).

NAAKWAMA ANKRAH, EXAMINING ATTORNEY

SN 86-041,537. SOLUTIONS IN SLEEP, LLC, WAYNESVILLE, OH. FILED 8-19-2013.

## Simply Silver

THE MARK CONSISTS OF STANDARD CHARACTERS WITHOUT CLAIM TO ANY PARTICULAR FONT, STYLE, SIZE, OR COLOR.

NO CLAIM IS MADE TO THE EXCLUSIVE RIGHT TO USE "SILVER", APART FROM THE MARK AS SHOWN.

FOR BED PILLOWS FEATURING SILVER IONS (U.S. CLS. 2, 13, 22, 25, 32 AND 50).

FIRST USE 11-1-2012; IN COMMERCE 3-18-2013.

ELIZABETH JACKSON, EXAMINING ATTORNEY

**CLASS 20—(Continued).**

SN 86-041,702. INNOVATION INTERNATIONAL CORPORATION, CARSON CITY, NV. FILED 8-19-2013.

## INNOVATION PANELS

THE MARK CONSISTS OF STANDARD CHARACTERS WITHOUT CLAIM TO ANY PARTICULAR FONT, STYLE, SIZE, OR COLOR.

NO CLAIM IS MADE TO THE EXCLUSIVE RIGHT TO USE "PANELS", APART FROM THE MARK AS SHOWN.

FOR BED HEADBOARDS; BEDROOM FURNITURE; BEDS; CABINETS; COMPUTER FURNITURE; CUSTOM FURNITURE; DESKS; DINING ROOM TABLES; DOORS FOR FURNITURE; DRAWERS; END TABLES; FURNITURE; FURNITURE CHESTS; FURNITURE FRAMES; FURNITURE PARTS; FURNITURE, NAMELY, DRESSERS; FURNITURE, NAMELY, WALL UNITS; FURNITURE, NAMELY, WARDROBES; LIVING ROOM FURNITURE; OFFICE FURNITURE; OFFICE TABLES; SEATING FURNITURE; SOFA BEDS; STANDING DESKS; TABLES; WOODEN BEDS (U.S. CLS. 2, 13, 22, 25, 32 AND 50).

FIRST USE 10-1-2011; IN COMMERCE 10-1-2011.

IRA J. GOODSaid, EXAMINING ATTORNEY

SN 86-047,372. GUCCN, L.L.C., NEWCASTLE, WA. FILED 8-25-2013.

## VSHINO

THE MARK CONSISTS OF STANDARD CHARACTERS WITHOUT CLAIM TO ANY PARTICULAR FONT, STYLE, SIZE, OR COLOR.

THE WORDING "VSHINO" HAS NO MEANING IN A FOREIGN LANGUAGE.

FOR BATHROOM AND SHAVING MIRRORS; BATHROOM FURNITURE; BATHROOM VANITIES; WALL FIXTURES, NAMELY, PLASTIC THREE-DIMENSIONAL DESIGNS TO BE ATTACHED TO THE WALLS OF BATHROOMS (U.S. CLS. 2, 13, 22, 25, 32 AND 50).

GIANCARLO CASTRO, EXAMINING ATTORNEY

SN 86-047,374. GUCCN, L.L.C., NEWCASTLE, WA. FILED 8-25-2013.

## ONELING

THE MARK CONSISTS OF STANDARD CHARACTERS WITHOUT CLAIM TO ANY PARTICULAR FONT, STYLE, SIZE, OR COLOR.

THE WORDING "ONELING" HAS NO MEANING IN A FOREIGN LANGUAGE.

FOR BEDS, MATTRESSES, PILLOWS AND BOLSTERS (U.S. CLS. 2, 13, 22, 25, 32 AND 50).

GIANCARLO CASTRO, EXAMINING ATTORNEY

**CLASS 20—(Continued).**

SN 86-053,448. SCOTT, SYLVIA, CHARLESTON, SC. FILED 9-1-2013.

**STRADDLE BAGS**

THE MARK CONSISTS OF STANDARD CHARACTERS WITHOUT CLAIM TO ANY PARTICULAR FONT, STYLE, SIZE, OR COLOR.

NO CLAIM IS MADE TO THE EXCLUSIVE RIGHT TO USE "BAGS", APART FROM THE MARK AS SHOWN.

FOR BABY CHANGING TABLES; BEDROOM FURNITURE; BEDS; BEDSIDE TABLES; BUNK BEDS; CHAIR BEDS; CHAIRS; DINING ROOM TABLES; DINING TABLES; DISPLAY TABLES; DRESSERS; EASY CHAIRS; FOLDING BEDS; FURNITURE FOR HOUSE, OFFICE AND GARDEN; FURNITURE, NAMELY, DRESSERS; HOSPITAL BEDS; LOUNGE CHAIRS; OFFICE CHAIRS; PORTABLE BEDS FOR PETS; RECLINING CHAIRS; SOFA BEDS; SOFAS (U.S. CLS. 2, 13, 22, 25, 32 AND 50).  
CAROL SPILS, EXAMINING ATTORNEY

SN 86-059,741. WARNER BROS. ENTERTAINMENT INC., BURBANK, CA. FILED 9-9-2013.

**HONEYDUKES**

THE MARK CONSISTS OF STANDARD CHARACTERS WITHOUT CLAIM TO ANY PARTICULAR FONT, STYLE, SIZE, OR COLOR.

OWNER OF U.S. REG. NOS. 3,901,354, 3,975,167 AND OTHERS.

FOR SLEEPING BAGS, PLASTIC CAKE DECORATIONS, NON-METAL KEY CHAINS, CHAIR PADS, DECK CHAIRS, CORKS FOR BOTTLES, PICTURE FRAMES, PILLOWS AND SEAT CUSHIONS, BOOSTER SEATS, INFANT WALKERS, BASSINETS, HIGH CHAIRS, HAND-HELD FLAT AND FOLDING FANS, DECORATIVE MOBILES, AND SOFT-SCULPTURE WALL DECORATIONS (U.S. CLS. 2, 13, 22, 25, 32 AND 50).

JUSTINE D. PARKER, EXAMINING ATTORNEY

SN 86-060,049. SELA PRODUCTS, LLC, EDMOND, OK. FILED 9-10-2013.

storage**werkz**

OWNER OF U.S. REG. NO. 4,406,580.  
THE MARK CONSISTS OF THE WORDS "STORAGE-WERKZ", NO SPACE BETWEEN THE WORDS. THE WORD "WERKZ" IS IN A BOLD FONT.  
FOR STORAGE RACKS (U.S. CLS. 2, 13, 22, 25, 32 AND 50).

FIRST USE 6-27-2012; IN COMMERCE 6-27-2012.  
JEFF DEFORD, EXAMINING ATTORNEY

**CLASS 20—(Continued).**

SN 86-060,543. DEIVIDAS KEREZIUS, STONY BROOK, NY. FILED 9-10-2013.

**PALMII**

THE MARK CONSISTS OF STANDARD CHARACTERS WITHOUT CLAIM TO ANY PARTICULAR FONT, STYLE, SIZE, OR COLOR.

FOR HEAD SUPPORTING PILLOWS; PILLOWS (U.S. CLS. 2, 13, 22, 25, 32 AND 50).

BRITTANY ESTELL, EXAMINING ATTORNEY

SN 86-066,860. BESA INNOVATION LLC, FLORHAM PARK, NJ. FILED 9-17-2013.

**Picture Poofect**

THE MARK CONSISTS OF STANDARD CHARACTERS WITHOUT CLAIM TO ANY PARTICULAR FONT, STYLE, SIZE, OR COLOR.

FOR PICTURE FRAMES (U.S. CLS. 2, 13, 22, 25, 32 AND 50).

PAUL E. FAHRENKOPF, EXAMINING ATTORNEY

SN 86-067,257. MARKISOL HOLDING AB, RONNEBY, SWEDEN, FILED 9-17-2013.

iFit

OWNER OF SWEDEN REG. NO. 504203, DATED 5-4-2012, EXPIRES 5-4-2022.

THE MARK CONSISTS OF "IFIT" IN STYLIZED WORDING.

FOR INTERIOR ROLLER-BLINDS OF TEXTILE (U.S. CLS. 2, 13, 22, 25, 32 AND 50).

JAMES MACFARLANE, EXAMINING ATTORNEY

**CLASS 20—(Continued).**

SN 86-068,926. PAUL ROBERT CHAIR, INC., TAYLORSVILLE, NC. FILED 9-19-2013.

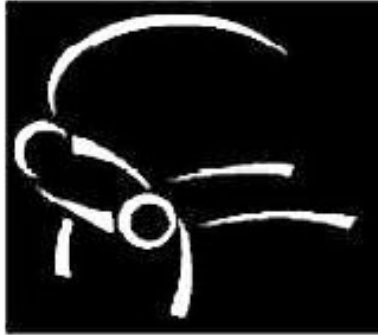

THE MARK CONSISTS OF THE PARTIAL IMAGE OF AN ITEM OF FURNITURE.  
FOR FURNITURE (U.S. CLS. 2, 13, 22, 25, 32 AND 50).  
FIRST USE 12-31-2001; IN COMMERCE 12-31-2001.  
NAKIA HENRY, EXAMINING ATTORNEY

SN 86-069,167. BERMAN, KENNETH M., SEBASTOPOL, CA. FILED 9-19-2013.

# Deck Dock

THE MARK CONSISTS OF STANDARD CHARACTERS WITHOUT CLAIM TO ANY PARTICULAR FONT, STYLE, SIZE, OR COLOR.  
FOR DISPLAY BOARDS; DISPLAY RACKS; METAL DISPLAY STANDS; WOODEN DISPLAY STANDS (U.S. CLS. 2, 13, 22, 25, 32 AND 50).  
FIRST USE 10-16-2012; IN COMMERCE 6-16-2013.  
MARCIE MILONE, EXAMINING ATTORNEY

SN 86-070,442. WERNER MEDIA PARTNERS, LLC, DBA NATURE'S SLEEP, LLC, DAVIE, FL. FILED 9-20-2013.

# CoutureSleep

THE MARK CONSISTS OF STANDARD CHARACTERS WITHOUT CLAIM TO ANY PARTICULAR FONT, STYLE, SIZE, OR COLOR.  
FOR BED FRAMES; BED HEADBOARDS; BED PILLOWS; BEDS; BEDS FOR HOUSEHOLD PETS; HOSPITAL BEDS; MATTRESS FOUNDATIONS; MATTRESS TOPPERS; MATTRESSES; PILLOWS; WOOD BED-STEADS (U.S. CLS. 2, 13, 22, 25, 32 AND 50).  
SCOTT BIBB, EXAMINING ATTORNEY

**CLASS 20—(Continued).**

SN 86-070,657. INTER-FURN, LLC, DBA PINNACLE DESIGN, WENTZVILLE, MO. FILED 9-20-2013.

# TIPSTOP

THE MARK CONSISTS OF STANDARD CHARACTERS WITHOUT CLAIM TO ANY PARTICULAR FONT, STYLE, SIZE, OR COLOR.  
FOR TELEVISION STANDS (U.S. CLS. 2, 13, 22, 25, 32 AND 50).  
DANNEAN HETZEL, EXAMINING ATTORNEY

SN 86-070,673. INTER-FURN, LLC, DBA PINNACLE DESIGN, WENTZVILLE, MO. FILED 9-20-2013.

# BASELOCK

THE MARK CONSISTS OF STANDARD CHARACTERS WITHOUT CLAIM TO ANY PARTICULAR FONT, STYLE, SIZE, OR COLOR.  
FOR TELEVISION STANDS (U.S. CLS. 2, 13, 22, 25, 32 AND 50).  
DANNEAN HETZEL, EXAMINING ATTORNEY

SN 86-071,490. CROWN SEATING, CENTENNIAL, CO. FILED 9-23-2013.

# ERGOTECH

THE MARK CONSISTS OF STANDARD CHARACTERS WITHOUT CLAIM TO ANY PARTICULAR FONT, STYLE, SIZE, OR COLOR.  
FOR TASK CHAIR WITH MESH SEATS AND BACKS FOR USE BY ARCHITECTURE AND DESIGN PROFESSIONALS (U.S. CLS. 2, 13, 22, 25, 32 AND 50).  
FIRST USE 5-31-2013; IN COMMERCE 5-31-2013.  
DEIRDRE ROBERTSON, EXAMINING ATTORNEY



**CLASS 20—(Continued).**

SN 86-071,987. MAYLINE COMPANY, LLC, SHEBOYGAN, WI. FILED 9-23-2013.

# GIST

THE MARK CONSISTS OF STANDARD CHARACTERS WITHOUT CLAIM TO ANY PARTICULAR FONT, STYLE, SIZE, OR COLOR.

FOR OFFICE FURNITURE, NAMELY, CHAIRS (U.S. CLS. 2, 13, 22, 25, 32 AND 50).  
THEODORE MCBRIDE, EXAMINING ATTORNEY

---

SN 86-079,827. TOMMY BAHAMA GROUP, INC., ATLANTA, GA. FILED 10-1-2013.

# Canimar

THE MARK CONSISTS OF STANDARD CHARACTERS WITHOUT CLAIM TO ANY PARTICULAR FONT, STYLE, SIZE, OR COLOR.

FOR FURNITURE (U.S. CLS. 2, 13, 22, 25, 32 AND 50).  
SHAILA LEWIS, EXAMINING ATTORNEY

---

SN 86-080,093. PARAMOUNT PICTURES CORPORATION, HOLLYWOOD, CA. FILED 10-1-2013.

JACK RYAN: SHADOW RECRUIT

THE MARK CONSISTS OF STANDARD CHARACTERS WITHOUT CLAIM TO ANY PARTICULAR FONT, STYLE, SIZE, OR COLOR.

THE NAME(S), PORTRAIT(S), AND/OR SIGNATURE(S) SHOWN IN THE MARK DOES NOT IDENTIFY A PARTICULAR LIVING INDIVIDUAL.

FOR DISPLAY BOARDS; KEY FOBS, NOT OF METAL; MIRRORS; NON-METAL KEY RINGS; PICTURE FRAMES; PILLOWS; SHADOW BOXES; SLEEPING BAGS (U.S. CLS. 2, 13, 22, 25, 32 AND 50).  
AHSEN KHAN, EXAMINING ATTORNEY

**CLASS 20—(Continued).**

SN 86-098,671. FURNITURE OF AMERICA, INC., ROWLAND HEIGHTS, CA. FILED 10-22-2013.

# Roll-N-Save

THE MARK CONSISTS OF STANDARD CHARACTERS WITHOUT CLAIM TO ANY PARTICULAR FONT, STYLE, SIZE, OR COLOR.

FOR FUTON MATTRESSES; MATTRESS FOUNDATIONS; MATTRESS TOPPERS; MATTRESSES; MATTRESSES AND PILLOWS; SLEEP PRODUCTS, NAMELY, MATTRESSES, SPRING MATTRESSES, BOX SPRINGS AND MATTRESS FOUNDATIONS; SPRING MATTRESSES (U.S. CLS. 2, 13, 22, 25, 32 AND 50).  
FIRST USE 10-1-2013; IN COMMERCE 10-1-2013.

MATTHEW MCDOWELL, EXAMINING ATTORNEY

---

SN 86-099,287. DREAMWELL, LTD., LAS VEGAS, NV. FILED 10-23-2013.

# BEAUTYREST

THE MARK CONSISTS OF STANDARD CHARACTERS WITHOUT CLAIM TO ANY PARTICULAR FONT, STYLE, SIZE, OR COLOR.

OWNER OF U.S. REG. NOS. 3,464,540, 4,339,589 AND OTHERS.

FOR FURNITURE, BEDSTEADS, BED FRAMES (U.S. CLS. 2, 13, 22, 25, 32 AND 50).

SHANNON TWOHIG, EXAMINING ATTORNEY

---

SN 86-107,958. NORTH STATES INDUSTRIES, INC., BLAINE, MN. FILED 11-1-2013.

# MYPET

THE MARK CONSISTS OF STANDARD CHARACTERS WITHOUT CLAIM TO ANY PARTICULAR FONT, STYLE, SIZE, OR COLOR.

FOR GATES FOR DOORWAYS USED TO RESTRAIN PETS (U.S. CLS. 2, 13, 22, 25, 32 AND 50).

DAVID TAYLOR, EXAMINING ATTORNEY

**CLASS 20—(Continued).**

SN 86-120,992. BUDGE INDUSTRIES LLC, LANSDALE, PA.  
FILED 11-17-2013.

# RUSTEC

THE MARK CONSISTS OF STANDARD CHARACTERS WITHOUT CLAIM TO ANY PARTICULAR FONT, STYLE, SIZE, OR COLOR.

FOR FITTED AND SEMI-FITTED FURNITURE COVERS NOT OF FABRIC FOR PROTECTING AGAINST CORROSION; FITTED AND SEMI-FITTED FABRIC FURNITURE COVERS FOR PROTECTING AGAINST CORROSION (U.S. CLS. 2, 13, 22, 25, 32 AND 50).

KATHY WANG, EXAMINING ATTORNEY

**CLASS 21—(Continued).**

SN 85-478,860. AMERICAN ALUPACK INDUSTRIES, INC.,  
OXNARD, CA. FILED 11-22-2011.

# ALCO FOIL

THE MARK CONSISTS OF STANDARD CHARACTERS WITHOUT CLAIM TO ANY PARTICULAR FONT, STYLE, SIZE, OR COLOR.

NO CLAIM IS MADE TO THE EXCLUSIVE RIGHT TO USE "FOIL", APART FROM THE MARK AS SHOWN.

FOR METAL FOIL PANS FOR COOKING (U.S. CLS. 2, 13, 23, 29, 30, 33, 40 AND 50).

LINDA ORNDORFF, EXAMINING ATTORNEY

SN 86-137,482. VIEJAS BAND OF KUMEYAAAY INDIANS,  
ALPINE, CA. FILED 12-6-2013.

# VIEJAS

THE MARK CONSISTS OF STANDARD CHARACTERS WITHOUT CLAIM TO ANY PARTICULAR FONT, STYLE, SIZE, OR COLOR.

OWNER OF U.S. REG. NOS. 2,569,162, 3,106,500 AND OTHERS.

THE ENGLISH TRANSLATION OF "VIEJAS" IN THE MARK IS "OLD" OR "AGED".

FOR PICTURE FRAMES (U.S. CLS. 2, 13, 22, 25, 32 AND 50).

KATHY DE JONGE, EXAMINING ATTORNEY

SN 85-757,275. PATEL, ANISH, DBA BRUSH BUDDIES,  
FONTANA, CA. FILED 10-18-2012.

# Soniclean

THE MARK CONSISTS OF STANDARD CHARACTERS WITHOUT CLAIM TO ANY PARTICULAR FONT, STYLE, SIZE, OR COLOR.

FOR ELECTRIC TOOTHBRUSHES; ELECTRICAL TOOTHBRUSHES (U.S. CLS. 2, 13, 23, 29, 30, 33, 40 AND 50).

FIRST USE 5-11-2012; IN COMMERCE 5-11-2012.

CAROLINE WOOD, EXAMINING ATTORNEY

**CLASS 21—HOUSEWARES AND GLASS**

SN 85-236,458. LOCAL WATER, LLC, ROWAYTON, CT.  
FILED 2-8-2011.

# GoBottle

THE MARK CONSISTS OF STANDARD CHARACTERS WITHOUT CLAIM TO ANY PARTICULAR FONT, STYLE, SIZE, OR COLOR.

FOR BOTTLES, SOLD EMPTY; INSULATING SLEEVE HOLDER FOR BOTTLES; PLASTIC WATER BOTTLES SOLD EMPTY; SPORTS BOTTLES SOLD EMPTY; SQUEEZE BOTTLE SOLD EMPTY (U.S. CLS. 2, 13, 23, 29, 30, 33, 40 AND 50).

RICHARD WHITE, EXAMINING ATTORNEY

SN 85-829,445. H2O4K9, INC., MONROVIA, CA. FILED 1-22-2013.

# H2O4K9

THE MARK CONSISTS OF STANDARD CHARACTERS WITHOUT CLAIM TO ANY PARTICULAR FONT, STYLE, SIZE, OR COLOR.

FOR REUSABLE WATER BOTTLES SOLD EMPTY, NAMELY, STAINLESS STEEL WATER BOTTLES, ALUMINUM WATER BOTTLES, WATER BOTTLES FOR PETS; WATER BOTTLE CARRIERS, NAMELY, INSULATING SLEEVE HOLDER FOR BOTTLES (U.S. CLS. 2, 13, 23, 29, 30, 33, 40 AND 50).

FIRST USE 9-0-2009; IN COMMERCE 9-0-2009.

MARLENE BELL, EXAMINING ATTORNEY

**CLASS 21—(Continued).**

SN 85-840,732. HANDI-FOIL CORPORATION, WHEELING, IL. FILED 2-5-2013.

**iCATER**

THE MARK CONSISTS OF STANDARD CHARACTERS WITHOUT CLAIM TO ANY PARTICULAR FONT, STYLE, SIZE, OR COLOR.

FOR NON-ELECTRIC ALUMINUM PANS AND ROASTING PANS WITH PLASTIC LIDS; CONTAINERS FORMED OF ALUMINUM FOIL WITH PLASTIC LIDS FOR HOUSEHOLD USE; PANS FORMED OF ALUMINUM FOIL WITH WIRE HANDLES AND PLASTIC LIDS; PANS FORMED OF ALUMINUM FOIL WITH PLASTIC LIDS; AND PLASTIC TRAYS FOR HOUSEHOLD USE (U.S. CLS. 2, 13, 23, 29, 30, 33, 40 AND 50).

STEVEN R. FINE, EXAMINING ATTORNEY

**CLASS 21—(Continued).**

SN 85-856,262. PARK, HYON, VERNON, CA. FILED 2-21-2013.

**FRESH20**

THE MARK CONSISTS OF STANDARD CHARACTERS WITHOUT CLAIM TO ANY PARTICULAR FONT, STYLE, SIZE, OR COLOR.

FOR PLASTIC CONTAINERS FOR DRINKING WATER, NAMELY, CUPS AND WATER BOTTLES SOLD EMPTY (U.S. CLS. 2, 13, 23, 29, 30, 33, 40 AND 50).

INGRID C. EULIN, EXAMINING ATTORNEY

SN 85-861,198. PREMIER PAN COMPANY, INC., CRESENT, PA. FILED 2-27-2013.

**AMERICAN BAKEWARE CLASSICS**

SN 85-840,738. HANDI-FOIL CORPORATION, WHEELING, IL. FILED 2-5-2013.

**iCATERING**

THE MARK CONSISTS OF STANDARD CHARACTERS WITHOUT CLAIM TO ANY PARTICULAR FONT, STYLE, SIZE, OR COLOR.

FOR NON-ELECTRIC ALUMINUM PANS AND ROASTING PANS WITH PLASTIC LIDS; CONTAINERS FORMED OF ALUMINUM FOIL WITH PLASTIC LIDS FOR HOUSEHOLD USE; PANS FORMED OF ALUMINUM FOIL WITH WIRE HANDLES AND PLASTIC LIDS; PANS FORMED OF ALUMINUM FOIL WITH PLASTIC LIDS; AND PLASTIC TRAYS FOR HOUSEHOLD USE (U.S. CLS. 2, 13, 23, 29, 30, 33, 40 AND 50).

STEVEN R. FINE, EXAMINING ATTORNEY

THE MARK CONSISTS OF STANDARD CHARACTERS WITHOUT CLAIM TO ANY PARTICULAR FONT, STYLE, SIZE, OR COLOR.

NO CLAIM IS MADE TO THE EXCLUSIVE RIGHT TO USE "AMERICAN BAKEWARE", APART FROM THE MARK AS SHOWN.

FOR BAKEWARE (U.S. CLS. 2, 13, 23, 29, 30, 33, 40 AND 50).

KIMBERLY PARKS, EXAMINING ATTORNEY

SN 85-864,768. QUEEN'S ATTIC, INC., PALM SPRINGS, CA. FILED 3-1-2013.

 **QUEEN'S ATTIC**

SN 85-852,889. WORLDWIDE DYNAMICS INC., OLD FORT, NC. FILED 2-18-2013.

**Hollister Motorcycle Rally**

THE MARK CONSISTS OF STANDARD CHARACTERS WITHOUT CLAIM TO ANY PARTICULAR FONT, STYLE, SIZE, OR COLOR.

NO CLAIM IS MADE TO THE EXCLUSIVE RIGHT TO USE "HOLLISTER", APART FROM THE MARK AS SHOWN.

FOR INSULATING SLEEVE HOLDERS FOR BEVERAGE CANS (U.S. CLS. 2, 13, 23, 29, 30, 33, 40 AND 50).

COLLEEN DOMBROW, EXAMINING ATTORNEY

THE MARK CONSISTS OF THE WORDING "QUEEN'S ATTIC" WITH A CROWN DESIGN OVER THE "Q" IN "QUEEN".

FOR HOUSEHOLD PRODUCTS, NAMELY, COUNTER-TOP HOLDERS FOR WINE BOTTLES (U.S. CLS. 2, 13, 23, 29, 30, 33, 40 AND 50).

FIRST USE 1-1-2013; IN COMMERCE 1-1-2013.

MARY ROSSMAN, EXAMINING ATTORNEY

**CLASS 21—(Continued).**

SN 85-870,663. BRASSTECH, INC., SANTA ANA, CA. FILED 3-8-2013.

# CAYDEN

THE MARK CONSISTS OF STANDARD CHARACTERS WITHOUT CLAIM TO ANY PARTICULAR FONT, STYLE, SIZE, OR COLOR.

FOR BATHROOM ACCESSORIES, NAMELY, TOWEL BARS, TOWEL RINGS, SOAP DISHES AND TOILET TISSUE HOLDERS (U.S. CLS. 2, 13, 23, 29, 30, 33, 40 AND 50).

DAVID I, EXAMINING ATTORNEY

SN 85-870,684. BRASSTECH, INC., SANTA ANA, CA. FILED 3-8-2013.

# EAVON

THE MARK CONSISTS OF STANDARD CHARACTERS WITHOUT CLAIM TO ANY PARTICULAR FONT, STYLE, SIZE, OR COLOR.

FOR BATHROOM ACCESSORIES, NAMELY, TOWEL BARS, TOWEL RINGS, SOAP DISHES AND TOILET TISSUE HOLDERS (U.S. CLS. 2, 13, 23, 29, 30, 33, 40 AND 50).

DAVID I, EXAMINING ATTORNEY

SN 85-871,813. PICKLE-BIOTIC LLC, OJAI, CA. FILED 3-9-2013.



**Pickle Biotic**  
Easy, Safe Probiotic Veggies You Can Make at Home

NO CLAIM IS MADE TO THE EXCLUSIVE RIGHT TO USE "PICKLE BIOTIC" AND "SAFE PROBIOTIC VEGGIES YOU CAN MAKE AT HOME", APART FROM THE MARK AS SHOWN.

THE COLOR(S) GREEN, LIGHT PURPLE, BROWN AND LIGHT ORANGE IS/ARE CLAIMED AS A FEATURE OF THE MARK.

THE MARK CONSISTS OF THE LITERAL ELEMENTS

**CLASS 21—(Continued).**

"PICKLE BIOTIC", "EASY", "SAFE PROBIOTIC VEGGIES YOU CAN MAKE AT HOME" WRITTEN IN STYLIZED FORM WHEREIN THE WORDS "PICKLE BIOTIC" ARE WRITTEN IN BROWN COLOR WITH AN IMAGE OF BEET WHICH IS OF LIGHT PURPLE COLOR AND CARROT IS OF LIGHT ORANGE COLOR PLACED BETWEEN THE WORDS. THE LITERAL ELEMENTS "EASY", "SAFE PROBIOTIC VEGGIES YOU CAN MAKE AT HOME" ARE WRITTEN IN GREEN COLOR EXACTLY BELOW THE WORDS "PICKLE BIOTIC" AS SHOWN IN THE MARK.

FOR PICKLING AND FERMENTATION KIT COMPRISED PRIMARILY OF PLASTIC CONTAINERS AND PLASTIC TUBING TO MAKE PRO-BIOTIC VEGETABLES AT HOME (U.S. CLS. 2, 13, 23, 29, 30, 33, 40 AND 50).

FIRST USE 1-1-2013; IN COMMERCE 1-1-2013.  
LINDA ORNDORFF, EXAMINING ATTORNEY

SN 85-879,210. LES PROMOTIONS ATLANTIQUES INC./ ATLANTIC PROMOTIONS INC., LONGUEUIL, QUEBEC, CANADA, FILED 3-18-2013.

# THE ROCK

THE MARK CONSISTS OF STANDARD CHARACTERS WITHOUT CLAIM TO ANY PARTICULAR FONT, STYLE, SIZE, OR COLOR.

PRIORITY CLAIMED UNDER SEC. 44(D) ON CANADA APPLICATION NO. 1604015, FILED 11-27-2012.

FOR COOKWARE, NAMELY, POTS, PANS, FRY PANS, SAUCEPANS, NON-ELECTRIC BROILERS, ROASTING PANS, DUTCH OVENS, SKILLETS AND BAKEWARE, NAMELY, CAKE, PIE AND BREAD MOULDS (U.S. CLS. 2, 13, 23, 29, 30, 33, 40 AND 50).

JOANNA DUKOVIC, EXAMINING ATTORNEY

**CLASS 21—(Continued).**

SN 85-885,865. RESTORATION HARDWARE, INC., CORTE MADERA, CA. FILED 3-25-2013.

RH

THE MARK CONSISTS OF STANDARD CHARACTERS WITHOUT CLAIM TO ANY PARTICULAR FONT, STYLE, SIZE, OR COLOR.

FOR BATH HARDWARE AND ACCESSORIES, NAMELY, TOWEL BARS, TOWEL RINGS, TISSUE HOLDERS, TISSUE STORAGE CANISTERS, TOOTHBRUSH HOLDERS, TOOTHBRUSH CONTAINERS, SOAP DISHES, DISPENSERS FOR LIQUID SOAP, TOILET BRUSHES AND PLUNGERS, TOILET PAPER HOLDERS, CANISTERS, WASTEBASKETS, SHOWER CADDIES; SHOWER RACKS; BASKETS FOR DOMESTIC USE, NOT OF METAL; LAUNDRY HAMPERS FOR DOMESTIC OR HOUSEHOLD USE; GENERAL PURPOSE STORAGE BINS FOR HOUSEHOLD USE; CANDLE HOLDERS NOT OF PRECIOUS METAL; BIRD CAGES; DECORATIVE GLASS BOTTLES AND JARS; DRINKING CUPS FOR BABIES AND CHILDREN; CONTAINERS NOT OF PRECIOUS METAL FOR SMALL ITEMS FOR HOUSEHOLD USE; SERVING TRAYS; DECORATIVE BOWLS; PLANTERS FOR FLOWERS AND PLANTS; URNS; GARDENING GLOVES; BOTTLE STOPPERS SPECIALLY ADAPTED FOR USE WITH WINE BOTTLES; WINE OPENERS; WINE CADDIES (U.S. CLS. 2, 13, 23, 29, 30, 33, 40 AND 50).

DAVID C. REIHNER, EXAMINING ATTORNEY

**CLASS 21—(Continued).**

SN 85-887,242. DISNEY ENTERPRISES, INC., BURBANK, CA. FILED 3-26-2013.

OLIVIA POPE

THE MARK CONSISTS OF STANDARD CHARACTERS WITHOUT CLAIM TO ANY PARTICULAR FONT, STYLE, SIZE, OR COLOR.

THE NAME(S), PORTRAIT(S), AND/OR SIGNATURE(S) SHOWN IN THE MARK DOES NOT IDENTIFY A PARTICULAR LIVING INDIVIDUAL.

FOR BAKEWARE; BEVERAGEWARE; HAIR BRUSHES AND COMBS; BOWLS; BUSTS OF CERAMIC, CRYSTAL, CHINA, TERRA COTTA, EARTHENWARE, PORCELAIN OR GLASS; COASTERS NOT OF PAPER AND NOT BEING TABLE LINEN; HOUSEHOLD CONTAINERS FOR FOOD AND BEVERAGES; CAKE PANS; CAKE MOLDS; CANDLE HOLDERS NOT OF PRECIOUS METAL; CANTEENS; FIGURINES MADE OF CERAMIC, CHINA, CRYSTAL, EARTHENWARE, GLASS, OR PORCELAIN; BEVERAGE GLASSWARE; COOKIE JARS; COOKIE CUTTERS; CORK SCREWS; CUPS; DECORATING BAGS FOR CONFECTIONERS; DECORATIVE CRYSTAL PRISMS; DECORATIVE GLASS; DECORATIVE PLATES; DINNERWARE; DISHWARE; SERVINGWARE FOR SERVING FOOD; HEAT-INSULATED VESSELS; KETTLES; LUNCH BOXES; LUNCH KITS COMPRISING LUNCH BOXES AND BEVERAGE CONTAINERS; SERVING TRAYS; MUGS; NAPKIN HOLDERS; NAPKIN RINGS NOT OF PRECIOUS METALS; PIE PANS; PIE SERVERS; PLATES; PORTABLE COOLERS; REMOVABLE INSULATORS FOR DRINK CANS AND BOTTLES; SPORTS BOTTLES SOLD EMPTY; SOAP DISHES; TEA POTS; TEA SETS; THERMAL INSULATED CONTAINERS FOR FOOD OR BEVERAGE; TOOTHBRUSHES; TRIVETS; VACUUM BOTTLES; WASTE BASKETS (U.S. CLS. 2, 13, 23, 29, 30, 33, 40 AND 50).

DORITT L. CARROLL, EXAMINING ATTORNEY

SN 85-891,971. SPITALETTA, EDWARD, HACKENSACK, NJ. FILED 4-1-2013.

FOODMATES

THE MARK CONSISTS OF STANDARD CHARACTERS WITHOUT CLAIM TO ANY PARTICULAR FONT, STYLE, SIZE, OR COLOR.

FOR HOUSEHOLD STORAGE CONTAINERS FOR FOOD (U.S. CLS. 2, 13, 23, 29, 30, 33, 40 AND 50).

FIRST USE 12-14-2012; IN COMMERCE 12-14-2012.

BRIAN PINO, EXAMINING ATTORNEY

**CLASS 21—(Continued).**

SN 85-949,946. BIRCHBOX, INC., NEW YORK, NY. FILED 6-4-2013.



OWNER OF U.S. REG. NOS. 3,949,015, 4,096,349 AND OTHERS.

THE MARK CONSISTS OF THE STYLIZED DESIGN OF THE OUTLINE OF THE LETTER "B" IN THE CENTER OF A DIAMOND. IN ADDITION, A SINGLE, SMALLER DIAMOND SHAPE APPEARS CENTERED WITHIN THE LETTER "B" AND IS THE ONLY ELEMENT CONTAINED WITHIN THE LETTER.

FOR COSMETIC BRUSHES; HAIR BRUSHES (U.S. CLS. 2, 13, 23, 29, 30, 33, 40 AND 50).

CORY BOONE, EXAMINING ATTORNEY

SN 85-964,502. RUBIN-KIRSCH, MONA, ROCKVILLE, MD. AND KIRSCH, LARRY, ROCKVILLE, MD. FILED 6-19-2013.

## Pet Wet Suit

THE MARK CONSISTS OF STANDARD CHARACTERS WITHOUT CLAIM TO ANY PARTICULAR FONT, STYLE, SIZE, OR COLOR.

NO CLAIM IS MADE TO THE EXCLUSIVE RIGHT TO USE "PET", APART FROM THE MARK AS SHOWN.

FOR PET GROOMING DEVICE, COMPRISED OF A NEOPRENE BAG FOR THE PURPOSE OF INSERTING A WATER SOURCE FOR BATHING AND GROOMING PETS (U.S. CLS. 2, 13, 23, 29, 30, 33, 40 AND 50).

JACQUELINE ABRAMS, EXAMINING ATTORNEY

**CLASS 21—(Continued).**

SN 85-966,827. WIN WIN APPLIANCES, LLC, LA GRANGE, IL. FILED 6-21-2013.

## BAKER'S 13

THE MARK CONSISTS OF STANDARD CHARACTERS WITHOUT CLAIM TO ANY PARTICULAR FONT, STYLE, SIZE, OR COLOR.

NO CLAIM IS MADE TO THE EXCLUSIVE RIGHT TO USE "BAKER'S", APART FROM THE MARK AS SHOWN.

FOR BAKEWARE, NAMELY, BAKING MATS, PASTRY MATS, CAKE MOLDS, COOKIE MOLDS, CAKE PANS, COOKIE CUTTERS, MUFFIN MOLDS, PIE FORMS IN THE NATURE OF PIE PANS, COOKIE SHEETS, BAKING PANS, COOKIE TRAY, BAKING COOLING TRAYS, BAKING LINERS, ROLLING PINS PASTRY BOARDS, PIE CRUST SHIELD; BAKING UTENSILS, NAMELY, SPATULAS, WHISKS, SPOONS, BAKING SPOONS IN THE NATURE OF MIXING SPOONS, MEASURING SPOONS, MEASURING CUPS, PASTRY WHEEL, PASTRY BRUSHES, ICING APPLICATORS, BISCUIT CUTTERS, PASTRY DECORATING UTENSILS, COOKIE DECORATING UTENSILS, PIE TOP CUTTERS, PASTRY/COOKIE DECORATING PEN, ICING SPATULA (U.S. CLS. 2, 13, 23, 29, 30, 33, 40 AND 50).

ANNE FARRELL, EXAMINING ATTORNEY

SN 85-972,619. TECHTRONIC FLOOR CARE TECHNOLOGY LIMITED, TORTOLA, BR. VIRGIN ISLANDS, FILED 6-28-2013.

## SWIVEL GLIDE

THE MARK CONSISTS OF STANDARD CHARACTERS WITHOUT CLAIM TO ANY PARTICULAR FONT, STYLE, SIZE, OR COLOR.

OWNER OF U.S. REG. NO. 2,484,145.

SEC. 2(F).

FOR CARPET SWEEPERS; CLEANING, DUSTING AND POLISHING CLOTHS; CLOTH FOR WIPING OR DUSTING; DUSTING OR CLEANING CLOTHS; FLOOR POLISH APPLICATORS MOUNTABLE ON A MOP HANDLE; FLOOR POLISH APPLICATORS MOUNTED ON MOP HANDLES; FLOOR WAX APPLICATOR MOUNTABLE ON A MOP HANDLE; MOPS; NON-ELECTRIC CARPET CLEANERS; NON-ELECTRIC CARPET SWEEPERS (U.S. CLS. 2, 13, 23, 29, 30, 33, 40 AND 50).

DOMINIC FATHY, EXAMINING ATTORNEY

**CLASS 21—(Continued).**

SN 86-005,637. WORLD SOURCE PARTNERS LLC, PENNSAUKEN, NJ. FILED 7-9-2013.



NO CLAIM IS MADE TO THE EXCLUSIVE RIGHT TO USE "POTTERY COMPANY", APART FROM THE MARK AS SHOWN.

THE COLOR(S) RED, GREEN, AND YELLOW IS/ARE CLAIMED AS A FEATURE OF THE MARK.

THE MARK CONSISTS OF THE WORDS "THE SUN" AND "POTTERY COMPANY" APPEARING ON TWO LINES, WITH THE WORD "THE" IN RED, "SUN" IN YELLOW, "POTTERY" IN GREEN, AND "COMPANY" IN RED. ON THE RIGHT OF THE WORD PORTION OF THE MARKS ARE DEPICTED TWO GREEN HILLS AND A YELLOW SUN. THREE TREES HAVING GREEN LEAVES AND RED TRUNKS APPEAR ON THE FIRST HILL.

FOR FLOWER POTS (U.S. CLS. 2, 13, 23, 29, 30, 33, 40 AND 50).

HEATHER SAPP, EXAMINING ATTORNEY

SN 86-010,847. EMPIAL III, LLC, LINCOLN, RI. FILED 7-15-2013.

## WINGERZ

THE MARK CONSISTS OF STANDARD CHARACTERS WITHOUT CLAIM TO ANY PARTICULAR FONT, STYLE, SIZE, OR COLOR.

FOR DISPOSABLE NON-IMPREGNATED PLASTIC FINGER WIPES FOR EATING (U.S. CLS. 2, 13, 23, 29, 30, 33, 40 AND 50).

DOMINIC J. FERRAIUOLO, EXAMINING ATTORNEY

SN 86-010,850. EMPIAL III, LLC, LINCOLN, RI. FILED 7-15-2013.

## GET MESSY

THE MARK CONSISTS OF STANDARD CHARACTERS WITHOUT CLAIM TO ANY PARTICULAR FONT, STYLE, SIZE, OR COLOR.

FOR DISPOSABLE NON-IMPREGNATED PLASTIC FINGER WIPES FOR EATING (U.S. CLS. 2, 13, 23, 29, 30, 33, 40 AND 50).

DOMINIC J. FERRAIUOLO, EXAMINING ATTORNEY

**CLASS 21—(Continued).**

SN 86-019,422. HYACINTH MARKETING, LLC, NEWTOWN, PA. FILED 7-25-2013.

## CAVE TOOLS

THE MARK CONSISTS OF STANDARD CHARACTERS WITHOUT CLAIM TO ANY PARTICULAR FONT, STYLE, SIZE, OR COLOR.

NO CLAIM IS MADE TO THE EXCLUSIVE RIGHT TO USE "TOOLS", APART FROM THE MARK AS SHOWN.

FOR UTENSILS FOR BARBECUES, NAMELY, CLEANING AND BASTING BRUSHES, TONGS, SKEWERS; CUTTING BOARDS; PLATES (U.S. CLS. 2, 13, 23, 29, 30, 33, 40 AND 50).

FIRST USE 5-28-2013; IN COMMERCE 5-28-2013.

ALICIA COLLINS, EXAMINING ATTORNEY

SN 86-021,414. PARK, PETER JONG, PASADENA, CA. FILED 7-26-2013.

## Walkaway Cookware

THE MARK CONSISTS OF STANDARD CHARACTERS WITHOUT CLAIM TO ANY PARTICULAR FONT, STYLE, SIZE, OR COLOR.

NO CLAIM IS MADE TO THE EXCLUSIVE RIGHT TO USE "COOKWARE", APART FROM THE MARK AS SHOWN.

FOR COOKWARE, NAMELY, POTS, PANS, POT LIDS, POT AND PAN COVERS, CONTAINERS FOR FOOD NOT OF PRECIOUS METAL (U.S. CLS. 2, 13, 23, 29, 30, 33, 40 AND 50).

FIRST USE 1-1-1996; IN COMMERCE 1-1-1996.

EMILY CHUO, EXAMINING ATTORNEY

SN 86-029,069. ASHTEL STUDIOS INC, DBA BRUSH BUD- DIES, FONTANA, CA. FILED 8-5-2013.

## Smart Care

THE MARK CONSISTS OF STANDARD CHARACTERS WITHOUT CLAIM TO ANY PARTICULAR FONT, STYLE, SIZE, OR COLOR.

NO CLAIM IS MADE TO THE EXCLUSIVE RIGHT TO USE "CARE", APART FROM THE MARK AS SHOWN.

FOR MANUAL TOOTHBRUSHES; ORAL CARE KIT COMPRISING MANUAL TOOTHBRUSHES AND FLOSS (U.S. CLS. 2, 13, 23, 29, 30, 33, 40 AND 50).

KIM MONINGHOFF, EXAMINING ATTORNEY

**CLASS 21—(Continued).**

SN 86-031,432. AXELBAND ACCESSORIES LLC, OAKLAND PARK, FL. FILED 8-7-2013.

**AKB**  
A X E L B A N D

FOR BARTENDING KIT COMPOSED OF A BOTTLE OPENER WITH A MAGNETIC ATTACHMENT, AND A COMBINATION PEN-FLASHLIGHT, SOLD TOGETHER WITH A MAGNETIC ARMBAND THAT INCLUDES HOLSTER INSERTS FOR HOLDING THE PEN-FLASHLIGHT (U.S. CLS. 2, 13, 23, 29, 30, 33, 40 AND 50).  
KIM MONINGHOFF, EXAMINING ATTORNEY

SN 86-036,442. MIKKELSEN, JOHN, WAYZATA, MN. FILED 8-13-2013.

**Karbage Kan**

THE MARK CONSISTS OF STANDARD CHARACTERS WITHOUT CLAIM TO ANY PARTICULAR FONT, STYLE, SIZE, OR COLOR.

NO CLAIM IS MADE TO THE EXCLUSIVE RIGHT TO USE "KAN", APART FROM THE MARK AS SHOWN.

FOR GARBAGE CAN (U.S. CLS. 2, 13, 23, 29, 30, 33, 40 AND 50).

JOHN E. MICHOS, EXAMINING ATTORNEY

SN 86-036,587. KEITH BETZEN D/B/A/ BETZEN MFG., UNIONVILLE, IN. FILED 8-13-2013.

**FATSOFF**

THE MARK CONSISTS OF STANDARD CHARACTERS WITHOUT CLAIM TO ANY PARTICULAR FONT, STYLE, SIZE, OR COLOR.

FOR HOUSEHOLD UTENSILS, NAMELY, LADLES, SOUP SERVING SPOONS, SKIMMERS (U.S. CLS. 2, 13, 23, 29, 30, 33, 40 AND 50).

FIRST USE 0-0-1995; IN COMMERCE 0-0-1995.

KEVIN MITTLER, EXAMINING ATTORNEY

**CLASS 21—(Continued).**

SN 86-038,920. HARLAN BROWN, SHERIDAN, AR. FILED 8-15-2013.

**RV SlideSwiper**

THE MARK CONSISTS OF STANDARD CHARACTERS WITHOUT CLAIM TO ANY PARTICULAR FONT, STYLE, SIZE, OR COLOR.

NO CLAIM IS MADE TO THE EXCLUSIVE RIGHT TO USE "RV", APART FROM THE MARK AS SHOWN.

FOR BROOMS (U.S. CLS. 2, 13, 23, 29, 30, 33, 40 AND 50).

FIRST USE 8-15-2013; IN COMMERCE 8-15-2013.

CURTIS FRENCH, EXAMINING ATTORNEY

SN 86-039,052. SOLIS, JACQUELINE, SAN FRANCISCO, CA. FILED 8-15-2013.

**Vibrationally Attuned Water**

THE MARK CONSISTS OF STANDARD CHARACTERS WITHOUT CLAIM TO ANY PARTICULAR FONT, STYLE, SIZE, OR COLOR.

NO CLAIM IS MADE TO THE EXCLUSIVE RIGHT TO USE "WATER", APART FROM THE MARK AS SHOWN.

FOR WATER BOTTLES SOLD EMPTY (U.S. CLS. 2, 13, 23, 29, 30, 33, 40 AND 50).

TARAH HARDY, EXAMINING ATTORNEY

SN 86-039,929. ROYAL COUNCIL OF THE REAL FAIRYLAND, LLC, WILMINGTON, NC. FILED 8-16-2013.



OWNER OF U.S. REG. NOS. 2,980,841 AND 3,691,569.

NO CLAIM IS MADE TO THE EXCLUSIVE RIGHT TO USE "TOOTH", APART FROM THE MARK AS SHOWN.

THE MARK CONSISTS OF A RIBBON BANNER WITH A CLUSTER OF ROSES ON EACH RIBBON END AND A HEART WITH WINGS SITS ON THE BOTTOM CENTER OF THE RIBBON BANNER AND THE STYLIZED WORDS "THE REAL TOOTH FAIRIES" ARE IN THE CENTER OF THE RIBBON BANNER.

FOR TOOTHBRUSHES; ELECTRIC TOOTHBRUSHES; ELECTRIC TOOTHBRUSHES WITH A TIMER; LIGHT UP TOOTHBRUSHES; WATER APPARATUS FOR CLEANING TEETH AND GUMS FOR HOUSEHOLD USE; DENTAL FLOSS; AND TOOTHBRUSH HOLDERS (U.S. CLS. 2, 13, 23, 29, 30, 33, 40 AND 50).

FIRST USE 4-13-2011; IN COMMERCE 4-13-2011.

CHRISTOPHER LAW, EXAMINING ATTORNEY



**CLASS 21—(Continued).**

SN 86-040,711. EFX PERFORMANCE, INC., MISSION VIEJO, CA. FILED 8-16-2013.

# GREEN FRIDGE

THE MARK CONSISTS OF STANDARD CHARACTERS WITHOUT CLAIM TO ANY PARTICULAR FONT, STYLE, SIZE, OR COLOR.

NO CLAIM IS MADE TO THE EXCLUSIVE RIGHT TO USE "GREEN", APART FROM THE MARK AS SHOWN.

FOR HOUSEHOLD CONTAINERS FOR FOODS (U.S. CLS. 2, 13, 23, 29, 30, 33, 40 AND 50).

LAURA KOVALSKY, EXAMINING ATTORNEY

SN 86-040,935. REVELAE GROUP, LLC, DBA YUMMI POUCH, ISSAQUAH, WA. FILED S.R. 8-18-2013; AM. P.R. 12-9-2013.

# Yummi Pouch

THE MARK CONSISTS OF STANDARD CHARACTERS WITHOUT CLAIM TO ANY PARTICULAR FONT, STYLE, SIZE, OR COLOR.

NO CLAIM IS MADE TO THE EXCLUSIVE RIGHT TO USE "POUCH", APART FROM THE MARK AS SHOWN.

FOR RECYCLABLE FLEXIBLE PLASTIC POUCHES SOLD EMPTY FOR HOLDING WATER OR NUTRITIONAL LIQUIDS (U.S. CLS. 2, 13, 23, 29, 30, 33, 40 AND 50).

FIRST USE 7-1-2012; IN COMMERCE 1-1-2013.  
DAVID TAYLOR, EXAMINING ATTORNEY

SN 86-041,035. PHILIP R. PALUMBO, CARLSBAD, CA. FILED 8-18-2013.



NO CLAIM IS MADE TO THE EXCLUSIVE RIGHT TO USE "CERVEZA", APART FROM THE MARK AS SHOWN.

THE COLOR(S) BLACK, WHITE, RED, YELLOW, BROWN, GREEN, AND BEIGE IS/ARE CLAIMED AS A FEATURE OF THE MARK.

THE MARK CONSISTS OF A BEIGE, BROWN, BLACK

**CLASS 21—(Continued).**

AND WHITE SKULL ON A TORSO DRESSED IN A BLACK JACKET WITH WHITE ACCENTS, A RED BOW AND A WHITE SHIRT WITH A BROWN AND BLACK SNAKE WITH YELLOW EYES, RED MOUTH, WHITE FANGS, AND A YELLOW AND BROWN RATTLER WRAPPED AROUND THE NECK AND WHITE AND BLACK ROSES WITH GREEN AND BLACK LEAVES, AND THE WORDING "EL GORDO" IN WHITE OUTLINED IN BLACK AND GREEN AND THE WORD "CERVEZA" IN BEIGE ON A BROWN TO RED BACKGROUND.

THE ENGLISH TRANSLATION OF "EL GORDO" AND "CERVEZA" IN THE MARK IS "THE FAT ONE", "THE BIG ONE" AND "BEER".

FOR BEER MUGS; INSULATED BAGS FOR FOOD OR BEVERAGE FOR DOMESTIC USE; INSULATED CONTAINERS FOR BEVERAGE CANS FOR DOMESTIC USE; INSULATED CONTAINERS FOR FOOD OR BEVERAGE FOR DOMESTIC USE; INSULATING SLEEVE HOLDER FOR BEVERAGE CUPS; INSULATING SLEEVE HOLDER FOR BOTTLES; INSULATING SLEEVE HOLDERS FOR BEVERAGE CANS; THERMAL INSULATED BAGS FOR FOOD OR BEVERAGES; THERMAL INSULATED CONTAINERS FOR FOOD OR BEVERAGES; THERMAL INSULATED WRAP FOR CANS TO KEEP THE CONTENTS COLD OR HOT (U.S. CLS. 2, 13, 23, 29, 30, 33, 40 AND 50).

DEIRDRE ROBERTSON, EXAMINING ATTORNEY

SN 86-041,041. PHILIP R. PALUMBO, CARLSBAD, CA. FILED 8-18-2013.



NO CLAIM IS MADE TO THE EXCLUSIVE RIGHT TO USE "CERVEZA NEGRA", APART FROM THE MARK AS SHOWN.

THE COLOR(S) BLACK, WHITE, RED, YELLOW, GREEN, BROWN, GOLD, BLUE AND BEIGE IS/ARE CLAIMED AS A FEATURE OF THE MARK.

THE MARK CONSISTS OF A BEIGE, BLACK AND WHITE SKULL WITH GREEN LEAVES ON A TORSO DRESSED IN A RED, GOLD AND BLUE MILITARY JACKET WITH BROWN LAPELS SURROUNDED BY YELLOW AND RED FLOWERS ON GREEN STEMS WITH GREEN LEAVES, AND THE WORDING "EL JEFE" IN WHITE OUTLINED IN BLACK AND GREEN AND THE WORD "CERVEZA NEGRA" IN BEIGE ON A BLACK BACKGROUND.

THE ENGLISH TRANSLATION OF "EL JEFE" AND "CERVEZA" AND "NEGRA" IN THE MARK IS "THE BOSS", "THE CHIEF", "THE LEADER" AND "BEER" AND "BLACK".

FOR BEER MUGS; INSULATED BAGS FOR FOOD OR BEVERAGE FOR DOMESTIC USE; INSULATED CONTAINERS FOR BEVERAGE CANS FOR DOMESTIC USE; INSULATED CONTAINERS FOR FOOD OR BEVERAGE FOR DOMESTIC USE; INSULATING SLEEVE HOLDER FOR BEVERAGE CUPS; INSULATING SLEEVE HOLDER FOR BOTTLES; INSULATING SLEEVE HOLDERS FOR BEVERAGE CANS; THERMAL INSULATED BAGS FOR FOOD OR BEVERAGES; THERMAL INSULATED CONTAINERS FOR FOOD OR BEVERAGES; THERMAL INSULATED WRAP FOR CANS TO KEEP THE CONTENTS COLD OR HOT (U.S. CLS. 2, 13, 23, 29, 30, 33, 40 AND 50).

DEIRDRE ROBERTSON, EXAMINING ATTORNEY

**CLASS 21—(Continued).**

SN 86-041,259. RONAY GROUP LLC, FORT WALTON BEACH, FL. FILED 8-19-2013.

# Intelli Pot

THE MARK CONSISTS OF STANDARD CHARACTERS WITHOUT CLAIM TO ANY PARTICULAR FONT, STYLE, SIZE, OR COLOR.

NO CLAIM IS MADE TO THE EXCLUSIVE RIGHT TO USE "POT", APART FROM THE MARK AS SHOWN.

FOR PLANTERS FOR FLOWERS AND PLANTS (U.S. CLS. 2, 13, 23, 29, 30, 33, 40 AND 50).

SHAVELL MCPHERSON, EXAMINING ATTORNEY

**CLASS 21—(Continued).**

SN 86-044,194. KIBBEE, YVONNE J., WEST HILLS, CA. FILED 8-21-2013.

# EasyFold

THE MARK CONSISTS OF STANDARD CHARACTERS WITHOUT CLAIM TO ANY PARTICULAR FONT, STYLE, SIZE, OR COLOR.

OWNER OF U.S. REG. NO. 3,283,694.

FOR CARDBOARD HAND OPERATED FRAME FOR WINDING AND STORING HOUSEHOLD LINENS (U.S. CLS. 2, 13, 23, 29, 30, 33, 40 AND 50).

FIRST USE 6-24-2005; IN COMMERCE 9-20-2005.

DANIEL CAPSHAW, EXAMINING ATTORNEY

SN 86-042,630. MADD HATE DESIGN LLC, MADISON, GA. FILED 8-20-2013.

# REDNECK CHILLER

THE MARK CONSISTS OF STANDARD CHARACTERS WITHOUT CLAIM TO ANY PARTICULAR FONT, STYLE, SIZE, OR COLOR.

NO CLAIM IS MADE TO THE EXCLUSIVE RIGHT TO USE "CHILLER", APART FROM THE MARK AS SHOWN.

FOR PORTABLE COOLERS (U.S. CLS. 2, 13, 23, 29, 30, 33, 40 AND 50).

SHANNON TWOHIG, EXAMINING ATTORNEY

SN 86-045,165. MULLARKEY, SHARON, MANSFIELD, TX. FILED 8-22-2013.

# PAMPERED SOAK

THE MARK CONSISTS OF STANDARD CHARACTERS WITHOUT CLAIM TO ANY PARTICULAR FONT, STYLE, SIZE, OR COLOR.

OWNER OF U.S. REG. NO. 4,393,905.

NO CLAIM IS MADE TO THE EXCLUSIVE RIGHT TO USE "SOAK", APART FROM THE MARK AS SHOWN.

FOR MANICURE SOAKING CONTAINER, NAMELY, A SOAKING CONTAINER FOR IMMERSING FINGERS AND FINGER NAILS IN WATER AND NON-MEDICATED SOLUTIONS AND HAVING FINGER COMPARTMENTS FOR ENHANCED SOAKING, SOLD EMPTY (U.S. CLS. 2, 13, 23, 29, 30, 33, 40 AND 50).

ELIZABETH CHANG, EXAMINING ATTORNEY

SN 86-042,839. LAST LID, LLC, NEW YORK, NY. FILED 8-20-2013.

# LAST LID

THE MARK CONSISTS OF STANDARD CHARACTERS WITHOUT CLAIM TO ANY PARTICULAR FONT, STYLE, SIZE, OR COLOR.

NO CLAIM IS MADE TO THE EXCLUSIVE RIGHT TO USE "LID", APART FROM THE MARK AS SHOWN.

FOR FITTED TRASH RECEPTACLE COVERS (U.S. CLS. 2, 13, 23, 29, 30, 33, 40 AND 50).

FIRST USE 5-31-2012; IN COMMERCE 5-31-2012.

ALLISON SCHRODY, EXAMINING ATTORNEY

SN 86-045,666. TERZIAN, ALEXANDER, QUINCY, MA. FILED 8-22-2013.

# drinkhand

THE MARK CONSISTS OF STANDARD CHARACTERS WITHOUT CLAIM TO ANY PARTICULAR FONT, STYLE, SIZE, OR COLOR.

FOR RUBBER STRAPS SPECIFICALLY DESIGNED FOR PLASTIC DRINKING CUPS, FOR SECURING THE CUP TO A HUMAN HAND (U.S. CLS. 2, 13, 23, 29, 30, 33, 40 AND 50).

COLLEEN KEARNEY, EXAMINING ATTORNEY

**CLASS 21—(Continued).**

SN 86-048,026. STYLE ASIA INC., MOONACHIE, NJ. FILED 8-26-2013.

**CHEFS BASICS**

THE MARK CONSISTS OF STANDARD CHARACTERS WITHOUT CLAIM TO ANY PARTICULAR FONT, STYLE, SIZE, OR COLOR.

OWNER OF U.S. REG. NO. 3,485,890.

NO CLAIM IS MADE TO THE EXCLUSIVE RIGHT TO USE "CHEFS", APART FROM THE MARK AS SHOWN.

FOR FRYING PANS; UTENSILS FOR BARBEQUE, NAMELY, BARBEQUE SETS CONSISTING PRIMARILY OF FORKS, KNIVES, TONGS, SPATULAS, AND BRUSHES; HOUSEHOLD CONTAINERS FOR FOOD; NON-ELECTRIC TEA KETTLES; CASSEPOLE DISHES (U.S. CLS. 2, 13, 23, 29, 30, 33, 40 AND 50).

FIRST USE 0-0-2003; IN COMMERCE 0-0-2003.

HANNO RITTNER, EXAMINING ATTORNEY

SN 86-054,915. NINGBO RE-COOK IMP. & EXP. CO., LTD., ZHEJIANG, CHINA, FILED 9-3-2013.

**Re·Cook**

THE MARK CONSISTS OF STYLIZED LETTERS "RE-COOK" AND A POT DESIGN UNDER THE LETTER E.

FOR BEVERAGE GLASSWARE; BRUSHES FOR BASTING MEAT; BRUSHES FOR WASHING UP; CAKE BRUSHES; CAKE MOLDS; CHOPPING BOARDS FOR KITCHEN USE; CLEANING BRUSHES FOR HOUSEHOLD USE; COFFEE SERVICES; CONTAINERS FOR HOUSEHOLD OR KITCHEN USE; COOKING POT SETS; COOKING POTS AND PANS; COOKING UTENSILS, NAMELY, BARBECUE BRANDERS; COOKING UTENSILS, NAMELY, GRILLS; CUTTING BOARDS FOR THE KITCHEN; GRILLS IN THE NATURE OF COOKING UTENSILS; KITCHEN LADLES; KITCHEN UTENSILS, NAMELY, POURING AND STRAINING SPOUTS; LUNCH BOXES MADE OF PLASTIC; PORCELAIN FLOWER POTS; PORCELAIN MUGS; TEA SERVICES (U.S. CLS. 2, 13, 23, 29, 30, 33, 40 AND 50).

FIRST USE 5-6-2009; IN COMMERCE 5-6-2009.

DONALD JOHNSON, EXAMINING ATTORNEY

**CLASS 21—(Continued).**

SN 86-061,970. BOOGINHEAD LLC, ISSAQUAH, WA. FILED 9-11-2013.

**SIPPIGRIP**

THE MARK CONSISTS OF STANDARD CHARACTERS WITHOUT CLAIM TO ANY PARTICULAR FONT, STYLE, SIZE, OR COLOR.

OWNER OF U.S. REG. NO. 3,434,730.

FOR BABY AND TODDLER FEEDING ACCESSORY PRODUCTS, NAMELY, TETHERS SPECIALLY DESIGNED FOR SECURING TRAINING CUPS FOR BABIES AND CHILDREN (U.S. CLS. 2, 13, 23, 29, 30, 33, 40 AND 50).

FIRST USE 4-15-2006; IN COMMERCE 4-15-2006.

ELI HELLMAN, EXAMINING ATTORNEY

SN 86-066,125. BENFATTI, GENE, SCOTCH PLAINS, NJ. FILED 9-16-2013.

**RACKULA**

THE MARK CONSISTS OF STANDARD CHARACTERS WITHOUT CLAIM TO ANY PARTICULAR FONT, STYLE, SIZE, OR COLOR.

FOR HOUSEHOLD UTENSILS, NAMELY, SPATULAS (U.S. CLS. 2, 13, 23, 29, 30, 33, 40 AND 50).

SHAILA LEWIS, EXAMINING ATTORNEY

SN 86-066,407. BEACHBEACON, HESPERIA, CA. FILED 9-17-2013.

**BEACHBEACON**

THE MARK CONSISTS OF THE STYLIZED TEXT "BEACHBEACON" WITH THE SECOND LETTER "A" DISPLAYING 5 RAYS AT THE TOP.

FOR GLASS JARS (U.S. CLS. 2, 13, 23, 29, 30, 33, 40 AND 50).

MORGAN WYNNE, EXAMINING ATTORNEY

**CLASS 21—(Continued).**

SN 86-066,674. THE TRANZONIC COMPANIES, CLEVELAND, OH. FILED 9-17-2013.

## TACK-KLEEN

THE MARK CONSISTS OF STANDARD CHARACTERS WITHOUT CLAIM TO ANY PARTICULAR FONT, STYLE, SIZE, OR COLOR.

FOR ALL-PURPOSE WIPING CLOTHS (U.S. CLS. 2, 13, 23, 29, 30, 33, 40 AND 50).

FIRST USE 3-19-2001; IN COMMERCE 3-19-2001.  
MELISSA VALLILLO, EXAMINING ATTORNEY

**CLASS 21—(Continued).**

SN 86-067,429. BOOSTEK CORPORATION, HOUSTON, TX. FILED 9-17-2013.



THE MARK CONSISTS OF A LOWERCASE LETTER "B" IN A STYLIZED FONT WITH A HALF RAINDROP SHAPE IN FLUSH ALIGNMENT WITH THE LINEAR SIDE OF THE LETTER.

FOR BOTTLES, SOLD EMPTY; CUPS; EMPTY WATER BOTTLES FOR BICYCLES; PLASTIC CUPS; PLASTIC WATER BOTTLES SOLD EMPTY; REUSABLE PLASTIC WATER BOTTLES SOLD EMPTY; REUSABLE STAINLESS STEEL WATER BOTTLES SOLD EMPTY; SPORTS BOTTLES SOLD EMPTY; WATER BOTTLES SOLD EMPTY (U.S. CLS. 2, 13, 23, 29, 30, 33, 40 AND 50).

FIRST USE 9-10-2013; IN COMMERCE 9-10-2013.  
NICHOLAS COLEMAN, EXAMINING ATTORNEY

SN 86-068,014. WALLBEYOND INTERNATIONAL INC., CHINO HILLS, CA. FILED 9-18-2013.

## INDY VAC

THE MARK CONSISTS OF STANDARD CHARACTERS WITHOUT CLAIM TO ANY PARTICULAR FONT, STYLE, SIZE, OR COLOR.

NO CLAIM IS MADE TO THE EXCLUSIVE RIGHT TO USE "VAC", APART FROM THE MARK AS SHOWN.

FOR FLOOR POLISH APPLICATORS MOUNTABLE ON A MOP HANDLE; FLOOR POLISH APPLICATORS MOUNTED ON MOP HANDLES; FLOOR WAX APPLICATOR MOUNTABLE ON A MOP HANDLE; MOP WRINGERS; MOPS (U.S. CLS. 2, 13, 23, 29, 30, 33, 40 AND 50).

KATHERINE STOIDES, EXAMINING ATTORNEY

SN 86-067,118. VERITURE, INC., CEDAR HILLS, UT. FILED 9-17-2013.

## Pantry Elements

THE MARK CONSISTS OF STANDARD CHARACTERS WITHOUT CLAIM TO ANY PARTICULAR FONT, STYLE, SIZE, OR COLOR.

FOR BAKEWARE, NAMELY, CAKE MOLDS, CUP CAKE MOLDS, PASTRY MOLDS, CHOCOLATE MOLDS, COOKIE SHEETS, AND CAKE PANS; BAKING MATS, BAKING SHEETS; TRIVETS; MUFFIN PANS; ICE CUBE MOLDS; HOUSEHOLD AND KITCHEN UTENSILS, NAMELY, GRATERS, COOKING GRATERS, POT AND PAN SCRAPERS, SPATULAS, TURNERS, WHISKS, SERVING TONGS, SPOONS, NAMELY, MIXING, SERVING, SLOTTED AND COOKING SPOONS (U.S. CLS. 2, 13, 23, 29, 30, 33, 40 AND 50).

FIRST USE 3-21-2013; IN COMMERCE 6-1-2013.  
KIMBERLY FRYE, EXAMINING ATTORNEY

SN 86-068,844. SEA LARK ENTERPRISES INC., SMITH-TOWN, NY. FILED 9-19-2013.

## SOAP LIFT

THE MARK CONSISTS OF STANDARD CHARACTERS WITHOUT CLAIM TO ANY PARTICULAR FONT, STYLE, SIZE, OR COLOR.

NO CLAIM IS MADE TO THE EXCLUSIVE RIGHT TO USE "SOAP", APART FROM THE MARK AS SHOWN.

FOR SOAP HOLDERS (U.S. CLS. 2, 13, 23, 29, 30, 33, 40 AND 50).

FIRST USE 1-2-2011; IN COMMERCE 1-2-2011.

ARETHA SOMERVILLE, EXAMINING ATTORNEY

**CLASS 21—(Continued).**

SN 86-069,278. HARDING, SUSAN, NEW ORLEANS, LA.  
FILED 9-19-2013.

**BUG AND DRUG BUCKLE**

THE MARK CONSISTS OF STANDARD CHARACTERS  
WITHOUT CLAIM TO ANY PARTICULAR FONT, STYLE,  
SIZE, OR COLOR.

FOR COVERS FOR DRINKING GLASSES (U.S. CLS. 2,  
13, 23, 29, 30, 33, 40 AND 50).  
AISHA CLARKE, EXAMINING ATTORNEY

SN 86-069,484. ANNIHILARE MEDICAL SYSTEMS, LIN-  
COLNTON, NC. FILED 9-19-2013.

**Annihilyzer**

THE MARK CONSISTS OF STANDARD CHARACTERS  
WITHOUT CLAIM TO ANY PARTICULAR FONT, STYLE,  
SIZE, OR COLOR.

FOR DISPENSERS FOR CLEANING AND DISINFECT-  
ING SOLUTIONS (U.S. CLS. 2, 13, 23, 29, 30, 33, 40 AND  
50).

FIRST USE 9-11-2013; IN COMMERCE 9-19-2013.  
WILLIAM ROSSMAN, EXAMINING ATTORNEY

SN 86-070,580. DIVERSEY, INC., STURTEVANT, WI. FILED  
9-20-2013.

**REVOFLOW**

THE MARK CONSISTS OF STANDARD CHARACTERS  
WITHOUT CLAIM TO ANY PARTICULAR FONT, STYLE,  
SIZE, OR COLOR.

FOR DISPENSERS FOR CLEANING AND DISINFEC-  
TANT PREPARATIONS (U.S. CLS. 2, 13, 23, 29, 30, 33, 40  
AND 50).

FIRST USE 6-4-2013; IN COMMERCE 6-4-2013.  
NATALIE POLZER, EXAMINING ATTORNEY

**CLASS 21—(Continued).**

SN 86-076,835. LAWSON PRODUCTS, INC., CHICAGO, IL.  
FILED 9-27-2013.

**FALCONGRIP**

THE MARK CONSISTS OF STANDARD CHARACTERS  
WITHOUT CLAIM TO ANY PARTICULAR FONT, STYLE,  
SIZE, OR COLOR.

OWNER OF U.S. REG. NO. 4,442,605.  
FOR DISPOSABLE LATEX AND NITRILE GLOVES  
FOR GENERAL USE (U.S. CLS. 2, 13, 23, 29, 30, 33, 40  
AND 50).

JULIE WATSON, EXAMINING ATTORNEY

SN 86-079,961. PARAMOUNT PICTURES CORPORATION,  
HOLLYWOOD, CA. FILED 10-1-2013.

**JACK RYAN: SHADOW RECRUIT**

THE MARK CONSISTS OF STANDARD CHARACTERS  
WITHOUT CLAIM TO ANY PARTICULAR FONT, STYLE,  
SIZE, OR COLOR.

THE NAME(S), PORTRAIT(S), AND/OR SIGNATURE(S)  
SHOWN IN THE MARK DOES NOT IDENTIFY A PARTI-  
CULAR LIVING INDIVIDUAL.

FOR BEVERAGE GLASSWARE; BOTTLE OPENERS;  
CHINA ORNAMENTS; COASTERS, NOT OF PAPER  
AND OTHER THAN TABLE LINEN; COOKIE JARS;  
DECORATIVE PLATES; LUNCH BOXES; MUGS; PAPER  
AND PLASTIC CUPS; PAPER PLATES; PIGGY BANKS;  
SHOT GLASSES; SOAP DISPENSERS; WASTE PAPER  
BASKETS (U.S. CLS. 2, 13, 23, 29, 30, 33, 40 AND 50).

AHSEN KHAN, EXAMINING ATTORNEY

SN 86-086,808. BEEFEATER'S HOLDING COMPANY, INC.,  
NORTH BERGEN, NJ. FILED 10-9-2013.

**FLOSS'EMS**

THE MARK CONSISTS OF STANDARD CHARACTERS  
WITHOUT CLAIM TO ANY PARTICULAR FONT, STYLE,  
SIZE, OR COLOR.

FOR PET DENTAL FLOSS (U.S. CLS. 2, 13, 23, 29, 30,  
33, 40 AND 50).

BARBARA GAYNOR, EXAMINING ATTORNEY

**CLASS 21—(Continued).**

SN 86-090,471. BEEFEATER'S HOLDING COMPANY, INC.,  
NORTH BERGEN, NJ. FILED 10-14-2013.

**CLEANBETWEEN**

THE MARK CONSISTS OF STANDARD CHARACTERS  
WITHOUT CLAIM TO ANY PARTICULAR FONT, STYLE,  
SIZE, OR COLOR.

FOR PET DENTAL FLOSS (U.S. CLS. 2, 13, 23, 29, 30,  
33, 40 AND 50).  
BARBARA GAYNOR, EXAMINING ATTORNEY

SN 86-094,323. HOME ESSENTIALS & BEYOND, INC.,  
JERSEY CITY, NJ. FILED 10-17-2013.



NO CLAIM IS MADE TO THE EXCLUSIVE RIGHT TO  
USE "QUALITY" AND "ICE COLD DRINK" AND "GLASS-  
WARE", APART FROM THE MARK AS SHOWN.

THE MARK CONSISTS OF THE WORDS "QUALITY",  
"REFRESHING", "ICE COLD DRINK" AND "GLASS-  
WARE", WITH THE WORDS SURROUNDED BY BRACK-  
ETS, A SWIRL DESIGN LOCATED BETWEEN "QUALITY"  
AND "REFRESHING", AND A PAIR OF BRANCHES  
SURROUNDING A CIRCLE LOCATED UNDER THE  
BRACKETS.

FOR BEVERAGE GLASSWARE (U.S. CLS. 2, 13, 23, 29,  
30, 33, 40 AND 50).  
STEPHANIE ALI, EXAMINING ATTORNEY

SN 86-120,994. BUDGE INDUSTRIES LLC, LANSDALE, PA.  
FILED 11-17-2013.

**RUSTEC**

THE MARK CONSISTS OF STANDARD CHARACTERS  
WITHOUT CLAIM TO ANY PARTICULAR FONT, STYLE,  
SIZE, OR COLOR.

FOR COOKING UTENSILS, NAMELY, GRILL COV-  
ERS (U.S. CLS. 2, 13, 23, 29, 30, 33, 40 AND 50).  
KATHY WANG, EXAMINING ATTORNEY

**CLASS 22—CORDAGE AND FIBERS**

SN 85-948,403. NINGHAI CHUANGXIN TOURISTS PRO-  
DUCTS CO., LTD., ZHEJIANG, CHINA, FILED 6-2-2013.



THE MARK CONSISTS OF STYLIZED LETTERS "MSC"  
IN A RECTANGLE WITH A CURVE LINE SUPERIMPOSED  
OVER THE LETTERS.

FOR AWNINGS; CAMOUFLAGE NETS; HAMMOCKS;  
PACKAGING BAGS OF TEXTILE MATERIAL; SACKS  
OR BAGS FOR THE TRANSPORTATION OR STORAGE  
OF MATERIALS IN BULK; SAILS; TARPAULINS;  
TENTS; UNFITTED COVERS FOR BOATS AND MAR-  
INE VEHICLES; UNFITTED VEHICLE COVERS (U.S.  
CLS. 1, 2, 7, 19, 22, 42 AND 50).

FIRST USE 1-26-2010; IN COMMERCE 1-26-2010.  
MARILYN IZZI, EXAMINING ATTORNEY

SN 86-111,050. HAMPTON PRODUCTS INTERNATIONAL  
CORPORATION, FOOTHILL RANCH, CA. FILED 11-5-  
2013.

**PERFORMANCE ENGINEERED**

THE MARK CONSISTS OF STANDARD CHARACTERS  
WITHOUT CLAIM TO ANY PARTICULAR FONT, STYLE,  
SIZE, OR COLOR.

OWNER OF U.S. REG. NO. 2,805,941.  
SEC. 2(F).  
FOR NON-METAL DEVICES FOR HANDLING, SE-  
CURING AND STOWING CARGO, NAMELY, TIE-  
DOWNS, LOAD-HANDLING, BUNDLE-SECURING,  
STRETCH, AND TOWING STRAPS; ALL-PURPOSE  
STRAPS COMPRISED OF SYNTHETIC TEXTILE MATE-  
RIALS; COMMERCIAL NETS (U.S. CLS. 1, 2, 7, 19, 22, 42  
AND 50).

FIRST USE 6-10-2003; IN COMMERCE 6-10-2003.  
HOWARD SMIGA, EXAMINING ATTORNEY

**CLASS 24—FABRICS**

SN 76-713,596. AG TECHNOLOGIES, INC., HILLSBOROUGH, NJ. FILED 3-1-2013.

**CUDDLE SMART**

THE MARK CONSISTS OF STANDARD CHARACTERS WITHOUT CLAIM TO ANY PARTICULAR FONT, STYLE, SIZE, OR COLOR.

FOR LINENS; TOWELS; BEDDING, NAMELY, PILLOWCASE COVERS AND BED BLANKETS (U.S. CLS. 42 AND 50).

CIMMERIAN COLEMAN, EXAMINING ATTORNEY

SN 76-714,982. GUNTERSVILLE BREATHABLES, INC., ARAB, AL. FILED 9-19-2013.

**ICOOL**

THE MARK CONSISTS OF STANDARD CHARACTERS WITHOUT CLAIM TO ANY PARTICULAR FONT, STYLE, SIZE, OR COLOR.

FOR TOWELS WITH COOLING EVAPORATIVE PROPERTIES AND COOLING EFFECTS FOR THERAPEUTIC PURPOSES; COOLING TOWELS NOT FOR MEDICAL OR PROTECTIVE PURPOSES (U.S. CLS. 42 AND 50).

SUZANNE BLANE, EXAMINING ATTORNEY

SN 79-127,907. THE SUFFERFEST PTE LTD, SINGAPORE, FILED 2-15-2013.



PRIORITY DATE OF 9-13-2012 IS CLAIMED. OWNER OF INTERNATIONAL REGISTRATION 1154616 DATED 2-15-2013, EXPIRES 2-15-2023.

THE COLOR(S) BLACK, WHITE AND RED IS/ARE CLAIMED AS A FEATURE OF THE MARK.

THE MARK CONSISTS OF A RECTANGLE WITH A BLACK BAND AT THE TOP, A WHITE BAND IN THE MIDDLE, AND A RED BAND AT THE BOTTOM. THE WHITE BAND HAS A RECTANGULAR DESIGN WITH RED ON EACH END, A FACE THAT HAS A WHITE IN THE BACKGROUND WITH BLACK HAIR ON THE SIDES, BLACK EYEBROWS, BLACK EYES WITH BLACK STREAKS, AND BLACK LINES THAT APPEAR AS WRINKLES. THE WHITE LETTERS "IWBMATTKYT" APPEAR ON THE RED STRIPE.

FOR BANNERS AND FLAGS OF TEXTILE (U.S. CLS. 42 AND 50).

RAMONA ORTIGA, EXAMINING ATTORNEY

**CLASS 24—(Continued).**

SN 79-132,604. PUNING TEXTILE AND CLOTHING TECHNOLOGY INSTITUTE, PUNING, GUANGDONG, CHINA, FILED 6-5-2013.



OWNER OF INTERNATIONAL REGISTRATION 1166632 DATED 6-5-2013, EXPIRES 6-5-2023.

THE COLOR(S) COLORS WHITE, AQUA, BLUE, AND NAVY BLUE IS/ARE CLAIMED AS A FEATURE OF THE MARK.

THE MARK CONSISTS OF A SPHERE MADE UP OF BLUE AND WHITE BANDS AT THE TOP AND WHITE, AQUA, BLUE, AND NAVY BLUE RECTANGLES AT THE BOTTOM. THE WHITE TEXT "GT&CTI" APPEARS ON THE SECOND BLUE BAND FROM THE TOP.

FOR WOOLEN CLOTH; FELT CLOTH; TOWELS OF TEXTILE; NON-WOVEN TEXTILE FABRICS; COTTON FABRICS; BED CLOTHES, NAMELY, FITTED SHEETS, DUVETS, BED BLANKETS AND COMFORTERS; UNFITTED FABRIC FURNITURE COVERS; WALL HANGINGS OF TEXTILE; CURTAINS OF TEXTILE OR PLASTIC; WASHING MITTS (U.S. CLS. 42 AND 50).

SAMUAL PAQUIN, EXAMINING ATTORNEY

SN 79-135,359. COSILAN AG, SWITZERLAND, FILED 7-15-2013.

**COSILAN**

THE MARK CONSISTS OF STANDARD CHARACTERS WITHOUT CLAIM TO ANY PARTICULAR FONT, STYLE, SIZE, OR COLOR.

PRIORITY DATE OF 5-14-2013 IS CLAIMED. OWNER OF INTERNATIONAL REGISTRATION 1173550 DATED 7-15-2013, EXPIRES 7-15-2023.

OWNER OF U.S. REG. NO. 3,120,852.

FOR WOVEN FABRICS; TEXTILE TABLECLOTHS; PRINTED SINGLE-COLOR TEXTILE MATERIALS, NAMELY, MIXED FIBER FABRICS; PRINTED SINGLE-COLOR MESH-WOVEN FABRICS; PRINTED SINGLE-COLOR FINE KNITTED FABRICS; ALL OF THE FOREGOING GOODS COMPRISED OF COTTON, SILK AND/OR WOOL (U.S. CLS. 42 AND 50).

SIMON TENG, EXAMINING ATTORNEY

**CLASS 24—(Continued).**

SN 85-698,704. DDSL ENTERPRISES LLC, DBA BONCHOS, MILTON, GA. FILED S.R. 8-8-2012; AM. P.R. 1-8-2014.

# Bonchos

THE MARK CONSISTS OF STANDARD CHARACTERS WITHOUT CLAIM TO ANY PARTICULAR FONT, STYLE, SIZE, OR COLOR.

FOR BABY BLANKETS (U.S. CLS. 42 AND 50).  
FIRST USE 10-15-2011; IN COMMERCE 10-15-2011.  
ANDREA HACK, EXAMINING ATTORNEY

---

SN 85-735,684. TIENS GROUP CO., LTD., TIANJIN, CHINA, FILED 9-21-2012.

# BANNERSTORE

THE MARK CONSISTS OF STANDARD CHARACTERS WITHOUT CLAIM TO ANY PARTICULAR FONT, STYLE, SIZE, OR COLOR.

FOR BED COVERS; QUILTS; DUVETS; BED LINEN AND PILLOW COVERS; COTTON-PADDED MATTRESS COVERS; QUILT COVERS; WASHING GLOVES; BED BLANKETS; TOWELS OF TEXTILE; BATH TOWELS; UNFITTED FABRIC FURNITURE COVERS (U.S. CLS. 42 AND 50).

LINDA ESTRADA, EXAMINING ATTORNEY

---

SN 85-818,538. KUATRO, LLC, SAN DIEGO, CA. FILED 1-8-2013.

# Craving Cool

THE MARK CONSISTS OF STANDARD CHARACTERS WITHOUT CLAIM TO ANY PARTICULAR FONT, STYLE, SIZE, OR COLOR.

FOR WINDOW TREATMENTS, NAMELY, FABRIC AND VINYL CURTAINS, DRAPES, POUFS, SWAGS, AND FABRIC VALANCES; WINDOW COVERINGS, NAMELY, FABRIC AND VINYL CURTAINS, DRAPES, POUFS, SWAGS, AND FABRIC VALANCES; BEDDING, NAMELY, SHEETS, BED LINENS, BED THROWS, SHAMS, PILLOW CASES, BEDSPREADS, BED BLANKETS AND COMFORTERS; TOWELS (U.S. CLS. 42 AND 50).

GISELLE AGOSTO, EXAMINING ATTORNEY

**CLASS 24—(Continued).**

SN 85-833,017. ANNA'S LINENS, INC., COSTA MESA, CA. FILED 1-25-2013.



OWNER OF U.S. REG. NO. 3,973,724.  
THE MARK CONSISTS OF A STYLIZED CAPITAL LETTER "B", SLANTED TO THE LEFT, STENCILED ON A SOLID BACKGROUND, WITH THE WORD "BELLA" IN STANDARD LOWER-CASE LETTERS UNDERNEATH.

FOR TABLECLOTHS OF TEXTILES; BLANKET THROWS (U.S. CLS. 42 AND 50).

FIRST USE 9-0-2011; IN COMMERCE 9-0-2011.

GINA HAYES, EXAMINING ATTORNEY

---

SN 85-875,734. MONIKA WALKER, LA MESA, CA. FILED 3-14-2013.

# Bendy Blanket

THE MARK CONSISTS OF STANDARD CHARACTERS WITHOUT CLAIM TO ANY PARTICULAR FONT, STYLE, SIZE, OR COLOR.

NO CLAIM IS MADE TO THE EXCLUSIVE RIGHT TO USE "BLANKET", APART FROM THE MARK AS SHOWN.

FOR BABY BEDDING, NAMELY, BUNDLE BAGS, SWADDLING BLANKETS, CRIB BUMPERS, FITTED CRIB SHEETS, CRIB SKIRTS, CRIB BLANKETS, AND DIAPER CHANGING PAD COVERS NOT OF PAPER; BABY BLANKETS; BED BLANKETS; BED SHEETS, FITTED BED SHEET COVERS, BED FLAT SHEETS, AND PILLOW CASES USED IN THE BEDDING; HEALTH CARE, HOME-HEALTH CARE AND NURSING HOME INDUSTRIES MADE OF BIODEGRADABLE FILM CREATED FROM RENEWABLE BIO-POLYMER RESOURCES; BLANKET THROWS; BLANKETS FOR OUTDOOR USE; CHILDREN'S BLANKETS; CHILDREN'S BED SHEETS, PILLOW CASES, AND BLANKETS; LAP BLANKETS; RECEIVING BLANKETS; TRAVELLING BLANKETS (U.S. CLS. 42 AND 50).

ELISSA GARBER KON, EXAMINING ATTORNEY



**CLASS 24—(Continued).**

SN 85-887,253. DISNEY ENTERPRISES, INC., BURBANK, CA. FILED 3-26-2013.

**OLIVIA POPE**

THE MARK CONSISTS OF STANDARD CHARACTERS WITHOUT CLAIM TO ANY PARTICULAR FONT, STYLE, SIZE, OR COLOR.

THE NAME(S), PORTRAIT(S), AND/OR SIGNATURE(S) SHOWN IN THE MARK DOES NOT IDENTIFY A PARTICULAR LIVING INDIVIDUAL.

FOR AFGHANS; BARBECUE MITTS; BATH LINEN; BATH TOWELS; BED BLANKETS; BED CANOPIES; BED LINEN; BED SHEETS; BED SKIRTS; BED SPREADS; BLANKET THROWS; CALICO; CHILDREN'S BLANKETS; CLOTH COASTERS; CLOTH DOILIES; CLOTH FLAGS; CLOTH PENNANTS; COMFORTERS; CRIB BUMPERS; CURTAINS; FABRIC FLAGS; FELT PENNANTS; GOLF TOWELS; HAND TOWELS; HANDKERCHIEFS; HOODED TOWELS; HOUSEHOLD LINENS; KITCHEN TOWELS; OVEN MITTS; PILLOW CASES; PILLOW COVERS; PLASTIC TABLE COVERS; POT HOLDERS; QUILTS; RECEIVING BLANKETS; SILK BLANKETS; TABLE LINEN; TEXTILE NAPKINS; TEXTILE PLACE MATS; TEXTILE TABLECLOTHS; THROWS; TOWELS; WASHCLOTHS; WOOLEN BLANKETS (U.S. CLS. 42 AND 50).

DORITT L. CARROLL, EXAMINING ATTORNEY

**CLASS 24—(Continued).**

SN 85-899,735. OLIVEME, LLC, LOS ANGELES, CA. FILED 4-10-2013.



SN 85-896,988. DISNEY ENTERPRISES, INC., BURBANK, CA. FILED 4-5-2013.

**FINDING DORY**

THE MARK CONSISTS OF STANDARD CHARACTERS WITHOUT CLAIM TO ANY PARTICULAR FONT, STYLE, SIZE, OR COLOR.

FOR AFGHANS; BARBECUE MITTS; BATH LINEN; BATH TOWELS; BED BLANKETS; BED CANOPIES; BED LINEN; BED SHEETS; BED SKIRTS; BED SPREADS; BLANKET THROWS; CALICO; CHILDREN'S BLANKETS; CLOTH COASTERS; CLOTH DOILIES; CLOTH FLAGS; CLOTH PENNANTS; COMFORTERS; CRIB BUMPERS; CURTAINS; FABRIC FLAGS; FELT PENNANTS; GOLF TOWELS; HAND TOWELS; HANDKERCHIEFS; HOODED TOWELS; HOUSEHOLD LINENS; KITCHEN TOWELS; OVEN MITTS; PILLOW CASES; PILLOW COVERS; PLASTIC TABLE COVERS; POT HOLDERS; QUILTS; RECEIVING BLANKETS; SILK BLANKETS; TABLE LINEN; TEXTILE NAPKINS; TEXTILE PLACE MATS; TEXTILE TABLECLOTHS; THROWS; TOWELS; WASHCLOTHS; WOOLEN BLANKETS (U.S. CLS. 42 AND 50).

LEIGH CAROLINE CASE, EXAMINING ATTORNEY

THE MARK CONSISTS OF MOVING FROM LEFT TO RIGHT: FIRST, A STYLIZED HAND-DRAWN IMAGE OF A DOWNWARD BENDING OLIVE BRANCH WITH ONE OLIVE AT THE END OF THE BRANCH. ABOVE THE OLIVE APPEAR TWO OUTLINED OLIVE LEAVES THAT EXTEND FROM THE BRANCH OPPOSITE EACH OTHER. THE FIRST AND SLIGHTLY LARGER LEAF IS CLOSER TO THE OLIVE AND POINTS DOWNWARD. THE SECOND LEAF IS SLIGHTLY FARTHER AWAY FROM THE OLIVE THAN THE FIRST LEAF, AND POINTS UPWARD. TO THE RIGHT OF THE OLIVE, OLIVE BRANCH AND OLIVE LEAVES IMAGE APPEARS THE SINGLE WORD "DEBBY" WHICH IS WRITTEN IN ALL LOWER CASE HANDWRITTEN LETTERS.

FOR BATH LINEN; BED AND TABLE LINEN; BED AND TABLE LINEN, WALL HANGINGS OF TEXTILE; BED LINEN; BED LINEN AND TABLE LINEN; DINING LINENS; FABRIC TABLE RUNNERS; FABRIC TABLE TOPPERS; HOUSEHOLD LINEN; HOUSEHOLD LINEN, INCLUDING FACE TOWELS; KITCHEN LINENS; KITCHEN TOWELS; LINEN FOR HOUSEHOLD PURPOSES; OVEN MITTS; TABLE CLOTH OF TEXTILE; TABLE LINEN; TABLE LINEN OF TEXTILE; TABLE LINEN, NAMELY, COASTERS; TABLE LINEN, NAMELY, COASTERS, NAPKINS, PLACE MATS, APRONS; TABLE NAPKINS OF TEXTILE; TABLE PADS (U.S. CLS. 42 AND 50).

DAWN FELDMAN, EXAMINING ATTORNEY

**CLASS 24—(Continued).**

SN 85-901,548. STEINNES, SERINE E., NEWPORT, ME. FILED S.R. 4-11-2013; AM. P.R. 4-11-2013.

**Make Your Home Serine**

THE MARK CONSISTS OF STANDARD CHARACTERS WITHOUT CLAIM TO ANY PARTICULAR FONT, STYLE, SIZE, OR COLOR.

FOR BABY BEDDING, NAMELY, BUNDLE BAGS, SWADDLING BLANKETS, CRIB BUMPERS, FITTED CRIB SHEETS, CRIB SKIRTS, CRIB BLANKETS, AND DIAPER CHANGING PAD COVERS NOT OF PAPER; BED AND TABLE LINEN; BED AND TABLE LINEN, WALL HANGINGS OF TEXTILE; BED BLANKETS; BED CANOPIES; BED COVERS; BED LINEN; BED LINEN AND TABLE LINEN; BED PADS; BED SHEETS; BED SHEETS OF PAPER; BED SHEETS, FITTED BED SHEET COVERS, BED FLAT SHEETS, AND PILLOW CASES USED IN THE BEDDING, HEALTH CARE, HOME-HEALTH CARE AND NURSING HOME INDUSTRIES MADE OF BIODEGRADABLE FILM CREATED FROM RENEWABLE BIO-POLYMER RESOURCES; BED SKIRTS; BED SPREADS; BED THROWS; CHILDREN'S BED SHEETS, PILLOW CASES, AND BLANKETS; FITTED BED SHEETS; FITTED BED SHEETS FOR PETS; FLAME RETARDANT FABRICS FOR THE MANUFACTURE OF BEDDING AND UPHOLSTERED FURNITURE; FLAT BED SHEETS; PAPER BED COVERS; PILLOW-TOP, LOW-PROFILE BED SKIRTS; SILK BED BLANKETS; TABLE AND BED LINEN (U.S. CLS. 42 AND 50).

JULIE WATSON, EXAMINING ATTORNEY

SN 85-925,452. KAHN LUCAS LANCASTER, INC., NEW YORK, NY. FILED 5-7-2013.



THE MARK CONSISTS OF THE WORDS "TOGETHER FOREVER" CENTERED OVER A HEART, IN WHICH THE WORD "TOGETHER" APPEARS CENTERED OVER THE WORD "FOREVER". THE LETTER "O" IN "TOGETHER" IS REPRESENTED IN THE SHAPE OF A HEART. THE WORDS "IMAGINED BY" APPEAR BELOW THE WORD "FOREVER", AND BENEATH THAT APPEAR THE WORDS "DOLLIE & ME".

FOR TEXTILE PRODUCTS, NAMELY, NON-WOVEN TEXTILE FABRICS, SLEEPING BAGS IN THE NATURE OF SHEETING, AND FABRIC WINDOW COVERINGS AND TREATMENTS BEING CURTAINS, DRAPERIES, SHEERS, SWAGS AND VALANCES; BED BLANKETS; BED CANOPIES; BED COVERS; BED LINEN; BED PADS; BED SHEETS; PILLOW CASES; BED SKIRTS; BED SPREADS; BED THROWS; COMFORTERS; DUST RUFFLES; SHAMS; TOWELS (U.S. CLS. 42 AND 50).

JOHN DWYER, EXAMINING ATTORNEY

**CLASS 24—(Continued).**

SN 85-958,597. LIVINGUARD TECHNOLOGIES PRIVATE LIMITED, NAVI MUMBAI, INDIA, FILED 6-13-2013.

**LIVINGUARD**

THE MARK CONSISTS OF STANDARD CHARACTERS WITHOUT CLAIM TO ANY PARTICULAR FONT, STYLE, SIZE, OR COLOR.

THE WORDING "LIVINGUARD" HAS NO MEANING IN A FOREIGN LANGUAGE.

FOR TREATED AND DISINFECTANT TEXTILE FABRIC FOR USE IN WATER FILTERING FOR DISINFECTION, IN THE MANUFACTURE OF CLOTHING, IN HOME TEXTILES IN THE NATURE OF KITCHEN TOWELS, BED SHEETS AND BED LINEN, IN UPHOLSTERY AND CURTAINS, IN PROTECTIVE EQUIPMENT IN THE NATURE OF WORKERS UNIFORMS, APRONS, COATS AND IN HOSPITALS FOR SURGICAL GOWNS, SCRUBS FOR DOCTORS AND RELATED HEALTH CARE WORKERS, CURTAINS, BED LINEN, BANDAGES AND WOUND DRESSINGS; WOVEN AND KNITTED FABRICS FOR THE MANUFACTURING OF CLOTHING; WOVEN FABRICS FOR THE MANUFACTURING OF WORKWEAR, SLEEPWEAR, CURTAINS, DRAPES, UPHOLSTERY FABRICS, BLANKETS, ALL TREATED FOR DISINFECTION; BED AND TABLE LINEN; FILTERING MATERIALS OF TEXTILE, NAMELY, POROUS FABRICS SUCH AS GAUZE, MUSLIN AND DENSELY WOVEN OR KNITTED FABRICS; NATURAL AND SYNTHETIC FABRICS FOR TEXTILE USE; SYNTHETIC FIBER FABRICS INCLUDING BLENDS FOR THE MANUFACTURE OF CLOTHING, HOME TEXTILES, WORKWEAR, UNIFORMS, FILTERING MEDIA AND RELATED USES (U.S. CLS. 42 AND 50).

LEIGH CAROLINE CASE, EXAMINING ATTORNEY

SN 86-033,897. TEX-TECH INDUSTRIES, INC., PORTLAND, ME. FILED 8-9-2013.

**TEXTECH**

THE MARK CONSISTS OF STANDARD CHARACTERS WITHOUT CLAIM TO ANY PARTICULAR FONT, STYLE, SIZE, OR COLOR.

FOR WOVEN AND NON-WOVEN FABRICS IN THE PIECE (U.S. CLS. 42 AND 50).

FIRST USE 4-3-1984; IN COMMERCE 4-3-1984.

BRENDAN REGAN, EXAMINING ATTORNEY

**CLASS 24—(Continued).**

SN 86-035,510. S. LICHTENBERG & CO., NEW YORK, NY.  
FILED 8-12-2013.

**NO. 918**

THE MARK CONSISTS OF STANDARD CHARACTERS WITHOUT CLAIM TO ANY PARTICULAR FONT, STYLE, SIZE, OR COLOR.

FOR FABRIC WINDOW COVERINGS AND WINDOW TREATMENTS, NAMELY, CURTAINS, DRAPERIES, SHEERS, SWAGS AND VALANCES (U.S. CLS. 42 AND 50).

MARLENE BELL, EXAMINING ATTORNEY

---

SN 86-041,827. LEVINSOHN TEXTILE CO., INC., NEW YORK, NY. FILED 8-19-2013.

**MAGIC SKIRT**

THE MARK CONSISTS OF STANDARD CHARACTERS WITHOUT CLAIM TO ANY PARTICULAR FONT, STYLE, SIZE, OR COLOR.

NO CLAIM IS MADE TO THE EXCLUSIVE RIGHT TO USE "SKIRT", APART FROM THE MARK AS SHOWN.

FOR BEDDING PRODUCTS, NAMELY, BED SKIRTS AND DUST RUFFLES FOR BEDS (U.S. CLS. 42 AND 50).

FIRST USE 5-6-2012; IN COMMERCE 5-6-2012.

JILL PRATER, EXAMINING ATTORNEY

---

SN 86-047,380. GUCCO, L.L.C., NEWCASTLE, WA. FILED 8-25-2013.

**ELSALA**

THE MARK CONSISTS OF STANDARD CHARACTERS WITHOUT CLAIM TO ANY PARTICULAR FONT, STYLE, SIZE, OR COLOR.

THE WORDING "ELSALA" HAS NO MEANING IN A FOREIGN LANGUAGE.

FOR BED AND TABLE LINEN; BED BLANKETS; BED CANOPIES; BED COVERS; BED LINEN; BED LINEN AND TABLE LINEN; BED PADS; BED SHEETS; BED SHEETS, FITTED BED SHEET COVERS, BED FLAT SHEETS, AND PILLOW CASES USED IN THE BEDDING, HEALTH CARE, HOME-HEALTH CARE AND NURSING HOME INDUSTRIES MADE OF BIODEGRADABLE FILM CREATED FROM RENEWABLE BIO-POLYMER RESOURCES; BED SKIRTS; BED SPREADS; BED THROWS; CHILDREN'S BED SHEETS, PILLOW CASES, AND BLANKETS; FITTED BED SHEETS; FLAT BED SHEETS (U.S. CLS. 42 AND 50).

GIANCARLO CASTRO, EXAMINING ATTORNEY

**CLASS 24—(Continued).**

SN 86-067,084. BOW WOW SHEETS LLC, GERMANTOWN, TN. FILED 9-17-2013.

**BOW WOW SHEETS**

THE MARK CONSISTS OF STANDARD CHARACTERS WITHOUT CLAIM TO ANY PARTICULAR FONT, STYLE, SIZE, OR COLOR.

NO CLAIM IS MADE TO THE EXCLUSIVE RIGHT TO USE "SHEETS", APART FROM THE MARK AS SHOWN.

FOR FITTED BED SHEETS FOR PETS (U.S. CLS. 42 AND 50).

FIRST USE 5-15-2013; IN COMMERCE 5-15-2013.

SUSAN RICHARDS, EXAMINING ATTORNEY

---

SN 86-067,951. PIXELPLACEMENT LLC, BALTIMORE, MD. FILED 9-18-2013.

**TaTops**

THE MARK CONSISTS OF STANDARD CHARACTERS WITHOUT CLAIM TO ANY PARTICULAR FONT, STYLE, SIZE, OR COLOR.

FOR FABRIC DRAPES DESIGNED TO CONCEAL THE ACT OF BREASTFEEDING IN PUBLIC (U.S. CLS. 42 AND 50).

FIRST USE 8-21-2013; IN COMMERCE 8-21-2013.

EUGENIA MARTIN, EXAMINING ATTORNEY

---

SN 86-068,458. AMG CELEBRATIONS, INC., GIBSONIA, PA. FILED 9-18-2013.

**THROVE**

THE MARK CONSISTS OF STANDARD CHARACTERS WITHOUT CLAIM TO ANY PARTICULAR FONT, STYLE, SIZE, OR COLOR.

FOR THROWS (U.S. CLS. 42 AND 50).

NICHOLAS ALTREE, EXAMINING ATTORNEY

**CLASS 24—(Continued).**

SN 86-069,102. OH, DANIEL, GILBERT, AZ. FILED 9-19-2013.

TICKLE YOUR BABY'S SENSES

THE MARK CONSISTS OF STANDARD CHARACTERS WITHOUT CLAIM TO ANY PARTICULAR FONT, STYLE, SIZE, OR COLOR.

FOR TABLE PADS (U.S. CLS. 42 AND 50).  
ANDREA HACK, EXAMINING ATTORNEY

---

SN 86-069,366. M. ROGERS DESIGN, INC, GLENVIEW, IL.  
FILED 9-19-2013.

TRIVARA

THE MARK CONSISTS OF STANDARD CHARACTERS WITHOUT CLAIM TO ANY PARTICULAR FONT, STYLE, SIZE, OR COLOR.

FOR TEXTILES, NAMELY STRETCHABLE FABRIC FOR RECEIVING PRINTABLE GRAPHICS FOR USE IN TEMPORARY TENSIONED FABRIC STRUCTURES AND DISPLAYS (U.S. CLS. 42 AND 50).  
LIEF MARTIN, EXAMINING ATTORNEY

---

SN 86-069,563. BALLET MAKERS, INC., TOTOWA, NJ.  
FILED 9-19-2013.

STUDIODRI

THE MARK CONSISTS OF STANDARD CHARACTERS WITHOUT CLAIM TO ANY PARTICULAR FONT, STYLE, SIZE, OR COLOR.

FOR POLYESTER SPANDEX MATERIAL HAVING CHEMICAL PROPERTIES FOR MOISTURE WICKING AND QUICK DRYING FOR USE IN DANCE APPAREL (U.S. CLS. 42 AND 50).

MARIA-VICTORIA SUAREZ, EXAMINING ATTORNEY

**CLASS 24—(Continued).**

SN 86-069,630. LOUIS HORNICK &amp; CO., INC., NEW YORK, NY. FILED 9-19-2013.



OWNER OF U.S. REG. NO. 2,153,690.  
THE NAME(S), PORTRAIT(S), AND/OR SIGNATURE(S) SHOWN IN THE MARK IDENTIFIES "LOUIS HORNICK III", WHOSE CONSENT(S) TO REGISTER IS MADE OF RECORD.

THE MARK CONSISTS OF THE WORDS "LOUIS HORNICK" IN STYLIZED LETTERING WITHIN CONCENTRIC OVALS.

FOR HOME FASHION PRODUCTS, NAMELY, BATH LINENS, BED LINENS, HOUSEHOLD LINENS, TABLE LINENS, CURTAIN FABRIC, NET CURTAINS, WINDOW CURTAINS, DUVETS, TOWELS OF TEXTILE, BED SHEETS, PILLOW CASES, BEDSPREADS, THROWS, BED BLANKETS, BLANKET THROWS AND LAP BLANKETS, SHOWER CURTAINS, DUST RUFFLES, TABLE CLOTHS NOT OF PAPER, WINDOW DRAPERIES; FABRIC WINDOW COVERINGS AND TREATMENTS, NAMELY, CURTAINS, DRAPERIES, SHEERS, SWAGS, VALANCES AND FABRIC WINDOW TREATMENTS, NAMELY, TIERS (U.S. CLS. 42 AND 50).  
TEJBIR SINGH, EXAMINING ATTORNEY

---

SN 86-069,696. FAGOLAR INC, FLUSHING, NY. FILED 9-19-2013.

Fagolar

THE MARK CONSISTS OF THE LETTERS F, A, AND G FOLLOWED BY A SPHERE-SHAPED OBJECT, FOLLOWED BY A STYLIZED LETTER L, AND FOLLOWED BY THE LETTERS A AND R. THE SPHERE-SHAPED OBJECT RESEMBLES A GLOBE MADE UP OF THREADS. THE STYLIZED LETTER L RESEMBLES THE LETTER P. TAKEN TOGETHER, THE LETTERS AND OBJECT SPELL OUT "FAGOLAR".

FOR BED BLANKETS; BED SHEETS; COMFORTERS; CURTAINS AND TOWELS; HANDKERCHIEFS; PILLOW COVERS; PLACE MATS OF TEXTILE MATERIAL; QUILT COVERS; QUILTS; SHOWER CURTAINS; TABLECLOTHS, NOT OF PAPER; WASHCLOTHS (U.S. CLS. 42 AND 50).

FIRST USE 9-12-2013; IN COMMERCE 9-18-2013.  
MORGAN WYNNE, EXAMINING ATTORNEY

**CLASS 24—(Continued).**

SN 86-072,132. MARWAH CORPORATION, ONTARIO, CA.  
FILED 9-23-2013.

# TRIBECA LIVING

THE MARK CONSISTS OF STANDARD CHARACTERS WITHOUT CLAIM TO ANY PARTICULAR FONT, STYLE, SIZE, OR COLOR.

FOR BABY BEDDING, NAMELY, BUNDLE BAGS, SWADDLING BLANKETS, CRIB BUMPERS, FITTED CRIB SHEETS, CRIB SKIRTS, CRIB BLANKETS, AND DIAPER CHANGING PAD COVERS NOT OF PAPER; BED BLANKETS; BED COVERS; BED SHEETS; BED SKIRTS; BED SPREADS; BED THROWS; BEDSPREADS; CHILDREN'S BED SHEETS, PILLOW CASES, AND BLANKETS; COMFORTERS; CONTOUR SHEETS; CURTAINS; DUVET COVERS; FITTED BED SHEETS; FLAT BED SHEETS; PILLOW CASES; PILLOW SHAMS; PILLOWCASES; SHEET SETS (U.S. CLS. 42 AND 50).

FIRST USE 12-31-2008; IN COMMERCE 12-31-2008.  
JOHN WILKE, EXAMINING ATTORNEY

**CLASS 24—(Continued).**

SN 86-076,641. TOMMIE COPPER INC., MT. KISCO, NY.  
FILED 9-27-2013.

# COPPER DRY

THE MARK CONSISTS OF STANDARD CHARACTERS WITHOUT CLAIM TO ANY PARTICULAR FONT, STYLE, SIZE, OR COLOR.

NO CLAIM IS MADE TO THE EXCLUSIVE RIGHT TO USE "COPPER", APART FROM THE MARK AS SHOWN.

FOR TEXTILE FABRICS FOR USE IN MAKING CLOTHING AND HOUSEHOLD FURNISHINGS ALL FEATURING COPPER-INFUSED YARN (U.S. CLS. 42 AND 50).

ANNE E. GUSTASON, EXAMINING ATTORNEY

SN 86-076,647. TOMMIE COPPER INC., MT. KISCO, NY.  
FILED 9-27-2013.

# COPPER FLEX

THE MARK CONSISTS OF STANDARD CHARACTERS WITHOUT CLAIM TO ANY PARTICULAR FONT, STYLE, SIZE, OR COLOR.

NO CLAIM IS MADE TO THE EXCLUSIVE RIGHT TO USE "COPPER", APART FROM THE MARK AS SHOWN.

FOR TEXTILE FABRICS FOR USE IN MAKING CLOTHING AND HOUSEHOLD FURNISHINGS ALL FEATURING COPPER-INFUSED YARN (U.S. CLS. 42 AND 50).

ANNE E. GUSTASON, EXAMINING ATTORNEY

SN 86-076,605. TOMMIE COPPER INC., MT. KISCO, NY.  
FILED 9-27-2013.

# COLD COPPER

THE MARK CONSISTS OF STANDARD CHARACTERS WITHOUT CLAIM TO ANY PARTICULAR FONT, STYLE, SIZE, OR COLOR.

NO CLAIM IS MADE TO THE EXCLUSIVE RIGHT TO USE "COPPER", APART FROM THE MARK AS SHOWN.

FOR TEXTILE FABRICS FOR USE IN MAKING CLOTHING AND HOUSEHOLD FURNISHINGS ALL FEATURING COPPER-INFUSED YARN (U.S. CLS. 42 AND 50).

ANNE E. GUSTASON, EXAMINING ATTORNEY

SN 86-076,654. TOMMIE COPPER INC., MT. KISCO, NY.  
FILED 9-27-2013.

# HOT COPPER

THE MARK CONSISTS OF STANDARD CHARACTERS WITHOUT CLAIM TO ANY PARTICULAR FONT, STYLE, SIZE, OR COLOR.

NO CLAIM IS MADE TO THE EXCLUSIVE RIGHT TO USE "COPPER", APART FROM THE MARK AS SHOWN.

FOR TEXTILE FABRICS FOR USE IN MAKING CLOTHING AND HOUSEHOLD FURNISHINGS ALL FEATURING COPPER-INFUSED YARN (U.S. CLS. 42 AND 50).

ANNE E. GUSTASON, EXAMINING ATTORNEY

SN 86-076,623. TOMMIE COPPER INC., MT. KISCO, NY.  
FILED 9-27-2013.

# COPPER COOL

THE MARK CONSISTS OF STANDARD CHARACTERS WITHOUT CLAIM TO ANY PARTICULAR FONT, STYLE, SIZE, OR COLOR.

NO CLAIM IS MADE TO THE EXCLUSIVE RIGHT TO USE "COPPER", APART FROM THE MARK AS SHOWN.

FOR TEXTILE FABRICS FOR USE IN MAKING CLOTHING AND HOUSEHOLD FURNISHINGS ALL FEATURING COPPER-INFUSED YARN (U.S. CLS. 42 AND 50).

ANNE E. GUSTASON, EXAMINING ATTORNEY

**CLASS 24—(Continued).**

SN 86-080,079. PARAMOUNT PICTURES CORPORATION, HOLLYWOOD, CA. FILED 10-1-2013.

JACK RYAN: SHADOW RECRUIT

THE MARK CONSISTS OF STANDARD CHARACTERS WITHOUT CLAIM TO ANY PARTICULAR FONT, STYLE, SIZE, OR COLOR.

THE NAME(S), PORTRAIT(S), AND/OR SIGNATURE(S) SHOWN IN THE MARK DOES NOT IDENTIFY A PARTICULAR LIVING INDIVIDUAL.

FOR BED COVERS; BED SHEETS; COMFORTERS; CURTAINS; PILLOW CASES; PLASTIC TABLE COVERS; SHOWER CURTAINS; TEXTILE TABLECLOTHS; TOWELS (U.S. CLS. 42 AND 50).

AHSEN KHAN, EXAMINING ATTORNEY

**CLASS 24—(Continued).**

SN 86-098,891. INDIAN MOTORCYCLE INTERNATIONAL, LLC, MEDINA, MN. FILED 10-23-2013.



OWNER OF U.S. REG. NO. 2,927,365. NO CLAIM IS MADE TO THE EXCLUSIVE RIGHT TO USE "1901", APART FROM THE MARK AS SHOWN.

THE MARK CONSISTS OF AN INDIAN HEADRESS LOCATED WITHIN A CIRCLE CONTAINING THE WORDS "INDIAN MOTORCYCLE 1901".

FOR BLANKETS, NAMELY, BLANKET THROWS, BED BLANKETS, LAP BLANKETS (U.S. CLS. 42 AND 50).

KATHY DE JONGE, EXAMINING ATTORNEY

SN 86-098,899. INDIAN MOTORCYCLE INTERNATIONAL, LLC, MEDINA, MN. FILED 10-23-2013.



OWNER OF U.S. REG. NO. 2,927,365. THE MARK CONSISTS OF THE WORD "INDIAN" IN A STYLIZED FORM.

FOR BLANKETS, NAMELY, BLANKET THROWS, BED BLANKETS, LAP BLANKETS (U.S. CLS. 42 AND 50).

KATHY DE JONGE, EXAMINING ATTORNEY

SN 86-098,886. INDIAN MOTORCYCLE INTERNATIONAL, LLC, MEDINA, MN. FILED 10-23-2013.



SN 86-098,901. INDIAN MOTORCYCLE INTERNATIONAL, LLC, MEDINA, MN. FILED 10-23-2013.

**INDIAN MOTORCYCLE**

OWNER OF U.S. REG. NO. 2,927,365. THE MARK CONSISTS OF THE STYLIZED WORDS "INDIAN MOTORCYCLE" LOCATED WITHIN AN INDIAN HEADRESS DESIGN.

FOR BLANKETS, NAMELY, BLANKET THROWS, BED BLANKETS, LAP BLANKETS (U.S. CLS. 42 AND 50).

KATHY DE JONGE, EXAMINING ATTORNEY

THE MARK CONSISTS OF STANDARD CHARACTERS WITHOUT CLAIM TO ANY PARTICULAR FONT, STYLE, SIZE, OR COLOR.

OWNER OF U.S. REG. NO. 2,927,365. FOR BLANKETS, NAMELY, BLANKET THROWS, BED BLANKETS, LAP BLANKETS (U.S. CLS. 42 AND 50).

KATHY DE JONGE, EXAMINING ATTORNEY

**CLASS 24—(Continued).**

SN 86-117,291. PERFORMANCE FABRICS, INC., GRAND RAPIDS, MI. FILED 11-13-2013.

**ColdRush**

THE MARK CONSISTS OF STANDARD CHARACTERS WITHOUT CLAIM TO ANY PARTICULAR FONT, STYLE, SIZE, OR COLOR.

FOR COOLING TOWELS NOT FOR MEDICAL OR PROTECTIVE PURPOSES (U.S. CLS. 42 AND 50).

TRACY WHITTAKER-BROWN, EXAMINING ATTORNEY

**CLASS 25—CLOTHING**

SN 76-715,014. NATIONAL MILL INDUSTRY, INC, CRANFORD, NJ. FILED 9-23-2013.

**RUGGED FRONTIER**

THE MARK CONSISTS OF STANDARD CHARACTERS WITHOUT CLAIM TO ANY PARTICULAR FONT, STYLE, SIZE, OR COLOR.

FOR MEN'S, WOMEN'S AND CHILDREN'S APPAREL, NAMELY, PANTS, SHIRTS, THERMAL UNDERWEAR, LOUNGE PANTS, SOCKS, TOPS, MITTENS, GLOVES, HATS, SCARVES, EARMUFFS, HEAD WRAPS, SWEAT-SHIRTS, SWEAT JACKETS, AND HEADWEAR (U.S. CLS. 22 AND 39).

FIRST USE 7-15-2013; IN COMMERCE 7-15-2013.

IRA J. GOODSAD, EXAMINING ATTORNEY

SN 77-289,535. COLUMBIA INSURANCE COMPANY, OMAHA, NE. FILED 9-26-2007.

**SÖL**

THE MARK CONSISTS OF STANDARD CHARACTERS WITHOUT CLAIM TO ANY PARTICULAR FONT, STYLE, SIZE, OR COLOR.

THE ENGLISH TRANSLATION OF "SÖL" IN THE MARK IS "DULSE".

FOR FOOTWEAR (U.S. CLS. 22 AND 39).

KATHLEEN M. VANSTON, EXAMINING ATTORNEY

SN 77-525,382. BELLO FITNESS LTDA, RIO DE JANEIRO, BRAZIL, FILED 7-17-2008.

**Body Up**

THE MARK CONSISTS OF STANDARD CHARACTERS WITHOUT CLAIM TO ANY PARTICULAR FONT, STYLE, SIZE, OR COLOR.

FOR CLOTHING, NAMELY, SHIRTS, PANTS, LEGGINGS, BODYSUITS, SHORTS, BREECHES, T-SHIRTS, SOCKS, BEACHWEAR; FOOTWEAR; HEADGEAR, NAMELY, BASEBALL CAPS (U.S. CLS. 22 AND 39).

BRIDGETT SMITH, EXAMINING ATTORNEY

SN 86-130,941. SWADDLEDESIGNS, LLC, SEATTLE, WA. FILED 11-27-2013.



SwaddleClub

NO CLAIM IS MADE TO THE EXCLUSIVE RIGHT TO USE "SWADDLE" AND THE DESIGN OF THE QUICK RESPONSE CODE, APART FROM THE MARK AS SHOWN.

THE MARK CONSISTS OF THE LITERAL ELEMENT "SWADDLECLUB" BELOW A QUICK RESPONSE DESIGN CODE FRAMED BY A SCROLLED PATTERN ON ALL FOUR SIDES; THE QUICK RESPONSE DESIGN CODE ENCOMPASSING THE LITERAL ELEMENT "SWADDLE" CENTERED-RIGHT OVER A HEART DESIGN AND THE LITERAL ELEMENT "CLUB".

FOR BABY BEDDING, NAMELY, BUNDLE BAGS, SWADDLING BLANKETS, CRIB BUMPER, FITTED CRIB SHEETS, CRIB SKIRTS, CRIB BLANKETS, AND DIAPER CHANGING PAD COVERS NOT OF PAPER; BABY BLANKETS (U.S. CLS. 42 AND 50).

COLLEEN KEARNEY, EXAMINING ATTORNEY

**CLASS 25—(Continued).**

SN 77-878,114. HAYMAN, HILARY, LOS ANGELES, CA. FILED 11-20-2009.

## LeSpy Couture

THE MARK CONSISTS OF STANDARD CHARACTERS WITHOUT CLAIM TO ANY PARTICULAR FONT, STYLE, SIZE, OR COLOR.

NO CLAIM IS MADE TO THE EXCLUSIVE RIGHT TO USE "COUTURE", APART FROM THE MARK AS SHOWN.

FOR CLOTHING, NAMELY, PANTS, SKIRTS, DRESSES, T-SHIRTS, TOPS, BLOUSES, BLAZERS, JOGGING SUITS, HOODED SWEATSHIRTS, SHIRTS, JEANS, UNDERWEAR, SWIMWEAR, TUNICS, CAMISOLES, PULL OVERS, TROUSERS, SHORTS (U.S. CLS. 22 AND 39).

LEIGH CAROLINE CASE, EXAMINING ATTORNEY

---

SN 77-883,572. BARDOWN SPORTS INCORPORATED, OAKVILLE, ONTARIO, CANADA, FILED 12-1-2009.

## BARDOWN

THE MARK CONSISTS OF STANDARD CHARACTERS WITHOUT CLAIM TO ANY PARTICULAR FONT, STYLE, SIZE, OR COLOR.

PRIORITY CLAIMED UNDER SEC. 44(D) ON CANADA APPLICATION NO. 1447125, FILED 8-5-2009, REG. NO. TMA828773, DATED 7-30-2012, EXPIRES 7-30-2027.

FOR (BASED ON INTENT TO USE) (BASED ON 44(E)) CLOTHING, NAMELY, T-SHIRTS AND LONG-SLEEVED SHIRTS; (BASED ON INTENT TO USE) CLOTHING, NAMELY, HOODED SWEATSHIRTS, SWEATERS, PANTS, JOGGING PANTS, TRACK PANTS, WINTER JACKETS, UNDERWEAR, SHORTS, FOOTWEAR, SHOES, SANDALS, FLIP-FLOPS, HEADWEAR, HATS, WINTER HATS, TOQUES, AND BELTS (U.S. CLS. 22 AND 39).

SUSAN RICHARDS, EXAMINING ATTORNEY

---

SN 77-911,344. DAVIS, LISA, WALPOLE, NH. FILED 1-13-2010.

## SHE-SHIRT

THE MARK CONSISTS OF STANDARD CHARACTERS WITHOUT CLAIM TO ANY PARTICULAR FONT, STYLE, SIZE, OR COLOR.

FOR CLOTHING, NAMELY, SHORT-SLEEVED OR LONG-SLEEVED T-SHIRTS WITH A FEMININE NECKLINE; A BASIC T-SHIRT, TEE SHIRT, T SHIRT WITH A SCOOP, V NECK, SQUARE NECK OR BOAT NECK LINE (U.S. CLS. 22 AND 39).

YAT SYE, LEE, EXAMINING ATTORNEY

**CLASS 25—(Continued).**

SN 77-924,624. NEVICA IP LIMITED, SHIREBROOK, UNITED KINGDOM, FILED 2-1-2010.

## NEVICA

THE MARK CONSISTS OF STANDARD CHARACTERS WITHOUT CLAIM TO ANY PARTICULAR FONT, STYLE, SIZE, OR COLOR.

THE ENGLISH TRANSLATION OF "NEVICA" IN THE MARK IS "TO SNOW".

FOR CLOTHING, NAMELY, JACKETS, ANORAKS, PARKAS, COATS, OVERALLS, TROUSERS, CAPS, HATS, GLOVES, SWEATERS, SHIRTS AND JUMPSUITS; SKI CLOTHING, NAMELY, SKI OVERALLS, SKI SUITS, SKI COATS, SKI PANTS AND JUMPSUITS (U.S. CLS. 22 AND 39).

FIRST USE 0-0-1984; IN COMMERCE 0-0-1984.

JAY FLOWERS, EXAMINING ATTORNEY

---

SN 77-928,953. MANN & BROS., INC, NEW YORK, NY. FILED 2-5-2010.



THE MARK CONSISTS OF THE LETTER "X" WHICH IS CENTERED BEHIND THE WORD "BELOW" WITH ROWS OF GRADIENT DOTS RUNNING HORIZONTALLY BEHIND THE WORDING AND EXTENDING BEYOND THE WORDING.

FOR ATHLETIC APPAREL, NAMELY, SHIRTS, PANTS, JACKETS, FOOTWEAR, HATS AND CAPS, ATHLETIC UNIFORMS; BASELAYER BOTTOMS; BASELAYER TOPS; BOTTOMS; HATS; LONG UNDERWEAR; OUTDOOR GLOVES; PERSPIRATION ABSORBENT UNDERWEAR CLOTHING; SKI GLOVES; SPORTS CAPS AND HATS; THERMAL UNDERWEAR; TOPS; UNDERWEAR (U.S. CLS. 22 AND 39).

FIRST USE 1-20-2009; IN COMMERCE 7-25-2009.

KELLEY WELLS, EXAMINING ATTORNEY



**CLASS 25—(Continued).**

SN 79-125,007. SHENZHEN LIANGZI FASHION INDUSTRIAL CO., LTD., CHINA, FILED 12-20-2012.

**TANGY**  
collection

OWNER OF INTERNATIONAL REGISTRATION 1147150 DATED 12-20-2012, EXPIRES 12-20-2022.

NO CLAIM IS MADE TO THE EXCLUSIVE RIGHT TO USE "COLLECTION", APART FROM THE MARK AS SHOWN.

THE MARK CONSISTS OF THE WORDING "TANGY COLLECTION" IN A STYLIZED FONT, WITH THE LETTERS "A" AND "Y" DEPICTED WITH STYLIZED HEARTS WITHIN THEM.

FOR WOMEN'S CLOTHING, NAMELY, SHIRTS, DRESSES, SKIRTS, BLOUSES; MENSWEAR, NAMELY, SUITS, SHIRTS, PANTS; FOOTWEAR; HATS; HOSIERY; GIRDLES; LAYETTES FOR USE AS CLOTHING; PELERINES; WEDDING DRESSES; GLOVES FOR USE AS CLOTHING; MASQUERADE COSTUMES (U.S. CLS. 22 AND 39).

JAMES MACFARLANE, EXAMINING ATTORNEY

**CLASS 25—(Continued).**

SN 79-128,208. G.L.G. S.R.L., ITALY, FILED 2-5-2013.

*GIUSEPPE PAPINI*

THE MARK CONSISTS OF STANDARD CHARACTERS WITHOUT CLAIM TO ANY PARTICULAR FONT, STYLE, SIZE, OR COLOR.

OWNER OF INTERNATIONAL REGISTRATION 0901194 DATED 8-10-2006, EXPIRES 8-10-2016.

THE NAME "GIUSEPPE PAPINI" IDENTIFIES A LIVING INDIVIDUAL WHOSE CONSENT IS OF RECORD.

FOR CLOTHING, NAMELY, TROUSERS, PANTS, EVENING DRESSES, SUITS, SKIRTS, MINISKIRTS, COATS, PULLOVERS, JUMPERS, SWEATERS, JACKETS, BLAZERS, BLOUSES, SHORTS, SHIRTS, T-SHIRTS, POLO-SHIRTS, WEDDING GOWNS, WEDDING DRESSES, ROBES, SWIMSUITS, SWIMWEAR, BEACHWEAR, BERMUDA SHORTS, LEGGINGS, UNDERWEAR, BELTS, NECKTIES, TIES, BANDANAS, FOULARDS, SCARVES, VEILS, SHAWLS, STOLEES, WRISTBANDS, WAISTCOATS, HATS, CAPS, SOCKS, SHOES, SLIPPERS AND BOOTS (U.S. CLS. 22 AND 39).

JORDAN BAKER, EXAMINING ATTORNEY

SN 79-126,952. CLAES RICHTER, SWEDEN, FILED 2-13-2013.



PRIORITY DATE OF 8-16-2012 IS CLAIMED.

OWNER OF INTERNATIONAL REGISTRATION 1152051 DATED 2-13-2013, EXPIRES 2-13-2023.

A CIRCLE WITH THE WORD "VERTICAL" ON TOP AND AN UPSIDE DOWN "HORIZON" AT THE BOTTOM; IN THE MIDDLE OF THE CIRCLE IS A "V", A CURVED LINE AND AN "H" BENEATH.

FOR CLOTHING, NAMELY, JACKETS, PANTS, SHIRTS, T-SHIRTS AND GLOVES; HEADWEAR; FOOTWEAR; FUNCTIONAL OUTDOOR CLOTHING, NAMELY, RAINWEAR, SKIWEAR, WIND PANTS, WIND JACKETS, AND WATER-REPELLANT JACKETS AND PANTS; DOWN OUTERWEAR, NAMELY, DOWN COATS, DOWN JACKET AND DOWN VESTS (U.S. CLS. 22 AND 39).

ELIZABETH KAJUBI, EXAMINING ATTORNEY

SN 79-129,630. P.EMME DI MICHELE PAGLIERO & C. - S.N.C., ITALY, FILED 2-19-2013.

**SETTEFILI**

THE MARK CONSISTS OF STANDARD CHARACTERS WITHOUT CLAIM TO ANY PARTICULAR FONT, STYLE, SIZE, OR COLOR.

OWNER OF INTERNATIONAL REGISTRATION 1067684 DATED 1-28-2011, EXPIRES 1-28-2021.

THE ENGLISH TRANSLATION OF THE FOREIGN WORD(S) IN THE MARK IS "SEVEN THREADS".

FOR CLOTHING, NAMELY, COATS, MANTLES, RAINCOATS, OVERCOATS, WAISTCOATS, PARKAS, ANORAKS, BLOUSONS, DRESSES, DRESSES FOR WOMEN, SUITS, SKIRTS, JACKETS, SPORT JACKETS, BLAZERS, WIND-RESISTANT JACKETS, TROUSERS, SPORT TROUSERS, JEANS, PANTS, SHORTS, SHIRTS, T-SHIRTS, BLOUSES, JERSEYS, SWEATERS, CARDIGANS, PULLOVERS, STOCKINGS, SOCKS, UNDERWEAR, CORSETS, NIGHTGOWNS, PAJAMAS, BATHROBES, BATHING SUITS, SUN SUITS, SWEAT SUITS, SHOWER CAPS, TIES, NECKTIES, SCARVES, SHAWLS, FOULARDS, GLOVES, SASHES, BELTS, BREECHES, VESTS, WEDDING DRESSES, CAMISOLES, DANCE COSTUMES, MASQUERADE COSTUMES, THEATRICAL COSTUMES, LAYETTES, BERETS, EAR MUFFS AS CLOTHING, LEGGINGS, MANTILLAS; FOOTWEAR, NAMELY, SHOES, WOMEN'S SHOES, CASUAL SHOES, SPORTING SHOES, GYMNASTIC SHOES, BEACH SHOES, GALOSHES, BOOTS, SLIPPERS, SANDALS; HEADGEAR, NAMELY, CAPS, HATS (U.S. CLS. 22 AND 39).

TASNEEM HUSSAIN, EXAMINING ATTORNEY

**CLASS 25—(Continued).**

SN 79-133,531. J. CHOO LIMITED, UNITED KINGDOM, FILED 6-10-2013.



PRIORITY DATE OF 12-12-2012 IS CLAIMED.  
OWNER OF INTERNATIONAL REGISTRATION 1169173  
DATED 6-10-2013, EXPIRES 6-10-2023.

THE MARK CONSISTS OF A DESIGN OF A SCORPION. THE BROKEN LINES DEPICTING THE SOLE OF A SHOE INDICATE PLACEMENT OF THE MARK ON THE GOODS ONLY AND ARE NOT PART OF THE MARK.

FOR FOOTWEAR (U.S. CLS. 22 AND 39).  
LINDA LAVACHE, EXAMINING ATTORNEY

SN 79-134,381. MARUYASU CORPORATION, JAPAN, FILED 5-13-2013.



OWNER OF INTERNATIONAL REGISTRATION 1171286  
DATED 5-13-2013, EXPIRES 5-13-2023.

NO CLAIM IS MADE TO THE EXCLUSIVE RIGHT TO USE "PUNTO D'ORO", APART FROM THE MARK AS SHOWN.

THE MARK CONSISTS OF A SERIES OF STITCHES NEXT TO THE STYLIZED WORDING.

THE ENGLISH TRANSLATION OF THE FOREIGN WORD(S) IN THE MARK IS: "GOLDEN STITCH".

FOR EVENING DRESSES; SCHOOL UNIFORMS; CHILDREN'S WEAR, NAMELY, CHILDREN'S SHIRTS, PANTS, JACKETS, JUMPERS, SLEEPWEAR, PAJAMAS, ROMPERS, AND ONE-PIECE GARMENTS; WORKING CLOTHING, NAMELY, UNIFORMS; JACKETS; JOGGING PANTS; SWEAT PANTS; SUITS; SKIRTS; SPORT JACKETS; SKI PANTS; TROUSERS; SMOCKS; FORMALWEAR, NAMELY, GOWNS AND TUXEDOS; OVERCOATS; TOPCOATS; MANTLES; RAINCOATS; CARDIGANS; SWEATERS; VESTS AND WAISTCOATS; OPEN-NECKED SHIRTS; CUFFS; COLLARS; SPORT SHIRTS; BLOUSES; POLO SHIRTS; SHIRTS FOR SUITS; NIGHT GOWNS; NEGLIGEES; JAPANESE SLEEPING ROBES; PAJAMAS; BATH ROBES; CAMISOLES; CORSETS; COMBINATIONS; SHIRTS; CHEMISES; DRAWERS AND UNDERPANTS; SLIPS; PANTIES, SHORTS AND BRIEFS; BRASSIERES; PETTICOATS; SWIMWEAR; SWIMMING CAPS; SASH BANDS FOR KIMONO; BUSTLE HOLDER BANDS FOR OBI; BUSTLES FOR OBI-KNOTS; WAIST STRINGS FOR KIMONOS; UNDERSHIRTS FOR KIMONOS; TIGHTENING-UP STRINGS FOR KIMONOS; WRAP BELTS FOR KIMONOS; FULL-LENGTH KIMONOS; SHORT OVERCOAT FOR KIMONO; STRING FASTENERS FOR HAORI; PLEATED SKIRTS FOR FORMAL KIMONOS; DETACHABLE NECKPIECES FOR KIMONOS; SLEEP MASKS; APRONS; COLLAR PROTECTORS; SOCKS AND STOCKINGS; PUTTEES AND GAITERS; FUR STOLEES; SHAWLS; SCARVES; JAPANESE STYLE SOCKS; JAPANESE STYLE SOCKS COVERS; GLOVES AND MITTENS; NECKTIES; NECKERCHIEVES; BANDANAS; CLOTHING IN THE NATURE OF THERMAL SUPPORTERS, NAMELY, THERMAL UNDERWEAR; MUFFLERS; EAR MUFFS; COWLS; NIGHTCAPS; HEADGEAR FOR WEAR, NAMELY, HATS, CAPS AND VISORS (U.S. CLS. 22 AND 39).

BRENDAN MCCAULEY, EXAMINING ATTORNEY

**CLASS 25—(Continued).**

SN 79-135,555. WENZHOU JUUSNN SHOES INDUSTRY; COMPANY LIMITED, CHINA, FILED 8-2-2013.

OWNER OF INTERNATIONAL REGISTRATION 1174033  
DATED 8-2-2013, EXPIRES 8-2-2023.

THE MARK CONSISTS OF THE STYLIZED WORDING "JUUSNN" ON THE LEFT SIDE OF TWO CHINESE CHARACTERS WHICH ARE TRANSLITERATED AS "JU SHENG" AND TRANSLATED AS "HUGE", "HOLY" RESPECTIVELY.

THE ENGLISH TRANSLATION OF THE WORD "JE SHENG" IN THE MARK IS "HUGE, HOLY".

THE NON-LATIN CHARACTERS IN THE MARK TRANSLITERATE TO "JE SHENG" AND THIS MEANS "HUGE, HOLY" IN ENGLISH.

FOR CLOTHING, NAMELY, SKIRTS, COATS, TOPS, BLOUSES, SWEATSHIRTS, SUITS, VESTS, DRESSES, SWEATERS, SWEATPANTS, SHORTS AND PANTS; FOOTWEAR; BATHING SUITS; HATS; HOSIERY; GLOVES AS CLOTHING; SCARFS; BELTS AS CLOTHING (U.S. CLS. 22 AND 39).

ELISSA GARBER KON, EXAMINING ATTORNEY

SN 79-138,181. CREENSTONE INTERNATIONAL B.V., NETHERLANDS, FILED 4-23-2013.

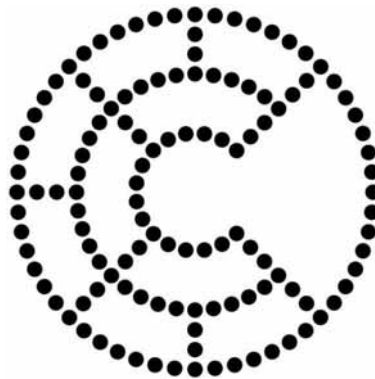

PRIORITY DATE OF 12-31-2012 IS CLAIMED.  
OWNER OF INTERNATIONAL REGISTRATION 1181003  
DATED 4-23-2013, EXPIRES 4-23-2023.

THE MARK CONSISTS OF A STYLIZED LETTER "C" COMPRISED OF DOTS.

FOR CLOTHING, NAMELY, COATS, PANTS, JACKETS, CAPS, HATS, FOOTWEAR (U.S. CLS. 22 AND 39).

BRIAN PINO, EXAMINING ATTORNEY

**CLASS 25—(Continued).**

SN 85-062,997. M.A.D CLOTHING APPAREL LTD, BROOKLYN, NY. FILED 6-15-2010.

**SWEET KIZZ**

THE MARK CONSISTS OF STANDARD CHARACTERS WITHOUT CLAIM TO ANY PARTICULAR FONT, STYLE, SIZE, OR COLOR.

FOR CLOTHING SHIELDS, NAMELY, PADS APPLIED TO THE UNDERARMS OF SHIRTS, BLOUSES AND SWEATERS; CREW NECK SWEATERS; MOCK TURTLE-NECK SWEATERS; SWEATERS; TURTLENECK SWEATERS; V-NECK SWEATERS (U.S. CLS. 22 AND 39).

FIRST USE 6-1-2008; IN COMMERCE 6-1-2008.  
ELLEN B. AWRICH, EXAMINING ATTORNEY

SN 85-252,687. JOSEPH CAMPBELL FOUNDATION, SAN ANSELMO, CA. FILED 2-26-2011.

**MYTHWEAR**

THE MARK CONSISTS OF STANDARD CHARACTERS WITHOUT CLAIM TO ANY PARTICULAR FONT, STYLE, SIZE, OR COLOR.

FOR CLOTHING, NAMELY, T-SHIRTS, TANK TOPS, SWEAT SHIRTS AND HATS SOLD ON A PROPRIETARY WEBSITE, PROPRIETARY STOREFRONTS AT SPECIALTY ONLINE MERCHANDISERS, AND AT OFFICIAL EVENTS (U.S. CLS. 22 AND 39).

FIRST USE 6-11-2010; IN COMMERCE 6-11-2010.  
MARGARET POWER, EXAMINING ATTORNEY

SN 85-388,878. MAIDENFORM LLC, WINSTON-SALEM, NC. FILED 8-3-2011.

**WEIGHTLESS COMFORT**

THE MARK CONSISTS OF STANDARD CHARACTERS WITHOUT CLAIM TO ANY PARTICULAR FONT, STYLE, SIZE, OR COLOR.

FOR FOUNDATION GARMENTS; WOMEN'S UNDERGARMENTS; LINGERIE; WOMEN'S INTIMATE APPAREL, NAMELY, BRASSIERES, PANTIES, AND SHAPEWEAR, NAMELY, CONTROL BRIEFS, BOY SHORTS, THIGH-SLIMMERS, PANTLINERS, BODY GIRDLES, ROMPERS, WAISTNIPPERS, SLIPS, UNITARDS, BODY SUITS AND BODY SHAPERS (U.S. CLS. 22 AND 39).

JUSTINE D. PARKER, EXAMINING ATTORNEY

**CLASS 25—(Continued).**

SN 85-402,306. SYSCO GUEST SUPPLY, LLC, MONMOUTH JUNCTION, NJ. FILED 8-19-2011.

**ACCLAIM**

THE MARK CONSISTS OF STANDARD CHARACTERS WITHOUT CLAIM TO ANY PARTICULAR FONT, STYLE, SIZE, OR COLOR.

FOR BATHROBES; SLIPPERS (U.S. CLS. 22 AND 39).  
ALAIN LAPTER, EXAMINING ATTORNEY

SN 85-433,633. ULTIMATE APOCALYPSE APPAREL LLC, PORT SAINT LUCIE, FL. FILED 9-28-2011.

**APOCALYPSE MMA**

THE MARK CONSISTS OF STANDARD CHARACTERS WITHOUT CLAIM TO ANY PARTICULAR FONT, STYLE, SIZE, OR COLOR.

NO CLAIM IS MADE TO THE EXCLUSIVE RIGHT TO USE "MMA", APART FROM THE MARK AS SHOWN.

FOR CLOTHING, NAMELY, T-SHIRTS, SHORTS, HATS, PANTS, SWEATSHIRTS, SHIRTS, UNDERWEAR, CAPS, BEANIES, SKULL CAPS, TANK TOPS, JERSEYS, BRIEFS, WRISTBANDS, BELTS AND JACKETS (U.S. CLS. 22 AND 39).

ELLEN PERKINS, EXAMINING ATTORNEY

SN 85-538,068. HOWEY, BRET, SUNLAND, CA. FILED 2-9-2012.

**Prowler Athletics**

THE MARK CONSISTS OF STANDARD CHARACTERS WITHOUT CLAIM TO ANY PARTICULAR FONT, STYLE, SIZE, OR COLOR.

NO CLAIM IS MADE TO THE EXCLUSIVE RIGHT TO USE "ATHLETICS", APART FROM THE MARK AS SHOWN.

FOR SHORTS; SWEATPANTS; SWEATSHIRTS; T-SHIRTS; TANK TOPS (U.S. CLS. 22 AND 39).

EDWARD NELSON, EXAMINING ATTORNEY

**CLASS 25—(Continued).**

SN 85-588,656. MATTEL, INC., EL SEGUNDO, CA. FILED 4-4-2012.

**ZOMBISAURS**

THE MARK CONSISTS OF STANDARD CHARACTERS WITHOUT CLAIM TO ANY PARTICULAR FONT, STYLE, SIZE, OR COLOR.

PRIORITY CLAIMED UNDER SEC. 44(D) ON FED REP GERMANY APPLICATION NO. 302011069092, FILED 12-22-2011, REG. NO. 302011069092, DATED 12-22-2011, EXPIRES 12-31-2021.

FOR CLOTHING, NAMELY, TOPS, BOTTOMS, UNDERGARMENTS, SLEEPWEAR, JACKETS, SWIMWEAR, SOCKS, HALLOWEEN COSTUMES, COSTUMES FOR USE IN ROLE PLAYING GAMES; HEADWEAR AND FOOTWEAR (U.S. CLS. 22 AND 39).

BRIDGETT SMITH, EXAMINING ATTORNEY

SN 85-605,774. URBAN MOSAICS, HUBER HEIGHTS, OH. FILED 4-23-2012.

**URBAN MOSAICS**

THE MARK CONSISTS OF STANDARD CHARACTERS WITHOUT CLAIM TO ANY PARTICULAR FONT, STYLE, SIZE, OR COLOR.

NO CLAIM IS MADE TO THE EXCLUSIVE RIGHT TO USE "URBAN", APART FROM THE MARK AS SHOWN.

FOR HATS; LONG-SLEEVED SHIRTS; PANTS; SHORTS; SKIRTS; SWEATSHIRTS; T-SHIRTS (U.S. CLS. 22 AND 39).

DAVID MURRAY, EXAMINING ATTORNEY

SN 85-612,671. WUNSCH, STACEY, HOWORTH, NJ. FILED 4-30-2012.

**SLOPPY MOMMY**

THE MARK CONSISTS OF STANDARD CHARACTERS WITHOUT CLAIM TO ANY PARTICULAR FONT, STYLE, SIZE, OR COLOR.

FOR CHILDREN'S AND INFANTS' CLOTH BIBS; WEARABLE GARMENTS AND CLOTHING, NAMELY, SHIRTS (U.S. CLS. 22 AND 39).

GIANCARLO CASTRO, EXAMINING ATTORNEY

**CLASS 25—(Continued).**

SN 85-625,262. MINNESOTA VIKINGS FOOTBALL, LLC, EDEN PRAIRE, MN. FILED 5-15-2012.



OWNER OF U.S. REG. NO. 4,179,759.

THE MARK CONSISTS OF A STYLIZED LETTER "M" AND "V" ENCLOSED IN A STYLIZED LETTER "C".

FOR SHIRTS, TOPS, T-SHIRTS, TANK TOPS, SWEATSHIRTS (U.S. CLS. 22 AND 39).

FIRST USE 0-0-1999; IN COMMERCE 0-0-1999.

SUSAN BILLHEIMER, EXAMINING ATTORNEY

SN 85-626,305. BOLLINGER SPORTS L.L.C., GRAND PRAIRIE, TX. FILED 5-15-2012.



THE MARK CONSISTS OF A CIRCLE ON TOP OF TWO PILLARS.

FOR CLOTHING, NAMELY, SWEAT SUIT, SAUNA SUIT, WAIST TRIMMING BELT, SHORTS, T-SHIRT, SWEATSHIRT, YOGA PANTS, YOGA SHIRTS, SOCKS (U.S. CLS. 22 AND 39).

ALEXANDER L. POWERS, EXAMINING ATTORNEY

SN 85-674,036. TOMORROW INDUSTRIES, INC., LOS ANGELES, CA. FILED 7-11-2012.

**Alphapup**

THE MARK CONSISTS OF STANDARD CHARACTERS WITHOUT CLAIM TO ANY PARTICULAR FONT, STYLE, SIZE, OR COLOR.

FOR WEARABLE GARMENTS AND CLOTHING, NAMELY, SHIRTS (U.S. CLS. 22 AND 39).

COLLEEN MULCRONE, EXAMINING ATTORNEY

**CLASS 25—(Continued).**

SN 85-684,062. SKECHERS U.S.A., INC. II, MANHATTAN BEACH, CA. FILED 7-23-2012.



OWNER OF U.S. REG. NOS. 3,758,513 AND 3,792,066. THE MARK CONSISTS OF THE WORDS "RELAXED FIT" SURROUNDED BY A STYLIZED RECTANGLE.

SEC. 2(F).  
FOR FOOTWEAR, NAMELY, SHOES, AND SNEAKERS; AND APPAREL, NAMELY, TOPS, SHIRTS, BLOUSES, T-SHIRTS, SWEAT SHIRTS, SPORTS JERSEYS, SWEATERS, BOTTOMS, TROUSERS, PANTS, SWEAT PANTS, SHORTS, JACKETS, COATS, OVERCOATS, PULLOVERS, JUMPERS, DRESSES, SKIRTS, BEACHWEAR, SWIMSUITS, UNDERWEAR, LINGERIE, HEADWEAR, HATS, CAPS, BEANIES, VISORS, TIES, SOCKS, BELTS, GLOVES, SCARVES, AND WRISTBANDS (U.S. CLS. 22 AND 39).

BERNICE MIDDLETON, EXAMINING ATTORNEY

**CLASS 25—(Continued).**

SN 85-695,628. SHANGHAI FENSHANG FASHION CO., LTD., SHANGHAI, CHINA, FILED 8-5-2012.



PRIORITY CLAIMED UNDER SEC. 44(D) ON CHINA APPLICATION NO. 10813956, FILED 4-23-2012, REG. NO. 10813956, DATED 7-14-2013, EXPIRES 7-13-2023.

THE MARK CONSISTS OF THE WORD "MULTIEX" IN STYLIZED LETTERING.

FOR BABY LAYETTES FOR CLOTHING; BATHING SUITS; BELTS; CAPS; GLOVES; MEN'S SUITS, WOMEN'S SUITS; SCARVES; SHOES; SOCKS; WATER-PROOF JACKETS AND PANTS (U.S. CLS. 22 AND 39).

LINDA ORNDORFF, EXAMINING ATTORNEY

SN 85-696,960. GORDY, SKYLER, LOS ANGELES, CA. FILED 8-7-2012.



THE MARK CONSISTS OF STANDARD CHARACTERS WITHOUT CLAIM TO ANY PARTICULAR FONT, STYLE, SIZE, OR COLOR.

FOR CLOTHING, NAMELY, T-SHIRTS AND CAPS (U.S. CLS. 22 AND 39).

C. DIONNE CLYBURN, EXAMINING ATTORNEY

SN 85-685,081. TRIPLE 5 INC., MONTRÉAL, QUEBEC, CANADA, FILED 7-24-2012.



THE MARK CONSISTS OF STANDARD CHARACTERS WITHOUT CLAIM TO ANY PARTICULAR FONT, STYLE, SIZE, OR COLOR.

PRIORITY CLAIMED UNDER SEC. 44(D) ON CANADA APPLICATION NO. 1578262, FILED 5-18-2012, REG. NO. TMA863555, DATED 10-25-2013, EXPIRES 10-25-2028.

THE ENGLISH TRANSLATION OF "PYAAR" IN THE MARK IS "LOVE".

FOR CLOTHING, AND ACCESSORIES, NAMELY, BLOUSES, SKIRTS, SHIRTS, SKIRTS SETS, PANTS, CAPRI PANTS, PANT SETS, SLACKS, SHORTS, DRESSES, JACKETS, BLAZERS, COATS, SCARVES, SWEATERS, VESTS, CAR COATS, TRENCH COATS, HATS, CAPS, GLOVES, T-SHIRTS, SWEAT SHIRTS, SWEAT PANTS, CAMISOLES, LEGGINGS, JUMP-SUITS, HALTER TOPS, TANK-TOPS, SWIM SUITS, AFTER-SWIM SUITS, BEACH ROBES, BEACH COVER-UPS, BEACH WRAPS, LEOTARDS, SOCKS, MITTENS, KNIT COORDINATES, NAMELY, SWEATERS, CARDIGANS, PULL-OVER'S, KNITTED DRESSES, KNITTED VESTS AND KNITTED BLAZERS; AND BELTS, SCARVES, SHAWLS (U.S. CLS. 22 AND 39).

KAREN SEVERSON, EXAMINING ATTORNEY

SN 85-697,110. MISSES DRESSY, LONG ISLAND CITY, NY. FILED 8-7-2012.



THE MARK CONSISTS OF THE WORDING "MISSES DRESSY" IN STYLIZED LETTERING WITH A CAPITAL "M" AND "D".

FOR DRESSES; HOSIERY; SHOES; UNDERGARMENTS (U.S. CLS. 22 AND 39).

FIRST USE 2-1-2011; IN COMMERCE 2-1-2011.

MATTHEW EINSTEIN, EXAMINING ATTORNEY

**CLASS 25—(Continued).**

SN 85-738,611. GOOD'S STORE, INC., NEW HOLLAND, PA.  
FILED 9-26-2012.

**Weaverland Collection**

THE MARK CONSISTS OF STANDARD CHARACTERS WITHOUT CLAIM TO ANY PARTICULAR FONT, STYLE, SIZE, OR COLOR.

NO CLAIM IS MADE TO THE EXCLUSIVE RIGHT TO USE "COLLECTION", APART FROM THE MARK AS SHOWN.

FOR MENSWEAR, NAMELY SHIRTS, PANTS, VESTS, SUITS AND HATS (U.S. CLS. 22 AND 39).

FIRST USE 1-1-1997; IN COMMERCE 1-1-1997.  
JAMES GRIFFIN, EXAMINING ATTORNEY

**CLASS 25—(Continued).**

SN 85-765,489. JOHNSON, ROBERT M., HUNTSVILLE, AL.  
FILED 10-28-2012.

THE NAME(S), PORTRAIT(S), AND/OR SIGNATURE(S) SHOWN IN THE MARK DOES NOT IDENTIFY A PARTICULAR LIVING INDIVIDUAL.

THE MARK CONSISTS OF OF THE WORDING "ALLEY KATZ" IN STYLIZED HANDWRITTEN LETTERS DEPICTING A SIGNATURE.

FOR WOMEN'S CLOTHING, NAMELY, SHIRTS, DRESSES, SKIRTS, BLOUSES (U.S. CLS. 22 AND 39).  
DEBORAH MEINERS, EXAMINING ATTORNEY

SN 85-750,742. FRAGILE TENSION LLC, NEW YORK, NY.  
FILED 10-10-2012.

**Fragile Tension**

THE MARK CONSISTS OF STANDARD CHARACTERS WITHOUT CLAIM TO ANY PARTICULAR FONT, STYLE, SIZE, OR COLOR.

FOR BLAZERS; COATS; JACKETS; PANTS; SCARVES; SHIRTS; SWEATERS; T-SHIRTS; TANK TOPS (U.S. CLS. 22 AND 39).

JENNIFER MARTIN, EXAMINING ATTORNEY

SN 85-773,619. BOYDSTON, JOHN C., AKA JOHNNY BOYD,  
OCEANSIDE, CA. FILED 11-7-2012.

**Swing Lover**

THE MARK CONSISTS OF STANDARD CHARACTERS WITHOUT CLAIM TO ANY PARTICULAR FONT, STYLE, SIZE, OR COLOR.

FOR APPAREL FOR MEN, NAMELY, SHIRTS, PANTS, HATS, JACKETS, NECKTIES, SCARVES, AND POCKET SQUARES; APPAREL FOR WOMEN, NAMELY, TOPS, PANTS, SHORTS, JACKETS, AND SCARVES; APPAREL FOR CHILDREN, NAMELY, SHIRTS, PANTS, HATS, JACKETS AND CLOTH BIBS; BODY SUITS FOR INFANTS (U.S. CLS. 22 AND 39).

WILLIAM BRECKENFELD, EXAMINING ATTORNEY

SN 85-761,481. JULIA CHOI, ANAHEIM, CA. FILED 10-23-2012.

**SUMMER OF LOVE COTERIE**

THE MARK CONSISTS OF STANDARD CHARACTERS WITHOUT CLAIM TO ANY PARTICULAR FONT, STYLE, SIZE, OR COLOR.

THE ENGLISH TRANSLATION OF "COTERIE" IN THE MARK IS "CLIQUE".

FOR CLOTHING, NAMELY, SWIM WEAR, COVER UPS, OUTER WEAR, NAMELY, JACKETS, COATS, SHAWLS AND WRAPS, AND HATS FOR MEN, WOMEN AND CHILDREN; HEAD GEAR, NAMELY, HATS AND CAPS AND RELATED ACCESSORIES FOR MEN, WOMEN AND CHILDREN, NAMELY, SCARVES (U.S. CLS. 22 AND 39).

BARBARA BROWN, EXAMINING ATTORNEY

SN 85-790,790. RODNEY, GODFREY WINSTON, LAURELTON, NY. FILED 11-29-2012.

**BURNING SPEAR**

THE MARK CONSISTS OF STANDARD CHARACTERS WITHOUT CLAIM TO ANY PARTICULAR FONT, STYLE, SIZE, OR COLOR.

OWNER OF U.S. REG. NO. 2,857,519.

FOR BELTS; FOOTWEAR; HATS; HEADBANDS; JACKETS; JEANS; NECKTIES; OVERALLS; PANTS; RAINWEAR; SCARVES; SHIRTS; SHORTS; SLEEPWEAR; SOCKS; SUSPENDERS; SWEATERS; SWEATPANTS; SWEATSHIRTS; UNDERWEAR; VESTS; ALL THE FOREGOING SOLD IN DIRECT ASSOCIATION WITH A PARTICULAR MUSICAL PERFORMER VIA CONCERTS OF THE MUSICAL PERFORMER AND THE MUSICAL PERFORMER'S WEBSITE (U.S. CLS. 22 AND 39).

FIRST USE 12-31-1987; IN COMMERCE 12-31-1987.

MATTHEW PAPPAS, EXAMINING ATTORNEY

**CLASS 25—(Continued).**

SN 85-804,180. HOLLOWAY, PATRICIA, FAIRBANKS, AK. FILED 12-17-2012.

**American Flower Farmer**

THE MARK CONSISTS OF STANDARD CHARACTERS WITHOUT CLAIM TO ANY PARTICULAR FONT, STYLE, SIZE, OR COLOR.

NO CLAIM IS MADE TO THE EXCLUSIVE RIGHT TO USE "AMERICAN", APART FROM THE MARK AS SHOWN. FOR HATS; JACKETS; T-SHIRTS (U.S. CLS. 22 AND 39).

CHRISIE B. KING, EXAMINING ATTORNEY

SN 85-825,086. TRVPGXD LLC, NEW YORK, NY. FILED 1-16-2013.

**TRAP GXD**

THE MARK CONSISTS OF STANDARD CHARACTERS WITHOUT CLAIM TO ANY PARTICULAR FONT, STYLE, SIZE, OR COLOR.

FOR ATHLETIC APPAREL, NAMELY, SHIRTS, PANTS, JACKETS, FOOTWEAR, HATS AND CAPS, ATHLETIC UNIFORMS; HOODS; T-SHIRTS; TOPS (U.S. CLS. 22 AND 39).

FIRST USE 1-1-2011; IN COMMERCE 9-1-2012.  
WENDELL PHILLIPS, EXAMINING ATTORNEY

SN 85-828,284. JARVA, WENDY, RONKONKOMA, NY. FILED 1-21-2013.

THE MARK CONSISTS OF THE LETTERS "SI", A FANCIFUL LETTER "C", WHICH RESEMBLES THE LETTER "G", A FANCIFUL LETTER "C" TURNED BACKWARDS, WHICH RESEMBLES THE LETTER "D", AND THE LETTERS "HIC". THE TWO FANCIFUL LETTER "C'S" HAVE TWO CIRCLES IN THE CENTER AND THERE ARE TWO INCLINED LINES, WHICH ARE MIRROR IMAGES OF EACH OTHER, ABOVE THE TWO FANCIFUL LETTER "C'S". THE ARRANGEMENT OF THE CIRCLES IN THE CENTER OF THE TWO FANCIFUL "C'S" AND THE INCLINED LINES ABOVE THE TWO FANCIFUL "C'S" RESEMBLES TWO EYEBALLS WITH EYEBROWS ABOVE THEM.

FOR CLOTHING FOR MIXED MARTIAL ARTS FOR WOMEN, NAMELY, FEMALE FIGHT SHORTS, KIMONOS, FEMALE MARTIAL ARTS UNIFORMS, NAMELY, GIs, GI BELTS FOR MIXED MARTIAL ARTS, FEMALE RASH GUARDS, FEMALE FIGHT-SHIRTS, AND HOODED SWEAT SHIRTS, SOLD AT MIXED MARTIAL ART TOURNAMENTS AND ON WEBSITES DIRECTED TO MIXED MARTIAL ARTS (U.S. CLS. 22 AND 39).

ANNE MADDEN, EXAMINING ATTORNEY

**CLASS 25—(Continued).**

SN 85-832,817. HOT PURSUIT, LLC, EUGENE, OR. FILED 1-25-2013.

**HOT PURSUIT**

THE MARK CONSISTS OF STANDARD CHARACTERS WITHOUT CLAIM TO ANY PARTICULAR FONT, STYLE, SIZE, OR COLOR.

FOR CLOTHING, NAMELY, PANTS, VESTS, JACKETS, TOPS, BOTTOMS, SCARVES, GLOVES (U.S. CLS. 22 AND 39).

BRIDGETT SMITH, EXAMINING ATTORNEY

SN 85-839,994. HUNTER BOOT LIMITED, EDINBURGH, UNITED KINGDOM, FILED 2-4-2013.

**HUNTER BALMORAL**

THE MARK CONSISTS OF STANDARD CHARACTERS WITHOUT CLAIM TO ANY PARTICULAR FONT, STYLE, SIZE, OR COLOR.

PRIORITY CLAIMED UNDER SEC. 44(D) ON UNITED KINGDOM APPLICATION NO. 2650349, FILED 1-30-2013, REG. NO. 2650349, DATED 11-10-2013, EXPIRES 11-10-2023.

OWNER OF U.S. REG. NO. 3,876,340.

NO CLAIM IS MADE TO THE EXCLUSIVE RIGHT TO USE "BALMORAL". LIMITED TO BALMORAL-TYPE SHOES, BALMORAL-TYPE FOOTWEAR, BALMORAL-TYPE SHOES OF LEATHER., APART FROM THE MARK AS SHOWN.

FOR FOOTWEAR; BOOTS; WELLINGTON BOOTS; WATERPROOF BOOTS; WATERPROOF FOOTWEAR; GALOSHES; WATERPROOF CLOGS; SHOES; SHOES OF RUBBER, LEATHER OR OTHER MATERIALS; SANDALS; FLIP-FLOPS; SLIPPERS; WELTS FOR BOOTS AND SHOES; NON-SLIPPING SOLES AND CLEATS FOR BOOTS; INNER SOLES; HEELS AND SOLES FOR FOOTWEAR; INSOLES FOR BOOTS AND SHOES; LINERS FOR BOOTS AND SHOES; SOCKS FOR USE WITH WELLINGTON BOOTS AND WATERPROOF BOOTS; SOCKS; SPORTS FOOTWEAR, NAMELY, RUBBER SHOES, TRAINING SHOES AND ATHLETIC SHOES; AFTER-SPORTS FOOTWEAR; BALMORAL-TYPE SHOES; BALMORAL-TYPE FOOTWEAR; BALMORAL-TYPE SHOES OF LEATHER (U.S. CLS. 22 AND 39).

ODESSA BIBBINS, EXAMINING ATTORNEY

**CLASS 25—(Continued).**

SN 85-845,381. ZHOU NANJUN, LIUZHOU, CHINA, FILED 2-8-2013.



THE MARK CONSISTS OF THE WORDING "KAOLA TREE" AND THE DESIGN OF A KOALA BEAR IN FRONT OF A TREE, WITH THE DESIGN ELEMENTS BEING IN A CIRCULAR BORDER, ALL OVER CHINESE LETTERING.

THE NON-LATIN CHARACTERS IN THE MARK TRANSLITERATE TO "COW LA SHOE", AND THIS MEANS "KOALA TREE" IN ENGLISH.

FOR BIBS NOT OF PAPER; BRACES; FOOTWEAR; GLOVES AS CLOTHING; HEADGEAR, NAMELY, HATS AND CAPS; SCARFS; SLEEPING GARMENTS; SOCKS AND STOCKINGS (U.S. CLS. 22 AND 39).

FIRST USE 11-4-2011; IN COMMERCE 8-25-2012.

JOHN DALIER, EXAMINING ATTORNEY

**CLASS 25—(Continued).**

SN 85-850,693. JOHNSON, JAHA, NEW YORK, NY. FILED 2-14-2013.



THE MARK CONSISTS OF CIRCLE WITHIN A CIRCLE WITH THE LETTERS "B" "N" "Y".

FOR CLOTHING, NAMELY, PANTS, SKIRTS, SHIRTS, COATS, JACKETS, SOCKS, UNDERWEAR, SWIMWEAR, LINGERIE, HATS, GLOVES, SHOES, TIES, BELTS (U.S. CLS. 22 AND 39).

CARYN GLASSER, EXAMINING ATTORNEY

SN 85-852,317. THE OHIO STATE UNIVERSITY, COLUMBUS, OH. FILED 2-18-2013.

SN 85-847,348. FLORY, ARTHUR R., HUNTINGTON BEACH, CA. FILED S.R. 2-12-2013; AM. P.R. 12-7-2013.

**CASUAL MOMENTS**

THE MARK CONSISTS OF STANDARD CHARACTERS WITHOUT CLAIM TO ANY PARTICULAR FONT, STYLE, SIZE, OR COLOR.

FOR ROBES (U.S. CLS. 22 AND 39).

FIRST USE 12-3-2004; IN COMMERCE 12-3-2004.

MAYUR VAGHANI, EXAMINING ATTORNEY

**BUCKEYE TARTAN**

THE MARK CONSISTS OF STANDARD CHARACTERS WITHOUT CLAIM TO ANY PARTICULAR FONT, STYLE, SIZE, OR COLOR.

OWNER OF U.S. REG. NO. 1,267,035.

NO CLAIM IS MADE TO THE EXCLUSIVE RIGHT TO USE "TARTAN", APART FROM THE MARK AS SHOWN.

FOR CLOTHING, NAMELY, KILTS, SKIRTS, SCARVES, TIES (U.S. CLS. 22 AND 39).

SARA BENJAMIN, EXAMINING ATTORNEY



**CLASS 25—(Continued).**

SN 85-854,244. SOTO, JUAN JOSE, LOS ANGELES, CA. FILED 2-19-2013.



NO CLAIM IS MADE TO THE EXCLUSIVE RIGHT TO USE "APPAREL", APART FROM THE MARK AS SHOWN.

THE COLOR(S) GOLD AND BROWN IS/ARE CLAIMED AS A FEATURE OF THE MARK.

THE MARK CONSISTS OF A STYLIZED LETTER "H" IN A CIRCULAR CARRIER IN GOLD AND BROWN, WITH THE WORDING "APPAREL" APPEARING IN BROWN BELOW IT.

FOR BOTTOMS; DRESSES; FOOTWEAR; HATS; HEADWEAR; LOUNGEWEAR; PANTS; SHIRTS; SKIRTS; SLEEPWEAR; SWIMWEAR; TOPS; UNDERWEAR (U.S. CLS. 22 AND 39).

LUCY ARANT, EXAMINING ATTORNEY

SN 85-857,121. WE DESIGN GROUP, AVENTURA, FL. FILED 2-22-2013.

**LOVE CUPKS WORLD**

THE MARK CONSISTS OF STANDARD CHARACTERS WITHOUT CLAIM TO ANY PARTICULAR FONT, STYLE, SIZE, OR COLOR.

FOR CLOTHING, NAMELY, TOPS, BOTTOMS, HOODED SWEATSHIRTS, LONG-SLEEVE SHIRTS, OPEN-NECKED SHIRTS, SHIRTS, SHORT-SLEEVE SHIRTS, T-SHIRTS, FOOTWEAR, HEADWEAR, UNDERWEAR, TANK TOPS, SWEAT PANTS, SWEAT SHIRTS, SWEAT SUITS, SHORTS, AND PANTS (U.S. CLS. 22 AND 39).

Laura KOVALSKY, EXAMINING ATTORNEY

**CLASS 25—(Continued).**

SN 85-858,405. PICART KRISHNA, MOUNT VERNON, NY. FILED 2-24-2013.

**Colo-Red The Complexion Of Life**

THE MARK CONSISTS OF STANDARD CHARACTERS WITHOUT CLAIM TO ANY PARTICULAR FONT, STYLE, SIZE, OR COLOR.

FOR APPAREL FOR DANCERS, NAMELY, TEE SHIRTS, SWEATSHIRTS, PANTS, LEGGINGS, SHORTS AND JACKETS; ATHLETIC APPAREL, NAMELY, SHIRTS, PANTS, JACKETS, FOOTWEAR, HATS AND CAPS, ATHLETIC UNIFORMS; CHILDREN'S AND INFANT'S APPAREL, NAMELY, JUMPERS, OVERALL SLEEPWEAR, PAJAMAS, ROMPERS AND ONE-PIECE GARMENTS; HOODS; JACKETS; JERSEYS; PANTS; SHIRTS; T-SHIRTS; TEE SHIRTS; WOMEN'S CLOTHING, NAMELY, SHIRTS, DRESSES, SKIRTS, BLOUSES (U.S. CLS. 22 AND 39).

FIRST USE 2-5-2012; IN COMMERCE 8-12-2012.

DORITT L. CARROLL, EXAMINING ATTORNEY

SN 85-858,534. VICENCIO, JUSTIN, HOWELL, NJ. FILED 2-24-2013.

**SNKR CARTEL**

THE MARK CONSISTS OF STANDARD CHARACTERS WITHOUT CLAIM TO ANY PARTICULAR FONT, STYLE, SIZE, OR COLOR.

FOR CLOTHING, NAMELY, PANTS; SHIRTS; JACKETS; ATHLETIC WEAR, NAMELY, ATHLETIC PANTS, SHIRTS, SHOES AND SHORTS; HATS; HOODIES; JERSEYS; UNDERGARMENTS; PAJAMAS (U.S. CLS. 22 AND 39).

FIRST USE 11-1-2012; IN COMMERCE 12-22-2012.

MIAH ROSENBERG, EXAMINING ATTORNEY

SN 85-859,772. BYFIELD LEON DIANDRE, DBA UNDER GOD BY: BYFIELD, LYNDHURST, OH. FILED 2-25-2013.

**UNDER GOD By: Byfield**

THE MARK CONSISTS OF STANDARD CHARACTERS WITHOUT CLAIM TO ANY PARTICULAR FONT, STYLE, SIZE, OR COLOR.

FOR COATS; DENIMS; HATS; JACKETS; LONG-SLEEVED SHIRTS; PANTS; POLO SHIRTS; SHIRTS; SHOES (U.S. CLS. 22 AND 39).

FIRST USE 8-28-2012; IN COMMERCE 10-25-2012.

KAELIE KUNG, EXAMINING ATTORNEY

**CLASS 25—(Continued).**

SN 85-860,084. WORLD WRESTLING ENTERTAINMENT, INC., STAMFORD, CT. FILED 2-26-2013.

**WWE PAYBACK**

THE MARK CONSISTS OF STANDARD CHARACTERS WITHOUT CLAIM TO ANY PARTICULAR FONT, STYLE, SIZE, OR COLOR.

OWNER OF U.S. REG. NOS. 2,772,683, 3,541,956 AND OTHERS.

FOR CLOTHING, NAMELY, TOPS, SHIRTS, JACKETS, BOTTOMS, PANTS, SHORTS, UNDERWEAR, PAJAMAS; CLOTHING TIES; GLOVES; HALLOWEEN AND MASQUERADE COSTUMES; FOOTWEAR, NAMELY, SHOES, SNEAKERS, SLIPPERS; HEADWEAR, NAMELY, HATS; WRIST BANDS; BANDANNAS (U.S. CLS. 22 AND 39).  
SALLY SHIH, EXAMINING ATTORNEY

---

SN 85-860,163. ROSADO, MANUEL C, DBA SALT WHORE, OAKLAND PARK, FL. AND FINGER, DAVID A, DBA SALT WHORE, OAKLAND PARK, FL. FILED S.R. 2-26-2013; AM. P.R. 11-21-2013.

**Salt Whore**

THE MARK CONSISTS OF STANDARD CHARACTERS WITHOUT CLAIM TO ANY PARTICULAR FONT, STYLE, SIZE, OR COLOR.

FOR A-SHIRTS; FISHING SHIRTS; SHIRTS AND SHORT-SLEEVED SHIRTS; SHORT-SLEEVED SHIRTS; T-SHIRTS; WEARABLE GARMENTS AND CLOTHING, NAMELY, SHIRTS (U.S. CLS. 22 AND 39).  
CAROLINE WOOD, EXAMINING ATTORNEY

---

SN 85-860,926. SURF 9, LLC, FORT MYERS, FL. FILED 2-26-2013.

**ECOZERO**

THE MARK CONSISTS OF STANDARD CHARACTERS WITHOUT CLAIM TO ANY PARTICULAR FONT, STYLE, SIZE, OR COLOR.

FOR ENVIRONMENTALLY-FRIENDLY FOOTWEAR; ENVIRONMENTALLY-FRIENDLY CLOTHING, NAMELY, T-SHIRTS, SHORTS, SWIM WEAR, BOARD SHORTS, BIKINIS, CAPS, HATS, PANTS, CASUAL SHIRTS (U.S. CLS. 22 AND 39).  
MARK SHINER, EXAMINING ATTORNEY

**CLASS 25—(Continued).**

SN 85-860,936. MCGUINNESS, ALEXIS, HUNTINGTON BEACH, CA. FILED 2-26-2013.



NO CLAIM IS MADE TO THE EXCLUSIVE RIGHT TO USE "BURPING CAPE", APART FROM THE MARK AS SHOWN.

THE MARK CONSISTS OF A DIAMOND SHAPED FIGURE WITH THE WORD "SUPER" ON TOP INSIDE THE DIAMOND FIGURE AND THE WORD "MAMA" UNDER THE WORD SUPER. IN A RECTANGULAR SHAPE AT THE BOTTOM OF THE DIAMOND THE WORDS "BURPING CAPE" ARE WRITTEN INSIDE THE RECTANGLE IN CAPITAL LETTERS.

FOR NURSING APPAREL, NAMELY, BURPING CAPES IN THE NATURE OF A ONE-ARMED SLEEVED GARMENT THAT IS REVERSIBLE FOR THE USE OF THE LEFT OR RIGHT ARM, AND WHICH LATCHES AROUND THE USER'S NECK, HAS A WET-RESISTANT INNER LINER, IS LONG IN LENGTH IN THE FRONT AND BACK TO PROTECT THE USER'S SHIRT OR BLOUSE FROM SPIT UP, AND HAS EXCESS FABRIC IN THE FRONT AND BACK TO COVER THE INFANT DURING BREAST FEEDING (U.S. CLS. 22 AND 39).  
JENNIFER MARTIN, EXAMINING ATTORNEY

---

SN 85-861,512. SIMS, AVERY, ROYAL OAK, MI. FILED 2-27-2013.

**AVETON**

THE MARK CONSISTS OF STANDARD CHARACTERS WITHOUT CLAIM TO ANY PARTICULAR FONT, STYLE, SIZE, OR COLOR.

OWNER OF U.S. REG. NO. 4,230,243.  
FOR APPAREL, NAMELY, T-SHIRTS, HATS, SOCKS, VARSITY JACKETS, PANTS (U.S. CLS. 22 AND 39).  
FIRST USE 6-1-2007; IN COMMERCE 1-1-2009.  
ZACHARY R. SPARER, EXAMINING ATTORNEY

**CLASS 25—(Continued).**

SN 85-867,307. ONELOVELIFESTYLE, SANTA BARBARA, CA. FILED 3-5-2013.

**CLASS 25—(Continued).**

SN 85-875,101. MORRISON, DONALD, ALOYSIUS, BRISTOW, VA. FILED 3-13-2013.

**ALL FAMILY NO FRIENDS**

THE MARK CONSISTS OF STANDARD CHARACTERS WITHOUT CLAIM TO ANY PARTICULAR FONT, STYLE, SIZE, OR COLOR.

FOR BEANIES; BOXER BRIEFS; BUTTON DOWN SHIRTS; CREW NECK SWEATERS; HATS; HEADBANDS FOR CLOTHING; JACKETS; JERSEYS; LONG-SLEEVED SHIRTS; PANTS; SHORT-SLEEVED SHIRTS; SHORTS; SOCKS; SWEATERS; SWEATPANTS; T-SHIRTS; TANK-TOPS (U.S. CLS. 22 AND 39).

JOHN SCHUYLER YARD, EXAMINING ATTORNEY

The glass is Always  
11/10ths full!

SN 85-871,944. PAUL KALDY, DBA URFIGHT, ELIZABETH-TON, TN. FILED S.R. 3-9-2013; AM. P.R. 11-11-2013.

**It's UrFight - Win It!**

THE MARK CONSISTS OF STANDARD CHARACTERS WITHOUT CLAIM TO ANY PARTICULAR FONT, STYLE, SIZE, OR COLOR.

FOR ATHLETIC APPAREL, NAMELY, SHIRTS, PANTS, JACKETS, FOOTWEAR, HATS AND CAPS, ATHLETIC UNIFORMS (U.S. CLS. 22 AND 39).

FIRST USE 8-1-2010; IN COMMERCE 5-11-2011.  
CARYN GLASSER, EXAMINING ATTORNEY

THE MARK CONSISTS OF STANDARD CHARACTERS WITHOUT CLAIM TO ANY PARTICULAR FONT, STYLE, SIZE, OR COLOR.

FOR A-SHIRTS; APPAREL FOR DANCERS, NAMELY, TEE SHIRTS, SWEATSHIRTS, PANTS, LEGGINGS, SHORTS AND JACKETS; ATHLETIC APPAREL, NAMELY, SHIRTS, PANTS, JACKETS, FOOTWEAR, HATS AND CAPS, ATHLETIC UNIFORMS; ATHLETIC SHIRTS; BODY SHIRTS; BUTTON DOWN SHIRTS; BUTTON-FRONT ALOHA SHIRTS; CAMOUFLAGE SHIRTS; CAMP SHIRTS; CLOTHING FOR ATHLETIC USE, NAMELY, PADDED SHIRTS; CLOTHING FOR BABIES, TODDLERS AND CHILDREN, TREATED WITH FIRE AND HEAT RETARDANTS, NAMELY, PAJAMAS, JACKETS, SHIRTS, PANTS, JUMPERS; CLOTHING SHIELDS, NAMELY, PADS APPLIED TO THE UNDER-ARMS OF SHIRTS, BLOUSES AND SWEATERS; COLLARED SHIRTS; DRESS SHIRTS; FISHING SHIRTS; GOLF PANTS, SHIRTS AND SKIRTS; GOLF SHIRTS; HOODED SWEAT SHIRTS; HUNTING SHIRTS; KNIT SHIRTS; LEATHER SHIRTS; LONG-SLEEVED SHIRTS; MATERNITY CLOTHING, NAMELY, SHIRTS, PANTS, SHORTS FOR WOMEN; MOISTURE-WICKING SPORTS SHIRTS; NIGHT SHIRTS; OPEN-NECKED SHIRTS; OVER SHIRTS; PIQUE SHIRTS; POLO SHIRTS; RUGBY SHIRTS; SHIRT FRONTS; SHIRT INSERTS, NAMELY, DICKIES; SHIRT YOKES; SHIRTS; SHIRTS AND SHORT-SLEEVED SHIRTS; SHIRTS AND SLIPS; SHIRTS FOR INFANTS, BABIES, TODDLERS AND CHILDREN; SHIRTS FOR SUITS; SHORT-SLEEVED OR LONG-SLEEVED T-SHIRTS; SHORT-SLEEVED SHIRTS; SLEEP SHIRTS; SLEEVES WORN SEPARATE AND APART FROM BLOUSES, SHIRTS AND OTHER TOPS; SNAP CROTCH SHIRTS FOR INFANTS AND TODDLERS; SPORT SHIRTS; SPORTS SHIRTS; SPORTS SHIRTS WITH SHORT SLEEVES; SUN PROTECTIVE CLOTHING, NAMELY, SHIRTS, PANTS, SHORTS FOR CHILDREN, WOMEN, MEN; SWEAT SHIRTS; T-SHIRTS; T-SHIRTS FOR CHILDREN, WOMEN, MEN; TEE SHIRTS; TRIATHLON CLOTHING, NAMELY, TRIATHLON TIGHTS, TRIATHLON SHORTS, TRIATHLON SING-LETS, TRIATHLON SHIRTS, TRIATHLON SUITS; TUR-TLE NECK SHIRTS; WEARABLE GARMENTS AND CLOTHING, NAMELY, SHIRTS; WIND SHIRTS; WOMEN'S CLOTHING, NAMELY, SHIRTS, DRESSES, SKIRTS, BLOUSES; YOGA SHIRTS (U.S. CLS. 22 AND 39).

SUNG IN, EXAMINING ATTORNEY

SN 85-873,111. SEXICAN, LLC, LAS VEGAS, NV. FILED 3-11-2013.

**Sexican**

THE MARK CONSISTS OF STANDARD CHARACTERS WITHOUT CLAIM TO ANY PARTICULAR FONT, STYLE, SIZE, OR COLOR.

FOR MEN'S, WOMEN'S, AND CHILDREN'S CLOTH-ING, NAMELY, SHIRTS, VESTS, SWEATERS, SHOES, CAPS, BANDANAS, SHORTS, SWEAT SHIRTS, PANTS, AND BELTS FOR CLOTHING, SOCKS, SWIM WEAR, JACKETS, RAIN WEAR, BLOUSES, DRESSES, FOOT-WEAR, HOSIERY, SCARVES, HATS, HEAD BANDS, PAJAMAS AND SLEEP WEAR, LINGERIE, BRAS, PAN-TIES (U.S. CLS. 22 AND 39).

FIRST USE 4-0-2000; IN COMMERCE 4-0-2000.  
MEREDITH MARESCA, EXAMINING ATTORNEY

**CLASS 25—(Continued).**

SN 85-876,156. BENCHMARK BRANDS, INC., NORCROSS, GA. FILED 3-14-2013.



OWNER OF U.S. REG. NO. 3,326,996.  
THE MARK CONSISTS OF THE WORDING "PEDA BELLA" SEPARATED BY THE WHIMSICAL OUTLINE OF A FOOTPRINT.

THE ENGLISH TRANSLATION OF "BELLA" IN THE MARK IS "BEAUTY."

FOR SHOE COMFORT AIDS FOR PRIMARILY NON-ORTHOPEDIC PURPOSES, NAMELY, HEEL PROTECTORS, HEEL LINERS, FOREFOOT CUSHIONS, SLING BACK SHOE CUSHIONING STRAPS, HEEL PADS, INSOLES, HALF INSOLES, SHOE PADDING, SHOE THONG STRAP PADDING, BALL-OF-FOOT CUSHIONS; SPECIALTY SOCKS AND OTHER KNITTED ITEMS DESIGNED FOR WOMEN'S SHOES, NAMELY, FOOT TUBES, SPLIT TOE FOOT TUBES, HALF-SOCKS, LOAFER SOCKS, INNERSOCKS, NO SHOW SOCKS, SEAM-FREE SOCKS, TOE COVERS WITH AND WITHOUT GEL PADDING INCORPORATED INTO KNITTED MATERIAL, ALL FOR PRIMARILY NON-ORTHOPEDIC PURPOSES (U.S. CLS. 22 AND 39).

FIRST USE 2-28-2013; IN COMMERCE 2-28-2013.  
LINDA LAVACHE, EXAMINING ATTORNEY

**CLASS 25—(Continued).**

SN 85-882,200. PELIGROSO SPIRITS COMPANY, LLC, SAN CLEMENTE, CA. FILED 3-21-2013.



THE MARK CONSISTS OF THE TERM "CINN" WITH THE NUMBER "42" APPEARING TO ITS LOWER RIGHT AND WITH A STYLIZED FLAME DESIGN IN LIEU OF A "DOT" ON THE LETTER "I".

FOR HEADWEAR; FOOTWEAR; CLOTHING, NAMELY, T-SHIRTS, CAPS, FLEECE PULLOVERS, FLEECE JACKETS, SWEATSHIRTS, HATS AND BEANIES (U.S. CLS. 22 AND 39).

JACQUELINE ABRAMS, EXAMINING ATTORNEY

SN 85-877,036. MCPHAIL, JAMES, W., DENISON, TX. FILED 3-15-2013.



THE MARK CONSISTS OF STANDARD CHARACTERS WITHOUT CLAIM TO ANY PARTICULAR FONT, STYLE, SIZE, OR COLOR.

NO CLAIM IS MADE TO THE EXCLUSIVE RIGHT TO USE "DENIM COMPANY", APART FROM THE MARK AS SHOWN.

THE NAME(S), PORTRAIT(S), AND/OR SIGNATURE(S) SHOWN IN THE MARK DOES NOT IDENTIFY A PARTICULAR LIVING INDIVIDUAL.

FOR DENIM JEANS (U.S. CLS. 22 AND 39).  
LINDA MICKLEBURGH, EXAMINING ATTORNEY

SN 85-882,658. CHANCE LINK HOLDINGS LIMITED, KOWLOON, HONG KONG, FILED 3-21-2013.



OWNER OF HONG KONG REG. NO. 302421161, DATED 10-31-2012, EXPIRES 10-31-2022.

THE MARK CONSISTS OF THE WORDS "BLANCAR" AND "SA" WITH FOUR DESIGN LINES WITHIN THE LETTER "O" FORMING A STYLIZED ROSE.

THE WORDING "BLANCAR SA" HAS NO MEANING IN A FOREIGN LANGUAGE THOUGH THE TERM "BLANCA ROSA" TRANSLATES TO "WHITE ROSE" IN SPANISH.

FOR CLOTHING, NAMELY, FOOTWEAR, SHOES, HEADWEAR, GLOVES, SHOWER CAPS, SWIMSUITS, BELTS, SASHES FOR WEAR, WEDDING DRESSES, AND SLEEP MASKS (U.S. CLS. 22 AND 39).

GINA FINK, EXAMINING ATTORNEY

**CLASS 25—(Continued).**

SN 85-887,251. DISNEY ENTERPRISES, INC., BURBANK, CA. FILED 3-26-2013.

**OLIVIA POPE**

THE MARK CONSISTS OF STANDARD CHARACTERS WITHOUT CLAIM TO ANY PARTICULAR FONT, STYLE, SIZE, OR COLOR.

THE NAME(S), PORTRAIT(S), AND/OR SIGNATURE(S) SHOWN IN THE MARK DOES NOT IDENTIFY A PARTICULAR LIVING INDIVIDUAL.

FOR FOOTWEAR; HEADWEAR; CLOTHING, NAMELY, APRONS, BEACHWEAR, BELTS, BOTTOMS, CHAPS, CLOAKS, CLOTH BIBS, COATS, COSTUMES FOR USE IN ROLE-PLAYING GAMES, BEACH COVER-UPS, CUMMERBUNDS, DRESSES, EAR MUFFS, GOWNS, GLOVES, HALLOWEEN COSTUMES, HOSIERY, INFANTWEAR, JACKETS, LEOTARDS, LINGERIE, LOUNGEWEAR, MITTENS, OVERALLS, PANTS, PONCHOS, RAINWEAR, SCARVES, SHIRTS, SHORTS, SKIRTS, SLEEPWEAR, SOCKS, SUITS, SWEATERS, SWEATSHIRTS, SWIMWEAR, TIES, TOPS, UNDERWEAR, WRIST BANDS (U.S. CLS. 22 AND 39).

DORITT L. CARROLL, EXAMINING ATTORNEY

**CLASS 25—(Continued).**

SN 85-897,011. DISNEY ENTERPRISES, INC., BURBANK, CA. FILED 4-5-2013.

**FINDING DORY**

THE MARK CONSISTS OF STANDARD CHARACTERS WITHOUT CLAIM TO ANY PARTICULAR FONT, STYLE, SIZE, OR COLOR.

FOR FOOTWEAR; HEADWEAR; CLOTHING, NAMELY, APRONS, BEACHWEAR, BELTS, BOTTOMS, CHAPS, CLOAKS, CLOTH BIBS, COATS, COSTUMES FOR USE IN ROLE-PLAYING GAMES, BEACH COVER-UPS, CUMMERBUNDS, DRESSES, EAR MUFFS, GOWNS, GLOVES, HALLOWEEN COSTUMES, HOSIERY, INFANTWEAR, JACKETS, LEOTARDS, LINGERIE, LOUNGEWEAR, MITTENS, OVERALLS, PANTS, PONCHOS, RAINWEAR, SCARVES, SHIRTS, SHORTS, SKIRTS, SLEEPWEAR, SOCKS, SUITS, SWEATERS, SWEATSHIRTS, SWIMWEAR, TIES, TOPS, UNDERWEAR, WRIST BANDS (U.S. CLS. 22 AND 39).

LEIGH CAROLINE CASE, EXAMINING ATTORNEY

SN 85-897,562. OYL RACING, LLC, GILBERT, AZ. FILED 4-8-2013.

**On Your Left Racing**

THE MARK CONSISTS OF STANDARD CHARACTERS WITHOUT CLAIM TO ANY PARTICULAR FONT, STYLE, SIZE, OR COLOR.

NO CLAIM IS MADE TO THE EXCLUSIVE RIGHT TO USE "RACING", APART FROM THE MARK AS SHOWN.

FOR HATS; SHORTS; T-SHIRTS (U.S. CLS. 22 AND 39).

EUGENIA MARTIN, EXAMINING ATTORNEY

SN 85-893,060. THE NATIONAL ASSOCIATION OF PROFESSIONAL BASEBALL LEAGUES, INC., ST. PETERSBURG, FL. FILED 4-2-2013.

**OAKLAND OAKS**

THE MARK CONSISTS OF STANDARD CHARACTERS WITHOUT CLAIM TO ANY PARTICULAR FONT, STYLE, SIZE, OR COLOR.

NO CLAIM IS MADE TO THE EXCLUSIVE RIGHT TO USE "OAKLAND", APART FROM THE MARK AS SHOWN.

FOR CLOTHING, NAMELY, BASEBALL JERSEYS, JACKETS, SHIRTS, T-SHIRTS, SWEATSHIRTS, HATS, AND CAPS (U.S. CLS. 22 AND 39).

FIRST USE 4-30-1992; IN COMMERCE 4-30-1992.

ALISON POLLACK, EXAMINING ATTORNEY

SN 85-898,324. NIKE, INC., BEAVERTON, OR. FILED 4-8-2013.

**HYPERFLECT**

THE MARK CONSISTS OF STANDARD CHARACTERS WITHOUT CLAIM TO ANY PARTICULAR FONT, STYLE, SIZE, OR COLOR.

FOR CLOTHING, NAMELY, GLOVES, HATS, JACKETS, PANTS, SCARVES, SHIRTS, SHORTS, SWEATSHIRTS, SWEATPANTS, T-SHIRTS, TIGHTS, VESTS (U.S. CLS. 22 AND 39).

JANET LEE, EXAMINING ATTORNEY

**CLASS 25—(Continued).**

SN 85-907,879. COLUMBIA INSURANCE COMPANY, OMAHA, NE. FILED 4-18-2013.

**BUKS BY WALK-OVER**

THE MARK CONSISTS OF STANDARD CHARACTERS WITHOUT CLAIM TO ANY PARTICULAR FONT, STYLE, SIZE, OR COLOR.

OWNER OF U.S. REG. NOS. 3,463,120 AND 4,307,573.

THE ENGLISH TRANSLATION OF "BUKS" IN THE MARK IS "RIFLE".

FOR FOOTWEAR AND CLOTHING, NAMELY, BELTS, DRESSES, GLOVES, JACKETS, NECKWEAR, NIGHTWEAR, PANTS, SUITS, SWIMWEAR, SKIRTS, TOPS, BOTTOMS, UNDERWEAR, HEADWEAR, UNIFORMS, SHIRTS, SWEATSHIRTS, SWEATPANTS, SHORTS, SWEATERS, COATS, WRISTBANDS, SOCKS, HOSIERY, T-SHIRTS, SCARVES, CAPS, VESTS, AND PULLOVERS (U.S. CLS. 22 AND 39).

LUCY ARANT, EXAMINING ATTORNEY

SN 85-911,297. WALLACE, ALLEN, FALLS CHURCH, VA. AND FREEMAN, JERNAY, FALLS CHURCH, VA. FILED 4-22-2013.

**TOGETHERWEAR**

THE MARK CONSISTS OF STANDARD CHARACTERS WITHOUT CLAIM TO ANY PARTICULAR FONT, STYLE, SIZE, OR COLOR.

OWNER OF U.S. REG. NO. 3,747,260.

FOR BELTS; CAPS; FOOTWEAR; HATS; JACKETS; PANTS; RUNNING SUITS; SHIRTS; SOCKS; SUITS; SWEAT SUITS; SWEATPANTS; SWEATSHIRTS; T-SHIRTS; UNDERSHIRTS (U.S. CLS. 22 AND 39).

FIRST USE 12-0-2012. THE MARK WAS FIRST USED ANYWHERE IN A DIFFERENT FORM OTHER THAN THAT SOUGHT TO BE REGISTERED AT LEAST AS EARLY AS 12/00/1998; IN COMMERCE 12-0-2012. THE MARK WAS FIRST USED IN COMMERCE IN A DIFFERENT FORM OTHER THAN THAT SOUGHT TO BE REGISTERED AT LEAST AS EARLY AS 12/00/1998.

JAY FLOWERS, EXAMINING ATTORNEY

SN 85-913,467. 13 RATTLES, INC., NEW YORK, NY. FILED 4-24-2013.

**LOVSLAVE**

THE MARK CONSISTS OF STANDARD CHARACTERS WITHOUT CLAIM TO ANY PARTICULAR FONT, STYLE, SIZE, OR COLOR.

FOR CLOTHING, NAMELY, JEANS, SHIRTS, TEE SHIRTS, TANK TOPS, SWEAT SHIRTS, SWEATERS, JACKETS AND COATS (U.S. CLS. 22 AND 39).

DOMINICK J. SALEMI, EXAMINING ATTORNEY

**CLASS 25—(Continued).**

SN 85-917,145. SUHYANG NETWORKS CO., LTD, SEOUL, REPUBLIC OF KOREA, FILED 4-29-2013.



OWNER OF REPUBLIC OF KOREA REG. NO. 0489663, DATED 3-16-2001, EXPIRES 3-16-2021.

THE MARK CONSISTS OF THE WORD "BLUEDOG", WITH THE LETTERS "ED" APPEARING SUPERIMPOSED OVER THE SIDE PROFILE REPRESENTATION OF A DOG.

FOR CLOTHING, NAMELY, OVERCOATS, JUMPERS, SKIRTS, SUITS, ONE-PIECE DRESSES, JACKETS, BLUE JEANS, TWO-PIECED DRESSES, PARKAS, BUTTON-FRONT ALOHA SHIRTS, BLOUSES, SWIMSUITS, SWEATERS, SPORT SHIRTS, DRESS SHIRTS, AND T-SHIRTS; FOOTWEAR, NAMELY, BASKETBALL SHOES, SHOES, AND SANDALS; HEADGEAR, NAMELY, HATS; AND LEATHER BELTS (U.S. CLS. 22 AND 39).

WON TEAK OH, EXAMINING ATTORNEY

SN 85-918,581. LION HEART CLOTHING LINE COMPANY, CORP, BURTONSVILLE, MD. FILED 4-30-2013.



THE MARK CONSISTS OF AN IRREGULAR SHAPE RESEMBLING A MEDIEVAL FLAG WITH THE STYLIZED LETTERS "L" AND "H". OVERLAID ON THESE STYLIZED LETTERS IS THE DRAMATIZED IMAGE OF A LION.

FOR CLOTHING, NAMELY, T-SHIRTS, POLO SHIRTS, DRESS SHIRTS, HATS, UNDERWEAR, JEANS, PANTS, JACKETS, SWEATSHIRTS, BELTS, SOCKS, SHORTS, SWEATPANTS, HOODED SWEATSHIRTS, SKIRTS, LINGERIE AND FOOTWEAR (U.S. CLS. 22 AND 39).

RONALD AIKENS, EXAMINING ATTORNEY

**CLASS 25—(Continued).**

SN 85-918,587. LION HEART CLOTHING LINE COMPANY, CORP, BURTONSVILLE, MD. FILED 4-30-2013.



THE MARK CONSISTS OF AN IRREGULAR SHAPE RESEMBLING A MEDIEVAL FLAG WITH THE STYLIZED LETTERS "L" AND "H". OVERLAID ON THESE STYLIZED LETTERS IS THE DRAMATIZED IMAGE OF A LION.

FOR CLOTHING, NAMELY, T-SHIRTS, POLO SHIRTS, DRESS SHIRTS, HATS, UNDERWEAR, JEANS, PANTS, JACKETS, SWEATSHIRTS, BELTS, SOCKS, SHORTS, SKIRTS, SWEATPANTS, HOODED SWEATSHIRTS, LINGERIE AND FOOTWEAR (U.S. CLS. 22 AND 39).

RONALD AIKENS, EXAMINING ATTORNEY

SN 85-921,143. FRECO, LLC, OMAHA, NE. FILED 5-2-2013.

**FRECO**

THE MARK CONSISTS OF STANDARD CHARACTERS WITHOUT CLAIM TO ANY PARTICULAR FONT, STYLE, SIZE, OR COLOR.

THE WORDING "FRECO" HAS NO MEANING IN A FOREIGN LANGUAGE.

FOR SHIRTS, T-SHIRTS, SHORTS, PANTS, SWEAT SUITS, SWEAT SHIRTS, HATS, GLOVES, WRESTLING SHOES, SOCKS, WRESTLING LEOTARD AND TIGHTS, ANKLE BANDS, WRIST BANDS AND BELTS; ATHLETIC APPAREL, NAMELY, ATHLETIC UNIFORMS, SPORTING OFFICIAL'S UNIFORMS (U.S. CLS. 22 AND 39).

FIRST USE 5-9-2011; IN COMMERCE 7-1-2012.

ARETHA SOMERVILLE, EXAMINING ATTORNEY

**CLASS 25—(Continued).**

SN 85-923,317. PELIGROSO SPIRITS COMPANY, LLC, SAN CLEMENTE, CA. FILED 5-3-2013.

**PELIGROSO**

THE MARK CONSISTS OF STANDARD CHARACTERS WITHOUT CLAIM TO ANY PARTICULAR FONT, STYLE, SIZE, OR COLOR.

OWNER OF U.S. REG. NO. 3,871,599.

THE ENGLISH TRANSLATION OF "PELIGROSO" IN THE MARK IS "DANGEROUS".

FOR CLOTHING, NAMELY, HEADWEAR, FOOTWEAR, T-SHIRTS, CAPS, FLEECE PULLOVERS, FLEECE JACKETS, SWEATSHIRTS, HATS AND BEANIES (U.S. CLS. 22 AND 39).

JACQUELINE ABRAMS, EXAMINING ATTORNEY

SN 85-930,552. ROCKY BRANDS, INC., NELSONVILLE, OH. FILED 5-13-2013.

**SILENTHUNTER**

THE MARK CONSISTS OF STANDARD CHARACTERS WITHOUT CLAIM TO ANY PARTICULAR FONT, STYLE, SIZE, OR COLOR.

OWNER OF U.S. REG. NO. 2,982,826.

FOR FOOTWEAR (U.S. CLS. 22 AND 39).

ASMAT KHAN, EXAMINING ATTORNEY

SN 85-933,443. WRIGHT, SHIMON T, DETROIT, MI. FILED 5-15-2013.

**John Doe**

THE MARK CONSISTS OF STANDARD CHARACTERS WITHOUT CLAIM TO ANY PARTICULAR FONT, STYLE, SIZE, OR COLOR.

THE NAME(S), PORTRAIT(S), AND/OR SIGNATURE(S) SHOWN IN THE MARK DOES NOT IDENTIFY A PARTICULAR LIVING INDIVIDUAL.

FOR T-SHIRTS FOR MEN, WOMEN (U.S. CLS. 22 AND 39).

FIRST USE 4-30-2013; IN COMMERCE 4-30-2013.

HOWARD B. LEVINE, EXAMINING ATTORNEY

**CLASS 25—(Continued).**

SN 85-934,481. DIGILIO SR., GERALD, ASTORIA, NY. FILED 5-16-2013.



THE MARK CONSISTS OF THE STYLIZED LETTERS "IMNY".  
FOR HATS; SHIRTS (U.S. CLS. 22 AND 39).  
FIRST USE 7-0-2012; IN COMMERCE 3-0-2013.  
JAY FLOWERS, EXAMINING ATTORNEY

SN 85-940,205. NEUMANN, JAMES, ANDREWS, AUSTRALIA, FILED 5-22-2013.

Hatspot

THE MARK CONSISTS OF STANDARD CHARACTERS WITHOUT CLAIM TO ANY PARTICULAR FONT, STYLE, SIZE, OR COLOR.  
PRIORITY CLAIMED UNDER SEC. 44(D) ON AUSTRALIA APPLICATION NO. 1548590, FILED 3-27-2013, REG. NO. 1548950, DATED 9-26-2013, EXPIRES 3-27-2023.  
FOR BUCKET CAPS; CAP PEAKS; CAP VISORS; CAPS; CAPS WITH VISORS; CHILDREN'S HEADWEAR; HATS; HATS FOR INFANTS, BABIES, TODDLERS AND CHILDREN; HEADGEAR, NAMELY, HATS, CAPS AND VISORS; HEADWEAR; KNITTED CAPS; LEATHER HATS; LEATHER HEADWEAR; RAIN HATS; SCARFS; SMALL HATS; SUN VISORS; SWIM CAPS; SWIMMING CAPS; SWIMMING CAPS; TOP HATS; VISORS; WOMEN'S HATS AND HOODS; WOOLLY HATS (U.S. CLS. 22 AND 39).  
MORGAN WYNNE, EXAMINING ATTORNEY

**CLASS 25—(Continued).**

SN 85-943,986. GLORIETTE BEKLEIDUNGSWERK GESELLSCHAFT M.B.H., STEGERSBACH, AUSTRIA, FILED 5-28-2013.



PRIORITY CLAIMED UNDER SEC. 44(D) ON AUSTRIA APPLICATION NO. AM6029/2012, FILED 11-27-2012, REG. NO. 270784, DATED 2-4-2013, EXPIRES 2-4-2023.  
THE MARK CONSISTS OF THE CAPITAL LETTER "G" TOGETHER WITH THE IMAGE OF A DEER.  
FOR CLOTHING, NAMELY, OUTER CLOTHING, NAMELY, T-SHIRTS, PULLOVERS, JUMPERS, WAIST COATS, VESTS, SOCKS, SHORTS, TIES, SCARFS, JACKETS, COATS; POLO SHIRTS; SHIRTS; BLOUSES (U.S. CLS. 22 AND 39).  
SHAUNIA CARLYLE, EXAMINING ATTORNEY

SN 85-945,587. LORI LEVINE, NEW YORK, NY. FILED 5-29-2013.



NO CLAIM IS MADE TO THE EXCLUSIVE RIGHT TO USE "VINTAGE AND RECLAIMED", APART FROM THE MARK AS SHOWN.  
THE MARK CONSISTS OF A RING CONTAINING THE WORDS "COMES WITH BAGGAGE", BISECTED HORIZONTALLY BY A BAND CONTAINING THE LETTERS "CWB", WITH THE WORD "VINTAGE" ABOVE THE BAND AND THE WORD "RECLAIMED" BELOW THE BAND.  
FOR APPAREL, NAMELY, BELTS, BLAZERS, BLOUSES, BODY SUITS, CAFTANS, CLOAKS, COATS, GLOVES, GOWNS, HEAD WEAR, JACKETS, PAJAMAS, PANTS, ROBES, SCARVES, LEGGINGS, SHIRTS, SHORTS, SWEATPANTS, SWEATSHIRTS, T-SHIRTS, SOCKS; INTIMATES, NAMELY, BOXERS, UNDERWEAR AND BRAS; CHILDREN'S AND INFANTS APPAREL, NAMELY, JUMPERS, SLEEPWEAR, PAJAMAS, ROMPERS AND ONE-PIECE GARMENTS; SHOES (U.S. CLS. 22 AND 39).  
DAVID H. STINE, EXAMINING ATTORNEY



**CLASS 25—(Continued).**

SN 85-949,160. THE BURTON CORPORATION, BURLINGTON, VT. FILED 6-3-2013.

**ANALOG TECHNICAL FASHION**

THE MARK CONSISTS OF STANDARD CHARACTERS WITHOUT CLAIM TO ANY PARTICULAR FONT, STYLE, SIZE, OR COLOR.

NO CLAIM IS MADE TO THE EXCLUSIVE RIGHT TO USE "FASHION", APART FROM THE MARK AS SHOWN.

FOR CLOTHING, NAMELY, JACKETS, PULLOVERS, SWEATSHIRTS, SWEATPANTS, SHELLS, PANTS, SNOWBOARD PANTS, SHIRTS, HATS, CAPS, HEADWEAR, FACEMASKS, GLOVES, MITTS, VESTS, SWEATERS, UNDERGARMENTS, UNDERWEAR, AND SOCKS (U.S. CLS. 22 AND 39).

SALLY SHIH, EXAMINING ATTORNEY

**CLASS 25—(Continued).**

SN 85-961,894. SAYAG, THIERRY, CHARBONNIERES LES BAIN, FRANCE, FILED 6-17-2013.

# OLIVER GRANT

THE MARK CONSISTS OF STANDARD CHARACTERS WITHOUT CLAIM TO ANY PARTICULAR FONT, STYLE, SIZE, OR COLOR.

OWNER OF ERPN CMNTY TM OFC REG. NO. 4619111, DATED 7-28-2006, EXPIRES 7-28-2016.

THE NAME "OLIVER GRANT" DOES NOT IDENTIFY A LIVING INDIVIDUAL.

FOR CLOTHING, NAMELY, COATS, RAINCOATS, OVERCOATS, JACKETS, WAISTCOATS, BLOUSONS, THREE-QUARTER LENGTH COATS, CARDIGANS, SUITS, SPORT JACKETS, DRESS SHIRTS, PANTS, TROUSERS, SWEATERS, BERMUDA SHORTS, SHORTS, SWIMWEAR, DRESSES, SKIRTS, SHIRTS, T-SHIRTS, OVERALLS, BLOUSES, UNDERWEAR, TRACKSUITS, POLO-SHIRTS, SHORT-SLEEVED VESTS, PULLOVERS, SOCKS, GLOVES, TIES, SCARVES, WOOLEN HATS, CAPS AND HATS, BELTS FOR CLOTHING, POCKET SQUARES; FOOTWEAR, TENNIS AND SPORT SHOES, BOOTS, SLIPPERS, PAJAMAS, ROBES (U.S. CLS. 22 AND 39).

ANNE E. GUSTASON, EXAMINING ATTORNEY

SN 85-964,533. HUNG NGUYEN, TORRANCE, CA. FILED 6-19-2013.

SN 85-961,745. AORAKI DENIM, MONTCLAIR, NJ. FILED 6-17-2013.



NO CLAIM IS MADE TO THE EXCLUSIVE RIGHT TO USE "DENIM" AND "PERFORMANCE STYLE VERSATILITY", APART FROM THE MARK AS SHOWN. FOR DENIM JEANS (U.S. CLS. 22 AND 39). DAVID TOOLEY, EXAMINING ATTORNEY



OWNER OF U.S. REG. NO. 4,341,376. THE COLOR(S) GREEN AND GOLD IS/ARE CLAIMED AS A FEATURE OF THE MARK.

THE MARK CONSISTS OF TWO STYLIZED LETTERS "C", ARRANGED CLOSE TO ONE ANOTHER, WITH THE FIRST ONE IN GREEN COLOR SLIGHTLY HIGHER AND TO THE LEFT, AND THE SECOND ONE IN GOLD COLOR SLIGHTLY LOWER AND TO THE RIGHT. ON THE RIGHT SIDE, NEXT TO THE TWO "C"S SITS A GREEN CROSS, WITH - ON TOP OF IT AND IN GOLD COLOR - THE TRADITIONAL SYMBOL OF MEDICINE, THE CADUCEUS OF HERMES, FEATURING TWO SNAKES AROUND A WINGED STAFF. UNDERNEATH IT ALL THE WORD "GANNA CLINIC" IN GOLD COLOR, ALL IN UPPER CASE. FOR SHIRTS (U.S. CLS. 22 AND 39).

FIRST USE 6-28-2012; IN COMMERCE 6-28-2012. DARRYL SPRUILL, EXAMINING ATTORNEY

**CLASS 25—(Continued).**

SN 85-964,873. THE TRUSTEE OF THE KAM INTER VIVOS TRUST, AN ILLINOIS TRUST COMPRISING JOHN M. KING, A UNITED STATES CITIZEN, CHICAGO, IL. FILED 6-20-2013.

TAKING SUGAR OUT OF SUGAR  
DIABETES

THE MARK CONSISTS OF STANDARD CHARACTERS WITHOUT CLAIM TO ANY PARTICULAR FONT, STYLE, SIZE, OR COLOR.

FOR CLOTHING, NAMELY, HEADWEAR, FOOTWEAR, TOPS, BOTTOMS, T-SHIRTS, POLO SHIRTS, TANK TOPS, SWEATERS, SWEAT PANTS, SWEATSHIRTS, HOODED SWEATSHIRTS, HATS, CAPS (U.S. CLS. 22 AND 39).

MATTHEW MCDOWELL, EXAMINING ATTORNEY

SN 85-967,124. GINA WISSMILLER, PORTLAND, OR. FILED 6-21-2013.

barely buddies

THE MARK CONSISTS OF STANDARD CHARACTERS WITHOUT CLAIM TO ANY PARTICULAR FONT, STYLE, SIZE, OR COLOR.

OWNER OF U.S. REG. NO. 3,805,922.  
FOR GIRLS UNDERWEAR (U.S. CLS. 22 AND 39).  
FIRST USE 1-4-2013; IN COMMERCE 4-28-2013.  
TINA L. SNAPP, EXAMINING ATTORNEY

SN 85-969,211. MANDUKA LLC, EL SEGUNDO, CA. FILED 6-25-2013.



OWNER OF U.S. REG. NO. 3,749,312.  
THE MARK CONSISTS OF A DESIGN OF A FROG INSIDE A CIRCLE.

FOR CLOTHING, NAMELY, TOPS, BOTTOMS, TIGHTS, SHORTS, PANTS, TANK TOPS, SKIRTS, DRESSES, JACKETS, WRAPS, HEADWEAR, AND FOOTWEAR (U.S. CLS. 22 AND 39).

ALICIA COLLINS, EXAMINING ATTORNEY

**CLASS 25—(Continued).**

SN 86-000,663. SUMO STEAKS LLC, PHILADELPHIA, PA. FILED 7-2-2013.



OWNER OF U.S. REG. NO. 4,175,564.  
THE MARK CONSISTS OF A STYLIZED IMAGE OF A SUMO WRESTLER APPEARING INSIDE A STYLIZED CIRCLE.

FOR ATHLETIC APPAREL, NAMELY, SHIRTS, PANTS, JACKETS, FOOTWEAR, HATS AND CAPS, ATHLETIC UNIFORMS; BOTTOMS; JACKETS; TOPS (U.S. CLS. 22 AND 39).

FIRST USE 11-1-2010; IN COMMERCE 11-1-2010.  
MARYNELLE WILSON, EXAMINING ATTORNEY

SN 86-002,706. HUNTER, FREDERICK SO, NEW YORK, NY. AND SHELTON, JABARI, NEW YORK, NY. FILED 7-4-2013.

VLONE

THE MARK CONSISTS OF STANDARD CHARACTERS WITHOUT CLAIM TO ANY PARTICULAR FONT, STYLE, SIZE, OR COLOR.

FOR CLOTHING, NAMELY, T-SHIRTS, SWEATSHIRTS, UNDERSHIRTS, JEANS, PANTS, SHORTS, JACKETS, COATS, HATS, SOCKS, AND SNEAKERS; FOOTWEAR; UNDERWEAR (U.S. CLS. 22 AND 39).

FIRST USE 4-1-2012; IN COMMERCE 4-1-2012.  
BRENDAN MCCAULEY, EXAMINING ATTORNEY

**CLASS 25—(Continued).**

SN 86-006,082. DON'T WEAR CLOTHING, LLC, EASTVALE, CA. FILED 7-10-2013.



NO CLAIM IS MADE TO THE EXCLUSIVE RIGHT TO USE "CLOTHING", APART FROM THE MARK AS SHOWN. THE MARK CONSISTS OF THE STYLIZED TEXT "DON'TWEAR" WITH A DESIGN OF AN X GRAPHIC IN THE CENTER OF THE "O" AND A DESIGN OF A CHERRY BOMB IN THE CENTER OF THE "R" WITH THE STYLIZED TEXT "CLOTHING" BENEATH THAT. FOR HATS; HOODED SWEATSHIRTS; JACKETS; PANTS; SHIRTS; SHORTS; SWEATSHIRTS; SWIMWEAR; T-SHIRTS; UNDERGARMENTS; WRISTBANDS (U.S. CLS. 22 AND 39). FIRST USE 8-5-2011; IN COMMERCE 5-1-2013. STEVEN PEREZ, EXAMINING ATTORNEY

SN 86-010,038. WEHRLE, DAVID, DALLAS, TX. FILED 7-15-2013.

chronicle New York

THE MARK CONSISTS OF STANDARD CHARACTERS WITHOUT CLAIM TO ANY PARTICULAR FONT, STYLE, SIZE, OR COLOR. NO CLAIM IS MADE TO THE EXCLUSIVE RIGHT TO USE "NEW YORK", APART FROM THE MARK AS SHOWN. FOR HATS (U.S. CLS. 22 AND 39). FIRST USE 6-1-2013; IN COMMERCE 6-10-2013. IRA J. GOODSaid, EXAMINING ATTORNEY

**CLASS 25—(Continued).**

SN 86-010,993. WILBERTO A ESPARRA, OAKLAND, FL. AND MERANDA J KNIERIEM, OAKLAND, FL. FILED 7-16-2013.



NO CLAIM IS MADE TO THE EXCLUSIVE RIGHT TO USE "INC.", APART FROM THE MARK AS SHOWN. THE COLOR(S) BLACK OR WHITE, HOT PINK AND TURQUOISE IS/ARE CLAIMED AS A FEATURE OF THE MARK. THE MARK CONSISTS OF "OSH!WOW INC." IS BLACK OR WHITE. THEY EXCLAMATION AND/OR I HAS A TURQUOISE BOX AT BOTTOM. THE "WOW" HAS BOLD LETTERS AND THE "O" IS A CIRCLE WITH A STAR INSIDE. THE LAST "W" HAS "INC." WRITING ON THE SIDE IN BLACK OR WHITE FONT. THE CIRCLE HAS A BLACK OUTLINE WITH HOT PINK INSIDE AND A STAR INSIDE WITH BLACK OUTLINE AND INSIDE TURQUOISE. FOR APPAREL FOR DANCERS, NAMELY, TEE SHIRTS, SWEATSHIRTS, PANTS, LEGGINGS, SHORTS AND JACKETS; ATHLETIC APPAREL, NAMELY, SHIRTS, PANTS, JACKETS, FOOTWEAR, HATS AND CAPS, ATHLETIC UNIFORMS; ATHLETIC SHIRTS; BODY SHIRTS; BOXER SHORTS; BRIEFS; BUTTON DOWN SHIRTS; CAMOUFLAGE SHIRTS; COLLARED SHIRTS; DENIM JACKETS; DENIMS; DRESS PANTS; DRESS SHIRTS; DRESS SUITS; DRESSES; DRESSING GOWNS; GYM SHORTS; HOODED SWEAT SHIRTS; HOODED SWEATSHIRTS; LADIES' UNDERWEAR; LEATHER SHIRTS; LONG-SLEEVED SHIRTS; MEN'S DRESS SOCKS; MEN'S SOCKS; MEN'S UNDERWEAR; OPEN-NECKED SHIRTS; PANTIES, SHORTS AND BRIEFS; POLO SHIRTS; SHIRTS; SHIRTS AND SHORT-SLEEVED SHIRTS; SHIRTS FOR SUITS; SHORT-SLEEVED OR LONG-SLEEVED T-SHIRTS; SHORT-SLEEVED SHIRTS; SHORTS; SKIRTS; SKIRTS AND DRESSES; SOCKS; SPORT SHIRTS; SWEAT JACKETS; SWEAT PANTS; SWEAT SHIRTS; T-SHIRTS; TANK TOPS; TANK-TOPS; THONGS; UNDERWEAR; UNDERWEAR, NAMELY, BOY SHORTS; WEARABLE GARMENTS AND CLOTHING, NAMELY, SHIRTS; WOMEN'S CLOTHING, NAMELY, SHIRTS, DRESSES, SKIRTS, BLOUSES; WOMEN'S UNDERWEAR; YOGA SHIRTS (U.S. CLS. 22 AND 39). DOMINICK J. SALEMI, EXAMINING ATTORNEY

SN 86-011,964. LEE, SUKJAE, FULLERTON, CA. FILED 7-16-2013.

Wells Grace

THE MARK CONSISTS OF STANDARD CHARACTERS WITHOUT CLAIM TO ANY PARTICULAR FONT, STYLE, SIZE, OR COLOR. "WELLS GRACE" DOES NOT IDENTIFY A LIVING INDIVIDUAL. FOR BLOUSES; DRESSES; JACKETS; JUMPERS; JUMPSUITS; LEGGINGS; PANTS; ROMPERS; SHIRTS; SHORTS; SKIRTS; SWEATERS; VESTS (U.S. CLS. 22 AND 39). DAVID C. REIHNER, EXAMINING ATTORNEY

**CLASS 25—(Continued).**

SN 86-012,339. THREE WISE DONKEYS, LLC, BOSTON, MA.  
FILED 7-17-2013.



THE MARK CONSISTS OF STANDARD CHARACTERS WITHOUT CLAIM TO ANY PARTICULAR FONT, STYLE, SIZE, OR COLOR.

FOR SHIRTS, PANTS, SHORTS, BELTS, JACKETS, COATS, SKIRTS, BLOUSES, DRESSES, BOOTS, SHOES, SOCKS, HATS, CAPS, UNDERGARMENTS, STOCKINGS, SWEATERS, SWEATSHIRTS, GLOVES, CASUAL CLOTHING FOR MEN IN THE NATURE OF JEANS, CASUAL CLOTHING FOR WOMEN IN THE NATURE OF JEANS (U.S. CLS. 22 AND 39).

VIVIAN MICZNIK FIRST, EXAMINING ATTORNEY

---

SN 86-012,759. THE HOOP GROUP, INC., NEPTUNE, NJ.  
FILED 7-17-2013.



OWNER OF U.S. REG. NOS. 4,013,121, 4,013,123 AND OTHERS.

NO CLAIM IS MADE TO THE EXCLUSIVE RIGHT TO USE "GROUP", APART FROM THE MARK AS SHOWN.

THE COLOR(S) BLACK, WHITE, AND BLUE IS/ARE CLAIMED AS A FEATURE OF THE MARK.

THE MARK CONSISTS OF THE WORD "HOOP" STAGGERED ABOVE THE WORD "GROUP" COLORED IN WHITE AND OUTLINED IN BLACK, WITH THE LETTERS "O" BEING REPLACED WITH A DESIGN CONSISTING OF THE OUTLINE OF A BASKETBALL IN BLACK IN WHICH THERE IS DEPICTED NORTH, CENTRAL, AND SOUTH AMERICA COLORED IN BLUE AGAINST A WHITE BACKGROUND.

FOR PROMOTIONAL PRODUCTS, NAMELY, CLOTHING IN THE NATURE OF SHIRTS, SHORTS, HATS, AND JACKETS (U.S. CLS. 22 AND 39).

FIRST USE 1-1-2011; IN COMMERCE 1-1-2011.

KAREN BRACEY, EXAMINING ATTORNEY

**CLASS 25—(Continued).**

SN 86-012,765. THE HOOP GROUP, INC., NEPTUNE, NJ.  
FILED 7-17-2013.



OWNER OF U.S. REG. NOS. 4,013,121, 4,013,123 AND OTHERS.

NO CLAIM IS MADE TO THE EXCLUSIVE RIGHT TO USE "GROUP", APART FROM THE MARK AS SHOWN.

THE COLOR(S) BLACK, WHITE, AND BLUE IS/ARE CLAIMED AS A FEATURE OF THE MARK.

THE MARK CONSISTS OF THE WORDS "HOOP" AND "GROUP" SIDE BY SIDE COLORED IN WHITE AND OUTLINED IN BLACK, WITH THE LETTERS "O" BEING REPLACED WITH A DESIGN CONSISTING OF THE OUTLINE OF A BASKETBALL IN BLACK IN WHICH THERE IS DEPICTED NORTH, CENTRAL, AND SOUTH AMERICA COLORED IN BLUE AGAINST A WHITE BACKGROUND.

FOR PROMOTIONAL PRODUCTS, NAMELY, CLOTHING IN THE NATURE OF SHIRTS, SHORTS, HATS, AND JACKETS (U.S. CLS. 22 AND 39).

FIRST USE 1-1-2011; IN COMMERCE 1-1-2011.

KAREN BRACEY, EXAMINING ATTORNEY

---

SN 86-013,652. SUDDS, JOHN C., IRVING, TX. AND SUDDS, SUKJA, IRVING, TX. FILED 7-18-2013.



NO CLAIM IS MADE TO THE EXCLUSIVE RIGHT TO USE "APPAREL", APART FROM THE MARK AS SHOWN.

THE MARK CONSISTS OF A LOWER CASE "L" USED TO

**CLASS 25—(Continued).**

BEGIN THE WORD "LEAF" WHILE AN UPPER CASE "B" IS USED TO BEGIN THE WORD "BUILDER". BOTH WORDS ARE ADJOINED TO ARRIVE AT THE SINGULAR WORD "LEAFBUILDER". WITH REGARDS TO THE APPEARANCE AND DESIGN OF THE "LB" MARK ITSELF THE WORD "LEAFBUILDER" IS ELONGATED IN A VERTICAL POSITION, AND THEN INTEGRATED INTO A LOWER CASE "L" SECTION OF A LARGE BOLD "LB" GRAPHIC. THE WORD "APPAREL" IS ADDED DIRECTLY BENEATH THE "LB" GRAPHIC DESIGN.

FOR PANTS, CAPRI PANTS, DENIM JEANS, SHORTS, T-SHIRTS, CUSTOMIZED SLOGAN T-SHIRTS, POLO-SHIRTS, BLOUSES, SKIRTS, LONG-SLEEVE AND SHORT-SLEEVE DRESS SHIRTS, TANK-TOPS, LEISURE COVERALLS, MUSCLE TEES, JACKETS, APRONS, DRESS SHOES, SNEAKERS, HUARACHES SANDALS, SANDALS, SLIPPERS, BALL CAPS, APPLE HATS, SKULLCAPS, BELT, BANDANA, SUN HATS, VISOR HATS, STRAW HATS, CASUAL GLOVES, HAND-MITTENS, SOCKS, FOOTIES, PAJAMAS, UNDERGARMENTS, SWEATERS, HOODED SWEATSHIRTS, NECKTIE, BOW-TIES, SCARFS, SHAWLS, WRAPS, BATHROBES, CIGAR ROBES, GOWNS; MEN, WOMEN AND CHILDREN SUITS, DRESSES, RECRUITERS' UNIQUE PROPRIETARY RANKING SYSTEM APPAREL FOR MEN AND WOMEN, NAMELY, T-SHIRTS, SHORTS, JERSEYS, PANTS, MUSCLE SHIRTS, TANK-TOPS, SWEATERS, JACKETS, HOODED SWEATSHIRTS, WARM-UP PANTS AND SHORTS, TRACK-SUITS, BALL CAPS, WALKING SHOES, RUNNING SHOES, DRESS SHIRTS, COATS, OCCUPATIONAL PERFORMANCE PREFERENCE WEAR (OPPW) FOR MEN, WOMEN AND TEENS, NAMELY, T-SHIRTS, LONG SLEEVE SHIRTS, SHORT SLEEVE SHIRTS, PANTS, MUSCLE SHIRTS, BOOTS, COVERALLS, TANK-TOPS, WALKING SHOES, RUNNING SHOES, SANDALS, FLUORESCENT VESTS, FLUORESCENT JACKETS, FLUORESCENT HATS AND BALL CAPS, FLUORESCENT PANTS, FLUORESCENT SHOES, FLUORESCENT SHIRTS, BALL CAPS, HATS, PULL-DOWN HATS, COATS, SWEATERS, HOODED SWEATSHIRTS, WARM-UP PANTS AND SHORTS, WARM-UP JACKETS, TRACKSUITS, WETSUITS, FOOTBALL CLEATS, FOOTBALL PANTS, FOOTBALL JERSEYS, BASEBALL PANTS, BASEBALL JERSEYS, BASEBALL CLEATS, HOCKEY JERSEYS, HOCKEY SHORTS, HOCKEY SHOES, HOCKEY SOCKS, SOCCER SHORTS, SOCCER JERSEYS, SOCCER CLEATS, BASKETBALL SHORTS, BASKETBALL JERSEYS, BASKETBALL SHOES, BOXING SHORTS, BOXING ROBES, SPORTS JERSEYS, SPORTS SOCKS, GOLF SHIRTS, GOLF SHOES, GOLF TROUSERS, HEADBANDS, SPORTS SHIRTS, RAIN WEAR, WIND RESISTANT JACKETS, WRISTBANDS, SWIMWEAR, SPORTS SKIRTS, CYCLING PANTS, CYCLING SHORTS, BIB-SHORTS AND BIB TIGHTS; CYCLING GILETS, CYCLING JACKETS, CYCLING COMPRESSION SLEEVES, SOCKS, CYCLING HATS AND CAPS, CYCLING SHOES AND SANDALS, GENERAL CYCLING SOCKS; CYCLING LEG, KNEE AND ARM WARMERS; CYCLING TIGHTS AND KNICKERS, TENNIS SKORTS BEING SKIRTS, TENNIS CAPRI PANTS, TENNIS SHORTS, TENNIS TANK-TOPS, TENNIS DRESSES, TENNIS SHIRTS, TENNIS SHOES, TRACK PANTS, TRACK SHOES, TRACK SHORTS, TRACK TIGHTS, COMPRESSION SHORTS, COMPRESSION TIGHTS, COMPRESSION SHIRTS, COMPRESSION SOCKS, COMPRESSION ARM SLEEVE, COMPRESSION LEG SLEEVE, ACTIVE-WEAR APPAREL FOR MEN, WOMEN AND CHILDREN, NAMELY, T-SHIRTS, MUSCLE SHIRTS, TANK-TOPS, POLO SHIRTS, UNDERGARMENTS, WARM-UP PANTS AND SHORTS, WARM-UP JACKETS, SWEATSHIRTS, HOODED SWEATSHIRTS, TRACKSUITS, WETSUITS, FOOTBALL CLEATS, FOOTBALL PANTS, FOOTBALL JERSEYS, BASEBALL PANTS, BASEBALL JERSEYS, BASEBALL CLEATS, HOCKEY JERSEYS, HOCKEY SHORTS, HOCKEY SHOES, HOCKEY SOCKS, SOCCER SHORTS, SOCCER JERSEYS, SOCCER CLEATS, BASKETBALL SHORTS, BASKETBALL JERSEYS, BASKETBALL SHOES, BOXING SHORTS, BOXING ROBES, SPORTS JERSEYS, SPORTS SOCKS, COMPRESSION GARMENTS FOR ATHLETIC OR OTHER NON-MEDICAL USE, NAMELY, COMPRESSION SHORTS, COMPRESSION TIGHTS, COMPRESSION SHIRTS, COMPRESSION SOCKS, COMPRESSION ARM SLEEVE AND COMPRESSION LEG SLEEVE, HEADBANDS, WRISTBANDS, CYCLING PANTS, CYCLING SHORTS, BIB-SHORTS AND BIB TIGHTS; CYCLING GILETS,

**CLASS 25—(Continued).**

CYCLING JACKETS, CYCLING COMPRESSION SLEEVES, SOCKS, CYCLING HATS AND CAPS, CYCLING SHOES AND SANDALS, GENERAL CYCLING SOCKS; CYCLING LEG, KNEE AND ARM WARMERS; CYCLING TIGHTS AND KNICKERS, SWIMWEAR, SPORTS SKIRTS, WALKING SHOES, RUNNING SHOES, GOLF SHOES, GOLF TROUSERS, TENNIS SKORTS BEING SKIRTS, TENNIS CAPRI PANTS, TENNIS SHORTS, TENNIS TANK-TOPS, TENNIS DRESSES, TENNIS SHIRTS, TENNIS SHOES, TRACK PANTS, TRACK SHOES, TRACK SHORTS, TRACK TIGHTS, BABY APPAREL FOR INFANT BOYS AND GIRLS, NAMELY, SHIRTS, PANTS, BIBS, SOCKS, SHOES, SNEAKERS, PULL-DOWN HATS, HATS AND BALL CAPS, WIND RESISTANT JACKETS, COATS AND JACKETS, OUTDOOR APPAREL FOR MEN, WOMEN AND CHILDREN INCLUDES, NAMELY, OVERCOATS, COATS, WIND RESISTANT JACKETS, JACKETS, FISHING VESTS, FISHING TROUSERS, FISHING HATS, THERMAL UNDERWEAR, LONG JOHN'S TOPS AND BOTTOMS, COLD-WEATHER SOCKS, COLD-WEATHER GLOVES, PULL-DOWN HATS, EAR-MUFFS, RAIN-WEAR, SNOW-BOOTS, HUNTING APPAREL FOR MEN, WOMEN AND CHILDREN, NAMELY, CAMOUFLAGE T-SHIRTS, CAMOUFLAGE PANTS, CAMOUFLAGE JACKETS, CAMOUFLAGE VESTS, HUNTING BOOTS, SOCKS, CAMOUFLAGE HATS AND CAPS, SOCIAL MEDIA APPAREL FOR MEN, WOMEN AND CHILDREN, NAMELY, LEAFBUILDER HUMANITARIAN NERD SOCIETY T-SHIRTS, SWEATERS, HOODED SWEATSHIRTS, JACKETS, PANTS, BALL CAPS; FAITH-BASED APPAREL FOR MEN, WOMEN AND CHILDREN, NAMELY, DIVINE YE T-SHIRTS, T-SHIRTS, SWEATERS, HOODED SWEATSHIRTS, JACKETS, PANTS, BALL CAPS (U.S. CLS. 22 AND 39).

FIRST USE 9-2-2009; IN COMMERCE 9-2-2009.

BRIAN CALLAGHAN, EXAMINING ATTORNEY

SN 86-016,185. VELEZ RICAFORT, EDWARD, FAIRFIELD, CA. FILED 7-22-2013.

---

## Clean Slate Gear

THE MARK CONSISTS OF STANDARD CHARACTERS WITHOUT CLAIM TO ANY PARTICULAR FONT, STYLE, SIZE, OR COLOR.

NO CLAIM IS MADE TO THE EXCLUSIVE RIGHT TO USE "GEAR", APART FROM THE MARK AS SHOWN.

FOR BEANIES; HATS; SWEATERS; T-SHIRTS; TANK TOPS (U.S. CLS. 22 AND 39).

MATTHEW MCDOWELL, EXAMINING ATTORNEY

**CLASS 25—(Continued).**

SN 86-018,157. KID BULLY, HEMPSTEAD, NY. FILED 7-23-2013.



THE MARK CONSISTS OF A DESIGN OF A CARTOON CHARACTER WITH AN ELEPHANT MAN SHAPED FIGURE INSIDE HIS OVERLY SHAPED HEAD. THE CARTOON CHARACTER IS WEARING A SHIRT WITH A DESIGN IN THE MIDDLE. THIS DESIGN APPEARS BELOW THAT DESIGN AND NEXT TO THE WORDS "KIDBULLY". THE LETTER "K" IS BACKWARDS. THE WORD "BULLY" IS IN BOLD.

FOR ATHLETIC APPAREL, NAMELY, SHIRTS, PANTS, JACKETS, FOOTWEAR, HATS AND CAPS, ATHLETIC UNIFORMS (U.S. CLS. 22 AND 39).

SETH A. RAPPAPORT, EXAMINING ATTORNEY

SN 86-018,762. BIANCA LEE, DBA ELLE CLOTHING, LOS ANGELES, CA. FILED 7-24-2013.

# LUCID-PINK

THE MARK CONSISTS OF STANDARD CHARACTERS WITHOUT CLAIM TO ANY PARTICULAR FONT, STYLE, SIZE, OR COLOR.

FOR CLOTHING, NAMELY, DRESSES, TOPS, PANTS, SLACKS, JEANS, JACKETS, BLOUSES, SKIRTS, AND SHORTS (U.S. CLS. 22 AND 39).

FIRST USE 4-15-2013; IN COMMERCE 4-15-2013.

LINDA MICKLEBURGH, EXAMINING ATTORNEY

**CLASS 25—(Continued).**

SN 86-019,505. GOCKEL-BRENNER, ANJA KATHARINA, MAINZ, FED REP GERMANY, FILED 7-25-2013.

womanice  
by anja gockel

PRIORITY CLAIMED UNDER SEC. 44(D) ON ERP CMNTY TM OFC APPLICATION NO. 011570033, FILED 1-31-2013.

OWNER OF U.S. REG. NO. 3,799,631.

THE NAME "ANJA GOCKEL" IDENTIFIES A LIVING INDIVIDUAL WHOSE CONSENT IS OF RECORD.

THE MARK CONSISTS OF THE LITERAL ELEMENT "WOMANICE" AND THE LITERAL ELEMENT "BY ANJA" SEPARATED FROM THE LITERAL ELEMENT "GOCKEL" BY A DESIGN ELEMENT CONSISTING OF AN OPEN CIRCLE HAVING A PERIOD (I.E. DOT) AT THE CENTER AND A SERIES OF THREE LEFT-FACING JAGGED EDGES.

FOR CLOTHING, NAMELY, SHIRTS, PANTS, COATS, DRESSES, SKIRTS, BLOUSES, BLAZERS, JUMPERS, SWEATERS, PULLOVERS AND TOPS; FOOTWEAR, HEADGEAR, NAMELY, HATS AND CAPS (U.S. CLS. 22 AND 39).

KIMBERLY PERRY, EXAMINING ATTORNEY

SN 86-019,553. JAMM INDUSTRIES CORP., DBA BORDEAUX, LOS ANGELES, CA. FILED 7-25-2013.

# MOVVU

THE MARK CONSISTS OF STANDARD CHARACTERS WITHOUT CLAIM TO ANY PARTICULAR FONT, STYLE, SIZE, OR COLOR.

THE WORDING "MOVVU" HAS NO MEANING IN A FOREIGN LANGUAGE.

FOR FABRIC SOLD AS AN INTEGRAL COMPONENT OF FINISHED CLOTHING ITEMS, NAMELY, LEGGINGS, PANTS, SHORTS, SKIRTS, JACKETS, PULLOVERS, TANK TOPS, BRA TOPS, AND LONG SLEEVE TOPS (U.S. CLS. 22 AND 39).

MAYUR VAGHANI, EXAMINING ATTORNEY

**CLASS 25—(Continued).**

SN 86-019,922. TELESCOPE MANAGEMENT GROUP, LLC, RALEIGH, NC. FILED 7-25-2013.

# MOSSIQUE

THE MARK CONSISTS OF STANDARD CHARACTERS WITHOUT CLAIM TO ANY PARTICULAR FONT, STYLE, SIZE, OR COLOR.

THE WORDING "MOSSIQUE" HAS NO MEANING IN A FOREIGN LANGUAGE.

FOR CLOTHING, NAMELY, DENIM SHIRTS, DENIM PANTS, DENIM JACKETS, DENIM JEANS, DRESSES, JACKETS, COATS, ROMPERS, PANTS, SHORTS, SKIRTS, SWEATERS, KNIT DRESSES, KNIT JACKETS, KNIT SKIRTS, KNIT TOPS, SWIMWEAR, VESTS, YOGA PANTS AND SHIRTS, LINGERIE, AND LEGGINGS; BELTS FOR CLOTHING; GLOVES; HATS; SCARVES (U.S. CLS. 22 AND 39).

JACLYN KIDWELL WALKER, EXAMINING ATTORNEY

SN 86-020,609. KING'S ROAD APPAREL, INC., LOS ANGELES, CA. FILED 7-26-2013.



NO CLAIM IS MADE TO THE EXCLUSIVE RIGHT TO USE "AMERICAN MADE", APART FROM THE MARK AS SHOWN.

THE COLOR(S) GRAY, RED, WHITE, AND BLUE IS/ARE CLAIMED AS A FEATURE OF THE MARK.

THE MARK CONSISTS OF THE CENTER PORTION OF A FLAG SIMILAR TO THE FLAG OF GREAT BRITAIN OVERLAID WITH THE SHADOW OF A DESIGN OF A PORTION OF THE FLAG OF THE UNITED STATES COMPRISING SEVERAL STARS AND STRIPES. SUPERIMPOSED ON THE DESIGNS IS THE WORDING "LONDON BORN. AMERICAN MADE." THE COLOR BLUE APPEARS IN THE TRIANGULAR SHAPES IN THE CORNERS OF THE MARK. THE COLOR RED APPEARS IN THE TRIANGLES TOWARD THE CENTER TOP OF THE MARK, IN THE CROSS DESIGN, AND IN THE DIAGONAL QUADRILATERAL DESIGNS AT THE BOTTOM OF THE DRAWING. THE COLOR WHITE APPEARS IN THE WORDING IN THE MARK AND IN THE REMAINDER OF THE BRITISH FLAG DESIGN. HOWEVER, THE STRIPES AND THE BACKGROUND OF THE STARS FROM THE AMERICAN FLAG DESIGN THAT ARE OVERLAID ON PORTIONS OF THE BRITISH FLAG DESIGN ARE GRAY, AND THEY CAUSE THE GRAY TO BE MIXED WITH THE UNDERLYING PORTION OF THE BRITISH FLAG DESIGN.

FOR HATS; JACKETS; PANTS; SHIRTS; SHORTS; SWEATERS; SWEATSHIRTS; UNDERWEAR; VESTS; WOMEN'S CLOTHING, NAMELY, SHIRTS, DRESSES, SKIRTS, BLOUSES (U.S. CLS. 22 AND 39).

FIRST USE 6-0-2013; IN COMMERCE 6-0-2013.

MAUREEN DALL, EXAMINING ATTORNEY

**CLASS 25—(Continued).**

SN 86-021,312. MERMAID BAY, INC., HOUSTON, TX. FILED 7-26-2013.

# Mermaid Bay, Inc.

THE MARK CONSISTS OF STANDARD CHARACTERS WITHOUT CLAIM TO ANY PARTICULAR FONT, STYLE, SIZE, OR COLOR.

NO CLAIM IS MADE TO THE EXCLUSIVE RIGHT TO USE "INC.", APART FROM THE MARK AS SHOWN.

FOR WOMEN'S CLOTHING, NAMELY, SHIRTS, DRESSES, SKIRTS, BLOUSES (U.S. CLS. 22 AND 39).

JOSETTE BEVERLY, EXAMINING ATTORNEY

SN 86-022,779. ONE DISTRIBUTION SARL, LUXEMBOURG, LUXEMBOURG, FILED 7-29-2013.

# SUPRA

THE MARK CONSISTS OF STANDARD CHARACTERS WITHOUT CLAIM TO ANY PARTICULAR FONT, STYLE, SIZE, OR COLOR.

OWNER OF U.S. REG. NOS. 3,559,015, 3,944,032 AND OTHERS.

FOR CLOTHING, NAMELY, JEANS, SHORTS, PANTS, TRUNKS, SWIMWEAR, SHIRTS, TANK TOPS, T-SHIRTS, JACKETS, VESTS, OVERALLS, SWEATSHIRTS, HOODED SWEATSHIRTS, FLEECE PULLOVERS; BELTS; HEADWEAR, HATS, CAPS, BEANIES, SOCKS, AND SCARVES (U.S. CLS. 22 AND 39).

KEVIN MITTLER, EXAMINING ATTORNEY

**CLASS 25—(Continued).**

SN 86-023,282. STREET LIFE LLC., WEST PALM BEACH, FL. FILED 7-30-2013.



THE MARK CONSISTS OF THE MARK CONSIST OF A CHECK MARK NEXT TO THE WORD "DAT".

FOR A-SHIRTS; ANTI-SWEAT UNDERCLOTHING; ANTI-SWEAT UNDERWEAR; APPAREL FOR DANCERS, NAMELY, TEE SHIRTS, SWEATSHIRTS, PANTS, LEGGINGS, SHORTS AND JACKETS; ATHLETIC APPAREL, NAMELY, SHIRTS, PANTS, JACKETS, FOOTWEAR, HATS AND CAPS, ATHLETIC UNIFORMS; ATHLETIC SHIRTS; BASEBALL CAPS AND HATS; BODY SHIRTS; BUTTON DOWN SHIRTS; BUTTON-FRONT ALOHA SHIRTS; CAMOUFLAGE SHIRTS; CAMP SHIRTS; CHILDREN'S AND INFANT'S APPAREL, NAMELY, JUMPERS, OVERALL SLEEPWEAR, PAJAMAS, ROMPERS AND ONE-PIECE GARMENTS; CLOTHING FOR ATHLETIC USE, NAMELY, PADDED SHIRTS; CLOTHING FOR BABIES, TODDLERS AND CHILDREN, TREATED WITH FIRE AND HEAT RETARDANTS, NAMELY, PAJAMAS, JACKETS, SHIRTS, PANTS, JUMPERS; CLOTHING SHIELDS, NAMELY, PADS APPLIED TO THE UNDERARMS OF SHIRTS, BLOUSES AND SWEATERS; COLLARED SHIRTS; DRESS SHIRTS; FISHING SHIRTS; GIFT PACKAGES SOLD AS A UNIT CONSISTING PRIMARILY OF A SWEATSHIRT AND ALSO INCLUDING A PHOTO FRAME, A COFFEE MUG, AND A TOTE BAG; GOLF PANTS, SHIRTS AND SKIRTS; GOLF SHIRTS; HAT BANDS; HATS; HATS FOR INFANTS, BABIES, TODDLERS AND CHILDREN; HOODED SWEAT SHIRTS; HOODED SWEATSHIRTS; HUNTING SHIRTS; JEANS; JEGGINGS, NAMELY, PANTS THAT ARE PARTIALLY JEANS AND PARTIALLY LEGGINGS; KNIT SHIRTS; LEATHER SHIRTS; LONG-SLEEVED SHIRTS; MATERNITY CLOTHING, NAMELY, WOMAN'S, CHILDREN'S SHIRTS, PANTS, SHORTS, SOCKS, SHOES, HATS; MOISTURE-WICKING SPORTS SHIRTS; NIGHT SHIRTS; OPEN-NECKED SHIRTS; OVER SHIRTS; PIQUE SHIRTS; POLO SHIRTS; RAMIE SHIRTS; RUGBY SHIRTS; SHIRT FRONTS; SHIRT INSERTS, NAMELY, DICKIES; SHIRT YOKES; SHIRTS; SHIRTS AND SHORT-SLEEVED SHIRTS; SHIRTS AND SLIPS; SHIRTS FOR INFANTS, BABIES, TODDLERS AND CHILDREN; SHIRTS FOR SUITS; SHORT-SLEEVED OR LONG-SLEEVED T-SHIRTS; SHORT-SLEEVED SHIRTS; SLEEP SHIRTS; SLEEVES WORN SEPARATE AND APART FROM BLOUSES, SHIRTS AND OTHER TOPS; SNAP CROTCH SHIRTS FOR INFANTS AND TODDLERS; SPORT SHIRTS; SPORTS SHIRTS; SPORTS SHIRTS WITH SHORT SLEEVES; SUN PROTECTIVE CLOTHING, NAMELY, SHIRTS, HATS, PANTS, SOCKS; SWEAT SHIRTS; SWEATSHIRTS; TEE SHIRTS; TRIATHLON CLOTHING, NAMELY, TRIATHLON TIGHTS, TRIATHLON SHORTS, TRIATHLON SINGLET, TRIATHLON SHIRTS, TRIATHLON SUITS; TURTLE NECK SHIRTS; WEARABLE GARMENTS AND CLOTHING, NAMELY, SHIRTS; WIND SHIRTS; WOMEN'S CLOTHING, NAMELY, SHIRTS, DRESSES, SKIRTS, BLOUSES; YOGA SHIRTS (U.S. CLS. 22 AND 39).

THOMAS MANOR, EXAMINING ATTORNEY

**CLASS 25—(Continued).**

SN 86-024,316. DEAN BIRMINGHAM, MIAMI, FL. FILED 7-31-2013.

**PARTY PATROL**

THE MARK CONSISTS OF STANDARD CHARACTERS WITHOUT CLAIM TO ANY PARTICULAR FONT, STYLE, SIZE, OR COLOR.

FOR HATS; JACKETS; SHIRTS (U.S. CLS. 22 AND 39). FIRST USE 2-18-2011; IN COMMERCE 2-18-2011. VIVIAN MICZNIK FIRST, EXAMINING ATTORNEY

SN 86-025,466. JORDAN TAYLOR INC., NEW YORK, NY. FILED 7-31-2013.

**JORDAN TAYLOR**

THE MARK CONSISTS OF STANDARD CHARACTERS WITHOUT CLAIM TO ANY PARTICULAR FONT, STYLE, SIZE, OR COLOR.

THE NAME(S), PORTRAIT(S), AND/OR SIGNATURE(S) SHOWN IN THE MARK IDENTIFIES A LIVING INDIVIDUAL WHOSE CONSENT(S) TO REGISTER IS MADE OF RECORD.

FOR BEACH COVER-UPS; BLOUSES; DRESSES; KNIT TOPS; PANTS; SHIRTS; SWIM WEAR; SWIMSUITS; TANK TOPS; TOPS; TUNICS (U.S. CLS. 22 AND 39).

FIRST USE 12-1-1992; IN COMMERCE 12-1-1992.

AMY KERTGATE, EXAMINING ATTORNEY

SN 86-025,632. NARVAEZ, KEIKO, SAN CLEMENTE, CA. FILED 8-1-2013.

**DAKKO BABY**

THE MARK CONSISTS OF STANDARD CHARACTERS WITHOUT CLAIM TO ANY PARTICULAR FONT, STYLE, SIZE, OR COLOR.

NO CLAIM IS MADE TO THE EXCLUSIVE RIGHT TO USE "BABY", APART FROM THE MARK AS SHOWN.

THE ENGLISH TRANSLATION OF "DAKKO" IN THE MARK IS "TO CARRY A CHILD IN ARMS".

FOR BABY BIBS NOT OF PAPER; HATS; PANTS; SKIRTS; T-SHIRTS (U.S. CLS. 22 AND 39).

FIRST USE 4-21-2008; IN COMMERCE 4-21-2009.

REGINA DRUMMOND, EXAMINING ATTORNEY



**CLASS 25—(Continued).**

SN 86-025,797. TIGHE, AUSTIN, AUSTIN, TX. FILED 8-1-2013.

**It's Not Texas. It's Austin.**

THE MARK CONSISTS OF STANDARD CHARACTERS WITHOUT CLAIM TO ANY PARTICULAR FONT, STYLE, SIZE, OR COLOR.  
FOR CLOTHING, NAMELY, HATS AND T-SHIRTS (U.S. CLS. 22 AND 39).  
PAULA MAHONEY, EXAMINING ATTORNEY

**CLASS 25—(Continued).**

SN 86-026,139. NITEMOVESLLC, DETROIT, MI. FILED 8-1-2013.

SN 86-025,825. TIGHE, AUSTIN, AUSTIN, TX. FILED 8-1-2013.

**I'm not from Texas. I'm from Austin**

THE MARK CONSISTS OF STANDARD CHARACTERS WITHOUT CLAIM TO ANY PARTICULAR FONT, STYLE, SIZE, OR COLOR.  
FOR CLOTHING, NAMELY, HATS AND T-SHIRTS (U.S. CLS. 22 AND 39).  
PAULA MAHONEY, EXAMINING ATTORNEY



SN 86-026,115. TURBO HOLDINGS INC, SAYREVILLE, NJ. FILED 8-1-2013.



THE MARK CONSISTS OF THE LETTER "V" FORMED BY TWO TRIANGLES, TWO QUADRILATERALS, AND A DIAMOND AT THE BASE.  
FOR TOPS (U.S. CLS. 22 AND 39).  
SAMUAL PAQUIN, EXAMINING ATTORNEY

NO CLAIM IS MADE TO THE EXCLUSIVE RIGHT TO USE "BABY", APART FROM THE MARK AS SHOWN.  
THE MARK CONSISTS OF THE STYLIZED WORDING "BA-BI DUMPLING." BELOW THE WORDING IS A DESIGN OF A DUCK PLAYING WITH A SAILBOAT ON A PUDDLE FOR ATHLETIC APPAREL, NAMELY, SHIRTS, PANTS, JACKETS, FOOTWEAR, HATS AND CAPS, ATHLETIC UNIFORMS (U.S. CLS. 22 AND 39).  
FIRST USE 11-14-2005; IN COMMERCE 11-14-2005.  
KERI CANTONE, EXAMINING ATTORNEY

**CLASS 25—(Continued).**

SN 86-027,970. FIGHT JUNKIE LLC, LAS VEGAS, NV. FILED 8-3-2013.

## Fight Junkie

THE MARK CONSISTS OF STANDARD CHARACTERS WITHOUT CLAIM TO ANY PARTICULAR FONT, STYLE, SIZE, OR COLOR.

NO CLAIM IS MADE TO THE EXCLUSIVE RIGHT TO USE "FIGHT", APART FROM THE MARK AS SHOWN.

FOR ATHLETIC APPAREL, NAMELY, SHIRTS, PANTS, JACKETS, FOOTWEAR, HATS AND CAPS, ATHLETIC UNIFORMS; BANDANAS; BELTS; BOARD SHORTS; BODY SHIRTS; BOXING SHOES; BOXING SHORTS; BUTTON DOWN SHIRTS; CAPS; CHILDREN'S AND INFANT'S APPAREL, NAMELY, JUMPERS, OVER-ALL SLEEPWEAR, PAJAMAS, ROMPERS AND ONE-PIECE GARMENTS; CHILDREN'S HEADWEAR; CLOTHING FOR WEAR IN JUDO PRACTICES; CLOTHING FOR WEAR IN WRESTLING GAMES; COATS; CREW NECKS; DO RAGS; FIGHT SHORTS FOR MIXED MARTIAL ARTS OR GRAPPLING; FINGERLESS GLOVES; FOOTWEAR; GYM PANTS; GYM SHORTS; GYM SUITS; HATS; HATS FOR INFANTS, BABIES, TODDLERS AND CHILDREN; HEAD SWEATBANDS; HEAD WEAR; HEADBANDS; HOODED PULLOVERS; HOODED SWEAT SHIRTS; HOODED SWEATSHIRTS; JACKETS; JACKETS AND SOCKS; JERSEYS; JOGGING OUTFITS; JOGGING PANTS; JOGGING SUITS; JUDO SUITS; KIMONOS; MARTIAL ARTS UNIFORMS; MARTIAL ARTS UNIFORMS, NAMELY, GIS; MEN'S SOCKS; MIXED MARTIAL ARTS SUITS; MOISTURE-WICKING SPORTS BRAS; MOISTURE-WICKING SPORTS PANTS; MOISTURE-WICKING SPORTS SHIRTS; MUSCLE TOPS; PANTS; PULLOVERS; RASH GUARDS; ROBES; RUNNING SUITS; SHIRTS AND SHORT-SLEEVED SHIRTS; SHIRTS FOR INFANTS, BABIES, TODDLERS AND CHILDREN; SHORT SETS; SHORT-SLEEVED OR LONG-SLEEVED T-SHIRTS; SHORT-SLEEVED SHIRTS; SKULL CAPS; SLEEVED OR SLEEVELESS JACKETS; SLEEVELESS JERSEYS; SOCKS; T-SHIRTS; TANK TOPS; TANK-TOPS; TEE SHIRTS; TRACK JACKETS; TRACK PANTS; TRACK SUITS; TRACKSUITS; WARM UP SUITS; WARM-UP SUITS; WOMEN'S CLOTHING, NAMELY, SHIRTS, DRESSES, SKIRTS, BLOUSES (U.S. CLS. 22 AND 39).

FIRST USE 4-8-2006; IN COMMERCE 4-8-2006.  
NAKIA HENRY, EXAMINING ATTORNEY

SN 86-028,162. PAK, JEAN, LOS ANGELES, CA. FILED 8-4-2013.

## Nora Noh

THE MARK CONSISTS OF STANDARD CHARACTERS WITHOUT CLAIM TO ANY PARTICULAR FONT, STYLE, SIZE, OR COLOR.

THE NAME "NORA NOH" DOES NOT IDENTIFY A PARTICULAR LIVING INDIVIDUAL.

FOR BATHING SUITS; BLOUSES; CAMISOLES; DRESSES; JUMP SUITS; SCARVES; SHIRTS; SKIRTS; SLACKS; T-SHIRTS (U.S. CLS. 22 AND 39).

IRA J. GOODSaid, EXAMINING ATTORNEY

**CLASS 25—(Continued).**

SN 86-028,163. MH TRADING INC., WALNUT, CA. FILED 8-4-2013.

## Next Jeans

THE MARK CONSISTS OF STANDARD CHARACTERS WITHOUT CLAIM TO ANY PARTICULAR FONT, STYLE, SIZE, OR COLOR.

NO CLAIM IS MADE TO THE EXCLUSIVE RIGHT TO USE "JEANS", APART FROM THE MARK AS SHOWN.

FOR CLOTHING, NAMELY, T-SHIRTS, PULLOVERS, SWEATERS, JACKETS, COATS, JEANS, PANTS, UNDERWEAR, SHORTS, SKIRTS, DRESSES (U.S. CLS. 22 AND 39).

SUSAN RICHARDS, EXAMINING ATTORNEY

SN 86-029,232. BEYLER & TÜRK, LLC, DBA BEYLER & TÜRK, NEW YORK, NY. FILED 8-5-2013.

## BEYLER & TÜRK

THE MARK CONSISTS OF STANDARD CHARACTERS WITHOUT CLAIM TO ANY PARTICULAR FONT, STYLE, SIZE, OR COLOR.

FOR BUTTON DOWN SHIRTS; CUSTOM MADE TO MEASURE SUITS FOR MEN AND WOMEN; DRESS PANTS; DRESS SHIRTS; JEANS; MEN'S SUITS; PANTS; POCKET SQUARES; SHIRTS FOR SUITS; TIES; WOMEN'S CLOTHING, NAMELY, SHIRTS, DRESSES, SKIRTS, BLOUSES (U.S. CLS. 22 AND 39).

FIRST USE 7-25-2011; IN COMMERCE 7-25-2011.  
KIMBERLY CLARKE, EXAMINING ATTORNEY

SN 86-029,392. DEMETRA CORNWELL, CORONA, CA. FILED 8-5-2013.

## TWIG & SPARROW

THE MARK CONSISTS OF STANDARD CHARACTERS WITHOUT CLAIM TO ANY PARTICULAR FONT, STYLE, SIZE, OR COLOR.

FOR HEADPIECES, NAMELY, HEADWEAR; HEADBANDS AND VEILS (U.S. CLS. 22 AND 39).

FIRST USE 4-1-2011; IN COMMERCE 4-1-2011.  
EDWARD NELSON, EXAMINING ATTORNEY

**CLASS 25—(Continued).**

SN 86-029,411. RILESTON PTY LTD, SOUTH BRISBANE, AUSTRALIA, FILED 8-6-2013.



NO CLAIM IS MADE TO THE EXCLUSIVE RIGHT TO USE "DESIGNED BY" AND "AUSTRALIA", APART FROM THE MARK AS SHOWN.

THE MARK CONSISTS OF A PICTURE OF A DISPOSABLE CUP WITH THE WORDS "DESIGNED BY CAFE LATTE AUSTRALIA" APPEARING WITHIN THE CUP.

FOR BANDANAS; BEANIES; BLOUSES; BOTTOMS; CAPS; COATS; DRESS SHIRTS; DRESSES; FOOTWEAR; GLOVES; HATS; HEAD SCARVES; HEADBANDS; HOSIERY; JACKETS; JEANS; JUMPERS; KNIT SHIRTS; LINGERIE; NIGHT GOWNS; NIGHT SHIRTS; PANTS; PANTYHOSE; PETTICOATS; POLO SHIRTS; SCARVES; SHAWLS; SHIRTS; SHORT-SLEEVED SHIRTS; SHORTS; SHOULDER WRAPS; SINGLET; SKIRT SUITS; SKIRTS; SOCKS; STOLE; SUITS; SWEAT SHIRTS; SWEATERS; T-SHIRTS; TOPS; UNDERWEAR; VISORS (U.S. CLS. 22 AND 39).

CHRISTOPHER REAMS, EXAMINING ATTORNEY

**CLASS 25—(Continued).**

SN 86-029,692. TEXTILEMA, S. DE R.L. DE C.V., GUADALAJARA, JALISCO, MEXICO, FILED 8-6-2013.

TU DISEÑAS TU VIDA NOSOTROS  
LA MODA MODACLUB

THE MARK CONSISTS OF STANDARD CHARACTERS WITHOUT CLAIM TO ANY PARTICULAR FONT, STYLE, SIZE, OR COLOR.

NO CLAIM IS MADE TO THE EXCLUSIVE RIGHT TO USE "MODA CLUB", APART FROM THE MARK AS SHOWN.

THE ENGLISH TRANSLATION OF "TU DISEÑAS TU VIDA NOSOTROS LA MODA MODACLUB" IN THE MARK IS "YOU DESIGN YOUR LIFE WE DESIGN THE FASHION FASHIONCLUB".

FOR BELTS; BODY SHIRTS; BOTTOMS; CLOTHING FOR ATHLETIC USE, NAMELY, PADDED PANTS; CLOTHING FOR ATHLETIC USE, NAMELY, PADDED SHIRTS; CLOTHING FOR ATHLETIC USE, NAMELY, PADDED SHORTS; CLOTHING, NAMELY, HAND-WARMERS; CLOTHING, NAMELY, KHAKIS; CLOTHING, NAMELY, NECK TUBES; COATS; COMBINATIONS; FOULARDS; GLOVES AS CLOTHING; HOODS; JACKETS; JEANS; JERSEYS; KNIT SHIRTS; LEATHER BELTS; LEGGINS; LINGERIE; MATERNITY CLOTHING, NAMELY, SHIRTS, DRESSES, SKIRTS, BLOUSES; MEN'S UNDERWEAR; OVERALLS; PANTYHOSE; POLO SHIRTS; SHIRTS; SHIRTS FOR SUITS; SHORT SETS; SLEEP SHIRTS; SOCKS; SWEATERS; SWIMWEAR; T-SHIRTS; TOPS; TURTLE NECK SHIRTS; UNDERWEAR; VESTS; WOMEN'S CLOTHING, NAMELY, SHIRTS, DRESSES, SKIRTS, BLOUSES; WOMEN'S UNDERWEAR (U.S. CLS. 22 AND 39).

SETH A. RAPPAPORT, EXAMINING ATTORNEY

SN 86-030,099. BRYAN A. PATE, LAKELAND, FL. FILED 8-6-2013.

**EPIC**  
MUSCLE

NO CLAIM IS MADE TO THE EXCLUSIVE RIGHT TO USE "MUSCLE" FOR HOODED SWEATSHIRTS, SWEATSHIRTS, T-SHIRTS AND TANK TOPS IN INTERNATIONAL CLASS 25, APART FROM THE MARK AS SHOWN.

THE MARK CONSISTS OF THE WORD "EPIC" WITH SPACES IN THE LETTERS OVER THE WORD "MUSCLE".

FOR HATS; HOODED SWEATSHIRTS; PANTS; SHORTS; SWEATSHIRTS; T-SHIRTS; TANK TOPS (U.S. CLS. 22 AND 39).

ELIZABETH JACKSON, EXAMINING ATTORNEY

**CLASS 25—(Continued).**

SN 86-030,800. RILESTON PTY LTD, SOUTH BRISBANE, AUSTRALIA, FILED 8-7-2013.

**Designed by Café Latté Australia**

NO CLAIM IS MADE TO THE EXCLUSIVE RIGHT TO USE "DESIGNED BY" AND "AUSTRALIA", APART FROM THE MARK AS SHOWN.

THE MARK CONSISTS OF THE WORDS "DESIGNED BY CAFE LATTE AUSTRALIA".

FOR BANDANAS; BEANIES; BLOUSES; BOTTOMS; CAPS; COATS; DRESS SHIRTS; DRESSES; FOOTWEAR; GLOVES; HATS; HEAD SCARVES; HEAD WEAR; HEADBANDS; HOSIERY; JACKETS; JEANS; JUMPERS; KNIT SHIRTS; LINGERIE; NIGHT GOWNS; NIGHT SHIRTS; PANTS; PANTYHOSE; PETTICOATS; POLO SHIRTS; SHIRTS; SHORT-SLEEVED SHIRTS; SHORTS; SHOULDER WRAPS; SINGLETS; SKIRT SUITS; SKIRTS; SOCKS; STOLEES; SUITS; SWEAT SHIRTS; SWEATERS; T-SHIRTS; TOPS; UNDERWEAR; VISORS (U.S. CLS. 22 AND 39).

CHRISTOPHER REAMS, EXAMINING ATTORNEY

**CLASS 25—(Continued).**

SN 86-031,843. DUKATZ, CHRISTINE, POINT ARENA, CA. FILED 8-7-2013.



THE MARK CONSISTS OF THE STYLIZED TEXT "IF THE TIARA FITS..." NEXT TO A STYLIZED DESIGN OF A TIARA AND FLOWERS.

FOR T-SHIRTS, SWEATSHIRTS, JACKETS, HOODED SWEATSHIRTS, PAJAMAS, SOCKS, TIGHTS, BIKINIS AND WRAPS, JEANS, SWEAT PANTS, SPORTS HEADBANDS AND WRISTBANDS, BANDANAS, CAPRIS, SKIRTS, SHORTS, TANK TOPS, SWEATERS, BLAZERS, BELTS, AND GLOVES (U.S. CLS. 22 AND 39).

AMY KELLY, EXAMINING ATTORNEY

SN 86-031,253. STRADA SHOE LTDA., CAMPO BOM - RS 9370000, BRAZIL, FILED 8-7-2013.

**URBAN BALLERINAS**

THE MARK CONSISTS OF STANDARD CHARACTERS WITHOUT CLAIM TO ANY PARTICULAR FONT, STYLE, SIZE, OR COLOR.

NO CLAIM IS MADE TO THE EXCLUSIVE RIGHT TO USE "BALLERINAS", APART FROM THE MARK AS SHOWN.

FOR SHOES, SLIPPERS, FOOTWEAR (U.S. CLS. 22 AND 39).

CHRISIE B. KING, EXAMINING ATTORNEY

SN 86-032,164. HOO YAH GEAR, LLC, KINSALE, VA. FILED 8-8-2013.



NO CLAIM IS MADE TO THE EXCLUSIVE RIGHT TO USE "GEAR", APART FROM THE MARK AS SHOWN.

THE MARK CONSISTS OF A STYLIZED "H" AND "G" WITH THE "G" WRAPPING AROUND THE "H" APPEARING IN FRONT OF THE WORDS "HOO YAH GEAR".

FOR FOOTWEAR; HATS; JACKETS; PANTS; SHIRTS; SHORTS; SWEAT SHIRTS; T-SHIRTS (U.S. CLS. 22 AND 39).

PATRICIA EVANKO, EXAMINING ATTORNEY

SN 86-031,319. GEEZER TRACK CLUB, LLC, LOCUST GROVE, GA. FILED 8-7-2013.

**Geezer Track Club**

THE MARK CONSISTS OF STANDARD CHARACTERS WITHOUT CLAIM TO ANY PARTICULAR FONT, STYLE, SIZE, OR COLOR.

NO CLAIM IS MADE TO THE EXCLUSIVE RIGHT TO USE "TRACK CLUB", APART FROM THE MARK AS SHOWN.

FOR CLOTHING FOR ATHLETIC USE, NAMELY, T-SHIRTS (U.S. CLS. 22 AND 39).

FIRST USE 6-5-2013; IN COMMERCE 6-5-2013.

TEJBIR SINGH, EXAMINING ATTORNEY

SN 86-033,371. 22CANS LIMITED, LONDON, UNITED KINGDOM, FILED 8-9-2013.

**GODUS**

THE MARK CONSISTS OF STANDARD CHARACTERS WITHOUT CLAIM TO ANY PARTICULAR FONT, STYLE, SIZE, OR COLOR.

PRIORITY CLAIMED UNDER SEC. 44(D) ON ERPNTY TM OFC APPLICATION NO. 011945227, FILED 7-1-2013, REG. NO. 011945227, DATED 11-26-2013, EXPIRES 7-1-2023.

FOR FOOTWEAR; HALLOWEEN COSTUMES; HEADGEAR, NAMELY, HATS AND CAPS; JACKETS; MASQUERADE COSTUMES; NECKTIES; SCARFS; SHIRTS; SHOES; SHORTS; SOCKS; SWEATSHIRTS; T-SHIRTS; TOPS (U.S. CLS. 22 AND 39).

SAMUEL E. SHARPER JR., EXAMINING ATTORNEY

**CLASS 25—(Continued).**

SN 86-033,596. RYAN, THOMAS P, DBA THOMAS P. RYAN, GLENDALE, WI. FILED 8-9-2013.

## Glad Hand Gloves

THE MARK CONSISTS OF STANDARD CHARACTERS WITHOUT CLAIM TO ANY PARTICULAR FONT, STYLE, SIZE, OR COLOR.

NO CLAIM IS MADE TO THE EXCLUSIVE RIGHT TO USE "HAND GLOVES", APART FROM THE MARK AS SHOWN.

FOR GLOVES; GLOVES FOR APPAREL (U.S. CLS. 22 AND 39).

REBECCA GILBERT, EXAMINING ATTORNEY

---

SN 86-033,923. KNITCRAFT CORPORATION, WINONA, MN. FILED 8-9-2013.

## HERITAGE BY ST. CROIX

THE MARK CONSISTS OF STANDARD CHARACTERS WITHOUT CLAIM TO ANY PARTICULAR FONT, STYLE, SIZE, OR COLOR.

OWNER OF U.S. REG. NOS. 1,330,944, 1,858,032 AND 3,101,974.

FOR JACKETS, TROUSERS, SHIRTS, HOSIERY, SWEATERS, SKIRTS, DRESSES (U.S. CLS. 22 AND 39).

CHRISTOPHER REAMS, EXAMINING ATTORNEY

---

SN 86-034,942. XVII LLC, HOUSTON, TX. FILED 8-12-2013.



NO CLAIM IS MADE TO THE EXCLUSIVE RIGHT TO USE "UNDERWEAR", APART FROM THE MARK AS SHOWN.

THE MARK CONSISTS OF THE STYLIZED ROMAN NUMERALS "XVII" AND THE WORD "UNDERWEAR" NEXT TO A DESIGN OF A WOLF'S HEAD HOWLING.

FOR MEN'S UNDERWEAR (U.S. CLS. 22 AND 39).

FIRST USE 3-26-2013; IN COMMERCE 3-26-2013.

PAUL MORENO, EXAMINING ATTORNEY

**CLASS 25—(Continued).**

SN 86-036,148. HUTTO, BENJAMIN, FRANKLIN, TN. FILED 8-13-2013.



NO CLAIM IS MADE TO THE EXCLUSIVE RIGHT TO USE "CLOTHING CO." AND "EST. MMXIII", APART FROM THE MARK AS SHOWN.

THE COLOR(S) DARK BLUE, DARK RED, AND WHITE IS/ARE CLAIMED AS A FEATURE OF THE MARK.

THE MARK CONSISTS OF AN OVAL BORDER IN DARK BLUE COLOR. INSIDE THE DARK BLUE OVAL IS A WHITE COLOR CONCENTRIC OVAL. IN THE MIDDLE OF THE CONCENTRIC OVALS IS AN AIRPLANE IN WHITE COLOR ON A DARK RED COLOR BACKGROUND. ABOVE THE PLANE ARE FIVE FIVE-POINTED STARS DEPICTED IN THE COLOR WHITE. ABOVE THE STARS IS THE WORDING "SKYSAIL BAY" IN WHITE COLOR. BELOW THE PLANE ARE TWO FIVE-POINTED STARS IN WHITE COLOR AND THE WORDING "EST. MMXIII" IN WHITE COLOR BETWEEN THE TWO STARS. BELOW THE WORDING "EST. MMXIII" IS THE WORDING "CLOTHING CO." IN WHITE COLOR.

FOR SHORT-SLEEVED T-SHIRTS, LONG-SLEEVED T-SHIRTS (U.S. CLS. 22 AND 39).

SUI DUONG, EXAMINING ATTORNEY

---

SN 86-036,203. TARRANT, PETI, VENTURA, CA. FILED 8-13-2013.

## Co' Ampin'

THE MARK CONSISTS OF STANDARD CHARACTERS WITHOUT CLAIM TO ANY PARTICULAR FONT, STYLE, SIZE, OR COLOR.

FOR CLOTHING, NAMELY, T-SHIRTS, HATS, BANDANNAS, SWEATSHIRTS, SWEATBANDS, AND BUTTON UP SHIRTS (U.S. CLS. 22 AND 39).

LAURA FIONDA, EXAMINING ATTORNEY

**CLASS 25—(Continued).**

SN 86-036,364. CHANT, JOHN, POMPANO BEACH, FL. AND GONZALES, DANNY, POMPANO BEACH, FL. FILED 8-13-2013.

**LOCAL H20 Custom Threads**

THE MARK CONSISTS OF STANDARD CHARACTERS WITHOUT CLAIM TO ANY PARTICULAR FONT, STYLE, SIZE, OR COLOR.

NO CLAIM IS MADE TO THE EXCLUSIVE RIGHT TO USE "CUSTOM THREADS", APART FROM THE MARK AS SHOWN.

FOR BANDANAS; FOOTWEAR; HATS; JACKETS; PANTS; RASH GUARDS; SANDALS; SCARVES; SHIRTS; SHOES; SHORTS; SOCKS; SWIM TRUNKS; SWIMWEAR; VISORS (U.S. CLS. 22 AND 39).

FIRST USE 1-1-2009; IN COMMERCE 1-1-2010.  
AMY ALFIERI, EXAMINING ATTORNEY

SN 86-036,467. EDWARD H. BOHLIN, INC., DALLAS, TX. FILED 8-13-2013.

**BOHLIN**

THE MARK CONSISTS OF STANDARD CHARACTERS WITHOUT CLAIM TO ANY PARTICULAR FONT, STYLE, SIZE, OR COLOR.

OWNER OF U.S. REG. NO. 2,532,045.

SEC. 2(F).

FOR BELTS (U.S. CLS. 22 AND 39).

FIRST USE 9-30-2009; IN COMMERCE 9-30-2009.  
DAVID MURRAY, EXAMINING ATTORNEY

SN 86-036,670. DJRDRJAN, ELISABETH, SANTOS, BRAZIL, FILED 8-13-2013.

**Haus von Krone**

THE MARK CONSISTS OF STANDARD CHARACTERS WITHOUT CLAIM TO ANY PARTICULAR FONT, STYLE, SIZE, OR COLOR.

THE ENGLISH TRANSLATION OF "HAUS" IN THE MARK IS "HOUSE".

FOR APRONS; BABY BODYSUITS; BASEBALL CAPS AND HATS; BLOUSES; CAMISOLES; CAP VISORS; CAPS; FOOTWEAR; HATS; HEADBANDS AGAINST SWEATING; HOODED SWEAT SHIRTS; JACKETS AND SOCKS; JEANS; NECKTIES; OVERALLS; PANTS; SCARFS; SHAWLS AND STOLE; SHIRTS AND SHORT-SLEEVED SHIRTS; SKIRTS AND DRESSES; SLACKS; SPORT COATS; SUITS; SUSPENDERS; SWEAT JACKETS; SWEAT PANTS; SWEAT SHIRTS; SWEAT SHORTS; SWEAT SUITS; SWEATERS; SWIMWEAR; T-SHIRTS; TROUSERS; UNDERWEAR; VESTS (U.S. CLS. 22 AND 39).

BERYL GARDNER, EXAMINING ATTORNEY

**CLASS 25—(Continued).**

SN 86-036,690. PETTENATI S/A-INDUSTRIA TEXTIL, CAXIAS DO SUL-RS, BRAZIL, FILED 8-13-2013.

**PETTENATI**

THE MARK CONSISTS OF STANDARD CHARACTERS WITHOUT CLAIM TO ANY PARTICULAR FONT, STYLE, SIZE, OR COLOR.

OWNER OF U.S. REG. NOS. 3,626,364 AND 4,260,115.

SEC. 2(F).

FOR CLOTHING, NAMELY, SHIRTS, SUITS, PANTS, SKIRTS, SHORTS, JACKETS, SOCKS, PAJAMAS, UNDERWEAR, LOUNGEWEAR; UNDERGARMENTS, PULLOVERS, JUMPERS, SWEATERS, SWEATSHIRTS, BLOUSES, SWEATERS, T-SHIRTS AND JOGGING SUITS (U.S. CLS. 22 AND 39).

CURTIS FRENCH, EXAMINING ATTORNEY

SN 86-036,839. NEFRIN, LLC., CHINO HILLS, CA. FILED 8-13-2013.



THE MARK CONSISTS OF A KETTLE BELL FOLLOWED BY THE DASH SYMBOL FOLLOWED BY THE STYLIZED WORDING "NEFRIN" WHICH IS SPLIT IN THE MIDDLE WITH AN APOSTROPHE.

THE WORDING "NEFRIN" HAS NO MEANING IN A FOREIGN LANGUAGE.

FOR ATHLETIC APPAREL, NAMELY, SHIRTS, PANTS, JACKETS, FOOTWEAR, HATS AND CAPS, ATHLETIC UNIFORMS (U.S. CLS. 22 AND 39).

FIRST USE 12-8-2012; IN COMMERCE 1-5-2013.  
MICHAEL ENGEL, EXAMINING ATTORNEY

SN 86-036,945. LAGRANGE LEATHER, LLC, STATE ROAD, NC. FILED 8-13-2013.

**LAGRANGE**

THE MARK CONSISTS OF STANDARD CHARACTERS WITHOUT CLAIM TO ANY PARTICULAR FONT, STYLE, SIZE, OR COLOR.

SEC. 2(F).

FOR FOOTWEAR, NAMELY, COWBOY BOOTS; BELTS; SOCKS (U.S. CLS. 22 AND 39).

FIRST USE 0-0-1993; IN COMMERCE 0-0-1993.

ARETHA SOMERVILLE, EXAMINING ATTORNEY

**CLASS 25—(Continued).**

SN 86-036,979. LAGRANGE LEATHER, LLC, STATE ROAD, NC. FILED 8-13-2013.



THE MARK CONSISTS OF STYLIZED LETTERS "LAGRANGE" WITH THE "L" FORMING PART OF A HORSE HEAD.

FOR FOOTWEAR, NAMELY, COWBOY BOOTS; BELTS; SOCKS (U.S. CLS. 22 AND 39). FIRST USE 0-0-1993; IN COMMERCE 0-0-1993. ARETHA SOMERVILLE, EXAMINING ATTORNEY

**CLASS 25—(Continued).**

SN 86-037,541. RENELIAN MUSIC, INC., THOUSAND OAKS, CA. FILED 8-14-2013.



THE MARK CONSISTS OF THE WORDS "LOVE LIFE" IN BLOCK LETTERS, SURROUNDED BY RAYS, AND ABOVE A DIAMOND-LIKE DESIGN CONTAINING THE OVERLAPPING LETTERS "LL".

FOR BEANIES; HATS; JACKETS; LONG SLEEVE PULLOVERS; SWEATSHIRTS; T-SHIRTS; TANK TOPS (U.S. CLS. 22 AND 39). FIRST USE 8-3-2013; IN COMMERCE 8-3-2013. TASHIA BUNCH, EXAMINING ATTORNEY

SN 86-037,117. OUTRAGEOUS INC., NORMANDY PARK, WA. FILED 8-14-2013.

**Work Ready**

THE MARK CONSISTS OF STANDARD CHARACTERS WITHOUT CLAIM TO ANY PARTICULAR FONT, STYLE, SIZE, OR COLOR.

NO CLAIM IS MADE TO THE EXCLUSIVE RIGHT TO USE "WORK", APART FROM THE MARK AS SHOWN.

FOR GLOVES; HATS; JACKETS; PANTS; SHIRTS; SWEATERS (U.S. CLS. 22 AND 39).

FIRST USE 5-1-2013; IN COMMERCE 5-1-2013. NICHOLAS COLEMAN, EXAMINING ATTORNEY

SN 86-037,568. RED ZONE SUPPLEMENTS LLC, BOISE, ID. FILED 8-14-2013.

SN 86-037,425. PATTERSON, IRENE, ALAMEDA, CA. FILED 8-14-2013.



**loveyourcountryloveyourworld**

THE MARK CONSISTS OF (FROM LEFT TO RIGHT) AN AMERICAN FLAG APPEARING INSIDE A CIRCLE SHAPE, A HEART, AND A WORLD, CONNECTED WITH HORIZONTAL LINES. DIRECTLY BELOW THAT, APPEARS THE TEXT "LOVEYOURCOUNTRYLOVEYOURWORLD" WITH THE FIRST LETTER "O" IN "LOVE" BEING A HEART SHAPE AND THE LAST LETTER "O" IN "WORLD" BEING A HEART SHAPE.

FOR HATS; PANTS; SHIRTS; SWEATSHIRTS; T-SHIRTS (U.S. CLS. 22 AND 39). KATHERINE E. HALMEN, EXAMINING ATTORNEY

THE MARK CONSISTS OF STANDARD CHARACTERS WITHOUT CLAIM TO ANY PARTICULAR FONT, STYLE, SIZE, OR COLOR.

NO CLAIM IS MADE TO THE EXCLUSIVE RIGHT TO USE "ATHLETIC", APART FROM THE MARK AS SHOWN.

FOR ATHLETIC APPAREL, NAMELY, SHIRTS, PANTS, JACKETS, FOOTWEAR, HATS AND CAPS, ATHLETIC UNIFORMS (U.S. CLS. 22 AND 39).

TASHIA BUNCH, EXAMINING ATTORNEY

**Live Athletic**

**CLASS 25—(Continued).**

SN 86-037,876. VEGA, PATRICIA, BAKERSFIELD, CA. FILED 8-14-2013.

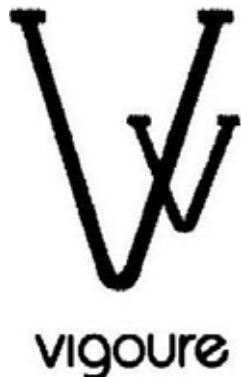

THE MARK CONSISTS OF TWO LETTER "V'S" OVERLAPPING EACH OTHER, ONE LARGER THAN THE ONE OVERLAPPING IT. BOTH OF THE LETTER "V'S" HAVE A FINISHING EDGE AT THE END OF EACH LINE FINISHING OFF THE "V". BELOW THE TWO "V'S" THE STYLIZED WORD "VIGOURE" IS PLACED.

FOR DRESSES; HATS; PANTS; SCARVES; SHORTS; SKIRTS; T-SHIRTS; TANK TOPS (U.S. CLS. 22 AND 39). FIRST USE 6-30-2013; IN COMMERCE 6-30-2013. DOMINIC J. FERRAIUOLO, EXAMINING ATTORNEY

SN 86-038,107. MAIRA DA COSTA MATSUI, SAN FRANCISCO, CA. FILED 8-14-2013.

**PORRADA GEAR**

THE MARK CONSISTS OF STANDARD CHARACTERS WITHOUT CLAIM TO ANY PARTICULAR FONT, STYLE, SIZE, OR COLOR.

NO CLAIM IS MADE TO THE EXCLUSIVE RIGHT TO USE "GEAR", APART FROM THE MARK AS SHOWN.

FOR APPAREL, NAMELY, ATHLETIC SHORTS; FIGHT SHORTS FOR MIXED MARTIAL ARTS OR GRAPPLING; HOODED SWEATSHIRTS; MARTIAL ARTS UNIFORMS, NAMELY, GIS; RASH GUARDS; AND T-SHIRTS (U.S. CLS. 22 AND 39).

FIRST USE 7-31-2009; IN COMMERCE 7-31-2009. SKYE YOUNG, EXAMINING ATTORNEY

**CLASS 25—(Continued).**

SN 86-038,200. YOUKNOW APPAREL, LLC, FOREST HILLS, NY. FILED 8-14-2013.

**Knowledge Never Obtains  
Weakness**

THE MARK CONSISTS OF STANDARD CHARACTERS WITHOUT CLAIM TO ANY PARTICULAR FONT, STYLE, SIZE, OR COLOR.

FOR HATS; SWEATERS; T-SHIRTS (U.S. CLS. 22 AND 39).

FIRST USE 1-15-2011; IN COMMERCE 5-1-2011. SUSAN RICHARDS, EXAMINING ATTORNEY

SN 86-038,214. PETERSON, JUDE, TEMECULA, CA. FILED 8-14-2013.



NO CLAIM IS MADE TO THE EXCLUSIVE RIGHT TO USE "CLOTHING CO", APART FROM THE MARK AS SHOWN.

THE MARK CONSISTS OF A STYLIZED IMAGE OF THE SATANIC CROSS, WHICH IS A VARIATION OF THE ALCHEMICAL SYMBOL FOR SULFUR THAT REPRESENTS FIRE AND BRIMSTONE WITH THE TEXT "I Y F CLOTHING CO".

FOR HATS; HOODED SWEATSHIRTS; SOCKS; T-SHIRTS (U.S. CLS. 22 AND 39).

DAVID ELTON, EXAMINING ATTORNEY

SN 86-038,528. VALDES, YANIRY, TERRACE DORAL, FL. FILED 8-15-2013.

**Love Below Lingerie**

THE MARK CONSISTS OF STANDARD CHARACTERS WITHOUT CLAIM TO ANY PARTICULAR FONT, STYLE, SIZE, OR COLOR.

NO CLAIM IS MADE TO THE EXCLUSIVE RIGHT TO USE "LINGERIE", APART FROM THE MARK AS SHOWN.

FOR BRAS; LINGERIE; PANTIES; UNDER GARMENTS; UNDERWEAR (U.S. CLS. 22 AND 39).

KAMAL PREET, EXAMINING ATTORNEY



**CLASS 25—(Continued).**

SN 86-038,774. ADELARD AND EDWARDS, INC., SAN FRANCISCO, CA. FILED 8-15-2013.

**PRATT & HART**

THE MARK CONSISTS OF STANDARD CHARACTERS WITHOUT CLAIM TO ANY PARTICULAR FONT, STYLE, SIZE, OR COLOR.

FOR GLOVES, NAMELY, GLOVES MADE OF SKIN, HIDE OR FUR (U.S. CLS. 22 AND 39).

FIRST USE 4-30-2012; IN COMMERCE 4-30-2012.  
FLORENTINA BLANDU, EXAMINING ATTORNEY

---

SN 86-038,821. ADELARD AND EDWARDS, INC., SAN FRANCISCO, CA. FILED 8-15-2013.

**TOUGH GLOVES**

THE MARK CONSISTS OF STANDARD CHARACTERS WITHOUT CLAIM TO ANY PARTICULAR FONT, STYLE, SIZE, OR COLOR.

NO CLAIM IS MADE TO THE EXCLUSIVE RIGHT TO USE "GLOVES", APART FROM THE MARK AS SHOWN.

FOR GLOVES, NAMELY, GLOVES MADE OF SKIN, HIDE OR FUR (U.S. CLS. 22 AND 39).

FIRST USE 10-31-1998; IN COMMERCE 10-31-1998.  
FLORENTINA BLANDU, EXAMINING ATTORNEY

---

SN 86-039,298. CYNTHIA ROWLEY, NEW YORK, NY. FILED 8-15-2013.

**ROWLEY DITCH BRITCHES**

THE MARK CONSISTS OF STANDARD CHARACTERS WITHOUT CLAIM TO ANY PARTICULAR FONT, STYLE, SIZE, OR COLOR.

OWNER OF U.S. REG. NOS. 3,212,424, 4,035,601 AND OTHERS.

NO CLAIM IS MADE TO THE EXCLUSIVE RIGHT TO USE "BRITCHES", APART FROM THE MARK AS SHOWN.

FOR BOARD SHORTS, RASH GUARDS, SWIMWEAR AND WETSUITS (U.S. CLS. 22 AND 39).

MEGHAN REINHART, EXAMINING ATTORNEY

**CLASS 25—(Continued).**

SN 86-039,492. NICOLE HANSEL, BEVERLY HILLS, CA. FILED 8-15-2013.

**NIKKI PEREZ**

THE MARK CONSISTS OF STANDARD CHARACTERS WITHOUT CLAIM TO ANY PARTICULAR FONT, STYLE, SIZE, OR COLOR.

"NIKKI PEREZ" IDENTIFIES THE PSEUDONYM OF NICOLE HANSEL, A LIVING INDIVIDUAL WHOSE CONSENT IS OF RECORD.

FOR CLOTHING, NAMELY, MEN'S, WOMEN'S, MISSY'S, JUNIORS', CHILDREN'S AND INFANTS' JEANS, PANTS, TROUSERS, CAPRIS, LEGGINGS, SHORTS, OVERALLS, SKIRTS, DRESSES, TOPS, T-SHIRTS, SWEATSHIRTS, BLOUSES, SHIRTS, JACKETS, VESTS, COATS, SWEATERS, CARDIGANS, SCARVES, SOCKS, BANDANAS, NECKTIES, BELTS, BOOTS, SANDALS, FOOTWEAR, HATS, CAPS, HEADWEAR, UNDERWEAR, LINGERIE, PAJAMAS, SWIMWEAR, AND GLOVES (U.S. CLS. 22 AND 39).

REBECCA GILBERT, EXAMINING ATTORNEY

---

SN 86-039,750. GREGORY J. WHITWORTH, APOPKA, FL. FILED 8-16-2013.



THE MARK CONSISTS OF THE WORD "CALICO" ABOVE THE WORD "CREEK", BOTH IN STYLIZED FORM WITH DISTRESSED AND/OR RUSTIC MARKINGS, WHEREIN BOTH THE CAPITAL LETTER "C" ARE SHAPED AS A HORSESHOE, EACH HAVING THREE DIAMONDS ON THE TOP AND BOTTOM OF THE LETTER, AND THE BOTTOM "C" OVERLAPPING WITH THE TOP "C" SO THAT ONLY A PORTION OF THE MIDDLE DIAMOND OF THE TOP "C" APPEARS.

FOR COUNTRY WESTERN APPAREL, EXCLUDING HUNTING APPAREL, NAMELY, T-SHIRTS, HATS, AND SWEATSHIRTS (U.S. CLS. 22 AND 39).

ZHALEH DELANEY, EXAMINING ATTORNEY

**CLASS 25—(Continued).**

SN 86-039,932. BRONOX LTD., MONROVIA, LIBERIA, FILED 8-16-2013.

**CLASS 25—(Continued).**

SN 86-040,533. JESUS MATIAS, KEW GARDENS, NY. FILED 8-16-2013.

## FREEMAN KIDS

THE MARK CONSISTS OF STANDARD CHARACTERS WITHOUT CLAIM TO ANY PARTICULAR FONT, STYLE, SIZE, OR COLOR.

OWNER OF U.S. REG. NOS. 296,637, 588,121 AND 1,081,839.

NO CLAIM IS MADE TO THE EXCLUSIVE RIGHT TO USE "KIDS", APART FROM THE MARK AS SHOWN.

FOR CHILDREN'S FOOTWEAR (U.S. CLS. 22 AND 39).  
LINDA POWELL, EXAMINING ATTORNEY

---

SN 86-040,031. RESCUE CHIC, LLC, PALM BEACH GARDENS, FL. FILED 8-16-2013.

## Rescue Chic

THE MARK CONSISTS OF STANDARD CHARACTERS WITHOUT CLAIM TO ANY PARTICULAR FONT, STYLE, SIZE, OR COLOR.

NO CLAIM IS MADE TO THE EXCLUSIVE RIGHT TO USE "CHIC", APART FROM THE MARK AS SHOWN.

FOR HEADGEAR, NAMELY, HATS AND CAPS; JACKETS; JEANS; SWEATSHIRTS; T-SHIRTS (U.S. CLS. 22 AND 39).

TRACY WHITTAKER-BROWN, EXAMINING ATTORNEY

---

SN 86-040,162. WHITE, JOVAN, UNIVERSITY PLACE, WA. FILED 8-16-2013.

## Arch Bianco.

THE MARK CONSISTS OF STANDARD CHARACTERS WITHOUT CLAIM TO ANY PARTICULAR FONT, STYLE, SIZE, OR COLOR.

THE NAME "ARCH BIANCO" DOES NOT IDENTIFY A LIVING INDIVIDUAL.

THE ENGLISH TRANSLATION OF THE WORD "BIANCO" IN THE MARK IS "WHITE".

FOR HATS; T-SHIRTS; TANK TOPS (U.S. CLS. 22 AND 39).

ZACHARY CROMER, EXAMINING ATTORNEY



NO CLAIM IS MADE TO THE EXCLUSIVE RIGHT TO USE "NEW YORK", APART FROM THE MARK AS SHOWN.

THE MARK CONSISTS OF A DRAWING OF AN ANGEL TAKING FLIGHT WHILE GRASPING A WOMAN AROUND THE WAIST BELOW WHICH APPEARS THE WORDING "VERUM ES CORRUPTA NEW YORK". THE RECTANGULAR BORDER IS NOT A FEATURE OF THE MARK.

THE ENGLISH TRANSLATION OF "VERUM ES CORRUPTA" IN THE MARK IS "TRUTH IS CORRUPT".

FOR CLOTHING, NAMELY, SHIRTS, LONG-SLEEVED SHIRTS, T-SHIRTS, UNDER SHIRTS, NIGHT SHIRTS, RUGBY SHIRTS, POLO SHIRTS, JERSEYS, DRESS SHIRTS, PANTS, SLACKS, JEANS, CARGO PANTS, STRETCH PANTS, DENIM JEANS, JUMP SUITS, SHORTS, TOPS, STRETCH TOPS, TUBE TOPS, CROP TOPS, TANK TOPS, TANKINIS, HALTER TOPS, SWEAT SHIRTS, HOODED SWEAT SHIRTS, SWEAT JACKETS, SWEAT SHORTS, SWEAT PANTS, WRAPS, WARM-UP SUITS, JOGGING SUITS, TRACK SUITS, PLAY SUITS, BLOUSES, SKIRTS, DRESSES, SWEATERS, VESTS, FLEECE VESTS, PULLOVERS, SNOW SUITS, PARKAS, ANORAKS, PONCHOS, JACKETS, DINNER JACKETS, REVERSIBLE JACKETS, WIND-RESISTANT JACKETS, SHELL JACKETS, SPORTS JACKETS, JEAN JACKETS, COATS, HEAVY COATS, OVER COATS, TOP COATS, BLAZERS, LAYETTES, BEANIES, HATS, VISORS, HEADBANDS, HEAD WEAR, EAR MUFFS, APRONS, SCARVES, BANDANAS, BELTS, SUSPENDERS, NECK WEAR, UNDERWEAR, THERMAL UNDERWEAR, BRIEFS, SOCKS, ROBES, LEG WARMERS, HOSIERY, LEGGINGS, TIGHTS, GLOVES, MITTENS, FOOTWEAR, SHOES, SNEAKERS, BOOTS (U.S. CLS. 22 AND 39).

LEE-ANNE BERNS, EXAMINING ATTORNEY

**CLASS 25—(Continued).**

SN 86-040,617. BIG COUNTRY TRADE EXCHANGE INC., DBA COTTONPLACE, MONTEREY PARK, CA. FILED 8-16-2013.



NO CLAIM IS MADE TO THE EXCLUSIVE RIGHT TO USE "AMERICANS", APART FROM THE MARK AS SHOWN.

THE COLOR(S) RED, WHITE, BLUE, AND GRAY IS/ARE CLAIMED AS A FEATURE OF THE MARK.

THE MARK CONSISTS OF THE WORD "AMERICANS" IN WHITE IN TWO RECTANGLES WITH WHITE STARS ALONG THE TOP EDGE. THE LETTER "A" IS LOCATED IN THE RED LEFT RECTANGLE; "ERICANS" IS IN THE BLUE RIGHT RECTANGLE. A GRAY BANNER IS ON TOP OF EACH RECTANGLE.

FOR GARMENTS AND APPAREL, NAMELY, SKIRTS, SHORTS, DRESSES, PANTS, TOPS, SHIRTS, T-SHIRTS, SWEATERS, PULLOVERS, JACKETS, COATS, VESTS, BLOUSES, JEANS (U.S. CLS. 22 AND 39).

FIRST USE 8-2-2013; IN COMMERCE 8-2-2013.  
KAREN K. BUSH, EXAMINING ATTORNEY

**CLASS 25—(Continued).**

SN 86-040,905. EROS SPORT, INC., DBA EROS SPORT, LAGUNA NIGUEL, CA. FILED 8-17-2013.



NO CLAIM IS MADE TO THE EXCLUSIVE RIGHT TO USE "SPORT", APART FROM THE MARK AS SHOWN.

THE MARK CONSISTS OF THE WORDING "EROS SPORT" AT THE BOTTOM OF TWO STYLIZED BOOMERANG SHAPES THAT ARE REFLECTED ONE ON TOP OF THE OTHER WITH THE CENTER POINTS CLOSEST TO EACH OTHER.

FOR ATHLETIC APPAREL, NAMELY, SHIRTS, PANTS, JACKETS, FOOTWEAR, HATS AND CAPS, ATHLETIC UNIFORMS; ATHLETIC SHORTS (U.S. CLS. 22 AND 39).

FIRST USE 10-24-2012; IN COMMERCE 8-9-2013.  
RONALD MCMORROW, EXAMINING ATTORNEY

SN 86-040,940. KREKEL, SALLI MORITA, KANEOHE, HI. FILED 8-18-2013.

# Colors Of Me

THE MARK CONSISTS OF STANDARD CHARACTERS WITHOUT CLAIM TO ANY PARTICULAR FONT, STYLE, SIZE, OR COLOR.

FOR GIFT PACKAGES SOLD AS A UNIT CONSISTING PRIMARILY OF A SWEATSHIRT AND ALSO INCLUDING A PHOTO FRAME, A COFFEE MUG, AND A TOTE BAG; INFANT AND TODDLER ONE PIECE CLOTHING; SHORT-SLEEVED OR LONG-SLEEVED T-SHIRTS; T-SHIRTS; T-SHIRTS FOR CHILDREN (U.S. CLS. 22 AND 39).

DAVID TAYLOR, EXAMINING ATTORNEY

SN 86-040,678. STAFFORD, CHRISTOPHER, COLUMBIA, MD. FILED 8-16-2013.

## Stressed Out Gorilla Gear

THE MARK CONSISTS OF STANDARD CHARACTERS WITHOUT CLAIM TO ANY PARTICULAR FONT, STYLE, SIZE, OR COLOR.

NO CLAIM IS MADE TO THE EXCLUSIVE RIGHT TO USE "GEAR", APART FROM THE MARK AS SHOWN.

FOR CHILDREN'S AND INFANT'S APPAREL, NAMELY, JUMPERS, OVERALL SLEEPWEAR, PAJAMAS, ROMPERS AND ONE-PIECE GARMENTS; HATS; JERSEYS; LEGGINGS; SWEAT SHIRTS; SWEATSUITS; T-SHIRTS; TANK TOPS (U.S. CLS. 22 AND 39).

CIMMERIAN COLEMAN, EXAMINING ATTORNEY

SN 86-040,942. KREKEL, SALLI MORITA, KANEOHE, HI. FILED 8-18-2013.

# 100% Half

THE MARK CONSISTS OF STANDARD CHARACTERS WITHOUT CLAIM TO ANY PARTICULAR FONT, STYLE, SIZE, OR COLOR.

FOR INFANT AND TODDLER ONE PIECE CLOTHING; SHORT-SLEEVED OR LONG-SLEEVED T-SHIRTS; T-SHIRTS (U.S. CLS. 22 AND 39).

DAVID TAYLOR, EXAMINING ATTORNEY

**CLASS 25—(Continued).**

SN 86-041,037. PHILIP R. PALUMBO, CARLSBAD, CA. FILED 8-18-2013.



THE COLOR(S) BLACK, WHITE, RED, YELLOW, BROWN, GREEN, AND BEIGE IS/ARE CLAIMED AS A FEATURE OF THE MARK.

THE MARK CONSISTS OF A BEIGE, BROWN, BLACK AND WHITE SKULL ON A TORSO DRESSED IN A BLACK JACKET WITH WHITE ACCENTS, A RED BOW AND A WHITE SHIRT WITH A BROWN AND BLACK SNAKE WITH YELLOW EYES, RED MOUTH, WHITE FANGS, AND A YELLOW AND BROWN RATTLER WRAPPED AROUND THE NECK AND WHITE AND BLACK ROSES WITH GREEN AND BLACK LEAVES, AND THE WORDING "EL GORDO" IN WHITE OUTLINED IN BLACK AND GREEN AND THE WORD "CERVEZA" IN BEIGE ON A BROWN TO RED BACKGROUND.

THE ENGLISH TRANSLATION OF "EL GORDO" AND "CERVEZA" IN THE MARK IS "THE FAT ONE", "THE BIG ONE" AND "BEER".

FOR BASEBALL CAPS; BASEBALL CAPS AND HATS; BOTTOMS; CAPS; CROP PANTS; CROP TOPS; FLEECE BOTTOMS; FLEECE PULLOVERS; FLEECE SHORTS; FLEECE TOPS; FLEECE VESTS; HEAD SWEATBANDS; HEADBANDS AGAINST SWEATING; HOODED SWEAT SHIRTS; HOODED SWEATSHIRTS; JOGGING OUTFITS; JOGGING PANTS; JOGGING SUITS; SWEAT JACKETS; SWEAT PANTS; SWEAT SHIRTS; SWEAT SHORTS; SWEATBANDS; SWEATPANTS; SWEATSHIRTS; T-SHIRTS; TANK TOPS; TANK-TOPS; TEE SHIRTS (U.S. CLS. 22 AND 39).

DEIRDRE ROBERTSON, EXAMINING ATTORNEY

SN 86-041,366. CREATIVE TECHNOLOGIES, LLC, PORT WASHINGTON, NY. FILED 8-19-2013.

# HEAD TUNES

THE MARK CONSISTS OF STANDARD CHARACTERS WITHOUT CLAIM TO ANY PARTICULAR FONT, STYLE, SIZE, OR COLOR.

FOR SKI HATS, HEADBANDS, EAR MUFFS, AND HATS, MADE OF COTTON, WOOL, KNIT OR FLEECE, FOR BOYS, GIRLS, LADIES AND MEN, ALL WITH BUILT-IN SPEAKERS TO LISTEN TO MUSIC (U.S. CLS. 22 AND 39).

ESTHER BELENKER, EXAMINING ATTORNEY

**CLASS 25—(Continued).**

SN 86-041,814. SEDAGHATMEHR, DONYA, WILMINGTON, CA. FILED 8-19-2013.

# Bowtie Chicks

THE MARK CONSISTS OF STANDARD CHARACTERS WITHOUT CLAIM TO ANY PARTICULAR FONT, STYLE, SIZE, OR COLOR.

NO CLAIM IS MADE TO THE EXCLUSIVE RIGHT TO USE "BOWTIE", APART FROM THE MARK AS SHOWN. FOR BOTTOMS; DRESSES; TOPS (U.S. CLS. 22 AND 39).

FIRST USE 9-0-2011; IN COMMERCE 7-0-2012.

MARGERY A. TIERNEY, EXAMINING ATTORNEY

SN 86-042,297. LEE, BIVIAN LEWIS, METAIRIE, LA. FILED S.R. 8-20-2013; AM. P.R. 12-6-2013.

# Son of a Saint

THE MARK CONSISTS OF STANDARD CHARACTERS WITHOUT CLAIM TO ANY PARTICULAR FONT, STYLE, SIZE, OR COLOR.

FOR T-SHIRTS FOR BABIES, CHILDREN, TEEN-AGERS AND ADULTS (U.S. CLS. 22 AND 39).

FIRST USE 7-1-2011; IN COMMERCE 10-1-2011.

KRISTINA MORRIS, EXAMINING ATTORNEY

SN 86-042,534. KARIBU KIKOY, LLC, BROOKLYN, NY. FILED 8-20-2013.



NO CLAIM IS MADE TO THE EXCLUSIVE RIGHT TO USE "KIKOY", APART FROM THE MARK AS SHOWN.

THE MARK CONSISTS OF AN OUTER CIRCULAR BORDER WITH THE WORD "KARIBU" UNDER THE TOP OF THE CIRCLE AND THE WORD "KIKOY" ABOVE THE BOTTOM OF THE OUTER CIRCLE. IN BETWEEN THE WORDS IS AN INNER CIRCLE WITH A PICTURE OF A LIZARD IN IT.

THE ENGLISH TRANSLATION OF THE SWAHILI WORD "KARIBU" IN THE MARK IS "WELCOME".

FOR SARONGS (U.S. CLS. 22 AND 39).

FIRST USE 3-12-2013; IN COMMERCE 3-12-2013.

ANDREW LEASER, EXAMINING ATTORNEY

**CLASS 25—(Continued).**

SN 86-042,612. HIRYDE, LAMAR, SC. FILED 8-20-2013.

# HiRyde Radical Rags

THE MARK CONSISTS OF STANDARD CHARACTERS WITHOUT CLAIM TO ANY PARTICULAR FONT, STYLE, SIZE, OR COLOR.

NO CLAIM IS MADE TO THE EXCLUSIVE RIGHT TO USE "RAGS", APART FROM THE MARK AS SHOWN.

FOR BANDANAS; BEACHWEAR; HATS; SHORTS; T-SHIRTS; TANK TOPS (U.S. CLS. 22 AND 39).

ANTHONY RINKER, EXAMINING ATTORNEY

**CLASS 25—(Continued).**

SN 86-043,133. BLATT, MYLES, WELLINGTON, FL. FILED 8-20-2013.

# MB Drop Apparel

THE MARK CONSISTS OF STANDARD CHARACTERS WITHOUT CLAIM TO ANY PARTICULAR FONT, STYLE, SIZE, OR COLOR.

NO CLAIM IS MADE TO THE EXCLUSIVE RIGHT TO USE "APPAREL", APART FROM THE MARK AS SHOWN.

FOR FOOTWEAR; HATS; JACKETS; PANTS; SHIRTS; SOCKS; SWIMWEAR (U.S. CLS. 22 AND 39).

FIRST USE 1-1-2013; IN COMMERCE 6-1-2013.

ALISON POLLACK, EXAMINING ATTORNEY

SN 86-042,695. MASSARO, COREY, LEVITTOWN, NY. FILED 8-20-2013.

# MOTIVATED NY

THE MARK CONSISTS OF STANDARD CHARACTERS WITHOUT CLAIM TO ANY PARTICULAR FONT, STYLE, SIZE, OR COLOR.

NO CLAIM IS MADE TO THE EXCLUSIVE RIGHT TO USE "NY", APART FROM THE MARK AS SHOWN.

FOR ATHLETIC APPAREL, NAMELY, SHIRTS, PANTS, JACKETS, FOOTWEAR, HATS AND CAPS, ATHLETIC UNIFORMS (U.S. CLS. 22 AND 39).

KATHRYN COWARD, EXAMINING ATTORNEY

# IM EXCLUSIVE

THE MARK CONSISTS OF STANDARD CHARACTERS WITHOUT CLAIM TO ANY PARTICULAR FONT, STYLE, SIZE, OR COLOR.

FOR CLOTHING, NAMELY, T-SHIRTS, TANK TOPS, POLO SHIRTS, BUTTON FRONT SHIRTS, SWEAT SHIRTS, DRESS SHIRTS, AND CAPS (U.S. CLS. 22 AND 39).

DAVID TOOLEY, EXAMINING ATTORNEY

SN 86-042,780. NICHOLAS BENNETT, WALTHAM, MA. FILED 8-20-2013.

# MOTIVEWEAR

THE MARK CONSISTS OF STANDARD CHARACTERS WITHOUT CLAIM TO ANY PARTICULAR FONT, STYLE, SIZE, OR COLOR.

FOR APPAREL, NAMELY, HATS, VISORS, PANTS, SHORTS, LEGGINGS, TIGHTS, TOPS, TEE SHIRTS, TANK TOPS, SPORTS BRAS, LONG SLEEVES, AND SWEATPANTS (U.S. CLS. 22 AND 39).

KELLY BOULTON, EXAMINING ATTORNEY

SN 86-043,642. U.S. HERITAGE BRANDS LLC, NEW YORK, NY. FILED 8-21-2013.



THE MARK CONSISTS OF A SCEPTER DESIGN. FOR SHOES; T-SHIRTS; SHIRTS; POLO SHIRTS; BLOUSES; SWEATERS; DRESSES; SKIRTS; PANTS; SLACKS; JEANS; MEN'S SUITS; WOMEN'S SUITS; MEN'S UNDERWEAR; WOMEN'S UNDERWEAR; BRAS; LINGERIE; NIGHTGOWNS; SOCKS; HOSIERY; JACKETS; COATS; RAIN WEAR; SWEAT SUITS; WARM-UP SUITS; LEGGINGS; SPORTS BRAS; BEACHWEAR; SWIMWEAR; LOUNGEWEAR, NAMELY, BOXER BRIEFS, PAJAMAS, AND SHIRTS; HATS, CAPS, GLOVES, SCARVES AND BELTS (U.S. CLS. 22 AND 39).

RENEE MCCRAY, EXAMINING ATTORNEY

**CLASS 25—(Continued).**

SN 86-043,688. SIN CITY SPIDER, LAS VEGAS, NV. FILED 8-21-2013.

## Sin City Spider

THE MARK CONSISTS OF STANDARD CHARACTERS WITHOUT CLAIM TO ANY PARTICULAR FONT, STYLE, SIZE, OR COLOR.

NO CLAIM IS MADE TO THE EXCLUSIVE RIGHT TO USE "SIN CITY", APART FROM THE MARK AS SHOWN.

FOR HATS; SWEATSHIRTS; T-SHIRTS (U.S. CLS. 22 AND 39).

FIRST USE 7-1-2013; IN COMMERCE 7-1-2013.

BRENDAN MCCAULEY, EXAMINING ATTORNEY

---

SN 86-043,705. BC HATS, INC., ST. AUGUSTINE, FL. FILED 8-21-2013.

## BILL CONNER

THE MARK CONSISTS OF STANDARD CHARACTERS WITHOUT CLAIM TO ANY PARTICULAR FONT, STYLE, SIZE, OR COLOR.

THE NAME(S), PORTRAIT(S), AND/OR SIGNATURE(S) SHOWN IN THE MARK IDENTIFIES "BILL CONNER", WHOSE CONSENT(S) TO REGISTER IS MADE OF RECORD.

FOR HATS (U.S. CLS. 22 AND 39).

FIRST USE 4-0-1969; IN COMMERCE 4-0-1969.

ZACHARY R. SPARER, EXAMINING ATTORNEY

---

SN 86-043,773. CONKLETON, CHRISTOPHER, TEXARKANA, AR. AND WILLIAMS, JOSEPH, TEXARKANA, AR. FILED 8-21-2013.

## Spaced Out Nerds

THE MARK CONSISTS OF STANDARD CHARACTERS WITHOUT CLAIM TO ANY PARTICULAR FONT, STYLE, SIZE, OR COLOR.

FOR COATS; HATS; JACKETS; PANTS; SHOES; SOCKS; T-SHIRTS; UNDERWEAR; VESTS (U.S. CLS. 22 AND 39).

TINA L. SNAPP, EXAMINING ATTORNEY

**CLASS 25—(Continued).**

SN 86-044,078. HILLIARD, MARLENE, HOUSTON, TX. FILED 8-21-2013.

## ROMONZA

THE MARK CONSISTS OF STANDARD CHARACTERS WITHOUT CLAIM TO ANY PARTICULAR FONT, STYLE, SIZE, OR COLOR.

THE WORDING "ROMONZA" HAS NO MEANING IN A FOREIGN LANGUAGE.

FOR BELTS; BOOTS; BUSTIERS; CLOTHING, NAMELY, MATERNITY BANDS; CORSETS; DRESSES; HATS; HOSIERY; LINGERIE; MATERNITY BRAS; MATERNITY CLOTHING, NAMELY, DRESSES; MATERNITY LINGERIE; MATERNITY SLEEPWEAR; PANTS; ROBES; SCARVES; SHIRTS; SHOES; SHORTS; SKIRTS; SKORTS; SOCKS; SWIMSUITS; TUNICS; UNDERGARMENTS; UNDERWEAR; WRAPS (U.S. CLS. 22 AND 39).

FIRST USE 9-0-2010; IN COMMERCE 9-0-2010.

JILLIAN CANTOR, EXAMINING ATTORNEY

---

SN 86-044,304. MILLER, PETER, BRASELTON, GA. FILED 8-21-2013.

## 316FC

THE MARK CONSISTS OF STANDARD CHARACTERS WITHOUT CLAIM TO ANY PARTICULAR FONT, STYLE, SIZE, OR COLOR.

FOR CLOTHING, NAMELY, SPORTS SHIRTS, SHORTS, TRACKSUITS, SWEAT TOPS, SWEAT BOTTOMS, CAPS AND HATS, T-SHIRTS (U.S. CLS. 22 AND 39).

ELIZABETH CHANG, EXAMINING ATTORNEY

**CLASS 25—(Continued).**

SN 86-044,580. ILL ERA, LLC, WOODHAVEN, NY. FILED 8-21-2013.



THE MARK CONSISTS OF THE WORD "ILLERA" A VERTICALLY ORIENTED RECTANGLE WITH ILL IN STYLIZED UPPER CASE LETTERS ABOVE ERA IN STYLIZED LOWER CASE LETTERS SEPARATED BY A HORIZONTAL LINE.

FOR T-SHIRTS (U.S. CLS. 22 AND 39),  
ZHALEH DELANEY, EXAMINING ATTORNEY

**CLASS 25—(Continued).**

SN 86-044,965. KNICKERBOCKER MANUFACTURING COMPANY, LA JOLLA, CA. FILED S.R. 8-22-2013; AM. P.R. 8-22-2013.

Knickerbocker Mfg. Co.

THE MARK CONSISTS OF STANDARD CHARACTERS WITHOUT CLAIM TO ANY PARTICULAR FONT, STYLE, SIZE, OR COLOR.

NO CLAIM IS MADE TO THE EXCLUSIVE RIGHT TO USE "MFG. CO.", APART FROM THE MARK AS SHOWN. FOR BEANIES; BUTTON DOWN SHIRTS; COATS; HATS; JACKETS; POCKET SQUARES; SOCKS; SWEATERS; SWEATSHIRTS; T-SHIRTS (U.S. CLS. 22 AND 39). FIRST USE 4-1-2013; IN COMMERCE 5-23-2013.  
CARYN GLASSER, EXAMINING ATTORNEY

SN 86-044,825. KEITH, JAESEN, OAKBROOK TERRACE, IL. FILED 8-22-2013.



THE MARK CONSISTS OF A DESIGN OF A LION'S HEAD.

FOR ATHLETIC APPAREL, NAMELY, SHIRTS, PANTS, JACKETS, FOOTWEAR, HATS AND CAPS, ATHLETIC UNIFORMS; CHILDREN'S AND INFANT'S APPAREL, NAMELY, JUMPERS, OVERALL SLEEPWEAR, PAJAMAS, ROMPERS AND ONE-PIECE GARMENTS; CHILDREN'S AND INFANT'S APPAREL TREATED WITH FIRE AND HEAT RETARDANTS, NAMELY, JUMPERS, OVERALL SLEEPWEAR, PAJAMAS, ROMPERS AND ONE-PIECE GARMENTS; GLOVES FOR APPAREL; APPAREL FOR DANCERS, NAMELY, TEE SHIRTS, SWEATSHIRTS, PANTS, LEGGINGS, SHORTS AND JACKETS (U.S. CLS. 22 AND 39).  
LEE-ANNE BERNS, EXAMINING ATTORNEY

SN 86-045,513. EXCLUSIVE GAME, INC., SMYRNA, GA. FILED 8-22-2013.



THE MARK CONSISTS OF A WINGED SHIELD WITH SHADING ON THE WINGS AND SHIELD, CONTAINING WITHIN THE SHIELD A SCRIPTED CAPITAL "E" INTERSECTING A SCRIPTED CAPITAL "G" IN THE CENTER PORTION OF THE SHIELD, OVER A BACKGROUND OF THREE STARS POSITIONED ABOVE A SERIES OF SEVEN VERTICAL STRIPES.

FOR JACKETS, HATS, VESTS, SWEATSHIRTS, HOODED SWEATSHIRTS, T-SHIRTS, LONG-SLEEVED T-SHIRTS, SWEATPANTS, LEATHER PANTS (U.S. CLS. 22 AND 39).

FIRST USE 3-0-2003; IN COMMERCE 3-0-2003.  
JILLIAN CANTOR, EXAMINING ATTORNEY

**CLASS 25—(Continued).**

SN 86-046,324. MICHAEL LLC, LOS ANGELES, CA. FILED 8-23-2013.

**BRITCHES GREAT OUTDOORS**

THE MARK CONSISTS OF STANDARD CHARACTERS WITHOUT CLAIM TO ANY PARTICULAR FONT, STYLE, SIZE, OR COLOR.

NO CLAIM IS MADE TO THE EXCLUSIVE RIGHT TO USE "BRITCHES", APART FROM THE MARK AS SHOWN.

FOR MEN'S AND WOMEN'S CLOTHING—NAMELY, JEANS AND SHORTS; TROUSERS; OVERALLS; DRESS, CASUAL AND KNIT SHIRTS; SPORT COATS AND BLAZERS; WOMEN'S DRESSES AND SKIRTS; SWEATSHIRTS AND SWEAT BANDS; REGULAR VESTS AND DOWN VESTS; DOWN HOODS; SWEATERS; GLOVES; BELTS; TIES; SUSPENDERS; SOCKS; ROBES; UNDERWEAR; NIGHTSHIRTS; SCARVES AND MUFFLERS; POCKET SQUARES; HATS; SWIMWEAR; OUTERWEAR JACKETS; SHOES, SLIPPERS AND DOWN BOOTIES (U.S. CLS. 22 AND 39).

FIRST USE 10-20-2001; IN COMMERCE 10-20-2001.  
KEVON CHISOLM, EXAMINING ATTORNEY

SN 86-046,607. SPIKER, INC., MIRAMAR BEACH, FL. FILED 8-23-2013.



NO CLAIM IS MADE TO THE EXCLUSIVE RIGHT TO USE "CLOTHING COMPANY", APART FROM THE MARK AS SHOWN.

THE COLOR(S) RED, GRAY, BLACK, AND WHITE IS/ ARE CLAIMED AS A FEATURE OF THE MARK.

THE MARK CONSISTS OF THE WORD "HIGHLY" IN A STYLIZED RED CURSIVE FONT. BELOW THE WORD "HIGHLY" IS A SET OF GRAY HANDCUFFS. UNDERNEATH THE HANDCUFFS THERE IS A RED BANNER WITH THE WORD "ILLEGAL" APPEARING IN WHITE BOLD FONT ACROSS THE BANNER. UNDERNEATH THE BANNER ARE THE WORDS "CLOTHING COMPANY" IN BLACK FONT.

FOR WEARABLE GARMENTS AND CLOTHING, NAMELY, SHIRTS (U.S. CLS. 22 AND 39).  
MIDGE BUTLER, EXAMINING ATTORNEY

**CLASS 25—(Continued).**

SN 86-047,030. TIM HOLMAN, OCEANSIDE, CA. FILED 8-23-2013.

**MAGIC PUTTER**

THE MARK CONSISTS OF STANDARD CHARACTERS WITHOUT CLAIM TO ANY PARTICULAR FONT, STYLE, SIZE, OR COLOR.

OWNER OF U.S. REG. NO. 4,211,257.  
FOR ATHLETIC APPAREL, NAMELY, SHIRTS, PANTS, JACKETS, FOOTWEAR, HATS AND CAPS, ATHLETIC UNIFORMS; COLLARED SHIRTS; EYE-SHADES; GLOVES AS CLOTHING; GOLF PANTS, SHIRTS AND SKIRTS; HEADBANDS FOR CLOTHING (U.S. CLS. 22 AND 39).

FIRST USE 1-1-2013; IN COMMERCE 1-1-2013.  
WILLIAM VERHOSEK, EXAMINING ATTORNEY

SN 86-047,555. MR. CAMPOUT, INC., LAS VEGAS, NV. FILED 8-26-2013.



NO CLAIM IS MADE TO THE EXCLUSIVE RIGHT TO USE "COWBOY BOOTS", APART FROM THE MARK AS SHOWN.

THE MARK CONSISTS OF A COWBOY SITTING ON A FEW LOGS, WEARING COWBOY BOOTS, SITTING AT A CAMPFIRE, WITH A COUPLE CACTI IN BACKGROUND, THEN MOUNTAINS IN THE BACK OF THAT, THEN A LARGE SETTING SUN IN THE BACK. THEN SURROUNDING THIS SCENE ARE THE WORDS, "MR CAMPOUT COWBOY BOOTS". THE WORDS "MR CAMPOUT" ARE ABOVE THE SCENE AND THE WORDS "COWBOY BOOTS" ARE BELOW THE SCENE. THE LOGO MAY BE VARIOUS SIZES.

FOR BOOTS (U.S. CLS. 22 AND 39).  
MIDGE BUTLER, EXAMINING ATTORNEY



**CLASS 25—(Continued).**

SN 86-047,902. BURGA, AMBER, RANCHO CUCAMONGA, CA. FILED 8-26-2013.

**SWEAT IS MY SPARKLE**

THE MARK CONSISTS OF STANDARD CHARACTERS WITHOUT CLAIM TO ANY PARTICULAR FONT, STYLE, SIZE, OR COLOR.

FOR CLOTHING, NAMELY, T-SHIRTS, SLEEVELESS T-SHIRTS, LONG SLEEVED T-SHIRTS, V-NECK T-SHIRTS, TANK TOPS, CAPRIS, FLEECE TOPS, FLEECE BOTTOMS, TOPS, SPORTS BRAS, TRACK JACKETS, SWEATSHIRTS, HOODED SWEATSHIRTS, PAJAMAS, YOGA PANTS, SWEATPANTS, SHORTS, TRACK PANTS, CAPS, HEADBANDS FOR CLOTHING, WRISTBANDS, SOCKS (U.S. CLS. 22 AND 39).

TRACY WHITTAKER-BROWN, EXAMINING ATTORNEY

**CLASS 25—(Continued).**

SN 86-048,510. PATEL, KAVIN, SCOTTSDALE, AZ. AND PATEL, DHARUV, SCOTTSDALE, AZ. FILED 8-26-2013.



THE MARK CONSISTS OF A STYLIZED CIRCLE ATOP A STYLIZED HALF-CIRCLE WITH A STYLIZED WEDGE PROTRUDING FROM THE RIGHT UPPER PORTION OF THE CIRCLE AND SIMILAR STYLIZED WEDGES PROTRUDING FROM EITHER SIDE OF THE INTERSECTION BETWEEN THE STYLIZED CIRCLE AND THE STYLIZED HALF-CIRCLE.

FOR SHORT-SLEEVED OR LONG-SLEEVED T-SHIRTS (U.S. CLS. 22 AND 39).

ELLEN B. AWRICH, EXAMINING ATTORNEY

SN 86-048,052. BEER SAVAGE LLC, COSTA MESA, CA. FILED 8-26-2013.

**BEER SAVAGE**

THE MARK CONSISTS OF STANDARD CHARACTERS WITHOUT CLAIM TO ANY PARTICULAR FONT, STYLE, SIZE, OR COLOR.

FOR T-SHIRTS, SWEAT SHIRTS, HATS (U.S. CLS. 22 AND 39).

FIRST USE 5-1-2012; IN COMMERCE 5-1-2012.  
AMY ALFIERI, EXAMINING ATTORNEY

SN 86-048,514. PATEL, KAVIN, SCOTTSDALE, AZ. AND PATEL, DHARUV, SCOTTSDALE, AZ. FILED 8-26-2013.



THE MARK CONSISTS OF A THICKLY OUTLINED CIRCLE INSIDE WHICH IS ATTACHED TO THE RIGHT-INNER-SIDE OF THE THICKLY OUTLINED CIRCLE A REVERSED, STYLIZED LETTER "C".

FOR SHORT-SLEEVED OR LONG-SLEEVED T-SHIRTS (U.S. CLS. 22 AND 39).

ELLEN B. AWRICH, EXAMINING ATTORNEY

**CLASS 25—(Continued).**

SN 86-049,685. SMITH, DANIEL A, MELBOURNE, FL. FILED 8-27-2013.

# SHE SUPS

THE MARK CONSISTS OF STANDARD CHARACTERS WITHOUT CLAIM TO ANY PARTICULAR FONT, STYLE, SIZE, OR COLOR.

FOR APPAREL FOR DANCERS, NAMELY, TEE SHIRTS, SWEATSHIRTS, PANTS, LEGGINGS, SHORTS AND JACKETS; ATHLETIC APPAREL, NAMELY, SHIRTS, PANTS, JACKETS, FOOTWEAR, HATS AND CAPS, ATHLETIC UNIFORMS (U.S. CLS. 22 AND 39).

FIRST USE 8-1-2013; IN COMMERCE 8-1-2013.  
WILLIAM VERHOSEK, EXAMINING ATTORNEY

SN 86-055,215. AMERICAN K-9 DETECTION SERVICES, LLC, LAKE MARY, FL. FILED 9-4-2013.

# AMK9

THE MARK CONSISTS OF STANDARD CHARACTERS WITHOUT CLAIM TO ANY PARTICULAR FONT, STYLE, SIZE, OR COLOR.

OWNER OF U.S. REG. NO. 3,625,574.  
FOR BASEBALL CAPS AND HATS; BUTTON DOWN SHIRTS; CARGO PANTS; COLLARED SHIRTS; DRESS SHIRTS; HATS; HEADGEAR, NAMELY, HATS; HOODED SWEAT SHIRTS; LONG-SLEEVED SHIRTS; PANTS; POLO SHIRTS; SHIRTS; SHIRTS AND SHORT-SLEEVED SHIRTS; SHORT-SLEEVED OR LONG-SLEEVED T-SHIRTS; SHORT-SLEEVED SHIRTS; SPORTS CAPS AND HATS; SWEAT SHIRTS; T-SHIRTS; T-SHIRTS FOR MEN AND WOMEN; TEE SHIRTS; WEARABLE GARMENTS AND CLOTHING, NAMELY, SHIRTS (U.S. CLS. 22 AND 39).

TARAH HARDY, EXAMINING ATTORNEY

SN 86-055,419. QUE DEVELOPMENT & DESIGN, LLC, BEVERLY HILLS, CA. FILED 9-4-2013.



MaurKnits  
Bespoke - By Hand

NO CLAIM IS MADE TO THE EXCLUSIVE RIGHT TO USE "BESPOKE" AND "BY HAND", APART FROM THE MARK AS SHOWN.

THE MARK CONSISTS OF THE WORD "MAURKNITS"

**CLASS 25—(Continued).**

IN STYLIZED LETTERS WITH A CAPITAL "M" AND LOWERCASE "AUR", WITH A CAPITAL "K" AND THE LOWERCASE LETTERS "NITS", WITH THE WORD "BESPOKE" HAVING THE FIRST LETTER "B" CAPITALIZED AND WITH A HYPHEN AFTER THE WORD "BESPOKE" AND THE WORDS "BY HAND" AFTER THE HYPHEN WHERE THE "B" IN "BY" IS CAPITALIZED AND THE "H" IN "HAND" IS CAPITALIZED. A BUTTERFLY SET WITHIN A DASHED RECTANGLE IS SET TO THE LEFT OF THE WORDS.

FOR COWLS, SWEATERS, SCARVES, SHAWLS, NECK WARMERS IN THE NATURE OF SCARVES, AND HAND WARMERS IN THE NATURE OF GLOVES, EAR WARMERS, HATS, SKIRTS, BOOTIES, GLOVES, MITTENS, WRIST BANDS IN THE NATURE OF CLOTHING, COATS, JACKETS, SWEATER COATS, POLO SWEATERS, CARDIGANS, BELTS, VESTS, BODY SHAWLS, SOCKS, KNEE HIGH SOCKS, CAPELETS, LEG WARMERS, CAPES, VESTS, TUNICS, KNIT DRESSES, PULL-OVERS, CARDIGANS, SHRUGS, MUFFS, MUFFLERS, WRAPS (U.S. CLS. 22 AND 39).

ADA HAN, EXAMINING ATTORNEY

SN 86-056,066. GURLEY, MORTON ADAM, AKA ADAM, AUBURN, AL. FILED 9-4-2013.



NO CLAIM IS MADE TO THE EXCLUSIVE RIGHT TO USE THE OUTLINE OF THE STATES OF MISSISSIPPI, ALABAMA AND GEORGIA, APART FROM THE MARK AS SHOWN.

THE MARK CONSISTS OF THE THREE STATES MISSISSIPPI, ALABAMA, AND GEORGIA, IN THAT ORDER. EACH STATE HAS ONE OR MORE RIVERS RUNNING HORIZONTALLY ACROSS THE MIDDLE OF IT GIVING THE STATE A DISTINCT CHARACTERISTIC. THE RIVERS ON THE STATE OF MISSISSIPPI TRANSFORM THE STATE TO APPEAR LIKE AN S, AND THE RIVERS ON BOTH ALABAMA AND GEORGIA MAKE THE STATES APPEAR TO CONFORM INTO THE LETTER C.

FOR COLLARED SHIRTS; HATS; LONG-SLEEVED SHIRTS; OPEN-NECKED SHIRTS; PANTS; SHIRTS; SHORT-SLEEVED OR LONG-SLEEVED T-SHIRTS; SHORT-SLEEVED SHIRTS; T-SHIRTS (U.S. CLS. 22 AND 39).

FIRST USE 9-3-2013, THE MARK WAS FIRST USED ANYWHERE IN A DIFFERENT FORM OTHER THAN THAT SOUGHT TO BE REGISTERED AT LEAST AS EARLY AS 08/31/2013; IN COMMERCE 9-3-2013, THE MARK WAS FIRST USED IN COMMERCE IN A DIFFERENT FORM OTHER THAN THAT SOUGHT TO BE REGISTERED AT LEAST AS EARLY AS 08/31/2013.

JEFFREY LOOK, EXAMINING ATTORNEY

**CLASS 25—(Continued).**

SN 86-059,857. C. CONSULTING, ALLENTOWN, PA. FILED 9-9-2013.

**BRICK CITY CLOTHING BC**

THE MARK CONSISTS OF STANDARD CHARACTERS WITHOUT CLAIM TO ANY PARTICULAR FONT, STYLE, SIZE, OR COLOR.

NO CLAIM IS MADE TO THE EXCLUSIVE RIGHT TO USE "CLOTHING", APART FROM THE MARK AS SHOWN. FOR WEARABLE GARMENTS AND CLOTHING, NAMELY, SHIRTS (U.S. CLS. 22 AND 39).  
JENNIFER DIXON, EXAMINING ATTORNEY

SN 86-059,924. BURGA, AMBER, RANCHO CUCAMONGA, CA. FILED 9-10-2013.

**FITNESS FLAUNT WEAR**

THE MARK CONSISTS OF STANDARD CHARACTERS WITHOUT CLAIM TO ANY PARTICULAR FONT, STYLE, SIZE, OR COLOR.

NO CLAIM IS MADE TO THE EXCLUSIVE RIGHT TO USE "FITNESS" AND "WEAR", APART FROM THE MARK AS SHOWN.

FOR CLOTHING, NAMELY, T-SHIRTS, SLEEVELESS T-SHIRTS, LONG SLEEVED T-SHIRTS, V-NECK T-SHIRTS, TANK TOPS, CAPRIS, FLEECE TOPS, FLEECE BOTTOMS, TOPS, SPORTS BRAS, TRACK JACKETS, SWEATSHIRTS, HOODED SWEATSHIRTS, PAJAMAS, YOGA PANTS, SWEATPANTS, SHORTS, TRACK PANTS, CAPS, HEADBANDS FOR CLOTHING, WRISTBANDS, SOCKS (U.S. CLS. 22 AND 39).

TRACY WHITTAKER-BROWN, EXAMINING ATTORNEY

SN 86-060,408. KOMAR LAYERING, LLC, NEW YORK, NY. FILED 9-10-2013.

**SLEEP ESSENTIALS**

THE MARK CONSISTS OF STANDARD CHARACTERS WITHOUT CLAIM TO ANY PARTICULAR FONT, STYLE, SIZE, OR COLOR.

NO CLAIM IS MADE TO THE EXCLUSIVE RIGHT TO USE "SLEEP", APART FROM THE MARK AS SHOWN.

FOR BOTTOMS; FOOTWEAR; HEADWEAR; LINGERIE; PAJAMAS; SLEEPWEAR; SLIPPER SOCKS; SLIPPERS; TOPS; UNDERWEAR; WEARABLE BLANKETS IN THE NATURE OF BLANKETS WITH SLEEVES (U.S. CLS. 22 AND 39).

AMY ALFIERI, EXAMINING ATTORNEY

**CLASS 25—(Continued).**

SN 86-060,586. TEXAS A&M UNIVERSITY, COLLEGE STATION, TX. FILED 9-10-2013.



OWNER OF U.S. REG. NOS. 1,865,734, 1,980,475 AND OTHERS.

THE MARK CONSISTS OF "A&M" IN STYLIZED FONT. FOR BASEBALL CAPS AND HATS; BUTTON DOWN SHIRTS; POLO SHIRTS; SHIRTS; SWEATERS (U.S. CLS. 22 AND 39).

FIRST USE 8-17-1996; IN COMMERCE 8-17-1996.

KAELIE KUNG, EXAMINING ATTORNEY

SN 86-060,687. MCDANIELS, DARRYL, JAMAICA, NY. AND BLAMOVILLE, ERIK, JAMAICA, NY. FILED 9-10-2013.



THE COLOR(S) RED AND BLACK IS/ARE CLAIMED AS A FEATURE OF THE MARK.

THE MARK CONSISTS OF THE STYLIZED RED WORD "MUSIC", ABOVE THE STYLIZED BLACK WORDING "SUCCEEDS WHERE RELIGION & POLITICS" FAIL - DMC.

FOR HATS; HOODED SWEATSHIRTS; SWEAT PANTS; SWEATSHIRTS; T-SHIRTS; TANK TOPS (U.S. CLS. 22 AND 39).

SUSAN RICHARDS, EXAMINING ATTORNEY

SN 86-061,131. BENJAMINS SHOE CORPORATION, SAN FRANCISCO, CA. FILED 9-10-2013.

**BENJAMINS**

THE MARK CONSISTS OF STANDARD CHARACTERS WITHOUT CLAIM TO ANY PARTICULAR FONT, STYLE, SIZE, OR COLOR.

FOR BOAT SHOES; CANVAS SHOES; DECK-SHOES; LEATHER SHOES; LEISURE SHOES; SHOES; TENNIS SHOES; WATERPROOF LEATHER SHOES (U.S. CLS. 22 AND 39).

AMY ALFIERI, EXAMINING ATTORNEY

**CLASS 25—(Continued).**

SN 86-062,386. GUSTAVUS, EVERALD, JAMAICA, NY. FILED 9-12-2013.

OUT OF ONE

THE MARK CONSISTS OF STANDARD CHARACTERS WITHOUT CLAIM TO ANY PARTICULAR FONT, STYLE, SIZE, OR COLOR.

FOR CLOTHING NAMELY T-SHIRTS, SHIRTS, TOPS, SWEATERS, SWEATSHIRTS, HOODED SWEATSHIRTS; COATS, JERSEYS, JACKETS; BOTTOMS, PANTS, TROUSERS, JEANS, SHORTS, SWEATPANTS, PAJAMAS; DRESSES; SKIRTS; BLOUSES; UNDERWEAR; SWIMWEAR; HEADWEAR; FOOTWEAR (U.S. CLS. 22 AND 39).

SUSAN RICHARDS, EXAMINING ATTORNEY

SN 86-062,728. POINT6, LLC, STEAMBOAT SPRINGS, CO. FILED 9-12-2013.

point6

THE MARK CONSISTS OF STANDARD CHARACTERS WITHOUT CLAIM TO ANY PARTICULAR FONT, STYLE, SIZE, OR COLOR.

OWNER OF U.S. REG. NO. 3,895,545.  
FOR CLOTHING COMPRISED OF AT LEAST 30% WOOL BY COMPOSITION, NAMELY, SHIRTS, PANTS, T-SHIRTS, SHORTS, SWEATERS, SWEATSHIRTS, UNDERGARMENTS, UNDERSHIRTS, THERMAL UNDERWEAR, NECK GAITERS, HEADWEAR, BEANIES, CAPS, BASEBALL CAPS, SKI HATS, GLOVES, SCARVES, ATHLETIC SHIRTS, ATHLETIC PANTS, ATHLETIC SHORTS, JOGGING SUITS, SWEAT SUITS, AND FOOTWEAR, NOT MARKETED THROUGH MASS MERCHANDISERS EXCEPT THROUGH SPECIALTY SECTIONS OR BOUTIQUES DEDICATED TO SPECIFIC BRANDS OR TO ACTIVE OUTDOOR WEAR AND LOCATED WITHIN A MASS MERCHANDISER STORE (U.S. CLS. 22 AND 39).  
JACLYN KIDWELL WALKER, EXAMINING ATTORNEY

**CLASS 25—(Continued).**

SN 86-062,822. POINT6, LLC, STEAMBOAT SPRINGS, CO. FILED 9-12-2013.



OWNER OF U.S. REG. NO. 3,486,094.  
THE MARK CONSISTS OF A LOGO INCORPORATING A STYLIZED NUMBER SIX.

FOR CLOTHING, NAMELY, SHIRTS, PANTS, T-SHIRTS, SHORTS, SWEATERS, SWEATSHIRTS, UNDERGARMENTS, UNDERSHIRTS, THERMAL UNDERWEAR, NECK GAITERS, HEADWEAR, BEANIES, CAPS, BASEBALL CAPS, SKI HATS, GLOVES, SCARVES, SOCKS, ATHLETIC SHIRTS, ATHLETIC PANTS, ATHLETIC SHORTS, JOGGING SUITS, SWEAT SUITS, AND FOOTWEAR (U.S. CLS. 22 AND 39).  
JACLYN KIDWELL WALKER, EXAMINING ATTORNEY

SN 86-062,828. KRAMER, DIRK, CROSBY, TX. FILED 9-12-2013.

Don't Drone Me Bro

THE MARK CONSISTS OF STANDARD CHARACTERS WITHOUT CLAIM TO ANY PARTICULAR FONT, STYLE, SIZE, OR COLOR.

FOR HATS; T-SHIRTS (U.S. CLS. 22 AND 39).  
JACLYN KIDWELL WALKER, EXAMINING ATTORNEY

**CLASS 25—(Continued).**

SN 86-063,264. MARR, TRAVIS, CARLSBAD, CA. FILED 9-12-2013.



THE MARK CONSISTS OF A STYLIZED UPPERCASE LETTER "A" WITH A SLIGHTLY ROTATED NUMBER TWO CONJOINED ON THE LOWER RIGHT LEG OF THE "A".

FOR CLOTHING, NAMELY, HATS, JACKETS, SHIRTS, SWEATERS, SCARVES, BEANIES, PANTS, SOCKS, GLOVES, BOOTS, SHOES, THERMALS, WATER SHORTS, AND HEADBANDS (U.S. CLS. 22 AND 39).

LANA PHAM, EXAMINING ATTORNEY

---

SN 86-063,483. CEDAR TECHNOLOGIES INTERNATIONAL, LTD., CENTRAL CITY, HONG KONG, FILED 9-12-2013.

# AERSOOTHE

THE MARK CONSISTS OF STANDARD CHARACTERS WITHOUT CLAIM TO ANY PARTICULAR FONT, STYLE, SIZE, OR COLOR.

FOR ATHLETIC FOOTWEAR; BEACH FOOTWEAR; CLIMBING FOOTWEAR; FOOTWEAR; FOOTWEAR FOR MEN; FOOTWEAR FOR MEN AND WOMEN; FOOTWEAR FOR TRACK AND FIELD ATHLETICS; FOOTWEAR FOR WOMEN; FOOTWEAR MADE OF WOOD; FOOTWEAR NOT FOR SPORTS; FOOTWEAR, NAMELY, PUMPS; FOOTWEAR, NAMELY, RUBBERS; FOOTWEAR, NAMELY, WORK BOOTS; INSOLES FOR FOOTWEAR; JAPANESE FOOTWEAR OF RICE STRAW (WARAJI); JAPANESE SPLIT-TOED WORK FOOTWEAR (JIKATABI); NON-SLIP SOLES FOR FOOTWEAR; NON-SLIP SOLES FOR FOOTWEAR, NAMELY, FOR PUMPS; SCIENTIFIC AND TECHNOLOGICAL APPAREL, NAMELY, SHIRTS, PANTS, JACKETS, FOOTWEAR, HATS AND CAPS, UNIFORMS; SOLES FOR FOOTWEAR THONGS; TIPS FOR FOOTWEAR; VISCOUS GEL POLYMER SOLD AS A COMPONENT OF FINISHED CUSTOM CUSHIONED FOOTWEAR FOR NON-ORTHOPEDIC PURPOSES AND APPAREL; WATER REPELLING FOOTWEAR; WATERPROOF FOOTWEAR; WOODEN SHOES (U.S. CLS. 22 AND 39).

PAUL E. FAHRENKOPF, EXAMINING ATTORNEY

**CLASS 25—(Continued).**

SN 86-063,633. ROBERTS, KENNETH, BAYONNE, NJ. FILED 9-13-2013.



THE MARK CONSISTS OF A DESIGN OF A HERALDIC-STYLE CREST WITH A KNIGHT'S HELMET ON TOP AND A FLOWING MANTLE (ROBE) ENCOMPASSING THE TOP AND SIDES OF THE SHIELD. THE SHIELD ITSELF HAS 3 VISIBLE QUADRANTS. IN THE UPPER QUADRANT IS A TAU CROSS. IN THE RIGHT/LOWER QUADRANT IS A SKELETON KEY AND A SIX POINTED STAR. IN THE LEFT QUADRANT IS THE HEAD OF A FIRE BREATHING WOLF. BENEATH THE SHIELD IS A BANNER WITH THE STYLIZED TEXT "VITA SECRETUM" WITHIN THE BANNER.

THE ENGLISH TRANSLATION OF VITA SECRETUM IN THE MARK IS SECRET LIFE.

FOR HATS; PANTS; SWEATSHIRTS; T-SHIRTS (U.S. CLS. 22 AND 39).

ELIZABETH CHANG, EXAMINING ATTORNEY

---

SN 86-063,802. JANSEN, KEVIN, LOMITA, CA. FILED 9-13-2013.



THE MARK CONSISTS OF A HAND DRAWN ANCHOR WITH THE WORD "SUNK" UNDERNEATH IT IN THE SAME HAND DRAWN STYLE.

FOR BEANIES; HATS; SWEATSHIRTS; T-SHIRTS (U.S. CLS. 22 AND 39).

KEVIN MITTLER, EXAMINING ATTORNEY

**CLASS 25—(Continued).**

SN 86-064,099. CHEMOUL PATRICK, LOS ANGELES, CA.  
FILED 9-13-2013.

## SWEET SCIENCE

THE MARK CONSISTS OF STANDARD CHARACTERS WITHOUT CLAIM TO ANY PARTICULAR FONT, STYLE, SIZE, OR COLOR.

FOR MEN'S AND WOMEN'S DENIM JEANS, SHIRTS, JACKETS, T-SHIRTS, SKIRTS, SWEATS, TANK TOP, SWEATERS (U.S. CLS. 22 AND 39).

FIRST USE 1-1-2013; IN COMMERCE 1-1-2013.  
SUI DUONG, EXAMINING ATTORNEY

SN 86-064,261. HOOPER, CHERYL, SAMMAMISH, WA.  
FILED 9-13-2013.

## Field 11

THE MARK CONSISTS OF STANDARD CHARACTERS WITHOUT CLAIM TO ANY PARTICULAR FONT, STYLE, SIZE, OR COLOR.

FOR HATS; SHIRTS; SWEATSHIRTS; T-SHIRTS (U.S. CLS. 22 AND 39).

FIRST USE 8-9-2013; IN COMMERCE 8-9-2013.  
CURTIS FRENCH, EXAMINING ATTORNEY

SN 86-064,274. KENDALL JUDD, NEW YORK, NY. FILED 9-13-2013.

## Over Here Hustling. Ohh!!!

THE MARK CONSISTS OF STANDARD CHARACTERS WITHOUT CLAIM TO ANY PARTICULAR FONT, STYLE, SIZE, OR COLOR.

FOR HATS; HOODED SWEATSHIRTS; JACKETS; PANTS; SHOES; SHORT-SLEEVED OR LONG-SLEEVED T-SHIRTS; SHORTS; SWEATERS; SWEATSHIRTS; T-SHIRTS; TANK TOPS (U.S. CLS. 22 AND 39).

APRIL REEVES, EXAMINING ATTORNEY

**CLASS 25—(Continued).**

SN 86-064,604. TRUE VICTORY, LLC, INDIAN ROCKS BEACH, FL. FILED 9-13-2013.



THE MARK CONSISTS OF FOUR OBJECTS, TWO TRAPEZOIDAL AND TWO TRIANGULAR, ARRANGED TO PRESENT AN OUTLINE OF A CROSS IN THE BACKGROUND IMAGE. THE TRAPEZOIDAL AND TRIANGULAR BLOCKS ARE ARRANGED TO PRESENT A V SHAPE TO PROVIDE THE IMPRESSION OF A CROSS BISECTING THE V.

FOR ATHLETIC APPAREL, NAMELY, SHIRTS, PANTS, JACKETS, FOOTWEAR, HATS AND CAPS, ATHLETIC UNIFORMS; WEARABLE GARMENTS AND CLOTHING, NAMELY, SHIRTS (U.S. CLS. 22 AND 39).

FIRST USE 8-1-2012; IN COMMERCE 8-1-2012.  
MARY ROSSMAN, EXAMINING ATTORNEY

SN 86-064,704. TURN ON PRODUCTS INC., NEW YORK, NY. FILED 9-13-2013.

## ALMOST FAMOUS DREAM

THE MARK CONSISTS OF STANDARD CHARACTERS WITHOUT CLAIM TO ANY PARTICULAR FONT, STYLE, SIZE, OR COLOR.

FOR CLOTHING, NAMELY, LADIES' AND GIRLS' SLACKS, PANTS, TANK TOPS, SHORTS, VESTS, JACKETS, BLAZERS, BLOUSES, T-SHIRTS, DRESSES, SKIRTS AND COATS (U.S. CLS. 22 AND 39).

FIRST USE 7-19-2013; IN COMMERCE 7-19-2013.

MARGERY A. TIERNEY, EXAMINING ATTORNEY

**CLASS 25—(Continued).**

SN 86-064,894. SAMANTHA P. GARCIA, DBA LOVE LYRICS, HUNTINGTON BEACH, CA. FILED 9-14-2013.

# LOVE LYRICS

THE MARK CONSISTS OF STANDARD CHARACTERS WITHOUT CLAIM TO ANY PARTICULAR FONT, STYLE, SIZE, OR COLOR.

FOR CLOTHING AND HEADWEAR, NAMELY T-SHIRTS, SHORTS, SWEAT SHIRTS, SWIMWEAR, JACKETS, BELTS, SUITS, JEANS, SLACKS, WOVEN SHIRTS, DRESS SHIRTS, TANK TOPS, SOCKS, SWEATERS, HATS, BEANIES, CAPS, FOOTWEAR (U.S. CLS. 22 AND 39).

TAMARA FRAZIER, EXAMINING ATTORNEY

---

SN 86-064,981. MAZARIEGOS, LUIS A, PEMBROKE PINES, FL. FILED 9-15-2013.

# iDance

THE MARK CONSISTS OF STANDARD CHARACTERS WITHOUT CLAIM TO ANY PARTICULAR FONT, STYLE, SIZE, OR COLOR.

FOR ADULT NOVELTY GAG CLOTHING ITEM, NAMELY, SOCKS; BELTS FOR CLOTHING; BOTTOMS; CLOTHING, NAMELY, ATHLETIC SLEEVES; GLOVES AS CLOTHING; HEAD WRAPS; HEADBANDS FOR CLOTHING; HOODS; INFANT AND TODDLER ONE PIECE CLOTHING; JACKETS; JERSEYS; NON-DISPOSABLE CLOTH TRAINING PANTS; PARTS OF CLOTHING, NAMELY, GUSSETS FOR TIGHTS, GUSSETS FOR STOCKINGS, GUSSETS FOR BATHING SUITS, GUSSETS FOR UNDERWEAR, GUSSETS FOR LEOTARDS AND GUSSETS FOR FOOTLETS; SHORT SETS; TOPS; TRAVEL CLOTHING CONTAINED IN A PACKAGE COMPRISING REVERSIBLE JACKETS, PANTS, SKIRTS, TOPS AND A BELT OR SCARF; WEARABLE GARMENTS AND CLOTHING, NAMELY, SHIRTS; WOMEN'S CLOTHING, NAMELY, SHIRTS, DRESSES, SKIRTS, BLOUSES; WRIST BANDS (U.S. CLS. 22 AND 39).

MEREDITH MARESCA, EXAMINING ATTORNEY

**CLASS 25—(Continued).**

SN 86-065,120. BALEAF (XIAMEN) INVESTMENT GROUP CO., LTD, SIMING DIST, XIAMEN, CHINA, FILED 9-16-2013.



THE MARK CONSISTS OF THE WORD "BALEAF" ON THE LEFT AND A LEAF DESIGN ON THE RIGHT.

THE WORDING BALEAF HAS NO MEANING IN A FOREIGN LANGUAGE.

FOR BATHING SUITS; FOOTWEAR; GIRDLES; GLOVES; HEADGEAR, NAMELY, HATS, CAPS; HOSIERY; JACKETS; LAYETTES; MASQUERADE COSTUMES; SCARVES; WATERPROOF JACKETS AND PANTS (U.S. CLS. 22 AND 39).

GILBERT SWIFT, EXAMINING ATTORNEY

---

SN 86-065,141. SILENCE, ERIN MICHELLE, RHODES, IA, FILED 9-16-2013.

# Silence U

THE MARK CONSISTS OF STANDARD CHARACTERS WITHOUT CLAIM TO ANY PARTICULAR FONT, STYLE, SIZE, OR COLOR.

FOR BASEBALL CAPS AND HATS; HOODED SWEATSHIRTS FOR MEN, WOMEN, CHILDREN; SWEATPANTS; T-SHIRTS (U.S. CLS. 22 AND 39).

HOWARD B. LEVINE, EXAMINING ATTORNEY

**CLASS 25—(Continued).**

SN 86-065,175. AUTEUR BY GUIDARA, LAS VEGAS, NV. FILED 9-16-2013.



THE MARK CONSISTS OF A COMBINATION OF STYLIZED LETTERS "B" "A" AND "G." "B" IS THE LEFT SIDE OF THE MARK, "A" IS IN THE MIDDLE OF THE MARK, AND "G" IS THE RIGHT SIDE OF THE MARK.

FOR BELTS; CAFTANS; CAPES; COATS; DRESSES; EVENING GOWNS; GOWNS; HATS; JACKETS; JEANS; LINGERIE; PAJAMAS; PANTS; ROBES; SCARVES; SHIRTS; SHOES; SHORTS; SKIRTS; SLIPS; SOCKS; SUITS; SWEATERS; SWIMWEAR; TIES; TUXEDOS; VESTS (U.S. CLS. 22 AND 39).

KYLE PEETE, EXAMINING ATTORNEY

SN 86-065,232. MERRICKS, MATTHEW, OXNARD, CA. AND MERRICKS, JOHANNA, OXNARD, CA. FILED 9-16-2013.

## Lord's Armor

THE MARK CONSISTS OF STANDARD CHARACTERS WITHOUT CLAIM TO ANY PARTICULAR FONT, STYLE, SIZE, OR COLOR.

FOR JACKETS; SHIRTS AND SHORT-SLEEVED SHIRTS; SHORTS; SOCKS; SPORT STOCKINGS; SPORTS CAPS AND HATS; SPORTS JACKETS; SPORTS JERSEYS; SPORTS OVER UNIFORMS; SPORTS SHIRTS WITH SHORT SLEEVES; SWEAT PANTS; T-SHIRTS; UNDERGARMENTS (U.S. CLS. 22 AND 39).

SHAILA LEWIS, EXAMINING ATTORNEY

**CLASS 25—(Continued).**

SN 86-065,265. RHEMEDIA, LLC, ATLANTA, GA. FILED 9-16-2013.

## BELIEVE IN THE SEED

THE MARK CONSISTS OF STANDARD CHARACTERS WITHOUT CLAIM TO ANY PARTICULAR FONT, STYLE, SIZE, OR COLOR.

FOR HENLEY SHIRTS, POLO SHIRTS, T-SHIRTS, SWEATSHIRTS, DENIM SHIRTS, JACKETS, BASEBALL CAPS, GOLF CAPS, PRINTED T-SHIRTS, SUMMER CAPS, OXFORD MEN AND LADIES DRESS SHIRTS (U.S. CLS. 22 AND 39).

EUGENIA MARTIN, EXAMINING ATTORNEY

SN 86-065,604. SHREDDED CULTURE, LLC., PIPERSVILLE, PA. FILED 9-16-2013.



THE MARK CONSISTS OF STYLIZED LETTER "S" LOGO MARK WITH THE STYLIZED TEXT "SHREDDED CULTURE" TO THE RIGHT.

FOR HATS; SWEATSHIRTS; T-SHIRTS; TANK TOPS (U.S. CLS. 22 AND 39).

HOWARD B. LEVINE, EXAMINING ATTORNEY

SN 86-065,663. STEVEN A. SELLERS, BOCA RATON, FL. FILED 9-16-2013.

## OCEAN STALKER

THE MARK CONSISTS OF STANDARD CHARACTERS WITHOUT CLAIM TO ANY PARTICULAR FONT, STYLE, SIZE, OR COLOR.

FOR HATS; SHIRTS; T-SHIRTS (U.S. CLS. 22 AND 39).

RUDY R. SINGLETON, EXAMINING ATTORNEY



**CLASS 25—(Continued).**

SN 86-065,666. OCCEAN, BILLY, BOYNTON BEACH, FL. AND OCCEAN, JIMMY, BOYNTON BEACH, FL. AND ANDRE, MATTHEW, BOYNTON BEACH, FL. AND TERMILLEN, ANICE, BOYNTON BEACH, FL. FILED 9-16-2013.

**FLY PERCEPTION**

THE MARK CONSISTS OF STANDARD CHARACTERS WITHOUT CLAIM TO ANY PARTICULAR FONT, STYLE, SIZE, OR COLOR.

FOR BEANIES; BELTS; CREW NECKS; HATS; JACKETS; PANTS; SHOES; T-SHIRTS (U.S. CLS. 22 AND 39).  
RUDY R. SINGLETON, EXAMINING ATTORNEY

SN 86-065,767. HOMETOWN SOLE INC., DBA RUN COLORADO, GREENWOOD VILLAGE, CO. FILED 9-16-2013.

**Run Texas**

THE MARK CONSISTS OF STANDARD CHARACTERS WITHOUT CLAIM TO ANY PARTICULAR FONT, STYLE, SIZE, OR COLOR.

NO CLAIM IS MADE TO THE EXCLUSIVE RIGHT TO USE "TEXAS", APART FROM THE MARK AS SHOWN.

FOR ATHLETIC APPAREL, NAMELY, SHIRTS, PANTS, JACKETS, FOOTWEAR, HATS AND CAPS, ATHLETIC UNIFORMS; ATHLETIC SHIRTS (U.S. CLS. 22 AND 39).

FIRST USE 9-4-2013; IN COMMERCE 9-4-2013.

WANDA KAY PRICE, EXAMINING ATTORNEY

SN 86-065,954. SCHWARZ, BRAD, CLEVELAND, OH. FILED 9-16-2013.

**Late Bloomers Brewing**

THE MARK CONSISTS OF STANDARD CHARACTERS WITHOUT CLAIM TO ANY PARTICULAR FONT, STYLE, SIZE, OR COLOR.

FOR HATS; HOODED SWEATSHIRTS; T-SHIRTS (U.S. CLS. 22 AND 39).

SHAUNIA CARLYLE, EXAMINING ATTORNEY

**CLASS 25—(Continued).**

SN 86-065,969. GALVIS, GEORGE, HIALEAH, FL. FILED 9-16-2013.

**CYRENEUS**

THE MARK CONSISTS OF STANDARD CHARACTERS WITHOUT CLAIM TO ANY PARTICULAR FONT, STYLE, SIZE, OR COLOR.

FOR POLO SHIRTS; T-SHIRTS (U.S. CLS. 22 AND 39).  
JENNIFER BUTTON, EXAMINING ATTORNEY

SN 86-066,163. MOONEY, BRIAN, ABINGDON, MD. FILED 9-16-2013.



THE MARK CONSISTS OF THE WORD "HELP" IN CAPITAL LETTERS; BENEATH THE WORD "HELP", THE ACRONYM "HUMANITY'S EIGHTH LARGEST POPULATION" APPEARS (CENTERED) IN A GLOWING ELLIPSIS; BENEATH THE ACRONYM, THE WORD "ORPHANS" APPEARS (CENTERED); THE FONT FOR THE WORD "ORPHANS" IS DISTRESSED IN APPEARANCE.

FOR T-SHIRTS (U.S. CLS. 22 AND 39).

MARILYN IZZI, EXAMINING ATTORNEY

SN 86-066,184. LIN, WEIJIE, ROSEMEAD, CA. FILED 9-16-2013.



THE MARK CONSISTS OF A STYLIZED DESIGN OF "W".  
FOR BOOTS; BRAS; INFANTS' SHOES AND BOOTS; LADIES' BOOTS; LEISURE SHOES; LONG UNDERWEAR; MEN'S SOCKS; MEN'S UNDERWEAR; PAJAMAS; SHOES; SOCKS; SOCKS AND STOCKINGS; SPORTS SHOES; STRAPLESS BRAS; UNDERWEAR; WOMEN'S SHOES; WOMEN'S UNDERWEAR; WOVEN OR KNITTED UNDERWEAR (U.S. CLS. 22 AND 39).

FIRST USE 5-2-2013; IN COMMERCE 5-15-2013.

GEORGE LORENZO, EXAMINING ATTORNEY

**CLASS 25—(Continued).**

SN 86-066,251. BLUESEVENTY USA LLC, SEATTLE, WA.  
FILED 9-16-2013.



OWNER OF U.S. REG. NO. 3,286,912.  
THE MARK CONSISTS OF THREE WAVE OR SWIRL  
DESIGNS INTERCONNECTED INTO AN OVAL SHAPE.  
FOR ATHLETIC PANTS; ATHLETIC SHIRTS; ATH-  
LETIC SHORTS; ATHLETIC TIGHTS; BATHING CAPS;  
BOTTOMS; CYCLING SHORTS; RUNNING SUITS;  
SHORTS; SINGLET; SWIM CAPS; SWIM SUITS; SWIM  
TRUNKS; SWIM WEAR; SWIM WEAR FOR GENTLE-  
MEN AND LADIES; SWIMMING CAPS; SWIMMING  
COSTUMES; SWIMMING TRUNKS; TOPS; TRIATHLON  
CLOTHING, NAMELY, TRIATHLON TIGHTS, TRIATH-  
LON SHORTS, TRIATHLON SINGLET, TRIATHLON  
SHIRTS, TRIATHLON SUITS; WET SUIT GLOVES; WET-  
SUITS (U.S. CLS. 22 AND 39).  
FIRST USE 9-15-2005; IN COMMERCE 9-15-2005.  
COLLEEN DOMBROW, EXAMINING ATTORNEY

SN 86-066,358. YU, ZANG, HANGZHOU, CHINA, FILED 9-  
17-2013.

**SEXYINLIFE**

THE MARK CONSISTS OF STANDARD CHARACTERS  
WITHOUT CLAIM TO ANY PARTICULAR FONT, STYLE,  
SIZE, OR COLOR.  
FOR ADULT EROTIC LINGERIE NAMELY, BRAS,  
PANTIES, STOCKINGS, GARTERS, GARTER SKIRTS,  
NEGLIGEEES; FANTASY COSTUMES FOR ROLE-PLAY-  
ING AND COMPONENTS THEREOF NAMELY  
DRESSES, KIMONOS, SKIRTS, MINISKIRTS, JUMPERS,  
APRONS, BODY SUITS, VESTS, T-SHIRTS, BLOUSES,  
TOPS, SHORTS, COATS, CAPES, HATS, HEADBANDS,  
BELTS, AND SWIMSUITS (U.S. CLS. 22 AND 39).  
NORA BUCHANAN WILL, EXAMINING ATTORNEY

**CLASS 25—(Continued).**

SN 86-066,381. ANDY MAPPLE, WINTER GARDEN, FL.  
FILED 9-17-2013.



THE MARK CONSISTS OF ZIG ZAG LINES.  
FOR CLOTHING, NAMELY, T-SHIRTS, SWEAT-  
SHIRTS, JACKETS, HATS, WATERSKI BOOTS, BATH-  
ING SUITS, WETSUITS, BOARD SHORTS, GOLF SHIRTS  
(U.S. CLS. 22 AND 39).  
FIRST USE 9-30-2003; IN COMMERCE 9-30-2003.  
LINDA POWELL, EXAMINING ATTORNEY

SN 86-066,438. SMALLGROWNUP, HOLLYWOOD, FL.  
FILED 9-17-2013.

**SMallGROWNup**

THE MARK CONSISTS OF STANDARD CHARACTERS  
WITHOUT CLAIM TO ANY PARTICULAR FONT, STYLE,  
SIZE, OR COLOR.  
FOR HATS; ONE-PIECE GARMENTS FOR CHIL-  
DREN; SHIRTS (U.S. CLS. 22 AND 39).  
KEVIN CORWIN, EXAMINING ATTORNEY

SN 86-066,446. MORTON, KWABENE, MOUNT JULIET, TN,  
AND MCELORY, ANTHONY, MOUNT JULIET, TN.  
FILED 9-17-2013.

**BOOM! Because of Others  
Outside of Myself!**

THE MARK CONSISTS OF STANDARD CHARACTERS  
WITHOUT CLAIM TO ANY PARTICULAR FONT, STYLE,  
SIZE, OR COLOR.  
FOR HEADBANDS; SWEATSHIRTS; T-SHIRTS;  
WRISTBANDS (U.S. CLS. 22 AND 39).  
ZACHARY BELLO, EXAMINING ATTORNEY

**CLASS 25—(Continued).**

SN 86-066,459. STRETCH-O-RAMA, INC., NEW YORK, NY. FILED 9-17-2013.

**ROBERTO CAVALERI**

THE MARK CONSISTS OF STANDARD CHARACTERS WITHOUT CLAIM TO ANY PARTICULAR FONT, STYLE, SIZE, OR COLOR.

THE NAME(S), PORTRAIT(S), AND/OR SIGNATURE(S) SHOWN IN THE MARK DOES NOT IDENTIFY A PARTICULAR LIVING INDIVIDUAL.

FOR PANTS, JEANS, JUMPSUITS, SHORTS, SHIRTS, SWEATERS, VESTS, JACKETS, OVERALLS, SWIMSUITS, SOCKS, UNDERWEAR, T-SHIRTS, BLOUSES, SKIRTS, DRESSES, TIGHTS, HATS, CAPS, SCARVES, GLOVES, FOOTWEAR, SWEATPANTS, SWEATSHIRTS, COATS, INFANTWEAR (U.S. CLS. 22 AND 39).

JOHN KELLY, EXAMINING ATTORNEY



SN 86-066,465. SARDINA, MARK, ATHOL, MA. FILED 9-17-2013.

**MARK THOMAS**

THE MARK CONSISTS OF STANDARD CHARACTERS WITHOUT CLAIM TO ANY PARTICULAR FONT, STYLE, SIZE, OR COLOR.

THE NAME(S), PORTRAIT(S), AND/OR SIGNATURE(S) SHOWN IN THE MARK DOES NOT IDENTIFY A PARTICULAR LIVING INDIVIDUAL.

FOR ATHLETIC PANTS; ATHLETIC SHIRTS; ATHLETIC SHORTS; BASEBALL CAPS; COATS; CROP TOPS; GLOVES; GOLF SHIRTS; HATS; HATS FOR INFANTS, BABIES, TODDLERS AND CHILDREN; HOODED SWEAT SHIRTS; JACKETS; KNITTED CAPS; LONG-SLEEVED SHIRTS; PANTIES, SHORTS AND BRIEFS; PANTS; POLO SHIRTS; RUGBY SHIRTS; SHIRTS FOR INFANTS, BABIES, TODDLERS AND CHILDREN; SHORT-SLEEVED OR LONG-SLEEVED T-SHIRTS; SHORT-SLEEVED SHIRTS; SHORTS; SKIRTS; SPORTS CAPS AND HATS; SPORTS JACKETS; SPORTS PANTS; SPORTS SHIRTS; SWEAT PANTS; SWEAT SHIRTS; SWEAT SHORTS; SWEATERS; T-SHIRTS; TANK TOPS; UNDERWEAR; VESTS; WRISTBANDS (U.S. CLS. 22 AND 39).

STEVEN R. FINE, EXAMINING ATTORNEY

**CLASS 25—(Continued).**

SN 86-066,468. ANCHOR IT SHIRT STAY FRIENDLY DESIGN, LLC, FAIRFAX, VA. FILED 9-17-2013.

**ANCHOR IT**

THE MARK CONSISTS OF STANDARD CHARACTERS WITHOUT CLAIM TO ANY PARTICULAR FONT, STYLE, SIZE, OR COLOR.

FOR SHIRTS (U.S. CLS. 22 AND 39).  
FIRST USE 9-16-2013; IN COMMERCE 9-16-2013.  
STEVEN R. FINE, EXAMINING ATTORNEY



SN 86-066,479. PRICE, LORETTA, DBA PEACE LOVE SKULLS, CLAREMORE, OK. FILED 9-17-2013.

**Peace Love Skulls**

THE MARK CONSISTS OF STANDARD CHARACTERS WITHOUT CLAIM TO ANY PARTICULAR FONT, STYLE, SIZE, OR COLOR.

FOR ATHLETIC APPAREL, NAMELY, SHIRTS, PANTS, JACKETS, FOOTWEAR, HATS AND CAPS, ATHLETIC UNIFORMS; SWEATSHIRTS; YOGA PANTS; YOGA SHIRTS (U.S. CLS. 22 AND 39).  
KYLE PEETE, EXAMINING ATTORNEY



SN 86-066,506. MORRISON, SCOTT E, OLD TOWN, ME. FILED 9-17-2013.

**Phat n Fit**

THE MARK CONSISTS OF STANDARD CHARACTERS WITHOUT CLAIM TO ANY PARTICULAR FONT, STYLE, SIZE, OR COLOR.

FOR A-SHIRTS; APPAREL FOR DANCERS, NAMELY, TEE SHIRTS, SWEATSHIRTS, PANTS, LEGGINGS, SHORTS AND JACKETS; ATHLETIC APPAREL, NAMELY, SHIRTS, PANTS, JACKETS, FOOTWEAR, HATS AND CAPS, ATHLETIC UNIFORMS; ATHLETIC SHIRTS; BODY SHIRTS; BUTTON DOWN SHIRTS (U.S. CLS. 22 AND 39).

CIMMERIAN COLEMAN, EXAMINING ATTORNEY

**CLASS 25—(Continued).**

SN 86-066,540. GUSTAVUS, EVERALD, JAMAICA, NY. FILED 9-17-2013.



NO CLAIM IS MADE TO THE EXCLUSIVE RIGHT TO USE "JEANS" AND "THREADS", APART FROM THE MARK AS SHOWN.

THE MARK CONSISTS OF THE LITERAL ELEMENTS "TRAUMATIZED JEANS TRENDS TRAUMA THREDZ" WRITTEN IN STYLIZED FORM WHEREIN "TRAUMA THREDZ" ARE PLACED ONE BELOW THE OTHER VERTICALLY, LETTER "T" OF "TRAUMA" EXTENDED OVER THE LETTERS "RAUMA" AND LETTER "T" OF "THREDZ" EXTENDED OVER THE LETTERS "HREDZ", WORDING "TRAUMATIZED JEANS" "TRENDS" ARE PLACED AT THE TOP WHEREIN "TRAUMATIZED" IS PLACED AT THE LEFT SIDE AND WORDING "JEANS TRENDS" AT THE RIGHT SIDE WHICH IS UNDER LINED BY LIKE OF HEART BEAT LINE IMAGE.

FOR CLOTHING, NAMELY, T-SHIRTS, SHIRTS, TOPS, SWEATERS, SWEATSHIRTS, HOODED SWEATSHIRTS; COATS, JERSEYS, JACKETS; BOTTOMS, PANTS, TROUSERS, JEANS, SHORTS, SWEATPANTS, PAJAMAS; DRESSES; SKIRTS; BLOUSES; UNDERWEAR; SWIMWEAR; HEADWEAR; FOOTWEAR (U.S. CLS. 22 AND 39).

SUSAN RICHARDS, EXAMINING ATTORNEY

SN 86-066,717. WRITTEN101 INC., SAINT ALBANS, NY. FILED 9-17-2013.



THE MARK CONSISTS OF A LARGE CAPITAL LETTER "S" WITH SMALLER LOWER CASE LETTERS "EELED" DIRECTLY UNDER THE LETTER "S".

FOR HATS; PANTS; SHIRTS; T-SHIRTS (U.S. CLS. 22 AND 39).

FIRST USE 4-2-2009; IN COMMERCE 1-29-2011. KELLY TRUSILO, EXAMINING ATTORNEY

**CLASS 25—(Continued).**

SN 86-066,735. CARSON MANUFACTURING LLC, CLACKAMAS, OR. FILED 9-17-2013.



THE MARK CONSISTS OF 3 RUNNING LEGS. FOR SHOES (U.S. CLS. 22 AND 39). TINA BROWN, EXAMINING ATTORNEY

SN 86-066,777. JEFFRIES, JAMES R., PUYALLUP, WA. AND JEFFRIES, MONICA E., PUYALLUP, WA. FILED 9-17-2013.



THE MARK CONSISTS OF THE STYLIZED TEXT "WAYSICK".

FOR HATS; POLO SHIRTS; T-SHIRTS; TANK TOPS (U.S. CLS. 22 AND 39).

SANI KHOURI, EXAMINING ATTORNEY

SN 86-066,785. NARDIELLO, STEVEN, COLTS NECK, NJ. FILED 9-17-2013.



THE MARK CONSISTS OF STANDARD CHARACTERS WITHOUT CLAIM TO ANY PARTICULAR FONT, STYLE, SIZE, OR COLOR.

FOR ATHLETIC SHIRTS; BASEBALL CAPS AND HATS; BEANIES; BUTTON DOWN SHIRTS; CAMOUFLAGE GLOVES; CAMOUFLAGE JACKETS; CAMOUFLAGE PANTS; CAMOUFLAGE SHIRTS; CAMOUFLAGE VESTS; CAP VISORS; CHAPS; FLEECE PULLOVERS; FLEECE TOPS; HATS; HEADWEAR; HUNTING JACKETS; SWEATSHIRTS; T-SHIRTS (U.S. CLS. 22 AND 39).

AISHA CLARKE, EXAMINING ATTORNEY

**CLASS 25—(Continued).**

SN 86-066,847. CLAEA LLC, NEW YORK, NY. FILED 9-17-2013.



THE MARK CONSISTS OF THE ARTISTIC RENDERING OF A TURTLE WITH POLKA DOTS.

FOR CLOTHING, NAMELY, DRESSES, BLOUSES, T-SHIRTS, SHIRTS, SWEATSHIRTS, SKIRTS, LEGGINGS, SHORTS, PANTS, SWEATPANTS, ROMPERS, VESTS, JACKETS, COATS, RAINWEAR, SCARVES, GLOVES, SOCKS, SWIMWEAR, BEACHWEAR, INFANT WEAR; HEADWEAR (U.S. CLS. 22 AND 39).

FIRST USE 8-0-2013; IN COMMERCE 8-0-2013.  
AISHA CLARKE, EXAMINING ATTORNEY

SN 86-066,907. BRENDA BURKE, GAINESVILLE, GA. FILED 9-17-2013.

## Fat Girls Can

THE MARK CONSISTS OF STANDARD CHARACTERS WITHOUT CLAIM TO ANY PARTICULAR FONT, STYLE, SIZE, OR COLOR.

FOR SHIRTS (U.S. CLS. 22 AND 39).  
FIRST USE 8-1-2013; IN COMMERCE 8-1-2013.  
RAMONA ORTIGA, EXAMINING ATTORNEY

SN 86-067,071. LA SENZA CORPORATION, HALIFAX, NOVA SCOTIA, CANADA, FILED 9-17-2013.

## ITEC

THE MARK CONSISTS OF STANDARD CHARACTERS WITHOUT CLAIM TO ANY PARTICULAR FONT, STYLE, SIZE, OR COLOR.

FOR BRAS (U.S. CLS. 22 AND 39).  
FIRST USE 12-31-2005; IN COMMERCE 12-31-2005.  
SUSAN RICHARDS, EXAMINING ATTORNEY

**CLASS 25—(Continued).**

SN 86-067,088. LA SENZA CORPORATION, HALIFAX, NOVA SCOTIA, CANADA, FILED 9-17-2013.

## GLITTERATI

THE MARK CONSISTS OF STANDARD CHARACTERS WITHOUT CLAIM TO ANY PARTICULAR FONT, STYLE, SIZE, OR COLOR.

FOR BRAS; LINGERIE; PANTIES (U.S. CLS. 22 AND 39).  
SUSAN RICHARDS, EXAMINING ATTORNEY

SN 86-067,158. ZONATEX S.A.S., MEDELLIN - ANTIOQUIA, COLOMBIA, FILED 9-17-2013.



NO CLAIM IS MADE TO THE EXCLUSIVE RIGHT TO USE "UNDERWEAR", APART FROM THE MARK AS SHOWN.

THE MARK CONSISTS OF THE LETTERS "XT" IN PROMINENT SIZE BELOW OF WHICH APPEARS THE WORDING "XTREMEN" IN SMALLER SIZE, BELOW OF WHICH APPEARS THE WORDING "UNDERWEAR" IN EVEN SMALLER SIZE, INSIDE A RECTANGULAR STRIP, ALL OF THE WORDING IN STYLIZED LETTERS.

FOR BOXER BRIEFS; BOXER SHORTS; MEN'S UNDERWEAR (U.S. CLS. 22 AND 39).  
EDWARD FENNESSY, EXAMINING ATTORNEY

SN 86-067,159. CAMACHO, DION, BRONX, NY. FILED 9-17-2013.

## JU ALREADY KNO

THE MARK CONSISTS OF STANDARD CHARACTERS WITHOUT CLAIM TO ANY PARTICULAR FONT, STYLE, SIZE, OR COLOR.

FOR HATS; JACKETS; PANTS; SHIRTS; SHORTS; SWEATSHIRTS; UNDERWEAR (U.S. CLS. 22 AND 39).  
FIRST USE 7-0-2006; IN COMMERCE 7-0-2006.  
DAVID BROOKSHIRE, EXAMINING ATTORNEY

**CLASS 25—(Continued).**

SN 86-067,188. SIMMONS, ARIELLE M, DECATUR, GA. FILED 9-17-2013.

## Respect The Call Time

THE MARK CONSISTS OF STANDARD CHARACTERS WITHOUT CLAIM TO ANY PARTICULAR FONT, STYLE, SIZE, OR COLOR.

FOR T-SHIRTS (U.S. CLS. 22 AND 39),  
CAROL SPILS, EXAMINING ATTORNEY

---

SN 86-067,289. MARK, NATASHA, STUDIO CITY, CA. FILED 9-17-2013.

## ANGRYBOYSCLUB

THE MARK CONSISTS OF STANDARD CHARACTERS WITHOUT CLAIM TO ANY PARTICULAR FONT, STYLE, SIZE, OR COLOR.

FOR HEADWEAR; SHIRTS; TOPS (U.S. CLS. 22 AND 39).

FIRST USE 8-1-2012; IN COMMERCE 8-1-2012.  
AMEEN IMAM, EXAMINING ATTORNEY

---

SN 86-067,313. FAIR ENDS, LLC, ST. IGNATIUS, MT. FILED 9-17-2013.

## FairEnds

THE MARK CONSISTS OF STANDARD CHARACTERS WITHOUT CLAIM TO ANY PARTICULAR FONT, STYLE, SIZE, OR COLOR.

FOR ATHLETIC APPAREL, NAMELY, SHIRTS, PANTS, JACKETS, FOOTWEAR, HATS AND CAPS, ATHLETIC UNIFORMS; BASEBALL CAPS AND HATS (U.S. CLS. 22 AND 39).

FIRST USE 5-26-2011; IN COMMERCE 5-26-2011.  
LAURA FIONDA, EXAMINING ATTORNEY

**CLASS 25—(Continued).**

SN 86-067,339. FAIR ENDS, LLC, ST. IGNATIUS, MT. FILED 9-17-2013.



THE MARK CONSISTS OF THE WORDING "FAIRENDS" AT THE BOTTOM OF AND INSIDE A STYLIZED, SYMMETRICAL MOUNTAIN PEAK.

FOR ATHLETIC APPAREL, NAMELY, SHIRTS, PANTS, JACKETS, FOOTWEAR, HATS AND CAPS, ATHLETIC UNIFORMS; BASEBALL CAPS AND HATS (U.S. CLS. 22 AND 39).

FIRST USE 5-26-2011; IN COMMERCE 5-26-2011.  
LAURA FIONDA, EXAMINING ATTORNEY

---

SN 86-067,344. MARK, NATASHA, STUDIO CITY, CA. FILED 9-17-2013.



THE MARK CONSISTS OF A STYLIZED LOWER CASE LETTER "A"; A STYLIZED UPPER CASE LETTER "B" WITHIN THE CIRCLE PORTION OF THE AFOREMENTIONED LETTER "A" PLACED ON ITS SIDE SO THAT THE HUMPS IN THE LETTER "B" APPEAR AS EYES; A STYLIZED LETTER "C" WITHIN THE CIRCLE PORTION OF THE AFOREMENTIONED LETTER "A" AND BELOW THE AFOREMENTIONED LETTER "B" PLACED ON ITS SIDE SO IT APPEARS TO FORM A FROWNING MOUTH.

FOR HEADWEAR; SHIRTS; TOPS (U.S. CLS. 22 AND 39).  
FIRST USE 8-1-2012; IN COMMERCE 8-1-2012.  
AMEEN IMAM, EXAMINING ATTORNEY

**CLASS 25—(Continued).**

SN 86-067,370. FARRELL, JOHN, NEWPORT BEACH, CA. FILED 9-17-2013.

UDSRVIT

THE MARK CONSISTS OF THE TEXT "UDSRVIT" IN "EUROSTILE" FONT.

FOR ATHLETIC WEAR, NAMELY, SWEAT PANTS, SWEAT SHIRTS, ATHLETIC PANTS, ATHLETIC SHORTS, TANK TOPS, HOODED SWEATSHIRTS, SOCKS, AND MEN'S SWIM TRUNK, AND MENS AND WOMENS UNDERWEAR, AND BASEBALL HATS (U.S. CLS. 22 AND 39).

JASON TURNER, EXAMINING ATTORNEY

SN 86-067,386. MADRID, DANIELA, TEMPE, AZ. FILED 9-17-2013.



THE MARK CONSISTS OF A SILHOUETTE OF A FIT WOMAN WITH LONG HAIR HOLDING A WEIGHT IN HER LEFT HAND WHILE HER RIGHT ARM IS ON HER HIP ALONG WITH THE WORDS "MUSCLE DOLL" IN A CURSIVE FONT.

FOR ATHLETIC APPAREL, NAMELY, SHIRTS, PANTS, JACKETS, FOOTWEAR, HATS AND CAPS, ATHLETIC UNIFORMS; ATHLETIC PANTS; ATHLETIC SHIRTS; ATHLETIC SHORTS; BODY SHIRTS; BOXER SHORTS; BRAS; CROP PANTS; CYCLING SHORTS; FLEECE SHORTS; GYM PANTS; GYM SHORTS; HEAD SCARVES; HEAD SWEATBANDS; HEAD WEAR; HEADBANDS; HEADBANDS AGAINST SWEATING; HEADBANDS FOR CLOTHING; HOODED SWEAT SHIRTS; HOODED SWEATSHIRTS; JACKET LINERS; JACKETS; JACKETS AND SOCKS; JOGGING PANTS; LONG-SLEEVED SHIRTS; LOUNGE PANTS; MOISTURE-WICKING SPORTS BRAS; MOISTURE-WICKING SPORTS PANTS; OPEN-NECKED SHIRTS; OUTER JACKETS; PANTIES, SHORTS AND BRIEFS; PANTS; POLO SHIRTS; RAINPROOF JACKETS; REVERSIBLE JACKETS; SHELL JACKETS; SHIRTS; SHIRTS AND SHORT-SLEEVED SHIRTS; SHORT-SLEEVED OR LONG-SLEEVED T-SHIRTS; SHORT-SLEEVED SHIRTS; SHORTS; SLEEVED OR SLEEVELESS JACKETS; SPORT SHIRTS; SPORTS BRA; SPORTS BRAS; SPORTS JACKETS; SPORTS PANTS; SPORTS SHIRTS; SPORTS SHIRTS WITH SHORT SLEEVES; STRETCH PANTS; SWEAT BANDS; SWEAT JACKETS; SWEAT PANTS; SWEAT SHIRTS; SWEAT SHORTS; SWEATSHIRTS; T-SHIRTS; TEE SHIRTS; TRACK PANTS; UNDERWEAR, NAMELY, BOY SHORTS; WAIST BANDS; WALKING SHORTS; WATERPROOF JACKETS AND PANTS; WOMEN'S ATHLETIC TOPS WITH BUILT-IN BRAS; YOGA PANTS; YOGA SHIRTS (U.S. CLS. 22 AND 39).

RICHARD WHITE, EXAMINING ATTORNEY

**CLASS 25—(Continued).**

SN 86-067,395. MEYERHOFFER, INC., MONTARA, CA. FILED 9-17-2013.

SUR  
FOR  
WRD

THE MARK CONSISTS OF STANDARD CHARACTERS WITHOUT CLAIM TO ANY PARTICULAR FONT, STYLE, SIZE, OR COLOR.

FOR CLOTHING, NAMELY T-SHIRTS; SURF SHIRTS; COATS; JACKETS; JERSEYS; HOODED SWEATSHIRTS; PULLOVERS; HATS; CAPS; BATHING SUITS; SWIM SUITS; WET SUITS; BOARD SHORTS; PANTS (U.S. CLS. 22 AND 39).

FIRST USE 6-14-2012; IN COMMERCE 6-14-2012.  
KEVIN MITTLER, EXAMINING ATTORNEY

SN 86-067,440. DASHAMERICA, INC., LOUISVILLE, CO. FILED 9-17-2013.

SMOOTHIDITY

THE MARK CONSISTS OF STANDARD CHARACTERS WITHOUT CLAIM TO ANY PARTICULAR FONT, STYLE, SIZE, OR COLOR.

FOR ATHLETIC SHOES; FOOTWEAR; RUNNING SHOES; SHOES (U.S. CLS. 22 AND 39).

EUGENIA MARTIN, EXAMINING ATTORNEY

SN 86-067,626. TIME INC., NEW YORK, NY. FILED 9-18-2013.

INSTYLE ESSENTIALS

THE MARK CONSISTS OF STANDARD CHARACTERS WITHOUT CLAIM TO ANY PARTICULAR FONT, STYLE, SIZE, OR COLOR.

OWNER OF U.S. REG. NOS. 1,851,469, 3,715,128 AND OTHERS.

FOR SHIRTS (U.S. CLS. 22 AND 39).

FIRST USE 8-15-2013; IN COMMERCE 8-15-2013.

LINDA ESTRADA, EXAMINING ATTORNEY

**CLASS 25—(Continued).**

SN 86-067,690. HALGUNSETH, MARK, FORT LAUDERDALE, FL. FILED 9-18-2013.

**Authentic Gay**

THE MARK CONSISTS OF STANDARD CHARACTERS WITHOUT CLAIM TO ANY PARTICULAR FONT, STYLE, SIZE, OR COLOR.

FOR BATHING SUITS; PANTS; SHIRTS; SHORTS; SKIRTS; SOCKS (U.S. CLS. 22 AND 39).

ROBERT C. CLARK JR., EXAMINING ATTORNEY

SN 86-067,719. CREIGHTON UNIVERSITY, OMAHA, NE. FILED 9-18-2013.



THE MARK CONSISTS OF STYLIZED BIRD HEAD. FOR ATHLETIC APPAREL, NAMELY, SHIRTS, PANTS, JACKETS, FOOTWEAR, HATS AND CAPS, ATHLETIC UNIFORMS (U.S. CLS. 22 AND 39). FIRST USE 10-9-2013; IN COMMERCE 10-9-2013. DARRYL SPRUILL, EXAMINING ATTORNEY

SN 86-067,873. BOWEN, EMMA E, BROOKLYN, NY. FILED 9-18-2013.

**Najla**

THE MARK CONSISTS OF STANDARD CHARACTERS WITHOUT CLAIM TO ANY PARTICULAR FONT, STYLE, SIZE, OR COLOR.

FOR BRASSIERES; CAMISOLES; LINGERIE; ROBES; SLEEPING GARMENTS; UNDERWEAR (U.S. CLS. 22 AND 39).

MORGAN WYNNE, EXAMINING ATTORNEY

**CLASS 25—(Continued).**

SN 86-067,891. AMADOR, LUIS, BRONX, NY. AND LECLER, SAMUEL, BRONX, NY. FILED 9-18-2013.

**FLASH LIFE**

THE MARK CONSISTS OF STANDARD CHARACTERS WITHOUT CLAIM TO ANY PARTICULAR FONT, STYLE, SIZE, OR COLOR.

FOR CREW NECK SWEATERS; HEADWEAR; HOODED PULLOVERS; HOODED SWEATSHIRTS; SHORT-SLEEVED OR LONG-SLEEVED T-SHIRTS; SWEATERS; T-SHIRTS; V-NECK SWEATERS (U.S. CLS. 22 AND 39).

FIRST USE 3-0-2010; IN COMMERCE 3-0-2010.

TRACY CROSS, EXAMINING ATTORNEY

SN 86-067,922. PAYTON INVESTMENTS, LLC LIMITED LIABILITY DELAWARE, YORKVILLE, IL. FILED 9-18-2013.



THE MARK CONSISTS OF SILHOUETTE OF A MAN RUNNING WITH A FOOTBALL.

FOR ATHLETIC APPAREL, NAMELY, SHIRTS, PANTS, JACKETS, FOOTWEAR, HATS AND CAPS, ATHLETIC UNIFORMS (U.S. CLS. 22 AND 39).

FIRST USE 9-1-2008; IN COMMERCE 9-1-2008.

KATHERINE STOIDES, EXAMINING ATTORNEY

SN 86-068,020. DEADSTOCK DESIGN GROUP, LLC, SAN LORENZO, CA. FILED 9-18-2013.

**SAVS**

THE MARK CONSISTS OF STANDARD CHARACTERS WITHOUT CLAIM TO ANY PARTICULAR FONT, STYLE, SIZE, OR COLOR.

FOR CLOTHING, NAMELY, TOPS, SHIRTS, T-SHIRTS, BOTTOMS, SHORTS, HOODED SWEATSHIRTS, JACKETS, HEADWEAR, SOCKS (U.S. CLS. 22 AND 39).

FIRST USE 6-15-2012; IN COMMERCE 6-15-2012.

MORGAN WYNNE, EXAMINING ATTORNEY



**CLASS 25—(Continued).**

SN 86-068,085. ANGELIQUE GONZALEZ, WILIMINGTON, CA. AND ARTURO GONZALEZ, WILMINGTON, CA. FILED 9-18-2013.

# champions do

THE MARK CONSISTS OF STANDARD CHARACTERS WITHOUT CLAIM TO ANY PARTICULAR FONT, STYLE, SIZE, OR COLOR.

FOR T-SHIRTS (U.S. CLS. 22 AND 39).  
LINDA POWELL, EXAMINING ATTORNEY

**CLASS 25—(Continued).**

SN 86-068,190. LYPAH BELTS, OLMSTEAD FALLS, OH. FILED 9-18-2013.



SN 86-068,103. RANFLISTA, CHULA VISTA, CA. FILED 9-18-2013.



THE NAME(S), PORTRAIT(S), AND/OR SIGNATURE(S) SHOWN IN THE MARK DOES NOT IDENTIFY A PARTICULAR LIVING INDIVIDUAL.

THE MARK CONSISTS OF THE WORDING "RANFLISTA" IN STYLIZED FONT. DIRECTLY ABOVE THE WORDING IS AN IMAGE THAT DEPICTS A SKELETON HEAD WITH A HAT ON, AND ARMS CONNECTED TO THE CHARACTERS "F" AND "L".

THE WORDING "RANFLISTA" HAS NO MEANING IN A FOREIGN LANGUAGE.

FOR BEANIES; BELTS FOR CLOTHING; CAPS; HOODED SWEATSHIRTS; JACKETS; LEGGINGS; PANTS; SHOES; SHORT-SLEEVED OR LONG-SLEEVED T-SHIRTS; SHORTS; SWEATERS; SWEATSHIRTS; T-SHIRTS; TANK TOPS; TOPS (U.S. CLS. 22 AND 39).

FIRST USE 8-1-2013; IN COMMERCE 9-1-2013.  
NORA BUCHANAN WILL, EXAMINING ATTORNEY

NO CLAIM IS MADE TO THE EXCLUSIVE RIGHT TO USE "BELTS", APART FROM THE MARK AS SHOWN.

THE COLOR(S) PURPLE AND BLACK IS/ARE CLAIMED AS A FEATURE OF THE MARK.

THE MARK CONSISTS OF OF THE WORD LYPAH IN A STYLIZED LARGE BLACK FONT. BELOW THE WORD LYPAH IS THE WORD BELTS PRESENTED IN A STYLIZED PURPLE FONT. THE LETTER E IN THE WORD BELTS IS PRESENTED IN THE FORM OF A BELT. TO THE RIGHT OF THE WORDS LYPAH BELTS THE WORDS LEAVE YOUR PURSE AT HOME ARE PRESENTED IN A SEMI-CIRCULAR FORM. THE WORDS ARE PRESENTED IN A BLACK FONT EXCEPT FOR THE FIRST LETTER IN EACH WORD WHICH IS PRESENTED IN PURPLE. THE WORD BELTS IS UNDERLINED WITH A STYLIZED CURVED SHAPE.

FOR BELTS; DRESSES; SKIRTS (U.S. CLS. 22 AND 39).  
FIRST USE 12-5-2012; IN COMMERCE 12-5-2012.  
EUGENIA MARTIN, EXAMINING ATTORNEY

SN 86-068,182. FUSION UNLIMITED, LLC, IRVINE, CA. FILED 9-18-2013.

# VISSLA

THE MARK CONSISTS OF STANDARD CHARACTERS WITHOUT CLAIM TO ANY PARTICULAR FONT, STYLE, SIZE, OR COLOR.

FOR SHIRTS, T-SHIRTS, WOVEN SHIRTS, SWEATSHIRTS, SWEATERS, TANK TOPS, CAMISOLES, PAJAMAS, BOXERS, UNDERWEAR, DRESSES, SKIRTS, SWEAT PANTS, PANTS, SHORTS, SWIMWEAR, BELTS, SOCKS, SCARVES, HATS, CAPS, BEANIES, VISORS (U.S. CLS. 22 AND 39).

AISHA CLARKE, EXAMINING ATTORNEY

SN 86-068,341. BARLOW, DAVID, VISTA, CA. FILED 9-18-2013.

Warning: Women may appear  
larger when sober!!!

THE MARK CONSISTS OF STANDARD CHARACTERS WITHOUT CLAIM TO ANY PARTICULAR FONT, STYLE, SIZE, OR COLOR.

FOR HATS; T-SHIRTS (U.S. CLS. 22 AND 39).  
KEVIN CORWIN, EXAMINING ATTORNEY

**CLASS 25—(Continued).**

SN 86-068,351. FROST, FRANCIS, PAKURA, AUCKLAND, NEW ZEALAND, FILED 9-18-2013.

**Little Flock of Horrors**

THE MARK CONSISTS OF STANDARD CHARACTERS WITHOUT CLAIM TO ANY PARTICULAR FONT, STYLE, SIZE, OR COLOR.

FOR PANTS, SHIRTS, T-SHIRTS, LONG SLEEVE T-SHIRTS, DRESSES, HATS, BEANIES, SOCKS, SWEATERS, HOODED SWEATSHIRTS, SWEATSHIRTS, JEANS, CARDIGANS, SWEATPANTS (U.S. CLS. 22 AND 39).

FIRST USE 1-8-2011; IN COMMERCE 1-8-2011.  
LANA PHAM, EXAMINING ATTORNEY

**CLASS 25—(Continued).**

SN 86-068,440. LOGAN, CHAD, VICTORVILLE, CA. FILED 9-18-2013.



THE MARK CONSISTS OF A SILHOUETTE OF A MAN AND DOG WALKING, THE MAN IS HOLDING A POOP BAG IN HIS RIGHT HAND. THE WORDS, "DO THE RIGHT THING" ARE CURVED ABOVE THE DOG LEASH. THE WORDS, "PICKUP THAT POO!" ARE UNDER THE SILHOUETTE OF THE MAN AND DOG WALKING.

FOR T-SHIRTS (U.S. CLS. 22 AND 39).  
FIRST USE 9-1-2013; IN COMMERCE 9-1-2013.  
ALLISON SCHRODY, EXAMINING ATTORNEY

SN 86-068,413. ROBERT J. WALCZYK JR., BELLEVUE, WI. FILED 9-18-2013.

**WALLEYE BOB**

THE MARK CONSISTS OF STANDARD CHARACTERS WITHOUT CLAIM TO ANY PARTICULAR FONT, STYLE, SIZE, OR COLOR.

FOR T-SHIRTS, SHIRTS, SWEATSHIRTS, CAPS, SHORTS AND JACKETS (U.S. CLS. 22 AND 39).

FIRST USE 12-19-2001; IN COMMERCE 12-26-2001.  
AMY C. KEAN, EXAMINING ATTORNEY

SN 86-068,483. WESTHOVEN, KYLE, DALLAS, GA. FILED 9-18-2013.

SN 86-068,424. NDB HOLDINGS LLC, NEW YORK, NY. FILED 9-18-2013.

**Just Enough Kink**

THE MARK CONSISTS OF STANDARD CHARACTERS WITHOUT CLAIM TO ANY PARTICULAR FONT, STYLE, SIZE, OR COLOR.

FOR BASEBALL CAPS AND HATS; HOSIERY; LINGERIE; SHORT-SLEEVED OR LONG-SLEEVED T-SHIRTS; SWEAT BANDS; SWEAT PANTS (U.S. CLS. 22 AND 39).

AMY C. KEAN, EXAMINING ATTORNEY



THE MARK CONSISTS OF A PICTURE OF A WOUNDED RACCOON WITH "X"'S OVER ITS EYES AND ITS TONGUE HANGING OUT.

FOR HATS; SWEATSHIRTS; T-SHIRTS (U.S. CLS. 22 AND 39).

TINA L. SNAPP, EXAMINING ATTORNEY

**CLASS 25—(Continued).**

SN 86-068,520. MORRISSETTE, DAVID, NORTHBRIDGE, MA. FILED 9-18-2013.

**CLASS 25—(Continued).**

SN 86-068,779. ROYAL JUSTICE LLC, GOSHEN, KY. FILED 9-18-2013.

## Royal Justice

THE MARK CONSISTS OF THE STYLIZED TERMS "WE'RE STRAIGHT" SITUATED ABOVE THE STYLIZED CHARACTERS OF A MAN AND A WOMAN. UNDERNEATH THE CHARACTERS ARE THE STYLIZED TERMS "WE RATE AND WE CAN PROCREATE".

FOR HATS; HOODED SWEAT SHIRTS; JACKETS; PANTS; SHIRTS; SHORT-SLEEVED OR LONG-SLEEVED T-SHIRTS; SHORTS; SOCKS; SWEAT SHIRTS; SWEATERS; T-SHIRTS; UNDERWEAR (U.S. CLS. 22 AND 39).  
RONALD MCMORROW, EXAMINING ATTORNEY

SN 86-068,521. MANIFEST VISION PROJECT, FOLSOM, CA. FILED 9-18-2013.

### MANIFEST VISION PROJECT

THE MARK CONSISTS OF STANDARD CHARACTERS WITHOUT CLAIM TO ANY PARTICULAR FONT, STYLE, SIZE, OR COLOR.

FOR BEANIES; HATS; JACKETS; JERSEYS; LONG-SLEEVED SHIRTS; SHIRTS; SOCKS; SWEATSHIRTS; T-SHIRTS; TANK TOPS (U.S. CLS. 22 AND 39).  
BARBARA A. GOLD, EXAMINING ATTORNEY

THE MARK CONSISTS OF STANDARD CHARACTERS WITHOUT CLAIM TO ANY PARTICULAR FONT, STYLE, SIZE, OR COLOR.

FOR (BASED ON USE IN COMMERCE) OVER SHIRTS; SHIRTS; SHIRTS AND SHORT-SLEEVED SHIRTS; SHORT-SLEEVED OR LONG-SLEEVED T-SHIRTS; SHORT-SLEEVED SHIRTS; T-SHIRTS; TEE SHIRTS; WEARABLE GARMENTS AND CLOTHING, NAMELY, SHIRTS(BASED ON INTENT TO USE) ANKLE SOCKS; BASEBALL CAPS; BASEBALL CAPS AND HATS; BATHING SUITS; BATHING SUITS FOR MEN; BATHING TRUNKS; BEANIES; BELTS; BELTS FOR CLOTHING; BELTS MADE FROM IMITATION LEATHER; BELTS MADE OF LEATHER; BELTS MADE OUT OF CLOTH; BELTS OF TEXTILE; BIKINIS; BOARD SHORTS; BOXER BRIEFS; BOXER SHORTS; FABRIC BELTS; HATS; HOODED SWEAT SHIRTS; JEANS; KNIT SHIRTS; LADIES' UNDERWEAR; LEATHER BELTS; LONG-SLEEVED SHIRTS; MEN'S DRESS SOCKS; MEN'S SOCKS; MEN'S UNDERWEAR; OPEN-NECKED SHIRTS; SOCKS; SOCKS AND STOCKINGS; SPORTS CAPS AND HATS; SWEAT SHIRTS; SWIM SUITS; SWIM TRUNKS; SWIM WEAR FOR GENTLEMEN AND LADIES; SWIMSUITS; THONGS; UNDERWEAR; UNDERWEAR, NAMELY, BOY SHORTS; V-NECK SWEATERS; WAIST BELTS; WOMEN'S UNDERWEAR (U.S. CLS. 22 AND 39).  
FIRST USE 9-1-2013; IN COMMERCE 9-10-2013.  
MARIA-VICTORIA SUAREZ, EXAMINING ATTORNEY

**CLASS 25—(Continued).**

SN 86-068,788. ROYAL JUSTICE LLC, GOSHEN, KY. FILED 9-19-2013.



THE MARK CONSISTS OF A CAPITALIZED "R" IN THE CENTER OF THE LOGO WITH CROWN OVERLAYING THE TOP-LEFT OF THE "R".

FOR (BASED ON USE IN COMMERCE) OVER SHIRTS; SHIRTS; SHIRTS AND SHORT-SLEEVED SHIRTS; SHORT-SLEEVED OR LONG-SLEEVED T-SHIRTS; SHORT-SLEEVED SHIRTS; T-SHIRTS; TEE SHIRTS; WEARABLE GARMENTS AND CLOTHING, NAMELY, SHIRTS(BASED ON INTENT TO USE) ANKLE SOCKS; BASEBALL CAPS; BASEBALL CAPS AND HATS; BATHING SUITS; BATHING SUITS FOR MEN; BATHING TRUNKS; BEANIES; BELTS; BELTS FOR CLOTHING; BELTS MADE FROM IMITATION LEATHER; BELTS MADE OF LEATHER; BELTS MADE OUT OF CLOTH; BELTS OF TEXTILE; BIKINIS; BOARD SHORTS; BOXER BRIEFS; BOXER SHORTS; FABRIC BELTS; HATS; HOODED SWEAT SHIRTS; JEANS; KNIT SHIRTS; LADIES' UNDERWEAR; LEATHER BELTS; LONG-SLEEVED SHIRTS; MEN'S DRESS SOCKS; MEN'S SOCKS; MEN'S UNDERWEAR; OPEN-NECKED SHIRTS; SOCKS; SOCKS AND STOCKINGS; SPORTS CAPS AND HATS; SWEAT SHIRTS; SWIM SUITS; SWIM TRUNKS; SWIM WEAR FOR GENTLEMEN AND LADIES; SWIM-SUITS; THONGS; UNDERWEAR; UNDERWEAR, NAMELY, BOY SHORTS; V-NECK SWEATERS; WAIST BELTS; WOMEN'S UNDERWEAR (U.S. CLS. 22 AND 39). FIRST USE 9-1-2013; IN COMMERCE 9-10-2013.

MARIA-VICTORIA SUAREZ, EXAMINING ATTORNEY

SN 86-068,797. CHAN, ANGUS, CITY OF INDUSTRY, CA. FILED 9-19-2013.

# GENESEAM

THE MARK CONSISTS OF STANDARD CHARACTERS WITHOUT CLAIM TO ANY PARTICULAR FONT, STYLE, SIZE, OR COLOR.

FOR APRES-SKI SHOES; AQUA SHOES; ATHLETIC APPAREL, NAMELY, SHIRTS, PANTS, JACKETS, FOOTWEAR, HATS AND CAPS, ATHLETIC UNIFORMS; ATHLETIC FOOTWEAR; ATHLETIC SHOES; BALLET SHOES; BALLROOM DANCING SHOES; BASEBALL SHOES; BEACH FOOTWEAR; BEACH SHOES; BOAT SHOES; BOWLING SHOES; BOXING SHOES; CANVAS SHOES; CLEATS FOR ATTACHMENT TO SPORTS SHOES; CLIMBING FOOTWEAR; CLIMBING SHOES; CLOTHING EXTENSION USED TO EXTEND THE NORMAL SIZE RANGE OF CLOTHING ITEMS TO ACCOMMODATE PREGNANCY SIZE CHANGES; CLOTHING FOR ATHLETIC USE, NAMELY, PADDED ELBOW COMPRESSION SLEEVES BEING PART OF AN ATH-

**CLASS 25—(Continued).**

LETIC GARMENT; CLOTHING FOR ATHLETIC USE, NAMELY, PADDED PANTS; CLOTHING FOR ATHLETIC USE, NAMELY, PADDED SHIRTS; CLOTHING FOR ATHLETIC USE, NAMELY, PADDED SHORTS; CLOTHING FOR BABIES, TODDLERS AND CHILDREN, TREATED WITH FIRE AND HEAT RETARDANTS, NAMELY, PAJAMAS, JACKETS, SHIRTS, PANTS, JUMPERS; CLOTHING FOR WEAR IN JUDO PRACTICES; CLOTHING FOR WEAR IN WRESTLING GAMES; CLOTHING ITEMS, NAMELY, ADHESIVE POCKETS THAT MAY BE AFFIXED DIRECTLY TO THE BODY AS A DECORATIVE PIECE OF CLOTHING WITH UTILITY; CLOTHING ITEMS, NAMELY, ADHESIVE POCKETS THAT MAY BE AFFIXED DIRECTLY TO THE INSIDE OF CLOTHING FOR STORAGE AND SAFEKEEPING OF PERSONAL ITEMS; CLOTHING ITEMS, NAMELY, BLINDFOLDS WORN OVER THE EYES; CLOTHING ITEMS, NAMELY, GAGS WORN OVER THE MOUTH; CLOTHING SHIELDS, NAMELY, PADS APPLIED TO THE UNDERARMS OF SHIRTS, BLOUSES AND SWEATERS; CLOTHING, NAMELY, ARM WARMERS; CLOTHING, NAMELY, ATHLETIC SLEEVES; CLOTHING, NAMELY, BASE LAYERS; CLOTHING, NAMELY, COWLS AND SMOKE RING SCARVES; CLOTHING, NAMELY, CROPS; CLOTHING, NAMELY, FOLK COSTUMES; CLOTHING, NAMELY, HAND-WARMERS; CLOTHING, NAMELY, KHAKIS; CLOTHING, NAMELY, KNEE WARMERS; CLOTHING, NAMELY, MATERNITY BANDS; CLOTHING, NAMELY, NECK TUBES; CLOTHING, NAMELY, THOBES; CLOTHING, NAMELY, WRAP-AROUNDS; COATS OF DENIM; CYCLING SHOES; DANCE SHOES; DECK-SHOES; DENIM JACKETS; DENIMS; DRAWERS; DRIVERS; DUSTERS; EYESHADES; FITTED SHOE OR BOOT COVERING TO PROTECT THE SHOES OR BOOT FROM WATER OR OTHER DAMAGE; FLIP FLOPS; FOOTBALL SHOES; FOOTWEAR; FOOTWEAR FOR MEN; FOOTWEAR FOR MEN AND WOMEN; FOOTWEAR FOR TRACK AND FIELD ATHLETICS; FOOTWEAR FOR WOMEN; FOOTWEAR MADE OF VINYL; FOOTWEAR MADE OF WOOD; FOOTWEAR NOT FOR SPORTS; FOOTWEAR, NAMELY, PUMPS; FOOTWEAR, NAMELY, RUBBERS; FOOTWEAR, NAMELY, WORK BOOTS; FOULARDS; GLOVES AS CLOTHING; GOLF SHOES; GYMNASTIC SHOES; HANDBALL SHOES; HEAD WRAPS; HEADBANDS FOR CLOTHING; HEEL PIECES FOR SHOES; HOCKEY SHOES; HOODS; INFANT AND TODDLER ONE PIECE CLOTHING; INFANTS' SHOES AND BOOTS; INSOLES; INSOLES FOR FOOTWEAR; JACKETS; JEANS; JEGGINGS, NAMELY, PANTS THAT ARE PARTIALLY JEANS AND PARTIALLY LEGGINGS; JERSEYS; LEATHER BELTS; LEATHER SHOES; LEISURE SHOES; MANTLES; MOUNTAINEERING SHOES; MUFFLERS; NON-SLIP SOLES FOR FOOTWEAR; PAPER HATS FOR USE AS CLOTHING ITEMS; PAPER SHOES USED WHEN GOING THROUGH METAL DETECTORS TO KEEP FEET AND SOCKS CLEAN; PARTS OF CLOTHING, NAMELY, GUSSETS FOR TIGHTS, GUSSETS FOR STOCKINGS, GUSSETS FOR BATHING SUITS, GUSSETS FOR UNDERWEAR, GUSSETS FOR LEOTARDS AND GUSSETS FOR FOOTLETS; PARTS OF CLOTHING, NAMELY, UNDERARM GUSSETS; PARTY HATS; PERSPIRATION ABSORBENT UNDERWEAR CLOTHING; PLATFORM SHOES; POCKET SQUARES; POCKETS FOR CLOTHING; POLYMER CUSTOM CUSHIONED SHOE INSERTS FOR PRIMARILY NON-ORTHOPEDIC PURPOSES; PROTECTIVE METAL MEMBERS FOR SHOES AND BOOTS; PUMPS; RIDING SHOES; RUBBER SHOES; RUGBY SHOES; RUNNING PADS THAT STRAP ONTO SHOES; RUNNING SHOES; SANDALS AND BEACH SHOES; SHIFTS; SHOE ACCESSORIES, NAMELY, FITTED DECORATIVE COVERS FOR SHOES; SHOE COVERS FOR USE WHEN WEARING SHOES; SHOE DOWELS; SHOE INSERTS FOR PRIMARILY NON-ORTHOPEDIC PURPOSES; SHOE INSERTS FOR PRIMARILY NON-ORTHOPEDIC PURPOSES THAT ALSO DEODORIZE SHOES; SHOE LINERS; SHOE PEGS; SHOE SOLES; SHOE STRAPS; SHOE UPPERS; SHOES; SHOES SOLES FOR REPAIR; SHOES WITH HOOK AND PILE FASTENING TAPES; SHORT SETS; SHOULDER WRAPS; SHOULDER WRAPS FOR CLOTHING; SKI AND SNOWBOARD SHOES AND PARTS THEREOF; SKIING SHOES; SOCCER SHOES; SOLES FOR FOOTWEAR; SPORTS SHOES; SWADDLING CLOTHES; TAP SHOES; TENNIS SHOES; THONGS; TIES; TIPS FOR FOOTWEAR; TONGUE OR PULLSTRAP FOR SHOES AND BOOTS; TOPS; TRACK

**CLASS 25—(Continued).**

AND FIELD SHOES; TRAINING SHOES; TRAVEL CLOTHING CONTAINED IN A PACKAGE COMPRISING REVERSIBLE JACKETS, PANTS, SKIRTS, TOPS AND A BELT OR SCARF; TRIATHLON CLOTHING, NAMELY, TRIATHLON TIGHTS, TRIATHLON SHORTS, TRIATHLON SINGLET, TRIATHLON SHIRTS, TRIATHLON SUITS; UNDERARM CLOTHING SHIELDS; VISCOUS GEL POLYMER SOLD AS A COMPONENT OF FINISHED CUSTOM CUSHIONED FOOTWEAR FOR NON-ORTHOPEDIC PURPOSES AND APPAREL; VOLLEYBALL SHOES; WATER REPELLING FOOTWEAR; WATER REPELLING LEATHER SHOES AND BOOTS; WATERPROOF FOOTWEAR; WATERPROOF LEATHER SHOES; WATERPROOF LEATHER SHOES AND BOOTS; WEARABLE GARMENTS AND CLOTHING, NAMELY, SHIRTS; WELTS FOR BOOTS AND SHOES; WOMEN'S CLOTHING, NAMELY, SHIRTS, DRESSES, SKIRTS, BLOUSES; WOMEN'S SHOES; WOMEN'S SHOES, NAMELY, FOLDABLE FLATS; WOODEN SHOES; WORK SHOES AND BOOTS; WRAPS; WRIST BANDS; WRISTBANDS (U.S. CLS. 22 AND 39).

FIRST USE 7-30-2013; IN COMMERCE 7-30-2013.  
RUDY R. SINGLETON, EXAMINING ATTORNEY

SN 86-068,800. CHAN, ANGUS, CITY OF INDUSTRY, CA.  
FILED 9-19-2013.

# RIVETJETT

THE MARK CONSISTS OF STANDARD CHARACTERS WITHOUT CLAIM TO ANY PARTICULAR FONT, STYLE, SIZE, OR COLOR.

FOR ADULT NOVELTY GAG CLOTHING ITEM, NAMELY, SOCKS; ANGLERS' SHOES; APRES-SKI SHOES; AQUA SHOES; ATHLETIC APPAREL, NAMELY, SHIRTS, PANTS, JACKETS, FOOTWEAR, HATS AND CAPS, ATHLETIC UNIFORMS; ATHLETIC FOOTWEAR; ATHLETIC SHOES; BABIES' PANTS; BABY LAYETTES FOR CLOTHING; BALLET SHOES; BALLROOM DANCING SHOES; BASEBALL SHOES; BEACH FOOTWEAR; BEACH SHOES; BELTS; BELTS FOR CLOTHING; BELTS MADE OUT OF CLOTH; BIBS NOT OF CLOTH OR PAPER; BOAT SHOES; BOTTOMS; BOWLING SHOES; BOXING SHOES; CANVAS SHOES; CHILDREN'S AND INFANTS' CLOTH BIBS; CHILDREN'S CLOTH EATING BIBS; CLEATS FOR ATTACHMENT TO SPORTS SHOES; CLIMBING FOOTWEAR; CLIMBING SHOES; CLOTH BIBS; CLOTH BIBS FOR ADULT DINERS; CLOTH BIBS FOR USE BY SENIOR CITIZENS OR PHYSICALLY-OR MENTALLY-CHALLENGED PERSONS; CLOTHING EXTENSION USED TO EXTEND THE NORMAL SIZE RANGE OF CLOTHING ITEMS TO ACCOMMODATE PREGNANCY SIZE CHANGES; CLOTHING FOR ATHLETIC USE, NAMELY, PADDED ELBOW COMPRESSION SLEEVES BEING PART OF AN ATHLETIC GARMENT; CLOTHING FOR ATHLETIC USE, NAMELY, PADDED PANTS; CLOTHING FOR ATHLETIC USE, NAMELY, PADDED SHIRTS; CLOTHING FOR ATHLETIC USE, NAMELY, PADDED SHORTS; CLOTHING FOR BABIES, TODDLERS AND CHILDREN, TREATED WITH FIRE AND HEAT RETARDANTS, NAMELY, PAJAMAS, JACKETS, SHIRTS, PANTS, JUMPERS; CLOTHING FOR WEAR IN JUDO PRACTICES; CLOTHING FOR WEAR IN WRESTLING GAMES; CLOTHING ITEMS, NAMELY, ADHESIVE POCKETS THAT MAY BE AFFIXED DIRECTLY TO THE BODY AS A DECORATIVE PIECE OF CLOTHING WITH UTILITY; CLOTHING ITEMS, NAMELY, ADHESIVE POCKETS THAT MAY BE AFFIXED DIRECTLY TO THE INSIDE OF CLOTHING FOR STORAGE AND SAFEKEEPING OF PERSONAL ITEMS; CLOTHING ITEMS, NAMELY, BLINDFOLDS WORN OVER THE EYES; CLOTHING ITEMS, NAMELY, GAGS WORN OVER THE MOUTH; CLOTHING SHIELDS, NAMELY, PADS APPLIED TO THE UNDERARMS OF SHIRTS,

**CLASS 25—(Continued).**

BLOUSES AND SWEATERS; CLOTHING, NAMELY, ARM WARMERS; CLOTHING, NAMELY, ATHLETIC SLEEVES; CLOTHING, NAMELY, BASE LAYERS; CLOTHING, NAMELY, COWLS AND SMOKE RING SCARVES; CLOTHING, NAMELY, CROPS; CLOTHING, NAMELY, FOLK COSTUMES; CLOTHING, NAMELY, HAND-WARMERS; CLOTHING, NAMELY, KHAKIS; CLOTHING, NAMELY, KNEE WARMERS; CLOTHING, NAMELY, MATERNITY BANDS; CLOTHING, NAMELY, NECK TUBES; CLOTHING, NAMELY, THOBES; CLOTHING, NAMELY, WRAP-AROUNDS; COATS OF DENIM; COMBINATIONS; CORSETS; CYCLING SHOES; DANCE SHOES; DECK-SHOES; DENIM JACKETS; DENIMS; DRAWERS; DRIVERS; DUSTERS; EYESHADES; FITTED SHOE OR BOOT COVERING TO PROTECT THE SHOES OR BOOT FROM WATER OR OTHER DAMAGE; FLIP FLOPS; FOOTBALL SHOES; FOOTWEAR; FOOTWEAR FOR MEN; FOOTWEAR FOR MEN AND WOMEN; FOOTWEAR FOR TRACK AND FIELD ATHLETICS; FOOTWEAR FOR WOMEN; FOOTWEAR MADE OF VINYL; FOOTWEAR MADE OF WOOD; FOOTWEAR NOT FOR SPORTS; FOOTWEAR, NAMELY, PUMPS; FOOTWEAR, NAMELY, RUBBERS; FOOTWEAR, NAMELY, WORK BOOTS; FOULARDS; GLOVES AS CLOTHING; GOLF SHOES; GYMNASIAC SHOES; HANDBALL SHOES; HEAD WRAPS; HEADBANDS FOR CLOTHING; HEEL PIECES FOR SHOES; HOCKEY SHOES; HOODS; INFANT AND TODDLER ONE PIECE CLOTHING; INFANTS' SHOES AND BOOTS; INSOLES; INSOLES FOR FOOTWEAR; JACKETS; JAPANESE FOOTWEAR OF RICE STRAW (WARAJI); JAPANESE SPLIT-TOED WORK FOOTWEAR (JIKATABI); JEANS; JEGGINGS, NAMELY, PANTS THAT ARE PARTIALLY JEANS AND PARTIALLY LEGGINGS; JERSEYS; LEATHER BELTS; LEATHER SHOES; LEISURE SHOES; MANTLES; MOUNTAINEERING SHOES; MUFFLERS; NON-DISPOSABLE CLOTH TRAINING PANTS; NON-SLIP SOLES FOR FOOTWEAR; PAPER HATS FOR USE AS CLOTHING ITEMS; PAPER SHOES USED WHEN GOING THROUGH METAL DETECTORS TO KEEP FEET AND SOCKS CLEAN; PARTS OF CLOTHING, NAMELY, GUSSETS FOR TIGHTS, GUSSETS FOR STOCKINGS, GUSSETS FOR BATHING SUITS, GUSSETS FOR UNDERWEAR, GUSSETS FOR LEOTARDS AND GUSSETS FOR FOOTLETS; PARTS OF CLOTHING, NAMELY, UNDERARM GUSSETS; PARTY HATS; PERSPIRATION ABSORBENT UNDERWEAR CLOTHING; PLATFORM SHOES; POCKET SQUARES; POCKETS FOR CLOTHING; POLYMER CUSTOM CUSHIONED SHOE INSERTS FOR PRIMARILY NON-ORTHOPEDIC PURPOSES; PROTECTIVE METAL MEMBERS FOR SHOES AND BOOTS; PUMPS; RIDING SHOES; RUBBER SHOES; RUGBY SHOES; RUNNING PADS THAT STRAP ONTO SHOES; RUNNING SHOES; SANDALS AND BEACH SHOES; SHIRTS; SHOE ACCESSORIES, NAMELY, FITTED DECORATIVE COVERS FOR SHOES; SHOE COVERS FOR USE WHEN WEARING SHOES; SHOE DOWELS; SHOE INSERTS FOR PRIMARILY NON-ORTHOPEDIC PURPOSES; SHOE INSERTS FOR PRIMARILY NON-ORTHOPEDIC PURPOSES THAT ALSO DEODORIZE SHOES; SHOE LINERS; SHOE PEGS; SHOE SOLES; SHOE STRAPS; SHOE UPPERS; SHOES; SHOES SOLES FOR REPAIR; SHOES WITH HOOK AND PILE FASTENING TAPES; SHORT SETS; SHOULDER WRAPS; SHOULDER WRAPS FOR CLOTHING; SKI AND SNOWBOARD SHOES AND PARTS THEREOF; SKIING SHOES; SOCCER SHOES; SOLES FOR FOOTWEAR; SPORTS SHOES; SWADDLING CLOTHES; TAP SHOES; TENNIS SHOES; THONGS; TIES; TIPS FOR FOOTWEAR; TONGUE OR PULLSTRAP FOR SHOES AND BOOTS; TOPS; TRACK AND FIELD SHOES; TRAINING SHOES; TRAVEL CLOTHING CONTAINED IN A PACKAGE COMPRISING REVERSIBLE JACKETS, PANTS, SKIRTS, TOPS AND A BELT OR SCARF; TRIATHLON CLOTHING, NAMELY, TRIATHLON TIGHTS, TRIATHLON SHORTS, TRIATHLON SINGLET, TRIATHLON SHIRTS, TRIATHLON SUITS; UNDERARM CLOTHING SHIELDS; VISCOUS GEL POLYMER SOLD AS A COMPONENT OF FINISHED CUSTOM CUSHIONED FOOTWEAR FOR NON-ORTHO-

**CLASS 25—(Continued).**

PEDIC PURPOSES AND APPAREL; VOLLEYBALL SHOES; WATER REPELLING FOOTWEAR; WATER REPELLING LEATHER SHOES AND BOOTS; WATER-PROOF FOOTWEAR; WATERPROOF LEATHER SHOES; WATERPROOF LEATHER SHOES AND BOOTS; WEARABLE GARMENTS AND CLOTHING, NAMELY, SHIRTS; WELTS FOR BOOTS AND SHOES; WOMEN'S CLOTHING, NAMELY, SHIRTS, DRESSES, SKIRTS, BLOUSES; WOMEN'S SHOES; WOMEN'S SHOES, NAMELY, FOLDABLE FLATS; WOODEN SHOES; WORK SHOES AND BOOTS; WRAPS; WRIST BANDS; WRIST-BANDS (U.S. CLS. 22 AND 39).

FIRST USE 7-30-2013; IN COMMERCE 7-30-2013.

RUDY R. SINGLETON, EXAMINING ATTORNEY

SN 86-068,802. CHAN, ANGUS, CITY OF INDUSTRY, CA. FILED 9-19-2013.

# Anladia

THE MARK CONSISTS OF STANDARD CHARACTERS WITHOUT CLAIM TO ANY PARTICULAR FONT, STYLE, SIZE, OR COLOR.

FOR ADULT NOVELTY GAG CLOTHING ITEM, NAMELY, SOCKS; ANGLERS' SHOES; APRES-SKI SHOES; AQUA SHOES; ATHLETIC APPAREL, NAMELY, SHIRTS, PANTS, JACKETS, FOOTWEAR, HATS AND CAPS, ATHLETIC UNIFORMS; ATHLETIC FOOTWEAR; ATHLETIC SHOES; BABIES' PANTS; BABY LAYETTES FOR CLOTHING; BALLET SHOES; BALLROOM DANCING SHOES; BASEBALL SHOES; BEACH FOOTWEAR; BEACH SHOES; BELTS; BELTS FOR CLOTHING; BELTS MADE OUT OF CLOTH; BIBS NOT OF CLOTH OR PAPER; BOAT SHOES; BOTTOMS; BOWLING SHOES; BOXING SHOES; CANVAS SHOES; CHILDREN'S AND INFANTS' CLOTH BIBS; CHILDREN'S CLOTH EATING BIBS; CLEATS FOR ATTACHMENT TO SPORTS SHOES; CLIMBING FOOTWEAR; CLIMBING SHOES; CLOTH BIBS; CLOTH BIBS FOR ADULT DINERS; CLOTH BIBS FOR USE BY SENIOR CITIZENS OR PHYSICALLY- OR MENTALLY-CHALLENGED PERSONS; CLOTHING EXTENSION USED TO EXTEND THE NORMAL SIZE RANGE OF CLOTHING ITEMS TO ACCOMMODATE PREGNANCY SIZE CHANGES; CLOTHING FOR ATHLETIC USE, NAMELY, PADDED ELBOW COMPRESSION SLEEVES BEING PART OF AN ATHLETIC GARMENT; CLOTHING FOR ATHLETIC USE, NAMELY, PADDED PANTS; CLOTHING FOR ATHLETIC USE, NAMELY, PADDED SHIRTS; CLOTHING FOR ATHLETIC USE, NAMELY, PADDED SHORTS; CLOTHING FOR BABIES, TODDLERS AND CHILDREN, TREATED WITH FIRE AND HEAT RETARDANTS, NAMELY, PAJAMAS, JACKETS, SHIRTS, PANTS, JUMPERS; CLOTHING FOR WEAR IN JUDO PRACTICES; CLOTHING FOR WEAR IN WRESTLING GAMES; CLOTHING ITEMS, NAMELY, ADHESIVE POCKETS THAT MAY BE AFFIXED DIRECTLY TO THE BODY AS A DECORATIVE PIECE OF CLOTHING WITH UTILITY; CLOTHING ITEMS, NAMELY, ADHESIVE POCKETS THAT MAY BE AFFIXED DIRECTLY TO THE INSIDE OF CLOTHING FOR STORAGE AND SAFEKEEPING OF PERSONAL ITEMS; CLOTHING ITEMS, NAMELY, BLINDFOLDS WORN OVER THE EYES; CLOTHING ITEMS, NAMELY, GAGS WORN OVER THE MOUTH; CLOTHING SHIELDS, NAMELY, PADS APPLIED TO THE UNDERARMS OF SHIRTS, BLOUSES AND SWEATERS; CLOTHING, NAMELY, ARM WARMERS; CLOTHING, NAMELY, ATHLETIC SLEEVES; CLOTHING, NAMELY, BASE LAYERS; CLOTHING, NAMELY, COWLS AND SMOKE RING SCARVES; CLOTHING, NAMELY, CROPS; CLOTHING, NAMELY, FOLK COSTUMES; CLOTHING, NAMELY, HAND-WARMERS; CLOTHING, NAMELY, KHAKIS; CLOTHING, NAMELY, KNEE WARMERS; CLOTHING, NAMELY, MATERNITY BANDS; CLOTHING, NAMELY,

**CLASS 25—(Continued).**

NECK TUBES; CLOTHING, NAMELY, THOBES; CLOTHING, NAMELY, WRAP-AROUNDS; COATS OF DENIM; COMBINATIONS; CORSETS; CYCLING SHOES; DANCE SHOES; DECK-SHOES; DENIM JACKETS; DENIMS; DRAWERS; DRIVERS; DUSTERS; EYESHADES; FITTED SHOE OR BOOT COVERING TO PROTECT THE SHOES OR BOOT FROM WATER OR OTHER DAMAGE; FLIP FLOPS; FOOTBALL SHOES; FOOTWEAR; FOOTWEAR; FOOTWEAR FOR MEN; FOOTWEAR FOR MEN AND WOMEN; FOOTWEAR FOR TRACK AND FIELD ATHLETICS; FOOTWEAR FOR WOMEN; FOOTWEAR MADE OF VINYL; FOOTWEAR MADE OF WOOD; FOOTWEAR NOT FOR SPORTS; FOOTWEAR, NAMELY, PUMPS; FOOTWEAR, NAMELY, RUBBERS; FOOTWEAR, NAMELY, WORK BOOTS; FOULARDS; GLOVES AS CLOTHING; GOLF SHOES; GYMNASTIC SHOES; HANDBALL SHOES; HEAD WRAPS; HEADBANDS FOR CLOTHING; HEEL PIECES FOR SHOES; HOCKEY SHOES; HOODS; INFANT AND TODDLER ONE PIECE CLOTHING; INFANTS' SHOES AND BOOTS; INSOLES; INSOLES FOR FOOTWEAR; JACKETS; JAPANESE FOOTWEAR OF RICE STRAW (WARAJI); JAPANESE SPLIT-TOED WORK FOOTWEAR (JIKATABI); JEANS; JEGGINGS, NAMELY, PANTS THAT ARE PARTIALLY JEANS AND PARTIALLY LEGGINGS; JERSEYS; LEATHER BELTS; LEATHER SHOES; LEISURE SHOES; MANTLES; MOUNTAINEERING SHOES; MUFFLERS; NON-DISPOSABLE CLOTH TRAINING PANTS; NON-SLIP SOLES FOR FOOTWEAR; PAPER HATS FOR USE AS CLOTHING ITEMS; PAPER SHOES USED WHEN GOING THROUGH METAL DETECTORS TO KEEP FEET AND SOCKS CLEAN; PARTS OF CLOTHING, NAMELY, GUSSETS FOR TIGHTS, GUSSETS FOR STOCKINGS, GUSSETS FOR BATHING SUITS, GUSSETS FOR UNDERWEAR, GUSSETS FOR LEOTARDS AND GUSSETS FOR FOOTLETS; PARTS OF CLOTHING, NAMELY, UNDERARM GUSSETS; PARTY HATS; PERSPIRATION ABSORBENT UNDERWEAR CLOTHING; PLATFORM SHOES; POCKET SQUARES; POCKETS FOR CLOTHING; POLYMER CUSTOM CUSHIONED SHOE INSERTS FOR PRIMARILY NON-ORTHOPEDIC PURPOSES; PROTECTIVE METAL MEMBERS FOR SHOES AND BOOTS; PUMPS; RIDING SHOES; RUBBER SHOES; RUGBY SHOES; RUNNING PADS THAT STRAP ONTO SHOES; RUNNING SHOES; SANDALS AND BEACH SHOES; SHIFTS; SHOE ACCESSORIES, NAMELY, FITTED DECORATIVE COVERS FOR SHOES; SHOE COVERS FOR USE WHEN WEARING SHOES; SHOE DOWELS; SHOE INSERTS FOR PRIMARILY NON-ORTHOPEDIC PURPOSES; SHOE INSERTS FOR PRIMARILY NON-ORTHOPEDIC PURPOSES THAT ALSO DEODORIZE SHOES; SHOE LINERS; SHOE PEGS; SHOE SOLES; SHOE STRAPS; SHOE UPPERS; SHOES; SHOES SOLES FOR REPAIR; SHOES WITH HOOK AND PILE FASTENING TAPES; SHORT SETS; SHOULDER WRAPS; SHOULDER WRAPS FOR CLOTHING; SKI AND SNOWBOARD SHOES AND PARTS THEREOF; SKIING SHOES; SOCCER SHOES; SOLES FOR FOOTWEAR; SPORTS SHOES; SWADDLING CLOTHES; TAP SHOES; TENNIS SHOES; THONGS; TIES; TIPS FOR FOOTWEAR; TONGUE OR PULLSTRAP FOR SHOES AND BOOTS; TOPS; TRACK AND FIELD SHOES; TRAINING SHOES; TRAVEL CLOTHING CONTAINED IN A PACKAGE COMPRISING REVERSIBLE JACKETS, PANTS, SKIRTS, TOPS AND A BELT OR SCARF; TRIATHLON CLOTHING, NAMELY, TRIATHLON TIGHTS, TRIATHLON SHORTS, TRIATHLON SINGLETTS, TRIATHLON SHIRTS, TRIATHLON SUITS; UNDERARM CLOTHING SHIELDS; VISCOUS GEL POLYMER SOLD AS A COMPONENT OF FINISHED CUSTOM CUSHIONED FOOTWEAR FOR NON-ORTHOPEDIC PURPOSES AND APPAREL; VOLLEYBALL SHOES; WATER REPELLING FOOTWEAR; WATER REPELLING LEATHER SHOES AND BOOTS; WATER-PROOF FOOTWEAR; WATERPROOF LEATHER SHOES; WATERPROOF LEATHER SHOES AND BOOTS; WEARABLE GARMENTS AND CLOTHING, NAMELY, SHIRTS; WELTS FOR BOOTS AND SHOES; WOMEN'S CLOTHING, NAMELY, SHIRTS, DRESSES, SKIRTS, BLOUSES; WOMEN'S SHOES; WOMEN'S SHOES, NAMELY, FOLDABLE FLATS; WOODEN SHOES; WORK SHOES AND BOOTS; WRAPS; WRIST BANDS; WRIST-BANDS (U.S. CLS. 22 AND 39).

FIRST USE 4-26-2012; IN COMMERCE 4-26-2012.

RUDY R. SINGLETON, EXAMINING ATTORNEY

**CLASS 25—(Continued).**

SN 86-068,928. PALMER, ROLAND, BROOKLYN, NY. FILED 9-19-2013.



THE MARK CONSISTS OF THE STYLIZED LETTERS "NHAL" ABOVE THE STYLIZED WORDS "NEVER HALF ASS LIFE". TO THE LEFT OF THE LETTERS IS A CIRCLE CONTAINING THE STYLIZED LETTERS "NH" ABOVE THE STYLIZED LETTERS "AL".

FOR HATS; T-SHIRTS (U.S. CLS. 22 AND 39).  
ELLEN BURNS, EXAMINING ATTORNEY

**CLASS 25—(Continued).**

SN 86-069,110. WOJNO-ORANSKI, MONICA, WESTFIELD, NJ. FILED 9-19-2013.

**PRETTY FLIRTS**

THE MARK CONSISTS OF STANDARD CHARACTERS WITHOUT CLAIM TO ANY PARTICULAR FONT, STYLE, SIZE, OR COLOR.

FOR CLOTHING NAMELY T-SHIRTS, SHIRTS, TOPS, CAMIS, SWEATSHIRTS; BOTTOMS, SHORTS, SWEATPANTS, PAJAMAS; DRESSES; SKIRTS; BLOUSES; UNDERGARMENTS; CAMISOLES; BRAS; SWIMWEAR; HEADWEAR (U.S. CLS. 22 AND 39).

BARBARA BROWN, EXAMINING ATTORNEY

SN 86-068,954. FOO, RICK, DENVER, CO. FILED 9-19-2013.

**There's more to beauty  
than breast and booty.**

THE MARK CONSISTS OF STANDARD CHARACTERS WITHOUT CLAIM TO ANY PARTICULAR FONT, STYLE, SIZE, OR COLOR.

FOR HATS; SHIRTS; UNDERWEAR (U.S. CLS. 22 AND 39).

ELLEN BURNS, EXAMINING ATTORNEY

SN 86-069,125. BELLE NEPTUNE, BERKELEY, CA. FILED 9-19-2013.

**Belle Neptune**

THE MARK CONSISTS OF STANDARD CHARACTERS WITHOUT CLAIM TO ANY PARTICULAR FONT, STYLE, SIZE, OR COLOR.

THE NAME(S), PORTRAIT(S), AND/OR SIGNATURE(S) SHOWN IN THE MARK DOES NOT IDENTIFY A PARTICULAR LIVING INDIVIDUAL.

THE ENGLISH TRANSLATION OF "BELLE NEPTUNE" IN THE MARK IS "BEAUTIFUL NEPTUNE".

FOR BLOUSES; DRESSES; HOODED SWEATSHIRTS; JACKETS; PANTS; SHORT-SLEEVED OR LONG-SLEEVED T-SHIRTS; SHORTS; SKIRTS; SWEATERS; SWEATSHIRTS; T-SHIRTS; WOMEN'S CLOTHING, NAMELY, SHIRTS, DRESSES, SKIRTS, BLOUSES (U.S. CLS. 22 AND 39).

SUNG IN, EXAMINING ATTORNEY

SN 86-068,967. DEVOUT GEEK, SAINT LEONARD, MD. FILED 9-19-2013.

**Devout Geek**

THE MARK CONSISTS OF STANDARD CHARACTERS WITHOUT CLAIM TO ANY PARTICULAR FONT, STYLE, SIZE, OR COLOR.

FOR ATHLETIC APPAREL, NAMELY, SHIRTS, PANTS, JACKETS, FOOTWEAR, HATS AND CAPS, ATHLETIC UNIFORMS; ATHLETIC SHIRTS; BUTTON DOWN SHIRTS; GOLF SHIRTS; HOODED SWEAT SHIRTS; LONG-SLEEVED SHIRTS; POLO SHIRTS; SHIRTS; SPORT SHIRTS; SWEAT SHIRTS; T-SHIRTS; T-SHIRTS FOR MEN, WOMEN, CHILDREN; TEE SHIRTS; TURTLE NECK SHIRTS; WEARABLE GARMENTS AND CLOTHING, NAMELY, SHIRTS; WIND SHIRTS (U.S. CLS. 22 AND 39).

ELLEN BURNS, EXAMINING ATTORNEY

SN 86-069,159. COPENHAVER, KEN, MARYSVILLE, WA. FILED 9-19-2013.

**SACKNADO**

THE MARK CONSISTS OF STANDARD CHARACTERS WITHOUT CLAIM TO ANY PARTICULAR FONT, STYLE, SIZE, OR COLOR.

FOR T-SHIRTS, SHIRTS, SWEATSHIRTS, HOODED SWEATSHIRTS; HATS, CAPS, HEADBANDS (U.S. CLS. 22 AND 39).

MATTHEW EINSTEIN, EXAMINING ATTORNEY

**CLASS 25—(Continued).**

SN 86-069,349. BARROW, JAMES, BIG SUR, CA. FILED 9-19-2013.

**NICKEL DIGGER**

THE MARK CONSISTS OF STANDARD CHARACTERS WITHOUT CLAIM TO ANY PARTICULAR FONT, STYLE, SIZE, OR COLOR.

FOR BELTS; COATS; DRESS SUITS; DRESSES; FOOTWEAR; HEADGEAR, NAMELY, HATS AND CAPS; JACKETS; OVERALLS; PAJAMAS; PANTS; SKIRTS; SWEATSHIRTS; SWEATSUITS; SWIMWEAR; T-SHIRTS; UNDERWEAR; VISORS (U.S. CLS. 22 AND 39).

JERI J. FICKES, EXAMINING ATTORNEY

SN 86-069,453. SQUEEM CORPORATION, ORLANDO, FL. FILED 9-19-2013.

**DIVAFIT**

THE MARK CONSISTS OF STANDARD CHARACTERS WITHOUT CLAIM TO ANY PARTICULAR FONT, STYLE, SIZE, OR COLOR.

FOR CORSETS; FOUNDATION GARMENTS; GIRDLES; SHAPEWEAR, NAMELY, MATERNITY BANDS; TOPS; UNDERGARMENTS; WAIST BANDS; WAIST CINCHERS (U.S. CLS. 22 AND 39).

FIRST USE 1-1-2003; IN COMMERCE 1-1-2003.

TRACY WHITTAKER-BROWN, EXAMINING ATTORNEY

SN 86-069,462. SIMPSON, CHRISTINA CELESTE, EL SEGUNDO, CA. AND CELESTE, LIZ, EL SEGUNDO, CA. AND CELESTE, BOBBIE, EL SEGUNDO, CA. FILED 9-19-2013.

**TOLUTINA**

THE MARK CONSISTS OF STANDARD CHARACTERS WITHOUT CLAIM TO ANY PARTICULAR FONT, STYLE, SIZE, OR COLOR.

FOR APPAREL, NAMELY APRONS, HOUSECOATS AND SMOCKS (U.S. CLS. 22 AND 39).

KATINA MISTER, EXAMINING ATTORNEY

**CLASS 25—(Continued).**

SN 86-069,526. HONEYLIFE, LLC, HASTINGS, FL. FILED 9-19-2013.



THE MARK CONSISTS OF THE STYLIZED TEXT "HONEY LIFE" WITH HONEY DRIPPING OFF THE LETTERS AND A DESIGN OF A HONEY BEE OVER THE LETTER "Y".

FOR CLOTHING, NAMELY, HATS AND T-SHIRTS (U.S. CLS. 22 AND 39).

TINA BROWN, EXAMINING ATTORNEY

SN 86-069,652. JIMENEZ, WILLIAMS, NORWALK, CA. AND ALVAREZ, IVAN, NORWALK, CA. FILED 9-19-2013.



FOR BELTS; BLAZERS; BLOUSES; CAPS; COATS; CULOTTES; DRESSES; FOOTWEAR; GLOVES; HATS; HEADWEAR; HOODS; JACKETS; JEANS; JERSEYS; JUMPSUITS; NECKWEAR; PANTS; RAINWEAR; SCARVES; SHIRTS; SHORTS; SKIRTS; SOCKS; SWEATERS; T-SHIRTS; TUNICS; UNDERWEAR; VESTS (U.S. CLS. 22 AND 39).

FIRST USE 6-16-2010; IN COMMERCE 6-16-2010.

SARA BENJAMIN, EXAMINING ATTORNEY

SN 86-069,672. MINNICK, MICHAEL, CAPE CORAL, FL. AND MINNICK, RICHARD, CAPE CORAL, FL. AND MINNICK, JOANN, CAPE CORAL, FL. FILED 9-19-2013.

**Moonshine Rednecks**

THE MARK CONSISTS OF STANDARD CHARACTERS WITHOUT CLAIM TO ANY PARTICULAR FONT, STYLE, SIZE, OR COLOR.

FOR T-SHIRTS (U.S. CLS. 22 AND 39).

AISHA CLARKE, EXAMINING ATTORNEY



**CLASS 25—(Continued).**

SN 86-069,689. GOLDEN BRAND INC., LOS ANGELES, CA. FILED 9-19-2013.

# LOVE THE QUEEN

THE MARK CONSISTS OF STANDARD CHARACTERS WITHOUT CLAIM TO ANY PARTICULAR FONT, STYLE, SIZE, OR COLOR.

FOR APPAREL FOR DANCERS, NAMELY, TEE SHIRTS, SWEATSHIRTS, PANTS, LEGGINGS, SHORTS AND JACKETS; ATHLETIC SKIRTS; CAPRI PANTS; CARGO PANTS; CROP PANTS; CROP TOPS; DENIMS; DRESS PANTS; FLEECE TOPS; GOLF PANTS, SHIRTS AND SKIRTS; GYM PANTS; HALTER TOPS; HORSE-RIDING PANTS; JEGGINGS, NAMELY, PANTS THAT ARE PARTIALLY JEANS AND PARTIALLY LEGGINGS; JOGGING PANTS; KNIT SKIRTS; KNIT TOPS; LEATHER PANTS; LEATHER SKIRTS; LEG WARMERS; LEGGINGS; LEGGINS; LOUNGE PANTS; PANTS; PLEATED SKIRTS FOR FORMAL KIMONOS (HAKAMA); POLO KNIT TOPS; SKIRT SUITS; SKIRTS; SKIRTS AND DRESSES; SPORTS PANTS; STRETCH PANTS; SWEAT PANTS; TANK TOPS; TANK-TOPS; TAP PANTS; TOP COATS; TOPS; TRACK PANTS; TRAVEL CLOTHING CONTAINED IN A PACKAGE COMPRISING REVERSIBLE JACKETS, PANTS, SKIRTS, TOPS AND A BELT OR SCARF; WOMEN'S CLOTHING, NAMELY, SHIRTS, DRESSES, SKIRTS, BLOUSES; WOMEN'S TOPS, NAMELY, CAMIS; WOVEN SKIRTS; WOVEN TOPS; YOGA PANTS (U.S. CLS. 22 AND 39).

FIRST USE 2-1-2012; IN COMMERCE 6-15-2012.

REGINA DRUMMOND, EXAMINING ATTORNEY

SN 86-069,691. REED, ROBERT, WESTLAKE VILLAGE, CA. FILED 9-19-2013.

# HONU LIFE

THE MARK CONSISTS OF STANDARD CHARACTERS WITHOUT CLAIM TO ANY PARTICULAR FONT, STYLE, SIZE, OR COLOR.

FOR CLOTHING, NAMELY, T-SHIRTS, SHIRTS, PANTS, SHORTS; HEADWEAR; FOOTWEAR (U.S. CLS. 22 AND 39).

REGINA DRUMMOND, EXAMINING ATTORNEY

**CLASS 25—(Continued).**

SN 86-069,801. ANNE K. STILLWELL, NAPLES, FL. FILED 9-19-2013.

# KIANE STILLWELL

THE MARK CONSISTS OF STANDARD CHARACTERS WITHOUT CLAIM TO ANY PARTICULAR FONT, STYLE, SIZE, OR COLOR.

THE NAME(S), PORTRAIT(S), AND/OR SIGNATURE(S) SHOWN IN THE MARK DOES NOT IDENTIFY A PARTICULAR LIVING INDIVIDUAL.

FOR DRESSES; JEANS; PANTS; SKIRTS; SWEATERS; TOPS (U.S. CLS. 22 AND 39).

TINA L. SNAPP, EXAMINING ATTORNEY

SN 86-069,803. ASKARI LLC, CHULA VISTA, CA. FILED 9-19-2013.

# 3 Askari

THE MARK CONSISTS OF STANDARD CHARACTERS WITHOUT CLAIM TO ANY PARTICULAR FONT, STYLE, SIZE, OR COLOR.

FOR GLOVES; HATS; JACKETS; JEANS; SHIRTS; SHOES; SOCKS; UNDERWEAR; WRIST BANDS (U.S. CLS. 22 AND 39).

TINA L. SNAPP, EXAMINING ATTORNEY

SN 86-069,866. KEHREN, SHERI, OAKDALE, PA. FILED 9-19-2013.

# BE WHAT INSPIRES YOU

THE MARK CONSISTS OF STANDARD CHARACTERS WITHOUT CLAIM TO ANY PARTICULAR FONT, STYLE, SIZE, OR COLOR.

FOR BRAS; GLOVES; HATS; HOODED SWEATSHIRTS; JACKETS; PANTS; SCARVES; SHORT-SLEEVED OR LONG-SLEEVED T-SHIRTS; SHORTS; SOCKS; TANK TOPS; UNDERWEAR (U.S. CLS. 22 AND 39).

JENNIFER WILLISTON, EXAMINING ATTORNEY

**CLASS 25—(Continued).**

SN 86-069,899. LAMONT BERRYMAN, DBA ROMEOS WHISPERS, SACRAMENTO, CA. FILED 9-19-2013.

## Romeos Whispers

THE MARK CONSISTS OF STANDARD CHARACTERS WITHOUT CLAIM TO ANY PARTICULAR FONT, STYLE, SIZE, OR COLOR.  
FOR MEN'S UNDERWEAR (U.S. CLS. 22 AND 39).  
SOPHIA S. KIM, EXAMINING ATTORNEY

SN 86-069,939. MAHER, CHERRY, UNION CITY, CA. FILED 9-20-2013.

## SKETCH.LAB

THE MARK CONSISTS OF STANDARD CHARACTERS WITHOUT CLAIM TO ANY PARTICULAR FONT, STYLE, SIZE, OR COLOR.  
FOR CLOTHING NAMELY T-SHIRTS, SHIRTS, TOPS, VESTS, SWEATERS, SWEATSHIRTS, HOODED SWEATSHIRTS; COATS, JERSEYS, JACKETS; BOTTOMS, PANTS, TROUSERS, JEANS, SHORTS, SWEATPANTS, PAJAMAS; DRESSES; SKIRTS; BLOUSES; UNDERWEAR; SWIMWEAR; HEADWEAR, SCARVES; FOOTWEAR; GLOVES; OVERALLS; JUMPERS (U.S. CLS. 22 AND 39).  
B. PARADEWELAI, EXAMINING ATTORNEY

SN 86-070,062. WOLVERINE WORLD WIDE, INC., ROCKFORD, MI. FILED 9-20-2013.

## CUSHE

THE MARK CONSISTS OF STANDARD CHARACTERS WITHOUT CLAIM TO ANY PARTICULAR FONT, STYLE, SIZE, OR COLOR.  
OWNER OF U.S. REG. NOS. 3,291,086 AND 3,871,992.  
FOR BELTS; COATS; DRESSES; GLOVES; HATS; JACKETS; PANTS; SCARVES; SHIRTS; SHORTS; SKIRTS; SKORTS; SOCKS; SWEATERS; SWEATSHIRTS; T-SHIRTS; VESTS (U.S. CLS. 22 AND 39).  
JONATHAN FALK, EXAMINING ATTORNEY

**CLASS 25—(Continued).**

SN 86-070,181. PALAZZO, ETHAN, CHARLESTOWN, IN. FILED 9-20-2013.

## Simply Hype

THE MARK CONSISTS OF STANDARD CHARACTERS WITHOUT CLAIM TO ANY PARTICULAR FONT, STYLE, SIZE, OR COLOR.  
FOR HATS; JACKETS; PANTS; SHIRTS; SHORTS (U.S. CLS. 22 AND 39).  
KAPIL BHANOT, EXAMINING ATTORNEY

SN 86-070,193. NEW KARMA CLOTHING LLC, FORT WAYNE, IN. FILED 9-20-2013.

## NEW KARMA

THE MARK CONSISTS OF STANDARD CHARACTERS WITHOUT CLAIM TO ANY PARTICULAR FONT, STYLE, SIZE, OR COLOR.  
FOR BASEBALL CAPS AND HATS; BEANIES; CLOTHING, NAMELY, KHAKIS; HATS FOR INFANTS, BABIES, TODDLERS AND CHILDREN; HEADBANDS FOR CLOTHING; HOODED SWEATSHIRTS FOR MEN, WOMEN AND CHILDREN; INFANT AND TODDLER ONE PIECE CLOTHING; JEANS; JERSEYS; MEN'S AND WOMEN'S JACKETS, COATS, TROUSERS, VESTS; MEN'S SOCKS; MEN'S UNDERWEAR; SWEATSHIRTS FOR MEN, WOMEN AND CHILDREN; T-SHIRTS FOR MEN, WOMEN AND CHILDREN; TOPS; WEARABLE GARMENTS AND CLOTHING, NAMELY, SHIRTS; WOMEN'S CLOTHING, NAMELY, SHIRTS, DRESSES, SKIRTS, BLOUSES; WRISTBANDS (U.S. CLS. 22 AND 39).  
SETH A. RAPPAPORT, EXAMINING ATTORNEY

SN 86-070,212. EUREVO, MIAMI, FL. FILED 9-20-2013.

## EUREVO

THE MARK CONSISTS OF STANDARD CHARACTERS WITHOUT CLAIM TO ANY PARTICULAR FONT, STYLE, SIZE, OR COLOR.  
FOR CLOTHING, NAMELY, T-SHIRTS, SWEATSHIRTS, SWEATERS, JACKETS, SHORTS, PANTS, SWIMSUITS, AND HATS FOR SURFING, SNOWBOARDING, SKATEBOARDING, PADDLE-BOARDING, SKIING, SWIMMING, AND DIVING (U.S. CLS. 22 AND 39).  
RONALD MCMORROW, EXAMINING ATTORNEY

**CLASS 25—(Continued).**

SN 86-070,253. LE, KHOA, CEDAR PARK, TX. FILED 9-20-2013.

**Tight Lines and Big Tines!**

THE MARK CONSISTS OF STANDARD CHARACTERS WITHOUT CLAIM TO ANY PARTICULAR FONT, STYLE, SIZE, OR COLOR.

FOR HATS; T-SHIRTS (U.S. CLS. 22 AND 39).  
FIRST USE 12-9-2012; IN COMMERCE 1-23-2013.  
ANDREA HACK, EXAMINING ATTORNEY

---

SN 86-070,290. WORZALLA, DAVID BERNARD, SAUKVILLE, WI. FILED 9-20-2013.

**1800327BAND**

THE MARK CONSISTS OF STANDARD CHARACTERS WITHOUT CLAIM TO ANY PARTICULAR FONT, STYLE, SIZE, OR COLOR.

FOR HATS; JACKETS; PANTS; POLO SHIRTS; SHIRTS; SHORTS; SWEATSHIRTS (U.S. CLS. 22 AND 39).  
DOMINICK J. SALEMI, EXAMINING ATTORNEY

---

SN 86-070,406. INVERSIONES EASTON S.A, NEW YORK, NY. FILED 9-20-2013.

**guacamole is my life**

THE MARK CONSISTS OF STANDARD CHARACTERS WITHOUT CLAIM TO ANY PARTICULAR FONT, STYLE, SIZE, OR COLOR.

FOR HATS; SWEATERS; T-SHIRTS (U.S. CLS. 22 AND 39).  
JEFFREY LOOK, EXAMINING ATTORNEY

**CLASS 25—(Continued).**

SN 86-070,476. MAGNOLIA INTELLECTUAL PROPERTY, LLC, NEW YORK, NY. FILED 9-20-2013.



THE COLOR(S) BROWN AND PASTEL GREEN IS/ARE CLAIMED AS A FEATURE OF THE MARK.

THE MARK CONSISTS OF A STYLIZED REPRESENTATION OF A CUPCAKE WITH FROSTING COVERING THE ENTIRE TOP OF THE CUPCAKE. THE BOTTOM OF THE CUPCAKE IS BROWN AND HAS A SCALLOPED TOP SIMULATING A CUPCAKE LINER. THE FROSTING IS PASTEL GREEN. THE WHITE IN THE DRAWING REPRESENTS BACKGROUND AREAS ONLY AND IS NOT PART OF THE MARK.

FOR HEADWEAR; INFANTWEAR; NIGHT SHIRTS; SHIRTS; T-SHIRTS; TOPS (U.S. CLS. 22 AND 39).  
FIRST USE 6-13-2013; IN COMMERCE 6-13-2013.  
LINDA QUIGLEY, EXAMINING ATTORNEY

---

SN 86-070,620. WATERSWIM S.A.S., ANTIOQUIA, COLOMBIA, FILED 9-20-2013.



THE COLOR(S) LIGHT BLUE, DARK BLUE AND BLACK IS/ARE CLAIMED AS A FEATURE OF THE MARK.

THE MARK CONSISTS OF A SWIMMING MAN OVER AN OVAL LIKE DESIGN FORMED BY TWO BOOMERANG LIKE FIGURES, BELOW WHICH APPEARS THE WORDING "WATERSWIM" IN STYLIZED LETTERS. THE LIGHT BLUE COLOR APPEARS IN THE TWO BOOMERANG FIGURES. THE DARK BLUE COLOR APPEARS IN THE SWIMMING MAN. THE COLOR BLACK APPEARS IN THE WORD "WATERSWIM".

FOR BATHING SUITS; BLOUSES; DRESSES; JACKETS; LADIES' SUITS; MEN'S AND WOMEN'S JACKETS, COATS, TROUSERS, VESTS; MEN'S SUITS; PANTS; SHIRTS; SHOWER CAPS; SKIRTS; SPORTS BRAS; SPORTS JACKETS; SPORTS JERSEYS; SPORTS PANTS; SPORTS SHIRTS; SUITS; SWIM SUITS; SWIM WEAR FOR GENTLEMEN AND LADIES; SWIMMING CAPS; T-SHIRTS (U.S. CLS. 22 AND 39).

ALEXANDER L. POWERS, EXAMINING ATTORNEY

**CLASS 25—(Continued).**

SN 86-070,662. CHARLES PORTER BOUTIQUE, INC., PHILADELPHIA, PA. FILED 9-20-2013.

**Brick & Elm**

THE MARK CONSISTS OF STANDARD CHARACTERS WITHOUT CLAIM TO ANY PARTICULAR FONT, STYLE, SIZE, OR COLOR.

FOR BELTS; COATS; DENIMS; HATS; JACKETS; PANTIES; PANTS; SHIRTS; SKIRTS AND DRESSES; SOCKS; SWEAT SHIRTS; SWEATERS; T-SHIRTS; TOPS; UNDERGARMENTS; UNDERWEAR (U.S. CLS. 22 AND 39).

FIRST USE 9-6-2013; IN COMMERCE 9-6-2013.  
DANNEAN HETZEL, EXAMINING ATTORNEY

SN 86-070,676. TUTTLEMONDO, NIKKI, MURRIETA, CA. FILED 9-20-2013.

**Curve Nation**

THE MARK CONSISTS OF STANDARD CHARACTERS WITHOUT CLAIM TO ANY PARTICULAR FONT, STYLE, SIZE, OR COLOR.

FOR BRAS; DRESSES; PANTS; SHIRTS; SHOES; SKIRTS; UNDERWEAR (U.S. CLS. 22 AND 39).  
DANNEAN HETZEL, EXAMINING ATTORNEY

SN 86-070,681. PINE WAY CLOTHING LLC, MIAMI, FL. FILED 9-20-2013.

**OAKS & PINES**

THE MARK CONSISTS OF STANDARD CHARACTERS WITHOUT CLAIM TO ANY PARTICULAR FONT, STYLE, SIZE, OR COLOR.

FOR FOOTWEAR; HOSIERY; NECKWEAR; UNDERWEAR (U.S. CLS. 22 AND 39).

JENNIFER RICHARDSON, EXAMINING ATTORNEY

**CLASS 25—(Continued).**

SN 86-070,821. WRIGHT, JAMES PAUL, ROCKY MOUNT, NC. FILED 9-20-2013.

**DO A NEW THING**

THE MARK CONSISTS OF STANDARD CHARACTERS WITHOUT CLAIM TO ANY PARTICULAR FONT, STYLE, SIZE, OR COLOR.

FOR SHIRTS (U.S. CLS. 22 AND 39).

JOANNA DUKOVIC, EXAMINING ATTORNEY

SN 86-070,828. COPELAND, LARRY, KEMPNER, TX. FILED 9-20-2013.



THE STIPPLING IS FOR SHADING PURPOSES ONLY. THE MARK CONSISTS OF THE NAME "MZ HUSTLE" STYLIZED, WITH A DIAMOND FOR A (PUNCTUATION MARK)AFTER THE Z IN "MZ". A PICTURE OF WOMAN'S "LIPSTICK" KISS IN THE BACKGROUND.

FOR JEANS; SHIRTS; SOCKS; UNDERGARMENTS (U.S. CLS. 22 AND 39).

B. PARADEWELAI, EXAMINING ATTORNEY

SN 86-070,885. PAKTER, PASCAL, DBA DO OR DIE, LLC., ENCINITAS, NY. AND PAKTER, KERSTIN, DBA DO OR DIE, LLC., ENCINITAS, CA. FILED 9-20-2013.

**PRO COMP**

THE MARK CONSISTS OF STANDARD CHARACTERS WITHOUT CLAIM TO ANY PARTICULAR FONT, STYLE, SIZE, OR COLOR.

FOR ATHLETIC APPAREL, NAMELY, SHIRTS, PANTS, JACKETS, FOOTWEAR, HATS AND CAPS, ATHLETIC UNIFORMS (U.S. CLS. 22 AND 39).

FIRST USE 1-12-2011; IN COMMERCE 5-17-2011.

ANDREA HACK, EXAMINING ATTORNEY

**CLASS 25—(Continued).**

SN 86-070,930. TALKING FROG, LLC, TEMECULA, CA.  
FILED 9-20-2013.

# Talking Frog

THE MARK CONSISTS OF STANDARD CHARACTERS WITHOUT CLAIM TO ANY PARTICULAR FONT, STYLE, SIZE, OR COLOR.

FOR CAPS; COATS; HATS; JACKETS; PANTS; SHORTS; SOCKS; SWEATSHIRTS; SWIM WEAR; T-SHIRTS (U.S. CLS. 22 AND 39).

BARBARA A. GOLD, EXAMINING ATTORNEY

**CLASS 25—(Continued).**

SN 86-071,059. SCOTT SHOE CO., LTD., HONOLULU, HI.  
FILED 9-20-2013.

# CHOOSE ALOHA

THE MARK CONSISTS OF STANDARD CHARACTERS WITHOUT CLAIM TO ANY PARTICULAR FONT, STYLE, SIZE, OR COLOR.

FOR SANDALS; SLIPPERS (U.S. CLS. 22 AND 39).

FIRST USE 7-1-2013; IN COMMERCE 7-1-2013.

KATINA MISTER, EXAMINING ATTORNEY

SN 86-070,997. SEXTON, JOE ALAN, BIRMINGHAM, AL.  
FILED 9-20-2013.



THE COLOR(S) RED AND WHITE IS/ARE CLAIMED AS A FEATURE OF THE MARK.

THE MARK CONSISTS OF A RED OVAL WITH A WHITE CIRCLE INSIDE WITH A RED OVAL AND WHITE LETTERS R, T, R IN THE MIDDLE.

FOR BASEBALL CAPS AND HATS; GOLF SHIRTS; POLO SHIRTS (U.S. CLS. 22 AND 39).

FIRST USE 9-8-2007; IN COMMERCE 9-8-2007.

RONALD MCMORROW, EXAMINING ATTORNEY

SN 86-071,090. WESTERN PRODUCTS/ SUMMIT HATS,  
HOUSTON, TX. FILED 9-20-2013.

# The Bound Edge

THE MARK CONSISTS OF STANDARD CHARACTERS WITHOUT CLAIM TO ANY PARTICULAR FONT, STYLE, SIZE, OR COLOR.

FOR HATS (U.S. CLS. 22 AND 39).

ARETHA SOMERVILLE, EXAMINING ATTORNEY

SN 86-071,043. PORTER, KAREN, CHARLOTTE, NC. FILED  
9-20-2013.

# Bohemian Posh

THE MARK CONSISTS OF STANDARD CHARACTERS WITHOUT CLAIM TO ANY PARTICULAR FONT, STYLE, SIZE, OR COLOR.

FOR BELTS; BLOUSES; DRESSES; FOOTWEAR; HATS; LOUNGEWEAR; PANTS; SCARVES; SHIRTS (U.S. CLS. 22 AND 39).

ARETHA SOMERVILLE, EXAMINING ATTORNEY

SN 86-071,225. KHIET VANDY, KENT, WA. FILED 9-22-2013.

# sick

THE MARK CONSISTS OF STANDARD CHARACTERS WITHOUT CLAIM TO ANY PARTICULAR FONT, STYLE, SIZE, OR COLOR.

FOR APPAREL FOR DANCERS, NAMELY, TEE SHIRTS, SWEATSHIRTS, PANTS, LEGGINGS, SHORTS AND JACKETS (U.S. CLS. 22 AND 39).

FIRST USE 9-1-2013; IN COMMERCE 9-21-2013.

JENNIFER MARTIN, EXAMINING ATTORNEY

**CLASS 25—(Continued).**

SN 86-071,319. CATHY QIN, EAST WINDSOR, NJ. FILED 9-22-2013.

# ForJolly

THE MARK CONSISTS OF STANDARD CHARACTERS WITHOUT CLAIM TO ANY PARTICULAR FONT, STYLE, SIZE, OR COLOR.

FOR BRAS; DRESS PANTS; DRESS SUITS; JEGGINGS, NAMELY, PANTS THAT ARE PARTIALLY JEANS AND PARTIALLY LEGGINGS; LADIES' UNDERWEAR; LEGGINGS; MEN'S UNDERWEAR; PANTS; SOCKS; SPORTS BRAS; SWEATERS; UNDER GARMENTS; UNIFORMS; WOMEN'S UNDERWEAR; WOOLLEN SOCKS (U.S. CLS. 22 AND 39).

DAVID MURRAY, EXAMINING ATTORNEY

SN 86-071,321. CATHERINE MULHOLLAND, DBA PACIFIC REHAB INC, CAREFREE, AZ. FILED 9-22-2013.

# Arizona is Hot....literally

THE MARK CONSISTS OF STANDARD CHARACTERS WITHOUT CLAIM TO ANY PARTICULAR FONT, STYLE, SIZE, OR COLOR.

FOR ATHLETIC APPAREL, NAMELY, SHIRTS, PANTS, JACKETS, FOOTWEAR, HATS AND CAPS, ATHLETIC UNIFORMS; ATHLETIC SHIRTS; BODY SHIRTS (U.S. CLS. 22 AND 39).

MATTHEW EINSTEIN, EXAMINING ATTORNEY

SN 86-071,378. SHORT, JORDYN A., FORT WASHINGTON, MD. FILED 9-22-2013.

# PRETTY GIRL MOVEMENT

THE MARK CONSISTS OF STANDARD CHARACTERS WITHOUT CLAIM TO ANY PARTICULAR FONT, STYLE, SIZE, OR COLOR.

FOR ATHLETIC PANTS; ATHLETIC SHIRTS; HOODED SWEATSHIRTS; LONG-SLEEVED SHIRTS; SWEATSHIRTS; T-SHIRTS (U.S. CLS. 22 AND 39).

BRENDAN MCCAULEY, EXAMINING ATTORNEY

**CLASS 25—(Continued).**

SN 86-071,867. ROBERT W. COOMBS, SURPRISE, AZ. FILED 9-23-2013.

# HOTOCRACY

THE MARK CONSISTS OF STANDARD CHARACTERS WITHOUT CLAIM TO ANY PARTICULAR FONT, STYLE, SIZE, OR COLOR.

FOR CAPS; HATS; LONG-SLEEVED SHIRTS; PANTS; SHIRTS AND SHORT-SLEEVED SHIRTS; SHORT-SLEEVED OR LONG-SLEEVED T-SHIRTS; SHORTS; SWEATPANTS; SWEATSHIRTS; UNDERWEAR (U.S. CLS. 22 AND 39).

ELI HELLMAN, EXAMINING ATTORNEY

SN 86-071,930. MOONEY, BRIAN, ABINGDON, MD. FILED 9-23-2013.

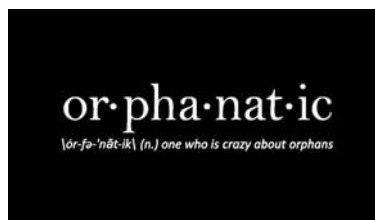

THE MARK CONSISTS OF LOGO APPEARS IN LOWER CASE LETTERS; THE WORD "ORPHANATIC" IS DIVIDED USING PHONETIC SYMBOLS AS THE FOLLOWING "OR-PHA.NAT.IC "; BENEATH THE LOGO, THE PHONETIC SPELLING OF THE WORD "ORPHANATIC" APPEARS; FOLLOWED BY A FICTITIOUS DICTIONARY DEFINITION, WHICH READS, "ONE WHO IS CRAZY ABOUT ORPHANS".

FOR T-SHIRTS (U.S. CLS. 22 AND 39).  
MARILYN IZZI, EXAMINING ATTORNEY

SN 86-071,946. LANCE, KOKO, BROOKLYN, NY. AND HAMMOUDI, DASSINE, BROOKLYN, NY. FILED 9-23-2013.

# VELLUM

THE MARK CONSISTS OF STANDARD CHARACTERS WITHOUT CLAIM TO ANY PARTICULAR FONT, STYLE, SIZE, OR COLOR.

FOR BLAZERS; DRESSES; FOOTWEAR; HOODED SWEATSHIRTS; LEGGINGS; PANTS; SHIRTS; SKIRTS; T-SHIRTS (U.S. CLS. 22 AND 39).

JULIE WATSON, EXAMINING ATTORNEY

**CLASS 25—(Continued).**

SN 86-072,020. MYERS, JONATHAN, LAKEWOOD, CA. FILED 9-23-2013.

# Cobra Lord

THE MARK CONSISTS OF STANDARD CHARACTERS WITHOUT CLAIM TO ANY PARTICULAR FONT, STYLE, SIZE, OR COLOR.  
FOR HATS; JACKETS; T-SHIRTS (U.S. CLS. 22 AND 39).  
FIRST USE 10-1-2009; IN COMMERCE 6-6-2011.  
MICHAEL ENGEL, EXAMINING ATTORNEY

**CLASS 25—(Continued).**

SN 86-072,123. TRIMBLE, RICHIE, LOS ANGELES, CA. FILED 9-23-2013.

# STOOPIDTALL

THE MARK CONSISTS OF STANDARD CHARACTERS WITHOUT CLAIM TO ANY PARTICULAR FONT, STYLE, SIZE, OR COLOR.  
FOR BATHING SUITS; BOTTOMS; CAPS; FOOTWEAR; HATS; HEADWEAR; JACKETS; PANTS; SHIRTS; SHORTS; SWIMWEAR; TOPS (U.S. CLS. 22 AND 39).  
MEREDITH MARESCA, EXAMINING ATTORNEY

SN 86-072,054. FILKINS, JAMES, MT. WASHINGTON, MA. FILED 9-23-2013.

# Gravity Optional

THE MARK CONSISTS OF STANDARD CHARACTERS WITHOUT CLAIM TO ANY PARTICULAR FONT, STYLE, SIZE, OR COLOR.  
FOR CLOTHING, NAMELY, T-SHIRTS, PANTS, ATHLETIC WARM-UP SUITS, HATS, CYCLING JERSEYS, SWEATSHIRTS, AND SWEATPANTS (U.S. CLS. 22 AND 39).  
ALEX KEAM, EXAMINING ATTORNEY

SN 86-072,158. MELL, TROY, TAVERNIER, FL. FILED 9-23-2013.

# REEL H2O

THE MARK CONSISTS OF STANDARD CHARACTERS WITHOUT CLAIM TO ANY PARTICULAR FONT, STYLE, SIZE, OR COLOR.  
FOR HATS; SHIRTS; SHORTS (U.S. CLS. 22 AND 39).  
JOHN WILKE, EXAMINING ATTORNEY

SN 86-072,092. SHABBY MAMMAL, GLENDALE, CA. FILED 9-23-2013.

# City Living. Nature Loving.

THE MARK CONSISTS OF STANDARD CHARACTERS WITHOUT CLAIM TO ANY PARTICULAR FONT, STYLE, SIZE, OR COLOR.  
FOR SHOES; T-SHIRTS (U.S. CLS. 22 AND 39).  
JOHN WILKE, EXAMINING ATTORNEY

SN 86-072,386. BETHEA, RAQIA, EAST ORANGE, NJ. FILED 9-23-2013.

# Quitters Neverlast

THE MARK CONSISTS OF STANDARD CHARACTERS WITHOUT CLAIM TO ANY PARTICULAR FONT, STYLE, SIZE, OR COLOR.  
FOR PANTS; SHIRTS; TANK TOPS (U.S. CLS. 22 AND 39).  
FIRST USE 10-13-2012; IN COMMERCE 10-13-2012.  
REBECCA GILBERT, EXAMINING ATTORNEY

**CLASS 25—(Continued).**

SN 86-072,448. NICK'S CUSTOM BOOTS LLC, DBA NICKS CUSTOM BOOTS, SPOKANE, WA. FILED 9-23-2013.

**HOT SHOT**

THE MARK CONSISTS OF STANDARD CHARACTERS WITHOUT CLAIM TO ANY PARTICULAR FONT, STYLE, SIZE, OR COLOR.

FOR BOOTS (U.S. CLS. 22 AND 39).  
FIRST USE 1-1-1980; IN COMMERCE 1-1-1980.  
RONALD MCMORROW, EXAMINING ATTORNEY

SN 86-072,504. JUMPSIES LLC, SUNRISE, FL. FILED 9-23-2013.

**JUMPSIES**

THE MARK CONSISTS OF STANDARD CHARACTERS WITHOUT CLAIM TO ANY PARTICULAR FONT, STYLE, SIZE, OR COLOR.

FOR BATHING SUITS; BLOUSES; CAPS; DRESSES; LEGGINGS; PANTS; SHIRTS; SHORTS; SKIRTS; SUITS; SWEATERS; T-SHIRTS (U.S. CLS. 22 AND 39).  
FIRST USE 2-19-2013; IN COMMERCE 5-25-2013.  
GIANCARLO CASTRO, EXAMINING ATTORNEY

SN 86-072,955. ZION INTERNATIONAL, LLC, JEFFERSONVILLE, PA. FILED 9-24-2013.



THE MARK CONSISTS OF A RIBBON FORMED INTO A BOW, WITH THE ENDS OF THE RIBBON CROSSING OVER TO FORM THE SHAPE OF A HEART.

FOR CLOTHING ITEMS, NAMELY, BLINDFOLDS WORN OVER THE EYES; CLOTHING ITEMS, NAMELY, GAGS WORN OVER THE MOUTH; COSTUMES FOR ROLE-PLAYING GAMES; LINGERIE; SLEEPWEAR; T-SHIRTS; DRESSES; SKIRTS; PANTS; JEANS; WOMEN'S TOPS, NAMELY, BLOUSES, TANK TOPS, CAMISOLES, AND TUNICS; SWEATERS; PULLOVERS; COATS; JACKETS; AND SWIMWEAR (U.S. CLS. 22 AND 39).

APRIL ROACH, EXAMINING ATTORNEY

**CLASS 25—(Continued).**

SN 86-073,819. HEMP HELPS, L3C, PALOS HILLS, IL. FILED 9-24-2013.



THE MARK CONSISTS OF A LOGO WHICH CONSISTS OF TWO LOWER CASE "H'S" WITH A CURVE BELOW THE TWO "H'S", RESULTING IN A SMILEY FACE EFFECT.

FOR ANKLE SOCKS; BASEBALL CAPS AND HATS; BOAT SHOES; BRIEFS; CANVAS SHOES; CREW NECK SWEATERS; DENIM JACKETS; DOWN JACKETS; DRESS PANTS; DRESS SHIRTS; DRESSES; EAR BANDS; EAR MUFFS; EVENING DRESSES; FLIP FLOPS; FOOTWEAR; FOOTWEAR FOR MEN; FOOTWEAR FOR MEN AND WOMEN; FOOTWEAR FOR WOMEN; HATS; HATS FOR INFANTS, BABIES, TODDLERS AND CHILDREN; HEADBANDS; HEADBANDS FOR CLOTHING; HOODED SWEATSHIRTS; JACKETS; KNIT DRESSES; KNIT JACKETS; KNIT SKIRTS; KNITTED GLOVES; LADIES' UNDERWEAR; LEISURE SHOES; LONG JACKETS; MEN'S AND WOMEN'S JACKETS, COATS, TROUSERS, VESTS; MEN'S DRESS SOCKS; MEN'S UNDERWEAR; MOCK TURTLE-NECK SWEATERS; OUTDOOR GLOVES; OUTER JACKETS; PAJAMA BOTTOMS; PAJAMAS; RAIN JACKETS; REVERSIBLE JACKETS; RUNNING SHOES; SANDALS AND BEACH SHOES; SCARVES; SHELL JACKETS; SHOES; SHORT-SLEEVED OR LONG-SLEEVED T-SHIRTS; SHORTS; SHOULDER SCARVES; SKI GLOVES; SKIRTS; SKIRTS AND DRESSES; SLEEP PANTS; SLEEVED OR SLEEVELESS JACKETS; SNOWBOARD GLOVES; SNOWBOARD JACKETS; SOCKS; SOCKS AND STOCKINGS; SPORTS CAPS AND HATS; SPORTS PANTS; SPORTS SHOES; STRETCH PANTS; SWEAT PANTS; SWEATERS; SWEATSHIRTS; TANK TOPS; TENNIS SHOES; THONGS; TRACK JACKETS; TRACK PANTS; TURTLENECK SWEATERS; UNDERWEAR; V-NECK SWEATERS; WIND-JACKETS; WINTER COATS; WOMEN'S CLOTHING, NAMELY, SHIRTS, DRESSES, SKIRTS, BLOUSES; WOMEN'S HATS AND HOODS; WOMEN'S SHOES; WOMEN'S UNDERWEAR; WOOLLY HATS; WOVEN SKIRTS; YOGA PANTS (U.S. CLS. 22 AND 39).

FIRST USE 6-15-2013; IN COMMERCE 9-20-2013.

DAVID MURRAY, EXAMINING ATTORNEY



**CLASS 25—(Continued).**

SN 86-074,549. CHARLES KOMAR & SONS, INC, NEW YORK, NY. FILED 9-25-2013.

MOONLIGHT SONATA

THE MARK CONSISTS OF STANDARD CHARACTERS WITHOUT CLAIM TO ANY PARTICULAR FONT, STYLE, SIZE, OR COLOR.

FOR BELTS; BOTTOMS; FLIP FLOPS; FOOTWEAR; HEADBANDS; HEADWEAR; HOSIERY; KNITTED UNDERWEAR; LEGGINGS; LINGERIE; LONG UNDERWEAR; LOUNGEWEAR; MUKLUKS; PAJAMAS; PANTYHOSE; ROBES; SANDALS; SARONGS; SCARFS; SLEEPWEAR; SLIPPER SOCKS; SLIPPERS; SWEAT BANDS; SWEAT JACKETS; SWEAT PANTS; SWEAT SHIRTS; SWEAT SHORTS; SWEAT SUITS; THERMAL UNDERWEAR; TOPS; UNDERWEAR; WEARABLE BLANKETS IN THE NATURE OF BLANKETS WITH SLEEVES; WRIST BANDS (U.S. CLS. 22 AND 39).

MARCIE MILONE, EXAMINING ATTORNEY

**CLASS 25—(Continued).**

SN 86-079,785. BEBE STUDIO, INC., LOS ANGELES, CA. FILED 10-1-2013.



OWNER OF U.S. REG. NO. 3,509,651.

THE MARK CONSISTS OF THE STYLIZED NUMBER "2" AND THE STYLIZED LETTER "B" ON ONE LINE, FOLLOWED BY A STYLIZED "BEBE" IN LOWERCASE ON THE LINE BELOW IT.

THE ENGLISH TRANSLATION OF THE WORD "BEBE" IN THE MARK IS "QUEEN OF HEARTS IN A PERSIAN DECK OF CARDS".

FOR ARTICLES OF CLOTHING, NAMELY, SHIRTS, T-SHIRTS, SKIRTS, BLOUSES, PANTS, TROUSERS, SLACKS, LEGGINGS, JACKETS, DRESSES, SHORTS, COATS, SWEATERS, SUITS, DRESSES, GYM SUITS, JOGGING SUITS, SWEAT PANTS, SWEAT SHIRTS, SWEAT SUITS, TRACK PANTS, TRACK SUITS; ACCESSORIES, NAMELY, BELTS, SCARVES AND HATS; BATHING SUITS; BODY SUITS; FOOTWEAR, NAMELY, ATHLETIC SHOES, ESPADRILLES, SANDALS, LOAFERS, BOOTS, WEDGES, FLATS, MULES, PUMPS AND THONGS (U.S. CLS. 22 AND 39).

FIRST USE 6-17-2013; IN COMMERCE 6-17-2013.

KATHLEEN LORENZO, EXAMINING ATTORNEY

SN 86-076,937. RESIGNATION HOLDINGS, LLC, ALTADENA, CA. FILED 9-27-2013.

CHIVE TEES

THE MARK CONSISTS OF STANDARD CHARACTERS WITHOUT CLAIM TO ANY PARTICULAR FONT, STYLE, SIZE, OR COLOR.

OWNER OF U.S. REG. NO. 4,358,082.

NO CLAIM IS MADE TO THE EXCLUSIVE RIGHT TO USE "TEES", APART FROM THE MARK AS SHOWN.

FOR CLOTHES, NAMELY, SHIRTS, SWEATSHIRTS, AND INFANT BODY SUITS (U.S. CLS. 22 AND 39).

FIRST USE 5-31-2011; IN COMMERCE 5-31-2011.

LINDA POWELL, EXAMINING ATTORNEY

SN 86-080,025. PARAMOUNT PICTURES CORPORATION, HOLLYWOOD, CA. FILED 10-1-2013.

JACK RYAN: SHADOW RECRUIT

THE MARK CONSISTS OF STANDARD CHARACTERS WITHOUT CLAIM TO ANY PARTICULAR FONT, STYLE, SIZE, OR COLOR.

THE NAME(S), PORTRAIT(S), AND/OR SIGNATURE(S) SHOWN IN THE MARK DOES NOT IDENTIFY A PARTICULAR LIVING INDIVIDUAL.

FOR APRONS; BATHING SUITS; BELTS; BOXER SHORTS; CAPS; COATS; GLOVES; HALLOWEEN COSTUMES; HATS; JACKETS AND SOCKS; PAJAMAS; SANDALS AND BEACH SHOES; SCARVES; SHORT-SLEEVED OR LONG-SLEEVED T-SHIRTS; SWEATSHIRTS (U.S. CLS. 22 AND 39).

AHSEN KHAN, EXAMINING ATTORNEY

**CLASS 25—(Continued).**

SN 86-080,222. GABE DE KONING, CARLSBAD, CA. FILED 10-1-2013.

## Random Shores

THE MARK CONSISTS OF STANDARD CHARACTERS WITHOUT CLAIM TO ANY PARTICULAR FONT, STYLE, SIZE, OR COLOR.

FOR ATHLETIC SHIRTS; BOTTOMS; COLLARED SHIRTS; DRESS SHIRTS; GOLF SHIRTS; HOODED SWEAT SHIRTS; HOODS; OVER SHIRTS; SHIRTS; SHORT-SLEEVED OR LONG-SLEEVED T-SHIRTS; SHORT-SLEEVED SHIRTS; SPORTS SHIRTS; SWEAT SHIRTS; T-SHIRTS; TOPS; WEARABLE GARMENTS AND CLOTHING, NAMELY, SHIRTS (U.S. CLS. 22 AND 39).

MATTHEW MCDOWELL, EXAMINING ATTORNEY

**CLASS 25—(Continued).**

SN 86-085,122. SIMPLER PRODUCTS LLC, SUNNYVALE, CA. FILED 10-8-2013.

## Simpler Baby

THE MARK CONSISTS OF STANDARD CHARACTERS WITHOUT CLAIM TO ANY PARTICULAR FONT, STYLE, SIZE, OR COLOR.

NO CLAIM IS MADE TO THE EXCLUSIVE RIGHT TO USE "BABY", APART FROM THE MARK AS SHOWN.

FOR INFANT WEARABLE BLANKETS (U.S. CLS. 22 AND 39).

WON TEAK OH, EXAMINING ATTORNEY

SN 86-081,013. JONES INVESTMENT CO. INC., WILMINGTON, DE. FILED 10-2-2013.

## GLO

THE MARK CONSISTS OF STANDARD CHARACTERS WITHOUT CLAIM TO ANY PARTICULAR FONT, STYLE, SIZE, OR COLOR.

OWNER OF U.S. REG. NOS. 3,731,417, 3,731,419 AND OTHERS.

THE NAME(S), PORTRAIT(S), AND/OR SIGNATURE(S) SHOWN IN THE MARK DOES NOT IDENTIFY A PARTICULAR LIVING INDIVIDUAL.

FOR BOTTOMS; TOPS (U.S. CLS. 22 AND 39).

EDWARD FENNESSY, EXAMINING ATTORNEY

SN 86-089,287. HAAS OUTDOORS, INC., WEST POINT, MS. FILED 10-11-2013.

## BREAK-UP INFINITY

THE MARK CONSISTS OF STANDARD CHARACTERS WITHOUT CLAIM TO ANY PARTICULAR FONT, STYLE, SIZE, OR COLOR.

OWNER OF U.S. REG. NO. 3,908,228.

FOR SOCKS; UNDERWEAR (U.S. CLS. 22 AND 39).

DAVID MURRAY, EXAMINING ATTORNEY

SN 86-081,022. JONES INVESTMENT CO. INC., WILMINGTON, DE. FILED 10-2-2013.

## GLO

THE MARK CONSISTS OF STANDARD CHARACTERS WITHOUT CLAIM TO ANY PARTICULAR FONT, STYLE, SIZE, OR COLOR.

OWNER OF U.S. REG. NOS. 3,731,417, 3,731,419 AND OTHERS.

THE NAME(S), PORTRAIT(S), AND/OR SIGNATURE(S) SHOWN IN THE MARK DOES NOT IDENTIFY A PARTICULAR LIVING INDIVIDUAL.

FOR FOOTWEAR (U.S. CLS. 22 AND 39).

EDWARD FENNESSY, EXAMINING ATTORNEY

SN 86-089,290. HAAS OUTDOORS, INC., WEST POINT, MS. FILED 10-11-2013.

## BOTTOMLAND

THE MARK CONSISTS OF STANDARD CHARACTERS WITHOUT CLAIM TO ANY PARTICULAR FONT, STYLE, SIZE, OR COLOR.

OWNER OF U.S. REG. NO. 1,657,878.

FOR SOCKS; UNDERWEAR (U.S. CLS. 22 AND 39).

DAVID MURRAY, EXAMINING ATTORNEY

**CLASS 25—(Continued).**

SN 86-089,304. HAAS OUTDOORS, INC., WEST POINT, MS. FILED 10-11-2013.



OWNER OF U.S. REG. NOS. 4,369,929 AND 4,393,774.  
 THE MARK CONSISTS OF THE WORDING "MOSSY OAK SHADOW GRASS BLADES" BELOW A TREE ENCLOSED IN AN OVAL.  
 FOR SOCKS; UNDERWEAR (U.S. CLS. 22 AND 39).  
 DAVID MURRAY, EXAMINING ATTORNEY

SN 86-089,307. HAAS OUTDOORS, INC., WEST POINT, MS. FILED 10-11-2013.



OWNER OF U.S. REG. NO. 2,838,170.  
 THE MARK CONSISTS OF THE WORDING "MOSSY OAK OBSESSION" BELOW A TREE ENCLOSED IN AN OVAL.  
 FOR SOCKS; UNDERWEAR (U.S. CLS. 22 AND 39).  
 DAVID MURRAY, EXAMINING ATTORNEY

SN 86-091,040. SHABBY MAMMAL, GLENDALE, CA. FILED 10-14-2013.



THE MARK CONSISTS OF A RABBIT FACE LAYERED

**CLASS 25—(Continued).**

ON TOP OF PLANTS/ACORN SEMETRICAL DECOR, WITH A PROFILE BIRD HEAD BELOW TO THE LEFT, SIX-PETALED/SIX-LEAFED FLOWER DIRECTLY BELOW RABBIT, A PROFILE MOUSE HEAD BELOW TO THE RIGHT, SYMETRICAL TWO-LEAFED CLIPPINGS DIRECTLY BELOW BIRD AND MOUSE HEADS, SYMETRICAL BEE DIRECTLY BELOW FLOWER, STYLIZED "SHABBY MAMMAL" TEXT BELOW DRAWING SLIGHTLY TO LEFT INCLUDING FIVE SURROUNDING SPLASH-LIKE ILLUSTRATIONS.  
 FOR T-SHIRTS (U.S. CLS. 22 AND 39).  
 JOHN WILKE, EXAMINING ATTORNEY

SN 86-091,091. GTFM, INC., NEW YORK, NY. FILED 10-14-2013.

# FB STATUS

THE MARK CONSISTS OF STANDARD CHARACTERS WITHOUT CLAIM TO ANY PARTICULAR FONT, STYLE, SIZE, OR COLOR.  
 OWNER OF U.S. REG. NOS. 2,065,987, 3,955,072 AND OTHERS.  
 FOR FOOTWEAR; HEADWEAR; JACKETS; PANTS; SHIRTS (U.S. CLS. 22 AND 39).  
 ELIZABETH KAJUBI, EXAMINING ATTORNEY

SN 86-092,089. ALFRED BENJAMIN PANTOJA, NEWPORT BEACH, CA. FILED 10-15-2013.



THE MARK CONSISTS OF A STYLIZED WAVE AND MOUNTAIN.  
 FOR CLOTHING, NAMELY, SHIRTS, TEE-SHIRTS, SHORTS AND PANTS, JACKETS, SWEATERS, SWEAT-SHIRTS, HOODIES, AND PARKAS; FOOTWEAR; AND HEADGEAR, NAMELY, HATS AND CAPS (U.S. CLS. 22 AND 39).  
 GRETTA YAO, EXAMINING ATTORNEY

**CLASS 25—(Continued).**

SN 86-092,485. RETAIL ROYALTY COMPANY, LAS VEGAS, NV. FILED 10-16-2013.



OWNER OF U.S. REG. NOS. 3,878,197 AND 4,144,347.  
NO CLAIM IS MADE TO THE EXCLUSIVE RIGHT TO USE "TANK", APART FROM THE MARK AS SHOWN.

THE MARK CONSISTS OF A DESIGN OF A FLYING EAGLE ABOVE THE WORD "ALOHA" WITH THE "O" FILLED IN, WHICH IS ABOVE THE WORD "TANK", ALL ABOVE A JAGGED HORIZONTAL LINE.

FOR TOPS (U.S. CLS. 22 AND 39).  
AMY C. KEAN, EXAMINING ATTORNEY

SN 86-092,859. MUNRO & COMPANY, INC., HOT SPRINGS, AR. FILED 10-16-2013.



OWNER OF U.S. REG. NOS. 1,851,542, 2,870,670 AND 3,670,660.

THE MARK CONSISTS OF THE DESIGN OF A STYLIZED CHILD'S FOOTPRINT, WITH THE STYLIZED WORDS "PERFECTION BY JUMPING-JACKS" CONTAINED THEREIN, ALL WITHIN THE OUTLINE OF A SHOE PRINT CONTAINING A STRIPE ACROSS IT. THE STIPPLING IS FOR SHADING PURPOSES.

FOR CHILDREN'S SHOES (U.S. CLS. 22 AND 39).  
FIRST USE 10-1-2008; IN COMMERCE 10-1-2008.  
TRICIA SONNEBORN, EXAMINING ATTORNEY

**CLASS 25—(Continued).**

SN 86-093,097. KELLEY, MICHAEL, GLENWOOD, IL. FILED 10-16-2013.

## Owl Nation

THE MARK CONSISTS OF STANDARD CHARACTERS WITHOUT CLAIM TO ANY PARTICULAR FONT, STYLE, SIZE, OR COLOR.

FOR CLOTHING, NAMELY, TEE SHIRTS, SHIRTS, JEANS, JACKETS, COATS, PANTS, BELTS, HATS, HEADWEAR, SWEATSHIRTS, SWEAT PANTS, DRESSES, SKIRTS, SOCKS, UNDERWEAR AND FOOTWEAR (U.S. CLS. 22 AND 39).

MICHAEL WEBSTER, EXAMINING ATTORNEY

SN 86-093,345. SKECHERS U.S.A., INC. II, MANHATTAN BEACH, CA. FILED 10-16-2013.

## SKECHERS PERFORMANCE FITKNIT

THE MARK CONSISTS OF STANDARD CHARACTERS WITHOUT CLAIM TO ANY PARTICULAR FONT, STYLE, SIZE, OR COLOR.

OWNER OF U.S. REG. NOS. 1,851,977, 3,881,671 AND OTHERS.

NO CLAIM IS MADE TO THE EXCLUSIVE RIGHT TO USE "PERFORMANCE", APART FROM THE MARK AS SHOWN.

FOR FOOTWEAR (U.S. CLS. 22 AND 39).  
AISHA CLARKE, EXAMINING ATTORNEY

SN 86-093,923. U CHIC LLC, KANSAS CITY, MO. FILED 10-17-2013.

## UCHIC

THE MARK CONSISTS OF STANDARD CHARACTERS WITHOUT CLAIM TO ANY PARTICULAR FONT, STYLE, SIZE, OR COLOR.

OWNER OF U.S. REG. NOS. 3,367,860, 4,076,672 AND 4,353,102.

FOR CLOTHING, NAMELY, TEE SHIRTS (U.S. CLS. 22 AND 39).

FIRST USE 8-20-2013; IN COMMERCE 8-20-2013.  
ELIZABETH HUGHITT, EXAMINING ATTORNEY

**CLASS 25—(Continued).**

SN 86-096,548. JESUS MATIAS, KEW GARDENS, NY. FILED 10-21-2013.

**VERUM ES CORRUPTA**

THE MARK CONSISTS OF STANDARD CHARACTERS WITHOUT CLAIM TO ANY PARTICULAR FONT, STYLE, SIZE, OR COLOR.

THE ENGLISH TRANSLATION OF "VERUM ES CORRUPTA" IS "TRUTH IS CORRUPT".

FOR CLOTHING, NAMELY, SHIRTS, LONG-SLEEVED SHIRTS, T-SHIRTS, UNDER SHIRTS, NIGHT SHIRTS, RUGBY SHIRTS, POLO SHIRTS, JERSEYS, DRESS SHIRTS, PANTS, SLACKS, JEANS, CARGO PANTS, STRETCH PANTS, DENIM JEANS, JUMP SUITS, SHORTS, TOPS, STRETCH TOPS, TUBE TOPS, CROP TOPS, TANK TOPS, TANKINIS, HALTER TOPS, SWEAT SHIRTS, HOODED SWEAT SHIRTS, SWEAT JACKETS, SWEAT SHORTS, SWEAT PANTS, WRAPS, WARM-UP SUITS, JOGGING SUITS, TRACK SUITS, PLAY SUITS, BLOUSES, SKIRTS, DRESSES, SWEATERS, VESTS, FLEECE VESTS, PULLOVERS, SNOW SUITS, PARKAS, ANORAKS, PONCHOS, JACKETS, DINNER JACKETS, REVERSIBLE JACKETS, WIND-RESISTANT JACKETS, SHELL JACKETS, SPORTS JACKETS, JEAN JACKETS, COATS, HEAVY COATS, OVER COATS, TOP COATS, BLAZERS, LAYETTES, BEANIES, HATS, VISORS, HEADBANDS, HEAD WEAR, EAR MUFFS, APRONS, SCARVES, BANDANAS, BELTS, SUSPENDERS, NECK WEAR, UNDERWEAR, THERMAL UNDERWEAR, BRIEFS, SOCKS, ROBES, LEG WARMERS, HOSIERY, LEGGINGS, TIGHTS, GLOVES, MITTENS, FOOTWEAR, SHOES, SNEAKERS, BOOTS (U.S. CLS. 22 AND 39).

LEE-ANNE BERNS, EXAMINING ATTORNEY

SN 86-097,578. TOTES ISOTONER CORPORATION, CINCINNATI, OH. FILED 10-22-2013.

**PUDDLE FLATS**

THE MARK CONSISTS OF STANDARD CHARACTERS WITHOUT CLAIM TO ANY PARTICULAR FONT, STYLE, SIZE, OR COLOR.

NO CLAIM IS MADE TO THE EXCLUSIVE RIGHT TO USE "FLATS", APART FROM THE MARK AS SHOWN.

FOR FOOTWEAR (U.S. CLS. 22 AND 39).

TINA BROWN, EXAMINING ATTORNEY

**CLASS 25—(Continued).**

SN 86-097,646. THE CARTOON NETWORK, INC., ATLANTA, GA. FILED 10-22-2013.

**THE AMAZING WORLD OF GUMBALL**

THE MARK CONSISTS OF STANDARD CHARACTERS WITHOUT CLAIM TO ANY PARTICULAR FONT, STYLE, SIZE, OR COLOR.

OWNER OF U.S. REG. NO. 3,982,522.

FOR HATS, FOOTWEAR AND HALLOWEEN COSTUMES (U.S. CLS. 22 AND 39).

CHRISTOPHER LAW, EXAMINING ATTORNEY

SN 86-098,312. SPARRINGSJÖ, OLOF, SE-421 30, SWEDEN, FILED 10-22-2013.

**BODY SCIENCE**

THE MARK CONSISTS OF STANDARD CHARACTERS WITHOUT CLAIM TO ANY PARTICULAR FONT, STYLE, SIZE, OR COLOR.

FOR ANKLE SOCKS; ATHLETIC UNIFORMS; BOXER BRIEFS; BOXER SHORTS; BRIEFS; COATS; DRESSES; FLEECE PULLOVERS; FOOTWEAR; HOODED PULLOVERS; JOGGING PANTS; MEN'S SOCKS; RAIN JACKETS; RAIN TROUSERS; RAINPROOF JACKETS; RUNNING SHOES; SHORT-SLEEVED OR LONG-SLEEVED T-SHIRTS; SHORT-SLEEVED SHIRTS; SKORTS; SLEEVELESS JERSEYS; SNOW PANTS; SNOWBOARD GLOVES; SPORTS JERSEYS; SPORTS PANTS; SPORTS SHIRTS; SWEAT BANDS; SWEAT PANTS; THONG UNDERWEAR; TRAINING SHOES; UNDERSHIRTS; UNITARDS; VISORS; WIND PANTS; WIND RESISTANT JACKETS; WIND SHIRTS (U.S. CLS. 22 AND 39).

CARYN GLASSER, EXAMINING ATTORNEY

SN 86-103,976. M.EURYSTTHEE CLOTHING LLC, HOUSTON, TX. FILED 10-29-2013.

**It's A Conceited Feel**

THE MARK CONSISTS OF STANDARD CHARACTERS WITHOUT CLAIM TO ANY PARTICULAR FONT, STYLE, SIZE, OR COLOR.

FOR HATS; JEANS; SHIRTS (U.S. CLS. 22 AND 39).

ALEXANDER L. POWERS, EXAMINING ATTORNEY

**CLASS 25—(Continued).**

SN 86-109,462. CHARLOTTE RUSSE MERCHANDISING, INC., SAN DIEGO, CA. FILED 11-4-2013.



THE MARK CONSISTS OF A HEART SHAPE WITH THE LETTERS "CXO".

FOR CLOTHING, NAMELY, LOUNGEWEAR, SWEATSHIRTS, SWEATERS, SWEATPANTS, TOPS, BOTTOMS, PANTS, T-SHIRTS AND INTIMATES (U.S. CLS. 22 AND 39).

FIRST USE 9-0-2013; IN COMMERCE 9-0-2013.  
LINDA QUIGLEY, EXAMINING ATTORNEY

SN 86-109,986. SKECHERS U.S.A., INC. II, MANHATTAN BEACH, CA. FILED 11-4-2013.

**FLEX WEAVE**

THE MARK CONSISTS OF STANDARD CHARACTERS WITHOUT CLAIM TO ANY PARTICULAR FONT, STYLE, SIZE, OR COLOR.

NO CLAIM IS MADE TO THE EXCLUSIVE RIGHT TO USE "FLEX", APART FROM THE MARK AS SHOWN.

FOR FOOTWEAR (U.S. CLS. 22 AND 39).  
AISHA CLARKE, EXAMINING ATTORNEY

SN 86-110,071. GUSTAVUS, EVERALD, JAMAICA, NY. FILED 11-5-2013.



NO CLAIM IS MADE TO THE EXCLUSIVE RIGHT TO USE "THREADS", APART FROM THE MARK AS SHOWN.

THE MARK CONSISTS OF LITERAL ELEMENTS "TRAUMA THREDZ" WRITTEN IN STYLIZED FORM WHEREIN BELOW THE LITERAL ELEMENTS A LINE IS PASSING THROUGH IN CENTER BECOMING MONITOR WAVE LIKE IMAGE.

FOR TOPS AND BOTTOMS (U.S. CLS. 22 AND 39).  
SUSAN RICHARDS, EXAMINING ATTORNEY

**CLASS 25—(Continued).**

SN 86-110,858. SARDINA, MARK, ATHOL, MA. FILED 11-5-2013.

**WALKING THROUGH**

THE MARK CONSISTS OF STANDARD CHARACTERS WITHOUT CLAIM TO ANY PARTICULAR FONT, STYLE, SIZE, OR COLOR.

FOR ATHLETIC PANTS; ATHLETIC SHIRTS; ATHLETIC SHORTS; BASEBALL CAPS; COATS; CROP TOPS; GLOVES; GOLF SHIRTS; HATS; HATS FOR INFANTS, BABIES, TODDLERS AND CHILDREN; HOODED SWEATSHIRTS; JACKETS; KNITTED CAPS; LONG-SLEEVED SHIRTS; PANTIES, SHORTS AND BRIEFS; PANTS; POLO SHIRTS; RUGBY SHIRTS; SHIRTS FOR INFANTS, BABIES, TODDLERS AND CHILDREN; SHORT-SLEEVED OR LONG-SLEEVED T-SHIRTS; SHORT-SLEEVED SHIRTS; SHORTS; SKIRTS; SPORT SHIRTS; SPORTS CAPS AND HATS; SPORTS JACKETS; SPORTS PANTS; SPORTS SHIRTS; SWEAT PANTS; SWEAT SHIRTS; SWEAT SHORTS; SWEATERS; T-SHIRTS; TANK TOPS; UNDERWEAR; VESTS; WRISTBANDS (U.S. CLS. 22 AND 39).

STEVEN R. FINE, EXAMINING ATTORNEY

SN 86-111,000. JORDAN, VICHAA, DBA MEEK LIFE COLLECTION, LOS ANGELES, CA. FILED 11-5-2013.



NO CLAIM IS MADE TO THE EXCLUSIVE RIGHT TO USE "COLLECTION", APART FROM THE MARK AS SHOWN.

THE MARK CONSISTS OF THE WORDS "MEEK LIFE COLLECTION" IN THE SHAPE OF A CROSS, WITH "MEEKLIFE" EXTENDED VERTICALLY AND "COLLECTION" EXTENDED HORIZONTALLY. "MEEKLIFE" AND "COLLECTION" INTERSECT AT THE SECOND "E" OF "MEEK" AND THE "E" OF "COLLECTION". THE MARK ALSO CONSISTS OF 3 STARS OVER THE "M" OF THE WORD "MEEK".

FOR BASEBALL CAPS AND HATS; DENIMS; HEELS; JEGGINGS, NAMELY, PANTS THAT ARE PARTIALLY JEANS AND PARTIALLY LEGGINGS; PANTS; PLATFORM SHOES; SANDALS; SHORT-SLEEVED OR LONG-SLEEVED T-SHIRTS; SNEAKERS; SWEATSHIRTS; T-SHIRTS; T-SHIRTS FOR BABIES; TANK TOPS (U.S. CLS. 22 AND 39).

DARRYL SPRUILL, EXAMINING ATTORNEY

**CLASS 25—(Continued).**

SN 86-111,495. ASHLEY NETTIE, INC., NEW YORK, NY. FILED 11-6-2013.

Element<sup>5</sup>  
by BERNARDO

OWNER OF U.S. REG. NOS. 1,979,147, 2,911,578 AND OTHERS.

THE MARK CONSISTS OF THE WORD "ELEMENT" TO THE RIGHT OF WHICH AND SLIGHTLY ELEVATED IS THE LETTER "S" WHICH RESEMBLES A ROUNDED NUMBER 5; UNDERNEATH THE WORD "ELEMENT" IS THE WORDING "BY BERNARDO".

FOR OUTERWEAR, NAMELY, JACKETS, COATS, VESTS, RAINCOATS, WHETHER MADE OF OR WITH DOWN, POLYFILL, LEATHER, FUR-LINED, FUR, COTTON, AND OTHER FABRIC OR MATERIAL, OR ANY COMBINATIONS THEREOF (U.S. CLS. 22 AND 39).

JILLIAN CANTOR, EXAMINING ATTORNEY

SN 86-117,065. KIMSAPRINCESS INC., WOODLAND HILLS, CA. AND 2DIE4KOURT, WOODLAND HILLS, CA. AND KHLOMONEY INC., WOODLAND HILLS, CA. FILED 11-12-2013.

kardashian  
kids

NO CLAIM IS MADE TO THE EXCLUSIVE RIGHT TO USE KIDS, APART FROM THE MARK AS SHOWN.

THE NAME "KARDASHIAN" IDENTIFIES KIMBERLY KARDASHIAN, KOURTNEY KARDASHIAN AND KHLOE KARDASHIAN ODOM, LIVING INDIVIDUALS WHOSE CONSENT IS OF RECORD.

THE MARK CONSISTS OF THE STYLIZED WORDS KARDASHIAN KIDS, WHERE A STAR IS USED TO DOT THE "I" IN "KARDASHIAN" AND "KIDS".

FOR CHILDREN'S AND INFANT'S APPAREL, NAMELY CLOTH BIBS, LAYETTES, INFANT SLEEPERS, INFANT WEARABLE BLANKETS, JUMPERS, SLEEPWEAR, PAJAMAS, ROMPERS, ONE-PIECE GARMENTS, BATHROBES, SHOWER CAPS, CHASUBLES, UNDERWEAR, BOXER SHORTS, SHIRTS, GOLF SHIRTS, T-SHIRTS, POLO SHIRTS, KNIT TOPS, WOVEN TOPS, SWEATSHIRTS, TANK TOPS, SWEATERS, BLOUSES, JERSEYS, TURTLENECKS, SHORTS, SWEATPANTS, WARM-UP SUITS, BLAZERS, SPORT COATS, TROUSERS, JEANS, SKIRTS, DRESSES, WEDDING DRESSES, SUITS, OVERALLS, JUMPERS, VESTS, JACKETS, COATS, RAINCOATS, PARKAS, PONCHOS, SWIMWEAR, BIKINIS, SWIM TRUNKS, OVERCOATS, RAINWEAR, WIND RESISTANT JACKETS, CLOTHING FOR DANCING, NAMELY, LEOTARDS AND BALLET SUITS; BELTS MADE OF LEATHER, TIES; HEADGEAR, NAMELY, HATS, WOOL HATS, CAPS, VISORS, HEADBANDS, EAR MUFFS; SCARVES, SHAWLS, WRISTBANDS; FOOTWEAR, GYM SHOES, SNEAKERS, SOCKS, STOCKINGS, HOSIERY, SHOES, BOOTS, BEACH SHOES, SANDALS, SLIPPERS, GLOVES, SUSPENDERS (U.S. CLS. 22 AND 39).

KAREN BRACEY, EXAMINING ATTORNEY

**CLASS 25—(Continued).**

SN 86-117,066. KIMSAPRINCESS INC., WOODLAND HILLS, CA. AND 2DIE4KOURT, WOODLAND HILLS, CA. AND KHLOMONEY INC., WOODLAND HILLS, CA. FILED 11-12-2013.

KARDASHIAN KIDS

THE MARK CONSISTS OF STANDARD CHARACTERS WITHOUT CLAIM TO ANY PARTICULAR FONT, STYLE, SIZE, OR COLOR.

NO CLAIM IS MADE TO THE EXCLUSIVE RIGHT TO USE "KIDS", APART FROM THE MARK AS SHOWN.

THE NAME "KARDASHIAN" IDENTIFIES KIMBERLY KARDASHIAN, KOURTNEY KARDASHIAN AND KHLOE KARDASHIAN ODOM, LIVING INDIVIDUALS WHOSE CONSENT IS OF RECORD.

FOR CHILDREN'S AND INFANT'S APPAREL, NAMELY, CLOTH BIBS, LAYETTES, INFANT SLEEPERS, INFANT WEARABLE BLANKETS, JUMPERS, SLEEPWEAR, PAJAMAS, ROMPERS, ONE-PIECE GARMENTS, BATHROBES, SHOWER CAPS, CHASUBLES, UNDERWEAR, BOXER SHORTS, SHIRTS, GOLF SHIRTS, T-SHIRTS, POLO SHIRTS, KNIT TOPS, WOVEN TOPS, SWEATSHIRTS, TANK TOPS, SWEATERS, BLOUSES, JERSEYS, TURTLENECKS, SHORTS, SWEATPANTS, WARM-UP SUITS, BLAZERS, SPORT COATS, TROUSERS, JEANS, SKIRTS, DRESSES, WEDDING DRESSES, SUITS, OVERALLS, JUMPERS, VESTS, JACKETS, COATS, RAINCOATS, PARKAS, PONCHOS, SWIMWEAR, BIKINIS, SWIM TRUNKS, OVERCOATS, RAINWEAR, WIND RESISTANT JACKETS, CLOTHING FOR DANCING, NAMELY, LEOTARDS AND BALLET SUITS; BELTS MADE OF LEATHER, TIES; HEADGEAR, NAMELY, HATS, WOOL HATS, CAPS, VISORS, HEADBANDS, EAR MUFFS; SCARVES, SHAWLS, WRISTBANDS; FOOTWEAR, GYM SHOES, SNEAKERS, SOCKS, STOCKINGS, HOSIERY, SHOES, BOOTS, BEACH SHOES, SANDALS, SLIPPERS, GLOVES, SUSPENDERS (U.S. CLS. 22 AND 39).

KAREN BRACEY, EXAMINING ATTORNEY

SN 86-118,921. TWO LEFT FEET BRANDS, LLC, DBA HOOK + ALBERT, LOS ANGELES, CA. FILED 11-14-2013.

h+A Gray

THE MARK CONSISTS OF STANDARD CHARACTERS WITHOUT CLAIM TO ANY PARTICULAR FONT, STYLE, SIZE, OR COLOR.

OWNER OF U.S. REG. NO. 4,097,120.

NO CLAIM IS MADE TO THE EXCLUSIVE RIGHT TO USE "GRAY", APART FROM THE MARK AS SHOWN.

FOR ANKLE SOCKS; ANKLETS; HOSIERY; MEN'S DRESS SOCKS; MEN'S SOCKS; SHOE LINERS; SOCKS; SOCKS AND STOCKINGS (U.S. CLS. 22 AND 39).

COURTNEY ALVAREZ, EXAMINING ATTORNEY

**CLASS 25—(Continued).**

SN 86-121,235. ENOCHIAN, INC., NARROWSBURG, NY.  
FILED 11-18-2013.



THE MARK CONSISTS OF THE WORDS "PAMELA  
MAYER" IN STYLIZED LETTERING AND A DESIGN  
RESEMBLING TWO VERTICAL BANDS WITH A HALO  
DESIGN AT THE TOP.

FOR JACKETS; LEATHER BELTS; LEATHER JACK-  
ETS; LEATHER PANTS; LEATHER SHIRTS; LEATHER  
VESTS; PANTS; SHORTS; SUEDE JACKETS; SWEATERS;  
WOMEN'S CLOTHING, NAMELY, SHIRTS, DRESSES,  
SKIRTS, BLOUSES (U.S. CLS. 22 AND 39).

FIRST USE 11-16-2013; IN COMMERCE 11-16-2013.  
SUSAN STIGLITZ, EXAMINING ATTORNEY

SN 86-121,698. WRANGLER APPAREL CORP., WILMING-  
TON, DE. FILED 11-18-2013.



OWNER OF U.S. REG. NO. 3,522,028.  
THE MARK CONSISTS OF A STAR IN SPIRAL ROPE.  
FOR JEANS; PANTS; SHIRTS (U.S. CLS. 22 AND 39).  
FIRST USE 3-4-2004; IN COMMERCE 3-4-2004.  
LEE-ANNE BERNIS, EXAMINING ATTORNEY

**CLASS 25—(Continued).**

SN 86-122,257. EXTREME EXPOSURE, LLC, HILO, HI.  
FILED 11-18-2013.

## Experience Aloha

THE MARK CONSISTS OF STANDARD CHARACTERS  
WITHOUT CLAIM TO ANY PARTICULAR FONT, STYLE,  
SIZE, OR COLOR.

FOR ATHLETIC APPAREL, NAMELY, SHIRTS,  
PANTS, JACKETS, FOOTWEAR, HATS AND CAPS,  
ATHLETIC UNIFORMS (U.S. CLS. 22 AND 39).  
RENEE MCCRAY, EXAMINING ATTORNEY

SN 86-122,452. FLEX WATCHES, INC., SAN DIEGO, CA.  
FILED 11-19-2013.

## FLXN

THE MARK CONSISTS OF STANDARD CHARACTERS  
WITHOUT CLAIM TO ANY PARTICULAR FONT, STYLE,  
SIZE, OR COLOR.

FOR CAPS; HATS; JACKETS; SHIRTS; SWEAT  
SHIRTS; T-SHIRTS (U.S. CLS. 22 AND 39).  
RENEE MCCRAY, EXAMINING ATTORNEY

SN 86-124,220. LA SENZA CORPORATION, HALIFAX,  
NOVA SCOTIA, CANADA, FILED 11-20-2013.

## HELLO SUGAR

THE MARK CONSISTS OF STANDARD CHARACTERS  
WITHOUT CLAIM TO ANY PARTICULAR FONT, STYLE,  
SIZE, OR COLOR.

OWNER OF U.S. REG. NO. 4,286,371.  
FOR BRAS, PANTIES, AND LINGERIE (U.S. CLS. 22  
AND 39).  
FIRST USE 7-7-2007; IN COMMERCE 7-7-2007.  
SUSAN RICHARDS, EXAMINING ATTORNEY



**CLASS 25—(Continued).**

SN 86-129,662. BALLET MAKERS, INC., TOTOWA, NJ.  
FILED 11-26-2013.

# TAPSONIC

THE MARK CONSISTS OF STANDARD CHARACTERS WITHOUT CLAIM TO ANY PARTICULAR FONT, STYLE, SIZE, OR COLOR.

FOR TAP SHOES AND TAPS FOR SHOES (U.S. CLS. 22 AND 39).

MARIA-VICTORIA SUAREZ, EXAMINING ATTORNEY

---

SN 86-129,790. ALDI INC., BATAVIA, IL. FILED 11-26-2013.

# ADVENTURIDGE

THE MARK CONSISTS OF STANDARD CHARACTERS WITHOUT CLAIM TO ANY PARTICULAR FONT, STYLE, SIZE, OR COLOR.

OWNER OF U.S. REG. NOS. 2,743,211 AND 4,429,458.

FOR TREKKING SHOES; FOOTWEAR; HATS; JACKETS; TROUSERS (U.S. CLS. 22 AND 39).

ALEX KEAM, EXAMINING ATTORNEY

---

SN 86-135,774. STRETCH-O-RAMA, INC., NEW YORK, NY.  
FILED 12-5-2013.



**Psycho Monkey**

THE MARK CONSISTS OF THE SKULL OF A MONKEY WITH CROSS BONES AND THE WORDS "PSYCHO MONKEY".

FOR CLOTHING, NAMELY, PANTS, JEANS, JACKETS, COATS, SHIRTS, SWEATERS, SWEATSHIRTS AND SWEAT PANTS, DRESSES, SHORTS, SUITS, SHOES, SLIPPERS, UNDERWEAR, HOSIERY, SWIMWEAR, HEADWEAR AND LAYETTE (U.S. CLS. 22 AND 39).

JOHN KELLY, EXAMINING ATTORNEY

**CLASS 25—(Continued).**

SN 86-138,216. STRETCH-O-RAMA, INC., NEW YORK, NY.  
FILED 12-9-2013.



**Crazy Monkey**

THE MARK CONSISTS OF THE SKULL OF A MONKEY WITH CROSS BONES AND THE WORDS "CRAZY MONKEY".

FOR CLOTHING, NAMELY, PANTS, JEANS, COATS, SHIRTS, SWEATERS, SWEATSHIRTS AND SWEAT PANTS, DRESSES, SHORTS, SUITS, SHOES, SLIPPERS, UNDERWEAR, HOSIERY, SWIMWEAR, HEADWEAR AND LAYETTE (U.S. CLS. 22 AND 39).

JOHN KELLY, EXAMINING ATTORNEY

---

SN 86-138,965. FLEX WATCHES, INC., SAN DIEGO, CA.  
FILED 12-9-2013.

# The Living Memoir

THE MARK CONSISTS OF STANDARD CHARACTERS WITHOUT CLAIM TO ANY PARTICULAR FONT, STYLE, SIZE, OR COLOR.

FOR CAPS; HATS; SHIRTS; SWEAT SHIRTS; T-SHIRTS (U.S. CLS. 22 AND 39).

FIRST USE 7-1-2011; IN COMMERCE 10-1-2011.

RENEE MCCRAY, EXAMINING ATTORNEY

**CLASS 25—(Continued).**

SN 86-139,297. LEXI MILLER, SAN FRANCISCO, CA. FILED 12-10-2013.



THE MARK CONSISTS OF AN ENCIRCLED IMAGE OF CLOVER SHAPE CONSISTING OF ONE LINE AND FOUR HEART SHAPED SEGMENTS.

FOR FITNESS APPAREL, NAMELY, T-SHIRTS, SLEEVELESS T-SHIRTS, LONG SLEEVES T-SHIRTS, V-NECK T-SHIRTS, TANK TOPS, CAPRIS, FLEECE TOPS, TOPS, SPORTS BRAS, TRACK JACKETS, SWEATSHIRTS, HOODED SWEATSHIRTS, PAJAMAS, YOGA PANTS, SWEATPANTS, PANTS, SHORTS, TRACK PANTS, CAPS, HEADBANDS, SOCKS; HEADWEAR; FOOTWEAR (U.S. CLS. 22 AND 39).

JULIE GUTTADAURO, EXAMINING ATTORNEY

**CLASS 26—FANCY GOODS**

SN 85-879,418. RA BRANDS, L.L.C., MADISON, NC. FILED 3-18-2013.

REMINGTON OPS OPTIMUM  
PURSUIT SERIES

THE MARK CONSISTS OF STANDARD CHARACTERS WITHOUT CLAIM TO ANY PARTICULAR FONT, STYLE, SIZE, OR COLOR.

OWNER OF U.S. REG. NOS. 187,871, 1,092,498 AND OTHERS.

NO CLAIM IS MADE TO THE EXCLUSIVE RIGHT TO USE "SERIES", APART FROM THE MARK AS SHOWN.

FOR ORNAMENTAL CLOTH PATCHES (U.S. CLS. 37, 39, 40, 42 AND 50).

JESSICA FATHY, EXAMINING ATTORNEY

**CLASS 26—(Continued).**

SN 86-028,090. C&J PRODUCTS, INC, LAKE WORTH, FL. FILED 8-3-2013.

## SHELL OBSESSIONS

THE MARK CONSISTS OF STANDARD CHARACTERS WITHOUT CLAIM TO ANY PARTICULAR FONT, STYLE, SIZE, OR COLOR.

NO CLAIM IS MADE TO THE EXCLUSIVE RIGHT TO USE "SHELL", APART FROM THE MARK AS SHOWN.

FOR BARRETTES; HAIR ACCESSORIES, NAMELY, HAIR CLIPS, BOBBY PINS, AND BARRETTES; HAIR BANDS; HAIR BARRETTES; HAIR CLIPS; HAIR ORNAMENTS; HAIR ORNAMENTS IN THE FORM OF COMBS; HAIR ORNAMENTS NOT OF PRECIOUS METAL; HAIR PINS; HAIR PINS AND GRIPS (U.S. CLS. 37, 39, 40, 42 AND 50).

FIRST USE 7-15-2013; IN COMMERCE 7-17-2013.

LEIGH CAROLINE CASE, EXAMINING ATTORNEY

SN 86-029,811. HAIRROOTZ INC., DBA HAIRROOTZ, AC-WORTH, GA. FILED 8-6-2013.

## HairRootz

THE MARK CONSISTS OF STANDARD CHARACTERS WITHOUT CLAIM TO ANY PARTICULAR FONT, STYLE, SIZE, OR COLOR.

FOR WIGS, HAIRPIECES, AND ADD-IN AND ADD-ON HAIR ACCESSORIES CONSTRUCTED PRIMARILY OF SYNTHETIC AND/OR HUMAN HAIR (U.S. CLS. 37, 39, 40, 42 AND 50).

FIRST USE 4-4-2013; IN COMMERCE 4-4-2013.

ALISON POLLACK, EXAMINING ATTORNEY

SN 86-037,686. SHOE CANDI, LLC, WOODLAND PARK, NJ. FILED 8-14-2013.

## Sassy Strapps

THE MARK CONSISTS OF STANDARD CHARACTERS WITHOUT CLAIM TO ANY PARTICULAR FONT, STYLE, SIZE, OR COLOR.

NO CLAIM IS MADE TO THE EXCLUSIVE RIGHT TO USE "STRAPS", APART FROM THE MARK AS SHOWN.

FOR CHARMS FOR SHOES; SHOE ORNAMENTS NOT OF PRECIOUS METAL (U.S. CLS. 37, 39, 40, 42 AND 50).

FIRST USE 7-24-2012; IN COMMERCE 3-31-2013.

LINDA E. BLOHM, EXAMINING ATTORNEY

**CLASS 26—(Continued).**

SN 86-050,533. SHOE CANDI, LLC, WOODLAND PARK, NJ. FILED 8-28-2013.



NO CLAIM IS MADE TO THE EXCLUSIVE RIGHT TO USE "STRAPPS", APART FROM THE MARK AS SHOWN.

THE COLOR(S) PURPLE, BEIGE, AND WHITE IS/ARE CLAIMED AS A FEATURE OF THE MARK.

THE MARK CONSISTS OF THE PURPLE FILLED SILHOUETTE OF A YOUNG WOMAN WEARING A KNEE-LENGTH SKIRT WITH BEIGE PLEATING; HER LONG HAIR IS SUCH THAT IT APPEARS THAT IT IS BEING BLOWN BY WIND, THE WOMAN IS HOLDING A PURPLE PURSE IN HER LEFT HAND WHILE STANDING ON HER RIGHT FOOT WITH HER LEFT LEG KICKED UP SHOWING OFF BEIGE HIGH-HEELED SHOES ADORNED WITH TWINKLING WHITE RHINESTONE STRAPS ON HER SHOES; THE WORDING "SASSY STRAPPS", SHOWN IN THE COLOR PURPLE, APPEARS TO THE RIGHT OF THE WOMAN IN SUCH A WAY THAT THE TWO WORDS ARE STACKED ON TOP OF EACH OTHER WITH THE FIRST "S" IN BOTH WORDS BEING SHARED.

FOR CHARMS FOR SHOES; SHOE ORNAMENTS NOT OF PRECIOUS METAL (U.S. CLS. 37, 39, 40, 42 AND 50).

FIRST USE 7-24-2012; IN COMMERCE 3-31-2013.

LINDA E. BLOHM, EXAMINING ATTORNEY

SN 86-063,892. HAIRODDS LLC, NEW YORK, NY. FILED 9-13-2013.

# St. Moire

THE MARK CONSISTS OF STANDARD CHARACTERS WITHOUT CLAIM TO ANY PARTICULAR FONT, STYLE, SIZE, OR COLOR.

FOR HAIR EXTENSIONS; WIGS, HAIRPIECES, AND ADD-IN AND ADD-ON HAIR ACCESSORIES CONSTRUCTED PRIMARILY OF SYNTHETIC AND/OR HUMAN HAIR (U.S. CLS. 37, 39, 40, 42 AND 50).

SOPHIA S. KIM, EXAMINING ATTORNEY

**CLASS 26—(Continued).**

SN 86-066,075. FASHION IMEX LLC, DBA TONY OF BEVERLY, MOORPARK, CA. FILED 9-16-2013.

# Tony of Beverly

THE MARK CONSISTS OF STANDARD CHARACTERS WITHOUT CLAIM TO ANY PARTICULAR FONT, STYLE, SIZE, OR COLOR.

FOR WIGS, HAIRPIECES, AND ADD-IN AND ADD-ON HAIR ACCESSORIES CONSTRUCTED PRIMARILY OF SYNTHETIC AND/OR HUMAN HAIR (U.S. CLS. 37, 39, 40, 42 AND 50).

FIRST USE 1-1-1978; IN COMMERCE 1-1-1978.

ROSELLE HERRERA, EXAMINING ATTORNEY

SN 86-069,272. OQUA, UFUOMA, DBA STRETCH-A-WEAVE, HOUSTON, TX. FILED 9-19-2013.



THE COLOR(S) CYAN AND MAGENTA AND BLACK IS/ARE CLAIMED AS A FEATURE OF THE MARK.

THE MARK CONSISTS OF DRAWING OF A STYLIZED, CARTOON-LIKE FEMALE BODY FIGURE, WITH EXAGGERATED, BIG, LONG BLOWING HAIR IN MAGENTA AND CYAN - WITH THE WORD STRETCH-A-WEAVE POSITIONED TO THE RIGHT IN BLACK COLOR.

FOR WIGS, HAIRPIECES, AND ADD-IN AND ADD-ON HAIR ACCESSORIES CONSTRUCTED PRIMARILY OF SYNTHETIC AND/OR HUMAN HAIR (U.S. CLS. 37, 39, 40, 42 AND 50).

FIRST USE 3-1-2013; IN COMMERCE 3-1-2013.

AISHA CLARKE, EXAMINING ATTORNEY

**CLASS 26—(Continued).**

SN 86-093,805. SUN TAIYANG CO., LTD, DBA OUTRE, MOONACHIE,, NJ. FILED 10-17-2013.

**SIMPLY BRAZILIAN BUNDLE  
REMI**

THE MARK CONSISTS OF STANDARD CHARACTERS WITHOUT CLAIM TO ANY PARTICULAR FONT, STYLE, SIZE, OR COLOR.

NO CLAIM IS MADE TO THE EXCLUSIVE RIGHT TO USE "BRAZILIAN BUNDLE" AND "REMI", APART FROM THE MARK AS SHOWN.

FOR HAIR EXTENSIONS; HAIR PIECES; HAIR PIECES AND WIGS; WIG CAPS; WIGS; WIGS, HAIR-PIECES, AND ADD-IN AND ADD-ON HAIR ACCESSORIES CONSTRUCTED PRIMARILY OF SYNTHETIC AND/OR HUMAN HAIR (U.S. CLS. 37, 39, 40, 42 AND 50).

HENRY S. ZAK, EXAMINING ATTORNEY

SN 86-099,203. ISIS COLLECTIONS INC., CARLSTADT, NJ. FILED 10-23-2013.



OWNER OF U.S. REG. NO. 2,722,480.  
THE MARK CONSISTS OF FOUR CHARACTERS, "ISIS" WITH CHUBBY LINES.

FOR HAIR PRODUCTS, NAMELY, HAIR BANDS; HAIR BOWS; HAIR NETS; HAIR ORNAMENTS; HAIR PIECES; HUMAN AND SYNTHETIC HAIR FOR HAIR WEAVING; SILICON COATED HUMAN HAIR; FALLS; PONYTAILS; PONYTAIL HOLDERS; TAPE FOR FIXING HAIR PIECES AND WIGS; AND WAVING PINS FOR THE HAIR (U.S. CLS. 37, 39, 40, 42 AND 50).

FIRST USE 3-10-2010; IN COMMERCE 3-10-2010.  
CAROLYN CATALDO, EXAMINING ATTORNEY

**CLASS 26—(Continued).**

SN 86-107,830. LOX EXTENSIONS LLC, DBA LOX EXTENSIONS, SHELBY TWP, MI. FILED 11-1-2013.

**Clip Art Beauty**

THE MARK CONSISTS OF STANDARD CHARACTERS WITHOUT CLAIM TO ANY PARTICULAR FONT, STYLE, SIZE, OR COLOR.

NO CLAIM IS MADE TO THE EXCLUSIVE RIGHT TO USE "BEAUTY", APART FROM THE MARK AS SHOWN.

FOR HAIR EXTENSIONS (U.S. CLS. 37, 39, 40, 42 AND 50).

CORY BOONE, EXAMINING ATTORNEY

**CLASS 27—FLOOR COVERINGS**

SN 79-127,457. UNILIN BVBA, BELGIUM, FILED 12-21-2012.

**LIVYN**

THE MARK CONSISTS OF STANDARD CHARACTERS WITHOUT CLAIM TO ANY PARTICULAR FONT, STYLE, SIZE, OR COLOR.

PRIORITY DATE OF 9-4-2012 IS CLAIMED.

OWNER OF INTERNATIONAL REGISTRATION 1153389 DATED 12-21-2012, EXPIRES 12-21-2022.

FOR CARPETS, RUGS, MATS AND MATTING, LINOLEUM FOR USE ON FLOORS AND COVERING EXISTING FLOORS; VINYL FOR USE ON FLOORS AND FLOOR COVERINGS; NON-TEXTILE WALL HANGINGS; TAPESTRY-STYLE WALL HANGINGS, NOT OF TEXTILE; GYMNASIUM MATS; VINYL FLOOR COVERINGS; CARPET UNDERLAY; RUGS (U.S. CLS. 19, 20, 37, 42 AND 50).

YAT SYE, LEE, EXAMINING ATTORNEY

SN 85-604,920. COLUMBIA INSURANCE COMPANY, OMAHA, NE. FILED 4-23-2012.

**COLOR PLAY**

THE MARK CONSISTS OF STANDARD CHARACTERS WITHOUT CLAIM TO ANY PARTICULAR FONT, STYLE, SIZE, OR COLOR.

FOR CARPET TILES (U.S. CLS. 19, 20, 37, 42 AND 50).  
FIRST USE 8-1-2005; IN COMMERCE 8-1-2005.

HENRY S. ZAK, EXAMINING ATTORNEY

**CLASS 27—(Continued).**

SN 85-861,440. TAI PING LIMITED, ROAD TOWN, TORTOLA, BR. VIRGIN ISLANDS, FILED 2-27-2013.



PRIORITY CLAIMED UNDER SEC. 44(D) ON FRANCE APPLICATION NO. 133985983, FILED 2-26-2013, REG. NO. 133985983, DATED 2-26-2013, EXPIRES 2-25-2023.

NO CLAIM IS MADE TO THE EXCLUSIVE RIGHT TO USE "LA MANUFACTURE" AND "DEPUIS 1924", APART FROM THE MARK AS SHOWN.

THE MARK CONSISTS OF THE WORD "LA MANUFACTURE" ON TOP OF THE WORD "COGOLIN" IN STYLIZED LETTERING AND "DEPUIS 1924" APPEARS AT THE BOTTOM.

THE ENGLISH TRANSLATION OF "LA MANUFACTURE" AND "DEPUIS" IN THE MARK IS "MADE" AND "SINCE".

FOR CARPETS, RUGS, MATS AND MATTING, LINOLEUM FOR COVERING EXISTING FLOORS; NON-TEXTILE WALL HANGINGS (U.S. CLS. 19, 20, 37, 42 AND 50).

DAVID HOFFMAN, EXAMINING ATTORNEY

SN 86-029,070. ENVIRONMENTAL GRAPHICS, INC., HOPKINS, MN. FILED 8-5-2013.

**CANVAS YOUR WAY**

THE MARK CONSISTS OF STANDARD CHARACTERS WITHOUT CLAIM TO ANY PARTICULAR FONT, STYLE, SIZE, OR COLOR.

OWNER OF U.S. REG. NOS. 3,061,653 AND 3,785,258.

NO CLAIM IS MADE TO THE EXCLUSIVE RIGHT TO USE "CANVAS", APART FROM THE MARK AS SHOWN.

FOR WALLCOVERING PRINTED ON CANVAS (U.S. CLS. 19, 20, 37, 42 AND 50).

FRED CARL, EXAMINING ATTORNEY

**CLASS 27—(Continued).**

SN 86-035,412. MANNINGTON MILLS, INC., SALEM, NJ. FILED 8-12-2013.

**VEGA II**

THE MARK CONSISTS OF STANDARD CHARACTERS WITHOUT CLAIM TO ANY PARTICULAR FONT, STYLE, SIZE, OR COLOR.

OWNER OF U.S. REG. NO. 2,549,674.

FOR RESILIENT HARD SURFACE COVERING FOR FLOORS, WALLS AND OTHER SURFACES; VINYL FLOOR COVERINGS (U.S. CLS. 19, 20, 37, 42 AND 50).

FIRST USE 2-1-1992; IN COMMERCE 2-1-1992.

SHARON MEIER, EXAMINING ATTORNEY

SN 86-047,378. GUCCN, L.L.C., NEWCASTLE, WA. FILED 8-25-2013.

**UCALAN**

THE MARK CONSISTS OF STANDARD CHARACTERS WITHOUT CLAIM TO ANY PARTICULAR FONT, STYLE, SIZE, OR COLOR.

THE WORDING "UCALAN" HAS NO MEANING IN A FOREIGN LANGUAGE.

FOR CARPETS; CARPETS AND RUGS; CARPETS, RUGS, MATS AND MATTING, LINOLEUM FOR COVERING EXISTING FLOORS (U.S. CLS. 19, 20, 37, 42 AND 50).

GIANCARLO CASTRO, EXAMINING ATTORNEY

SN 86-047,442. RUGS PLUS HOME ACCESSORIES INC, FOUNTAIN VALLEY, CA. FILED 8-26-2013.

**Rugs Plus**

THE MARK CONSISTS OF STANDARD CHARACTERS WITHOUT CLAIM TO ANY PARTICULAR FONT, STYLE, SIZE, OR COLOR.

NO CLAIM IS MADE TO THE EXCLUSIVE RIGHT TO USE "RUGS", APART FROM THE MARK AS SHOWN.

FOR AREA RUGS, ORIENTAL RUGS, PERSIAN RUGS (U.S. CLS. 19, 20, 37, 42 AND 50).

FIRST USE 4-1-1988; IN COMMERCE 4-1-1988.

JOHN WILKE, EXAMINING ATTORNEY

**CLASS 27—(Continued).**

SN 86-067,223. SHAW CONTRACT FLOORING SERVICES, INC., DALTON, GA. FILED 9-17-2013.



THE MARK CONSISTS OF THE LETTERS "H" AND "C" FOLLOWED BY THE DEGREE SYMBOL.

FOR COOLING COMPONENT, NAMELY, SUPER ABSORBENT PARTICLES WITHIN THE INFILL, SOLD AS AN INTEGRAL PART OF ARTIFICIAL TURF (U.S. CLS. 19, 20, 37, 42 AND 50).

MARIA-VICTORIA SUAREZ, EXAMINING ATTORNEY

---

SN 86-069,181. MARKETING AND SALES MANAGEMENT CORP., DBA MSM INDUSTRIES, SMYRNA, TN. FILED 9-19-2013.

**Econo-Lock**

THE MARK CONSISTS OF STANDARD CHARACTERS WITHOUT CLAIM TO ANY PARTICULAR FONT, STYLE, SIZE, OR COLOR.

FOR CARPET UNDERLAYS, NAMELY, RUG GRIPPERS (U.S. CLS. 19, 20, 37, 42 AND 50).

FIRST USE 10-31-2010; IN COMMERCE 10-31-2010.

DAVID TAYLOR, EXAMINING ATTORNEY

---

SN 86-069,187. MARKETING AND SALES MANAGEMENT CORP., DBA MSM INDUSTRIES, SMYRNA, TN. FILED 9-19-2013.

**Duo-Lock**

THE MARK CONSISTS OF STANDARD CHARACTERS WITHOUT CLAIM TO ANY PARTICULAR FONT, STYLE, SIZE, OR COLOR.

FOR CARPET UNDERLAYS, NAMELY, RUG GRIPPERS (U.S. CLS. 19, 20, 37, 42 AND 50).

FIRST USE 1-17-1996; IN COMMERCE 1-17-1996.

DAVID TAYLOR, EXAMINING ATTORNEY

**CLASS 27—(Continued).**

SN 86-124,415. GALLEHER CORPORATION, SANTA FE SPRINGS, CA. FILED 11-20-2013.



OWNER OF U.S. REG. NO. 4,449,140.  
NO CLAIM IS MADE TO THE EXCLUSIVE RIGHT TO USE "CARPET", APART FROM THE MARK AS SHOWN.

THE MARK CONSISTS OF THE TERM "SEQUOIA" POSITIONED ABOVE THE TERM "CARPET", WITH BROKEN HORIZONTAL LINES SEPARATING THE TERMS, A CARPET ROLL DESIGN REPRESENTING THE LETTER "O" IN THE TERM "SEQUOIA", AND A LEAF DESIGN REPRESENTING THE DOT IN THE LETTER "I" IN THE TERM "SEQUOIA". TWO HORIZONTAL LINES APPEAR ON EACH SIDE OF THE TERM "CARPET".

FOR CARPETS (U.S. CLS. 19, 20, 37, 42 AND 50).

FIRST USE 6-1-2013; IN COMMERCE 6-1-2013.

JOANNA FIORELLI, EXAMINING ATTORNEY

**CLASS 28—TOYS AND SPORTING GOODS**

SN 85-549,426. STARMARK PET PRODUCTS, INC., HUTTO, TX. FILED 2-22-2012.

**DOGZONE**

THE MARK CONSISTS OF STANDARD CHARACTERS WITHOUT CLAIM TO ANY PARTICULAR FONT, STYLE, SIZE, OR COLOR.

FOR RAISED PLATFORM, CONSTRUCTED OF TUBULAR STEEL WITH A TOP SURFACE MADE OF NYLON OR OTHER FABRIC, USED AS A DOG TRAINING DEVICE AND AS A LOCATION FOR INTERACTIVE PLAY (U.S. CLS. 22, 23, 38 AND 50).

LIEF MARTIN, EXAMINING ATTORNEY

**CLASS 28—(Continued).**

SN 85-588,650. MATTEL, INC., EL SEGUNDO, CA. FILED 4-4-2012.

**ZOMBISAURS**

THE MARK CONSISTS OF STANDARD CHARACTERS WITHOUT CLAIM TO ANY PARTICULAR FONT, STYLE, SIZE, OR COLOR.

PRIORITY CLAIMED UNDER SEC. 44(D) ON FED REP GERMANY APPLICATION NO. 302011069092, FILED 12-22-2011, REG. NO. 302011069092, DATED 12-22-2011, EXPIRES 12-31-2021.

FOR GAMES AND PLAYTHINGS, NAMELY, TOY VEHICLES AND ACCESSORIES THEREFOR, TOY FIGURES AND ACCESSORIES THEREFOR, ACTION FIGURES AND ACCESSORIES THEREFOR, TOY VEHICLE PLAYSETS AND ACCESSORIES THEREFOR, TOY FIGURE PLAYSETS AND ACCESSORIES THEREFOR, CARD GAMES, BOARD GAMES, HANDHELD UNITS FOR PLAYING ELECTRONIC GAMES, ROLE PLAYING GAMES; GYMNASIAC AND SPORTING ARTICLES, NAMELY, SKATEBOARDS, ELBOW AND KNEE PADS FOR ATHLETIC USE NOT INCLUDED IN OTHER CLASSES (U.S. CLS. 22, 23, 38 AND 50).

BRIDGETT SMITH, EXAMINING ATTORNEY

SN 85-589,129. TINY LOVE LTD., TEL AVIV, ISRAEL, FILED 4-4-2012.

**MY NATURE PALS**

THE MARK CONSISTS OF STANDARD CHARACTERS WITHOUT CLAIM TO ANY PARTICULAR FONT, STYLE, SIZE, OR COLOR.

OWNER OF ISRAEL REG. NO. 245621, DATED 11-3-2013, EXPIRES 4-3-2022.

FOR TOYS AND PLAYTHING FOR BABIES, INFANTS AND CHILDREN, NAMELY, CHILDREN'S MULTIPLE ACTIVITY CENTERS COMPRISED OF PLAY MATS AND FLEXIBLE ARCHES FOR SUSPENDING TOYS, TOY MOBILES, TOY ANIMALS, PLUSH TOYS, AND STUFFED TOYS; TOY ANIMALS, PLUSH TOYS, STUFFED TOYS, SQUEAKER TOYS, MUSICAL TOYS, BABY RATTLES INCORPORATING TEETHING RING; MULTIPLE ACTIVITY TOYS; PLUSH TOYS IN THE SHAPE OF A BOOK; PLAY MATS; PLUSH AND STUFFED TOYS AND TOY ANIMALS; TOY MOBILES (U.S. CLS. 22, 23, 38 AND 50).

TEJBIR SINGH, EXAMINING ATTORNEY

**CLASS 28—(Continued).**

SN 85-679,796. FREUND, CRAIG J, PITTSBURGH, PA. FILED 7-17-2012.

**Ever Square**

THE MARK CONSISTS OF STANDARD CHARACTERS WITHOUT CLAIM TO ANY PARTICULAR FONT, STYLE, SIZE, OR COLOR.

FOR GOLF TRAINING APPARATUS, NAMELY, DEVICES USED TO HELP GROOVE A REPETITIVE PUTTING STROKE (U.S. CLS. 22, 23, 38 AND 50).

MICHAEL ENGEL, EXAMINING ATTORNEY

SN 85-691,891. MENAKER, CYNTHIA LAUREN, PALM BEACH GARDENS, FL. FILED 7-31-2012.

**OMG**

THE MARK CONSISTS OF STANDARD CHARACTERS WITHOUT CLAIM TO ANY PARTICULAR FONT, STYLE, SIZE, OR COLOR.

FOR EXERCISE EQUIPMENT, NAMELY, FOR LATERAL MOVEMENT IN A SKATING MOTION; EXERCISE EQUIPMENT, NAMELY, ROWING MACHINES; EXERCISE EQUIPMENT, NAMELY, MANUALLY OPERATED JOGGING MACHINES; EXERCISE EQUIPMENT, NAMELY, STAIR-STEPPING MACHINES; EXERCISE EQUIPMENT, NAMELY, STATIONARY CYCLES; EXERCISE EQUIPMENT, NAMELY, ABDOMINAL BOARDS; EXERCISE EQUIPMENT, NAMELY, CHEST EXPANDERS; EXERCISE EQUIPMENT, NAMELY, CHEST PULLS; EXERCISE EQUIPMENT, NAMELY, ROTARY ABDOMINAL BOARDS; EXERCISE EQUIPMENT, NAMELY, SHOULDER STRETCHER USING RESISTANCE CABLES; EXERCISE EQUIPMENT, NAMELY, SHOULDER STRETCHER USING A CABLE; EXERCISE EQUIPMENT, NAMELY, VIRTUAL REALITY TRAINING CYCLES; EXERCISE EQUIPMENT, NAMELY, INFLATABLE BALLS; EXERCISE EQUIPMENT, NAMELY, EXERCISE BANDS, TRAINING ARS; EXERCISE EQUIPMENT, NAMELY, STRAPS THAT ARE AFFIXED TO DOORS FOR PERFORMANCE OF VARIOUS EXERCISES USING BODY WEIGHT RESISTANCE; WEIGHTS, NAMELY, BAR-BELLS, DUMB-BELLS; EXERCISE MACHINES INCORPORATING ELECTRONIC AND VIDEO GAME CONTROLLERS; PHYSICAL FITNESS EQUIPMENT, NAMELY, SPORT BALLS, DUMB-BELLS, EXERCISE WEIGHTS, KETTLE BELLS; FITNESS EQUIPMENT, NAMELY, STRAPS USED FOR YOGA AND OTHER FITNESS ACTIVITIES AND FOR CARRYING A YOGA MAT; SPORTING GOODS, NAMELY, A SPORTS TRAINING DEVICE TO IMPROVE STRENGTH, TONING, CONDITIONING, BALANCE, AND PROPRICEPTION; MANUALLY-OPERATED EXERCISE EQUIPMENT; MANUALLY-OPERATED EXERCISE EQUIPMENT FOR PHYSICAL FITNESS PURPOSES; PHYSICAL FITNESS EQUIPMENT, NAMELY, EXERCISE BANDS, TRAINING BARS; PHYSICAL FITNESS EQUIPMENT, NAMELY, SPORT BALLS, DUMB-BELLS, EXERCISE WEIGHTS, KETTLE BELLS (U.S. CLS. 22, 23, 38 AND 50).

JOHN HWANG, EXAMINING ATTORNEY

**CLASS 28—(Continued).**

SN 85-708,652. ARISTOCRAT TECHNOLOGIES AUSTRALIA PTY LTD., NORTH RYDE, NSW, AUSTRALIA, FILED 8-21-2012.

**SILVER WOLF**

THE MARK CONSISTS OF STANDARD CHARACTERS WITHOUT CLAIM TO ANY PARTICULAR FONT, STYLE, SIZE, OR COLOR.

PRIORITY CLAIMED UNDER SEC. 44(D) ON AUSTRALIA APPLICATION NO. 1492145, FILED 5-22-2012, REG. NO. 1492145, DATED 5-22-2012, EXPIRES 5-22-2022.

OWNER OF U.S. REG. NOS. 3,491,650, 4,058,912 AND OTHERS.

FOR ELECTRONIC GAMING MACHINES, NAMELY, DEVICES WHICH ACCEPT A WAGER (U.S. CLS. 22, 23, 38 AND 50).

SHAVELL MCPHERSON, EXAMINING ATTORNEY

---

SN 85-711,071. TURNER ENTERTAINMENT CO., BURBANK, CA. FILED 8-23-2012.

**HAUNTED FOREST**

THE MARK CONSISTS OF STANDARD CHARACTERS WITHOUT CLAIM TO ANY PARTICULAR FONT, STYLE, SIZE, OR COLOR.

OWNER OF U.S. REG. NO. 4,339,442.

FOR GAMING DEVICES, NAMELY, GAMING MACHINES, SLOT MACHINES, WITH OR WITHOUT VIDEO OUTPUT; GAMING MACHINES INCLUDING SLOT MACHINES AND VIDEO LOTTERY TERMINALS (U.S. CLS. 22, 23, 38 AND 50).

KATHRYN COWARD, EXAMINING ATTORNEY

---

SN 85-764,839. BATTAT INC., PLATTSBURGH, NY. FILED 10-26-2012.

**HOLIDAY HAILEY**

THE MARK CONSISTS OF STANDARD CHARACTERS WITHOUT CLAIM TO ANY PARTICULAR FONT, STYLE, SIZE, OR COLOR.

FOR DOLLS AND ACCESSORIES THEREFOR (U.S. CLS. 22, 23, 38 AND 50).

CHRISTINA SOBRAL, EXAMINING ATTORNEY

**CLASS 28—(Continued).**

SN 85-792,362. I-STAR ENTERTAINMENT LLC, GREAT NECK, NY. FILED 12-1-2012.

**FLYING HEROES**

THE MARK CONSISTS OF STANDARD CHARACTERS WITHOUT CLAIM TO ANY PARTICULAR FONT, STYLE, SIZE, OR COLOR.

NO CLAIM IS MADE TO THE EXCLUSIVE RIGHT TO USE "FLYING", APART FROM THE MARK AS SHOWN.

FOR TOYS, NAMELY, DOLLS, DOLL PLAYSETS, ACTION FIGURE TOYS, BATH TOYS, BATHTUB TOYS, BATTERY-OPERATED ACTION TOYS, BENDABLE TOYS, COLLECTABLE TOY FIGURES, CONSTRUCTION TOYS, CRIB TOYS, CAT TOYS, DOG TOYS, DRAWING TOYS, ELECTRIC ACTION TOYS, ELECTRONIC LEARNING TOYS, ELECTRIC TOY VEHICLES, ELECTRONICALLY OPERATED TOY MOTOR VEHICLES, FANTASY CHARACTER TOYS, TOY FLYING SAUCERS, INFANT TOYS, MECHANICAL TOYS, MODEL TOY VEHICLES, MODELED PLASTIC TOY FIGURINES, MOLDED TOY FIGURES, MUSIC BOX TOYS, MUSICAL TOYS, NON-ELECTRONIC TOY VEHICLES, PARTY FAVORS IN THE NATURE OF SMALL TOYS, PET TOYS, PLASTIC CHARACTER TOYS, PLAY MATS FOR USE WITH TOY VEHICLES, PLUSH TOYS, POP-UP TOYS, PRINTING TOYS, POSITIONABLE TOY FIGURES, PULL TOYS, PUNCHING TOYS, PUSH TOYS, RADIO-CONTROLLED TOY VEHICLES, RIDE-ABLE TOY VEHICLES, ROLE PLAYING TOYS IN THE NATURE OF PLAY SETS FOR CHILDREN TO IMITATE REAL LIFE OCCUPATIONS, RUBBER CHARACTER TOYS, SAND TOYS, SANDBOX TOYS, SCALE MODEL KITS, SKETCHING TOYS, SOFT SCULPTURE TOYS, SQUEEZE TOYS, STACKING TOYS, STUFFED AND PLUSH TOYS, STUFFED TOYS, TALKING TOYS, TOSING DISC TOYS, TOY AIRPLANES, TOY AND NOVELTY FACE MASKS, TOY ANIMALS, TOY ARMOR, TOY ARTIFICIAL FINGERNAILS, TOY BAKE-WARE AND COOKWARE, TOY BALLOONS, TOY BANKS, TOY BOATS, TOY BOWS AND ARROWS, TOY BUILDING BLOCKS, TOY BUTTERFLY NETS, TOY CANDY DISPENSERS, TOY CARS, TOY CLOCKS AND WATCHES, TOY CONSTRUCTION BLOCKS, TOY CONSTRUCTION SETS, TOY FIGURES, TOY FILM CARTRIDGES AND VIEWERS, TOY FIREWORKS, TOY FURNITURE, TOY GLIDERS, TOY HOUSES, TOY MASKS, TOY MICROSCOPES, TOY MOBILES, TOY MODEL TRAIN SETS, TOY MODEL HOBBY-CRAFT KITS, TOY MODELING DOUGH, TOY MUSIC BOXES, TOY PISTOLS, TOY PUTTY, TOY RECORD PLAYERS, TOY ROBOTS, TOY ROCKETS, TOY SCOOTERS, TOY SNOW GLOBES, TOY SWORDS, TOY TELESCOPES, TOY TOOLS, TOY VEHICLES, TOY WATCHES, TOY WATER GLOBES, TOY WEAPONS, TOY WHISTLES, BEAN BAG ANIMALS, TRANSFORMING ROBOTIC TOYS, WATER SQUIRTING TOYS, WATER TOYS, WIND-UP TOYS, DISC TOSS TOYS, CHILDREN'S MULTIPLE ACTIVITY TOYS, ARTICLES OF CLOTHING FOR TOYS, BABY MULTIPLE ACTIVITY TOYS, CASES FOR TOY VEHICLES, CASES FOR TOY DOLLS, TOY DOLLS, BOARD GAMES, CARD GAMES, HAND-HELD UNITS FOR PLAYING VIDEO GAMES OTHER THAN THOSE ADAPTED FOR USE WITH AN EXTERNAL DISPLAY SCREEN OR MONITOR, PUZZLE GAMES, HAND-HELD UNITS FOR PLAYING ELECTRONIC GAMES OTHER THAN THOSE ADAPTED FOR USE WITH AN EXTERNAL DISPLAY SCREEN OR MONITOR, APPARATUS FOR ELECTRONIC GAMES OTHER THAN THOSE ADAPTED FOR USE WITH AN EXTERNAL DISPLAY SCREEN OR MONITOR; KITES; ELECTRONIC BUILDING BLOCKS THAT LIGHT UP; ELECTRONIC TOY VEHICLES; PLUSH ANIMALS THAT PLAY MUSIC, TOY GUITARS, TOY MUSICAL INSTRUMENTS, TOY PIANOS, TOY DRUMSGIRLS' TOYS, NAMELY, DOLLS, FIGURINES, PLUSH TOYS, PLASTIC TOYS, DRESS-UP SETS, ROLE PLAY TOYS; BOY'S TOYS, NAMELY, ACTION FIGURES; ACTION TOYS, NAMELY, ELECTRONIC ACTION TOYS; FIGURINES, NAMELY,



**CLASS 28—(Continued).**

MOLDED PLASTIC TOY FIGURINES; CHARACTER TOYS, NAMELY, PLASTIC CHARACTER TOYS AND PLUSH CHARACTER TOYS; TOY WITH BOOK, NAMELY, CHILDREN'S MULTIPLE ACTIVITY TOYS SOLD AS A UNIT WITH PRINTED BOOK; CHILDREN'S GAMES, NAMELY, BOARD GAMES, CARD GAMES, PUZZLE GAMES, AND APPARATUS FOR ELECTRONIC GAMES OTHER THAN THOSE ADAPTED FOR USE WITH AN EXTERNAL DISPLAY SCREEN OR MONITOR; TOY ELECTRONICS, NAMELY, ELECTRONIC EDUCATIONAL GAME MACHINES FOR CHILDREN AND ELECTRONIC NON-EDUCATIONAL GAME MACHINES FOR CHILDREN (U.S. CLS. 22, 23, 38 AND 50).  
WILLIAM ROSSMAN, EXAMINING ATTORNEY

---

SN 85-806,975. CLOUD B, INC., GARDENA, CA. FILED 12-19-2012.

**TWILIGHT TURTLE TUNES T3**

THE MARK CONSISTS OF STANDARD CHARACTERS WITHOUT CLAIM TO ANY PARTICULAR FONT, STYLE, SIZE, OR COLOR.

OWNER OF U.S. REG. NOS. 3,096,834, 4,026,733 AND 4,221,512.

NO CLAIM IS MADE TO THE EXCLUSIVE RIGHT TO USE "TURTLE TUNES", APART FROM THE MARK AS SHOWN.

FOR TOYS, NAMELY, SOFT SCULPTURE TOYS (U.S. CLS. 22, 23, 38 AND 50).

DEBORAH LOBO, EXAMINING ATTORNEY

---

SN 85-815,944. AQUALUNG INTERNATIONAL, PARIS, FRANCE, FILED 1-4-2013.

**ZIP VX**

THE MARK CONSISTS OF STANDARD CHARACTERS WITHOUT CLAIM TO ANY PARTICULAR FONT, STYLE, SIZE, OR COLOR.

OWNER OF FRANCE REG. NO. 123.933.944, DATED 7-13-2012, EXPIRES 7-13-2022.

FOR SWIMMING FINS (U.S. CLS. 22, 23, 38 AND 50).  
FIRST USE 5-21-2012; IN COMMERCE 5-21-2012.

KATHLEEN KOLACZ, EXAMINING ATTORNEY

**CLASS 28—(Continued).**

SN 85-830,510. NEW ORLEANS HORNETS NBA, LLC, METAIRIE, LA. FILED 1-23-2013.



THE MARK CONSISTS OF STYLIZED DESIGNS OF A PELICAN'S HEAD AND A BASKETBALL APPEARING WITHIN A STYLIZED DESIGN OF A FLEUR-DE-LIS.

FOR TOYS, GAMES AND SPORTING GOODS, NAMELY, BASKETBALLS, GOLF BALLS, PLAYGROUND BALLS, SPORTS BALLS, RUBBER ACTION BALLS AND FOAM ACTION BALLS, PLUSH BALLS FOR GAMES, PLASTIC BALLS FOR GAMES, BASKETBALL NETS, BASKETBALL BACKBOARDS, MINIATURE BASKETBALL BACKBOARDS, PUMPS FOR INFLATING BASKETBALLS AND NEEDLES THEREFORE; GOLF CLUBS, GOLF BAGS, GOLF PUTTERS, GOLF ACCESSORIES, NAMELY, DIVOT REPAIR TOOLS, TEES, BALL MARKERS, GOLF BAG COVERS, CLUB HEAD COVERS, GOLF GLOVES, GOLF BALL SLEEVES, GOLF PUTTING GREENS; BILLIARD CUE RACKS, BILLIARD BALLS, BILLIARD BALL RACKS, DART BOARD CABINETS, ELECTRONIC BASKETBALL TABLE TOP GAMES, BASKETBALL TABLE TOP GAMES, BASKETBALL BOARD GAMES, ACTION SKILL GAMES, ADULT'S AND CHILDREN'S PARTY GAMES, TRIVIA INFORMATION GAMES AND ELECTRONIC VIDEO ARCADE GAME MACHINES. BASKETBALL KIT COMPRISED OF A NET AND WHISTLE, DOLLS, DECORATIVE DOLLS, COLLECTIBLE DOLLS, TOY ACTION FIGURES, BOBBLEHEAD ACTION FIGURES, STUFFED TOYS, PLUSH TOYS, JIGSAW PUZZLES, TOY BUILDING BLOCKS, CHRISTMAS TREE ORNAMENTS AND CHRISTMAS STOCKINGS; TOY VEHICLES IN THE NATURE OF CARS, TRUCKS, TRAINS AND VANS, ALL CONTAINING BASKETBALL THEMES, NOVELTY FOAM TOYS IN THE SHAPES OF FINGERS AND TROPHIES, TOY TROPHIES, PLAYING CARDS, CARD GAMES, TOY NOISEMAKERS, PET TOYS; BEACH TOYS, NAMELY, BEACH BALLS, INFLATABLE BALLS, TOY PAILS, TOY SHOVELS, SAND TOYS, SAND BOX TOYS, WATER-SQUIRTING TOYS; POOL ACCESSORIES, NAMELY, SWIM FLOATS, POOL FLOATS, TOY WATER RAFTS, FOAM FLOATS, SWIM RINGS, POOL RINGS, FOAM RINGS, BODY BOARDS, SURF BOARDS, SWIM FINS, SURF FINS, ARM FLOATS AND WATER WING SWIM AIDS FOR RECREATIONAL USE; VOLLEYBALL GAME KITS COMPRISED OF BALL, NET, SIDELINES AND WHISTLE, AND WATER POLO GAME KITS COMPRISED OF BALL, NET AND WHISTLE; DECORATIVE CLOTH WIND SOCKS (U.S. CLS. 22, 23, 38 AND 50).

ALICE BENMAMAN, EXAMINING ATTORNEY

**CLASS 28—(Continued).**

SN 85-830,773. NEW ORLEANS HORNETS NBA, LLC, METAIRIE, LA. FILED 1-23-2013.



NO CLAIM IS MADE TO THE EXCLUSIVE RIGHT TO USE "CRESCENT CITY" AND "BASKETBALL", APART FROM THE MARK AS SHOWN.

THE MARK CONSISTS OF THE WORDS "CRESCENT CITY BASKETBALL" AND TWO (2) STYLIZED FLEURS-DE-LIS APPEARING WITHIN A SOLID CIRCLE OR CIRCULAR BAND. INSIDE THE EMPTY SPACE WITHIN THE CENTER OF THE CIRCLE OR CIRCULAR BAND IS A STYLIZED DESIGN OF A BASKETBALL; THE NEGATIVE SPACE AROUND THE BASKETBALL FORMS A CRESCENT DESIGN.

FOR TOYS, GAMES AND SPORTING GOODS, NAMELY, BASKETBALLS, GOLF BALLS, PLAYGROUND BALLS, SPORTS BALLS, RUBBER ACTION BALLS AND FOAM ACTION BALLS, PLUSH BALLS FOR GAMES, PLASTIC BALLS FOR GAMES, BASKETBALL NETS, BASKETBALL BACKBOARDS, MINIATURE BASKETBALL BACKBOARDS, PUMPS FOR INFLATING BASKETBALLS AND NEEDLES THEREFOR; GOLF CLUBS, GOLF BAGS, GOLF PUTTERS, GOLF ACCESSORIES, NAMELY, DIVOT REPAIR TOOLS, TEES, BALL MARKERS, GOLF BAG COVERS, CLUB HEAD COVERS, GOLF GLOVES, GOLF BALL SLEEVES, GOLF PUTTING GREENS; BILLIARD CUE RACKS, BILLIARD BALLS, BILLIARD BALL RACKS, DART BOARD CABINETS, ELECTRONIC BASKETBALL TABLE TOP GAMES, BASKETBALL TABLE TOP GAMES, BASKETBALL BOARD GAMES, ACTION SKILL GAMES, ADULT'S AND CHILDREN'S PARTY GAMES, TRIVIA INFORMATION GAMES AND ELECTRONIC VIDEO ARCADE GAME MACHINES, BASKETBALL KIT COMPRISED OF A NET AND WHISTLE, DOLLS, DECORATIVE DOLLS, COLLECTIBLE DOLLS, TOY ACTION FIGURES, BOBBLEHEAD ACTION FIGURES, STUFFED TOYS, PLUSH TOYS, JIGSAW PUZZLES, TOY BUILDING BLOCKS, CHRISTMAS TREE ORNAMENTS AND CHRISTMAS STOCKINGS; TOY VEHICLES IN THE NATURE OF CARS, TRUCKS, TRAINS AND VANS, ALL CONTAINING BASKETBALL THEMES, NOVELTY FOAM TOYS IN THE SHAPES OF FINGERS AND TROPHIES, TOY TROPHIES, PLAYING CARDS, CARD GAMES, TOY NOISEMAKERS, PET TOYS; BEACH TOYS, NAMELY, BEACH BALLS, INFLATABLE BALLS, TOY PAILS, TOY SHOVELS, SAND TOYS, SAND BOX TOYS, WATER-SQUIRTING TOYS; POOL ACCESSORIES, NAMELY, SWIM FLOATS, POOL FLOATS, TOY WATER RAFTS, FOAM FLOATS, SWIM RINGS, POOL RINGS, FOAM RINGS, BODY BOARDS, SURF BOARDS, SWIM FINS, SURF FINS, ARM FLOATS AND WATER WING SWIM AIDS FOR RECREATIONAL USE; VOLLEYBALL GAME KITS COMPRISED OF BALL, NET, SIDELINES AND WHISTLE, AND WATER POLO GAME KITS COMPRISED OF BALL, NET AND WHISTLE; DECORATIVE CLOTH WIND SOCKS (U.S. CLS. 22, 38 AND 50).

Alice Benmaman, Examining Attorney

**CLASS 28—(Continued).**

SN 85-843,654. THROW GLOW, LLC, MANHATTAN BEACH, CA. FILED 2-7-2013.

**THROW GLOW**

THE MARK CONSISTS OF STANDARD CHARACTERS WITHOUT CLAIM TO ANY PARTICULAR FONT, STYLE, SIZE, OR COLOR.

NO CLAIM IS MADE TO THE EXCLUSIVE RIGHT TO USE "GLOW", APART FROM THE MARK AS SHOWN.

FOR FITTED PROTECTIVE COVERS SPECIALLY ADAPTED FOR SPORTS EQUIPMENT, NAMELY, FOOTBALLS, BASEBALLS, SOCCER BALLS, DISCS, BASKETBALLS, RUGBY BALLS, VOLLEYBALLS, SOFTBALLS, WATER POLO BALLS, FIELD HOCKEY BALLS, CRICKET BALLS, TENNIS BALLS, LACROSSE BALLS, DODGE BALLS, AUSTRALIAN FOOTBALLS, SHOT-PUT BALLS, AND HAND BALLS (U.S. CLS. 22, 23, 38 AND 50).

Beryl Gardner, Examining Attorney

SN 85-853,159. PAO FENG WORLDWIDE CO., LTD., NEW TAIPEI CITY, TAIWAN, FILED 2-19-2013.



PRIORITY CLAIMED UNDER SEC. 44(D) ON TAIWAN APPLICATION NO. 101061082, FILED 10-26-2012, REG. NO. 01582814, DATED 6-1-2013, EXPIRES 5-31-2023.

THE COLOR(S) BLACK, YELLOW AND BLUE IS/ARE CLAIMED AS A FEATURE OF THE MARK.

THE MARK CONSISTS OF THE STYLIZED WORD "PAO" IN BLACK INSIDE A YELLOW RECTANGLE WITH ROUNDED ANGLES, THE SPACE INSIDE THE LETTER "P" AND "O" IN BLUE, AND THE WORD "FENG" IN BLACK AT THE BOTTOM, IN BETWEEN TWO HAND DESIGNS IN BLACK.

THE ENGLISH TRANSLATION OF "PAO" IN THE MARK IS "MAINTENANCE", "CONSERVATION", "UP KEEP". THE ENGLISH TRANSLATION OF THE WORD "FENG" IN THE MARK IS "PART OF SHARP WEAPON".

FOR BASKETBALLS; BATTERY OPERATED ACTION TOYS; CHESS GAMES; CHRISTMAS TREE DECORATIONS; CHRISTMAS TREE ORNAMENTS; CONSTRUCTION TOYS; JIGSAW PUZZLES; MAGIC TRICKS; MUSICAL TOYS; PET TOYS; PLAYING CARDS; STUFFED TOYS; TOY BUILDING BLOCKS; TOY CARS; TOY ROBOTS (U.S. CLS. 22, 23, 38 AND 50).

Dezmona Mizelle, Examining Attorney

**CLASS 28—(Continued).**

SN 85-865,349. ODEH, NIDAL, 86153 AUGSBURG, FED REP GERMANY, FILED 3-4-2013.



The logo consists of the word "nano" in a grey, lowercase, sans-serif font, positioned to the left of the word "golf" in a larger, green, lowercase, sans-serif font.

NO CLAIM IS MADE TO THE EXCLUSIVE RIGHT TO USE "GOLF", APART FROM THE MARK AS SHOWN.  
THE COLOR(S) GREY, GREEN IS/ARE CLAIMED AS A FEATURE OF THE MARK.

THE MARK CONSISTS OF THE WORD "GOLF" IN GREEN LETTERS AND THE WORD "NANO" IN GREY LETTERS.

FOR MOLDED TOY FIGURES; TOYS IN THE NATURE MINIATURIZED GOLF PRACTICE PLATFORMS, GOLF CLUBS AND GOLF BALLS, GOLF TABLE TOP GAMES (U.S. CLS. 22, 23, 38 AND 50).

LINDA MICKLEBURGH, EXAMINING ATTORNEY

SN 85-884,784. DAVIS FISHING TECHNOLOGIES, INC., EDISTO ISLAND, SC. FILED 3-24-2013.

# HERCULINK

THE MARK CONSISTS OF STANDARD CHARACTERS WITHOUT CLAIM TO ANY PARTICULAR FONT, STYLE, SIZE, OR COLOR.

FOR TERMINAL TACKLE, NAMELY, METAL CONNECTORS FOR FISHING LURES (U.S. CLS. 22, 23, 38 AND 50).

MICHAEL ENGEL, EXAMINING ATTORNEY

SN 85-885,205. MATTEL, INC., EL SEGUNDO, CA. FILED 3-25-2013.

# SECRET CREEPERS

THE MARK CONSISTS OF STANDARD CHARACTERS WITHOUT CLAIM TO ANY PARTICULAR FONT, STYLE, SIZE, OR COLOR.

OWNER OF U.S. REG. NO. 4,265,603.  
FOR TOY ANIMAL FIGURES AND ACCESSORIES THEREFOR (U.S. CLS. 22, 23, 38 AND 50).

WON TEAK OH, EXAMINING ATTORNEY

**CLASS 28—(Continued).**

SN 85-885,446. MATTEL, INC., EL SEGUNDO, CA. FILED 3-25-2013.

# BARBER

THE MARK CONSISTS OF STANDARD CHARACTERS WITHOUT CLAIM TO ANY PARTICULAR FONT, STYLE, SIZE, OR COLOR.

FOR TOY FIGURES AND ACCESSORIES THEREFOR (U.S. CLS. 22, 23, 38 AND 50).

WON TEAK OH, EXAMINING ATTORNEY

SN 85-886,462. FIVE TIMES THE FUN, LLC, WINDSOR, WI. FILED 3-26-2013.

# ULTIMATE BATTLE FORTS

THE MARK CONSISTS OF STANDARD CHARACTERS WITHOUT CLAIM TO ANY PARTICULAR FONT, STYLE, SIZE, OR COLOR.

NO CLAIM IS MADE TO THE EXCLUSIVE RIGHT TO USE "ULTIMATE" AND "FORTS", APART FROM THE MARK AS SHOWN.

FOR TOY BUILDING PANELS OR WALLS CAPABLE OF INTERCONNECTION; TOY BUILDING STRUCTURES (U.S. CLS. 22, 23, 38 AND 50).

MARGARET POWER, EXAMINING ATTORNEY

SN 85-895,161. IGT, RENO, NV. FILED 4-4-2013.

# FIRE COMPANY 5

THE MARK CONSISTS OF STANDARD CHARACTERS WITHOUT CLAIM TO ANY PARTICULAR FONT, STYLE, SIZE, OR COLOR.

NO CLAIM IS MADE TO THE EXCLUSIVE RIGHT TO USE "COMPANY", APART FROM THE MARK AS SHOWN.  
FOR GAMING MACHINES, NAMELY, DEVICES WHICH ACCEPT A WAGER (U.S. CLS. 22, 23, 38 AND 50).

BRIDGETT SMITH, EXAMINING ATTORNEY

**CLASS 28—(Continued).**

SN 85-895,611. GEOFFREY, LLC, WAYNE, NJ. FILED 4-4-2013.

**SCREAM 'N SPEED**

THE MARK CONSISTS OF STANDARD CHARACTERS WITHOUT CLAIM TO ANY PARTICULAR FONT, STYLE, SIZE, OR COLOR.

FOR TOY VEHICLES AND ACCESSORIES THEREFOR, NAMELY, RACE CARS AND TOY VEHICLE TRACK SETS (U.S. CLS. 22, 23, 38 AND 50).

INGA ERVIN, EXAMINING ATTORNEY

SN 85-896,559. LEGO JURIS A/S, BILLUND, DK-7190, DENMARK, FILED 4-5-2013.

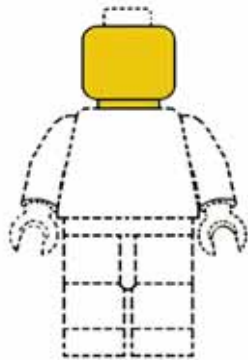

THE COLOR(S) YELLOW IS/ARE CLAIMED AS A FEATURE OF THE MARK.

THE MARK CONSISTS OF A 3-DIMENSIONAL CONFIGURATION OF A CYLINDRICAL YELLOW TOY FIGURE HEAD, ON TOP OF A YELLOW CYLINDRICAL NECK. THE DOTS OUTLINING THE TOY FIGURE SHOW THE PLACEMENT OF THE MARK ON THE GOODS AND ARE NOT PART OF THE MARK.

SEC. 2(F).

FOR TOY FIGURES; PLAY FIGURES; POSITIONABLE TOY FIGURES; MODELED PLASTIC TOY FIGURINES; THREE DIMENSIONAL POSITIONABLE TOY FIGURES SOLD AS A UNIT WITH OTHER TOYS; CONSTRUCTION TOYS; TOY CONSTRUCTION SETS (U.S. CLS. 22, 23, 38 AND 50).

FIRST USE 0-0-1978; IN COMMERCE 0-0-1978.

DAVID TOOLEY, EXAMINING ATTORNEY

**CLASS 28—(Continued).**

SN 85-897,017. DISNEY ENTERPRISES, INC., BURBANK, CA. FILED 4-5-2013.

**FINDING DORY**

THE MARK CONSISTS OF STANDARD CHARACTERS WITHOUT CLAIM TO ANY PARTICULAR FONT, STYLE, SIZE, OR COLOR.

FOR ACTION SKILL GAMES; ACTION FIGURES AND ACCESSORIES THEREFOR; BOARD GAMES; CARD GAMES; CHILDREN'S MULTIPLE ACTIVITY TOYS; BADMINTON SETS; BALLOONS; BASKETBALLS; BATH TOYS; BASEBALL BATS; BASEBALLS; BEACH BALLS; BEAN BAGS; BEAN BAG DOLLS; TOY BUILDING BLOCKS; BOWLING BALLS; BUBBLE MAKING WANDS AND SOLUTION SETS; CHESS SETS; CHILDREN'S PLAY COSMETICS; CHRISTMAS STOCKINGS; CHRISTMAS TREE ORNAMENTS AND DECORATIONS; COLLECTABLE TOY FIGURES; CRIB MOBILES; CRIB TOYS; DISC TOSS TOYS; DOLLS; DOLL CLOTHING; DOLL ACCESSORIES; DOLL PLAYSETS; ELECTRIC ACTION TOYS; EQUIPMENT SOLD AS A UNIT FOR PLAYING CARD GAMES; FISHING TACKLE; FOOTBALLS; GOLF BALLS; GOLF GLOVES; GOLF BALL MARKERS; HAND-HELD UNITS FOR PLAYING ELECTRONIC GAMES OTHER THAN THOSE ADAPTED FOR USE WITH OR WITHOUT AN EXTERNAL DISPLAY SCREEN OR MONITOR; HOCKEY PUCKS; HOCKEY STICKS; INFANT TOYS; INFLATABLE TOYS; JIGSAW PUZZLES; JUMP ROPES; KITES; MAGIC TRICKS; MARBLES; MANIPULATIVE GAMES; MECHANICAL TOYS; MUSIC BOX TOYS; MUSICAL TOYS; PARLOR GAMES; PARTY FAVORS IN THE NATURE OF SMALL TOYS; PAPER PARTY HATS; PARTY GAMES; PLAYING CARDS; PLUSH TOYS; PUPPETS; ROLLER SKATES; RUBBER BALLS; SKATEBOARDS; SNOW BOARDS; SNOW GLOBES; SOCCER BALLS; SPINNING TOPS; SQUEEZE TOYS; STUFFED TOYS; TABLE TENNIS BALLS; TABLE TENNIS PADDLES AND RACKETS; TABLE TENNIS TABLES; TALKING TOYS; TARGET GAMES; TEDDY BEARS; TENNIS BALLS; TENNIS RACKETS; TOY ACTION FIGURES AND ACCESSORIES THEREFOR; TOY BUCKET AND SHOVEL SETS; TOY MOBILES; TOY VEHICLES; TOY SCOOTERS; TOY CARS; TOY MODEL HOBBYCRAFT KITS; TOY FIGURES; TOY BANKS; TOY TRUCKS; TOY WATCHES; TOY WEAPONS; VIDEO GAME MACHINES FOR USE WITH TELEVISIONS; VOLLEY BALLS; WIND-UP TOYS; YO-YOS (U.S. CLS. 22, 23, 38 AND 50).

LEIGH CAROLINE CASE, EXAMINING ATTORNEY

SN 85-913,407. SPIN MASTER LTD., TORONTO, ONTARIO, CANADA, FILED 4-24-2013.

**HANDBOARD**

THE MARK CONSISTS OF STANDARD CHARACTERS WITHOUT CLAIM TO ANY PARTICULAR FONT, STYLE, SIZE, OR COLOR.

FOR MINIATURE TOY VEHICLES, NAMELY, MINIATURE TOY SKATEBOARDS AND ACCESSORIES FOR MINIATURE TOY VEHICLES (U.S. CLS. 22, 23, 38 AND 50).

JOHN DWYER, EXAMINING ATTORNEY

**CLASS 28—(Continued).**

SN 85-931,128. CONQUISTADOR GAMES INC., GRANVILLE, OH. FILED 5-14-2013.

## Fútbol Strategy

THE MARK CONSISTS OF STANDARD CHARACTERS WITHOUT CLAIM TO ANY PARTICULAR FONT, STYLE, SIZE, OR COLOR.

FOR BOARD GAMES; CARD GAMES; EQUIPMENT SOLD AS A UNIT FOR PLAYING BOARD GAMES; EQUIPMENT SOLD AS A UNIT FOR PLAYING CARD GAMES; GAME CARDS (U.S. CLS. 22, 23, 38 AND 50).

AMY C. KEAN, EXAMINING ATTORNEY

SN 85-945,899. WARSENAL LLC, ALTAMONTE SPRINGS, FL. FILED 5-30-2013.

## Warsenal Purveyors of Artful Gaming Elements

THE MARK CONSISTS OF STANDARD CHARACTERS WITHOUT CLAIM TO ANY PARTICULAR FONT, STYLE, SIZE, OR COLOR.

NO CLAIM IS MADE TO THE EXCLUSIVE RIGHT TO USE "PURVEYORS OF ARTFUL GAMING ELEMENTS", APART FROM THE MARK AS SHOWN.

FOR PLAYING PIECES IN THE NATURE OF MINIATURE ACTION FIGURES AND TOY MODEL VEHICLES FOR USE WITH TABLE TOP HOBBY BATTLE GAMES IN THE NATURE OF BATTLE, WAR AND SKIRMISH GAMES, AND FANTASY GAMES (U.S. CLS. 22, 23, 38 AND 50).

FIRST USE 9-1-2012; IN COMMERCE 10-1-2012.  
KATINA MISTER, EXAMINING ATTORNEY

SN 85-947,063. WILDGAME INNOVATIONS, LLC, BROUSSARD, LA. FILED 5-31-2013.

## RUT HUNTER

THE MARK CONSISTS OF STANDARD CHARACTERS WITHOUT CLAIM TO ANY PARTICULAR FONT, STYLE, SIZE, OR COLOR.

NO CLAIM IS MADE TO THE EXCLUSIVE RIGHT TO USE "HUNTER", APART FROM THE MARK AS SHOWN. FOR HUNTING GAME CALLS (U.S. CLS. 22, 23, 38 AND 50).

FIRST USE 11-8-2008; IN COMMERCE 11-8-2008.  
THEODORE MCBRIDE, EXAMINING ATTORNEY

**CLASS 28—(Continued).**

SN 85-951,686. SPORTS GAMES INTERNATIONAL UNLIMITED, INC., PARKER, CO. FILED 6-5-2013.

## DOODLE EYES

THE MARK CONSISTS OF STANDARD CHARACTERS WITHOUT CLAIM TO ANY PARTICULAR FONT, STYLE, SIZE, OR COLOR.

FOR HOBBY CRAFT KITS COMPRISED OF UNCURLED CLEAR AND/OR TINTED PLASTIC BLANKS CUT IN THE SHAPE OF EYE GLASSES FOR MAKING DECORATED TOY EYE GLASSES AND PARTY FAVOR SMALL TOYS IN THE SHAPE OF EYE GLASSES, WITH STICKERS, MARKERS AND PAPER SLEEVES, SOLD AS A UNIT (U.S. CLS. 22, 23, 38 AND 50).

DOMINIC J. FERRAIUOLO, EXAMINING ATTORNEY

SN 85-953,916. BLUBERI GROUP INC., DRUMMONDVILLE, QUEBEC, CANADA, FILED 6-7-2013.

## GREENBACKS TOURNAMENT

THE MARK CONSISTS OF STANDARD CHARACTERS WITHOUT CLAIM TO ANY PARTICULAR FONT, STYLE, SIZE, OR COLOR.

FOR COMPONENT FEATURE OF GAMING MACHINES, NAMELY, EMBEDDED GAME SOFTWARE SOLD AS PART OF MACHINE; COMPONENT FEATURE OF GAMING MACHINES, NAMELY, EMBEDDED GAME SOFTWARE FEATURE SOLD AS PART OF MACHINE; WAGERING GAMING MACHINE COMPONENT SOLD AS PART OF GOODS, NAMELY, EMBEDDED SOFTWARE FOR A FEATURE ACTIVE IN A WAGERING GAME (U.S. CLS. 22, 23, 38 AND 50).

EMILY CARLSEN, EXAMINING ATTORNEY

SN 85-962,853. MEGA BRANDS INC., MONTREAL (QC), CANADA, FILED 6-18-2013.

## EMOTII

THE MARK CONSISTS OF STANDARD CHARACTERS WITHOUT CLAIM TO ANY PARTICULAR FONT, STYLE, SIZE, OR COLOR.

FOR TOYS, GAMES AND PLAYTHINGS, NAMELY, CONSTRUCTION TOYS, TOY FIGURINES, COLLECTIBLE TOY FIGURINES, PLAYSETS FOR TOY FIGURINES, ACTION FIGURES, PLAYSETS FOR ACTION FIGURES, CASES FOR TOY FIGURINES, CASES FOR ACTION FIGURES (U.S. CLS. 22, 23, 38 AND 50).

JULIE GUTTADAURO, EXAMINING ATTORNEY

**CLASS 28—(Continued).**

SN 86-003,982. MATTEL, INC., EL SEGUNDO, CA. FILED 7-8-2013.

**BEAUTIFUL BUTTERFLY**

THE MARK CONSISTS OF STANDARD CHARACTERS WITHOUT CLAIM TO ANY PARTICULAR FONT, STYLE, SIZE, OR COLOR.

OWNER OF U.S. REG. NO. 3,443,982.  
FOR DOLLS, DOLL CLOTHING AND DOLL ACCESSORIES (U.S. CLS. 22, 23, 38 AND 50).  
FIRST USE 11-4-2013; IN COMMERCE 11-4-2013.  
CHRISTINE MARTIN, EXAMINING ATTORNEY

SN 86-005,111. INNOVATIVE PROCUREMENT, LLC, OSAGE BEACH, MO. FILED 7-9-2013.

**GRANITE RIVER OUTDOORS**

THE MARK CONSISTS OF STANDARD CHARACTERS WITHOUT CLAIM TO ANY PARTICULAR FONT, STYLE, SIZE, OR COLOR.

NO CLAIM IS MADE TO THE EXCLUSIVE RIGHT TO USE "OUTDOORS", APART FROM THE MARK AS SHOWN.  
FOR FISHING TACKLE; FISHING TACKLE BAGS; FISHING TACKLE BOXES; REELS FOR FISHING; RODS FOR FISHING (U.S. CLS. 22, 23, 38 AND 50).  
FIRST USE 7-9-2013; IN COMMERCE 7-9-2013.  
KATHLEEN M. VANSTON, EXAMINING ATTORNEY

SN 86-009,384. GRAVES, CLARKE, SAN DIEGO, CA. FILED 7-12-2013.

**SURFIVALKIT**

THE MARK CONSISTS OF STANDARD CHARACTERS WITHOUT CLAIM TO ANY PARTICULAR FONT, STYLE, SIZE, OR COLOR.

FOR KITS COMPRISED OF SURFBOARD WAX, SURFBOARD ACCESSORY IN THE NATURE OF A COMB FOR THE APPLICATION OF SURFBOARD WAX, SURFBOARD ACCESSORY IN THE NATURE OF A SURFBOARD SKEG, SURFBOARD STRING LEASH, SURFBOARD DING REPAIR KIT COMPRISED OF PADDLE BOARD AND SURFBOARD REPAIR PATCHES AND TUBES OF ADHESIVES, AND STICKERS, SOLD AS A UNIT (U.S. CLS. 22, 23, 38 AND 50).  
FIRST USE 7-11-2013; IN COMMERCE 7-11-2013.  
ANDREW RHIM, EXAMINING ATTORNEY

**CLASS 28—(Continued).**

SN 86-010,909. RAY, JAMES A., DBA TWO 75 GAMES, LAFAYETTE, TN. FILED 7-16-2013.



NO CLAIM IS MADE TO THE EXCLUSIVE RIGHT TO USE "GAMES", APART FROM THE MARK AS SHOWN.

THE MARK CONSISTS OF THE WORD "TWO" THAT SITS ON ITS SIDE BESIDE THE NUMBER "75". BOTH WORD AND NUMBER (TWO75) FIT INSIDE AN OUTLINED BOX. THE OUTLINED IS BESIDE THE WORD "GAMES". THE WORD "GAMES" IS ALSO OUTLINED.  
FOR PLAYING CARDS AND CARD GAMES (U.S. CLS. 22, 23, 38 AND 50).  
VIVIAN MICZNIK FIRST, EXAMINING ATTORNEY

SN 86-021,519. HANLE, ALINE, AUSTIN, TX. FILED 7-26-2013.

**COSMIC COMPASS GAME**

THE MARK CONSISTS OF STANDARD CHARACTERS WITHOUT CLAIM TO ANY PARTICULAR FONT, STYLE, SIZE, OR COLOR.

NO CLAIM IS MADE TO THE EXCLUSIVE RIGHT TO USE "COMPASS GAME", APART FROM THE MARK AS SHOWN.  
FOR BOARD GAMES (U.S. CLS. 22, 23, 38 AND 50).  
BERYL GARDNER, EXAMINING ATTORNEY

SN 86-022,649. LAURENT DOLL, INC., LOS ANGELES, CA. FILED 7-29-2013.

**Laurent Doll**

THE MARK CONSISTS OF STANDARD CHARACTERS WITHOUT CLAIM TO ANY PARTICULAR FONT, STYLE, SIZE, OR COLOR.

NO CLAIM IS MADE TO THE EXCLUSIVE RIGHT TO USE "DOLL", APART FROM THE MARK AS SHOWN.  
FOR DOLL ACCESSORIES (U.S. CLS. 22, 23, 38 AND 50).  
FIRST USE 1-1-2009; IN COMMERCE 1-1-2009.  
CAROLINE WOOD, EXAMINING ATTORNEY

**CLASS 28—(Continued).**

SN 86-023,536. LEISURE ACTIVITIES CO., LTD., SHAN DONG, CHINA, FILED 7-30-2013.



THE COLOR(S) ORANGE, YELLOW, PINK, BLACK, WHITE, RED, GREEN AND BROWN IS/ARE CLAIMED AS A FEATURE OF THE MARK.

THE MARK CONSISTS OF A LARGE SUN-SHAPED BACKGROUND WITH FIVE VISIBLE POINTS IN YELLOW AND OUTLINED IN ORANGE WITH THE WORDS "LEISURE ACTIVITIES" IN PINK WITH A BLACK SHADOW AND THE WORDS "THE INCREDIBLE IDEA COMPANY" IN BLACK; IN THE FOREGROUND IS A PINK MAN WITH A RED HAT, RED SHORTS AND BLACK SUNGLASSES ON A WHITE HAMMOCK BETWEEN TWO TREES WITH GREEN GRASS AT THEIR BASE WHEREIN THE STUMPS OF THE TREES ARE BROWN AND THE TOPS OF THE TREES ARE GREEN; "WE MAKE FUN EASY!" APPEARS IN BLACK BELOW THE MAN IN THE HAMMOCK AND THE WORD "FUN" IS IN CAPITAL LETTERS AND IS UNDERLINED.

FOR INFLATABLE GAMES, NAMELY, BOUNCE HOUSES, INFLATABLE SLIDES, INFLATABLE POOLS, INFLATABLE MAZES, INFLATABLE OBSTACLE COURSES, INFLATABLE BOXING RINGS, INFLATABLE JOUSTING RINGS, SEALED AIR INFLATABLES AND INFLATABLE TENTS (U.S. CLS. 22, 23, 38 AND 50).

FIRST USE 7-15-2004; IN COMMERCE 3-3-2010.  
JONATHAN FALK, EXAMINING ATTORNEY

**CLASS 28—(Continued).**

SN 86-031,414. TOYSHOCK USA LLC, MIAMI, FL. FILED 8-7-2013.



NO CLAIM IS MADE TO THE EXCLUSIVE RIGHT TO USE BABY, APART FROM THE MARK AS SHOWN.

THE MARK CONSISTS OF THE WORD "FANTASTIC" IN A BOLD STYLIZED FONT, A DESIGN OF A STAR BEHIND THE LETTER "C", THE WORD "BABY" BELOW THE WORD "FANTASTIC" IN A BOLD STYLIZED FONT. AN IMAGE OF A DIAPER PIN TO THE BOTTOM LEFT SIDE OF THE LETTER "B" IN "BABY".

FOR DOLLS, NAMELY, FASHION AND TALKING DOLLS; ELECTRONIC LEARNING TOYS, RADIO CONTROL TOYS, NAMELY, CARS, HELICOPTERS, AIRPLANES; ROLE PLAYING TOYS, RIDE-ON TOYS, BILLIARD TABLES, PLUSH TOYS, ACTION FIGURES, GAME TABLES, MUSICAL TOYS, BALLS FOR SPORTS, INFLATABLE TOYS, BODY BOARDS, TABLE TENNIS SET, BOWLING BALLS, PUNCHING TOYS, TENNIS RACKETS, TABLE TENNIS RACKET (U.S. CLS. 22, 23, 38 AND 50).

DAVID TAYLOR, EXAMINING ATTORNEY

SN 86-030,061. ARISTOCRAT TECHNOLOGIES AUSTRALIA PTY LTD., NORTH RYDE, NSW, AUSTRALIA, FILED 8-6-2013.

**MEGA BET**

THE MARK CONSISTS OF STANDARD CHARACTERS WITHOUT CLAIM TO ANY PARTICULAR FONT, STYLE, SIZE, OR COLOR.

OWNER OF U.S. REG. NOS. 3,723,143, 4,051,892 AND OTHERS.

NO CLAIM IS MADE TO THE EXCLUSIVE RIGHT TO USE "BET", APART FROM THE MARK AS SHOWN.

FOR GAMING DEVICES, NAMELY, GAMING MACHINES (U.S. CLS. 22, 23, 38 AND 50).

JENNY PARK, EXAMINING ATTORNEY

SN 86-032,268. ROBEEN, TIM, HARDIN, IL. FILED 8-8-2013.

**NOCTURNAL NONTYPICAL**

THE MARK CONSISTS OF STANDARD CHARACTERS WITHOUT CLAIM TO ANY PARTICULAR FONT, STYLE, SIZE, OR COLOR.

NO CLAIM IS MADE TO THE EXCLUSIVE RIGHT TO USE "NONTYPICAL", APART FROM THE MARK AS SHOWN.

FOR ANIMAL ATTRACTANT SCENTS (U.S. CLS. 22, 23, 38 AND 50).

FIRST USE 8-1-2013; IN COMMERCE 8-1-2013.

NICHOLAS ALTREE, EXAMINING ATTORNEY

**CLASS 28—(Continued).**

SN 86-033,350. UNIVERSAL ENTERTAINMENT CORPORATION, TOKYO 135-0063, JAPAN, FILED 8-9-2013.

## ULTRA STACK FEATURE PANDA

THE MARK CONSISTS OF STANDARD CHARACTERS WITHOUT CLAIM TO ANY PARTICULAR FONT, STYLE, SIZE, OR COLOR.

NO CLAIM IS MADE TO THE EXCLUSIVE RIGHT TO USE "STACK FEATURE", APART FROM THE MARK AS SHOWN.

FOR SLOT MACHINES AND REPLACEMENT PARTS THEREFOR; VIDEO SLOT MACHINES AND REPLACEMENT PARTS THEREFOR; GAMING MACHINES AND REPLACEMENT PARTS THEREFOR; GAMING MACHINES WITH A LIQUID CRYSTAL DISPLAY AND REPLACEMENT PARTS THEREFOR; MECHANICAL REEL TYPE SLOT MACHINES WITH A LIQUID CRYSTAL DISPLAY AND REPLACEMENT PARTS THEREFOR (U.S. CLS. 22, 23, 38 AND 50).

ELIZABETH CHANG, EXAMINING ATTORNEY

**CLASS 28—(Continued).**

SN 86-033,396. 22CANS LIMITED, LONDON, UNITED KINGDOM, FILED 8-9-2013.

## GODUS

THE MARK CONSISTS OF STANDARD CHARACTERS WITHOUT CLAIM TO ANY PARTICULAR FONT, STYLE, SIZE, OR COLOR.

PRIORITY CLAIMED UNDER SEC. 44(D) ON ERP N CMNTY TM OFC APPLICATION NO. 011945227, FILED 7-1-2013, REG. NO. 011945227, DATED 11-26-2013, EXPIRES 7-1-2023.

FOR ACTION FIGURES; COMPUTER GAME JOYSTICKS; PLAYER-OPERATED ELECTRONIC CONTROLLERS FOR ELECTRONIC VIDEO GAME MACHINES; VIDEO GAME CONSOLES FOR USE WITH AN EXTERNAL DISPLAY SCREEN OR MONITOR (U.S. CLS. 22, 23, 38 AND 50).

SAMUEL E. SHARPER JR., EXAMINING ATTORNEY

SN 86-033,672. SQUIRREL, LLC, SANDY, UT. FILED 8-9-2013.

SN 86-033,369. UNIVERSAL ENTERTAINMENT CORPORATION, TOKYO 135-0063, JAPAN, FILED 8-9-2013.

## ULTRA STACK FEATURE ROSE

THE MARK CONSISTS OF STANDARD CHARACTERS WITHOUT CLAIM TO ANY PARTICULAR FONT, STYLE, SIZE, OR COLOR.

NO CLAIM IS MADE TO THE EXCLUSIVE RIGHT TO USE "STACK FEATURE", APART FROM THE MARK AS SHOWN.

FOR SLOT MACHINES AND REPLACEMENT PARTS THEREFOR; VIDEO SLOT MACHINES AND REPLACEMENT PARTS THEREFOR; GAMING MACHINES AND REPLACEMENT PARTS THEREFOR; GAMING MACHINES WITH A LIQUID CRYSTAL DISPLAY AND REPLACEMENT PARTS THEREFOR; MECHANICAL REEL TYPE SLOT MACHINES WITH A LIQUID CRYSTAL DISPLAY AND REPLACEMENT PARTS THEREFOR (U.S. CLS. 22, 23, 38 AND 50).

ELIZABETH CHANG, EXAMINING ATTORNEY



NO CLAIM IS MADE TO THE EXCLUSIVE RIGHT TO USE "SQUIRREL", APART FROM THE MARK AS SHOWN.

THE MARK CONSISTS OF THE WORDING "SQUIRREL" CENTERED BETWEEN TWO WINGS.

FOR SPORTING ARTICLES NAMELY A WING SUIT USED IN SKYDIVING AND BASE JUMPING (U.S. CLS. 22, 23, 38 AND 50).

FIRST USE 5-1-2012; IN COMMERCE 5-1-2012.

DANIEL CAPSHAW, EXAMINING ATTORNEY



**CLASS 28—(Continued).**

SN 86-036,165. TOYSHOCK USA LLC, CORAL GABLES, FL.  
FILED 8-13-2013.



NO CLAIM IS MADE TO THE EXCLUSIVE RIGHT TO USE "BABY", APART FROM THE MARK AS SHOWN.

THE MARK CONSISTS OF AN OVAL SHAPE WITH THE WORD "BABY" IN A BOLD STYLIZED FONT AND THE WORD "NURSE" BELOW THE WORD "BABY" IN A BOLD STYLIZED FONT. AN IMAGE OF A BUTTERFLY TO THE TOP LEFT OUTER SIDE OF THE OVAL, A SHAPE OF A HEART BELOW THE BUTTERFLY TO THE LEFT. AN IMAGE SIGNIFYING A HAND DRAWN STAR TO THE LEFT BOTTOM SIDE OF THE OVAL AND A SECOND BUTTERFLY TO THE RIGHT OUTER SIDE OF THE OVAL. FOR DOLLS, NAMELY, FASHION AND TALKING DOLLS (U.S. CLS. 22, 23, 38 AND 50).

DAVID TAYLOR, EXAMINING ATTORNEY

SN 86-036,410. PLASTIC TECHNOLOGIES, INC., ELGIN, IL.  
FILED 8-13-2013.



NO CLAIM IS MADE TO THE EXCLUSIVE RIGHT TO USE "SPORT POST", APART FROM THE MARK AS SHOWN.

THE COLOR(S) ORANGE AND BLACK IS/ARE CLAIMED AS A FEATURE OF THE MARK.

THE MARK CONSISTS OF THE STYLIZED WORDS "SPORT POST" OUTLINED IN ORANGE AND COLORED BLACK. THE LETTER "P" IS SHARED BY "SPORT" AND "POST" IN SUCH A WAY THAT IT IS ARRANGED TO DEPICT A POST SIGN. SPECIFICALLY, "SPORT" RUNS HORIZONTALLY, WHILE "POST" RUNS VERTICALLY INSIDE A VERTICAL ORANGE RECTANGLE. IN BETWEEN EACH LETTER OF "SPORT" IS A BLACK CIRCLE.

FOR OUTDOOR ACTIVITY GAME EQUIPMENT SOLD AS A UNIT COMPRISING SPORT POST MARKER FOR PLAYING GAMES; PHYSICAL FITNESS EQUIPMENT, NAMELY, CROSS TRAINING POST MARKER; SPORTING GOODS AND EQUIPMENT FOR SPEED TRAINING, NAMELY, RINGS, CONES, SPEED LADDERS, COACHING STICKS, TRAINING ARCHES, ANKLE BANDS, RESISTANCE CHUTES, HURDLES (U.S. CLS. 22, 23, 38 AND 50).

SIMON TENG, EXAMINING ATTORNEY

**CLASS 28—(Continued).**

SN 86-039,521. CAPEZIO, VICTORIA, PALATINE, IL. FILED  
8-15-2013.

**PRINCESS CANDY**

THE MARK CONSISTS OF STANDARD CHARACTERS WITHOUT CLAIM TO ANY PARTICULAR FONT, STYLE, SIZE, OR COLOR.

FOR STUFFED AND PLUSH TOYS AND DOLLS; DOLLS AND ACCESSORIES THEREFOR; FIGURES, NAMELY, TOY, ACTION, AND COLLECTABLE, AND ACCESSORIES THEREFOR; GAMES, NAMELY, BOARD, CARD, AND PUZZLE; FITTED PLASTIC FILMS KNOWN AS SKINS FOR COVERING AND PROTECTING ELECTRONIC APPARATUS, NAMELY, VIDEO GAME CONSOLES AND THE CONTROLLERS AND ACCESSORIES THEREFOR AND HAND-HELD VIDEO GAME UNITS; PROTECTIVE CARRYING CASES SPECIFICALLY ADAPTED FOR HAND-HELD VIDEO GAME UNITS AND ACCESSORIES THEREFOR; CHRISTMAS TREE ORNAMENTS AND DECORATIONS (U.S. CLS. 22, 23, 38 AND 50).

PAM WILLIS, EXAMINING ATTORNEY

SN 86-039,647. KMA CONCEPTS LIMITED, TSIM SHA TSUI,  
KOWLOON, HONG KONG, FILED 8-16-2013.

**SKY GLIDERZ**

THE MARK CONSISTS OF STANDARD CHARACTERS WITHOUT CLAIM TO ANY PARTICULAR FONT, STYLE, SIZE, OR COLOR.

NO CLAIM IS MADE TO THE EXCLUSIVE RIGHT TO USE "GLIDERS", APART FROM THE MARK AS SHOWN.

FOR HAND-POWERED NON-MECHANICAL FLYING TOY; TOY AIRPLANES; TOY GLIDERS (U.S. CLS. 22, 23, 38 AND 50).

NATALIE POLZER, EXAMINING ATTORNEY

SN 86-039,880. KMA CONCEPTS LIMITED, TSIM SHA TSUI,  
KOWLOON, HONG KONG, FILED 8-16-2013.

**FIRETEK BOW**

THE MARK CONSISTS OF STANDARD CHARACTERS WITHOUT CLAIM TO ANY PARTICULAR FONT, STYLE, SIZE, OR COLOR.

NO CLAIM IS MADE TO THE EXCLUSIVE RIGHT TO USE "BOW", APART FROM THE MARK AS SHOWN.

FOR ARROWS; TOY BOWS AND ARROWS; TOY WEAPONS (U.S. CLS. 22, 23, 38 AND 50).

NATALIE POLZER, EXAMINING ATTORNEY

**CLASS 28—(Continued).**

SN 86-039,886. KMA CONCEPTS LIMITED, TSIM SHA TSUI, KOWLOON, HONG KONG, FILED 8-16-2013.

**FIRETEK ROCKETZ**

THE MARK CONSISTS OF STANDARD CHARACTERS WITHOUT CLAIM TO ANY PARTICULAR FONT, STYLE, SIZE, OR COLOR.

NO CLAIM IS MADE TO THE EXCLUSIVE RIGHT TO USE "ROCKETZ", APART FROM THE MARK AS SHOWN. FOR TOY ROCKETS (U.S. CLS. 22, 23, 38 AND 50). NATALIE POLZER, EXAMINING ATTORNEY

**CLASS 28—(Continued).**

SN 86-042,325. CANOBBIO, DAN K, FRISCO, TX. FILED 8-20-2013.

**PET A LOONS**

THE MARK CONSISTS OF STANDARD CHARACTERS WITHOUT CLAIM TO ANY PARTICULAR FONT, STYLE, SIZE, OR COLOR.

FOR BALLOON TOYS (U.S. CLS. 22, 23, 38 AND 50). DEIRDRE ROBERTSON, EXAMINING ATTORNEY

SN 86-040,553. FUNDACION TELETON MEXICO, A.C., TLALNEPANTLA DE BAZ, MEXICO, FILED 8-16-2013.



OWNER OF U.S. REG. NOS. 2,972,929, 4,197,670 AND OTHERS.

THE COLOR(S) WHITE, YELLOW AND PURPLE IS/ARE CLAIMED AS A FEATURE OF THE MARK.

THE MARK CONSISTS OF A YELLOW AND PURPLE HEART WITH WHITE HANDS AND A DIAGONAL WHITE BAND SUPERIMPOSED OVER THE HEART.

FOR CHILDREN'S EDUCATIONAL TOYS FOR DEVELOPING MOTOR SKILLS AND REHABILITATION OF HANDICAPPED CHILDREN (U.S. CLS. 22, 23, 38 AND 50).

KAREN K. BUSH, EXAMINING ATTORNEY

SN 86-043,195. WM K. WALTHERS, INC., MILWAUKEE, WI. FILED 8-20-2013.

**CORNERSTONE**

THE MARK CONSISTS OF STANDARD CHARACTERS WITHOUT CLAIM TO ANY PARTICULAR FONT, STYLE, SIZE, OR COLOR.

OWNER OF U.S. REG. NO. 1,611,402.

FOR TOY MODEL TRAIN SETS, TOY MODEL TRAIN CARS, TOY LOCOMOTIVES AND PARTS AND ACCESSORIES THEREFOR, ALL SOLD EXCLUSIVELY THROUGH ONLINE, CATALOG AND RETAIL STORE CHANNELS (U.S. CLS. 22, 23, 38 AND 50).

FIRST USE 1-15-2012; IN COMMERCE 1-15-2012.

LAURIE MAYES, EXAMINING ATTORNEY

SN 86-043,914. PLAYCORE IP SUB, INC., CHATTANOOGA, TN. FILED 8-21-2013.



OWNER OF U.S. REG. NO. 2,722,098.

THE MARK CONSISTS OF AN EXCLAMATION POINT AND A CURVED LINE.

FOR PLAYGROUND EQUIPMENT, NAMELY, MANUALLY ROTATABLE RIDES, SEE-SAWS, AND BALANCING, JUMPING, CLIMBING, BOUNCING AND TRACK RIDE UNITS (U.S. CLS. 22, 23, 38 AND 50).

FIRST USE 1-0-2007; IN COMMERCE 1-0-2007.

JAMES MACFARLANE, EXAMINING ATTORNEY

SN 86-040,788. KMA CONCEPTS LIMITED, TSIM SHA TSUI, KOWLOON, HONG KONG, FILED 8-16-2013.

**FIRETEK SHOTZ**

THE MARK CONSISTS OF STANDARD CHARACTERS WITHOUT CLAIM TO ANY PARTICULAR FONT, STYLE, SIZE, OR COLOR.

NO CLAIM IS MADE TO THE EXCLUSIVE RIGHT TO USE "SHOTS", APART FROM THE MARK AS SHOWN.

FOR SLING SHOTS; TOY BOWS AND ARROWS; TOY WEAPONS (U.S. CLS. 22, 23, 38 AND 50).

NATALIE POLZER, EXAMINING ATTORNEY

**CLASS 28—(Continued).**

SN 86-044,546. THATE, ROBERT, J., BEDFORD, NH. FILED 8-21-2013.

# YaYa

THE MARK CONSISTS OF STANDARD CHARACTERS WITHOUT CLAIM TO ANY PARTICULAR FONT, STYLE, SIZE, OR COLOR.

FOR SPINNING TOPS (U.S. CLS. 22, 23, 38 AND 50).  
FIRST USE 2-14-2000; IN COMMERCE 2-14-2000.  
GIANCARLO CASTRO, EXAMINING ATTORNEY

**CLASS 28—(Continued).**

SN 86-046,441. SENTEQ CO., LTD., TAINAN, TAIWAN, FILED 8-23-2013.



SN 86-045,917. MACDONALD, DAVID, DARTMOUTH, CANADA, FILED 8-23-2013.

# PUCK COMMANDER

THE MARK CONSISTS OF STANDARD CHARACTERS WITHOUT CLAIM TO ANY PARTICULAR FONT, STYLE, SIZE, OR COLOR.

NO CLAIM IS MADE TO THE EXCLUSIVE RIGHT TO USE "PUCK", APART FROM THE MARK AS SHOWN.

FOR HOCKEY STICKS (U.S. CLS. 22, 23, 38 AND 50).  
SUNG IN, EXAMINING ATTORNEY

SN 86-046,042. KELLY BARROW, CATOOSA, OK. FILED 8-23-2013.

# SēClūCity Seek. Clues. City

THE MARK CONSISTS OF STANDARD CHARACTERS WITHOUT CLAIM TO ANY PARTICULAR FONT, STYLE, SIZE, OR COLOR.

FOR BOARD GAMES; CARD GAMES; EQUIPMENT SOLD AS A UNIT FOR PLAYING BOARD GAMES; GAME CARDS; PARLOR GAMES; PARLOUR GAMES; PARTY GAMES; PUZZLE GAMES; TRIVIA GAME PLAYED WITH CARDS AND GAME COMPONENTS (U.S. CLS. 22, 23, 38 AND 50).

FIRST USE 1-13-2013; IN COMMERCE 1-13-2013.  
DAVID TAYLOR, EXAMINING ATTORNEY

OWNER OF U.S. REG. NO. 4,086,379.

THE MARK CONSISTS OF A RECTANGLE DESIGN WITH ROUNDED UPPER LEFT AND LOWER RIGHT CORNERS AND A SERIES OF SHAPES ARRANGED TO RESEMBLE A PERSON IN THE LOWER LEFT CORNER OF THE RECTANGLE. TO THE RIGHT OF THE RECTANGLE IS THE WORD "SENTEQ" IN A STYLIZED FONT.

FOR MEN'S ATHLETIC SUPPORTERS; ELBOW GUARDS; HAND PADS FOR ATHLETIC USE; KNEE GUARDS; KARATE HEAD GUARDS; LEG GUARDS FOR ATHLETIC USE; SHIN GUARDS FOR ATHLETIC USE; WRIST GUARDS FOR ATHLETIC USE; PROTECTIVE SUPPORTS FOR SHOULDER AND ELBOWS; CHEST PROTECTORS FOR SPORTS; ATHLETIC PROTECTIVE ARM PADS FOR SNOWBOARDING; ATHLETIC PROTECTIVE ARM PADS FOR SKATEBOARDING; HAND PADS FOR ATHLETIC USE; SHOULDER PADS FOR ATHLETIC USE; ANKLE AND WRIST WEIGHTS FOR EXERCISE; ARM GUARDS FOR ATHLETIC USE; LEG WEIGHTS; SPORTS EQUIPMENT FOR BOXING AND MARTIAL ARTS, NAMELY, BOXING GLOVES, MIXED MARTIAL ARTS GLOVES, PUNCHING MITTS, AND SHIN GUARDS; EXERCISE EQUIPMENT, NAMELY, NECK AND SHOULDER SUPPORTED WEIGHTS FOR TWISTING AND LIFTING EXERCISES; HEAD GUARDS FOR RUGBY TRAINING PURPOSES (U.S. CLS. 22, 23, 38 AND 50).

FIRST USE 11-0-2010; IN COMMERCE 11-0-2010.

REBECCA POVARCHUK, EXAMINING ATTORNEY

**CLASS 28—(Continued).**

SN 86-046,611. SPIKER, INC., MIRAMAR BEACH, FL. FILED 8-23-2013.



NO CLAIM IS MADE TO THE EXCLUSIVE RIGHT TO USE "BOARDING", APART FROM THE MARK AS SHOWN. THE MARK CONSISTS OF A STYLIZED DEPICTION OF A PERSON ON A SURFBOARD OR SKATEBOARD. BELOW THE STYLIZED PERSON ARE THE WORDS "HIGHLY ILLEGAL BOARDING".

FOR SKIM BOARDS (U.S. CLS. 22, 23, 38 AND 50).  
MIDGE BUTLER, EXAMINING ATTORNEY

**CLASS 28—(Continued).**

SN 86-047,491. PICCOLO BROTHERS, LLC, LYNNWOOD, WA. FILED 8-26-2013.

**BATTLESTRAP**

THE MARK CONSISTS OF STANDARD CHARACTERS WITHOUT CLAIM TO ANY PARTICULAR FONT, STYLE, SIZE, OR COLOR.

FOR GAME CONTROLLER ACCESSORY, NAMELY, A NECK STRAP AND HOLSTER COMBINATION FOR HOLDING A GAME CONTROLLER (U.S. CLS. 22, 23, 38 AND 50).

KELLEY WELLS, EXAMINING ATTORNEY

SN 86-046,614. SPIKER, INC., MIRAMAR BEACH, FL. FILED 8-23-2013.



NO CLAIM IS MADE TO THE EXCLUSIVE RIGHT TO USE "SKATE COMPANY", APART FROM THE MARK AS SHOWN.

THE COLOR(S) YELLOW, BLACK, AND RED IS/ARE CLAIMED AS A FEATURE OF THE MARK.

THE MARK CONSISTS OF A YELLOW AND BLACK STYLIZED CROSSWALK ROAD SIGN. APPEARING IN THE CENTER OF THE ROAD SIGN IS A STYLIZED DEPICTION OF A PERSON WITH A HAT RIDDING A SKATE BOARD. TO THE LEFT OF THE STYLIZED PERSON ARE THE WORDS "HIGHLY ILLEGAL" IN RED FONT. BELOW THE STYLIZED PERSON ARE THE WORDS "SKATE COMPANY" IN BLACK FONT.

FOR SKATEBOARDS (U.S. CLS. 22, 23, 38 AND 50).  
MIDGE BUTLER, EXAMINING ATTORNEY

SN 86-055,013. ENE, LLC, CINCINNATI, OH. FILED 9-4-2013.

**LA TILDE**

THE MARK CONSISTS OF STANDARD CHARACTERS WITHOUT CLAIM TO ANY PARTICULAR FONT, STYLE, SIZE, OR COLOR.

THE ENGLISH TRANSLATION OF THE WORD "LA" IN THE MARK IS "THE".

FOR ATHLETIC EQUIPMENT, NAMELY, BASEBALL GLOVES, BASEBALL BATS, AND BALLS FOR SPORTS AND FOOTBALLS, BASEBALLS, SOCCER BALLS, BOCCE BALLS, GOLF BALLS, TENNIS BALLS, CROQUET BALLS, BOWLING BALLS, BILLIARD BALLS, TABLE TENNIS BALLS, AND VOLLEY BALLS (U.S. CLS. 22, 23, 38 AND 50).

SUSAN RICHARDS, EXAMINING ATTORNEY

**CLASS 28—(Continued).**

SN 86-055,553. WARNER BROS. ENTERTAINMENT INC., BURBANK, CA. FILED 9-4-2013.

**POTTERMORE**

THE MARK CONSISTS OF STANDARD CHARACTERS WITHOUT CLAIM TO ANY PARTICULAR FONT, STYLE, SIZE, OR COLOR.

OWNER OF U.S. REG. NO. 4,376,701.

FOR TOYS AND SPORTING GOODS, INCLUDING GAMES AND PLAYTHINGS, NAMELY, ACTION FIGURES AND ACCESSORIES THEREFOR; PLUSH TOYS; BALLOONS; RIDE-ON TOYS; EQUIPMENT SOLD AS A UNIT FOR PLAYING CARD GAMES; TOY VEHICLES; DOLLS; HAND-HELD GAME UNITS FOR PLAYING ELECTRONIC GAMES OTHER THAN THOSE ADAPTED FOR USE WITH AN EXTERNAL DISPLAY SCREEN OR MONITOR; GAME EQUIPMENT SOLD AS A UNIT FOR PLAYING A BOARD GAME, A CARD GAME, A PARLOR GAME AND AN ACTION TYPE TARGET GAME; STAND ALONE VIDEO OUTPUT GAME MACHINES; JIGSAW AND MANIPULATIVE PUZZLES; BALLS, NAMELY, PLAYGROUND BALLS, SOCCER BALLS, BASKETBALLS; SWIMMING FLOATS FOR RECREATIONAL USE; TOY BAKEWARE AND TOY COOKWARE; TOY BANKS; TOY SNOW GLOBES; AND CHRISTMAS TREE ORNAMENTS (U.S. CLS. 22, 23, 38 AND 50).

JUSTINE D. PARKER, EXAMINING ATTORNEY

SN 86-058,365. SMART MONKEY DISTRIBUTION, SANTA CRUZ, CA. FILED 9-6-2013.



NO CLAIM IS MADE TO THE EXCLUSIVE RIGHT TO USE "SKATEBOARDS", APART FROM THE MARK AS SHOWN.

THE STIPPLING IN THE DRAWING IS FOR SHADING PURPOSES ONLY.

THE MARK CONSISTS OF A 3-DIMENSIONAL CUBE, WITH A SMALL BLOCK MISSING, WITH THE WORDING "CONSOLIDATED SKATEBOARDS" APPEARING BENEATH THE CUBE DESIGN.

FOR SKATEBOARDS (U.S. CLS. 22, 23, 38 AND 50).

FIRST USE 4-1-1992; IN COMMERCE 4-1-1992.

ANDREW RHIM, EXAMINING ATTORNEY

**CLASS 28—(Continued).**

SN 86-062,571. MATTEL, INC., EL SEGUNDO, CA. FILED 9-12-2013.

**MALIBU MARKET!**

THE MARK CONSISTS OF STANDARD CHARACTERS WITHOUT CLAIM TO ANY PARTICULAR FONT, STYLE, SIZE, OR COLOR.

OWNER OF U.S. REG. NOS. 2,897,987 AND 4,077,967.

FOR DOLLS, DOLL CLOTHING AND DOLL ACCESSORIES, DOLL PLAYSETS AND ACCESSORIES THEREFOR (U.S. CLS. 22, 23, 38 AND 50).

BRIDGETT SMITH, EXAMINING ATTORNEY

SN 86-062,766. KITTRICH CORPORATION, LA MIRADA, CA. FILED 9-12-2013.

**Zenfinity**

THE MARK CONSISTS OF STANDARD CHARACTERS WITHOUT CLAIM TO ANY PARTICULAR FONT, STYLE, SIZE, OR COLOR.

FOR YOGA MATS (U.S. CLS. 22, 23, 38 AND 50).

ANGELA DUONG, EXAMINING ATTORNEY

SN 86-064,156. NIELSEN, RICHARD A, CHICAGO, IL. FILED 9-13-2013.

**RICK NIELSEN**

THE MARK CONSISTS OF STANDARD CHARACTERS WITHOUT CLAIM TO ANY PARTICULAR FONT, STYLE, SIZE, OR COLOR.

OWNER OF U.S. REG. NOS. 4,309,059 AND 4,312,715.

THE NAME(S), PORTRAIT(S), AND/OR SIGNATURE(S) SHOWN IN THE MARK IDENTIFIES RICHARD A NIELSEN, WHOSE CONSENT(S) TO REGISTER IS MADE OF RECORD.

FOR COLLECTIBLE MINIATURE TOY GUITARS (U.S. CLS. 22, 23, 38 AND 50).

GEORGE LORENZO, EXAMINING ATTORNEY

**CLASS 28—(Continued).**

SN 86-064,339. KRAYZELBURG, LENNY, LOS ANGELES, CA. FILED 9-13-2013.

**SWIMRIGHT**

THE MARK CONSISTS OF STANDARD CHARACTERS WITHOUT CLAIM TO ANY PARTICULAR FONT, STYLE, SIZE, OR COLOR.

FOR SWIMMING AIDS, NAMELY, POOL RINGS, ARM FLOATS, FLOAT BARS ALL FOR RECREATIONAL AND ATHLETIC USE; RING BUOYS FOR RECREATIONAL AND ATHLETIC USE, SWIMMING KICK BOARDS, FLOATING KICKING MATS FOR RECREATIONAL AND ATHLETIC USE; SWIMMING FLOTATION BOARDS FOR RECREATIONAL AND ATHLETIC USE; SWIMMING GLOVES; SWIMMING FLIPPERS; SWIM FINS; SWIM PADDLES; TOYS, NAMELY, BALLS FOR GAMES AND ACTION FIGURES; SWIM RINGS FOR RECREATIONAL AND ATHLETIC USE; WATER-RESISTANT TOY ANIMALS; WATER-RESISTANT TOY STICKS; SWIMMING PADS FOR KNEES FOR RECREATIONAL AND ATHLETIC USE (U.S. CLS. 22, 23, 38 AND 50).

CHRISTINA SOBRAL, EXAMINING ATTORNEY

SN 86-064,516. RHINO SPORTS GROUP, LLC, WEAVERVILLE, NC. FILED 9-13-2013.



NO CLAIM IS MADE TO THE EXCLUSIVE RIGHT TO USE "SPORTS GROUP", APART FROM THE MARK AS SHOWN.

THE MARK CONSISTS OF IMAGE OF HEAD OF RHINOCEROS SURROUNDED BY A CIRCLE WITH WORD "RHINO" AND "SPORTS GROUP" WITHIN A RECTANGULAR SHAPE.

FOR PLATFORM TENNIS BALLS (U.S. CLS. 22, 23, 38 AND 50).

FIRST USE 5-3-2013; IN COMMERCE 5-3-2013.

KATHERINE STOIDES, EXAMINING ATTORNEY

SN 86-064,582. CLOUD B, INC., GARDENA, CA. FILED 9-13-2013.

**TWILIGHT BUDDIES**

THE MARK CONSISTS OF STANDARD CHARACTERS WITHOUT CLAIM TO ANY PARTICULAR FONT, STYLE, SIZE, OR COLOR.

OWNER OF U.S. REG. NOS. 3,096,834, 4,026,733 AND OTHERS.

FOR HARD SCULPTURE TOYS; SOFT SCULPTURE TOYS; PLUSH TOYS (U.S. CLS. 22, 23, 38 AND 50).

LANA PHAM, EXAMINING ATTORNEY

**CLASS 28—(Continued).**

SN 86-065,385. JENNIFER O'HAGAN, ROCKAWAY PARK, NY. AND KELLY WEISMULLER, ROCKAWAY PARK, NY. FILED 9-16-2013.

**SWEET DREAMS HEROES**

THE MARK CONSISTS OF STANDARD CHARACTERS WITHOUT CLAIM TO ANY PARTICULAR FONT, STYLE, SIZE, OR COLOR.

FOR DOLL CLOTHING; DOLL COSTUMES; DOLLS AND ACCESSORIES THEREFOR; PLUSH DOLLS; SHOES FOR DOLLS (U.S. CLS. 22, 23, 38 AND 50).

GEORGE LORENZO, EXAMINING ATTORNEY

SN 86-065,525. EXCELSIOR FISH CORP., DBA HASKELL'S BAIT & TACKLE, EAST QUOGUE, NY. FILED 9-16-2013.

**HASKELL**

THE MARK CONSISTS OF STANDARD CHARACTERS WITHOUT CLAIM TO ANY PARTICULAR FONT, STYLE, SIZE, OR COLOR.

SEC. 2(F).

FOR FISHING LURE PARTS; FISHING LURES; FISHING RODS; FISHING TACKLE (U.S. CLS. 22, 23, 38 AND 50).

FIRST USE 11-30-2007; IN COMMERCE 11-30-2007.

HEATHER SAPP, EXAMINING ATTORNEY

SN 86-065,657. MERLE F. GARDNER, MEMPHIS, TN. FILED 9-16-2013.

**ALL AMERICAN**

THE MARK CONSISTS OF STANDARD CHARACTERS WITHOUT CLAIM TO ANY PARTICULAR FONT, STYLE, SIZE, OR COLOR.

FOR DUCK CALL (U.S. CLS. 22, 23, 38 AND 50).

FIRST USE 2-1-2013; IN COMMERCE 2-1-2013.

CHARLES L. JENKINS, EXAMINING ATTORNEY

**CLASS 28—(Continued).**

SN 86-065,746. LANDSCAPE STRUCTURES, INC., DELA-  
NOP, MN. FILED 9-16-2013.

# FLYWHEEL

THE MARK CONSISTS OF STANDARD CHARACTERS  
WITHOUT CLAIM TO ANY PARTICULAR FONT, STYLE,  
SIZE, OR COLOR.

FOR PLAYGROUND EQUIPMENT, NAMELY, CLIMB-  
ING UNITS AND MECHANISMS THAT USERS HANG  
FROM WHILE ROTATING IN CIRCLES (U.S. CLS. 22, 23,  
38 AND 50).

FIRST USE 4-12-2013; IN COMMERCE 4-12-2013.  
ALLISON HOLTZ, EXAMINING ATTORNEY

**CLASS 28—(Continued).**

SN 86-066,253. MGA ENTERTAINMENT, INC., VAN NUYS,  
CA. FILED 9-16-2013.

# LALALOOPSY BABIES

THE MARK CONSISTS OF STANDARD CHARACTERS  
WITHOUT CLAIM TO ANY PARTICULAR FONT, STYLE,  
SIZE, OR COLOR.

OWNER OF U.S. REG. NOS. 3,974,681, 4,280,006 AND  
OTHERS.

NO CLAIM IS MADE TO THE EXCLUSIVE RIGHT TO  
USE "BABIES", APART FROM THE MARK AS SHOWN.

FOR ACTION FIGURES AND PLAYSETS THEREFOR;  
BEAN BAG DOLLS; BOARD GAMES; CARD GAMES;  
CHRISTMAS TREE ORNAMENTS, EXCEPT CONFEC-  
TIONERY OR ILLUMINATION ARTICLES; DOLLS;  
DOLL CLOTHING; DOLL ACCESSORIES; HAND HELD  
UNIT FOR PLAYING ELECTRONIC GAMES OTHER  
THAN THOSE ADAPTED FOR USE WITH AN EXTER-  
NAL DISPLAY SCREEN OR MONITOR; PLAYING  
CARDS; PLUSH TOYS; PUPPETS; JIGSAW PUZZLES;  
AND TOY VEHICLES AND PLAYSETS THEREFOR (U.S.  
CLS. 22, 23, 38 AND 50).

COLLEEN DOMBROW, EXAMINING ATTORNEY

SN 86-066,059. MGA ENTERTAINMENT, INC., VAN NUYS,  
CA. FILED 9-16-2013.

# LALALOOPSY GIRLS

THE MARK CONSISTS OF STANDARD CHARACTERS  
WITHOUT CLAIM TO ANY PARTICULAR FONT, STYLE,  
SIZE, OR COLOR.

OWNER OF U.S. REG. NOS. 3,974,681, 4,280,006 AND  
OTHERS.

NO CLAIM IS MADE TO THE EXCLUSIVE RIGHT TO  
USE "GIRLS", APART FROM THE MARK AS SHOWN.

FOR ACTION FIGURES AND PLAYSETS THEREFOR;  
BEAN BAG DOLLS; BOARD GAMES; CARD GAMES;  
CHRISTMAS TREE ORNAMENTS, EXCEPT CONFEC-  
TIONERY OR ILLUMINATION ARTICLES; DOLLS;  
DOLL CLOTHING; DOLL ACCESSORIES; HAND HELD  
UNIT FOR PLAYING ELECTRONIC GAMES OTHER  
THAN THOSE ADAPTED FOR USE WITH AN EXTER-  
NAL DISPLAY SCREEN OR MONITOR; PLAYING  
CARDS; PLUSH TOYS; PUPPETS; JIGSAW PUZZLES;  
AND TOY VEHICLES AND PLAYSETS THEREFOR (U.S.  
CLS. 22, 23, 38 AND 50).

COLLEEN DOMBROW, EXAMINING ATTORNEY

SN 86-066,385. ANDY MAPPLE, WINTER GARDEN, FL.  
FILED 9-17-2013.



THE MARK CONSISTS OF ZIG ZAG LINES,  
FOR WATER SKIS, WAKEBOARDS, WATERSKI  
GLOVES, WATERSKI TOW ROPES, WATERSKI HAN-  
DLES (U.S. CLS. 22, 23, 38 AND 50).

FIRST USE 9-30-2003; IN COMMERCE 9-30-2003.  
LINDA POWELL, EXAMINING ATTORNEY

**CLASS 28—(Continued).**

SN 86-066,580. G.I. SPORTZ, INC., ST. LAURENT, QUEBEC, CANADA, FILED 9-17-2013.

# CRAZE

THE MARK CONSISTS OF STANDARD CHARACTERS WITHOUT CLAIM TO ANY PARTICULAR FONT, STYLE, SIZE, OR COLOR.

FOR PAINTBALLS (U.S. CLS. 22, 23, 38 AND 50).  
FIRST USE 9-16-2013; IN COMMERCE 9-16-2013.  
CURTIS FRENCH, EXAMINING ATTORNEY

---

SN 86-066,696. ROGERS, KIM, SILVANA, WA. FILED 9-17-2013.

# SPIDERWINGS

THE MARK CONSISTS OF STANDARD CHARACTERS WITHOUT CLAIM TO ANY PARTICULAR FONT, STYLE, SIZE, OR COLOR.

FOR EXERCISE EQUIPMENT, NAMELY, ADJUSTABLE SUPPORT STAND FOR PERFORMING CALISTHENIC AND STRETCHING EXERCISES (U.S. CLS. 22, 23, 38 AND 50).

HEATHER THOMPSON, EXAMINING ATTORNEY

---

SN 86-067,383. MEYERHOFFER, INC., MONTARA, CA. FILED 9-17-2013.

# SUR FOR WRD

THE MARK CONSISTS OF STANDARD CHARACTERS WITHOUT CLAIM TO ANY PARTICULAR FONT, STYLE, SIZE, OR COLOR.

FOR SPORTING EQUIPMENT, NAMELY, SURFBOARDS, SURFBOARD FINS, RESTRAINT STRAPS FOR SURFBOARDS, SURFBOARD LEASHES, SURFBOARD WAX, SURFING BODY BOARDS, BODY SURFING HAND BOARDS; BAGS SPECIALLY ADAPTED FOR SPORTING EQUIPMENT, NAMELY, BAGS FOR SURFBOARDS, SURFBOARD FINS, SURFBOARD EQUIPMENT, AND BODY BOARDS (U.S. CLS. 22, 23, 38 AND 50).

FIRST USE 6-0-2011; IN COMMERCE 1-5-2012.  
KEVIN MITTLER, EXAMINING ATTORNEY

**CLASS 28—(Continued).**

SN 86-067,480. 0947477 B.C. LTD., VICTORIA, CANADA, FILED 9-17-2013.

# FARM DICE

THE MARK CONSISTS OF STANDARD CHARACTERS WITHOUT CLAIM TO ANY PARTICULAR FONT, STYLE, SIZE, OR COLOR.

NO CLAIM IS MADE TO THE EXCLUSIVE RIGHT TO USE "DICE", APART FROM THE MARK AS SHOWN.

FOR ACTION SKILL GAMES; CRAPS GAME PLAYING EQUIPMENT; DICE GAMES; EQUIPMENT SOLD AS A UNIT FOR PLAYING CRAPS GAMES; GAMING CHIPS; GO GAMES; PARLOR GAMES; TABLETOP GAMES (U.S. CLS. 22, 23, 38 AND 50).

GINA FINK, EXAMINING ATTORNEY

---

SN 86-067,614. PROFORMANCE HOOPS, LLC, JOHN'S CREEK, GA. FILED 9-18-2013.

# POWER ARC 90

THE MARK CONSISTS OF STANDARD CHARACTERS WITHOUT CLAIM TO ANY PARTICULAR FONT, STYLE, SIZE, OR COLOR.

FOR HEIGHT AND ANGLE ADJUSTMENT MECHANISMS FOR BASKETBALL GOAL SETS (U.S. CLS. 22, 23, 38 AND 50).

FIRST USE 9-10-2013; IN COMMERCE 9-10-2013.

KATINA MISTER, EXAMINING ATTORNEY

---

SN 86-067,703. NOVA TECHNOLOGIES, LLC, GREENVILLE, SC. FILED 9-18-2013.

# LOST GALLEON GOLD

THE MARK CONSISTS OF STANDARD CHARACTERS WITHOUT CLAIM TO ANY PARTICULAR FONT, STYLE, SIZE, OR COLOR.

FOR GAMING MACHINES, NAMELY, ELECTRONIC SLOT AND BINGO MACHINES (U.S. CLS. 22, 23, 38 AND 50).

SUI DUONG, EXAMINING ATTORNEY



**CLASS 28—(Continued).**

SN 86-067,711. BOMMERSCHEIM SISTERS COMPANY,  
DURANGO, CO. FILED 9-18-2013.

EVERYBODY NEEDS A BUDDIE!

THE MARK CONSISTS OF STANDARD CHARACTERS  
WITHOUT CLAIM TO ANY PARTICULAR FONT, STYLE,  
SIZE, OR COLOR.

OWNER OF U.S. REG. NO. 4,338,619.  
FOR PLUSH TOYS (U.S. CLS. 22, 23, 38 AND 50).  
FIRST USE 5-30-2013; IN COMMERCE 5-30-2013.  
SUSAN RICHARDS, EXAMINING ATTORNEY

**CLASS 28—(Continued).**

SN 86-067,834. POKETTI LLC, PALO ALTO, CA. FILED 9-18-  
2013.

Poketti

THE MARK CONSISTS OF STANDARD CHARACTERS  
WITHOUT CLAIM TO ANY PARTICULAR FONT, STYLE,  
SIZE, OR COLOR.

FOR STUFFED AND PLUSH TOYS (U.S. CLS. 22, 23, 38  
AND 50).  
FIRST USE 1-15-2013; IN COMMERCE 6-1-2013.  
TRACY WHITTAKER-BROWN, EXAMINING ATTOR-  
NEY

SN 86-067,723. BOMMERSCHEIM SISTERS COMPANY,  
DURANGO, CO. FILED 9-18-2013.

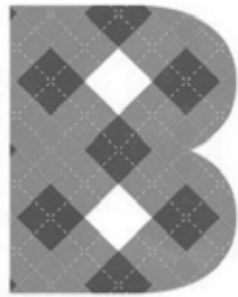

THE MARK CONSISTS OF AN UPPER CASE LETTER "B"  
IN A PLAID DESIGN.

FOR PLUSH TOYS (U.S. CLS. 22, 23, 38 AND 50).  
FIRST USE 11-3-2012; IN COMMERCE 11-3-2012.  
SUSAN RICHARDS, EXAMINING ATTORNEY

SN 86-067,974. SUNRISE IMAGE INC, BROOKLYN, NY.  
FILED 9-18-2013.

2PO

THE MARK CONSISTS OF STANDARD CHARACTERS  
WITHOUT CLAIM TO ANY PARTICULAR FONT, STYLE,  
SIZE, OR COLOR.

FOR NON-ELECTRONIC TOY VEHICLES; PARTY  
GAMES; PLAYING CARD GAME ACCESSORIES,  
NAMELY, PLAYING CARD CASES, PLAYING CARD  
HOLDERS, MATS FOR USE IN CONNECTION WITH  
PLAYING CARD GAMES, PLAYING CARD SHUF-  
FLING DEVICES AND DICE; TOY VEHICLES AND  
ACCESSORIES THEREFOR (U.S. CLS. 22, 23, 38 AND 50).  
FIRST USE 12-1-2012; IN COMMERCE 12-1-2012.  
DAVID MURRAY, EXAMINING ATTORNEY

SN 86-067,727. NOVA TECHNOLOGIES, LLC, GREENVILLE,  
SC. FILED 9-18-2013.

DRAGON'S HEAT

THE MARK CONSISTS OF STANDARD CHARACTERS  
WITHOUT CLAIM TO ANY PARTICULAR FONT, STYLE,  
SIZE, OR COLOR.

FOR GAMING MACHINES, NAMELY, ELECTRONIC  
SLOT AND BINGO MACHINES (U.S. CLS. 22, 23, 38 AND  
50).  
SUI DUONG, EXAMINING ATTORNEY

SN 86-068,212. POOF-SLINKY, LLC, CANTON, MI. FILED 9-  
18-2013.

YUCK-O

THE MARK CONSISTS OF STANDARD CHARACTERS  
WITHOUT CLAIM TO ANY PARTICULAR FONT, STYLE,  
SIZE, OR COLOR.

FOR TOYS, GAMES AND PLAYTHINGS, NAMELY,  
TOY ACTIVITY HOBBY CRAFT SETS FOR USE IN  
MAKING MALLEABLE AND POWDER SUBSTANCES  
FOR USE BY CHILDREN TO CREATE TOY SNOT,  
FAKE BLOOD, FAKE VOMIT, AND ITCHING POWDER  
(U.S. CLS. 22, 23, 38 AND 50).  
FIRST USE 11-6-2012; IN COMMERCE 11-6-2012.  
NAKIA HENRY, EXAMINING ATTORNEY

**CLASS 28—(Continued).**

SN 86-068,241. POSSIBILITY PLACE, LLC, SAINT LOUIS, MO. FILED 9-18-2013.

# BEMEES

THE MARK CONSISTS OF STANDARD CHARACTERS WITHOUT CLAIM TO ANY PARTICULAR FONT, STYLE, SIZE, OR COLOR.

FOR GAMES, PLAYTHINGS, AND SPORTING GOODS, NAMELY, ACTION FIGURES AND ACCESSORIES THEREFORE; STUFFED TOY ANIMALS; BABY MULTIPLE ACTIVITY TOYS; TOY BAKEWARE AND COOKWARE; BALLOONS; TOY BANKS; BATH TOYS; BATH TUB TOYS; INFLATABLE BATH TOYS; RIDE-ON TOYS; INFLATABLE RIDE-ON TOYS, EQUIPMENT SOLD AS A UNIT FOR PLAYING CARD GAMES; TOY CARS; DOLLS, BEANBAG DOLLS; PAPER DOLLS, RAG DOLLS, SOFT SCULPTURE DOLLS, DOLL ACCESSORIES AND PLAYSETS THEREFOR, NAMELY, DOLL CASES, DOLL CLOTHING; DOLL HOUSE FURNISHINGS, DOLL COSTUMES; STUFFED TOYS; CHECKER SETS; CHESS SETS; CHILDREN'S PLAY COSMETICS; CHILDREN'S MULTIPLE ACTIVITY TOYS; TOY CONSTRUCTION BLOCKS; INFANT ACTION CRIB TOYS; FLYING DISCS; ELECTRONIC HAND HELD GAME UNITS; ELECTRONIC GAME EQUIPMENT WITH A WATCH FUNCTION; ELECTRONICALLY OPERATED TOY MOTOR VEHICLES; BOARD GAMES AND GAME EQUIPMENT SOLD AS A UNIT FOR PLAYING BOARD GAMES; CARD GAMES; MANIPULATIVE GAMES; PARLOR GAMES; ROLE-PLAYING GAMES; STAND-ALONE VIDEO PARLOR COMPUTER GAME MACHINES; ACTION TYPE TARGET GAMES; COIN OPERATED AND NON-COIN OPERATED STAND-ALONE VIDEO OUTPUT GAME MACHINES; ROCKING HORSES; JIGSAW PUZZLES; KITES; MANIPULATIVE PUZZLES; PAPER FACE MASKS; TOY MODEL TRAIN SETS; TOY MODEL VEHICLES AND RELATED ACCESSORIES SOLD AS A UNIT; TOY MAGIC TRICKS, TOY WHISTLES; PARTY FAVORS IN THE NATURE OF SMALL TOYS; TOY CAP PISTOLS; PLUSH TOYS; SOFT SCULPTURE PLUSH TOYS; MANIPULATIVE PUZZLES, NAMELY, THREE DIMENSIONAL CUBE TYPE PUZZLES; TOY RECORD PLAYER FOR PLAYING TUNES AND CASSETTES AND DISCS THEREFOR; SKATEBOARDS; ICE SKATES; TOY ROLLER SKATES; TOY IN-LINE SKATES AND ACCESSORIES, NAMELY, KNEE, WRIST, AND ELBOW PADS; WATER SQUIRTING TOYS; TEDDY BEARS; WIND UP WALKING TOYS, WIND-UP TOYS; NON-MOTORIZED NON-ELECTRIC MOBILE SELF-PROPELLED RIDEABLE TOY VEHICLES; TOY TRUCKS; TWIRLING BATONS; TOY ZIP GUNS; GYMNASTIC APPARATUS; BALLS, NAMELY, PLAYGROUND BALLS, SOCCER BALLS, SPORT BALLS, BASEBALLS, BASKETBALLS, AND FOAM BALLS; BASEBALL GLOVES; SWIMMING AIDS, NAMELY, SWIMMING FLOATS FOR RECREATIONAL USE; HEAD COVERS FOR GOLF CLUBS; GOLF BALLS; GOLF CLUBS; INFLATABLE SWIMMING POOLS FOR RECREATIONAL USE; KICK BOARD FLOATATION DEVICES FOR RECREATIONAL USE; GYMNASTIC PARALLEL BARS; SKIS; SNOW SKIS; SNOW BOARDS; SKIPPING ROPES; JUMP ROPES; SNOW SLEDS FOR RECREATIONAL USE; SURF FINS; SURFBOARDS; SWIM BOARDS FOR RECREATIONAL USE; BODY BOARDS; SWIM FINS; INFLATABLE AND BUOYANT BATH TOYS; WATER TOYS AND RIDE ON TOYS; MUSICAL TOYS; LATEX SQUEEZE TOYS; EXERCISE EQUIPMENT, NAMELY, STATIONARY BIKES, TREADMILLS, STAIR STEPPING MACHINES; EXERCISE EQUIPMENT, NAMELY, WEIGHT LIFTING MACHINES, AND FREE WEIGHTS; PLAYING CARDS (U.S. CLS. 22, 23, 38 AND 50).

TINA BROWN, EXAMINING ATTORNEY

**CLASS 28—(Continued).**

SN 86-069,365. SOLACE SUP BOARDS LLC, WHALEYVILLE, MD. FILED 9-19-2013.



NO CLAIM IS MADE TO THE EXCLUSIVE RIGHT TO USE "SUP BOARDS", APART FROM THE MARK AS SHOWN.

THE MARK CONSISTS OF TWO WATER DROPS THAT FORM THE LETTER "S" AT A SLANT, THE WORD "SOLACE" IS ABOVE THE TEXT "SUP BOARDS", WHICH IS IN A CUSTOM CURSIVE WRITING.

FOR SURFBOARDS; PADDLE BOARDS; PADDLES FOR USE WITH SURFBOARDS; PADDLES FOR USE WITH PADDLE BOARDS; SURFBOARD FINS; PADDLE BOARD FINS; SURFBOARD TRACTION PADS; PADDLE BOARD TRACTION PADS (U.S. CLS. 22, 23, 38 AND 50). FIRST USE 3-1-2013; IN COMMERCE 7-15-2013.

LIEF MARTIN, EXAMINING ATTORNEY

SN 86-069,701. NOWSTALGIC TOYS, INC., CANAL WINCHESTER, OH. FILED 9-19-2013.

M.U.S.C.L.E. MILLIONS OF  
UNUSUAL SMALL CREATURES  
LURKING EVERYWHERE

THE MARK CONSISTS OF STANDARD CHARACTERS WITHOUT CLAIM TO ANY PARTICULAR FONT, STYLE, SIZE, OR COLOR.

FOR TOY FIGURES (U.S. CLS. 22, 23, 38 AND 50).  
KATHERINE CONNOLLY, EXAMINING ATTORNEY

SN 86-070,516. GEOFFREY, LLC, WAYNE, NJ. FILED 9-20-2013.

# TENDER TEARS

THE MARK CONSISTS OF STANDARD CHARACTERS WITHOUT CLAIM TO ANY PARTICULAR FONT, STYLE, SIZE, OR COLOR.

FOR DOLLS AND DOLL ACCESSORIES (U.S. CLS. 22, 23, 38 AND 50).

ANGELA M. MICHELI, EXAMINING ATTORNEY

**CLASS 28—(Continued).**

SN 86-070,529. POULSEN-CASCADE TACKLE, LLC, CLACK-AMAS, OR. FILED 9-20-2013.

**HALF-FAST**

THE MARK CONSISTS OF STANDARD CHARACTERS WITHOUT CLAIM TO ANY PARTICULAR FONT, STYLE, SIZE, OR COLOR.

FOR FISHING TACKLE; TERMINAL TACKLE (U.S. CLS. 22, 23, 38 AND 50).

FIRST USE 3-3-1953; IN COMMERCE 3-10-1954.  
ANDREA HACK, EXAMINING ATTORNEY

**CLASS 28—(Continued).**

SN 86-071,081. ANNIE SUNBEAM, LLC, FORT LAUDERDALE, FL. FILED 9-20-2013.

**THE SOLUTION TO POLLUTION  
CREW**

THE MARK CONSISTS OF STANDARD CHARACTERS WITHOUT CLAIM TO ANY PARTICULAR FONT, STYLE, SIZE, OR COLOR.

FOR TOYS AND GAMES, NAMELY, ACTION FIGURES AND ACCESSORIES THEREFOR, BALLOONS, BATH TOYS, BATTERY OPERATED ACTION TOYS, BOARD GAMES, CARD GAMES, CHILDREN'S MULTIPLE ACTIVITY TOYS, CHRISTMAS TREE ORNAMENTS AND DECORATIONS, COSTUME MASKS, CRIB TOYS, DOLLS AND ACCESSORIES THEREFOR, ELECTRONIC ACTION TOYS, ELECTRONIC EDUCATIONAL GAME MACHINES FOR CHILDREN, ELECTRONIC GAMES FOR THE TEACHING OF CHILDREN, ELECTRONIC LEARNING TOYS, FLYING DISCS, HAND HELD UNITS FOR PLAYING VIDEO GAMES OTHER THAN THOSE ADAPTED FOR USE WITH AN EXTERNAL DISPLAY SCREEN OR MONITOR, HAND PUPPETS, INFANT TOYS, INFLATABLE TOYS, KITES, LCD GAME MACHINES, MECHANICAL TOYS, MUSICAL TOYS, PARTY GAMES, PLAYING CARDS, PLAY SETS FOR ACTION FIGURES, PLUSH DOLLS AND TOYS, PUZZLES, ROLE PLAYING GAMES, SQUEEZE TOYS, STUFFED TOYS, TABLETOP GAMES, WATER TOYS, WIND-UP TOYS (U.S. CLS. 22, 23, 38 AND 50).

RON FAIRBANKS, EXAMINING ATTORNEY

SN 86-071,550. MATTEL, INC., EL SEGUNDO, CA. FILED 9-23-2013.

**ACTION SLAMMER**

THE MARK CONSISTS OF STANDARD CHARACTERS WITHOUT CLAIM TO ANY PARTICULAR FONT, STYLE, SIZE, OR COLOR.

FOR TOY VEHICLE PLAYSET FEATURE, NAMELY, AN ACTIVATION BUTTON (U.S. CLS. 22, 23, 38 AND 50).  
DANNEAN HETZEL, EXAMINING ATTORNEY

SN 86-071,007. KOLBE CORP, DBA KOLBE CORP, PHOENIX, AZ. FILED 9-20-2013.

**Glop Shop**

SN 86-073,659. FANTASMA TOYS, INC., NEW YORK, NY. FILED 9-24-2013.

**WEB ATTACK**

THE MARK CONSISTS OF STANDARD CHARACTERS WITHOUT CLAIM TO ANY PARTICULAR FONT, STYLE, SIZE, OR COLOR.

FOR EDUCATIONAL TOYS FOR IDENTIFYING AND DEVELOPING COGNITIVE STRENGTHS (U.S. CLS. 22, 23, 38 AND 50).

FIRST USE 10-13-1987; IN COMMERCE 10-13-1987.  
MORGAN WYNNE, EXAMINING ATTORNEY

THE MARK CONSISTS OF STANDARD CHARACTERS WITHOUT CLAIM TO ANY PARTICULAR FONT, STYLE, SIZE, OR COLOR.

FOR REMOTE CONTROL TOYS, NAMELY, VEHICLES, ANIMALS, INSECTS AND SPIDERS (U.S. CLS. 22, 23, 38 AND 50).

RUSS HERMAN, EXAMINING ATTORNEY

**CLASS 28—(Continued).**

SN 86-074,920. SHFL ENTERTAINMENT (AUSTRALASIA) PTY LIMITED, MILPERRA NSW 2214, AUSTRALIA, FILED 9-25-2013.

**EMPEROR'S SEAL**

THE MARK CONSISTS OF STANDARD CHARACTERS WITHOUT CLAIM TO ANY PARTICULAR FONT, STYLE, SIZE, OR COLOR.

FOR SLOT MACHINES; GAMBLING MACHINES; ELECTRONIC GAMING MACHINES; REPLACEMENT PARTS FOR ALL OF THE FOREGOING (U.S. CLS. 22, 23, 38 AND 50).

MARLENE BELL, EXAMINING ATTORNEY

**CLASS 28—(Continued).**

SN 86-077,516. STEIN, ELIOT, BURBANK, CA. FILED 9-27-2013.

**GOOD LUCK GORILLA**

THE MARK CONSISTS OF STANDARD CHARACTERS WITHOUT CLAIM TO ANY PARTICULAR FONT, STYLE, SIZE, OR COLOR.

NO CLAIM IS MADE TO THE EXCLUSIVE RIGHT TO USE "GORILLA", APART FROM THE MARK AS SHOWN.

FOR ACTION FIGURE TOYS; DOLLS AND DOLL ACCESSORIES, NAMELY, CLOTHING FOR DOLLS, DOLL ROOMS, DOLL BEDS, DOLL HOUSES, TOY FABRICS AND LINENS FOR DOLLS AND STROLLERS FOR DOLLS; PLUSH TOYS; STUFFED AND PLUSH TOYS; STUFFED TOY ANIMALS (U.S. CLS. 22, 23, 38 AND 50).

COLLEEN KEARNEY, EXAMINING ATTORNEY

SN 86-075,276. MATTEL, INC., EL SEGUNDO, CA. FILED 9-26-2013.

**STING ROD**

THE MARK CONSISTS OF STANDARD CHARACTERS WITHOUT CLAIM TO ANY PARTICULAR FONT, STYLE, SIZE, OR COLOR.

NO CLAIM IS MADE TO THE EXCLUSIVE RIGHT TO USE "ROD", APART FROM THE MARK AS SHOWN.

FOR TOY VEHICLES AND ACCESSORIES THEREFOR (U.S. CLS. 22, 23, 38 AND 50).

TRICIA SONNEBORN, EXAMINING ATTORNEY

SN 86-077,079. CLOUD B, INC., GARDENA, CA. FILED 9-27-2013.

**FRANKIE THE FOX**

THE MARK CONSISTS OF STANDARD CHARACTERS WITHOUT CLAIM TO ANY PARTICULAR FONT, STYLE, SIZE, OR COLOR.

NO CLAIM IS MADE TO THE EXCLUSIVE RIGHT TO USE "FOX", APART FROM THE MARK AS SHOWN.

FOR TOYS, NAMELY, PLUSH TOYS (U.S. CLS. 22, 23, 38 AND 50).

LANA PHAM, EXAMINING ATTORNEY

SN 86-077,903. HASBRO, INC., PAWTUCKET, RI. FILED 9-30-2013.

**SNACK AND SPILL BABY**

SN 86-077,085. CLOUD B, INC., GARDENA, CA. FILED 9-27-2013.

**COSMIC UFO**

THE MARK CONSISTS OF STANDARD CHARACTERS WITHOUT CLAIM TO ANY PARTICULAR FONT, STYLE, SIZE, OR COLOR.

NO CLAIM IS MADE TO THE EXCLUSIVE RIGHT TO USE "UFO", APART FROM THE MARK AS SHOWN.

FOR TOYS, NAMELY, HARD SCULPTURE TOYS (U.S. CLS. 22, 23, 38 AND 50).

LANA PHAM, EXAMINING ATTORNEY

THE MARK CONSISTS OF STANDARD CHARACTERS WITHOUT CLAIM TO ANY PARTICULAR FONT, STYLE, SIZE, OR COLOR.

NO CLAIM IS MADE TO THE EXCLUSIVE RIGHT TO USE "BABY", APART FROM THE MARK AS SHOWN.

FOR DOLLS, DOLL CLOTHING AND DOLL ACCESSORIES (U.S. CLS. 22, 23, 38 AND 50).

MICHAEL WEBSTER, EXAMINING ATTORNEY

**CLASS 28—(Continued).**

SN 86-079,943. PARAMOUNT PICTURES CORPORATION, HOLLYWOOD, CA. FILED 10-1-2013.

JACK RYAN: SHADOW RECRUIT

THE MARK CONSISTS OF STANDARD CHARACTERS WITHOUT CLAIM TO ANY PARTICULAR FONT, STYLE, SIZE, OR COLOR.

THE NAME(S), PORTRAIT(S), AND/OR SIGNATURE(S) SHOWN IN THE MARK DOES NOT IDENTIFY A PARTICULAR LIVING INDIVIDUAL.

FOR ACTION FIGURES AND ACCESSORIES THEREFOR; BASEBALL BATS; BASEBALLS; BOARD GAMES; CARD GAMES; CHRISTMAS TREE ORNAMENTS AND DECORATIONS; COSTUME MASKS; DARTS; ELECTRIC ACTION TOYS; ELECTRONIC NOVELTY TOYS, NAMELY, TOYS THAT ELECTRONICALLY RECORD, PLAY BACK, AND DISTORT OR MANIPULATE VOICES AND SOUNDS; FOOTBALLS; GAMING MACHINES, NAMELY, DEVICES WHICH ACCEPT A WAGER; GOLF CLUBS; JIGSAW AND MANIPULATIVE PUZZLES; KITES; MODELED PLASTIC TOY FIGURINES; PADDLE BALL GAMES; PLAYING CARDS; TOY MODEL HOBBY-CRAFT KITS; TOY VEHICLES AND ACCESSORIES THEREFOR; TOY WATCHES; YO-YOS (U.S. CLS. 22, 23, 38 AND 50).

AHSEN KHAN, EXAMINING ATTORNEY

SN 86-081,543. UNIVERSAL ENTERTAINMENT CORPORATION, TOKYO 135-0063, JAPAN, FILED 10-3-2013.

WARRIOR BEAUTY

花木兰

THE MARK CONSISTS OF THE WORDS "WARRIOR BEAUTY" LOCATED ABOVE THREE JAPANESE CHARACTERS.

THE NON-LATIN CHARACTERS IN THE MARK TRANSLITERATE TO "HU MU LAN" AND THIS MEANS "HUA MULAN", A LEGENDARY FIGURE FROM ANCIENT CHINA, IN ENGLISH.

FOR SLOT MACHINES AND REPLACEMENT PARTS THEREFOR; VIDEO SLOT MACHINES AND REPLACEMENT PARTS THEREFOR; GAMING MACHINES AND REPLACEMENT PARTS THEREFOR; GAMING MACHINES WITH A LIQUID CRYSTAL DISPLAY AND REPLACEMENT PARTS THEREFOR; MECHANICAL REEL TYPE SLOT MACHINES WITH A LIQUID CRYSTAL DISPLAY AND REPLACEMENT PARTS THEREFOR (U.S. CLS. 22, 23, 38 AND 50).

ELIZABETH CHANG, EXAMINING ATTORNEY

**CLASS 28—(Continued).**

SN 86-086,604. DOSKOCIL MANUFACTURING COMPANY, INC., ARLINGTON, TX. FILED 10-9-2013.

FLOPPY TUG

THE MARK CONSISTS OF STANDARD CHARACTERS WITHOUT CLAIM TO ANY PARTICULAR FONT, STYLE, SIZE, OR COLOR.

NO CLAIM IS MADE TO THE EXCLUSIVE RIGHT TO USE "TUG", APART FROM THE MARK AS SHOWN. FOR PET TOYS (U.S. CLS. 22, 23, 38 AND 50).

PAULA MAHONEY, EXAMINING ATTORNEY

SN 86-086,776. DOSKOCIL MANUFACTURING COMPANY, INC., ARLINGTON, TX. FILED 10-9-2013.

FLOPPY ROLLER

THE MARK CONSISTS OF STANDARD CHARACTERS WITHOUT CLAIM TO ANY PARTICULAR FONT, STYLE, SIZE, OR COLOR.

NO CLAIM IS MADE TO THE EXCLUSIVE RIGHT TO USE "ROLLER", APART FROM THE MARK AS SHOWN.

FOR PET TOYS (U.S. CLS. 22, 23, 38 AND 50).

PAULA MAHONEY, EXAMINING ATTORNEY

SN 86-086,951. DOSKOCIL MANUFACTURING COMPANY, INC., ARLINGTON, TX. FILED 10-9-2013.

KICK CUBE

THE MARK CONSISTS OF STANDARD CHARACTERS WITHOUT CLAIM TO ANY PARTICULAR FONT, STYLE, SIZE, OR COLOR.

NO CLAIM IS MADE TO THE EXCLUSIVE RIGHT TO USE "CUBE", APART FROM THE MARK AS SHOWN.

FOR PET TOYS (U.S. CLS. 22, 23, 38 AND 50).

PAULA MAHONEY, EXAMINING ATTORNEY

**CLASS 28—(Continued).**

SN 86-090,598. ABU AB, SVANGSTA, SWEDEN, FILED 10-14-2013.

**REGISTA**

THE MARK CONSISTS OF STANDARD CHARACTERS WITHOUT CLAIM TO ANY PARTICULAR FONT, STYLE, SIZE, OR COLOR.

THE WORDING "REGISTA" HAS NO MEANING IN A FOREIGN LANGUAGE.

FOR FISHING RODS; FISHING REELS; FISHING TACKLE (U.S. CLS. 22, 23, 38 AND 50).

LAURA KOVALSKY, EXAMINING ATTORNEY

---

SN 86-093,657. STEIN, ELIOT, BURBANK, CA. FILED 10-17-2013.

**TREASURE PETS**

THE MARK CONSISTS OF STANDARD CHARACTERS WITHOUT CLAIM TO ANY PARTICULAR FONT, STYLE, SIZE, OR COLOR.

NO CLAIM IS MADE TO THE EXCLUSIVE RIGHT TO USE "PETS", APART FROM THE MARK AS SHOWN.

FOR ACTION FIGURE TOYS; COLLECTABLE TOY FIGURES; PLUSH TOYS; STUFFED AND PLUSH TOYS; STUFFED TOY ANIMALS (U.S. CLS. 22, 23, 38 AND 50).

COLLEEN KEARNEY, EXAMINING ATTORNEY

---

SN 86-093,905. IGT, RENO, NV. FILED 10-17-2013.

**BENGAL EYES**

THE MARK CONSISTS OF STANDARD CHARACTERS WITHOUT CLAIM TO ANY PARTICULAR FONT, STYLE, SIZE, OR COLOR.

OWNER OF U.S. REG. NOS. 3,828,871 AND 4,070,975.

FOR GAMING MACHINES, NAMELY, DEVICES WHICH ACCEPT A WAGER (U.S. CLS. 22, 23, 38 AND 50).

MICHAEL TANNER, EXAMINING ATTORNEY

**CLASS 28—(Continued).**

SN 86-094,882. KMA CONCEPTS LIMITED, TSIM SHA TSUI, KOWLOON, HONG KONG, FILED 10-18-2013.

**Zing Shot**

THE MARK CONSISTS OF STANDARD CHARACTERS WITHOUT CLAIM TO ANY PARTICULAR FONT, STYLE, SIZE, OR COLOR.

OWNER OF U.S. REG. NOS. 3,469,484, 4,014,255 AND OTHERS.

NO CLAIM IS MADE TO THE EXCLUSIVE RIGHT TO USE "SHOT", APART FROM THE MARK AS SHOWN.

FOR SLING SHOTS; TOY WEAPONS (U.S. CLS. 22, 23, 38 AND 50).

FIRST USE 2-15-2010; IN COMMERCE 2-15-2010.

NATALIE POLZER, EXAMINING ATTORNEY

---

SN 86-095,188. SPEEDO INTERNATIONAL LIMITED, LONDON, UNITED KINGDOM, FILED 10-18-2013.

**SMAO**

THE MARK CONSISTS OF STANDARD CHARACTERS WITHOUT CLAIM TO ANY PARTICULAR FONT, STYLE, SIZE, OR COLOR.

FOR SWIM TRAINING PADDLES (U.S. CLS. 22, 23, 38 AND 50).

JENNIFER WILLISTON, EXAMINING ATTORNEY

---

SN 86-103,834. SHFL ENTERTAINMENT (AUSTRALASIA) PTY LIMITED, MILPERRA NSW 2214, AUSTRALIA, FILED 10-29-2013.

**FLOWER OF RICHES**

THE MARK CONSISTS OF STANDARD CHARACTERS WITHOUT CLAIM TO ANY PARTICULAR FONT, STYLE, SIZE, OR COLOR.

FOR SLOT MACHINES; GAMBLING MACHINES; ELECTRONIC GAMING MACHINES; REPLACEMENT PARTS FOR ALL OF THE FOREGOING (U.S. CLS. 22, 38 AND 50).

MARLENE BELL, EXAMINING ATTORNEY

**CLASS 28—(Continued).**

SN 86-106,364. HASBRO, INC., PAWTUCKET, RI. FILED 10-31-2013.

**SECRETS & SPIES**

THE MARK CONSISTS OF STANDARD CHARACTERS WITHOUT CLAIM TO ANY PARTICULAR FONT, STYLE, SIZE, OR COLOR.

OWNER OF U.S. REG. NO. 3,826,765.

FOR TOY SPORTING EQUIPMENT, NAMELY, TOY DART SHOOTERS AND TOY DARTS FOR USE THEREWITH, TOY BALL SHOOTERS AND TOY BALLS FOR USE THEREWITH; TOY CROSSBOWS AND TOY ARROWS FOR USE THEREWITH (U.S. CLS. 22, 23, 38 AND 50).

MICHAEL WEBSTER, EXAMINING ATTORNEY

SN 86-107,525. KONAMI GAMING, INC., LAS VEGAS, NV. FILED 11-1-2013.

**LIGHTNING BOLT 77**

THE MARK CONSISTS OF STANDARD CHARACTERS WITHOUT CLAIM TO ANY PARTICULAR FONT, STYLE, SIZE, OR COLOR.

OWNER OF U.S. REG. NO. 3,948,579.

NO CLAIM IS MADE TO THE EXCLUSIVE RIGHT TO USE "77", APART FROM THE MARK AS SHOWN.

FOR ELECTRONIC GAMING MACHINES, NAMELY, DEVICES WHICH ACCEPT A WAGER; GAMING DEVICES, NAMELY, GAMING MACHINES, SLOT MACHINES, BINGO MACHINES, WITH OR WITHOUT VIDEO OUTPUT; GAMING EQUIPMENT, NAMELY, SLOT MACHINES WITH OR WITHOUT VIDEO OUTPUT; GAMING MACHINES; GAMING MACHINES FEATURING A DEVICE THAT ACCEPTS WAGERS; GAMING MACHINES FOR GAMBLING; GAMING MACHINES INCLUDING SLOT MACHINES OR VIDEO LOTTERY TERMINALS; GAMING MACHINES THAT GENERATE OR DISPLAY WAGER OUTCOMES; GAMING MACHINES, NAMELY, SLOT MACHINES AND VIDEO LOTTERY TERMINALS; GAMING MACHINES, NAMELY, DEVICES WHICH ACCEPT A WAGER; GAMING MACHINES, NAMELY, ELECTRONIC SLOT AND BINGO MACHINES; MACHINES FOR PLAYING GAMES OF CHANCE; RECONFIGURABLE CASINO AND LOTTERY GAMING EQUIPMENT, NAMELY, GAMING MACHINES AND OPERATIONAL COMPUTER GAME SOFTWARE THEREFOR SOLD AS A UNIT; SLOT MACHINES (U.S. CLS. 22, 23, 38 AND 50).

CHERYL CLAYTON, EXAMINING ATTORNEY

**CLASS 28—(Continued).**

SN 86-111,915. KMA CONCEPTS LIMITED, TSIM SHA TSUI, KOWLOON, HONG KONG, FILED 11-6-2013.

**ZOMP ROCKETZ**

THE MARK CONSISTS OF STANDARD CHARACTERS WITHOUT CLAIM TO ANY PARTICULAR FONT, STYLE, SIZE, OR COLOR.

NO CLAIM IS MADE TO THE EXCLUSIVE RIGHT TO USE "ROCKETZ", APART FROM THE MARK AS SHOWN.

FOR AIR POWERED FLYING TOYS (U.S. CLS. 22, 23, 38 AND 50).

FIRST USE 2-20-2012; IN COMMERCE 2-20-2012.

NATALIE POLZER, EXAMINING ATTORNEY

SN 86-112,689. LAROSE INDUSTRIES, LLC, RANDOLPH, NJ. FILED 11-7-2013.

OWNER OF U.S. REG. NO. 4,306,247.

NO CLAIM IS MADE TO THE EXCLUSIVE RIGHT TO USE "CUBE", APART FROM THE MARK AS SHOWN.

THE MARK CONSISTS OF THE WORDS "LITE CUBE" IN A STYLIZED FORM.

FOR CONSTRUCTION TOYS, NAMELY, TOY BUILDING SETS, TOY BUILDING BLOCKS (U.S. CLS. 22, 23, 38 AND 50).

TOBY BULLOFF, EXAMINING ATTORNEY

SN 86-115,227. PLAYCORE IP SUB, INC., CHATTANOOGA, TN. FILED 11-11-2013.

**WAVE**

THE MARK CONSISTS OF STANDARD CHARACTERS WITHOUT CLAIM TO ANY PARTICULAR FONT, STYLE, SIZE, OR COLOR.

FOR PLAYGROUND EQUIPMENT, NAMELY, SLIDES AND CLIMBING UNITS; BRIDGES SPECIALLY DESIGNED FOR CONNECTING PLAYGROUND EQUIPMENT COMPONENTS AND SHADES SPECIALLY DESIGNED FOR PLAYGROUND EQUIPMENT (U.S. CLS. 22, 23, 38 AND 50).

FIRST USE 0-0-2001; IN COMMERCE 1-0-2001.

JAMES MACFARLANE, EXAMINING ATTORNEY

**CLASS 28—(Continued).**

SN 86-121,860. THOSE CHARACTERS FROM CLEVELAND, INC., CLEVELAND, OH. FILED 11-18-2013.

**HUCKLEBERRY PIE**

THE MARK CONSISTS OF STANDARD CHARACTERS WITHOUT CLAIM TO ANY PARTICULAR FONT, STYLE, SIZE, OR COLOR.

THE NAME(S), PORTRAIT(S), AND/OR SIGNATURE(S) SHOWN IN THE MARK DOES NOT IDENTIFY A PARTICULAR LIVING INDIVIDUAL.

FOR PLUSH TOYS; TOY ACTION FIGURES AND ACCESSORIES THEREFOR (U.S. CLS. 22, 23, 38 AND 50).  
DAVID MURRAY, EXAMINING ATTORNEY

---

SN 86-129,782. NOVA TECHNOLOGIES, LLC, GREENVILLE, SC. FILED 11-26-2013.

**ALTAZAR**

THE MARK CONSISTS OF STANDARD CHARACTERS WITHOUT CLAIM TO ANY PARTICULAR FONT, STYLE, SIZE, OR COLOR.

THE WORDING "ALTAZAR" HAS NO MEANING IN A FOREIGN LANGUAGE.

FOR GAMING MACHINES INCLUDING SLOT MACHINES OR VIDEO LOTTERY TERMINALS; GAMING MACHINES, NAMELY, ELECTRONIC SLOT AND BINGO MACHINES (U.S. CLS. 22, 23, 38 AND 50).  
SUI DUONG, EXAMINING ATTORNEY

---

SN 86-135,946. MIAMI TRIBE OF OKLAHOMA BUSINESS DEVELOPMENT AUTHORITY, A TRIBAL ENTERPRISE OF THE MIAMI TRIBE OF OKLAHOMA, MIAMI, OK. FILED 12-5-2013.

**Festival of Gems**

THE MARK CONSISTS OF STANDARD CHARACTERS WITHOUT CLAIM TO ANY PARTICULAR FONT, STYLE, SIZE, OR COLOR.

FOR GAMING DEVICES, NAMELY, GAMING MACHINES, SLOT MACHINES, BINGO MACHINES, WITH OR WITHOUT VIDEO OUTPUT (U.S. CLS. 22, 23, 38 AND 50).

FIRST USE 12-2-2013; IN COMMERCE 12-5-2013.  
KATHLEEN M. VANSTON, EXAMINING ATTORNEY

**CLASS 29—MEATS AND PROCESSED FOODS**

SN 77-694,085. INTERCONTINENTAL GREAT BRANDS LLC, EAST HANOVER, NJ. FILED 3-18-2009.



OWNER OF U.S. REG. NOS. 1,665,159, 3,463,095 AND OTHERS.

NO CLAIM IS MADE TO THE EXCLUSIVE RIGHT TO USE "SINCE 1960", APART FROM THE MARK AS SHOWN.

THE MARK CONSISTS OF A BLACK RECTANGLE WITH IMPERFECT EDGES WITH THE WORDS "BACK TO" IN SMALL WHITE LETTERS AND THE WORD "NATURE" IN WHITE CAPITAL LETTERS UNDERNEATH "BACK TO". A DESIGN OF A LEAF IS A STYLIZED SUBSTITUTE FOR THE LETTER "A" IN "NATURE". THE WORDS "SINCE 1960" ARE WRITTEN PERPENDICULAR TO THE RIGHT OF "BACK TO NATURE".

FOR PROCESSED NUTS; TRAIL MIX CONSISTING PRIMARILY OF PROCESSED NUTS, SEEDS, DRIED FRUIT AND ALSO INCLUDING CHOCOLATE (U.S. CL. 46).

FIRST USE 6-30-2008; IN COMMERCE 6-30-2008.  
RUDY R. SINGLETON, EXAMINING ATTORNEY

---

SN 79-125,258. QIAQIA FOOD CO., LTD., CHINA, FILED 12-21-2012.

**Guazi Premium**

PRIORITY DATE OF 9-5-2012 IS CLAIMED.  
OWNER OF INTERNATIONAL REGISTRATION 1147750 DATED 12-21-2012, EXPIRES 12-21-2022.

NO CLAIM IS MADE TO THE EXCLUSIVE RIGHT TO USE "PREMIUM", APART FROM THE MARK AS SHOWN.

THE LATIN LETTERS "GUAZI PREMIUM" APPEARING IN THE TRADEMARK HAVE NO SIGNIFICANCE IN THE RELEVANT TRADE OR INDUSTRY, OR ANY GEOGRAPHICAL SIGNIFICANCE, OR ANY MEANING IN A FOREIGN LANGUAGE.

FOR NUTS, PREPARED; PROCESSED SUNFLOWER SEEDS; PROCESSED MELON SEEDS; PEANUTS, PROCESSED; PROCESSED PINE NUTS; PROCESSED HAZELNUTS; COOKED BEANS; FRUIT-BASED SNACK FOOD; CRYSTALLIZED FRUITS; VEGETABLE-BASED SNACK FOOD (U.S. CL. 46).

JOHN DWYER, EXAMINING ATTORNEY



**CLASS 29—(Continued).**

SN 85-373,720. AUSTRALIS SEAFOODS S.A., LAS CONDES, SANTIAGO, CHILE, FILED 7-18-2011.



OWNER OF CHILE REG. NO. 948026, DATED 4-10-2012, EXPIRES 4-10-2022.

THE COLOR(S) AQUA BLUE AND GREEN IS/ARE CLAIMED AS A FEATURE OF THE MARK.

THE MARK CONSISTS OF AQUA BLUE AND GREEN FISH DESIGNS WHERE THE AQUA BLUE FISH DESIGN OVERLAPS THE GREEN FISH DESIGN.

FOR MEAT, MEAT EXTRACTS, FROZEN MEAT, CANNED MEAT, FISH, CANNED FISH, SEASHELLS NOT ALIVE, NAMELY, MUSSELS, CLAMS, OYSTERS AND SCALLOPS (U.S. CL. 46).

RAUL CORDOVA, EXAMINING ATTORNEY

SN 85-711,038. MOOSE MAPLE UK LTD., LONDON, UNITED KINGDOM, FILED 8-23-2012.

**MOOSE MAPLE**

THE MARK CONSISTS OF STANDARD CHARACTERS WITHOUT CLAIM TO ANY PARTICULAR FONT, STYLE, SIZE, OR COLOR.

PRIORITY CLAIMED UNDER SEC. 44(D) ON ERPNCMNTY TM OFC APPLICATION NO. 011102159, FILED 8-7-2012, REG. NO. 011102159, DATED 9-24-2013, EXPIRES 8-7-2022.

NO CLAIM IS MADE TO THE EXCLUSIVE RIGHT TO USE "MAPLE", APART FROM THE MARK AS SHOWN.

FOR BUTTER, MAPLE BUTTER (U.S. CL. 46).  
ZACHARY R. SPARER, EXAMINING ATTORNEY

**CLASS 29—(Continued).**

SN 85-724,460. REICHEL FOODS, INC., ROCHESTER, MN. FILED 9-10-2012.

**CRAVATIONS**

THE MARK CONSISTS OF STANDARD CHARACTERS WITHOUT CLAIM TO ANY PARTICULAR FONT, STYLE, SIZE, OR COLOR.

FOR FOOD ITEMS, NAMELY, COMBINATIONS OF APPLES AND CARAMEL, NAMELY, COMBINATION OF FOOD PRIMARILY CONSISTING OF PROCESSED APPLES AND ALSO CONTAINING CARAMEL; SALMON DIP AND CRACKERS, NAMELY, COMBINATION OF FOOD PRIMARILY CONSISTING OF SALMON DIP AND ALSO CONTAINING CRACKERS; MESQUITE CHICKEN SALAD AND CRACKERS, NAMELY, COMBINATION OF FOOD PRIMARILY CONSISTING OF MESQUITE CHICKEN SALAD AND ALSO CONTAINING CRACKERS; MESQUITE CHICKEN SALAD AND CELERY STICKS IN THE NATURE OF PROCESSED VEGETABLES; BUFFALO CHICKEN SALAD AND CRACKERS, NAMELY, COMBINATION OF FOOD PRIMARILY CONSISTING OF BUFFALO CHICKEN SALAD AND ALSO CONTAINING CRACKERS; AND THE COMBINATION OF MEAT STICKS IN THE NATURE OF PROCESSED MEAT AND BARBEQUE SAUCE, NAMELY, COMBINATION OF FOOD PRIMARILY CONSISTING OF MEAT STICKS IN THE NATURE OF PROCESSED MEAT AND ALSO CONTAINING BARBEQUE SAUCE (U.S. CL. 46).

JAMES STEIN, EXAMINING ATTORNEY

SN 85-844,136. MONTANA ED'S ENTERPRISES, LLC, FOUNTAIN VALLEY, CA. FILED 2-7-2013.

**MONTANA ED'S  
PREMIUM CHILI**

THE MARK CONSISTS OF STANDARD CHARACTERS WITHOUT CLAIM TO ANY PARTICULAR FONT, STYLE, SIZE, OR COLOR.

NO CLAIM IS MADE TO THE EXCLUSIVE RIGHT TO USE "PREMIUM CHILI", APART FROM THE MARK AS SHOWN.

THE NAME(S), PORTRAIT(S), AND/OR SIGNATURE(S) SHOWN IN THE MARK DOES NOT IDENTIFY A PARTICULAR LIVING INDIVIDUAL.

FOR CHILI (U.S. CL. 46).  
KHANH LE, EXAMINING ATTORNEY

**CLASS 29—(Continued).**

SN 85-868,242. O'GRADY, DENNIS Q., DBA JIVE JERKY, POCONO LAKE, PA. FILED S.R. 3-6-2013; AM. P.R. 6-19-2013.

## JIVE JERKY

THE MARK CONSISTS OF STANDARD CHARACTERS WITHOUT CLAIM TO ANY PARTICULAR FONT, STYLE, SIZE, OR COLOR.

NO CLAIM IS MADE TO THE EXCLUSIVE RIGHT TO USE "JERKY", APART FROM THE MARK AS SHOWN.

FOR BEEF JERKY; JERKY (U.S. CL. 46).

FIRST USE 1-1-2011; IN COMMERCE 1-1-2013.

SAMUEL E. SHARPER JR., EXAMINING ATTORNEY

SN 85-869,143. MICHAEL SHUR, DBA SHURKY JURKY, GRESHAM, OR. FILED 3-6-2013.

## Meat Your Taste Buds

THE MARK CONSISTS OF STANDARD CHARACTERS WITHOUT CLAIM TO ANY PARTICULAR FONT, STYLE, SIZE, OR COLOR.

FOR BEEF JERKY; DRIED BEEF; DRIED CRANBERRIES; DRIED DATES; DRIED FRUIT AND VEGETABLES; DRIED FRUIT MIXES; DRIED FRUIT-BASED SNACKS; DRIED FRUITS; JERKY; PROCESSED MUSHROOMS (U.S. CL. 46).

FIRST USE 3-1-2010; IN COMMERCE 3-1-2010.

LUCY ARANT, EXAMINING ATTORNEY

SN 85-890,042. WONDERFULLY RAW GOURMET, LLC, WATSONVILLE, CA. FILED 3-29-2013.

## Brussel Bytes

THE MARK CONSISTS OF STANDARD CHARACTERS WITHOUT CLAIM TO ANY PARTICULAR FONT, STYLE, SIZE, OR COLOR.

NO CLAIM IS MADE TO THE EXCLUSIVE RIGHT TO USE "BITES", APART FROM THE MARK AS SHOWN.

FOR BRUSSEL SPROUT COCONUT SNACK MIX (U.S. CL. 46).

FIRST USE 2-15-2013; IN COMMERCE 2-15-2013.

CHRIS WELLS, EXAMINING ATTORNEY

**CLASS 29—(Continued).**

SN 85-906,046. SPANITZ BROTHERS' COMPANY LLC, HUNTINGTON WOODS, MI. FILED 4-16-2013.



NO CLAIM IS MADE TO THE EXCLUSIVE RIGHT TO USE "BROS. SAUSAGE CO.", APART FROM THE MARK AS SHOWN.

THE COLOR(S) BROWN, WHITE AND BLACK IS/ARE CLAIMED AS A FEATURE OF THE MARK.

THE MARK CONSISTS OF A WHITE SAUSAGE LINK ON A WHITE FORK WITH TWO BROWN LETTER "P"'S, ONE IN REVERSE, IN THE BACKGROUND AND THE NAME "SPANITZ BROS." IN BLACK AND "SAUSAGE CO." IN BROWN.

FOR PRESERVED MEATS AND SAUSAGES (U.S. CL. 46).

FIRST USE 5-8-2006; IN COMMERCE 5-8-2006.

KATHLEEN M. VANSTON, EXAMINING ATTORNEY

SN 85-907,394. DISNEY ENTERPRISES, INC., BURBANK, CA. FILED 4-17-2013.

## TOY STORY

THE MARK CONSISTS OF STANDARD CHARACTERS WITHOUT CLAIM TO ANY PARTICULAR FONT, STYLE, SIZE, OR COLOR.

OWNER OF U.S. REG. NOS. 3,905,741, 4,358,259 AND OTHERS.

FOR CHEESE; APPLESAUCE; BANANA CHIPS; BUTTER OR BUTTER SUBSTITUTES; CHEESE AND CRACKER COMBINATIONS; CHEESE SPREAD; CANDIED FRUIT; CHOCOLATE MILK; CHILI; DRIED FRUIT-BASED SNACKS; DAIRY PRODUCTS EXCLUDING ICE CREAM, ICE MILK AND FROZEN YOGURT; DIPS; DRINKING YOGURTS; EGGS; FROZEN MEALS CONSISTING PRIMARILY OF MEAT, FISH, POULTRY OR VEGETABLES; FRUIT PEELS AND PRESERVES; FRUIT SALADS; HAMBURGER; HOT DOGS; JAMS; JELLIES; MARGARINE; MARMALADES; MEAT, FISH, POULTRY AND GAME; NUT BUTTERS; PICKLES; PEANUT BUTTER; POTATO CHIPS; POTATO SALAD; POTATO-BASED SNACK FOODS; PROCESSED, CANNED, BOTTLED, DRIED, FROZEN, COOKED, OR PRESERVED FRUITS AND VEGETABLES; PROCESSED FRUITS AND VEGETABLES; POWDERED MILK; SNACK MIX CONSISTING PRIMARILY OF PROCESSED FRUITS, PROCESSED NUTS AND/OR RAISINS; SOUP MIXES; VEGGIE BURGER PATTIES (U.S. CL. 46).

LEIGH CAROLINE CASE, EXAMINING ATTORNEY

**CLASS 29—(Continued).**

SN 85-914,828. TYSON FOODS, INC., SPRINGDALE, AR.  
FILED 4-25-2013.

**CLASS 29—(Continued).**

SN 85-959,247. DR. CHUNG'S FOOD CO., LTD., CHUNG-  
CHEONGBUK-DO, REPUBLIC OF KOREA, FILED 6-13-  
2013.

**GRAND OPENINGS**

THE MARK CONSISTS OF STANDARD CHARACTERS  
WITHOUT CLAIM TO ANY PARTICULAR FONT, STYLE,  
SIZE, OR COLOR.

FOR DOUGH-ENROBED FOODS CONSISTING PRI-  
MARILY OF A DOUGH-BASED WRAPPER WITH FILL-  
INGS CONSISTING POULTRY, BEEF OR PORK, WITH  
CHEESE AND SAUCES (U.S. CL. 46).

CURTIS FRENCH, EXAMINING ATTORNEY

---

SN 85-925,690. 9071-3975 QUÉBEC INC., YAMACHICHE  
(QUÉBEC), CANADA, FILED 5-7-2013.

**MUGIFUJI**

THE MARK CONSISTS OF STANDARD CHARACTERS  
WITHOUT CLAIM TO ANY PARTICULAR FONT, STYLE,  
SIZE, OR COLOR.

PRIORITY CLAIMED UNDER SEC. 44(D) ON CANADA  
APPLICATION NO. 1601621, FILED 11-8-2012, REG. NO.  
TMA865,983, DATED 11-26-2013, EXPIRES 11-26-2028.

THE ENGLISH TRANSLATION OF "MUGI" AND "FUJI"  
IN THE MARK IS "BARLAY" AND "MOUNT FUJI".

FOR PORK (U.S. CL. 46).

KIMBERLY PERRY, EXAMINING ATTORNEY

---

SN 85-937,020. HEB GROCERY COMPANY LP, SAN ANTO-  
NIO, TX. FILED 5-20-2013.

**H-E-B ORGANICS**

THE MARK CONSISTS OF STANDARD CHARACTERS  
WITHOUT CLAIM TO ANY PARTICULAR FONT, STYLE,  
SIZE, OR COLOR.

OWNER OF U.S. REG. NOS. 3,194,958, 3,930,507 AND  
OTHERS.

NO CLAIM IS MADE TO THE EXCLUSIVE RIGHT TO  
USE "ORGANICS", APART FROM THE MARK AS SHOWN.

FOR ORGANIC CHEESES, MILK, SOY MILK, BUT-  
TER, BUTTER SUBSTITUTES, MARGARINE, CANNED  
BEANS, CANNED OR BOTTLED FRUITS, DRIED  
FRUITS, FROZEN FRUITS, FROZEN VEGETABLES,  
FRUIT SPREADS, CANNED OR BOTTLED VEGETA-  
BLES, EDIBLE OILS, COOKING OILS, EGGS, EGG  
WHITES, CREAM CHEESE, SOUPS, CANNED TOMA-  
TOES, POTATO CHIPS, VEGETABLE CHIPS (U.S. CL.  
46).

AISHA CLARKE, EXAMINING ATTORNEY



NO CLAIM IS MADE TO THE EXCLUSIVE RIGHT TO  
USE "FOOD" AND THE NON-LATIN CHARACTERS THAT  
TRANSLITERATE TO "SIK POOM", APART FROM THE  
MARK AS SHOWN.

THE NAME "DR. CHUNG" IDENTIFIES A LIVING  
INDIVIDUAL WHOSE CONSENT IS OF RECORD.

THE COLOR(S) BLUE, GREEN, RED AND WHITE IS/ARE  
CLAIMED AS A FEATURE OF THE MARK.

THE MARK CONSISTS OF THE STYLIZED WORDS "DR.  
CHUNG'S FOOD" IN GREEN. ABOVE "DR. CHUNG'S  
FOOD" ARE A CIRCLE, A TRIANGLE AND A RECTAN-  
GULAR DESIGN. THE CIRCLE IS BLUE WITH THE  
KOREAN CHARACTER IN WHITE. THE TRIANGLE IS  
GREEN WITH THE KOREAN CHARACTER IN WHITE.  
UNDERNEATH THE GREEN TRIANGLE IS A GREEN  
LINE. THE RECTANGULAR DESIGN IS RED WITH THE  
KOREAN CHARACTER IN WHITE.

THE NON-LATIN CHARACTERS IN THE MARK TRANS-  
LITERATE TO "CHUNG, SIK, POOM" AND THIS MEANS  
"CHUNG FOOD" IN ENGLISH.

FOR KIDNEY BEANS PRESERVED; MUNG BEANS  
PRESERVED; PROCESSED PEANUTS; PROCESSED  
FRUITS; PEAS PRESERVED; BROAD BEANS PRE-  
SERVED; BEANS PRESERVED; RED BEANS PRE-  
SERVED; THICK TOFU; TOFU; SOYA BEAN MILK;  
FERMENTED MILK; BUTTER; BUTTER CREAM; POW-  
DERED MILK FOR FOOD PURPOSES, EXCEPT FOR  
INFANTS; SOUR MILK PRODUCTS, NAMELY, SOUR  
CREAM; GOATS MILK; SHEEP MILK; CONDENSED  
MILK SWEETENED AND UNSWEETENED AND WITH  
AND WITHOUT THE FAT REMOVED; YOGURT; MILK;  
LACTIC ACID BACTERIA DRINKS; LACTIC ACID  
DRINKS; WHEY; CHEESE; KEFIR MILK BEVERAGE;  
CONDENSED MILK; KOUMISS MILK BEVERAGES;  
WHIPPED CREAM; FRUIT POWDERS FOR USE AS A  
FOOD ADDITIVE FOR CULINARY PURPOSES (U.S. CL.  
46).

PAUL CROWLEY, EXAMINING ATTORNEY

**CLASS 29—(Continued).**

SN 86-026,041. BUNGE OILS, INC., ST. LOUIS, MO. FILED 8-1-2013.

**PRISTINE GOURMET**

THE MARK CONSISTS OF STANDARD CHARACTERS WITHOUT CLAIM TO ANY PARTICULAR FONT, STYLE, SIZE, OR COLOR.

NO CLAIM IS MADE TO THE EXCLUSIVE RIGHT TO USE "GOURMET", APART FROM THE MARK AS SHOWN.

FOR VIRGIN CULINARY OILS MADE FROM SEEDS, VEGETABLES, NUTS OR FRUITS EXCLUDING PALM, AND BLENDS THEREOF; COLD PRESSED VIRGIN CULINARY OILS MADE FROM SEEDS, VEGETABLES, NUTS OR FRUITS EXCLUDING PALM, AND BLENDS THEREOF; EXTRA VIRGIN COLD PRESSED CULINARY OILS MADE FROM SEEDS, VEGETABLES, NUTS OR FRUITS EXCLUDING PALM, AND BLENDS THEREOF (U.S. CL. 46).

DONALD JOHNSON, EXAMINING ATTORNEY

SN 86-026,213. D & Y CHEESE, INC., CORFU, NY. FILED 8-1-2013.

**STEAKHOUSE ONION**

THE MARK CONSISTS OF STANDARD CHARACTERS WITHOUT CLAIM TO ANY PARTICULAR FONT, STYLE, SIZE, OR COLOR.

NO CLAIM IS MADE TO THE EXCLUSIVE RIGHT TO USE "ONION", APART FROM THE MARK AS SHOWN.

FOR CHEESE (U.S. CL. 46).

FIRST USE 6-13-2011; IN COMMERCE 6-13-2011.

LINDA MICKLEBURGH, EXAMINING ATTORNEY

SN 86-027,362. BARBARA LYNCH INSTANT NUTRITION COMPANY, INC., BOSTON, MA. FILED 8-2-2013.

**Barbara Lynch Made**

THE MARK CONSISTS OF STANDARD CHARACTERS WITHOUT CLAIM TO ANY PARTICULAR FONT, STYLE, SIZE, OR COLOR.

THE NAME(S), PORTRAIT(S), AND/OR SIGNATURE(S) SHOWN IN THE MARK IDENTIFIES "BARBARA LYNCH", WHOSE CONSENT(S) TO REGISTER IS MADE OF RECORD.

FOR DRIED FRUIT AND VEGETABLES; DRIED VEGETABLES; DRIED VEGETABLES, NAMELY, WHOLE SLICED VEGETABLES THAT ARE SLOW AIR DRIED (U.S. CL. 46).

GRETCHEN ULRICH, EXAMINING ATTORNEY

**CLASS 29—(Continued).**

SN 86-031,214. MOORE, JEFFREY, DRIVE, TX. FILED 8-7-2013.

**CURLY WINGS**

THE MARK CONSISTS OF STANDARD CHARACTERS WITHOUT CLAIM TO ANY PARTICULAR FONT, STYLE, SIZE, OR COLOR.

NO CLAIM IS MADE TO THE EXCLUSIVE RIGHT TO USE "WINGS", APART FROM THE MARK AS SHOWN.

FOR CHICKEN; CHICKEN WINGS (U.S. CL. 46).

EMILY CARLSEN, EXAMINING ATTORNEY

SN 86-032,904. BENTON SMOKY MOUNTAIN COUNTRY HAMS, INC., MADISONVILLE, TN. FILED 8-8-2013.

**BENTON'S**

THE MARK CONSISTS OF STANDARD CHARACTERS WITHOUT CLAIM TO ANY PARTICULAR FONT, STYLE, SIZE, OR COLOR.

SEC. 2(F).

FOR BACON; HAM; SAUSAGES (U.S. CL. 46).

FIRST USE 10-1-1978; IN COMMERCE 10-1-1978.

GIANCARLO CASTRO, EXAMINING ATTORNEY

SN 86-033,380. END TIMES GROUP, INC., SEFFNER, FL. FILED 8-9-2013.



NO CLAIM IS MADE TO THE EXCLUSIVE RIGHT TO USE "PREMIUM OAK - WOOD SMOKED BEEF JERKY" AND "BARBEQUE", APART FROM THE MARK AS SHOWN.

THE STIPPLING IS FOR SHADING PURPOSES.

THE MARK CONSISTS OF THE STYLIZED WORDS "PREMIUM OAK" - "WOOD SMOKED BEEF JERKY END TIMES BARBEQUE ENDTIMESBBQ.COM", WITH A CARTOON FIGURE OF JESUS IN THE CENTER, FACING A STEAK ON A GRILL.

FOR BEEF JERKY (U.S. CL. 46).

FIRST USE 4-6-2013; IN COMMERCE 6-1-2013.

ESTHER BELENKER, EXAMINING ATTORNEY

**CLASS 29—(Continued).**

SN 86-037,800. JONMOR INVESTMENTS, INC., WILMINGTON, DE. FILED 8-14-2013.



OWNER OF U.S. REG. NOS. 4,013,319 AND 4,196,013.  
NO CLAIM IS MADE TO THE EXCLUSIVE RIGHT TO USE "HEALTHY", APART FROM THE MARK AS SHOWN.  
THE COLOR(S) GREEN, BLUE AND WHITE IS/ARE CLAIMED AS A FEATURE OF THE MARK.  
THE MARK CONSISTS OF THE WORDS "HEALTHY ONES" IN THE COLOR WHITE IN STYLIZED FONT, WITH THE WORD "ONES" POSITIONED BELOW THE WORD "HEALTHY", BOTH WORDS POSITIONED IN THE MIDDLE OF A BLUE OVAL OUTLINED BY A GREEN OUTER OVAL. A HEART IS CONNECTED TO THE "S" ON THE WORD "ONES".  
FOR DELI MEATS (U.S. CL. 46).  
ARETHA SOMERVILLE, EXAMINING ATTORNEY

SN 86-039,249. STONYFIELD FARM, INC., LONDONDERY, NH. FILED 8-15-2013.

**OBSESSIVELY ORGANIC.  
PURELY DELICIOUS.**

THE MARK CONSISTS OF STANDARD CHARACTERS WITHOUT CLAIM TO ANY PARTICULAR FONT, STYLE, SIZE, OR COLOR.  
FOR ORGANIC DAIRY PRODUCTS EXCLUDING ICE CREAM, ICE MILK AND FROZEN YOGURT (U.S. CL. 46).  
FIRST USE 7-12-2013; IN COMMERCE 8-14-2013.  
MELISSA VALLILLO, EXAMINING ATTORNEY

**CLASS 29—(Continued).**

SN 86-040,011. MALESIS, GEORGIA, CARLSBAD, CA. FILED 8-16-2013.



THE COLOR(S) YELLOW, BLUE, AND GREEN IS/ARE CLAIMED AS A FEATURE OF THE MARK.  
THE MARK CONSISTS OF THE STYLIZED WORDING "YOG-OATS" COMPRISED OF DARKER AND LIGHTER SHADES OF BLUE. THERE IS A YELLOW SUN OUTLINED WITH BLUE TO THE LEFT OF THE WORDING AND A GREEN UNDERSCORE OUTLINED IN BLUE BENEATH THE SUN AND THE WORDING.  
FOR DAIRY PRODUCTS EXCLUDING ICE CREAM, ICE MILK AND FROZEN YOGURT; GREEK YOGURT; MILK PRODUCTS EXCLUDING ICE CREAM, ICE MILK AND FROZEN YOGURT; ORGANIC DAIRY PRODUCTS EXCLUDING ICE CREAM, ICE MILK AND FROZEN YOGURT; YOGURT; YOGURTS; ALL THE FOREGOING GOODS CONTAINING OATS AS AN INGREDIENT (U.S. CL. 46).  
ESTHER BELENKER, EXAMINING ATTORNEY

SN 86-042,228. CATTENEO, RAYMOND C., SAN LUIS OBISPO, CA. AND CATTANEO, NINA-MARIE, SAN LUIS OBISPO, CA. FILED 8-19-2013.

**RAY'S OWN BRAND**

THE MARK CONSISTS OF STANDARD CHARACTERS WITHOUT CLAIM TO ANY PARTICULAR FONT, STYLE, SIZE, OR COLOR.  
NO CLAIM IS MADE TO THE EXCLUSIVE RIGHT TO USE "BRAND", APART FROM THE MARK AS SHOWN.  
FOR MEAT (U.S. CL. 46).  
FIRST USE 1-1-2003; IN COMMERCE 1-1-2003.  
CHRISTINA SOBRAL, EXAMINING ATTORNEY

SN 86-051,649. CHS INC., INVER GROVE HEIGHTS, MN. FILED 8-29-2013.



OWNER OF U.S. REG. NO. 2,381,300.  
NO CLAIM IS MADE TO THE EXCLUSIVE RIGHT TO USE "EGGS", APART FROM THE MARK AS SHOWN.  
THE MARK CONSISTS OF THE WORDS "HAMILTON EGGS" IN A STYLIZED FORM WITH THE "G'S IN THE WORD "EGGS" USING A STYLIZED EGG SHAPE.  
FOR EGGS (U.S. CL. 46).  
ZACHARY CROMER, EXAMINING ATTORNEY

**CLASS 29—(Continued).**

SN 86-054,523. FARM FRESH FOOD SUPPLIERS, INC., AMITE, LA. FILED 9-3-2013.



THE MARK CONSISTS OF A BARN AND SILO DESIGN. FOR MEAT-BASED SNACK FOODS (U.S. CL. 46). FIRST USE 6-3-1983; IN COMMERCE 6-3-1983. JOHN KELLY, EXAMINING ATTORNEY

SN 86-061,221. DIMATTIA, CHRISTOPHER, CHARLESTON, SC. FILED 9-11-2013.

**TATER TACHOS**

THE MARK CONSISTS OF STANDARD CHARACTERS WITHOUT CLAIM TO ANY PARTICULAR FONT, STYLE, SIZE, OR COLOR.

NO CLAIM IS MADE TO THE EXCLUSIVE RIGHT TO USE "TATER", APART FROM THE MARK AS SHOWN.

FOR PREPARED ENTREES, NAMELY, RESTAURANT MENU ITEM CONSISTING PRIMARILY OF POTATOES, SEASONED HASH BROWN POTATOES FORMED INTO SMALL CYLINDRICAL SHAPES, AND CHEESE (U.S. CL. 46).

FIRST USE 4-15-2008; IN COMMERCE 4-15-2008. SUSAN RICHARDS, EXAMINING ATTORNEY

SN 86-064,102. SUN WORLD INTERNATIONAL, LLC, BAKERSFIELD, CA. FILED 9-13-2013.

**SUN WORLD**

THE MARK CONSISTS OF STANDARD CHARACTERS WITHOUT CLAIM TO ANY PARTICULAR FONT, STYLE, SIZE, OR COLOR.

OWNER OF U.S. REG. NOS. 1,061,802, 1,133,787 AND 1,853,223.

FOR DRIED FRUITS (U.S. CL. 46). SUI DUONG, EXAMINING ATTORNEY

**CLASS 29—(Continued).**

SN 86-065,246. THE BRINERY, LLC, ANN ARBOR, MI. FILED 9-16-2013.

**THE BRINERY STIMULATING  
YOUR INNER ECONOMY**

THE MARK CONSISTS OF STANDARD CHARACTERS WITHOUT CLAIM TO ANY PARTICULAR FONT, STYLE, SIZE, OR COLOR.

FOR FERMENTED VEGETABLES (U.S. CL. 46).

FIRST USE 4-8-2010; IN COMMERCE 4-8-2010.

DEBORAH MEINERS, EXAMINING ATTORNEY

SN 86-066,132. THENUTFACTORY.COM, BERLIN, CT. FILED 9-16-2013.

**The Temptery**

THE MARK CONSISTS OF STANDARD CHARACTERS WITHOUT CLAIM TO ANY PARTICULAR FONT, STYLE, SIZE, OR COLOR.

FOR DRIED FRUITS; NUT-BASED SNACK FOODS; PROCESSED NUTS (U.S. CL. 46).

SHAILA LEWIS, EXAMINING ATTORNEY

SN 86-066,683. ANDERSON INTERNATIONAL FOODS, INC., JERSEY CITY, NJ. FILED 9-17-2013.

**SINCERELY, BRIGITTE**

THE MARK CONSISTS OF STANDARD CHARACTERS WITHOUT CLAIM TO ANY PARTICULAR FONT, STYLE, SIZE, OR COLOR.

OWNER OF U.S. REG. NO. 3,305,720.

FOR CHEESE (U.S. CL. 46).

FIRST USE 11-14-2006; IN COMMERCE 11-14-2006.

HEATHER THOMPSON, EXAMINING ATTORNEY

**CLASS 29—(Continued).**

SN 86-066,945. STRAUSS FRESH FOODS LTD., PETACH TIKVA, ISRAEL, FILED 9-17-2013.

# ACHLA

THE MARK CONSISTS OF STANDARD CHARACTERS WITHOUT CLAIM TO ANY PARTICULAR FONT, STYLE, SIZE, OR COLOR.

OWNER OF U.S. REG. NO. 2,991,012.  
THE ENGLISH TRANSLATION OF "ACHLA" IN THE MARK IS "GOOD OR GREAT".  
FOR DIPS; VEGETABLE SALADS; VEGETABLE-BASED SPREADS (U.S. CL. 46).  
MARY ROSSMAN, EXAMINING ATTORNEY

**CLASS 29—(Continued).**

SN 86-068,922. CHOBANI, INC., NORWICH, NY. FILED 9-19-2013.

# HOW MATTERS

THE MARK CONSISTS OF STANDARD CHARACTERS WITHOUT CLAIM TO ANY PARTICULAR FONT, STYLE, SIZE, OR COLOR.

FOR YOGURT; GREEK YOGURT; DAIRY PRODUCTS EXCLUDING ICE CREAM, ICE MILK AND FROZEN YOGURT (U.S. CL. 46).  
NAKIA HENRY, EXAMINING ATTORNEY

SN 86-067,081. BOOTS CHICAGO LLC, CHICAGO, IL. FILED 9-17-2013.

# Village Batch

THE MARK CONSISTS OF STANDARD CHARACTERS WITHOUT CLAIM TO ANY PARTICULAR FONT, STYLE, SIZE, OR COLOR.

FOR OLIVE OIL FOR CONSUMPTION (U.S. CL. 46).  
FIRST USE 7-7-2013; IN COMMERCE 8-7-2013.  
KAELIE KUNG, EXAMINING ATTORNEY

SN 86-069,166. YODELAY YOGURT, LLC., VERONA, WI. FILED 9-19-2013.

# YODELAY

THE MARK CONSISTS OF STANDARD CHARACTERS WITHOUT CLAIM TO ANY PARTICULAR FONT, STYLE, SIZE, OR COLOR.

FOR YOGURT (U.S. CL. 46).  
FIRST USE 9-26-2011; IN COMMERCE 9-26-2011.  
MARCIE MILONE, EXAMINING ATTORNEY

SN 86-067,888. ADAM WEINER, HYANNIS, MA. FILED 9-18-2013.

# Nantucket LightChip

THE MARK CONSISTS OF STANDARD CHARACTERS WITHOUT CLAIM TO ANY PARTICULAR FONT, STYLE, SIZE, OR COLOR.

FOR POTATO CHIPS; POTATO CRISPS; POTATO CRISPS AND CHIPS; POTATO FRIES; POTATO PUFFS; POTATO-BASED SNACK FOODS; PROCESSED POTATOES; PROCESSED SWEET POTATOES (U.S. CL. 46).  
TRACY CROSS, EXAMINING ATTORNEY

SN 86-070,264. LODERS CROKLAAN B.V., WORMERVEER, NETHERLANDS, FILED 9-20-2013.

# FUSERITE

THE MARK CONSISTS OF STANDARD CHARACTERS WITHOUT CLAIM TO ANY PARTICULAR FONT, STYLE, SIZE, OR COLOR.

FOR EDIBLE OILS AND FATS; NON HYDROGENATED BAKERY SHORTENINGS; SHORTENINGS FOR BAKERY GOODS WHICH EITHER REPLACE A FLAVOR OR IMPART A FLAVOR AND/OR COLOR INTO THE GOODS (U.S. CL. 46).  
ANDREA HACK, EXAMINING ATTORNEY

**CLASS 29—(Continued).**

SN 86-070,772. SMITH, ROB, MCKINNEY, TX. FILED 9-20-2013.

# TotDogs

THE MARK CONSISTS OF STANDARD CHARACTERS WITHOUT CLAIM TO ANY PARTICULAR FONT, STYLE, SIZE, OR COLOR.

FOR PROCESSED SAUSAGE ENCASED IN SHREDDED POTATOES (U.S. CL. 46).  
ERNEST SHOSHO, EXAMINING ATTORNEY

**CLASS 29—(Continued).**

SN 86-072,043. ALDI INC., BATAVIA, IL. FILED 9-23-2013.

# FIT & ACTIVE

THE MARK CONSISTS OF STANDARD CHARACTERS WITHOUT CLAIM TO ANY PARTICULAR FONT, STYLE, SIZE, OR COLOR.

OWNER OF U.S. REG. NOS. 3,055,975, 3,228,334 AND 3,327,112.  
FOR EGG WHITES (U.S. CL. 46).  
FIRST USE 7-16-2013; IN COMMERCE 7-16-2013.  
ALEX KEAM, EXAMINING ATTORNEY

SN 86-070,915. SUPERFUZION, LLC, MIAMI, FL. FILED 9-20-2013.

# SUPERFUZION

THE MARK CONSISTS OF STANDARD CHARACTERS WITHOUT CLAIM TO ANY PARTICULAR FONT, STYLE, SIZE, OR COLOR.

FOR NUT BUTTERS; SNACK MIX CONSISTING PRIMARILY OF PROCESSED NUTS, AND ALSO INCLUDING SEEDS, DRIED FRUITS AND GRAINS, AND CHOCOLATE; ORGANIC NUT, SEED, FRUIT AND GRAIN-BASED SNACK BARS (U.S. CL. 46).

FIRST USE 9-17-2013; IN COMMERCE 9-17-2013.  
BARBARA A. GOLD, EXAMINING ATTORNEY

SN 86-075,320. GENERAL MILLS MARKETING, INC., MINNEAPOLIS, MN. FILED 9-26-2013.

# TROPICAL TERROR

THE MARK CONSISTS OF STANDARD CHARACTERS WITHOUT CLAIM TO ANY PARTICULAR FONT, STYLE, SIZE, OR COLOR.

OWNER OF U.S. REG. NOS. 2,555,914 AND 3,555,011.  
NO CLAIM IS MADE TO THE EXCLUSIVE RIGHT TO USE "TROPICAL", APART FROM THE MARK AS SHOWN.  
FOR FRUIT-BASED SNACK FOOD (U.S. CL. 46).  
FIRST USE 8-19-2013; IN COMMERCE 8-19-2013.  
ZACHARY CROMER, EXAMINING ATTORNEY

SN 86-071,788. KENNETH ROCHFORD, DBA SCHOOL GARDEN PRESERVES, CLOVERDALE, CA. FILED 9-23-2013.

# SCHOOL GARDEN

THE MARK CONSISTS OF STANDARD CHARACTERS WITHOUT CLAIM TO ANY PARTICULAR FONT, STYLE, SIZE, OR COLOR.

FOR JAMS AND MARMALADES (U.S. CL. 46).  
FIRST USE 4-4-2011; IN COMMERCE 12-17-2011.  
ELISSA GARBER KON, EXAMINING ATTORNEY

SN 86-078,585. FARM FRESH FOOD SUPPLIERS, INC., AMITE, LA. FILED 9-30-2013.

# MATT & DANA

THE MARK CONSISTS OF STANDARD CHARACTERS WITHOUT CLAIM TO ANY PARTICULAR FONT, STYLE, SIZE, OR COLOR.

FOR MEAT-BASED SNACK FOODS (U.S. CL. 46).  
FIRST USE 1-1-1986; IN COMMERCE 1-1-1986.  
JOHN KELLY, EXAMINING ATTORNEY



**CLASS 29—(Continued).**

SN 86-088,708. BUNGE OILS, INC., ST. LOUIS, MO. FILED 10-10-2013.



NO CLAIM IS MADE TO THE EXCLUSIVE RIGHT TO USE "GOURMET", "EXTRA VIRGIN COLD PRESSED SUNFLOWER OIL" AND THE REPRESENTATION OF A SUNFLOWER, APART FROM THE MARK AS SHOWN.

THE COLOR(S) BLACK, WHITE, YELLOW, REDDISH-BROWN AND DARK BROWN IS/ARE CLAIMED AS A FEATURE OF THE MARK.

THE MARK CONSISTS OF THE WORDS "PRISTINE GOURMET" IN BLACK LETTERS ABOVE THE WORDS "EXTRA VIRGIN" WITH A LINE FLOURISH IN BETWEEN, ABOVE THE WORDS "COLD PRESSED SUNFLOWER OIL" IN WHITE LETTERS ON A BLACK RECTANGULAR BACKGROUND WITH A WHITE PERIMETER LINE, AND A STYLIZED SUNFLOWER HEAD THEREBELOW IN THE COLORS YELLOW, REDDISH BROWN AND DARK BROWN.

FOR VIRGIN CULINARY OILS MADE FROM SEEDS, VEGETABLES, NUTS OR FRUITS EXCLUDING PALM AND BLENDS THEREOF; COLD PRESSED VIRGIN CULINARY OILS MADE FROM SEEDS, VEGETABLES, NUTS OR FRUITS EXCLUDING PALM, AND BLENDS THEREOF; EXTRA VIRGIN COLD PRESSED CULINARY OILS MADE FROM SEEDS, VEGETABLES, NUTS OR FRUITS EXCLUDING PALM, AND BLENDS THEREOF (U.S. CL. 46).

DONALD JOHNSON, EXAMINING ATTORNEY

**CLASS 29—(Continued).**

SN 86-107,063. TURNER DAIRY FARMS, INC., PITTSBURGH, PA. FILED 10-31-2013.



NO CLAIM IS MADE TO THE EXCLUSIVE RIGHT TO USE "HIGHER STANDARD", APART FROM THE MARK AS SHOWN.

THE MARK CONSISTS OF A STYLIZED COW WITH A STYLIZED HORIZON INSIDE A STYLIZED SUN BURST WITH A STYLIZED BANNER CONTAINING THE WORDING "A HIGHER STANDARD" BENEATH THE COW.

FOR MILK, VANILLA MILK, STRAWBERRY MILK, BUTTERMILK AND BUTTER (U.S. CL. 46).

FIRST USE 6-30-2002; IN COMMERCE 6-30-2002.  
BRITTANY ESTELL, EXAMINING ATTORNEY

SN 86-115,831. SPIELBERG, MAX, LOS ANGELES, CA. FILED 11-11-2013.

**RENEW**

THE MARK CONSISTS OF STANDARD CHARACTERS WITHOUT CLAIM TO ANY PARTICULAR FONT, STYLE, SIZE, OR COLOR.

FOR DAIRY-BASED FOOD BEVERAGES (U.S. CL. 46).  
JAMES LOVELACE, EXAMINING ATTORNEY

**CLASS 29—(Continued).**

SN 86-122,301. PONTE DA CAMARA, MARTA, DBA NIBNAKS, PALO ALTO, CA. FILED 11-19-2013.



THE MARK CONSISTS OF THE TERM "NIBNAKS" IN STYLIZED FONT.

FOR TRAIL MIX CONSISTING PRIMARILY OF PROCESSED NUTS, AND ALSO INCLUDING DRIED FRUITS; SNACK MIX CONSISTING OF DEHYDRATED FRUIT AND PROCESSED NUTS; SNACK MIX CONSISTING OF PRIMARILY OF PROCESSED NUTS, SEEDS, DRIED FRUIT AND ALSO INCLUDING CHOCOLATE; SNACK MIX CONSISTING PRIMARILY OF PROCESSED FRUITS, PROCESSED NUTS AND/OR RAISINS; TRAIL MIX CONSISTING PRIMARILY OF PROCESSED NUTS, SEEDS, DRIED FRUIT AND ALSO INCLUDING CHOCOLATE (U.S. CL. 46).

FIRST USE 7-1-2012; IN COMMERCE 7-1-2012.  
MATTHEW GALAN, EXAMINING ATTORNEY

---

SN 86-127,729. SPIELBERG, MAX, LOS ANGELES, CA. FILED 11-24-2013.



THE MARK CONSISTS OF STANDARD CHARACTERS WITHOUT CLAIM TO ANY PARTICULAR FONT, STYLE, SIZE, OR COLOR.

FOR DAIRY-BASED BEVERAGES (U.S. CL. 46).  
JAMES LOVELACE, EXAMINING ATTORNEY

---

SN 86-133,461. DEAN FOODS COMPANY, DALLAS, TX. FILED 12-3-2013.



THE MARK CONSISTS OF STANDARD CHARACTERS WITHOUT CLAIM TO ANY PARTICULAR FONT, STYLE, SIZE, OR COLOR.

OWNER OF U.S. REG. NO. 3,875,009.  
FOR DAIRY-BASED BEVERAGES (U.S. CL. 46).  
MICHAEL TANNER, EXAMINING ATTORNEY

**CLASS 30—STAPLE FOODS**

SN 79-126,072. ARAN ARD TEORANTA, IRELAND, FILED 1-10-2013.



OWNER OF INTERNATIONAL REGISTRATION 1131151 DATED 2-16-2012, EXPIRES 2-16-2022.

NO CLAIM IS MADE TO THE EXCLUSIVE RIGHT TO USE "BAKERY GLUTEN & WHEAT FREE", APART FROM THE MARK AS SHOWN.

THE COLOR(S) RED, BLACK, WHITE, AND GREY IS/ARE CLAIMED AS A FEATURE OF THE MARK.

THE MARK CONSISTS OF A HANGING SIGN IN THE COLORS BLACK, RED AND GREY WITH THE WORDS "PURE BRED BAKERY GLUTEN & WHEAT FREE" IN WHITE, WITH THE DESIGN OF A BUTTERFLY IN THE COLOR RED ON THE TOP OF THE SIGN.

FOR BREAD; CAKES, NAMELY, FRUIT LOAVES; SCONES; PANCAKES; PASTRY; TARTS; PIES; CAKES; BISCUITS; COOKIES; ALL BEING GLUTEN FREE (U.S. CL. 46).

ANNE E. GUSTASON, EXAMINING ATTORNEY

---

SN 79-131,763. LANTMÄNNEN EK. FÖR., SWEDEN, FILED 4-10-2013.

**SCHULSTAD BAKERY SOLUTIONS**

THE MARK CONSISTS OF STANDARD CHARACTERS WITHOUT CLAIM TO ANY PARTICULAR FONT, STYLE, SIZE, OR COLOR.

PRIORITY DATE OF 3-21-2013 IS CLAIMED.

OWNER OF INTERNATIONAL REGISTRATION 1164509 DATED 4-10-2013, EXPIRES 4-10-2023.

OWNER OF U.S. REG. NO. 3,121,010.

NO CLAIM IS MADE TO THE EXCLUSIVE RIGHT TO USE "BAKERY", APART FROM THE MARK AS SHOWN.

FOR COFFEE, TEA, COCOA AND ARTIFICIAL COFFEE; RICE; TAPIOCA AND SAGO; ICES; SUGAR; HONEY; TREACLE; YEAST, BAKING POWDER; SALT; MUSTARD; VINEGAR, SAUCES; SPICES; ICE; FLOUR AND PREPARATIONS MADE FROM CEREALS, NAMELY, GRANOLA SNACKS, CEREAL BARS, CEREAL BASED SNACK FOODS AND CEREAL BASED ENERGY BARS; SNACK FOODS CONSISTING MAINLY OF BREAD WITH FILLINGS OR TOPPINGS; BREAD AND PASTRY, INCLUDING DANISH PASTRY, CROISSANTS, RYE BREAD, WHEAT BREAD IN THE NATURE OF BAGUETTES, BREAKFAST ROLLS, SANDWICH LOAFS AND BUNS, CAKES AND MUFFINS, ALL THE AFORESAID GOODS IN THE FORM OF READY-MADE PRODUCTS, PRE-RISED DOUGH AND IN FROZEN FORM (U.S. CL. 46).

KATHERINE CONNOLLY, EXAMINING ATTORNEY

**CLASS 30—(Continued).**

SN 79-135,946. SONAFI, FRANCE, FILED 7-5-2013.

# BAHIBE

THE MARK CONSISTS OF STANDARD CHARACTERS WITHOUT CLAIM TO ANY PARTICULAR FONT, STYLE, SIZE, OR COLOR.

PRIORITY DATE OF 3-12-2013 IS CLAIMED.

OWNER OF INTERNATIONAL REGISTRATION 1175060 DATED 7-5-2013, EXPIRES 7-5-2023.

THE WORD(S) "BAHIBE" HAS NO MEANING IN A FOREIGN LANGUAGE.

FOR COCOA: COCOA PRODUCTS, NAMELY, COCOA-BASED INGREDIENT IN CONFECTIONERY PRODUCTS; CHOCOLATE; CHOCOLATE PRODUCTS, NAMELY, CHOCOLATE BARS AND CHOCOLATE CONFECTIONS (U.S. CL. 46).

JANICE KIM, EXAMINING ATTORNEY

**CLASS 30—(Continued).**

SN 85-361,916. HILLBILLY SPECIALTIES, LLC, LEXINGTON, KY. FILED 7-1-2011.



NO CLAIM IS MADE TO THE EXCLUSIVE RIGHT TO USE "MARINADE", APART FROM THE MARK AS SHOWN.

THE MARK CONSISTS OF THE WORD "MOONSHINE" ABOVE THE LETTERS "XXX" INSIDE A SOLID OVAL, INSIDE A LINED OVAL, WHICH IS ABOVE THE WORD "MARINADE".

FOR GRILLING, BASTING AND COOKING SAUCES (U.S. CL. 46).

FIRST USE 9-29-2011; IN COMMERCE 9-29-2011.  
SAIMA MAKHDOOM, EXAMINING ATTORNEY

SN 85-053,675. DORA'S NATURALS, INC., SOUTH HACKENSACK, NJ. FILED 6-3-2010.

# ZEN

THE MARK CONSISTS OF STANDARD CHARACTERS WITHOUT CLAIM TO ANY PARTICULAR FONT, STYLE, SIZE, OR COLOR.

OWNER OF U.S. REG. NO. 3,043,429.

FOR PUDDING; LIVE CULTURE NON-DAIRY ORGANIC DESSERT PUDDINGS (U.S. CL. 46).

FIRST USE 8-0-2011; IN COMMERCE 8-0-2011.

NELSON SNYDER, EXAMINING ATTORNEY

SN 85-421,995. LEE &amp; LEE, INC., DBA 4CS ASIAN AMERICAN GRILLE, GREEN BAY, WI. FILED 9-14-2011.

SN 85-213,954. GRUPO BIMBO, S.A. B. DE C.V., MEXICO CITY, MEXICO, FILED 1-10-2011.

# MOLI

THE MARK CONSISTS OF STANDARD CHARACTERS WITHOUT CLAIM TO ANY PARTICULAR FONT, STYLE, SIZE, OR COLOR.

OWNER OF COSTA RICA REG. NO. 123362, DATED 12-14-2000, EXPIRES 12-14-2020.

OWNER OF U.S. REG. NO. 3,884,152.

FOR CRACKERS AND DONUTS (U.S. CL. 46).

JEFF DEFORD, EXAMINING ATTORNEY

# PACKER BURGER

THE MARK CONSISTS OF STANDARD CHARACTERS WITHOUT CLAIM TO ANY PARTICULAR FONT, STYLE, SIZE, OR COLOR.

NO CLAIM IS MADE TO THE EXCLUSIVE RIGHT TO USE "BURGER", APART FROM THE MARK AS SHOWN.

FOR HAMBURGER SANDWICHES (U.S. CL. 46).

FIRST USE 1-26-2011; IN COMMERCE 1-26-2011.

SKYE YOUNG, EXAMINING ATTORNEY

**CLASS 30—(Continued).**

SN 85-480,769. SHASHA BREAD COMPANY INC., TORONTO, ONTARIO, CANADA, FILED 11-25-2011.



PRIORITY CLAIMED UNDER SEC. 44(D) ON CANADA APPLICATION NO. 1544778, FILED 9-22-2011, REG. NO. 838457, DATED 12-14-2012, EXPIRES 12-14-2027.

THE MARK CONSISTS OF THE SILHOUETTE DESIGN OF A MAN WITH VINES WITH LEAVES WRAPPED AROUND HIS HEAD, BODY AND LEGS. THERE IS A WAVY LINE BELOW THE FIGURE AND THE WORDS "BIO-BODY" ABOVE THE LINE AND BETWEEN THE LEGS.

FOR BAKED GOODS, NAMELY, BREADS, CAKES, COOKIES, PASTRIES, PIZZA CRUSTS, AND PASTA; SEEDS, NAMELY, PROCESSED EDIBLE SEEDS; SPROUTED GRAINS, NAMELY, SPROUTED GRAINS PROCESSED FOR EATING; CEREALS, NAMELY, BREAKFAST CEREALS (U.S. CL. 46).

ANNE FARRELL, EXAMINING ATTORNEY

SN 85-645,095. CARDIELLO, ELISABETH, STATEN ISLAND, NY. FILED 6-6-2012.

# UNIMATIC

THE MARK CONSISTS OF STANDARD CHARACTERS WITHOUT CLAIM TO ANY PARTICULAR FONT, STYLE, SIZE, OR COLOR.

FOR COFFEE; COFFEE; COFFEE AND COFFEE SUBSTITUTES; COFFEE AND TEA; COFFEE BASED BEVERAGES; COFFEE BEANS; GROUND COFFEE BEANS; ROASTED COFFEE BEANS (U.S. CL. 46).

NORA BUCHANAN WILL, EXAMINING ATTORNEY

**CLASS 30—(Continued).**

SN 85-661,466. ROYCE' CONFECT CO., LTD., SAPPORO-SHI, HOKKAIDO, JAPAN, FILED 6-26-2012.



OWNER OF U.S. REG. NOS. 2,976,406 AND 3,462,609.  
NO CLAIM IS MADE TO THE EXCLUSIVE RIGHT TO USE "BATON COOKIES", "COCONUT", "A LONG AND THIN COOKIE COATED WITH FINE CHOCOLATE ON ONE SIDE." AND THE NON-LATIN CHARACTERS THAT TRANSLITERATE TO "BATON KUKKI KOKONATTU", APART FROM THE MARK AS SHOWN.

THE COLOR(S) YELLOW AND BROWN IS/ARE CLAIMED AS A FEATURE OF THE MARK.

THE MARK CONSISTS OF A CONFIGURATION OF YELLOW AND BROWN-COLORED PRODUCT PACKAGING FOR COOKIES CONSISTING OF A YELLOW-COLORED RECTANGLE OUTLINED IN DOTTED LINES FEATURING BROWN-COLORED BRUSHED LINES RESEMBLING PALM FRONDS AND A STYLIZED DESIGN COMPRISED OF THE LETTERS "RRRR" POSITIONED IN A DIAMOND SHAPE ALONG WITH THE WORDING "BATON COOKIES", "COCONUT", "A LONG AND THIN COOKIE COATED WITH FINE CHOCOLATE ON ONE SIDE. A PERFECT MATCH OF ROASTED COCONUT FLAVOR WITH CRUNCHY TEXTURE AND SMOOTH CHOCOLATE MAKES IT IRRESISTIBLE.", "ROYCE" AND "WWW.E-ROYCE.COM" ALL SHOWN IN BROWN STYLIZED FONT AND A BROWN RECTANGLE FEATURING JAPANESE CHARACTERS SHOWN IN YELLOW. THE MATTER SHOWN IN BROKEN OR DOTTED LINES IS NOT PART OF THE MARK AND SERVES ONLY TO SHOW THE POSITION OR PLACEMENT OF THE MARK.

THE ENGLISH TRANSLATION OF "ROIZU BATON KUKKI KOKONATTU" IN THE MARK IS "ROYCE BATON COOKIE COCONUT".

THE NON-LATIN CHARACTERS IN THE MARK TRANSLITERATE TO "ROIZU BATON KUKKI KOKONATTU" AND THIS MEANS "ROYCE BATON COOKIE COCONUT" IN ENGLISH.

FOR COOKIES (U.S. CL. 46).

DAVID YONTEF, EXAMINING ATTORNEY

**CLASS 30—(Continued).**

SN 85-676,129. EMECHE, LLC, BROOKLYN, NY. FILED 7-13-2012.



NO CLAIM IS MADE TO THE EXCLUSIVE RIGHT TO USE "EMECHÉ CUPCAKES", APART FROM THE MARK AS SHOWN.

THE COLOR(S) BLUE AND PURPLE IS/ARE CLAIMED AS A FEATURE OF THE MARK.

THE MARK CONSISTS OF THE WORD "EMECHÉ" IN BLUE LETTERS AND HAS ACCENT MARKS ABOVE THE SECOND AND THIRD "E"'S. NEXT TO THE FIRST "E" IS A CUPCAKE INSIDE OF A MARTINI GLASS. THE CUPCAKE IS BLUE AND PURPLE AND THE MARTINI GLASS IS BLUE. UNDER "EMECHÉ" IS THE WORD "CUPCAKES" THAT HAS PURPLE LETTERS.

THE ENGLISH TRANSLATION OF "EMECHÉ" IN THE MARK IS "TIPSY".

FOR BAKERY GOODS (U.S. CL. 46).  
FIRST USE 11-1-2011; IN COMMERCE 11-15-2011.  
DAVID I, EXAMINING ATTORNEY

**CLASS 30—(Continued).**

SN 85-771,516. GRUPO BIMBO, S.A. B. DE C.V., MEXICO CITY, MEXICO, FILED 11-5-2012.



SN 85-702,186. CHRISTIAN EAST AFRICAN AND EQUATORIAL DEVELOPMENT TRUST, DBA UGANDAN GOLD COFFEE, WEXFORD, PA. FILED 8-13-2012.



OWNER OF U.S. REG. NO. 3,342,690.

NO CLAIM IS MADE TO THE EXCLUSIVE RIGHT TO USE "UGANDAN" AND "GREAT COFFEE", APART FROM THE MARK AS SHOWN.

THE COLOR(S) BLACK, RED, GOLD IS/ARE CLAIMED AS A FEATURE OF THE MARK.

THE MARK CONSISTS OF A BLACK, GOLD AND RED SILHOUETTE OF A MAN CARRING A BASKET OF COFFEE BEANS ON HIS HEAD ON A GOLD BACKGROUND, A BLACK ARCH OVER THE SILHOUETTE WHICH CONTAINS THE RED WORDS "GREAT COFFEE NEW LIFE" WITH A COFFEE BEAN BETWEEN THE WORDS "COFFEE" AND "NEW" AND A BLACK BASE WITH THE WORDS "UGANDAN GOLD".

FOR COFFEE (U.S. CL. 46).  
FIRST USE 12-5-2010; IN COMMERCE 12-5-2010.  
WARREN L. OLANDRIA, EXAMINING ATTORNEY

OWNER OF U.S. REG. NOS. 1,588,057, 3,241,933 AND OTHERS.

NO CLAIM IS MADE TO THE EXCLUSIVE RIGHT TO USE "2 CREME-FILLED CUP CAKES; NET WT. 2.82 OZ (CONT. NET 80G); PER SERVING 290 CALORIES" AND THE PICTORIAL REPRESENTATION OF THE CUPCAKES, APART FROM THE MARK AS SHOWN.

THE COLOR(S) BLUE, WHITE, YELLOW, BLACK, ORANGE, GREEN, BROWN AND RED IS/ARE CLAIMED AS A FEATURE OF THE MARK.

THE MARK CONSISTS OF DESIGN FEATURES AND WORDING ON A SNACK FOOD BAG; THE WORD "MARINELA" IS IN BLUE OUTLINED IN WHITE, THE WORD "PINGUINOS" IS IN WHITE OUTLINED IN BLUE, THE NUMBER "2" IS IN BLUE AGAINST A CIRCLE HAVING A YELLOW AND ORANGE CENTER OUTLINED IN RED. THE WORDING "2 CREME-FILLED CUP CAKES" IS IN WHITE OUTLINED IN RED, THE WORDING "NET WT. 2.82 OZ (CONT. NET 80G)" IS IN WHITE, THE WORDING "PER SERVING 290 CALORIES" IS IN BLUE OUTLINED IN WHITE; THE DESIGN FEATURES TWO CUPCAKES IN BROWN WITH WHITE CRÈME FILLING AND WHITE ICING, WITH A PENGUIN IN BLACK AND WHITE WITH AN ORANGE BEAK WEARING A YELLOW HAT AND GREEN SWEATER STANDING NEXT TO ONE CUPCAKE, AND A PENGUIN IN BLACK AND WHITE WITH AN ORANGE BEAK WEARING BLACK HEADPHONES AND A RED JACKET SITTING ON TOP OF THE OTHER CUPCAKE, ALL AGAINST A BLUE BACKGROUND. THE SHAPE OF THE SNACK FOOD BAG IS NOT CLAIMED AS A PART OF THE MARK. THE DOTTED LINES SHOW THE POSITION OF THE MARK ON THE BAG.

THE ENGLISH TRANSLATION OF "PINGUINOS" IN THE MARK IS "PENGUINS".

THE WORDING "MARINELA" HAS NO MEANING IN A FOREIGN LANGUAGE.

FOR SNACK CAKES (U.S. CL. 46).  
FIRST USE 1-31-2012; IN COMMERCE 1-31-2012.  
KATHY DE JONGE, EXAMINING ATTORNEY

**CLASS 30—(Continued).**

SN 85-785,045. ALIBERT S.R.L., PREGANZIOL (TV), ITALY, FILED 11-21-2012.



OWNER OF U.S. REG. NO. 2,141,735.

NO CLAIM IS MADE TO THE EXCLUSIVE RIGHT TO USE "DAL 1967" AND "ITALY", APART FROM THE MARK AS SHOWN.

THE MARK CONSISTS OF THE WORDS "ENJOY" AND "ITALY" ON EITHER SIDE OF AN OVAL SHAPED SEAL WITH THE WORDS "ALIBERT" AND "DAL 1967" WITHIN THE OVAL SHAPED SEAL.

THE ENGLISH TRANSLATION OF "DAL" IN THE MARK IS "SINCE".

FOR ALIMENTARY PASTA; FILLED ALIMENTARY PASTA; FILLED ALIMENTARY PASTA, NAMELY TORTELLINI, TORTELLONI, AND CAPPELLETTI; PASTA; SPECIAL ALIMENTARY PASTA MADE WITH AND WITHOUT EGG; FLOUR BASED GNOCCHI; BAKERY PRODUCTS; READYMADE, PREPARED, PACKAGED MEALS CONSISTING PRIMARILY OF PASTA, SAUCES AND PASTA SERVED WITH SAUCES; MAYONNAISE (U.S. CL. 46).

COURTNEY ALVAREZ, EXAMINING ATTORNEY

SN 85-810,716. GRANUM, INCORPORATED, SEATTLE, WA. FILED 12-26-2012.



NO CLAIM IS MADE TO THE EXCLUSIVE RIGHT TO USE "ORGANIC TEAS", APART FROM THE MARK AS SHOWN.

THE MARK CONSISTS OF THE STYLIZED WORDING "CHOICE ORGANIC TEAS" WITH THE DOT FOR THE "I" IN "CHOICE" IN THE IMAGE OF STEAM RISING.

SEC. 2(F).

FOR ORGANIC HERBAL TEA; ORGANIC TEA (U.S. CL. 46).

FIRST USE 3-14-1989; IN COMMERCE 3-14-1989.  
KRISTIN DAHLING, EXAMINING ATTORNEY

SN 85-813,452. ZOGG, EDWARD, ONTARIO, NY. FILED 12-31-2012.

## Mission Grounds

THE MARK CONSISTS OF STANDARD CHARACTERS WITHOUT CLAIM TO ANY PARTICULAR FONT, STYLE, SIZE, OR COLOR.

FOR COFFEE BEANS; GROUND COFFEE BEANS (U.S. CL. 46).

JUSTINE D. PARKER, EXAMINING ATTORNEY

**CLASS 30—(Continued).**

SN 85-825,046. DUTCH BROS. L.L.C., GRANTS PASS, OR. FILED 1-16-2013.

## DUTCH COFFEE

THE MARK CONSISTS OF STANDARD CHARACTERS WITHOUT CLAIM TO ANY PARTICULAR FONT, STYLE, SIZE, OR COLOR.

NO CLAIM IS MADE TO THE EXCLUSIVE RIGHT TO USE "COFFEE", APART FROM THE MARK AS SHOWN.

SEC. 2(F) AS TO "DUTCH".

FOR COFFEE BASED BEVERAGES (U.S. CL. 46).

FIRST USE 0-0-1992; IN COMMERCE 0-0-1992.

BRIAN NEVILLE, EXAMINING ATTORNEY

SN 85-826,317. MICHAEL SHEENA, SOUTHFIELD, MI. FILED 1-17-2013.

## EatSmart

THE MARK CONSISTS OF STANDARD CHARACTERS WITHOUT CLAIM TO ANY PARTICULAR FONT, STYLE, SIZE, OR COLOR.

FOR WHITE VINEGAR; APPLE CIDER VINEGAR; RED WINE VINEGAR; PANCAKE SYRUP; COOKIES; KETCHUP; MUSTARD; SALAD DRESSING (U.S. CL. 46).

TINA BROWN, EXAMINING ATTORNEY

SN 85-841,207. THE NATURAL TEA COMPANY (H.K.) LIMITED, HONG KONG, HONG KONG, FILED 2-5-2013.

## FLORTÉ

THE MARK CONSISTS OF STANDARD CHARACTERS WITHOUT CLAIM TO ANY PARTICULAR FONT, STYLE, SIZE, OR COLOR.

OWNER OF U.S. REG. NO. 3,154,695.

FOR TEA, FRUIT INFUSIONS, NAMELY, HERBAL INFUSIONS, FRUIT BASED INFUSIONS, CITRUS INFUSIONS, BERRY INFUSIONS, APPLE INFUSIONS, PASSION FRUIT INFUSIONS AND KIWI INFUSIONS, TEA-BASED BEVERAGES, HONEY, TISANES AND HERBAL TEAS (U.S. CL. 46).

FIRST USE 7-9-2002; IN COMMERCE 6-1-2005.

SANI KHOURI, EXAMINING ATTORNEY

**CLASS 30—(Continued).**

SN 85-854,590. SHEWAKRAMANI, JAYESH, SKOKIE, IL.  
FILED 2-20-2013.

**SHREE GANESHA FOODS**

THE MARK CONSISTS OF STANDARD CHARACTERS  
WITHOUT CLAIM TO ANY PARTICULAR FONT, STYLE,  
SIZE, OR COLOR.

NO CLAIM IS MADE TO THE EXCLUSIVE RIGHT TO  
USE "FOODS", APART FROM THE MARK AS SHOWN.

FOR BAKERY GOODS; BISCUITS; BREAD; CEREAL  
BASED SNACK FOOD; CHUTNEY; COOKIES; EDIBLE  
SPICES; FLOUR; PROCESSED GRAINS; PROCESSED  
WHEAT; RICE; SAUCES; SPICES (U.S. CL. 46).

EVIN L. KOZAK, EXAMINING ATTORNEY

SN 85-856,746. ALPIE LLC, LAUDERHILL, FL. FILED 2-21-  
2013.

**AL PIE**

THE MARK CONSISTS OF STANDARD CHARACTERS  
WITHOUT CLAIM TO ANY PARTICULAR FONT, STYLE,  
SIZE, OR COLOR.

NO CLAIM IS MADE TO THE EXCLUSIVE RIGHT TO  
USE "PIE", APART FROM THE MARK AS SHOWN.

FOR PIES (U.S. CL. 46).

EVIN L. KOZAK, EXAMINING ATTORNEY

SN 85-857,008. BARTEE, CHARLES, PENSACOLA, FL.  
FILED 2-22-2013.

**BARTEE FARMS**

THE MARK CONSISTS OF STANDARD CHARACTERS  
WITHOUT CLAIM TO ANY PARTICULAR FONT, STYLE,  
SIZE, OR COLOR.

NO CLAIM IS MADE TO THE EXCLUSIVE RIGHT TO  
USE "FARMS", APART FROM THE MARK AS SHOWN.

FOR HONEY (U.S. CL. 46).

BARBARA GAYNOR, EXAMINING ATTORNEY

**CLASS 30—(Continued).**

SN 85-858,099. CREAM, INC., MILLBRAE, CA. FILED 2-22-  
2013.

**CREAM COOKIES RULE  
EVERYTHING AROUND ME**

THE MARK CONSISTS OF STANDARD CHARACTERS  
WITHOUT CLAIM TO ANY PARTICULAR FONT, STYLE,  
SIZE, OR COLOR.

OWNER OF U.S. REG. NOS. 4,095,831, 4,114,165 AND  
4,418,046.

NO CLAIM IS MADE TO THE EXCLUSIVE RIGHT TO  
USE "CREAM" AND "COOKIES", APART FROM THE  
MARK AS SHOWN.

FOR ICE CREAM (U.S. CL. 46).

FIRST USE 12-6-2010; IN COMMERCE 12-6-2010.

CARYN GLASSER, EXAMINING ATTORNEY

SN 85-863,445. BOTTOM LINE FOOD PROCESSORS, INC.,  
DBA MICHAEL ANGELO'S GOURMET FOODS, INC.,  
AUSTIN, TX. FILED 2-28-2013.

**MICHAEL ANGELO'S**

THE MARK CONSISTS OF STANDARD CHARACTERS  
WITHOUT CLAIM TO ANY PARTICULAR FONT, STYLE,  
SIZE, OR COLOR.

OWNER OF U.S. REG. NOS. 1,668,677, 2,956,659 AND  
OTHERS.

THE NAME(S), PORTRAIT(S), AND/OR SIGNATURE(S)  
SHOWN IN THE MARK IDENTIFIES "MICHAEL ANGE-  
LO", WHOSE CONSENT(S) TO REGISTER IS MADE OF  
RECORD.

FOR DRIED PASTA (U.S. CL. 46).

JEAN IM, EXAMINING ATTORNEY

SN 85-863,450. BOTTOM LINE FOOD PROCESSORS, INC.,  
DBA MICHAEL ANGELO'S GOURMET FOODS, INC.,  
AUSTIN, TX. FILED 2-28-2013.

**MICHAEL ANGELO'S**

THE MARK CONSISTS OF STANDARD CHARACTERS  
WITHOUT CLAIM TO ANY PARTICULAR FONT, STYLE,  
SIZE, OR COLOR.

OWNER OF U.S. REG. NOS. 1,668,677, 2,956,659 AND  
OTHERS.

THE NAME(S), PORTRAIT(S), AND/OR SIGNATURE(S)  
SHOWN IN THE MARK IDENTIFIES "MICHAEL ANGE-  
LO", WHOSE CONSENT(S) TO REGISTER IS MADE OF  
RECORD.

FOR FROZEN PIZZA (U.S. CL. 46).

JEAN IM, EXAMINING ATTORNEY

**CLASS 30—(Continued).**

SN 85-865,732. NZURI GOURMET, LLC, ELIZABETH, NJ.  
FILED 3-4-2013.

## Nzuri Gourmet

THE MARK CONSISTS OF STANDARD CHARACTERS WITHOUT CLAIM TO ANY PARTICULAR FONT, STYLE, SIZE, OR COLOR.

NO CLAIM IS MADE TO THE EXCLUSIVE RIGHT TO USE "GOURMET", APART FROM THE MARK AS SHOWN. THE ENGLISH TRANSLATION OF "NZURI" IN THE MARK IS "GOOD".

FOR HOT SAUCE; READY-MADE SAUCES (U.S. CL. 46).

FIRST USE 8-5-2012; IN COMMERCE 12-3-2012.  
DARRYL SPRUILL, EXAMINING ATTORNEY

---

SN 85-872,758. CHOCOLAT PLUS, LLC, LAKEWAY, TX.  
FILED 3-11-2013.

## CHOCOLAT PLUS

THE MARK CONSISTS OF STANDARD CHARACTERS WITHOUT CLAIM TO ANY PARTICULAR FONT, STYLE, SIZE, OR COLOR.

NO CLAIM IS MADE TO THE EXCLUSIVE RIGHT TO USE "CHOCOLAT", APART FROM THE MARK AS SHOWN.

THE ENGLISH TRANSLATION OF THE WORD "CHOCOLAT" IN THE MARK IS "CHOCOLATE".

FOR CHOCOLATE; CHOCOLATE AND CHOCOLATES; CHOCOLATE BARS; CHOCOLATE BASED INGREDIENT FOR USE IN ICE CREAM MIX; CHOCOLATE CANDIES; CHOCOLATE CHIPS; CHOCOLATE CONFECTIONS; CHOCOLATE FONDUE; CHOCOLATE FOR TOPPINGS; CHOCOLATE MOUSSE; CHOCOLATE PASTES; CHOCOLATE SAUCE; CHOCOLATE SYRUP; CHOCOLATE TOPPING; CHOCOLATE TRUFFLES; CHOCOLATE-BASED BEVERAGES; CHOCOLATES AND CHOCOLATE BASED READY TO EAT CANDIES AND SNACKS; CHOCOLATES CONTAINING NUTRIENTS; CONFECTIONERIES, NAMELY, SNACK FOODS, NAMELY, CHOCOLATE; FILLED CHOCOLATE; GIFT BASKETS CONTAINING CANDY; GUMMY CANDIES; HOT CHOCOLATE; MILK CHOCOLATE; MIXES FOR CANDY MAKING (U.S. CL. 46).

MARGARET POWER, EXAMINING ATTORNEY

**CLASS 30—(Continued).**

SN 85-873,242. NYC KOLACHE INC., BROOKLYN, NY.  
FILED 3-11-2013.



NO CLAIM IS MADE TO THE EXCLUSIVE RIGHT TO USE "NYC", "KOLACHE" AND "EUROPEAN", APART FROM THE MARK AS SHOWN.

THE MARK CONSISTS OF THE STACKED WORDING, "NYC", "KOLACHE" AND "ORIGINAL EUROPEAN TASTE" IN WHICH THE WORD "KOLACHE" APPEARS INSIDE A BANNER; ABOVE THE BANNER IS THE DESIGN OF A SCALLOPED-EDGED SEAL WITH CONCENTRIC CIRCLES AND STARS, SUPERIMPOSED BY A STATUE OF LIBERTY WEARING A CHEF'S HAT, HOLDING A ROLLING PIN AND TABLET BEARING THE INSCRIPTION "MARCH MMXIII".

FOR KOLACHES (U.S. CL. 46).  
FIRST USE 2-12-2013; IN COMMERCE 3-8-2013.  
FRANK LATTUCA, EXAMINING ATTORNEY

---

SN 85-875,195. GRUPO BIMBO, S.A. B. DE C.V., MEXICO CITY, MEXICO, FILED 3-13-2013.

## SANISSIMO

THE MARK CONSISTS OF STANDARD CHARACTERS WITHOUT CLAIM TO ANY PARTICULAR FONT, STYLE, SIZE, OR COLOR.

OWNER OF U.S. REG. NOS. 2,956,247 AND 4,191,896.

THE ENGLISH TRANSLATION OF "SANISSIMO" IN THE MARK IS "VERY HEALTHY" OR "HEALTHIEST".

SEC. 2(F).

FOR CORN CHIPS (U.S. CL. 46).

FIRST USE 7-23-1997; IN COMMERCE 7-23-1997.  
TASNEEM HUSSAIN, EXAMINING ATTORNEY



**CLASS 30—(Continued).**

SN 85-878,810. SAPORI ANTICHI INTERNATIONAL IMPORT, ELK GROVE VILLAGE, IL. FILED 3-18-2013.



NO CLAIM IS MADE TO THE EXCLUSIVE RIGHT TO USE "GELATO", APART FROM THE MARK AS SHOWN.

THE MARK CONSISTS OF THE STYLIZED TEXT "GELATO" OVER THE STYLIZED TEXT "D'ORO" UNDER A DESIGN OF ICE CREAM WITH CHOCOLATE SAUCE, CRUSHED PEANUTS, AND ORANGE SLICES.

THE ENGLISH TRANSLATION OF "GELATO D'ORO" IN THE MARK IS "GOLD ICE CREAM".

FOR GELATO; SORBET (U.S. CL. 46).

FIRST USE 12-1-2012; IN COMMERCE 12-1-2012.

DOMINIC J. FERRAIUOLO, EXAMINING ATTORNEY

SN 85-882,392. ALIMENTITALIA SRL & CO. SAS, TRENTO, ITALY, FILED 3-21-2013.

**POMODORO & C.**

THE MARK CONSISTS OF STANDARD CHARACTERS WITHOUT CLAIM TO ANY PARTICULAR FONT, STYLE, SIZE, OR COLOR.

OWNER OF U.S. REG. NOS. 3,698,069 AND 3,756,713.

NO CLAIM IS MADE TO THE EXCLUSIVE RIGHT TO USE "POMODORO", APART FROM THE MARK AS SHOWN.

THE ENGLISH TRANSLATION OF "POMODORO" IN THE MARK IS "TOMATO".

FOR PASTA; DRIED PASTA; DRIED STUFFED PASTA; STUFFED PASTA; DOUGH-ENROBED FOODS CONSISTING OF A DOUGH-BASED WRAPPER WITH FILLING CONSISTING PRIMARILY OF FRUITS, VEGETABLES AND CHEESE; FLOUR-BASED GNOCCHI (U.S. CL. 46).

HEATHER THOMPSON, EXAMINING ATTORNEY

**CLASS 30—(Continued).**

SN 85-884,347. ANHING CORPORATION, LOS ANGELES, CA. FILED 3-22-2013.



OWNER OF U.S. REG. NOS. 1,765,348, 3,210,067 AND OTHERS.

THE MARK CONSISTS OF A FANCIFUL OVAL DESIGN OF A DRAGON AND A PHOENIX.

FOR RICE, PROCESSED RICE, DRIED RICE SLICES AND RICE NOODLES (U.S. CL. 46).

FIRST USE 10-23-2012; IN COMMERCE 10-25-2012.

DAVID TAYLOR, EXAMINING ATTORNEY

SN 85-889,242. M2H INVESTMENTS, INC., DBA DILLANOS COFFEE ROASTERS, INC., SUMNER, WA. FILED 3-28-2013.

**AVA BLONDE**

THE MARK CONSISTS OF STANDARD CHARACTERS WITHOUT CLAIM TO ANY PARTICULAR FONT, STYLE, SIZE, OR COLOR.

NO CLAIM IS MADE TO THE EXCLUSIVE RIGHT TO USE "BLONDE", APART FROM THE MARK AS SHOWN.

I, CHRIS HEYER, AS MOTHER/FATHER OF THE MINOR, AVA, DO HEREBY GIVE CONSENT TO REGISTRATION OF THE NAME "AVA BLONDE" AS A TRADEMARK BY M2H INVESTMENTS, INC., DBA DILLANOS COFFEE ROASTERS, INC.

FOR GROUND AND WHOLE BEAN COFFEE, BEVERAGES WITH A COFFEE BASE, AND READY-TO-DRINK COFFEE-BASED BEVERAGES (U.S. CL. 46).

FIRST USE 9-30-2012; IN COMMERCE 9-30-2012.

SUSAN RICHARDS, EXAMINING ATTORNEY

**CLASS 30—(Continued).**

SN 85-901,178. HEB GROCERY COMPANY, LP, SAN ANTONIO, TX. FILED 4-11-2013.



OWNER OF U.S. REG. NOS. 1,840,693, 1,867,930 AND 3,930,507.

NO CLAIM IS MADE TO THE EXCLUSIVE RIGHT TO USE "QUESO ROJO", APART FROM THE MARK AS SHOWN.

THE COLOR(S) RED, WHITE AND BROWN IS/ARE CLAIMED AS A FEATURE OF THE MARK.

THE MARK CONSISTS OF THE LETTERS "H-E-B" IN WHITE, SUPERIMPOSED OVER A RED OVAL WITH A WHITE AND A RED BORDER, ALL ABOVE THE STYLIZED WORDS "QUESO ROJO" IN BROWN.

THE ENGLISH TRANSLATION OF "QUESO ROJO" IN THE MARK IS "RED CHEESE".

FOR PASTA SAUCE (U.S. CL. 46).

AISHA CLARKE, EXAMINING ATTORNEY

**CLASS 30—(Continued).**

SN 85-908,342. SIGNATURE FOOD MARKETING, LLC, PENDERGRASS, GA. FILED 4-18-2013.

## SIGNATURE SELECT

THE MARK CONSISTS OF STANDARD CHARACTERS WITHOUT CLAIM TO ANY PARTICULAR FONT, STYLE, SIZE, OR COLOR.

NO CLAIM IS MADE TO THE EXCLUSIVE RIGHT TO USE "SELECT", APART FROM THE MARK AS SHOWN.

FOR FRUIT COBBLER, FROZEN PREPARED PIZZA, YEAST ROLLS, CHEESEBURGER SLIDERS, TAMALES, PANCAKES, JAMAICAN MEAT PIES (PREPARED), BAGELS, BISCUITS, SAUSAGE BISCUITS, HUSH PUPPIES, CHICKEN SLIDERS, WAFFLES (U.S. CL. 46).

DAVID MURRAY, EXAMINING ATTORNEY

SN 85-906,274. MELENA, MONICA, OXNARD, CA. FILED 4-16-2013.



NO CLAIM IS MADE TO THE EXCLUSIVE RIGHT TO USE "MEXICAN FOOD", APART FROM THE MARK AS SHOWN.

THE NAME "MONICA MELENA" IDENTIFIES A LIVING INDIVIDUAL WHOSE CONSENT IS OF RECORD.

THE COLOR(S) RED, BLUE, GREEN, AND WHITE IS/ARE CLAIMED AS A FEATURE OF THE MARK.

THE MARK CONSISTS OF A STYLIZED DEPICTION OF A FLOWER IN RED AND WHITE ABOVE TWO GREEN LINES MEANT TO DEPICT LEAVES. THE WORDING "MONICA MELENA" APPEARS IN THE COLOR BLUE ABOVE THE WORDING "THE NEW TASTE OF MEXICAN FOOD", WHICH APPEARS IN THE COLOR GREEN.

FOR BURRITOS, CHOCOLATE BASED BEVERAGES WITH MILK, NAMELY, CHAMPURRADO, CORN BASED DRINK IN THE NATURE OF A FOOD BASED BEVERAGE CONSISTING PRIMARILY OF MAIZE AND PORRIDGE, NAMELY, ATOLE, CHOCOLATE, TAMALES, FLAN, COOKIES, MACAROONS, EMPANADAS, DESSERT PUDDINGS, DRESSINGS FOR FOOD, NAMELY, SALAD DRESSINGS, SALSAS; CONDIMENTS FOR SALADS, NAMELY, CROUTONS, AND TORTILLA STRIPS (U.S. CL. 46).

CIMMERIAN COLEMAN, EXAMINING ATTORNEY

SN 85-912,847. BAKERY BOUTIQUE, INC., DBA DONNA B'S GOURMET COOKIES, LAGUNA NIGUEL, CA. FILED 4-24-2013.

Donna B's Frozen Gourmet  
Cookie Dough

THE MARK CONSISTS OF STANDARD CHARACTERS WITHOUT CLAIM TO ANY PARTICULAR FONT, STYLE, SIZE, OR COLOR.

NO CLAIM IS MADE TO THE EXCLUSIVE RIGHT TO USE "FROZEN GOURMET COOKIE DOUGH", APART FROM THE MARK AS SHOWN.

THE NAME(S), PORTRAIT(S), AND/OR SIGNATURE(S) SHOWN IN THE MARK IDENTIFIES "DONNA" BIELKE BILLMAN, WHOSE CONSENT(S) TO REGISTER IS MADE OF RECORD.

FOR FROZEN COOKIE DOUGH (U.S. CL. 46).

FIRST USE 8-17-1993; IN COMMERCE 8-17-1993.

AMY ALFIERI, EXAMINING ATTORNEY

**CLASS 30—(Continued).**

SN 85-922,941. HONEYCOMB PROJECT MANAGEMENT LTD., KENLEY, SURREY, UNITED KINGDOM, FILED 5-3-2013.

**CLASS 30—(Continued).**

SN 85-922,970. HONEYCOMB PROJECT MANAGEMENT LTD., KENLEY, SURREY, UNITED KINGDOM, FILED 5-3-2013.

Monty Bojangles



THE MARK CONSISTS OF STANDARD CHARACTERS WITHOUT CLAIM TO ANY PARTICULAR FONT, STYLE, SIZE, OR COLOR.

OWNER OF UNITED KINGDOM REG. NO. 2580703, DATED 5-9-2011, EXPIRES 5-9-2021.

THE NAME(S), PORTRAIT(S), AND/OR SIGNATURE(S) SHOWN IN THE MARK DOES NOT IDENTIFY A PARTICULAR LIVING INDIVIDUAL.

FOR COFFEE, COFFEE ESSENCES, COFFEE EXTRACTS; MIXTURES OF COFFEE AND CHICORY, CHICORY AND CHICORY MIXTURES, ALL FOR USE AS SUBSTITUTES FOR COFFEE; TEA, TEA EXTRACTS; COCOA; CHOCOLATE; CHOCOLATE PRODUCTS, NAMELY, CHOCOLATE BARS, FILLED CHOCOLATES, ENROBED TRUFFLES, DUSTED TRUFFLES, MOULDED CHOCOLATES, AND HOLLOW MOLDED CHOCOLATE; SUGAR, MALTOSE FOR FOOD, RICE, TAPIOCA, SAGO, COUSCOUS, CONFECTIONERY MADE OF SUGAR AND CANDY, NAMELY, PASTILLES, BOILED CANDIES, GUMMY CANDIES, PRESSED CANDY, FUDGES, TOFFEES, ICES, CHOCOLATE COMPOUND CONFECTIONS, AND BON BONS; BREAKFAST CEREALS; PASTRY; PIZZA, BREAD; BISCUITS; COOKIES; CAKES; ICE, ICE CREAM, WATER ICES, FROZEN CONFECTIONS; HONEY; PREPARATIONS CONSISTING WHOLLY OR SUBSTANTIALLY WHOLLY OF SUGAR, FOR USE AS SUBSTITUTES FOR HONEY; TREACLE, MOLASSES; KETCHUP; CUSTARD POWDER; DESSERTS, NAMELY, CAKES, BISCUITS, CHOCOLATE COVERED CREPES; PUDDINGS; YEAST, BAKING POWDER; SALT, PEPPER, MUSTARD; VINEGAR; CHUTNEY; SPICES AND SEASONINGS; MEAT PIES; MAYONNAISE; MEAT TENDERIZERS FOR HOUSEHOLD PURPOSES; ROYAL JELLY FOR HUMAN CONSUMPTION OTHER THAN FOR MEDICINAL PURPOSES; NATURAL SWEETENERS; SALAD DRESSINGS; SANDWICHES (U.S. CL. 46).

STEVEN PEREZ, EXAMINING ATTORNEY

OWNER OF UNITED KINGDOM REG. NO. 2580714, DATED 5-9-2011, EXPIRES 5-9-2021.

NO CLAIM IS MADE TO THE EXCLUSIVE RIGHT TO USE "FINE CONFECTIONERS OF LONDON", APART FROM THE MARK AS SHOWN.

THE NAME(S), PORTRAIT(S), AND/OR SIGNATURE(S) SHOWN IN THE MARK DOES NOT IDENTIFY A PARTICULAR LIVING INDIVIDUAL.

THE MARK CONSISTS OF A SHADED RECTANGULAR FRAME CONTAINING A SILHOUETTE OF A BACKWARDS FACING CAT WITH THE HEAD FACING TO THE LEFT AND THE TAIL ELONGATED TO THE RIGHT. THE CAT IS LOCATED TO THE RIGHT OF THE WORD "THE" IN STYLIZED FONT AND OVER THE WORDS "MONTY BOJANGLES FINE CONFECTIONERS OF LONDON" IN STYLIZED FONT.

FOR COFFEE, COFFEE ESSENCES, COFFEE EXTRACTS; MIXTURES OF COFFEE AND CHICORY, CHICORY AND CHICORY MIXTURES, ALL FOR USE AS SUBSTITUTES FOR COFFEE; TEA, TEA EXTRACTS; COCOA; CHOCOLATE; CHOCOLATE PRODUCTS, NAMELY, CHOCOLATE BARS, FILLED CHOCOLATES, ENROBED TRUFFLES, DUSTED TRUFFLES, MOULDED CHOCOLATES, AND HOLLOW MOLDED CHOCOLATE; SUGAR, MALTOSE FOR FOOD, RICE, TAPIOCA, SAGO, COUSCOUS, CONFECTIONERY MADE OF SUGAR AND CANDY, NAMELY, PASTILLES, BOILED CANDIES, GUMMY CANDIES, PRESSED CANDY, FUDGES, TOFFEES, ICES, CHOCOLATE COMPOUND CONFECTIONS, AND BON BONS; BREAKFAST CEREALS; PASTRY; PIZZA, BREAD; BISCUITS; COOKIES; CAKES; ICE, ICE CREAM, WATER ICES, FROZEN CONFECTIONS; HONEY; PREPARATIONS CONSISTING WHOLLY OR SUBSTANTIALLY WHOLLY OF SUGAR, FOR USE AS SUBSTITUTES FOR HONEY; TREACLE, MOLASSES; KETCHUP; CUSTARD POWDER; DESSERTS, NAMELY, CAKES, BISCUITS, CHOCOLATE COVERED CREPES; PUDDINGS; YEAST, BAKING POWDER; SALT, PEPPER, MUSTARD; VINEGAR; CHUTNEY; SPICES AND SEASONINGS; MEAT PIES; MAYONNAISE; MEAT TENDERIZERS FOR HOUSEHOLD PURPOSES; ROYAL JELLY FOR HUMAN CONSUMPTION OTHER THAN FOR MEDICINAL PURPOSES; NATURAL SWEETENERS; SALAD DRESSINGS; SANDWICHES (U.S. CL. 46).

STEVEN PEREZ, EXAMINING ATTORNEY

**CLASS 30—(Continued).**

SN 85-923,122. KELLOGG NORTH AMERICA COMPANY, BATTLE CREEK, MI. FILED 5-3-2013.

**EGGO BITES**

THE MARK CONSISTS OF STANDARD CHARACTERS WITHOUT CLAIM TO ANY PARTICULAR FONT, STYLE, SIZE, OR COLOR.

OWNER OF U.S. REG. NOS. 692,163, 3,359,488 AND OTHERS.

NO CLAIM IS MADE TO THE EXCLUSIVE RIGHT TO USE "BITES", APART FROM THE MARK AS SHOWN.

FOR FROZEN BREAKFAST FOODS, NAMELY, WAFFLES, PANCAKES, FRENCH TOAST (U.S. CL. 46).  
KIMBERLY PARKS, EXAMINING ATTORNEY

---

SN 85-937,032. HEB GROCERY COMPANY, LP, SAN ANTONIO, TX. FILED 5-20-2013.

**H-E-B ORGANICS**

THE MARK CONSISTS OF STANDARD CHARACTERS WITHOUT CLAIM TO ANY PARTICULAR FONT, STYLE, SIZE, OR COLOR.

OWNER OF U.S. REG. NOS. 3,194,958, 3,930,507 AND OTHERS.

NO CLAIM IS MADE TO THE EXCLUSIVE RIGHT TO USE "ORGANICS", APART FROM THE MARK AS SHOWN.

FOR ORGANIC SUGAR, KETCHUP, MUSTARD, CRACKERS, FROZEN WAFFLES, BREAKFAST CEREAL, PROCESSED CEREALS, PANCAKE SYRUP, PASTA, RICE, PASTA SAUCE, POPCORN, PREPARED MEALS CONSISTING PRIMARILY OF PASTA OR RICE, TORTILLA CHIPS, PRETZELS, TOMATO SAUCE (U.S. CL. 46).

AISHA CLARKE, EXAMINING ATTORNEY

---

SN 85-940,371. SANTA FE SPICES, INC., SAN DIEGO, CA. FILED 5-23-2013.

**Out Of Mexico**

THE MARK CONSISTS OF STANDARD CHARACTERS WITHOUT CLAIM TO ANY PARTICULAR FONT, STYLE, SIZE, OR COLOR.

NO CLAIM IS MADE TO THE EXCLUSIVE RIGHT TO USE "MEXICO", APART FROM THE MARK AS SHOWN.

FOR CHILI PODS FOR USE AS A SEASONING; CHILI POWDERS; DRIED CHILI PEPPERS (U.S. CL. 46).  
FIRST USE 1-10-2012; IN COMMERCE 1-10-2012.  
TIMOTHY FINNEGAN, EXAMINING ATTORNEY

**CLASS 30—(Continued).**

SN 85-948,941. BURSON, EMILY, MARINA DEL REY, CA. FILED 6-3-2013.

**PROFESSOR WHIRLEYPANTS**

THE MARK CONSISTS OF STANDARD CHARACTERS WITHOUT CLAIM TO ANY PARTICULAR FONT, STYLE, SIZE, OR COLOR.

FOR GRANOLA-BASED SNACK BARS (U.S. CL. 46).  
ANNE FARRELL, EXAMINING ATTORNEY

---

SN 85-970,247. UNITED UR FOR INVESTMENT COMPANY, AMMAN, JORDAN, FILED 6-26-2013.



NO CLAIM IS MADE TO THE EXCLUSIVE RIGHT TO USE "SWISS CAFE", APART FROM THE MARK AS SHOWN.

THE COLOR(S) DARK RED AND YELLOW IS/ARE CLAIMED AS A FEATURE OF THE MARK.

THE MARK CONSISTS OF AN EMBOSSED OVAL SHAPE, WHILE THE COLOR OF THIS SHAPE IS A GRADIENT DARK RED TO YELLOW; INSIDE WHICH IS ANOTHER SMALL OVAL SHAPE WRITTEN INSIDE IT THE LETTERS "UR" IN A GRADIENT YELLOW COLOR, UNDERNEATH IS THE WORDING "ROYAL SWISS CAFE" ONE ON TOP OF THE OTHER WRITTEN IN GRADIENT YELLOW COLOR, AND BELOW THESE WORDS IS A DRAWING OF 5 STARS ALIGNED IN THE CENTER NEXT TO EACH OTHER ALSO IN A GRADIENT YELLOW COLOR. THE COLOR BLACK BEHIND THE EMBOSSED OVAL SHAPED DESIGN IS BACKGROUND AND IS NOT CLAIMED AS A FEATURE OF THE MARK.

FOR ARTIFICIAL COFFEE; COFFEE; INSTANT COFFEE (U.S. CL. 46).

FIRST USE 3-10-2011; IN COMMERCE 3-10-2011.  
KATHRYN COWARD, EXAMINING ATTORNEY

**CLASS 30—(Continued).**

SN 85-972,615. KUNAL MIRCHANDANI, WILLEMSTAD, CURACAO, FILED 6-28-2013.



OWNER OF CURACAO REG. NO. 16231, DATED 1-10-2013, EXPIRES 1-10-2023.

NO CLAIM IS MADE TO THE EXCLUSIVE RIGHT TO USE "MIRACLE TREE", APART FROM THE MARK AS SHOWN.

THE COLOR(S) BLACK, WHITE, DARK GREEN, LIGHT GREEN, ORANGE IS/ARE CLAIMED AS A FEATURE OF THE MARK.

THE MARK CONSISTS OF THE STYLIZED WORDS "MIRACLE TREE" IN BLACK ABOVE WHICH AND CENTERED ABOVE THE LETTERS "CLE" IN "MIRACLE" IS A DESIGN OF A WHITE FLOWER WITH FOUR PETALS WITH AN ORANGE CENTER WITH THREE LEAVES THAT ARE EACH HALF GREEN AND HALF LIGHT GREEN ABOVE AND TO THE RIGHT AND LEFT SIDE OF THE FLOWER.

FOR BREAD AND PASTRY; COCOA; COFFEE AND ARTIFICIAL COFFEE; COFFEE AND TEA; CONFECTIONERY MADE OF SUGAR; FLOUR; HONEY; MUSTARD; RICE; SAGO; SAUCES; SPICES; SUGAR; TAPIOCA; TREACLE; VINEGAR; YEAST; YEAST, BAKING POWDER (U.S. CL. 46).

FIRST USE 5-10-2012; IN COMMERCE 8-14-2012.  
CHRISTINA SOBRAL, EXAMINING ATTORNEY

SN 86-003,349. AKUA LANI LLC, CAPTAIN COOK, HI. FILED 7-5-2013.

## Original Hawaiian Lava Sauce

THE MARK CONSISTS OF STANDARD CHARACTERS WITHOUT CLAIM TO ANY PARTICULAR FONT, STYLE, SIZE, OR COLOR.

NO CLAIM IS MADE TO THE EXCLUSIVE RIGHT TO USE "ORIGINAL HAWAIIAN" AND "SAUCE", APART FROM THE MARK AS SHOWN.

FOR HOT SAUCE (U.S. CL. 46).  
FIRST USE 5-1-2013; IN COMMERCE 6-1-2013.  
ODESSA BIBBINS, EXAMINING ATTORNEY

**CLASS 30—(Continued).**

SN 86-019,879. DOUGH SHOP PIZZA DOUGH, INC., BURNSVILLE, MN. FILED 7-25-2013.

FOR PEOPLE WHO KNEAD FRESH  
DOUGH!

THE MARK CONSISTS OF STANDARD CHARACTERS WITHOUT CLAIM TO ANY PARTICULAR FONT, STYLE, SIZE, OR COLOR.

FOR PIZZA CRUST; PIZZA DOUGH; PIZZA SAUCE (U.S. CL. 46).

FIRST USE 8-0-1998; IN COMMERCE 8-0-1998.  
DAVID TAYLOR, EXAMINING ATTORNEY

SN 86-020,155. MADRUGADA ALIMENTOS LTDA., VENANCIO AIRES, BRAZIL, FILED 7-25-2013.

## MADRUGADA

THE MARK CONSISTS OF STANDARD CHARACTERS WITHOUT CLAIM TO ANY PARTICULAR FONT, STYLE, SIZE, OR COLOR.

THE ENGLISH TRANSLATION OF THE WORD "MADRUGADA" IN THE MARK IS "BREAK OF DAWN".

FOR TEA; DESSERT PUDDINGS; FLAVORED, SWEETENED GELATIN DESSERTS (U.S. CL. 46).

FIRST USE 6-30-2013; IN COMMERCE 6-30-2013.  
KAREN BRACEY, EXAMINING ATTORNEY

SN 86-020,815. SWERVE IP, LLC, JEFFERSON, LA. FILED 7-26-2013.



OWNER OF U.S. REG. NO. 3,679,639.

THE COLOR(S) RED, ORANGE, GREEN, PURPLE, TEAL AND YELLOW IS/ARE CLAIMED AS A FEATURE OF THE MARK.

THE MARK CONSISTS OF THE WORD "SWERVE" IN THE COLOR ORANGE WITH A RED, ORANGE, TEAL, GREEN, AND PURPLE FLOWER APPEARING OVER THE "R" AND THE "V" AND A RED, TEAL, YELLOW, GREEN, PURPLE AND ORANGE HUMMING BIRD APPEARING TO THE RIGHT OF THE WORD.

FOR NATURAL SWEETENER (U.S. CL. 46).  
FIRST USE 6-1-2011; IN COMMERCE 10-1-2011.  
COLLEEN DOMBROW, EXAMINING ATTORNEY

**CLASS 30—(Continued).**

SN 86-021,816. DEMIRJIAN, RYAN, GLENDALE, CA. FILED 7-28-2013.

# Kill Sauce

THE MARK CONSISTS OF STANDARD CHARACTERS WITHOUT CLAIM TO ANY PARTICULAR FONT, STYLE, SIZE, OR COLOR.

NO CLAIM IS MADE TO THE EXCLUSIVE RIGHT TO USE "SAUCE", APART FROM THE MARK AS SHOWN.

FOR HOT SAUCE; SAUCES (U.S. CL. 46).  
FONG HSU, EXAMINING ATTORNEY

**CLASS 30—(Continued).**

SN 86-026,640. EXO LLC, BROOKLYN, NY. FILED 8-1-2013.

# Exo

THE MARK CONSISTS OF STANDARD CHARACTERS WITHOUT CLAIM TO ANY PARTICULAR FONT, STYLE, SIZE, OR COLOR.

FOR GRAIN BASED, NUTRIENT DENSE READY-TO-EAT FOOD BARS, ALSO CONTAINING NUTS, SEEDS, DRIED FRUIT, AND INSECT FLOUR; GRANOLA-BASED SNACK BARS; INSECT FLOUR IN THE NATURE OF CRUSHED INSECTS FOR FOOD PURPOSES (U.S. CL. 46).

FIRST USE 7-0-2013; IN COMMERCE 7-0-2013.

KIM SAITO, EXAMINING ATTORNEY

SN 86-027,667. OPPENHEIMER CHOCOLATES, U.S.A., INC., BROOKLYN, NY. FILED 8-2-2013.

# ZAZERS

THE MARK CONSISTS OF STANDARD CHARACTERS WITHOUT CLAIM TO ANY PARTICULAR FONT, STYLE, SIZE, OR COLOR.

FOR CANDIES; CANDY; CANDY BARS; CANDY CAKE DECORATIONS; CANDY COATED APPLES; CANDY COATED POPCORN; CANDY CONTAINING ALCOHOLIC BEVERAGE CONTENT AND FLAVOR; CANDY DECORATIONS FOR CAKES; CANDY FOR FOOD; CANDY MINTS; CANDY SPRINKLES; CANDY WITH CARAMEL; CANDY WITH COCOA; CANDY, NAMELY, DRAGEES; CHOCOLATE CANDIES; CHOCOLATES AND CHOCOLATE BASED READY TO EAT CANDIES AND SNACKS; COTTON CANDY; FRUIT JELLY CANDY; GIFT BASKETS CONTAINING CANDY; GUMMY CANDIES; ICE CANDIES; PEPPERMINT CANDY; STARCH-BASED CANDIES (AME); SUGARLESS CANDIES; SWEETS (U.S. CL. 46).

FIRST USE 6-26-2013; IN COMMERCE 6-26-2013.

SETH A. RAPPAPORT, EXAMINING ATTORNEY

SN 86-023,369. DISTRIBUIDORA LUCEMA S.A., SAN JOSE, COSTA RICA, FILED 7-30-2013.



NO CLAIM IS MADE TO THE EXCLUSIVE RIGHT TO USE "PASTAS", APART FROM THE MARK AS SHOWN.

THE COLOR(S) GOLD, YELLOW, BLUE, WHITE GREEN, AND RED ORANGE IS/ARE CLAIMED AS A FEATURE OF THE MARK.

THE MARK CONSISTS OF THE WORDING "LUCEMA" IN WHITE SCRIPT LETTERING WITH AN ORANGE OVAL BACKGROUND WITH YELLOW AND GOLD TRIM AND GOLD WHEAT BELOW IT. THE WORDING "PASTAS" IN WHITE BLOCK LETTERING IS BELOW WITHIN A BLUE RECTANGLE WITH WHITE TRIM. BELOW THAT ARE THREE SMALL BOXES, WHICH ARE GREEN, WHITE AND RED FROM LEFT TO RIGHT.

FOR PASTAS (U.S. CL. 46).

FRANK LATTUCA, EXAMINING ATTORNEY

SN 86-028,710. CHOCOLATES GAROTO S.A., VILA VELHA - ES, BRAZIL, FILED 8-5-2013.

# MUNDY

THE MARK CONSISTS OF STANDARD CHARACTERS WITHOUT CLAIM TO ANY PARTICULAR FONT, STYLE, SIZE, OR COLOR.

OWNER OF U.S. REG. NO. 2,159,005.

FOR CHOCOLATE; BONBONS; ICE CREAMS; COOKIES; BISCUITS; CANDIES; COCOA; CONFECTIONERY PRODUCTS, NAMELY, CHOCOLATE CONFECTIONS (U.S. CL. 46).

STEPHANIE ALI, EXAMINING ATTORNEY

**CLASS 30—(Continued).**

SN 86-029,439. ROMANO, LENOR, NEW YORK, NY. FILED 8-6-2013.

**THE COOKIE HABERDASHERY**

THE MARK CONSISTS OF STANDARD CHARACTERS WITHOUT CLAIM TO ANY PARTICULAR FONT, STYLE, SIZE, OR COLOR.

NO CLAIM IS MADE TO THE EXCLUSIVE RIGHT TO USE "COOKIE", APART FROM THE MARK AS SHOWN. FOR COOKIES AND CRACKERS (U.S. CL. 46). FRED CARL, EXAMINING ATTORNEY

SN 86-030,668. DEMIRJIAN, RYAN, GLENDALE, CA. FILED 8-6-2013.

**KILL  
SAUCE**

NO CLAIM IS MADE TO THE EXCLUSIVE RIGHT TO USE "SAUCE", APART FROM THE MARK AS SHOWN. THE MARK CONSISTS OF THE STYLIZED WORDS "KILL SAUCE" FOR HOT SAUCE; SAUCES (U.S. CL. 46). FONG HSU, EXAMINING ATTORNEY

SN 86-030,933. LUCILA'S HOMEMADE, LLC, CHICAGO, IL. FILED 8-7-2013.

**Alfie**

THE MARK CONSISTS OF STANDARD CHARACTERS WITHOUT CLAIM TO ANY PARTICULAR FONT, STYLE, SIZE, OR COLOR. FOR COOKIES (U.S. CL. 46). FIRST USE 12-12-2010; IN COMMERCE 12-12-2010. CHARLOTTE CORWIN, EXAMINING ATTORNEY

**CLASS 30—(Continued).**

SN 86-033,932. FOR THE TROOPS, INC., ATLANTIC BEACH, FL. FILED 8-9-2013.

**For the Troops Brand**

THE MARK CONSISTS OF STANDARD CHARACTERS WITHOUT CLAIM TO ANY PARTICULAR FONT, STYLE, SIZE, OR COLOR.

NO CLAIM IS MADE TO THE EXCLUSIVE RIGHT TO USE "BRAND", APART FROM THE MARK AS SHOWN. FOR BARBECUE SAUCE; COCKTAIL SAUCES; CONDIMENT, NAMELY, PEPPER SAUCE; HOT SAUCE; PASTA SAUCE; SALAD DRESSINGS; SALSA (U.S. CL. 46).

FIRST USE 6-1-2012; IN COMMERCE 6-1-2012. SUSAN RICHARDS, EXAMINING ATTORNEY

SN 86-034,993. LONESTAR DOUGH BOYS, LLC, AUSTIN, TX. FILED 8-12-2013.

**CUCKOO KOLACHE**

THE MARK CONSISTS OF STANDARD CHARACTERS WITHOUT CLAIM TO ANY PARTICULAR FONT, STYLE, SIZE, OR COLOR.

NO CLAIM IS MADE TO THE EXCLUSIVE RIGHT TO USE "KOLACHE", APART FROM THE MARK AS SHOWN. FOR KOLACHES (U.S. CL. 46). FIRST USE 4-1-2013; IN COMMERCE 4-1-2013. FONG HSU, EXAMINING ATTORNEY

SN 86-035,917. TAKARI INTERNATIONAL, INC., ONTARIO, CA. FILED 8-12-2013.

**BARQUILLOS ROYAL**

THE MARK CONSISTS OF STANDARD CHARACTERS WITHOUT CLAIM TO ANY PARTICULAR FONT, STYLE, SIZE, OR COLOR.

NO CLAIM IS MADE TO THE EXCLUSIVE RIGHT TO USE "BARQUILLOS", APART FROM THE MARK AS SHOWN.

FOR COOKIE, BISCUITS, CANDY (U.S. CL. 46). FIRST USE 5-21-2010; IN COMMERCE 5-21-2010. ROSELLE HERRERA, EXAMINING ATTORNEY

**CLASS 30—(Continued).**

SN 86-038,901. PERRY'S ICE CREAM COMPANY, INC., AKRON, NY. FILED 8-15-2013.

## OTTO'S CUPCAKE

THE MARK CONSISTS OF STANDARD CHARACTERS WITHOUT CLAIM TO ANY PARTICULAR FONT, STYLE, SIZE, OR COLOR.

NO CLAIM IS MADE TO THE EXCLUSIVE RIGHT TO USE "CUPCAKE", APART FROM THE MARK AS SHOWN, FOR ICE CREAM (U.S. CL. 46).

INGRID C. EULIN, EXAMINING ATTORNEY

**CLASS 30—(Continued).**

SN 86-040,526. PHU NHUAN SERVICE JOINT STOCK COMPANY, HO CHI MINH CITY, VIETNAM, FILED 8-16-2013.



NO CLAIM IS MADE TO THE EXCLUSIVE RIGHT TO USE "PEPPER" OR THE PICTORIAL REPRESENTATION OF A PEPPER POD, APART FROM THE MARK AS SHOWN.

THE COLOR(S) LIGHT GREEN, DARK GREEN, AND WHITE IS/ARE CLAIMED AS A FEATURE OF THE MARK.

THE MARK CONSISTS OF AN ILLUSTRATION OF A PEPPER POD IN LIGHT GREEN AND GREEN WITH THE LITERAL ELEMENT "MSC" IN WHITE LETTERS WITH A GREEN OUTLINE AND THE WORD "PEPPER" IN GREEN LETTERS WITH A LIGHT GREEN OUTLINE UNDERNEATH THE PEPPER ENCLOSED BY A DARK GREEN CIRCLE; OTHER WHITE AREAS APPEARING INSIDE THE CIRCLE REPRESENT BACKGROUND.

FOR PEPPER (U.S. CL. 46).

DAVID H. STINE, EXAMINING ATTORNEY

SN 86-040,565. RDE, LLC, EDMONDS, WA. FILED 8-16-2013.

## CARAMELPOLITAN

THE MARK CONSISTS OF STANDARD CHARACTERS WITHOUT CLAIM TO ANY PARTICULAR FONT, STYLE, SIZE, OR COLOR.

FOR FLAVORINGS PACKAGED IN PREMEASURED DOSAGES FOR BEVERAGES (U.S. CL. 46).

PAM WILLIS, EXAMINING ATTORNEY

SN 86-040,582. RDE, LLC, EDMONDS, WA. FILED 8-16-2013.

## OOH LA VANILLA

THE MARK CONSISTS OF STANDARD CHARACTERS WITHOUT CLAIM TO ANY PARTICULAR FONT, STYLE, SIZE, OR COLOR.

NO CLAIM IS MADE TO THE EXCLUSIVE RIGHT TO USE "HOT SAUCE", APART FROM THE MARK AS SHOWN.

FOR HOT SAUCE (U.S. CL. 46).

ANTHONY RINKER, EXAMINING ATTORNEY

THE MARK CONSISTS OF STANDARD CHARACTERS WITHOUT CLAIM TO ANY PARTICULAR FONT, STYLE, SIZE, OR COLOR.

NO CLAIM IS MADE TO THE EXCLUSIVE RIGHT TO USE "VANILLA", APART FROM THE MARK AS SHOWN.

FOR FLAVORINGS PACKAGED IN PREMEASURED DOSAGES FOR BEVERAGES (U.S. CL. 46).

PAM WILLIS, EXAMINING ATTORNEY



**CLASS 30—(Continued).**

SN 86-040,777. WESTERN BEEF RETAIL, INC., RIDGEWOOD, NY. FILED 8-16-2013.

**CAFÉ MATTEO**

THE MARK CONSISTS OF STANDARD CHARACTERS WITHOUT CLAIM TO ANY PARTICULAR FONT, STYLE, SIZE, OR COLOR.

NO CLAIM IS MADE TO THE EXCLUSIVE RIGHT TO USE "CAFE", APART FROM THE MARK AS SHOWN.

FOR (BASED ON USE IN COMMERCE) COFFEE; COFFEE, NAMELY, COFFEE PACKAGED IN COFFEE BRICKS; COFFEE BRICKS; AND GROUND COFFEE; (BASED ON INTENT TO USE) COFFEE, NAMELY, COFFEE PACKAGED IN COFFEE PODS; AND COFFEE PODS (U.S. CL. 46).

FIRST USE 7-22-2013; IN COMMERCE 7-22-2013.  
DOUGLAS LEE, EXAMINING ATTORNEY

SN 86-041,581. WESTERN BEEF RETAIL, INC., RIDGEWOOD, NY. FILED 8-19-2013.



NO CLAIM IS MADE TO THE EXCLUSIVE RIGHT TO USE "CAFE", APART FROM THE MARK AS SHOWN.

THE MARK CONSISTS OF THE STYLIZED WORDS "CAFÉ" AND "MATTEO", WHEREIN THE "CAFÉ" IS LOCATED ABOVE THE "MATTEO". THE RECTANGULAR BACKGROUND DESIGN IS NOT PART OF THE MARK.

FOR (BASED ON USE IN COMMERCE) COFFEE; COFFEE, NAMELY, COFFEE PACKAGED IN COFFEE BRICKS; COFFEE BRICKS; AND GROUND COFFEE; (BASED ON INTENT TO USE) COFFEE, NAMELY, COFFEE PACKAGED IN COFFEE PODS; AND COFFEE PODS (U.S. CL. 46).

FIRST USE 7-22-2013; IN COMMERCE 7-22-2013.  
DOUGLAS LEE, EXAMINING ATTORNEY

**CLASS 30—(Continued).**

SN 86-041,718. SOCIETE DES PRODUITS NESTLE S.A., 1800 VEVEY, SWITZERLAND, FILED 8-19-2013.



OWNER OF U.S. REG. NOS. 184,498, 1,086,568 AND OTHERS.

THE MARK CONSISTS OF A DESIGN OF THREE CARNATION FLOWERS AND ATTACHED STEMS AND LEAVES.

FOR BAKING KITS CONSISTING OF MIXES FOR BAKERY GOODS, FUDGE, PIES, AND BREAD (U.S. CL. 46).

FIRST USE 10-30-2007; IN COMMERCE 10-30-2007.  
CORY BOONE, EXAMINING ATTORNEY

SN 86-042,366. DUNN, JAMBA, BOULDER, CO. FILED 8-20-2013.

**ROWDY MERMAID KOMBUCHA**

THE MARK CONSISTS OF STANDARD CHARACTERS WITHOUT CLAIM TO ANY PARTICULAR FONT, STYLE, SIZE, OR COLOR.

NO CLAIM IS MADE TO THE EXCLUSIVE RIGHT TO USE "KOMBUCHA", APART FROM THE MARK AS SHOWN.

FOR TEA-BASED BEVERAGES; TEA-BASED BEVERAGES WITH FRUIT FLAVOURING; TEA-BASED ICED BEVERAGES; BEVERAGES MADE OF TEA; MIXES IN THE NATURE OF CONCENTRATES, SYRUPS OR POWDERS USED IN THE PREPARATION OF TEA BASED BEVERAGES (U.S. CL. 46).

JONATHAN FALK, EXAMINING ATTORNEY

SN 86-043,487. BUCHANAN, TIFFANY N., DBA BLUEBIRD DESSERT COMPANY, THOUSAND OAKS, CA. FILED 8-21-2013.

**FREEZER MONKEY**

THE MARK CONSISTS OF STANDARD CHARACTERS WITHOUT CLAIM TO ANY PARTICULAR FONT, STYLE, SIZE, OR COLOR.

FOR FROZEN CONFECTIONS (U.S. CL. 46).

FIRST USE 3-31-2012; IN COMMERCE 3-31-2012.

JENNIFER WILLISTON, EXAMINING ATTORNEY

**CLASS 30—(Continued).**

SN 86-044,012. LONESTAR DOUGH BOYS, LLC, AUSTIN, TX. FILED 8-21-2013.



NO CLAIM IS MADE TO THE EXCLUSIVE RIGHT TO USE "KOLACHE", APART FROM THE MARK AS SHOWN.

THE COLOR(S) RED, BLUE, YELLOW, WHITE AND BLACK IS/ARE CLAIMED AS A FEATURE OF THE MARK.

THE MARK CONSISTS OF THE HEAD OF A CUCKOO BIRD WITH YELLOW BEAK AND RED COCKSCOMB WITH A BLUE FACE AND BLACK, RED, AND WHITE EYE WITH THE WORDS "CUCKOO KOLACHE" IN RED AND BLUE UNDERNEATH THE HEAD, ALL OUTLINED IN BLACK.

FOR KOLACHES (U.S. CL. 46).

FIRST USE 4-1-2013; IN COMMERCE 4-1-2013.

FONG HSU, EXAMINING ATTORNEY

SN 86-044,371. SANCHEZ BARTRA, JOSE CARLOS, LIMA, PERU, FILED 8-21-2013.

**BROWNIE FOR ASTRONAUTS**



NO CLAIM IS MADE TO THE EXCLUSIVE RIGHT TO USE "BROWNIE FOR ASTRONAUTS", APART FROM THE MARK AS SHOWN.

THE COLOR(S) BROWN, PINK AND GREEN IS/ARE CLAIMED AS A FEATURE OF THE MARK.

THE MARK CONSISTS OF THE WORDING "BROWNIE FOR ASTRONAUTS" IN BROWN AND PINK STYLIZED FONT ABOVE A STYLIZED DESIGN DEPICTING A PERSON IN A RUNNING POSITION SHOWN IN THE COLORS PINK AND GREEN.

FOR BROWNIE MIXES; BROWNIES; PASTRIES (U.S. CL. 46).

DAVID YONTEF, EXAMINING ATTORNEY

**CLASS 30—(Continued).**

SN 86-044,439. O'DONNELL, TARA, LOUISVILLE, KY. FILED 8-21-2013.

## Bluegrass Biscuit

THE MARK CONSISTS OF STANDARD CHARACTERS WITHOUT CLAIM TO ANY PARTICULAR FONT, STYLE, SIZE, OR COLOR.

NO CLAIM IS MADE TO THE EXCLUSIVE RIGHT TO USE "BISCUIT", APART FROM THE MARK AS SHOWN.

FOR BISCUITS; BREAD; CAKES; COOKIES; PIES; SAUCES (U.S. CL. 46).

FIRST USE 6-21-2013; IN COMMERCE 6-21-2013.

ALICE BENMAMAN, EXAMINING ATTORNEY

SN 86-044,459. BEAR MOUNTAIN COFFEE ROASTERS INC., YORKTOWN HEIGHTS, NY. FILED 8-21-2013.

## WICKED GOOD TEA

THE MARK CONSISTS OF STANDARD CHARACTERS WITHOUT CLAIM TO ANY PARTICULAR FONT, STYLE, SIZE, OR COLOR.

NO CLAIM IS MADE TO THE EXCLUSIVE RIGHT TO USE "TEA", APART FROM THE MARK AS SHOWN.

FOR TEA; TEA BAGS; TEA EXTRACTS (U.S. CL. 46).

FIRST USE 5-17-2013; IN COMMERCE 5-17-2013.

ANDREW RHIM, EXAMINING ATTORNEY

SN 86-045,054. CAVECHICK, INC., PARK RIDGE, IL. FILED 8-22-2013.

## Be Healthy Be Natural Be Tempted

THE MARK CONSISTS OF STANDARD CHARACTERS WITHOUT CLAIM TO ANY PARTICULAR FONT, STYLE, SIZE, OR COLOR.

FOR COOKIES (U.S. CL. 46).

FIRST USE 7-1-2010; IN COMMERCE 8-15-2010.

MARY ROSSMAN, EXAMINING ATTORNEY

**CLASS 30—(Continued).**

SN 86-046,487. DAHER, OMAR, TUSTIN, CA. FILED 8-23-2013.

**VIBE ELITE LIQUIDS**

THE MARK CONSISTS OF STANDARD CHARACTERS WITHOUT CLAIM TO ANY PARTICULAR FONT, STYLE, SIZE, OR COLOR.

NO CLAIM IS MADE TO THE EXCLUSIVE RIGHT TO USE "LIQUIDS", APART FROM THE MARK AS SHOWN.

FOR ELECTRONIC CIGARETTE LIQUID (E-LIQUID) COMPRISED OF FLAVORINGS IN LIQUID FORM USED TO REFILL ELECTRONIC CIGARETTE CARTRIDGES (U.S. CL. 46).

C. DIONNE CLYBURN, EXAMINING ATTORNEY

**CLASS 30—(Continued).**

SN 86-055,009. GASPARILLA ENTERPRISES, LLC, DBA PARROT BAY FOODS, CAPE CORAL, FL. FILED 9-4-2013.

**PARROT BAY FOODS**

THE MARK CONSISTS OF STANDARD CHARACTERS WITHOUT CLAIM TO ANY PARTICULAR FONT, STYLE, SIZE, OR COLOR.

NO CLAIM IS MADE TO THE EXCLUSIVE RIGHT TO USE "FOODS", APART FROM THE MARK AS SHOWN.

FOR BAKING SPICES; DRY SPICE RUB FOR MEATS AND FISH; EDIBLE SPICES; FOOD CONDIMENT CONSISTING PRIMARILY OF KETCHUP AND SALSA; INSTANT SPICE BLENDS; SALSA; SPICE BLENDS; SPICE RUBS; SPICES; SPICES IN THE FORM OF POWDERS; TOMATO-BASED SALSA (U.S. CL. 46).

SUSAN RICHARDS, EXAMINING ATTORNEY

SN 86-047,746. ANDERSON, CHRIS, LOS ANGELES, CA. FILED 8-26-2013.

**POWNUTS**

THE MARK CONSISTS OF STANDARD CHARACTERS WITHOUT CLAIM TO ANY PARTICULAR FONT, STYLE, SIZE, OR COLOR.

THE WORDING "POWNUTS" HAS NO MEANING IN A FOREIGN LANGUAGE.

FOR DONUTS; BAKERY PRODUCTS (U.S. CL. 46).

ANDREW RHIM, EXAMINING ATTORNEY

SN 86-057,799. SOCIETE DES PRODUITS NESTLE S.A., 1800 VEVEY, SWITZERLAND, FILED 9-6-2013.

**DESIGN A PIZZA**

THE MARK CONSISTS OF STANDARD CHARACTERS WITHOUT CLAIM TO ANY PARTICULAR FONT, STYLE, SIZE, OR COLOR.

NO CLAIM IS MADE TO THE EXCLUSIVE RIGHT TO USE "PIZZA", APART FROM THE MARK AS SHOWN.

FOR PIZZA; KITS COMPRISED OF INGREDIENTS FOR PREPARING PIZZA (U.S. CL. 46).

ANNE FARRELL, EXAMINING ATTORNEY

SN 86-049,417. MUDDY WATERS KAVA INC., DBA ROOT OF HAPPINESS KAVA BAR, FAIR OAKS, CA. FILED 8-27-2013.

**ROOT OF HAPPINESS**

THE MARK CONSISTS OF STANDARD CHARACTERS WITHOUT CLAIM TO ANY PARTICULAR FONT, STYLE, SIZE, OR COLOR.

FOR HERBAL TEA FOR FOOD PURPOSES; HERBAL FOOD BEVERAGES CONTAINING KAVA; PASTES CONTAINING KAVA, FOR FOOD PURPOSES (U.S. CL. 46).

FIRST USE 6-22-2011; IN COMMERCE 12-7-2012.

JERI J. FICKES, EXAMINING ATTORNEY

SN 86-060,666. GANO EXCEL INDUSTRIES, IRWINDALE, CA. FILED 9-10-2013.

**Gafé**

THE MARK CONSISTS OF STANDARD CHARACTERS WITHOUT CLAIM TO ANY PARTICULAR FONT, STYLE, SIZE, OR COLOR.

FOR BEVERAGES MADE OF COFFEE; BEVERAGES WITH A COFFEE BASE; COFFEE; COFFEE CAPSULES CONTAINING COFFEE FOR BREWING; COFFEE-BASED BEVERAGES; COFFEE-BASED ICED BEVERAGES (U.S. CL. 46).

JEANIE LEE, EXAMINING ATTORNEY

**CLASS 30—(Continued).**

SN 86-062,724. GRUPO LA FLORIDA MÉXICO, S.A. DE C.V., ESTADO DE MÉXICO, MEXICO, FILED 9-12-2013.



OWNER OF U.S. REG. NO. 3,907,276.  
 NO CLAIM IS MADE TO THE EXCLUSIVE RIGHT TO USE "INSTANT YEAST" AND "LEVADURA INSTANTANEA", APART FROM THE MARK AS SHOWN.  
 THE COLOR(S) GRAY, BLACK WHITE IS/ARE CLAIMED AS A FEATURE OF THE MARK.  
 THE MARK CONSISTS OF A GRAY RIBBON DESIGN RUNNING FROM TOP TO BOTTOM, SUPERIMPOSED ON THE RIBBON IS A CIRCLE, THE OUTER AND INNER RINGS OF THE CIRCLE ARE WHITE, THE INSIDE OF THE CIRCLE IS BLACK WITH THE WORDS "INSTANT YEAST" IN WHITE ON THE TOP PART OF THE CIRCLE AND THE WORDING "LEVADURA INSTANTANEA" IN WHITE IN THE LOWER PART OF THE CIRCLE, THE WORDING "BAKER'S CHOICE" IN WHITE OUTLINED IN BLACK APPEARS IN THE CENTER OF THE CIRCLE.  
 THE ENGLISH TRANSLATION OF "LEVADURA INSTANTANEA" IN THE MARK IS "INSTANT YEAST".  
 FOR YEAST (U.S. CL. 46).  
 BARBARA BROWN, EXAMINING ATTORNEY

**CLASS 30—(Continued).**

SN 86-062,740. TRÊS CORAÇÕES ALIMENTOS S.A., EUSEBIO, CEARA, BRAZIL, FILED 9-12-2013.



THE COLOR(S) RED, YELLOW, ORANGE, WHITE AND GREEN IS/ARE CLAIMED AS A FEATURE OF THE MARK.  
 THE MARK CONSISTS OF A YELLOW AND ORANGE CIRCLE WITH A WHITE BORDER AND WITHIN THE CIRCLE APPEARS THE WORDS SANTA CLARA IN RED OUTLINED IN WHITE AND BELOW THAT APPEARS SIX RED BALLS WITH WHITE CIRCLES ON THEM AND BELOW THAT APPEARS SIX GREEN TWO-SIDED WEDGES.  
 FOR COFFEE AND COFFEE PRODUCTS, NAMELY, COFFEE BEANS, ROASTED COFFEE, GROUND COFFEE, DECAFFEINATED COFFEE, ESPRESSO (U.S. CL. 46).  
 MARILYN IZZI, EXAMINING ATTORNEY

SN 86-062,778. AL NUKALY INTERNATIONAL TRADING CO., JEDDAH, SAUDI ARABIA, FILED 9-12-2013.



THE MARK CONSISTS OF A RECTANGLE AND FANCIFUL WREATH DESIGN WHICH HAS A STYLIZED "N" INSIDE. THE UPPER PORTION OF THE "N" DESIGN INCLUDES A CIRCULAR ELEMENT. THE LOWER PORTION OF THE DESIGN INCLUDES THE STYLIZED WORD "NUKALY" AND ITS ARABIC EQUIVALENT.  
 THE NON-LATIN CHARACTERS IN THE MARK TRANSLITERATE TO "NUKALY" AND THIS HAS NO MEANING IN A FOREIGN LANGUAGE.  
 FOR CHOCOLATES AND CHOCOLATE WAFERS; CONFECTIONARY MADE OF SUGAR, NAMELY, CANDIES, CHOCOLATE-COVERED FRUITS, NUTS AND WAFERS (U.S. CL. 46).  
 JASON TURNER, EXAMINING ATTORNEY

**CLASS 30—(Continued).**

SN 86-062,890. AL NUKALY INTERNATIONAL TRADING CO., JEDDAH, SAUDI ARABIA, FILED 9-12-2013.



THE MARK CONSISTS OF THE STYLIZED WORD "KIKADO" AND ITS ARABIC EQUIVALENT.

THE NON-LATIN CHARACTERS IN THE MARK TRANSLITERATE TO "KIKADO" AND THIS HAS NO MEANING IN A FOREIGN LANGUAGE.

FOR CHOCOLATES AND CHOCOLATE WAFERS; CONFECTIONARY MADE OF SUGAR, NAMELY, CANDIES, CHOCOLATE-COVERED FRUITS, NUTS AND WAFERS (U.S. CL. 46).

JASON TURNER, EXAMINING ATTORNEY

SN 86-062,987. MOREY'S BAKERY, LLC, COLDWATER, MI. FILED 9-12-2013.

# MOREY'S

THE MARK CONSISTS OF STANDARD CHARACTERS WITHOUT CLAIM TO ANY PARTICULAR FONT, STYLE, SIZE, OR COLOR.

FOR BAKERY GOODS (U.S. CL. 46).

FIRST USE 8-27-2013; IN COMMERCE 8-27-2013.

PAUL E. FAHRENKOPF, EXAMINING ATTORNEY

SN 86-064,578. FIGI'S, INC., MARSHFIELD, WI. FILED 9-13-2013.

# S'MOO

THE MARK CONSISTS OF STANDARD CHARACTERS WITHOUT CLAIM TO ANY PARTICULAR FONT, STYLE, SIZE, OR COLOR.

FOR SNACK MIX CONSISTING PRIMARILY OF CARAMEL OR CANDY COATED POPPED POPCORN, ALMONDS, PECANS, CASHEWS, MIXED NUTS AND PEANUTS (U.S. CL. 46).

FIRST USE 8-31-2011; IN COMMERCE 8-31-2011.

ANNE FARRELL, EXAMINING ATTORNEY

**CLASS 30—(Continued).**

SN 86-065,189. RAUS COFFEE COMPANY, LLC, STAMFORD, CT. FILED 9-16-2013.

# ROMAN JOY

THE MARK CONSISTS OF STANDARD CHARACTERS WITHOUT CLAIM TO ANY PARTICULAR FONT, STYLE, SIZE, OR COLOR.

FOR BEVERAGES MADE OF COFFEE; BEVERAGES WITH A COFFEE BASE; CAFFEINE-FREE COFFEE; COFFEE BASED BEVERAGES; COFFEE BEVERAGES WITH MILK; COFFEE-BASED BEVERAGE CONTAINING MILK; COFFEE-BASED BEVERAGES; ICED COFFEE; PREPARED COFFEE AND COFFEE-BASED BEVERAGES (U.S. CL. 46).

FIRST USE 7-4-2013; IN COMMERCE 7-4-2013.

JOANNA DUKOVIC, EXAMINING ATTORNEY

SN 86-065,378. MILO'S FRANCHISE COMPANY, INC., BIRMINGHAM, AL. FILED 9-16-2013.

# STAY SAUCY

THE MARK CONSISTS OF STANDARD CHARACTERS WITHOUT CLAIM TO ANY PARTICULAR FONT, STYLE, SIZE, OR COLOR.

FOR HAMBURGER SANDWICHES; SANDWICHES; SANDWICHES, NAMELY, CHICKEN SANDWICHES (U.S. CL. 46).

ERNEST SHOSHO, EXAMINING ATTORNEY

SN 86-065,595. LANGS CHOCOLATES LLC, WILLIAMSPORT, PA. FILED 9-16-2013.

# KARMALICIOUS

THE MARK CONSISTS OF STANDARD CHARACTERS WITHOUT CLAIM TO ANY PARTICULAR FONT, STYLE, SIZE, OR COLOR.

FOR CANDIES; CANDY WITH CARAMEL; CHOCOLATE CANDIES; CHOCOLATES AND CHOCOLATE BASED READY TO EAT CANDIES AND SNACKS; SWEETS (U.S. CL. 46).

FIRST USE 9-9-2013; IN COMMERCE 9-9-2013.

DAVID COLLIER, EXAMINING ATTORNEY

**CLASS 30—(Continued).**

SN 86-066,310. JAN MALAN HOFMEYR, BRYN MAWR, PA. AND JOHANNA GERTRUIDA HOFMEYR, BRYN MAWR, PA. FILED 9-17-2013.

**IN.OUT.EAT.**

THE MARK CONSISTS OF STANDARD CHARACTERS WITHOUT CLAIM TO ANY PARTICULAR FONT, STYLE, SIZE, OR COLOR.

FOR BISCUITS; BISCUITS AND BREAD; BUTTER BISCUITS; CHOCOLATE COVERED COOKIES; COOKIES; COOKIES AND CRACKERS; FOOD PACKAGE COMBINATIONS CONSISTING PRIMARILY OF BREAD, CRACKERS AND/OR COOKIES; SHORTBREAD BISCUITS (U.S. CL. 46).

FIRST USE 12-10-2012; IN COMMERCE 9-16-2013.  
NORA BUCHANAN WILL, EXAMINING ATTORNEY

SN 86-066,786. BUTTERMILK INC, WEST COVINA, CA. FILED 9-17-2013.

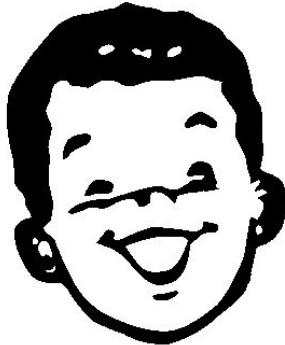

THE MARK CONSISTS OF A BOY'S SMILING FACE TILTED TO THE LEFT WITH HIS RIGHT EYE WINKING. FOR PANCAKE MIXES; DONUTS MIXES (U.S. CL. 46).  
FIRST USE 11-1-2009; IN COMMERCE 6-15-2013.  
AISHA CLARKE, EXAMINING ATTORNEY

SN 86-066,808. BOUNDLESS NUTRITION LLC, DBA BOUNDLESS NUTRITION, AUSTIN, TX. FILED 9-17-2013.

**Give Bar**

THE MARK CONSISTS OF STANDARD CHARACTERS WITHOUT CLAIM TO ANY PARTICULAR FONT, STYLE, SIZE, OR COLOR.

NO CLAIM IS MADE TO THE EXCLUSIVE RIGHT TO USE "BAR", APART FROM THE MARK AS SHOWN.

FOR GRAIN-BASED FOOD BARS ALSO CONTAINING FRUITS, NUTS, AND SEEDS IN A PROTEIN BASE (U.S. CL. 46).

SAIMA MAKHDOOM, EXAMINING ATTORNEY

**CLASS 30—(Continued).**

SN 86-066,822. E.D. SMITH FOODS, LTD., WINONA, ONTARIO, CANADA, FILED 9-17-2013.

**PUBMASTER**

THE MARK CONSISTS OF STANDARD CHARACTERS WITHOUT CLAIM TO ANY PARTICULAR FONT, STYLE, SIZE, OR COLOR.

FOR MARINADES; SALAD DRESSINGS; SAUCES (U.S. CL. 46).

JEANIE LEE, EXAMINING ATTORNEY

SN 86-066,852. MCDONALD'S CORPORATION, OAK BROOK, IL. FILED 9-17-2013.



OWNER OF U.S. REG. NO. 1,653,279.

THE COLOR(S) WHITE, BLACK, RED, YELLOW, GOLDEN, PINK, BROWN AND GRAY IS/ARE CLAIMED AS A FEATURE OF THE MARK.

THE MARK CONSISTS OF A BOX-SHAPED CHARACTER DESIGN IN THE COLOR RED WITH OPEN SMILING MOUTH SHOWING TEETH IN THE COLOR WHITE AND TONGUE IN THE COLOR PINK THE EYES ARE WHITE, BROWN AND BLACK. THE CHARACTER HAS UPWARD RAISED OUTSTRETCHED ARMS IN THE COLORS WHITE AND GRAY, LEGS IN THE COLORS WHITE AND GRAY WITH BLACK AND WHITE SHOES AND ONE LEG EXTENDED OUTWARD SHOWING A GRAY SOLE OF THE SHOE AND A YELLOW/ GOLDEN ARCHES LOGO APPEARS ON THE TOP OF THE CHARACTER DESIGN.

FOR MILK PREPARATION, NAMELY, ICE MILK BARS (U.S. CL. 46).

RAMONA ORTIGA, EXAMINING ATTORNEY

**CLASS 30—(Continued).**

SN 86-066,968. JEAUX'S BOYS, LLC, HAMBURG, AR. FILED 9-17-2013.

*"Sauce Up Your Tailgate"*

THE MARK CONSISTS OF THE TERMS "SAUCE UP YOUR TAILGATE" IN STYLIZED FONT. FOR SAUCES (U.S. CL. 46). FIRST USE 8-1-2013; IN COMMERCE 8-1-2013. REGINA DRUMMOND, EXAMINING ATTORNEY

SN 86-067,057. RALCORP HOLDINGS, INC., OMAHA, NE. FILED 9-17-2013.

MAKING EVERY DAY FESTIVE

THE MARK CONSISTS OF STANDARD CHARACTERS WITHOUT CLAIM TO ANY PARTICULAR FONT, STYLE, SIZE, OR COLOR. FOR COOKIES (U.S. CL. 46). FIRST USE 12-5-2013; IN COMMERCE 12-5-2013. SKYE YOUNG, EXAMINING ATTORNEY

SN 86-067,129. KRAFT CANADA INC., DON MILLS ONTARIO, CANADA, FILED 9-17-2013.

**NABOB**

THE MARK CONSISTS OF STANDARD CHARACTERS WITHOUT CLAIM TO ANY PARTICULAR FONT, STYLE, SIZE, OR COLOR. FOR COFFEE (U.S. CL. 46). SHAVELL MCPHERSON, EXAMINING ATTORNEY

**CLASS 30—(Continued).**

SN 86-067,237. RED MILL FARMS, INC., MOOSIC, PA. FILED 9-17-2013.

**MACAROONKING**

THE MARK CONSISTS OF STANDARD CHARACTERS WITHOUT CLAIM TO ANY PARTICULAR FONT, STYLE, SIZE, OR COLOR. FOR MACAROONS (U.S. CL. 46). DAVID MURRAY, EXAMINING ATTORNEY

SN 86-067,484. DELUSCIOUS COOKIES & MILK, LLC, LOS ANGELES, CA. FILED 9-17-2013.

**VGf**

THE MARK CONSISTS OF STANDARD CHARACTERS WITHOUT CLAIM TO ANY PARTICULAR FONT, STYLE, SIZE, OR COLOR. FOR BAKERY DESSERTS; BAKERY GOODS; BAKERY PRODUCTS, NAMELY, SWEET BAKERY GOODS; COOKIES (U.S. CL. 46). EDWARD FENNESSY, EXAMINING ATTORNEY

SN 86-067,578. VICTOR LASTER, MURRAYVILLE, GA. FILED 9-18-2013.

**POLAR SNOW**

THE MARK CONSISTS OF STANDARD CHARACTERS WITHOUT CLAIM TO ANY PARTICULAR FONT, STYLE, SIZE, OR COLOR. FOR CONCENTRATES USED IN THE PREPARATION OF FLAVORING SYRUPS FOR SHAVED ICE CONFECTIONS; SHAVED ICE CONFECTIONS (U.S. CL. 46). FIRST USE 3-31-2010; IN COMMERCE 3-31-2010. SKYE YOUNG, EXAMINING ATTORNEY

**CLASS 30—(Continued).**

SN 86-067,666. SNAP DOG, INC., PORT WASHINGTON, NY.  
FILED 9-18-2013.

SUMMER'S VIBE

THE MARK CONSISTS OF STANDARD CHARACTERS WITHOUT CLAIM TO ANY PARTICULAR FONT, STYLE, SIZE, OR COLOR.

FOR TEA; TEA-BASED BEVERAGES (U.S. CL. 46).  
RAMONA ORTIGA, EXAMINING ATTORNEY

SN 86-068,012. THE LIFE IS GOOD COMPANY, BOSTON, MA. FILED 9-18-2013.

BREW WHAT YOU LIKE. LIKE  
WHAT YOU BREW.

THE MARK CONSISTS OF STANDARD CHARACTERS WITHOUT CLAIM TO ANY PARTICULAR FONT, STYLE, SIZE, OR COLOR.

FOR COFFEE; COFFEE BASED BEVERAGES; COFFEE BEANS; COFFEE CAPSULES CONTAINING COFFEE FOR BREWING; COFFEE PODS; GROUND COFFEE BEANS; INSTANT COFFEE; PREPARED COFFEE AND COFFEE-BASED BEVERAGES; ROASTED COFFEE BEANS (U.S. CL. 46).

ALEXANDER L. POWERS, EXAMINING ATTORNEY

SN 86-068,133. DENOVO BEVERAGE, DBA ROOTEA, SAN FRANCISCO, CA. FILED 9-18-2013.

YOOT

THE MARK CONSISTS OF STANDARD CHARACTERS WITHOUT CLAIM TO ANY PARTICULAR FONT, STYLE, SIZE, OR COLOR.

FOR BEVERAGES WITH A TEA BASE; HERBAL TEA (U.S. CL. 46).

HEATHER THOMPSON, EXAMINING ATTORNEY

**CLASS 30—(Continued).**

SN 86-068,589. DOROQUIA HOLATHETA CO., LTD., OSAKA, JAPAN, FILED 9-18-2013.



THE MARK CONSISTS OF A STYLIZED DESIGN OF THE WORD "PABLO" WITH THE "P" ATTACHED AT THE BOTTOM TO AN "A", A FANCIFUL "B", AN "L" CONNECTED TO THE TOP OF THE "P" AND AN END FIGURE TO REPRESENT THE "O" PLACED TO THE RIGHT OF THE WORD "PABLO".

THE WORDING "PABLO" HAS NO MEANING IN A FOREIGN LANGUAGE.

FOR CAKES; CHOCOLATE; COOKIES; ICE CREAM; PASTRIES; TARTS; WAFFLES (U.S. CL. 46).  
RUDY R. SINGLETON, EXAMINING ATTORNEY

SN 86-069,260. CHERRY REPUBLIC, INC., GLEN ARBOR, MI. FILED 9-19-2013.

BOOMCHUNKAS

THE MARK CONSISTS OF STANDARD CHARACTERS WITHOUT CLAIM TO ANY PARTICULAR FONT, STYLE, SIZE, OR COLOR.

FOR COOKIES (U.S. CL. 46).  
FIRST USE 4-30-1992; IN COMMERCE 4-30-1992.  
SUNG IN, EXAMINING ATTORNEY

SN 86-069,321. SWAYNE II, LAWRENCE S, CHARLOTTE, NC. FILED 9-19-2013.

Wingzza Mambo Sauce

THE MARK CONSISTS OF STANDARD CHARACTERS WITHOUT CLAIM TO ANY PARTICULAR FONT, STYLE, SIZE, OR COLOR.

OWNER OF U.S. REG. NO. 4,368,084.

NO CLAIM IS MADE TO THE EXCLUSIVE RIGHT TO USE "MAMBO SAUCE", APART FROM THE MARK AS SHOWN.

FOR BARBECUE SAUCE; CHICKEN WING SAUCE; DIPPING SAUCES; HOT SAUCE; MARINADES (U.S. CL. 46).

FIRST USE 6-1-2010; IN COMMERCE 10-1-2011.  
JUHI KAVEESHVAR, EXAMINING ATTORNEY



**CLASS 30—(Continued).**

SN 86-069,460. CALTAGIRONE, FRANCESCA BELLAVISTA, MIAMI, FL. FILED 9-19-2013.

# CRAVECLEAN

THE MARK CONSISTS OF STANDARD CHARACTERS WITHOUT CLAIM TO ANY PARTICULAR FONT, STYLE, SIZE, OR COLOR.

FOR CUPCAKES (U.S. CL. 46).  
FIRST USE 2-3-2013; IN COMMERCE 2-3-2013.  
WILLIAM ROSSMAN, EXAMINING ATTORNEY

**CLASS 30—(Continued).**

SN 86-070,263. MOHABAT, SOHAYLE, MANTECA, CA. FILED 9-20-2013.

# cookies love cream

THE MARK CONSISTS OF STANDARD CHARACTERS WITHOUT CLAIM TO ANY PARTICULAR FONT, STYLE, SIZE, OR COLOR.

FOR COOKIES; ICE-CREAM (U.S. CL. 46).  
ANDREA HACK, EXAMINING ATTORNEY

SN 86-069,479. CALTAGIRONE, FRANCESCA BELLAVISTA, MIAMI, FL. FILED 9-19-2013.



THE MARK CONSISTS OF "CRAVECLEAN SIMPLY CLEAN EATS.COM" WITH THE TWO LEAVES ABOVE THE WORD MARK AND SURROUNDED BY A HEXAGONAL PATTERN OF DOTS AND LINES.

FOR CUPCAKES (U.S. CL. 46).  
FIRST USE 4-15-2013; IN COMMERCE 4-15-2013.  
WILLIAM ROSSMAN, EXAMINING ATTORNEY

SN 86-070,356. ORA INVESTMENTS LLC, MIAMI, FL. FILED 9-20-2013.

# TENUP

SN 86-069,703. HALL, XIOMARA, TEMECULA, CA. FILED 9-19-2013.

# Intensi-FIRE

THE MARK CONSISTS OF STANDARD CHARACTERS WITHOUT CLAIM TO ANY PARTICULAR FONT, STYLE, SIZE, OR COLOR.

FOR SAUCES (U.S. CL. 46).  
MELISSA VALLILLO, EXAMINING ATTORNEY

THE MARK CONSISTS OF STANDARD CHARACTERS WITHOUT CLAIM TO ANY PARTICULAR FONT, STYLE, SIZE, OR COLOR.

FOR BEVERAGES MADE OF COFFEE; BEVERAGES MADE OF TEA; BEVERAGES WITH A CHOCOLATE BASE; BEVERAGES WITH A COFFEE BASE; BEVERAGES WITH A TEA BASE; COCOA-BASED BEVERAGES; COFFEE BASED BEVERAGES; COFFEE FLAVORED SYRUP USED IN MAKING FOOD BEVERAGES; COFFEE-BASED BEVERAGES; COFFEE-BASED ICED BEVERAGES; FLAVOR ENHANCERS USED IN FOOD AND BEVERAGE PRODUCTS; FLAVORINGS FOR BEVERAGES; MIXES IN THE NATURE OF CONCENTRATES, SYRUPS OR POWDERS USED IN THE PREPARATION OF TEA BASED BEVERAGES; TEA-BASED BEVERAGES; TEA-BASED BEVERAGES WITH FRUIT FLAVORING; TEA-BASED ICED BEVERAGES (U.S. CL. 46).

DARRYL SPRUILL, EXAMINING ATTORNEY

**CLASS 30—(Continued).**

SN 86-070,504. MAGNOLIA INTELLECTUAL PROPERTY, LLC, NEW YORK, NY. FILED 9-20-2013.



THE COLOR(S) BROWN AND PASTEL GREEN IS/ARE CLAIMED AS A FEATURE OF THE MARK.

THE MARK CONSISTS OF A STYLIZED REPRESENTATION OF A CUPCAKE WITH FROSTING COVERING THE ENTIRE TOP OF THE CUPCAKE. THE BOTTOM OF THE CUPCAKE IS BROWN AND HAS A SCALLOPED TOP SIMULATING A CUPCAKE LINER. THE FROSTING IS PASTEL GREEN. THE WHITE IN THE DRAWING REPRESENTS BACKGROUND AREAS ONLY AND IS NOT PART OF THE MARK.

FOR GIFT BASKETS COMPRISED PRIMARILY OF BAKERY GOODS AND BAKERY DESSERTS (U.S. CL. 46).

FIRST USE 6-13-2013; IN COMMERCE 6-13-2013.  
LINDA QUIGLEY, EXAMINING ATTORNEY

SN 86-070,650. THE POP ICON, LLC, MIAMI, FL. FILED 9-20-2013.

**THE POP ICON**

THE MARK CONSISTS OF STANDARD CHARACTERS WITHOUT CLAIM TO ANY PARTICULAR FONT, STYLE, SIZE, OR COLOR.

FOR CANDY; LOLLIPOPS; SWEETS (U.S. CL. 46).  
JACQUELINE ABRAMS, EXAMINING ATTORNEY

SN 86-072,351. HAMMOND'S CANDIES SINCE 1920 II, LLC, DBA OLD DOMINION PEANUT COMPANY SINCE 1913, DENVER, CO. FILED 9-23-2013.

**Brittlecorn**

THE MARK CONSISTS OF STANDARD CHARACTERS WITHOUT CLAIM TO ANY PARTICULAR FONT, STYLE, SIZE, OR COLOR.

FOR CARAMEL POPCORN (U.S. CL. 46).  
FIRST USE 6-13-2013; IN COMMERCE 6-13-2013.  
SALLY SHIH, EXAMINING ATTORNEY

**CLASS 30—(Continued).**

SN 86-072,353. LEE, DANIEL, WHITTIER, CA. FILED 9-23-2013.

**INNOVAPE**

THE MARK CONSISTS OF STANDARD CHARACTERS WITHOUT CLAIM TO ANY PARTICULAR FONT, STYLE, SIZE, OR COLOR.

FOR CHEMICAL FLAVORINGS IN LIQUID FORM USED TO REFILL ELECTRONIC CIGARETTE CARTRIDGES; ELECTRONIC CIGARETTE LIQUID (E-LIQUID) COMPRISED OF FLAVORINGS IN LIQUID FORM USED TO REFILL ELECTRONIC CIGARETTE CARTRIDGES (U.S. CL. 46).

FIRST USE 8-11-2013; IN COMMERCE 9-1-2013.  
SALLY SHIH, EXAMINING ATTORNEY

SN 86-072,358. HAMMONDS CANDIES SINCE 1920 II, LLC, DBA OLD DOMINION PEANUT COMPANY SINCE 1913, DENVER, CO. FILED 9-23-2013.

**Brittlecorn**

THE MARK CONSISTS OF THE WORD "BRITTELCORN" WITH A POPPED POPCORN KERNEL REPLACING THE LETTER "O".

FOR CARAMEL POPCORN (U.S. CL. 46).  
FIRST USE 6-13-2013; IN COMMERCE 6-13-2013.  
SALLY SHIH, EXAMINING ATTORNEY

SN 86-072,450. LAIDLEY, LE'KISCH M., TUJUNGA, CA. FILED 9-23-2013.

**LE'KISCH LAIDLEY'S THE LORD'S COOKIE**

THE MARK CONSISTS OF STANDARD CHARACTERS WITHOUT CLAIM TO ANY PARTICULAR FONT, STYLE, SIZE, OR COLOR.

NO CLAIM IS MADE TO THE EXCLUSIVE RIGHT TO USE "COOKIE", APART FROM THE MARK AS SHOWN.

THE NAME "LE'KISCH LAIDLEY" IDENTIFIES A LIVING INDIVIDUAL WHOSE CONSENT IS OF RECORD.

FOR BAKERY DESSERTS; BAKERY GOODS; BAKERY PRODUCTS; BROWNIES; CAKES; COOKIES; CUP CAKES; GRAIN-BASED FOOD BARS ALSO CONTAINING CHOCOLATE, RAISINS, COCONUTS OR NUTS; QUINOA-BASED FOOD BARS; READY TO EAT, CEREAL DERIVED FOOD BARS (U.S. CL. 46).

MEREDITH MARESCA, EXAMINING ATTORNEY

**CLASS 30—(Continued).**

SN 86-074,830. NORTHERN FOOD I/E INC., WESTBURY, NY. FILED 9-25-2013.

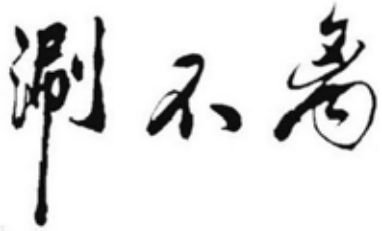

THE MARK CONSISTS OF THREE CHINESE CHARACTERS IN A ROW WRITTEN IN A STYLIZED FONT.

THE NON-LATIN CHARACTERS IN THE MARK TRANSLITERATE TO "SHUAN", "BU" AND "LI" AND THIS MEANS "ONE CANNOT TEAR ONESELF AWAY FROM IT" IN ENGLISH.

FOR FLAVORINGS AND SEASONINGS; FOOD SEASONINGS; SEASONING MIXES; SEASONINGS (U.S. CL. 46).

FIRST USE 9-30-2000; IN COMMERCE 9-30-2000.  
MARC LEIPZIG, EXAMINING ATTORNEY

**CLASS 30—(Continued).**

SN 86-078,473. FROZEN SPECIALTIES, INC., PERRYSBURG, OH. FILED 9-30-2013.



THE COLOR(S) GREEN, RED, GREY AND WHITE IS/ ARE CLAIMED AS A FEATURE OF THE MARK.

THE MARK CONSISTS OF THE WORD "SIGNOR" IN GREEN STYLIZED LETTERS, THE WORD "PREMIO'S" IN RED ALL CAPITAL AND STYLIZED LETTERS WITH WHITE SPLASHES ON THE LAST THREE LETTERS, AND A FICTITIOUS GREY AND WHITE MALE HAVING A MOUSTACHE, WEARING A CHEF'S HAT AND A GREEN, RED AND WHITE SCARF TIED AROUND HIS NECK.

THE ENGLISH TRANSLATION OF THE WORD "SIGNOR" IN THE MARK IS "SIR" OR "MR.". THE ENGLISH TRANSLATION OF "PREMIO" IN THE MARK IS "PRIZE" OR "REWARD".

FOR FROZEN PIZZA (U.S. CL. 46).  
BRENDAN MCCAULEY, EXAMINING ATTORNEY

SN 86-077,110. SOCIETE DES PRODUITS NESTLE S.A., 1800 VEVEY, SWITZERLAND, FILED 9-27-2013.

## PASTA FOR ALL

THE MARK CONSISTS OF STANDARD CHARACTERS WITHOUT CLAIM TO ANY PARTICULAR FONT, STYLE, SIZE, OR COLOR.

FOR PASTA; FROZEN PREPARED ENTREES CONSISTING PRIMARILY OF PASTA OR RICE; SAUCES (U.S. CL. 46).

ANNE FARRELL, EXAMINING ATTORNEY

SN 86-082,005. GRUMA CORPORATION, IRVING, TX. FILED 10-3-2013.

## ESTILO PEPITO

THE MARK CONSISTS OF STANDARD CHARACTERS WITHOUT CLAIM TO ANY PARTICULAR FONT, STYLE, SIZE, OR COLOR.

OWNER OF U.S. REG. NOS. 2,354,786, 3,306,373 AND 4,420,212.

THE ENGLISH TRANSLATION OF "ESTILO" IN THE MARK IS "STYLE".

FOR TORTILLAS, TACO SHELLS, TOSTADAS, TORTILLA CHIPS (U.S. CL. 46).

KEVIN MITTLER, EXAMINING ATTORNEY

SN 86-078,281. FRUTIFRESCA, INC., NORTH HOLLYWOOD, CA. FILED 9-30-2013.

## SO GOOD, YOU CAN'T EAT JUST ONE!

THE MARK CONSISTS OF STANDARD CHARACTERS WITHOUT CLAIM TO ANY PARTICULAR FONT, STYLE, SIZE, OR COLOR.

FOR FROZEN JUICE BARS; FRUIT ICE BAR; ICE CREAM DESSERTS; SORBETS (U.S. CL. 46).

FIRST USE 7-1-2005; IN COMMERCE 7-1-2005.  
DAVID TOOLEY, EXAMINING ATTORNEY

SN 86-094,113. DISCOVERY COMMUNICATIONS, LLC, SILVER SPRING, MD. FILED 10-17-2013.

## ANIMAL PLANET

THE MARK CONSISTS OF STANDARD CHARACTERS WITHOUT CLAIM TO ANY PARTICULAR FONT, STYLE, SIZE, OR COLOR.

FOR CANDY; BUBBLE GUM AND CHEWING GUM; COOKIES; CRACKERS (U.S. CL. 46).

FIRST USE 4-0-2012; IN COMMERCE 4-0-2012.  
SHARON MEIER, EXAMINING ATTORNEY

**CLASS 30—(Continued).**

SN 86-104,512. D-GENERATION, INC., DAYTONA BEACH, FL. FILED 10-29-2013.

# OCEANWASH

THE MARK CONSISTS OF STANDARD CHARACTERS WITHOUT CLAIM TO ANY PARTICULAR FONT, STYLE, SIZE, OR COLOR.

OWNER OF U.S. REG. NO. 4,425,720.  
FOR CANDY; CHEWING GUM (U.S. CL. 46).  
FIRST USE 10-29-2013; IN COMMERCE 10-29-2013.  
RONALD MCMORROW, EXAMINING ATTORNEY

---

SN 86-109,497. ZAK, ROGER W., PALMER, AK. AND ZAK, RHONDA I., PALMER, AK. FILED 11-4-2013.

# Denali Mountain

THE MARK CONSISTS OF STANDARD CHARACTERS WITHOUT CLAIM TO ANY PARTICULAR FONT, STYLE, SIZE, OR COLOR.

NO CLAIM IS MADE TO THE EXCLUSIVE RIGHT TO USE "DENALI", APART FROM THE MARK AS SHOWN.  
FOR COFFEE (U.S. CL. 46).  
FIRST USE 8-21-2010; IN COMMERCE 8-21-2010.  
LUCY ARANT, EXAMINING ATTORNEY

---

SN 86-109,740. DNA DISTRIBUTORS, INC., BARTLETT, IL. FILED 11-4-2013.

# JUST JUICE

THE MARK CONSISTS OF STANDARD CHARACTERS WITHOUT CLAIM TO ANY PARTICULAR FONT, STYLE, SIZE, OR COLOR.

NO CLAIM IS MADE TO THE EXCLUSIVE RIGHT TO USE "JUICE", APART FROM THE MARK AS SHOWN.  
FOR ELECTRONIC CIGARETTE LIQUID (E-LIQUID) COMPRISED OF FLAVORINGS IN LIQUID FORM USED TO REFILL ELECTRONIC CIGARETTE CARTRIDGES (U.S. CL. 46).  
ASMAT KHAN, EXAMINING ATTORNEY

**CLASS 30—(Continued).**

SN 86-115,032. GREEN MOUNTAIN COFFEE ROASTERS, INC., WATERBURY, VT. FILED 11-11-2013.

# MOTOR MOKA

THE MARK CONSISTS OF STANDARD CHARACTERS WITHOUT CLAIM TO ANY PARTICULAR FONT, STYLE, SIZE, OR COLOR.

OWNER OF U.S. REG. NO. 1,796,594.  
NO CLAIM IS MADE TO THE EXCLUSIVE RIGHT TO USE "MOCHA", APART FROM THE MARK AS SHOWN.  
FOR COFFEE (U.S. CL. 46).  
EUGENIA MARTIN, EXAMINING ATTORNEY

---

SN 86-118,031. MORAN, MAX, VISTA, CA. FILED 11-13-2013.

# INDIAN JOE

THE MARK CONSISTS OF STANDARD CHARACTERS WITHOUT CLAIM TO ANY PARTICULAR FONT, STYLE, SIZE, OR COLOR.

OWNER OF U.S. REG. NOS. 3,748,890 AND 4,396,340.  
FOR COFFEE, TEA, SPICES, BARBECUE SAUCE (U.S. CL. 46).  
FIRST USE 10-31-2013; IN COMMERCE 10-31-2013.  
KATHY DE JONGE, EXAMINING ATTORNEY

---

SN 86-123,893. WISE OWL TRADEMARK HOLDINGS, LLC, NEW YORK, NY. FILED 11-20-2013.

# The Classic

THE MARK CONSISTS OF STANDARD CHARACTERS WITHOUT CLAIM TO ANY PARTICULAR FONT, STYLE, SIZE, OR COLOR.

FOR TEA (U.S. CL. 46).  
FIRST USE 8-1-2013; IN COMMERCE 8-1-2013.  
CHRISTOPHER LAW, EXAMINING ATTORNEY

**CLASS 30—(Continued).**

SN 86-123,899. WISE OWL TRADEMARK HOLDINGS, LLC,  
NEW YORK, NY. FILED 11-20-2013.

# Coco-Lada

THE MARK CONSISTS OF STANDARD CHARACTERS  
WITHOUT CLAIM TO ANY PARTICULAR FONT, STYLE,  
SIZE, OR COLOR.

FOR TEA (U.S. CL. 46).  
FIRST USE 8-1-2013; IN COMMERCE 8-1-2013.  
CHRISTOPHER LAW, EXAMINING ATTORNEY

SN 86-133,527. EXPRESS CAFE AND BAKERY, LLC, THE,  
SAVANNAH, GA. FILED 12-3-2013.

# ÉCROUSANT

THE MARK CONSISTS OF STANDARD CHARACTERS  
WITHOUT CLAIM TO ANY PARTICULAR FONT, STYLE,  
SIZE, OR COLOR.

FOR PASTRIES (U.S. CL. 46).  
FIRST USE 11-22-2013; IN COMMERCE 11-22-2013.  
KEVIN MITTLER, EXAMINING ATTORNEY

SN 86-144,425. DEAN FOODS COMPANY, DALLAS, TX.  
FILED 12-16-2013.

# FRUMOO

THE MARK CONSISTS OF STANDARD CHARACTERS  
WITHOUT CLAIM TO ANY PARTICULAR FONT, STYLE,  
SIZE, OR COLOR.

OWNER OF U.S. REG. NO. 3,875,009.  
FOR ICE CREAM; ICE CREAM BARS; ICE CREAM  
SANDWICHES (U.S. CL. 46).  
MICHAEL TANNER, EXAMINING ATTORNEY

**CLASS 31—NATURAL AGRICULTURAL PRO-  
DUCTS**

SN 79-137,742. RIJK ZWAAN ZAADTEELT EN ZAADHAN-  
DEL B.V., NETHERLANDS, FILED 7-22-2013.

Sharing a healthy future



PRIORITY DATE OF 3-29-2013 IS CLAIMED.  
OWNER OF INTERNATIONAL REGISTRATION 1179789  
DATED 7-22-2013, EXPIRES 7-22-2023.

OWNER OF U.S. REG. NO. 2,679,662.  
THE MARK CONSISTS OF THE WORDING "SHARING A  
HEALTHY FUTURE" FOLLOWED BY A STYLIZED "R"  
AND "Z" FORMING A SEEDLING DESIGN ABOVE THE  
WORDING "RIJK ZWAAN".

FOR AGRICULTURAL AND HORTICULTURAL PRO-  
DUCTS AND GRAINS, NAMELY, FRESH FRUITS AND  
VEGETABLES; SEEDS, NAMELY, SEEDS FOR FRUITS  
AND VEGETABLES; NATURAL PLANTS AND FLOW-  
ERS (U.S. CLS. 1 AND 46).

DAVID MURRAY, EXAMINING ATTORNEY

SN 85-495,321. JASON BAILEY, CALGARY, AB T3G 5C6,  
CANADA, FILED 12-14-2011.

# CHEWY & MOOCH

THE MARK CONSISTS OF STANDARD CHARACTERS  
WITHOUT CLAIM TO ANY PARTICULAR FONT, STYLE,  
SIZE, OR COLOR.

PRIORITY CLAIMED UNDER SEC. 44(D) ON CANADA  
APPLICATION NO. 1532936, FILED 6-22-2011, REG. NO.  
TMA864398, DATED 11-6-2013, EXPIRES 11-6-2028.

FOR EDIBLE PET TREATS, DIGESTIBLE CHEWING  
BONES FOR DOGS, EDIBLE PET CHEWS (U.S. CLS. 1  
AND 46).

ELLEN BURNS, EXAMINING ATTORNEY

SN 85-672,771. OASIS INTERTRADE LIMITED, TORTOLA,  
BR. VIRGIN ISLANDS, FILED 7-10-2012.

# DELIZIO

THE MARK CONSISTS OF STANDARD CHARACTERS  
WITHOUT CLAIM TO ANY PARTICULAR FONT, STYLE,  
SIZE, OR COLOR.

OWNER OF U.S. REG. NO. 4,098,022.  
THE ENGLISH TRANSLATION OF "DELIZIO" IN THE  
MARK IS "DELIGHT".

FOR BIRD SEED, GRASS SEEDS, FOODSTUFFS FOR  
ANIMALS (U.S. CLS. 1 AND 46).

KATHERINE CHANG, EXAMINING ATTORNEY

**CLASS 31—(Continued).**

SN 85-681,703. FRESHTEC, INC., PISMO BEACH, CA. FILED 7-19-2012.

## EVERFRESH

THE MARK CONSISTS OF STANDARD CHARACTERS WITHOUT CLAIM TO ANY PARTICULAR FONT, STYLE, SIZE, OR COLOR.

FOR CUT FLOWERS; NATURAL PLANTS AND FLOWERS (U.S. CLS. 1 AND 46).

CURTIS FRENCH, EXAMINING ATTORNEY

---

SN 85-785,607. PAWS BARKERY, INC., LANSDALE, PA. FILED 11-21-2012.

## PAWS BARKERY

THE MARK CONSISTS OF STANDARD CHARACTERS WITHOUT CLAIM TO ANY PARTICULAR FONT, STYLE, SIZE, OR COLOR.

NO CLAIM IS MADE TO THE EXCLUSIVE RIGHT TO USE "BARKERY", APART FROM THE MARK AS SHOWN. FOR PET TREATS (U.S. CLS. 1 AND 46).

FIRST USE 1-1-2001; IN COMMERCE 1-1-2001.  
PATRICIA EVANKO, EXAMINING ATTORNEY

---

SN 85-826,079. SWEET CLOVER PRODUCE, LLC, WALLA WALLA, WA. FILED 1-17-2013.

## Gloria

THE MARK CONSISTS OF STANDARD CHARACTERS WITHOUT CLAIM TO ANY PARTICULAR FONT, STYLE, SIZE, OR COLOR.

FOR FRESH ONIONS (U.S. CLS. 1 AND 46).  
FIRST USE 7-0-1955; IN COMMERCE 7-0-1955.  
PAUL CROWLEY, EXAMINING ATTORNEY

**CLASS 31—(Continued).**

SN 85-865,493. CHEWZY DOGS, LLC, DBA JUST DOGS GOURMET, MENDOTA HEIGHTS, MN. FILED 3-4-2013.

## THE WORLD'S TASTIEST GOURMET DOG TREATS

THE MARK CONSISTS OF STANDARD CHARACTERS WITHOUT CLAIM TO ANY PARTICULAR FONT, STYLE, SIZE, OR COLOR.

NO CLAIM IS MADE TO THE EXCLUSIVE RIGHT TO USE "GOURMET DOG TREATS", APART FROM THE MARK AS SHOWN.

SEC. 2(F).  
FOR DOG BISCUITS; DOG TREATS (U.S. CLS. 1 AND 46).

FIRST USE 11-30-2007; IN COMMERCE 11-30-2007.  
SHARON MEIER, EXAMINING ATTORNEY

---

SN 85-913,913. SPIN MASTER LTD., TORONTO, ONTARIO, CANADA, FILED 4-24-2013.

## EARTH BUDDY

THE MARK CONSISTS OF STANDARD CHARACTERS WITHOUT CLAIM TO ANY PARTICULAR FONT, STYLE, SIZE, OR COLOR.

OWNER OF CANADA REG. NO. TMA451891, DATED 12-15-1995, EXPIRES 12-15-2025.

OWNER OF CANADA REG. NO. TMA674913, DATED 10-16-2006, EXPIRES 10-16-2021.

FOR GRASS SEED SOLD TOGETHER AS A UNIT WITH DECORATIVE NOVELTY ITEMS FABRICATED BY FILLING A SUITABLY-SHAPED POROUS FABRIC WITH SAWDUST AND GRASS SEED, INTENDED TO BE WATERED IN ORDER TO ALLOW GRASS TO GROW IN PREDETERMINED AREAS; BEAN SEEDS PRE-POTTED IN DECORATIVE POTS THAT ARE INSCRIBED WITH MESSAGES AND WHICH GROW INTO PLANTS THAT DISPLAY THE MESSAGES; BEAN SEEDS PRE-POTTED IN DECORATIVE EGGS THAT ARE INSCRIBED WITH MESSAGES THAT REVEAL THE MESSAGES UPON HATCHING FROM THE EGGS; FLOWER SEEDS IN VACUUM SEALED CANS, SUCH THAT WHEN THE CAN IS OPENED AND WATER IS ADDED, THE FLOWER STARTS TO BLOOM (U.S. CLS. 1 AND 46).

JOHN DWYER, EXAMINING ATTORNEY

**CLASS 31—(Continued).**

SN 85-928,897. CARPA DORADA, S.L., CASTELLÓN, SPAIN, FILED 5-10-2013.

# CLEMCOTT

THE MARK CONSISTS OF STANDARD CHARACTERS WITHOUT CLAIM TO ANY PARTICULAR FONT, STYLE, SIZE, OR COLOR.

OWNER OF SPAIN REG. NO. 2.620.961, DATED 7-20-2005, EXPIRES 11-4-2014.

OWNER OF U.S. REG. NO. 3,411,332.

THE WORD(S) "CLEMCOTT" HAS NO MEANING IN A FOREIGN LANGUAGE.

FOR AGRICULTURAL PRODUCTS, NAMELY, AGRICULTURAL GRAINS FOR PLANTING, BULBS FOR AGRICULTURAL PURPOSES, SPORES AND SPAWN FOR AGRICULTURAL PURPOSES, LIVING PLANTS AND FRESH FRUITS, NAMELY, CITRUS FRUITS (U.S. CLS. 1 AND 46).

PAUL MORENO, EXAMINING ATTORNEY

---

SN 85-936,943. SIGMA ALIMENTOS, S.A. DE C.V., SAN PEDRO GARZA GARCIA, MEXICO, FILED 5-20-2013.

# BAR-S

THE MARK CONSISTS OF STANDARD CHARACTERS WITHOUT CLAIM TO ANY PARTICULAR FONT, STYLE, SIZE, OR COLOR.

PRIORITY CLAIMED UNDER SEC. 44(D) ON MEXICO APPLICATION NO. 1370127, FILED 5-2-2013, REG. NO. 1394657, DATED 8-30-2013, EXPIRES 5-2-2023.

OWNER OF U.S. REG. NOS. 1,283,523, 4,107,841 AND OTHERS.

FOR FOOD FOR ANIMALS (U.S. CLS. 1 AND 46).

JORDAN BAKER, EXAMINING ATTORNEY

---

SN 85-936,989. SIGMA ALIMENTOS, S.A. DE C.V., SAN PEDRO GARZA GARCIA, MEXICO, FILED 5-20-2013.

# LONGMONT

THE MARK CONSISTS OF STANDARD CHARACTERS WITHOUT CLAIM TO ANY PARTICULAR FONT, STYLE, SIZE, OR COLOR.

PRIORITY CLAIMED UNDER SEC. 44(D) ON MEXICO APPLICATION NO. 1370124, FILED 5-2-2013, REG. NO. 1394654, DATED 8-30-2013, EXPIRES 5-2-2023.

OWNER OF U.S. REG. NOS. 1,514,742 AND 3,808,334.

FOR FOOD FOR ANIMALS (U.S. CLS. 1 AND 46).

JORDAN BAKER, EXAMINING ATTORNEY

**CLASS 31—(Continued).**

SN 85-937,040. SIGMA ALIMENTOS, S.A. DE C.V., SAN PEDRO GARZA GARCIA, MEXICO, FILED 5-20-2013.

# FUD

THE MARK CONSISTS OF STANDARD CHARACTERS WITHOUT CLAIM TO ANY PARTICULAR FONT, STYLE, SIZE, OR COLOR.

PRIORITY CLAIMED UNDER SEC. 44(D) ON MEXICO APPLICATION NO. 1370126, FILED 5-2-2013, REG. NO. 1394656, DATED 8-30-2013, EXPIRES 5-2-2023.

OWNER OF U.S. REG. NOS. 3,191,237, 3,739,083 AND OTHERS.

FOR FOOD FOR ANIMALS (U.S. CLS. 1 AND 46).

JORDAN BAKER, EXAMINING ATTORNEY

---

SN 85-937,061. SIGMA ALIMENTOS, S.A. DE C.V., SAN PEDRO GARZA GARCIA, MEXICO, FILED 5-20-2013.

# PLAYERO

THE MARK CONSISTS OF STANDARD CHARACTERS WITHOUT CLAIM TO ANY PARTICULAR FONT, STYLE, SIZE, OR COLOR.

PRIORITY CLAIMED UNDER SEC. 44(D) ON MEXICO APPLICATION NO. 1370129, FILED 5-2-2013, REG. NO. 1394658, DATED 8-30-2013, EXPIRES 5-2-2023.

THE ENGLISH TRANSLATION OF "PLAYERO" IN THE MARK IS "BEACHCOMER" OR "BEACHBUM".

FOR FOOD FOR ANIMALS (U.S. CLS. 1 AND 46).

JORDAN BAKER, EXAMINING ATTORNEY

---

SN 85-937,139. SIGMA ALIMENTOS, S.A. DE C.V., SAN PEDRO GARZA GARCIA, MEXICO, FILED 5-20-2013.

# SR SAN RAFAEL

THE MARK CONSISTS OF STANDARD CHARACTERS WITHOUT CLAIM TO ANY PARTICULAR FONT, STYLE, SIZE, OR COLOR.

PRIORITY CLAIMED UNDER SEC. 44(D) ON MEXICO APPLICATION NO. 1370125, FILED 5-2-2013, REG. NO. 1394655, DATED 8-30-2013, EXPIRES 5-2-2023.

OWNER OF U.S. REG. NOS. 1,750,270, 3,858,846 AND 3,860,751.

THE ENGLISH TRANSLATION OF "SAN RAFAEL" IN THE MARK IS "SAINT RAFAEL" OR "RAPHAEL".

FOR FOOD FOR ANIMALS (U.S. CLS. 1 AND 46).

JORDAN BAKER, EXAMINING ATTORNEY

**CLASS 31—(Continued).**

SN 85-941,678. DOW AGROSCIENCES LLC, INDIANAPOLIS, IN. FILED 5-24-2013.

**DELTA FORCE**

THE MARK CONSISTS OF STANDARD CHARACTERS WITHOUT CLAIM TO ANY PARTICULAR FONT, STYLE, SIZE, OR COLOR.

THE WORDING "DELTA FORCE" HAS NO MEANING OTHER THAN TRADEMARK SIGNIFICANCE. FOR AGRICULTURAL SEEDS (U.S. CLS. 1 AND 46). BARBARA BROWN, EXAMINING ATTORNEY

**CLASS 31—(Continued).**

SN 85-961,566. JAMES WEBB, RENSSELAER, NY. FILED 6-17-2013.

**WEBB**

THE MARK CONSISTS OF STANDARD CHARACTERS WITHOUT CLAIM TO ANY PARTICULAR FONT, STYLE, SIZE, OR COLOR.

SEC. 2(F). FOR NATURAL PLANTS; NATURAL FLOWERS; FRESH FRUIT; FRESH HERBS; FRESH VEGETABLES (U.S. CLS. 1 AND 46).

FIRST USE 9-12-2004; IN COMMERCE 9-12-2004. WENDY JUN, EXAMINING ATTORNEY

SN 85-961,586. JAMES WEBB, RENSSELAER, NY. FILED 6-17-2013.

SN 85-942,125. BRUBAKKEN AND REINBOLD, INC., DBA LANDMARK TURF & NATIVE SEED, SPOKANE, WA. FILED 5-24-2013.



OWNER OF U.S. REG. NO. 4,367,940. NO CLAIM IS MADE TO THE EXCLUSIVE RIGHT TO USE "VITALITY" OR "SEED", APART FROM THE MARK AS SHOWN.

THE COLOR(S) LIGHT GREEN AND DARK GREEN IS/ ARE CLAIMED AS A FEATURE OF THE MARK.

THE MARK CONSISTS OF THE DESIGN OF A RECTANGLE BISECTED BY A CHEVRON DESIGN APPROXIMATELY MIDPOINT, WITH THE TOP PART OF THE RECTANGLE IN LIGHT GREEN COLOR AND THE BOTTOM PART IN DARK GREEN COLOR. BELOW THIS DESIGN ARE THE STYLIZED WORDINGS "VITALITY" IN DARK GREEN AND "SEED WITH CONFIDENCE" IN LIGHT GREEN COLOR.

FOR GRASS SEED (U.S. CLS. 1 AND 46). FIRST USE 11-25-2013; IN COMMERCE 11-25-2013. DAWN HAN, EXAMINING ATTORNEY

**WEBB FAMILY FARM**

THE MARK CONSISTS OF STANDARD CHARACTERS WITHOUT CLAIM TO ANY PARTICULAR FONT, STYLE, SIZE, OR COLOR.

SEC. 2(F). FOR NATURAL PLANTS; NATURAL FLOWERS; FRESH FRUIT; FRESH HERBS; FRESH VEGETABLES (U.S. CLS. 1 AND 46).

FIRST USE 9-12-2004; IN COMMERCE 9-12-2004. WENDY JUN, EXAMINING ATTORNEY

SN 86-017,287. CP (DELAWARE) INC., WILMINGTON, DE. FILED 7-23-2013.



NO CLAIM IS MADE TO THE EXCLUSIVE RIGHT TO USE "ROSES", APART FROM THE MARK AS SHOWN.

THE MARK CONSISTS OF THE WORDING "MY HOMETOWN ROSES" IN STYLIZED FONT.

FOR LIVE ROSE PLANTS (U.S. CLS. 1 AND 46). DAVID MURRAY, EXAMINING ATTORNEY



**CLASS 31—(Continued).**

SN 86-032,895. ROBERT RIESENMAN, DBA DUBI DELI, EL DORADO HILLS, CA. FILED 8-8-2013.

# DUBI

THE MARK CONSISTS OF STANDARD CHARACTERS WITHOUT CLAIM TO ANY PARTICULAR FONT, STYLE, SIZE, OR COLOR.

FOR FEEDER INSECTS (U.S. CLS. 1 AND 46).  
FIRST USE 1-1-2011; IN COMMERCE 1-1-2011.  
RON FAIRBANKS, EXAMINING ATTORNEY

SN 86-034,534. LEE MALACHI, NEW YORK, NY. AND TERIKA MALACHI, NEW YORK, NY. FILED 8-10-2013.

# FETCH FRIES

THE MARK CONSISTS OF STANDARD CHARACTERS WITHOUT CLAIM TO ANY PARTICULAR FONT, STYLE, SIZE, OR COLOR.

NO CLAIM IS MADE TO THE EXCLUSIVE RIGHT TO USE "FRIES", APART FROM THE MARK AS SHOWN.  
FOR DOG TREATS; EDIBLE CHEWS FOR DOGS; EDIBLE ORGANIC PET TREATS FOR DOGS; PET TREATS (U.S. CLS. 1 AND 46).  
FIRST USE 2-1-2011; IN COMMERCE 8-4-2012.  
AMY HELLA, EXAMINING ATTORNEY

SN 86-038,497. HORTECH, INC., SPRING LAKE, MI. FILED 8-15-2013.

# SEDUM ACRE OLIVIA'S GOLD

THE MARK CONSISTS OF STANDARD CHARACTERS WITHOUT CLAIM TO ANY PARTICULAR FONT, STYLE, SIZE, OR COLOR.

NO CLAIM IS MADE TO THE EXCLUSIVE RIGHT TO USE "SEDUM ACRE" AND "GOLD", APART FROM THE MARK AS SHOWN.  
FOR LIVING PLANTS, NAMELY, LOW LYING GROUND COVER (U.S. CLS. 1 AND 46).  
CATHERINE TARCU, EXAMINING ATTORNEY

**CLASS 31—(Continued).**

SN 86-041,126. AGROEXPORT LLC, PHARR, TX. AND RODRIGUEZ, JOSE, PHARR, TX. FILED 8-19-2013.

# VILLITA SLICE

THE MARK CONSISTS OF STANDARD CHARACTERS WITHOUT CLAIM TO ANY PARTICULAR FONT, STYLE, SIZE, OR COLOR.

NO CLAIM IS MADE TO THE EXCLUSIVE RIGHT TO USE "SLICE", APART FROM THE MARK AS SHOWN.  
THE ENGLISH TRANSLATION OF THE WORD "VILLITA" IN THE MARK IS "SMALL TOWN".  
FOR FRESH AVOCADOS (U.S. CLS. 1 AND 46).  
AMY KERTGATE, EXAMINING ATTORNEY

SN 86-042,357. YANA KLIMOVITSKY, JERUSALEM, ISRAEL, FILED 8-20-2013.

# You are flowering till a last will not wilt

THE MARK CONSISTS OF STANDARD CHARACTERS WITHOUT CLAIM TO ANY PARTICULAR FONT, STYLE, SIZE, OR COLOR.

FOR BOUQUET OF LIVE FLOWERS WITH ONE ARTIFICIAL FLOWER INSIDE (U.S. CLS. 1 AND 46).  
FONG HSU, EXAMINING ATTORNEY

SN 86-044,331. CLASSIC MEDIA, LLC, NEW YORK, NY. FILED 8-21-2013.

# LASSIE NATURALS

THE MARK CONSISTS OF STANDARD CHARACTERS WITHOUT CLAIM TO ANY PARTICULAR FONT, STYLE, SIZE, OR COLOR.

OWNER OF U.S. REG. NOS. 3,242,129, 3,490,413 AND OTHERS.

NO CLAIM IS MADE TO THE EXCLUSIVE RIGHT TO USE "NATURALS", APART FROM THE MARK AS SHOWN.  
FOR PET FOODS, EDIBLE CHEWS FOR DOGS, DOG TREATS, DOG BISCUITS; ALL OF THE FOREGOING MADE IN WHOLE OR SUBSTANTIAL PART FROM NATURAL INGREDIENTS (U.S. CLS. 1 AND 46).  
MEGHAN REINHART, EXAMINING ATTORNEY

**CLASS 31—(Continued).**

SN 86-059,966. CHURCH & DWIGHT CO., INC., EWING, NJ.  
FILED 9-10-2013.

**ODOR BUSTER**

THE MARK CONSISTS OF STANDARD CHARACTERS WITHOUT CLAIM TO ANY PARTICULAR FONT, STYLE, SIZE, OR COLOR.

NO CLAIM IS MADE TO THE EXCLUSIVE RIGHT TO USE "ODOR", APART FROM THE MARK AS SHOWN.

FOR CAT LITTER (U.S. CLS. 1 AND 46).

WENDY GOODMAN, EXAMINING ATTORNEY

SN 86-064,607. HI-Q FOOD PRODUCTS CO., LTD., BANG-  
PLEE, SAMUTPRAKARN, THAILAND, FILED 9-13-2013.



THE MARK CONSISTS OF A DARK BOX WITH ROUNDED EDGES CONTAINING A LIGHT SILHOUETTE OF A SITTING CAT IN THE RIGHT PORTION OF THE BOX AND THE STYLIZED WORD "VILARE" CENTRALLY ALIGNED.

FOR PET FOODS; CANNED FOOD FOR PETS; ANIMAL FOODSTUFFS; PET BEVERAGES (U.S. CLS. 1 AND 46).

CHERYL CLAYTON, EXAMINING ATTORNEY

SN 86-065,541. TWO LITTLE FISHIES, INC., MIAMI GAR-  
DENS, FL. FILED 9-16-2013.

**SpiraPlan**

THE MARK CONSISTS OF STANDARD CHARACTERS WITHOUT CLAIM TO ANY PARTICULAR FONT, STYLE, SIZE, OR COLOR.

FOR FISH FOOD; UNPROCESSED SPIRULINA (U.S. CLS. 1 AND 46).

DAVID COLLIER, EXAMINING ATTORNEY

**CLASS 31—(Continued).**

SN 86-066,736. STRONG PRONG BRAND GINSENG CO.,  
LLC, BIRCH RIVER, WV. FILED 9-17-2013.

**STRONG PRONG BRAND GINSENG**

THE MARK CONSISTS OF STANDARD CHARACTERS WITHOUT CLAIM TO ANY PARTICULAR FONT, STYLE, SIZE, OR COLOR.

NO CLAIM IS MADE TO THE EXCLUSIVE RIGHT TO USE "BRAND" AND "GINSENG", APART FROM THE MARK AS SHOWN.

FOR RAW GINSENG ROOT OF THE WILD VARIETY (U.S. CLS. 1 AND 46).

MARC LEIPZIG, EXAMINING ATTORNEY

SN 86-067,702. BOW-WOW BAR, KETCHUM, ID. FILED 9-18-  
2013.

**BOW-WOW Bar**

THE MARK CONSISTS OF STANDARD CHARACTERS WITHOUT CLAIM TO ANY PARTICULAR FONT, STYLE, SIZE, OR COLOR.

NO CLAIM IS MADE TO THE EXCLUSIVE RIGHT TO USE "BAR", APART FROM THE MARK AS SHOWN.

FOR DOG TREATS (U.S. CLS. 1 AND 46).

FIRST USE 8-0-2013; IN COMMERCE 8-0-2013.

LINDA ESTRADA, EXAMINING ATTORNEY

SN 86-068,679. JUDITH COPPOLA, NORTH BELLMORE, NY.  
FILED 9-18-2013.

**PuPs n PeePs**

THE MARK CONSISTS OF STANDARD CHARACTERS WITHOUT CLAIM TO ANY PARTICULAR FONT, STYLE, SIZE, OR COLOR.

FOR PET TREATS (U.S. CLS. 1 AND 46).

CAROL SPILS, EXAMINING ATTORNEY

**CLASS 31—(Continued).**

SN 86-070,703. INTERNATIONAL GREENHOUSE PRODUCE, S.A. DE C.V., CULIACAN, SINALOA, MEXICO, FILED 9-20-2013.



THE MARK CONSISTS OF THE LETTERS "IGP" IN STYLIZED FORMAT WITH A DIAMOND BETWEEN THE "I" AND "G" AND A DIAMOND BETWEEN THE "G" AND "P".

FOR FRESH CUCUMBERS; FRESH EGGPLANTS; FRESH FRUITS; FRESH PEPPERS; FRESH TOMATOES; FRESH VEGETABLES (U.S. CLS. 1 AND 46).  
VERNA BETH RIRIE, EXAMINING ATTORNEY

**CLASS 31—(Continued).**

SN 86-070,733. INTERNATIONAL GREENHOUSE PRODUCE, S.A. DE C.V., CULIACAN, SINALOA, MEXICO, FILED 9-20-2013.



THE MARK CONSISTS OF A DESIGN OF A GLOBE WITH A GRID DESIGN THEREON, A 5-SIDED POLYGON ON THE FRONT OF THE GLOBE WITH A TREE DESIGN CONTAINED THEREIN.

FOR FRESH CUCUMBERS; FRESH EGGPLANTS; FRESH FRUITS; FRESH PEPPERS; FRESH TOMATOES; FRESH VEGETABLES (U.S. CLS. 1 AND 46).  
VERNA BETH RIRIE, EXAMINING ATTORNEY

SN 86-072,049. RUSH DIRECT, INC, WOOD DALE, IL. FILED 9-23-2013.

SN 86-070,713. INTERNATIONAL GREENHOUSE PRODUCE, S.A. DE C.V., CULIACAN, SINALOA, MEXICO, FILED 9-20-2013.



THE MARK CONSISTS OF A DESIGN OF A GLOBE WITH A GRID DESIGN THEREON, A 5-SIDED POLYGON ON THE FRONT OF THE GLOBE WITH A TREE DESIGN CONTAINED THEREIN AND THE LETTERS "IGP" IN STYLIZED FORMAT WITH A DIAMOND BETWEEN THE "I" AND "G" AND A DIAMOND BETWEEN THE "G" AND "P" SHOWN BELOW THE GLOBE.

FOR FRESH CUCUMBERS; FRESH EGGPLANTS; FRESH FRUITS; FRESH PEPPERS; FRESH TOMATOES; FRESH VEGETABLES (U.S. CLS. 1 AND 46).  
VERNA BETH RIRIE, EXAMINING ATTORNEY

**Bac-N-Licious**

THE MARK CONSISTS OF STANDARD CHARACTERS WITHOUT CLAIM TO ANY PARTICULAR FONT, STYLE, SIZE, OR COLOR.

FOR DOG TREATS; EDIBLE CHEWS FOR DOGS (U.S. CLS. 1 AND 46).  
FIRST USE 1-1-2013; IN COMMERCE 1-1-2013.  
ALEX KEAM, EXAMINING ATTORNEY

SN 86-072,557. DAVIS VETERINARY MEDICAL CONSULTING, INC., DAVIS, CA. FILED 9-23-2013.

**BALANCE IT**

THE MARK CONSISTS OF STANDARD CHARACTERS WITHOUT CLAIM TO ANY PARTICULAR FONT, STYLE, SIZE, OR COLOR.

OWNER OF U.S. REG. NO. 3,094,401.  
FOR CAT FOOD; DOG FOOD; PET FOOD (U.S. CLS. 1 AND 46).  
FIRST USE 9-23-2013; IN COMMERCE 9-23-2013.  
ANDREW LEASER, EXAMINING ATTORNEY

**CLASS 31—(Continued).**

SN 86-075,894. TRU RX LLC, EAGLE, ID. FILED 9-26-2013.

# RED RHINO

THE MARK CONSISTS OF STANDARD CHARACTERS WITHOUT CLAIM TO ANY PARTICULAR FONT, STYLE, SIZE, OR COLOR.

FOR DOG FOOD (U.S. CLS. 1 AND 46).  
TRACY CROSS, EXAMINING ATTORNEY

SN 86-093,443. TRU RX LLC, EAGLE, ID. FILED 10-16-2013.

# DELIGHTIBLES

THE MARK CONSISTS OF STANDARD CHARACTERS WITHOUT CLAIM TO ANY PARTICULAR FONT, STYLE, SIZE, OR COLOR.

FOR EDIBLE PET TREATS FOR CATS (U.S. CLS. 1 AND 46).  
TRACY CROSS, EXAMINING ATTORNEY

SN 86-096,736. PAUL'S PET FOOD DELIVERY EXPRESS, INC., ANAHEIM, CA. FILED 10-21-2013.



THE MARK CONSISTS OF A DESIGN OF A DOG NAMED ROCCO WITH SPOTS ON HIS LEFT EYE AND BACK WITH A GRIN, DARK SHADE ON HIS NOSE AND DARK LARGE PAWS, AND A DESIGN OF A CAT NAMED CHARLES WITH AN EYEGLASS PIECE IN HIS LEFT EYE CONNECTED TO A CHAIN LINKING TO A COLLAR WITH AN ID TAG, A GRIN ON HIS FACE, AND PAWS, EARS, EYES, MOUTH, AND A TAIL IN A DARK SHADE THAN THE REST OF HIS FELINE BODY.

FOR PET FOOD (U.S. CLS. 1 AND 46).  
FIRST USE 10-1-2012; IN COMMERCE 10-1-2012.  
SAMUEL E. SHARPER JR., EXAMINING ATTORNEY

**CLASS 31—(Continued).**

SN 86-104,857. TARGET BRANDS, INC., MINNEAPOLIS, MN. FILED 10-29-2013.



OWNER OF U.S. REG. NOS. 4,006,681, 4,112,470 AND OTHERS.

NO CLAIM IS MADE TO THE EXCLUSIVE RIGHT TO USE "FARMS", APART FROM THE MARK AS SHOWN.

THE MARK CONSISTS OF A ROOSTER STACKED ON TOP OF THE WORDS "SAVOR EVERYDAY" IN UPPER CASE LETTERS STACKED ON TOP OF THE WORDS "ARCHER FARMS" IN LOWER CASE LETTERS.

FOR RAW AND FRESH FRUIT AND VEGETABLES; RAW AND UNPROCESSED NUTS (U.S. CLS. 1 AND 46).  
MEREDITH MARESCA, EXAMINING ATTORNEY

SN 86-105,642. POWER PET COMPANY, INC., NATIONAL CITY, CA. FILED 10-30-2013.

# Powerpet

OWNER OF U.S. REG. NOS. 3,564,502 AND 3,652,417.  
THE MARK CONSISTS OF THE WORD "POWERPET" IN BLOCK LETTERS AND SURFACE SHADING ON THE RIGHT PORTION OF THE LETTERS AND BLACK SHADOWING UNDER EACH LETTER WITH A PAW PRINT INSIDE THE LETTER "O".

FOR DOG FOOD, DOG FOOD TREATS, EDIBLE CHEWS FOR ANIMALS (U.S. CLS. 1 AND 46).  
FIRST USE 2-12-2009; IN COMMERCE 2-12-2009.  
ANN E. SAPPENFIELD, EXAMINING ATTORNEY

**CLASS 31—(Continued).**

SN 86-121,004. BLUE BUFFALO COMPANY, LTD., WILTON, CT. FILED 11-17-2013.

**HERBAL ATTRACTION**

THE MARK CONSISTS OF STANDARD CHARACTERS WITHOUT CLAIM TO ANY PARTICULAR FONT, STYLE, SIZE, OR COLOR.

NO CLAIM IS MADE TO THE EXCLUSIVE RIGHT TO USE "HERBAL", APART FROM THE MARK AS SHOWN.

FOR ANIMAL LITTER; CAT LITTER; KITTY LITTER (U.S. CLS. 1 AND 46).

ALLISON SCHRODY, EXAMINING ATTORNEY

**CLASS 32—(Continued).**

SN 79-127,957. THE STATE OF QUEENSLAND; ACTING THROUGH THE DEPARTMENT OF AGRICULTURE; FISHERIES AND FORESTRY, AUSTRALIA, FILED 10-23-2012.



PRIORITY DATE OF 4-23-2012 IS CLAIMED. OWNER OF INTERNATIONAL REGISTRATION 1154693 DATED 10-23-2012, EXPIRES 10-23-2022.

NO CLAIM IS MADE TO THE EXCLUSIVE RIGHT TO USE "PLANT SAP", APART FROM THE MARK AS SHOWN.

THE MARK CONSISTS OF THE STYLIZED TEXT "PLANTSAP", WITH A LEAF DESIGN ELEMENT, THE STEM OF WHICH BEGINS JUST ABOVE AND BETWEEN THE "T" AND "S", POINTING UPWARDS. THE LEAF IS FOLDED DOWNWARD AT APPROXIMATELY ITS MID-POINT, WITH THE TIP OF THE LEAF POINTING TOWARD THE TOP OF THE "A" IN "SAP", WHICH IS REPLACED WITH A DESIGN ELEMENT CONSISTING OF A CIRCULAR DROPLET WITHIN A TEARDROP-SHAPED DROPLET; THE TEARDROP-SHAPED DROPLET APPEARS TO BE DRIPPING FROM THE TIP OF THE LEAF DESIGN ELEMENT. THERE ARE FOUR HORIZONTAL LINES BISECTING THE VERTICAL PART OF THE LETTER "P" IN "PLANT", AND ONE HORIZONTAL LINE BISECTING THE TEARDROP-SHAPED DROPLET, DELINEATING THE BOTTOM OF THE LETTER "A".

FOR BEVERAGES CONSISTING OF A BLEND OF FRUIT AND VEGETABLE JUICES; BEVERAGES MADE FROM FRUIT CONCENTRATES; EDIBLE ESSENCES FOR MAKING BEVERAGES IN FROZEN OR LIQUID FORM, NAMELY, EDIBLE ESSENCES FOR MAKING CARBONATED BEVERAGES, VEGETABLE BEVERAGES, VEGETABLE DRINKS, VEGETABLE JUICES, FRUIT BEVERAGES, FRUIT DRINKS, FRUIT JUICES, FRUIT JUICE BEVERAGES THAT CONTAIN MULTIVITAMINS, BEVERAGES CONSISTING OF A BLEND OF FRUIT AND VEGETABLE JUICES, BEVERAGES CONTAINING FRUIT OR VEGETABLE JUICES, DRINKING WATERS, FLAVORED WATERS, MINERAL WATERS, AERATED WATERS, OR ISOTONIC BEVERAGES; EDIBLE ESSENCES FOR MAKING BEVERAGES IN FROZEN OR LIQUID FORM, NAMELY, EDIBLE ESSENCES PREPARED FROM OR CONTAINING JUICES, CONCENTRATES OR EXTRACTS OF SUGAR CANE, SUGAR BEET, SORGHUM, PALM SYRUP, FRUITS OR VEGETABLES; SPORTS DRINKS CONTAINING ELECTROLYTES IN FROZEN OR LIQUID FORM FOR GENERAL AND SPORTS PURPOSES; SPORTS DRINKS CONTAINING ELECTROLYTES IN FROZEN OR LIQUID FORM FOR GENERAL AND SPORTS PURPOSES, NAMELY, SPORTS DRINKS PREPARED FROM JUICES, CONCENTRATES OR EXTRACTS OF SUGAR CANE, SUGAR BEET, SORGHUM, PALM SYRUP, FRUITS OR VEGETABLES; NON-ALCOHOLIC VEGETABLE EXTRACTS USED IN THE PREPARATION OF BEVERAGES; NON-ALCOHOLIC VEGETABLE EXTRACTS FOR MAKING BEVERAGES IN FROZEN OR LIQUID FORM, NAMELY, EXTRACTS IN THE FORM OF SYRUPS, CONCENTRATES OR POWDERS FOR MAKING BEVERAGES; NON-ALCOHOLIC VEGETABLE EXTRACTS FOR MAKING BEVERAGES IN FROZEN OR LIQUID FORM, NAMELY, EXTRACTS FOR MAKING CARBONATED BEVERAGES, VEGETABLE BEVERAGES, VEGETABLE DRINKS, VEGETABLE JUICES, BEVERAGES CONSISTING OF A BLEND OF FRUIT AND VEGETABLE JUICES, BEVERAGES CONTAINING VEGETABLE JUICES, DRINKING WATERS, FLAVORED WATERS, MINERAL WATERS, AERATED WATERS, OR ISOTONIC BEVERAGES; FRUIT BEVERAGES; FRUIT DRINKS; FRUIT JUICES; ISOTONIC BEVERAGES; FRUIT JUICE BEVERAGES THAT CONTAIN MULTI VITAMINS; NON-

**CLASS 32—LIGHT BEVERAGES**

SN 76-715,270. BALTICA BREWERIES, RU-194292 SAIN PETERSBURG, RUSSIAN FED., FILED 12-23-2009.



PRIORITY CLAIMED UNDER SEC. 44(D) ON RUSSIAN FED. APPLICATION NO. 2009715087, FILED 6-29-2009.

NO CLAIM IS MADE TO THE EXCLUSIVE RIGHT TO USE "ZATECKY", APART FROM THE MARK AS SHOWN.

THE COLOR(S) GREEN, YELLOW, RED, GRAY AND WHITE IS/ARE CLAIMED AS A FEATURE OF THE MARK.

THE MARK CONSISTS OF THE WORDS "ZATECKY GUS" AND THE DESIGN OF A RED AND YELLOW CREST CONTAINING A WHITE DUCK HEAD. THE WORDS "ZATECKY GUS" APPEAR IN GREEN COLOR AND ARE OUTLINED IN YELLOW. THESE APPEAR ABOVE A YELLOW CITY SCENE DESIGN AND BELOW THE CREST DESIGN. THE WORDS AND DESIGN ARE INSIDE A WHITE OVAL DESIGN THAT IS OUTLINED IN GREEN AND YELLOW. THE ENTIRE MARK IS ON A BACKGROUND OF GRAY AND YELLOW.

FOR BEER (U.S. CLS. 45, 46 AND 48).

FIRST USE 7-0-2009; IN COMMERCE 4-0-2010.

MARGERY A. TIERNEY, EXAMINING ATTORNEY

**CLASS 32—(Continued).**

ALCOHOLIC BEVERAGES IN FROZEN OR LIQUID FORM PREPARED FROM JUICES, CONCENTRATES OR EXTRACTS OF SUGAR CANE, SUGAR BEET, SORGHUM, PALM SYRUP, FRUITS OR VEGETABLES; NON-ALCOHOLIC BEVERAGES IN FROZEN OR LIQUID FORM, NAMELY, CARBONATED BEVERAGES, VEGETABLE BEVERAGES, VEGETABLE DRINKS, VEGETABLE JUICES, FRUIT BEVERAGES, FRUIT DRINKS, FRUIT JUICES, FRUIT JUICE BEVERAGES THAT CONTAIN MULTI-VITAMINS, BEVERAGES CONSISTING OF A BLEND OF FRUIT AND VEGETABLE JUICES, BEVERAGES CONTAINING FRUIT OR VEGETABLE JUICES, DRINKING WATERS, FLAVORED WATERS, MINERAL WATERS, AERATED WATERS, OR ISOTONIC BEVERAGES; PREPARATIONS FOR MAKING BEVERAGES IN FROZEN OR LIQUID FORM, NAMELY, PREPARATIONS FOR MAKING CARBONATED BEVERAGES, VEGETABLE BEVERAGES, VEGETABLE DRINKS, VEGETABLE JUICES, FRUIT BEVERAGES, FRUIT DRINKS, FRUIT JUICES, FRUIT JUICE BEVERAGES THAT CONTAIN MULTI-VITAMINS, BEVERAGES CONSISTING OF A BLEND OF FRUIT AND VEGETABLE JUICES, BEVERAGES CONTAINING FRUIT OR VEGETABLE JUICES, DRINKING WATERS, FLAVORED WATERS, MINERAL WATERS, AERATED WATERS, OR ISOTONIC BEVERAGES; PREPARATIONS FOR MAKING BEVERAGES IN FROZEN OR LIQUID FORM, NAMELY, PREPARATIONS PREPARED FROM OR CONTAINING JUICES, CONCENTRATES OR EXTRACTS OF SUGAR CANE, SUGAR BEET, SORGHUM, PALM SYRUP, FRUITS OR VEGETABLES; PREPARATIONS OF SUGAR CANE, SUGAR BEET, SORGHUM, PALM SYRUP, FRUITS OR VEGETABLES FOR MAKING BEVERAGES IN FROZEN OR LIQUID FORM, NAMELY, PREPARATIONS IN THE FORM OF SYRUPS, CONCENTRATES OR POWDERS FOR MAKING BEVERAGES; WATER BEVERAGES (U.S. CLS. 45, 46 AND 48).

WENDELL PHILLIPS, EXAMINING ATTORNEY

---

SN 79-136,198. HAMIDIYE KAYNAK SULARI SANAYI TURIZM VE TICARET ANONIM SIRKETI, ISTANBUL, TURKEY, FILED 7-3-2013.



OWNER OF INTERNATIONAL REGISTRATION 1175761 DATED 7-3-2013, EXPIRES 7-3-2023.

THE COLOR(S) BLACK, BLUE AND WHITE IS/ARE CLAIMED AS A FEATURE OF THE MARK.

THE MARK CONSISTS OF THE LETTERS "ESVA" IN THE COLOR BLACK SUPERIMPOSED OVER A BLUE AND WHITE SKY BACKGROUND WITH A FADED IMAGE OF A BUILDING IN THE BACKGROUND.

FOR MINERAL WATER, SPRING WATER, TABLE WATER, SODA WATER (U.S. CLS. 45, 46 AND 48).

GENE MACIOL, EXAMINING ATTORNEY

**CLASS 32—(Continued).**

SN 79-137,644. PRIVATBRAUEREI EICHBAUM GMBH & CO. KG, FED REP GERMANY, FILED 9-4-2013.



PRIORITY DATE OF 5-22-2013 IS CLAIMED. OWNER OF INTERNATIONAL REGISTRATION 1179593 DATED 9-4-2013, EXPIRES 9-4-2023.

THE COLOR(S) BLACK, BROWN, RED, OCHRE AND WHITE IS/ARE CLAIMED AS A FEATURE OF THE MARK.

THE MARK CONSISTS OF THE TERM "KARAMALZ" IN WHITE LETTERING WITHIN A BROWN OBLONG SHAPE WITH FIVE CHEVRONS ABOVE IT IN THE DESCENDING COLORS OF BROWN, WHITE, OCHRE, WHITE AND RED, WITH INWARD CURVING BROWN LINES TO THE LEFT AND RIGHT OF THE BROWN OBLONG, ALL WITHIN A BLACK RECTANGLE.

FOR NON-ALCOHOLIC BEVERAGES, NAMELY, NON-ALCOHOLIC MALT BEVERAGES; MALT BEER; MALT DRINKS, NAMELY, MALT BEERS AND NON-ALCOHOLIC MALT BEVERAGES (U.S. CLS. 45, 46 AND 48).

JOHN DWYER, EXAMINING ATTORNEY

---

SN 85-447,779. U&ME BEVERAGE COMPANY, MISSISSAUGA, ONTARIO, CANADA, FILED 10-14-2011.



THE MARK CONSISTS OF THE WORDS "NATURE'S SQUEEZE" IN STYLIZED LETTERS WITH TWO DROPS OF LIQUID TAKING THE PLACE OF THE APOSTROPHE.

FOR FRUIT DRINKS AND JUICES (U.S. CLS. 45, 46 AND 48).

PATRICIA EVANKO, EXAMINING ATTORNEY

**CLASS 32—(Continued).**

SN 85-671,737. AGRO VALUE LIMITED, KAMPALA, UGANDA, FILED 7-9-2012.

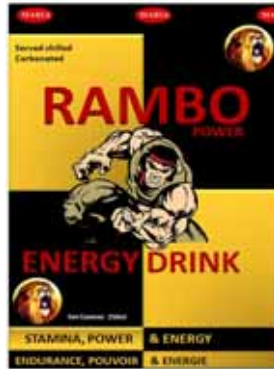

NO CLAIM IS MADE TO THE EXCLUSIVE RIGHT TO USE "STAMINA, POWER & ENERGY", "ENDURANCE, POUVOIR & ENERGIE", "SERVED CHILLED", "CARBONATED" AND "NET CONTENT: 250 ML", APART FROM THE MARK AS SHOWN.

THE COLOR(S) YELLOW, KHAKI, TAN, BLACK, WHITE AND RED IS/ARE CLAIMED AS A FEATURE OF THE MARK.

THE MARK CONSISTS OF THE DESIGN OF A MAN WITH A TAN SKIN AND BLACK SHADING, KHAKI CLOTHING, BLACK HAIR, A RED BANDANA POSITIONED BETWEEN THE WORDING "RAMBO POWER" AND "ENERGY DRINK" BOTH OF WHICH ARE IN RED LETTERS. THE BACKGROUND CONSISTS OF BLACK AND YELLOW RECTANGLES. THE DESIGN OF A LION'S HEAD IN SHADES OF TAN, YELLOW AND BLACK APPEAR IN THE UPPER RIGHT AND LOWER LEFT CORNERS WITH BLACK BACKGROUNDS. THE WORDING "STAMINA, POWER & ENERGY" APPEARS AT THE BOTTOM OF THE DRAWING; THE TERMS "STAMINA, POWER" ARE IN BLACK LETTERS ON A YELLOW RECTANGULAR BACKGROUND, AND "& ENERGY" IS IN YELLOW LETTERS ON A BLACK RECTANGULAR BACKGROUND; THE WORDING "ENDURANCE, POUVOIR & ENERGIE" ALSO APPEARS AT THE BOTTOM OF THE DRAWING WHEREIN THE TERMS "ENDURANCE, POUVOIR" ARE IN YELLOW LETTERS ON A BLACK RECTANGULAR BACKGROUND AND "& ENERGIE" IS IN BLACK LETTERS ON A YELLOW RECTANGULAR BACKGROUND. THE WORDING "MARIA" APPEARS IN WHITE LETTERS ON RED OVALS ACROSS THE TOP OF THE MARK ON A BLACK BACKGROUND. THE WORDING "SERVED CHILLED" AND "CARBONATED" APPEARS IN BLACK LETTERS ON THE UPPER LEFT YELLOW RECTANGLE AND THE WORDING "NET CONTENT: 250 ML" APPEARS IN WHITE LETTERS ON THE LOWER LEFT BLACK RECTANGLE.

THE ENGLISH TRANSLATION OF "ENDURANCE", "POUVOIR", "ENERGIE" IN THE MARK IS "STAMINA", "POWER", "ENERGY".

FOR MINERAL AND AERATED CARBONATED WATERS, ENERGY DRINKS, AND OTHER NON-ALCOHOLIC DRINKS, NAMELY, SOFT DRINKS, ENERGY DRINKS, CIDER; FRUIT DRINKS AND FRUIT JUICES; CARBONATED ENERGY DRINKS; CONCENTRATES, SYRUPS AND POWDERS USED IN THE PREPARATION OF SOFT DRINKS AND ENERGY DRINKS (U.S. CLS. 45, 46 AND 48).

FIRST USE 4-2-2012; IN COMMERCE 4-2-2012.  
KAREN BRACEY, EXAMINING ATTORNEY

**CLASS 32—(Continued).**

SN 85-828,177. NEW JERSEY BEVERAGE DISTRIBUTORS, LLC, EDISON, NJ. FILED 1-21-2013.



NO CLAIM IS MADE TO THE EXCLUSIVE RIGHT TO USE "VITAMIN DOSE", APART FROM THE MARK AS SHOWN.

THE COLOR(S) WHITE, ORANGE, YELLOW, DARK GREEN, LIGHT GREEN, DARK BLUE, LIGHT BLUE, AND GRAY IS/ARE CLAIMED AS A FEATURE OF THE MARK.

THE MARK CONSISTS OF THE WORDING "VITAMIN DOSE" IN WHITE LETTERING REPEATED THREE TIMES, EACH TIME THE WORD "DOSE" IS WRITTEN HORIZONTALLY WITH INTERLOCKING "D" AND "O" WITH THE WORD "VITAMIN" WRITTEN TO THE LEFT OF THE WORD "DOSE" AND WRITTEN VERTICALLY. THE FIRST ITERATION SHOWS THE WORDING AGAINST ALTERNATING VERTICAL BANDING OF ORANGE AND YELLOW. THE SECOND ITERATION SHOWS THE WORDING AGAINST ALTERNATING VERTICAL BANDING OF DARK AND LIGHT GREEN. THE THIRD ITERATION SHOWS THE WORDING AGAINST ALTERNATING VERTICAL BANDING OF DARK AND LIGHT BLUE. THE ITERATIONS ARE SEPARATED BY VERTICAL GRAY BANDS.

FOR NON-ALCOHOLIC BEVERAGES CONTAINING VITAMINS, NAMELY, ENERGY DRINKS (U.S. CLS. 45, 46 AND 48).

FLORENTINA BLANDU, EXAMINING ATTORNEY

SN 85-836,722. NIAGARA BOTTLING, LLC, ONTARIO, CA. FILED 1-30-2013.

**ECO-AIR**

THE MARK CONSISTS OF STANDARD CHARACTERS WITHOUT CLAIM TO ANY PARTICULAR FONT, STYLE, SIZE, OR COLOR.

OWNER OF U.S. REG. NO. 3,966,725.

FOR BOTTLED WATER; PLASTIC BOTTLE SOLD AS AN INTEGRAL COMPONENT OF BOTTLED WATER; PLASTIC BOTTLE SOLD FILLED WITH WATER; PLASTIC PACKAGING SOLD AS AN INTEGRAL COMPONENT OF BOTTLED WATER (U.S. CLS. 45, 46 AND 48).

FIRST USE 12-20-2010; IN COMMERCE 12-20-2010.  
STEVEN JACKSON, EXAMINING ATTORNEY

**CLASS 32—(Continued).**

SN 85-837,957. IAN MACAULAY MACLENNAN, VANCOUVER, BC, CANADA, FILED 1-31-2013.



NO CLAIM IS MADE TO THE EXCLUSIVE RIGHT TO USE "MICROBREWERY", APART FROM THE MARK AS SHOWN.

THE MARK CONSISTS OF AN EAGLE WITH OUTSTRETCHED WINGS SUPERIMPOSED OVER THREE CONCENTRIC CIRCLES WHERE THE OUTER CIRCLE IS A THIN CIRCLE. THE MIDDLE CIRCLE IS A SOLID CIRCLE WITH A SERIES OF FIVE-POINTED STARS WHERE FIVE STARS ARE VISIBLE ABOVE THE EAGLE, TWO PARTIAL STARS ARE VISIBLE UNDER THE WINGS OF THE EAGLE, AND FOUR PARTIAL STARS ARE VISIBLE UNDERNEATH THE EAGLE. THE MIDDLE CIRCLE SHOWS SKY AND CLOUDS ABOVE THE EAGLE. THE EAGLE HOLDS A BANNER IN ITS MOUTH THAT CONTAINS THE WORDING "MICRO BREWERY" WITH LINES ABOVE AND BELOW THE WORDS. ABOVE THE CIRCLES IS A BANNER CONTAINING THE WORDS "THE GREAT AMERICAN".

FOR MALT EXTRACTS AND PROCESSED HOPS FOR BREWING BEER IN BREWERY EQUIPMENT (U.S. CLS. 45, 46 AND 48).

FIRST USE 12-31-1994; IN COMMERCE 12-31-1994.  
TIMOTHY O. SCHIMPF, EXAMINING ATTORNEY

SN 85-838,169. NEW JERSEY BEER COMPANY, NORTH BERGEN, NJ. FILED 2-1-2013.

**HUDSON PALE ALE**

THE MARK CONSISTS OF STANDARD CHARACTERS WITHOUT CLAIM TO ANY PARTICULAR FONT, STYLE, SIZE, OR COLOR.

NO CLAIM IS MADE TO THE EXCLUSIVE RIGHT TO USE "PALE ALE", APART FROM THE MARK AS SHOWN.

FOR ALE; ALES (U.S. CLS. 45, 46 AND 48).  
FIRST USE 5-15-2010; IN COMMERCE 5-15-2010.  
JOHN DALIER, EXAMINING ATTORNEY

**CLASS 32—(Continued).**

SN 85-854,839. HILL, SHAUN, DBA HILL FARMSTEAD BREWERY, GREENSBORO BEND, VT. FILED 2-20-2013.

**Edward**

THE MARK CONSISTS OF STANDARD CHARACTERS WITHOUT CLAIM TO ANY PARTICULAR FONT, STYLE, SIZE, OR COLOR.

FOR BEER, ALE, LAGER, STOUT AND PORTER (U.S. CLS. 45, 46 AND 48).

FIRST USE 4-1-2010; IN COMMERCE 4-1-2010.  
ALISON POLLACK, EXAMINING ATTORNEY

SN 85-854,943. HARDISON, SCOTT, PHOENIX, AZ. FILED 2-20-2013.

**Sacred Hops Brewing Company**

THE MARK CONSISTS OF STANDARD CHARACTERS WITHOUT CLAIM TO ANY PARTICULAR FONT, STYLE, SIZE, OR COLOR.

NO CLAIM IS MADE TO THE EXCLUSIVE RIGHT TO USE "HOPS BREWING COMPANY", APART FROM THE MARK AS SHOWN.

FOR BEER (U.S. CLS. 45, 46 AND 48).  
HOWARD SMIGA, EXAMINING ATTORNEY

SN 85-855,672. CERVESES LA GARDÈNIA S.L., ALCOVER (TARRAGONA), SPAIN, FILED 2-20-2013.



THE MARK CONSISTS OF A DRAWING DEPICTING THE HEAD AND SHOULDERS OF A SMILING WOMAN WEARING A STRIPED BLOUSE WITH A FLOWER CORSAGE ON THE RIGHT SHOULDER AND THE WORD "CARMEN".

FOR BEER (U.S. CLS. 45, 46 AND 48).  
MARK SHINER, EXAMINING ATTORNEY



**CLASS 32—(Continued).**

SN 85-861,063. KESHISHYAN, OVSEP JOEY, PANORAMA CITY, CA. FILED 2-26-2013.

# Hanasui

THE MARK CONSISTS OF STANDARD CHARACTERS WITHOUT CLAIM TO ANY PARTICULAR FONT, STYLE, SIZE, OR COLOR.

FOR BOTTLED DRINKING WATER; DISTILLED DRINKING WATER; DRINKING WATER; DRINKING WATER WITH VITAMINS; FLAVORED BOTTLED WATER; FLAVOURED MINERAL WATER; MINERAL WATER; SPARKLING WATER; SPRING WATER; STILL WATER; WATER BEVERAGES (U.S. CLS. 45, 46 AND 48).  
KAREN BRACEY, EXAMINING ATTORNEY

SN 85-861,071. KESHISHYAN, OVSEP JOEY, PANORAMA CITY, CA. FILED 2-26-2013.

# Drink Flowers

THE MARK CONSISTS OF STANDARD CHARACTERS WITHOUT CLAIM TO ANY PARTICULAR FONT, STYLE, SIZE, OR COLOR.

NO CLAIM IS MADE TO THE EXCLUSIVE RIGHT TO USE "FLOWERS", APART FROM THE MARK AS SHOWN.

FOR BOTTLED DRINKING WATER; DISTILLED DRINKING WATER; DRINKING WATER; DRINKING WATER WITH VITAMINS; FLAVORED BOTTLED WATER; FLAVOURED MINERAL WATER; MINERAL WATER; SPARKLING WATER; SPRING WATER; STILL WATER; WATER BEVERAGES (U.S. CLS. 45, 46 AND 48).  
KAREN BRACEY, EXAMINING ATTORNEY

SN 85-907,403. DISNEY ENTERPRISES, INC., BURBANK, CA. FILED 4-17-2013.

# TOY STORY

THE MARK CONSISTS OF STANDARD CHARACTERS WITHOUT CLAIM TO ANY PARTICULAR FONT, STYLE, SIZE, OR COLOR.

OWNER OF U.S. REG. NOS. 3,905,741, 4,358,259 AND OTHERS.

FOR DRINKING WATER; ENERGY DRINKS; FLAVORED WATERS; JUICE BASE CONCENTRATES; LEMONADE; NON-ALCOHOLIC PUNCH; NON-ALCOHOLIC BEVERAGES, NAMELY, CARBONATED BEVERAGES; SMOOTHIES; SPARKLING WATER; SPORTS DRINKS; SYRUPS FOR MAKING SOFT DRINKS; TABLE WATER; VEGETABLE JUICES (U.S. CLS. 45, 46 AND 48).  
LEIGH CAROLINE CASE, EXAMINING ATTORNEY

**CLASS 32—(Continued).**

SN 85-910,685. BALTIKA BREWERIES, SAINT-PETERSBURG, RUSSIAN FED., FILED 4-22-2013.



OWNER OF U.S. REG. NO. 3,517,069.

NO CLAIM IS MADE TO THE EXCLUSIVE RIGHT TO USE "LAGER AMBER PRODUCT OF RUSSIA" AND CYRILLIC CHARACTERS MEANING "TRADITION QUALITY", "MARK OF QUALITY OF XXI CENTURY", APART FROM THE MARK AS SHOWN.

THE COLOR(S) WHITE, RED, GOLD, BLACK, GREY IS/ARE CLAIMED AS A FEATURE OF THE MARK.

THE MARK CONSISTS OF A DESIGN OF A STYLIZED RHOMB IN WHITE COLOR WITH WHITE, RED AND GOLD OUTLINING; TWO CONCENTRIC CIRCLES IN RED AND WHITE COLORS WITH BLACK AND GOLD OUTLINING AND A SHIELD IN GOLD COLOR WITH A HEAD OF A BEAR IN BLACK COLOR INSIDE THE SMALLER CIRCLE AND GOLD CYRILLIC CHARACTERS WITH TWO GOLD DOTS INSIDE THE BIGGER CIRCLE; STYLIZED WHEAT SPIKELETS IN GOLD COLOR ON BOTH SIDES OF THE CIRCLE; THE WORDING "YARPIVO" IN STYLIZED FONT IN BLACK COLOR WITH WHITE, RED AND GOLD OUTLINING; THE WORDING "LAGER" IN SMALLER FONT BELOW IN GOLD COLOR WITH BLACK SHADE; THE WORDING "AMBER" IN BLACK COLOR BELOW; A RECTANGLE IN GREY COLOR WITH THREE MEDALS IN THE BACKGROUND IN WHITE COLOR; WORDING "PRODUCT OF RUSSIA" IN STYLIZED FONT IN BLACK COLOR ALL LOCATED INSIDE THE RECTANGLE; A LINE IN GOLD COLOR AT THE BOTTOM OF THE RECTANGLE, WITH TWO MEDALS IN GOLD COLOR WITH BLACK OUTLINING, WITH MISCELLANEOUS DESIGNS AND CYRILLIC CHARACTERS IN BLACK COLOR AT THE BOTTOM OF THE RECTANGLE.

THE NON-LATIN CHARACTERS IN THE MARK TRANSLITERATE TO "TRADITSYIY KACHESTVO ZNAK KACHESTVA VEKA" AND THIS MEANS "TRADITION QUALITY", "MARK OF QUALITY OF XXI CENTURY" IN ENGLISH.

FOR BEER (U.S. CLS. 45, 46 AND 48).  
FIRST USE 5-0-2012; IN COMMERCE 5-0-2012.  
LIEF MARTIN, EXAMINING ATTORNEY

**CLASS 32—(Continued).**

SN 85-910,952. BALTIKA BREWERIES, SAINT-PETERSBURG, RUSSIAN FED., FILED 4-22-2013.



OWNER OF U.S. REG. NOS. 3,302,960, 3,668,483 AND OTHERS.

NO CLAIM IS MADE TO THE EXCLUSIVE RIGHT TO USE "BREWED IN RUSSIA CLASSIC BEER", CYRILLIC CHARACTERS WHICH MEAN "BEER BREWING COMPANY", "FOUNDED IN 1990", APART FROM THE MARK AS SHOWN.

THE COLOR(S) WHITE, BLACK, RED, GOLD, BLUE, LIGHT BLUE, AND DARK BLUE IS/ARE CLAIMED AS A FEATURE OF THE MARK.

THE MARK CONSISTS OF AN OVAL WITH GOLD, RED, DARK BLUE, LIGHT BLUE, AND BLUE OUTLINING, AND STRIPES IN BLUE AND DARK BLUE COLORS INSIDE; A RIBBON IN DARK BLUE COLOR WITH HORIZONTAL LINES, IN BLUE AND DARK BLUE COLOR ON BOTH SIDES, AND WITH GOLD, BLACK AND BLUE OUTLINING, IS LOCATED ACROSS THE OVAL, WITH THE WORDING "BALTIKA" IN STYLIZED FONT AND THREE WAVY LINES ALL IN LIGHT BLUE COLOR WITH GOLD OUTLINING, AND A NUMBER "3" IN WHITE COLOR WITH GOLD AND BLACK OUTLINING OVERLAPPING THE RIBBON; WORDING "BREWED IN RUSSIA" IN GOLD COLOR LOCATED INSIDE THE TOP OF THE OVAL; A DESIGN OF TWO CONCENTRIC CIRCLES IN WHITE AND RED COLORS WITH BLACK AND GOLD OUTLINING, AND WITH THREE WAVY LINES IN WHITE AND GOLD COLOR INSIDE THE SMALLER CIRCLE WITH CYRILLIC CHARACTERS IN BLACK COLOR INSIDE THE BIGGER CIRCLE; A DESIGN OF A CROWN IN GOLD AND RED, WITH BLACK OUTLINING, APPEARS ON TOP OF THE CIRCLES, WITH LEAVES AND FLOWERS ON BOTH SIDES OF THE CIRCLES IN GOLD COLOR WITH BLACK OUTLINING; A SMALLER RIBBON IN WHITE COLOR WITH BLACK OUTLINING ON BOTH SIDES OF THE CIRCLES WITH CYRILLIC CHARACTERS, AND THE DATE "1990", ALL IN BLACK, INSIDE THE SMALLER RIBBON; STYLIZED WORDING "CLASSIC BEER" WITH A WAVY LINE, ALL IN WHITE COLOR WITH BLACK OUTLINING, BELOW THE NUMBER "3".

THE NON-LATIN CHARACTERS IN THE MARK TRANSLITERATE TO "PIVOVARENNAVAYA KOMPANYA BALTIKA OSNOVANNAYA V 1990 G" AND THIS MEANS "BEER BREWING COMPANY BALTIKA", "FOUNDED IN 1990" IN ENGLISH.

FOR BEER (U.S. CLS. 45, 46 AND 48).  
FIRST USE 7-0-2007; IN COMMERCE 7-0-2007.  
LIEF MARTIN, EXAMINING ATTORNEY

**CLASS 32—(Continued).**

SN 85-916,503. S.P. GRIP PRODUCTS, INC., BRIDGEVIEW, IL. FILED 4-26-2013.

**KICK-START YOUR DAY!**

THE MARK CONSISTS OF STANDARD CHARACTERS WITHOUT CLAIM TO ANY PARTICULAR FONT, STYLE, SIZE, OR COLOR.

FOR NON-ALCOHOLIC COCKTAIL BASES; NON-ALCOHOLIC COCKTAIL MIXES (U.S. CLS. 45, 46 AND 48).  
FIRST USE 12-1-2002; IN COMMERCE 12-1-2002.  
LINDA E. BLOHM, EXAMINING ATTORNEY

SN 85-918,950. ANHEUSER-BUSCH LLC, ST. LOUIS, MO. FILED 4-30-2013.



THE MARK CONSISTS OF A SCALLOPED CIRCLE WITH A WHITE TRIANGLE.

FOR BEER (U.S. CLS. 45, 46 AND 48).  
JOANNA DUKOVIC, EXAMINING ATTORNEY

SN 85-937,048. HEB GROCERY COMPANY, LP, SAN ANTONIO, TX. FILED 5-20-2013.

**H-E-B ORGANICS**

THE MARK CONSISTS OF STANDARD CHARACTERS WITHOUT CLAIM TO ANY PARTICULAR FONT, STYLE, SIZE, OR COLOR.

OWNER OF U.S. REG. NOS. 3,194,958, 3,930,507 AND OTHERS.

NO CLAIM IS MADE TO THE EXCLUSIVE RIGHT TO USE "ORGANICS", APART FROM THE MARK AS SHOWN.

FOR ORGANIC FRUIT JUICES AND VEGETABLE JUICES (U.S. CLS. 45, 46 AND 48).

AISHA CLARKE, EXAMINING ATTORNEY

**CLASS 32—(Continued).**

SN 85-965,121. U4IC BREWING, INC., BELLE PLAIN, MN.  
FILED 6-20-2013.

**CAR SHOW AMERICAN ALE**

THE MARK CONSISTS OF STANDARD CHARACTERS WITHOUT CLAIM TO ANY PARTICULAR FONT, STYLE, SIZE, OR COLOR.

NO CLAIM IS MADE TO THE EXCLUSIVE RIGHT TO USE "AMERICAN ALE", APART FROM THE MARK AS SHOWN.

FOR BEER (U.S. CLS. 45, 46 AND 48).  
AISHA CLARKE, EXAMINING ATTORNEY

**CLASS 32—(Continued).**

SN 86-008,847. NORTH COAST BREWING CO., INC., FORT BRAGG, CA. FILED 7-12-2013.



NO CLAIM IS MADE TO THE EXCLUSIVE RIGHT TO USE "NORTH COAST BREWING CO.", APART FROM THE MARK AS SHOWN.

THE COLOR(S) BLACK, WHITE AND RED IS/ARE CLAIMED AS A FEATURE OF THE MARK.

THE MARK CONSISTS OF A BLACK RING, WITH BLACK TEETH AROUND THE OUTER BORDER OF THE RING, AND THE WORDS "NORTH COAST BREWING CO." IN WHITE IMPRINTED ON THE RING, WITH THE CAPITAL LETTERS "N" AND "C" IN BLACK OVERLAPPING INSIDE THE RING, AND A RED SYMBOL INSIDE THE RING ABOVE THE LETTER "N" CONSISTING OF FOUR LEAVES IN A CROSS LIKE PATTERN AND FIVE RECTANGLES LINED UP AMONG THE LEAVES.

FOR BEER, ALE, LAGER, STOUT AND PORTER (U.S. CLS. 45, 46 AND 48).

FIRST USE 3-1-2011; IN COMMERCE 3-1-2011.  
KATHY DE JONGE, EXAMINING ATTORNEY

SN 86-001,099. JUSTCOCKTAIL LIMITED, MIDDLESEX, UNITED KINGDOM. FILED 7-2-2013.

# Keizen

THE MARK CONSISTS OF STANDARD CHARACTERS WITHOUT CLAIM TO ANY PARTICULAR FONT, STYLE, SIZE, OR COLOR.

PRIORITY CLAIMED UNDER SEC. 44(D) ON UNITED KINGDOM APPLICATION NO. UK0000300024, FILED 1-5-2013, REG. NO. UK0000300024, DATED 4-2-2013, EXPIRES 4-2-2023.

THE NAME "KEIZEN" DOES NOT IDENTIFY A LIVING INDIVIDUAL.

THE WORDING "KEIZEN" HAS NO MEANING IN A FOREIGN LANGUAGE.

FOR ESSENCES FOR MAKING NON-ALCOHOLIC BEVERAGES; NON-ALCOHOLIC BEVERAGES CONTAINING FRUIT JUICES; NON-ALCOHOLIC BEVERAGES WITH TEA FLAVOR; NON-ALCOHOLIC BEVERAGES, NAMELY, CARBONATED BEVERAGES; NON-ALCOHOLIC COCKTAIL BASES; NON-ALCOHOLIC COCKTAIL MIXES; NON-ALCOHOLIC COCKTAILS; NON-ALCOHOLIC COCKTAILS, NAMELY, MOCKTAILS (U.S. CLS. 45, 46 AND 48).

KRISTIN CARLSON, EXAMINING ATTORNEY

SN 86-010,137. SBD HOLDINGS GROUP CORP., BONITA SPRINGS, FL. FILED 7-15-2013.

**LIFE IS BETTER ON THE BEACH**

THE MARK CONSISTS OF STANDARD CHARACTERS WITHOUT CLAIM TO ANY PARTICULAR FONT, STYLE, SIZE, OR COLOR.

FOR SMOOTHIES, FRUIT JUICES, SOFT DRINKS AND SPORTS DRINKS, DRINKING WATER, AERATED WATER, MINERAL WATER, SELTZER WATER, ISOTONIC BEVERAGES, PREPARATIONS FOR MAKING BEVERAGES, NAMELY, FRUIT DRINKS AND SOFT DRINKS, SWEET CIDER, TOMATO JUICE, VEGETABLE JUICES, BEER (U.S. CLS. 45, 46 AND 48).

FRED CARL, EXAMINING ATTORNEY

SN 86-008,373. MIA BREWING CO, DORAL, FL. FILED 7-12-2013.

**M.I.A. Castaway**

THE MARK CONSISTS OF STANDARD CHARACTERS WITHOUT CLAIM TO ANY PARTICULAR FONT, STYLE, SIZE, OR COLOR.

FOR BEERS (U.S. CLS. 45, 46 AND 48).  
MAUREEN DALL, EXAMINING ATTORNEY

**CLASS 32—(Continued).**

SN 86-022,277. LAWRENCEVILLE BREWERY, INC., PITTSBURGH, PA. FILED 7-29-2013.

**SAAZ MONSTER**

THE MARK CONSISTS OF STANDARD CHARACTERS WITHOUT CLAIM TO ANY PARTICULAR FONT, STYLE, SIZE, OR COLOR.

NO CLAIM IS MADE TO THE EXCLUSIVE RIGHT TO USE "SAAZ", APART FROM THE MARK AS SHOWN.

FOR BEER (U.S. CLS. 45, 46 AND 48).  
MATTHEW PAPPAS, EXAMINING ATTORNEY

**CLASS 32—(Continued).**

SN 86-037,380. TRIM TAB BREWING CO., LLC, BIRMINGHAM, AL. FILED 8-14-2013.



SN 86-027,440. KRIKIT, LLC, ST. LOUIS, MO. FILED 8-2-2013.

**LOCATINI**

THE MARK CONSISTS OF STANDARD CHARACTERS WITHOUT CLAIM TO ANY PARTICULAR FONT, STYLE, SIZE, OR COLOR.

FOR FLAVORED NON-ALCOHOLIC COCKTAIL MIXES THAT CAN BE USED WITH BOTH ALCOHOLIC AND NON-ALCOHOLIC BEVERAGES (U.S. CLS. 45, 46 AND 48).

MEREDITH MARESCA, EXAMINING ATTORNEY

NO CLAIM IS MADE TO THE EXCLUSIVE RIGHT TO USE "BREWING" AND "BIRMINGHAM", APART FROM THE MARK AS SHOWN.

THE MARK CONSISTS OF A CIRCLE WITH THE WORDS "GRAVITATIONAL NECTAR" ABOVE A STAR ABOVE THE WORDS "TRIMTAB BREWING" ABOVE "05" AND "33" AND THE INITIALS "TT" WITH A TRIANGLE BELOW THE CIRCLE AND SLIGHTLY OVERLAPPING THE CIRCLE WITH THE WORDS "A SPIRIT OF QUALITY" INSIDE THE OVERLAP AND "BIRMINGHAM" INSIDE THE TRIANGLE BUT OUTSIDE THE OVERLAP.

FOR BEER; BEER, ALE AND LAGER; BEERS; FLAVORED BEERS; HOP EXTRACTS FOR MANUFACTURING BEER; MALT BEER; PROCESSED HOPS FOR USE IN MAKING BEER (U.S. CLS. 45, 46 AND 48).

JILL PRATER, EXAMINING ATTORNEY

SN 86-034,923. TRIM TAB BREWING CO., LLC, BIRMINGHAM, AL. FILED 8-12-2013.

**TRIMTAB BREWING**

THE MARK CONSISTS OF STANDARD CHARACTERS WITHOUT CLAIM TO ANY PARTICULAR FONT, STYLE, SIZE, OR COLOR.

NO CLAIM IS MADE TO THE EXCLUSIVE RIGHT TO USE "BREWING", APART FROM THE MARK AS SHOWN.

FOR BEER; BEERS; FLAVORED BEERS; HOP EXTRACTS FOR MANUFACTURING BEER; MALT BEER; MALT EXTRACTS FOR MAKING BEER; PROCESSED HOPS FOR USE IN MAKING BEER (U.S. CLS. 45, 46 AND 48).

JILL PRATER, EXAMINING ATTORNEY

SN 86-037,726. ONE GOOD ARROW INC., GREAT NECK, NY. FILED 8-14-2013.

**Ye Old Panther Piss**

THE MARK CONSISTS OF STANDARD CHARACTERS WITHOUT CLAIM TO ANY PARTICULAR FONT, STYLE, SIZE, OR COLOR.

FOR BEER (U.S. CLS. 45, 46 AND 48).

JERI J. FICKES, EXAMINING ATTORNEY

**CLASS 32—(Continued).**

SN 86-041,040. PHILIP R. PALUMBO, CARLSBAD, CA. FILED 8-18-2013.



NO CLAIM IS MADE TO THE EXCLUSIVE RIGHT TO USE "CERVEZA", APART FROM THE MARK AS SHOWN.

THE COLOR(S) BLACK, WHITE, RED, YELLOW, BROWN, GREEN, AND BEIGE IS/ARE CLAIMED AS A FEATURE OF THE MARK.

THE MARK CONSISTS OF A BEIGE, BROWN, BLACK AND WHITE SKULL ON A TORSO DRESSED IN A BLACK JACKET WITH WHITE ACCENTS, A RED BOW AND A WHITE SHIRT WITH A BROWN AND BLACK SNAKE WITH YELLOW EYES, RED MOUTH, WHITE FANGS, AND A YELLOW AND BROWN RATTLER WRAPPED AROUND THE NECK AND WHITE AND BLACK ROSES WITH GREEN AND BLACK LEAVES, AND THE WORDING "EL GORDO" IN WHITE OUTLINED IN BLACK AND GREEN AND THE WORD "CERVEZA" IN BEIGE ON A BROWN TO RED BACKGROUND.

THE ENGLISH TRANSLATION OF "EL GORDO" AND "CERVEZA" IN THE MARK IS "THE FAT ONE", "THE BIG ONE" AND "BEER".

FOR ALCOHOL-FREE BEERS; ALE; ALE AND PORTER; ALES; BEER; BEER, ALE AND LAGER; BEER, ALE AND PORTER; BEER, ALE, LAGER, STOUT AND PORTER; BEER, ALE, LAGER, STOUT, PORTER, SHANDY; BEER-BASED COOLERS; BEERS; BLACK BEER; BREWED MALT-BASED ALCOHOLIC BEVERAGE IN THE NATURE OF A BEER; LAGER; LAGERS; MALT BEER; NON-ALCOHOLIC BEER; PALE BEER; PILSNER; PORTER; PORTER (U.S. CLS. 45, 46 AND 48).

DEIRDRE ROBERTSON, EXAMINING ATTORNEY

**CLASS 32—(Continued).**

SN 86-041,650. BRAVO MEXICO BEVERAGE, LLC., HIALEAH, FL. FILED 8-19-2013.



OWNER OF U.S. REG. NO. 4,277,145.  
 THE MARK CONSISTS OF THE WORDS "BRAVO MEXICO" IN STYLIZED FORM WITH A DEPICTION OF A SOMBRERO ON TOP OF THE LETTER "O" ON "BRAVO". A DEPICTION OF A SOCCER BALL TO THE LEFT OF THE LETTER "B" ON "BRAVO" IS SHOWN WITH LINING DEPICTING SPEED TO ITS RIGHT AND EXTENDING THROUGH THE WORDING. A DEPICTION OF A SOCCER PLAYER KICKING A BALL IS SHOWN BELOW THE WORDING.

THE ENGLISH TRANSLATION OF "BRAVO" IN THE MARK IS "BRAVE".

FOR ENERGY DRINKS (U.S. CLS. 45, 46 AND 48).

FIRST USE 6-15-2012; IN COMMERCE 6-15-2012.

JENNIFER DIXON, EXAMINING ATTORNEY

SN 86-042,155. LEE, DAVID K., CLAREMONT, CA. FILED 8-19-2013.

**CARE WATER**

THE MARK CONSISTS OF STANDARD CHARACTERS WITHOUT CLAIM TO ANY PARTICULAR FONT, STYLE, SIZE, OR COLOR.

NO CLAIM IS MADE TO THE EXCLUSIVE RIGHT TO USE "WATER", APART FROM THE MARK AS SHOWN.

FOR BOTTLED DRINKING WATER (U.S. CLS. 45, 46 AND 48).

LINDA E. BLOHM, EXAMINING ATTORNEY

**CLASS 32—(Continued).**

SN 86-042,502. GREEN MOONSHINE, NANUET, NY. FILED 8-20-2013.

**Green Moonshine, LLC**

THE MARK CONSISTS OF STANDARD CHARACTERS WITHOUT CLAIM TO ANY PARTICULAR FONT, STYLE, SIZE, OR COLOR.

NO CLAIM IS MADE TO THE EXCLUSIVE RIGHT TO USE "GREEN" AND "LLC", APART FROM THE MARK AS SHOWN.

FOR FRUIT JUICE; SMOOTHIES; VEGETABLE JUICE (U.S. CLS. 45, 46 AND 48).

KELLY BOULTON, EXAMINING ATTORNEY

**CLASS 32—(Continued).**

SN 86-043,798. NATIONAL DAIRY, LLC, DALLAS, TX. FILED 8-21-2013.

**SABA SUN BURST**

THE MARK CONSISTS OF STANDARD CHARACTERS WITHOUT CLAIM TO ANY PARTICULAR FONT, STYLE, SIZE, OR COLOR.

OWNER OF U.S. REG. NO. 3,491,333.

FOR BOTTLED WATER (U.S. CLS. 45, 46 AND 48).

LAURA GOLDEN, EXAMINING ATTORNEY

SN 86-042,563. H2O: HAPPINESS TO OTHERS, LOS ANGELES, CA. FILED 8-20-2013.

**H2O: Happiness to Others**

THE MARK CONSISTS OF STANDARD CHARACTERS WITHOUT CLAIM TO ANY PARTICULAR FONT, STYLE, SIZE, OR COLOR.

NO CLAIM IS MADE TO THE EXCLUSIVE RIGHT TO USE "H2O", APART FROM THE MARK AS SHOWN.

FOR DRINKING WATER (U.S. CLS. 45, 46 AND 48).

MARILYN IZZI, EXAMINING ATTORNEY

SN 86-043,882. SEVENTH WAVE BREWING, INC., FOXBORO, MA. FILED 8-21-2013.

**Seventh Wave Brewing**

THE MARK CONSISTS OF STANDARD CHARACTERS WITHOUT CLAIM TO ANY PARTICULAR FONT, STYLE, SIZE, OR COLOR.

NO CLAIM IS MADE TO THE EXCLUSIVE RIGHT TO USE "BREWING", APART FROM THE MARK AS SHOWN.

FOR BEER (U.S. CLS. 45, 46 AND 48).

ESTHER BELENKER, EXAMINING ATTORNEY

SN 86-043,545. TELEVISA, S.A. DE C.V., SANTA FE, MEXICO, FILED 8-21-2013.

**QUE BONITO AMOR**

THE MARK CONSISTS OF STANDARD CHARACTERS WITHOUT CLAIM TO ANY PARTICULAR FONT, STYLE, SIZE, OR COLOR.

THE ENGLISH TRANSLATION OF "QUE BONITO AMOR" IN THE MARK IS "WHAT A BEAUTIFUL LOVE".

FOR ESSENCES FOR MAKING NON-ALCOHOLIC BEVERAGES; POWDERS FOR MAKING EFFERVESCENT SOFT DRINKS; SYRUPS FOR BEVERAGES; POWDERED SOFT DRINK MIX (U.S. CLS. 45, 46 AND 48).

COLLEEN KEARNEY, EXAMINING ATTORNEY

SN 86-043,911. SEVENTH WAVE BREWING, INC., FOXBORO, MA. FILED 8-21-2013.

**7TH WAVE BREWING**

THE MARK CONSISTS OF STANDARD CHARACTERS WITHOUT CLAIM TO ANY PARTICULAR FONT, STYLE, SIZE, OR COLOR.

NO CLAIM IS MADE TO THE EXCLUSIVE RIGHT TO USE "BREWING", APART FROM THE MARK AS SHOWN.

FOR BEER (U.S. CLS. 45, 46 AND 48).

ESTHER BELENKER, EXAMINING ATTORNEY

**CLASS 32—(Continued).**

SN 86-044,084. MSP, INC, DENVER, CO. FILED 8-21-2013.

**5280 Energy Drink**

THE MARK CONSISTS OF STANDARD CHARACTERS WITHOUT CLAIM TO ANY PARTICULAR FONT, STYLE, SIZE, OR COLOR.

NO CLAIM IS MADE TO THE EXCLUSIVE RIGHT TO USE "ENERGY DRINK", APART FROM THE MARK AS SHOWN.

FOR ENERGY DRINKS (U.S. CLS. 45, 46 AND 48).  
ANDREA BUTLER, EXAMINING ATTORNEY

---

SN 86-045,794. SKINNY NUTRITIONAL CORP, DBA SKINNY NUTRITIONAL CORP., RADNOR, PA. FILED 8-22-2013.

**Skinny Juice**

THE MARK CONSISTS OF STANDARD CHARACTERS WITHOUT CLAIM TO ANY PARTICULAR FONT, STYLE, SIZE, OR COLOR.

OWNER OF U.S. REG. NOS. 2,557,075, 3,886,580 AND OTHERS.

NO CLAIM IS MADE TO THE EXCLUSIVE RIGHT TO USE "JUICE", APART FROM THE MARK AS SHOWN.

FOR FRUIT DRINKS AND FRUIT JUICES; NON-ALCOHOLIC BEVERAGES CONTAINING FRUIT JUICES (U.S. CLS. 45, 46 AND 48).

JERI J. FICKES, EXAMINING ATTORNEY

---

SN 86-046,760. DAD AND DUDES BREWERIA, LLC, CENTENNIAL, CO. FILED 8-23-2013.

**Dude's Brews**

THE MARK CONSISTS OF STANDARD CHARACTERS WITHOUT CLAIM TO ANY PARTICULAR FONT, STYLE, SIZE, OR COLOR.

OWNER OF U.S. REG. NO. 3,932,487.

NO CLAIM IS MADE TO THE EXCLUSIVE RIGHT TO USE "BREWS", APART FROM THE MARK AS SHOWN.

FOR BEER; BEER, ALE, LAGER, STOUT AND PORTER; BEERS (U.S. CLS. 45, 46 AND 48).

FIRST USE 2-1-2012; IN COMMERCE 8-4-2012.

ASMAT KHAN, EXAMINING ATTORNEY

**CLASS 32—(Continued).**

SN 86-047,944. K &amp; C CORK AND BOTTLE LLC., PLANT CITY, FL. FILED 8-26-2013.

**Two Henrys Brewing Company**

THE MARK CONSISTS OF STANDARD CHARACTERS WITHOUT CLAIM TO ANY PARTICULAR FONT, STYLE, SIZE, OR COLOR.

NO CLAIM IS MADE TO THE EXCLUSIVE RIGHT TO USE "BREWING COMPANY", APART FROM THE MARK AS SHOWN.

FOR BEER (U.S. CLS. 45, 46 AND 48).  
JILL PRATER, EXAMINING ATTORNEY

---

SN 86-051,943. NINKASI BREWERY, LLC, EUGENE, OR. FILED 8-29-2013.

**Ninkasi Elevation**

THE MARK CONSISTS OF STANDARD CHARACTERS WITHOUT CLAIM TO ANY PARTICULAR FONT, STYLE, SIZE, OR COLOR.

OWNER OF U.S. REG. NOS. 3,442,524, 3,868,249 AND OTHERS.

FOR BEER (U.S. CLS. 45, 46 AND 48).

DOMINIC FATHY, EXAMINING ATTORNEY

---

SN 86-051,954. NINKASI BREWERY, LLC, EUGENE, OR. FILED 8-29-2013.

**Ninkasi Relaxation**

THE MARK CONSISTS OF STANDARD CHARACTERS WITHOUT CLAIM TO ANY PARTICULAR FONT, STYLE, SIZE, OR COLOR.

OWNER OF U.S. REG. NOS. 3,442,524, 3,868,249 AND OTHERS.

FOR BEER (U.S. CLS. 45, 46 AND 48).

DOMINIC FATHY, EXAMINING ATTORNEY

**CLASS 32—(Continued).**

SN 86-058,639. JOHNSON, VALASHIA D, MIDWAY, FL.  
FILED 9-8-2013.

**VALO S**

THE MARK CONSISTS OF STANDARD CHARACTERS WITHOUT CLAIM TO ANY PARTICULAR FONT, STYLE, SIZE, OR COLOR.

FOR BEAUTY BEVERAGES, NAMELY, FRUIT JUICES AND ENERGY DRINKS CONTAINING NUTRITIONAL SUPPLEMENTS; FRUIT-FLAVOURED BEVERAGES; NON-ALCOHOLIC BEVERAGES CONTAINING FRUIT JUICES; SYRUPS FOR MAKING BEVERAGES; WATER BEVERAGES (U.S. CLS. 45, 46 AND 48).

ANNE MADDEN, EXAMINING ATTORNEY

SN 86-058,825. THE COCA-COLA COMPANY, ATLANTA, GA. FILED 9-9-2013.

**COCA-COLA LIFE**

THE MARK CONSISTS OF STANDARD CHARACTERS WITHOUT CLAIM TO ANY PARTICULAR FONT, STYLE, SIZE, OR COLOR.

OWNER OF U.S. REG. NOS. 22,406, 3,252,896 AND OTHERS.

FOR SOFT DRINKS (U.S. CLS. 45, 46 AND 48).  
LINDA ESTRADA, EXAMINING ATTORNEY

SN 86-059,987. LONERIDER BREWING COMPANY, RA-LEIGH, NC. FILED 9-10-2013.

**TRUE BRITT**

THE MARK CONSISTS OF STANDARD CHARACTERS WITHOUT CLAIM TO ANY PARTICULAR FONT, STYLE, SIZE, OR COLOR.

FOR BEER, ALE, LAGER, STOUT AND PORTER (U.S. CLS. 45, 46 AND 48).

MARTHA FROMM, EXAMINING ATTORNEY

**CLASS 32—(Continued).**

SN 86-062,906. W&S CHARITABLE FOUNDATION INC., RAMSEY, NJ. FILED 9-12-2013.

**CHRISTMAS JAM**

THE MARK CONSISTS OF STANDARD CHARACTERS WITHOUT CLAIM TO ANY PARTICULAR FONT, STYLE, SIZE, OR COLOR.

FOR ALE; BEER (U.S. CLS. 45, 46 AND 48).  
PAUL CROWLEY, EXAMINING ATTORNEY

SN 86-064,113. COUNTRY BOY BREWING, L.L.C., GEORGE-TOWN, KY. FILED 9-13-2013.

**Cougar Bait**

THE MARK CONSISTS OF STANDARD CHARACTERS WITHOUT CLAIM TO ANY PARTICULAR FONT, STYLE, SIZE, OR COLOR.

FOR BEER; BEER MAKING KIT; BEER WORT; BEER, ALE AND LAGER; BEER, ALE AND PORTER; BEER, ALE, LAGER, STOUT AND PORTER; BEER, ALE, LAGER, STOUT, PORTER, SHANDY; BEER-BASED COCKTAILS; BEER-BASED COOLERS; BEERS; BREWED MALT-BASED ALCOHOLIC BEVERAGE IN THE NATURE OF A BEER; EXTRACTS OF HOPS FOR MAKING BEER; FLAVORED BEERS; HOP EXTRACTS FOR MANUFACTURING BEER; MALT BEER; MALT EXTRACTS FOR MAKING BEER; PALE BEER; PORTER; PROCESSED HOPS FOR USE IN MAKING BEER (U.S. CLS. 45, 46 AND 48).

FIRST USE 1-1-2012; IN COMMERCE 1-11-2013.  
ELLEN BURNS, EXAMINING ATTORNEY



**CLASS 32—(Continued).**

SN 86-066,118. INTRACOASTAL BREWING COMPANY, LLC, MELBOURNE, FL. FILED 9-16-2013.



NO CLAIM IS MADE TO THE EXCLUSIVE RIGHT TO USE "BREWING COMPANY", APART FROM THE MARK AS SHOWN.

THE MARK CONSISTS OF A LARGE OUTER CIRCLE WHICH CONTAINS THE WORDS "INTRACOASTAL BREWING COMPANY" ON THE BOTTOM OF THE CIRCLE. THE INNER CIRCLE CONTAINS THE TERM "INTRA" EXTENDING INTO THE OUTER CIRCLE. A PALM TREE EXTENDS FROM THE INSIDE CIRCLE WITH THE PALMS EXTENDING INTO THE OUTER CIRCLE.

FOR BEER, ALE, LAGER, STOUT AND PORTER (U.S. CLS. 45, 46 AND 48).

FIRST USE 8-1-2013; IN COMMERCE 8-1-2013.

HEATHER THOMPSON, EXAMINING ATTORNEY

SN 86-066,121. BIG BEND CATTLE COMPANY, LLC, AUSTIN, TX. FILED 9-16-2013.

**BLUE HEELER**

THE MARK CONSISTS OF STANDARD CHARACTERS WITHOUT CLAIM TO ANY PARTICULAR FONT, STYLE, SIZE, OR COLOR.

FOR ENERGY DRINKS (U.S. CLS. 45, 46 AND 48).

SHAILA LEWIS, EXAMINING ATTORNEY

**CLASS 32—(Continued).**

SN 86-066,367. MALIBU MARY, LLC, MALIBU, CA. FILED 9-17-2013.

**POP POUR PARTY**

THE MARK CONSISTS OF STANDARD CHARACTERS WITHOUT CLAIM TO ANY PARTICULAR FONT, STYLE, SIZE, OR COLOR.

FOR FRUIT BEVERAGES; FROZEN FRUIT BEVERAGES; FRUIT-BASED BEVERAGES; FRUIT-FLAVORED BEVERAGES; TOMATO JUICE BEVERAGES; NON-ALCOHOLIC COCKTAIL MIXES (U.S. CLS. 45, 46 AND 48).

FIRST USE 10-1-2012; IN COMMERCE 10-1-2012.

NORA BUCHANAN WILL, EXAMINING ATTORNEY

SN 86-066,469. CROWN VALLEY WINERY, INC., STE. GENEVIEVE, MO. FILED 9-17-2013.

**905**

THE MARK CONSISTS OF STANDARD CHARACTERS WITHOUT CLAIM TO ANY PARTICULAR FONT, STYLE, SIZE, OR COLOR.

FOR BEERS (U.S. CLS. 45, 46 AND 48).

NORA BUCHANAN WILL, EXAMINING ATTORNEY

SN 86-066,490. 638 BREWING COMPANY, INC., DBA FOOTHILLS BREWING, WINSTON SALEM, NC. FILED 9-17-2013.

**FROSTBITE**

THE MARK CONSISTS OF STANDARD CHARACTERS WITHOUT CLAIM TO ANY PARTICULAR FONT, STYLE, SIZE, OR COLOR.

FOR BEER (U.S. CLS. 45, 46 AND 48).

FIRST USE 11-1-1997; IN COMMERCE 11-1-1997.

KYLE PEETE, EXAMINING ATTORNEY

**CLASS 32—(Continued).**

SN 86-066,543. DANIEL NATHAN, LYNN, MA. FILED 9-17-2013.

**FILTERED BY THE FOREST**

THE MARK CONSISTS OF STANDARD CHARACTERS WITHOUT CLAIM TO ANY PARTICULAR FONT, STYLE, SIZE, OR COLOR.

FOR MAPLE WATER (U.S. CLS. 45, 46 AND 48).  
TINA BROWN, EXAMINING ATTORNEY

SN 86-067,679. GRAPEVINE CRAFT BREWERY, LLC, DBA GRAPEVINE CRAFT BREWERY, GRAPEVINE, TX. FILED 9-18-2013.



THE MARK CONSISTS OF A STYLIZED VERSION OF THE LETTER "G" AND A FIVE POINT STAR LOCATED DIRECTLY ABOVE THE LETTER "G".

FOR BEER; BEER, ALE AND LAGER; BEER, ALE AND PORTER; BEER, ALE, LAGER, STOUT AND PORTER; BEERS; BLACK BEER; BREWED MALT-BASED ALCOHOLIC BEVERAGE IN THE NATURE OF A BEER; COFFEE-FLAVORED BEER; FLAVORED BEERS; MALT BEER; MALT LIQUOR; PALE BEER; PORTER (U.S. CLS. 45, 46 AND 48).

FIRST USE 11-9-2012; IN COMMERCE 4-1-2013.  
ROBIN CHOSID, EXAMINING ATTORNEY

SN 86-068,381. HOP YOURS BREWING COMPANY, LLC, KENNESAW, GA. FILED 9-18-2013.

**HOP YOURS**

THE MARK CONSISTS OF STANDARD CHARACTERS WITHOUT CLAIM TO ANY PARTICULAR FONT, STYLE, SIZE, OR COLOR.

NO CLAIM IS MADE TO THE EXCLUSIVE RIGHT TO USE "HOP", APART FROM THE MARK AS SHOWN.  
FOR BEER (U.S. CLS. 45, 46 AND 48).  
NICHOLAS COLEMAN, EXAMINING ATTORNEY

**CLASS 32—(Continued).**

SN 86-068,534. LEON, EDUARDO, DORAL, FL. FILED 9-18-2013.

**Reward Your Thirst**

THE MARK CONSISTS OF STANDARD CHARACTERS WITHOUT CLAIM TO ANY PARTICULAR FONT, STYLE, SIZE, OR COLOR.

FOR BEERS (U.S. CLS. 45, 46 AND 48).  
RONALD MCMORROW, EXAMINING ATTORNEY

SN 86-068,814. NILSEN, NILS, TACOMA, WA. AND NILSEN, BARRY, TACOMA, WA. FILED 9-19-2013.

**SCARVES UP**

THE MARK CONSISTS OF STANDARD CHARACTERS WITHOUT CLAIM TO ANY PARTICULAR FONT, STYLE, SIZE, OR COLOR.

FOR BEERS; MALT BEER (U.S. CLS. 45, 46 AND 48).  
ROSELLE HERRERA, EXAMINING ATTORNEY

SN 86-069,045. MARBLE BREWERY, INC., ALBUQUERQUE, NM. FILED 9-19-2013.

**MARBLE**

THE MARK CONSISTS OF STANDARD CHARACTERS WITHOUT CLAIM TO ANY PARTICULAR FONT, STYLE, SIZE, OR COLOR.

FOR LIGHT BEVERAGES, NAMELY BEER (U.S. CLS. 45, 46 AND 48).  
FIRST USE 5-1-2008; IN COMMERCE 5-1-2008.  
STEPHANIE ALI, EXAMINING ATTORNEY

**CLASS 32—(Continued).**

SN 86-069,236. MOTU GLOBAL, LLC, UPLAND, CA. FILED 9-19-2013.

## Little Island

THE MARK CONSISTS OF STANDARD CHARACTERS WITHOUT CLAIM TO ANY PARTICULAR FONT, STYLE, SIZE, OR COLOR.

FOR COCONUT JUICE; COCONUT MILK; COCONUT WATER (U.S. CLS. 45, 46 AND 48).  
SUNG IN, EXAMINING ATTORNEY

---

SN 86-069,378. HARMONIC BREWING, LLC, SAN FRANCISCO, CA. FILED 9-19-2013.

## Harmonic Brewing

THE MARK CONSISTS OF STANDARD CHARACTERS WITHOUT CLAIM TO ANY PARTICULAR FONT, STYLE, SIZE, OR COLOR.

NO CLAIM IS MADE TO THE EXCLUSIVE RIGHT TO USE "BREWING", APART FROM THE MARK AS SHOWN.

FOR BEER (U.S. CLS. 45, 46 AND 48).  
FIRST USE 5-4-2013; IN COMMERCE 5-4-2013.  
DOMINIC FATHY, EXAMINING ATTORNEY

---

SN 86-070,279. HERETIC BREWING COMPANY, ELK GROVE, CA. FILED 9-20-2013.

## Evil<sup>3</sup>

OWNER OF U.S. REG. NOS. 4,110,103 AND 4,147,890.  
THE MARK CONSISTS OF THE WORD "EVIL" WITH A SUPERSCRIPT NUMBER "3".

FOR BEER (U.S. CLS. 45, 46 AND 48).  
SHARON MEIER, EXAMINING ATTORNEY

**CLASS 32—(Continued).**

SN 86-070,883. INDIE BREWING COMPANY LLC, AKA INDIE BREWING, HAWTHORNE, CA. FILED 9-20-2013.



THE MARK CONSISTS OF A HOP WITH THE SKYLINE OF LOS ANGELES ON THE TOP CIRCULAR SIDE OF THE HOP.

FOR BEER; BEER, ALE AND LAGER; BEER, ALE AND PORTER; BEER, ALE, LAGER, STOUT AND PORTER; BEERS (U.S. CLS. 45, 46 AND 48).  
LANA PHAM, EXAMINING ATTORNEY

---

SN 86-071,518. IARIA, DANIEL M, INDIANAPOLIS, IN. FILED 9-23-2013.

## Chocolate Soldier

THE MARK CONSISTS OF STANDARD CHARACTERS WITHOUT CLAIM TO ANY PARTICULAR FONT, STYLE, SIZE, OR COLOR.

NO CLAIM IS MADE TO THE EXCLUSIVE RIGHT TO USE "CHOCOLATE", APART FROM THE MARK AS SHOWN.

FOR SOFT DRINKS, NAMELY, NON-CARBONATED MILK OR WATER BASED SOFT DRINK FLAVORED WITH CHOCOLATE (U.S. CLS. 45, 46 AND 48).  
FIRST USE 9-8-2013; IN COMMERCE 9-8-2013.

LAURIE KAUFMAN, EXAMINING ATTORNEY

**CLASS 32—(Continued).**

SN 86-072,885. INTRACOASTAL BREWING COMPANY, LLC, MELBOURNE, FL. FILED 9-24-2013.

## INTRACOASTAL BREWING COMPANY

THE MARK CONSISTS OF STANDARD CHARACTERS WITHOUT CLAIM TO ANY PARTICULAR FONT, STYLE, SIZE, OR COLOR.

NO CLAIM IS MADE TO THE EXCLUSIVE RIGHT TO USE "BREWING COMPANY", APART FROM THE MARK AS SHOWN.

FOR BEER, ALE, LAGER, STOUT, PORTER, SHANDY (U.S. CLS. 45, 46 AND 48).

FIRST USE 8-1-2013; IN COMMERCE 8-1-2013.

HEATHER THOMPSON, EXAMINING ATTORNEY

SN 86-075,128. THE COCA-COLA COMPANY, ATLANTA, GA. FILED 9-26-2013.

## MAKE IT POSSIBLE

THE MARK CONSISTS OF STANDARD CHARACTERS WITHOUT CLAIM TO ANY PARTICULAR FONT, STYLE, SIZE, OR COLOR.

OWNER OF U.S. REG. NO. 3,742,990.

FOR SOFT DRINKS (U.S. CLS. 45, 46 AND 48).

KIM SAITO, EXAMINING ATTORNEY

SN 86-085,356. ENTERCOM COMMUNICATIONS CORP., BALA CYNWYD, PA. FILED 10-8-2013.

## REVERED RED

THE MARK CONSISTS OF STANDARD CHARACTERS WITHOUT CLAIM TO ANY PARTICULAR FONT, STYLE, SIZE, OR COLOR.

NO CLAIM IS MADE TO THE EXCLUSIVE RIGHT TO USE "RED", APART FROM THE MARK AS SHOWN.

FOR BEER (U.S. CLS. 45, 46 AND 48).

KATHERINE STOIDES, EXAMINING ATTORNEY

**CLASS 32—(Continued).**

SN 86-088,422. LIFE PLUS STYLE GOURMET LLC, NEW YORK, NY. FILED 10-10-2013.

## C IS FOR COCKTAILS

THE MARK CONSISTS OF STANDARD CHARACTERS WITHOUT CLAIM TO ANY PARTICULAR FONT, STYLE, SIZE, OR COLOR.

FOR NON-ALCOHOLIC COCKTAIL MIXES; NON-ALCOHOLIC COCKTAILS, NAMELY, MOCKTAILS; SOFT DRINKS (U.S. CLS. 45, 46 AND 48).

FIRST USE 8-26-2013; IN COMMERCE 8-26-2013.

TINA L. SNAPP, EXAMINING ATTORNEY

SN 86-089,885. COUNTRY BOY BREWING, L.L.C., GEORGETOWN, KY. FILED 10-11-2013.



THE MARK CONSISTS OF THREE FIVE-POINT STARS IN A HORIZONTAL LINE, FOLLOWED BY THE OUTLINE OF A CLASSICAL STYLE TRUCK, FOLLOWED BY THREE FIVE-POINT STARS IN A HORIZONTAL LINE.

FOR BEER (U.S. CLS. 45, 46 AND 48).

FIRST USE 1-1-2012; IN COMMERCE 1-11-2013.

ELLEN BURNS, EXAMINING ATTORNEY

SN 86-098,426. ODOBESCU GHENADIE, DBA ODOBESCU GHENADIE, MONTREAL, CANADA, FILED 10-22-2013.

## BRAVUS

THE MARK CONSISTS OF STANDARD CHARACTERS WITHOUT CLAIM TO ANY PARTICULAR FONT, STYLE, SIZE, OR COLOR.

FOR BEER; BEER MAKING KIT; BEER WORT; BEER, ALE AND LAGER; BEER, ALE AND PORTER; BEER, ALE, LAGER, STOUT AND PORTER; BEER, ALE, LAGER, STOUT, PORTER, SHANDY; BEER-BASED COCKTAILS; BEER-BASED COOLERS; BEERS; BLACK BEER; BREWED MALT-BASED ALCOHOLIC BEVERAGE IN THE NATURE OF A BEER; DE-ALCOHOLISED BEER; FLAVORED BEERS; GINGER BEER; IMITATION BEER; MALT BEER; NON-ALCOHOLIC BEER; NON-ALCOHOLIC BEER FLAVORED BEVERAGES; PALE BEER; PORTER; PROCESSED HOPS FOR USE IN MAKING BEER (U.S. CLS. 45, 46 AND 48).

JESSICA FATHY, EXAMINING ATTORNEY

**CLASS 32—(Continued).**

SN 86-106,807. GREEN MOUNTAIN COFFEE ROASTERS, INC., WATERBURY, VT. FILED 10-31-2013.

**RED BARN SODA**

THE MARK CONSISTS OF STANDARD CHARACTERS WITHOUT CLAIM TO ANY PARTICULAR FONT, STYLE, SIZE, OR COLOR.

NO CLAIM IS MADE TO THE EXCLUSIVE RIGHT TO USE "SODA", APART FROM THE MARK AS SHOWN.

FOR SYRUPS FOR MAKING BEVERAGES; PREPARATIONS FOR MAKING BEVERAGES, NAMELY, CONCENTRATES USED IN THE PREPARATION OF SOFT DRINKS AND FRUIT DRINKS; SYRUP PODS, NAMELY, DISPOSABLE CAPSULES CONTAINING SYRUPS FOR MAKING BEVERAGES (U.S. CLS. 45, 46 AND 48).

EUGENIA MARTIN, EXAMINING ATTORNEY

---

SN 86-106,817. GREEN MOUNTAIN COFFEE ROASTERS, INC., WATERBURY, VT. FILED 10-31-2013.

**RITA & TINA'S COCKTAIL JOURNEYS**

THE MARK CONSISTS OF STANDARD CHARACTERS WITHOUT CLAIM TO ANY PARTICULAR FONT, STYLE, SIZE, OR COLOR.

NO CLAIM IS MADE TO THE EXCLUSIVE RIGHT TO USE "COCKTAIL", APART FROM THE MARK AS SHOWN.

FOR SYRUPS FOR MAKING BEVERAGES; PREPARATIONS FOR MAKING BEVERAGES, NAMELY, CONCENTRATES USED IN THE PREPARATION OF SOFT DRINKS AND FRUIT DRINKS; SYRUP PODS, NAMELY, DISPOSABLE CAPSULES CONTAINING SYRUPS FOR MAKING BEVERAGES (U.S. CLS. 45, 46 AND 48).

EUGENIA MARTIN, EXAMINING ATTORNEY

---

SN 86-106,835. GREEN MOUNTAIN COFFEE ROASTERS, INC., WATERBURY, VT. FILED 10-31-2013.

**FLYTE**

THE MARK CONSISTS OF STANDARD CHARACTERS WITHOUT CLAIM TO ANY PARTICULAR FONT, STYLE, SIZE, OR COLOR.

FOR CONCENTRATES, SYRUPS OR POWDERS USED IN THE PREPARATION OF SPORTS AND ENERGY DRINKS; SYRUPS FOR MAKING BEVERAGES; PREPARATIONS FOR MAKING BEVERAGES, NAMELY, CONCENTRATES USED IN THE PREPARATION OF SOFT DRINKS AND FRUIT DRINKS; SYRUP PODS, NAMELY, DISPOSABLE CAPSULES CONTAINING SYRUPS FOR MAKING BEVERAGES (U.S. CLS. 45, 46 AND 48).

EUGENIA MARTIN, EXAMINING ATTORNEY

**CLASS 32—(Continued).**

SN 86-108,228. NINKASI BREWERY, LLC, EUGENE, OR. FILED 11-1-2013.

**Oatis**

THE MARK CONSISTS OF STANDARD CHARACTERS WITHOUT CLAIM TO ANY PARTICULAR FONT, STYLE, SIZE, OR COLOR.

OWNER OF U.S. REG. NO. 3,717,105.

FOR BEER (U.S. CLS. 45, 46 AND 48).

FIRST USE 9-25-2008; IN COMMERCE 9-25-2008.

DOMINIC FATHY, EXAMINING ATTORNEY

---

SN 86-115,051. PEPSICO, INC., PURCHASE, NY. FILED 11-11-2013.



OWNER OF U.S. REG. NOS. 1,917,411, 3,383,131 AND OTHERS.

THE COLOR(S) BLUE, WHITE AND PURPLE IS/ARE CLAIMED AS A FEATURE OF THE MARK.

THE MARK CONSISTS OF THE WORDS "AQUAFINA" IN STYLIZED BLUE LETTERS, "FLAVORSPLASH" IN STYLIZED WHITE LETTERS AND "THAT'S GRAPE!" IN STYLIZED BLUE LETTERS. THERE IS A BLUE ARC DESIGN UNDERNEATH "AQUAFINA", AND THERE ARE SCATTERED BLUE BUBBLE DESIGNS ON THE BACKGROUND. THE ENTIRE MARK RESIDES ON A PURPLE BACKGROUND.

FOR FLAVORED CARBONATED DRINKING WATER (U.S. CLS. 45, 46 AND 48).

EVIN L. KOZAK, EXAMINING ATTORNEY

**CLASS 32—(Continued).**

SN 86-129,981. LUBIN, ALEX, ROSLYN HEIGHTS, NY.  
FILED 11-26-2013.

# BURP

THE MARK CONSISTS OF STANDARD CHARACTERS WITHOUT CLAIM TO ANY PARTICULAR FONT, STYLE, SIZE, OR COLOR.

FOR AERATED WATER; ICE CREAM SODA; SELTZER WATER; SODA POPS; SODA WATER; SOFT DRINKS, NAMELY, SODAS (U.S. CLS. 45, 46 AND 48).  
AISHA CLARKE, EXAMINING ATTORNEY

**CLASS 32—(Continued).**

SN 86-137,749. WYNWOOD BREWING COMPANY LLC,  
MIAMI, FL. FILED 12-7-2013.

# FLAGLER SAISON

THE MARK CONSISTS OF STANDARD CHARACTERS WITHOUT CLAIM TO ANY PARTICULAR FONT, STYLE, SIZE, OR COLOR.

NO CLAIM IS MADE TO THE EXCLUSIVE RIGHT TO USE "SAISON", APART FROM THE MARK AS SHOWN.

THE ENGLISH TRANSLATION OF THE WORD "SAISON" IN THE MARK IS "SEASON".

FOR BEER (U.S. CLS. 45, 46 AND 48).  
JESSICA FATHY, EXAMINING ATTORNEY

SN 86-137,662. WYNWOOD BREWING COMPANY LLC,  
MIAMI, FL. FILED 12-6-2013.

# INSANE IN THE PLANTAIN

THE MARK CONSISTS OF STANDARD CHARACTERS WITHOUT CLAIM TO ANY PARTICULAR FONT, STYLE, SIZE, OR COLOR.

FOR BEER (U.S. CLS. 45, 46 AND 48).  
JESSICA FATHY, EXAMINING ATTORNEY

SN 86-137,750. WYNWOOD BREWING COMPANY LLC,  
DBA WYNWOOD BREWING COMPANY, MIAMI, FL.  
FILED 12-7-2013.

# OCTOPUS ON THE WALL

THE MARK CONSISTS OF STANDARD CHARACTERS WITHOUT CLAIM TO ANY PARTICULAR FONT, STYLE, SIZE, OR COLOR.

FOR BEER (U.S. CLS. 45, 46 AND 48).  
JESSICA FATHY, EXAMINING ATTORNEY

SN 86-137,671. WYNWOOD BREWING COMPANY LLC,  
MIAMI, FL. FILED 12-6-2013.

# WYNWOOD FOX

THE MARK CONSISTS OF STANDARD CHARACTERS WITHOUT CLAIM TO ANY PARTICULAR FONT, STYLE, SIZE, OR COLOR.

NO CLAIM IS MADE TO THE EXCLUSIVE RIGHT TO USE "WYNWOOD", APART FROM THE MARK AS SHOWN.  
FOR BEER (U.S. CLS. 45, 46 AND 48).  
JESSICA FATHY, EXAMINING ATTORNEY

SN 86-138,060. GREEN MOUNTAIN COFFEE ROASTERS,  
INC., WATERBURY, VT. FILED 12-9-2013.

# UNION STREET LOUNGE

THE MARK CONSISTS OF STANDARD CHARACTERS WITHOUT CLAIM TO ANY PARTICULAR FONT, STYLE, SIZE, OR COLOR.

FOR SYRUPS FOR MAKING BEVERAGES; PREPARATIONS FOR MAKING BEVERAGES, NAMELY, CONCENTRATES USED IN THE PREPARATION OF SOFT DRINKS AND FRUIT DRINKS; SYRUP PODS, NAMELY, DISPOSABLE CAPSULES CONTAINING SYRUPS FOR MAKING BEVERAGES (U.S. CLS. 45, 46 AND 48).

EUGENIA MARTIN, EXAMINING ATTORNEY

**CLASS 32—(Continued).**

SN 86-139,502. LUBIN, ALEX, ROSLYN HEIGHTS, NY.  
FILED 12-10-2013.

# Aquafy

THE MARK CONSISTS OF STANDARD CHARACTERS WITHOUT CLAIM TO ANY PARTICULAR FONT, STYLE, SIZE, OR COLOR.

FOR BOTTLED DRINKING WATER; BOTTLED WATER; DRINKING WATER WITH VITAMINS; FLAVORED BOTTLED WATER; PURIFIED BOTTLED DRINKING WATER; SPORTS DRINKS CONTAINING ELECTROLYTES; SPORTS DRINKS ENHANCED WITH VITAMINS, MINERALS, NUTRIENTS (U.S. CLS. 45, 46 AND 48).

AISHA CLARKE, EXAMINING ATTORNEY

SN 86-141,485. GREEN MOUNTAIN COFFEE ROASTERS, INC., WATERBURY, VT. FILED 12-12-2013.

# SODA PEOPLE

THE MARK CONSISTS OF STANDARD CHARACTERS WITHOUT CLAIM TO ANY PARTICULAR FONT, STYLE, SIZE, OR COLOR.

NO CLAIM IS MADE TO THE EXCLUSIVE RIGHT TO USE "SODA", APART FROM THE MARK AS SHOWN.

FOR SYRUPS FOR MAKING BEVERAGES; PREPARATIONS FOR MAKING BEVERAGES, NAMELY, CONCENTRATES USED IN THE PREPARATION OF SOFT DRINKS AND FRUIT DRINKS; SYRUP PODS, NAMELY, DISPOSABLE CAPSULES CONTAINING SYRUPS FOR MAKING BEVERAGES (U.S. CLS. 45, 46 AND 48).

EUGENIA MARTIN, EXAMINING ATTORNEY

SN 86-143,564. KISS CATALOG, LTD., PINE BROOK, NJ.  
FILED 12-13-2013.

# KISS DESTROYER

THE MARK CONSISTS OF STANDARD CHARACTERS WITHOUT CLAIM TO ANY PARTICULAR FONT, STYLE, SIZE, OR COLOR.

FOR BEER (U.S. CLS. 45, 46 AND 48).

ROSELLE HERRERA, EXAMINING ATTORNEY

**CLASS 33—WINES AND SPIRITS**

SN 79-125,359. QUINTA DA ARCHEIRA -, SOCIEDADE AGRICOLA, LDA., PORTUGAL, FILED 12-18-2012.

# PINTA NEGRA

THE MARK CONSISTS OF STANDARD CHARACTERS WITHOUT CLAIM TO ANY PARTICULAR FONT, STYLE, SIZE, OR COLOR.

OWNER OF INTERNATIONAL REGISTRATION 1147998 DATED 12-18-2012, EXPIRES 12-18-2022.

THE ENGLISH TRANSLATION OF "PINTA NEGRA" IN THE MARK IS "BLACK PAINT".

FOR ALCOHOLIC BEVERAGES, EXCEPT BEERS; ALCOHOLIC BEVERAGES CONTAINING FRUIT; WINES, DIGESTERS IN THE NATURE OF LIQUEURS AND SPIRITS (U.S. CLS. 47 AND 49).

JULIE VEPPUMTHARA, EXAMINING ATTORNEY

SN 79-127,654. BODEGAS Y VIÑEDOS DEL JALON, S.A., SPAIN, FILED 2-11-2013.

# LAS PIZARRAS DEL JALON

THE MARK CONSISTS OF STANDARD CHARACTERS WITHOUT CLAIM TO ANY PARTICULAR FONT, STYLE, SIZE, OR COLOR.

OWNER OF INTERNATIONAL REGISTRATION 1153855 DATED 2-11-2013, EXPIRES 2-11-2023.

THE ENGLISH TRANSLATION OF "LAS PIZARRAS DEL JALON" IN THE MARK IS "THE SLATES OF JALON".

FOR RED, WHITE AND ROSE WINES (U.S. CLS. 47 AND 49).

TINA L. SNAPP, EXAMINING ATTORNEY

SN 79-131,293. SOCIETA' AGRICOLA - VALPANERA S.A.S.; DI DAL VECCHIO GIAMPIETRO E C., ITALY, FILED 12-19-2012.

# VALPANERA

THE MARK CONSISTS OF STANDARD CHARACTERS WITHOUT CLAIM TO ANY PARTICULAR FONT, STYLE, SIZE, OR COLOR.

OWNER OF INTERNATIONAL REGISTRATION 1163259 DATED 12-19-2012, EXPIRES 12-19-2022.

FOR ALCOHOLIC BEVERAGES EXCEPT BEERS; ALCOHOLIC FRUIT COCKTAIL DRINKS; ALCOHOLIC ESSENCES; ALCOHOLIC EXTRACTS; ALCOHOLIC MIXED BEVERAGES EXCEPT BEERS; APERITIF WINES; APERITIFS; APERITIFS WITH A WINE BASE; CHAMPAGNE; COOKING WINE; DISTILLED SPIRITS; FORTIFIED WINES; FRUIT WINE; GRAPE WINE; HONEY WINE; KITS FOR MAKING WINE; LIQUEURS; NATURALLY SPARKLING WINES; RED WINE; ROSE WINE; SPARKLING WINES; STILL WINES; SWEET WINES; TABLE WINES; WHITE WINE; WINE; WINE-BASED DRINKS (U.S. CLS. 47 AND 49).

ELLEN B. AWRICH, EXAMINING ATTORNEY

**CLASS 33—(Continued).**

SN 79-131,715. COOPERATIVA AGRICOLA DE; SANTO ISIDRO DE PEGÕES.; CRL, PORTUGAL, FILED 4-4-2013.

**ADEGA DE PEGÕES**

THE MARK CONSISTS OF STANDARD CHARACTERS WITHOUT CLAIM TO ANY PARTICULAR FONT, STYLE, SIZE, OR COLOR.

OWNER OF INTERNATIONAL REGISTRATION 1164371 DATED 4-4-2013, EXPIRES 4-4-2023.

NO CLAIM IS MADE TO THE EXCLUSIVE RIGHT TO USE "ADEGA", APART FROM THE MARK AS SHOWN.

THE ENGLISH TRANSLATION OF THE FOREIGN WORD(S) IN THE MARK IS: "WINERY OF PEGÕES".

SEC. 2(F).

FOR ALCOHOLIC BEVERAGES EXCEPT BEERS (U.S. CLS. 47 AND 49).

JUHI KAVEESHVAR, EXAMINING ATTORNEY

SN 79-132,290. CHATEAU LAROSE TRINTAUDON, FRANCE, FILED 5-30-2013.

**LES HAUTS DE PERGANSON**

THE MARK CONSISTS OF STANDARD CHARACTERS WITHOUT CLAIM TO ANY PARTICULAR FONT, STYLE, SIZE, OR COLOR.

OWNER OF INTERNATIONAL REGISTRATION 1165882 DATED 5-30-2013, EXPIRES 5-30-2023.

OWNER OF U.S. REG. NO. 4,315,316.

THE ENGLISH TRANSLATION OF "LES HAUTS DE PERGANSON" IN THE MARK IS "THE HIGH OF PERGANSON".

FOR AOC WINE PROTECTED BY THE APPELLATION OF ORIGIN "HAUT-MÉDOC" (U.S. CLS. 47 AND 49).

PAUL MORENO, EXAMINING ATTORNEY

**CLASS 33—(Continued).**

SN 79-134,874. S.C. CHATEAU BELAIR-MONANGE, FRANCE, FILED 7-8-2013.



OWNER OF INTERNATIONAL REGISTRATION 1172373 DATED 7-8-2013, EXPIRES 7-8-2023.

OWNER OF U.S. REG. NO. 3,903,208.

NO CLAIM IS MADE TO THE EXCLUSIVE RIGHT TO USE "CHATEAU", APART FROM THE MARK AS SHOWN.

THE COLOR(S) RED, WHITE AND BLACK IS/ARE CLAIMED AS A FEATURE OF THE MARK.

THE MARK CONSISTS OF "CHATEAU BELAIR MONANGE" IN BLACK COLOR, AND AN ANGEL DESIGN IN RED COLOR, WITHIN A RECTANGLE DESIGN IN WHITE COLOR, WITHIN A SECOND LARGER RECTANGLE IN BLACK COLOR.

FOR WINES WITH PROTECTED APPELLATION OF ORIGIN (U.S. CLS. 47 AND 49).

TEJBIR SINGH, EXAMINING ATTORNEY

SN 79-137,352. CAVIT CANTINA VITICOLTORI; CONSORZIO CANTINE SOCIALI DEL TRENINO; SOCIETA COOPERATIVA, ITALY, FILED 9-20-2013.

**ALTEMASI**

THE MARK CONSISTS OF STANDARD CHARACTERS WITHOUT CLAIM TO ANY PARTICULAR FONT, STYLE, SIZE, OR COLOR.

OWNER OF INTERNATIONAL REGISTRATION 0988915 DATED 11-11-2008, EXPIRES 11-11-2018.

THE WORDING "ALTEMASI" HAS NO MEANING IN A FOREIGN LANGUAGE.

FOR WINES, SPARKLING WINES (U.S. CLS. 47 AND 49).

DEBORAH LOBO, EXAMINING ATTORNEY

SN 79-138,482. A. DE FUSSIGNY, FRANCE, FILED 9-13-2013.

**ANECDOTE**

PRIORITY DATE OF 8-30-2013 IS CLAIMED.

OWNER OF INTERNATIONAL REGISTRATION 1181765 DATED 9-13-2013, EXPIRES 9-13-2023.

FOR VODKA (U.S. CLS. 47 AND 49).

DAVID HOFFMAN, EXAMINING ATTORNEY



**CLASS 33—(Continued).**

SN 79-138,706. WINE CELLAR VILLA MELNIK, BULGARIA,  
FILED 9-17-2013.

# BERGULE

THE MARK CONSISTS OF STANDARD CHARACTERS  
WITHOUT CLAIM TO ANY PARTICULAR FONT, STYLE,  
SIZE, OR COLOR.

OWNER OF INTERNATIONAL REGISTRATION 1182314  
DATED 9-17-2013, EXPIRES 9-17-2023.

FOR ALCOHOLIC BEVERAGES (EXCEPT BEERS);  
WINES (U.S. CLS. 47 AND 49).

LAURIE MAYES, EXAMINING ATTORNEY

**CLASS 33—(Continued).**

SN 85-691,707. Z & U SPIRITUOSEN MARKETING GMBH,  
VIENNA, AUSTRIA, FILED 7-31-2012.



OWNER OF ERPN CMNTY TM OFC REG. NO. 010942589,  
DATED 1-25-2013, EXPIRES 6-6-2022.

OWNER OF U.S. REG. NOS. 3,223,346, 3,451,065 AND  
OTHERS.

NO CLAIM IS MADE TO THE EXCLUSIVE RIGHT TO  
USE THE ROUNDED BOTTLE SHAPE, "ASZALTSZILVA-  
AGYON-TOLGYFAHORDOBAN", "1790" AND "SZILVA",  
APART FROM THE MARK AS SHOWN.

THE COLOR(S) BLACK, RED, GREEN, GOLD AND  
WHITE IS/ARE CLAIMED AS A FEATURE OF THE MARK.

THE MARK CONSISTS OF A THREE-DIMENSIONAL  
BOTTLE DESIGN CONTAINING A DESIGN OF A GOLD  
CROSS WITH THE BORDERS ON A RED CIRCLE WITH  
GOLD BORDERS AND THE WORD "UNICUM" IN WHITE  
BELOW THE CROSS DESIGN AND A DESIGN OF A PRUNE  
AND A CASK BELOW THE WORD "UNICUM". THE  
WORDS "SZILVA" IN WHITE, "ASZALTSZILVA - AGYON -  
TOLGYFAHORDOBAN" IN GOLD AND "ZWACK" IN  
BLACK APPEAR BELOW THE WORD "UNICUM". THE  
DATE "1790" AND A RED, WHITE AND GREEN BANNER  
APPEAR ON THE BOTTLENECK LABEL. THE DOTTED  
LINES OUTLINING THE BOTTLE CAP ARE INTENDED TO  
SHOW THE POSITION OF THE MARK ON THE GOODS  
AND ARE NOT PART OF THE MARK.

THE ENGLISH TRANSLATION OF "SZILVA" IN THE  
MARK IS "PLUM". THE WORD(S) "ZWACK" AND "UNI-  
CUM" HAVE NO MEANING IN A FOREIGN LANGUAGE.

FOR ALCOHOLIC BEVERAGES EXCEPT BEER (U.S.  
CLS. 47 AND 49).

DOMINICK J. SALEMI, EXAMINING ATTORNEY

SN 85-181,242. PERINETTI, ESTELA INES, GUAYMAL-  
LEN5500-MENDOZA, ARGENTINA, FILED 11-19-2010.

## ESTELA PERINETTI

THE MARK CONSISTS OF STANDARD CHARACTERS  
WITHOUT CLAIM TO ANY PARTICULAR FONT, STYLE,  
SIZE, OR COLOR.

PRIORITY CLAIMED UNDER SEC. 44(D) ON ARGENTI-  
NA APPLICATION NO. 3045051, FILED 11-9-2010, REG. NO.  
2,447,650, DATED 12-19-2011, EXPIRES 12-19-2021.

THE NAME(S), PORTRAIT(S), AND/OR SIGNATURE(S)  
SHOWN IN THE MARK IDENTIFIES "ESTELA PERINET-  
TI", WHOSE CONSENT(S) TO REGISTER IS MADE OF  
RECORD.

FOR WINES (U.S. CLS. 47 AND 49).

KATHERINE STOIDES, EXAMINING ATTORNEY

SN 85-671,272. WEMYSS VINTAGE MALTS LTD, EDIN-  
BURGH, UNITED KINGDOM, FILED 7-9-2012.

## THE HIVE

THE MARK CONSISTS OF STANDARD CHARACTERS  
WITHOUT CLAIM TO ANY PARTICULAR FONT, STYLE,  
SIZE, OR COLOR.

FOR WHISKEY; MALT WHISKEY; BLENDED WHIS-  
KEY; SCOTCH WHISKEY; WHISKEY BASED LIQUEURS  
(U.S. CLS. 47 AND 49).

FIRST USE 9-0-2008; IN COMMERCE 9-0-2008.

KATINA MISTER, EXAMINING ATTORNEY

SN 85-784,598. BEACH HOUSE WINERY, INC., FALL-  
BROOK, CA. FILED 11-20-2012.

## Beach House Winery

THE MARK CONSISTS OF STANDARD CHARACTERS  
WITHOUT CLAIM TO ANY PARTICULAR FONT, STYLE,  
SIZE, OR COLOR.

NO CLAIM IS MADE TO THE EXCLUSIVE RIGHT TO  
USE "WINERY", APART FROM THE MARK AS SHOWN.

FOR WINE (U.S. CLS. 47 AND 49).

FIRST USE 3-1-2005; IN COMMERCE 3-1-2005.

SKYE YOUNG, EXAMINING ATTORNEY

**CLASS 33—(Continued).**

SN 85-824,089. V'GUARA INC., SALT LAKE CITY, UT.  
FILED 1-15-2013.

## Country Vodka

THE MARK CONSISTS OF STANDARD CHARACTERS WITHOUT CLAIM TO ANY PARTICULAR FONT, STYLE, SIZE, OR COLOR.

NO CLAIM IS MADE TO THE EXCLUSIVE RIGHT TO USE "VODKA", APART FROM THE MARK AS SHOWN.

FOR ALCOHOLIC BEVERAGES EXCEPT BEERS (U.S. CLS. 47 AND 49).

THOMAS MANOR, EXAMINING ATTORNEY

---

SN 85-837,532. CMZ GROUP LTD SEZC, GRAND CAYMAN, KY1-1105, CAYMAN ISLANDS, FILED 1-31-2013.

## PIRATE'S CHOICE

THE MARK CONSISTS OF STANDARD CHARACTERS WITHOUT CLAIM TO ANY PARTICULAR FONT, STYLE, SIZE, OR COLOR.

FOR DISTILLED SPIRITS (U.S. CLS. 47 AND 49).  
KATHLEEN M. VANSTON, EXAMINING ATTORNEY

---

SN 85-851,031. BNA WINE GROUP, LLC, NASHVILLE, TN.  
FILED 2-15-2013.

## NANNA'S

THE MARK CONSISTS OF STANDARD CHARACTERS WITHOUT CLAIM TO ANY PARTICULAR FONT, STYLE, SIZE, OR COLOR.

FOR ALCOHOLIC BEVERAGES, NAMELY, WINE (U.S. CLS. 47 AND 49).

GINA FINK, EXAMINING ATTORNEY

**CLASS 33—(Continued).**

SN 85-870,735. SOVEREIGN BRANDS, LLC, NEW YORK, NY. FILED 3-8-2013.

## BUMBU

THE MARK CONSISTS OF STANDARD CHARACTERS WITHOUT CLAIM TO ANY PARTICULAR FONT, STYLE, SIZE, OR COLOR.

PRIORITY CLAIMED UNDER SEC. 44(D) ON ERPN CMNTY TM OFC APPLICATION NO. 011579463, FILED 2-15-2013, REG. NO. 011579463, DATED 12-18-2013, EXPIRES 2-15-2023.

THE WORD(S) "BUMBU" HAS NO MEANING IN A FOREIGN LANGUAGE.

FOR DISTILLED SPIRITS; RUM; SPIRITS AND LIQUEURS (U.S. CLS. 47 AND 49).

JAMES LOVELACE, EXAMINING ATTORNEY

---

SN 85-905,973. CATWINEUSA, S.L., BARCELONA, SPAIN, FILED 4-16-2013.



THE MARK CONSISTS OF THE NUMBER "4" WHICH IS FORMED BY TWO SETS OF FOUR PARALLEL LINES; THE FIRST SET OF PARALLEL LINES ARE VERTICAL; THE SECOND SET OF VERTICAL LINES ARE HORIZONTAL AND THEN BEND UP VERTICALLY TO MEET THE VERTICAL LINES. THE BLACK BACKGROUND IS NOT PART OF THE MARK.

FOR WINES AND SPARKLING WINES (U.S. CLS. 47 AND 49).

BILL DAWE, EXAMINING ATTORNEY

**CLASS 33—(Continued).**

SN 85-915,631. DEATH'S DOOR SPIRITS, LLC, MIDDLETON, WI. FILED 4-26-2013.

**WONDERMINT**

THE MARK CONSISTS OF STANDARD CHARACTERS WITHOUT CLAIM TO ANY PARTICULAR FONT, STYLE, SIZE, OR COLOR.

FOR ALCOHOLIC BEVERAGES, NAMELY, FLAVORED SCHNAPPS (U.S. CLS. 47 AND 49).  
SUSAN STIGLITZ, EXAMINING ATTORNEY

SN 85-915,642. DEATH'S DOOR SPIRITS, LLC, MIDDLETON, WI. FILED 4-26-2013.

**KRINGLE CREAM**

THE MARK CONSISTS OF STANDARD CHARACTERS WITHOUT CLAIM TO ANY PARTICULAR FONT, STYLE, SIZE, OR COLOR.

NO CLAIM IS MADE TO THE EXCLUSIVE RIGHT TO USE "CREAM", APART FROM THE MARK AS SHOWN.  
FOR ALCOHOLIC BEVERAGES, NAMELY, VODKA (U.S. CLS. 47 AND 49).  
SUSAN STIGLITZ, EXAMINING ATTORNEY

SN 85-939,288. PERNOD RICARD WINEMAKERS PTY LTD, DULWICH, AUSTRALIA, FILED 5-22-2013.

**KING CAB**

THE MARK CONSISTS OF STANDARD CHARACTERS WITHOUT CLAIM TO ANY PARTICULAR FONT, STYLE, SIZE, OR COLOR.

NO CLAIM IS MADE TO THE EXCLUSIVE RIGHT TO USE "CAB", APART FROM THE MARK AS SHOWN.  
FOR ALCOHOLIC BEVERAGES EXCEPT BEERS (U.S. CLS. 47 AND 49).  
JOHN WILKE, EXAMINING ATTORNEY

**CLASS 33—(Continued).**

SN 85-954,764. ELIXIR DE AGAVE, S.A. DE C.V., OAXACA DE JUAREZ, MEXICO, FILED 6-10-2013.

**MEZCAL RÍO REVUELTO**

THE MARK CONSISTS OF STANDARD CHARACTERS WITHOUT CLAIM TO ANY PARTICULAR FONT, STYLE, SIZE, OR COLOR.

NO CLAIM IS MADE TO THE EXCLUSIVE RIGHT TO USE "MEZCAL", APART FROM THE MARK AS SHOWN.  
THE ENGLISH TRANSLATION OF "RÍO REVUELTO" IN THE MARK IS "STIRRED-UP RIVER, TROUBLED RIVER".  
FOR MEZCAL (U.S. CLS. 47 AND 49).  
MATTHEW MCDOWELL, EXAMINING ATTORNEY

SN 85-955,801. G3 ENTERPRISES, INC., MODESTO, CA. FILED 6-10-2013.



OWNER OF U.S. REG. NO. 2,741,309.  
THE NAME SHOWN IN THE MARK DOES NOT IDENTIFY A PARTICULAR LIVING INDIVIDUAL.

THE MARK CONSISTS OF THE LETTERS "L","O","U","I","S" "M" "M","A","R","T","I","N","I" IN STYLIZED CAPITAL LETTERS WITH THE LETTER "M" IN SMALLER FONT WITH ONE SMALL CIRCLE ON EACH SIDE OF THE "M" AND A DIAMOND UNDERNEATH, CENTERED BENEATH THE RECTANGLE IS A CROWN. THE DETAILS AT THE TOP OF THE CROWN CONSIST OF THE STYLIZED CAPITAL LETTERS "L","M","M" WITH SMALL CIRCLES IN BETWEEN AND ON TOP OF THE LETTERS.

FOR WINES, EXCLUDING VERMOUTH (U.S. CLS. 47 AND 49).

FIRST USE 11-30-2010; IN COMMERCE 11-30-2010.  
SUSAN RICHARDS, EXAMINING ATTORNEY

SN 86-005,888. ELIXIR DE AGAVE, S.A. DE C.V., OAXACA DE JUAREZ, MEXICO, FILED 7-9-2013.

**CUANDO EL RIO SUENA ES QUE  
MEZCAL LLEVA**

THE MARK CONSISTS OF STANDARD CHARACTERS WITHOUT CLAIM TO ANY PARTICULAR FONT, STYLE, SIZE, OR COLOR.

NO CLAIM IS MADE TO THE EXCLUSIVE RIGHT TO USE "MEZCAL", APART FROM THE MARK AS SHOWN.  
THE ENGLISH TRANSLATION OF "CUANDO EL RIO SUENA ES QUE MEZCAL LLEVA" IN THE MARK IS "WHEN THE RIVER SOUNDS IT IS BECAUSE IS CARRYING MEZCAL".

FOR MEZCAL (U.S. CLS. 47 AND 49).  
MATTHEW MCDOWELL, EXAMINING ATTORNEY

**CLASS 33—(Continued).**

SN 86-016,414. WINERY EXCHANGE, INC., NOVATO, CA. FILED 7-22-2013.

**THE GOOD LOT**

THE MARK CONSISTS OF STANDARD CHARACTERS WITHOUT CLAIM TO ANY PARTICULAR FONT, STYLE, SIZE, OR COLOR.

FOR ALCOHOLIC BEVERAGES EXCEPT BEERS (U.S. CLS. 47 AND 49).

MORGAN WYNNE, EXAMINING ATTORNEY

SN 86-016,432. MAISON DE LA VIE, LTD., DBA GOLDEN MOON DISTILLERY, GOLDEN, CO. FILED 7-22-2013.

**Amer Dit Picon**

THE MARK CONSISTS OF STANDARD CHARACTERS WITHOUT CLAIM TO ANY PARTICULAR FONT, STYLE, SIZE, OR COLOR.

NO CLAIM IS MADE TO THE EXCLUSIVE RIGHT TO USE "AMER", APART FROM THE MARK AS SHOWN.

"AMER DIT PICON" FUNCTIONALLY TRANSLATES AS "A BITTERS AS PICON SAID THEY SHOULD BE."

FOR ALCOHOLIC APERITIF BITTERS; ALCOHOLIC BITTERS; APERITIFS WITH A DISTILLED ALCOHOLIC LIQUOR BASE; EXTRACTS OF SPIRITUOUS LIQUORS; FLAVORED TONIC LIQUORS; HERB LIQUEURS; LIQUEURS; LIQUOR; SPIRITS AND LIQUEURS; TONIC LIQUOR CONTAINING HERB EXTRACTS (HOMEISHU); TONIC LIQUOR CONTAINING MAMUSHI-SNAKE EXTRACTS (MAMUSHI-ZAKE); TONIC LIQUOR FLAVORED WITH JAPANESE PLUM EXTRACTS (UMESHU); TONIC LIQUOR FLAVORED WITH PINE NEEDLE EXTRACTS (MATSUBA-ZAKE); WINES AND LIQUEURS (U.S. CLS. 47 AND 49).

FIRST USE 3-1-2013; IN COMMERCE 7-16-2013.

KATHRYN COWARD, EXAMINING ATTORNEY

SN 86-030,412. TIGODA USA, INC, WASHINGTON, PA. FILED 8-6-2013.

**ZVA VODKA**

THE MARK CONSISTS OF STANDARD CHARACTERS WITHOUT CLAIM TO ANY PARTICULAR FONT, STYLE, SIZE, OR COLOR.

NO CLAIM IS MADE TO THE EXCLUSIVE RIGHT TO USE "VODKA", APART FROM THE MARK AS SHOWN.

FOR DISTILLED SPIRITS (U.S. CLS. 47 AND 49).

FONG HSU, EXAMINING ATTORNEY

**CLASS 33—(Continued).**

SN 86-037,759. R & A BAILEYS AND CO, DUBLIN 12, IRELAND, FILED 8-14-2013.



OWNER OF U.S. REG. NOS. 1,185,090, 3,985,574 AND OTHERS.

NO CLAIM IS MADE TO THE EXCLUSIVE RIGHT TO USE "THE ORIGINAL IRISH CREAM" AND "VANILLA CINNAMON", APART FROM THE MARK AS SHOWN.

THE COLOR(S) BLACK, GOLD, ORANGE, WHITE, CREAM AND BROWN IS/ARE CLAIMED AS A FEATURE OF THE MARK.

THE MARK CONSISTS OF A RECTANGULAR BLACK BACKGROUND WITH AN ARCHED TOP AND ARCHED BANNER DESIGN OUTLINED IN GOLD WITH AN ORANGE INTERIOR AND THE WORD "BAILEYS" IN CREAM-COLOR AND OUTLINED IN GOLD; BELOW THE ORANGE BANNER DESIGN ARE THE WORDS "THE ORIGINAL IRISH CREAM" IN WHITE, UNDER WHICH APPEAR THE WORDS "VANILLA CINNAMON" IN A WHITE STYLIZED FONT WITH A WHITE LINE BELOW; UNDER THESE WORDS IS A CREAM-COLORED FLOWER DESIGN, WITH A CREAM-COLORED SWIRL DESIGN COMING OUT OF THE LEFT OF THE FLOWER DESIGN; COMING OUT OF THE RIGHT OF THE FLOWER DESIGN IS A CINNAMON STICK DESIGN INCORPORATED INTO A CREAM-COLORED AND BROWN-COLORED SWIRL.

FOR ALCOHOLIC BEVERAGES EXCEPT BEERS (U.S. CLS. 47 AND 49).

LINDA E. BLOHM, EXAMINING ATTORNEY

SN 86-037,861. JACK DANIEL'S PROPERTIES, INC., SAN RAFAEL, CA. FILED 8-14-2013.

**NO. 27 GOLD**

THE MARK CONSISTS OF STANDARD CHARACTERS WITHOUT CLAIM TO ANY PARTICULAR FONT, STYLE, SIZE, OR COLOR.

OWNER OF U.S. REG. NOS. 582,789, 1,942,451 AND OTHERS.

NO CLAIM IS MADE TO THE EXCLUSIVE RIGHT TO USE "GOLD", APART FROM THE MARK AS SHOWN.

FOR DISTILLED SPIRITS (U.S. CLS. 47 AND 49).

LINDA POWELL, EXAMINING ATTORNEY

**CLASS 33—(Continued).**

SN 86-037,909. JACK DANIEL'S PROPERTIES, INC., SAN RAFAEL, CA. FILED 8-14-2013.



OWNER OF U.S. REG. NOS. 582,789, 1,758,658 AND 1,942,451.

NO CLAIM IS MADE TO THE EXCLUSIVE RIGHT TO USE "GOLD", APART FROM THE MARK AS SHOWN.

THE NAME "JACK DANIEL" DOES NOT IDENTIFY A LIVING INDIVIDUAL.

THE MARK CONSISTS OF THE STYLIZED WORDING "JACK DANIEL'S" ABOVE AN OVAL SHAPED FILIGREE DESIGN SURROUNDING THE STYLIZED WORDING "NO. 27" ALL ABOVE THE WORD "GOLD" IN A SHADED OVAL CARRIER.

FOR DISTILLED SPIRITS (U.S. CLS. 47 AND 49).  
LINDA POWELL, EXAMINING ATTORNEY

SN 86-037,931. JACK DANIEL'S PROPERTIES, INC., SAN RAFAEL, CA. FILED 8-14-2013.



OWNER OF U.S. REG. NOS. 582,789, 1,942,451 AND OTHERS.

NO CLAIM IS MADE TO THE EXCLUSIVE RIGHT TO USE "GOLD", APART FROM THE MARK AS SHOWN.

THE NAME "JACK DANIEL" DOES NOT IDENTIFY A LIVING INDIVIDUAL.

THE MARK CONSISTS OF THE STYLIZED WORDING "JACK DANIEL'S" TO THE LEFT OF AN OVAL SHAPED FILIGREE DESIGN SURROUNDING THE STYLIZED WORDING "NO. 27" ABOVE THE WORD "GOLD" IN A SHADED OVAL CARRIER.

FOR DISTILLED SPIRITS (U.S. CLS. 47 AND 49).  
LINDA POWELL, EXAMINING ATTORNEY

**CLASS 33—(Continued).**

SN 86-037,951. JACK DANIEL'S PROPERTIES, INC., SAN RAFAEL, CA. FILED 8-14-2013.



OWNER OF U.S. REG. NOS. 582,789, 1,942,451 AND OTHERS.

NO CLAIM IS MADE TO THE EXCLUSIVE RIGHT TO USE "GOLD" AND "TENNESSEE WHISKEY", APART FROM THE MARK AS SHOWN.

THE NAME "JACK DANIEL" DOES NOT IDENTIFY A LIVING INDIVIDUAL.

THE MARK CONSISTS OF THE STYLIZED WORDING "JACK DANIEL'S" ABOVE AN OVAL SHAPED FILIGREE DESIGN SURROUNDING THE STYLIZED WORDING "NO. 27" ALL ABOVE THE WORD "GOLD" IN A SHADED OVAL CARRIER THAT IS ABOVE THE WORDS "TENNESSEE WHISKEY", WITH ALL THE FOREGOING FRAMED IN A FILIGREE RECTANGULAR BORDER.

FOR DISTILLED SPIRITS (U.S. CLS. 47 AND 49).  
LINDA POWELL, EXAMINING ATTORNEY

SN 86-038,429. DCD ENTERPRISES, DBA UNDISCOVERED WINES, LA HABRA HEIGHTS, CA. FILED 8-15-2013.

# DONAIRE

THE MARK CONSISTS OF STANDARD CHARACTERS WITHOUT CLAIM TO ANY PARTICULAR FONT, STYLE, SIZE, OR COLOR.

THE ENGLISH TRANSLATION OF "DONAIRE" IS "GRACEFULNESS."

FOR WINES (U.S. CLS. 47 AND 49).  
JOHN E. MICHOS, EXAMINING ATTORNEY

**CLASS 33—(Continued).**

SN 86-038,519. BITTERCUBE, LLC, MILWAUKEE, WI.  
FILED 8-15-2013.

**BITTERCUBE BITTERS**

THE MARK CONSISTS OF STANDARD CHARACTERS WITHOUT CLAIM TO ANY PARTICULAR FONT, STYLE, SIZE, OR COLOR.

NO CLAIM IS MADE TO THE EXCLUSIVE RIGHT TO USE "BITTERS", APART FROM THE MARK AS SHOWN.

FOR ALCOHOLIC BITTERS (U.S. CLS. 47 AND 49).

FIRST USE 10-21-2010; IN COMMERCE 10-21-2010.

AMY HELLA, EXAMINING ATTORNEY

**CLASS 33—(Continued).**

SN 86-040,378. ALLEY 6 CRAFT DISTILLERY, LLC,  
HEALDSBURG, CA. FILED 8-16-2013.

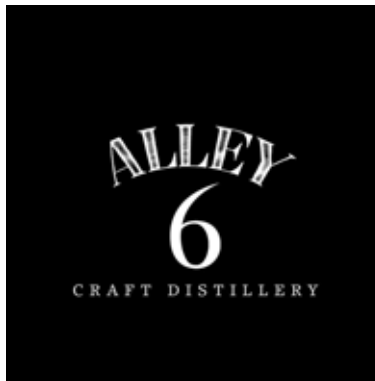

NO CLAIM IS MADE TO THE EXCLUSIVE RIGHT TO USE "CRAFT DISTILLERY", APART FROM THE MARK AS SHOWN.

THE MARK CONSISTS OF STYLIZED WORDS "ALLEY 6 CRAFT DISTILLERY" WITH BLACK BACKGROUND AND WHITE TEXT.

FOR DISTILLED SPIRITS (U.S. CLS. 47 AND 49).

TARAH HARDY, EXAMINING ATTORNEY

SN 86-039,532. V VINEYARDS, SANTA ROSA, CA. FILED 8-15-2013.



**V. VINEYARDS**  
SONOMA COUNTY

NO CLAIM IS MADE TO THE EXCLUSIVE RIGHT TO USE "VINEYARDS" AND "SONOMA COUNTY", APART FROM THE MARK AS SHOWN.

THE MARK CONSISTS OF AN IMAGE OF SYMMETRICAL LEAVES CONNECTED TO AN OVERLAPPING STEM FORMING A "V" WITH THE WORDS "V. VINEYARDS" BENEATH THE IMAGE AND THE WORDS "SONOMA COUNTY" AT THE BOTTOM.

FOR ALCOHOLIC BEVERAGES, NAMELY, WINES, SPARKLING WINES AND SPIRITS (U.S. CLS. 47 AND 49).

FIRST USE 7-1-2013; IN COMMERCE 7-1-2013.

JOHN WILKE, EXAMINING ATTORNEY

SN 86-041,357. BOOTLEGGERS LLC, WHITE PINE, TN.  
FILED 8-19-2013.

**Bootleggers Distillery**

THE MARK CONSISTS OF STANDARD CHARACTERS WITHOUT CLAIM TO ANY PARTICULAR FONT, STYLE, SIZE, OR COLOR.

NO CLAIM IS MADE TO THE EXCLUSIVE RIGHT TO USE "DISTILLERY", APART FROM THE MARK AS SHOWN.

FOR LIQUOR (U.S. CLS. 47 AND 49).

ANDREW LEASER, EXAMINING ATTORNEY

SN 86-041,622. CANOPY LICENSING, LLC, NAPA, CA.  
FILED 8-19-2013.

**WINES WOMEN LOVE**

THE MARK CONSISTS OF STANDARD CHARACTERS WITHOUT CLAIM TO ANY PARTICULAR FONT, STYLE, SIZE, OR COLOR.

NO CLAIM IS MADE TO THE EXCLUSIVE RIGHT TO USE "WINES", APART FROM THE MARK AS SHOWN.

FOR ALCOHOLIC BEVERAGES EXCEPT BEERS (U.S. CLS. 47 AND 49).

JILL PRATER, EXAMINING ATTORNEY

**CLASS 33—(Continued).**

SN 86-041,627. ATLANTIC IMPORTING COMPANY, INC., FRAMINGHAM, MA. FILED 8-19-2013.

# ABIGAIL ROSE

THE MARK CONSISTS OF STANDARD CHARACTERS WITHOUT CLAIM TO ANY PARTICULAR FONT, STYLE, SIZE, OR COLOR.

THE NAME SHOWN IN THE MARK IDENTIFIES ABIGAIL ROSE SIEGAL, A LIVING INDIVIDUAL WHOSE CONSENT IS OF RECORD.

FOR ALCOHOLIC BEVERAGES EXCEPT BEERS; WINE (U.S. CLS. 47 AND 49).

GEOFFREY FOSDICK, EXAMINING ATTORNEY



SN 86-041,963. BLUE FARM LLC, SONOMA, CA. FILED 8-19-2013.

# BLUE FARM

THE MARK CONSISTS OF STANDARD CHARACTERS WITHOUT CLAIM TO ANY PARTICULAR FONT, STYLE, SIZE, OR COLOR.

NO CLAIM IS MADE TO THE EXCLUSIVE RIGHT TO USE "FARM", APART FROM THE MARK AS SHOWN.

FOR ALCOHOLIC BEVERAGES EXCEPT BEERS; WINES (U.S. CLS. 47 AND 49).

ANGELA M. MICHELI, EXAMINING ATTORNEY



SN 86-042,067. ASTOR HOME LTD., LYNDHURST, NJ. FILED 8-19-2013.

# LORD ASTOR

THE MARK CONSISTS OF STANDARD CHARACTERS WITHOUT CLAIM TO ANY PARTICULAR FONT, STYLE, SIZE, OR COLOR.

OWNER OF U.S. REG. NOS. 1,064,997 AND 3,179,708.

THE NAME(S), PORTRAIT(S), AND/OR SIGNATURE(S) SHOWN IN THE MARK DOES NOT IDENTIFY A PARTICULAR LIVING INDIVIDUAL.

FOR DISTILLED SPIRITS; GIN (U.S. CLS. 47 AND 49).

JOHN GARTNER, EXAMINING ATTORNEY

**CLASS 33—(Continued).**

SN 86-043,205. OLIVER WINE CO., INC., BLOOMINGTON, IN. FILED 8-20-2013.

# WE LIVE FOR SATURDAY

THE MARK CONSISTS OF STANDARD CHARACTERS WITHOUT CLAIM TO ANY PARTICULAR FONT, STYLE, SIZE, OR COLOR.

FOR WINES (U.S. CLS. 47 AND 49).

ANDREA K. NADELMAN, EXAMINING ATTORNEY



SN 86-043,550. MCKIBBEN, GARY D., MERIDIAN, TX. FILED 8-21-2013.

# HOBO HOOCH

THE MARK CONSISTS OF STANDARD CHARACTERS WITHOUT CLAIM TO ANY PARTICULAR FONT, STYLE, SIZE, OR COLOR.

NO CLAIM IS MADE TO THE EXCLUSIVE RIGHT TO USE "HOOCH", APART FROM THE MARK AS SHOWN.

FOR APERITIF WINES; GRAPE WINE; PORT WINES; RED WINE; RED WINES; WHITE WINE; WINE; WINES; WINES AND SPARKLING WINES (U.S. CLS. 47 AND 49).

FIRST USE 7-1-2011; IN COMMERCE 7-1-2011.

NAKWAMA ANKRAH, EXAMINING ATTORNEY



SN 86-044,031. PRESTIGE IMPORTS, LLC, MOUNT CLEMENS, MI. FILED 8-21-2013.

# CAMO CONSERVE HUNTING & FISHING BOURBON WHISKEY

THE MARK CONSISTS OF STANDARD CHARACTERS WITHOUT CLAIM TO ANY PARTICULAR FONT, STYLE, SIZE, OR COLOR.

NO CLAIM IS MADE TO THE EXCLUSIVE RIGHT TO USE "BOURBON WHISKEY", APART FROM THE MARK AS SHOWN.

FOR BOURBON; BOURBON WHISKY; WHISKY (U.S. CLS. 47 AND 49).

KATHERINE STOIDES, EXAMINING ATTORNEY

**CLASS 33—(Continued).**

SN 86-044,165. SYMPOSIUM WINE COLLECTION, LLC, PEABODY, MA. FILED 8-21-2013.



NO CLAIM IS MADE TO THE EXCLUSIVE RIGHT TO USE "WINES", APART FROM THE MARK AS SHOWN. THE COLOR(S) PURPLE, WHITE, AND BLACK IS/ARE CLAIMED AS A FEATURE OF THE MARK.

THE MARK CONSISTS OF PURPLE CAPITAL STYLIZED "SRW" WITH THE "W" APPEARING AS A MIX OF PURPLE AND WHITE DOTS SIMILAR TO A GRAPE VINE. "STANDING ROCK WINES" APPEARS IN BLACK CAPITAL LETTERS BELOW THE IMAGE.

FOR WINES (U.S. CLS. 47 AND 49).  
CHRISTINA SOBRAL, EXAMINING ATTORNEY

SN 86-044,427. MADRONA VINEYARDS LP, CAMINO, CA. FILED 8-21-2013.

**RUCKSACK CELLARS**

THE MARK CONSISTS OF STANDARD CHARACTERS WITHOUT CLAIM TO ANY PARTICULAR FONT, STYLE, SIZE, OR COLOR.

NO CLAIM IS MADE TO THE EXCLUSIVE RIGHT TO USE "CELLARS", APART FROM THE MARK AS SHOWN. FOR WINE (U.S. CLS. 47 AND 49).  
JOHN GARTNER, EXAMINING ATTORNEY

SN 86-044,545. DAVID M. GROSS, DALLAS, TX. FILED 8-21-2013.

**Rey Toro**

THE MARK CONSISTS OF STANDARD CHARACTERS WITHOUT CLAIM TO ANY PARTICULAR FONT, STYLE, SIZE, OR COLOR.

THE ENGLISH TRANSLATION OF "REY TORO" IS "KING BULL".

FOR DISTILLED SPIRITS; TEQUILA (U.S. CLS. 47 AND 49).  
GIANCARLO CASTRO, EXAMINING ATTORNEY

**CLASS 33—(Continued).**

SN 86-044,765. DREW FAMILY CELLARS, ELK, CA. FILED 8-22-2013.

**FIELD STATION RANCH**

THE MARK CONSISTS OF STANDARD CHARACTERS WITHOUT CLAIM TO ANY PARTICULAR FONT, STYLE, SIZE, OR COLOR.

NO CLAIM IS MADE TO THE EXCLUSIVE RIGHT TO USE "RANCH", APART FROM THE MARK AS SHOWN. FOR WINES (U.S. CLS. 47 AND 49).  
KIMBERLY FRYE, EXAMINING ATTORNEY

SN 86-046,137. CONSTELLATION BRANDS U.S. OPERATIONS, INC., CANANDAIGUA, NY. FILED 8-23-2013.

**RADACIOUS**

THE MARK CONSISTS OF STANDARD CHARACTERS WITHOUT CLAIM TO ANY PARTICULAR FONT, STYLE, SIZE, OR COLOR.

THE WORDING "RADACIOUS" HAS NO MEANING IN A FOREIGN LANGUAGE.

FOR WINE (U.S. CLS. 47 AND 49).  
FONG HSU, EXAMINING ATTORNEY

SN 86-046,473. PATERNO IMPORTS, LTD., DBA TERLATO WINES INTERNATIONAL, LAKE BLUFF, IL. FILED 8-23-2013.

**TERLATO FAMILY VINEYARDS**

THE MARK CONSISTS OF STANDARD CHARACTERS WITHOUT CLAIM TO ANY PARTICULAR FONT, STYLE, SIZE, OR COLOR.

OWNER OF U.S. REG. NO. 3,374,502. NO CLAIM IS MADE TO THE EXCLUSIVE RIGHT TO USE "FAMILY VINEYARDS", APART FROM THE MARK AS SHOWN.

SEC. 2(F).  
FOR WINE (U.S. CLS. 47 AND 49).  
FIRST USE 3-1-2007; IN COMMERCE 3-1-2007.  
DONALD JOHNSON, EXAMINING ATTORNEY



**CLASS 33—(Continued).**

SN 86-046,576. FLAT ROCK CIDER WORKS, LLC, FLAT ROCK, NC. FILED 8-23-2013.

**Naked Apple Hard Cider**

THE MARK CONSISTS OF STANDARD CHARACTERS WITHOUT CLAIM TO ANY PARTICULAR FONT, STYLE, SIZE, OR COLOR.

NO CLAIM IS MADE TO THE EXCLUSIVE RIGHT TO USE "APPLE HARD CIDER", APART FROM THE MARK AS SHOWN.

FOR HARD CIDER (U.S. CLS. 47 AND 49).  
ANDREA HACK, EXAMINING ATTORNEY

---

SN 86-047,195. GARCIA, RUBEN DANIEL, LOS ANGELES, CA. FILED 8-24-2013.

**El Ranchero**

THE MARK CONSISTS OF STANDARD CHARACTERS WITHOUT CLAIM TO ANY PARTICULAR FONT, STYLE, SIZE, OR COLOR.

THE ENGLISH TRANSLATION OF THE WORD "EL RANCHERO" IN THE MARK IS "THE RANCH".

FOR DISTILLED SPIRITS OF AGAVE (U.S. CLS. 47 AND 49).

MORGAN WYNNE, EXAMINING ATTORNEY

---

SN 86-059,716. BOUCH, DUSTIN J, NEWPORT BEACH, CA. AND GSCHWENDTNER, STEPHANIE N, NEWPORT BEACH, CA. FILED 9-9-2013.

**Champony**

THE MARK CONSISTS OF STANDARD CHARACTERS WITHOUT CLAIM TO ANY PARTICULAR FONT, STYLE, SIZE, OR COLOR.

FOR RED WINES; ROSE WINE; SPARKLING FRUIT WINE; SPARKLING GRAPE WINE; SPARKLING WINES; STILL WINES; STRAWBERRY WINE; SWEET WINES; TABLE WINES; TONIC SWEET GRAPE WINE CONTAINING EXTRACTS FROM GINSENG AND CONCHONA BARK (NINJIN-KINATETSU WINE); WHITE WINE; WINE; WINE COOLERS; WINE PUNCH; WINE PUNCHES; WINE-BASED BEVERAGE, NAMELY, PIQUETTE; WINES; WINES AND FORTIFIED WINES; WINES AND LIQUEURS (U.S. CLS. 47 AND 49).

DAVID HOFFMAN, EXAMINING ATTORNEY

**CLASS 33—(Continued).**

SN 86-061,250. CIRCUIT OF THE AMERICAS LLC, AUSTIN, TX. FILED 9-11-2013.

**COTA FLAME**

THE MARK CONSISTS OF STANDARD CHARACTERS WITHOUT CLAIM TO ANY PARTICULAR FONT, STYLE, SIZE, OR COLOR.

FOR PREPARED ALCOHOLIC COCKTAILS; ALCOHOLIC FRUIT COCKTAIL DRINKS (U.S. CLS. 47 AND 49).

DONALD JOHNSON, EXAMINING ATTORNEY

---

SN 86-062,472. BENDIGO ESTATE PARTNERSHIP (N.Z.) LIMITED, 9342 CROMWELL, NEW ZEALAND, FILED 9-12-2013.

**QUARTZ REEF**

THE MARK CONSISTS OF STANDARD CHARACTERS WITHOUT CLAIM TO ANY PARTICULAR FONT, STYLE, SIZE, OR COLOR.

OWNER OF U.S. REG. NO. 2,990,857.

FOR WINE (U.S. CLS. 47 AND 49).

FIRST USE 0-0-1998; IN COMMERCE 0-0-2001.

BERNICE MIDDLETON, EXAMINING ATTORNEY

---

SN 86-063,900. VINA CONCHA Y TORO S.A., LAS CONDES, SANTIAGO, CHILE, FILED 9-13-2013.

**LATIN LOVER**

THE MARK CONSISTS OF STANDARD CHARACTERS WITHOUT CLAIM TO ANY PARTICULAR FONT, STYLE, SIZE, OR COLOR.

FOR WINE (U.S. CLS. 47 AND 49).

SOPHIA S. KIM, EXAMINING ATTORNEY

**CLASS 33—(Continued).**

SN 86-064,691. BRESSLER VINEYARDS, LLC, ST. HELENA, CA. FILED 9-13-2013.

# BRESSLER

THE MARK CONSISTS OF STANDARD CHARACTERS WITHOUT CLAIM TO ANY PARTICULAR FONT, STYLE, SIZE, OR COLOR.

OWNER OF U.S. REG. NO. 3,300,268.  
SEC. 2(F).  
FOR ALCOHOLIC BEVERAGES EXCEPT BEERS (U.S. CLS. 47 AND 49).  
FIRST USE 1-26-2004; IN COMMERCE 1-26-2004.  
JAY BESCH, EXAMINING ATTORNEY

**CLASS 33—(Continued).**

SN 86-065,147. NOSIO SPA, MEZZOCORONA, ITALY, FILED 9-16-2013.

# DALILA

THE MARK CONSISTS OF STANDARD CHARACTERS WITHOUT CLAIM TO ANY PARTICULAR FONT, STYLE, SIZE, OR COLOR.

FOR WINES; WINES AND SPARKLING WINES (U.S. CLS. 47 AND 49).  
FIRST USE 12-1-2009; IN COMMERCE 12-1-2009.  
HOWARD B. LEVINE, EXAMINING ATTORNEY

SN 86-064,880. SAMANTHA SHEEHAN IMPORTS, NAPA, CA. FILED 9-14-2013.

# HIGGS BOSON

THE MARK CONSISTS OF STANDARD CHARACTERS WITHOUT CLAIM TO ANY PARTICULAR FONT, STYLE, SIZE, OR COLOR.

FOR WINES (U.S. CLS. 47 AND 49).  
KATHERINE M. DUBRAY, EXAMINING ATTORNEY

SN 86-065,295. FIESTA VINEYARD AND WINERY, LLC, LOMETA, TX. FILED 9-16-2013.

# HOME SWEET HOME

THE MARK CONSISTS OF STANDARD CHARACTERS WITHOUT CLAIM TO ANY PARTICULAR FONT, STYLE, SIZE, OR COLOR.

FOR GRAPE WINE; RED WINE; SWEET WINES; WINE (U.S. CLS. 47 AND 49).  
FIRST USE 6-1-2011; IN COMMERCE 6-1-2011.  
DOMINICK J. SALEMI, EXAMINING ATTORNEY

SN 86-064,882. SAMANTHA SHEEHAN IMPORTS, NAPA, CA. FILED 9-14-2013.

# LO & BEHOLD

THE MARK CONSISTS OF STANDARD CHARACTERS WITHOUT CLAIM TO ANY PARTICULAR FONT, STYLE, SIZE, OR COLOR.

FOR WINES (U.S. CLS. 47 AND 49).  
KATHERINE M. DUBRAY, EXAMINING ATTORNEY

SN 86-065,341. VAN DERHAM, KATARINA, NORTH HOLLYWOOD, CA. FILED 9-16-2013.

# GLAMARITA

THE MARK CONSISTS OF STANDARD CHARACTERS WITHOUT CLAIM TO ANY PARTICULAR FONT, STYLE, SIZE, OR COLOR.

FOR ALCOHOLIC BEVERAGES EXCEPT BEERS; ALCOHOLIC COCKTAIL MIXES; PREPARED ALCOHOLIC COCKTAIL (U.S. CLS. 47 AND 49).  
JONATHAN FALK, EXAMINING ATTORNEY

**CLASS 33—(Continued).**

SN 86-065,374. VAN DERHAM, KATARINA, NORTH HOLLYWOOD, CA. FILED 9-16-2013.

**VIVATINI**

THE MARK CONSISTS OF STANDARD CHARACTERS WITHOUT CLAIM TO ANY PARTICULAR FONT, STYLE, SIZE, OR COLOR.

FOR ALCOHOLIC BEVERAGES EXCEPT BEERS; ALCOHOLIC COCKTAIL MIXES; PREPARED ALCOHOLIC COCKTAIL (U.S. CLS. 47 AND 49).  
JONATHAN FALK, EXAMINING ATTORNEY

SN 86-065,386. PINE RIDGE WINERY, LLC, NAPA, CA. FILED 9-16-2013.

**EMPYREAL**

THE MARK CONSISTS OF STANDARD CHARACTERS WITHOUT CLAIM TO ANY PARTICULAR FONT, STYLE, SIZE, OR COLOR.

FOR WINE (U.S. CLS. 47 AND 49).  
KERI CANTONE, EXAMINING ATTORNEY

SN 86-065,579. L2 TECHNOLOGIES LLC, BATTLE GROUND, WA. FILED 9-16-2013.

**Viskey**

THE MARK CONSISTS OF STANDARD CHARACTERS WITHOUT CLAIM TO ANY PARTICULAR FONT, STYLE, SIZE, OR COLOR.

FOR ALCOHOL MIX OF VODKA AND WHISKEY (U.S. CLS. 47 AND 49).  
FIRST USE 8-0-2013; IN COMMERCE 8-28-2013.  
JOHN GARTNER, EXAMINING ATTORNEY

**CLASS 33—(Continued).**

SN 86-065,971. SCHEINFELD WINE COMPANY, LLC, ROSELAND, NJ. FILED 9-16-2013.

**WINE MAKERS. CHANGE MAKERS. TROUBLE MAKERS.**

THE MARK CONSISTS OF STANDARD CHARACTERS WITHOUT CLAIM TO ANY PARTICULAR FONT, STYLE, SIZE, OR COLOR.

FOR WINE (U.S. CLS. 47 AND 49).  
JENNIFER BUTTON, EXAMINING ATTORNEY

SN 86-066,810. MODERN HOUSE WINES LLC, OAKVILLE, CA. FILED 9-17-2013.

**MINE/YOURS/OURS**

THE MARK CONSISTS OF STANDARD CHARACTERS WITHOUT CLAIM TO ANY PARTICULAR FONT, STYLE, SIZE, OR COLOR.

FOR WINE (U.S. CLS. 47 AND 49).  
JENNY PARK, EXAMINING ATTORNEY

SN 86-067,299. HALL, ROBERT C., PLACERVILLE, CA. FILED 9-17-2013.

**SLATE RIDGE**

THE MARK CONSISTS OF STANDARD CHARACTERS WITHOUT CLAIM TO ANY PARTICULAR FONT, STYLE, SIZE, OR COLOR.

FOR WINES (U.S. CLS. 47 AND 49).  
FIRST USE 9-15-2003; IN COMMERCE 6-4-2004.  
SUNG IN, EXAMINING ATTORNEY

SN 86-067,408. BARKETT, MICHAEL LEE, TULSA, OK. FILED 9-17-2013.

**Happy Housewives**

THE MARK CONSISTS OF STANDARD CHARACTERS WITHOUT CLAIM TO ANY PARTICULAR FONT, STYLE, SIZE, OR COLOR.

FOR WINE; WINES; WINES AND LIQUEURS (U.S. CLS. 47 AND 49).  
NICHOLAS COLEMAN, EXAMINING ATTORNEY

**CLASS 33—(Continued).**

SN 86-067,660. ROTNOFSKY, JULIAN A, SAN ANTONIO, TX. FILED 9-18-2013.

## Saints & Generals

THE MARK CONSISTS OF STANDARD CHARACTERS WITHOUT CLAIM TO ANY PARTICULAR FONT, STYLE, SIZE, OR COLOR.

FOR LIQUOR; LIQUOR AND LIQUEUR BEVERAGES, NAMELY, TEQUILA (U.S. CLS. 47 AND 49).  
JOHN KELLY, EXAMINING ATTORNEY

---

SN 86-068,153. JRD IMC, LLC, COLLEGE POINT, NY. FILED 9-18-2013.

## BC CORDIALS

THE MARK CONSISTS OF STANDARD CHARACTERS WITHOUT CLAIM TO ANY PARTICULAR FONT, STYLE, SIZE, OR COLOR.

NO CLAIM IS MADE TO THE EXCLUSIVE RIGHT TO USE "CORDIALS", APART FROM THE MARK AS SHOWN.  
FOR DISTILLED SPIRITS (U.S. CLS. 47 AND 49).  
KATHERINE STOIDES, EXAMINING ATTORNEY

---

SN 86-068,156. SANCHEZ, JAVIER EDUARDO MORALES, HUIXQUILUCAN, MEXICO, FILED 9-18-2013.

## MEZCAMAICA

THE MARK CONSISTS OF STANDARD CHARACTERS WITHOUT CLAIM TO ANY PARTICULAR FONT, STYLE, SIZE, OR COLOR.

OWNER OF MEXICO REG. NO. 1345830, DATED 10-8-2012, EXPIRES 10-8-2022.

FOR ALCOHOLIC BEVERAGES EXCEPT BEER (U.S. CLS. 47 AND 49).

DAVID MURRAY, EXAMINING ATTORNEY

**CLASS 33—(Continued).**

SN 86-068,218. TIEDEMANN WINES, LLC, ELKHART, IN. FILED 9-18-2013.



THE COLOR(S) BLACK, RED, AND WHITE IS/ARE CLAIMED AS A FEATURE OF THE MARK.

THE MARK CONSISTS OF A STEMLESS WINE GLASS PARTIALLY FILLED WITH RED WINE CREATED WITH SIX CURVED LINES, THREE RED, REPRESENTING THE WINE IN THE GLASS, WITH A WHITE CURVED LINE SHOWING INTERSECTION OF WINE AND TWO BLACK—THE OUTLINE OF THE TOP AND RIGHT SIDE OF THE GLASS.

FOR WINE (U.S. CLS. 47 AND 49).

FIRST USE 11-29-2010; IN COMMERCE 11-29-2010.

REGINA DRUMMOND, EXAMINING ATTORNEY

---

SN 86-068,255. JRD IMC, LLC, COLLEGE POINT, NY. FILED 9-18-2013.

## WAR EAGLE

THE MARK CONSISTS OF STANDARD CHARACTERS WITHOUT CLAIM TO ANY PARTICULAR FONT, STYLE, SIZE, OR COLOR.

FOR DISTILLED SPIRITS (U.S. CLS. 47 AND 49).

KATHERINE STOIDES, EXAMINING ATTORNEY

---

SN 86-068,276. JRD IMC, LLC, COLLEGE POINT, NY. FILED 9-18-2013.

## HAWKS DALE

THE MARK CONSISTS OF STANDARD CHARACTERS WITHOUT CLAIM TO ANY PARTICULAR FONT, STYLE, SIZE, OR COLOR.

THE NAME "HAWKS DALE" SHOWN IN THE MARK DOES NOT IDENTIFY A LIVING INDIVIDUAL.

FOR WINE (U.S. CLS. 47 AND 49).

KATHERINE STOIDES, EXAMINING ATTORNEY

**CLASS 33—(Continued).**

SN 86-068,294. TURNBULL WINE CELLARS, OAKVILLE, CA. FILED 9-18-2013.

# TURNBULL

THE MARK CONSISTS OF STANDARD CHARACTERS WITHOUT CLAIM TO ANY PARTICULAR FONT, STYLE, SIZE, OR COLOR.  
FOR WINES (U.S. CLS. 47 AND 49).  
FIRST USE 8-18-1981; IN COMMERCE 1-15-1982.  
WILLIAM ROSSMAN, EXAMINING ATTORNEY

**CLASS 33—(Continued).**

SN 86-069,189. JAMES EWERS, SAINT HELENA, CA. FILED 9-19-2013.

# INDIVISIBLE

THE MARK CONSISTS OF STANDARD CHARACTERS WITHOUT CLAIM TO ANY PARTICULAR FONT, STYLE, SIZE, OR COLOR.  
FOR WINE (U.S. CLS. 47 AND 49).  
DAVID TAYLOR, EXAMINING ATTORNEY

SN 86-068,317. JRD IMC, LLC, COLLEGE POINT, NY. FILED 9-18-2013.

# JACK CROSS

THE MARK CONSISTS OF STANDARD CHARACTERS WITHOUT CLAIM TO ANY PARTICULAR FONT, STYLE, SIZE, OR COLOR.  
THE NAME "JACK CROSS" SHOWN IN THE MARK DOES NOT IDENTIFY A LIVING INDIVIDUAL.  
FOR DISTILLED SPIRITS (U.S. CLS. 47 AND 49).  
FIRST USE 8-1-2013; IN COMMERCE 8-1-2013.  
KATHERINE STOIDES, EXAMINING ATTORNEY

SN 86-069,212. MASTER BRANDS HOLDINGS INC., RIDGE-FIELD, CT. FILED 9-19-2013.

# Cosmodello

THE MARK CONSISTS OF STANDARD CHARACTERS WITHOUT CLAIM TO ANY PARTICULAR FONT, STYLE, SIZE, OR COLOR.  
THE WORDING "COSMODELLO" HAS NO MEANING IN A FOREIGN LANGUAGE.  
FOR WINE; WINES (U.S. CLS. 47 AND 49).  
MARCIE MILONE, EXAMINING ATTORNEY

SN 86-068,636. FLANEUR WINES LLC, PORTLAND, OR. FILED 9-18-2013.

# FLÂNEUR

THE MARK CONSISTS OF STANDARD CHARACTERS WITHOUT CLAIM TO ANY PARTICULAR FONT, STYLE, SIZE, OR COLOR.  
THE ENGLISH TRANSLATION OF "FLANEUR" IN THE MARK IS "STROLLER".  
FOR WINE (U.S. CLS. 47 AND 49).  
NAKIA HENRY, EXAMINING ATTORNEY

SN 86-069,242. RAYMOND, YVES, 33480 LISTRAC MEDOC, FRANCE, FILED 9-19-2013.

# CHATEAU SARANSOT DUPRE

THE MARK CONSISTS OF STANDARD CHARACTERS WITHOUT CLAIM TO ANY PARTICULAR FONT, STYLE, SIZE, OR COLOR.  
NO CLAIM IS MADE TO THE EXCLUSIVE RIGHT TO USE "CHATEAU", APART FROM THE MARK AS SHOWN.  
FOR WINES (U.S. CLS. 47 AND 49).  
FIRST USE 5-25-1998; IN COMMERCE 6-26-1998.  
LINDSEY BEN, EXAMINING ATTORNEY

**CLASS 33—(Continued).**

SN 86-069,869. PAUL HOBBS WINERY L.P., HEALDSBURG, CA. FILED 9-19-2013.

**NATHAN COOMBS ESTATE**

THE MARK CONSISTS OF STANDARD CHARACTERS WITHOUT CLAIM TO ANY PARTICULAR FONT, STYLE, SIZE, OR COLOR.

NO CLAIM IS MADE TO THE EXCLUSIVE RIGHT TO USE "ESTATE", APART FROM THE MARK AS SHOWN.

THE NAME(S), PORTRAIT(S), AND/OR SIGNATURE(S) SHOWN IN THE MARK DOES NOT IDENTIFY A PARTICULAR LIVING INDIVIDUAL.

FOR ALCOHOLIC BEVERAGES EXCEPT BEERS; WINES (U.S. CLS. 47 AND 49).

KATHERINE STOIDES, EXAMINING ATTORNEY

---

SN 86-070,121. ST. JULIAN WINE COMPANY, INC., PAW PAW, MI. FILED 9-20-2013.

**HEAD GAMES**

THE MARK CONSISTS OF STANDARD CHARACTERS WITHOUT CLAIM TO ANY PARTICULAR FONT, STYLE, SIZE, OR COLOR.

FOR WINE (U.S. CLS. 47 AND 49).

FIRST USE 9-13-2013; IN COMMERCE 9-13-2013.

KAREN SEVERSON, EXAMINING ATTORNEY

---

SN 86-070,184. E. & J. GALLO WINERY, MODESTO, CA. FILED 9-20-2013.

**ZARAPE**

THE MARK CONSISTS OF STANDARD CHARACTERS WITHOUT CLAIM TO ANY PARTICULAR FONT, STYLE, SIZE, OR COLOR.

THE ENGLISH TRANSLATION OF "ZARAPE" IN THE MARK IS "SHAWL".

FOR ALCOHOLIC BEVERAGES EXCEPT BEERS (U.S. CLS. 47 AND 49).

ROBIN CHOSID, EXAMINING ATTORNEY

**CLASS 33—(Continued).**

SN 86-070,195. E. & J. GALLO WINERY, MODESTO, CA. FILED 9-20-2013.

**SARAPE**

THE MARK CONSISTS OF STANDARD CHARACTERS WITHOUT CLAIM TO ANY PARTICULAR FONT, STYLE, SIZE, OR COLOR.

THE ENGLISH TRANSLATION OF "SARAPE" IN THE MARK IS "SHAWL".

FOR ALCOHOLIC BEVERAGES EXCEPT BEERS (U.S. CLS. 47 AND 49).

ROBIN CHOSID, EXAMINING ATTORNEY

---

SN 86-070,216. E. & J. GALLO WINERY, MODESTO, CA. FILED 9-20-2013.

**APOTHIC SMOKE**

THE MARK CONSISTS OF STANDARD CHARACTERS WITHOUT CLAIM TO ANY PARTICULAR FONT, STYLE, SIZE, OR COLOR.

OWNER OF U.S. REG. NOS. 3,713,187 AND 4,093,343.

FOR ALCOHOLIC BEVERAGES EXCEPT BEERS (U.S. CLS. 47 AND 49).

ROBIN CHOSID, EXAMINING ATTORNEY

---

SN 86-070,729. MENDOZA PARTNERS, LLC, CHICAGO, IL. FILED 9-20-2013.

**SLANTWALK**

THE MARK CONSISTS OF STANDARD CHARACTERS WITHOUT CLAIM TO ANY PARTICULAR FONT, STYLE, SIZE, OR COLOR.

FOR WINES (U.S. CLS. 47 AND 49).

FIRST USE 7-1-2010; IN COMMERCE 7-1-2010.

DAVID MURRAY, EXAMINING ATTORNEY

**CLASS 33—(Continued).**

SN 86-070,927. RIVIERA IMPORTS, LLC, BROOKLYN, NY.  
FILED 9-20-2013.

**ECAANA**

THE MARK CONSISTS OF STANDARD CHARACTERS  
WITHOUT CLAIM TO ANY PARTICULAR FONT, STYLE,  
SIZE, OR COLOR.  
FOR WINE (U.S. CLS. 47 AND 49).  
MARC LEIPZIG, EXAMINING ATTORNEY

SN 86-070,956. PHEASANTBROOK, L.L.C., EAGLE POINT,  
OR. FILED 9-20-2013.

**DIRT ROAD**

THE MARK CONSISTS OF STANDARD CHARACTERS  
WITHOUT CLAIM TO ANY PARTICULAR FONT, STYLE,  
SIZE, OR COLOR.  
FOR DISTILLED SPIRITS (U.S. CLS. 47 AND 49).  
ALEXANDER L. POWERS, EXAMINING ATTORNEY

SN 86-070,967. PHEASANTBROOK, L.L.C., EAGLE POINT,  
OR. FILED 9-20-2013.

**PHEASANTBROOK**

THE MARK CONSISTS OF STANDARD CHARACTERS  
WITHOUT CLAIM TO ANY PARTICULAR FONT, STYLE,  
SIZE, OR COLOR.  
FOR DISTILLED SPIRITS (U.S. CLS. 47 AND 49).  
ALEXANDER L. POWERS, EXAMINING ATTORNEY

SN 86-071,058. SASSY NORTH AMERICA, LLC, WARNER  
ROBINS, GA. FILED 9-20-2013.

**It's Not Just A Wine, It's  
An Attitude!**

THE MARK CONSISTS OF STANDARD CHARACTERS  
WITHOUT CLAIM TO ANY PARTICULAR FONT, STYLE,  
SIZE, OR COLOR.  
FOR WINE (U.S. CLS. 47 AND 49).  
FIRST USE 8-1-2013; IN COMMERCE 9-1-2013.  
KATINA MISTER, EXAMINING ATTORNEY

**CLASS 33—(Continued).**

SN 86-071,155. WESTFORD FOOD & BEV LLC, REDDING,  
CT. FILED 9-21-2013.

**Mythic Mountain**

THE MARK CONSISTS OF STANDARD CHARACTERS  
WITHOUT CLAIM TO ANY PARTICULAR FONT, STYLE,  
SIZE, OR COLOR.  
FOR WINES AND SPARKLING WINES (U.S. CLS. 47  
AND 49).  
JENNIFER MARTIN, EXAMINING ATTORNEY

SN 86-071,185. DAVIS, SONYA B., SAN DIEGO, CA. FILED 9-  
21-2013.

**Good times with a  
conscience**

THE MARK CONSISTS OF STANDARD CHARACTERS  
WITHOUT CLAIM TO ANY PARTICULAR FONT, STYLE,  
SIZE, OR COLOR.  
FOR WINES AND FORTIFIED WINES; WINES AND  
SPARKLING WINES (U.S. CLS. 47 AND 49).  
IRA J. GOODSaid, EXAMINING ATTORNEY

SN 86-071,207. CARRICO, FRANCIS H., FARMINGTON  
HILLS, MI. AND DONNA J. CARRICO, FARMINGTON  
HILLS, MI. FILED 9-21-2013.

**MANITOU RIDGE**

THE MARK CONSISTS OF STANDARD CHARACTERS  
WITHOUT CLAIM TO ANY PARTICULAR FONT, STYLE,  
SIZE, OR COLOR.  
FOR WINES AND LIQUEURS (U.S. CLS. 47 AND 49).  
FIRST USE 10-1-2009; IN COMMERCE 10-1-2009.  
BRIN ANDERSON, EXAMINING ATTORNEY

**CLASS 33—(Continued).**

SN 86-071,642. TYPO LIKKER, LAKE SAINT LOUIS, MO.  
FILED 9-23-2013.

**Take(s) your pants off**

THE MARK CONSISTS OF STANDARD CHARACTERS  
WITHOUT CLAIM TO ANY PARTICULAR FONT, STYLE,  
SIZE, OR COLOR.

FOR LIQUOR; WHISKY (U.S. CLS. 47 AND 49).  
VIVIAN MICZNIK FIRST, EXAMINING ATTORNEY

SN 86-071,652. TYPO LIKKER, LAKE SAINT LOUIS, MO.  
FILED 9-23-2013.

**TYPO Shine**

THE MARK CONSISTS OF STANDARD CHARACTERS  
WITHOUT CLAIM TO ANY PARTICULAR FONT, STYLE,  
SIZE, OR COLOR.

FOR LIQUOR; WHISKY (U.S. CLS. 47 AND 49).  
VIVIAN MICZNIK FIRST, EXAMINING ATTORNEY

SN 86-071,654. TYPO LIKKER, LAKE SAINT LOUIS, MO.  
FILED 9-23-2013.

**TYPO Moonshine**

THE MARK CONSISTS OF STANDARD CHARACTERS  
WITHOUT CLAIM TO ANY PARTICULAR FONT, STYLE,  
SIZE, OR COLOR.

FOR LIQUOR; WHISKY (U.S. CLS. 47 AND 49).  
VIVIAN MICZNIK FIRST, EXAMINING ATTORNEY

SN 86-071,694. MINASSIAN-YOUNG VINEYARDS, INC.,  
PASO ROBLES, CA. FILED 9-23-2013.

**BEYOND THE PALE**

THE MARK CONSISTS OF STANDARD CHARACTERS  
WITHOUT CLAIM TO ANY PARTICULAR FONT, STYLE,  
SIZE, OR COLOR.

FOR WINE (U.S. CLS. 47 AND 49).  
FIRST USE 8-30-2008; IN COMMERCE 8-30-2008.  
KATHY DE JONGE, EXAMINING ATTORNEY

**CLASS 33—(Continued).**

SN 86-071,724. JRD IMC, LLC, COLLEGE POINT, NY. FILED  
9-23-2013.

**DON QUESTO**

THE MARK CONSISTS OF STANDARD CHARACTERS  
WITHOUT CLAIM TO ANY PARTICULAR FONT, STYLE,  
SIZE, OR COLOR.

"DON QUESTO" DOES NOT IDENTIFY A LIVING  
INDIVIDUAL.

THE ENGLISH TRANSLATION OF THE WORD "QUES-  
TO" IN THE MARK IS "THIS".

FOR TEQUILA (U.S. CLS. 47 AND 49).  
FIRST USE 9-20-2013; IN COMMERCE 9-20-2013.  
KATHERINE STOIDES, EXAMINING ATTORNEY

SN 86-072,204. TERRAVANT WINE COMPANY, LLC,  
BUELLTON, CA. FILED 9-23-2013.

**HORSESHOE FLATS**

THE MARK CONSISTS OF STANDARD CHARACTERS  
WITHOUT CLAIM TO ANY PARTICULAR FONT, STYLE,  
SIZE, OR COLOR.

FOR WINE; WINES (U.S. CLS. 47 AND 49).  
ANDREW LEASER, EXAMINING ATTORNEY

SN 86-073,249. JACK DANIEL'S PROPERTIES, INC., SAN  
RAFAEL, CA. FILED 9-24-2013.

**HONEY HYSTERIA**

THE MARK CONSISTS OF STANDARD CHARACTERS  
WITHOUT CLAIM TO ANY PARTICULAR FONT, STYLE,  
SIZE, OR COLOR.

NO CLAIM IS MADE TO THE EXCLUSIVE RIGHT TO  
USE "HONEY", APART FROM THE MARK AS SHOWN.

FOR DISTILLED SPIRITS (U.S. CLS. 47 AND 49).  
LINDA POWELL, EXAMINING ATTORNEY



**CLASS 33—(Continued).**

SN 86-073,540. ANTIPOD LTD, HEVRON, ISRAEL, FILED 9-24-2013.

JERUSALEM HEIGHTS WINERY

THE MARK CONSISTS OF STANDARD CHARACTERS WITHOUT CLAIM TO ANY PARTICULAR FONT, STYLE, SIZE, OR COLOR.

OWNER OF U.S. REG. NO. 4,383,994.  
NO CLAIM IS MADE TO THE EXCLUSIVE RIGHT TO USE "WINERY", APART FROM THE MARK AS SHOWN. SEC. 2(F) AS TO "JERUSALEM".  
FOR WINES (U.S. CLS. 47 AND 49).  
JASON BLAIR, EXAMINING ATTORNEY

SN 86-074,475. AXIAL GLOBALIZACION DE VINOS S.L., ZARAGOZA, SPAIN, FILED 9-25-2013.

GRJ360

THE MARK CONSISTS OF STANDARD CHARACTERS WITHOUT CLAIM TO ANY PARTICULAR FONT, STYLE, SIZE, OR COLOR.

FOR ALCOHOLIC BEVERAGES, EXCEPT BEERS; WINES (U.S. CLS. 47 AND 49).  
FIRST USE 8-31-2013; IN COMMERCE 8-31-2013.  
SCOTT BIBB, EXAMINING ATTORNEY

SN 86-077,334. E. & J. GALLO WINERY, MODESTO, CA. FILED 9-27-2013.

RIVET

THE MARK CONSISTS OF STANDARD CHARACTERS WITHOUT CLAIM TO ANY PARTICULAR FONT, STYLE, SIZE, OR COLOR.

FOR ALCOHOLIC BEVERAGES EXCEPT BEERS (U.S. CLS. 47 AND 49).  
ROBIN CHOSID, EXAMINING ATTORNEY

**CLASS 33—(Continued).**

SN 86-077,360. E. & J. GALLO WINERY, MODESTO, CA. FILED 9-27-2013.

RIVETS

THE MARK CONSISTS OF STANDARD CHARACTERS WITHOUT CLAIM TO ANY PARTICULAR FONT, STYLE, SIZE, OR COLOR.

FOR ALCOHOLIC BEVERAGES EXCEPT BEERS (U.S. CLS. 47 AND 49).  
ROBIN CHOSID, EXAMINING ATTORNEY

SN 86-077,384. E. & J. GALLO WINERY, MODESTO, CA. FILED 9-27-2013.

RIVETER

THE MARK CONSISTS OF STANDARD CHARACTERS WITHOUT CLAIM TO ANY PARTICULAR FONT, STYLE, SIZE, OR COLOR.

FOR ALCOHOLIC BEVERAGES EXCEPT BEERS (U.S. CLS. 47 AND 49).  
ROBIN CHOSID, EXAMINING ATTORNEY

SN 86-077,395. E. & J. GALLO WINERY, MODESTO, CA. FILED 9-27-2013.

RIVETER'S

THE MARK CONSISTS OF STANDARD CHARACTERS WITHOUT CLAIM TO ANY PARTICULAR FONT, STYLE, SIZE, OR COLOR.

FOR ALCOHOLIC BEVERAGES EXCEPT BEERS (U.S. CLS. 47 AND 49).  
ROBIN CHOSID, EXAMINING ATTORNEY

SN 86-087,411. E. & J. GALLO WINERY, MODESTO, CA. FILED 10-9-2013.

APOTHIC SPICE

THE MARK CONSISTS OF STANDARD CHARACTERS WITHOUT CLAIM TO ANY PARTICULAR FONT, STYLE, SIZE, OR COLOR.

OWNER OF U.S. REG. NOS. 3,713,187 AND 4,093,343.  
NO CLAIM IS MADE TO THE EXCLUSIVE RIGHT TO USE "SPICE", APART FROM THE MARK AS SHOWN.  
FOR ALCOHOLIC BEVERAGES EXCEPT BEERS (U.S. CLS. 47 AND 49).  
ROBIN CHOSID, EXAMINING ATTORNEY

**CLASS 33—(Continued).**

SN 86-087,425. E. & J. GALLO WINERY, MODESTO, CA.  
FILED 10-9-2013.

**APOTHIC FROST**

THE MARK CONSISTS OF STANDARD CHARACTERS WITHOUT CLAIM TO ANY PARTICULAR FONT, STYLE, SIZE, OR COLOR.

OWNER OF U.S. REG. NOS. 3,713,187 AND 4,093,343.  
FOR ALCOHOLIC BEVERAGES EXCEPT BEERS (U.S. CLS. 47 AND 49).  
ROBIN CHOSID, EXAMINING ATTORNEY

**CLASS 33—(Continued).**

SN 86-091,304. DE AMOR TEQUILA LLC, CEDAR PARK, TX.  
FILED 10-15-2013.



THE MARK CONSISTS OF LITERAL ELEMENTS "AMORADA" WRITTEN IN STYLIZED FORM WHEREIN A HEART LIKE IMAGE APPEARS AROUND THE LETTERS "ORA"

THE WORDING "AMORADA" HAS NO MEANING IN A FOREIGN LANGUAGE.  
FOR TEQUILA (U.S. CLS. 47 AND 49).  
JEFFREY LOOK, EXAMINING ATTORNEY

SN 86-087,622. DON SEBASTIANI & SONS INTERNATIONAL WINE NEGOCIANTS, SONOMA, CA. FILED 10-9-2013.

**FETTER'S SPRINGS**

THE MARK CONSISTS OF STANDARD CHARACTERS WITHOUT CLAIM TO ANY PARTICULAR FONT, STYLE, SIZE, OR COLOR.

FOR WINE (U.S. CLS. 47 AND 49).  
THEODORE MCBRIDE, EXAMINING ATTORNEY

SN 86-091,499. KW INTELLECTUAL PROPERTIES, INC., POLK CITY, FL. FILED 10-15-2013.

**NAKED IN JAMAICA**

THE MARK CONSISTS OF STANDARD CHARACTERS WITHOUT CLAIM TO ANY PARTICULAR FONT, STYLE, SIZE, OR COLOR.

OWNER OF U.S. REG. NOS. 3,420,773 AND 3,421,024.  
FOR RUM (U.S. CLS. 47 AND 49).  
SUI DUONG, EXAMINING ATTORNEY

SN 86-089,964. NEFARIOUS BRANDS, INC., VENTURA, CA.  
FILED 10-11-2013.

**VAZO**

THE MARK CONSISTS OF STANDARD CHARACTERS WITHOUT CLAIM TO ANY PARTICULAR FONT, STYLE, SIZE, OR COLOR.

FOR LIQUOR; TEQUILA (U.S. CLS. 47 AND 49).  
DAWN FELDMAN, EXAMINING ATTORNEY

SN 86-094,611. CROWN VALLEY WINERY, INC., DBA CROWN VALLEY DISTILLING CO., STE. GENEVIEVE, MO. FILED 10-17-2013.

**FRONT PORCH SIPPIN' AT ITS  
FINEST**

THE MARK CONSISTS OF STANDARD CHARACTERS WITHOUT CLAIM TO ANY PARTICULAR FONT, STYLE, SIZE, OR COLOR.

FOR ALCOHOLIC BEVERAGES EXCEPT BEERS; DISTILLED SPIRITS; WHISKEY (U.S. CLS. 47 AND 49).  
NORA BUCHANAN WILL, EXAMINING ATTORNEY

**CLASS 33—(Continued).**

SN 86-096,379. WESTFORD FOOD & BEV LLC, REDDING, CT. FILED 10-21-2013.

# REDACTED

THE MARK CONSISTS OF STANDARD CHARACTERS WITHOUT CLAIM TO ANY PARTICULAR FONT, STYLE, SIZE, OR COLOR.

FOR WINES AND SPARKLING WINES (U.S. CLS. 47 AND 49).

JENNIFER MARTIN, EXAMINING ATTORNEY

SN 86-097,223. TERRAVANT WINE COMPANY, LLC, BUELLTON, CA. FILED 10-21-2013.

# COUNTERPART

THE MARK CONSISTS OF STANDARD CHARACTERS WITHOUT CLAIM TO ANY PARTICULAR FONT, STYLE, SIZE, OR COLOR.

FOR WINE; WINES (U.S. CLS. 47 AND 49).

ANDREW LEASER, EXAMINING ATTORNEY

SN 86-098,047. BYE JOE CORPORATION, HOUSTON, TX. FILED 10-22-2013.



NO CLAIM IS MADE TO THE EXCLUSIVE RIGHT TO USE THE NON-LATIN CHARACTERS THAT TRANSLITERATE TO "BAI JIU" AND MEANS WHITE LIQUOR IN ENGLISH, APART FROM THE MARK AS SHOWN.

THE MARK CONSISTS OF A COMIC STYLE SPEECH BUBBLE SURROUNDING TWO CHINESE CHARACTERS.

THE NON-LATIN CHARACTERS IN THE MARK TRANSLITERATE TO "BAI JIU" AND THIS MEANS "WHITE LIQUOR" IN ENGLISH.

FOR CHINESE WHITE LIQUOR (BAIGANR) (U.S. CLS. 47 AND 49).

FIRST USE 3-7-2013; IN COMMERCE 3-7-2013.

SKYE YOUNG, EXAMINING ATTORNEY

**CLASS 33—(Continued).**

SN 86-098,383. JAGUAR HOMBRE, LLC, NAPLES, FL. FILED 10-22-2013.

# JAGUAR HOMBRE

THE MARK CONSISTS OF STANDARD CHARACTERS WITHOUT CLAIM TO ANY PARTICULAR FONT, STYLE, SIZE, OR COLOR.

THE ENGLISH TRANSLATION OF THE WORD "HOMBRE" IN THE MARK IS "MAN".

FOR WINES (U.S. CLS. 47 AND 49).

FIRST USE 9-22-2013; IN COMMERCE 9-22-2013.

DAWN HAN, EXAMINING ATTORNEY

SN 86-104,126. QUATERNA, LLC, DBA LA QUATERNA, NAPA, CA. FILED 10-29-2013.

# Stone Rose

THE MARK CONSISTS OF STANDARD CHARACTERS WITHOUT CLAIM TO ANY PARTICULAR FONT, STYLE, SIZE, OR COLOR.

NO CLAIM IS MADE TO THE EXCLUSIVE RIGHT TO USE "ROSE", APART FROM THE MARK AS SHOWN.

FOR WINES (U.S. CLS. 47 AND 49).

DOUGLAS LEE, EXAMINING ATTORNEY

SN 86-108,088. OLIVER WINE CO., INC., BLOOMINGTON, IN. FILED 11-1-2013.

# EVERYONE LOVES OLIVER

THE MARK CONSISTS OF STANDARD CHARACTERS WITHOUT CLAIM TO ANY PARTICULAR FONT, STYLE, SIZE, OR COLOR.

OWNER OF U.S. REG. NO. 3,438,887.

FOR WINES (U.S. CLS. 47 AND 49).

FIRST USE 2-4-2013; IN COMMERCE 3-28-2013.

ANDREA K. NADELMAN, EXAMINING ATTORNEY

**CLASS 33—(Continued).**

SN 86-109,407. OLIVER WINE CO., INC., BLOOMINGTON, IN. FILED 11-4-2013.

**BUBBLECRAFT**

THE MARK CONSISTS OF STANDARD CHARACTERS WITHOUT CLAIM TO ANY PARTICULAR FONT, STYLE, SIZE, OR COLOR.

FOR FRIZZANTE STYLE WINES AND CARBONATED ALCOHOLIC BEVERAGES, EXCEPT BEER (U.S. CLS. 47 AND 49).

ANDREA K. NADELMAN, EXAMINING ATTORNEY

SN 86-110,333. E. & J. GALLO WINERY, MODESTO, CA. FILED 11-5-2013.

**APOTHIC FIRE**

THE MARK CONSISTS OF STANDARD CHARACTERS WITHOUT CLAIM TO ANY PARTICULAR FONT, STYLE, SIZE, OR COLOR.

OWNER OF U.S. REG. NOS. 3,713,187, 4,093,343 AND 4,301,466.

FOR WINES (U.S. CLS. 47 AND 49).

ROBIN CHOSID, EXAMINING ATTORNEY

SN 86-112,953. RS/MR SELECTIONS, LLC, NEW YORK, NY. FILED 11-7-2013.

**CARINO ROSSO**

THE MARK CONSISTS OF STANDARD CHARACTERS WITHOUT CLAIM TO ANY PARTICULAR FONT, STYLE, SIZE, OR COLOR.

NO CLAIM IS MADE TO THE EXCLUSIVE RIGHT TO USE "ROSSO", APART FROM THE MARK AS SHOWN.

THE ENGLISH TRANSLATION OF "CARINO ROSSO" IS "CUTE RED".

FOR WINE (U.S. CLS. 47 AND 49).

BRIAN PINO, EXAMINING ATTORNEY

**CLASS 33—(Continued).**

SN 86-115,368. DON SEBASTIANI & SONS INTERNATIONAL WINE NEGOCIANTS, SONOMA, CA. FILED 11-11-2013.

**QUEENS PEAK**

THE MARK CONSISTS OF STANDARD CHARACTERS WITHOUT CLAIM TO ANY PARTICULAR FONT, STYLE, SIZE, OR COLOR.

FOR WINE (U.S. CLS. 47 AND 49).

THEODORE MCBRIDE, EXAMINING ATTORNEY

SN 86-123,197. TERRAVANT WINE COMPANY, LLC, BUELLTON, CA. FILED 11-19-2013.

**SVAGO BUONO**

THE MARK CONSISTS OF STANDARD CHARACTERS WITHOUT CLAIM TO ANY PARTICULAR FONT, STYLE, SIZE, OR COLOR.

THE ENGLISH TRANSLATION OF "SVAGO BUONO" IN THE MARK IS "GOOD FUN".

FOR WINE: WINES (U.S. CLS. 47 AND 49).

ANDREW LEASER, EXAMINING ATTORNEY

SN 86-124,635. DON SEBASTIANI & SONS INTERNATIONAL WINE NEGOCIANTS, SONOMA, CA. FILED 11-20-2013.

**ORVILLE'S FINEST SHINE**

THE MARK CONSISTS OF STANDARD CHARACTERS WITHOUT CLAIM TO ANY PARTICULAR FONT, STYLE, SIZE, OR COLOR.

NO CLAIM IS MADE TO THE EXCLUSIVE RIGHT TO USE "FINEST SHINE", APART FROM THE MARK AS SHOWN.

FOR ALCOHOLIC BEVERAGES EXCEPT BEERS (U.S. CLS. 47 AND 49).

THEODORE MCBRIDE, EXAMINING ATTORNEY

**CLASS 34—SMOKERS' ARTICLES**

SN 85-052,854. FANTASIA DISTRIBUTION, INC., ANAHEIM, CA. FILED 6-2-2010.

# RAINBOW

THE MARK CONSISTS OF STANDARD CHARACTERS WITHOUT CLAIM TO ANY PARTICULAR FONT, STYLE, SIZE, OR COLOR.  
FOR HOOKAH TOBACCO; MOLASSES TOBACCO (U.S. CLS. 2, 8, 9 AND 17).  
FIRST USE 11-24-2009; IN COMMERCE 11-24-2009.  
FRED CARL, EXAMINING ATTORNEY

---

SN 85-872,605. SCANDINAVIAN TOBACCO LANE LIMITED, TUCKER, GA. FILED 3-11-2013.

# HS-3

THE MARK CONSISTS OF STANDARD CHARACTERS WITHOUT CLAIM TO ANY PARTICULAR FONT, STYLE, SIZE, OR COLOR.  
FOR TOBACCO (U.S. CLS. 2, 8, 9 AND 17).  
FIRST USE 1-1-1985; IN COMMERCE 1-1-1985.  
SANJEEV VOHRA, EXAMINING ATTORNEY

---

SN 85-872,658. SCANDINAVIAN TOBACCO LANE LIMITED, TUCKER, GA. FILED 3-11-2013.

# LL7

THE MARK CONSISTS OF STANDARD CHARACTERS WITHOUT CLAIM TO ANY PARTICULAR FONT, STYLE, SIZE, OR COLOR.  
FOR TOBACCO (U.S. CLS. 2, 8, 9 AND 17).  
FIRST USE 1-1-1985; IN COMMERCE 1-1-1985.  
SANJEEV VOHRA, EXAMINING ATTORNEY

**CLASS 34—(Continued).**

SN 85-903,278. PLOOM, INC., SAN FRANCISCO, CA. FILED 4-12-2013.

# POTRERO

THE MARK CONSISTS OF STANDARD CHARACTERS WITHOUT CLAIM TO ANY PARTICULAR FONT, STYLE, SIZE, OR COLOR.  
THE ENGLISH TRANSLATION OF THE WORD "POTRERO" IN THE MARK IS "PASTURE".  
FOR PROCESSED TOBACCO PODS (U.S. CLS. 2, 8, 9 AND 17).  
FIRST USE 8-7-2013; IN COMMERCE 8-7-2013.  
CAROL SPILS, EXAMINING ATTORNEY

---

SN 85-921,135. CIGARS INTERNATIONAL, INC., BETHLEHEM, PA. FILED 5-2-2013.

# CASEY JONES

THE MARK CONSISTS OF STANDARD CHARACTERS WITHOUT CLAIM TO ANY PARTICULAR FONT, STYLE, SIZE, OR COLOR.  
THE NAME "CASEY JONES" DOES NOT IDENTIFY A LIVING INDIVIDUAL.  
FOR PIPE TOBACCO (U.S. CLS. 2, 8, 9 AND 17).  
JOHN KELLY, EXAMINING ATTORNEY

---

SN 85-951,478. REYNOLDS INNOVATIONS INC., WINSTON-SALEM, NC. FILED 6-5-2013.

# CAMEL VINTAGE

THE MARK CONSISTS OF STANDARD CHARACTERS WITHOUT CLAIM TO ANY PARTICULAR FONT, STYLE, SIZE, OR COLOR.  
OWNER OF U.S. REG. NOS. 126,760, 1,693,466 AND OTHERS.  
NO CLAIM IS MADE TO THE EXCLUSIVE RIGHT TO USE "VINTAGE", APART FROM THE MARK AS SHOWN.  
FOR CIGARETTES (U.S. CLS. 2, 8, 9 AND 17).  
WILLIAM P. SHANAHAN, EXAMINING ATTORNEY

**CLASS 34—(Continued).**

SN 85-966,123. JAPAN TOBACCO INC., MINATO-KU TOKYO, JAPAN, FILED 6-21-2013.



OWNER OF JAPAN REG. NO. 5582210, DATED 5-17-2013, EXPIRES 5-17-2023.

OWNER OF U.S. REG. NO. 4,120,171.

THE MARK CONSISTS OF THE WORD "MEVIUS" WITH A DESIGN ABOVE THE "M" CONSISTING OF TWO CURVED LINES FACING EACH OTHER SURROUNDING AN OVAL SHAPE, SEVERAL SMALL CIRCLES CURVE AROUND THE RIGHT SIDE OF THE WORD AND UNDERNEATH.

FOR TOBACCO; SMOKING TOBACCO; PIPE TOBACCO; CIGARETTES, CIGARS, SNUFF; CIGARETTE PAPERS, CIGARETTE PAPER TUBES; CIGARETTE LIGHTERS NOT MADE OF PRECIOUS METAL; MATCHES (U.S. CLS. 2, 8, 9 AND 17).

KYLE PEETE, EXAMINING ATTORNEY

**CLASS 34—(Continued).**

SN 86-009,179. SWISHER INTERNATIONAL, INC., JACKSONVILLE, FL. FILED 7-12-2013.

**STICKY SWEETS**

THE MARK CONSISTS OF STANDARD CHARACTERS WITHOUT CLAIM TO ANY PARTICULAR FONT, STYLE, SIZE, OR COLOR.

NO CLAIM IS MADE TO THE EXCLUSIVE RIGHT TO USE "SWEETS", APART FROM THE MARK AS SHOWN.

FOR CIGARS (U.S. CLS. 2, 8, 9 AND 17).

MAYUR VAGHANI, EXAMINING ATTORNEY

SN 86-015,438. GENERAL CIGAR CO., INC., GLEN ALLEN, VA. FILED 7-19-2013.

**HOMAGE**

THE MARK CONSISTS OF STANDARD CHARACTERS WITHOUT CLAIM TO ANY PARTICULAR FONT, STYLE, SIZE, OR COLOR.

FOR CIGARS; CIGAR ACCESSORIES, NAMELY, CIGAR BOXES, CIGAR CUTTERS, CIGAR CASES NOT OF PRECIOUS METAL, HUMIDORS, LIGHTERS, AND ASHTRAYS (U.S. CLS. 2, 8, 9 AND 17).

MARY CRAWFORD, EXAMINING ATTORNEY

SN 85-971,345. SENSADO CIGAR COMPANY, LLC, NASHVILLE, TN. FILED 6-27-2013.

**SENSADO**

THE MARK CONSISTS OF STANDARD CHARACTERS WITHOUT CLAIM TO ANY PARTICULAR FONT, STYLE, SIZE, OR COLOR.

THE WORDING "SENSADO" HAS NO MEANING IN A FOREIGN LANGUAGE.

FOR CIGARS (U.S. CLS. 2, 8, 9 AND 17).

JOHN DALIER, EXAMINING ATTORNEY

SN 86-016,119. MITRAANZ, LLC, JERSEY CITY, NJ. FILED 7-22-2013.



THE COLOR(S) BLACK, ORANGE AND YELLOW IS/ARE CLAIMED AS A FEATURE OF THE MARK.

THE MARK CONSISTS OF "NAAZ" WRITTEN IN A TOP TO BOTTOM YELLOW TO ORANGE GRADIENT WITH BLACK OUTLINE, THE HORIZONTAL LINE IN THE "A"'S MISSING, HAVING A LEFT TO RIGHT ORANGE AND YELLOW GRADIENT THERE BELOW.

FOR ELECTRONIC CIGARETTES; ELECTRONIC HOOKAHS (U.S. CLS. 2, 8, 9 AND 17).

SUSAN STIGLITZ, EXAMINING ATTORNEY

**CLASS 34—(Continued).**

SN 86-019,615. GROSSMAN, EVAN TODD, JUPITER, FL.  
FILED 7-25-2013.



THE MARK CONSISTS OF THE WORD "PIXOTINE" WITH A TOOTHPICK AS PART OF THE LETTER "X".  
FOR TOOTHPICKS INCLUDING NICOTINE FOR USE AS A CIGARETTE SUBSTITUTE (U.S. CLS. 2, 8, 9 AND 17).

REBECCA SMITH, EXAMINING ATTORNEY

SN 86-028,484. UPC DISTRIBUTION, INC., TOLUCA LAKE, CA. FILED 8-5-2013.



THE MARK CONSISTS OF VERTICAL LINES LIKE THAT OF A UPC BARCODE WITH VARIOUS SPACING AND THICKNESS' ACCOMPANYING THE LETTERS "UPC", WHICH IS THE BOTTOM RIGHT IN ALL CAPITAL LETTERS. THE STRIPES DO NOT IDENTIFY OR REPRESENT ANY TYPE OF CODING.

FOR ELECTRONIC SMOKING PIPES; TOBACCO PIPES; TOBACCO WATER PIPES (U.S. CLS. 2, 8, 9 AND 17).

FIRST USE 1-1-2012; IN COMMERCE 3-1-2012.  
BRIDGETT SMITH, EXAMINING ATTORNEY

SN 86-031,153. INTERMATCH SWEDEN AB, MALMO, 211 34, SWEDEN, FILED 8-7-2013.

ARTESANOS DE DOS LIGAS

THE MARK CONSISTS OF STANDARD CHARACTERS WITHOUT CLAIM TO ANY PARTICULAR FONT, STYLE, SIZE, OR COLOR.

OWNER OF U.S. REG. NO. 4,246,476.  
THE ENGLISH TRANSLATION OF "ARTESANOS DE DOS LIGAS" IN THE MARK IS "ARTISANS (OR CRAFTSMEN) OF THE TWO LEAGUES (OR COMBINATIONS)".  
FOR CIGARS (U.S. CLS. 2, 8, 9 AND 17).

ALLISON HOLTZ, EXAMINING ATTORNEY

**CLASS 34—(Continued).**

SN 86-038,802. LEWIS, MIKE, SAN DIEGO, CA. FILED 8-15-2013.

MIX GS

THE MARK CONSISTS OF STANDARD CHARACTERS WITHOUT CLAIM TO ANY PARTICULAR FONT, STYLE, SIZE, OR COLOR.

NO CLAIM IS MADE TO THE EXCLUSIVE RIGHT TO USE "MIX", APART FROM THE MARK AS SHOWN.

FOR ELECTRONIC CIGARETTE REFILL CARTRIDGES SOLD EMPTY; ELECTRONIC CIGARETTES (U.S. CLS. 2, 8, 9 AND 17).

BRIN ANDERSON, EXAMINING ATTORNEY

SN 86-038,892. KYLE J. HOOVER, RHOME, TX. FILED 8-15-2013.

BLESSED LEAF

THE MARK CONSISTS OF STANDARD CHARACTERS WITHOUT CLAIM TO ANY PARTICULAR FONT, STYLE, SIZE, OR COLOR.

NO CLAIM IS MADE TO THE EXCLUSIVE RIGHT TO USE "LEAF", APART FROM THE MARK AS SHOWN.

FOR CIGARS (U.S. CLS. 2, 8, 9 AND 17).  
CURTIS FRENCH, EXAMINING ATTORNEY

SN 86-040,241. LA FAMILIA CIGARS, LLC, MIAMI, FL. FILED 8-16-2013.



THE MARK CONSISTS OF A KNIGHT'S HELMET WITH

**CLASS 34—(Continued).**

FEATHERS ON TOP OF THE HELMET. UNDER THE HELMET IS A SHIELD. WITHIN THE SHIELD IS AN EAGLE FACING LEFT, WITH A CROWN, AND WINGS SPREAD OPEN. FROM THE BOTTOM OF THE SHIELD EXTENDING LEFT, RIGHT, AND UPWARD ARE TWO LAUREL WREATHS. BETWEEN THE LAUREL WREATHS, SHIELD, AND HELMET ARE PAISLEY SWIRLS WITH A TEARDROP LIKE EFFECT. UNDERNEATH THE SHIELD AND LAUREL LEAF DEPICTION APPEARS THE STYLIZED, LETTERS "LFC".

FOR CIGAR AND CIGARETTE BOXES; CIGAR AND CIGARETTE BOXES NOT OF PRECIOUS METAL; CIGAR AND CIGARETTE BOXES OF PRECIOUS METAL; CIGAR BOXES; CIGAR BOXES NOT OF PRECIOUS METAL; CIGAR BOXES OF PRECIOUS METAL; CIGAR CASES; CIGAR CASES OF PRECIOUS METAL; CIGAR CUTTERS; CIGAR HOLDERS; CIGAR HOLDERS OF PRECIOUS METAL; CIGAR HUMIDIFIERS; CIGAR LIGHTERS; CIGAR TUBES; CIGAR WRAPS; CIGARS; ELECTRIC CIGARS; ELECTRONIC CIGARS; FILTERED CIGARS AND CIGARETTES; HOLDERS FOR CIGAR AND CIGARETTE OF PRECIOUS METAL; HOLDERS FOR CIGARS AND CIGARETTES; HOLDERS OF CIGARS AND CIGARETTES OF PRECIOUS METAL; NON-ELECTRIC CIGAR LIGHTERS NOT OF PRECIOUS METAL; SMOKELESS CIGAR VAPORIZER PIPES; SMOKERS' ARTICLES, NAMELY, CIGAR GLUE; SMOKERS' ARTICLES, NAMELY, CIGAR RELIGHTING LIQUID SOLUTION; SMOKERS' ARTICLES, NAMELY, CIGAR STORAGE TUBES; SMOKERS' ARTICLES, NAMELY, CONTAINMENT CLIPS USED TO KEEP A CIGAR FROM FALLING APART; SMOKERS' ARTICLES, NAMELY, OUTDOOR CIGAR AND CIGARETTE DISPOSAL UNITS; SMOKERS' ARTICLES, NAMELY, OUTDOOR RECEPTACLES FOR CIGAR AND CIGARETTE ASH AND WASTE; TOBACCO, CIGARS AND CIGARETTES (U.S. CLS. 2, 8, 9 AND 17).

LINDA QUIGLEY, EXAMINING ATTORNEY

SN 86-044,375. EDMONSTON, JOSEPH H, AUSTELL, GA. FILED 8-21-2013.

## BigAss Lighters

THE MARK CONSISTS OF STANDARD CHARACTERS WITHOUT CLAIM TO ANY PARTICULAR FONT, STYLE, SIZE, OR COLOR.

NO CLAIM IS MADE TO THE EXCLUSIVE RIGHT TO USE "LIGHTERS", APART FROM THE MARK AS SHOWN. FOR CIGAR LIGHTERS (U.S. CLS. 2, 8, 9 AND 17).

JORDAN BAKER, EXAMINING ATTORNEY

**CLASS 34—(Continued).**

SN 86-054,496. FUENTE MARKETING LTD., PROVIDENCIALES, TURKS/CAICOS IS., FILED 9-3-2013.

## DESTINO AL SIGLO

THE MARK CONSISTS OF STANDARD CHARACTERS WITHOUT CLAIM TO ANY PARTICULAR FONT, STYLE, SIZE, OR COLOR.

OWNER OF U.S. REG. NOS. 4,102,588 AND 4,444,692. THE ENGLISH TRANSLATION OF "DESTINO AL SIGLO" IN THE MARK IS "DESTINY TO CENTURY".

FOR HUMIDORS (U.S. CLS. 2, 8, 9 AND 17).

FIRST USE 7-31-2012; IN COMMERCE 7-31-2012.

KEVIN DINALLO, EXAMINING ATTORNEY

SN 86-060,765. INDIAN MOTORCYCLE INTERNATIONAL, LLC, MEDINA, MN. FILED 9-10-2013.



The logo for Indian Motorcycle features the word "Indian" in a large, stylized, cursive script font. Below it, the word "MOTORCYCLE" is written in a smaller, bold, sans-serif, all-caps font.

OWNER OF U.S. REG. NOS. 2,927,365 AND 2,971,391. THE MARK CONSISTS OF THE WORD "INDIAN" IN SCRIPT FONT ABOVE THE WORD "MOTORCYCLE".

FOR TOBACCO, CIGARS AND CIGARETTES; CIGAR AND CIGARETTE BOXES AND CASES; CIGARETTE LIGHTERS NOT OF PRECIOUS METAL NOT FOR AUTOMOBILES; ASHTRAYS (U.S. CLS. 2, 8, 9 AND 17).

KATHY DE JONGE, EXAMINING ATTORNEY

SN 86-070,702. DAP INCORPORATED, HANGZHOU, ZHEJIANG, CHINA, FILED 9-20-2013.

## HipVap

THE MARK CONSISTS OF STANDARD CHARACTERS WITHOUT CLAIM TO ANY PARTICULAR FONT, STYLE, SIZE, OR COLOR.

FOR ELECTRONIC CIGARETTES; ELECTRONIC CIGARETTES FOR USE AS AN ALTERNATIVE TO TRADITIONAL CIGARETTES; SMOKELESS CIGARETTE VAPORIZER PIPE (U.S. CLS. 2, 8, 9 AND 17).

VERNA BETH RIRIE, EXAMINING ATTORNEY



**CLASS 34—(Continued).**

SN 86-071,888. PHILIP MORRIS USA INC., RICHMOND, VA.  
FILED 9-23-2013.

# SIENNA

THE MARK CONSISTS OF STANDARD CHARACTERS WITHOUT CLAIM TO ANY PARTICULAR FONT, STYLE, SIZE, OR COLOR.

OWNER OF U.S. REG. NO. 1,935,567.  
FOR TOBACCO PRODUCTS, NAMELY, CIGARETTES (U.S. CLS. 2, 8, 9 AND 17).  
ELIZABETH CHANG, EXAMINING ATTORNEY

SN 86-072,098. AMMODOR, LLC, OAK RIDGE, NC. FILED 9-23-2013.

# Ammodor

THE MARK CONSISTS OF STANDARD CHARACTERS WITHOUT CLAIM TO ANY PARTICULAR FONT, STYLE, SIZE, OR COLOR.

FOR HUMIDORS (U.S. CLS. 2, 8, 9 AND 17).  
FIRST USE 2-25-2012; IN COMMERCE 2-25-2012.  
JOHN WILKE, EXAMINING ATTORNEY

SN 86-077,892. POINT CONCEPTION CREATIONS, MORRO BAY, CA. FILED 9-30-2013.



THE MARK CONSISTS OF A DESIGN OF AN OVAL SHAPE, WITH A BREAK IN THE BOTTOM WHICH DROPS DOWN A LITTLE, AND ALSO CONTAINS A DOT IN THE MIDDLE.

FOR TOBACCO WATER PIPES (U.S. CLS. 2, 8, 9 AND 17).  
FIRST USE 1-1-2010; IN COMMERCE 1-1-2010.  
JACLYN KIDWELL WALKER, EXAMINING ATTORNEY

**CLASS 34—(Continued).**

SN 86-081,265. POINT CONCEPTION CREATIONS, MORRO BAY, CA. FILED 10-2-2013.



THE MARK CONSISTS OF THE LETTERS "MB" CONNECTED TOGETHER TO FORM A STYLIZED "M" WITH A "B" SHAPE ON THE RIGHT SIDE.

FOR TOBACCO WATER PIPES (U.S. CLS. 2, 8, 9 AND 17).  
FIRST USE 1-1-2010; IN COMMERCE 1-1-2010.  
JACLYN KIDWELL WALKER, EXAMINING ATTORNEY

SN 86-097,760. OG DISTRIBUTION, INC., NORTHBROOK, IL. FILED 10-22-2013.

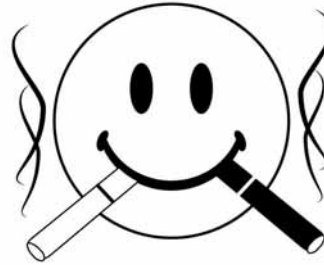

THE MARK CONSISTS OF A SMILEY FACE WITH TWO VAPORIZERS COMING OUT OF EACH SIDE OF ITS MOUTH WITH SMOKE RISING FROM EACH OF THEM.

FOR ELECTRIC VAPORIZERS FOR CONCENTRATES, ESSENTIAL OILS AND LOOSE LEAF HERBS, NAMELY, SMOKELESS CIGARETTE VAPORIZER PIPE; HAND OPERATED VAPORIZERS FOR HOUSEHOLD USE FOR CONCENTRATES, ESSENTIAL OILS AND LOOSE LEAF HERBS, NAMELY, SMOKELESS CIGARETTE VAPORIZER PIPE; ELECTRONIC SMOKELESS CIGARETTES FOR USE AS AN ALTERNATIVE TO TRADITIONAL CIGARETTES; SMOKELESS CIGARETTE VAPORIZER PIPE (U.S. CLS. 2, 8, 9 AND 17).  
LINDSEY BEN, EXAMINING ATTORNEY

SN 86-127,884. PHILIP MORRIS USA INC., RICHMOND, VA. FILED 11-25-2013.

# MARLBORO SLATE

THE MARK CONSISTS OF STANDARD CHARACTERS WITHOUT CLAIM TO ANY PARTICULAR FONT, STYLE, SIZE, OR COLOR.

OWNER OF U.S. REG. NOS. 63,288, 938,510 AND OTHERS.  
FOR TOBACCO PRODUCTS, NAMELY, CIGARETTES (U.S. CLS. 2, 8, 9 AND 17).  
ELIZABETH CHANG, EXAMINING ATTORNEY

**CLASS 34—(Continued).****SERVICE MARKS****CLASS 35—ADVERTISING AND BUSINESS**

SN 76-714,840. TRI-COUNTY ELECTRIC COOPERATIVE, RUSHFORD, MN. AND HAWKEYE TRI-COUNTY ELECTRIC COOPERATIVE, CRESCO, IA. FILED 8-27-2013.

**RENEWABLE RAYS**

THE MARK CONSISTS OF STANDARD CHARACTERS WITHOUT CLAIM TO ANY PARTICULAR FONT, STYLE, SIZE, OR COLOR.

NO CLAIM IS MADE TO THE EXCLUSIVE RIGHT TO USE "RENEWABLE", APART FROM THE MARK AS SHOWN.

FOR RETAIL ELECTRIC PROVIDER SERVICES, NAMELY, PROVIDING A SERVICE THAT ALLOWS CUSTOMERS TO PURCHASE ENERGY, NAMELY, ELECTRICITY AND RENEWABLE ENERGY (U.S. CLS. 100, 101 AND 102).

CATHERINE TARCU, EXAMINING ATTORNEY

SN 79-137,418. THORSTEN SCHWEIGERT, FED REP GERMANY, FILED 8-1-2013.

**Voucheria**

THE MARK CONSISTS OF STANDARD CHARACTERS WITHOUT CLAIM TO ANY PARTICULAR FONT, STYLE, SIZE, OR COLOR.

OWNER OF INTERNATIONAL REGISTRATION 1178832 DATED 8-1-2013, EXPIRES 8-1-2023.

FOR RETAIL SERVICES SUPPORTED BY DATA PROCESSING APPARATUS AND COMPUTERS FEATURING THE SALE AND REDEMPTION OF GIFT VOUCHERS IN DIGITAL OR PRINTED FORM, NAMELY, ISSUING GIFT CERTIFICATES WHICH MAY THEN BE REDEEMED FOR GOODS OR SERVICES, PROMOTING THE GOODS OF OTHERS BY MEANS OF PROVIDING ONLINE GIFT CERTIFICATES, ONLINE RETAIL STORE SERVICES FEATURING THE SALE OF GIFT CARDS OF OTHERS, MERCHANDISING SERVICES FOR INDUCING THE PURCHASING PUBLIC TO BUY THE GOODS OF OTHERS THROUGH A PROMOTIONAL GIFT VOUCHER REDEMPTION PROGRAM (U.S. CLS. 100, 101 AND 102).

SAIMA MAKHDOOM, EXAMINING ATTORNEY

**CLASS 35—(Continued).**

SN 79-138,303. RASMUSSEN FINANCE APS, DENMARK, FILED 8-20-2013.

**IAFR**

THE MARK CONSISTS OF STANDARD CHARACTERS WITHOUT CLAIM TO ANY PARTICULAR FONT, STYLE, SIZE, OR COLOR.

OWNER OF INTERNATIONAL REGISTRATION 1181302 DATED 8-20-2013, EXPIRES 8-20-2023.

FOR ADVERTISING; BUSINESS MANAGEMENT; BUSINESS ADMINISTRATION; OFFICE FUNCTIONS (U.S. CLS. 100, 101 AND 102).

SIMON TENG, EXAMINING ATTORNEY

SN 85-407,338. INTERNATIONAL DATA GROUP, INC., FRAMINGHAM, MA. FILED 8-25-2011.

**IT ROADMAP**

THE MARK CONSISTS OF STANDARD CHARACTERS WITHOUT CLAIM TO ANY PARTICULAR FONT, STYLE, SIZE, OR COLOR.

NO CLAIM IS MADE TO THE EXCLUSIVE RIGHT TO USE "IT", APART FROM THE MARK AS SHOWN.

FOR ARRANGING AND CONDUCTING TRADE SHOWS, BUSINESS EXPOSITIONS, BUSINESS EXHIBITIONS, BUSINESS SEMINARS, AND BUSINESS CONFERENCES IN THE FIELDS COMPUTERS, COMPUTER SOFTWARE, ONLINE SERVICES, HIGH TECHNOLOGY, INFORMATION TECHNOLOGY, INFORMATION SERVICES, COMMUNICATIONS, AND TELECOMMUNICATIONS (U.S. CLS. 100, 101 AND 102).

FIRST USE 11-30-2004; IN COMMERCE 11-30-2004.

KRISTIN DAHLING, EXAMINING ATTORNEY

SN 85-415,724. GARFINKLE MOOSETRAP CORPORATION, MAITLAND, FL. FILED 9-6-2011.

**Fairvilla's Sexy Things**

THE MARK CONSISTS OF STANDARD CHARACTERS WITHOUT CLAIM TO ANY PARTICULAR FONT, STYLE, SIZE, OR COLOR.

NO CLAIM IS MADE TO THE EXCLUSIVE RIGHT TO USE "FAIRVILLA'S", APART FROM THE MARK AS SHOWN.

FOR RETAIL STORE AND ON-LINE RETAIL STORE SERVICES FEATURING APPAREL, LINGERIE, FANTASY-WEAR, COSTUMES, SHOES, BOOKS, MAGAZINES, DVDS, NOVELTIES, GIFTS AND INTIMACY AND WELLNESS PRODUCTS (U.S. CLS. 100, 101 AND 102).

FIRST USE 4-15-2011; IN COMMERCE 4-15-2011.

ASMAT KHAN, EXAMINING ATTORNEY

**CLASS 35—(Continued).**

SN 85-443,751. CURATOR, LLC, SEATTLE, WA. FILED 10-10-2011.

# CURATOR

THE MARK CONSISTS OF STANDARD CHARACTERS WITHOUT CLAIM TO ANY PARTICULAR FONT, STYLE, SIZE, OR COLOR.

OWNER OF U.S. REG. NOS. 4,070,868 AND 4,084,180.

FOR ADVERTISING SERVICES, PUBLIC RELATIONS AND MARKETING SERVICES, NAMELY, PROMOTING AND MARKETING THE GOODS AND SERVICES OF OTHERS THROUGH ALL PUBLIC COMMUNICATION MEANS; BRANDING SERVICES, NAMELY, CONSULTING, DEVELOPMENT, MANAGEMENT AND MARKETING OF BRANDS FOR BUSINESSES; MARKETING CONSULTING; BUSINESS CONSULTATION AND MANAGEMENT REGARDING MARKETING ACTIVITIES AND LAUNCHING OF NEW PRODUCTS AND SERVICES; CREATIVE MARKETING DESIGN SERVICES; DEVELOPMENT OF MARKETING STRATEGIES AND CONCEPTS; PROVIDING MARKETING AND PROMOTION OF SPECIAL EVENTS; SOCIAL MEDIA STRATEGY AND MARKETING CONSULTANCY (U.S. CLS. 100, 101 AND 102).

FIRST USE 4-30-2009; IN COMMERCE 4-30-2009.

JASON BLAIR, EXAMINING ATTORNEY

**CLASS 35—(Continued).**

SN 85-591,904. WEB PRESENCE, INC., DBA MORBIZ, KIRKLAND, WA. FILED 4-7-2012.

# Business Delivered MORBiZ

THE MARK CONSISTS OF STANDARD CHARACTERS WITHOUT CLAIM TO ANY PARTICULAR FONT, STYLE, SIZE, OR COLOR.

NO CLAIM IS MADE TO THE EXCLUSIVE RIGHT TO USE "BUSINESS", APART FROM THE MARK AS SHOWN.

FOR ADVERTISING AND MARKETING SERVICES PROVIDED BY MEANS OF INDIRECT METHODS OF MARKETING COMMUNICATIONS, NAMELY, SOCIAL MEDIA, SEARCH ENGINE MARKETING, INQUIRY MARKETING, INTERNET MARKETING, MOBILE MARKETING, BLOGGING AND OTHER FORMS OF PASSIVE, SHARABLE OR VIRAL COMMUNICATIONS CHANNELS (U.S. CLS. 100, 101 AND 102).

FIRST USE 4-1-2011; IN COMMERCE 4-1-2011.

JESSICA A. POWERS, EXAMINING ATTORNEY

SN 85-446,525. TECK RESOURCES LIMITED, VANCOUVER, B.C., CANADA, FILED 10-13-2011.

# ZINC SAVES LIVES

THE MARK CONSISTS OF STANDARD CHARACTERS WITHOUT CLAIM TO ANY PARTICULAR FONT, STYLE, SIZE, OR COLOR.

PRIORITY CLAIMED UNDER SEC. 44(D) ON CANADA APPLICATION NO. 1540981, FILED 8-24-2011, REG. NO. TMA863623, DATED 10-25-2013, EXPIRES 10-25-2028.

FOR CHARITABLE SERVICES, NAMELY, THE ADMINISTRATION AND COORDINATION OF MATCHING PROGRAMS WITH NON-PROFIT ORGANIZATIONS TO MATCH CHARITABLE CONTRIBUTIONS OR GIFTS OF THIRD PARTY DONORS IN SUPPORT OF INTERNATIONAL HEALTHCARE, EDUCATIONAL AND WELFARE INITIATIVES OF CHILDREN AND FAMILIES (U.S. CLS. 100, 101 AND 102).

CHRISTINA SOBRAL, EXAMINING ATTORNEY

SN 85-595,117. AVANTI INTERACTIVE, LLC, BEVERLY HILLS, CA. FILED 4-11-2012.

# Avanti Interactive

THE MARK CONSISTS OF STANDARD CHARACTERS WITHOUT CLAIM TO ANY PARTICULAR FONT, STYLE, SIZE, OR COLOR.

NO CLAIM IS MADE TO THE EXCLUSIVE RIGHT TO USE "INTERACTIVE", APART FROM THE MARK AS SHOWN.

FOR ADVERTISING AND MARKETING SERVICES OUTSIDE THE MUSIC BUSINESS PROVIDED BY MEANS OF INDIRECT METHODS OF MARKETING COMMUNICATIONS, NAMELY, SOCIAL MEDIA, SEARCH ENGINE MARKETING, INQUIRY MARKETING, INTERNET MARKETING, MOBILE MARKETING, BLOGGING AND OTHER FORMS OF PASSIVE, SHARABLE OR VIRAL COMMUNICATIONS CHANNELS (U.S. CLS. 100, 101 AND 102).

FIRST USE 10-26-2009; IN COMMERCE 10-26-2009.

EMILY CHUO, EXAMINING ATTORNEY

**CLASS 35—(Continued).**

SN 85-633,101. PURE SCIENCE APPLICATIONS, LLC, DBA THE SCIENCE PROJECT, NEW YORK, NY. FILED 5-23-2012.

**CLASS 35—(Continued).**

SN 85-654,132. CBSA INVESTMENTS PTY LTD, QUEENSLAND, AUSTRALIA, FILED 6-18-2012.

## Theater of Retail

THE MARK CONSISTS OF STANDARD CHARACTERS WITHOUT CLAIM TO ANY PARTICULAR FONT, STYLE, SIZE, OR COLOR.

NO CLAIM IS MADE TO THE EXCLUSIVE RIGHT TO USE "RETAIL", APART FROM THE MARK AS SHOWN.

FOR ADVERTISING AND PUBLICITY SERVICES, NAMELY, PROMOTING THE GOODS, SERVICES, BRAND IDENTITY AND COMMERCIAL INFORMATION AND NEWS OF THIRD PARTIES THROUGH PRINT, AUDIO, VIDEO, DIGITAL AND ON-LINE MEDIUM (U.S. CLS. 100, 101 AND 102).

KEVIN CORWIN, EXAMINING ATTORNEY



SN 85-636,536. ANTHONY DIAZ, LAS VEGAS, NV. AND LANI DIZON, LAS VEGAS, NV. FILED 5-28-2012.

## RACE 2 EMBRACE

THE MARK CONSISTS OF STANDARD CHARACTERS WITHOUT CLAIM TO ANY PARTICULAR FONT, STYLE, SIZE, OR COLOR.

NO CLAIM IS MADE TO THE EXCLUSIVE RIGHT TO USE "RACE", APART FROM THE MARK AS SHOWN.

FOR CHARITABLE SERVICES, NAMELY, COORDINATION OF NON-MONETARY CONTRIBUTIONS TO CHARITIES AND NON-PROFITS; ORGANIZING AND CONDUCTING CHARITY AUCTIONS FOR CHARITABLE FUNDRAISING PURPOSES; PROMOTIONAL SERVICES, NAMELY, PROMOTING THE CHARITIES OF OTHERS; PROVIDING A WEBSITE FOR MANAGING, CONDUCTING AND ORGANIZING ONLINE AUCTIONS THAT ARE DESIGNED TO RAISE MONEY FOR SELECTED CHARITIES (U.S. CLS. 100, 101 AND 102).

FIRST USE 10-3-2010; IN COMMERCE 3-21-2012.  
CAROLINE WOOD, EXAMINING ATTORNEY

NO CLAIM IS MADE TO THE EXCLUSIVE RIGHT TO USE "AUSTRALIA", APART FROM THE MARK AS SHOWN.

THE MARK CONSISTS OF THE WORDS "CITY BEACH" INSIDE A SQUARE DESIGN AND THE WORD "AUSTRALIA" UNDERNEATH.

FOR RETAIL STORE SERVICES FEATURING CLOTHING, CLOTHING ACCESSORIES, HEADGEAR, FOOTWEAR, SPORTING ARTICLES, BAGS, BEACH BAGS, BACKPACKS, WALLETS, STICKERS, TOWELS, SKATEBOARDS, SURFBOARDS, GAMES AND PLAYTHINGS; IMPORT AGENCY SERVICES IN THE FIELD OF CLOTHING, CLOTHING ACCESSORIES, HEADGEAR, FOOTWEAR, SPORTING ARTICLES, BAGS, BEACH BAGS, BACKPACKS, WALLETS, STICKERS, TOWELS, SKATEBOARDS, SURFBOARDS, GAMES AND PLAYTHINGS (U.S. CLS. 100, 101 AND 102).

CAITLIN WATTS-FITZGERALD, EXAMINING ATTORNEY

**CLASS 35—(Continued).**

SN 85-687,043. TRAFFIC AUDIT BUREAU FOR MEDIA MEASUREMENT, INC., NEW YORK, NY. FILED 7-25-2012.

**CLASS 35—(Continued).**

SN 85-687,651. CLICKTOTE, INC., SAN DIEGO, CA. FILED 7-26-2012.

# clicktote

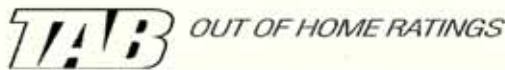

**TAB** OUT OF HOME RATINGS

THE MARK CONSISTS OF STANDARD CHARACTERS WITHOUT CLAIM TO ANY PARTICULAR FONT, STYLE, SIZE, OR COLOR.

FOR INTERNET BASED ORDER FULFILLMENT SERVICES; TRANSPORTATION AND DELIVERY SERVICES, NAMELY, ON-LINE ORDERING SERVICES IN THE FIELD OF DELIVERY OF CONSUMER PRODUCTS, NAMELY, GROCERIES, HOME IMPROVEMENT PRODUCTS, OFFICE SUPPLIES, APPAREL AND ACCESSORIES, SPORTING GOODS, COMPUTERS, ELECTRONICS, TOILETRIES, HOUSEWARES, HOME FURNISHINGS, AUTOMOTIVE PARTS AND ACCESSORIES, BOOKS, MUSIC, VIDEOS, JEWELRY, TOYS AND RESTAURANT TAKEOUT FOOD (U.S. CLS. 100, 101 AND 102).

SUSAN BILLHEIMER, EXAMINING ATTORNEY

OWNER OF U.S. REG. NOS. 3,680,431, 3,763,760 AND OTHERS.

NO CLAIM IS MADE TO THE EXCLUSIVE RIGHT TO USE "OUT OF HOME RATINGS", APART FROM THE MARK AS SHOWN.

THE MARK CONSISTS OF THE WORD "TAB" IN BLOCK HOLLOW SLANTED LETTERS, FOLLOWED BY THE WORDS "OUT OF HOME RATINGS" DRAWN WITH NARROW SOLID SLANTED LINES.

FOR MARKET RESEARCH SERVICES; ADVERTISING RESEARCH SERVICES; BUSINESS RESEARCH SERVICES; CONDUCTING, ANALYZING, AND PREPARING REPORTS REGARDING CONSUMER, ADVERTISING, MEDIA VIEWING; OUT OF HOME MEDIA AUDITING, NAMELY, TO DETERMINE HOW MANY PEOPLE HAVE THE OPPORTUNITY TO SEE A PARTICULAR OUT OF HOME SIGN SUCH AS BULLETINS, 30 SHEET POSTERS, TRANSIT SHELTERS, EIGHT SHEETS, TRUCKSIDE/MOBILE, POSTCARD DISPLAYS AND SKI AREA DISPLAYS IN PARTICULAR OUTDOOR ADVERTISING RESEARCH SERVICES AND MEDIA AUDIENCE MEASUREMENT SERVICES; MEDIA RESEARCH SERVICES; MEDIA RATING SERVICES, NAMELY, RATING THE EFFECTIVENESS OF MEDIA ADVERTISING FOR OTHERS; COLLECTING AND COMPILATION OF INFORMATION REGARDING THE AUDIT OF OUT OF HOME MEDIA, NAMELY, TO DETERMINE HOW MANY PEOPLE HAVE THE OPPORTUNITY TO SEE A PARTICULAR OUT OF HOME SIGN SUCH AS BULLETINS, 30 SHEET POSTERS, TRANSIT SHELTERS, EIGHT SHEETS, TRUCKSIDE/MOBILE, POSTCARD DISPLAYS AND SKI AREA DISPLAYS AND PROVIDING SUCH INFORMATION VIA THE INTERNET AND PRINTED REPORTS TO THIRD PARTIES; COMPILING INFORMATION ABOUT COMMERCIAL ADVERTISEMENTS; PREPARING SPECIAL STUDIES REPORTS INVOLVING MARKET SURVEY TECHNIQUES PREPARED TO THE ORDER OF THE CUSTOMER (U.S. CLS. 100, 101 AND 102).

MICHAEL WEBSTER, EXAMINING ATTORNEY

SN 85-695,743. PRUITTHEALTH, INC., NORCROSS, GA. FILED 8-6-2012.

# U ASYST

THE MARK CONSISTS OF STANDARD CHARACTERS WITHOUT CLAIM TO ANY PARTICULAR FONT, STYLE, SIZE, OR COLOR.

FOR PROVIDING A SECURE INTRANET WEBSITE IN THE FIELD OF HUMAN RESOURCE MANAGEMENT THAT ALLOWS EMPLOYEES IN THE FIELD OF HEALTHCARE TO VIEW, MANAGE, AND MODIFY CONTENT, NAMELY, EMPLOYEE BENEFIT INFORMATION AND EMPLOYEE INFORMATION; PROVIDING A SECURE INTRANET WEBSITE USED TO PLACE ON-LINE COMMERCIAL ORDERS IN THE FIELD OF MEDICAL SUPPLIES (U.S. CLS. 100, 101 AND 102).

STEVEN JACKSON, EXAMINING ATTORNEY

**CLASS 35—(Continued).**

SN 85-705,944. PROJECTDOG, INC., NEWBURYPORT, MA. FILED 8-16-2012.



THE COLOR(S) GREEN, GREY, BLACK AND WHITE IS/ ARE CLAIMED AS A FEATURE OF THE MARK.

THE MARK CONSISTS OF AN IMAGE OF A GREEN DOG, OUTLINED IN BLACK WITH BLACK AND WHITE EYES AND A GREY NOSE, THAT IS WALKING AND WEARING A GREY COLLAR WITH THREE WHITE CIRCLES ON THE COLLAR AND THE TERM "PROJECTDOG" TO THE RIGHT OF THE DOG APPEARING IN BLACK

FOR BUSINESS MANAGEMENT SERVICES, NAMELY, DOCUMENT RECORDS MANAGEMENT IN THE FORM OF DOCUMENT INDEXING, PREPARATION OF INVITATIONS, OFFERS, REQUESTS FOR PROPOSALS AND BIDS FOR CONSTRUCTION PROJECTS, ASSISTANCE WITH CONTRACT PROCUREMENT, ORGANIZING PROJECT MANAGEMENT COLLABORATION MEETINGS, TRACKING OF HISTORICAL BUSINESS MANAGEMENT DATA FOR PROJECTS, AND PROVIDING ANALYSIS OF BUSINESS COMPETITORS, ALL THE FOREGOING IN THE FIELD OF CONSTRUCTION; BUSINESS MANAGEMENT SERVICES, NAMELY, TRACKING NOTIFICATIONS OF INVITATIONS, OFFERS, BIDS, AND REQUESTS FOR PROPOSALS, IN THE FIELD OF CONSTRUCTION PROJECTS (U.S. CLS. 100, 101 AND 102).

FIRST USE 10-9-2001; IN COMMERCE 1-25-2002.  
ANTHONY RINKER, EXAMINING ATTORNEY

SN 85-706,187. MSP HOLDINGS, LLC, DBA ACK, AUSTIN, TX. FILED 8-17-2012.



THE MARK CONSISTS OF THE LETTERS "ACK" SURROUNDED BY STYLIZED SHAPES REPRESENTING MOUNTAINS AND WATER WITH A KAYAK BETWEEN THE LETTERS AND WATER.

FOR RETAIL STORE SERVICES VIA THE INTERNET, MAIL ORDER AND RETAIL OUTLETS FEATURING OUTDOOR RECREATION EQUIPMENT AND ACCESSORIES, TRAVEL EQUIPMENT AND ACCESSORIES, APPAREL, FOOT AND HEAD WEAR, FOOD AND FOOD PREPARATION EQUIPMENT, BOOKS, MAGAZINES, VIDEOS AND MAPS AND SAFETY GEAR AND PROMOTING THE GOODS AND SERVICES OF SUPPLIERS AND PARTNERS VIA THE INTERNET AND IN PRINTED ADVERTISEMENTS (U.S. CLS. 100, 101 AND 102).

FIRST USE 1-1-1999; IN COMMERCE 1-1-1999.  
JOHN DALIER, EXAMINING ATTORNEY

**CLASS 35—(Continued).**

SN 85-706,953. BUSINESS DATA, INC., INGLEWOOD, CA. FILED 8-17-2012.

**BDI**

THE MARK CONSISTS OF STANDARD CHARACTERS WITHOUT CLAIM TO ANY PARTICULAR FONT, STYLE, SIZE, OR COLOR.

OWNER OF U.S. REG. NO. 4,080,316.  
FOR DIRECT MAIL ADVERTISING, BUSINESS MARKETING AND DIRECT MAIL CONSULTING SERVICES (U.S. CLS. 100, 101 AND 102).  
FIRST USE 12-11-1984; IN COMMERCE 6-0-1997.  
SHARON MEIER, EXAMINING ATTORNEY

SN 85-712,770. FARM JOURNAL, INC., PHILADELPHIA, PA. FILED 8-24-2012.

**FARM JOURNAL LEGACY ADVISORS**

THE MARK CONSISTS OF STANDARD CHARACTERS WITHOUT CLAIM TO ANY PARTICULAR FONT, STYLE, SIZE, OR COLOR.

OWNER OF U.S. REG. NOS. 513,620, 4,014,920 AND OTHERS.

NO CLAIM IS MADE TO THE EXCLUSIVE RIGHT TO USE "LEGACY ADVISORS", APART FROM THE MARK AS SHOWN.

SEC. 2(F) AS TO "FARM JOURNAL".  
FOR PROVIDING AN ON-LINE COMPUTER DATABASE IN THE FIELD OF BUSINESS SUCCESSION PLANNING IN THE FIELD OF AGRICULTURE; MAINTAINING A REGISTRY OF FARM SUCCESSION CANDIDATES; PROVIDING INFORMATION ABOUT BUSINESS SUCCESSION PLANNING IN THE FIELD OF AGRICULTURE (U.S. CLS. 100, 101 AND 102).  
CHRISIE B. KING, EXAMINING ATTORNEY

SN 85-720,457. PRUITTHEALTH, INC., NORCROSS, GA. FILED 9-5-2012.

**U-ASSIST**

THE MARK CONSISTS OF STANDARD CHARACTERS WITHOUT CLAIM TO ANY PARTICULAR FONT, STYLE, SIZE, OR COLOR.

FOR PROVIDING A SECURE INTRANET WEBSITE IN THE FIELD OF HUMAN RESOURCE MANAGEMENT THAT ALLOWS EMPLOYEES IN THE FIELD OF HEALTHCARE TO VIEW, MANAGE, AND MODIFY CONTENT, NAMELY, EMPLOYEE BENEFIT INFORMATION AND EMPLOYEE INFORMATION; PROVIDING A SECURE INTRANET WEBSITE USED TO PLACE ON-LINE COMMERCIAL ORDERS IN THE FIELD OF MEDICAL SUPPLIES (U.S. CLS. 100, 101 AND 102).

STEVEN JACKSON, EXAMINING ATTORNEY

**CLASS 35—(Continued).**

SN 85-727,933. NUTPHREE'S BAKERY, INC., MT. PROSPECT, IL. FILED 9-13-2012.

**NUTPHREE'S CUPCAKES**

THE MARK CONSISTS OF STANDARD CHARACTERS WITHOUT CLAIM TO ANY PARTICULAR FONT, STYLE, SIZE, OR COLOR.

NO CLAIM IS MADE TO THE EXCLUSIVE RIGHT TO USE "NUT-FREE CUPCAKES", APART FROM THE MARK AS SHOWN.

FOR RETAIL BAKERY SHOP FEATURING CUPCAKES, CAKES AND OTHER BAKED GOODS THAT ARE 100% FREE OF PEANUTS AND TREE NUTS (U.S. CLS. 100, 101 AND 102).

FIRST USE 9-0-2011; IN COMMERCE 9-0-2011.  
WILLIAM JACKSON, EXAMINING ATTORNEY

**CLASS 35—(Continued).**

SN 85-758,933. TEMPNOLOGY LLC, FORMERLY COOLCORE, LLC, PORTSMOUTH, NH. FILED 10-19-2012.

**COOLCORE**

THE MARK CONSISTS OF STANDARD CHARACTERS WITHOUT CLAIM TO ANY PARTICULAR FONT, STYLE, SIZE, OR COLOR.

FOR ONLINE RETAIL STORE SERVICES FEATURING COOLING TOWELS, EXCLUDING CLOTHING, HELMETS, HATS, FOOTWEAR, TOWELS, BAGS AND OTHER ITEMS OF CLOTHING OR APPAREL SOLD, GIVEN, INTENDED FOR SALE, OR ADVERTISED AND DIRECTED TO AND INTENDED TO BE USED BY RIDERS, MANUFACTURERS OR SELLERS OF MOTORCYCLES, REGARDLESS OF THE QUANTITY OF WHEELS, HELMETS DIRECTED TO AND INTENDED TO BE USED BY MOTORCYCLE, SNOWMOBILE AND ATV RIDERS (U.S. CLS. 100, 101 AND 102).

LAURIE MAYES, EXAMINING ATTORNEY

SN 85-770,810. DELICIOUS CONCEPTS, INC., HOUSTON, TX. FILED 11-2-2012.

**DELICIOUS CONCEPTS**

THE MARK CONSISTS OF STANDARD CHARACTERS WITHOUT CLAIM TO ANY PARTICULAR FONT, STYLE, SIZE, OR COLOR.

FOR FRANCHISING, NAMELY, OFFERING BUSINESS MANAGEMENT ASSISTANCE IN THE ESTABLISHMENT AND/OR OPERATION OF RESTAURANTS; OFFERING BUSINESS MANAGEMENT ASSISTANCE IN THE ESTABLISHMENT AND/OR OPERATION OF RESTAURANTS; RESTAURANT FRANCHISING, NAMELY, OFFERING BUSINESS MANAGEMENT ASSISTANCE IN THE ESTABLISHMENT AND/OR OPERATION OF RESTAURANTS; RESTAURANT MANAGEMENT FOR OTHERS (U.S. CLS. 100, 101 AND 102).

FIRST USE 10-15-2009; IN COMMERCE 10-15-2009.  
BERYL GARDNER, EXAMINING ATTORNEY

SN 85-735,483. PHILANTHROPY NORTHWEST, SEATTLE, WA. FILED 9-21-2012.

**THE GIVING PRACTICE**

THE MARK CONSISTS OF STANDARD CHARACTERS WITHOUT CLAIM TO ANY PARTICULAR FONT, STYLE, SIZE, OR COLOR.

SEC. 2(F).

FOR BUSINESS MANAGEMENT CONSULTING, STRATEGIC PLANNING AND BUSINESS ADVISORY SERVICES PROVIDED TO FOUNDATIONS AND OTHER FUNDERS, AND NONPROFIT ORGANIZATIONS; PROVIDING BUSINESS ADVICE IN THE FIELD OF PHILANTHROPY, CHARITABLE GIVING, FOUNDATION SERVICES AND NONPROFIT FUNDING; CHARITABLE SERVICES, NAMELY, PROMOTING PUBLIC AWARENESS OF THE NEED FOR PHILANTHROPY (U.S. CLS. 100, 101 AND 102).

FIRST USE 3-31-2001; IN COMMERCE 3-31-2002.  
JERI J. FICKES, EXAMINING ATTORNEY

SN 85-770,857. ACCESS POINT PARTNERS LLC, AKA JOB SEARCH PUBLISHERS LLC, WILTON, CT. FILED 11-3-2012.

**Access Point Partners**

THE MARK CONSISTS OF STANDARD CHARACTERS WITHOUT CLAIM TO ANY PARTICULAR FONT, STYLE, SIZE, OR COLOR.

NO CLAIM IS MADE TO THE EXCLUSIVE RIGHT TO USE "PARTNERS", APART FROM THE MARK AS SHOWN, FOR EMPLOYMENT RECRUITING CONSULTATION (U.S. CLS. 100, 101 AND 102).

FIRST USE 9-17-2010; IN COMMERCE 9-17-2010.  
ANDREA HACK, EXAMINING ATTORNEY

**CLASS 35—(Continued).**

SN 85-776,487. FITZENZ, JOHN A., DBA HUMAN CAPITAL SOURCE, INC, SAN JOSE, CA. FILED S.R. 11-10-2012; AM. P.R. 9-12-2013.

## HUMAN CAPITAL SOURCE

Manage Tomorrow, Today

THE MARK CONSISTS OF STANDARD CHARACTERS WITHOUT CLAIM TO ANY PARTICULAR FONT, STYLE, SIZE, OR COLOR.

NO CLAIM IS MADE TO THE EXCLUSIVE RIGHT TO USE "HUMAN CAPITAL", APART FROM THE MARK AS SHOWN.

FOR ASSISTANCE, ADVISORY SERVICES AND CONSULTANCY WITH REGARD TO BUSINESS PLANNING, BUSINESS ANALYSIS, BUSINESS MANAGEMENT, AND BUSINESS ORGANIZATION (U.S. CLS. 100, 101 AND 102).

FIRST USE 8-1-2003; IN COMMERCE 8-1-2003.  
LINDA ESTRADA, EXAMINING ATTORNEY

SN 85-789,481. ABCDENT, LLC, PORT WASHINGTON, NY. FILED 11-28-2012.

## ABCDENT

THE MARK CONSISTS OF STANDARD CHARACTERS WITHOUT CLAIM TO ANY PARTICULAR FONT, STYLE, SIZE, OR COLOR.

FOR PROVIDING A WEBSITE FOR DENTAL PRACTICE MANAGEMENT AND ADMINISTRATIVE SUPPORT SERVICES TO INDIVIDUAL DENTISTS OR GROUP PRACTICES (U.S. CLS. 100, 101 AND 102).

FIRST USE 1-0-2010; IN COMMERCE 1-0-2010.  
JENNIFER RICHARDSON, EXAMINING ATTORNEY

SN 85-793,356. SECURE THE WORLD, INC., WESTWOOD, MA. FILED 12-3-2012.



THE MARK CONSISTS OF A SQUARE WITH ROUNDED EDGES THAT HAS BEEN OUTLINED TWICE. THE STYLIZED WORDING "SECURE THE WORLD" IS SITUATED IN THE LOWER HALF OF THE SQUARE WITH "SECURE"

**CLASS 35—(Continued).**

SITUATED ABOVE "THE WORLD". A CURVED LINE IS SITUATED BENEATH "WORLD". A DESIGN COMPRISED OF GLOBE AND PADLOCK ELEMENTS IS SITUATED ABOVE THE WORDING. THE BODY OF THE LOCK IS COMPRISED OF A GLOBE WITH A KEYHOLE IN THE CENTER. THE GLOBE DEPICTS THE CONTINENTS AND IT IS COVERED IN A SQUARE GRID. THREE RINGS CIRCUMVENT THE GLOBE AND THREE SEPARATE CIRCLES DEPICT WHERE RINGS INTERSECT. A CURVED BAND EXTENDS FROM THE TOP OF THE GLOBE.

FOR BUSINESS CONSULTING SERVICES IN THE FIELD OF INFORMATION ASSURANCE (U.S. CLS. 100, 101 AND 102).

GRETCHEN ULRICH, EXAMINING ATTORNEY

SN 85-801,754. IPPOLITO, JOHN J., FOX RIVER GROVE, IL. FILED 12-13-2012.

## AERMED LOGISTIX

THE MARK CONSISTS OF STANDARD CHARACTERS WITHOUT CLAIM TO ANY PARTICULAR FONT, STYLE, SIZE, OR COLOR.

NO CLAIM IS MADE TO THE EXCLUSIVE RIGHT TO USE "AIR MED", APART FROM THE MARK AS SHOWN.

FOR STAFFING FIRM FOR MEDICAL PERSONNEL (U.S. CLS. 100, 101 AND 102).

SANJEEV VOHRA, EXAMINING ATTORNEY

SN 85-802,795. THE CAMPAIGN GROUP, INC., PHILADELPHIA, PA. FILED 12-14-2012.



OWNER OF U.S. REG. NO. 1,807,885.

NO CLAIM IS MADE TO THE EXCLUSIVE RIGHT TO USE "THE CAMPAIGN GROUP, INC.", APART FROM THE MARK AS SHOWN.

THE COLOR(S) RED, WHITE AND BLUE IS/ARE CLAIMED AS A FEATURE OF THE MARK.

THE MARK CONSISTS OF WHITE SIGNS AGAINST A BACKGROUND THAT IS HALF RED AND HALF BLUE, OVER BLUE LETTERING SPELLING OUT "THE CAMPAIGN GROUP, INC."

FOR POLITICAL CONSULTING SERVICES, NAMELY, PROVIDING ADVICE ON STRATEGIES FOR AND CONDUCT OF CAMPAIGNS FOR ELECTIVE OFFICE; ADVERTISING SERVICES, NAMELY, PREPARING AND PLACING PRINT, AUDIO, AND AUDIO-VISUAL ADVERTISEMENTS FOR USE IN CAMPAIGNS FOR ELECTIVE OFFICE (U.S. CLS. 100, 101 AND 102).

FIRST USE 0-0-1986; IN COMMERCE 0-0-1986.  
LEIGH LOWRY, EXAMINING ATTORNEY



**CLASS 35—(Continued).**

SN 85-808,359. MARTINO, JESSICA, NEW YORK, NY. FILED 12-20-2012.

# Clique Chic

THE MARK CONSISTS OF STANDARD CHARACTERS WITHOUT CLAIM TO ANY PARTICULAR FONT, STYLE, SIZE, OR COLOR.

FOR ON-LINE RETAIL STORE SERVICES FEATURING CLOTHING, SHOES, AND CLOTHING ACCESSORIES (U.S. CLS. 100, 101 AND 102).

ANDREA HACK, EXAMINING ATTORNEY

SN 85-815,811. HUMANA INC., LOUISVILLE, KY. FILED 1-4-2013.

# CANVAS

THE MARK CONSISTS OF STANDARD CHARACTERS WITHOUT CLAIM TO ANY PARTICULAR FONT, STYLE, SIZE, OR COLOR.

FOR BUSINESS MANAGEMENT SERVICES, NAMELY, PROVIDING CUSTOMER RELATIONSHIP MANAGEMENT SERVICES AND SALES SUPPORT MANAGEMENT SERVICES; BUSINESS MANAGEMENT CONSULTING SERVICES RELATING TO CUSTOMER RELATIONSHIP MANAGEMENT, SALES SUPPORT MANAGEMENT AND MARKETING AUTOMATION (U.S. CLS. 100, 101 AND 102).

WANDA KAY PRICE, EXAMINING ATTORNEY

SN 85-822,884. RAILPROS, INC., MISSION VIEJO, CA. FILED 1-14-2013.

# RAILPROS

THE MARK CONSISTS OF STANDARD CHARACTERS WITHOUT CLAIM TO ANY PARTICULAR FONT, STYLE, SIZE, OR COLOR.

FOR BUSINESS CONSULTATION IN THE FIELD OF TRANSPORTATION INDUSTRY; RECRUITMENT AND PLACEMENT OF PERSONNEL IN THE FIELD OF TRANSPORTATION INDUSTRY; TEMPORARY PERSONNEL SERVICES (U.S. CLS. 100, 101 AND 102).

FIRST USE 5-1-2000; IN COMMERCE 1-11-2001.

DAVID I, EXAMINING ATTORNEY

**CLASS 35—(Continued).**

SN 85-824,290. NATIONAL COATINGS & SUPPLIES, INC., RALEIGH, NC. FILED 1-16-2013.

# AIM AUTOMATED INVENTORY MANAGEMENT

THE MARK CONSISTS OF STANDARD CHARACTERS WITHOUT CLAIM TO ANY PARTICULAR FONT, STYLE, SIZE, OR COLOR.

OWNER OF U.S. REG. NO. 3,191,012.

NO CLAIM IS MADE TO THE EXCLUSIVE RIGHT TO USE "AUTOMATED INVENTORY MANAGEMENT", APART FROM THE MARK AS SHOWN.

FOR INVENTORY MANAGEMENT IN THE FIELD OF AUTOMOTIVE PAINT, BODY SHOP SUPPLIES, AND EQUIPMENT (U.S. CLS. 100, 101 AND 102).

FIRST USE 1-3-2005; IN COMMERCE 1-3-2005.

JAY BESCH, EXAMINING ATTORNEY

SN 85-825,072. TERRAMAR PROJECT, INC., NEW YORK, NY. FILED 1-16-2013.

# TerraMar

THE MARK CONSISTS OF STANDARD CHARACTERS WITHOUT CLAIM TO ANY PARTICULAR FONT, STYLE, SIZE, OR COLOR.

FOR PROVIDING AN INTERNET WEBSITE FEATURING NEWS AND INFORMATION IN THE FIELD OF NATURAL RESOURCE MANAGEMENT RELATING TO THE ENVIRONMENT AND PUBLIC LANDS; PUBLIC ADVOCACY TO PROMOTE AWARENESS OF THE HIGH SEAS (U.S. CLS. 100, 101 AND 102).

FIRST USE 11-1-2011; IN COMMERCE 12-1-2011.

ALLISON HOLTZ, EXAMINING ATTORNEY

SN 85-826,570. THE ANNIE E. CASEY FOUNDATION, INC., BALTIMORE, MD. FILED 1-18-2013.



THE ANNIE E. CASEY FOUNDATION

OWNER OF U.S. REG. NOS. 2,477,633, 2,685,168 AND 4,395,619.

NO CLAIM IS MADE TO THE EXCLUSIVE RIGHT TO USE "FOUNDATION", APART FROM THE MARK AS SHOWN.

THE NAME "ANNIE E. CASEY" DOES NOT IDENTIFY A LIVING INDIVIDUAL.

THE COLOR(S) ORANGE AND GREY IS/ARE CLAIMED AS A FEATURE OF THE MARK.

THE MARK CONSISTS OF THE LITERAL PORTION OF THE MARK SHOWN TO THE RIGHT OF A DESIGN COMPRISED OF DESIGN OF A "C" SHOWN IN ON ORANGE INTERSECTED BY A PARTIAL CIRCULAR DESIGN SHOWN IN GREY. ABOVE THE DESIGN IS A SMALL SOLID GREY CIRCLE.

FOR ADVOCATING FOR PUBLIC POLICY IN THE FIELD OF DISADVANTAGED CHILDREN AND YOUTH (U.S. CLS. 100, 101 AND 102).

FIRST USE 1-14-2013; IN COMMERCE 1-14-2013.

LINDA ESTRADA, EXAMINING ATTORNEY

**CLASS 35—(Continued).**

SN 85-829,751. VERIMED IPA, LLC, WESLEY CHAPEL, FL. FILED 1-23-2013.



THE MARK CONSISTS OF THE STYLIZED WORD "VERIMED" WITH A DESIGN OF A PARTIAL CIRCLE ABOVE THE LETTER "E".

FOR BUSINESS CONSULTING SERVICES IN THE FIELD OF PHYSICIAN PRACTICES; PROVIDING BUSINESS ADMINISTRATION AND BUSINESS MANAGEMENT SERVICES FOR PRIMARY CARE PHYSICIANS, SAID SERVICES CONSISTING OF NEGOTIATING GLOBAL RISK CONTRACTS WITH MEDICAID AND MEDICARE PLANS TO HELP PRIMARY CARE PHYSICIANS OBTAIN ADVANTAGEOUS FUNDING AND REIMBURSEMENT FOR MEDICAL SERVICES, SERVICE FUND MANAGEMENT SERVICES RELATED TO AIDING THE PRIMARY CARE PHYSICIANS IN MANAGING RELATIONSHIPS AND UTILIZING FUNDS AVAILABLE FROM INSURANCE COMPANIES, COST REALLOCATION SERVICES RELATED TO ENSURING THAT COSTS FROM PATIENTS THAT SHOULD BE ALLOCATED TO PREVIOUS PROVIDERS ARE REDIRECTED, CLAIMS CONTESTATION SERVICES RELATED TO AUDITING CLAIMS MADE BY PRIMARY CARE PHYSICIANS TO INSURANCE COMPANIES TO MAKE SURE THEY ARE PAID PROPERLY AND CONTEST IMPROPERLY PAID CLAIMS, VERIFICATION OF CODING FOR AND DOCUMENTATION OF MEDICAL SERVICES RELATED TO ENSURING THAT PRIMARY CARE PHYSICIANS ENGAGE IN PROPER CODING AND DOCUMENTATION OF MEDICAL SERVICES TO ENSURE PROPER REIMBURSEMENT FROM MEDICARE AND MEDICAID, CREDENTIALING RELATED TO AIDING THE PRIMARY CARE PHYSICIANS IN ENTERING INTO RELATIONSHIPS WITH ADDITIONAL INSURANCE COMPANIES, FINANCIAL ASSISTANCE RELATED TO HELPING PRIMARY CARE PHYSICIANS TAKE ADVANTAGE OF GLOBAL RISK CONTRACTS TO RECEIVE FINANCIAL ADVANCES, CASE MANAGEMENT AND DISEASE MANAGEMENT SERVICES RELATED TO HELPING PRIMARY CARE PHYSICIANS TRACK AND MANAGE PATIENTS, AND UTILIZATION MANAGEMENT SERVICES RELATED TO AIDING PRIMARY CARE PHYSICIANS WITH THE MEDICAL COST PATTERNS OF PATIENTS ASSIGNED TO THEIR PANEL (U.S. CLS. 100, 101 AND 102).

FIRST USE 8-0-2011; IN COMMERCE 8-0-2011.

MARC LEIPZIG, EXAMINING ATTORNEY

**CLASS 35—(Continued).**

SN 85-830,243. THE LUBRIZOL CORPORATION, WICKLIFFE, OH. FILED 1-23-2013.

**PUDDLING PROOF**

THE MARK CONSISTS OF STANDARD CHARACTERS WITHOUT CLAIM TO ANY PARTICULAR FONT, STYLE, SIZE, OR COLOR.

FOR PROVIDING CONSUMER INFORMATION ON ADDITIVES, LUBRICANTS AND FLUIDS IN CONNECTION WITH OFF HIGHWAY MOTOR VEHICLES TO CONSUMERS, END USERS, CUSTOMERS, DISTRIBUTORS AND REPRESENTATIVES (U.S. CLS. 100, 101 AND 102).

MARILYN IZZI, EXAMINING ATTORNEY

SN 85-831,573. NAKEES, LLC, TAMPA, FL. FILED 1-24-2013.



THE MARK CONSISTS OF AN IMAGE OF A GIRL ON A WOODEN SWING WITH A HAT, FLOWING HAIR, HIGH HEELS AND SUNGLASSES.

FOR ONLINE RETAIL STORE SERVICES PROVIDING CLOTHING AND ADULT PRODUCTS, NAMELY, SEX TOYS, COSTUMES, GAMES, AND LINGERIE (U.S. CLS. 100, 101 AND 102).

SAMUAL PAQUIN, EXAMINING ATTORNEY

SN 85-833,070. TICKLE & WOO, LLC, DALTON, PA. FILED 1-25-2013.

**Packages with Purpose**

THE MARK CONSISTS OF STANDARD CHARACTERS WITHOUT CLAIM TO ANY PARTICULAR FONT, STYLE, SIZE, OR COLOR.

FOR PROMOTIONAL SERVICES, NAMELY, PROMOTING THE GOODS AND SERVICES OF OTHERS BY MEANS OF A WEB SITE THAT DIRECTS GIFT ITEMS AND REMINDER ITEMS TO CURRENT AND PROSPECTIVE CLIENTS (U.S. CLS. 100, 101 AND 102).

MARC LEIPZIG, EXAMINING ATTORNEY

**CLASS 35—(Continued).**

SN 85-833,102. TICKLE & WOO, LLC, DALTON, PA. FILED 1-25-2013.

# TickleBox

THE MARK CONSISTS OF STANDARD CHARACTERS WITHOUT CLAIM TO ANY PARTICULAR FONT, STYLE, SIZE, OR COLOR.

FOR PROMOTIONAL SERVICES, NAMELY, PROMOTING THE GOODS AND SERVICES OF OTHERS BY MEANS OF A WEB SITE THAT DIRECTS GIFT ITEMS AND REMINDER ITEMS TO CURRENT AND PROSPECTIVE CLIENTS (U.S. CLS. 100, 101 AND 102).

MARC LEIPZIG, EXAMINING ATTORNEY

**CLASS 35—(Continued).**

SN 85-835,109. HAROLD E. HILL, ZIONSVILLE, IN. FILED 1-29-2013.



NO CLAIM IS MADE TO THE EXCLUSIVE RIGHT TO USE "OUTDOORS", APART FROM THE MARK AS SHOWN. THE COLOR(S) BLACK AND WHITE IS/ARE CLAIMED AS A FEATURE OF THE MARK.

THE MARK CONSISTS OF WHITE LETTERS AND A WHITE PANTHER ON A BLACK RECTANGULAR BACKGROUND.

FOR RETAIL STORE SERVICES FEATURING OUTDOOR HUNTING EQUIPMENT AND APPAREL (U.S. CLS. 100, 101 AND 102).

RONALD DELGIZZI, EXAMINING ATTORNEY

SN 85-833,312. CONNECTHER, AUSTIN, TX. FILED 1-26-2013.

# Girls Impact the World

THE MARK CONSISTS OF STANDARD CHARACTERS WITHOUT CLAIM TO ANY PARTICULAR FONT, STYLE, SIZE, OR COLOR.

FOR PUBLIC ADVOCACY TO PROMOTE AWARENESS OF ISSUES RELATING TO ADVANCING EDUCATION, GLOBAL HEALTH, ECONOMIC INDEPENDENCE, POVERTY ALLEVIATION AND GENDER PARITY FOR WOMEN AND GIRLS GLOBALLY (U.S. CLS. 100, 101 AND 102).

FIRST USE 5-1-2012; IN COMMERCE 5-1-2012.

JULIE WATSON, EXAMINING ATTORNEY

SN 85-835,998. GORCZYCA, ELLEN, NEW YORK, NY. FILED 1-30-2013.

SN 85-833,528. RILEY'S CATCH, WEDDINGTON, NC. FILED 1-28-2013.

# Riley's Catch

THE MARK CONSISTS OF STANDARD CHARACTERS WITHOUT CLAIM TO ANY PARTICULAR FONT, STYLE, SIZE, OR COLOR.

NO CLAIM IS MADE TO THE EXCLUSIVE RIGHT TO USE "CATCH", APART FROM THE MARK AS SHOWN.

FOR FISHING CLUB FOR YOUNG PEOPLE, NAMELY, CLUB SERVICES, NAMELY, PROMOTING THE INTERESTS OF FISHING FOR YOUNG PEOPLE; PROMOTING SPORT FISHING COMPETITIONS OF OTHERS; PROMOTING PUBLIC AWARENESS OF THE NEED FOR YOUNG PEOPLE TO BE INVOLVED IN THE ACTIVITY OF FISHING (U.S. CLS. 100, 101 AND 102).

SCOTT BIBB, EXAMINING ATTORNEY

# BEASTLY GOOD BAKERY

THE MARK CONSISTS OF STANDARD CHARACTERS WITHOUT CLAIM TO ANY PARTICULAR FONT, STYLE, SIZE, OR COLOR.

NO CLAIM IS MADE TO THE EXCLUSIVE RIGHT TO USE "BAKERY", APART FROM THE MARK AS SHOWN.

FOR ONLINE RETAIL BAKERY SHOPS; RETAIL BAKERY SHOPS (U.S. CLS. 100, 101 AND 102).

BRIAN PINO, EXAMINING ATTORNEY

**CLASS 35—(Continued).**

SN 85-836,571. PLANALYTICS, INC., BERWYN, PA. FILED 1-30-2013.

# GASBUYER

THE MARK CONSISTS OF STANDARD CHARACTERS WITHOUT CLAIM TO ANY PARTICULAR FONT, STYLE, SIZE, OR COLOR.

OWNER OF U.S. REG. NO. 3,376,671.

SEC. 2(F).

FOR PROVIDING INFORMATION PERTAINING TO A GOODS MERCANTILE EXCHANGE THROUGH USE OF NATURAL GAS MARKET FORECASTING SOFTWARE INCORPORATING WEATHER BASED INFORMATION AS A FUNDAMENTAL AND TECHNICAL ANALYSIS TOOL ENABLING CUSTOMERS TO ESTIMATE, MEASURE, AND MANAGE RISKS IN THE AREA OF PRICING, PURCHASING, SELLING, AND HEDGING NATURAL GAS (U.S. CLS. 100, 101 AND 102).

FIRST USE 6-1-2005; IN COMMERCE 6-1-2005.

MARC LEIPZIG, EXAMINING ATTORNEY

**CLASS 35—(Continued).**

SN 85-837,293. NEW WORLD RV, LLC, BOWLING GREEN, KY. FILED 1-31-2013.



THE COLOR(S) RED, BLUE, GRAY, AND WHITE IS/ARE CLAIMED AS A FEATURE OF THE MARK.

THE MARK CONSISTS OF THE WORDING "NEW-WORLD RV" WITH THE TERMS "NEW" AND "RV" IN RED AND THE TERM "WORLD" IN BLUE, AND A COMPASS DESIGN IN THE LETTER "O" IN THE TERM "WORLD" FEATURING RED AND WHITE ARROWS AND A GRAY CENTER; THE GRAY RECTANGULAR CARRIER REPRESENTS BACKGROUND, OUTLINING, SHADING, AND/OR TRANSPARENT AREAS AND IS NOT PART OF THE MARK.

FOR RETAIL STORE SERVICES FEATURING RVs, MOTORHOMES, TRAVEL TRAILERS, CAMPERS, FIFTH WHEEL TRAILERS, HORSE TRAILERS AND AFTER-MARKET RV SUPPLIES (U.S. CLS. 100, 101 AND 102).

FIRST USE 11-1-2011; IN COMMERCE 11-1-2011.  
BARNEY CHARLON, EXAMINING ATTORNEY

SN 85-837,216. PLANALYTICS, INC., BERWYN, PA. FILED 1-31-2013.

# ENERGYBUYER

THE MARK CONSISTS OF STANDARD CHARACTERS WITHOUT CLAIM TO ANY PARTICULAR FONT, STYLE, SIZE, OR COLOR.

OWNER OF U.S. REG. NO. 3,376,672.

SEC. 2(F).

FOR PROVIDING INFORMATION PERTAINING TO A GOODS MERCANTILE EXCHANGE THROUGH USE OF ENERGY FORECASTING SOFTWARE INCORPORATING WEATHER BASED INFORMATION AS A FUNDAMENTAL AND TECHNICAL ANALYSIS TOOL ENABLING CUSTOMERS TO ESTIMATE, MEASURE, AND MANAGE RISKS IN THE AREA OF PRICING, PURCHASING, SELLING, AND HEDGING HEATING AND FUEL OIL AND OTHER FORMS OF ENERGY (U.S. CLS. 100, 101 AND 102).

FIRST USE 9-1-2006; IN COMMERCE 9-1-2006.

MARC LEIPZIG, EXAMINING ATTORNEY

SN 85-837,555. CURRAN, CHARLEY, SAN FRANCISCO, CA. FILED 1-31-2013.

# pick out of the hat

THE MARK CONSISTS OF STANDARD CHARACTERS WITHOUT CLAIM TO ANY PARTICULAR FONT, STYLE, SIZE, OR COLOR.

FOR OPERATING AN ON-LINE COMMUNITY FOR SELLERS OF GOODS AND/OR SERVICES WHICH ALLOWS LOCATION BASED RETAILERS AND ESTABLISHMENTS A MEANS TO OFFER DONATIONS OF THEIR GOODS AND/OR SERVICES TO THE COMMUNITY AS WELL AS DISCOUNTS AND COUPONS THAT CAN BE USED TOWARDS THE PURCHASE OF THEIR GOODS AND SERVICES (U.S. CLS. 100, 101 AND 102).

ELIZABETH KAJUBI, EXAMINING ATTORNEY

**CLASS 35—(Continued).**

SN 85-842,846. FORESEE RESULTS, INC., ANN ARBOR, MI. FILED 2-6-2013.

 The logo consists of the letters "W O M I" in a bold, sans-serif font. The letter "W" has a small triangle pointing upwards from its bottom center. The letter "M" has a small triangle pointing downwards from its top center.

THE MARK CONSISTS OF THE LETTERS "W O M I" IN STYLIZED FONT WITH A TRIANGLE SHAPE LOCATED BELOW THE LETTER "W" AND POINTING UP INTO THE "W", AND A TRIANGLE SHAPE LOCATED ABOVE THE LETTER "M" AND POINTING DOWN INTO THE "M".

FOR DATA PROCESSING SERVICES OF DATA FROM USERS AND FROM USERS' INTERACTIONS ACROSS THE CUSTOMER TOUCH POINTS OF OTHERS TO MEASURE AND ANALYZE DATA RELATED TO THE ACTIVITIES, ATTITUDES, BEHAVIORS, AND INTENTIONS OF THE USERS; DATA PROCESSING SERVICES OF DATA FROM USERS AND FROM USERS' INTERACTIONS ACROSS THE CUSTOMER TOUCH POINTS OF OTHERS TO MEASURE AND ANALYZE THE ABILITY OF THE CUSTOMER TOUCH POINTS OF OTHERS TO INFLUENCE THE ACTIVITIES, ATTITUDES, BEHAVIORS, AND INTENTIONS OF THE USERS (U.S. CLS. 100, 101 AND 102).

SUSAN LESLIE DUBOIS, EXAMINING ATTORNEY

SN 85-846,922. RAISE MARKETPLACE, INC., CHICAGO, IL. FILED 2-11-2013.

 The logo is the word "Raise" written in a bold, cursive script font. The letters are slanted upwards from left to right.

THE MARK CONSISTS OF THE WORD "RAISE" IN A CURSIVE FONT ON A DIAGONAL LINE RISING FROM THE LEFT TO THE RIGHT.

FOR ON-LINE MARKETPLACE FOR SELLERS AND BUYERS OF GIFT CARDS, IN-STORE CREDIT VOUCHERS AND MARKETING INCENTIVES IN THE NATURE OF GIFT CERTIFICATES, COUPONS AND REBATE VOUCHERS (U.S. CLS. 100, 101 AND 102).

HAI-LY LAM, EXAMINING ATTORNEY

SN 85-847,528. MUSE COMMUNICATIONS, INC., LOS ANGELES, CA. FILED 2-12-2013.

 The logo is the word "MUSEOLOGY" in a bold, sans-serif font.

THE MARK CONSISTS OF STANDARD CHARACTERS WITHOUT CLAIM TO ANY PARTICULAR FONT, STYLE, SIZE, OR COLOR.

FOR ADVERTISING AND PROMOTION SERVICES AND RELATED CONSULTING, ADVERTISING AGENCY, PUBLICITY SERVICES FOR ADVERTISING PURPOSES AND ADVERTISING SERVICES, NAMELY, PROMOTING THE BRANDS, GOODS AND SERVICES OF OTHERS (U.S. CLS. 100, 101 AND 102).

CHRISTINE MARTIN, EXAMINING ATTORNEY

**CLASS 35—(Continued).**

SN 85-847,945. TALENTCIRCLES, INC., SAN BRUNO, CA. FILED 2-12-2013.

 The logo is the word "TALENTSCAN" in a bold, sans-serif font.

THE MARK CONSISTS OF STANDARD CHARACTERS WITHOUT CLAIM TO ANY PARTICULAR FONT, STYLE, SIZE, OR COLOR.

FOR PROVIDING A DATA BASE OF RESUMES OF PROSPECTIVE EMPLOYEES BY SCANNING RESUME DOCUMENTS; PROVIDING PERSONNEL PLACEMENT OR EMPLOYMENT SERVICES IN THE NATURE OF RESUME PREPARATION, APPLICATION, CHECKING, REVIEWING, RECRUITMENT PREPARATION AND GENERAL EMPLOYMENT INFORMATION BY SCANNING RESUME DOCUMENTS (U.S. CLS. 100, 101 AND 102).

ZACHARY BELLO, EXAMINING ATTORNEY

SN 85-848,607. BLUE CALYPSO, LLC, DALLAS, TX. FILED 2-13-2013.

 The logo is the word "SOCIALECHO" in a bold, sans-serif font.

THE MARK CONSISTS OF STANDARD CHARACTERS WITHOUT CLAIM TO ANY PARTICULAR FONT, STYLE, SIZE, OR COLOR.

FOR PROVIDING ELECTRONIC ADVERTISEMENT DISTRIBUTION VIA COMPUTER NETWORKS (U.S. CLS. 100, 101 AND 102).

MEGHAN REINHART, EXAMINING ATTORNEY

SN 85-850,642. HERITAGE PROVIDER NETWORK, NORTH-RIDGE, CA. FILED 2-14-2013.

 The logo is the word "CareXchange" in a bold, sans-serif font.

THE MARK CONSISTS OF STANDARD CHARACTERS WITHOUT CLAIM TO ANY PARTICULAR FONT, STYLE, SIZE, OR COLOR.

FOR RECRUITING AND COORDINATING VOLUNTEERS TO PROVIDE NON-MEDICAL AND SOCIAL SUPPORT SERVICES INCLUDING ASSISTANCE WITH ACTIVITIES OF DAILY LIVING TO MEDICARE BENEFICIARIES (U.S. CLS. 100, 101 AND 102).

NAKWAMA ANKRAH, EXAMINING ATTORNEY

**CLASS 35—(Continued).**

SN 85-850,879. ACTIONET, INC., VIENNA, VA. FILED 2-15-2013.

# AMES

THE MARK CONSISTS OF STANDARD CHARACTERS WITHOUT CLAIM TO ANY PARTICULAR FONT, STYLE, SIZE, OR COLOR.

FOR BUSINESS CONSULTANCY AS WELL AS DEVELOPMENT OF PROCESSES AND COORDINATION OF SERVICES TO AUTOMATE COMMON, REPETITIVE BUSINESS ACTIVITIES IN HUMAN RESOURCES, SUPPLY CHAIN MANAGEMENT, LOGISTICS, AND FINANCE TO INCREASE EFFICIENCY, REDUCE COSTS, COMPLY WITH REGULATIONS, AND FOCUS ON THE AGENCY MISSION; BUSINESS CONSULTING SERVICES IN THE FIELDS OF CORPORATE PERFORMANCE MANAGEMENT, BUSINESS DATA ANALYTICS, BUSINESS DATA COLLECTION, BUSINESS DATA INTEGRATION; BUSINESS INTELLIGENCE SERVICES (U.S. CLS. 100, 101 AND 102).

ADA HAN, EXAMINING ATTORNEY

SN 85-851,178. STOREBOUND LLC, NEW YORK, NY. FILED 2-15-2013.

# STOREBOUND

THE MARK CONSISTS OF STANDARD CHARACTERS WITHOUT CLAIM TO ANY PARTICULAR FONT, STYLE, SIZE, OR COLOR.

OWNER OF U.S. REG. NO. 4,257,580.

FOR ON-LINE RETAIL STORE SERVICES FEATURING A WIDE VARIETY OF CONSUMER GOODS OF OTHERS; ON-LINE RETAIL STORE SERVICES FEATURING KITCHEN PRODUCTS AND HOUSEHOLD PRODUCTS; RETAIL STORE SERVICES FEATURING KITCHEN PRODUCTS AND HOUSEHOLD PRODUCTS ACCESSIBLE ON-LINE AND BY TELEPHONE, FACSIMILE AND MAIL ORDER (U.S. CLS. 100, 101 AND 102).

FIRST USE 6-30-2011; IN COMMERCE 6-30-2011.

LAURA GOLDEN, EXAMINING ATTORNEY

**CLASS 35—(Continued).**

SN 85-853,391. TAPPER'S FINE JEWELRY, INC., WEST BLOOMFIELD, MI. FILED 2-19-2013.

## Tapper's The Engagement Store

THE MARK CONSISTS OF STANDARD CHARACTERS WITHOUT CLAIM TO ANY PARTICULAR FONT, STYLE, SIZE, OR COLOR.

NO CLAIM IS MADE TO THE EXCLUSIVE RIGHT TO USE "ENGAGEMENT STORE", APART FROM THE MARK AS SHOWN.

FOR RETAIL JEWELRY STORES (U.S. CLS. 100, 101 AND 102).

FIRST USE 10-12-2012; IN COMMERCE 10-12-2012.

KIM MONINGHOFF, EXAMINING ATTORNEY

SN 85-856,120. VERTIGO ACTIVATIONS, LLC., TORRANCE, CA. FILED 2-21-2013.



THE COLOR(S) BLACK, GREY AND GREEN IS/ARE CLAIMED AS A FEATURE OF THE MARK.

THE MARK CONSISTS OF THE WORD "VERTIGO" IN BLACK STYLIZED FONT AND A GEOMETRIC DESIGN COMPRISED OF FOUR OVALS SHOWN IN GREY, EXCEPT FOR THE SECOND OVAL APPEARING IN GREEN.

FOR ADVERTISING AGENCIES; BUSINESS ADMINISTRATION AND MANAGEMENT; BUSINESS ADMINISTRATION ASSISTANCE; BUSINESS CONSULTING SERVICES, NAMELY, PROVIDING ASSISTANCE IN DEVELOPMENT OF BUSINESS STRATEGIES AND CREATIVE IDEATION; PROVIDING OFFICE FUNCTIONS (U.S. CLS. 100, 101 AND 102).

DAVID YONTEF, EXAMINING ATTORNEY

SN 85-858,846. SPN COLORS INC, WHITE PLAINS, NY. FILED 2-25-2013.

# SPN Colors

THE MARK CONSISTS OF STANDARD CHARACTERS WITHOUT CLAIM TO ANY PARTICULAR FONT, STYLE, SIZE, OR COLOR.

FOR ON-LINE RETAIL STORE SERVICES FEATURING A WIDE VARIETY OF CONSUMER GOODS OF OTHERS (U.S. CLS. 100, 101 AND 102).

FIRST USE 10-5-2012; IN COMMERCE 10-5-2012.

KIM MONINGHOFF, EXAMINING ATTORNEY

**CLASS 35—(Continued).**

SN 85-860,634. BORKLUND, STEPHANIE ELIZABETH, CO-LUMBIA, MO. FILED 2-26-2013.

**I AM ONE**

THE MARK CONSISTS OF STANDARD CHARACTERS WITHOUT CLAIM TO ANY PARTICULAR FONT, STYLE, SIZE, OR COLOR.

FOR PROMOTING PUBLIC AWARENESS OF THE DANGERS AND CONSEQUENCES OF BULLYING; PUBLIC ADVOCACY TO PROMOTE AWARENESS OF THE DANGERS AND CONSEQUENCES OF BULLYING; PROVIDING A WEBSITE FEATURING INFORMATION AND NON-DOWNLOADABLE VIDEOS PROMOTING PUBLIC AWARENESS OF THE DANGERS AND CONSEQUENCES OF BULLYING (U.S. CLS. 100, 101 AND 102).  
GEOFFREY FOSDICK, EXAMINING ATTORNEY

---

SN 85-867,215. KERSTEN DIRECT, LTD., RICHARDSON, TX. FILED 3-5-2013.

**KerstenDirect**

THE MARK CONSISTS OF STANDARD CHARACTERS WITHOUT CLAIM TO ANY PARTICULAR FONT, STYLE, SIZE, OR COLOR.

FOR DIRECT MARKETING SERVICES, NAMELY, PROVIDING DIRECT MAIL AND DIRECT RESPONSE MARKETING FOR OTHERS (U.S. CLS. 100, 101 AND 102).  
FIRST USE 2-25-2013; IN COMMERCE 2-27-2013.  
JOHN DWYER, EXAMINING ATTORNEY

---

SN 85-867,286. KERSTEN DIRECT, LTD., RICHARDSON, TX. FILED 3-5-2013.

**KerstenDirect**

THE COLOR(S) GRAY, YELLOW AND MAROON IS/ARE CLAIMED AS A FEATURE OF THE MARK.

THE MARK CONSISTS OF THE MAROON WORD "KERSTEN" FOLLOWED BY THE GRAY WORD "DIRECT" PRECEDED BY A BACKWARDS GRAY AND YELLOW LETTER "K"

FOR DIRECT MARKETING SERVICES, NAMELY, PROVIDING DIRECT MAIL AND DIRECT RESPONSE MARKETING FOR OTHERS (U.S. CLS. 100, 101 AND 102).  
FIRST USE 2-25-2013; IN COMMERCE 2-27-2013.  
JOHN DWYER, EXAMINING ATTORNEY

**CLASS 35—(Continued).**

SN 85-867,360. FIFTH STREET GAMING, LLC, LAS VEGAS, NV. FILED 3-5-2013.

**DOWNTOWN3RD**

THE MARK CONSISTS OF STANDARD CHARACTERS WITHOUT CLAIM TO ANY PARTICULAR FONT, STYLE, SIZE, OR COLOR.

FOR COOPERATIVE ADVERTISING AND MARKETING SERVICES PROMOTING THE GOODS AND SERVICES OF OTHERS TO FACILITATE ECONOMIC AND PHYSICAL REDEVELOPMENT AND RESIDENTIAL AND COMMERCIAL REVITALIZATION OF URBAN LAS VEGAS; ADVERTISING AND MARKETING SERVICES, NAMELY, PROMOTING THE GOODS AND SERVICES OF OTHERS TO FACILITATE THE REVITALIZATION AND REDEVELOPMENT OF URBAN LAS VEGAS; DEVELOPING PROMOTIONAL CAMPAIGNS FOR BUSINESS TO FACILITATE AND SUPPORT CONSTRUCTION AND FINANCING OF COMMERCIAL AND RESIDENTIAL REDEVELOPMENT WITHIN URBAN LAS VEGAS; PROMOTING ECONOMIC DEVELOPMENT, PARTICULARLY THE HOUSING AND COMMERCIAL REAL ESTATE SECTORS, WITHIN THE CITY OF LAS VEGAS (U.S. CLS. 100, 101 AND 102).  
FIRST USE 10-0-2011; IN COMMERCE 10-0-2011.  
JOHN SCHUYLER YARD, EXAMINING ATTORNEY

---

SN 85-867,396. FIFTH STREET GAMING, LLC, LAS VEGAS, NV. FILED 3-5-2013.



THE MARK CONSISTS OF THE LOWER-CASE LETTERS "DT" IN STYLIZED FORM WHERE THE "T" FEATURES A SUPERSCRIP "3" IN STYLIZED FORM ALL OF WHICH IS CENTERED WITHIN A SOLID CIRCLE.

FOR COOPERATIVE ADVERTISING AND MARKETING SERVICES PROMOTING THE GOODS AND SERVICES OF OTHERS TO FACILITATE ECONOMIC AND PHYSICAL REDEVELOPMENT AND RESIDENTIAL AND COMMERCIAL REVITALIZATION OF URBAN LAS VEGAS; ADVERTISING AND MARKETING SERVICES, NAMELY, PROMOTING THE GOODS AND SERVICES OF OTHERS TO FACILITATE THE REVITALIZATION AND REDEVELOPMENT OF URBAN LAS VEGAS; DEVELOPING PROMOTIONAL CAMPAIGNS FOR BUSINESS TO FACILITATE AND SUPPORT CONSTRUCTION AND FINANCING OF COMMERCIAL AND RESIDENTIAL REDEVELOPMENT WITHIN URBAN LAS VEGAS; PROMOTING ECONOMIC DEVELOPMENT, PARTICULARLY THE HOUSING AND COMMERCIAL REAL ESTATE SECTORS, WITHIN THE CITY OF LAS VEGAS (U.S. CLS. 100, 101 AND 102).  
FIRST USE 10-0-2011; IN COMMERCE 10-0-2011.  
JOHN SCHUYLER YARD, EXAMINING ATTORNEY

**CLASS 35—(Continued).**

SN 85-867,765. OD EXCELLENCE, LLC, HEALDSBURG, CA. FILED 3-5-2013.

# ODX

THE MARK CONSISTS OF STANDARD CHARACTERS WITHOUT CLAIM TO ANY PARTICULAR FONT, STYLE, SIZE, OR COLOR.

FOR BUSINESS ORGANIZATION AND MANAGEMENT CONSULTING SERVICES FOR EYE CARE PROFESSIONALS, NAMELY, OPTOMETRISTS (U.S. CLS. 100, 101 AND 102).

FIRST USE 2-11-2008; IN COMMERCE 2-20-2008.  
DAVID MURRAY, EXAMINING ATTORNEY

SN 85-868,193. GORDON-SMITH, HENRY, NEW YORK, NY. FILED 3-6-2013.

# AGRITECTURE

THE MARK CONSISTS OF STANDARD CHARACTERS WITHOUT CLAIM TO ANY PARTICULAR FONT, STYLE, SIZE, OR COLOR.

FOR BUSINESS CONSULTING, INQUIRIES OR INFORMATION; BUSINESS CONSULTING SERVICES RELATED TO INTEGRATING FOOD PRODUCTION TO BUSINESSES AND SUSTAINABLE URBAN AGRICULTURE; BUSINESS CONSULTING SERVICES IN THE URBAN AGRICULTURAL FIELD; CONSULTING SERVICES RELATING TO ADVISE ON MARKETING AND SALES OF HIGH-DENSITY URBAN FARMING EQUIPMENT; BUSINESS ADVISORY SERVICES IN THE FIELDS OF INTERIOR DESIGN, URBAN PLANNING DESIGN, ARCHITECTURE, BUSINESS STRATEGY IMPROVEMENT (U.S. CLS. 100, 101 AND 102).

ALICE BENMAMAN, EXAMINING ATTORNEY

SN 85-870,055. MARCHEX, INC., SEATTLE, WA. FILED 3-7-2013.

# CALL DNA

THE MARK CONSISTS OF STANDARD CHARACTERS WITHOUT CLAIM TO ANY PARTICULAR FONT, STYLE, SIZE, OR COLOR.

NO CLAIM IS MADE TO THE EXCLUSIVE RIGHT TO USE "CALL", APART FROM THE MARK AS SHOWN.

FOR ADVERTISING SERVICES; PAY PER CALL ADVERTISING SERVICES; MOBILE ADVERTISING SERVICES; MARKET RESEARCH SERVICES, NAMELY, MONITORING, COLLECTING, AGGREGATING, ANALYZING AND REPORTING ON INTERACTIONS BETWEEN CONSUMERS AND COMPANIES, INCLUDING INTERACTIONS VIA TELEPHONE CALLS BETWEEN CONSUMERS AND COMPANIES; ADVERTISING AND MARKETING SERVICES, NAMELY, PROFESSIONAL AND TECHNICAL CONSULTING SERVICES IN THE FIELD OF BUSINESS CALL ANALYTICS; BUSINESS ANALYSIS OF CALL DATA (U.S. CLS. 100, 101 AND 102).

KATHERINE CHANG, EXAMINING ATTORNEY

**CLASS 35—(Continued).**

SN 85-871,460. BEN & JERRY'S HOMEMADE, INC., SOUTH BURLINGTON, VT. FILED 3-8-2013.



THE COLOR(S) RED, WHITE, YELLOW, TAN, ORANGE AND BLACK IS/ARE CLAIMED AS A FEATURE OF THE MARK.

THE MARK CONSISTS OF A RED CIRCLE CONTAINING THE WORDS "HAPPY COWS" IN WHITE STYLIZED LETTERS, ENCIRCLING A BLACK AND WHITE COW ALL ON TOP OF A YELLOW, ORANGE AND TAN CIRCLE. FOR PROMOTIONAL ACTIVITIES, NAMELY, PROMOTING SUSTAINABLE DAIRY FARMING (U.S. CLS. 100, 101 AND 102).

JAMES MACFARLANE, EXAMINING ATTORNEY

SN 85-876,988. MAYCOU LLC, WASHINGTON, DC. FILED 3-15-2013.

# goTenTen

THE MARK CONSISTS OF STANDARD CHARACTERS WITHOUT CLAIM TO ANY PARTICULAR FONT, STYLE, SIZE, OR COLOR.

FOR BUSINESS SERVICES, NAMELY, PROVIDING AN ONLINE NETWORK FOR CONTRACTORS TO RECEIVE BIDDING OPPORTUNITIES BY MEANS OF AN ONLINE MARKETPLACE FOR THE PURPOSE OF DEVELOPING BUSINESS FOR SUSTAINABLE RELATED BUILDING PRODUCTS AND SERVICES; BUSINESS SERVICES, NAMELY, PROVIDING AN ONLINE NETWORK FOR CONTRACTORS TO RECEIVE LEADS AND BIDDING OPPORTUNITIES BY MEANS OF AN ONLINE MARKETPLACE FOR THE PURPOSE OF DEVELOPING BUSINESS; BUSINESS SERVICES, NAMELY, PROVIDING AN ONLINE NETWORK FOR CONTRACTORS TO RECEIVE LEADS AND BIDDING OPPORTUNITIES BY MEANS OF AN ONLINE MARKETPLACE FOR THE PURPOSE OF DEVELOPING BUSINESS FOR ENERGY RELATED PRODUCTS AND SERVICES; BUSINESS SERVICES, NAMELY, PROVIDING AN ONLINE NETWORK FOR CONTRACTORS TO RECEIVE LEADS AND BIDDING OPPORTUNITIES BY MEANS OF AN ONLINE MARKETPLACE FOR THE PURPOSE OF DEVELOPING BUSINESS IN THE GOODS AND SERVICES INDUSTRY; DEVELOPMENT OF MARKETING STRATEGIES, CON-



**CLASS 35—(Continued).**

CEPTS AND TACTICS, NAMELY, AUDIENCE DEVELOPMENT, BRAND AWARENESS, ONLINE COMMUNITY BUILDING AND DIGITAL WORD OF MOUTH COMMUNICATIONS; ONLINE ADVERTISEMENTS; ONLINE ADVERTISING AND PROMOTIONAL SERVICES; ONLINE BUSINESS RESEARCH SERVICES THAT ALLOW USERS TO SHARE OPINIONS WITH A MARKETING RESEARCH COMPANY RELATED TO EVERYDAY CONSUMER PRODUCTS AND SERVICES; OPERATING ON-LINE MARKETPLACES FOR SELLERS OF GOODS AND/OR SERVICES; PROVIDING A WEBSITE FEATURING AN ONLINE MARKETPLACE FOR EXCHANGING GOODS AND SERVICES WITH OTHER USERS; PROVIDING ONLINE BUSINESS MANAGEMENT SERVICES INCLUDING ACCOUNTING, MARKETING, BUSINESS PROJECT MANAGEMENT, AND BUSINESS DEVELOPMENT; SHOPPING FACILITATION SERVICES, NAMELY, PROVIDING AN ONLINE COMPARISON-SHOPPING SEARCH ENGINE FOR OBTAINING PURCHASING INFORMATION (U.S. CLS. 100, 101 AND 102).  
CHRISTINA SOBRAL, EXAMINING ATTORNEY

---

SN 85-878,208. ISDALE, MARGARET, BRYN MAWR, PA. FILED 3-17-2013.

**wealthaven**

THE MARK CONSISTS OF STANDARD CHARACTERS WITHOUT CLAIM TO ANY PARTICULAR FONT, STYLE, SIZE, OR COLOR.  
FOR BUSINESS MANAGEMENT CONSULTANCY AND ADVISORY SERVICES (U.S. CLS. 100, 101 AND 102).  
FIRST USE 3-5-2011; IN COMMERCE 3-5-2011.  
ARETHA SOMERVILLE, EXAMINING ATTORNEY

---

SN 85-878,926. GLOBAL BICYCLIST, LLC, NEW YORK, NY. FILED 3-18-2013.



NO CLAIM IS MADE TO THE EXCLUSIVE RIGHT TO USE "GLOBAL BICYCLISTS" AND "EST. 2013", APART FROM THE MARK AS SHOWN.  
THE COLOR(S) RED, WHITE, BLUE, YELLOW, BLACK, GREEN, GOLD, AND PINK IS/ARE CLAIMED AS A FEATURE OF THE MARK.  
THE MARK CONSISTS OF THE WORDING "GLOBAL BICYCLISTS" AND "EST. 2013" IN BLACK, ALL WITHIN A

**CLASS 35—(Continued).**

GREEN BICYCLE WHEEL WITH GOLD TRIM AND BLACK SPOKES, WITH STYLIZED VERSIONS OF THE NATIONAL FLAGS OF THE UNITED STATES, FRANCE, AUSTRALIA, THE NETHERLANDS, NORWAY, BELGIUM, SWITZERLAND, ITALY, ENGLAND, CHINA, JAPAN, GERMANY, DENMARK, SPAIN, FINLAND, AND SWEDEN BETWEEN THE BLACK SPOKES, IN THE COLORS RED, WHITE, BLUE, YELLOW, BLACK, GREEN, GOLD, AND PINK, ALL ABOVE A GOLD WREATH ON A BLACK BACKGROUND.  
FOR ON-LINE RETAIL STORE SERVICES FEATURING BICYCLES, BICYCLE PARTS, BICYCLE CLOTHING; RETAIL STORE SERVICES FEATURING BICYCLES AND BICYCLE CLOTHING (U.S. CLS. 100, 101 AND 102).  
AMY KELLY, EXAMINING ATTORNEY

---

SN 85-879,113. HALLE'S CLOSET, LOS ANGELES, CA. FILED 3-18-2013.

**HALLE'S CLOSET**

THE MARK CONSISTS OF STANDARD CHARACTERS WITHOUT CLAIM TO ANY PARTICULAR FONT, STYLE, SIZE, OR COLOR.  
FOR RETAIL STORE SERVICES IN THE FIELD OF CLOTHING, JEWELRY, CANDLES, AND HOUSEHOLD FURNISHINGS AND ONLINE RETAIL STORE SERVICES IN THE FIELD OF CLOTHING, JEWELRY, CANDLES, AND HOUSEHOLD FURNISHINGS (U.S. CLS. 100, 101 AND 102).  
CHARLOTTE CORWIN, EXAMINING ATTORNEY

---

SN 85-893,981. CHEVRON INTELLECTUAL PROPERTY LLC, SAN RAMON, CA. FILED 4-3-2013.

**ENERGY FOR GOOD**

THE MARK CONSISTS OF STANDARD CHARACTERS WITHOUT CLAIM TO ANY PARTICULAR FONT, STYLE, SIZE, OR COLOR.  
FOR PUBLIC ADVOCACY TO PROMOTE AWARENESS OF EDUCATION, WELLNESS AND ECONOMIC DEVELOPMENT PROGRAMS THAT ADDRESS ISSUES IMPACTING ENERGY INDUSTRY EMPLOYEES AND COMMUNITIES WHERE THE INDUSTRY OPERATES (U.S. CLS. 100, 101 AND 102).  
SUSAN STIGLITZ, EXAMINING ATTORNEY

**CLASS 35—(Continued).**

SN 85-897,703. O'MARA, TIMOTHY, FRONT ROYAL, VA. FILED 4-8-2013.

4422

THE MARK CONSISTS OF STANDARD CHARACTERS WITHOUT CLAIM TO ANY PARTICULAR FONT, STYLE, SIZE, OR COLOR.

FOR ON-LINE RETAIL STORE SERVICES FEATURING A WIDE VARIETY OF CONSUMER GOODS OF OTHERS (U.S. CLS. 100, 101 AND 102).  
PRISCILLA MILTON, EXAMINING ATTORNEY

SN 85-898,483. DEARJAMES, LLC, LOS ANGELES, CA. FILED 4-8-2013.

DearJames

THE MARK CONSISTS OF STANDARD CHARACTERS WITHOUT CLAIM TO ANY PARTICULAR FONT, STYLE, SIZE, OR COLOR.

FOR PROVIDING ADVICE IN THE FIELDS OF BUSINESS LEADERSHIP DEVELOPMENT, BUSINESS MANAGEMENT, BUSINESS DEVELOPMENT, CAREER, EMPLOYMENT, NAMELY, SEEKING EMPLOYMENT AND EMPLOYMENT STAFFING, AND GOAL SETTING, NAMELY, BUSINESS ADVICE AND INFORMATION, ALL IN PERSON AND VIA VARIOUS GLOBAL COMMUNICATION NETWORKS; ONLINE RETAIL STORE SERVICES FEATURING HOME ACCESSORIES, CANDLES AND CLOTHING (U.S. CLS. 100, 101 AND 102).  
JAMES STEIN, EXAMINING ATTORNEY

**CLASS 35—(Continued).**

SN 85-898,635. KELLOGG NORTH AMERICA COMPANY, BATTLE CREEK, MI. FILED 4-9-2013.

KELLOGG'S FAMILY REWARDS

THE MARK CONSISTS OF STANDARD CHARACTERS WITHOUT CLAIM TO ANY PARTICULAR FONT, STYLE, SIZE, OR COLOR.

OWNER OF U.S. REG. NOS. 147,454, 1,727,738 AND OTHERS.

NO CLAIM IS MADE TO THE EXCLUSIVE RIGHT TO USE "FAMILY REWARDS", APART FROM THE MARK AS SHOWN.

FOR PROVIDING INCENTIVE AWARD PROGRAMS THROUGH ISSUANCE AND PROCESSING OF LOYALTY POINTS FOR PURCHASE OF A COMPANY'S GOODS AND SERVICES; CONSUMER REWARD PROGRAMS FOR ADVERTISING AND PROMOTIONAL PURPOSES WHICH PERMIT CONSUMERS TO EARN REWARDS, PRIZES AND COUPONS BASED ON PURCHASES AND OTHER ACTIVITIES (U.S. CLS. 100, 101 AND 102).

FIRST USE 6-0-2012; IN COMMERCE 6-0-2012.  
KIMBERLY PARKS, EXAMINING ATTORNEY

SN 85-901,774. ORGILL, INC., MEMPHIS, TN. FILED 4-11-2013.



THE COLOR(S) BLUE, GREEN, WHITE, YELLOW IS/ARE CLAIMED AS A FEATURE OF THE MARK.

THE MARK CONSISTS OF THE WORDS "DOLLARCENTRAL" WITH THE WORD "DOLLAR" IN DARK GREEN OUTLINED IN WHITE AND THE WORD "CENTRAL" IN LIGHT GREEN OUTLINED IN WHITE WITH A BLUE DOLLAR SIGN WITH YELLOW HIGHLIGHTS INSIDE A GREEN CIRCLE ON EACH END OF THE WORD, OVER A HORIZONTAL BLUE BAND OUTLINED IN GREEN AT THE TOP AND BOTTOM.

FOR MANAGEMENT ON BEHALF OF COMMERCIAL ENTERPRISES IN TERMS OF SUPPLYING THEM WITH INEXPENSIVE CONSUMER GOODS (U.S. CLS. 100, 101 AND 102).

FIRST USE 2-21-2013; IN COMMERCE 2-21-2013.  
DORITT L. CARROLL, EXAMINING ATTORNEY

**CLASS 35—(Continued).**

SN 85-904,136. GRAY SERVICES L.L.C., PHOENIX, AZ. FILED 4-15-2013.



THE MARK CONSISTS OF A SQUARE BOX TILTED TOWARD THE LEFT ON TOP INCLUDING CURVED LINES AND OPEN CIRCLES.

FOR PROVIDING COMMERCIAL DIRECTORY INFORMATION PERTAINING TO LOCAL MERCHANTS AND BUSINESSES TO RESIDENTS AND VISITORS OF A MASTER-PLANNED COMMUNITY (U.S. CLS. 100, 101 AND 102).

FIRST USE 8-0-1997; IN COMMERCE 8-0-1997.  
DAVID H. STINE, EXAMINING ATTORNEY

**CLASS 35—(Continued).**

SN 85-909,798. ROCKSTAR INDUSTRIES LLP, SEATTLE, WA. FILED 4-19-2013.

# BUTTONMAKERS

THE MARK CONSISTS OF STANDARD CHARACTERS WITHOUT CLAIM TO ANY PARTICULAR FONT, STYLE, SIZE, OR COLOR.

OWNER OF U.S. REG. NO. 3,836,324.  
SEC. 2(F).

FOR ONLINE RETAIL STORE SERVICES FEATURING BUTTONS, MACHINES FOR MAKING BUTTONS, BUTTON PARTS, AND ACCESSORIES FOR BUTTONS (U.S. CLS. 100, 101 AND 102).

FIRST USE 9-0-2004; IN COMMERCE 9-0-2004.  
LEIGH CAROLINE CASE, EXAMINING ATTORNEY

SN 85-910,634. KEY MEDIA SOLUTIONS, LLC, SIOUX FALLS, SD. FILED 4-22-2013.

# KEYMEDIA

THE MARK CONSISTS OF STANDARD CHARACTERS WITHOUT CLAIM TO ANY PARTICULAR FONT, STYLE, SIZE, OR COLOR.

FOR ONLINE ADVERTISING SERVICES FOR OTHERS, NAMELY, INTERNET AND DIGITAL MEDIA CONSULTATION IN THE NATURE OF PLANNING, BUYING, AND ANALYSIS OF ONLINE MEDIA STRATEGY FOR THE PURPOSE OF INTERNET AD BUYING; ONLINE ADVERTISING SERVICES FOR OTHERS, NAMELY, INTERNET AND DIGITAL MEDIA CONSULTATION IN THE NATURE OF SEARCH ENGINE MARKETING, ONLINE DISPLAY ADVERTISING, SOCIAL MEDIA STRATEGY IN THE NATURE OF HELPING CLIENTS CREATE AND EXTEND THEIR PRODUCT AND BRAND STRATEGIES BY BUILDING VIRALLY ENGAGING MARKETING SOLUTIONS, MOBILE SEARCH ENGINE MARKETING, MOBILE DISPLAY ADVERTISING, AND REAL TIME ADVERTISING BUYING FOR BUSINESSES AND ORGANIZATIONS (U.S. CLS. 100, 101 AND 102).

FIRST USE 2-0-2011; IN COMMERCE 3-0-2011.  
RONALD DELGIZZI, EXAMINING ATTORNEY

SN 85-905,966. HOMETASK, INC., SEATTLE, WA. FILED 4-16-2013.

# HACO TACO

THE MARK CONSISTS OF STANDARD CHARACTERS WITHOUT CLAIM TO ANY PARTICULAR FONT, STYLE, SIZE, OR COLOR.

NO CLAIM IS MADE TO THE EXCLUSIVE RIGHT TO USE "TACO", APART FROM THE MARK AS SHOWN.

THE ENGLISH TRANSLATION OF "HACO" IN THE MARK IS "TO MAKE".

FOR RESTAURANT FRANCHISING, NAMELY, OFFERING BUSINESS MANAGEMENT ASSISTANCE IN THE ESTABLISHMENT AND/OR OPERATION OF RESTAURANTS (U.S. CLS. 100, 101 AND 102).

FIRST USE 3-11-2013; IN COMMERCE 3-11-2013.  
KIM MONINGHOFF, EXAMINING ATTORNEY

**CLASS 35—(Continued).**

SN 85-923,986. CALDERON, JESSICA, PACOIMA, CA. FILED 5-6-2013.

THE MARK CONSISTS OF THE STYLIZED TEXT "INDIGENOZ GEMZ", WHERE THE FIRST "I" IN "INDIGENOZ" IS SHAPED LIKE AN EAGLE FEATHER FACING DOWNWARD WITH A DESIGN OF A MEDICINE WHEEL AT THE TOP OF THE "I". A DESIGN OF A STYLIZED RECTANGLE-SHAPED GEM APPEARS AFTER THE "Z" IN "GEMZ".

FOR ON-LINE RETAIL STORE SERVICES FEATURING CLOTHING (U.S. CLS. 100, 101 AND 102).  
LINDA LAVACHE, EXAMINING ATTORNEY

**CLASS 35—(Continued).**

SN 85-933,917. QPHARMA, INC., MORRISTOWN, NJ. FILED 5-16-2013.

THE MARK CONSISTS OF STANDARD CHARACTERS WITHOUT CLAIM TO ANY PARTICULAR FONT, STYLE, SIZE, OR COLOR.

FOR BUSINESS ASSISTANCE, ADVISORY AND CONSULTING SERVICES IN THE FIELD OF PRODUCT/BRAND LAUNCHES FOR PHARMACEUTICAL, MEDICAL DEVICE, BIOLOGICS, AND OTHER LIFE SCIENCES COMPANIES (U.S. CLS. 100, 101 AND 102).

SUSAN RICHARDS, EXAMINING ATTORNEY

SN 85-933,907. SHOP SMART, LLC, CHICAGO, IL. FILED 5-16-2013.



NO CLAIM IS MADE TO THE EXCLUSIVE RIGHT TO USE "SAVINGS SINCE 2001" AND "DEALS", APART FROM THE MARK AS SHOWN.

THE NAME(S), PORTRAIT(S), AND/OR SIGNATURE(S) SHOWN IN THE MARK IDENTIFIES "BRADLEY P. WILSON", WHOSE CONSENT(S) TO REGISTER IS MADE OF RECORD.

THE MARK CONSISTS OF A CIRCLE CONTAINING THE WORDS "HANDPICKED SAVINGS" AT THE TOP OF THE CIRCLE AND "SINCE 2001" AT THE BOTTOM OF THE CIRCLE WITH THE WORDS "BRAD'S DEALS" IN THE MIDDLE OF THE CIRCLE.

FOR PROVIDING A SEARCHABLE ON-LINE ADVERTISING WEBSITE AND GUIDE FEATURING THE GOODS AND SERVICES OF OTHER VENDORS VIA THE INTERNET (U.S. CLS. 100, 101 AND 102).

SUSAN RICHARDS, EXAMINING ATTORNEY

SN 85-935,580. VECTOR ADVISORY, LLC, BOYTON BEACH, FL. FILED 5-17-2013.



NO CLAIM IS MADE TO THE EXCLUSIVE RIGHT TO USE "ADVISORY, LLC", APART FROM THE MARK AS SHOWN.

THE COLOR(S) BLUE AND BLACK IS/ARE CLAIMED AS A FEATURE OF THE MARK.

THE MARK CONSISTS OF THE STYLIZED LETTERS "VA" WHERE THE FIRST PART OF THE "V" AND THE FAR ARM OF THE "A" ARE IN THE COLOR BLUE WHERE THE REMAINING PORTIONS OF THE LETTER ARE IN BLACK, OVER THE WORDING "VECTOR ADVISORY, LLC" IN BLACK.

FOR BUSINESS CONSULTING IN THE AREAS OF: STRATEGIC PLANNING, BUSINESS PLANNING, CRISIS MANAGEMENT, AND RISK MANAGEMENT; LEADERSHIP DEVELOPMENT AND EXECUTIVE COMPENSATION; PRODUCT AND SERVICE LINE DEVELOPMENT, MARKETING AND ADVERTISEMENT, BRANDING, AND DISTRIBUTION CHANNEL DEVELOPMENT AND OPTIMIZATION; CORPORATE GOVERNANCE AND PRODUCTIVITY OPTIMIZATION; AND MERGERS AND ACQUISITIONS, DUE DILIGENCE, BUSINESS SUCCESSION PLANNING, AND OWNER AND INVESTOR EXIT STRATEGIES (U.S. CLS. 100, 101 AND 102).

FIRST USE 5-7-2013; IN COMMERCE 5-7-2013.

LINDA ORNDORFF, EXAMINING ATTORNEY

**CLASS 35—(Continued).**

SN 85-936,136. HIGGINS, VIRGINIA M, DBA THAT BALD CHICK, HAZELWOOD, MO. FILED 5-18-2013.

## That Bald Chick

THE MARK CONSISTS OF STANDARD CHARACTERS WITHOUT CLAIM TO ANY PARTICULAR FONT, STYLE, SIZE, OR COLOR.

FOR ADVERTISING AND MARKETING SERVICES PROVIDED BY MEANS OF INDIRECT METHODS OF MARKETING COMMUNICATIONS, NAMELY, SOCIAL MEDIA, SEARCH ENGINE MARKETING, INQUIRY MARKETING, INTERNET MARKETING, MOBILE MARKETING, BLOGGING AND OTHER FORMS OF PASSIVE, SHARABLE OR VIRAL COMMUNICATIONS CHANNELS (U.S. CLS. 100, 101 AND 102).

FIRST USE 12-24-2010; IN COMMERCE 12-24-2010.  
KERI CANTONE, EXAMINING ATTORNEY

**CLASS 35—(Continued).**

SN 85-936,823. DENELLE FEDOR, SAN JOSE, CA. FILED 5-20-2013.

## DISCOVER SAN JOSE

THE MARK CONSISTS OF STANDARD CHARACTERS WITHOUT CLAIM TO ANY PARTICULAR FONT, STYLE, SIZE, OR COLOR.

NO CLAIM IS MADE TO THE EXCLUSIVE RIGHT TO USE "SAN JOSE", APART FROM THE MARK AS SHOWN.

FOR ADVERTISING, MARKETING AND PROMOTION SERVICES, NAMELY, PROMOTING THE CULTURAL, HISTORICAL, RECREATIONAL, AND ENVIRONMENTAL ADVANTAGES AND BENEFITS OF LIVING IN AND VISITING SAN JOSE, CALIFORNIA AND PROMOTING TOURISM, BUSINESS AND ECONOMIC DEVELOPMENT THROUGH ALL TYPES OF MEDIA, INCLUDING THROUGH THE DISTRIBUTION OF ADVERTISING MATERIALS IN THE NATURE OF CARDS DEPICTING HISTORICAL SITES, PUBLIC GATHERING PLACES, AND PLACES OF INTEREST, IN THE CITY OF SAN JOSE, CALIFORNIA (U.S. CLS. 100, 101 AND 102).

KRISTINA MORRIS, EXAMINING ATTORNEY

SN 85-944,910. DAVIS, CHRISTOPHER, SANTA CLARITA, CA. FILED 5-29-2013.

## RosterBound

THE MARK CONSISTS OF STANDARD CHARACTERS WITHOUT CLAIM TO ANY PARTICULAR FONT, STYLE, SIZE, OR COLOR.

FOR COMPUTER SERVICES, NAMELY, CREATING AN ON-LINE COMMUNITY FOR STUDENTS, STUDENT ATHLETES AND PARENTS, GUARDIANS, COACHES AND SCOUTS OF STUDENTS AND STUDENT ATHLETES FOR THE PURPOSES OF LEARNING ABOUT THE COLLEGE RECRUITING PROCESS AND FINDING OR FILLING A ROSTER SPOT (U.S. CLS. 100, 101 AND 102).

AMY C. KEAN, EXAMINING ATTORNEY

SN 85-936,813. DENELLE FEDOR, SAN JOSE, CA. FILED 5-20-2013.

## CELEBRATE SAN JOSE

THE MARK CONSISTS OF STANDARD CHARACTERS WITHOUT CLAIM TO ANY PARTICULAR FONT, STYLE, SIZE, OR COLOR.

NO CLAIM IS MADE TO THE EXCLUSIVE RIGHT TO USE "SAN JOSE", APART FROM THE MARK AS SHOWN.

FOR ADVERTISING, MARKETING AND PROMOTION SERVICES, NAMELY, PROMOTING THE CULTURAL, HISTORICAL, RECREATIONAL, AND ENVIRONMENTAL ADVANTAGES AND BENEFITS OF LIVING IN AND VISITING SAN JOSE, CALIFORNIA AND PROMOTING TOURISM, BUSINESS AND ECONOMIC DEVELOPMENT THROUGH ALL TYPES OF MEDIA, INCLUDING THROUGH THE DISTRIBUTION OF ADVERTISING MATERIALS IN THE NATURE OF CARDS DEPICTING HISTORICAL SITES, PUBLIC GATHERING PLACES, AND PLACES OF INTEREST, IN THE CITY OF SAN JOSE, CALIFORNIA (U.S. CLS. 100, 101 AND 102).

KRISTINA MORRIS, EXAMINING ATTORNEY

SN 85-953,118. TEAMCME, PENDLETON, OR. FILED 6-6-2013.

## TeamCME

THE MARK CONSISTS OF STANDARD CHARACTERS WITHOUT CLAIM TO ANY PARTICULAR FONT, STYLE, SIZE, OR COLOR.

FOR MAINTAINING A REGISTRY OF MEDICAL EXAMINERS CERTIFIED BY THE U.S. DEPARTMENT OF TRANSPORTATION OR U.S. DEPARTMENT OF HOMELAND SECURITY (U.S. CLS. 100, 101 AND 102).

FIRST USE 6-1-2010; IN COMMERCE 6-1-2010.  
JOANNA DUKOVIC, EXAMINING ATTORNEY

**CLASS 35—(Continued).**

SN 85-957,144. THE REGENTS OF THE UNIVERSITY OF COLORADO, A BODY CORPORATE, DENVER, CO. FILED 6-11-2013.

UNIVERSITY OF COLORADO  
HEALTH AND WELFARE TRUST

THE MARK CONSISTS OF STANDARD CHARACTERS WITHOUT CLAIM TO ANY PARTICULAR FONT, STYLE, SIZE, OR COLOR.

OWNER OF U.S. REG. NOS. 1,728,230, 3,912,904 AND 4,370,104.

NO CLAIM IS MADE TO THE EXCLUSIVE RIGHT TO USE "HEALTH AND WELFARE TRUST", APART FROM THE MARK AS SHOWN.

SEC. 2(F) AS TO "UNIVERSITY OF COLORADO". FOR COST MANAGEMENT AND ADMINISTRATION OF THE WELFARE PLANS FOR EMPLOYEES AND RETIREES (U.S. CLS. 100, 101 AND 102).

FIRST USE 7-1-2010; IN COMMERCE 7-1-2010.  
ANNE MADDEN, EXAMINING ATTORNEY

SN 85-961,779. EQUANCY, 75116 PARIS, FRANCE, FILED 6-17-2013.

EQUANCY

THE MARK CONSISTS OF STANDARD CHARACTERS WITHOUT CLAIM TO ANY PARTICULAR FONT, STYLE, SIZE, OR COLOR.

FOR PROVIDING BUSINESS MANAGEMENT INFORMATION ON A WIDE VARIETY OF TOPICS TO SERVICE PROVIDING PROFESSIONALS; ADVERTISING SERVICES, NAMELY, CREATING CORPORATE BRAND IDENTITY FOR OTHERS; MARKET RESEARCH SERVICES; BUSINESS MANAGEMENT; PUBLIC OPINION POLLING AND MARKET OPINION POLLING FOR BUSINESS OR ADVERTISING PURPOSES; BUSINESS MANAGEMENT CONSULTATION, IN THE FIELD OF SALES, MARKETING, AND NEW TECHNOLOGIES; BUSINESS ADVICE REGARDING INTELLECTUAL PROPERTY RIGHTS (U.S. CLS. 100, 101 AND 102).

FIRST USE 12-23-2008; IN COMMERCE 12-23-2008.  
LINDSEY BEN, EXAMINING ATTORNEY

**CLASS 35—(Continued).**

SN 85-966,363. JACOB D ROTH, TA MALCHIS JUDAICA, BKLYN, NY. FILED 6-21-2013.

malchis

THE MARK CONSISTS OF STANDARD CHARACTERS WITHOUT CLAIM TO ANY PARTICULAR FONT, STYLE, SIZE, OR COLOR.

FOR RETAIL AND WHOLESALE STORE SERVICES FEATURING JUDAIC GOODS IN THE NATURE OF CLOTHING, EMBROIDERIES AND JUDAIC GOODS BEING TZIZIYOT AND TALITOT (U.S. CLS. 100, 101 AND 102).

FIRST USE 4-20-2006; IN COMMERCE 4-20-2006.  
COLLEEN KEARNEY, EXAMINING ATTORNEY

SN 85-967,788. HOSPITAL QUALITY INSTITUTE, SACRAMENTO, CA. FILED 6-24-2013.



NO CLAIM IS MADE TO THE EXCLUSIVE RIGHT TO USE "HOSPITAL QUALITY INSTITUTE", APART FROM THE MARK AS SHOWN.

THE MARK CONSISTS OF A RIBBON DESIGN CURLED IN THE SHAPE OF THE LETTER "Q" AND THE WORDS "HOSPITAL QUALITY INSTITUTE" TO ITS RIGHT.

FOR ASSOCIATION SERVICES, NAMELY, PROMOTING THE INTERESTS OF HOSPITALS AND HOSPITAL SYSTEMS, HOSPITAL COLLABORATIVES, PATIENT SAFETY ORGANIZATIONS AND HEALTH CARE ASSOCIATIONS (U.S. CLS. 100, 101 AND 102).

DAWN HAN, EXAMINING ATTORNEY

SN 85-972,514. NUNDULU LLC, BROOKLYN, NY. FILED 6-28-2013.

Madison Ancient and Tribal  
Art

THE MARK CONSISTS OF STANDARD CHARACTERS WITHOUT CLAIM TO ANY PARTICULAR FONT, STYLE, SIZE, OR COLOR.

NO CLAIM IS MADE TO THE EXCLUSIVE RIGHT TO USE "ANCIENT AND TRIBAL ART", APART FROM THE MARK AS SHOWN.

FOR CONDUCTING TRADE SHOWS IN THE FIELD OF ART (U.S. CLS. 100, 101 AND 102).

FIRST USE 4-1-2012; IN COMMERCE 4-1-2012.  
LINDSEY BEN, EXAMINING ATTORNEY

**CLASS 35—(Continued).**

SN 85-974,112. PLAYBOY ENTERPRISES INTERNATIONAL, INC., BEVERLY HILLS, CA. FILED 7-1-2013.

# PLAYBOY

THE MARK CONSISTS OF STANDARD CHARACTERS WITHOUT CLAIM TO ANY PARTICULAR FONT, STYLE, SIZE, OR COLOR.

OWNER OF U.S. REG. NOS. 2,661,622, 3,242,491 AND OTHERS.

FOR RETAIL STORE SERVICES FEATURING CLOTHING, NOVELTIES, PUBLICATIONS, LINGERIE, JEWELRY, CDS AND VIDEOS, GAMES AND TOYS, PAPER GOODS, HOME ACCESSORIES, SPORTING GOODS, ELECTRONICS, HOUSE WARES, CANDY, CONFECTIONS AND SMOKER'S ARTICLES (U.S. CLS. 100, 101 AND 102).

ELIZABETH CHANG, EXAMINING ATTORNEY

---

SN 86-003,136. REK GROUP, LLC, LAWRENCEBURG, TN. FILED 7-5-2013.

## ALL STAR ABRASIVES

THE MARK CONSISTS OF STANDARD CHARACTERS WITHOUT CLAIM TO ANY PARTICULAR FONT, STYLE, SIZE, OR COLOR.

NO CLAIM IS MADE TO THE EXCLUSIVE RIGHT TO USE "ABRASIVES", APART FROM THE MARK AS SHOWN.

FOR RESELLER SERVICES, NAMELY, DISTRIBUTORSHIP SERVICES IN THE FIELD OF ABRASIVES CONSISTING OF SANDPAPER, SANDING BLOCKS, AND GRINDING WHEELS (U.S. CLS. 100, 101 AND 102).

FIRST USE 8-14-2012; IN COMMERCE 8-14-2012.

BERYL GARDNER, EXAMINING ATTORNEY

---

SN 86-006,056. SODAPOP MEDIA, LLC, LEWISVILLE, TX. FILED 7-10-2013.

## SodaPop Media

THE MARK CONSISTS OF STANDARD CHARACTERS WITHOUT CLAIM TO ANY PARTICULAR FONT, STYLE, SIZE, OR COLOR.

NO CLAIM IS MADE TO THE EXCLUSIVE RIGHT TO USE "MEDIA", APART FROM THE MARK AS SHOWN.

FOR BUSINESS MARKETING SOLUTIONS SERVICES, NAMELY, BUSINESS MARKETING CONSULTING; BRANDING SERVICES, NAMELY, CONSULTING, DEVELOPMENT, MANAGEMENT AND MARKETING OF BRANDS FOR BUSINESSES AND/OR INDIVIDUALS; PROVIDING MARKETING CONSULTING IN THE FIELD OF SOCIAL MEDIA (U.S. CLS. 100, 101 AND 102).

FIRST USE 3-19-2004; IN COMMERCE 3-19-2004.

CAROLINE WOOD, EXAMINING ATTORNEY

**CLASS 35—(Continued).**

SN 86-006,059. SODAPOP MEDIA LLC, LEWISVILLE, TX. FILED 7-10-2013.



NO CLAIM IS MADE TO THE EXCLUSIVE RIGHT TO USE "MEDIA", APART FROM THE MARK AS SHOWN.

THE MARK CONSISTS OF THE WORDING "SODA POP MEDIA", WHERE THE LETTERS IN THE WORD "SODA" ARE STYLIZED, IN PARTICULAR THE LETTER "O" WHICH IS DESIGNED LIKE A SPARKLING BUBBLE, WITH TWO CONSECUTIVE SMALLER BUBBLES PORTRAYING ESCAPING BUBBLES OF GAS. THE LETTERS IN THE WORD "POP" SHOWN BELOW THE WORD "SODA" ARE ALSO STYLIZED, WITH THE LETTER "O" DESIGNED LIKE A SPARKLING BUBBLE. THE WORD "MEDIA" COMES BELOW THE WORD "POP" AND IT IS POSITIONED BETWEEN THE LOWER SECTIONS OF THE LETTERS "P" IN "POP".

FOR BUSINESS MARKETING SOLUTIONS SERVICES, NAMELY, BUSINESS MARKETING CONSULTING; BRANDING SERVICES, NAMELY, CONSULTING, DEVELOPMENT, MANAGEMENT AND MARKETING OF BRANDS FOR BUSINESSES AND/OR INDIVIDUALS; PROVIDING MARKETING CONSULTING IN THE FIELD OF SOCIAL MEDIA (U.S. CLS. 100, 101 AND 102).

FIRST USE 3-19-2004; IN COMMERCE 3-19-2004.

CAROLINE WOOD, EXAMINING ATTORNEY

---

SN 86-006,289. FARBER, RANDY S., CHICAGO, IL. FILED 7-10-2013.

## IPLAYGOLFCARD.COM

THE MARK CONSISTS OF STANDARD CHARACTERS WITHOUT CLAIM TO ANY PARTICULAR FONT, STYLE, SIZE, OR COLOR.

FOR ONLINE RETAIL STORE SERVICES FEATURING GIFT CARDS (U.S. CLS. 100, 101 AND 102).

KIM MONINGHOFF, EXAMINING ATTORNEY

**CLASS 35—(Continued).**

SN 86-006,572. MATTHEW WONG, SYOSSET, NY. FILED 7-10-2013.

# AMPit

THE MARK CONSISTS OF STANDARD CHARACTERS WITHOUT CLAIM TO ANY PARTICULAR FONT, STYLE, SIZE, OR COLOR.

FOR SOCIAL MEDIA MARKETING SERVICES; ADVERTISING AND MARKETING SERVICES, NAMELY, PROMOTING THE GOODS AND SERVICES OF OTHERS; ADVERTISING, MARKETING AND PROMOTION SERVICES VIA A SOCIAL MEDIA AND ADVERTISING PLATFORM FOR PROMOTING THE GOODS AND SERVICES OF OTHERS; ONLINE RETAIL STORE SERVICES FEATURING BOOKS, MOVIES, DVDS, MUSIC, CDS, VIDEO GAMES, ELECTRONICS, COMPUTERS, TABLETS, MOBILE DEVICES, BEAUTY PRODUCTS, HEALTH PRODUCTS, TOYS, CLOTHING, FOOTWEAR, JEWELRY, SPORTS EQUIPMENT, APPAREL AND FOOD AND HOME PRODUCTS (U.S. CLS. 100, 101 AND 102).

JAY BESCH, EXAMINING ATTORNEY

SN 86-007,282. SONIDO MASK, INC., SAN MATEO, CA. FILED 7-11-2013.



NO CLAIM IS MADE TO THE EXCLUSIVE RIGHT TO USE "SONIDO MASK", APART FROM THE MARK AS SHOWN.

THE COLOR(S) GRAY, BLACK, WHITE AND RED IS/ARE CLAIMED AS A FEATURE OF THE MARK.

THE MARK CONSISTS OF THE STYLIZED TEXT "SONIDO MASK" ALL IN GRAY EXCEPT FOR THE "I" WHICH IS IN RED. BETWEEN THE WORDS IS A DESIGN OF A MASK WEARING HEADPHONES, THE HEADPHONES ARE RED AND BLACK, THE FACIAL AREA IS GRAY, THE NOSE IS BLACK AND THE EYES ARE BLACK AND RED. THE HEAD AREA IS BLACK AND WHITE STRIPED. THE BACKGROUND OF THE MARK IS WHITE, AND IS NOT CLAIMED AS A FEATURE OF THE MARK.

THE ENGLISH TRANSLATION OF THE WORD "SONIDO" IN THE MARK IS "SOUND".

FOR DISTRIBUTORSHIP SERVICES IN THE FIELD OF ELECTRONIC PRODUCTS; MARKETING SERVICES; ON-LINE RETAIL STORE SERVICES FEATURING VARIOUS ELECTRONIC EQUIPMENT; RETAIL STORE SERVICES FEATURING VARIOUS ELECTRONIC EQUIPMENT (U.S. CLS. 100, 101 AND 102).

KERI CANTONE, EXAMINING ATTORNEY

**CLASS 35—(Continued).**

SN 86-007,531. CSAM MARKETING, INC., SOMERVILLE, NJ. FILED 7-11-2013.

# CLASS COMPETE

THE MARK CONSISTS OF STANDARD CHARACTERS WITHOUT CLAIM TO ANY PARTICULAR FONT, STYLE, SIZE, OR COLOR.

FOR OPERATION OF AN ONLINE MARKETPLACE IN THE FIELD OF EDUCATIONAL COMPUTER SOFTWARE (U.S. CLS. 100, 101 AND 102).

FIRST USE 12-5-2013; IN COMMERCE 12-5-2013.  
INGRID C. EULIN, EXAMINING ATTORNEY

SN 86-008,384. ZHANG, JEANNETTE L, MONROVIA, CA. FILED 7-12-2013.



THE WORDING "MEPAB" HAS NO MEANING OTHER THAN TRADEMARK SIGNIFICANCE.

FOR PROVIDING A WEBSITE FEATURING CONSUMER INFORMATION, NAMELY, DIRECTORY INFORMATION, RATINGS, REVIEWS, PHOTOS, QUESTIONS AND ANSWERS, REFERRALS AND RECOMMENDATIONS RELATING TO BUSINESSES, SERVICE PROVIDERS, EVENTS, PUBLIC SERVICES AND GOVERNMENT AGENCIES; PROVIDING CONSUMER INFORMATION, NAMELY, COMPILATIONS, RANKINGS, RATINGS, REVIEWS, REFERRALS AND RECOMMENDATIONS RELATING TO BUSINESSES, SERVICE PROVIDERS, EVENTS, PUBLIC SERVICES AND GOVERNMENT AGENCIES; ADVERTISING, MARKETING AND PROMOTION SERVICES, NAMELY, PROVIDING INFORMATION REGARDING DISCOUNTS, COUPONS, REBATES, VOUCHERS, LINKS TO RETAIL WEBSITE OF OTHERS, AND SPECIAL OFFERS FOR THE GOODS AND SERVICES OF OTHERS (U.S. CLS. 100, 101 AND 102).

FIRST USE 2-20-2013; IN COMMERCE 2-20-2013.  
KATHRYN COWARD, EXAMINING ATTORNEY



**CLASS 35—(Continued).**

SN 86-008,504. TOY TRADERS, LLC, LAKEWOOD, NJ.  
FILED 7-12-2013.

TOYS 4 THOUGHT

THE MARK CONSISTS OF STANDARD CHARACTERS WITHOUT CLAIM TO ANY PARTICULAR FONT, STYLE, SIZE, OR COLOR.

NO CLAIM IS MADE TO THE EXCLUSIVE RIGHT TO USE "TOYS", APART FROM THE MARK AS SHOWN.

FOR RETAIL STORE SERVICES FEATURING TOYS AND GAMES (U.S. CLS. 100, 101 AND 102).

FIRST USE 7-9-2013; IN COMMERCE 7-9-2013.

DAVID I, EXAMINING ATTORNEY

SN 86-008,834. FC KERBECK & SONS, PALMYRA, NJ.  
FILED 7-12-2013.

FC KERBECK & SONS

THE MARK CONSISTS OF STANDARD CHARACTERS WITHOUT CLAIM TO ANY PARTICULAR FONT, STYLE, SIZE, OR COLOR.

NO CLAIM IS MADE TO THE EXCLUSIVE RIGHT TO USE "& SONS", APART FROM THE MARK AS SHOWN.

THE NAME(S), PORTRAIT(S), AND/OR SIGNATURE(S) SHOWN IN THE MARK DOES NOT IDENTIFY A PARTICULAR LIVING INDIVIDUAL.

FOR AUTOMOBILE DEALERSHIPS (U.S. CLS. 100, 101 AND 102).

KATHERINE CONNOLLY, EXAMINING ATTORNEY

**CLASS 35—(Continued).**

SN 86-008,851. PROVIDE, INC., CAMBRIDGE, MA. FILED 7-12-2013.



THE MARK CONSISTS OF THE WORD "PROVIDE" IN LARGE LOWER-CASE LETTERS OVER THE WORDING "EVERYONE HAS A ROLE" IN SMALLER UPPER-CASE LETTERS, WITH AN UMBRELLA-SHAPED DESIGN OVER THE "I" IN "PROVIDE" COMPRISED OF SIX DOTS THAT GRADUATE IN SHADING FROM DARK TO LIGHT.

FOR PUBLIC ADVOCACY TO PROMOTE AWARENESS OF THE NEED FOR ACCESSIBLE QUALITY ABORTION, MISCARRIAGE MANAGEMENT AND REPRODUCTIVE HEALTH CARE SERVICES AND RELATED COUNSELING SERVICES; PUBLIC ADVOCACY TO PROMOTE AWARENESS OF THE NEED FOR REFERRING INDIVIDUALS TO ABORTION, MISCARRIAGE MANAGEMENT AND REPRODUCTIVE HEALTH CARE SERVICES AND RELATED COUNSELING SERVICES; PUBLIC ADVOCACY TO PROMOTE AWARENESS OF THE NEED TO TRAIN HEALTH CARE PROVIDERS IN ABORTION, MISCARRIAGE MANAGEMENT AND REPRODUCTIVE HEALTH CARE SERVICES, AND THE NEED TO TRAIN HEALTH CARE PROVIDERS AND SOCIAL SERVICE PROVIDERS IN RELATED COUNSELING SERVICES (U.S. CLS. 100, 101 AND 102).

FIRST USE 9-17-2012; IN COMMERCE 9-17-2012.

STEVEN PEREZ, EXAMINING ATTORNEY

SN 86-009,313. DUJO LLC, WINTER PARK, FL. FILED 7-12-2013.

DUJO

THE MARK CONSISTS OF STANDARD CHARACTERS WITHOUT CLAIM TO ANY PARTICULAR FONT, STYLE, SIZE, OR COLOR.

FOR TESTING, ANALYSIS AND EVALUATION OF THE KNOWLEDGE, SKILLS AND ABILITY OF OTHERS TO PREDICT LEADERSHIP SKILLS AND ASSESS TRAINING NEEDS OF INDIVIDUALS IN THE WORKPLACE; HUMAN RESOURCES SERVICES, NAMELY, PERSONNEL SELECTION FOR OTHERS (U.S. CLS. 100, 101 AND 102).

FIRST USE 1-5-2012; IN COMMERCE 1-5-2012.

BRIDGETT SMITH, EXAMINING ATTORNEY

**CLASS 35—(Continued).**

SN 86-011,180. JENKINS, ALAN K, DBA IN CLASS LEARNING CENTERS, ST. PETERSBURG, FL. FILED 7-16-2013.

## Happy Hour Network

THE MARK CONSISTS OF STANDARD CHARACTERS WITHOUT CLAIM TO ANY PARTICULAR FONT, STYLE, SIZE, OR COLOR.

NO CLAIM IS MADE TO THE EXCLUSIVE RIGHT TO USE "NETWORK", APART FROM THE MARK AS SHOWN. FOR ADVERTISING, MARKETING AND PROMOTIONAL SERVICES RELATED TO ALL INDUSTRIES FOR THE PURPOSE OF FACILITATING NETWORKING AND SOCIALIZING OPPORTUNITIES FOR BUSINESS PURPOSES (U.S. CLS. 100, 101 AND 102).

FIRST USE 12-1-1990; IN COMMERCE 1-1-1993.  
RICHARD WHITE, EXAMINING ATTORNEY

---

SN 86-011,634. SAW ENTERPRISES LLC, DBA PETBOX, SAN DIEGO, CA. FILED 7-16-2013.

## GETPETBOX

THE MARK CONSISTS OF STANDARD CHARACTERS WITHOUT CLAIM TO ANY PARTICULAR FONT, STYLE, SIZE, OR COLOR.

FOR ON-LINE RETAIL STORE SERVICES AND MAIL ORDER SERVICES FEATURING PET PRODUCTS (U.S. CLS. 100, 101 AND 102).

TIMOTHY FINNEGAN, EXAMINING ATTORNEY

---

SN 86-011,718. POC NETWORK TECHNOLOGIES, INC., CORAL GABLES, FL. FILED 7-16-2013.

## CROSS BENEFIT CLEARINGHOUSE

THE MARK CONSISTS OF STANDARD CHARACTERS WITHOUT CLAIM TO ANY PARTICULAR FONT, STYLE, SIZE, OR COLOR.

NO CLAIM IS MADE TO THE EXCLUSIVE RIGHT TO USE "BENEFIT CLEARINGHOUSE", APART FROM THE MARK AS SHOWN.

FOR MEDICAL CLAIMS MANAGEMENT SERVICES, NAMELY, RECEIVING, DATA ENTERING, AND REPRICING OF TRANSACTIONS THAT ARE ORIGINATED BY PHYSICIANS, HOSPITALS, PHARMACIES AND ANCILLARY MEDICAL CARE PROVIDERS; BILLING SERVICES (U.S. CLS. 100, 101 AND 102).

CAROLINE WOOD, EXAMINING ATTORNEY

**CLASS 35—(Continued).**

SN 86-011,752. POC NETWORK TECHNOLOGIES, INC., CORAL GABLES, FL. FILED 7-16-2013.



THE MARK CONSISTS OF THE WORD "TRANSACTRX" LOCATED TO THE RIGHT SIDE OF AN ARROW DESIGN. FOR MEDICAL CLAIMS MANAGEMENT SERVICES, NAMELY, RECEIVING, DATA ENTERING, AND REPRICING OF TRANSACTIONS THAT ARE ORIGINATED BY PHYSICIANS, HOSPITALS, PHARMACIES AND ANCILLARY MEDICAL CARE PROVIDERS; BILLING SERVICES (U.S. CLS. 100, 101 AND 102).

CAROLINE WOOD, EXAMINING ATTORNEY

---

SN 86-012,886. FRESH CUT CREATIVE, INC., SEAL BEACH, CA. FILED 7-17-2013.

## FRESH CUT CREATIVE

THE MARK CONSISTS OF STANDARD CHARACTERS WITHOUT CLAIM TO ANY PARTICULAR FONT, STYLE, SIZE, OR COLOR.

NO CLAIM IS MADE TO THE EXCLUSIVE RIGHT TO USE "CREATIVE", APART FROM THE MARK AS SHOWN.

FOR PRODUCTION AGENCY, NAMELY, ADVERTISING AGENCY SPECIALIZING IN THE DEVELOPMENT OF MARKETING IDEAS AND SOLUTIONS FOR BUSINESSES THROUGH ADVERTISING MATERIALS, COMMERCIALS, PROMOS, PROMOTIONAL VIDEOS AND WEB CONTENT; PRODUCTION OF ADVERTISING MATERIALS, COMMERCIALS, PROMOS AND PROMOTIONAL VIDEOS AND PROMOTIONAL CONTENT (U.S. CLS. 100, 101 AND 102).

FIRST USE 7-12-2011; IN COMMERCE 1-23-2012.

KAMAL PREET, EXAMINING ATTORNEY

**CLASS 35—(Continued).**

SN 86-016,701. THE HERRING IMPACT GROUP, LLC, ST. LOUIS, MO. FILED 7-22-2013.

# Impact Group

THE MARK CONSISTS OF STANDARD CHARACTERS WITHOUT CLAIM TO ANY PARTICULAR FONT, STYLE, SIZE, OR COLOR.

NO CLAIM IS MADE TO THE EXCLUSIVE RIGHT TO USE "GROUP", APART FROM THE MARK AS SHOWN.

FOR CONSULTING SERVICES IN THE FIELD OF HUMAN RESOURCES DEVELOPMENT, NAMELY, FOR THE PROMOTION OF EMPLOYEE RETENTION, CAREER GROWTH, AND INCREASED PRODUCTIVITY FOR EMPLOYEES AND EMPLOYERS; CONSULTING SERVICES IN THE FIELD OF HUMAN RESOURCES DEVELOPMENT, NAMELY, UTILIZING TECHNOLOGY FOR THE PROMOTION OF EMPLOYEE RETENTION, CAREER GROWTH AND INCREASED PRODUCTIVITY FOR EMPLOYEES AND EMPLOYERS (U.S. CLS. 100, 101 AND 102).

FIRST USE 3-31-1986; IN COMMERCE 12-31-1988.  
HENRY S. ZAK, EXAMINING ATTORNEY

---

SN 86-017,191. TRUE WEDDING LINKS, INC., SOLANA BEACH, CA. FILED 7-23-2013.

# True Venues

THE MARK CONSISTS OF STANDARD CHARACTERS WITHOUT CLAIM TO ANY PARTICULAR FONT, STYLE, SIZE, OR COLOR.

NO CLAIM IS MADE TO THE EXCLUSIVE RIGHT TO USE "VENUES", APART FROM THE MARK AS SHOWN.

FOR VENDOR MANAGEMENT SERVICES FOR WEDDINGS AND SOCIAL EVENTS (U.S. CLS. 100, 101 AND 102).

ELIZABETH KAJUBI, EXAMINING ATTORNEY

**CLASS 35—(Continued).**

SN 86-018,302. GROW THE PRODUCE SHOP, INC., MANHATTAN BEACH, CA. FILED 7-24-2013.

# Farm Fresh. City Fast

THE MARK CONSISTS OF STANDARD CHARACTERS WITHOUT CLAIM TO ANY PARTICULAR FONT, STYLE, SIZE, OR COLOR.

NO CLAIM IS MADE TO THE EXCLUSIVE RIGHT TO USE "FARM FRESH", APART FROM THE MARK AS SHOWN.

FOR ON-LINE RETAIL STORE SERVICES FEATURING FARM FRESH FRUITS, VEGETABLES, MEAT, DAIRY, WINE AND VARIOUS GROCERY ITEMS; RETAIL STORE SERVICES FEATURING FARM FRESH FRUITS, VEGETABLES, MEAT, DAIRY, WINE AND VARIOUS GROCERY ITEMS (U.S. CLS. 100, 101 AND 102).

WILLIAM BRECKENFELD, EXAMINING ATTORNEY

---

SN 86-018,595. HAWK AMERICAN OUTDOORS, INC., CONCORD, CA. FILED 7-24-2013.

# HAWK AMERICAN OUTDOORS

THE MARK CONSISTS OF STANDARD CHARACTERS WITHOUT CLAIM TO ANY PARTICULAR FONT, STYLE, SIZE, OR COLOR.

NO CLAIM IS MADE TO THE EXCLUSIVE RIGHT TO USE "AMERICAN OUTDOORS", APART FROM THE MARK AS SHOWN.

FOR ONLINE RETAIL STORE SERVICES FOR FIREARMS, PARTS AND ACCESSORIES FOR FIREARMS, AMMUNITION, AND HUNTING EQUIPMENT AND CLOTHING (U.S. CLS. 100, 101 AND 102).

SALLY SHIH, EXAMINING ATTORNEY

---

SN 86-020,128. ZAPLINE, INC., LODI, CA. FILED 7-25-2013.

# VICZIN

THE MARK CONSISTS OF STANDARD CHARACTERS WITHOUT CLAIM TO ANY PARTICULAR FONT, STYLE, SIZE, OR COLOR.

FOR ADMINISTERING A WINE CLUB BY MEANS OF SELECTING WINES BASED ON CONSUMER EXPECTATIONS AND ARRANGING PERIODIC SHIPMENT TO CLUB MEMBERS (U.S. CLS. 100, 101 AND 102).

FIRST USE 6-15-2013; IN COMMERCE 6-15-2013.  
TASHIA BUNCH, EXAMINING ATTORNEY

**CLASS 35—(Continued).**

SN 86-020,256. AAL ENTERPRISES, LLC, DBA HUMAN INTERCONNECTED MUSIC, OAKLAND, CA. FILED 7-25-2013.

**Human Interconnected Music**

THE MARK CONSISTS OF STANDARD CHARACTERS WITHOUT CLAIM TO ANY PARTICULAR FONT, STYLE, SIZE, OR COLOR.

NO CLAIM IS MADE TO THE EXCLUSIVE RIGHT TO USE "MUSIC", APART FROM THE MARK AS SHOWN.

FOR ENTERTAINMENT MARKETING SERVICES, NAMELY, MARKETING, PROMOTION AND ADVERTISING FOR INDEPENDENT RECORDING ARTISTS; ENTERTAINMENT MARKETING SERVICES, NAMELY, MARKETING, PROMOTION AND ADVERTISING FOR RECORDING AND PERFORMING ARTISTS; PERSONAL MANAGEMENT SERVICES FOR ENTERTAINERS; TALENT AGENCIES; TALENT AGENCIES FOR MUSICAL ARTISTS; TALENT AGENCY SERVICES; TALENT MANAGEMENT SERVICES FOR MUSICAL ARTISTS (U.S. CLS. 100, 101 AND 102).

FIRST USE 7-1-2013; IN COMMERCE 7-1-2013.

ROBERT C. CLARK JR., EXAMINING ATTORNEY

---

SN 86-020,413. GOLD RUSH BRANDS, LLC, SCARSDALE, NY. FILED 7-25-2013.

**THE MEDICINE CABINET**

THE MARK CONSISTS OF STANDARD CHARACTERS WITHOUT CLAIM TO ANY PARTICULAR FONT, STYLE, SIZE, OR COLOR.

FOR ON-LINE RETAIL STORE SERVICES FEATURING A WIDE VARIETY OF CONSUMER GOODS OF OTHERS; RETAIL DRUG STORE SERVICES; RETAIL STORE SERVICES FEATURING A WIDE VARIETY OF CONSUMER GOODS OF OTHERS (U.S. CLS. 100, 101 AND 102).

SHAILA LEWIS, EXAMINING ATTORNEY

---

SN 86-020,740. HALCYON CORPORATE SERVICES, INC., BROOKLYN, NY. FILED 7-26-2013.

**AccrediFi**

THE MARK CONSISTS OF STANDARD CHARACTERS WITHOUT CLAIM TO ANY PARTICULAR FONT, STYLE, SIZE, OR COLOR.

FOR PROVIDING INFORMATION AS TO THE FINANCIAL QUALIFICATIONS OF INVESTORS SEEKING TO PURCHASE CERTAIN TYPES OF SECURITIES AND INVESTMENTS (U.S. CLS. 100, 101 AND 102).

JERI J. FICKES, EXAMINING ATTORNEY

**CLASS 35—(Continued).**

SN 86-020,782. CITY OF ALLIANCE NEBRASKA, ALLIANCE, NE. FILED 7-26-2013.

**BUILDING THE BEST HOMETOWN  
IN AMERICA**

THE MARK CONSISTS OF STANDARD CHARACTERS WITHOUT CLAIM TO ANY PARTICULAR FONT, STYLE, SIZE, OR COLOR.

FOR LOCAL GOVERNMENT SERVICES, NAMELY, PROMOTING BUSINESS, PROMOTING TOURISM FOR THE CITY OF ALLIANCE, NEBRASKA; CONVENTION AND VISITOR BUREAU SERVICES, NAMELY, PROMOTING CONVENTIONS, PROMOTING BUSINESS FOR THE CITY OF ALLIANCE, NEBRASKA, INCLUDING ALSO SUCH SERVICES UNDER THE CITY OF CHOICE INITIATIVE AND THE CENTER OF COMMUNITY SERVICE EXCELLENCE; ADVERTISING, MARKETING AND PROMOTING ECONOMIC DEVELOPMENT, TOURISM AND HISTORIC ATTRACTIONS IN THE CITY OF ALLIANCE, NEBRASKA; ADVERTISING, MARKETING AND PROMOTING THE BUSINESS AND RESIDENTIAL INTERESTS OF LOCAL BUSINESSES AND INHABITANTS OF THE CITY OF ALLIANCE, NEBRASKA; ADVERTISING, MARKETING AND PROMOTING ECONOMIC DEVELOPMENT, BUSINESS AND CIVIC INTERESTS RELATED TO AND UNDER THE CITY OF CHOICE INITIATIVE AND AS A CENTER OF COMMUNITY SERVICE EXCELLENCE PROGRAMS IN THE CITY OF ALLIANCE, NEBRASKA; GOVERNMENT AND CHAMBER OF COMMERCE SERVICES, NAMELY, PROMOTING ECONOMIC DEVELOPMENT, BUSINESS, COMMERCE, RECREATION, TOURISM, CULTURAL AND HISTORICAL INTERESTS IN FOR THE CITY OF ALLIANCE, NEBRASKA; CHAMBER OF COMMERCE SERVICES, NAMELY, MARKETING, ORGANIZING, CONDUCTING AND PROMOTING FAIRS, AUCTIONS, SPECIAL EVENTS AND EXHIBITIONS FOR BUSINESS DEVELOPMENT, EMPLOYMENT, PERSONAL DEVELOPMENT, EDUCATION, LEISURE, SPORTS, SOCIAL INTERACTION, AND ENTERTAINMENT PURPOSES; CHAMBER OF COMMERCE SERVICES, NAMELY, PROMOTING COMMUNITY FACILITIES, MUSEUMS AND ORGANIZATIONS IN ALLIANCE, NEBRASKA FOR BUSINESS DEVELOPMENT, EMPLOYMENT, PERSONAL DEVELOPMENT AND EDUCATION (U.S. CLS. 100, 101 AND 102).

FIRST USE 9-19-2011; IN COMMERCE 1-2-2013.

SAIMA MAKHDOOM, EXAMINING ATTORNEY

**CLASS 35—(Continued).**

SN 86-020,835. CITY OF ALLIANCE NEBRASKA, ALLIANCE, NE. FILED 7-26-2013.



THE MARK CONSISTS OF A SUN RISING OVER A HILL WITH THE WORD "ALLIANCE" UNDERNEATH.

FOR LOCAL GOVERNMENT SERVICES, NAMELY, PROMOTING BUSINESS, PROMOTING TOURISM FOR THE CITY OF ALLIANCE, NEBRASKA; CONVENTION AND VISITOR BUREAU SERVICES, NAMELY, PROMOTING CONVENTIONS, PROMOTING BUSINESS FOR THE CITY OF ALLIANCE, NEBRASKA, INCLUDING ALSO SUCH SERVICES UNDER THE CITY OF CHOICE INITIATIVE AND THE CENTER OF COMMUNITY SERVICE EXCELLENCE; ADVERTISING, MARKETING AND PROMOTING ECONOMIC DEVELOPMENT, TOURISM AND HISTORIC ATTRACTIONS IN THE CITY OF ALLIANCE, NEBRASKA; ADVERTISING, MARKETING AND PROMOTING THE BUSINESS AND RESIDENTIAL INTERESTS OF LOCAL BUSINESSES AND INHABITANTS OF THE CITY OF ALLIANCE, NEBRASKA; ADVERTISING, MARKETING AND PROMOTING ECONOMIC DEVELOPMENT, BUSINESS AND CIVIC INTERESTS RELATED TO AND UNDER THE CITY OF CHOICE INITIATIVE AND AS A CENTER OF COMMUNITY SERVICE EXCELLENCE PROGRAMS IN THE CITY OF ALLIANCE, NEBRASKA; GOVERNMENT AND CHAMBER OF COMMERCE SERVICES, NAMELY, PROMOTING ECONOMIC DEVELOPMENT, BUSINESS, COMMERCE, RECREATION, TOURISM, CULTURAL AND HISTORICAL INTERESTS IN FOR THE CITY OF ALLIANCE, NEBRASKA; CHAMBER OF COMMERCE SERVICES, NAMELY, MARKETING, ORGANIZING, CONDUCTING AND PROMOTING FAIRS, AUCTIONS, SPECIAL EVENTS AND EXHIBITIONS FOR BUSINESS DEVELOPMENT, EMPLOYMENT, PERSONAL DEVELOPMENT, EDUCATION, LEISURE, SPORTS, SOCIAL INTERACTION, AND ENTERTAINMENT PURPOSES; CHAMBER OF COMMERCE SERVICES, NAMELY, PROMOTING COMMUNITY FACILITIES, MUSEUMS AND ORGANIZATIONS IN ALLIANCE, NEBRASKA FOR BUSINESS DEVELOPMENT, EMPLOYMENT, PERSONAL DEVELOPMENT AND EDUCATION (U.S. CLS. 100, 101 AND 102).

FIRST USE 9-19-2011; IN COMMERCE 1-2-2013.  
SAIMA MAKHDOOM, EXAMINING ATTORNEY

**CLASS 35—(Continued).**

SN 86-021,059. FIZBO, LLC, ATLANTA, GA. FILED 7-26-2013.



NO CLAIM IS MADE TO THE EXCLUSIVE RIGHT TO USE "FSBO", APART FROM THE MARK AS SHOWN.

THE MARK CONSISTS OF THE STYLIZED WORD "FIZBO" WITH THE LETTERS IN DOUBLE LINES AND A LEFT FACING ARROW FORMING THE TOP OF THE "Z" AND A RIGHT FACING ARROW FORMING THE BOTTOM OF THE "Z".

FOR PROVIDING A WEB SITE THAT FEATURES AN ON-LINE MARKET FOR USERS TO LIST OFFERED OR WANTED PERSONAL AND BUSINESS ASSETS, EXCLUDING HOMES AND REAL ESTATE, AND SKILLS FOR HIRE, RENT, SALE OR AUCTION TRANSACTED ON THE BASIS OF PREDEFINED PERFORMANCE AND CLOSING TERMS AND CONDITIONS (U.S. CLS. 100, 101 AND 102).

ELISSA GARBER KON, EXAMINING ATTORNEY

SN 86-021,190. RITTER COMMUNICATIONS HOLDINGS, INC., DBA RITTER COMMUNICATIONS, JONESBORO, AR. FILED 7-26-2013.



NO CLAIM IS MADE TO THE EXCLUSIVE RIGHT TO USE "YOUR HR", APART FROM THE MARK AS SHOWN.

THE COLOR(S) BLACK AND ORANGE IS/ARE CLAIMED AS A FEATURE OF THE MARK.

THE MARK CONSISTS OF THE WORDS "YOUR HR" IN BOLD FONT. "YOUR" IS IN BLACK, THE "H" IN "HR" IS IN ORANGE, AND THE "R" IN "HR" IS IN BLACK. THERE IS AN ORANGE BRUSHSTROKE STARTING IN THE BOTTOM LEFT CORNER AND ENDING UP AT A POINT IN THE BOTTOM RIGHT CORNER; THIS STROKE IS USED TO FORM THE HORIZONTAL LINE IN THE "H" IN "HR".

FOR CONSULTING SERVICES IN THE FIELDS OF BUSINESS MANAGEMENT, HUMAN RESOURCES, AND BUSINESS ORGANIZATIONAL DESIGN; EMPLOYEE ADMINISTRATION SERVICES; EMPLOYMENT HIRING, RECRUITING, PLACEMENT, STAFFING AND CAREER NETWORKING SERVICES; HUMAN RESOURCE ANALYSIS AND CONSULTING SERVICES; HUMAN RESOURCES CONSULTATION; PROVIDING OFFICE FUNCTIONS; SERVING AS A HUMAN RESOURCES DEPARTMENT FOR OTHERS (U.S. CLS. 100, 101 AND 102).

FIRST USE 11-29-2012; IN COMMERCE 11-29-2012.  
AMY ALFIERI, EXAMINING ATTORNEY

**CLASS 35—(Continued).**

SN 86-023,385. LORRAINE TYNE INC., BEACON, NY. FILED 7-30-2013.

# Lorraine Tyne

THE MARK CONSISTS OF STANDARD CHARACTERS WITHOUT CLAIM TO ANY PARTICULAR FONT, STYLE, SIZE, OR COLOR.

THE NAME "LORRAINE TYNE" DOES NOT IDENTIFY A LIVING INDIVIDUAL.

FOR ON-LINE RETAIL STORE SERVICES FEATURING WOMEN'S ACCESSORIES, HATS, BELTS, JEWELRY; RETAIL STORE SERVICES FEATURING WOMEN'S ACCESSORIES, HATS, BELTS, JEWELRY (U.S. CLS. 100, 101 AND 102).

FIRST USE 12-12-2012; IN COMMERCE 12-12-2012.  
YAT SYE, LEE, EXAMINING ATTORNEY

**CLASS 35—(Continued).**

SN 86-024,984. NATURAL WONDERS GALLERY, INC., DBA THE ROTELLA GALLERY, LAS VEGAS, NV. FILED 7-31-2013.

ROTELLA  GALLERY

NO CLAIM IS MADE TO THE EXCLUSIVE RIGHT TO USE "GALLERY", APART FROM THE MARK AS SHOWN. THE MARK CONSISTS OF THE WORD "ROTELLA", FOLLOWED BY THE WORD "THE" IN A SMALLER FONT SIZE, ABOVE A GEOMETRIC PATTERN OF EIGHT OVERLAPPING SPIRALS ARRANGED IN A CIRCULAR PATTERN, FOLLOWED BY THE WORD "GALLERY".

FOR ART GALLERY SERVICES; ONLINE ART GALLERIES; ART GALLERIES FEATURING PHOTOGRAPHIC PRINTS, PAINTINGS, SCULPTURES AND OTHER WORKS OF ART BEING OFFERED FOR SALE; RETAIL AND WHOLESALE STORE SERVICES FEATURING ARTWORK, PAPER GOODS, PHOTOGRAPHIC PRINTS, POSTERS, ART REPRODUCTION PRINTS, PEN/INK DRAWINGS, LITHOGRAPHIC PRINTS, LIMITED EDITION PRINTS, AND OTHER ART (U.S. CLS. 100, 101 AND 102).

FIRST USE 7-31-2013; IN COMMERCE 7-31-2013.  
RONALD MCMORROW, EXAMINING ATTORNEY

SN 86-024,500. REBEL INTERACTIVE, INC., OMAHA, NE. FILED 7-31-2013.



THE MARK CONSISTS OF TWO CONCENTRIC CIRCLES, WITH THE SHADED INNER CIRCLE CONTAINING THE UNSHADED LOWER CASE LETTER "R" WITH THE SHADED NUMBER "2" WRITTEN IN THE CURVED HORIZONTAL STEM OF THE LETTER, "R", WITH A SHADED BORDER OF THE UNSHADED OUTER CIRCLE.

FOR BRAND CONCEPT AND BRAND DEVELOPMENT SERVICES FOR CORPORATE AND INDIVIDUAL CLIENTS; BRAND EVALUATION SERVICES; BRANDING SERVICES, NAMELY, CONSULTING, DEVELOPMENT, MANAGEMENT AND MARKETING OF BRANDS FOR BUSINESSES AND/OR INDIVIDUALS; MARKETING AND BRANDING SERVICES, NAMELY, PROVIDING CUSTOMIZED COMMUNICATION PROGRAMS TO OBTAIN CONSUMER INSIGHTS AND DEVELOP BRANDING STRATEGIES (U.S. CLS. 100, 101 AND 102).

FIRST USE 1-11-1999; IN COMMERCE 1-11-1999.  
ODESSA BIBBINS, EXAMINING ATTORNEY

SN 86-024,985. NATURAL WONDERS GALLERY, INC., DBA THE ROTELLA GALLERY, LAS VEGAS, NV. FILED 7-31-2013.



THE MARK CONSISTS OF A GEOMETRIC PATTERN CONSISTING OF EIGHT OVERLAPPING SPIRALS ARRANGED IN A CIRCULAR PATTERN.

FOR ART GALLERY SERVICES; ONLINE ART GALLERIES; ART GALLERIES FEATURING PHOTOGRAPHIC PRINTS, PAINTINGS, SCULPTURES AND OTHER WORKS OF ART BEING OFFERED FOR SALE; RETAIL AND WHOLESALE STORE SERVICES FEATURING ARTWORK, PAPER GOODS, PHOTOGRAPHIC PRINTS, POSTERS, ART REPRODUCTION PRINTS, PEN/INK DRAWINGS, LITHOGRAPHIC PRINTS, LIMITED EDITION PRINTS, AND OTHER ART (U.S. CLS. 100, 101 AND 102).

FIRST USE 7-31-2013; IN COMMERCE 7-31-2013.  
RONALD MCMORROW, EXAMINING ATTORNEY

**CLASS 35—(Continued).**

SN 86-025,637. BUSINESS BRAGGER, INC., FORT LAUDERDALE, FL. FILED 8-1-2013.



NO CLAIM IS MADE TO THE EXCLUSIVE RIGHT TO USE "BUSINESS" OR "INC." OR "SOCIAL INFLUENCE MARKETING", APART FROM THE MARK AS SHOWN.

THE COLOR(S) ORANGE, LIGHT BLUE, AND DARK BLUE IS/ARE CLAIMED AS A FEATURE OF THE MARK.

THE MARK CONSISTS OF THE LIGHT BLUE WORD "BUSINESS" WHERE THE "B" IS A CAPITAL LETTER AND WHERE THE REMAINING LETTERS ARE LOWERCASE AND THE ENTIRE WORD APPEARS IN LIGHT BLUE EXCEPT WHERE THERE IS AN ORANGE DOT OF THE "I" IS FORMED BY A DESIGN ELEMENT COMPRISING WAVES OF A SATELLITE SIGNAL. THE WORD DARK BLUE WORD "BRAGGER" APPEARS BELOW "BUSINESS" IN DARK BLUE IN LOWERCASE LETTERS, AND WHERE THE TERM "I NC." APPEARS IN LOWERCASE ORANGE LETTERS TO THE RIGHT OF "BRAGGER." THE ORANGE WORDING "SOCIAL INFLUENCE MARKETING" APPEARS TO THE LEFT SIDE OF "BRAGGER."

FOR ADVERTISING AND MARKETING SERVICES PROVIDED BY MEANS OF INDIRECT METHODS OF MARKETING COMMUNICATIONS, NAMELY, SOCIAL MEDIA, SEARCH ENGINE MARKETING, INQUIRY MARKETING, INTERNET MARKETING, MOBILE MARKETING, BLOGGING AND OTHER FORMS OF PASSIVE, SHARABLE OR VIRAL COMMUNICATIONS CHANNELS; ADVERTISING AND MARKETING SERVICES, NAMELY, PROMOTING THE GOODS AND SERVICES OF OTHERS; SOCIAL MEDIA STRATEGY AND MARKETING CONSULTANCY FOCUSING ON HELPING CLIENTS CREATE AND EXTEND THEIR PRODUCT AND BRAND STRATEGIES BY BUILDING VIRALLY ENGAGING MARKETING SOLUTIONS (U.S. CLS. 100, 101 AND 102).

FIRST USE 12-1-2011; IN COMMERCE 12-1-2011.

TRACY WHITTAKER-BROWN, EXAMINING ATTORNEY

SN 86-025,789. LEXINGTON FAMILY OFFICE & TRUST, LLC, DAYTONA BEACH, FL. FILED 8-1-2013.

# Sneak Quel

THE MARK CONSISTS OF STANDARD CHARACTERS WITHOUT CLAIM TO ANY PARTICULAR FONT, STYLE, SIZE, OR COLOR.

FOR ADVERTISING AND PUBLICITY SERVICES RELATED TO A PREVIEW OF A MOVIE OR OTHER EVENT (U.S. CLS. 100, 101 AND 102).

KEVIN MITTLER, EXAMINING ATTORNEY

**CLASS 35—(Continued).**

SN 86-025,805. SILVER, TRISHA L., NAPLES, FL. FILED 8-1-2013.

**SILVERSTAR CITY GUIDE**

THE MARK CONSISTS OF STANDARD CHARACTERS WITHOUT CLAIM TO ANY PARTICULAR FONT, STYLE, SIZE, OR COLOR.

NO CLAIM IS MADE TO THE EXCLUSIVE RIGHT TO USE "CITY GUIDE", APART FROM THE MARK AS SHOWN.

FOR PROVIDING A SEARCHABLE ONLINE ADVERTISING WEBSITE AND GUIDE FEATURING THE GOODS AND SERVICES OF OTHERS VIA THE INTERNET (U.S. CLS. 100, 101 AND 102).

FIRST USE 6-0-2013; IN COMMERCE 6-0-2013.

JOSETTE BEVERLY, EXAMINING ATTORNEY

SN 86-026,093. ICUITY LLC, WEXFORD, PA. FILED 8-1-2013.

# ICUITY

THE MARK CONSISTS OF STANDARD CHARACTERS WITHOUT CLAIM TO ANY PARTICULAR FONT, STYLE, SIZE, OR COLOR.

FOR PROVIDING BUSINESS CONSULTING SERVICES USING COMPUTER SIMULATION TO ASSESS AND DEVELOP SOLUTIONS FOR BETTER RESOURCE ALLOCATIONS PRIMARILY IN THE HEALTHCARE INDUSTRY (U.S. CLS. 100, 101 AND 102).

SHAUNIA CARLYLE, EXAMINING ATTORNEY

SN 86-026,850. THE WIZBANG COMPANY, LLC, GREEN BAY, WI. FILED 8-2-2013.

The  
**WIZBANG**  
C o m p a n y

NO CLAIM IS MADE TO THE EXCLUSIVE RIGHT TO USE "COMPANY", APART FROM THE MARK AS SHOWN.

THE MARK CONSISTS OF THE STYLIZED TEXT "THE WIZBANG COMPANY" WITH A RECTANGULAR BOX AROUND "WIZBANG" AND A LINE UNDER THE "COMPANY".

FOR BUSINESS CONSULTATION; BUSINESS CONSULTATION IN THE FIELD OF MARKETING; ON-LINE RETAIL STORE SERVICES FEATURING DOWNLOADABLE PRE-RECORDED MUSIC AND VIDEO (U.S. CLS. 100, 101 AND 102).

FIRST USE 5-30-2012; IN COMMERCE 5-30-2012.

BRIDGETT SMITH, EXAMINING ATTORNEY

**CLASS 35—(Continued).**

SN 86-026,971. PRESCIENT LOGISTICS, LLC, LAKE MARY, FL. FILED 8-2-2013.



NO CLAIM IS MADE TO THE EXCLUSIVE RIGHT TO USE "SCRUBS.COM", APART FROM THE MARK AS SHOWN.

THE MARK CONSISTS OF A MEDICAL SCRUB SHIRT WITH POCKET ON RIGHT, WITH THE TEXT "REP" ABOVE THE TEXT "SCRUBS.COM" UNDERLINED IN THE CENTER AND MERGED WITHIN THE SHIRT.

FOR ON-LINE RETAIL STORE SERVICES FEATURING POLYPROPYLENE DISPOSABLE MEDICAL SCRUB SETS CONSISTING OF SHIRTS, PANTS, TWO BOU-FANT CAPS, BOOTIES AND COVERALLS; VENDING MACHINE SERVICES (U.S. CLS. 100, 101 AND 102).

FIRST USE 1-1-2012; IN COMMERCE 1-1-2012.  
LINDA QUIGLEY, EXAMINING ATTORNEY

SN 86-027,026. JDL HOLDINGS, LLC, FAIRBURY, IL. FILED 8-2-2013.

## Koehl Bros., Inc.

THE MARK CONSISTS OF STANDARD CHARACTERS WITHOUT CLAIM TO ANY PARTICULAR FONT, STYLE, SIZE, OR COLOR.

NO CLAIM IS MADE TO THE EXCLUSIVE RIGHT TO USE "BROS., INC.", APART FROM THE MARK AS SHOWN.

FOR DEALERSHIPS IN THE FIELD OF AGRICULTURAL EQUIPMENT AND OTHER AGRICULTURAL PRODUCTION-RELATED GOODS (U.S. CLS. 100, 101 AND 102).

FIRST USE 11-1-1962; IN COMMERCE 11-1-1962.  
ALLISON HOLTZ, EXAMINING ATTORNEY

SN 86-028,486. PLAN B CONSULTANTS, INC., WISNER, NE. FILED 8-5-2013.

## Right Fit Lead

THE MARK CONSISTS OF STANDARD CHARACTERS WITHOUT CLAIM TO ANY PARTICULAR FONT, STYLE, SIZE, OR COLOR.

NO CLAIM IS MADE TO THE EXCLUSIVE RIGHT TO USE "LEAD", APART FROM THE MARK AS SHOWN.

FOR BUSINESS CONSULTING SERVICES IN THE FIELD OF HOSPITALITY INDUSTRY (U.S. CLS. 100, 101 AND 102).

FIRST USE 6-1-2013; IN COMMERCE 7-8-2013.  
BRIDGETT SMITH, EXAMINING ATTORNEY

**CLASS 35—(Continued).**

SN 86-028,779. SURRENDER LABS, LLC, HOMESTEAD, FL. FILED 8-5-2013.

## SURRENDER LABS

THE MARK CONSISTS OF STANDARD CHARACTERS WITHOUT CLAIM TO ANY PARTICULAR FONT, STYLE, SIZE, OR COLOR.

NO CLAIM IS MADE TO THE EXCLUSIVE RIGHT TO USE "LABS", APART FROM THE MARK AS SHOWN.

FOR ON-LINE RETAIL STORE SERVICES FEATURING NUTRITIONAL PRODUCTS (U.S. CLS. 100, 101 AND 102).

FIRST USE 7-28-2013; IN COMMERCE 7-28-2013.  
SHAILA LEWIS, EXAMINING ATTORNEY

SN 86-028,980. ANNA'S LINENS, INC., COSTA MESA, CA. FILED 8-5-2013.

## IT'S NOT MAGIC. IT'S JUST ANNA'S.

THE MARK CONSISTS OF STANDARD CHARACTERS WITHOUT CLAIM TO ANY PARTICULAR FONT, STYLE, SIZE, OR COLOR.

FOR RETAIL STORE SERVICES, ONLINE RETAIL STORE SERVICES, AND ONLINE RETAIL STORE SERVICES PROVIDED VIA WIRELESS MOBILE DEVICES, NAMELY, MOBILE PHONES AND TABLET COMPUTERS, FEATURING LINENS, BEDDING, HOME FURNISHINGS, HOME DÉCOR, FURNITURE, HOUSEWARES, KITCHEN APPLIANCES, KITCHEN ACCESSORIES, BATHROOM ACCESSORIES, TABLEWARE, CARPETS, WINDOW TREATMENTS, HOUSEHOLD STORAGE PRODUCTS, AND HOME GARDENING PRODUCTS (U.S. CLS. 100, 101 AND 102).

FIRST USE 7-1-2013; IN COMMERCE 7-1-2013.  
MEREDITH MARESCA, EXAMINING ATTORNEY

SN 86-029,108. KATHLEEN BARTHOLOMEW LLC, FRIDAY HARBOR, WA. FILED 8-5-2013.

## "CAN YOU HEAL ME NOW?"

THE MARK CONSISTS OF STANDARD CHARACTERS WITHOUT CLAIM TO ANY PARTICULAR FONT, STYLE, SIZE, OR COLOR.

FOR ADVERTISING, PROMOTION AND MARKETING SERVICES FOR THE HEALTHCARE PRODUCTS AND SERVICES OF OTHERS (U.S. CLS. 100, 101 AND 102).

KATHLEEN M. VANSTON, EXAMINING ATTORNEY



**CLASS 35—(Continued).**

SN 86-029,207. GARCIA III, JOSE LUIS, HALEIWA, HI. FILED 8-5-2013.



THE COLOR(S) RED, YELLOW, GREEN AND BLACK IS/ ARE CLAIMED AS A FEATURE OF THE MARK.

THE MARK CONSISTS OF THE WORDING "YEA MAN" IN BLACK LETTERING WITH A FIVE POINTED STAR OUTLINED IN BLACK BETWEEN "YEA AND MAN". THE COLORS RED, YELLOW, GREEN AND BLACK ARE INSIDE THE STAR IN VARIOUS GEOMETRIC SHAPES ALL OUTLINED IN BLACK.

FOR ON-LINE RETAIL STORE SERVICES FEATURING CLOTHING.; RETAIL STORE SERVICES FEATURING CLOTHING (U.S. CLS. 100, 101 AND 102).

FIRST USE 6-20-2013; IN COMMERCE 6-21-2013.  
TINA MAI, EXAMINING ATTORNEY

**CLASS 35—(Continued).**

SN 86-029,822. JBM EVENTS, INC., GREENVILLE, SC. FILED 8-6-2013.



NO CLAIM IS MADE TO THE EXCLUSIVE RIGHT TO USE "GREENVILLE CHAMBER" AND "BUSINESS EXPO", APART FROM THE MARK AS SHOWN.

THE MARK CONSISTS OF THE WORD "BUSINESS" OVER THE WORD "EXPO". THE "X" IS STYLIZED. THERE IS A LINE ON THE LEFT OF THE WORDS AND THE BOTTOM. TO THE LEFT OF THAT LINE THE WORDS "GREENVILLE CHAMBER" ARE RUNNING VERTICALLY. UNDER THE LINE ARE THE WORDS "DRIVING BUSINESS".

FOR ORGANIZATION OF BUSINESS CONVENTIONS (U.S. CLS. 100, 101 AND 102).

FIRST USE 5-1-2012; IN COMMERCE 5-1-2012.  
CHARLES L. JENKINS, EXAMINING ATTORNEY

SN 86-029,617. JBM EVENTS, INC., GREENVILLE, SC. FILED 8-6-2013.



NO CLAIM IS MADE TO THE EXCLUSIVE RIGHT TO USE "ASSOCIATES", APART FROM THE MARK AS SHOWN.

THE MARK CONSISTS OF THE LETTERS "JBM" OVER AN AMPERSAND AND THE WORD "ASSOCIATES". THERE IS A STYLIZED FLEUR-DE-LIS TO THE RIGHT OF THE LETTERS "JBM".

FOR ARRANGING AND CONDUCTING SPECIAL EVENTS FOR COMMERCIAL, PROMOTIONAL OR ADVERTISING PURPOSES (U.S. CLS. 100, 101 AND 102).

FIRST USE 6-1-2012; IN COMMERCE 6-1-2012.  
CHARLES L. JENKINS, EXAMINING ATTORNEY

SN 86-029,839. JBM EVENTS, INC., GREENVILLE, SC. FILED 8-6-2013.



NO CLAIM IS MADE TO THE EXCLUSIVE RIGHT TO USE "CHARLESTON BOAT SHOW", APART FROM THE MARK AS SHOWN.

THE MARK CONSISTS OF THE WORD "CHARLESTON" IS WRITTEN IN AN ARC OVER THE IMAGE OF A BOAT IN WAVES WITH SUN BEAMS BEHIND IT. UNDER THAT IMAGE ARE THE WORDS "BOAT SHOW". THERE IS A SHADOW BEHIND THE IMAGE.

FOR CONDUCTING TRADE SHOWS IN THE FIELD OF BOATS (U.S. CLS. 100, 101 AND 102).

FIRST USE 6-1-2007; IN COMMERCE 6-1-2007.  
CHARLES L. JENKINS, EXAMINING ATTORNEY

**CLASS 35—(Continued).**

SN 86-030,235. HOUSES IN SAN ANTONIO LTD., SAN ANTONIO, TX. FILED 8-6-2013.



THE MARK CONSISTS OF A STYLIZED LETTER "H" SURROUNDED BY A CIRCLE AND HAVING A DOORWAY DESIGN IN THE MIDDLE OF THE "H".

FOR ADVERTISING OF COMMERCIAL OR RESIDENTIAL REAL ESTATE; MATCHING CONSUMERS WITH PROFESSIONALS IN THE FIELD OF REAL ESTATE; MATCHING CONSUMERS WITH REAL ESTATE PROFESSIONALS IN THE FIELD OF REAL ESTATE SERVICES VIA COMPUTER NETWORK; MATCHING POTENTIAL BUYERS TO FACILITATE CO-OWNERSHIP OF RESIDENTIAL REAL PROPERTY (U.S. CLS. 100, 101 AND 102).

FIRST USE 5-1-2013; IN COMMERCE 5-1-2013.  
GIANCARLO CASTRO, EXAMINING ATTORNEY

SN 86-030,736. NATIONAL EDUCATION LOAN NETWORK, INC., LINCOLN, NE. FILED 8-6-2013.

**RESUMEEDGE**

THE MARK CONSISTS OF STANDARD CHARACTERS WITHOUT CLAIM TO ANY PARTICULAR FONT, STYLE, SIZE, OR COLOR.

FOR RESUME AND COVER LETTER EDITING AND WRITING SERVICES FOR ACADEMIC AND BUSINESS CUSTOMERS VIA THE INTERNET (U.S. CLS. 100, 101 AND 102).

FIRST USE 1-1-2001; IN COMMERCE 1-1-2001.  
COLLEEN MULCRONE, EXAMINING ATTORNEY

**CLASS 35—(Continued).**

SN 86-030,857. TIKWID, LLC, DENVER, CO. FILED 8-7-2013.



THE MARK CONSISTS OF THE WORD "TIKWID" IN A STYLIZED FONT SURROUNDED BY A BLACK FRAME ON A WHITE BACKGROUND AND HAVING A PERIOD AFTER THE WORD.

FOR RETAIL CLOTHING STORES (U.S. CLS. 100, 101 AND 102).

FIRST USE 5-1-2013; IN COMMERCE 6-1-2013.  
ELLEN PERKINS, EXAMINING ATTORNEY

SN 86-031,043. MISSISSIPPI CASINO OPERATORS ASSOCIATION, INC., AKA MCOA, JACKSON, MS. FILED 8-7-2013.



NO CLAIM IS MADE TO THE EXCLUSIVE RIGHT TO USE "MISSISSIPPI GAMING AND HOSPITALITY ASSOCIATION" AND THE PICTORIAL REPRESENTATION OF THE STATE OF MISSISSIPPI, APART FROM THE MARK AS SHOWN.

THE MARK CONSISTS OF THE LETTERS "MGHA" WITH AN OUTLINE OF THE STATE OF "MISSISSIPPI" INSIDE THE "G" FOLLOWED BY THE WORDS "MISSISSIPPI GAMING & HOSPITALITY" ON THE LINE DIRECTLY BELOW AND THE WORD "ASSOCIATION" ON THE SECOND LINE BELOW.

FOR ASSOCIATION SERVICES, NAMELY, PROMOTING THE INTERESTS OF THE GAMING INDUSTRY AND GAMING ENTERTAINMENT (U.S. CLS. 100, 101 AND 102).

BRITTANY ESTELL, EXAMINING ATTORNEY

**CLASS 35—(Continued).**

SN 86-031,095. HUBCAPS UNLIMITED, MILWAUKEE, WI. FILED 8-7-2013.

**CLASS 35—(Continued).**

SN 86-032,729. MIDNIGHT OIL CREATIVE, LLC, BURBANK, CA. FILED 8-8-2013.

**HUBCAPS UNLIMITED**

**MIDNIGHT OIL**

THE MARK CONSISTS OF STANDARD CHARACTERS WITHOUT CLAIM TO ANY PARTICULAR FONT, STYLE, SIZE, OR COLOR.

NO CLAIM IS MADE TO THE EXCLUSIVE RIGHT TO USE "HUBCAPS", APART FROM THE MARK AS SHOWN.

FOR ON-LINE RETAIL STORE SERVICES FEATURING HUBCAPS, HUB CAPS, WHEEL COVERS, WHEEL COVERS, CHROME WHEEL SKINS, WHEEL SKINS, WHEEL SIMULATORS, WHEEL LINERS, WHEELS, RIMS, TRIM RINGS AND OTHER AUTOMOTIVE ACCESSORIES; RETAIL STORE SERVICES FEATURING HUBCAPS, HUB CAPS, WHEEL COVERS, WHEEL COVERS, CHROME WHEEL SKINS, WHEEL SKINS, WHEEL SIMULATORS, WHEEL LINERS, WHEELS, RIMS, TRIM RINGS AND OTHER AUTOMOTIVE ACCESSORIES (U.S. CLS. 100, 101 AND 102).

FIRST USE 1-1-1980; IN COMMERCE 1-1-1980.  
HAI-LY LAM, EXAMINING ATTORNEY

THE MARK CONSISTS OF STANDARD CHARACTERS WITHOUT CLAIM TO ANY PARTICULAR FONT, STYLE, SIZE, OR COLOR.

FOR BRANDING SERVICES, NAMELY, CONSULTING, DEVELOPMENT, MANAGEMENT AND MARKETING OF BRANDS FOR BUSINESSES AND/OR INDIVIDUALS; DEVELOPING PROMOTIONAL CAMPAIGNS FOR BUSINESS; MARKET RESEARCH AND BUSINESS ANALYSIS; PLANNING, DESIGN, DEVELOPMENT, MAINTENANCE, TRACKING AND REPORTING OF ONLINE MARKETING ACTIVITIES FOR THIRD PARTIES; CREATIVE MARKETING DESIGN SERVICES; CONSULTATION SERVICES, NAMELY, CREATIVE AND STRATEGIC CONSULTATION REGARDING DEVELOPMENT AND PRODUCTION OF MARKETING CAMPAIGNS FOR OTHERS; BUSINESS CONSULTING SERVICES, NAMELY, PROVIDING ASSISTANCE IN DEVELOPMENT OF BUSINESS STRATEGIES AND CREATIVE IDEATION; PRODUCTION OF ADVERTISING MATTER AND COMMERCIALS; PRODUCTION OF ADVERTISING MATERIALS (U.S. CLS. 100, 101 AND 102).

FIRST USE 7-15-2003; IN COMMERCE 7-15-2003.  
LINDA M. KING, EXAMINING ATTORNEY

SN 86-031,481. ALEX REIDY & COMPANY, PITTSBURGH, PA. FILED 8-7-2013.

SN 86-032,767. PEERLESS MEDICAL INC., MILFORD, PA. FILED 8-8-2013.

**Lead Confident.**

**Drug 123**

THE MARK CONSISTS OF STANDARD CHARACTERS WITHOUT CLAIM TO ANY PARTICULAR FONT, STYLE, SIZE, OR COLOR.

FOR MANAGEMENT CONSULTING AND ADVISORY SERVICES IN THE AREAS OF CORPORATE GROWTH STRATEGY, INNOVATION AND GROWTH PROCESSES, ORGANIZATIONAL TRANSFORMATION, AND TALENT MANAGEMENT AND DEVELOPMENT STRATEGIES (U.S. CLS. 100, 101 AND 102).

TIMOTHY FINNEGAN, EXAMINING ATTORNEY

THE MARK CONSISTS OF STANDARD CHARACTERS WITHOUT CLAIM TO ANY PARTICULAR FONT, STYLE, SIZE, OR COLOR.

NO CLAIM IS MADE TO THE EXCLUSIVE RIGHT TO USE "DRUG", APART FROM THE MARK AS SHOWN.

FOR RETAIL AND MAIL ORDER PHARMACY SERVICES (U.S. CLS. 100, 101 AND 102).

PAUL CROWLEY, EXAMINING ATTORNEY

**CLASS 35—(Continued).**

SN 86-033,066. BETHEL NEW LIFE, CHICAGO, IL. FILED 8-8-2013.



THE MARK CONSISTS OF A CROSS MADE UP OF FOUR PEOPLE WITH THEIR HEADS TOGETHER, FOLLOWED BY THE TEXT "BETHEL NEW LIFE" IN A SIMILAR FONT, WITH "BETHEL" ON TOP AND "NEW LIFE" BELOW.

FOR PROMOTING ECONOMIC DEVELOPMENT BY PROVIDING BUSINESS ASSISTANCE, ADVISORY AND CONSULTING SERVICES IN THE FIELDS OF JOB TRAINING, EDUCATION AND COUNSELING (U.S. CLS. 100, 101 AND 102).

DAVID BROOKSHIRE, EXAMINING ATTORNEY

**CLASS 35—(Continued).**

SN 86-034,308. SUNMEX, LLC, TUCSON, AZ. FILED 8-9-2013.



NO CLAIM IS MADE TO THE EXCLUSIVE RIGHT TO USE "E-CIGARETTE", APART FROM THE MARK AS SHOWN.

THE MARK CONSISTS OF TWO PARABOLAS WHICH TOGETHER REPRESENT A MODEL OF AN ATOMIC STRUCTURE, INCLUDING SPHERES REPRESENTING ELECTRONS, ALONG WITH THE WORDS ATOMIC "E-CIGARETTE".

FOR ONLINE RETAIL STORE AND RETAIL STORE SERVICES FEATURING ELECTRONIC CIGARETTES AND ELECTRONIC CIGARETTE ACCESSORIES (U.S. CLS. 100, 101 AND 102).

FIRST USE 6-1-2013; IN COMMERCE 6-1-2013.

KIMBERLY PARKS, EXAMINING ATTORNEY

SN 86-034,395. LIU, RAY, FOSTER CITY, CA. FILED 8-9-2013.

SN 86-033,921. CYPRESS PHARMACY, INC., FORT MYERS, FL. FILED 8-9-2013.

Cypress Pharmacy



NO CLAIM IS MADE TO THE EXCLUSIVE RIGHT TO USE "SENIOR CARE", APART FROM THE MARK AS SHOWN.

THE MARK CONSISTS OF TWO OVERLAPPING CIRCLES WITH THE NUMBER "1" IN EACH CIRCLE AND A PLUS SIGN BETWEEN WHERE THE CIRCLES OVERLAP, AND THE STYLIZED WORDING "SENIOR CARE" BELOW THE CIRCLES.

FOR EMPLOYMENT AGENCY SERVICES, NAMELY, TEMPORARY AND PERMANENT PLACEMENT OF CAREGIVERS THAT WILL PROVIDE NON MEDICAL IN-HOME SUPPORT SERVICES, NAMELY, ASSISTANCE WITH ACTIVITIES OF DAILY LIVING, SOCIAL SERVICES, AND HOME CARE FOR SENIOR PERSONS (U.S. CLS. 100, 101 AND 102).

FIRST USE 9-16-2013; IN COMMERCE 9-16-2013.

DEZMONA MIZELLE, EXAMINING ATTORNEY

THE MARK CONSISTS OF STANDARD CHARACTERS WITHOUT CLAIM TO ANY PARTICULAR FONT, STYLE, SIZE, OR COLOR.

NO CLAIM IS MADE TO THE EXCLUSIVE RIGHT TO USE "PHARMACY", APART FROM THE MARK AS SHOWN.

FOR RETAIL PHARMACY SERVICES (U.S. CLS. 100, 101 AND 102).

FIRST USE 4-17-1984; IN COMMERCE 4-17-1984.

ARETHA SOMERVILLE, EXAMINING ATTORNEY

**CLASS 35—(Continued).**

SN 86-034,399. LIU, RAY, FOSTER CITY, CA. FILED 8-9-2013.

**1+1 Senior Care**

THE MARK CONSISTS OF STANDARD CHARACTERS WITHOUT CLAIM TO ANY PARTICULAR FONT, STYLE, SIZE, OR COLOR.

NO CLAIM IS MADE TO THE EXCLUSIVE RIGHT TO USE "SENIOR CARE", APART FROM THE MARK AS SHOWN.

FOR EMPLOYMENT AGENCY SERVICES, NAMELY, TEMPORARY AND PERMANENT PLACEMENT OF CAREGIVERS THAT WILL PROVIDE NON MEDICAL IN-HOME SUPPORT SERVICES, NAMELY, ASSISTANCE WITH ACTIVITIES OF DAILY LIVING, SOCIAL SERVICES, AND HOME CARE FOR SENIOR PERSONS (U.S. CLS. 100, 101 AND 102).

FIRST USE 9-16-2013; IN COMMERCE 9-16-2013.  
DEZMONA MIZELLE, EXAMINING ATTORNEY

SN 86-034,495. TRUE SOURCE HONEY, LLC, WASHINGTON, DC. FILED 8-10-2013.



OWNER OF U.S. REG. NOS. 4,116,139, 4,134,507 AND OTHERS.

NO CLAIM IS MADE TO THE EXCLUSIVE RIGHT TO USE "TRUE SOURCE HONEY", APART FROM THE MARK AS SHOWN.

THE COLOR(S) GREEN, YELLOW, BLACK AND WHITE IS/ARE CLAIMED AS A FEATURE OF THE MARK.

THE MARK CONSISTS OF A HORIZONTAL RECTANGLE WITH A GREEN BORDER, WITH A THIN GREEN VERTICAL LINE BEGINNING AT THE BOTTOM BORDER EXTENDING HALFWAY UP IN THE MIDDLE OF THE RECTANGLE, DIVIDING THE RECTANGLE IN HALF. IN THE LEFT HALF OF THE RECTANGLE, THE WORD "TRUE" AND BELOW IT, THE WORD "SOURCE" APPEAR IN GREEN CAPITAL LETTERS; BETWEEN THE WORDS "TRUE SOURCE" AND THE CENTER LINE, IS A DRAWING OF A HONEY BEE, WITH A SEGMENTED YELLOW BODY AND HEAD WITH EACH SEGMENT OUTLINED IN BLACK, AND WHITE WINGS OUTLINED IN BLACK. ON THE RIGHT SIDE OF THE RECTANGLE, THE WORD "HONEY" APPEARS IN GREEN. THE COLOR WHITE APPEARS IN THE BACKGROUND OF THE RECTANGLE.

FOR ASSOCIATION SERVICES, NAMELY, PROMOTING THE INTERESTS OF UNITED STATES HONEY PRODUCERS; PROMOTING PUBLIC AWARENESS OF THE BENEFITS OF DOMESTICALLY PRODUCED HONEY AND THE DANGERS TO SAFETY AND PURITY OF HONEY OBTAINED OR IMPORTED IN CIRCUMVENTION OF U.S. LAW (U.S. CLS. 100, 101 AND 102).

JENNIFER WILLISTON, EXAMINING ATTORNEY

**CLASS 35—(Continued).**

SN 86-034,533. XCUTION INC., HOUSTON, TX. FILED 8-10-2013.



THE COLOR(S) ORANGE AND BLACK IS/ARE CLAIMED AS A FEATURE OF THE MARK.

THE MARK CONSISTS OF AN ORANGE "X" THAT IS SHAPED LIKE A PERSON, FOLLOWED BY THE STYLIZED BLACK LETTERING "CUTION", REPRESENTING THE WHOLE TERM "XCUTION". THE BACKGROUND IS NOT CLAIMED AS A FEATURE OF THE MARK.

FOR BUSINESS MANAGEMENT CONSULTING AND ADVISORY SERVICES (U.S. CLS. 100, 101 AND 102).

FIRST USE 1-15-2002; IN COMMERCE 2-10-2008.  
AMY HELLA, EXAMINING ATTORNEY

SN 86-034,812. URGENT CARE ASSOCIATION OF AMERICA, NAPERVILLE, IL. FILED 8-12-2013.

**UCAOA**

THE MARK CONSISTS OF STANDARD CHARACTERS WITHOUT CLAIM TO ANY PARTICULAR FONT, STYLE, SIZE, OR COLOR.

OWNER OF U.S. REG. NO. 3,608,847.

FOR ASSOCIATION SERVICES, NAMELY, PROMOTING THE INTERESTS OF THE URGENT CARE INDUSTRY (U.S. CLS. 100, 101 AND 102).

FIRST USE 1-0-2004; IN COMMERCE 1-0-2004.  
ESTHER BELENKER, EXAMINING ATTORNEY

SN 86-034,813. JOE'S ROCK SHOP, ORDERVILLE, UT. FILED 8-12-2013.

**Home of the Utah Septarian Nodule**

THE MARK CONSISTS OF STANDARD CHARACTERS WITHOUT CLAIM TO ANY PARTICULAR FONT, STYLE, SIZE, OR COLOR.

NO CLAIM IS MADE TO THE EXCLUSIVE RIGHT TO USE "UTAH SEPTARIAN NODULE", APART FROM THE MARK AS SHOWN.

FOR RETAIL SHOPS FEATURING HAND POLISHED STONES, AND ROCKS AND MINERALS PURCHASED FROM DEALERS FOR RESALE (U.S. CLS. 100, 101 AND 102).

FIRST USE 3-1-1954; IN COMMERCE 3-1-1954.  
ESTHER BELENKER, EXAMINING ATTORNEY

**CLASS 35—(Continued).**

SN 86-034,988. ESE A. O'DIAH, KEW GARDENS, NY. AND LIQUORBOX INC., DBA LIQUORBOX.CO, KEW GARDENS, NY. FILED 8-12-2013.



THE COLOR(S) BLACK AND WHITE IS/ARE CLAIMED AS A FEATURE OF THE MARK.

THE MARK CONSISTS OF THE DESIGN OF A BOTTLE IN WHITE WITH A SMALL, BLACK LABEL AROUND THE BOTTLE NECK; THE WORDING "LIQUORBOX" APPEARS VERTICALLY IN BLACK ALONG THE SIDE OF THE BOTTLE; THE LETTER "I" IN "LIQUORBOX" APPEARS AS A BOTTLE DESIGN, AS WELL; THE ENTIRE MARK APPEARS ON A BLACK BACKGROUND.

FOR ON-LINE RETAIL STORE SERVICES FEATURING PHYSICAL AND VIRTUAL MERCHANDISE FOR USE BY MEMBERS OF AN ONLINE COMMUNITY IN CONNECTION WITH A DESIGNATED WEBSITE FEATURING FICTIONAL CHARACTERS; PROMOTING AND MARKETING THE GOODS AND SERVICES OF OTHERS BY DISTRIBUTING COUPONS AND PROVIDING HYPERLINKS TO WEBSITES; PROMOTING THE GOODS AND SERVICES OF OTHERS BY PROVIDING A WEBSITE FEATURING COUPONS, REBATES, PRICE-COMPARISON INFORMATION, PRODUCT REVIEWS, LINKS TO THE RETAIL WEBSITES OF OTHERS, AND DISCOUNT INFORMATION; PROMOTING THE GOODS AND SERVICES OF OTHERS BY PROVIDING A WEBSITE FEATURING COUPONS, REBATES, PRODUCT REVIEWS AND DISCOUNT INFORMATION; PROMOTING THE GOODS AND SERVICES OF OTHERS BY PROVIDING A WEBSITE FEATURING PROMOTIONAL MATERIALS, DISCOUNT VOUCHERS, PRICE-COMPARISON INFORMATION, PRODUCT REVIEWS AND DISCOUNT INFORMATION (U.S. CLS. 100, 101 AND 102).

SKYE YOUNG, EXAMINING ATTORNEY

**CLASS 35—(Continued).**

SN 86-035,176. TONY VENTURES LLC, AMMON, ID. FILED 8-12-2013.

## Expressions Vinyl.com

THE MARK CONSISTS OF STANDARD CHARACTERS WITHOUT CLAIM TO ANY PARTICULAR FONT, STYLE, SIZE, OR COLOR.

NO CLAIM IS MADE TO THE EXCLUSIVE RIGHT TO USE "VINYL.COM", APART FROM THE MARK AS SHOWN.

FOR ON-LINE RETAIL STORE SERVICES FEATURING ADHESIVE VINYL SIGN MAKING SUPPLIES INCLUDING PRESSURE SENSITIVE ADHESIVES AS WELL AS HEAT ACTIVATED ADHESIVES (U.S. CLS. 100, 101 AND 102).

FIRST USE 12-28-2009; IN COMMERCE 12-28-2009.

JULIE WATSON, EXAMINING ATTORNEY

---

SN 86-035,198. ROC NATION LLC, BEVERLY HILLS, CA. FILED 8-12-2013.

## DIAMOND THEORY MARKETING

THE MARK CONSISTS OF STANDARD CHARACTERS WITHOUT CLAIM TO ANY PARTICULAR FONT, STYLE, SIZE, OR COLOR.

NO CLAIM IS MADE TO THE EXCLUSIVE RIGHT TO USE "MARKETING", APART FROM THE MARK AS SHOWN.

FOR ADVERTISING AND MARKETING SERVICES, NAMELY, PROMOTING THE GOODS AND SERVICES OF OTHERS; DEVELOPMENT OF MARKETING STRATEGIES, CONCEPTS AND TACTICS, NAMELY, AUDIENCE DEVELOPMENT, BRAND AWARENESS, ONLINE COMMUNITY BUILDING, DIGITAL WORD OF MOUTH COMMUNICATIONS AND CUSTOMER AND USER EXPERIENCE ENHANCEMENT; DEVELOPMENT OF ADVERTISING CAMPAIGNS FOR PRINT MEDIA, WEB PAGES, MOBILE MEDIA, AND DIRECT MARKETING; PLANNING, DESIGN, DEVELOPMENT, MAINTENANCE, TRACKING AND REPORTING OF ONLINE MARKETING ACTIVITIES FOR OTHERS; DESIGN OF ADVERTISING MATERIALS FOR OTHERS; DISSEMINATION OF ADVERTISING FOR OTHERS VIA THE INTERNET AND PUBLIC AND PRIVATE WIRELESS NETWORKS FOR DISPLAY ON MOBILE DEVICES; PROMOTING THE GOODS AND SERVICES OF OTHERS THROUGH SEARCH ENGINE REFERRAL TRAFFIC ANALYSIS AND REPORTING (U.S. CLS. 100, 101 AND 102).

CURTIS FRENCH, EXAMINING ATTORNEY

**CLASS 35—(Continued).**

SN 86-035,310. TXU ENERGY RETAIL COMPANY LLC, IRVING, TX. FILED 8-12-2013.

**TXU ENERGY FREE NIGHTS**

THE MARK CONSISTS OF STANDARD CHARACTERS WITHOUT CLAIM TO ANY PARTICULAR FONT, STYLE, SIZE, OR COLOR.

OWNER OF U.S. REG. NOS. 4,234,409, 4,347,068 AND OTHERS.

NO CLAIM IS MADE TO THE EXCLUSIVE RIGHT TO USE "ENERGY" AND "FREE NIGHTS", APART FROM THE MARK AS SHOWN.

FOR RETAIL ELECTRIC UTILITY SERVICES, NAMELY, THE PROCUREMENT AND PURCHASING OF ELECTRICITY FOR OTHERS; CUSTOMER BONUS AND INCENTIVE PROGRAM IN WHICH CUSTOMERS ARE PROVIDED DISCOUNTS ON PRODUCTS AND SERVICES OF OTHERS BASED ON THEIR STATUS AS ENERGY CUSTOMERS AND THEIR CONSUMPTION OF ENERGY SERVICES (U.S. CLS. 100, 101 AND 102).

FIRST USE 5-30-2013; IN COMMERCE 5-30-2013.  
ANDREA HACK, EXAMINING ATTORNEY

**CLASS 35—(Continued).**

SN 86-035,479. TXU ENERGY RETAIL COMPANY LLC, IRVING, TX. FILED 8-12-2013.

**RIGHT TIME DISCOUNT**

THE MARK CONSISTS OF STANDARD CHARACTERS WITHOUT CLAIM TO ANY PARTICULAR FONT, STYLE, SIZE, OR COLOR.

NO CLAIM IS MADE TO THE EXCLUSIVE RIGHT TO USE "DISCOUNT", APART FROM THE MARK AS SHOWN.

FOR RETAIL ELECTRIC UTILITY SERVICES, NAMELY, THE PROCUREMENT AND PURCHASING OF ELECTRICITY FOR OTHERS; CUSTOMER BONUS AND INCENTIVE PROGRAM IN WHICH CUSTOMERS ARE PROVIDED DISCOUNTS ON PRODUCTS AND SERVICES OF OTHERS BASED ON THEIR STATUS AS ENERGY CUSTOMERS AND THEIR CONSUMPTION OF ENERGY SERVICES (U.S. CLS. 100, 101 AND 102).

ANDREA HACK, EXAMINING ATTORNEY

SN 86-035,497. DIGITAL FLASH NYC LLC, BROOKLYN, NY. FILED 8-12-2013.

**DIGITALFLASH**

SN 86-035,359. TXU ENERGY RETAIL COMPANY LLC, IRVING, TX. FILED 8-12-2013.

**TXU ENERGY FREE WEEKENDS**

THE MARK CONSISTS OF STANDARD CHARACTERS WITHOUT CLAIM TO ANY PARTICULAR FONT, STYLE, SIZE, OR COLOR.

OWNER OF U.S. REG. NOS. 4,234,409, 4,347,068 AND OTHERS.

NO CLAIM IS MADE TO THE EXCLUSIVE RIGHT TO USE "ENERGY" AND "FREE WEEKENDS", APART FROM THE MARK AS SHOWN.

FOR RETAIL ELECTRIC UTILITY SERVICES, NAMELY, THE PROCUREMENT AND PURCHASING OF ELECTRICITY FOR OTHERS; CUSTOMER BONUS AND INCENTIVE PROGRAM IN WHICH CUSTOMERS ARE PROVIDED DISCOUNTS ON PRODUCTS AND SERVICES OF OTHERS BASED ON THEIR STATUS AS ENERGY CUSTOMERS AND THEIR CONSUMPTION OF ENERGY SERVICES (U.S. CLS. 100, 101 AND 102).

FIRST USE 5-30-2013; IN COMMERCE 5-30-2013.  
ANDREA HACK, EXAMINING ATTORNEY

THE MARK CONSISTS OF STANDARD CHARACTERS WITHOUT CLAIM TO ANY PARTICULAR FONT, STYLE, SIZE, OR COLOR.

FOR MARKETING SERVICES; ADVERTISING AND MARKETING SERVICES, NAMELY, PROMOTING THE GOODS AND SERVICES OF OTHERS; DEVELOPMENT OF MARKETING STRATEGIES, CONCEPTS AND TACTICS, NAMELY, AUDIENCE DEVELOPMENT, BRAND AWARENESS, ONLINE COMMUNITY BUILDING AND DIGITAL COMMUNICATIONS; MARKET RESEARCH AND BUSINESS ANALYSIS SERVICES; PUBLIC RELATIONS; CONTESTS AND INCENTIVE AWARD PROGRAMS TO PROMOTE THE SALE OF PRODUCTS AND SERVICES OF OTHERS; ARRANGING AND CONDUCTING SPECIAL EVENTS FOR COMMERCIAL, PROMOTIONAL OR ADVERTISING PURPOSES; MARKET REPORTS AND STUDIES AND PROVISION OF MARKET REPORTS AND STUDIES TO OTHERS (U.S. CLS. 100, 101 AND 102).

FIRST USE 10-18-2009; IN COMMERCE 11-16-2009.  
MARLENE BELL, EXAMINING ATTORNEY

**CLASS 35—(Continued).**

SN 86-035,518. TXU ENERGY RETAIL COMPANY LLC, IRVING, TX. FILED 8-12-2013.

**RIGHT TIME SAVINGS**

THE MARK CONSISTS OF STANDARD CHARACTERS WITHOUT CLAIM TO ANY PARTICULAR FONT, STYLE, SIZE, OR COLOR.

NO CLAIM IS MADE TO THE EXCLUSIVE RIGHT TO USE "SAVINGS", APART FROM THE MARK AS SHOWN.

FOR RETAIL ELECTRIC UTILITY SERVICES, NAMELY, THE PROCUREMENT AND PURCHASING OF ELECTRICITY FOR OTHERS; CUSTOMER BONUS AND INCENTIVE PROGRAM IN WHICH CUSTOMERS ARE PROVIDED DISCOUNTS ON PRODUCTS AND SERVICES OF OTHERS BASED ON THEIR STATUS AS ENERGY CUSTOMERS AND THEIR CONSUMPTION OF ENERGY SERVICES (U.S. CLS. 100, 101 AND 102).

FIRST USE 5-30-2013; IN COMMERCE 5-30-2013.  
ANDREA HACK, EXAMINING ATTORNEY

**CLASS 35—(Continued).**

SN 86-035,780. MUD BLUD, HOLLY HILL, FL. FILED 8-12-2013.

**MUDBLUD**

THE MARK CONSISTS OF STANDARD CHARACTERS WITHOUT CLAIM TO ANY PARTICULAR FONT, STYLE, SIZE, OR COLOR.

FOR PREPARATION OF CUSTOMIZED PROMOTIONAL AND MERCHANDISING MATERIALS FOR OTHERS; PREPARING PROMOTIONAL AND MERCHANDISING MATERIAL FOR OTHERS; PRODUCT MERCHANDISING; PROVIDING AN INTERNET WEBSITE PORTAL FEATURING LINKS TO MUSIC-RELATED MERCHANDISE FOR RETAIL PURPOSES (U.S. CLS. 100, 101 AND 102).

EDWARD NELSON, EXAMINING ATTORNEY

SN 86-035,617. GEOSTRATEGIES INC, TURLOCK, CA. FILED 8-12-2013.



NO CLAIM IS MADE TO THE EXCLUSIVE RIGHT TO USE "ANALYTICS", APART FROM THE MARK AS SHOWN.

THE COLOR(S) BLUE, GRAY, AND RED IS/ARE CLAIMED AS A FEATURE OF THE MARK.

THE MARK CONSISTS OF "EPIPHANY" IN BLUE WITH A SUPERSCRIPED RED "A" WITH THE SUBSCRIBED WORD "ANALYTICS" IN GRAY.

FOR BUSINESS CONSULTING AND INFORMATION SERVICES (U.S. CLS. 100, 101 AND 102).

FIRST USE 1-15-2010; IN COMMERCE 1-15-2010.  
ALLISON HOLTZ, EXAMINING ATTORNEY

SN 86-036,248. ARKOMA BASIN EXPLORATION, AKA ARKOMA, ROCKWALL, TX. FILED 8-13-2013.

**Underground Thinking**

THE MARK CONSISTS OF STANDARD CHARACTERS WITHOUT CLAIM TO ANY PARTICULAR FONT, STYLE, SIZE, OR COLOR.

FOR BUSINESS ASSISTANCE AND BUSINESS CONSULTANCY SERVICES FOR BUSINESS AND SCIENCE COMPANIES IN THE ENERGY SECTOR (U.S. CLS. 100, 101 AND 102).

FIRST USE 5-15-2013; IN COMMERCE 5-15-2013.  
WARREN L. OLANDRIA, EXAMINING ATTORNEY

SN 86-035,631. GEOSTRATEGIES INC, TURLOCK, CA. FILED 8-12-2013.



THE COLOR(S) BLUE, RED, AND GRAY IS/ARE CLAIMED AS A FEATURE OF THE MARK.

THE MARK CONSISTS OF BLUE "EPIPHANY" WITH SUPERSCRIPED RED A AND THE SUBSCRIBED WORD "INSIGHTS" IN GRAY.

FOR BUSINESS CONSULTING AND INFORMATION SERVICES (U.S. CLS. 100, 101 AND 102).

FIRST USE 7-1-2013; IN COMMERCE 8-1-2013.  
ALLISON HOLTZ, EXAMINING ATTORNEY

SN 86-036,319. MIC2 CONSULTING, ALTADENA, CA. FILED 8-13-2013.

**MIC2 Consulting**

THE MARK CONSISTS OF STANDARD CHARACTERS WITHOUT CLAIM TO ANY PARTICULAR FONT, STYLE, SIZE, OR COLOR.

NO CLAIM IS MADE TO THE EXCLUSIVE RIGHT TO USE "CONSULTING", APART FROM THE MARK AS SHOWN.

FOR BUSINESS MARKETING CONSULTING SERVICES (U.S. CLS. 100, 101 AND 102).

JENNIFER DIXON, EXAMINING ATTORNEY



**CLASS 35—(Continued).**

SN 86-036,368. ROYAL WARRANTS INC., NEW YORK, NY. FILED 8-13-2013.

# Crest and Co.

THE MARK CONSISTS OF STANDARD CHARACTERS WITHOUT CLAIM TO ANY PARTICULAR FONT, STYLE, SIZE, OR COLOR.

NO CLAIM IS MADE TO THE EXCLUSIVE RIGHT TO USE "CO.", APART FROM THE MARK AS SHOWN.

FOR ONLINE AND RETAIL STORE SERVICES FEATURING LUXURY GOODS AND ARTISANAL PRODUCTS, NAMELY, JEWELRY, WATCHES, HOME WARES, FASHION ACCESSORIES, ANTIQUES, AND GOURMET FOOD ITEMS (U.S. CLS. 100, 101 AND 102). ELLEN PERKINS, EXAMINING ATTORNEY

SN 86-036,469. NICHOLS HERBERT, LA CROSSE, WI. FILED 8-13-2013.



THE COLOR(S) BLUE, GREEN, BROWN, TAN, LIGHT BROWN, YELLOW, BLACK, WHITE, GRAY IS/ARE CLAIMED AS A FEATURE OF THE MARK.

THE MARK CONSISTS OF THE WORD "SUSTAINABULL" WITH "SUSTAINA" IN BLUE LETTERS AND "BULL" IN GREEN LETTERS IS AT THE BOTTOM OF THE MARK. A MALE BULL-HUMAN FIGURE IS LOCATED ABOVE WORD "SUSTAINABULL" WEARING BLACK SHOES WITH WHITE BOTTOM OF SHOES, GREEN PANTS WITH BOTTOMS ROLLED UP AND BLACK ON THE PANT SEAMS, A BLUE JACKET WITH A BLUE HOOD AND BLACK ON SEAMS AND BUTTONS, A YELLOW SHIRT UNDER THE JACKET WITH BLACK ON THE BOTTOM OF THE SHIRT, THE BULL HAS HIS ARMS CROSSED WITH HIS LIGHT TAN HANDS REVEALED, THE BULL IS SMILING AND THE FACE IS TAN WITH BLACK HAIR ON CHIN, THE BULL HAS A GRAY RING

**CLASS 35—(Continued).**

THROUGH THE TAN NOSE AND BLACK GLASSES WITH A TINT OF GREEN. THE EYES ARE WHITE WITH BLACK PUPILS AND TINT OF WHITE, THE EYEBROWS ARE BROWN AND HAIR IS BROWN, THE BULL'S HORNS ARE GREEN AND THE HAT IS BLUE WITH SEAMS IN BLACK. THE BULL IS LEANING ON THE LETTER'S "I.M." WHICH ARE BLUE AND A CIRCULAR YELLOW SUN IN THE BACKGROUND WITH THE SEVEN YELLOW TRIANGLE SHAPED RAYS ABOVE THE CIRCLE SUN. BELOW THE "I.M." IS A GREEN LINE.

FOR BUSINESS CONSULTING IN THE FIELD OF ENVIRONMENTAL MANAGEMENT, NAMELY, ADVISING BUSINESSES AND INDIVIDUALS ON ISSUES OF ENVIRONMENTAL IMPACT, CONSERVATION, PRESERVATION AND PROTECTION, AND ECONOMIC ANALYSIS FOR BUSINESS PURPOSES; CHARITABLE SERVICES, NAMELY, PROMOTING ENVIRONMENTAL AWARENESS TO CHILDREN; PROMOTING PUBLIC AWARENESS OF ENVIRONMENTAL MATTERS; PROMOTING THE INTERESTS OF PEOPLE CONCERNED WITH HEALTH, COMMUNITY AND ENVIRONMENTAL SUSTAINABILITY ISSUES (U.S. CLS. 100, 101 AND 102). FIRST USE 1-20-2013; IN COMMERCE 6-1-2013.

JILL PRATER, EXAMINING ATTORNEY

SN 86-036,511. THE HANDCRAFTED SOAP AND COSMETIC GUILD, INC., SARATOGA SPRINGS, NY. FILED 8-13-2013.



THE COLOR(S) LIGHT GREEN, DARK GREEN, WHITE, GRAY, BEIGE AND TAN IS/ARE CLAIMED AS A FEATURE OF THE MARK.

THE MARK CONSISTS OF A DARK GREEN DIAMOND BORDERED BY A WHITE DIAMOND BORDERED BY A LIGHT GREEN DIAMOND. INSIDE THE DARK GREEN DIAMOND ARE TWO BEIGE AND TAN HANDS HOLDING A GRAY, LIGHT GREEN, AND WHITE CONTAINER AND GRAY AND WHITE BAR OF SOAP.

FOR ASSOCIATION SERVICES, NAMELY, PROMOTING THE INTERESTS OF PEOPLE WHO MAKE HANDCRAFTED SOAPS AND COSMETICS; TRADE ASSOCIATION SERVICES, NAMELY, PROMOTING THE INTERESTS OF PEOPLE WHO SELL HANDCRAFTED SOAPS AND COSMETICS (U.S. CLS. 100, 101 AND 102).

FIRST USE 3-30-2013; IN COMMERCE 3-30-2013. KRISTIN DAHLING, EXAMINING ATTORNEY

**CLASS 35—(Continued).**

SN 86-036,672. CARMAX BUSINESS SERVICES, LLC, RICHMOND, VA. FILED 8-13-2013.



OWNER OF U.S. REG. NO. 2,323,178.  
THE MARK CONSISTS OF THE STYLIZED LETTERS "CA" INSIDE A SHADED CIRCLE. A STYLIZED GAVEL APPEARS THROUGH THE LETTERS "C" AND "A".  
FOR MOTOR VEHICLE AUCTION SERVICES (U.S. CLS. 100, 101 AND 102).  
BERYL GARDNER, EXAMINING ATTORNEY

SN 86-036,684. VELVET SLIPPER LLC, HOUSTON, TX. FILED 8-13-2013.

**THE NIGHT CIRCUS**

THE MARK CONSISTS OF STANDARD CHARACTERS WITHOUT CLAIM TO ANY PARTICULAR FONT, STYLE, SIZE, OR COLOR.  
FOR MOBILE RETAIL STORE SERVICES FEATURING CLOTHING, JEWELRY, SHOES; RETAIL STORE SERVICES FEATURING CLOTHING, JEWELRY, SHOES (U.S. CLS. 100, 101 AND 102).  
BERYL GARDNER, EXAMINING ATTORNEY

SN 86-037,006. NEBULA PARTNERS,LLC, DBA NEBULA PARTNERS, ALPHARETTA, GA. FILED 8-13-2013.

**IntelliGenie**

THE MARK CONSISTS OF STANDARD CHARACTERS WITHOUT CLAIM TO ANY PARTICULAR FONT, STYLE, SIZE, OR COLOR.  
FOR EXPERT EVALUATIONS AND REPORTS RELATING TO BUSINESS MATTERS (U.S. CLS. 100, 101 AND 102).  
FIRST USE 7-9-2013; IN COMMERCE 7-9-2013.  
GEOFFREY FOSDICK, EXAMINING ATTORNEY

**CLASS 35—(Continued).**

SN 86-037,128. HOLBROOK L ZAKORY, DBA ZAK LANE, NEW SMYRNA BEACH, FL. AND HOWELL M ELDIS, NEW SMYRNA BEACH, FL. FILED 8-14-2013.

**Eolith Studios**

THE MARK CONSISTS OF STANDARD CHARACTERS WITHOUT CLAIM TO ANY PARTICULAR FONT, STYLE, SIZE, OR COLOR.

NO CLAIM IS MADE TO THE EXCLUSIVE RIGHT TO USE "STUDIOS", APART FROM THE MARK AS SHOWN.  
FOR COMMISSIONING OF WORKS OF ART (U.S. CLS. 100, 101 AND 102).  
MELISSA VALLILLO, EXAMINING ATTORNEY

SN 86-037,233. RECALIBRATE STRATEGIES, LLC, DBA RECALIBRATE STRATEGIES, SHAWNEE, KS. FILED 8-14-2013.



NO CLAIM IS MADE TO THE EXCLUSIVE RIGHT TO USE "STRATEGIES", APART FROM THE MARK AS SHOWN.

THE COLOR(S) BLUE, ORANGE, GREEN AND PURPLE IS/ARE CLAIMED AS A FEATURE OF THE MARK.  
THE MARK CONSISTS OF THE WORDS "RECALIBRATE STRATEGIES" IN STYLIZED BLUE LETTERING WRITTEN ON TWO LINES AND FOUR CURVED, GEOMETRIC SHAPES IN BLUE, GREEN, ORANGE AND PURPLE FORMING A CIRCLE TO THE LEFT OF THE WORDS.  
FOR CONSULTING SERVICES RELATING TO BUSINESS AND BRAND GROWTH THROUGH INSIGHTS, IDEAS AND STRATEGY (U.S. CLS. 100, 101 AND 102).  
FIRST USE 6-10-2013; IN COMMERCE 6-10-2013.  
KHANH LE, EXAMINING ATTORNEY

SN 86-037,590. PHARAOH DELIVERY ENTERPRISES, STOCKBRIDGE, GA. FILED 8-14-2013.

**Popcorn Divine**

THE MARK CONSISTS OF STANDARD CHARACTERS WITHOUT CLAIM TO ANY PARTICULAR FONT, STYLE, SIZE, OR COLOR.

NO CLAIM IS MADE TO THE EXCLUSIVE RIGHT TO USE "POPCORN", APART FROM THE MARK AS SHOWN.  
FOR RETAIL STORE SERVICES FEATURING OVER TWO HUNDRED FIFTY FLAVORS OF GOURMET POPCORN (U.S. CLS. 100, 101 AND 102).  
DAVID YONTEF, EXAMINING ATTORNEY

**CLASS 35—(Continued).**

SN 86-037,594. THE BULLITT AGENCY, INC., WASHINGTON, DC. FILED 8-14-2013.

**THE BULLITT AGENCY**

THE MARK CONSISTS OF STANDARD CHARACTERS WITHOUT CLAIM TO ANY PARTICULAR FONT, STYLE, SIZE, OR COLOR.

OWNER OF U.S. REG. NO. 2,786,043.

NO CLAIM IS MADE TO THE EXCLUSIVE RIGHT TO USE "AGENCY", APART FROM THE MARK AS SHOWN.

FOR TALENT AGENCY SERVICES, NAMELY, TALENT MANAGEMENT SERVICES AND EMPLOYMENT SERVICES IN THE NATURE OF TALENT CASTING FOR MUSICIANS, DISC JOCKEYS AND MUSIC PRODUCERS IN THE FIELDS OF MUSIC, VIDEO AND FILMS (U.S. CLS. 100, 101 AND 102).

FIRST USE 7-15-2011; IN COMMERCE 7-15-2011.

DAVID YONTEF, EXAMINING ATTORNEY

**CLASS 35—(Continued).**

SN 86-038,121. AMERICAN PICK, INC., FORMERLY AMERICANPICK, INC., KELLER, TX. FILED 8-14-2013.

**AMERICAN PICK**

THE MARK CONSISTS OF STANDARD CHARACTERS WITHOUT CLAIM TO ANY PARTICULAR FONT, STYLE, SIZE, OR COLOR.

NO CLAIM IS MADE TO THE EXCLUSIVE RIGHT TO USE "AMERICAN", APART FROM THE MARK AS SHOWN.

FOR ON-LINE AUCTION SERVICES FEATURING ANTIQUES, COLLECTIBLES AND MEMORABILIA; ON-LINE TRADING SERVICES IN WHICH SELLER POSTS PRODUCTS TO BE AUCTIONED AND BIDDING IS DONE VIA THE INTERNET (U.S. CLS. 100, 101 AND 102).

CHERYL CLAYTON, EXAMINING ATTORNEY

SN 86-037,769. PRATT INDUSTRIES, INC., CONYERS, GA. FILED 8-14-2013.

**Pratt Plus**

THE MARK CONSISTS OF STANDARD CHARACTERS WITHOUT CLAIM TO ANY PARTICULAR FONT, STYLE, SIZE, OR COLOR.

OWNER OF U.S. REG. NOS. 3,616,081, 3,737,012 AND OTHERS.

FOR ONLINE RETAIL STORE SERVICES FEATURING GOODS IN THE FIELDS OF PACKAGING, MOVING, AND STORAGE (U.S. CLS. 100, 101 AND 102).

FIRST USE 7-31-2012; IN COMMERCE 7-31-2012.

KATHLEEN M. VANSTON, EXAMINING ATTORNEY

SN 86-038,283. SOCKS TO BE YOU, LLC, DBA SOCKS TO BE YOU, TOBYHANNA, PA. FILED 8-14-2013.

**Socks to be You**

THE MARK CONSISTS OF STANDARD CHARACTERS WITHOUT CLAIM TO ANY PARTICULAR FONT, STYLE, SIZE, OR COLOR.

FOR RETAIL STORE SERVICES FEATURING MEN'S, WOMEN'S, AND CHILDREN'S CLOTHING, SOCKS, SOCK PUPPETS AND SOCK DOLLS (U.S. CLS. 100, 101 AND 102).

FIRST USE 5-4-2013; IN COMMERCE 5-4-2013.

ZACHARY CROMER, EXAMINING ATTORNEY

SN 86-037,792. ORGANIC TO GREEN, INC., PACIFIC PALISADES, CA. FILED 8-14-2013.

**BEAUTY CIRQUE**

THE MARK CONSISTS OF STANDARD CHARACTERS WITHOUT CLAIM TO ANY PARTICULAR FONT, STYLE, SIZE, OR COLOR.

NO CLAIM IS MADE TO THE EXCLUSIVE RIGHT TO USE "BEAUTY", APART FROM THE MARK AS SHOWN.

FOR ON-LINE RETAIL STORE SERVICES FEATURING BEAUTY AND LIFESTYLE PRODUCTS; RETAIL SHOPS FEATURING BEAUTY AND LIFESTYLE PRODUCTS (U.S. CLS. 100, 101 AND 102).

FIRST USE 1-0-2009; IN COMMERCE 1-0-2009.

KIM MONINGHOFF, EXAMINING ATTORNEY

SN 86-038,411. LOLSPOTS.COM LLC, SANTA MONICA, CA. FILED 8-15-2013.

**LOLSPOTS**

THE MARK CONSISTS OF STANDARD CHARACTERS WITHOUT CLAIM TO ANY PARTICULAR FONT, STYLE, SIZE, OR COLOR.

FOR ADVERTISING AND COMMERCIAL INFORMATION SERVICES, VIA THE INTERNET; ADVERTISING AND BUSINESS SERVICES, NAMELY, PROVIDING A SEARCHABLE ONLINE ADVERTISING WEBSITE AND INFORMATIONAL GUIDE FEATURING THE GOODS AND SERVICES OF OTHER VENDORS VIA THE INTERNET IN THE FIELD OF CONSUMER PRODUCTS; PROVIDING AN INTERNET WEBSITE PORTAL FEATURING PROMOTION AND ADVERTISING FOR HOME SERVICE PROVIDERS AND PRODUCT MANUFACTURERS; PROMOTING AND MARKETING THE GOODS AND SERVICES OF OTHERS BY PROVIDING HYPERLINKS TO WEBSITES OF OTHERS (U.S. CLS. 100, 101 AND 102).

FIRST USE 9-1-2012; IN COMMERCE 9-1-2012.

MICHAEL SOUDERS, EXAMINING ATTORNEY

**CLASS 35—(Continued).**

SN 86-038,451. CAPINEL S.A., MONTEVIDEO, URUGUAY, FILED 8-15-2013.

## LA MARTINA

THE MARK CONSISTS OF STANDARD CHARACTERS WITHOUT CLAIM TO ANY PARTICULAR FONT, STYLE, SIZE, OR COLOR.

OWNER OF U.S. REG. NOS. 1,442,210 AND 3,011,932. THE ENGLISH TRANSLATION OF "LA MARTINA" IS "THE MORNING".

FOR RETAIL AND ONLINE RETAIL STORE SERVICES FEATURING CLOTHING, BAGS, PERFUME, JEWELRY, BOOKS, ACCESSORIES, AND POLO EQUIPMENT (U.S. CLS. 100, 101 AND 102).

FIRST USE 0-0-2004; IN COMMERCE 0-0-2004. BRIAN PINO, EXAMINING ATTORNEY

---

SN 86-038,460. UBIQUITY GLOBAL SERVICES, INC., NEW YORK, NY. FILED 8-15-2013.

## TOGETHER, LET'S BE UBIQUITOUS

THE MARK CONSISTS OF STANDARD CHARACTERS WITHOUT CLAIM TO ANY PARTICULAR FONT, STYLE, SIZE, OR COLOR.

FOR CUSTOMER SERVICES, NAMELY, CUSTOMER SERVICE MANAGEMENT FOR OTHERS; BUSINESS PROCESS OUTSOURCING SERVICES; OPERATION OF CALL CENTERS FOR OTHERS (U.S. CLS. 100, 101 AND 102).

JAMES MACFARLANE, EXAMINING ATTORNEY

---

SN 86-038,552. 45 RUE LAFFITTE, MUNDELEIN, IL. FILED 8-15-2013.

## 45 RUE LAFFITTE

THE MARK CONSISTS OF STANDARD CHARACTERS WITHOUT CLAIM TO ANY PARTICULAR FONT, STYLE, SIZE, OR COLOR.

THE ENGLISH TRANSLATION OF THE WORD "RUE" IN THE MARK IS "STREET", AND THE WORDING "LAFFITTE" HAS NO MEANING IN A FOREIGN LANGUAGE.

FOR CHARITABLE SERVICES, NAMELY, ORGANIZING AND DEVELOPING ARTISTIC PROJECTS AIMED AT IMPROVING THE LIVES OF INDIVIDUALS IN NEED; CHARITABLE SERVICES, NAMELY, CONNECTING INDIVIDUALS IN NEED WITH PEOPLE WHO ARE WILLING TO SUPPORT THE INDIVIDUAL'S ARTISTIC DEVELOPMENT (U.S. CLS. 100, 101 AND 102).

ALLISON SCHRODY, EXAMINING ATTORNEY

**CLASS 35—(Continued).**

SN 86-038,589. SHOWTEES LLC, FAIRFAX, VA. FILED 8-15-2013.



NO CLAIM IS MADE TO THE EXCLUSIVE RIGHT TO USE "SHOW TEES", APART FROM THE MARK AS SHOWN.

THE MARK CONSISTS OF A CLOTHING HANGER WITH A SINGLE EYE AND THE TEXT "SHOWTEES" WRITTEN BELOW THE HANGER.

FOR ON-LINE RETAIL STORE SERVICES FEATURING T-SHIRTS, TANK TOPS, SWEATERS, HOODED SWEATSHIRTS, SWEATSHIRTS, CAPS, PANTS, AND SOCKS (U.S. CLS. 100, 101 AND 102).

FIRST USE 8-4-2013; IN COMMERCE 8-4-2013. ALEX KEAM, EXAMINING ATTORNEY

---

SN 86-038,649. G.C. FRANCHISING SYSTEMS, INC., DBA THE GROWTH COACH, CINCINNATI, OH. FILED 8-15-2013.

## Feed your dreams. Starve your fears.

THE MARK CONSISTS OF STANDARD CHARACTERS WITHOUT CLAIM TO ANY PARTICULAR FONT, STYLE, SIZE, OR COLOR.

FOR BUSINESS-MANAGEMENT CONSULTING; BUSINESS CONSULTING; BUSINESS DEVELOPMENT SERVICES; BUSINESS-MARKETING CONSULTING SERVICES; PROVIDING INFORMATION IN THE FIELDS OF BUSINESS MANAGEMENT, AND BUSINESS ADVERTISING, MARKETING, AND PROMOTION SERVICES; MARKETING-PLAN DEVELOPMENT; SALES PROMOTION SERVICES; BUSINESS CONSULTATION SERVICES IN THE FIELD OF BUSINESS CHANGE MANAGEMENT; BUSINESS ORGANIZATION DEVELOPMENT AND CONSULTING SERVICES; BUSINESS CONSULTATION SERVICES IN THE FIELD OF BUSINESS PROCESS MANAGEMENT; BUSINESS STRATEGIC-MANAGEMENT AND PLANNING SERVICES; BUSINESS MANAGEMENT PLANNING; BUSINESS NETWORKING; CONDUCTING BUSINESS RESEARCH AND SURVEYS; BUSINESS SUPERVISION; COMMERCIAL AND INDUSTRIAL MANAGEMENT ASSISTANCE; BUSINESS ADVISORY SERVICES; BUSINESS LEADERSHIP DEVELOPMENT, MANAGEMENT TEAM DEVELOPMENT, AND BUSINESS SYSTEMS IMPROVEMENT, NAMELY, BUSINESS MANAGEMENT CONSULTATION IN THE FIELD OF EXECUTIVE AND LEADERSHIP DEVELOPMENT; PERSONNEL-MANAGEMENT CONSULTATION; PREPARING BUSINESS REPORTS; ARRANGING AND CONDUCTING TRADE SHOWS AND BUSINESS CONFERENCES IN THE FIELD OF BUSINESS AND BUSINESS MANAGEMENT; FRANCHISING, NAMELY, OFFERING BUSINESS MANAGEMENT ASSISTANCE IN THE ESTABLISHMENT AND OPERATION OF BUSINESSES IN THE FIELDS OF BUSINESS MANAGEMENT, BUSINESS CONSULTATION, MARKETING, ADVERTISING AND PROMOTION (U.S. CLS. 100, 101 AND 102).

FIRST USE 10-1-2012; IN COMMERCE 10-1-2012. ALISON POLLACK, EXAMINING ATTORNEY

**CLASS 35—(Continued).**

SN 86-038,717. POLYNESIAN CULTURAL CENTER, LAIE, HI. FILED 8-15-2013.



OWNER OF U.S. REG. NO. 4,442,613.  
 THE MARK CONSISTS OF THE WORD "ULU" IN BLOCK LETTER FORMAT WITH LINES WITHIN EACH LETTER AND A LEAF DESIGN TO THE RIGHT OF THE WORD AND ATTACHED TO THE LETTER "U".  
 THE ENGLISH TRANSLATION OF "ULU" IN THE MARK IS "TO GROW", "INCREASE", "THRIVE", "MATURE" AND "EXTEND".  
 FOR RETAIL GIFT SHOPS; RETAIL STORE SERVICES FEATURING SOUVENIRS (U.S. CLS. 100, 101 AND 102).  
 FIRST USE 3-14-2013; IN COMMERCE 3-14-2013.  
 BRIAN PINO, EXAMINING ATTORNEY

**CLASS 35—(Continued).**

SN 86-038,736. GOLDEN, VICTORIA L, FORMERLY LOST ART GALLERY, ST. AUGUSTINE, FL. FILED 8-15-2013.



NO CLAIM IS MADE TO THE EXCLUSIVE RIGHT TO USE "ART GALLERY" AND "OBJECTS D'ART", APART FROM THE MARK AS SHOWN.  
 THE COLOR(S) COPPER IS/ARE CLAIMED AS A FEATURE OF THE MARK.  
 THE MARK CONSISTS OF A TWO-HANDLED URN SHADED AND OUTLINED IN A COPPER COLOR WITH THE WORDS "LOST ART GALLERY" IN COPPER OVERLAPPING INTO THE URN AND THE WORDS "OBJECTS D'ART WITH A PAST " IN COPPER BELOW. THE COLOR WHITE IS FOR BACKGROUND PURPOSES ONLY AND IS NOT CLAIMED AS A FEATURE OF THE MARK.  
 FOR ART GALLERIES; ART GALLERY SERVICES; ON-LINE ART GALLERIES (U.S. CLS. 100, 101 AND 102).  
 FIRST USE 4-30-1989; IN COMMERCE 7-1-1994.  
 JOHN WILKE, EXAMINING ATTORNEY

SN 86-038,721. PHARAOH DELIVERY ENTERPRISES, STOCKBRIDGE, GA. FILED 8-15-2013.



NO CLAIM IS MADE TO THE EXCLUSIVE RIGHT TO USE "POPCORN", APART FROM THE MARK AS SHOWN.  
 THE MARK CONSISTS OF THE WORDING "POPCORN DIVINE" IN STYLIZED FONT WHEREBY THE LETTER "V" IS SUPERIMPOSED OVER A HEART DESIGN.  
 FOR RETAIL STORE SERVICES FEATURING OVER TWO HUNDRED FIFTY FLAVORS OF GOURMET POPCORN (U.S. CLS. 100, 101 AND 102).  
 DAVID YONTEF, EXAMINING ATTORNEY

SN 86-038,880. HELLOFLO, INC., BROOKLYN, NY. FILED 8-15-2013.



OWNER OF U.S. REG. NO. 4,338,616.  
 THE MARK CONSISTS OF THE WORDING "HELLO FLO" IN A CIRCULAR SEAL WITH SEVEN SMALL DOTS, AND A DESIGN OF A GIRL WEARING A BOW IN HER HAIR AND WINKING.  
 FOR ON-LINE RETAIL STORE SERVICES FEATURING FEMININE CARE PRODUCTS, TAMPONS, SANITARY PADS AND PANTY LINERS; ON-LINE SUBSCRIPTION-BASED MAIL ORDER SERVICES FEATURING FEMININE CARE PRODUCTS, TAMPONS, SANITARY PADS AND PANTY LINERS (U.S. CLS. 100, 101 AND 102).  
 FIRST USE 8-1-2012; IN COMMERCE 8-1-2012.  
 GIANCARLO CASTRO, EXAMINING ATTORNEY

**CLASS 35—(Continued).**

SN 86-038,946. SUNSHINE & CLOVER, CROTON ON HUDSON, NY. FILED 8-15-2013.



NO CLAIM IS MADE TO THE EXCLUSIVE RIGHT TO USE "FLOWERS GIFTS DECOR DESIGN", APART FROM THE MARK AS SHOWN.

THE MARK CONSISTS OF THE STYLIZED TEXT "SUNSHINE &" WITH THE STYLIZED TEXT "CLOVER" BENEATH THAT AND THE STYLIZED TEXT "FLOWERS GIFTS DECOR DESIGN" BENEATH THAT. THE LETTER "I" IN "SUNSHINE" AND THE LETTER "L" IN CLOVER ARE ATTACHED CREATING ONE LETTER AND THE DOT ABOVE THE "I" IS A FLOWER DESIGN.

FOR RETAIL STORE SERVICES FEATURING FRESH FLOWERS, GIFTS, JEWELRY, TOYS, STATIONERY, PARTY SUPPLIES, CLOTHING, FLORAL PRODUCTS, CANDY, AND BATH AND BODY PRODUCTS (U.S. CLS. 100, 101 AND 102).

FIRST USE 3-27-2013; IN COMMERCE 3-27-2013.  
JOHN DWYER, EXAMINING ATTORNEY

SN 86-039,004. BIRCH GLOBAL, INC., WILMINGTON, DE. FILED 8-15-2013.



**DecorGoods**  
.com

NO CLAIM IS MADE TO THE EXCLUSIVE RIGHT TO USE ".COM", APART FROM THE MARK AS SHOWN.

THE COLOR(S) WHITE, BLACK, PURPLE, RED, BURGUNDY, BLUE, ORANGE AND FUCHSIA IS/ARE CLAIMED AS A FEATURE OF THE MARK.

THE MARK CONSISTS OF THE PHRASE "DECORGOODS.COM", WRITTEN IN BLACK CURSIVE FONT TYPE, WITH A CAPITAL "D" AND "G", AND ".COM" UNDERNEATH, ALIGNED TO THE RIGHT, AND POSITIONED UNDER THE MAIN LOGO IMAGE CONSISTING OF A CIRCULAR SHAPE COMPOSED OF VARIOUS SIZED CIRCLES WHICH ARE PURPLE, RED, BURGUNDY, BLUE, ORANGE, AND FUCHSIA, WITH THE MAIN COMPONENT OF THE LOGO IMAGE IN WHITE COLORED LETTER "D", POSITIONED IN THE CENTER OF THE MAIN CIRCLE, WITH THE SAME FONT TYPE AS THE FIRST CAPITAL LETTER OF THE MAIN PHRASE.

FOR ON-LINE RETAIL DEPARTMENT STORE SERVICES; ON-LINE RETAIL STORE SERVICES FEATURING A WIDE VARIETY OF CONSUMER GOODS OF OTHERS; ON-LINE RETAIL STORE SERVICES FEATURING HOME FURNISHINGS AND HOME DECOR PRODUCTS (U.S. CLS. 100, 101 AND 102).

FIRST USE 11-18-2010; IN COMMERCE 1-31-2013.  
CAROLINE WOOD, EXAMINING ATTORNEY

**CLASS 35—(Continued).**

SN 86-039,043. CUTISPHARMA, INC., WOBURN, MA. FILED 8-15-2013.

**CPPC**

THE MARK CONSISTS OF STANDARD CHARACTERS WITHOUT CLAIM TO ANY PARTICULAR FONT, STYLE, SIZE, OR COLOR.

FOR BUSINESS NETWORKING SERVICES, NAMELY, BRINGING TOGETHER PHARMACISTS AND OTHER HEALTH CARE PROFESSIONALS FOR NETWORKING AND EXCHANGING IDEAS (U.S. CLS. 100, 101 AND 102).

KRISTIN DAHLING, EXAMINING ATTORNEY

SN 86-039,069. FLASH DASH BAZAAR INC., MYRTLE BEACH, SC. FILED 8-15-2013.

**FLASH DASH BAZAAR**

THE MARK CONSISTS OF STANDARD CHARACTERS WITHOUT CLAIM TO ANY PARTICULAR FONT, STYLE, SIZE, OR COLOR.

NO CLAIM IS MADE TO THE EXCLUSIVE RIGHT TO USE "BAZAAR", APART FROM THE MARK AS SHOWN.

FOR ON-LINE RETAIL STORE SERVICES FEATURING DISCOUNTED GOODS IN THE FIELD OF GENERAL CONSUMER MERCHANDISE (U.S. CLS. 100, 101 AND 102).

NATALIE POLZER, EXAMINING ATTORNEY

SN 86-039,181. THE PERT GROUP, INC., FARMINGTON, CT. FILED 8-15-2013.

**Brandvantage**

THE MARK CONSISTS OF STANDARD CHARACTERS WITHOUT CLAIM TO ANY PARTICULAR FONT, STYLE, SIZE, OR COLOR.

FOR MARKET RESEARCH CONSULTING; BRAND RESEARCH CONSULTING AND TESTING; CONDUCTING BUSINESS AND MARKET RESEARCH; ANALYSIS, EVALUATION AND BRAND ESTABLISHMENT OF TRADEMARKS, PRODUCT TRADE DRESS, TRADE NAMES AND DOMAIN NAMES; CONCEPT AND BRAND DEVELOPMENT FOR CORPORATE CLIENTS (U.S. CLS. 100, 101 AND 102).

JAMES GRIFFIN, EXAMINING ATTORNEY

**CLASS 35—(Continued).**

SN 86-039,350. ARIZONA SCHOOL ADMINISTRATORS INC., AKA ASA, PHOENIX, AZ. FILED 8-15-2013.



OWNER OF U.S. REG. NO. 3,404,986.  
NO CLAIM IS MADE TO THE EXCLUSIVE RIGHT TO USE "ARIZONA SCHOOL ADMINISTRATORS", APART FROM THE MARK AS SHOWN.

THE COLOR(S) TEAL, WHITE IS/ARE CLAIMED AS A FEATURE OF THE MARK.

THE MARK CONSISTS OF STYLIZED LETTERS, "ASA", WITH THE "S" SLIGHTLY RAISED IN BETWEEN THE TWO "A"'S THEN UNDERLINED. THE WORDS "ARIZONA SCHOOL ADMINISTRATORS" IS BELOW THE LINE IN A SMALLER FONT. THE LETTERS ARE TEAL IN COLOR WITH WHITE HIGHLIGHTS PRESENT IN THE "ASA" LETTERING.

FOR PUBLIC ADVOCACY TO PROMOTE AWARENESS OF THE ROLES OF EDUCATIONAL IMPROVEMENT (U.S. CLS. 100, 101 AND 102).

FIRST USE 8-1-2012; IN COMMERCE 8-1-2012.  
BRIN ANDERSON, EXAMINING ATTORNEY

SN 86-039,409. THINK ANEW INC., SPRINGBORO, OH. FILED 8-15-2013.



NO CLAIM IS MADE TO THE EXCLUSIVE RIGHT TO USE "LEADERSHIP", APART FROM THE MARK AS SHOWN.

THE COLOR(S) BLACK, RED, WHITE AND BLUE IS/ARE CLAIMED AS A FEATURE OF THE MARK.

THE MARK CONSISTS OF THE WORDING "80/20 LEADERSHIP CHARACTER, COMPETENCE & COURAGE" IN STYLIZED BOLD BLACK LETTERING WRITTEN ON TWO LINES. A BLUE RECTANGLE WITH CURVED CORNERS APPEARS TO THE LEFT OF THE WORDING "80/20 LEADERSHIP CHARACTER, COMPETENCE & COURAGE". A RED TRIANGLE POINTING DOWN AND A WHITE TRIANGLE POINTING UP APPEARS INSIDE THE RECTANGLE.

FOR BUSINESS CONSULTING SERVICES IN THE FIELD OF MANUFACTURING AND LEADERSHIP (U.S. CLS. 100, 101 AND 102).

FIRST USE 1-1-2010; IN COMMERCE 1-1-2010.  
JANICE L. MCMORROW, EXAMINING ATTORNEY

**CLASS 35—(Continued).**

SN 86-039,861. CORE ACCESS GROUP, INDIANAPOLIS, IN. FILED 8-16-2013.



NO CLAIM IS MADE TO THE EXCLUSIVE RIGHT TO USE "GROUP", APART FROM THE MARK AS SHOWN.

THE MARK CONSISTS OF THE WORD "CORE" WHEREBY AN ADDITIONAL SEMI-CIRCULAR ELEMENT, INCLUDING A LARGER PORTION AND A SMALLER PORTION, IS ADDED TO THE TOP AND BOTTOM OF THE "O" IN THE WORD "CORE". ALSO INCLUDED BENEATH AND TO THE RIGHT OF THE WORD "CORE" ARE THE WORDS "ACCESS GROUP".

FOR BUSINESS MANAGEMENT CONSULTATION IN THE FIELD OF PROMOTION OPPORTUNITY ASSESSMENT, PROMOTION EFFECTIVENESS, PAYER PROMOTION STRATEGY, ACCOUNT MANAGER AND SALES FORCE PROMOTION STRATEGY AND DISTRIBUTION STRATEGY (U.S. CLS. 100, 101 AND 102).

FIRST USE 9-5-2012; IN COMMERCE 9-5-2012.  
ANDREA BUTLER, EXAMINING ATTORNEY

SN 86-039,889. PURDUE FEDERAL CREDIT UNION, WEST LAFAYETTE, IN. FILED 8-16-2013.

## My Member Perks

THE MARK CONSISTS OF STANDARD CHARACTERS WITHOUT CLAIM TO ANY PARTICULAR FONT, STYLE, SIZE, OR COLOR.

NO CLAIM IS MADE TO THE EXCLUSIVE RIGHT TO USE "MEMBER PERKS", APART FROM THE MARK AS SHOWN.

FOR ARRANGING AND CONDUCTING INCENTIVE REWARD PROGRAMS TO PROMOTE THE SALE OF CREDIT UNION SERVICES (U.S. CLS. 100, 101 AND 102).

FIRST USE 4-25-2013; IN COMMERCE 8-1-2013.  
JEFF DEFORD, EXAMINING ATTORNEY

SN 86-040,230. LOVABLE BABIES, SUISUN CITY, CA. FILED 8-16-2013.



NO CLAIM IS MADE TO THE EXCLUSIVE RIGHT TO USE "BABIES", APART FROM THE MARK AS SHOWN.

THE MARK CONSISTS OF A DESIGN OF AN ICON WITH THE STYLIZED LETTERS "LB" INSIDE OF IT AND THE STYLIZED TEXT "LOVABLE BABIES" BENEATH THE ICON.

FOR ON-LINE RETAIL STORE SERVICES FEATURING LADIES' AND CHILDREN'S CLOTHING, SOCKS, MAKE-UPS (U.S. CLS. 100, 101 AND 102).

CATHERINE TARCU, EXAMINING ATTORNEY

**CLASS 35—(Continued).**

SN 86-040,318. THE CARTRIDGE DEPOT, LLC, OWINGS MILLS, MD. FILED 8-16-2013.

**CARTRIDGE DEPOT**

THE MARK CONSISTS OF STANDARD CHARACTERS WITHOUT CLAIM TO ANY PARTICULAR FONT, STYLE, SIZE, OR COLOR.

OWNER OF U.S. REG. NO. 3,007,431.

NO CLAIM IS MADE TO THE EXCLUSIVE RIGHT TO USE "CARTRIDGE", APART FROM THE MARK AS SHOWN.

FOR RETAIL STORE SERVICES FEATURING INK, INKJET AND TONER CARTRIDGES; WHOLESALE STORE SERVICES FEATURING INK, INKJET AND TONER CARTRIDGES; ONLINE RETAIL STORE SERVICES FEATURING INK, INKJET AND TONER CARTRIDGES; ONLINE WHOLESALE STORE SERVICES FEATURING INK, INKJET AND TONER CARTRIDGES; WHOLESALE DISTRIBUTORSHIPS FEATURING INK, INKJET AND TONER CARTRIDGES (U.S. CLS. 100, 101 AND 102).

TOBY BULLOFF, EXAMINING ATTORNEY

**CLASS 35—(Continued).**

SN 86-040,597. FUNDACION TELETON MEXICO, A.C., TLALNEPANTLA DE BAZ, MEXICO, FILED 8-16-2013.



OWNER OF U.S. REG. NOS. 2,972,929, 4,197,670 AND OTHERS.

THE COLOR(S) WHITE, YELLOW AND PURPLE IS/ARE CLAIMED AS A FEATURE OF THE MARK.

THE MARK CONSISTS OF A YELLOW AND PURPLE HEART WITH WHITE HANDS AND A DIAGONAL WHITE BAND SUPERIMPOSED OVER THE HEART.

FOR PRODUCTION AND DISTRIBUTION OF RADIO AND TELEVISION COMMERCIALS; PROMOTING THE GOODS AND SERVICES OF OTHERS BY ARRANGING FOR SPONSORS TO AFFILIATE THEIR GOODS AND SERVICES WITH FUNDRAISERS FOR CHILDREN; TELEMARKETING; TELEPHONE AND TELEVISION AUCTIONS (U.S. CLS. 100, 101 AND 102).

KAREN K. BUSH, EXAMINING ATTORNEY

SN 86-040,558. DEKE DIGITAL, WHEAT RIDGE, CO. FILED 8-16-2013.



THE COLOR(S) RED, BLUE, AND GREY IS/ARE CLAIMED AS A FEATURE OF THE MARK.

THE MARK CONSISTS OF A V-SHAPED DESIGN MADE UP OF THREE RED CIRCLES AND TWO GREY ARROWS, WITH A BLUE "X" APPEARING IN THE MIDDLE OF THE DESIGN, TO THE RIGHT OF WHICH APPEARS THE WORDING DEKEDIGITAL, WITH THE WORD "DEKE" IN RED, AND THE WORD "DIGITAL" IN BLUE WITH RED DOTS OVER EACH "I".

FOR DEVELOPMENT OF MARKETING STRATEGIES, CONCEPTS AND TACTICS, NAMELY, AUDIENCE DEVELOPMENT, BRAND AWARENESS, ONLINE COMMUNITY BUILDING AND DIGITAL WORD OF MOUTH COMMUNICATIONS (U.S. CLS. 100, 101 AND 102).

FIRST USE 7-15-2013; IN COMMERCE 7-15-2013.

ANDREW LEASER, EXAMINING ATTORNEY

SN 86-040,634. ARTICLE CULTURE COMPANY LLC, CINCINNATI, OH. FILED 8-16-2013.



THE MARK CONSISTS OF A STYLIZED LETTER "A" WITH A DISTINCTIVE, DOWNWARD-SLOPING, MIDDLE CROSSBAR.

FOR RETAIL STORE SERVICES FEATURING CLOTHING (U.S. CLS. 100, 101 AND 102).

PAUL E. FAHRENKOPF, EXAMINING ATTORNEY



**CLASS 35—(Continued).**

SN 86-040,747. GIFT GATHER, INC., CARLSBAD, CA. FILED 8-16-2013.

**GIFT GATHER**

THE MARK CONSISTS OF STANDARD CHARACTERS WITHOUT CLAIM TO ANY PARTICULAR FONT, STYLE, SIZE, OR COLOR.

NO CLAIM IS MADE TO THE EXCLUSIVE RIGHT TO USE "GIFT", APART FROM THE MARK AS SHOWN.

FOR GIFT REGISTRY SERVICES; PROVIDING A WEBSITE FEATURING GIFT REGISTRY SERVICES (U.S. CLS. 100, 101 AND 102).

FIRST USE 1-20-2013; IN COMMERCE 1-20-2013.  
LINDA MICKLEBURGH, EXAMINING ATTORNEY

SN 86-040,916. BURTON, MARTHA L., SAINT LOUIS, MO. FILED 8-17-2013.

**Foot On It**

THE MARK CONSISTS OF STANDARD CHARACTERS WITHOUT CLAIM TO ANY PARTICULAR FONT, STYLE, SIZE, OR COLOR.

FOR RETAIL AND ON-LINE RETAIL STORE SERVICES FEATURING WOMEN, MEN, CHILDREN AND BABY APPAREL, CLOTHING, NAMELY, T-SHIRTS, JACKETS, FLEECE JACKETS, PANTS, SWIM SUITS, TANK TOPS, BOXER SHORTS, SKIRTS, SHORTS, VESTS, SWEATERS, SWEAT SHIRTS, SWEAT PANTS, ROBES, CAPS, HEADWEAR, FLEECE TOPS, HEADBANDS, WRISTBANDS, GYM SHORTS, SLEEPWEAR, PAJAMAS AND NIGHT GOWNS, SOCKS, SHOES, SOLES OF SHOES, MERCHANDISE, NAMELY, TOYS, STUFFED ANIMALS, KEY CHAINS OF METAL AND PLASTIC, KEY CHAINS OF PRECIOUS METAL, KEY CHAINS AS JEWELRY, STICKERS, BUMPER STICKERS, CALENDARS, MAGAZINES, STATIONERY CARDS, RUBBER STAMPS, POSTERS, BLANK POSTCARDS, PARTIALLY PRINTED POSTCARDS, PICTURE POSTCARDS, ADDRESS PLATES, ENGRAVING PLATES, BOOK PLATES AND BOOK COVERS, MOUNTED AND UNMOUNTED PHOTOGRAPHS, TISSUE PAPER, TRASH BAGS, PEN AND PENCILS TRAYS, DOCUMENT FILE TRAYS, PAPER, PENS, PENCILS, PENCIL HOLDERS, DESK PADS, WALL CALENDARS, FOUNTAIN PENS, DRINKING MUGS, DISHES, COFFEE TRAVEL MUGS, COFFEE MUGS, CUPS, GENERAL PURPOSE BAGS MADE OF FABRIC AND PLASTIC, GREETING CARDS, NAPKINS, AND PAPER NAPKINS, CELL PHONE SOFTWARE APPLICATIONS TO DELIVER RINGTONES AND INTERACTIVE COMEDIC ENTERTAINMENT AND MOTIVATION FOR MOBILE PHONES, EXERCISE PRODUCTS, NAMELY, EXERCISE VIDEOS, GYM EQUIPMENT IN THE NATURE OF WEIGHTS, EXERCISE STRAPS, DUMB BELLS, TOYS, NAMELY, ACTION FIGURES, DOLLS, COMPUTER GAMES, LICENSE PLATE COVERS, BEDDING TO INCLUDE SHEETS, COMFORTERS, PILLOW SLIPS, PILLOWS, TOWEL BOWLS, BILL BOARDS, JEWELRY, FLOWER POTS, FLOOR RUGS, BELTS, WATER BOTTLES, BROOM, MOPS (U.S. CLS. 100, 101 AND 102).

DARRYL SPRUILL, EXAMINING ATTORNEY

**CLASS 35—(Continued).**

SN 86-040,949. EXECUTIVE SPORTS GROUP INC., NEW YORK, NY. FILED 8-18-2013.

**GO CHARITY**

THE MARK CONSISTS OF STANDARD CHARACTERS WITHOUT CLAIM TO ANY PARTICULAR FONT, STYLE, SIZE, OR COLOR.

NO CLAIM IS MADE TO THE EXCLUSIVE RIGHT TO USE "CHARITY", APART FROM THE MARK AS SHOWN.

FOR ARRANGING AND CONDUCTING AUCTIONS; ARRANGING AND CONDUCTION OF AUCTION SALES; AUCTION MANAGEMENT SERVICES PROVIDED TO OTHERS OVER AN ON-LINE WEB SITE ACCESSED THROUGH A GLOBAL COMPUTER NETWORK; AUCTION SERVICES; AUCTIONEERING OF PROPERTY; BUSINESS MANAGEMENT ASSISTANCE AND PARTICULARLY CARRYING OUT TASKS NECESSARY FOR THE SMOOTH CONDUCT OF SALES BY AUCTION; DEVELOPING AND MANAGING THE CHARITABLE GIVING PROGRAMS OF OTHERS; ON-LINE AUCTION SERVICES; ON-LINE AUCTIONEERING SERVICES VIA THE INTERNET; ORGANIZING AND CONDUCTING CHARITY AUCTIONS FOR CHARITABLE FUNDRAISING PURPOSES (U.S. CLS. 100, 101 AND 102).

FIRST USE 6-1-2008; IN COMMERCE 6-1-2008.  
DAVID TAYLOR, EXAMINING ATTORNEY

SN 86-041,027. BEHAN, DAN, GRAND HAVEN, MI. FILED 8-18-2013.

**Gratitude Growing**

THE MARK CONSISTS OF STANDARD CHARACTERS WITHOUT CLAIM TO ANY PARTICULAR FONT, STYLE, SIZE, OR COLOR.

NO CLAIM IS MADE TO THE EXCLUSIVE RIGHT TO USE "GRATITUDE", APART FROM THE MARK AS SHOWN.

FOR ORGANIZING AND DEVELOPING CHARITABLE PROJECTS THAT AIM TO IMPROVE THE WELL BEING OF OLDER ADULTS THROUGH THE PRACTICE AND APPLICATION OF GRATITUDE ON A SOCIETAL LEVEL (U.S. CLS. 100, 101 AND 102).

FIRST USE 3-1-2010; IN COMMERCE 3-1-2010.  
DANIEL CAPSHAW, EXAMINING ATTORNEY

**CLASS 35—(Continued).**

SN 86-041,232. PRATT INDUSTRIES, INC., CONYERS, GA. FILED 8-19-2013.



THE MARK CONSISTS OF A FOUR SIDED BACKGROUND WITH A STYLIZED "P" WITHIN THE FOUR SIDED BACKGROUND.

FOR ONLINE RETAIL STORE SERVICES FEATURING GOODS IN THE FIELDS OF PACKAGING, MOVING, AND STORAGE (U.S. CLS. 100, 101 AND 102).

FIRST USE 7-31-2012; IN COMMERCE 7-31-2012.  
KATHLEEN M. VANSTON, EXAMINING ATTORNEY

---

SN 86-041,430. REVENADE, HOUSTON, TX. FILED 8-19-2013.



FOR CONSULTING SERVICES IN THE FIELD OF SALES AND MARKETING (U.S. CLS. 100, 101 AND 102).  
FIRST USE 10-0-2010; IN COMMERCE 10-0-2010.  
DAVID TOOLEY, EXAMINING ATTORNEY

---

SN 86-041,564. SCALERX, BOCA RATON, FL. FILED 8-19-2013.

**Your Prescription for Growth**

THE MARK CONSISTS OF STANDARD CHARACTERS WITHOUT CLAIM TO ANY PARTICULAR FONT, STYLE, SIZE, OR COLOR.

FOR CONSULTING SERVICES IN THE FIELD OF INTERNET MARKETING, DATABASE MANAGEMENT, BUSINESS ORGANIZATIONAL DESIGN, AND BUSINESS STRATEGY (U.S. CLS. 100, 101 AND 102).  
ROSELLE HERRERA, EXAMINING ATTORNEY

**CLASS 35—(Continued).**

SN 86-041,586. WATSON KENNEDY INC., SEATTLE, WA. FILED 8-19-2013.

**WATSON KENNEDY**

THE MARK CONSISTS OF STANDARD CHARACTERS WITHOUT CLAIM TO ANY PARTICULAR FONT, STYLE, SIZE, OR COLOR.

THE NAME "WATSON KENNEDY" DOES NOT IDENTIFY A LIVING INDIVIDUAL.

FOR ON-LINE RETAIL STORE SERVICES FEATURING HOME PRODUCTS, NAMELY, GLASSWARE, KITCHEN UTENSILS, SILVERWARE, CROCKERY, CHINA, VASES, DRINK WARE, CANDLES, CANDLESTICKS, LINENS, FURNITURE, STATIONERY, JEWELRY, MUSICAL CD-ROMS, BOOKS, FOOD PRODUCTS, NAMELY, SLATS, VINEGARS, OLIVES, CHOCOLATES, BREADS, CANDIES, DRESSINGS, CRACKERS, PRESERVES, SPICES, HOME-CLEANING PRODUCTS NAMELY, SOAPS, DETERGENTS, PERFUMES, BODY LOTIONS AND CREMES; RETAIL STORE SERVICES FEATURING A WIDE VARIETY OF CONSUMER GOODS OF OTHERS; RETAIL STORE SERVICES FEATURING HOME PRODUCTS, NAMELY, GLASSWARE, KITCHEN UTENSILS, SILVERWARE, CROCKERY, CHINA, VASES, DRINK WARE, CANDLES, CANDLESTICKS, SCENT DIFFUSERS, LINENS, FURNITURE, STATIONERY, JEWELRY, MUSICAL CD-ROMS, BOOKS, FOOD PRODUCTS, NAMELY, SLATS, VINEGARS, OLIVES, CHOCOLATES, BREADS, CANDIES, DRESSINGS, CRACKERS, PRESERVES, SPICES, HOME-CLEANING PRODUCTS, NAMELY, SOAPS, DETERGENTS, PERFUMES, BODY LOTIONS AND CREMES; RETAIL VARIETY STORES (U.S. CLS. 100, 101 AND 102).

FIRST USE 11-23-1998; IN COMMERCE 11-23-1998.  
HANNO RITTNER, EXAMINING ATTORNEY

---

SN 86-041,799. OUTREACH, INC., MADISON, WI. FILED 8-19-2013.



THE COLOR(S) BLACK, RED, ORANGE, YELLOW, GREEN, BLUE, VIOLET IS/ARE CLAIMED AS A FEATURE OF THE MARK.

THE MARK CONSISTS OF BLACK INK DRAWING OF SUN WITH RAYS, BRUSH STROKE BANDS OF COLOR INCLUDING RED, ORANGE, YELLOW, GREEN, BLUE, AND VIOLET IN THAT ORDER FROM TOP TO BOTTOM.

FOR CHARITABLE SERVICES, NAMELY, PROMOTING PUBLIC AWARENESS OF LESBIAN, GAY, BISEXUAL, AND TRANSGENDER (LGBT) ISSUES (U.S. CLS. 100, 101 AND 102).

FIRST USE 7-8-2004; IN COMMERCE 8-1-2011.  
MARGERY A. TIERNEY, EXAMINING ATTORNEY

**CLASS 35—(Continued).**

SN 86-041,886. EPOW NATION, FORT WORTH, TX. FILED 8-19-2013.



THE COLOR(S) BLACK, GRAY, YELLOW, AND RED IS/ ARE CLAIMED AS A FEATURE OF THE MARK.

THE MARK CONSISTS OF THE WORDING "EPOW NATION" IN STYLIZED LETTERING, WITH "E" IN BLACK AND GRAY WITH BLACK SHADOWING, AND "POW" IN YELLOW WITH BLACK SHADOWING, ABOVE THE WORD "NATION" IN GRAY WITH GRAY SHADOWING, ALL SUPERIMPOSED OVER A RED SPIKE DESIGN, WITH ALL ELEMENTS OUTLINED IN BLACK.

FOR ON-LINE RETAIL STORE SERVICES FEATURING COMIC BOOKS (U.S. CLS. 100, 101 AND 102).  
AMY KELLY, EXAMINING ATTORNEY

**CLASS 35—(Continued).**

SN 86-042,010. NATURAL WONDERS GALLERY, INC., DBA ROTELLA GALLERY, LAS VEGAS, NV. FILED 8-19-2013.

ROTELLA  GALLERY

NO CLAIM IS MADE TO THE EXCLUSIVE RIGHT TO USE "GALLERY", APART FROM THE MARK AS SHOWN.

THE MARK CONSISTS OF THE WORD "ROTELLA", FOLLOWED BY A GEOMETRIC PATTERN CONSISTING OF EIGHT OVERLAPPING SPIRALS ARRANGED IN A CIRCULAR PATTERN, FOLLOWED BY THE WORD "GALLERY".

FOR ART GALLERY SERVICES; ONLINE ART GALLERIES; ART GALLERIES FEATURING SALES OF PHOTOGRAPHIC PRINTS, PAINTINGS, SCULPTURES AND OTHER WORKS OF ART; RETAIL AND WHOLESALE STORE SERVICES FEATURING ARTWORK, PAPER GOODS, PHOTOGRAPHIC PRINTS, POSTERS, ART REPRODUCTION PRINTS, PEN/INK DRAWINGS, LITHOGRAPHIC PRINTS, LIMITED EDITION PRINTS, AND OTHER ART (U.S. CLS. 100, 101 AND 102).

FIRST USE 7-31-2013; IN COMMERCE 7-31-2013.  
RONALD MCMORROW, EXAMINING ATTORNEY

SN 86-041,965. DOREL JUVENILE GROUP, INC., FOXBORO, MA. FILED 8-19-2013.

**CARE FOR PRECIOUS LIFE**

THE MARK CONSISTS OF STANDARD CHARACTERS WITHOUT CLAIM TO ANY PARTICULAR FONT, STYLE, SIZE, OR COLOR.

FOR WHOLESALE DISTRIBUTORSHIPS FEATURING JUVENILE PRODUCTS; ONLINE RETAIL STORE SERVICES FEATURING JUVENILE PRODUCTS; PROVIDING A WEBSITE FEATURING COMMERCIAL INFORMATION AND ADVICE FOR CONSUMERS ABOUT JUVENILE PRODUCTS, CHILD CARE, CHILD SAFETY, HOME SAFETY, AND CHILD HEALTH (U.S. CLS. 100, 101 AND 102).

ANGELA M. MICHELI, EXAMINING ATTORNEY

SN 86-042,355. GATEWAY STRATEGIST, LLC, MOORESVILLE, NC. FILED 8-20-2013.

**ABILITY NATION**

THE MARK CONSISTS OF STANDARD CHARACTERS WITHOUT CLAIM TO ANY PARTICULAR FONT, STYLE, SIZE, OR COLOR.

FOR CHARITABLE SERVICES, NAMELY, EMPLOYMENT COUNSELING, RECRUITMENT AND STAFFING SERVICES FOR INDIVIDUALS WITH DISABILITIES; BUSINESS DEVELOPMENT SERVICES, NAMELY, PROVIDING START-UP SUPPORT FOR STAY AT HOME BUSINESSES OF OTHERS WITH DISABILITIES AND BUSINESS CONSULTATION REGARDING EMPLOYMENT OPPORTUNITIES FOR DISABLED PEOPLE THROUGH CREATION OF RETAIL PRODUCTS; BUSINESS SERVICES, NAMELY, OFFERING TECHNICAL AND BUSINESS MANAGEMENT ASSISTANCE IN THE ESTABLISHMENT AND OPERATION OF HOME BASED AND NON-HOME BASED BUSINESSES; PROVIDING A WEBSITE THAT MATCHES CONSUMERS WITH LEGITIMATE HOME BASED BUSINESSES, FRANCHISES AND WORK FROM HOME OPPORTUNITIES; ASSOCIATION SERVICES, NAMELY, PROMOTING THE INTERESTS OF SMALL AND HOME BASED BUSINESSES (U.S. CLS. 100, 101 AND 102).

FIRST USE 8-1-2011; IN COMMERCE 8-1-2011.  
JOHN E. MICHOS, EXAMINING ATTORNEY

SN 86-041,972. WITMER PUBLIC SAFETY GROUP, INC., COATESVILLE, PA. FILED 8-19-2013.

**GIDEON TACTICAL**

THE MARK CONSISTS OF STANDARD CHARACTERS WITHOUT CLAIM TO ANY PARTICULAR FONT, STYLE, SIZE, OR COLOR.

NO CLAIM IS MADE TO THE EXCLUSIVE RIGHT TO USE "TACTICAL", APART FROM THE MARK AS SHOWN.

FOR ONLINE RETAIL STORE SERVICES FEATURING PRODUCTS AND APPAREL USED IN CONNECTION WITH LAW ENFORCEMENT AND THE SPORT SHOOTING MARKET (U.S. CLS. 100, 101 AND 102).

CHRISTINA SOBRAL, EXAMINING ATTORNEY

**CLASS 35—(Continued).**

SN 86-042,438. INTERNATIONAL CONSERVATION CAUCUS FOUNDATION, 501(C)(3), WASHINGTON, DC. FILED 8-20-2013.



NO CLAIM IS MADE TO THE EXCLUSIVE RIGHT TO USE "INTERNATIONAL CONSERVATION CORPS" OR "ESTABLISHED 2012", APART FROM THE MARK AS SHOWN.

THE MARK CONSISTS OF A CREST WITH A HORIZONTAL BAR ACROSS IT DIVIDING IT INTO TWO UNEQUAL PORTIONS. THE TOP SMALLER PORTION OF THE CREST HAS THE WORDS "INTERNATIONAL CONSERVATION CORPS". THE BOTTOM PORTION OF THE CREST HAS THE DESIGN OF A GLOBE WITH A PLANT IN THE MIDDLE AND THE WORDS "ESTABLISHED 2012" BENEATH IT.

FOR PERSONNEL MANAGEMENT SERVICES IN THE FIELDS OF NATIONAL RESOURCE CONSERVATION AND MANAGEMENT; EMPLOYMENT SERVICES, NAMELY, RECRUITING INDIVIDUALS TO TRAIN OTHERS IN THE FIELDS OF NATURAL RESOURCE CONSERVATION AND MANAGEMENT (U.S. CLS. 100, 101 AND 102).

FIRST USE 7-30-2012; IN COMMERCE 7-30-2012.  
MATTHEW EINSTEIN, EXAMINING ATTORNEY

**CLASS 35—(Continued).**

SN 86-042,613. THOMAS, TRESSA, LIBERTYVILLE, IL. FILED 8-20-2013.



THE COLOR(S) WHITE, BLACK, YELLOW, AND GOLD IS/ARE CLAIMED AS A FEATURE OF THE MARK.

THE MARK CONSISTS OF THE TERMS "THYCK TROUPE" WITH A SILHOUETTE OF A CURVY WOMAN IN WHITE WITH A BLACK OUTLINE OF HER BODY THAT FORMS THE "Y" IN "THYCK". THE LETTERS "TH CK" APPEAR IN BLACK; THE SMALLER TERM "TROUPE" APPEARS IN YELLOW AND GOLD WITH A BLACK OUTLINE ON THE RIGHT HAND SIDE OF THE WOMAN BELOW "THYCK".

FOR ORGANIZING AND DEVELOPING CHARITABLE PROJECTS THAT AIM TO EDUCATE, ENCOURAGE AND ENERGIZE "PLUS SIZE" MEMBERS OF SOCIETY THAT ACTIVELY PURSUE PROFESSIONAL CAREERS IN THE PERFORMING ARTS INDUSTRY (U.S. CLS. 100, 101 AND 102).

FIRST USE 1-1-2009; IN COMMERCE 4-20-2009.  
ANTHONY RINKER, EXAMINING ATTORNEY

SN 86-042,541. HAGGLEFREE, LLC, CARMEL, IN. FILED 8-20-2013.



NO CLAIM IS MADE TO THE EXCLUSIVE RIGHT TO USE "HAGGLE FREE", APART FROM THE MARK AS SHOWN.

THE STIPPLING IS FOR SHADING PURPOSES ONLY. THE MARK CONSISTS OF A RECTANGLE IN THE FORM OF A STYLIZED LICENSE PLATE WITH ROUNDED CORNERS CONTAINING LOWER CASE "HAGGLE" IN CONJUNCTION WITH UPPER CASE "FREE". THERE IS A CIRCLE IN EACH CORNER OF THE RECTANGLE.

FOR OPERATING ON-LINE MARKETPLACES FEATURING PUBLIC CONSUMERS SELLING VEHICLES TO AUTOMOBILE DEALERS AND AUTOMOBILE DEALERS BUYING VEHICLES DIRECTLY FROM PUBLIC SELLERS (U.S. CLS. 100, 101 AND 102).

ELISSA GARBER KON, EXAMINING ATTORNEY

SN 86-042,656. PARTS TOWN, LLC, ADDISON, IL. FILED 8-20-2013.



THE COLOR(S) RED AND GRAY IS/ARE CLAIMED AS A FEATURE OF THE MARK.

THE MARK CONSISTS OF THE WORDING "PARTSPIN". "PART" IS IN RED LETTERING AND "SPIN" IS IN GRAY LETTERING. THE COLOR WHITE APPEARS IN THE BACKGROUND AND TRANSPARENT AREAS AND IS NOT PART OF THE MARK.

FOR PROVIDING CONSUMER PRODUCT INFORMATION IN THE FIELD OF COMMERCIAL COOKING EQUIPMENT AND COMMERCIAL COOKING EQUIPMENT PARTS VIA A WEBSITE OR OTHER ONLINE APPLICATION (U.S. CLS. 100, 101 AND 102).

FIRST USE 8-6-2013; IN COMMERCE 8-6-2013.  
WENDY GOODMAN, EXAMINING ATTORNEY

**CLASS 35—(Continued).**

SN 86-042,773. SENZIG'S INC., SHAWANO, WI. FILED 8-20-2013.

**WISCONSIN'S FURNITURE GIANT**

THE MARK CONSISTS OF STANDARD CHARACTERS WITHOUT CLAIM TO ANY PARTICULAR FONT, STYLE, SIZE, OR COLOR.

NO CLAIM IS MADE TO THE EXCLUSIVE RIGHT TO USE "WISCONSIN'S FURNITURE", APART FROM THE MARK AS SHOWN.

FOR ON-LINE RETAIL STORE SERVICES FEATURING FURNITURE, FURNISHINGS AND HOME ACCESSORIES; RETAIL STORE SERVICES FEATURING FURNITURE, FURNISHINGS AND HOME ACCESSORIES (U.S. CLS. 100, 101 AND 102).

FIRST USE 10-31-2006; IN COMMERCE 10-31-2006.  
MARILYN IZZI, EXAMINING ATTORNEY

**CLASS 35—(Continued).**

SN 86-043,243. PARTS TOWN, LLC, ADDISON, IL. FILED 8-20-2013.

**PartSPIN**

THE MARK CONSISTS OF STANDARD CHARACTERS WITHOUT CLAIM TO ANY PARTICULAR FONT, STYLE, SIZE, OR COLOR.

FOR PROVIDING CONSUMER PRODUCT INFORMATION IN THE FIELD OF COMMERCIAL COOKING EQUIPMENT AND COMMERCIAL COOKING EQUIPMENT PARTS VIA A WEBSITE OR OTHER ONLINE APPLICATION (U.S. CLS. 100, 101 AND 102).

FIRST USE 8-6-2013; IN COMMERCE 8-6-2013.  
WENDY GOODMAN, EXAMINING ATTORNEY

SN 86-043,030. DEVICE PITSTOP, LLC, WAYZATA, MN. FILED 8-20-2013.

**DEVICE PITSTOP**

THE MARK CONSISTS OF STANDARD CHARACTERS WITHOUT CLAIM TO ANY PARTICULAR FONT, STYLE, SIZE, OR COLOR.

NO CLAIM IS MADE TO THE EXCLUSIVE RIGHT TO USE "DEVICE", APART FROM THE MARK AS SHOWN.

FOR FRANCHISING, NAMELY, OFFERING BUSINESS MANAGEMENT ASSISTANCE IN THE ESTABLISHMENT AND/OR OPERATION OF RETAIL STORES FEATURING NEW AND USED CONSUMER ELECTRONIC DEVICES; RETAIL STORE SERVICES FEATURING NEW AND USED CONSUMER ELECTRONIC DEVICES (U.S. CLS. 100, 101 AND 102).

MARK SHINER, EXAMINING ATTORNEY

SN 86-043,719. IGNITE NETWORKING GROUP OF FLORIDA, INC., DBA MAKE3, MAKE3 COMMUNITY, SAINT PETERSBURG, FL. FILED 8-21-2013.



SN 86-043,086. LINDSAY, CABE, DBA AHSTIN, AUSTIN, TX. FILED 8-20-2013.

**Ahstin**

THE MARK CONSISTS OF STANDARD CHARACTERS WITHOUT CLAIM TO ANY PARTICULAR FONT, STYLE, SIZE, OR COLOR.

THE WORDING "AHSTIN" HAS NO MEANING IN A FOREIGN LANGUAGE.

FOR ADVERTISING AND PUBLICITY SERVICES, NAMELY, PROMOTING THE GOODS, SERVICES, BRAND IDENTITY AND COMMERCIAL INFORMATION AND NEWS OF THIRD PARTIES THROUGH PRINT, AUDIO, VIDEO, DIGITAL AND ON-LINE MEDIUM (U.S. CLS. 100, 101 AND 102).

FIRST USE 8-26-2009; IN COMMERCE 7-16-2011.  
KATHERINE CHANG, EXAMINING ATTORNEY

NO CLAIM IS MADE TO THE EXCLUSIVE RIGHT TO USE "BUSINESS NETWORK", APART FROM THE MARK AS SHOWN.

THE COLOR(S) LIGHT-TEAL, DARK-TEAL AND BLACK IS/ARE CLAIMED AS A FEATURE OF THE MARK.

THE MARK CONSISTS OF A LIGHT-TEAL BUBBLE WITH DARK-TEAL OUTLINE, CONTAINING THREE CENTERED SMALL CIRCLES WITH DARK-TEAL OUTLINE, ABOVE THE WORDING "MAKE3 BUSINESS NETWORK" IN TEAL LETTERING ABOVE THE WORDING "MAKE FRIENDS MAKE MONEY MAKE A DIFFERENCE" IN BLACK LETTERING. THE BACKGROUND FOR THE ENTIRE MARK IS TRANSPARENT.

FOR ADVERTISING, MARKETING AND PROMOTIONAL SERVICES RELATED TO ALL INDUSTRIES FOR THE PURPOSE OF FACILITATING NETWORKING AND SOCIALIZING OPPORTUNITIES FOR BUSINESS PURPOSES; BUSINESS NETWORKING; GENERAL BUSINESS NETWORKING REFERRAL SERVICES, NAMELY, PROMOTING THE GOODS AND SERVICES OF OTHERS BY PASSING BUSINESS LEADS AND REFERRALS AMONG GROUP MEMBERS; ON-LINE BUSINESS NETWORKING SERVICES; ON-LINE PROFESSIONAL NETWORKING SERVICES (U.S. CLS. 100, 101 AND 102).

FIRST USE 6-0-2012; IN COMMERCE 6-0-2012.  
DAVID MURRAY, EXAMINING ATTORNEY

**CLASS 35—(Continued).**

SN 86-043,829. ASSOCIATION OF POSTCONSUMER PLASTIC RECYCLERS, WASHINGTON, DC. FILED 8-21-2013.



OWNER OF U.S. REG. NOS. 2,524,100 AND 4,202,639.  
FOR ASSOCIATION SERVICES, NAMELY, PROMOTING THE INTERESTS OF POSTCONSUMER PLASTICS RECYCLERS (U.S. CLS. 100, 101 AND 102).  
DAVID TOOLEY, EXAMINING ATTORNEY

SN 86-043,871. DANIELA MORELLO, FLAGLER BEACH, FL.  
FILED 8-21-2013.



OWNER OF U.S. REG. NO. 4,088,718.  
NO CLAIM IS MADE TO THE EXCLUSIVE RIGHT TO USE "BIZCARD" AND "SUPERFAST PRINTING AND SIGNS", APART FROM THE MARK AS SHOWN.

THE MARK CONSISTS OF THE WORD "BIZCARD XPRESS" IN SOLID ALL CAPS LETTERS, WITH THE LETTER "B", "C" AND "X" IN LARGER SIZE FONT THAN THE OTHER LETTERS. UNDER THE WORD "BIZCARD XPRESS" IS A RECTANGULAR CARRIER IN DARKER SHADING WITH 3 WHITE STRIPS CUT OUT UNDER THE WORD "BIZ". IN THE SOLID SHADED AREA, THE WORDS "SUPERFAST PRINTING & SIGNS" IS WRITTEN IN WHITE FONT.

FOR RETAIL STORE SERVICES FEATURING PRINTING AND SIGNAGE PRODUCTS; PHOTOCOPYING SERVICES (U.S. CLS. 100, 101 AND 102).

FIRST USE 4-23-2013; IN COMMERCE 4-23-2013.  
CHRISTOPHER REAMS, EXAMINING ATTORNEY

**CLASS 35—(Continued).**

SN 86-043,883. DEMANDENGINE, INC., ATLANTA, GA.  
FILED 8-21-2013.

## CALEM

THE MARK CONSISTS OF STANDARD CHARACTERS WITHOUT CLAIM TO ANY PARTICULAR FONT, STYLE, SIZE, OR COLOR.

FOR EDUCATION BUSINESS SERVICES, NAMELY, PROVIDING BUSINESS CONFERENCES IN THE FIELD OF ENROLLMENT MANAGEMENT PRACTICES OF COLLEGES AND UNIVERSITIES AND THEIR ACADEMIC PROGRAMS DEDICATED FOR ADULT, OR POST-TRADITIONAL STUDENTS (U.S. CLS. 100, 101 AND 102).

FIRST USE 2-18-2013; IN COMMERCE 2-18-2013.  
ANDREA K. NADELMAN, EXAMINING ATTORNEY

SN 86-043,913. NEW CENTURY AUTO SALES, INC., DBA RIGHTWAY AUTOMOTIVE CREDIT, SAGINAW, MI.  
FILED 8-21-2013.



NO CLAIM IS MADE TO THE EXCLUSIVE RIGHT TO USE "AUTOMOTIVE CREDIT", APART FROM THE MARK AS SHOWN.

THE COLOR(S) WHITE, BLACK AND ORANGE IS/ARE CLAIMED AS A FEATURE OF THE MARK.

THE MARK CONSISTS OF THE WORD "RIGHT" IN BLACK BUBBLE LETTERS FILLED IN WITH WHITE, THE WORD "WAY" IS TO THE RIGHT OF THE WORD "RIGHT" WITH NO SPACE. "WAY" IS BLACK BUBBLE LETTERS FILLED IN WITH ORANGE. THE WORDS "AUTOMOTIVE CREDIT" ARE BLACK BUBBLE LETTERS FILLED IN WITH WHITE AND ARE 1/3RD THE SIZE OF THE FONT SIZE USED FOR "RIGHTWAY". "AUTOMOTIVE CREDIT" IS POSITIONED UNDER "HTWA" OF "RIGHTWAY".

FOR AUTOMOBILE DEALERSHIPS (U.S. CLS. 100, 101 AND 102).

FIRST USE 12-31-1999; IN COMMERCE 12-31-1999.  
ESTHER BELENKER, EXAMINING ATTORNEY

SN 86-044,042. MORRISON, ARIC, PETERBOROUGH, NH.  
FILED 8-21-2013.

## Kandles Across America

THE MARK CONSISTS OF STANDARD CHARACTERS WITHOUT CLAIM TO ANY PARTICULAR FONT, STYLE, SIZE, OR COLOR.

FOR CHARITABLE SERVICES, NAMELY, PROMOTING PUBLIC AWARENESS OF THE NEED FOR ORGAN DONORS (U.S. CLS. 100, 101 AND 102).

KATHLEEN LORENZO, EXAMINING ATTORNEY

**CLASS 35—(Continued).**

SN 86-044,106. SCRIPTCYCLE LLC, ASHEVILLE, NC. FILED 8-21-2013.

# Scriptcycle

THE MARK CONSISTS OF STANDARD CHARACTERS WITHOUT CLAIM TO ANY PARTICULAR FONT, STYLE, SIZE, OR COLOR.

FOR RETAIL PHARMACY SERVICES (U.S. CLS. 100, 101 AND 102).

HANNO RITTNER, EXAMINING ATTORNEY

---

SN 86-044,178. GRANDSLAM PERFORMANCE ASSOCIATES, LLC, FAYETTEVILLE, AR. FILED 8-21-2013.



OWNER OF U.S. REG. NO. 4,430,020.

THE MARK CONSISTS OF A SQUARE TEXT BUBBLE COMPRISED OF INDICATOR ARROWS WITH THREE FIGURES WITHIN THE TEXT BUBBLE WITH THE PHRASE "SERVE2PERFORM" IN LOWER CASE LETTERS UNDER THE TEXT BOX GRAPHIC.

FOR BRAND CONCEPT AND BRAND DEVELOPMENT SERVICES FOR CORPORATE AND INDIVIDUAL CLIENTS; BUSINESS CONSULTATION IN THE FIELD OF BUSINESS LEADERSHIP DEVELOPMENT; BUSINESS CONSULTING SERVICES, NAMELY, PROVIDING ASSISTANCE IN DEVELOPMENT OF BUSINESS STRATEGIES AND CREATIVE IDEATION; BUSINESS MANAGEMENT CONSULTANCY AS WELL AS DEVELOPMENT OF PROCESSES FOR THE ANALYSIS AND THE IMPLEMENTATION OF STRATEGY PLANS AND MANAGEMENT PROJECTS; BUSINESS MANAGEMENT CONSULTATION IN THE FIELD OF EXECUTIVE AND LEADERSHIP DEVELOPMENT; BUSINESS MANAGEMENT CONSULTING IN THE FIELD OF TEAM DEVELOPMENT; CHARITABLE SERVICES, NAMELY, PROVIDING A FREE ONLINE RESOURCE IN THE NATURE OF A WEBSITE FOR CONNECTING PEOPLE WHO HAVE SERVICE NEEDS WITH PEOPLE WHO ARE WILLING TO PROVIDE VOLUNTEER SERVICES; CONSULTATION SERVICES, NAMELY, CREATIVE AND STRATEGIC CONSULTATION REGARDING DEVELOPMENT AND PRODUCTION OF MARKETING CAMPAIGNS FOR OTHERS; CONSULTING SERVICES IN THE FIELD OF HUMAN RESOURCES DEVELOPMENT, NAMELY, UTILIZING TECHNOLOGY FOR THE PROMOTION OF EMPLOYEE RETENTION, CAREER GROWTH AND INCREASED PRODUCTIVITY FOR EMPLOYEES AND EMPLOYERS; PROVISION OF SPACE ON WEBSITES FOR ADVERTISING GOODS AND SERVICES (U.S. CLS. 100, 101 AND 102).

FIRST USE 8-21-2013; IN COMMERCE 8-21-2013.

MARK SHINER, EXAMINING ATTORNEY

**CLASS 35—(Continued).**

SN 86-044,336. LLI INC., MIAMI BEACH, FL. FILED 8-21-2013.

# JUST FROM ITALY

THE MARK CONSISTS OF STANDARD CHARACTERS WITHOUT CLAIM TO ANY PARTICULAR FONT, STYLE, SIZE, OR COLOR.

FOR IMPORT AND EXPORT AGENCIES; IMPORT AND EXPORT SERVICES IN THE FIELD OF FOOD, ALCOHOLIC AND NON-ALCOHOLIC BEVERAGES; WHOLESALE FOOD AND BEVERAGE DISTRIBUTORSHIP SERVICES; ALL OF THE FOREGOING FEATURING GOODS FROM ITALY (U.S. CLS. 100, 101 AND 102).

MEGHAN REINHART, EXAMINING ATTORNEY

---

SN 86-044,368. BOND MUSIC GROUP, NEW YORK, NY. FILED 8-21-2013.

# Bond Music Group

THE MARK CONSISTS OF STANDARD CHARACTERS WITHOUT CLAIM TO ANY PARTICULAR FONT, STYLE, SIZE, OR COLOR.

NO CLAIM IS MADE TO THE EXCLUSIVE RIGHT TO USE "MUSIC GROUP", APART FROM THE MARK AS SHOWN.

FOR TALENT AGENCY SERVICES; MANAGEMENT OF PERFORMING ARTISTS; PROMOTING THE CONCERTS OF OTHERS (U.S. CLS. 100, 101 AND 102).

FIRST USE 9-1-2008; IN COMMERCE 1-1-2009.

DAVID YONTEF, EXAMINING ATTORNEY

**CLASS 35—(Continued).**

SN 86-044,408. VOTIV, INC., AKA VOTIV, SEATTLE, WA.  
FILED 8-21-2013.

## Votiv Management

THE MARK CONSISTS OF STANDARD CHARACTERS WITHOUT CLAIM TO ANY PARTICULAR FONT, STYLE, SIZE, OR COLOR.

NO CLAIM IS MADE TO THE EXCLUSIVE RIGHT TO USE "MANAGEMENT", APART FROM THE MARK AS SHOWN.

FOR BUSINESS MANAGEMENT SERVICES, NAMELY, MANAGING SUBSIDIARY CORPORATE ENTITIES IN THE FIELDS OF AUDIO AND VISUAL ENTERTAINMENT PRODUCTION, PROMOTION, AND DISTRIBUTORSHIPS; RECORD LABEL SERVICES, NAMELY, DISTRIBUTORSHIP SERVICES IN THE FIELD OF MUSICAL AND NON-MUSICAL SOUND RECORDINGS AND VIDEO RECORDINGS FOR ADVERTISING AND PUBLICITY PURPOSES; ADVERTISING AND PROMOTION SERVICES AND RELATED CONSULTING SERVICES IN THE FIELD OF MUSIC PRODUCTION AND DISTRIBUTORSHIP SERVICES IN THE FIELD OF MUSICAL AND NON-MUSICAL SOUND RECORDINGS AND VIDEO RECORDINGS; ADVERTISING AND PUBLICITY SERVICES; ASSOCIATION SERVICES, NAMELY, PROMOTING THE INTERESTS OF MUSICIANS, SINGERS, SONGWRITERS, MUSICAL PERFORMERS AND ARTISTS; ORGANIZATION OF PROMOTIONS USING AUDIO-VISUAL MEDIA; PROMOTING THE CONCERTS OF OTHERS; MANAGEMENT SERVICES FOR RECORDING AND PERFORMING ARTISTS; ADVERTISING, NAMELY, PROMOTION OF PRODUCTS AND SERVICES OF THIRD PARTIES THROUGH SPONSORING ARRANGEMENTS; COMMERCIAL ADMINISTRATION OF THE LICENSING OF MUSIC EVENTS OF OTHERS; COMMERCIAL ADMINISTRATION OF THE LICENSING OF MUSICAL AND NON-MUSICAL SOUND RECORDINGS OF OTHERS (U.S. CLS. 100, 101 AND 102).

HOWARD B. LEVINE, EXAMINING ATTORNEY

SN 86-044,431. MITCHELL, ERIC, JOLIET, IL. FILED 8-21-2013.

## AttorneyLeader, Corp.

THE MARK CONSISTS OF STANDARD CHARACTERS WITHOUT CLAIM TO ANY PARTICULAR FONT, STYLE, SIZE, OR COLOR.

NO CLAIM IS MADE TO THE EXCLUSIVE RIGHT TO USE "CORP.", APART FROM THE MARK AS SHOWN.

FOR BUSINESS NETWORKING (U.S. CLS. 100, 101 AND 102).

ALLISON HOLTZ, EXAMINING ATTORNEY

**CLASS 35—(Continued).**

SN 86-044,566. REN ACQUISITION, INC., PLYMOUTH, CA.  
FILED 8-21-2013.



NO CLAIM IS MADE TO THE EXCLUSIVE RIGHT TO USE "BLENDS" AND "FINE WINES & SPIRITS", APART FROM THE MARK AS SHOWN.

THE MARK CONSISTS OF A WHIMSICALLY DRAWN CIRCLE WITH SHORT AND LONG OVERLAPPING BRUSH STROKES DIRECTLY TO THE LEFT OF "BLENDS" WITH "FINE WINE & SPIRITS" WRITTEN DIRECTLY UNDERNEATH SMALLER FONT.

FOR MARKETING, ADVERTISING, AND PROMOTING THE SALE OF WINE AND SPIRITS (U.S. CLS. 100, 101 AND 102).

ANTHONY RINKER, EXAMINING ATTORNEY

SN 86-044,622. DANIELA MORELLO, FLAGLER BEACH, FL.  
FILED 8-21-2013.



OWNER OF U.S. REG. NO. 4,088,718.

NO CLAIM IS MADE TO THE EXCLUSIVE RIGHT TO USE "BIZCARD" AND "SUPERFAST PRINTING AND SIGNS", APART FROM THE MARK AS SHOWN.

THE COLOR(S) GREEN, RED, WHITE AND BLACK IS/ARE CLAIMED AS A FEATURE OF THE MARK.

THE MARK CONSISTS OF THE WORD "BIZCARD XPRESS" IS ALL IN CAPS WITH THE LETTER "B", "C" AND "X" IN LARGER SIZE IMPACT FONT, IN THE COLOR GREEN OUTLINED IN A THIN LINE OF BLACK, THAN THE OTHER LETTERS. THE LETTERS ARE SOLID IN COLOR. UNDER THE WORD "BIZCARD XPRESS" THERE IS A RED RECTANGLE WITH 3 WHITE STRIPS CUT OUT UNDER THE WORD "BIZ". IN THE SOLID COLORED AREA THE WORDS "SUPERFAST PRINTING & SIGNS" IS WRITTEN IN WHITE IMPACT FONT WITH EACH LETTER HAVING A BLACK SHADOW.

FOR RETAIL STORE SERVICES FEATURING PRINTING AND SIGNAGE PRODUCTS; PHOTOCOPYING SERVICES (U.S. CLS. 100, 101 AND 102).

FIRST USE 4-23-2013; IN COMMERCE 4-23-2013.

CHRISTOPHER REAMS, EXAMINING ATTORNEY



**CLASS 35—(Continued).**

SN 86-044,748. SHORESIDE PROMOTIONS, INC., E. HAMP-  
TON, NY. FILED 8-22-2013.

**SHORESIDE PROMOTIONS**

THE MARK CONSISTS OF STANDARD CHARACTERS  
WITHOUT CLAIM TO ANY PARTICULAR FONT, STYLE,  
SIZE, OR COLOR.

NO CLAIM IS MADE TO THE EXCLUSIVE RIGHT TO  
USE "PROMOTIONS", APART FROM THE MARK AS  
SHOWN.

FOR ADVERTISING SERVICES, NAMELY, PROMOT-  
ING AND MARKETING THE GOODS AND SERVICES  
OF OTHERS IN THE FIELD OF TRAVEL, SHOPPING  
AND DINING VIA PRINT AND ELECTRONIC MEDIA  
(U.S. CLS. 100, 101 AND 102).

GRETCHEN ULRICH, EXAMINING ATTORNEY

**CLASS 35—(Continued).**

SN 86-044,836. MR. BAMBOO, INC., BENSENVILLE, IL.  
FILED 8-22-2013.

**Bam Good**

THE MARK CONSISTS OF STANDARD CHARACTERS  
WITHOUT CLAIM TO ANY PARTICULAR FONT, STYLE,  
SIZE, OR COLOR.

OWNER OF U.S. REG. NOS. 3,259,512, 3,900,054 AND  
4,371,787.

FOR ON-LINE RETAIL STORE SERVICES FEATUR-  
ING FLOORING, FLOORING ACCESSORIES, FURNI-  
TURE, DOORS AND HOUSEHOLD FURNISHINGS  
MADE FROM BAMBOO AND OTHER WOOD; RETAIL  
OUTLETS FEATURING FLOORING, FLOORING AC-  
CESSORIES, FURNITURE, DOORS AND HOUSEHOLD  
FURNISHINGS MADE FROM BAMBOO AND OTHER  
WOOD; RETAIL STORE SERVICES FEATURING  
FLOORING, FLOORING ACCESSORIES, FURNITURE,  
DOORS AND HOUSEHOLD FURNISHINGS MADE  
FROM BAMBOO AND OTHER WOOD (U.S. CLS. 100,  
101 AND 102).

FIRST USE 3-28-2013; IN COMMERCE 3-28-2013.

WILLIAM JACKSON, EXAMINING ATTORNEY

SN 86-044,941. SCALERX, BOCA RATON, FL. FILED 8-22-  
2013.

**ScaleRx**

THE MARK CONSISTS OF STANDARD CHARACTERS  
WITHOUT CLAIM TO ANY PARTICULAR FONT, STYLE,  
SIZE, OR COLOR.

FOR CONSULTING SERVICES IN THE FIELD OF  
INTERNET MARKETING, DATABASE MANAGEMENT,  
BUSINESS ORGANIZATIONAL DESIGN, AND BUSI-  
NESS STRATEGY (U.S. CLS. 100, 101 AND 102).

ROSELLE HERRERA, EXAMINING ATTORNEY

SN 86-044,759. WATERKEEPER ALLIANCE, NEW YORK,  
NY. FILED 8-22-2013.

**COASTKEEPER**

THE MARK CONSISTS OF STANDARD CHARACTERS  
WITHOUT CLAIM TO ANY PARTICULAR FONT, STYLE,  
SIZE, OR COLOR.

OWNER OF U.S. REG. NOS. 2,530,116, 2,764,483 AND  
OTHERS.

FOR PROMOTING PUBLIC AWARENESS OF THE  
NEED FOR CONSERVATION OF NATURAL RE-  
SOURCES (U.S. CLS. 100, 101 AND 102).

FIRST USE 0-0-1998; IN COMMERCE 0-0-1998.

KIMBERLY FRYE, EXAMINING ATTORNEY

SN 86-045,592. PHORENT, LLC, SAN MATEO, CA. FILED 8-  
22-2013.

**PhoRent**

THE MARK CONSISTS OF STANDARD CHARACTERS  
WITHOUT CLAIM TO ANY PARTICULAR FONT, STYLE,  
SIZE, OR COLOR.

FOR OPERATING AN ON-LINE PEER-TO-PEER REN-  
TAL MARKETPLACE (U.S. CLS. 100, 101 AND 102).

FIRST USE 8-1-2013; IN COMMERCE 8-1-2013.

ESTHER BELENKER, EXAMINING ATTORNEY

**CLASS 35—(Continued).**

SN 86-045,594. PHORENT, LLC, SAN MATEO, CA. FILED 8-22-2013.



NO CLAIM IS MADE TO THE EXCLUSIVE RIGHT TO USE "RENT", APART FROM THE MARK AS SHOWN.

THE COLOR(S) RED, WHITE, BLACK AND GRAY IS/ARE CLAIMED AS A FEATURE OF THE MARK.

THE MARK CONSISTS OF A RECTANGULAR SIGN IN RED WITH A WHITE INNER OUTLINE, CONTAINING THE WORDS "PHO RENT" WITH "PHO" IN A WHITE CURSIVE AND "RENT" IN BLACK BLOCK LETTERS. THE SIGN IS HUNG AT AN ANGLE. IT HAS A WHITE CIRCLE AT THE TOP LEFT AND TOP RIGHT, WITH A GRAY DIAGONAL LINE REPRESENTING A WIRE OR STRING EXTENDING UPWARD FROM EACH CIRCLE IN A V SHAPE. A SLIGHT SHADOW IS PLACED ON THE LOWER LEFT AND RIGHT CORNERS OF THE SIGN.

FOR OPERATING AN ON-LINE PEER-TO-PEER RENTAL MARKETPLACE (U.S. CLS. 100, 101 AND 102).

FIRST USE 8-1-2013; IN COMMERCE 8-1-2013.

ESTHER BELENKER, EXAMINING ATTORNEY

**CLASS 35—(Continued).**

SN 86-045,850. DFUZE ENTERTAINMENT MEDIA, LLC, NEW YORK, NY. FILED 8-22-2013.

**SMELL THE FEAR**

THE MARK CONSISTS OF STANDARD CHARACTERS WITHOUT CLAIM TO ANY PARTICULAR FONT, STYLE, SIZE, OR COLOR.

FOR ADVERTISING AND MARKETING; ADVERTISING AND MARKETING SERVICES PROVIDED BY MEANS OF INDIRECT METHODS OF MARKETING COMMUNICATIONS, NAMELY, SOCIAL MEDIA, SEARCH ENGINE MARKETING, INQUIRY MARKETING, INTERNET MARKETING, MOBILE MARKETING, BLOGGING AND OTHER FORMS OF PASSIVE, SHARABLE OR VIRAL COMMUNICATIONS CHANNELS; PRODUCT MERCHANDISING; PRODUCTION OF FILM AND TELEVISION ADVERTISING; PRODUCTION OF TELEVISION COMMERCIALS; TELEVISION ADVERTISING (U.S. CLS. 100, 101 AND 102).

JUDITH HELFMAN, EXAMINING ATTORNEY

SN 86-045,987. UPSTATE ARMORY GROUP INC., SIMPSONVILLE, SC. FILED 8-23-2013.

SN 86-045,846. DFUZE ENTERTAINMENT MEDIA, LLC, NEW YORK, NY. FILED 8-22-2013.

**Upstate Armory Group****G Sniff**

THE MARK CONSISTS OF STANDARD CHARACTERS WITHOUT CLAIM TO ANY PARTICULAR FONT, STYLE, SIZE, OR COLOR.

NO CLAIM IS MADE TO THE EXCLUSIVE RIGHT TO USE "SNIFF", APART FROM THE MARK AS SHOWN.

FOR ADVERTISING THROUGH ALL PUBLIC COMMUNICATION MEANS; ADVERTISING VIA ELECTRONIC MEDIA AND SPECIFICALLY THE INTERNET; ADVERTISING, INCLUDING ON-LINE ADVERTISING ON A COMPUTER NETWORK; PRODUCT MERCHANDISING; PRODUCTION OF FILM AND TELEVISION ADVERTISING; PRODUCTION OF TELEVISION COMMERCIALS; TELEVISION ADVERTISING (U.S. CLS. 100, 101 AND 102).

JUDITH HELFMAN, EXAMINING ATTORNEY

THE MARK CONSISTS OF STANDARD CHARACTERS WITHOUT CLAIM TO ANY PARTICULAR FONT, STYLE, SIZE, OR COLOR.

NO CLAIM IS MADE TO THE EXCLUSIVE RIGHT TO USE "ARMORY GROUP", APART FROM THE MARK AS SHOWN.

FOR ELECTRONIC CATALOG SERVICES FEATURING FIREARMS, FIREARM ACCESSORIES AND EQUIPMENT, AMMUNITION, APPAREL, SHOOTING ACCESSORIES, HUNTING ACCESSORIES AND EQUIPMENT; ON-LINE RETAIL STORE SERVICES FEATURING FIREARMS, FIREARM ACCESSORIES AND EQUIPMENT, AMMUNITION, APPAREL, SHOOTING ACCESSORIES AND EQUIPMENT, HUNTING ACCESSORIES AND EQUIPMENT; RETAIL SPORTING GOODS STORES; TELEPHONE ORDERING SERVICES IN THE FIELD OF FIREARMS, FIREARM ACCESSORIES AND EQUIPMENT, AMMUNITION, APPAREL, SHOOTING ACCESSORIES AND EQUIPMENT, HUNTING ACCESSORIES AND EQUIPMENT (U.S. CLS. 100, 101 AND 102).

FIRST USE 10-0-2006; IN COMMERCE 10-0-2006.

ELISSA GARBER KON, EXAMINING ATTORNEY

**CLASS 35—(Continued).**

SN 86-046,191. EQUIXP, LLC, HOUSTON, TX. FILED 8-23-2013.



THE MARK CONSISTS OF CAPITAL LETTERS "EXP" SET IN A PARALLELOGRAM (RECTANGLE WITH LEFT AND RIGHT SIDES SLANTED TO THE RIGHT). UNDER THE BOX IS THE TEXT "EQUIXP". TWO TRIANGLES APPEAR ON EACH SIDE OF THE BOX NEXT TO THE SLANTED SIDES; THE TRIANGLES ARE SIZED AND PLACED TO GIVE THE LOGO THE GRAPHIC APPEARANCE OF A BOX.

FOR ONLINE WHOLESALE STORE SERVICES FEATURING HEAVY EQUIPMENT (U.S. CLS. 100, 101 AND 102).

FIRST USE 1-1-2007; IN COMMERCE 1-1-2007.  
KAREN K. BUSH, EXAMINING ATTORNEY

**CLASS 35—(Continued).**

SN 86-046,655. WASHINGTON, DC CONVENTION & TOURISM CORPORATION, DBA DESTINATION DC, WASHINGTON, DC. FILED 8-23-2013.



OWNER OF U.S. REG. NOS. 3,925,907 AND 4,084,178.  
NO CLAIM IS MADE TO THE EXCLUSIVE RIGHT TO USE "DC", APART FROM THE MARK AS SHOWN.

THE MARK CONSISTS OF THE LETTERS "DC" SEPARATED BY A STAR POSITIONED ABOVE AND SLIGHTLY TO THE LESS OF THE UNDERLINED WORDING "COOL".

FOR CONVENTION AND VISITORS BUREAU SERVICES, NAMELY, PROMOTING BUSINESS, TOURISM AND THE HOLDING OF CONVENTIONS IN THE WASHINGTON, D.C. AREA; PROMOTING RECREATION AND TOURISM IN THE WASHINGTON, D.C. AREA (U.S. CLS. 100, 101 AND 102).

KATHLEEN M. VANSTON, EXAMINING ATTORNEY

SN 86-046,672. SKINNY NUTRITIONAL CORP., DBA SKINNY NUTRITIONAL CORP., BRYN MAWR, PA. FILED 8-23-2013.

## Skinny Shot

THE MARK CONSISTS OF STANDARD CHARACTERS WITHOUT CLAIM TO ANY PARTICULAR FONT, STYLE, SIZE, OR COLOR.

FOR ADVERTISING AND MARKETING (U.S. CLS. 100, 101 AND 102).

BRENDAN MCCAULEY, EXAMINING ATTORNEY

SN 86-046,396. GEAR DIGITAL, LLC, NEW YORK, NY. FILED 8-23-2013.

## Gear Digital

THE MARK CONSISTS OF STANDARD CHARACTERS WITHOUT CLAIM TO ANY PARTICULAR FONT, STYLE, SIZE, OR COLOR.

NO CLAIM IS MADE TO THE EXCLUSIVE RIGHT TO USE "DIGITAL", APART FROM THE MARK AS SHOWN.

FOR MARKETING SERVICES (U.S. CLS. 100, 101 AND 102).

MARGERY A. TIERNEY, EXAMINING ATTORNEY

SN 86-046,724. SKINNY NUTRITIONAL CORP., DBA SKINNY NUTRITIONAL CORP., BRYN MAWR, PA. FILED 8-23-2013.

## Body In Balance

THE MARK CONSISTS OF STANDARD CHARACTERS WITHOUT CLAIM TO ANY PARTICULAR FONT, STYLE, SIZE, OR COLOR.

FOR ADVERTISING AND MARKETING (U.S. CLS. 100, 101 AND 102).

BRENDAN MCCAULEY, EXAMINING ATTORNEY

**CLASS 35—(Continued).**

SN 86-047,464. ZOWEY'S BOUTIQUE LLC, EAST ST LOUIS, IL. FILED 8-26-2013.

## ZOWEY'S BOUTIQUE

THE MARK CONSISTS OF STANDARD CHARACTERS WITHOUT CLAIM TO ANY PARTICULAR FONT, STYLE, SIZE, OR COLOR.

NO CLAIM IS MADE TO THE EXCLUSIVE RIGHT TO USE "BOUTIQUE", APART FROM THE MARK AS SHOWN.

FOR RETAIL STORE SERVICES FEATURING PLUS SIZE WOMEN CLOTHING, WOMEN ACCESSORIES, AND WOMEN JUNIOR SIZE CLOTHING (U.S. CLS. 100, 101 AND 102).

ANTHONY RINKER, EXAMINING ATTORNEY

**CLASS 35—(Continued).**

SN 86-047,831. MEDLARS LLC, SAN ANTONIO, TX. FILED 8-26-2013.

## SHARE THE JOY, SHARE THE JOURNEY

THE MARK CONSISTS OF STANDARD CHARACTERS WITHOUT CLAIM TO ANY PARTICULAR FONT, STYLE, SIZE, OR COLOR.

FOR RETAIL STORE SERVICES FEATURING JEWELRY (U.S. CLS. 100, 101 AND 102).

STEVEN R. FINE, EXAMINING ATTORNEY

SN 86-047,845. HART JR., WALLACE, SAN CLEMENTE, CA. FILED 8-26-2013.

## Ocean Auto Sales

THE MARK CONSISTS OF STANDARD CHARACTERS WITHOUT CLAIM TO ANY PARTICULAR FONT, STYLE, SIZE, OR COLOR.

NO CLAIM IS MADE TO THE EXCLUSIVE RIGHT TO USE "AUTO SALES", APART FROM THE MARK AS SHOWN.

FOR AUTOMOBILE DEALERSHIP SERVICES (U.S. CLS. 100, 101 AND 102).

FIRST USE 9-28-1998; IN COMMERCE 9-28-1998.

DORITT L. CARROLL, EXAMINING ATTORNEY

SN 86-047,988. CANNON BLUE ENTERPRISES, INC., KEY WEST, FL. FILED 8-26-2013.

## PALM TREE PILOTS

THE MARK CONSISTS OF STANDARD CHARACTERS WITHOUT CLAIM TO ANY PARTICULAR FONT, STYLE, SIZE, OR COLOR.

FOR ADMINISTERING A T-SHIRT CLUB BY MEANS OF SELECTING T-SHIRTS BASED ON CUSTOMER EXPECTATIONS AND ARRANGING PERIODIC SHIPMENT TO CLUB MEMBERS; ON-LINE RETAIL STORES FEATURING CLOTHING (U.S. CLS. 100, 101 AND 102).

AMY ALFIERI, EXAMINING ATTORNEY

SN 86-047,619. THE EXECUTIVES' ASSOCIATION OF NEW YORK CITY, NEW YORK, NY. FILED 8-26-2013.



EXECUTIVES'  
ASSOCIATION  
NEW YORK CITY

NO CLAIM IS MADE TO THE EXCLUSIVE RIGHT TO USE "EXECUTIVES' ASSOCIATION NEW YORK CITY", APART FROM THE MARK AS SHOWN.

THE MARK CONSISTS OF THE WORDS "EXECUTIVES' ASSOCIATION NEW YORK CITY" BELOW THREE BARS OF THREE DIFFERENT LENGTHS.

FOR ASSOCIATION SERVICES FOR A PROFESSIONAL BUSINESS NETWORKING ORGANIZATION CONSISTING OF BUSINESS OWNERS AND SENIOR LEVEL DECISION MAKES IN BUSINESS ACTIVITIES IN THE GREATER NEW YORK CITY AREA, NAMELY, BUSINESS REFERRAL SERVICES AND BUSINESS INFORMATION SERVICES FOR THE MEMBERS (U.S. CLS. 100, 101 AND 102).

FIRST USE 0-0-1931; IN COMMERCE 0-0-1931.

KHANH LE, EXAMINING ATTORNEY

**CLASS 35—(Continued).**

SN 86-048,142. SHARMA, VIJAY, STERLING, VA. FILED 8-26-2013.

# ACCOUNT RIGHT

THE MARK CONSISTS OF STANDARD CHARACTERS WITHOUT CLAIM TO ANY PARTICULAR FONT, STYLE, SIZE, OR COLOR.

NO CLAIM IS MADE TO THE EXCLUSIVE RIGHT TO USE "ACCOUNT", APART FROM THE MARK AS SHOWN.

FOR ACCOUNTING SERVICES; ADMINISTRATION, BILLING AND RECONCILIATION OF ACCOUNTS ON BEHALF OF OTHERS; TAX ASSESSMENT; TAX AND TAXATION PLANNING, ADVICE, INFORMATION AND CONSULTANCY SERVICES; TAX PREPARATION (U.S. CLS. 100, 101 AND 102).

FIRST USE 1-1-2005; IN COMMERCE 1-1-2005.  
DAWN HAN, EXAMINING ATTORNEY

**CLASS 35—(Continued).**

SN 86-051,752. MOTOFUEL LLC, FRANKLIN, WI. FILED 8-29-2013.

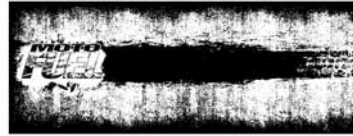

THE MARK CONSISTS OF A RECTANGULAR SHAPE FORMED WITH STIPPLING, THE IMPRINT OF A TIRE TREAD, AND THE WORD "MOTO" OVER THE WORD "FUEL".

FOR RENTAL OF ADVERTISING SPACE ON WEB SITES (U.S. CLS. 100, 101 AND 102).

FIRST USE 11-1-2011; IN COMMERCE 7-1-2013.  
DAVID C. REIHNER, EXAMINING ATTORNEY

SN 86-048,346. PLANNED PARENTHOOD FEDERATION OF AMERICA, INC., NEW YORK, NY. FILED 8-26-2013.

# REPUBLICANS FOR PLANNED PARENTHOOD

THE MARK CONSISTS OF STANDARD CHARACTERS WITHOUT CLAIM TO ANY PARTICULAR FONT, STYLE, SIZE, OR COLOR.

OWNER OF U.S. REG. NOS. 608,113, 4,374,745 AND OTHERS.

FOR PROMOTING PUBLIC AWARENESS OF THE NEED FOR PROTECTING WOMEN'S REPRODUCTIVE RIGHTS, AND REPRODUCTIVE AND SEXUAL HEALTH; PUBLIC ADVOCACY TO PROMOTE AWARENESS OF THE NEED FOR PROTECTING WOMEN'S REPRODUCTIVE RIGHTS, AND REPRODUCTIVE AND SEXUAL HEALTH; LOBBYING SERVICES, NAMELY, PROMOTING THE INTERESTS OF WOMEN IN THE FIELDS OF LEGISLATION AND REGULATION CONCERNING WOMEN'S REPRODUCTIVE RIGHTS, AND REPRODUCTIVE AND SEXUAL HEALTH (U.S. CLS. 100, 101 AND 102).

FIRST USE 8-20-2012; IN COMMERCE 8-20-2012.  
WON TEAK OH, EXAMINING ATTORNEY

SN 86-053,635. PROCESSWEAVER, INC., SANTA CLARA, CA. FILED 9-2-2013.



THE MARK CONSISTS OF INTERLOCKING LINES FORMING A DESIGN.

FOR BUSINESS MANAGEMENT SERVICES, NAMELY, MANAGING LOGISTICS, REVERSE LOGISTICS, LOGISTICS EXECUTION, LOGISTICS EXECUTION VISIBILITY AND SYNCHRONIZATION, PROCESS FLOW AND PROCESS MODELLING, SUPPLY AND DEMAND FORECASTING AND PRODUCT DISTRIBUTION PROCESSES FOR OTHERS; BUSINESS MANAGEMENT AND CONSULTATION RELATING TO THE PLANNING AND EXECUTION OF TRANSPORTATION OF DOCUMENTS, PACKAGES AND FREIGHT BY LAND AND AIR; GLOBAL TRADE MANAGEMENT AND MANAGEMENT OF MANUFACTURING, WAREHOUSING, INVENTORY AND DISTRIBUTION OF ON-LINE BUSINESS PROCESS AUTOMATION SOFTWARE APPLICATIONS FOR USE IN FIELD OF ELECTRONIC COMMERCE; BUSINESS PROCESS OUTSOURCING IN THE FIELD OF LOGISTICS EXECUTION, LOGISTICS MANAGEMENT OF ITEM AVAILABILITY TO FINAL DELIVERY (FINANCIAL RECORDS MANAGEMENT) OF DOCUMENTS, PACKAGES AND FREIGHT BY LAND AND AIR; PROVIDING A WEBSITE WHEREBY BUYERS, SUPPLIERS, AND TRANSPORTATION CARRIERS CAN EXCHANGE ORDERING AND FULFILLMENT OBLIGATIONS, IN THE NATURE OF PROVIDING NOTICE OF SHIPMENT STATUS TO CUSTOMERS IN THE DOCUMENT, PACKAGE AND FREIGHT TRANSPORTATION INDUSTRY (U.S. CLS. 100, 101 AND 102).

FIRST USE 4-24-2006; IN COMMERCE 4-24-2006.  
SHARON MEIER, EXAMINING ATTORNEY

SN 86-051,284. MATTRESS DISCOUNTERS IP LLC, HICKSVILLE, NY. FILED 8-29-2013.

# HAVE A GOOD NIGHT'S SLEEP ON US

THE MARK CONSISTS OF STANDARD CHARACTERS WITHOUT CLAIM TO ANY PARTICULAR FONT, STYLE, SIZE, OR COLOR.

FOR RETAIL STORE SERVICES FEATURING MATTRESSES, BEDS, BEDDING AND SLEEP PRODUCTS (U.S. CLS. 100, 101 AND 102).

FIRST USE 8-1-1985; IN COMMERCE 8-1-1985.  
BRIDGETT SMITH, EXAMINING ATTORNEY

**CLASS 35—(Continued).**

SN 86-054,010. LOVE'S TRAVEL STOPS & COUNTRY STORES, INC., OKLAHOMA CITY, OK. FILED 9-3-2013.



OWNER OF U.S. REG. NOS. 3,197,921, 3,197,923 AND OTHERS.

THE MARK CONSISTS OF THE WORD "LOVE'S" IN STYLIZED FORMAT WITH A HEART FOR THE APOSTROPHE AND AN ECHOING HEARTS DESIGN TO THE LEFT OF THE WORD "LOVE'S".

FOR RETAIL CONVENIENCE STORE SERVICES, RETAIL GASOLINE STATION SERVICES, RETAIL DIESEL FUELING STATION SERVICES; RETAIL STORE SERVICES FEATURING CONVENIENCE STORE ITEMS AND GASOLINE (U.S. CLS. 100, 101 AND 102).

LINDA E. BLOHM, EXAMINING ATTORNEY

SN 86-055,015. HOUSEHOLD NAME, BROOKLYN, NY. FILED 9-4-2013.

## HOUSEHOLD NAME

THE MARK CONSISTS OF STANDARD CHARACTERS WITHOUT CLAIM TO ANY PARTICULAR FONT, STYLE, SIZE, OR COLOR.

FOR CREATIVE DEVELOPMENT OF PRINT AND TELEVISION ADVERTISING; DIRECTION AND MAKING OF TELEVISION COMMERCIALS AND PRODUCTION OF TELEVISION COMMERCIALS; BRAND MARKETING SERVICES, NAMELY, CREATING BRAND IMAGES FOR PRODUCTS AND SERVICES OF OTHERS; BUSINESS CONSULTATION; BUSINESS MARKETING SERVICES; ARRANGING PRODUCT AND SERVICE ENDORSEMENT OPPORTUNITIES, NAMELY, PROMOTING THE GOODS AND SERVICES OF OTHERS (U.S. CLS. 100, 101 AND 102).

FIRST USE 9-11-2001; IN COMMERCE 1-21-2003.  
SUSAN RICHARDS, EXAMINING ATTORNEY

SN 86-055,238. NGO, TOAN, RIVERDALE, MD. FILED 9-4-2013.

## INTELLIGENTUAS

THE MARK CONSISTS OF STANDARD CHARACTERS WITHOUT CLAIM TO ANY PARTICULAR FONT, STYLE, SIZE, OR COLOR.

FOR ON-LINE RETAIL STORE SERVICES FEATURING REMOTE CONTROL HELICOPTERS AND ACCESSORIES (U.S. CLS. 100, 101 AND 102).

FIRST USE 7-0-2013; IN COMMERCE 7-0-2013.  
ANNE MADDEN, EXAMINING ATTORNEY

**CLASS 35—(Continued).**

SN 86-055,806. JAKE ONLINE SOLUTIONS, LLC, COLLIERVILLE, TN. FILED 9-4-2013.



THE MARK CONSISTS OF A CAPITAL LETTER "S" INSIDE A BOX WITH ROUNDED CORNERS. IN CENTER OF CAPITAL LETTER "S", THERE IS A MAGNIFYING GLASS WITH A SMALLER CAPITAL LETTER "F" INSIDE THE MAGNIFYING GLASS. DROPS OF WATER ARE LOCATED ON THE MARK.

FOR PROVIDING A WEB SITE FEATURING PRODUCT RATINGS OF THE CONSUMER GOODS OF OTHERS IN THE FIELD OF CAR WASH INDUSTRY, NAMELY, RATINGS AND REVIEWS OF CAR WASH RELATED PRODUCTS; PROVIDING A WEB SITE FEATURING PRODUCT RATINGS OF THE CONSUMER SERVICES OF OTHERS IN THE FIELD OF CAR WASH INDUSTRY, NAMELY, RATINGS AND REVIEWS OF CAR WASHES; ONLINE BUSINESS DIRECTORIES FEATURING LOCATIONS OF CAR WASHES IN A SELECTED AREA (U.S. CLS. 100, 101 AND 102).

FIRST USE 9-30-2012; IN COMMERCE 9-30-2012.  
WILLIAM VERHOSEK, EXAMINING ATTORNEY

SN 86-057,607. DAFFY'S INC., SECAUCUS, NJ. FILED 9-6-2013.

## DAFFY'S

THE MARK CONSISTS OF STANDARD CHARACTERS WITHOUT CLAIM TO ANY PARTICULAR FONT, STYLE, SIZE, OR COLOR.

OWNER OF U.S. REG. NOS. 1,485,741 AND 3,344,294.  
FOR RETAIL STORE SERVICES FEATURING A WIDE VARIETY OF CONSUMER GOODS OF OTHERS (U.S. CLS. 100, 101 AND 102).

ERIN FALK, EXAMINING ATTORNEY

**CLASS 35—(Continued).**

SN 86-058,561. BLINDDISTRIBUTORS.COM, LLC, LAS VEGAS, NV. FILED 9-7-2013.

## Blinds Etc

THE MARK CONSISTS OF STANDARD CHARACTERS WITHOUT CLAIM TO ANY PARTICULAR FONT, STYLE, SIZE, OR COLOR.

NO CLAIM IS MADE TO THE EXCLUSIVE RIGHT TO USE "BLINDS", APART FROM THE MARK AS SHOWN.

FOR RETAIL STORE SERVICES FEATURING BLINDS, SHADES, WINDOW COVERINGS AND TREATMENTS (U.S. CLS. 100, 101 AND 102).

FIRST USE 7-0-2013; IN COMMERCE 7-0-2013.

TINA L. SNAPP, EXAMINING ATTORNEY

SN 86-058,944. ZIP CARBON ASSESSORIA E CONSULTORIA AMBIENTAL SA, SAO PAULO, BRAZIL, FILED 9-9-2013.



THE COLOR(S) WHITE, WHITE IVORY, BLUE, BLACK, GRAY IS/ARE CLAIMED AS A FEATURE OF THE MARK.

THE MARK CONSISTS OF THE IMAGE OF A BEAR, STYLIZED LETTERS "Z", "C" AND "O" AND NUMBER "2". BEHIND THE BEAR, STYLIZED LETTERS "Z", "C" AND "O" AND THE NUMBER "2" A FIGURE APPEARS SIMILAR TO A BLUE RECTANGLE WITH ROUNDED EDGES. THE BEAR IS IVORY WHITE WITH BLACK MUZZLE AND EYE AND CASTS A SHADOW GRAY. STYLIZED LETTERS "Z", "C" AND "O" AND NUMBER "2" ARE WHITE.

FOR ADVERTISING AND COMMERCIAL INFORMATION SERVICES, VIA THE INTERNET; CONTESTS AND INCENTIVE AWARD PROGRAMS TO PROMOTE THE SALE OF PRODUCTS AND SERVICES OF OTHERS; DEVELOPING ADVERTISING CAMPAIGNS FOR OTHERS GEARED TOWARD ENVIRONMENTAL ISSUES; PROMOTING PUBLIC AWARENESS OF ENVIRONMENTAL MATTERS; PROMOTING THE GOODS AND SERVICES OF OTHERS BY PROVIDING A MOBILE APPLICATION FEATURING COUPONS, DISCOUNTS OR SPECIAL OFFERINGS ON GOODS AND SERVICES PROVIDED BY OTHERS; PROVIDING CONSUMER PRODUCT INFORMATION RELATING TO THE IMPACT OF CONSUMER PRODUCTS ON ENVIRONMENTAL PRESERVATION (U.S. CLS. 100, 101 AND 102).

NELSON SNYDER, EXAMINING ATTORNEY

**CLASS 35—(Continued).**

SN 86-059,299. THE MOBILE APE, INC., BELLEVUE, WA. FILED 9-9-2013.

## THE MOBILE APE

THE MARK CONSISTS OF STANDARD CHARACTERS WITHOUT CLAIM TO ANY PARTICULAR FONT, STYLE, SIZE, OR COLOR.

NO CLAIM IS MADE TO THE EXCLUSIVE RIGHT TO USE "MOBILE", APART FROM THE MARK AS SHOWN.

FOR BUSINESS-CONSULTING AND MANAGEMENT SERVICES RELATING TO BUSINESS ISSUES ASSOCIATED WITH NEW-PRODUCT AND SERVICE DEVELOPMENT; BUSINESS-CONSULTING SERVICES RELATING TO BUSINESS ISSUES ASSOCIATED WITH THE DESIGN OF MOBILE AND WIRELESS-COMMUNICATIONS SYSTEMS AND SOFTWARE APPLICATIONS USED IN MARKETING AND RETAIL SOLUTIONS (U.S. CLS. 100, 101 AND 102).

SUSAN RICHARDS, EXAMINING ATTORNEY

SN 86-059,386. MATTRESS DISCOUNTERS IP LLC, HICKSVILLE, NY. FILED 9-9-2013.

## MATTRESS KING

THE MARK CONSISTS OF STANDARD CHARACTERS WITHOUT CLAIM TO ANY PARTICULAR FONT, STYLE, SIZE, OR COLOR.

OWNER OF U.S. REG. NO. 3,371,327.

NO CLAIM IS MADE TO THE EXCLUSIVE RIGHT TO USE "MATTRESS", APART FROM THE MARK AS SHOWN.

FOR RETAIL STORE SERVICES FEATURING MATTRESSES, BEDS, BEDDING AND SLEEP PRODUCTS (U.S. CLS. 100, 101 AND 102).

FIRST USE 4-18-1993; IN COMMERCE 4-18-1993.

BRIDGETT SMITH, EXAMINING ATTORNEY

SN 86-061,009. CASTING PARTNERS LLC, MIAMI BEACH, FL. FILED 9-10-2013.

## Casting Partners

THE MARK CONSISTS OF STANDARD CHARACTERS WITHOUT CLAIM TO ANY PARTICULAR FONT, STYLE, SIZE, OR COLOR.

NO CLAIM IS MADE TO THE EXCLUSIVE RIGHT TO USE "CASTING", APART FROM THE MARK AS SHOWN.

FOR EMPLOYMENT SERVICES IN THE NATURE OF TALENT CASTING IN THE FIELD(S) OF FILM, TELEVISION, COMMERCIALS, PRINT, VIDEO AND NEW MEDIA (U.S. CLS. 100, 101 AND 102).

FIRST USE 5-0-2011; IN COMMERCE 5-0-2011.

ADA HAN, EXAMINING ATTORNEY

**CLASS 35—(Continued).**

SN 86-061,380. AMERICAN IRON AND STEEL INSTITUTE, WASHINGTON, DC. FILED 9-11-2013.

STEEL IS WIDELY RECOGNIZED  
AS THE MATERIAL THAT  
AUGMENTS THE WELL-BEING OF  
PEOPLE AND THE PLANET

THE MARK CONSISTS OF STANDARD CHARACTERS WITHOUT CLAIM TO ANY PARTICULAR FONT, STYLE, SIZE, OR COLOR.

FOR TRADE ASSOCIATION SERVICES, NAMELY, PROMOTING THE CONSUMPTION AND PUBLIC PERCEPTION OF STEEL AND STEEL PRODUCTS THROUGH THE DISSEMINATION OF INFORMATION ABOUT STEEL, STEEL SUSTAINABILITY, STEEL PRODUCTS AND THE STEEL INDUSTRY (U.S. CLS. 100, 101 AND 102).

CAROLINE WOOD, EXAMINING ATTORNEY

SN 86-061,613. STRATAGO ELECTRONICS, INC., CARDIFF-BY-THE-SEA, CA. FILED 9-11-2013.

**STRATAGO ELECTRONICS**

THE MARK CONSISTS OF STANDARD CHARACTERS WITHOUT CLAIM TO ANY PARTICULAR FONT, STYLE, SIZE, OR COLOR.

NO CLAIM IS MADE TO THE EXCLUSIVE RIGHT TO USE "ELECTRONICS", APART FROM THE MARK AS SHOWN.

FOR DISTRIBUTORSHIP SERVICES IN THE FIELD OF ELECTRONICS (U.S. CLS. 100, 101 AND 102).

STEVEN PEREZ, EXAMINING ATTORNEY

SN 86-061,917. CAD GREEN ACRES CORPORATION, HUNTINGTON BEACH, CA. FILED 9-11-2013.



NO CLAIM IS MADE TO THE EXCLUSIVE RIGHT TO USE "STAFFING", APART FROM THE MARK AS SHOWN.

THE MARK CONSIST OF THE WORDS "PEOPLE TO PEOPLE STAFFING" UNDERLINED AND WITH THE LETTER "P" IN THE FIRST WORD OF THE MARK IN A STYLIZED PRESENTATION WITH AN EXPONENTIAL NUMERAL "2" INSIDE A STYLIZED HALO.

FOR EMPLOYMENT AGENCY SERVICES, NAMELY, FILLING THE TEMPORARY AND PERMANENT STAFFING NEEDS OF BUSINESSES; EMPLOYMENT HIRING, RECRUITING, PLACEMENT, STAFFING AND CAREER NETWORKING SERVICES; EMPLOYMENT STAFFING CONSULTATION SERVICES; EMPLOYMENT STAFFING IN THE FIELD OF IMAGE RECOGNITION AND BRANDING (U.S. CLS. 100, 101 AND 102).

FIRST USE 6-1-2009; IN COMMERCE 6-1-2009.  
SUSAN RICHARDS, EXAMINING ATTORNEY

**CLASS 35—(Continued).**

SN 86-061,942. CAD GREEN ACRES CORPORATION, HUNTINGTON BEACH, CA. FILED 9-11-2013.



THE MARK CONSISTS OF THE STYLIZED LETTER "P" WITH AN EXPONENTIAL NUMERAL "2" INSIDE OF A STYLIZED HALO.

FOR EMPLOYMENT AGENCY SERVICES, NAMELY, FILLING THE TEMPORARY AND PERMANENT STAFFING NEEDS OF BUSINESSES; EMPLOYMENT HIRING, RECRUITING, PLACEMENT, STAFFING AND CAREER NETWORKING SERVICES; EMPLOYMENT STAFFING CONSULTATION SERVICES; EMPLOYMENT STAFFING IN THE FIELD OF IMAGE RECOGNITION AND BRANDING (U.S. CLS. 100, 101 AND 102).

FIRST USE 6-1-2009; IN COMMERCE 6-1-2009.  
SUSAN RICHARDS, EXAMINING ATTORNEY

SN 86-061,983. CAD GREEN ACRES CORPORATION, HUNTINGTON BEACH, CA. FILED 9-11-2013.



NO CLAIM IS MADE TO THE EXCLUSIVE RIGHT TO USE "CORPORATION", APART FROM THE MARK AS SHOWN.

THE MARK CONSISTS OF THE WORDS "CAD GREEN ACRES, CORPORATION" AND A DESIGN OF A STYLIZED LANDSCAPE WITH GRASS.

FOR EMPLOYMENT AGENCY SERVICES, NAMELY, FILLING THE TEMPORARY AND PERMANENT STAFFING NEEDS OF BUSINESSES; EMPLOYMENT HIRING, RECRUITING, PLACEMENT, STAFFING AND CAREER NETWORKING SERVICES; EMPLOYMENT STAFFING CONSULTATION SERVICES; EMPLOYMENT STAFFING IN THE FIELD OF IMAGE RECOGNITION AND BRANDING (U.S. CLS. 100, 101 AND 102).

FIRST USE 6-1-2009; IN COMMERCE 6-1-2009.  
SUSAN RICHARDS, EXAMINING ATTORNEY



**CLASS 35—(Continued).**

SN 86-062,627. FRIENDS OF FREELAND FOUNDATION, ALEXANDRIA, VA. FILED 9-12-2013.



THE COLOR(S) BLUE, ORANGE, GREEN, AND BLACK IS/ARE CLAIMED AS A FEATURE OF THE MARK.

THE MARK CONSISTS OF BLUE, ORANGE AND GREEN SWASHES ON A TRANSPARENT BACKGROUND, WITH THE BLACK LETTERING "FREELAND" OVER THE GREEN SWASH AND BACKGROUND. THE COLOR WHITE IS USED TO INDICATE BACKGROUND OR TRANSPARENT PORTIONS AND IS NOT PART OF THE MARK.

FOR CHARITABLE SERVICES, NAMELY PROMOTING AWARENESS AND PREVENTION OF WILDLIFE TRAFFICKING AND HUMAN SLAVERY (U.S. CLS. 100, 101 AND 102).

FIRST USE 4-29-2009; IN COMMERCE 7-0-2011.

JUSTINE D. PARKER, EXAMINING ATTORNEY

**CLASS 35—(Continued).**

SN 86-063,862. MARRIOTT INTERNATIONAL, INC., BETHESDA, MD. FILED 9-13-2013.

OWNER OF U.S. REG. NOS. 3,931,368, 4,091,566 AND OTHERS.

THE MARK CONSISTS OF A STYLIZED VERSION OF THE WORD "EDITION".

FOR BUSINESS MANAGEMENT SERVICES IN THE FIELD OF CONDOMINIUMS AND APARTMENT BUILDINGS (U.S. CLS. 100, 101 AND 102).

INGRID C. EULIN, EXAMINING ATTORNEY

SN 86-063,544. GRAY, NOAH, SEALE, AL. FILED 9-12-2013.



THE COLOR(S) WHITE, BLACK IS/ARE CLAIMED AS A FEATURE OF THE MARK.

THE MARK CONSISTS OF "TGS TRUEGAMERScore.COM" IN WHITE ON BLACK BACKGROUND WITH BLACK LIGHTNING THROUGH LETTERS.

FOR ON-LINE RETAIL STORE SERVICES FEATURING ADVERTISEMENT MATERIALS, PENS, CARDS, CLOTHING, HATS, SHOES, BANNERS, PAPER (U.S. CLS. 100, 101 AND 102).

ARETHA SOMERVILLE, EXAMINING ATTORNEY

SN 86-064,857. INTELLECTUAL EYES, LLC, MCLEAN, VA. FILED 9-14-2013.

THE MARK CONSISTS OF STANDARD CHARACTERS WITHOUT CLAIM TO ANY PARTICULAR FONT, STYLE, SIZE, OR COLOR.

FOR PROVIDING AN INTERNET WEBSITE FEATURING BUSINESS INFORMATION RELATED TO THE FIELD OF FRANCHISING AND FRANCHISE COMPANIES; PROVIDING BUSINESS INFORMATION RELATED TO THE FIELD OF FRANCHISING, NAMELY, A LISTING OF PRIVATE EQUITY FIRMS AND OF FRANCHISORS INVOLVED WITH THE FIELD OF PRIVATE EQUITY INVESTING (U.S. CLS. 100, 101 AND 102).

FIRST USE 2-5-2013; IN COMMERCE 2-5-2013.

EUGENIA MARTIN, EXAMINING ATTORNEY

**CLASS 35—(Continued).**

SN 86-064,895. ALEKSANDR KOSACHEVSKY, INDIANAPOLIS, IN. FILED 9-14-2013.

# OfferMe

THE MARK CONSISTS OF STANDARD CHARACTERS WITHOUT CLAIM TO ANY PARTICULAR FONT, STYLE, SIZE, OR COLOR.

FOR ON-LINE AUCTION SERVICES; PROVIDING INTERNET AUCTION SERVICES VIA E-COMMERCE SOFTWARE AND SERVER; PROVIDING ON-LINE AUCTION SERVICES (U.S. CLS. 100, 101 AND 102).  
TAMARA FRAZIER, EXAMINING ATTORNEY

---

SN 86-064,987. AARON MATHEW FALZARANO, UTICA, NY. FILED 9-15-2013.

# U+I can

THE MARK CONSISTS OF STANDARD CHARACTERS WITHOUT CLAIM TO ANY PARTICULAR FONT, STYLE, SIZE, OR COLOR.

FOR PROMOTING THE INTERESTS OF PEOPLE CONCERNED WITH HEALTH, COMMUNITY AND ENVIRONMENTAL SUSTAINABILITY ISSUES (U.S. CLS. 100, 101 AND 102).  
KAELIE KUNG, EXAMINING ATTORNEY

---

SN 86-065,234. GINSBERG'S INSTITUTIONAL FOODS, INC., HUDSON, NY. FILED 9-16-2013.



THE MARK CONSISTS OF A HAND HOLDING A PLATTER, ABOVE WHICH IS THE WORD "GINSBERG'S", ABOVE WHICH IS A FOOD COVER.

FOR WHOLESALE AND RETAIL STORE SERVICES FEATURING FOOD PRODUCTS (U.S. CLS. 100, 101 AND 102).

FIRST USE 11-30-2006; IN COMMERCE 11-30-2006.  
SHAILA LEWIS, EXAMINING ATTORNEY

**CLASS 35—(Continued).**

SN 86-065,243. CRAIG MURRAY PRODUCTIONS, LLC, BURBANK, CA. FILED 9-16-2013.

# TRICKY SQUID

THE MARK CONSISTS OF STANDARD CHARACTERS WITHOUT CLAIM TO ANY PARTICULAR FONT, STYLE, SIZE, OR COLOR.

FOR ADVERTISING AND MARKETING; ADVERTISING AND MARKETING SERVICES, NAMELY, PROMOTING THE GOODS AND SERVICES OF OTHERS; ADVERTISING AND PROMOTIONAL SERVICES; PROMOTION AND MARKETING SERVICES AND RELATED CONSULTING (U.S. CLS. 100, 101 AND 102).  
DEBORAH MEINERS, EXAMINING ATTORNEY

---

SN 86-065,248. SAM MARKETING INC, CLINTON TOWNSHIP, MI. FILED 9-16-2013.

# SAVE SOME SCRATCH

THE MARK CONSISTS OF STANDARD CHARACTERS WITHOUT CLAIM TO ANY PARTICULAR FONT, STYLE, SIZE, OR COLOR.

FOR ADVERTISING AND DIRECTORY SERVICES, NAMELY, PROMOTING THE SERVICES OF OTHERS BY PROVIDING A WEB PAGE FEATURING LINKS TO THE WEBSITES OF OTHERS; ADVERTISING AND MARKETING; ADVERTISING AND MARKETING SERVICES, NAMELY, PROMOTING THE GOODS AND SERVICES OF OTHERS (U.S. CLS. 100, 101 AND 102).  
ERNEST SHOSHO, EXAMINING ATTORNEY

---

SN 86-065,261. NEXTLOGISTIX LLC, ALPHARETTA, GA. FILED 9-16-2013.

# NEXTLOGISTIX

THE MARK CONSISTS OF STANDARD CHARACTERS WITHOUT CLAIM TO ANY PARTICULAR FONT, STYLE, SIZE, OR COLOR.

FOR LOGISTICS MANAGEMENT IN THE FIELD OF FOOD SERVICE; TRANSPORTATION LOGISTICS SERVICES, NAMELY, ARRANGING THE TRANSPORTATION OF GOODS FOR OTHERS (U.S. CLS. 100, 101 AND 102).

HEATHER SAPP, EXAMINING ATTORNEY

**CLASS 35—(Continued).**

SN 86-065,294. ROGERS, MATT, DBA CASH 4 MOTORCYCLES, SUNBURY, OH. FILED 9-16-2013.

**Cash 4 Motorcycles**

THE MARK CONSISTS OF STANDARD CHARACTERS WITHOUT CLAIM TO ANY PARTICULAR FONT, STYLE, SIZE, OR COLOR.

OWNER OF U.S. REG. NO. 3,545,584.  
SEC. 2(F).  
FOR MOTORCYCLE DEALERSHIP SERVICES (U.S. CLS. 100, 101 AND 102).  
FIRST USE 7-25-2005; IN COMMERCE 1-3-2006.  
DOMINICK J. SALEMI, EXAMINING ATTORNEY

---

SN 86-065,407. STAMPEDE LABS INC., SAN FRANCISCO, CA. FILED 9-16-2013.

**Credible**

THE MARK CONSISTS OF STANDARD CHARACTERS WITHOUT CLAIM TO ANY PARTICULAR FONT, STYLE, SIZE, OR COLOR.

FOR MATCHING BORROWERS WITH POTENTIAL LENDERS IN THE FIELD OF CONSUMER AND MORTGAGE LENDING; PROMOTING THE GOODS AND SERVICES OF OTHERS BY PROVIDING A WEBSITE FEATURING COUPONS, REBATES, PRICE-COMPARISON INFORMATION, PRODUCT REVIEWS, CENTRALIZED PRODUCT APPLICATION PROCESSES, LINKS TO THE RETAIL WEBSITES OF OTHERS AND DISCOUNT INFORMATION (U.S. CLS. 100, 101 AND 102).  
HOWARD B. LEVINE, EXAMINING ATTORNEY

---

SN 86-065,463. STARTED.IN, SEATTLE, WA. FILED 9-16-2013.

**STARTED.IN**

THE MARK CONSISTS OF STANDARD CHARACTERS WITHOUT CLAIM TO ANY PARTICULAR FONT, STYLE, SIZE, OR COLOR.

FOR PROVIDING ON-LINE SEARCHABLE DATABASES AND ON-LINE COMPUTER DATABASES FEATURING BUSINESS INFORMATION AND BUSINESS CONTACTS; PROMOTING THE GOODS AND SERVICES OF OTHERS OVER THE INTERNET (U.S. CLS. 100, 101 AND 102).  
ERNEST SHOSHO, EXAMINING ATTORNEY

**CLASS 35—(Continued).**

SN 86-065,480. SKILLNADO CORPORATION, NEW YORK, NY. FILED 9-16-2013.

**SKILLNADO**

THE MARK CONSISTS OF STANDARD CHARACTERS WITHOUT CLAIM TO ANY PARTICULAR FONT, STYLE, SIZE, OR COLOR.

FOR ADVERTISING AND MARKETING SERVICES, NAMELY, PROMOTING THE GOODS AND SERVICES OF OTHERS; ADVERTISING, MARKETING AND PROMOTION SERVICES; BRANDING SERVICES, NAMELY, CONSULTING, DEVELOPMENT, MANAGEMENT AND MARKETING OF BRANDS FOR BUSINESSES AND/OR INDIVIDUALS; BUSINESS ADVISORY SERVICES IN THE FIELD OF BUSINESS DEVELOPMENT; BUSINESS ADVISORY SERVICES, CONSULTANCY AND INFORMATION; BUSINESS CONSULTING AND INFORMATION SERVICES; BUSINESS MARKETING SERVICES; BUSINESS RESEARCH; COMPILING AND ANALYZING STATISTICS, DATA AND OTHER SOURCES OF INFORMATION FOR BUSINESS PURPOSES; INFORMATION SERVICES RELATING TO BUSINESS MATTERS; ON-LINE BUSINESS NETWORKING SERVICES (U.S. CLS. 100, 101 AND 102).

CHARLES L. JENKINS, EXAMINING ATTORNEY

---

SN 86-065,503. CONSUMER ELECTRONICS ASSOCIATION, ARLINGTON, VA. FILED 9-16-2013.

**EUREKA PARK**

THE MARK CONSISTS OF STANDARD CHARACTERS WITHOUT CLAIM TO ANY PARTICULAR FONT, STYLE, SIZE, OR COLOR.

FOR ORGANIZING, PROMOTING AND CONDUCTING A TRADESHOW FEATURING NEW PRODUCTS DEVELOPED BY STARTUP COMPANIES AND ENTREPRENEURIAL BUSINESSES (U.S. CLS. 100, 101 AND 102).

FIRST USE 1-1-2013; IN COMMERCE 1-1-2013.  
JENNIFER BUTTON, EXAMINING ATTORNEY

---

SN 86-065,660. HEART TO HEART INVESTMENTS, LLC, ASHEBORO, NC, NC. FILED 9-16-2013.

**SHARE IT TO WEAR IT**

THE MARK CONSISTS OF STANDARD CHARACTERS WITHOUT CLAIM TO ANY PARTICULAR FONT, STYLE, SIZE, OR COLOR.

FOR RETAIL CLOTHING BOUTIQUES (U.S. CLS. 100, 101 AND 102).  
FIRST USE 1-1-2013; IN COMMERCE 1-1-2013.  
KATHERINE STOIDES, EXAMINING ATTORNEY

**CLASS 35—(Continued).**

SN 86-065,829. PATEL, USHA MAYAN, YORBA LINDA, CA.  
FILED 9-16-2013.



THE MARK CONSISTS OF "SOFIAZ Z" IS STYLIZED.  
FOR ON-LINE RETAIL STORE SERVICES FEATUR-  
ING FOOTWEAR (U.S. CLS. 100, 101 AND 102).  
FIRST USE 4-1-2013; IN COMMERCE 4-1-2013.  
SUZANNE BLANE, EXAMINING ATTORNEY

SN 86-065,863. VAPOR TRADING COMPANY, HOUSTON,  
TX. FILED 9-16-2013.



NO CLAIM IS MADE TO THE EXCLUSIVE RIGHT TO  
USE "VAPOR TRADING CO." AND "EST. 2013", APART  
FROM THE MARK AS SHOWN.

THE COLOR(S) BLUE AND WHITE IS/ARE CLAIMED AS  
A FEATURE OF THE MARK.

THE MARK CONSISTS OF VAPOR TRADING CO IN A  
BLUE BANNER IN WHITE STYLIZED FONT. BELOW THIS  
IS EST. 2013 IN BLUE STYLIZED FONT. BELOW THIS ARE  
TWO CREATURES HOLDING A CIRCLE WHICH HAS V T  
CO. IN BLUE STYLIZED FONT WITHIN IT AS WELL AS  
THREE CROSSES. THEY ARE ALSO HOLDING A SHIELD  
WITH 3 WHITE CROWNS AND THREE BLUE STRIPES.  
BELOW THIS IS A BLUE BANNER WITH AUT VIAM  
INVENIUM AUT FACIAM IN WHITE STYLIZED FONT.

THE ENGLISH TRANSLATION OF AUT VIAM INVE-  
NIUM AUT FACIAM IN THE MARK IS OR THE WAY FIND  
OR FACE.

FOR ON-LINE RETAIL STORE SERVICES FEATUR-  
ING ELECTRONIC CIGARETTES AND ACCESSORIES;  
RETAIL STORES FEATURING ELECTRONIC CIGAR-  
ETTES AND ACCESSORIES (U.S. CLS. 100, 101 AND 102).

FIRST USE 9-15-2013; IN COMMERCE 9-15-2013.  
COLLEEN KEARNEY, EXAMINING ATTORNEY

**CLASS 35—(Continued).**

SN 86-065,944. DOVER ENTERPRISES LLC, RACINE, WI.  
FILED 9-16-2013.



THE MARK CONSISTS OF STANDARD CHARACTERS  
WITHOUT CLAIM TO ANY PARTICULAR FONT, STYLE,  
SIZE, OR COLOR.

FOR ON-LINE RETAIL STORE SERVICES FEATUR-  
ING SEX TOYS, HUMAN SEXUALITY PRODUCTS,  
ADULT ENTERTAINMENT PRODUCTS, LINGERIE,  
HUMAN SEXUALITY BOOKS, AND EROTIC NOVELS  
(U.S. CLS. 100, 101 AND 102).

MAUREEN DALL, EXAMINING ATTORNEY

SN 86-065,986. BUDGET BLINDS, INC., ORANGE, CA.  
FILED 9-16-2013.

SERVICE IS ALWAYS IN STYLE

THE MARK CONSISTS OF STANDARD CHARACTERS  
WITHOUT CLAIM TO ANY PARTICULAR FONT, STYLE,  
SIZE, OR COLOR.

FOR DISTRIBUTORSHIP AND RETAIL STORE SER-  
VICES IN THE FIELD OF WINDOW COVERINGS (U.S.  
CLS. 100, 101 AND 102).

CURTIS FRENCH, EXAMINING ATTORNEY

SN 86-066,009. PLUMBING-HEATING-COOLING CON-  
TRACTORS-NATIONAL ASSOCIATION, FALLS  
CHURCH, VA. FILED 9-16-2013.



THE MARK CONSISTS OF STANDARD CHARACTERS  
WITHOUT CLAIM TO ANY PARTICULAR FONT, STYLE,  
SIZE, OR COLOR.

FOR ASSOCIATION SERVICES, NAMELY, PROMOT-  
ING THE INTERESTS OF PLUMBING, HEATING AND  
COOLING CONTRACTORS AND THE PLUMBING,  
HEATING AND COOLING INDUSTRY (U.S. CLS. 100,  
101 AND 102).

FIRST USE 9-13-2013; IN COMMERCE 9-13-2013.  
KATINA MISTER, EXAMINING ATTORNEY

**CLASS 35—(Continued).**

SN 86-066,321. TRANSLATION - RIGHT LEFT, LLC, TRENTON, NJ. FILED 9-17-2013.



THE COLOR(S) BLACK, WHITE, ORANGE, GREEN AND BLUE IS/ARE CLAIMED AS A FEATURE OF THE MARK.

THE MARK CONSISTS OF A BLACK BLOCK LETTER "T" IN THE MIDDLE AND ABOVE THE CENTER OF TWO CONNECTED BOXES. THE BOX ON THE LOWER LEFT IS ORANGE AND INCLUDES A WHITE BLOCK LETTER "R" WHILE THE BOX ON THE LOWER RIGHT IS BLUE AND INCLUDES A WHITE BLOCK LETTER "L". A GREEN TRIANGLE OPEN AT THE LINE BETWEEN THE BOXES CLOSES WITHIN THE BLUE BOX. THE LETTER "T" AND BOTH BOXES ARE WITHIN A BLACK LINED TRIANGLE WITH ITS ONE POINT ABOVE THE LETTER "T" AND THE OTHER TWO POINTS IN LINE WITH THE LOWER EDGE OF THE BOXES.

FOR ASSISTANCE, ADVISORY SERVICES AND CONSULTANCY WITH REGARD TO BUSINESS PLANNING, BUSINESS ANALYSIS, BUSINESS MANAGEMENT, AND BUSINESS ORGANIZATION; BUSINESS ADVISORY SERVICES, CONSULTANCY AND INFORMATION; BUSINESS ASSISTANCE, ADVISORY AND CONSULTING SERVICES IN THE FIELD OF CREATIVE INNOVATIONS; BUSINESS CONSULTATION; BUSINESS CONSULTATION AND MANAGEMENT REGARDING MARKETING ACTIVITIES AND LAUNCHING OF NEW PRODUCTS; BUSINESS CONSULTING SERVICES IN THE FIELD OF CREATIVE INNOVATIONS; BUSINESS DEVELOPMENT CONSULTING SERVICES; BUSINESS MANAGEMENT AND ENTERPRISE ORGANIZATION CONSULTANCY; CONSULTANCY SERVICES REGARDING BUSINESS STRATEGIES; CONSULTING SERVICES IN BUSINESS ORGANIZATION AND MANAGEMENT; CONSULTING SERVICES IN THE FIELD OF MANAGING INTELLECTUAL PROPERTIES; MANAGEMENT AND BUSINESS CONSULTING SERVICES IN THE FIELD OF CREATIVE INNOVATIONS; NEW BUSINESS VENTURE DEVELOPMENT AND FORMATION CONSULTING SERVICES; PROVIDING CONSULTING SERVICES IN THE FIELD OF FACILITATING THE PLANNING, BUYING, AND SELLING OF MEDIA (U.S. CLS. 100, 101 AND 102).

VIVIAN MICZNIK FIRST, EXAMINING ATTORNEY

**CLASS 35—(Continued).**

SN 86-066,329. BURKE, JEFFREY ALAN, PALOS VERDES ESTATES, CA. FILED 9-17-2013.

personalizing products  
never felt better

THE MARK CONSISTS OF STANDARD CHARACTERS WITHOUT CLAIM TO ANY PARTICULAR FONT, STYLE, SIZE, OR COLOR.

FOR MAIL ORDER AND ONLINE ORDERING SERVICES FEATURING CUSTOMIZED IMPRINTING OF APPAREL, DRINKWARE, OUTDOOR AND LEISURE PRODUCTS, TRADE SHOW PRODUCTS AND SIGNAGE, AUTO SUPPLIES, HOME GOODS AND TOOLS, FOOD AND CANDY, STATIONERY, WELLNESS AND SAFETY KITS, BAGS, OFFICE SUPPLIES AND AWARDS, TECHNOLOGY ITEMS SUCH AS COMPUTER ACCESSORIES, TOYS AND NOVELTIES, AND WRITING IMPLEMENTS, ALL IMPRINTED WITH CUSTOMERS' TRADEMARKS, SERVICE MARKS, TRADE NAMES AND RELATED CUSTOMER INFORMATION (U.S. CLS. 100, 101 AND 102).

FIRST USE 9-1-2013; IN COMMERCE 9-1-2013.  
DAVID TAYLOR, EXAMINING ATTORNEY

SN 86-066,352. NGUYEN, LUC, SAN JOSE, CA. FILED 9-17-2013.

NETDEALSHOP

THE MARK CONSISTS OF STANDARD CHARACTERS WITHOUT CLAIM TO ANY PARTICULAR FONT, STYLE, SIZE, OR COLOR.

FOR ONLINE RETAIL STORE SERVICES FEATURING CLOTHING, FOOTWEAR, NECKTIES, SUNGLASSES, BAGS, FASHION ACCESSORIES, INTERNATIONAL CULTURAL DRESSES AND COSTUMES (U.S. CLS. 100, 101 AND 102).

FIRST USE 9-9-2013; IN COMMERCE 9-9-2013.  
ROSELLE HERRERA, EXAMINING ATTORNEY

SN 86-066,416. BINNO, JOE, HOLLY, MI. FILED 9-17-2013.

25/25

THE MARK CONSISTS OF STANDARD CHARACTERS WITHOUT CLAIM TO ANY PARTICULAR FONT, STYLE, SIZE, OR COLOR.

FOR SALES PROMOTION SERVICES (U.S. CLS. 100, 101 AND 102).

ARETHA SOMERVILLE, EXAMINING ATTORNEY

**CLASS 35—(Continued).**

SN 86-066,440. GOLD, JOELYNE, LAS VEGAS, NV. FILED 9-17-2013.



THE MARK CONSISTS OF THE STYLIZED TEXT "LOVE&TOADS" WITH SPARKLES THROUGHOUT THE TEXT AND A DESIGN OF A WITCH KISSING A TOAD TO THE RIGHT OF THE TEXT.

FOR ON-LINE RETAIL STORE SERVICES FEATURING CANDLES, HERBS, OILS, AMULETS, TALISMANS, GRIS GRIS BAGS, STONES, INCENSE, TEAS, T-SHIRTS, HATS, AND APRONS (U.S. CLS. 100, 101 AND 102).

KEVIN CORWIN, EXAMINING ATTORNEY

**CLASS 35—(Continued).**

SN 86-066,634. NSA, LLC, COLLIERVILLE, TN. FILED 9-17-2013.

**GENERATION WHY**

THE MARK CONSISTS OF STANDARD CHARACTERS WITHOUT CLAIM TO ANY PARTICULAR FONT, STYLE, SIZE, OR COLOR.

FOR BUSINESS CONSULTATION SERVICES, NAMELY, PROVIDING ASSISTANCE TO DEALERS AND DISTRIBUTORS IN THE RECRUITING OF DEALERS AND DISTRIBUTORS FOR A MULTI-LEVEL SALES PROGRAM (U.S. CLS. 100, 101 AND 102).

EUGENIA MARTIN, EXAMINING ATTORNEY

SN 86-066,792. DORFMAN, WILLIAM M, LOS ANGELES, CA. FILED 9-17-2013.

SN 86-066,450. AMERICAN ELECTRIC POWER COMPANY, INC., COLUMBUS, OH. FILED 9-17-2013.

**Smiles for Life**

THE MARK CONSISTS OF STANDARD CHARACTERS WITHOUT CLAIM TO ANY PARTICULAR FONT, STYLE, SIZE, OR COLOR.

FOR DEVELOPING PROMOTIONAL CAMPAIGNS FOR BUSINESS (U.S. CLS. 100, 101 AND 102).

SANI KHOURI, EXAMINING ATTORNEY

SN 86-066,846. OKEN, WAYNE, POMPANO BEACH, FL. FILED 9-17-2013.

THE COLOR(S) RED PANTONE 485C AND GRAY PANTONE 424C IS/ARE CLAIMED AS A FEATURE OF THE MARK.

THE MARK CONSISTS OF A GRAY PANTONE 424C LETTER "P" DERIVED FROM A COMBINATION OF GEOMETRIC SHAPES BELOW WHICH IS POSITIONED A RED PANTONE 485C JAGGED LINE FORMING A STYLIZED LETTER "E".

FOR HOME ENERGY ASSESSMENT SERVICES FOR THE PURPOSE OF DETERMINING ENERGY EFFICIENCY OR USAGE MANAGEMENT; INFORMATION IN THE FIELD OF ENERGY EFFICIENCY; PROVISION OF INFORMATION, ADVICE AND CONSULTANCY IN RELATION TO ENERGY EFFICIENCY; CONSULTING SERVICES IN THE FIELD OF ENERGY EFFICIENCY FOR RESIDENTIAL AND COMMERCIAL FACILITIES (U.S. CLS. 100, 101 AND 102).

FIRST USE 6-1-2013; IN COMMERCE 6-1-2013.  
ZACHARY BELLO, EXAMINING ATTORNEY

**The People's Effort**

THE MARK CONSISTS OF STANDARD CHARACTERS WITHOUT CLAIM TO ANY PARTICULAR FONT, STYLE, SIZE, OR COLOR.

FOR POLITICAL PARTY SERVICES, NAMELY, PROMOTING THE INTERESTS OF A POLITICAL ORGANIZATION (U.S. CLS. 100, 101 AND 102).

AISHA CLARKE, EXAMINING ATTORNEY

**CLASS 35—(Continued).**

SN 86-066,880. TEAM FOUR HORSEMEN, GLENEDEN BEACH, OR. FILED 9-17-2013.

**TEAM FOUR HORSEMEN**

THE MARK CONSISTS OF STANDARD CHARACTERS WITHOUT CLAIM TO ANY PARTICULAR FONT, STYLE, SIZE, OR COLOR.

FOR PROMOTION OF A NOT-FOR-PROFIT AND RECREATIONAL SPORTING CLUB; PRESENTATION OF GOODS ON COMMUNICATION MEDIA FOR RETAIL PURPOSES (U.S. CLS. 100, 101 AND 102).

KAELIE KUNG, EXAMINING ATTORNEY

SN 86-066,892. BLASTPAGE.NET, LIMITED LIABILITY COMPANY, DALLAS, TX. FILED 9-17-2013.

**BLASTPAGE.NET**

THE MARK CONSISTS OF STANDARD CHARACTERS WITHOUT CLAIM TO ANY PARTICULAR FONT, STYLE, SIZE, OR COLOR.

FOR PROVIDING A WEB SITE FEATURING ON-LINE CLASSIFIED ADVERTISEMENTS POSTED BY USERS (U.S. CLS. 100, 101 AND 102).

FIRST USE 3-15-2013; IN COMMERCE 9-11-2013.

JOHN SCHUYLER YARD, EXAMINING ATTORNEY

SN 86-067,026. VISAVO, MIDDLETON, MA. FILED 9-17-2013.

**Visavo**

THE MARK CONSISTS OF STANDARD CHARACTERS WITHOUT CLAIM TO ANY PARTICULAR FONT, STYLE, SIZE, OR COLOR.

FOR BUSINESS CONSULTING AND INFORMATION SERVICES (U.S. CLS. 100, 101 AND 102).

SKYE YOUNG, EXAMINING ATTORNEY

**CLASS 35—(Continued).**

SN 86-067,034. CAIRDEAN CAFE, LLC, ST. HELENA, CA. FILED 9-17-2013.

**ROSGAL**

THE MARK CONSISTS OF STANDARD CHARACTERS WITHOUT CLAIM TO ANY PARTICULAR FONT, STYLE, SIZE, OR COLOR.

FOR RETAIL STORE SERVICES FEATURING A WIDE VARIETY OF CONSUMER GOODS OF OTHERS (U.S. CLS. 100, 101 AND 102).

SKYE YOUNG, EXAMINING ATTORNEY

SN 86-067,109. PRIVALOVA, NATALIYA, PRINCETON, NJ. FILED 9-17-2013.

**YOUIE**

THE MARK CONSISTS OF STANDARD CHARACTERS WITHOUT CLAIM TO ANY PARTICULAR FONT, STYLE, SIZE, OR COLOR.

FOR ADVERTISING SERVICES, NAMELY, PROMOTING AND MARKETING THE GOODS AND SERVICES OF OTHERS THROUGH ALL PUBLIC COMMUNICATION MEANS; ANALYSIS OF MARKET RESEARCH DATA AND STATISTICS; ARRANGING OF BUYING AND SELLING CONTRACTS FOR THIRD PARTIES; ASSISTANCE IN MANAGEMENT OF BUSINESS ACTIVITIES; ASSISTANCE, ADVISORY SERVICES AND CONSULTANCY WITH REGARD TO BUSINESS PLANNING, BUSINESS ANALYSIS, BUSINESS MANAGEMENT, AND BUSINESS ORGANIZATION; ASSISTANCE, ADVISORY SERVICES AND CONSULTANCY WITH REGARD TO BUSINESS PLANNING, BUSINESS ANALYSIS, BUSINESS MANAGEMENT, BUSINESS ORGANIZATION, MARKETING AND CUSTOMER ANALYSIS; ATTORNEY REFERRALS; BUSINESS ADMINISTRATION OF PRE-PAID LEGAL SERVICES; BUSINESS ADVICE AND INFORMATION; BUSINESS ADVISORY SERVICES, CONSULTANCY AND INFORMATION; BUSINESS ANALYSIS AND BUSINESS STRATEGIC PLANNING SERVICES IN THE TECHNOLOGY INDUSTRY; BUSINESS INFORMATION MANAGEMENT, NAMELY, ELECTRONIC REPORTING OF BUSINESS INFORMATION, BUSINESS ANALYTICS, NAMELY, BUSINESS INVESTIGATIONS, EVALUATIONS, EXPERT APPRAISALS, INFORMATION AND RESEARCH, TRADE SPEND BUSINESS MANAGEMENT; BUSINESS MANAGEMENT AND ADVICE; BUSINESS MANAGEMENT AND CONSULTATION; BUSINESS MANAGEMENT SERVICES, NAMELY, MANAGING LOGISTICS, REVERSE LOGISTICS, SUPPLY CHAIN SERVICES, SUPPLY CHAIN VISIBILITY AND SYNCHRONIZATION, SUPPLY AND DEMAND FORECASTING AND PRODUCT DISTRIBUTION PROCESSES FOR OTHERS; BUSINESS SERVICES, NAMELY, ASSISTING THE OWNERS OF INTELLECTUAL PROPERTY AND INTANGIBLE ASSETS IN FINDING INVESTORS; BUSINESS SERVICES, NAMELY, CONSUMER RESEARCH AND CONSULTING RELATED THERETO; CONSULTING REGARDING INTELLECTUAL PROPERTY BUSINESS RISK MITIGATION PROCESSES; CONSULTING SERVICES IN THE FIELD OF MANAGING INTELLECTUAL PROPERTIES; CONSUMER RESEARCH; DATA PROCESSING SERVICES; DOCTOR REFERRALS; ENROLLING STUDENTS IN THE EDUCATIONAL PROGRAMS OF OTHERS; ESTATE MANAGEMENT, NAMELY, ASSIS-

**CLASS 35—(Continued).**

TANCE IN THE GATHERING AND ORGANIZATION OF PERSONAL VITAL AND FINANCIAL RECORDS IN CONJUNCTION WITH INSTRUCTIONS FOR HANDLING OF SUCH DOCUMENTS BY OTHERS, INCLUDING EXECUTORS AND ATTORNEYS, UPON DEATH OR WHEN OTHERWISE NECESSARY; EVENT PLANNING AND MANAGEMENT FOR MARKETING, BRANDING, PROMOTING OR ADVERTISING THE GOODS AND SERVICES OF OTHERS; EXCHANGE SERVICES, NAMELY, BARTERING OF GOODS FOR OTHERS; FINANCIAL STATEMENT PREPARATION AND ANALYSIS FOR BUSINESSES; HUMAN RESOURCES SERVICES, NAMELY, PERSONNEL SELECTION FOR OTHERS; MANAGEMENT ASSISTANCE; MARKET RESEARCH AND MARKET INTELLIGENCE SERVICES; MEDIATION AND CONCLUSION OF COMMERCIAL TRANSACTIONS FOR OTHERS; NANNY REFERRAL AGENCY SERVICES; OPERATIONAL BUSINESS ASSISTANCE TO ENTERPRISES; OUTSOURCING SERVICES IN THE NATURE OF ARRANGING SERVICE CONTRACTS FOR OTHERS; PERSONAL MANAGEMENT SERVICES FOR ENTERTAINERS; PERSONAL MANAGEMENT SERVICES FOR MUSICAL PERFORMERS; PROJECT MANAGEMENT SERVICES FOR OTHERS IN THE FIELDS OF LANGUAGE TRANSLATION, CUSTOM WRITING, TEXT ADAPTATION, INTERPRETING AND PROOFREADING; PROVIDING BUSINESS INTELLIGENCE SERVICES; PROVIDING ONLINE BUSINESS MANAGEMENT SERVICES INCLUDING ACCOUNTING, MARKETING, BUSINESS PROJECT MANAGEMENT, AND BUSINESS DEVELOPMENT; PROVIDING TRAVEL MANAGEMENT SERVICES; PUBLIC RELATIONS; SECRETARIAL AND CLERICAL SERVICES; SERVING AS A HUMAN RESOURCES DEPARTMENT FOR OTHERS; TRANSPORTATION LOGISTICS SERVICES, NAMELY, ARRANGING THE TRANSPORTATION OF GOODS FOR OTHERS; TURNKEY RETAIL START-UP SERVICES, NAMELY, COORDINATION AND ASSUMPTION OF RESPONSIBILITY FOR ALL ASPECTS OF THE STORE-OPENING PROCESS OF OTHERS (U.S. CLS. 100, 101 AND 102).

SHAVELL MCPHERSON, EXAMINING ATTORNEY

SN 86-067,111. SUPERMAX HEALTHCARE, INC., AURORA, IL. FILED 9-17-2013.

**AURELIA CARES**

THE MARK CONSISTS OF STANDARD CHARACTERS WITHOUT CLAIM TO ANY PARTICULAR FONT, STYLE, SIZE, OR COLOR.

OWNER OF U.S. REG. NOS. 3,000,179 AND 3,037,301.

FOR ORGANIZING AND DEVELOPING CHARITABLE PROJECTS THAT AIM TO PROMOTE AWARENESS AND RESEARCH FOR OVARIAN CANCER (U.S. CLS. 100, 101 AND 102).

JULIE GUTTADAURO, EXAMINING ATTORNEY

**CLASS 35—(Continued).**

SN 86-067,117. HUMAN, INC., DBA FRIENDS & NEIGHBORS, MINNEAPOLIS, MN. FILED 9-17-2013.

**Friends & Neighbors**

THE MARK CONSISTS OF STANDARD CHARACTERS WITHOUT CLAIM TO ANY PARTICULAR FONT, STYLE, SIZE, OR COLOR.

FOR BRANDING SERVICES, NAMELY, CONSULTING, DEVELOPMENT, MANAGEMENT AND MARKETING OF BRANDS FOR BUSINESSES AND/OR INDIVIDUALS (U.S. CLS. 100, 101 AND 102).

FIRST USE 1-1-2013; IN COMMERCE 9-9-2013.

NAKIA HENRY, EXAMINING ATTORNEY

SN 86-067,132. EXPRESS, LLC, COLUMBUS, OH. FILED 9-17-2013.

**MIND THE TREND**

THE MARK CONSISTS OF STANDARD CHARACTERS WITHOUT CLAIM TO ANY PARTICULAR FONT, STYLE, SIZE, OR COLOR.

FOR RETAIL STORE SERVICES AND ON-LINE RETAIL STORE SERVICES ALL FEATURING CLOTHING, FOOTWEAR, CLOTHING ACCESSORIES, BAGS, JEWELRY, WATCHES, EYEWEAR, HOSIERY, AND PERSONAL CARE PRODUCTS (U.S. CLS. 100, 101 AND 102).

DAVID ELTON, EXAMINING ATTORNEY

SN 86-067,186. RODRIGUEZ, ALONSO, DBA TAX IQ, LANTANA, TX. FILED 9-17-2013.

**TAX IQ**

THE MARK CONSISTS OF STANDARD CHARACTERS WITHOUT CLAIM TO ANY PARTICULAR FONT, STYLE, SIZE, OR COLOR.

NO CLAIM IS MADE TO THE EXCLUSIVE RIGHT TO USE "TAX", APART FROM THE MARK AS SHOWN.

FOR ACCOUNTANCY SERVICES; ACCOUNTING CONSULTATION; ADMINISTRATION, BILLING AND RECONCILIATION OF ACCOUNTS ON BEHALF OF OTHERS; INCOME TAX CONSULTATION; INCOME TAX PREPARATION; TAX AND TAXATION PLANNING, ADVICE, INFORMATION AND CONSULTANCY SERVICES; TAX CONSULTATION; TAX FILING SERVICES (U.S. CLS. 100, 101 AND 102).

CAROL SPILS, EXAMINING ATTORNEY



**CLASS 35—(Continued).**

SN 86-067,234. RAD AND REFINED INC., LOS ANGELES, CA. FILED 9-17-2013.

# Rad and Refined

THE MARK CONSISTS OF STANDARD CHARACTERS WITHOUT CLAIM TO ANY PARTICULAR FONT, STYLE, SIZE, OR COLOR.

FOR ON-LINE RETAIL STORE SERVICES FEATURING FASHION CLOTHING, APPAREL, BAG, BELT, JEWELRY AND EYEWEAR ACCESSORIES AND RELATED GOODS (U.S. CLS. 100, 101 AND 102).

FIRST USE 11-1-2011; IN COMMERCE 11-1-2011.  
SUNG IN, EXAMINING ATTORNEY

---

SN 86-067,236. AMERICAN HOUSING VENTURES, LLC, NEWPORT BEACH, CA. FILED 9-17-2013.

# LIVE RIGHT

THE MARK CONSISTS OF STANDARD CHARACTERS WITHOUT CLAIM TO ANY PARTICULAR FONT, STYLE, SIZE, OR COLOR.

FOR REAL ESTATE MARKETING SERVICES IN THE FIELD OF SINGLE FAMILY HOMES IN SINGLE FAMILY RENTAL COMMUNITIES (U.S. CLS. 100, 101 AND 102).

SUNG IN, EXAMINING ATTORNEY

---

SN 86-067,271. RAD AND REFINED INC., LOS ANGELES, CA. FILED 9-17-2013.

# RAD+REFINED

THE MARK CONSISTS OF TWO WORDS, "RAD" AND "REFINED" IN STYLIZED FORM, CONNECTED BY THE SYMBOL "+".

FOR ON-LINE RETAIL STORE SERVICES FEATURING FASHION CLOTHING, APPAREL, BAG, BELT, JEWELRY AND EYEWEAR ACCESSORIES AND RELATED GOODS (U.S. CLS. 100, 101 AND 102).

FIRST USE 11-1-2011; IN COMMERCE 11-1-2011.  
SUNG IN, EXAMINING ATTORNEY

**CLASS 35—(Continued).**

SN 86-067,283. FOOD GATHERERS, ANN ARBOR, MI. FILED 9-17-2013.

# FOOD GATHERERS

THE MARK CONSISTS OF STANDARD CHARACTERS WITHOUT CLAIM TO ANY PARTICULAR FONT, STYLE, SIZE, OR COLOR.

SEC. 2(F).

FOR CHARITABLE SERVICES IN THE NATURE OF COORDINATION OF THE PROCUREMENT AND DISTRIBUTION OF FOOD DONATIONS FROM THE GENERAL PUBLIC TO NEEDY PERSONS; CHARITABLE SERVICES, NAMELY, COORDINATION OF THE PROCUREMENT AND DISTRIBUTION OF FOOD DONATIONS FROM MANUFACTURERS, WHOLESALERS, RETAILERS, AND GOVERNMENT AGENCIES TO ORGANIZATIONS PROVIDING FREE FOOD TO NEEDY PEOPLE (U.S. CLS. 100, 101 AND 102).

FIRST USE 1-27-1989; IN COMMERCE 1-27-1989.  
SUNG IN, EXAMINING ATTORNEY

---

SN 86-067,285. FOOD GATHERERS, ANN ARBOR, MI. FILED 9-17-2013.

# FIGHTING HUNGER WHERE WE LIVE

THE MARK CONSISTS OF STANDARD CHARACTERS WITHOUT CLAIM TO ANY PARTICULAR FONT, STYLE, SIZE, OR COLOR.

FOR CHARITABLE SERVICES IN THE NATURE OF COORDINATION OF THE PROCUREMENT AND DISTRIBUTION OF FOOD DONATIONS FROM THE GENERAL PUBLIC TO NEEDY PERSONS; CHARITABLE SERVICES, NAMELY, COORDINATION OF THE PROCUREMENT AND DISTRIBUTION OF FOOD DONATIONS FROM MANUFACTURERS, WHOLESALERS, RETAILERS, AND GOVERNMENT AGENCIES TO ORGANIZATIONS PROVIDING FREE FOOD TO NEEDY PEOPLE (U.S. CLS. 100, 101 AND 102).

FIRST USE 1-27-1989; IN COMMERCE 1-27-1989.  
SUNG IN, EXAMINING ATTORNEY

**CLASS 35—(Continued).**

SN 86-067,325. RIVER MIST SALES, LAKE HAVASU CITY, AZ. FILED 9-17-2013.



THE MARK CONSISTS OF A DESIGN OF A MOUNTAIN WITH A DESIGN OF A VAPOR IN IT WITH THE STYLIZED UNDERLINED TEXT "RIVERMIST" BELOW IT.

FOR RETAIL STORE SERVICES FEATURING A WIDE VARIETY OF CONSUMER GOODS OF OTHERS; WHOLESALE STORE SERVICES FEATURING A WIDE VARIETY OF CONSUMER GOODS OF OTHERS (U.S. CLS. 100, 101 AND 102).

TIMOTHY FINNEGAN, EXAMINING ATTORNEY

**CLASS 35—(Continued).**

SN 86-067,355. MOBERI, LLC, PORTLAND, OR. FILED 9-17-2013.



THE COLOR(S) GREEN, PINK AND WHITE IS/ARE CLAIMED AS A FEATURE OF THE MARK.

THE MARK CONSISTS OF A GREEN CALLOUT BALLOON WITH THE WORD "MOBERI" IN THE MIDDLE OF THE BALLOON IN STYLIZED FORM WITH THE "O" IN MOBERI RESEMBLING THE CRANKSET OF A BICYCLE. THE LETTERS ARE WHITE EXCEPT FOR THE STYLIZED "O" AND THE STYLIZED DOT ON THE "I" WHICH ARE PINK.

FOR CONCESSION STAND FEATURING SMOOTHIES, JUICES AND PROTEIN DRINKS (U.S. CLS. 100, 101 AND 102).

FIRST USE 4-12-2011; IN COMMERCE 4-12-2011.

AMEEN IMAM, EXAMINING ATTORNEY

SN 86-067,357. P.LION INC, HOUSTON, TX. FILED 9-17-2013.

SN 86-067,337. HRB INNOVATIONS, INC., LAS VEGAS, NV. FILED 9-17-2013.

# PinkLion

**GET YOUR BILLION BACK,  
AMERICA**

THE MARK CONSISTS OF STANDARD CHARACTERS WITHOUT CLAIM TO ANY PARTICULAR FONT, STYLE, SIZE, OR COLOR.

FOR PREPARATION OF TAX RETURNS FOR OTHERS (U.S. CLS. 100, 101 AND 102).

LAURA FIONDA, EXAMINING ATTORNEY

THE MARK CONSISTS OF STANDARD CHARACTERS WITHOUT CLAIM TO ANY PARTICULAR FONT, STYLE, SIZE, OR COLOR.

FOR BUSINESS SERVICES, NAMELY, PROVIDING AN ONLINE NETWORK FOR CONTRACTORS TO RECEIVE LEADS AND BIDDING OPPORTUNITIES BY MEANS OF AN ONLINE MARKETPLACE FOR THE PURPOSE OF DEVELOPING BUSINESS; OPERATING ON-LINE MARKETPLACES FEATURING A PLATFORM ENABLING BUYERS TO CONNECT WITH SELLERS FOR PRE-MADE GOODS AND CUSTOM REQUESTS; OPERATING ON-LINE MARKETPLACES FOR SELLERS AND BUYERS OF GOODS AND/OR SERVICES; PROVIDING A WEBSITE FEATURING AN ONLINE MARKETPLACE FOR EXCHANGING GOODS AND SERVICES WITH OTHER USERS (U.S. CLS. 100, 101 AND 102).

AMEEN IMAM, EXAMINING ATTORNEY

**CLASS 35—(Continued).**

SN 86-067,558. SILK, ROSA, BETHLEHEM, PA. FILED 9-18-2013.

BE "SCENTSLESS" BE YOU

THE MARK CONSISTS OF STANDARD CHARACTERS WITHOUT CLAIM TO ANY PARTICULAR FONT, STYLE, SIZE, OR COLOR.

FOR PROMOTING PUBLIC AWARENESS OF ENVIRONMENTAL ISSUES AND INITIATIVES; PROMOTING PUBLIC AWARENESS OF ENVIRONMENTAL MATTERS (U.S. CLS. 100, 101 AND 102).

MARCIE MILONE, EXAMINING ATTORNEY

---

SN 86-067,572. SMA MEDIA LLC, WILMINGTON, DE. FILED 9-18-2013.

ADNUBO

THE MARK CONSISTS OF STANDARD CHARACTERS WITHOUT CLAIM TO ANY PARTICULAR FONT, STYLE, SIZE, OR COLOR.

THE WORDING "ADNUBO" HAS NO MEANING IN A FOREIGN LANGUAGE.

FOR ADVERTISING AND MARKETING SERVICES PROVIDED BY MEANS OF INDIRECT METHODS OF MARKETING COMMUNICATIONS, NAMELY, SOCIAL MEDIA, SEARCH ENGINE MARKETING, INQUIRY MARKETING, INTERNET MARKETING, MOBILE MARKETING, BLOGGING AND OTHER FORMS OF PASSIVE, SHARABLE OR VIRAL COMMUNICATIONS CHANNELS (U.S. CLS. 100, 101 AND 102).

FIRST USE 7-29-2013; IN COMMERCE 7-29-2013.  
SANJEEV VOHRA, EXAMINING ATTORNEY

---

SN 86-067,633. REYES, JOSEPH B., GLENDALE, CA. FILED 9-18-2013.

T.I.C.H.R.

THE MARK CONSISTS OF STANDARD CHARACTERS WITHOUT CLAIM TO ANY PARTICULAR FONT, STYLE, SIZE, OR COLOR.

FOR HUMAN RESOURCES MANAGEMENT (U.S. CLS. 100, 101 AND 102).

FIRST USE 9-1-2013; IN COMMERCE 9-1-2013.  
SUZANNE BLANE, EXAMINING ATTORNEY

**CLASS 35—(Continued).**

SN 86-067,648. BROADWAY MEDIA GROUP, INC., DBA SHOPPINGBOSS.COM, ALPHARETTA, GA. FILED 9-18-2013.

ShoppingBoss

THE MARK CONSISTS OF STANDARD CHARACTERS WITHOUT CLAIM TO ANY PARTICULAR FONT, STYLE, SIZE, OR COLOR.

FOR ADVERTISING SERVICES, NAMELY, PROMOTING THE GIFT CARDS OF OTHERS; PROMOTING THE GOODS AND SERVICES OF OTHERS BY MEANS OF OPERATING AN ON-LINE SHOPPING MALL WITH LINKS TO THE RETAIL WEB SITES OF OTHERS; PROMOTING THE GOODS AND SERVICES OF OTHERS BY PROVIDING AN INTERACTIVE WEBSITE WHERE USERS CAN INCREASE THE CURRENT VALUE OF AN ONLINE DISCOUNT BEING OFFERED BY PURCHASING THE GOODS AND SERVICES ASSOCIATED WITH THAT DISCOUNT IN THE FORM OF AN ONLINE COUPON, VOUCHER OR GIFT CARD; PROMOTIONAL SERVICES, NAMELY, PROMOTING THE GOODS OF OTHERS BY MEANS OF PROVIDING ONLINE GIFT CARDS (U.S. CLS. 100, 101 AND 102).

FIRST USE 3-21-2013; IN COMMERCE 6-10-2013.  
SUZANNE BLANE, EXAMINING ATTORNEY

---

SN 86-067,662. SMA MEDIA LLC, WILMINGTON, DE. FILED 9-18-2013.

MOBTOPUS

THE MARK CONSISTS OF STANDARD CHARACTERS WITHOUT CLAIM TO ANY PARTICULAR FONT, STYLE, SIZE, OR COLOR.

THE WORDING "MOBTOPUS" HAS NO MEANING IN A FOREIGN LANGUAGE.

FOR ADVERTISING AND MARKETING SERVICES PROVIDED BY MEANS OF INDIRECT METHODS OF MARKETING COMMUNICATIONS, NAMELY, SOCIAL MEDIA, SEARCH ENGINE MARKETING, INQUIRY MARKETING, INTERNET MARKETING, MOBILE MARKETING, BLOGGING AND OTHER FORMS OF PASSIVE, SHARABLE OR VIRAL COMMUNICATIONS CHANNELS (U.S. CLS. 100, 101 AND 102).

FIRST USE 6-17-2013; IN COMMERCE 6-17-2013.  
SANJEEV VOHRA, EXAMINING ATTORNEY

**CLASS 35—(Continued).**

SN 86-067,669. MEIJER, INC., GRAND RAPIDS, MI. FILED 9-18-2013.

tail greater

THE MARK CONSISTS OF STANDARD CHARACTERS WITHOUT CLAIM TO ANY PARTICULAR FONT, STYLE, SIZE, OR COLOR.

FOR RETAIL STORE SERVICES FEATURING A WIDE VARIETY OF CONSUMER GOODS OF OTHERS (U.S. CLS. 100, 101 AND 102).

FIRST USE 9-6-2013; IN COMMERCE 9-6-2013.  
RAMONA ORTIGA, EXAMINING ATTORNEY

**CLASS 35—(Continued).**

SN 86-067,813. PENKETH, MELLENY, ROUND ROCK, TX. FILED 9-18-2013.

WHEN WE ALL GROW UP

THE MARK CONSISTS OF STANDARD CHARACTERS WITHOUT CLAIM TO ANY PARTICULAR FONT, STYLE, SIZE, OR COLOR.

FOR PROVIDING CAREER INFORMATION; PROVIDING ON-LINE EMPLOYMENT INFORMATION IN THE FIELD OF CAREERS (U.S. CLS. 100, 101 AND 102).

MARIA-VICTORIA SUAREZ, EXAMINING ATTORNEY

SN 86-067,707. MOBILITY SOLUTIONS OF AMERICA, INC., KENNESAW, GA. FILED 9-18-2013.

MAK'N MOVES

THE MARK CONSISTS OF STANDARD CHARACTERS WITHOUT CLAIM TO ANY PARTICULAR FONT, STYLE, SIZE, OR COLOR.

FOR RETAIL STORE SERVICES FEATURING MOBILITY AND ACCESSIBILITY PRODUCTS, NAMELY, MANUAL AND POWER WHEELCHAIRS, POWER MOBILITY SCOOTERS, STAIR LIFTS, AND VERTICAL PLATFORM LIFTS (U.S. CLS. 100, 101 AND 102).

LINDA ESTRADA, EXAMINING ATTORNEY

SN 86-067,880. BRUCE WALDMAN, STOCKERTOWN, PA. FILED 9-18-2013.

THE NATIONAL EXEMPLAR

THE MARK CONSISTS OF STANDARD CHARACTERS WITHOUT CLAIM TO ANY PARTICULAR FONT, STYLE, SIZE, OR COLOR.

NO CLAIM IS MADE TO THE EXCLUSIVE RIGHT TO USE "NATIONAL", APART FROM THE MARK AS SHOWN. FOR ART GALLERIES (U.S. CLS. 100, 101 AND 102).

FIRST USE 4-9-2011; IN COMMERCE 4-9-2011.  
EUGENIA MARTIN, EXAMINING ATTORNEY

SN 86-067,803. ELECTRIC PINEAPPLE, LLC, CROSS ROADS, TX. FILED 9-18-2013.

VeriSnak

THE MARK CONSISTS OF STANDARD CHARACTERS WITHOUT CLAIM TO ANY PARTICULAR FONT, STYLE, SIZE, OR COLOR.

FOR ON-LINE ORDERING SERVICES FEATURING SNACK FOODS AND OTHER FOODS FOR DELIVERY (U.S. CLS. 100, 101 AND 102).

FIRST USE 8-31-2013; IN COMMERCE 8-31-2013.  
MARIA-VICTORIA SUAREZ, EXAMINING ATTORNEY

SN 86-067,913. KEYRIOUS LLC, CHICAGO, IL. FILED 9-18-2013.

Keyrious

THE MARK CONSISTS OF STANDARD CHARACTERS WITHOUT CLAIM TO ANY PARTICULAR FONT, STYLE, SIZE, OR COLOR.

FOR COMPUTERIZED ON-LINE RETAIL STORE SERVICES IN THE FIELD OF EXPERIENTIAL GIFTS (U.S. CLS. 100, 101 AND 102).

NORA BUCHANAN WILL, EXAMINING ATTORNEY

**CLASS 35—(Continued).**

SN 86-067,956. SHAKIR, SALAH, DBA STH BUSINESS, CARTERVILLE, IL. FILED 9-18-2013.

# Xproctor

THE MARK CONSISTS OF STANDARD CHARACTERS WITHOUT CLAIM TO ANY PARTICULAR FONT, STYLE, SIZE, OR COLOR.

FOR TRACKING STUDENT PERFORMANCE FOR EDUCATIONAL ADMINISTRATION PURPOSES (U.S. CLS. 100, 101 AND 102).  
CAROL SPILS, EXAMINING ATTORNEY

SN 86-067,989. BOURNE LOGISTICS MARKETING, LTD., SILVER SPRINGS, NV. FILED 9-18-2013.

# BLACKNLA

THE MARK CONSISTS OF STANDARD CHARACTERS WITHOUT CLAIM TO ANY PARTICULAR FONT, STYLE, SIZE, OR COLOR.

FOR ON-LINE ADVERTISING SERVICES FOR OTHERS; PREPARING PROMOTIONAL AND MERCHANDISING MATERIAL FOR OTHERS (U.S. CLS. 100, 101 AND 102).  
FIRST USE 0-0-2000; IN COMMERCE 0-0-2000.  
MARTHA SANTOMARTINO, EXAMINING ATTORNEY

SN 86-067,998. BOURNE LOGISTICS MARKETING, LTD., SILVER SPRINGS, NV. FILED 9-18-2013.

# CITY ALERT

THE MARK CONSISTS OF STANDARD CHARACTERS WITHOUT CLAIM TO ANY PARTICULAR FONT, STYLE, SIZE, OR COLOR.

FOR ON-LINE ADVERTISING SERVICES FOR OTHERS; PREPARING PROMOTIONAL AND MERCHANDISING MATERIAL FOR OTHERS (U.S. CLS. 100, 101 AND 102).  
FIRST USE 0-0-2001; IN COMMERCE 0-0-2001.  
MARTHA SANTOMARTINO, EXAMINING ATTORNEY

**CLASS 35—(Continued).**

SN 86-068,005. NOTERIETY, INC., DUBOIS, PA. FILED 9-18-2013.

# NOTERIETY

THE MARK CONSISTS OF STANDARD CHARACTERS WITHOUT CLAIM TO ANY PARTICULAR FONT, STYLE, SIZE, OR COLOR.

FOR PROVIDING A WEBSITE FEATURING AN ON-LINE MARKETPLACE FOR STUDENTS TO SELL, PURCHASE, AND EXCHANGE COURSE MATERIALS, REPORTS, AND NOTES WITH OTHER USERS (U.S. CLS. 100, 101 AND 102).  
MORGAN WYNNE, EXAMINING ATTORNEY

SN 86-068,024. CROWDREASON LIMITED LIABILITY COMPANY, FAIRVIEW, TX. FILED 9-18-2013.

# Crowd Reason

THE MARK CONSISTS OF STANDARD CHARACTERS WITHOUT CLAIM TO ANY PARTICULAR FONT, STYLE, SIZE, OR COLOR.

FOR BUSINESS CONSULTATION IN THE FIELD OF THE IMPLEMENTATION OF AUTOMATION AND WORKFLOW SYSTEMS TO FACILITATE THE CLIENT INTEGRATION WITH ONLINE NETWORKS FOR CONTRACTORS; BUSINESS CONSULTING SERVICES IN THE FIELD OF DEVELOPING APPLICATIONS TO MANAGE AN ONLINE NETWORK FOR CLIENTS TO ENGAGE CONTRACTORS TO DELIVER SERVICES; BUSINESS MANAGEMENT AND CONSULTATION IN THE FIELD OF IDENTIFYING OPPORTUNITIES FOR THE INTEGRATION SYSTEMS TO FACILITATE AUGMENTATION OF EXISTING WORKFORCE WITH AN ONLINE WORKFORCE; BUSINESS SERVICES, NAMELY, PROVIDING AN ONLINE NETWORK FOR CONTRACTORS TO RECEIVE BIDDING OPPORTUNITIES BY MEANS OF AN ONLINE MARKETPLACE FOR THE PURPOSE OF DEVELOPING BUSINESS FOR SUSTAINABLE RELATED BUILDING PRODUCTS AND SERVICES (U.S. CLS. 100, 101 AND 102).  
TINA BROWN, EXAMINING ATTORNEY

SN 86-068,041. WILLIAM M. DORFMAN, LOS ANGELES, CA. FILED 9-18-2013.

# Go Bright

THE MARK CONSISTS OF STANDARD CHARACTERS WITHOUT CLAIM TO ANY PARTICULAR FONT, STYLE, SIZE, OR COLOR.

FOR BUSINESS SERVICES, NAMELY, DEVELOPING FUNDRAISING CAMPAIGNS FOR OTHERS (U.S. CLS. 100, 101 AND 102).  
SKYE YOUNG, EXAMINING ATTORNEY

**CLASS 35—(Continued).**

SN 86-068,137. THE VALSPAR CORPORATION, MINNEAPOLIS, MN. FILED 9-18-2013.

**RIGHT PAINT RIGHT COLORS  
RIGHT TOOLS, RIGHT NOW!**

THE MARK CONSISTS OF STANDARD CHARACTERS WITHOUT CLAIM TO ANY PARTICULAR FONT, STYLE, SIZE, OR COLOR.

FOR MOBILE RETAIL STORE SERVICES FEATURING PAINTS, STAINS, PRIMERS, AND RELATED SUNDRIES; ON-LINE WHOLESALE AND RETAIL STORE SERVICES FEATURING PAINTS, STAINS, PRIMERS, AND RELATED SUNDRIES; RETAIL STORE AND ON-LINE STORE SERVICES FEATURING PAINTS, STAINS, PRIMERS, AND RELATED SUNDRIES; WHOLESALE AND RETAIL STORE SERVICES FEATURING PAINTS, STAINS, PRIMERS, AND RELATED SUNDRIES (U.S. CLS. 100, 101 AND 102).

FIRST USE 10-31-2012; IN COMMERCE 10-31-2012.  
JOHN LINCOSKI, EXAMINING ATTORNEY

---

SN 86-068,236. REPUBLIC CLOTHING CORPORATION, NEW YORK, NY. FILED 9-18-2013.

**PREMISE**

THE MARK CONSISTS OF STANDARD CHARACTERS WITHOUT CLAIM TO ANY PARTICULAR FONT, STYLE, SIZE, OR COLOR.

FOR RETAIL STORE SERVICES FEATURING CLOTHING (U.S. CLS. 100, 101 AND 102).

EUGENIA MARTIN, EXAMINING ATTORNEY

---

SN 86-068,425. OMELICH, INC., CHAPPAQUA, NY. FILED 9-18-2013.

**COUTUREDossier**

THE MARK CONSISTS OF STANDARD CHARACTERS WITHOUT CLAIM TO ANY PARTICULAR FONT, STYLE, SIZE, OR COLOR.

FOR RETAIL STORE SERVICES FEATURING CLOTHING, JEWELRY, FOOTWEAR, HANDBAGS, PURSES, BAGS; ON-LINE RETAIL STORE SERVICES FEATURING CLOTHING, JEWELRY, FOOTWEAR, HANDBAGS, PURSES, BAGS (U.S. CLS. 100, 101 AND 102).

FIRST USE 9-30-2010; IN COMMERCE 9-30-2010.  
BARBARA A. GOLD, EXAMINING ATTORNEY

**CLASS 35—(Continued).**

SN 86-068,443. MISSOURI CREDIT UNION LEAGUE, ST. LOUIS, MO. FILED 9-18-2013.

**BANK ON MORE THE CREDIT  
UNIONS OF MISSOURI**

THE MARK CONSISTS OF STANDARD CHARACTERS WITHOUT CLAIM TO ANY PARTICULAR FONT, STYLE, SIZE, OR COLOR.

NO CLAIM IS MADE TO THE EXCLUSIVE RIGHT TO USE "CREDIT UNIONS OF MISSOURI", APART FROM THE MARK AS SHOWN.

FOR TRADE ASSOCIATION SERVICES, NAMELY, PROMOTING THE INTERESTS OF CREDIT UNIONS (U.S. CLS. 100, 101 AND 102).

FIRST USE 3-0-2013; IN COMMERCE 3-0-2013.  
KATHERINE STOIDES, EXAMINING ATTORNEY

---

SN 86-068,478. OMELICH, INC., CHAPPAQUA, NY. FILED 9-18-2013.

**Sell it. Spot it. Swap it.**

THE MARK CONSISTS OF STANDARD CHARACTERS WITHOUT CLAIM TO ANY PARTICULAR FONT, STYLE, SIZE, OR COLOR.

FOR RETAIL STORE SERVICES FEATURING CLOTHING, JEWELRY, FOOTWEAR, HANDBAGS, PURSES, BAGS; ON-LINE RETAIL STORE SERVICES FEATURING CLOTHING, JEWELRY, FOOTWEAR, HANDBAGS, PURSES, BAGS (U.S. CLS. 100, 101 AND 102).

FIRST USE 9-30-2010; IN COMMERCE 9-30-2010.  
BARBARA A. GOLD, EXAMINING ATTORNEY

**CLASS 35—(Continued).**

SN 86-068,504. SUE SILVA, ALPHARETTA, GA. FILED 9-18-2013.

# SUPERUS

THE MARK CONSISTS OF STANDARD CHARACTERS WITHOUT CLAIM TO ANY PARTICULAR FONT, STYLE, SIZE, OR COLOR.

FOR ADVERTISING AND MARKETING; ADVERTISING AND MARKETING SERVICES, NAMELY, PROMOTING THE GOODS AND SERVICES OF OTHERS; ADVERTISING, MARKETING AND PROMOTION SERVICES; BRANDING SERVICES, NAMELY, CONSULTING, DEVELOPMENT, MANAGEMENT AND MARKETING OF BRANDS FOR BUSINESSES AND/OR INDIVIDUALS; BUSINESS CONSULTATION AND MANAGEMENT REGARDING MARKETING ACTIVITIES AND LAUNCHING OF NEW PRODUCTS; BUSINESS MARKETING SERVICES; CONSULTATION SERVICES, NAMELY, CREATIVE AND STRATEGIC CONSULTATION REGARDING DEVELOPMENT AND PRODUCTION OF MARKETING CAMPAIGNS FOR OTHERS; CONSULTING SERVICES IN THE FIELD OF INTERNET MARKETING; DEVELOPMENT OF MARKETING STRATEGIES AND CONCEPTS; MARKETING CONSULTING; PROMOTION AND MARKETING SERVICES AND RELATED CONSULTING (U.S. CLS. 100, 101 AND 102).

SARA BENJAMIN, EXAMINING ATTORNEY

SN 86-068,512. OMELICH, INC., CHAPPAQUA, NY. FILED 9-18-2013.

# CODO DO

THE MARK CONSISTS OF THE FANCIFUL WORD "CODO" IN STYLIZED LETTERING IN A STACKED RECTANGULAR PRESENTATION.

FOR RETAIL STORE SERVICES FEATURING CLOTHING, JEWELRY, FOOTWEAR, HANDBAGS, PURSES, BAGS; ON-LINE RETAIL STORE SERVICES FEATURING CLOTHING, JEWELRY, FOOTWEAR, HANDBAGS, PURSES, BAGS (U.S. CLS. 100, 101 AND 102).

FIRST USE 7-12-2013; IN COMMERCE 7-12-2013.  
BARBARA A. GOLD, EXAMINING ATTORNEY

**CLASS 35—(Continued).**

SN 86-068,668. STUDIO MODERNA S.A., LUGANO, SWITZERLAND, FILED 9-18-2013.

# STUDIO MODERNA

THE MARK CONSISTS OF STANDARD CHARACTERS WITHOUT CLAIM TO ANY PARTICULAR FONT, STYLE, SIZE, OR COLOR.

OWNER OF U.S. REG. NO. 3,409,293.

NO CLAIM IS MADE TO THE EXCLUSIVE RIGHT TO USE "STUDIO", APART FROM THE MARK AS SHOWN.

THE ENGLISH TRANSLATION OF THE WORD "STUDIO MODERNA" IN THE MARK IS "MODERN STUDIO".

FOR WHOLESALE AND RETAIL STORE SERVICES AVAILABLE THROUGH COMPUTER COMMUNICATIONS AND DIRECT RESPONSE RETAIL SERVICES BY MEANS OF INFOMERCIALS FEATURING GENERAL CONSUMER MERCHANDISE, NAMELY, CAR CARE PRODUCTS, NAMELY, CLEANING PREPARATIONS FOR AUTOMOBILES INCLUDING DETERGENTS, WAX, CLEANERS, POLISHES, FRAGRANCES AND DEODORIZERS AND POLYMER SEALANT FOR CLEANING, SHINING AND PROTECTING AUTOMOBILE EXTERIOR SURFACES, BEAUTY PRODUCTS, NAMELY, COSMETICS, PERFUME AND HAIR CARE PRODUCTS, BEDDING, BICYCLES, CLOTHING, NAMELY, SLEEP WEAR, ROBES, SHIRTS, PANTS, SHORTS, TOPS, BOTTOMS, HEAD WEAR AND BELTS, HOUSEHOLD AND COOKING APPARATUS, NAMELY, JUICERS, MICROWAVE OVENS, COFFEE MAKERS, ELECTRIC GRILLS, WAFFLE IRONS, RICE COOKERS, HOT PLATES, POPCORN POPPING MACHINES, PRESSURE COOKERS, SKILLETS, TOASTERS, WOKS, AND BLENDERS, GRINDERS AND MIXERS, ELECTRIC SKIN CARE APPARATUS, NAMELY, RAZORS AND HAIR CLIPPERS, ELECTRIC FLOOR CLEANING APPARATUS, NAMELY, VACUUM CLEANERS AND POWER-OPERATED POLISHERS, FOOTWEAR, HEALTH AND PERSONAL CARE ARTICLES, NAMELY, ELECTRIC SKIN CARE, HAIR REMOVAL CREAM AND ELECTROLYSIS APPARATUS FOR HAIR REMOVAL, TOOTHBRUSHES, MATTRESSES, CUSHIONS, CHAIR COVERS, SPORTS AND PHYSICAL FITNESS ARTICLES, NAMELY, AEROBIC EXERCISE EQUIPMENT, SKI SIMULATOR MACHINES, CROSS-TRAINERS, NAMELY, AIR WALKER-TYPE EXERCISERS, STEPPER EXERCISE MACHINES, ROWING SIMULATOR MACHINES AND WEIGHT TRAINING MACHINES, STRENGTH TRAINING MACHINES, FITNESS AND EXERCISE MACHINES AND EXERCISE BALLS, ORTHOPEDIC APPARATUS FOR THE TREATMENT OF BACK, SPINAL OR OTHER MUSCULAR AND JOINT PAIN AND DISORDERS, NAMELY, EXERCISE MACHINES FOR THERAPEUTIC PURPOSES; ADVERTISING, NAMELY, PROMOTION RELATING TO THE SALE OF ARTICLES VIA TELEPHONE FOR THIRD PARTIES BY THE TRANSMISSION OF ADVERTISING MATERIAL AND MESSAGES ON COMPUTER NETWORKS; ELECTRONIC RECEIPT AND PROCESSING OF ORDERS FOR OTHERS; ARRANGING DELIVERY OF PACKAGES, FREIGHT AND PARCELS VIA GROUND AND AIR CARRIER; ADVERTISING SERVICES; MARKET RESEARCH AND SALES PROMOTION FOR GOODS AND SERVICES OF THIRD PARTIES, NAMELY, PREPARING, PLACING AND DISSEMINATION OF ADVERTISEMENTS IN THE PRINT MEDIA, ON RADIO, TELEVISION, IN CATALOGUES AND THROUGH A GLOBAL COMPUTER NETWORK AND THE INTERNET; PROMOTION, ADVERTISING AND MARKETING OF ONLINE WEBSITES; PRODUCING AUDIO AND VIDEO INFOMERCIALS; ARRANGING AND CONDUCTING OF SALES AND MARKETING BUSINESS CONFERENCES; GATHERING, PREPARATION AND PLACEMENT OF ADVERTISING IN VARIOUS MEDIA, NAMELY, ELECTRONIC MEDIA, PRINTED MATTER, RADIO, TELEVISION, CATALOGUES, GLOBAL COMPUTER NETWORK, THE INTERNET AND THE PRESS; BUSINESS MANAGEMENT; PURCHASING AGENT SERVICES; MARKET RESEARCH FOR THIRD PARTIES; MARKET RESEARCH STUDIES; ADVERTISING AGENCIES; DISSEMINATION OF TELEVISION ADVERTISING MATERIAL; PUBLICATION OF PUBLICITY TEXTS (U.S. CLS. 100, 101 AND 102).

CAROL SPILS, EXAMINING ATTORNEY

**CLASS 35—(Continued).**

SN 86-068,706. KHOLBAS, INC., SAN FRANCISCO, CA.  
FILED 9-18-2013.

# KHOLBA

THE MARK CONSISTS OF STANDARD CHARACTERS WITHOUT CLAIM TO ANY PARTICULAR FONT, STYLE, SIZE, OR COLOR.

THE WORDING "KHOLBA" HAS NO MEANING IN A FOREIGN LANGUAGE.

FOR ADVERTISING SERVICES, NAMELY, PROMOTING THE BRANDS, GOODS AND SERVICES OF OTHERS; BUSINESS CONSULTING SERVICES IN THE AGRICULTURAL FIELD; FARMERS' MARKETS; ON-LINE ADVERTISING VIA A COMPUTER COMMUNICATIONS NETWORK; RESEARCH AND ANALYSIS IN THE FIELDS OF ECONOMICS AND ECONOMIC POLICY; SUPERMARKETS (U.S. CLS. 100, 101 AND 102).  
CAROL SPILS, EXAMINING ATTORNEY

---

SN 86-068,760. STARR, CHRISTA S, DBA JEWELRY GEEK,  
STUDIO CITY, CA. FILED 9-18-2013.

# Jewelry Geek

THE MARK CONSISTS OF STANDARD CHARACTERS WITHOUT CLAIM TO ANY PARTICULAR FONT, STYLE, SIZE, OR COLOR.

NO CLAIM IS MADE TO THE EXCLUSIVE RIGHT TO USE "JEWELRY", APART FROM THE MARK AS SHOWN.

FOR ON-LINE WHOLESALE AND RETAIL STORE SERVICES FEATURING JEWELRY; WHOLESALE AND RETAIL STORE SERVICES FEATURING JEWELRY (U.S. CLS. 100, 101 AND 102).

FIRST USE 6-1-2006; IN COMMERCE 6-1-2006.  
KATHERINE STOIDES, EXAMINING ATTORNEY

---

SN 86-068,791. KURT REECE, AKA KURT, SAN ANTONIO,  
TX. FILED 9-19-2013.

# RUZTIK

THE MARK CONSISTS OF STANDARD CHARACTERS WITHOUT CLAIM TO ANY PARTICULAR FONT, STYLE, SIZE, OR COLOR.

FOR ON-LINE RETAIL DEPARTMENT STORE SERVICES; ON-LINE RETAIL GIFT SHOPS; ON-LINE RETAIL STORE SERVICES FEATURING A WIDE VARIETY OF CONSUMER GOODS OF OTHERS (U.S. CLS. 100, 101 AND 102).  
ALEXANDER L. POWERS, EXAMINING ATTORNEY

**CLASS 35—(Continued).**

SN 86-068,822. SMA MEDIA LLC, WILMINGTON, DE.  
FILED 9-19-2013.

# GROOVAD

THE MARK CONSISTS OF STANDARD CHARACTERS WITHOUT CLAIM TO ANY PARTICULAR FONT, STYLE, SIZE, OR COLOR.

THE WORDING "GROOVAD" HAS NO MEANING IN A FOREIGN LANGUAGE.

FOR ADVERTISING AND MARKETING SERVICES PROVIDED BY MEANS OF INDIRECT METHODS OF MARKETING COMMUNICATIONS, NAMELY, SOCIAL MEDIA, SEARCH ENGINE MARKETING, INQUIRY MARKETING, INTERNET MARKETING, MOBILE MARKETING, BLOGGING AND OTHER FORMS OF PASSIVE, SHARABLE OR VIRAL COMMUNICATIONS CHANNELS (U.S. CLS. 100, 101 AND 102).  
FIRST USE 9-2-2013; IN COMMERCE 9-2-2013.  
SANJEEV VOHRA, EXAMINING ATTORNEY

---

SN 86-068,888. BRG COMMUNICATIONS, INC., ALEXAN-  
DRIA, VA. FILED 9-19-2013.

# COMMUNICATIONS FOR BETTER LIVING

THE MARK CONSISTS OF STANDARD CHARACTERS WITHOUT CLAIM TO ANY PARTICULAR FONT, STYLE, SIZE, OR COLOR.

FOR ADVERTISING SERVICES, NAMELY, PROMOTING AND MARKETING THE GOODS AND SERVICES OF OTHERS THROUGH ALL PUBLIC COMMUNICATION MEANS; BRAND CONCEPT AND BRAND DEVELOPMENT SERVICES FOR CORPORATE AND INDIVIDUAL CLIENTS; MARKETING SERVICES; PROMOTING, ADVERTISING AND MARKETING OF THE BRANDS, PRODUCTS, SERVICES AND ONLINE WEBSITES OF INDIVIDUALS, BUSINESSES AND NONPROFIT ORGANIZATIONS; SOCIAL MEDIA STRATEGY AND MARKETING CONSULTANCY FOCUSING ON HELPING CLIENTS CREATE AND EXTEND THEIR PRODUCT AND BRAND STRATEGIES BY BUILDING VIRALLY ENGAGING MARKETING SOLUTIONS (U.S. CLS. 100, 101 AND 102).

FIRST USE 9-19-2013; IN COMMERCE 9-19-2013.  
BRENDAN MCCAULEY, EXAMINING ATTORNEY



**CLASS 35—(Continued).**

SN 86-069,113. CODI, INC., HARRISBURG, PA. FILED 9-19-2013.

OWNER OF U.S. REG. NOS. 1,950,702, 3,641,620 AND OTHERS.

FOR RETAIL SERVICES BY DIRECT SOLICITATION BY SALES AGENTS AND ONLINE RETAIL STORES ALL FEATURING COMPUTER CARRYING CASES, COMPUTER PERIPHERALS AND COMPUTER LOCKS AND ANCHORS (U.S. CLS. 100, 101 AND 102).

FIRST USE 4-30-2006; IN COMMERCE 4-30-2006.  
BARBARA BROWN, EXAMINING ATTORNEY

**CLASS 35—(Continued).**

SN 86-069,421. MEDICAL REIMBURSEMENT CONSULTANTS, INC. AKA MRC BILLING, KOKOMO, IN. FILED 9-19-2013.

THE MARK CONSISTS OF STANDARD CHARACTERS WITHOUT CLAIM TO ANY PARTICULAR FONT, STYLE, SIZE, OR COLOR.

FOR MEDICAL BILLING (U.S. CLS. 100, 101 AND 102).  
FIRST USE 7-2-2008; IN COMMERCE 7-2-2008.  
LIEF MARTIN, EXAMINING ATTORNEY

SN 86-069,518. BUSINESS CONNECTIONS, LLC, BALTIMORE, MD. FILED 9-19-2013.

**BEERS AND CAREERS**

SN 86-069,262. SUPERIOR SHARED SERVICES, INC., WILLIAMSVILLE, NY. FILED 9-19-2013.

THE MARK CONSISTS OF STANDARD CHARACTERS WITHOUT CLAIM TO ANY PARTICULAR FONT, STYLE, SIZE, OR COLOR.

FOR EMPLOYMENT PLACEMENT AND STAFFING SERVICES; HUMAN RESOURCES CONSULTING SERVICES; PROCUREMENT SERVICES, NAMELY, LABOR CONTRACTING SERVICES; EMPLOYEE RECRUITING SERVICES; BUSINESS MANAGEMENT SERVICES, NAMELY, MANAGEMENT OF TEMPORARY EMPLOYEE SUPPLIERS AND ENTIRE TEMPORARY EMPLOYEE POPULATIONS FOR OTHERS; VENDOR MANAGEMENT SERVICES, NAMELY, MANAGING PROCESSES ASSOCIATED WITH TEMPORARY LABOR FOR OTHERS; TEMPORARY LABOR STAFFING SERVICES, NAMELY, PROVIDING STAFF AUGMENTATION SERVICES, INCLUDING CONTRACT AND TEMPORARY LABOR AND CONTRACT-TO-DIRECT HIRE SERVICES, OUTSOURCED STAFFING, CORPORATE RECRUITING, MANAGING AND SUPPLYING TEMPORARY AND DIRECT ADMINISTRATIVE, CLERICAL, ACCOUNTING, CUSTOMER SERVICE, MARKETING, ENGINEERING, INFORMATION TECHNOLOGY, DESIGN, DRAFTING, LIGHT INDUSTRIAL, AND OTHER TECHNICAL WORKERS; OUTSOURCING SERVICES IN THE FIELD OF COMPUTER-AIDED DESIGN AND DRAFTING (U.S. CLS. 100, 101 AND 102).

AISHA CLARKE, EXAMINING ATTORNEY

THE MARK CONSISTS OF STANDARD CHARACTERS WITHOUT CLAIM TO ANY PARTICULAR FONT, STYLE, SIZE, OR COLOR.

FOR BUSINESS NETWORKING; EMPLOYMENT HIRING, RECRUITING, PLACEMENT, STAFFING AND CAREER NETWORKING SERVICES; EVENT PLANNING AND MANAGEMENT FOR MARKETING, BRANDING, PROMOTING OR ADVERTISING THE GOODS AND SERVICES OF OTHERS; GENERAL BUSINESS NETWORKING REFERRAL SERVICES, NAMELY, PROMOTING THE GOODS AND SERVICES OF OTHERS BY PASSING BUSINESS LEADS AND REFERRALS AMONG GROUP MEMBERS; ON-LINE BUSINESS NETWORKING SERVICES; PROVIDING NETWORKING OPPORTUNITIES FOR INDIVIDUALS SEEKING EMPLOYMENT; SPECIAL EVENT PLANNING FOR BUSINESS PURPOSES; SPECIAL EVENT PLANNING FOR COMMERCIAL, PROMOTIONAL OR ADVERTISING PURPOSES (U.S. CLS. 100, 101 AND 102).

FIRST USE 3-27-2013; IN COMMERCE 3-27-2013.  
MORGAN WYNNE, EXAMINING ATTORNEY

SN 86-069,542. IMPACTGRC, LONG LAKE, MN. FILED 9-19-2013.

THE MARK CONSISTS OF STANDARD CHARACTERS WITHOUT CLAIM TO ANY PARTICULAR FONT, STYLE, SIZE, OR COLOR.

FOR MARKETING SERVICES (U.S. CLS. 100, 101 AND 102).

MAUREEN DALL, EXAMINING ATTORNEY

**CLASS 35—(Continued).**

SN 86-069,549. BUSTI, STEVE, AUSTIN, TX. FILED 9-19-2013.

# SFANTHOR

THE MARK CONSISTS OF STANDARD CHARACTERS WITHOUT CLAIM TO ANY PARTICULAR FONT, STYLE, SIZE, OR COLOR.

FOR RETAIL STORE SERVICES FEATURING SCIENCE FICTION, FANTASY, AND HORROR RELATED MERCHANDISE (U.S. CLS. 100, 101 AND 102).  
MATTHEW GALAN, EXAMINING ATTORNEY



SN 86-069,613. THE MARPA GROUP INC, WINTERVILLE, NC. FILED 9-19-2013.

# Careers That Make A Difference

THE MARK CONSISTS OF STANDARD CHARACTERS WITHOUT CLAIM TO ANY PARTICULAR FONT, STYLE, SIZE, OR COLOR.

FOR PROVIDING ON-LINE EMPLOYMENT INFORMATION IN THE FIELD OF LAW ENFORCEMENT (U.S. CLS. 100, 101 AND 102).  
FIRST USE 7-24-2006; IN COMMERCE 7-24-2006.  
COURTNEY ALVAREZ, EXAMINING ATTORNEY



SN 86-069,616. BUSINESS NEWS AMERICAS LIMITADA, SANTIAGO, CHILE, FILED 9-19-2013.

# BNAMERICAS

THE MARK CONSISTS OF STANDARD CHARACTERS WITHOUT CLAIM TO ANY PARTICULAR FONT, STYLE, SIZE, OR COLOR.

FOR PROVIDING BUSINESS INFORMATION IN THE FIELDS OF TELECOMMUNICATIONS, E-BUSINESS, ELECTRIC POWER, OIL AND GAS, MINING, METALS, INFRASTRUCTURE, PRIVATIZATION, BANKING, WATER AND WASTE, AND INSURANCE VIA GLOBAL COMPUTER NETWORKS (U.S. CLS. 100, 101 AND 102).  
FIRST USE 1-0-2000; IN COMMERCE 1-0-2000.  
COURTNEY ALVAREZ, EXAMINING ATTORNEY

**CLASS 35—(Continued).**

SN 86-069,656. INTERNATIONAL DRUM HORSE ASSOCIATION, YUMA, AZ. FILED 9-19-2013.



THE MARK CONSISTS OF AN ORIGINAL PIECE OF ART WORK OF A DRUM HORSE.

FOR MAINTAINING A REGISTRY OF BREEDS IN THE FIELD OF HORSES (U.S. CLS. 100, 101 AND 102).  
FIRST USE 3-16-2006; IN COMMERCE 3-16-2006.  
LINDSEY BEN, EXAMINING ATTORNEY



SN 86-069,738. ALWAYS ON CALL ANSWERING SERVICE, LLC, CONCORD, NH. FILED 9-19-2013.

# ALWAYS ON CALL

THE MARK CONSISTS OF STANDARD CHARACTERS WITHOUT CLAIM TO ANY PARTICULAR FONT, STYLE, SIZE, OR COLOR.

FOR TELEPHONE ANSWERING SERVICE (U.S. CLS. 100, 101 AND 102).  
FIRST USE 0-0-1992; IN COMMERCE 0-0-1992.  
AMY C. KEAN, EXAMINING ATTORNEY

**CLASS 35—(Continued).**

SN 86-069,826. UPINION INC., WILMINGTON, DE. FILED 9-19-2013.



THE COLOR(S) PURPLE IS/ARE CLAIMED AS A FEATURE OF THE MARK.

THE MARK CONSISTS OF "UPINION" IN PURPLE COLOR.

FOR BUSINESS INFORMATION MANAGEMENT, NAMELY, ELECTRONIC REPORTING OF BUSINESS INFORMATION, BUSINESS ANALYTICS, NAMELY, BUSINESS INVESTIGATIONS, EVALUATIONS, EXPERT APPRAISALS, INFORMATION AND RESEARCH, TRADE SPEND BUSINESS MANAGEMENT; BUSINESS INVESTIGATIONS, EVALUATIONS, EXPERT APPRAISALS, INFORMATION AND RESEARCH; CONDUCTING BUSINESS RESEARCH AND SURVEYS; CONDUCTING BUSINESS SURVEYS; CONDUCTING MARKET SURVEYS; CONDUCTING ON-LINE BUSINESS MANAGEMENT RESEARCH SURVEYS; CONSUMER SURVEY SERVICES; PROFIT SURVEY AND ANALYSIS; PUBLIC OPINION SURVEYS (U.S. CLS. 100, 101 AND 102).

JILLIAN CANTOR, EXAMINING ATTORNEY

---

SN 86-069,838. UPINION INC., WILMINGTON, DE. FILED 9-19-2013.



THE MARK CONSISTS OF STANDARD CHARACTERS WITHOUT CLAIM TO ANY PARTICULAR FONT, STYLE, SIZE, OR COLOR.

FOR BUSINESS INFORMATION MANAGEMENT, NAMELY, ELECTRONIC REPORTING OF BUSINESS INFORMATION, BUSINESS ANALYTICS, NAMELY, BUSINESS INVESTIGATIONS, EVALUATIONS, EXPERT APPRAISALS, INFORMATION AND RESEARCH, TRADE SPEND BUSINESS MANAGEMENT; BUSINESS INVESTIGATIONS, EVALUATIONS, EXPERT APPRAISALS, INFORMATION AND RESEARCH; CONDUCTING BUSINESS RESEARCH AND SURVEYS; CONDUCTING BUSINESS SURVEYS; CONDUCTING MARKET SURVEYS; CONDUCTING ON-LINE BUSINESS MANAGEMENT RESEARCH SURVEYS; CONSUMER SURVEY SERVICES; PROFIT SURVEY AND ANALYSIS; PUBLIC OPINION SURVEYS (U.S. CLS. 100, 101 AND 102).

JILLIAN CANTOR, EXAMINING ATTORNEY

**CLASS 35—(Continued).**

SN 86-070,232. AGRUVEX LLC, MEMPHIS, TN. FILED 9-20-2013.



THE STIPPLING IS FOR SHADING PURPOSES ONLY.

THE MARK CONSISTS OF A DESIGN OF A STYLIZED HALF EARTH-GLOBE SEPARATED BY THE STYLIZED TEXT "AGRUVEX" FROM STYLIZED ROWS ARRANGED IN FAN SHAPES WITH A PLANT SHOOT IN THE MIDDLE.

FOR BUSINESS ADVISORY AND CONSULTANCY SERVICES RELATING TO EXPORT, EXPORT SERVICES, EXPORT PROMOTION INFORMATION AND SERVICES; EXPORT AGENCY SERVICES FOR THE GOODS OF OTHERS; EXPORT AND IMPORT AGENCIES; EXPORT AND IMPORT AGENCIES IN THE FIELD OF NONDURABLE CONSUMER PRODUCTS AND HOME PRODUCTS; GOODS IMPORT-EXPORT AGENCIES; IMPORT AND EXPORT AGENCIES; IMPORT-EXPORT AGENCIES IN THE FIELD OF ENERGY; IMPORT-EXPORT AGENCIES IN THE FIELD OF NON-DURABLE CONSUMER PRODUCTS AND HOME PRODUCTS (U.S. CLS. 100, 101 AND 102).

FIRST USE 12-28-2006; IN COMMERCE 4-15-2013.

TINA MAI, EXAMINING ATTORNEY

---

SN 86-070,236. KENCHI GROUP INC, NEW YORK, NY. FILED 9-20-2013.



THE MARK CONSISTS OF STANDARD CHARACTERS WITHOUT CLAIM TO ANY PARTICULAR FONT, STYLE, SIZE, OR COLOR.

FOR PROCUREMENT SERVICES, NAMELY, PURCHASING OF EQUIPMENT AND COMMODITIES FOR OTHERS; PROCURING OF CONTRACTS FOR THE PURCHASE OF EQUIPMENT AND COMMODITIES; BUSINESS CONSULTING SERVICES IN THE FIELD OF EQUIPMENT AND COMMODITIES PURCHASING AND PROCUREMENT; BUSINESS ADVICE AND INFORMATION RELATING TO LOANS, FINANCE AND CAPITAL (U.S. CLS. 100, 101 AND 102).

JAMES GRIFFIN, EXAMINING ATTORNEY

**CLASS 35—(Continued).**

SN 86-070,246. INSIGNIA SYSTEMS, INC, MINNEAPOLIS, MN. FILED 9-20-2013.

**INSPIRE SHOPPERS. DELIVER  
VALUE.**

THE MARK CONSISTS OF STANDARD CHARACTERS WITHOUT CLAIM TO ANY PARTICULAR FONT, STYLE, SIZE, OR COLOR.

FOR RENTAL AND DESIGN OF IN-STORE SIGNAGE FOR ADVERTISING PURPOSES; REPORTING OF SALES RESULTS BY VOLUME OF UNITS BASED ON THE UNIVERSAL PRODUCT CODE FOR OTHERS (U.S. CLS. 100, 101 AND 102).

FIRST USE 12-1-2012; IN COMMERCE 12-1-2012.  
JAMES GRIFFIN, EXAMINING ATTORNEY

---

SN 86-070,344. NOTT, JACQUELINE M., AUBURN, CA. FILED 9-20-2013.

**SPARKLY PONY**

THE MARK CONSISTS OF STANDARD CHARACTERS WITHOUT CLAIM TO ANY PARTICULAR FONT, STYLE, SIZE, OR COLOR.

FOR ONLINE RETAIL GIFT SHOP (U.S. CLS. 100, 101 AND 102).

FIRST USE 12-1-2010; IN COMMERCE 12-1-2010.  
ANDREA HACK, EXAMINING ATTORNEY

---

SN 86-070,365. MAKING CHANGE, ALEXANDRIA, VA. FILED 9-20-2013.



THE MARK CONSISTS OF THE WORDS MAKING CHANGE WITH CIRCLES ABOVE FORMING AN ARCH BEGINNING WITH THE LETTER "I" WITH A SMALL CIRCLE FOLLOWED BY 3 MORE CIRCLES, EACH CIRCLE INCREASING SIZE AND THE 4TH CIRCLE ENDING ABOVE THE LETTER "C" IN CHANGE.

FOR BUSINESS AND MARKETING CONSULTATION SERVICES TO RETAILERS AND FOOD INDUSTRY ORGANIZATIONS TO CREATE COMPLETE, TURN-KEY FUNDRAISING PROGRAMS AMONG THEIR CUSTOMERS FOR THE BENEFIT OF THIRD PARTY NON-PROFIT ORGANIZATIONS (U.S. CLS. 100, 101 AND 102).

FIRST USE 2-15-2013; IN COMMERCE 2-15-2013.  
RAMONA ORTIGA, EXAMINING ATTORNEY

**CLASS 35—(Continued).**

SN 86-070,393. DIGITAL TOUCHPOINT INCORPORATED, DALLAS, TX. FILED 9-20-2013.

**COMMEND**

THE MARK CONSISTS OF STANDARD CHARACTERS WITHOUT CLAIM TO ANY PARTICULAR FONT, STYLE, SIZE, OR COLOR.

FOR CONDUCTING BUSINESS AND MARKET RESEARCH SURVEYS USING COMPUTER SOFTWARE, NAMELY CUSTOMER SATISFACTION SURVEYS; COMPILING AND ANALYZING STATISTICS, DATA AND OTHER SOURCES OF INFORMATION USING COMPUTER SOFTWARE FOR BUSINESS PURPOSES, NAMELY RESULTS OF CUSTOMER SATISFACTION SURVEYS AND CUSTOMER FEEDBACK; CUSTOMER AND BUSINESS REFERRAL SERVICES, NAMELY, PROMOTING THE GOODS AND SERVICES OF OTHERS BY OFFERING OPPORTUNITIES FOR CUSTOMERS TO PROVIDE ENDORSEMENTS AND SHARE EXPERIENCES VIA SOCIAL MEDIA, AND RECEIVE REWARDS FOR GENERATING NEW CUSTOMERS (U.S. CLS. 100, 101 AND 102).

FIRST USE 8-15-2013; IN COMMERCE 9-1-2013.  
ESTHER BELENKER, EXAMINING ATTORNEY

---

SN 86-070,397. DIGITAL TOUCHPOINT INCORPORATED, DALLAS, TX. FILED 9-20-2013.



THE MARK CONSISTS OF THE WORD "COMMEND" PRECEDED BY A QUOTATION BUBBLE CONTAINING THREE DOTS IN A HORIZONTAL ROW; A SMALLER QUOTATION BUBBLE APPEARS ABOVE THE LETTERS "C" AND "O" IN THE WORD "COMMEND".

FOR CONDUCTING BUSINESS AND MARKET RESEARCH SURVEYS USING COMPUTER SOFTWARE, NAMELY CUSTOMER SATISFACTION SURVEYS; COMPILING AND ANALYZING STATISTICS, DATA AND OTHER SOURCES OF INFORMATION USING COMPUTER SOFTWARE FOR BUSINESS PURPOSES, NAMELY RESULTS OF CUSTOMER SATISFACTION SURVEYS AND CUSTOMER FEEDBACK; CUSTOMER AND BUSINESS REFERRAL SERVICES, NAMELY, PROMOTING THE GOODS AND SERVICES OF OTHERS BY OFFERING OPPORTUNITIES FOR CUSTOMERS TO PROVIDE ENDORSEMENTS AND SHARE EXPERIENCES VIA SOCIAL MEDIA, AND RECEIVE REWARDS FOR GENERATING NEW CUSTOMERS (U.S. CLS. 100, 101 AND 102).

FIRST USE 8-15-2013; IN COMMERCE 9-1-2013.  
ESTHER BELENKER, EXAMINING ATTORNEY

**CLASS 35—(Continued).**

SN 86-070,540. BTI BRAND INNOVATIONS INC., MISSISSAUGA, CANADA, FILED 9-20-2013.

**MILES DRIVEN**

THE MARK CONSISTS OF STANDARD CHARACTERS WITHOUT CLAIM TO ANY PARTICULAR FONT, STYLE, SIZE, OR COLOR.

FOR ADMINISTRATION OF A CUSTOMER LOYALTY PROGRAM WHICH PROVIDES PERSONALIZED INCENTIVES TO PARTICIPANT CUSTOMERS PROMOTING RETENTION THROUGH ONGOING ENGAGEMENT, PERSONALIZED OFFERS, AND ANALYTICS; ARRANGING AND CONDUCTING INCENTIVE REWARD PROGRAMS TO PROMOTE THE SALE OF AUTOMOBILES, PARTS, ACCESSORIES, CARE PRODUCTS, AFTERMARKET GOODS, AND SERVICES PROVIDED BY A PARTICIPATING DEALERSHIP THROUGH A PERSONALIZED LOYALTY PROGRAM (U.S. CLS. 100, 101 AND 102).

MORGAN WYNNE, EXAMINING ATTORNEY

**CLASS 35—(Continued).**

SN 86-070,640. DEAL RAVEN, LLC, JACKSON, WY. FILED 9-20-2013.



THE COLOR(S) BLACK AND RED IS/ARE CLAIMED AS A FEATURE OF THE MARK.

THE MARK CONSISTS OF THE STYLIZED TERM "DEAL" IN BLACK AND THE STYLIZED TERM "RAVEN" IN RED. THE TERM "DEAL" IS INCLOSED IN A STYLIZED RED AND BLACK SHOPPING CART DESIGN.

FOR ON-LINE RETAIL STORE SERVICES FEATURING A WIDE VARIETY OF CONSUMER GOODS OF OTHERS (U.S. CLS. 100, 101 AND 102).

SOPHIA S. KIM, EXAMINING ATTORNEY

SN 86-070,596. BTI BRAND INNOVATIONS INC., MISSISSAUGA, CANADA, FILED 9-20-2013.



THE MARK CONSISTS OF THREE ABUTTING CIRCLES IN AN EQUILATERAL TRIANGULAR ARRANGEMENT CENTRALLY WITHIN A LARGE CIRCLE AND THE WORDS "MILES DRIVEN" DISPOSED OVER THE SENTENCE "THE MORE YOU DRIVE, THE MORE YOU SAVE".

FOR ADMINISTRATION OF A CUSTOMER LOYALTY PROGRAM WHICH PROVIDES PERSONALIZED INCENTIVES TO PARTICIPANT CUSTOMERS PROMOTING RETENTION THROUGH ONGOING ENGAGEMENT, PERSONALIZED OFFERS, AND ANALYTICS; ARRANGING AND CONDUCTING INCENTIVE REWARD PROGRAMS TO PROMOTE THE SALE OF AUTOMOBILES, PARTS, ACCESSORIES, CARE PRODUCTS, AFTERMARKET GOODS, AND SERVICES PROVIDED BY A PARTICIPATING DEALERSHIP THROUGH A PERSONALIZED LOYALTY PROGRAM (U.S. CLS. 100, 101 AND 102).

MORGAN WYNNE, EXAMINING ATTORNEY

**DARE MIGHTY THINGS**

THE MARK CONSISTS OF STANDARD CHARACTERS WITHOUT CLAIM TO ANY PARTICULAR FONT, STYLE, SIZE, OR COLOR.

FOR AUTOMOBILE DEALERSHIPS (U.S. CLS. 100, 101 AND 102).

LANA PHAM, EXAMINING ATTORNEY

SN 86-070,694. MAZDA MOTOR OF AMERICA, INC., IRVINE, CA. FILED 9-20-2013.

**KEEP DRIVING**

THE MARK CONSISTS OF STANDARD CHARACTERS WITHOUT CLAIM TO ANY PARTICULAR FONT, STYLE, SIZE, OR COLOR.

NO CLAIM IS MADE TO THE EXCLUSIVE RIGHT TO USE "DRIVING", APART FROM THE MARK AS SHOWN.

FOR AUTOMOBILE DEALERSHIPS (U.S. CLS. 100, 101 AND 102).

LANA PHAM, EXAMINING ATTORNEY

**CLASS 35—(Continued).**

SN 86-070,721. CONSULTING NINJAS INC., NEWARK, CA. FILED 9-20-2013.

**PARENTING SIMPLIFIED!**

THE MARK CONSISTS OF STANDARD CHARACTERS WITHOUT CLAIM TO ANY PARTICULAR FONT, STYLE, SIZE, OR COLOR.

FOR ONLINE RETAIL STORE SERVICES FEATURING BABY PRODUCTS (U.S. CLS. 100, 101 AND 102).  
AISHA CLARKE, EXAMINING ATTORNEY

**CLASS 35—(Continued).**

SN 86-070,959. SMALLEY FAMILY HOLDINGS, LLC, ORLANDO, FL. FILED 9-20-2013.

**Let YOUR Voice Be Heard**

THE MARK CONSISTS OF STANDARD CHARACTERS WITHOUT CLAIM TO ANY PARTICULAR FONT, STYLE, SIZE, OR COLOR.

FOR TAX ADVISORY SERVICES (U.S. CLS. 100, 101 AND 102).

FIRST USE 9-1-2013; IN COMMERCE 9-1-2013.  
RENEE MCCRAY, EXAMINING ATTORNEY

SN 86-070,814. SMOKESCREEN, LLC, OCEAN SPRINGS, MS. FILED 9-20-2013.



THE MARK CONSISTS OF A CIRCLE WITH TWO STYLIZED LETTER "S"'S THAT APPEAR TO BE VAPOR RISING IN THE CENTER.

FOR RETAIL STORE SERVICES FEATURING ELECTRONIC CIGARETTES AND RELATED SUPPLIES (U.S. CLS. 100, 101 AND 102).

FIRST USE 6-18-2012; IN COMMERCE 6-18-2012.  
ROSELLE HERRERA, EXAMINING ATTORNEY

SN 86-071,082. ALLAN JIM SCULPTURE AND DESIGN, INC., HONOLULU, HI. FILED 9-20-2013.

**EKTOPIA**

THE MARK CONSISTS OF STANDARD CHARACTERS WITHOUT CLAIM TO ANY PARTICULAR FONT, STYLE, SIZE, OR COLOR.

FOR ART GALLERIES; ART GALLERY SERVICES (U.S. CLS. 100, 101 AND 102).

FIRST USE 9-1-2012; IN COMMERCE 9-1-2012.  
STEPHANIE ALI, EXAMINING ATTORNEY

SN 86-070,906. TINYLIGHTBULBS LLC, DBA TINYLIGHTBULBS, DACONO, CO. FILED 9-20-2013.

**TinyLightbulbs**

THE MARK CONSISTS OF STANDARD CHARACTERS WITHOUT CLAIM TO ANY PARTICULAR FONT, STYLE, SIZE, OR COLOR.

FOR COMPUTERIZED ON-LINE RETAIL STORE SERVICES IN THE FIELD OF GENERAL CONSUMER GOODS, NAMELY CROWDFUNDED GOODS (U.S. CLS. 100, 101 AND 102).

FIRST USE 1-16-2012; IN COMMERCE 1-16-2012.  
STEVEN JACKSON, EXAMINING ATTORNEY

SN 86-071,112. LINKSHOT, LLC, ENCINITAS, CA. FILED 9-21-2013.



THE COLOR(S) BLUE AND WHITE IS/ARE CLAIMED AS A FEATURE OF THE MARK.

THE MARK CONSISTS OF A BLUE BOX WITH ROUNDED EDGES THAT IS LIGHT ON THE TOP AND FADES TO DARK ON THE BOTTOM. IN THE CENTER OF THE BOX ARE TWO HANDS IN WHITE THAT ARE SHAKING EACH OTHER.

FOR ON-LINE BUSINESS NETWORKING SERVICES; ON-LINE PROFESSIONAL NETWORKING SERVICES (U.S. CLS. 100, 101 AND 102).

JAY BESCH, EXAMINING ATTORNEY

**CLASS 35—(Continued).**

SN 86-071,115. KOPP, KENNETH B, GREENVILLE, SC. FILED 9-21-2013.



NO CLAIM IS MADE TO THE EXCLUSIVE RIGHT TO USE "SPORTING GOODS", APART FROM THE MARK AS SHOWN.

FOR RETAIL STORE SERVICES FEATURING SPORTING GOODS AND EQUIPMENT, FITNESS EQUIPMENT, APPAREL AND FOOTWEAR; ONLINE RETAIL STORE SERVICES FEATURING SPORTING GOODS AND EQUIPMENT, FITNESS EQUIPMENT, APPAREL AND FOOTWEAR (U.S. CLS. 100, 101 AND 102).

FIRST USE 9-20-2013; IN COMMERCE 9-20-2013.  
CHRISTINE MARTIN, EXAMINING ATTORNEY

**CLASS 35—(Continued).**

SN 86-071,309. ACCESS AMERICAN EDUCATION, LLC, WYNNEWOOD, PA. FILED 9-22-2013.



THE COLOR(S) RED AND BLUE IS/ARE CLAIMED AS A FEATURE OF THE MARK.

THE MARK CONSISTS OF THE MARK CONSISTS OF A BLUE EQUILATERAL TRIANGLE WITH A RED BORDER ALONG THE LEFT AND BOTTOM AND A RED BAR RUNNING HORIZONTALLY ACROSS THE CENTER WITH THE UPPER CASE LETTERS A A E BELOW THE TRIANGLE. EACH LETTER "A" IS COLORED BLUE AND THE LETTER "E" IS COLORED RED.

FOR ENROLLING STUDENTS IN THE EDUCATIONAL PROGRAMS OF OTHERS; RECRUITMENT OF STUDENTS FOR HIGHER EDUCATION INSTITUTIONS (U.S. CLS. 100, 101 AND 102).

FIRST USE 1-11-2009; IN COMMERCE 1-11-2009.  
DORITT L. CARROLL, EXAMINING ATTORNEY

SN 86-071,125. PUROHIT, FALGUNI, LAWRENCEVILLE, NJ. FILED 9-21-2013.

UNIQUE TOUCH OF TRADITION

THE MARK CONSISTS OF STANDARD CHARACTERS WITHOUT CLAIM TO ANY PARTICULAR FONT, STYLE, SIZE, OR COLOR.

FOR ONLINE RETAIL STORE SERVICES FEATURING HOUSEHOLD FURNISHINGS (U.S. CLS. 100, 101 AND 102).

DOUGLAS LEE, EXAMINING ATTORNEY

SN 86-071,828. CYLIENT, LLC, JOHNSTON, IA. FILED 9-23-2013.

Change-Able

THE MARK CONSISTS OF STANDARD CHARACTERS WITHOUT CLAIM TO ANY PARTICULAR FONT, STYLE, SIZE, OR COLOR.

FOR BUSINESS CONSULTATION IN THE FIELD OF BUSINESS LEADERSHIP DEVELOPMENT; BUSINESS CONSULTATION IN THE FIELD OF EDUCATION LEADERSHIP DEVELOPMENT; BUSINESS MANAGEMENT CONSULTATION IN THE FIELD OF EXECUTIVE AND LEADERSHIP DEVELOPMENT; CONSULTING SERVICES IN BUSINESS LEADERSHIP DEVELOPMENT AND BUSINESS MANAGEMENT (U.S. CLS. 100, 101 AND 102).

FIRST USE 8-26-2013; IN COMMERCE 8-26-2013.  
FLORENTINA BLANDU, EXAMINING ATTORNEY

**CLASS 35—(Continued).**

SN 86-071,920. BUFFALO HOLDINGS, LLC, NASHVILLE, TN. FILED 9-23-2013.

**ASK ME ABOUT FRACKING**

THE MARK CONSISTS OF STANDARD CHARACTERS WITHOUT CLAIM TO ANY PARTICULAR FONT, STYLE, SIZE, OR COLOR.

FOR PROMOTING PUBLIC AWARENESS OF FRACKING (U.S. CLS. 100, 101 AND 102).

JULIE WATSON, EXAMINING ATTORNEY

---

SN 86-071,941. TASTE MONKEY INC., BELLEVUE, WA. FILED 9-23-2013.

**TASTE MONKEY**

THE MARK CONSISTS OF STANDARD CHARACTERS WITHOUT CLAIM TO ANY PARTICULAR FONT, STYLE, SIZE, OR COLOR.

FOR INTERNET MARKETING SERVICES OF WINE AND ALCOHOL RELATED PRODUCTS (U.S. CLS. 100, 101 AND 102).

FIRST USE 2-7-2011; IN COMMERCE 2-7-2011.

IRA J. GOODSaid, EXAMINING ATTORNEY

---

SN 86-071,992. EVANS, JAY K., HONOLULU, HI. FILED 9-23-2013.

**MONTAJ 9**

THE MARK CONSISTS OF STANDARD CHARACTERS WITHOUT CLAIM TO ANY PARTICULAR FONT, STYLE, SIZE, OR COLOR.

FOR ADVERTISING AND PUBLICITY SERVICES, NAMELY, PROMOTING THE GOODS, SERVICES, BRAND IDENTITY AND COMMERCIAL INFORMATION AND NEWS OF THIRD PARTIES THROUGH PRINT, AUDIO, VIDEO, DIGITAL AND ON-LINE MEDIUM; ADVERTISING SERVICES, NAMELY, PRODUCTION OF SPECIAL EFFECTS INCLUDING MODEL-MAKING SERVICES, COMPUTER-GENERATED IMAGERY AND COMPUTER-GENERATED GRAPHICS FOR THE PRODUCTION OF COMMERCIALS; POST-PRODUCTION EDITING SERVICES FOR VIDEO AND AUDIO COMMERCIALS; PRODUCTION AND DISTRIBUTION OF RADIO AND TELEVISION COMMERCIALS; PRODUCTION OF ADVERTISING MATTER AND COMMERCIALS (U.S. CLS. 100, 101 AND 102).

FIRST USE 0-0-2008; IN COMMERCE 0-0-2008.

ANTHONY RINKER, EXAMINING ATTORNEY

**CLASS 35—(Continued).**

SN 86-072,011. INTELLECTUAL BLONDE LLC, AUSTIN, TX. FILED 9-23-2013.

**Intellectual Blonde**

THE MARK CONSISTS OF STANDARD CHARACTERS WITHOUT CLAIM TO ANY PARTICULAR FONT, STYLE, SIZE, OR COLOR.

FOR BRANDING SERVICES, NAMELY, CONSULTING, DEVELOPMENT, MANAGEMENT AND MARKETING OF BRANDS FOR BUSINESSES AND/OR INDIVIDUALS; BUSINESS MANAGEMENT CONSULTANCY AS WELL AS DEVELOPMENT OF PROCESSES FOR THE ANALYSIS AND THE IMPLEMENTATION OF STRATEGY PLANS AND MANAGEMENT PROJECTS (U.S. CLS. 100, 101 AND 102).

FIRST USE 1-1-2013; IN COMMERCE 1-1-2013.

ELLEN B. AWRICH, EXAMINING ATTORNEY

---

SN 86-072,061. TIME INC., NEW YORK, NY. FILED 9-23-2013.

**INSTYLE**

THE MARK CONSISTS OF STANDARD CHARACTERS WITHOUT CLAIM TO ANY PARTICULAR FONT, STYLE, SIZE, OR COLOR.

OWNER OF U.S. REG. NOS. 1,851,469, 3,715,128 AND OTHERS.

FOR ON-LINE RETAIL STORE SERVICES FEATURING CLOTHING, NAMELY SHIRTS (U.S. CLS. 100, 101 AND 102).

FIRST USE 8-15-2013; IN COMMERCE 8-15-2013.

LINDA ESTRADA, EXAMINING ATTORNEY



**CLASS 35—(Continued).**

SN 86-072,124. DEKKINGA, JAAP, WASHINGTON, DC.  
FILED 9-23-2013.



NO CLAIM IS MADE TO THE EXCLUSIVE RIGHT TO USE "DC", APART FROM THE MARK AS SHOWN.

THE MARK CONSISTS OF A STYLIZED LETTER "B" WRITTEN NEXT TO A FIVE POINT STAR. UNDERNEATH ARE THE LETTERS "DC".

FOR PROMOTING PUBLIC AWARENESS OF DC METRO AREA (U.S. CLS. 100, 101 AND 102).

FIRST USE 6-28-2010; IN COMMERCE 6-28-2010.  
DAVID MURRAY, EXAMINING ATTORNEY

SN 86-072,249. NJOY, INC., SCOTTSDALE, AZ. FILED 9-23-2013.

**NJOY**

THE MARK CONSISTS OF STANDARD CHARACTERS WITHOUT CLAIM TO ANY PARTICULAR FONT, STYLE, SIZE, OR COLOR.

OWNER OF U.S. REG. NOS. 3,427,769 AND 4,091,150.  
FOR ON-LINE RETAIL STORE SERVICES FEATURING ECIGARETTES, VAPORIZERS AND ACCESSORIES AND SMOKE SHOP ACCESSORIES; RETAIL OUTLETS FEATURING ECIGARETTES, VAPORIZERS AND ACCESSORIES AND SMOKE SHOP ACCESSORIES (U.S. CLS. 100, 101 AND 102).

MICHAEL ENGEL, EXAMINING ATTORNEY

**CLASS 35—(Continued).**

SN 86-072,526. WISETAILS, LLC, AKA WISE TAILS, OJAI, CA. FILED 9-23-2013.

**WISE TAILS**

THE MARK CONSISTS OF STANDARD CHARACTERS WITHOUT CLAIM TO ANY PARTICULAR FONT, STYLE, SIZE, OR COLOR.

FOR RETAIL STORE SERVICES FEATURING PET SUPPLIES, PET TOYS, PET TREATS AND OTHER PET-RELATED PRODUCTS (U.S. CLS. 100, 101 AND 102).

FIRST USE 2-1-2013; IN COMMERCE 2-1-2013.  
RUSS HERMAN, EXAMINING ATTORNEY

SN 86-072,535. DRIVEN SOCIETY LLC, MT. LAUREL, NJ.  
FILED 9-23-2013.

**DRIVEN  
SOCIETY**

THE MARK CONSISTS OF STYLIZED WORDS "DRIVEN SOCIETY" IN A BLOCK LETTER TEXT, FILLED WITH THE NEW YORK CITY SKYLINE IN BLACK AND WHITE.

FOR ADVERTISING AND MARKETING SERVICES, NAMELY, PROMOTING THE GOODS AND SERVICES OF OTHERS (U.S. CLS. 100, 101 AND 102).

FIRST USE 10-12-2012; IN COMMERCE 7-1-2013.  
ZACHARY R. SPARER, EXAMINING ATTORNEY

SN 86-072,540. HOURLYNERD, INC., BOSTON, MA. FILED 9-23-2013.

**HOURLYNERD**

THE MARK CONSISTS OF STANDARD CHARACTERS WITHOUT CLAIM TO ANY PARTICULAR FONT, STYLE, SIZE, OR COLOR.

FOR ONLINE MARKETPLACE FOR BUSINESS CONSULTATION AND ADVISORY SERVICES (U.S. CLS. 100, 101 AND 102).

FIRST USE 2-5-2013; IN COMMERCE 2-12-2013.  
KRISTIN CARLSON, EXAMINING ATTORNEY

**CLASS 35—(Continued).**

SN 86-073,670. TRACTOR SUPPLY CO. OF TEXAS, LP, BRENTWOOD, TN. FILED 9-24-2013.

**NEIGHBOR'S CLUB**

THE MARK CONSISTS OF STANDARD CHARACTERS WITHOUT CLAIM TO ANY PARTICULAR FONT, STYLE, SIZE, OR COLOR.

NO CLAIM IS MADE TO THE EXCLUSIVE RIGHT TO USE "CLUB", APART FROM THE MARK AS SHOWN.

FOR RETAIL STORE SERVICES FEATURING FARM SUPPLIES, HARDWARE, AUTOMOTIVE SUPPLIES, PET SUPPLIES, CLOTHING, FOOTWEAR, TOOLS, LAWN AND GARDEN SUPPLIES, AND GENERAL MERCHANDISE; PROVIDING A CUSTOMER REWARD PROGRAM IN THE NATURE OF INCENTIVE AWARD PROGRAMS FOR NEW AND EXISTING CUSTOMERS BY MEANS OF ISSUING GIFT CARDS, DISCOUNTS AND SPECIAL OFFERS, AS WELL AS PROVIDING GIFTS, RECOGNITION AND SPECIAL PRIVILEGES (U.S. CLS. 100, 101 AND 102).

THOMAS MANOR, EXAMINING ATTORNEY

SN 86-073,897. GROWTH AGENDA LIMITED, LONDON, UNITED KINGDOM, FILED 9-25-2013.

**thegrowthagenda**

THE MARK CONSISTS OF THE LITERAL ELEMENTS "THEGROWTHAGENDA" WRITTEN IN STYLIZED FORM. FOR BUSINESS MANAGEMENT CONSULTING AND ADVISORY SERVICES; CONSULTING SERVICES IN BUSINESS ORGANIZATION AND MANAGEMENT; BUSINESS STRATEGIC PLANNING SERVICES (U.S. CLS. 100, 101 AND 102).

FIRST USE 1-3-2011; IN COMMERCE 1-3-2011.  
JAMES A. RAUEN, EXAMINING ATTORNEY

SN 86-075,360. DAHER, OMAR, MISSION VIEJO, CA. FILED 9-26-2013.

**CLUB VAPOR U.S.A.**

THE MARK CONSISTS OF STANDARD CHARACTERS WITHOUT CLAIM TO ANY PARTICULAR FONT, STYLE, SIZE, OR COLOR.

NO CLAIM IS MADE TO THE EXCLUSIVE RIGHT TO USE "VAPOR U.S.A.", APART FROM THE MARK AS SHOWN.

FOR RETAIL STORE SERVICES AND ONLINE RETAIL STORE SERVICE FEATURING E-CIGARETTE, E-LIQUID, COMPRISED OF FLAVORING IN LIQUID FORM USED TO REFILL ELECTRONIC CIGARETTE CARTRIDGES AND ELECTRONIC SMOKING DEVICES, NAMELY, ELECTRONIC HOOKAH, ELECTRONIC HOOKAH HOSE, ELECTRONIC VAPOR PENS (U.S. CLS. 100, 101 AND 102).

C. DIONNE CLYBURN, EXAMINING ATTORNEY

**CLASS 35—(Continued).**

SN 86-075,569. CAREINGTON INTERNATIONAL CORPORATION, FRISCO, TX. FILED 9-26-2013.

**DENTALPASS**

THE MARK CONSISTS OF STANDARD CHARACTERS WITHOUT CLAIM TO ANY PARTICULAR FONT, STYLE, SIZE, OR COLOR.

FOR OPERATION AND ADMINISTRATION OF A TRANSACTION-BASED DISCOUNT DENTAL CARE PROGRAM WHICH ENABLES PARTICIPANTS TO OBTAIN DISCOUNTS ON DENTAL CARE SERVICES THROUGH USE OF A DISCOUNT DENTAL MEMBERSHIP CARD (U.S. CLS. 100, 101 AND 102).

FIRST USE 6-1-2013; IN COMMERCE 6-1-2013.  
BILL DAWE, EXAMINING ATTORNEY

SN 86-075,809. LEO BURNETT COMPANY, INC., CHICAGO, IL. FILED 9-26-2013.

**DecisionDNA**

THE MARK CONSISTS OF STANDARD CHARACTERS WITHOUT CLAIM TO ANY PARTICULAR FONT, STYLE, SIZE, OR COLOR.

FOR ADVERTISING AGENCIES; MARKETING RESEARCH SERVICES USED IN CONNECTION WITH ADVERTISING AND MARKETING ADVICE (U.S. CLS. 100, 101 AND 102).

FIRST USE 9-26-2013; IN COMMERCE 9-26-2013.  
STEVEN JACKSON, EXAMINING ATTORNEY

SN 86-076,172. COMMUNITY PARAMEDIC CONSULTING LLC, SAINT PAUL, MN. FILED 9-26-2013.

**CPSeeker LLC**

THE MARK CONSISTS OF STANDARD CHARACTERS WITHOUT CLAIM TO ANY PARTICULAR FONT, STYLE, SIZE, OR COLOR.

NO CLAIM IS MADE TO THE EXCLUSIVE RIGHT TO USE "LLC", APART FROM THE MARK AS SHOWN.

FOR PROVIDING A DATABASE OF RESUMES OF PROSPECTIVE COMMUNITY PARAMEDIC EMPLOYEES FOR POTENTIAL EMPLOYERS TO BROWSE THROUGH AND CONTACT THE INDIVIDUALS FOR HIRE (U.S. CLS. 100, 101 AND 102).

MARYNELLE WILSON, EXAMINING ATTORNEY

**CLASS 35—(Continued).**

SN 86-077,902. FLAT 3, LLC, ISLE OF PALMS, SC. FILED 9-30-2013.



THE MARK CONSISTS OF TWO CIRCLES, EACH COMPOSED OF FOUR ARROWS WITH THE ARROWS OF THE TWO CIRCLES POINTING IN OPPOSITE DIRECTIONS, ENCLOSING THE ADJACENT CHARACTERS "F" AND "3".

FOR ON-LINE RETAIL STORE SERVICES FEATURING EXTREME SPORTS PRODUCTS, NAMELY, KITEBOARDS, KITEBOARDING KITES, CONTROL BARS, HARNESSES, AND SURFBOARDS; PROVIDING REFERRALS FOR EXTREME SPORTS LESSONS VIA GLOBAL COMPUTER NETWORK (U.S. CLS. 100, 101 AND 102).

FIRST USE 7-0-2013; IN COMMERCE 7-0-2013.  
DAVID TAYLOR, EXAMINING ATTORNEY

**CLASS 35—(Continued).**

SN 86-078,404. GOVX, INC., LA JOLLA, CA. FILED 9-30-2013.



OWNER OF U.S. REG. NOS. 4,070,859, 4,379,607 AND 4,379,608.

NO CLAIM IS MADE TO THE EXCLUSIVE RIGHT TO USE "FOR MILITARY & GOVERNMENT", APART FROM THE MARK AS SHOWN.

THE MARK CONSISTS OF A DIVIDED RECTANGLE IN WHICH "GOV" IS WRITTEN IN A STYLIZED FONT, FOLLOWED BY "X" IN A LARGER FONT, ABOVE THE WORDS "FOR MILITARY & GOVERNMENT", WHICH ARE WRITTEN OUTSIDE THE RECTANGLE.

FOR ON-LINE ORDERING SERVICES FEATURING GENERAL MERCHANDISE AND GENERAL CONSUMER GOODS; ON-LINE RETAIL STORE SERVICES FEATURING A WIDE VARIETY OF CONSUMER GOODS OF OTHERS; PROMOTING THE GOODS AND SERVICES OF OTHERS VIA A GLOBAL COMPUTER NETWORK (U.S. CLS. 100, 101 AND 102).

FIRST USE 10-2-2012; IN COMMERCE 10-2-2012.  
ESTHER BELENKER, EXAMINING ATTORNEY

SN 86-078,366. GOVX, INC., LA JOLLA, CA. FILED 9-30-2013.



OWNER OF U.S. REG. NOS. 4,070,859, 4,379,607 AND 4,379,608.

THE MARK CONSISTS OF A DIVIDED RECTANGLE IN WHICH "GOV" IS WRITTEN IN A STYLIZED FONT, FOLLOWED BY "X" IN A LARGER TYPE SIZE.

FOR ON-LINE ORDERING SERVICES FEATURING GENERAL MERCHANDISE AND GENERAL CONSUMER GOODS; ON-LINE RETAIL STORE SERVICES FEATURING A WIDE VARIETY OF CONSUMER GOODS OF OTHERS; PROMOTING THE GOODS AND SERVICES OF OTHERS VIA A GLOBAL COMPUTER NETWORK (U.S. CLS. 100, 101 AND 102).

FIRST USE 8-16-2011; IN COMMERCE 8-16-2011.  
ESTHER BELENKER, EXAMINING ATTORNEY

SN 86-078,432. GOVX, INC., LA JOLLA, CA. FILED 9-30-2013.



OWNER OF U.S. REG. NOS. 4,070,859, 4,379,607 AND 4,379,608.

NO CLAIM IS MADE TO THE EXCLUSIVE RIGHT TO USE "VERIFY", APART FROM THE MARK AS SHOWN.

THE MARK CONSISTS OF A SHIELD WITH ONE STAR ON ITS FRONT, FOLLOWED BY "GOVX" WRITTEN IN A STYLIZED FONT, ABOVE "VERIFY".

FOR ON-LINE ORDERING SERVICES FEATURING GENERAL MERCHANDISE AND GENERAL CONSUMER GOODS; ON-LINE RETAIL STORE SERVICES FEATURING A WIDE VARIETY OF CONSUMER GOODS OF OTHERS; PROMOTING THE GOODS AND SERVICES OF OTHERS VIA A GLOBAL COMPUTER NETWORK (U.S. CLS. 100, 101 AND 102).

ESTHER BELENKER, EXAMINING ATTORNEY

**CLASS 35—(Continued).**

SN 86-078,447. GOVX, INC., LA JOLLA, CA. FILED 9-30-2013.

# GovX.com

THE MARK CONSISTS OF STANDARD CHARACTERS WITHOUT CLAIM TO ANY PARTICULAR FONT, STYLE, SIZE, OR COLOR.

OWNER OF U.S. REG. NOS. 4,070,859, 4,379,607 AND 4,379,608.

FOR ON-LINE ORDERING SERVICES FEATURING GENERAL MERCHANDISE AND GENERAL CONSUMER GOODS; ON-LINE RETAIL STORE SERVICES FEATURING A WIDE VARIETY OF CONSUMER GOODS OF OTHERS; PROMOTING THE GOODS AND SERVICES OF OTHERS VIA A GLOBAL COMPUTER NETWORK (U.S. CLS. 100, 101 AND 102).

FIRST USE 8-16-2011; IN COMMERCE 8-16-2011.  
ESTHER BELENKER, EXAMINING ATTORNEY

**CLASS 35—(Continued).**

SN 86-079,938. LAB INFORMATION TECHNOLOGY INCORPORATED, DBA LABUSA, CARPENTERSVILLE, IL. AND MARTIN LASTER, PEARLAND, TX. FILED 10-1-2013.

# LABUSA

THE MARK CONSISTS OF STANDARD CHARACTERS WITHOUT CLAIM TO ANY PARTICULAR FONT, STYLE, SIZE, OR COLOR.

FOR BUSINESS ADVISORY SERVICES, CONSULTANCY AND INFORMATION; BUSINESS CONSULTING AND BUSINESS INFORMATION FOR ENTERPRISES; BUSINESS CONSULTING SERVICES RELATING TO THE INTEGRATION OF THE AREAS OF BUSINESS PROCESS TECHNOLOGY, ORGANIZATIONAL LEARNING, CHANGE MANAGEMENT, AND OPERATIONAL SUSTAINABILITY (U.S. CLS. 100, 101 AND 102).

TAMARA FRAZIER, EXAMINING ATTORNEY

SN 86-079,651. BEBE STUDIO, INC., LOS ANGELES, CA. FILED 10-1-2013.



OWNER OF U.S. REG. NO. 3,509,651.

THE MARK CONSISTS OF A STYLIZED NUMBER "2" AND STYLIZED LETTER "B" ON ONE LINE, FOLLOWED BY A STYLIZED "BEBE" IN LOWERCASE ON THE LINE BELOW IT.

THE ENGLISH TRANSLATION OF THE WORD "BEBE" IN THE MARK IS "QUEEN OF HEARTS IN A PERSIAN DECK OF CARDS".

FOR RETAIL STORE SERVICES FEATURING WOMEN'S CLOTHING AND ACCESSORIES FOR ADULTS AND TEENS; ON-LINE RETAIL STORE SERVICES FEATURING WOMEN'S CLOTHING AND ACCESSORIES FOR ADULTS AND TEENS (U.S. CLS. 100, 101 AND 102).

FIRST USE 8-3-2013; IN COMMERCE 8-3-2013.  
KATHLEEN LORENZO, EXAMINING ATTORNEY

SN 86-080,116. EXXON MOBIL CORPORATION, IRVING, TX. FILED 10-1-2013.



OWNER OF U.S. REG. NOS. 1,048,286, 1,049,824 AND 1,052,601.

THE COLOR(S) RED AND BLUE IS/ARE CLAIMED AS A FEATURE OF THE MARK.

THE MARK CONSISTS OF THE MARK "MOBIL" WHERE THE LETTERS "M", "B", "I" AND "L" ARE IN BLUE AND THE LETTER "O" IS IN RED.

FOR CUSTOMER LOYALTY SERVICES FOR COMMERCIAL, PROMOTIONAL AND/OR ADVERTISING PURPOSES IN THE FIELD OF GASOLINE SERVICE STATIONS, CONVENIENCE STORES AND CAR WASHES (U.S. CLS. 100, 101 AND 102).

FIRST USE 3-4-2011; IN COMMERCE 3-4-2011.  
SOPHIA S. KIM, EXAMINING ATTORNEY

**CLASS 35—(Continued).**

SN 86-082,871. BLUCARAT LLC, NEW YORK, NY. FILED 10-4-2013.

**BLUCARAT**

THE MARK CONSISTS OF STANDARD CHARACTERS WITHOUT CLAIM TO ANY PARTICULAR FONT, STYLE, SIZE, OR COLOR.

FOR PROVIDING A WEB-BASED SYSTEM AND ONLINE PORTAL IN THE FIELD OF E-COMMERCE FOR CONSUMERS TO ENTER, MANAGE AND MODIFY THEIR CONSUMER PREFERENCE INFORMATION FOR USE BY MERCHANTS TO CREATE AND MANAGE OFFERS FOR DELIVERY TO CONSUMERS; PROVIDING COMMERCIAL INFORMATION UPDATES ONLINE AND OVER A GLOBAL COMPUTER NETWORK IN THE FIELDS OF BUSINESS AND COMMERCE (U.S. CLS. 100, 101 AND 102).

RONALD MCMORROW, EXAMINING ATTORNEY

SN 86-086,601. BEACHFRONT FYI LLC, KENOSHA, WI. FILED 10-9-2013.



THE MARK CONSISTS OF "BEACHFRONTFYI" PRECEDED BY TWO FORWARD ARROWS IN A RECTANGULAR BOX.

FOR PROMOTING THE GOODS AND SERVICES OF OTHERS BY PROVIDING A WEBSITE FEATURING PRODUCT INFORMATION, PROMOTIONAL OFFERS, AND DISCOUNT INFORMATION FOR LOCAL BUSINESSES (U.S. CLS. 100, 101 AND 102).

ROGER T. MCDORMAN, EXAMINING ATTORNEY

SN 86-086,787. GTRC SERVICES, INC, WESTLAKE VILLAGE ROAD, IL. FILED 10-9-2013.

**ALL WE SELL IS THE  
GREATEST FEELING ON EARTH**

THE MARK CONSISTS OF STANDARD CHARACTERS WITHOUT CLAIM TO ANY PARTICULAR FONT, STYLE, SIZE, OR COLOR.

FOR RETAIL STORE SERVICES AND ONLINE RETAIL STORE SERVICES FEATURING GUITARS, AMPLIFIERS, KEYBOARDS, PERCUSSION PRO-AUDIO, DRUMS, SHEET MUSIC, MUSIC BOOKS AND ACCESSORIES AND COMPONENT PARTS THEREFOR (U.S. CLS. 100, 101 AND 102).

TRACY FLETCHER, EXAMINING ATTORNEY

**CLASS 35—(Continued).**

SN 86-086,970. ROI, INC., MIAMI BEACH, FL. FILED 10-9-2013.

**SHOPPER FOOTPRINTS**

THE MARK CONSISTS OF STANDARD CHARACTERS WITHOUT CLAIM TO ANY PARTICULAR FONT, STYLE, SIZE, OR COLOR.

NO CLAIM IS MADE TO THE EXCLUSIVE RIGHT TO USE "SHOPPER", APART FROM THE MARK AS SHOWN.

FOR BUSINESS INFORMATION SERVICES, NAMELY, PROVIDING A COMPILATION OF STATISTICAL DATA REGARDING THE ACTIVITIES OF RETAIL CONSUMERS WHILE IN STORES (U.S. CLS. 100, 101 AND 102).

JAMES GRIFFIN, EXAMINING ATTORNEY

SN 86-087,525. E-FILLIATE, INC., RANCHO CORDOVA, CA. FILED 10-9-2013.

**FUSEBOX**

THE MARK CONSISTS OF STANDARD CHARACTERS WITHOUT CLAIM TO ANY PARTICULAR FONT, STYLE, SIZE, OR COLOR.

FOR VENDING MACHINE SERVICES (U.S. CLS. 100, 101 AND 102).

REGINA DRUMMOND, EXAMINING ATTORNEY

SN 86-088,175. HRB INNOVATIONS, INC., LAS VEGAS, NV. FILED 10-10-2013.

**RECUPERA TUS 1000 MILLONES  
AMÉRICA**

THE MARK CONSISTS OF STANDARD CHARACTERS WITHOUT CLAIM TO ANY PARTICULAR FONT, STYLE, SIZE, OR COLOR.

THE ENGLISH TRANSLATION OF "RECUPERA TUS 1000 MILLONES AMERICA" IN THE MARK IS "GET YOUR BILLION BACK, AMERICA".

FOR PREPARATION OF TAX RETURNS FOR OTHERS (U.S. CLS. 100, 101 AND 102).

LAURA FIONDA, EXAMINING ATTORNEY

**CLASS 35—(Continued).**

SN 86-090,901. MARKET COLOR, INC., ORLANDO, FL.  
FILED 10-14-2013.



NO CLAIM IS MADE TO THE EXCLUSIVE RIGHT TO USE "MARKET", APART FROM THE MARK AS SHOWN.

THE MARK CONSISTS OF THE OUTLINE OF A BUILDING OR HUT, THREE DOTS, AND TWO WORDS: "MARKET COLORS".

FOR ON-LINE RETAIL STORE SERVICES FEATURING CONSUMER GOODS NAMELY, CLOTHING, JEWELRY, HANDBAGS, PURSES, HOME ACCESSORIES, AND OTHER SIMILAR ITEMS (U.S. CLS. 100, 101 AND 102).

FIRST USE 8-29-2011; IN COMMERCE 8-29-2011.  
EUGENIA MARTIN, EXAMINING ATTORNEY

SN 86-091,056. MOLORI DESIGN LLC, WOODLAND HILLS, CA. FILED 10-14-2013.

ABBOT KINNEY BEACH HOUSE

THE MARK CONSISTS OF STANDARD CHARACTERS WITHOUT CLAIM TO ANY PARTICULAR FONT, STYLE, SIZE, OR COLOR.

THE NAME "ABBOT KINNEY" DOES NOT IDENTIFY A LIVING INDIVIDUAL.

FOR RETAIL STORE SERVICES AND ON-LINE RETAIL STORE SERVICES FEATURING LIGHTING FIXTURES, HOME DÉCOR, LINENS, CLOTHING, AND TEXTILES (U.S. CLS. 100, 101 AND 102).

TRACY WHITTAKER-BROWN, EXAMINING ATTORNEY

**CLASS 35—(Continued).**

SN 86-091,365. MDD MARKETING, INC., HOUSTON, TX.  
FILED 10-15-2013.

## AED TODAY

THE MARK CONSISTS OF STANDARD CHARACTERS WITHOUT CLAIM TO ANY PARTICULAR FONT, STYLE, SIZE, OR COLOR.

NO CLAIM IS MADE TO THE EXCLUSIVE RIGHT TO USE "AED", APART FROM THE MARK AS SHOWN.

FOR ON-LINE RETAIL STORE SERVICES FEATURING DEFIBRILLATORS, AEDS, AUTOMATED EXTERNAL DEFIBRILLATORS, MANUAL EXTERNAL DEFIBRILLATORS, AND RELATED PRODUCTS AND ACCESSORIES, NAMELY, BATTERIES, ELECTRODE PADS, AED TRAINING DEVICES, PORTABLE OXYGEN TANKS, CPR RESPONDER KITS, FIRST AID KITS, AED MANAGEMENT SOFTWARE PROGRAMS, AND DEFIBRILLATOR STORAGE AND TRANSPORTATION PRODUCTS IN THE NATURE OF WALL CABINETS, WALL SIGNS FOR INDICATING THE LOCATION OF AN AED, CARRY CASES, HARD-SHELL CASES, AND WATER-PROOF CASES (U.S. CLS. 100, 101 AND 102).

FIRST USE 4-1-2009; IN COMMERCE 4-1-2009.

ELIZABETH HUGHITT, EXAMINING ATTORNEY

SN 86-091,698. MEIJER, INC., GRAND RAPIDS, MI. FILED 10-15-2013.

## A Supercenter of Possibilities

THE MARK CONSISTS OF STANDARD CHARACTERS WITHOUT CLAIM TO ANY PARTICULAR FONT, STYLE, SIZE, OR COLOR.

FOR EMPLOYMENT HIRING, RECRUITING, PLACEMENT, STAFFING AND CAREER NETWORKING SERVICES; PERSONNEL PLACEMENT AND RECRUITMENT; PROFESSIONAL STAFFING AND RECRUITING SERVICES; PROVIDING ON-LINE EMPLOYMENT INFORMATION IN THE FIELD OF RETAIL; PROVIDING ON-LINE INTERACTIVE EMPLOYMENT COUNSELING AND RECRUITMENT SERVICES; RECRUITMENT AND PLACEMENT OF PERSONNEL IN THE FIELD OF RETAIL (U.S. CLS. 100, 101 AND 102).

FIRST USE 9-25-2013; IN COMMERCE 9-25-2013.

RAMONA ORTIGA, EXAMINING ATTORNEY

**CLASS 35—(Continued).**

SN 86-092,646. GANDER MOUNTAIN COMPANY, ST. PAUL, MN. FILED 10-16-2013.



OWNER OF U.S. REG. NOS. 2,857,420, 3,705,857 AND OTHERS.

NO CLAIM IS MADE TO THE EXCLUSIVE RIGHT TO USE "LAW ENFORCEMENT SALES", APART FROM THE MARK AS SHOWN.

THE MARK CONSISTS OF "GANDER MTN." IN A STYLIZED FONT ABOVE A RECTANGULAR FIGURE CONTAINING THE WORDS "LAW ENFORCEMENT" WITH THE WORD "SALES" UNDERNEATH AND A STYLIZED RENDERING OF A GOOSE FLYING ABOVE A MOUNTAIN WITHIN A CIRCULAR MEDALLION ALL WITHIN AND AGAINST AN OVAL DESIGN WITH AN OUTER RING.

FOR RETAIL STORE, MAIL ORDER, AND ONLINE RETAIL STORE SERVICES FEATURING FIREARMS, FIREARM ACCESSORIES, AMMUNITION, FOOTWEAR, AND APPAREL (U.S. CLS. 100, 101 AND 102).

TRICIA SONNEBORN, EXAMINING ATTORNEY

**CLASS 35—(Continued).**

SN 86-092,782. LORD & SONS, INC., SAN JOSE, CA. FILED 10-16-2013.

# BINBOX

THE MARK CONSISTS OF STANDARD CHARACTERS WITHOUT CLAIM TO ANY PARTICULAR FONT, STYLE, SIZE, OR COLOR.

FOR INVENTORY MANAGEMENT SERVICES (U.S. CLS. 100, 101 AND 102).

LAURA GOLDEN, EXAMINING ATTORNEY

SN 86-093,156. HOVIS AUTO SUPPLY, INC., MERCER, PA. FILED 10-16-2013.



SN 86-092,745. DST SYSTEMS, INC., KANSAS CITY, MO. FILED 10-16-2013.

# SECURE CROWD

THE MARK CONSISTS OF STANDARD CHARACTERS WITHOUT CLAIM TO ANY PARTICULAR FONT, STYLE, SIZE, OR COLOR.

NO CLAIM IS MADE TO THE EXCLUSIVE RIGHT TO USE "SECURE", APART FROM THE MARK AS SHOWN.

FOR DATA PROCESSING SERVICES BY BONDED EMPLOYEES FEATURING A VIRTUAL ASSEMBLY LINE THAT BREAKS WORK INTO SMALLER SEGMENTS THAT CAN BE PERFORMED AT HIGH QUALITY AND LOW COST WHILE PROVIDING PROTECTION OF USERS' SENSITIVE PERSONAL INFORMATION BECAUSE A WHOLE DOCUMENT IS NEVER SHOWN TO ONE PROCESSOR (U.S. CLS. 100, 101 AND 102).

PAUL CROWLEY, EXAMINING ATTORNEY

NO CLAIM IS MADE TO THE EXCLUSIVE RIGHT TO USE "AUTO & TRUCK SUPPLY", APART FROM THE MARK AS SHOWN.

THE COLOR(S) RED, WHITE AND BLACK IS/ARE CLAIMED AS A FEATURE OF THE MARK.

THE MARK CONSISTS OF THE WORDING "HOVIS HOVIS AUTO & TRUCK SUPPLY" IN STYLIZED UPPER-CASE BLOCK LETTERING. THE FIRST WORD "HOVIS" APPEARS IN WHITE SMALLER SIZE LETTERS INSIDE THE LETTER "H". THE SECOND WORD "HOVIS" APPEARS IN RED WITH A WHITE INNER OUTLINE AND A BLACK OUTER OUTLINE. NINE WHITE HORIZONTAL LINES APPEAR ON THE LEFT SIDE OF THE LETTER "H". A BLACK AND WHITE CHECKERED FLAG APPEARS UNDERLAYING THE LEFT SIDE OF THE LETTER "H". THE WORDING "AUTO & TRUCK SUPPLY" APPEARS IN WHITE FOLLOWED BY A BLACK OUTLINE.

FOR RETAIL STORE SERVICES FEATURING AFTER-MARKET AUTOMOTIVE, HEAVY DUTY, PAINT AND BODY SUPPLIES, TOOLS AND EQUIPMENT; WHOLESALE STORE SERVICES FEATURING AFTERMARKET AUTOMOTIVE, HEAVY DUTY, PAINT AND BODY SUPPLIES, TOOLS AND EQUIPMENT (U.S. CLS. 100, 101 AND 102).

FIRST USE 10-1-1987; IN COMMERCE 10-1-1987.

ROBIN CHOSID, EXAMINING ATTORNEY

**CLASS 35—(Continued).**

SN 86-094,668. BUDGET BLINDS, INC., ORANGE, CA. FILED 10-17-2013.

## M2O BLINDS

THE MARK CONSISTS OF STANDARD CHARACTERS WITHOUT CLAIM TO ANY PARTICULAR FONT, STYLE, SIZE, OR COLOR.

NO CLAIM IS MADE TO THE EXCLUSIVE RIGHT TO USE "BLINDS", APART FROM THE MARK AS SHOWN.

FOR ELECTRONIC COMMERCE SERVICES, NAMELY, PROVIDING INFORMATION ABOUT WINDOW COVERING PRODUCTS VIA TELECOMMUNICATION NETWORKS FOR ADVERTISING AND SALE PURPOSES; DISTRIBUTORSHIP AND RETAIL STORE SERVICES IN THE FIELD OF WINDOW COVERINGS (U.S. CLS. 100, 101 AND 102).

CURTIS FRENCH, EXAMINING ATTORNEY

---

SN 86-095,259. DPI ENERGY LLC, DBA TRUSMART ENERGY LLC, HOUSTON, TX. FILED S.R. 10-18-2013; AM. P.R. 1-2-2014.

## SmartChoice

THE MARK CONSISTS OF STANDARD CHARACTERS WITHOUT CLAIM TO ANY PARTICULAR FONT, STYLE, SIZE, OR COLOR.

FOR RETAIL ELECTRICITY PROVIDER SERVICES, NAMELY, PROVIDING A SERVICE THAT ALLOWS CUSTOMERS TO PURCHASE ENERGY, NAMELY, ELECTRICITY, AND RENEWABLE ENERGY (U.S. CLS. 100, 101 AND 102).

FIRST USE 11-0-2011; IN COMMERCE 11-0-2011.  
ANDREA HACK, EXAMINING ATTORNEY

---

SN 86-095,431. GUIDEONE MUTUAL INSURANCE COMPANY, WEST DES MOINES, IA. FILED 10-18-2013.

## GUIDEONE LIFESTAGES

THE MARK CONSISTS OF STANDARD CHARACTERS WITHOUT CLAIM TO ANY PARTICULAR FONT, STYLE, SIZE, OR COLOR.

FOR BILLING AND MARKETING OF AUTOMOBILE, HOMEOWNERS AND UMBRELLA EXCESS LIABILITY INSURANCE POLICIES (U.S. CLS. 100, 101 AND 102).

LIEF MARTIN, EXAMINING ATTORNEY

**CLASS 35—(Continued).**

SN 86-095,821. DPI ENERGY LLC, DBA TRUSMART ENERGY LLC, HOUSTON, TX. FILED S.R. 10-18-2013; AM. P.R. 1-2-2014.

## SmartUse

THE MARK CONSISTS OF STANDARD CHARACTERS WITHOUT CLAIM TO ANY PARTICULAR FONT, STYLE, SIZE, OR COLOR.

FOR CHARITABLE SERVICES, NAMELY, COORDINATION OF THE PROCUREMENT AND DISTRIBUTION OF GIFT-IN-KIND PRODUCT DONATIONS FROM MANUFACTURERS, WHOLESALERS, RETAILERS, AND GOVERNMENT AGENCIES TO ORGANIZATIONS PROVIDING FREE PRODUCTS TO NEEDY PEOPLE; RETAIL ELECTRICITY PROVIDER SERVICES, NAMELY, PROVIDING A SERVICE THAT ALLOWS CUSTOMERS TO PURCHASE ENERGY, NAMELY, ELECTRICITY, AND RENEWABLE ENERGY (U.S. CLS. 100, 101 AND 102).

FIRST USE 8-0-2013; IN COMMERCE 8-0-2013.  
ANDREA HACK, EXAMINING ATTORNEY

---

SN 86-096,188. SMALLEY FAMILY HOLDINGS, LLC, ORLANDO, FL. FILED S.R. 10-20-2013; AM. P.R. 12-28-2013.

We are doing something  
amazing, and we want you  
to be part of it

THE MARK CONSISTS OF STANDARD CHARACTERS WITHOUT CLAIM TO ANY PARTICULAR FONT, STYLE, SIZE, OR COLOR.

FOR TAX ADVISORY SERVICES; TAX AND TAXATION PLANNING, ADVICE, INFORMATION AND CONSULTANCY SERVICES; TAX ASSESSMENT; TAX CONSULTATION; TAX DECLARATION PROCEDURE SERVICES; TAX FILING SERVICES; TAX LIEN MANAGEMENT SERVICES; TAX PREPARATION; TAX PREPARATION SERVICES PROVIDED IN-PERSON (U.S. CLS. 100, 101 AND 102).

FIRST USE 3-26-2013; IN COMMERCE 3-26-2013.  
RENEE MCCRAY, EXAMINING ATTORNEY



**CLASS 35—(Continued).**

SN 86-096,658. CRAIG MURRAY PRODUCTIONS, LLC, BURBANK, CA. FILED 10-21-2013.

TRICKY  
SQUID

THE MARK CONSISTS OF THE WORDS "TRICKY SQUID" WITH THE LETTER "Q" DEPICTING A TENTACLE.

FOR ADVERTISING AND MARKETING; ADVERTISING AND MARKETING SERVICES, NAMELY, PROMOTING THE GOODS AND SERVICES OF OTHERS; ADVERTISING AND PROMOTIONAL SERVICES; PROMOTION AND MARKETING SERVICES AND RELATED CONSULTING (U.S. CLS. 100, 101 AND 102).

DEBORAH MEINERS, EXAMINING ATTORNEY

SN 86-097,264. DPI ENERGY LLC, DBA TRUSMART ENERGY LLC, HOUSTON, TX. FILED S.R. 10-21-2013; AM. P.R. 1-2-2014.

SmartPay

THE MARK CONSISTS OF STANDARD CHARACTERS WITHOUT CLAIM TO ANY PARTICULAR FONT, STYLE, SIZE, OR COLOR.

FOR RETAIL ELECTRICITY PROVIDER SERVICES, NAMELY, PROVIDING A SERVICE THAT ALLOWS CUSTOMERS TO PURCHASE ENERGY, NAMELY, ELECTRICITY, AND RENEWABLE ENERGY (U.S. CLS. 100, 101 AND 102).

FIRST USE 10-18-2013; IN COMMERCE 10-18-2013.  
ANDREA HACK, EXAMINING ATTORNEY

SN 86-097,319. DPI ENERGY LLC, DBA TRUSMART ENERGY LLC, HOUSTON, TX. FILED S.R. 10-21-2013; AM. P.R. 1-2-2014.

TruSmart Energy

THE MARK CONSISTS OF STANDARD CHARACTERS WITHOUT CLAIM TO ANY PARTICULAR FONT, STYLE, SIZE, OR COLOR.

NO CLAIM IS MADE TO THE EXCLUSIVE RIGHT TO USE "ENERGY", APART FROM THE MARK AS SHOWN.

FOR RETAIL ELECTRICITY PROVIDER SERVICES, NAMELY, PROVIDING A SERVICE THAT ALLOWS CUSTOMERS TO PURCHASE ENERGY, NAMELY, ELECTRICITY, AND RENEWABLE ENERGY (U.S. CLS. 100, 101 AND 102).

FIRST USE 11-0-2011; IN COMMERCE 11-0-2011.  
ANDREA HACK, EXAMINING ATTORNEY

**CLASS 35—(Continued).**

SN 86-097,535. GREEN PROFESSIONALS, SACRAMENTO, CA. FILED 10-22-2013.



THE MARK CONSISTS OF A DESIGN OF A CIRCLE OF 3 SEMI-CIRCLES, EACH WITH A CIRCLE CENTERED ON ITS BACKSIDE.

FOR BUSINESS CONSULTING AND MANAGEMENT IN THE FIELD OF WATER AND ENERGY CONSERVATION WITH RESPECT TO BRANDING, CONSERVATION PROJECTS, AND MARKETING (U.S. CLS. 100, 101 AND 102).

NATALIE POLZER, EXAMINING ATTORNEY

SN 86-098,360. DN MARKS LLC, WINTER PARK, FL. FILED 10-22-2013.

The X Factor

THE MARK CONSISTS OF STANDARD CHARACTERS WITHOUT CLAIM TO ANY PARTICULAR FONT, STYLE, SIZE, OR COLOR.

FOR ADVERTISING AND MARKETING SERVICES PROVIDED BY MEANS OF INDIRECT METHODS OF MARKETING COMMUNICATIONS, NAMELY, SOCIAL MEDIA, SEARCH ENGINE MARKETING, INQUIRY MARKETING, INTERNET MARKETING, MOBILE MARKETING, BLOGGING AND OTHER FORMS OF PASSIVE, SHARABLE OR VIRAL COMMUNICATIONS CHANNELS; ADVERTISING SERVICES, PUBLIC RELATIONS AND MARKETING SERVICES, NAMELY, PROMOTING AND MARKETING THE GOODS AND SERVICES OF OTHERS THROUGH ALL PUBLIC COMMUNICATION MEANS; ADVERTISING, MARKETING AND PROMOTIONAL SERVICES RELATED TO ALL INDUSTRIES FOR THE PURPOSE OF FACILITATING NETWORKING AND SOCIALIZING OPPORTUNITIES FOR BUSINESS PURPOSES; BRANDING SERVICES, NAMELY, CONSULTING, DEVELOPMENT, MANAGEMENT AND MARKETING OF BRANDS FOR BUSINESSES AND/OR INDIVIDUALS; MARKETING AND BRANDING SERVICES, NAMELY, PROVIDING CUSTOMIZED COMMUNICATION PROGRAMS TO OBTAIN CONSUMER INSIGHTS AND DEVELOP BRANDING STRATEGIES; MARKETING SERVICES (U.S. CLS. 100, 101 AND 102).

JOANNA FIORELLI, EXAMINING ATTORNEY

**CLASS 35—(Continued).**

SN 86-098,591. SPERRY VAN NESS INTERNATIONAL CORPORATION, IRVINE, CA. FILED 10-22-2013.



OWNER OF U.S. REG. NOS. 1,717,172, 3,622,338 AND 4,190,584.

NO CLAIM IS MADE TO THE EXCLUSIVE RIGHT TO USE "COMMERCIAL REAL ESTATE ADVISORS", APART FROM THE MARK AS SHOWN.

THE MARK CONSISTS OF THE WORDS "SPERRY VAN NESS" DIRECTLY ABOVE THE WORDS "COMMERCIAL REAL ESTATE ADVISORS", WITH 3 ANGLED PILLAR STRUCTURES EACH NEXT TO 3 SMALLER ANGLED PILLAR STRUCTURES DIRECTLY TO THE LEFT OF THE WORDS "SPERRY VAN NESS".

FOR FRANCHISE SERVICES, NAMELY, OFFERING BUSINESS MANAGEMENT ASSISTANCE IN THE ESTABLISHMENT AND OPERATION OF BUSINESSES PROVIDING COMMERCIAL REAL ESTATE BROKERAGE SERVICES, NAMELY, BUSINESSES ACTING AS A BROKER, SALESPERSON, AGENT OR FINDER FOR OR ON BEHALF OF SELLERS, BUYERS, LESSORS, TENANTS OR OTHERS IN CONNECTION WITH THE LISTING, CO-LISTING, OFFERING, SELLING, PURCHASING, EXCHANGING, AUCTIONING, LEASING, RENTING, CONSULTING EXPERT WITNESS TESTIMONY, OR MANAGING OF COMMERCIAL REAL PROPERTY, INCLUDING VACANT LAND TRANSACTIONS AND PERSONAL PROPERTY ANCILLARY THERETO, MORTGAGE LOAN AND BROKERAGE SERVICES AND SUPPORT TO SUCH BUSINESSES THROUGH AN INTEGRATED SOFTWARE PLATFORM (U.S. CLS. 100, 101 AND 102).

FIRST USE 1-1-2004; IN COMMERCE 1-1-2004.

SAMUEL E. SHARPER JR., EXAMINING ATTORNEY

**CLASS 35—(Continued).**

SN 86-100,170. GREATER LOUISVILLE CONVENTION & VISITORS BUREAU, LOUISVILLE, KY. FILED 10-24-2013.



OWNER OF U.S. REG. NOS. 3,474,128, 3,908,216 AND OTHERS.

NO CLAIM IS MADE TO THE EXCLUSIVE RIGHT TO USE "LOUISVILLE" OR "BOURBON", APART FROM THE MARK AS SHOWN.

THE MARK CONSISTS OF THE WORD "LOUISVILLE" ACROSS THE MIDDLE OF TWO CONCENTRIC CIRCLES. THE WORDS "THE CULINARY CAPITAL OF BOURBON COUNTRY" ARE INSIDE THE INNER CIRCLE. AN UPRIGHT AND INVERTED FLEUR DE LIS ARE ABOVE AND BELOW "LOUISVILLE".

FOR CONVENTION AND VISITORS BUREAU SERVICES, NAMELY, PROMOTING BUSINESS AND TOURISM IN THE KENTUCKY BOURBON-PRODUCING AREA (U.S. CLS. 100, 101 AND 102).

IRA J. GOODSaid, EXAMINING ATTORNEY

SN 86-102,863. FARM JOURNAL AGRICULTURAL FOUNDATION, PHILADELPHIA, PA. FILED 10-28-2013.



THE MARK CONSISTS OF A GLOBE WITH A STEM AND LEAF, ATOP AN OVAL SHADOW AND THE WORDS "FARMERS FEEDING THE WORLD".

FOR PROMOTING PUBLIC AWARENESS OF THE NEEDS OF THE HUNGRY THROUGH COMMUNITY INVOLVEMENT (U.S. CLS. 100, 101 AND 102).

FIRST USE 10-0-2010; IN COMMERCE 10-0-2010.

LINDA POWELL, EXAMINING ATTORNEY

**CLASS 35—(Continued).**

SN 86-103,295. NEW ORLEANS TOURISM MARKETING CORPORATION, NEW ORLEANS, LA. FILED 10-28-2013.

# MY NOLA

THE MARK CONSISTS OF STANDARD CHARACTERS WITHOUT CLAIM TO ANY PARTICULAR FONT, STYLE, SIZE, OR COLOR.

OWNER OF U.S. REG. NO. 4,408,608.

NO CLAIM IS MADE TO THE EXCLUSIVE RIGHT TO USE "NOLA", APART FROM THE MARK AS SHOWN.

FOR CONVENTION AND VISITORS BUREAU SERVICES, NAMELY, PROMOTING BUSINESS AND TOURISM IN THE NEW ORLEANS METROPOLITAN AREA (U.S. CLS. 100, 101 AND 102).

BRIDGETT SMITH, EXAMINING ATTORNEY

SN 86-107,133. GOLF OUTLETS OF AMERICA, INC., THOUSAND PALMS, CA. FILED 10-31-2013.

# ShOp247

NO CLAIM IS MADE TO THE EXCLUSIVE RIGHT TO USE "SHOP 247", APART FROM THE MARK AS SHOWN.

THE MARK CONSISTS OF "SHOP247" WITH A CLOCK DESIGN AS THE "O" IN "SHOP".

FOR ADVERTISING SERVICES; BUSINESS MANAGEMENT; BUSINESS ADMINISTRATION; RETAIL STORE SERVICES, WHOLESALE ORDERING SERVICES, MAIL ORDER SERVICES, ELECTRONIC AND ONLINE RETAIL STORE SERVICES IN THE FIELD OF PHARMACEUTICAL AND VETERINARY PREPARATIONS, SANITARY PREPARATIONS FOR MEDICAL PURPOSES, DIETETIC SUBSTANCES ADAPTED FOR MEDICAL USE, FOOD FOR BABIES, PLASTERS, MATERIALS FOR DRESSINGS, MATERIAL FOR STOPPING TEETH, DENTAL WAX, DISINFECTANTS, ANTI-RHEUMATISM BRACELETS, ANTI-RHEUMATISM BRACELETS FOR THERAPEUTIC USE, BRACELETS FOR MEDICAL PURPOSES, MAGNETIC BRACELETS FOR MEDICAL PURPOSES, COMMON METALS AND THEIR ALLOYS, METAL BUILDING MATERIALS, TRANSPORTABLE BUILDINGS OF METAL, MATERIALS OF METAL FOR RAILWAY TRACKS, NON-ELECTRIC CABLES AND WIRES OF COMMON METAL, IRONMONGERY, PIPES AND TUBES OF METAL, SAFES, ORES, GAZEBOS PRIMARILY OF METAL, METALLIC STORAGE BOXES, HAND TOOLS AND HAND OPERATED IMPLEMENTS, CUTLERY, SIDE ARMS, RAZORS, TONGS, CUTLERY BOXES, SCIENTIFIC, NAUTICAL, SURVEYING, ELECTRIC, PHOTOGRAPHIC, CINEMATOGRAPHIC, OPTICAL, WEIGHING, MEASURING, SIGNALING, CHECKING SUPERVISION, LIFE-SAVING AND TEACHING APPARATUS AND INSTRUMENTS, APPARATUS FOR RECORDING, TRANSMISSION OR REPRODUCTION OF SOUND OR IMAGES, MAGNETIC DATA CARRIERS, RECORDING DISCS, AUTOMATIC VENDING MACHINES AND MECHANISMS FOR COIN-OPERATED APPARATUS, CASH REGISTERS, CALCULATING MACHINES, DATA PROCESSING EQUIPMENT AND COMPUTERS, FIRE-EXTINGUISHING APPARATUS, PROTECTIVE CLOTHING, HEADGEAR AND FOOTWEAR, SPORTING ARTICLES, PADDING FOR PROTECTIVE PURPOSE, GLOVES FOR PROTECTION, GLOVES FOR GAMES AND SPORT, KNEE PADS, KNEE, SHIN AND WRIST GUARDS ALL FOR PROTECTION AGAINST INJURY, HELMETS, PROTECTIVE

**CLASS 35—(Continued).**

HELMETS, PROTECTIVE SPORTS HELMETS, SPORTS BAGS ADAPTED TO CONTAIN PROTECTIVE HELMETS, PROTECTIVE SUITS, SAFETY NETS, HARNESSES AND RESTRAINTS, SUNGLASSES, SPECTACLES, EYE SHADES, EYE PROTECTION PRODUCTS, AUDIO AND VISUAL APPARATUS AND INSTRUMENTS, COMPUTER AND ELECTRONIC GAMES, COIN, TOKEN AND CARD OPERATED GAMING DEVICES AND MACHINES, SLOT MACHINES, BATTERIES, RECHARGEABLE BATTERIES, COMPUTER SOFTWARE, COMPUTER PROGRAMS, DATA RECORDED IN ELECTRONIC, OPTICAL OR MAGNETIC FORM, VIDEOS, TAPES AND DISCS, CDS, CD-ROMS, CDIS, DVDS, MACHINE READABLE MEDIA, MAGNIFYING GLASSES, TELESCOPES, BINOCULARS, DIGITAL CAMERAS, MOUSE MATS, ELECTRONIC PUBLICATIONS DOWNLOADABLE FROM DATABASES OR THE INTERNET, MAGNETIC BRACELETS FOR MEDICAL PURPOSES, BACK ANKLE NECK WRIST AND SHOULDER SUPPORTS WITH MAGNETS FOR THE SPORTS INDUSTRY FOR THERAPEUTIC USE, DEVICES APPARATUS AND INSTRUMENTS FOR USE IN MAGNOTHERAPEUTIC TREATMENT, MAGNOTHERAPY DEVICES AND APPARATUS, THERAPEUTIC MAGNETIC DEVICES TO BE WORN EXTERNALLY ON THE BODY FOR MAGNOTHERAPY PURPOSES, APPARATUS AND INSTRUMENTS FOR MAGNET THERAPY, APPARATUS FOR LIGHTING, HEATING, STEAM GENERATING, COOKING, REFRIGERATING, DRYING, VENTILATING, WATER SUPPLY AND SANITARY PURPOSES, GAS HEATERS, PATIO HEATERS, CHIMINEAS, BARBEQUES, GRILLS, ICE CUBE MAKING MACHINES, ICE CREAM MAKERS, SPAS IN THE NATURE OF HEATED POOLS, INFLATABLE SPAS, PORTABLE TOILETS, VEHICLES, APPARATUS FOR LOCOMOTION BY LAND, AIR OR WATER, BICYCLES, RACING BIKES, MOUNTAIN BIKES, MOTORIZED BICYCLES, POWER ASSISTED BICYCLES, GOLF CARTS, MOTORIZED GOLF CARTS, MOTORIZED LAND VEHICLES FOR GOLF USE, GOLF TROLLEYS, GOLF BAG TROLLEYS, WHEELED CARRIERS FOR GOLFING USE, NON-METALLIC BUILDING MATERIALS, NON-METALLIC RIGID PIPES FOR BUILDING, ASPHALT, PITCH AND BITUMEN, NON-METALLIC TRANSPORTABLE BUILDINGS, MONUMENTS, NOT OF METAL, NON-METALLIC GAZEBOS, PRECIOUS METALS AND THEIR ALLOYS AND GOODS IN PRECIOUS METALS OR COATED THEREWITH, JEWELRY, COSTUME JEWELRY, PRECIOUS STONES, HOROLOGICAL AND CHRONOMETRIC INSTRUMENTS, CLOCKS AND WATCHES, JEWELRY WITH MAGNETS FOR THERAPEUTIC USE, LEATHER AND IMITATIONS OF LEATHER AND GOODS MADE OF THESE MATERIALS, ANIMAL SKINS, HIDES, TRUNKS AND TRAVELLING BAGS, UMBRELLAS, GOLF UMBRELLAS, PARASOLS AND WALKING STICKS, WHIPS, HARNESS AND SADDLERY, ARTICLES OF LUGGAGE, BAGS, BAGS OF LEATHER AND IMITATION LEATHER, SPORTS BAGS, ATHLETIC BAGS, BAGS FOR CLOTHES AND SHOES, BELT AND HIP BAGS, CANVAS BAGS, CARRY-ALL BAGS, CASUAL BAGS, CHANGING BAGS, DUFFLE BAGS, SHOPPING BAGS, SHOULDER BAGS, TOTE BAGS, CAMPING BAGS, BAGS FOR CAMPERS, ARTICLES OF LUGGAGE, HANDBAGS, BACKPACKS, SATCHELS, HAVERSACKS, KNAPSACKS, RUCKSACKS, CAMPING BAGS, BAGS FOR CAMPERS, HOLLERS, CASES, CASES OF LEATHER AND IMITATION LEATHER, ATTACHÉ CASES, BRIEF CASES, BUSINESS CARD CASES, CREDIT CARD CASES, DOCUMENT CASES, DRIVING LICENSE CASES, OVERNIGHT CASES, TRAVEL CASES, WALLETS, PURSES, TRUNKS, KEY CASES, SHOOTING STICKS, LEATHER OR LEATHER BOARD BOXES, FURNITURE, MIRRORS, PICTURE FRAMES, GOODS OF WOOD, CORK, REED, CANE, WICKER, HORN, BONE, IVORY, WHALEBONE, SHELL, AMBER, MOTHER-OF-PEARL, MEERSCHAUM AND SUBSTITUTES FOR ALL THESE MATERIALS, OR OF PLASTICS, NON-METALLIC TENT PEGS AND STAKES, NON-METALLIC TENT POLES, CAMPING FURNITURE, FOLDING CAMPING CHAIRS, MATTRESSES, CAMPING MATTRESSES, SLEEPING BAGS FOR CAMPING, SLEEPING MATS FOR CAMPING, CAMP BEDS, INFLATABLE MATTRESSES, GARDEN FURNITURE, FURNITURE OF PLASTIC, PICNIC FURNITURE, WOODEN AND PLASTIC STORAGE BOXES, CHAIRS, PLASTIC CHAIRS, FOLDING CHAIRS, TABLES, PLASTIC TABLES, FOLDING TABLES, BENCHES,

**CLASS 35—(Continued).**

PLASTIC BENCHES, FOLDING BENCHES, HOUSEHOLD OR KITCHEN UTENSILS AND CONTAINERS, COMBS AND SPONGES, BRUSHES, BRUSH MAKING MATERIALS, ARTICLES FOR CLEANING PURPOSES, STEELWOOL, UNWORKED OR SEMIWORKED GLASS, GLASSWARE, PORCELAIN, EARTHENWARE, ICE CUBE TRAYS, SKEWERS, ROPES, STRING, NETS, TENTS, AWNINGS, TARPAULINS, SAILS, SACKS AND BAGS, PADDING AND STUFFING MATERIALS, RAW FIBROUS TEXTILE MATERIALS, CAMPING TENTS, MOUNTAINEERING TENTS, AWNING FOR TENTS, TEXTILE STORAGE BAGS FOR TENTS, ROPES FOR TENTS, AWNINGS FOR CARAVANS AND VEHICLES, MARQUEES, TEXTILES AND TEXTILE GOODS, BED AND TABLE COVERS, TOWELS, LOOSE COVERS FOR GARDEN FURNITURE, LOOSE COVERS FOR FURNITURE OF PLASTIC, CLOTHING, FOOTWEAR, HEADGEAR, LEISURE CLOTHING, FOOTWEAR AND HEADGEAR, SPORTS CLOTHING, FOOTWEAR AND HEADGEAR, GOLF CRICKET HOCKEY BASEBALL TENNIS BADMINTON SQUASH CLIMBING AND CYCLING CLOTHING FOOTWEAR AND HEADGEAR, WINTER SPORT CLOTHING FOOTWEAR AND HEADGEAR, FISHING CLOTHING FOOTWEAR AND HEADGEAR, WATERPROOF CLOTHING FOOTWEAR AND HEADGEAR, THERMAL CLOTHING FOOTWEAR AND HEADGEAR, PROTECTIVE CLOTHING WET SUITS FOR WATER SKIING, BELTS FOR WEAR, SWEAT BANDS, HEAD BANDS, WRISTBANDS, VISORS, BOBBLE HATS, BASEBALL CAPS, BEANIE HATS, GAMES AND PLAYTHINGS, GYMNASTIC AND SPORTING ARTICLES, SPORTS APPARATUS, FITNESS APPARATUS, APPARATUS FOR USE IN CRICKET, CRICKET BATS, CRICKET WICKETS, CRICKET BALLS, CRICKET PADS, CRICKET BAGS, APPARATUS FOR USE IN GOLF, GOLF CLUBS, GOLF PUTTERS, GOLF IRONS, GOLF CLUB HEADS AND SHAFTS, GOLF CLUB GRIPS, GOLF CLUB BAGS, CADDIES, TROLLEY BAGS FOR GOLF EQUIPMENT, GOLF BAGS, GOLF CLUB HEAD COVERS, GOLF BALLS, GOLF BALL MARKERS, GOLF BALL RETRIEVERS, GOLF BALL SPOTTERS, GOLF TEES, GOLF TEE BAGS, GOLF GLOVES AND GRIPS, GOLF MATS, GOLF PRACTICE APPARATUS, GOLF SWING ALIGNMENT APPARATUS, GOLF TRAINING AIDS, RACKETS AND STICKS FOR SPORTING PURPOSES, BALLS AND SHUTTLECOCKS, SPORTS BAGS AND HOLDALLS ADAPTED TO CONTAIN SPORTS APPARATUS, GLOVES FOR SPORTING PURPOSES, GLOVES FOR GAMES AND SPORT, PROTECTIVE PADDED ARTICLES FOR USE IN PLAYING A SPECIFIC SPORT INCLUDING GOLF AND CRICKET, LEG GUARDS, PROTECTORS FOR ELBOWS AND KNEES WHEN PARTICIPATING IN SPORT, SHIN, FACE AND MOUTH GUARDS FOR SPORTING PURPOSES, APPARATUS FOR USE IN SKIING, BAGS ADAPTED FOR ARTICLES OF SKIING, SKIS, SKI POLES AND STICKS, SKI BOARDS, SNOW BOARDS, SURFBOARDS, WAX FOR SKIS, ARTICLES FOR PLAYING DARTS, DARTS, DART BARRELS, DART FLIGHTS, CONTAINERS ADAPTED FOR HOLDING DARTS, DART BOARDS, DISTANCE MATS FOR USE IN DARTS, FISHING TACKLE, FISHING FLOATS, FISHING RODS, FISHING REELS, FISHING ARTICLES, FISHING ACCESSORIES, SAFETY NETS, HARNESSES AND RESTRAINTS BEING SPORTING EQUIPMENT, CLIMBERS' HARNESSES, GAMING APPARATUS, DEVICES AND MACHINES, TRAMPOLINES, TRAMPOLINE LADDERS, TRAMPOLINE COVERS, PARTS AND FITTINGS FOR THE AFORESAID GOODS; PROVISION OF ADVICE AND INFORMATION TO CONSUMERS REGARDING THE SELECTION OF THE ABOVE PRODUCTS AND ITEMS TO BE PURCHASED; PROVIDING CONSUMER PRODUCT CONSULTANCY, INFORMATION AND ADVISORY SERVICES FOR THE ABOVE PRODUCTS VIA TELEPHONE (U.S. CLS. 100, 101 AND 102).

TARAH HARDY, EXAMINING ATTORNEY

**CLASS 35—(Continued).**

SN 86-111,349. INTERNATIONAL DRUM HORSE ASSOCIATION, YUMA, AZ. FILED 11-6-2013.

## Ride To The Beat Of A Different Drum

THE MARK CONSISTS OF STANDARD CHARACTERS WITHOUT CLAIM TO ANY PARTICULAR FONT, STYLE, SIZE, OR COLOR.

FOR MAINTAINING A REGISTRY OF BREEDS IN THE FIELD OF HORSES (U.S. CLS. 100, 101 AND 102).

FIRST USE 3-16-2006; IN COMMERCE 3-16-2006.

LINDSEY BEN, EXAMINING ATTORNEY

SN 86-112,535. ALLIANCE DATA SYSTEMS CORPORATION, PLANO, TX. FILED 11-7-2013.

## ASPIRE IMAGINE MORE

THE MARK CONSISTS OF STANDARD CHARACTERS WITHOUT CLAIM TO ANY PARTICULAR FONT, STYLE, SIZE, OR COLOR.

FOR ADVERTISING AND MARKETING SERVICES, NAMELY, PROMOTING THE GOODS AND SERVICES OF OTHERS; BUSINESS MARKETING CONSULTING SERVICES; CONSULTATION SERVICES, NAMELY, CREATIVE AND STRATEGIC CONSULTATION REGARDING DEVELOPMENT AND PRODUCTION OF MARKETING CAMPAIGNS FOR OTHERS; DIRECT MARKETING ADVERTISING FOR OTHERS; DIRECT MARKETING CONSULTING SERVICES; MARKETING SERVICES (U.S. CLS. 100, 101 AND 102).

ROBERT STRUCK, EXAMINING ATTORNEY

SN 86-113,076. CAIRDEAN CAFE, LLC, ST. HELENA, CA. FILED 11-7-2013.

## BUTTERSCOTS

THE MARK CONSISTS OF STANDARD CHARACTERS WITHOUT CLAIM TO ANY PARTICULAR FONT, STYLE, SIZE, OR COLOR.

FOR RETAIL BAKERY SHOPS; RETAIL STORE SERVICES FEATURING DELI PRODUCTS AND PREPARED FOODS (U.S. CLS. 100, 101 AND 102).

SKYE YOUNG, EXAMINING ATTORNEY

**CLASS 35—(Continued).**

SN 86-114,267. NEW ORLEANS TOURISM AND MARKETING CORPORATION, NEW ORLEANS, LA. FILED 11-8-2013.



NO CLAIM IS MADE TO THE EXCLUSIVE RIGHT TO USE "NOLA", APART FROM THE MARK AS SHOWN.

THE MARK CONSISTS OF THE WORDS "MY NOLA" IN STYLIZED FONT WITH A FLEUR D' LIS APPEARING BETWEEN THEM.

FOR CONVENTION AND VISITORS BUREAU SERVICES, NAMELY, PROMOTING BUSINESS AND TOURISM IN THE NEW ORLEANS METROPOLITAN AREA (U.S. CLS. 100, 101 AND 102).

BRIDGETT SMITH, EXAMINING ATTORNEY

**CLASS 35—(Continued).**

SN 86-118,080. TRI-RUNNING, LLC, LAFAYETTE, LA. FILED 11-13-2013.



NO CLAIM IS MADE TO THE EXCLUSIVE RIGHT TO USE "RUNNING" AND "LAFAYETTE, LA", APART FROM THE MARK AS SHOWN.

THE MARK CONSISTS OF THE STYLIZED TEXT "TRI" WITHIN A BOX WITH A SIDEWAYS TRIANGLE SEPARATING ANOTHER BOX CONTAINING THE STYLIZED TEXT "RUNNING" TO THE RIGHT WITH THE STYLIZED TEXT "LAFAYETTE, LA" UNDERNEATH THE BOX CONTAINING THE STYLIZED TEXT "RUNNING".

FOR RETAIL SHOPS FEATURING CLOTHING, SHOES AND APPAREL (U.S. CLS. 100, 101 AND 102).

FIRST USE 8-8-2008; IN COMMERCE 8-8-2008.  
ANGELA DUONG, EXAMINING ATTORNEY

SN 86-121,293. PACIFICO, INC., HOLLYWOOD, FL. FILED 11-18-2013.

SN 86-115,692. TRI-RUNNING, LLC, LAFAYETTE, LA. FILED 11-11-2013.

**M MARKETING MATTERS****TRI RUNNING**

THE MARK CONSISTS OF STANDARD CHARACTERS WITHOUT CLAIM TO ANY PARTICULAR FONT, STYLE, SIZE, OR COLOR.

OWNER OF U.S. REG. NOS. 3,534,430 AND 3,718,000.

NO CLAIM IS MADE TO THE EXCLUSIVE RIGHT TO USE "MARKETING", APART FROM THE MARK AS SHOWN.

SEC. 2(F).

FOR ADVERTISING AND MARKETING SERVICES, NAMELY, PROMOTING THE GOODS AND SERVICES OF OTHERS (U.S. CLS. 100, 101 AND 102).

FIRST USE 7-17-2000, THE MARK WAS FIRST USED ANYWHERE IN A DIFFERENT FORM OTHER THAN THAT SOUGHT TO BE REGISTERED AT LEAST AS EARLY AS 07/17/2000; IN COMMERCE 7-17-2000, THE MARK WAS FIRST USED IN COMMERCE IN A DIFFERENT FORM OTHER THAN THAT SOUGHT TO BE REGISTERED AT LEAST AS EARLY AS 07/17/2000.

KAREN SEVERSON, EXAMINING ATTORNEY

THE MARK CONSISTS OF STANDARD CHARACTERS WITHOUT CLAIM TO ANY PARTICULAR FONT, STYLE, SIZE, OR COLOR.

NO CLAIM IS MADE TO THE EXCLUSIVE RIGHT TO USE "RUNNING", APART FROM THE MARK AS SHOWN. FOR RETAIL SHOPS FEATURING CLOTHING, SHOES AND APPAREL (U.S. CLS. 100, 101 AND 102).

FIRST USE 2-1-2003; IN COMMERCE 2-1-2003.  
ANGELA DUONG, EXAMINING ATTORNEY

**CLASS 35—(Continued).**

SN 86-128,234. CISNEROS CORPORATION, CORAL GABLES, FL. FILED 11-25-2013.



OWNER OF U.S. REG. NOS. 4,362,006 AND 4,444,070.  
NO CLAIM IS MADE TO THE EXCLUSIVE RIGHT TO USE "CORPORATION", APART FROM THE MARK AS SHOWN.

THE COLOR(S) BLUE, SILVER/GRAY AND BLACK IS/ARE CLAIMED AS A FEATURE OF THE MARK.

THE MARK CONSISTS OF TWO BLUE AND SILVER/GRAY INTERLOCKING "C"S WITH THE WORDS "CISNEROS CORPORATION" IN BLACK AND HORIZONTALLY SET IN TWO LINES TO THE RIGHT OF THE DESIGN.

FOR BUSINESS AND MANAGEMENT CONSULTING, INFORMATION AND ADVISORY SERVICES (U.S. CLS. 100, 101 AND 102).

FIRST USE 5-30-2012; IN COMMERCE 5-30-2012.  
KATHERINE CHANG, EXAMINING ATTORNEY

SN 86-128,862. MISSOURI CREDIT UNION LEAGUE, ST. LOUIS, MO. FILED 11-25-2013.



OWNER OF U.S. REG. NO. 2,828,461.  
NO CLAIM IS MADE TO THE EXCLUSIVE RIGHT TO USE "CREDIT UNION ASSOCIATION", APART FROM THE MARK AS SHOWN.

THE MARK CONSISTS OF THE WORDS "MISSOURI CREDIT UNION ASSOCIATION" TO THE RIGHT OF A STYLIZED "M" WITHIN A CIRCLE.

SEC. 2(F) AS TO "MISSOURI CREDIT UNION ASSOCIATION".

FOR TRADE ASSOCIATION SERVICES, NAMELY, PROMOTING THE INTERESTS OF CREDIT UNIONS; BUSINESS CONSULTATION SERVICES FOR THE FINANCIAL SERVICES INDUSTRY; BUSINESS MARKETING CONSULTATION SERVICES FOR THE FINANCIAL SERVICES INDUSTRY (U.S. CLS. 100, 101 AND 102).

FIRST USE 12-0-2003; IN COMMERCE 12-0-2003.  
KATHERINE STOIDES, EXAMINING ATTORNEY

**CLASS 35—(Continued).**

SN 86-132,636. DOLLAR SHAVE CLUB, INC., VENICE, CA. FILED 12-2-2013.

**Build a Better Bathroom**

THE MARK CONSISTS OF STANDARD CHARACTERS WITHOUT CLAIM TO ANY PARTICULAR FONT, STYLE, SIZE, OR COLOR.

FOR COMPUTERIZED ON-LINE ORDERING SERVICES IN THE FIELD OF SHAVING PRODUCTS AND ACCESSORIES; COMPUTERIZED ON-LINE RETAIL STORE SERVICES IN THE FIELD OF SHAVING PRODUCTS AND ACCESSORIES; ON-LINE RETAIL STORE SERVICES FEATURING SHAVING PRODUCTS AND ACCESSORIES (U.S. CLS. 100, 101 AND 102).

ESTHER A. BORSUK, EXAMINING ATTORNEY

SN 86-132,656. DOLLAR SHAVE CLUB, INC., VENICE, CA. FILED 12-2-2013.

**Build a Smarter Bathroom**

THE MARK CONSISTS OF STANDARD CHARACTERS WITHOUT CLAIM TO ANY PARTICULAR FONT, STYLE, SIZE, OR COLOR.

FOR COMPUTERIZED ON-LINE ORDERING SERVICES IN THE FIELD OF SHAVING PRODUCTS AND ACCESSORIES; COMPUTERIZED ON-LINE RETAIL STORE SERVICES IN THE FIELD OF SHAVING PRODUCTS AND ACCESSORIES; ON-LINE RETAIL STORE SERVICES FEATURING SHAVING PRODUCTS AND ACCESSORIES (U.S. CLS. 100, 101 AND 102).

ESTHER A. BORSUK, EXAMINING ATTORNEY

SN 86-135,239. MILESTONE TAX GROUP, LLC, ORLANDO, FL. FILED 12-4-2013.



NO CLAIM IS MADE TO THE EXCLUSIVE RIGHT TO USE "TAX SERVICES", APART FROM THE MARK AS SHOWN.

THE MARK CONSISTS OF TWIN TRIANGLES OVERLAPPED TO FORM TWO PEAKS IN THE SHAPE OF AN "M" WITH THE WORD "MILESTONE" TO THE RIGHT OF THE IMAGE; A DIAMOND OVERLAYS THE "O" IN THE WORD "MILESTONE", UNDERNEATH WHICH ARE THE WORDS "TAX SERVICES", ALL WORDS BEING IN CAPITAL LETTERS.

FOR INCOME TAX PREPARATION; TAX ADVISORY SERVICES; TAX FILING SERVICES (U.S. CLS. 100, 101 AND 102).

FIRST USE 9-1-2013; IN COMMERCE 9-1-2013.  
BRENDAN REGAN, EXAMINING ATTORNEY

**CLASS 35—(Continued).**

SN 86-975,055. DAFFY'S INC., SECAUCUS, NJ. FILED 9-6-2013.

**DAFFY'S**

THE MARK CONSISTS OF STANDARD CHARACTERS WITHOUT CLAIM TO ANY PARTICULAR FONT, STYLE, SIZE, OR COLOR.

OWNER OF U.S. REG. NOS. 1,485,741 AND 3,344,294. FOR ON-LINE RETAIL STORE SERVICES FEATURING A WIDE VARIETY OF CONSUMER GOODS OF OTHERS (U.S. CLS. 100, 101 AND 102). FIRST USE 11-7-2013; IN COMMERCE 11-7-2013. ERIN FALK, EXAMINING ATTORNEY

SN 86-975,056. DAFFY'S INC., SECAUCUS, NJ. FILED 9-6-2013.

**DAFFY'S. HIGH FASHION. LOW PRICES.**

THE MARK CONSISTS OF STANDARD CHARACTERS WITHOUT CLAIM TO ANY PARTICULAR FONT, STYLE, SIZE, OR COLOR.

OWNER OF U.S. REG. NOS. 1,485,741 AND 3,344,294. FOR ON-LINE RETAIL STORE SERVICES FEATURING A WIDE VARIETY OF CONSUMER GOODS OF OTHERS (U.S. CLS. 100, 101 AND 102). FIRST USE 11-7-2013; IN COMMERCE 11-7-2013. ERIN FALK, EXAMINING ATTORNEY

**CLASS 36—INSURANCE AND FINANCIAL**

SN 76-714,069. JACKSON-HARLEY, JANE, WASHINGTON, DC, WA. FILED 5-1-2013.

**HAL JACKSON'S LEGACY**

THE MARK CONSISTS OF STANDARD CHARACTERS WITHOUT CLAIM TO ANY PARTICULAR FONT, STYLE, SIZE, OR COLOR.

THE NAME "HAL JACKSON" DOES NOT IDENTIFY A LIVING INDIVIDUAL. FOR PROVIDING EDUCATIONAL SCHOLARSHIPS FOR HIGH SCHOOL AND COLLEGE STUDENTS IN THE FIELD OF COMMUNICATION AND VISUAL AND PERFORMING ARTS, HIGH SCHOOL AND COLLEGE CONSULTING SERVICES, NAMELY, ASSISTING STUDENTS IN APPLYING FOR SCHOLARSHIPS IN THE FIELDS OF COMMUNICATION AND VISUAL AND PERFORMING ARTS (U.S. CLS. 100, 101 AND 102). TINA BROWN, EXAMINING ATTORNEY

**CLASS 36—(Continued).**

SN 76-714,566. CASE ALUMNI ASSOCIATION INCORPORATED, CLEVELAND, OH. FILED 7-17-2013.

**case starter**  
CASE ALUMNI ASSOCIATION

NO CLAIM IS MADE TO THE EXCLUSIVE RIGHT TO USE "ALUMNI ASSOCIATION", APART FROM THE MARK AS SHOWN.

THE MARK CONSISTS OF THE WORDS "CASE STARTER" WITH THREE SPACED-APART ARCS THERE BETWEEN AND ALL POSITIONED ABOVE THE WORDS "CASE ALUMNI ASSOCIATION".

FOR PROVIDING A WEBSITE WHERE DONORS SEARCH FOR AND MAKE MONETARY DONATIONS THROUGH CROWD-FUNDING TO SPECIFIC PROJECTS OF A PHILANTHROPIC NATURE TO BENEFIT AN EDUCATIONAL INSTITUTION, SPECIFICALLY THE CASE SCHOOL OF ENGINEERING AND THE MATHEMATICS AND SCIENCES AT CASE WESTERN RESERVE UNIVERSITY (U.S. CLS. 100, 101 AND 102). FIRST USE 4-25-2013; IN COMMERCE 4-25-2013. TASHIA BUNCH, EXAMINING ATTORNEY

SN 76-714,567. CASE ALUMNI ASSOCIATION INCORPORATED, CLEVELAND, OH. FILED 7-17-2013.

**CASESTARTER**

THE MARK CONSISTS OF STANDARD CHARACTERS WITHOUT CLAIM TO ANY PARTICULAR FONT, STYLE, SIZE, OR COLOR.

FOR PROVIDING A WEBSITE WHERE DONORS SEARCH FOR AND MAKE MONETARY DONATIONS THROUGH CROWD-FUNDING TO SPECIFIC PROJECTS OF A PHILANTHROPIC NATURE TO BENEFIT AN EDUCATIONAL INSTITUTION, SPECIFICALLY THE CASE SCHOOL OF ENGINEERING AND THE MATHEMATICS AND SCIENCES AT CASE WESTERN RESERVE UNIVERSITY (U.S. CLS. 100, 101 AND 102). FIRST USE 4-25-2013; IN COMMERCE 4-25-2013. TASHIA BUNCH, EXAMINING ATTORNEY

SN 76-714,976. CITIZENS EQUITY FIRST CREDIT UNION, PEORIA, IL. FILED 9-17-2013.

**CEFCU+**

THE MARK CONSISTS OF STANDARD CHARACTERS WITHOUT CLAIM TO ANY PARTICULAR FONT, STYLE, SIZE, OR COLOR.

OWNER OF U.S. REG. NOS. 2,228,393, 2,291,587 AND OTHERS. FOR CREDIT UNION SERVICES (U.S. CLS. 100, 101 AND 102). NAKIA HENRY, EXAMINING ATTORNEY

**CLASS 36—(Continued).**

SN 77-162,610. STATE STREET CORPORATION, BOSTON, MA. FILED 4-22-2007.

**EUROPE DYNAMIC EDGE**

THE MARK CONSISTS OF STANDARD CHARACTERS WITHOUT CLAIM TO ANY PARTICULAR FONT, STYLE, SIZE, OR COLOR.

NO CLAIM IS MADE TO THE EXCLUSIVE RIGHT TO USE "EUROPE DYNAMIC", APART FROM THE MARK AS SHOWN.

FOR FUNDS INVESTMENT (U.S. CLS. 100, 101 AND 102).

JOHN WILKE, EXAMINING ATTORNEY

---

SN 85-490,884. INVENTURE HOLDINGS, INC., WEST CHESTER, PA. FILED 12-8-2011.

**VENTURE INSURANCE PROGRAMS**

THE MARK CONSISTS OF STANDARD CHARACTERS WITHOUT CLAIM TO ANY PARTICULAR FONT, STYLE, SIZE, OR COLOR.

NO CLAIM IS MADE TO THE EXCLUSIVE RIGHT TO USE "INSURANCE PROGRAMS", APART FROM THE MARK AS SHOWN.

SEC. 2(F).  
FOR ADMINISTRATION OF PROPERTY AND CASUALTY INSURANCE FOR BUSINESSES AND CLUBS (U.S. CLS. 100, 101 AND 102).

FIRST USE 10-30-1996; IN COMMERCE 10-30-1996.  
TINA BROWN, EXAMINING ATTORNEY

**CLASS 36—(Continued).**

SN 85-577,895. SBLI USA MUTUAL LIFE INSURANCE COMPANY, INC., NEW YORK, NY. FILED 3-23-2012.

**SBLI USA PAYCHECK PROTECTOR**

THE MARK CONSISTS OF STANDARD CHARACTERS WITHOUT CLAIM TO ANY PARTICULAR FONT, STYLE, SIZE, OR COLOR.

OWNER OF U.S. REG. NOS. 3,624,713, 3,697,121 AND 3,863,163.

NO CLAIM IS MADE TO THE EXCLUSIVE RIGHT TO USE "USA PAYCHECK PROTECTOR", APART FROM THE MARK AS SHOWN.

FOR UNDERWRITING, ADMINISTRATION, AND CLAIMS ADMINISTRATION OF INDIVIDUAL LIFE, HEALTH, ACCIDENT AND DISABILITY INSURANCE POLICIES AND ANNUITIES MARKETED TO INDIVIDUALS AND EXCLUDING GROUP POLICIES AND POLICIES SPECIFICALLY TARGETED TO INDIVIDUALS BECAUSE OF THEIR EMPLOYMENT BY OR ASSOCIATION WITH SCHOOLS, MUNICIPALITIES, OR AUTOMOBILE ASSOCIATIONS (U.S. CLS. 100, 101 AND 102).

ELI HELLMAN, EXAMINING ATTORNEY

---

SN 85-615,291. BANK OF MONTREAL, TORONTO, ONTARIO, CANADA, FILED 5-3-2012.

**CONFIDENCE COMES WITH A PLAN**

THE MARK CONSISTS OF STANDARD CHARACTERS WITHOUT CLAIM TO ANY PARTICULAR FONT, STYLE, SIZE, OR COLOR.

PRIORITY CLAIMED UNDER SEC. 44(D) ON CANADA APPLICATION NO. 1573730, FILED 4-18-2012, REG. NO. TMA857,722, DATED 8-14-2013, EXPIRES 8-14-2028.

FOR BANKING SERVICES, FINANCIAL SERVICES, NAMELY, FINANCIAL PLANNING RELATED TO INVESTMENTS AND RETIREMENT PLANS (U.S. CLS. 100, 101 AND 102).

WILLIAM BRECKENFELD, EXAMINING ATTORNEY



**CLASS 36—(Continued).**

SN 85-639,085. PRONTO MONEY TRANSFER INC., MANHATTAN BEACH, CA. FILED 5-30-2012.



NO CLAIM IS MADE TO THE EXCLUSIVE RIGHT TO USE "MONEY TRANSFER", APART FROM THE MARK AS SHOWN.

THE MARK CONSISTS OF THE WORDS "PRONTO MONEY TRANSFER", WITH THE "S" IN "TRANSFER" BEING A FANCIFUL DOLLAR SIGN, AND WITH AN ABSTRACT LINE DESIGN BELOW PART OF THE WORD "PRONTO".

FOR PROVIDING DIVERSIFIED FINANCIAL SERVICES, NAMELY, MONEY TRANSFER, MONEY REMITTANCE, CREDIT CONSULTATION, AND CHECK CASHING (U.S. CLS. 100, 101 AND 102).

REBECCA GILBERT, EXAMINING ATTORNEY

**CLASS 36—(Continued).**

SN 85-664,349. BANESCO INTERNATIONAL CORP., MIAMI, FL. FILED 6-28-2012.



SN 85-664,327. BANESCO INTERNATIONAL CORP., MIAMI, FL. FILED 6-28-2012.



OWNER OF U.S. REG. NO. 3,867,143.

THE MARK CONSISTS OF CIRCLES ABOVE AN OVAL THAT ARE TO THE LEFT OF THE PHRASE "BANESCO CONTIGO".

THE ENGLISH TRANSLATION OF "CONTIGO" IN THE MARK IS "WITH YOU".

FOR BANKING SERVICES, NAMELY, CHECKING ACCOUNT SERVICES, SAVINGS ACCOUNT SERVICES, CERTIFICATE OF DEPOSIT ACCOUNT SERVICES, ON-LINE BANKING SERVICES, CREDIT CARD SERVICES, DEBIT CARD SERVICES, AUTOMATED TELLER MACHINE SERVICES, DIRECT DEPOSIT SERVICES, LENDING SERVICES, NAMELY, PROVIDING AND ARRANGING COMMERCIAL AND CONSUMER LOANS AND LINES OF CREDIT, INCLUDING MORTGAGE LOANS AND LINES OF CREDIT; FULL RANGE OF INSURANCE AND FINANCIAL SERVICES, NAMELY, BANKING SERVICES, REAL ESTATE AND MORTGAGE BROKERAGE SERVICES; TRUST, ESTATE, AND FIDUCIARY MANAGEMENT SERVICES, NAMELY, TRUST MANAGEMENT ACCOUNTS, ESTATE TRUST MANAGEMENT, FINANCIAL ASSET MANAGEMENT; INVESTMENT ADVISORY AND CONSULTING SERVICES, SECURITIES BROKERAGE AND TRADING SERVICES, SECURITIES CONSULTATION SERVICES, NAMELY, SECURITY BROKERAGE SERVICES; UNDERWRITING SERVICES, NAMELY, SECURITIES UNDERWRITING TRANSACTION SERVICES AND REAL ESTATE INSURANCE UNDERWRITING SERVICES; ELECTRONIC CREDIT CARD TRANSACTIONS, ELECTRONIC DEBIT TRANSACTIONS; INVESTMENT SERVICES, NAMELY, HEDGE FUND INVESTMENT SERVICES, MUTUAL FUND INVESTMENT, ASSET ACQUISITION, CONSULTATION, DEVELOPMENT, AND MANAGEMENT SERVICES (U.S. CLS. 100, 101 AND 102).

FIRST USE 1-31-1992; IN COMMERCE 1-31-1994.  
WANDA KAY PRICE, EXAMINING ATTORNEY

OWNER OF U.S. REG. NO. 3,867,143.

THE MARK CONSISTS OF CIRCLES ABOVE AN OVAL THAT IS ABOVE THE WORD "BANESCO".

FOR BANKING SERVICES, NAMELY, CHECKING ACCOUNT SERVICES, SAVINGS ACCOUNT SERVICES, CERTIFICATE OF DEPOSIT ACCOUNT SERVICES, ON-LINE BANKING SERVICES, CREDIT CARD SERVICES, DEBIT CARD SERVICES, AUTOMATED TELLER MACHINE SERVICES, DIRECT DEPOSIT SERVICES, LENDING SERVICES, NAMELY, PROVIDING AND ARRANGING COMMERCIAL AND CONSUMER LOANS AND LINES OF CREDIT, INCLUDING MORTGAGE LOANS AND LINES OF CREDIT; FULL RANGE OF INSURANCE AND FINANCIAL SERVICES, NAMELY, BANKING SERVICES, REAL ESTATE AND MORTGAGE BROKERAGE SERVICES; TRUST, ESTATE, AND FIDUCIARY MANAGEMENT SERVICES, NAMELY, TRUST MANAGEMENT ACCOUNTS, ESTATE TRUST MANAGEMENT, FINANCIAL ASSET MANAGEMENT; INVESTMENT ADVISORY AND CONSULTING SERVICES, SECURITIES BROKERAGE AND TRADING SERVICES, SECURITIES CONSULTATION SERVICES, NAMELY, SECURITY BROKERAGE SERVICES; UNDERWRITING SERVICES, NAMELY, SECURITIES UNDERWRITING TRANSACTION SERVICES AND REAL ESTATE INSURANCE UNDERWRITING SERVICES; ELECTRONIC CREDIT CARD TRANSACTIONS, ELECTRONIC DEBIT TRANSACTIONS; INVESTMENT SERVICES, NAMELY, HEDGE FUND INVESTMENT SERVICES, MUTUAL FUND INVESTMENT, ASSET ACQUISITION, CONSULTATION, DEVELOPMENT, AND MANAGEMENT SERVICES (U.S. CLS. 100, 101 AND 102).

FIRST USE 1-31-1992; IN COMMERCE 1-31-1994.  
WANDA KAY PRICE, EXAMINING ATTORNEY

**CLASS 36—(Continued).**

SN 85-664,359. BANESCO INTERNATIONAL CORP., MIAMI, FL. FILED 6-28-2012.



OWNER OF U.S. REG. NO. 3,867,143.  
 THE MARK CONSISTS OF CIRCLES ABOVE AN OVAL THAT ARE TO THE LEFT OF THE PHRASE "BANESCO".  
 FOR BANKING SERVICES, NAMELY, CHECKING ACCOUNT SERVICES, SAVINGS ACCOUNT SERVICES, CERTIFICATE OF DEPOSIT ACCOUNT SERVICES, ON-LINE BANKING SERVICES, CREDIT CARD SERVICES, DEBIT CARD SERVICES, AUTOMATED TELLER MACHINE SERVICES, DIRECT DEPOSIT SERVICES, LENDING SERVICES, NAMELY, PROVIDING AND ARRANGING COMMERCIAL AND CONSUMER LOANS AND LINES OF CREDIT, INCLUDING MORTGAGE LOANS AND LINES OF CREDIT; FULL RANGE OF INSURANCE AND FINANCIAL SERVICES, NAMELY, BANKING SERVICES, REAL ESTATE AND MORTGAGE BROKERAGE SERVICES; TRUST, ESTATE, AND FIDUCIARY MANAGEMENT SERVICES, NAMELY, TRUST MANAGEMENT ACCOUNTS, ESTATE TRUST MANAGEMENT, FINANCIAL ASSET MANAGEMENT; INVESTMENT ADVISORY AND CONSULTING SERVICES, SECURITIES BROKERAGE AND TRADING SERVICES, SECURITIES CONSULTATION SERVICES, NAMELY, SECURITY BROKERAGE SERVICES; UNDERWRITING SERVICES, NAMELY, SECURITIES UNDERWRITING TRANSACTION SERVICES AND REAL ESTATE INSURANCE UNDERWRITING SERVICES; ELECTRONIC CREDIT CARD TRANSACTIONS, ELECTRONIC DEBIT TRANSACTIONS; INVESTMENT SERVICES, NAMELY, HEDGE FUND INVESTMENT SERVICES, MUTUAL FUND INVESTMENT, ASSET ACQUISITION, CONSULTATION, DEVELOPMENT, AND MANAGEMENT SERVICES (U.S. CLS. 100, 101 AND 102).  
 FIRST USE 1-31-1992; IN COMMERCE 1-31-1994.  
 WANDA KAY PRICE, EXAMINING ATTORNEY

**CLASS 36—(Continued).**

SN 85-664,376. BANESCO INTERNATIONAL CORP., MIAMI, FL. FILED 6-28-2012.



OWNER OF U.S. REG. NO. 3,867,143.  
 THE MARK CONSISTS OF CIRCLES ABOVE AN OVAL THAT ARE TO THE LEFT OF THE PHRASE "BANESCO HERE WITH YOU".  
 FOR BANKING SERVICES, NAMELY, CHECKING ACCOUNT SERVICES, SAVINGS ACCOUNT SERVICES, CERTIFICATE OF DEPOSIT ACCOUNT SERVICES, ON-LINE BANKING SERVICES, CREDIT CARD SERVICES, DEBIT CARD SERVICES, AUTOMATED TELLER MACHINE SERVICES, DIRECT DEPOSIT SERVICES, LENDING SERVICES, NAMELY, PROVIDING AND ARRANGING COMMERCIAL AND CONSUMER LOANS AND LINES OF CREDIT, INCLUDING MORTGAGE LOANS AND LINES OF CREDIT; FULL RANGE OF INSURANCE AND FINANCIAL SERVICES, NAMELY, BANKING SERVICES, REAL ESTATE AND MORTGAGE BROKERAGE SERVICES; TRUST, ESTATE, AND FIDUCIARY MANAGEMENT SERVICES, NAMELY, TRUST MANAGEMENT ACCOUNTS, ESTATE TRUST MANAGEMENT, FINANCIAL ASSET MANAGEMENT; INVESTMENT ADVISORY AND CONSULTING SERVICES, SECURITIES BROKERAGE AND TRADING SERVICES, SECURITIES CONSULTATION SERVICES, NAMELY, SECURITY BROKERAGE SERVICES; UNDERWRITING SERVICES, NAMELY, SECURITIES UNDERWRITING TRANSACTION SERVICES AND REAL ESTATE INSURANCE UNDERWRITING SERVICES; ELECTRONIC CREDIT CARD TRANSACTIONS, ELECTRONIC DEBIT TRANSACTIONS; INVESTMENT SERVICES, NAMELY, HEDGE FUND INVESTMENT SERVICES, MUTUAL FUND INVESTMENT, ASSET ACQUISITION, CONSULTATION, DEVELOPMENT, AND MANAGEMENT SERVICES (U.S. CLS. 100, 101 AND 102).  
 FIRST USE 1-31-1992; IN COMMERCE 1-31-1994.  
 WANDA KAY PRICE, EXAMINING ATTORNEY

**CLASS 36—(Continued).**

SN 85-784,368. NEUBERGER BERMAN GROUP LLC, NEW YORK, NY. FILED 11-20-2012.



OWNER OF U.S. REG. NO. 2,815,456.  
 THE MARK CONSISTS OF THE LETTERS NB IN CHINESE CHARACTERS.  
 THE NON-LATIN CHARACTERS IN THE MARK TRANSLITERATE TO "LU BO" AND THIS HAS NO MEANING IN A FOREIGN LANGUAGE.  
 FOR FINANCIAL SERVICES, NAMELY, INVESTMENT ADVISORY, INVESTMENT MANAGEMENT, ASSET MANAGEMENT, PORTFOLIO MANAGEMENT, INVESTMENT BROKERAGE, SECURITIES BROKERAGE, INVESTMENT CONSULTATION, WEALTH MANAGEMENT, AND FINANCIAL PLANNING SERVICES; FINANCIAL AND INVESTMENT SERVICES, NAMELY, INVESTMENT ADVISORY AND INVESTMENT MANAGEMENT AND BROKERAGE OF SECURITIES, HEDGE FUNDS, PRIVATE EQUITY FUNDS, WRAP FEE PROGRAMS, SEPARATE ACCOUNTS, VARIABLE ANNUITY PROGRAMS, STOCKS, BONDS, COMMODITIES, DERIVATIVES AND DEBT INVESTMENT, AND LIMITED PARTNERSHIPS; FINANCIAL SERVICES, NAMELY, FINANCIAL RESEARCH, FINANCIAL ANALYSIS, CONSULTATION, RECORD KEEPING AND INFORMATION SERVICES, TRANSFER AGENT SERVICES, CUSTODIAN SERVICES, MANAGEMENT AND INVESTMENT OF FUNDS AND ASSETS OF OTHERS, CAPITAL INVESTMENT SERVICES, AND FINANCIAL TRANSACTION SERVICES; FINANCIAL SERVICES, NAMELY, MUTUAL FUND ADVISORY AND INVESTMENT MANAGEMENT SERVICES, MUTUAL FUND DISTRIBUTION SERVICES, MUTUAL FUND UNDERWRITING AND ADMINISTRATION SERVICES, AND VARIABLE ANNUITIES INVESTMENT SERVICES; CLEARANCE SERVICES, NAMELY, CLEARING AND SETTLING FINANCIAL TRANSACTIONS ON BEHALF OF OTHERS; MAINTAINING ASSETS AND SECURITIES FOR OTHERS, AND CONFIRMING AND TRACKING FINANCIAL TRANSACTIONS FOR OTHERS; INSURANCE INVESTMENT SERVICES; TRUST AND ESTATE PLANNING AND MANAGEMENT SERVICES; RETIREMENT PLANNING SERVICES; REAL ESTATE INVESTMENT TRUST ADVISORY AND MANAGEMENT SERVICES; PROVIDING A WEB SITE FEATURING FINANCIAL INFORMATION AND FINANCIAL ADVICE (U.S. CLS. 100, 101 AND 102).  
 SUSAN RICHARDS, EXAMINING ATTORNEY

**CLASS 36—(Continued).**

SN 85-818,073. JIMMY SANDERS INCORPORATED, CLEVELAND, MS. FILED 1-8-2013.

# FARMLINE

THE MARK CONSISTS OF STANDARD CHARACTERS WITHOUT CLAIM TO ANY PARTICULAR FONT, STYLE, SIZE, OR COLOR.  
 FOR FINANCING AND LOAN SERVICES FOR AGRICULTURAL PRODUCERS, NAMELY, OPERATING LOANS, INPUT LOANS, AND LOANS FOR CROP NUTRIENTS, CROP PROTECTION, SEED, APPLICATION SERVICES, FUEL, RENT, LABOR, IRRIGATION EXPENSES, REPAIRS AND SOIL TESTING (U.S. CLS. 100, 101 AND 102).  
 FIRST USE 6-28-2011; IN COMMERCE 6-28-2011.  
 ASMAT KHAN, EXAMINING ATTORNEY

SN 85-820,525. COLLEEN'S DREAM FOUNDATION, PHOENIX, AZ. FILED 1-10-2013.

## COLLEEN'S DREAM FOUNDATION

THE MARK CONSISTS OF STANDARD CHARACTERS WITHOUT CLAIM TO ANY PARTICULAR FONT, STYLE, SIZE, OR COLOR.  
 NO CLAIM IS MADE TO THE EXCLUSIVE RIGHT TO USE "FOUNDATION", APART FROM THE MARK AS SHOWN.  
 FOR CHARITABLE FUNDRAISING SERVICES, NAMELY, ORGANIZING AND CONDUCTING SPECIAL EVENTS TO RAISE FUNDS IN THE FIELD OF OVARIAN CANCER RESEARCH (U.S. CLS. 100, 101 AND 102).  
 TARAH HARDY, EXAMINING ATTORNEY

SN 85-820,548. COLLEEN'S DREAM FOUNDATION, PHOENIX, AZ. FILED 1-10-2013.



NO CLAIM IS MADE TO THE EXCLUSIVE RIGHT TO USE "FOUNDATION", APART FROM THE MARK AS SHOWN.  
 THE COLOR(S) TEAL AND GREY IS/ARE CLAIMED AS A FEATURE OF THE MARK.  
 THE MARK CONSISTS OF A TEAL RIBBON IN THE STYLIZED SHAPE OF A BIRD FOLLOWED BY THE WORD "COLLEEN'S" IN TEAL, FOLLOWED BY THE WORDS "DREAM FOUNDATION" IN GREY.  
 FOR CHARITABLE FUNDRAISING SERVICES, NAMELY, ORGANIZING AND CONDUCTING SPECIAL EVENTS TO RAISE FUNDS IN THE FIELD OF OVARIAN CANCER RESEARCH (U.S. CLS. 100, 101 AND 102).  
 TARAH HARDY, EXAMINING ATTORNEY

**CLASS 36—(Continued).**

SN 85-826,942. MAYMONT FOUNDATION, RICHMOND, VA. FILED 1-18-2013.



THE MARK CONSISTS OF A DESIGN FEATURING THREE CONCENTRIC OVALS WHEREIN THE INNER MOST OVAL CONTAINS A SWAN DESIGN.

FOR CHARITABLE FUNDRAISING (U.S. CLS. 100, 101 AND 102).

FIRST USE 12-31-2010; IN COMMERCE 4-7-2011.  
TRACY WHITTAKER-BROWN, EXAMINING ATTORNEY

SN 85-848,782. CORECO MANAGEMENT, INC., MIAMI, FL. FILED 2-13-2013.



NO CLAIM IS MADE TO THE EXCLUSIVE RIGHT TO USE "PRIVATE EQUITY", APART FROM THE MARK AS SHOWN.

THE MARK CONSISTS OF THE WORDS "PRIVATE EQUITY" BELOW A HORIZONTAL LINE AND THE WORD "CORECO" ABOVE THE LINE, ALL TO THE RIGHT OF A SQUARE, INSIDE OF WHICH IS THE LETTER "C" IN THE TOP RIGHT CORNER OF THE SQUARE AND A LARGER "C" IN THE BOTTOM LEFT CORNER OF THE SQUARE.

FOR FINANCIAL INVESTMENT SERVICES, NAMELY, PRIVATE EQUITY FUND INVESTMENT SERVICES (U.S. CLS. 100, 101 AND 102).

FIRST USE 1-9-2013; IN COMMERCE 1-9-2013.  
JUDITH HELFMAN, EXAMINING ATTORNEY

**CLASS 36—(Continued).**

SN 85-850,699. FEDERALQUOTE.COM, BOCA RATON, FL. FILED 2-14-2013.



NO CLAIM IS MADE TO THE EXCLUSIVE RIGHT TO USE "FEDERAL QUOTE AMERICA'S INSURANCE COMPANY", APART FROM THE MARK AS SHOWN.

THE MARK CONSISTS OF LITERAL ELEMENTS "FEDERAL QUOTE AMERICA'S INSURANCE COMPANY" WRITTEN IN STYLIZED FORM WHEREIN THE WORDS "FEDERAL QUOTE" ARE WRITTEN INSIDE A HALF STAR WITH A GEOMETRICAL DESIGN. THE LITERAL ELEMENTS "AMERICA'S INSURANCE COMPANY" IS WRITTEN BENEATH WORD "QUOTE" AS SHOWN IN THE MARK.

FOR INSURANCE CONSULTING IN THE FIELD OF AUTOMOBILE, LIFE, HEALTH, FIRE, DENTAL, TRAVELERS AND COMMERCIAL INSURANCE; INSURANCE INFORMATION AND CONSULTANCY; LIFE INSURANCE BROKERAGE; PROVIDING AUTOMOBILE, LIFE, HEALTH, FIRE, DENTAL, TRAVELERS AND COMMERCIAL INSURANCE RATE QUOTES (U.S. CLS. 100, 101 AND 102).

FIRST USE 1-1-2013; IN COMMERCE 1-1-2013.  
SIDDHARTH JAGANNATHAN, EXAMINING ATTORNEY

SN 85-853,518. NATIONAL FOUNDATION FOR SYNDICATE RESEARCH, SUPPORT AND EDUCATION, MASCOUTAH, IL. FILED 2-19-2013.

## The Helping Hands People

THE MARK CONSISTS OF STANDARD CHARACTERS WITHOUT CLAIM TO ANY PARTICULAR FONT, STYLE, SIZE, OR COLOR.

FOR CHARITABLE SERVICES, NAMELY, PROVIDING FINANCIAL SUPPORT TO DISADVANTAGED PATIENTS FOR THE PURPOSE OF FACILITATING GOOD HEALTH (U.S. CLS. 100, 101 AND 102).

FIRST USE 1-15-2013; IN COMMERCE 1-15-2013.  
FLORENTINA BLANDU, EXAMINING ATTORNEY

**CLASS 36—(Continued).**

SN 85-860,685. HEART HEALTH FOUNDATION, ANNAPOLIS, MD. FILED 2-26-2013.



NO CLAIM IS MADE TO THE EXCLUSIVE RIGHT TO USE "HEART HEALTH FOUNDATION", APART FROM THE MARK AS SHOWN.

THE MARK CONSISTS OF STYLIZED HUMAN FIGURES THAT FORM A STYLIZED HEART FOLLOWED BY THE WORDS "HEART HEALTH FOUNDATION".

FOR CHARITABLE FOUNDATION SERVICES, NAMELY, FUND RAISING AND FINANCIAL SPONSORSHIP OF EDUCATION AND RESEARCH IN DEVELOPING TECHNIQUES FOR DIAGNOSES, TREATMENT, AND PREVENTION OF HEART DISEASE AND VASCULAR DISEASES (U.S. CLS. 100, 101 AND 102).

FIRST USE 8-1-2012; IN COMMERCE 8-1-2012.  
APRIL ROACH, EXAMINING ATTORNEY

SN 85-867,556. RENTCENTIVES CORP., NEW YORK, NY. FILED 3-5-2013.

**RENTREWARDS**

THE MARK CONSISTS OF STANDARD CHARACTERS WITHOUT CLAIM TO ANY PARTICULAR FONT, STYLE, SIZE, OR COLOR.

FOR FINANCIAL ADMINISTRATION OF CREDIT CARD ACCOUNTS; FINANCIAL ADMINISTRATION OF DEBIT CARD ACCOUNTS; CREDIT CARD SERVICES; BILL PAYMENT SERVICES; PROVIDING PERSONAL LOANS AND LINES OF CREDIT (U.S. CLS. 100, 101 AND 102).

ZACHARY BELLO, EXAMINING ATTORNEY

SN 85-878,610. COLLEEN'S DREAM FOUNDATION, PHOENIX, AZ. FILED 3-18-2013.

**KICKING FOR THE DREAM**

THE MARK CONSISTS OF STANDARD CHARACTERS WITHOUT CLAIM TO ANY PARTICULAR FONT, STYLE, SIZE, OR COLOR.

FOR CHARITABLE FUNDRAISING SERVICES, NAMELY, ORGANIZING AND CONDUCTING SPECIAL EVENTS TO RAISE FUNDS IN THE FIELD OF OVARIAN CANCER RESEARCH (U.S. CLS. 100, 101 AND 102).

DOMINICK J. SALEMI, EXAMINING ATTORNEY

**CLASS 36—(Continued).**

SN 85-878,626. COLLEEN'S DREAM FOUNDATION, PHOENIX, AZ. FILED 3-18-2013.

BEATING CANCER ONE KICK AT  
A TIME

THE MARK CONSISTS OF STANDARD CHARACTERS WITHOUT CLAIM TO ANY PARTICULAR FONT, STYLE, SIZE, OR COLOR.

FOR CHARITABLE FUNDRAISING SERVICES, NAMELY, ORGANIZING AND CONDUCTING SPECIAL EVENTS TO RAISE FUNDS IN THE FIELD OF OVARIAN CANCER RESEARCH (U.S. CLS. 100, 101 AND 102).

DOMINICK J. SALEMI, EXAMINING ATTORNEY

SN 85-885,855. EDWARD D. JONES & CO. L. P., ST. LOUIS, MO. FILED 3-25-2013.

**BRIDGEBUILDER**

THE MARK CONSISTS OF STANDARD CHARACTERS WITHOUT CLAIM TO ANY PARTICULAR FONT, STYLE, SIZE, OR COLOR.

FOR MUTUAL FUND INVESTMENT (U.S. CLS. 100, 101 AND 102).

BRIDGETT SMITH, EXAMINING ATTORNEY

SN 85-885,866. EDWARD D. JONES & CO. L. P., ST. LOUIS, MO. FILED 3-25-2013.



THE COLOR(S) GREEN AND YELLOW IS/ARE CLAIMED AS A FEATURE OF THE MARK.

THE MARK CONSISTS OF THE WORD "BRIDGEBUILDER" APPEARING IN A STYLIZED MANNER, WITH EACH "B" IN THE WORD APPEARING IN UPPER CASE AND THE OTHER LETTERS APPEARING IN LOWER CASE, WITH THE "BRIDGE" PORTION OF THE WORD IN GREEN AND THE "BUILDER" PORTION OF THE WORD IN YELLOW, AND WITH AN ARCH APPEARING BENEATH THE WORD. THE PORTION OF THE ARCH THAT APPEARS BENEATH THE "EB" IN THE WORD APPEARS IN YELLOW, AND THE PORTION OF THE ARCH THAT APPEARS BENEATH THE "BUILDER" IN THE WORD APPEARS IN GREEN.

FOR MUTUAL FUND INVESTMENT (U.S. CLS. 100, 101 AND 102).

BRIDGETT SMITH, EXAMINING ATTORNEY

**CLASS 36—(Continued).**

SN 85-904,106. GRAY SERVICES L.L.C., PHOENIX, AZ. FILED 4-15-2013.



THE MARK CONSISTS OF A SQUARE BOX TILTED TOWARD THE LEFT ON TOP INCLUDING CURVED LINES AND OPEN CIRCLES.

FOR SHOPPING CENTER, OFFICE PARK AND INDUSTRIAL PARK SERVICES, NAMELY, LEASING OF COMMERCIAL AND INDUSTRIAL REAL ESTATE; REAL ESTATE LEASING; REAL ESTATE AGENCY SERVICES; REAL ESTATE BROKERAGE; REAL ESTATE MANAGEMENT; LEASING OF OFFICE SPACE; LEASING OF SHOPPING CENTER SPACE (U.S. CLS. 100, 101 AND 102).

FIRST USE 1-0-1999; IN COMMERCE 1-0-1999.  
DAVID H. STINE, EXAMINING ATTORNEY

**CLASS 36—(Continued).**

SN 85-915,026. WEIGHT LOSS SURGERY FOUNDATION OF AMERICA, DAVIS, CA. FILED 4-25-2013.



NO CLAIM IS MADE TO THE EXCLUSIVE RIGHT TO USE "WEIGHT LOSS SURGERY FOUNDATION OF AMERICA", APART FROM THE MARK AS SHOWN.

THE STIPLING IS A FEATURE OF THE MARK AND DOES NOT INDICATE COLOR.

THE MARK CONSISTS OF A CIRCLE THAT CONTAINS THREE PEOPLE HUGGING. THE CIRCLE IS WRAPPED IN A MEASURING TAPE CINCHING THE CIRCLE IN TOWARDS THE PEOPLE. ON TOP OF THE CIRCLE IS THE WORDS "WEIGHT LOSS SURGERY" AND UNDER THE CIRCLE IS "FOUNDATION OF AMERICA".

FOR PROVIDING GRANTS TO PEOPLE TO GET WEIGHT LOSS SURGERY AND OTHER RELATED MEDICAL PROCEDURES (U.S. CLS. 100, 101 AND 102).

FIRST USE 4-26-2010; IN COMMERCE 4-26-2010.  
HENRY S. ZAK, EXAMINING ATTORNEY

SN 85-910,879. BESTPASS, INC., ALBANY, NY. FILED 4-22-2013.



NO CLAIM IS MADE TO THE EXCLUSIVE RIGHT TO USE "BESTPASS", APART FROM THE MARK AS SHOWN.

THE COLOR(S) LIGHT BLUE, DARK BLUE, AND YELLOW IS/ARE CLAIMED AS A FEATURE OF THE MARK.

THE MARK CONSISTS OF THE DESIGN OF THREE GATES IN LIGHT BLUE WITH A YELLOW DOT AT THE TOP OF EACH GATE ABOVE THE WORD "BESTPASS" IN DARK BLUE.

FOR ELECTRONIC TOLL COLLECTION SERVICES, NAMELY, FINANCIAL MANAGEMENT AND PRE-PAID COLLECTION OF TOLLS FOR OTHERS (U.S. CLS. 100, 101 AND 102).

FIRST USE 10-1-2010; IN COMMERCE 10-1-2010.  
HANNO RITTNER, EXAMINING ATTORNEY

SN 85-916,287. QUICKEN LOANS INC., DETROIT, MI. FILED 4-26-2013.

MYQL

THE MARK CONSISTS OF STANDARD CHARACTERS WITHOUT CLAIM TO ANY PARTICULAR FONT, STYLE, SIZE, OR COLOR.

FOR LOAN FINANCING, CONSUMER LENDING SERVICES, MORTGAGE LENDING AND PROVIDING FINANCIAL INFORMATION ON LOANS ALL VIA ELECTRONIC MEANS (U.S. CLS. 100, 101 AND 102).

FIRST USE 6-21-2011; IN COMMERCE 6-21-2011.  
ANGELA DUONG, EXAMINING ATTORNEY

**CLASS 36—(Continued).**

SN 85-935,657. MOTORISTS MUTUAL INSURANCE COMPANY, COLUMBUS, OH. FILED 5-17-2013.



OWNER OF U.S. REG. NOS. 2,688,520, 4,261,073 AND OTHERS.

NO CLAIM IS MADE TO THE EXCLUSIVE RIGHT TO USE "MUTUAL INSURANCE COMPANY", APART FROM THE MARK AS SHOWN.

THE MARK CONSISTS OF BLOCK LETTERS "M" AND "I", TO THE RIGHT OF WHICH IS "MOTORISTS MUTUAL INSURANCE COMPANY A MEMBER OF THE MOTORISTS INSURANCE GROUP - YOU KNOW US".

SEC. 2(F) AS TO "MOTORISTS".

FOR UNDERWRITING SERVICES IN THE FIELD OF AUTO, HOME, BUSINESS, LIFE, AND PROPERTY AND CASUALTY INSURANCE (U.S. CLS. 100, 101 AND 102).

FIRST USE 7-20-2012; IN COMMERCE 7-20-2012.  
GIANCARLO CASTRO, EXAMINING ATTORNEY

SN 85-944,126. CARS 4 CAUSES, VENTURA, CA. FILED 5-28-2013.



NO CLAIM IS MADE TO THE EXCLUSIVE RIGHT TO USE "AMERICA'S 1ST VEHICLE DONATION CHARITY", APART FROM THE MARK AS SHOWN.

THE MARK CONSISTS OF THE WORDS "AMERICA'S", "1ST" AND "CHARITY" WITHIN A RIBBON AWARD DESIGN, AN OUTLINE AROUND THE NUMBER "1" AND THE WORDS "VEHICLE" AND "DONATION" WITHIN A RECTANGULAR BOX SUPERIMPOSED OVER THE RIBBON AWARD DESIGN.

FOR CHARITABLE FUNDRAISING SERVICES BY MEANS OF CHARITABLE FUNDRAISING FOR DONOR DESIGNATED CHARITIES, NAMELY, SOLICITING, REPAIRING, AND SELLING DONATED VEHICLES FOR CHARITABLE FUNDRAISING PURPOSES DIRECTED TO SAID DESIGNATED CHARITY (U.S. CLS. 100, 101 AND 102).

FIRST USE 1-6-2011; IN COMMERCE 1-6-2011.  
SHAILA LEWIS, EXAMINING ATTORNEY

**CLASS 36—(Continued).**

SN 85-949,230. BERKHEIMER OUTSOURCING, INC., DBA BERKHEIMER ONESOURCE, BETHLEHEM, PA. FILED 6-3-2013.

## Outsource, Insource or OneSource

THE MARK CONSISTS OF STANDARD CHARACTERS WITHOUT CLAIM TO ANY PARTICULAR FONT, STYLE, SIZE, OR COLOR.

FOR BILL PAYMENT SERVICES; BILL PAYMENT SERVICES PROVIDED THROUGH A WEBSITE; ELECTRONIC PAYMENT SERVICES INVOLVING ELECTRONIC PROCESSING AND SUBSEQUENT TRANSMISSION OF BILL PAYMENT DATA (U.S. CLS. 100, 101 AND 102).

FIRST USE 5-8-2013; IN COMMERCE 5-8-2013.  
SUSAN RICHARDS, EXAMINING ATTORNEY

SN 85-950,736. NATIONSTAR MORTGAGE LLC, LEWISVILLE, TX. FILED 6-4-2013.

## HELPING YOU ACHIEVE MORE

THE MARK CONSISTS OF STANDARD CHARACTERS WITHOUT CLAIM TO ANY PARTICULAR FONT, STYLE, SIZE, OR COLOR.

FOR MORTGAGE BANKING SERVICES, NAMELY, ORIGINATION, ACQUISITION, SERVICING, SECURITIZATION AND BROKERAGE OF MORTGAGE LOANS (U.S. CLS. 100, 101 AND 102).

FIRST USE 5-31-2010; IN COMMERCE 5-31-2010.  
KATHERINE CHANG, EXAMINING ATTORNEY

SN 85-957,157. THE REGENTS OF THE UNIVERSITY OF COLORADO, A BODY CORPORATE, DENVER, CO. FILED 6-11-2013.

## UNIVERSITY OF COLORADO HEALTH AND WELFARE PLAN

THE MARK CONSISTS OF STANDARD CHARACTERS WITHOUT CLAIM TO ANY PARTICULAR FONT, STYLE, SIZE, OR COLOR.

OWNER OF U.S. REG. NOS. 1,728,230, 3,912,904 AND 4,370,104.

NO CLAIM IS MADE TO THE EXCLUSIVE RIGHT TO USE "HEALTH AND WELFARE PLAN", APART FROM THE MARK AS SHOWN.

SEC. 2(F) AS TO "UNIVERSITY OF COLORADO".

FOR PROVIDING WELFARE BENEFIT PLANS FOR EMPLOYEES AND RETIREES (U.S. CLS. 100, 101 AND 102).

FIRST USE 7-1-2010; IN COMMERCE 7-1-2010.  
ANNE MADDEN, EXAMINING ATTORNEY

**CLASS 36—(Continued).**

SN 85-959,962. ACE LIMITED, ZURICH, SWITZERLAND, FILED 6-14-2013.

## ACE TRAVEL APP

THE MARK CONSISTS OF STANDARD CHARACTERS WITHOUT CLAIM TO ANY PARTICULAR FONT, STYLE, SIZE, OR COLOR.

OWNER OF U.S. REG. NOS. 2,778,828, 4,353,311 AND OTHERS.

NO CLAIM IS MADE TO THE EXCLUSIVE RIGHT TO USE "TRAVEL APP", APART FROM THE MARK AS SHOWN.

FOR INSURANCE UNDERWRITING SERVICES IN THE FIELD OF TRAVEL ACCIDENT SERVICES (U.S. CLS. 100, 101 AND 102).

ROGER T. MCDORMAN, EXAMINING ATTORNEY

SN 85-971,411. MCLEAN MORTGAGE CORPORATION, FAIRFAX, VA. FILED 6-27-2013.



NO CLAIM IS MADE TO THE EXCLUSIVE RIGHT TO USE "MCLEAN MORTGAGE CORPORATION", APART FROM THE MARK AS SHOWN.

THE COLOR(S) GOLD, BLUE AND BLACK IS/ARE CLAIMED AS A FEATURE OF THE MARK.

THE MARK CONSISTS OF A GOLD LEAF IN THE UPPER RIGHT HAND CORNER, OVER "MCLEAN" IN BLUE CAPITAL LETTERS DIRECTLY OVER "MORTGAGE COMPANY" IN BLACK CAPITAL LETTERS.

FOR FINANCIAL SERVICES, NAMELY, MORTGAGE PLANNING; FINANCIAL SERVICES, NAMELY, MORTGAGE REFINANCING; MORTGAGE BANKING; MORTGAGE BANKING SERVICES, NAMELY, ORIGINATION, ACQUISITION, SERVICING, SECURITIZATION AND BROKERAGE OF MORTGAGE LOANS; MORTGAGE LENDING; MORTGAGE SERVICES, NAMELY, BUYER PRE-QUALIFICATION OF MORTGAGES FOR MORTGAGE BROKERS AND BANKS (U.S. CLS. 100, 101 AND 102).

FIRST USE 5-1-2008; IN COMMERCE 5-1-2008.

C. DIONNE CLYBURN, EXAMINING ATTORNEY

**CLASS 36—(Continued).**

SN 85-971,438. MCLEAN MORTGAGE CORPORATION, FAIRFAX, VA. FILED 6-27-2013.

## THE RIGHT CHOICE FOR MORTGAGE LENDING

NO CLAIM IS MADE TO THE EXCLUSIVE RIGHT TO USE "MORTGAGE LENDING", APART FROM THE MARK AS SHOWN.

THE COLOR(S) GREY AND BLUE IS/ARE CLAIMED AS A FEATURE OF THE MARK.

THE MARK CONSISTS OF THE TEXT "THE RIGHT CHOICE FOR" IN CAPITAL GREY LETTERS FOLLOWED BY THE TEXT "MORTGAGE LENDING" IN CAPITAL BLUE LETTERS.

FOR FINANCIAL SERVICES, NAMELY, MORTGAGE PLANNING; FINANCIAL SERVICES, NAMELY, MORTGAGE REFINANCING; MORTGAGE BANKING; MORTGAGE BANKING SERVICES, NAMELY, ORIGINATION, ACQUISITION, SERVICING, SECURITIZATION AND BROKERAGE OF MORTGAGE LOANS; MORTGAGE LENDING; MORTGAGE SERVICES, NAMELY, BUYER PRE-QUALIFICATION OF MORTGAGES FOR MORTGAGE BROKERS AND BANKS (U.S. CLS. 100, 101 AND 102).

FIRST USE 1-1-2012; IN COMMERCE 1-1-2012.

C. DIONNE CLYBURN, EXAMINING ATTORNEY

SN 86-003,125. DEPARTMENT OF VETERANS AFFAIRS, WASHINGTON, DC. FILED 7-5-2013.

## VA Loan Electronic Reporting Interface

THE MARK CONSISTS OF STANDARD CHARACTERS WITHOUT CLAIM TO ANY PARTICULAR FONT, STYLE, SIZE, OR COLOR.

SEC. 2(F).

FOR PROVIDING AN INTERNET WEBSITE PORTAL FEATURING INFORMATION ON VA-GUARANTEED LOANS FOR OVERSIGHT PURPOSES (U.S. CLS. 100, 101 AND 102).

FIRST USE 3-1-2002; IN COMMERCE 11-14-2003.

KAREN K. BUSH, EXAMINING ATTORNEY

SN 86-003,934. ALLIANZ LIFE INSURANCE COMPANY OF NORTH AMERICA, MINNEAPOLIS, MN. FILED 7-8-2013.

## SIGNATURE 7

THE MARK CONSISTS OF STANDARD CHARACTERS WITHOUT CLAIM TO ANY PARTICULAR FONT, STYLE, SIZE, OR COLOR.

NO CLAIM IS MADE TO THE EXCLUSIVE RIGHT TO USE "7", APART FROM THE MARK AS SHOWN.

FOR ANNUITY UNDERWRITING; FINANCIAL ADVICE AND CONSULTANCY SERVICES; INSURANCE UNDERWRITING IN THE FIELD OF ANNUITIES; UNDERWRITING, ISSUANCE AND ADMINISTRATION OF ANNUITIES (U.S. CLS. 100, 101 AND 102).

JANICE L. MCMORROW, EXAMINING ATTORNEY



**CLASS 36—(Continued).**

SN 86-006,041. BOWERS, BILL, DALLAS, TX. FILED 7-10-2013.

**401K COMPANION**

THE MARK CONSISTS OF STANDARD CHARACTERS WITHOUT CLAIM TO ANY PARTICULAR FONT, STYLE, SIZE, OR COLOR.

NO CLAIM IS MADE TO THE EXCLUSIVE RIGHT TO USE "401K", APART FROM THE MARK AS SHOWN.

FOR FINANCIAL PLANNING FOR RETIREMENT; FINANCIAL ADMINISTRATION OF RETIREMENT PLANS (U.S. CLS. 100, 101 AND 102).

CHRISTINE MARTIN, EXAMINING ATTORNEY

---

SN 86-012,477. IUL TECHNOLOGIES, INC., OAKLAND PARK, FL. FILED 7-17-2013.

**myIUL**

THE MARK CONSISTS OF STANDARD CHARACTERS WITHOUT CLAIM TO ANY PARTICULAR FONT, STYLE, SIZE, OR COLOR.

FOR INSURANCE AND FINANCIAL INFORMATION AND CONSULTANCY SERVICES (U.S. CLS. 100, 101 AND 102).

FIRST USE 11-11-2011; IN COMMERCE 11-11-2011.

ANDREW LEASER, EXAMINING ATTORNEY

---

SN 86-019,434. CARDONA CASTLE LLC, NORTH CALDWELL, NJ. FILED 7-25-2013.



NO CLAIM IS MADE TO THE EXCLUSIVE RIGHT TO USE THE GREEK LETTER "ALPHA", APART FROM THE MARK AS SHOWN.

THE MARK CONSISTS OF GREEK LETTER ALPHA INSCRIBED WITHIN A SERIES OF CLOUD-LIKE ELEMENTS.

FOR FINANCIAL INFORMATION PROVIDED BY ELECTRONIC MEANS (U.S. CLS. 100, 101 AND 102).

DORITT L. CARROLL, EXAMINING ATTORNEY

**CLASS 36—(Continued).**

SN 86-019,441. CARDONA CASTLE LLC, NORTH CALDWELL, NJ. FILED 7-25-2013.

**visible alpha**

THE MARK CONSISTS OF STANDARD CHARACTERS WITHOUT CLAIM TO ANY PARTICULAR FONT, STYLE, SIZE, OR COLOR.

NO CLAIM IS MADE TO THE EXCLUSIVE RIGHT TO USE "ALPHA", APART FROM THE MARK AS SHOWN.

FOR FINANCIAL INFORMATION PROVIDED BY ELECTRONIC MEANS (U.S. CLS. 100, 101 AND 102).

DORITT L. CARROLL, EXAMINING ATTORNEY

---

SN 86-021,300. VISION SERVICE PLAN, RANCHO CORDOVA, CA. FILED 7-26-2013.



THE MARK CONSISTS OF THE WORD "LOOK" WHERE THE LETTERS "O" AND "O" ARE REPLACED WITH THE FRAME OF A PAIR OF GLASSES.

FOR ADMINISTRATION OF PREFERRED PROVIDER PLANS IN THE FIELD OF VISION CARE (U.S. CLS. 100, 101 AND 102).

FIRST USE 6-5-2013; IN COMMERCE 6-5-2013.

PATRICIA EVANKO, EXAMINING ATTORNEY

---

SN 86-021,831. SAVAGE, TODD, MOYIE SPRINGS, ID. FILED 7-28-2013.

**Survival Retreat Consulting**

THE MARK CONSISTS OF STANDARD CHARACTERS WITHOUT CLAIM TO ANY PARTICULAR FONT, STYLE, SIZE, OR COLOR.

NO CLAIM IS MADE TO THE EXCLUSIVE RIGHT TO USE "CONSULTING", APART FROM THE MARK AS SHOWN.

FOR REAL ESTATE CONSULTANCY (U.S. CLS. 100, 101 AND 102).

FIRST USE 9-1-2012; IN COMMERCE 9-1-2012.

SHAUNIA CARLYLE, EXAMINING ATTORNEY

**CLASS 36—(Continued).**

SN 86-023,059. NATIONAL FIRE & MARINE INSURANCE COMPANY, OMAHA, NE. FILED 7-30-2013.



NO CLAIM IS MADE TO THE EXCLUSIVE RIGHT TO USE "SPECIALTY INSURANCE A DIVISION OF THE" AND "GROUP OF INSURANCE COMPANIES", APART FROM THE MARK AS SHOWN.

THE MARK CONSISTS OF THE WORDING "SPECIALTY INSURANCE" ON TWO LINES. TO THE LEFT OF THIS WORDING ARE THE LETTERS "BH" IN LOWER CASE LETTERING INSIDE A SINGLE LINE SQUARE WITH TWO OPENINGS. BELOW THE SQUARE IS THE WORDING "A DIVISION OF THE BERKSHIRE HATHAWAY" ABOVE THE WORDING "GROUP OF INSURANCE COMPANIES".

FOR INSURANCE UNDERWRITING IN THE FIELD OF PROPERTY, CASUALTY, PROFESSIONAL AND EXECUTIVE LIABILITY INSURANCE (U.S. CLS. 100, 101 AND 102).

FIRST USE 7-15-2013; IN COMMERCE 7-15-2013.  
WENDY JUN, EXAMINING ATTORNEY

**CLASS 36—(Continued).**

SN 86-024,700. MARSHALL & STERLING INC., POUGH-KEEPSIE, NY. FILED 7-31-2013.

## MARSHALL & STERLING INSURANCE

THE MARK CONSISTS OF STANDARD CHARACTERS WITHOUT CLAIM TO ANY PARTICULAR FONT, STYLE, SIZE, OR COLOR.

NO CLAIM IS MADE TO THE EXCLUSIVE RIGHT TO USE "INSURANCE", APART FROM THE MARK AS SHOWN.

FOR INSURANCE BROKERAGE; INSURANCE SERVICES, NAMELY, UNDERWRITING BUSINESS, HOME, AUTO, LIFE, AND GROUP HEALTH INSURANCE; PROCESSING, ADMINISTERING AND MANAGING EMPLOYEE BENEFIT PLANS CONCERNING INSURANCE; ADMINISTRATION OF PRE-PAID HEALTH CARE PLANS AND ORGANIZING PRE-PAID HEALTH CARE PLANS; FINANCIAL AND INVESTMENT SERVICES, NAMELY, MANAGEMENT AND BROKERAGE IN THE FIELDS OF FIDELITY AND FIDUCIARY BONDS AND FINANCIAL SPECIALTY RISK MANAGEMENT, FINANCIAL PLANNING AND WEALTH MANAGEMENT SERVICES (U.S. CLS. 100, 101 AND 102).

FIRST USE 12-21-1920; IN COMMERCE 12-21-1920.  
LOURDES AYALA, EXAMINING ATTORNEY

SN 86-025,470. REVENUEWIRE INC., VICTORIA, B.C., CANADA, FILED 7-31-2013.

## AFFILIATEWIRE

THE MARK CONSISTS OF STANDARD CHARACTERS WITHOUT CLAIM TO ANY PARTICULAR FONT, STYLE, SIZE, OR COLOR.

FOR PROVIDING ELECTRONIC PROCESSING OF ACH TRANSACTIONS (U.S. CLS. 100, 101 AND 102).  
AMY KERTGATE, EXAMINING ATTORNEY

SN 86-024,308. YESKE BUIE INC., SAN FRANCISCO, CA. FILED 7-31-2013.

## EVIDENCE-BASED FINANCIAL PLANNING

THE MARK CONSISTS OF STANDARD CHARACTERS WITHOUT CLAIM TO ANY PARTICULAR FONT, STYLE, SIZE, OR COLOR.

OWNER OF U.S. REG. NO. 3,855,201.

NO CLAIM IS MADE TO THE EXCLUSIVE RIGHT TO USE "FINANCIAL PLANNING", APART FROM THE MARK AS SHOWN.

SEC. 2(F).

FOR FINANCIAL PLANNING AND INVESTMENT MANAGEMENT SERVICES (U.S. CLS. 100, 101 AND 102).

FIRST USE 5-0-2008; IN COMMERCE 5-0-2008.

AMY KELLY, EXAMINING ATTORNEY

SN 86-025,746. AMERICAN INTERNATIONAL GROUP, INC., NEW YORK, NY. FILED 8-1-2013.

## LIFETIME INCOME PLUS

THE MARK CONSISTS OF STANDARD CHARACTERS WITHOUT CLAIM TO ANY PARTICULAR FONT, STYLE, SIZE, OR COLOR.

OWNER OF U.S. REG. NO. 4,079,705.

NO CLAIM IS MADE TO THE EXCLUSIVE RIGHT TO USE "LIFETIME INCOME", APART FROM THE MARK AS SHOWN.

FOR ANNUITY UNDERWRITING; ISSUANCE AND ADMINISTRATION OF ANNUITIES (U.S. CLS. 100, 101 AND 102).

FIRST USE 7-29-2013; IN COMMERCE 7-29-2013.

SAMUAL PAQUIN, EXAMINING ATTORNEY

**CLASS 36—(Continued).**

SN 86-025,791. LEXINGTON FAMILY OFFICE & TRUST, LLC, DAYTONA BEACH, FL. FILED 8-1-2013.

**Lexington Family Office & Trust**

THE MARK CONSISTS OF STANDARD CHARACTERS WITHOUT CLAIM TO ANY PARTICULAR FONT, STYLE, SIZE, OR COLOR.

NO CLAIM IS MADE TO THE EXCLUSIVE RIGHT TO USE "FAMILY OFFICE & TRUST", APART FROM THE MARK AS SHOWN.

FOR FINANCIAL SERVICES, NAMELY, WEALTH MANAGEMENT SERVICES; FINANCIAL TRUST ADMINISTRATION; FINANCIAL TRUST PLANNING; INVESTMENT MANAGEMENT (U.S. CLS. 100, 101 AND 102).

KEVIN MITTLER, EXAMINING ATTORNEY



SN 86-026,230. MEMBER ONE FEDERAL CREDIT UNION, ROANOKE, VA. FILED 8-1-2013.

**SAVE THIS BUY THAT**

THE MARK CONSISTS OF STANDARD CHARACTERS WITHOUT CLAIM TO ANY PARTICULAR FONT, STYLE, SIZE, OR COLOR.

FOR PROVIDING EDUCATIONAL FINANCIAL TIPS CONCERNING HOW BEST TO HANDLE MONEY WISELY, TO SHOP, AND TO SAVE (U.S. CLS. 100, 101 AND 102).

FIRST USE 7-16-2012; IN COMMERCE 7-16-2012.  
MICHAEL WIENER, EXAMINING ATTORNEY



SN 86-028,043. PROFESSOR DIDIER SORNETTE, GOKHAUSEN, SWITZERLAND, FILED 8-3-2013.

**DS LPPL Confidence**

THE MARK CONSISTS OF STANDARD CHARACTERS WITHOUT CLAIM TO ANY PARTICULAR FONT, STYLE, SIZE, OR COLOR.

FOR FINANCIAL ANALYSIS; FINANCIAL RESEARCH AND INFORMATION SERVICES; FINANCIAL SERVICES, NAMELY, PROVIDING INFORMATION IN THE FIELDS OF FOREIGN CURRENCY, COMMODITIES, FINANCIAL DERIVATIVES, INTEREST RATE PRODUCTS, AND EQUITIES VIA THE INTERNET AND INTRANET SYSTEMS (U.S. CLS. 100, 101 AND 102).  
RAUL CORDOVA, EXAMINING ATTORNEY

**CLASS 36—(Continued).**

SN 86-028,075. PROFESSOR DIDIER SORNETTE, GOKHAUSEN, SWITZERLAND, FILED 8-3-2013.

**DS LPPL Trust**

THE MARK CONSISTS OF STANDARD CHARACTERS WITHOUT CLAIM TO ANY PARTICULAR FONT, STYLE, SIZE, OR COLOR.

FOR FINANCIAL ANALYSIS; FINANCIAL RESEARCH AND INFORMATION SERVICES; FINANCIAL SERVICES, NAMELY, PROVIDING INFORMATION IN THE FIELDS OF FOREIGN CURRENCY, COMMODITIES, FINANCIAL DERIVATIVES, INTEREST RATE PRODUCTS, AND EQUITIES VIA THE INTERNET AND INTRANET SYSTEMS (U.S. CLS. 100, 101 AND 102).  
RAUL CORDOVA, EXAMINING ATTORNEY



SN 86-033,329. ALTAVISTA WEALTH MANAGEMENT, INC., ASHEVILLE, NC. FILED 8-9-2013.

**ALTAVISTA WEALTH MANAGEMENT**

THE MARK CONSISTS OF STANDARD CHARACTERS WITHOUT CLAIM TO ANY PARTICULAR FONT, STYLE, SIZE, OR COLOR.

NO CLAIM IS MADE TO THE EXCLUSIVE RIGHT TO USE "WEALTH MANAGEMENT", APART FROM THE MARK AS SHOWN.

THE ENGLISH TRANSLATION OF "ALTA VISTA" IS "HIGH VIEW".

FOR FINANCIAL PLANNING, WEALTH MANAGEMENT AND FINANCIAL ASSET MANAGEMENT SERVICES (U.S. CLS. 100, 101 AND 102).  
FIRST USE 3-21-2003; IN COMMERCE 3-21-2003.  
DAWN FELDMAN, EXAMINING ATTORNEY

**CLASS 36—(Continued).**

SN 86-035,031. REPUBLICAN PARTY OF PENNSYLVANIA, HARRISBURG, PA. FILED 8-12-2013.



NO CLAIM IS MADE TO THE EXCLUSIVE RIGHT TO USE "CLUB" AND THE PICTORIAL REPRESENTATION OF THE COMMONWEALTH OF PENNSYLVANIA, APART FROM THE MARK AS SHOWN.

THE COLOR(S) GOLD AND RED IS/ARE CLAIMED AS A FEATURE OF THE MARK.

THE MARK CONSISTS OF A RED ELEPHANT SILHOUETTE OVERLAYING A GOLD SHAPE OF THE COMMONWEALTH OF PENNSYLVANIA, BELOW THE ELEPHANT IS THE WORD "COMMONWEALTH" IN RED CAPITAL LETTERS AND UNDERLINED IN GOLD, AND BELOW THAT IS THE WORD "CLUB" IN RED CAPITAL LETTERS AND FLANKED BY TWO GOLD STARS ON EACH SIDE.

FOR POLITICAL FUNDRAISING SERVICES (U.S. CLS. 100, 101 AND 102).

FIRST USE 1-1-2011; IN COMMERCE 1-1-2011.  
DOUGLAS LEE, EXAMINING ATTORNEY

SN 86-035,223. FIRST FLORIDIAN REALTY & FINANCE LLC, WINTER PARK, FL. FILED 8-12-2013.

**FIRST FLORIDIAN**

THE MARK CONSISTS OF STANDARD CHARACTERS WITHOUT CLAIM TO ANY PARTICULAR FONT, STYLE, SIZE, OR COLOR.

NO CLAIM IS MADE TO THE EXCLUSIVE RIGHT TO USE "FLORIDIAN", APART FROM THE MARK AS SHOWN.

FOR ASSESSMENT AND MANAGEMENT OF REAL ESTATE; COMMERCIAL AND RESIDENTIAL REAL ESTATE AGENCY SERVICES; LEASING OF REAL ESTATE; REAL ESTATE AGENCIES; REAL ESTATE CONSULTATION; RENTAL OF APARTMENTS AND OFFICES; REAL ESTATE BROKERAGE; REAL ESTATE FINANCING SERVICES; REAL ESTATE INVESTMENT SERVICES; REAL ESTATE MANAGEMENT SERVICES; FINANCIAL SERVICES, NAMELY, MORTGAGE PLANNING, LOSS MITIGATION SERVICES FOR UNDER- OR NON-PERFORMING MORTGAGE LOANS, MORTGAGE REFINANCING; MORTGAGE BANKING SERVICES, NAMELY, ORIGINATION, ACQUISITION, SERVICING, SECURITIZATION AND BROKERAGE OF MORTGAGE LOANS; MORTGAGE FORECLOSURE SERVICES; FINANCIAL INFORMATION AND EVALUATIONS; FINANCIAL EVALUATION, TRACKING, ANALYSIS, FORECASTING, CONSULTANCY, ADVISORY AND RESEARCH SERVICES RELATING TO SECURITIES AND OTHER FINANCIAL INSTRUMENTS (U.S. CLS. 100, 101 AND 102).

FIRST USE 1-30-2008; IN COMMERCE 1-30-2008.  
EDWARD FENNESSY, EXAMINING ATTORNEY

**CLASS 36—(Continued).**

SN 86-035,266. POPULAR, INC., SAN JUAN, PUERTO RICO, FILED 8-12-2013.



OWNER OF U.S. REG. NOS. 1,008,477, 1,882,478 AND 4,297,682.

NO CLAIM IS MADE TO THE EXCLUSIVE RIGHT TO USE "5 K", APART FROM THE MARK AS SHOWN.

THE COLOR(S) WHITE, DARK BLUE, RED AND LIGHT BLUE IS/ARE CLAIMED AS A FEATURE OF THE MARK.

THE MARK CONSISTS OF THE LARGE NUMBER "5" IN WHITE ON THE LEFT, THE LETTER "K" TO THE RIGHT IN DARK BLUE, A RED SQUARE BENEATH THE "K" WITH A WHITE CIRCLE IN THE CENTER AND LETTERS "BPPR" IN RED INSIDE THE CIRCLE; INSIDE A LARGE SQUARE BACKGROUND IN LIGHT BLUE.

FOR CHARITABLE FUNDRAISING SERVICES BY MEANS OF RUNNING AND WALKING EVENTS (U.S. CLS. 100, 101 AND 102).

FIRST USE 6-13-2011; IN COMMERCE 6-13-2011.  
CAITLIN WATTS-FITZGERALD, EXAMINING ATTORNEY

SN 86-035,308. REPUBLICAN PARTY OF PENNSYLVANIA, HARRISBURG, PA. FILED 8-12-2013.



NO CLAIM IS MADE TO THE EXCLUSIVE RIGHT TO USE "CLUB" AND THE PICTORIAL REPRESENTATION OF THE COMMONWEALTH OF PENNSYLVANIA, APART FROM THE MARK AS SHOWN.

THE COLOR(S) GOLD AND RED IS/ARE CLAIMED AS A FEATURE OF THE MARK.

THE MARK CONSISTS OF A RED ELEPHANT SILHOUETTE OVERLAYING A GOLD SHAPE OF THE COMMONWEALTH OF PENNSYLVANIA, TO THE RIGHT OF THE ELEPHANT IS THE WORD "COMMONWEALTH" IN RED CAPITAL LETTERS AND UNDERLINED IN GOLD, AND BELOW THAT IS THE WORD "CLUB" IN RED CAPITAL LETTERS AND FLANKED BY TWO GOLD STARS ON EACH SIDE.

FOR POLITICAL FUNDRAISING SERVICES (U.S. CLS. 100, 101 AND 102).

FIRST USE 1-1-2011; IN COMMERCE 1-1-2011.  
DOUGLAS LEE, EXAMINING ATTORNEY

**CLASS 36—(Continued).**

SN 86-035,470. CONFIDENT FINANCIAL SOLUTIONS, INC., BOULDER, CO. FILED 8-12-2013.



NO CLAIM IS MADE TO THE EXCLUSIVE RIGHT TO USE "FINANCIAL SOLUTIONS", APART FROM THE MARK AS SHOWN.

THE MARK CONSISTS OF THE INITIALS "CFS" WITH AN ARC SHAPE FLOWING BACK AND DOWNWARD FROM THE "F" AND A VERTICAL LINE TO THE RIGHT OF "CFS" AND THE WORDS "CONFIDENT FINANCIAL SOLUTIONS" IN VERTICAL ALIGNMENT TO THE RIGHT OF THE VERTICAL LINE.

FOR AUTOMOTIVE REPAIR FINANCING; FINANCING OF LOANS FOR AUTOMOTIVE REPAIRS; UNDERWRITING WARRANTY PROGRAMS IN THE FIELD OF AUTOMOTIVE REPAIR AND AUTOMOTIVE PRODUCTS; INSURANCE SERVICES, NAMELY, UNDERWRITING EXTENDED WARRANTY CONTRACTS IN THE FIELD AUTOMOTIVE REPAIR AND AUTOMOTIVE PRODUCTS (U.S. CLS. 100, 101 AND 102).

CAITLIN WATTS-FITZGERALD, EXAMINING ATTORNEY

---

SN 86-036,389. SOUTH DAKOTA TRUST COMPANY, LLC, SIOUX FALLS, SD. FILED 8-13-2013.

# SDTC

THE MARK CONSISTS OF STANDARD CHARACTERS WITHOUT CLAIM TO ANY PARTICULAR FONT, STYLE, SIZE, OR COLOR.

FOR TRUST SERVICES, NAMELY, INVESTMENT AND TRUST COMPANY SERVICES, AND TRUST ADMINISTRATION, NAMELY, FINANCIAL TRUST ADMINISTRATION, ESTATE TRUST ADMINISTRATION, AND REAL ESTATE TRUST ADMINISTRATION (U.S. CLS. 100, 101 AND 102).

FIRST USE 5-0-2002; IN COMMERCE 5-0-2002.

MARYNELLE WILSON, EXAMINING ATTORNEY

**CLASS 36—(Continued).**

SN 86-037,718. EDGEWATER MARKETS LLC, DBA FX PRIME TRADER, NEW YORK, NY. FILED 8-14-2013.

## FX Prime Trader

NO CLAIM IS MADE TO THE EXCLUSIVE RIGHT TO USE "FX" AND "TRADER", APART FROM THE MARK AS SHOWN.

THE COLOR(S) RED AND BLACK IS/ARE CLAIMED AS A FEATURE OF THE MARK.

THE MARK CONSISTS OF THE WORDING "FX PRIME" IN BLACK OVER THE WORDING "TRADER" IN BLACK WITH A RED LINE BETWEEN THE TWO ROWS OF LETTERING.

FOR FINANCIAL SERVICES, NAMELY, PROVIDING FOR THE EXCHANGE OF FOREIGN CURRENCY, COMMODITIES, FINANCIAL DERIVATIVES, INTEREST RATE PRODUCTS, AND EQUITIES VIA THE INTERNET AND INTRANET SYSTEMS (U.S. CLS. 100, 101 AND 102).

KAPIL BHANOT, EXAMINING ATTORNEY

---

SN 86-038,192. BRISKWATER, LLC, FAIRFAX, VA. FILED 8-14-2013.

## Barringer Point

THE MARK CONSISTS OF STANDARD CHARACTERS WITHOUT CLAIM TO ANY PARTICULAR FONT, STYLE, SIZE, OR COLOR.

FOR FINANCIAL SERVICES, NAMELY, OPERATION AND MANAGEMENT OF HEDGE FUNDS, COMMODITY POOLS AND OTHER COLLECTIVE INVESTMENT VEHICLES, AND TRADING FOR OTHERS OF SECURITIES, OPTIONS, FUTURES, DERIVATIVES, DEBT INSTRUMENTS AND COMMODITIES (U.S. CLS. 100, 101 AND 102).

SUSAN RICHARDS, EXAMINING ATTORNEY

---

SN 86-038,240. ANDREWS ADVISORY ASSOCIATES, LLC, HONOLULU, HI. FILED 8-14-2013.

## DIVIDEND BOOSTERS DISCIPLINE

THE MARK CONSISTS OF STANDARD CHARACTERS WITHOUT CLAIM TO ANY PARTICULAR FONT, STYLE, SIZE, OR COLOR.

NO CLAIM IS MADE TO THE EXCLUSIVE RIGHT TO USE "DIVIDEND" OR "DISCIPLINE", APART FROM THE MARK AS SHOWN.

FOR FINANCIAL PORTFOLIO MANAGEMENT (U.S. CLS. 100, 101 AND 102).

WILLIAM JACKSON, EXAMINING ATTORNEY

**CLASS 36—(Continued).**

SN 86-038,503. CIGNA INTELLECTUAL PROPERTY, INC., WILMINGTON, DE. FILED 8-15-2013.

## CIGNA MEDICARE RX SECURE-XTRA

THE MARK CONSISTS OF STANDARD CHARACTERS WITHOUT CLAIM TO ANY PARTICULAR FONT, STYLE, SIZE, OR COLOR.

OWNER OF U.S. REG. NOS. 3,419,585, 3,470,116 AND OTHERS.

NO CLAIM IS MADE TO THE EXCLUSIVE RIGHT TO USE "MEDICARE RX", APART FROM THE MARK AS SHOWN.

FOR UNDERWRITING AND ADMINISTRATION OF MEDICARE PART D PRESCRIPTION DRUG PLANS FOR INDIVIDUALS ELIGIBLE FOR MEDICARE (U.S. CLS. 100, 101 AND 102).

AMY HELLA, EXAMINING ATTORNEY

---

SN 86-038,510. CIGNA INTELLECTUAL PROPERTY, INC., WILMINGTON, DE. FILED 8-15-2013.

## CIGNA MEDICARE RX SECURE

THE MARK CONSISTS OF STANDARD CHARACTERS WITHOUT CLAIM TO ANY PARTICULAR FONT, STYLE, SIZE, OR COLOR.

OWNER OF U.S. REG. NOS. 3,419,585, 3,470,116 AND OTHERS.

NO CLAIM IS MADE TO THE EXCLUSIVE RIGHT TO USE "MEDICARE RX", APART FROM THE MARK AS SHOWN.

FOR UNDERWRITING AND ADMINISTRATION OF MEDICARE PART D PRESCRIPTION DRUG PLANS FOR INDIVIDUALS ELIGIBLE FOR MEDICARE (U.S. CLS. 100, 101 AND 102).

AMY HELLA, EXAMINING ATTORNEY

---

SN 86-038,517. CIGNA INTELLECTUAL PROPERTY, INC., WILMINGTON, DE. FILED 8-15-2013.

## CIGNA MEDICARE RX SECURE-MAX

THE MARK CONSISTS OF STANDARD CHARACTERS WITHOUT CLAIM TO ANY PARTICULAR FONT, STYLE, SIZE, OR COLOR.

OWNER OF U.S. REG. NOS. 3,419,585, 3,470,116 AND OTHERS.

NO CLAIM IS MADE TO THE EXCLUSIVE RIGHT TO USE "MEDICARE RX", APART FROM THE MARK AS SHOWN.

FOR UNDERWRITING AND ADMINISTRATION OF MEDICARE PART D PRESCRIPTION DRUG PLANS FOR INDIVIDUALS ELIGIBLE FOR MEDICARE (U.S. CLS. 100, 101 AND 102).

AMY HELLA, EXAMINING ATTORNEY

**CLASS 36—(Continued).**

SN 86-039,354. ROOT CAPITAL, INC., CAMBRIDGE, MA. FILED 8-15-2013.

## ROOT CAPITAL

THE MARK CONSISTS OF STANDARD CHARACTERS WITHOUT CLAIM TO ANY PARTICULAR FONT, STYLE, SIZE, OR COLOR.

OWNER OF U.S. REG. NOS. 3,575,444, 3,687,066 AND OTHERS.

NO CLAIM IS MADE TO THE EXCLUSIVE RIGHT TO USE "CAPITAL", APART FROM THE MARK AS SHOWN.

FOR CAPITAL INVESTMENT SERVICES FOR THE PURPOSE OF PROVIDING CAPITAL TO BUSINESSES IN DEVELOPING COUNTRIES IN ORDER TO PROMOTE ECONOMIC DEVELOPMENT AND SOUND ENVIRONMENTAL PRACTICES (U.S. CLS. 100, 101 AND 102).

FIRST USE 5-31-2007; IN COMMERCE 5-31-2007.

ELIZABETH JACKSON, EXAMINING ATTORNEY

---

SN 86-039,858. SANCTIFIED SOULS, VALPARAISO, IN. FILED 8-16-2013.



THE MARK CONSISTS OF THE STYLIZED WORDS "SANCTIFIED SOULS". THERE IS A ROCKER BOX THAT READS "SANCTIFIED SOULS". BELOW THAT IS A FREE FLOATING GARGOYLE.

FOR FUNDRAISING SERVICES, BY MEANS OF ORGANIZING, ARRANGING AND CONDUCTING FUNDRAISING PROGRAMS FOR THE BENEFIT OF SCHOOLS AND NON-PROFIT ORGANIZATIONS (U.S. CLS. 100, 101 AND 102).

ANDREA BUTLER, EXAMINING ATTORNEY

**CLASS 36—(Continued).**

SN 86-039,920. PURDUE FEDERAL CREDIT UNION, WEST LAFAYETTE, IN. FILED 8-16-2013.

# My Member Perks

THE MARK CONSISTS OF STANDARD CHARACTERS WITHOUT CLAIM TO ANY PARTICULAR FONT, STYLE, SIZE, OR COLOR.

NO CLAIM IS MADE TO THE EXCLUSIVE RIGHT TO USE "MEMBER PERKS", APART FROM THE MARK AS SHOWN.

FOR CREDIT UNION SERVICES FEATURING MEMBER RELATIONSHIP REWARDS AND LOYALTY PROGRAMS (U.S. CLS. 100, 101 AND 102).

FIRST USE 4-25-2013; IN COMMERCE 8-1-2013.  
JEFF DEFORD, EXAMINING ATTORNEY

**CLASS 36—(Continued).**

SN 86-041,214. ASHTON STEWART & CO. INC., NEW YORK, NY. FILED 8-19-2013.

# ASHTON STEWART

THE MARK CONSISTS OF STANDARD CHARACTERS WITHOUT CLAIM TO ANY PARTICULAR FONT, STYLE, SIZE, OR COLOR.

THE NAME "ASHTON STEWART" DOES NOT IDENTIFY A LIVING INDIVIDUAL.

FOR INVESTMENT BANKING SERVICES; FINANCIAL ADVISORY AND CONSULTANCY SERVICES; CAPITAL RAISING SERVICES FOR OTHERS (U.S. CLS. 100, 101 AND 102).

FIRST USE 11-0-2010; IN COMMERCE 11-0-2010.  
CURTIS FRENCH, EXAMINING ATTORNEY

SN 86-040,613. FUNDACION TELETON MEXICO, A.C., TLALNEPANTLA DE BAZ, MEXICO, FILED 8-16-2013.



OWNER OF U.S. REG. NOS. 2,972,929, 4,197,670 AND OTHERS.

THE COLOR(S) WHITE, YELLOW AND PURPLE IS/ARE CLAIMED AS A FEATURE OF THE MARK.

THE MARK CONSISTS OF A YELLOW AND PURPLE HEART WITH WHITE HANDS AND A DIAGONAL WHITE BAND SUPERIMPOSED OVER THE HEART.

FOR CHARITABLE FUNDRAISING; CHARITABLE FUNDRAISING SERVICES BY MEANS OF AN ENTERTAINMENT EVENT; CHARITABLE FUNDRAISING SERVICES BY MEANS OF MUSICAL CONCERTS; CHARITABLE FUNDRAISING SERVICES BY MEANS OF ORGANIZING AND CONDUCTING SPECIAL EVENTS; CHARITABLE FUNDRAISING SERVICES, BY MEANS OF ELEEMOSYNARY SERVICES IN THE FIELD OF COLLECTION, MANAGEMENT, AND DISBURSEMENTS OF MONEY IN CONNECTION WITH PROGRAMS AND FACILITIES FOR THE WELFARE OF CHILDREN; ELEEMOSYNARY SERVICES IN THE FIELD OF MONETARY DONATIONS (U.S. CLS. 100, 101 AND 102).

KAREN K. BUSH, EXAMINING ATTORNEY

SN 86-041,857. DEL REY URBAN CAPITAL, LLC, SANTA MONICA, CA. FILED 8-19-2013.

# DRU Brokerage

THE MARK CONSISTS OF STANDARD CHARACTERS WITHOUT CLAIM TO ANY PARTICULAR FONT, STYLE, SIZE, OR COLOR.

NO CLAIM IS MADE TO THE EXCLUSIVE RIGHT TO USE "BROKERAGE", APART FROM THE MARK AS SHOWN.

FOR REAL ESTATE BROKERAGE (U.S. CLS. 100, 101 AND 102).

FIRST USE 8-1-2013; IN COMMERCE 8-1-2013.  
COLLEEN DOMBROW, EXAMINING ATTORNEY

**CLASS 36—(Continued).**

SN 86-042,115. WORLD WIDE INSURANCE SERVICES, INC., MESA, AZ. FILED 8-19-2013.



NO CLAIM IS MADE TO THE EXCLUSIVE RIGHT TO USE "HEALTH INSURANCE EXPRESS", APART FROM THE MARK AS SHOWN.

THE COLOR(S) BLUE, WHITE, AND ORANGE IS/ARE CLAIMED AS A FEATURE OF THE MARK.

THE MARK CONSISTS OF THE STACKED WORDING "HEALTH INSURANCE EXPRESS" WHEREIN "HEALTH" APPEARS IN BLUE, "INSURANCE" APPEARS IN ORANGE, AND "EXPRESS" APPEARS IN BLUE WITH WHITE GRADIENT SHADING. A WHITE STAR APPEARS AT THE CENTER OF THE "A" IN "HEALTH", AND THIS STAR IS TRAILED BY A WHITE AND ORANGE COMET. THE BACKGROUND OF THE MARK IS A WHITE RECTANGLE FOR INSURANCE BROKERAGE SERVICES (U.S. CLS. 100, 101 AND 102).

ANDREA HACK, EXAMINING ATTORNEY

**CLASS 36—(Continued).**

SN 86-042,904. SOURCE INTERNATIONAL, INC., ORANGE PARK, FL. FILED 8-20-2013.



NO CLAIM IS MADE TO THE EXCLUSIVE RIGHT TO USE "INTERNATIONAL INSURANCE & FINANCIAL SERVICES", APART FROM THE MARK AS SHOWN.

THE MARK CONSISTS OF THE WORD "SOURCE" TO THE LEFT OF AN IMAGE OF A SUN. UNDERNEATH IS A LINE AND THEN THE WORD "INTERNATIONAL" AND THE WORDS "INSURANCE & FINANCIAL SERVICES" ARE LOCATED UNDERNEATH THE "NATIONAL" IN "INTERNATIONAL".

FOR FINANCING SERVICES; FINANCIAL SERVICES, NAMELY, PROVIDING FINANCING OF IN-STORE PURCHASES ON BEHALF OF MERCHANTS (U.S. CLS. 100, 101 AND 102).

FIRST USE 1-0-2006; IN COMMERCE 1-0-2006.  
DEBORAH LOBO, EXAMINING ATTORNEY

SN 86-042,564. PROVIDENT HEALTHCARE PARTNERS, LLC, BOSTON, MA. FILED 8-20-2013.



THE COLOR(S) BLUE AND WHITE IS/ARE CLAIMED AS A FEATURE OF THE MARK.

THE MARK CONSISTS OF A WHITE GEOMETRIC SUNBURST DESIGN ON A BLUE DIAMOND SHAPE. THE WHITE BACKGROUND IS USED TO SHOW PLACEMENT, AND IS NOT CLAIMED AS A FEATURE OF THE MARK.

FOR INVESTMENT BANKING SERVICES; MERCHANT BANKING SERVICES; PRIVATE EQUITY CONSULTANT SERVICES; VENTURE CAPITAL ADVISORY SERVICES (U.S. CLS. 100, 101 AND 102).

FIRST USE 7-1-2002; IN COMMERCE 7-1-2002.  
EVIN L. KOZAK, EXAMINING ATTORNEY

SN 86-043,092. DOWN SYNDROME ASSOCIATION OF SOUTH TEXAS, SAN ANTONIO, TX. FILED 8-20-2013.



THE MARK CONSISTS OF TWO STYLIZED INDIVIDUALS HOLDING HANDS, WITH THE ARMS AND LEGS OF THE TWO INDIVIDUALS FORMING A HEART SHAPE, AND THE STYLIZED WORDING "HELP US GIVE SUPPORT" ABOVE THE WORDING "HUGS".

FOR CHARITABLE FOUNDATION SERVICES, NAMELY, PROVIDING FUNDRAISING ACTIVITIES, FUNDING, SCHOLARSHIPS AND/OR FINANCIAL ASSISTANCE FOR INDIVIDUALS WITH DOWN SYNDROME, DEVELOPMENTAL DISABILITIES, AND SPECIAL NEEDS; CHARITABLE FUNDRAISING; CHARITABLE FUNDRAISING SERVICES (U.S. CLS. 100, 101 AND 102).

FIRST USE 10-31-2011; IN COMMERCE 10-31-2011.  
MATTHEW GALAN, EXAMINING ATTORNEY



**CLASS 36—(Continued).**

SN 86-043,286. OASIS LUXURY RENTALS INCORPORATED, ROAD TOWN, TORTOLA, BR. VIRGIN ISLANDS, FILED 8-20-2013.

OASIS COLLECTIONS



NO CLAIM IS MADE TO THE EXCLUSIVE RIGHT TO USE "COLLECTIONS", APART FROM THE MARK AS SHOWN.

THE MARK CONSISTS OF THE WORDS "OASIS COLLECTIONS" ABOVE A HORIZONTAL LINE ABOVE A FANCIFUL DESIGN.

FOR REAL ESTATE SERVICES, NAMELY, RENTAL OF SHORT-TERM FURNISHED APARTMENTS; REAL ESTATE SERVICES, NAMELY, RENTAL OF VACATION HOMES (U.S. CLS. 100, 101 AND 102).

FIRST USE 6-30-2011; IN COMMERCE 6-30-2011.  
ALISON POLLACK, EXAMINING ATTORNEY

SN 86-043,336. VISION LAUNCH MEDIA GROUP, LLC., BELEN, NM. FILED 8-20-2013.

VISION  
LAUNCH

THE MARK CONSISTS OF THE WORDS "VISION LAUNCH" WITH A GLOBE IN PLACE OF THE "O" IN "VISION" CREATED TO LOOK LIKE AN EYE.

FOR FINANCIAL SERVICES, NAMELY, PROVIDING INVESTMENT FUNDING FOR FILM AND MUSIC INDUSTRY PROJECTS THROUGH CONTRIBUTIONS FROM COMMUNITY CONTRIBUTORS AND ACCREDITED INVESTORS VIA GLOBAL COMPUTER NETWORK (U.S. CLS. 100, 101 AND 102).

FIRST USE 7-1-2013; IN COMMERCE 8-1-2013.  
KATHLEEN M. VANSTON, EXAMINING ATTORNEY

**CLASS 36—(Continued).**

SN 86-043,685. TEAM1 REAL ESTATE LLC, DBA NAPLES REAL ESTATE GUYS, NAPLES, FL. FILED 8-21-2013.

Naples Real Estate Guys

THE MARK CONSISTS OF STANDARD CHARACTERS WITHOUT CLAIM TO ANY PARTICULAR FONT, STYLE, SIZE, OR COLOR.

NO CLAIM IS MADE TO THE EXCLUSIVE RIGHT TO USE "NAPLES REAL ESTATE", APART FROM THE MARK AS SHOWN.

FOR PROVIDING A DATABASE OF INFORMATION ABOUT RESIDENTIAL REAL ESTATE LISTINGS IN DIFFERENT NEIGHBORHOODS AND COMMUNITIES; PROVIDING A DATABASE OF RESIDENTIAL REAL ESTATE LISTINGS WITHIN NEIGHBORHOODS AND COMMUNITIES SPECIFICALLY IDENTIFIED BY USERS; PROVIDING AN INTERNET WEBSITE PORTAL OFFERING INFORMATION IN THE FIELDS OF REAL ESTATE CONCERNING THE PURCHASE AND SALE OF NEW AND RESALE HOMES AND CONDOS; PROVIDING INFORMATION IN THE FIELD OF REAL ESTATE BY MEANS OF LINKING THE WEB SITE TO OTHER WEB SITES FEATURING REAL ESTATE INFORMATION; PROVIDING INFORMATION IN THE FIELD OF REAL ESTATE VIA THE INTERNET; PROVIDING REAL ESTATE LISTINGS AND REAL ESTATE INFORMATION VIA THE INTERNET; PROVIDING REAL ESTATE LISTINGS VIA THE INTERNET; REAL ESTATE ACQUISITION SERVICES; REAL ESTATE AGENCIES; REAL ESTATE BROKERAGE; REAL ESTATE CONSULTANCY; REAL ESTATE CONSULTATION; REAL ESTATE ESCROW SERVICES; REAL ESTATE LISTING; REAL ESTATE MANAGEMENT CONSULTATION; RESIDENTIAL REAL ESTATE AGENCY SERVICES (U.S. CLS. 100, 101 AND 102).

FIRST USE 8-15-2009; IN COMMERCE 6-22-2010.  
SHANNON TWOHIG, EXAMINING ATTORNEY

SN 86-043,967. INDIAN MOTORCYCLE INTERNATIONAL, LLC, MEDINA, MN. FILED 8-21-2013.

INDIAN MOTORCYCLE ASSURANCE

THE MARK CONSISTS OF STANDARD CHARACTERS WITHOUT CLAIM TO ANY PARTICULAR FONT, STYLE, SIZE, OR COLOR.

OWNER OF U.S. REG. NOS. 921,459, 4,325,612 AND OTHERS.

NO CLAIM IS MADE TO THE EXCLUSIVE RIGHT TO USE "MOTORCYCLE ASSURANCE", APART FROM THE MARK AS SHOWN.

FOR EXTENDED WARRANTY AND SERVICE CONTRACTS FOR PURCHASERS OF RECREATIONAL VEHICLES (U.S. CLS. 100, 101 AND 102).

KATHY DE JONGE, EXAMINING ATTORNEY

**CLASS 36—(Continued).**

SN 86-044,063. MEDIA BENEFITS CORP., DBA MEDIA BENEFITS INSURANCE SERVICES, HOLLYWOOD, CA. FILED 8-21-2013.

**MEDIA BENEFITS INSURANCE  
SERVICES**

THE MARK CONSISTS OF STANDARD CHARACTERS WITHOUT CLAIM TO ANY PARTICULAR FONT, STYLE, SIZE, OR COLOR.

NO CLAIM IS MADE TO THE EXCLUSIVE RIGHT TO USE "BENEFITS INSURANCE SERVICES", APART FROM THE MARK AS SHOWN.

FOR INSURANCE SERVICES, NAMELY, UNDERWRITING, ISSUANCE AND ADMINISTRATION OF AUTOMOBILE, TRAILERS, MOTORCYCLES, BOATS AND PERSONAL WATERCRAFT, MOBILE HOMES AND RVS, BUSINESS, RENTER'S AND HOMEOWNERS INSURANCE (U.S. CLS. 100, 101 AND 102).

FIRST USE 3-1-2013; IN COMMERCE 3-1-2013.  
STEPHANIE ALI, EXAMINING ATTORNEY

SN 86-044,066. HEALTH CARE SERVICE CORPORATION, CHICAGO, IL. FILED 8-21-2013.

**LIFESTYLE ASSURANCE**

THE MARK CONSISTS OF STANDARD CHARACTERS WITHOUT CLAIM TO ANY PARTICULAR FONT, STYLE, SIZE, OR COLOR.

NO CLAIM IS MADE TO THE EXCLUSIVE RIGHT TO USE "ASSURANCE", APART FROM THE MARK AS SHOWN.

FOR INSURANCE SERVICES, NAMELY, UNDERWRITING, ADMINISTRATION AND BROKERAGE OF CRITICAL ILLNESS INSURANCE (U.S. CLS. 100, 101 AND 102).

FRANK LATTUCA, EXAMINING ATTORNEY

SN 86-044,240. NOWACEK, DAVID, SAN ANTONIO, TX. FILED 8-21-2013.

**Grade Bank**

NO CLAIM IS MADE TO THE EXCLUSIVE RIGHT TO USE "BANK", APART FROM THE MARK AS SHOWN.

FOR ADMINISTRATION OF SAVINGS ACCOUNTS; CHARITABLE FUNDRAISING SERVICES, BY MEANS OF ELEEMOSYNARY SERVICES IN THE FIELD OF COLLECTION, MANAGEMENT, AND DISBURSEMENTS OF MONEY IN CONNECTION WITH PROGRAMS AND FACILITIES FOR THE WELFARE OF CHILDREN; FINANCIAL SERVICES, NAMELY, SAVINGS PROGRAMS FOR YOUTHS; SAVINGS ACCOUNT SERVICES (U.S. CLS. 100, 101 AND 102).

KATHRYN COWARD, EXAMINING ATTORNEY

**CLASS 36—(Continued).**

SN 86-044,257. COPS AGAINST CANCER, ANKENY, IA. FILED 8-21-2013.

**COPS AGAINST CANCER**

THE MARK CONSISTS OF STANDARD CHARACTERS WITHOUT CLAIM TO ANY PARTICULAR FONT, STYLE, SIZE, OR COLOR.

NO CLAIM IS MADE TO THE EXCLUSIVE RIGHT TO USE "COPS" OR "CANCER", APART FROM THE MARK AS SHOWN.

FOR CHARITABLE SERVICES, NAMELY, PROVIDING FUNDRAISING SERVICES TO BENEFIT THOSE WHOSE LIVES ARE AFFECTED BY CANCER (U.S. CLS. 100, 101 AND 102).

FIRST USE 3-1-2010; IN COMMERCE 3-1-2010.  
DORITT L. CARROLL, EXAMINING ATTORNEY

SN 86-044,307. BENCH, JOHN DAVID, DBA SANTA ANA BAIL BONDS, LANCASTER, CA. FILED 8-21-2013.



NO CLAIM IS MADE TO THE EXCLUSIVE RIGHT TO USE "SANTA ANA BAIL BONDS", APART FROM THE MARK AS SHOWN.

THE MARK CONSISTS OF THE WORDS "SANTA ANA BAIL BONDS" WHEREIN A HALO APPEARS ABOVE THE UPPERCASE "A".

FOR BAIL BONDING (U.S. CLS. 100, 101 AND 102).  
FIRST USE 8-20-2013; IN COMMERCE 8-20-2013.  
HANNO RITTNER, EXAMINING ATTORNEY

SN 86-044,792. WEINSTEIN MANAGEMENT CO., INC., GLEN ALLEN, VA. FILED 8-22-2013.

**ABBINGTON AT NORTHAMPTON**

THE MARK CONSISTS OF STANDARD CHARACTERS WITHOUT CLAIM TO ANY PARTICULAR FONT, STYLE, SIZE, OR COLOR.

NO CLAIM IS MADE TO THE EXCLUSIVE RIGHT TO USE "NORTHAMPTON", APART FROM THE MARK AS SHOWN.

FOR REAL ESTATE SERVICES, NAMELY, LEASING AND MANAGEMENT OF REAL PROPERTY (U.S. CLS. 100, 101 AND 102).

FIRST USE 3-1-2013; IN COMMERCE 3-1-2013.  
KAREN SEVERSON, EXAMINING ATTORNEY

**CLASS 36—(Continued).**

SN 86-044,794. WEINSTEIN MANAGEMENT CO., INC., GLEN ALLEN, VA. FILED 8-22-2013.

ABBINGTON AT HAMPTON CENTER

THE MARK CONSISTS OF STANDARD CHARACTERS WITHOUT CLAIM TO ANY PARTICULAR FONT, STYLE, SIZE, OR COLOR.

NO CLAIM IS MADE TO THE EXCLUSIVE RIGHT TO USE "HAMPTON CENTER", APART FROM THE MARK AS SHOWN.

FOR REAL ESTATE SERVICES, NAMELY, LEASING AND MANAGEMENT OF REAL PROPERTY (U.S. CLS. 100, 101 AND 102).

FIRST USE 6-1-2012; IN COMMERCE 6-1-2012.  
KAREN SEVERSON, EXAMINING ATTORNEY

---

SN 86-045,064. SPARK HOLDINGS, LLC, CHARLOTTE, NC. FILED 8-22-2013.

CLEARPATH FOUNDATION

THE MARK CONSISTS OF STANDARD CHARACTERS WITHOUT CLAIM TO ANY PARTICULAR FONT, STYLE, SIZE, OR COLOR.

NO CLAIM IS MADE TO THE EXCLUSIVE RIGHT TO USE "FOUNDATION", APART FROM THE MARK AS SHOWN.

FOR CHARITABLE FOUNDATION SERVICES, NAMELY, PROVIDING FINANCIAL ASSISTANCE FOR PROGRAMS AND SERVICES OF OTHERS (U.S. CLS. 100, 101 AND 102).

MIAH ROSENBERG, EXAMINING ATTORNEY

---

SN 86-045,561. JOHN M. FICKEWIRTH, OJAI, CA. FILED 8-22-2013.

BENEFITS TRANQUILITY

THE MARK CONSISTS OF STANDARD CHARACTERS WITHOUT CLAIM TO ANY PARTICULAR FONT, STYLE, SIZE, OR COLOR.

NO CLAIM IS MADE TO THE EXCLUSIVE RIGHT TO USE "BENEFITS", APART FROM THE MARK AS SHOWN.

FOR INSURANCE ADMINISTRATIVE SERVICES, INSURANCE BROKERAGE SERVICES, INSURANCE UNDERWRITING SERVICES IN THE FIELD OF LIFE, HEALTH, ACCIDENT, DISABILITY AND LONGTERM CARE INSURANCE (U.S. CLS. 100, 101 AND 102).

WENDY GOODMAN, EXAMINING ATTORNEY

**CLASS 36—(Continued).**

SN 86-047,060. H&F CAPITAL SOLUTIONS, INC., GRAPEVINE, TX. FILED 8-23-2013.



NO CLAIM IS MADE TO THE EXCLUSIVE RIGHT TO USE "CAPITAL SOLUTIONS", APART FROM THE MARK AS SHOWN.

THE COLOR(S) BLACK, BLUE, AND GRAY IS/ARE CLAIMED AS A FEATURE OF THE MARK.

THE MARK CONSISTS OF THE LETTER "H" IN BLACK, FOLLOWED BY AN AMPERSAND IN BLUE IN A LARGER FONT SIZE, FOLLOWED BY THE LETTER "F" IN BLACK, FOLLOWED BY THE WORDS "CAPITAL SOLUTIONS" IN BLACK IN A SMALL FONT SIZE, UNDERNEATH A GRAY LINE.

FOR COMMERCIAL LOAN ORIGINATION SERVICES; FINANCIAL SERVICES, NAMELY, CORPORATE WORKOUT, DEBT RESTRUCTURING, RECEIVERSHIP, AND LOAN RESOLUTION FOR COMMERCIAL LOANS; COMMERCIAL REAL ESTATE SHORT SALES (U.S. CLS. 100, 101 AND 102).

FIRST USE 8-9-2013; IN COMMERCE 8-9-2013.  
LINDA E. BLOHM, EXAMINING ATTORNEY

---

SN 86-047,522. MINNESOTA CATHOLIC CREDIT UNION, LITTLE CANADA, MN. FILED 8-26-2013.



NO CLAIM IS MADE TO THE EXCLUSIVE RIGHT TO USE "MN CATHOLIC CREDIT UNION", APART FROM THE MARK AS SHOWN.

THE MARK CONSISTS OF THE LETTERS "MN" PRECEDING A CROSS, FOLLOWED BY THE WORD "CATHOLIC". THE WORDS "CREDIT UNION" APPEAR BENEATH THE WORD "CATHOLIC". THERE IS A LINE UNDER THE WORDS "CREDIT UNION". BENEATH THE LINE THE WORDS "SERVICE TO BELIEVE IN" APPEAR.

FOR CREDIT UNION SERVICES (U.S. CLS. 100, 101 AND 102).

FIRST USE 10-17-2011; IN COMMERCE 10-17-2011.  
EMILY CHUO, EXAMINING ATTORNEY

**CLASS 36—(Continued).**

SN 86-048,121. RIVIERA FINANCE LLC, REDONDO BEACH, CA. FILED 8-26-2013.

# ROAM

THE MARK CONSISTS OF STANDARD CHARACTERS WITHOUT CLAIM TO ANY PARTICULAR FONT, STYLE, SIZE, OR COLOR.

FOR FINANCIAL SERVICES, NAMELY, ON-LINE ACCOUNT INFORMATION SERVICES FOR CUSTOMERS OF A FACTORING SERVICE, NAMELY, PROVIDING CUSTOMER'S WITH LISTINGS OF THE CUSTOMER'S INVOICES OUTSTANDING, INVOICE AGING, CREDIT LIMIT, CREDIT AVAILABILITY, RESERVE BALANCE, INVOICE DETAIL, CUSTOMER DETAIL AND FACTORING SCHEDULES, CONDUCTED VIA A GLOBAL COMPUTER NETWORK IN THE FIELD OF FACTORING (U.S. CLS. 100, 101 AND 102).

FIRST USE 7-25-2001; IN COMMERCE 7-25-2001.  
GRETTA YAO, EXAMINING ATTORNEY

SN 86-048,525. TECH STREET VENTURES, LLC, BRYAN, TX. FILED 8-26-2013.

# TECH STREET

THE MARK CONSISTS OF STANDARD CHARACTERS WITHOUT CLAIM TO ANY PARTICULAR FONT, STYLE, SIZE, OR COLOR.

NO CLAIM IS MADE TO THE EXCLUSIVE RIGHT TO USE "TECH", APART FROM THE MARK AS SHOWN.

FOR FINANCIAL AND INVESTMENT SERVICES, NAMELY, ASSET AND INVESTMENT ACQUISITION, CONSULTATION, ADVISORY AND DEVELOPMENT; INCUBATION SERVICES, NAMELY, PROVIDING FINANCING TO FREELANCERS, START-UPS, EXISTING BUSINESSES AND NON-PROFITS; VENTURE CAPITAL SERVICES, NAMELY, PROVIDING FINANCING TO EMERGING AND START-UP COMPANIES (U.S. CLS. 100, 101 AND 102).

LAURIE KAUFMAN, EXAMINING ATTORNEY

**CLASS 36—(Continued).**

SN 86-051,278. SAMARITAN FOUNDATION, INC., BRIARWOOD, NY. FILED 8-29-2013.



THE COLOR(S) ORANGE AND WHITE IS/ARE CLAIMED AS A FEATURE OF THE MARK.

THE MARK CONSISTS OF A DESIGN OF CONTINUOUS LINES FORMING STYLIZED LETTERS SPELLING SAMARITAN. THE LETTERS APPEAR IN WHITE, WITH THE LETTERS "S", "A", AND "M" APPEARING ON THE FIRST LINE OF THE DESIGN SURROUNDED BY ORANGE, THE LETTERS "A", "R", AND "I" APPEAR ON THE SECOND LINE OF THE DESIGN SURROUNDED BY ORANGE, AND THE LETTERS "T", "A", AND "N" APPEAR ON THE THIRD LINE OF THE DESIGN SURROUNDED BY ORANGE.

FOR CHARITABLE FOUNDATION SERVICES, NAMELY, PROVIDING FINANCIAL SUPPORT, FINANCIAL ASSISTANCE, AND FUNDRAISING ACTIVITIES FOR PROGRAMS AND SERVICES TO ASSIST THE HOMELESS, VETERANS, FAMILIES, CHILDREN, AND SENIOR CITIZENS (U.S. CLS. 100, 101 AND 102).

FIRST USE 7-31-2013; IN COMMERCE 7-31-2013.  
ANN E. SAPPENFIELD, EXAMINING ATTORNEY

SN 86-054,352. NADIA NADERI, GREENBRAE, CA. FILED 9-3-2013.



THE MARK CONSISTS OF A HOUSE WITH A "W" IN THE MIDDLE FOLLOWED BY "HIZOFFER".

FOR PROVIDING A DATABASE OF RESIDENTIAL REAL ESTATE LISTINGS WITHIN NEIGHBORHOODS AND COMMUNITIES SPECIFICALLY IDENTIFIED BY USERS; PROVIDING INFORMATION IN THE FIELD OF REAL ESTATE BY MEANS OF LINKING THE WEB SITE TO OTHER WEB SITES FEATURING REAL ESTATE INFORMATION; PROVIDING INFORMATION IN THE FIELD OF REAL ESTATE VIA THE INTERNET; PROVIDING REAL ESTATE LISTINGS AND REAL ESTATE INFORMATION VIA THE INTERNET; PROVIDING REAL ESTATE LISTINGS VIA THE INTERNET; REAL ESTATE ACQUISITION SERVICES (U.S. CLS. 100, 101 AND 102).

PAUL E. FAHRENKOPF, EXAMINING ATTORNEY

**CLASS 36—(Continued).**

SN 86-055,030. BUILDASIGN, LLC., DBA BUILDASIGN-COM, AUSTIN, TX. FILED 9-4-2013.

**PHILANTHROPITCH**

THE MARK CONSISTS OF STANDARD CHARACTERS WITHOUT CLAIM TO ANY PARTICULAR FONT, STYLE, SIZE, OR COLOR.

FOR CHARITABLE FUNDRAISING BY MEANS OF AN ENTERTAINMENT EVENT (U.S. CLS. 100, 101 AND 102).

FIRST USE 2-1-2013; IN COMMERCE 2-1-2013.  
SUSAN RICHARDS, EXAMINING ATTORNEY

SN 86-057,301. EPPERLY, DAVID C., COLUMBUS, GA. FILED 9-5-2013.

**CHANGING OIL CHANGING LIVES**

THE MARK CONSISTS OF STANDARD CHARACTERS WITHOUT CLAIM TO ANY PARTICULAR FONT, STYLE, SIZE, OR COLOR.

FOR CHARITABLE FUNDRAISING SERVICES BY MEANS OF SELLING OIL CHANGES TO RAISE FUNDS FOR CHARITABLE ORGANIZATIONS (U.S. CLS. 100, 101 AND 102).

FIRST USE 1-31-2011; IN COMMERCE 1-31-2011.  
ANN E. SAPPENFIELD, EXAMINING ATTORNEY

SN 86-059,557. BACK-OUR-VETS, INC., HOUSTON, TX. FILED 9-9-2013.

**BACK-OUR-VETS**

THE MARK CONSISTS OF STANDARD CHARACTERS WITHOUT CLAIM TO ANY PARTICULAR FONT, STYLE, SIZE, OR COLOR.

FOR CHARITABLE FUNDRAISING SERVICES; CHARITABLE FUNDRAISING SERVICES, BY MEANS OF PROVIDING INDIVIDUALS AND BUSINESSES WITH THE INFORMATION AND OPPORTUNITY TO MAKE MONETARY DONATIONS TO HELP VETERANS AND THEIR FAMILIES; CHARITABLE FUNDRAISING TO SUPPORT VETERANS AND THEIR FAMILIES (U.S. CLS. 100, 101 AND 102).

FIRST USE 8-0-2012; IN COMMERCE 8-0-2012.  
KEVIN DINALLO, EXAMINING ATTORNEY

**CLASS 36—(Continued).**

SN 86-060,086. INETICO, INC., DBA PAR3, TAMPA, FL. FILED 9-10-2013.

**PAR3**

THE MARK CONSISTS OF STANDARD CHARACTERS WITHOUT CLAIM TO ANY PARTICULAR FONT, STYLE, SIZE, OR COLOR.

FOR CLAIMS ADJUSTMENT IN THE FIELD OF INSURANCE (U.S. CLS. 100, 101 AND 102).

FIRST USE 5-1-2013; IN COMMERCE 5-1-2013.  
JORDAN BAKER, EXAMINING ATTORNEY

SN 86-063,242. MARRIOTT INTERNATIONAL, INC., BETHESDA, MD. FILED 9-12-2013.

**EDITION**

OWNER OF U.S. REG. NOS. 3,931,368, 4,091,566 AND OTHERS.

THE MARK CONSISTS OF A STYLIZED VERSION OF THE WORD "EDITION".

FOR REAL ESTATE SERVICES, NAMELY, LISTING, BROKERAGE, LEASING AND MANAGEMENT OF APARTMENTS AND CONDOMINIUM RESIDENTIAL UNITS (U.S. CLS. 100, 101 AND 102).

INGRID C. EULIN, EXAMINING ATTORNEY

SN 86-063,679. XLIT LTD., DUBLIN 2, IRELAND, FILED 9-13-2013.

**FAST FAST FORWARD**

THE MARK CONSISTS OF STANDARD CHARACTERS WITHOUT CLAIM TO ANY PARTICULAR FONT, STYLE, SIZE, OR COLOR.

FOR PROVIDING A WEBSITE FEATURING INFORMATION IN THE FIELDS OF INSURANCE AND REINSURANCE (U.S. CLS. 100, 101 AND 102).

FIRST USE 6-6-2013; IN COMMERCE 6-6-2013.  
FLORENTINA BLANDU, EXAMINING ATTORNEY

**CLASS 36—(Continued).**

SN 86-063,696. OKINUS, INC., PELHAM, GA. FILED 9-13-2013.



THE MARK CONSISTS OF THE LETTERS "OK" ON A CIRCLE AND A CONCENTRIC CIRCLE AROUND THOSE ELEMENTS.

FOR FACILITATING AND ARRANGING FOR THE FINANCING OF FURNITURE, APPLIANCES, ELECTRONICS AND JEWELRY; FINANCING OF PURCHASES; FINANCING SERVICES; LEASE-PURCHASE FINANCING (U.S. CLS. 100, 101 AND 102).

FIRST USE 5-31-2008; IN COMMERCE 5-31-2008.  
TRACY FLETCHER, EXAMINING ATTORNEY

SN 86-064,106. SKBA CAPITAL MANAGEMENT LLC, SAN FRANCISCO, CA. FILED 9-13-2013.

## Baywood

THE MARK CONSISTS OF STANDARD CHARACTERS WITHOUT CLAIM TO ANY PARTICULAR FONT, STYLE, SIZE, OR COLOR.

FOR FINANCIAL SERVICES, NAMELY, A TOTAL PORTFOLIO OFFERING FOR HIGH NET WORTH CLIENTS CONSISTING OF BOTH SEPARATE ACCOUNTS AND MUTUAL FUNDS FOR EQUITY AND FIXED INCOME INVESTMENTS; MUTUAL FUND ADVISORY SERVICES (U.S. CLS. 100, 101 AND 102).  
INGA ERVIN, EXAMINING ATTORNEY

SN 86-064,233. PAYIN 3, LLC, PROVO, UT. FILED 9-13-2013.

## PAYIN3

THE MARK CONSISTS OF STANDARD CHARACTERS WITHOUT CLAIM TO ANY PARTICULAR FONT, STYLE, SIZE, OR COLOR.

FOR CREDIT SERVICES, NAMELY, PROVIDING REVOLVING CREDIT ACCOUNT SERVICES AND BILL PAYMENT SERVICES TO OTHERS (U.S. CLS. 100, 101 AND 102).

LESLIE RICHARDS, EXAMINING ATTORNEY

**CLASS 36—(Continued).**

SN 86-064,351. THE WILLIAM FALL GROUP, TOLEDO, OH. FILED 9-13-2013.

## MARKET\$ENSE

THE MARK CONSISTS OF STANDARD CHARACTERS WITHOUT CLAIM TO ANY PARTICULAR FONT, STYLE, SIZE, OR COLOR.

FOR FINANCIAL EVALUATION FOR INSURANCE PURPOSES; FINANCIAL INFORMATION AND EVALUATIONS; FINANCIAL VALUATION OF PERSONAL PROPERTY AND REAL ESTATE; REAL ESTATE APPRAISAL AND VALUATION; REAL ESTATE VALUATION SERVICES (U.S. CLS. 100, 101 AND 102).

KYLE PEETE, EXAMINING ATTORNEY

SN 86-065,448. STAMPEDE LABS INC., SAN FRANCISCO, CA. FILED 9-16-2013.

## Credible

THE MARK CONSISTS OF STANDARD CHARACTERS WITHOUT CLAIM TO ANY PARTICULAR FONT, STYLE, SIZE, OR COLOR.

FOR CONSUMER LENDING SERVICES; INSURANCE BROKERAGE SERVICES; INSURANCE INFORMATION AND CONSULTANCY (U.S. CLS. 100, 101 AND 102).

HOWARD B. LEVINE, EXAMINING ATTORNEY

SN 86-065,491. TORA HOLDINGS, INC., BURLINGAME, CA. FILED 9-16-2013.

## TORA BLOCX

THE MARK CONSISTS OF STANDARD CHARACTERS WITHOUT CLAIM TO ANY PARTICULAR FONT, STYLE, SIZE, OR COLOR.

OWNER OF U.S. REG. NOS. 3,261,003, 3,567,651 AND OTHERS.

FOR FINANCIAL AND INVESTMENT SERVICES, NAMELY, MANAGEMENT AND BROKERAGE IN THE FIELD OF EQUITIES, FUTURES, STOCKS, BONDS, AND OTHER SECURITIES FOR OTHERS; INVESTMENT SERVICES, NAMELY, MANAGEMENT AND BROKERAGE IN THE FIELD OF EQUITIES, FUTURES, STOCKS, BONDS AND OTHER SECURITIES IN ASIAN MARKETS; PROVIDING INFORMATION AND ANALYSIS VIA THE INTERNET IN THE FIELD OF FINANCIAL INVESTMENTS; FINANCIAL ANALYSIS IN THE FIELDS OF FINANCIAL INVESTMENTS, FINANCE AND MARKET TRENDS; FINANCIAL AND INVESTMENT SERVICES, NAMELY, PROVIDING A BLOCK CROSSING UTILITY FOR CLEARED DERIVATIVES (U.S. CLS. 100, 101 AND 102).

THEODORE MCBRIDE, EXAMINING ATTORNEY

**CLASS 36—(Continued).**

SN 86-065,749. HEALTHMARKETS, INC., NORTH RICH-  
LAND HILLS, TX. FILED 9-16-2013.



OWNER OF U.S. REG. NOS. 3,174,646, 3,420,692 AND OTHERS.

THE MARK CONSISTS OF THE WORD "HEALTH" APPEARING IN LOWER CASE OVER THE WORD "MARKETS" APPEARING IN LOWER CASE WITH THE STEM OF THE LAST LETTER "H" IN "HEALTH" CONJOINED WITH THE STEM OF THE LETTER "K" IN THE WORD "MARKET".

FOR INSURANCE AGENCY SERVICES (U.S. CLS. 100, 101 AND 102).

INGA ERVIN, EXAMINING ATTORNEY

**CLASS 36—(Continued).**

SN 86-066,748. PALM SPRINGS GETAWAYS, INC., PALM SPRINGS, CA. FILED 9-17-2013.



NO CLAIM IS MADE TO THE EXCLUSIVE RIGHT TO USE "PALM SPRINGS GETAWAYS", APART FROM THE MARK AS SHOWN.

THE MARK CONSISTS OF A MID-CENTURY HOME WITH A PALM TREE IN THE UPPER LEFT QUADRANT, UNDERSCORED WITH A WIDE LINE. THE TEXT "PALM SPRINGS" IS CENTERED BELOW THE DESIGN, AND THE TEXT "GETAWAYS" IS CENTERED BELOW "PALM SPRINGS".

FOR REAL ESTATE SERVICES, NAMELY, RENTAL OF VACATION HOMES (U.S. CLS. 100, 101 AND 102).

FIRST USE 9-7-2012; IN COMMERCE 11-13-2012.

JASON BLAIR, EXAMINING ATTORNEY

SN 86-066,020. FIDELITY & GUARANTY LIFE INSURANCE COMPANY, BALTIMORE, MD. FILED 9-16-2013.

**FG LIFE-HERITAGE**

THE MARK CONSISTS OF STANDARD CHARACTERS WITHOUT CLAIM TO ANY PARTICULAR FONT, STYLE, SIZE, OR COLOR.

OWNER OF U.S. REG. NOS. 4,095,749, 4,329,509 AND OTHERS.

FOR INSURANCE SERVICES, NAMELY, UNDERWRITING, ISSUING AND ADMINISTRATION OF LIFE INSURANCE; UNDERWRITING, ISSUANCE AND ADMINISTRATION OF ANNUITIES (U.S. CLS. 100, 101 AND 102).

LINDA POWELL, EXAMINING ATTORNEY

SN 86-066,965. FICAP STRATEGIC PARTNERS, LLC, PITTSBURGH, PA. FILED 9-17-2013.

**LUV YA BLACK AND GOLD**

THE MARK CONSISTS OF STANDARD CHARACTERS WITHOUT CLAIM TO ANY PARTICULAR FONT, STYLE, SIZE, OR COLOR.

FOR ATM BANKING SERVICES; BANKING SERVICES (U.S. CLS. 100, 101 AND 102).

SCOTT BIBB, EXAMINING ATTORNEY

**CLASS 36—(Continued).**

SN 86-066,996. NEW ALBION PARTNERS, LLC, SAN FRANCISCO, CA. FILED 9-17-2013.

NEW ALBION PARTNERS

THE MARK CONSISTS OF STANDARD CHARACTERS WITHOUT CLAIM TO ANY PARTICULAR FONT, STYLE, SIZE, OR COLOR.

FOR FINANCIAL ADVISORY AND CONSULTANCY SERVICES; FINANCIAL ANALYSIS AND RESEARCH SERVICES; FINANCIAL AND INVESTMENT SERVICES, NAMELY, MANAGEMENT AND BROKERAGE IN THE FIELDS OF STOCKS, BONDS, OPTIONS, COMMODITIES, FUTURES AND OTHER SECURITIES, AND THE INVESTMENT OF FUNDS OF OTHERS; PROVIDING FINANCIAL SERVICES WITH RESPECT TO SECURITIES AND OTHER FINANCIAL INSTRUMENTS AND PRODUCTS, NAMELY, TRADING OF AND INVESTMENTS IN SECURITIES AND FINANCIAL INSTRUMENTS AND PRODUCTS FOR OTHERS; PROVIDING STOCK/SECURITIES MARKET INFORMATION (U.S. CLS. 100, 101 AND 102).

FIRST USE 11-1-2011; IN COMMERCE 1-2-2012.  
LEIGH CAROLINE CASE, EXAMINING ATTORNEY

**CLASS 36—(Continued).**

SN 86-067,022. FEDERATED NATIONAL HOLDING COMPANY, SUNRISE, FL. FILED 9-17-2013.

FedNat

THE MARK CONSISTS OF STANDARD CHARACTERS WITHOUT CLAIM TO ANY PARTICULAR FONT, STYLE, SIZE, OR COLOR.

FOR INSURANCE SERVICES, NAMELY, UNDERWRITING, ISSUING AND ADMINISTRATING HOMEOWNERS, COMMERCIAL GENERAL LIABILITY, FEDERAL FLOOD, PERSONAL AUTO, MARINE AND WORKERS COMPENSATION INSURANCE; INSURANCE AGENCY AND BROKERAGE SERVICES; INSURANCE ADMINISTRATION SERVICES, NAMELY, ASSISTING OTHERS WITH COLLECTING INSURANCE PREMIUMS AND PROCESSING AND ADJUSTING INSURANCE CLAIMS (U.S. CLS. 100, 101 AND 102).

FIRST USE 1-6-1992; IN COMMERCE 1-6-1992.  
DONALD JOHNSON, EXAMINING ATTORNEY

SN 86-067,013. WALLOASIS LLC, RICHMOND, VA. FILED 9-17-2013.

WALLOASIS

THE MARK CONSISTS OF STANDARD CHARACTERS WITHOUT CLAIM TO ANY PARTICULAR FONT, STYLE, SIZE, OR COLOR.

FOR PROVIDING REAL ESTATE LISTINGS AND REAL ESTATE INFORMATION VIA THE INTERNET; REAL ESTATE MULTIPLE LISTING SERVICES (U.S. CLS. 100, 101 AND 102).

FIRST USE 6-8-2009; IN COMMERCE 6-8-2009.  
TINA BROWN, EXAMINING ATTORNEY

SN 86-067,241. AMERICAN HOUSING VENTURES, LLC, NEWPORT BEACH, CA. FILED 9-17-2013.

LIVE RIGHT

THE MARK CONSISTS OF STANDARD CHARACTERS WITHOUT CLAIM TO ANY PARTICULAR FONT, STYLE, SIZE, OR COLOR.

FOR REAL ESTATE SERVICES, NAMELY, LEASING OF SINGLE FAMILY HOMES IN SINGLE FAMILY RENTAL COMMUNITIES, AND MANAGEMENT OF SINGLE FAMILY HOMES IN SINGLE FAMILY RENTAL COMMUNITIES (U.S. CLS. 100, 101 AND 102).

SUNG IN, EXAMINING ATTORNEY



**CLASS 36—(Continued).**

SN 86-067,714. FEDERATED NATIONAL HOLDING COMPANY, SUNRISE, FL. FILED 9-18-2013.



THE MARK CONSISTS OF THE WORDS "FED" AND "NAT" SEPARATED BY A FIVE-POINT STAR HAVING AN OPENING BETWEEN THE LOWER TWO POINTS.

FOR INSURANCE SERVICES, NAMELY, UNDERWRITING, ISSUING AND ADMINISTRATING HOMEOWNERS, COMMERCIAL GENERAL LIABILITY, FEDERAL FLOOD, PERSONAL AUTO, MARINE AND WORKERS COMPENSATION INSURANCE; INSURANCE AGENCY AND BROKERAGE SERVICES; INSURANCE ADMINISTRATION SERVICES, NAMELY, ASSISTING OTHERS WITH COLLECTING INSURANCE PREMIUMS AND PROCESSING AND ADJUSTING INSURANCE CLAIMS (U.S. CLS. 100, 101 AND 102).

DONALD JOHNSON, EXAMINING ATTORNEY

SN 86-067,840. NATIONWIDE PAYMENT SOLUTIONS, LLC, SCARBOROUGH, ME. FILED 9-18-2013.

**FROM TRANSACTION TO SATISFACTION**

THE MARK CONSISTS OF STANDARD CHARACTERS WITHOUT CLAIM TO ANY PARTICULAR FONT, STYLE, SIZE, OR COLOR.

FOR PROVIDING ELECTRONIC PROCESSING OF ELECTRONIC FUNDS TRANSFER, ACH, CREDIT CARD, DEBIT CARD, ELECTRONIC CHECK AND ELECTRONIC PAYMENTS (U.S. CLS. 100, 101 AND 102).  
MORGAN WYNNE, EXAMINING ATTORNEY

**CLASS 36—(Continued).**

SN 86-067,853. NATIONWIDE PAYMENT SOLUTIONS, LLC, SCARBOROUGH, ME. FILED 9-18-2013.



THE MARK CONSISTS OF THE LETTERS "NP" IN A STYLIZED FONT WITHIN CIRCLE.

FOR PROVIDING ELECTRONIC PROCESSING OF ELECTRONIC FUNDS TRANSFER, ACH, CREDIT CARD, DEBIT CARD, ELECTRONIC CHECK AND ELECTRONIC PAYMENTS (U.S. CLS. 100, 101 AND 102).  
MORGAN WYNNE, EXAMINING ATTORNEY

SN 86-068,263. PUBLIC SCHOOLS FIRST NC, INC., RALEIGH, NC. FILED 9-18-2013.

**DRINK RED FOR PUBLIC ED**

THE MARK CONSISTS OF STANDARD CHARACTERS WITHOUT CLAIM TO ANY PARTICULAR FONT, STYLE, SIZE, OR COLOR.

FOR CHARITABLE SERVICES, NAMELY, FUNDRAISING SERVICES BY MEANS OF ORGANIZING SPECIAL EVENTS FOR SUPPORT OF PUBLIC EDUCATION (U.S. CLS. 100, 101 AND 102).  
JEFFREY LOOK, EXAMINING ATTORNEY

SN 86-068,297. 24-7 INTERNATIONAL LLC, PINE BROOK, NJ. FILED 9-18-2013.

**BUMPER TO BUMPER**

THE MARK CONSISTS OF STANDARD CHARACTERS WITHOUT CLAIM TO ANY PARTICULAR FONT, STYLE, SIZE, OR COLOR.

FOR PROVIDING WARRANTIES FOR LUGGAGE (U.S. CLS. 100, 101 AND 102).  
FIRST USE 11-30-2005; IN COMMERCE 11-30-2005.  
ROBIN CHOSID, EXAMINING ATTORNEY

**CLASS 36—(Continued).**

SN 86-068,445. MONITOR LIABILITY MANAGERS, LLC, ROLLING MEADOWS, IL. FILED 9-18-2013.

# ExecSuite

THE MARK CONSISTS OF STANDARD CHARACTERS WITHOUT CLAIM TO ANY PARTICULAR FONT, STYLE, SIZE, OR COLOR.

FOR INSURANCE ADMINISTRATION; INSURANCE ADMINISTRATION IN THE FIELD OF PROFESSIONAL AND EXECUTIVE LIABILITY INSURANCE; INSURANCE BROKERAGE SERVICES; INSURANCE CLAIMS ADMINISTRATION; INSURANCE CLAIMS PROCESSING; INSURANCE CONSULTANCY; INSURANCE CONSULTATION; INSURANCE INFORMATION AND CONSULTANCY; INSURANCE SERVICES, NAMELY, UNDERWRITING PROFESSIONAL AND EXECUTIVE LIABILITY INSURANCE; INSURANCE SERVICES, NAMELY, UNDERWRITING, ISSUANCE AND ADMINISTRATION OF PROFESSIONAL AND EXECUTIVE LIABILITY INSURANCE; INSURANCE UNDERWRITING CONSULTATION (U.S. CLS. 100, 101 AND 102).

FIRST USE 9-18-2013; IN COMMERCE 9-18-2013.  
KATHERINE STOIDES, EXAMINING ATTORNEY

**CLASS 36—(Continued).**

SN 86-068,718. MAIN STREET AMERICA GROUP, INC., JACKSONVILLE, FL. FILED 9-18-2013.

YOU ARE ON THE RIGHT TRACK  
WITH MAIN LINE BOP

THE MARK CONSISTS OF STANDARD CHARACTERS WITHOUT CLAIM TO ANY PARTICULAR FONT, STYLE, SIZE, OR COLOR.

FOR PROPERTY AND CASUALTY INSURANCE UNDERWRITING SERVICES (U.S. CLS. 100, 101 AND 102).  
FIRST USE 2-3-2009; IN COMMERCE 2-3-2009.  
STEVEN PEREZ, EXAMINING ATTORNEY

SN 86-069,099. DECADIAN, LLC, DBA DECADIAN, BLAIR, NE. FILED 9-19-2013.

# DECADIAN

THE MARK CONSISTS OF STANDARD CHARACTERS WITHOUT CLAIM TO ANY PARTICULAR FONT, STYLE, SIZE, OR COLOR.

FOR COMMODITY INVESTMENT ADVICE (U.S. CLS. 100, 101 AND 102).  
FIRST USE 2-21-2013; IN COMMERCE 2-21-2013.  
SUNG IN, EXAMINING ATTORNEY

SN 86-068,472. ALDAMERE VENTURES, INC., HOUSTON, TX. FILED 9-18-2013.



FIRSTHARBOR

OWNER OF U.S. REG. NO. 2,754,995.

THE MARK CONSISTS OF A STYLIZED VERSION OF A LIGHT HOUSE IN THE DARKNESS, WITH THREE RAYS OF LIGHT EXTENDING FROM THE TOP OF IT, BOTH IN THE LEFT AND RIGHT DIRECTIONS, ALL ENCLOSED IN AN OUTER CIRCLE. TO THE RIGHT OF THE MIDDLE OF THE OUTER CIRCLE ARE THE WORDS "FIRST HARBOR".

FOR FINANCIAL SERVICES, NAMELY, INVESTMENT CONSULTATION SERVICES, MUTUAL FUND INVESTMENT SERVICES, FEE-BASED ASSET MANAGEMENT SERVICES, FEE-BASED FINANCIAL PLANNING SERVICES, AND FINANCIAL PLANNING FEATURING QUALIFIED AND NON-QUALIFIED RETIREMENT PLANS (U.S. CLS. 100, 101 AND 102).

FIRST USE 9-18-2013; IN COMMERCE 9-18-2013.  
ALLISON SCHRODY, EXAMINING ATTORNEY

SN 86-069,257. FIRST SERVICE CREDIT UNION, HOUSTON, TX. FILED 9-19-2013.

BANK LIKE YOU OWN THE  
PLACE... BECAUSE YOU DO!

THE MARK CONSISTS OF STANDARD CHARACTERS WITHOUT CLAIM TO ANY PARTICULAR FONT, STYLE, SIZE, OR COLOR.

FOR BANKING SERVICES; CREDIT UNION SERVICES (U.S. CLS. 100, 101 AND 102).  
FIRST USE 4-5-2012; IN COMMERCE 4-5-2012.  
SUNG IN, EXAMINING ATTORNEY

**CLASS 36—(Continued).**

SN 86-069,283. FIRST SERVICE CREDIT UNION, HOUSTON, TX. FILED 9-19-2013.

BANK LIKE YOU OWN THE PLACE

THE MARK CONSISTS OF STANDARD CHARACTERS WITHOUT CLAIM TO ANY PARTICULAR FONT, STYLE, SIZE, OR COLOR.

FOR BANKING SERVICES; CREDIT UNION SERVICES (U.S. CLS. 100, 101 AND 102).  
FIRST USE 4-5-2012; IN COMMERCE 4-5-2012.  
SUNG IN, EXAMINING ATTORNEY



SN 86-069,312. PCR CAPITAL CORPORATION, ALBERTA, CANADA, FILED 9-19-2013.

WE PROTECT YOUR CORPORATE  
HEARTBEAT

THE MARK CONSISTS OF STANDARD CHARACTERS WITHOUT CLAIM TO ANY PARTICULAR FONT, STYLE, SIZE, OR COLOR.

FOR COLLECTION AGENCY SERVICES (U.S. CLS. 100, 101 AND 102).  
FIRST USE 8-2-2013; IN COMMERCE 8-2-2013.  
HEATHER THOMPSON, EXAMINING ATTORNEY



SN 86-069,483. U.S. PLATFORM DEVELOPMENT GROUP LLC, PRINCETON, NJ. FILED 9-19-2013.

OfferBoard

THE MARK CONSISTS OF STANDARD CHARACTERS WITHOUT CLAIM TO ANY PARTICULAR FONT, STYLE, SIZE, OR COLOR.

FOR FINANCIAL SERVICES, NAMELY, RAISING DEBT AND EQUITY CAPITAL FOR OTHERS; PRIVATE PLACEMENTS OF HEDGE FUNDS, PRIVATE EQUITY FUNDS, SECURITIES AND DERIVATIVES FOR OTHERS (U.S. CLS. 100, 101 AND 102).  
FIRST USE 5-0-2013; IN COMMERCE 7-0-2013.  
JOANNA FIORELLI, EXAMINING ATTORNEY

**CLASS 36—(Continued).**

SN 86-069,520. ACUITY WEALTH MANAGEMENT, LLC, HOPEWELL, NJ. FILED 9-19-2013.

SECURE YOUR POSSIBILITIES

THE MARK CONSISTS OF STANDARD CHARACTERS WITHOUT CLAIM TO ANY PARTICULAR FONT, STYLE, SIZE, OR COLOR.

FOR FINANCIAL SERVICES, NAMELY, INVESTMENT ADVICE, INVESTMENT MANAGEMENT, INVESTMENT CONSULTATION AND INVESTMENT OF FUNDS FOR OTHERS, INCLUDING PRIVATE AND PUBLIC EQUITY AND DEBT INVESTMENT SERVICES (U.S. CLS. 100, 101 AND 102).  
FIRST USE 9-4-2013; IN COMMERCE 9-4-2013.  
MORGAN WYNNE, EXAMINING ATTORNEY



SN 86-069,633. ACUITY WEALTH MANAGEMENT, LLC, HOPEWELL, NJ. FILED 9-19-2013.



THE MARK CONSISTS OF THE LETTER "A" SUPERIMPOSED OVER A STYLIZED ATOMIC MODEL DESIGN.

FOR FINANCIAL SERVICES, NAMELY, INVESTMENT ADVICE, INVESTMENT MANAGEMENT, INVESTMENT CONSULTATION AND INVESTMENT OF FUNDS FOR OTHERS, INCLUDING PRIVATE AND PUBLIC EQUITY AND DEBT INVESTMENT SERVICES (U.S. CLS. 100, 101 AND 102).  
FIRST USE 9-4-2013; IN COMMERCE 9-4-2013.  
MORGAN WYNNE, EXAMINING ATTORNEY

**CLASS 36—(Continued).**

SN 86-069,639. CUSACK, JACOB, ALEXANDRIA, VA. FILED 9-19-2013.

## CrossBoundary

THE MARK CONSISTS OF STANDARD CHARACTERS WITHOUT CLAIM TO ANY PARTICULAR FONT, STYLE, SIZE, OR COLOR.

FOR INVESTMENT AND ECONOMIC DEVELOPMENT ADVISORY SERVICES IN FRONTIER MARKETS AND CONFLICT ZONES; STRATEGIC CONSULTING FOR FINANCIAL ANALYSIS AND INTELLIGENCE PLATFORMS, FOCUSING ON INNOVATIVE METHODS OF ASSESSING INVESTMENT AND CREDIT RISK IN EMERGING MARKETS (U.S. CLS. 100, 101 AND 102).

FIRST USE 11-1-2011; IN COMMERCE 11-1-2011.

CIMMERIAN COLEMAN, EXAMINING ATTORNEY

---

SN 86-069,671. QUISK, INC., SUNNYVALE, CA. FILED 9-19-2013.



THE MARK CONSISTS OF A STYLIZED LETTER "Q".  
FOR FINANCIAL TRANSACTION SERVICES, NAMELY, PROVIDING SECURE COMMERCIAL TRANSACTIONS AND PAYMENT OPTIONS USING A MOBILE PHONE NUMBER AND PIN; FINANCIAL SERVICES, NAMELY, FUNDING ONLINE CASH ACCOUNTS FROM PREPAID CASH CARDS, BANK ACCOUNTS AND CREDIT CARD ACCOUNTS; FINANCIAL SERVICES, NAMELY, MICROFINANCE LENDING SERVICES; FINANCIAL SERVICES, NAMELY, PROVIDING A VIRTUAL CURRENCY FOR USE BY MEMBERS OF AN ON-LINE COMMUNITY VIA A GLOBAL COMPUTER NETWORK; FINANCIAL SERVICES, NAMELY, PROVIDING FOR THE EXCHANGE OF FOREIGN CURRENCY, COMMODITIES, FINANCIAL DERIVATIVES, INTEREST RATE PRODUCTS, AND EQUITIES VIA THE INTERNET AND INTRANET SYSTEMS (U.S. CLS. 100, 101 AND 102).

AISHA CLARKE, EXAMINING ATTORNEY

**CLASS 36—(Continued).**

SN 86-069,825. BYRON UDELL & ASSOCIATES, INC., WHEELING, IL. FILED 9-19-2013.

## accuQuote

OWNER OF U.S. REG. NOS. 2,071,724, 3,512,591 AND OTHERS.

THE MARK CONSISTS OF THE STYLIZED WORD ACCUQUOTE WITH THE "Q" APPEARING LARGER THAN THE OTHER LETTERS.

FOR BROKERAGE IN THE FIELD OF INSURANCE (U.S. CLS. 100, 101 AND 102).

FIRST USE 5-0-2012. THE MARK WAS FIRST USED ANYWHERE IN A DIFFERENT FORM OTHER THAN THAT SOUGHT TO BE REGISTERED AT LEAST AS EARLY AS 01/01/1995 ; IN COMMERCE 5-0-2012. THE MARK WAS FIRST USED IN COMMERCE IN A DIFFERENT FORM OTHER THAN THAT SOUGHT TO BE REGISTERED AT LEAST AS EARLY AS 00/00/1995.

HEATHER SAPP, EXAMINING ATTORNEY

---

SN 86-070,185. LANCER MANAGEMENT COMPANY, INC., LONG BEACH, NY. FILED 9-20-2013.

## LANCER INSTAQUOTE

THE MARK CONSISTS OF STANDARD CHARACTERS WITHOUT CLAIM TO ANY PARTICULAR FONT, STYLE, SIZE, OR COLOR.

OWNER OF U.S. REG. NOS. 3,777,093, 3,777,094 AND 3,777,163.

FOR PROVIDING COMMERCIAL VEHICLE AND COMMERCIAL GARAGE INSURANCE ADMINISTRATION, BROKERAGE, AND UNDERWRITING SERVICES; PROVIDING COMMERCIAL VEHICLE AND COMMERCIAL GARAGE INSURANCE RATE QUOTES (U.S. CLS. 100, 101 AND 102).

FIRST USE 10-18-2012; IN COMMERCE 10-18-2012.

JENNIFER MARTIN, EXAMINING ATTORNEY

**CLASS 36—(Continued).**

SN 86-070,382. MAKING CHANGE, ALEXANDRIA, VA.  
FILED 9-20-2013.



THE MARK CONSISTS OF THE WORDS "MAKING CHANGE" WITH CIRCLES ABOVE FORMING AN ARCH BEGINNING WITH THE LETTER "I" WITH A SMALL CIRCLE FOLLOWED BY 3 MORE CIRCLES, EACH CIRCLE INCREASING SIZE AND THE 4TH CIRCLE ENDING ABOVE THE LETTER "C" IN "CHANGE".

FOR CHARITABLE FUND-RAISING PROGRAMS CREATED AND ORGANIZED ON BEHALF OF RETAILERS AND THE RETAIL FOOD INDUSTRY FOR THE BENEFIT OF THIRD PARTY NON-PROFIT ORGANIZATIONS HELPING TO ALLEVIATE HUNGER, BENEFIT BREAST CANCER VICTIMS, PROMOTE ANIMAL WELFARE, ENVIRONMENTAL AND EDUCATION INTERESTS AND ASSIST WOUNDED U.S. MILITARY SERVICE MEMBERS (U.S. CLS. 100, 101 AND 102).  
RAMONA ORTIGA, EXAMINING ATTORNEY

**CLASS 36—(Continued).**

SN 86-070,503. PATRICIA BYRNE, MT. PLEASANT, SC.  
FILED 9-20-2013.

## CUPS ACROSS

THE MARK CONSISTS OF STANDARD CHARACTERS WITHOUT CLAIM TO ANY PARTICULAR FONT, STYLE, SIZE, OR COLOR.

FOR CHARITABLE FUNDRAISING SERVICES BY MEANS OF AN ENTERTAINMENT EVENT (U.S. CLS. 100, 101 AND 102).

ANDREA HACK, EXAMINING ATTORNEY

SN 86-070,505. STONECREEK CAPITAL, LLC, IRVINE, CA.  
FILED 9-20-2013.

## STONECREEK CAPITAL

THE MARK CONSISTS OF STANDARD CHARACTERS WITHOUT CLAIM TO ANY PARTICULAR FONT, STYLE, SIZE, OR COLOR.

NO CLAIM IS MADE TO THE EXCLUSIVE RIGHT TO USE "CAPITAL", APART FROM THE MARK AS SHOWN.

FOR PROVIDING VENTURE CAPITAL, DEVELOPMENT CAPITAL, PRIVATE EQUITY AND INVESTMENT FUNDING (U.S. CLS. 100, 101 AND 102).

FIRST USE 4-24-2008; IN COMMERCE 4-24-2008.  
DOUGLAS LEE, EXAMINING ATTORNEY

SN 86-070,495. FLEXMINDER, INC., SEATTLE, WA. FILED  
9-20-2013.

## FLEXMINDER

THE MARK CONSISTS OF STANDARD CHARACTERS WITHOUT CLAIM TO ANY PARTICULAR FONT, STYLE, SIZE, OR COLOR.

FOR EMPLOYEE BENEFIT MANAGEMENT SERVICES, NAMELY, PROVIDING HEALTH INSURANCE CLAIMS DOCUMENTATION FOR USE BY THIRD PARTY ADMINISTRATORS FOR THE ADMINISTRATION OF EMPLOYEE FLEXIBLE SPENDING ARRANGEMENTS AND HEALTHCARE REIMBURSEMENT ACCOUNTS; PROVIDING A WEBSITE THAT PROVIDES FLEXIBLE SPENDING ARRANGEMENT AND HEALTHCARE REIMBURSEMENT ACCOUNT PARTICIPANTS WITH INFORMATION REGARDING CLAIMS STATUS, BALANCES, FSA-ELIGIBLE GOODS AND SERVICES, AND TECHNOLOGY FOR AGGREGATING PERSONAL HEALTH INSURANCE CLAIMS TO BE ELECTRONICALLY SUBMITTED TO THEIR THIRD PARTY ADMINISTRATOR (U.S. CLS. 100, 101 AND 102).

FIRST USE 6-15-2011; IN COMMERCE 6-15-2011.  
HEATHER SAPP, EXAMINING ATTORNEY

SN 86-070,518. STONECREEK CAPITAL, LLC, IRVINE, CA.  
FILED 9-20-2013.

## PARTNERS IN VALUE CREATION

THE MARK CONSISTS OF STANDARD CHARACTERS WITHOUT CLAIM TO ANY PARTICULAR FONT, STYLE, SIZE, OR COLOR.

FOR PROVIDING VENTURE CAPITAL, DEVELOPMENT CAPITAL, PRIVATE EQUITY AND INVESTMENT FUNDING (U.S. CLS. 100, 101 AND 102).

DOUGLAS LEE, EXAMINING ATTORNEY

**CLASS 36—(Continued).**

SN 86-070,648. PLAN INVESTMENT FUND, INC., OAKBROOK TERRACE, IL. FILED 9-20-2013.

**CLASS 36—(Continued).**

SN 86-070,833. FRANKLIN RESOURCES, INC., DBA FRANKLIN TEMPLETON INVESTMENTS, SAN MATEO, CA. FILED 9-20-2013.

**PIF**

**BEYOND THE BENCHMARK**

THE MARK CONSISTS OF STANDARD CHARACTERS WITHOUT CLAIM TO ANY PARTICULAR FONT, STYLE, SIZE, OR COLOR.  
 FOR MUTUAL FUND INVESTMENT (U.S. CLS. 100, 101 AND 102).  
 FIRST USE 8-10-2010; IN COMMERCE 8-10-2010.  
 SOPHIA S. KIM, EXAMINING ATTORNEY

THE MARK CONSISTS OF STANDARD CHARACTERS WITHOUT CLAIM TO ANY PARTICULAR FONT, STYLE, SIZE, OR COLOR.  
 FOR ADVICE RELATING TO INVESTMENTS; ESTABLISHING MUTUAL FUNDS FOR OTHERS; FINANCIAL ADVISORY AND CONSULTANCY SERVICES; FINANCIAL ANALYSIS AND CONSULTATION; FINANCIAL INFORMATION AND ADVISORY SERVICES; FINANCIAL SERVICES, NAMELY, INVESTMENT ADVICE, INVESTMENT MANAGEMENT, INVESTMENT CONSULTATION AND INVESTMENT OF FUNDS FOR OTHERS, INCLUDING PRIVATE AND PUBLIC EQUITY AND DEBT INVESTMENT SERVICES; FINANCIAL SERVICES, NAMELY, INVESTMENT FUND TRANSFER AND TRANSACTION SERVICES; FUNDS INVESTMENT; INVESTMENT ADVISORY SERVICES; INVESTMENT CONSULTATION; INVESTMENT MANAGEMENT; INVESTMENT OF FUNDS FOR OTHERS; MUTUAL FUND DISTRIBUTION; MUTUAL FUND INVESTMENT; MUTUAL FUNDS AND CAPITAL INVESTMENT (U.S. CLS. 100, 101 AND 102).  
 JOANNA FIORELLI, EXAMINING ATTORNEY

SN 86-070,653. PLAN INVESTMENT FUND, INC., OAKBROOK TERRACE, IL. FILED 9-20-2013.

SN 86-070,837. UNCUBED, LLC, ALPHARETTA, GA. FILED 9-20-2013.

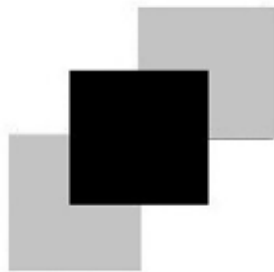

**UNCUBED**

THE MARK CONSISTS OF THREE OVERLAPPING SQUARES.  
 FOR MUTUAL FUND INVESTMENT (U.S. CLS. 100, 101 AND 102).  
 FIRST USE 8-10-2010; IN COMMERCE 8-10-2010.  
 JACQUELINE ABRAMS, EXAMINING ATTORNEY

THE MARK CONSISTS OF STANDARD CHARACTERS WITHOUT CLAIM TO ANY PARTICULAR FONT, STYLE, SIZE, OR COLOR.  
 FOR RENTAL OF OFFICE AND MEETING SPACE (U.S. CLS. 100, 101 AND 102).  
 TEJBIR SINGH, EXAMINING ATTORNEY

**CLASS 36—(Continued).**

SN 86-070,840. FRANKLIN RESOURCES, INC., DBA FRANKLIN TEMPLETON INVESTMENTS, SAN MATEO, CA. FILED 9-20-2013.

**BEYOND THE BENCHMARKS**

THE MARK CONSISTS OF STANDARD CHARACTERS WITHOUT CLAIM TO ANY PARTICULAR FONT, STYLE, SIZE, OR COLOR.

FOR ADVICE RELATING TO INVESTMENTS; ESTABLISHING MUTUAL FUNDS FOR OTHERS; FINANCIAL ADVISORY AND CONSULTANCY SERVICES; FINANCIAL ANALYSIS AND CONSULTATION; FINANCIAL INFORMATION AND ADVISORY SERVICES; FINANCIAL SERVICES, NAMELY, INVESTMENT ADVICE, INVESTMENT MANAGEMENT, INVESTMENT CONSULTATION AND INVESTMENT OF FUNDS FOR OTHERS, INCLUDING PRIVATE AND PUBLIC EQUITY AND DEBT INVESTMENT SERVICES; FINANCIAL SERVICES, NAMELY, INVESTMENT FUND TRANSFER AND TRANSACTION SERVICES; FUNDS INVESTMENT; INVESTMENT ADVISORY SERVICES; INVESTMENT CONSULTATION; INVESTMENT MANAGEMENT; INVESTMENT OF FUNDS FOR OTHERS; MUTUAL FUND DISTRIBUTION; MUTUAL FUND INVESTMENT; MUTUAL FUNDS AND CAPITAL INVESTMENT (U.S. CLS. 100, 101 AND 102).

JOANNA FIORELLI, EXAMINING ATTORNEY

SN 86-070,849. FRANKLIN RESOURCES, INC., DBA FRANKLIN TEMPLETON INVESTMENTS, SAN MATEO, CA. FILED 9-20-2013.

**BUILD A BETTER CLIENT EXPERIENCE**

THE MARK CONSISTS OF STANDARD CHARACTERS WITHOUT CLAIM TO ANY PARTICULAR FONT, STYLE, SIZE, OR COLOR.

OWNER OF U.S. REG. NOS. 3,319,309, 3,473,117 AND 3,690,359.

FOR ADVICE RELATING TO INVESTMENTS; ESTABLISHING MUTUAL FUNDS FOR OTHERS; FINANCIAL ADVISORY AND CONSULTANCY SERVICES; FINANCIAL ANALYSIS AND CONSULTATION; FINANCIAL INFORMATION AND ADVISORY SERVICES; FINANCIAL SERVICES, NAMELY, INVESTMENT ADVICE, INVESTMENT MANAGEMENT, INVESTMENT CONSULTATION AND INVESTMENT OF FUNDS FOR OTHERS, INCLUDING PRIVATE AND PUBLIC EQUITY AND DEBT INVESTMENT SERVICES; FINANCIAL SERVICES, NAMELY, INVESTMENT FUND TRANSFER AND TRANSACTION SERVICES; FUNDS INVESTMENT; INVESTMENT ADVISORY SERVICES; INVESTMENT CONSULTATION; INVESTMENT MANAGEMENT; INVESTMENT OF FUNDS FOR OTHERS; MUTUAL FUND DISTRIBUTION; MUTUAL FUND INVESTMENT; MUTUAL FUNDS AND CAPITAL INVESTMENT (U.S. CLS. 100, 101 AND 102).

JOANNA FIORELLI, EXAMINING ATTORNEY

**CLASS 36—(Continued).**

SN 86-070,853. MAXIM VERITAS CAPITAL, IRVINE, CA. FILED 9-20-2013.

**MortgageDuck**

THE MARK CONSISTS OF STANDARD CHARACTERS WITHOUT CLAIM TO ANY PARTICULAR FONT, STYLE, SIZE, OR COLOR.

FOR MORTGAGE BANKING; MORTGAGE BROKERAGE (U.S. CLS. 100, 101 AND 102).

TINA L. SNAPP, EXAMINING ATTORNEY

SN 86-070,880. OBER, KALER, GRIMES & SHRIVER, A PROFESSIONAL CORPORATION, BALTIMORE, MD. FILED 9-20-2013.

**FOR OUR KIDS. FOR OUR FUTURE.**

THE MARK CONSISTS OF STANDARD CHARACTERS WITHOUT CLAIM TO ANY PARTICULAR FONT, STYLE, SIZE, OR COLOR.

FOR CHARITABLE SERVICES, NAMELY, A GRANTS PROGRAM ESTABLISHED TO AWARD MONEY TO NONPROFITS SERVING CHILDREN AND YOUTH (U.S. CLS. 100, 101 AND 102).

MORGAN WYNNE, EXAMINING ATTORNEY

SN 86-071,482. ADVANCE MAGAZINE PUBLISHERS INC., NEW YORK, NY. FILED 9-23-2013.

**CHANGE OF HEART**

THE MARK CONSISTS OF STANDARD CHARACTERS WITHOUT CLAIM TO ANY PARTICULAR FONT, STYLE, SIZE, OR COLOR.

FOR CHARITABLE FUNDRAISING SERVICES BY MEANS OF ORGANIZING AND CONDUCTING FUNDRAISING EVENTS IN THE NATURE OF FITNESS AND EXERCISE CLASSES TO PROMOTE HEART HEALTHY LIFESTYLES (U.S. CLS. 100, 101 AND 102).

ALEX KEAM, EXAMINING ATTORNEY

**CLASS 36—(Continued).**

SN 86-071,725. THE SAVINGS BANK LIFE INSURANCE COMPANY OF MASSACHUSETTS, WOBURN, MA. FILED 9-23-2013.

**CLASS 36—(Continued).**

SN 86-072,121. SOMERVILLE BANK & TRUST CO., SOMERVILLE, TN. FILED 9-23-2013.

**IT JUST MAKES SENSE**

THE MARK CONSISTS OF STANDARD CHARACTERS WITHOUT CLAIM TO ANY PARTICULAR FONT, STYLE, SIZE, OR COLOR.

FOR INSURANCE SERVICES, NAMELY ISSUING ANNUITIES AND UNDERWRITING LIFE INSURANCE POLICIES (U.S. CLS. 100, 101 AND 102).

RENEE MCCRAY, EXAMINING ATTORNEY

**SOMERVILLE BANK & TRUST CO.**

THE MARK CONSISTS OF STANDARD CHARACTERS WITHOUT CLAIM TO ANY PARTICULAR FONT, STYLE, SIZE, OR COLOR.

NO CLAIM IS MADE TO THE EXCLUSIVE RIGHT TO USE "BANK & TRUST CO.", APART FROM THE MARK AS SHOWN.

SEC. 2(F).

FOR BANKING SERVICES (U.S. CLS. 100, 101 AND 102).

FIRST USE 1-1-1910; IN COMMERCE 1-1-1910.

ANDREA HACK, EXAMINING ATTORNEY

SN 86-071,752. HN REAL ESTATE GROUP, L.L.C., ATLANTA, GA. FILED 9-23-2013.

**HARRY NORMAN**

THE MARK CONSISTS OF STANDARD CHARACTERS WITHOUT CLAIM TO ANY PARTICULAR FONT, STYLE, SIZE, OR COLOR.

OWNER OF U.S. REG. NO. 3,539,603.

THE NAME(S), PORTRAIT(S), AND/OR SIGNATURE(S) SHOWN IN THE MARK DOES NOT IDENTIFY A PARTICULAR LIVING INDIVIDUAL.

FOR REAL ESTATE BROKERAGE (U.S. CLS. 100, 101 AND 102).

FIRST USE 12-31-1930; IN COMMERCE 12-31-1930.

DEBORAH MEINERS, EXAMINING ATTORNEY

SN 86-072,508. AMTRUST NORTH AMERICA, INC., NEW YORK, NY. FILED 9-23-2013.

SN 86-071,980. HN REAL ESTATE GROUP, L.L.C., ATLANTA, GA. FILED 9-23-2013.

**ezAuto****TOWNSHIP TITLE**

THE MARK CONSISTS OF STANDARD CHARACTERS WITHOUT CLAIM TO ANY PARTICULAR FONT, STYLE, SIZE, OR COLOR.

NO CLAIM IS MADE TO THE EXCLUSIVE RIGHT TO USE "TITLE", APART FROM THE MARK AS SHOWN.

FOR BROKERAGE IN THE FIELD OF TITLE INSURANCE; REAL ESTATE TITLE INSURANCE UNDERWRITING SERVICES (U.S. CLS. 100, 101 AND 102).

FIRST USE 12-31-2006; IN COMMERCE 12-31-2006.

DEBORAH MEINERS, EXAMINING ATTORNEY

THE MARK CONSISTS OF STANDARD CHARACTERS WITHOUT CLAIM TO ANY PARTICULAR FONT, STYLE, SIZE, OR COLOR.

FOR INSURANCE AND REINSURANCE UNDERWRITING SERVICES; INSURANCE ADMINISTRATION SERVICES; INSURANCE SERVICES, NAMELY, UNDERWRITING AUTOMOBILE AND VEHICLE INSURANCE; INSURANCE SERVICES, NAMELY, UNDERWRITING, ISSUANCE AND ADMINISTRATION OF AUTOMOBILES AND VEHICLES INSURANCE (U.S. CLS. 100, 101 AND 102).

ANTHONY RINKER, EXAMINING ATTORNEY



**CLASS 36—(Continued).**

SN 86-075,379. DITECH MORTGAGE CORP, FT. WASHINGTON, PA. FILED 9-26-2013.



OWNER OF U.S. REG. NO. 2,158,800.  
THE MARK CONSISTS OF THE SHAPE OF A HOUSE.  
FOR REAL ESTATE MORTGAGE BANKING AND LENDING SERVICES; LOAN ORIGATION AND FINANCING VIA A GLOBAL COMMUNICATIONS NETWORK; HOME EQUITY LOANS; MORTGAGE LENDING (U.S. CLS. 100, 101 AND 102).  
REGINA DRUMMOND, EXAMINING ATTORNEY

SN 86-075,432. DITECH MORTGAGE CORP, FT. WASHINGTON, PA. FILED 9-26-2013.



OWNER OF U.S. REG. NO. 2,158,800.  
THE COLOR(S) RED, GREEN AND BLUE IS/ARE CLAIMED AS A FEATURE OF THE MARK.  
THE MARK CONSISTS OF THE SHAPE OF A HOUSE FEATURING THE COLOR RED ON THE LEFT HALF OF THE HOUSE, GREEN ON THE RIGHT HALF OF THE HOUSE AND A BLUE ROOF.  
FOR REAL ESTATE MORTGAGE BANKING AND LENDING SERVICES; LOAN ORIGATION AND FINANCING VIA A GLOBAL COMMUNICATIONS NETWORK; HOME EQUITY LOANS; MORTGAGE LENDING (U.S. CLS. 100, 101 AND 102).  
REGINA DRUMMOND, EXAMINING ATTORNEY

**CLASS 36—(Continued).**

SN 86-075,480. DITECH MORTGAGE CORP, FT. WASHINGTON, PA. FILED 9-26-2013.



OWNER OF U.S. REG. NO. 2,158,800.  
THE MARK CONSISTS OF THE SHAPE OF A HOUSE WITH THE WORD "DITECH" TO THE RIGHT IN A SPECIALIZED FONT.  
FOR REAL ESTATE MORTGAGE BANKING AND LENDING SERVICES; LOAN ORIGATION AND FINANCING VIA A GLOBAL COMMUNICATIONS NETWORK; HOME EQUITY LOANS; MORTGAGE LENDING (U.S. CLS. 100, 101 AND 102).  
REGINA DRUMMOND, EXAMINING ATTORNEY

SN 86-075,570. DITECH MORTGAGE CORP, FT. WASHINGTON, PA. FILED 9-26-2013.



OWNER OF U.S. REG. NO. 2,158,800.  
THE COLOR(S) RED, GREEN AND BLUE IS/ARE CLAIMED AS A FEATURE OF THE MARK.  
THE MARK CONSISTS OF THE SHAPE OF A HOUSE FEATURING THE COLOR RED ON THE LEFT HALF OF THE HOUSE, GREEN ON THE RIGHT HALF OF THE HOUSE AND A BLUE ROOF AND THE WORDING "DITECH" TO THE RIGHT IN BLUE SPECIALIZED FONT.  
FOR REAL ESTATE MORTGAGE BANKING AND LENDING SERVICES; LOAN ORIGATION AND FINANCING VIA A GLOBAL COMMUNICATIONS NETWORK; HOME EQUITY LOANS; MORTGAGE LENDING (U.S. CLS. 100, 101 AND 102).  
REGINA DRUMMOND, EXAMINING ATTORNEY

SN 86-075,633. DITECH MORTGAGE CORP, FT. WASHINGTON, PA. FILED 9-26-2013.



OWNER OF U.S. REG. NO. 2,158,800.  
THE MARK CONSISTS OF THE WORD "DITECH" IN A SPECIALIZED FONT.  
FOR REAL ESTATE MORTGAGE BANKING AND LENDING SERVICES; LOAN ORIGATION AND FINANCING VIA A GLOBAL COMMUNICATIONS NETWORK; HOME EQUITY LOANS; MORTGAGE LENDING (U.S. CLS. 100, 101 AND 102).  
REGINA DRUMMOND, EXAMINING ATTORNEY

**CLASS 36—(Continued).**

SN 86-075,676. DITECH MORTGAGE CORP, FT. WASHINGTON, PA. FILED 9-26-2013.



OWNER OF U.S. REG. NO. 2,158,800.  
THE COLOR(S) BLUE IS/ARE CLAIMED AS A FEATURE OF THE MARK.

THE MARK CONSISTS OF THE WORD "DITECH" IN BLUE AND A SPECIALIZED FONT.

FOR REAL ESTATE MORTGAGE BANKING AND LENDING SERVICES; LOAN ORIGATION AND FINANCING VIA A GLOBAL COMMUNICATIONS NETWORK; HOME EQUITY LOANS; MORTGAGE LENDING (U.S. CLS. 100, 101 AND 102).

REGINA DRUMMOND, EXAMINING ATTORNEY

SN 86-079,559. AMERICAN AUTO GUARDIAN, INC., SCHAUMBURG, IL. FILED 10-1-2013.



NO CLAIM IS MADE TO THE EXCLUSIVE RIGHT TO USE "MECHANICAL GAP", APART FROM THE MARK AS SHOWN.

THE COLOR(S) BLACK, RED AND WHITE IS/ARE CLAIMED AS A FEATURE OF THE MARK.

THE MARK CONSISTS OF A BLACK LETTER "M" OUTLINED IN WHITE, A BLACK LETTER "E" OUTLINED IN WHITE, A BLACK LETTER "C" OUTLINED IN WHITE, A BLACK LETTER "H" OUTLINED IN WHITE, A BLACK LETTER "A" OUTLINED IN WHITE, A BLACK LETTER "N" OUTLINED IN WHITE, A BLACK LETTER "I" OUTLINED IN WHITE, A BLACK LETTER "C" OUTLINED IN WHITE, A BLACK LETTER "A" OUTLINED IN WHITE, A BLACK LETTER "L" OUTLINED IN WHITE, A BLACK LETTER "G" OUTLINED IN WHITE, A BLACK LETTER "A" OUTLINED IN WHITE, A BLACK LETTER "P" OUTLINED IN WHITE, ENCLOSED IN A RED CIRCULAR SWISH.

FOR EXTENDED WARRANTY SERVICES, NAMELY, SERVICE CONTRACTS (U.S. CLS. 100, 101 AND 102).

MARILYN IZZI, EXAMINING ATTORNEY

**CLASS 36—(Continued).**

SN 86-080,753. BARON CAPITAL GROUP, INC., NEW YORK, NY. FILED 10-2-2013.

**BARON DISCOVERY FUND**

THE MARK CONSISTS OF STANDARD CHARACTERS WITHOUT CLAIM TO ANY PARTICULAR FONT, STYLE, SIZE, OR COLOR.

OWNER OF U.S. REG. NOS. 2,961,602, 4,322,820 AND OTHERS.

NO CLAIM IS MADE TO THE EXCLUSIVE RIGHT TO USE "DISCOVERY FUND", APART FROM THE MARK AS SHOWN.

FOR INVESTMENT MANAGEMENT; MUTUAL FUND INVESTMENT (U.S. CLS. 100, 101 AND 102).

FIRST USE 9-30-2013; IN COMMERCE 9-30-2013.

PAUL E. FAHRENKOPF, EXAMINING ATTORNEY

SN 86-091,389. THE PRUDENTIAL INSURANCE COMPANY OF AMERICA, NEWARK, NJ. FILED 10-15-2013.

**PRUTERM**

THE MARK CONSISTS OF STANDARD CHARACTERS WITHOUT CLAIM TO ANY PARTICULAR FONT, STYLE, SIZE, OR COLOR.

OWNER OF U.S. REG. NO. 4,080,869.

FOR ADMINISTERING LIFE INSURANCE (U.S. CLS. 100, 101 AND 102).

FIRST USE 2-14-2011; IN COMMERCE 2-14-2011.

ELLEN PERKINS, EXAMINING ATTORNEY

SN 86-091,608. GOLDEN CONSIDERATIONS, INC., YORK, PA. FILED 10-15-2013.

**SPECIAL CONSIDERATIONS**

THE MARK CONSISTS OF STANDARD CHARACTERS WITHOUT CLAIM TO ANY PARTICULAR FONT, STYLE, SIZE, OR COLOR.

OWNER OF U.S. REG. NO. 4,391,192.

FOR PRE-PAID FUNERAL EXPENSE SERVICES (U.S. CLS. 100, 101 AND 102).

FIRST USE 8-0-2011; IN COMMERCE 8-0-2011.

ZACHARY BELLO, EXAMINING ATTORNEY

**CLASS 36—(Continued).**

SN 86-091,611. GOLDEN CONSIDERATIONS, INC., YORK, PA. FILED 10-15-2013.



OWNER OF U.S. REG. NO. 4,391,192.  
THE COLOR(S) GOLD, GREEN AND WHITE IS/ARE CLAIMED AS A FEATURE OF THE MARK.  
THE MARK CONSISTS OF THE STYLIZED LETTERS "SC" IN GOLD WITH GREEN AND WHITE HIGHLIGHTS OVER A GREEN BAR BEARING THE PHRASE "SPECIAL CONSIDERATIONS" IN WHITE.  
FOR PRE-PAID FUNERAL EXPENSE SERVICES (U.S. CLS. 100, 101 AND 102).  
FIRST USE 8-0-2011; IN COMMERCE 8-0-2011.  
ZACHARY BELLO, EXAMINING ATTORNEY

SN 86-091,779. DEALPOINT MERRILL EQUITIES, LLC, WOODLAND HILLS, CA. AND SPERRY VAN NESS INTERNATIONAL CORPORATION, IRVINE, CA. FILED 10-15-2013.



NO CLAIM IS MADE TO THE EXCLUSIVE RIGHT TO USE "EQUITIES", APART FROM THE MARK AS SHOWN.  
THE COLOR(S) BLUE AND GREY IS/ARE CLAIMED AS A FEATURE OF THE MARK.

THE MARK CONSISTS OF 3 BLUE ANGLED PILLAR STRUCTURES EACH NEXT TO 3 SMALLER GREY ANGLED PILLAR STRUCTURES APPEARING DIRECTLY ABOVE THE WORDS "SPERRY VAN NESS" IN BLUE STYLIZED LETTERING, WITH THE WORD "DEALPOINT" IN STYLIZED LETTERING APPEARING DIRECTLY BELOW THE WORDS "SPERRY VAN NESS" WITH THE LETTERS "DEAL" IN GREY AND THE LETTERS "POINT" IN BLUE AND A GREY CURVED SLASH APPEARING DIRECTLY ABOVE THE LETTER "I" AND A BLUE CURVED SLASH APPEARING FROM THE UPPER LEFT CORNER OF THE LETTER "N", WITH THE WORD "MERRILL" IN GREY STYLIZED LETTERING APPEARING DIRECTLY BELOW THE WORD "DEALPOINT" WITH A GREY LINE DIRECTLY TO THE LEFT OF THE WORD "MERRILL", AND THE WORD "EQUITIES" IN BLUE STYLIZED LETTERING APPEARING DIRECTLY BELOW THE GREY LINE AND WORD "MERRILL".

FOR BROKERAGE SERVICES IN THE FIELD OF INVESTMENT REAL ESTATE (U.S. CLS. 100, 101 AND 102).

FIRST USE 10-1-2013; IN COMMERCE 10-1-2013.  
SAMUEL E. SHARPER JR., EXAMINING ATTORNEY

**CLASS 36—(Continued).**

SN 86-093,133. BANK OF AMERICA CORPORATION, CHARLOTTE, NC. FILED 10-16-2013.

理想生活 始于互连互通

THE MARK CONSISTS OF THE WORDS AN IDEAL LIFE STARTS FROM CONNECTING WITH EACH OTHER IN SIMPLIFIED CHINESE CHARACTERS.

THE NON-LATIN CHARACTERS IN THE MARK TRANSLITERATE TO "LI XIANG SHENG HUO SHI YU HU LIAN HU TONG" AND THIS MEANS "AN IDEAL LIFE STARTS FROM CONNECTING WITH EACH OTHER" IN ENGLISH.

FOR BANKING AND FINANCING SERVICES (U.S. CLS. 100, 101 AND 102).  
CHRISTOPHER REAMS, EXAMINING ATTORNEY

SN 86-093,135. BANK OF AMERICA CORPORATION, CHARLOTTE, NC. FILED 10-16-2013.

理想生活 始於互連互通

THE MARK CONSISTS OF THE WORDS AN IDEAL LIFE STARTS FROM CONNECTING WITH EACH OTHER IN TRADITIONAL CHINESE CHARACTERS.

THE NON-LATIN CHARACTERS IN THE MARK TRANSLITERATE TO "LI XIANG SHENG HUO SHI YU HU LIAN HU TONG" AND THIS MEANS "AN IDEAL LIFE STARTS FROM CONNECTING WITH EACH OTHER" IN ENGLISH.

FOR BANKING AND FINANCING SERVICES (U.S. CLS. 100, 101 AND 102).  
CHRISTOPHER REAMS, EXAMINING ATTORNEY

SN 86-093,138. BANK OF AMERICA CORPORATION, CHARLOTTE, NC. FILED 10-16-2013.

우리가 함께할 때 더 나은 세상이 열립니다

THE MARK CONSISTS OF THE WORDS A BETTER LIFE OPENS WHEN WE ARE TOGETHER IN KOREAN CHARACTERS.

THE NON-LATIN CHARACTERS IN THE MARK TRANSLITERATE TO "WOO RI GA HAM KAE HAL DDAE DHU NA EUN" AND THIS MEANS "A BETTER LIFE OPENS WHEN WE ARE TOGETHER" IN ENGLISH.

FOR BANKING AND FINANCING SERVICES (U.S. CLS. 100, 101 AND 102).  
CHRISTOPHER REAMS, EXAMINING ATTORNEY

SN 86-093,141. BANK OF AMERICA CORPORATION, CHARLOTTE, NC. FILED 10-16-2013.

Cuộc sống sẽ tốt đẹp hơn khi chúng ta kết nối

THE MARKS CONSISTS OF THE VIETNAMESE WORDING "CUOC SONG SE TOT DEP HON KHI CHUNG TA KET NOI" WITH DIACRITICS.

THE ENGLISH TRANSLATION OF "CUOC SONG SE TOT DEP HON KHI CHUNG TA KET NOI" IN THE MARK IS "LIFE IS BETTER WHEN WE ARE CONNECTED/LINKED".

FOR BANKING AND FINANCING SERVICES (U.S. CLS. 100, 101 AND 102).  
CHRISTOPHER REAMS, EXAMINING ATTORNEY

**CLASS 36—(Continued).**

SN 86-093,651. UNITED SERVICES AUTOMOBILE ASSOCIATION, SAN ANTONIO, TX. FILED 10-17-2013.

**AGENT ON A BELT**

THE MARK CONSISTS OF STANDARD CHARACTERS WITHOUT CLAIM TO ANY PARTICULAR FONT, STYLE, SIZE, OR COLOR.

NO CLAIM IS MADE TO THE EXCLUSIVE RIGHT TO USE "AGENT", APART FROM THE MARK AS SHOWN.

FOR INSURANCE SERVICES, NAMELY, UNDERWRITING, ISSUING AND ADMINISTRATION OF ALL TYPES OF INSURANCES; CONSULTING AND INFORMATION CONCERNING INSURANCE; INSURANCE AGENCY AND BROKERAGE SERVICES (U.S. CLS. 100, 101 AND 102).

TARAH HARDY, EXAMINING ATTORNEY

SN 86-093,903. UNITED SERVICES AUTOMOBILE ASSOCIATION, SAN ANTONIO, TX. FILED 10-17-2013.

**ADVISOR ON A BELT**

THE MARK CONSISTS OF STANDARD CHARACTERS WITHOUT CLAIM TO ANY PARTICULAR FONT, STYLE, SIZE, OR COLOR.

NO CLAIM IS MADE TO THE EXCLUSIVE RIGHT TO USE "ADVISOR", APART FROM THE MARK AS SHOWN.

FOR FINANCIAL AND INVESTMENT SERVICES, NAMELY, MANAGEMENT AND BROKERAGE IN THE FIELDS OF STOCKS, BONDS, OPTIONS, COMMODITIES, MUTUAL FUNDS, REAL ESTATE, FUTURES AND OTHER SECURITIES, AND THE INVESTMENT OF FUNDS OF OTHERS; FINANCIAL AND INVESTMENT INFORMATION, ADVICE, ANALYSIS, CONSULTATION, RESEARCH, PLANNING AND MANAGEMENT SERVICES; FINANCIAL ASSET MANAGEMENT; TRUST MANAGEMENT ACCOUNTS; ESTATE TRUST MANAGEMENT (U.S. CLS. 100, 101 AND 102).

TARAH HARDY, EXAMINING ATTORNEY

**CLASS 36—(Continued).**

SN 86-095,442. COLUMBIA COLLECTION SERVICE, INC., MILWAUKIE, OR. FILED 10-18-2013.

**COLUMBIA COLLECTION SERVICE**

THE MARK CONSISTS OF STANDARD CHARACTERS WITHOUT CLAIM TO ANY PARTICULAR FONT, STYLE, SIZE, OR COLOR.

NO CLAIM IS MADE TO THE EXCLUSIVE RIGHT TO USE "COLLECTION SERVICE", APART FROM THE MARK AS SHOWN.

FOR COLLECTION AGENCIES; COLLECTION OF DEBTS; COLLECTION OF MONEY OWED FROM SETTLEMENTS; COLLECTION OF RENTS; DEBT COLLECTION; DEBT COLLECTION AGENCIES; DEBT RECOVERY AND COLLECTION AGENCIES (U.S. CLS. 100, 101 AND 102).

FIRST USE 8-20-1985; IN COMMERCE 8-20-1985.

MARLENE BELL, EXAMINING ATTORNEY

SN 86-102,882. FARM JOURNAL AGRICULTURAL FOUNDATION, PHILADELPHIA, PA. FILED 10-28-2013.



THE MARK CONSISTS OF A GLOBE WITH A STEM AND LEAF, ATOP AN OVAL SHADOW AND THE WORDS "FARMERS FEEDING THE WORLD".

FOR CHARITABLE FUNDRAISING SERVICES (U.S. CLS. 100, 101 AND 102).

FIRST USE 10-0-2010; IN COMMERCE 10-0-2010.

LINDA POWELL, EXAMINING ATTORNEY

SN 86-105,254. AMERICAN INTERNATIONAL GROUP, INC., NEW YORK, NY. FILED 10-30-2013.

**INCOMEDGE**

THE MARK CONSISTS OF STANDARD CHARACTERS WITHOUT CLAIM TO ANY PARTICULAR FONT, STYLE, SIZE, OR COLOR.

OWNER OF U.S. REG. NO. 3,365,459.

FOR ANNUITY UNDERWRITING; ISSUANCE AND ADMINISTRATION OF ANNUITIES (U.S. CLS. 100, 101 AND 102).

EUGENIA MARTIN, EXAMINING ATTORNEY

**CLASS 36—(Continued).**

SN 86-105,840. INETICO, INC., DBA PAR3, TAMPA, FL. FILED 10-30-2013.



NO CLAIM IS MADE TO THE EXCLUSIVE RIGHT TO USE "MEDICARE BASED" AND "REIMBURSEMENT RATES", APART FROM THE MARK AS SHOWN.

THE COLOR(S) GREEN AND WHITE IS/ARE CLAIMED AS A FEATURE OF THE MARK.

THE MARK CONSISTS OF THE STYLIZED GREEN WORDING "PAR" POSITIONED WITHIN A GREEN OVAL DESIGN, AND THE STYLIZED NUMBER "3" IN WHITE, ALSO WITHIN THE GREEN OVAL; THE BACKGROUND OF THE "3" PORTION OF THE MARK IS SHADED GREEN; AT THE BOTTOM OF THE MARK IS THE GREEN WORDING "MEDICARE BASED REASONABLE REIMBURSEMENT RATES".

FOR CLAIMS ADJUSTMENT IN THE FIELD OF INSURANCE (U.S. CLS. 100, 101 AND 102).

FIRST USE 5-1-2013; IN COMMERCE 5-1-2013.

JORDAN BAKER, EXAMINING ATTORNEY

**CLASS 36—(Continued).**

SN 86-110,564. STONEBRIDGE CASUALTY INSURANCE COMPANY, COLUMBUS, OH. FILED 11-5-2013.

**BIGRING**

THE MARK CONSISTS OF STANDARD CHARACTERS WITHOUT CLAIM TO ANY PARTICULAR FONT, STYLE, SIZE, OR COLOR.

FOR INSURANCE SERVICES, NAMELY, BROKERAGE, UNDERWRITING, AND ADMINISTRATION OF INSURANCE FOR BICYCLES AND BICYCLE ACCESSORIES, COVERING PROPERTY DAMAGE AND THEFT, EMERGENCY TRANSPORTATION, RENTAL REIMBURSEMENT, HELMET REPLACEMENT, ACCIDENT HOSPITALIZATION AND PHYSICAL THERAPY (U.S. CLS. 100, 101 AND 102).

TAMARA FRAZIER, EXAMINING ATTORNEY

SN 86-108,783. SMALLEY FAMILY HOLDINGS, LLC, ORLANDO, FL. FILED 11-3-2013.

**Everybody Needs an Estate  
Plan**

THE MARK CONSISTS OF STANDARD CHARACTERS WITHOUT CLAIM TO ANY PARTICULAR FONT, STYLE, SIZE, OR COLOR.

NO CLAIM IS MADE TO THE EXCLUSIVE RIGHT TO USE "ESTATE PLAN", APART FROM THE MARK AS SHOWN.

FOR ESTATE PLANNING (U.S. CLS. 100, 101 AND 102).

FIRST USE 11-3-2013; IN COMMERCE 11-3-2013.

RENEE MCCRAY, EXAMINING ATTORNEY

SN 86-110,586. STONEBRIDGE CASUALTY INSURANCE COMPANY, COLUMBUS, OH. FILED 11-5-2013.

**INSURANCE FOR WHAT MOVES  
YOU**

THE MARK CONSISTS OF STANDARD CHARACTERS WITHOUT CLAIM TO ANY PARTICULAR FONT, STYLE, SIZE, OR COLOR.

FOR INSURANCE SERVICES, NAMELY, BROKERAGE, UNDERWRITING, AND ADMINISTRATION OF INSURANCE FOR BICYCLES AND BICYCLE ACCESSORIES, COVERING PROPERTY DAMAGE AND THEFT, EMERGENCY TRANSPORTATION, RENTAL REIMBURSEMENT, HELMET REPLACEMENT, ACCIDENT HOSPITALIZATION AND PHYSICAL THERAPY (U.S. CLS. 100, 101 AND 102).

TAMARA FRAZIER, EXAMINING ATTORNEY

**CLASS 36—(Continued).**

SN 86-110,625. STONEBRIDGE CASUALTY INSURANCE COMPANY, COLUMBUS, OH. FILED 11-5-2013.



NO CLAIM IS MADE TO THE EXCLUSIVE RIGHT TO USE "BIKE INSURANCE", APART FROM THE MARK AS SHOWN.

THE MARK CONSISTS OF A BICYCLE OVER THE WORDS "BIGRING BIKE INSURANCE" ALL INSIDE A SPROCKET.

FOR INSURANCE SERVICES, NAMELY, BROKERAGE, UNDERWRITING, AND ADMINISTRATION OF INSURANCE FOR BICYCLES AND BICYCLE ACCESSORIES, COVERING PROPERTY DAMAGE AND THEFT, EMERGENCY TRANSPORTATION, RENTAL REIMBURSEMENT, HELMET REPLACEMENT, ACCIDENT HOSPITALIZATION AND PHYSICAL THERAPY (U.S. CLS. 100, 101 AND 102).

TAMARA FRAZIER, EXAMINING ATTORNEY

---

SN 86-110,676. SPYROPOULOS, PHIL, KEANSBURG, NJ. FILED 11-5-2013.

# hELLO

THE MARK CONSISTS OF STANDARD CHARACTERS WITHOUT CLAIM TO ANY PARTICULAR FONT, STYLE, SIZE, OR COLOR.

FOR CHARITABLE FUNDRAISING, NAMELY, CONDUCTING EVENTS TO RAISE FUNDS FOR CHARITIES AND URBAN RENEWAL PROJECTS (U.S. CLS. 100, 101 AND 102).

FIRST USE 5-1-2009; IN COMMERCE 5-1-2011.  
JOHN WILKE, EXAMINING ATTORNEY

---

SN 86-113,698. SIEMENS INDUSTRY, INC., ALPHARETTA, GA. FILED 11-8-2013.

# Product Guard

THE MARK CONSISTS OF STANDARD CHARACTERS WITHOUT CLAIM TO ANY PARTICULAR FONT, STYLE, SIZE, OR COLOR.

NO CLAIM IS MADE TO THE EXCLUSIVE RIGHT TO USE "PRODUCT", APART FROM THE MARK AS SHOWN.

FOR PROVIDING WARRANTY SERVICES, NAMELY, EXTENDED SERVICE CONTRACTS FOR HVAC PRODUCTS (U.S. CLS. 100, 101 AND 102).

SALLY SHIH, EXAMINING ATTORNEY

**CLASS 36—(Continued).**

SN 86-113,703. SIEMENS INDUSTRY, INC., ALPHARETTA, GA. FILED 11-8-2013.

# Product Guard Plus 3

THE MARK CONSISTS OF STANDARD CHARACTERS WITHOUT CLAIM TO ANY PARTICULAR FONT, STYLE, SIZE, OR COLOR.

NO CLAIM IS MADE TO THE EXCLUSIVE RIGHT TO USE "PRODUCT", APART FROM THE MARK AS SHOWN.

FOR PROVIDING WARRANTY SERVICES, NAMELY, EXTENDED SERVICE CONTRACTS FOR HVAC PRODUCTS (U.S. CLS. 100, 101 AND 102).

SALLY SHIH, EXAMINING ATTORNEY

---

SN 86-114,165. ZIONS BANCORPORATION, SALT LAKE CITY, UT. FILED 11-8-2013.

# VECTRAVIEW

THE MARK CONSISTS OF STANDARD CHARACTERS WITHOUT CLAIM TO ANY PARTICULAR FONT, STYLE, SIZE, OR COLOR.

OWNER OF U.S. REG. NOS. 1,604,952, 2,719,821 AND OTHERS.

FOR BANKING AND FINANCIAL SERVICES, NAMELY, PROVIDING ON-LINE BANKING AND MONEY MANAGEMENT SERVICES (U.S. CLS. 100, 101 AND 102).

FIRST USE 3-12-2010, THE MARK WAS FIRST USED ANYWHERE IN A DIFFERENT FORM OTHER THAN THAT SOUGHT TO BE REGISTERED AT LEAST AS EARLY AS 11/16/1989.; IN COMMERCE 3-12-2010, THE MARK WAS FIRST USED IN COMMERCE IN A DIFFERENT FORM OTHER THAN THAT SOUGHT TO BE REGISTERED AT LEAST AS EARLY AS 11/16/1989..

HEATHER BIDDULPH, EXAMINING ATTORNEY

**CLASS 36—(Continued).**

SN 86-114,286. GUESTLOGIX, INC., TORONTO, CANADA, FILED 11-8-2013.

**POWER ANCILLARY REVENUE**

THE MARK CONSISTS OF STANDARD CHARACTERS WITHOUT CLAIM TO ANY PARTICULAR FONT, STYLE, SIZE, OR COLOR.

NO CLAIM IS MADE TO THE EXCLUSIVE RIGHT TO USE "ANCILLARY REVENUE", APART FROM THE MARK AS SHOWN.

FOR PROVISION OF ELECTRONIC MONEY TRANSFER SERVICES; PROVISION OF ELECTRONIC COMMERCE PAYMENT SERVICES, NAMELY, ESTABLISHING FUNDED ACCOUNTS USED TO PURCHASE GOODS ON THE INTERNET; PROVISION OF SERVICES FOR CURRENCY EXCHANGE AND TRANSFER IN RETAIL SALES AND TRANSACTIONS; PROVISION OF INTEGRATED PAYMENT SYSTEMS AND BACK OFFICE SERVICES, NAMELY, PAYMENT PROCESSING SERVICES MADE WITH CASH, CREDIT AND OTHER PAYMENT CARDS AND VOUCHERS IN CUSTOMER PRESENT TRANSACTIONS; PROVISION OF ELECTRONIC AND WIRELESS MONEY TRANSFER SERVICES VIA BARCODE SCANNING; CLEARING AND RECONCILING FINANCIAL TRANSACTIONS VIA A GLOBAL COMPUTER NETWORK; TAX PAYMENT PROCESSING SERVICES (U.S. CLS. 100, 101 AND 102).

ELIZABETH CHANG, EXAMINING ATTORNEY



SN 86-122,814. VITAL FEDERAL CREDIT UNION, DUNCAN, SC. FILED 11-19-2013.



THE MARK CONSISTS OF A "V" SUPERIMPOSED ON TOP OF A SECOND "V".

FOR CREDIT UNION SERVICES (U.S. CLS. 100, 101 AND 102).

MARY ROSSMAN, EXAMINING ATTORNEY

**CLASS 36—(Continued).**

SN 86-124,544. SHELL TRADEMARK MANAGEMENT BV, THE HAGUE, NETHERLANDS, FILED 11-20-2013.

**SHELL FLEET NAVIGATOR**

THE MARK CONSISTS OF STANDARD CHARACTERS WITHOUT CLAIM TO ANY PARTICULAR FONT, STYLE, SIZE, OR COLOR.

OWNER OF U.S. REG. NOS. 2,198,391, 2,318,464 AND OTHERS.

NO CLAIM IS MADE TO THE EXCLUSIVE RIGHT TO USE "FLEET", APART FROM THE MARK AS SHOWN.

FOR CREDIT CARD SERVICES (U.S. CLS. 100, 101 AND 102).

FIRST USE 9-3-2013; IN COMMERCE 9-3-2013.

LEIGH CAROLINE CASE, EXAMINING ATTORNEY



SN 86-124,549. SHELL TRADEMARK MANAGEMENT BV, THE HAGUE, NETHERLANDS, FILED 11-20-2013.

**FLEET NAVIGATOR**

THE MARK CONSISTS OF STANDARD CHARACTERS WITHOUT CLAIM TO ANY PARTICULAR FONT, STYLE, SIZE, OR COLOR.

OWNER OF U.S. REG. NOS. 2,198,391, 2,318,464 AND OTHERS.

NO CLAIM IS MADE TO THE EXCLUSIVE RIGHT TO USE "FLEET", APART FROM THE MARK AS SHOWN.

FOR CREDIT CARD SERVICES (U.S. CLS. 100, 101 AND 102).

FIRST USE 9-3-2013; IN COMMERCE 9-3-2013.

LEIGH CAROLINE CASE, EXAMINING ATTORNEY

**CLASS 36—(Continued).**

SN 86-125,972. TIME INC., NEW YORK, NY. FILED 11-21-2013.

**MONEY**

THE MARK CONSISTS OF STANDARD CHARACTERS WITHOUT CLAIM TO ANY PARTICULAR FONT, STYLE, SIZE, OR COLOR.

OWNER OF U.S. REG. NOS. 2,722,926, 3,060,419 AND 3,555,474.  
SEC. 2(F).

FOR FINANCIAL INFORMATION PROVIDED BY ELECTRONIC MEANS IN THE FIELD OF JOBS AND EMPLOYMENT, PERSONAL FINANCE, FINANCIAL ASPECTS OF RETIREMENT, ESTATE PLANNING, MUTUAL FUNDS, INVESTING AND REAL ESTATE MARKETS; PROVIDING AN ON-LINE COMPUTER DATABASE IN THE FIELD OF STOCK/SECURITIES MARKET INFORMATION; PROVIDING INFORMATION AND ADVICE IN THE FIELD OF FINANCE, FINANCIAL INVESTMENTS, FINANCIAL VALUATIONS, AND THE FINANCIAL ASPECTS OF RETIREMENT; PROVIDING INFORMATION IN THE FIELD OF PERSONAL FINANCE; PROVIDING INFORMATION IN THE FIELD OF REAL ESTATE VIA THE INTERNET (U.S. CLS. 100, 101 AND 102).

FIRST USE 3-18-1995; IN COMMERCE 3-18-1995.  
LINDA ESTRADA, EXAMINING ATTORNEY

SN 86-136,113. AMTRUST NORTH AMERICA, INC., NEW YORK, NY. FILED 12-5-2013.

**ezBOP**

THE MARK CONSISTS OF STANDARD CHARACTERS WITHOUT CLAIM TO ANY PARTICULAR FONT, STYLE, SIZE, OR COLOR.

FOR INSURANCE AND REINSURANCE UNDERWRITING SERVICES; INSURANCE ADMINISTRATION SERVICES; INSURANCE SERVICES, NAMELY, UNDERWRITING BUSINESS OWNERS' POLICY INSURANCE; INSURANCE SERVICES, NAMELY, UNDERWRITING, ISSUANCE AND ADMINISTRATION OF BUSINESS OWNERS' POLICY INSURANCE (U.S. CLS. 100, 101 AND 102).

ANTHONY RINKER, EXAMINING ATTORNEY

**CLASS 36—(Continued).**

SN 86-136,153. AMTRUST NORTH AMERICA, INC., NEW YORK, NY. FILED 12-5-2013.

**ezBOP** 

THE MARK CONSISTS OF THE TERM "EZBOP" IN STYLIZED LETTERING WITH A CURSOR SYMBOL TO THE UPPER RIGHT.

FOR INSURANCE AND REINSURANCE UNDERWRITING SERVICES; INSURANCE ADMINISTRATION SERVICES; INSURANCE SERVICES, NAMELY, UNDERWRITING BUSINESS OWNERS' POLICY INSURANCE; INSURANCE SERVICES, NAMELY, UNDERWRITING, ISSUANCE AND ADMINISTRATION OF BUSINESS OWNERS' POLICY INSURANCE (U.S. CLS. 100, 101 AND 102).

ANTHONY RINKER, EXAMINING ATTORNEY

SN 86-136,298. AMTRUST NORTH AMERICA, INC., NEW YORK, NY. FILED 12-5-2013.

**ezComp**

THE MARK CONSISTS OF STANDARD CHARACTERS WITHOUT CLAIM TO ANY PARTICULAR FONT, STYLE, SIZE, OR COLOR.

FOR INSURANCE AND REINSURANCE UNDERWRITING SERVICES; INSURANCE ADMINISTRATION SERVICES; INSURANCE SERVICES, NAMELY, UNDERWRITING WORKERS' COMPENSATION INSURANCE; INSURANCE SERVICES, NAMELY, UNDERWRITING, ISSUANCE AND ADMINISTRATION OF WORKERS' COMPENSATION INSURANCE (U.S. CLS. 100, 101 AND 102).

ANTHONY RINKER, EXAMINING ATTORNEY



**CLASS 36—(Continued).**

SN 86-136,325. AMTRUST NORTH AMERICA, INC., NEW YORK, NY. FILED 12-5-2013.



THE MARK CONSISTS OF THE TERM "EZCOMP" IN STYLIZED LETTERING WITH A CURSOR SYMBOL TO THE UPPER RIGHT.

FOR INSURANCE AND REINSURANCE UNDERWRITING SERVICES; INSURANCE ADMINISTRATION SERVICES; INSURANCE SERVICES, NAMELY, UNDERWRITING WORKERS' COMPENSATION INSURANCE; INSURANCE SERVICES, NAMELY, UNDERWRITING, ISSUANCE AND ADMINISTRATION OF WORKERS' COMPENSATION INSURANCE (U.S. CLS. 100, 101 AND 102).

ANTHONY RINKER, EXAMINING ATTORNEY

**CLASS 36—(Continued).**

SN 86-140,753. FRANKLIN RESOURCES, INC., DBA FRANKLIN TEMPLETON INVESTMENTS, SAN MATEO, CA. FILED 12-11-2013.



---

SN 86-136,338. AMTRUST NORTH AMERICA, INC., NEW YORK, NY. FILED 12-5-2013.



THE MARK CONSISTS OF THE TERM "EZAUTO" IN STYLIZED LETTERING WITH A CURSOR SYMBOL TO THE UPPER RIGHT.

FOR INSURANCE AND REINSURANCE UNDERWRITING SERVICES; INSURANCE ADMINISTRATION SERVICES; INSURANCE SERVICES, NAMELY, UNDERWRITING AUTOMOBILE AND VEHICLE INSURANCE; INSURANCE SERVICES, NAMELY, UNDERWRITING, ISSUANCE AND ADMINISTRATION OF AUTOMOBILES AND VEHICLES INSURANCE (U.S. CLS. 100, 101 AND 102).

ANTHONY RINKER, EXAMINING ATTORNEY

THE MARK CONSISTS OF STANDARD CHARACTERS WITHOUT CLAIM TO ANY PARTICULAR FONT, STYLE, SIZE, OR COLOR.

OWNER OF U.S. REG. NOS. 1,607,629, 3,271,447 AND OTHERS.

NO CLAIM IS MADE TO THE EXCLUSIVE RIGHT TO USE "SOLUTIONS", APART FROM THE MARK AS SHOWN.

THE NAME "FRANKLIN TEMPLETON" DOES NOT IDENTIFY A LIVING INDIVIDUAL.

FOR ADVICE RELATING TO INVESTMENTS; ESTABLISHING MUTUAL FUNDS FOR OTHERS; FINANCIAL ADVISORY AND CONSULTANCY SERVICES; FINANCIAL ANALYSIS AND CONSULTATION; FINANCIAL INFORMATION AND ADVISORY SERVICES; FINANCIAL SERVICES, NAMELY, INVESTMENT ADVICE, INVESTMENT MANAGEMENT, INVESTMENT CONSULTATION AND INVESTMENT OF FUNDS FOR OTHERS, INCLUDING PRIVATE AND PUBLIC EQUITY AND DEBT INVESTMENT SERVICES; FINANCIAL SERVICES, NAMELY, INVESTMENT FUND TRANSFER AND TRANSACTION SERVICES; FUNDS INVESTMENT; INVESTMENT ADVISORY SERVICES; INVESTMENT CONSULTATION; INVESTMENT MANAGEMENT; INVESTMENT OF FUNDS FOR OTHERS; MUTUAL FUND DISTRIBUTION; MUTUAL FUND INVESTMENT; MUTUAL FUNDS AND CAPITAL INVESTMENT; TRANSFER AGENCY SERVICES RENDERED TO ISSUERS OF INVESTMENT SECURITIES (U.S. CLS. 100, 101 AND 102).

JOANNA FIORELLI, EXAMINING ATTORNEY

**CLASS 37—CONSTRUCTION AND REPAIR**

SN 79-133,485. KOMATSU LTD., JAPAN, FILED 3-27-2013.



OWNER OF INTERNATIONAL REGISTRATION 1169064  
DATED 3-27-2013, EXPIRES 3-27-2023.

OWNER OF U.S. REG. NOS. 1,071,304, 3,845,358 AND  
OTHERS.

NO CLAIM IS MADE TO THE EXCLUSIVE RIGHT TO  
USE "CARE", APART FROM THE MARK AS SHOWN.

THE MARK CONSISTS OF THE STYLIZED WORDING  
"KOMATSU CARE" WITH OVERLINING AND UNDER-  
LINING AND THE DESIGN OF A PARTIAL WRENCH ON  
THE UPPER LEFT OF THE WORDING.

THE ENGLISH TRANSLATION OF "KOMATSU" IN THE  
MARK IS "SMALL PINE TREE".

FOR REPAIR OR MAINTENANCE OF CONSTRUCTION  
MACHINES, APPARATUS AND THEIR PARTS;  
REPAIR OR MAINTENANCE OF LOADING-UNLOADING  
MACHINES, APPARATUS AND THEIR PARTS;  
REPAIR OR MAINTENANCE OF EARTH MOVING  
MACHINES, APPARATUS AND THEIR PARTS; REPAIR,  
CLEANING, MAINTENANCE AND PAINTING OF  
AUTOMOBILES AND THEIR PARTS; REPAIR OR  
MAINTENANCE OF ELECTRONIC MACHINES, APPA-  
RATUS AND THEIR PARTS; REPAIR OR MAINTENANCE  
OF TELECOMMUNICATION MACHINES,  
APPARATUS AND THEIR PARTS; REPAIR OR MAINTENANCE  
OF ELECTRIC MOTORS AND THEIR PARTS;  
REPAIR OR MAINTENANCE OF POWER DISTRIBUTION  
OR CONTROL MACHINES, APPARATUS AND  
THEIR PARTS; REPAIR OR MAINTENANCE OF POWER  
GENERATORS AND THEIR PARTS; REPAIR OR MAINTENANCE  
OF MINING MACHINES, APPARATUS AND  
THEIR PARTS; REPAIR OR MAINTENANCE OF FORK  
LIFTS, FORK LIFT TRUCKS, DUMP TRUCKS AND  
THEIR PARTS; REPAIR OR MAINTENANCE OF EARTH  
MOVING MACHINES, APPARATUS AND THEIR PARTS  
FOR USE IN FORESTRY (U.S. CLS. 100, 103 AND 106).

AMY HELLA, EXAMINING ATTORNEY

**CLASS 37—(Continued).**

SN 79-133,486. KOMATSU LTD., JAPAN, FILED 3-27-2013.

**KOMATSU CARE**

THE MARK CONSISTS OF STANDARD CHARACTERS  
WITHOUT CLAIM TO ANY PARTICULAR FONT, STYLE,  
SIZE, OR COLOR.

OWNER OF INTERNATIONAL REGISTRATION 1169066  
DATED 3-27-2013, EXPIRES 3-27-2023.

OWNER OF U.S. REG. NOS. 1,071,304, 3,845,358 AND  
OTHERS.

NO CLAIM IS MADE TO THE EXCLUSIVE RIGHT TO  
USE "CARE", APART FROM THE MARK AS SHOWN.

THE ENGLISH TRANSLATION OF "KOMATSU" IN THE  
MARK IS "SMALL PINE TREE".

FOR REPAIR OR MAINTENANCE OF CONSTRUCTION  
MACHINES, APPARATUS AND THEIR PARTS;  
REPAIR OR MAINTENANCE OF LOADING-UNLOADING  
MACHINES, APPARATUS AND THEIR PARTS;  
REPAIR OR MAINTENANCE OF EARTH MOVING  
MACHINES, APPARATUS AND THEIR PARTS; REPAIR,  
CLEANING, MAINTENANCE AND PAINTING OF  
AUTOMOBILES AND THEIR PARTS; REPAIR OR  
MAINTENANCE OF ELECTRONIC MACHINES, APPA-  
RATUS AND THEIR PARTS; REPAIR OR MAINTENANCE  
OF TELECOMMUNICATION MACHINES,  
APPARATUS AND THEIR PARTS; REPAIR OR MAINTENANCE  
OF ELECTRIC MOTORS AND THEIR PARTS;  
REPAIR OR MAINTENANCE OF POWER DISTRIBUTION  
OR CONTROL MACHINES, APPARATUS AND  
THEIR PARTS; REPAIR OR MAINTENANCE OF POWER  
GENERATORS AND THEIR PARTS; REPAIR OR MAINTENANCE  
OF MINING MACHINES, APPARATUS AND  
THEIR PARTS; REPAIR OR MAINTENANCE OF FORK  
LIFTS, FORK LIFT TRUCKS, DUMP TRUCKS AND  
THEIR PARTS; REPAIR OR MAINTENANCE OF EARTH  
MOVING MACHINES, APPARATUS AND THEIR PARTS  
FOR USE IN FORESTRY (U.S. CLS. 100, 103 AND 106).

AMY HELLA, EXAMINING ATTORNEY

SN 85-009,313. IFUZE TECHNOLOGIES, LLC, COLUMBUS,  
OH. FILED 4-8-2010.

THE MARK CONSISTS OF STANDARD CHARACTERS  
WITHOUT CLAIM TO ANY PARTICULAR FONT, STYLE,  
SIZE, OR COLOR.

FOR INSTALLATION, MAINTENANCE, REPAIR,  
AND CONSULTING RELATED THERETO IN THE  
FIELD OF ELECTRONIC EQUIPMENT AND SYSTEMS,  
NAMELY, AUDIO/VISUAL SYSTEMS, HOME THEATER  
SYSTEMS, AUTOMATION SYSTEMS, MUSIC SYSTEMS,  
FLAT PANEL SYSTEMS, SECURITY SYSTEMS, PERSONAL  
EMERGENCY RESPONSE SYSTEMS, SAFETY  
SYSTEMS, AND HEALTH MONITORING SYSTEMS  
(U.S. CLS. 100, 103 AND 106).

FIRST USE 12-17-2009; IN COMMERCE 2-10-2010.

YAT SYE, LEE, EXAMINING ATTORNEY

**CLASS 37—(Continued).**

SN 85-587,413. TOVAR SNOW PROFESSIONS, INC., EAST DUNDEE, IL. FILED 4-3-2012.

**ZERO TOLERANCE**

THE MARK CONSISTS OF STANDARD CHARACTERS WITHOUT CLAIM TO ANY PARTICULAR FONT, STYLE, SIZE, OR COLOR.

FOR SNOW AND ICE REMOVAL SERVICES (U.S. CLS. 100, 103 AND 106).

FIRST USE 12-30-1991; IN COMMERCE 12-30-1991.  
KATHERINE CHANG, EXAMINING ATTORNEY

---

SN 85-808,249. ENERGY FLUIDS, INC., OKLAHOMA CITY, OK. FILED 12-20-2012.

**ENERGY FLUIDS, INC.**

THE MARK CONSISTS OF STANDARD CHARACTERS WITHOUT CLAIM TO ANY PARTICULAR FONT, STYLE, SIZE, OR COLOR.

NO CLAIM IS MADE TO THE EXCLUSIVE RIGHT TO USE "INC.", APART FROM THE MARK AS SHOWN.

SEC. 2(F).  
FOR TECHNICAL CONSULTING IN THE FIELD OF OIL AND GAS DRILLING (U.S. CLS. 100, 103 AND 106).  
FIRST USE 11-1-2000; IN COMMERCE 11-1-2000.  
AMY C. KEAN, EXAMINING ATTORNEY

---

SN 85-836,433. VANBORTEL AIRCRAFT, INC., ARLINGTON, TX. FILED 1-30-2013.

**FEEL THE LOVE**

THE MARK CONSISTS OF STANDARD CHARACTERS WITHOUT CLAIM TO ANY PARTICULAR FONT, STYLE, SIZE, OR COLOR.

FOR REPAIR AND MAINTENANCE OF AIRCRAFT AND AUTOMOBILES (U.S. CLS. 100, 103 AND 106).  
ALLISON HOLTZ, EXAMINING ATTORNEY

**CLASS 37—(Continued).**

SN 85-848,706. MOBILE FLEET, INC., FARMINGDALE, NY. FILED 2-13-2013.

**LIGHTBARS**

THE MARK CONSISTS OF STANDARD CHARACTERS WITHOUT CLAIM TO ANY PARTICULAR FONT, STYLE, SIZE, OR COLOR.

FOR INSTALLATION OF RADIOS, REMOTE CONTROL STARTERS FOR EMERGENCY AND MUNICIPAL VEHICLES, ELECTRONIC LICENSE PLATE READERS, MOBILE VIDEO SYSTEMS COMPRISING CAMERAS AND AUDIO AND VIDEO RECORDERS FOR MOUNTING IN EMERGENCY AND POLICE VEHICLES, AND KITS PRIMARILY COMPRISED OF RADAR APPARATUS AND ALSO CONTAINING CONSOLES IN THE NATURE OF COMPUTER MOUNTING CONSOLES, CONSOLE BEVERAGE HOLDERS, CONSOLES FOR CAMERAS, RADIOS, AUDIO AND VIDEO RECORDERS, RADAR APPARATUS AND, CANINE (K9) CONTAINER SOLD AS A UNIT (U.S. CLS. 100, 103 AND 106).  
JENNIFER RICHARDSON, EXAMINING ATTORNEY

---

SN 85-860,241. S. D. MYERS, INC., TALLMADGE, OH. FILED 2-26-2013.

**SDMyers** ACTS 4:12

OWNER OF U.S. REG. NOS. 1,296,919, 1,297,244 AND 1,647,042.

NO CLAIM IS MADE TO THE EXCLUSIVE RIGHT TO USE "ACTS 4:12", APART FROM THE MARK AS SHOWN.

THE NAME "SD MYERS" DOES NOT IDENTIFY A LIVING INDIVIDUAL.

THE MARK CONSISTS OF THE LETTERS "SDMYERS" IN A LARGE, BOLD PRINT. THE LETTERS "SDM" ARE CAPITALIZED. "ACTS 4:12" IS IN A SMALL FONT IN ALL CAPITAL LETTERS OVER THE LOWER CASE LETTERS OF "SDMYERS" AND IS RIGHT JUSTIFIED.

FOR TRANSFORMER MAINTENANCE SERVICES (U.S. CLS. 100, 103 AND 106).

FIRST USE 12-31-2012; IN COMMERCE 12-31-2012.  
MICHAEL ENGEL, EXAMINING ATTORNEY

**CLASS 37—(Continued).**

SN 85-899,329. VAN DAELE DEVELOPMENT CORPORATION, RIVERSIDE, CA. FILED 4-9-2013.

Van Daele

THE MARK CONSISTS OF STANDARD CHARACTERS WITHOUT CLAIM TO ANY PARTICULAR FONT, STYLE, SIZE, OR COLOR.

SEC. 2(F).  
FOR REAL ESTATE DEVELOPMENT; RESIDENTIAL REAL ESTATE BUILDING CONSTRUCTION; REAL ESTATE SITE SELECTION; CONSTRUCTION SERVICES, NAMELY, PLANNING, LAYING OUT AND CONSTRUCTION OF RESIDENTIAL BUILDINGS; CONSTRUCTION MANAGEMENT SUPERVISION; LAND DEVELOPMENT SERVICES, NAMELY, PLANNING AND LAYING OUT OF RESIDENTIAL DEVELOPMENTS IN PLANNED COMMUNITIES (U.S. CLS. 100, 103 AND 106).

FIRST USE 3-13-1987; IN COMMERCE 3-13-1987.  
DANIEL CAPSHAW, EXAMINING ATTORNEY

---

SN 85-900,019. CHEVRON INTELLECTUAL PROPERTY LLC, SAN RAMON, CA. FILED 4-10-2013.



THE COLOR(S) YELLOW, GRAY AND WHITE IS/ARE CLAIMED AS A FEATURE OF THE MARK.

THE MARK CONSISTS OF THE COLOR YELLOW APPEARS IN THE LETTER "H" AND THE COLOR GRAY APPEARS IN THE DESIGN PORTION COMPRISING A STYLIZED REPRESENTATION OF A HYDROGEN ATOM. THE COLOR WHITE APPEARS WITHIN THE CIRCULAR PORTION OF THE HYDROGEN ATOM DESIGN.

FOR AUTOMOBILE SERVICE STATION SERVICES; AUTOMOBILE REPAIR AND MAINTENANCE SERVICES (U.S. CLS. 100, 103 AND 106).

SUSAN STIGLITZ, EXAMINING ATTORNEY

**CLASS 37—(Continued).**

SN 85-900,449. VAN DAELE DEVELOPMENT CORPORATION, RIVERSIDE, CA. FILED 4-10-2013.



NO CLAIM IS MADE TO THE EXCLUSIVE RIGHT TO USE "HOMES", APART FROM THE MARK AS SHOWN.

THE COLOR(S) WHITE, BLACK, GOLD, AND BURGUNDY IS/ARE CLAIMED AS A FEATURE OF THE MARK.

THE MARK CONSISTS OF THE WORDS "VAN DAELE HOMES" APPEARING IN WHITE IN STYLIZED FONT AND CENTERED ON THE TOP HALF OF A BLACK RECTANGLE. BELOW THOSE WORDS, IN THE BOTTOM HALF OF THE BLACK RECTANGLE AND JUSTIFIED TO THE RIGHT, THE WORDS "ONE FAMILY. ONE PROMISE." APPEAR IN GOLD STYLIZED FONT. THIN WHITE LINES THE SAME WIDTH AS THE BLACK RECTANGLE APPEAR IMMEDIATELY ABOVE AND BELOW THE BLACK RECTANGLE. THICKER BURGUNDY LINES THE SAME WIDTH AS THE BLACK RECTANGLE APPEAR IMMEDIATELY ABOVE AND BELOW THE WHITE LINES.

FOR REAL ESTATE DEVELOPMENT; RESIDENTIAL REAL ESTATE BUILDING CONSTRUCTION; REAL ESTATE SITE SELECTION; CONSTRUCTION SERVICES, NAMELY, PLANNING, LAYING OUT AND CONSTRUCTION OF RESIDENTIAL BUILDINGS; CONSTRUCTION MANAGEMENT SUPERVISION; LAND DEVELOPMENT SERVICES, NAMELY, PLANNING AND LAYING OUT OF RESIDENTIAL DEVELOPMENTS IN PLANNED COMMUNITIES (U.S. CLS. 100, 103 AND 106).

FIRST USE 11-20-2012; IN COMMERCE 11-20-2012.  
DANIEL CAPSHAW, EXAMINING ATTORNEY

---

SN 85-900,840. VAN DAELE DEVELOPMENT CORPORATION, RIVERSIDE, CA. FILED 4-10-2013.

*You'll feel good about your new home.*

THE MARK CONSISTS OF THE STYLIZED WORDING "YOU'LL FEEL GOOD ABOUT YOUR NEW HOME."

FOR REAL ESTATE DEVELOPMENT; RESIDENTIAL REAL ESTATE BUILDING CONSTRUCTION; REAL ESTATE SITE SELECTION; CONSTRUCTION SERVICES, NAMELY, PLANNING, LAYING OUT AND CONSTRUCTION OF RESIDENTIAL BUILDINGS; CONSTRUCTION MANAGEMENT SUPERVISION; LAND DEVELOPMENT SERVICES, NAMELY, PLANNING AND LAYING OUT OF RESIDENTIAL DEVELOPMENTS IN PLANNED COMMUNITIES (U.S. CLS. 100, 103 AND 106).

FIRST USE 11-20-2012; IN COMMERCE 11-20-2012.  
DANIEL CAPSHAW, EXAMINING ATTORNEY

**CLASS 37—(Continued).**

SN 85-917,968. HALL FINANCIAL GROUP, LTD., FRISCO, TX. FILED 4-29-2013.

### HALL ARTS TOWER

THE MARK CONSISTS OF STANDARD CHARACTERS WITHOUT CLAIM TO ANY PARTICULAR FONT, STYLE, SIZE, OR COLOR.

OWNER OF U.S. REG. NOS. 3,040,849, 3,342,491 AND 4,080,848.

NO CLAIM IS MADE TO THE EXCLUSIVE RIGHT TO USE "TOWER", APART FROM THE MARK AS SHOWN.

FOR BUILDING CONSTRUCTION AND REPAIR OF OFFICE BUILDINGS, RESTAURANTS, RETAIL STORES, HEALTH CLUBS, APARTMENTS AND MULTI-FAMILY PROPERTIES (U.S. CLS. 100, 103 AND 106).  
KATHRYN COWARD, EXAMINING ATTORNEY

**CLASS 37—(Continued).**

SN 85-938,371. RAINSERVATION, LLC, PORTER, TX. FILED 5-21-2013.



THE COLOR(S) BLUE, GREEN, AND BLACK IS/ARE CLAIMED AS A FEATURE OF THE MARK.

THE MARK CONSISTS OF AN ABSTRACT DRAWING OF A BLUE DROP OF WATER HAVING A GREEN LEAF COMING UP FROM THE RIGHT SIDE OF THE DROP OF WATER. THE COLOR BLACK IS USED TO OUTLINE THE DROP OF WATER AND TO PRODUCE A SHADOW EFFECT FOR THE LEAF.

FOR INSTALLATION AND MAINTENANCE OF RAINWATER HARVESTING SYSTEMS; INSTALLATION AND MAINTENANCE OF LAWN SPRINKLER SYSTEMS; INSTALLATION AND MAINTENANCE OF GUTTERS; INSTALLATION AND MAINTENANCE OF LED NIGHT LIGHTING SYSTEMS (U.S. CLS. 100, 103 AND 106).

FIRST USE 0-0-2012; IN COMMERCE 0-0-2012.  
ANTHONY RINKER, EXAMINING ATTORNEY

SN 85-923,546. MUFF STUFF, SOUTH GATE, CA. FILED 5-4-2013.



NO CLAIM IS MADE TO THE EXCLUSIVE RIGHT TO USE "EXHAUST HEAT-SHIELDS", APART FROM THE MARK AS SHOWN.

THE COLOR(S) BLACK, WHITE AND GREEN IS/ARE CLAIMED AS A FEATURE OF THE MARK.

THE MARK CONSISTS OF THE STYLIZED WORDING "MUFF STUFF" IN GREEN LETTERING OUTLINED IN WHITE ON BLACK BACKGROUND. ALSO INCLUDES ITALICIZED WORDING "EXHAUST HEAT-SHIELDS" IN WHITE LETTERING.

FOR MOTORCYCLE CUSTOMIZATION SERVICES (U.S. CLS. 100, 103 AND 106).  
CIMMERIAN COLEMAN, EXAMINING ATTORNEY

SN 85-962,329. MORAN ENVIRONMENTAL RECOVERY, LLC, RANDOLF, MA. FILED 6-18-2013.

SN 85-927,327. GENERAL MOTORS LLC, DETROIT, MI. FILED 5-9-2013.



NO CLAIM IS MADE TO THE EXCLUSIVE RIGHT TO USE "CERTIFIED SERVICE" AND "EXPRESS", APART FROM THE MARK AS SHOWN.

THE MARK CONSISTS OF THE WORDING "CERTIFIED SERVICE" ABOVE A BLACK RECTRANGULAR BOX WITH TWO WHITE STRIPES WITHIN THAT GIVE THE APPEARANCE OF A ROAD DESIGN WITH THE WORDING EXPRESS.

FOR MAINTENANCE AND REPAIR SERVICES FOR MOTOR VEHICLES (U.S. CLS. 100, 103 AND 106).  
FIRST USE 2-25-2012; IN COMMERCE 2-25-2012.  
JANICE L. MCMORROW, EXAMINING ATTORNEY



THE MARK CONSISTS OF STANDARD CHARACTERS WITHOUT CLAIM TO ANY PARTICULAR FONT, STYLE, SIZE, OR COLOR.

FOR CLEANING OF COMMERCIAL OR INDUSTRIAL PREMISES; JANITORIAL SERVICES; VEHICLE SERVICING, NAMELY, MOTOR VEHICLE MAINTENANCE AND REPAIR (U.S. CLS. 100, 103 AND 106).

FIRST USE 0-0-1974; IN COMMERCE 0-0-1974.  
INGRID C. EULIN, EXAMINING ATTORNEY

**CLASS 37—(Continued).**

SN 85-962,340. MORAN ENVIRONMENTAL RECOVERY, LLC, RANDOLPH, MA. FILED 6-18-2013.



THE MARK CONSISTS OF A FANCIFUL "D" WITH A DIAGONAL LINE RUNNING FROM TOP LEFT TO BOTTOM RIGHT SEPARATING A FILLED ELEMENT ON THE LEFT FROM AN OUTLINED ELEMENT ON THE RIGHT.

FOR CLEANING OF COMMERCIAL OR INDUSTRIAL PREMISES; JANITORIAL SERVICES; VEHICLE SERVICING, NAMELY, MOTOR VEHICLE MAINTENANCE AND REPAIR (U.S. CLS. 100, 103 AND 106).

FIRST USE 0-0-2012; IN COMMERCE 0-0-2012.  
INGRID C. EULIN, EXAMINING ATTORNEY

SN 85-967,851. ONECITY IP, LLC, INDIANAPOLIS, IN. FILED 6-24-2013.



THE MARK CONSISTS OF THE COMPOUND WORD "ONECITY" WITH THE NUMBER "1" IN PLACE OF THE LETTER "I". THE WORDING "COLLABORATION INNOVATION TECHNOLOGY YOU" IS BELOW "ONECITY", AND A VERTICAL LINE SEPARATES EACH PAIR OF HORIZONTALLY ADJACENT WORDS.

FOR REAL ESTATE DEVELOPMENT (U.S. CLS. 100, 103 AND 106).

FIRST USE 8-7-2012; IN COMMERCE 8-7-2012.  
ESTHER A. BORSUK, EXAMINING ATTORNEY

**CLASS 37—(Continued).**

SN 86-003,217. F.C. FRANCHISING SYSTEMS, INC., CINCINNATI, OH. FILED 7-5-2013.

## Fresh Coat Painting Done Right

THE MARK CONSISTS OF STANDARD CHARACTERS WITHOUT CLAIM TO ANY PARTICULAR FONT, STYLE, SIZE, OR COLOR.

NO CLAIM IS MADE TO THE EXCLUSIVE RIGHT TO USE "PAINTING", APART FROM THE MARK AS SHOWN. FOR CONSULTATION RELATING TO PAINTING OF BUILDINGS (U.S. CLS. 100, 103 AND 106).  
ERIN FALK, EXAMINING ATTORNEY

SN 86-025,862. CARSON CORPORATION, LAFAYETTE, NJ. FILED 8-1-2013.



NO CLAIM IS MADE TO THE EXCLUSIVE RIGHT TO USE "CORPORATION", APART FROM THE MARK AS SHOWN.

THE COLOR(S) BLUE AND GOLD IS/ARE CLAIMED AS A FEATURE OF THE MARK.

THE MARK CONSISTS OF A BLUE AND GOLD RECTANGLE CONTAINING A STYLIZED BLOCK LETTER "C" ALSO IN BLUE IN GOLD, ABOVE THE WORD "CARSON" IN BLUE CAPITAL LETTERS OUTLINED IN GOLD, WHICH APPEARS ABOVE THE WORD "CORPORATION" IN BLUE CAPITAL LETTERS OUTLINED IN GOLD.

FOR CONSTRUCTION SERVICES, NAMELY, DIRECTIONAL DRILLING, SITE EXCAVATION AND CIVIL CONSTRUCTION (U.S. CLS. 100, 103 AND 106).

FIRST USE 7-29-2013; IN COMMERCE 7-29-2013.  
KATHERINE M. DUBRAY, EXAMINING ATTORNEY

SN 86-030,397. FIX IT RITE PC REPAIR, NORFOLK, VA. FILED 8-6-2013.

## Fix it Rite PC Repair

THE MARK CONSISTS OF STANDARD CHARACTERS WITHOUT CLAIM TO ANY PARTICULAR FONT, STYLE, SIZE, OR COLOR.

NO CLAIM IS MADE TO THE EXCLUSIVE RIGHT TO USE "PC REPAIR", APART FROM THE MARK AS SHOWN. FOR INSTALLATION, MAINTENANCE AND REPAIR OF CONSUMER ELECTRONICS (U.S. CLS. 100, 103 AND 106).

FIRST USE 10-1-2012; IN COMMERCE 11-1-2012.  
ANTHONY RINKER, EXAMINING ATTORNEY

**CLASS 37—(Continued).**

SN 86-035,233. CONCERT TECHNOLOGIES, DULLES, VA. FILED 8-12-2013.

## RiserSafe

THE MARK CONSISTS OF STANDARD CHARACTERS WITHOUT CLAIM TO ANY PARTICULAR FONT, STYLE, SIZE, OR COLOR.

FOR INSTALLATION AND MAINTENANCE OF TELECOMMUNICATIONS CABLING AND EQUIPMENT, TELECOMMUNICATIONS INFRASTRUCTURE, TELECOMMUNICATION CIRCUITS, WIDE AREA NETWORKS, WIRELESS TECHNOLOGIES, TELEPHONY SYSTEMS, IP TELEPHONY, VOICE OVER IP, SECURITY DEVICES, SECURITY CAMERAS, VIDEO SURVEILLANCE, ACCESS CONTROL, BUILDING AUTOMATION SYSTEMS, DISTRIBUTED ANTENNA SYSTEMS, SELF-SERVE KIOSKS, DIGITAL SIGNAGE, VIDEO CONFERENCING, INTELLIGENT MEETING SPACES, STRUCTURED CABLING, DEMARC EXTENSIONS, EQUIPMENT CONFIGURATION, FIELD ENGINEERING, VOICE, DATA, INTERNET AND WIRELESS APPLICATIONS, TELECOMMUNICATIONS INFRASTRUCTURE MOVES, ADDS AND CHANGES; TELECOMMUNICATION WIRING (U.S. CLS. 100, 103 AND 106).

FIRST USE 1-7-2013; IN COMMERCE 1-7-2013.  
ROBERT C. CLARK JR., EXAMINING ATTORNEY

SN 86-036,718. DUNCAN GALVANIZING CORPORATION, EVERETT, MA. FILED 8-13-2013.



OWNER OF U.S. REG. NOS. 1,996,734, 3,727,446 AND OTHERS.

NO CLAIM IS MADE TO THE EXCLUSIVE RIGHT TO USE "GALVANIZING", APART FROM THE MARK AS SHOWN.

THE MARK CONSISTS OF THE WORD "DUNCAN" OVER THE TERM "GALVANIZING" WITH A STYLIZED LETTER "D" ON AN INCOMPLETE QUADRILATERAL THAT SERVES AS THE BACKGROUND FOR A SERIES OF SIX HORIZONTAL BANDS THAT ARE PRESENTED IN BETWEEN THE LETTER "D" AND THE BACKGROUND, AND WITH A SHADOW CAST BY THE LETTER "D" ONTO THE BACKGROUND.

FOR APPLICATION OF COATINGS FOR OTHERS, NAMELY, APPLYING DECORATIVE AND PROTECTIVE COATINGS TO METALS (U.S. CLS. 100, 103 AND 106).

FIRST USE 6-0-2013; IN COMMERCE 6-0-2013.  
TRACY WHITTAKER-BROWN, EXAMINING ATTORNEY

**CLASS 37—(Continued).**

SN 86-039,176. CHUTEMASTER ENVIRONMENTAL INC., UNION, NJ. FILED 8-15-2013.

## Chute Master Environmental

THE MARK CONSISTS OF STANDARD CHARACTERS WITHOUT CLAIM TO ANY PARTICULAR FONT, STYLE, SIZE, OR COLOR.

NO CLAIM IS MADE TO THE EXCLUSIVE RIGHT TO USE "CHUTE" AND "ENVIRONMENTAL", APART FROM THE MARK AS SHOWN.

FOR CLEANING AND REPAIR OF AIRDUCTS, TRASH CHUTES, AND BUILDINGS (U.S. CLS. 100, 103 AND 106).

FIRST USE 11-21-2001; IN COMMERCE 11-21-2001.  
JAMES GRIFFIN, EXAMINING ATTORNEY

SN 86-039,923. MAND, MENIFEE, CA. FILED 8-16-2013.

## All In Maintenance

THE MARK CONSISTS OF STANDARD CHARACTERS WITHOUT CLAIM TO ANY PARTICULAR FONT, STYLE, SIZE, OR COLOR.

NO CLAIM IS MADE TO THE EXCLUSIVE RIGHT TO USE "MAINTENANCE", APART FROM THE MARK AS SHOWN.

FOR MEDICAL EQUIPMENT MAINTENANCE AND REPAIR (U.S. CLS. 100, 103 AND 106).

JEFF DEFORD, EXAMINING ATTORNEY

SN 86-039,930. CAR TLC LLC, CHICAGO, IL. FILED 8-16-2013.

## CAR TLC

THE MARK CONSISTS OF STANDARD CHARACTERS WITHOUT CLAIM TO ANY PARTICULAR FONT, STYLE, SIZE, OR COLOR.

NO CLAIM IS MADE TO THE EXCLUSIVE RIGHT TO USE "CAR", APART FROM THE MARK AS SHOWN.

FOR VEHICLE MAINTENANCE SERVICES, INCLUDING, LUBRICATING CHASSIS, CHANGING MOTOR OIL, CHANGING OIL, AIR AND CABIN FILTERS, SERVICING TRANSMISSION, REFILLING BRAKE, POWER STEERING, RADIATOR, WINDSHIELD WASHER, ANTIFREEZE AND BATTERY RESERVOIRS TO PROPER FLUID LEVELS, CHANGING WINDSHIELD WIPER BLADES, INFLATING TIRES TO PROPER PRESSURE, VACUUMING INTERIORS, WASHING WINDOWS, WASHING VEHICLE, ROTATING AND REPAIRING TIRES, CHANGING BELTS AND HOSES, CHANGING BRAKE PADS AND BRAKE ROTORS, REPAIRING BRAKES AND BRAKE ROTORS, CHANGING HEADLIGHTS AND BULBS (U.S. CLS. 100, 103 AND 106).

FIRST USE 4-30-2011; IN COMMERCE 4-30-2011.  
DANIEL S. STRINGER, EXAMINING ATTORNEY

**CLASS 37—(Continued).**

SN 86-040,286. CAR TLC LLC, CHICAGO, IL. FILED 8-16-2013.

# FLEET TLC

THE MARK CONSISTS OF STANDARD CHARACTERS WITHOUT CLAIM TO ANY PARTICULAR FONT, STYLE, SIZE, OR COLOR.

NO CLAIM IS MADE TO THE EXCLUSIVE RIGHT TO USE "FLEET", APART FROM THE MARK AS SHOWN.

FOR VEHICLE MAINTENANCE SERVICES, INCLUDING, LUBRICATING CHASSIS, CHANGING MOTOR OIL, CHANGING OIL, AIR AND CABIN FILTERS, SERVICING TRANSMISSION, REFILLING BRAKE, POWER STEERING, RADIATOR, WINDSHIELD WASHER, ANTIFREEZE AND BATTERY RESERVOIRS TO PROPER FLUID LEVELS, CHANGING WINDSHIELD WIPER BLADES, INFLATING TIRES TO PROPER PRESSURE, VACUUMING INTERIORS, WASHING WINDOWS, WASHING VEHICLE, ROTATING AND REPAIRING TIRES, CHANGING BELTS AND HOSES, CHANGING BRAKE PADS AND BRAKE ROTORS, REPAIRING BRAKES AND BRAKE ROTORS, CHANGING HEADLIGHTS AND BULBS (U.S. CLS. 100, 103 AND 106).

FIRST USE 6-30-2013; IN COMMERCE 6-30-2013.  
DANIEL S. STRINGER, EXAMINING ATTORNEY

**CLASS 37—(Continued).**

SN 86-041,315. JAMES CORPORATION, DBA JAMES CONSTRUCTION, CARNEGIE, PA. FILED 8-19-2013.

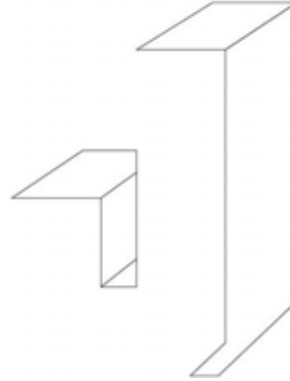

OWNER OF U.S. REG. NO. 3,539,389.

THE MARK CONSISTS OF AN OUTLINE OF THE TOP AND RIGHT SIDES OF AN ISOMETRIC CAPITAL "J".

FOR BUILDING CONSTRUCTION AND REPAIR (U.S. CLS. 100, 103 AND 106).

FIRST USE 7-26-2013; IN COMMERCE 7-26-2013.  
SHANNON TWOHIG, EXAMINING ATTORNEY

SN 86-041,340. JAMES CORPORATION, DBA JAMES CONSTRUCTION, CARNEGIE, PA. FILED 8-19-2013.

SN 86-040,322. JAMES CORPORATION, DBA JAMES CONSTRUCTION, CARNEGIE, PA. FILED 8-16-2013.

# JAMES CONSTRUCTION

THE MARK CONSISTS OF STANDARD CHARACTERS WITHOUT CLAIM TO ANY PARTICULAR FONT, STYLE, SIZE, OR COLOR.

NO CLAIM IS MADE TO THE EXCLUSIVE RIGHT TO USE "CONSTRUCTION", APART FROM THE MARK AS SHOWN.

FOR BUILDING CONSTRUCTION AND REPAIR (U.S. CLS. 100, 103 AND 106).

FIRST USE 1-2-1981; IN COMMERCE 1-2-1981.  
SHANNON TWOHIG, EXAMINING ATTORNEY



OWNER OF U.S. REG. NO. 3,539,389.

THE COLOR(S) WHITE, LIGHT GREEN AND DARK GREEN IS/ARE CLAIMED AS A FEATURE OF THE MARK.

THE MARK CONSISTS OF AN OUTLINE OF THE TOP AND RIGHT SIDES OF AN ISOMETRIC CAPITAL "J", WITH THE TOP SIDES SHOWN IN LIGHT GREEN AND THE RIGHT SIDES SHOWN IN DARK GREEN AND THE FRONT PANEL SHOWN IN WHITE.

FOR BUILDING CONSTRUCTION AND REPAIR (U.S. CLS. 100, 103 AND 106).

FIRST USE 7-26-2013; IN COMMERCE 7-26-2013.  
SHANNON TWOHIG, EXAMINING ATTORNEY



**CLASS 37—(Continued).**

SN 86-043,109. NOATHAN FABRICATION, LLC, LEXINGTON, NC. FILED 8-20-2013.

**C&S CUSTOM**

THE MARK CONSISTS OF STANDARD CHARACTERS WITHOUT CLAIM TO ANY PARTICULAR FONT, STYLE, SIZE, OR COLOR.

NO CLAIM IS MADE TO THE EXCLUSIVE RIGHT TO USE "CUSTOM", APART FROM THE MARK AS SHOWN. FOR MOTORCYCLE CUSTOMIZATION SERVICES (U.S. CLS. 100, 103 AND 106).

FIRST USE 3-1-1999; IN COMMERCE 3-1-1999.  
WENDY GOODMAN, EXAMINING ATTORNEY

**CLASS 37—(Continued).**

SN 86-043,749. CLOCKWORK IP, LLC, SARASOTA, FL. FILED 8-21-2013.



OWNER OF U.S. REG. NO. 3,904,870. THE MARK CONSISTS OF A STYLIZED LIGHTBULB CONTAINING A CITYSCAPE AND THE PHRASE "TURNING YOUR DARKNESS INTO LIGHT".

FOR REPAIR, MAINTENANCE, AND INSTALLATION OF ELECTRICAL WIRING, OUTLETS, LIGHT FIXTURES, AND ELECTRICAL PANELS, ELECTRICAL CONTRACTOR SERVICES (U.S. CLS. 100, 103 AND 106).  
ELIZABETH CHANG, EXAMINING ATTORNEY

SN 86-043,666. BAY HARBOR COMPANY, LLC, BAY HARBOR, MI. FILED 8-21-2013.

**Bay Harbor Toy Boxes**

THE MARK CONSISTS OF STANDARD CHARACTERS WITHOUT CLAIM TO ANY PARTICULAR FONT, STYLE, SIZE, OR COLOR.

OWNER OF U.S. REG. NOS. 2,137,668, 3,015,696 AND OTHERS.

SEC. 2(F) AS TO "BAY HARBOR".  
FOR REAL ESTATE DEVELOPMENT (U.S. CLS. 100, 103 AND 106).  
FIRST USE 8-3-2012; IN COMMERCE 11-7-2012.  
ANDREW RHIM, EXAMINING ATTORNEY

SN 86-044,575. ICRACKED INC., DBA ICRACKED, DALLAS, TX. FILED 8-21-2013.



THE COLOR(S) DARK BLUE, LIGHT BLUE AND WHITE IS/ARE CLAIMED AS A FEATURE OF THE MARK.

THE MARK CONSISTS OF FOUR-LIMBED CHARACTER SET IN AN ASYMMETRICAL POSE AS IT BALANCES ON ITS LEFT 'LEG'. ITS HEAD IS SHAPED AS A PIN THAT IS OFTEN USED TO INDICATE MAP LOCATIONS, AN OVAL SHAPE WITH ONE POINTED END AT THE BOTTOM AND AN OPEN WHITE CIRCLE IN THE CENTER. MARK IS DIVIDED INTO THREE PARTS: THE HEAD, ARMS, AND

**CLASS 37—(Continued).**

LEGS. THE ARMS APPEAR IN THE MIDDLE OF THE LOGO AS AN ASYMMETRICAL SHAPE WITH ONE BULB-SHAPED HAND POINTED UPWARD, AND THE OTHER POINTED DOWNWARD. THE LEGS FORM THE LOWER PORTION WITH TWO BULBOUS ENDS BOTH POINTED DOWNWARD. THE COLORS WHITE APPEARS IN THE CIRCLE IN THE POINTED PIN REPRESENTING THE HEAD, THE COLOR DARK BLUE APPEARS WITHIN THE HEAD AND LEGS, AND THE COLOR LIGHT BLUE APPEARS WITHIN THE ARMS.

FOR COMPUTER HARDWARE INSTALLATION AND REPAIR, INCLUDING MOBILE PERFORMANCE OF SUCH SERVICES ON CUSTOMER PREMISES; INSTALLATION AND REPAIR OF COMPUTER HARDWARE; INSTALLATION, MAINTENANCE AND REPAIR OF CELL PHONE RELATED HARDWARE; INSTALLATION, MAINTENANCE AND REPAIR OF COMPUTER HARDWARE; MAINTENANCE AND REPAIR OF TELECOMMUNICATIONS NETWORKING HARDWARE, APPARATUS, AND INSTRUMENTS; TECHNICAL SUPPORT SERVICES, NAMELY, TECHNICAL ADVICE RELATED TO THE REPAIR OF CELL PHONE HARDWARE AND MOBILE DEVICES; TECHNICAL SUPPORT SERVICES, NAMELY, TROUBLESHOOTING IN THE NATURE OF THE REPAIR OF COMPUTER HARDWARE (U.S. CLS. 100, 103 AND 106).

FIRST USE 7-16-2013; IN COMMERCE 7-16-2013.  
MARY ROSSMAN, EXAMINING ATTORNEY

**CLASS 37—(Continued).**

SN 86-044,725. HILT, TIFFANY, ATLANTA, GA. FILED 8-22-2013.

**BROAD WITH A BRUSH**

THE MARK CONSISTS OF STANDARD CHARACTERS WITHOUT CLAIM TO ANY PARTICULAR FONT, STYLE, SIZE, OR COLOR.

FOR APPLYING FINISHES TO WALLS AND OBJECTS, NAMELY, APPLICATION OF DECORATIVE COATINGS TO WALLS AND WOOD, METAL, AND LEATHER OBJECTS; PAINTING (U.S. CLS. 100, 103 AND 106).

FIRST USE 8-19-2013; IN COMMERCE 8-19-2013.  
LINDA LAVACHE, EXAMINING ATTORNEY

SN 86-044,587. ICRACKED INC., DBA ICRACKED, DALLAS, TX. FILED 8-21-2013.

iCracked

OWNER OF U.S. REG. NO. 3,954,372.  
THE MARK CONSISTS OF "ICRACKED" IN A STYLIZED FONT.

FOR COMPUTER HARDWARE INSTALLATION AND REPAIR, INCLUDING MOBILE PERFORMANCE OF SUCH SERVICES ON CUSTOMER PREMISES; INSTALLATION AND REPAIR OF COMPUTER HARDWARE; INSTALLATION, MAINTENANCE AND REPAIR OF CELL PHONE RELATED HARDWARE; INSTALLATION, MAINTENANCE AND REPAIR OF COMPUTER HARDWARE; MAINTENANCE AND REPAIR OF TELECOMMUNICATIONS NETWORKING HARDWARE, APPARATUS, AND INSTRUMENTS; TECHNICAL SUPPORT SERVICES, NAMELY, TECHNICAL ADVICE RELATED TO THE REPAIR OF CELL PHONE HARDWARE AND MOBILE DEVICES; TECHNICAL SUPPORT SERVICES, NAMELY, TROUBLESHOOTING IN THE NATURE OF THE REPAIR OF COMPUTER HARDWARE (U.S. CLS. 100, 103 AND 106).

FIRST USE 7-16-2013; IN COMMERCE 7-16-2013.  
MARY ROSSMAN, EXAMINING ATTORNEY

SN 86-045,006. COMPUTER PHONE REPAIR, VALLEY STREAM, NY. FILED 8-22-2013.



NO CLAIM IS MADE TO THE EXCLUSIVE RIGHT TO USE "COMPUTER PHONE REPAIR", APART FROM THE MARK AS SHOWN.

THE STIPPLING IS FOR SHADING PURPOSES ONLY.  
THE MARK CONSISTS OF THE STYLIZED TEXT "COMPUTER PHONE REPAIR" WITH A DESIGN OF A STETHOSCOPE TO THE LEFT OF THE TEXT AND A DESIGN OF A SMARTPHONE TO THE RIGHT OF THE TEXT.

FOR REPAIR OF COMPUTERS AND PHONES (U.S. CLS. 100, 103 AND 106).  
FIRST USE 1-1-2013; IN COMMERCE 1-1-2013.  
ROSELLE HERRERA, EXAMINING ATTORNEY

**CLASS 37—(Continued).**

SN 86-047,946. AUTOWORKS REFINISHING INC., DALLAS, TX. FILED 8-26-2013.



NO CLAIM IS MADE TO THE EXCLUSIVE RIGHT TO USE "AUTOWORKS REFINISHING INC.", APART FROM THE MARK AS SHOWN.

THE COLOR(S) GREEN, BLUE, RED, PURPLE, AND BLACK IS/ARE CLAIMED AS A FEATURE OF THE MARK. THE MARK CONSISTS OF THE WORDS "AUTOWORKS" IN BLACK IN CAPITAL LETTERS UNDERLINED IN BLACK AND ABOVE "REFINISHING INC." IN BLACK LOCATED TO THE RIGHT OF A CIRCULAR PATTERN DESIGN COMPRISING OF THE LETTERS "A" AND "R" IN GREEN, BLUE, RED AND PURPLE COLORS

FOR REPAIR OF AUTOMOBILES, NAMELY, EXTERNAL AND INTERIOR SURFACE REPAIR AND BODY PAINTING (U.S. CLS. 100, 103 AND 106).

FIRST USE 1-1-2004; IN COMMERCE 1-15-2004.  
JILL PRATER, EXAMINING ATTORNEY

SN 86-048,747. HEADLIGHTS MADE NEW, ELKIN, NC. FILED 8-27-2013.

## Headlights Made New

THE MARK CONSISTS OF STANDARD CHARACTERS WITHOUT CLAIM TO ANY PARTICULAR FONT, STYLE, SIZE, OR COLOR.

NO CLAIM IS MADE TO THE EXCLUSIVE RIGHT TO USE "HEADLIGHTS", APART FROM THE MARK AS SHOWN.

FOR REFURBISHING OF VEHICLE HEADLIGHT AND ANY PLASTIC/POLYCARBONATE SURFACE; RESTORATION IN THE FIELD OF VEHICLE HEADLIGHT AND ANY PLASTIC/POLYCARBONATE SURFACE (U.S. CLS. 100, 103 AND 106).

FIRST USE 1-1-2007; IN COMMERCE 1-1-2007.  
ADA HAN, EXAMINING ATTORNEY

**CLASS 37—(Continued).**

SN 86-051,639. CHARTER HOMES BUILDING COMPANY, LANCASTER, PA. FILED 8-29-2013.

## CH+N CONSTRUCTION

THE MARK CONSISTS OF STANDARD CHARACTERS WITHOUT CLAIM TO ANY PARTICULAR FONT, STYLE, SIZE, OR COLOR.

OWNER OF U.S. REG. NOS. 3,327,552 AND 3,452,483.

NO CLAIM IS MADE TO THE EXCLUSIVE RIGHT TO USE "CONSTRUCTION", APART FROM THE MARK AS SHOWN.

FOR CONSTRUCTION SERVICES, NAMELY, PLANNING, LAYING OUT AND CONSTRUCTION OF A PLANNED RESIDENTIAL COMMUNITY (U.S. CLS. 100, 103 AND 106).

FIRST USE 10-0-2009; IN COMMERCE 10-0-2009.

LESLIE RICHARDS, EXAMINING ATTORNEY

SN 86-051,643. CHARTER HOMES BUILDING COMPANY, LANCASTER, PA. FILED 8-29-2013.

## CH+N SITE CONSTRUCTION

THE MARK CONSISTS OF STANDARD CHARACTERS WITHOUT CLAIM TO ANY PARTICULAR FONT, STYLE, SIZE, OR COLOR.

OWNER OF U.S. REG. NOS. 3,327,552 AND 3,452,483.

NO CLAIM IS MADE TO THE EXCLUSIVE RIGHT TO USE "SITE CONSTRUCTION", APART FROM THE MARK AS SHOWN.

FOR CONSTRUCTION SERVICES, NAMELY, CONCRETE PAVING, SITE CLEARING, EXCAVATION, PAD PREPARATION, GRADING, AND ASPHALT PAVING SERVICES (U.S. CLS. 100, 103 AND 106).

FIRST USE 4-0-2013; IN COMMERCE 4-0-2013.

LESLIE RICHARDS, EXAMINING ATTORNEY

SN 86-058,433. TRAINOR, PATRICK, HOBOKEN, NJ. FILED 9-7-2013.

## The Poop Shoot

THE MARK CONSISTS OF STANDARD CHARACTERS WITHOUT CLAIM TO ANY PARTICULAR FONT, STYLE, SIZE, OR COLOR.

NO CLAIM IS MADE TO THE EXCLUSIVE RIGHT TO USE "POOP", APART FROM THE MARK AS SHOWN.

FOR PET WASTE REMOVAL SERVICES (U.S. CLS. 100, 103 AND 106).

TRACY FLETCHER, EXAMINING ATTORNEY

**CLASS 37—(Continued).**

SN 86-058,555. BLINDDISTRIBUTORS.COM, LLC, LAS VEGAS, NV. FILED 9-7-2013.

**Blind Doctor**

THE MARK CONSISTS OF STANDARD CHARACTERS WITHOUT CLAIM TO ANY PARTICULAR FONT, STYLE, SIZE, OR COLOR.

NO CLAIM IS MADE TO THE EXCLUSIVE RIGHT TO USE "BLIND", APART FROM THE MARK AS SHOWN.

FOR INSTALLATION, REPAIR AND REPLACEMENT OF BLINDS, SHADES, WINDOW COVERINGS AND TREATMENTS (U.S. CLS. 100, 103 AND 106).

FIRST USE 12-0-2009; IN COMMERCE 12-0-2009.

TINA L. SNAPP, EXAMINING ATTORNEY

---

SN 86-058,556. BLINDDISTRIBUTORS.COM, LLC, LAS VEGAS, NV. FILED 9-7-2013.

**Blinds Etc**

THE MARK CONSISTS OF STANDARD CHARACTERS WITHOUT CLAIM TO ANY PARTICULAR FONT, STYLE, SIZE, OR COLOR.

NO CLAIM IS MADE TO THE EXCLUSIVE RIGHT TO USE "BLINDS", APART FROM THE MARK AS SHOWN.

FOR INSTALLATION, REPAIR AND REPLACEMENT OF BLINDS, SHADES, WINDOW COVERINGS AND TREATMENTS (U.S. CLS. 100, 103 AND 106).

FIRST USE 7-0-2013; IN COMMERCE 7-0-2013.

TINA L. SNAPP, EXAMINING ATTORNEY

---

SN 86-061,516. A-STRONG CLEANING SERVICE LLC, LIVONIA, MI. FILED 9-11-2013.

**A-Strong**

THE MARK CONSISTS OF STANDARD CHARACTERS WITHOUT CLAIM TO ANY PARTICULAR FONT, STYLE, SIZE, OR COLOR.

FOR CLEANING OF BUILDINGS AND RESIDENTIAL HOUSES; JANITORIAL SERVICES; CARPET CLEANING; FLOOR POLISHING; FLOOR SANDING; HARDWOOD FLOOR COATING SERVICES (U.S. CLS. 100, 103 AND 106).

FIRST USE 9-3-2013; IN COMMERCE 9-3-2013.

PAUL E. FAHRENKOPF, EXAMINING ATTORNEY

**CLASS 37—(Continued).**

SN 86-061,802. TARASYUK, LESLIE, CAPE CORAL, FL. FILED 9-11-2013.

**Lelly**

THE MARK CONSISTS OF STANDARD CHARACTERS WITHOUT CLAIM TO ANY PARTICULAR FONT, STYLE, SIZE, OR COLOR.

FOR UPHOLSTERY AND REPAIR SERVICES IN THE NATURE OF UPHOLSTERY OF CHAIRS, CUSHIONS, MARINE VESSEL INTERIOR FURNITURE AND ACCESSORIES; AND UPHOLSTERY AND REPAIR OF CHAIRS, CUSHIONS, AND MARINE VESSEL INTERIOR FURNITURE AND ACCESSORIES (U.S. CLS. 100, 103 AND 106).

FIRST USE 9-8-2013; IN COMMERCE 9-8-2013.

SUSAN RICHARDS, EXAMINING ATTORNEY

---

SN 86-063,886. EXXON MOBIL CORPORATION, IRVING, TX. FILED 9-13-2013.

**NAFPAC**

THE MARK CONSISTS OF STANDARD CHARACTERS WITHOUT CLAIM TO ANY PARTICULAR FONT, STYLE, SIZE, OR COLOR.

FOR GRAVEL PACKING OF WELLS THAT PENETRATE SUBTERRANEAN OIL AND GAS RESERVOIRS (U.S. CLS. 100, 103 AND 106).

SOPHIA S. KIM, EXAMINING ATTORNEY

---

SN 86-065,672. REBOTIX, LLC, ST. PETERSBURG, FL. FILED 9-16-2013.

**REBOTIX**

THE MARK CONSISTS OF STANDARD CHARACTERS WITHOUT CLAIM TO ANY PARTICULAR FONT, STYLE, SIZE, OR COLOR.

FOR REPAIR AND REFURBISHMENT OF MEDICAL EQUIPMENT (U.S. CLS. 100, 103 AND 106).

MEREDITH MARESCA, EXAMINING ATTORNEY

**CLASS 37—(Continued).**

SN 86-065,679. DINGMAN'S COLLISION CENTER, INC., OMAHA, NE. FILED 9-16-2013.

DINGMAN'S COLLISION CENTER

THE MARK CONSISTS OF STANDARD CHARACTERS WITHOUT CLAIM TO ANY PARTICULAR FONT, STYLE, SIZE, OR COLOR.

NO CLAIM IS MADE TO THE EXCLUSIVE RIGHT TO USE "COLLISION CENTER", APART FROM THE MARK AS SHOWN.

SEC. 2(F) AS TO "DINGMAN'S".  
FOR AUTOMOTIVE COLLISION REPAIR SERVICES (U.S. CLS. 100, 103 AND 106).  
FIRST USE 0-0-1983; IN COMMERCE 0-0-1983.  
JAMES A. RAUEN, EXAMINING ATTORNEY

SN 86-065,681. REBOTIX, LLC, ST. PETERSBURG, FL. FILED 9-16-2013.



THE MARK CONSISTS OF A STYLIZED LETTER PRESCRIPTION SYMBOL AS THE LETTER "R" BEGINNING THE WORD REBOTIX WITH THE WORDS "YOUR PRESCRIPTION FOR SAVINGS" APPEARING BELOW THE LETTERS "EBOTIX".

FOR REPAIR AND REFURBISHMENT OF MEDICAL EQUIPMENT (U.S. CLS. 100, 103 AND 106).  
MEREDITH MARESCA, EXAMINING ATTORNEY

SN 86-066,501. RUFTY-PEEDIN DESIGN BUILDERS, LLC, RALEIGH, NC. FILED 9-17-2013.

RUFTY PEEDIN

THE MARK CONSISTS OF STANDARD CHARACTERS WITHOUT CLAIM TO ANY PARTICULAR FONT, STYLE, SIZE, OR COLOR.

FOR CONSTRUCTION SERVICES, NAMELY, PLANNING, LAYING OUT AND CUSTOM CONSTRUCTION OF COMMERCIAL BUILDINGS (U.S. CLS. 100, 103 AND 106).

FIRST USE 4-1-2011; IN COMMERCE 4-1-2011.  
CIMMERIAN COLEMAN, EXAMINING ATTORNEY

**CLASS 37—(Continued).**

SN 86-066,910. DELVALLE, MIKE, WOODRIDGE, IL. FILED 9-17-2013.

deltronics

THE MARK CONSISTS OF STANDARD CHARACTERS WITHOUT CLAIM TO ANY PARTICULAR FONT, STYLE, SIZE, OR COLOR.

FOR REPAIR OF AUDIO PRODUCTS AND MUSICAL INSTRUMENTS (U.S. CLS. 100, 103 AND 106).  
FIRST USE 7-1-1986; IN COMMERCE 7-1-1986.  
TRACY CROSS, EXAMINING ATTORNEY

SN 86-067,249. AMERICAN HOUSING VENTURES, LLC, NEWPORT BEACH, CA. FILED 9-17-2013.

LIVE RIGHT

THE MARK CONSISTS OF STANDARD CHARACTERS WITHOUT CLAIM TO ANY PARTICULAR FONT, STYLE, SIZE, OR COLOR.

FOR REAL ESTATE DEVELOPMENT SERVICES IN THE FIELD OF SINGLE FAMILY HOMES IN SINGLE FAMILY RENTAL COMMUNITIES (U.S. CLS. 100, 103 AND 106).

SUNG IN, EXAMINING ATTORNEY

SN 86-069,286. FISHER DEVELOPMENT, INC., SAN FRANCISCO, CA. FILED 9-19-2013.



THE MARK CONSISTS OF THE CAPITAL LETTER F IN A CIRCLE, WITH THE HORIZONTAL STROKE IN THE F IN THE SHAPE OF A NAIL.

FOR CONSTRUCTION PROJECT MANAGEMENT SERVICES; CONSTRUCTION SERVICES, NAMELY, PLANNING, LAYING OUT AND CUSTOM CONSTRUCTION OF COMMERCIAL BUILDINGS (U.S. CLS. 100, 103 AND 106).

NAKIA HENRY, EXAMINING ATTORNEY

**CLASS 37—(Continued).**

SN 86-069,781. ZOOM SEWER & DRAIN CLEANING SERVICE, INC., NORRISTOWN, PA. FILED 9-19-2013.

FAST. FOCUSED. ZOOM.

THE MARK CONSISTS OF STANDARD CHARACTERS WITHOUT CLAIM TO ANY PARTICULAR FONT, STYLE, SIZE, OR COLOR.

OWNER OF U.S. REG. NOS. 2,886,272, 3,630,754 AND 4,186,144.

FOR MUNICIPAL, COMMERCIAL, INDUSTRIAL AND RESIDENTIAL PLUMBING, SEWER, DRAIN AND PIPE CLEANING, INSPECTION AND REPAIR SERVICES (U.S. CLS. 100, 103 AND 106).

FIRST USE 9-12-2013; IN COMMERCE 9-12-2013.

JACQUELINE ABRAMS, EXAMINING ATTORNEY

SN 86-070,335. FCCG DETAILING, LLC, DBA GTECHNIQ STUDIO, WILTON, CT. FILED 9-20-2013.

GTECHNIQ STUDIO

THE MARK CONSISTS OF STANDARD CHARACTERS WITHOUT CLAIM TO ANY PARTICULAR FONT, STYLE, SIZE, OR COLOR.

FOR AIRPLANE MAINTENANCE AND REPAIR; AUTOMOBILE BODY REPAIR AND FINISHING FOR OTHERS; AUTOMOBILE CLEANING; AUTOMOBILE CUSTOMIZATION SERVICES; AUTOMOBILE DETAILING; AUTOMOBILE LUBRICATION; AUTOMOBILE PINSTRIPING; AUTOMOBILE RECONDITIONING SERVICES; AUTOMOBILE WASHING; CONSULTATION SERVICES IN THE FIELD OF YACHT AND BOAT CONVERSION, RENOVATION, REFIT AND REPAIR; VEHICLE DETAILING; VEHICLE MAINTENANCE; VEHICLE MAINTENANCE AND REPAIR; VEHICLE MAINTENANCE CONSULTATION; VEHICLE PAINTING; VEHICLE POLISHING; YACHT AND BOAT CONVERSION, RENOVATION, REFIT AND REPAIR (U.S. CLS. 100, 103 AND 106).

SUZANNE BLANE, EXAMINING ATTORNEY

SN 86-070,338. BED BUG BURNERS LLC, NEW PHILADELPHIA, OH. FILED 9-20-2013.

WE PUT THE HEAT ON BED BUGS

THE MARK CONSISTS OF STANDARD CHARACTERS WITHOUT CLAIM TO ANY PARTICULAR FONT, STYLE, SIZE, OR COLOR.

FOR EXTERMINATING CONSULTATION; PEST CONTROL; PEST CONTROL AND EXTERMINATION OTHER THAN FOR AGRICULTURAL PURPOSES (U.S. CLS. 100, 103 AND 106).

FIRST USE 4-28-2010; IN COMMERCE 4-28-2010.

LINDSEY BEN, EXAMINING ATTORNEY

**CLASS 37—(Continued).**

SN 86-077,013. PEAK ALARM COMPANY, INC., SALT LAKE CITY, UT. FILED 9-27-2013.



NO CLAIM IS MADE TO THE EXCLUSIVE RIGHT TO USE "ALARM", APART FROM THE MARK AS SHOWN.

THE COLOR(S) RED, WHITE AND BLACK IS/ARE CLAIMED AS A FEATURE OF THE MARK.

THE MARK CONSISTS OF THE RED LETTERS "PEAK" IMMEDIATELY FOLLOWED BY THE BLACK LETTERS "ALARM" WITH A BADGE DESIGN IMMEDIATELY ABOVE THE BLACK LETTERS "ALARM" THAT CONSISTS OF A LEFT SIDE THAT IS RED WITH THE WHITE LETTERS "PEAK", A MIDDLE ROUNDED TRAPEZOIDAL SHAPE OUTLINED IN BLACK WITH BLACK AND WHITE MOUNTAIN PEAKS AND WHITE SKY INSIDE THE SHAPE AND A LEFT SIDE THAT IS READ WITH THE WHITE LETTERS "ALARM", ALL OUTLINED IN BLACK. THE BACKGROUND OF THE MARK IS TRANSPARENT.

FOR FIRE AND/OR BURGLAR ALARM INSTALLATION AND/OR REPAIR (U.S. CLS. 100, 103 AND 106).

FIRST USE 1-1-1976; IN COMMERCE 1-1-1976.

MORGAN WYNNE, EXAMINING ATTORNEY

SN 86-082,591. WEATHERFORD/LAMB, INC., HOUSTON, TX. FILED 10-4-2013.

CemSure

THE MARK CONSISTS OF STANDARD CHARACTERS WITHOUT CLAIM TO ANY PARTICULAR FONT, STYLE, SIZE, OR COLOR.

FOR PRODUCTION WELL CLEANOUT SERVICES OF PARAFFINS, WAXES, ASPHALTENES, AND OTHER HYDROCARBON DEPOSITS FROM THE NEAR WELLBORE OF PRODUCING OIL AND GAS WELLS (U.S. CLS. 100, 103 AND 106).

JANET LEE, EXAMINING ATTORNEY

SN 86-111,382. GUIDEONE TAYLOR BALL CONSTRUCTION SERVICES, WEST DES MOINES, IA. FILED 11-6-2013.

HELPING YOU REBUILD YOUR  
WORLD

THE MARK CONSISTS OF STANDARD CHARACTERS WITHOUT CLAIM TO ANY PARTICULAR FONT, STYLE, SIZE, OR COLOR.

FOR BUILDING CONSTRUCTION SERVICES, AND REPAIRING AND RENOVATING CHURCHES AND OTHER WORSHIP FACILITIES, AS WELL AS SCHOOLS, SENIOR LIVING FACILITIES AND MEDICAL FACILITIES (U.S. CLS. 100, 103 AND 106).

JEAN IM, EXAMINING ATTORNEY

**CLASS 37—(Continued).**

SN 86-123,808. THE HYBRID SHOP LLC, GAINESVILLE, VA. FILED 11-20-2013.



THE COLOR(S) GREEN, BLACK AND WHITE IS/ARE CLAIMED AS A FEATURE OF THE MARK.

THE MARK CONSISTS OF AN IMAGE OF A BATTERY IN BLACK, THE BATTERY HAVING A POSITIVE AND NEGATIVE TERMINAL, WITH A WHITE MINUS "-" SYMBOL ON THE LEFT, AND A WHITE PLUS "+" SYMBOL ON THE RIGHT; THE BATTERY IS ENCIRCLED BY A GREEN CIRCLE; THE GREEN CIRCLE IS COMPOSED OF FOUR ARROWS MOVING IN A COUNTERCLOCKWISE DIRECTION, AND WHOSE COLOR SHIFTS GRADUALLY FROM DARK GREEN TO LIGHT GREEN, MOVING FROM THE BASE OF THE ARROW TO THE TIP OF THE ARROW; STARTING FROM THE TOP RIGHT HAND PORTION OF THE GREEN CIRCLE IS A LIGHT GREEN LIGHTNING BOLT THAT BISECTS THE BLACK BATTERY AND ENDS AT THE LOWER LEFT HAND PORTION OF THE GREEN CIRCLE. THE WHITE THAT APPEARS INSIDE THE GREEN CIRCLE BUT OUTSIDE THE BATTERY DESIGN IS INTENDED TO REPRESENT BACKGROUND OR A TRANSPARENT AREA AND IS NOT CLAIMED AS A FEATURE OF THE MARK.

FOR REPAIR AND MAINTENANCE OF VEHICLES; REPAIR OF AUTOMOBILES, NAMELY, BATTERY CONDITIONING OF HYBRID VEHICLES (U.S. CLS. 100, 103 AND 106).

FIRST USE 4-29-2013; IN COMMERCE 4-29-2013.  
WENDELL PHILLIPS, EXAMINING ATTORNEY

**CLASS 38—COMMUNICATION**

SN 85-697,666. DISNEY ENTERPRISES, INC., BURBANK, CA. FILED 8-7-2012.

**SPOONFUL**

THE MARK CONSISTS OF STANDARD CHARACTERS WITHOUT CLAIM TO ANY PARTICULAR FONT, STYLE, SIZE, OR COLOR.

PRIORITY CLAIMED UNDER SEC. 44(D) ON CHILE APPLICATION NO. 995284. FILED 2-23-2012.

FOR PROVIDING AN ONLINE ELECTRONIC BULLETIN BOARD FOR TRANSMISSION OF MESSAGES AMONG USERS (U.S. CLS. 100, 101 AND 104).

COLLEEN MULCRONE, EXAMINING ATTORNEY

**CLASS 38—(Continued).**

SN 85-774,513. VIJU INC., PARSIPPANY, NJ. FILED 11-8-2012.

**VIJU**

THE MARK CONSISTS OF STANDARD CHARACTERS WITHOUT CLAIM TO ANY PARTICULAR FONT, STYLE, SIZE, OR COLOR.

FOR AUDIO TELECONFERENCING, VIDEO AND WEB CONFERENCING SERVICES (U.S. CLS. 100, 101 AND 104).

FIRST USE 4-1-2010; IN COMMERCE 4-1-2010.  
ANNE FARRELL, EXAMINING ATTORNEY

SN 85-844,123. VIRTUAL FAN NETWORK, INC., SAN FRANCISCO, CA. FILED 2-7-2013.



THE COLOR(S) RED IS/ARE CLAIMED AS A FEATURE OF THE MARK.

THE MARK CONSISTS OF THE STYLIZED LETTER "S" IN RED.

FOR COMPUTER SERVICES PROVIDED OVER THE GLOBAL COMMUNICATIONS NETWORK, MOBILE DEVICES, WIRELESS INTERNET NETWORKS OR SYSTEMS AND OTHER COMPUTER AND ELECTRONIC COMMUNICATION NETWORKS, NAMELY, PROVIDING ACCESS FOR REGISTERED USERS TO A WEBSITE FEATURING INFORMATION, VIDEO AND AUDIO CONTENT RELATING TO SPECIFIC ATHLETES; PROVIDING ONLINE FORUMS, ELECTRONIC BULLETIN BOARDS AND CHAT ROOMS FOR COMMUNICATION ON TOPICS OF SPORTS AND GENERAL INTEREST; PROVIDING ONLINE COMMUNICATIONS LINKS WHICH TRANSFER WEB SITE USERS TO THIRD PARTY WEB SITES RELATING TO SPECIFIC ATHLETES; PROVIDING ACCESS VIA THE INTERNET TO THIRD PARTY WEB SITES OR DISTRIBUTED CONTENT UNITS VIA A UNIVERSAL LOGIN; AUDIO, TEXT AND VIDEO BROADCASTING SERVICES OVER COMPUTER OR OTHER COMMUNICATION NETWORKS, NAMELY, BROADCASTING OF ELECTRONICALLY UPLOADED, POSTED, DISPLAYED, TAGGED AND TRANSMITTED DATA, INFORMATION, AUDIO AND VIDEO IMAGES (U.S. CLS. 100, 101 AND 104).

KATHERINE CHANG, EXAMINING ATTORNEY

**CLASS 38—(Continued).**

SN 85-844,126. VIRTUAL FAN NETWORK, INC., SAN FRANCISCO, CA. FILED 2-7-2013.



THE COLOR(S) RED IS/ARE CLAIMED AS A FEATURE OF THE MARK.

THE MARK CONSISTS OF THE STYLIZED WORD "SQOR" IN RED LETTERING.

FOR COMPUTER SERVICES PROVIDED OVER THE GLOBAL COMMUNICATIONS NETWORK, MOBILE DEVICES, WIRELESS INTERNET NETWORKS OR SYSTEMS AND OTHER COMPUTER AND ELECTRONIC COMMUNICATION NETWORKS, NAMELY, PROVIDING ACCESS FOR REGISTERED USERS TO A WEBSITE FEATURING INFORMATION, VIDEO AND AUDIO CONTENT RELATING TO SPECIFIC ATHLETES; PROVIDING ONLINE FORUMS, ELECTRONIC BULLETIN BOARDS AND CHAT ROOMS FOR COMMUNICATION ON TOPICS OF SPORTS AND GENERAL INTEREST; PROVIDING ONLINE COMMUNICATIONS LINKS WHICH TRANSFER WEB SITE USERS TO THIRD PARTY WEB SITES RELATING TO SPECIFIC ATHLETES; PROVIDING ACCESS VIA THE INTERNET TO THIRD PARTY WEB SITES OR DISTRIBUTED CONTENT UNITS VIA A UNIVERSAL LOGIN; AUDIO, TEXT AND VIDEO BROADCASTING SERVICES OVER COMPUTER OR OTHER COMMUNICATION NETWORKS, NAMELY, BROADCASTING OF ELECTRONICALLY UPLOADED, POSTED, DISPLAYED, TAGGED AND TRANSMITTED DATA, INFORMATION, AUDIO AND VIDEO IMAGES (U.S. CLS. 100, 101 AND 104).

KATHERINE CHANG, EXAMINING ATTORNEY

SN 85-851,302. NATIONAL INSTRUMENTS CORPORATION, AUSTIN, TX. FILED 2-15-2013.

**BIG ANALOG DATA**

THE MARK CONSISTS OF STANDARD CHARACTERS WITHOUT CLAIM TO ANY PARTICULAR FONT, STYLE, SIZE, OR COLOR.

NO CLAIM IS MADE TO THE EXCLUSIVE RIGHT TO USE "ANALOG DATA", APART FROM THE MARK AS SHOWN.

FOR INFORMATION TRANSMISSION SERVICES VIA DIGITAL NETWORKS (U.S. CLS. 100, 101 AND 104).

CHRISTINA SOBRAL, EXAMINING ATTORNEY

**CLASS 38—(Continued).**

SN 85-851,622. MIGHTY MEDIA GROUP LP, DALLAS, TX. FILED 2-15-2013.

**Guess What's Next?**

THE MARK CONSISTS OF STANDARD CHARACTERS WITHOUT CLAIM TO ANY PARTICULAR FONT, STYLE, SIZE, OR COLOR.

FOR RADIO BROADCASTING (U.S. CLS. 100, 101 AND 104).

ALICE BENMAMAN, EXAMINING ATTORNEY

SN 85-880,687. SCAN, INC., OREM, UT. FILED 3-20-2013.



NO CLAIM IS MADE TO THE EXCLUSIVE RIGHT TO USE "SCAN", APART FROM THE MARK AS SHOWN.

THE COLOR(S) RED AND WHITE IS/ARE CLAIMED AS A FEATURE OF THE MARK.

THE MARK CONSISTS OF THE WORDING "SCAN" IN WHITE TO THE RIGHT OF A BROKEN WHITE SQUARE ON A RED TRIANGLE WITH ROUNDED CORNERS.

FOR COMPUTER TRANSMISSION OF INFORMATION ACCESSED VIA A VISUAL REFERENCE OR CODE, NAMELY, A QUICK RESPONSE (QR) CODE, BAR CODE, AND RFID TAGS VIA A COMPUTER OR MOBILE DEVICE FOR PURPOSES OF SHARING, DISTRIBUTING AND ADVERTISING VARIOUS PRODUCTS AND SERVICES (U.S. CLS. 100, 101 AND 104).

JANET LEE, EXAMINING ATTORNEY

SN 85-954,898. VESTRUM HEALTH, LLC, KNOXVILLE, TN. FILED 6-10-2013.

**VESTRUM HEALTH**

THE MARK CONSISTS OF STANDARD CHARACTERS WITHOUT CLAIM TO ANY PARTICULAR FONT, STYLE, SIZE, OR COLOR.

NO CLAIM IS MADE TO THE EXCLUSIVE RIGHT TO USE "HEALTH", APART FROM THE MARK AS SHOWN.

FOR PROVIDING ACCESS TO AN ELECTRONIC DATABASE OF MEDICAL HEALTH RECORDS TO HEALTHCARE PROVIDERS AND PURCHASERS OF HEALTH CARE DATA (U.S. CLS. 100, 101 AND 104).

MARC LEIPZIG, EXAMINING ATTORNEY



**CLASS 38—(Continued).**

SN 85-970,090. LIVECHAT SOFTWARE SPÓLKA AKCYJNA, DBA LIVECHAT (PRODUCT NAME), LIVECHAT, INC.(NAME OF THE COMPANY IN THE U.S.) OR LIVECHATINC.COM (INTERNET DOMAIN), WROCLAW, POLAND, FILED 6-26-2013.



NO CLAIM IS MADE TO THE EXCLUSIVE RIGHT TO USE "LIVECHAT", APART FROM THE MARK AS SHOWN. THE COLOR(S) BLACK AND ORANGE. IS/ARE CLAIMED AS A FEATURE OF THE MARK.

THE MARK CONSISTS OF STYLIZED WORD "LIVECHAT", "LIVE" IN BLACK COLOR AND "CHAT" IN ORANGE COLOR, SURROUNDED BY CLOUD IN BLACK COLOR.

SEC. 2(F).

FOR COMMUNICATIONS SERVICES, NAMELY, TRANSMITTING STREAMED SOUND AND AUDIOVISUAL RECORDINGS VIA THE INTERNET; DELIVERY OF MESSAGES BY ELECTRONIC TRANSMISSION; E-MAIL FORWARDING SERVICES; ELECTRONIC DATA INTERCHANGE (EDI) SERVICES; ELECTRONIC DELIVERY OF IMAGES AND PHOTOGRAPHS VIA A GLOBAL COMPUTER NETWORK; ELECTRONIC MAIL SERVICES; ELECTRONIC MESSAGING SYSTEM, NAMELY, ELECTRONIC QUEUING SERVICES; ELECTRONIC STORE-AND-FORWARD MESSAGING; ELECTRONIC TRANSMISSION OF DATA AND DOCUMENTS VIA COMPUTER TERMINALS; ELECTRONIC TRANSMISSION OF MESSAGES AND DATA; ELECTRONIC VOICE MESSAGING, NAMELY, THE RECORDING AND SUBSEQUENT TRANSMISSION OF VOICE MESSAGES BY TELEPHONE; ELECTRONIC, ELECTRIC, AND DIGITAL TRANSMISSION OF VOICE, DATA, IMAGES, SIGNALS, AND MESSAGES; WEB MESSAGING (U.S. CLS. 100, 101 AND 104).

FIRST USE 6-25-2002; IN COMMERCE 6-25-2002. CHRISTOPHER LAW, EXAMINING ATTORNEY

**CLASS 38—(Continued).**

SN 86-022,945. MALONE, DAMAN JAMES, TA HAVEN OF HORRORS, CALGARY, ALBERTA, CANADA, FILED 7-29-2013.



NO CLAIM IS MADE TO THE EXCLUSIVE RIGHT TO USE "HORRORS", APART FROM THE MARK AS SHOWN. THE STIPPLING IS FOR SHADING PURPOSES ONLY.

THE COLOR(S) BLACK, WHITE AND RED IS/ARE CLAIMED AS A FEATURE OF THE MARK.

THE MARK CONSISTS OF THE STYLIZED WORDING "MIDNITE HAVEN" IN RED ARCHED IN THE TOP PORTION AND THE STYLIZED WORDING "OF HORRORS" IN RED ARCHED IN THE BOTTOM PORTION OF A BLACK CIRCLE WITH A RED OUTLINE, WITH A WHITE CIRCLE REPRESENTING A MOON WITH AN IMAGE OF A BLACK TOP HAT WITH 2 BLACK BATS ABOVE IT, ONE SMALL AND ONE LARGE, IN THE CENTER OF THE BLACK CIRCLE AND THE STYLIZED WORDING "WITH CHESTER HORRORS" IN RED TO THE RIGHT OF AND BELOW THE BLACK TOP HAT.

FOR VIDEO STREAMING SERVICES VIA THE INTERNET, FEATURING INDEPENDENT FILMS AND MOVIES (U.S. CLS. 100, 101 AND 104).

DOMINIC J. FERRAIUOLO, EXAMINING ATTORNEY

SN 86-033,655. ODK MEDIA, INC., SANTA ANA, CA. FILED 8-9-2013.



NO CLAIM IS MADE TO THE EXCLUSIVE RIGHT TO USE "ON DEMAND KOREA", APART FROM THE MARK AS SHOWN.

THE MARK CONSISTS OF THE WORD "ON" WITH THE CENTER OF THE "O" IN THE SHAPE OF A TRIANGLE FOLLOWED BY THE WORD "DEMAND" WITH THE WORD "KOREA" SET ABOVE THE WORD "DEMAND".

FOR AUDIO AND VIDEO BROADCASTING SERVICES OVER THE INTERNET; BROADCASTING OF VIDEO AND AUDIO PROGRAMMING OVER THE INTERNET; STREAMING OF AUDIO MATERIAL ON THE INTERNET; STREAMING OF AUDIO, VISUAL AND AUDIOVISUAL MATERIAL VIA A GLOBAL COMPUTER NETWORK; STREAMING OF VIDEO MATERIAL ON THE INTERNET; VIDEO BROADCASTING; VIDEO BROADCASTING SERVICES VIA THE INTERNET (U.S. CLS. 100, 101 AND 104).

FIRST USE 3-0-2012; IN COMMERCE 3-0-2012. IRA J. GOODSaid, EXAMINING ATTORNEY

**CLASS 38—(Continued).**

SN 86-036,411. REALSOULFUL, INC., SCOTTSDALE, AZ. FILED 8-13-2013.

## Soulful Networking

THE MARK CONSISTS OF STANDARD CHARACTERS WITHOUT CLAIM TO ANY PARTICULAR FONT, STYLE, SIZE, OR COLOR.

NO CLAIM IS MADE TO THE EXCLUSIVE RIGHT TO USE "NETWORKING", APART FROM THE MARK AS SHOWN.

FOR PROVIDING ACCESS TO COMPUTER DATABASES IN THE FIELDS OF SOCIAL NETWORKING, SOCIAL INTRODUCTION AND DATING; PEER-TO-PEER PHOTO SHARING SERVICES, NAMELY, ELECTRONIC TRANSMISSION OF DIGITAL PHOTO FILES AMONG INTERNET USERS; PROVIDING ACCESS TO COMPUTER, ELECTRONIC AND ONLINE DATABASES; TELECOMMUNICATIONS SERVICES, NAMELY, ELECTRONIC TRANSMISSION OF DATA, MESSAGES AND INFORMATION; PROVIDING ONLINE FORUMS FOR COMMUNICATION ON TOPICS OF GENERAL INTEREST; PROVIDING ONLINE COMMUNICATIONS LINKS WHICH TRANSFER WEB SITE USERS TO OTHER LOCAL AND GLOBAL WEB PAGES; PROVIDING ACCESS TO WEB SITES FOR OTHERS HOSTED ON COMPUTER SERVERS ACCESSIBLE VIA A GLOBAL COMPUTER NETWORK; PROVIDING ONLINE CHAT ROOMS AND ELECTRONIC BULLETIN BOARDS FOR TRANSMISSION OF MESSAGES AMONG USERS IN THE FIELD OF GENERAL INTEREST; AUDIO, TEXT AND VIDEO BROADCASTING SERVICES OVER COMPUTER OR OTHER COMMUNICATION NETWORKS, NAMELY, UPLOADING, POSTING, DISPLAYING, TAGGING, AND ELECTRONICALLY TRANSMITTING DATA, INFORMATION, AUDIO AND VIDEO IMAGES; DELIVERY OF DIGITAL MUSIC BY ELECTRONIC TRANSMISSION (U.S. CLS. 100, 101 AND 104).

DAVID MURRAY, EXAMINING ATTORNEY

SN 86-040,561. FUNDACION TELETON MEXICO, A.C., TLALNEPANTLA DE BAZ, MEXICO, FILED 8-16-2013.



OWNER OF U.S. REG. NOS. 2,972,929, 4,197,670 AND OTHERS.

THE COLOR(S) WHITE, YELLOW AND PURPLE IS/ARE CLAIMED AS A FEATURE OF THE MARK.

THE MARK CONSISTS OF A YELLOW AND PURPLE HEART WITH WHITE HANDS AND A DIAGONAL WHITE BAND SUPERIMPOSED OVER THE HEART.

FOR CABLE TELEVISION TRANSMISSION; TELEVISION BROADCASTING; TELEVISION TRANSMISSION SERVICES (U.S. CLS. 100, 101 AND 104).

KAREN K. BUSH, EXAMINING ATTORNEY

**CLASS 38—(Continued).**

SN 86-040,567. LONDON TRUST MEDIA, INCORPORATED, LOS ANGELES, CA. FILED 8-16-2013.



THE COLOR(S) GREEN, WHITE, AND BLACK IS/ARE CLAIMED AS A FEATURE OF THE MARK.

THE MARK CONSISTS OF A GREEN ANTHROPO-MORPHIC LOCK OVER A WHITE BACKGROUND, THE LOCK HAVING ARMS, LEGS, A TORSO, AND A FACE, THE ARMS BEING TO THE SIDES OF THE TORSO, THE TORSO ALSO SHOWING A WHITE LOCK IN THE CENTER AND A WHITE HORIZONTAL LINE BETWEEN THE LOWER TORSO BELOW THE WHITE LOCK AND LEGS, THE BOLT OF THE LOCK SERVING AS THE HEAD, AND THE SPACE BETWEEN THE BOLT AND UPPER LOCK AS A WHITE FACE, INCLUDING A PAIR OF EYES AND A MOUTH, EACH COLORED IN BLACK.

FOR INFORMATION TRANSMISSION SERVICES VIA DIGITAL NETWORKS; PROVIDING PRIVATE AND SECURE REAL TIME ELECTRONIC COMMUNICATION OVER A COMPUTER NETWORK (U.S. CLS. 100, 101 AND 104).

FIRST USE 9-14-2010; IN COMMERCE 9-14-2010.

CIMMERIAN COLEMAN, EXAMINING ATTORNEY

SN 86-041,654. POCKETSTOP, LLC, DALLAS, TX. FILED 8-19-2013.

## REDFLAG

THE MARK CONSISTS OF STANDARD CHARACTERS WITHOUT CLAIM TO ANY PARTICULAR FONT, STYLE, SIZE, OR COLOR.

FOR COMMUNICATION SERVICES, NAMELY, TRANSMISSION OF VOICE, AUDIO, VISUAL IMAGES AND DATA BY TELECOMMUNICATIONS NETWORKS, WIRELESS COMMUNICATION NETWORKS, THE INTERNET, INFORMATION SERVICES NETWORKS AND DATA NETWORKS (U.S. CLS. 100, 101 AND 104).

FIRST USE 4-1-2013; IN COMMERCE 7-9-2013.

JENNIFER DIXON, EXAMINING ATTORNEY

**CLASS 38—(Continued).**

SN 86-044,146. RUM BUM DISTRIBUTORS, INC., MIAMI, FL. FILED 8-21-2013.

RUMBUMRADIO.COM

THE MARK CONSISTS OF STANDARD CHARACTERS WITHOUT CLAIM TO ANY PARTICULAR FONT, STYLE, SIZE, OR COLOR.

OWNER OF U.S. REG. NOS. 4,146,862, 4,358,218 AND OTHERS.

FOR BROADCASTING SERVICES VIA THE INTERNET AND THE WORLDWIDE WEB; TELECOMMUNICATION SERVICES, NAMELY, PROVIDING TRANSMISSION OF VOICE, DATA, VIDEO, AND MEDIA CONTENT VIA THE INTERNET AND WORLDWIDE WEB (U.S. CLS. 100, 101 AND 104).

ALISON POLLACK, EXAMINING ATTORNEY

SN 86-044,598. MASSIE, PERRY T, PRESCOTT, AZ. FILED 8-21-2013.

REDNECK CHANNEL

THE MARK CONSISTS OF STANDARD CHARACTERS WITHOUT CLAIM TO ANY PARTICULAR FONT, STYLE, SIZE, OR COLOR.

NO CLAIM IS MADE TO THE EXCLUSIVE RIGHT TO USE "CHANNEL", APART FROM THE MARK AS SHOWN.

FOR BROADCAST OF CABLE TELEVISION PROGRAMMES; BROADCASTING OF VIDEO AND AUDIO PROGRAMMING OVER THE INTERNET; CABLE TELEVISION BROADCASTING; ELECTRONIC TRANSMISSION OF VOICE, DATA AND IMAGES BY TELEVISION AND VIDEO BROADCASTING; INTERNET BROADCASTING SERVICES; SATELLITE TELEVISION BROADCASTING; SUBSCRIPTION TELEVISION BROADCASTING; TELEVISION PROGRAMME BROADCASTING VIA CABLE; VIDEO BROADCASTING; VIDEO BROADCASTING SERVICES OVER THE INTERNET OR OTHER COMMUNICATIONS NETWORK, NAMELY, ELECTRONICALLY TRANSMITTING VIDEO CLIPS (U.S. CLS. 100, 101 AND 104).

AMY KELLY, EXAMINING ATTORNEY

**CLASS 38—(Continued).**

SN 86-055,525. CIRBN, LLC, NORMAL, IL. FILED 9-4-2013.



THE COLOR(S) GREEN, ORANGE, AND BLUE IS/ARE CLAIMED AS A FEATURE OF THE MARK.

THE MARK CONSISTS OF THE ACRONYM "CIRBN" IN GREEN, THE WORDS "CONNECTING COMMUNITIES" BELOW IN ORANGE, AND A DESIGN CONSISTING OF THREE INTERLOCKING TRIANGULAR RINGS IN GREEN, ORANGE, AND BLUE TO THE LEFT.

FOR TELECOMMUNICATION SERVICES, NAMELY, PROVIDING INTERNET ACCESS VIA BROADBAND FIBER OPTIC NETWORKS (U.S. CLS. 100, 101 AND 104).

FIRST USE 8-1-2013; IN COMMERCE 8-1-2013.

KEVON CHISOLM, EXAMINING ATTORNEY

SN 86-062,535. LEVEL 3 COMMUNICATIONS, LLC, BROOMFIELD, CO. FILED 9-12-2013.

VPN STRONG START

THE MARK CONSISTS OF STANDARD CHARACTERS WITHOUT CLAIM TO ANY PARTICULAR FONT, STYLE, SIZE, OR COLOR.

NO CLAIM IS MADE TO THE EXCLUSIVE RIGHT TO USE "VPN", APART FROM THE MARK AS SHOWN.

FOR PROVIDING VIRTUAL PRIVATE NETWORK (VPN) SERVICES (U.S. CLS. 100, 101 AND 104).

SUSAN RICHARDS, EXAMINING ATTORNEY

SN 86-063,852. SPANISH BROADCASTING SYSTEM, INC., MIAMI, FL. FILED 9-13-2013.

OJOPINIONES

THE MARK CONSISTS OF STANDARD CHARACTERS WITHOUT CLAIM TO ANY PARTICULAR FONT, STYLE, SIZE, OR COLOR.

FOR RADIO AND TELEVISION BROADCASTING (U.S. CLS. 100, 101 AND 104).

RONALD MCMORROW, EXAMINING ATTORNEY

**CLASS 38—(Continued).**

SN 86-066,600. HAPPY GRASSHOPPER, LLC, SAFETY HARBOR, FL. FILED 9-17-2013.

**HG-Recruits**

THE MARK CONSISTS OF STANDARD CHARACTERS WITHOUT CLAIM TO ANY PARTICULAR FONT, STYLE, SIZE, OR COLOR.  
FOR PROVIDING E-MAIL SERVICES (U.S. CLS. 100, 101 AND 104).  
FIRST USE 8-13-2013; IN COMMERCE 8-13-2013.  
ROBIN CHOSID, EXAMINING ATTORNEY

SN 86-066,621. CAPSTAR RADIO OPERATING COMPANY, SAN ANTONIO, TX. FILED 9-17-2013.

**THE BREAKFAST CLUB**

THE MARK CONSISTS OF STANDARD CHARACTERS WITHOUT CLAIM TO ANY PARTICULAR FONT, STYLE, SIZE, OR COLOR.  
FOR TELEVISION BROADCASTING (U.S. CLS. 100, 101 AND 104).  
ARETHA SOMERVILLE, EXAMINING ATTORNEY

SN 86-066,626. HAPPY GRASSHOPPER, LLC, SAFETY HARBOR, FL. FILED 9-17-2013.

**Position-Me**

THE MARK CONSISTS OF STANDARD CHARACTERS WITHOUT CLAIM TO ANY PARTICULAR FONT, STYLE, SIZE, OR COLOR.  
FOR PROVIDING E-MAIL SERVICES (U.S. CLS. 100, 101 AND 104).  
FIRST USE 8-13-2013; IN COMMERCE 8-13-2013.  
ROBIN CHOSID, EXAMINING ATTORNEY

**CLASS 38—(Continued).**

SN 86-067,102. METAMAKO TECHNOLOGY LP, SYDNEY, AUSTRALIA, FILED 9-17-2013.

**METAMAKO**

THE MARK CONSISTS OF STANDARD CHARACTERS WITHOUT CLAIM TO ANY PARTICULAR FONT, STYLE, SIZE, OR COLOR.  
FOR TRANSMISSION OF INFORMATION BY ELECTRONIC COMMUNICATIONS NETWORKS (U.S. CLS. 100, 101 AND 104).  
SHAVELL MCPHERSON, EXAMINING ATTORNEY

SN 86-067,577. SMA MEDIA LLC, WILMINGTON, DE. FILED 9-18-2013.

**ADNUBO**

THE MARK CONSISTS OF STANDARD CHARACTERS WITHOUT CLAIM TO ANY PARTICULAR FONT, STYLE, SIZE, OR COLOR.  
THE WORDING "ADNUBO" HAS NO MEANING IN A FOREIGN LANGUAGE.  
FOR MOBILE MEDIA SERVICES IN THE NATURE OF ELECTRONIC TRANSMISSION OF ENTERTAINMENT MEDIA CONTENT (U.S. CLS. 100, 101 AND 104).  
FIRST USE 7-29-2013; IN COMMERCE 7-29-2013.  
SANJEEV VOHRA, EXAMINING ATTORNEY

SN 86-067,770. SMA MEDIA LLC, WILMINGTON, DE. FILED 9-18-2013.

**MOBTOPUS**

THE MARK CONSISTS OF STANDARD CHARACTERS WITHOUT CLAIM TO ANY PARTICULAR FONT, STYLE, SIZE, OR COLOR.  
THE WORDING "MOBTOPUS" HAS NO MEANING IN A FOREIGN LANGUAGE.  
FOR MOBILE MEDIA SERVICES IN THE NATURE OF ELECTRONIC TRANSMISSION OF ENTERTAINMENT MEDIA CONTENT (U.S. CLS. 100, 101 AND 104).  
FIRST USE 6-17-2013; IN COMMERCE 6-17-2013.  
SANJEEV VOHRA, EXAMINING ATTORNEY

**CLASS 38—(Continued).**

SN 86-068,001. KATZ, RONALD A., LOS ANGELES, CA. FILED 9-18-2013.

# TELEBUYER

THE MARK CONSISTS OF STANDARD CHARACTERS WITHOUT CLAIM TO ANY PARTICULAR FONT, STYLE, SIZE, OR COLOR.

FOR PROVIDING FACILITIES AND EQUIPMENT FOR VIDEO CONFERENCING; TRANSMISSION OF INFORMATION THROUGH VIDEO COMMUNICATION SYSTEMS (U.S. CLS. 100, 101 AND 104).

MARTHA SANTOMARTINO, EXAMINING ATTORNEY

---

SN 86-068,135. WHEAT STATE TELEPHONE, INC., UDALL, KS. FILED 9-18-2013.

# EnFusionTV

THE MARK CONSISTS OF STANDARD CHARACTERS WITHOUT CLAIM TO ANY PARTICULAR FONT, STYLE, SIZE, OR COLOR.

FOR TELECOMMUNICATION SERVICES, NAMELY, LOCAL AND LONG DISTANCE TRANSMISSION OF VOICE, DATA, GRAPHICS AND VIDEO BY MEANS OF BROADBAND OPTICAL OR WIRELESS NETWORKS; TELEVISION TRANSMISSION SERVICES (U.S. CLS. 100, 101 AND 104).

FIRST USE 9-3-2013; IN COMMERCE 9-3-2013.  
HEATHER THOMPSON, EXAMINING ATTORNEY

---

SN 86-068,753. KEANE, BRIAN DAVID, NASHVILLE, TN. FILED 9-18-2013.

# Playola

THE MARK CONSISTS OF STANDARD CHARACTERS WITHOUT CLAIM TO ANY PARTICULAR FONT, STYLE, SIZE, OR COLOR.

FOR STREAMING OF AUDIO MATERIAL ON THE INTERNET (U.S. CLS. 100, 101 AND 104).

JESSICA FATHY, EXAMINING ATTORNEY

**CLASS 38—(Continued).**

SN 86-068,758. WILLY MONTANEZ, NORTH HALEDON, NJ. FILED 9-18-2013.

# Sole Survivor

THE MARK CONSISTS OF STANDARD CHARACTERS WITHOUT CLAIM TO ANY PARTICULAR FONT, STYLE, SIZE, OR COLOR.

FOR AUDIO AND VIDEO BROADCASTING SERVICES OVER THE INTERNET; AUDIO AND VIDEO BROADCASTING SERVICES OVER THE INTERNET IN THE FIELD OF ENTERTAINMENT; AUDIO BROADCASTING; AUDIO TELECONFERENCING; BROADCAST COMMUNICATION SERVICES, NAMELY, TRANSMITTING E-MAILS, FAXES, TEXT MESSAGES AND TELEPHONE VOICE MESSAGES TO DESIGNATED RECIPIENTS FOR OTHERS; BROADCASTING OF RADIO AND TELEVISION PROGRAMMES; BROADCASTING OF VIDEO AND AUDIO PROGRAMMING OVER THE INTERNET; BROADCASTING SERVICES AND PROVISION OF TELECOMMUNICATION ACCESS TO FILMS AND TELEVISION PROGRAMMES PROVIDED VIA A VIDEO-ON-DEMAND SERVICE; BROADCASTING SERVICES AND PROVISION OF TELECOMMUNICATION ACCESS TO VIDEO AND AUDIO CONTENT PROVIDED VIA A VIDEO-ON-DEMAND SERVICE VIA THE INTERNET; BROADCASTING SERVICES, NAMELY, TRANSMISSION OF ADVERTISING PROGRAMS AND MEDIA ADVERTISING COMMUNICATIONS VIA DIGITAL COMMUNICATIONS NETWORKS; COMMUNICATION SERVICES, NAMELY, ELECTRONIC TRANSMISSION OF DATA AND DOCUMENTS AMONG USERS OF COMPUTERS; COMMUNICATION SERVICES, NAMELY, TRANSMISSION OF VOICE, AUDIO, VISUAL IMAGES AND DATA BY TELECOMMUNICATIONS NETWORKS, WIRELESS COMMUNICATION NETWORKS, THE INTERNET, INFORMATION SERVICES NETWORKS AND DATA NETWORKS; COMMUNICATION VIA ANALOGUE AND DIGITAL COMPUTER TERMINALS; COMMUNICATIONS SERVICES, NAMELY, TRANSMITTING STREAMED SOUND AND AUDIOVISUAL RECORDINGS VIA THE INTERNET; COMMUNICATIONS VIA ANALOGUE AND DIGITAL COMPUTER TERMINALS; COMPUTER AIDED TRANSMISSION OF INFORMATION AND IMAGES; COMPUTER-AIDED TRANSMISSION OF MESSAGES AND IMAGES; CONSULTING IN THE FIELD OF TELECOMMUNICATION SERVICES, NAMELY, TRANSMISSION OF VOICE, DATA, AND DOCUMENTS VIA TELECOMMUNICATIONS NETWORKS; DATA TRANSMISSION AND RECEPTION SERVICES VIA TELECOMMUNICATION MEANS; ELECTRONIC STORE-AND-FORWARD MESSAGING; ELECTRONIC TRANSMISSION AND STREAMING OF DIGITAL MEDIA CONTENT FOR OTHERS VIA GLOBAL AND LOCAL COMPUTER NETWORKS; ELECTRONIC TRANSMISSION FOR OTHERS OF SECURITIES AND FINANCIAL INFORMATION VIA COMPUTER LINKING SERVICES, NAMELY, COMMUNICATING AND ROUTING TRADE INFORMATION INVOLVING ORDERS, ENTRY AND EXECUTION SERVICES, TO OTHERS VIA A GLOBAL COMPUTER NETWORK; ELECTRONIC TRANSMISSION OF DATA AND DOCUMENTS VIA COMPUTER TERMINALS; ELECTRONIC TRANSMISSION OF DATA AND DOCUMENTS VIA COMPUTER TERMINALS AND ELECTRONIC DEVICES; ELECTRONIC TRANSMISSION OF FACSIMILE COMMUNICATIONS AND DATA FEATURING ENCRYPTION AND DECRYPTION; ELECTRONIC TRANSMISSION OF INFORMATION POSTED TO USENET NEWSGROUPS AND DISCUSSION GROUPS VIA A GLOBAL COMPUTER NETWORK; ELECTRONIC TRANSMISSION OF MAIL AND MESSAGES; ELECTRONIC TRANSMISSION OF MESSAGES AND DATA; ELECTRONIC TRANSMISSION OF VOICE, DATA AND IMAGES BY TELEVISION AND VIDEO BROADCASTING; ELECTRONIC VOICE MESSAGING, NAMELY, THE RECORDING AND SUBSEQUENT TRANSMISSION OF VOICE MESSAGES BY TELEPHONE; PROVIDING

**CLASS 38—(Continued).**

ELECTRONIC TRANSMISSION OF CREDIT CARD TRANSACTION DATA AND ELECTRONIC PAYMENT DATA VIA A GLOBAL COMPUTER NETWORK; RADIO AND TELEVISION BROADCASTING SERVICES; RADIO AND TELEVISION PROGRAMME BROADCASTING; RADIO BROADCASTING OF INFORMATION AND OTHER PROGRAMS; SATELLITE TRANSMISSION OF MESSAGES AND DATA FOR NAVIGATION BY AIR; SATELLITE TRANSMISSION SERVICES, TELEVISION AND RADIO BROADCASTING SERVICES; SATELLITE, CABLE, NETWORK TRANSMISSION OF SOUNDS, IMAGES, SIGNALS AND DATA; SIGNAL TRANSMISSION FOR ELECTRONIC COMMERCE VIA TELECOMMUNICATION SYSTEMS AND DATA COMMUNICATION SYSTEMS; SIMULCASTING BROADCAST TELEVISION OVER GLOBAL COMMUNICATION NETWORKS, THE INTERNET AND WIRELESS NETWORKS; SOUND AND PICTURE TRANSMISSION VIA SATELLITE; STREAMING OF AUDIO MATERIAL ON THE INTERNET; STREAMING OF AUDIO, VISUAL AND AUDIOVISUAL MATERIAL VIA A GLOBAL COMPUTER NETWORK; STREAMING OF VIDEO MATERIAL ON THE INTERNET; STREAMING OF AUDIO, VIDEO AND MULTIMEDIA MATERIAL ON THE INTERNET; TELEPHONE RELAY SERVICES USING ON-SCREEN VIDEO; TELEPHONE SERVICES AND TELETEXT SERVICES; TELEVISION AND RADIO BROADCASTING SERVICES; TEXT AND NUMERIC WIRELESS DIGITAL MESSAGING SERVICES; TRANSMISSION AND DISTRIBUTION OF DATA OR AUDIO VISUAL IMAGES VIA A GLOBAL COMPUTER NETWORK OR THE INTERNET; TRANSMISSION AND RECEIVING BY RADIO; VIDEO BROADCASTING; VIDEO BROADCASTING AND TRANSMISSION SERVICES VIA THE INTERNET, FEATURING FILMS AND MOVIES; VIDEO BROADCASTING SERVICES OVER THE INTERNET OR OTHER COMMUNICATIONS NETWORK FEATURING THE UPLOADED, POSTED AND TAGGED VIDEOS OF OTHERS; VIDEO BROADCASTING SERVICES OVER THE INTERNET OR OTHER COMMUNICATIONS NETWORK, NAMELY, ELECTRONICALLY TRANSMITTING VIDEO CLIPS; VIDEO BROADCASTING SERVICES VIA THE INTERNET; VIDEO ON DEMAND TRANSMISSIONS; VIDEO TELEPHONE SERVICES; VIDEO TRANSMISSION OVER DIGITAL NETWORKS; VIDEO-ON-DEMAND TRANSMISSION SERVICES; VIDEO-ON-DEMAND TRANSMISSION SERVICES VIA THE INTERNET (U.S. CLS. 100, 101 AND 104).

KATHERINE STOIDES, EXAMINING ATTORNEY

---

SN 86-069,223. THE TRUSTEES OF INDIANA UNIVERSITY, BLOOMINGTON, IN. FILED 9-19-2013.

**WFIU**

THE MARK CONSISTS OF STANDARD CHARACTERS WITHOUT CLAIM TO ANY PARTICULAR FONT, STYLE, SIZE, OR COLOR.

FOR RADIO BROADCASTING (U.S. CLS. 100, 101 AND 104).

FIRST USE 9-30-1950; IN COMMERCE 9-30-1950.  
HEATHER BIDDULPH, EXAMINING ATTORNEY

**CLASS 38—(Continued).**

SN 86-069,224. THE TRUSTEES OF INDIANA UNIVERSITY, BLOOMINGTON, IN. FILED 9-19-2013.

**WTIU**

THE MARK CONSISTS OF STANDARD CHARACTERS WITHOUT CLAIM TO ANY PARTICULAR FONT, STYLE, SIZE, OR COLOR.

FOR TELEVISION BROADCASTING (U.S. CLS. 100, 101 AND 104).

FIRST USE 3-3-1969; IN COMMERCE 3-3-1969.

HEATHER BIDDULPH, EXAMINING ATTORNEY

---

SN 86-070,793. FASTLY, INC., SAN FRANCISCO, CA. FILED 9-20-2013.

**FASTLY**

THE MARK CONSISTS OF STANDARD CHARACTERS WITHOUT CLAIM TO ANY PARTICULAR FONT, STYLE, SIZE, OR COLOR.

FOR DELIVERING THIRD PARTY WEB CONTENT AND SOFTWARE APPLICATIONS FROM A NETWORK OF MANAGED SERVERS TO PROVIDE ACCELERATED MULTIPLE-USER ACCESS TO A GLOBAL COMPUTER INFORMATION NETWORK; STREAMING OF AUDIO, VISUAL, TEXT, VIDEO AND AUDIOVISUAL MATERIAL ON THE INTERNET, NAMELY, PROVIDING CONTENT DELIVERY NETWORK (CDN) SERVICES THAT DYNAMICALLY STREAM AND ORGANIZE THIRD PARTY WEB CONTENT FOR OPTIMIZED FLOW TO END USERS (U.S. CLS. 100, 101 AND 104).

MICHAEL WEBSTER, EXAMINING ATTORNEY

---

SN 86-071,172. THE DIGITAL FILM CENTER, LLC, DBA DIGITAL FILM ACADEMY, NEW YORK, NE. FILED 9-21-2013.

**Monetize Your Media!**

THE MARK CONSISTS OF STANDARD CHARACTERS WITHOUT CLAIM TO ANY PARTICULAR FONT, STYLE, SIZE, OR COLOR.

FOR INTERACTIVE DELIVERY OF VIDEO OVER DIGITAL NETWORKS (U.S. CLS. 100, 101 AND 104).

IRA J. GOODSaid, EXAMINING ATTORNEY

**CLASS 38—(Continued).**

SN 86-076,966. AT&T INTELLECTUAL PROPERTY II, L.P., RENO, NV. FILED 9-27-2013.

# AT&T WORLD-FI

THE MARK CONSISTS OF STANDARD CHARACTERS WITHOUT CLAIM TO ANY PARTICULAR FONT, STYLE, SIZE, OR COLOR.

OWNER OF U.S. REG. NOS. 1,293,305, 3,884,434 AND OTHERS.

FOR COMMUNICATION SERVICES, NAMELY, TRANSMISSION OF VOICE, AUDIO, VISUAL IMAGES AND DATA BY TELECOMMUNICATIONS NETWORKS, WIRELESS COMMUNICATION NETWORKS, THE INTERNET, INFORMATION SERVICES NETWORKS AND DATA NETWORKS (U.S. CLS. 100, 101 AND 104).

DARRYL SPRUILL, EXAMINING ATTORNEY

**CLASS 38—(Continued).**

SN 86-095,875. MDU ENTERPRISES, INC., DBA BULK TV & INTERNET, RALEIGH, NC. FILED 10-18-2013.



NO CLAIM IS MADE TO THE EXCLUSIVE RIGHT TO USE "BULK TV", APART FROM THE MARK AS SHOWN.

THE COLOR(S) RED AND WHITE IS/ARE CLAIMED AS A FEATURE OF THE MARK.

THE MARK CONSISTS OF THE WORDS "BULK TV" IS WHITE IN A RED BACKGROUND WITH ROUNDED EDGES.

FOR SATELLITE, CABLE, NETWORK TRANSMISSION OF SOUNDS, IMAGES, SIGNALS AND DATA (U.S. CLS. 100, 101 AND 104).

FIRST USE 3-18-2005; IN COMMERCE 3-18-2005.

GRETTA YAO, EXAMINING ATTORNEY

SN 86-088,203. ADRIANA SHAW, NEW YORK, NY. FILED 10-10-2013.

# HERFLIX

THE MARK CONSISTS OF STANDARD CHARACTERS WITHOUT CLAIM TO ANY PARTICULAR FONT, STYLE, SIZE, OR COLOR.

FOR AUDIO AND VIDEO ON DEMAND TRANSMISSIONS; STREAMING OF AUDIO AND VISUAL MATERIAL VIA A GLOBAL COMPUTER NETWORK SELECTED FOR WOMEN VIEWERS; AUDIO AND VIDEO BROADCASTING; TELECOMMUNICATION SERVICES, NAMELY, TRANSMISSION OF AUDIO AND VIDEO SELECTED FOR WOMEN VIEWERS BY MEANS OF TELECOMMUNICATIONS NETWORKS, WIRELESS COMMUNICATION NETWORKS, AND THE INTERNET; TELECOMMUNICATION SERVICES, NAMELY, TRANSMISSION OF AUDIO AND VIDEO CONTENT FROM WOMEN FILMMAKERS VIA THE INTERNET AND MOBILE WIRELESS DEVICES; PROVIDING SUBSCRIPTION-BASED E-MAIL SERVICES TO WOMEN FEATURING DAILY, WEEKLY AND MONTHLY CALENDARS OF RECOMMENDED MOVIES AND TELEVISION SHOWS (U.S. CLS. 100, 101 AND 104).

FIRST USE 1-16-2007; IN COMMERCE 1-16-2007.

DAVID YONTEF, EXAMINING ATTORNEY

**CLASS 39—TRANSPORTATION AND STORAGE**

SN 85-667,747. PUB CRAWL NEW YORK LLC, NEW YORK, NY. FILED 7-3-2012.



NO CLAIM IS MADE TO THE EXCLUSIVE RIGHT TO USE "PUB CRAWL" AND "NEW YORK" AND THE IMAGE OF NEW YORK CITY SKYLINE, APART FROM THE MARK AS SHOWN.

THE MARK CONSISTS OF A STYLIZED CITY SKYLINE WITH THE STYLIZED TEXT "PUB CRAWL" AT THE BASE OF IT. THE LETTER "U" IS STYLIZED AS A MUG. BELOW THIS TEXT IS THE STYLIZED TEXT "NEW YORK" IN WHICH THE LETTER "Y" IS STYLIZED AS A MARTINI GLASS. THE WORDS "NEW YORK" ARE SURROUNDED BY A RECTANGLE AND THE BASE OF THE RECTANGLE IS CONNECTED BY A LINE TO THE SKYLINE IMAGE ON EACH SIDE.

FOR TOUR OPERATING AND ORGANIZING (U.S. CLS. 100 AND 105).

FIRST USE 1-1-2012; IN COMMERCE 3-1-2012.

SUE LAWRENCE, EXAMINING ATTORNEY

**CLASS 39—(Continued).**

SN 85-694,286. ALASKA MOUNTAIN GUIDES INTERNATIONAL, INC., DBA MOUNTAIN GUIDES INTERNATIONAL, HAINES, AK. FILED 8-2-2012.



NO CLAIM IS MADE TO THE EXCLUSIVE RIGHT TO USE "MOUNTAIN GUIDES" AND "INTERNATIONAL", APART FROM THE MARK AS SHOWN.

THE MARK CONSISTS OF THE STYLIZED WORDS "MOUNTAIN GUIDES INTERNATIONAL" WITH TWO PICK AXES CRISSCROSSED IN THE CENTER OF THE STYLIZED WORDS.

FOR TOUR GUIDE SERVICES; ARRANGING, ORGANIZING, AND CONDUCTING TOURS (U.S. CLS. 100 AND 105).

FIRST USE 12-0-2009; IN COMMERCE 12-0-2009.  
ODESSA BIBBINS, EXAMINING ATTORNEY

SN 85-850,303. ATX AIR SERVICES, LLC, DALLAS, TX. FILED 2-14-2013.



NO CLAIM IS MADE TO THE EXCLUSIVE RIGHT TO USE "AIR SERVICES", APART FROM THE MARK AS SHOWN.

THE MARK CONSISTS OF THE LETTERS "ATX" TO THE LEFT OF THE WORDING "AIR SERVICES". THERE IS A DESIGN OF A STAR BETWEEN THE LETTERS "A" AND "T" IN "ATX".

FOR AIR CHARTER SERVICES, NAMELY AIR TRANSPORTATION OF PASSENGERS AND FREIGHT (U.S. CLS. 100 AND 105).

CORY BOONE, EXAMINING ATTORNEY

**CLASS 39—(Continued).**

SN 85-858,298. SAREGHA RESTAURANT GROUP, LLC, DBA SAREGHA RESTAURANT GROUP, LLC, OWINGS MILLS, MD. FILED 2-23-2013.

# Soyombo

THE MARK CONSISTS OF STANDARD CHARACTERS WITHOUT CLAIM TO ANY PARTICULAR FONT, STYLE, SIZE, OR COLOR.

FOR DELIVERY OF FOOD BY RESTAURANTS (U.S. CLS. 100 AND 105).  
DARRYL SPRUILL, EXAMINING ATTORNEY

SN 85-883,522. LINK SNACKS, INC., MINONG, WI. FILED 3-22-2013.



NO CLAIM IS MADE TO THE EXCLUSIVE RIGHT TO USE "JET RIDE", APART FROM THE MARK AS SHOWN.

THE COLOR(S) RED AND BLACK IS/ARE CLAIMED AS A FEATURE OF THE MARK.

THE MARK CONSISTS OF THE WORD "JET" IN RED AND THE WORD "RIDE" IN BLACK UNDERLINED IN RED AND THE LETTER "E" ON "RIDE" USING A JET FACING TO THE RIGHT AS THE TOP LINE OF THE LETTER "E".

FOR AIR CHARTER SERVICES; AIR CHARTER TRANSPORTATION SERVICES; RENTAL OF AIRCRAFT; TRANSPORT BY AIRCRAFT (U.S. CLS. 100 AND 105).

SETH A. RAPPAPORT, EXAMINING ATTORNEY

SN 85-903,875. DAVIS, JEFFREY E., LOUISVILLE, KY. FILED 4-15-2013.



NO CLAIM IS MADE TO THE EXCLUSIVE RIGHT TO USE "THE B4B ALLIANCE", APART FROM THE MARK AS SHOWN.

THE MARK CONSISTS OF A CRESCENT ABOVE THE TEXT "THE B4B ALLIANCE".

FOR DELIVERY OF GOODS; PACKAGING ARTICLES FOR TRANSPORTATION; PACKAGING ARTICLES TO THE ORDER AND SPECIFICATION OF OTHERS; TRANSPORTATION AND STORAGE OF GOODS; WAREHOUSING SERVICES (U.S. CLS. 100 AND 105).

FIRST USE 0-0-2011; IN COMMERCE 0-0-2011.  
LINDA LAVACHE, EXAMINING ATTORNEY



**CLASS 39—(Continued).**

SN 86-006,276. MFPI GROUP, INC., DBA HARMONY INTERNATIONAL, KENNESAW, GA. FILED 7-10-2013.



NO CLAIM IS MADE TO THE EXCLUSIVE RIGHT TO USE "JOURNEYS", APART FROM THE MARK AS SHOWN. THE MARK CONSISTS OF A SCRIPTED "JOE" WITH A LARGE LETTER "J" WITH "JOURNEYS WITH" PRINTED ABOVE THE "J" ALONG WITH A SERIES OF WAVY LINES.

FOR ARRANGING EXCURSIONS FOR TOURISTS; ARRANGING OF TRAVEL TOURS AND CRUISES; ARRANGING TRAVEL TOURS; CONDUCTING SIGHT-SEEING TRAVEL TOURS FOR OTHERS; COORDINATING TRAVEL ARRANGEMENTS FOR INDIVIDUALS AND FOR GROUPS; ESCORTING OF TRAVELLERS; MAKING TRAVEL AND EXCURSION ARRANGEMENTS FOR BANDS AND ORCHESTRAS; ORGANIZATION OF EXCURSIONS; ORGANIZATION OF TRAVEL; TRAVEL PLANNING FOR INDIVIDUALS, FAMILIES, AND GROUPS FOR SPECIAL OCCASIONS SUCH AS DESTINATION WEDDINGS AND HONEYMOONS; TRAVEL TOUR GUIDE SERVICES; TRAVEL TOUR OPERATING AND ORGANIZING; TRAVEL TOUR ORGANIZING; TRAVEL, EXCURSION AND CRUISE ARRANGEMENT (U.S. CLS. 100 AND 105).

FIRST USE 3-1-2009; IN COMMERCE 3-1-2009.  
ALICE BENMAMAN, EXAMINING ATTORNEY

**CLASS 39—(Continued).**

SN 86-009,416. PIRCH, INC., SAN DIEGO, CA. FILED 7-12-2013.

**PIRCH**

THE MARK CONSISTS OF STANDARD CHARACTERS WITHOUT CLAIM TO ANY PARTICULAR FONT, STYLE, SIZE, OR COLOR.

FOR DELIVERY OF KITCHEN, BATHROOM, LAUNDRY AND OUTDOOR APPLIANCES, FIXTURES, HARDWARE, AND RELATED ACCESSORIES (U.S. CLS. 100 AND 105).

FIRST USE 7-19-2013; IN COMMERCE 7-19-2013.  
KATHERINE CHANG, EXAMINING ATTORNEY

SN 86-008,934. WASTEMANAGEMENTONLINE.COM, INC., UTICA, MI. FILED 7-12-2013.



NO CLAIM IS MADE TO THE EXCLUSIVE RIGHT TO USE "WASTE" AND "ONLINE.COM" AND THE RECYCLING SYMBOL, APART FROM THE MARK AS SHOWN. THE MARK CONSISTS OF A DUMP TRUCK FIGURE BESIDE THE "WASTEMANAGEMENTONLINE.COM".

FOR WASTE DISPOSAL SERVICES, NAMELY, RENTAL OF DUMPSTERS; TRASH SERVICES, NAMELY, RENTAL OF DUMPSTERS, TRASH CONTAINERS AND ROLL-OFF TRASH CONTAINERS; PROVIDING ONLINE INFORMATION IN THE FIELD OF GARBAGE COLLECTION AND TRASH REMOVAL AND STORAGE SERVICES (U.S. CLS. 100 AND 105).

FIRST USE 3-23-2001; IN COMMERCE 3-23-2001.  
SAIMA MAKHDOOM, EXAMINING ATTORNEY



NO CLAIM IS MADE TO THE EXCLUSIVE RIGHT TO USE "SUGAR DADDIE TRAVEL.COM THE DISCREET TRAVEL AGENCY", APART FROM THE MARK AS SHOWN.

THE COLOR(S) RED, WHITE, BLACK AND TAN IS/ARE CLAIMED AS A FEATURE OF THE MARK.

THE MARK CONSISTS OF OPEN MOUTH RED LIPS, SHOWING WHITE TEETH A TAN POINTING FINGER OVER LIPS WITH A BLACK NAIL AND WHITE AIRPLANE WORDS "SUGAR DADDIE" IN BLACK RIGHT UNDER MOUTH AND FINGER FOLLOWED BY "TRAVEL.COM" IN WHITE HIGHLIGHTED WITH A RED BOX UNDER "SUGAR DADDIE" AND THE LAST "THE DISCREET TRAVEL AGENCY" WRITTEN IN BLACK.

FOR COORDINATING TRAVEL ARRANGEMENTS FOR INDIVIDUALS AND FOR GROUPS (U.S. CLS. 100 AND 105).

TINA MAI, EXAMINING ATTORNEY

**CLASS 39—(Continued).**

SN 86-025,123. HAWAIIAN ISLANDS FORWARDERS, LA MIRADA, CA. FILED 7-31-2013.



NO CLAIM IS MADE TO THE EXCLUSIVE RIGHT TO USE THE MAP OF THE HAWAIIAN ISLANDS AND "HAWAIIAN ISLAND FORWARDERS", APART FROM THE MARK AS SHOWN.

THE COLOR(S) BLUE, WHITE, BROWN, PURPLE, PINK AND YELLOW IS/ARE CLAIMED AS A FEATURE OF THE MARK.

THE MARK CONSISTS OF A BLUE OVAL WITH THE WORDING "HAWAIIAN ISLAND FORWARDERS" IN YELLOW AND WHITE AND A MAP OF THE STATE OF HAWAII IN WHITE. THE OVAL IS OUTLINED IN YELLOW WITH A PINK DOUBLE HELIX DESIGN AT THE TOP AND BOTTOM. ON THE RIGHT AND LEFT BORDER OF THE OVAL ARE BROWN, WHITE, AND PURPLE FLOWERS.

FOR TRANSPORT AND DELIVERY OF GOODS; TRANSPORTATION AND DELIVERY SERVICES BY AIR, ROAD, RAIL AND SEA; AND TRANSPORTATION AND STORAGE OF GOODS (U.S. CLS. 100 AND 105).

FIRST USE 6-1-2013; IN COMMERCE 6-1-2013.  
KIM SAITO, EXAMINING ATTORNEY

SN 86-025,234. SAN DIEGO ASSOCIATION OF GOVERNMENTS, AKA SANDAG, SAN DIEGO, CA. FILED 7-31-2013.

# 511sd.com

THE MARK CONSISTS OF STANDARD CHARACTERS WITHOUT CLAIM TO ANY PARTICULAR FONT, STYLE, SIZE, OR COLOR.

SEC. 2(F).

FOR PROVIDING A WEB SITE AND WEB SITE LINKS TO GEOGRAPHIC INFORMATION, MAP IMAGES, AND TRIP ROUTING (U.S. CLS. 100 AND 105).

FIRST USE 6-14-2007; IN COMMERCE 6-14-2007.  
LAURIE KAUFMAN, EXAMINING ATTORNEY

**CLASS 39—(Continued).**

SN 86-027,891. INDIANAPOLIS AIRPORT AUTHORITY, INDIANAPOLIS, IN. FILED 8-2-2013.

# IND

THE MARK CONSISTS OF STANDARD CHARACTERS WITHOUT CLAIM TO ANY PARTICULAR FONT, STYLE, SIZE, OR COLOR.

SEC. 2(F).

FOR AIRPORT PASSENGER SHUTTLE SERVICES BETWEEN THE AIRPORT PARKING FACILITIES AND THE AIRPORT; AIRPORT SERVICES; PARKING GARAGES SERVICES; PARKING LOT SERVICES; PARKING SPACE RESERVATION SERVICE (U.S. CLS. 100 AND 105).

FIRST USE 12-1-1948; IN COMMERCE 12-1-1948.

JULIE GUTTADAURO, EXAMINING ATTORNEY

SN 86-027,901. BRISTIN TRAVEL, LLC, DBA MRBEACHES.COM, FAYETTEVILLE, AR. FILED 8-2-2013.

# MrBeaches

THE MARK CONSISTS OF STANDARD CHARACTERS WITHOUT CLAIM TO ANY PARTICULAR FONT, STYLE, SIZE, OR COLOR.

THE NAME "MRBEACHES" DOES NOT IDENTIFY A LIVING INDIVIDUAL.

FOR TRAVEL AGENCY SERVICES, NAMELY, MAKING RESERVATIONS AND BOOKINGS FOR TRANSPORTATION (U.S. CLS. 100 AND 105).

FIRST USE 2-10-2012; IN COMMERCE 8-1-2013.

AMY KELLY, EXAMINING ATTORNEY

**CLASS 39—(Continued).**

SN 86-030,067. SOLOMON, BENJAMIN T., DENVER, CO. FILED 8-6-2013.

# XODUS ONE

THE MARK CONSISTS OF STANDARD CHARACTERS WITHOUT CLAIM TO ANY PARTICULAR FONT, STYLE, SIZE, OR COLOR.

FOR SPACE EXPLORATION SERVICES, NAMELY, ORGANIZING, ARRANGING, RESERVING, AND CONDUCTING COMMERCIAL SPACE ACTIVITIES INCLUDING SUB-ORBITAL, ORBITAL, INTERPLANETARY, INTERSTELLAR AND INTERGALACTIC SPACE FLIGHTS; AND SPACE EXPLORATORY ACTIVITIES, NAMELY, EXCURSIONS TO SUB-ORBITAL, ORBITAL, INTERPLANETARY, INTERSTELLAR AND INTERGALACTIC DESTINATIONS; SPACE PROPULSION SERVICES, NAMELY, SPACE TRANSPORT SERVICES OF GOODS AND PASSENGERS FOR SUB-ORBITAL, ORBITAL, INTERPLANETARY, INTERSTELLAR AND INTERGALACTIC SPACE FLIGHTS (U.S. CLS. 100 AND 105).

JORDAN BAKER, EXAMINING ATTORNEY

**CLASS 39—(Continued).**

SN 86-041,798. KETTMAN, CURTIS, DBA FUNDERFUL TRAVEL, TITUSVILLE, FL. AND KETTMAN, FRANCI, DBA FUNDERFUL TRAVEL, TITUSVILLE, FL. FILED 8-19-2013.

# FUNDERFUL TRAVEL

THE MARK CONSISTS OF STANDARD CHARACTERS WITHOUT CLAIM TO ANY PARTICULAR FONT, STYLE, SIZE, OR COLOR.

NO CLAIM IS MADE TO THE EXCLUSIVE RIGHT TO USE "TRAVEL", APART FROM THE MARK AS SHOWN. FOR ARRANGING OF TRAVEL TOURS AND CRUISES (U.S. CLS. 100 AND 105).

FIRST USE 4-17-2013; IN COMMERCE 4-23-2013.

MARGERY A. TIERNEY, EXAMINING ATTORNEY

SN 86-031,066. MAGELLAN MIDSTREAM PARTNERS, L.P., TULSA, OK. FILED 8-7-2013.

## MOVING WHAT MOVES AMERICA

THE MARK CONSISTS OF STANDARD CHARACTERS WITHOUT CLAIM TO ANY PARTICULAR FONT, STYLE, SIZE, OR COLOR.

FOR TRANSPORT THROUGH PIPELINES (U.S. CLS. 100 AND 105).

FIRST USE 6-30-2011; IN COMMERCE 6-30-2011.

SUSAN RICHARDS, EXAMINING ATTORNEY

SN 86-041,880. ZINDELL, MARISSA, BUFFALO GROVE, IL. FILED 8-19-2013.



SN 86-033,320. AMERICAN METAL SUPPLY CO., BLUE ASH, OH. FILED 8-9-2013.

# 24-7 METALS

THE MARK CONSISTS OF STANDARD CHARACTERS WITHOUT CLAIM TO ANY PARTICULAR FONT, STYLE, SIZE, OR COLOR.

NO CLAIM IS MADE TO THE EXCLUSIVE RIGHT TO USE "METALS", APART FROM THE MARK AS SHOWN.

FOR WHOLESALE DISTRIBUTION SERVICES IN THE FIELD OF METAL AND PLASTICS USED AS RAW MATERIALS (U.S. CLS. 100 AND 105).

FIRST USE 11-7-2013; IN COMMERCE 11-7-2013.

DAWN FELDMAN, EXAMINING ATTORNEY

NO CLAIM IS MADE TO THE EXCLUSIVE RIGHT TO USE "TRIP" AND "TRAVEL", APART FROM THE MARK AS SHOWN.

THE MARK CONSISTS OF "TRIP LOVE TRAVEL" WRITTEN ON THE BOTTOM HALF OF A RECTANGLE. THE RECTANGLE HAS A DOUBLE BORDER. THE RECTANGLE IS DIVIDED IN HALF HORIZONTALLY BY A DOTTED LINE RUNNING FROM THE LEFT SIDE OF THE RECTANGLE TO THE RIGHT. ABOVE THE DOTTED LINE ARE THREE BOLD CIRCLES-ONE CIRCLE ON THE LEFT SIDE, ONE IN THE MIDDLE, AND ONE ON THE RIGHT SIDE. THERE IS A SUITCASE IN THE LEFT CIRCLE, A HEART IN THE MIDDLE CIRCLE, AND AN AIRPLANE IN THE RIGHT CIRCLE. THE LEFT CIRCLE IS CONNECTED TO THE MIDDLE CIRCLE AND THE MIDDLE CIRCLE IS CONNECTED TO THE RIGHT CIRCLE BY A BOLD SOLD LINE.

FOR ONLINE TRAVEL SERVICES PROVIDING CUSTOMIZED TRAVEL GUIDE SERVICES (U.S. CLS. 100 AND 105).

FIRST USE 1-1-2012; IN COMMERCE 1-1-2012.

CARYN GLASSER, EXAMINING ATTORNEY

**CLASS 39—(Continued).**

SN 86-042,517. MAIL DELIVERY SYSTEMS, INC, SIGNAL HILL, CA. FILED 8-20-2013.



NO CLAIM IS MADE TO THE EXCLUSIVE RIGHT TO USE "SINCE 1956", APART FROM THE MARK AS SHOWN.

THE MARK CONSISTS OF A SMALL MAN WITH AN OVERSIZED EYE AND WEARING A HAT THAT APPEARS TO BE RUNNING WITH A PACKAGE UNDER HIS/HER ARM. TO THE RIGHT OF THE CHARACTER ARE THE STYLIZED LETTERS "MDS" WITH THE STYLIZED TEXT "SINCE 1956" BELOW THE LETTER "S" IN "MDS".

FOR COURIER SERVICES AND TRANSPORTATION SERVICES, NAMELY, TRANSPORT BY LAND (U.S. CLS. 100 AND 105).

FIRST USE 6-1-2009; IN COMMERCE 6-1-2009.

COURTNEY ALVAREZ, EXAMINING ATTORNEY

SN 86-044,000. RICHARD A. KRUGER, DBA DIAMOND LIMOUSINE, FAIRFAX, IA. FILED 8-21-2013.

**DIAMOND LIMOUSINE**

THE MARK CONSISTS OF STANDARD CHARACTERS WITHOUT CLAIM TO ANY PARTICULAR FONT, STYLE, SIZE, OR COLOR.

NO CLAIM IS MADE TO THE EXCLUSIVE RIGHT TO USE "LIMOUSINE", APART FROM THE MARK AS SHOWN.

FOR LIMOUSINE SERVICES (U.S. CLS. 100 AND 105).

FIRST USE 2-1-2003; IN COMMERCE 2-1-2003.

KATHERINE STOIDES, EXAMINING ATTORNEY

SN 86-045,089. THINK PINK, INC., PARK RIDGE, IL. FILED 8-22-2013.



OWNER OF U.S. REG. NO. 4,054,286.

NO CLAIM IS MADE TO THE EXCLUSIVE RIGHT TO USE "PINK TAXI", APART FROM THE MARK AS SHOWN.

THE MARK CONSISTS OF THE STYLIZED WORDING "PINK TAXI" FEATURING A STYLIZED RIBBON AS THE "X" IN "TAXI".

FOR LIMOUSINE SERVICES; TAXI TRANSPORT; TAXI TRANSPORT FOR PEOPLE IN WHEELCHAIRS (U.S. CLS. 100 AND 105).

FIRST USE 7-1-2010; IN COMMERCE 7-1-2010.

BERYL GARDNER, EXAMINING ATTORNEY

**CLASS 39—(Continued).**

SN 86-051,390. URBAN WHEELY INC., FORMERLY BIKE LOTS LLC, NEW YORK, NY. FILED 8-29-2013.

**URBAN WHEELY**

THE MARK CONSISTS OF STANDARD CHARACTERS WITHOUT CLAIM TO ANY PARTICULAR FONT, STYLE, SIZE, OR COLOR.

NO CLAIM IS MADE TO THE EXCLUSIVE RIGHT TO USE "URBAN", APART FROM THE MARK AS SHOWN.

FOR BICYCLE PARKING SERVICES (U.S. CLS. 100 AND 105).

SUSAN RICHARDS, EXAMINING ATTORNEY

SN 86-064,170. SEA AIR FREIGHT EXPRESS, INC., BELLEVUE, WA. FILED 9-13-2013.



THE MARK CONSISTS OF THE LETTERS "SAFE" IN A STYLIZED FORMAT WITH THREE HORIZONTAL LINES UNDERNEATH, EACH PROGRESSIVELY THICKER THAN THE ONE ABOVE IT.

FOR FREIGHT FORWARDING SERVICES (U.S. CLS. 100 AND 105).

FIRST USE 4-15-2003; IN COMMERCE 4-15-2003.

WILLIAM JACKSON, EXAMINING ATTORNEY

SN 86-064,594. ETHAN GAS OIL, LLC., HOUSTON, TX. FILED 9-13-2013.

**EGO**

THE MARK CONSISTS OF STANDARD CHARACTERS WITHOUT CLAIM TO ANY PARTICULAR FONT, STYLE, SIZE, OR COLOR.

PRIORITY CLAIMED UNDER SEC. 44(D) ON MEXICO APPLICATION NO. 1406715, FILED 8-23-2013.

FOR RAILWAY TRANSPORT; TRANSPORT, LEASING AND RENTAL OF RAILCARS, RAILWAY CARS, STORAGE CONTAINERS AND RAILWAY TANK CARS, WITHOUT MOTOR; FREIGHT CAR RENTAL; STORAGE OF PETROLEUM AND ITS PRODUCTS OR WASTE; STORAGE, DISTRIBUTION, AND TRANSPORTATION OF LIQUEFIED PETROLEUM GAS (U.S. CLS. 100 AND 105).

CHERYL CLAYTON, EXAMINING ATTORNEY

**CLASS 39—(Continued).**

SN 86-065,310. ENTERPRISE HOLDINGS, INC., ST. LOUIS, MO. FILED 9-16-2013.



THE MARK CONSISTS OF VERTICAL LINE SEGMENTS ABOVE AND BELOW THE LETTERS "EH".  
 FOR VEHICLE RENTAL AND LEASING SERVICES; AND RESERVATION SERVICES FOR THE RENTAL AND LEASING OF VEHICLES, NAMELY RENTAL RESERVATIONS FOR AUTOMOBILES, TRUCKS, CARS, LAND VEHICLES (U.S. CLS. 100 AND 105).  
 NAKIA HENRY, EXAMINING ATTORNEY

---

SN 86-065,633. EPN TRAVEL SERVICES, INC., DOUGLASSVILLE, PA. FILED 9-16-2013.



THE MARK CONSISTS OF THE STYLIZED WORD "EPNTRAVEL" WITH AN AIRPLANE FLYING ABOVE THE LETTER "P" AND A CITY SKYLINE WITH A SETTING SUN TO THE LEFT OF THE WORD.  
 FOR ARRANGING TRAVEL TOURS FOR EDUCATIONAL EXPERIENCES; COORDINATING TRAVEL ARRANGEMENTS FOR INDIVIDUALS AND FOR GROUPS; MAKING TRAVEL AND EXCURSION ARRANGEMENTS FOR BANDS AND ORCHESTRAS (U.S. CLS. 100 AND 105).  
 FIRST USE 12-31-2012; IN COMMERCE 12-31-2012.  
 MARIA-VICTORIA SUAREZ, EXAMINING ATTORNEY

**CLASS 39—(Continued).**

SN 86-065,804. ENTERPRISE HOLDINGS, INC., ST. LOUIS, MO. FILED 9-16-2013.



OWNER OF U.S. REG. NOS. 3,503,173, 4,119,617 AND OTHERS.  
 THE COLOR(S) GREEN, WHITE AND BLACK IS/ARE CLAIMED AS A FEATURE OF THE MARK.  
 THE MARK CONSISTS OF A WHITE LETTER "E" INSIDE A GREEN SQUARE, POSITIONED ABOVE THE WORDING "PLUS" IN BLACK LETTERS.  
 FOR VEHICLE RENTAL AND LEASING SERVICES; AND RESERVATION SERVICES FOR THE RENTAL AND LEASING OF VEHICLES, NAMELY RENTAL RESERVATIONS FOR AUTOMOBILES, TRUCKS, CARS, LAND VEHICLES (U.S. CLS. 100 AND 105).  
 FIRST USE 7-2-2007; IN COMMERCE 7-2-2007.  
 NAKIA HENRY, EXAMINING ATTORNEY

---

SN 86-066,117. ISLAND HOLDING CORPORATION, ISLAMORADA, FL. FILED 9-16-2013.

**Bud n' Mary's**

THE MARK CONSISTS OF STANDARD CHARACTERS WITHOUT CLAIM TO ANY PARTICULAR FONT, STYLE, SIZE, OR COLOR.  
 FOR BOAT RENTAL; CONDUCTING DIVING CHARTERS; CONDUCTING FISHING CHARTERS (U.S. CLS. 100 AND 105).  
 FIRST USE 12-31-1944; IN COMMERCE 12-31-1944.  
 HEATHER THOMPSON, EXAMINING ATTORNEY

**CLASS 39—(Continued).**

SN 86-066,415. ATLANTA PEACH MOVERS, INC., DORAVILLE, GA. FILED 9-17-2013.

## FIND A WAY

THE MARK CONSISTS OF STANDARD CHARACTERS WITHOUT CLAIM TO ANY PARTICULAR FONT, STYLE, SIZE, OR COLOR.

FOR MOVING AND STORAGE OF FURNITURE, MISCELLANEOUS HOUSEHOLD ITEMS, AND MISCELLANEOUS BUSINESS ITEMS; PACKING ARTICLES FOR TRANSPORTATION; RENTAL OF MOVING EQUIPMENT, NAMELY, PADS, STRAPS, HITCHES, DOLLIES, BOXES, CARRIERS, AND HAND TRUCKS; RENTAL OF TRUCKS; TRANSPORT OF GOODS AND FURNITURE OF OTHERS BY TRUCK, VAN, OR AUTOMOBILE (U.S. CLS. 100 AND 105).

NORA BUCHANAN WILL, EXAMINING ATTORNEY

**CLASS 39—(Continued).**

SN 86-068,749. ARIK AIR LIMITED, IKEJA, LAGOS, NIGERIA, FILED 9-18-2013.



THE MARK CONSISTS OF STYLIZED WINGS. FOR AIRLINE TRANSPORTATION SERVICES (U.S. CLS. 100 AND 105).

FIRST USE 4-0-2010; IN COMMERCE 4-0-2010.  
STEPHANIE ALI, EXAMINING ATTORNEY

SN 86-070,305. JUNK RESCUE COMPANY, LLC, CHARLOTTE, NC. FILED 9-20-2013.

## "Give Junk A Second Chance!"

SN 86-067,052. WALKER, CYRUS, DBA DATA DEFENDERS, CHICAGO, IL. FILED 9-17-2013.



THE MARK CONSISTS OF STANDARD CHARACTERS WITHOUT CLAIM TO ANY PARTICULAR FONT, STYLE, SIZE, OR COLOR.

FOR JUNK REMOVAL AND RECYCLING PICK UP SERVICES (U.S. CLS. 100 AND 105).

FIRST USE 10-1-2008; IN COMMERCE 1-1-2009.  
DOMINICK J. SALEMI, EXAMINING ATTORNEY

SN 86-070,487. O.B. MANAGEMENT SERVICES, INC., ORLANDO, FL. FILED 9-20-2013.

## MY PLACE SELF STORAGE

THE MARK CONSISTS OF THE WORDS "DATA DEFENDERS" IN SAN-SERIF FONT, CAPITAL INITIAL LETTERS AND SMALL CAPS THEREAFTER, WITH A STYLIZED HUMAN FORM STRETCHING FROM BELOW AND TO THE RIGHT OF THE TERM "DATA" AND UPWARDS TO THE RIGHT BETWEEN THE TWO WORDS, THE HEAD AND HANDS BEING FILLED-IN CIRCLES, THE ARM TO THE RIGHT EXTENDING TO THE RIGHT AND THEN UPWARDS AND THE ARM TO THE LEFT EXTENDING LEFTWARD AND THEN DOWN TO NEAR THE SECOND "A" OF "DATA", AND THE WORDS "DEFENDERS OF THE INFORMATION WORLD" IN SANS SERIF ITALIC FONT BENEATH THE "DATA DEFENDERS" LINE OF TEXT.

FOR ELECTRONIC STORAGE OF DATA; STORAGE SERVICES FOR ARCHIVING ELECTRONIC DATA; TEMPORARY ELECTRONIC STORAGE OF INFORMATION AND DATA (U.S. CLS. 100 AND 105).

FIRST USE 2-28-2005; IN COMMERCE 2-28-2005.  
SKYE YOUNG, EXAMINING ATTORNEY

THE MARK CONSISTS OF STANDARD CHARACTERS WITHOUT CLAIM TO ANY PARTICULAR FONT, STYLE, SIZE, OR COLOR.

NO CLAIM IS MADE TO THE EXCLUSIVE RIGHT TO USE "SELF STORAGE", APART FROM THE MARK AS SHOWN.

FOR PROVIDING SELF-STORAGE FACILITIES FOR OTHERS (U.S. CLS. 100 AND 105).

KARANENDRA S. CHHINA, EXAMINING ATTORNEY

**CLASS 39—(Continued).**

SN 86-070,799. FASTLY, INC., SAN FRANCISCO, CA. FILED 9-20-2013.

# FASTLY

THE MARK CONSISTS OF STANDARD CHARACTERS WITHOUT CLAIM TO ANY PARTICULAR FONT, STYLE, SIZE, OR COLOR.

FOR ELECTRONIC STORAGE OF DATA, NAMELY, THIRD PARTY WEB CONTENT (U.S. CLS. 100 AND 105).  
MICHAEL WEBSTER, EXAMINING ATTORNEY

SN 86-071,056. ZTO EXPRESS CO., LTD., SHANGHAI, CHINA, FILED 9-20-2013.

# 中通

THE MARK CONSISTS OF TWO CHINESE CHARACTERS.

THE NON-LATIN CHARACTERS IN THE MARK TRANSLITERATE TO ZHONG TONG AND THIS HAS NO MEANING IN A FOREIGN LANGUAGE.

FOR DELIVERY AND STORAGE OF GOODS; DELIVERY OF GOODS; DELIVERY OF GOODS BY MAIL ORDER; DELIVERY OF GOODS BY TRUCK, AIR, RAIL, OCEAN SHIPPING; DELIVERY OF NEWSPAPERS; DOCUMENT DELIVERY; MESSAGE DELIVERY; NEWSPAPER DELIVERY; PARCEL DELIVERY; PROVIDING OCEAN TRANSPORTATION, STORAGE AND DELIVERY SERVICES; SHIPPING AND DELIVERY SERVICES, NAMELY, PICKUP, TRANSPORTATION, AND DELIVERY OF PACKAGES AND LETTERS BY VARIOUS MODES OF TRANSPORTATION; STORAGE AND DELIVERY OF GOODS; SUPPLY CHAIN LOGISTICS AND REVERSE LOGISTICS SERVICES, NAMELY, STORAGE, TRANSPORTATION AND DELIVERY OF DOCUMENTS, PACKAGES, RAW MATERIALS, AND OTHER FREIGHT FOR OTHERS BY AIR, RAIL, SHIP OR TRUCK; SUPPLY CHAIN LOGISTICS AND REVERSE LOGISTICS SERVICES, NAMELY, STORAGE, TRANSPORTATION AND DELIVERY OF GOODS FOR OTHERS BY AIR, RAIL, SHIP OR TRUCK; TRANSPORT AND DELIVERY OF GOODS; TRANSPORTATION AND DELIVERY SERVICES BY AIR, ROAD, RAIL AND SEA (U.S. CLS. 100 AND 105).

KATINA MISTER, EXAMINING ATTORNEY

**CLASS 39—(Continued).**

SN 86-079,522. BARON T. LTD., DBA CARMEL, NEW YORK, NY. FILED 10-1-2013.

## Need a Ride? Just Carmel It!

THE MARK CONSISTS OF STANDARD CHARACTERS WITHOUT CLAIM TO ANY PARTICULAR FONT, STYLE, SIZE, OR COLOR.

OWNER OF U.S. REG. NO. 3,073,155.  
FOR TRANSPORT OF PASSENGERS (U.S. CLS. 100 AND 105).

FIRST USE 5-9-2013; IN COMMERCE 5-9-2013.

THEODORE MCBRIDE, EXAMINING ATTORNEY

SN 86-098,042. PRATT INDUSTRIES, INC., CONYERS, GA. FILED 10-22-2013.



OWNER OF U.S. REG. NOS. 3,616,081, 3,737,012 AND OTHERS.

NO CLAIM IS MADE TO THE EXCLUSIVE RIGHT TO USE "LOGISTICS", APART FROM THE MARK AS SHOWN. THE MARK CONSISTS OF THE WORD "PRATT" IN LARGE, BOLD LETTERS WITH THE WORD "LOGISTICS" IN SMALLER, ITALIC LETTERS BELOW AND ALIGNED TOWARDS THE RIGHT END OF "PRATT", WITH THREE OVERLAPPING CRESCENTS CENTERED AROUND THE LEFT END OF "PRATT".

FOR TRANSPORTATION OF GOODS BY TRUCK (U.S. CLS. 100 AND 105).

KATHLEEN M. VANSTON, EXAMINING ATTORNEY

SN 86-112,373. YOFIMETER LLC, LA JOLLA, CA. FILED 11-6-2013.

# YOFICLOUD

THE MARK CONSISTS OF STANDARD CHARACTERS WITHOUT CLAIM TO ANY PARTICULAR FONT, STYLE, SIZE, OR COLOR.

FOR CLOUD BASED ELECTRONIC STORAGE OF PATIENT MEDICAL DATA (U.S. CLS. 100 AND 105).

TOBY BULLOFF, EXAMINING ATTORNEY

**CLASS 39—(Continued).**

SN 86-113,732. GERONIMO TRANSPORT SERVICES, LLC, MIDLAND, TX. FILED 11-8-2013.



THE COLOR(S) BLACK, WHITE, AND RED IS/ARE CLAIMED AS A FEATURE OF THE MARK.

THE MARK CONSISTS OF A PROFILE OF A NATIVE AMERICAN IN BLACK WEARING A BLACK AND WHITE HEADDRESS WITH A CAPITAL LETTER "G" IN THE COLOR RED ON A WHITE BACKGROUND IN THE CENTER OF THE HEADDRESS.

FOR TRUCKING SERVICES, NAMELY, HAULING OF WASTE WATER (U.S. CLS. 100 AND 105).  
KATHLEEN M. VANSTON, EXAMINING ATTORNEY

SN 86-116,172. TGW TRAVEL, INC, DBA TOURS GONE WILD, MIAMI BEACH, FL. FILED 11-12-2013.

**TOURS GONE WILD**

THE MARK CONSISTS OF STANDARD CHARACTERS WITHOUT CLAIM TO ANY PARTICULAR FONT, STYLE, SIZE, OR COLOR.

NO CLAIM IS MADE TO THE EXCLUSIVE RIGHT TO USE "TOURS", APART FROM THE MARK AS SHOWN.

FOR ARRANGING EXCURSIONS FOR TOURISTS; ARRANGING TRAVEL TOURS; COORDINATING TRAVEL ARRANGEMENTS FOR INDIVIDUALS AND FOR GROUPS; TRAVEL BOOKING AGENCIES; TRAVEL INFORMATION SERVICES; TRAVEL TICKET RESERVATION SERVICE; TRAVEL TOUR GUIDE SERVICES (U.S. CLS. 100 AND 105).

FIRST USE 8-11-2003; IN COMMERCE 1-9-2004.  
MARY ROSSMAN, EXAMINING ATTORNEY

**CLASS 39—(Continued).**

SN 86-117,715. BOURNE LOGISTICS MARKETING, LTD., SILVER SPRINGS, NV. FILED 11-13-2013.

**GROWN & SEXY CRUISE**

THE MARK CONSISTS OF STANDARD CHARACTERS WITHOUT CLAIM TO ANY PARTICULAR FONT, STYLE, SIZE, OR COLOR.

OWNER OF U.S. REG. NO. 4,432,370.

NO CLAIM IS MADE TO THE EXCLUSIVE RIGHT TO USE "CRUISE", APART FROM THE MARK AS SHOWN. FOR ARRANGING OF TRAVEL TOURS AND CRUISES (U.S. CLS. 100 AND 105).

FIRST USE 0-0-2000; IN COMMERCE 0-0-2000.

MARTHA SANTOMARTINO, EXAMINING ATTORNEY

**CLASS 40—MATERIAL TREATMENT**

SN 85-656,020. PACIFIC HIDE & FUR DEPOT, GREAT FALLS, MT. FILED 6-19-2012.



OWNER OF U.S. REG. NO. 3,829,703.

NO CLAIM IS MADE TO THE EXCLUSIVE RIGHT TO USE "E-RECYCLING", APART FROM THE MARK AS SHOWN.

THE COLOR(S) ORANGE, GREEN, BLACK AND WHITE IS/ARE CLAIMED AS A FEATURE OF THE MARK.

THE MARK CONSISTS OF A LARGE "P" WITH 3 ARROWS ENCIRCLING IT IN WHITE. COLORS IN THE CIRCLE ARE ORANGE GRADUATING TO GREEN WITH THE WORDS "PACIFIC E-RECYCLING" NEXT TO IT IN BLACK.

FOR RECYCLING OF ELECTRONICS AND RECHARGEABLE BATTERIES (U.S. CLS. 100, 103 AND 106).

FIRST USE 5-1-2012; IN COMMERCE 5-1-2012.  
LAURIE MAYES, EXAMINING ATTORNEY



**CLASS 40—(Continued).**

SN 85-918,083. MUNOZ, MARY, PITTSBURG, CA. AND CAMPBELL, CHRISTOPHER, PITTSBURG, CA. FILED 4-29-2013.

# FormURLife

THE MARK CONSISTS OF STANDARD CHARACTERS WITHOUT CLAIM TO ANY PARTICULAR FONT, STYLE, SIZE, OR COLOR.

FOR CUSTOM MANUFACTURE OF CONSUMER GOODS FOR OTHERS, NAMELY, THREE DIMENSIONAL PRINTING (3DP) (U.S. CLS. 100, 103 AND 106).  
FIRST USE 6-1-2012; IN COMMERCE 1-20-2013.  
DEIRDRE ROBERTSON, EXAMINING ATTORNEY

**CLASS 40—(Continued).**

SN 86-016,792. RUFF RONNALL, DBA THE PINK STRAWBERRY CONFECTIONS, BEACHWOOD, OH. FILED 7-22-2013.

# THE PINK STRAWBERRY

THE MARK CONSISTS OF STANDARD CHARACTERS WITHOUT CLAIM TO ANY PARTICULAR FONT, STYLE, SIZE, OR COLOR.

FOR CUSTOM FABRICATION OF CONFECTION DISPLAYS FOR WEDDINGS, CELEBRATIONS, AND SPECIAL EVENTS (U.S. CLS. 100, 103 AND 106).  
FIRST USE 1-1-2011; IN COMMERCE 2-14-2012.  
YAT SYE, LEE, EXAMINING ATTORNEY

SN 85-957,251. J. ROUSEK TOY COMPANY, INC., BISHOP, CA. FILED 6-11-2013.

# SOUVENIR SELECT

THE MARK CONSISTS OF STANDARD CHARACTERS WITHOUT CLAIM TO ANY PARTICULAR FONT, STYLE, SIZE, OR COLOR.

NO CLAIM IS MADE TO THE EXCLUSIVE RIGHT TO USE "SOUVENIR", APART FROM THE MARK AS SHOWN.  
FOR CUSTOM IMPRINTING OF PENS AND PENCILS FOR THE SOUVENIR INDUSTRY (U.S. CLS. 100, 103 AND 106).

FIRST USE 9-12-2013; IN COMMERCE 9-12-2013.  
MARTHA SANTOMARTINO, EXAMINING ATTORNEY

SN 86-017,615. GEORGIA-PACIFIC CORRUGATED LLC, ATLANTA, GA. FILED 7-23-2013.



THE MARK CONSISTS OF A RECTANGULAR BOX IN A THREE DIMENSIONAL FORMAT SHOWING IMAGES OF A MAN'S SUIT, TEDDY BEAR, MIXER, MAN'S SHOE, PENCIL, TAPE DISPENSER, PILL BOTTLE, PURSE AND CAMERA, LOCATED TO THE LEFT SIDE OF THE WORD "CUBELOGIC".

FOR CUSTOM MANUFACTURE OF CORRUGATED BOXES FOR OTHERS (U.S. CLS. 100, 103 AND 106).  
JOHN WILKE, EXAMINING ATTORNEY

SN 86-007,651. GEORGIA-PACIFIC CORRUGATED LLC, ATLANTA, GA. FILED 7-11-2013.

# CUBELOGIC

THE MARK CONSISTS OF STANDARD CHARACTERS WITHOUT CLAIM TO ANY PARTICULAR FONT, STYLE, SIZE, OR COLOR.

FOR CUSTOM MANUFACTURE OF CORRUGATED BOXES FOR OTHERS (U.S. CLS. 100, 103 AND 106).  
JOHN WILKE, EXAMINING ATTORNEY

SN 86-042,427. MOLDCURE PRO LLC, ROSELAND, NJ. FILED 8-20-2013.

# MoldCure Pro

THE MARK CONSISTS OF STANDARD CHARACTERS WITHOUT CLAIM TO ANY PARTICULAR FONT, STYLE, SIZE, OR COLOR.

NO CLAIM IS MADE TO THE EXCLUSIVE RIGHT TO USE "PRO", APART FROM THE MARK AS SHOWN.  
FOR MOLD REMEDIATION SERVICES (U.S. CLS. 100, 103 AND 106).

FIRST USE 1-6-2011; IN COMMERCE 1-6-2011.  
JEFF DEFORD, EXAMINING ATTORNEY

**CLASS 40—(Continued).**

SN 86-043,569. CUSTOM PRINTERS, GRAND RAPIDS, MI. FILED 8-21-2013.



THE MARK CONSISTS OF 4 CIRCLES STACKED 2X2, A FORWARD SLASH AND THE TEXT "SPOT ON".  
FOR PRINTING SERVICES (U.S. CLS. 100, 103 AND 106).

FIRST USE 4-0-2009; IN COMMERCE 4-0-2009.  
CARYN GLASSER, EXAMINING ATTORNEY

SN 86-046,059. FAVARO, EVAN, FAIR LAWN, NJ. FILED 8-23-2013.



NO CLAIM IS MADE TO THE EXCLUSIVE RIGHT TO USE "MOTORS", APART FROM THE MARK AS SHOWN.

THE COLOR(S) RED AND TAN IS/ARE CLAIMED AS A FEATURE OF THE MARK.

THE MARK CONSISTS OF A TAN OVAL OUTLINED IN RED, CONTAINING THE STYLIZED RED WORD "SPEAK" ON THE LEFT, A STYLIZED OUTLINE OF A FACE WITH RED FEATURES, INCLUDING A RED HELMET WITH SPIKES, RED NOSE AND OUTLINES OF RED EYES, PUPILS, TEETH AND MOUTH AND TONGUE, WITH TAN SKIN AND 4 TAN LINES ON THE HAT THAT FLANK A SMALL RED CIRCLE DESIGN WITH A TAN NUMBER "11", TAN TEETH AND EYES, IN THE CENTER OF THE OVAL, AND THE STYLIZED RED WORD "EASY" TO THE RIGHT. BELOW THE OVAL IS THE TAN STYLIZED WORD "MOTORS", FEATURING A RED OUTLINE.

FOR CUSTOM BUILDING OF MOTORCYCLES; CUSTOM BUILDING OF HOT RODS (U.S. CLS. 100, 103 AND 106).

FIRST USE 4-0-2011; IN COMMERCE 4-0-2011.  
NAKIA HENRY, EXAMINING ATTORNEY

**CLASS 40—(Continued).**

SN 86-057,829. FAVARO, EVAN, FAIR LAWN, NJ. FILED 9-6-2013.

**SPEAKEASY MOTORS**

THE MARK CONSISTS OF STANDARD CHARACTERS WITHOUT CLAIM TO ANY PARTICULAR FONT, STYLE, SIZE, OR COLOR.

NO CLAIM IS MADE TO THE EXCLUSIVE RIGHT TO USE "MOTORS", APART FROM THE MARK AS SHOWN.

FOR CUSTOM BUILDING OF MOTORCYCLES; CUSTOM BUILDING OF HOT RODS (U.S. CLS. 100, 103 AND 106).

FIRST USE 4-0-2011; IN COMMERCE 4-0-2011.  
NAKIA HENRY, EXAMINING ATTORNEY

SN 86-069,927. OOSHIRTS INC., BERKELEY, CA. FILED 9-19-2013.

**SHIRTS.IO**

THE MARK CONSISTS OF STANDARD CHARACTERS WITHOUT CLAIM TO ANY PARTICULAR FONT, STYLE, SIZE, OR COLOR.

OWNER OF U.S. REG. NO. 4,197,809.

FOR DIGITAL PRINTING; PRINTING; PRINTING SERVICES; SCREEN PRINTING (U.S. CLS. 100, 103 AND 106).

FIRST USE 3-28-2013; IN COMMERCE 3-28-2013.  
KATHERINE STOIDES, EXAMINING ATTORNEY

SN 86-071,149. BROTHERS BREWING, LLC, BOONVILLE, NC. FILED 9-21-2013.

**Brothers Brewing, LLC**

THE MARK CONSISTS OF STANDARD CHARACTERS WITHOUT CLAIM TO ANY PARTICULAR FONT, STYLE, SIZE, OR COLOR.

NO CLAIM IS MADE TO THE EXCLUSIVE RIGHT TO USE "BREWING, LLC", APART FROM THE MARK AS SHOWN.

FOR BEER MAKING AND BREWING SERVICES (U.S. CLS. 100, 103 AND 106).

MICHAEL ENGEL, EXAMINING ATTORNEY

**CLASS 40—(Continued).**

SN 86-072,252. ENOCH MANUFACTURING COMPANY,  
CLACKAMAS, OR. FILED 9-23-2013.

**CLASS 40—(Continued).**

SN 86-113,834. BARKSDALE, JASON, EVERGREEN, CO.  
FILED 11-8-2013.

# ENOCH

THE MARK CONSISTS OF STANDARD CHARACTERS  
WITHOUT CLAIM TO ANY PARTICULAR FONT, STYLE,  
SIZE, OR COLOR.

FOR MACHINE SHOP SERVICES, NAMELY, MA-  
CHINING PARTS FOR OTHERS (U.S. CLS. 100, 103  
AND 106).

FIRST USE 0-0-1949; IN COMMERCE 0-0-1949.  
SHANNON TWOHIG, EXAMINING ATTORNEY



SN 86-073,379. OOSHIRTS INC., BERKELEY, CA. FILED 9-  
24-2013.

# OOSHIRTS

Bear Mountain Brewing  
Company

THE MARK CONSISTS OF STANDARD CHARACTERS  
WITHOUT CLAIM TO ANY PARTICULAR FONT, STYLE,  
SIZE, OR COLOR.

OWNER OF U.S. REG. NO. 4,197,809.  
FOR DIGITAL PRINTING; PRINTING; PRINTING  
SERVICES; SCREEN PRINTING (U.S. CLS. 100, 103  
AND 106).

FIRST USE 1-1-2008; IN COMMERCE 1-1-2008.  
KATHERINE STOIDES, EXAMINING ATTORNEY



SN 86-097,850. CERTAINTTEED CORPORATION, VALLEY  
FORGE, PA. FILED 10-22-2013.

# ROOFING RESPONSIBLY

THE MARK CONSISTS OF STANDARD CHARACTERS  
WITHOUT CLAIM TO ANY PARTICULAR FONT, STYLE,  
SIZE, OR COLOR.

OWNER OF U.S. REG. NO. 3,897,976.  
NO CLAIM IS MADE TO THE EXCLUSIVE RIGHT TO  
USE "ROOFING", APART FROM THE MARK AS SHOWN.  
FOR RECYCLING OF ASPHALT ROOFING (U.S. CLS.  
100, 103 AND 106).

FIRST USE 5-19-2010; IN COMMERCE 10-15-2010.  
CHRISIE B. KING, EXAMINING ATTORNEY

THE MARK CONSISTS OF STANDARD CHARACTERS  
WITHOUT CLAIM TO ANY PARTICULAR FONT, STYLE,  
SIZE, OR COLOR.

NO CLAIM IS MADE TO THE EXCLUSIVE RIGHT TO  
USE "BREWING COMPANY", APART FROM THE MARK  
AS SHOWN.

FOR BEER MAKING AND BREWING SERVICES (U.S.  
CLS. 100, 103 AND 106).

LYNDSEY KUYKENDALL, EXAMINING ATTORNEY

**CLASS 41—EDUCATION AND ENTERTAINMENT**

SN 76-712,721. INSIDER PRODUCTIONS, LLC, LOS ANGELES, CA. FILED 10-26-2012.



NO CLAIM IS MADE TO THE EXCLUSIVE RIGHT TO USE "LOLA", APART FROM THE MARK AS SHOWN.

THE WORD, "QUEEN LOLA", HAS A CROWN ON TOP OF THE LETTER "Q" WHICH HAS ROSES, STEMS AND LEAVES DRAWN AT THE INTERIOR OF THE LETTER "Q" AND WITH SIMILAR DESIGN OF ROSES, STEMS AND LEAVES DRAWN BESIDE THE WORD "LOLA" LOCATED AFTER THE WORD "A" OF "LOLA".

THE ENGLISH TRANSLATION OR MEANING OF THE FILIPINO WORD, "LOLA", IN THE MARK IS "GRANDMOTHER".

FOR ENTERTAINMENT EVENT PRODUCTION SERVICES, NAMELY, ARRANGING, ORGANIZING, AND CONDUCTING BEAUTY PAGEANTS, PERSONAL APPEARANCES BY WINNERS AND CANDIDATES OF CULTURAL AND BEAUTY PAGEANTS, AND FASHION SHOWS FOR ENTERTAINMENT PURPOSES; ENTERTAINMENT IN THE NATURE OF CULTURAL AND BEAUTY PAGEANTS CONDUCTED ON A REGIONAL, NATIONAL AND INTERNATIONAL BASIS FOR GRANDMOTHERS; ENTERTAINMENT IN THE NATURE OF CULTURAL AND BEAUTY PAGEANTS CONDUCTED ON A REGIONAL, NATIONAL AND INTERNATIONAL BASIS; ENTERTAINMENT SERVICES, NAMELY, PERSONAL APPEARANCES BY THE WINNERS AND CONTESTANTS OF CULTURAL AND BEAUTY PAGEANTS; ENTERTAINMENT IN THE NATURE OF FASHION SHOWS FOR ENTERTAINMENT PURPOSES; TRAINING IN THE FIELD OF MODELING, ACTING, MAKE-UP AND APPLICATION OF COSMETICS, POISE, PUBLIC SPEAKING AND ETIQUETTE; CONDUCTING WORKSHOPS AND SEMINARS ON MODELING, ACTING, MAKE-UP AND APPLICATION OF COSMETICS, POISE, PUBLIC SPEAKING AND ETIQUETTE; AND, ORGANIZING COMMUNITY FESTIVALS FEATURING CULTURAL SHOWS, NAMELY, DANCING, SINGING, ACTING, FASHION SHOWS AND MUSIC (U.S. CLS. 100, 101 AND 107).

FIRST USE 5-1-2012; IN COMMERCE 5-1-2012.  
MARC LEIPZIG, EXAMINING ATTORNEY

SN 76-714,990. VOHNE LICHE KENNELS, INC., DENVER, IN. FILED 9-20-2013.



THE MARK CONSISTS OF STANDARD CHARACTERS WITHOUT CLAIM TO ANY PARTICULAR FONT, STYLE, SIZE, OR COLOR.

FOR ANIMAL TRAINING, NAMELY, TRAINING OF K9 UNIT DOGS FOR MILITARY AND POLICE (U.S. CLS. 100, 101 AND 107).

APRIL ROACH, EXAMINING ATTORNEY

**CLASS 41—(Continued).**

SN 77-955,261. WARM SPRINGS PRODUCTIONS, LLC, MISSOULA, MT. FILED 3-10-2010.

**HUNTER'S BUCKET LIST**

THE MARK CONSISTS OF STANDARD CHARACTERS WITHOUT CLAIM TO ANY PARTICULAR FONT, STYLE, SIZE, OR COLOR.

NO CLAIM IS MADE TO THE EXCLUSIVE RIGHT TO USE "HUNTER'S", APART FROM THE MARK AS SHOWN.

FOR ENTERTAINMENT IN THE NATURE OF ONGOING TELEVISION PROGRAMS IN THE FIELD OF HUNTING (U.S. CLS. 100, 101 AND 107).

BRENDAN MCCAULEY, EXAMINING ATTORNEY

SN 79-127,669. CHANGING TO WIN LIMITED, UNITED KINGDOM, FILED 1-25-2013.



PRIORITY DATE OF 7-25-2012 IS CLAIMED.  
OWNER OF INTERNATIONAL REGISTRATION 1153889 DATED 1-25-2013, EXPIRES 1-25-2023.

THE MARK CONSISTS OF A SILHOUETTE OF A HUMAN FIGURE, COMPOSED OF SEPARATE HEAD, TORSO, ARM, AND LEG SHAPES.

FOR PROVIDING EDUCATIONAL INFORMATION TO SPECTATORS, VIEWERS, AND READERS REGARDING SPORTS, HEALTH, AND FITNESS EVENTS IN WHICH COMPETITORS HAVE PHYSICAL OR INTELLECTUAL DISABILITIES; PROVIDING EDUCATIONAL INFORMATION TO SPECTATORS, VIEWERS, AND READERS REGARDING MOTOR RACING, NAMELY, INFORMATION ABOUT THE STRESSES PLACED ON THE BODY OF A DRIVER DURING A RACE. ENTERTAINMENT, NAMELY, ENTERTAINMENT IN THE NATURE OF ONGOING SPORTS TELEVISION PROGRAMS, ONGOING SPORTS TELEVISION SHOWS COVERING MOTOR RACING, ONGOING SPORTS TELEVISION SHOWS COVERING ATHLETES WITH A RANGE OF PHYSICAL AND INTELLECTUAL DISABILITIES, ONGOING SPORTS TELEVISION SHOWS COVERING COMPETITIONS IN WHICH THE COMPETITORS HAVE PHYSICAL OR INTELLECTUAL DISABILITIES; ORGANISING SPORTING AND CULTURAL ACTIVITIES; PROVISION OF INFORMATION RELATING TO SPORT, MOTOR RACING, FITNESS, COMPETITORS, ATHLETES AND PERSONALITIES IN THE FIELD OF SPORT AND ENTERTAINMENT; INFORMATION, CONSULTANCY AND ADVISORY SERVICES RELATING TO ALL OF THE AFORESAID (U.S. CLS. 100, 101 AND 107).

ROGER T. MCDORMAN, EXAMINING ATTORNEY

**CLASS 41—(Continued).**

SN 79-129,078. AMBROGIO S.R.L., ITALY, FILED 2-21-2013.



PRIORITY DATE OF 1-30-2013 IS CLAIMED.  
OWNER OF INTERNATIONAL REGISTRATION 1157630  
DATED 2-21-2013, EXPIRES 2-21-2023.

NO CLAIM IS MADE TO THE EXCLUSIVE RIGHT TO  
USE "RACING", APART FROM THE MARK AS SHOWN.

THE COLOR(S) BLUE, LIGHT BLUE, AND WHITE IS/  
ARE CLAIMED AS A FEATURE OF THE MARK.

THE MARK CONSISTS THE LETTERS "A", "M", "B", "R",  
"O", "G" AND "O" OF THE WORD "AMBROGIO", IN  
SLIGHTLY STYLIZED CHARACTERS; LIGHT BLUE: THE  
WORD "RACING" IN SLIGHTLY STYLIZED CHARAC-  
TERS, SITUATED UNDER THE FINAL LETTERS OF THE  
WORD "AMBROGIO"; LIGHT BLUE AND WHITE: THE  
FOUR CIRCLES OF DIFFERENT SIZE, SITUATED VER-  
TICALLY FROM THE BIGGER ONE TO THE SMALLER ONE,  
FORMING THE LETTER "I" OF THE WORD "AMBROGIO".

FOR ENTERTAINMENT SERVICES IN THE NATURE  
OF MOTOR SPORTS RACES BY A RACING TEAM;  
ENTERTAINMENT SERVICES, NAMELY, PARTICIPA-  
TION BY A RACING TEAM IN MOTOR SPORTS RACES;  
SPORTING ACTIVITIES, NAMELY, ORGANIZING AND  
OPERATING A MOTOR SPORTS RACING TEAM; OR-  
GANIZING OF MOTOR SPORTS RACING EXHIBITIONS  
AND COMPETITIONS FOR SPORTING AND ENTER-  
TAINMENT PURPOSES (U.S. CLS. 100, 101 AND 107).

JAMES GRIFFIN, EXAMINING ATTORNEY

**CLASS 41—(Continued).**

SN 85-496,770. BETTS, KATHERINE, NEW YORK, NY, FILED 12-15-2011.

EVERYDAY ICON

THE MARK CONSISTS OF STANDARD CHARACTERS  
WITHOUT CLAIM TO ANY PARTICULAR FONT, STYLE,  
SIZE, OR COLOR.

FOR PROVIDING A WEBSITE FEATURING BLOGS  
AND NON-DOWNLOADABLE PUBLICATIONS IN THE  
NATURE OF ARTICLES IN THE FIELD OF FASHION  
(U.S. CLS. 100, 101 AND 107).

JENNY PARK, EXAMINING ATTORNEY

SN 85-501,092. EDUCATIONAL SERVICES OF AMERICA,  
AKA ESA, NASHVILLE, TN. FILED 12-21-2011.



SN 85-444,304. SEVERANCE, SCOTT, CHICAGO, IL. FILED  
10-11-2011.

GLOBAL GAME

THE MARK CONSISTS OF STANDARD CHARACTERS  
WITHOUT CLAIM TO ANY PARTICULAR FONT, STYLE,  
SIZE, OR COLOR.

NO CLAIM IS MADE TO THE EXCLUSIVE RIGHT TO  
USE "GLOBAL", APART FROM THE MARK AS SHOWN.

FOR EDUCATIONAL SERVICES, NAMELY, PROVID-  
ING ONLINE INSTRUCTION IN THE FIELD OF TRAD-  
ING VIA AN ONLINE WEBSITE; VOCATIONAL  
EDUCATION IN THE FIELD OF TRADING (U.S. CLS.  
100, 101 AND 107).

MICHELLE DUBOIS, EXAMINING ATTORNEY

OWNER OF U.S. REG. NO. 3,452,532.

NO CLAIM IS MADE TO THE EXCLUSIVE RIGHT TO  
USE "EDUCATIONAL SERVICES OF AMERICA", APART  
FROM THE MARK AS SHOWN.

THE MARK CONSISTS OF A STYLIZED "E" IN A BLOCK;  
A STYLIZED "S" IN A BLOCK; A STYLIZED "A" IN A  
BLOCK. "EDUCATIONAL SERVICES OF AMERICA" WRIT-  
TEN ON THE RIGHT-HAND SIDE OF "ESA".

FOR EDUCATING AT SENIOR HIGH SCHOOLS;  
EDUCATIONAL SERVICES IN THE NATURE OF SPE-  
CIAL EDUCATION AND AT-RISK SCHOOLS; EDUCA-  
TIONAL SERVICES, NAMELY, PROVIDING COURSES  
OF INSTRUCTION AT THE ELEMENTARY AND SEC-  
ONDARY LEVEL AND DISTRIBUTION OF COURSE  
MATERIAL IN CONNECTION THEREWITH; ON-LINE  
EDUCATION CREDIT AND DEGREE EVALUATION  
AND COMPARISON SERVICES; PROVIDING COURSES  
OF INSTRUCTION AT THE PREK THROUGH SECOND-  
ARY LEVEL; PROVIDING EDUCATIONAL MENTOR-  
ING SERVICES AND PROGRAMS IN THE FIELD OF  
AT-RISK STUDENTS AND POST-SECONDARY STU-  
DENTS WITH SPECIAL NEEDS (U.S. CLS. 100, 101  
AND 107).

FIRST USE 5-5-2011; IN COMMERCE 5-5-2011.

JOHN DWYER, EXAMINING ATTORNEY

**CLASS 41—(Continued).**

SN 85-522,421. LISA H. BONNER, NEW YORK, NY. FILED 1-23-2012.

# SINGLISTA

THE MARK CONSISTS OF STANDARD CHARACTERS WITHOUT CLAIM TO ANY PARTICULAR FONT, STYLE, SIZE, OR COLOR.

FOR ON-LINE JOURNALS, NAMELY, BLOGS FEATURING TRAVEL; ENTERTAINMENT SERVICES, NAMELY, PROVIDING ON-GOING RADIO AND TELEVISION PROGRAMS IN THE FIELD OF TRAVEL; MOTION PICTURE FILM PRODUCTION; ARRANGING AND CONDUCTING SPECIAL EVENTS FOR SOCIAL ENTERTAINMENT PURPOSES (U.S. CLS. 100, 101 AND 107).

MARK T. MULLEN, EXAMINING ATTORNEY

SN 85-528,533. PROLIFIC MUSIC GROUP, INC., VENICE, CA. FILED 1-30-2012.

# PROLIFIC MUSIC GROUP

THE MARK CONSISTS OF STANDARD CHARACTERS WITHOUT CLAIM TO ANY PARTICULAR FONT, STYLE, SIZE, OR COLOR.

NO CLAIM IS MADE TO THE EXCLUSIVE RIGHT TO USE "MUSIC GROUP", APART FROM THE MARK AS SHOWN.

FOR ENTERTAINMENT RECORDING AND PRODUCTION SERVICES, NAMELY, MUSIC, VIDEO AND PERFORMANCE RECORDING AND PRODUCTION SERVICES (U.S. CLS. 100, 101 AND 107).

JULIE WATSON, EXAMINING ATTORNEY

SN 85-528,541. PROLIFIC MUSIC GROUP, INC., VENICE, CA. FILED 1-30-2012.



NO CLAIM IS MADE TO THE EXCLUSIVE RIGHT TO USE "MUSIC GROUP", APART FROM THE MARK AS SHOWN.

THE MARK CONSISTS OF THE WORDS "PROLIFIC MUSIC GROUP". THE "O" AND "L" CHARACTERS IN THE WORD "PROLIFIC" ARE DESIGNED TO APPEAR LIKE A TURNABLE WHILE THE "C" CHARACTER IS DESIGNED TO LOOK LIKE A SET OF HEADPHONES; AND THE LETTER "M" IN THE WORD "MUSIC" AND THE LETTER "O" IN THE WORD "GROUP" APPEAR TO BE WRAPPED WITH WIRE.

FOR ENTERTAINMENT RECORDING AND PRODUCTION SERVICES, NAMELY, MUSIC, VIDEO AND PERFORMANCE RECORDING AND PRODUCTION SERVICES (U.S. CLS. 100, 101 AND 107).

JULIE WATSON, EXAMINING ATTORNEY

**CLASS 41—(Continued).**

SN 85-599,107. LIFE TRANSFORMING COACHING, DBA NATALIE FOREST / LIFE TRANSFORMING COACHING / HEALING ISIS, JOPPA, MD. FILED 4-16-2012.

# LIFE TRANSFORMING COACHING

THE MARK CONSISTS OF STANDARD CHARACTERS WITHOUT CLAIM TO ANY PARTICULAR FONT, STYLE, SIZE, OR COLOR.

NO CLAIM IS MADE TO THE EXCLUSIVE RIGHT TO USE "COACHING", APART FROM THE MARK AS SHOWN.

FOR BUSINESS TRAINING IN THE FIELD OF NETWORKING; LIFE COACHING SERVICES IN THE FIELD OF LIFE, WELLNESS, ABUNDANCE, HAPPINESS, FAMILY, FRIENDS AND SPIRITUALITY; PEER TO PEER COACHING SERVICES IN THE FIELD OF LIFE, WELLNESS, ABUNDANCE, HAPPINESS, FAMILY, FRIENDS AND SPIRITUALITY; PERSONAL COACHING SERVICES IN THE FIELD OF LIFE, WELLNESS, ABUNDANCE, HAPPINESS, FAMILY, FRIENDS AND SPIRITUALITY; PROFESSIONAL COACHING SERVICES IN THE FIELD OF LIFE, WELLNESS, ABUNDANCE, HAPPINESS, FAMILY, FRIENDS AND SPIRITUALITY; PROVIDING GROUP COACHING IN THE FIELD OF LIFE, WELLNESS, ABUNDANCE, HAPPINESS, FAMILY, FRIENDS AND SPIRITUALITY (U.S. CLS. 100, 101 AND 107).

FIRST USE 4-13-2012; IN COMMERCE 4-13-2012.  
ROBERT STRUCK, EXAMINING ATTORNEY

SN 85-599,197. DISNEY ENTERPRISES, INC., BURBANK, CA. FILED 4-16-2012.

# ARMIES OF MAGIC

THE MARK CONSISTS OF STANDARD CHARACTERS WITHOUT CLAIM TO ANY PARTICULAR FONT, STYLE, SIZE, OR COLOR.

PRIORITY CLAIMED UNDER SEC. 44(D) ON URUGUAY APPLICATION NO. 430100, FILED 12-5-2011.

FOR ENTERTAINMENT SERVICES, NAMELY, PROVIDING ONLINE COMPUTER GAMES, ONLINE ENHANCEMENTS FOR COMPUTER GAMES, AND PROVIDING ONLINE GAMES; PROVIDING INFORMATION RELATING TO COMPUTER GAMES AND GAME ENHANCEMENTS VIA GLOBAL COMPUTER NETWORKS AND ELECTRONIC COMMUNICATION NETWORKS FOR USE IN CONNECTION WITH COMPUTERS, MOBILE COMPUTERS, MEDIA PLAYERS, CELLULAR PHONES, WIRELESS DEVICES AND PORTABLE AND HANDHELD DIGITAL ELECTRONIC DEVICES; PROVIDING AN ONLINE ENTERTAINMENT INFORMATION SERVICE FEATURING INFORMATION REGARDING COMPUTER GAMES, ENHANCEMENTS FOR COMPUTER GAMES, ONLINE GAMES, AND GAME APPLICATIONS VIA GLOBAL COMPUTER NETWORKS AND ELECTRONIC COMMUNICATION NETWORKS FOR USE IN CONNECTION WITH COMPUTERS, MOBILE COMPUTERS, MEDIA PLAYERS, CELLULAR PHONES, WIRELESS DEVICES AND PORTABLE AND HANDHELD DIGITAL ELECTRONIC DEVICES; PROVIDING TEMPORARY USE OF NON-DOWNLOADABLE COMPUTER GAMES; PROVIDING TEMPORARY USE OF NON-DOWNLOADABLE SOFTWARE FOR PLAYING COMPUTER GAMES; PROVIDING TEMPORARY USE OF NON-DOWNLOADABLE SOFTWARE TO ENABLE PLAYING AND OTHERWISE PROVIDING COMPUTER GAMES (U.S. CLS. 100, 101 AND 107).

MICHAEL W. BAIRD, EXAMINING ATTORNEY

**CLASS 41—(Continued).**

SN 85-600,147. THE HUMPHREY GROUP INC., TORONTO, ONTARIO, CANADA, FILED 4-17-2012.

**TAKING THE STAGE**

THE MARK CONSISTS OF STANDARD CHARACTERS WITHOUT CLAIM TO ANY PARTICULAR FONT, STYLE, SIZE, OR COLOR.

PRIORITY CLAIMED UNDER SEC. 44(D) ON CANADA APPLICATION NO. 1265792, FILED 10-19-2011, REG. NO. TMA677043, DATED 12-3-2013, EXPIRES 12-3-2028.

OWNER OF U.S. REG. NO. 3,274,516.

FOR COACHING, AND TRAINING SERVICES IN THE FIELD OF PRESENTATIONS, PERSONAL AND BUSINESS COMMUNICATIONS SKILLS, PUBLIC SPEAKING AND INFORMAL SPEAKING; EDUCATIONAL SERVICES, NAMELY, PROVIDING CLASSES, SEMINARS, WORKSHOPS IN THE FIELD OF PRESENTATIONS, PERSONAL AND BUSINESS COMMUNICATIONS SKILLS, PUBLIC SPEAKING AND INFORMAL SPEAKING; ARRANGING AND CONDUCTING SEMINARS, WORKSHOPS, EDUCATIONAL AND TRAINING PROGRAMS IN THE FIELD OF PRESENTATIONS, PERSONAL AND BUSINESS COMMUNICATIONS SKILLS, PUBLIC SPEAKING AND INFORMAL SPEAKING (U.S. CLS. 100, 101 AND 107).

MEREDITH MARESCA, EXAMINING ATTORNEY

SN 85-707,084. 1ST AND 15TH PRODUCTIONS INC., NEW YORK, NY. FILED 8-17-2012.

**1st & 15th**

THE MARK CONSISTS OF STANDARD CHARACTERS WITHOUT CLAIM TO ANY PARTICULAR FONT, STYLE, SIZE, OR COLOR.

OWNER OF U.S. REG. NOS. 3,508,131 AND 3,618,268.

FOR ENTERTAINMENT SERVICES, NAMELY, LIVE MUSIC CONCERTS, SONGWRITING SERVICES, RECORDING STUDIO PRODUCTION SERVICES, MUSIC PUBLISHING SERVICES, SPECIAL EVENTS PRODUCTION SERVICES PERTAINING TO ENTERTAINMENT RELATED EVENTS (U.S. CLS. 100, 101 AND 107).

FIRST USE 9-1-2006; IN COMMERCE 9-1-2006.

PAM WILLIS, EXAMINING ATTORNEY

**CLASS 41—(Continued).**

SN 85-730,520. GENRE FILMS, INC., LOS ANGELES, CA. FILED 9-17-2012.

**KINBERG GENRE PRODUCTION**

THE MARK CONSISTS OF STANDARD CHARACTERS WITHOUT CLAIM TO ANY PARTICULAR FONT, STYLE, SIZE, OR COLOR.

NO CLAIM IS MADE TO THE EXCLUSIVE RIGHT TO USE "PRODUCTION", APART FROM THE MARK AS SHOWN.

FOR ENTERTAINMENT SERVICES, NAMELY, FILM AND TELEVISION PRODUCTION SERVICES (U.S. CLS. 100, 101 AND 107).

BRIDGETT SMITH, EXAMINING ATTORNEY

SN 85-735,225. BLACKLIGHT, LLC, BEVERLY HILLS, CA. FILED 9-21-2012.

**BLACKLIGHT**

THE MARK CONSISTS OF STANDARD CHARACTERS WITHOUT CLAIM TO ANY PARTICULAR FONT, STYLE, SIZE, OR COLOR.

FOR MUSIC VIDEO PRODUCTION; PRODUCTION AND DISTRIBUTION OF MOTION PICTURES; PRODUCTION AND DISTRIBUTION OF TELEVISION SHOWS AND MOVIES (U.S. CLS. 100, 101 AND 107).

HANNO RITTNER, EXAMINING ATTORNEY

SN 85-738,987. POPSUGAR INC., SAN FRANCISCO, CA. FILED 9-26-2012.

**THE CIRCLE OF MOMS MONEY SAVER**

THE MARK CONSISTS OF STANDARD CHARACTERS WITHOUT CLAIM TO ANY PARTICULAR FONT, STYLE, SIZE, OR COLOR.

OWNER OF U.S. REG. NOS. 3,847,199, 3,847,200 AND 4,035,482.

NO CLAIM IS MADE TO THE EXCLUSIVE RIGHT TO USE "MONEY SAVER", APART FROM THE MARK AS SHOWN.

FOR PROMOTING THE GOODS OF OTHERS VIA NEWSLETTERS, NAMELY, PROVIDING ONLINE NON-DOWNLOADABLE NEWSLETTERS AND NEWSLETTERS VIA E-MAIL, ALL PROMOTING THE GOODS OF OTHERS BY PROVIDING INFORMATION REGARDING DISCOUNTS, COUPONS, REBATES, VOUCHERS AND SPECIAL OFFERS FOR THE GOODS OF OTHERS (U.S. CLS. 100, 101 AND 107).

FIRST USE 9-17-2012; IN COMMERCE 9-17-2012.

MAUREEN DALL, EXAMINING ATTORNEY

**CLASS 41—(Continued).**

SN 85-739,853. MINNESOTA AFRICAN WOMEN'S ASSOCIATION, BROOKLYN CENTER, MN. FILED 9-27-2012.

# MAWA

THE MARK CONSISTS OF STANDARD CHARACTERS WITHOUT CLAIM TO ANY PARTICULAR FONT, STYLE, SIZE, OR COLOR.

FOR PROMOTING THE HEALTH AND WELL-BEING OF AFRICAN WOMEN AND THEIR FAMILIES THROUGH CULTURAL SERVICES, NAMELY, PROVIDING AFRICAN DANCE LESSONS, ORGANIZING CHOIR PERFORMANCES, ORGANIZING CULTURAL AND ARTS EVENTS, AND CONDUCTING CULTURAL AWARENESS WORKSHOPS AND ACTIVITIES FOR SCHOOLS, ORGANIZATIONS AND OTHERS THAT REQUEST THE TRAINING TO HELP THEM WORK WITH AFRICAN CLIENTS; PROMOTING THE HEALTH AND WELL-BEING OF AFRICAN WOMEN AND THEIR FAMILIES THROUGH ENTERTAINMENT SERVICES, NAMELY, ORGANIZING DANCE AND CHOIR PERFORMANCES; PROMOTING THE HEALTH AND WELL-BEING OF AFRICAN WOMEN AND THEIR FAMILIES THROUGH CHARITABLE SERVICES, NAMELY, MENTORING SERVICES IN THE FIELD OF JOB READINESS SKILLS AND THE MANAGEMENT OF LEGAL, HEALTH AND HOUSING ISSUES; PROVIDING AFTER SCHOOL EDUCATIONAL PROGRAMS FOR GIRLS CONCERNING BUILDING SELF-ESTEEM, MAKING FRIENDS, DEALING WITH PEER PRESSURE, COLLEGE ATTENDANCE, FINANCIAL LITERACY, TEEN PREGNANCY PREVENTION, AND CIVIL PARTICIPATION; ARRANGING AND CONDUCTING EDUCATIONAL WORKSHOPS, SEMINARS AND CONFERENCES IN THE FIELD OF SOCIAL SERVICES, JOB READINESS SKILLS, HEALTH EDUCATION, HIV/AIDS AWARENESS (U.S. CLS. 100, 101 AND 107).

MARK SHINER, EXAMINING ATTORNEY

SN 85-745,923. STARYKOWICZ, PETER, ROUND LAKE, IL. FILED 10-4-2012.

# GLOW DASH

THE MARK CONSISTS OF STANDARD CHARACTERS WITHOUT CLAIM TO ANY PARTICULAR FONT, STYLE, SIZE, OR COLOR.

NO CLAIM IS MADE TO THE EXCLUSIVE RIGHT TO USE "DASH", APART FROM THE MARK AS SHOWN.

FOR ORGANIZING, ARRANGING, AND CONDUCTING RUNNING AND WALKING SPORTING EVENTS (U.S. CLS. 100, 101 AND 107).

FIRST USE 9-25-2012; IN COMMERCE 9-25-2012.

ELLEN BURNS, EXAMINING ATTORNEY

**CLASS 41—(Continued).**

SN 85-769,593. WORSHIP CATALYST, INC., SAHUARITA, AZ. FILED 11-1-2012.

# Worship Catalyst

THE MARK CONSISTS OF STANDARD CHARACTERS WITHOUT CLAIM TO ANY PARTICULAR FONT, STYLE, SIZE, OR COLOR.

NO CLAIM IS MADE TO THE EXCLUSIVE RIGHT TO USE "WORSHIP", APART FROM THE MARK AS SHOWN.

FOR RELIGIOUS INSTRUCTION SERVICES; TRAINING SERVICES IN THE FIELD OF MUSIC (U.S. CLS. 100, 101 AND 107).

DAWN FELDMAN, EXAMINING ATTORNEY

SN 85-775,611. SALMAN ABOUZIED, JERSEY CITY, NJ. FILED 11-9-2012.

# Ten Cities

THE MARK CONSISTS OF STANDARD CHARACTERS WITHOUT CLAIM TO ANY PARTICULAR FONT, STYLE, SIZE, OR COLOR.

FOR ENTERTAINMENT, NAMELY, LIVE PERFORMANCES BY A MUSICAL BAND (U.S. CLS. 100, 101 AND 107).

FIRST USE 6-1-2007; IN COMMERCE 6-1-2007.

AMY KERTGATE, EXAMINING ATTORNEY

SN 85-798,130. PONESS II, SAMUEL F., DBA PENNSYLVANIA SAFE DRIVER SCHOOL, STRABANE, PA. FILED 12-8-2012.



NO CLAIM IS MADE TO THE EXCLUSIVE RIGHT TO USE "PA SAFE DRIVER SCHOOL" AND THE GEOGRAPHICAL OUTLINE OF THE STATE OF PENNSYLVANIA, APART FROM THE MARK AS SHOWN.

THE COLOR(S) YELLOW, BLACK, BLUE, MEDIUM BLUE, DARK BLUE, AND GRAY IS/ARE CLAIMED AS A FEATURE OF THE MARK.

THE MARK CONSISTS OF THE STYLIZED WORDING



**CLASS 41—(Continued).**

"PA SAFE DRIVER SCHOOL" ABOVE A BLACK STEERING WHEEL WITH DOUBLE YELLOW LINES IN THE SHAPE OF THE STATE OF PENNSYLVANIA AND THE BLUE LETTERS PSDS INSIDE AT THE CENTER WITHIN A YELLOW OUTLINE AND BLUE BACKGROUND OF A KEYSTONE THAT HAS A GRAY SHOULDER-LAP SEAT BELT SECURING THE KEYSTONE AND THE STYLIZED WORDING "STEERING DRIVERS IN A SAFE DIRECTION." UNDERNEATH. THE COLOR WHITE IS EMPLOYED MERELY AS BACKGROUND.

FOR DRIVER SAFETY TRAINING (U.S. CLS. 100, 101 AND 107).

FIRST USE 7-1-2011; IN COMMERCE 1-1-2012.

DOMINICK J. SALEMI, EXAMINING ATTORNEY

**CLASS 41—(Continued).**

SN 85-818,280. SCOTT, LEROY, DBA LEROY SCOTT, LPC, ZACHARY, LA. FILED 1-8-2013.



The REALATIONSHIP  
COACH

SN 85-810,535. JANSMA DESIGN LLC, BELLINGHAM, WA. FILED 12-26-2012.

## ACI Cockpit360°

THE MARK CONSISTS OF STANDARD CHARACTERS WITHOUT CLAIM TO ANY PARTICULAR FONT, STYLE, SIZE, OR COLOR.

NO CLAIM IS MADE TO THE EXCLUSIVE RIGHT TO USE "COCKPIT 360°", APART FROM THE MARK AS SHOWN.

FOR DIGITAL PHOTOGRAPHIC SERVICES IN THE AVIATION FIELD TO DOCUMENT AIRCRAFT INTERIORS FOR PRINT AND DIGITAL MEDIA AND SMART PHONE APPLICATIONS (U.S. CLS. 100, 101 AND 107).

FIRST USE 1-1-2009; IN COMMERCE 1-1-2009.

STEVEN R. FINE, EXAMINING ATTORNEY

NO CLAIM IS MADE TO THE EXCLUSIVE RIGHT TO USE "COACH", APART FROM THE MARK AS SHOWN.

THE MARK CONSISTS OF THE WORDING "THE REALATIONSHIP COACH" IN A STYLIZED FONT.

FOR LIFE COACHING SERVICES IN THE FIELD OF RELATIONSHIPS; PERSONAL COACHING SERVICES IN THE FIELD OF LIFE LESSONS; PROFESSIONAL COACHING SERVICES IN THE FIELD OF MARRIAGE; PROVIDING GROUP COACHING IN THE FIELD OF LIFE RELATIONSHIPS (U.S. CLS. 100, 101 AND 107).

THEODORE MCBRIDE, EXAMINING ATTORNEY

SN 85-817,230. JESSICA LEE BODGE, MUKILTEO, WA. FILED 1-7-2013.



Little Miss  
of America

NO CLAIM IS MADE TO THE EXCLUSIVE RIGHT TO USE "AMERICA", APART FROM THE MARK AS SHOWN.

THE MARK CONSISTS OF A DESIGN OF A BEADED CROWN OVER THE WORDS "LITTLE MISS" IN CURSIVE WRITING WITH INITIAL CAPITAL LETTERS. THE BOTTOM OF THE "L" UNDERScores THE WORDS "LITTLE MISS" AND IS IN THE IMAGE OF A ROSE. THE WORDS "OF AMERICA" ARE UNDERNEATH THE DESIGN OF THE ROSE.

FOR ENTERTAINMENT IN THE NATURE OF BEAUTY PAGEANTS (U.S. CLS. 100, 101 AND 107).

FIRST USE 6-1-2011; IN COMMERCE 6-1-2011.

LEIGH CAROLINE CASE, EXAMINING ATTORNEY

## KINDNESS UNIVERSITY

THE MARK CONSISTS OF STANDARD CHARACTERS WITHOUT CLAIM TO ANY PARTICULAR FONT, STYLE, SIZE, OR COLOR.

NO CLAIM IS MADE TO THE EXCLUSIVE RIGHT TO USE "UNIVERSITY", APART FROM THE MARK AS SHOWN.

FOR EDUCATION SERVICES, NAMELY, PROVIDING CLASSES, WORKSHOPS, CULTURAL EVENTS, CONFERENCES AND INSTRUCTION IN THE FIELD OF PROMOTING PUBLIC AWARENESS OF THE NEED TO DO GOOD, TO PROMOTE ETHICAL AND CHARACTER VALUES, TO BE A GOOD CITIZEN AND TO PERFORM COMMUNITY SERVICES AND CHARITABLE ACTIVITIES; ENTERTAINMENT SERVICES, NAMELY, ORGANIZING AND CONDUCTING SOCIAL ENTERTAINMENT AND CULTURAL EVENTS TO ENCOURAGE THE DOING OF KIND ACTS FOR OTHERS (U.S. CLS. 100, 101 AND 107).

FIRST USE 8-30-2012; IN COMMERCE 8-30-2012.

ANNE E. GUSTASON, EXAMINING ATTORNEY

**CLASS 41—(Continued).**

SN 85-830,566. TWENTIETH CENTURY FOX FILM CORPORATION, LOS ANGELES, CA. FILED 1-23-2013.

# TYRANT

THE MARK CONSISTS OF STANDARD CHARACTERS WITHOUT CLAIM TO ANY PARTICULAR FONT, STYLE, SIZE, OR COLOR.

FOR ENTERTAINMENT SERVICES IN THE NATURE OF A TELEVISION SERIES FEATURING DRAMA (U.S. CLS. 100, 101 AND 107).

WILLIAM BRECKENFELD, EXAMINING ATTORNEY

---

SN 85-837,053. FRANCESCA ZOBELE, NEW YORK, NY. FILED 1-30-2013.

# THE HEALTHY POT

THE MARK CONSISTS OF STANDARD CHARACTERS WITHOUT CLAIM TO ANY PARTICULAR FONT, STYLE, SIZE, OR COLOR.

NO CLAIM IS MADE TO THE EXCLUSIVE RIGHT TO USE "HEALTHY", APART FROM THE MARK AS SHOWN. FOR CONDUCTING SEMINARS, LECTURES AND WORKSHOPS IN THE FIELDS OF WEIGHT LOSS, WEIGHT CONTROL, NUTRITION AND FITNESS (U.S. CLS. 100, 101 AND 107).

FIRST USE 1-29-2013; IN COMMERCE 1-29-2013.  
BRIDGETT SMITH, EXAMINING ATTORNEY

---

SN 85-838,616. JULIE LIN, LOS ANGELES, CA. FILED 2-1-2013.

# LIFE OF A TROPHY WIFE

THE MARK CONSISTS OF STANDARD CHARACTERS WITHOUT CLAIM TO ANY PARTICULAR FONT, STYLE, SIZE, OR COLOR.

FOR ON-LINE JOURNALS, NAMELY, BLOGS FEATURING FASHION AND LIFESTYLE (U.S. CLS. 100, 101 AND 107).

FIRST USE 2-28-2012; IN COMMERCE 2-28-2012.  
DANIEL CAPSHAW, EXAMINING ATTORNEY

**CLASS 41—(Continued).**

SN 85-838,692. MACK CHAPMAN, AKA GRIZZ CHAPMAN, YONKERS, NY. FILED 2-1-2013.

# Grizz

THE MARK CONSISTS OF STANDARD CHARACTERS WITHOUT CLAIM TO ANY PARTICULAR FONT, STYLE, SIZE, OR COLOR.

FOR EDUCATIONAL AND ENTERTAINMENT SERVICES, NAMELY, PROVIDING MOTIVATIONAL AND EDUCATIONAL SPEAKERS; EDUCATIONAL AND ENTERTAINMENT SERVICES, NAMELY, PROVIDING MOTIVATIONAL AND EDUCATIONAL SPEAKERS IN THE FIELD OF SELF- AND PERSONAL IMPROVEMENT; EDUCATIONAL AND ENTERTAINMENT SERVICES, NAMELY, PROVIDING MOTIVATIONAL SPEAKING SERVICES IN THE FIELD OF KIDNEY DISEASE; ENTERTAINMENT IN THE NATURE OF LIVE PERFORMANCES BY A COMEDIAN OR TELEVISION PERSONALITY; ENTERTAINMENT IN THE NATURE OF VISUAL AND AUDIO PERFORMANCES BY MUSICIANS; ENTERTAINMENT IN THE NATURE OF VISUAL AND AUDIO PERFORMANCES, NAMELY, MUSICAL BAND, ROCK GROUP, GYMNASTIC, DANCE, AND BALLET PERFORMANCES; ENTERTAINMENT IN THE NATURE OF VISUAL AND AUDIO PERFORMANCES BY AN ACTOR; ENTERTAINMENT SERVICES BY A MUSICAL ARTIST AND PRODUCER, NAMELY, MUSICAL COMPOSITION FOR OTHERS AND PRODUCTION OF MUSICAL SOUND RECORDINGS; ENTERTAINMENT SERVICES IN THE NATURE OF COMEDY SHOWS; ENTERTAINMENT SERVICES IN THE NATURE OF RECORDING, PRODUCTION AND POST-PRODUCTION SERVICES IN THE FIELD OF MUSIC; ENTERTAINMENT SERVICES IN THE NATURE OF COMEDY PERFORMANCES; ENTERTAINMENT SERVICES, NAMELY, LIVE, TELEVISED AND MOVIE APPEARANCES BY A PROFESSIONAL ENTERTAINER; ENTERTAINMENT SERVICES, NAMELY, PERSONAL APPEARANCES BY A TELEVISION STAR; ENTERTAINMENT SERVICES, NAMELY, PROVIDING A WEBSITE AT WHICH THE GENERAL PUBLIC CAN RECEIVE ADVICE FROM AN INDIVIDUAL OR ENTITY CONCERNING HAPPINESS, SUCH ADVICE BEING FOR ENTERTAINMENT PURPOSES ONLY; ENTERTAINMENT SERVICES, NAMELY, PROVIDING ON-LINE REVIEWS OF MOVIES; ENTERTAINMENT, NAMELY, LIVE PERFORMANCES BY A MUSICAL BAND; ENTERTAINMENT, NAMELY, LIVE PERFORMANCES BY MUSICAL BANDS; ENTERTAINMENT, NAMELY, LIVE PERFORMANCES BY ROCK GROUPS; PROVIDING AN IN-PERSON EDUCATIONAL FORUM IN THE FIELD OF BRANDING (U.S. CLS. 100, 101 AND 107).

FIRST USE 8-1-2010; IN COMMERCE 8-1-2010.  
JULIE WATSON, EXAMINING ATTORNEY

**CLASS 41—(Continued).**

SN 85-842,772. TWENTIETH CENTURY FOX FILM CORPORATION, LOS ANGELES, CA. FILED 2-6-2013.

# SLEEPY HOLLOW

THE MARK CONSISTS OF STANDARD CHARACTERS WITHOUT CLAIM TO ANY PARTICULAR FONT, STYLE, SIZE, OR COLOR.

FOR ENTERTAINMENT SERVICES IN THE NATURE OF A TELEVISION SERIES FEATURING DRAMA; ENTERTAINMENT SERVICES IN THE NATURE OF NON-DOWNLOADABLE VIDEOS FEATURING TELEVISION SHOWS TRANSMITTED VIA THE INTERNET AND WIRELESS COMMUNICATION NETWORKS (U.S. CLS. 100, 101 AND 107).

WILLIAM BRECKENFELD, EXAMINING ATTORNEY



SN 85-846,700. TWENTIETH CENTURY FOX FILM CORPORATION, LOS ANGELES, CA. FILED 2-11-2013.

# DELIRIUM

THE MARK CONSISTS OF STANDARD CHARACTERS WITHOUT CLAIM TO ANY PARTICULAR FONT, STYLE, SIZE, OR COLOR.

FOR ENTERTAINMENT SERVICES IN THE NATURE OF A TELEVISION SERIES FEATURING DRAMA; PROVIDING ON-LINE INFORMATION IN THE FIELD OF TELEVISION AND VIDEO ENTERTAINMENT FEATURING DRAMA VIA THE INTERNET; ENTERTAINMENT SERVICES IN THE NATURE OF NON-DOWNLOADABLE VIDEOS AND IMAGES FEATURING TELEVISION SHOWS TRANSMITTED VIA THE INTERNET AND WIRELESS COMMUNICATION NETWORKS; ON-LINE JOURNALS, NAMELY, BLOGS FEATURING PERSONAL OPINIONS ABOUT A DRAMATIC TELEVISION SERIES; ENTERTAINMENT AMUSEMENT PARK AND THEME PARK SERVICES (U.S. CLS. 100, 101 AND 107).

THEODORE MCBRIDE, EXAMINING ATTORNEY

**CLASS 41—(Continued).**

SN 85-848,219. MASTER OF MOM, INC., AKA WWW.MASTEROFMOM.COM, FORT LAUDERDALE, FL. FILED 2-12-2013.

# Master of Mom

THE MARK CONSISTS OF STANDARD CHARACTERS WITHOUT CLAIM TO ANY PARTICULAR FONT, STYLE, SIZE, OR COLOR.

FOR COOKING INSTRUCTION; ENTERTAINMENT SERVICES, NAMELY, PROVIDING A WEBSITE AT WHICH THE GENERAL PUBLIC CAN RECEIVE ADVICE FROM AN INDIVIDUAL OR ENTITY CONCERNING HAPPINESS, SUCH ADVICE BEING FOR ENTERTAINMENT PURPOSES ONLY; ENTERTAINMENT SERVICES, NAMELY, PROVIDING A WEBSITE FEATURING ADVICE CONCERNING PERSONAL RELATIONSHIPS, SUCH ADVICE BEING FOR ENTERTAINMENT PURPOSES ONLY; PROVIDING EDUCATIONAL DEMONSTRATIONS (U.S. CLS. 100, 101 AND 107).

FIRST USE 1-1-2013; IN COMMERCE 1-1-2013.  
ADA HAN, EXAMINING ATTORNEY



SN 85-849,123. MPH MOTORSPORTS, KERVILLE, TX. FILED 2-13-2013.

# DESTINATION X

THE MARK CONSISTS OF STANDARD CHARACTERS WITHOUT CLAIM TO ANY PARTICULAR FONT, STYLE, SIZE, OR COLOR.

FOR ENTERTAINMENT SERVICES, NAMELY, SWEEPSTAKES, PROMOTIONS, CONTESTS, AND GIVE-AWAYS DESIGNED TO REWARD PROGRAM PARTICIPANTS; OFFERING SWEEPSTAKES, PROMOTIONS, CONTESTS, AND GIVE-AWAYS TO REGISTERED USERS (U.S. CLS. 100, 101 AND 107).

FIRST USE 1-4-2013; IN COMMERCE 1-4-2013.  
KAREN K. BUSH, EXAMINING ATTORNEY

**CLASS 41—(Continued).**

SN 85-849,432. MGM RESORTS INTERNATIONAL, LAS VEGAS, NV. FILED 2-13-2013.



OWNER OF U.S. REG. NOS. 1,043,787, 3,870,709 AND OTHERS.

NO CLAIM IS MADE TO THE EXCLUSIVE RIGHT TO USE "SPRINGFIELD", APART FROM THE MARK AS SHOWN.

THE MARK CONSISTS OF THE LETTERS "MGM" AND THE WORD "SPRINGFIELD" SEPARATED BY A DEPICTION OF LIONHEAD CONTAINED BETWEEN DOUBLE HORIZONTAL LINES ABOVE AND BELOW.

FOR ENTERTAINMENT IN THE NATURE OF CASINO SERVICES; PROVIDING CASINO SERVICES FEATURING A CASINO PLAYERS REWARDS PROGRAM; ENTERTAINMENT SERVICES, NAMELY, LIVE PERFORMANCES FEATURING MUSICIANS, MUSIC AND SINGERS, PRERECORDED MUSIC AND VIDEO, AND DANCERS; ARRANGING FOR TICKET RESERVATIONS FOR SHOWS AND OTHER ENTERTAINMENT EVENTS PROVIDED IN CONNECTION WITH A RESORT HOTEL OR CASINO; CONDUCTING AND PROVIDING FACILITIES FOR SPECIAL EVENTS FEATURING CASINO AND GAMING CONTESTS AND TOURNAMENTS; NIGHTCLUBS; PROVIDING FACILITIES FOR RECREATION ACTIVITIES; SPECIAL EVENT PLANNING FOR SOCIAL ENTERTAINMENT PURPOSES; HEALTH CLUB SERVICES, NAMELY, PROVIDING EQUIPMENT IN THE FIELD OF PHYSICAL EXERCISE (U.S. CLS. 100, 101 AND 107).

CAROLINE WOOD, EXAMINING ATTORNEY

SN 85-850,407. JAY SAND, DBA ALL AROUND THIS WORLD, PHILADELPHIA, PA. FILED 2-14-2013.



OWNER OF U.S. REG. NO. 3,865,807.  
THE COLOR(S) BLUE IS/ARE CLAIMED AS A FEATURE OF THE MARK.

THE MARK CONSISTS OF A SMILING MUSICAL NOTE BURSTING FREE FROM TWO CONCENTRIC CIRCLES. THE NOTE IS IN FRONT OF THE SKY FEATURING CLOUDS AND BEAMS OF LIGHT. THE WORDS "ALL AROUND THIS WORLD" ARE VISIBLE IN THE TOP LEFT PART OF THE IMAGE BETWEEN THE TWO CIRCLES. THE LOGO IS MULTIPLE SHADES OF BLUE.

FOR EDUCATIONAL SERVICES, NAMELY, DEVELOPING CURRICULUM FOR EDUCATORS (U.S. CLS. 100, 101 AND 107).

FIRST USE 2-14-2013; IN COMMERCE 2-14-2013.  
INGRID C. EULIN, EXAMINING ATTORNEY

**CLASS 41—(Continued).**

SN 85-851,011. REDNECKS WITH PAYCHECKS OFF-ROAD, LLC, DBA REDNECKS WITH PAYCHECKS, HALTOM CITY, TX. FILED 2-15-2013.

**Rednecks With Paychecks**

THE MARK CONSISTS OF STANDARD CHARACTERS WITHOUT CLAIM TO ANY PARTICULAR FONT, STYLE, SIZE, OR COLOR.

FOR CONDUCTING ENTERTAINMENT EXHIBITIONS IN THE NATURE OF OFF ROAD DRIVING (U.S. CLS. 100, 101 AND 107).

FIRST USE 8-15-2011; IN COMMERCE 9-5-2011.  
AMEEN IMAM, EXAMINING ATTORNEY

SN 85-852,137. TONIC, LLC, AUSTIN, TX. FILED 2-17-2013.

**PLAY DIRTY**

THE MARK CONSISTS OF STANDARD CHARACTERS WITHOUT CLAIM TO ANY PARTICULAR FONT, STYLE, SIZE, OR COLOR.

FOR CONSULTING SERVICES IN THE FIELDS OF FITNESS AND EXERCISE; EDUCATIONAL SERVICES, NAMELY, DEVELOPING, ARRANGING, AND CONDUCTING EDUCATIONAL CONFERENCES AND PROGRAMS AND PROVIDING COURSES OF INSTRUCTION IN THE FIELD OF FITNESS AND EXERCISE (U.S. CLS. 100, 101 AND 107).

FIRST USE 1-1-2006; IN COMMERCE 1-1-2006.  
DAVID TOOLEY, EXAMINING ATTORNEY

**CLASS 41—(Continued).**

SN 85-852,237. GRANADOS SANTIAGO, NORTH HOLLYWOOD, CA. AND ALLEN TAHKUS EKEDAL, PASADENA, CA. FILED 2-18-2013.

# The Fetching

THE MARK CONSISTS OF STANDARD CHARACTERS WITHOUT CLAIM TO ANY PARTICULAR FONT, STYLE, SIZE, OR COLOR.

FOR ENTERTAINMENT IN THE NATURE OF A LIVE MUSICAL PERFORMER, MUSICAL BAND OR MUSICAL GROUP; ENTERTAINMENT IN THE NATURE OF LIVE PERFORMANCES BY A MUSICAL ARTIST, MUSICAL GROUP OR MUSICAL BAND; ENTERTAINMENT IN THE NATURE OF VISUAL AND AUDIO PERFORMANCES BY A MUSICAL ARTIST, MUSICAL GROUP AND MUSICAL BAND; ENTERTAINMENT, NAMELY, LIVE MUSIC CONCERTS; ENTERTAINMENT, NAMELY, PERSONAL APPEARANCES BY A MUSICIAN, MUSICAL GROUP OR MUSICAL BAND; ENTERTAINMENT SERVICES, NAMELY, PROVIDING A WEB SITE FEATURING NON-DOWNLOADABLE MUSICAL PERFORMANCES, MUSICAL VIDEOS, RELATED FILM CLIPS, PHOTOGRAPHS, AND OTHER MULTIMEDIA MATERIALS FEATURING MUSIC (U.S. CLS. 100, 101 AND 107).

FIRST USE 9-3-2012; IN COMMERCE 9-3-2012.  
PAULA MAHONEY, EXAMINING ATTORNEY

---

SN 85-852,355. DEES, WAYNE, SEATTLE, WA. FILED 2-18-2013.

## ALL CONCERT ENTERTAINMENT

THE MARK CONSISTS OF STANDARD CHARACTERS WITHOUT CLAIM TO ANY PARTICULAR FONT, STYLE, SIZE, OR COLOR.

NO CLAIM IS MADE TO THE EXCLUSIVE RIGHT TO USE "CONCERT ENTERTAINMENT", APART FROM THE MARK AS SHOWN.

FOR ENTERTAINMENT SERVICES, NAMELY, PROVIDING CONCERT PERFORMANCES THROUGH WEBCASTS ON THE INTERNET (U.S. CLS. 100, 101 AND 107).  
CAITLIN WATTS-FITZGERALD, EXAMINING ATTORNEY

**CLASS 41—(Continued).**

SN 85-853,129. MERLIN ENTERTAINMENTS GROUP U.S. HOLDINGS INC., CARLSBAD, CA. FILED 2-18-2013.

# COASTERSAURUS

THE MARK CONSISTS OF STANDARD CHARACTERS WITHOUT CLAIM TO ANY PARTICULAR FONT, STYLE, SIZE, OR COLOR.

FOR EDUCATION SERVICES, NAMELY, CONDUCTING EXHIBITIONS, SEMINARS, WORKSHOPS AND LECTURES IN CONNECTION WITH, RELATED TO OR ARRANGED AT THEME PARKS, INDOOR THEME PARKS, AMUSEMENT PARKS, MUSEUMS, PLANETARIUM DISPLAYS, ZOOS AND AQUARIUMS; PROVIDING OF TRAINING, NAMELY, TRAINING IN THE MANAGEMENT AND ADMINISTRATION OF THEME PARKS, INDOOR THEME PARKS, AMUSEMENT PARKS, MUSEUMS, PLANETARIUM DISPLAYS, ZOOS AND AQUARIUMS; ORGANIZING SPORTING ACTIVITIES FOR VISITORS; PROVIDING LEISURE ATTRACTIONS, NAMELY, THEME PARKS, INDOOR THEME PARKS, ZOOS, MUSEUMS, PLANETARIUM DISPLAYS AND AQUARIUMS; FUNFAIR AND AMUSEMENT PARK SERVICES, NAMELY, PROVIDING AMUSEMENT FACILITIES, INCLUDING AMUSEMENT PARK RIDES; THEME PARK SERVICES; AMUSEMENT PARK SERVICES; MARINE LIFE CENTRES; LASER LIGHT EXHIBITIONS AND DISPLAYS; AMUSEMENT ARCADE SERVICES; ENTERTAINMENT SERVICES IN THE NATURE OF THEME PARKS, INDOOR THEME PARKS, AMUSEMENT PARKS, MUSEUMS, PLANETARIUM DISPLAYS, ZOOS AND AQUARIUM SHOWS; EDUCATIONAL SERVICES, NAMELY, PROVIDING DISPLAYS AND EXHIBITS IN CONNECTION WITH, RELATED TO OR ARRANGED AT THEME PARKS, INDOOR THEME PARKS, AMUSEMENT PARKS, MUSEUMS, PLANETARIUM DISPLAYS, ZOOS AND AQUARIUMS; ARRANGING, CONDUCTING AND HOSTING OF EXHIBITIONS, CONFERENCES AND SEMINARS FOR CULTURAL, EDUCATIONAL OR ENTERTAINMENT PURPOSES; ZOOLOGICAL GARDENS; PARKS AND GARDENS FOR RECREATIONAL PURPOSES; CIRCUS ENTERTAINMENT SERVICES; PARTY PLANNING SERVICES; PUBLICATION OF BOOKS AND TEXTS; PROVIDING INFORMATION AND CONSULTATION IN RELATION TO THE AFOREMENTIONED SERVICES (U.S. CLS. 100, 101 AND 107).

WANDA KAY PRICE, EXAMINING ATTORNEY

---

SN 85-853,894. BRIDAS CORPORATION, TORTOLA, BR. VIRGIN ISLANDS, FILED 2-19-2013.

# AXION MUSIC

THE MARK CONSISTS OF STANDARD CHARACTERS WITHOUT CLAIM TO ANY PARTICULAR FONT, STYLE, SIZE, OR COLOR.

NO CLAIM IS MADE TO THE EXCLUSIVE RIGHT TO USE "MUSIC", APART FROM THE MARK AS SHOWN.

FOR ARRANGING AND CONDUCTING CONCERTS, PROVISION OF INFORMATION RELATING TO MUSIC, NONE OF WHICH RELATE TO BYZANTINE MUSIC (U.S. CLS. 100, 101 AND 107).

KRISTIN CARLSON, EXAMINING ATTORNEY

**CLASS 41—(Continued).**

SN 85-854,065. FINNFEST, USA, INC., MINNEAPOLIS, MN.  
FILED 2-19-2013.

**FINNFEST USA**

THE MARK CONSISTS OF STANDARD CHARACTERS WITHOUT CLAIM TO ANY PARTICULAR FONT, STYLE, SIZE, OR COLOR.

SEC. 2(F).

FOR ENTERTAINMENT AND EDUCATION SERVICES, NAMELY, PLANNING AND CONDUCTING A FESTIVAL FEATURING A VARIETY OF ACTIVITIES CONCERNING FINLAND AND FINNISH AMERICA, NAMELY, ART EXHIBITIONS, ARTS AND CRAFTS WORKSHOPS, LECTURES, FORUMS, SEMINARS AND PANEL DISCUSSIONS ABOUT FINLAND AND FINNISH AMERICA, MUSIC AND THEATRICAL EXHIBITIONS, GAMES AND CONTESTS OF ATHLETIC SKILL, AND OPENING CEREMONIES WITH SPEAKERS AND SINGING AND MUSICAL PERFORMANCES (U.S. CLS. 100, 101 AND 107).

FIRST USE 8-5-1983; IN COMMERCE 8-5-1983.  
SUSAN STIGLITZ, EXAMINING ATTORNEY

---

SN 85-854,283. LAU, KEITH, BELLEVUE, WA. FILED 2-19-2013.

**ATELIER NOIR**

THE MARK CONSISTS OF STANDARD CHARACTERS WITHOUT CLAIM TO ANY PARTICULAR FONT, STYLE, SIZE, OR COLOR.

NO CLAIM IS MADE TO THE EXCLUSIVE RIGHT TO USE "ATELIER", APART FROM THE MARK AS SHOWN.

THE ENGLISH TRANSLATION OF "ATELIER NOIR" IN THE MARK IS "STUDIO BLACK".

FOR PHOTOGRAPHY (U.S. CLS. 100, 101 AND 107).

FIRST USE 7-29-2001; IN COMMERCE 6-20-2005.  
KAREN SEVERSON, EXAMINING ATTORNEY

---

SN 85-856,090. WARD, ROBIN A., FORT WORTH, TX. FILED 2-21-2013.

**Math Goggles**

THE MARK CONSISTS OF STANDARD CHARACTERS WITHOUT CLAIM TO ANY PARTICULAR FONT, STYLE, SIZE, OR COLOR.

OWNER OF U.S. REG. NOS. 3,662,389 AND 3,993,208.

NO CLAIM IS MADE TO THE EXCLUSIVE RIGHT TO USE "MATH", APART FROM THE MARK AS SHOWN.

FOR PROVIDING AFTER SCHOOL EDUCATIONAL PROGRAMS FOR CHILDREN IN GRADES PRE-K - 12 (U.S. CLS. 100, 101 AND 107).

FIRST USE 9-20-2009; IN COMMERCE 9-1-2011.  
JUSTINE D. PARKER, EXAMINING ATTORNEY

**CLASS 41—(Continued).**

SN 85-856,133. RUSTED ROOSTER, LLC, SANFORD, MI.  
FILED 2-21-2013.

**RIVAL WILD**

THE MARK CONSISTS OF STANDARD CHARACTERS WITHOUT CLAIM TO ANY PARTICULAR FONT, STYLE, SIZE, OR COLOR.

FOR ENTERTAINMENT SERVICES IN THE NATURE OF A REALITY-BASED ONGOING TELEVISION SERIES; A REALITY BASED ONGOING HUNTING TELEVISION SERIES; A REALITY BASED MULTIMEDIA PROGRAM SERIES FEATURING SURVIVAL HUNTING DISTRIBUTED VIA VARIOUS PLATFORMS ACROSS MULTIPLE FORMS OF TRANSMISSION MEDIA; PRODUCTION OF A REALITY-BASED TELEVISION SERIES; PRODUCTION OF A REALITY BASED SURVIVAL HUNTING MULTIMEDIA PROGRAM SERIES; PRODUCTION OF A LIVE-ACTION HUNTING RELATED TELEVISION SERIES; AND PRODUCTION OF A LIVE-ACTION HUNTING RELATED MULTIMEDIA PROGRAM SERIES FOR DISPLAY OR BROADCAST OVER AT LEAST ONE COMMUNICATION NETWORK (U.S. CLS. 100, 101 AND 107).

KATHERINE CHANG, EXAMINING ATTORNEY

---

SN 85-856,614. POLITE, CORNELIUS, LOS ANGELES, CA.  
FILED 2-21-2013.

**Rainbow Skyland**

THE MARK CONSISTS OF STANDARD CHARACTERS WITHOUT CLAIM TO ANY PARTICULAR FONT, STYLE, SIZE, OR COLOR.

FOR AMUSEMENT PARK AND THEME PARK SERVICES; INTERACTIVE EDUCATIONAL AND ENTERTAINMENT SERVICES, NAMELY, PROVIDING A WEB-BASED VIRTUAL EDUCATIONAL THEME-PARK FEATURING SCIENCE EDUCATION; PROVIDING THEME PARK SERVICES (U.S. CLS. 100, 101 AND 107).

KYLE PEETE, EXAMINING ATTORNEY

---

SN 85-856,625. MIGHTY MEDIA GROUP LP, DALLAS, TX.  
FILED 2-21-2013.

**Rebel On Beale**

THE MARK CONSISTS OF STANDARD CHARACTERS WITHOUT CLAIM TO ANY PARTICULAR FONT, STYLE, SIZE, OR COLOR.

FOR ARRANGING AND CONDUCTING OF CONCERTS (U.S. CLS. 100, 101 AND 107).

FIRST USE 4-30-2012; IN COMMERCE 5-7-2012.  
ALICE BENMAMAN, EXAMINING ATTORNEY

**CLASS 41—(Continued).**

SN 85-856,637. ADVENTIST HEALTH SYSTEM/SUNBELT, IN., ALTAMONTE SPRINGS, FL. FILED 2-21-2013.

**BABY PLACE ACADEMY**

THE MARK CONSISTS OF STANDARD CHARACTERS WITHOUT CLAIM TO ANY PARTICULAR FONT, STYLE, SIZE, OR COLOR.

NO CLAIM IS MADE TO THE EXCLUSIVE RIGHT TO USE "BABY" AND "ACADEMY", APART FROM THE MARK AS SHOWN.

FOR EDUCATIONAL SERVICES, NAMELY, CONDUCTING CLASSES, TRAINING PROGRAMS, WORKSHOPS, MEETINGS, AND DEMONSTRATIONS IN THE FIELDS OF PARENTING, BREAST FEEDING AND CHILD CARE (U.S. CLS. 100, 101 AND 107).

FIRST USE 7-31-2011; IN COMMERCE 7-31-2011.  
ALLISON HOLTZ, EXAMINING ATTORNEY

---

SN 85-856,684. SMARTPROS LTD., HAWTHORNE, NY. FILED 2-21-2013.

**COGNISTAR**

THE MARK CONSISTS OF STANDARD CHARACTERS WITHOUT CLAIM TO ANY PARTICULAR FONT, STYLE, SIZE, OR COLOR.

FOR EDUCATIONAL SERVICES, NAMELY, PROVIDING COURSES OF INSTRUCTION TO PROFESSIONALS IN THE FIELD OF INSURANCE, FINANCE, ACCOUNTING, SECURITIES, MEDICINE, LAW, MANAGEMENT, EDUCATION, REAL ESTATE, BUSINESS, TECHNOLOGY, RELIGIOUS STUDIES, SCIENCES AND ENGINEERING AND DISTRIBUTING COURSE MATERIAL IN CONNECTION THEREWITH (U.S. CLS. 100, 101 AND 107).

FIRST USE 7-0-2000; IN COMMERCE 7-0-2000.  
ALISON POLLACK, EXAMINING ATTORNEY

---

SN 85-856,793. VENDLEY, KENNETH, PALO ALTO, CA. FILED 2-21-2013.

**MOTORSCAPE International**

THE MARK CONSISTS OF STANDARD CHARACTERS WITHOUT CLAIM TO ANY PARTICULAR FONT, STYLE, SIZE, OR COLOR.

NO CLAIM IS MADE TO THE EXCLUSIVE RIGHT TO USE "INTERNATIONAL", APART FROM THE MARK AS SHOWN.

FOR MULTIMEDIA PRODUCTION SERVICES IN THE FIELD OF MOTORIZED VEHICLES (U.S. CLS. 100, 101 AND 107).

LAURA KOVALSKY, EXAMINING ATTORNEY

**CLASS 41—(Continued).**

SN 85-857,357. LEQ, HANNIBAL, PHOENIX, AZ. FILED 2-22-2013.

**#BODYBAGGZ**

THE MARK CONSISTS OF STANDARD CHARACTERS WITHOUT CLAIM TO ANY PARTICULAR FONT, STYLE, SIZE, OR COLOR.

FOR ENTERTAINMENT IN THE NATURE OF LIVE VISUAL AND AUDIO PERFORMANCES BY A SINGER; ENTERTAINMENT SERVICES IN THE NATURE OF LIVE MUSICAL PERFORMANCES; SONG WRITING SERVICES FOR NON-ADVERTISING PURPOSES; LYRIC WRITING SERVICES (U.S. CLS. 100, 101 AND 107).

ALEX KEAM, EXAMINING ATTORNEY

---

SN 85-858,895. PEZ-MAR, INC., LOS ANGELES, CA. FILED 2-25-2013.

**MARIO LOPEZ**

THE MARK CONSISTS OF STANDARD CHARACTERS WITHOUT CLAIM TO ANY PARTICULAR FONT, STYLE, SIZE, OR COLOR.

THE NAME(S), PORTRAIT(S), AND/OR SIGNATURE(S) SHOWN IN THE MARK IDENTIFIES "MARIO LOPEZ", WHOSE CONSENT(S) TO REGISTER IS MADE OF RECORD.

FOR ENTERTAINMENT SERVICES IN THE NATURE OF ON-GOING TELEVISION, RADIO AND DIGITAL MEDIA PROGRAMS IN THE FIELD OF COMEDY, VARIETY, MUSIC AND EDUCATION; ENTERTAINMENT SERVICES, NAMELY, APPEARANCES BY A PROFESSIONAL ENTERTAINER APPEARING LIVE, TELEVISED, VIA GLOBAL COMPUTER NETWORKS, OR IN MOVIES AND DIGITAL MEDIA (U.S. CLS. 100, 101 AND 107).

FIRST USE 9-0-1992; IN COMMERCE 9-0-1992.  
FRED CARL, EXAMINING ATTORNEY

**CLASS 41—(Continued).**

SN 85-859,730. MACK METIER, LLC, ATLANTA, GA. FILED 2-25-2013.

**GODDESS CHEYENNE**

THE MARK CONSISTS OF STANDARD CHARACTERS WITHOUT CLAIM TO ANY PARTICULAR FONT, STYLE, SIZE, OR COLOR.

THE NAME(S), PORTRAIT(S), AND/OR SIGNATURE(S) SHOWN IN THE MARK IDENTIFIES TRACY LYNN CHEYENNE MCMAHAN, WHOSE CONSENT(S) TO REGISTER IS MADE OF RECORD.

FOR DIGITAL VIDEO, AUDIO, AND MULTIMEDIA PUBLISHING SERVICES; ENTERTAINMENT IN THE NATURE OF DANCE PERFORMANCES; ENTERTAINMENT SERVICES IN THE NATURE OF LIVE VISUAL AND AUDIO PERFORMANCES BY AN ACTRESS; ENTERTAINMENT SERVICES IN THE NATURE OF LIVE PERFORMANCES BY AN ADULT PERFORMANCE ARTISTS; ENTERTAINMENT SERVICES IN THE NATURE OF LIVE DOMINATRIX PERFORMANCES, ENTERTAINMENT SERVICES, NAMELY, PROVIDING A WEB SITE FEATURING NON-DOWNLOADABLE ADULT-THEMED PHOTOGRAPHS AND VIDEOS; ENTERTAINMENT SERVICES, NAMELY, PROVIDING A WEB SITE FEATURING NON-DOWNLOADABLE MUSICAL PERFORMANCES, MUSICAL VIDEOS, RELATED FILM CLIPS, PHOTOGRAPHS, AND OTHER MULTIMEDIA MATERIALS FEATURING DOMINATION; ENTERTAINMENT SERVICES, NAMELY, PROVIDING A WEB SITE FEATURING PHOTOGRAPHIC, VIDEO AND PROSE PRESENTATIONS FEATURING DOMINATION; FASHION MODELING FOR ENTERTAINMENT PURPOSES; MODELING FOR ARTISTS; PERSONAL FITNESS TRAINING SERVICES AND CONSULTANCY (U.S. CLS. 100, 101 AND 107).

FIRST USE 1-1-1999; IN COMMERCE 1-1-1999.

DOMINIC J. FERRAIUOLO, EXAMINING ATTORNEY

---

SN 85-861,260. WINDSOR CASINO LIMITED, WINDSOR, ONTARIO, CANADA, FILED 2-27-2013.



NO CLAIM IS MADE TO THE EXCLUSIVE RIGHT TO USE "CASINO WINDSOR", APART FROM THE MARK AS SHOWN.

THE MARK CONSISTS OF THE WORDS "CASINO WINDSOR" WITH TWO WAVY LINES UNDERNEATH.

FOR CASINOS (U.S. CLS. 100, 101 AND 107).

KEVON CHISOLM, EXAMINING ATTORNEY

**CLASS 41—(Continued).**

SN 85-861,465. ALIVE MEDIA GROUP LLC, ST LOUIS, MO. FILED 2-27-2013.

**Saint Louis Fashion Week**

THE MARK CONSISTS OF STANDARD CHARACTERS WITHOUT CLAIM TO ANY PARTICULAR FONT, STYLE, SIZE, OR COLOR.

NO CLAIM IS MADE TO THE EXCLUSIVE RIGHT TO USE "FASHION WEEK", APART FROM THE MARK AS SHOWN.

SEC. 2(F).

FOR ARRANGING AND CONDUCTING SPECIAL EVENTS FOR SOCIAL ENTERTAINMENT PURPOSES (U.S. CLS. 100, 101 AND 107).

FIRST USE 1-1-2006; IN COMMERCE 1-1-2007.

JOHN GARTNER, EXAMINING ATTORNEY

---

SN 85-863,337. STELLA M. HOLMES, MIAMI, FL. FILED 2-28-2013.

**WEST ENCOUNTERS EAST**

THE MARK CONSISTS OF STANDARD CHARACTERS WITHOUT CLAIM TO ANY PARTICULAR FONT, STYLE, SIZE, OR COLOR.

OWNER OF U.S. REG. NO. 4,180,912.

FOR EDUCATIONAL AND ENTERTAINMENT SERVICES, NAMELY, PRODUCTION OF A SERIES OF DOCUMENTARY FILMS (U.S. CLS. 100, 101 AND 107).

HENRY S. ZAK, EXAMINING ATTORNEY

---

SN 85-864,975. FARR, DAVID, LOS ANGELES, CA. FILED 3-2-2013.

**STRIPPERS 2 U**

THE MARK CONSISTS OF STANDARD CHARACTERS WITHOUT CLAIM TO ANY PARTICULAR FONT, STYLE, SIZE, OR COLOR.

NO CLAIM IS MADE TO THE EXCLUSIVE RIGHT TO USE "STRIPPERS", APART FROM THE MARK AS SHOWN.

FOR ENTERTAINMENT SERVICES, NAMELY, PERFORMING EROTIC DANCE REVUES AT VENUES THAT ARE SELECTED BY CUSTOMERS; EXOTIC DANCING SERVICES (U.S. CLS. 100, 101 AND 107).

FIRST USE 4-30-2012; IN COMMERCE 4-30-2012.

ZACHARY BELLO, EXAMINING ATTORNEY



**CLASS 41—(Continued).**

SN 85-867,089. PURDUE RESEARCH FOUNDATION, WEST LAFAYETTE, IN. FILED 3-5-2013.

## PURDUE OWL

THE MARK CONSISTS OF STANDARD CHARACTERS WITHOUT CLAIM TO ANY PARTICULAR FONT, STYLE, SIZE, OR COLOR.

OWNER OF U.S. REG. NO. 3,879,028.

NO CLAIM IS MADE TO THE EXCLUSIVE RIGHT TO USE "OWL", APART FROM THE MARK AS SHOWN.

FOR EDUCATION SERVICES, NAMELY, PROVIDING ON-LINE RESOURCES IN THE FIELD OF LANGUAGE AND WRITING, NAMELY, RESOURCES IN THE NATURE OF ONLINE TRAINING RELATED TO ENGLISH AS A SECOND LANGUAGE, OUTLINING, WRITING PROCESS, GRAMMAR, QUOTATIONS, INTERNATIONAL STYLISTIC CONSIDERATIONS, ACADEMIC WRITING, RESEARCH PAPER WRITING, JOB SEARCH WRITING AND MEDICAL WRITING, AND DISTRIBUTION OF COURSE MATERIALS IN CONNECTION THEREWITH (U.S. CLS. 100, 101 AND 107).

FIRST USE 1-1-2012; IN COMMERCE 1-1-2012.

ERIN FALK, EXAMINING ATTORNEY

SN 85-867,682. BRAINZ S.A.S., BOGOTA D.C., COLOMBIA, FILED 3-5-2013.



NO CLAIM IS MADE TO THE EXCLUSIVE RIGHT TO USE "SOCIAL STREET SOCCER", APART FROM THE MARK AS SHOWN.

THE COLOR(S) ORANGE, BLACK, WHITE AND YELLOW IS/ARE CLAIMED AS A FEATURE OF THE MARK.

THE MARK CONSISTS OF A SOCCER BALL WITH A TRAILING FLAME ON ITS LEFT SIDE OVER WHICH APPEARS THE WORDING "SOCIAL STREET SOCCER" IN STYLIZED LETTERS. EACH WORD APPEARS OVER A SEPARATE BANNER. THE COLOR ORANGE APPEARS IN THE FLAME, IN THE SOCCER BALL AND IN THE BANNER ON WHICH THE WORD "SOCIAL" APPEARS. THE COLOR BLACK APPEARS IN THE SOCCER BALL, IN THE WORD "SOCIAL" AND IN THE BANNERS ON WHICH APPEAR THE WORDS "STREET" AND "SOCIAL" APPEAR. THE COLOR WHITE APPEARS IN THE WORDS "STREET" AND "SOCCER" AND IN THE SOCCERBALL. THE COLOR YELLOW APPEARS IN THE SOCCER BALL.

FOR ENTERTAINMENT SERVICES, NAMELY, PROVIDING ONLINE INTERACTIVE GAME SERVICES FOR STREET SOCCER GAMES PLAYED WITH COMPUTERS, COMMUNICATION NETWORKS, CELLPHONES, TABLETS, MP3 OR SIMILAR DEVICES (U.S. CLS. 100, 101 AND 107).

ANNE MADDEN, EXAMINING ATTORNEY

**CLASS 41—(Continued).**

SN 85-870,819. STRATFORD UNIVERSITY, INC., FALLS CHURCH, VA. FILED 3-8-2013.

## IT'S TIME TO BE MORE

THE MARK CONSISTS OF STANDARD CHARACTERS WITHOUT CLAIM TO ANY PARTICULAR FONT, STYLE, SIZE, OR COLOR.

FOR EDUCATIONAL SERVICES, NAMELY, PROVIDING ACCREDITED AND CERTIFIED COURSES OF POST-SECONDARY INSTRUCTION; PROVIDING EDUCATIONAL SERVICES, NAMELY, CONDUCTING SEMINARS, PROGRAMS AND WORKSHOPS IN THE FIELD OF SPECIALIZED NEEDS OF TECHNOLOGICALLY-BASED BUSINESSES; VOCATIONAL EDUCATION IN THE FIELDS OF MECHANICS, COMPUTERS, ELECTRONICS, ENGINEERING, TECHNICAL SCIENCES, NAMELY, ENVIRONMENTAL REMEDIATION, ELECTRICAL, MECHANICAL AND PROFESSIONAL TRADES, NAMELY, VOCATIONAL EDUCATION FOR AUTO MECHANICS, ELECTRICIANS, PLUMBERS, PROFESSIONALS IN MECHANICAL, HEATING, VENTILATION AND AIR CONDITIONING SERVICES; PROVIDING EDUCATIONAL SERVICES, NAMELY, CONDUCTING SEMINARS, PROGRAMS AND WORKSHOPS IN THE FIELD OF ENGINEERING, TECHNICAL SCIENCES, NAMELY, ENVIRONMENTAL REMEDIATION, COMPUTER SCIENCE, COMPUTER PROGRAMMING AND COMPUTER NETWORKING, CULINARY ARTS, HOTEL AND EVENT MANAGEMENT, BUSINESS TRAINING AND BUSINESS ADMINISTRATION, ACCOUNTING, HEALTH SCIENCES AND NURSING; EDUCATIONAL SERVICES, NAMELY, THE TRAINING OF OTHERS THROUGH COURSES, SEMINARS, PROGRAMS AND WORKSHOPS IN THE AREAS OF COMPUTER SCIENCE, COMPUTER PROGRAMMING AND COMPUTER NETWORKING, CULINARY ARTS, HOTEL AND EVENT MANAGEMENT, BUSINESS ADMINISTRATION, ACCOUNTING, HEALTH SCIENCES AND NURSING; AND DISTRIBUTION OF PRINTED MATTER IN CONJUNCTION THEREWITH ALL OF THE FOREGOING, NAMELY, NEWSLETTERS AND REPORTS, INSTRUCTIONAL TEACHING AND TRAINING MANUALS, REFERENCE BOOKS, WORKBOOKS, TEXTBOOKS, CATALOGS, BOOKS, CLASSROOM AND INDEPENDENT STUDY GUIDES, PAMPHLETS, LEAFLETS, DIRECTORIES, CALENDARS, BROCHURES, CHARTS, FACT SHEETS, ALL OF THE ABOVE IN THE FIELDS OF ENGINEERING, TECHNICAL SCIENCES, NAMELY, ENVIRONMENTAL REMEDIATION, VOCATIONAL TRAINING, IN THE FIELDS OF MECHANICS, COMPUTERS, COMPUTER SCIENCE, COMPUTER PROGRAMMING AND COMPUTER NETWORKING, CULINARY ARTS, HOTEL AND EVENT MANAGEMENT, BUSINESS TRAINING, BUSINESS ADMINISTRATION, HEALTH SCIENCES AND NURSING (U.S. CLS. 100, 101 AND 107).

DAVID MURRAY, EXAMINING ATTORNEY

**CLASS 41—(Continued).**

SN 85-872,208. BB DEVELOPMENT LLC, DBA OXFORD CASINO, OXFORD, ME. FILED 3-11-2013.



NO CLAIM IS MADE TO THE EXCLUSIVE RIGHT TO USE "OXFORD CASINO", APART FROM THE MARK AS SHOWN.

THE MARK CONSISTS OF THE WORDING "OXFORD CASINO", WITH THE LETTERS OF THE WORD "CASINO" ENCLOSED WITHIN SIX CIRCLES, AND GEOMETRIC FIGURES AND LINES ABOVE THEM DEPICTING OR SUGGESTIVE OF A GABLE AND THREE TREES.

FOR CASINOS; ENTERTAINMENT SERVICES, NAMELY, CASINO GAMING; GAMING SERVICES IN THE NATURE OF CASINO GAMING; PROVIDING CASINO SERVICES FEATURING A CASINO PLAYERS REWARDS PROGRAM (U.S. CLS. 100, 101 AND 107).

FIRST USE 4-8-2012; IN COMMERCE 5-25-2012.  
ANNE MADDEN, EXAMINING ATTORNEY

**CLASS 41—(Continued).**

SN 85-872,738. NATIONAL RESTAURANT ASSOCIATION, WASHINGTON, DC. FILED 3-11-2013.



NO CLAIM IS MADE TO THE EXCLUSIVE RIGHT TO USE "MARKETING EXECUTIVES GROUP", APART FROM THE MARK AS SHOWN.

THE MARK CONSISTS OF THE WORD "MEG" IN A WORD BUBBLE WITHIN ANOTHER WORD BUBBLE LEFT OF THE WORDS "MARKETING EXECUTIVES GROUP" WHICH ARE STACKED HORIZONTALLY.

FOR EDUCATIONAL SERVICES, NAMELY, CONDUCTING STUDY GROUPS AND SEMINARS IN THE FIELD OF BUSINESS MANAGEMENT OF RESTAURANTS (U.S. CLS. 100, 101 AND 107).

FIRST USE 5-31-2009; IN COMMERCE 5-31-2009.  
JERI J. FICKES, EXAMINING ATTORNEY

SN 85-872,627. YOUNG KI LEE, GOYANG-SI, GYEONGGI-DO, REPUBLIC OF KOREA, FILED 3-11-2013.

**MEGARACER**

THE MARK CONSISTS OF STANDARD CHARACTERS WITHOUT CLAIM TO ANY PARTICULAR FONT, STYLE, SIZE, OR COLOR.

FOR DISTRIBUTION OTHER THAN TRANSPORTATION OF CARTOON FILMS, CINE FILMS, TELEVISION PROGRAMMES FOR OTHERS AND MOVIES; DISTRIBUTION OTHER THAN TRANSPORTATION OF TELEVISION PROGRAMMES FOR OTHERS; PRODUCTION OF CARTOON FILMS, CINE FILMS, TELEVISION PROGRAMMES AND VIDEO MOVIES; PRODUCTION OF CARTOON FILMS ANIMATION CHARACTERS AND SPECIAL EFFECTS ANIMATION SERVICES FOR FILM AND VIDEO; PRODUCTION OF ANIMATION MOVIES VIA COMPUTERS; ANIMATION PRODUCTION SERVICES; PRODUCTION OF VIDEO MOVIES; PROVISION OF INFORMATION RELATING TO ELECTRONIC COMPUTER GAMES PROVIDED VIA THE INTERNET (U.S. CLS. 100, 101 AND 107).

ALICE BENMAMAN, EXAMINING ATTORNEY

SN 85-872,895. CBS STUDIOS INC., STUDIO CITY, CA. FILED 3-11-2013.

**NCIS: RED**

THE MARK CONSISTS OF STANDARD CHARACTERS WITHOUT CLAIM TO ANY PARTICULAR FONT, STYLE, SIZE, OR COLOR.

OWNER OF U.S. REG. NOS. 3,955,035, 3,961,732 AND 4,055,049.

SEC. 2(F) AS TO "NCIS".

FOR ENTERTAINMENT SERVICES, NAMELY, A CONTINUING TELEVISION SERIES FEATURING DRAMA RENDERED THROUGH THE MEDIA OF TELEVISION, CABLE, SATELLITE, RADIO, TELEPHONE AND BROADBAND SYSTEMS, AND VIA THE INTERNET, AND PORTABLE AND WIRELESS COMMUNICATION DEVICES; PROVIDING NON-DOWNLOADABLE ENTERTAINMENT PROGRAMMING VIA A VIDEO-ON-DEMAND SERVICES AND INFORMATION IN THE FIELD OF ENTERTAINMENT RENDERED VIA THE INTERNET, AND PORTABLE AND WIRELESS COMMUNICATION DEVICES (U.S. CLS. 100, 101 AND 107).

DAVID H. STINE, EXAMINING ATTORNEY

**CLASS 41—(Continued).**

SN 85-873,125. BELIEVE FITNESS, INC., STATEN ISLAND, NY. FILED 3-11-2013.

# Believe Fitness

THE MARK CONSISTS OF STANDARD CHARACTERS WITHOUT CLAIM TO ANY PARTICULAR FONT, STYLE, SIZE, OR COLOR.

NO CLAIM IS MADE TO THE EXCLUSIVE RIGHT TO USE "FITNESS", APART FROM THE MARK AS SHOWN.

FOR INSTRUCTION SERVICES, NAMELY, INSTRUCTION IN THE FIELD OF HEALTH AND PHYSICAL FITNESS; EDUCATIONAL SERVICES, NAMELY, INSTRUCTION AND TRAINING IN THE FIELDS OF FITNESS AND NUTRITION; INSTRUCTION PROGRAMS, NAMELY, PROVIDING EXERCISE CLASSES FOR GROUPS OF INDIVIDUALS (U.S. CLS. 100, 101 AND 107).

FIRST USE 1-1-2012; IN COMMERCE 4-1-2012.  
NICHOLAS ALTREE, EXAMINING ATTORNEY

**CLASS 41—(Continued).**

SN 85-874,485. JACOBS, NICHOLAS, NORCROSS, GA. FILED 3-13-2013.

# SWEAT ATLANTA

THE MARK CONSISTS OF STANDARD CHARACTERS WITHOUT CLAIM TO ANY PARTICULAR FONT, STYLE, SIZE, OR COLOR.

NO CLAIM IS MADE TO THE EXCLUSIVE RIGHT TO USE "ATLANTA", APART FROM THE MARK AS SHOWN.

FOR PERSONAL FITNESS TRAINING SERVICES AND CONSULTANCY; CONDUCTING FITNESS CLASSES; ORGANIZING COMMUNITY SPORTING AND CULTURAL EVENTS; PERSONAL TRAINING PROVIDED IN CONNECTION WITH WEIGHT LOSS AND EXERCISE PROGRAMS; PROVIDING ASSISTANCE, PERSONAL TRAINING AND PHYSICAL FITNESS CONSULTATION TO CORPORATE CLIENTS TO HELP THEIR EMPLOYEES MAKE PHYSICAL FITNESS, STRENGTH, CONDITIONING, AND EXERCISE ALTERATIONS IN THEIR DAILY LIVING (U.S. CLS. 100, 101 AND 107).

FIRST USE 1-1-2011; IN COMMERCE 1-1-2011.  
MARTHA SANTOMARTINO, EXAMINING ATTORNEY

SN 85-873,534. YOUNG KI LEE, GOYANG-SI, GYEONGGI-DO, REPUBLIC OF KOREA, FILED 3-12-2013.

# SKYRUNNER

THE MARK CONSISTS OF STANDARD CHARACTERS WITHOUT CLAIM TO ANY PARTICULAR FONT, STYLE, SIZE, OR COLOR.

FOR DISTRIBUTION OTHER THAN TRANSPORTATION OF CARTOON FILMS, CINE FILMS, TELEVISION PROGRAMMES FOR OTHERS AND MOVIES; DISTRIBUTION OTHER THAN TRANSPORTATION OF TELEVISION PROGRAMMES FOR OTHERS; PRODUCTION OF CARTOON FILMS, CINE FILMS, TELEVISION PROGRAMMES AND VIDEO MOVIES; PRODUCTION OF CARTOON FILMS ANIMATION CHARACTERS AND SPECIAL EFFECTS ANIMATION SERVICES FOR FILM AND VIDEO; PRODUCTION OF ANIMATION MOVIES VIA COMPUTERS; ANIMATION PRODUCTION SERVICES; PRODUCTION OF VIDEO MOVIES; PROVISION OF INFORMATION RELATING TO ELECTRONIC COMPUTER GAMES PROVIDED VIA THE INTERNET (U.S. CLS. 100, 101 AND 107).

ALICE BENMAMAN, EXAMINING ATTORNEY

SN 85-878,629. BB DEVELOPMENT LLC, DBA OXFORD CASINO, OXFORD, ME. FILED 3-18-2013.



NO CLAIM IS MADE TO THE EXCLUSIVE RIGHT TO USE "OXFORD REWARDS LOYALTY CLUB", APART FROM THE MARK AS SHOWN.

THE MARK CONSISTS OF LINKED OR INTERLOCKING LETTERS "OR" WITHIN CONCENTRIC CIRCLES, ALL ABOVE THE WORDING "OXFORD REWARDS LOYALTY CLUB".

FOR PROVIDING CASINO SERVICES FEATURING A CASINO PLAYERS REWARDS PROGRAM; PROVIDING CASINO SERVICES FEATURING STORED VALUE MEMBERSHIP CARDS FOR REDEEMING CASH, DISCOUNTS, AND OTHER BENEFITS (U.S. CLS. 100, 101 AND 107).

FIRST USE 7-1-2012; IN COMMERCE 7-1-2012.  
ANNE MADDEN, EXAMINING ATTORNEY

**CLASS 41—(Continued).**

SN 85-885,998. CANINE SUPPORT TEAMS, INC., TEMECULA, CA. FILED 3-25-2013.



NO CLAIM IS MADE TO THE EXCLUSIVE RIGHT TO USE "PRISON PUP PROGRAM", APART FROM THE MARK AS SHOWN.

THE MARK CONSISTS OF THE WORDING "PRISON PUP PROGRAM" AND A SQUARE THAT ENCLOSES A STYLIZED DOG PAW PRINT, WHEREIN THE DOG PAW IS BEHIND VERTICAL LINES THAT EXTEND VERTICALLY FROM THE BOTTOM TO THE TOP OF THE SQUARE.

FOR CHARITABLE SERVICES, NAMELY, TRAINING INMATES AS DOG TRAINERS, GROOMERS, AND TECHNICIANS FOR SERVICE DOGS IN THE DISABLED COMMUNITY (U.S. CLS. 100, 101 AND 107).

FIRST USE 1-1-2003; IN COMMERCE 1-1-2003.

JACQUELINE ABRAMS, EXAMINING ATTORNEY

SN 85-889,495. MWR HOLDINGS, LLC, BOCA RATON, FL. FILED 3-28-2013.



NO CLAIM IS MADE TO THE EXCLUSIVE RIGHT TO USE "SUPER SOCCER", APART FROM THE MARK AS SHOWN.

THE COLOR(S) WHITE, BLACK, BLUE, YELLOW, PURPLE, GRAY, RED AND GREEN IS/ARE CLAIMED AS A FEATURE OF THE MARK.

THE MARK CONSISTS OF THE WORDING "SUPER SOCCER" SHOWN IN HALF BLUE AND HALF PURPLE, AND ALL LETTERS OUTLINED IN WHITE, BLACK AND YELLOW. BEHIND THE WORDING IS AN IMAGE OF A CHARACTER WHOSE HEAD IS A BLACK AND WHITE SOCCER BALL, AND BEHIND THE CHARACTER IS A GRAY SOCCER GOAL NET. THE CHARACTER HAS WHITE HANDS, A RED TONGUE, AND IS WEARING A GREEN SHIRT, WITH YELLOW ARM BANDS, AND IS WEARING A BLACK WHISTLE AROUND HIS NECK.

FOR EDUCATION SERVICES, NAMELY, CONDUCTING A PHYSICAL FITNESS SOCCER PROGRAM WITHIN CHILD CARE CENTERS (U.S. CLS. 100, 101 AND 107).

MICHAEL ENGEL, EXAMINING ATTORNEY

**CLASS 41—(Continued).**

SN 85-889,600. THE CHOOSE COLLEGE EDUCATIONAL FOUNDATION, INCORPORATED, OAKLAND, CA. FILED 3-28-2013.

## Choose College

THE MARK CONSISTS OF STANDARD CHARACTERS WITHOUT CLAIM TO ANY PARTICULAR FONT, STYLE, SIZE, OR COLOR.

FOR PROVIDING EDUCATIONAL AND MOTIVATIONAL PROGRAMS FOR STUDENTS IN GRADES K-12, NAMELY, ACADEMIC ADVISEMENT AND MENTORING; COMMUNITY EVENTS FEATURING INFORMATION AND RESOURCES ABOUT EDUCATIONAL OPPORTUNITIES, COLLEGE PREPARATION, COLLEGE FINANCIAL ASSISTANCE, AND SAT REGISTRATION; REGISTRATION OF STUDENTS FOR COLLEGE ENTRANCE EXAMS; REFERRALS TO PROSPECTIVE COLLEGE STUDENTS IN THE FIELD OF ACADEMIC SUPPORT AND ASSISTANCE (U.S. CLS. 100, 101 AND 107).

FIRST USE 9-22-2009; IN COMMERCE 9-22-2009.

JOHN WILKE, EXAMINING ATTORNEY

SN 85-889,643. AFRICAN AMERICAN REGIONAL EDUCATION ALLIANCES (AAREA), OAKLAND, CA. FILED 3-28-2013.



NO CLAIM IS MADE TO THE EXCLUSIVE RIGHT TO USE "AFRICAN AMERICAN REGIONAL EDUCATIONAL ALLIANCES", APART FROM THE MARK AS SHOWN.

THE MARK CONSISTS OF LARGE CAPITAL LETTERS "AAREA" DIRECTLY ABOVE SMALLER CAPITAL LETTERS "AFRICAN AMERICAN REGIONAL EDUCATIONAL ALLIANCES", WHICH IS DIRECTLY ABOVE A SINGULAR LINE. IN BETWEEN THE LETTERS "A" AND "R" OF "AAREA" IS A SWOOSH THAT OPENS IN FRONT OF THE "A" AND SITS IN FRONT OF THE "R". THE SWOOSH EXTENDS ALL THE WAY PAST AND IN BETWEEN "AMERICAN" AND "REGIONAL".

FOR PROVIDING EDUCATIONAL PROGRAMS FOR THE AFRICAN AMERICAN COMMUNITY, NAMELY, COLLABORATIVE EDUCATIONAL SERVICES IN THE NATURE OF SEMINARS, WORKSHOPS, AND CONFERENCES ON THE SUBJECT OF EDUCATION AND WORK-LIFE BALANCE, AND PROFESSIONAL DEVELOPMENT OPPORTUNITIES, NAMELY, NETWORKING EVENTS FOR EDUCATORS, FAITH-BASED COMMUNITY MEMBERS AND PROFESSIONALS IN THE FIELD OF EDUCATION OF AFRICAN AMERICAN STUDENTS; HOSTING PROFESSIONAL DEVELOPMENT AND NETWORKING EVENTS FOR EDUCATORS, NAMELY, SEMINARS, WORKSHOPS, AND CONFERENCES ABOUT WORK-LIFE BALANCE; PROVIDING SEMINARS, WORKSHOPS, CONFERENCES, AWARDS, AND OUTREACH ACTIVITIES FOR STUDENTS AND PARENTS WITH THE GOAL OF INCREASING PARTICIPATION AND SUCCESS IN HIGHER EDUCATION (U.S. CLS. 100, 101 AND 107).

FIRST USE 7-15-2012; IN COMMERCE 7-15-2012.

LEIGH CAROLINE CASE, EXAMINING ATTORNEY

**CLASS 41—(Continued).**

SN 85-892,543. WASHINGTON YU YING PUBLIC CHARTER SCHOOL, WASHINGTON, DC. FILED 4-2-2013.

YU YING

THE MARK CONSISTS OF STANDARD CHARACTERS WITHOUT CLAIM TO ANY PARTICULAR FONT, STYLE, SIZE, OR COLOR.

THE ENGLISH TRANSLATION OF "YU YING" IN THE MARK IS "NURTURING EXCELLENCE".

FOR EDUCATION SERVICES, NAMELY, PROVIDING CLASSROOM INSTRUCTION IN GENERAL EDUCATION AND LANGUAGE IMMERSION AT THE ELEMENTARY SCHOOL LEVEL (U.S. CLS. 100, 101 AND 107).

FIRST USE 9-2-2008; IN COMMERCE 9-2-2008.  
DEBORAH LOBO, EXAMINING ATTORNEY

---

SN 85-892,550. WASHINGTON YU YING PUBLIC CHARTER SCHOOL, WASHINGTON, DC. FILED 4-2-2013.



NO CLAIM IS MADE TO THE EXCLUSIVE RIGHT TO USE "WASHINGTON" AND "PUBLIC CHARTER SCHOOL", APART FROM THE MARK AS SHOWN.

THE MARK CONSISTS OF TWO SQUARES NEXT TO EACH OTHER EACH WITH A CHINESE CHARACTER INSIDE WITH THE WORDING "WASHINGTON YU YING PUBLIC CHARTER SCHOOL" BELOW THE SQUARES.

THE ENGLISH TRANSLATION OF "YU YING" IS "NURTURING EXCELLENCE".

THE NON-LATIN CHARACTERS IN THE MARK TRANSLITERATE TO YU YING AND THIS MEANS NURTURING EXCELLENCE IN ENGLISH.

FOR EDUCATION SERVICES, NAMELY, PROVIDING CLASSROOM INSTRUCTION IN GENERAL EDUCATION AND LANGUAGE IMMERSION AT THE ELEMENTARY SCHOOL LEVEL (U.S. CLS. 100, 101 AND 107).

FIRST USE 9-2-2008; IN COMMERCE 9-2-2008.  
DEBORAH LOBO, EXAMINING ATTORNEY

**CLASS 41—(Continued).**

SN 85-892,837. SLINKEE'S ENTERPRISES, INC., ALEXANDRIA, LA. FILED 4-2-2013.



THE COLOR(S) WHITE, MAGENTA, TEAL IS/ARE CLAIMED AS A FEATURE OF THE MARK.

THE MARK CONSISTS OF THE STYLIZED WORDING "SLINKEE'S" IN TEAL. POSITIONED UNDERNEATH IS THE STYLIZED WORDING "A STRETCH ON FUN!" IN MAGENTA WITH A TEAL DASH UNDER THIS PHRASE. POSITIONED TO THE LEFT OF THE WORDING AND PHRASE IS A SPIRAL SHAPE WITH TWO EYES IN MAGENTA AND WHITE AND A SMILE AT THE TOP OF THE SPIRAL IN MAGENTA.

FOR AMUSEMENT ARCADES; CHILDREN'S ENTERTAINMENT AND AMUSEMENT CENTERS, NAMELY, INTERACTIVE PLAY AREAS (U.S. CLS. 100, 101 AND 107).

FIRST USE 12-5-2009; IN COMMERCE 12-5-2009.  
BRIAN CALLAGHAN, EXAMINING ATTORNEY

---

SN 85-894,598. THE CHOOSE COLLEGE EDUCATIONAL FOUNDATION, INCORPORATED, OAKLAND, CA. FILED 4-3-2013.

Not Just Four Years,  
Choose College For Life

THE MARK CONSISTS OF STANDARD CHARACTERS WITHOUT CLAIM TO ANY PARTICULAR FONT, STYLE, SIZE, OR COLOR.

FOR PROVIDING EDUCATIONAL AND MOTIVATIONAL PROGRAMS FOR STUDENTS IN GRADES K-12, NAMELY, ACADEMIC ADVISEMENT AND MENTORING; COMMUNITY EVENTS FEATURING INFORMATION AND RESOURCES ABOUT EDUCATIONAL OPPORTUNITIES, COLLEGE PREPARATION, COLLEGE FINANCIAL ASSISTANCE, AND SAT REGISTRATION; ASSISTING STUDENTS IN REGISTERING FOR COLLEGE ENTRANCE EXAMS; REFERRALS TO PROSPECTIVE COLLEGE STUDENTS IN THE FIELD OF ACADEMIC SUPPORT AND ASSISTANCE (U.S. CLS. 100, 101 AND 107).

FIRST USE 9-22-2009; IN COMMERCE 9-22-2009.  
JOHN WILKE, EXAMINING ATTORNEY

**CLASS 41—(Continued).**

SN 85-894,903. MUSICAL PICTURES, LLC, MORGANTOWN, WV. FILED 4-4-2013.



NO CLAIM IS MADE TO THE EXCLUSIVE RIGHT TO USE "MUSICAL PICTURES", APART FROM THE MARK AS SHOWN.

THE MARK CONSISTS OF THE STYLIZED WORDS "MAGICAL MUSICAL PICTURES" SURROUNDED BY A CLOUD WITH SIX (6) STARS AND THREE (3) MUSIC NOTES OR SYMBOLS ABOVE THE WORDING, AND EIGHT (8) STARS AND FOUR (4) MUSIC NOTES OR SYMBOLS BELOW THE WORDING ALL WITHIN THE CLOUD.

FOR EDUCATION SERVICES, NAMELY, PROVIDING ON-LINE WEB CONTENT IN THE NATURE OF LESSONS, MUSIC WITH NARRATION, AND CLASSES IN THE FIELD OF PRE-KINDERGARTEN THROUGH TWELFTH GRADE CULTURAL, ART, AND MUSIC EDUCATION (U.S. CLS. 100, 101 AND 107).

DARRYL SPRUILL, EXAMINING ATTORNEY

---

SN 85-894,922. MUSICAL PICTURES, LLC, MORGANTOWN, WV. FILED 4-4-2013.

## Magical Musical Pictures

THE MARK CONSISTS OF STANDARD CHARACTERS WITHOUT CLAIM TO ANY PARTICULAR FONT, STYLE, SIZE, OR COLOR.

NO CLAIM IS MADE TO THE EXCLUSIVE RIGHT TO USE "MUSICAL PICTURES", APART FROM THE MARK AS SHOWN.

FOR EDUCATION SERVICES, NAMELY, PROVIDING ON-LINE WEB CONTENT IN THE NATURE OF LESSONS, MUSIC WITH NARRATION, AND CLASSES IN THE FIELD OF PRE-KINDERGARTEN THROUGH TWELFTH GRADE CULTURAL, ART, AND MUSIC EDUCATION (U.S. CLS. 100, 101 AND 107).

DARRYL SPRUILL, EXAMINING ATTORNEY

**CLASS 41—(Continued).**

SN 85-897,022. DISNEY ENTERPRISES, INC., BURBANK, CA. FILED 4-5-2013.

## FINDING DORY

THE MARK CONSISTS OF STANDARD CHARACTERS WITHOUT CLAIM TO ANY PARTICULAR FONT, STYLE, SIZE, OR COLOR.

FOR PRODUCTION, AND RENTAL OF MOTION PICTURE FILMS; PRODUCTION, PRESENTATION, DISTRIBUTION, AND RENTAL OF TELEVISION AND RADIO PROGRAMS; PRODUCTION, PRESENTATION, AND RENTAL OF SOUND AND VISUAL RECORDINGS; PRODUCTION OF LIVE-ACTION AND ANIMATED ENTERTAINMENT SHOWS AND INTERACTIVE PROGRAMS FOR DISTRIBUTION VIA AUDIO AND VISUAL MEDIA, AND ELECTRONIC MEANS; PROVIDING ENTERTAINMENT SERVICES VIA A GLOBAL COMMUNICATION NETWORK IN THE NATURE OF ONLINE GAMES AND WEBSITES FEATURING A WIDE VARIETY OF GENERAL INTEREST ENTERTAINMENT INFORMATION RELATING TO TELEVISION SHOW PROGRAMS, MUSICAL VIDEOS; AMUSEMENT PARK AND THEME PARK SERVICES; EDUCATIONAL AND ENTERTAINMENT SERVICES RENDERED IN OR RELATING TO THEME PARKS, NAMELY, LIVE STAGE SHOWS, LIVE AMUSEMENT PARK SHOWS, LIVE PERFORMANCES BY COSTUMED CHARACTERS, AND PRESENTATION OF LIVE THEATRICAL PERFORMANCES; PRESENTATION OF LIVE STAGE SHOWS; THEATER PRODUCTIONS; ENTERTAINER SERVICES, NAMELY, LIVE APPEARANCES BY A PROFESSIONAL ENTERTAINER (U.S. CLS. 100, 101 AND 107).

LEIGH CAROLINE CASE, EXAMINING ATTORNEY

---

SN 85-899,733. CASIE, ATLANTA, GA. FILED 4-10-2013.

## GROWING GLOBAL KIDS

THE MARK CONSISTS OF STANDARD CHARACTERS WITHOUT CLAIM TO ANY PARTICULAR FONT, STYLE, SIZE, OR COLOR.

FOR EDUCATION SERVICES, NAMELY, PROVIDING HANDS-ON OPPORTUNITIES FOR CHILDREN IN THE FIELD OF INTUITIVE ENGINEERING THROUGH LIVE, BROADCAST, AND ON-LINE CLASSES, SEMINARS, WORKSHOPS, TRAINING AND CURRICULUM DEVELOPMENT FOR CHILDREN, PARENTS AND EDUCATORS; EDUCATION SERVICES, NAMELY, PROVIDING LIVE AND ON-LINE CLASSES, SEMINARS, WORKSHOPS IN THE FIELD OF LANGUAGE, SOCIAL STUDIES, MATHEMATICS, SCIENCE AND TECHNOLOGY, ARTS, AND PERSONAL, SOCIAL AND PHYSICAL EDUCATION (U.S. CLS. 100, 101 AND 107).

DAWN FELDMAN, EXAMINING ATTORNEY

**CLASS 41—(Continued).**

SN 85-900,321. KEVIN MOORE, SANTA MONICA, CA. FILED 4-10-2013.

# KEB' MO'

THE MARK CONSISTS OF STANDARD CHARACTERS WITHOUT CLAIM TO ANY PARTICULAR FONT, STYLE, SIZE, OR COLOR.

THE NAME SHOWN IN THE MARK IDENTIFIES KEVIN MOORE, WHOSE CONSENT TO REGISTER IS MADE OF RECORD.

FOR ENTERTAINMENT SERVICES IN THE NATURE OF LIVE PERFORMANCES, LIVE MUSIC CONCERTS, AND PERSONAL APPEARANCES, ALL BY A MUSICIAN; ENTERTAINMENT SERVICES IN THE NATURE OF AUDIO AND VISUAL PERFORMANCES BY A MUSICIAN; AUDIO AND VIDEO RECORDING SERVICES (U.S. CLS. 100, 101 AND 107).

FIRST USE 7-0-1994; IN COMMERCE 7-0-1994.  
WILLIAM BRECKENFELD, EXAMINING ATTORNEY

**CLASS 41—(Continued).**

SN 85-901,350. NAVEENA DARSHAN, SUFFERN, NY. FILED 4-11-2013.

# Beyond The Curve

THE MARK CONSISTS OF STANDARD CHARACTERS WITHOUT CLAIM TO ANY PARTICULAR FONT, STYLE, SIZE, OR COLOR.

FOR EDUCATION SERVICES, NAMELY, PROVIDING ON-LINE AND IN-PERSON EDUCATIONAL MENTORING TO AT-RISK INDIVIDUALS AND INMATES TO ASSIST AND COACH WITH EDUCATION OPTIONS FOR EMPLOYMENT DEVELOPMENT AND COLLEGE LEVEL COURSES (U.S. CLS. 100, 101 AND 107).

JUDITH HELFMAN, EXAMINING ATTORNEY

SN 85-900,720. NATIONAL COUNCIL OF YOUNG MENS CHRISTIAN ASSOCIATIONS OF THE UNITED STATES OF AMERICA, CHICAGO, IL. FILED 4-10-2013.



## ARMED SERVICES YMCA

OWNER OF U.S. REG. NOS. 659,629, 3,917,712 AND OTHERS.

NO CLAIM IS MADE TO THE EXCLUSIVE RIGHT TO USE "ARMED SERVICES", APART FROM THE MARK AS SHOWN.

THE MARK CONSISTS OF THE TERM "THE" ON THE LEFT HAND SIDE OF A STYLIZED LETTER "Y" WHICH INCLUDES AN UPSIDE DOWN TRIANGULAR SHAPED OBJECT ON THE UPPER RIGHT CORNER. THE ACRONYM "YMCA" AND "5 STARS" APPEARS ON THE RIGHT SIDE OF THE STYLIZED "Y" AND THE WORDS "ARMED SERVICES YMCA" UNDERNEATH THE DESIGN.

FOR EDUCATIONAL AND ENTERTAINMENT SERVICES, NAMELY, CONDUCTING PROGRAMS DESIGNED TO PROMOTE THE PHYSICAL, MENTAL AND SPIRITUAL DEVELOPMENT OF OTHERS IN THE ARMED FORCES PERSONNEL (U.S. CLS. 100, 101 AND 107).

ANDREA HACK, EXAMINING ATTORNEY

SN 85-905,277. ROYAL CARIBBEAN CRUISES LTD., MIAMI, FL. FILED 4-16-2013.

# North Star

THE MARK CONSISTS OF STANDARD CHARACTERS WITHOUT CLAIM TO ANY PARTICULAR FONT, STYLE, SIZE, OR COLOR.

FOR ENTERTAINMENT SERVICES, NAMELY, PROVIDING VIEWING AND OBSERVATION SERVICES FROM AN OBSERVATION CAPSULE RAISED FROM A CRUISE SHIP (U.S. CLS. 100, 101 AND 107).

BILL DAWE, EXAMINING ATTORNEY

SN 85-905,284. ROYAL CARIBBEAN CRUISES LTD., MIAMI, FL. FILED 4-16-2013.

# RipCord

THE MARK CONSISTS OF STANDARD CHARACTERS WITHOUT CLAIM TO ANY PARTICULAR FONT, STYLE, SIZE, OR COLOR.

FOR ENTERTAINMENT SERVICES, NAMELY, PROVIDING FACILITIES FOR SIMULATED SKYDIVING (U.S. CLS. 100, 101 AND 107).

BILL DAWE, EXAMINING ATTORNEY

**CLASS 41—(Continued).**

SN 85-910,035. PEAK ATHLETICS PLUS, LLC, HIGHLANDS RANCH, CO. FILED 4-20-2013.

## Peak Athletics

THE MARK CONSISTS OF STANDARD CHARACTERS WITHOUT CLAIM TO ANY PARTICULAR FONT, STYLE, SIZE, OR COLOR.

OWNER OF U.S. REG. NO. 3,226,828.

NO CLAIM IS MADE TO THE EXCLUSIVE RIGHT TO USE "ATHLETICS", APART FROM THE MARK AS SHOWN.

FOR DANCE CLUB SERVICES; DANCE EVENTS; DANCE INSTRUCTION; DANCE INSTRUCTION FOR CHILDREN; DANCE STUDIOS; EDUCATION SERVICES, NAMELY, PROVIDING CLASSES AND INSTRUCTION IN THE FIELD OF DANCE; ENCOURAGING PARTICIPATION IN CHEERLEADING, DANCE AND SPIRIT-RELATED COMPETITIONS AND EVENTS BY ESTABLISHING RULES AND PROVIDING GOVERNANCE FOR THE COMPETITIONS AND EVENTS; ENTERTAINMENT IN THE NATURE OF GYMNAS TIC PERFORMANCES; ENTERTAINMENT SERVICES, NAMELY, CHEERLEADING; ENTERTAINMENT SERVICES, NAMELY, PRODUCING CHEERLEADING, DANCE AND SPIRIT-RELATED COMPETITIONS AND EVENTS; GYMNAS TIC INSTRUCTION; ORGANIZATION OF DANCING EVENTS; ORGANIZING COMMUNITY FESTIVALS FEATURING PRIMARILY CHEERLEADING COMPETITIONS, DANCE COMPETITIONS, GYMNAS TIC COMPETITIONS, CHEERLEADING CLINICS, DANCE CLINICS, TUMBLING CLINICS, TUMBLING EXHIBITIONS AND ALSO PROVIDING TRAINING AND REGISTRATION FOR COMPETITIONS; PROVIDING GYMNAS TIC FACILITIES (U.S. CLS. 100, 101 AND 107).

FIRST USE 3-1-2000; IN COMMERCE 3-1-2000.  
WILLIAM VERHOSEK, EXAMINING ATTORNEY

SN 85-913,828. COBAN MTC, LLC, NEW YORK, NY. FILED 4-24-2013.

## Coban Lookchaomaesaitong

THE MARK CONSISTS OF STANDARD CHARACTERS WITHOUT CLAIM TO ANY PARTICULAR FONT, STYLE, SIZE, OR COLOR.

OWNER OF U.S. REG. NO. 4,179,008.

THE NAME(S), PORTRAIT(S), AND/OR SIGNATURE(S) SHOWN IN THE MARK IDENTIFIES BANLU ANWISSET, A LIVING INDIVIDUAL, WHOSE CONSENT(S) TO REGISTER IS MADE OF RECORD.

FOR CONDUCTING ENTERTAINMENT EXHIBITIONS IN THE NATURE OF LIVE MUAY THAI EVENTS; MARTIAL ARTS INSTRUCTION (U.S. CLS. 100, 101 AND 107).

FIRST USE 0-0-1996; IN COMMERCE 0-0-1996.  
KRISTINA MORRIS, EXAMINING ATTORNEY

**CLASS 41—(Continued).**

SN 85-913,851. COBAN MTC, LLC, NEW YORK, NY. FILED 4-24-2013.

## Coban Lookchaomaesaitong

THE MARK CONSISTS OF STANDARD CHARACTERS WITHOUT CLAIM TO ANY PARTICULAR FONT, STYLE, SIZE, OR COLOR.

OWNER OF U.S. REG. NO. 4,179,008.

THE NAME(S), PORTRAIT(S), AND/OR SIGNATURE(S) SHOWN IN THE MARK IDENTIFIES BANLU ANWISSET, A LIVING INDIVIDUAL, WHOSE CONSENT(S) TO REGISTER IS MADE OF RECORD.

FOR CONDUCTING ENTERTAINMENT EXHIBITIONS IN THE NATURE OF LIVE MUAY THAI EVENTS; MARTIAL ARTS INSTRUCTION (U.S. CLS. 100, 101 AND 107).

FIRST USE 0-0-1996; IN COMMERCE 0-0-1996.  
KRISTINA MORRIS, EXAMINING ATTORNEY

SN 85-920,549. HUPERT, ANDREW, MASSAPEQUA, NY. FILED 5-1-2013.

## CHINA SOLVED

THE MARK CONSISTS OF STANDARD CHARACTERS WITHOUT CLAIM TO ANY PARTICULAR FONT, STYLE, SIZE, OR COLOR.

NO CLAIM IS MADE TO THE EXCLUSIVE RIGHT TO USE "CHINA", APART FROM THE MARK AS SHOWN.

FOR EDUCATION SERVICES, NAMELY, PROVIDING ONLINE CLASSES, COURSES, WEBCASTS, SEMINARS, AND FACE TO FACE TRAINING IN THE FIELD OF DOING BUSINESS IN CHINA; PROFESSIONAL COACHING SERVICES IN THE FIELD OF DOING BUSINESS IN CHINA; TRAINING SERVICES IN THE FIELD OF DOING BUSINESS IN CHINA (U.S. CLS. 100, 101 AND 107).

FIRST USE 12-27-2004; IN COMMERCE 2-28-2012.  
KERI CANTONE, EXAMINING ATTORNEY



**CLASS 41—(Continued).**

SN 85-921,629. MARKOU, MONTSERRAT, NEW YORK, NY. FILED 5-2-2013.

THE HEALTHY WAY TO PARTY!

THE MARK CONSISTS OF STANDARD CHARACTERS WITHOUT CLAIM TO ANY PARTICULAR FONT, STYLE, SIZE, OR COLOR.

FOR CONDUCTING FITNESS CLASSES WITH TRAMPOLINES; PERSONAL FITNESS TRAINING SERVICES FEATURING AEROBIC AND ANAEROBIC ACTIVITIES COMBINED WITH RESISTANCE AND FLEXIBILITY TRAINING USING TRAMPOLINES; PHYSICAL FITNESS CONDITIONING CLASSES WITH TRAMPOLINES; PHYSICAL FITNESS INSTRUCTION USING TRAMPOLINES; PHYSICAL FITNESS STUDIO SERVICES, NAMELY, PROVIDING EXERCISE CLASSES, BODY SCULPTING CLASSES, AND GROUP FITNESS CLASSES USING TRAMPOLINES; PHYSICAL FITNESS TRAINING SERVICES; PROVIDING TRAINING FOR INSTRUCTORS IN THE FIELD OF TRAMPOLINE FITNESS (U.S. CLS. 100, 101 AND 107).

FIRST USE 3-1-2012; IN COMMERCE 3-1-2012.  
JENNIFER DIXON, EXAMINING ATTORNEY

**CLASS 41—(Continued).**

SN 85-924,495. LIFESTORY CORPORATION, DBA LIFESTORY RESEARCH, NEWPORT BEACH, CA. FILED 5-6-2013.

Influence Quotient

THE MARK CONSISTS OF STANDARD CHARACTERS WITHOUT CLAIM TO ANY PARTICULAR FONT, STYLE, SIZE, OR COLOR.

FOR EDUCATIONAL SERVICES, NAMELY, CONDUCTING SEMINARS, WORKSHOPS, TESTING, LECTURES AND CLASSES IN THE FIELD OF SALES, LEADERSHIP, MANAGEMENT AND PERSONAL DEVELOPMENT (U.S. CLS. 100, 101 AND 107).

FIRST USE 1-1-2012; IN COMMERCE 1-10-2012.  
TINA MAI, EXAMINING ATTORNEY

SN 85-922,449. IMAX CORPORATION, MISSISSAUGA, ONTARIO, CANADA, FILED 5-3-2013.



OWNER OF U.S. REG. NOS. 1,283,679, 2,426,984 AND OTHERS.

THE MARK CONSISTS OF THE WORD "IMAX" TO THE LEFT OF INTERLOCKING DOUBLE "F" LETTERS IN A SQUARE DESIGN.

FOR ENTERTAINMENT SERVICES, NAMELY, ORGANIZING AND CONDUCTING MOVIE SCREENINGS (U.S. CLS. 100, 101 AND 107).

FIRST USE 4-29-2013; IN COMMERCE 4-29-2013.  
LINDA ORNDORFF, EXAMINING ATTORNEY

SN 85-924,531. GED TESTING SERVICE LLC, BLOOMINGTON, MN. FILED 5-6-2013.

MARCH WITH US

THE MARK CONSISTS OF STANDARD CHARACTERS WITHOUT CLAIM TO ANY PARTICULAR FONT, STYLE, SIZE, OR COLOR.

FOR EDUCATIONAL SERVICES, NAMELY, PREPARING STANDARDIZED TESTS FOR EDUCATIONAL TESTING IN THE FIELDS OF LANGUAGE ARTS, READING, WRITING, MATHEMATICS, SCIENCE AND SOCIAL STUDIES FOR THE ASSESSMENT OF STUDENT ACHIEVEMENT, HIGH SCHOOL LEVEL PROFICIENCY AND CAREER AND COLLEGE READINESS; PROVIDING INFORMATION AND TEST PREPARATION MATERIALS FOR EDUCATIONAL TESTING IN THE FIELDS OF LANGUAGE ARTS, READING, WRITING, MATHEMATICS, SCIENCE AND SOCIAL STUDIES FOR THE ASSESSMENT OF STUDENT ACHIEVEMENT, HIGH SCHOOL LEVEL PROFICIENCY AND CAREER AND COLLEGE READINESS; PREPARING, ADMINISTERING, SCORING AND ANALYZING STANDARDIZED TESTS THEREFOR (U.S. CLS. 100, 101 AND 107).

CYNTHIA TRIPI, EXAMINING ATTORNEY

**CLASS 41—(Continued).**

SN 85-925,621. TRUSUM VISIONS, DBA NATIONAL ASSOCIATION OF SALES PROFESSIONALS (NASP), LIVONIA, MI. FILED S.R. 5-7-2013; AM. P.R. 12-11-2013.

# CPSP

THE MARK CONSISTS OF STANDARD CHARACTERS WITHOUT CLAIM TO ANY PARTICULAR FONT, STYLE, SIZE, OR COLOR.

FOR EDUCATION SERVICES, NAMELY, PROVIDING ONLINE TRAINING AND PERSONAL COACHING FEATURING SALES, MARKETING AND SALES LEADERSHIP (U.S. CLS. 100, 101 AND 107).

FIRST USE 6-15-2007; IN COMMERCE 12-13-2010.  
PATRICIA EVANKO, EXAMINING ATTORNEY

SN 85-925,654. TRUSUM VISIONS, DBA EXPERIENCE-U, LIVONIA, MI. FILED S.R. 5-7-2013; AM. P.R. 12-11-2013.

# InnerLift

THE MARK CONSISTS OF STANDARD CHARACTERS WITHOUT CLAIM TO ANY PARTICULAR FONT, STYLE, SIZE, OR COLOR.

FOR PROVIDING ONLINE TRAINING AND PERSONAL COACHING FEATURING PERSONAL DEVELOPMENT AND WELLNESS FOR PLASTIC SURGERY AND HEALTH CARE PROCEDURE RECIPIENTS (U.S. CLS. 100, 101 AND 107).

FIRST USE 2-27-2012; IN COMMERCE 4-5-2013.  
PATRICIA EVANKO, EXAMINING ATTORNEY

SN 85-930,894. 3STUDIOSOUNDS, LLC, LOS ANGELES, CA. FILED 5-13-2013.



NO CLAIM IS MADE TO THE EXCLUSIVE RIGHT TO USE "ENHANCED MEDIA", APART FROM THE MARK AS SHOWN.

THE MARK CONSISTS OF A CIRCLE WITHIN A CIRCLE, AND WITH THE INNER CIRCLE IS A VIBRATING MEASUREMENT DESIGN; TO THE RIGHT OF THE DESIGN IS THE WORD "ENHANCED" AND UNDERNEATH THE WORD "ENHANCED" IS THE WORD "MEDIA".

FOR MUSIC PRODUCTION SERVICES; SOUND RECORDINGS PRODUCTION SERVICES; MUSIC POST PRODUCTION SERVICES; SOUND RECORDINGS POST PRODUCTION SERVICES; MUSIC VIDEO PRODUCTION SERVICES (U.S. CLS. 100, 101 AND 107).

FIRST USE 1-1-2013; IN COMMERCE 1-1-2013.  
B. PARADEWELAI, EXAMINING ATTORNEY

**CLASS 41—(Continued).**

SN 85-932,707. CONVOY OF HOPE, SPRINGFIELD, MO. FILED 5-15-2013.



THE MARK CONSISTS OF THE SHAPE OF A HEART FORMED BY TWO HANDS IN THE ACT OF SHAKING.

FOR CHARITABLE SERVICES, NAMELY, PROVIDING SCHOOL SUPPLIES TO CHILDREN IN NEED; EDUCATIONAL SERVICES, NAMELY, CONDUCTING SEMINARS, DISCUSSION FORUMS, CONFERENCES, WORKSHOPS, AND DISTRIBUTION OF PRINTED MATERIALS IN CONNECTION THEREWITH, ALL IN THE FIELDS OF CHRISTIANITY, RELIGION, THEOLOGY, SPIRITUALITY, AND SERVING THE NEEDS OF IMPOVERISHED, DISADVANTAGED, AND SUFFERING PEOPLE AND VICTIMS OF NATURAL DISASTERS (U.S. CLS. 100, 101 AND 107).

FIRST USE 4-15-2013; IN COMMERCE 4-15-2013.  
COURTNEY ALVAREZ, EXAMINING ATTORNEY

SN 85-934,507. JERU TILLMAN, WOODLAND HILLS, CA. FILED 5-16-2013.

# INSIDE JOKES

THE MARK CONSISTS OF STANDARD CHARACTERS WITHOUT CLAIM TO ANY PARTICULAR FONT, STYLE, SIZE, OR COLOR.

NO CLAIM IS MADE TO THE EXCLUSIVE RIGHT TO USE "JOKES", APART FROM THE MARK AS SHOWN.

FOR COMEDY CLUB SERVICES; ENTERTAINMENT IN THE NATURE OF LIVE VISUAL AND AUDIO PERFORMANCES, AND MUSICAL, VARIETY, NEWS AND COMEDY SHOWS; ENTERTAINMENT SERVICES IN THE NATURE OF COMEDY SHOWS; PRESENTATION OF LIVE COMEDY SHOWS (U.S. CLS. 100, 101 AND 107).

JAY FLOWERS, EXAMINING ATTORNEY

**CLASS 41—(Continued).**

SN 85-934,644. DULCE C. RUIZ, WOODLAND HILLS, CA. FILED 5-16-2013.

**DULCE CANDY**

THE MARK CONSISTS OF STANDARD CHARACTERS WITHOUT CLAIM TO ANY PARTICULAR FONT, STYLE, SIZE, OR COLOR.

THE NAME(S), PORTRAIT(S), AND/OR SIGNATURE(S) SHOWN IN THE MARK IDENTIFIES DULCE C. RUIZ, WHOSE CONSENT(S) TO REGISTER IS MADE OF RECORD.

THE ENGLISH TRANSLATION OF "DULCE" IN THE MARK IS "SWEET".

FOR ON-LINE JOURNALS, NAMELY, BLOGS FEATURING FASHION, BEAUTY, LIFESTYLE, AND TRAVEL (U.S. CLS. 100, 101 AND 107).

FIRST USE 6-1-2008; IN COMMERCE 6-1-2008.  
KAPIL BHANOT, EXAMINING ATTORNEY

---

SN 85-935,152. POPEXPRT INC., SAN FRANCISCO, CA. FILED 5-17-2013.

**GET BETTER AT LIFE, WORK  
AND PLAY**

THE MARK CONSISTS OF STANDARD CHARACTERS WITHOUT CLAIM TO ANY PARTICULAR FONT, STYLE, SIZE, OR COLOR.

FOR EDUCATION SERVICES, NAMELY, CONDUCTING COACHING SERVICES VIA LIVE WEB-CHATS AND ONLINE VIDEOS IN THE FIELDS OF RELATIONSHIPS, CAREER, PARENTING, TUTORING, FITNESS, BUSINESS, HOBBIES, SPIRITUALITY, WELLNESS, LANGUAGE AND MUSIC (U.S. CLS. 100, 101 AND 107).

FIRST USE 4-15-2013; IN COMMERCE 4-15-2013.  
MARLENE BELL, EXAMINING ATTORNEY

---

SN 85-935,415. BLOGSON LLC, LOUISIANA, MO. FILED 5-17-2013.

**BLOGSON**

THE MARK CONSISTS OF STANDARD CHARACTERS WITHOUT CLAIM TO ANY PARTICULAR FONT, STYLE, SIZE, OR COLOR.

FOR PROVIDING A WEBSITE FEATURING NON-DOWNLOADABLE ARTICLES IN THE FIELDS OF HEALTH, FITNESS, NUTRITION, PERSONAL RELATIONSHIPS, PERSONAL FINANCE, ASSET PROTECTION, RECREATIONAL ACTIVITIES, TRAVEL, TECHNOLOGY, WRITING TECHNIQUES AND STRATEGIES, ONLINE ARTICLE AND CONTENT PROMOTION, AND SOCIAL MEDIA (U.S. CLS. 100, 101 AND 107).

FIRST USE 12-0-2012; IN COMMERCE 12-0-2012.  
MARILYN IZZI, EXAMINING ATTORNEY

**CLASS 41—(Continued).**

SN 85-935,495. HC1.COM INC., INDIANAPOLIS, IN. FILED 5-17-2013.



OWNER OF U.S. REG. NOS. 4,044,988, 4,361,476 AND 4,387,071.

NO CLAIM IS MADE TO THE EXCLUSIVE RIGHT TO USE "ACADEMY", APART FROM THE MARK AS SHOWN.

THE MARK CONSISTS OF A CIRCLE WITH THE OUTLINE OF THE TOP OF A CLOUD ABOVE THE TERM "HC1" IN THE MIDDLE OF THE CIRCLE AND THE IMAGE OF A RIBBON ACROSS THE LOWER PORTION OF THE CIRCLE WITH THE WORD "ACADEMY" ON THE RIBBON.

FOR EDUCATIONAL SERVICES, NAMELY, PROVIDING WEB-BASED AND CLASSROOM TRAINING FOR OTHERS IN THE USE OF SOFTWARE (U.S. CLS. 100, 101 AND 107).

FIRST USE 7-1-2012; IN COMMERCE 7-1-2012.  
JENNIFER MARTIN, EXAMINING ATTORNEY

---

SN 85-935,558. HC1.COM INC., INDIANAPOLIS, IN. FILED 5-17-2013.

**HC1 ACADEMY**

THE MARK CONSISTS OF STANDARD CHARACTERS WITHOUT CLAIM TO ANY PARTICULAR FONT, STYLE, SIZE, OR COLOR.

OWNER OF U.S. REG. NOS. 4,044,988, 4,361,476 AND 4,387,071.

NO CLAIM IS MADE TO THE EXCLUSIVE RIGHT TO USE "ACADEMY", APART FROM THE MARK AS SHOWN.

FOR EDUCATIONAL SERVICES, NAMELY, PROVIDING WEB-BASED AND CLASSROOM TRAINING FOR OTHERS IN THE USE OF SOFTWARE (U.S. CLS. 100, 101 AND 107).

FIRST USE 7-1-2012; IN COMMERCE 7-1-2012.  
JENNIFER MARTIN, EXAMINING ATTORNEY

**CLASS 41—(Continued).**

SN 85-939,544. CAREER EDUCATION CORPORATION, SCHAUMBURG, IL. FILED 5-22-2013.

**THE SERIOUS U**

THE MARK CONSISTS OF STANDARD CHARACTERS WITHOUT CLAIM TO ANY PARTICULAR FONT, STYLE, SIZE, OR COLOR.

NO CLAIM IS MADE TO THE EXCLUSIVE RIGHT TO USE "U", APART FROM THE MARK AS SHOWN.

FOR EDUCATIONAL SERVICES, NAMELY, PROVIDING COURSES OF INSTRUCTION AT THE POST-SECONDARY LEVEL AND DISTRIBUTING COURSE MATERIALS IN CONNECTION THEREWITH; EDUCATIONAL SERVICES, NAMELY, PROVIDING ON-LINE COURSES OF INSTRUCTION AT THE POST-SECONDARY LEVEL AND DISTRIBUTING COURSE MATERIALS IN CONNECTION THEREWITH (U.S. CLS. 100, 101 AND 107).

FIRST USE 1-0-2012; IN COMMERCE 1-0-2012.  
VERNA BETH RIRIE, EXAMINING ATTORNEY

SN 85-940,140. EVANS, MELISSA, DETROIT, MI. FILED 5-22-2013.

**Melissa Evans**

THE MARK CONSISTS OF STANDARD CHARACTERS WITHOUT CLAIM TO ANY PARTICULAR FONT, STYLE, SIZE, OR COLOR.

THE NAME "MELISSA EVANS" IDENTIFIES A LIVING INDIVIDUAL WHOSE CONSENT IS OF RECORD.

FOR PROVIDING MOTIVATIONAL SPEAKING SERVICES IN THE FIELD OF SELF IMAGE, GOAL SETTING, PLANNING, ORGANIZING, AND TECHNIQUES FOR ATTRACTING ABUNDANCE; PERSONAL APPEARANCES BY A CELEBRITY EDUCATOR, MOTIVATIONAL SPEAKER AND AUTHOR; BUSINESS TRAINING CONSULTANCY SERVICES; LEADERSHIP DEVELOPMENT TRAINING IN THE FIELD OF BUSINESS AND CHARITABLE PROJECTS; BUSINESS TRAINING IN THE FIELD OF LEADERSHIP DEVELOPMENT, EXECUTIVE COACHING, PERSONAL DEVELOPMENT, IMAGE DEVELOPMENT, PLANNING AND ORGANIZING; BOOK PUBLISHING; EDUCATIONAL SERVICES, NAMELY, DEVELOPING CURRICULUM FOR OTHERS IN THE FIELD OF SELF IMAGE, GOAL SETTING, PLANNING, ORGANIZING, AND TECHNIQUES FOR ATTRACTING ABUNDANCE; EDUCATIONAL SERVICES, NAMELY, PROVIDING PODCASTS, WEBCASTS AND VIDEO SEGMENTS IN THE FIELD OF PERSONAL ACHIEVEMENT, GOAL SETTING, PLANNING, ORGANIZING, AND TECHNIQUES FOR ATTRACTING ABUNDANCE; EDUCATION SERVICES, NAMELY, PROVIDING LIVE AND ON-LINE TRAINING, CLASSES, WORKSHOPS AND SEMINARS IN THE FIELD PERSONAL ACHIEVEMENT, GOAL SETTING, PLANNING, ORGANIZING, AND TECHNIQUES FOR ATTRACTING ABUNDANCE (U.S. CLS. 100, 101 AND 107).

FIRST USE 1-1-2001; IN COMMERCE 1-1-2001.  
LEIGH CAROLINE CASE, EXAMINING ATTORNEY

**CLASS 41—(Continued).**

SN 85-944,415. CONSTELLATION 52 GLOBAL, BOWIE, MD. FILED 5-28-2013.

**CONSTELLATION 52 GLOBAL**

THE MARK CONSISTS OF STANDARD CHARACTERS WITHOUT CLAIM TO ANY PARTICULAR FONT, STYLE, SIZE, OR COLOR.

NO CLAIM IS MADE TO THE EXCLUSIVE RIGHT TO USE "GLOBAL", APART FROM THE MARK AS SHOWN.

FOR PROVIDING CLASSES, WORKSHOPS, SEMINARS AND CAMPS IN THE FIELDS OF FITNESS, EXERCISE, BOXING, KICK BOXING AND MIXED MARTIAL ARTS (U.S. CLS. 100, 101 AND 107).

FIRST USE 12-0-2011; IN COMMERCE 3-0-2012.  
ALEX KEAM, EXAMINING ATTORNEY

SN 85-948,034. ARTS AND SERVICES FOR DISABLED, INC., LONG BEACH, CA. FILED 5-31-2013.



NO CLAIM IS MADE TO THE EXCLUSIVE RIGHT TO USE "A PROJECT OF ARTS & SERVICES FOR DISABLED, INC.", APART FROM THE MARK AS SHOWN.

THE COLOR(S) RED, WHITE, BLUE, PINK, ORANGE, BLACK AND YELLOW IS/ARE CLAIMED AS A FEATURE OF THE MARK.

THE MARK CONSISTS OF THE WORDING "ARTBEAT" IN WHITE, FOLLOWED BY THE WORD "FOR" IN ORANGE, FOLLOWED BY THE WORD "HUMANITY" IN WHITE. THE PHRASE IS SURROUNDED BY A RED BACKGROUND AND IS SUPERIMPOSED ON A PINK HEART WITH A BLACK OUTLINE AND ADDITIONAL OUTLINES OF THE HEART IN BLUE AND YELLOW AND RED. THE FOLLOWING WORDING "A PROJECT OF ARTS & SERVICES FOR DISABLED, INC." APPEARS BELOW LEFT OF THE HEART DESIGN IN THE COLOR BLACK.

FOR CHARITABLE SERVICES, NAMELY, PROVIDING WORKSHOPS AND CLASSES IN THE FIELD OF ART (U.S. CLS. 100, 101 AND 107).

FIRST USE 6-0-2007; IN COMMERCE 6-0-2007.  
LESLEY LAMOTHE, EXAMINING ATTORNEY

**CLASS 41—(Continued).**

SN 85-948,093. ARTS AND SERVICES FOR DISABLED, INC.,  
LONG BEACH, CA. FILED 5-31-2013.



NO CLAIM IS MADE TO THE EXCLUSIVE RIGHT TO USE "RADIO", APART FROM THE MARK AS SHOWN.

THE COLOR(S) ORANGE IS/ARE CLAIMED AS A FEATURE OF THE MARK.

THE MARK CONSISTS OF A STYLIZED REEL-TO-REEL RADIO IN SHADES OF ORANGE WITH THE PHRASE "ARTBEAT RADIO" UNDERNEATH IN ORANGE.

FOR ENTERTAINMENT SERVICES, NAMELY, PROVIDING PODCASTS IN THE FIELD OF MUSIC/POETRY FROM THE DISABLED (U.S. CLS. 100, 101 AND 107).

FIRST USE 1-0-2009; IN COMMERCE 1-0-2009.  
LESLEY LAMOTHE, EXAMINING ATTORNEY

SN 85-948,227. TEAM MELZER ATHLETIC DEVELOPMENT,  
INC, DBA TEAM PILATES, NINE MILE FALLS, WA.  
FILED 6-1-2013.

# Bootylates

THE MARK CONSISTS OF STANDARD CHARACTERS WITHOUT CLAIM TO ANY PARTICULAR FONT, STYLE, SIZE, OR COLOR.

FOR PROVIDING FITNESS AND EXERCISE STUDIO SERVICES, NAMELY, PILATES INSTRUCTION AND TRAINING; YOGA INSTRUCTION (U.S. CLS. 100, 101 AND 107).

FIRST USE 5-31-2013; IN COMMERCE 5-31-2013.  
CHRISTINA SOBRAL, EXAMINING ATTORNEY

**CLASS 41—(Continued).**

SN 85-949,294. HOLMGREN, CHANNELL, RENO, NV.  
FILED 6-3-2013.

## Inspired By Purpose

THE MARK CONSISTS OF STANDARD CHARACTERS WITHOUT CLAIM TO ANY PARTICULAR FONT, STYLE, SIZE, OR COLOR.

FOR PROVIDING MENTORING, ASSISTANCE, PERSONAL TRAINING AND PHYSICAL FITNESS CONSULTATION TO INDIVIDUALS TO HELP THEM MAKE PHYSICAL FITNESS, STRENGTH, CONDITIONING, AND EXERCISE IMPROVEMENT IN THEIR DAILY LIVING (U.S. CLS. 100, 101 AND 107).

DOUGLAS LEE, EXAMINING ATTORNEY

SN 85-951,500. THE FORUM FOR YOUTH INVESTMENT,  
WASHINGTON, DC. FILED 6-5-2013.

## DAVID P. WEIKART CENTER FOR YOUTH PROGRAM QUALITY

THE MARK CONSISTS OF STANDARD CHARACTERS WITHOUT CLAIM TO ANY PARTICULAR FONT, STYLE, SIZE, OR COLOR.

NO CLAIM IS MADE TO THE EXCLUSIVE RIGHT TO USE "CENTER FOR YOUTH PROGRAM QUALITY", APART FROM THE MARK AS SHOWN.

THE NAME(S), PORTRAIT(S), AND/OR SIGNATURE(S) SHOWN IN THE MARK DOES NOT IDENTIFY A PARTICULAR LIVING INDIVIDUAL.

FOR EDUCATIONAL SERVICES IN THE NATURE OF EVALUATING AND ASSESSING CURRICULUM FOR YOUTH, STAFF PRACTICES, AND PROGRAM IMPROVEMENT IN YOUTH ORGANIZATIONS VIA OBSERVATION AND INTERVIEWS; TRAINING IN THE FIELD OF EDUCATION AND YOUTH PROGRAMS, SPECIFICALLY ASSESSMENT AND DEVELOPMENT OF PROGRAM IMPROVEMENT STRATEGIES FOR ACCOUNTABILITY PURPOSES (U.S. CLS. 100, 101 AND 107).

FIRST USE 12-15-2009; IN COMMERCE 12-15-2009.  
CHRISTOPHER LAW, EXAMINING ATTORNEY

**CLASS 41—(Continued).**

SN 85-951,707. THE FORUM FOR YOUTH INVESTMENT, WASHINGTON, DC. FILED 6-5-2013.



NO CLAIM IS MADE TO THE EXCLUSIVE RIGHT TO USE "CENTER FOR YOUTH PROGRAM QUALITY", APART FROM THE MARK AS SHOWN.

THE NAME(S), PORTRAIT(S), AND/OR SIGNATURE(S) SHOWN IN THE MARK DOES NOT IDENTIFY A PARTICULAR LIVING INDIVIDUAL.

THE COLOR(S) GREEN, WHITE AND BLACK IS/ARE CLAIMED AS A FEATURE OF THE MARK.

THE MARK CONSISTS OF THE WORDING "DAVID P. WEIKART" IN GREEN, THE WORDING "CENTER FOR YOUTH PROGRAM QUALITY" IN BLACK AND A GREEN SQUARE CONTAINING A WHITE PYRAMID WITH THREE HORIZONTAL PARALLEL GREEN LINES SPACED EQUALLY BETWEEN THE TOP AND BOTTOM OF THE PYRAMID.

FOR EDUCATIONAL SERVICES IN THE NATURE OF EVALUATING AND ASSESSING CURRICULUM FOR YOUTH, STAFF PRACTICES, AND PROGRAM IMPROVEMENT IN YOUTH ORGANIZATIONS VIA OBSERVATION AND INTERVIEWS; TRAINING IN THE FIELD OF EDUCATION AND YOUTH PROGRAMS, SPECIFICALLY ASSESSMENT AND DEVELOPMENT OF PROGRAM IMPROVEMENT STRATEGIES FOR ACCOUNTABILITY PURPOSES (U.S. CLS. 100, 101 AND 107).

FIRST USE 12-15-2009; IN COMMERCE 12-15-2009.  
CHRISTOPHER LAW, EXAMINING ATTORNEY

SN 85-953,355. ER MARKS, INC., WILMINGTON, DE. FILED 6-7-2013.

**Q SESSIONS LIVE**

THE MARK CONSISTS OF STANDARD CHARACTERS WITHOUT CLAIM TO ANY PARTICULAR FONT, STYLE, SIZE, OR COLOR.

NO CLAIM IS MADE TO THE EXCLUSIVE RIGHT TO USE "SESSIONS LIVE", APART FROM THE MARK AS SHOWN.

FOR ENTERTAINMENT SERVICES, NAMELY, AN ONGOING SERIES FEATURING HOME SHOPPING SHOWS AND LIVE MUSICAL PERFORMANCES BROADCAST PROVIDED THROUGH TELEVISION AND THE INTERNET (U.S. CLS. 100, 101 AND 107).

LINDA ORNDORFF, EXAMINING ATTORNEY

**CLASS 41—(Continued).**

SN 85-954,056. THE JOHNS HOPKINS UNIVERSITY, BALTIMORE, MD. FILED 6-7-2013.

**GENES TO SOCIETY**

THE MARK CONSISTS OF STANDARD CHARACTERS WITHOUT CLAIM TO ANY PARTICULAR FONT, STYLE, SIZE, OR COLOR.

FOR PROVIDING ONLINE PUBLICATIONS IN THE NATURE OF CURRICULUM IN THE FIELD OF MEDICAL EDUCATION; MEDICAL EDUCATION SERVICES, NAMELY, PROVIDING COURSES, CLASSES, SEMINARS AND WORKSHOPS IN THE FIELD OF MEDICINE; CONSULTING SERVICES IN THE FIELD OF MEDICAL EDUCATION, NAMELY, CONSULTING RELATING TO PROVIDING EDUCATION SERVICES IN THE FIELD OF MEDICINE; AND CURRICULUM DEVELOPMENT FOR OTHERS IN THE FIELD OF MEDICAL EDUCATION (U.S. CLS. 100, 101 AND 107).

FIRST USE 1-0-2004; IN COMMERCE 1-0-2004.  
MAUREEN DALL, EXAMINING ATTORNEY

SN 85-955,268. CBS RADIO INC., NEW YORK, NY. FILED 6-10-2013.

**GAMEDAY WAREHOUSE**

THE MARK CONSISTS OF STANDARD CHARACTERS WITHOUT CLAIM TO ANY PARTICULAR FONT, STYLE, SIZE, OR COLOR.

NO CLAIM IS MADE TO THE EXCLUSIVE RIGHT TO USE "WAREHOUSE", APART FROM THE MARK AS SHOWN.

FOR ENTERTAINMENT SERVICES, NAMELY, CONDUCTING SPORTS-THEMED PARTIES (U.S. CLS. 100, 101 AND 107).

FIRST USE 8-16-2010; IN COMMERCE 8-16-2010.  
TRACY FLETCHER, EXAMINING ATTORNEY

**CLASS 41—(Continued).**

SN 85-958,316. DREAMBOX LEARNING, INC., BELLEVUE, WA. FILED 6-12-2013.

DREAMBOX

THE MARK CONSISTS OF STANDARD CHARACTERS WITHOUT CLAIM TO ANY PARTICULAR FONT, STYLE, SIZE, OR COLOR.

OWNER OF U.S. REG. NOS. 3,534,834, 4,264,245 AND OTHERS.

FOR EDUCATIONAL SERVICES, NAMELY, COMPILING AND ANALYZING EDUCATIONAL TEST SCORES AND RELATED STUDENT PERFORMANCE HABITS AND DATA FOR OTHERS FOR EDUCATIONAL PURPOSES; PROVIDING INFORMATION ABOUT EDUCATION; ONLINE EDUCATIONAL SERVICES, NAMELY, PROVIDING COURSES OF INSTRUCTION AND ONLINE EDUCATIONAL COMPUTER GAMES AND PUZZLES AT THE PRIMARY, SECONDARY, COLLEGE, GRADUATE AND POST-GRADUATE LEVELS; SUPPLEMENTAL AND REMEDIAL EDUCATIONAL SERVICES, NAMELY, PROVIDING ON-LINE CLASSES, EDUCATIONAL ASSESSMENT SERVICES, WORKSHOPS, SEMINARS, TUTORING AND MENTORING IN THE FIELDS OF READING AND MATHEMATICS; PROVIDING INSTRUCTIONAL INFORMATION IN THE FIELD OF DIAGNOSTIC AND PRESCRIPTIVE INSTRUCTIONAL TECHNIQUES USED BY EDUCATORS AND TEACHERS FOR RENDERING INDIVIDUALIZED AND PERSONALIZED LESSONS IN THE FIELDS OF SUPPLEMENTAL AND REMEDIAL EDUCATION; EDUCATION SERVICES, NAMELY, PROVIDING FORMATIVE AND SUMMATIVE EDUCATIONAL ASSESSMENT SERVICES AND DEVELOPING SUGGESTED CURRICULA FOR EDUCATORS AND TEACHERS IN RELATION TO STUDENT ASSESSMENT RESULTS; EDUCATION CONSULTATION IN THE FIELD OF K-12, COLLEGE, GRADUATE AND POST-GRADUATE LEVEL EDUCATIONAL SYSTEMS FOR SCHOOLS REGARDING TEACHER TRAINING, ALIGNING EDUCATIONAL AND INSTRUCTIONAL CURRICULUM WITH STATE CURRICULUM TEACHING STANDARDS AND EDUCATIONAL ASSESSMENT OF TEACHERS; ON-LINE JOURNALS, NAMELY, BLOGS FEATURING INFORMATION ABOUT EDUCATION (U.S. CLS. 100, 101 AND 107).

DAVID YONTEF, EXAMINING ATTORNEY

**CLASS 41—(Continued).**

SN 85-958,327. DREAMBOX LEARNING, INC., BELLEVUE, WA. FILED 6-12-2013.



OWNER OF U.S. REG. NOS. 4,264,245 AND 4,264,280.  
THE MARK CONSISTS OF A LOWERCASE LETTER "D" IN STYLIZED FONT.

FOR EDUCATIONAL SERVICES, NAMELY, COMPILING AND ANALYZING EDUCATIONAL TEST SCORES, AND RELATED STUDENT PERFORMANCE HABITS AND DATA FOR OTHERS; PROVIDING EDUCATIONAL DATA AND EDUCATIONAL DATA REPORTS; ONLINE EDUCATIONAL SERVICES, NAMELY, PROVIDING COURSES OF INSTRUCTION AND ONLINE EDUCATIONAL COMPUTER GAMES AND PUZZLES AT THE PRIMARY, SECONDARY, COLLEGE, GRADUATE AND POST-GRADUATE LEVELS; SUPPLEMENTAL AND REMEDIAL EDUCATIONAL SERVICES, NAMELY, ONLINE CLASSES, ASSESSMENTS, WORKSHOPS, SEMINARS, TUTORING AND MENTORING IN THE FIELDS OF READING AND MATHEMATICS; PROVIDING EDUCATIONAL INFORMATION AND INSTRUCTION IN THE FIELD OF DIAGNOSTIC AND PRESCRIPTIVE INSTRUCTIONAL TECHNIQUES USED BY EDUCATORS AND TEACHERS FOR RENDERING INDIVIDUALIZED AND PERSONALIZED INSTRUCTION IN THE FIELDS OF SUPPLEMENTAL AND REMEDIAL EDUCATION; EDUCATION SERVICES, NAMELY, PROVIDING FORMATIVE AND SUMMATIVE EDUCATIONAL ASSESSMENTS AND DEVELOPING CURRICULA BASED THEREON; EDUCATION CONSULTATION SERVICES IN THE FIELD OF K-12, COLLEGE, GRADUATE AND POST-GRADUATE LEVEL EDUCATIONAL SYSTEMS FOR SCHOOLS REGARDING TEACHER TRAINING, ALIGNMENT OF EDUCATIONAL AND INSTRUCTIONAL CURRICULUM WITH STATE CURRICULUM TEACHING STANDARDS AND EDUCATIONAL ASSESSMENT OF TEACHERS; ON-LINE JOURNALS, NAMELY, BLOGS FEATURING INFORMATION ABOUT EDUCATION (U.S. CLS. 100, 101 AND 107).

AHSEN KHAN, EXAMINING ATTORNEY

**CLASS 41—(Continued).**

SN 85-960,236. DELPHI MARITIME, LLC, SEATTLE, WA. FILED 6-14-2013.

**DELPHI MARITIME**

THE MARK CONSISTS OF STANDARD CHARACTERS WITHOUT CLAIM TO ANY PARTICULAR FONT, STYLE, SIZE, OR COLOR.

NO CLAIM IS MADE TO THE EXCLUSIVE RIGHT TO USE "MARITIME", APART FROM THE MARK AS SHOWN.

FOR EDUCATION SERVICES, NAMELY, PROVIDING ONBOARD AND SHORE SIDE EDUCATIONAL TRAINING, DEVELOPMENT AND ASSESSMENT PROGRAMS FOR CREW MEMBERS IN THE FIELD OF MARITIME SKILLS (U.S. CLS. 100, 101 AND 107).

FIRST USE 5-9-2008; IN COMMERCE 5-9-2008.

BARBARA RUTLAND, EXAMINING ATTORNEY

---

SN 85-961,746. SANTA FE UNIVERSITY OF ART AND DESIGN, LLC, SANTA FE, NM. FILED 6-17-2013.

**OUTDOOR VISION FEST**

THE MARK CONSISTS OF STANDARD CHARACTERS WITHOUT CLAIM TO ANY PARTICULAR FONT, STYLE, SIZE, OR COLOR.

NO CLAIM IS MADE TO THE EXCLUSIVE RIGHT TO USE "OUTDOOR" AND "FEST", APART FROM THE MARK AS SHOWN.

FOR EDUCATIONAL AND ENTERTAINMENT SERVICES, NAMELY, PROVIDING LIVE IN-PERSON AND ON-LINE EVENTS, ARTS FESTIVALS, PHOTOGRAPHY FESTIVALS, AND EXHIBITIONS FEATURING ART INSTALLATIONS OF DESIGN, ANIMATION, FULL MOTION VIDEO, VIDEO MAPPING, MOTION GRAPHICS AND INTERACTIVE MULTIMEDIA (U.S. CLS. 100, 101 AND 107).

FIRST USE 4-0-2011; IN COMMERCE 4-0-2011.

WENDELL PHILLIPS, EXAMINING ATTORNEY

**CLASS 41—(Continued).**

SN 85-961,764. SANTA FE UNIVERSITY OF ART AND DESIGN, LLC, SANTA FE, NM. FILED 6-17-2013.



NO CLAIM IS MADE TO THE EXCLUSIVE RIGHT TO USE "OUTDOOR" AND "FEST", APART FROM THE MARK AS SHOWN.

THE MARK CONSISTS OF FOUR CONCENTRIC OVALS WITH POINTED SIDES, WHERE THE LETTERS "OVF" APPEAR IN THE CENTER OVAL AND THE WORDS "OUTDOOR VISION FEST" APPEAR BELOW. THE OVERALL SHAPE OF THE DESIGN ELEMENT IS THAT OF A STYLIZED EYE.

FOR EDUCATIONAL AND ENTERTAINMENT SERVICES, NAMELY, PROVIDING LIVE IN-PERSON AND ON-LINE EVENTS, ARTS FESTIVALS, PHOTOGRAPHY FESTIVALS, AND EXHIBITIONS FEATURING ART INSTALLATIONS OF DESIGN, ANIMATION, FULL MOTION VIDEO, VIDEO MAPPING, MOTION GRAPHICS AND INTERACTIVE MULTIMEDIA (U.S. CLS. 100, 101 AND 107).

FIRST USE 4-0-2011; IN COMMERCE 4-0-2011.

WENDELL PHILLIPS, EXAMINING ATTORNEY

---

SN 85-963,754. TV ONE, LLC, SILVER SPRING, MD. FILED 6-19-2013.

**R&B Divas**

THE MARK CONSISTS OF STANDARD CHARACTERS WITHOUT CLAIM TO ANY PARTICULAR FONT, STYLE, SIZE, OR COLOR.

NO CLAIM IS MADE TO THE EXCLUSIVE RIGHT TO USE "R&B", APART FROM THE MARK AS SHOWN.

FOR ENTERTAINMENT, NAMELY, LIVE MUSIC CONCERTS, LIVE PERFORMANCES IN THE NATURE OF MUSICAL AND DANCE PERFORMANCES, ROAD SHOWS, LIVE STAGE EVENTS, THEATRICAL PERFORMANCES, AND AUDIENCE PARTICIPATION IN SUCH EVENTS (U.S. CLS. 100, 101 AND 107).

HELENE LIWINSKI, EXAMINING ATTORNEY



**CLASS 41—(Continued).**

SN 85-964,608. RISE FINANCIAL PATHWAYS, A NON-PROFIT PUBLIC BENEFIT CORPORATION, LOS ANGELES, CA. FILED 6-19-2013.

**CLASS 41—(Continued).**

SN 85-972,956. UNIVERSITY OF SANTA MONICA, SANTA MONICA, CA. FILED 6-28-2013.

**RISE FINANCIAL PATHWAYS**

THE MARK CONSISTS OF STANDARD CHARACTERS WITHOUT CLAIM TO ANY PARTICULAR FONT, STYLE, SIZE, OR COLOR.

NO CLAIM IS MADE TO THE EXCLUSIVE RIGHT TO USE "FINANCIAL", APART FROM THE MARK AS SHOWN.

FOR FINANCIAL EDUCATION SERVICES, NAMELY, PROVIDING ONGOING WORKSHOPS AND SEMINARS OF INSTRUCTION AND WORKSHOPS IN THE FIELD OF FINANCE, SMALL BUSINESS DEVELOPMENT, AND SMALL BUSINESS EXPANSION (U.S. CLS. 100, 101 AND 107).

FIRST USE 1-14-2013; IN COMMERCE 1-14-2013.  
RON FAIRBANKS, EXAMINING ATTORNEY

OWNER OF U.S. REG. NO. 4,294,751.

NO CLAIM IS MADE TO THE EXCLUSIVE RIGHT TO USE "SPIRITUAL AWAKENING" AND "LIFE PURPOSE", APART FROM THE MARK AS SHOWN.

THE MARK CONSISTS OF THE WORDING "SPIRITUAL AWAKENING, LIFE PURPOSE, MEANINGFUL CONTRIBUTION", AROUND THE OUTSIDE PERIMETER OF A CIRCLE - WHICH ENCOMPASSES A STYLIZED MULTI-WINGED ANGEL DESIGN IMPOSED ON THREE GEOMETRICAL CIRCLES.

FOR ORGANIZING AND CONDUCTING SEMINARS AND WORKSHOPS TO HELP OTHERS DEVELOP PERSONAL GROWTH, INTERPERSONAL RELATIONSHIPS AND PERSONAL EXPRESSION AND DISTRIBUTING COURSE MATERIALS IN CONNECTION THEREWITH; EDUCATION SERVICES, NAMELY, CONDUCTING TRAINING CLASSES AND COURSES RELATING TO PERSONAL GROWTH, INTERPERSONAL RELATIONSHIPS AND PERSONAL EXPRESSION; ORGANIZING AND CONDUCTING SEMINARS, WORKSHOPS, AND COURSES RELATING TO SPIRITUAL PSYCHOLOGY, PERSONAL GROWTH, INTERPERSONAL RELATIONSHIPS AND PERSONAL EXPRESSION LEADING TO MASTER OF ARTS DEGREES IN SPIRITUAL PSYCHOLOGY AND MASTER OF ARTS DEGREES IN SPIRITUAL PSYCHOLOGY WITH AN EMPHASIS IN CONSCIOUSNESS, HEALTH AND HEALING; EDUCATION INFORMATION SERVICES; ONLINE EDUCATION SERVICES, NAMELY, CONDUCTING TRAINING CLASSES AND COURSES RELATING TO PERSONAL GROWTH, INTERPERSONAL RELATIONSHIPS AND PERSONAL EXPRESSION; CONDUCTING LIVE AND ONLINE WORKSHOPS, SEMINARS AND CLASSES IN THE FIELDS OF SPIRITUAL PSYCHOLOGY, PERSONAL GROWTH, INTERPERSONAL RELATIONSHIPS AND PERSONAL EXPRESSION LEADING TO MASTER OF ARTS DEGREES IN SPIRITUAL PSYCHOLOGY AND MASTER OF ARTS DEGREES IN SPIRITUAL PSYCHOLOGY WITH AN EMPHASIS IN CONSCIOUSNESS, HEALTH AND HEALING; PROVIDING A WEBSITE FEATURING INFORMATION ABOUT EDUCATION; EDUCATION SERVICES, NAMELY, PROVIDING LIVE AND ONLINE CLASSES, WORKSHOPS AND SEMINARS IN THE FIELDS OF PERSONAL GROWTH, INTERPERSONAL RELATIONSHIPS, PERSONAL EXPRESSION AND SPIRITUAL PSYCHOLOGY (U.S. CLS. 100, 101 AND 107).

FIRST USE 4-4-2013; IN COMMERCE 4-4-2013.

JANICE L. MCMORROW, EXAMINING ATTORNEY

**CLASS 41—(Continued).**

SN 85-980,633. DS2DIO, LLC, BEVERLY HILLS, CA. FILED 11-7-2012.

 The logo for DS2DIO features the letters 'DS' in a stylized, bold font where the 'S' is integrated with the 'D'. This is followed by '2DIO' in a clean, sans-serif font.

FOR ENTERTAINMENT SERVICES, NAMELY, PROVIDING NON-DOWNLOADABLE VIDEOS, MULTIMEDIA CONTENT FOR INSTRUCTIONAL AND ENTERTAINMENT PURPOSES, AND INFORMATION, NEWS AND COMMENTARY ONLINE, PRIMARILY IN THE FIELD OF DANCE BUT ALSO IN THE FIELD OF MUSIC RELATING TO DANCE; ENTERTAINMENT SERVICES, NAMELY, PRODUCTION AND DISTRIBUTION OF VIDEOS, MULTIMEDIA CONTENT FOR INSTRUCTIONAL AND ENTERTAINMENT PURPOSES, AND INFORMATION, NEWS AND COMMENTARY ONLINE, PRIMARILY IN THE FIELD OF DANCE BUT ALSO IN THE FIELD OF MUSIC RELATING TO DANCE (U.S. CLS. 100, 101 AND 107).

FIRST USE 5-14-2012; IN COMMERCE 5-14-2012.  
ELI HELLMAN, EXAMINING ATTORNEY

---

SN 86-000,672. OSSEIRAN, ALIA, MEREDITH, NH. FILED 7-2-2013.

## Cooch Coach

THE MARK CONSISTS OF STANDARD CHARACTERS WITHOUT CLAIM TO ANY PARTICULAR FONT, STYLE, SIZE, OR COLOR.

FOR PROVIDING ON-LINE MAGAZINES IN THE FIELD OF WOMEN'S VAGINAL AND SEXUAL HEALTH (U.S. CLS. 100, 101 AND 107).

KAREN K. BUSH, EXAMINING ATTORNEY

**CLASS 41—(Continued).**

SN 86-007,317. UTAH STATE UNIVERSITY, LOGAN, UT. FILED 7-11-2013.

## Marriage Survival

THE MARK CONSISTS OF STANDARD CHARACTERS WITHOUT CLAIM TO ANY PARTICULAR FONT, STYLE, SIZE, OR COLOR.

NO CLAIM IS MADE TO THE EXCLUSIVE RIGHT TO USE "MARRIAGE", APART FROM THE MARK AS SHOWN.

FOR EDUCATIONAL SERVICES, NAMELY, CONDUCTING CLASSES, SEMINARS, CONFERENCES, WORKSHOPS AND ON-LINE CLASSES IN THE FIELD OF MARRIAGE ENRICHMENT AND DISTRIBUTING COURSE MATERIALS IN CONNECTION THEREWITH; ON-LINE JOURNALS, NAMELY, BLOGS FEATURING INFORMATION, COMMENTS, QUESTIONS AND ANSWERS ON THE SUBJECT OF MARRIAGE ENRICHMENT (U.S. CLS. 100, 101 AND 107).

DAVID C. REIHNER, EXAMINING ATTORNEY

---

SN 86-007,498. CSAM MARKETING, INC., SOMERVILLE, NJ. FILED 7-11-2013.

## CLASS COMPETE

THE MARK CONSISTS OF STANDARD CHARACTERS WITHOUT CLAIM TO ANY PARTICULAR FONT, STYLE, SIZE, OR COLOR.

FOR EDUCATIONAL SERVICES, NAMELY, PROVIDING NON-DOWNLOADABLE EDUCATIONAL AUDIO-VISUAL MATERIAL IN THE FIELD OF COMMON CORE EDUCATIONAL SUBJECT MATTER (U.S. CLS. 100, 101 AND 107).

FIRST USE 12-5-2013; IN COMMERCE 12-5-2013.

INGRID C. EULIN, EXAMINING ATTORNEY

---

SN 86-009,648. SIERRA CANYON HIGH SCHOOL FOUNDATION, DBA SIERRA CANYON SCHOOL, CHATSWORTH, CA. FILED S.R. 7-13-2013; AM. P.R. 1-9-2014.

## Sierra Canyon School

THE MARK CONSISTS OF STANDARD CHARACTERS WITHOUT CLAIM TO ANY PARTICULAR FONT, STYLE, SIZE, OR COLOR.

NO CLAIM IS MADE TO THE EXCLUSIVE RIGHT TO USE "SCHOOL", APART FROM THE MARK AS SHOWN.

FOR EDUCATION SERVICES, NAMELY, PROVIDING PRE-KINDERGARTEN THROUGH 12TH GRADE CLASSROOM INSTRUCTION AT AN INDEPENDENT PRIVATE SCHOOL (U.S. CLS. 100, 101 AND 107).

FIRST USE 9-1-1972; IN COMMERCE 9-1-1972.

BILL DAWE, EXAMINING ATTORNEY

**CLASS 41—(Continued).**

SN 86-009,653. SIERRA CANYON HIGH SCHOOL FOUNDATION, DBA SIERRA CANYON SCHOOL, CHATSWORTH, CA. FILED S.R. 7-14-2013; AM. P.R. 1-9-2014.

**Fostering a Community of Excellence**

THE MARK CONSISTS OF STANDARD CHARACTERS WITHOUT CLAIM TO ANY PARTICULAR FONT, STYLE, SIZE, OR COLOR.  
 FOR EDUCATION SERVICES, NAMELY, PROVIDING PRE-KINDERGARTEN THROUGH 12TH GRADE CLASSROOM INSTRUCTION AT AN INDEPENDENT PRIVATE SCHOOL (U.S. CLS. 100, 101 AND 107).  
 FIRST USE 9-1-2008; IN COMMERCE 9-1-2008.  
 BILL DAWE, EXAMINING ATTORNEY

SN 86-009,704. COLLECTIVE IMPACT, LLC, BRIDGEVILLE, PA. FILED 7-14-2013.



OWNER OF U.S. REG. NO. 4,322,428.  
 NO CLAIM IS MADE TO THE EXCLUSIVE RIGHT TO USE "COMMUNITY DESIGN INNOVATIONS", APART FROM THE MARK AS SHOWN.  
 THE COLOR(S) BLUE, GREEN, YELLOW, WHITE AND BROWN IS/ARE CLAIMED AS A FEATURE OF THE MARK.  
 THE MARK CONSISTS OF THE STYLIZED WORDS "COMMUNITY DESIGN" IN BLUE APPEARING ABOVE THE STYLIZED WORD "INNOVATIONS" IN GREEN. THE "I" IN "INNOVATIONS" IS DRAWN TO APPEAR AS A FLOWER IN YELLOW, BROWN, BLUE, GREEN AND WHITE.  
 FOR EDUCATION SERVICES, NAMELY, PROVIDING TRAINING AND INSTRUCTION IN THE FIELD OF COMMUNITY AND ORGANIZATIONAL DEVELOPMENT (U.S. CLS. 100, 101 AND 107).  
 FIRST USE 0-0-2011; IN COMMERCE 0-0-2011.  
 JULIE GUTTADAURO, EXAMINING ATTORNEY

**CLASS 41—(Continued).**

SN 86-010,971. G4S YOUTH SERVICES LLC, JUPITER, FL. FILED 7-16-2013.

**TEAM OF ONE**

THE MARK CONSISTS OF STANDARD CHARACTERS WITHOUT CLAIM TO ANY PARTICULAR FONT, STYLE, SIZE, OR COLOR.  
 FOR YOUTH MENTORING, NAMELY, EDUCATIONAL SUPPORT SERVICES FOR YOUTH IN THE NATURE OF PROVIDING CLASSES AND SEMINARS IN THE FIELD OF PERSONAL GROWTH, EDUCATIONAL MENTORING SERVICES AND PROGRAMS IN THE FIELDS OF SELF-CONFIDENCE AND INTEGRITY (U.S. CLS. 100, 101 AND 107).  
 ELLEN PERKINS, EXAMINING ATTORNEY

SN 86-012,031. G4S YOUTH SERVICES LLC, JUPITER, FL. FILED 7-16-2013.



THE MARK CONSISTS OF THE SILHOUETTE OR SHADOW OF AN ADULT REACHING FOR THE HAND OF A CHILD ENCLOSED IN A SHADED SQUARE.  
 FOR YOUTH MENTORING, NAMELY, EDUCATIONAL SUPPORT SERVICES FOR YOUTH IN THE NATURE OF PROVIDING CLASSES AND SEMINARS IN THE FIELD OF PERSONAL GROWTH, EDUCATIONAL MENTORING SERVICES AND PROGRAMS IN THE FIELDS OF SELF-CONFIDENCE AND INTEGRITY (U.S. CLS. 100, 101 AND 107).  
 ELLEN PERKINS, EXAMINING ATTORNEY

**CLASS 41—(Continued).**

SN 86-012,769. THE HOOP GROUP, INC., NEPTUNE, NJ. FILED 7-17-2013.



OWNER OF U.S. REG. NOS. 4,013,121, 4,013,123 AND OTHERS.

NO CLAIM IS MADE TO THE EXCLUSIVE RIGHT TO USE "GROUP", APART FROM THE MARK AS SHOWN.

THE COLOR(S) BLACK, WHITE, AND BLUE IS/ARE CLAIMED AS A FEATURE OF THE MARK.

THE MARK CONSISTS OF THE WORDS "HOOP" AND "GROUP" SIDE BY SIDE COLORED IN WHITE AND OUTLINED IN BLACK, WITH THE LETTERS "O" BEING REPLACED WITH A DESIGN CONSISTING OF THE OUTLINE OF A BASKETBALL IN BLACK IN WHICH THERE IS DEPICTED NORTH, CENTRAL, AND SOUTH AMERICA COLORED IN BLUE AGAINST A WHITE BACKGROUND.

FOR EDUCATIONAL AND ENTERTAINMENT SERVICES, NAMELY, BASKETBALL PROGRAMS IN THE NATURE OF BASKETBALL GAMES, INSTRUCTION, CAMPS AND TOURNAMENTS (U.S. CLS. 100, 101 AND 107).

FIRST USE 1-1-2011; IN COMMERCE 1-1-2011.  
KAREN BRACEY, EXAMINING ATTORNEY

SN 86-012,785. THE HOOP GROUP, INC., NEPTUNE, NJ. FILED 7-17-2013.



OWNER OF U.S. REG. NOS. 4,013,121, 4,013,123 AND OTHERS.

NO CLAIM IS MADE TO THE EXCLUSIVE RIGHT TO USE "GROUP", APART FROM THE MARK AS SHOWN.

THE COLOR(S) BLACK, WHITE, AND BLUE IS/ARE CLAIMED AS A FEATURE OF THE MARK.

THE MARK CONSISTS OF THE WORD "HOOP" STAGGERED ABOVE THE WORD "GROUP" COLORED IN WHITE AND OUTLINED IN BLACK, WITH THE LETTERS "O" BEING REPLACED WITH A DESIGN CONSISTING OF THE OUTLINE OF A BASKETBALL IN BLACK IN WHICH THERE IS DEPICTED NORTH, CENTRAL, AND SOUTH AMERICA COLORED IN BLUE AGAINST A WHITE BACKGROUND.

FOR EDUCATIONAL AND ENTERTAINMENT SERVICES, NAMELY, BASKETBALL PROGRAMS IN THE NATURE OF BASKETBALL GAMES, INSTRUCTION, CAMPS AND TOURNAMENTS (U.S. CLS. 100, 101 AND 107).

FIRST USE 1-1-2011; IN COMMERCE 1-1-2011.  
KAREN BRACEY, EXAMINING ATTORNEY

**CLASS 41—(Continued).**

SN 86-012,875. VICTORY ACADEMY, INC., BLOOMINGTON, IL. FILED 7-17-2013.

# MIGHTY KIDS

THE MARK CONSISTS OF STANDARD CHARACTERS WITHOUT CLAIM TO ANY PARTICULAR FONT, STYLE, SIZE, OR COLOR.

NO CLAIM IS MADE TO THE EXCLUSIVE RIGHT TO USE "KIDS", APART FROM THE MARK AS SHOWN.

FOR MARTIAL ARTS INSTRUCTION (U.S. CLS. 100, 101 AND 107).

FIRST USE 12-31-2005; IN COMMERCE 12-31-2005.  
FRANK LATTUCA, EXAMINING ATTORNEY

SN 86-013,628. ALI INTERNATIONAL, LLC, LOS ANGELES, CA. FILED 7-18-2013.

# GLAMBITION

THE MARK CONSISTS OF STANDARD CHARACTERS WITHOUT CLAIM TO ANY PARTICULAR FONT, STYLE, SIZE, OR COLOR.

FOR EDUCATIONAL SERVICES, NAMELY, CONDUCTING PROGRAMS IN THE FIELD OF SMALL BUSINESS MARKETING AND INTERNET MARKETING; EDUCATION SERVICES, NAMELY, PROVIDING CLASSES, WORKSHOPS AND SEMINARS IN THE FIELDS OF SMALL BUSINESS MARKETING AND INTERNET MARKETING AND DISTRIBUTION OF COURSE MATERIAL IN CONNECTION THEREWITH; PROVIDING INFORMATION ONLINE IN THE FIELD OF PUBLISHING AN ELECTRONIC MAGAZINE; PROVIDING ONLINE ELECTRONIC NEWSLETTERS VIA EMAIL IN THE FIELD OF PUBLISHING; EDUCATIONAL SERVICES, NAMELY, PROVIDING A WEBSITE TO PROVIDE ON-LINE CLASSES, SEMINARS, AND LECTURES IN THE FIELD OF PROFESSIONAL COACHING IN THE FIELD OF BUSINESS; EDUCATIONAL SERVICES, NAMELY, PROVIDING EDUCATIONAL INFORMATION IN THE FORMAT OF CLASSES, LECTURES, AND SEMINARS, IN THE FIELD OF BUSINESS, AND DISTRIBUTING COURSE MATERIAL IN THE NATURE OF TEXTBOOKS AND MANUALS THEREWITH; PROVIDING CONTINUING BUSINESS EDUCATION COURSES AND DISTRIBUTING COURSE MATERIAL IN THE NATURE OF TEXTBOOKS, PRERECORDED CDS AND DVDS, MANUALS, BUSINESS NEWSLETTERS, AND MAGAZINES IN CONNECTION THEREWITH; PROFESSIONAL COACHING SERVICES IN THE FIELD OF BUSINESS (U.S. CLS. 100, 101 AND 107).

KATHERINE M. DUBRAY, EXAMINING ATTORNEY

**CLASS 41—(Continued).**

SN 86-015,033. CENTRAL STATE UNIVERSITY, WILBER-FORCE, OH. FILED 7-19-2013.

# tASK4Health

THE MARK CONSISTS OF STANDARD CHARACTERS WITHOUT CLAIM TO ANY PARTICULAR FONT, STYLE, SIZE, OR COLOR.

FOR EDUCATIONAL SERVICES, NAMELY, CONDUCTING ONLINE SEMINARS AND WORKSHOPS IN THE FIELD OF MINORITY ELDERLY HEALTH (U.S. CLS. 100, 101 AND 107).

PAUL E. FAHRENKOPF, EXAMINING ATTORNEY

---

SN 86-015,170. BROWN II, WILLIAM J, BIRMINGHAM, AL. FILED 7-19-2013.

# Real Beats For Real Artists

THE MARK CONSISTS OF STANDARD CHARACTERS WITHOUT CLAIM TO ANY PARTICULAR FONT, STYLE, SIZE, OR COLOR.

FOR COMPOSITION OF MUSIC FOR OTHERS; ENTERTAINMENT SERVICES BY A MUSICAL ARTIST AND PRODUCER, NAMELY, MUSICAL COMPOSITION FOR OTHERS AND PRODUCTION OF MUSICAL SOUND RECORDINGS; MUSIC COMPOSITION AND TRANSCRIPTION FOR OTHERS; MUSIC COMPOSITION FOR OTHERS; MUSIC COMPOSITION SERVICES; MUSIC PRODUCTION SERVICES; POST-PRODUCTION EDITING SERVICES IN THE FIELD OF MUSIC, VIDEOS AND FILM; PRODUCTION OF MUSICAL SOUND RECORDING; PRODUCTION OF SOUND AND MUSIC VIDEO RECORDINGS; PROVIDING AN INTERNET WEBSITE PORTAL IN THE FIELD OF MUSIC (U.S. CLS. 100, 101 AND 107).

FIRST USE 9-1-2007; IN COMMERCE 9-1-2007.

JOSETTE BEVERLY, EXAMINING ATTORNEY

**CLASS 41—(Continued).**

SN 86-017,392. LYNN, JACK M., LAGUNA BEACH, CA. FILED 7-23-2013.



NO CLAIM IS MADE TO THE EXCLUSIVE RIGHT TO USE "FITNESS", APART FROM THE MARK AS SHOWN.

THE MARK CONSISTS OF A HUMAN HAVING A MUSCULAR PHYSIQUE, STANDING WITH ARMS AND LEGS OUT-STRETCHED, BOTH IN A V SHAPE. THE HUMAN APPEARS ABOVE THE WORDS "TIME DEFIANCE FITNESS".

FOR PHYSICAL FITNESS TRAINING SERVICES (U.S. CLS. 100, 101 AND 107).

FIRST USE 10-1-2007; IN COMMERCE 10-1-2007.

JOANNA DUKOVIC, EXAMINING ATTORNEY

---

SN 86-018,184. MADLINE LLC, WEST HILLS, CA. FILED 7-24-2013.

# ROADZIES

THE MARK CONSISTS OF STANDARD CHARACTERS WITHOUT CLAIM TO ANY PARTICULAR FONT, STYLE, SIZE, OR COLOR.

FOR ENTERTAINMENT SERVICES, NAMELY, PROVIDING A WEBSITE FEATURING BLOGS IN THE FIELD OF HOMESCHOOLING AND TRAVEL; PROVIDING A WEBSITE FOR ENTERTAINMENT PURPOSES FEATURING VIDEOS ABOUT HOMESCHOOLING WHILE TRAVELING; ENTERTAINMENT SERVICES, NAMELY, PROVIDING PODCASTS IN THE FIELD OF TRAVEL (U.S. CLS. 100, 101 AND 107).

FIRST USE 12-1-2012; IN COMMERCE 12-1-2012.

ASMAT KHAN, EXAMINING ATTORNEY

**CLASS 41—(Continued).**

SN 86-020,159. PAUL FERRARA, MANALAPAN, NJ. FILED 7-25-2013.

## The Makeup Bar

THE MARK CONSISTS OF STANDARD CHARACTERS WITHOUT CLAIM TO ANY PARTICULAR FONT, STYLE, SIZE, OR COLOR.

NO CLAIM IS MADE TO THE EXCLUSIVE RIGHT TO USE "MAKEUP", APART FROM THE MARK AS SHOWN.

FOR INSTRUCTIONAL CLASSES AND EDUCATIONAL SEMINARS FOR COSMETOLOGY STUDENTS IN THE FIELD OF MAKEUP, AIRBRUSHING, COSMETICS, AND HAIRSTYLING (U.S. CLS. 100, 101 AND 107).

ANDREA HACK, EXAMINING ATTORNEY

SN 86-021,830. POE, RICHARD TODD, EWING, IL. FILED 7-28-2013.

## Southern Illinois Bullets

THE MARK CONSISTS OF STANDARD CHARACTERS WITHOUT CLAIM TO ANY PARTICULAR FONT, STYLE, SIZE, OR COLOR.

NO CLAIM IS MADE TO THE EXCLUSIVE RIGHT TO USE "SOUTHERN ILLINOIS", APART FROM THE MARK AS SHOWN.

FOR AMATEUR YOUTH SPORTS SERVICES, NAMELY, ORGANIZING AND PROVIDING YOUTH SPORTS ACTIVITIES; ENTERTAINMENT SERVICES, NAMELY, PARTICIPATION IN BASEBALL (U.S. CLS. 100, 101 AND 107).

FIRST USE 6-1-2000; IN COMMERCE 6-1-2000.

SHAUNIA CARLYLE, EXAMINING ATTORNEY

SN 86-023,159. FORUM TO ADVANCE MINORITIES IN ENGINEERING, INC., DBA FAME, INC., WILMINGTON, DE. FILED 7-30-2013.



THE COLOR(S) DARK BLUE, WHITE, LIGHT BLUE IS/ ARE CLAIMED AS A FEATURE OF THE MARK.

THE MARK CONSISTS OF THE WORDING "STEMULATE" IN LIGHT BLUE AND WHITE WITH A DARK BLUE OUTLINE, WITH "STEM" IN WHITE CAPITAL LETTERS, AND "ULATE" IN LIGHT BLUE LOWER CASE LETTERS. THE WORDING IS SUPERIMPOSED ON A DARK BLUE GLOBE WITH LIGHT BLUE CONTINENTS. THE GLOBE IS CIRCLED BY DARK BLUE AND WHITE DESIGN ELE-

**CLASS 41—(Continued).**

MENTS CONSISTING OF A WHITE LABORATORY BEAKER OUTLINED IN DARK BLUE AND CONTAINING A DARK BLUE LIQUID WITH WHITE BUBBLES, A WHITE LIGHT BULB OUTLINED IN DARK BLUE WITH DARK BLUE LINES EXTENDING FROM THE LIGHT BULB, A WHITE MOBILE PHONE OUTLINED IN DARK BLUE AND CONTAINING A DARK BLUE ARROW IN THE CENTER, A DARK BLUE ATOM, A DARK BLUE LAMP, A DARK BLUE CARBON MOLECULE, A DARK BLUE MICROPHONE, A WHITE MONITOR OUTLINED IN DARK BLUE WITH TWO DARK BLUE ARCING LINES AND A DOT IN THE CENTER, A WHITE DIALOG BUBBLE CONTAINING THREE DARK BLUE DOTS, WITH A DARK BLUE SHADOW BEHIND THE WHITE DIALOG BUBBLE, A DARK BLUE SATELLITE, AND A WHITE LAPTOP OUTLINED IN DARK BLUE WITH A DARK BLUE ARROW IN THE UPPER LEFT SIDE OF THE LAPTOP SCREEN.

FOR CHARITABLE SERVICES, NAMELY, PROVIDING EDUCATIONAL MATERIALS IN THE NATURE OF SYLLABI, WORKSHEETS, ASSIGNMENTS AND NOTEBOOKS IN THE FIELDS OF SCIENCE, TECHNOLOGY, ENGINEERING, AND MATH TO STUDENTS SPECIFICALLY WITH A FOCUS ON UNDERREPRESENTED MINORITIES AND WOMEN; CHARITABLE SERVICES, NAMELY, PROVIDING FACILITIES FOR EDUCATIONAL CLASSES, WORKSHOPS, AND TUTORING IN THE FIELDS OF SCIENCE, TECHNOLOGY, ENGINEERING, AND MATH TO STUDENTS SPECIFICALLY WITH A FOCUS ON UNDERREPRESENTED MINORITIES AND WOMEN; CHARITABLE DONATION SERVICES, NAMELY, PROVIDING CLASSES, TUTORING, AND MENTORING IN THE FIELDS OF SCIENCE, TECHNOLOGY, ENGINEERING AND MATH; CONSULTATION IN THE FIELD OF K-12 EDUCATIONAL SYSTEMS; DEVELOPING EDUCATIONAL MANUALS FOR OTHERS IN THE FIELD OF STEM EDUCATION, NAMELY, SCIENCE, TECHNOLOGY, ENGINEERING AND MATH; DEVELOPMENT AND DISSEMINATION OF EDUCATIONAL MATERIALS OF OTHERS IN THE FIELD OF STEM EDUCATION, NAMELY, SCIENCE, TECHNOLOGY, ENGINEERING AND MATH; EDUCATING AT SENIOR HIGH SCHOOLS; EDUCATION IN THE FIELDS OF SCIENCE, TECHNOLOGY, ENGINEERING AND MATH RENDERED THROUGH CORRESPONDENCE COURSES; EDUCATION SERVICES IN THE NATURE OF COURSES AT THE UNIVERSITY LEVEL; EDUCATION SERVICES, NAMELY, MENTORING IN THE FIELD OF SCIENCE, TECHNOLOGY, ENGINEERING AND MATH; EDUCATION SERVICES, NAMELY, PROVIDING HANDS-ON OPPORTUNITIES FOR CHILDREN IN THE FIELD OF INTUITIVE ENGINEERING THROUGH LIVE, BROADCAST, AND ON-LINE CLASSES, SEMINARS, WORKSHOPS, TRAINING AND CURRICULUM DEVELOPMENT FOR CHILDREN, PARENTS AND EDUCATORS; EDUCATION SERVICES, NAMELY, PROVIDING KINDERGARTEN THROUGH 12TH GRADE (K-12) CLASSROOM INSTRUCTION; EDUCATION SERVICES, NAMELY, PROVIDING MENTORING, TUTORING, CLASSES, SEMINARS AND WORKSHOPS IN THE FIELD OF SCIENCE, TECHNOLOGY, ENGINEERING AND MATH; EDUCATIONAL COUNSELING SERVICES TO ASSIST STUDENTS IN PLANNING AND PREPARING FOR FURTHER EDUCATION; EDUCATIONAL SERVICES, NAMELY, CONDUCTING PROGRAMS IN THE FIELD OF STEM EDUCATION, NAMELY, SCIENCE, TECHNOLOGY, ENGINEERING AND MATH; EDUCATIONAL SERVICES, NAMELY, CONDUCTING CLASSES, TUTORING, AND MENTORING IN THE FIELD OF STEM EDUCATION, NAMELY, SCIENCE, TECHNOLOGY, ENGINEERING AND MATH, AND DISTRIBUTION OF PRINTED MATERIALS IN CONNECTION THEREWITH IN HARD COPY OR ELECTRONIC FORMAT ON THE SAME TOPICS; EDUCATIONAL SERVICES, NAMELY, DEVELOPING CURRICULUM FOR EDUCATORS; EDUCATIONAL SERVICES, NAMELY, DEVELOPING CURRICULUM FOR OTHERS IN THE FIELD OF STEM EDUCATION, NAMELY, SCIENCE, TECHNOLOGY, ENGINEERING AND MATH; EDUCATIONAL SERVICES, NAMELY, PROVIDING INCENTIVES TO STUDENTS TO DEMONSTRATE EXCELLENCE IN THE FIELD OF SCIENCE, TECHNOLOGY, ENGINEERING, AND MATH; PROVIDING AFTER SCHOOL EDUCATIONAL PROGRAMS FOR CHILDREN IN GRADES K-12 (U.S. CLS. 100, 101 AND 107).

MEREDITH MARESCA, EXAMINING ATTORNEY

**CLASS 41—(Continued).**

SN 86-023,690. COLLEGESOURCE, INC., SAN DIEGO, CA. FILED 7-30-2013.

## TRANSFEROLOGY

THE MARK CONSISTS OF STANDARD CHARACTERS WITHOUT CLAIM TO ANY PARTICULAR FONT, STYLE, SIZE, OR COLOR.

FOR PROVIDING AN ON-LINE SEARCHABLE DATABASE TO ASSIST STUDENTS IN DETERMINING HOW COLLEGES AND UNIVERSITIES MAY ACCEPT PREVIOUS COURSE CREDIT AND LEARNING EXPERIENCES TOWARD DEGREE COMPLETION (U.S. CLS. 100, 101 AND 107).

SHAUNIA CARLYLE, EXAMINING ATTORNEY

**CLASS 41—(Continued).**

SN 86-024,196. CINTTYA'S CHEMISTRY CIRCUS, DBA LITTLE BEAKERS, CYPRESS, TX. FILED 7-31-2013.



OWNER OF U.S. REG. NO. 4,220,847.

THE MARK CONSISTS OF DESIGN OF A BOY HOLDING A PIECE OF LABORATORY TESTING EQUIPMENT BEING A FLASK.

FOR EDUCATIONAL AND ENTERTAINMENT SERVICES FOR CHILDREN, NAMELY, PROVIDING INTERACTIVE PLAY AREAS, INSTRUCTIONAL CLASSES IN THE FIELD OF SCIENCE AND SOCIAL GATHERINGS FOR CHILDREN (U.S. CLS. 100, 101 AND 107).

FIRST USE 5-1-2013; IN COMMERCE 5-1-2013.  
BRENDAN REGAN, EXAMINING ATTORNEY

SN 86-023,967. TRANSVIDEO STUDIOS LLC, MOUNTAIN VIEW, CA. FILED 7-30-2013.

## Picturelab

THE MARK CONSISTS OF STANDARD CHARACTERS WITHOUT CLAIM TO ANY PARTICULAR FONT, STYLE, SIZE, OR COLOR.

FOR CREATIVE DESIGN SERVICES FOR FILM AND VIDEO PRODUCTION, NAMELY, MULTIMEDIA ENTERTAINMENT SERVICES IN THE NATURE OF DEVELOPMENT, PRODUCTION AND POST-PRODUCTION SERVICES IN THE FIELDS OF VIDEO AND FILMS (U.S. CLS. 100, 101 AND 107).

FIRST USE 10-25-2008; IN COMMERCE 10-25-2008.  
ANDREA BUTLER, EXAMINING ATTORNEY

SN 86-024,538. UNIVERSITY OF EVANSVILLE, EVANSVILLE, IN. FILED 7-31-2013.



THE MARK CONSISTS OF THE WORD "IMPACT" STYLIZED, WITH AN ARROW AT THE TOP OF THE "I" AND TO THE RIGHT OF THE "T".

FOR EDUCATIONAL SERVICES, NAMELY, CONDUCTING LECTURES, COURSES, WORKSHOPS, SEMINARS, SYMPOSIA, AND CONFERENCES AT THE UNIVERSITY UNDERGRADUATE AND GRADUATE LEVELS; ENTERTAINMENT SERVICES, NAMELY, ORGANIZING AND CONDUCTING CULTURAL EVENTS AND COLLEGE SPORTS COMPETITIONS (U.S. CLS. 100, 101 AND 107).

FIRST USE 4-1-2013; IN COMMERCE 4-1-2013.  
MARK SPARACINO, EXAMINING ATTORNEY

**CLASS 41—(Continued).**

SN 86-024,557. UNIVERSITY OF EVANSVILLE, EVANSVILLE, IN. FILED 7-31-2013.

**HARLAXTON**

THE MARK CONSISTS OF STANDARD CHARACTERS WITHOUT CLAIM TO ANY PARTICULAR FONT, STYLE, SIZE, OR COLOR.

SEC. 2(F).

FOR EDUCATIONAL SERVICES, NAMELY, CONDUCTING LECTURES, SEMINARS, CONFERENCES, COURSES OF INSTRUCTION, WORKSHOPS, AND SYMPOSIA AT THE UNDERGRADUATE LEVEL; ENTERTAINMENT SERVICES, NAMELY, ARRANGING AND CONDUCTING COLLEGE SPORTS COMPETITIONS AND ATHLETIC EVENTS; ENTERTAINMENT SERVICES IN THE NATURE OF ARRANGING AND CONDUCTING SHOWS FOR CULTURAL PURPOSES, NAMELY, PUBLIC SPEAKING EVENTS AND VISUAL, LITERARY, AND PERFORMING ARTS PRESENTATIONS; PROVIDING FACILITIES FOR RECREATION ACTIVITIES AND PROGRAMS (U.S. CLS. 100, 101 AND 107).

FIRST USE 0-0-1971; IN COMMERCE 0-0-1971.  
MARK SPARACINO, EXAMINING ATTORNEY

**CLASS 41—(Continued).**

SN 86-024,701. UNIVERSITY OF EVANSVILLE, EVANSVILLE, IN. FILED 7-31-2013.



THE MARK CONSISTS OF A MAN STANDING WITH HIS ARMS CROSSED.

FOR EDUCATIONAL SERVICES, NAMELY, CONDUCTING LECTURES, COURSES, WORKSHOPS, SEMINARS, SYMPOSIA, AND CONFERENCES AT THE UNIVERSITY UNDERGRADUATE AND GRADUATE LEVELS; ENTERTAINMENT SERVICES, NAMELY, ORGANIZING AND CONDUCTING AN ARRAY OF COLLEGE ATHLETIC SPORTS COMPETITIONS AND ATHLETIC EVENTS; ENTERTAINMENT SERVICES, NAMELY, PRESENTATION OF LIVE MUSICAL PERFORMANCES (U.S. CLS. 100, 101 AND 107).

FIRST USE 11-12-2011; IN COMMERCE 11-12-2011.  
MARK SPARACINO, EXAMINING ATTORNEY

SN 86-025,687. ORAL ROBERTS UNIVERSITY, TULSA, OK. FILED 8-1-2013.



SN 86-024,579. UNIVERSITY OF EVANSVILLE, EVANSVILLE, IN. FILED 7-31-2013.

**PURPLE ACES**

THE MARK CONSISTS OF STANDARD CHARACTERS WITHOUT CLAIM TO ANY PARTICULAR FONT, STYLE, SIZE, OR COLOR.

FOR ENTERTAINMENT SERVICES, NAMELY, ORGANIZING AND CONDUCTING AN ARRAY OF COLLEGE ATHLETIC SPORTS COMPETITIONS AND ATHLETIC EVENTS; ENTERTAINMENT SERVICES, NAMELY, PRESENTATION OF LIVE MUSICAL PERFORMANCES (U.S. CLS. 100, 101 AND 107).

FIRST USE 0-0-1926; IN COMMERCE 0-0-1926.  
MARK SPARACINO, EXAMINING ATTORNEY

OWNER OF U.S. REG. NOS. 1,262,975 AND 2,103,953.  
NO CLAIM IS MADE TO THE EXCLUSIVE RIGHT TO USE "UNIVERSITY", "COLLABORATIVE" AND "EDUCATION", APART FROM THE MARK AS SHOWN.

THE NAME "ORAL ROBERTS" DOES NOT IDENTIFY A LIVING INDIVIDUAL.

THE COLOR(S) DARK BLUE AND GOLD IS/ARE CLAIMED AS A FEATURE OF THE MARK.

THE MARK CONSISTS OF THE WORD "ORU" WRITTEN IN DARK BLUE ADJACENT TO A VERTICAL LINE WRITTEN IN GOLD WHICH IS ADJACENT TO THE WORDS "ORAL ROBERTS UNIVERSITY" WRITTEN IN GOLD WITH THE WORDS "COLLABORATIVE. ACCESS. EDUCATION" WRITTEN UNDERNEATH IN DARK BLUE.

FOR PROVIDING EDUCATIONAL SERVICES, NAMELY, COLLEGE AND GRADUATE LEVEL COURSES OF INSTRUCTION (U.S. CLS. 100, 101 AND 107).

MICHAEL WIENER, EXAMINING ATTORNEY



**CLASS 41—(Continued).**

SN 86-025,734. ORAL ROBERTS UNIVERSITY, TULSA, OK. FILED 8-1-2013.



OWNER OF U.S. REG. NO. 2,103,953.

NO CLAIM IS MADE TO THE EXCLUSIVE RIGHT TO USE "COLLABORATIVE" AND "EDUCATION", APART FROM THE MARK AS SHOWN.

THE COLOR(S) DARK BLUE AND GOLD IS/ARE CLAIMED AS A FEATURE OF THE MARK.

THE MARK CONSISTS OF THE WORD "ORU" WRITTEN IN DARK BLUE ADJACENT TO A VERTICAL LINE WRITTEN IN GOLD WHICH IS ADJACENT TO THE WORDS "COLLABORATIVE ACCESS EDUCATION" WRITTEN IN GOLD.

FOR PROVIDING EDUCATIONAL SERVICES, NAMELY, COLLEGE AND GRADUATE LEVEL COURSES OF INSTRUCTION (U.S. CLS. 100, 101 AND 107).

MICHAEL WIENER, EXAMINING ATTORNEY

**CLASS 41—(Continued).**

SN 86-026,007. FISCHER, KURT H., DBA THE INTERNATIONAL FOOD & BEVERAGE FORUM, MENDOCINO, CA. FILED 8-1-2013.

### The International Food & Beverage Forum Hall of Fame

THE MARK CONSISTS OF STANDARD CHARACTERS WITHOUT CLAIM TO ANY PARTICULAR FONT, STYLE, SIZE, OR COLOR.

OWNER OF U.S. REG. NO. 2,876,568.

NO CLAIM IS MADE TO THE EXCLUSIVE RIGHT TO USE "HALL OF FAME", APART FROM THE MARK AS SHOWN.

SEC. 2(F).

FOR MUSEUM SERVICES FEATURING CULINARY ARCHIVES OF DOCUMENTS AND OTHER INFORMATION PERTAINING TO THE FOOD AND BEVERAGE INDUSTRY AND TO HONOR THE PEOPLE WHO HAVE BEEN INSTRUMENTAL IN THE DEVELOPMENT OF THE FOOD AND BEVERAGE INDUSTRIES THROUGHOUT THE WORLD (U.S. CLS. 100, 101 AND 107).

FIRST USE 11-9-1998; IN COMMERCE 11-9-1998.

HELENE LIWINSKI, EXAMINING ATTORNEY

SN 86-027,493. VIRGINIA BEACH CINEMA, INC., VIRGINIA BEACH, VA. FILED 8-2-2013.

SN 86-025,787. VERAX FILMS, LLC, BIRMINGHAM, AL. FILED 8-1-2013.

## VERAX FILMS



NO CLAIM IS MADE TO THE EXCLUSIVE RIGHT TO USE "CINEMA", APART FROM THE MARK AS SHOWN.

THE COLOR(S) RED, BLACK AND WHITE IS/ARE CLAIMED AS A FEATURE OF THE MARK.

THE MARK CONSISTS OF THE WORDING "CINEMA CAFE" IN BLACK AND OUTLINED IN WHITE, WITH A DIAMOND-SHAPED CARRIER DESIGN IN THE BACKGROUND IN RED, WHITE AND BLACK.

SEC. 2(F) AS TO "CINEMA CAFE".

FOR MOTION PICTURE THEATERS; MOVIE THEATERS (U.S. CLS. 100, 101 AND 107).

FIRST USE 6-0-1993; IN COMMERCE 6-0-1993.

JAMES A. RAUEN, EXAMINING ATTORNEY

THE MARK CONSISTS OF STANDARD CHARACTERS WITHOUT CLAIM TO ANY PARTICULAR FONT, STYLE, SIZE, OR COLOR.

NO CLAIM IS MADE TO THE EXCLUSIVE RIGHT TO USE "FILMS", APART FROM THE MARK AS SHOWN.

FOR MOTION PICTURE FILM PRODUCTION; PRODUCTION OF TELEVISION PROGRAMS (U.S. CLS. 100, 101 AND 107).

KEVIN MITTLER, EXAMINING ATTORNEY

**CLASS 41—(Continued).**

SN 86-027,504. ADVANCE MAGAZINE PUBLISHERS, INC.,  
NEW YORK, NY. FILED 8-2-2013.

**THE SUNDAY SPILL**

THE MARK CONSISTS OF STANDARD CHARACTERS WITHOUT CLAIM TO ANY PARTICULAR FONT, STYLE, SIZE, OR COLOR.

NO CLAIM IS MADE TO THE EXCLUSIVE RIGHT TO USE "SUNDAY", APART FROM THE MARK AS SHOWN.

FOR PROVIDING AN ONLINE WEEKLY COLUMN FEATURING RECOMMENDATIONS ABOUT COSMETICS, MANICURES AND PEDICURES (U.S. CLS. 100, 101 AND 107).

FIRST USE 2-10-2013; IN COMMERCE 2-10-2013.

JAMES A. RAUEN, EXAMINING ATTORNEY

**CLASS 41—(Continued).**

SN 86-028,084. BARRA DEPORTIVA, S.A. DE C.V., MEXICO CITY, MEXICO, FILED 8-3-2013.



NO CLAIM IS MADE TO THE EXCLUSIVE RIGHT TO USE "FUTBOL", APART FROM THE MARK AS SHOWN.

THE MARK CONSISTS OF THE STYLIZED WORDING "FUTBOL EN SERIO", A STYLIZED SILHOUETTE OF A HUMAN FIGURE KICKING A SOCCER BALL ALL ON A SHIELD. THE SHADED BACKGROUND IS NOT A FEATURE OF THE MARK.

THE ENGLISH TRANSLATION OF "FUTBOL EN SERIO" IN THE MARK IS "SERIOUSLY SOCCER".

FOR ENTERTAINMENT SERVICES IN THE NATURE OF A CONTINUING SPORTS ANALYTICAL PROGRAM BROADCAST OVER THE INTERNET AND AN ONGOING SPORTS ANALYTICAL TELEVISION PROGRAM (U.S. CLS. 100, 101 AND 107).

DAVID BROOKSHIRE, EXAMINING ATTORNEY

SN 86-027,750. BOYD GAMING CORPORATION, LAS VEGAS, NV. FILED 8-2-2013.

**A-May-Zing  
MAY**

NO CLAIM IS MADE TO THE EXCLUSIVE RIGHT TO USE "MAY", APART FROM THE MARK AS SHOWN.

THE MARK CONSISTS OF THE WORDS "A-MAY-ZING MAY" IN STYLIZED FORM.

FOR ENTERTAINMENT IN THE NATURE OF CASINO SERVICES (U.S. CLS. 100, 101 AND 107).

FIRST USE 0-0-2009; IN COMMERCE 0-0-2009.

REGINA DRUMMOND, EXAMINING ATTORNEY

SN 86-029,443. DIGIAIMO, SUSAN, WEST CREEK, NJ. FILED 8-6-2013.

**KidZanity**  
Building Self Confidence, Strength and Character in Kids

THE MARK CONSISTS OF THE LITERAL ELEMENTS "KIDZANITY BUILDING SELF CONFIDENCE, STRENGTH AND CHARACTER IN KIDS" WRITTEN IN STYLIZED FORM WHEREIN WORD THE WORD "KIDZANITY" IS DEPICTED WITH A PERIOD BELOW THE LETTER "K", THE LETTER "I" IS PLACED WITH A STAR IN THE PLACE OF A DOT, AND THE LETTER "Z" IS DEPICTED AS THE IMAGE OF A HUMAN LIKE FIGURE RUNNING. THE WORDING "BUILDING SELF CONFIDENCE, STRENGTH AND CHARACTER IN KIDS" IS WRITTEN UNDERNEATH IT.

FOR PHYSICAL FITNESS TRAINING OF CHILDREN; EDUCATIONAL SERVICES, NAMELY, PROVIDING FITNESS PROGRAMS FOR CHILDREN (U.S. CLS. 100, 101 AND 107).

FIRST USE 2-23-2013; IN COMMERCE 2-23-2013.

INGA ERVIN, EXAMINING ATTORNEY

**CLASS 41—(Continued).**

SN 86-029,869. FARKAS, DAVID ABRAHAM, FULLERTON, CA. FILED 8-6-2013.

# Polo Buddies

THE MARK CONSISTS OF STANDARD CHARACTERS WITHOUT CLAIM TO ANY PARTICULAR FONT, STYLE, SIZE, OR COLOR.

NO CLAIM IS MADE TO THE EXCLUSIVE RIGHT TO USE "POLO", APART FROM THE MARK AS SHOWN.

FOR COACHING IN THE FIELD OF SPORTS (U.S. CLS. 100, 101 AND 107).

FIRST USE 11-1-2012; IN COMMERCE 11-1-2012.  
DOMINIC J. FERRAIUOLO, EXAMINING ATTORNEY

SN 86-030,122. JBM EVENTS, INC., GREENVILLE, SC. FILED 8-6-2013.



NO CLAIM IS MADE TO THE EXCLUSIVE RIGHT TO USE "A MENTORING EXPERIENCE FOR WOMEN", APART FROM THE MARK AS SHOWN.

THE MARK CONSISTS OF THE WORD "COFFEE" AT THE TOP OF THE MARK. UNDERNEATH THERE IS A STYLIZED IMAGE OF A COFFEE CUP AND SAUCER. TO THE LEFT OF THE COFFEE CUP IS THE WORD "TALK". AT THE BOTTOM OF THE MARK ARE THE WORDS "A MENTORING EXPERIENCE FOR WOMEN".

FOR CONDUCTING EDUCATIONAL EXHIBITIONS IN THE NATURE OF WOMEN'S LIFESTYLE (U.S. CLS. 100, 101 AND 107).

FIRST USE 12-1-2011; IN COMMERCE 12-1-2011.  
CHARLES L. JENKINS, EXAMINING ATTORNEY

**CLASS 41—(Continued).**

SN 86-030,201. WAVE GARDEN HAWAII LLC, KANEOHE, HI. FILED 8-6-2013.

# HONOKEA

THE MARK CONSISTS OF STANDARD CHARACTERS WITHOUT CLAIM TO ANY PARTICULAR FONT, STYLE, SIZE, OR COLOR.

THE ENGLISH TRANSLATION OF "HONOKEA" IN THE MARK IS "BAY OF THE WHITE CREST".

FOR AMUSEMENT PARKS; MUSEUMS; PROVIDING EDUCATIONAL SERVICES, NAMELY, PROVIDING CLASSES IN AGRICULTURE, PROVIDING CLASSES IN AQUACULTURE, PROVIDING CLASSES IN ENVIRONMENTAL SUSTAINABILITY, PROVIDING CLASSES IN SURFBOARD DESIGN AND SHAPING; PROVIDING FACILITIES FOR RECREATIONAL ACTIVITIES, NAMELY, SURFBOARD DESIGN AND SHAPING; RENTAL OF SURF BOARDS; PROVIDING PHYSICAL FITNESS AND EXERCISE SERVICES, NAMELY, SURF LESSONS, WATER SAFETY TRAINING, YOGA CLASSES AND PHYSICAL FITNESS INSTRUCTION; PROVIDING FACILITIES FOR RECREATIONAL ACTIVITIES, NAMELY, BEACH VOLLEYBALL TRAINING; PROVIDING FACILITIES FOR RECREATIONAL ACTIVITIES, NAMELY, ROCK CLIMBING; PROVIDING FACILITIES FOR RECREATIONAL ACTIVITIES, NAMELY, FLYING DISC SPORTS; PROVIDING ZIP LINE RIDES FOR RECREATIONAL PURPOSES; PROVIDING FACILITIES FOR RECREATIONAL ACTIVITIES, NAMELY, SLACKLINE TRAINING; PROVIDING ROPES CHALLENGE COURSES; PROVIDING FACILITIES FOR RECREATIONAL ACTIVITIES, NAMELY, SKATEBOARDING; PROVIDING FACILITIES FOR RECREATIONAL ACTIVITIES, NAMELY, TETHERED HOT AIR BALLOONING; PROVIDING FACILITIES FOR RECREATIONAL ACTIVITIES, NAMELY, TRAINING RUNNERS; AND PROVIDING FITNESS AND EXERCISE FACILITIES (U.S. CLS. 100, 101 AND 107).

STEVEN JACKSON, EXAMINING ATTORNEY

SN 86-030,950. RICHLAND LIBRARY, GREENVILLE, SC. FILED 8-7-2013.



NO CLAIM IS MADE TO THE EXCLUSIVE RIGHT TO USE "RICHLAND LIBRARY", APART FROM THE MARK AS SHOWN.

THE MARK CONSISTS OF A PARALLELOGRAM WITH ROUNDED CORNERS HAVING A SCALENE TRIANGLE DEPENDING FROM THE LOWER LEFT CORNER OF THE PARALLELOGRAM, THE SCALENE TRIANGLE EXTENDING FROM THE LOWER LEFT CORNER OF THE PARALLELOGRAM TOWARD THE SOUTHEAST DIRECTION FORMING AN ACUTE ANGLE WITH THE BOTTOM OF THE PARALLELOGRAM, THE SCALENE TRIANGLE HAV-

**CLASS 41—(Continued).**

ING TWO ANGULAR CORNERS AT ITS BASE FACING THE BOTTOM OF THE PARALLELOGRAM AND THIRD, ROUNDED CORNER AT ITS APEX, THE ROUNDED CORNER LOCATED APPROXIMATELY MIDWAY ALONG THE BOTTOM OF THE PARALLELOGRAM AND POINT AWAY FROM THE PARALLELOGRAM, THE WORDS "RICHLAND LIBRARY" APPEARING TO THE RIGHT OF THE PARALLELOGRAM WITH THE WORD "FRIENDS" APPEARING TO THE RIGHT OF THE PARALLELOGRAM BELOW THE WORDS "RICHLAND LIBRARY".

FOR LIBRARY SERVICES; PROVIDING INFORMATION IN THE FIELD OF LITERACY (U.S. CLS. 100, 101 AND 107).

FIRST USE 11-7-2012; IN COMMERCE 12-3-2012.  
MORGAN WYNNE, EXAMINING ATTORNEY

SN 86-030,961. RICHLAND LIBRARY, COLUMBIA, SC. FILED 8-7-2013.



NO CLAIM IS MADE TO THE EXCLUSIVE RIGHT TO USE "RICHLAND LIBRARY FOUNDATION", APART FROM THE MARK AS SHOWN.

THE MARK CONSISTS OF A PARALLELOGRAM WITH ROUNDED CORNERS HAVING A SCALENE TRIANGLE DEPENDING FROM THE LOWER LEFT CORNER OF THE PARALLELOGRAM, THE SCALENE TRIANGLE EXTENDING FROM THE LOWER LEFT CORNER OF THE PARALLELOGRAM TOWARD THE SOUTHEAST DIRECTION FORMING AN ACUTE ANGLE WITH THE BOTTOM OF THE PARALLELOGRAM, THE SCALENE TRIANGLE HAVING TWO ANGULAR CORNERS AT ITS BASE FACING THE BOTTOM OF THE PARALLELOGRAM AND THIRD, ROUNDED CORNER AT ITS APEX, THE ROUNDED CORNER LOCATED APPROXIMATELY MIDWAY ALONG THE BOTTOM OF THE PARALLELOGRAM AND POINT AWAY FROM THE PARALLELOGRAM, THE WORDS "RICHLAND LIBRARY" APPEARING TO THE RIGHT OF THE PARALLELOGRAM WITH THE WORD "FOUNDATION" APPEARING TO THE RIGHT OF THE PARALLELOGRAM BELOW THE WORDS "RICHLAND LIBRARY".

FOR LIBRARY SERVICES; PROVIDING INFORMATION IN THE FIELD OF LITERACY (U.S. CLS. 100, 101 AND 107).

FIRST USE 11-7-2012; IN COMMERCE 12-3-2012.  
MORGAN WYNNE, EXAMINING ATTORNEY

SN 86-030,973. RICHLAND LIBRARY, COLUMBIA, SC. FILED 8-7-2013.



NO CLAIM IS MADE TO THE EXCLUSIVE RIGHT TO USE "RICHLAND LIBRARY", APART FROM THE MARK AS SHOWN.

THE MARK CONSISTS OF A PARALLELOGRAM WITH ROUNDED CORNERS HAVING A SCALENE TRIANGLE DEPENDING FROM THE LOWER LEFT CORNER OF THE PARALLELOGRAM, THE SCALENE TRIANGLE EXTENDING FROM THE LOWER LEFT CORNER OF THE PARALLELOGRAM TOWARD THE SOUTHEAST DIRECTION FORMING AN ACUTE ANGLE WITH THE BOTTOM OF THE PARALLELOGRAM, THE SCALENE TRIANGLE HAV-

**CLASS 41—(Continued).**

ING TWO ANGULAR CORNERS AT ITS BASE FACING THE BOTTOM OF THE PARALLELOGRAM AND THIRD, ROUNDED CORNER AT ITS APEX, THE ROUNDED CORNER LOCATED APPROXIMATELY MIDWAY ALONG THE BOTTOM OF THE PARALLELOGRAM AND POINT AWAY FROM THE PARALLELOGRAM, THE WORD "RICHLAND" APPEARING TO THE RIGHT OF THE PARALLELOGRAM WITH THE WORD "LIBRARY" APPEARING TO THE RIGHT OF THE PARALLELOGRAM BELOW THE WORD "RICHLAND".

FOR LIBRARY SERVICES; PROVIDING INFORMATION IN THE FIELD OF LITERACY (U.S. CLS. 100, 101 AND 107).

FIRST USE 11-7-2012; IN COMMERCE 12-3-2012.  
MORGAN WYNNE, EXAMINING ATTORNEY

SN 86-031,491. ADVANCE MAGAZINE PUBLISHERS INC., NEW YORK, NY. FILED 8-7-2013.



THE COLOR(S) BLUE, BROWN, GRAY, BLACK AND WHITE IS/ARE CLAIMED AS A FEATURE OF THE MARK.

THE MARK CONSISTS OF THE STYLIZED WORDING "WHAT'S INSIDE" APPEARING IN WHITE INSIDE A BLACK RECTANGLE, BELOW A DESIGN OF A BLUE BRAIN RESTING ON A CIRCULAR BROWN PLATFORM, WITH A BROWN DOTTED LINE ENCIRCLING THE BRAIN DESIGN. THE WORDING AND BRAIN DESIGN APPEAR AGAINST A GRAY BACKGROUND. THE RECTANGULAR SHAPE OF THE GRAY BACKGROUND IS NOT CLAIMED AS A FEATURE OF THE MARK.

FOR ENTERTAINMENT SERVICES, NAMELY, AN ONGOING VIDEO SERIES FEATURING SCIENCE, INNOVATION AND TECHNOLOGY DELIVERED BY INTERNET AND DIGITAL NETWORKS (U.S. CLS. 100, 101 AND 107).

FIRST USE 6-28-2013; IN COMMERCE 6-28-2013.  
JERI J. FICKES, EXAMINING ATTORNEY

SN 86-032,445. GANNETT SATELLITE INFORMATION NETWORK, INC., MCLEAN, VA. FILED 8-8-2013.

# LEAD2FEED

THE MARK CONSISTS OF STANDARD CHARACTERS WITHOUT CLAIM TO ANY PARTICULAR FONT, STYLE, SIZE, OR COLOR.

FOR CONDUCTING EDUCATIONAL PROGRAMS REGARDING LEADERSHIP AND ANTI-HUNGER INITIATIVES (U.S. CLS. 100, 101 AND 107).

FIRST USE 8-0-2012; IN COMMERCE 8-0-2012.  
COLLEEN KEARNEY, EXAMINING ATTORNEY

**CLASS 41—(Continued).**

SN 86-032,512. JULIE BUCHMAN, BROOKLYN, NY. FILED 8-8-2013.

JURISTUDENTS INTERNATIONAL

THE MARK CONSISTS OF STANDARD CHARACTERS WITHOUT CLAIM TO ANY PARTICULAR FONT, STYLE, SIZE, OR COLOR.

NO CLAIM IS MADE TO THE EXCLUSIVE RIGHT TO USE "INTERNATIONAL", APART FROM THE MARK AS SHOWN.

FOR EDUCATIONAL SERVICES, NAMELY, PROVIDING ONLINE AND LIVE COURSES OF INSTRUCTION IN THE FIELD OF U.S. LAW AND JURISPRUDENCE (U.S. CLS. 100, 101 AND 107).

LINDA M. KING, EXAMINING ATTORNEY

**CLASS 41—(Continued).**

SN 86-033,423. 22CANS LIMITED, LONDON, UNITED KINGDOM, FILED 8-9-2013.

GODUS

THE MARK CONSISTS OF STANDARD CHARACTERS WITHOUT CLAIM TO ANY PARTICULAR FONT, STYLE, SIZE, OR COLOR.

PRIORITY CLAIMED UNDER SEC. 44(D) ON ERPNTY TM OFC APPLICATION NO. 011945227, FILED 7-1-2013, REG. NO. 011945227, DATED 11-26-2013, EXPIRES 7-1-2023.

FOR PROVIDING ON-LINE COMPUTER GAMES; PROVIDING A WEBSITE FOR ORGANIZING, PLANNING AND CONDUCTING EXHIBITIONS FOR ENTERTAINMENT PURPOSES AND SPECIAL EVENTS FOR SOCIAL ENTERTAINMENT PURPOSES BETWEEN COMPUTER GAME PLAYERS AND INTEREST GROUPS FOR ENTERTAINMENT PURPOSES; PROVIDING A WEBSITE FEATURING ENTERTAINMENT INFORMATION IN THE FIELDS OF ELECTRONIC GAME PROGRAMS, ELECTRONIC GAME PRODUCTS, AND ELECTRONIC GAME PRODUCTS AND PROGRAMS; ENTERTAINMENT SERVICES, NAMELY, PROVIDING ONLINE NON-DOWNLOADABLE INTERACTIVE, COMPUTER, VIDEO AND ELECTRONIC GAMES PROVIDED VIA NETWORK BETWEEN COMMUNICATIONS NETWORKS AND COMPUTERS OR MOBILE COMMUNICATION DEVICES; ENTERTAINMENT SERVICES IN THE NATURE OF CREATION, DEVELOPMENT, AND PRODUCTION OF VIDEO OR FILM, COMPUTER GAMES SOFTWARE, ANIMATION PRODUCTION OR ANIMATED FILM OR ON-LINE COMPUTER GAMES AND TELEVISION PROGRAMS; DIGITAL VIDEO, AUDIO, AND MULTIMEDIA PUBLISHING SERVICES, ELECTRONIC PUBLISHING SERVICES, NAMELY, PUBLICATION OF TEXT AND GRAPHIC WORKS OF OTHERS ON CD, DVD AND ONLINE FEATURING VIDEO GAMES; ENTERTAINMENT SERVICES, NAMELY, CONDUCTING CONTESTS; MULTIMEDIA ENTERTAINMENT SERVICES IN THE NATURE OF DEVELOPMENT, PRODUCTIONS AND POST-PRODUCTION SERVICES IN THE FIELD OF VIDEO AND FILM; MEDIA PRODUCTION SERVICES, NAMELY, VIDEO AND FILM PRODUCTION (U.S. CLS. 100, 101 AND 107).

SAMUEL E. SHARPER JR., EXAMINING ATTORNEY

SN 86-032,906. FIRE AND ICE FITNESS LLC, NEW YORK, NY. FILED 8-8-2013.

FIRE & ICE FITNESS

THE MARK CONSISTS OF STANDARD CHARACTERS WITHOUT CLAIM TO ANY PARTICULAR FONT, STYLE, SIZE, OR COLOR.

NO CLAIM IS MADE TO THE EXCLUSIVE RIGHT TO USE "FITNESS", APART FROM THE MARK AS SHOWN.

FOR PHYSICAL FITNESS CONSULTATION (U.S. CLS. 100, 101 AND 107).

FIRST USE 6-30-2011; IN COMMERCE 6-30-2011.  
KAPIL BHANOT, EXAMINING ATTORNEY

**CLASS 41—(Continued).**

SN 86-034,365. ANDERSON, GEORGE W, DBA SCOURGE RECORDS, OAKLAND, CA. FILED 8-9-2013.



THE MARK CONSISTS OF THE WORDS "FROM HELL" WITH A PENTAGRAM FOR THE "O" IN "FROM" AND STAIR STEP DOWN ELEMENT OF THE "L"'S IN "HELL".

FOR ENTERTAINMENT SERVICES IN THE NATURE OF LIVE VISUAL AND AUDIO PERFORMANCES, NAMELY, MUSICAL BAND, ROCK GROUP, GYMNASIAC, DANCE, AND BALLET PERFORMANCES (U.S. CLS. 100, 101 AND 107).

FIRST USE 3-26-2010; IN COMMERCE 3-26-2010.  
GISELLE AGOSTO, EXAMINING ATTORNEY

SN 86-034,432. PACIFIC ELECTRONIC MUSIC LLC, BEVERLY HILLS, CA. FILED 8-10-2013.

**PACIFIC ELECTRONIC MUSIC**

THE MARK CONSISTS OF STANDARD CHARACTERS WITHOUT CLAIM TO ANY PARTICULAR FONT, STYLE, SIZE, OR COLOR.

NO CLAIM IS MADE TO THE EXCLUSIVE RIGHT TO USE "ELECTRONIC MUSIC", APART FROM THE MARK AS SHOWN.

FOR ENTERTAINMENT SERVICES IN THE NATURE OF RECORDING, PRODUCTION AND POST-PRODUCTION SERVICES IN THE FIELD OF MUSIC; PRODUCTION OF LIVE ENTERTAINMENT EVENTS, NAMELY, LIVE MUSICAL CONCERTS AND FESTIVALS (U.S. CLS. 100, 101 AND 107).

SUSAN RICHARDS, EXAMINING ATTORNEY

**CLASS 41—(Continued).**

SN 86-034,578. LENDIT CONFERENCE LLC, DENVER, CO. FILED 8-11-2013.

# LENDIT

THE MARK CONSISTS OF STANDARD CHARACTERS WITHOUT CLAIM TO ANY PARTICULAR FONT, STYLE, SIZE, OR COLOR.

FOR ARRANGING AND CONDUCTING EDUCATIONAL CONFERENCES; EDUCATION SERVICES, NAMELY, PROVIDING SEMINARS, CONFERENCES, AND NETWORKING EVENTS IN THE FIELD OF ONLINE LENDING (U.S. CLS. 100, 101 AND 107).

FIRST USE 4-5-2013; IN COMMERCE 4-5-2013.  
STEVEN JACKSON, EXAMINING ATTORNEY

SN 86-035,000. ALLISON J. BURKE, MELROSE, MA. FILED 8-12-2013.

**ON THE SPOT YOGA**

THE MARK CONSISTS OF STANDARD CHARACTERS WITHOUT CLAIM TO ANY PARTICULAR FONT, STYLE, SIZE, OR COLOR.

NO CLAIM IS MADE TO THE EXCLUSIVE RIGHT TO USE "YOGA", APART FROM THE MARK AS SHOWN.

FOR YOGA INSTRUCTION (U.S. CLS. 100, 101 AND 107).

FONG HSU, EXAMINING ATTORNEY

SN 86-035,856. VINYL TEMPEST LLC, ASPEN, CO. FILED 8-12-2013.

**VINYL TEMPEST**

THE MARK CONSISTS OF STANDARD CHARACTERS WITHOUT CLAIM TO ANY PARTICULAR FONT, STYLE, SIZE, OR COLOR.

NO CLAIM IS MADE TO THE EXCLUSIVE RIGHT TO USE "VINYL", APART FROM THE MARK AS SHOWN.

FOR ON-LINE JOURNAL, NAMELY, A BLOG, FEATURING MUSICAL PLAYLISTS AND OTHER MUSIC AND SONG SETS AND COMBINATIONS; PROVIDING A WEBSITE FEATURING BLOGS IN THE NATURE OF SUGGESTIONS FOR MUSICAL SETS AND MUSICAL PLAYLISTS; PROVIDING A WEBSITE FEATURING BLOGS WHERE USERS CAN OBTAIN SUGGESTIONS REGARDING MUSICAL PLAYLISTS AND COMPOSITIONS AND ALSO OFFER SUGGESTIONS AS TO MUSICAL PLAYLISTS AND COMPOSITIONS AND REMINISCE ABOUT PERSONAL MUSICAL EXPERIENCES AND MEMORIES OF MUSIC (U.S. CLS. 100, 101 AND 107).

DOUGLAS LEE, EXAMINING ATTORNEY

**CLASS 41—(Continued).**

SN 86-035,912. CROWN JEWEL GIRLS, LLC, CHICAGO, IL. FILED 8-12-2013.

**CROWN JEWEL GIRLS**

THE MARK CONSISTS OF STANDARD CHARACTERS WITHOUT CLAIM TO ANY PARTICULAR FONT, STYLE, SIZE, OR COLOR.

FOR ENTERTAINMENT SERVICES, NAMELY, AN ONGOING MULTIMEDIA PROGRAM SERIES FEATURING SUPERHEROES TRANSMITTED THROUGH VARIOUS PLATFORMS ACROSS MULTIPLE FORMS OF ONLINE MEDIA (U.S. CLS. 100, 101 AND 107).

BRENDAN REGAN, EXAMINING ATTORNEY

**CLASS 41—(Continued).**

SN 86-036,440. SUSAN P. BYRNES HEALTH EDUCATION CENTER, INC., YORK, PA. FILED 8-13-2013.



NO CLAIM IS MADE TO THE EXCLUSIVE RIGHT TO USE "HEALTH EDUCATION CENTER", APART FROM THE MARK AS SHOWN.

THE MARK CONSISTS OF A STYLIZED HEART HAVING CONCENTRIC BANDS EXTENDING ACROSS THE HEART ONE ABOVE THE OTHER, THE WORD "BYRNES" ADJACENT TO THE UPPER RIGHT OF THE HEART AND ABOVE THE WORDS "HEALTH EDUCATION CENTER" WHICH ARE ADJACENT TO THE LOWER RIGHT OF THE HEART.

FOR EDUCATIONAL SERVICES, NAMELY, CONDUCTING CLASSES, SEMINARS, CONFERENCES, WORKSHOPS AND FIELD TRIPS IN THE FIELD OF HEALTH (U.S. CLS. 100, 101 AND 107).

FIRST USE 4-2-2013; IN COMMERCE 4-2-2013.  
KATINA MISTER, EXAMINING ATTORNEY

SN 86-035,964. PRICE, KELLY, MARINA DEL REY, CA. FILED 8-13-2013.

**NOT YOUR MAMA MONOLOGUES**

THE MARK CONSISTS OF STANDARD CHARACTERS WITHOUT CLAIM TO ANY PARTICULAR FONT, STYLE, SIZE, OR COLOR.

NO CLAIM IS MADE TO THE EXCLUSIVE RIGHT TO USE "MONOLOGUES", APART FROM THE MARK AS SHOWN.

FOR ENTERTAINMENT IN THE NATURE OF THEATER PRODUCTIONS; ENTERTAINMENT SERVICES IN THE NATURE OF LIVE DANCE AND MUSICAL PERFORMANCES; ENTERTAINMENT, NAMELY, LIVE PERFORMANCES BY A MUSICAL BAND; LIVE PERFORMANCES BY A MUSICAL GROUP; PRESENTATION OF MUSICAL PERFORMANCE; THEATRICAL AND MUSICAL FLOOR SHOWS PROVIDED AT PERFORMANCE VENUES (U.S. CLS. 100, 101 AND 107).

JESSICA A. POWERS, EXAMINING ATTORNEY

SN 86-036,477. SUSAN P. BYRNES HEALTH EDUCATION CENTER, INC., YORK, PA. FILED 8-13-2013.



NO CLAIM IS MADE TO THE EXCLUSIVE RIGHT TO USE "HEALTH EDUCATION CENTER", APART FROM THE MARK AS SHOWN.

THE MARK CONSISTS OF A STYLIZED HEART HAVING CONCENTRIC BANDS EXTENDING ACROSS THE HEART ONE ABOVE THE OTHER, THE WORD "BYRNES" BE- NEATH THE HEART AND ABOVE THE WORDS "HEALTH EDUCATION CENTER".

FOR EDUCATIONAL SERVICES, NAMELY, CONDUCTING CLASSES, SEMINARS, CONFERENCES, WORKSHOPS AND FIELD TRIPS IN THE FIELD OF HEALTH (U.S. CLS. 100, 101 AND 107).

FIRST USE 4-2-2013; IN COMMERCE 4-2-2013.  
KATINA MISTER, EXAMINING ATTORNEY

**CLASS 41—(Continued).**

SN 86-036,569. BEYOND MEASURE TRAINING, LLC, NAPERVILLE, IL. FILED 8-13-2013.



**BEYOND MEASURE TRAINING**

NO CLAIM IS MADE TO THE EXCLUSIVE RIGHT TO USE "TRAINING", APART FROM THE MARK AS SHOWN.

THE MARK CONSISTS OF A GEOMETRIC SYMBOL FORMED BY THE LETTERS "B" AND "M" ABOVE THE TERM "BEYOND MEASURE TRAINING".

FOR PERSONAL FITNESS TRAINING SERVICES AND CONSULTANCY; PHYSICAL FITNESS CONDITIONING CLASSES; PHYSICAL FITNESS CONSULTATION; PHYSICAL FITNESS INSTRUCTION; PROVIDING FACILITIES FOR SPORTS TRAINING; PROVIDING FITNESS AND EXERCISE FACILITIES; SPORTS TRAINING SERVICES (U.S. CLS. 100, 101 AND 107).

MARTHA FROMM, EXAMINING ATTORNEY

**CLASS 41—(Continued).**

SN 86-037,114. OMM TRAINING, LLC, PELHAM MANOR, NY. FILED 8-14-2013.

## Time for a Moment

THE MARK CONSISTS OF STANDARD CHARACTERS WITHOUT CLAIM TO ANY PARTICULAR FONT, STYLE, SIZE, OR COLOR.

FOR EDUCATIONAL SERVICES, NAMELY, CONDUCTING ONLINE, TELEPHONIC, AND ON GROUND TRAINING COURSES IN THE FIELD OF MEDITATION AND MINDFULNESS FOR STRESS RELIEF, DECISION-MAKING, LEADERSHIP, AND RESILIENCE, AND THE DISTRIBUTION OF COURSE MATERIALS, NAMELY, VIDEO LESSONS, AUDIO LESSONS, AND PDF TRANSCRIPTS, IN CONNECTION THEREWITH (U.S. CLS. 100, 101 AND 107).

FIRST USE 6-26-2013; IN COMMERCE 6-26-2013.

NICHOLAS COLEMAN, EXAMINING ATTORNEY

SN 86-037,566. RIVER VALLEY LEADER, INC., RUSSELLVILLE, AR. FILED 8-14-2013.

SN 86-037,064. KRAYZELBURG, LENNY, LOS ANGELES, CA. FILED 8-13-2013.

**SwimRIGHT**  
LEARN-TO-SWIM METHOD

## RIVER VALLEY LEADER

NO CLAIM IS MADE TO THE EXCLUSIVE RIGHT TO USE "LEARN-TO-SWIM METHOD", APART FROM THE MARK AS SHOWN.

THE MARK CONSISTS OF THE WORD "SWIMRIGHT" THE WORD "SWIM" IN "SWIMRIGHT" IS BOLDED BELOW WHICH IS THE WORDING "LEARN-TO-SWIM METHOD".

FOR SWIMMING INSTRUCTION; SWIM CAMPS (U.S. CLS. 100, 101 AND 107).

FIRST USE 8-15-2009; IN COMMERCE 8-15-2009.

CHRISTINA SOBRAL, EXAMINING ATTORNEY

THE MARK CONSISTS OF STANDARD CHARACTERS WITHOUT CLAIM TO ANY PARTICULAR FONT, STYLE, SIZE, OR COLOR.

NO CLAIM IS MADE TO THE EXCLUSIVE RIGHT TO USE "RIVER VALLEY", APART FROM THE MARK AS SHOWN.

FOR PUBLICATION OF ELECTRONIC NEWSPAPERS ACCESSIBLE VIA A GLOBAL COMPUTER NETWORK (U.S. CLS. 100, 101 AND 107).

FIRST USE 3-2-2011; IN COMMERCE 4-30-2011.

TASHIA BUNCH, EXAMINING ATTORNEY



**CLASS 41—(Continued).**

SN 86-037,582. RIVER VALLEY LEADER, INC., RUSSELLVILLE, AR. FILED 8-14-2013.



THE COLOR(S) BLACK, WHITE AND RED IS/ARE CLAIMED AS A FEATURE OF THE MARK.

THE MARK CONSISTS OF A CIRCLE CONTAINING RED IN THE UPPER RIGHT QUADRANT AND BLACK IN THE LOWER LEFT QUADRANT, WITH THE TWO QUADRANTS SEPARATED BY A WHITE CHECK/L SHAPE.

FOR PUBLICATION OF ELECTRONIC NEWSPAPERS ACCESSIBLE VIA A GLOBAL COMPUTER NETWORK (U.S. CLS. 100, 101 AND 107).

FIRST USE 4-30-2011; IN COMMERCE 4-30-2011.  
TASHIA BUNCH, EXAMINING ATTORNEY

**CLASS 41—(Continued).**

SN 86-038,639. FROWLEY, EDWARD, BROOKLINE, CT. FILED 8-15-2013.



THE COLOR(S) RED AND WHITE IS/ARE CLAIMED AS A FEATURE OF THE MARK.

THE MARK CONSISTS OF A RED CIRCLE WITH THE IMAGE TWO OF WHITE SEMI CIRCLES CONNECTING TO BE REPRESENTATIVE OF THE BODY OF A PERSON. INSIDE THE CIRCLE ABOVE THE SEMI CIRCLES IS A WHITE DOT TO BE REPRESENTATIVE OF A PERSON'S HEAD.

FOR PROVIDING INFORMATION IN THE FIELD OF CHILDREN'S EDUCATION; PROVIDING INFORMATION RELATING TO EDUCATION SERVICES FOR CHILDREN (U.S. CLS. 100, 101 AND 107).

FIRST USE 5-1-2013; IN COMMERCE 5-1-2013.  
AMY ALFIERI, EXAMINING ATTORNEY

SN 86-037,897. LEGACY MEDIA GROUP, LLC, IMPERIAL, MO. FILED 8-14-2013.



NO CLAIM IS MADE TO THE EXCLUSIVE RIGHT TO USE "VARSITY SPORTS", APART FROM THE MARK AS SHOWN.

THE MARK CONSISTS OF THE WORDING "GATEWAY VARSITY SPORTS" IN STYLIZED FONT WITH A STYLIZED GLIMMERING STAR ON THE BOTTOM OF THE FIRST "S" IN THE WORDING "SPORTS".

FOR PUBLICATION OF MAGAZINES (U.S. CLS. 100, 101 AND 107).  
FIRST USE 6-24-2013; IN COMMERCE 7-10-2013.  
SUZANNE BLANE, EXAMINING ATTORNEY

SN 86-038,656. NORTHWEST EVENT TECHNOLOGY LLC, BOTHELL, WA. FILED 8-15-2013.

Northwest Event  
Technology, LLC

THE MARK CONSISTS OF STANDARD CHARACTERS WITHOUT CLAIM TO ANY PARTICULAR FONT, STYLE, SIZE, OR COLOR.

NO CLAIM IS MADE TO THE EXCLUSIVE RIGHT TO USE "EVENT TECHNOLOGY, LLC", APART FROM THE MARK AS SHOWN.

FOR ARRANGING AND CONDUCTING SPECIAL EVENTS FOR SOCIAL ENTERTAINMENT PURPOSES; ENTERTAINMENT SERVICES IN THE NATURE OF DEVELOPMENT, CREATION, PRODUCTION AND POST-PRODUCTION SERVICES OF MULTIMEDIA ENTERTAINMENT CONTENT; RENTAL OF AUDIOVISUAL EQUIPMENT (U.S. CLS. 100, 101 AND 107).

FIRST USE 1-1-2011; IN COMMERCE 1-1-2011.  
LINDA ORNDORFF, EXAMINING ATTORNEY

**CLASS 41—(Continued).**

SN 86-039,506. LAWRENCE MEREDITH, AKA IMAGE 1 STUDIOS, LLC, TAZEWEEL, TN. FILED 8-15-2013.

**Agent Driven Learning**

THE MARK CONSISTS OF STANDARD CHARACTERS WITHOUT CLAIM TO ANY PARTICULAR FONT, STYLE, SIZE, OR COLOR.

NO CLAIM IS MADE TO THE EXCLUSIVE RIGHT TO USE "LEARNING", APART FROM THE MARK AS SHOWN. FOR EDUCATION SERVICES, NAMELY, PROVIDING CLASSES IN THE FIELDS OF PHOTOGRAPHY AND DIGITAL IMAGING (U.S. CLS. 100, 101 AND 107). FIRST USE 5-20-2013; IN COMMERCE 8-12-2013. PATRICIA EVANKO, EXAMINING ATTORNEY

SN 86-039,860. HARLOFF, KRISTIAN, LOS ANGELES, CA. AND ELLIS, MARK, LOS ANGELES, CA. FILED 8-16-2013.

**SCHMOES KNOW**

THE MARK CONSISTS OF STANDARD CHARACTERS WITHOUT CLAIM TO ANY PARTICULAR FONT, STYLE, SIZE, OR COLOR.

FOR ENTERTAINMENT MEDIA PRODUCTION SERVICES FOR MOTION PICTURES, TELEVISION AND INTERNET; ENTERTAINMENT SERVICES IN THE NATURE OF DEVELOPMENT, CREATION, PRODUCTION AND POST-PRODUCTION SERVICES OF MULTIMEDIA ENTERTAINMENT CONTENT; ENTERTAINMENT SERVICES, NAMELY, PROVIDING PODCASTS IN THE FIELD OF MOVIE/TV/ENTERTAINMENT NEWS (U.S. CLS. 100, 101 AND 107).

FIRST USE 10-19-2008; IN COMMERCE 10-19-2008. ANDREA BUTLER, EXAMINING ATTORNEY

SN 86-039,884. START CODE, LLC, DECATUR, GA. FILED 8-16-2013.

**START CODE**

THE MARK CONSISTS OF STANDARD CHARACTERS WITHOUT CLAIM TO ANY PARTICULAR FONT, STYLE, SIZE, OR COLOR.

FOR COMPUTER EDUCATION TRAINING SERVICES (U.S. CLS. 100, 101 AND 107). FIRST USE 1-1-2012; IN COMMERCE 4-1-2012. RONALD DELGIZZI, EXAMINING ATTORNEY

**CLASS 41—(Continued).**

SN 86-040,328. OXBRIDGE ACADEMY FOUNDATION, INC., WEST PALM BEACH, FL. FILED 8-16-2013.

**OXBRIDGE ACADEMY**

THE MARK CONSISTS OF STANDARD CHARACTERS WITHOUT CLAIM TO ANY PARTICULAR FONT, STYLE, SIZE, OR COLOR.

OWNER OF U.S. REG. NO. 4,379,577. NO CLAIM IS MADE TO THE EXCLUSIVE RIGHT TO USE "ACADEMY", APART FROM THE MARK AS SHOWN. FOR EDUCATIONAL SERVICES, NAMELY, A PRIVATE, INDEPENDENT SECONDARY SCHOOL FOR CHILDREN ENROLLED IN GRADES 9 THROUGH 12 (U.S. CLS. 100, 101 AND 107).

FIRST USE 9-7-2011; IN COMMERCE 9-7-2011. THEODORE MCBRIDE, EXAMINING ATTORNEY

SN 86-040,354. RENAISSANCE SERVICES, INC, COLORADO SPRINGS, CO. FILED 8-16-2013.



NO CLAIM IS MADE TO THE EXCLUSIVE RIGHT TO USE "EQUINE GUIDED LEARNING", APART FROM THE MARK AS SHOWN.

THE MARK CONSISTS OF A DESIGN OF A DIAMOND STANDING ON ONE TIP WITH FOUR SWIRLS INSIDE THE DIAMOND - THE MID PARTS OF THESE SWIRLS CROSS THE TIPS OF THE DIAMOND. THE BOTTOM PART OF THE DIAMOND IS SHADED DARKER THAN THE TOP PART OF THE DIAMOND. INSIDE THE SWIRLS IS A SILHOUETTE OF A HORSE HEAD LOOKING TOWARD THE RIGHT TIP OF THE DIAMOND. THE SILHOUETTE COULD BE OF A HORSE LOOKING EITHER TOWARD OR AWAY FROM VIEWER. TO THE RIGHT OF THE DIAMOND IS THE STYLIZED TEXT "EQUINE GUIDED LEARNING LET HORSES HELP".

FOR EDUCATION, TRAINING AND COACHING FOR ADULTS, NAMELY, WORKSHOPS, SEMINARS, RETREATS USING HORSES, FOR INDIVIDUALS, GROUPS, AND BUSINESSES ON THE TOPICS OF LEADERSHIP, SELF-AWARENESS, SELF-MANAGEMENT, CUSTOMER SERVICE, COMMUNICATION, GOAL ACHIEVEMENT, PROBLEM SOLVING, DECISION MAKING, AND TEAM BUILDING (U.S. CLS. 100, 101 AND 107).

FIRST USE 11-16-2005; IN COMMERCE 11-16-2005. JENNY PARK, EXAMINING ATTORNEY

**CLASS 41—(Continued).**

SN 86-040,585. FUNDACION TELETON MEXICO, A.C., TLALNEPANTLA DE BAZ, MEXICO, FILED 8-16-2013.



OWNER OF U.S. REG. NOS. 2,972,929, 4,197,670 AND OTHERS.

THE COLOR(S) WHITE, YELLOW AND PURPLE IS/ARE CLAIMED AS A FEATURE OF THE MARK.

THE MARK CONSISTS OF A YELLOW AND PURPLE HEART WITH WHITE HANDS AND A DIAGONAL WHITE BAND SUPERIMPOSED OVER THE HEART.

FOR EDUCATION SERVICES, NAMELY, PROVIDING CONDUCTING ON-LINE EXHIBITIONS AND DISPLAYS AND INTERACTIVE EXHIBITS IN THE FIELD OF FUNDRAISING FOR CHILDREN; EDUCATIONAL SERVICES, NAMELY, CONDUCTING PROGRAMS IN THE FIELD OF TELEVISION AND LIVE FUNDRAISING FOR CHILDREN; ENTERTAINMENT IN THE NATURE OF ONGOING TELEVISION PROGRAMS IN THE FIELD OF FUNDRAISERS FOR CHILDREN; ENTERTAINMENT, NAMELY, A CONTINUING FUNDRAISER FOR CHILDREN SHOW BROADCAST OVER TELEVISION, SATELITE, AUDIO, AND VIDEO MEDIA; ENTERTAINMENT, NAMELY, PRODUCTION OF TELEVISION FUNDRAISERS FOR CHILDREN (U.S. CLS. 100, 101 AND 107).

KAREN K. BUSH, EXAMINING ATTORNEY

SN 86-040,611. DJR HOLDINGS, LLC, NEW YORK, NY, FILED 8-16-2013.

**ALL DEF DIGITAL**

THE MARK CONSISTS OF STANDARD CHARACTERS WITHOUT CLAIM TO ANY PARTICULAR FONT, STYLE, SIZE, OR COLOR.

NO CLAIM IS MADE TO THE EXCLUSIVE RIGHT TO USE "DIGITAL", APART FROM THE MARK AS SHOWN.

FOR ENTERTAINMENT SERVICES, NAMELY, MULTIMEDIA PROGRAMS FEATURING COMEDY, MUSIC AND ANIMATION DISTRIBUTED VIA VARIOUS PLATFORMS ACROSS MULTIPLE FORMS OF TRANSMISSION MEDIA; PROVIDING A WEBSITE FEATURING NON-DOWNLOADABLE VIDEOS, NAMELY, VIDEO PRESENTATIONS OF A COMEDIC NATURE; PROVIDING A WEBSITE FOR ENTERTAINMENT PURPOSES FEATURING VIDEOS ABOUT COMEDY, MUSIC AND ANIMATION; PROVIDING A WEBSITE FEATURING NON-DOWNLOADABLE VIDEOS IN THE FIELD OF COMEDY, MUSIC AND ANIMATION; PRODUCTION OF HUMOROUS VIDEOS FOR THE INTERNET; PRODUCTION OF MUSICAL VIDEOS; ENTERTAINMENT SERVICES, NAMELY, PROVIDING ONGOING WEBSITES FEATURING COMEDY, MUSIC AND ANIMA-

**CLASS 41—(Continued).**

TION VIA A GLOBALCOMPUTER NETWORK; ENTERTAINMENT IN THE NATURE OF ONGOING ONLINE PROGRAMS IN THE FIELD OF COMEDY, MUSIC AND ANIMATION; ENTERTAINMENT SERVICES, NAMELY, PRODUCTION AND DISTRIBUTION OF ONGOING ON-LINE PROGRAMS IN THE FIELD OF COMEDY, MUSIC AND ANIMATION; ENTERTAINMENT SERVICES, NAMELY, PROVIDING ONGOING TELEVISION PROGRAMS IN THE FIELD OF COMEDY, MUSIC AND ANIMATION VIA A GLOBAL COMPUTER NETWORK; ENTERTAINMENT SERVICES, NAMELY, PROVIDING A WEB SITE FEATURING PHOTOGRAPHIC, AUDIO, VIDEO AND PROSE PRESENTATIONS FEATURING COMEDY, MUSIC AND ANIMATION; ENTERTAINMENT SERVICES, NAMELY, PROVIDING INFORMATION BY MEANS OF A GLOBAL COMPUTER NETWORK IN THE FIELDS OF CELEBRITIES, ENTERTAINMENT, AND POPULAR CULTURE; ENTERTAINMENT SERVICES, NAMELY, PROVIDING A WEBSITE FEATURING COMEDY VIDEOS, MUSIC VIDEOS AND ANIMATION (U.S. CLS. 100, 101 AND 107).

FIRST USE 6-14-2013; IN COMMERCE 6-14-2013.

TIMOTHY FINNEGAN, EXAMINING ATTORNEY

SN 86-040,833. OYLER, AMY, DOTHAN, AL. FILED 8-17-2013.

**MISS TRI-STATE BBQ FESTIVAL**

THE MARK CONSISTS OF STANDARD CHARACTERS WITHOUT CLAIM TO ANY PARTICULAR FONT, STYLE, SIZE, OR COLOR.

NO CLAIM IS MADE TO THE EXCLUSIVE RIGHT TO USE "TRI-STATE BBQ FESTIVAL", APART FROM THE MARK AS SHOWN.

FOR ENTERTAINMENT IN THE NATURE OF BEAUTY PAGEANTS (U.S. CLS. 100, 101 AND 107).

GRETCHEN ULRICH, EXAMINING ATTORNEY

**CLASS 41—(Continued).**

SN 86-040,872. HOEBEL FITNESS INC., NEW YORK, NY. FILED 8-17-2013.



NO CLAIM IS MADE TO THE EXCLUSIVE RIGHT TO USE "20 MINUTE BODY", APART FROM THE MARK AS SHOWN.

THE MARK CONSISTS OF THE WORDING "20 MINUTE BODY" WITH A SILHOUETTE OF A MAN IN A JUMPING POSITION INSIDE THE "0" WITH HIS KNEES PULLED INTO HIS CHEST AND ARMS OUTSTRETCHED BEHIND HIM.

FOR COUNSELING SERVICES IN THE FIELD OF PHYSICAL FITNESS; EDUCATIONAL SERVICES, NAMELY, CONDUCTING INDIVIDUAL AND GROUP PROGRAMS AND SEMINARS IN THE FIELD OF PHYSICAL AND MENTAL CONDITIONING, PHYSICAL FITNESS, YOGA, PILATES, MARTIAL ARTS, GENERAL HEALTH AND WELLNESS INCLUDING MEAL PREPARATION AND NUTRITION, COSMETIC FACIAL AND BODY TREATMENTS, POSTURAL ASSESSMENT AND EXERCISE, STRESS REDUCTION, LIFESTYLE MANAGEMENT AND INTEGRATIVE WELLNESS PHILOSOPHY; MARTIAL ARTS INSTRUCTION; PERSONAL FITNESS TRAINING SERVICES AND CONSULTANCY; PERSONAL TRAINING SERVICES, NAMELY, STRENGTH AND CONDITIONING TRAINING; PHYSICAL FITNESS CONSULTATION; PHYSICAL FITNESS INSTRUCTION; PHYSICAL FITNESS TRAINING OF INDIVIDUALS AND GROUPS; PHYSICAL FITNESS TRAINING SERVICES; PROVIDING FITNESS AND EXERCISE STUDIO SERVICES, NAMELY, PILATES INSTRUCTION AND TRAINING; YOGA INSTRUCTION (U.S. CLS. 100, 101 AND 107).

FIRST USE 1-1-2012; IN COMMERCE 1-1-2012.

ESTHER A. BORSUK, EXAMINING ATTORNEY

**CLASS 41—(Continued).**

SN 86-040,898. CD PUBLISHING, LLC, DBA CONTEXT-DRIVEN PRESS, PALM BAY, FL. FILED 8-17-2013.

context driven press

NO CLAIM IS MADE TO THE EXCLUSIVE RIGHT TO USE "PRESS", APART FROM THE MARK AS SHOWN.

THE MARK CONSISTS OF THE WORDS "CONTEXT-DRIVEN PRESS" WHERE THE LETTER "I" IS REPLACED BY A BUG COMPRISED OF TWO HEXAGONS STACKED ON EACH OTHER. TWO ANTENNAE RISE FROM THE TOP HEXAGON.

FOR BOOK PUBLISHING; PUBLICATION OF BOOKS; PUBLICATION OF TEXT BOOKS; PUBLISHING BOOKS IN THE FIELD OF SOFTWARE TESTING, SOFTWARE ENGINEERING, AND SOFTWARE DEVELOPMENT; PUBLISHING OF BOOKS, E-BOOKS, AUDIO BOOKS, MUSIC AND ILLUSTRATIONS (U.S. CLS. 100, 101 AND 107).

FIRST USE 6-9-2012; IN COMMERCE 6-9-2012.

RONALD MCMORROW, EXAMINING ATTORNEY

SN 86-040,902. ENTOURAGE MAGAZINE LLC, NEWARK, NJ. FILED 8-17-2013.

## Entourage Magazine

THE MARK CONSISTS OF STANDARD CHARACTERS WITHOUT CLAIM TO ANY PARTICULAR FONT, STYLE, SIZE, OR COLOR.

NO CLAIM IS MADE TO THE EXCLUSIVE RIGHT TO USE "MAGAZINE", APART FROM THE MARK AS SHOWN.

FOR PROVIDING ON-LINE MAGAZINES IN THE FIELD OF ENTERTAINMENT, FASHION AND COMMUNITY AFFAIRS (U.S. CLS. 100, 101 AND 107).

FIRST USE 12-0-2011; IN COMMERCE 12-0-2011.

RONALD MCMORROW, EXAMINING ATTORNEY

SN 86-040,998. LARKIN, MARILYNN, NEW YORK, NY. FILED 8-18-2013.

## POSTURABILITY

THE MARK CONSISTS OF STANDARD CHARACTERS WITHOUT CLAIM TO ANY PARTICULAR FONT, STYLE, SIZE, OR COLOR.

FOR EDUCATION SERVICES, NAMELY, PROVIDING CLASSES, MOTIVATIONAL WORKSHOPS, AND LECTURES ALL FEATURING SLIDESHOW PRESENTATIONS AND INFORMATION IN THE FIELD OF PHYSICAL EXERCISE FOR POSTURE IMPROVEMENT (U.S. CLS. 100, 101 AND 107).

FIRST USE 8-3-2013; IN COMMERCE 8-12-2013.

AMY ALFIERI, EXAMINING ATTORNEY

**CLASS 41—(Continued).**

SN 86-041,066. SAMI F. KADER, CITRUS HEIGHTS, CA.  
FILED 8-18-2013.

**SAMI'S CIRCUIT**

THE MARK CONSISTS OF STANDARD CHARACTERS WITHOUT CLAIM TO ANY PARTICULAR FONT, STYLE, SIZE, OR COLOR.

NO CLAIM IS MADE TO THE EXCLUSIVE RIGHT TO USE "CIRCUIT", APART FROM THE MARK AS SHOWN.

FOR HEALTH CLUB SERVICES, NAMELY, PROVIDING INSTRUCTION AND EQUIPMENT IN THE FIELD OF PHYSICAL EXERCISE (U.S. CLS. 100, 101 AND 107).

FIRST USE 7-25-2013; IN COMMERCE 7-25-2013.  
JORDAN BAKER, EXAMINING ATTORNEY

**CLASS 41—(Continued).**

SN 86-041,261. HURTADO, RICARDO, NORWALK, CA.  
FILED 8-19-2013.

**Raw Movement**

THE MARK CONSISTS OF STANDARD CHARACTERS WITHOUT CLAIM TO ANY PARTICULAR FONT, STYLE, SIZE, OR COLOR.

NO CLAIM IS MADE TO THE EXCLUSIVE RIGHT TO USE "MOVEMENT", APART FROM THE MARK AS SHOWN.

FOR PHYSICAL FITNESS TRAINING OF INDIVIDUALS AND GROUPS; PROVIDING FITNESS AND EXERCISE FACILITIES (U.S. CLS. 100, 101 AND 107).

SHAVELL MCPHERSON, EXAMINING ATTORNEY

SN 86-041,363. VERIA INTERNATIONAL LIMITED, HAMILTON HM 12, BERMUDA, FILED 8-19-2013.

**VERIA LIVING TOP 10**

THE MARK CONSISTS OF STANDARD CHARACTERS WITHOUT CLAIM TO ANY PARTICULAR FONT, STYLE, SIZE, OR COLOR.

OWNER OF U.S. REG. NOS. 3,664,064, 4,291,663 AND OTHERS.

NO CLAIM IS MADE TO THE EXCLUSIVE RIGHT TO USE "TOP 10", APART FROM THE MARK AS SHOWN.

THE ENGLISH TRANSLATION OF "VERIA" IN THE MARK IS "IT WOULD SEE".

FOR ENTERTAINMENT IN THE NATURE OF A TELEVISION SERIES FEATURING TOPICS ABOUT HEALTH AND WELLNESS, DIET AND NUTRITION, AND FOOD AND EXERCISE (U.S. CLS. 100, 101 AND 107).

ESTHER BELENKER, EXAMINING ATTORNEY

SN 86-041,414. ACEVEDO CATAQUET, ALEXANDER, SUNNYSIDE, NY. FILED 8-19-2013.

**ARDALA FILMS**

THE MARK CONSISTS OF STANDARD CHARACTERS WITHOUT CLAIM TO ANY PARTICULAR FONT, STYLE, SIZE, OR COLOR.

NO CLAIM IS MADE TO THE EXCLUSIVE RIGHT TO USE "FILMS", APART FROM THE MARK AS SHOWN.

FOR ENTERTAINMENT SERVICES, NAMELY, PROVIDING A WEB SITE FEATURING PHOTOGRAPHIC, AUDIO, VIDEO AND PROSE PRESENTATIONS FEATURING MOTION PICTURE FILMS (U.S. CLS. 100, 101 AND 107).

ANDREW LEASER, EXAMINING ATTORNEY

SN 86-041,230. THE CLIMBING LIFE GUIDES, INC., VICTORVILLE, CA. FILED 8-19-2013.



NO CLAIM IS MADE TO THE EXCLUSIVE RIGHT TO USE "CLIMBING" AND "GUIDES", APART FROM THE MARK AS SHOWN.

THE MARK CONSISTS OF A CENTRAL SINGLE LINE CIRCLE DESIGN FEATURING THE SILHOUETTE OF A CLIMBER REPELLING DOWN THE SIDE OF A ROCK AT AN ANGLE WITH SILHOUETTES OF ROCKS AND JOSHUA TREES BELOW. THE WORDING "THE CLIMBING LIFE" AND "GUIDES" ENCIRCLES THE CENTRAL DESIGN, AND IS SEPARATED BY TWO SMALL SHADED CIRCLES.

FOR INSTRUCTION IN THE FIELD OF ROCK CLIMBING; ROCK CLIMBING GUIDE SERVICES (U.S. CLS. 100, 101 AND 107).

FIRST USE 7-21-2013; IN COMMERCE 7-21-2013.  
ZHALEH DELANEY, EXAMINING ATTORNEY

**CLASS 41—(Continued).**

SN 86-041,500. THE NEW JERSEY SECOND AMENDMENT SOCIETY A NJ NON-PROFIT CORP., MANAHAWKIN, NJ. FILED 8-19-2013.



NO CLAIM IS MADE TO THE EXCLUSIVE RIGHT TO USE "NEW JERSEY SECOND AMENDMENT SOCIETY", APART FROM THE MARK AS SHOWN.

THE COLOR(S) BLUE, RED, WHITE, AND BLACK IS/ARE CLAIMED AS A FEATURE OF THE MARK.

THE MARK CONSISTS OF THE LETTERS "N" AND "J" IN WHITE OUTLINED IN BLACK. TO THE RIGHT OF THE LETTER "J" IS THE NUMBER "2" AND THE LETTER "A", BOTH IN RED AND OUTLINED IN BLACK. TO THE RIGHT OF THE LETTER "A" IS THE LETTER "S" IN WHITE AND OUTLINED IN BLACK. THE WORDS "NEW JERSEY SECOND AMENDMENT SOCIETY" APPEAR BELOW IN WHITE. ALL LETTERS AND WORDS APPEAR ON A BLUE RECTANGULAR BACKGROUND.

FOR EDUCATIONAL SERVICES, NAMELY, CONDUCTING CLASSES AND PRESENTATIONS ON THE USE OF SAFETY IN THE OPERATION OF FIREARMS (U.S. CLS. 100, 101 AND 107).

FIRST USE 7-0-2010; IN COMMERCE 7-0-2010.  
BRIN ANDERSON, EXAMINING ATTORNEY

**CLASS 41—(Continued).**

SN 86-041,658. FOLIOMETRIX, LLC, PORTLAND, OR. FILED 8-19-2013.

**THE REFERABLE ADVISOR**

THE MARK CONSISTS OF STANDARD CHARACTERS WITHOUT CLAIM TO ANY PARTICULAR FONT, STYLE, SIZE, OR COLOR.

NO CLAIM IS MADE TO THE EXCLUSIVE RIGHT TO USE "ADVISOR", APART FROM THE MARK AS SHOWN.

FOR WORKSHOPS AND SEMINARS IN THE FIELD OF FINANCIAL ADVISORY SERVICES (U.S. CLS. 100, 101 AND 107).

FIRST USE 7-3-2013; IN COMMERCE 7-3-2013.  
ANDREA HACK, EXAMINING ATTORNEY

SN 86-041,593. JERRY GHIONIS PHOTOGRAPHY, INC., BEVERLY HILLS, CA. FILED 8-19-2013.

**ICON INTERNATIONAL  
PHOTOGRAPHY AWARDS**

THE MARK CONSISTS OF STANDARD CHARACTERS WITHOUT CLAIM TO ANY PARTICULAR FONT, STYLE, SIZE, OR COLOR.

NO CLAIM IS MADE TO THE EXCLUSIVE RIGHT TO USE "INTERNATIONAL PHOTOGRAPHY AWARDS", APART FROM THE MARK AS SHOWN.

FOR ENTERTAINMENT AND EDUCATIONAL SERVICES, NAMELY, ARRANGING AND CONDUCTING AN ANNUAL COMPETITION IN THE ART OF PHOTOGRAPHY AND PRESENTATION OF AN AWARD CEREMONY IN CONNECTION THEREWITH, BOTH ONLINE AND IN PERSON; EDUCATION SERVICES, NAMELY, PROVIDING SEMINARS IN THE FIELD OF PHOTOGRAPHY CONDUCTED ONLINE AND IN PERSON (U.S. CLS. 100, 101 AND 107).

ELIZABETH JACKSON, EXAMINING ATTORNEY

SN 86-041,792. WORLD TEAMTENNIS, INC., NEW YORK, NY. FILED 8-19-2013.

**TEXAS WILD**

THE MARK CONSISTS OF STANDARD CHARACTERS WITHOUT CLAIM TO ANY PARTICULAR FONT, STYLE, SIZE, OR COLOR.

NO CLAIM IS MADE TO THE EXCLUSIVE RIGHT TO USE "TEXAS", APART FROM THE MARK AS SHOWN.

FOR ORGANIZING, CONDUCTING AND STAGING TENNIS COMPETITIONS, CLINICS AND EXHIBITIONS (U.S. CLS. 100, 101 AND 107).

FIRST USE 7-7-2013; IN COMMERCE 7-7-2013.  
REBECCA SMITH, EXAMINING ATTORNEY

**CLASS 41—(Continued).**

SN 86-041,940. STATS LLC, NORTHBROOK, IL. FILED 8-19-2013.



NO CLAIM IS MADE TO THE EXCLUSIVE RIGHT TO USE "10 YEAR ANNIVERSARY", APART FROM THE MARK AS SHOWN.

THE MARK CONSISTS OF A SHIELD CONTAINING A ROW OF STARS WITH THE WORDING "NFFC" APPEARING BELOW THE ROW OF STARS, A BANNER CONTAINING TO WORDING "10 YEAR ANNIVERSARY", AND A FOOTBALL APPEARING AT THE BASE OF THE SHIELD. THE BLACK BACKGROUND IS NOT CLAIMED AS A FEATURE OF THE MARK.

FOR PROVIDING ON-LINE COMPUTER GAMES; CONDUCTING FANTASY FOOTBALL CONTESTS; ON-LINE ENTERTAINMENT IN THE NATURE OF FANTASY FOOTBALL COMPETITIONS AMONG FANTASY FOOTBALL LEAGUES AND TEAMS, AND FANTASY FOOTBALL TOURNAMENTS; PROVIDING ON-LINE NEWS AND INFORMATION IN THE FIELDS OF COMPUTER GAMES, SPORTS AND SPORT FANTASY GAMES, SPORTS FIGURES, ATHLETES AND CELEBRITIES, AND SPORTS EVENTS (U.S. CLS. 100, 101 AND 107).

FIRST USE 3-31-2013; IN COMMERCE 3-31-2013.  
JENNIFER RICHARDSON, EXAMINING ATTORNEY

**CLASS 41—(Continued).**

SN 86-042,024. STATS LLC, NORTHBROOK, IL. FILED 8-19-2013.



SN 86-041,986. BOON MORGAN, HENDERSON, NV. FILED 8-19-2013.

# BoonLife

THE MARK CONSISTS OF STANDARD CHARACTERS WITHOUT CLAIM TO ANY PARTICULAR FONT, STYLE, SIZE, OR COLOR.

FOR PROVIDING A WEBSITE THAT DISPLAYS NEWS AND INFORMATION ABOUT EVENTS, NAMELY, SPORTING, CULTURAL, SOCIAL HAPPENINGS, CONVENTIONS, NIGHTLIFE, AND OTHER EVENTS FOR ENTERTAINMENT PURPOSES (U.S. CLS. 100, 101 AND 107).

BRIAN PINO, EXAMINING ATTORNEY

THE MARK CONSISTS OF A SHIELD CONTAINING TWO ROWS OF STARS WITH THE WORDING "NFBKC" APPEARING IN BETWEEN THE TWO ROWS OF STARS, AND A BASKETBALL APPEARING AT THE BASE OF THE SHIELD. THE GREY AND BLACK BACKGROUND IS NOT CLAIMED AS A FEATURE OF THE MARK.

FOR PROVIDING ON-LINE COMPUTER GAMES; CONDUCTING FANTASY BASKETBALL CONTESTS; ON-LINE ENTERTAINMENT IN THE NATURE OF FANTASY BASKETBALL COMPETITIONS AMONG FANTASY BASKETBALL LEAGUES AND TEAMS, AND FANTASY BASKETBALL TOURNAMENTS; PROVIDING ON-LINE NEWS AND INFORMATION IN THE FIELDS OF COMPUTER GAMES, SPORTS AND SPORT FANTASY GAMES, SPORTS FIGURES, ATHLETES AND CELEBRITIES, AND SPORTS EVENTS (U.S. CLS. 100, 101 AND 107).

FIRST USE 9-30-2006; IN COMMERCE 9-30-2006.  
JENNIFER RICHARDSON, EXAMINING ATTORNEY

**CLASS 41—(Continued).**

SN 86-042,113. STATS LLC, NORTHBROOK, IL. FILED 8-19-2013.



THE MARK CONSISTS OF A SHIELD CONTAINING TWO ROWS OF STARS WITH THE WORDING "NFBC" APPEARING IN BETWEEN THE TWO ROWS OF STARS, AND A BASEBALL APPEARING AT THE BASE OF THE SHIELD. THE BLACK BACKGROUND IS NOT CLAIMED AS A FEATURE OF THE MARK.

FOR PROVIDING ON-LINE COMPUTER GAMES; CONDUCTING FANTASY BASEBALL CONTESTS; ON-LINE ENTERTAINMENT IN THE NATURE OF FANTASY BASEBALL COMPETITIONS AMONG FANTASY BASEBALL LEAGUES AND TEAMS, AND FANTASY BASEBALL TOURNAMENTS; PROVIDING ON-LINE NEWS AND INFORMATION IN THE FIELDS OF COMPUTER GAMES, SPORTS AND SPORT FANTASY GAMES, SPORTS FIGURES, ATHLETES AND CELEBRITIES, AND SPORTS EVENTS (U.S. CLS. 100, 101 AND 107).

FIRST USE 3-31-2003; IN COMMERCE 3-31-2003.  
JENNIFER RICHARDSON, EXAMINING ATTORNEY

SN 86-042,191. ROBINSON, LANETTE, MIRAMAR, FL. FILED 8-19-2013.

**EXTRAS EXTREME**

THE MARK CONSISTS OF STANDARD CHARACTERS WITHOUT CLAIM TO ANY PARTICULAR FONT, STYLE, SIZE, OR COLOR.

NO CLAIM IS MADE TO THE EXCLUSIVE RIGHT TO USE "EXTRAS", APART FROM THE MARK AS SHOWN.

FOR ENTERTAINMENT SERVICES IN THE NATURE OF AN ONGOING REALITY BASED TELEVISION PROGRAM (U.S. CLS. 100, 101 AND 107).

DAVID ALESKOW, EXAMINING ATTORNEY

**CLASS 41—(Continued).**

SN 86-042,370. SPYROPOULOS, PHIL, KEANSBURG, NJ. FILED 8-20-2013.

**Hello Festival**

THE MARK CONSISTS OF STANDARD CHARACTERS WITHOUT CLAIM TO ANY PARTICULAR FONT, STYLE, SIZE, OR COLOR.

NO CLAIM IS MADE TO THE EXCLUSIVE RIGHT TO USE "FESTIVAL", APART FROM THE MARK AS SHOWN.

FOR ENTERTAINMENT IN THE NATURE OF A MUSIC FESTIVAL WITH ATTENDEE PARTICIPATION IN ACTIVITIES AND PERFORMANCES (U.S. CLS. 100, 101 AND 107).

FIRST USE 5-1-2009; IN COMMERCE 5-1-2011.  
JOHN WILKE, EXAMINING ATTORNEY

SN 86-042,423. MOUNT MARY UNIVERSITY, INC., MILWAUKEE, WI. FILED 8-20-2013.

**MOUNT MARY UNIVERSITY**

THE MARK CONSISTS OF STANDARD CHARACTERS WITHOUT CLAIM TO ANY PARTICULAR FONT, STYLE, SIZE, OR COLOR.

NO CLAIM IS MADE TO THE EXCLUSIVE RIGHT TO USE "UNIVERSITY", APART FROM THE MARK AS SHOWN.

FOR EDUCATION SERVICES IN THE NATURE OF COURSES AT THE UNIVERSITY LEVEL (U.S. CLS. 100, 101 AND 107).

FIRST USE 7-1-2013; IN COMMERCE 7-1-2013.  
JEFF DEFORD, EXAMINING ATTORNEY

SN 86-042,525. ROLSTON, KEVIN, WEST PALM BEACH, FL. FILED 8-20-2013.

**The KVJ Show**

THE MARK CONSISTS OF STANDARD CHARACTERS WITHOUT CLAIM TO ANY PARTICULAR FONT, STYLE, SIZE, OR COLOR.

NO CLAIM IS MADE TO THE EXCLUSIVE RIGHT TO USE "SHOW", APART FROM THE MARK AS SHOWN.

FOR ENTERTAINMENT, NAMELY, A CONTINUING COMEDY SHOW BROADCAST OVER RADIO AND INTERNET (U.S. CLS. 100, 101 AND 107).

FIRST USE 5-1-1999; IN COMMERCE 5-1-1999.  
MARILYN IZZI, EXAMINING ATTORNEY



**CLASS 41—(Continued).**

SN 86-042,555. COOMBS, ROB, WALL TOWNSHIP, NJ.  
FILED 8-20-2013.

**5 F.E.A.T.S.**

THE MARK CONSISTS OF STANDARD CHARACTERS WITHOUT CLAIM TO ANY PARTICULAR FONT, STYLE, SIZE, OR COLOR.

FOR EDUCATION SERVICES, NAMELY, PROVIDING PRESENTATIONS, CLASSES, AND SEMINARS IN THE FIELDS OF HEALTHCARE AND WELLNESS (U.S. CLS. 100, 101 AND 107).

JONATHAN FALK, EXAMINING ATTORNEY

**CLASS 41—(Continued).**

SN 86-043,087. BATES, JULIE ANNE, LOS ANGELES, CA.  
FILED 8-20-2013.

**Personal Chef Approach**

THE MARK CONSISTS OF STANDARD CHARACTERS WITHOUT CLAIM TO ANY PARTICULAR FONT, STYLE, SIZE, OR COLOR.

NO CLAIM IS MADE TO THE EXCLUSIVE RIGHT TO USE "PERSONAL CHEF", APART FROM THE MARK AS SHOWN.

FOR EDUCATIONAL SERVICES, NAMELY, PROVIDING ONLINE INSTRUCTION IN THE FIELD OF COOKING VIA AN ONLINE WEBSITE (U.S. CLS. 100, 101 AND 107).

FIRST USE 4-19-2011; IN COMMERCE 4-19-2011.  
KATHERINE CHANG, EXAMINING ATTORNEY

SN 86-042,721. THE SPORTS GIRLS LLC, HOLLYWOOD, FL.  
FILED 8-20-2013.



NO CLAIM IS MADE TO THE EXCLUSIVE RIGHT TO USE "SPORTS", "WOMEN", AND "GIRLS", APART FROM THE MARK AS SHOWN.

THE COLOR(S) BLACK AND RED IS/ARE CLAIMED AS A FEATURE OF THE MARK.

THE MARK CONSISTS OF A BLACK HEXAGONAL BACKBOARD WITH AN INNER RED LINING SURROUNDING THE BACKBOARD. ON TOP OF THE BACKBOARD THE SITS THE WORDS "ALL SPORTS . ALL WOMEN . ALL THE TIME". WITHIN THE TRANSPARENT HEXAGONAL BACKBOARD ARE THE WORDS "THE SPORTS GIRLS". SUPERIMPOSED ON THE "P" IN "SPORTS" IS A BLACK BASEBALL BAT IN ADDITION TO A FOOTBALL AFTER THE LETTER "S". SUPERIMPOSED ON THE POINT OF THE "I" IN THE WORD "GIRLS" IS A RED SPARKLING RUBY ENDING WITH A RED TRANSPARENT STILLETTO SITTING IN THE BOTTOM RIGHT CORNER OF THE BACKBOARD.

FOR ENTERTAINMENT IN THE NATURE OF PROVIDING AN INFORMATIONAL AND ENTERTAINMENT WEBSITE IN THE FIELDS OF CELEBRITY GOSSIP, ENTERTAINMENT, SPORTS AND FITNESS; PROVIDING A WEBSITE FEATURING INFORMATION ON EXERCISE AND FITNESS; PROVIDING A WEBSITE FOR ENTERTAINMENT PURPOSES FEATURING VIDEOS, PICTURES, AND INTERVIEWS ABOUT SPORTS (U.S. CLS. 100, 101 AND 107).

C. DIONNE CLYBURN, EXAMINING ATTORNEY

SN 86-043,149. STATS LLC, NORTHBROOK, IL. FILED 8-20-2013.



THE MARK CONSISTS OF A SHIELD CONTAINING TWO ROWS OF STARS WITH THE WORDING "NFFC" APPEARING IN BETWEEN THE TWO ROWS OF STARS, AND A FOOTBALL APPEARING AT THE BASE OF THE SHIELD.

FOR PROVIDING ON-LINE COMPUTER GAMES; CONDUCTING FANTASY FOOTBALL CONTESTS; ON-LINE ENTERTAINMENT IN THE NATURE OF FANTASY FOOTBALL COMPETITIONS AMONG FANTASY FOOTBALL LEAGUES AND TEAMS, AND FANTASY FOOTBALL TOURNAMENTS; PROVIDING ON-LINE NEWS AND INFORMATION IN THE FIELDS OF COMPUTER GAMES, SPORTS AND SPORT FANTASY GAMES, SPORTS FIGURES, ATHLETES AND CELEBRITIES, AND SPORTS EVENTS (U.S. CLS. 100, 101 AND 107).

FIRST USE 2-28-2005; IN COMMERCE 2-28-2005.  
JENNIFER RICHARDSON, EXAMINING ATTORNEY

**CLASS 41—(Continued).**

SN 86-043,467. MOMENTS OF FOCUS LLC, CULVER CITY, CA. FILED 8-20-2013.



THE MARK CONSISTS OF THE WORDING "INTERN TO VP" TO THE LEFT OF THE SILHOUETTES OF A MAN AND WOMAN WEARING BUSINESS SUITS.

FOR EDUCATION SERVICES, NAMELY, PROVIDING PANEL DISCUSSIONS IN THE FIELD OF PERSONAL AND PROFESSIONAL DEVELOPMENT (U.S. CLS. 100, 101 AND 107).

FIRST USE 12-0-2011; IN COMMERCE 5-23-2013.  
TINA BROWN, EXAMINING ATTORNEY

SN 86-043,494. HAJDU, ZOLTAN MIKLOS, LAS VEGAS, NV. FILED 8-21-2013.

**WHITE PALMS ACADEMY**

THE MARK CONSISTS OF STANDARD CHARACTERS WITHOUT CLAIM TO ANY PARTICULAR FONT, STYLE, SIZE, OR COLOR.

NO CLAIM IS MADE TO THE EXCLUSIVE RIGHT TO USE "ACADEMY", APART FROM THE MARK AS SHOWN.

FOR PROVIDING GYMNASIUM FACILITIES; GYMNASIUM INSTRUCTION; PERSONAL FITNESS TRAINING SERVICES AND CONSULTANCY; PERSONAL TRAINING SERVICES, NAMELY, STRENGTH AND CONDITIONING TRAINING AND SPEED TRAINING; PROVIDING FACILITIES FOR ACTING, CIRCUS, ACTION STUNTS, PARKOUR, SPORTS, PHYSICAL FITNESS TRAINING; ATHLETIC TRAINING SERVICES; PERSONAL FITNESS TRAINING SERVICES FEATURING AEROBIC AND ANAEROBIC ACTIVITIES COMBINED WITH RESISTANCE AND FLEXIBILITY TRAINING; MULTIMEDIA ENTERTAINMENT SERVICES IN THE NATURE OF RECORDING, PRODUCTION AND POST-PRODUCTION SERVICES IN THE FIELDS OF MUSIC, VIDEO, AND FILMS; DIGITAL VIDEO, AUDIO, AND MULTIMEDIA PUBLISHING SERVICES; CIRCUS PERFORMANCES (U.S. CLS. 100, 101 AND 107).

FIRST USE 6-10-2012; IN COMMERCE 5-4-2013.  
SUSAN STIGLITZ, EXAMINING ATTORNEY

**CLASS 41—(Continued).**

SN 86-043,543. YO ART, INC., CHARLESTON, SC. FILED 8-21-2013.

# YO ART

THE MARK CONSISTS OF STANDARD CHARACTERS WITHOUT CLAIM TO ANY PARTICULAR FONT, STYLE, SIZE, OR COLOR.

NO CLAIM IS MADE TO THE EXCLUSIVE RIGHT TO USE "ART", APART FROM THE MARK AS SHOWN.

FOR CHARITABLE SERVICES, NAMELY, EDUCATION FOR CHILDREN, NAMELY, TRAINING IN THE FIELD OF ARTS AND MEDIA ARTS (U.S. CLS. 100, 101 AND 107).

FIRST USE 8-0-2009; IN COMMERCE 8-0-2009.  
HANNO RITTNER, EXAMINING ATTORNEY

SN 86-043,637. FUNCTIONAL FITNESS ZONE INC., CORAL GABLES, FL. FILED 8-21-2013.

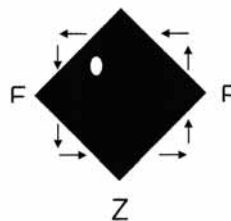

FUNCTIONAL FITNESS ZONE  
it's a lifestyle!

NO CLAIM IS MADE TO THE EXCLUSIVE RIGHT TO USE "FUNCTIONAL FITNESS", APART FROM THE MARK AS SHOWN.

THE MARK CONSISTS OF A SHADED DIAMOND, WHICH CONTAINS AN OVAL, OUTSIDE OF THE DIAMOND ARE EIGHT ARROWS POINTING COUNTER-CLOCKWISE AROUND THE DIAMOND, AND THE LETTER "F" APPEARS ON THE LEFT AND RIGHT SIDES OF THE DIAMOND; BELOW THE DIAMOND IS THE LETTER "Z"; UNDERNEATH WHICH ARE THE WORDS "FUNCTIONAL FITNESS ZONE", UNDERNEATH WHICH IS THE DESIGN OF A WEIGHT LIFTING BAR WITH THREE PLATES ON EACH SIDE, UNDERNEATH WHICH IS THE WORDING "IT'S A LIFESTYLE!"

FOR GYMNASIUMS; PROVIDING FITNESS AND EXERCISE FACILITIES (U.S. CLS. 100, 101 AND 107).

FIRST USE 8-13-2012; IN COMMERCE 8-13-2012.  
JILLIAN CANTOR, EXAMINING ATTORNEY

**CLASS 41—(Continued).**

SN 86-043,689. COACHINGAMERICANSOCCER.COM, OLNEY, MD. FILED 8-21-2013.



NO CLAIM IS MADE TO THE EXCLUSIVE RIGHT TO USE "COACHING AMERICAN SOCCER.COM", APART FROM THE MARK AS SHOWN.

THE MARK CONSISTS OF A SOCCER PLAYER KICKING A SOCCER BALL WITH THE WORDS "COACHING AMERICAN SOCCER.COM" TO THE RIGHT.

FOR PROVIDING A WEBSITE FEATURING INFORMATION ON SOCCER AND SOCCER INSTRUCTION (U.S. CLS. 100, 101 AND 107).

FIRST USE 12-1-2005; IN COMMERCE 12-1-2005.  
SUE LAWRENCE, EXAMINING ATTORNEY

SN 86-043,833. NATIONAL MILITARY FAMILY ASSOCIATION, ALEXANDRIA, VA. FILED 8-21-2013.



OWNER OF U.S. REG. NO. 3,278,694.  
THE COLOR(S) RED, BLUE AND PURPLE IS/ARE CLAIMED AS A FEATURE OF THE MARK.

THE MARK CONSISTS OF A PURPLE STAR WITH A LIGHTER PURPLE OUTLINE IS SUSPENDED OVER THE PHRASE "OPERATION PURPLE" IN THE SAME PURPLE-ON-PURPLE CONFIGURATION. THE DOT FOR THE "I" IN "OPERATION", LEADING OFF FROM THE STAR-DOT ARE THREE STYLIZED STRIPES, TWO BLUE AND ONE RED, TAPERING AND FADING OUT AT VARYING HEIGHTS ABOUT THE "U" IN "PURPLE". THE BLUE AND RED STRIPES HAVE THE EFFECT OF A CAPE.

FOR CHARITABLE SERVICES, NAMELY, PROVIDING CAMPS FOR CHILDREN OF DEPLOYED SERVICE MEMBERS AND MILITARY FAMILIES REINTEGRATING AFTER DEPLOYMENT (U.S. CLS. 100, 101 AND 107).

FIRST USE 4-15-2004; IN COMMERCE 5-1-2004.  
DAVID ALESKOW, EXAMINING ATTORNEY

**CLASS 41—(Continued).**

SN 86-043,945. PARTLAND, GEANNA, NEW YORK, NY. FILED 8-21-2013.

## Behavior Bitch

THE MARK CONSISTS OF STANDARD CHARACTERS WITHOUT CLAIM TO ANY PARTICULAR FONT, STYLE, SIZE, OR COLOR.

NO CLAIM IS MADE TO THE EXCLUSIVE RIGHT TO USE "BEHAVIOR", APART FROM THE MARK AS SHOWN. FOR COACHING IN THE FIELD OF HEALTH AND LIFESTYLE UTILIZING THE PRINCIPLES OF APPLIED BEHAVIOR ANALYSIS (U.S. CLS. 100, 101 AND 107).

JAMES LOVELACE, EXAMINING ATTORNEY

SN 86-044,025. NORTHERN VIRGINIA ASSOCIATION OF REALTORS, FAIRFAX, VA. FILED 8-21-2013.

## RAZORPATH

THE MARK CONSISTS OF STANDARD CHARACTERS WITHOUT CLAIM TO ANY PARTICULAR FONT, STYLE, SIZE, OR COLOR.

FOR EDUCATION SERVICES, NAMELY, PROVIDING ON-LINE CLASSES IN THE FIELD OF REAL ESTATE (U.S. CLS. 100, 101 AND 107).

FIRST USE 8-2-2013; IN COMMERCE 8-2-2013.  
SUI DUONG, EXAMINING ATTORNEY

SN 86-044,040. MELISSA CADY, D.O., AUSTIN, TX. FILED 8-21-2013.



THE COLOR(S) BLACK, RED AND WHITE IS/ARE CLAIMED AS A FEATURE OF THE MARK.

THE MARK CONSISTS OF THE WORD "CHALLENGE" OUTLINED IN WHITE WITH BLACK SHADOWS BEHIND EACH LETTER AND WITH THE LETTERS "CHA" IN BLACK, THE LETTERS "LLE" IN RED, AND THE LETTERS "NGE" IN BLACK TO CREATE THE APPEARANCE OF THE WORD "CHANGE" WITHIN THE WORD "CHALLENGE" AND THE WORDS "SEE CHANGE WITHIN CHALLENGE" UNDERNEATH THE WORD CHALLENGE IN RED AND BLACK LETTERS.

FOR ON-LINE JOURNALS, NAMELY, BLOGS FEATURING HEALTH EDUCATION, NAMELY, NUTRITION, PHYSICAL AND MENTAL HEALTH, DEALING WITH CHRONIC PAIN, AND ANESTHESIA (U.S. CLS. 100, 101 AND 107).

KHANH LE, EXAMINING ATTORNEY

**CLASS 41—(Continued).**

SN 86-044,363. B BARRE FITNESS LLC, LOUISVILLE, KY. FILED 8-21-2013.

# B.SILQUE

THE MARK CONSISTS OF STANDARD CHARACTERS WITHOUT CLAIM TO ANY PARTICULAR FONT, STYLE, SIZE, OR COLOR.

THE MARK DOES NOT IDENTIFY THE NAME OF ANY LIVING INDIVIDUAL.

THE WORDING "SILQUE" HAS NO MEANING IN A FOREIGN LANGUAGE.

FOR HEALTH CLUB SERVICES, NAMELY, PROVIDING FACILITIES, INSTRUCTION AND EQUIPMENT IN THE FIELD OF PHYSICAL EXERCISE AND FITNESS (U.S. CLS. 100, 101 AND 107).

JERI J. FICKES, EXAMINING ATTORNEY

---

SN 86-044,473. HA! MUSIK, CORP., GUAYNABO, PUERTO RICO, FILED 8-21-2013.

## WTF! WE THE FUTURE FEST

THE MARK CONSISTS OF STANDARD CHARACTERS WITHOUT CLAIM TO ANY PARTICULAR FONT, STYLE, SIZE, OR COLOR.

NO CLAIM IS MADE TO THE EXCLUSIVE RIGHT TO USE "FEST", APART FROM THE MARK AS SHOWN.

FOR CONDUCTING ENTERTAINMENT EXHIBITIONS IN THE NATURE OF ELECTRONIC AND INDIE ROCK MUSICAL FESTIVALS THAT WILL EMPHASIZE IN SHOW TECHNOLOGY AND ARTS (U.S. CLS. 100, 101 AND 107).

RONALD MCMORROW, EXAMINING ATTORNEY

---

SN 86-044,536. SPORTS BUSINESS INTERESTS, SPOKANE, WA. FILED 8-21-2013.

# SKOOKUM

THE MARK CONSISTS OF STANDARD CHARACTERS WITHOUT CLAIM TO ANY PARTICULAR FONT, STYLE, SIZE, OR COLOR.

FOR ENTERTAINMENT IN THE NATURE OF COMPETITIONS IN THE FIELDS OF MARTIAL ARTS, BOXING AND FITNESS (U.S. CLS. 100, 101 AND 107).

ZHALEH DELANEY, EXAMINING ATTORNEY

**CLASS 41—(Continued).**

SN 86-044,626. ELOY RODRIGUEZ, MIAMI, FL. FILED 8-21-2013.



NO CLAIM IS MADE TO THE EXCLUSIVE RIGHT TO USE "REVISTA", APART FROM THE MARK AS SHOWN.

THE COLOR(S) RED, BLACK AND GREEN IS/ARE CLAIMED AS A FEATURE OF THE MARK.

THE MARK CONSISTS OF THE WORDS "LA" IN GREEN STYLIZED FONT WITH BLACK OUTLINE AND SHADING TO THE LEFT OF THE WORD "GUINDA" IN RED STYLIZED FONT WITH BLACK OUTLINE AND SHADING WITH A GREEN STEM AND LEAF ON TOP OF THE "G" IN THE WORD "GUINDA" WITH THE WORDS "UNA REVISTA POLITICAMENTE INCORRECTA" IN GREEN STYLIZED SMALLER FONT BELOW THE "UINDA" IN THE WORD "GUINDA".

THE ENGLISH TRANSLATION OF "LA GUINDA UNA REVISTA POLITICAMENTE INCORRECTA" IN THE MARK IS "CHERRY ON TOP A POLITICALLY INCORRECT MAGAZINE".

FOR ON-LINE PUBLICATION OF MAGAZINE DEDICATED TO POLITICAL TOPICS (U.S. CLS. 100, 101 AND 107).

SHAVELL MCPHERSON, EXAMINING ATTORNEY

---

SN 86-045,311. REDMOND, PATRICK, BELLINGHAM, WA. FILED 8-22-2013.

## DRT DYNAMIC RESILIENCE TRAINING

THE MARK CONSISTS OF STANDARD CHARACTERS WITHOUT CLAIM TO ANY PARTICULAR FONT, STYLE, SIZE, OR COLOR.

NO CLAIM IS MADE TO THE EXCLUSIVE RIGHT TO USE "RESILIENCE TRAINING", APART FROM THE MARK AS SHOWN.

FOR PROVIDING CLASSES, WORKSHOPS, SEMINARS AND CAMPS IN THE FIELDS OF FITNESS, EXERCISE, MOVEMENT, AND WELLNESS (U.S. CLS. 100, 101 AND 107).

FIRST USE 9-3-2012; IN COMMERCE 9-3-2012.  
SUSAN RICHARDS, EXAMINING ATTORNEY

**CLASS 41—(Continued).**

SN 86-045,771. MICHAEL WATTS, HOUSTON, TX. FILED 8-22-2013.

DJ MICHAEL WATTS

THE MARK CONSISTS OF STANDARD CHARACTERS WITHOUT CLAIM TO ANY PARTICULAR FONT, STYLE, SIZE, OR COLOR.

NO CLAIM IS MADE TO THE EXCLUSIVE RIGHT TO USE "DJ", APART FROM THE MARK AS SHOWN.

THE NAME(S), PORTRAIT(S), AND/OR SIGNATURE(S) SHOWN IN THE MARK IDENTIFIES "MICHAEL WATTS", WHOSE CONSENT(S) TO REGISTER IS MADE OF RECORD.

FOR CHARITABLE SERVICES, NAMELY, MENTORING OF YOUTH IN THE FIELD OF RESPONSIBLE CHOICES, EDUCATION, SELF-ESTEEM AND PURSUING ASPIRATIONS; DISC JOCKEY SERVICES; EDUCATIONAL AND ENTERTAINMENT SERVICES, NAMELY, PROVIDING MOTIVATIONAL SPEAKING SERVICES IN THE FIELD OF RESPONSIBLE CHOICES, EDUCATION, SELF-ESTEEM AND PURSUING ASPIRATIONS PROVIDED TO YOUTH; ENTERTAINMENT IN THE NATURE OF LIVE RADIO PERSONALITY PERFORMANCES; ENTERTAINMENT SERVICES IN THE NATURE OF RECORDING, PRODUCTION AND POST-PRODUCTION SERVICES IN THE FIELD OF MUSIC; ENTERTAINMENT SERVICES, NAMELY, LIVE, TELEVISED AND MOVIE APPEARANCES BY A PROFESSIONAL ENTERTAINER (U.S. CLS. 100, 101 AND 107).

FIRST USE 1-1-1987; IN COMMERCE 1-1-1987.  
HEATHER BIDDULPH, EXAMINING ATTORNEY

**CLASS 41—(Continued).**

SN 86-046,058. BWW, LLC, FOLSOM, CA. FILED 8-23-2013.



NO CLAIM IS MADE TO THE EXCLUSIVE RIGHT TO USE "WEEKEND", APART FROM THE MARK AS SHOWN.

THE MARK CONSISTS OF THE STYLIZED WORDING "BIGWAKE WEEKEND" WITH A WAVE DESIGN THAT STARTS FROM THE TOP LEFT SIDE OF THE WORDING "BIGWAKE" AND CONTINUES TO THE BOTTOM RIGHT SIDE OF THE WORDING "BIGWAKE".

FOR ARRANGING AND CONDUCTING SPECIAL EVENTS FOR SOCIAL ENTERTAINMENT PURPOSES, NAMELY, A WATERSPORTS FESTIVAL EVENT WEEKEND COMBINING CULTURE, SPORTS AND ENTERTAINMENT (U.S. CLS. 100, 101 AND 107).

FIRST USE 5-1-2012; IN COMMERCE 5-31-2013.  
NICHOLAS ALTREE, EXAMINING ATTORNEY

SN 86-046,886. HYLAND, JOHN D, GAHANNA, OH. FILED 8-23-2013.

SN 86-045,841. MEYER, MICHAEL NATHANIEL, BROOKLYN, NY. FILED S.R. 8-22-2013; AM. P.R. 12-6-2013.

John Hyland

Picture More Business

THE MARK CONSISTS OF STANDARD CHARACTERS WITHOUT CLAIM TO ANY PARTICULAR FONT, STYLE, SIZE, OR COLOR.

FOR PHOTOGRAPHY SERVICES (U.S. CLS. 100, 101 AND 107).

FIRST USE 2-0-2012; IN COMMERCE 2-0-2012.  
KRISTIN DAHLING, EXAMINING ATTORNEY

THE MARK CONSISTS OF STANDARD CHARACTERS WITHOUT CLAIM TO ANY PARTICULAR FONT, STYLE, SIZE, OR COLOR.

THE NAME "JOHN HYLAND" IDENTIFIES A LIVING INDIVIDUAL WHOSE CONSENT TO REGISTER IS MADE OF RECORD.

FOR EDUCATIONAL SERVICES, NAMELY, PROVIDING EDUCATIONAL SPEAKERS IN THE FIELD OF BUSINESS DEVELOPMENT (U.S. CLS. 100, 101 AND 107).

ERIN FALK, EXAMINING ATTORNEY

**CLASS 41—(Continued).**

SN 86-047,183. GALLAGHER, KENNETH, J, DBA BUZZ ZONE MEDIA LLC, A LIMITED LIABILITY COMPANY ORGANIZED UNDER THE LAWS OF CALIFORNIA, ANAHEIM, CA. FILED 8-24-2013.

## The FAIL Zone

THE MARK CONSISTS OF STANDARD CHARACTERS WITHOUT CLAIM TO ANY PARTICULAR FONT, STYLE, SIZE, OR COLOR.

FOR PROVIDING AN ONLINE JOURNAL, NAMELY, A BLOG FEATURING THE WEB PAGES AND DATA FEEDS OF OTHERS FEATURING USER-DEFINED INFORMATION IN THE NATURE OF BLOG POSTS, NEW MEDIA CONTENT, OTHER ON-LINE CONTENT, PHOTOGRAPHS, AND AUDIO, VIDEO, PROSE, AND MULTIMEDIA PRESENTATIONS DEALING WITH NEWS, ENTERTAINMENT, AND SATIRICAL AND OTHER COMMENTARY, ALL REGARDING NEWS, CURRENT EVENTS, WORLD NEWS AND DEVELOPMENTS, AND TOPICS OF GENERAL INTEREST (U.S. CLS. 100, 101 AND 107).

BARBARA A. GOLD, EXAMINING ATTORNEY

SN 86-047,215. RUBIN, JOSEPH R., COATESVILLE, PA. FILED 8-24-2013.

## LifeΔFirstAid

THE MARK CONSISTS OF A TRIANGULAR-SHAPED FIGURE POSITIONED BETWEEN "LIFE" AND "FIRST-AID".

FOR EDUCATIONAL SERVICES, NAMELY, CONDUCTING CLASSES AND WORKSHOPS IN THE FIELDS OF CARDIOPULMONARY RESUSCITATION OR CPR, AUTOMATED EXTERNAL DEFIBRILLATION AND FIRST AID AND DISTRIBUTION OF TRAINING MATERIALS IN CONNECTION THEREWITH; TRAINING IN THE USE AND OPERATION OF AUTOMATED EXTERNAL DEFIBRILLATORS OR AED; TRAINING SERVICES IN THE FIELD OF CARDIOPULMONARY RESUSCITATION OR CPR, AUTOMATED EXTERNAL DEFIBRILLATION AND FIRST AID (U.S. CLS. 100, 101 AND 107).

FIRST USE 11-30-2011; IN COMMERCE 11-30-2011.

SUSAN RICHARDS, EXAMINING ATTORNEY

**CLASS 41—(Continued).**

SN 86-047,220. FLORISTS FOR CHANGE INC., STONE MOUNTAIN, GA. FILED 8-24-2013.

## Florists for Change

THE MARK CONSISTS OF STANDARD CHARACTERS WITHOUT CLAIM TO ANY PARTICULAR FONT, STYLE, SIZE, OR COLOR.

NO CLAIM IS MADE TO THE EXCLUSIVE RIGHT TO USE "FLORISTS", APART FROM THE MARK AS SHOWN.

FOR MEMBERSHIP CLUB SERVICES, NAMELY, PROVIDING TRAINING TO MEMBERS IN THE FIELD OF OPERATING TRADITIONAL, BRICK AND MORTAR, RETAIL FLORIST SHOPS (U.S. CLS. 100, 101 AND 107).

FIRST USE 8-11-2011; IN COMMERCE 8-11-2011.

SUSAN RICHARDS, EXAMINING ATTORNEY

SN 86-047,343. OSMARA VINDEL, MIAMI, FL. FILED 8-25-2013.

## The Butterfly Club

THE MARK CONSISTS OF STANDARD CHARACTERS WITHOUT CLAIM TO ANY PARTICULAR FONT, STYLE, SIZE, OR COLOR.

NO CLAIM IS MADE TO THE EXCLUSIVE RIGHT TO USE "CLUB", APART FROM THE MARK AS SHOWN.

FOR EDUCATION SERVICES, NAMELY, MENTORING IN THE FIELD OF PERSONAL IMPROVEMENT, FINANCIAL IMPROVEMENT, PHYSICAL FITNESS, MEDITATION, NUTRITION, MENTAL TRAINING, SPIRITUALITY, INSPIRATION, SELF-HELP, MOTIVATION AND WELLNESS; EDUCATION SERVICES, NAMELY, PROVIDING LIVE AND ON-LINE CLASSES, SEMINARS AND MENTORING IN THE FIELD OF PERSONAL IMPROVEMENT, FINANCIAL IMPROVEMENT, PHYSICAL FITNESS, MEDITATION, NUTRITION, MENTAL TRAINING, SPIRITUALITY, INSPIRATION, SELF-HELP, MOTIVATION AND WELLNESS; EDUCATIONAL AND ENTERTAINMENT SERVICES, NAMELY, PROVIDING MOTIVATIONAL SPEAKING SERVICES IN THE FIELD OF PERSONAL IMPROVEMENT, FINANCIAL IMPROVEMENT, PHYSICAL FITNESS, MEDITATION, NUTRITION, MENTAL TRAINING, SPIRITUALITY, INSPIRATION, SELF-HELP, MOTIVATION AND WELLNESS (U.S. CLS. 100, 101 AND 107).

FIRST USE 1-1-2013; IN COMMERCE 1-1-2013.

RONALD MCMORROW, EXAMINING ATTORNEY

**CLASS 41—(Continued).**

SN 86-047,528. CONTENT ENABLERS, INC., SARATOGA SPRINGS, NY. FILED 8-26-2013.

## compliance in context

THE MARK CONSISTS OF STANDARD CHARACTERS WITHOUT CLAIM TO ANY PARTICULAR FONT, STYLE, SIZE, OR COLOR.

NO CLAIM IS MADE TO THE EXCLUSIVE RIGHT TO USE "COMPLIANCE", APART FROM THE MARK AS SHOWN.

FOR EDUCATIONAL SERVICES, NAMELY, PROVIDING WEB-BASED AND CLASSROOM TRAINING ON REGULATORY COMPLIANCE (U.S. CLS. 100, 101 AND 107).

FIRST USE 8-1-2012; IN COMMERCE 8-1-2012.  
EMILY CHUO, EXAMINING ATTORNEY

---

SN 86-048,069. ALIA PALMER, DBA PRESCRIBED EVENTS, COSTA MESA, CA. FILED 8-26-2013.

## Taste of Paleo

THE MARK CONSISTS OF STANDARD CHARACTERS WITHOUT CLAIM TO ANY PARTICULAR FONT, STYLE, SIZE, OR COLOR.

NO CLAIM IS MADE TO THE EXCLUSIVE RIGHT TO USE "PALEO", APART FROM THE MARK AS SHOWN.

FOR CONDUCTING ENTERTAINMENT EXHIBITIONS IN THE NATURE OF FOOD FESTIVALS (U.S. CLS. 100, 101 AND 107).

FIRST USE 10-1-2012; IN COMMERCE 10-1-2012.  
KRISTIN DAHLING, EXAMINING ATTORNEY

---

SN 86-048,070. SCRIPTUREFIT, LLC, PLANO, TX. FILED 8-26-2013.

## SCRIPTUREFIT

THE MARK CONSISTS OF STANDARD CHARACTERS WITHOUT CLAIM TO ANY PARTICULAR FONT, STYLE, SIZE, OR COLOR.

FOR EDUCATIONAL SERVICES, NAMELY, CONDUCTING WORKSHOPS, SEMINARS, AND CLASSES, IN THE FIELD OF HEALTH, GENERAL FITNESS, EXERCISE, SPIRITUALITY AND SPIRITUAL DANCE (U.S. CLS. 100, 101 AND 107).

FIRST USE 10-1-2010; IN COMMERCE 6-1-2012.  
PAUL CROWLEY, EXAMINING ATTORNEY

**CLASS 41—(Continued).**

SN 86-048,161. USA FOOTBALL, INC., INDIANAPOLIS, IN. FILED 8-26-2013.



OWNER OF U.S. REG. NOS. 3,182,472, 3,241,236 AND 4,443,401.

NO CLAIM IS MADE TO THE EXCLUSIVE RIGHT TO USE "FOOTBALL", APART FROM THE MARK AS SHOWN.

THE MARK CONSISTS OF THE WORDS "USA" AND "FOOTBALL" IN SMALL, BLOCK, STYLIZED LETTERS PLACED ABOVE THE WORDS "HEADS" AND "UP" IN LARGER, CAPITALIZED, STYLIZED LETTERS, WITH THE WORD "FOOTBALL" PLACED BELOW THE WORDS "HEADS" AND "UP" IN SMALLER, CAPITALIZED, STYLIZED LETTERS, OUTLINED WITH TWO PARALLEL HORIZONTAL LINES, ONE PLACED ABOVE THE WORDS "HEADS" AND "UP" AND THE OTHER LINE PLACED BELOW THE WORD "FOOTBALL", WITH THE RENDITION OF A FOOTBALL SLANTING TO THE RIGHT, CONTAINING STAR SHAPES AND TWO CURVED STRIPES, PLACED BEHIND THE TEXT "HEADS", "UP", AND "FOOTBALL".  
SEC. 2(F) AS TO "USA FOOTBALL".

FOR EDUCATIONAL SERVICES, NAMELY, CONDUCTING PROGRAMS, CLASSES, SEMINARS, CONFERENCES, WORKSHOPS, TRAININGS, AND EXHIBITIONS, DISPLAYS, AND INTERACTIVE EXHIBITS ON FOOTBALL, PLAYER SAFETY, CONCUSSION RECOGNITION AND RESPONSE, COACHING EDUCATION, PROPER EQUIPMENT FITTING, AND PROPER TACKLING TECHNIQUES, AND THE DISTRIBUTION OF PRINTED MATERIALS IN CONNECTION THEREWITH IN HARD COPY OR ELECTRONIC FORMAT ON THE SAME TOPICS (U.S. CLS. 100, 101 AND 107).

FIRST USE 8-19-2013; IN COMMERCE 8-19-2013.  
JOANNA DUKOVIC, EXAMINING ATTORNEY

**CLASS 41—(Continued).**

SN 86-048,176. DREYFUS, JESSICA KUNG, SAN FRANCISCO, CA. AND DREYFUS, STEPHANE, SAN FRANCISCO, CA. FILED 8-26-2013.



THE COLOR(S) RED AND BLACK IS/ARE CLAIMED AS A FEATURE OF THE MARK.

THE MARK CONSISTS OF THREE RED CIRCLES OVERLAPPING ONE ANOTHER, BELOW IS THE TERM "TRIVENI" IN STYLIZED FONT IN BLACK.

THE ENGLISH TRANSLATION OF "TRIVENI" IN THE MARK IS "INTERSECTION OF 3 RIVERS".

FOR EDUCATIONAL SERVICES, NAMELY, CONDUCTING CLASSES, SEMINARS, CONFERENCES, WORKSHOPS, RETREATS, CAMPS AND FIELD TRIPS IN THE FIELD OF YOGA, PHILOSOPHY, SANSKRIT, AND MEDITATION AND DISTRIBUTION OF TRAINING MATERIAL IN CONNECTION THEREWITH; MEDITATION TRAINING; YOGA INSTRUCTION (U.S. CLS. 100, 101 AND 107).

FIRST USE 3-0-2013; IN COMMERCE 3-0-2013.  
GISELLE AGOSTO, EXAMINING ATTORNEY

SN 86-048,582. GRANDSTAFF, CHARLES, REMINGTON, IN. AND GRANDSTAFF, AMANDA, REMINGTON, IN. FILED 8-27-2013.

## Bonebrothers Outdoors

THE MARK CONSISTS OF STANDARD CHARACTERS WITHOUT CLAIM TO ANY PARTICULAR FONT, STYLE, SIZE, OR COLOR.

NO CLAIM IS MADE TO THE EXCLUSIVE RIGHT TO USE "OUTDOORS", APART FROM THE MARK AS SHOWN.

FOR EDUCATIONAL AND ENTERTAINMENT SERVICES, NAMELY, PROVIDING INFORMATION INCLUDING TIPS AND TRICKS ABOUT OUTDOORS ACTIVITIES VIA THE INTERNET TO MEN, WOMEN, AND CHILDREN WHO HAVE A PASSION FOR HUNTING, FISHING, AND OUTDOOR ACTIVITIES (U.S. CLS. 100, 101 AND 107).

KEVON CHISOLM, EXAMINING ATTORNEY

**CLASS 41—(Continued).**

SN 86-051,307. TRIFECTA MULTIMEDIA, DBA TRIFECTA CLINICAL, LOS ANGELES, CA. FILED 8-29-2013.

## ePresentOnline

THE MARK CONSISTS OF STANDARD CHARACTERS WITHOUT CLAIM TO ANY PARTICULAR FONT, STYLE, SIZE, OR COLOR.

FOR PROVIDING ONLINE TRAINING IN THE NATURE OF ONLINE CLASSES FOR CERTIFICATION IN CONDUCTION CLINICAL TRIALS RELATING TO PHARMACEUTICAL PRODUCTS AND MEDICAL DEVICES (U.S. CLS. 100, 101 AND 107).

FIRST USE 12-15-2005; IN COMMERCE 12-15-2005.  
SUSAN RICHARDS, EXAMINING ATTORNEY

SN 86-054,066. ACCESS INTELLIGENCE LLC, ROCKVILLE, MD. FILED 9-3-2013.

## NONPROFIT PR AWARDS

THE MARK CONSISTS OF STANDARD CHARACTERS WITHOUT CLAIM TO ANY PARTICULAR FONT, STYLE, SIZE, OR COLOR.

NO CLAIM IS MADE TO THE EXCLUSIVE RIGHT TO USE "PR AWARDS", APART FROM THE MARK AS SHOWN.

SEC. 2(F).

FOR PROVIDING RECOGNITION AND INCENTIVES BY THE WAY OF AWARDS TO DEMONSTRATE EXCELLENCE IN THE FIELD OF PUBLIC RELATIONS (U.S. CLS. 100, 101 AND 107).

FIRST USE 11-0-2005; IN COMMERCE 11-0-2005.  
MICHAEL SOUDERS, EXAMINING ATTORNEY

SN 86-054,208. TONY CARL WAAG, NEW YORK, NY. FILED 9-3-2013.

## Tap it Out

THE MARK CONSISTS OF STANDARD CHARACTERS WITHOUT CLAIM TO ANY PARTICULAR FONT, STYLE, SIZE, OR COLOR.

FOR A TAP DANCE EVENT THAT IS HELD OUTDOORS (U.S. CLS. 100, 101 AND 107).

FIRST USE 7-1-2012; IN COMMERCE 7-13-2012.  
AMY C. KEAN, EXAMINING ATTORNEY



**CLASS 41—(Continued).**

SN 86-057,160. ADAPT COURSEWARE, LLC, PITTSFORD, NY. FILED 9-5-2013.

**jump  
course**

NO CLAIM IS MADE TO THE EXCLUSIVE RIGHT TO USE "COURSE", APART FROM THE MARK AS SHOWN.

THE MARK CONSISTS OF THE WORD "JUMP" (WITH AN ENHANCED LETTER "J" AND THE LETTERS "U", "M", AND "P" SIZED TO DEPICT UPWARD MOTION) WRITTEN ABOVE THE WORD "COURSE", ALL IN LOWERCASE LETTERS.

FOR EDUCATION SERVICES, NAMELY, PROVIDING ON-LINE CLASSES IN THE FIELD OF GENERAL EDUCATION AT THE HIGH SCHOOL AND COLLEGE LEVEL, FOR EXAMPLE INTRODUCTION TO PSYCHOLOGY, INTRODUCTION TO SOCIOLOGY, ORGANIZATIONAL BEHAVIOR, FINANCIAL ACCOUNTING, FOUNDATIONS OF READING AND WRITING, STATISTICS, MACROECONOMICS, MICROECONOMICS, BUSINESS LAW, COLLEGE ALGEBRA, MARKETING AND AMERICAN GOVERNMENT (U.S. CLS. 100, 101 AND 107).

FIRST USE 8-5-2013; IN COMMERCE 8-12-2013.  
BRIAN NEVILLE, EXAMINING ATTORNEY

**CLASS 41—(Continued).**

SN 86-057,675. DANIEL AND WILSON, INC, DBA PATCHWERK RECORDING STUDIOS, ATLANTA, GA. FILED 9-6-2013.



OWNER OF U.S. REG. NOS. 3,858,221, 3,867,441 AND 4,249,456.

NO CLAIM IS MADE TO THE EXCLUSIVE RIGHT TO USE "SONICALLY SUPERIOR" OR "STUDIOS", APART FROM THE MARK AS SHOWN.

THE MARK CONSISTS OF CIRCULAR SEAL CONSISTING OF THE FOLLOWING: THE MARK CONSISTS OF THE LETTERS "P", "W", "R" SET IN A CUBE FORM OVER A CIRCULAR SEAL. THE CIRCULAR SEAL HAS THE LETTERS "SONICALLY SUPERIOR" PLACED AROUND TOP HALF AND THE LETTERS "PATCHWERK STUDIOS" PLACED AROUND THE LOWER HALF.

FOR AUDIO AND VIDEO RECORDING SERVICES; AUDIO RECORDING AND PRODUCTION; CONSULTATION AND ADVICE REGARDING MUSICAL SELECTIONS AND ARRANGEMENTS FOR SOUND RECORDINGS AND LIVE PERFORMANCES; CONSULTATION AND ADVICE REGARDING THE RENTAL OF RECORDING STUDIOS AND VENUES; DIGITAL VIDEO, AUDIO, AND MULTIMEDIA PUBLISHING SERVICES; EDITING OR RECORDING OF SOUNDS AND IMAGES; ENTERTAINMENT SERVICES IN THE NATURE OF RECORDING, PRODUCTION AND POST-PRODUCTION SERVICES IN THE FIELD OF MUSIC; ENTERTAINMENT SERVICES, NAMELY, PROVIDING A WEB SITE FEATURING PHOTOGRAPHIC, AUDIO, VIDEO AND PROSE PRESENTATIONS FEATURING AUDIO RECORDINGS; ENTERTAINMENT SERVICES, NAMELY, PROVIDING INFORMATION ABOUT A RECORDING ARTIST VIA AN ONLINE NETWORK; MULTIMEDIA ENTERTAINMENT SERVICES IN THE NATURE OF RECORDING, PRODUCTION AND POST-PRODUCTION SERVICES IN THE FIELDS OF MUSIC, VIDEO, AND FILMS; PRODUCTION OF AUDIO RECORDING; PRODUCTION OF MUSICAL SOUND RECORDING; PRODUCTION OF SOUND AND IMAGE RECORDINGS ON SOUND AND IMAGE CARRIERS; PRODUCTION OF SOUND AND MUSIC VIDEO RECORDINGS; PRODUCTION OF SOUND RECORDINGS; PRODUCTION OF SOUND RECORDINGS, NAMELY, CDS, MP3S, WAVS, AIFFS; PROVIDING AUDIO OR VIDEO STUDIOS; PROVISION OF INFORMATION RELATING TO TELEVISION, MOTION PICTURE FILM, AUDIO AND RADIO PRODUCTION; RECORD PRODUCTION; RECORDING STUDIO SERVICES; RECORDING STUDIOS; SOUND RECORDING STUDIOS (U.S. CLS. 100, 101 AND 107).

FIRST USE 1-1-2009; IN COMMERCE 1-1-2009.  
VERNA BETH RIRIE, EXAMINING ATTORNEY

**CLASS 41—(Continued).**

SN 86-059,489. ATLANTIC EDUCATION PARTNERS, INC., JACKSONVILLE, FL. FILED 9-9-2013.

**Acceleration Academy**

THE MARK CONSISTS OF STANDARD CHARACTERS WITHOUT CLAIM TO ANY PARTICULAR FONT, STYLE, SIZE, OR COLOR.

NO CLAIM IS MADE TO THE EXCLUSIVE RIGHT TO USE "ACADEMY", APART FROM THE MARK AS SHOWN. FOR EDUCATING AT SENIOR HIGH SCHOOLS (U.S. CLS. 100, 101 AND 107).

FIRST USE 5-22-2013; IN COMMERCE 5-22-2013.  
BRIAN NEVILLE, EXAMINING ATTORNEY

---

SN 86-061,289. WILLARSEN, JOSEPH, LAS VEGAS, NV. FILED 9-11-2013.

**Dentistry VT**

THE MARK CONSISTS OF STANDARD CHARACTERS WITHOUT CLAIM TO ANY PARTICULAR FONT, STYLE, SIZE, OR COLOR.

NO CLAIM IS MADE TO THE EXCLUSIVE RIGHT TO USE "DENTISTRY", APART FROM THE MARK AS SHOWN.

FOR EDUCATIONAL SERVICES, NAMELY, PROVIDING CONTINUING PROFESSIONAL EDUCATION COURSES IN THE FIELD OF GENERAL DENTISTRY, BIOMIMETIC DENTISTRY, IMPLANT DENTISTRY, COSMETIC DENTISTRY, NEUROMUSCULAR DENTISTRY, PERIODONTICS, ENDODONTICS, ORTHODONTICS, ORAL SURGERY, SPORTS DENTISTRY, LABORATORY TECHNIQUES AND PROCEDURES, PRACTICE MANAGEMENT, CAD-CAM DENTISTRY, AND DENTAL STAFF TRAINING; EDUCATIONAL SERVICES, NAMELY, PROVIDING ONLINE INSTRUCTION IN THE FIELD OF GENERAL DENTISTRY, BIOMIMETIC DENTISTRY, IMPLANT DENTISTRY, COSMETIC DENTISTRY, NEUROMUSCULAR DENTISTRY, PERIODONTICS, ENDODONTICS, ORTHODONTICS, ORAL SURGERY, SPORTS DENTISTRY, LABORATORY TECHNIQUES AND PROCEDURES, PRACTICE MANAGEMENT, CAD-CAM DENTISTRY, AND DENTAL STAFF TRAINING (U.S. CLS. 100, 101 AND 107).

CHARLOTTE CORWIN, EXAMINING ATTORNEY

**CLASS 41—(Continued).**

SN 86-061,622. AURIGO SOFTWARE TECHNOLOGIES INC., EAST SETAUKET, NY. FILED 9-11-2013.

**STONAVIGATOR**

THE MARK CONSISTS OF STANDARD CHARACTERS WITHOUT CLAIM TO ANY PARTICULAR FONT, STYLE, SIZE, OR COLOR.

FOR ON-LINE JOURNALS, NAMELY, BLOGS FEATURING INFORMATION AND OPINIONS RELATING TO SHUTDOWNS, TURNAROUNDS AND OUTAGES; PROVIDING A WEBSITE FEATURING BLOGS AND NON-DOWNLOADABLE PUBLICATIONS IN THE NATURE OF ARTICLES AND NOTICES IN THE FIELD(S) OF SHUTDOWNS, TURNAROUNDS AND OUTAGES; PROVIDING ON-LINE TRAINING VIA ONLINE WEBSITE INFORMATION IN THE FIELD OF SHUTDOWNS, TURNAROUNDS AND OUTAGES; TRAINING SERVICES IN THE FIELD OF SHUTDOWNS, TURNAROUNDS AND OUTAGES (U.S. CLS. 100, 101 AND 107).

FIRST USE 2-27-2012; IN COMMERCE 2-27-2012.  
FLORENTINA BLANDU, EXAMINING ATTORNEY

---

SN 86-061,653. BAPTISTE, BARON, PARK CITY, UT. FILED 9-11-2013.

**BARON BAPTISTE**

THE MARK CONSISTS OF STANDARD CHARACTERS WITHOUT CLAIM TO ANY PARTICULAR FONT, STYLE, SIZE, OR COLOR.

OWNER OF U.S. REG. NOS. 2,924,774, 2,963,663 AND 4,428,912.

THE NAME(S), PORTRAIT(S), AND/OR SIGNATURE(S) SHOWN IN THE MARK IDENTIFIES "BARON BAPTISTE", WHOSE CONSENT(S) TO REGISTER IS MADE OF RECORD.

FOR EDUCATION SERVICES, NAMELY, PROVIDING PROGRAMS, LIVE AND ON-LINE CLASSES, COURSES, CONFERENCES, WORKSHOPS AND RETREATS IN THE FIELD OF YOGA AND PERSONAL DEVELOPMENT (U.S. CLS. 100, 101 AND 107).

FIRST USE 1-1-2000; IN COMMERCE 9-30-2001.  
AMY HELLA, EXAMINING ATTORNEY

**CLASS 41—(Continued).**

SN 86-061,903. FARM FOUNDATION, NFP, OAK BROOK, IL. FILED 9-11-2013.



OWNER OF U.S. REG. NO. 4,174,310.  
THE COLOR(S) BROWN AND GREEN IS/ARE CLAIMED AS A FEATURE OF THE MARK.

THE MARK CONSISTS OF THE WORD "SOLUTIONS" DIRECTLY ABOVE THE WORDS "FROM THE LAND", ALL IN BROWN FONT AND WITHIN A BROWN HORIZONTAL RECTANGLE. THE TOP OF THE RECTANGLE HAS AN ADDITIONAL CONTOURED LINE ABOVE IT AND IS FILLED IN BROWN SO THE TOP OF THE RECTANGLE RESEMBLES SOIL. THE "O" IN THE WORD "SOLUTIONS" IS A SEED WITH ROOTS TO A GREEN, TWO-STEMMED PLANT EXTENDING VERTICALLY THROUGH THE TOP OF THE RECTANGLE.

FOR EDUCATIONAL SERVICES, NAMELY, CONDUCTING CONFERENCES, WORKSHOPS, SEMINARS, IN PERSON EDUCATIONAL FORUMS, FORUMS IN THE NATURE OF NON-DOWNLOADABLE WEBINARS, AND VIDEOS IN THE FIELD OF AGRICULTURAL AND ENVIRONMENTAL RESEARCH AND POLICY AND DISTRIBUTION OF EDUCATIONAL MATERIALS IN CONNECTION THEREWITH (U.S. CLS. 100, 101 AND 107).

FIRST USE 3-0-2013, THE MARK WAS FIRST USED ANYWHERE IN A DIFFERENT FORM OTHER THAN THAT SOUGHT TO BE REGISTERED AT LEAST AS EARLY AS 12/14/2010; IN COMMERCE 3-0-2013, THE MARK WAS FIRST USED IN COMMERCE IN A DIFFERENT FORM OTHER THAN THAT SOUGHT TO BE REGISTERED AT LEAST AS EARLY AS 12/14/2010.

HEATHER SAPP, EXAMINING ATTORNEY

SN 86-062,193. WARNER BROS. ENTERTAINMENT INC., BURBANK, CA. FILED 9-11-2013.

**FANTASTIC BEASTS**

THE MARK CONSISTS OF STANDARD CHARACTERS WITHOUT CLAIM TO ANY PARTICULAR FONT, STYLE, SIZE, OR COLOR.

FOR ENTERTAINMENT SERVICES IN THE NATURE OF LIVE-ACTION, COMEDY, DRAMA, ANIMATED AND REALITY TELEVISION SERIES; PRODUCTION OF LIVE-ACTION, COMEDY, DRAMA, ANIMATED AND REALITY TELEVISION SERIES; DISTRIBUTION AND DISPLAY OF LIVE-ACTION, COMEDY, DRAMA AND ANIMATED MOTION PICTURE THEATRICAL FILMS; PRODUCTION OF LIVE-ACTION, COMEDY, DRAMA AND ANIMATED MOTION PICTURE THEATRICAL FILMS; THEATRICAL PERFORMANCES BOTH ANIMATED AND LIVE ACTION; INTERNET SERVICES PROVIDING INFORMATION VIA AN ELECTRONIC GLOBAL COMPUTER NETWORK IN THE FIELD OF ENTERTAINMENT RELATING SPECIFICALLY TO MUSIC, MOVIES, AND TELEVISION; PROVIDING GENERAL INTEREST NEWS IN THE NATURE OF CURRENT EVENTS, ENTERTAINMENT INFORMATION, AND IN-

**CLASS 41—(Continued).**

FORMATION ON EDUCATION VIA A GLOBAL COMPUTER NETWORK; AND PROVIDING INFORMATION VIA AN ELECTRONIC GLOBAL COMMUNICATIONS NETWORK ON THE SUBJECT OF LIVE-ACTION, COMEDY, DRAMA AND ANIMATED MOTION PICTURE FILMS AND TELEVISION PROGRAMS; AND PRODUCTION OF LIVE-ACTION, COMEDY, DRAMA AND ANIMATED MOTION PICTURE FILMS FOR DISTRIBUTION VIA A GLOBAL COMPUTER NETWORK; ENTERTAINMENT SERVICES, NAMELY, AN ONGOING MULTIMEDIA PROGRAM SERIES FEATURING LIVE-ACTION, ANIMATED, COMEDY AND DRAMA FOR DISTRIBUTION VIA A GLOBAL COMPUTER NETWORK; ENTERTAINMENT SERVICES, NAMELY, PROVIDING COMPUTER GAMES ONLINE AND IN MOBILE WIRELESS FORM, PROVIDING TEMPORARY USE OF NON-DOWNLOADABLE COMPUTER GAMES, AND PROVIDING TEMPORARY USE OF NON-DOWNLOADABLE VIDEO GAMES; PRODUCTION OF VIDEO AND COMPUTER GAME SOFTWARE; PROVISION OF INFORMATION RELATING TO ELECTRONIC COMPUTER GAMES PROVIDED VIA THE INTERNET; PROVIDING A WEBSITE FEATURING NON-DOWNLOADABLE PUBLICATIONS IN THE NATURE OF COMIC BOOKS, STRATEGY GUIDES IN THE FIELD OF BOARD GAMES, VIDEO GAMES AND COMPUTER GAMES, FICTION BOOKS AND AUDIO BOOKS FEATURING CHARACTERS FROM ANIMATED, ACTION ADVENTURE, COMEDY AND/OR DRAMA FEATURES, CHILDREN'S BOOKS, COLORING BOOKS, GRAPHIC NOVELS, AND MAGAZINES FEATURING CHARACTERS FROM ANIMATED, ACTION ADVENTURE, COMEDY AND/OR DRAMA FEATURES; PUBLICATION OF BOOKS, COMIC BOOKS, STRATEGY GUIDES, FICTION BOOKS, AUDIO BOOKS, CHILDREN'S BOOKS, COLORING BOOKS, GRAPHIC NOVELS, MAGAZINES; PUBLISHING OF ELECTRONIC PUBLICATIONS (U.S. CLS. 100, 101 AND 107).

JUSTINE D. PARKER, EXAMINING ATTORNEY

SN 86-062,197. WARNER BROS. ENTERTAINMENT INC., BURBANK, CA. FILED 9-11-2013.

**KENILWORTHY WHISP**

THE MARK CONSISTS OF STANDARD CHARACTERS WITHOUT CLAIM TO ANY PARTICULAR FONT, STYLE, SIZE, OR COLOR.

FOR ENTERTAINMENT SERVICES IN THE NATURE OF LIVE-ACTION, COMEDY, DRAMA, ANIMATED AND REALITY TELEVISION SERIES; PRODUCTION OF LIVE-ACTION, COMEDY, DRAMA, ANIMATED AND REALITY TELEVISION SERIES; DISTRIBUTION AND DISPLAY OF LIVE-ACTION, COMEDY, DRAMA AND ANIMATED MOTION PICTURE THEATRICAL FILMS; PRODUCTION OF LIVE-ACTION, COMEDY, DRAMA AND ANIMATED MOTION PICTURE THEATRICAL FILMS; THEATRICAL PERFORMANCES BOTH ANIMATED AND LIVE ACTION; INTERNET SERVICES PROVIDING INFORMATION VIA AN ELECTRONIC GLOBAL COMPUTER NETWORK IN THE FIELD OF ENTERTAINMENT RELATING SPECIFICALLY TO MUSIC, MOVIES, AND TELEVISION; PROVIDING GENERAL INTEREST NEWS IN THE NATURE OF CURRENT EVENTS, ENTERTAINMENT INFORMATION, AND INFORMATION ON EDUCATION VIA A GLOBAL COMPUTER NETWORK; AND PROVIDING INFORMATION VIA AN ELECTRONIC GLOBAL COMMUNICATIONS NETWORK ON THE SUBJECT OF LIVE-ACTION, COMEDY, DRAMA AND ANIMATED MOTION PICTURE FILMS AND TELEVISION PROGRAMS; AND PRODUCTION OF LIVE-ACTION, COMEDY, DRAMA AND ANIMATED MOTION PICTURE FILMS FOR DISTRIBUTION VIA A GLOBAL COMPUTER NETWORK; ENTERTAINMENT SERVICES, NAMELY, AN

**CLASS 41—(Continued).**

ONGOING MULTIMEDIA PROGRAM SERIES FEATURING LIVE-ACTION, ANIMATED, COMEDY AND DRAMA FOR DISTRIBUTION VIA A GLOBAL COMPUTER NETWORK; ENTERTAINMENT SERVICES, NAMELY, PROVIDING COMPUTER GAMES ONLINE AND IN MOBILE WIRELESS FORM, PROVIDING TEMPORARY USE OF NON-DOWNLOADABLE COMPUTER GAMES, AND PROVIDING TEMPORARY USE OF NON-DOWNLOADABLE VIDEO GAMES; PRODUCTION OF VIDEO AND COMPUTER GAME SOFTWARE; PROVISION OF INFORMATION RELATING TO ELECTRONIC COMPUTER GAMES PROVIDED VIA THE INTERNET; PROVIDING A WEBSITE FEATURING NON-DOWNLOADABLE PUBLICATIONS IN THE NATURE OF COMIC BOOKS, STRATEGY GUIDES IN THE FIELD OF BOARD GAMES, VIDEO GAMES AND COMPUTER GAMES, FICTION BOOKS AND AUDIO BOOKS FEATURING CHARACTERS FROM ANIMATED, ACTION ADVENTURE, COMEDY AND/OR DRAMA FEATURES, CHILDREN'S BOOKS, COLORING BOOKS, GRAPHIC NOVELS, AND MAGAZINES FEATURING CHARACTERS FROM ANIMATED, ACTION ADVENTURE, COMEDY AND/OR DRAMA FEATURES; PUBLICATION OF BOOKS, COMIC BOOKS, STRATEGY GUIDES, FICTION BOOKS, AUDIO BOOKS, CHILDREN'S BOOKS, COLORING BOOKS, GRAPHIC NOVELS, MAGAZINES; PUBLISHING OF ELECTRONIC PUBLICATIONS (U.S. CLS. 100, 101 AND 107).

JUSTINE D. PARKER, EXAMINING ATTORNEY

---

SN 86-062,208. WARNER BROS. ENTERTAINMENT INC., BURBANK, CA. FILED 9-11-2013.

**FANTASTIC BEASTS & WHERE TO FIND THEM**

THE MARK CONSISTS OF STANDARD CHARACTERS WITHOUT CLAIM TO ANY PARTICULAR FONT, STYLE, SIZE, OR COLOR.

FOR ENTERTAINMENT SERVICES IN THE NATURE OF LIVE-ACTION, COMEDY, DRAMA, ANIMATED AND REALITY TELEVISION SERIES; PRODUCTION OF LIVE-ACTION, COMEDY, DRAMA, ANIMATED AND REALITY TELEVISION SERIES; DISTRIBUTION AND DISPLAY OF LIVE-ACTION, COMEDY, DRAMA AND ANIMATED MOTION PICTURE THEATRICAL FILMS; PRODUCTION OF LIVE-ACTION, COMEDY, DRAMA AND ANIMATED MOTION PICTURE THEATRICAL FILMS; THEATRICAL PERFORMANCES BOTH ANIMATED AND LIVE ACTION; INTERNET SERVICES PROVIDING INFORMATION VIA AN ELECTRONIC GLOBAL COMPUTER NETWORK IN THE FIELD OF ENTERTAINMENT RELATING SPECIFICALLY TO MUSIC, MOVIES, AND TELEVISION; PROVIDING GENERAL INTEREST NEWS IN THE NATURE OF CURRENT EVENTS, ENTERTAINMENT INFORMATION, AND INFORMATION ON EDUCATION VIA A GLOBAL COMPUTER NETWORK; AND PROVIDING INFORMATION VIA AN ELECTRONIC GLOBAL COMMUNICATIONS NETWORK ON THE SUBJECT OF LIVE-ACTION, COMEDY, DRAMA AND ANIMATED MOTION PICTURE FILMS AND TELEVISION PROGRAMS; AND PRODUCTION OF LIVE-ACTION, COMEDY, DRAMA AND ANIMATED MOTION PICTURE FILMS FOR DISTRIBUTION VIA A GLOBAL COMPUTER NETWORK; ENTERTAINMENT SERVICES, NAMELY, AN ONGOING MULTIMEDIA PROGRAM SERIES FEATURING LIVE-ACTION, ANIMATED, COMEDY AND DRAMA FOR DISTRIBUTION VIA A GLOBAL COMPUTER NETWORK; ENTERTAINMENT SERVICES, NAMELY, PROVIDING COMPUTER GAMES ONLINE AND IN MOBILE WIRELESS FORM, PROVIDING TEMPORARY USE OF NON-DOWNLOADABLE COMPUTER GAMES,

**CLASS 41—(Continued).**

AND PROVIDING TEMPORARY USE OF NON-DOWNLOADABLE VIDEO GAMES; PRODUCTION OF VIDEO AND COMPUTER GAME SOFTWARE; PROVISION OF INFORMATION RELATING TO ELECTRONIC COMPUTER GAMES PROVIDED VIA THE INTERNET; PROVIDING A WEBSITE FEATURING NON-DOWNLOADABLE PUBLICATIONS IN THE NATURE OF COMIC BOOKS, STRATEGY GUIDES IN THE FIELD OF BOARD GAMES, VIDEO GAMES AND COMPUTER GAMES, FICTION BOOKS AND AUDIO BOOKS FEATURING CHARACTERS FROM ANIMATED, ACTION ADVENTURE, COMEDY AND/OR DRAMA FEATURES, CHILDREN'S BOOKS, COLORING BOOKS, GRAPHIC NOVELS, AND MAGAZINES FEATURING CHARACTERS FROM ANIMATED, ACTION ADVENTURE, COMEDY AND/OR DRAMA FEATURES; PUBLICATION OF BOOKS, COMIC BOOKS, STRATEGY GUIDES, FICTION BOOKS, AUDIO BOOKS, CHILDREN'S BOOKS, COLORING BOOKS, GRAPHIC NOVELS, MAGAZINES; PUBLISHING OF ELECTRONIC PUBLICATIONS (U.S. CLS. 100, 101 AND 107).

JUSTINE D. PARKER, EXAMINING ATTORNEY

---

SN 86-062,316. HARRIS, TERE' J, ODESSA, TX. FILED 9-12-2013.

**Syndicate, The Lonely Gun**

THE MARK CONSISTS OF STANDARD CHARACTERS WITHOUT CLAIM TO ANY PARTICULAR FONT, STYLE, SIZE, OR COLOR.

FOR ENTERTAINMENT, NAMELY, LIVE ARTISTIC AND VISUAL ARTS PERFORMANCES; ENTERTAINMENT IN THE NATURE OF LIVE PERFORMANCES BY A MUSICAL ARTIST (U.S. CLS. 100, 101 AND 107).

MICHAEL WIENER, EXAMINING ATTORNEY

---

SN 86-062,509. WARNER BROS. ENTERTAINMENT INC., BURBANK, CA. FILED 9-12-2013.

**FANTASTIC BEASTS AND WHERE TO FIND THEM**

THE MARK CONSISTS OF STANDARD CHARACTERS WITHOUT CLAIM TO ANY PARTICULAR FONT, STYLE, SIZE, OR COLOR.

FOR ENTERTAINMENT SERVICES IN THE NATURE OF LIVE-ACTION, COMEDY, DRAMA, ANIMATED AND REALITY TELEVISION SERIES; PRODUCTION OF LIVE-ACTION, COMEDY, DRAMA, ANIMATED AND REALITY TELEVISION SERIES; DISTRIBUTION AND DISPLAY OF LIVE-ACTION, COMEDY, DRAMA AND ANIMATED MOTION PICTURE THEATRICAL FILMS; PRODUCTION OF LIVE-ACTION, COMEDY, DRAMA AND ANIMATED MOTION PICTURE THEATRICAL FILMS; THEATRICAL PERFORMANCES BOTH ANIMATED AND LIVE ACTION; INTERNET SERVICES PROVIDING INFORMATION VIA AN ELECTRONIC GLOBAL COMPUTER NETWORK IN THE FIELD OF ENTERTAINMENT RELATING SPECIFICALLY TO MUSIC, MOVIES, AND TELEVISION; PROVIDING GENERAL INTEREST NEWS IN THE NATURE OF CURRENT EVENTS, ENTERTAINMENT INFORMATION, AND INFORMATION ON EDUCATION VIA A GLOBAL COMPUTER NETWORK; AND PROVIDING INFORMATION

**CLASS 41—(Continued).**

VIA AN ELECTRONIC GLOBAL COMMUNICATIONS NETWORK ON THE SUBJECT OF LIVE-ACTION, COMEDY, DRAMA AND ANIMATED MOTION PICTURE FILMS AND TELEVISION PROGRAMS; AND PRODUCTION OF LIVE-ACTION, COMEDY, DRAMA AND ANIMATED MOTION PICTURE FILMS FOR DISTRIBUTION VIA A GLOBAL COMPUTER NETWORK; ENTERTAINMENT SERVICES, NAMELY, AN ONGOING MULTIMEDIA PROGRAM SERIES FEATURING LIVE-ACTION, ANIMATED, COMEDY AND DRAMA FOR DISTRIBUTION VIA A GLOBAL COMPUTER NETWORK; ENTERTAINMENT SERVICES, NAMELY, PROVIDING COMPUTER GAMES ONLINE AND IN MOBILE WIRELESS FORM, PROVIDING TEMPORARY USE OF NON-DOWNLOADABLE COMPUTER GAMES, AND PROVIDING TEMPORARY USE OF NON-DOWNLOADABLE VIDEO GAMES; PRODUCTION OF VIDEO AND COMPUTER GAME SOFTWARE; PROVISION OF INFORMATION RELATING TO ELECTRONIC COMPUTER GAMES PROVIDED VIA THE INTERNET; PROVIDING A WEBSITE FEATURING NON-DOWNLOADABLE PUBLICATIONS IN THE NATURE OF COMIC BOOKS, STRATEGY GUIDES IN THE FIELD OF BOARD GAMES, VIDEO GAMES AND COMPUTER GAMES, FICTION BOOKS AND AUDIO BOOKS FEATURING CHARACTERS FROM ANIMATED, ACTION ADVENTURE, COMEDY AND/OR DRAMA FEATURES, CHILDREN'S BOOKS, COLORING BOOKS, GRAPHIC NOVELS, AND MAGAZINES FEATURING CHARACTERS FROM ANIMATED, ACTION ADVENTURE, COMEDY AND/OR DRAMA FEATURES; PUBLICATION OF BOOKS, COMIC BOOKS, STRATEGY GUIDES, FICTION BOOKS, AUDIO BOOKS, CHILDREN'S BOOKS, COLORING BOOKS, GRAPHIC NOVELS, MAGAZINES; PUBLISHING OF ELECTRONIC PUBLICATIONS (U.S. CLS. 100, 101 AND 107).  
JUSTINE D. PARKER, EXAMINING ATTORNEY

SN 86-062,762. BMPRO/131ENT BLACK-MAGIC, MIAMI, FL. FILED 9-12-2013.

**BMpro/131ent Black-Magic**

THE MARK CONSISTS OF STANDARD CHARACTERS WITHOUT CLAIM TO ANY PARTICULAR FONT, STYLE, SIZE, OR COLOR.  
FOR FILM PRODUCTION; MEDIA PRODUCTION SERVICES, NAMELY, VIDEO AND FILM PRODUCTION; PRODUCTION OF FILMS; PRODUCTION OF MUSICAL VIDEOS; TELEVISION SHOW PRODUCTION (U.S. CLS. 100, 101 AND 107).  
CIMMERIAN COLEMAN, EXAMINING ATTORNEY

**CLASS 41—(Continued).**

SN 86-063,478. BUILDING PERFORMANCE CENTER, INC., FOLSOM, CA. FILED 9-12-2013.

**BPC**

THE MARK CONSISTS OF STANDARD CHARACTERS WITHOUT CLAIM TO ANY PARTICULAR FONT, STYLE, SIZE, OR COLOR.  
FOR EDUCATIONAL SERVICES, NAMELY, CONDUCTING LIVE AND ON-LINE CLASSES, SEMINARS, CONFERENCES, AND WORKSHOPS IN THE FIELD OF ENERGY RATING, ENERGY CONSERVATION, BUSINESS MANAGEMENT, FINANCING AND TECHNOLOGY AND DISTRIBUTION OF COURSE AND EDUCATIONAL MATERIALS IN CONNECTION THEREWITH (U.S. CLS. 100, 101 AND 107).  
FIRST USE 1-1-2012; IN COMMERCE 4-9-2012.  
PAUL E. FAHRENKOPF, EXAMINING ATTORNEY

SN 86-063,884. TIKI'S PLAYHOUSE, INC., GLENELG, MD. FILED 9-13-2013.



THE MARK CONSISTS OF A DOG HOLDING A CUP INSIDE A CIRCLE. IN AN OUTER CIRCLE, THE WORDING "K - 9 & COFFEE" IS AT THE TOP AND "BRING YOUR PUP AND GRAB A CUP" IS ON THE BOTTOM. THERE ARE TWO PAW PRINTS ON THE LEFT AND RIGHT SIDES, INSIDE THE OUTER CIRCLE.  
FOR ARRANGING, ORGANIZING, CONDUCTING, AND HOSTING SOCIAL ENTERTAINMENT EVENTS (U.S. CLS. 100, 101 AND 107).  
SOPHIA S. KIM, EXAMINING ATTORNEY

**CLASS 41—(Continued).**

SN 86-063,983. ABSOLUTELY DEFINED, INC., CHICAGO, IL. FILED 9-13-2013.

**ABSOLUTELY DEFINED**

THE MARK CONSISTS OF STANDARD CHARACTERS WITHOUT CLAIM TO ANY PARTICULAR FONT, STYLE, SIZE, OR COLOR.

FOR PROVIDING FITNESS TRAINING, EXERCISE AND CONDITIONING SERVICES TO INDIVIDUALS AND GROUPS (U.S. CLS. 100, 101 AND 107).

FIRST USE 5-1-2004; IN COMMERCE 9-12-2013.  
MARCIE MILONE, EXAMINING ATTORNEY

---

SN 86-064,014. GO FAST TRADEMARKS, LLC, TRAVERSE CITY, MI. FILED 9-13-2013.



OWNER OF U.S. REG. NOS. 3,326,563, 3,879,940 AND OTHERS.

THE MARK CONSISTS OF THE LETTER "F" FOLLOWED BY GEOMETRIC FIGURES REPRESENTING A PERSON RUNNING FORMING THE LETTER "A" AND IS FOLLOWED BY THE LETTERS "S" AND "T", THEN THE WORD "FITNESS".

FOR HEALTH CLUB SERVICES, NAMELY, PROVIDING INSTRUCTION AND EQUIPMENT IN THE FIELD OF PHYSICAL EXERCISE; PERSONAL TRAINING SERVICES, NAMELY, STRENGTH AND CONDITIONING TRAINING; PROVIDING INFORMATION IN THE FIELD OF EXERCISE TRAINING; EDUCATION SERVICES, NAMELY, PROVIDING CLASSES IN THE FIELD OF EXERCISE TRAINING (U.S. CLS. 100, 101 AND 107).

FIRST USE 8-18-2005; IN COMMERCE 8-18-2005.  
AMY C. KEAN, EXAMINING ATTORNEY

---

SN 86-064,112. CELESTE GIULIANO PHOTOGRAPHY, HAVERTOWN, PA. FILED 9-13-2013.

**Servin' up the best  
cheesecake in town!**

THE MARK CONSISTS OF STANDARD CHARACTERS WITHOUT CLAIM TO ANY PARTICULAR FONT, STYLE, SIZE, OR COLOR.

FOR PORTRAIT PHOTOGRAPHY (U.S. CLS. 100, 101 AND 107).

FIRST USE 2-1-2008; IN COMMERCE 2-1-2008.  
ELLEN BURNS, EXAMINING ATTORNEY

**CLASS 41—(Continued).**

SN 86-064,375. PERFECTSTREAK.COM, LLC, DALLAS, TX. FILED 9-13-2013.

**OUTSTREAK**

THE MARK CONSISTS OF STANDARD CHARACTERS WITHOUT CLAIM TO ANY PARTICULAR FONT, STYLE, SIZE, OR COLOR.

FOR ARRANGING OF CONTESTS; ENTERTAINMENT IN THE NATURE OF PROVIDING ONLINE FANTASY SPORTS GAMES, CONTESTS, STATISTICS, METRICS AND RANKINGS; ENTERTAINMENT SERVICES IN THE NATURE OF FANTASY SPORTS LEAGUES; ENTERTAINMENT SERVICES, NAMELY, CONDUCTING CONTESTS; ENTERTAINMENT SERVICES, NAMELY, PROVIDING TEMPORARY USE OF NON-DOWNLOADABLE INTERACTIVE GAMES; PROVIDING NEWS AND INFORMATION IN THE FIELD OF SPORTS; SWEEPSTAKE SERVICES (U.S. CLS. 100, 101 AND 107).

FIRST USE 9-4-2013; IN COMMERCE 9-4-2013.  
APRIL REEVES, EXAMINING ATTORNEY

---

SN 86-064,653. JOHNSON, KRISTEN L, INDIANAPOLIS, IN. FILED 9-13-2013.

**Lady Houdini**

THE MARK CONSISTS OF STANDARD CHARACTERS WITHOUT CLAIM TO ANY PARTICULAR FONT, STYLE, SIZE, OR COLOR.

THE NAME "LADY HOUDINI" IDENTIFIES THE STAGE NAME OF KRISTEN JOHNSON, A LIVING INDIVIDUAL WHOSE CONSENT IS OF RECORD.

FOR ENTERTAINMENT IN THE NATURE OF MAGIC SHOWS; ENTERTAINMENT IN THE NATURE OF LIVE ESCAPE PERFORMANCES, ILLUSIONS PERFORMANCES, MAGIC PERFORMANCES, STUNT PERFORMANCES; ENTERTAINMENT SERVICES IN THE NATURE OF ESCAPE PERFORMANCES, ILLUSIONS PERFORMANCES, MAGIC PERFORMANCES, STUNT PERFORMANCES (U.S. CLS. 100, 101 AND 107).

FIRST USE 4-15-2009; IN COMMERCE 4-15-2009.  
JENNY PARK, EXAMINING ATTORNEY

**CLASS 41—(Continued).**

SN 86-065,064. SILO, LLC, GAINESVILLE, FL. FILED 9-15-2013.

**SILO**

THE MARK CONSISTS OF STANDARD CHARACTERS WITHOUT CLAIM TO ANY PARTICULAR FONT, STYLE, SIZE, OR COLOR.

FOR ENTERTAINMENT SERVICES, NAMELY, ARRANGING AND CONDUCTING PARTIES; ENTERTAINMENT SERVICES, NAMELY, ARRANGING AND CONDUCTING SILENT DISCO EVENTS (U.S. CLS. 100, 101 AND 107).

DAVID MURRAY, EXAMINING ATTORNEY

---

SN 86-065,153. THE CORNER STUDIO, LLC., SAN FRANCISCO, CA. FILED 9-16-2013.

**G.I.T FIT**

THE MARK CONSISTS OF STANDARD CHARACTERS WITHOUT CLAIM TO ANY PARTICULAR FONT, STYLE, SIZE, OR COLOR.

NO CLAIM IS MADE TO THE EXCLUSIVE RIGHT TO USE "FIT", APART FROM THE MARK AS SHOWN.

FOR PHYSICAL FITNESS INSTRUCTION; PHYSICAL FITNESS STUDIO SERVICES, NAMELY, PROVIDING EXERCISE CLASSES, BODY SCULPTING CLASSES, AND GROUP FITNESS CLASSES; PHYSICAL FITNESS TRAINING OF INDIVIDUALS AND GROUPS (U.S. CLS. 100, 101 AND 107).

FIRST USE 1-1-2010; IN COMMERCE 1-1-2010.

KATHERINE CONNOLLY, EXAMINING ATTORNEY

---

SN 86-065,202. TAYLOR, LYNETTE, PEMBROKE PINES, FL. FILED 9-16-2013.

**MIZLT**

THE MARK CONSISTS OF STANDARD CHARACTERS WITHOUT CLAIM TO ANY PARTICULAR FONT, STYLE, SIZE, OR COLOR.

FOR BEAUTY ARTS INSTRUCTION; ENTERTAINMENT SERVICES IN THE NATURE OF AN ONGOING REALITY BASED TELEVISION PROGRAM; PROVIDING AUDIO OR VIDEO STUDIOS; RECORDING STUDIO SERVICES (U.S. CLS. 100, 101 AND 107).

KATHY DE JONGE, EXAMINING ATTORNEY

**CLASS 41—(Continued).**

SN 86-065,413. THE UNIVERSITY OF NORTH ALABAMA, FLORENCE, AL. FILED 9-16-2013.

**BUILDING THE PRIDE**

THE MARK CONSISTS OF STANDARD CHARACTERS WITHOUT CLAIM TO ANY PARTICULAR FONT, STYLE, SIZE, OR COLOR.

FOR EDUCATING AT UNIVERSITY OR COLLEGES; EDUCATION SERVICES IN THE NATURE OF COURSES AT THE UNIVERSITY LEVEL; ENCOURAGING AMATEUR SPORTS AND PHYSICAL EDUCATION BY ORGANIZING, SANCTIONING, CONDUCTING, REGULATING AND GOVERNING AMATEUR ATHLETIC PROGRAMS AND ACTIVITIES; ENCOURAGING INTERCOLLEGIATE ATHLETIC PROGRAMS BY ORGANIZING AND CONDUCTING EDUCATIONAL PROGRAMS AND ACTIVITIES FOR INTERCOLLEGIATE ATHLETES AND ALUMNI (U.S. CLS. 100, 101 AND 107).

FIRST USE 5-30-2012; IN COMMERCE 5-30-2012.

ROBERT C. CLARK JR., EXAMINING ATTORNEY

---

SN 86-065,527. SIME, LUIS, PROVIDENCE, RI. AND MARTINEZ, JOSE MISAEL, PROVIDENCE, RI. FILED 9-16-2013.

**HIGH TOWERS**

THE MARK CONSISTS OF STANDARD CHARACTERS WITHOUT CLAIM TO ANY PARTICULAR FONT, STYLE, SIZE, OR COLOR.

FOR ENTERTAINMENT IN THE NATURE OF LIVE PERFORMANCES BY A MUSICAL GROUP (U.S. CLS. 100, 101 AND 107).

FIRST USE 1-1-2004; IN COMMERCE 1-1-2004.

HEATHER SAPP, EXAMINING ATTORNEY

---

SN 86-065,771. BANDWAGON INDUSTRIES, INC., SAN FRANCISCO, CA. FILED 9-16-2013.

**BANDWAGON**

THE MARK CONSISTS OF STANDARD CHARACTERS WITHOUT CLAIM TO ANY PARTICULAR FONT, STYLE, SIZE, OR COLOR.

FOR RENTAL OF PROFESSIONAL SOUND EQUIPMENT AND PARTS, STATIONARY TEMPORARY STAGES, AND STAGE LIGHTING EQUIPMENT (U.S. CLS. 100, 101 AND 107).

WANDA KAY PRICE, EXAMINING ATTORNEY

**CLASS 41—(Continued).**

SN 86-065,779. SKATEBOUT, INC., SCOTTSDALE, AZ. FILED 9-16-2013.

**SKATEBOUT**

THE MARK CONSISTS OF THE WORD "SKATEBOUT" STYLIZED WITH THE SILHOUETTE OF A CITY SKYLINE ALONG THE BOTTOM PORTION OF THE LETTERING.

FOR ARRANGING AND CONDUCTING ATHLETIC COMPETITIONS; ENTERTAINMENT SERVICES, NAMELY, ARRANGING AND CONDUCTING OF COMPETITIONS FOR SKATEBOARDING; ORGANISATION OF SPORTS COMPETITIONS; ORGANIZATION OF SPORTS COMPETITIONS; ORGANIZING AND CONDUCTING ATHLETIC COMPETITIONS AND GAMES IN THE FIELD OF SKATEBOARDING; ORGANIZING, CONDUCTING AND OPERATING SKATEBOARDING TOURNAMENTS; PROVIDING A WEBSITE FEATURING ENTERTAINMENT INFORMATION; PROVIDING A WEBSITE FEATURING INFORMATION RELATING TO THE SPORT OF SKATEBOARDING; PROVIDING A WEBSITE FOR ENTERTAINMENT PURPOSES FEATURING VIDEOS ABOUT SKATEBOARDING (U.S. CLS. 100, 101 AND 107).

FIRST USE 12-27-2012; IN COMMERCE 2-28-2013.  
TRACY CROSS, EXAMINING ATTORNEY

**CLASS 41—(Continued).**

SN 86-065,788. SKATEBOUT, INC., SCOTTSDALE, AZ. FILED 9-16-2013.



THE MARK CONSISTS OF ROUNDED SQUARE WITH TARGET HASHMARK OVER SIMPLIFIED SIDE VIEW OF SKATEBOARD.

FOR ARRANGING AND CONDUCTING ATHLETIC COMPETITIONS; ENTERTAINMENT SERVICES, NAMELY, ARRANGING AND CONDUCTING OF COMPETITIONS FOR SKATEBOARDING; ORGANISATION OF SPORTS COMPETITIONS; ORGANIZATION OF SPORTS COMPETITIONS; ORGANIZING AND CONDUCTING ATHLETIC COMPETITIONS AND GAMES IN THE FIELD OF SKATEBOARDING; ORGANIZING, CONDUCTING AND OPERATING SKATEBOARDING TOURNAMENTS; PROVIDING A WEBSITE FEATURING ENTERTAINMENT INFORMATION; PROVIDING A WEBSITE FEATURING INFORMATION RELATING TO THE SPORT OF SKATEBOARDING; PROVIDING A WEBSITE FOR ENTERTAINMENT PURPOSES FEATURING VIDEOS ABOUT SKATEBOARDING (U.S. CLS. 100, 101 AND 107).

FIRST USE 12-27-2012; IN COMMERCE 2-28-2013.  
TRACY CROSS, EXAMINING ATTORNEY

SN 86-065,852. IT'S YOGA INTERNATIONAL, LLC, TOLEDO, OH. FILED 9-16-2013.

**THE ROCKET GETS YOU THERE  
FASTER**

THE MARK CONSISTS OF STANDARD CHARACTERS WITHOUT CLAIM TO ANY PARTICULAR FONT, STYLE, SIZE, OR COLOR.

FOR YOGA INSTRUCTION (U.S. CLS. 100, 101 AND 107).  
FIRST USE 6-0-1991; IN COMMERCE 6-0-1991.  
SANJEEV VOHRA, EXAMINING ATTORNEY



**CLASS 41—(Continued).**

SN 86-066,119. ADVANCED CORPORATE TEAMS, WOON-SOCKET, RI. FILED 9-16-2013.

# A.C.E.

THE MARK CONSISTS OF STANDARD CHARACTERS WITHOUT CLAIM TO ANY PARTICULAR FONT, STYLE, SIZE, OR COLOR.

FOR TRAINING SERVICES IN THE FIELD OF CONTINUOUS PROCESS IMPROVEMENT, PARTNER SATISFACTION, CONTINUOUS EMPLOYEE DEVELOPMENT, APPROPRIATE DECISIONS AND ACTIONS, EFFECTIVE PLANNING, TEAM ENVIRONMENT, PRODUCT OR SERVICE DEVELOPMENT ORGANIZATION RESULTS, NAME / BRAND RECOGNITION AND EFFECTIVE LEADERSHIP (U.S. CLS. 100, 101 AND 107).

HEATHER THOMPSON, EXAMINING ATTORNEY

---

SN 86-066,153. KAT ROWBEESHOW, LLC, RALEIGH, NC. FILED 9-16-2013.

# Kat Robichaud

THE MARK CONSISTS OF STANDARD CHARACTERS WITHOUT CLAIM TO ANY PARTICULAR FONT, STYLE, SIZE, OR COLOR.

THE NAME "KAT ROBICHAUD" IDENTIFIES A LIVING INDIVIDUAL WHOSE CONSENT IS OF RECORD.

FOR ENTERTAINMENT SERVICES, NAMELY, LIVE MUSICAL AND VOCAL PERFORMANCES BY A RECORDING ARTIST, MUSICAL ARTIST, MUSICAL BAND OR MUSICAL GROUP; ENTERTAINMENT SERVICES IN THE NATURE OF VISUAL AND AUDIO PERFORMANCES BY A RECORDING ARTIST, MUSICAL ARTIST, MUSICAL BAND OR MUSICAL GROUP; ENTERTAINMENT SERVICES, NAMELY, LIVE MUSIC CONCERTS; ENTERTAINMENT SERVICES, NAMELY, PERSONAL APPEARANCES BY A RECORDING AND MUSICAL ARTIST; PRODUCTION OF SOUND RECORDINGS IN THE NATURE OF MUSICAL AND VOCAL RECORDINGS; ENTERTAINMENT SERVICES, NAMELY, PROVIDING A WEBSITE FEATURING INFORMATION ABOUT MUSICAL PERFORMANCES AND OTHER ENTERTAINMENT INFORMATION RELATING TO A RECORDING ARTIST, MUSICAL ARTIST, MUSICAL BAND OR MUSICAL GROUP (U.S. CLS. 100, 101 AND 107).

CHARLES L. JENKINS, EXAMINING ATTORNEY

**CLASS 41—(Continued).**

SN 86-066,154. HOWES, TERESA M, SAN DIEGO, CA. FILED 9-16-2013.

# Color Yourself Skinny

THE MARK CONSISTS OF STANDARD CHARACTERS WITHOUT CLAIM TO ANY PARTICULAR FONT, STYLE, SIZE, OR COLOR.

FOR PROVIDING ON-LINE PUBLICATIONS IN THE NATURE OF E-BOOKS IN THE FIELD OF WEIGHT LOSS, WELLNESS AND COOKING (U.S. CLS. 100, 101 AND 107).

FIRST USE 6-12-2013; IN COMMERCE 9-12-2013.  
CHARLES L. JENKINS, EXAMINING ATTORNEY

---

SN 86-066,205. DESERTROCK ENTERTAINEMENT, INC., PALMDALE, CA. FILED 9-16-2013.

# SPYQUEST

THE MARK CONSISTS OF STANDARD CHARACTERS WITHOUT CLAIM TO ANY PARTICULAR FONT, STYLE, SIZE, OR COLOR.

FOR ENTERTAINMENT IN THE NATURE OF ONGOING DRAMATIC TELEVISION PROGRAMS; ENTERTAINMENT SERVICES, NAMELY, PROVIDING ON-LINE INTERACTIVE COMPUTER GAMES (U.S. CLS. 100, 101 AND 107).

FIRST USE 6-2-2008; IN COMMERCE 7-21-2013.  
MARCIE MILONE, EXAMINING ATTORNEY

**CLASS 41—(Continued).**

SN 86-066,341. FLEMING, MELINDA, DBA CURATED COOL, LOS ANGELES, CA. FILED 9-17-2013.

## Curated Cool

THE MARK CONSISTS OF STANDARD CHARACTERS WITHOUT CLAIM TO ANY PARTICULAR FONT, STYLE, SIZE, OR COLOR.

NO CLAIM IS MADE TO THE EXCLUSIVE RIGHT TO USE "CURATED", APART FROM THE MARK AS SHOWN.

FOR ON-LINE JOURNALS, NAMELY, BLOGS FEATURING TRAVEL REVIEWS, TRAVEL DESTINATIONS, VIDEO REVIEWS, PRODUCT REVIEWS, DESIGN ARTICLES, ART ARTICLES, DESIGN AND FASHION ADVICE.; PROVIDING A WEBSITE FEATURING BLOGS AND NON-DOWNLOADABLE PUBLICATIONS IN THE NATURE OF WEB SITE FEATURING ONLINE ARTICLES, DOCUMENTARIES, VIDEOS, AND CREATIVE INSPIRATION FOR USERS, WITH INFORMATION AND COMMENTARY IN THE FIELD(S) OF FASHION, DESIGN, ART, BEAUTY, TRAVEL, ENTERTAINMENT, INTERIOR DESIGN, TECHNOLOGY, CLOTHING, FURNITURE, DECOR, ART, BOOKS, FOOD, WINE, AND SPIRITS.; PROVIDING A WEBSITE FEATURING INFORMATION ABOUT ARTISTIC STYLES; PROVIDING A WEBSITE FEATURING INFORMATION IN THE FIELD OF ART, ART HISTORY, ART CULTURE AND ART APPRECIATION (U.S. CLS. 100, 101 AND 107).

FIRST USE 11-19-2012; IN COMMERCE 3-25-2013.  
KYLE PEETE, EXAMINING ATTORNEY

**CLASS 41—(Continued).**

SN 86-066,375. JILL COLLINS WILLIAMS, NOVATO, CA. FILED 9-17-2013.

## Silver Sexy & Strong

THE MARK CONSISTS OF STANDARD CHARACTERS WITHOUT CLAIM TO ANY PARTICULAR FONT, STYLE, SIZE, OR COLOR.

FOR CONSULTING SERVICES IN THE FIELDS OF FITNESS AND EXERCISE; GYMNASIAC INSTRUCTION; PERSONAL FITNESS TRAINING SERVICES AND CONSULTANCY; PERSONAL FITNESS TRAINING SERVICES FEATURING AEROBIC AND ANAEROBIC ACTIVITIES COMBINED WITH RESISTANCE AND FLEXIBILITY TRAINING; PERSONAL TRAINING PROVIDED IN CONNECTION WITH WEIGHT LOSS AND EXERCISE PROGRAMS; PERSONAL TRAINING SERVICES, NAMELY, STRENGTH AND CONDITIONING TRAINING; PROVIDING A WEB SITE FEATURING INFORMATION ON EXERCISE AND FITNESS; PROVIDING ASSISTANCE, PERSONAL TRAINING AND PHYSICAL FITNESS CONSULTATION TO CORPORATE CLIENTS TO HELP THEIR EMPLOYEES MAKE PHYSICAL FITNESS, STRENGTH, CONDITIONING, AND EXERCISE ALTERATIONS IN THEIR DAILY LIVING; PROVIDING ASSISTANCE, PERSONAL TRAINING AND PHYSICAL FITNESS CONSULTATION TO INDIVIDUALS TO HELP THEM MAKE PHYSICAL FITNESS, STRENGTH, CONDITIONING, AND EXERCISE IMPROVEMENT IN THEIR DAILY LIVING (U.S. CLS. 100, 101 AND 107).

FIRST USE 4-24-2013; IN COMMERCE 4-24-2013.  
ZACHARY BELLO, EXAMINING ATTORNEY

SN 86-066,392. ANDY MAPPLE, WINTER GARDEN, FL. FILED 9-17-2013.

SN 86-066,346. LOONEY, EDEN, MARCO ISLAND, FL. FILED 9-17-2013.

EDEN ROCKS MOVEMENT WITH A PURPOSE



THE MARK CONSISTS OF STANDARD CHARACTERS WITHOUT CLAIM TO ANY PARTICULAR FONT, STYLE, SIZE, OR COLOR.

FOR EDUCATION SERVICES, NAMELY, PROVIDING CLASSES, SEMINARS, WORKSHOPS TO IMPROVE YOUR OVERALL WELL BEING; CONDUCTING FITNESS CLASSES; TENNIS INSTRUCTION; SWIMMING INSTRUCTION; DANCE INSTRUCTION (U.S. CLS. 100, 101 AND 107).

FIRST USE 9-9-2013; IN COMMERCE 9-9-2013.  
ELLEN BURNS, EXAMINING ATTORNEY

THE MARK CONSISTS OF ZIG ZAG LINES.

FOR PERSONAL COACHING SERVICES IN THE FIELD OF WATER SKIING, PROFESSIONAL COACHING SERVICES IN THE FIELD OF WATER SKIING; SEMINARS IN THE FIELD OF WATER SKIING (U.S. CLS. 100, 101 AND 107).

FIRST USE 7-31-2012; IN COMMERCE 7-31-2012.  
LINDA POWELL, EXAMINING ATTORNEY

**CLASS 41—(Continued).**

SN 86-066,538. LOUI SOTERIOU, MANCHESTER, CT. FILED 9-17-2013.

**WarriorBall Epic Dodgeball**

THE MARK CONSISTS OF STANDARD CHARACTERS WITHOUT CLAIM TO ANY PARTICULAR FONT, STYLE, SIZE, OR COLOR.

NO CLAIM IS MADE TO THE EXCLUSIVE RIGHT TO USE "DODGEBALL", APART FROM THE MARK AS SHOWN.

FOR ENTERTAINMENT IN THE NATURE OF LIVE DODGEBALL TOURNAMENTS; ENTERTAINMENT SERVICES, NAMELY, ARRANGING AND CONDUCTING OF COMPETITIONS FOR DODGEBALL FOR DISTRIBUTION OVER TELEVISION, CABLE, SATELLITE, INTERNET AND OTHER MEDIA; ORGANIZING SPORTING EVENTS, NAMELY, LIVE EVENTS AND TOURNAMENTS IN THE FIELD OF DODGEBALL FOR DISTRIBUTION OVER TELEVISION, CABLE, SATELLITE, INTERNET AND OTHER MEDIA (U.S. CLS. 100, 101 AND 107).

FIRST USE 2-20-2013; IN COMMERCE 8-8-2013.  
HEATHER BIDDULPH, EXAMINING ATTORNEY

SN 86-066,559. LOUI SOTERIOU, MANCHESTER, CT. FILED 9-17-2013.

**WarriorBall**

THE MARK CONSISTS OF STANDARD CHARACTERS WITHOUT CLAIM TO ANY PARTICULAR FONT, STYLE, SIZE, OR COLOR.

FOR ENTERTAINMENT IN THE NATURE OF LIVE DODGEBALL TOURNAMENTS; ENTERTAINMENT SERVICES, NAMELY, ARRANGING AND CONDUCTING OF COMPETITIONS FOR DODGEBALL FOR DISTRIBUTION OVER TELEVISION, CABLE, SATELLITE, INTERNET AND OTHER MEDIA; ORGANIZING SPORTING EVENTS, NAMELY, LIVE EVENTS AND TOURNAMENTS IN THE FIELD OF DODGEBALL FOR DISTRIBUTION OVER TELEVISION, CABLE, SATELLITE, INTERNET AND OTHER MEDIA (U.S. CLS. 100, 101 AND 107).

FIRST USE 2-20-2013; IN COMMERCE 8-8-2013.  
HEATHER BIDDULPH, EXAMINING ATTORNEY

**CLASS 41—(Continued).**

SN 86-066,586. LOUI SOTERIOU, MANCHESTER, CT. FILED 9-17-2013.

**Epic Dodgeball**

THE MARK CONSISTS OF STANDARD CHARACTERS WITHOUT CLAIM TO ANY PARTICULAR FONT, STYLE, SIZE, OR COLOR.

NO CLAIM IS MADE TO THE EXCLUSIVE RIGHT TO USE "DODGEBALL", APART FROM THE MARK AS SHOWN.

FOR ENTERTAINMENT IN THE NATURE OF LIVE DODGEBALL TOURNAMENTS; ENTERTAINMENT SERVICES, NAMELY, ARRANGING AND CONDUCTING OF COMPETITIONS FOR DODGEBALL FOR DISTRIBUTION OVER TELEVISION, CABLE, SATELLITE, INTERNET AND OTHER MEDIA; ORGANIZING SPORTING EVENTS, NAMELY, LIVE EVENTS AND TOURNAMENTS IN THE FIELD OF DODGEBALL FOR DISTRIBUTION OVER TELEVISION, CABLE, SATELLITE, INTERNET AND OTHER MEDIA (U.S. CLS. 100, 101 AND 107).

FIRST USE 2-20-2013; IN COMMERCE 8-8-2013.  
HEATHER BIDDULPH, EXAMINING ATTORNEY

SN 86-066,593. MOORE, CHARLIE, CHESTER, NH. FILED 9-17-2013.

**MAD FISH**

THE MARK CONSISTS OF STANDARD CHARACTERS WITHOUT CLAIM TO ANY PARTICULAR FONT, STYLE, SIZE, OR COLOR.

FOR ENTERTAINMENT IN THE NATURE OF ONGOING TELEVISION PROGRAMS IN THE FIELD OF SITUATION COMEDIES; ENTERTAINMENT MEDIA PRODUCTION SERVICES FOR MOTION PICTURES, TELEVISION AND INTERNET; ENTERTAINMENT SERVICES IN THE NATURE OF CREATION, DEVELOPMENT, AND PRODUCTION OF TELEVISION PROGRAMMING; ENTERTAINMENT SERVICES, NAMELY, PROVIDING ONGOING TELEVISION PROGRAMS IN THE FIELD OF SITUATION COMEDIES VIA A GLOBAL COMPUTER NETWORK; ENTERTAINMENT SERVICES, NAMELY, THE PROVISION OF CONTINUING TELEVISION PROGRAM FEATURING SITUATION COMEDIES DELIVERED BY TELEVISION AND THE INTERNET; ENTERTAINMENT, NAMELY, PRODUCTION OF TELEVISION PROGRAMMING (U.S. CLS. 100, 101 AND 107).

NORA BUCHANAN WILL, EXAMINING ATTORNEY

**CLASS 41—(Continued).**

SN 86-066,742. FANFLEX LLC, CORONA DEL MAR, CA.  
FILED 9-17-2013.



Where bands meet demand. *Live.*

THE MARK CONSISTS OF THE TEXT "FANFLEX" DESIGNED WHERE THE "FAN" IS SOLID AND THE "FLEX" PORTION IS A GRADIENT. THERE IS THE GEO LOCATOR SYMBOL WITH A DIAL AT THE TOP AND A 16TH NOTE 'F' COMING OUT OF THE TOP. THE NEGATIVE SPACE IN THE "A" OF "FAN" IS THE GEO LOCATOR. THE SLOGAN "WHERE BANDS MEET DEMAND. LIVE." GOES ACROSS THE BOTTOM OF "FANFLEX".

FOR TICKET AGENCY SERVICES FOR ENTERTAINMENT EVENTS (U.S. CLS. 100, 101 AND 107).  
MARC LEIPZIG, EXAMINING ATTORNEY

SN 86-066,789. JOINING ACTIVE BODIES STUDIO, INC.,  
DBA JABS, CUTCHOGUE, NY. FILED 9-17-2013.

**Fueled by Enthusiasm -  
Motivated by Passion**

THE MARK CONSISTS OF STANDARD CHARACTERS WITHOUT CLAIM TO ANY PARTICULAR FONT, STYLE, SIZE, OR COLOR.

FOR HEALTH CLUB SERVICES, NAMELY, PROVIDING INSTRUCTION AND EQUIPMENT IN THE FIELD OF PHYSICAL EXERCISE (U.S. CLS. 100, 101 AND 107).  
FIRST USE 5-1-2011; IN COMMERCE 5-1-2011.  
AISHA CLARKE, EXAMINING ATTORNEY

SN 86-066,912. OMNI PARTNERS, LLC, ATLANTA, GA.  
FILED 9-17-2013.

**I FOUND IT.**

THE MARK CONSISTS OF STANDARD CHARACTERS WITHOUT CLAIM TO ANY PARTICULAR FONT, STYLE, SIZE, OR COLOR.

FOR ONLINE RELIGIOUS SERVICES, NAMELY, RELIGIOUS INSTRUCTION SERVICES (U.S. CLS. 100, 101 AND 107).  
TRACY CROSS, EXAMINING ATTORNEY

**CLASS 41—(Continued).**

SN 86-067,067. GIADA VALENTI, LLC, ASTORIA, NY.  
FILED 9-17-2013.

**From Venice With Love**

THE MARK CONSISTS OF STANDARD CHARACTERS WITHOUT CLAIM TO ANY PARTICULAR FONT, STYLE, SIZE, OR COLOR.

FOR ENTERTAINMENT SERVICES IN THE NATURE OF LIVE MUSICAL PERFORMANCES (U.S. CLS. 100, 101 AND 107).

FIRST USE 7-0-2012; IN COMMERCE 6-1-2013.

REGINA DRUMMOND, EXAMINING ATTORNEY

SN 86-067,151. EDUCATION 1ST, INC., MIAMI GARDENS,  
FL. FILED 9-17-2013.

**WHERE YOUR CHILD'S  
EDUCATION BEGINS**

THE MARK CONSISTS OF STANDARD CHARACTERS WITHOUT CLAIM TO ANY PARTICULAR FONT, STYLE, SIZE, OR COLOR.

FOR EDUCATIONAL SERVICES, NAMELY, PROVIDING COURSES OF INSTRUCTION AT THE EARLY CHILDHOOD AND PRE-SCHOOL LEVELS (U.S. CLS. 100, 101 AND 107).

FIRST USE 12-3-2012; IN COMMERCE 12-3-2012.

MAUREEN DALL, EXAMINING ATTORNEY

SN 86-067,255. UMPHREY'S MCGEE, INC., CHICAGO, IL.  
FILED 9-17-2013.

**UMPHREY'S MCGEE**

THE MARK CONSISTS OF STANDARD CHARACTERS WITHOUT CLAIM TO ANY PARTICULAR FONT, STYLE, SIZE, OR COLOR.

FOR LIVE PERFORMANCES BY A MUSICAL GROUP (U.S. CLS. 100, 101 AND 107).

FIRST USE 1-21-1998; IN COMMERCE 5-21-1998.

SUNG IN, EXAMINING ATTORNEY

**CLASS 41—(Continued).**

SN 86-067,460. LAURIE ITKIN, SAN DIEGO, CA. FILED 9-17-2013.

## Every Woman Should Know Her Options

THE MARK CONSISTS OF STANDARD CHARACTERS WITHOUT CLAIM TO ANY PARTICULAR FONT, STYLE, SIZE, OR COLOR.

FOR EDUCATION SERVICES, NAMELY, PROVIDING LIVE AND ON-LINE EDUCATION, WORKSHOPS, TALKS, SEMINARS IN THE FIELD OF FINANCIAL MANAGEMENT (U.S. CLS. 100, 101 AND 107).

FIRST USE 2-23-2013; IN COMMERCE 2-23-2013.  
SUZANNE BLANE, EXAMINING ATTORNEY

SN 86-067,619. UNIVERSITY ATHLETIC ASSOCIATION, GAINESVILLE, FL. FILED 9-18-2013.

## GATORS

THE MARK CONSISTS OF STANDARD CHARACTERS WITHOUT CLAIM TO ANY PARTICULAR FONT, STYLE, SIZE, OR COLOR.

FOR ARRANGING AND CONDUCTING ATHLETIC COMPETITIONS; ORGANIZING AND CONDUCTING COLLEGE SPORT COMPETITIONS AND ATHLETIC EVENTS; PROVIDING COLLEGIATE ATHLETIC AND SPORTING EVENTS (U.S. CLS. 100, 101 AND 107).

FIRST USE 0-0-1955; IN COMMERCE 0-0-1955.  
KATINA MISTER, EXAMINING ATTORNEY

SN 86-067,871. ART PRODUCTIONS, INC., PEACHTREE CITY, GA. FILED 9-18-2013.

## I READ FOR LOVE

THE MARK CONSISTS OF STANDARD CHARACTERS WITHOUT CLAIM TO ANY PARTICULAR FONT, STYLE, SIZE, OR COLOR.

FOR FAN CLUBS; BOOK READER FAN CLUBS (U.S. CLS. 100, 101 AND 107).

MORGAN WYNNE, EXAMINING ATTORNEY

**CLASS 41—(Continued).**

SN 86-067,876. SAN DIEGO STATE UNIVERSITY, COLLEGE OF EXTENDED STUDIES, SAN DIEGO, CA. FILED 9-18-2013.

## Never Stop Learning

THE MARK CONSISTS OF STANDARD CHARACTERS WITHOUT CLAIM TO ANY PARTICULAR FONT, STYLE, SIZE, OR COLOR.

FOR EDUCATIONAL SERVICES, NAMELY, CONDUCTING DISTANCE LEARNING INSTRUCTION AT THE SECONDARY, COLLEGE AND GRADUATE LEVELS (U.S. CLS. 100, 101 AND 107).

FIRST USE 6-1-2001; IN COMMERCE 6-1-2001.  
MICHAEL WIENER, EXAMINING ATTORNEY

SN 86-067,901. VIACOM INTERNATIONAL INC., NEW YORK, NY. FILED 9-18-2013.

## TOTAL DAD HUMOR

THE MARK CONSISTS OF STANDARD CHARACTERS WITHOUT CLAIM TO ANY PARTICULAR FONT, STYLE, SIZE, OR COLOR.

NO CLAIM IS MADE TO THE EXCLUSIVE RIGHT TO USE "DAD" AND "HUMOR", APART FROM THE MARK AS SHOWN.

FOR ENTERTAINMENT SERVICES IN THE NATURE OF CONTINUING PROGRAM SERIES, FEATURING LIVE ACTION, COMEDY AND DRAMA PROVIDED THROUGH CABLE TELEVISION, BROADCAST TELEVISION, INTERNET, VIDEO-ON-DEMAND, AND THROUGH OTHER FORMS OF TRANSMISSION MEDIA; PROVIDING ONLINE INFORMATION IN THE FIELD OF ENTERTAINMENT CONCERNING TELEVISION PROGRAMS (U.S. CLS. 100, 101 AND 107).

C. DIONNE CLYBURN, EXAMINING ATTORNEY

SN 86-067,915. JEFFREY M. DAVIS, HENDERSON, NV. FILED 9-18-2013.

## FETISH & FANTASY

THE MARK CONSISTS OF STANDARD CHARACTERS WITHOUT CLAIM TO ANY PARTICULAR FONT, STYLE, SIZE, OR COLOR.

OWNER OF U.S. REG. NO. 2,677,191.  
FOR ARRANGING, ORGANIZING, CONDUCTING, AND HOSTING SOCIAL ENTERTAINMENT EVENTS; ENTERTAINMENT EVENT BOOKING AGENCIES; SPECIAL EVENT PLANNING FOR SOCIAL ENTERTAINMENT PURPOSES (U.S. CLS. 100, 101 AND 107).

FIRST USE 10-1-1996; IN COMMERCE 10-1-1996.  
NICHOLAS ALTREE, EXAMINING ATTORNEY

**CLASS 41—(Continued).**

SN 86-067,926. KEYRIOUS LLC, CHICAGO, IL. FILED 9-18-2013.

# Keyrious

THE MARK CONSISTS OF STANDARD CHARACTERS WITHOUT CLAIM TO ANY PARTICULAR FONT, STYLE, SIZE, OR COLOR.

FOR ARRANGING AND CONDUCTING LIVE, INTERACTIVE, TREASURE HUNT GAMING ADVENTURES (U.S. CLS. 100, 101 AND 107).

NORA BUCHANAN WILL, EXAMINING ATTORNEY

---

SN 86-067,978. GAME SHOW NETWORK, LLC, SANTA MONICA, CA. FILED 9-18-2013.

# BEN BAILEY'S AMERICA

THE MARK CONSISTS OF STANDARD CHARACTERS WITHOUT CLAIM TO ANY PARTICULAR FONT, STYLE, SIZE, OR COLOR.

NO CLAIM IS MADE TO THE EXCLUSIVE RIGHT TO USE "AMERICA", APART FROM THE MARK AS SHOWN.

THE NAME(S), PORTRAIT(S), AND/OR SIGNATURE(S) SHOWN IN THE MARK IDENTIFIES BEN BAILEY, WHOSE CONSENT(S) TO REGISTER IS MADE OF RECORD.

FOR ELECTRONIC GAMES SERVICES PROVIDED BY MEANS OF THE INTERNET; ENTERTAINMENT IN THE NATURE OF AN ONGOING TELEVISION GAME SHOW; ENTERTAINMENT IN THE NATURE OF ONLINE, INTERACTIVE, AND MOBILE COMPUTER GAMES; ENTERTAINMENT SERVICES IN THE NATURE OF AN ONGOING REALITY BASED TELEVISION PROGRAM (U.S. CLS. 100, 101 AND 107).

MIAH ROSENBERG, EXAMINING ATTORNEY

---

SN 86-068,149. RUNRUSSELL, LLC, RUSSELL, KS. FILED 9-18-2013.

# Creepy Crawl

THE MARK CONSISTS OF STANDARD CHARACTERS WITHOUT CLAIM TO ANY PARTICULAR FONT, STYLE, SIZE, OR COLOR.

NO CLAIM IS MADE TO THE EXCLUSIVE RIGHT TO USE "CRAWL", APART FROM THE MARK AS SHOWN.

FOR ORGANIZING, ARRANGING, AND CONDUCTING COMPETITIVE AND NON-COMPETITIVE RACING AND OBSTACLE EVENTS (U.S. CLS. 100, 101 AND 107).

FIRST USE 8-1-2013; IN COMMERCE 8-1-2013.

ELLEN BURNS, EXAMINING ATTORNEY

**CLASS 41—(Continued).**

SN 86-068,441. RIO, JUSTIN, LAS VEGAS, NV. FILED 9-18-2013.

# ABCGT

THE MARK CONSISTS OF STANDARD CHARACTERS WITHOUT CLAIM TO ANY PARTICULAR FONT, STYLE, SIZE, OR COLOR.

FOR ENTERTAINMENT SERVICES, NAMELY, PROVIDING A WEB SITE FEATURING PHOTOGRAPHIC AND PROSE PRESENTATIONS FEATURING AUTOMOBILES; ENTERTAINMENT SERVICES, NAMELY, PROVIDING A WEB SITE FEATURING PHOTOGRAPHIC, AUDIO, VIDEO AND PROSE PRESENTATIONS FEATURING AUTOMOBILES (U.S. CLS. 100, 101 AND 107).

FIRST USE 1-7-2012; IN COMMERCE 6-29-2012.

ALLISON SCHRODY, EXAMINING ATTORNEY

---

SN 86-068,466. THE VELVET MODE INCORPORATED, SAN FRANCISCO, CA. FILED 9-18-2013.



THE MARK CONSISTS OF A CONVERSATION BALLON WITH THE TEXT "WEE!" INSIDE.

FOR RENTAL OF PORTABLE PHOTOGRAPHY AND/OR VIDEOGRAPHY BOOTHS FOR TAKING OF PICTURES AND VIDEOS (U.S. CLS. 100, 101 AND 107).

FIRST USE 12-11-2010; IN COMMERCE 12-11-2010.

ALLISON SCHRODY, EXAMINING ATTORNEY

---

SN 86-068,496. DRAFTPEDIA, LLC, ENCINO, CA. FILED 9-18-2013.

# SPORTSDB

THE MARK CONSISTS OF STANDARD CHARACTERS WITHOUT CLAIM TO ANY PARTICULAR FONT, STYLE, SIZE, OR COLOR.

FOR PROVIDING A WEBSITE PORTAL FEATURING ENTERTAINMENT, NEWS, IMAGES, ELECTRONIC MEDIA, DATA FILES, DATABASES, AND INFORMATION IN THE FIELD OF SPORTS; PROVIDING A WEBSITE FEATURING INFORMATION AND NEWS IN THE FIELD OF SPORTS (U.S. CLS. 100, 101 AND 107).

AISHA CLARKE, EXAMINING ATTORNEY

**CLASS 41—(Continued).**

SN 86-068,526. ENGINEERING FOR KIDS, INC., STAFFORD, VA. FILED 9-18-2013.

**EFK**

THE MARK CONSISTS OF STANDARD CHARACTERS WITHOUT CLAIM TO ANY PARTICULAR FONT, STYLE, SIZE, OR COLOR.

FOR EDUCATION SERVICES, NAMELY, PROVIDING SEMINARS, CLASSES, CAMPS, WORKSHOPS, CONFERENCES, AND PROGRAMS IN THE FIELDS OF MATH, SCIENCE, TECHNOLOGY, AND ENGINEERING (U.S. CLS. 100, 101 AND 107).

FIRST USE 9-12-2013; IN COMMERCE 9-12-2013.  
RONALD MCMORROW, EXAMINING ATTORNEY

**CLASS 41—(Continued).**

SN 86-068,812. RCS SPORTS, HOUSTON, TX. FILED 9-19-2013.

**RUCKER ON WOOD**

THE MARK CONSISTS OF STANDARD CHARACTERS WITHOUT CLAIM TO ANY PARTICULAR FONT, STYLE, SIZE, OR COLOR.

FOR ENTERTAINMENT IN THE NATURE OF BASKETBALL GAMES; ORGANIZING AND CONDUCTING GAMES IN THE FIELD OF BASKETBALL; ARRANGING AND CONDUCTING YOUTH BASKETBALL PROGRAMS; ORGANISATION OF SPORTS COMPETITIONS; ORGANIZING, CONDUCTING AND OPERATING BASKETBALL TOURNAMENTS; PROVIDING GYMNASIUMS (U.S. CLS. 100, 101 AND 107).

FIRST USE 8-18-2002; IN COMMERCE 9-13-2013.  
BARBARA A. GOLD, EXAMINING ATTORNEY

SN 86-068,627. SHADOW VENTURES, INC., SANTA MONICA, CA. AND PHIL STUTZ, SANTA MONICA, CA. FILED 9-18-2013.

**THE TOOLS**

THE MARK CONSISTS OF STANDARD CHARACTERS WITHOUT CLAIM TO ANY PARTICULAR FONT, STYLE, SIZE, OR COLOR.

FOR EDUCATIONAL SERVICES, NAMELY, CONDUCTING SEMINARS, LECTURES, TELESEMINARS, TELECLASSES, AND WORKSHOPS IN PERSONAL AWARENESS (U.S. CLS. 100, 101 AND 107).

FIRST USE 8-0-2012; IN COMMERCE 8-0-2012.  
SUSAN RICHARDS, EXAMINING ATTORNEY

SN 86-068,856. PENN NATIONAL GAMING, INC., WYOMISSING, PA. FILED 9-19-2013.

**MARQUEE MILLIONAIRE**

THE MARK CONSISTS OF STANDARD CHARACTERS WITHOUT CLAIM TO ANY PARTICULAR FONT, STYLE, SIZE, OR COLOR.

OWNER OF U.S. REG. NOS. 4,235,179 AND 4,439,130.  
FOR PROVIDING GAMING FACILITIES FOR PATRONS TO PLAY SLOT MACHINES; ENTERTAINMENT SERVICES, NAMELY, CONDUCTING LIVE SLOT GAME TOURNAMENTS (U.S. CLS. 100, 101 AND 107).

JEFF DEFORD, EXAMINING ATTORNEY

SN 86-068,713. DIPAK C. JAIN, EVANSTON, IL. FILED 9-18-2013.

**Performance with Purpose**

THE MARK CONSISTS OF STANDARD CHARACTERS WITHOUT CLAIM TO ANY PARTICULAR FONT, STYLE, SIZE, OR COLOR.

FOR PUBLICATION OF BOOKS, OF MAGAZINES, OF JOURNALS, OF NEWSPAPERS, OF PERIODICALS, OF CATALOGS, OF BROCHURES (U.S. CLS. 100, 101 AND 107).

DONALD JOHNSON, EXAMINING ATTORNEY

SN 86-068,874. PENN NATIONAL GAMING, INC., WYOMISSING, PA. FILED 9-19-2013.



OWNER OF U.S. REG. NOS. 4,235,179 AND 4,439,130.  
NO CLAIM IS MADE TO THE EXCLUSIVE RIGHT TO USE "SLOT TOURNAMENT", APART FROM THE MARK AS SHOWN.

THE MARK CONSISTS OF THE STYLIZED WORDING "MARQUEE MILLIONAIRE SLOT TOURNAMENT".

FOR PROVIDING GAMING FACILITIES FOR PATRONS TO PLAY SLOT MACHINES; ENTERTAINMENT SERVICES, NAMELY, CONDUCTING LIVE SLOT GAME TOURNAMENTS (U.S. CLS. 100, 101 AND 107).

JEFF DEFORD, EXAMINING ATTORNEY

**CLASS 41—(Continued).**

SN 86-068,929. THOR PALMER HOUSE HOTEL LLC, CHICAGO, IL. FILED 9-19-2013.

**HISTORY IS HOTT**

THE MARK CONSISTS OF STANDARD CHARACTERS WITHOUT CLAIM TO ANY PARTICULAR FONT, STYLE, SIZE, OR COLOR.  
FOR CONDUCTING GUIDED TOURS OF HISTORICAL SITES (U.S. CLS. 100, 101 AND 107).  
FIRST USE 10-0-2010; IN COMMERCE 10-0-2010.  
ELLEN BURNS, EXAMINING ATTORNEY

SN 86-068,970. THE CASE CHASE LLC, GREEN BAY, WI. FILED 9-19-2013.

**CASE CHASE**

THE MARK CONSISTS OF STANDARD CHARACTERS WITHOUT CLAIM TO ANY PARTICULAR FONT, STYLE, SIZE, OR COLOR.  
FOR ARRANGING AND CONDUCTING LIVE, INTERACTIVE, TREASURE HUNT GAMING ADVENTURES (U.S. CLS. 100, 101 AND 107).  
ELLEN BURNS, EXAMINING ATTORNEY

SN 86-069,231. FRESENIUS MEDICAL CARE HOLDINGS, INC., WALTHAM, MA. FILED 9-19-2013.



OWNER OF U.S. REG. NO. 3,784,089.  
THE MARK CONSISTS OF A BUTTERFLY IMAGE TO THE UPPER LEFT OF THE WORDS "MY KIDNEYS. MY CHOICE. EMPOWERMENT THROUGH EDUCATION".  
FOR PROVIDING EDUCATION PROGRAMS AND EDUCATIONAL MATERIALS, NAMELY, OFFERING SEMINARS, CLASSES, BROCHURES, PAMPHLETS AND OTHER WRITTEN MATERIALS FOR EDUCATING PATIENTS ABOUT CHRONIC KIDNEY DISEASE (U.S. CLS. 100, 101 AND 107).  
JANET LEE, EXAMINING ATTORNEY

**CLASS 41—(Continued).**

SN 86-069,253. HOOPMASTER INVESTMENTS, INC., MIAMI SPRINGS, FL. FILED 9-19-2013.

**SPORT OF COLLEGE**

THE MARK CONSISTS OF STANDARD CHARACTERS WITHOUT CLAIM TO ANY PARTICULAR FONT, STYLE, SIZE, OR COLOR.  
FOR ENTERTAINMENT IN THE NATURE OF BEAUTY PAGEANTS (U.S. CLS. 100, 101 AND 107).  
B. PARADEWELAI, EXAMINING ATTORNEY

SN 86-069,259. DEBORAH HUNTLEY, BRENTWOOD, TN. FILED 9-19-2013.

**ROVER'S REVENGE**

THE MARK CONSISTS OF STANDARD CHARACTERS WITHOUT CLAIM TO ANY PARTICULAR FONT, STYLE, SIZE, OR COLOR.  
FOR ENTERTAINMENT IN THE NATURE OF CANINE FLYBALL COMPETITIONS AND EXHIBITIONS; TRAINING OF DOGS TO PARTICIPATE IN FLYBALL (U.S. CLS. 100, 101 AND 107).  
AISHA CLARKE, EXAMINING ATTORNEY

SN 86-069,344. BOLASNY, ROSE ANN, LITTLE NECK, NY. FILED 9-19-2013.

**Bella Mia**

THE MARK CONSISTS OF STANDARD CHARACTERS WITHOUT CLAIM TO ANY PARTICULAR FONT, STYLE, SIZE, OR COLOR.  
THE ENGLISH TRANSLATION OF "BELLA MIA" IN THE MARK IS "MY BEAUTIFUL".  
FOR ENTERTAINMENT SERVICES, NAMELY, PERSONAL APPEARANCES BY A CELEBRITY DOG (U.S. CLS. 100, 101 AND 107).  
SCOTT BIBB, EXAMINING ATTORNEY



**CLASS 41—(Continued).**

SN 86-069,446. GREENEVILLE PUBLISHING COMPANY, LLC, GREENVILLE, TN. FILED 9-19-2013.

**GREENEVILLESUN.COM**

THE MARK CONSISTS OF STANDARD CHARACTERS WITHOUT CLAIM TO ANY PARTICULAR FONT, STYLE, SIZE, OR COLOR.

FOR PROVIDING ON-LINE NON-DOWNLOADABLE NEWSPAPERS (U.S. CLS. 100, 101 AND 107).  
FIRST USE 9-30-2007; IN COMMERCE 9-30-2007.  
HEATHER SAPP, EXAMINING ATTORNEY

---

SN 86-069,647. PLUTO BASKETBALL, COLORADO SPRINGS, CO. FILED 9-19-2013.

**Players Like Us Take Over**

THE MARK CONSISTS OF STANDARD CHARACTERS WITHOUT CLAIM TO ANY PARTICULAR FONT, STYLE, SIZE, OR COLOR.

FOR SPORTS INSTRUCTION SERVICES (U.S. CLS. 100, 101 AND 107).  
FIRST USE 10-1-2012; IN COMMERCE 1-1-2013.  
CIMMERIAN COLEMAN, EXAMINING ATTORNEY

---

SN 86-069,890. INNER LION, INC, SAN DIEGO, CA. FILED 9-19-2013.

**INNER LION**

THE MARK CONSISTS OF STANDARD CHARACTERS WITHOUT CLAIM TO ANY PARTICULAR FONT, STYLE, SIZE, OR COLOR.

FOR EDUCATION SERVICES, NAMELY, PROVIDING ONLINE COGNITIVE ASSESSMENTS AND TRAINING PROGRAMS THAT HELP IDENTIFY COGNITIVE STRENGTHS AND WEAKNESSES OF AN INDIVIDUAL; MEDITATION TRAINING; PUBLISHING OF BOOKS, E-BOOKS, AUDIO BOOKS, MUSIC AND ILLUSTRATIONS; EDUCATIONAL AND ENTERTAINMENT SERVICES, NAMELY, PROVIDING MOTIVATIONAL SPEAKING SERVICES IN THE FIELD OF EMPOWERMENT AND CAREER; PERSONAL COACHING SERVICES IN THE FIELD OF EMPOWERMENT (U.S. CLS. 100, 101 AND 107).

FIRST USE 1-10-2013; IN COMMERCE 4-1-2013.  
TINA BROWN, EXAMINING ATTORNEY

**CLASS 41—(Continued).**

SN 86-069,978. TINSLEY, PETER, SCHERERVILLE, IN. AND COMANSE, CHARLES, MUNSTER, IN. AND HORVATH, JOHN, MERRILLVILLE, IN. AND TRATAR, RICHARD, MUNSTER, IN. FILED 9-20-2013.

**FIVE GREYSTONE**

THE MARK CONSISTS OF STANDARD CHARACTERS WITHOUT CLAIM TO ANY PARTICULAR FONT, STYLE, SIZE, OR COLOR.

FOR ENTERTAINMENT, NAMELY, LIVE PERFORMANCES BY A MUSICAL BAND; COMPOSITION OF MUSIC FOR OTHERS; ENTERTAINMENT, NAMELY, LIVE MUSIC CONCERTS; PRODUCTION OF SOUND AND MUSIC VIDEO RECORDINGS; PROVISION OF INFORMATION RELATING TO MUSIC (U.S. CLS. 100, 101 AND 107).

LINDA POWELL, EXAMINING ATTORNEY

---

SN 86-069,980. TRI STATE EVENT GROUP INC., EAST ISLIP, NY. FILED 9-20-2013.

**GOT COLOR**

THE MARK CONSISTS OF STANDARD CHARACTERS WITHOUT CLAIM TO ANY PARTICULAR FONT, STYLE, SIZE, OR COLOR.

FOR ORGANIZING SPORTS COMPETITIONS, GAMES, AND RACES IN THE FIELD OF SWIMMING, RUNNING, CYCLING, AND TRIATHLONS (U.S. CLS. 100, 101 AND 107).

FIRST USE 9-1-2013; IN COMMERCE 9-1-2013.  
LINDA POWELL, EXAMINING ATTORNEY

---

SN 86-070,143. YLTA - THE YOUTH LEADERSHIP TRAINING ACADEMY INC., LAYTONSVILLE, MD. FILED 9-20-2013.

**My Money MatterZ**

THE MARK CONSISTS OF STANDARD CHARACTERS WITHOUT CLAIM TO ANY PARTICULAR FONT, STYLE, SIZE, OR COLOR.

FOR EDUCATIONAL SERVICES, NAMELY, CONDUCTING CLASSES, SEMINARS, CONFERENCES, WORKSHOPS, RETREATS, CAMPS AND FIELD TRIPS IN THE FIELD OF FINANCIAL LITERACY AND DISTRIBUTION OF TRAINING MATERIAL IN CONNECTION THEREWITH (U.S. CLS. 100, 101 AND 107).

FIRST USE 2-2-2009; IN COMMERCE 6-24-2011.  
RONALD MCMORROW, EXAMINING ATTORNEY

**CLASS 41—(Continued).**

SN 86-070,169. SUE MCCORMICK, LITTLETON, CO. FILED 9-20-2013.



THE MARK CONSISTS OF A MUSICAL SYMBOL IN THE FORM OF A FIGURE PERFORMING A CLASSIC YOGA POSE. THE TOP OF THE MARK SUGGESTS THE JOINING OF TWO HANDS ABOVE THE FIGURE'S HEAD.

FOR EDUCATIONAL SERVICES, NAMELY, CONDUCTING CLASSES AND INSTRUCTIONAL SESSIONS IN THE FIELD OF VOCAL COACHING USING YOGA, IN PERSON AND OVER THE INTERNET; INSTRUCTION IN THE FIELD OF VOCAL COACHING USING YOGA; YOGA INSTRUCTION (U.S. CLS. 100, 101 AND 107).

FIRST USE 5-10-2013; IN COMMERCE 5-10-2013.  
WILLIAM JACKSON, EXAMINING ATTORNEY

SN 86-070,214. YLTA - THE YOUTH LEADERSHIP TRAINING ACADEMY INC., DBA YLTA - YOUTH LEADERSHIP TRAINING ACADEMY INC., LAYTONSVILLE, MD. FILED 9-20-2013.

**Smart Money for Savvy Teens**

THE MARK CONSISTS OF STANDARD CHARACTERS WITHOUT CLAIM TO ANY PARTICULAR FONT, STYLE, SIZE, OR COLOR.

FOR EDUCATIONAL SERVICES, NAMELY, CONDUCTING CLASSES, SEMINARS, CONFERENCES, WORKSHOPS, RETREATS, CAMPS AND FIELD TRIPS IN THE FIELD OF FINANCIAL LITERACY AND DISTRIBUTION OF TRAINING MATERIAL IN CONNECTION THEREWITH (U.S. CLS. 100, 101 AND 107).

FIRST USE 2-2-2009; IN COMMERCE 7-25-2011.  
RONALD MCMORROW, EXAMINING ATTORNEY

**CLASS 41—(Continued).**

SN 86-070,297. BECOVITZ, LOU, RANCHO SANTA MARGARITA, CA. AND BECOVITZ, JOE, RANCHO SANTA MARGARITA, CA. FILED 9-20-2013.

# giftRevent

THE MARK CONSISTS OF STANDARD CHARACTERS WITHOUT CLAIM TO ANY PARTICULAR FONT, STYLE, SIZE, OR COLOR.

FOR PARTY AND WEDDING RECEPTION PLANNING AND COORDINATION SERVICES (U.S. CLS. 100, 101 AND 107).

FIRST USE 5-18-2013; IN COMMERCE 5-18-2013.  
DOMINICK J. SALEMI, EXAMINING ATTORNEY

SN 86-070,379. LEISERV, INC., LAKE FOREST, IL. FILED 9-20-2013.

# URBAN MISSION

THE MARK CONSISTS OF STANDARD CHARACTERS WITHOUT CLAIM TO ANY PARTICULAR FONT, STYLE, SIZE, OR COLOR.

FOR ENTERTAINMENT SERVICES, NAMELY, PROVIDING FACILITIES FOR CONDUCTING LASER TAG GAMES (U.S. CLS. 100, 101 AND 107).

JAMES MACFARLANE, EXAMINING ATTORNEY

SN 86-070,556. HESSTON COLLEGE, HESSTON, KS. FILED 9-20-2013.

# START HERE, GO EVERYWHERE

THE MARK CONSISTS OF STANDARD CHARACTERS WITHOUT CLAIM TO ANY PARTICULAR FONT, STYLE, SIZE, OR COLOR.

FOR EDUCATING AT UNIVERSITY OR COLLEGES; EDUCATION SERVICES IN THE NATURE OF COURSES AT THE UNIVERSITY LEVEL (U.S. CLS. 100, 101 AND 107).

FIRST USE 6-1-2001; IN COMMERCE 6-1-2001.  
ANNE MADDEN, EXAMINING ATTORNEY

**CLASS 41—(Continued).**

SN 86-070,663. CUMBERLAND UNIVERSITY, LEBANON, TN. FILED 9-20-2013.

**THE NET.WORK**

THE MARK CONSISTS OF STANDARD CHARACTERS WITHOUT CLAIM TO ANY PARTICULAR FONT, STYLE, SIZE, OR COLOR.

FOR EDUCATIONAL SERVICES, NAMELY, PROVIDING ON-LINE COURSES OF INSTRUCTION AT THE COLLEGE LEVEL (U.S. CLS. 100, 101 AND 107).

FIRST USE 9-18-2013; IN COMMERCE 9-18-2013.  
DANNEAN HETZEL, EXAMINING ATTORNEY

SN 86-070,669. DDT FITNESS LLC, DBA SOLDIERFIT, GAITHERSBURG, MD. FILED 9-20-2013.

**PRIDE NOT EGO**

THE MARK CONSISTS OF STANDARD CHARACTERS WITHOUT CLAIM TO ANY PARTICULAR FONT, STYLE, SIZE, OR COLOR.

FOR CONDUCTING FITNESS CLASSES; CONSULTING SERVICES IN THE FIELDS OF FITNESS AND EXERCISE; COUNSELING SERVICES IN THE FIELD OF PHYSICAL FITNESS; EDUCATIONAL SERVICES, NAMELY, PROVIDING COGNITIVE FITNESS PROGRAMS FOR SENIORS; PERSONAL FITNESS TRAINING SERVICES AND CONSULTANCY; PERSONAL FITNESS TRAINING SERVICES FEATURING AEROBIC AND ANAEROBIC ACTIVITIES COMBINED WITH RESISTANCE AND FLEXIBILITY TRAINING; PERSONAL FITNESS TRAINING SERVICES, NAMELY, PROVIDING CROSS-TRAINING INSTRUCTION TO TENNIS PLAYERS, BASED ON PILATES METHODS AND TENNIS TECHNIQUES, IN A STUDIO OR ON A TENNIS COURT; PHYSICAL FITNESS CONDITIONING CLASSES; PHYSICAL FITNESS CONSULTATION; PHYSICAL FITNESS INSTRUCTION; PHYSICAL FITNESS STUDIO SERVICES, NAMELY, PROVIDING EXERCISE CLASSES, BODY SCULPTING CLASSES, AND GROUP FITNESS CLASSES; PHYSICAL FITNESS STUDIO SERVICES, NAMELY, PROVIDING GROUP EXERCISE INSTRUCTION, EQUIPMENT, AND FACILITIES; PHYSICAL FITNESS TRAINING OF INDIVIDUALS AND GROUPS; PHYSICAL FITNESS TRAINING SERVICES; PROVIDING A WEB SITE FEATURING INFORMATION ON EXERCISE AND FITNESS; PROVIDING A WEBSITE FEATURING INFORMATION ON EXERCISE AND FITNESS; PROVIDING ASSISTANCE, PERSONAL

**CLASS 41—(Continued).**

TRAINING AND PHYSICAL FITNESS CONSULTATION TO CORPORATE CLIENTS TO HELP THEIR EMPLOYEES MAKE PHYSICAL FITNESS, STRENGTH, CONDITIONING, AND EXERCISE ALTERATIONS IN THEIR DAILY LIVING; PROVIDING ASSISTANCE, PERSONAL TRAINING AND PHYSICAL FITNESS CONSULTATION TO INDIVIDUALS TO HELP THEM MAKE PHYSICAL FITNESS, STRENGTH, CONDITIONING, AND EXERCISE IMPROVEMENT IN THEIR DAILY LIVING; PROVIDING CLASSES, WORKSHOPS, SEMINARS AND CAMPS IN THE FIELDS OF FITNESS, EXERCISE, BOXING, KICK BOXING AND MIXED MARTIAL ARTS; PROVIDING FITNESS AND EXERCISE FACILITIES; PROVIDING GENERAL FITNESS AND MIXED MARTIAL ARTS FACILITIES THAT REQUIRE MEMBERSHIPS AND ARE FOCUSED IN THE FIELDS OF GENERAL FITNESS, EXERCISE, AND MIXED MARTIAL ARTS; PROVIDING PHYSICAL FITNESS AND EXERCISE SERVICE, NAMELY, INDOOR CYCLING AND YOGA INSTRUCTION (U.S. CLS. 100, 101 AND 107).

FIRST USE 2-1-2012; IN COMMERCE 12-15-2012.  
NAKIA HENRY, EXAMINING ATTORNEY

SN 86-070,707. AMERICAN AUCTIONEERS, LLC, RIVERSIDE, CA. FILED 9-20-2013.

**THE HAPPY MEDIUM**

THE MARK CONSISTS OF STANDARD CHARACTERS WITHOUT CLAIM TO ANY PARTICULAR FONT, STYLE, SIZE, OR COLOR.

FOR EDUCATIONAL AND ENTERTAINMENT SERVICES, NAMELY, A CONTINUING PROGRAM ABOUT SPIRITUALITY AND CLAIRVOYANCE ACCESSIBLE BY MEANS OF RADIO, TELEVISION, SATELLITE, AUDIO, VIDEO, WEB-BASED APPLICATIONS, MOBILE PHONE APPLICATIONS, OR COMPUTER NETWORKS (U.S. CLS. 100, 101 AND 107).

AISHA CLARKE, EXAMINING ATTORNEY

SN 86-070,725. JEFFREY BENJAMIN BECERRA SR., OROVILLE, CA. FILED 9-20-2013.



THE COLOR(S) RED, BLACK, AND WHITE IS/ARE CLAIMED AS A FEATURE OF THE MARK.

THE MARK CONSISTS OF THE WORD "POSSESSED" OUTLINED IN RED FLAMES. THE TAIL OF THE LETTER "P" OF THE WORD "POSSESSED" EXTENDS AND LOOPS INTO AN ARROWHEAD RESEMBLING A DEVIL'S TAIL. BEHIND THE "O" OF THE WORD "POSSESSED" IS A STYLIZED UPSIDE-DOWN CROSS, WHITE IN COLOR. THE BACKGROUND OF THE MARK IS BLACK.

FOR ENTERTAINMENT, NAMELY, LIVE PERFORMANCES BY A MUSICAL BAND (U.S. CLS. 100, 101 AND 107).

FIRST USE 1-1-1983; IN COMMERCE 1-1-1983.  
DAVID MURRAY, EXAMINING ATTORNEY

**CLASS 41—(Continued).**

SN 86-070,755. CUNDIFF, JOEL, OVERLAND PARK, KS. FILED 9-20-2013.

**CHIEFS KINGDOM**

THE MARK CONSISTS OF STANDARD CHARACTERS WITHOUT CLAIM TO ANY PARTICULAR FONT, STYLE, SIZE, OR COLOR.  
FOR ON-LINE JOURNALS, NAMELY, BLOGS FEATURING SPORTS (U.S. CLS. 100, 101 AND 107).  
CHRISTOPHER LAW, EXAMINING ATTORNEY

SN 86-070,852. VDR INCORPORATED, AUBURN, CA. FILED 9-20-2013.

**Dog Training That Works!**

THE MARK CONSISTS OF STANDARD CHARACTERS WITHOUT CLAIM TO ANY PARTICULAR FONT, STYLE, SIZE, OR COLOR.  
FOR ANIMAL TRAINING; DOG TRAINING; KENNEL SERVICES, NAMELY, DOG TRAINING SERVICES; OBEDIENCE SCHOOL TRAINING FOR ANIMALS; PET OBEDIENCE TRAINING SERVICES; PET TRAINING SERVICES; PROVIDING INFORMATION AND ADVICE IN THE FIELD OF PET TRAINING; PROVIDING INFORMATION IN THE FIELDS OF ANIMALS AND PETS IN THE FIELD OF ANIMAL TRAINING AND ANIMAL EXHIBITIONS FOR EDUCATIONAL OR ENTERTAINMENT PURPOSES; TRAINING ANIMALS FOR OTHERS (U.S. CLS. 100, 101 AND 107).  
FIRST USE 3-12-2007; IN COMMERCE 3-12-2007.  
JASON BLAIR, EXAMINING ATTORNEY

SN 86-070,897. TALKING FROG, LLC, TEMECULA, CA. FILED 9-20-2013.

**Talking Frog**

THE MARK CONSISTS OF STANDARD CHARACTERS WITHOUT CLAIM TO ANY PARTICULAR FONT, STYLE, SIZE, OR COLOR.  
FOR ENTERTAINMENT SERVICES IN THE NATURE OF MOTORCYCLE RIDING, FREESTYLE MOTORCROSS, SUPERCROSS, BICYCLE MOTORCROSS, SKATEBOARD, SURFING AND SNOWBOARD PERFORMANCES (U.S. CLS. 100, 101 AND 107).  
BARBARA A. GOLD, EXAMINING ATTORNEY

**CLASS 41—(Continued).**

SN 86-070,944. FUTUREPOLY LLC, SEATTLE, WA. FILED 9-20-2013.

**FuturePoly**

THE MARK CONSISTS OF STANDARD CHARACTERS WITHOUT CLAIM TO ANY PARTICULAR FONT, STYLE, SIZE, OR COLOR.  
FOR EDUCATION SERVICES, NAMELY, PROVIDING MENTORING, TUTORING, CLASSES, SEMINARS AND WORKSHOPS IN THE FIELD OF VIDEO GAMES AND COMPUTER GAMES (U.S. CLS. 100, 101 AND 107).  
FIRST USE 12-1-2010; IN COMMERCE 12-15-2010.  
SUNG IN, EXAMINING ATTORNEY

SN 86-071,086. ANNIE SUNBEAM, LLC, FORT LAUDERDALE, FL. FILED 9-20-2013.

**THE SOLUTION TO POLLUTION  
CREW**

THE MARK CONSISTS OF STANDARD CHARACTERS WITHOUT CLAIM TO ANY PARTICULAR FONT, STYLE, SIZE, OR COLOR.  
FOR ENTERTAINMENT SERVICES IN THE NATURE OF ON-GOING TELEVISION PROGRAMS IN THE FIELD OF CHILDREN'S ENTERTAINMENT; PROVIDING ON-LINE INFORMATION IN THE FIELD OF TELEVISION AND VIDEO ENTERTAINMENT FEATURING CHILDREN'S ENTERTAINMENT VIA THE INTERNET; ENTERTAINMENT SERVICES IN THE NATURE OF VIDEOS AND IMAGES FEATURING TELEVISION SHOWS TRANSMITTED VIA THE INTERNET AND WIRELESS COMMUNICATION NETWORKS (U.S. CLS. 100, 101 AND 107).  
RON FAIRBANKS, EXAMINING ATTORNEY

SN 86-071,148. AL-MONITOR LLC, HOUSTON, TX. FILED 9-21-2013.

ALMONITOR 

OWNER OF U.S. REG. NO. 4,203,215.  
THE MARK CONSISTS OF THE WORDS "AL MONITOR" IN STYLIZED FORM WITH A STYLIZED GLOBE DESIGN IN PLACE OF THE SECOND LETTER "O" IN THE WORD "MONITOR".  
FOR ON-LINE NON-DOWNLOADABLE PUBLICATIONS FEATURING MIDDLE EASTERN POLITICAL, CULTURAL AND BUSINESS NEWS, NAMELY ARTICLES AND ARTICLES IN THE NATURE OF EDITORIALS, AND ALSO FEATURING NON-DOWNLOADABLE SOFTWARE WHICH ENABLES SUBSCRIBERS TO POST COMMENTS ONLINE RELATIVE TO THE SAME (U.S. CLS. 100, 101 AND 107).  
FIRST USE 10-21-2011; IN COMMERCE 2-13-2012.  
KATHERINE E. HALMEN, EXAMINING ATTORNEY

**CLASS 41—(Continued).**

SN 86-071,163. HC IP HOLDER LLC, WAUWATOSA, WI 53226, WI. FILED 9-21-2013.

# HISPA

THE MARK CONSISTS OF STANDARD CHARACTERS WITHOUT CLAIM TO ANY PARTICULAR FONT, STYLE, SIZE, OR COLOR.

FOR LANGUAGE INSTRUCTION (U.S. CLS. 100, 101 AND 107).

ELIZABETH CHANG, EXAMINING ATTORNEY

SN 86-071,379. PROTECTION OF THE HOLY MOTHER OF GOD ORTHODOX CHURCH, AKA ST. MARY'S ORTHODOX CHURCH, FALLS CHURCH, VA. FILED 9-22-2013.

# DOXACON

THE MARK CONSISTS OF STANDARD CHARACTERS WITHOUT CLAIM TO ANY PARTICULAR FONT, STYLE, SIZE, OR COLOR.

FOR EDUCATIONAL SERVICES, NAMELY, CONDUCTING CONFERENCES, SEMINARS, WORKSHOPS IN THE FIELD OF CHRISTIANITY, RELIGION, SPIRITUALITY, LITERATURE, MEDIA, SCIENCE FICTION, FANTASY, POPULAR CULTURE, FICTION WRITING, AND DISTRIBUTION OF PRINTED MATERIALS IN CONNECTION THEREWITH IN HARD COPY OR ELECTRONIC FORMAT ON THE SAME TOPICS (U.S. CLS. 100, 101 AND 107).

FIRST USE 7-19-2013; IN COMMERCE 7-19-2013.  
LINDSEY BEN, EXAMINING ATTORNEY

SN 86-071,501. BOARDROOM INC., STAMFORD, CT. FILED 9-23-2013.

# THE DAILY BURST

THE MARK CONSISTS OF STANDARD CHARACTERS WITHOUT CLAIM TO ANY PARTICULAR FONT, STYLE, SIZE, OR COLOR.

NO CLAIM IS MADE TO THE EXCLUSIVE RIGHT TO USE "DAILY", APART FROM THE MARK AS SHOWN.

FOR ONLINE ELECTRONIC NEWSLETTERS DELIVERED BY E-MAIL IN THE FIELDS OF PERSONAL INTEREST, LIFESTYLE, SELF-IMPROVEMENT, HEALTH, NUTRITION, AND FITNESS (U.S. CLS. 100, 101 AND 107).

REBECCA GILBERT, EXAMINING ATTORNEY

**CLASS 41—(Continued).**

SN 86-071,512. PLAY TO LEARN...LEARN TO PLAY, INC., ACTON, MA. FILED 9-23-2013.

# Play to Learn...Learn to Play

THE MARK CONSISTS OF STANDARD CHARACTERS WITHOUT CLAIM TO ANY PARTICULAR FONT, STYLE, SIZE, OR COLOR.

FOR EDUCATION SERVICES, NAMELY, PROVIDING MENTORING, TUTORING, CLASSES, SEMINARS AND WORKSHOPS IN THE FIELD OF AUTISM AND OTHER DEVELOPMENTAL DISABILITIES (U.S. CLS. 100, 101 AND 107).

FIRST USE 1-1-2008; IN COMMERCE 1-1-2008.  
ESTHER BELENKER, EXAMINING ATTORNEY

SN 86-071,597. BARNES, LAVERNE, MATTESON, IL. FILED 9-23-2013.

# Heal the Healer

THE MARK CONSISTS OF STANDARD CHARACTERS WITHOUT CLAIM TO ANY PARTICULAR FONT, STYLE, SIZE, OR COLOR.

FOR EDUCATIONAL SERVICES, NAMELY, PROVIDING CONFERENCES FOR HEALTHY LIFESTYLES, NAMELY, IN HOLISTIC HEALING (U.S. CLS. 100, 101 AND 107).

ESTHER A. BORSUK, EXAMINING ATTORNEY

SN 86-072,085. HOLLYWOOD AWARDS, LLC, NEW YORK, NY. FILED 9-23-2013.

# THE FIRST STOP OF THE AWARDS SEASON

THE MARK CONSISTS OF STANDARD CHARACTERS WITHOUT CLAIM TO ANY PARTICULAR FONT, STYLE, SIZE, OR COLOR.

FOR ENTERTAINMENT SERVICES, NAMELY, PROVIDING AWARDS TO DEMONSTRATE EXCELLENCE IN THE FIELDS OF MOTION PICTURES, TELEVISION, MUSIC, RADIO AND MULTIMEDIA BY USING A GLOBAL COMPUTER NETWORK DATABASE POLLING SYSTEM; ORGANIZE AND CONDUCT PROGRAMS TO GRANT AWARDS TO RECOGNIZE ACHIEVEMENTS IN THE FIELDS OF MOTION PICTURES, TELEVISION, MUSIC, RADIO, AND MULTIMEDIA TO RECIPIENTS CHOSEN VIA A GLOBAL COMPUTER NETWORK AND TELEVISION (U.S. CLS. 100, 101 AND 107).

FIRST USE 9-17-2013; IN COMMERCE 9-17-2013.  
JORDAN BAKER, EXAMINING ATTORNEY

**CLASS 41—(Continued).**

SN 86-072,264. NJOY, INC., SCOTTSDALE, AZ. FILED 9-23-2013.

# NJOY

THE MARK CONSISTS OF STANDARD CHARACTERS WITHOUT CLAIM TO ANY PARTICULAR FONT, STYLE, SIZE, OR COLOR.

OWNER OF U.S. REG. NOS. 3,427,769 AND 4,091,150. FOR VAPING LOUNGE SERVICES (U.S. CLS. 100, 101 AND 107).

MICHAEL ENGEL, EXAMINING ATTORNEY

SN 86-072,301. FUSION FITNESS, LLC, PRAIRIE VILLAGE, KS. FILED 9-23-2013.

# SWEAT LAB

THE MARK CONSISTS OF STANDARD CHARACTERS WITHOUT CLAIM TO ANY PARTICULAR FONT, STYLE, SIZE, OR COLOR.

FOR CONDUCTING CLASSES AND WORKSHOPS IN THE FIELD OF PHYSICAL FITNESS AND EXERCISE; PERSONAL TRAINING PROVIDED IN CONNECTION WITH WEIGHT LOSS AND EXERCISE PROGRAMS, NAMELY WEIGHT LOSS BOOT CAMP CLASSES AND WORKSHOPS; PERSONAL TRAINING CONSULTATION; PHYSICAL FITNESS STUDIO SERVICES, NAMELY, PROVIDING EXERCISE CLASSES, BODY SCULPTING CLASSES, YOGA INSTRUCTION, SPINNING, INDOOR CYCLING CLASSES AND GROUP FITNESS CLASSES; PROVIDING A WEBSITE FEATURING INFORMATION ON EXERCISE AND FITNESS; PROVIDING FITNESS AND EXERCISE FACILITIES; PROVIDING PHYSICAL FITNESS AND EXERCISE SERVICES, NAMELY, EXERCISE CLASSES, GROUP FITNESS CLASSES, BODY SCULPTING CLASSES, SPINNING CLASSES, INDOOR CYCLING AND YOGA INSTRUCTION (U.S. CLS. 100, 101 AND 107).

JOHN WILKE, EXAMINING ATTORNEY

SN 86-072,419. RUBEN CONSULTING GROUP, LTD., SAN FRANCISCO, CA. FILED 9-23-2013.

# LEADERSHIP TANGLES

THE MARK CONSISTS OF STANDARD CHARACTERS WITHOUT CLAIM TO ANY PARTICULAR FONT, STYLE, SIZE, OR COLOR.

FOR ON-LINE JOURNALS, NAMELY, BLOGS FEATURING CONTENT IN THE FIELDS OF BUSINESS, BUSINESS LEADERSHIP, BUSINESS COMMUNICATION AND EXECUTIVE COACHING (U.S. CLS. 100, 101 AND 107).

FIRST USE 1-27-2009; IN COMMERCE 1-27-2009. GIANCARLO CASTRO, EXAMINING ATTORNEY

**CLASS 41—(Continued).**

SN 86-072,546. CLARK, CHRISTIN, ARLINGTON, TX. AND JONES, GAYLON, LANCASTER, TX. FILED 9-23-2013.

# APOLLO'S INTERLUDE

THE MARK CONSISTS OF THE TEXT "APOLLO'S INTERLUDE".

FOR ENTERTAINMENT IN THE NATURE OF MUSICAL GROUP; ENTERTAINMENT SERVICES BY A MUSICAL ARTIST AND PRODUCER, NAMELY, MUSICAL COMPOSITION FOR OTHERS AND PRODUCTION OF MUSICAL SOUND RECORDINGS; ENTERTAINMENT SERVICES IN THE NATURE OF LIVE MUSICAL PERFORMANCES; ENTERTAINMENT SERVICES IN THE NATURE OF LIVE VISUAL AND AUDIO PERFORMANCES BY MUSICAL BAND; ENTERTAINMENT SERVICES IN THE NATURE OF LIVE VISUAL AND AUDIO PERFORMANCES, AND MUSICAL, VARIETY, NEWS AND COMEDY SHOWS; ENTERTAINMENT SERVICES IN THE NATURE OF LIVE VISUAL AND AUDIO PERFORMANCES, NAMELY, MUSICAL BAND, ROCK GROUP, GYMNASTIC, DANCE, AND BALLET PERFORMANCES; ENTERTAINMENT SERVICES IN THE NATURE OF PRESENTING LIVE MUSICAL PERFORMANCES; ENTERTAINMENT SERVICES IN THE NATURE OF RECORDING, PRODUCTION AND POST-PRODUCTION SERVICES IN THE FIELD OF MUSIC; ENTERTAINMENT SERVICES IN THE NATURE OF MUSICAL PERFORMANCES; LIVE PERFORMANCES BY A MUSICAL GROUP (U.S. CLS. 100, 101 AND 107).

FIRST USE 7-26-2013; IN COMMERCE 9-17-2013.

JOHN HWANG, EXAMINING ATTORNEY

SN 86-072,560. JOSHUA D. FRITH, BROOKLYN, NY. FILED 9-23-2013.



THE NAME(S), PORTRAIT(S), AND/OR SIGNATURE(S) SHOWN IN THE MARK IDENTIFIES JOSHUA D. FRITH, WHOSE CONSENT(S) TO REGISTER IS MADE OF RECORD.

THE COLOR(S) BROWN AND BURGUNDY IS/ARE CLAIMED AS A FEATURE OF THE MARK.

THE MARK CONSISTS OF THE LETTERS "J" AND "D" WITH "JOSHUA DWAIN" DIRECTLY UNDERNEATH. THE "J" AND "D" ARE IN A BROWN, ALL CAPS, DOUBLE LINE FONT. "JOSHUA DWAIN" IS BURGUNDY AND ALL CAPS.

FOR PARTY AND WEDDING RECEPTION PLANNING CONSULTATION SERVICES; PHOTOGRAPHY SERVICES; WEDDING PHOTOGRAPHY SERVICES (U.S. CLS. 100, 101 AND 107).

FIRST USE 1-1-2011; IN COMMERCE 1-1-2011.

ANTHONY RINKER, EXAMINING ATTORNEY

**CLASS 41—(Continued).**

SN 86-075,153. NATIONAL ENVIRONMENTAL TRAINERS, MARTINEZ, GA. FILED 9-26-2013.

# TIMEBoost

THE MARK CONSISTS OF STANDARD CHARACTERS WITHOUT CLAIM TO ANY PARTICULAR FONT, STYLE, SIZE, OR COLOR.

FOR PROVIDING ON-LINE TRAINING FOR COMPLIANCE WITH STATE AND FEDERAL REGULATIONS IN THE FIELD OF ENVIRONMENTAL HEALTH AND SAFETY (U.S. CLS. 100, 101 AND 107).

FIRST USE 9-26-2013; IN COMMERCE 9-26-2013.  
DAVID ALESKOW, EXAMINING ATTORNEY

---

SN 86-075,464. WEBBER, MALCOLM, GOSHEN, IN. FILED 9-26-2013.

# LEADERS BUILD LEADERS

THE MARK CONSISTS OF STANDARD CHARACTERS WITHOUT CLAIM TO ANY PARTICULAR FONT, STYLE, SIZE, OR COLOR.

FOR EDUCATIONAL SERVICES, NAMELY, CONDUCTING WORKSHOPS, SEMINARS, CONSULTATION IN THE FIELD OF HOLISTIC LEADER DEVELOPMENT, LEADER DEVELOPMENT EVALUATION, EVALUATION OF LEADERS' LIVES AND LEADERSHIP SKILLS, EVALUATION OF LEADERSHIP TRAINING PROCESSES AND DISTRIBUTION OF COURSE MATERIALS IN CONNECTION THEREWITH (U.S. CLS. 100, 101 AND 107).

FIRST USE 9-1-1999; IN COMMERCE 9-1-1999.  
REBECCA SMITH, EXAMINING ATTORNEY

---

SN 86-076,295. WEBBER, MALCOLM, GOSHEN, IN. FILED 9-26-2013.

# Transformational Theology

THE MARK CONSISTS OF STANDARD CHARACTERS WITHOUT CLAIM TO ANY PARTICULAR FONT, STYLE, SIZE, OR COLOR.

NO CLAIM IS MADE TO THE EXCLUSIVE RIGHT TO USE "THEOLOGY", APART FROM THE MARK AS SHOWN.

FOR EDUCATIONAL SERVICES, NAMELY, CONDUCTING WORKSHOPS, SEMINARS, CONSULTATION IN THE FIELD OF HOLISTIC LEADER DEVELOPMENT, LEADER DEVELOPMENT EVALUATION, EVALUATION OF LEADERS' LIVES AND LEADERSHIP SKILLS, EVALUATION OF LEADERSHIP TRAINING PROCESSES AND DISTRIBUTION OF COURSE MATERIALS IN CONNECTION THEREWITH (U.S. CLS. 100, 101 AND 107).

FIRST USE 3-11-2008; IN COMMERCE 3-11-2008.  
REBECCA SMITH, EXAMINING ATTORNEY

**CLASS 41—(Continued).**

SN 86-076,439. UNCOMMON CONTENT PARTNERS LLC, NEW YORK, NY. FILED 9-27-2013.

## HOOKED UP INVITATIONAL

THE MARK CONSISTS OF STANDARD CHARACTERS WITHOUT CLAIM TO ANY PARTICULAR FONT, STYLE, SIZE, OR COLOR.

NO CLAIM IS MADE TO THE EXCLUSIVE RIGHT TO USE "INVITATIONAL", APART FROM THE MARK AS SHOWN.

FOR ORGANIZING, CONDUCTING AND OPERATING FISHING TOURNAMENTS; ENTERTAINMENT IN THE NATURE OF FISHING TOURNAMENTS (U.S. CLS. 100, 101 AND 107).

ODESSA BIBBINS, EXAMINING ATTORNEY

---

SN 86-076,891. MIAMI VALLEY GAMING & RACING, LLC, BUFFALO, NY. FILED 9-27-2013.



THE MARK CONSISTS OF A SQUIGGLY LINE DESIGN. FOR WAGERING SERVICES; ENTERTAINMENT SERVICES, NAMELY, OPERATING GAMING DEVICES, CONDUCTING LIVE HORSE RACES AND ACCEPTING PARI-MUTUEL WAGERS ON LIVE RACES AND ON SIMULCAST RACES CONDUCTED AT OTHER RACE-TRACKS (U.S. CLS. 100, 101 AND 107).

NELSON SNYDER, EXAMINING ATTORNEY

**CLASS 41—(Continued).**

SN 86-079,449. GO-GO FITNESS LLC, WASHINGTON, DC. FILED 10-1-2013.

# Da-GoGo

THE MARK CONSISTS OF STANDARD CHARACTERS WITHOUT CLAIM TO ANY PARTICULAR FONT, STYLE, SIZE, OR COLOR.

FOR CONDUCTING FITNESS CLASSES; CONSULTING SERVICES IN THE FIELDS OF FITNESS AND EXERCISE; COUNSELING SERVICES IN THE FIELD OF PHYSICAL FITNESS; EDUCATION SERVICES, NAMELY, PROVIDING LIVE AND ON-LINE CLASSES, SEMINARS AND WORKSHOPS IN THE FIELD OF FITNESS AND HEALTH; EDUCATION SERVICES, NAMELY, PROVIDING ON-LINE CLASSES, SEMINARS, CONFERENCES, RETREATS AND WORKSHOPS IN THE FIELD OF FITNESS AND HEALTH; ORGANIZING, ARRANGING, AND CONDUCTING LIVE INSTRUCTIONAL PERFORMANCES IN THE FIELD OF FITNESS, EXERCISE AND HEALTH; PHYSICAL FITNESS CONDITIONING CLASSES; PHYSICAL FITNESS CONSULTATION; PHYSICAL FITNESS INSTRUCTION; PHYSICAL FITNESS STUDIO SERVICES, NAMELY, PROVIDING EXERCISE CLASSES, BODY SCULPTING CLASSES, AND GROUP FITNESS CLASSES; PHYSICAL FITNESS TRAINING OF INDIVIDUALS AND GROUPS; PHYSICAL FITNESS TRAINING SERVICES; PROVIDING ASSISTANCE, PERSONAL TRAINING AND PHYSICAL FITNESS CONSULTATION TO CORPORATE CLIENTS TO HELP THEIR EMPLOYEES MAKE PHYSICAL FITNESS, STRENGTH, CONDITIONING, AND EXERCISE ALTERATIONS IN THEIR DAILY LIVING; PROVIDING ASSISTANCE, PERSONAL TRAINING AND PHYSICAL FITNESS CONSULTATION TO INDIVIDUALS TO HELP THEM MAKE PHYSICAL FITNESS, STRENGTH, CONDITIONING, AND EXERCISE IMPROVEMENT IN THEIR DAILY LIVING (U.S. CLS. 100, 101 AND 107).

FIRST USE 9-0-2012; IN COMMERCE 9-0-2012.  
ANGELA DUONG, EXAMINING ATTORNEY

SN 86-079,758. ARTIFEX MUNDI SP. Z O.O., DBA ARTIFEX MUNDI, ZABRZE, 41-800, CA. FILED 10-1-2013.



ARTIFEX MUNDI

THE MARK CONSISTS OF THE WORDS "ARTIFEX MUNDI" WITH THE SILHOUETTE OF A CHILD REACHING UP TOWARDS A STAR.

FOR MULTIMEDIA ENTERTAINMENT SOFTWARE PRODUCTION SERVICES; PUBLISHING INTERACTIVE COMPUTER AND VIDEO GAME SOFTWARE (U.S. CLS. 100, 101 AND 107).

FIRST USE 0-0-2006; IN COMMERCE 0-0-2006.  
ROSELLE HERRERA, EXAMINING ATTORNEY

**CLASS 41—(Continued).**

SN 86-079,886. PARAMOUNT PICTURES CORPORATION, HOLLYWOOD, CA. FILED 10-1-2013.

JACK RYAN: SHADOW RECRUIT

THE MARK CONSISTS OF STANDARD CHARACTERS WITHOUT CLAIM TO ANY PARTICULAR FONT, STYLE, SIZE, OR COLOR.

THE NAME(S), PORTRAIT(S), AND/OR SIGNATURE(S) SHOWN IN THE MARK DOES NOT IDENTIFY A PARTICULAR LIVING INDIVIDUAL.

FOR ENTERTAINMENT SERVICES, NAMELY, PROVIDING ONLINE INFORMATION CONCERNING MOTION PICTURES IN THE FIELDS OF ACTION, DRAMA, AND SUSPENSE; PROVIDING WEBSITES FEATURING NON-DOWNLOADABLE IMAGES, AUDIO, VIDEO, TEXT, GRAPHICS AND RELATED INFORMATION IN THE FIELD OF MOTION PICTURES (U.S. CLS. 100, 101 AND 107).

AHSEN KHAN, EXAMINING ATTORNEY

SN 86-080,762. GENE SIMMONS COMPANY, PINE BROOK, NJ. FILED 10-2-2013.

# MOTION

THE MARK CONSISTS OF STANDARD CHARACTERS WITHOUT CLAIM TO ANY PARTICULAR FONT, STYLE, SIZE, OR COLOR.

FOR ENTERTAINMENT SERVICES, NAMELY, PRODUCTION AND DISTRIBUTION OF THEATRICAL MOTION PICTURES; PRODUCTION AND DISTRIBUTION OF A TELEVISION SERIES; PRODUCTION OF FILMS, VIDEO TAPES, VIDEOCASSETTES, VIDEO DISCS, DVDS, AUDIO TAPES AND COMPACT DISCS; SOUND RECORDING AND VIDEO ENTERTAINMENT SERVICES, NAMELY, PRODUCTION OF SOUND AND VIDEO RECORDINGS (U.S. CLS. 100, 101 AND 107).

KATHERINE STOIDES, EXAMINING ATTORNEY

SN 86-083,579. GLOBAL TRADEMARKS, INC., STOCKERTOWN, PA. FILED 10-5-2013.

# BABY'S ALL RIGHT

THE MARK CONSISTS OF STANDARD CHARACTERS WITHOUT CLAIM TO ANY PARTICULAR FONT, STYLE, SIZE, OR COLOR.

FOR ENTERTAINMENT SERVICES IN THE NATURE OF LIVE MUSICAL PERFORMANCES; NIGHTS-CLUBS (U.S. CLS. 100, 101 AND 107).

TEJBIR SINGH, EXAMINING ATTORNEY



**CLASS 41—(Continued).**

SN 86-088,403. UNIVISION ABC NEWS NETWORK, LLC, BURBANK, CA. FILED 10-10-2013.

**SOCCER GODS**

THE MARK CONSISTS OF STANDARD CHARACTERS WITHOUT CLAIM TO ANY PARTICULAR FONT, STYLE, SIZE, OR COLOR.

NO CLAIM IS MADE TO THE EXCLUSIVE RIGHT TO USE "SOCCER", APART FROM THE MARK AS SHOWN.

FOR ENTERTAINMENT SERVICES, NAMELY, AN ONGOING TELEVISION SPORTS PROGRAM (U.S. CLS. 100, 101 AND 107).

JEFF DEFORD, EXAMINING ATTORNEY

**CLASS 41—(Continued).**

SN 86-090,112. INGAGE CONSULTING, INC., AKA INGAGE, WOBURN, MA. FILED 10-12-2013.

**TORTAL**  
TRAINING

OWNER OF U.S. REG. NOS. 4,217,777 AND 4,217,830.

NO CLAIM IS MADE TO THE EXCLUSIVE RIGHT TO USE "TRAINING", APART FROM THE MARK AS SHOWN.

THE MARK CONSISTS OF THE WORDS "TORTAL TRAINING" WITH A GEAR (OF 8 COGS) IN THE PLACE OF THE "O" IN "TORTAL".

FOR TRAINING SERVICES IN THE FIELD OF BUSINESS, BUSINESS MANAGEMENT, FRANCHISE OPERATION, ADVERTISING, MARKETING, AND PROMOTION (U.S. CLS. 100, 101 AND 107).

FIRST USE 8-13-2012; IN COMMERCE 8-13-2012.

AISHA CLARKE, EXAMINING ATTORNEY

SN 86-089,694. VICTORY OUTREACH INTERNATIONAL, SAN DIMAS, CA. FILED 10-11-2013.

**Veti**

THE MARK CONSISTS OF THE WORD "VETI" IN STYLIZED FONT WITH THE LETTER "V" IN A SHADED DIAMOND.

FOR EDUCATIONAL SERVICES, NAMELY, CONDUCTING SEMINARS, CLASSES AND WORKSHOPS IN THE FIELD OF THEOLOGY AND MINISTRY AND DISTRIBUTION OF EDUCATIONAL MATERIALS IN CONNECTION THEREWITH (U.S. CLS. 100, 101 AND 107).

FIRST USE 3-0-2012; IN COMMERCE 3-0-2012.

JILLIAN CANTOR, EXAMINING ATTORNEY

SN 86-090,271. THE BUGARIE GROUP, HALLANDALE, FL. FILED 10-13-2013.

**ULTIMATE BODY**

THE MARK CONSISTS OF STANDARD CHARACTERS WITHOUT CLAIM TO ANY PARTICULAR FONT, STYLE, SIZE, OR COLOR.

FOR PROVIDING RECOGNITION AND INCENTIVES TO INDIVIDUALS AROUND THE WORLD BY THE WAY OF AWARDS TO DEMONSTRATE EXCELLENCE IN THE FIELDS OF LITERATURE, PERFORMING ARTS, CINEMATOGRAPHY, AUTOMOTIVE DESIGN, MANUFACTURING, TRAVEL, SPORTS, COMMUNITY SERVICE, FASHION, FILMS, FOOD, HEALTH, MODELING, MUSIC, DANCE, PHARMACEUTICALS, PHILANTHROPY, SCIENCE, AND TECHNOLOGY; ENTERTAINMENT IN THE NATURE OF AN ONGOING REALITY BASED TELEVISION PROGRAM (U.S. CLS. 100, 101 AND 107).

SHAVELL MCPHERSON, EXAMINING ATTORNEY

**CLASS 41—(Continued).**

SN 86-090,941. VIACOM INTERNATIONAL INC., NEW YORK, NY. FILED 10-14-2013.

**THE LINDA PERRY PROJECT**

THE MARK CONSISTS OF STANDARD CHARACTERS WITHOUT CLAIM TO ANY PARTICULAR FONT, STYLE, SIZE, OR COLOR.

NO CLAIM IS MADE TO THE EXCLUSIVE RIGHT TO USE "PROJECT", APART FROM THE MARK AS SHOWN.

THE NAME(S), PORTRAIT(S), AND/OR SIGNATURE(S) SHOWN IN THE MARK IDENTIFIES "LINDA PERRY", WHOSE CONSENT(S) TO REGISTER IS MADE OF RECORD.

FOR ENTERTAINMENT SERVICES IN THE NATURE OF CONTINUING PROGRAM SERIES, FEATURING LIVE ACTION, COMEDY AND DRAMA PROVIDED THROUGH CABLE TELEVISION, BROADCAST TELEVISION, INTERNET, VIDEO-ON-DEMAND, AND THROUGH OTHER FORMS OF TRANSMISSION MEDIA; PROVIDING ONLINE INFORMATION IN THE FIELD OF ENTERTAINMENT CONCERNING TELEVISION PROGRAMS (U.S. CLS. 100, 101 AND 107).

C. DIONNE CLYBURN, EXAMINING ATTORNEY

SN 86-091,556. EVANS, THOMAS, WAYNE, PA. FILED 10-15-2013.

**Fenix Fitness**

THE MARK CONSISTS OF STANDARD CHARACTERS WITHOUT CLAIM TO ANY PARTICULAR FONT, STYLE, SIZE, OR COLOR.

NO CLAIM IS MADE TO THE EXCLUSIVE RIGHT TO USE "FITNESS", APART FROM THE MARK AS SHOWN.

THE ENGLISH TRANSLATION OF "FENIX" IS "PHOENIX".

FOR PERSONAL FITNESS TRAINING SERVICES AND CONSULTANCY; PHYSICAL FITNESS INSTRUCTION (U.S. CLS. 100, 101 AND 107).

FIRST USE 1-1-2010; IN COMMERCE 1-1-2010.

JEANIE LEE, EXAMINING ATTORNEY

**CLASS 41—(Continued).**

SN 86-091,685. NATIONAL CENTER FOR FAMILY LITERACY, LOUISVILLE, KY. FILED 10-15-2013.



THE MARK CONSISTS OF A STYLIZED LOWER CASE LETTER "F" IN FRONT OF ARCING QUARTER CIRCLES THAT FORM A DESIGN ELEMENT.

FOR EDUCATIONAL SERVICES, NAMELY, PROVIDING EDUCATIONAL PROGRAMS THAT PROMOTE FAMILY AND COMMUNITY LITERACY AND PARENTS/CHILDREN LEARNING TOGETHER (U.S. CLS. 100, 101 AND 107).

ELLEN BURNS, EXAMINING ATTORNEY

SN 86-091,816. VICTORY OUTREACH INTERNATIONAL, SAN DIMAS, CA. FILED 10-15-2013.



NO CLAIM IS MADE TO THE EXCLUSIVE RIGHT TO USE "KIDS", APART FROM THE MARK AS SHOWN.

THE MARK CONSISTS OF THE WORD "KIDZ" IN SHADED BLOCK LETTERS WITH A STAR ABOVE THE LETTER "I" IN "KIDZ".

FOR EDUCATIONAL SERVICES, NAMELY, CONDUCTING SEMINARS, CLASSES AND WORKSHOPS IN THE FIELD OF THEOLOGY AND MINISTRY AND DISTRIBUTION OF EDUCATIONAL MATERIALS IN CONNECTION THEREWITH (U.S. CLS. 100, 101 AND 107).

FIRST USE 3-0-1993; IN COMMERCE 3-0-1993.

JILLIAN CANTOR, EXAMINING ATTORNEY

**CLASS 41—(Continued).**

SN 86-091,823. VICTORY OUTREACH INTERNATIONAL,  
SAN DIMAS, CA. FILED 10-15-2013.



THE MARK CONSISTS OF THE LETTER "G" INSIDE A CIRCLE.

FOR EDUCATIONAL SERVICES, NAMELY, CONDUCTING SEMINARS, CLASSES AND WORKSHOPS IN THE FIELD OF THEOLOGY AND MINISTRY AND DISTRIBUTION OF EDUCATIONAL MATERIALS IN CONNECTION THEREWITH (U.S. CLS. 100, 101 AND 107).

FIRST USE 1-0-2009; IN COMMERCE 1-0-2009.  
JILLIAN CANTOR, EXAMINING ATTORNEY

SN 86-092,031. DISCOVERY COMMUNICATIONS, LLC,  
SILVER SPRING, MD. FILED 10-15-2013.

**CUTE-A-THON**

THE MARK CONSISTS OF STANDARD CHARACTERS WITHOUT CLAIM TO ANY PARTICULAR FONT, STYLE, SIZE, OR COLOR.

FOR ENTERTAINMENT AND EDUCATIONAL SERVICES IN THE NATURE OF TELEVISION AND MULTIMEDIA PROGRAM SERIES FEATURING SUBJECTS OF GENERAL HUMAN INTEREST DISTRIBUTED VIA VARIOUS PLATFORMS ACROSS MULTIPLE FORMS OF TRANSMISSION MEDIA; PROVIDING ENTERTAINMENT INFORMATION TO OTHERS VIA A GLOBAL COMPUTER NETWORK (U.S. CLS. 100, 101 AND 107).

SHARON MEIER, EXAMINING ATTORNEY

SN 86-092,041. DISCOVERY COMMUNICATIONS, LLC,  
SILVER SPRING, MD. FILED 10-15-2013.

**CATURDAY**

THE MARK CONSISTS OF STANDARD CHARACTERS WITHOUT CLAIM TO ANY PARTICULAR FONT, STYLE, SIZE, OR COLOR.

FOR ENTERTAINMENT AND EDUCATIONAL SERVICES IN THE NATURE OF TELEVISION AND MULTIMEDIA PROGRAM SERIES FEATURING SUBJECTS OF GENERAL HUMAN INTEREST DISTRIBUTED VIA VARIOUS PLATFORMS ACROSS MULTIPLE FORMS OF TRANSMISSION MEDIA; PROVIDING ENTERTAINMENT INFORMATION TO OTHERS VIA A GLOBAL COMPUTER NETWORK (U.S. CLS. 100, 101 AND 107).

SHARON MEIER, EXAMINING ATTORNEY

**CLASS 41—(Continued).**

SN 86-094,193. IGT, RENO, NV. FILED 10-17-2013.

**BENGAL EYES**

THE MARK CONSISTS OF STANDARD CHARACTERS WITHOUT CLAIM TO ANY PARTICULAR FONT, STYLE, SIZE, OR COLOR.

OWNER OF U.S. REG. NOS. 3,828,871 AND 4,070,975.  
FOR ENTERTAINMENT SERVICES, NAMELY, PROVIDING ON-LINE COMPUTER GAMES (U.S. CLS. 100, 101 AND 107).

MICHAEL TANNER, EXAMINING ATTORNEY

SN 86-096,552. MCDONALD'S CORPORATION, OAK  
BROOK, IL. FILED 10-21-2013.

**RUN. JUMP. SWEAT. WIN.**

THE MARK CONSISTS OF STANDARD CHARACTERS WITHOUT CLAIM TO ANY PARTICULAR FONT, STYLE, SIZE, OR COLOR.

FOR ENTERTAINMENT SERVICES, NAMELY, CONDUCTING ATHLETIC EVENTS AND COMPETITIONS (U.S. CLS. 100, 101 AND 107).

RAMONA ORTIGA, EXAMINING ATTORNEY

SN 86-100,334. LENNON, YOKO ONO, NEW YORK, NY.  
FILED 10-24-2013.

**JOHN LENNON**

THE MARK CONSISTS OF STANDARD CHARACTERS WITHOUT CLAIM TO ANY PARTICULAR FONT, STYLE, SIZE, OR COLOR.

OWNER OF U.S. REG. NOS. 1,488,395, 2,676,604 AND OTHERS.

THE NAME(S), PORTRAIT(S), AND/OR SIGNATURE(S) SHOWN IN THE MARK DOES NOT IDENTIFY A PARTICULAR LIVING INDIVIDUAL.

FOR ENTERTAINMENT SERVICES IN THE NATURE OF LIVE MUSICAL PERFORMANCES (U.S. CLS. 100, 101 AND 107).

FIRST USE 12-7-1984; IN COMMERCE 12-31-2004.  
RICHARD WHITE, EXAMINING ATTORNEY

**CLASS 41—(Continued).**

SN 86-105,729. CYLIENT, LLC, JOHNSTON, IA. FILED 10-30-2013.

## COACHING FOR INSPIRED PERFORMANCE

THE MARK CONSISTS OF STANDARD CHARACTERS WITHOUT CLAIM TO ANY PARTICULAR FONT, STYLE, SIZE, OR COLOR.

FOR BUSINESS EDUCATION AND TRAINING SERVICES, NAMELY, DEVELOPING AND FACILITATING CUSTOMIZED LEADERSHIP AND EXECUTIVE DEVELOPMENT PROGRAMS, PROVIDING EXECUTIVE COACHING SERVICES, AND PROVIDING BUSINESS EDUCATION PROGRAMS TO EMPLOYEES AND EXECUTIVES (U.S. CLS. 100, 101 AND 107).

FLORENTINA BLANDU, EXAMINING ATTORNEY

---

SN 86-106,064. PRODIGAL SOCCER LLC, OKLAHOMA CITY, OK. FILED 10-30-2013.

## OKC FLYERS FC

THE MARK CONSISTS OF STANDARD CHARACTERS WITHOUT CLAIM TO ANY PARTICULAR FONT, STYLE, SIZE, OR COLOR.

NO CLAIM IS MADE TO THE EXCLUSIVE RIGHT TO USE "OKC" AND "FC", APART FROM THE MARK AS SHOWN.

FOR ENTERTAINMENT SERVICES, NAMELY, ORGANIZING, PROVIDING AND CONDUCTING PROFESSIONAL SOCCER EXHIBITIONS AND GAMES (U.S. CLS. 100, 101 AND 107).

SAIMA MAKHDOOM, EXAMINING ATTORNEY

---

SN 86-106,098. PRODIGAL SOCCER LLC, OKLAHOMA CITY, OK. FILED 10-30-2013.

## OKC WIND FC

THE MARK CONSISTS OF STANDARD CHARACTERS WITHOUT CLAIM TO ANY PARTICULAR FONT, STYLE, SIZE, OR COLOR.

NO CLAIM IS MADE TO THE EXCLUSIVE RIGHT TO USE "OKC" AND "FC", APART FROM THE MARK AS SHOWN.

FOR ENTERTAINMENT SERVICES, NAMELY, ORGANIZING, PROVIDING AND CONDUCTING PROFESSIONAL SOCCER EXHIBITIONS AND GAMES (U.S. CLS. 100, 101 AND 107).

SAIMA MAKHDOOM, EXAMINING ATTORNEY

**CLASS 41—(Continued).**

SN 86-106,121. PRODIGAL SOCCER LLC, OKLAHOMA CITY, OK. FILED 10-30-2013.

## OKC AEROS FC

THE MARK CONSISTS OF STANDARD CHARACTERS WITHOUT CLAIM TO ANY PARTICULAR FONT, STYLE, SIZE, OR COLOR.

NO CLAIM IS MADE TO THE EXCLUSIVE RIGHT TO USE "OKC" AND "FC", APART FROM THE MARK AS SHOWN.

FOR ENTERTAINMENT SERVICES, NAMELY, ORGANIZING, PROVIDING AND CONDUCTING PROFESSIONAL SOCCER EXHIBITIONS AND GAMES (U.S. CLS. 100, 101 AND 107).

SAIMA MAKHDOOM, EXAMINING ATTORNEY

---

SN 86-107,310. PRODIGAL SOCCER LLC, OKLAHOMA CITY, OK. FILED 10-31-2013.



NO CLAIM IS MADE TO THE EXCLUSIVE RIGHT TO USE "OKC" AND "FC", APART FROM THE MARK AS SHOWN.

THE COLOR(S) RED, BLUE, GRAY AND WHITE IS/ARE CLAIMED AS A FEATURE OF THE MARK.

THE MARK CONSISTS OF A DESIGN OF A SHIELD OUTLINED IN GRAY AND BLUE WITH RED STRIPES INSIDE THE SHIELD. THE TOP INTERIOR OF THE SHIELD CONTAINS THE LETTERS "OKC" IN WHITE. IN THE CENTER OF THE SHIELD IS A CURVED RECTANGLE COLORED IN BLUE AND OUTLINED IN WHITE. THE CENTER OF THE RECTANGLE CONTAINS "46ERS" IN WHITE. THE BOTTOM INTERIOR OF THE SHIELD HAS A STAR OUTLINED IN BLUE AND COLORED IN WHITE WITH A BLUE "FC" IN THE CENTER OF THE STAR.

FOR ENTERTAINMENT SERVICES, NAMELY, ORGANIZING, PROVIDING AND CONDUCTING PROFESSIONAL SOCCER EXHIBITIONS AND GAMES (U.S. CLS. 100, 101 AND 107).

SAIMA MAKHDOOM, EXAMINING ATTORNEY

**CLASS 41—(Continued).**

SN 86-107,358. PRODIGAL SOCCER LLC, OKLAHOMA CITY, OK. FILED 10-31-2013.



NO CLAIM IS MADE TO THE EXCLUSIVE RIGHT TO USE "OKLAHOMA CITY" AND "FC", APART FROM THE MARK AS SHOWN.

THE COLOR(S) MAROON, BLUE, GRAY AND WHITE IS/ARE CLAIMED AS A FEATURE OF THE MARK.

THE MARK CONSISTS OF A SHIELD DESIGN OUTLINED IN GRAY AND WHITE. THE INTERIOR OF THE SHIELD IS COLORED IN BLUE. THE CENTER OF THE SHIELD CONTAINS A CURVED RECTANGLE IN MAROON. AT THE TOP OF THE RECTANGLE ARE THE WORDS "OKLAHOMA CITY" IN GRAY. THE CENTER OF THE RECTANGLE CONTAINS THE WORD "FLYERS" IN WHITE AND SHADOWED IN GRAY. THE BOTTOM OF THE RECTANGLE CONSISTS OF THE LETTERS "FC" IN MAROON AND SEPARATED BY A SOCCER BALL IN MAROON AND WHITE. SUPERIMPOSED ON THE SHIELD IS A BIRD DESIGN IN MAROON AND SHADOWED IN GRAY.

FOR ENTERTAINMENT SERVICES, NAMELY, ORGANIZING, PROVIDING AND CONDUCTING PROFESSIONAL SOCCER EXHIBITIONS AND GAMES (U.S. CLS. 100, 101 AND 107).

SAIMA MAKHDOOM, EXAMINING ATTORNEY

**CLASS 41—(Continued).**

LINED IN GRAY AND THE LEFT HALF COLORED GRAY AND THE RIGHT HALF COLORED WHITE. AT THE TOP OF THE SHIELD IS THE SHAPE OF THE STATE OF OKLAHOMA IN DARK BLUE. BENEATH THE STATE DESIGN ARE THE WORDS "OKLAHOMA CITY" IN ROYAL BLUE. AT THE CENTER OF THE SHIELD IS THE WORD "SPIRIT" OUTLINED IN DARK BLUE. SUPERIMPOSED ON THE SHIELD IS A BIRD DESIGN IN DARK BLUE AND ROYAL BLUE HOLDING A SOCCER BALL IN WHITE AND DARK BLUE WITH ITS CLAWS.

FOR ENTERTAINMENT SERVICES, NAMELY, ORGANIZING, PROVIDING AND CONDUCTING PROFESSIONAL SOCCER EXHIBITIONS AND GAMES (U.S. CLS. 100, 101 AND 107).

SAIMA MAKHDOOM, EXAMINING ATTORNEY

SN 86-107,388. PRODIGAL SOCCER LLC, OKLAHOMA CITY, OK. FILED 10-31-2013.



SN 86-107,368. PRODIGAL SOCCER LLC, OKLAHOMA CITY, OK. FILED 10-31-2013.



NO CLAIM IS MADE TO THE EXCLUSIVE RIGHT TO USE "OKLAHOMA CITY" AND "FC" AND THE MAP SHOWING THE OUTLINE OF THE STATE OF OKLAHOMA, APART FROM THE MARK AS SHOWN.

THE COLOR(S) DARK BLUE, ROYAL BLUE, GRAY AND WHITE IS/ARE CLAIMED AS A FEATURE OF THE MARK.

THE MARK CONSISTS OF A SHIELD DESIGN OUT-

NO CLAIM IS MADE TO THE EXCLUSIVE RIGHT TO USE "OKLAHOMA CITY" AND "FC", APART FROM THE MARK AS SHOWN.

THE COLOR(S) BLUE, BLACK AND WHITE IS/ARE CLAIMED AS A FEATURE OF THE MARK.

THE MARK CONSISTS OF A BLACK SHIELD DESIGN FLAT AT THE TOP AND CURVED AT THE BOTTOM. AT THE TOP OF THE SHIELD ARE THE WORDS "OKLAHOMA CITY" IN BLUE APPEARING ABOVE THE WORD "WIND" IN WHITE. AT THE BOTTOM OF THE SHIELD APPEARS A WHITE CIRCLE WITH THE LETTERS "F", "C" IN BLUE IN THE CENTER OF THE CIRCLE. THE CENTER OF THE SHIELD CONSISTS OF A BLUE TRIANGLE AND BLUES STRIPES WHICH START HORIZONTALLY AND TAIL OFF VERTICALLY.

FOR ENTERTAINMENT SERVICES, NAMELY, ORGANIZING, PROVIDING AND CONDUCTING PROFESSIONAL SOCCER EXHIBITIONS AND GAMES (U.S. CLS. 100, 101 AND 107).

SAIMA MAKHDOOM, EXAMINING ATTORNEY

**CLASS 41—(Continued).**

SN 86-107,397. PRODIGAL SOCCER LLC, OKLAHOMA CITY, OK. FILED 10-31-2013.

**OKC 46ERS FC**

THE MARK CONSISTS OF STANDARD CHARACTERS WITHOUT CLAIM TO ANY PARTICULAR FONT, STYLE, SIZE, OR COLOR.

NO CLAIM IS MADE TO THE EXCLUSIVE RIGHT TO USE "OKC" AND "FC", APART FROM THE MARK AS SHOWN.

FOR ENTERTAINMENT SERVICES, NAMELY, ORGANIZING, PROVIDING AND CONDUCTING PROFESSIONAL SOCCER EXHIBITIONS AND GAMES (U.S. CLS. 100, 101 AND 107).

SAIMA MAKHDOOM, EXAMINING ATTORNEY

SN 86-109,055. SPANISH BROADCASTING SYSTEM, INC., MIAMI, FL. FILED 11-4-2013.

**APLAUSO**

THE MARK CONSISTS OF STANDARD CHARACTERS WITHOUT CLAIM TO ANY PARTICULAR FONT, STYLE, SIZE, OR COLOR.

THE ENGLISH TRANSLATION OF "APLAUSO" IN THE MARK IS "APPLAUSE".

FOR PROVIDING RECOGNITION AND INCENTIVES BY THE WAY OF AWARDS TO DEMONSTRATE EXCELLENCE IN THE FIELD OF SPANISH MUSIC; ENTERTAINMENT, NAMELY, LIVE MUSIC CONCERTS (U.S. CLS. 100, 101 AND 107).

RONALD MCMORROW, EXAMINING ATTORNEY

SN 86-109,148. 3000 PARADISE ROAD, L.L.C., LAS VEGAS, NV. FILED 11-4-2013.



OWNER OF U.S. REG. NO. 3,583,323. FOR WAGERING SERVICES (U.S. CLS. 100, 101 AND 107).

FIRST USE 1-0-2000; IN COMMERCE 1-0-2000. JOHN KELLY, EXAMINING ATTORNEY

**CLASS 41—(Continued).**

SN 86-109,338. CHRISTIANITY TODAY INTERNATIONAL, CAROL STREAM, IL. FILED 11-4-2013.

**Parse**

THE MARK CONSISTS OF STANDARD CHARACTERS WITHOUT CLAIM TO ANY PARTICULAR FONT, STYLE, SIZE, OR COLOR.

FOR ON-LINE JOURNALS, NAMELY, BLOGS FEATURING INFORMATION IN THE FIELD OF RELIGION; NON-DOWNLOADABLE ELECTRONIC PUBLICATIONS IN THE NATURE OF MAGAZINES AND NEWSLETTERS IN THE FIELD OF RELIGION (U.S. CLS. 100, 101 AND 107).

RENEE MCCRAY, EXAMINING ATTORNEY

SN 86-112,991. SPANISH BROADCASTING SYSTEM, INC., COCONUT GROVE, FL. FILED 11-7-2013.

**PlanetaM**

THE MARK CONSISTS OF STANDARD CHARACTERS WITHOUT CLAIM TO ANY PARTICULAR FONT, STYLE, SIZE, OR COLOR.

FOR PROVIDING INFORMATION RELATING TO LIVE MUSICAL AND THEATRICAL PERFORMANCES, ROAD SHOWS AND STAGE EVENTS, LIVE MUSIC CONCERTS, AND DATES, LOCATIONS AND TICKET INFORMATION FOR THESE PERFORMANCES VIA THE INTERNET; ARRANGING FOR TICKET RESERVATIONS FOR SHOWS AND OTHER ENTERTAINMENT EVENTS; BOOKING OF SEATS FOR SHOWS AND BOOKING OF THEATRE TICKETS; ON-LINE CONCERT AND ENTERTAINMENT TICKET AGENCY SERVICES (U.S. CLS. 100, 101 AND 107).

RONALD MCMORROW, EXAMINING ATTORNEY

SN 86-113,914. NEW ENGLAND PATRIOTS LLC, FOXBOROUGH, MA. FILED 11-8-2013.

**DO YOUR JOB**

THE MARK CONSISTS OF STANDARD CHARACTERS WITHOUT CLAIM TO ANY PARTICULAR FONT, STYLE, SIZE, OR COLOR.

FOR ENTERTAINMENT SERVICES, NAMELY, PROVIDING EXPERT COMMENTARY ON SPORTS EVENTS VIA THE INTERNET (U.S. CLS. 100, 101 AND 107).

FIRST USE 10-28-2013; IN COMMERCE 10-28-2013.

KELLY TRUSILO, EXAMINING ATTORNEY

**CLASS 41—(Continued).**

SN 86-115,072. SCRIPPS NETWORKS, LLC, KNOXVILLE, DC. FILED 11-11-2013.

**VACATION HOUSE FOR FREE**

THE MARK CONSISTS OF STANDARD CHARACTERS WITHOUT CLAIM TO ANY PARTICULAR FONT, STYLE, SIZE, OR COLOR.

NO CLAIM IS MADE TO THE EXCLUSIVE RIGHT TO USE "VACATION HOUSE", APART FROM THE MARK AS SHOWN.

FOR EDUCATIONAL AND ENTERTAINMENT SERVICES, NAMELY, A CONTINUING PROGRAM ABOUT HOME DESIGN, HOME BUILDING, REAL ESTATE AND RENOVATION ACCESSIBLE BY RADIO, TELEVISION, CABLE TELEVISION, THE INTERNET, WIRELESS NETWORKS, SATELLITE, AUDIO, VIDEO, AND COMPUTER NETWORKS (U.S. CLS. 100, 101 AND 107).

MICHAEL WIENER, EXAMINING ATTORNEY

SN 86-115,122. TRAVEL CHANNEL, LLC, THE, CHEVY CHASE, DC. FILED 11-11-2013.

**AUCTION ON WHEELS**

THE MARK CONSISTS OF STANDARD CHARACTERS WITHOUT CLAIM TO ANY PARTICULAR FONT, STYLE, SIZE, OR COLOR.

NO CLAIM IS MADE TO THE EXCLUSIVE RIGHT TO USE "AUCTION", APART FROM THE MARK AS SHOWN.

FOR EDUCATIONAL AND ENTERTAINMENT SERVICES, NAMELY, A CONTINUING PROGRAM ABOUT TRAVEL, ADVENTURE, CULTURE, AND LIFESTYLES ACCESSIBLE BY RADIO, TELEVISION, CABLE TELEVISION, THE INTERNET, WIRELESS NETWORKS, SATELLITE, AUDIO, VIDEO, AND COMPUTER NETWORKS (U.S. CLS. 100, 101 AND 107).

KATHERINE CONNOLLY, EXAMINING ATTORNEY

SN 86-119,581. TRIVERGANCE LLC, FORT LEE, NJ. FILED 11-14-2013.

**VACATION INVESTIGATION**

THE MARK CONSISTS OF STANDARD CHARACTERS WITHOUT CLAIM TO ANY PARTICULAR FONT, STYLE, SIZE, OR COLOR.

FOR ENTERTAINMENT SERVICES, NAMELY, ONGOING REALITY BASED PROGRAMS BROADCAST VIA THE INTERNET, TELEVISION, SATELLITE, AUDIO AND VIDEO MEDIA ABOUT TRAVEL AND TIME-SHARE SERVICES (U.S. CLS. 100, 101 AND 107).

ELLEN BURNS, EXAMINING ATTORNEY

**CLASS 41—(Continued).**

SN 86-120,049. FOUNDATION FOR NATIONAL PROGRESS, DBA MOTHER JONES, SAN FRANCISCO, CA. FILED 11-15-2013.

**Inquiring Minds**

THE MARK CONSISTS OF STANDARD CHARACTERS WITHOUT CLAIM TO ANY PARTICULAR FONT, STYLE, SIZE, OR COLOR.

FOR ENTERTAINMENT SERVICES, NAMELY, PROVIDING PODCASTS IN THE FIELD OF SCIENCE, POLITICS, AND SOCIETY (U.S. CLS. 100, 101 AND 107).

FIRST USE 9-20-2013; IN COMMERCE 9-20-2013.

ZACHARY R. SPARER, EXAMINING ATTORNEY

SN 86-120,286. LIFETOUCH INC., EDEN PRAIRIE, MN. FILED 11-15-2013.

**GRADSCAN**

THE MARK CONSISTS OF STANDARD CHARACTERS WITHOUT CLAIM TO ANY PARTICULAR FONT, STYLE, SIZE, OR COLOR.

FOR PHOTOGRAPHY SERVICES; MULTIMEDIA ENTERTAINMENT SERVICES IN THE NATURE OF PRODUCTION OF IMAGES AND TEXT FOR PLACEMENT ON LARGE VIDEO SCREENS DURING SPECIAL EVENTS (U.S. CLS. 100, 101 AND 107).

FIRST USE 5-11-2011; IN COMMERCE 5-11-2011.

LANA PHAM, EXAMINING ATTORNEY

SN 86-121,720. SEAWORLD PARKS & ENTERTAINMENT LLC, ORLANDO, FL. FILED 11-18-2013.

**IHU'S BREAKAWAY FALLS**

THE MARK CONSISTS OF STANDARD CHARACTERS WITHOUT CLAIM TO ANY PARTICULAR FONT, STYLE, SIZE, OR COLOR.

FOR AMUSEMENT PARK AND THEME PARK SERVICES; ENTERTAINMENT IN THE NATURE OF AN AMUSEMENT PARK RIDE (U.S. CLS. 100, 101 AND 107).

BRENDAN MCCAULEY, EXAMINING ATTORNEY

**CLASS 41—(Continued).**

SN 86-123,597. GRID TRAINING CORPORATION, DBA NORTHWEST LINEMAN COLLEGE, MERIDIAN, ID. FILED 11-19-2013.

**TRAINING IS OUR PASSION**

THE MARK CONSISTS OF STANDARD CHARACTERS WITHOUT CLAIM TO ANY PARTICULAR FONT, STYLE, SIZE, OR COLOR.

NO CLAIM IS MADE TO THE EXCLUSIVE RIGHT TO USE "TRAINING", APART FROM THE MARK AS SHOWN. FOR EDUCATIONAL SERVICES, NAMELY, CONDUCTING CLASSES, SEMINARS, CONFERENCES AND WORKSHOPS IN THE FIELDS OF TRAINING UTILITY FIELD WORKERS ON ASPECTS OF JOB PERFORMANCE AND SAFETY, AND DISTRIBUTION OF TRAINING MATERIALS IN CONNECTION THEREWITH (U.S. CLS. 100, 101 AND 107).

ODESSA BIBBINS, EXAMINING ATTORNEY

SN 86-130,949. ALL ACCESS TOUR, LLC, FLUSHING MEADOWS, NY. FILED 11-27-2013.

**All Axxess**

THE MARK CONSISTS OF STANDARD CHARACTERS WITHOUT CLAIM TO ANY PARTICULAR FONT, STYLE, SIZE, OR COLOR.

FOR ARRANGING AND CONDUCTING OF CONCERTS; ENTERTAINMENT, NAMELY, LIVE MUSIC CONCERTS (U.S. CLS. 100, 101 AND 107).

FIRST USE 8-28-2013; IN COMMERCE 8-28-2013.  
BILL DAWE, EXAMINING ATTORNEY

SN 86-131,072. INTERNET PHYSICIAN, INC., NORTH PLATTE, NE. FILED 11-27-2013.

**GAMEDAY CME**

THE MARK CONSISTS OF STANDARD CHARACTERS WITHOUT CLAIM TO ANY PARTICULAR FONT, STYLE, SIZE, OR COLOR.

NO CLAIM IS MADE TO THE EXCLUSIVE RIGHT TO USE "CME", APART FROM THE MARK AS SHOWN.

FOR EDUCATIONAL SERVICES, NAMELY, PROVIDING CONTINUING PROFESSIONAL EDUCATION COURSES IN THE FIELD OF HEALTHCARE AND MEDICINE (U.S. CLS. 100, 101 AND 107).

FIRST USE 11-11-2013; IN COMMERCE 11-11-2013.  
HEATHER BIDDULPH, EXAMINING ATTORNEY

**CLASS 41—(Continued).**

SN 86-138,673. RAW SCIENCE, INC., SHERMAN OAKS, CA. FILED 12-9-2013.

**ADVANCES THAT WILL CHANGE  
YOUR WORLD**

THE MARK CONSISTS OF STANDARD CHARACTERS WITHOUT CLAIM TO ANY PARTICULAR FONT, STYLE, SIZE, OR COLOR.

FOR ENTERTAINMENT SERVICES, NAMELY, PROVIDING A WEB SITE FEATURING PHOTOGRAPHIC, AUDIO, VIDEO AND PROSE PRESENTATIONS FEATURING SCIENCE, POLITICS, ECONOMICS, AND SOCIAL COMMENTARY; ENTERTAINMENT SERVICES, NAMELY, PROVIDING VIDEO PODCASTS IN THE FIELD OF SCIENCE, MEDICINE, MUSIC, TECHNOLOGY, EDUCATION, PSYCHOLOGY, ENVIRONMENTAL SCIENCE, CULTURAL COMMENTARY, SOCIAL COMMENTARY, POLITICAL COMMENTARY, ANTHROPOLOGY, SOCIOLOGY, ZOOLOGY, GEOLOGY, ASTRONOMY AND OTHER NATURAL AND PHYSICAL SCIENCES.; FILM AND VIDEO PRODUCTION (U.S. CLS. 100, 101 AND 107).

SUZANNE BLANE, EXAMINING ATTORNEY

**CLASS 42—SCIENTIFIC AND COMPUTER SERVICES**

SN 85-049,699. YUMM.COM, LLC, SAN DIEGO, CA. FILED 5-27-2010.

**YUMM**

THE MARK CONSISTS OF STANDARD CHARACTERS WITHOUT CLAIM TO ANY PARTICULAR FONT, STYLE, SIZE, OR COLOR.

FOR COMPUTER SERVICES, NAMELY, CREATING AN ON-LINE COMMUNITY FOR REGISTERED USERS TO PARTICIPATE IN DISCUSSIONS, GET FEEDBACK FROM THEIR PEERS, FORM VIRTUAL COMMUNITIES, AND ENGAGE IN SOCIAL NETWORKING; COMPUTER SERVICES, NAMELY, CREATING AN ON-LINE COMMUNITY FOR REGISTERED USERS TO PARTICIPATE IN DISCUSSIONS, GET FEEDBACK FROM THEIR PEERS, FORM VIRTUAL COMMUNITIES, AND ENGAGE IN SOCIAL NETWORKING FEATURING RECIPES, COOKING, AND RELATED PRODUCTS, NAMELY, RECIPES, FOOD, INGREDIENTS, FOOD COMPONENTS, GROCERIES, COOKWARE, UTENSILS, CUTLERY, KITCHEN APPLIANCES, COOKING TECHNIQUES, KITCHEN TOOLS; PROVIDING A WEBSITE FEATURING TECHNOLOGY THAT ENABLES USERS TO SHARE RECIPES, AND BOOKMARK RECIPES FROM THIRD PARTY WEBSITES (U.S. CLS. 100 AND 101).

DAVID I, EXAMINING ATTORNEY



**CLASS 42—(Continued).**

SN 85-509,726. LAWRENCE, HOPE M., PLEASANT GROVE, AL. FILED 1-5-2012.

D I V A  
Destined Influential Virtuous Anointed

THE MARK CONSISTS OF THE STYLIZED WORDING "DIVA" ABOVE THE STYLIZED WORDING "DESTINED INFLUENTIAL VIRTUOUS ANOINTED".

FOR CUSTOM DESIGN OF SHIRTS, PANTS, JEANS, SWEAT-SHIRTS BASED ON PERSONAL SELECTIONS MADE BY THE CUSTOMER (U.S. CLS. 100 AND 101).  
JAY BESCH, EXAMINING ATTORNEY

**CLASS 42—(Continued).**

SN 85-648,900. COLLIN, MICHEL, SURESNES, FRANCE, AND CLAUDOT, STEPHANIE, SURESNES, FRANCE, FILED 6-11-2012.

ADS AMERICAN DIGITAL SCORES

THE MARK CONSISTS OF STANDARD CHARACTERS WITHOUT CLAIM TO ANY PARTICULAR FONT, STYLE, SIZE, OR COLOR.

NO CLAIM IS MADE TO THE EXCLUSIVE RIGHT TO USE "AMERICAN DIGITAL SCORES", APART FROM THE MARK AS SHOWN.

FOR DIGITIZATION OF MUSICAL SCORES; ELECTRONIC SCANNING OF MUSICAL SCORES AND CONVERTING VISUALLY DISPLAYED MUSICAL SCORES TO DIGITAL FORM (U.S. CLS. 100 AND 101).

GIANCARLO CASTRO, EXAMINING ATTORNEY

SN 85-649,783. SIGMA-ALDRICH CO. LLC, ST. LOUIS, MO. FILED 6-12-2012.

CELL DESIGN STUDIO

THE MARK CONSISTS OF STANDARD CHARACTERS WITHOUT CLAIM TO ANY PARTICULAR FONT, STYLE, SIZE, OR COLOR.

NO CLAIM IS MADE TO THE EXCLUSIVE RIGHT TO USE "CELL DESIGN", APART FROM THE MARK AS SHOWN.

FOR CUSTOM DESIGN AND DEVELOPMENT OF ENGINEERED CELL LINES FOR OTHERS, FOR USE IN BASIC RESEARCH, DRUG DISCOVERY AND DEVELOPMENT AND BIOPRODUCTION (U.S. CLS. 100 AND 101).

FIRST USE 4-14-2011; IN COMMERCE 4-14-2011.  
ANNE MADDEN, EXAMINING ATTORNEY

SN 85-610,514. NETWORK OUTSOURCE, NEW HYDE PARK, NY. FILED 4-27-2012.



NO CLAIM IS MADE TO THE EXCLUSIVE RIGHT TO USE "CLOUDSOURCE SUPPORT", APART FROM THE MARK AS SHOWN.

THE MARK CONSISTS OF A SIMPLE CLOUD DESIGN WHICH PARTIALLY SURROUNDS THE WORDS "CLOUD-SOURCE SUPPORT". TO THE LEFT OF THE WORDS, AN IMAGE WITH FOUR OVERLAPPING SEMI-CIRCLES FORMS A CLOVER-LIKE SHAPE WITH FOUR DOTS AT THE END OF EACH CURVE.

FOR COMPUTER SERVICES, NAMELY, INTEGRATION OF PRIVATE AND PUBLIC CLOUD COMPUTING ENVIRONMENTS; PROVIDING VIRTUAL COMPUTER SYSTEMS AND VIRTUAL COMPUTER ENVIRONMENTS THROUGH CLOUD COMPUTING; TECHNICAL SUPPORT SERVICES, NAMELY, REMOTE AND ON-SITE INFRASTRUCTURE MANAGEMENT SERVICES FOR MONITORING, ADMINISTRATION AND MANAGEMENT OF PUBLIC AND PRIVATE CLOUD COMPUTING IT AND APPLICATION SYSTEMS (U.S. CLS. 100 AND 101).

FIRST USE 1-1-2012; IN COMMERCE 1-1-2012.  
BARNEY CHARLON, EXAMINING ATTORNEY

SN 85-653,695. ANSWERPORT INC, MILWAUKEE, WI. FILED 6-15-2012.

Skills Pipeline

THE MARK CONSISTS OF STANDARD CHARACTERS WITHOUT CLAIM TO ANY PARTICULAR FONT, STYLE, SIZE, OR COLOR.

NO CLAIM IS MADE TO THE EXCLUSIVE RIGHT TO USE "SKILLS", APART FROM THE MARK AS SHOWN.

FOR SOFTWARE AS A SERVICE (SAAS) SERVICES FEATURING SOFTWARE FOR PROFESSIONAL SERVICES FIRMS TO SHARE CUSTOMER REFERRALS AND SALES LEADS WITH THEIR NETWORK VIA THE INTERNET (U.S. CLS. 100 AND 101).

DAYNA BROWNE, EXAMINING ATTORNEY

**CLASS 42—(Continued).**

SN 85-671,660. FCI HOLDINGS DELAWARE, INC., WILMINGTON, DE. FILED 7-9-2012.



THE MARK CONSISTS OF AN ARCHWAY DESIGN MADE OF GEOMETRIC SHAPES WITH A CENTER KEYSTONE SHAPE AND THE WORDING "KMS" AS PART OF THE DESIGN.

FOR ENGINEERING SERVICES, NAMELY, CONDUCTING RESEARCH, AND ANALYZING GEOLOGIC STRESS AND MATTER TO PROVIDE STRUCTURAL ANALYSIS, NUMERICAL MODELING, 3-D MODELING, AND TO DEVELOP STRUCTURAL SUPPORT AND PRODUCTS FOR UNDERGROUND MINES AND TUNNELS, AS WELL AS FOR CIVIL CONSTRUCTION PRODUCTS (U.S. CLS. 100 AND 101).

FIRST USE 2-0-2012; IN COMMERCE 2-0-2012.

ARETHA SOMERVILLE, EXAMINING ATTORNEY

**CLASS 42—(Continued).**

SN 85-674,934. HEALTHSTAT RX, LLC, SMYRNA, GA. FILED 7-12-2012.

# MEDPLAN

THE MARK CONSISTS OF STANDARD CHARACTERS WITHOUT CLAIM TO ANY PARTICULAR FONT, STYLE, SIZE, OR COLOR.

FOR PLATFORM AS A SERVICE FEATURING COMPUTER SOFTWARE PLATFORMS FOR MANAGING AND REPORTING PATIENT MEDICATIONS (U.S. CLS. 100 AND 101).

FIRST USE 6-20-2012; IN COMMERCE 6-20-2012.

TEJBIR SINGH, EXAMINING ATTORNEY

SN 85-673,060. ANSWERPORT INC, MILWAUKEE, WI. FILED 7-10-2012.



NO CLAIM IS MADE TO THE EXCLUSIVE RIGHT TO USE "SKILLS", APART FROM THE MARK AS SHOWN.

THE COLOR(S) BLUE AND GRAY IS/ARE CLAIMED AS A FEATURE OF THE MARK.

THE MARK CONSISTS OF A BLUE CIRCULAR ICON WITH A PIPE DESIGN CUT THROUGH THE CENTER THAT APPEARS TO THE LEFT OF THE GRAY TEXT STYLIZED TEXT "SKILLS PIPELINE".

FOR SOFTWARE AS A SERVICE (SAAS) SERVICES FEATURING SOFTWARE FOR PROFESSIONAL SERVICES FIRMS TO SHARE CUSTOMER REFERRALS AND SALES LEADS WITH THEIR NETWORK VIA THE INTERNET (U.S. CLS. 100 AND 101).

DAYNA BROWNE, EXAMINING ATTORNEY

SN 85-694,111. CATILLER, ROBERT D., SANTA ANA, CA. AND CATILLER, SANDRA K., SANTA ANA, CA. FILED 8-2-2012.

# ValQual

THE MARK CONSISTS OF THE TERM "VALQUAL" IN A STYLIZED AND OUTLINED ITALICS FONT.

FOR DEVELOPMENT OF HOME AND OFFICE UNIVERSAL REMOTE CONTROL APPLICATIONS FOR SMART PHONES, TABLETS, AND PC PLATFORMS; DESIGNING INTERNET SITES FOR OTHERS (U.S. CLS. 100 AND 101).

GIANCARLO CASTRO, EXAMINING ATTORNEY

**CLASS 42—(Continued).**

SN 85-695,601. CODEGIN LLC, COLUMBUS, OH. FILED S.R.  
8-5-2012; AM. P.R. 5-31-2013.

# SNAGR

THE MARK CONSISTS OF STANDARD CHARACTERS WITHOUT CLAIM TO ANY PARTICULAR FONT, STYLE, SIZE, OR COLOR.

FOR SOFTWARE AS A SERVICE (SAAS) SERVICES FEATURING SOFTWARE FOR ORGANIZING AND VIEWING DIGITAL IMAGES AND PHOTOGRAPHS; FOR THE COLLECTION, EDITING, ORGANIZING, MODIFYING, BOOK MARKING, TRANSMISSION, STORAGE AND SHARING OF DATA AND INFORMATION; TO ENABLE THE TRANSMISSION OF PHOTOGRAPHS TO MOBILE TELEPHONES; AND TO ENABLE USERS TO MANIPULATE AND VIEW ELECTRIC AND ELECTRONIC VIDEO SURVEILLANCE INSTALLATIONS (U.S. CLS. 100 AND 101).

FIRST USE 12-19-2005; IN COMMERCE 8-27-2007.  
ELISSA GARBER KON, EXAMINING ATTORNEY

---

SN 85-709,793. WISHCLOUD LLC, AKA WISHCLOUDS,  
CORAL SPRINGS, FL. FILED 8-22-2012.

# WishCloud

THE MARK CONSISTS OF STANDARD CHARACTERS WITHOUT CLAIM TO ANY PARTICULAR FONT, STYLE, SIZE, OR COLOR.

FOR CLOUD COMPUTING FEATURING SOFTWARE FOR USE IN COLLECTING AND MANAGING PERSONALIZED WEB CONTENT (U.S. CLS. 100 AND 101).

TIMOTHY O. SCHIMPF, EXAMINING ATTORNEY

---

SN 85-767,633. ALLEGIS GROUP, INC., HANOVER, MD.  
FILED 10-31-2012.

# JOBSVIEW

THE MARK CONSISTS OF STANDARD CHARACTERS WITHOUT CLAIM TO ANY PARTICULAR FONT, STYLE, SIZE, OR COLOR.

FOR PROVIDING ON-LINE NON-DOWNLOADABLE SOFTWARE FOR THE CREATION OF UNIQUE EMPLOYMENT DESCRIPTIONS FOR THE PURPOSE OF EMPLOYMENT LISTINGS; PROVIDING TEMPORARY USE OF A WEB-BASED SOFTWARE APPLICATION FOR CUSTOMIZED CREATION OF INFORMATION AND COMMUNICATION IN THE FIELD OF EMPLOYMENT LISTINGS AND THE MARKETING OF EMPLOYMENT OPPORTUNITIES (U.S. CLS. 100 AND 101).

BRIDGETT SMITH, EXAMINING ATTORNEY

**CLASS 42—(Continued).**

SN 85-770,693. SANDSTORM DESIGN, INC., CHICAGO, IL.  
FILED 11-2-2012.

# SANDSTORM DESIGN

THE MARK CONSISTS OF STANDARD CHARACTERS WITHOUT CLAIM TO ANY PARTICULAR FONT, STYLE, SIZE, OR COLOR.

OWNER OF U.S. REG. NOS. 3,347,301 AND 3,466,187.

NO CLAIM IS MADE TO THE EXCLUSIVE RIGHT TO USE "DESIGN", APART FROM THE MARK AS SHOWN.

FOR COMPUTER CONSULTING SERVICES IN THE FIELD OF RESEARCH, DESIGN, SELECTION, IMPLEMENTATION AND USE OF COMPUTER HARDWARE AND SOFTWARE SYSTEMS FOR OTHERS; COMPUTER CONSULTATION SERVICES, NAMELY, DESIGNING, DEVELOPING AND IMPLEMENTING WEB SITES; COMPUTER CONSULTATION SERVICES IN THE FIELD OF COMPUTER TECHNOLOGIES USED IN THE FIELDS OF WEB APPLICATIONS, SOCIAL MEDIA APPLICATIONS, INTERACTIVE VIDEO, E-LEARNING, MOBILE WEB SITES, MOBILE APPLICATIONS, ONLINE CONTESTS, COMPUTER PROGRAMMING, DATABASE DEVELOPMENT, CONTENT MANAGEMENT SYSTEMS, DIGITAL CONTENT, AND GRAPHIC ART DESIGN (U.S. CLS. 100 AND 101).

FIRST USE 10-1-1998; IN COMMERCE 10-1-1998.  
ELLEN B. AWRICH, EXAMINING ATTORNEY

---

SN 85-802,730. MIDURE, MIKE, BERLIN, NJ. FILED 12-14-2012.

# Be Productive

THE MARK CONSISTS OF STANDARD CHARACTERS WITHOUT CLAIM TO ANY PARTICULAR FONT, STYLE, SIZE, OR COLOR.

FOR COMPUTER SERVICES, NAMELY, CREATING AN ON-LINE COMMUNITY FOR REGISTERED USERS TO PARTICIPATE IN DISCUSSIONS, GET FEEDBACK FROM THEIR PEERS, FORM VIRTUAL COMMUNITIES, AND ENGAGE IN SOCIAL NETWORKING FEATURING THE ABILITY FOR COLLEGE STUDENTS TO BUILD THEIR PROFESSIONAL PROFILES, SHOWCASE THEIR SCHOLASTIC ACHIEVEMENTS, NETWORK WITH OTHER STUDENTS WITH SIMILAR INTERESTS AND PURPOSES, FIND INTERNSHIPS AND CAREER-RELATED EXPERIENCES, COMMUNICATE WITH PROFESSORS AND PROFESSIONALS IN THEIR FUTURE FIELD, NETWORK OUTSIDE OF THEIR GEOGRAPHICAL AREA, NAMELY, NATIONALLY AND INTERNATIONALLY, AND PUT THEMSELVES IN FRONT OF POTENTIAL EMPLOYERS (U.S. CLS. 100 AND 101).

ASHA CLARKE, EXAMINING ATTORNEY

**CLASS 42—(Continued).**

SN 85-814,251. DELLA LUXA, LLC, AUBURNDALE, MA. FILED 1-2-2013.

**DELLA LUXA**

THE MARK CONSISTS OF STANDARD CHARACTERS WITHOUT CLAIM TO ANY PARTICULAR FONT, STYLE, SIZE, OR COLOR.

OWNER OF U.S. REG. NOS. 3,177,864 AND 3,202,631.

THE NAME(S), PORTRAIT(S), AND/OR SIGNATURE(S) SHOWN IN THE MARK DOES NOT IDENTIFY A PARTICULAR LIVING INDIVIDUAL.

THE ENGLISH TRANSLATION OF "DELLA" IN THE MARK IS "OF THE".

FOR CUSTOM DESIGN AND CONSULTATION IN THE FIELD OF FINE AND APPLIED ART USED FOR INTERIORS AND EXTERIORS, NAMELY, CUSTOM DESIGN OF, AND CONSULTATION ON THE USE OF MIXED MEDIA, MOSAIC, GLASS, METALS, CERAMIC, PORCELAIN, EARTHENWARE, FABRICS, THREAD, BRAIDS, FRINGES, CORDS AND TASSELS BASED UPON PERSONAL SELECTIONS OF THE CUSTOMER; GRAPHIC ARTS DESIGNING; CONSULTING IN THE FIELDS OF ART AND DESIGN, NAMELY, CONSULTING ON THE CREATION OF INTERIOR DESIGN FEATURES AND ELEMENTS BASED UPON CUSTOMER FEEDBACK; INDUSTRIAL AND GRAPHIC ART DESIGN; INTERIOR DESIGN SERVICES (U.S. CLS. 100 AND 101).

FIRST USE 2-0-2006; IN COMMERCE 2-0-2006.  
DAWN FELDMAN, EXAMINING ATTORNEY

SN 85-816,701. HANEY, INC., CINCINNATI, OH. FILED 1-7-2013.

**VIA ALLIANCE**

THE MARK CONSISTS OF STANDARD CHARACTERS WITHOUT CLAIM TO ANY PARTICULAR FONT, STYLE, SIZE, OR COLOR.

NO CLAIM IS MADE TO THE EXCLUSIVE RIGHT TO USE "ALLIANCE", APART FROM THE MARK AS SHOWN.

FOR CONSULTING SERVICES IN THE FIELD OF DESIGN AND DEVELOPMENT OF PRODUCT PACKAGING (U.S. CLS. 100 AND 101).

FIRST USE 11-6-2012; IN COMMERCE 11-6-2012.  
JULIE GUTTADAURO, EXAMINING ATTORNEY

**CLASS 42—(Continued).**

SN 85-817,252. CYBER X DESIGNS, LLC, ROCHELLE PARK, NJ. FILED 1-7-2013.

**ARTERIC**

THE MARK CONSISTS OF STANDARD CHARACTERS WITHOUT CLAIM TO ANY PARTICULAR FONT, STYLE, SIZE, OR COLOR.

FOR PLANNING, DESIGN, DEVELOPMENT, MAINTENANCE AND OPTIMIZATION OF ONLINE WEBSITES; PLANNING, DESIGN, DEVELOPMENT, MAINTENANCE AND OPTIMIZATION OF ONLINE WEB APPLICATIONS AND MOBILE APPLICATIONS FOR PHARMACEUTICAL, BIOTECHNOLOGY, AND HEALTHCARE COMPANIES; HOSTING THE WEBSITE OF OTHERS (U.S. CLS. 100 AND 101).

CYNTHIA RINALDI, EXAMINING ATTORNEY

SN 85-821,013. THE LIEBER INSTITUTE FOR BRAIN DEVELOPMENT, BALTIMORE, MD. FILED 1-11-2013.

**LIEBER INSTITUTE**

THE MARK CONSISTS OF STANDARD CHARACTERS WITHOUT CLAIM TO ANY PARTICULAR FONT, STYLE, SIZE, OR COLOR.

NO CLAIM IS MADE TO THE EXCLUSIVE RIGHT TO USE "INSTITUTE", APART FROM THE MARK AS SHOWN. SEC. 2(F).

FOR SCIENTIFIC AND MEDICAL RESEARCH AND BIOMEDICAL RESEARCH SERVICES IN THE FIELDS OF NEUROBIOLOGY, PHARMACOLOGY, GENETICS, BEHAVIORAL NEUROSCIENCE, AND NEUROSCIENCE (U.S. CLS. 100 AND 101).

FIRST USE 0-0-2010; IN COMMERCE 0-0-2010.  
ANNE MADDEN, EXAMINING ATTORNEY

SN 85-821,016. THE LIEBER INSTITUTE FOR BRAIN DEVELOPMENT, BALTIMORE, MD. FILED 1-11-2013.

**LIEBER INSTITUTE FOR BRAIN DEVELOPMENT**

THE MARK CONSISTS OF STANDARD CHARACTERS WITHOUT CLAIM TO ANY PARTICULAR FONT, STYLE, SIZE, OR COLOR.

NO CLAIM IS MADE TO THE EXCLUSIVE RIGHT TO USE "INSTITUTE", APART FROM THE MARK AS SHOWN. SEC. 2(F).

FOR SCIENTIFIC AND MEDICAL RESEARCH AND BIOMEDICAL RESEARCH SERVICES IN THE FIELDS OF NEUROBIOLOGY, PHARMACOLOGY, GENETICS, BEHAVIORAL NEUROSCIENCE, AND NEUROSCIENCE (U.S. CLS. 100 AND 101).

FIRST USE 0-0-2010; IN COMMERCE 0-0-2010.  
ANNE MADDEN, EXAMINING ATTORNEY

**CLASS 42—(Continued).**

SN 85-821,667. GNUMTEXT, LLC, BEVERLY HILLS, CA. FILED 1-11-2013.

**Local Source Textbook**

THE MARK CONSISTS OF STANDARD CHARACTERS WITHOUT CLAIM TO ANY PARTICULAR FONT, STYLE, SIZE, OR COLOR.

NO CLAIM IS MADE TO THE EXCLUSIVE RIGHT TO USE "TEXTBOOK", APART FROM THE MARK AS SHOWN.

FOR TESTING, ANALYSIS AND EVALUATION OF TEXTBOOKS OF OTHERS FOR THE PURPOSE OF CERTIFICATION (U.S. CLS. 100 AND 101).

FIRST USE 12-10-2012; IN COMMERCE 12-10-2012.  
CHRISTINA SOBRAL, EXAMINING ATTORNEY

SN 85-834,009. UNIVERSITY OF PITTSBURGH - OF THE COMMONWEALTH SYSTEM OF HIGHER EDUCATION, PITTSBURGH, PA. FILED 1-28-2013.

**UNIVERSITY OF PITTSBURGH**

THE MARK CONSISTS OF STANDARD CHARACTERS WITHOUT CLAIM TO ANY PARTICULAR FONT, STYLE, SIZE, OR COLOR.

OWNER OF U.S. REG. NOS. 1,240,632 AND 3,167,642.

SEC. 2(F).

FOR BASIC AND APPLIED SCIENTIFIC RESEARCH (U.S. CLS. 100 AND 101).

FIRST USE 7-11-1908. THE MARK WAS FIRST USED ANYWHERE IN A DIFFERENT FORM OTHER THAN THAT SOUGHT TO BE REGISTERED AT LEAST AS EARLY AS 07/11/1908; IN COMMERCE 7-11-1908. THE MARK WAS FIRST USED IN COMMERCE IN A DIFFERENT FORM OTHER THAN THAT SOUGHT TO BE REGISTERED AT LEAST AS EARLY AS 07/11/1908.

STEVEN JACKSON, EXAMINING ATTORNEY

**CLASS 42—(Continued).**

SN 85-834,834. UNIVERSITY OF PITTSBURGH -OF THE COMMONWEALTH SYSTEM OF HIGHER EDUCATION, PITTSBURGH, PA. FILED 1-29-2013.



OWNER OF U.S. REG. NOS. 3,022,683 AND 3,203,374.

NO CLAIM IS MADE TO THE EXCLUSIVE RIGHT TO USE "1787", APART FROM THE MARK AS SHOWN.

THE MARK CONSISTS OF A DESIGN WITH A CIRCULAR BORDER WITH THE WORDS "UNIVERSITY OF PITTSBURGH" AND WITHIN THE LOWER PORTION OF THE SEAL, THE WORDS "VERITAS", "VIRTUS" AND THE DATE "1787".

SEC. 2(F) AS TO "UNIVERSITY OF PITTSBURGH".

FOR BASIC AND APPLIED SCIENTIFIC RESEARCH (U.S. CLS. 100 AND 101).

FIRST USE 1-15-1994. THE MARK WAS FIRST USED ANYWHERE IN A DIFFERENT FORM OTHER THAN THAT SOUGHT TO BE REGISTERED AT LEAST AS EARLY AS 01/15/1994; IN COMMERCE 1-15-1994. THE MARK WAS FIRST USED IN COMMERCE IN A DIFFERENT FORM OTHER THAN THAT SOUGHT TO BE REGISTERED AT LEAST AS EARLY AS 01/15/1994.

STEVEN JACKSON, EXAMINING ATTORNEY

SN 85-835,795. OCEAN LAB, LLC, GLENDALE, CA. FILED 1-29-2013.

**OCEAN LAB**

THE MARK CONSISTS OF STANDARD CHARACTERS WITHOUT CLAIM TO ANY PARTICULAR FONT, STYLE, SIZE, OR COLOR.

NO CLAIM IS MADE TO THE EXCLUSIVE RIGHT TO USE "LAB", APART FROM THE MARK AS SHOWN.

FOR PROVIDING FACILITIES FOR SCIENTIFIC RESEARCH IN THE FIELD OF ROBOTICS; ENGINEERING SERVICES IN THE FIELD OF ROBOTICS; SCIENTIFIC RESEARCH, CONSULTING SERVICES AND DATA COLLECTION RELATING TO ENVIRONMENTAL ISSUES, UTILIZING ROBOTICS (U.S. CLS. 100 AND 101).

FIRST USE 7-1-2012; IN COMMERCE 7-1-2012.

ESTHER BELENKER, EXAMINING ATTORNEY

**CLASS 42—(Continued).**

SN 85-837,106. MAXTHON INTERNATIONAL LIMITED, ROAD TOWN, TORTOLA., BR.VIRGIN ISLANDS, FILED 1-30-2013.



NO CLAIM IS MADE TO THE EXCLUSIVE RIGHT TO USE "CLOUD BROWSER", APART FROM THE MARK AS SHOWN.

THE MARK CONSISTS OF STYLISED "M" WITH CLOUD DEVICE IN A SQUARE, THERE IS STYLISED WORDING "CLOUD BROWSER" UNDERNEATH.

FOR COMPUTER PROGRAMMING; COMPUTER SOFTWARE DESIGN; COMPUTER SYSTEMS ANALYSIS; CONSULTANCY IN THE FIELD OF SOFTWARE DESIGN; CREATING AND MAINTAINING WEB SITES FOR OTHERS; DESIGN AND DEVELOPMENT OF COMPUTER HARDWARE; DESIGN AND DEVELOPMENT OF COMPUTERS AND PROGRAMS FOR COMPUTERS; DESIGN AND DEVELOPMENT OF ON-LINE COMPUTER SOFTWARE SYSTEMS; HOSTING THE WEB SITES OF OTHERS ON A COMPUTER SERVER FOR A GLOBAL COMPUTER NETWORK; MONITORING OF COMPUTER SYSTEMS BY REMOTE ACCESS TO ENSURE PROPER FUNCTIONING; PROVISION OF SEARCH ENGINES FOR THE INTERNET; RENTAL OF WEB SERVERS; UPDATING OF COMPUTER SOFTWARE (U.S. CLS. 100 AND 101).

FIRST USE 12-10-2012; IN COMMERCE 12-10-2012.  
CHRISTOPHER LAW, EXAMINING ATTORNEY

SN 85-846,443. COMPUVERDE AB, KARLSKRONA, SWEDEN, FILED 2-11-2013.

# Compuverde

THE MARK CONSISTS OF STANDARD CHARACTERS WITHOUT CLAIM TO ANY PARTICULAR FONT, STYLE, SIZE, OR COLOR.

THE WORDING "COMPUVERDE" HAS NO MEANING IN A FOREIGN LANGUAGE.

FOR SOFTWARE DEVELOPMENT; DESIGN, TECHNICAL CONSULTING AND DEVELOPMENT OF SYSTEMS FOR DATA STORAGE SOLUTIONS (U.S. CLS. 100 AND 101).

FIRST USE 1-1-2011; IN COMMERCE 2-1-2012.  
NELSON SNYDER, EXAMINING ATTORNEY

**CLASS 42—(Continued).**

SN 85-846,512. COMPUVERDE AB, KARLSKRONA, SWEDEN, FILED 2-11-2013.



THE COLOR(S) LIGHT GREEN, MEDIUM GREEN, DARK GREEN, GREY, BLACK, AND WHITE IS/ARE CLAIMED AS A FEATURE OF THE MARK.

THE MARK CONSISTS OF THE STYLIZED TERM "COMPUVERDE" IN BLACK AND GREY TO THE RIGHT OF A STYLIZED LEAF IN MEDIUM AND DARK GREEN. A STYLIZED REPRESENTATION OF A FILE FOLDER APPEARS IN LIGHT GREEN BEHIND THE LEAF AND AROUND THE FIRST PORTION OF THE TERM "COMPUVERDE". THE WORDING AND DESIGNS APPEAR AGAINST A WHITE BACKGROUND THAT IS A FEATURE OF THE MARK.

THE WORDING "COMPUVERDE" HAS NO MEANING IN A FOREIGN LANGUAGE.

FOR SOFTWARE DEVELOPMENT; DESIGN, TECHNICAL CONSULTING AND DEVELOPMENT OF SYSTEMS FOR DATA STORAGE SOLUTIONS (U.S. CLS. 100 AND 101).

FIRST USE 1-1-2011; IN COMMERCE 2-1-2012.  
NELSON SNYDER, EXAMINING ATTORNEY

SN 85-847,427. AND FAUNA LLC, HOLDERNESS, NH. FILED 2-12-2013.

# and fauna

THE MARK CONSISTS OF STANDARD CHARACTERS WITHOUT CLAIM TO ANY PARTICULAR FONT, STYLE, SIZE, OR COLOR.

FOR ENVIRONMENTAL DESIGN, FINE ART DESIGN, AND MAPPING SERVICES FOR OTHERS SUCH AS PROFESSIONALS IN THE FIELDS OF LANDSCAPE ARCHITECTURE, ARCHITECTURE, URBAN AND REGIONAL PLANNING, EDUCATION, AND AGRICULTURE; PROVIDING A WEBSITE FEATURING INFORMATION RELATED TO ENVIRONMENTAL DESIGN AND FINE ART DESIGN; CUSTOM DESIGN OF FINE ART, APPLIED ART, AND ART INSTALLATIONS IN VARIOUS MEDIA; PROVIDING A WEBSITE FEATURING TECHNOLOGY THAT GIVES USERS THE ABILITY TO ACCESS MULTI-MEDIA FILES CONTAINING IMAGES OF DRAWINGS, MAPS, AND FINE ART WORKS, IN VARIOUS MEDIA SUCH AS DIGITAL AND ELECTRONIC MEDIA, PAINT AND DRAWING MEDIA, PAPER, CLOTH, WOOD, WAX, PLASTER, PLASTIC, METAL, CERAMICS, AND GLASS (U.S. CLS. 100 AND 101).

JULIE GUTTADAURO, EXAMINING ATTORNEY

**CLASS 42—(Continued).**

SN 85-850,863. ACTIONET, INC., VIENNA, VA. FILED 2-15-2013.

**VDI IN ACTION**

THE MARK CONSISTS OF STANDARD CHARACTERS WITHOUT CLAIM TO ANY PARTICULAR FONT, STYLE, SIZE, OR COLOR.

NO CLAIM IS MADE TO THE EXCLUSIVE RIGHT TO USE "VDI", APART FROM THE MARK AS SHOWN.

FOR COMPUTER SERVICES FOR DESKTOP VIRTUALIZATION HOSTING, SERVER VIRTUALIZATION HOSTING, AND APPLICATION VIRTUALIZATION HOSTING, NAMELY, TECHNICAL SUPPORT SERVICES IN THE NATURE OF REMOTE AND ON-SITE INFRASTRUCTURE MANAGEMENT SERVICES FOR MONITORING, ADMINISTRATION AND MANAGEMENT OF PUBLIC AND PRIVATE COMPUTING IT SYSTEMS COMPRISED OF OUTSOURCED AND CO-LOCATED SERVERS, DESKTOPS, VIRTUAL DESKTOPS, FIREWALLS, INFRASTRUCTURE SYSTEMS, DATA STORAGE SYSTEMS, AND APPLICATION SYSTEMS (U.S. CLS. 100 AND 101).

ADA HAN, EXAMINING ATTORNEY

SN 85-850,875. ACTIONET, INC., VIENNA, VA. FILED 2-15-2013.

**CLOUD IN ACTION**

THE MARK CONSISTS OF STANDARD CHARACTERS WITHOUT CLAIM TO ANY PARTICULAR FONT, STYLE, SIZE, OR COLOR.

NO CLAIM IS MADE TO THE EXCLUSIVE RIGHT TO USE "CLOUD", APART FROM THE MARK AS SHOWN.

FOR CONSULTING SERVICES IN THE FIELD OF CLOUD COMPUTING; PROVIDING VIRTUAL COMPUTER SYSTEMS AND VIRTUAL COMPUTER ENVIRONMENTS THROUGH CLOUD COMPUTING; TECHNICAL SUPPORT SERVICES, NAMELY, REMOTE AND ON-SITE INFRASTRUCTURE MANAGEMENT SERVICES FOR MONITORING, ADMINISTRATION AND MANAGEMENT OF PUBLIC AND PRIVATE CLOUD COMPUTING IT AND APPLICATION SYSTEMS (U.S. CLS. 100 AND 101).

ADA HAN, EXAMINING ATTORNEY

**CLASS 42—(Continued).**

SN 85-851,027. LEELOGIC, INC, MOBILE, AL. FILED 2-15-2013.

**BRIDELOGIC**

THE MARK CONSISTS OF STANDARD CHARACTERS WITHOUT CLAIM TO ANY PARTICULAR FONT, STYLE, SIZE, OR COLOR.

FOR SOFTWARE AS A SERVICE FEATURING SOFTWARE FOR USE IN COMPUTERIZED AND CENTRALIZED DATA MANAGEMENT, NAMELY, FOR THE ORGANIZATION AND LOCATION OF COMPUTERIZED DATA AND PHYSICAL ITEMS RELATING TO ALL ASPECTS OF PLANNING A WEDDING AND RELATED EVENTS (U.S. CLS. 100 AND 101).

GINA FINK, EXAMINING ATTORNEY

SN 85-851,261. NATIONAL INSTRUMENTS CORPORATION, AUSTIN, TX. FILED 2-15-2013.

**BIG ANALOG DATA**

THE MARK CONSISTS OF STANDARD CHARACTERS WITHOUT CLAIM TO ANY PARTICULAR FONT, STYLE, SIZE, OR COLOR.

NO CLAIM IS MADE TO THE EXCLUSIVE RIGHT TO USE "ANALOG DATA", APART FROM THE MARK AS SHOWN.

FOR TECHNICAL SERVICES FEATURING THE DESIGN AND DEVELOPMENT OF COMPUTER HARDWARE AND SOFTWARE, UPDATING COMPUTER SOFTWARE, PROVIDING TECHNICAL SUPPORT SERVICES IN THE NATURE OF COMPUTER ASSISTANCE VIA ON-LINE COMMUNICATIONS, NAMELY, INSTALLING AND DEPLOYING COMPUTER HARDWARE AND SOFTWARE, MANAGING AND MONITORING COMPUTER HARDWARE AND SOFTWARE FOR PREDICTIVE MAINTENANCE AND FAILURE ASSESSMENTS, DIAGNOSING AND TROUBLESHOOTING COMPUTER HARDWARE AND SOFTWARE FAILURES, PROVIDING ARCHIVING, BACK UP, PATCHING AND UPDATING OF SYSTEMS SOFTWARE AND FIRMWARE, AND RELATED CONSULTING SERVICES, ALL IN THE FIELDS OF SCIENTIFIC AND ENGINEERING DATA ACQUISITION, CONTROL AND ANALYSIS (U.S. CLS. 100 AND 101).

CHRISTINA SOBRAL, EXAMINING ATTORNEY

**CLASS 42—(Continued).**

SN 85-851,430. EMC CORPORATION, HOPKINTON, MA.  
FILED 2-15-2013.

**MYACCESSLIVE**

THE MARK CONSISTS OF STANDARD CHARACTERS WITHOUT CLAIM TO ANY PARTICULAR FONT, STYLE, SIZE, OR COLOR.

FOR CLOUD COMPUTING FEATURING SOFTWARE FOR USE IN IDENTITY AND ACCESS MANAGEMENT, AND REPORTING, ANALYTICS AND MANAGEMENT FOR A VARIETY OF DIFFERENT PROGRAMS AND APPLICATIONS (U.S. CLS. 100 AND 101).

FIRST USE 12-5-2012; IN COMMERCE 12-5-2012.  
MORGAN WYNNE, EXAMINING ATTORNEY

SN 85-852,340. NATIONAL INSTRUMENTS CORPORATION,  
AUSTIN, TX. FILED 2-18-2013.

**BAD**

THE MARK CONSISTS OF STANDARD CHARACTERS WITHOUT CLAIM TO ANY PARTICULAR FONT, STYLE, SIZE, OR COLOR.

FOR TECHNICAL SERVICES FEATURING THE DESIGN AND DEVELOPMENT OF COMPUTER HARDWARE AND SOFTWARE, UPDATING COMPUTER SOFTWARE, PROVIDING TECHNICAL SUPPORT SERVICES IN THE NATURE OF COMPUTER ASSISTANCE VIA ON-LINE COMMUNICATIONS, NAMELY, INSTALLING AND DEPLOYING COMPUTER HARDWARE AND SOFTWARE, MANAGING AND MONITORING COMPUTER HARDWARE AND SOFTWARE FOR PREDICTIVE MAINTENANCE AND FAILURE ASSESSMENTS, DIAGNOSING AND TROUBLESHOOTING COMPUTER HARDWARE AND SOFTWARE FAILURES, PROVIDING ARCHIVING, BACK UP, PATCHING AND UPDATING OF SYSTEMS SOFTWARE AND FIRMWARE, AND RELATED CONSULTING SERVICES, ALL IN THE FIELDS OF SCIENTIFIC AND ENGINEERING DATA ACQUISITION, CONTROL AND ANALYSIS (U.S. CLS. 100 AND 101).

CHRISTINA SOBRAL, EXAMINING ATTORNEY

**CLASS 42—(Continued).**

SN 85-857,767. LINK SYSTEMS INC., STAMFORD, CT.  
FILED 2-22-2013.

**PROLEASE MAINTENANCE**

THE MARK CONSISTS OF STANDARD CHARACTERS WITHOUT CLAIM TO ANY PARTICULAR FONT, STYLE, SIZE, OR COLOR.

OWNER OF U.S. REG. NO. 2,627,401.

NO CLAIM IS MADE TO THE EXCLUSIVE RIGHT TO USE "MAINTENANCE", APART FROM THE MARK AS SHOWN.

FOR SERVICES IN THE NATURE OF PROVIDING ONLINE NON-DOWNLOADABLE COMPUTER SOFTWARE FOR USE BY FACILITY DEPARTMENTS FOR MANAGING WORK ORDERS, PREVENTATIVE MAINTENANCE AND MAINTENANCE REPORTS, AND INVOICING (U.S. CLS. 100 AND 101).

FIRST USE 2-0-2012; IN COMMERCE 2-0-2012.

KEVIN MITTLER, EXAMINING ATTORNEY

SN 85-858,239. WORLD WIFI LTD, LUCAN, IRELAND,  
FILED 2-23-2013.

**WORLDWIFI**

THE MARK CONSISTS OF STANDARD CHARACTERS WITHOUT CLAIM TO ANY PARTICULAR FONT, STYLE, SIZE, OR COLOR.

FOR PROVIDING A WEB SITE FEATURING TEMPORARY USE OF NON-DOWNLOADABLE SOFTWARE THAT ENABLES USERS TO COMMUNICATE WITH MOBILE DEVICES THROUGH A WIRELESS NETWORK (U.S. CLS. 100 AND 101).

FIRST USE 11-17-2007; IN COMMERCE 11-17-2011.

GEOFFREY FOSDICK, EXAMINING ATTORNEY

SN 85-868,129. LIFEISLOTTERY LLC, BROOKLYN, NY.  
FILED 3-6-2013.

**LIFEISLOTTERY**

THE MARK CONSISTS OF STANDARD CHARACTERS WITHOUT CLAIM TO ANY PARTICULAR FONT, STYLE, SIZE, OR COLOR.

FOR COMPUTER AIDED GRAPHIC DESIGN; DESIGN, DEVELOPMENT, AND CONSULTING SERVICES RELATED THERETO IN THE FIELD OF VISUAL DISPLAYS; GRAPHIC DESIGN (U.S. CLS. 100 AND 101).

FIRST USE 1-1-2012; IN COMMERCE 1-1-2012.

KATHLEEN M. VANSTON, EXAMINING ATTORNEY



**CLASS 42—(Continued).**

SN 85-873,341. HCC CORPORATION, AUSTIN, TX. FILED 3-12-2013.

## Value StarIndex

THE MARK CONSISTS OF STANDARD CHARACTERS WITHOUT CLAIM TO ANY PARTICULAR FONT, STYLE, SIZE, OR COLOR.

OWNER OF U.S. REG. NO. 430,180.

NO CLAIM IS MADE TO THE EXCLUSIVE RIGHT TO USE "VALUE", APART FROM THE MARK AS SHOWN.

FOR PROVIDING A WEBSITE FEATURING A SEARCH ENGINE FOR RANKING HOSPITALS AS TO SUSTAINABILITY, TRANSPARENCY, ACCOUNTABILITY AND RELIABILITY DIVIDED BY COST (U.S. CLS. 100 AND 101).

FIRST USE 3-1-2013; IN COMMERCE 3-1-2013.  
BRIN ANDERSON, EXAMINING ATTORNEY

**CLASS 42—(Continued).**

SN 85-894,222. ADVANCED MANAGEMENT SOFTWARE, LLC, LANCASTER, PA. FILED 4-3-2013.

## BusTracks

THE MARK CONSISTS OF STANDARD CHARACTERS WITHOUT CLAIM TO ANY PARTICULAR FONT, STYLE, SIZE, OR COLOR.

FOR SOFTWARE AS A SERVICE (SAAS) SERVICES FEATURING SOFTWARE FOR TRANSPORTATION MANAGEMENT FOR SCHOOL DISTRICTS (U.S. CLS. 100 AND 101).

FIRST USE 1-1-2001; IN COMMERCE 1-1-2001.  
JOHN HWANG, EXAMINING ATTORNEY

SN 85-897,001. MEOPLE.NET, INC., MOUNTAIN VIEW, CA. FILED 4-5-2013.

## Meople

THE MARK CONSISTS OF STANDARD CHARACTERS WITHOUT CLAIM TO ANY PARTICULAR FONT, STYLE, SIZE, OR COLOR.

FOR COMPUTER SERVICES, NAMELY, SOCIAL NETWORK AGGREGATION SERVICES AND RSS AGGREGATION SERVICES WHICH ALLOWS USERS TO POST TO, TRACK OTHER USERS ON, VIEW CONTENT FROM AND PROMOTE BRANDS ON MULTIPLE SOCIAL NETWORK SITES SIMULTANEOUSLY; INTERNET-BASED CONTENT DELIVERY SERVICE PROVIDING WEBSITE OWNERS AND DEVELOPERS CUSTOMIZABLE STREAMS OF WEBSITE CONTENT OF THEIR CHOOSING (U.S. CLS. 100 AND 101).

THOMAS MANOR, EXAMINING ATTORNEY

SN 85-876,327. TAS ENERGY INC., HOUSTON, TX. FILED 3-14-2013.

## TAS Energy

THE MARK CONSISTS OF STANDARD CHARACTERS WITHOUT CLAIM TO ANY PARTICULAR FONT, STYLE, SIZE, OR COLOR.

OWNER OF U.S. REG. NOS. 3,179,559 AND 4,081,994.

NO CLAIM IS MADE TO THE EXCLUSIVE RIGHT TO USE "ENERGY", APART FROM THE MARK AS SHOWN.

FOR TECHNICAL CONSULTING IN THE FIELD OF ENGINEERING; DESIGN AND ENGINEERING OF INDUSTRIAL CHILLING UNITS USED IN GAS TURBINE POWER PLANTS FOR INLET CHILLING PURPOSES WITH AND WITHOUT THERMAL ENERGY STORAGE, DATA CENTERS, OIL AND GAS FACILITIES, AND IN THE HVAC SYSTEMS OF LARGE BUILDINGS; DESIGN AND ENGINEERING OF ORGANIC RANKINE CYCLE UNITS USED FOR GEOTHERMAL, WASTE HEAT AND SOLAR APPLICATIONS (U.S. CLS. 100 AND 101).

FIRST USE 6-23-2010; IN COMMERCE 6-23-2010.  
ANDREA HACK, EXAMINING ATTORNEY

SN 85-904,761. BARBELL PROJECT, LLC, DENVER, CO. FILED 4-15-2013.

## BARBELLPROJECT

THE MARK CONSISTS OF STANDARD CHARACTERS WITHOUT CLAIM TO ANY PARTICULAR FONT, STYLE, SIZE, OR COLOR.

FOR DEVELOPMENT OF COMPUTER SOFTWARE APPLICATIONS, NAMELY, SOFTWARE APPLICATIONS FOR MOBILE DEVICES (U.S. CLS. 100 AND 101).

DAVID MURRAY, EXAMINING ATTORNEY

**CLASS 42—(Continued).**

SN 85-908,647. IPOSITIONING INC, FRANKLIN, MA. FILED 4-18-2013.

## IPOSITIONING

THE MARK CONSISTS OF STANDARD CHARACTERS WITHOUT CLAIM TO ANY PARTICULAR FONT, STYLE, SIZE, OR COLOR.

FOR APPLICATION SERVICE PROVIDER FEATURING COMPUTER SOFTWARE FOR USE IN MARKETING OF MESSAGING, WEBSITES, BLOGS, LANDING PAGES, DIGITAL MEDIA AND SOCIAL MEDIA USING MARKETING ANALYTICS, MARKETING COMMUNICATIONS, CONTENT ACCESS AND MANAGEMENT, SOCIAL NETWORKS, SEARCH ENGINE OPTIMIZATION, CUSTOMER RELATION MANAGEMENT INTEGRATION AND ELECTRONIC MAIL INTEGRATION (U.S. CLS. 100 AND 101).

NAPOLEON SHARMA, EXAMINING ATTORNEY

**CLASS 42—(Continued).**

SN 85-913,469. SNELL, CHERYLYNN, AUSTIN, TX. FILED 4-24-2013.

## TOUCHING THE HEARTS OF MANY

THE MARK CONSISTS OF STANDARD CHARACTERS WITHOUT CLAIM TO ANY PARTICULAR FONT, STYLE, SIZE, OR COLOR.

FOR DESIGN SERVICES, NAMELY, CUSTOM DESIGN OF WEARABLE APPAREL, PAPER GOODS, MUGS, KEY CHAINS, AND SIGNS BASED ON PERSONAL SELECTIONS MADE BY THE CUSTOMER; GRAPHIC ARTS DESIGN; GRAPHIC DESIGN; GRAPHIC DESIGN SERVICES FOR WEARABLE APPAREL, PAPER GOODS, MUGS, KEY CHAINS, AND SIGNS (U.S. CLS. 100 AND 101).

FIRST USE 12-0-2011; IN COMMERCE 12-0-2012.

DOMINICK J. SALEMI, EXAMINING ATTORNEY

SN 85-914,133. AND FAUNA LLC, HOLDERNESS, NH. FILED 4-25-2013.

## Fencrest Studio

### SELF EXPRESSION DESIGN

THE MARK CONSISTS OF STANDARD CHARACTERS WITHOUT CLAIM TO ANY PARTICULAR FONT, STYLE, SIZE, OR COLOR.

NO CLAIM IS MADE TO THE EXCLUSIVE RIGHT TO USE "DESIGN", APART FROM THE MARK AS SHOWN.

FOR DESIGN SERVICES, NAMELY, CUSTOM DESIGN OF WEARABLE APPAREL, PAPER GOODS, MUGS, KEY CHAINS, AND SIGNS BASED ON PERSONAL SELECTIONS MADE BY THE CUSTOMER; GRAPHIC ARTS DESIGN; GRAPHIC DESIGN; GRAPHIC DESIGN SERVICES FOR WEARABLE APPAREL, PAPER GOODS, MUGS, KEY CHAINS, AND SIGNS (U.S. CLS. 100 AND 101).

FIRST USE 12-0-2011; IN COMMERCE 12-0-2012.

DOMINICK J. SALEMI, EXAMINING ATTORNEY

THE MARK CONSISTS OF STANDARD CHARACTERS WITHOUT CLAIM TO ANY PARTICULAR FONT, STYLE, SIZE, OR COLOR.

NO CLAIM IS MADE TO THE EXCLUSIVE RIGHT TO USE "STUDIO", APART FROM THE MARK AS SHOWN.

FOR ENVIRONMENTAL DESIGN, FINE ART DESIGN, AND MAPPING SERVICES FOR OTHERS SUCH AS PROFESSIONALS IN THE FIELDS OF LANDSCAPE ARCHITECTURE, ARCHITECTURE, URBAN AND REGIONAL PLANNING, EDUCATION, AND AGRICULTURE; PROVIDING A WEBSITE FEATURING INFORMATION RELATED TO ENVIRONMENTAL DESIGN AND FINE ART DESIGN; CUSTOM DESIGN OF FINE ART, APPLIED ART, AND ART INSTALLATIONS IN VARIOUS MEDIA; PROVIDING A WEBSITE FEATURING TECHNOLOGY THAT GIVES USERS THE ABILITY TO ACCESS MULTI-MEDIA FILES CONTAINING IMAGES OF DRAWINGS, MAPS, AND FINE ART WORKS, IN VARIOUS MEDIA SUCH AS DIGITAL AND ELECTRONIC MEDIA, PAINT AND DRAWING MEDIA, PAPER, CLOTH, WOOD, WAX, PLASTER, PLASTIC, METAL, CERAMICS, AND GLASS (U.S. CLS. 100 AND 101).

JULIE GUTTADAURO, EXAMINING ATTORNEY

**CLASS 42—(Continued).**

SN 85-926,108. SITE AND TOWER INFORMATION MANAGEMENT INC., OVERLAND PARK, KS. FILED 5-8-2013.

THE STIPLING IS FOR SHADING PURPOSES ONLY.  
THE MARK CONSISTS OF THE STYLIZED WORDING "STIM" WITH THE LETTER "T" BEING INCORPORATED INTO THE STYLIZED DESIGN OF A COMMUNICATION TOWER. THE LETTERS WHICH FORM THE WORD "STIM" ARE PARTIALLY SHADED.

FOR SOFTWARE AS A SERVICE (SAAS) SERVICES, NAMELY, HOSTING WEB-BASED DATABASE MANAGEMENT AND ENGINEERING ANALYSIS SOFTWARE FOR USE BY OTHERS IN THE ARCHITECTURE AND ENGINEERING (A AND E) FIELD FOR USE IN PROJECT MANAGEMENT AND ASSET MANAGEMENT OF CELL SITE, CELL TOWER, AND WIRELESS TELECOMMUNICATIONS NETWORK DESIGN, CONSTRUCTION, MAINTENANCE, INSTALLATION, UPGRADING, AND REMOVAL (U.S. CLS. 100 AND 101).

JIM RINGLE, EXAMINING ATTORNEY

**CLASS 42—(Continued).**

SN 85-964,254. HEATSYNC, INC., LOS ANGELES, CA. FILED 6-19-2013.

THE MARK CONSISTS OF STANDARD CHARACTERS WITHOUT CLAIM TO ANY PARTICULAR FONT, STYLE, SIZE, OR COLOR.

FOR PROVIDING INFORMATION VIA GLOBAL COMPUTER NETWORKS, NAMELY, ACTING AS AN APPLICATION SERVICE PROVIDER IN THE FIELD OF WEB ANALYTICS TO HOST COMPUTER APPLICATION SOFTWARE FOR COLLECTING, EDITING, ORGANIZING, MODIFYING, REPORTING, STORING, AND SHARING OF INFORMATION RELATED TO WEBSITE TRAFFIC, E-COMMERCE TRANSACTIONS, AND MARKETING CAMPAIGNS CONDUCTED VIA THE INTERNET (U.S. CLS. 100 AND 101).

FIRST USE 4-30-2013; IN COMMERCE 4-30-2013.

DAVID HOFFMAN, EXAMINING ATTORNEY

SN 85-927,757. SYSTEMS MODELING AND DEVELOPMENT, LLC, HUNTSVILLE, AL. FILED 5-9-2013.

THE MARK CONSISTS OF STANDARD CHARACTERS WITHOUT CLAIM TO ANY PARTICULAR FONT, STYLE, SIZE, OR COLOR.

FOR PROVIDING TECHNOLOGY CONSULTING IN THE FIELD OF EMERGENCY RESPONSE FOR COMMUNITIES (U.S. CLS. 100 AND 101).

FIRST USE 6-1-2012; IN COMMERCE 6-1-2012.

JOSETTE BEVERLY, EXAMINING ATTORNEY

SN 85-965,201. ECN AUTOMATION, INC, POENIX, AZ. FILED 6-20-2013.

NO CLAIM IS MADE TO THE EXCLUSIVE RIGHT TO USE "AUTOMATION" AND "I&C SOLUTIONS", APART FROM THE MARK AS SHOWN.

THE COLOR(S) WHITE, GRAY AND SKY BLUE IS/ARE CLAIMED AS A FEATURE OF THE MARK.

THE MARK CONSISTS OF A SKY BLUE CIRCLE WITH A WHITE CURVED LINE AND A WHITE DOT. AT THE RIGHT SIDE ARE THE SKY BLUE LETTERS "ECN" IN LOWER CASE LETTERS. BELOW IS THE WORD "AUTOMATION" IN GRAY LOWERCASE LETTERS. BELOW THIS ARE THE WORDS "YOUR PARTNER IN I&C SOLUTIONS" IN GRAY LETTERS.

FOR ENGINEERING IN DESIGN OF INSTRUMENTATION AND CONTROL SYSTEMS FOR THE MINING INDUSTRY; CONTROL ENGINEERING IN THE FIELD OF THE DEVELOPMENT OF INSTRUMENT SPECIFICATION, LOOP DIAGRAMS, LOGIC DIAGRAMS, CONTROL PANEL DESIGN, CONTROL ARCHITECTURE AND INSTRUMENT INSTALLATION DETAILS; COMPUTER SYSTEMS INTEGRATION IN THE FIELD OF PLC PROGRAMMING, HMI DESIGNING AND PROGRAMMING, CONTROL PANEL FABRICATION, FAT/SAT TESTING, COMMISSIONING, START UP AND TRAINING (U.S. CLS. 100 AND 101).

FIRST USE 0-0-2008; IN COMMERCE 0-0-2008.

KYLE PEETE, EXAMINING ATTORNEY

SN 85-934,459. PARTING WISHES, INC., OTTAWA, CANADA, FILED 5-16-2013.

THE MARK CONSISTS OF STANDARD CHARACTERS WITHOUT CLAIM TO ANY PARTICULAR FONT, STYLE, SIZE, OR COLOR.

FOR COMPUTER SERVICES, NAMELY, PROVIDING AN INTERACTIVE WEB SITE FEATURING TECHNOLOGY THAT ALLOWS USERS TO DRAFT THEIR OWN LEGAL DOCUMENTS (U.S. CLS. 100 AND 101).

FIRST USE 12-21-2005; IN COMMERCE 12-21-2005.

ANNE E. GUSTASON, EXAMINING ATTORNEY

**CLASS 42—(Continued).**

SN 85-973,919. HEATSYNC, INC., LOS ANGELES, CA. FILED 6-30-2013.



THE MARK CONSISTS OF A FLAME SURROUNDING A CURVED ARROW GOING FROM LEFT TO RIGHT ABOVE A CURVED ARROW GOING FROM RIGHT TO LEFT.

FOR PROVIDING INFORMATION VIA GLOBAL COMPUTER NETWORKS, NAMELY, ACTING AS AN APPLICATION SERVICE PROVIDER IN THE FIELD OF WEB ANALYTICS TO HOST COMPUTER APPLICATION SOFTWARE FOR COLLECTING, EDITING, ORGANIZING, MODIFYING, REPORTING, STORING, AND SHARING OF INFORMATION RELATED TO WEBSITE TRAFFIC, E-COMMERCE TRANSACTIONS, AND MARKETING CAMPAIGNS CONDUCTED VIA THE INTERNET (U.S. CLS. 100 AND 101).

FIRST USE 4-30-2013; IN COMMERCE 4-30-2013.  
DAVID HOFFMAN, EXAMINING ATTORNEY

SN 85-974,309. GIGA OMNI MEDIA, INC., SAN FRANCISCO, CA. FILED 7-1-2013.

OWNER OF U.S. REG. NOS. 4,257,536, 4,257,537 AND 4,267,631.

THE MARK CONSISTS OF THE STYLIZED LETTERS "G" AND "O".

FOR PROVIDING A WEBSITE FEATURING INFORMATION IN THE FIELD OF SCIENCE AND TECHNOLOGY (U.S. CLS. 100 AND 101).

DAVID HOFFMAN, EXAMINING ATTORNEY

**CLASS 42—(Continued).**

SN 85-974,427. BEN HACKMAN & COMPANY LLC, NEW YORK, NY. FILED 7-1-2013.

**DIAMOND DNA GRADING**

THE MARK CONSISTS OF STANDARD CHARACTERS WITHOUT CLAIM TO ANY PARTICULAR FONT, STYLE, SIZE, OR COLOR.

NO CLAIM IS MADE TO THE EXCLUSIVE RIGHT TO USE "DIAMOND" OR "GRADING", APART FROM THE MARK AS SHOWN.

FOR GEMOLOGICAL SERVICES, NAMELY, GRADING PRECIOUS STONES (U.S. CLS. 100 AND 101).  
BRITTANY ESTELL, EXAMINING ATTORNEY

SN 86-001,978. QUALITYTECH, LP, OVERLAND PARK, KS. FILED 7-3-2013.

**DATA CENTERS POWERED BY PEOPLE**

THE MARK CONSISTS OF STANDARD CHARACTERS WITHOUT CLAIM TO ANY PARTICULAR FONT, STYLE, SIZE, OR COLOR.

NO CLAIM IS MADE TO THE EXCLUSIVE RIGHT TO USE "DATA CENTERS", APART FROM THE MARK AS SHOWN.

FOR COMPUTER CO-LOCATION SERVICES, NAMELY, PROVIDING FACILITIES FOR THE LOCATION OF COMPUTER SERVERS WITH THE EQUIPMENT OF OTHERS (U.S. CLS. 100 AND 101).

MATTHEW MCDOWELL, EXAMINING ATTORNEY

SN 86-007,508. CSAM MARKETING, INC., SOMERVILLE, NJ. FILED 7-11-2013.

**CLASS COMPETE**

THE MARK CONSISTS OF STANDARD CHARACTERS WITHOUT CLAIM TO ANY PARTICULAR FONT, STYLE, SIZE, OR COLOR.

FOR PROVIDING OF ONLINE NON-DOWNLOADABLE SOFTWARE FOR THE PURPOSE OF CONTENT TRANSMISSION, DATABASE MANAGEMENT, DATA ANALYTICS, INFORMATION SHARING AND ANALYSIS, IN THE FIELD OF EDUCATION, TESTING ADMINISTRATION, SCORING AND ASSESSING PERFORMANCE ON GRADE SCHOOL AND HIGH SCHOOL EDUCATIONAL TASKS (U.S. CLS. 100 AND 101).

FIRST USE 12-5-2013; IN COMMERCE 12-5-2013.  
INGRID C. EULIN, EXAMINING ATTORNEY

**CLASS 42—(Continued).**

SN 86-011,845. ROGER D. VETRUBA, NORTH HOLLYWOOD, CA. FILED 7-16-2013.

# SwiftCloud

THE MARK CONSISTS OF STANDARD CHARACTERS WITHOUT CLAIM TO ANY PARTICULAR FONT, STYLE, SIZE, OR COLOR.

FOR PROVIDING A WEB SITE FEATURING TEMPORARY USE OF NON-DOWNLOADABLE SOFTWARE FOR PURPOSE OF DATA AND/OR ELECTRONIC MEDIA FILE MANAGEMENT, STORAGE, ANALYSIS AND MANIPULATION IN THE FIELDS OF ACCOUNTING, CUSTOMER RELATIONSHIP MANAGEMENT, TIME TRACKING FOR PURPOSE OF BILLING, TIME TRACKING OF EMPLOYEE ATTENDANCE, MARKETING, BUSINESS INTELLIGENCE, MONITORING OF TASK PROGRESSION AND COMPLETION AND PROJECT MANAGEMENT AND FOR FACILITATING COMMUNICATION BETWEEN USERS; PROVIDING TEMPORARY USE OF ON-LINE NON-DOWNLOADABLE SOFTWARE AND APPLICATIONS FOR MANAGEMENT, STORAGE, ANALYSIS AND SHARING OF DATA AND/OR ELECTRONIC MEDIA FILES IN THE FIELDS OF CUSTOMER RELATIONSHIP MANAGEMENT, PROJECT AND TASK MANAGEMENT, ACCOUNTING, SALES AND MARKETING, AND FOR COMMUNICATION BETWEEN CUSTOMER AND EMPLOYEE OR EMPLOYEE TO EMPLOYEE OR CUSTOMER TO CUSTOMER VIA ELECTRONIC MEDIA, NAMELY, WEBSITES AND/OR SOFTWARE APPLICATIONS (U.S. CLS. 100 AND 101).

FIRST USE 7-16-2013; IN COMMERCE 7-16-2013.  
KELLEY WELLS, EXAMINING ATTORNEY

---

SN 86-014,669. PARMENTER REALTY & INVESTMENT COMPANY, MIAMI, FL. FILED 7-19-2013.

# PARMENTERGREEN

THE MARK CONSISTS OF STANDARD CHARACTERS WITHOUT CLAIM TO ANY PARTICULAR FONT, STYLE, SIZE, OR COLOR.

FOR CONSULTING SERVICES IN THE FIELD OF ENVIRONMENTAL ASSESSMENT AND PLANNING (U.S. CLS. 100 AND 101).

FIRST USE 6-1-2013; IN COMMERCE 6-1-2013.  
CURTIS FRENCH, EXAMINING ATTORNEY

---

SN 86-018,644. CONTRAQER CORP., ARLINGTON, VA. FILED 7-24-2013.

# CONTRAQER

THE MARK CONSISTS OF STANDARD CHARACTERS WITHOUT CLAIM TO ANY PARTICULAR FONT, STYLE, SIZE, OR COLOR.

FOR SOFTWARE AS A SERVICE FEATURING SOFTWARE FOR WEB-BASED PROCUREMENT MANAGEMENT (U.S. CLS. 100 AND 101).

KEVIN MITTLER, EXAMINING ATTORNEY

**CLASS 42—(Continued).**

SN 86-019,665. IKASYSTEMS CORPORATION, SOUTHBOROUGH, MA. FILED 7-25-2013.



THE COLOR(S) TOURQUOISE, MEDIUM BLUE, GREEN, DARK BLUE, ORANGE, RED, AND WHITE IS/ARE CLAIMED AS A FEATURE OF THE MARK.

THE MARK CONSISTS OF AN ITALICIZED LOWER CASE "I" IN WHITE, SUPERIMPOSED ON A SQUARE OF MULTI-COLORED BLOCKS IN TURQUOISE, MEDIUM BLUE, GREEN, DARK BLUE, ORANGE AND RED, WITH THREE ROUNDED CORNERS.

FOR SOFTWARE AS A SERVICE (SAAS) FEATURING COMPUTER SOFTWARE USED IN RECORD MANAGEMENT, INFORMATION MANAGEMENT, BILLING, PAYMENTS, POSTING AND SECONDARY BILLING, ELECTRONIC DATA INTERCHANGE AND ELECTRONIC MESSAGING FOR THE HEALTHCARE INDUSTRY; SOFTWARE AS A SERVICE (SAAS) FEATURING COMPUTER SOFTWARE THAT PROCESSES, STORES, AND MANAGES PATIENT AND PROVIDER DATA IN ACCORDANCE WITH APPLICABLE STATE AND FEDERAL AGENCIES; SOFTWARE AS A SERVICE (SAAS) FEATURING COMPUTER SOFTWARE FOR MANAGING AND ANALYZING FINANCIAL INFORMATION OF HEALTHCARE PAYERS (U.S. CLS. 100 AND 101).

FIRST USE 3-0-2013; IN COMMERCE 3-0-2013.  
JAMES MACFARLANE, EXAMINING ATTORNEY

---

SN 86-022,061. FLOWSERVE MANAGEMENT COMPANY, IRVING, TX. FILED 7-29-2013.

# NORDCALC

THE MARK CONSISTS OF STANDARD CHARACTERS WITHOUT CLAIM TO ANY PARTICULAR FONT, STYLE, SIZE, OR COLOR.

FOR PROVIDING TEMPORARY USE OF A WEB-BASED SOFTWARE APPLICATION FOR USE IN GENERATING VALVE FLOW AND TORQUE CALCULATIONS, FACILITATING VALVE SIZING AND SELECTION, GENERATING VALVE ACTUATOR MOUNTING DATA, FACILITATING MULTIPOINT VALVE ARRANGEMENTS, PRODUCING VALVE LUBRICANT AND SEALANT RECOMMENDATIONS, GENERATING VALVE BLOWDOWN CALCULATIONS, MAINTAINING A SEARCHABLE USER REPORTS DATABASE OF VALVE CALCULATIONS, AND FACILITATING COMMUNICATIONS BETWEEN VALVE INSTALLERS AND CUSTOMERS FOR USE IN CUSTOMER SERVICE, GATHERING CUSTOMER FEEDBACK AND MARKET RESEARCH (U.S. CLS. 100 AND 101).

JANICE KIM, EXAMINING ATTORNEY

**CLASS 42—(Continued).**

SN 86-022,374. QUALITYTECH, LP, OVERLAND PARK, KS. FILED 7-29-2013.

**QTS 3 Cs**

THE MARK CONSISTS OF STANDARD CHARACTERS WITHOUT CLAIM TO ANY PARTICULAR FONT, STYLE, SIZE, OR COLOR.

OWNER OF U.S. REG. NOS. 3,390,394 AND 4,323,446. FOR COMPUTER CO-LOCATION SERVICES, NAMELY, PROVIDING FACILITIES FOR THE LOCATION OF COMPUTER SERVERS WITH THE EQUIPMENT OF OTHERS; PROVIDING TEMPORARY USE OF ON-LINE NON-DOWNLOADABLE CLOUD COMPUTING SOFTWARE FOR USE IN ELECTRONIC STORAGE OF DATA (U.S. CLS. 100 AND 101).

MATTHEW MCDOWELL, EXAMINING ATTORNEY



SN 86-022,404. QUALITYTECH, LP, OVERLAND PARK, KS. FILED 7-29-2013.

**QTS MEGA DATA CENTERS**

THE MARK CONSISTS OF STANDARD CHARACTERS WITHOUT CLAIM TO ANY PARTICULAR FONT, STYLE, SIZE, OR COLOR.

OWNER OF U.S. REG. NOS. 3,390,394 AND 4,323,446. NO CLAIM IS MADE TO THE EXCLUSIVE RIGHT TO USE "MEGA DATA CENTERS", APART FROM THE MARK AS SHOWN.

FOR COMPUTER CO-LOCATION SERVICES, NAMELY, PROVIDING FACILITIES FOR THE LOCATION OF COMPUTER SERVERS WITH THE EQUIPMENT OF OTHERS; PROVIDING TEMPORARY USE OF ON-LINE NON-DOWNLOADABLE CLOUD COMPUTING SOFTWARE FOR USE IN ELECTRONIC STORAGE OF DATA (U.S. CLS. 100 AND 101).

MATTHEW MCDOWELL, EXAMINING ATTORNEY

**CLASS 42—(Continued).**

SN 86-024,310. SAILTHRU, INC., NEW YORK, NY. FILED 7-31-2013.

**SAILTHRU SMART DATA**

THE MARK CONSISTS OF STANDARD CHARACTERS WITHOUT CLAIM TO ANY PARTICULAR FONT, STYLE, SIZE, OR COLOR.

OWNER OF U.S. REG. NO. 4,366,897. NO CLAIM IS MADE TO THE EXCLUSIVE RIGHT TO USE "DATA", APART FROM THE MARK AS SHOWN.

FOR PROVIDING ONLINE NON-DOWNLOADABLE SOFTWARE THAT ENABLES USERS TO CUSTOMIZE ELECTRONIC MAIL COMMUNICATIONS BASED ON CUSTOMERS' ONLINE BEHAVIOR AND ANY PURCHASE HISTORY; PROVIDING ONLINE NON-DOWNLOADABLE SOFTWARE THAT ENABLES USERS TO AUTOMATE THE DELIVERY OF CUSTOMIZED ELECTRONIC MAIL COMMUNICATIONS BASED ON CUSTOMERS' ONLINE BEHAVIOR AND ANY PURCHASE HISTORY; PROVIDING ONLINE NON-DOWNLOADABLE SOFTWARE THAT GENERATES REPORTS ON CUSTOMERS' ONLINE BEHAVIOR AND PURCHASE HISTORY (U.S. CLS. 100 AND 101).

FIRST USE 7-1-2013; IN COMMERCE 7-1-2013. AMY KELLY, EXAMINING ATTORNEY

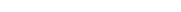

SN 86-025,841. ALBERTSON ENGINEERING INC., SAINT PAUL, MN. FILED 8-1-2013.

**Albertson Engineering Inc.**

THE MARK CONSISTS OF STANDARD CHARACTERS WITHOUT CLAIM TO ANY PARTICULAR FONT, STYLE, SIZE, OR COLOR.

NO CLAIM IS MADE TO THE EXCLUSIVE RIGHT TO USE "ENGINEERING INC.", APART FROM THE MARK AS SHOWN.

SEC. 2(F). FOR ENGINEERING DESIGN SERVICES (U.S. CLS. 100 AND 101). FIRST USE 11-2-1998; IN COMMERCE 11-2-1998. RONALD DELGIZZI, EXAMINING ATTORNEY

**CLASS 42—(Continued).**

SN 86-026,840. OREN USA, EDMOND, OK. FILED 8-2-2013.

**Whiteboard Mortgage**

THE MARK CONSISTS OF STANDARD CHARACTERS WITHOUT CLAIM TO ANY PARTICULAR FONT, STYLE, SIZE, OR COLOR.

NO CLAIM IS MADE TO THE EXCLUSIVE RIGHT TO USE "MORTGAGE", APART FROM THE MARK AS SHOWN.

FOR SOFTWARE AS A SERVICE (SAAS) SERVICES FEATURING SOFTWARE FOR PROCESSING AND GENERATING DOCUMENTS FOR USE IN THE FIELD OF MORTGAGE LENDING AND BROKERAGE FOR LOAN APPLICATION PROCESSING (U.S. CLS. 100 AND 101).

FIRST USE 7-29-2013; IN COMMERCE 7-29-2013.  
BRIDGETT SMITH, EXAMINING ATTORNEY

**CLASS 42—(Continued).**

SN 86-028,192. LIANG GE, REDMOND, WA. FILED 8-4-2013.



OWNER OF U.S. REG. NO. 4,232,478.

THE COLOR(S) MEDIUM BLUE AND DARK BLUE IS/ARE CLAIMED AS A FEATURE OF THE MARK.

THE MARK CONSISTS OF A LITERAL ELEMENT "S# SYSSHARP" IN STYLIZED FONT WITH A VERTICAL DARK BLUE LINE AFTER THE "#" SYMBOL. THE "S" IS IN MEDIUM BLUE, THE "#" SYMBOL IS IN MEDIUM AND DARK BLUE, THE "SYS" WORDING IS IN LIGHT BLUE, AND "SHARP" IS IN DARK BLUE. THE "S#" PORTION OF THE MARK IS IN BOLD AND ITALICIZED. WHITE INDICATES TRANSPARENT BACKGROUND AND IS NOT CLAIMED AS A FEATURE OF THE MARK.

FOR SOFTWARE DEVELOPMENT AND SOFTWARE CONSULTING SERVICES (U.S. CLS. 100 AND 101).

FIRST USE 7-1-2013; IN COMMERCE 7-1-2013.  
LAURA GOLDEN, EXAMINING ATTORNEY

SN 86-027,063. NORTHERN ILLINOIS UNIVERSITY, DEKALB, IL. FILED 8-2-2013.



THE COLOR(S) BLACK, WHITE, RED AND BLUE IS/ARE CLAIMED AS A FEATURE OF THE MARK.

THE MARK CONSISTS OF "EMHM EASY MACHINING OF HARD MATERIALS" WITH ALL OF THE WORDING IN BLACK WITH THE EXCEPTION OF THE SECOND "M" IN "EMHM", WHICH IS RED WITH BLACK SHADING AND CONTAINS A BLUE TRIANGLE. THERE IS A THIN UNDERLINE BENEATH THE ACRONYM THAT SHADES FROM BLACK TO RED. THE MARK APPEARS ON A WHITE BACKGROUND.

FOR ENGINEERING DESIGN SERVICES (U.S. CLS. 100 AND 101).

KIM MONINGHOFF, EXAMINING ATTORNEY

SN 86-029,837. PREMIER MEDICAL INC., FOUNTAIN INN, SC. FILED 8-6-2013.

**MD HeartPro**

THE MARK CONSISTS OF STANDARD CHARACTERS WITHOUT CLAIM TO ANY PARTICULAR FONT, STYLE, SIZE, OR COLOR.

NO CLAIM IS MADE TO THE EXCLUSIVE RIGHT TO USE "MD", APART FROM THE MARK AS SHOWN.

FOR MEDICAL LABORATORY SERVICES (U.S. CLS. 100 AND 101).

FIRST USE 8-5-2013; IN COMMERCE 8-5-2013.

DOMINIC J. FERRAIUOLO, EXAMINING ATTORNEY

**CLASS 42—(Continued).**

SN 86-031,380. TECHNOLOGY SOLUTIONS OF SC INC., SENECA, SC. FILED 8-7-2013.

**ARMORRACK**

THE MARK CONSISTS OF STANDARD CHARACTERS WITHOUT CLAIM TO ANY PARTICULAR FONT, STYLE, SIZE, OR COLOR.

FOR COMPUTER SERVICES, NAMELY, CLOUD HOSTING PROVIDER SERVICES; HOSTING OF DIGITAL CONTENT ON THE INTERNET; DESIGN, DEPLOYMENT AND MAINTENANCE OF CLOUD COMPUTING INFRASTRUCTURE SOFTWARE FOR OTHERS; TECHNICAL SUPPORT SERVICES, NAMELY, TROUBLE SHOOTING OF CLOUD COMPUTING INFRASTRUCTURE SOFTWARE ISSUES FOR OTHERS; HOSTING WEBSITES ON THE INTERNET; APPLICATION SERVICES PROVIDER, NAMELY, HOSTING COMPUTER SOFTWARE APPLICATIONS OF OTHERS (U.S. CLS. 100 AND 101).

SUE LAWRENCE, EXAMINING ATTORNEY

SN 86-031,454. FULTON, WADE, NASHVILLE, TN. FILED 8-7-2013.

**Level 5 Technology**

THE MARK CONSISTS OF STANDARD CHARACTERS WITHOUT CLAIM TO ANY PARTICULAR FONT, STYLE, SIZE, OR COLOR.

NO CLAIM IS MADE TO THE EXCLUSIVE RIGHT TO USE "TECHNOLOGY", APART FROM THE MARK AS SHOWN.

FOR COMPUTER SERVICES, NAMELY, ON-SITE MANAGEMENT OF INFORMATION TECHNOLOGY (IT) SYSTEMS; IT CONSULTING SERVICES; IT INTEGRATION SERVICES (U.S. CLS. 100 AND 101).

FIRST USE 7-1-2013; IN COMMERCE 7-1-2013.  
JAMES A. RAUEN, EXAMINING ATTORNEY

SN 86-032,259. JOSEPHINE HOMES, INC., SAN FRANCISCO, CA. FILED 8-8-2013.

**JOSEPHINE HOMES**

THE MARK CONSISTS OF STANDARD CHARACTERS WITHOUT CLAIM TO ANY PARTICULAR FONT, STYLE, SIZE, OR COLOR.

OWNER OF U.S. REG. NOS. 4,444,659 AND 4,444,660.  
NO CLAIM IS MADE TO THE EXCLUSIVE RIGHT TO USE "HOMES", APART FROM THE MARK AS SHOWN.

FOR INTERIOR DESIGN SERVICES INCLUDING SPACE PLANNING, FURNITURE SELECTION, MATERIAL AND SURFACE SELECTION (U.S. CLS. 100 AND 101).

SCOTT BIBB, EXAMINING ATTORNEY

**CLASS 42—(Continued).**

SN 86-032,272. JOSEPHINE HOMES, INC., SAN FRANCISCO, CA. FILED 8-8-2013.

**FIT FOR A KING**

THE MARK CONSISTS OF STANDARD CHARACTERS WITHOUT CLAIM TO ANY PARTICULAR FONT, STYLE, SIZE, OR COLOR.

OWNER OF U.S. REG. NO. 4,394,793.  
FOR INTERIOR DESIGN SERVICES INCLUDING SPACE PLANNING, FURNITURE SELECTION, MATERIAL AND SURFACE SELECTION (U.S. CLS. 100 AND 101).

SCOTT BIBB, EXAMINING ATTORNEY

SN 86-032,288. JOSEPHINE HOMES, INC., SAN FRANCISCO, CA. FILED 8-8-2013.



OWNER OF U.S. REG. NOS. 4,444,659 AND 4,444,660.  
THE MARK CONSISTS OF THE STYLIZED LETTERS "J" AND "H" FOLLOWED BY A BACKWARDS FACING "J".

FOR INTERIOR DESIGN SERVICES INCLUDING SPACE PLANNING, FURNITURE SELECTION, MATERIAL AND SURFACE SELECTION (U.S. CLS. 100 AND 101).

SCOTT BIBB, EXAMINING ATTORNEY



**CLASS 42—(Continued).**

SN 86-033,957. INTEGRATED WEB STRATEGY, LLC, PHOENIX, AZ. FILED 8-9-2013.



THE MARK CONSISTS OF A FIRST CHECK MARK TERMINATED IN AN ARROW ON THE UPWARD STROKE AND A SMALLER CHECK MARK POSITIONED ADJACENT THE FIRST CHECK MARK WITH THE LITERAL ELEMENT "CHANNELDEMOCRACY.COM" POSITIONED BENEATH BOTH CHECK MARKS.

FOR PROVIDING A WEBSITE FEATURING ON-LINE NON-DOWNLOADABLE SOFTWARE THAT ENABLES USERS TO ENGAGE IN LOBBYING ACTIVITIES (U.S. CLS. 100 AND 101).

FIRST USE 1-30-2013; IN COMMERCE 1-30-2013.  
ANGELA M. MICHELI, EXAMINING ATTORNEY

---

SN 86-033,982. MYRIAD DEVELOPMENT, INC., AUSTIN, TX. FILED 8-9-2013.

MYRIAD UNDERWRITING CENTER

THE MARK CONSISTS OF STANDARD CHARACTERS WITHOUT CLAIM TO ANY PARTICULAR FONT, STYLE, SIZE, OR COLOR.

NO CLAIM IS MADE TO THE EXCLUSIVE RIGHT TO USE "UNDERWRITING CENTER", APART FROM THE MARK AS SHOWN.

FOR PROVIDING TEMPORARY USE OF A NON-DOWNLOADABLE WEB-BASED SOFTWARE THAT STREAMLINES, STANDARDIZES AND AUTOMATES UNDERWRITING PROGRAM. PROVIDES BUSINESS PERFORMANCE MANAGEMENT, MAXIMIZES PROFITABILITY AND PERFORMANCE FOR PROPERTY BUSINESS FOR USE IN THE INSURANCE INDUSTRY (U.S. CLS. 100 AND 101).

ANGELA M. MICHELI, EXAMINING ATTORNEY

**CLASS 42—(Continued).**

SN 86-034,276. SYSIQ, INC., SAN FRANCISCO, CA. FILED 8-9-2013.

Smart ecommerce, delivered

THE MARK CONSISTS OF STANDARD CHARACTERS WITHOUT CLAIM TO ANY PARTICULAR FONT, STYLE, SIZE, OR COLOR.

NO CLAIM IS MADE TO THE EXCLUSIVE RIGHT TO USE "ECOMMERCE", APART FROM THE MARK AS SHOWN.

FOR COMPUTER SOFTWARE DEVELOPMENT AND COMPUTER PROGRAMMING DEVELOPMENT FOR OTHERS (U.S. CLS. 100 AND 101).

FIRST USE 11-12-2003; IN COMMERCE 11-12-2003.  
KIMBERLY PARKS, EXAMINING ATTORNEY

---

SN 86-035,044. NUTMEG PRINTING INC, BRANFORD, CT. FILED 8-12-2013.



THE MARK CONSISTS OF THE WORDING "MOSAIC" IN STYLIZED FONT. THE CHARACTER "O" DEPICTS THE IMAGE OF A SPIRAL MADE UP OF UNEVEN RECTANGULAR SHAPES THAT GIVE THE APPEARANCE OF SMALL STONES.

FOR COMPUTER WEBSITE DESIGN; GRAPHIC DESIGN (U.S. CLS. 100 AND 101).

CAITLIN WATTS-FITZGERALD, EXAMINING ATTORNEY

---

SN 86-036,680. PRAVIA, LLC, WINDSOR, CO. FILED 8-13-2013.

PRAVIA

THE MARK CONSISTS OF STANDARD CHARACTERS WITHOUT CLAIM TO ANY PARTICULAR FONT, STYLE, SIZE, OR COLOR.

FOR SCIENTIFIC AND TECHNOLOGICAL SERVICES, NAMELY, SCIENTIFIC RESEARCH, ANALYSIS AND MONITORING OF GEOGRAPHIC INFORMATION SYSTEM (GIS) DATA CAPTURED VIA REMOTE SENSING PAYLOADS ABOARD MANNED AND UNMANNED AIRCRAFT; REPORTING THE SCIENTIFIC RESEARCH DATA RECOVERED FROM GEOGRAPHIC INFORMATION SYSTEMS TO THE AGRICULTURE, ENERGY, CONSTRUCTION, SEARCH AND RESCUE, AND DISASTER RELIEF INDUSTRIES (U.S. CLS. 100 AND 101).

BERYL GARDNER, EXAMINING ATTORNEY

**CLASS 42—(Continued).**

SN 86-036,853. REVITAS, INC., PHILADELPHIA, PA. FILED 8-13-2013.

**REVITASNOW**

THE MARK CONSISTS OF STANDARD CHARACTERS WITHOUT CLAIM TO ANY PARTICULAR FONT, STYLE, SIZE, OR COLOR.

OWNER OF U.S. REG. NO. 4,306,385.

FOR SOFTWARE AS A SERVICE (SAAS) SERVICES, NAMELY, HOSTING SOFTWARE FOR USE BY OTHERS IN MANAGING CONTRACT OBLIGATIONS, OPTIMIZING CONTRACT PERFORMANCE, MANAGING CONTRACT LIFECYCLES, OPTIMIZING BUSINESS RELATIONSHIPS, TRACKING PAYMENTS, CALCULATING AND TRACKING PRICES, TRACKING REBATES, MANAGING REVENUE, ANALYZING PROFITABILITY, MONITORING RISKS, MONITORING REGULATIONS AND REGULATORY COMPLIANCE, AND MANAGING SUPPLY CHAINS (U.S. CLS. 100 AND 101).

FIRST USE 6-29-2012; IN COMMERCE 6-29-2012.  
JENNIFER WILLISTON, EXAMINING ATTORNEY

SN 86-037,270. MAYO FOUNDATION FOR MEDICAL EDUCATION AND RESEARCH, ROCHESTER, MN. FILED 8-14-2013.

**MAYOACCESS CONNECT**

THE MARK CONSISTS OF STANDARD CHARACTERS WITHOUT CLAIM TO ANY PARTICULAR FONT, STYLE, SIZE, OR COLOR.

OWNER OF U.S. REG. NO. 1,827,320.

FOR PROVIDING ONLINE, NON-DOWNLOADABLE COMPUTER SOFTWARE FOR ORDERING, ACCESSING AND MANAGING MEDICAL LABORATORY TEST INFORMATION, AND INSTRUCTION MANUALS THEREFOR (U.S. CLS. 100 AND 101).

JAY FLOWERS, EXAMINING ATTORNEY

SN 86-037,431. MCCHRISTAL GROUP LLC, ALEXANDRIA, VA. FILED 8-14-2013.

**SyncMatrix**

THE MARK CONSISTS OF STANDARD CHARACTERS WITHOUT CLAIM TO ANY PARTICULAR FONT, STYLE, SIZE, OR COLOR.

FOR PROVIDING TEMPORARY USE OF ON-LINE NON-DOWNLOADABLE SOFTWARE FOR SYNCHRONIZATION OF BUSINESS DATABASES IN A MATRICES FORMAT (U.S. CLS. 100 AND 101).

FIRST USE 1-15-2011; IN COMMERCE 7-8-2013.  
KATHERINE E. HALMEN, EXAMINING ATTORNEY

**CLASS 42—(Continued).**

SN 86-037,707. BLUEMARK, LLC, NEW PALTZ, NY. FILED 8-14-2013.

**BLUEWAY**

THE MARK CONSISTS OF STANDARD CHARACTERS WITHOUT CLAIM TO ANY PARTICULAR FONT, STYLE, SIZE, OR COLOR.

FOR SOFTWARE AS A SERVICE (SAAS) SERVICES FEATURING SOFTWARE FOR FACILITATING DATA EXCHANGES FOR HEALTHCARE PROVIDERS RELATED TO AUDIT PROGRAM MANAGEMENT, AND PROVIDING WEB-BASED ACCESS TO HEALTH INFORMATION, DENIALS MANAGEMENT SERVICES, INTERCONNECTIONS WITH MEDICAL CLAIM DATA SOURCES AND ELECTRONIC MEDICAL RECORDS THROUGH A PORTAL INTERFACE (U.S. CLS. 100 AND 101).

RENEE MCCRAY, EXAMINING ATTORNEY

SN 86-037,959. BOEHRINGER INVESTMENTS GROUP, INC., ORLANDO, FL. FILED 8-14-2013.



NO CLAIM IS MADE TO THE EXCLUSIVE RIGHT TO USE ".COM", APART FROM THE MARK AS SHOWN.

THE COLOR(S) BLACK AND BLUE IS/ARE CLAIMED AS A FEATURE OF THE MARK.

THE MARK CONSISTS OF THE BLACK WORDS "GET THE" CURVED ABOVE THE LARGER BLACK "C" IN THE WORD "CLICKS" ABOVE THE SMALLER BLACK LETTERS ".COM". THE "I" IN "CLICKS" IS REPRESENTED BY A BLUE ARROW AND DOT. THE COLOR WHITE REPRESENTS ONLY BACKGROUND AREA AND IS NOT CLAIMED AS A COLOR IN THE MARK.

FOR COMPUTER SERVICES, NAMELY, SEARCH ENGINE OPTIMIZATION (U.S. CLS. 100 AND 101).

FIRST USE 7-0-2012; IN COMMERCE 7-0-2012.  
MARYNELLE WILSON, EXAMINING ATTORNEY

SN 86-038,073. MYERS, RICHARD, WALNUT CREEK, CA. FILED 8-14-2013.

**HomeEco**

THE MARK CONSISTS OF STANDARD CHARACTERS WITHOUT CLAIM TO ANY PARTICULAR FONT, STYLE, SIZE, OR COLOR.

FOR ACCREDITATION SERVICES, NAMELY, SETTING AND PROVIDING STANDARDS FOR "GREEN HOME CERTIFICATION" WHICH CERTIFIES THAT A HOME IS BOTH ENERGY AND WATER EFFICIENT (U.S. CLS. 100 AND 101).

FIRST USE 1-1-2013; IN COMMERCE 1-1-2013.  
PAUL E. FAHRENKOPF, EXAMINING ATTORNEY

**CLASS 42—(Continued).**

SN 86-038,095. SPACEMUX, INC., PACIFIC PALISADES, CA. FILED 8-14-2013.

# SPACEMUX

THE MARK CONSISTS OF STANDARD CHARACTERS WITHOUT CLAIM TO ANY PARTICULAR FONT, STYLE, SIZE, OR COLOR.

FOR COMPUTER TECHNOLOGY AND SUPPORT SERVICES, NAMELY, TECHNICAL ADVICE RELATING TO OPERATION OF COMPUTERS AND TROUBLESHOOTING IN THE NATURE OF DIAGNOSING COMPUTER HARDWARE AND SOFTWARE PROBLEMS; COMPUTER NETWORK MANAGEMENT SERVICES (U.S. CLS. 100 AND 101).

SKYE YOUNG, EXAMINING ATTORNEY

**CLASS 42—(Continued).**

SN 86-039,398. THATHAPALLI CHINNARAJU, ARUN, DANBURY, CT. FILED 8-15-2013.

# Unimelon

THE MARK CONSISTS OF STANDARD CHARACTERS WITHOUT CLAIM TO ANY PARTICULAR FONT, STYLE, SIZE, OR COLOR.

FOR ADVISORY SERVICES IN THE FIELD OF PRODUCT DEVELOPMENT AND QUALITY IMPROVEMENT OF SOFTWARE; APPLICATION SERVICE PROVIDER (ASP) FEATURING SOFTWARE FOR USE CLINICAL TRIAL MANAGEMENT; APPLICATION SERVICE PROVIDER (ASP), NAMELY, HOSTING COMPUTER SOFTWARE APPLICATIONS OF OTHERS; APPLICATION SERVICE PROVIDER FEATURING APPLICATION PROGRAMMING INTERFACE (API) SOFTWARE FOR ELECTRONIC MEDICAL RECORDS MANAGEMENT; APPLICATION SERVICE PROVIDER, NAMELY, HOSTING, MANAGING, DEVELOPING, ANALYZING, AND MAINTAINING APPLICATIONS, SOFTWARE, AND WEB SITES, OF OTHERS IN THE FIELDS OF ADVERTISING AND MARKETING; APPLICATION SERVICE PROVIDER, NAMELY, HOSTING, MANAGING, DEVELOPING, ANALYZING, AND MAINTAINING APPLICATIONS, SOFTWARE, AND WEB SITES, OF OTHERS IN THE FIELDS OF HEALTHCARE, BENEFITS PROGRAMS, EMPLOYEE PRODUCTIVITY, RISK MANAGEMENT; APPLICATION SERVICE PROVIDER, NAMELY, HOSTING, MANAGING, DEVELOPING, AND MAINTAINING APPLICATIONS, SOFTWARE, AND WEB SITES, IN THE FIELDS OF PERSONAL PRODUCTIVITY, WIRELESS COMMUNICATION, MOBILE INFORMATION ACCESS, AND REMOTE DATA MANAGEMENT FOR WIRELESS DELIVERY OF CONTENT TO HANDHELD COMPUTERS, LAPTOPS AND MOBILE ELECTRONIC DEVICES; APPLICATION SERVICE PROVIDER, NAMELY, HOSTING, MANAGING, DEVELOPING, ANALYZING, AND MAINTAINING APPLICATIONS, SOFTWARE AND WEB SITES OF OTHERS IN THE FIELDS OF BIO/PHARMACEUTICAL; ARCHITECTURAL CONSULTANCY; ARCHITECTURAL CONSULTANCY SERVICES; ARCHITECTURAL CONSULTATION; BUSINESS TECHNOLOGY SOFTWARE CONSULTATION SERVICES; CLOUD COMPUTING FEATURING SOFTWARE FOR USE DATABASE MANAGEMENT AND MEDICAL RECORDS; COMPILING DATA FOR RESEARCH PURPOSES IN THE FIELD OF MEDICAL SCIENCE AND MEDICAL CONSULTANCY; COMPUTER AND COMPUTER SOFTWARE RENTAL; COMPUTER CONSULTATION; COMPUTER CONSULTATION IN THE FIELD OF COMPUTER SECURITY; COMPUTER HARDWARE AND SOFTWARE DESIGN; COMPUTER MONITORING SERVICE WHICH TRACKS APPLICATION SOFTWARE PERFORMANCE, PERFORMS PERIODIC MAINTENANCE AND PROVIDES REPORTS AND ALERTS CONCERNING SUCH PERFORMANCE; COMPUTER NETWORK DESIGN AND COMPUTER SOFTWARE DESIGN FOR THE INFORMATION TECHNOLOGY SYSTEMS; COMPUTER PROGRAMMING AND SOFTWARE DESIGN; COMPUTER PROGRAMMING SERVICES FOR OTHERS IN THE FIELD OF SOFTWARE CONFIGURATION MANAGEMENT; COMPUTER SERVICES, NAMELY, ACTING AS AN APPLICATION SERVICE PROVIDER IN THE FIELD OF INFORMATION MANAGEMENT TO HOST COMPUTER APPLICATION SOFTWARE FOR THE PURPOSE OF CLINICAL TRIAL MANAGEMENT; COMPUTER SERVICES, NAMELY, ACTING AS AN APPLICATION SERVICE PROVIDER IN THE FIELD OF KNOWLEDGE MANAGEMENT TO HOST COMPUTER APPLICATION SOFTWARE FOR THE PURPOSE OF ELECTRONIC MEDICAL RECORDS MANAGEMENT; COMPUTER SERVICES, NAMELY, INTEGRATION OF COMPUTER SOFTWARE INTO MULTIPLE SYSTEMS AND NETWORKS; COMPUTER SERVICES, NAMELY, OPERATING COMPUTER SYSTEMS AND COMPUTER NETWORKS FEATURING BROADBAND TRANSMISSION AND ENERGY TRANSMISSION SOFTWARE FOR

SN 86-038,434. DATATECH LABS, DENVER, CO. FILED 8-15-2013.

# DATATECH LABS

THE MARK CONSISTS OF STANDARD CHARACTERS WITHOUT CLAIM TO ANY PARTICULAR FONT, STYLE, SIZE, OR COLOR.

NO CLAIM IS MADE TO THE EXCLUSIVE RIGHT TO USE "LABS", APART FROM THE MARK AS SHOWN.

FOR COMPUTER SERVICES, NAMELY, DATA RECOVERY SERVICES (U.S. CLS. 100 AND 101).

JOHN E. MICHOS, EXAMINING ATTORNEY

SN 86-038,823. KINNSER SOFTWARE, INC., AUSTIN, TX. FILED 8-15-2013.

# KINNSER HOSPICE

THE MARK CONSISTS OF STANDARD CHARACTERS WITHOUT CLAIM TO ANY PARTICULAR FONT, STYLE, SIZE, OR COLOR.

NO CLAIM IS MADE TO THE EXCLUSIVE RIGHT TO USE "HOSPICE", APART FROM THE MARK AS SHOWN.

FOR PROVIDING NON-DOWNLOADABLE SOFTWARE FOR PATIENT MANAGEMENT IN THE FIELD OF PERSONALIZED HEALTHCARE DELIVERY AND HOSPICE CARE (U.S. CLS. 100 AND 101).

FIRST USE 8-12-2013; IN COMMERCE 8-12-2013.

FLORENTINA BLANDU, EXAMINING ATTORNEY

**CLASS 42—(Continued).**

PUBLIC UTILITIES AND OTHERS; COMPUTER SERVICES, NAMELY, REMOTE AND ON-SITE MANAGEMENT OF INFORMATION TECHNOLOGY SYSTEMS OF OTHERS; COMPUTER SERVICES, NAMELY, REMOTE MANAGEMENT OF INFORMATION TECHNOLOGY SYSTEMS FOR OTHERS; COMPUTER SOFTWARE DEVELOPMENT; COMPUTER SOFTWARE DEVELOPMENT AND COMPUTER PROGRAMMING DEVELOPMENT FOR OTHERS; COMPUTER SOFTWARE DEVELOPMENT IN THE FIELD OF MOBILE APPLICATIONS; COMPUTER SOFTWARE DEVELOPMENT IN THE FIELD OF BIO/PHARMACEUTICAL AND HEALTHCARE; COMPUTER SOFTWARE DEVELOPMENT, COMPUTER PROGRAMMING AND MAINTENANCE OF COMPUTER SOFTWARE FOR INSURANCE; COMPUTER SOFTWARE INSTALLATION AND MAINTENANCE; CONSULTING IN THE FIELD OF ENGINEERING; CONSULTING IN THE FIELD OF INFORMATION TECHNOLOGY; CONSULTING IN THE FIELD OF IT PROJECT MANAGEMENT; CONSULTING SERVICES FOR OTHERS IN THE FIELD OF DESIGN, PLANNING, AND IMPLEMENTATION PROJECT MANAGEMENT OF CLINICAL TRIALS; CONSULTING SERVICES IN THE DESIGN AND IMPLEMENTATION OF COMPUTER-BASED INFORMATION SYSTEMS FOR BUSINESSES; CONSULTING SERVICES IN THE FIELD OF CLOUD COMPUTING; CONSULTING SERVICES IN THE FIELD OF HOSTING COMPUTER SOFTWARE APPLICATIONS; CONSULTING SERVICES IN THE FIELD OF PROVIDING ONLINE, NON-DOWNLOADABLE SOFTWARE AND APPLICATIONS; CONSULTING SERVICES IN THE FIELD OF SOFTWARE AS A SERVICE (SAAS); CONSULTING SERVICES IN THE FIELD OF THE DESIGN OF COMPUTER SOFTWARE; CONSULTING SERVICES IN THE FIELDS OF BIOTECHNOLOGY, PHARMACEUTICAL RESEARCH AND DEVELOPMENT AND GENETIC SCIENCE; CONSULTING SERVICES IN THE FIELDS OF BIOTECHNOLOGY, PHARMACEUTICAL RESEARCH AND DEVELOPMENT, LABORATORY TESTING, DIAGNOSTICS, AND PHARMACOGENETICS; CREATING, MAINTAINING, AND MODERNIZING COMPUTER SOFTWARE (U.S. CLS. 100 AND 101).

MICHAEL SOUDERS, EXAMINING ATTORNEY

SN 86-039,645. SPRING, CRAIG O., TELLURIDE, CO. FILED 8-16-2013.

# LUMINOSITY

THE MARK CONSISTS OF STANDARD CHARACTERS WITHOUT CLAIM TO ANY PARTICULAR FONT, STYLE, SIZE, OR COLOR.

FOR ARCHITECTURAL LIGHTING DESIGN, ARCHITECTURAL DESIGN (U.S. CLS. 100 AND 101).

FIRST USE 3-14-2013; IN COMMERCE 4-5-2013.

FONG HSU, EXAMINING ATTORNEY

**CLASS 42—(Continued).**

SN 86-039,775. SHIFTJOCKEY, SUPERIOR, CO. FILED 8-16-2013.

# ShiftJockey

THE MARK CONSISTS OF STANDARD CHARACTERS WITHOUT CLAIM TO ANY PARTICULAR FONT, STYLE, SIZE, OR COLOR.

FOR APPLICATION SERVICE PROVIDER (ASP) FEATURING SOFTWARE FOR USE IN CREATING WORK SCHEDULES, SHARING WORK SCHEDULES, AND MANAGING EMPLOYEE SCHEDULES (U.S. CLS. 100 AND 101).

FIRST USE 1-1-2013; IN COMMERCE 6-20-2013.

DOMINICK J. SALEMI, EXAMINING ATTORNEY

SN 86-039,890. QUIDPOST.COM LLC, NORTHFIELD, NJ. FILED 8-16-2013.

# Quidpost

THE MARK CONSISTS OF STANDARD CHARACTERS WITHOUT CLAIM TO ANY PARTICULAR FONT, STYLE, SIZE, OR COLOR.

FOR COMPUTER SERVICES, NAMELY, PROVIDING INFORMATION BASED ON USER-SUBMITTED CONTENT, NAMELY, PROVIDING A WEB SITE FEATURING TECHNOLOGY THAT ENABLES USERS TO SHARE, BOOKMARK, INDEX, STORE, COLLECT AND SHOWCASE CONTENT, ARTICLES, IMAGES, CALENDARS, PRODUCTS, PROJECTS, AND OTHER INFORMATION RESOURCES IN ELECTRONIC FORM IN THE NATURE OF UNIFORM RESOURCE LOCATOR POSTINGS IN THE FIELDS OF POLLS, USER COMMENTARY, AND USER OPINION ON THE TOPICS OF BOOKS, BUSINESS, COLLEGE, CONSPIRACY THEORIES, CURRENT EVENTS, EDUCATION, ENTERTAINMENT, ENVIRONMENT, FASHION, FINANCE, FOOD, HEALTH, HISTORY, HUMOR, MEDIA, MISCELLANEOUS, MOVIES, MUSIC, POLITICS, RELIGION, SCIENCE, SPACE, SPORTS, TECHNOLOGY, TRAVEL, US NEWS, VIDEO GAMES, WEATHER, WORKPLACE, AND WORLD NEWS (U.S. CLS. 100 AND 101).

RONALD DELGIZZI, EXAMINING ATTORNEY

**CLASS 42—(Continued).**

SN 86-040,006. COLLLOR, LLC, ATLANTA, GA. FILED 8-16-2013.



THE COLOR(S) BLACK, MAGENTA, YELLOW, CYAN, AND GREEN IS/ARE CLAIMED AS A FEATURE OF THE MARK.

THE MARK CONSISTS OF THE WORD "COLLLOR"; THE FIRST TWO LOW-CASE LETTERS "C" AND "O" ARE IN BLACK, ALL FOUR LOW-CASE "L"'S ARE IN FOUR DIFFERENT COLORS: MAGENTA, YELLOW, CYAN AND GREEN, THE LAST TWO LOW-CASE LETTERS "O" AND "R" ARE IN BLACK.

FOR ON-LINE WEB SITE THAT ENABLES THE MANAGEMENT OF PRINT SYSTEMS OF OTHERS BY PROVIDING TECHNICAL MAINTENANCE AND PERFORMANCE REPORTS BASED ON DATA PROVIDED BY USERS; VISUAL DESIGN SERVICES IN THE NATURE OF DESIGNING VISUAL ELEMENTS FOR ON-LINE, BROADCAST, PRINT, OUTDOOR AND OTHER COMMUNICATION MEDIA (U.S. CLS. 100 AND 101).  
BRIAN CALLAGHAN, EXAMINING ATTORNEY

**CLASS 42—(Continued).**

SN 86-041,162. AURORA SOFTWARE TECHNOLOGY, INC., DBA CLOUDVISIT TELEMEDICINE, COLD SPRING, NY. FILED 8-19-2013.



NO CLAIM IS MADE TO THE EXCLUSIVE RIGHT TO USE "PSYCHIATRY", APART FROM THE MARK AS SHOWN.

THE MARK CONSISTS OF THE CAPITALIZED WORD "PSYCHIATRY" ABOVE WHICH APPEARS A DOTTED LINE, ABOVE WHICH APPEAR THE CONJOINED WORDS "CLOUD" AND "VISIT" WITH THE FIRST LETTER OF EACH WORD CAPITALIZED AND A SMALL CLOUD APPEARING ABOVE THE WORD "VISIT".

FOR APPLICATION SERVICE PROVIDER (ASP) FEATURING SOFTWARE FOR MANAGING A TELEMEDICINE HEALTH PRACTICE FOR USE BY PSYCHIATRISTS, PSYCHOLOGISTS AND MENTAL HEALTH PROFESSIONALS (U.S. CLS. 100 AND 101).

FIRST USE 11-15-2012; IN COMMERCE 11-15-2012.  
DAVID HOFFMAN, EXAMINING ATTORNEY

SN 86-040,751. SAGARACORP LLC, OPA LOCKA, FL. FILED 8-16-2013.



THE MARK CONSISTS OF A STYLIZED BONSAI TREE MADE OF STYLIZED ORIGAMI TRUNK, BRANCHES AND CONTAINER OVER THE WORDING "Q-BONSAI" WITH A LINE ABOVE AND BELOW THE WORDING. ALL OF THIS IS INSIDE OF A SHADED CIRCLE WITH A DOTTED LINE BORDER.

FOR APPLICATION SERVICE PROVIDER (ASP) FEATURING SOFTWARE FOR USE IN BUSINESS MANAGEMENT COMPRISED OF MODULES FOR MANAGEMENT OF INVENTORY, DOCUMENTS, PERSONNEL, ACCOUNTING, PAYROLL, HUMAN RESOURCES, INVOICING, POINT OF SALE, LEAD MANAGEMENT, HELP DESK, REQUESTS FOR CHANGE, LEAN / WASTE REDUCTION AND SECURITY (U.S. CLS. 100 AND 101).

FIRST USE 7-17-2013; IN COMMERCE 7-17-2013.  
MICHAEL WEBSTER, EXAMINING ATTORNEY

SN 86-041,242. LEFT-CLICK CORPORATION, NORTHAMPTON, MA. FILED 8-19-2013.

**LAST CALL MEDIA**

THE MARK CONSISTS OF STANDARD CHARACTERS WITHOUT CLAIM TO ANY PARTICULAR FONT, STYLE, SIZE, OR COLOR.

NO CLAIM IS MADE TO THE EXCLUSIVE RIGHT TO USE "MEDIA", APART FROM THE MARK AS SHOWN.

FOR COMPUTER WEBSITE DESIGN AND COMPUTER PROGRAMMING FOR OTHERS (U.S. CLS. 100 AND 101).

JEANIE LEE, EXAMINING ATTORNEY

**CLASS 42—(Continued).**

SN 86-041,676. RHINO SECURITY LABS, SEATTLE, WA. FILED 8-19-2013.



NO CLAIM IS MADE TO THE EXCLUSIVE RIGHT TO USE "SECURITY LABS", APART FROM THE MARK AS SHOWN.

THE MARK CONSISTS OF A DESIGN OF A RHINO HEAD WITH THE STYLIZED TEXT "RHINO SECURITY LABS" TO THE LEFT OF THE DESIGN AND THE STYLIZED TEXT "LEADING THE CHARGE FOR ENTERPRISE SECURITY" BENEATH THAT.

FOR COMPUTER FORENSIC SERVICES; COMPUTER SECURITY CONSULTANCY IN THE FIELD OF SCANNING AND PENETRATION TESTING OF COMPUTERS AND NETWORKS TO ASSESS INFORMATION SECURITY VULNERABILITY (U.S. CLS. 100 AND 101).

FIRST USE 3-1-2013; IN COMMERCE 3-1-2013.

MICHAEL SOUDERS, EXAMINING ATTORNEY

SN 86-041,767. TERRACE SOFTWARE, INC., SAN FRANCISCO, CA. FILED 8-19-2013.

## sure broker

THE MARK CONSISTS OF STANDARD CHARACTERS WITHOUT CLAIM TO ANY PARTICULAR FONT, STYLE, SIZE, OR COLOR.

NO CLAIM IS MADE TO THE EXCLUSIVE RIGHT TO USE "BROKER", APART FROM THE MARK AS SHOWN.

FOR PROVIDING A WEB SITE FEATURING TEMPORARY USE OF NON-DOWNLOADABLE COMPUTER SOFTWARE FOR DATABASE MANAGEMENT, STORING DATA, GENERATING REPORTS, CONTACT MANAGEMENT, TRACKING COMMISSIONS, PREPARATION OF BILLS, TRACKING ACCOUNTS PAYABLE AND RECEIVABLE, GENERAL LEDGER ACCOUNTING IN THE FIELD OF INSURANCE AGENCY SALES MANAGEMENT, OPERATIONS, BILLING AND ACCOUNTING (U.S. CLS. 100 AND 101).

FIRST USE 8-15-2013; IN COMMERCE 8-15-2013.

JENNY PARK, EXAMINING ATTORNEY

**CLASS 42—(Continued).**

SN 86-041,959. CRUMP TECHNOLOGIES, INC., BETTENDORF, IA. FILED 8-19-2013.

## MYDEALBROKER

THE MARK CONSISTS OF STANDARD CHARACTERS WITHOUT CLAIM TO ANY PARTICULAR FONT, STYLE, SIZE, OR COLOR.

FOR PROVIDING A WEBSITE FEATURING TECHNOLOGY THAT ENABLES USERS TO SHOP IN RETAIL STORES AND NEGOTIATE PRICES ON MERCHANDISE (U.S. CLS. 100 AND 101).

FIRST USE 10-25-2012; IN COMMERCE 2-18-2013.

ANGELA M. MICHELI, EXAMINING ATTORNEY

SN 86-042,622. MILES TECHNOLOGIES, INC., MOORESTOWN, NJ. FILED 8-20-2013.

## business by Miles

THE MARK CONSISTS OF STANDARD CHARACTERS WITHOUT CLAIM TO ANY PARTICULAR FONT, STYLE, SIZE, OR COLOR.

OWNER OF U.S. REG. NOS. 3,034,754 AND 3,053,434.

NO CLAIM IS MADE TO THE EXCLUSIVE RIGHT TO USE "BUSINESS", APART FROM THE MARK AS SHOWN.

FOR SOFTWARE AS A SERVICE (SAAS) SERVICES FEATURING SOFTWARE FOR MANAGING BUSINESS OPERATIONS AND PROVIDING REPORTS ON OPERATIONAL PERFORMANCE (U.S. CLS. 100 AND 101).

FIRST USE 1-1-2013; IN COMMERCE 5-1-2013.

BRENDAN MCCAULEY, EXAMINING ATTORNEY

SN 86-042,784. REALANALOGICS, INC., STATELINE, NV. FILED 8-20-2013.

## Escrow Velocity

THE MARK CONSISTS OF STANDARD CHARACTERS WITHOUT CLAIM TO ANY PARTICULAR FONT, STYLE, SIZE, OR COLOR.

NO CLAIM IS MADE TO THE EXCLUSIVE RIGHT TO USE "ESCROW", APART FROM THE MARK AS SHOWN.

FOR PROVIDING A WEBSITE FEATURING SOURCES, NAMELY, NON-DOWNLOADABLE SOFTWARE FOR MEASURING REAL ESTATE ESCROW PERIODS (U.S. CLS. 100 AND 101).

BRENDAN MCCAULEY, EXAMINING ATTORNEY

**CLASS 42—(Continued).**

SN 86-042,901. AQUA MANAGEMENT INC, AKA AMI, LAS VEGAS, NV. FILED 8-20-2013.

# sociobionics

THE MARK CONSISTS OF STANDARD CHARACTERS WITHOUT CLAIM TO ANY PARTICULAR FONT, STYLE, SIZE, OR COLOR.

FOR CLOUD COMPUTING FEATURING SOFTWARE FOR CONTROLLING INDUSTRIAL MACHINES; COMPUTER SERVICES, NAMELY, CLOUD HOSTING PROVIDER SERVICES; UPDATING AND MAINTAINING CLOUD-BASED COMPUTER SOFTWARE THROUGH PUBLIC CELLULAR NETWORKS (U.S. CLS. 100 AND 101).

ALAIN LAPTER, EXAMINING ATTORNEY

SN 86-042,995. FICIENT TECHNOLOGIES, LLC, DBA PARTSNAP, EULESS, TX. FILED 8-20-2013.

# Part\*Snap

THE COLOR(S) GRAY AND BLUE IS/ARE CLAIMED AS A FEATURE OF THE MARK.

THE MARK CONSISTS OF THE WORD "PARTSNAP" IN A SANS-SERIF FONT. THERE IS ALSO AN ASTERISK AFTER THE WORD "PART" AND BEFORE THE WORD "SNAP". "PART" IS IN GRAY AND THE ASTERISK AND "SNAP" ARE IN BLUE.

FOR CIVIL ENGINEERING FOR THE DESIGN OF POST-TENSIONING PRODUCTS AND MATERIALS; COMPUTER AIDED DESIGN FOR OTHERS; COMPUTER AIDED GRAPHIC DESIGN; COMPUTER GRAPHICS DESIGN SERVICES; COMPUTER GRAPHICS DESIGN SERVICES, NAMELY, CREATING OF 3D CAD MODELS AND ANIMATIONS; COMPUTER-AIDED DESIGN SERVICES; CONSULTING SERVICES IN THE FIELD OF DESIGN AND DEVELOPMENT OF ENGINEERING PROCESSES; CUSTOM DESIGN AND ENGINEERING OF CUSTOMIZED PRODUCTS FOR CONSUMER ELECTRONICS AND HOME GOODS; DESIGN OF ENGINEERING PRODUCTS; DESIGN OF MECHANICAL AND MICROMECHANICAL COMPONENTS; DESIGN OF MECHANICAL, ELECTROMECHANICAL AND OPTOELECTRONIC APPARATUS AND INSTRUMENTS; DESIGN OF MODELS, SETS AND PROPS FOR MOTION PICTURES, VIDEOS, COMMERCIALS AND MOVIE TRAILERS; DESIGN OF OPTICAL AND MICROOPTICAL COMPONENTS; DESIGN OF PRODUCTION FACILITIES; DESIGN, ENGINEERING, RESEARCH, DEVELOPMENT AND TESTING SERVICES IN THE FIELD OF POLYMERIC MATERIALS, POLYMER SYNTHESIS, AND MATERIALS CUSTOMIZATION FOR MEDICAL, SCIENTIFIC, AND TECHNOLOGICAL APPLICATIONS; DESIGNING AND DEVELOPING WEBSITES ON THE INTERNET; ENGINEERING DESIGN SERVICES; INDUSTRIAL DESIGN; INDUSTRIAL DESIGN SERVICES; MACHINE PART DESIGN SERVICES; MECHANICAL ENGINEERING; MECHANICAL RESEARCH; MECHANICAL RESEARCH IN THE FIELD OF MOTOR SPORTS; NEW PRODUCT DESIGN SERVICES; PRODUCT DESIGN AND DEVELOPMENT IN THE FIELD OF CONSUMER PRODUCTS, MEDICAL DEVICES, OIL AND GAS, CIVIL CONSTRUCTION, AUTOMOTIVE AND INDUSTRIAL PRODUCTS (U.S. CLS. 100 AND 101).

FIRST USE 10-1-2011; IN COMMERCE 10-1-2011.  
SHANNON TWOHIG, EXAMINING ATTORNEY

**CLASS 42—(Continued).**

SN 86-043,465. FORMZAPPER, LLC, DBA LENDINGSTANDARD, KANSAS CITY, MO. FILED 8-20-2013.

# LendingStandard

THE MARK CONSISTS OF STANDARD CHARACTERS WITHOUT CLAIM TO ANY PARTICULAR FONT, STYLE, SIZE, OR COLOR.

FOR PROVIDING A WEBSITE FEATURING NON-DOWNLOADABLE SOFTWARE FOR PROCESSING OR ORIGINATING LOANS IN THE FIELD OF MORTGAGE BANKING, LENDING AND REAL ESTATE VIA A GLOBAL COMPUTER NETWORK (U.S. CLS. 100 AND 101).

JASON BLAIR, EXAMINING ATTORNEY

SN 86-043,468. GOODSNITCH, LLC, WILMINGTON, DE. FILED 8-20-2013.

# Express Feedback by Goodsnitch

THE MARK CONSISTS OF THE TERMS "EXPRESS FEEDBACK BY GOODSNITCH" WITH A SEMICIRCLE UNDER THE DOUBLE "EE" IN THE TERM "FEEDBACK" AND UNDER THE DOUBLE "OO" IN THE TERM "GOODSNITCH" TO FORM A SMILEY FACE.

FOR PROVIDING ON-LINE NON-DOWNLOADABLE SOFTWARE FOR ALLOWING USERS TO PROVIDE RESPONSES AND COMMENTS TO A SERIES OF SURVEY AND FEEDBACK QUESTIONS ON GOODS AND SERVICES (U.S. CLS. 100 AND 101).

RENEE MCCRAY, EXAMINING ATTORNEY

SN 86-043,483. TERRACE SOFTWARE, INC., SAN FRANCISCO, CA. FILED 8-21-2013.

# POLICY DESK

THE MARK CONSISTS OF STANDARD CHARACTERS WITHOUT CLAIM TO ANY PARTICULAR FONT, STYLE, SIZE, OR COLOR.

NO CLAIM IS MADE TO THE EXCLUSIVE RIGHT TO USE "POLICY", APART FROM THE MARK AS SHOWN.

FOR PROVIDING A WEB SITE FEATURING TEMPORARY USE OF NON-DOWNLOADABLE COMPUTER SOFTWARE FOR DATABASE MANAGEMENT, STORING DATA, CREATING FORMS, GENERATING REPORTS, IN THE FIELD OF INSURANCE POLICY MANAGEMENT (U.S. CLS. 100 AND 101).

JENNY PARK, EXAMINING ATTORNEY

**CLASS 42—(Continued).**

SN 86-043,485. DIRT RESOURCE LLC, PINEDALE, WY. FILED 8-21-2013.



NO CLAIM IS MADE TO THE EXCLUSIVE RIGHT TO USE "RESOURCE", APART FROM THE MARK AS SHOWN. THE MARK CONSISTS OF THE STYLIZED WORDING "DIRT RESOURCE" WHERE EACH WORD IN SAID WORDING IS SURROUNDED BY A BOX-STYLE OUTLINE, ALL OF THE FORGOING EXISTING ON TOP OF A BLACK BACKGROUND, SAID BACKGROUND HAVING A SMUDGED APPEARANCE.

FOR PROVIDING A WEB SITE FEATURING TECHNOLOGY THAT ENABLES USERS TO OBTAIN AND PROVIDE INFORMATION REGARDING THE EARTH MATERIALS HANDLING INDUSTRY (U.S. CLS. 100 AND 101).

BRENDAN MCCAULEY, EXAMINING ATTORNEY

**CLASS 42—(Continued).**

ON THE RIGHT UPPER FLAP OF THE BOX ARE THE WORDS "BY: CYNTHIA LEE". THERE IS A PIECE OF TAPE ON THE LEFT SIDE OF THE BOX, A PAIR OF SCISSORS ON THE RIGHT SIDE OF THE BOX AND A RULER IN THE CENTER WHERE THE EDGES OF THE BOX MEET. THE BOX HAS A GLUE GUN COMING OUT OF IT WITH THE WORDS "HOT GLUE" WRITTEN ON IT AND DROPS OF GLUE COMING OUT OF THE GUN. IN THE UPPER RIGHT CORNER OF THE MARK IS A WAVY LINE WITH THE WORD "G MA" ABOVE IT.

FOR CUSTOM DESIGN OF BABY GIFTS BASED ON PERSONAL SELECTIONS MADE BY THE CUSTOMER (U.S. CLS. 100 AND 101).

JAMES LOVELACE, EXAMINING ATTORNEY

SN 86-043,801. EASTECH FLOW CONTROLS, INC., TULSA, OK. FILED 8-21-2013.

# I&I MAPPING

THE MARK CONSISTS OF STANDARD CHARACTERS WITHOUT CLAIM TO ANY PARTICULAR FONT, STYLE, SIZE, OR COLOR.

NO CLAIM IS MADE TO THE EXCLUSIVE RIGHT TO USE "MAPPING", APART FROM THE MARK AS SHOWN.

FOR DETECTION AND MEASUREMENT OF INFLOW AND INFILTRATION IN WASTEWATER COLLECTION SYSTEMS (U.S. CLS. 100 AND 101).

ANDREA HACK, EXAMINING ATTORNEY

SN 86-043,970. WHOISPLAYINGTONIGHT.COM, ROCHESTER, NY. FILED 8-21-2013.



SN 86-043,944. LEE CYNTHIA J, LANHAM, MD. FILED 8-21-2013.



THE NAME "CYNTHIA LEE" IDENTIFIES A LIVING INDIVIDUAL WHOSE CONSENT IS OF RECORD.

THE MARK CONSISTS OF A BOX WITH THE WORD "RELOADED." WRITTEN ON BOTH SIDES OF THE BOX.

THE MARK CONSISTS OF A STYLIZED THOUGHT CLOUD WITH A MUSICAL NOTE CONTAINED WITHIN. FOR PROVIDING A WEBSITE FEATURING A SEARCH ENGINE FOR LIVE MUSICAL PERFORMANCES (U.S. CLS. 100 AND 101).

EVIN L. KOZAK, EXAMINING ATTORNEY



**CLASS 42—(Continued).**

SN 86-044,282. NATIONAL ECZEMA ASSOCIATION FOR SCIENCE & EDUCATION, SAN RAFAEL, CA. FILED 8-21-2013.



OWNER OF U.S. REG. NOS. 3,503,882 AND 3,601,009.  
 NO CLAIM IS MADE TO THE EXCLUSIVE RIGHT TO USE "NATIONALECZEMA.ORG" AND "NATIONAL ECZEMA ASSOCIATION", APART FROM THE MARK AS SHOWN.  
 THE MARK CONSISTS OF A LOWER CASE LETTER "E" MADE OF DOTS, ENCIRCLED BY A RING THAT CONTAINS THE WORDS "ACCEPTED" AND "NATIONALECZEMA.ORG", BELOW WHICH IS A BOX CONTAINING THE WORDS "NATIONAL ECZEMA ASSOCIATION".  
 FOR ANALYSIS AND EVALUATION OF THE GOODS OF OTHERS FOR THE PURPOSE OF CERTIFICATION (U.S. CLS. 100 AND 101).  
 FIRST USE 1-25-2012; IN COMMERCE 1-25-2012.  
 SHAILA LEWIS, EXAMINING ATTORNEY

SN 86-044,454. OPENDOCTORS 247, INC., NEW YORK, NY. FILED 8-21-2013.

# openForms

THE MARK CONSISTS OF STANDARD CHARACTERS WITHOUT CLAIM TO ANY PARTICULAR FONT, STYLE, SIZE, OR COLOR.  
 OWNER OF U.S. REG. NOS. 4,026,014 AND 4,034,413.  
 FOR PROVIDING AN INTERNET WEBSITE PORTAL FEATURING AN ON-LINE NON-DOWNLOADABLE SOFTWARE INTERFACE THAT ALLOWS PATIENTS AND REFERRING PROVIDERS TO INTERACT AND COMMUNICATE WITH HEALTHCARE PROVIDERS, NAMELY, SOFTWARE FOR CAPTURING PATIENT INTAKE FORMS ELECTRONICALLY (U.S. CLS. 100 AND 101).  
 FIRST USE 8-14-2013; IN COMMERCE 8-14-2013.  
 JEFFERY COWARD, EXAMINING ATTORNEY

**CLASS 42—(Continued).**

SN 86-044,467. OPENDOCTORS 247, INC., NEW YORK, NY. FILED 8-21-2013.

# openPre-Auth

THE MARK CONSISTS OF STANDARD CHARACTERS WITHOUT CLAIM TO ANY PARTICULAR FONT, STYLE, SIZE, OR COLOR.  
 OWNER OF U.S. REG. NOS. 4,026,014 AND 4,034,413.  
 FOR PROVIDING AN INTERNET WEBSITE PORTAL FEATURING AN ON-LINE NON-DOWNLOADABLE SOFTWARE INTERFACE THAT ALLOWS PATIENTS AND REFERRING PROVIDERS TO INTERACT AND COMMUNICATE WITH HEALTHCARE PROVIDERS, NAMELY, SOFTWARE FOR DETERMINING ON-LINE APPOINTMENT AVAILABILITY BASED ON PRE-AUTHORIZATION REQUIREMENTS AND ELECTRONICALLY CAPTURING PRE-AUTHORIZATIONS (U.S. CLS. 100 AND 101).  
 FIRST USE 8-7-2013; IN COMMERCE 8-7-2013.  
 JEFFERY COWARD, EXAMINING ATTORNEY

SN 86-044,524. OPENDOCTORS 247, INC., NEW YORK, NY. FILED 8-21-2013.

# openOrders

THE MARK CONSISTS OF STANDARD CHARACTERS WITHOUT CLAIM TO ANY PARTICULAR FONT, STYLE, SIZE, OR COLOR.  
 OWNER OF U.S. REG. NOS. 4,026,014 AND 4,034,413.  
 FOR PROVIDING AN INTERNET WEBSITE PORTAL FEATURING AN ON-LINE NON-DOWNLOADABLE SOFTWARE INTERFACE THAT ALLOWS PATIENTS AND REFERRING PROVIDERS TO INTERACT AND COMMUNICATE WITH HEALTHCARE PROVIDERS, NAMELY, SOFTWARE FOR ALLOWING REFERRING PHYSICIANS TO ELECTRONICALLY ORDER AND SCHEDULE PATIENTS WITH PROVIDERS (U.S. CLS. 100 AND 101).  
 FIRST USE 8-7-2013; IN COMMERCE 8-7-2013.  
 JEFFERY COWARD, EXAMINING ATTORNEY

**CLASS 42—(Continued).**

SN 86-044,532. OPENDOCTORS 247, INC., NEW YORK, NY. FILED 8-21-2013.

openVerify

THE MARK CONSISTS OF STANDARD CHARACTERS WITHOUT CLAIM TO ANY PARTICULAR FONT, STYLE, SIZE, OR COLOR.

OWNER OF U.S. REG. NOS. 4,026,014 AND 4,034,413.  
FOR PROVIDING AN INTERNET WEBSITE PORTAL FEATURING AN ON-LINE NON-DOWNLOADABLE SOFTWARE INTERFACE THAT ALLOWS PATIENTS AND REFERRING PROVIDERS TO INTERACT AND COMMUNICATE WITH HEALTHCARE PROVIDERS, NAMELY, SOFTWARE FOR ELECTRONIC VERIFICATION OF INSURANCE ELIGIBILITY (U.S. CLS. 100 AND 101).

FIRST USE 8-20-2013; IN COMMERCE 8-20-2013.  
JEFFERY COWARD, EXAMINING ATTORNEY

**CLASS 42—(Continued).**

SN 86-045,248. INETXPERS CORPORATION, DBA GET REAL HEALTH, ROCKVILLE, MD. FILED 8-22-2013.



NO CLAIM IS MADE TO THE EXCLUSIVE RIGHT TO USE "PHR", APART FROM THE MARK AS SHOWN.

THE MARK CONSISTS OF A FLOWER-LIKE SYMBOL CONSISTING OF FOUR PETALS, EACH POINTING OUTWARD, AND EACH WITH AN OVAL ON THE INSIDE OF THE PETAL AND CREATING A DIAMOND IN THE MIDDLE OF THE FOUR OVALS. THE WORD "INSTANTPHR" APPEARS ADJACENT TO THE FLOWER PETALS.

FOR DEVELOPING COMPUTER SOFTWARE; SOFTWARE AS A SERVICE (SAAS) SERVICES FEATURING SOFTWARE FOR HEALTHCARE MANAGEMENT THAT ENABLES USERS TO ENTER, ACCESS, TRACK, MONITOR AND GENERATE HEALTH AND MEDICAL INFORMATION AND REPORTS (U.S. CLS. 100 AND 101).

FIRST USE 3-1-2011; IN COMMERCE 3-1-2011.  
COLLEEN KEARNEY, EXAMINING ATTORNEY

SN 86-044,538. OPENDOCTORS 247, INC., NEW YORK, NY. FILED 8-21-2013.

openReminders

THE MARK CONSISTS OF STANDARD CHARACTERS WITHOUT CLAIM TO ANY PARTICULAR FONT, STYLE, SIZE, OR COLOR.

OWNER OF U.S. REG. NOS. 4,026,014 AND 4,034,413.  
FOR PROVIDING AN INTERNET WEBSITE PORTAL FEATURING AN ON-LINE NON-DOWNLOADABLE SOFTWARE INTERFACE THAT ALLOWS PATIENTS AND REFERRING PROVIDERS TO INTERACT AND COMMUNICATE WITH HEALTHCARE PROVIDERS, NAMELY, SOFTWARE FOR PROVIDING PATIENT APPOINTMENT NOTIFICATIONS, CONFIRMATION REQUESTS, E-MAIL REMINDERS AND PROCEDURE INSTRUCTIONS (U.S. CLS. 100 AND 101).

FIRST USE 8-20-2013; IN COMMERCE 8-20-2013.  
JEFFERY COWARD, EXAMINING ATTORNEY

SN 86-045,362. OPENDOCTORS 247, INC., NEW YORK, NY. FILED 8-22-2013.

openPayments

THE MARK CONSISTS OF STANDARD CHARACTERS WITHOUT CLAIM TO ANY PARTICULAR FONT, STYLE, SIZE, OR COLOR.

OWNER OF U.S. REG. NOS. 4,026,014 AND 4,034,413.  
FOR PROVIDING AN INTERNET WEBSITE PORTAL FEATURING AN ON-LINE NON-DOWNLOADABLE SOFTWARE INTERFACE THAT ALLOWS PATIENTS AND REFERRING PROVIDERS TO INTERACT AND COMMUNICATE WITH HEALTHCARE PROVIDERS, NAMELY, SOFTWARE FOR INVOICING AND COLLECTION OF PATIENT BALANCES (U.S. CLS. 100 AND 101).

FIRST USE 8-21-2013; IN COMMERCE 8-21-2013.  
JEFFERY COWARD, EXAMINING ATTORNEY

**CLASS 42—(Continued).**

SN 86-045,413. TROY OZ INFORMATION SERVICES LLC, MADISON, SD. FILED 8-22-2013.



THE COLOR(S) GOLD AND BLACK IS/ARE CLAIMED AS A FEATURE OF THE MARK.

THE MARK CONSISTS OF THE WORDS, "TROY OZ", IN A STYLISTIC GOLD METALLIC FONT, WITH A STYLIZED GOLD CROWN DESIGN SET ATOP AND TILTED TO THE LEFT OF THE LETTER, "O", ALL ON A BLACK SQUARE BACKGROUND.

FOR CONSULTING SERVICES IN THE DESIGN AND IMPLEMENTATION OF COMPUTER-BASED INFORMATION SYSTEMS FOR BUSINESSES; CONSULTING SERVICES IN THE FIELD OF DESIGN, SELECTION, IMPLEMENTATION AND USE OF COMPUTER HARDWARE AND SOFTWARE SYSTEMS FOR OTHERS; IT CONSULTING SERVICES; PLANNING, DESIGN AND MANAGEMENT OF INFORMATION TECHNOLOGY SYSTEMS (U.S. CLS. 100 AND 101).

FIRST USE 3-29-2013; IN COMMERCE 3-29-2013.  
BERNICE MIDDLETON, EXAMINING ATTORNEY

SN 86-045,718. GOODSNITCH, LLC, WILMINGTON, DE. FILED 8-22-2013.

Express Feedback

NO CLAIM IS MADE TO THE EXCLUSIVE RIGHT TO USE "EXPRESS FEEDBACK", APART FROM THE MARK AS SHOWN.

THE MARK CONSISTS OF THE TERMS "EXPRESS" AND "FEEDBACK" HAVING A SEMICIRCLE UNDER THE DOUBLE "EE"'S WHICH ARE CONNECTED BY A LINE TO FORM A SMILEY FACE.

FOR PROVIDING ON-LINE NON-DOWNLOADABLE SOFTWARE FOR ALLOWING USERS TO PROVIDE RESPONSES AND COMMENTS TO A SERIES OF SURVEY AND FEEDBACK QUESTIONS ON GOODS AND SERVICES (U.S. CLS. 100 AND 101).

RENEE MCCRAY, EXAMINING ATTORNEY

**CLASS 42—(Continued).**

SN 86-047,912. TERZIAN, ALEXANDER, QUINCY, MA. FILED 8-26-2013.

Match My Nanny

THE MARK CONSISTS OF STANDARD CHARACTERS WITHOUT CLAIM TO ANY PARTICULAR FONT, STYLE, SIZE, OR COLOR.

NO CLAIM IS MADE TO THE EXCLUSIVE RIGHT TO USE "NANNY", APART FROM THE MARK AS SHOWN.

FOR PROVIDING ONLINE NON-DOWNLOADABLE SOFTWARE WHICH ALLOWS USERS TO MATCH CONSUMERS WITH PERSONAL CARE PROVIDERS BY SEARCHING AN ONLINE DATABASE (U.S. CLS. 100 AND 101).

COLLEEN KEARNEY, EXAMINING ATTORNEY

SN 86-048,125. WIGGINS, BILL, WINDSOR, CA. AND SCHISSLER, DAVID, WINDSOR, CA. FILED 8-26-2013.

FILE TEAM

THE MARK CONSISTS OF STANDARD CHARACTERS WITHOUT CLAIM TO ANY PARTICULAR FONT, STYLE, SIZE, OR COLOR.

NO CLAIM IS MADE TO THE EXCLUSIVE RIGHT TO USE "FILE", APART FROM THE MARK AS SHOWN.

FOR SOFTWARE AS A SERVICE FEATURING SOFTWARE FOR DIGITAL FILES MANAGEMENT AND DIGITAL DOCUMENTS MANAGEMENT (U.S. CLS. 100 AND 101).

FIRST USE 6-1-2013; IN COMMERCE 6-1-2013.  
AMY ALFIERI, EXAMINING ATTORNEY

SN 86-048,300. CONTROL-TEC LLC, ALLEN PARK, MI. FILED 8-26-2013.

QUALIFIER

THE MARK CONSISTS OF STANDARD CHARACTERS WITHOUT CLAIM TO ANY PARTICULAR FONT, STYLE, SIZE, OR COLOR.

FOR PROVIDING TEMPORARY USE OF A NON-DOWNLOADABLE WEB BASED APPLICATIONS FOR DISPLAYING, MANAGING AND ANALYZING VEHICLE DATA FOR THE PURPOSES OF ASSET MANAGEMENT, ROOT CAUSE ANALYSIS AND PROGNOSTICS (U.S. CLS. 100 AND 101).

FIRST USE 7-31-2009; IN COMMERCE 7-31-2009.  
JENNIFER MARTIN, EXAMINING ATTORNEY

**CLASS 42—(Continued).**

SN 86-049,085. MILES TECHNOLOGIES, INC., MOORESTOWN, NJ. FILED 8-27-2013.

**business**  
by *MILES*

OWNER OF U.S. REG. NOS. 3,034,754 AND 3,053,434.  
NO CLAIM IS MADE TO THE EXCLUSIVE RIGHT TO USE "BUSINESS", APART FROM THE MARK AS SHOWN.  
THE MARK CONSISTS OF THE STYLIZED TEXT "BUSINESS" WITH THE STYLIZED TEXT "BY MILES" BENEATH THAT AND TO THE RIGHT.

FOR SOFTWARE AS A SERVICE (SAAS) SERVICES FEATURING SOFTWARE FOR MANAGING BUSINESS OPERATIONS AND PROVIDING REPORTS ON OPERATIONAL PERFORMANCE (U.S. CLS. 100 AND 101).

FIRST USE 1-1-2013; IN COMMERCE 5-1-2013.  
BRENDAN MCCAULEY, EXAMINING ATTORNEY

---

SN 86-053,943. QUALITYTECH, LP, OVERLAND PARK, KS. FILED 9-3-2013.

QUALITY TECHNOLOGY SERVICES

THE MARK CONSISTS OF STANDARD CHARACTERS WITHOUT CLAIM TO ANY PARTICULAR FONT, STYLE, SIZE, OR COLOR.

OWNER OF U.S. REG. NO. 3,390,394.  
NO CLAIM IS MADE TO THE EXCLUSIVE RIGHT TO USE "TECHNOLOGY SERVICES", APART FROM THE MARK AS SHOWN.  
SEC. 2(F).

FOR COMPUTER CO-LOCATION SERVICES, NAMELY, PROVIDING FACILITIES FOR THE LOCATION OF COMPUTER SERVERS WITH THE EQUIPMENT OF OTHERS (U.S. CLS. 100 AND 101).

FIRST USE 9-1-2005; IN COMMERCE 9-1-2005.  
MATTHEW MCDOWELL, EXAMINING ATTORNEY

**CLASS 42—(Continued).**

SN 86-060,689. EXPENSEWATCH, INC., PLYMOUTH MEETING, PA. FILED 9-10-2013.



THE MARK CONSISTS OF A BENJAMIN FRANKLIN CARTOON IMAGE WHO IS WEARING PINCE-NEZ GLASSES. THE IMAGE HAS AN OVERSIZED HEAD RELATIVE TO A SMALLER, PORTLY BODY WITH A PUZZLE PIECE LOGO ON HIS LAPEL. HE IS HOLDING A KITE WITH RIBBONS ON THE TAIL AND AT THE END OF THE TAIL IS A KEY CONTAINING THE LETTERS "E" AND "W" ON THE BLADE OF THE KEY.

FOR PROVIDING ON-LINE NON-DOWNLOADABLE SOFTWARE PROGRAMS TO PROVIDE AUTOMATION, VISIBILITY, AND CONTROL OF COMPANY SPENDING PROCESSES BY ENABLING USERS TO CREATE, REVIEW, APPROVE, CATEGORIZE AND ANALYZE SPEND TRANSACTIONS INCLUDING EXPENSE REPORTS, PURCHASE REQUISITIONS AND PAYABLE INVOICES (U.S. CLS. 100 AND 101).

SUSAN RICHARDS, EXAMINING ATTORNEY

---

SN 86-061,125. COCO DEVELOPMENT, LLC, OMAHA, NE. FILED 9-10-2013.

EXCHANGEPOINT

THE MARK CONSISTS OF STANDARD CHARACTERS WITHOUT CLAIM TO ANY PARTICULAR FONT, STYLE, SIZE, OR COLOR.

FOR PROVIDING ON-LINE NON-DOWNLOADABLE SOFTWARE FOR USE IN THE PAYMENT AND COLLECTION OF HEALTH INSURANCE PREMIUMS FOR HEALTH PLANS AND STATE AND FEDERALLY-BASED HEALTH INSURANCE MARKETPLACES AND EXCHANGES (U.S. CLS. 100 AND 101).

AMY ALFIERI, EXAMINING ATTORNEY

**CLASS 42—(Continued).**

SN 86-061,975. DEVELOPMENTAL TEACHING, LLC., BEVERLY, MA. FILED 9-11-2013.

# TAPCIN

THE MARK CONSISTS OF STANDARD CHARACTERS WITHOUT CLAIM TO ANY PARTICULAR FONT, STYLE, SIZE, OR COLOR.

FOR PROVIDING A WEBSITE FEATURING NON-DOWNLOADABLE SOFTWARE FOR CREATING, ORGANIZING, MANAGING AND EXCHANGING TEACHER LESSON PLANS AND PLAN BOOKS (U.S. CLS. 100 AND 101).

FIRST USE 9-1-2013; IN COMMERCE 9-1-2013.  
DAWN HAN, EXAMINING ATTORNEY

**CLASS 42—(Continued).**

SN 86-061,981. ASSOCIATION OF CERTIFIED ANTI-MONEY LAUNDERING SPECIALISTS, LLC, MIAMI, FL. FILED 9-11-2013.

**ACAMS RISK ASSESSMENT**

THE MARK CONSISTS OF STANDARD CHARACTERS WITHOUT CLAIM TO ANY PARTICULAR FONT, STYLE, SIZE, OR COLOR.

OWNER OF U.S. REG. NOS. 2,757,124, 3,417,489 AND OTHERS.

NO CLAIM IS MADE TO THE EXCLUSIVE RIGHT TO USE "RISK ASSESSMENT", APART FROM THE MARK AS SHOWN.

FOR SOFTWARE AS A SERVICE (SAAS) SERVICES FEATURING SOFTWARE FOR RISK PROFILING OF MONEY LAUNDERING AND OTHER FINANCIAL CRIMES OF A FINANCIAL INSTITUTION'S PRODUCTS AND SERVICES, HIGH RISK JURISDICTIONS, AND HIGH RISK CUSTOMER TYPES AND ENTITIES (U.S. CLS. 100 AND 101).

SUSAN RICHARDS, EXAMINING ATTORNEY

SN 86-062,343. KIVUN HADASH SOFTWARE S.R. LTD., AKA CURIYO, JERUSALEM, ISRAEL, FILED 9-12-2013.

# CURIYO

THE MARK CONSISTS OF STANDARD CHARACTERS WITHOUT CLAIM TO ANY PARTICULAR FONT, STYLE, SIZE, OR COLOR.

FOR COMPUTER SERVICES, NAMELY, PROVIDING SEARCH ENGINES FOR OBTAINING DATA ON A GLOBAL COMPUTER NETWORK; COMPUTER SERVICES, NAMELY, PROVIDING SEARCH PLATFORMS TO ALLOW USERS TO RETRIEVE CONTENT RELATED TO TERMS ON A WEB PAGE (U.S. CLS. 100 AND 101).

FIRST USE 2-1-2013; IN COMMERCE 2-1-2013.  
STEVEN R. FINE, EXAMINING ATTORNEY

SN 86-061,978. ASSOCIATION OF CERTIFIED ANTI-MONEY LAUNDERING SPECIALISTS, LLC, MIAMI, FL. FILED 9-11-2013.

ACAMS RISK ASSESSMENT  
MEASURING, UNDERSTANDING,  
AND EXPLAINING AML RISK

SN 86-062,546. PACERRABBIT INC., PIEDMONT, CA. FILED 9-12-2013.

# NextLesson

THE MARK CONSISTS OF STANDARD CHARACTERS WITHOUT CLAIM TO ANY PARTICULAR FONT, STYLE, SIZE, OR COLOR.

OWNER OF U.S. REG. NOS. 2,757,124, 3,417,489 AND OTHERS.

NO CLAIM IS MADE TO THE EXCLUSIVE RIGHT TO USE "RISK ASSESSMENT", APART FROM THE MARK AS SHOWN.

FOR SOFTWARE AS A SERVICE (SAAS) SERVICES FEATURING SOFTWARE FOR RISK PROFILING OF MONEY LAUNDERING AND OTHER FINANCIAL CRIMES OF A FINANCIAL INSTITUTION'S PRODUCTS AND SERVICES, HIGH RISK JURISDICTIONS, AND HIGH RISK CUSTOMER TYPES AND ENTITIES (U.S. CLS. 100 AND 101).

SUSAN RICHARDS, EXAMINING ATTORNEY

THE MARK CONSISTS OF STANDARD CHARACTERS WITHOUT CLAIM TO ANY PARTICULAR FONT, STYLE, SIZE, OR COLOR.

FOR COMPUTER SERVICES, NAMELY, CREATING AN ON-LINE COMMUNITY FOR REGISTERED USERS TO PUBLISH, BUY AND SELL CONTENT, GET FEEDBACK FROM PEERS, FORM VIRTUAL COMMUNITIES, ENGAGE IN SOCIAL NETWORKING (U.S. CLS. 100 AND 101).

FIRST USE 7-30-2013; IN COMMERCE 7-31-2013.  
RUDY R. SINGLETON, EXAMINING ATTORNEY

**CLASS 42—(Continued).**

SN 86-062,692. ILДАР BOLTUNOV, MOUNTAIN VIEW, CA. FILED 9-12-2013.

# BioDigitalMe

THE MARK CONSISTS OF STANDARD CHARACTERS WITHOUT CLAIM TO ANY PARTICULAR FONT, STYLE, SIZE, OR COLOR.

FOR SOFTWARE AS A SERVICE (SAAS) SERVICES FEATURING SOFTWARE FOR PATIENT MEDICAL DATA FOR THE PURPOSE OF CREATING A PERSONALIZED MODEL OF A PATIENT (U.S. CLS. 100 AND 101).

CHRISTOPHER BUONGIORNO, EXAMINING ATTORNEY

**CLASS 42—(Continued).**

SN 86-063,974. MEDNOVUS, INC., LEUCADIA, CA. FILED 9-13-2013.

Our commitment to  
excellence is as serious  
as yours.

THE MARK CONSISTS OF STANDARD CHARACTERS WITHOUT CLAIM TO ANY PARTICULAR FONT, STYLE, SIZE, OR COLOR.

FOR TECHNICAL CONSULTANCY IN THE FIELD OF TECHNICAL RESEARCH OF FERROMAGNETIC DETECTORS FOR MRI SAFETY; CUSTOM DESIGN OF FERROMAGNETIC DETECTORS FOR MRI SAFETY (U.S. CLS. 100 AND 101).

FIRST USE 7-23-2013; IN COMMERCE 7-23-2013.  
BERYL GARDNER, EXAMINING ATTORNEY

SN 86-063,194. OPTIMALRESUME.COM, INC., DURHAM, NC. FILED 9-12-2013.

# THINKOPTIMAL

THE MARK CONSISTS OF STANDARD CHARACTERS WITHOUT CLAIM TO ANY PARTICULAR FONT, STYLE, SIZE, OR COLOR.

FOR PROVIDING TEMPORARY USE OF ON-LINE NON-DOWNLOADABLE SOFTWARE FOR UPLOADING, STORING, AND MANIPULATING RESUMES AND OTHER EMPLOYMENT RELATED MATERIALS, AND ACCESSING MATERIALS RELATED TO INTERVIEW SKILLS (U.S. CLS. 100 AND 101).

JENNIFER WILLISTON, EXAMINING ATTORNEY

SN 86-064,198. HACKSURFER, LLC, GLENELG, MD. FILED 9-13-2013.

# CYBERFACT

THE MARK CONSISTS OF STANDARD CHARACTERS WITHOUT CLAIM TO ANY PARTICULAR FONT, STYLE, SIZE, OR COLOR.

FOR PROVIDING A WEBSITE FEATURING INFORMATION IN THE FIELDS OF COMPUTER SECURITY, CYBER-SECURITY AND INTRUSION PROTECTION, INCLUDING DATA AND STATISTICS; PROVIDING A WEBSITE THAT GIVES USERS THE ABILITY TO CREATE AND PUBLISH INFORMATION, NAMELY, WRITING, PHOTOS AND VIDEOS, IN THE FIELDS OF COMPUTER SECURITY, CYBER-SECURITY AND INTRUSION PROTECTION (U.S. CLS. 100 AND 101).

BARBARA RUTLAND, EXAMINING ATTORNEY

SN 86-063,888. MILLER FELPAX CORPORATION, WIIONA, MN. FILED 9-13-2013.

# MILLER INGENUITY

THE MARK CONSISTS OF STANDARD CHARACTERS WITHOUT CLAIM TO ANY PARTICULAR FONT, STYLE, SIZE, OR COLOR.

FOR ENGINEERING SERVICES IN THE FIELDS OF TRAFFIC AND TRANSPORTATION (U.S. CLS. 100 AND 101).

SOPHIA S. KIM, EXAMINING ATTORNEY

SN 86-064,221. UNIVERSAL SYSTEMS LTD., DBA CARIS, FREDERICTON, NB, CANADA, FILED 9-13-2013.

# SIPS

THE MARK CONSISTS OF STANDARD CHARACTERS WITHOUT CLAIM TO ANY PARTICULAR FONT, STYLE, SIZE, OR COLOR.

FOR MARINE CHART UPDATING; MARINE, AERIAL AND LAND SURVEYING; SURVEYING AND ENGINEERING (U.S. CLS. 100 AND 101).

FIRST USE 12-31-1994; IN COMMERCE 12-31-1994.  
EVELYN BRADLEY, EXAMINING ATTORNEY

**CLASS 42—(Continued).**

SN 86-064,887. CICCONE, THOMAS, ALISO VIEJO, CA. FILED 9-14-2013.



THE COLOR(S) ORANGE IS/ARE CLAIMED AS A FEATURE OF THE MARK.

THE MARK CONSISTS OF THE LOWERCASE LETTER "P" IN SOLID ORANGE COLOR.

FOR COMPUTER GRAPHICS DESIGN SERVICES; COMPUTER SERVICES, NAMELY, CREATING, MAINTAINING, DESIGNING AND IMPLEMENTING WEB SITES FOR OTHERS; CREATING AND DESIGNING WEB PAGES FOR OTHERS; DESIGN, DEVELOPMENT, AND CONSULTING SERVICES RELATED THERETO IN THE FIELD OF GRAPHIC ARTS; GRAPHIC DESIGN SERVICES (U.S. CLS. 100 AND 101).

FIRST USE 9-8-2006; IN COMMERCE 9-8-2006.  
KATHERINE M. DUBRAY, EXAMINING ATTORNEY

**CLASS 42—(Continued).**

SN 86-065,089. PLETCHER, ADAM Q, GENOA CITY, WI. FILED 9-15-2013.



THE COLOR(S) RED, GREEN IS/ARE CLAIMED AS A FEATURE OF THE MARK.

THE MARK CONSISTS OF A GREEN UPPER CASE LETTER "T" WITH THE LOWER CASE LETTERS "AKE" WITHIN THE TOP RIGHT OF IT, FOLLOWED BY A GREEN THUMBS UP GRAPHIC HOLDING A GREEN LOWER CASE LETTER "T", FOLLOWED BY A GREEN LOWER CASE LETTER "T", FOLLOWED BY A GREEN LOWER CASE LETTER "O" HALF GREEN AND HALF RED IN COLOR WITH A GREEN LOWER CASE LETTER "R" WITHIN THE LOWER RIGHT PORTION OF IT, FOLLOWED BY A RED UPPER-CASE LETTER "L" WITH THE LOWER CASE LETTERS "EAVE" WITHIN THE LOWER PORTION OF IT, FOLLOWED BY A RED THUMBS DOWN GRAPHIC HOLDING A RED LOWER CASE LETTER "T", FOLLOWED BY A RED LOWER CASE LETTER "T".

FOR PROVIDING A WEBSITE THAT GIVES USERS THE ABILITY TO REVIEW VARIOUS PRINT, PHOTOGRAPHIC, GRAPHIC IMAGE, AND AUDIO AND VIDEO CONTENT AND UTILIZE A CUSTOM TEMPLATE TO PROVIDE INPUT, LIKES, DISLIKES, EDITS, CHANGES, MODIFICATIONS, OPINIONS, SUGGESTIONS, AND COMMENTS AND ENGAGE IN SOCIAL, BUSINESS AND COMMUNITY NETWORKING (U.S. CLS. 100 AND 101).

FIRST USE 8-26-2013; IN COMMERCE 9-10-2013.  
TRACY CROSS, EXAMINING ATTORNEY

SN 86-064,995. NEXUS VESTING GROUP, LLC, PLACENTIA, CA. FILED 9-15-2013.



OWNER OF U.S. REG. NO. 8,606,498.  
THE COLOR(S) BLUE, RED, AND GRAY IS/ARE CLAIMED AS A FEATURE OF THE MARK.

THE MARK CONSISTS OF THE WORDING "SEVA.ME", WHEREIN "SEVA" AND "ME" ARE IN BLUE AND THE "." IS IN RED; THE WORDING "BELIEVE IN YOU" IN GRAY; AND A GRAPHICAL REPRESENTATION OF A POWER SYMBOL TO THE LEFT OF THE LITERAL ELEMENTS, WHEREIN THE LOWER PORTION IS GRAY, THE MIDDLE PORTION IS BLUE, AND THE TOP PORTION IS RED.

FOR COMPUTER TECHNICAL SUPPORT SERVICES, NAMELY, 24/7 SERVICE DESK OR HELP DESK SERVICES FOR IT INFRASTRUCTURE, OPERATING SYSTEMS, DATABASE SYSTEMS, AND WEB APPLICATIONS (U.S. CLS. 100 AND 101).

FIRST USE 3-1-2012; IN COMMERCE 9-1-2013.  
KAELIE KUNG, EXAMINING ATTORNEY

SN 86-065,334. PEERHOOK LLC, NEWINGTON, CT. FILED 9-16-2013.



THE MARK CONSISTS OF THE TEXT "SPANGLE" OVER A GRAPHICAL REPRESENTATION OF A BOUNCING BALL THAT HAS STRUCK AND SLIGHTLY LIFTED THE "G" IN "SPANGLE".

FOR PROVIDING A WEBSITE FEATURING NON-DOWNLOADABLE SOFTWARE FOR SOCIAL NETWORKING AND INFORMATION SHARING; PROVIDING TEMPORARY USE OF A NON-DOWNLOADABLE WEB APPLICATION FOR SOCIAL NETWORKING AND INFORMATION SHARING; PROVIDING TEMPORARY USE OF ON-LINE NON-DOWNLOADABLE SOFTWARE AND APPLICATIONS FOR SOCIAL NETWORKING AND INFORMATION SHARING; SOFTWARE AS A SERVICE (SAAS) SERVICES FEATURING SOFTWARE FOR SOCIAL NETWORKING AND INFORMATION SHARING (U.S. CLS. 100 AND 101).

VERNA BETH RIRIE, EXAMINING ATTORNEY

**CLASS 42—(Continued).**

SN 86-065,474. AEOLIDIA, LLC, SEATTLE, WA. FILED 9-16-2013.

# AEOLIDIA

THE MARK CONSISTS OF STANDARD CHARACTERS WITHOUT CLAIM TO ANY PARTICULAR FONT, STYLE, SIZE, OR COLOR.

FOR COMPUTER WEBSITE DESIGN AND DEVELOPMENT; WEBSITE PUBLISHING, NAMELY CREATING A WEBSITE AND UPLOADING IT ONTO THE INTERNET SERVER; WEBSITE DESIGN CONSULTANCY; COMPUTER AIDED GRAPHIC DESIGN; GRAPHIC DESIGN SERVICES (U.S. CLS. 100 AND 101).

FIRST USE 8-12-2003; IN COMMERCE 8-12-2003.  
JONATHAN FALK, EXAMINING ATTORNEY

**CLASS 42—(Continued).**

SN 86-065,756. KNOWNHOST, LLC, WEST CHESTER, PA. FILED 9-16-2013.

# KnownHost

THE MARK CONSISTS OF STANDARD CHARACTERS WITHOUT CLAIM TO ANY PARTICULAR FONT, STYLE, SIZE, OR COLOR.

FOR COMPUTER SERVICES, NAMELY, MANAGING WEB SITES FOR OTHERS; DESIGN, CREATION, HOSTING, MAINTENANCE OF WEBSITES FOR OTHERS; HOSTING OF DIGITAL CONTENT ON THE INTERNET; INTERNET-BASED APPLICATION SERVICE PROVIDER, NAMELY, HOSTING, MANAGING, DEVELOPING, ANALYZING, AND MAINTAINING THE CODE, APPLICATIONS, AND SOFTWARE FOR WEB SITES OF OTHERS (U.S. CLS. 100 AND 101).

FIRST USE 3-4-2006; IN COMMERCE 3-4-2006.  
JOHN GARTNER, EXAMINING ATTORNEY

SN 86-065,479. SKILLNADO CORPORATION, NEW YORK, NY. FILED 9-16-2013.

# SKILLNADO

THE MARK CONSISTS OF STANDARD CHARACTERS WITHOUT CLAIM TO ANY PARTICULAR FONT, STYLE, SIZE, OR COLOR.

FOR COMPUTER SERVICES, NAMELY, CREATING AN ON-LINE COMMUNITY FOR REGISTERED USERS TO PARTICIPATE IN DISCUSSIONS, GET FEEDBACK FROM THEIR PEERS, FORM VIRTUAL COMMUNITIES, AND ENGAGE IN SOCIAL NETWORKING SERVICES IN THE FIELD OF BUSINESS DEVELOPMENT; PROVIDING A WEB SITE FEATURING TEMPORARY USE OF NON-DOWNLOADABLE SOFTWARE FOR BUSINESS DEVELOPMENT; PROVIDING AN ONLINE NETWORK SERVICE THAT ENABLES USERS TO SHARE DATA IN THE FIELD OF BUSINESS DEVELOPMENT AND PERSONAL DEVELOPMENT; PROVIDING TEMPORARY USE OF ON-LINE NON-DOWNLOADABLE SOFTWARE AND APPLICATIONS FOR BUSINESS DEVELOPMENT; RESEARCH AND DEVELOPMENT AND CONSULTATION RELATED THERETO IN THE FIELD OF BUSINESS DEVELOPMENT (U.S. CLS. 100 AND 101).

CHARLES L. JENKINS, EXAMINING ATTORNEY

SN 86-066,076. CRAMMINOLOGY LLC, WAYNE, NJ. FILED 9-16-2013.



THE MARK CONSISTS OF A BOOK WITH GLASSES AND EYES, WITH A BOOKMARK HANGING DOWN THAT RESEMBLES A TIE.

FOR PLATFORM AS A SERVICE (PAAS) FEATURING COMPUTER SOFTWARE PLATFORMS FOR TEST PREPARATION (U.S. CLS. 100 AND 101).

ROSELLE HERRERA, EXAMINING ATTORNEY



**CLASS 42—(Continued).**

SN 86-066,077. UNIVERSITY OF FASHION, INC., PORTOLA VALLEY, CA. FILED 9-16-2013.

## University of Fashion

THE MARK CONSISTS OF STANDARD CHARACTERS WITHOUT CLAIM TO ANY PARTICULAR FONT, STYLE, SIZE, OR COLOR.

OWNER OF U.S. REG. NO. 4,159,376.  
SEC. 2(F).

FOR PROVIDING A WEBSITE FEATURING NON-DOWNLOADABLE INSTRUCTIONAL VIDEOS IN THE FIELD OF FASHION DESIGN (U.S. CLS. 100 AND 101).

FIRST USE 5-8-2008; IN COMMERCE 5-8-2008.  
ROSELLE HERRERA, EXAMINING ATTORNEY

**CLASS 42—(Continued).**

SN 86-066,481. GOALSHARE, LLC, AUSTIN, TX. FILED 9-17-2013.

## GOALSHARE

SN 86-066,081. CRAMMINOLOGY LLC, WAYNE, NJ. FILED 9-16-2013.

## CRAMMINOLOGY

THE MARK CONSISTS OF STANDARD CHARACTERS WITHOUT CLAIM TO ANY PARTICULAR FONT, STYLE, SIZE, OR COLOR.

FOR PLATFORM AS A SERVICE (PAAS) FEATURING COMPUTER SOFTWARE PLATFORMS FOR TEST PREPARATION (U.S. CLS. 100 AND 101).

ROSELLE HERRERA, EXAMINING ATTORNEY

SN 86-066,398. ANDY MAPPLE, WINTER GARDEN, FL. FILED 9-17-2013.



THE MARK CONSISTS OF ZIG ZAG LINES.  
FOR PRODUCT RESEARCH AND DEVELOPMENT AND CONSULTATION RELATED THERETO IN FIELD OF WATER SKIS, PARTS AND FITTING THEREFORE; PROVIDING A WEB SITE THE ENABLES USERS TO SUBSCRIBE TO COACHING, MENTORING AND/OR EDUCATIONAL SERVICES RELATING TO WATER SKIING (U.S. CLS. 100 AND 101).

FIRST USE 10-30-2011; IN COMMERCE 10-30-2011.  
LINDA POWELL, EXAMINING ATTORNEY

THE MARK CONSISTS OF STANDARD CHARACTERS WITHOUT CLAIM TO ANY PARTICULAR FONT, STYLE, SIZE, OR COLOR.

FOR COMPUTER SERVICES, NAMELY, CREATING AN ONLINE COMMUNITY AND HOSTING AN ONLINE COMMUNITY WEBSITE FOR REGISTERED USERS TO PARTICIPATE IN DISCUSSIONS, GET FEEDBACK FROM THEIR PEERS, FORM VIRTUAL COMMUNITIES, CUSTOMIZE PERSONAL AND TEAM FITNESS PROFILES, PREPARE AN ONLINE GOAL CALENDAR, COMPLETE GOAL ASSESSMENTS AND EVALUATIONS, AND ENGAGE IN SOCIAL NETWORKING IN THE FIELDS OF PERSONAL DEVELOPMENT AND GOAL SETTING AND ACHIEVEMENT; PROVIDING ONLINE NON-DOWNLOADABLE PERSONAL DEVELOPMENT APPLICATION SOFTWARE FOR MANAGING AND LISTING GOALS, TRACKING PROGRESS, MOTIVATING AND PROVIDING ACCOUNTABILITY BY ANALYZING DATA AND GENERATING REPORTS VIA USER-DEFINED INFORMATION; APPLICATION SERVICE PROVIDER (ASP) FEATURING SOFTWARE TO ENABLE UPLOADING, POSTING, SHOWING, DISPLAYING, TAGGING, BLOGGING, SHARING OR OTHERWISE PROVIDING ELECTRONIC MEDIA OR INFORMATION OVER THE INTERNET OR OTHER COMMUNICATIONS NETWORK; COMPUTER SERVICES IN THE NATURE OF CUSTOMIZED WEB PAGES FEATURING USER-DEFINED INFORMATION, PERSONAL PROFILES AND INFORMATION; PROVIDING TEMPORARY USE OF NON-DOWNLOADABLE SOFTWARE APPLICATIONS FOR CLASSIFIEDS, VIRTUAL COMMUNITY, SOCIAL NETWORKING, PHOTO SHARING, VIDEO SHARING, CALENDARING, CALENDAR SHARING, AND TRANSMISSION OF PHOTOGRAPHIC IMAGES; PROVIDING A WEB SITE OVER THE INTERNET OR ELECTRONIC COMMUNICATIONS NETWORKS THAT GIVES COMPUTER USERS THE ABILITY TO UPLOAD, POST, SHOW, DISPLAY AND TAG VIDEO CLIPS; PROVIDING ON-LINE COMPUTER DATABASES AND ON-LINE SEARCHABLE DATABASES IN THE FIELD OF VIRTUAL COMMUNITY (U.S. CLS. 100 AND 101).

KYLE PEETE, EXAMINING ATTORNEY

**CLASS 42—(Continued).**

SN 86-066,526. MODERNIZING MEDICINE, INC., BOCA RATON, FL. FILED 9-17-2013.

# MODMED

THE MARK CONSISTS OF STANDARD CHARACTERS WITHOUT CLAIM TO ANY PARTICULAR FONT, STYLE, SIZE, OR COLOR.

FOR DATA SERVICES, NAMELY, ACTING AS AN APPLICATION SERVICE PROVIDER IN THE FIELD OF ELECTRONIC MEDICAL RECORDS / ELECTRONIC HEALTH RECORDS TO HOST COMPUTER APPLICATION SOFTWARE FOR THE COLLECTION, EDITING, ORGANIZING, MODIFYING, TRANSMISSION, STORAGE AND SHARING OF DATA; PROVIDING COMPUTER SOFTWARE SOLUTIONS, NAMELY, DESIGN AND DEVELOPMENT OF COMPUTER SOFTWARE AND ONLINE COMPUTER SOFTWARE SYSTEMS FOR HEALTHCARE AND MEDICAL ORGANIZATIONS AND PROVIDERS; COLLECTING, ANALYZING, AND DISTRIBUTING TO OTHERS DATA IN THE HEALTHCARE AND MEDICAL FIELDS; SOFTWARE AS A SERVICE (SAAS) SERVICES FEATURING SOFTWARE FOR PATIENT RECORDS AND BILLING, SCHEDULING, MEDICAL DECISION MAKING, CREATING PATIENT TREATMENT SCHEDULES, DATA PORTAL AND ORDERING AND MANAGING PRESCRIPTIONS AND TESTS, FOR USE BY HEALTHCARE AND MEDICAL ORGANIZATIONS AND PROVIDERS (U.S. CLS. 100 AND 101).

MORGAN WYNNE, EXAMINING ATTORNEY

SN 86-066,676. SOCKETLABS, INC., CLAYMONT, DE. FILED 9-17-2013.

# SOCKETLABS

THE MARK CONSISTS OF STANDARD CHARACTERS WITHOUT CLAIM TO ANY PARTICULAR FONT, STYLE, SIZE, OR COLOR.

OWNER OF U.S. REG. NO. 3,488,378.

FOR SOFTWARE AS A SERVICE, FEATURING SOFTWARE FOR USE IN DEVELOPMENT, PROCESSING, ANALYSIS, TRANSMISSION AND MANAGEMENT OF ELECTRONIC MAIL AND MESSAGES (U.S. CLS. 100 AND 101).

FIRST USE 8-28-2009; IN COMMERCE 8-28-2009.

NANCY CLARKE, EXAMINING ATTORNEY

**CLASS 42—(Continued).**

SN 86-066,728. GENERATION-I CONSULTING LLC, BALLWIN, MO. FILED 9-17-2013.

# RESPONSEBOOK

THE MARK CONSISTS OF STANDARD CHARACTERS WITHOUT CLAIM TO ANY PARTICULAR FONT, STYLE, SIZE, OR COLOR.

FOR SOFTWARE AS A SERVICE (SAAS) SERVICES FEATURING SOFTWARE FOR CREATING AND DISTRIBUTING CUSTOMER FEEDBACK SURVEYS, TRACKING AND COMPILING SURVEY RESULTS, AND GENERATING, USING, AND SHARING REPORTS BASED ON SURVEY RESULTS AND USER-DEFINED CRITERIA (U.S. CLS. 100 AND 101).

TINA BROWN, EXAMINING ATTORNEY

SN 86-066,733. GENERATION-I CONSULTING LLC, BALLWIN, MO. FILED 9-17-2013.

# JUST ONE QUESTION

THE MARK CONSISTS OF STANDARD CHARACTERS WITHOUT CLAIM TO ANY PARTICULAR FONT, STYLE, SIZE, OR COLOR.

FOR SOFTWARE AS A SERVICE (SAAS) SERVICES FEATURING SOFTWARE FOR CREATING AND DISTRIBUTING CUSTOMER FEEDBACK SURVEYS, TRACKING AND COMPILING SURVEY RESULTS, AND GENERATING, USING, AND SHARING REPORTS BASED ON SURVEY RESULTS AND USER-DEFINED CRITERIA (U.S. CLS. 100 AND 101).

TINA BROWN, EXAMINING ATTORNEY

SN 86-066,755. SOLVE FIRM LLC, DUBLIN, OH. FILED 9-17-2013.

# solve board

THE MARK CONSISTS OF THE WORD "SOLVE" ON THE TOP LINE AND THE WORD "BOARD" ON THE BOTTOM LINE. BOTH STYLIZED VERSIONS OF THE WORDS.

FOR PROVIDING TEMPORARY SUBSCRIPTION BASED USE OF A WEB BASED SOFTWARE APPLICATION FOR ORGANIZING, SHARING, AND PRESENTING INFORMATION AND DATA ONLINE (U.S. CLS. 100 AND 101).

MELISSA VALLILLO, EXAMINING ATTORNEY

**CLASS 42—(Continued).**

SN 86-066,893. BRAINPOP IP LLC, NEW YORK, NY. FILED 9-17-2013.

# SNAPTHOUGHT

THE MARK CONSISTS OF STANDARD CHARACTERS WITHOUT CLAIM TO ANY PARTICULAR FONT, STYLE, SIZE, OR COLOR.

FOR PROVIDING TEMPORARY USE OF ON-LINE NON-DOWNLOADABLE SOFTWARE FOR STORING, MANAGING, TRACKING, ANALYZING, AND REPORTING DATA IN THE FIELD OF PERSONALIZED EDUCATION; PROVIDING TEMPORARY USE OF ON-LINE NON-DOWNLOADABLE SOFTWARE FOR ENABLING USERS TO TAKE, UPLOAD, VIEW, TRANSMIT, EXCHANGE, SHARE AND DOWNLOAD DIGITAL PHOTOS, SCREENSHOTS, AND STUDENT-RELATED DATA FOR THE PURPOSE OF ACCESSING, MONITORING AND ANALYZING STUDENT ACTIVITY, PERFORMANCE AND PROGRESS; COMPUTER SERVICES, NAMELY, PROVIDING AN INTERACTIVE WEBSITE FEATURING TECHNOLOGY THAT ALLOWS USERS TO MANAGE, MONITOR AND ANALYZE STUDENT ACTIVITY, PERFORMANCE AND PROGRESS (U.S. CLS. 100 AND 101).

JOHN SCHUYLER YARD, EXAMINING ATTORNEY

---

SN 86-066,908. SOL VOLTAICS AB, LUND, SWEDEN, FILED 9-17-2013.

# AEROTAXY

THE MARK CONSISTS OF STANDARD CHARACTERS WITHOUT CLAIM TO ANY PARTICULAR FONT, STYLE, SIZE, OR COLOR.

FOR NEW TECHNOLOGY DEVELOPMENT FOR OTHERS IN THE FIELDS OF SEMICONDUCTOR MANUFACTURING, NANOTECHNOLOGY, NANOSCIENCES AND ADVANCED MATERIALS (U.S. CLS. 100 AND 101).

TRACY CROSS, EXAMINING ATTORNEY

**CLASS 42—(Continued).**

SN 86-066,920. DECISION INSIGHT INFORMATION GROUP S.A.R.L., LUXEMBOURG, LUXEMBOURG, FILED 9-17-2013.

# AERIALASSIST

THE MARK CONSISTS OF STANDARD CHARACTERS WITHOUT CLAIM TO ANY PARTICULAR FONT, STYLE, SIZE, OR COLOR.

FOR PROVIDING TEMPORARY USE OF ON-LINE NON-DOWNLOADABLE SOFTWARE AND APPLICATIONS FOR THE VIEWING OF REAL PROPERTY IMAGES AND THE VISUAL ASSESSMENT AND EVALUATION OF INSURANCE RISK POTENTIAL ASSOCIATED WITH THE REAL PROPERTY (U.S. CLS. 100 AND 101).

TRACY CROSS, EXAMINING ATTORNEY

---

SN 86-067,000. MEDICAL DIAGNOSTIC LABORATORIES, LLC, HAMILTON, NJ. FILED 9-17-2013.

# Hepnestic

THE MARK CONSISTS OF STANDARD CHARACTERS WITHOUT CLAIM TO ANY PARTICULAR FONT, STYLE, SIZE, OR COLOR.

FOR RESEARCH AND DEVELOPMENT IN THE FIELD OF PHARMACEUTICAL AND BIOTECHNOLOGY. FOR EXAMPLE, LIVER FUNCTION AND PATHOLOGY IN HUMANS (U.S. CLS. 100 AND 101).

ANN E. SAPPENFIELD, EXAMINING ATTORNEY

---

SN 86-067,333. HOLGUIN, DOUGLAS, QUEENS JACKSON HEIGHTS, NY. FILED 9-17-2013.

# geeksecuador

THE MARK CONSISTS OF STANDARD CHARACTERS WITHOUT CLAIM TO ANY PARTICULAR FONT, STYLE, SIZE, OR COLOR.

FOR PROVIDING A WEBSITE FEATURING TECHNICAL INFORMATION AND NEWS IN THE FIELD OF TECHNOLOGY (U.S. CLS. 100 AND 101).

FIRST USE 3-9-2013; IN COMMERCE 3-9-2013.

REBECCA POVARCHUK, EXAMINING ATTORNEY

**CLASS 42—(Continued).**

SN 86-067,457. VERNON L. PORTER, JR., TAHOE VISTA, CA. FILED 9-17-2013.

**RESERVESOFT**

THE MARK CONSISTS OF STANDARD CHARACTERS WITHOUT CLAIM TO ANY PARTICULAR FONT, STYLE, SIZE, OR COLOR.

OWNER OF U.S. REG. NO. 3,298,051.

FOR PROVIDING TEMPORARY USE OF A NON-DOWNLOADABLE WEB APPLICATION FOR FINANCIAL STUDIES OF CONDOMINIUM AND HOMEOWNER ASSOCIATIONS TO ENSURE THAT ADEQUATE FUNDS ARE AVAILABLE FOR THE REPLACEMENT OR MAINTENANCE OF MAJOR COMPONENTS IN COMMON INTEREST DEVELOPMENTS; PROVIDING TEMPORARY USE OF ON-LINE NON-DOWNLOADABLE SOFTWARE AND APPLICATIONS FOR FINANCIAL STUDIES OF CONDOMINIUM AND HOMEOWNER ASSOCIATIONS TO ENSURE THAT ADEQUATE FUNDS ARE AVAILABLE FOR THE REPLACEMENT OR MAINTENANCE OF MAJOR COMPONENTS IN COMMON INTEREST DEVELOPMENTS (U.S. CLS. 100 AND 101).

EVELYN BRADLEY, EXAMINING ATTORNEY

SN 86-067,556. QUESTR INC., IRVINE, CA. FILED 9-18-2013.

**DO AMAZING THINGS**

THE MARK CONSISTS OF STANDARD CHARACTERS WITHOUT CLAIM TO ANY PARTICULAR FONT, STYLE, SIZE, OR COLOR.

FOR COMPUTER SERVICES, NAMELY, CREATING AN ON-LINE COMMUNITY FOR REGISTERED USERS TO PARTICIPATE IN DISCUSSIONS, GET FEEDBACK FROM THEIR PEERS, FORM VIRTUAL COMMUNITIES, ENGAGE IN SOCIAL NETWORKING, SHARE STORIES AND GARNER/GIVE SUPPORT FOR PURSUING THEIR DREAMS (U.S. CLS. 100 AND 101).

MARY ROSSMAN, EXAMINING ATTORNEY

SN 86-067,715. INSTRUCTUS MEDIA, LTD., SAN ANTONIO, TX. FILED 9-18-2013.

**myINSTRUO**

THE MARK CONSISTS OF STANDARD CHARACTERS WITHOUT CLAIM TO ANY PARTICULAR FONT, STYLE, SIZE, OR COLOR.

FOR CREATING, MAINTAINING AND MODERNIZING COMPUTER SOFTWARE, AND SOFTWARE AS A SERVICE (SAAS) PLATFORMS (U.S. CLS. 100 AND 101).

SUSAN RICHARDS, EXAMINING ATTORNEY

**CLASS 42—(Continued).**

SN 86-067,836. MEYER, SCHERER & ROCKCASTLE, LTD., MINNEAPOLIS, MN. FILED 9-18-2013.

**MSR**

THE MARK CONSISTS OF STANDARD CHARACTERS WITHOUT CLAIM TO ANY PARTICULAR FONT, STYLE, SIZE, OR COLOR.

FOR ARCHITECTURAL SERVICES (U.S. CLS. 100 AND 101).

FIRST USE 0-0-1981; IN COMMERCE 0-0-1981.

EUGENIA MARTIN, EXAMINING ATTORNEY

SN 86-067,909. NEUROLINX RESEARCH INSTITUTE, INC., LA JOLLA, CA. FILED 9-18-2013.

**LIBERATING DISCOVERY**

THE MARK CONSISTS OF STANDARD CHARACTERS WITHOUT CLAIM TO ANY PARTICULAR FONT, STYLE, SIZE, OR COLOR.

FOR SCIENTIFIC RESEARCH (U.S. CLS. 100 AND 101).

FIRST USE 4-8-2008; IN COMMERCE 2-1-2010.

TRACY CROSS, EXAMINING ATTORNEY

SN 86-068,217. INSTAPARTY LLC, WHITE PLAINS, NY. FILED 9-18-2013.

**INSTAPARTY**

THE MARK CONSISTS OF STANDARD CHARACTERS WITHOUT CLAIM TO ANY PARTICULAR FONT, STYLE, SIZE, OR COLOR.

FOR COMPUTER SERVICES, NAMELY, HOSTING AN INTERACTIVE WEB SITE THAT ALLOWS USERS TO BOOK PARTIES WITH MEMBER RESTAURANTS AND BARS BASED ON USER PROVIDED INFORMATION, SUCH AS DATE, LOCATION, HEADCOUNT, FOOD AND DRINK REQUIREMENTS AND PRICE PER HEAD; COMPUTER SERVICES, NAMELY, HOSTING ON-LINE WEB FACILITIES FOR OTHERS FOR ORGANIZING AND CONDUCTING ONLINE MEETINGS, GATHERINGS, AND INTERACTIVE DISCUSSIONS (U.S. CLS. 100 AND 101).

RUDY R. SINGLETON, EXAMINING ATTORNEY

**CLASS 42—(Continued).**

SN 86-068,399. PROPERTYROOM.COM, INC., FREDERICK, MD. FILED 9-18-2013.

# MobiCat

THE MARK CONSISTS OF STANDARD CHARACTERS WITHOUT CLAIM TO ANY PARTICULAR FONT, STYLE, SIZE, OR COLOR.

FOR PLATFORM AS A SERVICE (PAAS) FEATURING COMPUTER SOFTWARE PLATFORMS FOR CATALOGING ITEMS (U.S. CLS. 100 AND 101).

DAVID TAYLOR, EXAMINING ATTORNEY

---

SN 86-068,406. PROPERTYROOM.COM, INC., FREDERICK, MD. FILED 9-18-2013.

# MobiSell

THE MARK CONSISTS OF STANDARD CHARACTERS WITHOUT CLAIM TO ANY PARTICULAR FONT, STYLE, SIZE, OR COLOR.

FOR PLATFORM AS A SERVICE (PAAS) FEATURING COMPUTER SOFTWARE PLATFORMS FOR CATALOGING ITEMS (U.S. CLS. 100 AND 101).

DAVID TAYLOR, EXAMINING ATTORNEY

---

SN 86-068,447. 3RAM GROUP LLC, GREENWICH, CT. FILED 9-18-2013.



NO CLAIM IS MADE TO THE EXCLUSIVE RIGHT TO USE "GROUP", APART FROM THE MARK AS SHOWN.

THE COLOR(S) RED, BLACK, AND WHITE IS/ARE CLAIMED AS A FEATURE OF THE MARK.

THE MARK CONSISTS OF A LARGE RED NUMERIC NUMBER THREE TO THE LEFT OF THE CAPITALIZED WORD "RAM" IN BLACK BLOCK LETTERING; THE CAPITALIZED WORD "GROUP" SITS BELOW THE WORD "RAM" AND IS IN BLACK STANDARD FONT. THE IMAGE OF A RAM'S HEAD IN WHITE OUTLINED IN BLACK SITS IN THE BACKGROUND LOOKING TO THE LEFT. THE RAM'S SNOUT IS VISIBLE THROUGH THE NUMERIC THREE WHILE THE RAM'S MANE SITS BEHIND THE "RAM GROUP" LETTERING.

FOR INFORMATION TECHNOLOGY CONSULTING SERVICES (U.S. CLS. 100 AND 101).

KATHERINE STOIDES, EXAMINING ATTORNEY

**CLASS 42—(Continued).**

SN 86-068,628. CIVIL & ENVIRONMENTAL CONSULTANTS, INC., PITTSBURGH, PA. FILED 9-18-2013.

## HIGHEST AND BEST USE...

THE MARK CONSISTS OF STANDARD CHARACTERS WITHOUT CLAIM TO ANY PARTICULAR FONT, STYLE, SIZE, OR COLOR.

FOR CONSULTING IN THE FIELD OF CIVIL AND ENVIRONMENTAL ENGINEERING AND SCIENCES (U.S. CLS. 100 AND 101).

FIRST USE 5-0-2013; IN COMMERCE 5-0-2013.

MORGAN WYNNE, EXAMINING ATTORNEY

---

SN 86-068,629. CIVIL & ENVIRONMENTAL CONSULTANTS, INC., PITTSBURGH, PA. FILED 9-18-2013.

## LEAN ON US...

THE MARK CONSISTS OF STANDARD CHARACTERS WITHOUT CLAIM TO ANY PARTICULAR FONT, STYLE, SIZE, OR COLOR.

FOR CONSULTING IN THE FIELD OF CIVIL AND ENVIRONMENTAL ENGINEERING AND SCIENCES (U.S. CLS. 100 AND 101).

FIRST USE 4-0-2013; IN COMMERCE 4-0-2013.

MORGAN WYNNE, EXAMINING ATTORNEY

---

SN 86-068,633. CIVIL & ENVIRONMENTAL CONSULTANTS, INC., PITTSBURGH, PA. FILED 9-18-2013.

## PEAK DEMANDS...

THE MARK CONSISTS OF STANDARD CHARACTERS WITHOUT CLAIM TO ANY PARTICULAR FONT, STYLE, SIZE, OR COLOR.

FOR CONSULTING IN THE FIELD OF CIVIL AND ENVIRONMENTAL ENGINEERING AND SCIENCES (U.S. CLS. 100 AND 101).

FIRST USE 1-0-2013; IN COMMERCE 1-0-2013.

MORGAN WYNNE, EXAMINING ATTORNEY

**CLASS 42—(Continued).**

SN 86-068,635. CIVIL & ENVIRONMENTAL CONSULTANTS, INC., PITTSBURGH, PA. FILED 9-18-2013.

**DEEPER RESERVES...**

THE MARK CONSISTS OF STANDARD CHARACTERS WITHOUT CLAIM TO ANY PARTICULAR FONT, STYLE, SIZE, OR COLOR.

FOR CONSULTING IN THE FIELD OF CIVIL AND ENVIRONMENTAL ENGINEERING AND SCIENCES (U.S. CLS. 100 AND 101).

FIRST USE 6-0-2013; IN COMMERCE 6-0-2013.

MORGAN WYNNE, EXAMINING ATTORNEY

SN 86-068,640. CIVIL & ENVIRONMENTAL CONSULTANTS, INC., PITTSBURGH, PA. FILED 9-18-2013.

**RELIABLE RESOURCES...**

THE MARK CONSISTS OF STANDARD CHARACTERS WITHOUT CLAIM TO ANY PARTICULAR FONT, STYLE, SIZE, OR COLOR.

FOR CONSULTING IN THE FIELD OF CIVIL AND ENVIRONMENTAL ENGINEERING AND SCIENCES (U.S. CLS. 100 AND 101).

FIRST USE 11-0-2012; IN COMMERCE 11-0-2012.

MORGAN WYNNE, EXAMINING ATTORNEY

SN 86-068,677. CALAMITY GYM LLC, DALLAS, TX. FILED 9-18-2013.



THE MARK CONSISTS OF A SHIELD HAVING A STYLIZED LOWER CASE "G" SITUATED APPROXIMATELY IN THE CENTER OF THE SHIELD AND A TEAR IN THE SHIELD ILLUSTRATED FROM THE OUTER RIGHT EDGE OF THE SHIELD TO THE STYLIZED LOWER CASE "G".

FOR PROVIDING NON-DOWNLOADABLE SOFTWARE FOR SHARING MULTIMEDIA CONTENT RELATED TO FITNESS AND HEALTH OVER THE INTERNET (U.S. CLS. 100 AND 101).

FIRST USE 9-2-2013; IN COMMERCE 9-2-2013.

SCOTT BIBB, EXAMINING ATTORNEY

**CLASS 42—(Continued).**

SN 86-068,820. FRESHDESIGN INTERACTIVE, INC., SAN JOSE, CA. FILED 9-19-2013.

**FRESHDESIGN**

THE MARK CONSISTS OF STANDARD CHARACTERS WITHOUT CLAIM TO ANY PARTICULAR FONT, STYLE, SIZE, OR COLOR.

FOR COMPUTER SOFTWARE DESIGN FOR OTHERS; COMPUTER SOFTWARE DEVELOPMENT; COMPUTER SOFTWARE CONSULTANCY; COMPUTER SOFTWARE DEVELOPMENT IN THE FIELD OF MOBILE APPLICATIONS (U.S. CLS. 100 AND 101).

FIRST USE 1-1-2013; IN COMMERCE 1-1-2013.

ANNE FARRELL, EXAMINING ATTORNEY

SN 86-068,840. FRESHDESIGN INTERACTIVE, INC., SAN JOSE, CA. FILED 9-19-2013.



THE MARK CONSISTS OF THE LITERAL ELEMENTS "FRESHDESIGN" WRITTEN IN STYLIZED FORM WHEREIN ON THE LEFT SIDE OF THE WORD THERE IS AN IMAGE OF WATER DROP WITH A TICK MARK INSIDE IT.

FOR COMPUTER SOFTWARE DESIGN FOR OTHERS; COMPUTER SOFTWARE DEVELOPMENT; COMPUTER SOFTWARE CONSULTANCY; COMPUTER SOFTWARE DEVELOPMENT IN THE FIELD OF MOBILE APPLICATIONS (U.S. CLS. 100 AND 101).

FIRST USE 1-1-2013; IN COMMERCE 1-1-2013.

ANNE FARRELL, EXAMINING ATTORNEY

SN 86-069,072. THE NATIONAL BOARD OF EXAMINERS IN OPTOMETRY, INC., CHARLOTTE, NC. FILED 9-19-2013.

**ABS**

THE MARK CONSISTS OF STANDARD CHARACTERS WITHOUT CLAIM TO ANY PARTICULAR FONT, STYLE, SIZE, OR COLOR.

FOR COMPUTER SERVICES, NAMELY, PROVIDING ONLINE NON-DOWNLOADABLE SOFTWARE FEATURING TEST QUESTIONS AND TESTING MATERIALS IN THE FIELD OF OPTOMETRY (U.S. CLS. 100 AND 101).

MORGAN WYNNE, EXAMINING ATTORNEY

**CLASS 42—(Continued).**

SN 86-069,130. MONTANA MAPPING & GPS, LLC, DBA ONXMAPS, MISSOULA, MT. FILED 9-19-2013.

EXPLORE LIKE NEVER BEFORE

THE MARK CONSISTS OF STANDARD CHARACTERS WITHOUT CLAIM TO ANY PARTICULAR FONT, STYLE, SIZE, OR COLOR.

FOR CARTOGRAPHY AND MAPPING; COMPUTER COMPATIBILITY SERVICES, NAMELY, DATA MAPPING; MAPPING SERVICES (U.S. CLS. 100 AND 101).  
FIRST USE 4-14-2012; IN COMMERCE 7-30-2013.  
SCOTT BIBB, EXAMINING ATTORNEY

**CLASS 42—(Continued).**

SN 86-069,491. FARIDOON S. KHOSRAVI, BALTIMORE, MD. FILED 9-19-2013.



THE MARK CONSISTS OF A PAIR OF OFFSET, SLIGHTLY OVERLAPPING, SHADOWED ARCHES SURROUNDING A CUBE.

FOR DESIGN, DEVELOPMENT, INSTALLATION, AND CUSTOMIZATION OF COMPUTER SOFTWARE, NAMELY, ACCOUNTING SOFTWARE (U.S. CLS. 100 AND 101).  
SARA BENJAMIN, EXAMINING ATTORNEY

SN 86-069,192. VOYAGER THERAPEUTICS, INC., BOSTON, MA. FILED 9-19-2013.

VOYAGER THERAPEUTICS

THE MARK CONSISTS OF STANDARD CHARACTERS WITHOUT CLAIM TO ANY PARTICULAR FONT, STYLE, SIZE, OR COLOR.

NO CLAIM IS MADE TO THE EXCLUSIVE RIGHT TO USE "THERAPEUTICS", APART FROM THE MARK AS SHOWN.

FOR PHARMACEUTICAL RESEARCH AND DEVELOPMENT IN THE FIELD OF GENE THERAPY (U.S. CLS. 100 AND 101).  
RENEE MCCRAY, EXAMINING ATTORNEY

SN 86-069,809. CLARK, CHRIS, BRENTWOOD, TN. FILED 9-19-2013.

BirdieFire

SN 86-069,380. LUKE R HESSLER L.L.C., TRAVERSE CITY, MI. FILED 9-19-2013.

YPRS

THE MARK CONSISTS OF STANDARD CHARACTERS WITHOUT CLAIM TO ANY PARTICULAR FONT, STYLE, SIZE, OR COLOR.

FOR PROVIDING A WEB SITE ALLOWING USERS TO UPLOAD ON-LINE VIDEOS FOR SHARING WITH OTHERS FOR MOTIVATIONAL AND INSPIRATIONAL PURPOSES (U.S. CLS. 100 AND 101).  
SCOTT BIBB, EXAMINING ATTORNEY

THE MARK CONSISTS OF STANDARD CHARACTERS WITHOUT CLAIM TO ANY PARTICULAR FONT, STYLE, SIZE, OR COLOR.

FOR SOFTWARE AS A SERVICE (SAAS) SERVICES FEATURING SOFTWARE FOR STATISTICAL ANALYSIS, STATISTICAL COMPARISON ANALYSIS, PRACTICE ANALYSIS, AND TOURNAMENT SCORE KEEPING APPLICATIONS (U.S. CLS. 100 AND 101).  
FIRST USE 4-17-2012; IN COMMERCE 12-9-2012.  
TRACY CROSS, EXAMINING ATTORNEY

**CLASS 42—(Continued).**

SN 86-070,044. HCL TECHNOLOGIES LTD., NOIDA, INDIA, FILED 9-20-2013.



THE COLOR(S) BLUE, TURQUOISE BLUE, ORANGE, DARK ORANGE, BLACK AND WHITE IS/ARE CLAIMED AS A FEATURE OF THE MARK.

THE MARK CONSISTS OF THE TERM "EFAAS" IN A STYLIZED FONT AND FOUR RECTANGULAR SHAPES OF VARIOUS COLORS. THE LETTERS "E", "A", "A", AND "S" ARE BLACK. THE LETTER "F" IS WHITE INSIDE A DARK ORANGE RECTANGULAR SHAPE. THE TERM "EFAAS" IS TO THE RIGHT OF THREE RECTANGULAR SHAPES, WHICH ARE COLORED BLUE, TURQUOISE BLUE, AND ORANGE RESPECTIVELY, FROM LEFT TO RIGHT.

FOR COMPUTER SERVICES, NAMELY, REMOTE AND ON-SITE MANAGEMENT OF THE INFORMATION TECHNOLOGY (IT) SYSTEMS OF OTHERS; CONSULTING IN THE FIELD OF INFORMATION TECHNOLOGY; PLANNING, DESIGN AND MANAGEMENT OF INFORMATION TECHNOLOGY SYSTEMS (U.S. CLS. 100 AND 101).

FIRST USE 9-1-2013; IN COMMERCE 9-1-2013.  
TOBY BULLOFF, EXAMINING ATTORNEY

---

SN 86-070,336. PHYSICIAN NETWORK ADVANTAGE, INC., FRESNO, CA. FILED 9-20-2013.

**PNA**

THE MARK CONSISTS OF STANDARD CHARACTERS WITHOUT CLAIM TO ANY PARTICULAR FONT, STYLE, SIZE, OR COLOR.

FOR DESIGN, DEVELOPMENT, AND IMPLEMENTATION OF TECHNOLOGY SOLUTIONS FOR HEALTH RECORD MANAGEMENT AND MEDICAL PRACTICE MANAGEMENT; TROUBLESHOOTING, MAINTENANCE, AND SUPPORT OF TECHNOLOGY SOLUTIONS FOR HEALTH RECORD MANAGEMENT AND MEDICAL PRACTICE MANAGEMENT; TECHNICAL CONSULTING IN THE FIELDS OF HEALTH RECORD MANAGEMENT AND MEDICAL PRACTICE MANAGEMENT; TRAINING IN THE USE AND OPERATION OF TECHNOLOGY SOLUTIONS FOR HEALTH RECORD MANAGEMENT AND MEDICAL PRACTICE MANAGEMENT (U.S. CLS. 100 AND 101).

FIRST USE 4-12-2011; IN COMMERCE 4-12-2011.  
SUZANNE BLANE, EXAMINING ATTORNEY

**CLASS 42—(Continued).**

SN 86-070,369. ABOUT SMILES INC., MELVILLE, NY. FILED 9-20-2013.

**YOU GO AS YOUR SMILE GOES**

THE MARK CONSISTS OF STANDARD CHARACTERS WITHOUT CLAIM TO ANY PARTICULAR FONT, STYLE, SIZE, OR COLOR.

FOR PROVIDING AN INTERACTIVE WEBSITE FEATURING TECHNOLOGY THAT ALLOWS USERS TO INPUT DENTAL INFORMATION AND OBTAIN MEDICAL OR HEALTH INFORMATION BASED ON THE INPUT DENTAL INFORMATION (U.S. CLS. 100 AND 101).

RAMONA ORTIGA, EXAMINING ATTORNEY

---

SN 86-070,385. ABOUT SMILES INC., MELVILLE, NY. FILED 9-20-2013.

**TEETH ARE LIKE TREES AND  
GUMS DON'T LIE**

THE MARK CONSISTS OF STANDARD CHARACTERS WITHOUT CLAIM TO ANY PARTICULAR FONT, STYLE, SIZE, OR COLOR.

FOR PROVIDING AN INTERACTIVE WEBSITE FEATURING TECHNOLOGY THAT ALLOWS USERS TO INPUT DENTAL INFORMATION AND OBTAIN MEDICAL OR HEALTH INFORMATION BASED ON THE INPUT DENTAL INFORMATION (U.S. CLS. 100 AND 101).

RAMONA ORTIGA, EXAMINING ATTORNEY

---

SN 86-070,568. SHAREHOLDER INSITE, INC., NASHVILLE, TN. FILED 9-20-2013.

**SHAREHOLDER INSITE**

THE MARK CONSISTS OF STANDARD CHARACTERS WITHOUT CLAIM TO ANY PARTICULAR FONT, STYLE, SIZE, OR COLOR.

NO CLAIM IS MADE TO THE EXCLUSIVE RIGHT TO USE "SHAREHOLDER", APART FROM THE MARK AS SHOWN.

FOR SOFTWARE AS A SERVICE (SAAS) SERVICES FEATURING SOFTWARE FOR TRACKING, MANAGING AND ANALYZING SHAREHOLDER DATA (U.S. CLS. 100 AND 101).

FIRST USE 1-1-2012; IN COMMERCE 1-1-2012.  
SUZANNE BLANE, EXAMINING ATTORNEY



**CLASS 42—(Continued).**

SN 86-070,609. SHAREHOLDER INSITE, INC., NASHVILLE, TN. FILED 9-20-2013.

# CAPCONTROLS

THE MARK CONSISTS OF STANDARD CHARACTERS WITHOUT CLAIM TO ANY PARTICULAR FONT, STYLE, SIZE, OR COLOR.

FOR SOFTWARE AS A SERVICE (SAAS) SERVICES FEATURING SOFTWARE FOR SUPPORTING PRIVATE COMPANIES IN SHAREHOLDER ADMINISTRATION AND ANALYSIS (U.S. CLS. 100 AND 101).

FIRST USE 1-1-2008; IN COMMERCE 1-1-2008.  
SUZANNE BLANE, EXAMINING ATTORNEY

---

SN 86-070,677. SHAREHOLDER INSITE, INC., NASHVILLE, TN. FILED 9-20-2013.



THE COLOR(S) ORANGE AND GRAY IS/ARE CLAIMED AS A FEATURE OF THE MARK.

THE MARK CONSISTS OF THE WORD "SHAREHOLDER" IN ORANGE WITH THE "O" COLORED SOLID ORANGE, AND THE WORD "INSITE" IN GRAY.

FOR SOFTWARE AS A SERVICE (SAAS) SERVICES FEATURING SOFTWARE FOR TRACKING, MANAGING AND ANALYZING SHAREHOLDER DATA (U.S. CLS. 100 AND 101).

FIRST USE 1-1-2012; IN COMMERCE 1-1-2012.  
SUZANNE BLANE, EXAMINING ATTORNEY

---

SN 86-070,879. MADETOORDER, INC., PLEASANTON, CA. FILED 9-20-2013.



THE COLOR(S) BROWN, WHITE, YELLOW, AND BLACK IS/ARE CLAIMED AS A FEATURE OF THE MARK.

THE MARK CONSISTS OF A STYLIZED BROWN AND WHITE MONKEY OUTLINED IN BLACK, WITH THE LETTERS "JAMS" IN YELLOW WITH BLACK OUTLINE APPEARING TO THE RIGHT OF THE MONKEY.

FOR PROVIDING A WEB SITE FEATURING TECHNOLOGY THAT ENABLES COMPANIES AND ORGANIZATIONS TO ADMINISTER AND MANAGE CUSTOMER INCENTIVE AWARD PROGRAMS (U.S. CLS. 100 AND 101).

FIRST USE 1-1-2011; IN COMMERCE 1-1-2011.  
MORGAN WYNNE, EXAMINING ATTORNEY

**CLASS 42—(Continued).**

SN 86-071,116. I VOWED, LLC, ATLANTA, GA. FILED 9-21-2013.

# Operating As One - Online & In Life

THE MARK CONSISTS OF STANDARD CHARACTERS WITHOUT CLAIM TO ANY PARTICULAR FONT, STYLE, SIZE, OR COLOR.

FOR COMPUTER SERVICES, NAMELY, CREATING AN ON-LINE COMMUNITY FOR REGISTERED USERS TO PARTICIPATE IN DISCUSSIONS, GET FEEDBACK FROM THEIR PEERS, FORM VIRTUAL COMMUNITIES, AND ENGAGE IN SOCIAL NETWORKING SERVICES IN THE FIELD OF MARRIAGE; PROVIDING CUSTOMIZED ON-LINE WEB PAGES AND DATA FEEDS FEATURING USER-DEFINED INFORMATION, WHICH INCLUDES BLOG POSTS, NEW MEDIA CONTENT, OTHER ON-LINE CONTENT, AND ON-LINE WEB LINKS TO OTHER WEBSITES (U.S. CLS. 100 AND 101).

FIRST USE 4-4-2012; IN COMMERCE 9-14-2013.  
DOUGLAS LEE, EXAMINING ATTORNEY

---

SN 86-071,136. EYELOOK LLC, SAN JOSE, CA. FILED 9-21-2013.

# EYELOOK

THE MARK CONSISTS OF STANDARD CHARACTERS WITHOUT CLAIM TO ANY PARTICULAR FONT, STYLE, SIZE, OR COLOR.

FOR COMPUTER SERVICES, NAMELY, CREATING AN ON-LINE COMMUNITY FOR REGISTERED USERS TO PROVIDE A VIDEO, PHOTO AND MESSAGE SHARING SOCIAL NETWORK (U.S. CLS. 100 AND 101).

JAMES A. RAUEN, EXAMINING ATTORNEY

---

SN 86-071,162. POTTS CONSULTING GROUP, LLC, DBA FEATURE[23], ST. AUGUSTINE, FL. FILED 9-21-2013.

# FEATURE[23]

THE MARK CONSISTS OF STANDARD CHARACTERS WITHOUT CLAIM TO ANY PARTICULAR FONT, STYLE, SIZE, OR COLOR.

FOR COMPUTER SOFTWARE CONSULTING; COMPUTER SOFTWARE DESIGN; COMPUTER SOFTWARE DEVELOPMENT; COMPUTER SOFTWARE DEVELOPMENT AND COMPUTER PROGRAMMING DEVELOPMENT FOR OTHERS (U.S. CLS. 100 AND 101).

FIRST USE 7-18-2012; IN COMMERCE 7-18-2012.  
DONALD JOHNSON, EXAMINING ATTORNEY

**CLASS 42—(Continued).**

SN 86-071,807. EMPOWER ENERGY TECHNOLOGY, L.L.C., ATLANTA, GA. FILED 9-23-2013.

## PowerEnfo

THE MARK CONSISTS OF STANDARD CHARACTERS WITHOUT CLAIM TO ANY PARTICULAR FONT, STYLE, SIZE, OR COLOR.

FOR DATA AUTOMATION AND COLLECTION SERVICE USING PROPRIETARY SOFTWARE TO EVALUATE, ANALYZE AND COLLECT SERVICE DATA; ELECTRICITY AND NATURAL GAS SERVICES, NAMELY, METER DATA MANAGEMENT AND ANALYSIS; ELECTRONIC MONITORING AND REPORTING OF NATURAL GAS, WATER, HOT WATER, ELECTRICITY, LIGHTING, OCCUPANCY, TEMPERATURE, ALARMS, SOLAR ENERGY AND OTHER BUILDING DATA USING COMPUTERS OR SENSORS (U.S. CLS. 100 AND 101).

JOHN WILKE, EXAMINING ATTORNEY

SN 86-071,852. PHT CORPORATION, BOSTON, MA. FILED 9-23-2013.

## LOGPAD APP

THE MARK CONSISTS OF STANDARD CHARACTERS WITHOUT CLAIM TO ANY PARTICULAR FONT, STYLE, SIZE, OR COLOR.

OWNER OF U.S. REG. NO. 2,341,822.

NO CLAIM IS MADE TO THE EXCLUSIVE RIGHT TO USE "APP", APART FROM THE MARK AS SHOWN.

FOR APPLICATION SERVICE PROVIDER SERVICES FEATURING SOFTWARE FOR THE COLLECTION, MANAGEMENT AND REPORTING BY OTHERS OF CLINICAL RESEARCH AND MARKETING; PROVIDING A DATABASE FEATURING MEDICAL AND SCIENTIFIC RESEARCH INFORMATION PERTAINING TO CLINICAL TRIALS OF PHARMACEUTICALS; PROVIDING A WEBSITE FEATURING MEDICAL AND SCIENTIFIC RESEARCH INFORMATION PERTAINING TO CLINICAL TRIALS OF PHARMACEUTICALS (U.S. CLS. 100 AND 101).

MICHAEL ENGEL, EXAMINING ATTORNEY

SN 86-072,410. C&M INTERIORS LLC, NORTHBROOK, IL. FILED 9-23-2013.

## THELUVITLIST

THE MARK CONSISTS OF STANDARD CHARACTERS WITHOUT CLAIM TO ANY PARTICULAR FONT, STYLE, SIZE, OR COLOR.

FOR INTERIOR DESIGN SERVICES (U.S. CLS. 100 AND 101).

ALLISON HOLTZ, EXAMINING ATTORNEY

**CLASS 42—(Continued).**

SN 86-072,990. ILDAR BOLTUNOV, MOUNTAIN VIEW, CA. FILED 9-24-2013.

## BioDigitalPet

THE MARK CONSISTS OF STANDARD CHARACTERS WITHOUT CLAIM TO ANY PARTICULAR FONT, STYLE, SIZE, OR COLOR.

FOR SOFTWARE AS A SERVICE (SAAS) SERVICES FEATURING SOFTWARE FOR PATIENT MEDICAL DATA FOR THE PURPOSE OF CREATING A PERSONALIZED MODEL OF A PET (U.S. CLS. 100 AND 101).

CHRISTOPHER BUONGIORNO, EXAMINING ATTORNEY

SN 86-077,198. ELASTICSEARCH BV, AMSTERDAM, NETHERLANDS, FILED 9-27-2013.

## KIBANA

THE MARK CONSISTS OF STANDARD CHARACTERS WITHOUT CLAIM TO ANY PARTICULAR FONT, STYLE, SIZE, OR COLOR.

THE WORD "KIBANA" HAS NO MEANING IN A FOREIGN LANGUAGE.

FOR PROVIDING ONLINE NON-DOWNLOADABLE SOFTWARE FOR USE IN VIEWING, ORGANIZING, AND ANALYZING DATA AND INFORMATION (U.S. CLS. 100 AND 101).

DAVID ELTON, EXAMINING ATTORNEY

SN 86-078,248. NATIONAL MEDICAL SERVICES, INC., WILLOW GROVE, PA. FILED 9-30-2013.

## ProofPositive an NMS Labs Confirmation Report

THE MARK CONSISTS OF STANDARD CHARACTERS WITHOUT CLAIM TO ANY PARTICULAR FONT, STYLE, SIZE, OR COLOR.

OWNER OF U.S. REG. NOS. 1,582,419, 3,773,650 AND 4,274,924.

NO CLAIM IS MADE TO THE EXCLUSIVE RIGHT TO USE "LABS CONFIRMATION REPORT", APART FROM THE MARK AS SHOWN.

FOR DRUG, ALCOHOL AND DNA SCREENING FOR FORENSIC RESEARCH PURPOSES; RESEARCH SERVICES IN THE FIELD OF FORENSIC SCIENCE, NAMELY, ANALYSIS, DETECTION AND ISOLATION OF BIOLOGICAL SUBSTANCES IN FORENSIC SAMPLES (U.S. CLS. 100 AND 101).

SHANNON TWOHIG, EXAMINING ATTORNEY

**CLASS 42—(Continued).**

SN 86-078,295. COGSTATE LTD., NEW HAVEN, CT. FILED 9-30-2013.

**CLASS 42—(Continued).**

SN 86-079,457. GALLAGHER BASSETT SERVICES, INC., ITASCA, IL. FILED 10-1-2013.

**COGSTATE**

**RISX-FACS**

THE MARK CONSISTS OF STANDARD CHARACTERS WITHOUT CLAIM TO ANY PARTICULAR FONT, STYLE, SIZE, OR COLOR.

OWNER OF U.S. REG. NO. 2,712,585.

FOR DESIGN AND DEVELOPMENT OF COMPUTER SOFTWARE; PROVIDING AN INTERACTIVE WEBSITE FEATURING TECHNOLOGY THAT ALLOWS USERS TO ASSESS AND MONITOR COGNITION AND TO PRODUCE COGNITIVE TESTING REPORTS (U.S. CLS. 100 AND 101).

MIAH ROSENBERG, EXAMINING ATTORNEY

THE MARK CONSISTS OF STANDARD CHARACTERS WITHOUT CLAIM TO ANY PARTICULAR FONT, STYLE, SIZE, OR COLOR.

OWNER OF U.S. REG. NOS. 1,302,269 AND 1,387,305. SEC. 2(F).

FOR PROVIDING TEMPORARY USE OF ONLINE NON-DOWNLOADABLE COMPUTER SOFTWARE FOR INFORMATION STORAGE AND RETRIEVAL SERVICES IN THE FIELD OF INSURANCE RISK MANAGEMENT; PROVIDING TEMPORARY USE OF ONLINE, NON-DOWNLOADABLE COMPUTER SOFTWARE FOR INSURANCE CLAIMS MANAGEMENT (U.S. CLS. 100 AND 101).

FIRST USE 4-22-1983; IN COMMERCE 4-22-1983. TINA MAI, EXAMINING ATTORNEY

SN 86-079,454. BARON T. LTD., DBA CARMEL, NEW YORK, NY. FILED 10-1-2013.

SN 86-084,205. CELGENE CORPORATION, SUMMIT, NJ. FILED 10-7-2013.

**Carmel**

**APICES**

THE MARK CONSISTS OF STANDARD CHARACTERS WITHOUT CLAIM TO ANY PARTICULAR FONT, STYLE, SIZE, OR COLOR.

OWNER OF U.S. REG. NO. 3,073,155.

FOR PROVIDING TEMPORARY USE OF ON-LINE NON-DOWNLOADABLE SOFTWARE FOR PROVIDING TRANSPORTATION RESERVATION SERVICES, PROVIDING A BOOKING SERVICE FOR CUSTOMERS WHO REQUEST TRANSPORTATION SERVICES AND FOR DISPATCHING MOTORIZED VEHICLES TO CUSTOMERS SEEKING TRANSPORTATION (U.S. CLS. 100 AND 101).

FIRST USE 6-13-2006; IN COMMERCE 6-13-2006. THEODORE MCBRIDE, EXAMINING ATTORNEY

THE MARK CONSISTS OF STANDARD CHARACTERS WITHOUT CLAIM TO ANY PARTICULAR FONT, STYLE, SIZE, OR COLOR.

FOR CONDUCTING CLINICAL TRIALS FOR OTHERS; CONDUCTING CLINICAL TRIALS FOR OTHERS ON THE SAFETY AND EFFECTIVENESS OF APREMILAST; CONDUCTING CLINICAL TRIALS FOR OTHERS ON THE SAFETY AND EFFECTIVENESS OF A DRUG FOR PSORIASIS, RHEUMATOID ARTHRITIS AND CANCER; CONDUCTING CLINICAL TRIALS FOR OTHERS ON THE SAFETY AND EFFECTIVENESS OF A DRUG DIRECTED TO PROSTATE-SPECIFIC ANTIGEN (U.S. CLS. 100 AND 101).

JENNY PARK, EXAMINING ATTORNEY

**CLASS 42—(Continued).**

SN 86-084,539. CELGENE CORPORATION, SUMMIT, NJ. FILED 10-7-2013.

**ROBUST**

THE MARK CONSISTS OF STANDARD CHARACTERS WITHOUT CLAIM TO ANY PARTICULAR FONT, STYLE, SIZE, OR COLOR.

FOR CONDUCTING CLINICAL TRIALS FOR OTHERS ON THE SAFETY AND EFFECTIVENESS OF DRUGS; CONDUCTING CLINICAL TRIALS FOR OTHERS ON THE SAFETY AND EFFECTIVENESS OF POMALIDIMIDE; CONDUCTING CLINICAL TRIALS FOR OTHERS ON THE SAFETY AND EFFECTIVENESS OF DRUGS FOR CANCER AND OTHER IMMUNE RELATED DISEASES; PROVIDING MEDICAL AND SCIENTIFIC RESEARCH INFORMATION IN THE FIELD OF CLINICAL TRIALS (U.S. CLS. 100 AND 101).

JENNY PARK, EXAMINING ATTORNEY

**CLASS 42—(Continued).**

SN 86-090,950. ARUBA NETWORKS, INC., SUNNYVALE, CA. FILED 10-14-2013.

**ARUBA CLOUD**

THE MARK CONSISTS OF STANDARD CHARACTERS WITHOUT CLAIM TO ANY PARTICULAR FONT, STYLE, SIZE, OR COLOR.

OWNER OF U.S. REG. NOS. 3,169,861, 3,254,260 AND 3,320,946.

NO CLAIM IS MADE TO THE EXCLUSIVE RIGHT TO USE "CLOUD", APART FROM THE MARK AS SHOWN.

FOR APPLICATION SERVICE PROVIDER, NAMELY, HOSTING, MANAGING, DEVELOPING, TROUBLE SHOOTING AND MAINTAINING APPLICATIONS, SOFTWARE, NETWORKS AND WEB SITES, IN THE FIELDS OF PERSONAL PRODUCTIVITY, WIRELESS COMMUNICATION, MOBILE INFORMATION ACCESS, AND REMOTE DATA MANAGEMENT FOR WIRELESS DELIVERY OF CONTENT TO HANDHELD COMPUTERS, LAPTOPS AND MOBILE ELECTRONIC DEVICES; COMPUTER SERVICES, NAMELY, CLOUD HOSTING PROVIDER SERVICES; ON-LINE NON-DOWNLOADABLE SOFTWARE FOR USE IN THE MANAGEMENT OF APPLICATIONS OPERATING ON INTERNET-ENABLED DEVICES, MOBILE DEVICES, PORTABLE MEDIA PLAYERS AND COMPUTERS IN THE FIELDS OF ANALYTICS, PERFORMANCE MANAGEMENT, REPORTING, CONFIGURATION MANAGEMENT, ASSET MANAGEMENT, DEPLOYMENT, PROVISIONING, COMPLIANCE, CONTENT SECURITY AND SECURITY MANAGEMENT; COMPUTER NETWORK CONFIGURATION SERVICES; COMPUTER NETWORK DESIGN FOR OTHERS; COMPUTER SECURITY SERVICES, NAMELY, RESTRICTING ACCESS TO AND BY COMPUTER NETWORKS TO AND OF UNDESIRED WEB SITES, MEDIA AND INDIVIDUALS AND FACILITIES; COMPUTER SERVICES, NAMELY, INTEGRATION OF PRIVATE AND PUBLIC CLOUD COMPUTING ENVIRONMENTS; TECHNICAL SUPPORT SERVICES, NAMELY, REMOTE AND ON-SITE INFRASTRUCTURE MANAGEMENT SERVICES FOR MONITORING, ADMINISTRATION AND MANAGEMENT OF PUBLIC AND PRIVATE CLOUD COMPUTING IT AND APPLICATION SYSTEMS; TECHNICAL CONSULTING SERVICES IN THE FIELDS OF DATACENTER ARCHITECTURE, PUBLIC AND PRIVATE CLOUD COMPUTING SOLUTIONS, AND EVALUATION AND IMPLEMENTATION OF NETWORK TECHNOLOGY AND SERVICES (U.S. CLS. 100 AND 101).

JOHN WILKE, EXAMINING ATTORNEY

SN 86-087,121. SILVERSTONE GROUP, INCORPORATED, OMAHA, NE. FILED 10-9-2013.

**BENEFITSQUE**

THE MARK CONSISTS OF STANDARD CHARACTERS WITHOUT CLAIM TO ANY PARTICULAR FONT, STYLE, SIZE, OR COLOR.

FOR PROVIDING TEMPORARY USE OF A WEB-BASED SOFTWARE APPLICATION CONSISTING OF HEALTH ENROLLMENT AND DECISION TOOLS FOR ASSISTING WITH ENROLLMENT IN EMPLOYEE HEALTH AND WELFARE BENEFIT PLANS (U.S. CLS. 100 AND 101).

CHRISIE B. KING, EXAMINING ATTORNEY

SN 86-089,108. SILVERSTONE GROUP, INCORPORATED, OMAHA, NE. FILED 10-11-2013.



THE MARK CONSISTS OF THE LITERAL ELEMENT "BENEFITSQUE" PRECEDED BY TWO SWIRL ELEMENTS INTERCONNECTING.

FOR PROVIDING TEMPORARY USE OF A WEB-BASED SOFTWARE APPLICATION CONSISTING OF HEALTH ENROLLMENT AND DECISION TOOLS FOR ASSISTING WITH ENROLLMENT IN EMPLOYEE HEALTH AND WELFARE BENEFIT PLANS (U.S. CLS. 100 AND 101).

CHRISIE B. KING, EXAMINING ATTORNEY

**CLASS 42—(Continued).**

SN 86-091,087. ADVISUAL, INC., SAN FRANCISCO, CA. FILED 10-14-2013.

**WORDMOUTH**

THE MARK CONSISTS OF STANDARD CHARACTERS WITHOUT CLAIM TO ANY PARTICULAR FONT, STYLE, SIZE, OR COLOR.

FOR PROVIDING TEMPORARY USE OF ONLINE NON-DOWNLOADABLE SOFTWARE FOR ANALYZING AND REPORTING ON INTERNET TRAFFIC AND KEYWORD PLACEMENT, FOR ASSESSING THE EFFECTIVENESS OF WEBSITE MARKETING BY MONITORING, TRACKING AND INCREASING THE EFFECTIVE USE OF ONLINE MARKETING EFFORTS AND KEYWORD SEARCH PERFORMANCE (U.S. CLS. 100 AND 101).

RUDY R. SINGLETON, EXAMINING ATTORNEY

---

SN 86-092,509. ADVISUAL, INC., SAN FRANCISCO, CA. FILED 10-16-2013.

**ADSTORE**

THE MARK CONSISTS OF STANDARD CHARACTERS WITHOUT CLAIM TO ANY PARTICULAR FONT, STYLE, SIZE, OR COLOR.

FOR PROVIDING TEMPORARY USE OF ONLINE NON-DOWNLOADABLE SOFTWARE FOR ANALYZING AND REPORTING ON INTERNET TRAFFIC AND KEYWORD PLACEMENT, FOR ASSESSING THE EFFECTIVENESS OF WEBSITE MARKETING BY MONITORING, TRACKING AND INCREASING THE EFFECTIVE USE OF ONLINE MARKETING EFFORTS AND KEYWORD SEARCH PERFORMANCE (U.S. CLS. 100 AND 101).

RUDY R. SINGLETON, EXAMINING ATTORNEY

---

SN 86-093,070. EXAPTIVE, INC., CAMBRIDGE, MA. FILED 10-16-2013.

**XAP**

THE MARK CONSISTS OF STANDARD CHARACTERS WITHOUT CLAIM TO ANY PARTICULAR FONT, STYLE, SIZE, OR COLOR.

FOR PROVIDING A WEB SITE FEATURING TEMPORARY USE OF NON-DOWNLOADABLE SOFTWARE FOR DATA VISUALIZATION AND CROSS-DISCIPLINARY COLLABORATION (U.S. CLS. 100 AND 101).

FIRST USE 9-27-2012; IN COMMERCE 9-27-2012.  
LANA PHAM, EXAMINING ATTORNEY

**CLASS 42—(Continued).**

SN 86-097,219. DONLEN CORPORATION, NORTHBROOK, IL. FILED 10-21-2013.

**DONLEN CARBON MEASURE**

THE MARK CONSISTS OF STANDARD CHARACTERS WITHOUT CLAIM TO ANY PARTICULAR FONT, STYLE, SIZE, OR COLOR.

OWNER OF U.S. REG. NOS. 3,033,780, 4,135,899 AND OTHERS.

NO CLAIM IS MADE TO THE EXCLUSIVE RIGHT TO USE "CARBON MEASURE", APART FROM THE MARK AS SHOWN.

FOR PROVIDING A WEBSITE THAT FEATURES RESEARCH INFORMATION ON REDUCTION OF GREENHOUSE GAS EMISSIONS FOR COMMERCIAL FLEETS; RESEARCH IN THE REDUCTION OF CARBON EMISSIONS; CONSULTING SERVICES IN THE FIELD OF ENVIRONMENTAL ASSESSMENT AND PLANNING, NAMELY, ASSISTING COMPANIES IN ESTABLISHING BASELINE FLEET EMISSIONS AND CREATION OF ACTIONABLE EMISSIONS REDUCTIONS PLANS TO INCREASE FUEL EFFICIENCY, REDUCE MILES TRAVELED, UTILIZE LOW-CARBON FUELS, AND DEPLOY TECHNOLOGICALLY ADVANCED VEHICLES TO REDUCE FUTURE FUEL EXPENDITURES AND PETROLEUM CONSUMPTION; PROVIDING USE OF NON-DOWNLOADABLE COMPUTER SOFTWARE VIA A GLOBAL COMPUTER NETWORK WHICH ALLOWS COMMERCIAL FLEET OPERATORS TO IMPORT DATA TO CREATE ACTIONABLE EMISSIONS REDUCTION PLANS WITH THE GOAL OF REDUCING THE COMPANY'S OVERALL VEHICLE EMISSIONS (U.S. CLS. 100 AND 101).

THEODORE MCBRIDE, EXAMINING ATTORNEY

---

SN 86-118,436. GUANGZHOU LONGMEI COMPUTER TECHNOLOGY CO., LTD., GUANGZHOU, GUANGDONG, CHINA, FILED 11-14-2013.

**Talknow**

THE MARK CONSISTS OF STANDARD CHARACTERS WITHOUT CLAIM TO ANY PARTICULAR FONT, STYLE, SIZE, OR COLOR.

THE WORDING "TALKNOW" HAS NO MEANING IN A FOREIGN LANGUAGE.

FOR COMPUTER PROGRAMMING; COMPUTER SOFTWARE DESIGN; COMPUTER SYSTEM DESIGN SERVICES; CONVERSION OF DATA OR DOCUMENTS FROM PHYSICAL TO ELECTRONIC MEDIA; CREATING AND MAINTAINING WEB SITES FOR OTHERS; DATA CONVERSION OF COMPUTER PROGRAMS AND DATA, NOT PHYSICAL CONVERSION; DESIGN AND DEVELOPMENT OF COMPUTER HARDWARE; MAINTENANCE OF COMPUTER SOFTWARE; RENTAL OF COMPUTER SOFTWARE; UPDATING OF COMPUTER SOFTWARE (U.S. CLS. 100 AND 101).

JEANIE LEE, EXAMINING ATTORNEY

**CLASS 42—(Continued).**

SN 86-119,259. SYS-TECH SOLUTIONS, INC., DBA SYSTECH INTERNATIONAL, CRANBURY, NJ. FILED 11-14-2013.



OWNER OF U.S. REG. NOS. 3,551,085, 3,694,662 AND OTHERS.

THE MARK CONSISTS OF TWELVE RECTANGLES FORMING A LARGER RECTANGLE DESIGN WITH THE WORDING "SYSTECH" IN LARGE STYLIZED LETTERS TO THE RIGHT OF THE DESIGN AND THE WORDING "PROVEN PROTECTION POWERFUL INSIGHT" BELOW THAT.

FOR DESIGN AND DEVELOPMENT OF COMPUTER SOFTWARE FOR CUSTOMIZATION OF COMPUTER COMPONENTS AND SOFTWARE USED IN MANUFACTURING FOR PACKAGING AND OPTIMIZING LINE PERFORMANCE THAT COMBINES VISION INSPECTION AND LINE AND PLANT MANAGEMENT SOFTWARE USED IN MANUFACTURING FOR PACKAGING; CUSTOMIZATION OF COMPUTER HARDWARE AND SOFTWARE USED FOR OPTIMIZING PACKAGING LINE PERFORMANCE BY FACILITATING THE SERIALIZATION OF PRODUCTS USING STANDARD AND NON-STANDARD CODES, AND FOR COLLECTING PERFORMANCE METRICS AND DATA IN CONNECTION WITH THE MANUFACTURE OF PACKAGING; CUSTOMIZATION OF COMPUTER HARDWARE AND SOFTWARE USED IN CONNECTION WITH THE MANUFACTURE OF PACKAGING THAT AGGREGATES PERFORMANCE METRICS AND KEY PERFORMANCE INDICATORS ACROSS MULTIPLE PACKAGING LINES AND ENABLES SERIALIZATION OF PRODUCTS USING STANDARD AND NONSTANDARD CODES FOR AN ENTIRE PACKAGING OPERATION; INSTALLATION, MAINTENANCE AND REPAIR OF COMPUTER SOFTWARE THAT COMBINES VISION INSPECTION AND LINE AND PLANT MANAGEMENT SOFTWARE USED TO MANUFACTURE PACKAGING; INSTALLATION, MAINTENANCE AND REPAIR OF COMPUTER SOFTWARE USED FOR MANAGING MACHINE VISION INSPECTION APPLICATIONS USED IN MANUFACTURING PACKAGING; CUSTOMIZATION OF COMPUTER HARDWARE AND SOFTWARE FOR OPTIMIZING PACKAGING LINE PERFORMANCE BY FACILITATING THE SERIALIZATION OF PRODUCTS USING STANDARD AND NON-STANDARD CODES, AND FOR COLLECTING PERFORMANCE METRICS AND DATA IN CONNECTION WITH THE MANUFACTURE OF PACKAGING THAT AGGREGATES PERFORMANCE METRICS AND KEY PERFORMANCE INDICATORS ACROSS MULTIPLE PACKAGING LINES AND ENABLES SERIALIZATION OF PRODUCTS USING STANDARD AND NONSTANDARD CODES FOR AN ENTIRE PACKAGING OPERATION; INSTALLATION, MAINTENANCE AND REPAIR OF COMPUTER SOFTWARE USED IN CONNECTION WITH THE MANUFACTURE OF PACKAGING THAT AGGREGATES PERFORMANCE METRICS AND KEY PERFORMANCE INDICATORS ACROSS MULTIPLE PACKAGING LINES AND ENABLES SERIALIZATION OF PRODUCTS USING STANDARD AND NONSTANDARD CODES FOR AN ENTIRE PACKAGING OPERATION; COMPUTER SOFTWARE CONSULTATION FOR SOFTWARE THAT COMBINES VISION INSPECTION AND LINE AND PLANT MANAGEMENT SOFTWARE USED TO MANUFACTURE PACKAGING; COMPUTER SOFTWARE CONSULTATION FOR SOFTWARE USED FOR MANAGING MACHINE VISION INSPECTION APPLICATIONS USED IN MANUFACTURING PACKAGING; COMPUTER SOFTWARE CONSULTATION FOR SOFTWARE USED FOR OPTIMIZING PACKAGING LINE PERFORMANCE BY FACILITATING THE SERIALIZATION OF PRODUCTS USING STANDARD AND NON-STANDARD CODES, AND FOR COLLECTING PERFORMANCE METRICS AND DATA IN CONNECTION WITH THE MANUFACTURE OF PACKAGING; COMPUTER SOFTWARE CONSULTATION FOR SOFTWARE USED IN CONNECTION WITH THE MANUFACTURE OF PACKAGING THAT AGGREGATES PERFORMANCE METRICS AND KEY PERFORMANCE INDICATORS ACROSS MULTIPLE PACKAGING LINES AND ENABLES SERIALIZATION OF PRODUCTS USING STANDARD AND NONSTANDARD CODES FOR AN ENTIRE PACKA-

**CLASS 42—(Continued).**

GING OPERATION; TECHNICAL SUPPORT SERVICES, NAMELY, TROUBLESHOOTING PROBLEMS OF COMPUTER HARDWARE AND SOFTWARE THAT COMBINES VISION INSPECTION AND LINE AND PLANT MANAGEMENT SOFTWARE USED TO MANUFACTURE PACKAGING; TECHNICAL SUPPORT SERVICES, NAMELY, TROUBLESHOOTING PROBLEMS OF COMPUTER HARDWARE AND SOFTWARE FOR MANAGING MACHINE VISION INSPECTION APPLICATIONS USED IN MANUFACTURING PACKAGING; TECHNICAL SUPPORT SERVICES, NAMELY, TROUBLESHOOTING PROBLEMS OF COMPUTER HARDWARE AND SOFTWARE FOR OPTIMIZING PACKAGING LINE PERFORMANCE BY FACILITATING THE SERIALIZATION OF PRODUCTS USING STANDARD AND NONSTANDARD CODES, AND FOR COLLECTING PERFORMANCE METRICS AND DATA IN CONNECTION WITH THE MANUFACTURE OF PACKAGING; TECHNICAL SUPPORT SERVICES, NAMELY, TROUBLESHOOTING PROBLEMS OF COMPUTER HARDWARE AND SOFTWARE USED IN CONNECTION WITH THE MANUFACTURE OF PACKAGING THAT AGGREGATES PERFORMANCE METRICS AND KEY PERFORMANCE INDICATORS ACROSS MULTIPLE PACKAGING LINES AND ENABLES SERIALIZATION OF PRODUCTS USING STANDARD AND NONSTANDARD CODES FOR AN ENTIRE PACKAGING OPERATION (U.S. CLS. 100 AND 101).

FIRST USE 11-11-2013; IN COMMERCE 11-11-2013.  
MATTHEW MCDOWELL, EXAMINING ATTORNEY

SN 86-120,374. PROGRESS SOFTWARE CORPORATION, BEDFORD, MA. FILED 11-15-2013.

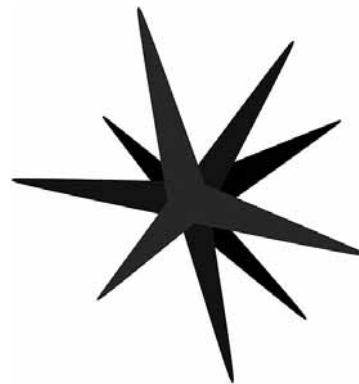

THE MARK CONSISTS OF A STYLIZED SPARK.

FOR COMPUTER AND TECHNICAL SUPPORT SERVICES, NAMELY, TROUBLESHOOTING OF COMPUTER SOFTWARE PROBLEMS, PROVIDING BACKUP COMPUTER PROGRAMS, MAINTENANCE, CONSULTING SERVICES, AND PROVIDING INFORMATION, ALL PERTAINING TO COMPUTER SOFTWARE PROGRAMS, AND PORTIONS THEREOF, NAMELY, THOSE PERTAINING TO LIVE ANALYTICS, ON-PREMISE APPLICATIONS, CLOUD PLATFORMS, SOCIAL NETWORKS, DATABASES, CRM AND ERP SYSTEMS, AND OTHER DATA DRIVEN SOURCES, TO ASSIST DEVELOPERS IN THE CREATION, MODIFICATION, AND DISTRIBUTION OF OTHER COMPUTER PROGRAMS VIA LOCAL, WIDE AREA, AND GLOBAL COMPUTER INFORMATION NETWORKS AND IN THE CLOUD; AND PROVIDING TEMPORARY USE OF ON-LINE NON-DOWNLOADABLE COMPUTER SOFTWARE DEVELOPMENT PROGRAMS AND SOFTWARE DEVELOPMENT TOOLS USED IN THE CREATION AND MODIFICATION OF OTHER COMPUTER PROGRAMS (U.S. CLS. 100 AND 101).

FIRST USE 10-5-2013; IN COMMERCE 10-5-2013.  
TAMARA FRAZIER, EXAMINING ATTORNEY

**CLASS 42—(Continued).**

SN 86-140,412. DNA DIAGNOSTICS CENTER, INC., FAIRFIELD, OH. FILED 12-11-2013.

# DNA ORIGINS

THE MARK CONSISTS OF STANDARD CHARACTERS WITHOUT CLAIM TO ANY PARTICULAR FONT, STYLE, SIZE, OR COLOR.

NO CLAIM IS MADE TO THE EXCLUSIVE RIGHT TO USE "DNA", APART FROM THE MARK AS SHOWN. FOR PATERNITY TESTING (U.S. CLS. 100 AND 101). JENNIFER BUTTON, EXAMINING ATTORNEY

**CLASS 43—(Continued).**

SN 85-385,970. BOJANGLES' INTERNATIONAL, LLC, CHARLOTTE, NC. FILED 8-1-2011.

## THINK INSIDE THE BOX

THE MARK CONSISTS OF STANDARD CHARACTERS WITHOUT CLAIM TO ANY PARTICULAR FONT, STYLE, SIZE, OR COLOR.

FOR RESTAURANT SERVICES, NAMELY PREPARING FRIED CHICKEN, VEGETABLES, PREPARED SIDE DISHES AND BISCUITS FOR CONSUMPTION ON OR OFF THE PREMISES (U.S. CLS. 100 AND 101).

WENDY JUN, EXAMINING ATTORNEY

SN 85-424,835. AARON E. DAVID, NEW ORLEANS, LA. FILED 9-16-2011.

**CLASS 43—HOTEL AND RESTAURANT SERVICES**

SN 76-715,237. KW BRANDS, LLC, WEST MONROE, LA. FILED 10-23-2013.



NO CLAIM IS MADE TO THE EXCLUSIVE RIGHT TO USE "DUCK DINER", APART FROM THE MARK AS SHOWN.

THE LIKENESS (OR, "PORTRAIT") IN THE MARK IDENTIFIES WILLIE ROBERTSON A LIVING INDIVIDUAL WHOSE CONSENT IS OF RECORD.

THE DESIGN CONSISTS OF WORDS AND A HEAD DESIGN, WITH THE WORD "WILLIE'S" IN A HANDWRITING FONT AT THE TOP OF THE DESIGN, AND IMMEDIATELY BENEATH THAT WORD ARE TWO WORDS IN ALL CAPS AND LARGE FONT OF "DUCK" SITUATED AT THE FAR LEFT AND "DINER" SITUATED AT THE FAR RIGHT AND WITH THE LAYOUT OF THE WORDS POSITIONED AS BEING ABOVE AND TO EACH SIDE OF THE DESIGN OF A DRAWING OF A MAN'S HEAD WITH A FULL BEARD AND SUNGLASSES AND A BANDANA DISPLAYING A REPRESENTATIVE DESIGN OF THE STARS AND STRIPES OF THE USA FLAG.

FOR RESTAURANT SERVICES (U.S. CLS. 100 AND 101).

ANDREA HACK, EXAMINING ATTORNEY



THE MARK CONSISTS OF A RECTANGLE CONTAINING A MAN WEARING A HAT AND SUIT. A SPEECH BUBBLE APPEARS TO HIS LEFT CONTAINING THE WORDING "WE'LL MAKE YOU A BURGER YOU CAN'T REFUSE!"

FOR RESTAURANT SERVICES (U.S. CLS. 100 AND 101).

YAT SYE, LEE, EXAMINING ATTORNEY

SN 85-507,392. LA GLORIA, SAN ANTONIO, TX. FILED 1-3-2012.

# La Gloria

THE MARK CONSISTS OF STANDARD CHARACTERS WITHOUT CLAIM TO ANY PARTICULAR FONT, STYLE, SIZE, OR COLOR.

THE ENGLISH TRANSLATION OF "LA GLORIA" IN THE MARK IS "THE GLORY".

FOR RESTAURANT SERVICES FEATURING AUTHENTIC REGIONAL MEXICAN CUISINE (U.S. CLS. 100 AND 101).

FIRST USE 5-1-2010; IN COMMERCE 5-1-2010.

LINDA ESTRADA, EXAMINING ATTORNEY

**CLASS 43—(Continued).**

SN 85-655,097. ABDOO, MICHAEL, GRAND RAPIDS, MI. FILED 6-19-2012.

# WING KINGZ

THE MARK CONSISTS OF STANDARD CHARACTERS WITHOUT CLAIM TO ANY PARTICULAR FONT, STYLE, SIZE, OR COLOR.

NO CLAIM IS MADE TO THE EXCLUSIVE RIGHT TO USE "WING", APART FROM THE MARK AS SHOWN.

FOR FAST-FOOD RESTAURANT SERVICES (U.S. CLS. 100 AND 101).

FIRST USE 8-31-2012; IN COMMERCE 8-31-2012.  
MEREDITH MARESCA, EXAMINING ATTORNEY

SN 85-703,299. EXPERIMENTS IN DINING, LLC, WASHINGTON, DC. FILED 8-14-2012.

# COTERIE

THE MARK CONSISTS OF STANDARD CHARACTERS WITHOUT CLAIM TO ANY PARTICULAR FONT, STYLE, SIZE, OR COLOR.

FOR MAKING RESERVATIONS AND BOOKINGS FOR RESTAURANTS AND MEALS (U.S. CLS. 100 AND 101).

FIRST USE 11-11-2011; IN COMMERCE 11-11-2011.  
LIEF MARTIN, EXAMINING ATTORNEY

SN 85-703,375. EXPERIMENTS IN DINING, LLC, WASHINGTON, DC. FILED 8-14-2012.

# THE COTERIE

THE MARK CONSISTS OF STANDARD CHARACTERS WITHOUT CLAIM TO ANY PARTICULAR FONT, STYLE, SIZE, OR COLOR.

FOR MAKING RESERVATIONS AND BOOKINGS FOR RESTAURANTS AND MEALS (U.S. CLS. 100 AND 101).

FIRST USE 11-11-2011; IN COMMERCE 11-11-2011.  
LIEF MARTIN, EXAMINING ATTORNEY

**CLASS 43—(Continued).**

SN 85-743,945. CAFE ENTERPRISES, INC., TAYLORS, SC. FILED 10-2-2012.

# T24

THE MARK CONSISTS OF STANDARD CHARACTERS WITHOUT CLAIM TO ANY PARTICULAR FONT, STYLE, SIZE, OR COLOR.

FOR RESTAURANT SERVICES AND BAR SERVICES (U.S. CLS. 100 AND 101).

DORITT L. CARROLL, EXAMINING ATTORNEY

SN 85-849,431. MGM RESORTS INTERNATIONAL, LAS VEGAS, NV. FILED 2-13-2013.



OWNER OF U.S. REG. NOS. 1,043,787, 3,870,709 AND OTHERS.

NO CLAIM IS MADE TO THE EXCLUSIVE RIGHT TO USE "SPRINGFIELD", APART FROM THE MARK AS SHOWN.

THE MARK CONSISTS OF THE LETTERS "MGM" AND THE WORD "SPRINGFIELD" SEPARATED BY A DEPICTION OF LIONHEAD CONTAINED BETWEEN DOUBLE HORIZONTAL LINES ABOVE AND BELOW.

FOR HOTELS; RESORT HOTELS; HOTEL SERVICES FOR PREFERRED CUSTOMERS; ARENA SERVICES, NAMELY, PROVIDING FACILITIES FOR SPORTS, CONCERTS, CONVENTIONS AND EXHIBITIONS; RESTAURANT SERVICES; BAR SERVICES; CATERING SERVICES; COCKTAIL LOUNGES; PROVIDING BANQUET AND SOCIAL FUNCTION FACILITIES FOR SPECIAL OCCASIONS; PROVIDING CONVENTION FACILITIES; PROVIDING FACILITIES FOR EXHIBITIONS (U.S. CLS. 100 AND 101).

CAROLINE WOOD, EXAMINING ATTORNEY

SN 85-861,115. WARWICK AMUSEMENTS CORPORATION, SANTA ROSA, CA. FILED 2-27-2013.



OWNER OF U.S. REG. NOS. 2,287,323 AND 2,287,324. NO CLAIM IS MADE TO THE EXCLUSIVE RIGHT TO USE "DENVER HOTEL", APART FROM THE MARK AS SHOWN.

THE COLOR(S) MAROON, GRAY IS/ARE CLAIMED AS A FEATURE OF THE MARK.

THE MARK CONSISTS OF A TREE ABOVE TWO LINES



**CLASS 43—(Continued).**

OF TEXT. THE TREE CONSISTS OF A LIGHT GRAY SILHOUETTE OF A PINE TREE WITH GRASS AROUND THE BASE OF THE TREE TRUNK. THE FIRST LINE OF TEXT THAT APPEARS AFTER THE LOGO READS; "WARWICK" IN ALL CAPITAL LETTERS IN THE COLOR MAROON. THE SECOND LINE OF TEXT READS; "DENVER HOTEL" IN ALL CAPITAL LETTERS IN THE COLOR GRAY. THE ENTIRE MARK HAS A CLEAR / WHITE BACKGROUND THAT CREATES A RECTANGLE AROUND THE LOGO AND TEXT.

FOR HOTEL ACCOMMODATION SERVICES (U.S. CLS. 100 AND 101).

FIRST USE 2-10-1964; IN COMMERCE 2-10-1964.  
MORGAN WYNNE, EXAMINING ATTORNEY

SN 85-866,383. WARWICK AMUSEMENTS CORPORATION, SEATTLE, WA. FILED 3-4-2013.



OWNER OF U.S. REG. NOS. 2,287,323 AND 2,287,324. NO CLAIM IS MADE TO THE EXCLUSIVE RIGHT TO USE "HOTEL, DALLAS", APART FROM THE MARK AS SHOWN.

THE COLOR(S) MAROON AND GRAY IS/ARE CLAIMED AS A FEATURE OF THE MARK.

THE MARK CONSISTS OF A LOGO PRECEDING TWO LINES OF TEXT. THE LOGO BEING TWO WINGED GRIFFONS LOOKING AT EACH OTHER WITH AN URN IN BETWEEN THEM. THE TWO GRIFFONS ARE SITTING ON THEIR HAUNCHES AND THEIR TAILS ARE UPRIGHT AND CURVED AT THE END. THE URN THAT SITS BETWEEN THEM IS AS TALL AS THE GRIFFONS. THE TWO GRIFFONS AND THE URN ARE IN THE COLOR GRAY. THE FIRST LINE OF TEXT THAT APPEARS AFTER THE LOGO READS; "WARWICK" IN MAROON. THE SECOND LINE OF TEXT READS; "MELROSE HOTEL, DALLAS" IN LIGHT GRAY. THE ENTIRE MARK HAS A CLEAR / WHITE BACKGROUND THAT CREATES A RECTANGLE AROUND THE LOGO AND TEXT.

FOR HOTEL ACCOMMODATION SERVICES (U.S. CLS. 100 AND 101).

FIRST USE 7-23-2003; IN COMMERCE 7-23-2003.  
MORGAN WYNNE, EXAMINING ATTORNEY

SN 85-866,418. WARWICK AMUSEMENTS CORPORATION, SEATTLE, WA. FILED 3-4-2013.



OWNER OF U.S. REG. NOS. 2,287,323 AND 2,287,324. NO CLAIM IS MADE TO THE EXCLUSIVE RIGHT TO USE "NEW YORK HOTEL", APART FROM THE MARK AS SHOWN.

THE COLOR(S) MAROON AND GRAY IS/ARE CLAIMED AS A FEATURE OF THE MARK.

THE MARK CONSISTS OF A LOGO PRECEDING TWO LINES OF TEXT, THE LOGO BEING AN ORNATE ORB

**CLASS 43—(Continued).**

WITH TWO GIRLS WITH FLOWING HAIR AND FLOWING HAIR ON OPPOSITE SIDES OF THE ORB LOOKING AT EACH OTHER WITH HANDS EXTENDED HOLDING THE ORB UPRIGHT. THERE ALSO APPEARS A BOYS FACE ON TOP OF THE ORB WITH ANGELS WINGS SPREAD OPEN ON BOTH SIDES. THE ORB SITS ON A DECORATIVE CURLED IRON LOOKING BASE, ALL IN GRAY COLOR. THE FIRST LINE OF TEXT THAT APPEARS AFTER THE LOGO READS; "WARWICK" IN ALL CAPITAL LETTERS IN THE COLOR MAROON. THE SECOND LINE OF TEXT READS; "NEW YORK HOTEL" IN ALL CAPITAL LETTERS IN THE COLOR GRAY. THE ENTIRE MARK HAS A CLEAR / WHITE BACKGROUND THAT CREATES A RECTANGLE AROUND THE LOGO AND TEXT.

FOR HOTEL ACCOMMODATION SERVICES (U.S. CLS. 100 AND 101).

FIRST USE 7-23-2003; IN COMMERCE 7-23-2003.  
MORGAN WYNNE, EXAMINING ATTORNEY

SN 85-884,243. PIER 23 CAFE, INC., SAN FRANCISCO, CA. FILED 3-22-2013.

Pier 23

THE MARK CONSISTS OF STANDARD CHARACTERS WITHOUT CLAIM TO ANY PARTICULAR FONT, STYLE, SIZE, OR COLOR.

FOR RESTAURANT SERVICES (U.S. CLS. 100 AND 101).

FIRST USE 6-10-2003; IN COMMERCE 6-10-2003.  
KYLE PEETE, EXAMINING ATTORNEY

SN 85-909,212. MICHAEL EDWARD NELSON, HOUSTON, TX. FILED 4-19-2013.



THE COLOR(S) GREEN IS/ARE CLAIMED AS A FEATURE OF THE MARK.

THE MARK CONSISTS OF A STYLIZED IMAGE OF ONE OF THE 208 SPECIES OF THE AGAVE PLANT IN THE COLOR GREEN.

FOR BAR AND RESTAURANT SERVICES (U.S. CLS. 100 AND 101).

GINA FINK, EXAMINING ATTORNEY

**CLASS 43—(Continued).**

SN 85-925,517. WAGRAM FINANCES, PARIS, FRANCE, FILED 5-7-2013.



NO CLAIM IS MADE TO THE EXCLUSIVE RIGHT TO USE "CAFÉ & CO", APART FROM THE MARK AS SHOWN. THE MARK CONSISTS OF THE WORD "COLUMBUS" APPEARING ABOVE A REPRESENTATION OF THE HEAD OF A BEAR WITH THE WORDS "CAFÉ & CO" APPEARING BELOW THE HEAD ALL WITHIN OVAL.

FOR BAR SERVICES; CAFÉ SERVICES; CAFETERIA SERVICES; SNACK BAR SERVICES; SELF-SERVICE RESTAURANTS; PROVIDING OF FOOD AND DRINK (U.S. CLS. 100 AND 101).

SALLY SHIH, EXAMINING ATTORNEY

SN 85-933,785. NAF-NAF MANAGEMENT, INC., NAPERVILLE, IL. FILED 5-16-2013.

**START A PITA REVOLUTION!**

THE MARK CONSISTS OF STANDARD CHARACTERS WITHOUT CLAIM TO ANY PARTICULAR FONT, STYLE, SIZE, OR COLOR.

FOR RESTAURANT SERVICES (U.S. CLS. 100 AND 101).

FIRST USE 1-1-2010; IN COMMERCE 1-1-2010.

AMY C. KEAN, EXAMINING ATTORNEY

SN 85-940,519. NEVERETT ALEXANDER EGGLESTON, III, RICHMOND, VA. FILED 5-23-2013.



THE MARK CONSISTS OF THE WORD "CROAKER'S" IN AN ARCH SHAPE ABOVE THE WORD "SPOT". SEC. 2(F) AS TO "CROAKER'S".

FOR RESTAURANT SERVICES (U.S. CLS. 100 AND 101).

FIRST USE 4-9-2001; IN COMMERCE 4-9-2001.

JUSTINE D. PARKER, EXAMINING ATTORNEY

**CLASS 43—(Continued).**

SN 85-941,611. THE KESSLER ENTERPRISE, INC., ORLANDO, FL. FILED 5-24-2013.

**The Inn on the Warf**

THE MARK CONSISTS OF STANDARD CHARACTERS WITHOUT CLAIM TO ANY PARTICULAR FONT, STYLE, SIZE, OR COLOR.

NO CLAIM IS MADE TO THE EXCLUSIVE RIGHT TO USE "INN", APART FROM THE MARK AS SHOWN.

FOR HOSPITALITY AND HOTEL SERVICES, NAMELY, PROVIDING HOTEL, MOTEL, RESTAURANT AND BAR SERVICES (U.S. CLS. 100 AND 101).

MARC LEIPZIG, EXAMINING ATTORNEY

SN 85-950,231. PIPALATO, LLC, MIAMI BEACH, FL. FILED 6-4-2013.



NO CLAIM IS MADE TO THE EXCLUSIVE RIGHT TO USE "FRESH" AND "ITALIAN", APART FROM THE MARK AS SHOWN.

THE MARK CONSISTS OF THE WORDS "PIPALATO FRESH. HONEST. ITALIAN," NEXT TO A LOGO OF A FORK POINTED UPWARDS HOLDING A PIECE OF PASTA TOPPED BY A STAR AND SURROUNDED BY A SQUARE BOX.

THE WORDING "PIPALATO" HAS NO MEANING IN A FOREIGN LANGUAGE.

FOR FAST-FOOD RESTAURANT SERVICES; RESTAURANT AND CAFÉ SERVICES; RESTAURANT AND CATERING SERVICES; RESTAURANT SERVICES; RESTAURANT SERVICES FEATURING ITALIAN FOOD; RESTAURANT SERVICES, INCLUDING SIT-DOWN SERVICE OF FOOD AND TAKE-OUT RESTAURANT SERVICES (U.S. CLS. 100 AND 101).

FIRST USE 5-1-2013; IN COMMERCE 5-1-2013.

PRISCILLA MILTON, EXAMINING ATTORNEY

**CLASS 43—(Continued).**

SN 86-000,666. SUMO STEAKS LLC, PHILADELPHIA, PA.  
FILED 7-2-2013.



OWNER OF U.S. REG. NO. 4,175,564.  
THE MARK CONSISTS OF A STYLIZED IMAGE OF A  
SUMO WRESTLER APPEARING INSIDE A STYLIZED  
CIRCLE.  
FOR CATERING SERVICES; RESTAURANT AND  
CAFE SERVICES (U.S. CLS. 100 AND 101).  
FIRST USE 11-1-2010; IN COMMERCE 11-1-2010.  
MARYNELLE WILSON, EXAMINING ATTORNEY

**CLASS 43—(Continued).**

SN 86-009,340. RIOT FEST CORPORATION, CHICAGO, IL.  
FILED 7-12-2013.

# Riot Feast

THE MARK CONSISTS OF STANDARD CHARACTERS  
WITHOUT CLAIM TO ANY PARTICULAR FONT, STYLE,  
SIZE, OR COLOR.  
OWNER OF U.S. REG. NO. 3,342,620.  
NO CLAIM IS MADE TO THE EXCLUSIVE RIGHT TO  
USE "FEAST", APART FROM THE MARK AS SHOWN.  
FOR PROVIDING OF FOOD AND DRINK (U.S. CLS.  
100 AND 101).  
FIRST USE 5-1-2009; IN COMMERCE 9-14-2012.  
DAWN HAN, EXAMINING ATTORNEY

SN 86-012,389. SURF TACO COASTAL CUISINE, POINT  
PLEASANT BEACH, NJ. FILED 7-17-2013.

# FIT TO RIP

SN 86-008,836. QUOGUE CLUB LLC, NEW YORK, NY.  
FILED 7-12-2013.



THE MARK CONSISTS OF DESIGN OF A TREE COM-  
PRISED OF STYLIZED "Q"'S.  
FOR HOTEL SERVICES; RESTAURANT SERVICES;  
PRIVATE RESIDENCE CLUB SERVICES, NAMELY,  
PROVIDING CLUB MEMBERS TEMPORARY ACCOM-  
MODATIONS IN COMPANY OWNED OR LEASED  
PRIVATE RESIDENCES; BAR SERVICES (U.S. CLS. 100  
AND 101).  
KRISTINA MORRIS, EXAMINING ATTORNEY

THE MARK CONSISTS OF STANDARD CHARACTERS  
WITHOUT CLAIM TO ANY PARTICULAR FONT, STYLE,  
SIZE, OR COLOR.  
FOR RESTAURANT SERVICES; RESTAURANT IN-  
FORMATION SERVICES (U.S. CLS. 100 AND 101).  
NATALIE POLZER, EXAMINING ATTORNEY

SN 86-014,765. RISO JITSUGYO CO., LTD., NARA, JAPAN,  
FILED 7-19-2013.



**KAMUKURA**  
SOUP WITH NOODLES

NO CLAIM IS MADE TO THE EXCLUSIVE RIGHT TO  
USE "SOUP WITH NOODLES", APART FROM THE MARK  
AS SHOWN.  
THE MARK CONSISTS OF THE WORDING "KAMU-  
KURA SOUP WITH NOODLES" ALONGSIDE A BOX  
CONTAINING JAPANESE CHARACTERS THAT TRANSLI-  
TERATE TO "DOUTONBORI, KAMUKURA, KAMU-  
KURA".  
THE WORDING "KAMUKURA" HAS NO MEANING IN A  
FOREIGN LANGUAGE.  
FOR PROVIDING OF FOOD AND DRINK; RESTAU-  
RANT SERVICES (U.S. CLS. 100 AND 101).  
MORGAN WYNNE, EXAMINING ATTORNEY

**CLASS 43—(Continued).**

SN 86-018,559. MSG FORUM, LLC, NEW YORK, NY. FILED 7-24-2013.



OWNER OF U.S. REG. NO. 1,222,923.

THE MARK CONSISTS OF A DESIGN CONSISTING OF A RENDERING OF A PORTION OF A BUILDING CONTAINING COLUMNS AND ARCHES WITH THE WORD "FORUM" TO THE RIGHT OF THE DESIGN.

FOR ARENA SERVICES, NAMELY, PROVIDING GENERAL PURPOSE FACILITIES FOR SPORTS, CONCERTS, ENTERTAINMENT EVENTS, CONVENTIONS AND EXHIBITIONS (U.S. CLS. 100 AND 101).

ELIZABETH KAJUBI, EXAMINING ATTORNEY

**CLASS 43—(Continued).**

SN 86-023,426. SUGAR AFTER DARK, INC., WORCESTER, MA. FILED 7-30-2013.



THE MARK CONSISTS OF A STYLIZED CUPCAKE. FOR RESTAURANT SERVICES (U.S. CLS. 100 AND 101).

FIRST USE 6-24-2013; IN COMMERCE 6-24-2013.  
LINDA MICKLEBURGH, EXAMINING ATTORNEY

SN 86-023,643. KHATRI, SHAZAD, SUGAR LAND, TX. FILED 7-30-2013.

## Dilpasand

THE MARK CONSISTS OF STANDARD CHARACTERS WITHOUT CLAIM TO ANY PARTICULAR FONT, STYLE, SIZE, OR COLOR.

THE WORDING "DILPASAND" HAS NO MEANING IN A FOREIGN LANGUAGE.

FOR RESTAURANT SERVICES, INCLUDING SIT-DOWN SERVICE OF FOOD AND TAKE-OUT RESTAURANT SERVICES (U.S. CLS. 100 AND 101).

FIRST USE 3-6-2010; IN COMMERCE 3-6-2010.  
ERIN FALK, EXAMINING ATTORNEY

SN 86-020,957. BELAIR CANTINA, INC., MILWAUKEE, WI. FILED 7-26-2013.



SN 86-025,252. YUMSEI CATERING CO INC, LONG BEACH, CA. FILED 7-31-2013.

## YUMSEI CATERING CO. WHERE FOOD DREAMS COME TRUE

NO CLAIM IS MADE TO THE EXCLUSIVE RIGHT TO USE "CANTINA", APART FROM THE MARK AS SHOWN.

THE MARK CONSISTS OF THE WORDING "BELAIR CANTINA" INSIDE A STYLIZED DESIGN OF THE SILHOUETTE OF A BULL WITH EMBROIDERY STITCHING AROUND THE EDGES OF THE DESIGN.

FOR BAR AND RESTAURANT SERVICES (U.S. CLS. 100 AND 101).

FIRST USE 8-13-2010; IN COMMERCE 9-22-2010.  
CORY BOONE, EXAMINING ATTORNEY

THE MARK CONSISTS OF STANDARD CHARACTERS WITHOUT CLAIM TO ANY PARTICULAR FONT, STYLE, SIZE, OR COLOR.

NO CLAIM IS MADE TO THE EXCLUSIVE RIGHT TO USE "CATERING CO.", APART FROM THE MARK AS SHOWN.

THE WORDING "YUMSEI" HAS NO MEANING IN A FOREIGN LANGUAGE.

FOR CATERING SERVICES (U.S. CLS. 100 AND 101).  
KAPIL BHANOT, EXAMINING ATTORNEY

**CLASS 43—(Continued).**

SN 86-027,505. VIRGINIA BEACH CINEMA, INC., VIRGINIA BEACH, VA. FILED 8-2-2013.



NO CLAIM IS MADE TO THE EXCLUSIVE RIGHT TO USE "CAFE", APART FROM THE MARK AS SHOWN.

THE COLOR(S) RED, BLACK AND WHITE IS/ARE CLAIMED AS A FEATURE OF THE MARK.

THE MARK CONSISTS OF THE WORDING "CINEMA CAFE" IN BLACK AND OUTLINED IN WHITE, WITH A DIAMOND-SHAPED CARRIER DESIGN IN THE BACKGROUND IN RED, WHITE AND BLACK.

SEC. 2(F) AS TO "CINEMA CAFE".

FOR BAR AND RESTAURANT SERVICES; BAR SERVICES; PROVIDING OF FOOD AND DRINK; RESTAURANT SERVICES; SERVING FOOD AND DRINKS; SNACK BAR SERVICES (U.S. CLS. 100 AND 101).

FIRST USE 6-0-1993; IN COMMERCE 6-0-1993.  
JAMES A. RAUEN, EXAMINING ATTORNEY

**CLASS 43—(Continued).**

SN 86-028,133. MOOSE, INC., SAN DIEGO, CA. FILED 8-3-2013.

**FRED'S MEXICAN CAFE**

THE MARK CONSISTS OF STANDARD CHARACTERS WITHOUT CLAIM TO ANY PARTICULAR FONT, STYLE, SIZE, OR COLOR.

OWNER OF U.S. REG. NO. 2,536,064.

NO CLAIM IS MADE TO THE EXCLUSIVE RIGHT TO USE "MEXICAN CAFE", APART FROM THE MARK AS SHOWN.

FOR BAR AND RESTAURANT SERVICES (U.S. CLS. 100 AND 101).

FIRST USE 4-1-1994; IN COMMERCE 4-1-1994.  
JAMES STEIN, EXAMINING ATTORNEY

SN 86-028,495. SCHWAB, GRANT T, OSHKOSH, WI. FILED 8-5-2013.

**BYO Pie**

THE MARK CONSISTS OF STANDARD CHARACTERS WITHOUT CLAIM TO ANY PARTICULAR FONT, STYLE, SIZE, OR COLOR.

NO CLAIM IS MADE TO THE EXCLUSIVE RIGHT TO USE "PIE", APART FROM THE MARK AS SHOWN.

FOR RESTAURANT SERVICES (U.S. CLS. 100 AND 101).

BRIDGETT SMITH, EXAMINING ATTORNEY

SN 86-027,510. PEZZO PER PEZZO, LLC, ST. PAUL, MN. FILED 8-2-2013.

**PEZZO PER PEZZO**

THE MARK CONSISTS OF STANDARD CHARACTERS WITHOUT CLAIM TO ANY PARTICULAR FONT, STYLE, SIZE, OR COLOR.

THE ENGLISH TRANSLATION OF THE WORD "PEZZO PER PEZZO" IN THE MARK IS "PIECE BY PIECE".

FOR RESTAURANT SERVICES; BAR SERVICES; CATERING SERVICES (U.S. CLS. 100 AND 101).

MEREDITH MARESCA, EXAMINING ATTORNEY

SN 86-031,176. ALVAREZ, GEORGE, CORAL GABLES, FL. FILED 8-7-2013.

**LosMarlins.com**

THE MARK CONSISTS OF STANDARD CHARACTERS WITHOUT CLAIM TO ANY PARTICULAR FONT, STYLE, SIZE, OR COLOR.

THE ENGLISH TRANSLATION OF THE WORD "LOS" IN THE MARK IS "THE".

FOR TRAVEL SERVICES, NAMELY, MAKING RESERVATIONS AND BOOKINGS FOR TEMPORARY LODGING; MAKING HOTEL AND TEMPORARY LODGING RESERVATIONS FOR INDIVIDUALS AND GROUPS VIA A GLOBAL COMPUTER NETWORK (U.S. CLS. 100 AND 101).

FIRST USE 2-19-2003; IN COMMERCE 2-19-2003.  
AMY KERTGATE, EXAMINING ATTORNEY

**CLASS 43—(Continued).**

SN 86-031,696. SELDOVIA, LDA, FUNCHAL, MADEIRA, PORTUGAL, FILED 8-7-2013.

# EB HOTEL

THE MARK CONSISTS OF STANDARD CHARACTERS WITHOUT CLAIM TO ANY PARTICULAR FONT, STYLE, SIZE, OR COLOR.

NO CLAIM IS MADE TO THE EXCLUSIVE RIGHT TO USE "HOTEL", APART FROM THE MARK AS SHOWN.

FOR HOTEL ACCOMMODATION SERVICES; PROVIDING OF FOOD AND DRINK (U.S. CLS. 100 AND 101).

FIRST USE 5-31-2013; IN COMMERCE 5-31-2013.  
DANNEAN HETZEL, EXAMINING ATTORNEY

**CLASS 43—(Continued).**

SN 86-034,653. BERRY GOOD YOGURT INC., PATCHOGUE, NY, FILED 8-11-2013.

## BERRY GOOD YOGURT CAFE

THE MARK CONSISTS OF STANDARD CHARACTERS WITHOUT CLAIM TO ANY PARTICULAR FONT, STYLE, SIZE, OR COLOR.

NO CLAIM IS MADE TO THE EXCLUSIVE RIGHT TO USE "BERRY" AND "YOGURT CAFE", APART FROM THE MARK AS SHOWN.

FOR FROZEN YOGURT SHOP SERVICES IN THE NATURE OF A RESTAURANT (U.S. CLS. 100 AND 101).  
FIRST USE 8-1-2012; IN COMMERCE 6-26-2013.

CAROLYN CATALDO, EXAMINING ATTORNEY

SN 86-035,498. ARAMARK CORPORATION, PHILADELPHIA, PA. FILED 8-12-2013.

## SANDWICH SHACK

HAND CRAFTED GREATNESS

NO CLAIM IS MADE TO THE EXCLUSIVE RIGHT TO USE "SANDWICH SHACK HAND CRAFTED", APART FROM THE MARK AS SHOWN.

THE MARK CONSISTS OF THE WORDING "SANDWICH SHACK" IN BROKEN LETTER FORM, IN UPPERCASE AND STYLIZED LETTERS, ALL ABOVE THE WORDING "HAND CRAFTED GREATNESS" IN UPPERCASE LETTERS.

FOR RESTAURANTS; RESTAURANT SERVICES; CONTRACT FOOD SERVICES; CATERING (U.S. CLS. 100 AND 101).

MARLENE BELL, EXAMINING ATTORNEY

SN 86-031,876. CLAWS AND CRAWLS, INC., DBA CLAWS AND CRAWLS, HERCULES, CA. FILED 8-7-2013.



THE COLOR(S) ORANGE, BROWN, BLUE, RED AND TAN IS/ARE CLAIMED AS A FEATURE OF THE MARK.

THE MARK CONSISTS OF A SOLID BROWN STYLIZED IMAGE OF A CRAB BEHIND THE WORDS "CLAWS" ABOVE "AND" ABOVE "CRAWLS". "CLAWS" IS IN ORANGE. "AND" IS IN BLUE. "CRAWLS" IS IN ORANGE FADING DOWNWARD TO RED. ALL WORDS HAVE TAN LINES AROUND THEM CREATING A 3D EFFECT.

FOR BAR AND RESTAURANT SERVICES; CAFE AND RESTAURANT SERVICES; CAFE-RESTAURANTS; CAFETERIA AND RESTAURANT SERVICES; FAST-FOOD RESTAURANT SERVICES; RESTAURANT AND CAFE SERVICES; RESTAURANT AND CATERING SERVICES; RESTAURANT AND HOTEL SERVICES; RESTAURANT SERVICES; RESTAURANT SERVICES FEATURING SEAFOOD; RESTAURANT SERVICES, INCLUDING SIT-DOWN SERVICE OF FOOD AND TAKE-OUT RESTAURANT SERVICES; RESTAURANT SERVICES, NAMELY, PROVIDING OF FOOD AND BEVERAGES FOR CONSUMPTION ON AND OFF THE PREMISES; RESTAURANT, BAR AND CATERING SERVICES; RESTAURANTS FEATURING HOME DELIVERY; SALAD BARS; SELF-SERVICE RESTAURANTS; TAKE-OUT RESTAURANT SERVICES (U.S. CLS. 100 AND 101).

FIRST USE 7-15-2013; IN COMMERCE 7-15-2013.  
ELISSA GARBER KON, EXAMINING ATTORNEY

SN 86-036,091. CORT BUSINESS SERVICES CORPORATION, CHANTILLY, VA. FILED 8-13-2013.

## CORT GLOBAL NETWORK

THE MARK CONSISTS OF STANDARD CHARACTERS WITHOUT CLAIM TO ANY PARTICULAR FONT, STYLE, SIZE, OR COLOR.

NO CLAIM IS MADE TO THE EXCLUSIVE RIGHT TO USE "GLOBAL NETWORK", APART FROM THE MARK AS SHOWN.

FOR RENTAL OF FURNITURE; RENTAL OF HOUSEHOLD APPLIANCES FOR USE IN TEMPORARY HOUSING ACCOMMODATIONS (U.S. CLS. 100 AND 101).

FIRST USE 1-31-2010; IN COMMERCE 1-31-2010.  
PAUL MORENO, EXAMINING ATTORNEY

**CLASS 43—(Continued).**

SN 86-037,182. RADISSON HOTELS INTERNATIONAL, INC., MINNEAPOLIS, MN. FILED 8-14-2013.

EXPERIENCE MEETINGS

THE MARK CONSISTS OF STANDARD CHARACTERS WITHOUT CLAIM TO ANY PARTICULAR FONT, STYLE, SIZE, OR COLOR.

NO CLAIM IS MADE TO THE EXCLUSIVE RIGHT TO USE "MEETINGS", APART FROM THE MARK AS SHOWN. FOR HOTEL SERVICES; PROVIDING TEMPORARY ACCOMMODATION (U.S. CLS. 100 AND 101).

ALAIN LAPTER, EXAMINING ATTORNEY

SN 86-038,326. LA GLORIA, SAN ANTONIO, TX. FILED 8-14-2013.



NO CLAIM IS MADE TO THE EXCLUSIVE RIGHT TO USE "STREET FOODS OF MEXICO", APART FROM THE MARK AS SHOWN.

THE COLOR(S) DARK BLUE, BLUE, LIGHT BLUE AND WHITE IS/ARE CLAIMED AS A FEATURE OF THE MARK.

THE MARK CONSISTS OF A STYLIZED BOX WITH AN OUTER RING IN DARK BLUE, THE NEXT RING IN BLUE, AND THE INNERMOST RING IN WHITE. THE WORDING "LA GLORIA" APPEARS IN DARK BLUE, LIGHT BLUE AND WHITE WITHIN THE STYLIZED BOX. THE WORDING "STREET FOODS OF MEXICO" IS IN WHITE AND APPEARS BELOW THE WORD "GLORIA". TO THE RIGHT OF THE WORD "LA" IS A DESIGN OF A HUMAN FACE IN THE MIDDLE OF A WING FORMATION. THE HUMAN FACE AND WING DESIGN IS DARK BLUE AND LIGHT BLUE. THE ENTIRE BACKGROUND OF THE INSIDE OF THE STYLIZED BOX IS IN LIGHT BLUE.

THE ENGLISH TRANSLATION OF THE WORD "LA GLORIA" IN THE MARK IS "THE GLORY".

FOR RESTAURANT AND COCKTAIL LOUNGE SERVICES, BAR SERVICES, CARRY-OUT RESTAURANT SERVICES, TAKE OUT RESTAURANT, CATERING SERVICES AND RESTAURANTS FEATURING HOME DELIVERY (U.S. CLS. 100 AND 101).

DAVID MURRAY, EXAMINING ATTORNEY

**CLASS 43—(Continued).**

SN 86-038,769. CHIKARANOMOTO COMPANY CO. LTD., FUKUOKA CITY, FUKUOKA, JAPAN, FILED 8-15-2013.



NO CLAIM IS MADE TO THE EXCLUSIVE RIGHT TO USE THE NON-LATIN CHARACTERS THAT TRANSLITERATE AND MEAN "RAMEN", APART FROM THE MARK AS SHOWN.

THE MARK CONSISTS OF JAPANESE CHARACTERS OVER THE WORDS "MEN-OH".

THE ENGLISH TRANSLATION OF "MEN-OH" IN THE MARK IS "RAMEN KING".

THE NON-LATIN CHARACTERS IN THE MARK TRANSLITERATE TO MEN-OH AND THIS MEANS RAMEN KING IN ENGLISH.

FOR RESTAURANT AND CAFE SERVICES (U.S. CLS. 100 AND 101).

SAMUEL E. SHARPER JR., EXAMINING ATTORNEY

SN 86-040,416. OROVERDE CORP., SAN JUAN, PUERTO RICO, FILED 8-16-2013.



THE COLOR(S) GREEN, DARK GREEN, YELLOW AND GOLD IS/ARE CLAIMED AS A FEATURE OF THE MARK.

THE MARK CONSISTS OF TWO OVERLAPPING LEAVES IN WHICH THE LEFT LEAF IS GREEN AND THE RIGHT LEAF IS DARK GREEN, A CIRCLE APPEARING ABOVE THE LEAVES IN WHICH THE CIRCLE IS YELLOW FADING TO GOLD COLOR AND THE GREEN WORDING "OROVERDE" APPEARING BENEATH THE DESIGN.

THE ENGLISH TRANSLATION OF "OROVERDE" IN THE MARK IS "GREEN GOLD".

FOR HOTEL SERVICES (U.S. CLS. 100 AND 101).

JENNY PARK, EXAMINING ATTORNEY

**CLASS 43—(Continued).**

SN 86-041,124. COMINGS, ROBERT, PAYNEVILLE, KY. FILED 8-19-2013.



THE MARK CONSISTS OF A PHOTOGRAPHIC REPRESENTATION OF A FORK WITH FIVE TINES REPRESENTING A HUMAN HAND WITH THE SECOND AND THIRD TINES RESEMBLING FINGERS BENT AND HELD DOWN BY THE FIFTH TINE, WHICH IS BENT TO THE LEFT LIKE A THUMB. THE SHADED, PATTERNED BACKGROUND IS NOT PART OF THE MARK.

FOR HOTEL, RESTAURANT AND CATERING SERVICES (U.S. CLS. 100 AND 101).  
AMY KERTGATE, EXAMINING ATTORNEY

SN 86-041,689. THE KATMINT LLC, BROOKLYN, NY. FILED 8-19-2013.



**The Katmint LLC**

NO CLAIM IS MADE TO THE EXCLUSIVE RIGHT TO USE "LLC", APART FROM THE MARK AS SHOWN.

THE MARK CONSISTS OF A DESIGN OF A CAT SILHOUETTE WITH EYES AND AN OUTLINE OF A NOSE AND MOUTH. THE CAT HAS FIVE WHISKERS ON EACH SIDE MADE OF CATMINT FLOWERS. THE DESIGN IS INSIDE A BOX. THE STYLIZED TEXT "THE KATMINT LLC" IS BENEATH THE BOX.

FOR CHILD CARE SERVICES (U.S. CLS. 100 AND 101).  
KEVIN DINALLO, EXAMINING ATTORNEY

**CLASS 43—(Continued).**

SN 86-041,749. BURGER 21 INTERNATIONAL, INC., TAMPA, FL. FILED 8-19-2013.



OWNER OF U.S. REG. NOS. 3,935,621, 4,154,530 AND 4,351,559.

NO CLAIM IS MADE TO THE EXCLUSIVE RIGHT TO USE "BURGER", APART FROM THE MARK AS SHOWN.

THE MARK CONSISTS OF THE LETTER "B" INSIDE A CIRCLE AND THE NUMBER "21" INSIDE A CIRCLE THAT OVERLAPS THE RIGHT SIDE OF THE B'S CIRCLE WITH THE WORDS "CRAVEABLE BURGER CREATIONS" APPEARING TO THE RIGHT.

FOR RESTAURANT SERVICES (U.S. CLS. 100 AND 101).

MARILYN IZZI, EXAMINING ATTORNEY

SN 86-041,785. HYEKYUNG HWANG, LOS ANGELES, CA. FILED 8-19-2013.



**THE REDBEAN HOUSE**

NO CLAIM IS MADE TO THE EXCLUSIVE RIGHT TO USE "HOUSE", APART FROM THE MARK AS SHOWN.

THE MARK CONSISTS OF THE CAPITAL LETTER "R" INSIDE OF A CIRCLE; THE CIRCLE IS CONTAINED WITHIN A FREE FORM DRAWING OF A WAX SEAL. THE CAPITAL WORDS "THE REDBEAN HOUSE" APPEAR UNDERNEATH THE DRAWING OF THE WAX SEAL.

FOR RESTAURANT AND CAFE SERVICES (U.S. CLS. 100 AND 101).

CHRISTOPHER LAW, EXAMINING ATTORNEY

SN 86-042,015. SHULA'S STEAK HOUSES, LLLP, FORT LAUDERDALE, FL. FILED 8-19-2013.

**SHULA'S STEAK & SEAFOOD**

THE MARK CONSISTS OF STANDARD CHARACTERS WITHOUT CLAIM TO ANY PARTICULAR FONT, STYLE, SIZE, OR COLOR.

OWNER OF U.S. REG. NOS. 3,112,116, 3,179,584 AND OTHERS.

NO CLAIM IS MADE TO THE EXCLUSIVE RIGHT TO USE "STEAK & SEAFOOD", APART FROM THE MARK AS SHOWN.

FOR PREPARATION OF FOOD AND BEVERAGES; RESTAURANT SERVICES (U.S. CLS. 100 AND 101).

CHRISTINA SOBRAL, EXAMINING ATTORNEY



**CLASS 43—(Continued).**

SN 86-042,470. CORPORATE HOUSING ASSOCIATES, LP, AKA WOODLANDS INTERIM HOUSING, THE WOODLANDS, TX. FILED 8-20-2013.

## Stress Free Temporary Housing with You in Mind

THE MARK CONSISTS OF STANDARD CHARACTERS WITHOUT CLAIM TO ANY PARTICULAR FONT, STYLE, SIZE, OR COLOR.

FOR PROVIDING TEMPORARY HOUSING ACCOMMODATIONS; RENTAL OF FURNITURE AND HOUSEHOLD FURNISHINGS IN THE NATURE OF APPLIANCES AND ELECTRONIC EQUIPMENT FOR USE IN TEMPORARY HOUSING ACCOMMODATIONS (U.S. CLS. 100 AND 101).

FIRST USE 9-1-2009; IN COMMERCE 9-1-2009.  
MIAH ROSENBERG, EXAMINING ATTORNEY

**CLASS 43—(Continued).**

SN 86-044,077. DOCTOR'S ASSOICATES INC., MILFORD, CT. FILED 8-21-2013.

## SUBWAY WHERE WINNERS EAT

THE MARK CONSISTS OF STANDARD CHARACTERS WITHOUT CLAIM TO ANY PARTICULAR FONT, STYLE, SIZE, OR COLOR.

OWNER OF U.S. REG. NOS. 1,174,608, 4,209,548 AND OTHERS.

FOR RESTAURANT SERVICES (U.S. CLS. 100 AND 101).

FIRST USE 8-1-2009; IN COMMERCE 8-1-2009.  
STEVEN PEREZ, EXAMINING ATTORNEY

SN 86-044,141. HORIZONTE CORP, MIAMI BEACH, FL. FILED 8-21-2013.

## Riviere South Beach Hotel

THE MARK CONSISTS OF STANDARD CHARACTERS WITHOUT CLAIM TO ANY PARTICULAR FONT, STYLE, SIZE, OR COLOR.

NO CLAIM IS MADE TO THE EXCLUSIVE RIGHT TO USE "SOUTH BEACH HOTEL", APART FROM THE MARK AS SHOWN.

FOR HOTEL SERVICES (U.S. CLS. 100 AND 101).  
FIRST USE 1-0-1995; IN COMMERCE 1-0-1995.

BRENDAN MCCAULEY, EXAMINING ATTORNEY

SN 86-042,703. FP HOLDINGS, L.P., LAS VEGAS, NV. FILED 8-20-2013.

# G-SUITE

THE MARK CONSISTS OF STANDARD CHARACTERS WITHOUT CLAIM TO ANY PARTICULAR FONT, STYLE, SIZE, OR COLOR.

OWNER OF U.S. REG. NO. 3,295,520.  
FOR HOTEL SERVICES (U.S. CLS. 100 AND 101).  
FIRST USE 12-30-2005; IN COMMERCE 12-30-2005.  
AMY C. KEAN, EXAMINING ATTORNEY

SN 86-044,268. LUOYANGUNCLE, INC., NEW YORK, NY. FILED 8-21-2013.



THE COLOR(S) YELLOW, ORANGE, BROWN, PINK, CREAM, BEIGE, BLACK, WHITE, AND GRAY IS/ARE CLAIMED AS A FEATURE OF THE MARK.

THE MARK CONSISTS OF A MALE CARTOON CHARACTER CONTAINED WITH TWO CONCENTRIC CIRCLES WHERE THE CENTER OF THE INNERMOST CIRCLE IS ORANGE. THE CONCENTRIC CIRCLES CREATE A WHITE RING WHEREIN THERE IS ORANGE WORDING WITH BLACK OUTLINE "UNCLE LUOYANG" WRITTEN TWICE WHERE THE CARTOON CHARACTER IS PARTIALLY BLOCKING THE LETTERS. THE CHARACTER IS WEARING A YELLOW HAT OUTLINED IN BLACK WITH A WHITE CIRCLE LOGO ON THE HAT ALSO OUTLINED IN BLACK AND CONTAINING THE ORANGE LETTER "U". THE CHARACTER HAS A BEIGE SKIN TONE AND A GRAY PATCH OF HAIR BENEATH THE HAT, WITH WHITE CIRCLES FOR EYES AND BLACK EYE COLOR WITH BLACK EYEBROWS AND BLACK MARKINGS REPRESENTING EARS, MOUTH, MUSTACHE, AND SIDEBURNS. THE CHARACTER'S PINK TONGUE IS STICKING

SN 86-043,177. UR HOSPITALITY, INC., WATERFORD, NY. FILED 8-20-2013.

## UNCLE RICO'S PIZZA

THE MARK CONSISTS OF STANDARD CHARACTERS WITHOUT CLAIM TO ANY PARTICULAR FONT, STYLE, SIZE, OR COLOR.

NO CLAIM IS MADE TO THE EXCLUSIVE RIGHT TO USE "PIZZA", APART FROM THE MARK AS SHOWN.

FOR RESTAURANT SERVICES (U.S. CLS. 100 AND 101).

ELIZABETH HUGHITT, EXAMINING ATTORNEY

**CLASS 43—(Continued).**

OUT AND OUTLINED IN BLACK. HE IS WEARING A YELLOW SHIRT WITH CREAM COLORED SLEEVE CUFFS AND IS WEARING A WHITE APRON. HE IS GIVING A THUMBS-UP SIGNAL WITH HIS RIGHT HAND. BROWN SHADOWING APPEARS ON THE CHARACTER'S SKIN. GRAY SHADOWING APPEARS ON THE CHARACTER'S CLOTHING. TO THE RIGHT OF THE DESIGN ARE ORANGE STYLIZED CHINESE CHARACTERS OUTLINED IN BLACK. BELOW THESE CHARACTERS IS THE STYLIZED BLACK WORDING "UNCLE LUOYANG".

THE NON-LATIN CHARACTERS IN THE MARK TRANSLITERATE TO "LUO YANG DA SHU" AND THIS MEANS "UNCLE LUOYANG" IN ENGLISH.

FOR RESTAURANT RESERVATION SERVICES; RESTAURANT SERVICES; RESTAURANT SERVICES FEATURING CHINESE FOOD; RESTAURANT SERVICES, INCLUDING SIT-DOWN SERVICE OF FOOD AND TAKE-OUT RESTAURANT SERVICES; RESTAURANT SERVICES, NAMELY, PROVIDING OF FOOD AND BEVERAGES FOR CONSUMPTION ON AND OFF THE PREMISES; RESTAURANT, BAR AND CATERING SERVICES; RESTAURANTS FEATURING HOME DELIVERY; SALAD BARS; SELF-SERVICE RESTAURANTS; TAKE-OUT RESTAURANT SERVICES (U.S. CLS. 100 AND 101).

FIRST USE 8-1-2013; IN COMMERCE 8-1-2013.  
ZACHARY R. SPARER, EXAMINING ATTORNEY

---

SN 86-044,951. GALLOWAY, SHELLY, SILVER SPRING, MD.  
FILED 8-22-2013.

**82 casual italian**

THE MARK CONSISTS OF STANDARD CHARACTERS WITHOUT CLAIM TO ANY PARTICULAR FONT, STYLE, SIZE, OR COLOR.

NO CLAIM IS MADE TO THE EXCLUSIVE RIGHT TO USE "CASUAL ITALIAN", APART FROM THE MARK AS SHOWN.

FOR RESTAURANT SERVICES FEATURING ITALIAN FOOD; TAKE-OUT RESTAURANT SERVICES (U.S. CLS. 100 AND 101).

JENNIFER MARTIN, EXAMINING ATTORNEY

---

SN 86-044,989. Z&H HOSPITALITY L.L.C., MINNEAPOLIS,  
MN. FILED 8-22-2013.

**AGRA CULTURE KITCHEN**

THE MARK CONSISTS OF STANDARD CHARACTERS WITHOUT CLAIM TO ANY PARTICULAR FONT, STYLE, SIZE, OR COLOR.

NO CLAIM IS MADE TO THE EXCLUSIVE RIGHT TO USE "KITCHEN", APART FROM THE MARK AS SHOWN.

FOR RESTAURANT AND TAKE-OUT RESTAURANT SERVICES (U.S. CLS. 100 AND 101).

SAIMA MAKHDOOM, EXAMINING ATTORNEY

**CLASS 43—(Continued).**

SN 86-045,236. Z&H HOSPITALITY L.L.C., MINNEAPOLIS,  
MN. FILED 8-22-2013.

**AGRA CULTURE KITCHEN &  
PRESS**

THE MARK CONSISTS OF STANDARD CHARACTERS WITHOUT CLAIM TO ANY PARTICULAR FONT, STYLE, SIZE, OR COLOR.

NO CLAIM IS MADE TO THE EXCLUSIVE RIGHT TO USE "KITCHEN", APART FROM THE MARK AS SHOWN.

FOR RESTAURANT AND TAKE-OUT RESTAURANT SERVICES (U.S. CLS. 100 AND 101).

SAIMA MAKHDOOM, EXAMINING ATTORNEY

---

SN 86-046,656. BURTONS GRILL, LLC, ANDOVER, MA.  
FILED 8-23-2013.

**RED HEAT TAVERN**

THE MARK CONSISTS OF STANDARD CHARACTERS WITHOUT CLAIM TO ANY PARTICULAR FONT, STYLE, SIZE, OR COLOR.

NO CLAIM IS MADE TO THE EXCLUSIVE RIGHT TO USE "TAVERN", APART FROM THE MARK AS SHOWN.

FOR BAR AND RESTAURANT SERVICES; RESTAURANT AND CAFE SERVICES; RESTAURANT SERVICES; RESTAURANT SERVICES, INCLUDING SIT-DOWN SERVICE OF FOOD AND TAKE-OUT RESTAURANT SERVICES (U.S. CLS. 100 AND 101).

MICHAEL ENGEL, EXAMINING ATTORNEY

---

SN 86-047,218. JOLT & BOLT COFFEE BAR & PASTICCERIA,  
LLC, BROOKLYN, NY. FILED 8-24-2013.

**Jolt & Bolt Coffee Bar &  
Pasticceria**

THE MARK CONSISTS OF STANDARD CHARACTERS WITHOUT CLAIM TO ANY PARTICULAR FONT, STYLE, SIZE, OR COLOR.

NO CLAIM IS MADE TO THE EXCLUSIVE RIGHT TO USE "COFFEE BAR & PASTICCERIA", APART FROM THE MARK AS SHOWN.

THE ENGLISH TRANSLATION OF THE WORD "PASTICCERIA" IN THE MARK IS "PASTRY SHOP".

FOR COFFEE SHOPS; PROVIDING OF FOOD AND DRINK VIA A MOBILE TRUCK (U.S. CLS. 100 AND 101).

SUSAN RICHARDS, EXAMINING ATTORNEY

**CLASS 43—(Continued).**

SN 86-048,045. KWON, TAE HO, ENGLEWOOD CLIFFS, NJ. FILED 8-26-2013.



NO CLAIM IS MADE TO THE EXCLUSIVE RIGHT TO USE "EST. 1986 WINE LOUNGE", APART FROM THE MARK AS SHOWN.

THE MARK CONSISTS OF THE TERMS "EST. 1986 WINE LOUNGE" WITHIN A FILIGREE DESIGN BORDER.

FOR BAR AND RESTAURANT SERVICES; CATERING SERVICES; COCKTAIL LOUNGE SERVICES; WINE BARS (U.S. CLS. 100 AND 101).

FIRST USE 3-0-2010; IN COMMERCE 3-0-2010.  
MORGAN WYNNE, EXAMINING ATTORNEY

**CLASS 43—(Continued).**

SN 86-049,228. DELLA ROCCA, PETER, NAPLES, FL. FILED 8-27-2013.



THE MARK CONSISTS OF A STYLIZED DEPICTION OF A CHEF, FROM THE KNEES UP, WITH BOTH ARMS OUTSTRETCHED TO THE RIGHT.

FOR BAR AND RESTAURANT SERVICES; RESTAURANT AND CATERING SERVICES; RESTAURANT SERVICES; RESTAURANT SERVICES FEATURING ITALIAN CUISINE; RESTAURANT SERVICES, INCLUDING SIT-DOWN SERVICE OF FOOD AND TAKE-OUT RESTAURANT SERVICES; RESTAURANT SERVICES, NAMELY, PROVIDING OF FOOD AND BEVERAGES FOR CONSUMPTION ON AND OFF THE PREMISES; RESTAURANT, BAR AND CATERING SERVICES; RESTAURANTS FEATURING HOME DELIVERY; TAKE-OUT RESTAURANT SERVICES (U.S. CLS. 100 AND 101).

FIRST USE 10-1-2012; IN COMMERCE 10-1-2012.  
GRETCHEN ULRICH, EXAMINING ATTORNEY

SN 86-048,517. POST EXCHANGE CATERING, INC., ROSWELL, GA. FILED 8-26-2013.

**Post Exchange Catering**

THE MARK CONSISTS OF STANDARD CHARACTERS WITHOUT CLAIM TO ANY PARTICULAR FONT, STYLE, SIZE, OR COLOR.

NO CLAIM IS MADE TO THE EXCLUSIVE RIGHT TO USE "CATERING", APART FROM THE MARK AS SHOWN. FOR CATERING FOR THE PROVISION OF FOOD AND BEVERAGES (U.S. CLS. 100 AND 101).

FIRST USE 1-5-1993; IN COMMERCE 1-5-1993.  
MORGAN WYNNE, EXAMINING ATTORNEY

SN 86-051,361. VEGOZ INC., PITTSBURG, CA. FILED 8-29-2013.

**GOTTA EATTA PITA**

THE MARK CONSISTS OF STANDARD CHARACTERS WITHOUT CLAIM TO ANY PARTICULAR FONT, STYLE, SIZE, OR COLOR.

NO CLAIM IS MADE TO THE EXCLUSIVE RIGHT TO USE "PITA", APART FROM THE MARK AS SHOWN.

FOR RESTAURANT AND CAFE SERVICES; RESTAURANT SERVICES FEATURING MEDITERRANEAN FOOD; RESTAURANT SERVICES, INCLUDING SIT-DOWN SERVICE OF FOOD AND TAKE-OUT RESTAURANT SERVICES (U.S. CLS. 100 AND 101).

FIRST USE 8-14-2013; IN COMMERCE 8-14-2013.  
SUSAN RICHARDS, EXAMINING ATTORNEY

**CLASS 43—(Continued).**

SN 86-051,388. VEGOZ INC., PITTSBURG, CA. FILED 8-29-2013.



NO CLAIM IS MADE TO THE EXCLUSIVE RIGHT TO USE "PITA" AND "FRESH MEDITERRANEAN", APART FROM THE MARK AS SHOWN.

THE MARK CONSISTS OF THE LITERAL ELEMENTS "GOTTA EATTA PITA FRESH MEDITERRANEAN" WRITTEN IN STYLIZED FORM AROUND A CIRCLE WHEREIN WORDING "GOTTA EATTA PITA" ARE PLACED CLOCK WISE AT THE TOP AND WORDING "FRESH MEDITERRANEAN" ARE PLACED ANTI-CLOCK WISE AND COVERED BY ANOTHER OUTLINED CIRCLE, AN IMAGE OF BAKING PAN WITH FOOD IMAGE PLACED INSIDE AN INNER CIRCLE.

FOR RESTAURANT AND CAFE SERVICES; RESTAURANT SERVICES FEATURING MEDITERRANEAN FOOD; RESTAURANT SERVICES, INCLUDING SIT-DOWN SERVICE OF FOOD AND TAKE-OUT RESTAURANT SERVICES (U.S. CLS. 100 AND 101).

FIRST USE 8-14-2013; IN COMMERCE 8-14-2013.  
SUSAN RICHARDS, EXAMINING ATTORNEY

**CLASS 43—(Continued).**

SN 86-062,526. THE EXPRESS CAFE AND BAKERY, LLC, SAVANNAH, GA. FILED 9-12-2013.

**IT ALL STARTS WITH FRESH**

THE MARK CONSISTS OF STANDARD CHARACTERS WITHOUT CLAIM TO ANY PARTICULAR FONT, STYLE, SIZE, OR COLOR.

FOR RESTAURANT AND CAFE SERVICES (U.S. CLS. 100 AND 101).

KEVIN MITTLER, EXAMINING ATTORNEY

SN 86-064,209. DOLORES CANNING CO., INC., LOS ANGELES, CA. FILED 9-13-2013.

**BERT'S SKIRTS**

THE MARK CONSISTS OF STANDARD CHARACTERS WITHOUT CLAIM TO ANY PARTICULAR FONT, STYLE, SIZE, OR COLOR.

NO CLAIM IS MADE TO THE EXCLUSIVE RIGHT TO USE "SKIRTS", APART FROM THE MARK AS SHOWN.

FOR RESTAURANT SERVICES, NAMELY, PROVIDING OF FOOD AND BEVERAGES FOR CONSUMPTION ON AND OFF THE PREMISES (U.S. CLS. 100 AND 101).  
FRED CARL, EXAMINING ATTORNEY

SN 86-054,474. SPILLERS GROUP, LLC, DALLAS, TX. FILED 9-3-2013.



THE MARK CONSISTS OF THE WORD "ENO'S" IN A CURSIVE SCRIPT WITH A WHEAT SHEAF TRAILING FROM THE DESCENDER OF THE LETTER "S".

FOR RESTAURANT SERVICES (U.S. CLS. 100 AND 101).

FIRST USE 9-13-2008; IN COMMERCE 9-13-2008.  
GILBERT SWIFT, EXAMINING ATTORNEY

SN 86-065,305. LOS COMALES DE MELROSE PARK INC., MELROSE PARK, IL. FILED 9-16-2013.

**Let's taco 'bout it**

THE MARK CONSISTS OF STANDARD CHARACTERS WITHOUT CLAIM TO ANY PARTICULAR FONT, STYLE, SIZE, OR COLOR.

FOR CAFE AND RESTAURANT SERVICES; CAFE-RESTAURANTS; PROVISION OF FOOD AND DRINK IN RESTAURANTS; RESTAURANT; RESTAURANT AND CAFE SERVICES; RESTAURANT AND CATERING SERVICES; RESTAURANT SERVICES; RESTAURANT SERVICES FEATURING SANDWICHES; RESTAURANT SERVICES FEATURING MEXICAN FOOD; RESTAURANT SERVICES, INCLUDING SIT-DOWN SERVICE OF FOOD AND TAKE-OUT RESTAURANT SERVICES; RESTAURANT SERVICES, NAMELY, PROVIDING OF FOOD AND BEVERAGES FOR CONSUMPTION ON AND OFF THE PREMISES; RESTAURANTS; RESTAURANTS FEATURING HOME DELIVERY; SELF SERVICE RESTAURANTS; SELF-SERVICE RESTAURANTS; TAKE-OUT RESTAURANT SERVICES (U.S. CLS. 100 AND 101).

FIRST USE 2-0-2013; IN COMMERCE 8-0-2013.

DOMINICK J. SALEMI, EXAMINING ATTORNEY

**CLASS 43—(Continued).**

SN 86-065,617. FANG, LIANG, IRVINE, CA. FILED 9-16-2013.

# DAI MEI

THE MARK CONSISTS OF STANDARD CHARACTERS WITHOUT CLAIM TO ANY PARTICULAR FONT, STYLE, SIZE, OR COLOR.

OWNER OF CHINA REG. NO. 6816985, DATED 6-7-2010, EXPIRES 6-7-2020.

THE ENGLISH TRANSLATION OF "DAI MEI" IN THE MARK IS "MINORITY GIRL".

FOR BAR AND RESTAURANT SERVICES; CAFE AND RESTAURANT SERVICES; CAFE-RESTAURANTS; RESTAURANT AND CAFE SERVICES; RESTAURANT AND CATERING SERVICES; RESTAURANT SERVICES; RESTAURANT SERVICES, INCLUDING SIT-DOWN SERVICE OF FOOD AND TAKE-OUT RESTAURANT SERVICES; RESTAURANT SERVICES, NAMELY, PROVIDING OF FOOD AND BEVERAGES FOR CONSUMPTION ON AND OFF THE PREMISES (U.S. CLS. 100 AND 101).

TINA BROWN, EXAMINING ATTORNEY

SN 86-065,641. FANG, LIANG, IRVINE, CA. FILED 9-16-2013.



THE MARK CONSISTS OF CHINESE CHARACTERS PRONOUNCED "DAI MEI".

THE NON-LATIN CHARACTERS IN THE MARK TRANSLITERATE TO "DAI MEI" AND THIS MEANS "MINORITY GIRL" IN ENGLISH.

FOR RESTAURANT AND CAFE SERVICES; RESTAURANT AND CATERING SERVICES; RESTAURANT SERVICES; RESTAURANT SERVICES, INCLUDING SIT-DOWN SERVICE OF FOOD AND TAKE-OUT RESTAURANT SERVICES; RESTAURANT SERVICES, NAMELY, PROVIDING OF FOOD AND BEVERAGES FOR CONSUMPTION ON AND OFF THE PREMISES (U.S. CLS. 100 AND 101).

TINA BROWN, EXAMINING ATTORNEY

SN 86-065,664. HEWN, LLC, EVANSTON, IL. FILED 9-16-2013.

# HEWN

THE MARK CONSISTS OF STANDARD CHARACTERS WITHOUT CLAIM TO ANY PARTICULAR FONT, STYLE, SIZE, OR COLOR.

FOR RESTAURANT AND CATERING SERVICES (U.S. CLS. 100 AND 101).

FIRST USE 6-1-2013; IN COMMERCE 6-1-2013.

CAROL SPILS, EXAMINING ATTORNEY

**CLASS 43—(Continued).**

SN 86-065,853. FANG, LIANG, IRVINE, CA. FILED 9-16-2013.

# SHENG HUO YING

THE MARK CONSISTS OF STANDARD CHARACTERS WITHOUT CLAIM TO ANY PARTICULAR FONT, STYLE, SIZE, OR COLOR.

OWNER OF CHINA REG. NO. 5821703, DATED 2-7-2010, EXPIRES 2-6-2020.

THE ENGLISH TRANSLATION OF "SHENG HUO YING" IN THE MARK IS "LOVE, PEACE CAMPSITE".

FOR RESTAURANT AND CAFE SERVICES; RESTAURANT AND CATERING SERVICES; RESTAURANT SERVICES; RESTAURANT SERVICES, INCLUDING SIT-DOWN SERVICE OF FOOD AND TAKE-OUT RESTAURANT SERVICES; RESTAURANT SERVICES, NAMELY, PROVIDING OF FOOD AND BEVERAGES FOR CONSUMPTION ON AND OFF THE PREMISES (U.S. CLS. 100 AND 101).

TINA BROWN, EXAMINING ATTORNEY

SN 86-065,879. FANG, LIANG, IRVINE, CA. FILED 9-16-2013.



THE MARK CONSISTS OF A CIRCULAR BULL'S EYE WITH THE WORDS "SHENG HUO YING" ON THE TOP OUTER CIRCLE AND "NO. 001" ON THE BOTTOM OF THE OUTER CIRCLE.

THE ENGLISH TRANSLATION OF "SHENG HUO YING" IN THE MARK IS "LOVE, PEACE CAMPSITE".

FOR RESTAURANT AND CAFE SERVICES; RESTAURANT AND CATERING SERVICES; RESTAURANT SERVICES; RESTAURANT SERVICES, INCLUDING SIT-DOWN SERVICE OF FOOD AND TAKE-OUT RESTAURANT SERVICES; RESTAURANT SERVICES, NAMELY, PROVIDING OF FOOD AND BEVERAGES FOR CONSUMPTION ON AND OFF THE PREMISES (U.S. CLS. 100 AND 101).

TINA BROWN, EXAMINING ATTORNEY

**CLASS 43—(Continued).**

SN 86-065,908. FANG, LIANG, IRVINE, CA. FILED 9-16-2013.

THE MARK CONSISTS OF CHINESE CHARACTERS PRONOUNCED SHENG HUO YING.

THE NON-LATIN CHARACTERS IN THE MARK TRANSLITERATE TO "SHENG HUO YING" AND THIS MEANS "LOVE, PEACE CAMPSITE" IN ENGLISH.

FOR RESTAURANT AND CAFE SERVICES; RESTAURANT AND CATERING SERVICES; RESTAURANT SERVICES; RESTAURANT SERVICES, INCLUDING SIT-DOWN SERVICE OF FOOD AND TAKE-OUT RESTAURANT SERVICES; RESTAURANT SERVICES, NAMELY, PROVIDING OF FOOD AND BEVERAGES FOR CONSUMPTION ON AND OFF THE PREMISES (U.S. CLS. 100 AND 101).

TINA BROWN, EXAMINING ATTORNEY

SN 86-065,926. DARDEN CONCEPTS, INC., ORLANDO, FL. FILED 9-16-2013.

**TASTES AND TOASTS OF ITALY**

THE MARK CONSISTS OF STANDARD CHARACTERS WITHOUT CLAIM TO ANY PARTICULAR FONT, STYLE, SIZE, OR COLOR.

FOR RESTAURANT SERVICES, INCLUDING SIT-DOWN SERVICE OF FOOD AND TAKE-OUT RESTAURANT SERVICES (U.S. CLS. 100 AND 101).

EUGENIA MARTIN, EXAMINING ATTORNEY

SN 86-066,750. ARANDOLA, LLC, SANTA MONICA, CA. FILED 9-17-2013.

**SLENDER KITCHEN**

THE MARK CONSISTS OF STANDARD CHARACTERS WITHOUT CLAIM TO ANY PARTICULAR FONT, STYLE, SIZE, OR COLOR.

FOR PROVIDING AN INTERNET WEBSITE IN THE FIELD OF HEALTHY COOKING, PREPARATION OF FOODS, AND RECIPES; PROVIDING AN INTERNET WEBSITE FEATURING INFORMATION AND TIPS IN THE FIELD OF HEALTHY COOKING, PREPARATION OF FOODS; PROVIDING AN INTERNET WEBSITE FEATURING COUNSELING SERVICES IN THE FIELD OF HEALTHY COOKING, PREPARATION OF FOODS, AND RECIPES; PROVIDING AN INTERNET WEBSITE FEATURING INFORMATION AND ADVISORY SERVICES IN THE FIELD OF HEALTHY COOKING, PREPARATION OF FOODS, AND RECIPES (U.S. CLS. 100 AND 101).

FIRST USE 11-18-2010; IN COMMERCE 11-18-2010.

KAELIE KUNG, EXAMINING ATTORNEY

**CLASS 43—(Continued).**

SN 86-067,002. DARDEN CONCEPTS, INC., ORLANDO, FL. FILED 9-17-2013.

**RUMTOBERFEST**

THE MARK CONSISTS OF STANDARD CHARACTERS WITHOUT CLAIM TO ANY PARTICULAR FONT, STYLE, SIZE, OR COLOR.

FOR RESTAURANT AND BAR SERVICES, INCLUDING RESTAURANT CARRYOUT SERVICES (U.S. CLS. 100 AND 101).

FIRST USE 9-30-2013; IN COMMERCE 9-30-2013.

EUGENIA MARTIN, EXAMINING ATTORNEY

SN 86-067,273. DINING CONCEPTS GROUP, LLC, MYRTLE BEACH, SC. FILED 9-17-2013.



THE MARK CONSISTS OF A TUNA FISH WITH ITS MOUTH OPENED, SHOWING SHARP TEETH AND WITH ITS TONGUE HANGING OUT TO THE SIDE.

FOR BAR AND RESTAURANT SERVICES (U.S. CLS. 100 AND 101).

FIRST USE 4-25-2013; IN COMMERCE 4-25-2013.

SUNG IN, EXAMINING ATTORNEY

SN 86-067,338. SALYANI VENTURES, LLC, DBA JUICE CENTRAL, SAN ANTONIO, TX. FILED 9-17-2013.

**JUICE CENTRAL**

THE MARK CONSISTS OF STANDARD CHARACTERS WITHOUT CLAIM TO ANY PARTICULAR FONT, STYLE, SIZE, OR COLOR.

NO CLAIM IS MADE TO THE EXCLUSIVE RIGHT TO USE "JUICE", APART FROM THE MARK AS SHOWN.

FOR JUICE BAR SERVICES (U.S. CLS. 100 AND 101).

LAURA FIONDA, EXAMINING ATTORNEY

**CLASS 43—(Continued).**

SN 86-067,349. ROMA DINING LLC, PLANO, TX. FILED 9-17-2013.



OWNER OF U.S. REG. NOS. 1,318,693, 4,061,762 AND OTHERS.

NO CLAIM IS MADE TO THE EXCLUSIVE RIGHT TO USE "FIRE GRILL & LOUNGE", APART FROM THE MARK AS SHOWN.

THE NAME(S), PORTRAIT(S), AND/OR SIGNATURE(S) SHOWN IN THE MARK DOES NOT IDENTIFY A PARTICULAR LIVING INDIVIDUAL.

THE COLOR(S) DARK BLUE (PANTONE 548 C), LIGHT BLUE (PANTONE 5415 C), RED (PANTONE 7621 C) IS/ARE CLAIMED AS A FEATURE OF THE MARK.

THE MARK CONSISTS OF THE WORDS "TONY ROMA'S" WITH THE LETTER "O" IN ROMA'S REPRESENTED BY A FLAME DESIGN IN RED AND THE REMAINING LETTERS IN BOLD LARGE FONT IN THE COLOR DARK BLUE. BELOW THESE WORDS ARE THE WORDS "FIRE GRILL" IN A SMALLER LOWER CASE FONT IN RED FOLLOWED BY AN AMPERSAND IN LIGHT BLUE FOLLOWED BY THE WORD "LOUNGE" ALSO IN SMALLER LOWER CASE FONT IN RED.

FOR RESTAURANT AND CATERING SERVICES (U.S. CLS. 100 AND 101).

ZACHARY BELLO, EXAMINING ATTORNEY

---

SN 86-067,443. HONEYBEE FRANCHISING COMPANY INC., LAKE MARY, FL. FILED 9-17-2013.

**HONEYBEE SCHOOLS**

THE MARK CONSISTS OF STANDARD CHARACTERS WITHOUT CLAIM TO ANY PARTICULAR FONT, STYLE, SIZE, OR COLOR.

NO CLAIM IS MADE TO THE EXCLUSIVE RIGHT TO USE "SCHOOLS", APART FROM THE MARK AS SHOWN.

FOR CHILD CARE SERVICES; PRESCHOOLER AND INFANT CARE AT DAYCARE CENTERS; PROVIDING CHILD CARE CENTERS; PROVIDING DAY CARE CENTERS (U.S. CLS. 100 AND 101).

JOHN SCHUYLER YARD, EXAMINING ATTORNEY

**CLASS 43—(Continued).**

SN 86-067,445. HONEYBEE FRANCHISING COMPANY INC., LAKE MARY, FL. FILED 9-17-2013.

**HONEYBEE ACADEMY**

THE MARK CONSISTS OF STANDARD CHARACTERS WITHOUT CLAIM TO ANY PARTICULAR FONT, STYLE, SIZE, OR COLOR.

NO CLAIM IS MADE TO THE EXCLUSIVE RIGHT TO USE "ACADEMY", APART FROM THE MARK AS SHOWN.

FOR CHILD CARE SERVICES; PRESCHOOLER AND INFANT CARE AT DAYCARE CENTERS; PROVIDING CHILD CARE CENTERS; PROVIDING DAY CARE CENTERS (U.S. CLS. 100 AND 101).

JOHN SCHUYLER YARD, EXAMINING ATTORNEY

---

SN 86-067,611. GRUPO INDUSTRIAL EMPREX S.A. DE C.V., MONTERREY, NUEVO LEON, MEXICO, FILED 9-18-2013.

**DELIXIA**

THE MARK CONSISTS OF STANDARD CHARACTERS WITHOUT CLAIM TO ANY PARTICULAR FONT, STYLE, SIZE, OR COLOR.

FOR PROVIDING OF FOOD AND DRINK (U.S. CLS. 100 AND 101).

KARANENDRA S. CHHINA, EXAMINING ATTORNEY

---

SN 86-067,877. OG4, LLC, CHARLOTTE, NC. FILED 9-18-2013.

**GRO**

THE MARK CONSISTS OF STANDARD CHARACTERS WITHOUT CLAIM TO ANY PARTICULAR FONT, STYLE, SIZE, OR COLOR.

FOR FAST-FOOD RESTAURANT SERVICES; RESTAURANT SERVICES (U.S. CLS. 100 AND 101).

EUGENIA MARTIN, EXAMINING ATTORNEY

**CLASS 43—(Continued).**

SN 86-067,887. GLOBAL DRG MANAGEMENT, INC., RICHARDSON, TX. FILED 9-18-2013.

**Oven & Cellar**

THE MARK CONSISTS OF STANDARD CHARACTERS WITHOUT CLAIM TO ANY PARTICULAR FONT, STYLE, SIZE, OR COLOR.

FOR BAR SERVICES; RESTAURANT SERVICES (U.S. CLS. 100 AND 101).  
TRACY CROSS, EXAMINING ATTORNEY

SN 86-068,380. HANOVER VENTURES, LLC, NEW YORK, NY. FILED 9-18-2013.

**THE DEAD RABBIT**

THE MARK CONSISTS OF STANDARD CHARACTERS WITHOUT CLAIM TO ANY PARTICULAR FONT, STYLE, SIZE, OR COLOR.

FOR BAR AND RESTAURANT SERVICES (U.S. CLS. 100 AND 101).  
FIRST USE 12-31-2012; IN COMMERCE 12-31-2012.  
NICHOLAS COLEMAN, EXAMINING ATTORNEY

SN 86-068,473. WANG, XIANHUI, GREAT NECK, NY. FILED 9-18-2013.

**CHINGER**

THE MARK CONSISTS OF WORD "CHINGER" IN BOLD BLACK LETTERS.

FOR BAR AND RESTAURANT SERVICES; CAFETERIA AND RESTAURANT SERVICES; CATERING IN FAST-FOOD CAFETERIAS; CATERING OF FOOD AND DRINKS; FAST-FOOD RESTAURANT SERVICES; FAST-FOOD RESTAURANTS AND SNACKBARS; FOOD AND DRINK CATERING; RESTAURANT; RESTAURANT AND BAR SERVICES; RESTAURANT AND BAR SERVICES, INCLUDING RESTAURANT CARRYOUT SERVICES; RESTAURANT AND CATERING SERVICES; RESTAURANT SERVICES; RESTAURANT SERVICES FEATURING SANDWICHES; RESTAURANT SERVICES, INCLUDING SIT-DOWN SERVICE OF FOOD AND TAKE-OUT RESTAURANT SERVICES; RESTAURANT SERVICES, NAMELY, PROVIDING OF FOOD AND BEVERAGES FOR CONSUMPTION ON AND OFF THE PREMISES; RESTAURANT, BAR AND CATERING SERVICES; SALAD BARS (U.S. CLS. 100 AND 101).  
FIRST USE 3-1-2013; IN COMMERCE 3-1-2013.

TINA L. SNAPP, EXAMINING ATTORNEY

**CLASS 43—(Continued).**

SN 86-068,700. SETTE LUNA, LLC, EASTON, PA. FILED 9-18-2013.

**SETTE LUNA**

THE MARK CONSISTS OF STANDARD CHARACTERS WITHOUT CLAIM TO ANY PARTICULAR FONT, STYLE, SIZE, OR COLOR.

THE ENGLISH TRANSLATION OF "SETTE LUNA" IN THE MARK IS "SEVEN MOON".

FOR RESTAURANT AND BAR SERVICES (U.S. CLS. 100 AND 101).

FIRST USE 10-17-2005; IN COMMERCE 10-17-2005.  
KYLE PEETE, EXAMINING ATTORNEY

SN 86-068,754. MIKASA EMPIRE RESTAURANT GROUP INC., NEW YORK, NY. FILED 9-18-2013.

**Sushi Couture by Mikasa**

THE MARK CONSISTS OF STANDARD CHARACTERS WITHOUT CLAIM TO ANY PARTICULAR FONT, STYLE, SIZE, OR COLOR.

NO CLAIM IS MADE TO THE EXCLUSIVE RIGHT TO USE "SUSHI", APART FROM THE MARK AS SHOWN.

FOR RESTAURANT, CAFE, BISTRO, BAR AND CATERING SERVICES; AND SERVING OF FOOD AND DRINK BEVERAGES (U.S. CLS. 100 AND 101).

KATHERINE STOIDES, EXAMINING ATTORNEY

SN 86-068,980. CLOAKED LLC, ROCHESTER, NY. FILED 9-19-2013.

**CLOAKED**

THE MARK CONSISTS OF STANDARD CHARACTERS WITHOUT CLAIM TO ANY PARTICULAR FONT, STYLE, SIZE, OR COLOR.

FOR RESTAURANT SERVICES (U.S. CLS. 100 AND 101).

TAMARA FRAZIER, EXAMINING ATTORNEY



**CLASS 43—(Continued).**

SN 86-069,033. CLOAKED LLC, ROCHESTER, NY. FILED 9-19-2013.



THE MARK CONSISTS OF A STYLIZED LETTER "C" FOLLOWED BY A STYLIZED LETTER "K" IN A VERTICAL ORIENTATION RESEMBLING A STICK FIGURE OF A PERSON. CENTERED WITHIN THE VERTICALLY ORIENTED LETTER "C", IN HORIZONTAL ORIENTATION, IS A STYLIZED LOWER CASE LETTER "O" FOLLOWED BY A STYLIZED LOWER CASE LETTER "A". CENTERED WITHIN THE LETTER "O" IS A STYLIZED LOWER CASE LETTER "D" AND CENTERED WITHIN THE LETTER "A" IS A STYLIZED LOWER CASE LETTER "E" SUCH THAT THE LETTERS "O" AND "A" FORM THE EYES OF A FACE WITH THE LETTER "C" FORMING THE HEAD. CENTERED BELOW THE LETTERS "O" AND "A" IS A STYLIZED UPPER CASE LETTER "L" APPEARING TO FORM THE NOSE OF A FACE. THE LETTER "K" FORMS THE HANDS AND THE LEGS OF THE STICK FIGURE. THE DESIGN USES ALL LETTERS OF THE NAME "CLOAKED" TO FORM A FACE.

FOR RESTAURANT SERVICES (U.S. CLS. 100 AND 101).

TAMARA FRAZIER, EXAMINING ATTORNEY

SN 86-069,168. WATERGATE HOLDINGS LLC, NEW YORK, NY. FILED 9-19-2013.

**WATERGATE**

THE MARK CONSISTS OF STANDARD CHARACTERS WITHOUT CLAIM TO ANY PARTICULAR FONT, STYLE, SIZE, OR COLOR.

FOR HOTEL SERVICES AND RESTAURANT SERVICES (U.S. CLS. 100 AND 101).

MORGAN WYNNE, EXAMINING ATTORNEY

**CLASS 43—(Continued).**

SN 86-069,169. CIPURA CORP., MIAMI, FL. FILED 9-19-2013.

**MANDOLIN AEGEAN BISTRO**

THE MARK CONSISTS OF STANDARD CHARACTERS WITHOUT CLAIM TO ANY PARTICULAR FONT, STYLE, SIZE, OR COLOR.

NO CLAIM IS MADE TO THE EXCLUSIVE RIGHT TO USE "AEGEAN BISTRO", APART FROM THE MARK AS SHOWN.

FOR RESTAURANT SERVICES (U.S. CLS. 100 AND 101).

FIRST USE 4-1-2009; IN COMMERCE 4-1-2009.

DAVID TAYLOR, EXAMINING ATTORNEY

SN 86-069,184. CIPURA CORP., MIAMI, FL. FILED 9-19-2013.



NO CLAIM IS MADE TO THE EXCLUSIVE RIGHT TO USE "AEGEAN BISTRO", APART FROM THE MARK AS SHOWN.

THE MARK CONSISTS OF THE WORDING "MANDOLIN AEGEAN BISTRO" AND DESIGN. THE DESIGN CONSISTS OF A MANDOLIN AND A BRANCH WITH LEAVES ON EACH SIDE OF THE MANDOLIN ALL WITHIN A SQUARE. BELOW THE DESIGN IS THE TERM "MANDOLIN" WHICH IS ABOVE THE WORDING "AEGEAN BISTRO".

FOR RESTAURANT SERVICES (U.S. CLS. 100 AND 101).

FIRST USE 4-1-2009; IN COMMERCE 4-1-2009.

DAVID TAYLOR, EXAMINING ATTORNEY

SN 86-069,254. AHMET ERKAYA, MIAMI, FL. FILED 9-19-2013.

**POOR MAN'S LOBSTER**

THE MARK CONSISTS OF STANDARD CHARACTERS WITHOUT CLAIM TO ANY PARTICULAR FONT, STYLE, SIZE, OR COLOR.

NO CLAIM IS MADE TO THE EXCLUSIVE RIGHT TO USE "LOBSTER", APART FROM THE MARK AS SHOWN.

FOR RESTAURANT SERVICES (U.S. CLS. 100 AND 101).

HEATHER THOMPSON, EXAMINING ATTORNEY

**CLASS 43—(Continued).**

SN 86-069,414. DOCTOR'S ASSOCIATES INC., MILFORD, CT. FILED 9-19-2013.

# JanuANY

THE MARK CONSISTS OF STANDARD CHARACTERS WITHOUT CLAIM TO ANY PARTICULAR FONT, STYLE, SIZE, OR COLOR.

FOR RESTAURANT SERVICES (U.S. CLS. 100 AND 101).

LIEF MARTIN, EXAMINING ATTORNEY

SN 86-069,649. CANTOR & DING ENTERPRISES LLC, NEW YORK, NY. FILED 9-19-2013.

# THE CHIPPED CUP

THE MARK CONSISTS OF STANDARD CHARACTERS WITHOUT CLAIM TO ANY PARTICULAR FONT, STYLE, SIZE, OR COLOR.

FOR COFFEE SHOPS; PREPARATION OF FOOD AND BEVERAGES; PROVIDING OF FOOD AND DRINK; RESTAURANT SERVICES, NAMELY, PROVIDING OF FOOD AND BEVERAGES FOR CONSUMPTION ON AND OFF THE PREMISES (U.S. CLS. 100 AND 101).

FIRST USE 7-1-2012; IN COMMERCE 7-2-2012.  
SARA BENJAMIN, EXAMINING ATTORNEY

SN 86-069,862. SETTE LUNA, LLC, EASTON, PA. FILED 9-19-2013.



NO CLAIM IS MADE TO THE EXCLUSIVE RIGHT TO USE "BISTRO BRASSERIE", APART FROM THE MARK AS SHOWN.

THE NAME(S), PORTRAIT(S), AND/OR SIGNATURE(S) SHOWN IN THE MARK DOES NOT IDENTIFY A PARTICULAR LIVING INDIVIDUAL.

THE COLOR(S) BURGUNDY AND GOLD IS/ARE CLAIMED AS A FEATURE OF THE MARK.

THE MARK CONSISTS OF A GOLD WEATHER VANE CHICKEN BETWEEN THE BURGUNDY STYLIZED WORDS "MAXIM'S" AND "22". CENTERED BELOW "MAXIM'S 22" IS A SOLID BURGUNDY HORIZONTAL LINE WITH ORNATE ENDS. BELOW THE LINE ARE THE WORDS "BISTRO BRASSERIE", IN BURGUNDY FONT, SEPARATED BY A BURGUNDY DOT. CENTERED BELOW THE WORDS "BISTRO BRASSERIE" IS ANOTHER SOLID BURGUNDY HORIZONTAL LINE WITH ORNATE ENDS.

THE ENGLISH TRANSLATION OF "BRASSERIE" IN THE MARK IS "BREWERY".

FOR RESTAURANT SERVICES (U.S. CLS. 100 AND 101).

FIRST USE 9-1-2012; IN COMMERCE 9-1-2012.  
KYLE PEETE, EXAMINING ATTORNEY

**CLASS 43—(Continued).**

SN 86-069,917. PIZZANESE, INC., ROCKVILLE, MD. FILED 9-19-2013.

# PIZZANESE

THE MARK CONSISTS OF STANDARD CHARACTERS WITHOUT CLAIM TO ANY PARTICULAR FONT, STYLE, SIZE, OR COLOR.

FOR RESTAURANT SERVICES (U.S. CLS. 100 AND 101).

SOPHIA S. KIM, EXAMINING ATTORNEY

SN 86-070,070. PERLMAN, DANIEL, NEW YORK, NY. FILED 9-20-2013.

# Dog Shed

THE MARK CONSISTS OF STANDARD CHARACTERS WITHOUT CLAIM TO ANY PARTICULAR FONT, STYLE, SIZE, OR COLOR.

FOR CAFE AND RESTAURANT SERVICES (U.S. CLS. 100 AND 101).

BRIN ANDERSON, EXAMINING ATTORNEY

SN 86-070,104. HURRICANE AMT, LLC, WEST PALM BEACH, FL. FILED 9-20-2013.

# HURRICANE

THE MARK CONSISTS OF STANDARD CHARACTERS WITHOUT CLAIM TO ANY PARTICULAR FONT, STYLE, SIZE, OR COLOR.

OWNER OF U.S. REG. NOS. 3,462,829, 3,502,128 AND OTHERS.

FOR RESTAURANT SERVICES, COCKTAIL LOUNGES, TAKE-OUT RESTAURANT SERVICES, AND CATERING (U.S. CLS. 100 AND 101).

FIRST USE 7-31-2003; IN COMMERCE 7-31-2003.

PAUL E. FAHRENKOPF, EXAMINING ATTORNEY

**CLASS 43—(Continued).**

SN 86-070,229. RAMADAN, HANI, ALEXANDRIA, VA. AND RAMADAN, HOSAM, ALEXANDRIA, VA. AND RAMADAN, MOHAMED, ALEXANDRIA, VA. FILED 9-20-2013.

## Favabean

THE MARK CONSISTS OF STANDARD CHARACTERS WITHOUT CLAIM TO ANY PARTICULAR FONT, STYLE, SIZE, OR COLOR.

FOR RESTAURANT SERVICES (U.S. CLS. 100 AND 101).  
TINA MAI, EXAMINING ATTORNEY

SN 86-070,269. SAMICHES LLC, PHILA, PA. FILED 9-20-2013.

## Samiches

THE MARK CONSISTS OF STANDARD CHARACTERS WITHOUT CLAIM TO ANY PARTICULAR FONT, STYLE, SIZE, OR COLOR.

FOR RESTAURANT SERVICES (U.S. CLS. 100 AND 101).  
FIRST USE 9-11-2007; IN COMMERCE 9-11-2007.  
CHERYL CLAYTON, EXAMINING ATTORNEY

SN 86-070,381. PBQ LLC, LARCHMONT, NY. FILED 9-20-2013.

## BARBACON

THE MARK CONSISTS OF STANDARD CHARACTERS WITHOUT CLAIM TO ANY PARTICULAR FONT, STYLE, SIZE, OR COLOR.

FOR RESTAURANT AND BAR SERVICES (U.S. CLS. 100 AND 101).  
MARCIE MILONE, EXAMINING ATTORNEY

**CLASS 43—(Continued).**

SN 86-070,414. WHITEWOOD RESTAURANTS, LLC, ORLANDO, FL. FILED 9-20-2013.

## WHITEWOOD

THE MARK CONSISTS OF STANDARD CHARACTERS WITHOUT CLAIM TO ANY PARTICULAR FONT, STYLE, SIZE, OR COLOR.

FOR RESTAURANT SERVICES (U.S. CLS. 100 AND 101).  
FIRST USE 10-31-2011; IN COMMERCE 10-31-2011.  
SHANNON TWOHIG, EXAMINING ATTORNEY

SN 86-070,444. WHITEWOOD RESTAURANTS, LLC, ORLANDO, FL. FILED 9-20-2013.



THE MARK CONSISTS OF A STYLIZED IMAGE OF FLAMES INSIDE A VERTICAL RECTANGLE.  
FOR RESTAURANT SERVICES (U.S. CLS. 100 AND 101).

FIRST USE 10-31-2011; IN COMMERCE 10-31-2011.  
SHANNON TWOHIG, EXAMINING ATTORNEY

SN 86-070,760. THE SKOOP NH, LLC, PETERBOROUGH, NH. FILED 9-20-2013.



THE MARK CONSISTS OF THE STYLIZED WORDS "SHACK N' CHEESE". THE "SHACK N' CHEESE" MARK CONSISTS OF A SKILLET BACKGROUND WITH THE "SHACK N' CHEESE" LETTERING PLACED INSIDE THE SKILLET DIVIDED BY A "SPORK" WHICH IS A SPOON AND FORK UTENSIL.

FOR FAST-FOOD RESTAURANT SERVICES (U.S. CLS. 100 AND 101).  
DAVID TAYLOR, EXAMINING ATTORNEY

**CLASS 43—(Continued).**

SN 86-070,855. LEAN ON GREEN, INC., LOS ANGELES, CA. FILED 9-20-2013.

**LEAN ON GREEN**

THE MARK CONSISTS OF STANDARD CHARACTERS WITHOUT CLAIM TO ANY PARTICULAR FONT, STYLE, SIZE, OR COLOR.

FOR CATERING SERVICES; RESTAURANT SERVICES, INCLUDING SIT-DOWN SERVICE OF FOOD AND TAKE-OUT RESTAURANT SERVICES (U.S. CLS. 100 AND 101).

TINA L. SNAPP, EXAMINING ATTORNEY

**CLASS 43—(Continued).**

SN 86-072,452. MIRAGE RESORTS INCORPORATED, LAS VEGAS, NV. FILED 9-23-2013.

**PORTOFINO**

THE MARK CONSISTS OF STANDARD CHARACTERS WITHOUT CLAIM TO ANY PARTICULAR FONT, STYLE, SIZE, OR COLOR.

FOR RESTAURANT SERVICES; BAR SERVICES; COCKTAIL LOUNGE SERVICES (U.S. CLS. 100 AND 101).

KAREN SEVERSON, EXAMINING ATTORNEY

SN 86-071,001. MONROY FERNANDEZ, LUIS, CD. JUÁREZ, CHIHUAHUA, MEXICO, FILED 9-20-2013.



THE COLOR(S) YELLOW, WHITE, RED, GREEN, ORANGE IS/ARE CLAIMED AS A FEATURE OF THE MARK.

THE MARK CONSISTS OF THE WORD "CHILAQUILAZZO", THE "C" IS SHOWN IN THE COLOR YELLOW; THE LETTERS "HILAQUILAZZO" ARE SHOWN IN RED; THE LETTER "I" IS REPRESENTED BY A GREEN, WHITE AND ORANGE JALAPEÑO. THERE IS AN EXCLAMATION MARK AT THE END IN GREEN WHITE AND YELLOW.

FOR RESTAURANT AND BAR SERVICES (U.S. CLS. 100 AND 101).

RONALD MCMORROW, EXAMINING ATTORNEY

SN 86-078,581. MSG FORUM, LLC, NEW YORK, NY. FILED 9-30-2013.

**FABULOUS FORUM**

THE MARK CONSISTS OF STANDARD CHARACTERS WITHOUT CLAIM TO ANY PARTICULAR FONT, STYLE, SIZE, OR COLOR.

OWNER OF U.S. REG. NO. 1,222,923.  
FOR ARENA SERVICES, NAMELY, PROVIDING GENERAL PURPOSE FACILITIES FOR SPORTS, CONCERTS, ENTERTAINMENT EVENTS, CONVENTIONS AND EXHIBITIONS (U.S. CLS. 100 AND 101).

ELIZABETH KAJUBI, EXAMINING ATTORNEY

SN 86-072,321. HENSCHEL, FRED, TRACY, CA. FILED 9-23-2013.

**Urban Fresh Fuel**

THE MARK CONSISTS OF STANDARD CHARACTERS WITHOUT CLAIM TO ANY PARTICULAR FONT, STYLE, SIZE, OR COLOR.

FOR RESTAURANT SERVICES (U.S. CLS. 100 AND 101).

TEJBIR SINGH, EXAMINING ATTORNEY

SN 86-083,205. GLOBAL TRADEMARKS, INC., STOCKERTOWN, PA. FILED 10-4-2013.

**BABY'S ALL RIGHT**

THE MARK CONSISTS OF STANDARD CHARACTERS WITHOUT CLAIM TO ANY PARTICULAR FONT, STYLE, SIZE, OR COLOR.

FOR RESTAURANT AND BAR SERVICES (U.S. CLS. 100 AND 101).

TEJBIR SINGH, EXAMINING ATTORNEY

**CLASS 43—(Continued).**

SN 86-085,931. PIZZERIA UNO CORPORATION, WILMINGTON, DE. FILED 10-8-2013.

**UNO PRONTO**

THE MARK CONSISTS OF STANDARD CHARACTERS WITHOUT CLAIM TO ANY PARTICULAR FONT, STYLE, SIZE, OR COLOR.

OWNER OF U.S. REG. NOS. 1,089,458, 1,586,246 AND OTHERS.

THE ENGLISH TRANSLATION OF THE WORD "UNO" IN THE MARK IS "ONE".

FOR RESTAURANT SERVICES; TAKE-OUT RESTAURANT SERVICES (U.S. CLS. 100 AND 101).

JUHI KAVEESHVAR, EXAMINING ATTORNEY

**CLASS 43—(Continued).**

SN 86-092,268. PIZZERIA UNO CORPORATION, WILMINGTON, DE. FILED 10-15-2013.

**UNO PIZZERIA & GRILL**

THE MARK CONSISTS OF STANDARD CHARACTERS WITHOUT CLAIM TO ANY PARTICULAR FONT, STYLE, SIZE, OR COLOR.

OWNER OF U.S. REG. NOS. 2,179,797, 2,946,476 AND OTHERS.

NO CLAIM IS MADE TO THE EXCLUSIVE RIGHT TO USE "PIZZERIA & GRILL", APART FROM THE MARK AS SHOWN.

THE ENGLISH TRANSLATION OF THE WORD "UNO" IN THE MARK IS "ONE".

FOR RESTAURANT AND BAR SERVICES; RESTAURANT SERVICES; TAKE-OUT RESTAURANT SERVICES (U.S. CLS. 100 AND 101).

JUHI KAVEESHVAR, EXAMINING ATTORNEY

SN 86-090,442. CHIKARANOMOTO COMPANY CO. LTD., FUKUOKA CITY, FUKUOKA, JAPAN, FILED 10-14-2013.



OWNER OF U.S. REG. NOS. 3,551,908, 3,678,490 AND 3,678,491.

NO CLAIM IS MADE TO THE EXCLUSIVE RIGHT TO USE "NY" AND THE NON-LATIN CHARACTERS THAT TRANSLITERATE AND MEAN HAKATA, APART FROM THE MARK AS SHOWN.

THE MARK CONSISTS OF CIRCLE AROUND A STRAIGHT LINE AND THREE WAVY LINES. BELOW THE CIRCLE ARE JAPANESE CHARACTERS WHICH ARE ABOVE THE WORDS "IPPUDO NY".

THE ENGLISH TRANSLATION OF "IPPUDO" IN THE MARK IS "BREEZY PLACE".

THE NON-LATIN CHARACTERS IN THE MARK TRANSLITERATE TO "HAKATA IPPUDO" AND THIS MEANS "HAKATA" (DISTRICT) AND "BREEZY PLACE" IN ENGLISH.

FOR RESTAURANT AND CAFE SERVICES (U.S. CLS. 100 AND 101).

FIRST USE 9-17-2013; IN COMMERCE 9-17-2013.

SAMUEL E. SHARPER JR., EXAMINING ATTORNEY

SN 86-093,339. KAIS & SKAN INC., SAN FRANCISCO, CA. FILED 10-16-2013.

**BARCHA**

THE MARK CONSISTS OF STANDARD CHARACTERS WITHOUT CLAIM TO ANY PARTICULAR FONT, STYLE, SIZE, OR COLOR.

FOR CATERING SERVICES; RESTAURANT SERVICES (U.S. CLS. 100 AND 101).

GEORGE LORENZO, EXAMINING ATTORNEY

SN 86-097,040. MAJOR INTELLECTUAL LLC, NEW YORK, NY. FILED 10-21-2013.

**DIRTY FRENCH**

THE MARK CONSISTS OF STANDARD CHARACTERS WITHOUT CLAIM TO ANY PARTICULAR FONT, STYLE, SIZE, OR COLOR.

NO CLAIM IS MADE TO THE EXCLUSIVE RIGHT TO USE "FRENCH", APART FROM THE MARK AS SHOWN.

FOR RESTAURANT SERVICES; BAR SERVICES (U.S. CLS. 100 AND 101).

ANDREW RHIM, EXAMINING ATTORNEY

**CLASS 43—(Continued).**

SN 86-097,282. PIZZERIA UNO CORPORATION, WILMINGTON, DE. FILED 10-21-2013.

**UNO'S PRONTO**

THE MARK CONSISTS OF STANDARD CHARACTERS WITHOUT CLAIM TO ANY PARTICULAR FONT, STYLE, SIZE, OR COLOR.

OWNER OF U.S. REG. NOS. 1,089,458, 1,329,014 AND 1,586,246.

THE ENGLISH TRANSLATION OF THE WORD "UNO" IN THE MARK IS "ONE".

FOR RESTAURANT SERVICES; TAKE-OUT RESTAURANT SERVICES (U.S. CLS. 100 AND 101).

JUHI KAVEESHVAR, EXAMINING ATTORNEY

**CLASS 43—(Continued).**

SN 86-106,760. PLAYBOY ENTERPRISES INTERNATIONAL, INC, BEVERLY HILLS, CA. FILED 10-31-2013.



OWNER OF U.S. REG. NOS. 3,270,161 AND 3,297,069.

THE MARK CONSISTS OF RABBIT HEAD DESIGN.

FOR BARS, CAFES, HOTELS; CATERING SERVICES; RESTAURANTS; HOTEL SERVICES; RESORT HOTEL SERVICES; WINE BAR SERVICES; COCKTAIL LOUNGE; COCKTAIL LOUNGE SERVICES; PROVIDING TEMPORARY ACCOMMODATION; RESORT LODGING SERVICES; SERVICES FOR PROVIDING FOOD AND DRINK; NIGHT CLUB RESERVATION SERVICES, NAMELY, ARRANGING FOR COCKTAILS AND TABLE SERVICES RESERVATIONS AT NIGHT CLUBS AND NIGHT CLUB EVENT; PROVIDING FACILITIES FOR CONVENTIONS, BANQUETS, SOCIAL FUNCTIONS, FUND RAISING, AND SPECIAL EVENTS (U.S. CLS. 100 AND 101).

AMEEN IMAM, EXAMINING ATTORNEY

SN 86-098,427. PLAYBOY ENTERPRISES INTERNATIONAL, INC, BEVERLY HILLS, CA. FILED 10-22-2013.

**PLAYBOY**

THE MARK CONSISTS OF STANDARD CHARACTERS WITHOUT CLAIM TO ANY PARTICULAR FONT, STYLE, SIZE, OR COLOR.

OWNER OF U.S. REG. NOS. 3,297,069 AND 3,385,834.

FOR BARS, CAFES, HOTELS; CATERING SERVICES; RESTAURANTS; HOTEL SERVICES; RESORT HOTEL SERVICES; WINE BAR SERVICES; COCKTAIL LOUNGE; COCKTAIL LOUNGE SERVICES; PROVIDING TEMPORARY ACCOMMODATION; RESORT LODGING SERVICES (U.S. CLS. 100 AND 101).

AMEEN IMAM, EXAMINING ATTORNEY

SN 86-110,785. MCDONALD'S CORPORATION, OAK BROOK, IL. FILED 11-5-2013.

**Team Every1**

SN 86-101,076. FIELD, CHERYL LYNN, MARION, OH. FILED 10-24-2013.

**LUIGI'S CITY PIZZA ITALIAN CUISINE NASHVILLE**

THE MARK CONSISTS OF STANDARD CHARACTERS WITHOUT CLAIM TO ANY PARTICULAR FONT, STYLE, SIZE, OR COLOR.

NO CLAIM IS MADE TO THE EXCLUSIVE RIGHT TO USE "CITY PIZZA ITALIAN CUISINE NASHVILLE", APART FROM THE MARK AS SHOWN.

FOR RESTAURANT SERVICES (U.S. CLS. 100 AND 101).

FIRST USE 10-24-2013; IN COMMERCE 10-24-2013. ANTHONY RINKER, EXAMINING ATTORNEY

THE MARK CONSISTS OF STANDARD CHARACTERS WITHOUT CLAIM TO ANY PARTICULAR FONT, STYLE, SIZE, OR COLOR.

FOR RESTAURANT SERVICES (U.S. CLS. 100 AND 101).

RAMONA ORTIGA, EXAMINING ATTORNEY

**CLASS 43—(Continued).**

SN 86-116,043. PIZZERIA UNO CORPORATION, WILMINGTON, DE. FILED 11-12-2013.

EST. 1943  
**UNO**  
PIZZERIA & GRILL

OWNER OF U.S. REG. NOS. 2,179,797, 2,946,476 AND OTHERS.

NO CLAIM IS MADE TO THE EXCLUSIVE RIGHT TO USE "PIZZERIA & GRILL EST. 1943", APART FROM THE MARK AS SHOWN.

THE MARK CONSISTS OF THE WORD "UNO" IN LARGE TYPE AT THE CENTER OF THE MARK, WITH THE PHRASE "EST. 1943" IN SMALLER TYPE ARCHED ABOVE THE WORD "UNO", AND THE PHRASE "PIZZERIA & GRILL" APPEARING HORIZONTALLY IN SMALL TYPE BELOW THE WORD "UNO".

THE ENGLISH TRANSLATION OF THE WORD "UNO" IN THE MARK IS "ONE".

FOR RESTAURANT AND BAR SERVICES; RESTAURANT SERVICES; TAKE-OUT RESTAURANT SERVICES (U.S. CLS. 100 AND 101).

JUHI KAVEESHVAR, EXAMINING ATTORNEY

SN 86-117,987. SAN ANTONIO WINERY, INC., LOS ANGELES, CA. FILED 11-13-2013.

**STELLA ROSA**

THE MARK CONSISTS OF STANDARD CHARACTERS WITHOUT CLAIM TO ANY PARTICULAR FONT, STYLE, SIZE, OR COLOR.

OWNER OF U.S. REG. NOS. 3,663,013 AND 4,000,417. THE ENGLISH TRANSLATION OF "STELLA ROSA" IS "PINK STAR" OR "STAR ROSE".

FOR BISTRO SERVICES (U.S. CLS. 100 AND 101).

FIRST USE 11-12-2013; IN COMMERCE 11-12-2013.  
BARBARA RUTLAND, EXAMINING ATTORNEY

SN 86-120,728. CONSILIENT RESTAURANTS HOLDINGS, LLC, DALLAS, TX. FILED 11-16-2013.

**AF+B**

THE MARK CONSISTS OF STANDARD CHARACTERS WITHOUT CLAIM TO ANY PARTICULAR FONT, STYLE, SIZE, OR COLOR.

FOR RESTAURANT AND BAR SERVICES (U.S. CLS. 100 AND 101).

BRIAN PINO, EXAMINING ATTORNEY

**CLASS 43—(Continued).**

SN 86-125,060. HURRICANE AMT, LLC, WEST PALM BEACH, FL. FILED 11-21-2013.

**HURRICANE TRACKER**

THE MARK CONSISTS OF STANDARD CHARACTERS WITHOUT CLAIM TO ANY PARTICULAR FONT, STYLE, SIZE, OR COLOR.

FOR RESTAURANT SERVICES, COCKTAIL LOUNGES, TAKE-OUT RESTAURANT SERVICES, AND CATERING (U.S. CLS. 100 AND 101).

FIRST USE 6-6-2011; IN COMMERCE 6-6-2011.

PAUL E. FAHRENKOPF, EXAMINING ATTORNEY

SN 86-130,434. DOCTOR'S ASSOCIATES INC., MILFORD, CT. FILED 11-27-2013.

**TURKEYTOPIA**

THE MARK CONSISTS OF STANDARD CHARACTERS WITHOUT CLAIM TO ANY PARTICULAR FONT, STYLE, SIZE, OR COLOR.

FOR RESTAURANT SERVICES, INCLUDING SIT-DOWN SERVICE OF FOOD AND TAKE-OUT RESTAURANT SERVICES (U.S. CLS. 100 AND 101).

FIRST USE 12-28-2012; IN COMMERCE 12-28-2012.

LIEF MARTIN, EXAMINING ATTORNEY

SN 86-141,308. SALYANI VENTURES LLC, DBA JUICE CENTRAL, SAN ANTONIO, TX. FILED 12-11-2013.

juice   
**CENTRAL**

NO CLAIM IS MADE TO THE EXCLUSIVE RIGHT TO USE "JUICE", APART FROM THE MARK AS SHOWN.

THE MARK CONSISTS OF TWO DIFFERENT FONTS FOR THE WORD "JUICE" AND FOR THE WORD "CENTRAL". THE WORD "JUICE" IS ABOVE AND UNALIGNED WITH THE WORD "CENTRAL". THE WORD "CENTRAL" JUTS OUT TO THE RIGHT OF THE WORD "JUICE". THE GRAPHIC ELEMENT IS IN THE SPACE CREATED BY THIS SHIFT, TO THE RIGHT OF THE WORD "JUICE" AND BEING ABOVE OF THE LAST FEW LETTERS OF THE

**CLASS 43—(Continued).**

WORD "CENTRAL". THE GRAPHIC ELEMENT IS AN AMORPHOUS SHAPE THAT MOST RESEMBLES A CIRCLE. INSIDE OF THIS SHAPE IS A BURST OF 11 RAYS OF DIFFERENT LENGTHS THAT MOVE FROM THE CENTER OUTWARDS IN AN ASYMMETRICAL MANNER. THE ENDS OF THESE RAYS HAVE LITTLE BUDS THAT RESEMBLE SEEDS SO THAT THE GRAPHIC ELEMENT IN ITS ENTIRETY IS SOMEWHAT OF AN ABSTRACT CROSS-SECTION OF AN EXOTIC FRUIT. THE FRUIT ITSELF IS A SOLID COLOR WITH THE SEEDS IN WHITE.  
FOR JUICE BAR SERVICES (U.S. CLS. 100 AND 101).  
LAURA FIONDA, EXAMINING ATTORNEY

**CLASS 44—MEDICAL, BEAUTY AND AGRICULTURAL SERVICES**

SN 77-804,510. RAYMOND L. FREY, II, DMD, P.C., DBA BLING DENTAL, PORTLAND, OR. FILED 8-13-2009.

WE WILL DAZZLE YOU... AND  
YOUR SMILE!

THE MARK CONSISTS OF STANDARD CHARACTERS WITHOUT CLAIM TO ANY PARTICULAR FONT, STYLE, SIZE, OR COLOR.

FOR DENTIST SERVICES, DENTAL COSMETIC SERVICES, DENTAL IMPLANT SERVICES, DENTISTRY, TEETH WHITENING SERVICES, DENTAL HYGIENIST SERVICES, CONSULTING SERVICES IN THE FIELD OF DENTAL SERVICES, DENTAL COSMETIC SERVICES AND DENTAL IMPLANT SERVICES (U.S. CLS. 100 AND 101).

FIRST USE 5-1-2009; IN COMMERCE 6-12-2009.  
KAREN SEVERSON, EXAMINING ATTORNEY

SN 85-460,150. ONCOSEC MEDICAL INCORPORATED, SAN DIEGO, CA. FILED 10-31-2011.

**OncSec**

THE COLOR(S) YELLOW, ORANGE, GOLD AND BLACK IS/ARE CLAIMED AS A FEATURE OF THE MARK.

THE MARK CONSISTS OF THE WORDING "ONCOSEC" WITH THE "O" BETWEEN "ONC" AND "SEC" COMPRISED OF SIX ROUND DOTS IN A CIRCLE WHEREIN THE DOTS ARE YELLOW, ORANGE AND GOLD AND ARE OUTLINED IN BLACK. THE LETTERING/WORDING "ONC" AND "SEC" APPEARS IN BLACK.

FOR CHEMOTHERAPEUTIC AND IMMUNOTHERAPEUTIC SERVICES FOR TREATING DISEASES, NAMELY, CANCER (U.S. CLS. 100 AND 101).

MEGHAN REINHART, EXAMINING ATTORNEY

**CLASS 44—(Continued).**

SN 85-677,281. CARIBBEAN OPTOMETRICS INC., TRUJILLO ALTO, PUERTO RICO, FILED 7-14-2012.



NO CLAIM IS MADE TO THE EXCLUSIVE RIGHT TO USE "EYE DOCTOR", APART FROM THE MARK AS SHOWN.

THE COLOR(S) RED, WHITE AND BLUE IS/ARE CLAIMED AS A FEATURE OF THE MARK.

THE MARK CONSISTS OF THE WORDING "THE EYE DOCTOR AL CUIDADO DE TUS OJOS" AND DESIGN. THE WORDING "THE EYE DOCTOR AL CUIDADO DE TUS OJOS" IS IN BLUE. THE DESIGN OF THE STYLIZED EYE IS IN BLUE AND WHITE. THE ZIG ZAG LINE GOING ACROSS THE EYE AND THRU THE TWO LINES OF WORDING IS IN RED OUTLINED IN WHITE AND OVER THE BLUE SECTION OF THE EYE.

THE ENGLISH TRANSLATION OF "AL CUIDADO DE TUS OJOS" IN THE MARK IS "TAKING CARE OF YOUR EYES".

FOR OPTOMETRY SERVICES (U.S. CLS. 100 AND 101).  
FIRST USE 6-1-2008; IN COMMERCE 4-25-2009.  
LOURDES AYALA, EXAMINING ATTORNEY

SN 85-708,327. NEW LIFE AGENCY, INC., RANCHO MIRAGE, CA. FILED 8-20-2012.

**NEW LIFE SURROGACY AGENCY**

THE MARK CONSISTS OF STANDARD CHARACTERS WITHOUT CLAIM TO ANY PARTICULAR FONT, STYLE, SIZE, OR COLOR.

NO CLAIM IS MADE TO THE EXCLUSIVE RIGHT TO USE "SURROGACY AGENCY", APART FROM THE MARK AS SHOWN.

FOR CONSULTING SERVICES IN THE FIELD OF WOMEN'S HEALTH; CONSULTING SERVICES IN THE FIELD OF MEDICAL CARE; CONSULTING SERVICES IN THE FIELD OF HUMAN FERTILITY TREATMENT, MATERNAL SURROGACY, HUMAN EGG DONATION, AND HUMAN SPERM DONATION (U.S. CLS. 100 AND 101).

MARIA-VICTORIA SUAREZ, EXAMINING ATTORNEY

SN 85-726,038. CARILION CLINIC MEDICARE SHARED SAVINGS COMPANY, LLC, ROANOKE, VA. FILED 9-11-2012.

**Doctors Connected**

THE MARK CONSISTS OF STANDARD CHARACTERS WITHOUT CLAIM TO ANY PARTICULAR FONT, STYLE, SIZE, OR COLOR.

NO CLAIM IS MADE TO THE EXCLUSIVE RIGHT TO USE "DOCTORS", APART FROM THE MARK AS SHOWN.

FOR MANAGED HEALTH CARE SERVICES IN THE NATURE OF ACCOUNTABLE CARE ORGANIZATIONS THAT PROVIDE HEALTH CARE TO MEDICARE BENEFICIARIES (U.S. CLS. 100 AND 101).

TEJBIR SINGH, EXAMINING ATTORNEY



**CLASS 44—(Continued).**

SN 85-770,476. TREAD SYSTEMS LLC, NEW ORLEANS, LA.  
FILED 11-2-2012.



THE MARK CONSISTS OF THE WORD "TREAD" IN ALL CAPITAL LETTERS, WITH THE LEFT TOP PORTION OF EACH LETTER BEARING A TRAILING AND POINTED END TO INDICATE MOVEMENT, AND WITH A DOUBLE-CHEVRON FOOTPRINT IN THE "D" OF THE WORD "TREAD", ALONG WITH AN UNDERSCORE BENEATH THE WORD "TREAD", ENDING IN A LARGE CHECK MARK.

FOR HEALTH ASSESSMENT SERVICES, NAMELY, PROVIDING METABOLIC ASSESSMENT PROFILES (MAP) TO CLIENTS OBTAINED BY USING A PORTABLE METABOLIC MEASUREMENT SYSTEM IN THE NATURE OF A UNIQUE, HEART-RATE BASED OVERVIEW OF THEIR OWN METABOLISM IN ORDER TO ASSIST IN REACHING WEIGHT LOSS, SPORTS PERFORMANCE, HEALTH, FITNESS, AND WELLNESS-RELATED GOALS; HEALTH CARE SERVICES, NAMELY, WELLNESS PROGRAMS; NUTRITIONAL THERAPY SERVICES; OCCUPATIONAL THERAPY SERVICES; PHYSICAL REHABILITATION; PHYSICAL THERAPY; PHYSICAL THERAPY EVALUATION, IDENTIFICATION, AND MANAGEMENT OF MOVEMENT DYSFUNCTION TO RESTORE, MAINTAIN, AND PROMOTE OPTIMAL PHYSICAL FUNCTION PREVENTING THE ONSET, SYMPTOMS AND PROGRESSION OF IMPAIRMENTS, FUNCTIONAL LIMITATIONS, AND DISABILITIES RESULTING FROM DISEASE, DISORDERS, CONDITIONS, OR INJURIES; PHYSICAL THERAPY IN THE NATURE OF MOVEMENT THERAPY; PROVIDING A WEB SITE FEATURING INFORMATION IN THE FIELD OF MENTAL HEALTH AND PHYSICAL HEALTH, INCLUDING LIVING A HEALTHY AND DISEASE FREE LIFE; PROVIDING A WEB SITE FEATURING INFORMATION ON HEALTH AND NUTRITION; PROVIDING A WEBSITE FEATURING INFORMATION ABOUT HEALTH, WELLNESS AND NUTRITION; PROVIDING A WEBSITE FEATURING INFORMATION AND ADVICE IN THE FIELDS OF DIET, WEIGHT LOSS, DIET PLANNING AND LIFESTYLE WELLNESS; PROVIDING ASSISTANCE, FITNESS EVALUATION AND CONSULTATION TO CORPORATE CLIENTS TO HELP THEIR EMPLOYEES MAKE HEALTH, WELLNESS AND NUTRITIONAL CHANGES IN THEIR DAILY LIVING TO IMPROVE HEALTH; PROVIDING ASSISTANCE, FITNESS EVALUATION AND CONSULTATION TO INDIVIDUALS TO HELP THEM MAKE HEALTH, WELLNESS AND NUTRITIONAL CHANGES IN THEIR DAILY LIVING TO IMPROVE HEALTH; PROVIDING WELLNESS SERVICES, NAMELY, PERSONAL ASSESSMENTS, PERSONALIZED ROUTINES, MAINTENANCE SCHEDULES, AND COUNSELING (U.S. CLS. 100 AND 101).

FIRST USE 9-15-2012; IN COMMERCE 9-15-2012.  
CHRISTOPHER LAW, EXAMINING ATTORNEY

**CLASS 44—(Continued).**

SN 85-823,851. BLUE CROSS BLUE SHIELD OF MICHIGAN,  
DETROIT, MI. FILED 1-15-2013.

# MOVE 2BFIT

THE MARK CONSISTS OF STANDARD CHARACTERS WITHOUT CLAIM TO ANY PARTICULAR FONT, STYLE, SIZE, OR COLOR.

FOR HEALTH AND WELLNESS PROGRAM, NAMELY, AN ONLINE PHYSICAL ACTIVITY PROGRAM THAT IS PROVIDED VIA A SOCIAL NETWORK AND THAT ENCOURAGES MEMBERS TO BE PHYSICALLY ACTIVE AND ALLOWS THEM TO TRACK THEIR PHYSICAL ACTIVITY THROUGH ONLINE TOOLS, COMPETE AND CHALLENGE OTHER MEMBERS; HEALTH AND WELLNESS PROGRAM, NAMELY, AN ONLINE PHYSICAL ACTIVITY PROGRAM THAT FEATURES INCENTIVE REWARDS BASED ON REACHING CERTAIN REQUIREMENTS TO PROMOTE PHYSICAL ACTIVITY (U.S. CLS. 100 AND 101).

ROSELLE HERRERA, EXAMINING ATTORNEY

SN 85-832,333. GALLUP INSTITUTE FOR PERSONAL FREEDOM, LLC, THE, KENNEBUNK, ME. FILED 1-25-2013.



NO CLAIM IS MADE TO THE EXCLUSIVE RIGHT TO USE "INSTITUTE" AND "PERSONAL", APART FROM THE MARK AS SHOWN.

THE STIPPLING IS FOR SHADING PURPOSES ONLY.

THE MARK CONSISTS OF A STYLIZED LOWER CASE LETTER "G" ALONG WITH THE WORDS "THE GALLUP INSTITUTE FOR PERSONAL FREEDOM".

FOR CLINICAL MENTAL HEALTH COUNSELING SERVICES; COGNITIVE THERAPY SERVICES; COUNSELING SERVICES IN THE FIELDS OF HEALTH, HERBALISM, AND LIFESTYLE WELLNESS; COUNSELING SERVICES IN THE FIELDS OF HEALTH, NUTRITION AND LIFESTYLE WELLNESS; MENTAL HEALTH COUNSELING AND PSYCHOTHERAPY AS IT RELATES TO RELATIONSHIPS; MENTAL HEALTH THERAPY SERVICES; PSYCHOLOGICAL ASSESSMENT SERVICES; PSYCHOLOGICAL CONSULTATION; PSYCHOLOGICAL COUNSELING; PSYCHOTHERAPY AND PSYCHOTHERAPY COUNSELING FOR CHILDREN AND ADULTS IN INDIVIDUAL AND FAMILY SESSIONS (U.S. CLS. 100 AND 101).

FIRST USE 3-19-2012; IN COMMERCE 12-17-2012.  
DAVID I, EXAMINING ATTORNEY

**CLASS 44—(Continued).**

SN 85-834,799. BALANCE & THRIVE LLC, WILLOUGHBY, OH. FILED 1-29-2013.

**Balance & Thrive**

THE MARK CONSISTS OF STANDARD CHARACTERS WITHOUT CLAIM TO ANY PARTICULAR FONT, STYLE, SIZE, OR COLOR.

FOR LIFESTYLE AND HEALTH WELLNESS CONSULTATION IN THE FIELDS OF NUTRITION AND DIETARY ADVICE, UTILIZING A HOLISTIC APPROACH THAT COMBINES NUTRITIONAL AND DIETARY INTERVENTIONS AND MENTAL HEALTH WELLNESS AND BEHAVIOR MODIFICATION (U.S. CLS. 100 AND 101).

FIRST USE 10-1-2012; IN COMMERCE 12-1-2012.  
WILLIAM P. SHANAHAN, EXAMINING ATTORNEY

SN 85-840,310. OSTER, RANDI, FAIRFIELD, CT. FILED 2-4-2013.

**EMPOWERED PATIENTS.  
IMPROVED OUTCOMES.**

THE MARK CONSISTS OF STANDARD CHARACTERS WITHOUT CLAIM TO ANY PARTICULAR FONT, STYLE, SIZE, OR COLOR.

FOR HEALTH CARE CONSULTING SERVICES IN THE FIELD OF PATIENT ADVOCACY, AS WELL AS CONSULTING SERVICES IN THE FIELD OF MEDICAL CARE FOR LONG TERM CARE NEEDS (U.S. CLS. 100 AND 101).

LINDA ESTRADA, EXAMINING ATTORNEY

SN 85-842,145. SEQUENOM, INC., SAN DIEGO, CA. FILED 2-6-2013.

**HEREDI-T**

THE MARK CONSISTS OF STANDARD CHARACTERS WITHOUT CLAIM TO ANY PARTICULAR FONT, STYLE, SIZE, OR COLOR.

FOR MEDICAL SERVICES; GENETIC, PRENATAL AND DIAGNOSTIC TESTING FOR MEDICAL PURPOSES; NUCLEIC ACID BASED TESTING FOR MEDICAL PURPOSES; MEDICAL SERVICES IN THE FIELDS OF NUCLEIC ACID ANALYSIS AND PRENATAL DIAGNOSIS AND GENETICS; MEDICAL MONITORING AND REPORTING SERVICES; PROVIDING ONLINE MEDICAL RECORD SERVICES (U.S. CLS. 100 AND 101).

DAVID COLLIER, EXAMINING ATTORNEY

**CLASS 44—(Continued).**

SN 85-848,297. MOKKAPATTI, RUPA, PITTSBURGH, PA. FILED 2-13-2013.

**High-speed internist access**

THE MARK CONSISTS OF STANDARD CHARACTERS WITHOUT CLAIM TO ANY PARTICULAR FONT, STYLE, SIZE, OR COLOR.

NO CLAIM IS MADE TO THE EXCLUSIVE RIGHT TO USE "INTERNIST ACCESS", APART FROM THE MARK AS SHOWN.

FOR PHYSICIAN SERVICES (U.S. CLS. 100 AND 101).  
LINDA ESTRADA, EXAMINING ATTORNEY

SN 85-852,672. WORK SYSTEMS REHAB & FITNESS, P.C., PELLA, IA. FILED 2-18-2013.

**WORK SYSTEMS REHAB AND  
FITNESS**

THE MARK CONSISTS OF STANDARD CHARACTERS WITHOUT CLAIM TO ANY PARTICULAR FONT, STYLE, SIZE, OR COLOR.

NO CLAIM IS MADE TO THE EXCLUSIVE RIGHT TO USE "REHAB AND FITNESS", APART FROM THE MARK AS SHOWN.

SEC. 2(F).  
FOR PHYSICAL THERAPY SERVICES AND OCCUPATIONAL THERAPY SERVICES (U.S. CLS. 100 AND 101).  
FIRST USE 5-24-2004; IN COMMERCE 5-24-2004.  
LINDA ORNDORFF, EXAMINING ATTORNEY

SN 85-858,596. PATIK, CHELSEY, KINNEAR, WY. FILED 2-25-2013.

**BEAUTY TUFF**

THE MARK CONSISTS OF STANDARD CHARACTERS WITHOUT CLAIM TO ANY PARTICULAR FONT, STYLE, SIZE, OR COLOR.

NO CLAIM IS MADE TO THE EXCLUSIVE RIGHT TO USE "BEAUTY", APART FROM THE MARK AS SHOWN.

FOR BEAUTY SALON SERVICES; TANNING SALONS; HAIR SALON SERVICES; NAIL CARE SALONS; MASSAGE THERAPY SERVICES; HEALTH SPA SERVICES, NAMELY, LASER TREATMENTS FOR ACNE, REJUVENATION, SCARS, TATTOO REMOVAL AND FOR FACIALS AND MASSAGE; HEALTH SPA SERVICES FOR HEALTH AND WELLNESS OF THE BODY AND SPIRIT, NAMELY, PROVIDING MASSAGE, FACIAL AND BODY TREATMENT SERVICES, COSMETIC BODY CARE SERVICES (U.S. CLS. 100 AND 101).

BERYL GARDNER, EXAMINING ATTORNEY

**CLASS 44—(Continued).**

SN 85-874,693. NW ALABAMA PRACTICE MANAGEMENT, LLC, SHEFFIELD, AL. FILED 3-13-2013.



NO CLAIM IS MADE TO THE EXCLUSIVE RIGHT TO USE "WOMEN'S HEALTH OPTIONS" AND "A HEALTHCARE AFFILIATE" AND "HOSPITAL", APART FROM THE MARK AS SHOWN.

THE COLOR(S) RED, GRAY AND BLACK IS/ARE CLAIMED AS A FEATURE OF THE MARK.

THE MARK CONSISTS OF THE WORD "WOMEN'S" IN RED, STYLIZED FONT POSITIONED ABOVE THE WORDS "HEALTH OPTIONS" IN RED FONT, WITH TWO PARALLEL GRAY LINES POSITIONED BELOW "HEALTH OPTIONS" AND THE WORDS "A HEALTHCARE AFFILIATE OF HELEN KELLER HOSPITAL" IN BLACK, LOWER CASE FONT POSITIONED BETWEEN THE PARALLEL GRAY LINES.

FOR MEDICAL SERVICES; HEALTH CARE SERVICES, NAMELY, GYNECOLOGY, OBSTETRICS, HORMONE REPLACEMENT THERAPY AND WEIGHT MANAGEMENT SERVICES (U.S. CLS. 100 AND 101).

FIRST USE 11-30-2011; IN COMMERCE 11-30-2011.  
GINA FINK, EXAMINING ATTORNEY

**CLASS 44—(Continued).**

SN 85-878,133. DARIN, LINDA, DBA THE DARIN METHOD, MAMARONECK, NY. FILED 3-16-2013.

## The Darin Method

THE MARK CONSISTS OF STANDARD CHARACTERS WITHOUT CLAIM TO ANY PARTICULAR FONT, STYLE, SIZE, OR COLOR.

NO CLAIM IS MADE TO THE EXCLUSIVE RIGHT TO USE "METHOD", APART FROM THE MARK AS SHOWN.  
SEC. 2(F).

FOR ADDICTION TREATMENT SERVICES; ALTERNATIVE MEDICINE SERVICES; AROMATHERAPY SERVICES; ENERGY HEALING SERVICES, NAMELY, STRESS MANAGEMENT AND STRESS REDUCTION COUNSELING FOR INDIVIDUALS TO ENHANCE THEIR LIVES; ENERGY HEALING SERVICES, NAMELY, THERAPEUTIC TOUCH SERVICES; HOLISTIC HEALTH SERVICES; MENTAL HEALTH COUNSELING AND PSYCHOTHERAPY AS IT RELATES TO RELATIONSHIPS; PROVIDING IN-PERSON ENERGY HEALING SERVICES; PROVIDING IN-PERSON HOLISTIC HEALTH CARE SERVICES; PSYCHOTHERAPY SERVICES; REIKI HEALING SERVICES; STRESS REDUCTION THERAPY (U.S. CLS. 100 AND 101).

FIRST USE 1-1-1996; IN COMMERCE 1-1-1996.

MARTHA SANTOMARTINO, EXAMINING ATTORNEY

SN 85-875,559. THE DISC INSTITUTE, P.C., CLINTON TOWNSHIP, MI. FILED 3-13-2013.

## The Disc Institute

THE MARK CONSISTS OF STANDARD CHARACTERS WITHOUT CLAIM TO ANY PARTICULAR FONT, STYLE, SIZE, OR COLOR.

SEC. 2(F).

FOR MEDICAL SERVICES (U.S. CLS. 100 AND 101).

FIRST USE 9-0-2008; IN COMMERCE 11-0-2008.

AMY C. KEAN, EXAMINING ATTORNEY

SN 85-878,781. EAGLE ADVANCEMENT INSTITUTE, WEST BLOOMFIELD, MI. FILED 3-18-2013.

## IOOT

THE MARK CONSISTS OF STANDARD CHARACTERS WITHOUT CLAIM TO ANY PARTICULAR FONT, STYLE, SIZE, OR COLOR.

FOR REHABILITATION OF DRUG ADDICTED PATIENTS BY WAY OF A RAPID DRUG DETOXIFICATION PROCESS AND SUBSEQUENT COUNSELING AND SUPPORT FOR PATIENTS ADDICTED TO DRUGS, OPIATES AND NARCOTICS (U.S. CLS. 100 AND 101).

GIANCARLO CASTRO, EXAMINING ATTORNEY

**CLASS 44—(Continued).**

SN 85-892,919. TAYLOR, WILLIAM B, KINSALE, VA. FILED 4-2-2013.

Rivah Vineyards at the  
Grove

THE MARK CONSISTS OF STANDARD CHARACTERS WITHOUT CLAIM TO ANY PARTICULAR FONT, STYLE, SIZE, OR COLOR.

NO CLAIM IS MADE TO THE EXCLUSIVE RIGHT TO USE "VINEYARDS", APART FROM THE MARK AS SHOWN.

FOR VINEYARD AND WINERY SERVICES, NAMELY, THE CULTIVATION OF GRAPES FOR OTHERS (U.S. CLS. 100 AND 101).

MARK SPARACINO, EXAMINING ATTORNEY

**CLASS 44—(Continued).**

SN 85-900,314. A ROBERT CROMEANS SALON, INC., VISTA, CA. FILED 4-10-2013.



NO CLAIM IS MADE TO THE EXCLUSIVE RIGHT TO USE "WALK IN SALON", APART FROM THE MARK AS SHOWN.

THE NAME(S), PORTRAIT(S), AND/OR SIGNATURE(S) SHOWN IN THE MARK IDENTIFIES "ROBERT CROMEANS", WHOSE CONSENT(S) TO REGISTER IS MADE OF RECORD.

THE MARK CONSISTS OF THE WORDS "WALK IN BY ROBERT CROMEANS" IN DIFFERENT FONT AND SIZE, APPEARING HORIZONTALLY, AND THE WORD "SALON" IN A DIFFERENT SIZE AND FONT APPEARING VERTICALLY BELOW THE LETTER "K" AND NEXT TO "IN".

FOR HAIR SALON SERVICES (U.S. CLS. 100 AND 101). FIRST USE 3-15-2011; IN COMMERCE 3-15-2011. THOMAS MANOR, EXAMINING ATTORNEY

SN 85-900,288. A ROBERT CROMEANS SALON, INC., VISTA, CA. FILED 4-10-2013.

WALK IN SALON BY ROBERT  
CROMEANS

THE MARK CONSISTS OF STANDARD CHARACTERS WITHOUT CLAIM TO ANY PARTICULAR FONT, STYLE, SIZE, OR COLOR.

NO CLAIM IS MADE TO THE EXCLUSIVE RIGHT TO USE "WALK IN SALON", APART FROM THE MARK AS SHOWN.

THE NAME(S), PORTRAIT(S), AND/OR SIGNATURE(S) SHOWN IN THE MARK IDENTIFIES "ROBERT CROMEANS", WHOSE CONSENT(S) TO REGISTER IS MADE OF RECORD.

FOR HAIR SALON SERVICES (U.S. CLS. 100 AND 101). FIRST USE 3-15-2011; IN COMMERCE 3-15-2011. THOMAS MANOR, EXAMINING ATTORNEY

SN 85-900,334. A ROBERT CROMEANS SALON, INC., VISTA, CA. FILED 4-10-2013.

A ROBERT CROMEANS SALON

THE MARK CONSISTS OF STANDARD CHARACTERS WITHOUT CLAIM TO ANY PARTICULAR FONT, STYLE, SIZE, OR COLOR.

NO CLAIM IS MADE TO THE EXCLUSIVE RIGHT TO USE "SALON", APART FROM THE MARK AS SHOWN.

THE NAME(S), PORTRAIT(S), AND/OR SIGNATURE(S) SHOWN IN THE MARK IDENTIFIES "ROBERT CROMEANS", WHOSE CONSENT(S) TO REGISTER IS MADE OF RECORD.

FOR HAIR SALON SERVICES (U.S. CLS. 100 AND 101). FIRST USE 1-1-1995; IN COMMERCE 1-1-1995. THOMAS MANOR, EXAMINING ATTORNEY

**CLASS 44—(Continued).**

SN 85-900,353. A ROBERT CROMEANS SALON, INC., VISTA, CA. FILED 4-10-2013.



NO CLAIM IS MADE TO THE EXCLUSIVE RIGHT TO USE "SALON", APART FROM THE MARK AS SHOWN.

THE NAME(S), PORTRAIT(S), AND/OR SIGNATURE(S) SHOWN IN THE MARK IDENTIFIES "ROBERT CROMEANS", WHOSE CONSENT(S) TO REGISTER IS MADE OF RECORD.

THE MARK CONSISTS OF THE WORDS "A ROBERT CROMEANS SALON" PRESENTED IN A FANCY FONT, AND FOUR SMALL SQUARES IN A SQUARE PATTERN IN EACH CORNER.

FOR HAIR SALON SERVICES (U.S. CLS. 100 AND 101). FIRST USE 1-1-1995; IN COMMERCE 1-1-1995. THOMAS MANOR, EXAMINING ATTORNEY

SN 85-900,370. A ROBERT CROMEANS SALON, INC., VISTA, CA. FILED 4-10-2013.



THE NAME(S), PORTRAIT(S), AND/OR SIGNATURE(S) SHOWN IN THE MARK IDENTIFIES ROBERT CROMEANS, WHOSE CONSENT(S) TO REGISTER IS MADE OF RECORD.

THE MARK CONSISTS OF VARIOUSLY SIZED SCISSORS IN A PATTERN WHICH FORMS A HUMAN FACE PLUS A SIGNATURE OF "ROBERT CROMEANS".

FOR HAIR SALON SERVICES (U.S. CLS. 100 AND 101). FIRST USE 1-15-2006; IN COMMERCE 1-15-2006. THOMAS MANOR, EXAMINING ATTORNEY

**CLASS 44—(Continued).**

SN 85-904,843. GOLD, MEREDITH, GLENDALE, CA. FILED 4-15-2013.



NO CLAIM IS MADE TO THE EXCLUSIVE RIGHT TO USE "SELF DEFENSE BASED NUTRITION STRATEGIES", APART FROM THE MARK AS SHOWN.

THE MARK CONSISTS OF A DESIGN OF A SLICE OF CAKE WITH A HAND CHOPPING THROUGH IT AND FRUIT AND VEGETABLES EXPLODING FROM WITHIN WITH THE STYLIZED TEXT "THE KUNG FOOD WAY" ABOVE THE DESIGN AND THE STYLIZED TEXT "SELF DEFENSE BASED NUTRITION STRATEGIES" BENEATH THE DESIGN.

FOR LIFE COACHING, NAMELY, NUTRITION COUNSELING (U.S. CLS. 100 AND 101).

FIRST USE 9-1-2012; IN COMMERCE 9-1-2012. BARBARA BROWN, EXAMINING ATTORNEY

SN 85-919,712. GUPTA, AMIT K, DBA CAFE AYURVEDA, CORTLANDT MANOR, NY. FILED 5-1-2013.

# Cafe Ayurveda

THE MARK CONSISTS OF STANDARD CHARACTERS WITHOUT CLAIM TO ANY PARTICULAR FONT, STYLE, SIZE, OR COLOR.

NO CLAIM IS MADE TO THE EXCLUSIVE RIGHT TO USE "AYURVEDA", APART FROM THE MARK AS SHOWN.

THE ENGLISH TRANSLATION OF "AYURVEDA" IN THE MARK IS "LIFE-KNOWLEDGE".

FOR CONSULTING SERVICES IN THE FIELDS OF HEALTH AND NUTRITION; COUNSELING SERVICES IN THE FIELDS OF HEALTH, HERBALISM, AND LIFESTYLE WELLNESS; COUNSELING SERVICES IN THE FIELDS OF HEALTH, NUTRITION AND LIFESTYLE WELLNESS; HEALTH CARE SERVICES, NAMELY, WELLNESS PROGRAMS; HEALTH COUNSELING; HEALTH SPA SERVICES FOR HEALTH AND WELLNESS OF THE BODY AND SPIRIT; HEALTH SPA SERVICES FOR HEALTH AND WELLNESS OF THE BODY AND SPIRIT OFFERED AT A HEALTH CLUB FACILITY; HEALTH SPA SERVICES FOR HEALTH AND WELLNESS OF THE BODY AND SPIRIT OFFERED AT A HEALTH RESORT; HEALTH SPA SERVICES FOR HEALTH AND WELLNESS OF THE BODY AND SPIRIT, NAMELY, PROVIDING MASSAGE, FACIAL AND BODY TREATMENT SERVICES, COSMETIC BODY CARE SERVICES; HEALTH SPA SERVICES FOR HEALTH AND WELLNESS OF THE MIND, BODY AND SPIRIT OFFERED IN OR FROM A REMOTE, MOBILE OR TEMPORARY ON-SITE LOCATION; HEALTH SPA SERVICES, NAMELY, BODY WRAPS, MUD TREATMENTS, SEAWEED TREATMENTS, HYDROTHERAPY BATHS, AND BODY SCRUBS; HEALTH SPA SERVICES, NAMELY, COSMETIC BODY CARE SERVICES; HEALTH SPA SERVICES, NAMELY, PROVIDING WEIGHT LOSS

**CLASS 44—(Continued).**

PROGRAMS; HOLISTIC HEALTH SERVICES; HOLISTIC HEALTH SERVICES FEATURING HERBAL MEDICINE; INTERNET-BASED HEALTH CARE INFORMATION SERVICES; MEDSPA SERVICES FOR HEALTH AND BEAUTY OF THE BODY AND SPIRIT; PROVIDING A WEB SITE FEATURING INFORMATION ON HEALTH AND NUTRITION; PROVIDING A WEBSITE FEATURING INFORMATION ABOUT HEALTH, WELLNESS AND NUTRITION; PROVIDING A WEBSITE FEATURING INFORMATION CONCERNING ALTERNATIVE HEALTH AND HEALING; PROVIDING ASSISTANCE, FITNESS EVALUATION AND CONSULTATION TO INDIVIDUALS TO HELP THEM MAKE HEALTH, WELLNESS AND NUTRITIONAL CHANGES IN THEIR DAILY LIVING TO IMPROVE HEALTH; PROVIDING IN-PERSON HOLISTIC HEALTH CARE SERVICES; PROVISION OF HEALTH CARE AND MEDICAL SERVICES BY HEALTH CARE PROFESSIONALS VIA THE INTERNET OR TELECOMMUNICATION NETWORKS; PROVISION OF MEDICAL SERVICES BY HEALTH CARE PROFESSIONALS VIA THE INTERNET OR TELECOMMUNICATION NETWORKS; WEB-BASED HEALTH ASSESSMENT SERVICES, NAMELY, A SERIES OF HEALTH-RELATED QUESTIONS FOR RESPONSE FROM THE USER THAT RESULT IN A REPORT THAT PROVIDES HEALTH-RELATED INFORMATION IN THE FORM OF RECOMMENDED EDUCATIONAL RESOURCES AND TREATMENT INFORMATION; WELLNESS AND HEALTH-RELATED CONSULTING SERVICES (U.S. CLS. 100 AND 101).

FIRST USE 9-1-2012; IN COMMERCE 4-9-2013.  
BERYL GARDNER, EXAMINING ATTORNEY

---

SN 85-940,699. SELECTHEALTH, INC., SALT LAKE CITY, UT. FILED 5-23-2013.

**SELECTHEALTH HEALTHY LIVING**

THE MARK CONSISTS OF STANDARD CHARACTERS WITHOUT CLAIM TO ANY PARTICULAR FONT, STYLE, SIZE, OR COLOR.

OWNER OF U.S. REG. NOS. 3,565,776, 3,847,847 AND 4,318,840.

NO CLAIM IS MADE TO THE EXCLUSIVE RIGHT TO USE "HEALTHY LIVING", APART FROM THE MARK AS SHOWN.

FOR HEALTHCARE AND MEDICAL MANAGEMENT, INFORMATION AND CONSULTING SERVICES IN THE FIELDS OF HEALTHCARE, MEDICINE, HEALTHCARE PROVIDERS, PREVENTATIVE CARE, SMOKING CESSATION, WOMEN'S HEALTH AND WELLNESS, PRENATAL HEALTH, WORK SITE HEALTH, SELF-CARE, DISEASE MANAGEMENT, BEHAVIORAL HEALTH, PHARMACY UTILIZATION MANAGEMENT, HEALTHY LIFESTYLES, HEALTHCARE QUALITY AND NUTRITION, HEALTHY ACTIVITY PROGRAMING, HEALTH INCENTIVES ADMINISTRATION, AND HEALTH REPORTING; WELLNESS CONSULTATION TO SUPPORT EMPLOYER WORKSITE WELLNESS TO ENCOURAGE HEALTHY BEHAVIORS FOR PARTICIPANTS, NAMELY, TELEPHONE AND DIGITAL HEALTH COACHING, HEALTH CONTENT INFORMATION IN THE FORM OF LIBRARY, MULTIMEDIA, INTERACTIVE TOOLS AND HEALTH CENTERS (U.S. CLS. 100 AND 101).

LINDA MICKLEBURGH, EXAMINING ATTORNEY

**CLASS 44—(Continued).**

SN 85-970,097. LAY, PATRICK, SAN JOSE, CA. FILED 6-26-2013.



NO CLAIM IS MADE TO THE EXCLUSIVE RIGHT TO USE "MD" AND "FACIAL PLASTIC & OCULOPLASTIC SURGERY", APART FROM THE MARK AS SHOWN.

THE NAME(S), PORTRAIT(S), AND/OR SIGNATURE(S) SHOWN IN THE MARK IDENTIFIES "CHASE LAY", WHOSE CONSENT(S) TO REGISTER IS MADE OF RECORD.

THE MARK CONSISTS OF A CIRCLE WITH MARK "CL" IN CAPITAL LETTERS IN CENTER OF THE CIRCLE AND BELOW IT IS MENTIONED, "CHASE LAY MD" IN CAPITAL LETTERS. OUTSIDE THE CIRCLE BELOW IS MENTIONED "FACIAL PLASTIC & OCULOPLASTIC SURGERY".

FOR COSMETIC AND PLASTIC SURGERY; COSMETIC AND PLASTIC SURGERY, NAMELY, A MINIMALLY INVASIVE FACE/NECK LIFT DONE UNDER LOCAL ANESTHESIA (U.S. CLS. 100 AND 101).

DAVID I, EXAMINING ATTORNEY

---

SN 85-972,827. SOUTH TAMPA KIDS DENTISTRY, LLC, TAMPA, FL. FILED 6-28-2013.



NO CLAIM IS MADE TO THE EXCLUSIVE RIGHT TO USE "SOUTH TAMPA KIDS DENTAL CREW", APART FROM THE MARK AS SHOWN.

THE COLOR(S) RED, DARK RED, TURQUOISE, BLACK, WHITE, AND BROWN IS/ARE CLAIMED AS A FEATURE OF THE MARK.

THE MARK CONSISTS OF TWO CONCENTRIC OVALS, THE SMALLER CENTER OVAL IS TURQUOISE IN COLOR AND OUTLINED IN BLACK, AND THE LARGER OUTER OVAL IS WHITE IN COLOR WITH A TURQUOISE BORDER OUTLINED IN BLACK. THE WORDING "SOUTH TAMPA KIDS" APPEARS IN RED LETTERS OUTLINED IN BLACK AND IS POSITIONED ABOVE THE SMALLER TURQUOISE CENTER OVAL, AND THE WORDING "DENTAL KREWE" APPEARS IN RED LETTERS OUTLINED IN BLACK AND IS POSITIONED BELOW THE SMALLER TURQUOISE CENTER OVAL. IN THE CENTER OF THE SMALLER TURQUOISE OVAL IS A DESIGN OF AN ANTHROPOMORPHIC

**CLASS 44—(Continued).**

TOOTH, IN THE COLOR WHITE WITH RED TONGUE AND BLACK MOUTH, DRESSED AS A PIRATE WITH A BROWN PEG LEG, WEARING A BLACK EYE PATCH, A DARK RED AND WHITE POLKA DOT BANDANA, AND A BLACK PIRATE'S HAT WITH A TOOTH AND TWO CROSSED TOOTHBRUSHES SILHOUETTED IN WHITE ON THE HAT. IN THE LARGER OUTER WHITE OVAL THERE ARE TWO BLACK SILHOUETTED PIRATE SHIPS ON EITHER SIDE OF THE ANTHROPOMORPHIC TOOTH PIRATE.

FOR DENTAL SERVICES, NAMELY, PEDIATRIC DENTISTRY (U.S. CLS. 100 AND 101).  
FIRST USE 5-13-2013; IN COMMERCE 5-13-2013.  
ANDREW RHIM, EXAMINING ATTORNEY

---

SN 86-001,297. LOCAL INITIATIVE HEALTH AUTHORITY OF LOS ANGELES COUNTY, LOS ANGELES, CA. FILED 7-2-2013.

**L.A. CARE COVERED**

THE MARK CONSISTS OF STANDARD CHARACTERS WITHOUT CLAIM TO ANY PARTICULAR FONT, STYLE, SIZE, OR COLOR.

OWNER OF U.S. REG. NOS. 3,081,195, 3,737,552 AND OTHERS.

SEC. 2(F) AS TO "L.A. CARE".  
FOR MANAGED HEALTHCARE SERVICES (U.S. CLS. 100 AND 101).  
ESTHER A. BORSUK, EXAMINING ATTORNEY

---

SN 86-001,791. IF&P FOODS, INC., INDIANAPOLIS, IN. FILED 7-3-2013.

**FIND YOUR FAVORITE**

THE MARK CONSISTS OF STANDARD CHARACTERS WITHOUT CLAIM TO ANY PARTICULAR FONT, STYLE, SIZE, OR COLOR.

FOR COMMUNITY OUTREACH SERVICES PROVIDED TO INDIVIDUALS AND GROUPS, NAMELY, PROVIDING EDUCATIONAL INFORMATION CONCERNING THE NUTRITIONAL BENEFITS OF CONSUMPTION OF FRESH FRUITS AND FRESH VEGETABLES (U.S. CLS. 100 AND 101).

FIRST USE 11-28-2012; IN COMMERCE 11-28-2012.  
BRIAN PINO, EXAMINING ATTORNEY

**CLASS 44—(Continued).**

SN 86-019,693. MINNESOTA EYE CONSULTANTS, P.A., MINNEAPOLIS, MN. FILED 7-25-2013.



NO CLAIM IS MADE TO THE EXCLUSIVE RIGHT TO USE "EYE CONSULTANTS, P.A.", APART FROM THE MARK AS SHOWN.

THE COLOR(S) PURPLE, LAVENDER, WHITE, ORANGE, YELLOW AND BLACK IS/ARE CLAIMED AS A FEATURE OF THE MARK.

THE MARK CONSISTS OF A STYLIZED EYE WITH A PURPLE OUTLINE, LAVENDER AND PURPLE CENTER AND A WHITE ARC THAT REPRESENTS A REFLECTION. THERE ARE ORANGE AND YELLOW HORIZONTAL LINES IN FRONT OF THE EYE. TO THE RIGHT IS THE WORDING "MINNESOTA EYE CONSULTANTS, P.A." IN BLACK.

SEC. 2(F) AS TO "MINNESOTA EYE CONSULTANTS, P.A."

FOR OPHTHALMOLOGY AND EYE CARE SERVICES, NAMELY, EYE EXAMINATIONS, LASER VISION CORRECTION SERVICES, EYE SURGERY, RECONSTRUCTIVE EYE SURGERY, CATARACT SURGERY, MEDICAL TREATMENT OF GLAUCOMA, OCULOPLASTIC SURGERY, MEDICAL TREATMENT OF CORNEA DISEASES AND CONDITIONS, EYELID SURGERY, AND TREATMENT OF EYE DISEASES AND CONDITIONS (U.S. CLS. 100 AND 101).

FIRST USE 3-6-2001; IN COMMERCE 3-6-2001.  
KATHERINE CHANG, EXAMINING ATTORNEY

---

SN 86-021,045. EMERGENCY VETERINARY CLINIC OF NORTHERNVIRGINIA, INC., VIENNA, VA. FILED 7-26-2013.



OWNER OF U.S. REG. NOS. 3,235,593 AND 3,241,035.  
THE MARK CONSISTS OF THE LETTER "O" WITH A SERIES OF INCREASINGLY SIZED SOLID CIRCLES ARAYED AT THE TOP OF THIS LETTER "O" (FORMING THE STYLIZATION OF A FOOTPAD) WITH A LOWER CASE "H" CENTERED WITHIN THE LETTER "O".

FOR VETERINARY SERVICES; VETERINARY SURGERY; VETERINARY MEDICAL SERVICES; VETERINARY DIAGNOSTIC SERVICES; VETERINARY DENTISTRY; EMERGENCY VETERINARY SERVICES; VETERINARY SPECIALTY SERVICES, NAMELY, PROVIDING MEDICAL, DIAGNOSTIC, SURGICAL AND DENTAL SERVICES FOR ANIMALS (U.S. CLS. 100 AND 101).

JOHN WILKE, EXAMINING ATTORNEY

**CLASS 44—(Continued).**

SN 86-026,069. EMERGENCY VETERINARY CLINIC OF NORTHERNVIRGINIA, INC., VIENNA, VA. FILED 8-1-2013.



OWNER OF U.S. REG. NOS. 3,235,593 AND 3,241,035.  
THE MARK CONSISTS OF THE WORD "HOPE" IN LOWER CASE AND WITH A SERIES OF INCREASINGLY SIZED SOLID CIRCLES ARRAYED AT THE TOP OF THE LETTER "O" PROVIDING THE SUGGESTION OF A FOOT PAD, AND A LINE BELOW.

FOR VETERINARY SERVICES; VETERINARY SURGERY; VETERINARY MEDICAL SERVICES; VETERINARY DIAGNOSTIC SERVICES; VETERINARY DENTISTRY; EMERGENCY VETERINARY SERVICES; VETERINARY SPECIALTY SERVICES, NAMELY, PROVIDING MEDICAL, DIAGNOSTIC, SURGICAL AND DENTAL SERVICES FOR ANIMALS (U.S. CLS. 100 AND 101).

JOHN WILKE, EXAMINING ATTORNEY

SN 86-029,003. VIRBAC CORPORATION, FORT WORTH, TX. FILED 8-5-2013.



THE MARK CONSISTS OF THE WORDS "REMINd ME" IN FANCIFUL FONTS, WITH THE WORD "ME" DEPICTED WITHIN THE OUTLINE OF AN ANIMAL PAW PRINT.

FOR VETERINARY PRESCRIPTION REFILL REMINDER SERVICES (U.S. CLS. 100 AND 101).

MEREDITH MARESCA, EXAMINING ATTORNEY

SN 86-032,698. GALVIN, PATRICIA, DBA DEECIE'S DOG HOUSE, VAN NUYS, CA. FILED 8-8-2013.

**DEECIE'S DOG HOUSE**

THE MARK CONSISTS OF STANDARD CHARACTERS WITHOUT CLAIM TO ANY PARTICULAR FONT, STYLE, SIZE, OR COLOR.

NO CLAIM IS MADE TO THE EXCLUSIVE RIGHT TO USE "DOG", APART FROM THE MARK AS SHOWN.

FOR PET DAY CARE SERVICES; DOG WALKING (U.S. CLS. 100 AND 101).

FIRST USE 8-1-2003; IN COMMERCE 8-1-2003.

BRIAN PINO, EXAMINING ATTORNEY

**CLASS 44—(Continued).**

SN 86-032,852. COZY'S CUTS FOR KIDS, INC., NEW YORK, NY. FILED 8-8-2013.

**COZY'S CUTS FOR KIDS**

THE MARK CONSISTS OF STANDARD CHARACTERS WITHOUT CLAIM TO ANY PARTICULAR FONT, STYLE, SIZE, OR COLOR.

OWNER OF U.S. REG. NO. 1,974,974.

NO CLAIM IS MADE TO THE EXCLUSIVE RIGHT TO USE "CUTS FOR KIDS", APART FROM THE MARK AS SHOWN.

FOR HAIR CUTTING SERVICES (U.S. CLS. 100 AND 101).

FIRST USE 12-4-1994; IN COMMERCE 12-4-1994.

WON TEAK OH, EXAMINING ATTORNEY

SN 86-033,813. EDGEWATER FLORIS NAILS AND SPA, INC., GREAT NECK, NY. FILED 8-9-2013.

**TUTTI**

THE MARK CONSISTS OF STANDARD CHARACTERS WITHOUT CLAIM TO ANY PARTICULAR FONT, STYLE, SIZE, OR COLOR.

FOR NAIL CARE SALON, BEAUTY SALON SERVICES; HAIR SALON SERVICES; SKIN CARE SALON; DAY SPA SERVICES NAMELY, NAIL CARE, MANICURE, PEDICURES, COSMETIC SKIN CARE FACIALS, MASSAGES (U.S. CLS. 100 AND 101).

FIRST USE 3-31-2012; IN COMMERCE 7-29-2013.

MARY CRAWFORD, EXAMINING ATTORNEY



**CLASS 44—(Continued).**

SN 86-034,737. A.I.R. LAWN CARE, LLC, ROCKVILLE, MD.  
FILED 8-12-2013.



NO CLAIM IS MADE TO THE EXCLUSIVE RIGHT TO USE "LAWN CARE", APART FROM THE MARK AS SHOWN.

THE MARK CONSISTS OF A DESIGN OF THE EARTH WITH THE STYLIZED TEXT "A.I.R. LAWN CARE" CENTERED IN THE EARTH, THE "A.I.R." IS ABOVE THE "LAWN CARE". THE WORDING IN THE MARK IS HIGHLY STYLIZED TO LOOKS LIKE CLOUDS.

FOR LAWN CARE (U.S. CLS. 100 AND 101).

FIRST USE 5-0-2010; IN COMMERCE 5-0-2011.

MATTHEW MCDOWELL, EXAMINING ATTORNEY

SN 86-038,638. ROSY TOMORROWS HERITAGE FARM,  
NORTH FORT MYERS, FL. FILED 8-15-2013.

## Rosy Tomorrows Heritage Farm

THE MARK CONSISTS OF STANDARD CHARACTERS WITHOUT CLAIM TO ANY PARTICULAR FONT, STYLE, SIZE, OR COLOR.

NO CLAIM IS MADE TO THE EXCLUSIVE RIGHT TO USE "HERITAGE FARM", APART FROM THE MARK AS SHOWN.

FOR ORGANIC FARMS IN THE FIELD OF MEATS, HONEY, FRUITS, AND VEGETABLES (U.S. CLS. 100 AND 101).

ANNE FARRELL, EXAMINING ATTORNEY

**CLASS 44—(Continued).**

SN 86-038,970. TOUCHDOWNS HAIRCUTS FOR MEN, LLC,  
ENGLEWOOD, OH. FILED 8-15-2013.

## Touchdowns Haircuts For Men

THE MARK CONSISTS OF STANDARD CHARACTERS WITHOUT CLAIM TO ANY PARTICULAR FONT, STYLE, SIZE, OR COLOR.

NO CLAIM IS MADE TO THE EXCLUSIVE RIGHT TO USE "HAIRCUTS FOR MEN", APART FROM THE MARK AS SHOWN.

FOR HAIR SALON SERVICES (U.S. CLS. 100 AND 101).

FIRST USE 12-19-2012; IN COMMERCE 4-1-2013.

KRISTIN CARLSON, EXAMINING ATTORNEY

SN 86-040,953. THRIVING MINDS BEHAVIORAL HEALTH  
CENTER, LLC, BRIGHTON, MI. FILED 8-18-2013.

## Thriving Minds Behavioral Health Center

THE MARK CONSISTS OF STANDARD CHARACTERS WITHOUT CLAIM TO ANY PARTICULAR FONT, STYLE, SIZE, OR COLOR.

NO CLAIM IS MADE TO THE EXCLUSIVE RIGHT TO USE "BEHAVIORAL HEALTH CENTER", APART FROM THE MARK AS SHOWN.

FOR PSYCHOTHERAPY AND PSYCHOTHERAPY COUNSELING FOR CHILDREN AND ADULTS IN INDIVIDUAL AND FAMILY SESSIONS (U.S. CLS. 100 AND 101).

FIRST USE 9-30-2012; IN COMMERCE 9-30-2012.

DAVID TAYLOR, EXAMINING ATTORNEY

SN 86-041,459. RENUVENATION MEDSPA, MIAMI, FL.  
FILED 8-19-2013.

## Renuvation MedSpa

THE MARK CONSISTS OF STANDARD CHARACTERS WITHOUT CLAIM TO ANY PARTICULAR FONT, STYLE, SIZE, OR COLOR.

NO CLAIM IS MADE TO THE EXCLUSIVE RIGHT TO USE "MEDSPA", APART FROM THE MARK AS SHOWN.

FOR MEDICAL SERVICES (U.S. CLS. 100 AND 101).

JENNIFER MARTIN, EXAMINING ATTORNEY

**CLASS 44—(Continued).**

SN 86-041,856. NORTHWEST COLLABORATIVE HEALTH, SEATTLE, WA. FILED 8-19-2013.

# Thank God For Sex

THE MARK CONSISTS OF STANDARD CHARACTERS WITHOUT CLAIM TO ANY PARTICULAR FONT, STYLE, SIZE, OR COLOR.

FOR PROVIDING A WEBSITE FEATURING NON-DOWNLOADABLE VIDEOS IN THE FIELD OF SEXUAL HEALTH (U.S. CLS. 100 AND 101).

COLLEEN DOMBROW, EXAMINING ATTORNEY

---

SN 86-041,871. ADVANCED MIGRAINE RELIEF AND TREATMENT CENTER, LLC, SPRING, TX. FILED 8-19-2013.

## TRANSFORMA PROCEDURE

THE MARK CONSISTS OF STANDARD CHARACTERS WITHOUT CLAIM TO ANY PARTICULAR FONT, STYLE, SIZE, OR COLOR.

NO CLAIM IS MADE TO THE EXCLUSIVE RIGHT TO USE "PROCEDURE", APART FROM THE MARK AS SHOWN.

THE ENGLISH TRANSLATION OF THE WORD "TRANSFORMA" IN THE MARK IS "TRANSFORMS".

FOR MINIMALLY INVASIVE SURGICAL SERVICES (U.S. CLS. 100 AND 101).

FIRST USE 6-15-2012; IN COMMERCE 6-15-2012.

JONATHAN FALK, EXAMINING ATTORNEY

---

SN 86-042,077. SMITH, ELAINE, EL CAJON, CA. FILED 8-19-2013.

# Smart Food Club

THE MARK CONSISTS OF STANDARD CHARACTERS WITHOUT CLAIM TO ANY PARTICULAR FONT, STYLE, SIZE, OR COLOR.

NO CLAIM IS MADE TO THE EXCLUSIVE RIGHT TO USE "FOOD CLUB", APART FROM THE MARK AS SHOWN.

FOR WEIGHT MANAGEMENT SERVICES, NAMELY, PROVIDING WEIGHT LOSS AND/OR WEIGHT MAINTENANCE PROGRAMS (U.S. CLS. 100 AND 101).

FIRST USE 6-1-2010; IN COMMERCE 7-1-2010.

MICHAEL KEATING, EXAMINING ATTORNEY

**CLASS 44—(Continued).**

SN 86-042,174. MARLI, INC., DBA SALON KOKOPELLI, BRIELLE, NJ. FILED 8-19-2013.

# salon kokopelli

THE MARK CONSISTS OF STANDARD CHARACTERS WITHOUT CLAIM TO ANY PARTICULAR FONT, STYLE, SIZE, OR COLOR.

NO CLAIM IS MADE TO THE EXCLUSIVE RIGHT TO USE "SALON", APART FROM THE MARK AS SHOWN.

FOR BEAUTY SALON SERVICES; BEAUTY SALONS; HAIR COLOR SALON SERVICES; HAIR SALON SERVICES; HAIR SALON SERVICES FOR MEN, WOMEN, CHILDREN; HAIR SALON SERVICES, NAMELY, HAIR CUTTING, STYLING, COLORING, AND HAIR EXTENSION SERVICES; HAIRDRESSING SALONS; NAIL CARE SALONS; SKIN CARE SALONS (U.S. CLS. 100 AND 101).

FIRST USE 10-14-1997; IN COMMERCE 10-14-1997.

CHRISTINA SOBRAL, EXAMINING ATTORNEY

---

SN 86-042,844. MANNIX, III, EDWARD T., BLOOMINGTON, IN. FILED 8-20-2013.

## Directed Compassion

THE MARK CONSISTS OF STANDARD CHARACTERS WITHOUT CLAIM TO ANY PARTICULAR FONT, STYLE, SIZE, OR COLOR.

NO CLAIM IS MADE TO THE EXCLUSIVE RIGHT TO USE "COMPASSION", APART FROM THE MARK AS SHOWN.

FOR PROVIDING BOTH IN-PERSON AND ON-LINE VIBRATIONAL ENERGY HEALING SERVICES (U.S. CLS. 100 AND 101).

FIRST USE 9-15-2011; IN COMMERCE 6-17-2012.

LAURIE MAYES, EXAMINING ATTORNEY

---

SN 86-042,959. SANTE OPERATIONS, LLC, SALEM, OR. FILED 8-20-2013.

## SANTE HEALTH CARE CONNECT

THE MARK CONSISTS OF STANDARD CHARACTERS WITHOUT CLAIM TO ANY PARTICULAR FONT, STYLE, SIZE, OR COLOR.

OWNER OF U.S. REG. NO. 4,218,387.

NO CLAIM IS MADE TO THE EXCLUSIVE RIGHT TO USE "SANTE" AND "HEALTH CARE", APART FROM THE MARK AS SHOWN.

THE ENGLISH TRANSLATION OF "SANTE" IN THE MARK IS "HEALTH".

FOR HEALTH CARE (U.S. CLS. 100 AND 101).

JOHN WILKE, EXAMINING ATTORNEY

**CLASS 44—(Continued).**

SN 86-042,981. CUSTOM DENTAL PC, EDMOND, OK. FILED 8-20-2013.

**FIRST CLASS DENTAL EXPERIENCES**

THE MARK CONSISTS OF STANDARD CHARACTERS WITHOUT CLAIM TO ANY PARTICULAR FONT, STYLE, SIZE, OR COLOR.  
 NO CLAIM IS MADE TO THE EXCLUSIVE RIGHT TO USE "DENTAL", APART FROM THE MARK AS SHOWN.  
 FOR DENTIST SERVICES; DENTISTRY (U.S. CLS. 100 AND 101).  
 ELLEN PERKINS, EXAMINING ATTORNEY

SN 86-042,994. SANTE OPERATIONS, LLC, SALEM, OR. FILED 8-20-2013.



OWNER OF U.S. REG. NO. 4,218,387.  
 NO CLAIM IS MADE TO THE EXCLUSIVE RIGHT TO USE "SANTE", APART FROM THE MARK AS SHOWN.  
 THE COLOR(S) BROWN, BURGUNDY, GOLD AND OFF-WHITE IS/ARE CLAIMED AS A FEATURE OF THE MARK.  
 THE MARK CONSISTS OF THE WORD "SANTE" IN BROWN STYLIZED LETTERS WITHIN A BURGUNDY OVAL, AND OVERLAPPING THE OVAL AT THE TOP IS ANOTHER BURGUNDY AND GOLD OVAL WITH A STYLIZED OFF-WHITE STYLIZED LETTER "S" IN THE CENTER ON A GOLD BACKGROUND.  
 THE ENGLISH TRANSLATION OF "SANTE" IN THE MARK IS "HEALTH".  
 FOR HOME HEALTH CARE SERVICES; HOSPICES (U.S. CLS. 100 AND 101).  
 JOHN WILKE, EXAMINING ATTORNEY

**CLASS 44—(Continued).**

SN 86-043,261. WDT ACQUISITION CORPORATION, ADDISON, TX. FILED 8-20-2013.

**"PEACE OF MIND" MAMMOGRAM**

THE MARK CONSISTS OF STANDARD CHARACTERS WITHOUT CLAIM TO ANY PARTICULAR FONT, STYLE, SIZE, OR COLOR.  
 NO CLAIM IS MADE TO THE EXCLUSIVE RIGHT TO USE "MAMMOGRAM", APART FROM THE MARK AS SHOWN.  
 FOR MEDICAL DIAGNOSTIC TESTING AND SERVICES, NAMELY, MAMMOGRAMS (U.S. CLS. 100 AND 101).  
 FIRST USE 7-1-2013; IN COMMERCE 7-1-2013.  
 AMY ALFIERI, EXAMINING ATTORNEY

SN 86-043,422. BARTHOLDSSON, OLA, GOTHENBURG, SWEDEN, FILED 8-20-2013.

**BTESTED**

THE MARK CONSISTS OF STANDARD CHARACTERS WITHOUT CLAIM TO ANY PARTICULAR FONT, STYLE, SIZE, OR COLOR.  
 FOR MEDICAL SERVICES, NAMELY, MEDICAL EXAMINATIONS ON HUMANS, GENERAL HEALTH TESTS, DNA SCREENING FOR MEDICAL PURPOSES, WEIGHT LOSS PROGRAM SERVICES, DIABETES MEDICAL EXAMINATIONS, CHOLESTEROL MEDICAL EXAMINATIONS, AND BIOLOGICAL MARKER MEDICAL EXAMINATIONS ON HUMANS; MEDICAL TESTING OF BLOOD, SALIVA, HAIR (U.S. CLS. 100 AND 101).  
 KAPIL BHANOT, EXAMINING ATTORNEY

SN 86-044,196. COMFORCARE HEALTH CARE HOLDINGS, INC, BLOOMFIELD HILLS, MI. FILED 8-21-2013.

**Joyful Melodies**

THE MARK CONSISTS OF STANDARD CHARACTERS WITHOUT CLAIM TO ANY PARTICULAR FONT, STYLE, SIZE, OR COLOR.  
 NO CLAIM IS MADE TO THE EXCLUSIVE RIGHT TO USE "MELODIES", APART FROM THE MARK AS SHOWN.  
 FOR MUSIC THERAPY FOR PHYSICAL, PSYCHOLOGICAL AND COGNITIVE PURPOSES (U.S. CLS. 100 AND 101).  
 JOHN WILKE, EXAMINING ATTORNEY

**CLASS 44—(Continued).**

SN 86-046,308. COSMETICARE, INC., NEWPORT BEACH, CA. FILED 8-23-2013.

**YOUR BEAUTIFUL BREASTS**

THE MARK CONSISTS OF STANDARD CHARACTERS WITHOUT CLAIM TO ANY PARTICULAR FONT, STYLE, SIZE, OR COLOR.

NO CLAIM IS MADE TO THE EXCLUSIVE RIGHT TO USE "BREASTS", APART FROM THE MARK AS SHOWN. FOR PLASTIC AND COSMETIC SURGERY SERVICES; OPERATION OF A MEDICAL CLINIC; MEDICAL SPA SERVICES, NAMELY, MINIMALLY AND NON-INVASIVE COSMETIC AND BODY FITNESS THERAPIES (U.S. CLS. 100 AND 101).

FIRST USE 5-31-2012; IN COMMERCE 5-31-2012.  
ESTHER BELENKER, EXAMINING ATTORNEY

SN 86-047,530. HEALTHREMÈDE, L.L.C., BATON ROUGE, LA. FILED 8-26-2013.

**HEALTHremède**

THE MARK CONSISTS OF STANDARD CHARACTERS WITHOUT CLAIM TO ANY PARTICULAR FONT, STYLE, SIZE, OR COLOR.

THE ENGLISH TRANSLATION OF THE WORD "REMEDE" IN THE MARK IS "REMEDY".

FOR HEALTHCARE SERVICES, NAMELY, URGENT CARE, OCCUPATIONAL MEDICINE, AND WELLNESS SERVICES (U.S. CLS. 100 AND 101).

FIRST USE 8-26-2013; IN COMMERCE 8-26-2013.  
EMILY CHUO, EXAMINING ATTORNEY

SN 86-058,615. INFORMATIONAL MEDIA BRANDS LLC, DBA A TO Z HEALTH LLC, TAMPA, FL. FILED 9-8-2013.

**HealthSlate**

THE MARK CONSISTS OF STANDARD CHARACTERS WITHOUT CLAIM TO ANY PARTICULAR FONT, STYLE, SIZE, OR COLOR.

FOR PROVIDING HEALTH INFORMATION (U.S. CLS. 100 AND 101).

FIRST USE 9-4-2012; IN COMMERCE 5-13-2013.  
ANNE MADDEN, EXAMINING ATTORNEY

**CLASS 44—(Continued).**

SN 86-060,539. CENTA MEDICAL GROUP, PA, LEXINGTON, SC. FILED 9-10-2013.

**CENTA Peds**

THE MARK CONSISTS OF STANDARD CHARACTERS WITHOUT CLAIM TO ANY PARTICULAR FONT, STYLE, SIZE, OR COLOR.

FOR PHYSICIAN SERVICES (U.S. CLS. 100 AND 101).  
ELLEN BURNS, EXAMINING ATTORNEY

SN 86-061,943. GET FIT KIDS CORNER, METAIRIE, LA. FILED 9-11-2013.

**get fit kids corner**

THE MARK CONSISTS OF STANDARD CHARACTERS WITHOUT CLAIM TO ANY PARTICULAR FONT, STYLE, SIZE, OR COLOR.

NO CLAIM IS MADE TO THE EXCLUSIVE RIGHT TO USE "GET FIT KIDS", APART FROM THE MARK AS SHOWN.

FOR HEALTH CARE SERVICES, NAMELY, HEALTH AND WELLNESS PROGRAMS IN FIELD OF CHILDHOOD OBESITY (U.S. CLS. 100 AND 101).

FIRST USE 11-30-2012; IN COMMERCE 11-30-2012.  
INGA ERVIN, EXAMINING ATTORNEY

SN 86-063,336. EVOL INK., TUSCALOOSA, AL. FILED 9-12-2013.



NO CLAIM IS MADE TO THE EXCLUSIVE RIGHT TO USE "INK", APART FROM THE MARK AS SHOWN.

THE MARK CONSISTS OF AN UPSIDE DOWN HEART CRACKED IN THE MIDDLE WITH THE LETTERS "EV" ON THE LEFT HALF AND "OL" ON THE RIGHT FORMING THE WORD "EVOL" IN STYLIZED FONT. BELOW THE "OL", ON THE RIGHT PORTION OF THE HEART, IS THE SMALLER STYLIZED WORD "INK".

FOR BODY PIERCING SERVICES; COSMETIC TATTOOING SERVICES; LASER TATTOO REMOVAL SERVICE; TATTOOING SERVICES (U.S. CLS. 100 AND 101).

FIRST USE 8-22-2012; IN COMMERCE 8-22-2012.  
RUDY R. SINGLETON, EXAMINING ATTORNEY

**CLASS 44—(Continued).**

SN 86-065,289. MEGA SUPER FUN LLC, CHULA VISTA, CA. FILED 9-16-2013.

LET THE SUNSHINE BE ON  
YOUR BODY

THE MARK CONSISTS OF STANDARD CHARACTERS WITHOUT CLAIM TO ANY PARTICULAR FONT, STYLE, SIZE, OR COLOR.  
FOR MASSAGE THERAPY SERVICES (U.S. CLS. 100 AND 101).  
DOMINICK J. SALEMI, EXAMINING ATTORNEY

SN 86-065,338. WEBMD LLC, NEW YORK, NY. FILED 9-16-2013.

BETTER INFORMATION. BETTER  
HEALTH.

THE MARK CONSISTS OF STANDARD CHARACTERS WITHOUT CLAIM TO ANY PARTICULAR FONT, STYLE, SIZE, OR COLOR.  
FOR PROVIDING AN INTERACTIVE WEBSITE FEATURING INFORMATION AND LINKS RELATED TO HEALTHCARE (U.S. CLS. 100 AND 101).  
FIRST USE 4-0-2006; IN COMMERCE 4-0-2006.  
VERNA BETH RIRIE, EXAMINING ATTORNEY

SN 86-065,345. ENZO BIOCHEM, INC., NEW YORK, NY. FILED 9-16-2013.

ALEQUEL

THE MARK CONSISTS OF STANDARD CHARACTERS WITHOUT CLAIM TO ANY PARTICULAR FONT, STYLE, SIZE, OR COLOR.  
FOR HEALTH CARE SERVICES, NAMELY, ORAL ADMINISTRATION TO PATIENTS OF AN AUTOLOGOUS PROTEIN CONTAINING COLON EXTRACT FOR THE TREATMENT OF CROHN'S DISEASE (U.S. CLS. 100 AND 101).  
KERI CANTONE, EXAMINING ATTORNEY

**CLASS 44—(Continued).**

SN 86-066,489. CELLBANK TECHNOLOGIES LLC, CLEVELAND, OH. FILED 9-17-2013.

MyStem

THE MARK CONSISTS OF STANDARD CHARACTERS WITHOUT CLAIM TO ANY PARTICULAR FONT, STYLE, SIZE, OR COLOR.  
FOR TISSUE BANK SERVICES (U.S. CLS. 100 AND 101).  
ANN E. SAPPENFIELD, EXAMINING ATTORNEY

SN 86-066,610. DENTISTRY FOR CHILDREN INC., ATLANTA, GA. FILED 9-17-2013.

d4c

THE MARK CONSISTS OF STANDARD CHARACTERS WITHOUT CLAIM TO ANY PARTICULAR FONT, STYLE, SIZE, OR COLOR.  
FOR DENTISTRY; PEDIATRIC DENTISTRY (U.S. CLS. 100 AND 101).  
NANCY CLARKE, EXAMINING ATTORNEY

SN 86-066,825. BONCIERGE, LLC, DBA DELECTABLE NUTRITION, LLC, MAHWAH, NJ. FILED 9-17-2013.

SCOOPADELLA

THE MARK CONSISTS OF STANDARD CHARACTERS WITHOUT CLAIM TO ANY PARTICULAR FONT, STYLE, SIZE, OR COLOR.  
FOR DIETARY AND NUTRITIONAL GUIDANCE; FOOD NUTRITION CONSULTATION; NUTRITION COUNSELING; PROVIDING A WEB SITE FEATURING INFORMATION ON HEALTH AND NUTRITION; PROVIDING AN ON-LINE COMPUTER DATABASE FEATURING INFORMATION REGARDING HEALTH AND NUTRITION; PROVIDING HEALTHY LIFESTYLE AND NUTRITION SERVICES, NAMELY, PERSONAL ASSESSMENTS, PERSONALIZED ROUTINES, MAINTENANCE SCHEDULES, AND COUNSELING (U.S. CLS. 100 AND 101).  
FIRST USE 9-9-2013; IN COMMERCE 9-9-2013.  
JEANIE LEE, EXAMINING ATTORNEY

**CLASS 44—(Continued).**

SN 86-067,043. SILVERMAN, CARY, EAST HANOVER, NJ. FILED 9-17-2013.



THE MARK CONSISTS OF A STYLIZED DESIGN OF AN EYE.

FOR MEDICAL SERVICES IN THE NATURE OF INTRAOCULAR LENS IMPLANTS, CORRECTIVE EYE SURGERY, CATARACT SURGERY, PRESBYOPIC REDUCTION SURGERY, LACL, LASIK, LASEK AND PRK REFRACTIVE SURGERY, EYE EXAMINATIONS, MEDICAL AND SURGICAL EYE CARE, GLAUCOMA AND RETINA TREATMENT AND SURGERY, TREATMENT OF CORNEAL AND EXTERNAL EYE DISEASES, EYE GLASS AND CONTACT LENS FITTING, PEDIATRIC EYE EXAMS AND EYE CARE, LOW VISION EYE CARE AND EMERGENCY EYE CARE; LASER VISION CORRECTION SERVICES; TREATMENT OF EYE DISEASES AND CONDITIONS; OPTOMETRY SERVICES; OPTICIAN SERVICES; PHYSICIAN SERVICES (U.S. CLS. 100 AND 101).

FIRST USE 0-0-1986; IN COMMERCE 0-0-1986.  
SKYE YOUNG, EXAMINING ATTORNEY

SN 86-067,470. KEITH, JEANETTE N, HOOVER, AL. FILED 9-17-2013.

**BHIP**

THE MARK CONSISTS OF STANDARD CHARACTERS WITHOUT CLAIM TO ANY PARTICULAR FONT, STYLE, SIZE, OR COLOR.

FOR MEDICAL CLINIC PROVIDING WEIGHT LOSS SOLUTIONS, SERVICES AND PROGRAMS, NUTRITION COUNSELING, HORMONE THERAPY, INCLUDING, BIOIDENTICAL HORMONE REPLACEMENT, ANTI AGING THERAPY, AND NATURAL HORMONE THERAPY, MEDICAL AESTHETIC PROCEDURES, INCLUDING, LASER HAIR REMOVAL, LASER PEELS, BOTULINUM TOXIN TREATMENTS, MICRODERMABRASION, LIPOSUCTION, VEIN TREATMENTS, VEIN THERAPY, CELLULITE TREATMENTS, BODY CONTOURING TREATMENTS, INJECTABLE FILLER TREATMENTS, FACIALS, AND SKIN CARE (U.S. CLS. 100 AND 101).

KATHLEEN LORENZO, EXAMINING ATTORNEY

**CLASS 44—(Continued).**

SN 86-067,665. FLOSS MANAGEMENT COMPANY, DALLAS, TX. FILED 9-18-2013.



THE MARK CONSISTS OF THE WORD "FLOSS" IN STYLIZED LETTERS APPEARING OVER THE WORDS "A NEW EXPERIENCE IN DENTISTRY".

FOR DENTAL SERVICES (U.S. CLS. 100 AND 101).  
FIRST USE 11-2-2007; IN COMMERCE 12-0-2007.  
RAMONA ORTIGA, EXAMINING ATTORNEY

SN 86-067,671. FLOSS MANAGEMENT COMPANY, DALLAS, TX. FILED 9-18-2013.



THE MARK CONSISTS OF THE WORD "FLOSS" IN STYLIZED FORM.

FOR DENTAL SERVICES (U.S. CLS. 100 AND 101).  
FIRST USE 11-2-2007; IN COMMERCE 12-0-2007.  
RAMONA ORTIGA, EXAMINING ATTORNEY

SN 86-067,706. CHIROPPLAN HAWAII, INC., WAHIAWA, HI. FILED 9-18-2013.

**We're Specialists in You!**

THE MARK CONSISTS OF STANDARD CHARACTERS WITHOUT CLAIM TO ANY PARTICULAR FONT, STYLE, SIZE, OR COLOR.

FOR CHIROPRACTIC SERVICES (U.S. CLS. 100 AND 101).  
FIRST USE 1-1-2000; IN COMMERCE 1-1-2000.  
LINDA ESTRADA, EXAMINING ATTORNEY

**CLASS 44—(Continued).**

SN 86-067,787. CELLMETRX CORPORATION, HARRISVILLE, MI. FILED 9-18-2013.

**WoundMetRx**

THE MARK CONSISTS OF STANDARD CHARACTERS WITHOUT CLAIM TO ANY PARTICULAR FONT, STYLE, SIZE, OR COLOR.

FOR MEDICAL SERVICES, NAMELY, USE OF BIOMEPEDANCE MEASUREMENTS TO ASSESS HEALING, INFLAMMATION, AND INFECTION CONDITIONS OF WOUNDS (U.S. CLS. 100 AND 101).

FIRST USE 3-31-2013; IN COMMERCE 3-31-2013.  
MORGAN WYNNE, EXAMINING ATTORNEY

**CLASS 44—(Continued).**

SN 86-068,144. SEQUENOM, INC., SAN DIEGO, CA. FILED 9-18-2013.

**HEREDIT**

THE MARK CONSISTS OF STANDARD CHARACTERS WITHOUT CLAIM TO ANY PARTICULAR FONT, STYLE, SIZE, OR COLOR.

FOR MEDICAL DIAGNOSTIC TESTING SERVICES (U.S. CLS. 100 AND 101).

NORA BUCHANAN WILL, EXAMINING ATTORNEY

SN 86-067,916. CELL SURGICAL INC, LOS ANGELES, CA. FILED 9-18-2013.

**StemMD**

THE MARK CONSISTS OF STANDARD CHARACTERS WITHOUT CLAIM TO ANY PARTICULAR FONT, STYLE, SIZE, OR COLOR.

FOR MEDICAL SERVICES AND MEDICAL TREATMENTS SPECIALIZING IN REGENERATIVE MEDICINE (U.S. CLS. 100 AND 101).

FIRST USE 10-17-2012; IN COMMERCE 10-17-2012.  
KATINA MISTER, EXAMINING ATTORNEY

SN 86-068,432. LEA MEDICAL PARTNERS, LLC, SILVER SPRING, MD. FILED 9-18-2013.

**LEA MEDICAL PARTNERS**

THE MARK CONSISTS OF STANDARD CHARACTERS WITHOUT CLAIM TO ANY PARTICULAR FONT, STYLE, SIZE, OR COLOR.

NO CLAIM IS MADE TO THE EXCLUSIVE RIGHT TO USE "MEDICAL PARTNERS", APART FROM THE MARK AS SHOWN.

FOR MEDICAL SERVICES (U.S. CLS. 100 AND 101).  
AMY C. KEAN, EXAMINING ATTORNEY

SN 86-068,125. M&K MARKETING, LLC, ATLANTA, GA. FILED 9-18-2013.

**1-800-FAST RELIEF**

THE MARK CONSISTS OF "1-800-FAST RELIEF", WHERE THE AREA CODE "800" IS IN DOTTED LINES TO SHOW PLACEMENT OF ANY THREE-DIGIT AREA CODE IN THE MARK.

FOR HEALTH CARE SERVICES; NAMELY MEDICAL, CHIROPRACTIC, PHYSICAL THERAPY, DIAGNOSTIC TESTING AND IMAGING SERVICES (U.S. CLS. 100 AND 101).

ZACHARY BELLO, EXAMINING ATTORNEY

SN 86-068,652. SEQUENOM, INC., SAN DIEGO, CA. FILED 9-18-2013.

**NEXTVIEW**

THE MARK CONSISTS OF STANDARD CHARACTERS WITHOUT CLAIM TO ANY PARTICULAR FONT, STYLE, SIZE, OR COLOR.

FOR MEDICAL DIAGNOSTIC TESTING SERVICES (U.S. CLS. 100 AND 101).

NORA BUCHANAN WILL, EXAMINING ATTORNEY

**CLASS 44—(Continued).**

SN 86-068,777. DONG TIAN FASHION (BEIJING) CULTURE COMMUNICATION CO., LTD., CHAOYANG DIST., BEIJING, CHINA, FILED 9-18-2013.

## 東田造型

THE MARK CONSISTS OF FOUR CHINESE CHARACTERS.

THE ENGLISH TRANSLATION OF FOUR CHINESE CHARACTERS IS "EAST" AND "FIELD OR LAND" FOR "DONG" AND "TIAN" RESPECTIVELY; "ZAO XING" MEANS "MOLD OR MODEL". THE WHOLE PHRASE "DONG TIAN ZAO XING" HAS NO SPECIFIC MEANING.

THE NON-LATIN CHARACTERS IN THE MARK TRANSLITERATE TO "DONG TIAN ZAO XING".

FOR OPERATION OF PUBLIC BATHS FOR SANITARY PURPOSES; PROVIDING TURKISH BATH FACILITIES; BEAUTY SALONS; HAIRDRESSING SALONS; MASSAGE; MANICURING; TATTOOING; SAUNA SERVICES; SOLARIUM SERVICES; HEALTH SPA SERVICES FOR HEALTH AND WELLNESS OF THE BODY AND SPIRIT, NAMELY, PROVIDING MASSAGE, FACIAL AND BODY TREATMENT SERVICES, COSMETIC BODY CARE SERVICES; BEAUTY CONSULTATION SERVICES; PROVIDING ON-SITE BEAUTY SERVICES, NAMELY, HAIR STYLING AND MAKE-UP APPLICATION SERVICES; VISAGISTS' SERVICES; BEAUTICIAN SERVICES (U.S. CLS. 100 AND 101).

MARIA-VICTORIA SUAREZ, EXAMINING ATTORNEY

SN 86-068,778. ALLISON BRANAN, SANDY, UT. FILED 9-18-2013.

## THE SWEETEST THINGZ

THE MARK CONSISTS OF STANDARD CHARACTERS WITHOUT CLAIM TO ANY PARTICULAR FONT, STYLE, SIZE, OR COLOR.

FOR BEAUTY SALONS; HAIR COLOR SALON SERVICES; HAIR SALON SERVICES; HAIR SALON SERVICES, NAMELY, HAIR CUTTING, STYLING, COLORING, AND HAIR EXTENSION SERVICES; HAIR SALON SERVICES, NAMELY, TREATMENTS TO PROTECT HAIR FROM EFFECTS OF EXPOSURE TO SUNLIGHT, HEAT, HUMIDITY AND CHLORINATED WATER; HAIRDRESSING SALONS; NAIL CARE SALONS; SALON SERVICES, NAMELY, FACIALS, MANICURES AND MESSAGES THAT ARE PROVIDED IN A TRAILER OUTFITTED WITH CHAIR, TABLE AND SINK ACCESSORIES (U.S. CLS. 100 AND 101).

FIRST USE 8-2-2013; IN COMMERCE 8-2-2013.

MARIA-VICTORIA SUAREZ, EXAMINING ATTORNEY

**CLASS 44—(Continued).**

SN 86-068,873. CHASE'N TAILS MOBILE PET STYLING, LLC, MARIETTA, GA. FILED 9-19-2013.

## Chase'n Tails

THE MARK CONSISTS OF STANDARD CHARACTERS WITHOUT CLAIM TO ANY PARTICULAR FONT, STYLE, SIZE, OR COLOR.

FOR PET GROOMING SERVICES (U.S. CLS. 100 AND 101).

FIRST USE 5-16-2013; IN COMMERCE 5-22-2013.

ANNE FARRELL, EXAMINING ATTORNEY

SN 86-068,920. CHASE'N TAILS MOBILE PET STYLING, LLC, MARIETTA, GA. FILED 9-19-2013.



THE MARK CONSISTS OF A DOG WITH A BEARD WEARING: SUNGLASSES; A SHORT-SLEEVED TIE-DYED SHIRT; FLOWER-PRINTED PANTS; AND BANDANNA WITH A PEACE SYMBOL ON IT, WHILE HOLDING SCISSORS IN LEFT HAND AND DISPLAYING THE V-SIGN WITH HIS RIGHT HAND STANDING IN FRONT OF SWIRLY LINES AND PAW PRINTS.

FOR PET GROOMING SERVICES (U.S. CLS. 100 AND 101).

FIRST USE 5-16-2013; IN COMMERCE 5-22-2013.

ANNE FARRELL, EXAMINING ATTORNEY

SN 86-069,238. ONLY THE FIT, LLC, DBA CARNAVITA-COM, MCLEAN, VA. FILED 9-19-2013.

## EAT.SWEAT.LIVE

THE MARK CONSISTS OF STANDARD CHARACTERS WITHOUT CLAIM TO ANY PARTICULAR FONT, STYLE, SIZE, OR COLOR.

FOR PROVIDING A WEBSITE FEATURING INFORMATION AND ADVICE IN THE FIELDS OF DIET, WEIGHT LOSS, DIET PLANNING AND LIFESTYLE WELLNESS (U.S. CLS. 100 AND 101).

FIRST USE 1-1-2011; IN COMMERCE 11-1-2012.

SUNG IN, EXAMINING ATTORNEY



**CLASS 44—(Continued).**

SN 86-069,423. WASHINGTON STATE UNIVERSITY OFFICE OF COMMERCIALIZATION, PULLMAN, WA. FILED 9-19-2013.

# HEALTHSUM

THE MARK CONSISTS OF STANDARD CHARACTERS WITHOUT CLAIM TO ANY PARTICULAR FONT, STYLE, SIZE, OR COLOR.

FOR VETERINARY SERVICES, NAMELY, CONSULTATION AND DISEASE MANAGEMENT (U.S. CLS. 100 AND 101).

HEATHER SAPP, EXAMINING ATTORNEY

**CLASS 44—(Continued).**

SN 86-070,259. MIGRAINE RELIEF CENTER PLLC, HOUSTON, TX. FILED 9-20-2013.

# M.I.S.O.N.

THE MARK CONSISTS OF STANDARD CHARACTERS WITHOUT CLAIM TO ANY PARTICULAR FONT, STYLE, SIZE, OR COLOR.

FOR MEDICAL SERVICES, NAMELY, SURGICAL AND MEDICAL SERVICES IN THE NATURE OF PROVIDING EVALUATION AND TREATMENT OF CAUSES OF MIGRAINE HEADACHES (U.S. CLS. 100 AND 101).

FIRST USE 9-15-2013; IN COMMERCE 9-15-2013.  
BRIN ANDERSON, EXAMINING ATTORNEY

SN 86-070,262. MIGRAINE RELIEF CENTER PLLC, HOUSTON, TX. FILED 9-20-2013.

# M.I.G.O.N.E.

THE MARK CONSISTS OF STANDARD CHARACTERS WITHOUT CLAIM TO ANY PARTICULAR FONT, STYLE, SIZE, OR COLOR.

FOR MEDICAL SERVICES, NAMELY, SURGICAL AND MEDICAL SERVICES IN THE NATURE OF PROVIDING EVALUATION AND TREATMENT OF CAUSES OF MIGRAINE HEADACHES (U.S. CLS. 100 AND 101).

FIRST USE 9-15-2013; IN COMMERCE 9-15-2013.  
BRIN ANDERSON, EXAMINING ATTORNEY

SN 86-070,746. TR HEALTH GROUP, LLC, DALLAS, TX. FILED 9-20-2013.

# INNOVATION360

THE MARK CONSISTS OF STANDARD CHARACTERS WITHOUT CLAIM TO ANY PARTICULAR FONT, STYLE, SIZE, OR COLOR.

FOR ADDICTION TREATMENT SERVICES; CLINICAL MENTAL HEALTH COUNSELING SERVICES; HEALTHCARE; HEALTHCARE SERVICES, NAMELY, INTEGRATED HEALTHCARE SERVICES WITH A NETWORK OF INTERNATIONAL HEALTHCARE PROVIDERS; REHABILITATION OF ALCOHOL ADDICTED PATIENTS; REHABILITATION OF DRUG ADDICTED PATIENTS; REHABILITATION OF NARCOTIC ADDICTED PATIENTS (U.S. CLS. 100 AND 101).

FIRST USE 3-1-2009; IN COMMERCE 3-1-2009.  
DAVID TAYLOR, EXAMINING ATTORNEY

SN 86-069,702. JUNG, HUI CHA, NORTH CHARLESTON, SC. FILED 9-19-2013.

# EnBo

THE MARK CONSISTS OF STANDARD CHARACTERS WITHOUT CLAIM TO ANY PARTICULAR FONT, STYLE, SIZE, OR COLOR.

FOR COUNSELING SERVICES IN THE FIELDS OF HEALTH, NUTRITION AND LIFESTYLE WELLNESS (U.S. CLS. 100 AND 101).

LINDSEY BEN, EXAMINING ATTORNEY

SN 86-069,907. BARBE, JUDY A., CASPER, WY. FILED 9-19-2013.

# LiveBest

THE MARK CONSISTS OF STANDARD CHARACTERS WITHOUT CLAIM TO ANY PARTICULAR FONT, STYLE, SIZE, OR COLOR.

FOR PROVIDING INFORMATION IN THE FIELDS OF HEALTH AND WELLNESS (U.S. CLS. 100 AND 101).

SOPHIA S. KIM, EXAMINING ATTORNEY

**CLASS 44—(Continued).**

SN 86-070,767. TR HEALTH GROUP, LLC, DALLAS, TX. FILED 9-20-2013.

TREATMENT IN THE MIDST OF  
LIFE

THE MARK CONSISTS OF STANDARD CHARACTERS WITHOUT CLAIM TO ANY PARTICULAR FONT, STYLE, SIZE, OR COLOR.

FOR ADDICTION TREATMENT SERVICES; CLINICAL MENTAL HEALTH COUNSELING SERVICES; HEALTHCARE; HEALTHCARE SERVICES, NAMELY, INTEGRATED HEALTHCARE SERVICES WITH A NETWORK OF INTERNATIONAL HEALTHCARE PROVIDERS; REHABILITATION OF ALCOHOL ADDICTED PATIENTS; REHABILITATION OF DRUG ADDICTED PATIENTS; REHABILITATION OF NARCOTIC ADDICTED PATIENTS (U.S. CLS. 100 AND 101).

FIRST USE 3-1-2009; IN COMMERCE 3-1-2009.  
DAVID TAYLOR, EXAMINING ATTORNEY

SN 86-071,153. MAULDIN, PATRICIA ANN, DBA EDEMA SPECIALISTS OF SOUTH FLORIDA, INC., DEERFIELD BEACH, FL. FILED 9-21-2013.

GOT SWELLING?!!

THE MARK CONSISTS OF STANDARD CHARACTERS WITHOUT CLAIM TO ANY PARTICULAR FONT, STYLE, SIZE, OR COLOR.

NO CLAIM IS MADE TO THE EXCLUSIVE RIGHT TO USE "SWELLING", APART FROM THE MARK AS SHOWN. FOR MEDICAL DIAGNOSIS AND TREATMENT OF EDEMA, LYMPHEDEMA, CHRONIC SWELLING, VEIN INSUFFICIENCY, DISEASES OF VEINS AND LYMPHATICS, OTHER DISEASES OF CIRCULATORY SYSTEM (U.S. CLS. 100 AND 101).

FIRST USE 2-13-2013; IN COMMERCE 2-13-2013.  
IRA J. GOODSaid, EXAMINING ATTORNEY

SN 86-073,579. HUNTER, COREY, NEW YORK, NY. FILED 9-24-2013.

Ainsworth Institute of  
Pain Management

THE MARK CONSISTS OF STANDARD CHARACTERS WITHOUT CLAIM TO ANY PARTICULAR FONT, STYLE, SIZE, OR COLOR.

NO CLAIM IS MADE TO THE EXCLUSIVE RIGHT TO USE "INSTITUTE OF PAIN MANAGEMENT", APART FROM THE MARK AS SHOWN.

FOR MEDICAL SERVICES SPECIALIZING IN PAIN MANAGEMENT (U.S. CLS. 100 AND 101).

FIRST USE 10-10-2012; IN COMMERCE 12-1-2012.  
ADA HAN, EXAMINING ATTORNEY

**CLASS 44—(Continued).**

SN 86-081,313. TEXAS ASSOCIATION OF COMMUNITY HEALTH CENTERS, INC., AUSTIN, TX. FILED 10-2-2013.



THE MARK CONSISTS OF "MY TEXAS" OVER THE LETTER "M", NEXT TO A STETHOSCOPE WITH A CIRCLE AND STAR DESIGN AND FORMING THE LETTER "Y", AND THE WORD "HEALTH" WHICH IS DIRECTLY OVER THE WORDS "AN EASY STEP FORWARD".

FOR PROVIDING HEALTHCARE INFORMATION (U.S. CLS. 100 AND 101).

JAMES STEIN, EXAMINING ATTORNEY

SN 86-087,073. PFIZER INC., NEW YORK, NY. FILED 10-9-2013.



NO CLAIM IS MADE TO THE EXCLUSIVE RIGHT TO USE "OPIOIDS", APART FROM THE MARK AS SHOWN.

THE MARK CONSISTS OF A DESIGN MADE UP OF FOUR INVERTED CORNERS WITH A DOT IN EACH FORMING FOUR STICK FIGURES TO THE LEFT OF THE WORDS "PROJECT ROOT RETHINK OPIOIDS".

FOR MEDICAL INFORMATION SERVICES, NAMELY, PROVIDING INFORMATION RELATED TO THE USE OF PRESCRIPTION OPIOIDS FOR PATIENTS WITH CHRONIC PAIN; ON-LINE INFORMATION SERVICES, NAMELY, PROVIDING INFORMATION RELATED TO THE USE OF PRESCRIPTION OPIOIDS FOR PATIENTS WITH CHRONIC PAIN (U.S. CLS. 100 AND 101).

JAMES GRIFFIN, EXAMINING ATTORNEY

SN 86-105,260. MESSAGE RETREAT & SPA, INC., NEW HOPE, MN. FILED 10-30-2013.

MESSAGE REFRESH & SPA

THE MARK CONSISTS OF STANDARD CHARACTERS WITHOUT CLAIM TO ANY PARTICULAR FONT, STYLE, SIZE, OR COLOR.

NO CLAIM IS MADE TO THE EXCLUSIVE RIGHT TO USE "MESSAGE" AND "SPA", APART FROM THE MARK AS SHOWN.

FOR HEALTH SPA SERVICES FOR HEALTH AND WELLNESS OF THE BODY AND SPIRIT, NAMELY, PROVIDING MASSAGE, FACIAL AND BODY TREATMENT SERVICES, COSMETIC BODY CARE SERVICES (U.S. CLS. 100 AND 101).

ANDREW LEASER, EXAMINING ATTORNEY

**CLASS 44—(Continued).**

SN 86-115,438. VIVE LIFESTYLE LLC, NEW YORK, NY. FILED 11-11-2013.

beauty where you are

THE MARK CONSISTS OF STANDARD CHARACTERS WITHOUT CLAIM TO ANY PARTICULAR FONT, STYLE, SIZE, OR COLOR.

FOR BEAUTY SERVICES, NAMELY, HAIR STYLING AND MAKEUP APPLICATION SERVICES; PROVIDING ON-SITE BEAUTY SERVICES, NAMELY, HAIR STYLING AND MAKEUP APPLICATION SERVICES (U.S. CLS. 100 AND 101).

SHARON MEIER, EXAMINING ATTORNEY

---

SN 86-117,272. ELSE, KEVIN, MEDIA, PA. FILED 11-13-2013.

INVEST IN YOUR HEALTH,  
INVEST IN YOURSELF

THE MARK CONSISTS OF STANDARD CHARACTERS WITHOUT CLAIM TO ANY PARTICULAR FONT, STYLE, SIZE, OR COLOR.

FOR PROVIDING A WEBSITE FEATURING INFORMATION ABOUT HEALTH, WELLNESS AND NUTRITION; PROVIDING A WEBSITE FEATURING INFORMATION AND ADVICE IN THE FIELDS OF DIET, WEIGHT LOSS, DIET PLANNING AND LIFESTYLE WELLNESS; PROVIDING A WEBSITE FEATURING INFORMATION REGARDING HEALTHY LIVING AND LIFESTYLE WELLNESS; PROVIDING INFORMATION IN THE FIELDS OF HEALTH AND WELLNESS; PROVIDING INFORMATION, NEWS AND COMMENTARY IN THE FIELD OF NUTRITION, HEALTH AND WELLNESS (U.S. CLS. 100 AND 101).

MAUREEN DALL, EXAMINING ATTORNEY

---

SN 86-122,029. TYSON FOODS, INC., SPRINGDALE, AR. FILED 11-18-2013.

Healthy Tots

THE MARK CONSISTS OF STANDARD CHARACTERS WITHOUT CLAIM TO ANY PARTICULAR FONT, STYLE, SIZE, OR COLOR.

FOR MEDICAL SERVICES, NAMELY, NURSING SERVICES FOR PREGNANT WOMEN (U.S. CLS. 100 AND 101).

JORDAN BAKER, EXAMINING ATTORNEY

**CLASS 44—(Continued).**

SN 86-129,936. TR HEALTH GROUP, LLC, DALLAS, TX. FILED 11-26-2013.

TRANSLATING INSIGHTS INTO  
BEHAVIORS

THE MARK CONSISTS OF STANDARD CHARACTERS WITHOUT CLAIM TO ANY PARTICULAR FONT, STYLE, SIZE, OR COLOR.

FOR ADDICTION TREATMENT SERVICES; CLINICAL MENTAL HEALTH COUNSELING SERVICES; HEALTHCARE; HEALTHCARE SERVICES, NAMELY, INTEGRATED HEALTHCARE SERVICES WITH A NETWORK OF INTERNATIONAL HEALTHCARE PROVIDERS; REHABILITATION OF ALCOHOL ADDICTED PATIENTS; REHABILITATION OF DRUG ADDICTED PATIENTS; REHABILITATION OF NARCOTIC ADDICTED PATIENTS (U.S. CLS. 100 AND 101).

FIRST USE 8-0-2011; IN COMMERCE 8-0-2011.

DAVID TAYLOR, EXAMINING ATTORNEY

**CLASS 45—PERSONAL AND LEGAL SERVICES**

SN 79-133,589. BEIJING WAN HUI DA; INTELLECTUAL PROPERTY AGENCY, CHINA, FILED 4-18-2013.

WAN HUI DA

OWNER OF INTERNATIONAL REGISTRATION 1169287 DATED 4-18-2013, EXPIRES 4-18-2023.

THE MARK CONSISTS OF THREE WORDS ALL IN CAPITAL LETTERS NAMELY "WAN" ON THE FAR LEFT, "HUI" IN THE MIDDLE AND "DA" ON THE FAR RIGHT; THE LETTERS "W", "H", "D" ARE OF THE SAME SIZE AND ARE A LITTLE BIGGER THAN THE OTHER LETTERS WHICH ARE ALSO IN THE SAME SIZE; THE THREE WORDS ARE ON THE SAME HORIZONTAL LINE.

THE ENGLISH TRANSLATION OF THE WORDING "WAN HUI DA" IN THE MARK IS "TEN THOUSAND", "BRIGHT" AND "REACH".

FOR COPYRIGHT MANAGEMENT; LEGAL RESEARCH; LICENSING OF INTELLECTUAL PROPERTY; INTELLECTUAL PROPERTY CONSULTANCY; INFRINGEMENT INVESTIGATIONS RELATED TO INTELLECTUAL PROPERTY; PERSONAL BACKGROUND INVESTIGATIONS; LITIGATION SERVICES; INTELLECTUAL PROPERTY WATCHING SERVICES; REGISTRATION OF DOMAIN NAMES; LICENSING OF COMPUTER SOFTWARE; DETECTIVE AGENCIES; MISSING PERSON INVESTIGATIONS (U.S. CLS. 100 AND 101).

TOBY BULLOFF, EXAMINING ATTORNEY

**CLASS 45—(Continued).**

SN 85-849,556. JONATHAN F. WINOCOUR, PC, DBA WINOCOUR LAW, DALLAS, TX. FILED 2-14-2013.

## law for humans

THE MARK CONSISTS OF STANDARD CHARACTERS WITHOUT CLAIM TO ANY PARTICULAR FONT, STYLE, SIZE, OR COLOR.

NO CLAIM IS MADE TO THE EXCLUSIVE RIGHT TO USE "LAW", APART FROM THE MARK AS SHOWN.

FOR LEGAL SERVICES, NAMELY, PROVIDING CUSTOMIZED DOCUMENTATION, INFORMATION, COUNSELING, ADVICE AND CONSULTATION SERVICES IN THE AREAS OF PERSONAL INJURY, EMPLOYMENT, CIVIL RIGHTS, AND CRIMINAL DEFENSE LAW; LEGAL SERVICES, NAMELY, PROVIDING CUSTOMIZED LEGAL INFORMATION, COUNSELING, ADVICE, AND LITIGATION SERVICES IN THE AREAS OF PERSONAL INJURY, EMPLOYMENT LAW, CIVIL RIGHTS, AND CRIMINAL DEFENSE LAW TO PEOPLE AND FAMILIES OF MODEST INCOMES (U.S. CLS. 100 AND 101).

FIRST USE 2-14-2013; IN COMMERCE 2-14-2013.  
B. PARADEWELAI, EXAMINING ATTORNEY

---

SN 85-856,670. CAMPUS CRUSADE FOR CHRIST, INC., AKA CRU, HERE'S LIFE INNER CITY, ORLANDO, FL. FILED 2-21-2013.

## SUMMER IN THE CITY

THE MARK CONSISTS OF STANDARD CHARACTERS WITHOUT CLAIM TO ANY PARTICULAR FONT, STYLE, SIZE, OR COLOR.

FOR EVANGELICAL AND MINISTERIAL SERVICES, NAMELY, PROVIDING FAITH-BASED MINISTRY INCLUDING DISCIPLESHIP IN THE FIELDS OF CROSS-CULTURAL MINISTRY, URBAN MINISTRY, RELIGION, AND PERSONAL SPIRITUAL GROWTH TO SERVE THE NEEDY, THE HOMELESS, SENIOR CITIZENS, AND THE IMPRISONED (U.S. CLS. 100 AND 101).

FIRST USE 12-1-1983; IN COMMERCE 12-1-1983.  
MAUREEN DALL, EXAMINING ATTORNEY

**CLASS 45—(Continued).**

SN 85-868,773. NEESER, JASON A., HOUSTON, TX. FILED S.R. 3-6-2013; AM. P.R. 12-30-2013.

## Inventor Soup

THE MARK CONSISTS OF STANDARD CHARACTERS WITHOUT CLAIM TO ANY PARTICULAR FONT, STYLE, SIZE, OR COLOR.

NO CLAIM IS MADE TO THE EXCLUSIVE RIGHT TO USE "INVENTOR", APART FROM THE MARK AS SHOWN. FOR PATENT AGENT SERVICES (U.S. CLS. 100 AND 101).

FIRST USE 3-2-2013; IN COMMERCE 3-2-2013.  
ELISSA GARBER KON, EXAMINING ATTORNEY

---

SN 85-880,298. POLSINELLI PC, KANSAS CITY, MO. FILED 3-19-2013.

## POLSINELLI

THE MARK CONSISTS OF STANDARD CHARACTERS WITHOUT CLAIM TO ANY PARTICULAR FONT, STYLE, SIZE, OR COLOR.

OWNER OF U.S. REG. NO. 3,644,824.  
SEC. 2(F).

FOR LEGAL SERVICES (U.S. CLS. 100 AND 101).  
FIRST USE 4-22-2013; IN COMMERCE 4-22-2013.  
ANNE MADDEN, EXAMINING ATTORNEY

---

SN 85-885,220. EMERSON ENDEAVORS, LLC, AKRON, OH. FILED 3-25-2013.

## PATENTING EXCELLENCE

THE MARK CONSISTS OF STANDARD CHARACTERS WITHOUT CLAIM TO ANY PARTICULAR FONT, STYLE, SIZE, OR COLOR.

FOR LEGAL SERVICES, NAMELY, INTELLECTUAL PROPERTY LAW SERVICES IN THE AREAS OF PATENTS, TRADEMARKS, AND COPYRIGHTS; LEGAL SERVICES, NAMELY, IDENTIFYING, CLEARING, OBTAINING, MAINTAINING, AND LICENSING INTELLECTUAL PROPERTY RIGHTS (U.S. CLS. 100 AND 101).

FIRST USE 1-10-2013; IN COMMERCE 1-10-2013.  
KAPIL BHANOT, EXAMINING ATTORNEY

**CLASS 45—(Continued).**

SN 85-885,236. EMERSON ENDEAVORS, LLC, AKRON, OH.  
FILED 3-25-2013.

COPYRIGHTING EXCELLENCE

THE MARK CONSISTS OF STANDARD CHARACTERS WITHOUT CLAIM TO ANY PARTICULAR FONT, STYLE, SIZE, OR COLOR.

FOR LEGAL SERVICES, NAMELY, INTELLECTUAL PROPERTY LAW SERVICES IN THE AREAS OF PATENTS, TRADEMARKS, AND COPYRIGHTS; LEGAL SERVICES, NAMELY, IDENTIFYING, CLEARING, OBTAINING, MAINTAINING, AND LICENSING INTELLECTUAL PROPERTY RIGHTS (U.S. CLS. 100 AND 101).  
FIRST USE 1-10-2013; IN COMMERCE 1-10-2013.

KAPIL BHANOT, EXAMINING ATTORNEY

**CLASS 45—(Continued).**

SN 86-021,126. ODR EXCHANGE A.S., 140 00 PRAHA 4,  
CZECH REPUBLIC, FILED 7-26-2013.

YOUSTICE

THE MARK CONSISTS OF STANDARD CHARACTERS WITHOUT CLAIM TO ANY PARTICULAR FONT, STYLE, SIZE, OR COLOR.

PRIORITY CLAIMED UNDER SEC. 44(D) ON ERPNCMNTY TM OFC APPLICATION NO. 011904431, FILED 6-17-2013, REG. NO. 011904431, DATED 11-25-2013, EXPIRES 6-17-2023.

FOR ALTERNATIVE DISPUTE RESOLUTION FOR ONLINE PURCHASERS AND SELLERS (U.S. CLS. 100 AND 101).

VERNA BETH RIRIE, EXAMINING ATTORNEY

SN 86-010,080. POND5 GMBH, GENÈVE, SWITZERLAND,  
FILED 7-15-2013.

PIXMAC

THE MARK CONSISTS OF STANDARD CHARACTERS WITHOUT CLAIM TO ANY PARTICULAR FONT, STYLE, SIZE, OR COLOR.

FOR LICENSING OF INTELLECTUAL PROPERTY OF OTHERS OBTAINED VIA DOWNLOAD; LICENSING OF INTELLECTUAL PROPERTY VIA COMPUTER NETWORKS AND GLOBAL COMMUNICATIONS NETWORKS; LICENSING OF INTELLECTUAL PROPERTY, NAMELY, DIGITAL MEDIA, IMAGES, PICTURES, PHOTOGRAPHS, STOCK PHOTOGRAPHS, STOCK FILM, STOCK VIDEO FOOTAGE, STILL IMAGES, ILLUSTRATIONS, MOVING IMAGES, FILM, VIDEO, GRAPHIC DESIGNS, VECTOR GRAPHICS, CLIP ART, NEWS IMAGES, AUDIO DATA, SOUND EFFECTS, MUSICAL RECORDINGS, MULTIMEDIA RECORDINGS, ANIMATIONS, ILLUSTRATIONS, GRAPHICAL COMPUTER SOFTWARE FILES, COMPUTER SOURCE CODE, GRAPHICAL TEMPLATES IN DOWNLOADABLE FORM, AFTER EFFECTS AND ELECTRONIC 3D GRAPHICAL MODELS (U.S. CLS. 100 AND 101).

FIRST USE 9-1-2008; IN COMMERCE 9-1-2008.  
KAREN SEVERSON, EXAMINING ATTORNEY

SN 86-021,131. ODR EXCHANGE A.S., 140 00 PRAHA 4,  
CZECH REPUBLIC, FILED 7-26-2013.



PRIORITY CLAIMED UNDER SEC. 44(D) ON ERPNCMNTY TM OFC APPLICATION NO. 011904455, FILED 6-17-2013, REG. NO. 011904455, DATED 11-25-2013, EXPIRES 6-17-2023.

THE COLOR(S) LIGHT PURPLE AND DARK PURPLE IS/ARE CLAIMED AS A FEATURE OF THE MARK.

THE MARK CONSISTS OF A TRANSPARENT STAR WITH A LIGHT PURPLE BORDER ON THE UPPER PORTION AND A DARK COLORED BORDER IN THE LOWER PORTION, WITH THE STYLIZED WORD "YOUSTICE" WITH THE UPPER PORTION IN LIGHT PURPLE AND THE LOWER PORTION IN DARK PURPLE.

FOR ALTERNATIVE DISPUTE RESOLUTION FOR ONLINE PURCHASERS AND SELLERS (U.S. CLS. 100 AND 101).

VERNA BETH RIRIE, EXAMINING ATTORNEY

**CLASS 45—(Continued).**

SN 86-022,064. PEACE OF MIND SITTERS, INC., ENCINO, CA. FILED 7-29-2013.



NO CLAIM IS MADE TO THE EXCLUSIVE RIGHT TO USE "SITTERS", APART FROM THE MARK AS SHOWN. THE MARK CONSISTS OF A PICTURE SILHOUETTE OF A FAMILY AND THE TEXT "PEACE OF MIND SITTERS" TO THE RIGHT OF THIS IMAGE.

FOR BABYSITTING SERVICES (U.S. CLS. 100 AND 101).

FIRST USE 4-1-2013; IN COMMERCE 4-1-2013.  
JANICE KIM, EXAMINING ATTORNEY

SN 86-023,781. RIVER OF LIFE, POMPANO BEACH, FL. FILED 7-30-2013.



NO CLAIM IS MADE TO THE EXCLUSIVE RIGHT TO USE "MINISTRY", APART FROM THE MARK AS SHOWN. THE COLOR(S) CREAM, BURGUNDY, GOLD, BLACK, AND GREY IS/ARE CLAIMED AS A FEATURE OF THE MARK.

THE MARK CONSISTS OF A CREAM TREE DESIGN WITH THREE RIVER LINES BELOW IT, THE FIRST AND THIRD RIVER LINE IS BURGUNDY COLOR AND THE SECOND MIDDLE RIVER LINE IS A GRADIENT FROM CREAM TO GOLD. THE WORDING "RIVER OF LIFE" APPEARS IN STYLIZED LETTERING TO THE RIGHT OF THE TREE. THE WORDING "RIVER" AND "LIFE" ARE BURGUNDY AND THE WORDING "OF" IS BLACK WITH A GREY SHADOW. THE WORDING "A MINISTRY OF VICTORIOUS LIVING" IS IN BLACK STYLIZED LETTERING UNDERNEATH "RIVER OF LIFE". A PARTIAL MIRROR IMAGE OF THE WORDING "A MINISTRY OF VICTORIOUS LIVING" APPEARS UNDERNEATH IT IN GREY.

FOR CHRISTIAN MINISTRY SERVICES; EVANGELISTIC AND MINISTERIAL SERVICES; MINISTERIAL SERVICES (U.S. CLS. 100 AND 101).

FIRST USE 6-12-2011; IN COMMERCE 6-12-2011.  
LANA PHAM, EXAMINING ATTORNEY

**CLASS 45—(Continued).**

SN 86-023,903. BLOCHSTAMPFOR LLC, WENTZVILLE, MO. FILED 7-30-2013.

## B.SUITED

THE MARK CONSISTS OF STANDARD CHARACTERS WITHOUT CLAIM TO ANY PARTICULAR FONT, STYLE, SIZE, OR COLOR.

FOR RENTAL OF BODYBUILDING COMPETITION BIKINIS (U.S. CLS. 100 AND 101).

SUSAN LESLIE DUBOIS, EXAMINING ATTORNEY

SN 86-026,064. ENVIROCOP, LLC, MOORESTOWN, NJ. FILED 8-1-2013.

## enviroCOP

THE MARK CONSISTS OF STANDARD CHARACTERS WITHOUT CLAIM TO ANY PARTICULAR FONT, STYLE, SIZE, OR COLOR.

FOR ADVICE AND CONSULTANCY ON ENVIRONMENTAL REGULATORY MATTERS; REVIEWING ENVIRONMENTAL DATA, ANALYZING THE DATA IN CONNECTION WITH ENVIRONMENTAL LAWS AND REGULATIONS, AND PREPARING ENVIRONMENTAL COMPLIANCE REPORTS; REVIEWING STANDARDS AND PRACTICES TO ASSURE COMPLIANCE WITH ENVIRONMENTAL LAWS AND REGULATIONS (U.S. CLS. 100 AND 101).

FIRST USE 7-23-2013; IN COMMERCE 8-1-2013.  
HELENE LIWINSKI, EXAMINING ATTORNEY

SN 86-027,166. MY LAST MEMO LLC, WESLEY CHAPEL, FL. FILED 8-2-2013.



NO CLAIM IS MADE TO THE EXCLUSIVE RIGHT TO USE "MEMO", APART FROM THE MARK AS SHOWN.

THE COLOR(S) BROWN, OLIVE, GRAY, BLACK, WHITE, RED, PINK, PURPLE, BLUE, YELLOW, AQUAMARINE, AND LIME IS/ARE CLAIMED AS A FEATURE OF THE MARK.

THE MARK CONSISTS OF THE WORDING "MY LAST

**CLASS 45—(Continued).**

MEMO" IN BLACK AND "WHERE MEMORIES ENDURE" IN AQUAMARINE AND A DESIGN OF A BLACK TREE WITH LEAVES DEPICTED AS BROWN, OLIVE, GRAY, BLACK, BLACK AND WHITE, RED, PINK, PURPLE, BLUE, YELLOW, AQUAMARINE AND LIME PHOTOGRAPHS, WITH PURPLE, BLACK AND GRAY PHOTOGRAPHS FALLING FROM THE TREE TO THE RIGHT SIDE AND A GRAY DOT ON THE UPPER LEFT OF THE TREE, WITH THE TREE FEATURING BLACK SHADOWING AT THE BOTTOM.

FOR PROVIDING A WEBSITE FOR USERS TO LEAVE PERSONALIZED CONTENT AND MESSAGES TO THEIR LOVED ONES, FRIENDS AND FAMILY, WHICH CONTENT AND MESSAGES WILL BE DELIVERED ONCE THEY HAVE PASSED ON (U.S. CLS. 100 AND 101).

MELISSA VALLILLO, EXAMINING ATTORNEY

SN 86-027,343. BWEB LLC, AIEA, HI. FILED 8-2-2013.

Fashionably

Doing

Things

Style

NO CLAIM IS MADE TO THE EXCLUSIVE RIGHT TO USE "STYLE", APART FROM THE MARK AS SHOWN.

THE MARK CONSISTS OF THE STYLIZED TEXT "FASHIONABLY DOING THINGS STYLE".

FOR PERSONAL STYLIST SERVICES, NAMELY, EVALUATING THE PHYSICAL ATTRIBUTES, LIFESTYLE, AND FASHION STYLES OF OTHERS AND RECOMMENDING CLOTHING AND ACCESSORIES TO ACHIEVE THE PERSONAL IMAGE DESIRED BY THE CLIENT (U.S. CLS. 100 AND 101).

HENRY S. ZAK, EXAMINING ATTORNEY

SN 86-033,310. OBANDO, JEFFREY, PACOIMA, CA. FILED 8-9-2013.

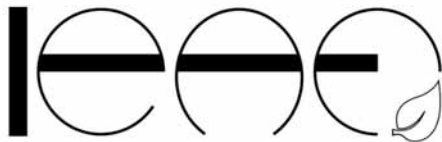

THE MARK CONSISTS OF THE WORD "LEAF" WITH A LEAF AT THE END OF THE WORD. THE "L" AND THE "E" ARE IN LOWER CASE AND THE "A" AND "F" ARE CAPITAL LETTERS. THE "I" IS THE SAME WIDTH AS

**CLASS 45—(Continued).**

THE BAR GOING ACROSS THE "E" THE "A" AND HALF OF THE "F". ALL OF THE LETTERS ARE SEPARATED BY THE SAME DISTANCE. THE "I" IS STRAIGHT UP AND DOWN. THE "E" "A" "F" HAVE A CIRCLE APPROACH GIVING IT A GLOBAL FEEL. THE LEAF STEM HAS THE LOOK LIKE IT IS A CONTINUATION OF THE BOTTOM OF THE "F" GIVING IT THE LOOK LIKE IT IS GOING UPWARDS MID CENTER OF THE LEAF, WITH THE TIP OF THE LEAF STOPPING RIGHT BELOW THE TOP PART OF THE "F" GIVING IT THE LOOK OF A FULL CIRCLE.

FOR FASHION TREND CONSULTING SERVICES; ONLINE SOCIAL NETWORKING SERVICES PROVIDED THROUGH A FASHION COMMUNITY WEBSITE; PERSONAL STYLIST SERVICES, NAMELY, EVALUATING THE PHYSICAL ATTRIBUTES, LIFESTYLE, AND FASHION STYLES OF OTHERS AND RECOMMENDING CLOTHING AND ACCESSORIES TO ACHIEVE THE PERSONAL IMAGE DESIRED BY THE CLIENT; PROVIDING FASHION INFORMATION; PROVIDING FASHION INFORMATION IN THE FIELD OF DURABILITY, FIT AND STYLE OF LINGERIE PRODUCTS VIA THE INTERNET; PROVIDING INFORMATION ABOUT FASHION; PROVIDING INFORMATION IN THE FIELD OF FASHION TRENDS; PROVIDING NEWS AND INFORMATION IN THE FIELD OF FASHION; PROVIDING ONLINE FASHION QUESTIONS TO HELP USERS DETERMINE THE STYLE OF CLOTHING BEST SUITED TO THEIR INDIVIDUAL NEEDS AND PREFERENCES; PROVISION OF A WEB SITE FEATURING INFORMATION ON FASHION (U.S. CLS. 100 AND 101).

COLLEEN KEARNEY, EXAMINING ATTORNEY

SN 86-034,240. ROSS BARNES LLP, RICHARDSON, TX. FILED 8-9-2013.

**PROTECTING YOUR INTELLECTUAL PROPERTY DEFENDING YOUR BUSINESS**

THE MARK CONSISTS OF STANDARD CHARACTERS WITHOUT CLAIM TO ANY PARTICULAR FONT, STYLE, SIZE, OR COLOR.

FOR LEGAL SERVICES (U.S. CLS. 100 AND 101).

MEREDITH MARESCA, EXAMINING ATTORNEY

SN 86-036,711. KARLSSON, RACKHAM HOKE, CAMBRIDGE, MA. FILED 8-13-2013.

**ZEPHYR LEGAL SERVICES**

THE MARK CONSISTS OF STANDARD CHARACTERS WITHOUT CLAIM TO ANY PARTICULAR FONT, STYLE, SIZE, OR COLOR.

NO CLAIM IS MADE TO THE EXCLUSIVE RIGHT TO USE "LEGAL SERVICES", APART FROM THE MARK AS SHOWN.

FOR LEGAL SERVICES (U.S. CLS. 100 AND 101).

SANI KHOURI, EXAMINING ATTORNEY

**CLASS 45—(Continued).**

SN 86-038,565. OUTSIDE IN ADVISORS, LLC, DBA OUTSIDE IN ADVISORS, NEWTON, MA. FILED 8-15-2013.

## Outside In Advisors

THE MARK CONSISTS OF STANDARD CHARACTERS WITHOUT CLAIM TO ANY PARTICULAR FONT, STYLE, SIZE, OR COLOR.

NO CLAIM IS MADE TO THE EXCLUSIVE RIGHT TO USE "ADVISORS", APART FROM THE MARK AS SHOWN.

FOR LEGAL SERVICES, NAMELY, PROVIDING CUSTOMIZED DOCUMENTATION, INFORMATION, COUNSELING, ADVICE AND CONSULTATION SERVICES IN ALL AREAS OF BUSINESS LAW (U.S. CLS. 100 AND 101).

FIRST USE 11-1-2012; IN COMMERCE 12-1-2012.  
STEVEN JACKSON, EXAMINING ATTORNEY

SN 86-038,683. OUTSIDE IN ADVISORS, LLC, DBA OUTSIDE IN ADVISORS, NEWTON, MA. FILED 8-15-2013.



NO CLAIM IS MADE TO THE EXCLUSIVE RIGHT TO USE "ADVISORS", "LEGAL", "CONSULTING", "STRATEGY", APART FROM THE MARK AS SHOWN.

THE COLOR(S) GRAY, ORANGE, AND WHITE IS/ARE CLAIMED AS A FEATURE OF THE MARK.

THE MARK CONSISTS OF "OUTSIDE IN ADVISORS LEGAL · CONSULTING · STRATEGY" WITH THE WORDS "OUTSIDE", "LEGAL", "CONSULTING" AND "STRATEGY" IN GRAY, AND THE WORD "IN" IN ORANGE, NEXT TO A STYLIZED LOGO CONSISTING OF THE LETTERS UPPERCASE "O" IN GRAY AND LOWERCASE "I" IN ORANGE, BOTH WITH WHITE HIGHLIGHTS ABOVE A GRAY SHADOW.

FOR LEGAL SERVICES, NAMELY, PROVIDING CUSTOMIZED DOCUMENTATION, INFORMATION, COUNSELING, ADVICE AND CONSULTATION SERVICES IN ALL AREAS OF BUSINESS LAW (U.S. CLS. 100 AND 101).

FIRST USE 11-1-2012; IN COMMERCE 5-30-2013.  
STEVEN JACKSON, EXAMINING ATTORNEY

SN 86-038,842. THE TEMPLE OF THE PRESENCE, INC., TUCSON, AZ. FILED 8-15-2013.

## Truth of Cosmic Law

THE MARK CONSISTS OF STANDARD CHARACTERS WITHOUT CLAIM TO ANY PARTICULAR FONT, STYLE, SIZE, OR COLOR.

NO CLAIM IS MADE TO THE EXCLUSIVE RIGHT TO USE "COSMIC LAW", APART FROM THE MARK AS SHOWN.

FOR EVANGELISTIC AND MINISTERIAL SERVICES (U.S. CLS. 100 AND 101).

FIRST USE 10-9-2005; IN COMMERCE 10-9-2005.  
RONALD MCMORROW, EXAMINING ATTORNEY

**CLASS 45—(Continued).**

SN 86-039,064. THE MICHAEL NEWTON INSTITUTE FOR LIFE BETWEEN LIVES HYPNOTHERAPY, INC., WILMINGTON, NC. FILED 8-15-2013.



OWNER OF U.S. REG. NOS. 4,022,236, 4,028,223 AND 4,213,517.

NO CLAIM IS MADE TO THE EXCLUSIVE RIGHT TO USE "INSTITUTE", APART FROM THE MARK AS SHOWN.

THE COLOR(S) PURPLE, YELLOW, WHITE, BEIGE, AND BLACK IS/ARE CLAIMED AS A FEATURE OF THE MARK.

THE MARK CONSISTS OF A PLURALITY OF NESTED OVALS OF INCREASINGLY LIGHTER SHADES OF PURPLE WITH A BEIGE, WHITE AND YELLOW CENTER AND A BLACK SILHOUETTE OF A PERSON IN THE CENTER OF THE OVAL WITH THE WORDS "THE NEWTON INSTITUTE" IN PURPLE AND UNDERLINED IN YELLOW AND THE WORDS "FOR LIFE BETWEEN LIVES HYPNOTHERAPY" UNDERNEATH IN PURPLE.

FOR SPIRITUAL HYPNOTHERAPY SERVICES (U.S. CLS. 100 AND 101).

FIRST USE 8-2-2002; IN COMMERCE 8-2-2002.  
ZACHARY CROMER, EXAMINING ATTORNEY

SN 86-039,706. NO-MORE-ID-THEFT.COM LLC, ELLENWOOD, GA. FILED 8-16-2013.



NO CLAIM IS MADE TO THE EXCLUSIVE RIGHT TO USE "ID-THEFT.COM" AND "VERIFY", APART FROM THE MARK AS SHOWN.

THE COLOR(S) WHITE, BLUE AND BLACK IS/ARE CLAIMED AS A FEATURE OF THE MARK.

THE MARK CONSISTS OF THE WORDING "NO-MORE-ID-THEFT.COM VERIFY" IN STYLIZED WHITE LETTERING WITHIN A BLACK SQUARE BACKGROUND. THE WORDING "NO-MORE-ID-THEFT.COM" APPEARS ARCHED ABOVE A BLUE HALF MAN CHARACTER. THE MAN APPEARS HOLDING UP HIS RIGHT ARM IN A STOP POSITION. A WHITE OUTLINE APPEARS IN THE MAN'S HAND, HEAD, EYES AND LIPS. A WHITE HIGHLIGHT APPEARS IN THE MAN'S PALM, FINGERTIPS AND FACE. THE WORDING "VERIFY" APPEARS IN UPPERCASE LETTERS SUPERIMPOSED ACROSS THE LOWER AREA OF THE MAN'S CHEST.

FOR FRAUD AND IDENTITY THEFT PROTECTION SERVICES (U.S. CLS. 100 AND 101).

ANDREW RHIM, EXAMINING ATTORNEY



**CLASS 45—(Continued).**

SN 86-040,625. KURTZ LAW GROUP, A PROFESSIONAL CORPORATION, WOODLAND HILLS, CA. FILED 8-16-2013.



NO CLAIM IS MADE TO THE EXCLUSIVE RIGHT TO USE "BEER DISTRIBUTION LAW" AND "LAW GROUP A PROFESSIONAL CORPORATION", APART FROM THE MARK AS SHOWN.

THE MARK CONSISTS OF THE WORDS "BEER DISTRIBUTION LAW" ABOVE A CIRCLE WHICH CONTAINS AN IMAGE OF A GLASS OF BEER WITH A DESIGN OF THE LETTERS "BK" IN A CIRCLE ON THE FACE OF THE GLASS; THE WORDS "KURTZ LAW GROUP" BELOW THE CIRCLE, AND THE WORDS "A PROFESSIONAL CORPORATION" AT THE BOTTOM. THE CIRCLE ON THE FACE OF THE GLASS CONTAINS IMAGES OF WHEAT ON EACH SIDE OF THE IMAGE OF THE GLASS OF BEER, SWIRLING UPWARDS TOWARDS THE TOP OF THE GLASS.

FOR LEGAL SERVICES (U.S. CLS. 100 AND 101).  
ANDREW LEASER, EXAMINING ATTORNEY

SN 86-041,169. MIZRAHI LAW OFFICES, LLC., NEW YORK, NY. FILED 8-19-2013.

**EvictNY**

THE MARK CONSISTS OF STANDARD CHARACTERS WITHOUT CLAIM TO ANY PARTICULAR FONT, STYLE, SIZE, OR COLOR.

FOR LEGAL SERVICES (U.S. CLS. 100 AND 101).  
FIRST USE 5-1-2011; IN COMMERCE 5-1-2011.  
LEIGH CAROLINE CASE, EXAMINING ATTORNEY

**CLASS 45—(Continued).**

SN 86-041,244. EDWARDS, DAVID R., SOUTHGATE, MI. FILED 8-19-2013.



THE MARK CONSISTS OF A SHIELD CONTAINING AN EAGLE. TO THE RIGHT OF THE SHIELD IS "THE227PROJECT" ABOVE "STRENGTHENING THE SPIRIT OF THE PUBLIC SAFETY COMMUNITY".

FOR PROVIDING SPIRITUAL COUNSELING AND EMOTIONAL SUPPORT SERVICES TO MEMBERS OF PUBLIC SAFETY AGENCIES AND THEIR FAMILIES (U.S. CLS. 100 AND 101).

FIRST USE 7-23-2013; IN COMMERCE 7-23-2013.  
KIMBERLY FRYE, EXAMINING ATTORNEY

SN 86-041,568. FAISAL CHARANIA, SUGAR LAND, TX. FILED 8-19-2013.



THE MARK CONSISTS OF THE LETTER "C" CIRCUMSCRIBING A MAP OF THE WORLD.

FOR LEGAL SERVICES (U.S. CLS. 100 AND 101).  
FIRST USE 3-15-2012; IN COMMERCE 3-15-2012.  
ROSELLE HERRERA, EXAMINING ATTORNEY

**CLASS 45—(Continued).**

SN 86-041,708. NILAN JOHNSON LEWIS PA, MINNEAPOLIS, MN. FILED 8-19-2013.

## Total Partnership

THE MARK CONSISTS OF STANDARD CHARACTERS WITHOUT CLAIM TO ANY PARTICULAR FONT, STYLE, SIZE, OR COLOR.

NO CLAIM IS MADE TO THE EXCLUSIVE RIGHT TO USE "PARTNERSHIP", APART FROM THE MARK AS SHOWN.

FOR PROVIDING CUSTOMIZED LEGAL INFORMATION, COUNSELING, AND ADVICE, AND LITIGATION SERVICES IN THE FIELD OF PRODUCT LIABILITY, MASS TORT, LABOR AND EMPLOYMENT, COMMERCIAL LITIGATION, HEALTH CARE, AND BUSINESS TRANSACTIONS (U.S. CLS. 100 AND 101).

DORITT L. CARROLL, EXAMINING ATTORNEY

SN 86-042,095. PARADIES LAW P.A., ODESSA, FL. FILED 8-19-2013.

## PARADIES

THE MARK CONSISTS OF STANDARD CHARACTERS WITHOUT CLAIM TO ANY PARTICULAR FONT, STYLE, SIZE, OR COLOR.

THE ENGLISH TRANSLATION OF THE WORD "PARADIES" IN THE MARK IS "PARADISE".

FOR LEGAL SERVICES (U.S. CLS. 100 AND 101).

FIRST USE 8-19-2013; IN COMMERCE 8-19-2013.

MARYNELLE WILSON, EXAMINING ATTORNEY

SN 86-043,433. ULTIMATE LOVE AND PASSION, INC., HIGHLAND PARK, IL. FILED 8-20-2013.



THE COLOR(S) RED AND BLACK IS/ARE CLAIMED AS A FEATURE OF THE MARK.

THE MARK CONSISTS OF THE WORDS "ULTIMATE LOVE AND PASSION", WITH THE WORD "LOVE" BEING IN CAPITAL LETTERS IN RED AND INCLUDES A DOUBLE HEART DESIGN ELEMENT IN RED. THE WORDS "ULTIMATE AND PASSION" ARE LOWER CASE AND IN BLACK.

FOR DATING SERVICES; INTERNET BASED SOCIAL NETWORKING, INTRODUCTION, AND DATING SERVICES (U.S. CLS. 100 AND 101).

FIRST USE 4-18-2012; IN COMMERCE 4-18-2012.

KAPIL BHANOT, EXAMINING ATTORNEY

**CLASS 45—(Continued).**

SN 86-044,435. THOMAS POLLART & MILLER, LLC, GREENWOOD VILLAGE, CO. FILED 8-21-2013.

## DIVORCE MATTERS

THE MARK CONSISTS OF STANDARD CHARACTERS WITHOUT CLAIM TO ANY PARTICULAR FONT, STYLE, SIZE, OR COLOR.

NO CLAIM IS MADE TO THE EXCLUSIVE RIGHT TO USE "DIVORCE", APART FROM THE MARK AS SHOWN.

FOR LEGAL SERVICES (U.S. CLS. 100 AND 101).

FIRST USE 2-7-2011; IN COMMERCE 7-26-2011.

ALLISON HOLTZ, EXAMINING ATTORNEY

SN 86-047,113. BROOKS, YEHLLEN, MANTECA, CA. FILED 8-24-2013.

## America is Built on the Backs of Immigrants

THE MARK CONSISTS OF STANDARD CHARACTERS WITHOUT CLAIM TO ANY PARTICULAR FONT, STYLE, SIZE, OR COLOR.

FOR LEGAL SERVICES (U.S. CLS. 100 AND 101).

FIRST USE 1-15-1999; IN COMMERCE 1-15-1999.

SKYE YOUNG, EXAMINING ATTORNEY

SN 86-048,718. TAFT & PARTNERS, LLC, LAWRENCEVILLE, NJ. FILED 8-27-2013.



OWNER OF U.S. REG. NO. 3,201,332.

THE MARK CONSISTS OF THE STYLIZED WORD "PHARMAPPOVE" WITH THE LETTER "V" APPEARING AS A REPRESENTATION OF A CHECK-MARK AND THE STYLIZED WORDS "PREPARE TO WIN." APPEARING BELOW.

FOR CONSULTING SERVICES IN THE FIELD OF REGULATORY APPROVAL OF NEW DRUGS, MEDICAL DEVICES, AND OVER-THE-COUNTER MEDICATIONS (U.S. CLS. 100 AND 101).

MICHAEL KEATING, EXAMINING ATTORNEY

**CLASS 45—(Continued).**

SN 86-061,648. DANIEL SANDOVAL, PRESTON, CT. FILED 9-11-2013.

**"Jesus didn't have kicks!"**

THE MARK CONSISTS OF STANDARD CHARACTERS WITHOUT CLAIM TO ANY PARTICULAR FONT, STYLE, SIZE, OR COLOR.

FOR PERSONAL GROWTH AND MOTIVATION CONSULTING SERVICES; PROVIDING A MOTIVATIONAL WEBSITE THE PRIMARY MISSION OF WHICH IS TO INCREASE PERSONAL HAPPINESS IN TERMS OF PERSONAL RELATIONSHIPS, PERSONAL GROWTH AND MOTIVATION, AND SELF-FULFILLMENT (U.S. CLS. 100 AND 101).  
PAUL E. FAHRENKOPF, EXAMINING ATTORNEY



SN 86-062,896. LAWRENCE, KEN, MERIDEN, CT. FILED 9-12-2013.

**PERSONAL SEARCH ENGINE**

THE MARK CONSISTS OF STANDARD CHARACTERS WITHOUT CLAIM TO ANY PARTICULAR FONT, STYLE, SIZE, OR COLOR.

NO CLAIM IS MADE TO THE EXCLUSIVE RIGHT TO USE "SEARCH ENGINE", APART FROM THE MARK AS SHOWN.  
FOR ON-LINE SOCIAL NETWORKING SERVICES (U.S. CLS. 100 AND 101).  
MARILYN IZZI, EXAMINING ATTORNEY



SN 86-064,593. ACCOMPLISHMOREGOALS, LLC, FOREST PARK, IL. FILED 9-13-2013.

**AMG - ACCOMPLISH MORE GOALS**

THE MARK CONSISTS OF STANDARD CHARACTERS WITHOUT CLAIM TO ANY PARTICULAR FONT, STYLE, SIZE, OR COLOR.

FOR PROVIDING A SOCIAL NETWORKING WEBSITE FOR USERS TO PLAN AND SHARE GOALS AND SUCCESS STORIES (U.S. CLS. 100 AND 101).  
ANNE FARRELL, EXAMINING ATTORNEY

**CLASS 45—(Continued).**

SN 86-065,736. WADDEY & PATTERSON, P.C., NASHVILLE, TN. FILED 9-16-2013.

**ORIGINAL THINKING. UNIQUE PROTECTION.**

THE MARK CONSISTS OF STANDARD CHARACTERS WITHOUT CLAIM TO ANY PARTICULAR FONT, STYLE, SIZE, OR COLOR.

FOR LEGAL CONSULTATION SERVICES; LEGAL SERVICES (U.S. CLS. 100 AND 101).  
ELIZABETH CHANG, EXAMINING ATTORNEY



SN 86-066,730. WAECHTER, JASON A., DBA LAW OFFICES OF JASON WAECHTER, SOUTHFIELD, MI. FILED 9-17-2013.

**THE NUMBER TO CALL IF YOU FALL**

THE MARK CONSISTS OF STANDARD CHARACTERS WITHOUT CLAIM TO ANY PARTICULAR FONT, STYLE, SIZE, OR COLOR.

FOR LEGAL SERVICES (U.S. CLS. 100 AND 101).  
FIRST USE 1-5-2012; IN COMMERCE 1-5-2012.  
DAVID TAYLOR, EXAMINING ATTORNEY



SN 86-067,216. HBO OLE PARTNERS, CORAL GABLES, FL. FILED 9-17-2013.



THE MARK CONSISTS OF THE WORD "PASEO" LOCATED TO THE RIGHT OF A SERIES OF CIRCLES OF VARIOUS SIZES RADIATING FROM A CENTRAL POINT.

THE ENGLISH TRANSLATION OF "PASEO" IN THE MARK IS "STROLL".

FOR COMPUTER SECURITY SERVICES IN THE NATURE OF PROVIDING AUTHENTICATION, ISSUANCE, VALIDATION AND REVOCATION OF DIGITAL CERTIFICATES; IDENTIFICATION VERIFICATION SERVICES, NAMELY, PROVIDING AUTHENTICATION OF PERSONAL IDENTIFICATION INFORMATION (U.S. CLS. 100 AND 101).  
ANDREA K. NADELMAN, EXAMINING ATTORNEY

**CLASS 45—(Continued).**

SN 86-067,300. MEET ME MEDIA INC., LOS ANGELES, CA.  
FILED 9-17-2013.

## Pass The Sugar

THE MARK CONSISTS OF STANDARD CHARACTERS WITHOUT CLAIM TO ANY PARTICULAR FONT, STYLE, SIZE, OR COLOR.

FOR COMPUTER DATING SERVICES; MATCHMAKING SERVICES; SOCIAL INTRODUCTION AGENCIES (U.S. CLS. 100 AND 101).

SUNG IN, EXAMINING ATTORNEY

SN 86-067,574. SWAGGERSCAN.COM, LLC, TALLAHASSEE, FL. FILED 9-18-2013.

## SWAGGERSCAN

THE MARK CONSISTS OF STANDARD CHARACTERS WITHOUT CLAIM TO ANY PARTICULAR FONT, STYLE, SIZE, OR COLOR.

FOR DATING SERVICES, NAMELY, PROVIDING AN ON-LINE COMPUTER DATABASE FEATURING SINGLE PEOPLE INTERESTED IN MEETING OTHER SINGLE PEOPLE (U.S. CLS. 100 AND 101).

SKYE YOUNG, EXAMINING ATTORNEY

SN 86-067,969. PRIVALOVA, NATALIYA, PRINCETON, NJ. FILED 9-18-2013.

## YOUIE

THE MARK CONSISTS OF STANDARD CHARACTERS WITHOUT CLAIM TO ANY PARTICULAR FONT, STYLE, SIZE, OR COLOR.

FOR BABYSITTING SERVICES; BACKGROUND INVESTIGATION AND RESEARCH SERVICES; CONCIERGE SERVICES FOR OTHERS COMPRISING MAKING REQUESTED PERSONAL ARRANGEMENTS AND RESERVATIONS AND PROVIDING CUSTOMER-SPECIFIC INFORMATION TO MEET INDIVIDUAL NEEDS RENDERED TOGETHER IN A HOME, OFFICE, ON-LINE, IN-PERSON, SCHOOL, JAIL; CONSERVATORSHIP SERVICES, NAMELY, MANAGING THE PERSONAL AFFAIRS OR ESTATE OF A PERSON WHO IS DEEMED INCAPABLE DUE TO REASONS SUCH AS AGE OR MENTAL LIMITATIONS; CONSULTATION SERVICES IN THE FIELD OF THE SAFETY NEEDS OF COMMERCIAL AND INDUSTRIAL COMPANIES; CONSULTING SERVICES IN THE FIELD OF MAINTAINING THE SECURITY AND INTEGRITY OF DATABASES; CONSULTING SERVICES IN THE FIELD OF NATIONAL SECURITY; CONSULTING SERVICES IN THE FIELD OF PUBLIC SAFETY; DOMAIN NAME REGISTRATION SERVICES; INTERVIEWING INDIVIDUALS FOR THE PURPOSE OF PRESERVING THEIR PERSONAL HIS-

**CLASS 45—(Continued).**

TORIES; LEGAL CONSULTATION SERVICES; LEGAL DOCUMENT PREPARATION AND RESEARCH SERVICES FOR ATTORNEYS; LEGAL DOCUMENT PREPARATION SERVICES; LEGAL SERVICES, NAMELY, INTELLECTUAL PROPERTY CONSULTING SERVICES IN THE FIELD OF IDENTIFICATION, STRATEGY, ANALYTICS, AND INVENTION; LEGAL SERVICES, NAMELY, PREPARATION OF APPLICATIONS FOR TRADEMARK REGISTRATION; LEGAL SERVICES, NAMELY, PROCESS SERVING; LEGAL SERVICES, NAMELY, PROVIDING CUSTOMIZED DOCUMENTATION, INFORMATION, COUNSELING, ADVICE AND CONSULTATION SERVICES IN ALL AREAS OF INTERNATIONAL OR OFFSHORE LAND ACQUISITION, DEVELOPMENT AND SALES FOR SELLERS AND BUYERS, AND THEIR OTHER SERVICE PROVIDERS, INCLUDING REAL ESTATE AGENTS, ATTORNEYS, INSURERS AND LENDERS; LEGAL SERVICES, NAMELY, PROVIDING CUSTOMIZED DOCUMENTATION, INFORMATION, COUNSELING, ADVICE AND CONSULTATION SERVICES IN ALL AREAS OF LAW TO PEOPLE AND FAMILIES OF MODEST INCOMES; LEGAL SERVICES, NAMELY, TRADEMARK MAINTENANCE SERVICES; LEGAL SERVICES, NAMELY, TRADEMARK SEARCHING AND CLEARANCE SERVICES; LICENSING OF INTELLECTUAL PROPERTY; LITIGATION SERVICES; LITIGATION SUPPORT SERVICES; LITIGATION SUPPORT SERVICES, NAMELY, CONDUCTING ELECTRONIC LEGAL DISCOVERY IN THE NATURE OF REVIEWING E-MAILS AND OTHER ELECTRONICALLY STORED INFORMATION THAT COULD BE RELEVANT EVIDENCE IN A LAWSUIT; MEDIATION; NANNY SERVICES; ON-LINE SOCIAL NETWORKING SERVICES; ON-SITE LEGAL SERVICES; PARALEGAL SERVICES; PATENT AGENT SERVICES; PERSONAL BODY GUARDING; PERSONAL CARE ASSISTANCE OF ACTIVITIES OF DAILY LIVING, SUCH AS BATHING, GROOMING AND PERSONAL MOBILITY FOR MENTALLY OR PHYSICALLY CHALLENGED PEOPLE; PERSONAL CHEF SERVICES; PERSONAL CONCIERGE SERVICES FOR OTHERS COMPRISING MAKING REQUESTED PERSONAL ARRANGEMENTS AND RESERVATIONS AND PROVIDING CUSTOMER-SPECIFIC INFORMATION TO MEET INDIVIDUAL NEEDS; PERSONAL CONCIERGE SERVICES FOR OTHERS COMPRISING MAKING REQUESTED PERSONAL ARRANGEMENTS AND RESERVATIONS, RUNNING ERRANDS AND PROVIDING CUSTOMER SPECIFIC INFORMATION TO MEET INDIVIDUAL NEEDS, ALL RENDERED IN BUSINESS ESTABLISHMENTS, OFFICE BUILDINGS, HOTELS, RESIDENTIAL COMPLEXES AND HOMES; PERSONAL FASHION CONSULTING SERVICES; PERSONAL GROWTH AND MOTIVATION CONSULTING SERVICES; PERSONAL IMAGE CONSULTING SERVICES; PERSONAL LETTER WRITING; PERSONAL LETTER WRITING FOR OTHERS; PERSONAL LIFESTYLE CONSULTING SERVICES; PERSONAL REMINDER SERVICES IN THE AREA OF UPCOMING IMPORTANT DATES AND EVENTS; PERSONAL SERVICES, NAMELY, CONSULTATION IN THE FIELD OF DIVORCE; PERSONAL STYLIST SERVICES, NAMELY, EVALUATING THE PHYSICAL ATTRIBUTES, LIFESTYLE, AND FASHION STYLES OF OTHERS AND RECOMMENDING CLOTHING AND ACCESSORIES TO ACHIEVE THE PERSONAL IMAGE DESIRED BY THE CLIENT; PERSONAL WARDROBE STYLING SERVICES; PROVIDING INFORMATION IN THE FIELD OF INTELLECTUAL PROPERTY LEGAL SERVICES; PROVIDING INFORMATION IN THE FIELD OF PERSONAL IMAGE DEVELOPMENT; PROVIDING LEGAL SERVICES BY MEANS OF CONSUMERS SENDING A TEXT MESSAGE TO A LAWYER VIA CELL PHONES; PROVIDING NON-MEDICAL ASSISTED LIVING SERVICES FOR PERSONAL PURPOSES IN THE NATURE OF SCHEDULING APPOINTMENTS, ANSWERING THE TELEPHONE, CHECKING MESSAGES, MAIL SORTING, MAIL HANDLING, MAIL RECEIVING AND SECRETARIAL AND CLERICAL SERVICES; PROVIDING NON-MEDICAL PERSONAL ASSISTANT SERVICES FOR OTHERS IN THE NATURE OF PLANNING, ORGANIZING, COORDINATING, ARRANGING AND ASSISTING INDIVI-

**CLASS 45—(Continued).**

DUALS TO PERFORM DAILY TASKS; PROVIDING PERSONAL SUPPORT SERVICES FOR PATIENTS AND FAMILIES OF PATIENTS, NAMELY, EMOTIONAL COUNSELING AND EMOTIONAL SUPPORT; PROVIDING WEDDING OFFICIANT SERVICES; PUBLIC DOCUMENT FILING SERVICES; PUBLIC RECORD INVESTIGATION SERVICES; REAL ESTATE CLOSING SERVICES; REGISTRATION OF DOMAIN NAMES FOR IDENTIFICATION OF USERS ON A GLOBAL COMPUTER NETWORK; SOCIAL INTRODUCTION AGENCIES; WEDDING CEREMONY PLANNING AND ARRANGING CONSULTATION SERVICES (U.S. CLS. 100 AND 101).  
SHAVELL MCPHERSON, EXAMINING ATTORNEY

---

SN 86-068,186. HERTZ SCHRAM PC, BLOOMFIELD HILLS, MI. FILED 9-18-2013.

**LegalPerks**

THE MARK CONSISTS OF STANDARD CHARACTERS WITHOUT CLAIM TO ANY PARTICULAR FONT, STYLE, SIZE, OR COLOR.  
FOR ATTORNEY AND LEGAL SERVICES (U.S. CLS. 100 AND 101).  
NICHOLAS ALTREE, EXAMINING ATTORNEY

---

SN 86-068,469. WEI HENG LAW FIRM, HAIDIAN DIST., BEIJING, CHINA, FILED 9-18-2013.

**EASTAR**

THE MARK CONSISTS OF STANDARD CHARACTERS WITHOUT CLAIM TO ANY PARTICULAR FONT, STYLE, SIZE, OR COLOR.  
FOR LEGAL SERVICES, NAMELY, INTELLECTUAL PROPERTY LAW SERVICES IN THE AREAS OF PATENTS, TRADEMARKS, AND COPYRIGHTS (U.S. CLS. 100 AND 101).  
TINA L. SNAPP, EXAMINING ATTORNEY

**CLASS 45—(Continued).**

SN 86-068,484. WEI HENG LAW FIRM, HAIDIAN DIST., BEIJING, CHINA, FILED 9-18-2013.

**亿思达**

THE MARK CONSISTS OF CHINESE CHARACTERS. THE NON-LATIN CHARACTERS IN THE MARK TRANSLITERATE TO YI SI DA AND THIS HAS NO MEANING IN A FOREIGN LANGUAGE.  
FOR LEGAL SERVICES, NAMELY, INTELLECTUAL PROPERTY LAW SERVICES IN THE AREAS OF PATENTS, TRADEMARKS, AND COPYRIGHTS (U.S. CLS. 100 AND 101).  
TINA L. SNAPP, EXAMINING ATTORNEY

---

SN 86-069,149. ALUM COMMUNITY, INC., REDWOOD CITY, CA. FILED 9-19-2013.

**alumcommunity**

THE MARK CONSISTS OF THE WORDS "ALUMCOMMUNITY" WITH A MORTAR BOARD CAP ABOVE THE "A".  
FOR ON-LINE SOCIAL NETWORKING SERVICES (U.S. CLS. 100 AND 101).  
MORGAN WYNNE, EXAMINING ATTORNEY

---

SN 86-070,446. ASIG LIMITED, EGHAM, SURREY, UNITED KINGDOM, FILED 9-20-2013.

**Your Life  is in Your Hands**

THE MARK CONSISTS OF THE WORDS "YOUR LIFE" TO THE SIDE OF AN UNBUCKLED SEATBELT WITH AN ELECTROCARDIOGRAM ABOVE THE SEATBELT. THE WORDS "IS IN YOUR HANDS" ARE BELOW THE WORDS "YOUR LIFE" AND THE SEATBELT.  
FOR PROVIDING INFORMATION CONCERNING AVIATION AND AUTOMOBILE SAFETY (U.S. CLS. 100 AND 101).  
FIRST USE 9-16-2013; IN COMMERCE 9-16-2013.  
ROSELLE HERRERA, EXAMINING ATTORNEY

**CLASS 45—(Continued).**

SN 86-070,826. LORNE E. BERKELEY, CORAL GABLES, FL. FILED 9-20-2013.

**LORNE E. BERKELEY**

THE MARK CONSISTS OF STANDARD CHARACTERS WITHOUT CLAIM TO ANY PARTICULAR FONT, STYLE, SIZE, OR COLOR.

THE NAME "LORNE E. BERKELEY" IDENTIFIES A LIVING INDIVIDUAL WHOSE CONSENT IS OF RECORD.

FOR LEGAL SERVICES; LEGAL SERVICES, NAMELY, INTELLECTUAL PROPERTY CONSULTING SERVICES IN THE FIELD OF IDENTIFICATION, STRATEGY, ANALYTICS, AND INVENTION; LEGAL SERVICES, NAMELY, PREPARATION OF APPLICATIONS FOR TRADEMARK REGISTRATION; LEGAL SERVICES, NAMELY, PROVIDING CUSTOMIZED DOCUMENTATION, INFORMATION, COUNSELING, ADVICE AND CONSULTATION SERVICES IN ALL AREAS OF CONSTRUCTION LITIGATION, ARCHITECTS AND ENGINEERS ERRORS AND OMISSIONS, CONSTRUCTION LIEN CLAIMS AND DEFENSE, BUSINESS LITIGATION AND TRANSACTIONS, GENERAL CONTRACT NEGOTIATION AND FORMATION, CRIMINAL LAW, LABOR AND EMPLOYMENT LAW, FAMILY LAW, INTELLECTUAL PROPERTY LAW; LEGAL SERVICES, NAMELY, PROVIDING CUSTOMIZED INFORMATION, COUNSELING, ADVICE AND LITIGATION SERVICES IN ALL AREAS OF EMPLOYMENT AND LABOR LAW FOR BOTH EMPLOYEES AND EMPLOYERS (U.S. CLS. 100 AND 101).

FIRST USE 5-7-2004; IN COMMERCE 5-7-2004.  
B. PARADEWELAI, EXAMINING ATTORNEY

---

SN 86-070,947. MEETMYPUP LLC, CHATTANOOGA, TN. FILED 9-20-2013.



THE MARK CONSISTS OF A SILHOUETTE OF A FRENCH BULLDOG PARTIALLY SITTING INSIDE A CIRCLE.

FOR ONLINE SOCIAL NETWORKING SERVICES IN THE FIELD OF DOGS AND PETS (U.S. CLS. 100 AND 101).

SUNG IN, EXAMINING ATTORNEY

**CLASS 45—(Continued).**

SN 86-070,982. GREENBERG & BEDERMAN, LLP, SILVER SPRING, MD. FILED 9-20-2013.

**GREENBERG & BEDERMAN**

THE MARK CONSISTS OF STANDARD CHARACTERS WITHOUT CLAIM TO ANY PARTICULAR FONT, STYLE, SIZE, OR COLOR.

FOR LEGAL SERVICES (U.S. CLS. 100 AND 101).  
FIRST USE 10-15-1985; IN COMMERCE 10-15-1985.  
GEORGE LORENZO, EXAMINING ATTORNEY

---

SN 86-070,990. MALAMMA, INC., SAN FRANCISCO, CA. FILED 9-20-2013.

# TapRoot

THE MARK CONSISTS OF STANDARD CHARACTERS WITHOUT CLAIM TO ANY PARTICULAR FONT, STYLE, SIZE, OR COLOR.

FOR INTERNET-BASED SOCIAL NETWORKING SERVICES (U.S. CLS. 100 AND 101).  
JEAN IM, EXAMINING ATTORNEY

---

SN 86-071,591. INTERNATIONAL GOSPEL OUTREACH CHURCH INCORPORATED, SMYRNA, GA. FILED 9-23-2013.

**THE PROPHET'S PERSPECTIVE**

THE MARK CONSISTS OF STANDARD CHARACTERS WITHOUT CLAIM TO ANY PARTICULAR FONT, STYLE, SIZE, OR COLOR.

FOR RELIGIOUS AND SPIRITUAL SERVICES, NAMELY, CONDUCTING RELIGIOUS WORSHIP, MARRIAGE CEREMONIES, BAPTISMAL CEREMONIES, BABY DEDICATIONS, BEREAVEMENT CEREMONIES, AND RELIGIOUS COUNSELING (U.S. CLS. 100 AND 101).

FIRST USE 5-0-2013; IN COMMERCE 5-0-2013.  
ESTHER A. BORSUK, EXAMINING ATTORNEY

**CLASS 45—(Continued).**

SN 86-072,156. FUZZROCKET, LLC, MASON, OH. FILED 9-23-2013.

**FUZZROCKET**

THE MARK CONSISTS OF STANDARD CHARACTERS WITHOUT CLAIM TO ANY PARTICULAR FONT, STYLE, SIZE, OR COLOR.

FOR ONLINE SOCIAL NETWORKING SERVICES IN THE FIELD OF PERFORMING ARTS (U.S. CLS. 100 AND 101).

DAVID COLLIER, EXAMINING ATTORNEY

**CLASS 45—(Continued).**

SN 86-072,189. ILCXSA SERVICES, LLC, FLEMING ISLAND, FL. FILED 9-23-2013.

**Hswing**

THE MARK CONSISTS OF STANDARD CHARACTERS WITHOUT CLAIM TO ANY PARTICULAR FONT, STYLE, SIZE, OR COLOR.

FOR INTERNET BASED SOCIAL NETWORKING, INTRODUCTION, AND DATING SERVICES (U.S. CLS. 100 AND 101).

FIRST USE 6-1-2007; IN COMMERCE 6-1-2007.

MATTHEW EINSTEIN, EXAMINING ATTORNEY

SN 86-072,163. FUZZROCKET, LLC, MASON, OH. FILED 9-23-2013.



THE MARK CONSISTS OF THE WORDING "FUZZROCKET" IN LOWERCASE LETTERS, WITH THE "FUZZ" PORTION IN ITALICIZED TEXT, AND THREE CURVED DIAMONDS OF DIFFERENT SIZES LOCATED ABOVE THE LETTERS "O" AND "C" OF THE WORDING.

FOR ONLINE SOCIAL NETWORKING SERVICES IN THE FIELD OF PERFORMING ARTS (U.S. CLS. 100 AND 101).

DAVID COLLIER, EXAMINING ATTORNEY

SN 86-075,109. MEETMYPUP LLC, CHATTANOOGA, TN. FILED 9-26-2013.

**connecting dogs around the globe**

THE MARK CONSISTS OF STANDARD CHARACTERS WITHOUT CLAIM TO ANY PARTICULAR FONT, STYLE, SIZE, OR COLOR.

FOR ONLINE SOCIAL NETWORKING SERVICES IN THE FIELD OF DOGS AND PETS (U.S. CLS. 100 AND 101).

SUNG IN, EXAMINING ATTORNEY

SN 86-072,166. FUZZROCKET, LLC, MASON, OH. FILED 9-23-2013.



THE MARK CONSISTS OF A CIRCLE WITH A ROCKET INSIDE, AND THREE CURVED DIAMONDS OF DIFFERENT SIZES LOCATED BELOW THE ROCKET.

FOR ONLINE SOCIAL NETWORKING SERVICES IN THE FIELD OF PERFORMING ARTS (U.S. CLS. 100 AND 101).

DAVID COLLIER, EXAMINING ATTORNEY

SN 86-075,992. KAILEN ROSENBERG HOLDINGS L. L. C., WAYZATA, MN. FILED 9-26-2013.

**LOVE LIFE BLUEPRINT**

THE MARK CONSISTS OF STANDARD CHARACTERS WITHOUT CLAIM TO ANY PARTICULAR FONT, STYLE, SIZE, OR COLOR.

NO CLAIM IS MADE TO THE EXCLUSIVE RIGHT TO USE "LOVE LIFE", APART FROM THE MARK AS SHOWN.

FOR CONSULTING IN THE FIELD OF PERSONAL RELATIONSHIPS; COUNSELING IN THE FIELD OF PERSONAL DEVELOPMENT, NAMELY, SELF-IMPROVEMENT, SELF-FULFILLMENT, AND INTERPERSONAL COMMUNICATION; DATING SERVICES; MATCHMAKING SERVICES; PROVIDING INFORMATION IN THE FIELD OF PERSONAL DEVELOPMENT, NAMELY, SELF-IMPROVEMENT, SELF-FULFILLMENT, AND INTERPERSONAL COMMUNICATION (U.S. CLS. 100 AND 101).

FIRST USE 4-1-2009; IN COMMERCE 4-1-2009.

RONALD MCMORROW, EXAMINING ATTORNEY

**CLASS 45—(Continued).**

SN 86-076,097. MEETMYPUP LLC, CHATTANOOGA, TN. FILED 9-26-2013.

**meetmypup**

THE MARK CONSISTS OF THE STYLIZED WRITING "MEETMYPUP" WITH NO SPACES AND THE WORD "PUP" IS BOLD.

FOR ONLINE SOCIAL NETWORKING SERVICES IN THE FIELD OF DOGS AND PETS (U.S. CLS. 100 AND 101).

SUNG IN, EXAMINING ATTORNEY

SN 86-076,851. GOOGLE INC., MOUNTAIN VIEW, CA. FILED 9-27-2013.

**You Tube**

THE MARK CONSISTS OF THE WORD "YOU" AND THE WORD "TUBE" IN A VIEWING MONITOR.

FOR ON-LINE SOCIAL NETWORKING SERVICES (U.S. CLS. 100 AND 101).

KRISTIN CARLSON, EXAMINING ATTORNEY

SN 86-076,952. WORD OF FAITH INTERNATIONAL CHRISTIAN CENTER, SOUTHFIELD, MI. FILED 9-27-2013.



NO CLAIM IS MADE TO THE EXCLUSIVE RIGHT TO USE "SPECIAL SERVICES MINISTRY", APART FROM THE MARK AS SHOWN.

THE MARK CONSISTS OF A CIRCLE WITH THE WORDS "HEARING EYES SPECIAL SERVICES MINISTRY" AROUND IT AND A HAND IN THE CENTER GESTURING I LOVE YOU IN SIGN LANGUAGE.

FOR EVANGELICAL AND MINISTERIAL SERVICES IN THE NATURE OF CONDUCTING CHURCH SERVICES AND PROMOTING CHRISTIAN BELIEFS THROUGH A RELIGIOUS ORGANIZATION FOR THE HEARING IMPAIRED; RELIGIOUS SERVICES, NAMELY, MINISTERIAL SERVICES, EVANGELICAL SERVICES, PREACHING SERVICES, CONDUCTING RELIGIOUS SERVICES, AND PERSONAL RELIGIOUS COUNSELING FOR THE HEARING IMPAIRED (U.S. CLS. 100 AND 101).

GISELLE AGOSTO, EXAMINING ATTORNEY

**CLASS 45—(Continued).**

SN 86-077,039. PEAK ALARM COMPANY, INC., SALT LAKE CITY, UT. FILED 9-27-2013.



NO CLAIM IS MADE TO THE EXCLUSIVE RIGHT TO USE "ALARM", APART FROM THE MARK AS SHOWN.

THE COLOR(S) RED, WHITE AND BLACK IS/ARE CLAIMED AS A FEATURE OF THE MARK.

THE MARK CONSISTS OF THE RED LETTERS "PEAK" IMMEDIATELY FOLLOWED BY THE BLACK LETTERS "ALARM" WITH A BADGE DESIGN IMMEDIATELY ABOVE THE BLACK LETTERS "ALARM" THAT CONSISTS OF A LEFT SIDE THAT IS RED WITH THE WHITE LETTERS "PEAK", A MIDDLE ROUNDED TRAPEZOIDAL SHAPE OUTLINED IN BLACK WITH BLACK AND WHITE MOUNTAIN PEAKS AND WHITE SKY INSIDE THE SHAPE AND A LEFT SIDE THAT IS READ WITH THE WHITE LETTERS "ALARM", ALL OUTLINED IN BLACK. THE BACKGROUND OF THE MARK IS TRANSPARENT.

FOR ALARM RESPONSE AND VERIFICATION SERVICES (U.S. CLS. 100 AND 101).

FIRST USE 1-1-1976; IN COMMERCE 1-1-1976.

MORGAN WYNNE, EXAMINING ATTORNEY

SN 86-078,229. VICTORY OUTREACH INTERNATIONAL, SAN DIMAS, CA. FILED 9-30-2013.

**TWILIGHT TREASURE MINISTRY**

THE MARK CONSISTS OF STANDARD CHARACTERS WITHOUT CLAIM TO ANY PARTICULAR FONT, STYLE, SIZE, OR COLOR.

NO CLAIM IS MADE TO THE EXCLUSIVE RIGHT TO USE "MINISTRY", APART FROM THE MARK AS SHOWN. FOR EVANGELISTIC AND MINISTERIAL SERVICES (U.S. CLS. 100 AND 101).

FIRST USE 1-1-1996; IN COMMERCE 1-1-1996.

JILLIAN CANTOR, EXAMINING ATTORNEY



**CLASS 45—(Continued).**

SN 86-078,231. VICTORY OUTREACH INTERNATIONAL,  
SAN DIMAS, CA. FILED 9-30-2013.

VICTORY OUTREACH  
INTERNATIONAL

THE MARK CONSISTS OF STANDARD CHARACTERS  
WITHOUT CLAIM TO ANY PARTICULAR FONT, STYLE,  
SIZE, OR COLOR.

OWNER OF U.S. REG. NOS. 3,384,310, 4,197,038 AND  
OTHERS.

NO CLAIM IS MADE TO THE EXCLUSIVE RIGHT TO  
USE "OUTREACH INTERNATIONAL", APART FROM THE  
MARK AS SHOWN.

FOR EVANGELISTIC AND MINISTERIAL SERVICES  
(U.S. CLS. 100 AND 101).

FIRST USE 9-0-1972; IN COMMERCE 9-0-1972.  
JILLIAN CANTOR, EXAMINING ATTORNEY

**CLASS 45—(Continued).**

SN 86-091,197. BOURNE LOGISTICS MARKETING, LTD.,  
SILVER SPRINGS, NV. FILED 10-14-2013.

BLACK BEACH

THE MARK CONSISTS OF STANDARD CHARACTERS  
WITHOUT CLAIM TO ANY PARTICULAR FONT, STYLE,  
SIZE, OR COLOR.

FOR CONCIERGE SERVICES FOR OTHERS COM-  
PRISING MAKING REQUESTED PERSONAL AR-  
RANGEMENTS AND RESERVATIONS AND  
PROVIDING CUSTOMER-SPECIFIC INFORMATION TO  
MEET INDIVIDUAL NEEDS RENDERED TOGETHER  
IN A SPECIAL EVENTS, ENTERTAINMENT AND HO-  
SPITALITY COMPANY; HOTEL CONCIERGE SERVICES;  
PERSONAL CONCIERGE SERVICES FOR OTHERS  
COMPRISING MAKING REQUESTED PERSONAL AR-  
RANGEMENTS AND RESERVATIONS, RUNNING ER-  
RANDS AND PROVIDING CUSTOMER SPECIFIC  
INFORMATION TO MEET INDIVIDUAL NEEDS, ALL  
RENDERED IN BUSINESS ESTABLISHMENTS, OFFICE  
BUILDINGS, HOTELS, RESIDENTIAL COMPLEXES  
AND HOMES (U.S. CLS. 100 AND 101).

FIRST USE 0-0-2000; IN COMMERCE 0-0-2000.  
MARTHA SANTOMARTINO, EXAMINING ATTORNEY

SN 86-082,889. BLUCARAT LLC, NEW YORK, NY. FILED 10-  
4-2013.

BLUCARAT

THE MARK CONSISTS OF STANDARD CHARACTERS  
WITHOUT CLAIM TO ANY PARTICULAR FONT, STYLE,  
SIZE, OR COLOR.

FOR ON-LINE AND INTERNET SOCIAL NETWORK-  
ING SERVICES; PROVIDING SOCIAL NETWORKING  
SERVICES FOR PURPOSES OF COMMENTARY, COM-  
PARISON, COLLABORATION, CONSULTATION, EVA-  
LUATION, ADVICE, DISCUSSION, RESEARCH,  
NOTIFICATION, REPORTING, IDENTIFICATION, IN-  
FORMATION SHARING, INDEXING, ENTERTAIN-  
MENT, PLEASURE, OR GENERAL INTEREST;  
PROVIDING ON-LINE COMPUTER DATABASES AND  
ON-LINE SEARCHABLE DATABASES IN THE FIELD OF  
SOCIAL NETWORKING (U.S. CLS. 100 AND 101).

RONALD MCMORROW, EXAMINING ATTORNEY

SN 86-092,619. PCS HOLDINGS, LLC, ORLANDO, FL. FILED  
10-16-2013.



OWNER OF U.S. REG. NOS. 4,096,165 AND 4,096,166.

NO CLAIM IS MADE TO THE EXCLUSIVE RIGHT TO  
USE "TIMESHARE PRO" AND "YOUR TIMESHARE TITLE  
CLOSER", APART FROM THE MARK AS SHOWN.

THE COLOR(S) BLUE, BLACK AND WHITE IS/ARE  
CLAIMED AS A FEATURE OF THE MARK.

THE MARK CONSISTS OF THE WORDING "TIMESHARE  
PRO" IN BLUE STYLIZED FONT OUTLINED IN BLACK,  
THREE BLUE-COLORED WAVY HORIZONTAL LINES  
AND THE BLUE STYLIZED WORD "PLUS" OUTLINED IN  
WHITE ALL SUPERIMPOSED OVER A BLACK-COLORED  
CROSS DESIGN AND THE BLACK STYLIZED WORDS  
"YOUR TIMESHARE TITLE CLOSER".

FOR REAL ESTATE CLOSING SERVICES (U.S. CLS.  
100 AND 101).

FIRST USE 9-20-2013; IN COMMERCE 9-20-2013.  
DAVID YONTEF, EXAMINING ATTORNEY

**CLASS 45—(Continued).**

SN 86-105,142. NANCY S. BROWN, DBA DYNAMIC CONFLICT RESOLUTION, LEES SUMMIT, MO. FILED 10-30-2013.



**Dynamic Conflict Resolution**  
A Vital, Interactive Process

NO CLAIM IS MADE TO THE EXCLUSIVE RIGHT TO USE "CONFLICT RESOLUTION" AND "INTERACTIVE PROCESS", APART FROM THE MARK AS SHOWN.

THE COLOR(S) BLACK, LIGHT BROWN, DARK BROWN, MEDIUM BROWN, PEACH, AND TAN IS/ARE CLAIMED AS A FEATURE OF THE MARK.

THE MARK CONSISTS OF THREE PEOPLE DEPICTED IN THE COLOR BROWN, WITH TWO PEOPLE GIVING EACH OTHER HIGH FIVES CONNECTED TO A THIRD PERSON IN THE MIDDLE ALL DEPICTED IN A CIRCLE. THE CIRCLE RESEMBLES A PIE SHAPE DESIGN WITH THE COLORS LIGHT BROWN, DARK BROWN, MEDIUM BROWN, PEACH, AND TAN ALTERNATING AROUND THE CIRCLE. THE WORDING "DYNAMIC CONFLICT RESOLUTION" APPEARS ABOVE THE WORDING "A VITAL, INTERACTIVE PROCESS" ALL IN THE COLOR BLACK AND TO THE UPPER SIDE CORNER OF THE DESIGN ELEMENT.

FOR ALTERNATIVE DISPUTE RESOLUTION; ALTERNATIVE DISPUTE RESOLUTION SERVICES (U.S. CLS. 100 AND 101).

FIRST USE 10-7-2013; IN COMMERCE 10-7-2013.  
DARRYL SPRUILL, EXAMINING ATTORNEY

SN 86-107,564. SMALLEY FAMILY HOLDINGS, LLC, ORLANDO, FL. FILED 11-1-2013.

**The Power of Nevada Corporations**

THE MARK CONSISTS OF STANDARD CHARACTERS WITHOUT CLAIM TO ANY PARTICULAR FONT, STYLE, SIZE, OR COLOR.

NO CLAIM IS MADE TO THE EXCLUSIVE RIGHT TO USE "NEVADA CORPORATIONS", APART FROM THE MARK AS SHOWN.

FOR LEGAL DOCUMENT PREPARATION SERVICES (U.S. CLS. 100 AND 101).

FIRST USE 10-31-2013; IN COMMERCE 10-31-2013.  
RENEE MCCRAY, EXAMINING ATTORNEY

**CLASS 45—(Continued).**

SN 86-113,940. ROYAL PALM COMPANIES, LLC, FORT LAUDERDALE, FL. FILED 11-8-2013.

**PARAMOUNT RESIDENCES**

THE MARK CONSISTS OF STANDARD CHARACTERS WITHOUT CLAIM TO ANY PARTICULAR FONT, STYLE, SIZE, OR COLOR.

NO CLAIM IS MADE TO THE EXCLUSIVE RIGHT TO USE "RESIDENCES", APART FROM THE MARK AS SHOWN.

FOR PERSONAL CONCIERGE SERVICES FOR OTHERS COMPRISING MAKING REQUESTED PERSONAL ARRANGEMENTS AND RESERVATIONS, RUNNING ERRANDS AND PROVIDING CUSTOMER SPECIFIC INFORMATION TO MEET INDIVIDUAL NEEDS, ALL RENDERED IN RESIDENTIAL COMPLEXES AND HOMES (U.S. CLS. 100 AND 101).

PATRICIA EVANKO, EXAMINING ATTORNEY

SN 86-119,574. BOURNE LOGISTICS MARKETING, LTD., SILVER SPRINGS, NV. FILED 11-14-2013.

**ATLANTA EXPLOSION**

THE MARK CONSISTS OF STANDARD CHARACTERS WITHOUT CLAIM TO ANY PARTICULAR FONT, STYLE, SIZE, OR COLOR.

NO CLAIM IS MADE TO THE EXCLUSIVE RIGHT TO USE "ATLANTA", APART FROM THE MARK AS SHOWN.

FOR CONCIERGE SERVICES FOR OTHERS COMPRISING MAKING REQUESTED PERSONAL ARRANGEMENTS AND RESERVATIONS AND PROVIDING CUSTOMER-SPECIFIC INFORMATION TO MEET INDIVIDUAL NEEDS RENDERED TOGETHER IN A SPECIAL EVENTS, SECRET-SOCIETY EVENTS, ENTERTAINMENT AND HOSPITALITY COMPANY; HOTEL CONCIERGE SERVICES; PERSONAL CONCIERGE SERVICES FOR OTHERS COMPRISING MAKING REQUESTED PERSONAL ARRANGEMENTS AND RESERVATIONS, RUNNING ERRANDS AND PROVIDING CUSTOMER SPECIFIC INFORMATION TO MEET INDIVIDUAL NEEDS, ALL RENDERED IN BUSINESS ESTABLISHMENTS, OFFICE BUILDINGS, HOTELS, RESIDENTIAL COMPLEXES AND HOMES (U.S. CLS. 100 AND 101).

FIRST USE 0-0-2003; IN COMMERCE 0-0-2003.  
MARTHA SANTOMARTINO, EXAMINING ATTORNEY

**CLASS 45—(Continued).**

SN 86-131,874. FUZZROCKET, LLC, MASON, OH. FILED 11-29-2013.



THE COLOR(S) SILVER, BLACK, RED, YELLOW, ORANGE AND GREEN IS/ARE CLAIMED AS A FEATURE OF THE MARK.

THE MARK CONSISTS OF A SILVER ROCKET WITH BLACK PANEL OUTLINES, RED FINS, A YELLOW AND ORANGE FLAME, AND A PAIR OF GREEN WINDOWS, DEPICTED IN FLIGHT.

FOR ONLINE SOCIAL NETWORKING SERVICES IN THE FIELD OF PERFORMING ARTS (U.S. CLS. 100 AND 101).

DAVID COLLIER, EXAMINING ATTORNEY

\* \* \* \* \*

## SECTION 4.—PRIOR UNITED STATES CLASSIFICATION

### APPLICATION IN ONE CLASS

#### COLLECTIVE MEMBERSHIP MARKS

CLASS 200—COLLECTIVE MEMBERSHIP  
SN 86-036,585. THE HANDCRAFTED SOAP AND COSMETIC GUILD, INC., SARATOGA SPRINGS, NY. FILED 8-13-2013.



NO CLAIM IS MADE TO THE EXCLUSIVE RIGHT TO USE "HANDCRAFTED SOAP & COSMETIC GUILD MEMBER", APART FROM THE MARK AS SHOWN.

THE COLOR(S) LIGHT GREEN, DARK GREEN, WHITE, GRAY, BEIGE, AND TAN IS/ARE CLAIMED AS A FEATURE OF THE MARK.

THE MARK CONSISTS OF A DARK GREEN DIAMOND BORDERED BY A WHITE DIAMOND BORDERED BY A LIGHT GREEN DIAMOND. INSIDE THE DARK GREEN DIAMOND ARE TWO BEIGE AND TAN HANDS HOLDING A GRAY, LIGHT GREEN, AND WHITE CONTAINER AND GRAY AND WHITE BAR OF SOAP. BELOW THIS APPEARS A LIGHT GREEN BANNER WITH THE WORDING "HANDCRAFTED SOAP & COSMETIC GUILD" IN WHITE, ABOVE A DARK GREEN BANNER WITH THE WORDING "MEMBER" IN LIGHT GREEN.

FOR INDICATING MEMBERSHIP IN A(N) ORGANIZATION WHOSE MEMBERS MAKE SOAP, COSMETICS, OR SOAP AND COSMETICS.

FIRST USE 7-15-2013; IN COMMERCE 7-15-2013.  
KRISTIN DAHLING, EXAMINING ATTORNEY

SN 86-104,769. MUSIC TEACHERS' ASSOCIATION OF CALIFORNIA, SAN FRANCISCO, CA. FILED 10-29-2013.

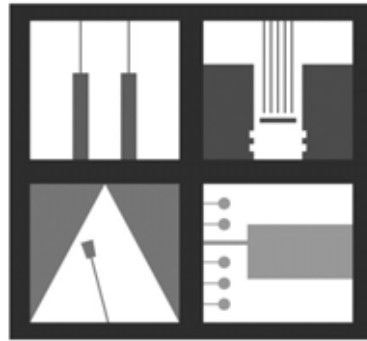

THE MARK CONSISTS OF THE STYLIZED LETTERS "MTAC" IN A SQUARE CONFIGURATION, WHEREIN THE "M" SUGGESTS THE KEYS OF A PIANO, THE "T" SUGGESTS THE NECK AND FRET OF A STRINGED INSTRUMENT, THE "A" SUGGESTS A METRONOME, AND THE "C" SUGGESTS KEY PADS OF A WIND INSTRUMENT.

FOR INDICATING MEMBERSHIP IN AN ASSOCIATION OF PROFESSIONAL MUSIC TEACHERS.

FIRST USE 8-28-2013; IN COMMERCE 8-28-2013.  
BARBARA GAYNOR, EXAMINING ATTORNEY

#### CERTIFICATION MARKS

#### CLASS B—SERVICES

SN 86-036,747. AMERICAN NATIONAL STANDARDS INSTITUTE, INCORPORATED, NEW YORK, NY. FILED 8-13-2013.



OWNER OF U.S. REG. NOS. 906,230, 3,081,726 AND OTHERS.

NO CLAIM IS MADE TO THE EXCLUSIVE RIGHT TO USE "ACCREDITED", APART FROM THE MARK AS SHOWN.

THE COLOR(S) BLUE AND WHITE IS/ARE CLAIMED AS A FEATURE OF THE MARK.

THE MARK CONSISTS OF A DESIGN OF AN OVAL IN BLUE WITH THE WORDS "ANSI ACCREDITED" IN WHITE. AROUND THE UPPER LEFT SIDE OF THE OVAL IS A CRESCENT IN BLUE.

THE CERTIFICATION MARK, AS INTENDED TO BE USED BY THOSE AUTHORIZED BY CERTIFIER, IS INTENDED TO CERTIFY THAT BODIES THAT OFFER CERTIFICATION, VALIDATION OR VERIFICATION (CONFORMITY ASSESSMENT) SERVICES HAVE BEEN ASSESSED AND RECOGNIZED COMPETENT IN ACCORDANCE WITH INTERNATIONAL AND INDUSTRY STANDARDS AS WELL AS CERTIFIER'S OWN POLICIES AND PROCEDURES.

FOR ACCREDITATION OF BODIES THAT PROVIDE CERTIFICATION, VALIDATION OR VERIFICATION OF PRODUCTS, SERVICES, PROCESSES, PERSONS, CERTIFICATES OR GREENHOUSE GAS ASSERTIONS, SUCH BODIES BEING DEFINED IN INTERNATIONAL STANDARDS AS CONFORMITY ASSESSMENT BODIES.

JENNIFER WILLISTON, EXAMINING ATTORNEY

SN 86-043,011. THE HANDCRAFTED SOAP AND COSMETIC GUILD, INC., SARATOGA SPRINGS, NY. FILED 8-20-2013.



NO CLAIM IS MADE TO THE EXCLUSIVE RIGHT TO USE "HANDCRAFTED SOAP & COSMETIC GUILD CERTIFIED SOAPMAKER", APART FROM THE MARK AS SHOWN.

THE COLOR(S) LIGHT GREEN, DARK GREEN, WHITE, GRAY, BEIGE AND TAN IS/ARE CLAIMED AS A FEATURE OF THE MARK.

THE MARK CONSISTS OF A DARK GREEN DIAMOND BORDERED BY A WHITE DIAMOND BORDERED BY A LIGHT GREEN DIAMOND. INSIDE THE DARK GREEN DIAMOND ARE TWO BEIGE AND TAN HANDS HOLDING A GRAY, LIGHT GREEN, AND WHITE CONTAINER AND GRAY AND WHITE BAR OF SOAP. BELOW THIS APPEARS A LIGHT GREEN BANNER WITH THE WORDING "HANDCRAFTED SOAP & COSMETIC GUILD" IN WHITE, ABOVE A DARK GREEN BANNER WITH THE WORDING "CERTIFIED SOAPMAKER" IN LIGHT GREEN.

THE CERTIFICATION MARK, AS USED BY AN AUTHORIZED PERSON, CERTIFIED THAT HE OR SHE HAS PASSED EXAMINATIONS DESIGNED TO MEASURE HIS OR HER PROFICIENCY IN MAKING SOAP AND THAT HE OR SHE HAS PLEDGED TO MEET OR EXCEED CERTAIN STANDARDS WHEN MAKING SOAP.

FOR SOAPMAKING.

FIRST USE 7-30-2013; IN COMMERCE 7-30-2013.

KRISTIN DAHLING, EXAMINING ATTORNEY

SN 86-036,823. AMERICAN NATIONAL STANDARDS INSTITUTE, INCORPORATED, NEW YORK, NY. FILED 8-13-2013.



OWNER OF U.S. REG. NOS. 906,230, 3,081,726 AND OTHERS.

NO CLAIM IS MADE TO THE EXCLUSIVE RIGHT TO USE "ACCREDITED", APART FROM THE MARK AS SHOWN.

THE MARK CONSISTS OF A DESIGN OF AN OVAL WITH THE WORDS "ANSI ACCREDITED". AROUND THE UPPER LEFT SIDE OF THE OVAL IS A CRESCENT.

THE CERTIFICATION MARK, AS INTENDED TO BE USED BY THOSE AUTHORIZED BY CERTIFIER, IS INTENDED TO CERTIFY THAT BODIES THAT OFFER CERTIFICATION, VALIDATION OR VERIFICATION (CONFORMITY ASSESSMENT) SERVICES HAVE BEEN ASSESSED AND RECOGNIZED COMPETENT IN ACCORDANCE WITH INTERNATIONAL AND INDUSTRY STANDARDS AS WELL AS CERTIFIER'S OWN POLICIES AND PROCEDURES.

FOR ACCREDITATION OF BODIES THAT PROVIDE CERTIFICATION, VALIDATION OR VERIFICATION OF PRODUCTS, SERVICES, PROCESSES, PERSONS, CERTIFICATES OR GREENHOUSE GAS ASSERTIONS, SUCH BODIES BEING DEFINED IN INTERNATIONAL STANDARDS AS CONFORMITY ASSESSMENT BODIES.

JENNIFER WILLISTON, EXAMINING ATTORNEY

SN 86-043,096. THE HANDCRAFTED SOAP AND COSMETIC GUILD, INC., SARATOGA SPRINGS, NY. FILED 8-20-2013.



NO CLAIM IS MADE TO THE EXCLUSIVE RIGHT TO USE "HANDCRAFTED SOAP & COSMETIC GUILD TEACHER", APART FROM THE MARK AS SHOWN.

THE COLOR(S) LIGHT GREEN, DARK GREEN, WHITE, GRAY, BEIGE AND TAN IS/ARE CLAIMED AS A FEATURE OF THE MARK.

THE MARK CONSISTS OF A DARK GREEN DIAMOND BORDERED BY A WHITE DIAMOND BORDERED BY A LIGHT GREEN DIAMOND. INSIDE THE DARK GREEN DIAMOND ARE TWO BEIGE AND TAN HANDS HOLDING A GRAY, LIGHT GREEN, AND WHITE CONTAINER AND GRAY AND WHITE BAR OF SOAP. BELOW THIS APPEARS A LIGHT GREEN BANNER WITH THE WORDING "HAND-CRAFTED SOAP & COSMETIC GUILD" IN WHITE, ABOVE A DARK GREEN BANNER WITH THE WORDING "TEACHER" IN LIGHT GREEN.

THE CERTIFICATION MARK, AS USED BY AN AUTHORIZED PERSON, CERTIFIES THAT HE OR SHE HAS PASSED EXAMINATIONS DESIGNED TO MEASURE HIS OR HER PROFICIENCY IN MAKING SOAP, THAT HE OR SHE HAS PLEDGED TO MEET OR EXCEED CERTAIN STANDARDS WHEN MAKING SOAP, AND THAT HE OR SHE HAS TAUGHT THE ART OF MAKING SOAP FOR A MINIMUM NUMBER OF HOURS.

FOR CLASSES AND TRAINING IN THE FIELD OF SOAPMAKING.

FIRST USE 7-30-2013; IN COMMERCE 7-30-2013. KRISTIN DAHLING, EXAMINING ATTORNEY

SN 86-069,583. NATIONAL STRENGTH AND CONDITIONING ASSOCIATION, COLORADO SPRINGS, CO. FILED 9-19-2013.

# CSPS

THE MARK CONSISTS OF STANDARD CHARACTERS WITHOUT CLAIM TO ANY PARTICULAR FONT, STYLE, SIZE, OR COLOR.

OWNER OF U.S. REG. NOS. 2,290,968 AND 2,561,457. THE CERTIFICATION MARK, AS USED BY AUTHORIZED PERSONS, CERTIFIES THAT THE SERVICES ARE BEING PERFORMED BY A PERSON MEETING STANDARDS AND TESTS OF COMPETENCY, SKILL, EXPERIENCE AND KNOWLEDGE SET BY THE CERTIFIER.

FOR PHYSICAL TRAINING AND CONDITIONING SERVICES.

FIRST USE 7-11-2012; IN COMMERCE 7-11-2012. MICHAEL KEATING, EXAMINING ATTORNEY

SN 86-066,765. DISTANT SHORES MEDIA, MINNEAPOLIS, MN. FILED 9-17-2013.

SN 86-094,682. THE COLLECTION HOLDINGS, LLC, COLUMBUS, OH. FILED 10-17-2013.

# The Collection

# Unfolding Word

THE MARK CONSISTS OF STANDARD CHARACTERS WITHOUT CLAIM TO ANY PARTICULAR FONT, STYLE, SIZE, OR COLOR.

THE CERTIFICATION MARK, AS INTENDED TO BE USED BY AUTHORIZED PERSONS, IS INTENDED TO CERTIFY THAT BEAUTY SALON SERVICES ARE PROVIDED BY MEMBERS OF THE CERTIFIERS' ORGANIZATION, MEETING THE CERTIFIED STANDARD THAT THE USER IS DULY LICENSED BY THE PROPER STATE BOARD OR AUTHORITY TO RENDER THE APPLICABLE BEAUTY SALON SERVICES AND POSSESS THE REQUIRED SKILL LEVEL OR QUALIFICATIONS SET BY SUCH BOARD OR AUTHORITATIVE ENTITY TO RENDER SUCH SERVICES.

FOR BEAUTY SALON SERVICES; BEAUTY SALONS; BEAUTY SPA SERVICES, NAMELY, COSMETIC BODY CARE; HAIR COLOR SALON SERVICES; HAIR SALON SERVICES; MAKING RESERVATIONS AND BOOKINGS FOR OTHERS AT BEAUTY SALONS; MAKING RESERVATIONS AND BOOKINGS FOR OTHERS FOR PHYSICAL AND BEAUTY TREATMENTS AT HEALTH SPAS; RENTAL OF MACHINES AND APPARATUS FOR USE IN BEAUTY SALONS OR BARBERS' SHOPS; SALON SERVICES, NAMELY, FACIALS, MANICURES AND MASSAGES; SKIN CARE SALONS.

SHANNON TWOHIG, EXAMINING ATTORNEY

THE MARK CONSISTS OF STANDARD CHARACTERS WITHOUT CLAIM TO ANY PARTICULAR FONT, STYLE, SIZE, OR COLOR.

THE CERTIFICATION MARK, AS INTENDED TO BE USED BY PERSONS AUTHORIZED BY THE CERTIFIER, IS INTENDED TO CERTIFY THAT THE CONTENT PROVIDED ADHERES TO PARTICULAR STANDARDS OF CHRISTIAN BELIEF AND IS SUBJECT TO PARTICULAR OPEN SOURCE LICENSES.

FOR PROVIDING PUBLISHING AND TRANSLATION SERVICES FOR AUDIO, VIDEO, PRINT, MOBILE PHONE AND WEBSITE APP CONTENT.

KELLY TRUSILO, EXAMINING ATTORNEY

\* \* \* \* \*

# TRADEMARK REGISTRATIONS ISSUED

## PRINCIPAL REGISTER

### SECTION 1.— INTERNATIONAL CLASSIFICATION

The short titles associated below with the international class numbers are terms designed merely for quick identification and are not an official part of the international classification. The full names of international classes are given in section 6.1 of the trademark rules of practice.

The designation "U.S. Cl." appearing in this section refers to the U.S. class in effect prior to Sep. 1, 1973 rather than the international class which applies to applications filed on or after that date. For adoption of international classification see notice in the OFFICIAL GAZETTE of Jun. 26, 1973 (911 O.G. TM 210).

#### CLASS 1—CHEMICALS

- 4,479,243. **QB QUADBOSS AND DESIGN**. TUCKER-ROCKY CORPORATION, INC., MULTIPLE CLASS, (INT. CLS. 1, 6, 7, 9, 11, 12 AND 22), (U.S. CLS. 1, 2, 5, 6, 7, 10, 12, 13, 14, 19, 21, 22, 23, 25, 26, 31, 34, 35, 36, 38, 42, 44, 46 AND 50). SN 76-711,840. PUB. 11-26-2013. FILED 7-2-2012.
- 4,479,271. **VIVAFLO (STANDARD CHARACTER)**. DANISCO A/S, MULTIPLE CLASS, (INT. CLS. 1 AND 31), (U.S. CLS. 1, 5, 6, 10, 26 AND 46). SN 79-099,540. PUB. 11-26-2013. FILED 4-5-2011.
- 4,479,285. **AQUA PAD AND DESIGN**. CHRYSAL INTERNATIONAL B.V., MULTIPLE CLASS, (INT. CLS. 1, 17 AND 22), (U.S. CLS. 1, 2, 5, 6, 7, 10, 12, 13, 19, 22, 26, 35, 42, 46 AND 50). SN 79-113,697. PUB. 11-26-2013. FILED 4-12-2012.
- 4,479,334. **ALOAPUR (STANDARD CHARACTER)**. PURAC BIOCHEM B.V., MULTIPLE CLASS, (INT. CLS. 1, 5 AND 31), (U.S. CLS. 1, 5, 6, 10, 18, 26, 44, 46, 51 AND 52). SN 79-124,050. PUB. 11-26-2013. FILED 11-9-2012.
- 4,479,372. **EUDRAGUARD (STANDARD CHARACTER)**. EVO-NIK INDUSTRIES AG, MULTIPLE CLASS, (INT. CLS. 1, 2 AND 5), (U.S. CLS. 1, 5, 6, 10, 11, 16, 18, 26, 44, 46, 51 AND 52). SN 79-126,297. PUB. 11-26-2013. FILED 12-19-2012.
- 4,479,408. **CALZOT (STANDARD CHARACTER)**. ALZCHEM AG, MULTIPLE CLASS, (INT. CLS. 1 AND 6), (U.S. CLS. 1, 2, 5, 6, 10, 12, 13, 14, 23, 25, 26, 46 AND 50). SN 79-127,449. PUB. 11-26-2013. FILED 1-22-2013.
- 4,479,461. **GLOBALTHERM (STANDARD CHARACTER)**. GLOBAL OIL COMPANY (EUROPE) LIMITED, (U.S. CLS. 1, 5, 6, 10, 26 AND 46). SN 79-131,277. PUB. 11-26-2013. FILED 5-21-2013.
- 4,479,662. **PRIME GUARD (STANDARD CHARACTER)**. PRIME AUTOMOTIVE WAREHOUSE, LLC, AKA PRIME AUTOMOTIVE WAREHOUSE, MULTIPLE CLASS, (INT. CLS. 1, 4, 7 AND 9), (U.S. CLS. 1, 5, 6, 10, 13, 15, 19, 21, 23, 26, 31, 34, 35, 36, 38 AND 46). SN 85-636,006. PUB. 6-4-2013. FILED 5-25-2012.
- 4,479,686. **MISCELLANEOUS DESIGN**. INTEGRATED PROTECTIVE COATINGS INC., MULTIPLE CLASS, (INT. CLS. 1, 2 AND 42), (U.S. CLS. 1, 5, 6, 10, 11, 16, 26, 46, 100 AND 101). SN 85-658,782. PUB. 11-26-2013. FILED 6-22-2012.
- 4,479,762. **MANDO (STYLIZED)**. MANDO CORPORATION, (U.S. CLS. 1, 5, 6, 10, 26 AND 46). SN 85-748,802. PUB. 11-26-2013. FILED 10-9-2012.
- 4,479,763. **MANDO (STYLIZED)**. MANDO CORPORATION, (U.S. CLS. 1, 5, 6, 10, 26 AND 46). SN 85-748,867. PUB. 11-26-2013. FILED 10-9-2012.
- 4,479,793. **ENERGY SAVER BLACKS (STANDARD CHARACTER)**. SID RICHARDSON CARBON, LTD., DBA SID RICHARDSON CARBON & ENERGY CO., (U.S. CLS. 1, 5, 6, 10, 26 AND 46). SN 85-769,170. PUB. 11-26-2013. FILED 11-1-2012.
- 4,479,849. **BIOCELL COLLAGEN (STANDARD CHARACTER)**. BIOCELL TECHNOLOGY, LLC, (U.S. CLS. 1, 5, 6, 10, 26 AND 46). SN 85-791,815. PUB. 11-26-2013. FILED 11-30-2012.
- 4,479,851. **BIOCELL COLLAGEN AND DESIGN**. BIOCELL TECHNOLOGY, LLC, (U.S. CLS. 1, 5, 6, 10, 26 AND 46). SN 85-791,866. PUB. 11-26-2013. FILED 11-30-2012.
- 4,479,863. **AVENGER ORGANICS AND DESIGN**. CUTTING EDGE FORMULATIONS, INC., MULTIPLE CLASS, (INT. CLS. 1 AND 5), (U.S. CLS. 1, 5, 6, 10, 18, 26, 44, 46, 51 AND 52). SN 85-795,489. PUB. 11-26-2013. FILED 12-5-2012.
- 4,480,008. **ASH GROVE AND DESIGN**. ASH GROVE CEMENT COMPANY, MULTIPLE CLASS, (INT. CLS. 1, 2, 17 AND 19), (U.S. CLS. 1, 5, 6, 10, 11, 12, 13, 16, 26, 33, 35, 46 AND 50). SN 85-833,602. PUB. 11-26-2013. FILED 1-28-2013.
- 4,480,009. **ASH GROVE PRO AND DESIGN**. ASH GROVE CEMENT COMPANY, MULTIPLE CLASS, (INT. CLS. 1, 2, 17 AND 19), (U.S. CLS. 1, 5, 6, 10, 11, 12, 13, 16, 26, 33, 35, 46 AND 50). SN 85-833,664. PUB. 11-26-2013. FILED 1-28-2013.
- 4,480,048. **RADIANTFLEX (STYLIZED)**. PHOSPHORTECH CORPORATION, DBA PHOSPHORTECH CORPORATION, (U.S. CLS. 1, 5, 6, 10, 26 AND 46). SN 85-850,050. PUB. 11-26-2013. FILED 2-14-2013.
- 4,480,053. **ENIVA (STANDARD CHARACTER)**. ENIVA USA, MULTIPLE CLASS, (INT. CLS. 1, 3 AND 5), (U.S. CLS. 1, 4, 5, 6, 10, 18, 26, 44, 46, 50, 51 AND 52). SN 85-851,637. PUB. 7-9-2013. FILED 2-15-2013.
- 4,480,083. **QUIK FIX (STANDARD CHARACTER)**. TECHNICAL RUBBER COMPANY, INC., (U.S. CLS. 1, 5, 6, 10, 26 AND 46). SN 85-861,919. PUB. 11-26-2013. FILED 2-27-2013.
- 4,480,102. **ALFAPRO (STANDARD CHARACTER)**. OMEGA PROTEIN CORPORATION, (U.S. CLS. 1, 5, 6, 10, 26 AND 46). SN 85-870,963. PUB. 11-26-2013. FILED 3-8-2013.
- 4,480,182. **INPRO (STANDARD CHARACTER)**. INPRO CORPORATION, MULTIPLE CLASS, (INT. CLS. 1, 20 AND 24), (U.S. CLS. 1, 2, 5, 6, 10, 13, 22, 25, 26, 32, 42, 46 AND 50). SN 85-900,960. PUB. 11-26-2013. FILED 4-10-2013.
- 4,480,183. **MISCELLANEOUS DESIGN**. HISAMITSU PHARMACEUTICAL CO., LTD., MULTIPLE CLASS, (INT. CLS. 1 AND 5), (U.S. CLS. 1, 5, 6, 10, 18, 26, 44, 46, 51 AND 52). SN 85-901,198. PUB. 11-26-2013. FILED 4-11-2013.
- 4,480,229. **BETABIO (STANDARD CHARACTER)**. S.S. STEINER, INC., MULTIPLE CLASS, (INT. CLS. 1 AND 5), (U.S. CLS. 1, 5, 6, 10, 18, 26, 44, 46, 51 AND 52). SN 85-913,740. PUB. 11-26-2013. FILED 4-24-2013.
- 4,480,350. **STEEL SEAL (STANDARD CHARACTER)**. BBB MANAGEMENT GROUP, LLC, (U.S. CLS. 1, 5, 6, 10, 26 AND 46). SN 85-941,780. PUB. 11-26-2013. FILED 5-24-2013.
- 4,480,421. **NU-GRO (STANDARD CHARACTER)**. WILBUR-ELLIS COMPANY, (U.S. CLS. 1, 5, 6, 10, 26 AND 46). SN 85-949,575. PUB. 8-6-2013. FILED 6-3-2013.
- 4,480,472. **DESERT JUICE CACTUS, AGAVE & SUCCULENT XERISCAPE FORMULA (STANDARD CHARACTER)**. MOON VALLEY NURSERY INC, (U.S. CLS. 1, 5, 6, 10, 26 AND 46). SN 85-956,550. PUB. 11-26-2013. FILED 6-11-2013.
- 4,480,516. **PERFEKT EARTH "HEAL THE EARTH HEAL YOURSELF" AND DESIGN**. JOHNSON, TALLY, (U.S. CLS. 1, 5, 6, 10, 26 AND 46). SN 85-962,360. PUB. 11-26-2013. FILED 6-18-2013.
- 4,480,547. **KOI LADY (STANDARD CHARACTER)**. WHITE KNIGHT COMMERCIAL FUNDING, LLC, DBA MIDWEST KOI AND KOI LADY PRODUCTS.COM, (U.S. CLS. 1, 5, 6, 10, 26 AND 46). SN 85-964,081. PUB. 11-26-2013. FILED 6-19-2013.
- 4,480,676. **CARB DEFENDER (STANDARD CHARACTER)**. DRIVEN RACING OIL, LLC, (U.S. CLS. 1, 5, 6, 10, 26 AND 46). SN 85-969,742. PUB. 11-26-2013. FILED 6-25-2013.

- 4,480,698. **MAD FARMER BE ONE (STANDARD CHARACTER)**. SOUTH COAST HORTICULTURAL SUPPLY, INC., (U.S. CLS. 1, 5, 6, 10, 26 AND 46). SN 85-970,844. PUB. 11-26-2013. FILED 6-26-2013.
- 4,480,704. **GANO EXCEL (STANDARD CHARACTER)**. GANO EXCEL INDUSTRIES SDN. BHD., MULTIPLE CLASS, (INT. CLS. 1, 3, 5, 30, 32 AND 35), (U.S. CLS. 1, 4, 5, 6, 10, 18, 26, 44, 45, 46, 48, 50, 51, 52, 100, 101 AND 102). SN 85-971,125. PUB. 11-26-2013. FILED 6-26-2013.
- 4,480,736. **CLICK-EASY (STANDARD CHARACTER)**. BERRY & ASSOCIATES, INC., (U.S. CLS. 1, 5, 6, 10, 26 AND 46). SN 85-972,704. PUB. 11-26-2013. FILED 6-28-2013.
- 4,481,098. **HF HOLLYFRONTIER (STYLIZED)**. HOLLYMARKS, LLC, (U.S. CLS. 1, 5, 6, 10, 26 AND 46). SN 86-004,440. PUB. 11-26-2013. FILED 7-8-2013.
- 4,481,106. **OMNIGROW (STANDARD CHARACTER)**. NEAL, DAVID E., AND MARTIN, SUSAN P., (U.S. CLS. 1, 5, 6, 10, 26 AND 46). SN 86-004,521. PUB. 11-26-2013. FILED 7-8-2013.
- 4,481,137. **COMBOTHERM (STANDARD CHARACTER)**. OCCIDENTAL CHEMICAL CORPORATION, (U.S. CLS. 1, 5, 6, 10, 26 AND 46). SN 86-005,088. PUB. 11-26-2013. FILED 7-9-2013.
- 4,481,140. **WELLIFE (STANDARD CHARACTER)**. HALLIBURTON ENERGY SERVICES, INC., (U.S. CLS. 1, 5, 6, 10, 26 AND 46). SN 86-005,109. PUB. 11-26-2013. FILED 7-9-2013.
- 4,481,179. **SPHEROLIP (STANDARD CHARACTER)**. MICHEL MERCIER PRODUCTS, DBA M.M.P., INC., (U.S. CLS. 1, 5, 6, 10, 26 AND 46). SN 86-005,684. PUB. 11-26-2013. FILED 7-9-2013.
- 4,481,182. **VEGELANE (STANDARD CHARACTER)**. MICHEL MERCIER PRODUCTS, DBA M.M.P., INC., (U.S. CLS. 1, 5, 6, 10, 26 AND 46). SN 86-005,694. PUB. 11-26-2013. FILED 7-9-2013.

## CLASS 2—PAINTS

- 4,479,270. **CORKWALL (STANDARD CHARACTER)**. AMORIM CORK COMPOSITES, S.A., MULTIPLE CLASS, (INT. CLS. 2 AND 17), (U.S. CLS. 1, 5, 6, 11, 12, 13, 16, 35 AND 50). SN 79-095,276. PUB. 11-26-2013. FILED 2-21-2011.
- 4,479,291. **ARTISTIX (STANDARD CHARACTER)**. XZILLION BV, MULTIPLE CLASS, (INT. CLS. 2, 8, 9, 16 AND 20), (U.S. CLS. 2, 5, 6, 11, 13, 16, 21, 22, 23, 25, 26, 28, 29, 32, 36, 37, 38, 44 AND 50). SN 79-115,712. PUB. 7-16-2013. FILED 2-16-2011.
- 4,479,372 ( See Class 1 for this trademark).
- 4,479,516. **C-FLOOR (STANDARD CHARACTER)**. CIN - CORPORAÇÃO INDUSTRIAL; DO NORTE, S.A., MULTIPLE CLASS, (INT. CLS. 2 AND 17), (U.S. CLS. 1, 5, 6, 11, 12, 13, 16, 35 AND 50). SN 79-136,611. PUB. 11-26-2013. FILED 6-6-2013.
- 4,479,582. **BLACKGOLD (STANDARD CHARACTER)**. MDS COATING TECHNOLOGIES CORPORATION, MULTIPLE CLASS, (INT. CLS. 2, 37, 40 AND 42), (U.S. CLS. 6, 11, 16, 100, 101, 103 AND 106). SN 85-533,679. PUB. 11-26-2013. FILED 2-3-2012.
- 4,479,606. **ENVIROVAR (STANDARD CHARACTER)**. SWIMC, INC., (U.S. CLS. 6, 11 AND 16). SN 85-578,434. PUB. 8-14-2012. FILED 3-23-2012.
- 4,479,609. **ENVIROMAX (STANDARD CHARACTER)**. SWIMC, INC., (U.S. CLS. 6, 11 AND 16). SN 85-579,715. PUB. 8-14-2012. FILED 3-26-2012.
- 4,479,686 ( See Class 1 for this trademark).
- 4,479,709. **CORROSION ENGINEERING AND DESIGN**. ERGON ASPHALT & EMULSIONS, INC., MULTIPLE CLASS, (INT. CLS. 2 AND 19), (U.S. CLS. 1, 6, 11, 12, 16, 33 AND 50). SN 85-687,294. PUB. 11-26-2013. FILED 7-26-2012.
- 4,479,710. **MISCELLANEOUS DESIGN**. ERGON ASPHALT & EMULSIONS, INC., MULTIPLE CLASS, (INT. CLS. 2 AND 19), (U.S. CLS. 1, 6, 11, 12, 16, 33 AND 50). SN 85-691,114. PUB. 11-26-2013. FILED 7-31-2012.
- 4,480,008 ( See Class 1 for this trademark).
- 4,480,009 ( See Class 1 for this trademark).
- 4,481,185. **ENDALL-RUST (STANDARD CHARACTER)**. SNEE CHEMICAL COMPANY, (U.S. CLS. 6, 11 AND 16). SN 86-005,749. PUB. 11-26-2013. FILED 7-9-2013.

## CLASS 3—COSMETICS AND CLEANING PREPARATIONS

- 4,479,246. **SHINEOLA (STANDARD CHARACTER)**. GLIP-TONE MANUFACTURING, INC., (U.S. CLS. 1, 4, 6, 50, 51 AND 52). SN 76-713,553. PUB. 7-23-2013. FILED 2-22-2013.
- 4,479,264. **CULTIVATE (STANDARD CHARACTER)**. RWACHSBERG HOLDINGS INC., (U.S. CLS. 1, 4, 6, 50, 51 AND 52). SN 77-954,612. PUB. 4-16-2013. FILED 3-9-2010.
- 4,479,272. **LONDINE (STYLIZED)**. LONDINE E.K., MULTIPLE CLASS, (INT. CLS. 3, 18 AND 25), (U.S. CLS. 1, 2, 3, 4, 6, 22, 39, 41, 50, 51 AND 52). SN 79-101,428. PUB. 11-26-2013. FILED 4-29-2011.
- 4,479,273. **BOSCO (STANDARD CHARACTER)**. BRANDS ENVIRONMENT ESTABLISHMENT, MULTIPLE CLASS, (INT. CLS. 3, 9, 14, 18, 20, 25, 28, 35, 41, 42 AND 43), (U.S. CLS. 1, 2, 3, 4, 6, 13, 21, 22, 23, 25, 26, 27, 28, 32, 36, 38, 39, 41, 50, 51, 52, 100, 101, 102 AND 107). SN 79-101,789. PUB. 12-25-2012. FILED 8-5-2011.
- 4,479,283. **CHRISTOPHER BAILEY (STANDARD CHARACTER)**. CHRISTOPHER BAILEY, MULTIPLE CLASS, (INT. CLS. 3, 9, 14, 18, 25, 35 AND 42), (U.S. CLS. 1, 2, 3, 4, 6, 21, 22, 23, 26, 27, 28, 36, 38, 39, 41, 50, 51, 52, 100, 101 AND 102). SN 79-113,317. PUB. 6-18-2013. FILED 10-6-2011.
- 4,479,289. **TEXTURES ZARA (STYLIZED)**. INDUSTRIA DE DISEÑO TEXTIL, S.A.; (INDITEX, S.A.), (U.S. CLS. 1, 4, 6, 50, 51 AND 52). SN 79-115,629. PUB. 11-26-2013. FILED 6-7-2012.
- 4,479,290. **VIVANCO AND DESIGN**. VIVANCO GMBH, MULTIPLE CLASS, (INT. CLS. 3, 9, 20 AND 35), (U.S. CLS. 1, 2, 4, 6, 13, 21, 22, 23, 25, 26, 32, 36, 38, 50, 51, 52, 100, 101 AND 102). SN 79-115,643. PUB. 11-26-2013. FILED 12-13-2011.
- 4,479,308. **SALMING (STANDARD CHARACTER)**. KING SALMING AB, MULTIPLE CLASS, (INT. CLS. 3, 25 AND 28), (U.S. CLS. 1, 4, 6, 22, 23, 38, 39, 50, 51 AND 52). SN 79-119,715. PUB. 11-26-2013. FILED 9-17-2012.
- 4,479,322. **CICASTIM (STANDARD CHARACTER)**. ACM, (U.S. CLS. 1, 4, 6, 50, 51 AND 52). SN 79-123,092. PUB. 11-26-2013. FILED 11-9-2012.
- 4,479,340. **PALAIS LUMIERE (STANDARD CHARACTER)**. PIERRE CARDIN, MULTIPLE CLASS, (INT. CLS. 3, 8, 18, 20, 21, 24, 25, 41 AND 43), (U.S. CLS. 1, 2, 3, 4, 6, 13, 22, 23, 25, 28, 29, 30, 32, 33, 39, 40, 41, 42, 44, 50, 51, 52, 100, 101 AND 107). SN 79-124,519. PUB. 11-26-2013. FILED 9-14-2012.
- 4,479,349. **CAPT N PAULS POLISH (STANDARD CHARACTER)**. MICHAEL SCHMIDT, MULTIPLE CLASS, (INT. CLS. 3 AND 16), (U.S. CLS. 1, 2, 4, 5, 6, 22, 23, 29, 37, 38, 50, 51 AND 52). SN 79-124,922. PUB. 11-26-2013. FILED 12-12-2012.
- 4,479,367. **MISCELLANEOUS DESIGN**. OUT FIT 7 LIMITED, MULTIPLE CLASS, (INT. CLS. 3, 9, 11, 14, 16, 18, 20, 21, 24, 25, 27, 28, 41 AND 42), (U.S. CLS. 1, 2, 3, 4, 5, 6, 13, 19, 20, 21, 22, 23, 25, 26, 27, 28, 29, 30, 31, 32, 33, 34, 36, 37, 38, 39, 40, 41, 42, 50, 51, 52, 100, 101 AND 107). SN 79-126,248. PUB. 11-26-2013. FILED 8-27-2012.
- 4,479,368. **TALKING PIERRE (STANDARD CHARACTER)**. OUT FIT 7 LIMITED, MULTIPLE CLASS, (INT. CLS. 3, 9, 11, 14, 16, 18, 20, 21, 24, 25, 27, 28, 41 AND 42), (U.S. CLS. 1, 2, 3, 4, 5, 6, 13, 19, 20, 21, 22, 23, 25, 26, 27, 28, 29, 30, 31, 32, 33, 34, 36, 37, 38, 39, 40, 41, 42, 50, 51, 52, 100, 101 AND 107). SN 79-126,249. PUB. 11-26-2013. FILED 8-27-2012.
- 4,479,395. **SOLAROMA (STANDARD CHARACTER)**. SOCIETE LABORATOIRES; D'AROMATOLOGIE APPLIQUEE, MULTIPLE CLASS, (INT. CLS. 3, 5, 29 AND 44), (U.S. CLS. 1, 4, 6, 18, 44, 46, 50, 51, 52, 100 AND 101). SN 79-126,968. PUB. 11-26-2013. FILED 11-9-2012.
- 4,479,404. **MISCELLANEOUS DESIGN**. S. TOUS, S.L., (U.S. CLS. 1, 4, 6, 50, 51 AND 52). SN 79-127,283. PUB. 11-26-2013. FILED 1-23-2013.
- 4,479,405. **MISCELLANEOUS DESIGN**. S. TOUS, S.L., (U.S. CLS. 1, 4, 6, 50, 51 AND 52). SN 79-127,284. PUB. 11-26-2013. FILED 1-23-2013.
- 4,479,434. **UEFA CHAMPIONS LEAGUE (STANDARD CHARACTER)**. UNION DES ASSOCIATIONS EUROPEENNES DE FOOTBALL (UEFA), MULTIPLE CLASS, (INT. CLS. 3, 4, 9, 12, 16, 18, 25, 28, 29, 32, 36, 37, 38, 39, 40, 41 AND 43), (U.S. CLS. 1, 2, 3, 4, 5, 6, 15, 19, 21, 22, 23, 26, 29, 31, 35, 36, 37, 38, 39, 41, 44, 45, 46, 48, 50, 51, 52, 100, 101, 102, 103, 104, 105, 106 AND 107). SN 79-128,886. PUB. 11-26-2013. FILED 1-11-2013.



- 4,479,438. **PLYZELBA (STANDARD CHARACTER)**. LEO PHARMA A/S, MULTIPLE CLASS, (INT. CLS. 3, 5 AND 10), (U.S. CLS. 1, 4, 6, 18, 26, 39, 44, 46, 50, 51 AND 52). SN 79-129,395. PUB. 7-9-2013. FILED 11-20-2012.
- 4,479,520. **ANNA INSPIRING JEWELLERY (STYLIZED)**. WENNA GMBH, MULTIPLE CLASS, (INT. CLS. 3 AND 18), (U.S. CLS. 1, 2, 3, 4, 6, 22, 41, 50, 51 AND 52). SN 79-975,301. PUB. 11-26-2013. FILED 1-22-2013.
- 4,479,530. **PUREZEE AND DESIGN**. DENISE LEMAY, MULTIPLE CLASS, (INT. CLS. 3 AND 11), (U.S. CLS. 1, 4, 6, 13, 21, 23, 31, 34, 50, 51 AND 52). SN 85-247,552. PUB. 11-26-2013. FILED 2-21-2011.
- 4,479,553. **SOFTSOAP PAMPERED HANDS JASMINE OASIS AND DESIGN**. IES ENTERPRISES, INC., (U.S. CLS. 1, 4, 6, 50, 51 AND 52). SN 85-437,091. PUB. 11-26-2013. FILED 9-30-2011.
- 4,479,558. **HOT KISS (STANDARD CHARACTER)**. HK WORLDWIDE LLC, MULTIPLE CLASS, (INT. CLS. 3, 9, 14, 18 AND 25), (U.S. CLS. 1, 2, 3, 4, 6, 21, 22, 23, 26, 27, 28, 36, 38, 39, 41, 50, 51 AND 52). SN 85-449,637. PUB. 3-27-2012. FILED 10-18-2011.
- 4,479,559. **FIRST KISS (STANDARD CHARACTER)**. HK WORLDWIDE LLC, MULTIPLE CLASS, (INT. CLS. 3, 9, 14, 18 AND 25), (U.S. CLS. 1, 2, 3, 4, 6, 21, 22, 23, 26, 27, 28, 36, 38, 39, 41, 50, 51 AND 52). SN 85-449,682. PUB. 3-27-2012. FILED 10-18-2011.
- 4,479,560. **HOT KISS AND DESIGN**. HK WORLDWIDE LLC, MULTIPLE CLASS, (INT. CLS. 3, 9, 14, 18 AND 25), (U.S. CLS. 1, 2, 3, 4, 6, 21, 22, 23, 26, 27, 28, 36, 38, 39, 41, 50, 51 AND 52). SN 85-449,746. PUB. 3-27-2012. FILED 10-18-2011.
- 4,479,568. **DAVID EMANUEL (STANDARD CHARACTER)**. DAVID LESLIE EMANUEL, MULTIPLE CLASS, (INT. CLS. 3, 9, 14, 16, 18, 21, 24, 25, 38 AND 41), (U.S. CLS. 1, 2, 3, 4, 5, 6, 13, 21, 22, 23, 26, 27, 28, 29, 30, 33, 36, 37, 38, 39, 40, 41, 42, 50, 51, 52, 100, 101, 104 AND 107). SN 85-474,678. PUB. 6-4-2013. FILED 11-16-2011.
- 4,479,571. **DRY SHOWER (STANDARD CHARACTER)**. ALEXANDER JAMES TRIMNELL, MULTIPLE CLASS, (INT. CLS. 3 AND 5), (U.S. CLS. 1, 4, 6, 18, 44, 46, 50, 51 AND 52). SN 85-480,235. PUB. 6-11-2013. FILED 11-23-2011.
- 4,479,572. **ULTRA BENEFITS (STANDARD CHARACTER)**. COSMEDICAL TECHNOLOGIES, INC., (U.S. CLS. 1, 4, 6, 50, 51 AND 52). SN 85-482,575. PUB. 5-8-2012. FILED 11-29-2011.
- 4,479,578. **MCQ (STYLIZED)**. AUTUMNPAPER LIMITED, MULTIPLE CLASS, (INT. CLS. 3, 9, 14, 18, 25 AND 35), (U.S. CLS. 1, 2, 3, 4, 6, 21, 22, 23, 26, 27, 28, 36, 38, 39, 41, 50, 51, 52, 100, 101 AND 102). SN 85-508,957. PUB. 6-11-2013. FILED 1-4-2012.
- 4,479,590. **CUTIBASE (STANDARD CHARACTER)**. CUTIMED, INC., (U.S. CLS. 1, 4, 6, 50, 51 AND 52). SN 85-546,050. PUB. 4-30-2013. FILED 2-17-2012.
- 4,479,591. **CUTIBASE CERAMYD AND DESIGN**. CUTIMED, INC., (U.S. CLS. 1, 4, 6, 50, 51 AND 52). SN 85-546,071. PUB. 10-16-2012. FILED 2-17-2012.
- 4,479,615. **AMARA HALAL COSMETICS AND DESIGN**. BAQI INC., (U.S. CLS. 1, 4, 6, 50, 51 AND 52). SN 85-599,729. PUB. 11-26-2013. FILED 4-17-2012.
- 4,479,671. **COUNTRY DIARY (STANDARD CHARACTER)**. LILYTIG LIMITED, AND ROWENA STOTT (DESIGNS) LIMITED, MULTIPLE CLASS, (INT. CLS. 3, 8, 11, 16, 20, 21, 24 AND 27), (U.S. CLS. 1, 2, 4, 5, 6, 13, 19, 20, 21, 22, 23, 25, 28, 29, 30, 31, 32, 33, 34, 37, 38, 40, 42, 44, 50, 51 AND 52). SN 85-645,726. PUB. 5-21-2013. FILED 6-7-2012.
- 4,479,703. **LIRIKOS MARINE UV WATER CUSHION (STANDARD CHARACTER)**. AMOREPACIFIC CORPORATION, (U.S. CLS. 1, 4, 6, 50, 51 AND 52). SN 85-679,592. PUB. 11-26-2013. FILED 7-17-2012.
- 4,479,733. **THERMAVEIN (STANDARD CHARACTER)**. THERMAVEIN LIMITED, MULTIPLE CLASS, (INT. CLS. 3, 10, 41 AND 44), (U.S. CLS. 1, 4, 6, 26, 39, 44, 50, 51, 52, 100, 101 AND 107). SN 85-724,942. PUB. 8-27-2013. FILED 9-10-2012.
- 4,479,739. **SPACE GLO (STANDARD CHARACTER)**. SMITH, EARL L., AND SMITH, PATRICIA M., (U.S. CLS. 1, 4, 6, 50, 51 AND 52). SN 85-729,089. PUB. 11-26-2013. FILED 9-14-2012.
- 4,479,821. **ROYAL & ANCIENT (STANDARD CHARACTER)**. ROYAL & ANCIENT LOTION, (U.S. CLS. 1, 4, 6, 50, 51 AND 52). SN 85-779,265. PUB. 11-26-2013. FILED 11-14-2012.
- 4,479,844. **COMFORT FOOD FOR THE SKIN (STANDARD CHARACTER)**. HONEY & IVY LLC, (U.S. CLS. 1, 4, 6, 50, 51 AND 52). SN 85-788,990. PUB. 5-28-2013. FILED 11-28-2012.
- 4,479,868. **MISCELLANEOUS DESIGN**. VAUGHAN INDUSTRIES, INC., MULTIPLE CLASS, (INT. CLS. 3 AND 8), (U.S. CLS. 1, 4, 6, 23, 28, 44, 50, 51 AND 52). SN 85-797,281. PUB. 11-26-2013. FILED 12-7-2012.
- 4,480,053 ( *See Class 1 for this trademark*).
- 4,480,088. **LAVA BATH (STANDARD CHARACTER)**. SONNY'S ENTERPRISES, INC., (U.S. CLS. 1, 4, 6, 50, 51 AND 52). SN 85-864,025. PUB. 8-13-2013. FILED 3-1-2013.
- 4,480,124. **MISCELLANEOUS DESIGN**. KOSE CORPORATION, (U.S. CLS. 1, 4, 6, 50, 51 AND 52). SN 85-880,458. PUB. 11-26-2013. FILED 3-19-2013.
- 4,480,127. **MUCHIE'S SKIN (STANDARD CHARACTER)**. MUCHIE'S SKIN, (U.S. CLS. 1, 4, 6, 50, 51 AND 52). SN 85-881,412. PUB. 11-26-2013. FILED 3-20-2013.
- 4,480,143. **STYLASH PROFESSIONAL EYELASH EXTENSIONS AND DESIGN**. SOBONG QUANE, (U.S. CLS. 1, 4, 6, 50, 51 AND 52). SN 85-886,275. PUB. 11-26-2013. FILED 3-26-2013.
- 4,480,155. **CHIVAS (STANDARD CHARACTER)**. CHIVAS HOLDINGS (IP) LIMITED, MULTIPLE CLASS, (INT. CLS. 3, 29, 30, 35 AND 41), (U.S. CLS. 1, 4, 6, 46, 50, 51, 52, 100, 101, 102 AND 107). SN 85-889,731. PUB. 11-26-2013. FILED 3-28-2013.
- 4,480,166. **XIOMARA NUTRINT (STANDARD CHARACTER)**. LABORATORIOS ZELL, S.A. DE C.V., (U.S. CLS. 1, 4, 6, 50, 51 AND 52). SN 85-895,933. PUB. 11-26-2013. FILED 4-5-2013.
- 4,480,179. **TASK (STANDARD CHARACTER)**. BENOSTAN INTERNATIONAL, LTD., (U.S. CLS. 1, 4, 6, 50, 51 AND 52). SN 85-899,924. PUB. 11-26-2013. FILED 4-10-2013.
- 4,480,260. **RETINOL REFORM (STANDARD CHARACTER)**. DARDEN, SHANI, AND FERRARI, ANTHONY, (U.S. CLS. 1, 4, 6, 50, 51 AND 52). SN 85-924,384. PUB. 11-26-2013. FILED 5-6-2013.
- 4,480,272. **SCAR HEAL (STANDARD CHARACTER)**. SCAR HEAL, INC., (U.S. CLS. 1, 4, 6, 50, 51 AND 52). SN 85-926,059. PUB. 11-26-2013. FILED 5-8-2013.
- 4,480,315. **COLOR CLUB SPIRIT (STANDARD CHARACTER)**. FORSYTHE COSMETIC GROUP, LTD., (U.S. CLS. 1, 4, 6, 50, 51 AND 52). SN 85-935,140. PUB. 11-26-2013. FILED 5-17-2013.
- 4,480,349. **MY MIO (STANDARD CHARACTER)**. MAMA MIO LIMITED, (U.S. CLS. 1, 4, 6, 50, 51 AND 52). SN 85-941,490. PUB. 11-26-2013. FILED 5-24-2013.
- 4,480,488. **LUCKY TIGER (STANDARD CHARACTER)**. LUCKY TIGER, LLC, (U.S. CLS. 1, 4, 6, 50, 51 AND 52). SN 85-958,156. PUB. 11-26-2013. FILED 6-12-2013.
- 4,480,532. **KOKOKAHN (STANDARD CHARACTER)**. KOKOKAHN, INC., (U.S. CLS. 1, 4, 6, 50, 51 AND 52). SN 85-963,618. PUB. 11-26-2013. FILED 6-19-2013.
- 4,480,557. **JULIEN FAREL (STANDARD CHARACTER)**. FAREL, DAVID JEAN JULIEN, AKA JULIEN FAREL, MULTIPLE CLASS, (INT. CLS. 3, 5, 11 AND 21), (U.S. CLS. 1, 2, 4, 6, 13, 18, 21, 23, 29, 30, 31, 33, 34, 40, 44, 46, 50, 51 AND 52). SN 85-964,342. PUB. 11-26-2013. FILED 6-19-2013.
- 4,480,569. **I MAKEUP AND DESIGN**. BEAUTY 21 COSMETICS, INC., (U.S. CLS. 1, 4, 6, 50, 51 AND 52). SN 85-964,975. PUB. 11-26-2013. FILED 6-20-2013.
- 4,480,593. **INK FIXX (STANDARD CHARACTER)**. LAKE VIEW LABORATORIES, INC., (U.S. CLS. 1, 4, 6, 50, 51 AND 52). SN 85-965,991. PUB. 11-26-2013. FILED 6-20-2013.
- 4,480,605. **TUANIS (STANDARD CHARACTER)**. BRANDING COST RICA, SA, MULTIPLE CLASS, (INT. CLS. 3, 9 AND 16), (U.S. CLS. 1, 2, 4, 5, 6, 21, 22, 23, 26, 29, 36, 37, 38, 50, 51 AND 52). SN 85-966,672. PUB. 11-26-2013. FILED 6-21-2013.
- 4,480,616. **TRIANA MIAMI AND DESIGN**. TRIANA SKIN CARE, L.L.C., (U.S. CLS. 1, 4, 6, 50, 51 AND 52). SN 85-967,422. PUB. 11-26-2013. FILED 6-23-2013.
- 4,480,637. **AGING BACKWARDS (STANDARD CHARACTER)**. AGING BACKWARDS, LLC, (U.S. CLS. 1, 4, 6, 50, 51 AND 52). SN 85-968,224. PUB. 11-26-2013. FILED 6-24-2013.
- 4,480,704 ( *See Class 1 for this trademark*).
- 4,480,774. **PERFUME TO THE PEOPLE (STANDARD CHARACTER)**. SUTKOWSKI, JENNIFER, (U.S. CLS. 1, 4, 6, 50, 51

- AND 52). SN 85-974,308. PUB. 11-26-2013. FILED 7-1-2013.
- 4,480,786. **LEROY'S CARPETS, INSTALLATIONS, CLEANING AND REPAIR (STANDARD CHARACTER)**. LANDRY, LEROY, DBA LEROY'S CARPETS, INSTALLATIONS, CLEANING AND REPAIR, (U.S. CLS. 1, 4, 6, 50, 51 AND 52). SN 85-974,807. PUB. 11-26-2013. FILED 7-1-2013.
- 4,480,816. **GLOXINIALIFE (STANDARD CHARACTER)**. GLOXINIALIFE, LLC, MULTIPLE CLASS, (INT. CLS. 3, 5 AND 44), (U.S. CLS. 1, 4, 6, 18, 44, 46, 50, 51, 52, 100 AND 101). SN 86-000,332. PUB. 11-26-2013. FILED 7-2-2013.
- 4,480,838. **BLASTITE (STANDARD CHARACTER)**. WASHINGTON MILLS MANAGEMENT, INC., (U.S. CLS. 1, 4, 6, 50, 51 AND 52). SN 86-000,641. PUB. 11-26-2013. FILED 7-2-2013.
- 4,480,885. **DUZZIT (STANDARD CHARACTER)**. 151 PRODUCTS LIMITED, (U.S. CLS. 1, 4, 6, 50, 51 AND 52). SN 86-001,425. PUB. 11-26-2013. FILED 7-3-2013.
- 4,480,971. **LET THE HEALING BEGIN (STANDARD CHARACTER)**. ELAJ, LLC, (U.S. CLS. 1, 4, 6, 50, 51 AND 52). SN 86-002,647. PUB. 11-26-2013. FILED 7-4-2013.
- 4,480,984. **I AM SIN (STANDARD CHARACTER)**. MAX, MASUMI, (U.S. CLS. 1, 4, 6, 50, 51 AND 52). SN 86-002,765. PUB. 11-26-2013. FILED 7-4-2013.
- 4,481,082. **COSMETECHNOLOGY (STANDARD CHARACTER)**. HICKS, RUTH, MULTIPLE CLASS, (INT. CLS. 3 AND 41), (U.S. CLS. 1, 4, 6, 50, 51, 52, 100, 101 AND 107). SN 86-004,025. PUB. 11-26-2013. FILED 7-8-2013.
- 4,481,092. **TRAVISDOWDY (STYLIZED)**. TRAVIS DOWDY PRODUCTS, (U.S. CLS. 1, 4, 6, 50, 51 AND 52). SN 86-004,174. PUB. 11-26-2013. FILED 7-8-2013.
- 4,481,112. **RITZY RHINO (STYLIZED)**. TOUCHDOWN MARKETING, (U.S. CLS. 1, 4, 6, 50, 51 AND 52). SN 86-004,609. PUB. 11-26-2013. FILED 7-8-2013.
- 4,481,125. **ASMODEL (STANDARD CHARACTER)**. SHENZHEN YUYACHEN COMMERCIAL AND TRADING CO., LTD., (U.S. CLS. 1, 4, 6, 50, 51 AND 52). SN 86-004,893. PUB. 11-26-2013. FILED 7-9-2013.

---

#### CLASS 4—LUBRICANTS AND FUELS

- 4,479,434 ( *See Class 3 for this trademark*).
- 4,479,662 ( *See Class 1 for this trademark*).
- 4,480,325. **SHELL LNG (STANDARD CHARACTER)**. SHELL TRADEMARK MANAGEMENT BV, (U.S. CLS. 1, 6 AND 15). SN 85-937,258. PUB. 11-26-2013. FILED 5-20-2013.
- 4,481,103. **HF HOLLYFRONTIER (STYLIZED)**. HOLLYMARKS, LLC, (U.S. CLS. 1, 6 AND 15). SN 86-004,487. PUB. 11-26-2013. FILED 7-8-2013.
- 4,481,164. **HF HOLLYFRONTIER (STYLIZED)**. HOLLYMARKS, LLC, (U.S. CLS. 1, 6 AND 15). SN 86-005,417. PUB. 11-26-2013. FILED 7-9-2013.

---

#### CLASS 5—PHARMACEUTICALS

- 4,479,256. **METABARRIER (STANDARD CHARACTER)**. FUJIFILM CORPORATION, (U.S. CLS. 6, 18, 44, 46, 51 AND 52). SN 77-690,274. PUB. 11-26-2013. FILED 3-13-2009.
- 4,479,321. **BELVITAL (STANDARD CHARACTER)**. SOCIÉTÉ CORYNE DE BRUYNES, MULTIPLE CLASS, (INT. CLS. 5 AND 10), (U.S. CLS. 6, 18, 26, 39, 44, 46, 51 AND 52). SN 79-122,779. PUB. 11-26-2013. FILED 9-12-2012.
- 4,479,327. **MEDIQ. COMMITTED TO YOUR CARE (STANDARD CHARACTER)**. MEDIQ N.V., MULTIPLE CLASS, (INT. CLS. 5, 10, 35, 39, 41 AND 44), (U.S. CLS. 6, 18, 26, 39, 44, 46, 51, 52, 100, 101, 102, 105 AND 107). SN 79-123,737. PUB. 11-26-2013. FILED 11-2-2012.
- 4,479,328. **EPIM (STANDARD CHARACTER)**. PROVENISIS LIMITED, MULTIPLE CLASS, (INT. CLS. 5, 10 AND 44), (U.S. CLS. 6, 18, 26, 39, 44, 46, 51, 52, 100 AND 101). SN 79-123,751. PUB. 11-26-2013. FILED 10-24-2012.
- 4,479,329. **PRODEN DENTALCARE (STANDARD CHARACTER)**. SDC SWEDENCARE AB, MULTIPLE CLASS, (INT. CLS. 5 AND 31), (U.S. CLS. 1, 6, 18, 44, 46, 51 AND 52). SN 79-123,880. PUB. 11-26-2013. FILED 11-29-2012.
- 4,479,331. **MEDIQ AND DESIGN**. MEDIQ N.V., MULTIPLE CLASS, (INT. CLS. 5, 10, 35, 39, 41 AND 44), (U.S. CLS. 6, 18, 26, 39, 44, 46, 51, 52, 100, 101, 102, 105 AND 107). SN 79-123,969. PUB. 11-26-2013. FILED 11-12-2012.
- 4,479,334 ( *See Class 1 for this trademark*).
- 4,479,372 ( *See Class 1 for this trademark*).
- 4,479,375. **SUGAR LILI (STANDARD CHARACTER)**. ANTHEA DONALD, (U.S. CLS. 6, 18, 44, 46, 51 AND 52). SN 79-126,533. PUB. 11-26-2013. FILED 12-21-2012.
- 4,479,395 ( *See Class 3 for this trademark*).
- 4,479,438 ( *See Class 3 for this trademark*).
- 4,479,444. **MYCEMO (STANDARD CHARACTER)**. IPSEN PHARMA S.A.S., (U.S. CLS. 6, 18, 44, 46, 51 AND 52). SN 79-129,717. PUB. 11-26-2013. FILED 3-6-2013.
- 4,479,450. **ACINO PHARMA - DELIVERING HEALTH (STANDARD CHARACTER)**. ACINO HOLDING AG, MULTIPLE CLASS, (INT. CLS. 5 AND 42), (U.S. CLS. 6, 18, 44, 46, 51, 52, 100 AND 101). SN 79-130,005. PUB. 11-26-2013. FILED 3-5-2013.
- 4,479,483. **NORFLO (STYLIZED)**. EYE TECH S.R.L. UNIPERSONALE, (U.S. CLS. 6, 18, 44, 46, 51 AND 52). SN 79-133,622. PUB. 11-26-2013. FILED 5-7-2013.
- 4,479,502. **GYTRIFO (STANDARD CHARACTER)**. BOEHRINGER INGELHEIM INTERNATIONAL GMBH, (U.S. CLS. 6, 18, 44, 46, 51 AND 52). SN 79-135,177. PUB. 11-26-2013. FILED 7-2-2013.
- 4,479,503. **XIOTRIF (STANDARD CHARACTER)**. BOEHRINGER INGELHEIM INTERNATIONAL GMBH, (U.S. CLS. 6, 18, 44, 46, 51 AND 52). SN 79-135,444. PUB. 11-26-2013. FILED 7-2-2013.
- 4,479,510. **HOLVIAN (STANDARD CHARACTER)**. NOVARTIS AG, (U.S. CLS. 6, 18, 44, 46, 51 AND 52). SN 79-136,155. PUB. 11-26-2013. FILED 8-26-2013.
- 4,479,511. **HOLVERO (STANDARD CHARACTER)**. NOVARTIS AG, (U.S. CLS. 6, 18, 44, 46, 51 AND 52). SN 79-136,156. PUB. 11-26-2013. FILED 8-26-2013.
- 4,479,513. **KMG (STANDARD CHARACTER)**. BEIJING SHENGYIYAO; TECHNOLOGY & DEVELOPMENT CO., LTD., (U.S. CLS. 6, 18, 44, 46, 51 AND 52). SN 79-136,362. PUB. 11-26-2013. FILED 2-7-2013.
- 4,479,532. **MOLD-BUSTER (STANDARD CHARACTER)**. CTA PRODUCTS GROUP, DBA CTA PRODUCTS GROUP, (U.S. CLS. 6, 18, 44, 46, 51 AND 52). SN 85-265,375. PUB. 11-26-2013. FILED 3-12-2011.
- 4,479,571 ( *See Class 3 for this trademark*).
- 4,479,649. **KOREA BO KAN YEONG AND DESIGN**. HWA-CHANG KOREA COMPANY, LTD., MULTIPLE CLASS, (INT. CLS. 5 AND 29), (U.S. CLS. 6, 18, 44, 46, 51 AND 52). SN 85-632,989. PUB. 11-26-2013. FILED 5-23-2012.
- 4,479,672. **BETAQUICK (STANDARD CHARACTER)**. SOCIÉTÉ DES PRODUITS NESTLÉ S.A., (U.S. CLS. 6, 18, 44, 46, 51 AND 52). SN 85-646,102. PUB. 11-26-2013. FILED 6-7-2012.
- 4,479,685. **STERION (STANDARD CHARACTER)**. ASPEN SURGICAL PRODUCTS, INC., MULTIPLE CLASS, (INT. CLS. 5 AND 10), (U.S. CLS. 6, 18, 26, 39, 44, 46, 51 AND 52). SN 85-657,512. PUB. 11-26-2013. FILED 6-21-2012.
- 4,479,725. **SEBOLYSE (STANDARD CHARACTER)**. DERM-CARE-VET PTY LTD, (U.S. CLS. 6, 18, 44, 46, 51 AND 52). SN 85-717,766. PUB. 2-5-2013. FILED 8-30-2012.
- 4,479,727. **GEOFIL (STANDARD CHARACTER)**. KURARAY CO., LTD., (U.S. CLS. 6, 18, 44, 46, 51 AND 52). SN 85-718,619. PUB. 7-16-2013. FILED 8-31-2012.
- 4,479,773. **CRAG (STANDARD CHARACTER)**. IMMUNOMYCOLOGICS, INC., (U.S. CLS. 6, 18, 44, 46, 51 AND 52). SN 85-756,607. PUB. 11-26-2013. FILED 10-17-2012.
- 4,479,795. **POMLOVID (STANDARD CHARACTER)**. CELGENE CORPORATION, (U.S. CLS. 6, 18, 44, 46, 51 AND 52). SN 85-770,120. PUB. 9-24-2013. FILED 11-2-2012.
- 4,479,797. **PRO-EN-ZYME (STANDARD CHARACTER)**. NUTRITION CENTER, INC., (U.S. CLS. 6, 18, 44, 46, 51 AND 52). SN 85-771,343. PUB. 11-26-2013. FILED 11-5-2012.
- 4,479,863 ( *See Class 1 for this trademark*).
- 4,479,870. **SCULPTRA AESTHETIC INJECTABLE POLY-LACTIC ACID STIMULATES COLAGEN FOR A NATURAL LOOK AND DESIGN**. VALEANT INTERNATIONAL BERMUDA, (U.S. CLS. 6, 18, 44, 46, 51 AND 52). SN 85-798,106. PUB. 11-26-2013. FILED 12-8-2012.

4,479,877. **PUMP FUEL INSANITY (STANDARD CHARACTER)**. FITLIFE BRANDS, INC., (U.S. CLS. 6, 18, 44, 46, 51 AND 52). SN 85-800,959. PUB. 2-26-2013. FILED 12-12-2012.

4,479,886. **EVOCORT (STANDARD CHARACTER)**. CIPLA LIMITED, (U.S. CLS. 6, 18, 44, 46, 51 AND 52). SN 85-802,115. PUB. 11-26-2013. FILED 12-13-2012.

4,479,887. **FURAMIST (STANDARD CHARACTER)**. CIPLA LIMITED, (U.S. CLS. 6, 18, 44, 46, 51 AND 52). SN 85-802,151. PUB. 11-26-2013. FILED 12-13-2012.

4,479,888. **FURASPRAY (STANDARD CHARACTER)**. CIPLA LIMITED, (U.S. CLS. 6, 18, 44, 46, 51 AND 52). SN 85-802,159. PUB. 11-26-2013. FILED 12-13-2012.

4,479,893. **HERBAL VERA (STANDARD CHARACTER)**. HERBAL VERA LLC, (U.S. CLS. 6, 18, 44, 46, 51 AND 52). SN 85-803,558. PUB. 11-26-2013. FILED 12-14-2012.

4,479,978. **SUPLIGEN (STANDARD CHARACTER)**. SOCIETE DES PRODUITS NESTLE S.A., (U.S. CLS. 6, 18, 44, 46, 51 AND 52). SN 85-824,454. PUB. 11-26-2013. FILED 1-16-2013.

4,480,053 ( *See Class 1 for this trademark*).

4,480,099. **CARD MEDIUM (STANDARD CHARACTER)**. HISAMITSU PHARMACEUTICAL CO., INC., (U.S. CLS. 6, 18, 44, 46, 51 AND 52). SN 85-869,252. PUB. 11-26-2013. FILED 3-7-2013.

4,480,153. **COR-PLUS (STANDARD CHARACTER)**. INSTITUTE OF NUTRITION, AKA DRA. MARIBEL SANTACRUZ, (U.S. CLS. 6, 18, 44, 46, 51 AND 52). SN 85-888,775. PUB. 11-26-2013. FILED 3-28-2013.

4,480,160. **OASIS THE ALLERGY DROP AND DESIGN**. NORTHWEST ANTIGEN LAB, LLC, (U.S. CLS. 6, 18, 44, 46, 51 AND 52). SN 85-893,228. PUB. 11-26-2013. FILED 4-2-2013.

4,480,183 ( *See Class 1 for this trademark*).

4,480,222. **JOINT JUICE (STYLIZED)**. PREMIER NUTRITION CORPORATION, AKA JOINT JUICE, INC., MULTIPLE CLASS, (INT. CLS. 5 AND 32), (U.S. CLS. 6, 18, 44, 45, 46, 48, 51 AND 52). SN 85-912,729. PUB. 11-26-2013. FILED 4-23-2013.

4,480,229 ( *See Class 1 for this trademark*).

4,480,263. **ASTAGRAF XL (STANDARD CHARACTER)**. ASTELLAS PHARMA INC., (U.S. CLS. 6, 18, 44, 46, 51 AND 52). SN 85-925,271. PUB. 11-26-2013. FILED 5-7-2013.

4,480,274. **FOUR65 ALL NATURAL MINERAL SUPPLEMENT AND DESIGN**. REDMOND, INCORPORATED, (U.S. CLS. 6, 18, 44, 46, 51 AND 52). SN 85-926,380. PUB. 11-26-2013. FILED 5-8-2013.

4,480,276. **V VETTER AND DESIGN**. ARZNEIMITTEL GMBH APOTHEKER VETTER & CO. RAVENSBURG, MULTIPLE CLASS, (INT. CLS. 5, 7, 10 AND 42), (U.S. CLS. 6, 13, 18, 19, 21, 23, 26, 31, 34, 35, 39, 44, 46, 51, 52, 100 AND 101). SN 85-926,577. PUB. 11-26-2013. FILED 5-8-2013.

4,480,311. **SUGARWISE (STANDARD CHARACTER)**. NAHABED, VASKEN, (U.S. CLS. 6, 18, 44, 46, 51 AND 52). SN 85-934,083. PUB. 11-26-2013. FILED 5-16-2013.

4,480,335. **RESVERATROL HX (STANDARD CHARACTER)**. INVITE HEALTH, INC., (U.S. CLS. 6, 18, 44, 46, 51 AND 52). SN 85-939,678. PUB. 11-26-2013. FILED 5-22-2013.

4,480,451. **MISCELLANEOUS DESIGN**. LIVERITE PRODUCTS, INC., (U.S. CLS. 6, 18, 44, 46, 51 AND 52). SN 85-953,833. PUB. 11-26-2013. FILED 6-7-2013.

4,480,500. **R RAINSHINE AND DESIGN**. RAIN SHINE, LLC, (U.S. CLS. 6, 18, 44, 46, 51 AND 52). SN 85-959,817. PUB. 11-26-2013. FILED 6-14-2013.

4,480,557 ( *See Class 3 for this trademark*).

4,480,594. **EG MOS AND DESIGN**. EG INTERNATIONAL (HK) LIMITED, (U.S. CLS. 6, 18, 44, 46, 51 AND 52). SN 85-966,125. PUB. 11-26-2013. FILED 6-21-2013.

4,480,649. **WEXFORD LABS (STANDARD CHARACTER)**. WEXFORD LABS, INC., (U.S. CLS. 6, 18, 44, 46, 51 AND 52). SN 85-968,475. PUB. 11-26-2013. FILED 6-24-2013.

4,480,694. **IDEAL OMEGA (STANDARD CHARACTER)**. BARLEAN'S ORGANIC OILS, L.L.C., (U.S. CLS. 6, 18, 44, 46, 51 AND 52). SN 85-970,742. PUB. 11-26-2013. FILED 6-26-2013.

4,480,704 ( *See Class 1 for this trademark*).

4,480,735. **LXWPRO (STANDARD CHARACTER)**. NUTRIGENIX, LLC, (U.S. CLS. 6, 18, 44, 46, 51 AND 52). SN 85-972,687. PUB. 11-26-2013. FILED 6-28-2013.

4,480,798. **BETAMIN (STANDARD CHARACTER)**. YICHING CHEN, (U.S. CLS. 6, 18, 44, 46, 51 AND 52). SN 86-000,053.

PUB. 11-26-2013. FILED 7-1-2013.

4,480,816 ( *See Class 3 for this trademark*).

4,481,006. **SYNTOCINON (STANDARD CHARACTER)**. NOVARTIS AG, (U.S. CLS. 6, 18, 44, 46, 51 AND 52). SN 86-002,974. PUB. 11-26-2013. FILED 7-5-2013.

4,481,009. **NATURENETICS (STANDARD CHARACTER)**. WEDO DIGITAL MARKETING LLC, (U.S. CLS. 6, 18, 44, 46, 51 AND 52). SN 86-002,997. PUB. 11-26-2013. FILED 7-5-2013.

4,481,043. **ENERGYBOLIZER (STANDARD CHARACTER)**. OLAX CORP., (U.S. CLS. 6, 18, 44, 46, 51 AND 52). SN 86-003,458. PUB. 11-26-2013. FILED 7-6-2013.

4,481,100. **MISCELLANEOUS DESIGN**. STEVEN ZHANG, (U.S. CLS. 6, 18, 44, 46, 51 AND 52). SN 86-004,451. PUB. 11-26-2013. FILED 7-8-2013.

4,481,175. **VEGLIFE (STANDARD CHARACTER)**. NUTRAMARKS, INC., (U.S. CLS. 6, 18, 44, 46, 51 AND 52). SN 86-005,615. PUB. 11-26-2013. FILED 7-9-2013.

4,481,181. **HEALTH SOLUTION PRIME AND DESIGN**. HEALTH SOLUTION USA, LLC, (U.S. CLS. 6, 18, 44, 46, 51 AND 52). SN 86-005,689. PUB. 11-26-2013. FILED 7-9-2013.

4,481,287. **REPROGAIN (STANDARD CHARACTER)**. WAWASAN AGROLIPIDS SDN BHD, (U.S. CLS. 6, 18, 44, 46, 51 AND 52). SN 86-061,434. PUB. 11-26-2013. FILED 9-11-2013.

4,481,293. **BEDLAM PLUS (STANDARD CHARACTER)**. MCLAUGHLIN GORMLEY KING COMPANY, (U.S. CLS. 6, 18, 44, 46, 51 AND 52). SN 86-069,438. PUB. 11-26-2013. FILED 9-19-2013.

4,481,294. **BEDLAM PLUS AND DESIGN**. MCLAUGHLIN GORMLEY KING COMPANY, (U.S. CLS. 6, 18, 44, 46, 51 AND 52). SN 86-069,444. PUB. 11-26-2013. FILED 9-19-2013.

---

## CLASS 6—METAL GOODS

4,479,243 ( *See Class 1 for this trademark*).

4,479,284. **ECOSYN (STANDARD CHARACTER)**. BOSSARD AG, MULTIPLE CLASS, (INT. CLS. 6 AND 42), (U.S. CLS. 2, 12, 13, 14, 23, 25, 50, 100 AND 101). SN 79-113,471. PUB. 11-26-2013. FILED 5-8-2012.

4,479,287. **NERI (STANDARD CHARACTER)**. NERI S.P.A., MULTIPLE CLASS, (INT. CLS. 6, 11 AND 20), (U.S. CLS. 2, 12, 13, 14, 21, 22, 23, 25, 31, 32, 34 AND 50). SN 79-114,246. PUB. 11-26-2013. FILED 5-4-2012.

4,479,294. **HYTRONICS AND DESIGN**. VOESTALPINE HYTRONICS GMBH, MULTIPLE CLASS, (INT. CLS. 6, 7, 9, 19 AND 42), (U.S. CLS. 1, 2, 12, 13, 14, 19, 21, 23, 25, 26, 31, 33, 34, 35, 36, 38, 50, 100 AND 101). SN 79-116,967. PUB. 6-18-2013. FILED 3-13-2012.

4,479,297. **UHP (STANDARD CHARACTER)**. JFE STEEL KABUSHIKI KAISHA, (U.S. CLS. 2, 12, 13, 14, 23, 25 AND 50). SN 79-117,639. PUB. 6-18-2013. FILED 4-5-2012.

4,479,324. **TERAMOTO (STYLIZED)**. TERAMOTO CORPORATION LTD., MULTIPLE CLASS, (INT. CLS. 6, 12, 20, 21, 27 AND 34), (U.S. CLS. 2, 8, 9, 12, 13, 14, 17, 19, 20, 21, 22, 23, 25, 29, 30, 31, 32, 33, 35, 37, 40, 42, 44 AND 50). SN 79-123,306. PUB. 11-26-2013. FILED 11-2-2012.

4,479,325. **G AND DESIGN**. GEHRLICHER SOLAR AG, MULTIPLE CLASS, (INT. CLS. 6, 7, 9, 11, 19, 35, 37, 38 AND 42), (U.S. CLS. 1, 2, 12, 13, 14, 19, 21, 23, 25, 26, 31, 33, 34, 35, 36, 38, 50, 100, 101, 102, 103, 104 AND 106). SN 79-123,491. PUB. 11-26-2013. FILED 6-28-2012.

4,479,344. **ASW DER GUTE DRAHT. AND DESIGN**. AGRO STEEL WIRE GMBH, (U.S. CLS. 2, 12, 13, 14, 23, 25 AND 50). SN 79-124,794. PUB. 11-26-2013. FILED 11-2-2012.

4,479,345. **AGRO HOLDING GMBH AND DESIGN**. AGRO HOLDING GMBH, (U.S. CLS. 2, 12, 13, 14, 23, 25 AND 50). SN 79-124,795. PUB. 11-26-2013. FILED 11-2-2012.

4,479,363. **ERK (STANDARD CHARACTER)**. 123-ENGINEERING & INNOVATION GMBH, MULTIPLE CLASS, (INT. CLS. 6, 7 AND 11), (U.S. CLS. 2, 12, 13, 14, 19, 21, 23, 25, 31, 34, 35 AND 50). SN 79-126,149. PUB. 11-26-2013. FILED 12-21-2012.

4,479,376. **EVERHARD (STANDARD CHARACTER)**. JFE STEEL KABUSHIKI KAISHA, (U.S. CLS. 2, 12, 13, 14, 23, 25 AND 50). SN 79-126,537. PUB. 11-26-2013. FILED 12-20-2012.

- 4,479,408 ( *See Class 1 for this trademark* ).
- 4,479,410. **CLEANSTAR (STANDARD CHARACTER)**. GEMÜ GEBR. MÜLLER APPARATEBAU; GMBH & CO. KOMMANDITGESELLSCHAFT, MULTIPLE CLASS, (INT. CLS. 6, 7, 9 AND 17), (U.S. CLS. 1, 2, 5, 12, 13, 14, 19, 21, 23, 25, 26, 31, 34, 35, 36, 38 AND 50). SN 79-127,600. PUB. 11-26-2013. FILED 12-19-2012.
- 4,479,443. **AMAG AND DESIGN**. AMAG AUSTRIA METALL AG, (U.S. CLS. 2, 12, 13, 14, 23, 25 AND 50). SN 79-129,684. PUB. 11-26-2013. FILED 2-21-2013.
- 4,479,456. **NEDCON (STYLIZED)**. NEDCON MAGAZIJN-RICHTING B.V., MULTIPLE CLASS, (INT. CLS. 6, 19, 20, 37 AND 42), (U.S. CLS. 1, 2, 12, 13, 14, 22, 23, 25, 32, 33, 50, 100, 101, 103 AND 106). SN 79-130,859. PUB. 11-26-2013. FILED 1-7-2013.
- 4,479,462. **CAEROE (STYLIZED)**. TELAIR INTERNATIONAL GMBH, MULTIPLE CLASS, (INT. CLS. 6, 7, 9 AND 20), (U.S. CLS. 2, 12, 13, 14, 19, 21, 22, 23, 25, 26, 31, 32, 34, 35, 36, 38 AND 50). SN 79-131,290. PUB. 11-26-2013. FILED 4-12-2013.
- 4,479,477. **MEGASOL (STANDARD CHARACTER)**. MARKUS GISLER, MULTIPLE CLASS, (INT. CLS. 6, 9, 11, 19, 37, 40 AND 42), (U.S. CLS. 1, 2, 12, 13, 14, 21, 23, 25, 26, 31, 33, 34, 36, 38, 50, 100, 101, 103 AND 106). SN 79-133,075. PUB. 11-26-2013. FILED 6-3-2013.
- 4,479,492. **MISCELLANEOUS DESIGN**. GVA KREFELD GMBH, MULTIPLE CLASS, (INT. CLS. 6, 7 AND 8), (U.S. CLS. 2, 12, 13, 14, 19, 21, 23, 25, 28, 31, 34, 35, 44 AND 50). SN 79-134,287. PUB. 11-26-2013. FILED 4-29-2013.
- 4,479,512. **OK-VISE (STANDARD CHARACTER)**. OK-VISE OY, (U.S. CLS. 2, 12, 13, 14, 23, 25 AND 50). SN 79-136,246. PUB. 11-26-2013. FILED 6-27-2013.
- 4,479,551. **STAINLESS DREAMS (STANDARD CHARACTER)**. STAINLESSDREAMS LTD., MULTIPLE CLASS, (INT. CLS. 6, 11 AND 20), (U.S. CLS. 2, 12, 13, 14, 21, 22, 23, 25, 31, 32, 34 AND 50). SN 85-435,860. PUB. 4-9-2013. FILED 9-29-2011.
- 4,479,862. **ESC STEEL (STANDARD CHARACTER)**. ESC STEEL INC., (U.S. CLS. 2, 12, 13, 14, 23, 25 AND 50). SN 85-795,080. PUB. 11-26-2013. FILED 12-5-2012.
- 4,479,883. **COBLESKILL (STANDARD CHARACTER)**. STATE UNIVERSITY OF NEW YORK BY AND ON BEHALF OF SUNY COBLESKILL, MULTIPLE CLASS, (INT. CLS. 6, 12, 16, 18, 20, 21, 22, 24, 25, 28 AND 41), (U.S. CLS. 1, 2, 3, 5, 7, 12, 13, 14, 19, 21, 22, 23, 25, 29, 30, 31, 32, 33, 35, 37, 38, 39, 40, 41, 42, 44, 50, 100, 101 AND 107). SN 85-801,544. PUB. 11-26-2013. FILED 12-13-2012.
- 4,479,918. **FLEX CORE (STANDARD CHARACTER)**. NEOPERL INTERNATIONAL AG, MULTIPLE CLASS, (INT. CLS. 6 AND 17), (U.S. CLS. 1, 2, 5, 12, 13, 14, 23, 25, 35 AND 50). SN 85-808,059. PUB. 11-26-2013. FILED 12-20-2012.
- 4,480,189. **YOUYOU (STANDARD CHARACTER)**. NINGBO YOUYOU INTERNATIONAL CO., LTD., (U.S. CLS. 2, 12, 13, 14, 23, 25 AND 50). SN 85-903,817. PUB. 11-26-2013. FILED 4-15-2013.
- 4,480,211. **ARAM (STANDARD CHARACTER)**. MICHAEL ARAM, INC., MULTIPLE CLASS, (INT. CLS. 6, 8, 11, 20 AND 21), (U.S. CLS. 2, 12, 13, 14, 21, 22, 23, 25, 28, 29, 30, 31, 32, 33, 34, 40, 44 AND 50). SN 85-909,824. PUB. 11-26-2013. FILED 4-19-2013.
- 4,480,280. **TRU-FLEX (STANDARD CHARACTER)**. TRU-FLEX METAL HOSE, LLC, MULTIPLE CLASS, (INT. CLS. 6 AND 7), (U.S. CLS. 2, 12, 13, 14, 19, 21, 23, 25, 31, 34, 35 AND 50). SN 85-926,707. PUB. 11-26-2013. FILED 5-8-2013.
- 4,480,371. **UNION AND DESIGN**. WIRECO WORLDGROUP INC., (U.S. CLS. 2, 12, 13, 14, 23, 25 AND 50). SN 85-944,174. PUB. 11-26-2013. FILED 5-28-2013.
- 4,480,648. **SKULL HOOKER (STANDARD CHARACTER)**. ROBERT J. SHAW, (U.S. CLS. 2, 12, 13, 14, 23, 25 AND 50). SN 85-968,442. PUB. 11-26-2013. FILED 6-24-2013.
- 4,480,679. **LEGEND (STYLIZED)**. INTERLINE BRANDS, INC., MULTIPLE CLASS, (INT. CLS. 6 AND 7), (U.S. CLS. 2, 12, 13, 14, 19, 21, 23, 25, 31, 34, 35 AND 50). SN 85-970,077. PUB. 11-26-2013. FILED 6-26-2013.
- 4,480,717. **KEY SMART (STANDARD CHARACTER)**. KEY-SMART, LLC, (U.S. CLS. 2, 12, 13, 14, 23, 25 AND 50). SN 85-971,862. PUB. 11-26-2013. FILED 6-27-2013.
- 4,480,803. **JASIT AND DESIGN**. YI FENG MANUFACTURING COMPANY LIMITED, (U.S. CLS. 2, 12, 13, 14, 23, 25 AND 50). SN 86-000,161. PUB. 11-26-2013. FILED 7-2-2013.
- 4,481,040. **MISCELLANEOUS DESIGN**. MULTIVERSE STUDIO INC., MULTIPLE CLASS, (INT. CLS. 6 AND 28), (U.S. CLS. 2, 12, 13, 14, 22, 23, 25, 38 AND 50). SN 86-003,420. PUB. 11-26-2013. FILED 7-5-2013.
- 4,481,051. **SCREENMEND (STANDARD CHARACTER)**. HOOKS, BRIAN P, (U.S. CLS. 2, 12, 13, 14, 23, 25 AND 50). SN 86-003,558. PUB. 11-26-2013. FILED 7-6-2013.
- 4,481,283. **GALVANIZED EXTRA HI-TENSILE (STANDARD CHARACTER)**. ACCENT PACKAGING INC., DBA ACCENT WIRE PRODUCTS, (U.S. CLS. 2, 12, 13, 14, 23, 25 AND 50). SN 86-060,023. PUB. 11-26-2013. FILED 9-10-2013.
- 4,481,284. **GALVANIZED APEX (STANDARD CHARACTER)**. ACCENT PACKAGING INC., DBA ACCENT WIRE PRODUCTS, (U.S. CLS. 2, 12, 13, 14, 23, 25 AND 50). SN 86-060,025. PUB. 11-26-2013. FILED 9-10-2013.
- 4,481,286. **ACCENT BUILDING MATERIALS (STANDARD CHARACTER)**. ACCENT PACKAGING INC., DBA ACCENT BUILDING MATERIALS, MULTIPLE CLASS, (INT. CLS. 6 AND 19), (U.S. CLS. 1, 2, 12, 13, 14, 23, 25, 33 AND 50). SN 86-061,287. PUB. 11-26-2013. FILED 9-11-2013.

---

## CLASS 7—MACHINERY

- 4,479,243 ( *See Class 1 for this trademark* ).
- 4,479,269. **S AND DESIGN**. SCHEUERLE FAHRZEUGFABRIK GMBH, MULTIPLE CLASS, (INT. CLS. 7, 9 AND 12), (U.S. CLS. 13, 19, 21, 23, 26, 31, 34, 35, 36, 38 AND 44). SN 79-073,613. PUB. 11-26-2013. FILED 4-9-2009.
- 4,479,294 ( *See Class 6 for this trademark* ).
- 4,479,301. **MVM AND DESIGN**. M.V.M. S.R.L., (U.S. CLS. 13, 19, 21, 23, 31, 34 AND 35). SN 79-118,063. PUB. 11-26-2013. FILED 7-10-2012.
- 4,479,303. **H AND DESIGN**. HENKE PROPERTY UG, MULTIPLE CLASS, (INT. CLS. 7, 12 AND 37), (U.S. CLS. 13, 19, 21, 23, 31, 34, 35, 44, 100, 103 AND 106). SN 79-118,395. PUB. 11-26-2013. FILED 5-4-2012.
- 4,479,318. **MISCELLANEOUS DESIGN**. METSO CORPORATION, MULTIPLE CLASS, (INT. CLS. 7, 9 AND 11), (U.S. CLS. 13, 19, 21, 23, 26, 31, 34, 35, 36 AND 38). SN 79-122,000. PUB. 11-26-2013. FILED 3-15-2012.
- 4,479,325 ( *See Class 6 for this trademark* ).
- 4,479,330. **HYBRIDSETTER (STANDARD CHARACTER)**. JOACHIM JAKOB, (U.S. CLS. 13, 19, 21, 23, 31, 34 AND 35). SN 79-123,884. PUB. 11-26-2013. FILED 10-24-2012.
- 4,479,353. **BBA PUMPS (STANDARD CHARACTER)**. BBA PARTICIPATIES B.V., MULTIPLE CLASS, (INT. CLS. 7, 35 AND 37), (U.S. CLS. 13, 19, 21, 23, 31, 34, 35, 100, 101, 102, 103 AND 106). SN 79-125,177. PUB. 11-26-2013. FILED 12-5-2012.
- 4,479,354. **HYDRA-LOK LITE (STANDARD CHARACTER)**. OIL STATES MCS LIMITED, MULTIPLE CLASS, (INT. CLS. 7 AND 9), (U.S. CLS. 13, 19, 21, 23, 26, 31, 34, 35, 36 AND 38). SN 79-125,299. PUB. 11-26-2013. FILED 11-28-2012.
- 4,479,359. **HYDRA-LOK (STYLIZED)**. OIL STATES MCS LIMITED, MULTIPLE CLASS, (INT. CLS. 7 AND 9), (U.S. CLS. 13, 19, 21, 23, 26, 31, 34, 35, 36 AND 38). SN 79-125,902. PUB. 11-26-2013. FILED 11-28-2012.
- 4,479,363 ( *See Class 6 for this trademark* ).
- 4,479,364. **QUANTUMFIBER (STANDARD CHARACTER)**. PARKER HANNIFIN MANUFACTURING; NETHERLANDS; (FILTRATION) B.V., MULTIPLE CLASS, (INT. CLS. 7 AND 11), (U.S. CLS. 13, 19, 21, 23, 31, 34 AND 35). SN 79-126,213. PUB. 11-26-2013. FILED 1-4-2013.
- 4,479,365. **QUANTUMFIBER AND DESIGN**. PARKER HANNIFIN MANUFACTURING; NETHERLANDS; (FILTRATION) B.V., MULTIPLE CLASS, (INT. CLS. 7 AND 11), (U.S. CLS. 13, 19, 21, 23, 31, 34 AND 35). SN 79-126,214. PUB. 11-26-2013. FILED 1-4-2013.
- 4,479,366. **SITMA (STANDARD CHARACTER)**. SITMA S.P.A., (U.S. CLS. 13, 19, 21, 23, 31, 34 AND 35). SN 79-126,231. PUB. 11-26-2013. FILED 12-18-2012.
- 4,479,385. **TRI SYSTEM (STANDARD CHARACTER)**. TOADENKA CORPORATION, MULTIPLE CLASS, (INT. CLS.

- 7, 9, 12 AND 40), (U.S. CLS. 13, 19, 21, 23, 26, 31, 34, 35, 36, 38, 44, 100, 103 AND 106). SN 79-126,719. PUB. 11-26-2013. FILED 1-11-2013.
- 4,479,410 ( *See Class 6 for this trademark*).
- 4,479,412. **ASLINKER (STANDARD CHARACTER)**. ANY-WIRE CORPORATION, MULTIPLE CLASS, (INT. CLS. 7 AND 9), (U.S. CLS. 13, 19, 21, 23, 26, 31, 34, 35, 36 AND 38). SN 79-127,648. PUB. 11-26-2013. FILED 9-12-2012.
- 4,479,430. **SAFANDARLEY (STANDARD CHARACTER)**. SAFAN B.V., (U.S. CLS. 13, 19, 21, 23, 31, 34 AND 35). SN 79-128,853. PUB. 11-26-2013. FILED 3-15-2013.
- 4,479,431. **SAFANDARLEY AND DESIGN**. SAFAN B.V., (U.S. CLS. 13, 19, 21, 23, 31, 34 AND 35). SN 79-128,854. PUB. 11-26-2013. FILED 3-15-2013.
- 4,479,435. **PST (STANDARD CHARACTER)**. EUGEN LÄGLER GMBH, MULTIPLE CLASS, (INT. CLS. 7, 37, 41 AND 42), (U.S. CLS. 13, 19, 21, 23, 31, 34, 35, 100, 101, 103, 106 AND 107). SN 79-129,058. PUB. 11-26-2013. FILED 11-9-2012.
- 4,479,437. **NIEHOFF N GRUPPE AND DESIGN**. MASCHINENFABRIK NIEHOFF; GMBH & CO. KG, (U.S. CLS. 13, 19, 21, 23, 31, 34 AND 35). SN 79-129,375. PUB. 11-26-2013. FILED 3-18-2013.
- 4,479,462 ( *See Class 6 for this trademark*).
- 4,479,468. **JMG AND DESIGN**. JMG CRANES S.R.L., (U.S. CLS. 13, 19, 21, 23, 31, 34 AND 35). SN 79-131,771. PUB. 11-26-2013. FILED 4-4-2013.
- 4,479,476. **MOVEROLL (STANDARD CHARACTER)**. MOVE-ROLL OY, MULTIPLE CLASS, (INT. CLS. 7, 39 AND 40), (U.S. CLS. 13, 19, 21, 23, 31, 34, 35, 100, 103, 105 AND 106). SN 79-132,848. PUB. 11-26-2013. FILED 4-24-2013.
- 4,479,482. **RGM RUDONG GENERAL MACHINERY AND DESIGN**. JIANGSU RUTONG PETROLEUM MACHINERY; CO., LTD., (U.S. CLS. 13, 19, 21, 23, 31, 34 AND 35). SN 79-133,609. PUB. 11-26-2013. FILED 6-5-2013.
- 4,479,490. **CHL (STANDARD CHARACTER)**. NINGBO WAN-FENG BEARING CO., LTD, (U.S. CLS. 13, 19, 21, 23, 31, 34 AND 35). SN 79-134,185. PUB. 11-26-2013. FILED 7-3-2013.
- 4,479,492 ( *See Class 6 for this trademark*).
- 4,479,522. **MOOG (STANDARD CHARACTER)**. MOOG INC., MULTIPLE CLASS, (INT. CLS. 7 AND 9), (U.S. CLS. 13, 19, 21, 23, 26, 31, 34, 35, 36 AND 38). SN 85-042,479. PUB. 6-4-2013. FILED 5-19-2010.
- 4,479,536. **CONNECT AND DESIGN**. JANOME SEWING MACHINE COMPANY LIMITED, MULTIPLE CLASS, (INT. CLS. 7 AND 9), (U.S. CLS. 13, 19, 21, 23, 26, 31, 34, 35, 36 AND 38). SN 85-324,889. PUB. 5-14-2013. FILED 5-19-2011.
- 4,479,537. **LINK AND DESIGN**. JANOME SEWING MACHINE COMPANY LIMITED, MULTIPLE CLASS, (INT. CLS. 7 AND 9), (U.S. CLS. 13, 19, 21, 23, 26, 31, 34, 35, 36 AND 38). SN 85-324,924. PUB. 5-14-2013. FILED 5-19-2011.
- 4,479,549. **LIMBA (STANDARD CHARACTER)**. SIEBEN, IRWIN, (U.S. CLS. 13, 19, 21, 23, 31, 34 AND 35). SN 85-416,954. PUB. 8-27-2013. FILED 9-7-2011.
- 4,479,576. **N-SCREEN (STANDARD CHARACTER)**. LG ELECTRONICS INC., MULTIPLE CLASS, (INT. CLS. 7, 9 AND 11), (U.S. CLS. 13, 19, 21, 23, 26, 31, 34, 35, 36 AND 38). SN 85-505,913. PUB. 6-18-2013. FILED 12-29-2011.
- 4,479,585. **KRAFIT (STYLIZED)**. SAEYANG MICROTECH CO., LTD., MULTIPLE CLASS, (INT. CLS. 7, 10 AND 35), (U.S. CLS. 13, 19, 21, 23, 26, 31, 34, 35, 39, 44, 100, 101 AND 102). SN 85-535,202. PUB. 11-26-2013. FILED 2-6-2012.
- 4,479,634. **4DX (STYLIZED)**. CJ 4DPLEX CO., LTD., (U.S. CLS. 13, 19, 21, 23, 31, 34 AND 35). SN 85-623,271. PUB. 11-26-2013. FILED 5-11-2012.
- 4,479,662 ( *See Class 1 for this trademark*).
- 4,479,935. **SLUSHER (STANDARD CHARACTER)**. SAWATZKE, TURNER C, (U.S. CLS. 13, 19, 21, 23, 31, 34 AND 35). SN 85-810,437. PUB. 11-26-2013. FILED 12-26-2012.
- 4,479,971. **ACHADO (STANDARD CHARACTER)**. ACHADO PTY LTD, (U.S. CLS. 13, 19, 21, 23, 31, 34 AND 35). SN 85-823,145. PUB. 11-26-2013. FILED 1-15-2013.
- 4,479,973. **LITTLE MIKE (STANDARD CHARACTER)**. GENERAL WIRE SPRING CO., (U.S. CLS. 13, 19, 21, 23, 31, 34 AND 35). SN 85-823,294. PUB. 11-26-2013. FILED 1-15-2013.
- 4,480,035. **POSI-TRACK (STANDARD CHARACTER)**. A.S.V., INC., (U.S. CLS. 13, 19, 21, 23, 31, 34 AND 35). SN 85-843,340. PUB. 11-26-2013. FILED 2-7-2013.
- 4,480,068. **KRAMM-LOX (STANDARD CHARACTER)**. RAMM, KARL, MULTIPLE CLASS, (INT. CLS. 7 AND 8), (U.S. CLS. 13, 19, 21, 23, 28, 31, 34, 35 AND 44). SN 85-858,977. PUB. 11-26-2013. FILED 2-25-2013.
- 4,480,276 ( *See Class 5 for this trademark*).
- 4,480,280 ( *See Class 6 for this trademark*).
- 4,480,341. **META (STANDARD CHARACTER)**. ROCK-TENN SHARED SERVICES, LLC, (U.S. CLS. 13, 19, 21, 23, 31, 34 AND 35). SN 85-941,030. PUB. 11-26-2013. FILED 5-23-2013.
- 4,480,443. **META SYSTEMS (STANDARD CHARACTER)**. ROCK-TENN SHARED SERVICES, LLC, MULTIPLE CLASS, (INT. CLS. 7 AND 16), (U.S. CLS. 2, 5, 13, 19, 21, 22, 23, 29, 31, 34, 35, 37, 38 AND 50). SN 85-952,196. PUB. 11-26-2013. FILED 6-6-2013.
- 4,480,679 ( *See Class 6 for this trademark*).
- 4,480,842. **AIR IS EVERYTHING TO ANYTHING THAT LIVES (STANDARD CHARACTER)**. GT AIRINJECT INC, (U.S. CLS. 13, 19, 21, 23, 31, 34 AND 35). SN 86-000,688. PUB. 11-26-2013. FILED 7-2-2013.
- 4,480,868. **MAXXREACH (STANDARD CHARACTER)**. FISCHBEIN LLC, (U.S. CLS. 13, 19, 21, 23, 31, 34 AND 35). SN 86-001,037. PUB. 11-26-2013. FILED 7-2-2013.
- 4,480,869. **ROUTELOADER (STANDARD CHARACTER)**. FISCHBEIN LLC, (U.S. CLS. 13, 19, 21, 23, 31, 34 AND 35). SN 86-001,048. PUB. 11-26-2013. FILED 7-2-2013.
- 4,480,870. **MAXXBOOM (STANDARD CHARACTER)**. FISCHBEIN LLC, (U.S. CLS. 13, 19, 21, 23, 31, 34 AND 35). SN 86-001,059. PUB. 11-26-2013. FILED 7-2-2013.
- 4,481,119. **IBOD (STANDARD CHARACTER)**. CORNERSTONE AUTOMATION SYSTEMS, LLC, (U.S. CLS. 13, 19, 21, 23, 31, 34 AND 35). SN 86-004,767. PUB. 11-26-2013. FILED 7-8-2013.
- 4,481,259. **MISCELLANEOUS DESIGN**. CHENGDU BEST DIAMOND BIT CO., LTD., (U.S. CLS. 13, 19, 21, 23, 31, 34 AND 35). SN 86-041,120. PUB. 11-26-2013. FILED 8-19-2013.
- 4,481,280. **BRAVE (STANDARD CHARACTER)**. GREAT NORTHERN EQUIPMENT DISTRIBUTING, INC., (U.S. CLS. 13, 19, 21, 23, 31, 34 AND 35). SN 86-058,373. PUB. 11-26-2013. FILED 9-6-2013.

---

## CLASS 8—HAND TOOLS

- 4,479,291 ( *See Class 2 for this trademark*).
- 4,479,315. **EARL KITCHEN AND DESIGN**. WUYI EARL KITCHEN SUPPLIES; CO., LTD, (U.S. CLS. 23, 28 AND 44). SN 79-121,742. PUB. 11-26-2013. FILED 10-10-2012.
- 4,479,340 ( *See Class 3 for this trademark*).
- 4,479,347. **BIOLOLOMER (STANDARD CHARACTER)**. GAIA FRANCE, S.A.R.L., MULTIPLE CLASS, (INT. CLS. 8, 16, 17 AND 20), (U.S. CLS. 1, 2, 5, 12, 13, 22, 23, 25, 28, 29, 32, 35, 37, 38, 44 AND 50). SN 79-124,894. PUB. 11-26-2013. FILED 11-27-2012.
- 4,479,492 ( *See Class 6 for this trademark*).
- 4,479,596. **HELPFUL HATTIE (STANDARD CHARACTER)**. E V (BABY) LIMITED, MULTIPLE CLASS, (INT. CLS. 8, 10, 11 AND 35), (U.S. CLS. 13, 21, 23, 26, 28, 31, 34, 39, 44, 100, 101 AND 102). SN 85-554,734. PUB. 2-26-2013. FILED 2-28-2012.
- 4,479,637. **MEL PARDUE (STANDARD CHARACTER)**. JOE PARDUE KNIVES, INCORPORATED, (U.S. CLS. 23, 28 AND 44). SN 85-623,662. PUB. 11-26-2013. FILED 5-11-2012.
- 4,479,671 ( *See Class 3 for this trademark*).
- 4,479,868 ( *See Class 3 for this trademark*).
- 4,480,063. **MARINE AMIGO (STANDARD CHARACTER)**. MARINE AMIGO, INC, (U.S. CLS. 23, 28 AND 44). SN 85-856,343. PUB. 11-26-2013. FILED 2-21-2013.
- 4,480,068 ( *See Class 7 for this trademark*).
- 4,480,211 ( *See Class 6 for this trademark*).
- 4,480,300. **WAVEFORK (STANDARD CHARACTER)**. CHROSTOWSKI, MATT, (U.S. CLS. 23, 28 AND 44). SN 85-931,377. PUB. 11-26-2013. FILED 5-14-2013.
- 4,480,804. **TUFF TUBE (STANDARD CHARACTER)**. UNITED TATTOO SUPPLY, INC., (U.S. CLS. 23, 28 AND 44). SN 86-000,166. PUB. 11-26-2013. FILED 7-2-2013.
- 4,480,926. **A TOOL THAT REALLY SUCKS! (STANDARD CHARACTER)**. RICHARD DEAN MCFARLAND, (U.S. CLS. 23, 28 AND 44). SN 86-002,085. PUB. 11-26-2013. FILED

7-3-2013.  
4,481,133. **T50PBN (STANDARD CHARACTER)**. ARROW FASTENER CO., LLC, (U.S. CLS. 23, 28 AND 44). SN 86-005,034. PUB. 11-26-2013. FILED 7-9-2013.

### CLASS 9—ELECTRICAL AND SCIENTIFIC APPARATUS

- 4,479,243 ( *See Class 1 for this trademark* ).  
4,479,249. **TRUEVERIFIER (STANDARD CHARACTER)**. ATOLLIC AB, (U.S. CLS. 21, 23, 26, 36 AND 38). SN 76-714,412. PUB. 11-26-2013. FILED 3-9-2011.  
4,479,252. **URBAN CHAOS FLEXWEAR (STANDARD CHARACTER)**. INTERNATIONAL POINT OF VIEW, (U.S. CLS. 21, 23, 26, 36 AND 38). SN 77-004,462. PUB. 11-26-2013. FILED 9-21-2006.  
4,479,265. **QA GUARDIAN**. WEBB, RICHARD H, (U.S. CLS. 21, 23, 26, 36 AND 38). SN 78-227,493. PUB. 11-26-2013. FILED 3-19-2003.  
4,479,268. **OERLIKON SKYMASTER (STANDARD CHARACTER)**. RHEINMETALL AIR DEFENCE AG, MULTIPLE CLASS, (INT. CLS. 2, 9, 21, 23, 26, 36 AND 38). SN 79-060,840. PUB. 11-26-2013. FILED 10-2-2008.  
4,479,269 ( *See Class 7 for this trademark* ).  
4,479,273 ( *See Class 3 for this trademark* ).  
4,479,275. **SAGITTA AND DESIGN**. EADS DEUTSCHLAND GMBH, MULTIPLE CLASS, (INT. CLS. 9, 12 AND 37), (U.S. CLS. 19, 21, 23, 26, 31, 35, 36, 38, 44, 100, 103 AND 106). SN 79-107,154. PUB. 11-26-2013. FILED 11-23-2011.  
4,479,277. **INFINITE SQUARE AND DESIGN**. INFINITE SQUARE S.A.S., MULTIPLE CLASS, (INT. CLS. 9, 35, 37, 38, 41 AND 42), (U.S. CLS. 21, 23, 26, 36, 38, 100, 101, 102, 103, 104, 106 AND 107). SN 79-111,658. PUB. 5-28-2013. FILED 11-16-2011.  
4,479,278. **ELSTER ENERGYICT AND DESIGN**. ELSTER GROUP SE, MULTIPLE CLASS, (INT. CLS. 9, 38 AND 42), (U.S. CLS. 21, 23, 26, 36, 38, 100, 101 AND 104). SN 79-111,912. PUB. 11-26-2013. FILED 2-23-2012.  
4,479,279. **VIPNET (STYLIZED)**. JOINT STOCK COMPANY "INFOTEC", MULTIPLE CLASS, (INT. CLS. 9, 16, 35, 37, 41 AND 42), (U.S. CLS. 2, 5, 21, 22, 23, 26, 29, 36, 37, 38, 50, 100, 101, 102, 103, 106 AND 107). SN 79-112,675. PUB. 11-26-2013. FILED 2-16-2012.  
4,479,280. **BALLUUN (STANDARD CHARACTER)**. BALLUUN AG, MULTIPLE CLASS, (INT. CLS. 9, 35, 38, 42 AND 45), (U.S. CLS. 21, 23, 26, 36, 38, 100, 101, 102 AND 104). SN 79-112,707. PUB. 11-26-2013. FILED 11-29-2011.  
4,479,283 ( *See Class 3 for this trademark* ).  
4,479,290 ( *See Class 3 for this trademark* ).  
4,479,291 ( *See Class 2 for this trademark* ).  
4,479,294 ( *See Class 6 for this trademark* ).  
4,479,295. **FOTOROBOT PHOTOROBOT AND DESIGN**. KAMIL HRBÁČEK, (U.S. CLS. 21, 23, 26, 36 AND 38). SN 79-117,498. PUB. 8-20-2013. FILED 3-19-2012.  
4,479,299. **MISCELLANEOUS DESIGN**. VENTUREPARK B.V., MULTIPLE CLASS, (INT. CLS. 9, 36 AND 38), (U.S. CLS. 21, 23, 26, 36, 38, 100, 101, 102 AND 104). SN 79-117,920. PUB. 11-26-2013. FILED 5-9-2012.  
4,479,304. **CLOUDBILLING AND DESIGN**. YELLOWTAIL HOLDING B.V., MULTIPLE CLASS, (INT. CLS. 9, 36 AND 42), (U.S. CLS. 21, 23, 26, 36, 38, 100, 101 AND 102). SN 79-118,656. PUB. 11-26-2013. FILED 7-17-2012.  
4,479,306. **TRAK (STYLIZED)**. ACCUMULATORENWERKE HOPPECKE CARL ZOELLNER & SOHN GMBH, (U.S. CLS. 21, 23, 26, 36 AND 38). SN 79-118,880. PUB. 11-26-2013. FILED 8-9-2012.  
4,479,307. **GLADIATORS OF ROME AND DESIGN**. RAINBOW S.R.L., MULTIPLE CLASS, (INT. CLS. 9, 16, 25, 28 AND 41), (U.S. CLS. 2, 5, 21, 22, 23, 26, 29, 36, 37, 38, 39, 50, 100, 101 AND 107). SN 79-119,495. PUB. 8-13-2013. FILED 12-23-2011.  
4,479,310. **LOST MONSTERS (STANDARD CHARACTER)**. THE DIGITAL PROJECT FACTORY PTY. LTD., MULTIPLE CLASS, (INT. CLS. 9, 28, 38 AND 41), (U.S. CLS. 21, 22, 23, 26, 36, 38, 50, 100, 101, 104 AND 107). SN 79-121,089. PUB. 9-3-2013. FILED 3-6-2012.  
4,479,314. **INNOVISE (STANDARD CHARACTER)**. INNOVISE PLC, MULTIPLE CLASS, (INT. CLS. 9 AND 42), (U.S. CLS. 21, 23, 26, 36, 38, 100 AND 101). SN 79-121,619. PUB. 6-25-2013. FILED 2-9-2012.  
4,479,318 ( *See Class 7 for this trademark* ).  
4,479,319. **MONCLER GRENOBLE AND DESIGN**. MONCLER S.P.A., MULTIPLE CLASS, (INT. CLS. 9, 18 AND 28), (U.S. CLS. 1, 2, 3, 21, 22, 23, 26, 36, 38, 41 AND 50). SN 79-122,261. PUB. 11-26-2013. FILED 5-9-2012.  
4,479,320. **BABY CAFÉ (STYLIZED)**. THE NATIONAL CHILDBIRTH TRUST, MULTIPLE CLASS, (INT. CLS. 9, 16, 41 AND 44), (U.S. CLS. 2, 5, 21, 22, 23, 26, 29, 36, 37, 38, 50, 100, 101 AND 107). SN 79-122,532. PUB. 11-26-2013. FILED 5-30-2012.  
4,479,323. **CIP 120 (STYLIZED)**. INLINGUA INTERNATIONAL AG, MULTIPLE CLASS, (INT. CLS. 9, 16 AND 41), (U.S. CLS. 2, 5, 21, 22, 23, 26, 29, 36, 37, 38, 50, 100, 101 AND 107). SN 79-123,125. PUB. 11-26-2013. FILED 11-21-2012.  
4,479,325 ( *See Class 6 for this trademark* ).  
4,479,338. **SP TM (STYLIZED)**. SAM SPORT AND MARKETING AG, (U.S. CLS. 21, 23, 26, 36 AND 38). SN 79-124,314. PUB. 11-26-2013. FILED 11-29-2012.  
4,479,339. **DIALEGO ... MOVES YOUR MIND AND DESIGN**. DIALEGO AG, MULTIPLE CLASS, (INT. CLS. 9, 35 AND 42), (U.S. CLS. 21, 23, 26, 36, 38, 100, 101 AND 102). SN 79-124,430. PUB. 11-26-2013. FILED 7-31-2012.  
4,479,342. **AMIGO AND DESIGN**. JOSÉ MANUEL BEADE RIOSECO, (U.S. CLS. 21, 23, 26, 36 AND 38). SN 79-124,560. PUB. 11-26-2013. FILED 10-30-2012.  
4,479,354 ( *See Class 7 for this trademark* ).  
4,479,356. **PRESSMATRIX (STANDARD CHARACTER)**. PRESSMATRIX GMBH, MULTIPLE CLASS, (INT. CLS. 9, 35, 38, 41 AND 42), (U.S. CLS. 21, 23, 26, 36, 38, 100, 101, 102, 104 AND 107). SN 79-125,848. PUB. 11-26-2013. FILED 12-7-2012.  
4,479,359 ( *See Class 7 for this trademark* ).  
4,479,367 ( *See Class 3 for this trademark* ).  
4,479,368 ( *See Class 3 for this trademark* ).  
4,479,374. **DOCXAM (STANDARD CHARACTER)**. THE ROYAL BANK OF SCOTLAND GROUP PLC, MULTIPLE CLASS, (INT. CLS. 9, 35, 36 AND 42), (U.S. CLS. 21, 23, 26, 36, 38, 100, 101 AND 102). SN 79-126,377. PUB. 11-26-2013. FILED 3-2-2012.  
4,479,384. **RUGBY DIVISION AND DESIGN**. RUGBY DIVISION SAS, MULTIPLE CLASS, (INT. CLS. 9, 25 AND 28), (U.S. CLS. 21, 22, 23, 26, 36, 38, 39 AND 50). SN 79-126,716. PUB. 11-26-2013. FILED 12-28-2012.  
4,479,385 ( *See Class 7 for this trademark* ).  
4,479,387. **MANCHESTER UNITED (STANDARD CHARACTER)**. MANCHESTER UNITED LIMITED, MULTIPLE CLASS, (INT. CLS. 9 AND 41), (U.S. CLS. 21, 23, 26, 36, 38, 100, 101 AND 107). SN 79-126,760. PUB. 11-26-2013. FILED 12-20-2012.  
4,479,391. **MOUNT & BLADE AND DESIGN**. TALEWORLDS ENTERTAINMENT IKISOFT.; YAZILIM BILGI VE ILETISIM.; EGITIM TEKNOLOJILERI.; VE HIZMETLERI ELEKTRONIK.; SANAYI VE TICARET LIMITED SIRKETI, MULTIPLE CLASS, (INT. CLS. 9, 28 AND 41), (U.S. CLS. 21, 22, 23, 26, 36, 38, 50, 100, 101 AND 107). SN 79-126,794. PUB. 11-26-2013. FILED 9-28-2012.  
4,479,394. **SECSIGN (STANDARD CHARACTER)**. SECCOMERCE; INFORMATIONSSYSTEME GMBH, MULTIPLE CLASS, (INT. CLS. 9 AND 42), (U.S. CLS. 21, 23, 26, 36, 38, 100 AND 101). SN 79-126,939. PUB. 11-26-2013. FILED 12-14-2012.  
4,479,399. **NOISE SENTINEL (STANDARD CHARACTER)**. BRÜEL & KJÆR SOUND & VIBRATION; MEASUREMENT A/S, MULTIPLE CLASS, (INT. CLS. 9, 35, 38 AND 42), (U.S. CLS. 21, 23, 26, 36, 38, 100, 101, 102 AND 104). SN 79-127,154. PUB. 11-26-2013. FILED 7-5-2012.  
4,479,402. **MEDISO (STYLIZED)**. MEDISO ORVOSI BERENDEZÉS FEJLESZTŐ; ÉS SZERVÍZ KFT., MULTIPLE CLASS, (INT. CLS. 9, 10 AND 42), (U.S. CLS. 21, 23, 26, 36, 38, 39, 44, 100 AND 101). SN 79-127,248. PUB. 11-26-2013. FILED 12-1-2012.  
4,479,406. **GADGETSHOP (STYLIZED)**. W.H. SMITH RETAIL HOLDINGS; LIMITED, MULTIPLE CLASS, (INT. CLS. 9

- AND 28), (U.S. CLS. 21, 22, 23, 26, 36, 38 AND 50). SN 79-127,409. PUB. 11-26-2013. FILED 12-7-2012.
- 4,479,407. **FF (STYLIZED)**. FERRARI S.P.A., MULTIPLE CLASS, (INT. CLS. 9, 12 AND 28), (U.S. CLS. 19, 21, 22, 23, 26, 31, 35, 36, 38, 44 AND 50). SN 79-127,430. PUB. 11-26-2013. FILED 6-10-2011.
- 4,479,410 ( *See Class 6 for this trademark*).
- 4,479,412 ( *See Class 7 for this trademark*).
- 4,479,413. **HELP CHILDREN FOUNDATION AND DESIGN**. HELP CHILDREN FOUNDATION; (STIFTUNG DES PRIVATRECHTS); VERTRETEN DURCH DEN VORSTAND; E. SACHS UND G. SACHS, MULTIPLE CLASS, (INT. CLS. 9, 14, 16, 18, 24, 25, 26, 28, 35, 36, 41, 42, 43 AND 44), (U.S. CLS. 1, 2, 3, 5, 21, 22, 23, 26, 27, 28, 29, 36, 37, 38, 39, 40, 41, 42, 50, 100, 101, 102 AND 107). SN 79-127,674. PUB. 11-26-2013. FILED 3-20-2012.
- 4,479,414. **VERSACRANE (STANDARD CHARACTER)**. KARL STORZ GMBH & CO. KG, MULTIPLE CLASS, (INT. CLS. 9, 10 AND 16), (U.S. CLS. 2, 5, 21, 22, 23, 26, 29, 36, 37, 38, 39, 44 AND 50). SN 79-127,763. PUB. 11-26-2013. FILED 2-5-2013.
- 4,479,418. **STREEMFIRE AND DESIGN**. STREEMFIRE GMBH, MULTIPLE CLASS, (INT. CLS. 9, 38 AND 42), (U.S. CLS. 21, 23, 26, 36, 38, 100, 101 AND 104). SN 79-128,118. PUB. 11-26-2013. FILED 9-18-2012.
- 4,479,419. **STREEMFIRE (STANDARD CHARACTER)**. STREEMFIRE GMBH, MULTIPLE CLASS, (INT. CLS. 9, 38 AND 42), (U.S. CLS. 21, 23, 26, 36, 38, 100, 101 AND 104). SN 79-128,119. PUB. 11-26-2013. FILED 9-18-2012.
- 4,479,434 ( *See Class 3 for this trademark*).
- 4,479,441. **VPAR (STANDARD CHARACTER)**. JULIAN SYKES, MULTIPLE CLASS, (INT. CLS. 9, 35, 38, 41 AND 42), (U.S. CLS. 21, 23, 26, 36, 38, 100, 101, 102, 104 AND 107). SN 79-129,511. PUB. 11-26-2013. FILED 9-1-2011.
- 4,479,448. **[Y ] (STYLIZED)**. HYBRIS AG, MULTIPLE CLASS, (INT. CLS. 9, 35, 38 AND 42), (U.S. CLS. 21, 23, 26, 36, 38, 100, 101, 102 AND 104). SN 79-129,970. PUB. 11-26-2013. FILED 3-6-2013.
- 4,479,452. **GILEAD (STANDARD CHARACTER)**. J JEANNE WHERRETT, AND ARTHUR G WHERRETT, MULTIPLE CLASS, (INT. CLS. 9 AND 16), (U.S. CLS. 2, 5, 21, 22, 23, 26, 29, 36, 37, 38 AND 50). SN 79-130,313. PUB. 11-26-2013. FILED 2-5-2013.
- 4,479,454. **CITYSHARE (STANDARD CHARACTER)**. MAARTEN GRAVEN, MULTIPLE CLASS, (INT. CLS. 9, 41 AND 43), (U.S. CLS. 21, 23, 26, 36, 38, 100, 101 AND 107). SN 79-130,614. PUB. 11-26-2013. FILED 4-12-2013.
- 4,479,455. **IZETTLE STORE (STANDARD CHARACTER)**. IZETTLE AB, MULTIPLE CLASS, (INT. CLS. 9, 36 AND 38), (U.S. CLS. 21, 23, 26, 36, 38, 100, 101, 102 AND 104). SN 79-130,836. PUB. 11-26-2013. FILED 4-12-2013.
- 4,479,460. **IZETTLE REGISTER (STANDARD CHARACTER)**. IZETTLE AB, MULTIPLE CLASS, (INT. CLS. 9, 36 AND 38), (U.S. CLS. 21, 23, 26, 36, 38, 100, 101, 102 AND 104). SN 79-131,177. PUB. 11-26-2013. FILED 4-12-2013.
- 4,479,462 ( *See Class 6 for this trademark*).
- 4,479,464. **IZETTLE WIRE (STANDARD CHARACTER)**. IZETTLE AB, MULTIPLE CLASS, (INT. CLS. 9, 36 AND 38), (U.S. CLS. 21, 23, 26, 36, 38, 100, 101, 102 AND 104). SN 79-131,518. PUB. 11-26-2013. FILED 4-12-2013.
- 4,479,467. **IZETTLE (STANDARD CHARACTER)**. IZETTLE AB, MULTIPLE CLASS, (INT. CLS. 9, 36 AND 38), (U.S. CLS. 21, 23, 26, 36, 38, 100, 101, 102 AND 104). SN 79-131,752. PUB. 11-26-2013. FILED 4-8-2013.
- 4,479,469. **DENOFFICE AND DESIGN**. THE INDIVIDUAL ENTREPRENEUR; DAVYDOVA ELENA GRIGOREVA, MULTIPLE CLASS, (INT. CLS. 9, 16, 35, 36, 38, 41 AND 42), (U.S. CLS. 2, 5, 21, 22, 23, 26, 29, 36, 37, 38, 50, 100, 101, 102, 104 AND 107). SN 79-132,004. PUB. 11-26-2013. FILED 1-30-2013.
- 4,479,477 ( *See Class 6 for this trademark*).
- 4,479,514. **KINTONE (STANDARD CHARACTER)**. CYBOZU, INC., MULTIPLE CLASS, (INT. CLS. 9 AND 42), (U.S. CLS. 21, 23, 26, 36, 38, 100 AND 101). SN 79-136,430. PUB. 11-26-2013. FILED 12-28-2012.
- 4,479,522 ( *See Class 7 for this trademark*).
- 4,479,529. **DRESS ASSISTANT (STANDARD CHARACTER)**. ECHENIQUE, LEONARDO LUIS, (U.S. CLS. 21, 23, 26, 36 AND 38). SN 85-208,843. PUB. 11-26-2013. FILED 1-2-2011.
- 4,479,536 ( *See Class 7 for this trademark*).
- 4,479,537 ( *See Class 7 for this trademark*).
- 4,479,538. **PRAXIS (STANDARD CHARACTER)**. EDUCATIONAL TESTING SERVICE, MULTIPLE CLASS, (INT. CLS. 9, 16, 35, 41 AND 42), (U.S. CLS. 2, 5, 21, 22, 23, 26, 29, 36, 37, 38, 50, 100, 101, 102 AND 107). SN 85-340,767. PUB. 11-26-2013. FILED 6-8-2011.
- 4,479,555. **SAMSUNG GALAXY TAB CREATIVE (STYLIZED)**. SAMSUNG ELECTRONICS CO., LTD., (U.S. CLS. 21, 23, 26, 36 AND 38). SN 85-446,472. PUB. 11-26-2013. FILED 10-13-2011.
- 4,479,556. **SAMSUNG GALAXY W WONDER (STYLIZED)**. SAMSUNG ELECTRONICS CO., LTD., (U.S. CLS. 21, 23, 26, 36 AND 38). SN 85-446,483. PUB. 11-26-2013. FILED 10-13-2011.
- 4,479,557. **SAMSUNG GALAXY R (STYLIZED)**. SAMSUNG ELECTRONICS CO., LTD., (U.S. CLS. 21, 23, 26, 36 AND 38). SN 85-446,491. PUB. 11-26-2013. FILED 10-13-2011.
- 4,479,558 ( *See Class 3 for this trademark*).
- 4,479,559 ( *See Class 3 for this trademark*).
- 4,479,560 ( *See Class 3 for this trademark*).
- 4,479,568 ( *See Class 3 for this trademark*).
- 4,479,569. **SAMSUNG ONE LINE AND DESIGN**. SAMSUNG ELECTRONICS CO., LTD., (U.S. CLS. 21, 23, 26, 36 AND 38). SN 85-475,835. PUB. 11-26-2013. FILED 11-17-2011.
- 4,479,575. **TRESONA (STANDARD CHARACTER)**. TRESONA MULTIMEDIA, LLC, MULTIPLE CLASS, (INT. CLS. 9, 35, 36, 38, 41 AND 42), (U.S. CLS. 21, 23, 26, 36, 38, 100, 101, 102, 104 AND 107). SN 85-500,773. PUB. 9-24-2013. FILED 12-21-2011.
- 4,479,576 ( *See Class 7 for this trademark*).
- 4,479,577. **FACET (STANDARD CHARACTER)**. FACET TECHNOLOGIES, INC., MULTIPLE CLASS, (INT. CLS. 9, 37 AND 42), (U.S. CLS. 21, 23, 26, 36, 38, 100, 101, 103 AND 106). SN 85-506,272. PUB. 7-16-2013. FILED 12-30-2011.
- 4,479,578 ( *See Class 3 for this trademark*).
- 4,479,588. **SMART FAITH (STANDARD CHARACTER)**. HAN-DA, JASON, (U.S. CLS. 21, 23, 26, 36 AND 38). SN 85-543,308. PUB. 11-26-2013. FILED 2-15-2012.
- 4,479,592. **POKER MOB (STANDARD CHARACTER)**. SOCIALPLAY, LTD., MULTIPLE CLASS, (INT. CLS. 9 AND 41), (U.S. CLS. 21, 23, 26, 36, 38, 100, 101 AND 107). SN 85-547,213. PUB. 9-24-2013. FILED 2-20-2012.
- 4,479,593. **PERFECT TEXAS HOLDEM POKER AND DESIGN**. SOCIALPLAY, LTD., MULTIPLE CLASS, (INT. CLS. 9 AND 41), (U.S. CLS. 21, 23, 26, 36, 38, 100, 101 AND 107). SN 85-547,225. PUB. 9-24-2013. FILED 2-20-2012.
- 4,479,594. **TOUCH ONE (STANDARD CHARACTER)**. LG ELECTRONICS INC., (U.S. CLS. 21, 23, 26, 36 AND 38). SN 85-548,283. PUB. 11-26-2013. FILED 2-21-2012.
- 4,479,603. **PE (STANDARD CHARACTER)**. PETROLEUM EXPERTS LIMITED, MULTIPLE CLASS, (INT. CLS. 9, 41 AND 42), (U.S. CLS. 21, 23, 26, 36, 38, 100, 101 AND 107). SN 85-572,198. PUB. 6-18-2013. FILED 3-16-2012.
- 4,479,605. **SALSA (STANDARD CHARACTER)**. RIMOWA GMBH, MULTIPLE CLASS, (INT. CLS. 9 AND 18), (U.S. CLS. 1, 2, 3, 21, 22, 23, 26, 36, 38 AND 41). SN 85-576,849. PUB. 8-27-2013. FILED 3-22-2012.
- 4,479,608. **FASTVIEW (STANDARD CHARACTER)**. RADWARE LTD., (U.S. CLS. 21, 23, 26, 36 AND 38). SN 85-579,406. PUB. 11-26-2013. FILED 3-26-2012.
- 4,479,623. **RUBBER TACOS (STANDARD CHARACTER)**. SAVA TRANSMEDIA INC., (U.S. CLS. 21, 23, 26, 36 AND 38). SN 85-615,743. PUB. 11-26-2013. FILED 5-3-2012.
- 4,479,632. **PAYMASTER A BETTER WAY TO PAY (STANDARD CHARACTER)**. PAYMASTER, INC., MULTIPLE CLASS, (INT. CLS. 9, 35 AND 36), (U.S. CLS. 21, 23, 26, 36, 38, 100, 101 AND 102). SN 85-622,506. PUB. 5-28-2013. FILED 5-11-2012.
- 4,479,638. **8BITCOLLECTIVE (STANDARD CHARACTER)**. 8BITCOLLECTIVE INC., (U.S. CLS. 21, 23, 26, 36 AND 38). SN 85-623,971. PUB. 11-26-2013. FILED 5-14-2012; AM. P.R. 9-30-2013.
- 4,479,646. **S.N.I.P.E.R. AND DESIGN**. LUNARLINE, INC., (U.S. CLS. 21, 23, 26, 36 AND 38). SN 85-631,430. PUB. 11-26-2013. FILED 5-22-2012.
- 4,479,647. **RAILSLIDE (STANDARD CHARACTER)**. ICEBERG COMMERCE INC., (U.S. CLS. 21, 23, 26, 36 AND 38). SN 85-

- 631,673. PUB. 11-26-2013. FILED 5-22-2012.
- 4,479,648. **ASSETTRACK (STANDARD CHARACTER)**. ASSET MANAGEMENT INTERNATIONAL, LLC, (U.S. CLS. 21, 23, 26, 36 AND 38). SN 85-632,233. PUB. 5-28-2013. FILED 5-22-2012.
- 4,479,651. **ELECTROFLOW (STANDARD CHARACTER)**. GHIAM, MEHRDAD FOTOOHI, (U.S. CLS. 21, 23, 26, 36 AND 38). SN 85-633,354. PUB. 11-26-2013. FILED 5-23-2012.
- 4,479,652. **ELECTROFLOW TECHNOLOGIES INC. (STANDARD CHARACTER)**. GHIAM, MEHRDAD FOTOOHI, (U.S. CLS. 21, 23, 26, 36 AND 38). SN 85-633,367. PUB. 11-26-2013. FILED 5-23-2012.
- 4,479,662 ( *See Class 1 for this trademark*).
- 4,479,663. **COMBAT CREATURES (STANDARD CHARACTER)**. CHINA INDUSTRIES LIMITED, MULTIPLE CLASS, (INT. CLS. 9, 16, 28 AND 41), (U.S. CLS. 2, 5, 21, 22, 23, 26, 29, 36, 37, 38, 50, 100, 101 AND 107). SN 85-636,236. PUB. 6-11-2013. FILED 5-25-2012.
- 4,479,674. **EABF (STANDARD CHARACTER)**. AFL TELECOMMUNICATIONS, LLC, (U.S. CLS. 21, 23, 26, 36 AND 38). SN 85-647,511. PUB. 11-26-2013. FILED 6-8-2012.
- 4,479,677. **EXU MEDIA (STANDARD CHARACTER)**. EXU MEDIA, LLC, MULTIPLE CLASS, (INT. CLS. 9 AND 41), (U.S. CLS. 21, 23, 26, 36, 38, 100, 101 AND 107). SN 85-650,099. PUB. 11-26-2013. FILED 6-12-2012.
- 4,479,678. **THE SCIENCE OF COMPLIANCE (STANDARD CHARACTER)**. NETWORK FRONTIERS, LLC, (U.S. CLS. 21, 23, 26, 36 AND 38). SN 85-650,161. PUB. 11-26-2013. FILED 6-12-2012.
- 4,479,680. **NETDIMENSIONS TALENT SUITE AND DESIGN**. NETDIMENSIONS LIMITED, MULTIPLE CLASS, (INT. CLS. 9, 35, 41 AND 42), (U.S. CLS. 21, 23, 26, 36, 38, 100, 101, 102 AND 107). SN 85-652,100. PUB. 11-26-2013. FILED 6-14-2012.
- 4,479,683. **DANG (STANDARD CHARACTER)**. DANG SHADES, (U.S. CLS. 21, 23, 26, 36 AND 38). SN 85-656,617. PUB. 11-26-2013. FILED 6-20-2012.
- 4,479,688. **OTT NETWORKS INTERNATIONAL (STANDARD CHARACTER)**. OVER THE TOP NETWORKS INTERNATIONAL, (U.S. CLS. 21, 23, 26, 36 AND 38). SN 85-660,551. PUB. 6-18-2013. FILED 6-25-2012.
- 4,479,692. **OTT NETWORKS (STANDARD CHARACTER)**. OVER THE TOP NETWORKS INTERNATIONAL, (U.S. CLS. 21, 23, 26, 36 AND 38). SN 85-664,307. PUB. 6-18-2013. FILED 6-28-2012.
- 4,479,699. **ALFA ROMEO (STYLIZED)**. FIAT GROUP MARKETING & CORPORATE COMMUNICATIONS S.P.A., MULTIPLE CLASS, (INT. CLS. 9, 12, 14, 16 AND 28), (U.S. CLS. 2, 5, 19, 21, 22, 23, 26, 27, 28, 29, 31, 35, 36, 37, 38, 44 AND 50). SN 85-672,877. PUB. 11-26-2013. FILED 7-10-2012.
- 4,479,705. **GEL DEFENDER (STANDARD CHARACTER)**. PSE TECHNOLOGY LLC, (U.S. CLS. 21, 23, 26, 36 AND 38). SN 85-680,508. PUB. 11-26-2013. FILED 7-18-2012.
- 4,479,715. **FILEMEDIC (STANDARD CHARACTER)**. FILEMEDIC SP. Z O.O., MULTIPLE CLASS, (INT. CLS. 9 AND 42), (U.S. CLS. 21, 23, 26, 36, 38, 100 AND 101). SN 85-697,788. PUB. 6-4-2013. FILED 8-7-2012.
- 4,479,724. **UTM (STANDARD CHARACTER)**. COPAN DIAGNOSTICS, INC., MULTIPLE CLASS, (INT. CLS. 9 AND 10), (U.S. CLS. 21, 23, 26, 36, 38, 39 AND 44). SN 85-716,117. PUB. 11-26-2013. FILED 8-29-2012.
- 4,479,732. **BROAMAN (STANDARD CHARACTER)**. BRUNKE, MARC, MULTIPLE CLASS, (INT. CLS. 9, 37 AND 42), (U.S. CLS. 21, 23, 26, 36, 38, 100, 101, 103 AND 106). SN 85-724,801. PUB. 8-20-2013. FILED 9-10-2012.
- 4,479,735. **TRAXPORTAL (STANDARD CHARACTER)**. TRAXID, LLC, (U.S. CLS. 21, 23, 26, 36 AND 38). SN 85-727,525. PUB. 7-16-2013. FILED 9-12-2012.
- 4,479,736. **TRAXID (STANDARD CHARACTER)**. TRAXID, LLC, (U.S. CLS. 21, 23, 26, 36 AND 38). SN 85-727,635. PUB. 7-16-2013. FILED 9-12-2012.
- 4,479,749. **MRLD (STANDARD CHARACTER)**. TAIYO YUDEN CO., LTD., (U.S. CLS. 21, 23, 26, 36 AND 38). SN 85-735,093. PUB. 11-26-2013. FILED 9-21-2012.
- 4,479,754. **MANPAK (STANDARD CHARACTER)**. SATELLITE INFORMATION SERVICES LIMITED, MULTIPLE CLASS, (INT. CLS. 9, 35 AND 38), (U.S. CLS. 21, 23, 26, 36, 38, 100, 101, 102 AND 104). SN 85-739,418. PUB. 11-26-2013. FILED 9-26-2012.
- 4,479,767. **BINOPTOMETER (STANDARD CHARACTER)**. OCULUS OPTIKGERAETE GMBH, MULTIPLE CLASS, (INT. CLS. 9 AND 10), (U.S. CLS. 21, 23, 26, 36, 38, 39 AND 44). SN 85-750,308. PUB. 11-26-2013. FILED 10-10-2012.
- 4,479,768. **EC (STANDARD CHARACTER)**. EDGECAST NETWORKS, INC, MULTIPLE CLASS, (INT. CLS. 9, 35 AND 42), (U.S. CLS. 21, 23, 26, 36, 38, 100, 101 AND 102). SN 85-750,917. PUB. 11-26-2013. FILED 10-10-2012.
- 4,479,778. **BURNING GLASS (STANDARD CHARACTER)**. BURNING GLASS INTERNATIONAL, INC., MULTIPLE CLASS, (INT. CLS. 9, 35 AND 42), (U.S. CLS. 21, 23, 26, 36, 38, 100, 101 AND 102). SN 85-758,815. PUB. 11-26-2013. FILED 10-19-2012.
- 4,479,781. **SPACED 360 AND DESIGN**. ORBITSOUND LIMITED, MULTIPLE CLASS, (INT. CLS. 9, 35 AND 42), (U.S. CLS. 21, 23, 26, 36, 38, 100, 101 AND 102). SN 85-761,735. PUB. 11-26-2013. FILED 10-23-2012.
- 4,479,798. **CHAMTCH ENTERPRISES AND DESIGN**. CHAMTECH INTERPRISES, INC., AKA CHAMTECH OPERATIONS, (U.S. CLS. 21, 23, 26, 36 AND 38). SN 85-771,839. PUB. 11-26-2013. FILED 11-5-2012.
- 4,479,803. **IP TECHNOLOGY LABS (STANDARD CHARACTER)**. IP TECHNOLOGY LABS, LLC, (U.S. CLS. 21, 23, 26, 36 AND 38). SN 85-774,748. PUB. 11-26-2013. FILED 11-8-2012.
- 4,479,810. **FEUERWEAR (STANDARD CHARACTER)**. FEUERWEAR GMBH & CO. KG, MULTIPLE CLASS, (INT. CLS. 9 AND 18), (U.S. CLS. 1, 2, 3, 21, 22, 23, 26, 36, 38 AND 41). SN 85-776,685. PUB. 11-26-2013. FILED 11-12-2012.
- 4,479,826. **G-BOX MIDNIGHT (STANDARD CHARACTER)**. GRANT SAMMY, (U.S. CLS. 21, 23, 26, 36 AND 38). SN 85-780,119. PUB. 11-26-2013. FILED 11-15-2012.
- 4,479,833. **KINGGOLD.COM (STANDARD CHARACTER)**. KING.COM LIMITED, MULTIPLE CLASS, (INT. CLS. 9, 25 AND 41), (U.S. CLS. 21, 22, 23, 26, 36, 38, 39, 100, 101 AND 107). SN 85-782,683. PUB. 9-10-2013. FILED 11-19-2012.
- 4,479,846. **SOCIAL BOOTH AND DESIGN**. SOCIAL BOOTH, MULTIPLE CLASS, (INT. CLS. 9 AND 41), (U.S. CLS. 21, 23, 26, 36, 38, 100, 101 AND 107). SN 85-789,984. PUB. 11-26-2013. FILED 11-28-2012.
- 4,479,852. **AMAZON STUDIOS (STANDARD CHARACTER)**. AMAZON TECHNOLOGIES, INC., MULTIPLE CLASS, (INT. CLS. 9, 16, 35, 38, 41, 42 AND 45), (U.S. CLS. 2, 5, 21, 22, 23, 26, 29, 36, 37, 38, 50, 100, 101, 102, 104 AND 107). SN 85-792,019. PUB. 11-26-2013. FILED 11-30-2012.
- 4,479,853. **TRINIDAD JAMES (STANDARD CHARACTER)**. GIRVAN HENRY, MULTIPLE CLASS, (INT. CLS. 9 AND 41), (U.S. CLS. 21, 23, 26, 36, 38, 100, 101 AND 107). SN 85-792,680. PUB. 11-26-2013. FILED S.R. 12-3-2012; AM. P.R. 9-27-2013.
- 4,479,882. **ABOUT A MILE (STANDARD CHARACTER)**. ABOUT A MILE, LLC, MULTIPLE CLASS, (INT. CLS. 9 AND 41), (U.S. CLS. 21, 23, 26, 36, 38, 100, 101 AND 107). SN 85-801,135. PUB. 11-26-2013. FILED 12-12-2012.
- 4,479,904. **CLAW COVER (STANDARD CHARACTER)**. WORLDWIDE PROTECTIVE PRODUCTS, LLC, (U.S. CLS. 21, 23, 26, 36 AND 38). SN 85-805,618. PUB. 11-26-2013. FILED 12-18-2012.
- 4,479,907. **XTOOL (STYLIZED)**. XTOOLTECH LLC, (U.S. CLS. 21, 23, 26, 36 AND 38). SN 85-806,025. PUB. 11-26-2013. FILED 12-18-2012.
- 4,479,910. **MEASURED PROGRESS COMMON CORE (STANDARD CHARACTER)**. MEASURED PROGRESS INC., MULTIPLE CLASS, (INT. CLS. 9 AND 41), (U.S. CLS. 21, 23, 26, 36, 38, 100, 101 AND 107). SN 85-806,398. PUB. 11-26-2013. FILED 12-19-2012.
- 4,479,926. **@RISK (STANDARD CHARACTER)**. PALISADE CORPORATION, DBA PALISADE CORPORATION, (U.S. CLS. 21, 23, 26, 36 AND 38). SN 85-809,560. PUB. 11-26-2013. FILED 12-21-2012.
- 4,479,949. **MISCELLANEOUS DESIGN**. NYSE GROUP, INC., MULTIPLE CLASS, (INT. CLS. 9, 16, 35, 36, 38 AND 41), (U.S. CLS. 2, 5, 21, 22, 23, 26, 29, 36, 37, 38, 50, 100, 101, 102, 104 AND 107). SN 85-814,898. PUB. 11-26-2013. FILED 1-3-2013.
- 4,479,956. **WX (STANDARD CHARACTER)**. WILEY X, INC.,



- MULTIPLE CLASS, (INT. CLS. 9 AND 41), (U.S. CLS. 21, 23, 26, 36, 38, 100, 101 AND 107). SN 85-817,328. PUB. 11-26-2013. FILED 1-7-2013.
- 4,479,963. **LIGITEK AND DESIGN. LIGITEK ELECTRONICS CO., LTD.**, (U.S. CLS. 21, 23, 26, 36 AND 38). SN 85-820,572. PUB. 11-26-2013. FILED 1-10-2013.
- 4,479,981. **MANUGRAPHY (STANDARD CHARACTER). PETER SEITZ, MULTIPLE CLASS, (INT. CLS. 9, 10 AND 42), (U.S. CLS. 21, 23, 26, 36, 38, 39, 44, 100 AND 101), (U.S. CLS. 21, 23, 26, 36 AND 38).** SN 85-825,382. PUB. 11-26-2013. FILED 1-17-2013.
- 4,479,990. **DIGS (STANDARD CHARACTER). ZILLOW, INC.**, (U.S. CLS. 21, 23, 26, 36 AND 38). SN 85-828,306. PUB. 5-14-2013. FILED 1-21-2013.
- 4,480,003. **ATTENDEASE (STANDARD CHARACTER). COVERALL CREW CORPORATION, MULTIPLE CLASS, (INT. CLS. 9, 35 AND 41), (U.S. CLS. 21, 23, 26, 36, 38, 100, 101, 102 AND 107).** SN 85-830,541. PUB. 11-26-2013. FILED 1-23-2013.
- 4,480,016. **MISCELLANEOUS DESIGN. NOVANOVAPOS, INC.**, (U.S. CLS. 21, 23, 26, 36 AND 38). SN 85-835,364. PUB. 11-26-2013. FILED 1-29-2013.
- 4,480,032. **PERSONALIZED EDUCATION STARTS AT ESCHOLAR (STANDARD CHARACTER). ESCHOLAR LLC, MULTIPLE CLASS, (INT. CLS. 9 AND 35), (U.S. CLS. 21, 23, 26, 36, 38, 100, 101 AND 102).** SN 85-842,250. PUB. 11-26-2013. FILED 2-6-2013.
- 4,480,036. **CW-SIM (STANDARD CHARACTER). MITSUBISHI ELECTRIC CORPORATION, (U.S. CLS. 21, 23, 26, 36 AND 38).** SN 85-843,362. PUB. 11-26-2013. FILED 2-7-2013.
- 4,480,051. **FRESH BOX (STANDARD CHARACTER). HIRSCHMANN AUTOMOTIVE GMBH, (U.S. CLS. 21, 23, 26, 36 AND 38).** SN 85-851,055. PUB. 11-26-2013. FILED 2-15-2013.
- 4,480,065. **ZEMS (STANDARD CHARACTER). TOKO ELECTRIC CORPORATION, (U.S. CLS. 21, 23, 26, 36 AND 38).** SN 85-857,474. PUB. 11-26-2013. FILED 2-22-2013.
- 4,480,082. **HM HEALTHCARE MOBILE AND DESIGN. HEALTHCARE MOBILE, LLC, (U.S. CLS. 21, 23, 26, 36 AND 38).** SN 85-861,585. PUB. 8-20-2013. FILED 2-27-2013.
- 4,480,092. **CB 500 (STANDARD CHARACTER). CONTINENTAL AUTOMOTIVE GMBH, (U.S. CLS. 21, 23, 26, 36 AND 38).** SN 85-866,778. PUB. 11-26-2013. FILED 3-5-2013.
- 4,480,094. **YOUNG TURKS (STANDARD CHARACTER). CAIUS PAWSON, MULTIPLE CLASS, (INT. CLS. 9, 16, 25, 35, 38 AND 41), (U.S. CLS. 2, 5, 21, 22, 23, 26, 29, 36, 37, 38, 39, 50, 100, 101, 102, 104 AND 107).** SN 85-867,036. PUB. 11-26-2013. FILED 3-5-2013.
- 4,480,114. **SPINSOLVE (STANDARD CHARACTER). MAGRIK HOLDINGS LIMITED, (U.S. CLS. 21, 23, 26, 36 AND 38).** SN 85-876,303. PUB. 11-26-2013. FILED 3-14-2013.
- 4,480,115. **PLAY:5 (STANDARD CHARACTER). SONOS, INC.**, (U.S. CLS. 21, 23, 26, 36 AND 38). SN 85-876,774. PUB. 11-26-2013. FILED 3-14-2013.
- 4,480,123. **MUTU (STANDARD CHARACTER). POWELL, WENDY, MULTIPLE CLASS, (INT. CLS. 9, 16 AND 41), (U.S. CLS. 2, 5, 21, 22, 23, 26, 29, 36, 37, 38, 50, 100, 101 AND 107).** SN 85-880,353. PUB. 11-26-2013. FILED 3-19-2013.
- 4,480,126. **DYNAVOX COMPASS (STANDARD CHARACTER). DYNAVOX SYSTEMS LLC, (U.S. CLS. 21, 23, 26, 36 AND 38).** SN 85-881,319. PUB. 11-26-2013. FILED 3-20-2013.
- 4,480,140. **GNOSIS (STANDARD CHARACTER). ADVANCED PRACTICE STRATEGIES, INC.**, (U.S. CLS. 21, 23, 26, 36 AND 38). SN 85-885,283. PUB. 11-26-2013. FILED 3-25-2013.
- 4,480,145. **GLASSY (STANDARD CHARACTER). GLASSY LLC, (U.S. CLS. 21, 23, 26, 36 AND 38).** SN 85-887,595. PUB. 11-26-2013. FILED 3-27-2013.
- 4,480,152. **R AND DESIGN. RADIANT OPTO-ELECTRONICS CORPORATION, MULTIPLE CLASS, (INT. CLS. 9, 11 AND 40), (U.S. CLS. 13, 21, 23, 26, 31, 34, 36, 38, 100, 103 AND 106).** SN 85-888,685. PUB. 8-27-2013. FILED 3-28-2013.
- 4,480,175. **MAGNETIC CHAT (STANDARD CHARACTER). MARC BAUER, (U.S. CLS. 21, 23, 26, 36 AND 38).** SN 85-898,603. PUB. 11-26-2013. FILED 4-9-2013.
- 4,480,176. **USERSCAPE (STANDARD CHARACTER). USERSCAPE, INC.**, (U.S. CLS. 21, 23, 26, 36 AND 38). SN 85-899,065. PUB. 11-26-2013. FILED 4-9-2013.
- 4,480,180. **G GRAPHICAL NETWORKS GET VISUAL ABOUT IT AND DESIGN. GRAPHICAL NETWORKS LLC, MULTIPLE CLASS, (INT. CLS. 9 AND 42), (U.S. CLS. 21, 23, 26, 36, 38, 100 AND 101).** SN 85-900,252. PUB. 11-26-2013. FILED 4-10-2013.
- 4,480,188. **AUTOCAL (STANDARD CHARACTER). GEO SEMICONDUCTOR INC.**, (U.S. CLS. 21, 23, 26, 36 AND 38). SN 85-903,196. PUB. 11-26-2013. FILED 4-12-2013.
- 4,480,199. **NASHAZ (STANDARD CHARACTER). PRUNKA, BRIAN, MULTIPLE CLASS, (INT. CLS. 9 AND 41), (U.S. CLS. 21, 23, 26, 36, 38, 100, 101 AND 107).** SN 85-906,031. PUB. 11-26-2013. FILED 4-16-2013.
- 4,480,204. **THE POWER BEYOND EXPECTATIONS (STANDARD CHARACTER). RF-LAMBDA USA INC.**, (U.S. CLS. 21, 23, 26, 36 AND 38). SN 85-908,520. PUB. 11-26-2013. FILED 4-18-2013.
- 4,480,205. **RF AND DESIGN. RF-LAMBDA USA INC.**, (U.S. CLS. 21, 23, 26, 36 AND 38). SN 85-908,738. PUB. 11-26-2013. FILED 4-18-2013.
- 4,480,206. **RF RF-LAMBDA THE POWER BEYOND EXPECTATIONS AND DESIGN. RF-LAMBDA USA INC.**, (U.S. CLS. 21, 23, 26, 36 AND 38). SN 85-908,746. PUB. 11-26-2013. FILED 4-18-2013.
- 4,480,219. **ARDUSAT (STANDARD CHARACTER). NANOSATISFI, INC.**, (U.S. CLS. 21, 23, 26, 36 AND 38). SN 85-911,511. PUB. 11-26-2013. FILED 4-22-2013.
- 4,480,221. **A AUTODESK AND DESIGN. AUTODESK, INC., MULTIPLE CLASS, (INT. CLS. 9, 41 AND 42), (U.S. CLS. 21, 23, 26, 36, 38, 100, 101 AND 107).** SN 85-912,280. PUB. 11-26-2013. FILED 4-23-2013.
- 4,480,236. **DINETIME (STANDARD CHARACTER). QSR AUTOMATIONS, INC., MULTIPLE CLASS, (INT. CLS. 9 AND 42), (U.S. CLS. 21, 23, 26, 36, 38, 100 AND 101).** SN 85-915,899. PUB. 11-26-2013. FILED 4-26-2013.
- 4,480,244. **MISCELLANEOUS DESIGN. VERBALIZEIT, INC.**, (U.S. CLS. 21, 23, 26, 36 AND 38). SN 85-922,104. PUB. 11-26-2013. FILED 5-2-2013.
- 4,480,250. **DIVINO SAPIEN (STANDARD CHARACTER). EMPYREAN GLOBAL, INCORPORATED, (U.S. CLS. 21, 23, 26, 36 AND 38).** SN 85-923,604. PUB. 11-26-2013. FILED 5-5-2013.
- 4,480,251. **KD AND DESIGN. YUYAO GOLD AUDIO PROFESSIONAL SOUND CO., LTD.**, (U.S. CLS. 21, 23, 26, 36 AND 38). SN 85-923,650. PUB. 11-26-2013. FILED 5-5-2013.
- 4,480,254. **MEZE HEADPHONES (STANDARD CHARACTER). ANTONIO MEZE, (U.S. CLS. 21, 23, 26, 36 AND 38).** SN 85-924,095. PUB. 11-26-2013. FILED 5-6-2013.
- 4,480,256. **SPECTRALWAVE (STANDARD CHARACTER). WEATHERFORD/LAMB, INC.**, (U.S. CLS. 21, 23, 26, 36 AND 38). SN 85-924,207. PUB. 11-26-2013. FILED 5-6-2013.
- 4,480,257. **KING'S HOLLY (STANDARD CHARACTER). BUSH, ALEX BRIAN, (U.S. CLS. 21, 23, 26, 36 AND 38).** SN 85-924,260. PUB. 11-26-2013. FILED 5-6-2013.
- 4,480,277. **IN COVER (STANDARD CHARACTER). DMI GLOBAL INC.**, (U.S. CLS. 21, 23, 26, 36 AND 38). SN 85-926,592. PUB. 11-26-2013. FILED 5-8-2013.
- 4,480,284. **SWISS VISIO(N) (STANDARD CHARACTER). VISIO GLOBAL SERVICES, INC.**, (U.S. CLS. 21, 23, 26, 36 AND 38). SN 85-927,656. PUB. 11-26-2013. FILED 5-9-2013.
- 4,480,298. **VIEW MAX AND DESIGN. MIC IMPORT EXPORT, INC. DBA VIEWMAX TECHNOLOGY, (U.S. CLS. 21, 23, 26, 36 AND 38).** SN 85-931,207. PUB. 11-26-2013. FILED 5-14-2013.
- 4,480,304. **M AND DESIGN. TYNDALE HOUSE PUBLISHERS, INC., MULTIPLE CLASS, (INT. CLS. 9 AND 16), (U.S. CLS. 2, 5, 21, 22, 23, 26, 29, 36, 37, 38 AND 50).** SN 85-931,972. PUB. 11-26-2013. FILED 5-14-2013.
- 4,480,305. **AILIANG (STANDARD CHARACTER). SAM HORSE CORPORATION, (U.S. CLS. 21, 23, 26, 36 AND 38).** SN 85-932,034. PUB. 11-26-2013. FILED 5-14-2013.
- 4,480,306. **MISCELLANEOUS DESIGN. WRIGHTSOFT CORPORATION, MULTIPLE CLASS, (INT. CLS. 9 AND 42), (U.S. CLS. 21, 23, 26, 36, 38, 100 AND 101).** SN 85-932,139. PUB. 11-26-2013. FILED 5-14-2013.
- 4,480,332. **OKPOLICY (STANDARD CHARACTER). OKLAHOMA POLICY INSTITUTE, INC., MULTIPLE CLASS, (INT. CLS. 9 AND 35), (U.S. CLS. 21, 23, 26, 36, 38, 100, 101 AND 102).** SN 85-939,240. PUB. 11-26-2013. FILED 5-22-2013.
- 4,480,338. **THE INTERGALACTIC NEMESIS (STANDARD CHARACTER). JASON NEULANDER, (U.S. CLS. 21, 23, 26, 36 AND 38).** SN 85-939,883. PUB. 11-26-2013. FILED 5-22-2013.

- 4,480,339. **THE INTERGALACTIC NEMESIS AND DESIGN.** JASON NEULANDER, (U.S. CLS. 21, 23, 26, 36 AND 38). SN 85-939,884. PUB. 11-26-2013. FILED 5-22-2013.
- 4,480,357. **OUR PASTIME'S FUTURE (STANDARD CHARACTER).** USA BASEBALL, MULTIPLE CLASS, (INT. CLS. 9, 14, 16, 25, 35 AND 41), (U.S. CLS. 2, 5, 21, 22, 23, 26, 27, 28, 29, 36, 37, 38, 39, 50, 100, 101, 102 AND 107). SN 85-942,259. PUB. 11-26-2013. FILED 5-24-2013.
- 4,480,365. **COMMERCE DECISION ENGINE (STANDARD CHARACTER).** METRATECH CORP., (U.S. CLS. 21, 23, 26, 36 AND 38). SN 85-943,239. PUB. 11-26-2013. FILED 5-28-2013.
- 4,480,370. **P2 SIMULATOR (STANDARD CHARACTER).** FULTON MANAGEMENT SERVICES, INC., (U.S. CLS. 21, 23, 26, 36 AND 38). SN 85-944,134. PUB. 11-26-2013. FILED 5-28-2013.
- 4,480,380. **WASTE DOWN REBELS (STANDARD CHARACTER).** RICK AYERS, (U.S. CLS. 21, 23, 26, 36 AND 38). SN 85-944,896. PUB. 11-26-2013. FILED 5-29-2013.
- 4,480,387. **BRIT + CO. (STANDARD CHARACTER).** BRIT MEDIA, INC., (U.S. CLS. 21, 23, 26, 36 AND 38). SN 85-945,541. PUB. 11-26-2013. FILED 5-29-2013.
- 4,480,403. **SMARTER SOCIAL CRM (STANDARD CHARACTER).** 3CSI, LLC, DBA DIGITAL ROOTS, MULTIPLE CLASS, (INT. CLS. 9, 35 AND 42), (U.S. CLS. 21, 23, 26, 36, 38, 100, 101 AND 102). SN 85-946,918. PUB. 11-26-2013. FILED 5-30-2013.
- 4,480,407. **COVERT (STANDARD CHARACTER).** BALBOA MANUFACTURING CO. LLC, (U.S. CLS. 21, 23, 26, 36 AND 38). SN 85-947,245. PUB. 11-26-2013. FILED 5-31-2013.
- 4,480,411. **DR AND DESIGN.** 3CSI, LLC, DBA DIGITAL ROOTS, MULTIPLE CLASS, (INT. CLS. 9, 35 AND 42), (U.S. CLS. 21, 23, 26, 36, 38, 100, 101 AND 102). SN 85-947,578. PUB. 11-26-2013. FILED 5-31-2013.
- 4,480,446. **LED MFG. USA. SIGNDADA.COM R G B L E D SIGM MFG AND DESIGN.** SALEEM ALI, DBA LED MFG, USA, (U.S. CLS. 21, 23, 26, 36 AND 38). SN 85-952,869. PUB. 11-26-2013. FILED 6-6-2013.
- 4,480,454. **SHIVA'S FORGE (STANDARD CHARACTER).** LENIHAN, THOMAS, E, (U.S. CLS. 21, 23, 26, 36 AND 38). SN 85-954,168. PUB. 11-26-2013. FILED 6-7-2013.
- 4,480,460. **SPHERE (STANDARD CHARACTER).** SPHERICAL, INC., (U.S. CLS. 21, 23, 26, 36 AND 38). SN 85-955,153. PUB. 11-26-2013. FILED 6-10-2013.
- 4,480,464. **LIK (STANDARD CHARACTER).** DR. JOHANNES HEIDENHAIN GMBH, (U.S. CLS. 21, 23, 26, 36 AND 38). SN 85-955,386. PUB. 11-26-2013. FILED 6-10-2013.
- 4,480,466. **ORTHOASSIST (STANDARD CHARACTER).** FRIEDMAN, CAROLYN R., MULTIPLE CLASS, (INT. CLS. 9 AND 41), (U.S. CLS. 21, 23, 26, 36, 38, 100, 101 AND 107). SN 85-955,848. PUB. 11-26-2013. FILED 6-10-2013.
- 4,480,474. **CALLPOD (STYLIZED).** CALLPOD, INC., (U.S. CLS. 21, 23, 26, 36 AND 38). SN 85-956,647. PUB. 11-26-2013. FILED 6-11-2013.
- 4,480,476. **DMSI INTERNATIONAL AND DESIGN.** DIVERSIFIED MATERIAL SPECIALISTS, INC, DBA DMSI INTERNATIONAL, (U.S. CLS. 21, 23, 26, 36 AND 38). SN 85-956,757. PUB. 11-26-2013. FILED 6-11-2013.
- 4,480,526. **FTR REPORTER SERVER (STANDARD CHARACTER).** FTR, LTD., (U.S. CLS. 21, 23, 26, 36 AND 38). SN 85-963,214. PUB. 11-26-2013. FILED 6-18-2013.
- 4,480,541. **G.T.POWERRC (STYLIZED).** LI JIAN, (U.S. CLS. 21, 23, 26, 36 AND 38). SN 85-963,852. PUB. 11-26-2013. FILED 6-19-2013.
- 4,480,546. **SWAY (STANDARD CHARACTER).** SWAY INC, (U.S. CLS. 21, 23, 26, 36 AND 38). SN 85-964,044. PUB. 11-26-2013. FILED 6-19-2013.
- 4,480,560. **FRANKI AMOUR (STYLIZED).** PUSH ENTERTAINMENT, LLC, MULTIPLE CLASS, (INT. CLS. 9 AND 41), (U.S. CLS. 21, 23, 26, 36, 38, 100, 101 AND 107). SN 85-964,460. PUB. 11-26-2013. FILED 6-19-2013.
- 4,480,578. **TRAFFICIQ (STANDARD CHARACTER).** BRICK-STREAM CORPORATION, MULTIPLE CLASS, (INT. CLS. 9, 35 AND 42), (U.S. CLS. 21, 23, 26, 36, 38, 100, 101 AND 102). SN 85-965,333. PUB. 11-26-2013. FILED 6-20-2013.
- 4,480,579. **QUEUEIQ (STANDARD CHARACTER).** BRICK-STREAM CORPORATION, MULTIPLE CLASS, (INT. CLS. 9, 35 AND 42), (U.S. CLS. 21, 23, 26, 36, 38, 100, 101 AND 102). SN 85-965,351. PUB. 11-26-2013. FILED 6-20-2013.
- 4,480,598. **TATTLE (STANDARD CHARACTER).** GET TATTLE INC., (U.S. CLS. 21, 23, 26, 36 AND 38). SN 85-966,277. PUB. 11-26-2013. FILED 6-21-2013.
- 4,480,600. **INNOVOLT (STANDARD CHARACTER).** INNOVOLT, INC., MULTIPLE CLASS, (INT. CLS. 9 AND 42), (U.S. CLS. 21, 23, 26, 36, 38, 100 AND 101). SN 85-966,368. PUB. 11-26-2013. FILED 6-21-2013.
- 4,480,602. **RFL AND DESIGN.** RFL ELECTRONICS INC., (U.S. CLS. 21, 23, 26, 36 AND 38). SN 85-966,452. PUB. 11-26-2013. FILED 6-21-2013.
- 4,480,605 ( *See Class 3 for this trademark*).
- 4,480,611. **RINGDNA (STANDARD CHARACTER).** RINGDNA, INC, MULTIPLE CLASS, (INT. CLS. 9 AND 38), (U.S. CLS. 21, 23, 26, 36, 38, 100, 101 AND 104). SN 85-967,133. PUB. 11-26-2013. FILED 6-21-2013.
- 4,480,622. **XOXO MOBILE (STYLIZED).** XOXO MOBILE, (U.S. CLS. 21, 23, 26, 36 AND 38). SN 85-967,728. PUB. 11-26-2013. FILED 6-24-2013.
- 4,480,623. **HITALK (STANDARD CHARACTER).** INTELLECTUAL FLAME CO., LTD., (U.S. CLS. 21, 23, 26, 36 AND 38). SN 85-967,735. PUB. 11-26-2013. FILED 6-24-2013.
- 4,480,652. **THREE ONE THREE RECORDS (STANDARD CHARACTER).** BUDDY NO LARRY INC, (U.S. CLS. 21, 23, 26, 36 AND 38). SN 85-968,653. PUB. 11-26-2013. FILED 6-24-2013.
- 4,480,666. **INCIPIO (STANDARD CHARACTER).** INCIPIO TECHNOLOGIES, INC., MULTIPLE CLASS, (INT. CLS. 9 AND 18), (U.S. CLS. 1, 2, 3, 21, 22, 23, 26, 36, 38 AND 41). SN 85-969,267. PUB. 11-26-2013. FILED 6-25-2013.
- 4,480,685. **3SP (STANDARD CHARACTER).** ENVISIONTEC, INC., (U.S. CLS. 21, 23, 26, 36 AND 38). SN 85-970,140. PUB. 11-26-2013. FILED 6-26-2013.
- 4,480,720. **EASY FLEX (STANDARD CHARACTER).** IOTTIE INC., (U.S. CLS. 21, 23, 26, 36 AND 38). SN 85-971,926. PUB. 11-26-2013. FILED 6-27-2013.
- 4,480,721. **THE TURBANATOR (STANDARD CHARACTER).** URBAN ECLIPSE LLC, (U.S. CLS. 21, 23, 26, 36 AND 38). SN 85-972,065. PUB. 11-26-2013. FILED 6-27-2013.
- 4,480,724. **THE BEST CASE FOR THE WORST CASE. (STANDARD CHARACTER).** EVAULT, INC., MULTIPLE CLASS, (INT. CLS. 9 AND 42), (U.S. CLS. 21, 23, 26, 36, 38, 100 AND 101). SN 85-972,225. PUB. 11-26-2013. FILED 6-27-2013.
- 4,480,727. **MYFINDS (STANDARD CHARACTER).** THEFIND, INC., MULTIPLE CLASS, (INT. CLS. 9 AND 35), (U.S. CLS. 21, 23, 26, 36, 38, 100, 101 AND 102). SN 85-972,406. PUB. 11-26-2013. FILED 6-28-2013.
- 4,480,730. **TOY NOT INCLUDED (STANDARD CHARACTER).** SIMOVE, SHERIDAN, (U.S. CLS. 21, 23, 26, 36 AND 38). SN 85-972,495. PUB. 11-26-2013. FILED 6-28-2013.
- 4,480,753. **KILO AND DESIGN.** KILO INC., (U.S. CLS. 21, 23, 26, 36 AND 38). SN 85-973,751. PUB. 11-26-2013. FILED 6-30-2013.
- 4,480,793. **FASTSKIN (STANDARD CHARACTER).** SPEEDO HOLDINGS B.V., (U.S. CLS. 21, 23, 26, 36 AND 38). SN 85-979,866. PUB. 11-26-2013. FILED 8-24-2011.
- 4,480,799. **KUTRONIX (STANDARD CHARACTER).** ADESSO, INC., (U.S. CLS. 21, 23, 26, 36 AND 38). SN 86-000,087. PUB. 11-26-2013. FILED 7-1-2013.
- 4,480,800. **9 DEADLY KILLER PUSSIES AND DESIGN.** CHATEL, ERICK, AKA ERICK SCARECROW, (U.S. CLS. 21, 23, 26, 36 AND 38). SN 86-000,098. PUB. 11-26-2013. FILED 7-1-2013.
- 4,480,809. **CVI CORRECTIVE VISION INTERNATIONAL AND DESIGN.** MAC TECHNOLOGIES LIMITED, (U.S. CLS. 21, 23, 26, 36 AND 38). SN 86-000,262. PUB. 11-26-2013. FILED 7-2-2013.
- 4,480,811. **CV (STANDARD CHARACTER).** MAC TECHNOLOGIES LIMITED, (U.S. CLS. 21, 23, 26, 36 AND 38). SN 86-000,267. PUB. 11-26-2013. FILED 7-2-2013.
- 4,480,813. **CHANGING EYEWEAR (STANDARD CHARACTER).** MAC TECHNOLOGIES LIMITED, (U.S. CLS. 21, 23, 26, 36 AND 38). SN 86-000,301. PUB. 11-26-2013. FILED 7-2-2013.
- 4,480,814. **CVI (STANDARD CHARACTER).** MAC TECHNOLOGIES LIMITED, (U.S. CLS. 21, 23, 26, 36 AND 38). SN 86-000,308. PUB. 11-26-2013. FILED 7-2-2013.

- 4,480,815. **MISCELLANEOUS DESIGN**. MAC TECHNOLOGIES LIMITED, (U.S. CLS. 21, 23, 26, 36 AND 38). SN 86-000,322. PUB. 11-26-2013. FILED 7-2-2013.
- 4,480,823. **BLUE PARD AND DESIGN**. SHANGHAI YIHENG TECHNOLOGY CO., LTD., (U.S. CLS. 21, 23, 26, 36 AND 38). SN 86-000,428. PUB. 11-26-2013. FILED 7-2-2013.
- 4,480,824. **WEEJAY (STANDARD CHARACTER)**. LASTRACK, LLC, MULTIPLE CLASS, (INT. CLS. 9 AND 38), (U.S. CLS. 21, 23, 26, 36, 38, 100, 101 AND 104). SN 86-000,443. PUB. 11-26-2013. FILED 7-2-2013.
- 4,480,833. **BRITE (STANDARD CHARACTER)**. ANGUS PERFORMANCE ADVISORS, LLC, (U.S. CLS. 21, 23, 26, 36 AND 38). SN 86-000,565. PUB. 11-26-2013. FILED 7-2-2013.
- 4,480,835. **UNDER WILD SKIES (STANDARD CHARACTER)**. ANTHONY S. MAKRIS, MULTIPLE CLASS, (INT. CLS. 9 AND 41), (U.S. CLS. 21, 23, 26, 36, 38, 100, 101 AND 107). SN 86-000,589. PUB. 11-26-2013. FILED 7-2-2013.
- 4,480,848. **MISCELLANEOUS DESIGN**. REQUESTZ SYSTEMS, LLC, (U.S. CLS. 21, 23, 26, 36 AND 38). SN 86-000,764. PUB. 11-26-2013. FILED 7-2-2013.
- 4,480,852. **SILVER TONGUE (STANDARD CHARACTER)**. DRAGONLORD ENTERPRISES, INC., (U.S. CLS. 21, 23, 26, 36 AND 38). SN 86-000,816. PUB. 11-26-2013. FILED 7-2-2013.
- 4,480,860. **COOL HUNTING (STANDARD CHARACTER)**. CAPTAIN LUCAS, INC., (U.S. CLS. 21, 23, 26, 36 AND 38). SN 86-000,897. PUB. 11-26-2013. FILED 7-2-2013.
- 4,480,874. **NYPO (STANDARD CHARACTER)**. ADAMS, JASON, (U.S. CLS. 21, 23, 26, 36 AND 38). SN 86-001,171. PUB. 11-26-2013. FILED 7-2-2013.
- 4,480,875. **EW ENDWIRE AND DESIGN**. WORLDWIDE PRODUCTS UNLIMITED, INC., (U.S. CLS. 21, 23, 26, 36 AND 38). SN 86-001,221. PUB. 11-26-2013. FILED 7-2-2013.
- 4,480,888. **METROPCS (STYLIZED)**. T-MOBILE USA, INC., MULTIPLE CLASS, (INT. CLS. 9, 35, 36 AND 38), (U.S. CLS. 21, 23, 26, 36, 38, 100, 101, 102 AND 104). SN 86-001,523. PUB. 11-26-2013. FILED 7-3-2013.
- 4,480,891. **METROPCS (STYLIZED)**. T-MOBILE USA, INC., MULTIPLE CLASS, (INT. CLS. 9, 35, 36 AND 38), (U.S. CLS. 21, 23, 26, 36, 38, 100, 101, 102 AND 104). SN 86-001,544. PUB. 11-26-2013. FILED 7-3-2013.
- 4,480,901. **FIBERMINI (STANDARD CHARACTER)**. LASER MECHANISMS, INC., (U.S. CLS. 21, 23, 26, 36 AND 38). SN 86-001,692. PUB. 11-26-2013. FILED 7-3-2013.
- 4,480,902. **COMIC JUMPER (STANDARD CHARACTER)**. MICROSOFT CORPORATION, (U.S. CLS. 21, 23, 26, 36 AND 38). SN 86-001,722. PUB. 11-26-2013. FILED 7-3-2013.
- 4,480,919. **TUF DUCK AND DESIGN**. CENTURION WIRELESS TECHNOLOGIES, INC., (U.S. CLS. 21, 23, 26, 36 AND 38). SN 86-002,015. PUB. 11-26-2013. FILED 7-3-2013.
- 4,480,923. **ROBOSCRUM (STANDARD CHARACTER)**. RAPID SCRUM LLC, (U.S. CLS. 21, 23, 26, 36 AND 38). SN 86-002,062. PUB. 11-26-2013. FILED 7-3-2013.
- 4,480,931. **IMAGINE NATION (STANDARD CHARACTER)**. CUGINI, CHRISTY, JR., MD, (U.S. CLS. 21, 23, 26, 36 AND 38). SN 86-002,164. PUB. 11-26-2013. FILED 7-3-2013.
- 4,480,939. **TWISTLE (STANDARD CHARACTER)**. TWISTLE, INC., DBA TWISTLE, MULTIPLE CLASS, (INT. CLS. 9, 38 AND 42), (U.S. CLS. 21, 23, 26, 36, 38, 100, 101 AND 104). SN 86-002,240. PUB. 11-26-2013. FILED 7-3-2013.
- 4,480,944. **WEEJAY.FM (STANDARD CHARACTER)**. LASTRACK, LLC, MULTIPLE CLASS, (INT. CLS. 9 AND 38), (U.S. CLS. 21, 23, 26, 36, 38, 100, 101 AND 104). SN 86-002,260. PUB. 11-26-2013. FILED 7-3-2013.
- 4,480,959. **EVILIVE (STANDARD CHARACTER)**. EVILIVE MUSIC LLC, MULTIPLE CLASS, (INT. CLS. 9 AND 41), (U.S. CLS. 21, 23, 26, 36, 38, 100, 101 AND 107). SN 86-002,459. PUB. 11-26-2013. FILED 7-3-2013.
- 4,480,961. **WS AND DESIGN**. LO 337 IP HOLDING, LLC, MULTIPLE CLASS, (INT. CLS. 9, 14, 25, 35 AND 41), (U.S. CLS. 2, 21, 22, 23, 26, 27, 28, 36, 38, 39, 50, 100, 101, 102 AND 107). SN 86-002,474. PUB. 11-26-2013. FILED 7-3-2013.
- 4,480,993. **ARPDEFENDER (STANDARD CHARACTER)**. SECURE INFORMATION DEVICES, INC., (U.S. CLS. 21, 23, 26, 36 AND 38). SN 86-002,824. PUB. 11-26-2013. FILED 7-4-2013.
- 4,480,996. **AOKIN (STYLIZED)**. SHENZHEN NONSTOP TECHNOLOGY CO., LTD, (U.S. CLS. 21, 23, 26, 36 AND 38). SN 86-002,854. PUB. 11-26-2013. FILED 7-4-2013.
- 4,480,998. **PAICK AND DESIGN**. PAICK INTERNATIONAL (HK) CO., LIMITED., (U.S. CLS. 21, 23, 26, 36 AND 38). SN 86-002,879. PUB. 11-26-2013. FILED 7-5-2013.
- 4,480,999. **ESSFLY (STANDARD CHARACTER)**. SHENZHEN EASYN TECHNOLOGY COMPANY LIMITED, (U.S. CLS. 21, 23, 26, 36 AND 38). SN 86-002,881. PUB. 11-26-2013. FILED 7-5-2013.
- 4,481,010. **MISCELLANEOUS DESIGN**. APPDYNAMICS, INC., MULTIPLE CLASS, (INT. CLS. 9, 37, 41 AND 42), (U.S. CLS. 21, 23, 26, 36, 38, 100, 101, 103, 106 AND 107). SN 86-003,000. PUB. 11-26-2013. FILED 7-5-2013.
- 4,481,017. **AGNITIO AND DESIGN**. AGNITIO, S.L., (U.S. CLS. 21, 23, 26, 36 AND 38). SN 86-003,053. PUB. 11-26-2013. FILED 7-5-2013.
- 4,481,025. **HERO BASH (STANDARD CHARACTER)**. ESC BROS, INC., (U.S. CLS. 21, 23, 26, 36 AND 38). SN 86-003,156. PUB. 11-26-2013. FILED 7-5-2013.
- 4,481,044. **MISCHIEF (STANDARD CHARACTER)**. 61 SOLUTIONS INC., (U.S. CLS. 21, 23, 26, 36 AND 38). SN 86-003,475. PUB. 11-26-2013. FILED 7-6-2013.
- 4,481,055. **KINGJOY AND DESIGN**. ZHONGSHAN KINGJOY PHOTOGRAPHIC EQUIPMENT CO.LTD, (U.S. CLS. 21, 23, 26, 36 AND 38). SN 86-003,586. PUB. 11-26-2013. FILED 7-7-2013.
- 4,481,065. **REMEMBER THE MILK (STANDARD CHARACTER)**. REMEMBER THE MILK, INC., MULTIPLE CLASS, (INT. CLS. 9 AND 42), (U.S. CLS. 21, 23, 26, 36, 38, 100 AND 101). SN 86-003,651. PUB. 11-26-2013. FILED 7-7-2013.
- 4,481,066. **TORU (STANDARD CHARACTER)**. RJR FASHION, INC., (U.S. CLS. 21, 23, 26, 36 AND 38). SN 86-003,685. PUB. 11-26-2013. FILED 7-7-2013.
- 4,481,067. **CLIPLESS (STANDARD CHARACTER)**. CLIPLESS LLC, (U.S. CLS. 21, 23, 26, 36 AND 38). SN 86-003,697. PUB. 11-26-2013. FILED 7-8-2013.
- 4,481,076. **RAVEN (STANDARD CHARACTER)**. TECORE NETWORKS, (U.S. CLS. 21, 23, 26, 36 AND 38). SN 86-003,857. PUB. 11-26-2013. FILED 7-8-2013.
- 4,481,090. **0MQ (STYLIZED)**. HINTJENS, PIETER, (U.S. CLS. 21, 23, 26, 36 AND 38). SN 86-004,104. PUB. 11-26-2013. FILED 7-8-2013.
- 4,481,097. **MISCELLANEOUS DESIGN**. THE COMPASSIONATE FRIENDS, MULTIPLE CLASS, (INT. CLS. 9 AND 16), (U.S. CLS. 2, 5, 21, 22, 23, 26, 29, 36, 37, 38 AND 50). SN 86-004,422. PUB. 11-26-2013. FILED 7-8-2013.
- 4,481,105. **EZHUB (STANDARD CHARACTER)**. LUMASENSE TECHNOLOGIES HOLDINGS, INC., (U.S. CLS. 21, 23, 26, 36 AND 38). SN 86-004,499. PUB. 11-26-2013. FILED 7-8-2013.
- 4,481,108. **GALAXY S 4 ACTIVE (STANDARD CHARACTER)**. SAMSUNG ELECTRONICS CO., LTD., (U.S. CLS. 21, 23, 26, 36 AND 38). SN 86-004,533. PUB. 11-26-2013. FILED 7-8-2013.
- 4,481,115. **MUSIC, FREEDOM, & HAPPINESS (STANDARD CHARACTER)**. LOS TRES JEFES LLC, (U.S. CLS. 21, 23, 26, 36 AND 38). SN 86-004,657. PUB. 11-26-2013. FILED 7-8-2013.
- 4,481,118. **GREEN MAMBA (STANDARD CHARACTER)**. HUC AMERICA, INC., (U.S. CLS. 21, 23, 26, 36 AND 38). SN 86-004,759. PUB. 11-26-2013. FILED 7-8-2013.
- 4,481,123. **PC CLEAN MAESTRO (STANDARD CHARACTER)**. COMPUCLEVER SYSTEMS INC., (U.S. CLS. 21, 23, 26, 36 AND 38). SN 86-004,865. PUB. 11-26-2013. FILED 7-9-2013.
- 4,481,131. **NESSY (STANDARD CHARACTER)**. NESSY LEARNING LTD., (U.S. CLS. 21, 23, 26, 36 AND 38). SN 86-004,980. PUB. 11-26-2013. FILED 7-9-2013.
- 4,481,144. **SMITE AND DESIGN**. HI-REZ STUDIOS, INC., (U.S. CLS. 21, 23, 26, 36 AND 38). SN 86-005,176. PUB. 11-26-2013. FILED 7-9-2013.
- 4,481,150. **MOODSNAP (STANDARD CHARACTER)**. EXPRESSIONALITY INC., (U.S. CLS. 21, 23, 26, 36 AND 38). SN 86-005,258. PUB. 11-26-2013. FILED 7-9-2013.
- 4,481,152. **EZLIT (STANDARD CHARACTER)**. PARIS INCORPORATED, DBA PARIS SIGNS, (U.S. CLS. 21, 23, 26, 36 AND 38). SN 86-005,283. PUB. 11-26-2013. FILED 7-9-2013.
- 4,481,158. **ACCESSFORALL (STANDARD CHARACTER)**. IMS GLOBAL LEARNING CONSORTIUM, INC., (U.S. CLS. 21, 23, 26, 36 AND 38). SN 86-005,345. PUB. 11-26-2013. FILED 7-9-2013.
- 4,481,165. **ABLECOMMERCE (STANDARD CHARACTER)**.

- ABLE SOLUTIONS CORPORATION, MULTIPLE CLASS, (INT. CLS. 9 AND 42), (U.S. CLS. 21, 23, 26, 36, 38, 100 AND 101). SN 86-005,478. PUB. 11-26-2013. FILED 7-9-2013.
- 4,481,172. **KEFENG (STYLIZED)**. RUIAN KEFENG ELECTRONIC CO., LTD., (U.S. CLS. 21, 23, 26, 36 AND 38). SN 86-005,550. PUB. 11-26-2013. FILED 7-9-2013.
- 4,481,180. **NOTABILITY (STANDARD CHARACTER)**. GINGER LABS, INC., (U.S. CLS. 21, 23, 26, 36 AND 38). SN 86-005,686. PUB. 11-26-2013. FILED 7-9-2013.
- 4,481,186. **SIGNEALZ (STANDARD CHARACTER)**. SIGNEALZ CORPORATION, MULTIPLE CLASS, (INT. CLS. 9, 35, 37 AND 42), (U.S. CLS. 21, 23, 26, 36, 38, 100, 101, 102, 103 AND 106). SN 86-005,751. PUB. 11-26-2013. FILED 7-9-2013.
- 4,481,189. **S AND DESIGN**. SIGNEALZ CORPORATION, MULTIPLE CLASS, (INT. CLS. 9, 35, 37 AND 42), (U.S. CLS. 21, 23, 26, 36, 38, 100, 101, 102, 103 AND 106). SN 86-005,778. PUB. 11-26-2013. FILED 7-9-2013.
- 4,481,190. **FRONTRANGE (STANDARD CHARACTER)**. FRONTRANGE SOLUTIONS USA INC., (U.S. CLS. 21, 23, 26, 36 AND 38). SN 86-005,802. PUB. 11-26-2013. FILED 7-9-2013.
- 4,481,192. **FRONTRANGE AND DESIGN**. FRONTRANGE SOLUTIONS USA INC., (U.S. CLS. 21, 23, 26, 36 AND 38). SN 86-005,812. PUB. 11-26-2013. FILED 7-9-2013.
- 4,481,194. **FRONTRANGE THE HEAT IS ON AND DESIGN**. FRONTRANGE SOLUTIONS USA INC., (U.S. CLS. 21, 23, 26, 36 AND 38). SN 86-005,818. PUB. 11-26-2013. FILED 7-9-2013.
- 4,481,196. **EMPIRE CONQUEST AND DESIGN**. 337 TECHNOLOGY LIMITED, (U.S. CLS. 21, 23, 26, 36 AND 38). SN 86-006,043. PUB. 11-26-2013. FILED 7-10-2013.
- 4,481,230. **TEL-TRU AND DESIGN**. TEL-TRU, INC., DBA TEL-TRU MANUFACTURING COMPANY, (U.S. CLS. 21, 23, 26, 36 AND 38). SN 86-022,268. PUB. 11-26-2013. FILED 7-29-2013.
- 4,481,256. **ZITRO KOI BINGO (STANDARD CHARACTER)**. ZITRO IP S.A.R.L., MULTIPLE CLASS, (INT. CLS. 9 AND 28), (U.S. CLS. 21, 22, 23, 26, 36, 38 AND 50). SN 86-039,302. PUB. 11-26-2013. FILED 8-15-2013.
- 4,481,257. **ZITRO PHOENIX BINGO (STANDARD CHARACTER)**. ZITRO IP S.A.R.L., MULTIPLE CLASS, (INT. CLS. 9 AND 28), (U.S. CLS. 21, 22, 23, 26, 36, 38 AND 50). SN 86-039,336. PUB. 11-26-2013. FILED 8-15-2013.
- 4,481,263. **URP (STANDARD CHARACTER)**. URSA MAJOR MEDIA INC., DBA CRAZY TOOTH STUDIO, (U.S. CLS. 21, 23, 26, 36 AND 38). SN 86-045,037. PUB. 11-26-2013. FILED 8-22-2013.
- 4,481,268. **MYCAMPUS (STANDARD CHARACTER)**. ZHENGZHOU DANDIAN TECHNOLOGY SOFTWARE LTD., (U.S. CLS. 21, 23, 26, 36 AND 38). SN 86-048,549. PUB. 11-26-2013. FILED 8-27-2013.
- 4,481,270. **CONSTANT POWER (STANDARD CHARACTER)**. ROYAL BATTERY DISTRIBUTORS, INC., DBA ROYAL BATTERY, (U.S. CLS. 21, 23, 26, 36 AND 38). SN 86-049,590. PUB. 11-26-2013. FILED 8-27-2013.
- 4,481,271. **MYTEACHER (STANDARD CHARACTER)**. ZHENGZHOU DANDIAN TECHNOLOGY SOFTWARE LTD., (U.S. CLS. 21, 23, 26, 36 AND 38). SN 86-049,791. PUB. 11-26-2013. FILED 8-28-2013.
- 4,481,290. **DIANETICS (STANDARD CHARACTER)**. RELIGIOUS TECHNOLOGY CENTER, (U.S. CLS. 21, 23, 26, 36 AND 38). SN 86-067,462. PUB. 11-26-2013. FILED 9-17-2013.
- 4,481,291. **MISCELLANEOUS DESIGN**. RELIGIOUS TECHNOLOGY CENTER, (U.S. CLS. 21, 23, 26, 36 AND 38). SN 86-067,471. PUB. 11-26-2013. FILED 9-17-2013.
- 26-2013. FILED 6-26-2012.
- 4,479,316. **C-SEAL (STANDARD CHARACTER)**. POLYGANICS B.V., (U.S. CLS. 26, 39 AND 44). SN 79-121,797. PUB. 10-15-2013. FILED 10-30-2012.
- 4,479,321 ( See Class 5 for this trademark).
- 4,479,327 ( See Class 5 for this trademark).
- 4,479,328 ( See Class 5 for this trademark).
- 4,479,331 ( See Class 5 for this trademark).
- 4,479,377. **BILICAL (STANDARD CHARACTER)**. KONINKLIJKE PHILIPS N.V., (U.S. CLS. 26, 39 AND 44). SN 79-126,564. PUB. 11-26-2013. FILED 12-19-2012.
- 4,479,378. **NUANCE (STANDARD CHARACTER)**. KONINKLIJKE PHILIPS N.V., (U.S. CLS. 26, 39 AND 44). SN 79-126,569. PUB. 11-26-2013. FILED 1-10-2013.
- 4,479,381. **UMH (STYLIZED)**. SHANGHAI UNITED IMAGING HEALTHCARE CO.,LTD., (U.S. CLS. 26, 39 AND 44). SN 79-126,655. PUB. 11-26-2013. FILED 11-11-2012.
- 4,479,382. **BILIECLIPSE (STANDARD CHARACTER)**. KONINKLIJKE PHILIPS N.V., (U.S. CLS. 26, 39 AND 44). SN 79-126,670. PUB. 11-26-2013. FILED 12-19-2012.
- 4,479,383. **INNOSPIRE (STANDARD CHARACTER)**. KONINKLIJKE PHILIPS N.V., (U.S. CLS. 26, 39 AND 44). SN 79-126,709. PUB. 11-26-2013. FILED 12-12-2012.
- 4,479,388. **JETOP (STANDARD CHARACTER)**. TAVTEC LTD., (U.S. CLS. 26, 39 AND 44). SN 79-126,782. PUB. 11-26-2013. FILED 1-2-2013.
- 4,479,396. **V600 (STANDARD CHARACTER)**. KONINKLIJKE PHILIPS N.V., (U.S. CLS. 26, 39 AND 44). SN 79-127,014. PUB. 11-26-2013. FILED 2-7-2013.
- 4,479,402 ( See Class 9 for this trademark).
- 4,479,414 ( See Class 9 for this trademark).
- 4,479,417. **HALF MOON (STYLIZED)**. KARL STORZ GMBH & CO. KG, MULTIPLE CLASS, (INT. CLS. 10 AND 16), (U.S. CLS. 2, 5, 22, 23, 26, 29, 37, 38, 39, 44 AND 50). SN 79-127,995. PUB. 11-26-2013. FILED 2-28-2013.
- 4,479,438 ( See Class 3 for this trademark).
- 4,479,480. **SENSEI (STANDARD CHARACTER)**. OTICON A/S, (U.S. CLS. 26, 39 AND 44). SN 79-133,320. PUB. 11-26-2013. FILED 6-27-2013.
- 4,479,504. **O AND DESIGN**. I.T.A. S.R.L.; INTERNATIONAL TOBACCO AGENCY, (U.S. CLS. 26, 39 AND 44). SN 79-135,450. PUB. 11-26-2013. FILED 7-2-2013.
- 4,479,505. **O AND DESIGN**. I.T.A. S.R.L.; INTERNATIONAL TOBACCO AGENCY, (U.S. CLS. 26, 39 AND 44). SN 79-135,451. PUB. 11-26-2013. FILED 7-2-2013.
- 4,479,506. **O AND DESIGN**. I.T.A. S.R.L.; INTERNATIONAL TOBACCO AGENCY, (U.S. CLS. 26, 39 AND 44). SN 79-135,452. PUB. 11-26-2013. FILED 7-2-2013.
- 4,479,507. **O AND DESIGN**. I.T.A. S.R.L.; INTERNATIONAL TOBACCO AGENCY, (U.S. CLS. 26, 39 AND 44). SN 79-135,453. PUB. 11-26-2013. FILED 7-2-2013.
- 4,479,509. **O AND DESIGN**. I.T.A. S.R.L.; INTERNATIONAL TOBACCO AGENCY, (U.S. CLS. 26, 39 AND 44). SN 79-135,889. PUB. 11-26-2013. FILED 7-2-2013.
- 4,479,524. **INTROES POCKET BOUGIE (STANDARD CHARACTER)**. BOMIMED INC., (U.S. CLS. 26, 39 AND 44). SN 85-105,100. PUB. 9-10-2013. FILED 8-11-2010.
- 4,479,539. **TK (STANDARD CHARACTER)**. LSI SOLUTIONS, INC., (U.S. CLS. 26, 39 AND 44). SN 85-342,648. PUB. 11-26-2013. FILED 6-9-2011.
- 4,479,584. **ACOMED (STANDARD CHARACTER)**. ACOMED INDUSTRIAL CO., LTD., (U.S. CLS. 26, 39 AND 44). SN 85-534,634. PUB. 7-30-2013. FILED 2-6-2012.
- 4,479,585 ( See Class 7 for this trademark).
- 4,479,596 ( See Class 8 for this trademark).
- 4,479,685 ( See Class 5 for this trademark).
- 4,479,694. **SWEDISH DENTAL IMPLANT & DENTURE CENTERS (STANDARD CHARACTER)**. THIRTEEN SIXTY, INC., MULTIPLE CLASS, (INT. CLS. 10 AND 44), (U.S. CLS. 26, 39, 44, 100 AND 101). SN 85-668,656. PUB. 11-26-2013. FILED 7-3-2012.
- 4,479,724 ( See Class 9 for this trademark).
- 4,479,733 ( See Class 3 for this trademark).
- 4,479,767 ( See Class 9 for this trademark).
- 4,479,769. **OTOSCAN (STANDARD CHARACTER)**. GN OTOMETRICS A/S, (U.S. CLS. 26, 39 AND 44). SN 85-752,771. PUB. 11-26-2013. FILED 10-12-2012.
- 4,479,941. **VASA (STANDARD CHARACTER)**. FEG TEXTIL-

#### CLASS 10—MEDICAL APPARATUS

- 4,479,266. **TRUE SPINAL DECOMPRESSION (STANDARD CHARACTER)**. AXIOM WORLDWIDE, INC., MULTIPLE CLASS, (INT. CLS. 10, 35 AND 40), (U.S. CLS. 26, 39, 44, 100, 101, 102, 103 AND 106). SN 78-635,361. PUB. 4-25-2006. FILED 5-23-2005.
- 4,479,292. **CORWAVE (STANDARD CHARACTER)**. CORWAVE, MULTIPLE CLASS, (INT. CLS. 10, 42 AND 44), (U.S. CLS. 26, 39, 44, 100 AND 101). SN 79-116,474. PUB. 11-

- TECHNIK FORSCHUNGS UND ENTWICKLUNGSGESELLSCHAFT MBH, (U.S. CLS. 26, 39 AND 44). SN 85-812,522. PUB. 11-26-2013. FILED 12-29-2012.
- 4,479,964. **KNEEGRIP II (STANDARD CHARACTER)**. SUN-MEDICA, INC., (U.S. CLS. 26, 39 AND 44). SN 85-821,079. PUB. 11-26-2013. FILED 1-11-2013.
- 4,479,981 ( *See Class 9 for this trademark*).
- 4,479,993. **PLANTARMAX (STANDARD CHARACTER)**. MERETE MEDICAL GMBH, (U.S. CLS. 26, 39 AND 44). SN 85-828,778. PUB. 11-26-2013. FILED 1-22-2013.
- 4,480,041. **QUATTRO II (STANDARD CHARACTER)**. ROSCOE MEDICAL, INC., (U.S. CLS. 26, 39 AND 44). SN 85-848,459. PUB. 11-26-2013. FILED 2-13-2013.
- 4,480,042. + **AND DESIGN**. OBAKHAN, JESU CHARLES, (U.S. CLS. 26, 39 AND 44). SN 85-848,540. PUB. 8-20-2013. FILED 2-13-2013.
- 4,480,075. **TRUE DILATATION (STANDARD CHARACTER)**. LOMA VISTA MEDICAL, INC., (U.S. CLS. 26, 39 AND 44). SN 85-859,586. PUB. 11-26-2013. FILED 2-25-2013.
- 4,480,111. **COAT CONTINUOUS OPEN AIRWAY THERAPY (STANDARD CHARACTER)**. SOMNOMED LIMITED, (U.S. CLS. 26, 39 AND 44). SN 85-875,813. PUB. 11-26-2013. FILED 3-14-2013.
- 4,480,112. **LIKORALL (STANDARD CHARACTER)**. LIKO RESEARCH & DEVELOPMENT AB, (U.S. CLS. 26, 39 AND 44). SN 85-875,976. PUB. 11-26-2013. FILED 3-14-2013.
- 4,480,185. **FLEXBRAID (STANDARD CHARACTER)**. ACUMED LLC, (U.S. CLS. 26, 39 AND 44). SN 85-901,876. PUB. 11-26-2013. FILED 4-11-2013.
- 4,480,200. **FUTURE DESIGN FABRICATIONS CUSTOM PROSTHETICS AND ORTHOTIC DEVICES AND DESIGN**. FUTURE O&P DESIGN FABRICATIONS, MULTIPLE CLASS, (INT. CLS. 10 AND 40), (U.S. CLS. 26, 39, 44, 100, 103 AND 106). SN 85-906,139. PUB. 11-26-2013. FILED 4-16-2013.
- 4,480,238. **MINILAP (STANDARD CHARACTER)**. MINI-LAP TECHNOLOGIES, INC., (U.S. CLS. 26, 39 AND 44). SN 85-919,031. PUB. 10-1-2013. FILED 4-30-2013.
- 4,480,276 ( *See Class 5 for this trademark*).
- 4,480,399. **COMET-PLUS (STANDARD CHARACTER)**. NATUS MEDICAL INCORPORATED, (U.S. CLS. 26, 39 AND 44). SN 85-946,632. PUB. 11-26-2013. FILED 5-30-2013.
- 4,480,442. **VOODOO WAND (STANDARD CHARACTER)**. DIGITAL MEDIA VENDING INTERNATIONAL LLC, (U.S. CLS. 26, 39 AND 44). SN 85-951,768. PUB. 11-26-2013. FILED 6-5-2013.
- 4,480,701. **THERA-SOM CAST (STANDARD CHARACTER)**. MEADE, THOMAS, (U.S. CLS. 26, 39 AND 44). SN 85-970,938. PUB. 11-26-2013. FILED 6-26-2013.
- 4,480,734. **MICRO-Q (STANDARD CHARACTER)**. AEROLASE CORPORATION, (U.S. CLS. 26, 39 AND 44). SN 85-972,629. PUB. 11-26-2013. FILED 6-28-2013.
- 4,480,837. **SLIDE-ON (STANDARD CHARACTER)**. VISION-SCIENCES, INC., (U.S. CLS. 26, 39 AND 44). SN 86-000,629. PUB. 11-26-2013. FILED 7-2-2013.
- 4,480,969. **AUSNY (STYLIZED)**. CHEN RULIN, (U.S. CLS. 26, 39 AND 44). SN 86-002,628. PUB. 11-26-2013. FILED 7-3-2013.
- 4,480,974. **SNOT-FREE (STANDARD CHARACTER)**. ULTIMATE VALUE SERVICES, INC., (U.S. CLS. 26, 39 AND 44). SN 86-002,683. PUB. 11-26-2013. FILED 7-4-2013.
- 4,481,234. **INSTAKOOL AND DESIGN**. NORTECH LABORATORIES INC, (U.S. CLS. 26, 39 AND 44). SN 86-024,643. PUB. 11-26-2013. FILED 7-31-2013.
- 124,648. PUB. 11-26-2013. FILED 10-15-2012.
- 4,479,362. **AIRFRYER AND DESIGN**. KONINKLIJKE PHILIPS N.V., (U.S. CLS. 13, 21, 23, 31 AND 34). SN 79-126,143. PUB. 11-26-2013. FILED 12-6-2012.
- 4,479,363 ( *See Class 6 for this trademark*).
- 4,479,364 ( *See Class 7 for this trademark*).
- 4,479,365 ( *See Class 7 for this trademark*).
- 4,479,367 ( *See Class 3 for this trademark*).
- 4,479,368 ( *See Class 3 for this trademark*).
- 4,479,373. **PARALLEL AND DESIGN**. KAJUFRAP SARL, (U.S. CLS. 13, 21, 23, 31 AND 34). SN 79-126,334. PUB. 11-26-2013. FILED 8-29-2012.
- 4,479,401. **MEGATRON (STANDARD CHARACTER)**. WERNER TH. WIESNER, (U.S. CLS. 13, 21, 23, 31 AND 34). SN 79-127,244. PUB. 11-26-2013. FILED 12-14-2012.
- 4,479,424. **HANSAPROTEC (STANDARD CHARACTER)**. HANSA METALLWERKE AG, MULTIPLE CLASS, (INT. CLS. 11, 20 AND 21), (U.S. CLS. 2, 13, 21, 22, 23, 25, 29, 30, 31, 32, 33, 34, 40 AND 50). SN 79-128,461. PUB. 11-26-2013. FILED 8-8-2012.
- 4,479,427. **HANSALOFT (STANDARD CHARACTER)**. HANSA METALLWERKE AG, MULTIPLE CLASS, (INT. CLS. 11, 20 AND 21), (U.S. CLS. 2, 13, 21, 22, 23, 25, 29, 30, 31, 32, 33, 34, 40 AND 50). SN 79-128,535. PUB. 11-26-2013. FILED 8-8-2012.
- 4,479,453. **LUCENTE (STANDARD CHARACTER)**. GRUPPO ROSTIROLA SRL, (U.S. CLS. 13, 21, 23, 31 AND 34). SN 79-130,343. PUB. 11-26-2013. FILED 3-27-2013.
- 4,479,472. **MISCELLANEOUS DESIGN**. KINGSUN OPTOELECTRONIC CO., LTD., (U.S. CLS. 13, 21, 23, 31 AND 34). SN 79-132,332. PUB. 11-26-2013. FILED 2-19-2013.
- 4,479,477 ( *See Class 6 for this trademark*).
- 4,479,530 ( *See Class 3 for this trademark*).
- 4,479,541. **SWIFT BEVERAGE (STANDARD CHARACTER)**. TROJAN TECHNOLOGIES, (U.S. CLS. 13, 21, 23, 31 AND 34). SN 85-345,555. PUB. 11-26-2013. FILED 6-14-2011.
- 4,479,551 ( *See Class 6 for this trademark*).
- 4,479,554. **AMWATER (STYLIZED)**. GUANGDONG HONGHUI METAL MANUFACTURE CO., LTD., (U.S. CLS. 13, 21, 23, 31 AND 34). SN 85-444,335. PUB. 7-23-2013. FILED 10-11-2011.
- 4,479,576 ( *See Class 7 for this trademark*).
- 4,479,586. **E AND DESIGN**. LG ELECTRONICS INC., (U.S. CLS. 13, 21, 23, 31 AND 34). SN 85-535,896. PUB. 11-26-2013. FILED 2-7-2012.
- 4,479,596 ( *See Class 8 for this trademark*).
- 4,479,604. **IN-EI ISSEY MIYAKE AND DESIGN**. KABUSHIKI KAISHA MIYAKE DESIGN JIMUSHO, DBA MIYAKE DESIGN STUDIO, (U.S. CLS. 13, 21, 23, 31 AND 34). SN 85-574,283. PUB. 11-26-2013. FILED 3-20-2012.
- 4,479,658. **NOSTALGIA (STANDARD CHARACTER)**. NOSTALGIA PRODUCTS GROUP, LLC, (U.S. CLS. 13, 21, 23, 31 AND 34). SN 85-635,028. PUB. 11-26-2013. FILED 5-24-2012.
- 4,479,671 ( *See Class 3 for this trademark*).
- 4,479,689. **SASHA ALEXANDRA (STYLIZED)**. MEGA SUPPLY STORE LLC, (U.S. CLS. 13, 21, 23, 31 AND 34). SN 85-663,135. PUB. 11-26-2013. FILED S.R. 6-27-2012; AM. P.R. 2-13-2013.
- 4,479,790. **KK KOOLANT KOOLERS AND DESIGN**. DIMPLEX THERMAL SOLUTIONS, INC., (U.S. CLS. 13, 21, 23, 31 AND 34). SN 85-766,927. PUB. 11-26-2013. FILED 10-30-2012.
- 4,479,874. **TASSIMO AMIA (STANDARD CHARACTER)**. KRAFT FOODS SCHWEIZ HOLDING GMBH, MULTIPLE CLASS, (INT. CLS. 11 AND 21), (U.S. CLS. 2, 13, 21, 23, 29, 30, 31, 33, 34, 40 AND 50). SN 85-799,903. PUB. 11-26-2013. FILED 12-11-2012.
- 4,479,908. **TASSIMO CHARMY (STANDARD CHARACTER)**. KRAFT FOODS SCHWEIZ HOLDING GMBH, MULTIPLE CLASS, (INT. CLS. 11 AND 21), (U.S. CLS. 2, 13, 21, 23, 29, 30, 31, 33, 34, 40 AND 50). SN 85-806,216. PUB. 11-26-2013. FILED 12-19-2012.
- 4,479,917. **CAFÉ BELLO (STYLIZED)**. NCM CO., LTD., (U.S. CLS. 13, 21, 23, 31 AND 34). SN 85-808,010. PUB. 11-26-2013. FILED 12-20-2012.
- 4,479,920. **STROBESTAR (STANDARD CHARACTER)**. WET, (U.S. CLS. 13, 21, 23, 31 AND 34). SN 85-808,596. PUB. 11-26-2013. FILED 12-21-2012.

## CLASS 11—ENVIRONMENTAL CONTROL APPARATUS

- 4,479,243 ( *See Class 1 for this trademark*).
- 4,479,287 ( *See Class 6 for this trademark*).
- 4,479,318 ( *See Class 7 for this trademark*).
- 4,479,325 ( *See Class 6 for this trademark*).
- 4,479,337. **PURESYS AND DESIGN**. PURESYS CO., LTD, (U.S. CLS. 13, 21, 23, 31 AND 34). SN 79-124,086. PUB. 11-26-2013. FILED 9-20-2012.
- 4,479,343. **SINTECO AMERICANA AND DESIGN**. SINTECO IMPIANTI S.R.L., (U.S. CLS. 13, 21, 23, 31 AND 34). SN 79-

- 4,479,933. **STARSTROBE (STANDARD CHARACTER)**. WET, (U.S. CLS. 13, 21, 23, 31 AND 34). SN 85-810,303. PUB. 11-26-2013. FILED 12-26-2012.
- 4,480,147. **OPTIMIZER (STANDARD CHARACTER)**. ENTEGRIS, INC., (U.S. CLS. 13, 21, 23, 31 AND 34). SN 85-887,807. PUB. 11-26-2013. FILED 3-27-2013.
- 4,480,152 ( *See Class 9 for this trademark*).
- 4,480,211 ( *See Class 6 for this trademark*).
- 4,480,248. **AQUA SEAT AND DESIGN**. GOMEZ ESPAÑA COLLIGNON, CARLO, (U.S. CLS. 13, 21, 23, 31 AND 34). SN 85-923,517. PUB. 11-26-2013. FILED 5-4-2013.
- 4,480,557 ( *See Class 3 for this trademark*).
- 4,480,585. **TRAP 10 (STANDARD CHARACTER)**. MPC INC., (U.S. CLS. 13, 21, 23, 31 AND 34). SN 85-965,562. PUB. 11-26-2013. FILED 6-20-2013.
- 4,480,647. **XTREME HEATERS AND DESIGN**. XTREME HEATERS, INC., (U.S. CLS. 13, 21, 23, 31 AND 34). SN 85-968,402. PUB. 11-26-2013. FILED 6-24-2013.
- 4,480,884. **MISCELLANEOUS DESIGN**. HANGZHOU PANASIA SANITARY WARE CO., LTD. (U.S. CLS. 13, 21, 23, 31 AND 34). SN 86-001,420. PUB. 11-26-2013. FILED 7-3-2013.
- 4,480,929. **ISHROOM (STANDARD CHARACTER)**. NICHOLS CUSTOM CERAMICS, LLC, (U.S. CLS. 13, 21, 23, 31 AND 34). SN 86-002,098. PUB. 11-26-2013. FILED 7-3-2013.
- 4,481,168. **GLOVELITE (STANDARD CHARACTER)**. 4TH DAY ENTERPRISES, LLC, (U.S. CLS. 13, 21, 23, 31 AND 34). SN 86-005,486. PUB. 11-26-2013. FILED 7-9-2013.
- 4,481,231. **ARCMAX (STANDARD CHARACTER)**. MAXLITE, (U.S. CLS. 13, 21, 23, 31 AND 34). SN 86-023,702. PUB. 11-26-2013. FILED 7-30-2013.
- 4,481,260. **BAYMAX (STANDARD CHARACTER)**. MAXLITE, (U.S. CLS. 13, 21, 23, 31 AND 34). SN 86-041,203. PUB. 11-26-2013. FILED 8-19-2013.
- 4,481,261. **STAXMAX (STANDARD CHARACTER)**. MAXLITE, (U.S. CLS. 13, 21, 23, 31 AND 34). SN 86-041,239. PUB. 11-26-2013. FILED 8-19-2013.
- 4,481,295. **PERMALED (STANDARD CHARACTER)**. OSRAM SYLVANIA INC., (U.S. CLS. 13, 21, 23, 31 AND 34). SN 86-074,031. PUB. 11-26-2013. FILED 9-25-2013.
- 
- CLASS 12—VEHICLES**
- 4,479,243 ( *See Class 1 for this trademark*).
- 4,479,253. **BACK RACK AND DESIGN**. BACKRACK INC., MULTIPLE CLASS, (INT. CLS. 12 AND 35), (U.S. CLS. 19, 21, 23, 31, 35, 44, 100, 101 AND 102). SN 77-421,393. PUB. 11-26-2013. FILED 3-13-2008.
- 4,479,269 ( *See Class 7 for this trademark*).
- 4,479,275 ( *See Class 9 for this trademark*).
- 4,479,303 ( *See Class 7 for this trademark*).
- 4,479,324 ( *See Class 6 for this trademark*).
- 4,479,369. **ESSLIFT (STANDARD CHARACTER)**. NORMET INTERNATIONAL LTD, (U.S. CLS. 19, 21, 23, 31, 35 AND 44). SN 79-126,269. PUB. 11-26-2013. FILED 10-26-2012.
- 4,479,370. **ESSMOUNT (STANDARD CHARACTER)**. NORMET INTERNATIONAL LTD, (U.S. CLS. 19, 21, 23, 31, 35 AND 44). SN 79-126,270. PUB. 11-26-2013. FILED 10-26-2012.
- 4,479,371. **ESSHIELD (STANDARD CHARACTER)**. NORMET INTERNATIONAL LTD, (U.S. CLS. 19, 21, 23, 31, 35 AND 44). SN 79-126,271. PUB. 11-26-2013. FILED 10-26-2012.
- 4,479,385 ( *See Class 7 for this trademark*).
- 4,479,407 ( *See Class 9 for this trademark*).
- 4,479,422. **ROLL JET ROLLJET (STYLIZED)**. TOMAZ HAM, MULTIPLE CLASS, (INT. CLS. 12, 18 AND 28), (U.S. CLS. 1, 2, 3, 19, 21, 22, 23, 31, 35, 38, 41, 44 AND 50). SN 79-128,267. PUB. 11-26-2013. FILED 3-11-2013.
- 4,479,434 ( *See Class 3 for this trademark*).
- 4,479,466. **NPS (STANDARD CHARACTER)**. NÖLLE-PEPIN GMBH & BETRIEBS KG, (U.S. CLS. 19, 21, 23, 31, 35 AND 44). SN 79-131,741. PUB. 11-26-2013. FILED 1-23-2013.
- 4,479,534. **LOYALTY IS LIKE ROYALTY - RIDE WITH PRIDE (STANDARD CHARACTER)**. CHARLES M. CHAMBERS, MULTIPLE CLASS, (INT. CLS. 12 AND 25), (U.S. CLS. 19, 21, 22, 23, 31, 35, 39 AND 44). SN 85-300,740. PUB. 6-18-2013. FILED 4-21-2011.
- 4,479,545. **POINT S (STANDARD CHARACTER)**. POINT S FRANCE, MULTIPLE CLASS, (INT. CLS. 12, 35, 37 AND 42), (U.S. CLS. 19, 21, 23, 31, 35, 44, 100, 101, 102, 103 AND 106). SN 85-383,563. PUB. 11-26-2013. FILED 7-28-2011.
- 4,479,546. **SOUTH BOATS (STANDARD CHARACTER)**. SOUTH BOATS IOW LIMITED, MULTIPLE CLASS, (INT. CLS. 12, 37, 40 AND 42), (U.S. CLS. 19, 21, 23, 31, 35, 44, 100, 101, 103 AND 106). SN 85-384,285. PUB. 8-7-2012. FILED 7-29-2011.
- 4,479,547. **POINT S AND DESIGN**. POINT S FRANCE, MULTIPLE CLASS, (INT. CLS. 12, 35, 37 AND 42), (U.S. CLS. 19, 21, 23, 31, 35, 44, 100, 101, 102, 103 AND 106). SN 85-384,341. PUB. 11-26-2013. FILED 7-29-2011.
- 4,479,566. **EBUS (STANDARD CHARACTER)**. EBUS, INC., MULTIPLE CLASS, (INT. CLS. 12 AND 37), (U.S. CLS. 19, 21, 23, 31, 35, 44, 100, 103 AND 106). SN 85-473,541. PUB. 11-26-2013. FILED 11-15-2011.
- 4,479,628. **WINTERCRAFT (STANDARD CHARACTER)**. KUMHO TIRE CO., INC., (U.S. CLS. 19, 21, 23, 31, 35 AND 44). SN 85-620,421. PUB. 11-26-2013. FILED 5-9-2012.
- 4,479,666. **TITAN THE GRIZZ AND DESIGN**. TITAN INTERNATIONAL, INC., (U.S. CLS. 19, 21, 23, 31, 35 AND 44). SN 85-638,740. PUB. 11-26-2013. FILED 5-30-2012.
- 4,479,699 ( *See Class 9 for this trademark*).
- 4,479,701. **MANDO (STYLIZED)**. MANDO CORPORATION, (U.S. CLS. 19, 21, 23, 31, 35 AND 44). SN 85-677,644. PUB. 11-26-2013. FILED 7-16-2012.
- 4,479,774. **TF TECHNO-FAB AND DESIGN**. TECHNO-FAB 9000 INC., (U.S. CLS. 19, 21, 23, 31, 35 AND 44). SN 85-756,669. PUB. 11-26-2013. FILED 10-17-2012.
- 4,479,775. **TF AND DESIGN**. TECHNO-FAB 9000 INC., (U.S. CLS. 19, 21, 23, 31, 35 AND 44). SN 85-756,686. PUB. 11-26-2013. FILED 10-17-2012.
- 4,479,776. **ROADJET (STANDARD CHARACTER)**. AUDI AG, MULTIPLE CLASS, (INT. CLS. 12 AND 28), (U.S. CLS. 19, 21, 22, 23, 31, 35, 38, 44 AND 50). SN 85-757,368. PUB. 11-26-2013. FILED 10-18-2012.
- 4,479,883 ( *See Class 6 for this trademark*).
- 4,480,026. **TROUT TRUCKING CO., INC. AND DESIGN**. TROUT TRUCKING CO., INC., (U.S. CLS. 19, 21, 23, 31, 35 AND 44). SN 85-838,945. PUB. 11-26-2013. FILED 2-1-2013.
- 4,480,037. **DURABRAKE (STANDARD CHARACTER)**. DURABRAKE CO., (U.S. CLS. 19, 21, 23, 31, 35 AND 44). SN 85-844,542. PUB. 6-25-2013. FILED 2-8-2013.
- 4,480,098. **AEROARMORED AND DESIGN**. YI-TING ENTERPRISE LTD., (U.S. CLS. 19, 21, 23, 31, 35 AND 44). SN 85-869,204. PUB. 11-26-2013. FILED 3-7-2013.
- 4,480,103. **RASCAL ERADICATOR (STANDARD CHARACTER)**. UPCS, LLC, (U.S. CLS. 19, 21, 23, 31, 35 AND 44). SN 85-871,365. PUB. 11-26-2013. FILED 3-8-2013.
- 4,480,156. **NO MORE EXCUSES (STANDARD CHARACTER)**. INDIANA MILLS & MANUFACTURING, INC., (U.S. CLS. 19, 21, 23, 31, 35 AND 44). SN 85-889,890. PUB. 11-26-2013. FILED 3-28-2013.
- 4,480,253. **AMERCO (STANDARD CHARACTER)**. CROWNTYRE INDUSTRIAL CO., LTD., (U.S. CLS. 19, 21, 23, 31, 35 AND 44). SN 85-923,731. PUB. 10-1-2013. FILED 5-5-2013.
- 4,480,297. **CYCLE PRO LLC AND DESIGN**. CYCLE PRO LLC, (U.S. CLS. 19, 21, 23, 31, 35 AND 44). SN 85-930,122. PUB. 10-22-2013. FILED 5-13-2013.
- 4,480,373. **BAZO (STANDARD CHARACTER)**. MKW ALLOY INC., (U.S. CLS. 19, 21, 23, 31, 35 AND 44). SN 85-944,337. PUB. 11-26-2013. FILED 5-28-2013.
- 4,480,414. **X-TREME GATE (STYLIZED)**. BR MARKETING GROUP, LLC, (U.S. CLS. 19, 21, 23, 31, 35 AND 44). SN 85-948,091. PUB. 11-26-2013. FILED 5-31-2013.
- 4,480,586. **FLEXIBLE TOUGHNESS (STANDARD CHARACTER)**. KEYSTONE GLOBAL LLC, (U.S. CLS. 19, 21, 23, 31, 35 AND 44). SN 85-965,573. PUB. 11-26-2013. FILED 6-20-2013.
- 4,480,591. **C.A.T. COMPACT ADULT TRICYCLE AND DESIGN**. CAMPBELL JR., DAVID LEE, (U.S. CLS. 19, 21, 23, 31, 35 AND 44). SN 85-965,795. PUB. 11-26-2013. FILED 6-20-2013.
- 4,480,904. **SPEC-1 RACING WHEELS (STANDARD CHARACTER)**. ELITE WHEEL DISTRIBUTORS INC., (U.S. CLS. 19, 21, 23, 31, 35 AND 44). SN 86-001,753. PUB. 11-26-2013. FILED 7-3-2013.
- 4,480,940. **FURINA (STANDARD CHARACTER)**. HARTMAN,

ROSS K., (U.S. CLS. 19, 21, 23, 31, 35 AND 44). SN 86-002,247. PUB. 11-26-2013. FILED 7-3-2013.  
 4,480,980. **ZIP GRIP GO (STANDARD CHARACTER)**. EZ ADVANCED SOLUTIONS, LLC. (U.S. CLS. 19, 21, 23, 31, 35 AND 44). SN 86-002,747. PUB. 11-26-2013. FILED 7-4-2013.  
 4,481,083. **FEATHER-RAFT AND DESIGN**. RUIZ, ELIAS, (U.S. CLS. 19, 21, 23, 31, 35 AND 44). SN 86-004,034. PUB. 11-26-2013. FILED 7-8-2013.  
 4,481,124. **TXP (STYLIZED)**. NINGBO SUNSTAR SHOCK ABSORBER CO., LTD., (U.S. CLS. 19, 21, 23, 31, 35 AND 44). SN 86-004,886. PUB. 11-26-2013. FILED 7-9-2013.  
 4,481,174. **KRYT AND DESIGN**. PM INVESTMENT VENTURES, LLC, (U.S. CLS. 19, 21, 23, 31, 35 AND 44). SN 86-005,588. PUB. 11-26-2013. FILED 7-9-2013.  
 4,481,251. **FROSTGUARD (STANDARD CHARACTER)**. DELK PRODUCTS, INC., (U.S. CLS. 19, 21, 23, 31, 35 AND 44). SN 86-034,356. PUB. 11-26-2013. FILED 8-9-2013.  
 4,481,252. **WINTERSHIELD (STANDARD CHARACTER)**. DELK PRODUCTS, INC., (U.S. CLS. 19, 21, 23, 31, 35 AND 44). SN 86-034,380. PUB. 11-26-2013. FILED 8-9-2013.

---

### CLASS 13—FIREARMS

4,479,268 ( *See Class 9 for this trademark* ).  
 4,479,831. **PERRY HUNSAKER KNUCKLESAVER BULLET-STARTER (STANDARD CHARACTER)**. JAMES PERRY HUNSAKER, (U.S. CLS. 2 AND 9). SN 85-781,757. PUB. 11-26-2013. FILED 11-16-2012.  
 4,479,999. **X AND DESIGN**. X PRODUCTS LLC, (U.S. CLS. 2 AND 9). SN 85-830,093. PUB. 11-26-2013. FILED 1-23-2013.  
 4,480,539. **AMMO KAN - AMMUNITION SPECIALISTS AND DESIGN**. AMMO KAN, LLC, MULTIPLE CLASS, (INT. CLS. 13 AND 35), (U.S. CLS. 2, 9, 100, 101 AND 102). SN 85-963,832. PUB. 11-26-2013. FILED 6-19-2013.  
 4,481,129. **A AND DESIGN**. DANIEL DEFENSE, (U.S. CLS. 2 AND 9). SN 86-004,961. PUB. 11-26-2013. FILED 7-9-2013.

---

### CLASS 14—JEWELRY

4,479,273 ( *See Class 3 for this trademark* ).  
 4,479,283 ( *See Class 3 for this trademark* ).  
 4,479,351. **CLAUDIUS (STANDARD CHARACTER)**. DEVERNOIS S.A., MULTIPLE CLASS, (INT. CLS. 14, 18 AND 25), (U.S. CLS. 1, 2, 3, 22, 27, 28, 39, 41 AND 50). SN 79-125,066. PUB. 11-26-2013. FILED 12-21-2012.  
 4,479,367 ( *See Class 3 for this trademark* ).  
 4,479,368 ( *See Class 3 for this trademark* ).  
 4,479,413 ( *See Class 9 for this trademark* ).  
 4,479,447. **A AMERICAN FRESHMAN AUTHENTIC CAMPUS CLOTHING AND DESIGN**. INTERNATIONAL MANAGEMENT GROUP; (UK) LIMITED, MULTIPLE CLASS, (INT. CLS. 14, 18, 25 AND 35), (U.S. CLS. 1, 2, 3, 22, 27, 28, 39, 41, 50, 100, 101 AND 102). SN 79-129,903. PUB. 11-26-2013. FILED 3-6-2013.  
 4,479,533. **PRECISTA (STANDARD CHARACTER)**. PLATTS, EDWARD, (U.S. CLS. 2, 27, 28 AND 50). SN 85-279,538. PUB. 11-26-2013. FILED 3-29-2011.  
 4,479,558 ( *See Class 3 for this trademark* ).  
 4,479,559 ( *See Class 3 for this trademark* ).  
 4,479,560 ( *See Class 3 for this trademark* ).  
 4,479,568 ( *See Class 3 for this trademark* ).  
 4,479,578 ( *See Class 3 for this trademark* ).  
 4,479,614. **MOTHER OF DIAMOND (STANDARD CHARACTER)**. NEMZER, ARIK, (U.S. CLS. 2, 27, 28 AND 50). SN 85-598,530. PUB. 11-26-2013. FILED 4-16-2012.  
 4,479,673. **VARIBELL (STANDARD CHARACTER)**. JOHJOH AB, MULTIPLE CLASS, (INT. CLS. 14 AND 42), (U.S. CLS. 2, 27, 28, 50, 100 AND 101). SN 85-646,936. PUB. 11-27-2012. FILED 6-8-2012.  
 4,479,699 ( *See Class 9 for this trademark* ).  
 4,479,764. **ALO (STANDARD CHARACTER)**. ALO JEWELRY, S.R.O., MULTIPLE CLASS, (INT. CLS. 14, 35, 40 AND 42), (U.S. CLS. 2, 27, 28, 50, 100, 101, 102, 103 AND 106). SN 85-

748,968. PUB. 10-8-2013. FILED 10-9-2012.  
 4,479,765. **ALO JEWELRY (STANDARD CHARACTER)**. ALO JEWELRY, S.R.O., MULTIPLE CLASS, (INT. CLS. 14, 35, 40 AND 42), (U.S. CLS. 2, 27, 28, 50, 100, 101, 102, 103 AND 106). SN 85-749,004. PUB. 10-8-2013. FILED 10-9-2012.  
 4,479,789. **CORONET SOLITAIRE AND DESIGN**. AARON SHUM JEWELRY LTD, (U.S. CLS. 2, 27, 28 AND 50). SN 85-766,684. PUB. 11-26-2013. FILED 10-30-2012.  
 4,479,906. **HIS HAND (STANDARD CHARACTER)**. GRATO INC., (U.S. CLS. 2, 27, 28 AND 50). SN 85-805,932. PUB. 11-26-2013. FILED 12-18-2012.  
 4,479,989. **JULI ZOFIA (STYLIZED)**. SHANGYING (SHANGHAI) JEWELRY CO., LTD., (U.S. CLS. 2, 27, 28 AND 50). SN 85-827,615. PUB. 11-26-2013. FILED 1-19-2013.  
 4,480,169. **ST AND DESIGN**. SENTIMENTAL TOUCH, LLC, (U.S. CLS. 2, 27, 28 AND 50). SN 85-897,092. PUB. 11-26-2013. FILED 4-5-2013.  
 4,480,357 ( *See Class 9 for this trademark* ).  
 4,480,363. **KISSOULA AND DESIGN**. KISSOULA JEWELRY COMPANY LIMITED, (U.S. CLS. 2, 27, 28 AND 50). SN 85-942,929. PUB. 11-26-2013. FILED 5-26-2013.  
 4,480,515. **ROMANCE NEVER DIES (STANDARD CHARACTER)**. MF JEWELRY, (U.S. CLS. 2, 27, 28 AND 50). SN 85-962,336. PUB. 11-26-2013. FILED 6-18-2013.  
 4,480,540. **PC AND DESIGN**. CREVOSHAY, PAULA, (U.S. CLS. 2, 27, 28 AND 50). SN 85-963,851. PUB. 11-26-2013. FILED 6-19-2013.  
 4,480,760. **MANAK (STANDARD CHARACTER)**. MANAK JEWELS INC., (U.S. CLS. 2, 27, 28 AND 50). SN 85-974,038. PUB. 11-26-2013. FILED 7-1-2013.  
 4,480,782. **DEMER (STANDARD CHARACTER)**. METZGER, DERIC, (U.S. CLS. 2, 27, 28 AND 50). SN 85-974,661. PUB. 11-26-2013. FILED 7-1-2013.  
 4,480,853. **SPEC OPS (STANDARD CHARACTER)**. MULTI TIME MACHINE, INC., (U.S. CLS. 2, 27, 28 AND 50). SN 86-000,817. PUB. 11-26-2013. FILED 7-2-2013.  
 4,480,854. **SPECIAL OPS (STANDARD CHARACTER)**. MULTI TIME MACHINE, INC., (U.S. CLS. 2, 27, 28 AND 50). SN 86-000,830. PUB. 11-26-2013. FILED 7-2-2013.  
 4,480,900. **HAVE A SPARKLING DAY! (STANDARD CHARACTER)**. D' ELEGANTE, INC., MULTIPLE CLASS, (INT. CLS. 14, 35, 36 AND 37), (U.S. CLS. 2, 27, 28, 50, 100, 101, 102, 103 AND 106). SN 86-001,671. PUB. 11-26-2013. FILED 7-3-2013.  
 4,480,917. **H D H AND DESIGN**. HENRY DESIGN STUDIO INC., (U.S. CLS. 2, 27, 28 AND 50). SN 86-002,003. PUB. 11-26-2013. FILED 7-3-2013.  
 4,480,930. **MISCELLANEOUS DESIGN**. BAGGINS, INC., (U.S. CLS. 2, 27, 28 AND 50). SN 86-002,156. PUB. 11-26-2013. FILED 7-3-2013.  
 4,480,961 ( *See Class 9 for this trademark* ).  
 4,480,965. **NO ONISS (STYLIZED)**. NISIMOV WATCH CO., INC., (U.S. CLS. 2, 27, 28 AND 50). SN 86-002,567. PUB. 11-26-2013. FILED 7-3-2013.  
 4,481,000. **NAGICIA (STANDARD CHARACTER)**. KIM, TRICIA, (U.S. CLS. 2, 27, 28 AND 50). SN 86-002,905. PUB. 11-26-2013. FILED 7-5-2013.  
 4,481,001. **BTWISTED (STANDARD CHARACTER)**. BTWISTED, INC., (U.S. CLS. 2, 27, 28 AND 50). SN 86-002,912. PUB. 11-26-2013. FILED 7-5-2013.  
 4,481,088. **RINGUARDIAN (STANDARD CHARACTER)**. WILBERT FUNERAL SERVICES, INC., (U.S. CLS. 2, 27, 28 AND 50). SN 86-004,078. PUB. 11-26-2013. FILED 7-8-2013.  
 4,481,122. **GVBORI (STANDARD CHARACTER)**. GVBORI GROUP CO.,LTD., (U.S. CLS. 2, 27, 28 AND 50). SN 86-004,843. PUB. 11-26-2013. FILED 7-8-2013.  
 4,481,211. **FOREVER COLOR (STANDARD CHARACTER)**. ANAYA GEMS INC., (U.S. CLS. 2, 27, 28 AND 50). SN 86-012,126. PUB. 11-26-2013. FILED 7-17-2013.  
 4,481,220. **CHAMPAGNE ELEGANCE (STANDARD CHARACTER)**. ANAYA GEMS INC., (U.S. CLS. 2, 27, 28 AND 50). SN 86-014,826. PUB. 11-26-2013. FILED 7-19-2013.  
 4,481,221. **CHAMPAGNE SENSATIONS (STANDARD CHARACTER)**. ANAYA GEMS INC., (U.S. CLS. 2, 27, 28 AND 50). SN 86-014,842. PUB. 11-26-2013. FILED 7-19-2013.  
 4,481,226. **ARCEAU LIFT (STANDARD CHARACTER)**. LA MONTRE HERMES S.A., (U.S. CLS. 2, 27, 28 AND 50). SN 86-018,927. PUB. 11-26-2013. FILED 7-24-2013.

**CLASS 15—MUSICAL INSTRUMENTS**

- 4,479,361. **DALLAPE'** (STANDARD CHARACTER). ROLAND EUROPE S.P.A., (U.S. CLS. 2, 21 AND 36). SN 79-125,995. PUB. 11-26-2013. FILED 12-27-2012.
- 4,479,995. **CONCORDE** (STANDARD CHARACTER). GOLD JACKSON ENTERPRISES LLC, DBA GJ2 GUITARS, (U.S. CLS. 2, 21 AND 36). SN 85-829,191. PUB. 11-26-2013. FILED 1-22-2013.
- 4,480,264. **DELL'ARTE** (STANDARD CHARACTER). COLA, ALAIN, DBA DELL'ARTE GUITARS & GYPSY JAZZ DISTRIBUTION, (U.S. CLS. 2, 21 AND 36). SN 85-925,323. PUB. 11-26-2013. FILED 5-7-2013.
- 4,480,481. **R.W. JAMESON** (STANDARD CHARACTER). MUSICIANS DISCOUNT WAREHOUSE, LLC, (U.S. CLS. 2, 21 AND 36). SN 85-957,520. PUB. 11-26-2013. FILED 6-12-2013.
- 4,481,074. **CRESTON** (STANDARD CHARACTER). CRESTON ELECTRIC INSTRUMENTS, LLC, (U.S. CLS. 2, 21 AND 36). SN 86-003,837. PUB. 11-26-2013. FILED 7-8-2013.
- 4,481,080. **MISCELLANEOUS DESIGN**. DARKGLASS ELECTRONICS, (U.S. CLS. 2, 21 AND 36). SN 86-004,010. PUB. 11-26-2013. FILED 7-8-2013.

**CLASS 16—PAPER GOODS AND PRINTED MATTER**

- 4,479,279 ( See Class 9 for this trademark).
- 4,479,281. **IDEBRILL IL PROFUMO DELLA FRESCHEZZA AND DESIGN**. ESSEQUATTRO S.P.A., (U.S. CLS. 2, 5, 22, 23, 29, 37, 38 AND 50). SN 79-113,099. PUB. 11-26-2013. FILED 4-12-2012.
- 4,479,282. **BIOBRIILL (STYLIZED)**. ESSEQUATTRO S.P.A., (U.S. CLS. 2, 5, 22, 23, 29, 37, 38 AND 50). SN 79-113,102. PUB. 11-26-2013. FILED 4-12-2012.
- 4,479,291 ( See Class 2 for this trademark).
- 4,479,296. **F.A.C.E.2 F@CE FACIAL AESTHETIC AND COSMETIC EVENTS SCIENTIFIC CONFERENCE FOR AESTHETIC EXPERTS AND DESIGN**. MONSIEUR PATRICK TREVIDIC, AND MONSIEUR PARIS JÉRÔME, AND MONSIEUR BRACCINI FRÉDÉRIC, MULTIPLE CLASS, (INT. CLS. 16, 35, 38, 41 AND 44), (U.S. CLS. 2, 5, 22, 23, 29, 37, 38, 50, 100, 101, 102, 104 AND 107). SN 79-117,593. PUB. 9-3-2013. FILED 4-3-2012.
- 4,479,300. **CULTURE IS FUTURE (STANDARD CHARACTER)**. FORUM D'AVIGNON, MULTIPLE CLASS, (INT. CLS. 16, 35, 38 AND 41), (U.S. CLS. 2, 5, 22, 23, 29, 37, 38, 50, 100, 101, 102, 104 AND 107). SN 79-117,925. PUB. 11-26-2013. FILED 7-19-2012.
- 4,479,307 ( See Class 9 for this trademark).
- 4,479,320 ( See Class 9 for this trademark).
- 4,479,323 ( See Class 9 for this trademark).
- 4,479,335. **TERRAFILT (STANDARD CHARACTER)**. TERRANOVA PAPERS, S.A., (U.S. CLS. 2, 5, 22, 23, 29, 37, 38 AND 50). SN 79-124,072. PUB. 11-26-2013. FILED 9-18-2012.
- 4,479,347 ( See Class 8 for this trademark).
- 4,479,349 ( See Class 3 for this trademark).
- 4,479,367 ( See Class 3 for this trademark).
- 4,479,368 ( See Class 3 for this trademark).
- 4,479,413 ( See Class 9 for this trademark).
- 4,479,414 ( See Class 9 for this trademark).
- 4,479,416. **ANGEL-5 AND DESIGN**. CARL JIMUKI KABUSHIKI KAISHA; (ALSO TRADING AS CARL MANUFACTURING CO., LTD.), (U.S. CLS. 2, 5, 22, 23, 29, 37, 38 AND 50). SN 79-127,911. PUB. 11-26-2013. FILED 2-26-2013.
- 4,479,417 ( See Class 10 for this trademark).
- 4,479,433. **MDEHO AND DESIGN**. HUANG SHENGWEI, MULTIPLE CLASS, (INT. CLS. 16, 18 AND 35), (U.S. CLS. 1, 2, 3, 5, 22, 23, 29, 37, 38, 41, 50, 100, 101 AND 102). SN 79-128,875. PUB. 11-26-2013. FILED 7-10-2012.
- 4,479,434 ( See Class 3 for this trademark).
- 4,479,452 ( See Class 9 for this trademark).
- 4,479,469 ( See Class 9 for this trademark).
- 4,479,501. **GORMITI AND DESIGN**. GIOCHI PREZIOSI S.P.A., MULTIPLE CLASS, (INT. CLS. 16, 28 AND 41), (U.S. CLS. 2, 5, 22, 23, 29, 37, 38, 50, 100, 101 AND 107). SN 79-135,077. PUB. 11-26-2013. FILED 11-2-2012.
- 4,479,525. **CRAFTER'S SCHOOLHOUSE (STANDARD CHARACTER)**. MULTICRAFT IMPORTS INC., MULTIPLE CLASS, (INT. CLS. 16 AND 28), (U.S. CLS. 2, 5, 22, 23, 29, 37, 38 AND 50). SN 85-135,794. PUB. 4-23-2013. FILED 9-22-2010.
- 4,479,526. **CRAFTER'S SCHOOLHOUSE AND DESIGN**. MULTICRAFT IMPORTS INC., MULTIPLE CLASS, (INT. CLS. 16 AND 28), (U.S. CLS. 2, 5, 22, 23, 29, 37, 38 AND 50). SN 85-135,820. PUB. 4-23-2013. FILED 9-22-2010.
- 4,479,535. **NEW YOU (STYLIZED)**. NEW YOU MEDIA LLC, MULTIPLE CLASS, (INT. CLS. 16 AND 41), (U.S. CLS. 2, 5, 22, 23, 29, 37, 38, 50, 100, 101 AND 107). SN 85-309,325. PUB. 11-26-2013. FILED 5-1-2011.
- 4,479,538 ( See Class 9 for this trademark).
- 4,479,543. **1 ROTARY CLUB CHICAGO AND DESIGN**. ROTARY INTERNATIONAL, MULTIPLE CLASS, (INT. CLS. 16, 35, 36, 41 AND 45), (U.S. CLS. 2, 5, 22, 23, 29, 37, 38, 50, 100, 101, 102 AND 107). SN 85-361,169. PUB. 11-26-2013. FILED 6-30-2011.
- 4,479,544. **RAW BEAUTY (STANDARD CHARACTER)**. CRIDER, LAKITA, MULTIPLE CLASS, (INT. CLS. 16 AND 41), (U.S. CLS. 2, 5, 22, 23, 29, 37, 38, 50, 100, 101 AND 107). SN 85-368,794. PUB. 7-24-2012. FILED 7-12-2011.
- 4,479,548. **PLIIO (STANDARD CHARACTER)**. FLO COLLECTION INC., (U.S. CLS. 2, 5, 22, 23, 29, 37, 38 AND 50). SN 85-413,905. PUB. 11-26-2013. FILED 9-2-2011.
- 4,479,568 ( See Class 3 for this trademark).
- 4,479,589. **RAINBOW (STANDARD CHARACTER)**. D.W. SPINKS (EMBOSSING) LTD., (U.S. CLS. 2, 5, 22, 23, 29, 37, 38 AND 50). SN 85-544,678. PUB. 7-16-2013. FILED 2-16-2012.
- 4,479,610. **PLANTA (STANDARD CHARACTER)**. SORIGUE FOUNDATION, MULTIPLE CLASS, (INT. CLS. 16, 25, 35 AND 41), (U.S. CLS. 2, 5, 22, 23, 29, 37, 38, 39, 50, 100, 101, 102 AND 107). SN 85-579,982. PUB. 11-26-2013. FILED 3-26-2012.
- 4,479,612. **QUIKCOOL AND DESIGN**. CARTER HOLT HARVEY LIMITED, (U.S. CLS. 2, 5, 22, 23, 29, 37, 38 AND 50). SN 85-587,410. PUB. 3-5-2013. FILED 4-3-2012.
- 4,479,650. **NEW LEADERS AND DESIGN**. NEW LEADERS, INC., MULTIPLE CLASS, (INT. CLS. 16 AND 41), (U.S. CLS. 2, 5, 22, 23, 29, 37, 38, 50, 100, 101 AND 107). SN 85-633,186. PUB. 11-26-2013. FILED 5-23-2012.
- 4,479,663 ( See Class 9 for this trademark).
- 4,479,670. **EDWARDIAN LADY (STANDARD CHARACTER)**. LILYTIG LIMITED, AND ROWENA STOTT (DESIGNS) LIMITED, MULTIPLE CLASS, (INT. CLS. 16, 20 AND 24), (U.S. CLS. 2, 5, 13, 22, 23, 25, 29, 32, 37, 38, 42 AND 50). SN 85-645,718. PUB. 6-4-2013. FILED 6-7-2012.
- 4,479,671 ( See Class 3 for this trademark).
- 4,479,687. **FENTRESS ARCHITECTS AND DESIGN**. FENTRESS ARCHITECTS, LTD., MULTIPLE CLASS, (INT. CLS. 16, 35 AND 42), (U.S. CLS. 2, 5, 22, 23, 29, 37, 38, 50, 100, 101 AND 102). SN 85-660,118. PUB. 11-26-2013. FILED 6-25-2012.
- 4,479,699 ( See Class 9 for this trademark).
- 4,479,702. **RENAL PHYSIOLOGY (STANDARD CHARACTER)**. AMERICAN PHYSIOLOGICAL SOCIETY, MULTIPLE CLASS, (INT. CLS. 16 AND 41), (U.S. CLS. 2, 5, 22, 23, 29, 37, 38, 50, 100, 101 AND 107). SN 85-679,273. PUB. 11-26-2013. FILED 7-17-2012.
- 4,479,706. **DENTISTRY HAS EVOLVED. HAS YOUR DENTIST? (STANDARD CHARACTER)**. SWEENEY, CAROLINE, (U.S. CLS. 2, 5, 22, 23, 29, 37, 38 AND 50). SN 85-684,434. PUB. 11-26-2013. FILED 7-23-2012.
- 4,479,760. **MEC MINERALS EDUCATION COALITION AND DESIGN**. SME FOUNDATION, MULTIPLE CLASS, (INT. CLS. 16 AND 41), (U.S. CLS. 2, 5, 22, 23, 29, 37, 38, 50, 100, 101 AND 107). SN 85-747,720. PUB. 11-26-2013. FILED 10-7-2012.
- 4,479,770. **FRESH 'R' PAX AND DESIGN**. MAXWELL CHASE TECHNOLOGIES, LLC, (U.S. CLS. 2, 5, 22, 23, 29, 37, 38 AND 50). SN 85-754,902. PUB. 11-26-2013. FILED 10-16-2012.
- 4,479,852 ( See Class 9 for this trademark).
- 4,479,856. **BACKWARD PRINTS (STANDARD CHARACTER)**. BRYNNE COGORNO, DBA BACKWARD PRINTS, (U.S. CLS. 2, 5, 22, 23, 29, 37, 38 AND 50). SN 85-793,437. PUB. 11-26-2013. FILED 12-3-2012.
- 4,479,857. **MISCELLANEOUS DESIGN**. BRYNNE COGORNO, DBA BACKWARD PRINTS, (U.S. CLS. 2, 5, 22, 23, 29,



- 37, 38 AND 50). SN 85-793,442. PUB. 11-26-2013. FILED 12-3-2012.
- 4,479,883 ( *See Class 6 for this trademark*).
- 4,479,922. **RTWW (STANDARD CHARACTER)**. ENNIS, ROY F., MULTIPLE CLASS, (INT. CLS. 16 AND 25), (U.S. CLS. 2, 5, 22, 23, 29, 37, 38, 39 AND 50). SN 85-808,989. PUB. 11-26-2013. FILED 12-21-2012.
- 4,479,949 ( *See Class 9 for this trademark*).
- 4,479,968. **VALRHO' NEWS (STANDARD CHARACTER)**. VALRHONA, MULTIPLE CLASS, (INT. CLS. 16, 30, 35, 38 AND 41), (U.S. CLS. 2, 5, 22, 23, 29, 37, 38, 46, 50, 100, 101, 102, 104 AND 107). SN 85-822,297. PUB. 8-13-2013. FILED 1-14-2013.
- 4,479,970. **VIEWPOINT (STANDARD CHARACTER)**. DOEREN MAYHEW & CO., P.C., DBA DOEREN MAYHEW, MULTIPLE CLASS, (INT. CLS. 16 AND 41), (U.S. CLS. 2, 5, 22, 23, 29, 37, 38, 50, 100, 101 AND 107). SN 85-822,959. PUB. 11-26-2013. FILED 1-14-2013.
- 4,479,988. **DOODLE ALL DAY (STANDARD CHARACTER)**. FOSTER, TERESA, (U.S. CLS. 2, 5, 22, 23, 29, 37, 38 AND 50). SN 85-827,260. PUB. 11-26-2013. FILED 1-18-2013.
- 4,480,006. **MORRIS ESSEX HEALTH & LIFE (STANDARD CHARACTER)**. WAINSCOT MEDIA, LLC, (U.S. CLS. 2, 5, 22, 23, 29, 37, 38 AND 50). SN 85-831,351. PUB. 11-26-2013. FILED 1-24-2013.
- 4,480,014. **BIOMICROFLUIDICS (STANDARD CHARACTER)**. AMERICAN INSTITUTE OF PHYSICS, INC., (U.S. CLS. 2, 5, 22, 23, 29, 37, 38 AND 50). SN 85-834,821. PUB. 11-26-2013. FILED 1-29-2013.
- 4,480,039. **MÉXICOAQUI AND DESIGN**. DIAZ, JOSE FELIX, AND FLORES, EDUARDO GONZALO, AND FLORES, EDUARDO, (U.S. CLS. 2, 5, 22, 23, 29, 37, 38 AND 50). SN 85-846,913. PUB. 11-26-2013. FILED 2-11-2013.
- 4,480,049. **VALRHONA TV (STANDARD CHARACTER)**. VALRHONA, MULTIPLE CLASS, (INT. CLS. 16, 30, 35, 38 AND 41), (U.S. CLS. 2, 5, 22, 23, 29, 37, 38, 46, 50, 100, 101, 102, 104 AND 107). SN 85-850,854. PUB. 6-25-2013. FILED 2-15-2013.
- 4,480,050. **VALRHONA . TV AND DESIGN**. VALRHONA, MULTIPLE CLASS, (INT. CLS. 16, 30, 35, 38 AND 41), (U.S. CLS. 2, 5, 22, 23, 29, 37, 38, 46, 50, 100, 101, 102, 104 AND 107). SN 85-850,862. PUB. 7-9-2013. FILED 2-15-2013.
- 4,480,064. **OH JOY! (STANDARD CHARACTER)**. NANTAKA JOY, INC., MULTIPLE CLASS, (INT. CLS. 16, 41 AND 42), (U.S. CLS. 2, 5, 22, 23, 29, 37, 38, 50, 100, 101 AND 107). SN 85-857,027. PUB. 8-20-2013. FILED 2-22-2013.
- 4,480,089. **INSIDE WE'RE ALL THE SAME (STANDARD CHARACTER)**. JUST BORN, INC., MULTIPLE CLASS, (INT. CLS. 16, 21 AND 25), (U.S. CLS. 2, 5, 13, 22, 23, 29, 30, 33, 37, 38, 39, 40 AND 50). SN 85-864,209. PUB. 11-26-2013. FILED 3-1-2013.
- 4,480,094 ( *See Class 9 for this trademark*).
- 4,480,105. **VALOR STUDIOS (STANDARD CHARACTER)**. VALOR STUDIOS, INC., (U.S. CLS. 2, 5, 22, 23, 29, 37, 38 AND 50). SN 85-871,836. PUB. 11-26-2013. FILED 3-9-2013.
- 4,480,123 ( *See Class 9 for this trademark*).
- 4,480,130. **NUTRITIONAL WELLNESS (STANDARD CHARACTER)**. MAXWELL PETERSEN ASSOCIATES, DBA MPA MEDIA, (U.S. CLS. 2, 5, 22, 23, 29, 37, 38 AND 50). SN 85-882,274. PUB. 11-26-2013. FILED 3-21-2013.
- 4,480,149. **WWD BEAUTYINC (STANDARD CHARACTER)**. ADVANCE MAGAZINE PUBLISHERS, INC., (U.S. CLS. 2, 5, 22, 23, 29, 37, 38 AND 50). SN 85-888,200. PUB. 11-26-2013. FILED 3-27-2013.
- 4,480,210. **AMERICAN ACUPUNCTURE COUNCIL NETWORK (STANDARD CHARACTER)**. AMERICAN ACUPUNCTURE COUNCIL, MULTIPLE CLASS, (INT. CLS. 16, 35, 36 AND 41), (U.S. CLS. 2, 5, 22, 23, 29, 37, 38, 50, 100, 101, 102 AND 107). SN 85-909,710. PUB. 11-26-2013. FILED 4-19-2013.
- 4,480,262. **KEEPSAKE GIFT CARDS (STANDARD CHARACTER)**. KINDNOTES, LLC, (U.S. CLS. 2, 5, 22, 23, 29, 37, 38 AND 50). SN 85-924,883. PUB. 11-26-2013. FILED 5-7-2013.
- 4,480,278. **CHURCH FINANCE TODAY (STANDARD CHARACTER)**. CHRISTIANITY TODAY INTERNATIONAL, (U.S. CLS. 2, 5, 22, 23, 29, 37, 38 AND 50). SN 85-926,596. PUB. 11-26-2013. FILED 5-8-2013.
- 4,480,304 ( *See Class 9 for this trademark*).
- 4,480,340. **SYMPHONY (STANDARD CHARACTER)**. DESERT VALLEY SERVICES, INC., (U.S. CLS. 2, 5, 22, 23, 29, 37, 38 AND 50). SN 85-940,273. PUB. 11-26-2013. FILED 5-22-2013.
- 4,480,342. **THE SANTA CLUB (STANDARD CHARACTER)**. MOSS, KELLY, (U.S. CLS. 2, 5, 22, 23, 29, 37, 38 AND 50). SN 85-941,033. PUB. 11-26-2013. FILED 5-23-2013.
- 4,480,357 ( *See Class 9 for this trademark*).
- 4,480,368. **NEW WEIGH SCALE STICKIES (STANDARD CHARACTER)**. KATHLEEN FEE, (U.S. CLS. 2, 5, 22, 23, 29, 37, 38 AND 50). SN 85-943,930. PUB. 11-26-2013. FILED 5-28-2013.
- 4,480,425. **REGINA PRESS (STANDARD CHARACTER)**. CATHOLIC BOOK PUBLISHING CORP., (U.S. CLS. 2, 5, 22, 23, 29, 37, 38 AND 50). SN 85-950,079. PUB. 11-26-2013. FILED 6-4-2013.
- 4,480,426. **REGINA CLASSICS (STANDARD CHARACTER)**. CATHOLIC BOOK PUBLISHING CORP., (U.S. CLS. 2, 5, 22, 23, 29, 37, 38 AND 50). SN 85-950,115. PUB. 11-26-2013. FILED 6-4-2013.
- 4,480,443 ( *See Class 7 for this trademark*).
- 4,480,492. **FRENCH BULL (STANDARD CHARACTER)**. FRENCH BULL LLC, (U.S. CLS. 2, 5, 22, 23, 29, 37, 38 AND 50). SN 85-958,618. PUB. 11-26-2013. FILED 6-13-2013.
- 4,480,530. **FIT KIDS PUBLISHING AND DESIGN**. RICHARDS, KATHERINE K, DBA FIT KIDS PUBLISHING, (U.S. CLS. 2, 5, 22, 23, 29, 37, 38 AND 50). SN 85-963,573. PUB. 11-26-2013. FILED 6-19-2013.
- 4,480,605 ( *See Class 3 for this trademark*).
- 4,480,607. **UNITED STATES MARINE CORPS (STANDARD CHARACTER)**. U.S. MARINE CORPS, A COMPONENT OF THE U.S. DEPARTMENT OF THE NAVY, (U.S. CLS. 2, 5, 22, 23, 29, 37, 38 AND 50). SN 85-966,755. PUB. 11-26-2013. FILED 6-21-2013.
- 4,480,614. **NHM NH MEASURES AND DESIGN**. HAWTHORNE, NATALIE D., DBA NH MEASURES, (U.S. CLS. 2, 5, 22, 23, 29, 37, 38 AND 50). SN 85-967,324. PUB. 11-26-2013. FILED 6-22-2013.
- 4,480,632. **NARFE EST. 1921 AND DESIGN**. NATIONAL ACTIVE AND RETIRED FEDERAL EMPLOYEES ASSOCIATION, AKA NARFE, MULTIPLE CLASS, (INT. CLS. 16, 35 AND 41), (U.S. CLS. 2, 5, 22, 23, 29, 37, 38, 50, 100, 101, 102 AND 107). SN 85-968,107. PUB. 11-26-2013. FILED 6-24-2013.
- 4,480,634. **NATIONAL ACTIVE AND RETIRED FEDERAL EMPLOYEES ASSOCIATION (STANDARD CHARACTER)**. NATIONAL ACTIVE AND RETIRED FEDERAL EMPLOYEES ASSOCIATION, AKA NARFE, MULTIPLE CLASS, (INT. CLS. 16, 35 AND 41), (U.S. CLS. 2, 5, 22, 23, 29, 37, 38, 50, 100, 101, 102 AND 107). SN 85-968,122. PUB. 11-26-2013. FILED 6-24-2013.
- 4,480,700. **PAC GUARD (STANDARD CHARACTER)**. PAC PAPER, INC., (U.S. CLS. 2, 5, 22, 23, 29, 37, 38 AND 50). SN 85-970,904. PUB. 11-26-2013. FILED 6-26-2013.
- 4,480,777. **SYNKOART (STANDARD CHARACTER)**. REBECCA BLAESING, (U.S. CLS. 2, 5, 22, 23, 29, 37, 38 AND 50). SN 85-974,472. PUB. 11-26-2013. FILED 7-1-2013.
- 4,480,780. **SANTA'S SECRET WORKSHOP (STANDARD CHARACTER)**. EERIE VENTURES, LLC, MULTIPLE CLASS, (INT. CLS. 16, 25, 28 AND 41), (U.S. CLS. 2, 5, 22, 23, 29, 37, 38, 39, 50, 100, 101 AND 107). SN 85-974,656. PUB. 11-26-2013. FILED 7-1-2013.
- 4,480,797. **INSTINCTIVELYRAW (STANDARD CHARACTER)**. LINKS BUSINESS GROUP LLC, (U.S. CLS. 2, 5, 22, 23, 29, 37, 38 AND 50). SN 85-980,839. PUB. 4-2-2013. FILED 8-25-2012.
- 4,480,805. **TOPRO (STANDARD CHARACTER)**. BES TECHNOLOGY INC., MULTIPLE CLASS, (INT. CLS. 16 AND 21), (U.S. CLS. 2, 5, 13, 22, 23, 29, 30, 33, 37, 38, 40 AND 50). SN 86-000,214. PUB. 11-26-2013. FILED 7-2-2013.
- 4,480,866. **HORRORHOUND (STANDARD CHARACTER)**. JEREMY J. SHELDON, (U.S. CLS. 2, 5, 22, 23, 29, 37, 38 AND 50). SN 86-001,000. PUB. 11-26-2013. FILED 7-2-2013.
- 4,480,879. **CAN YOU SOLVE THE MYSTERY? (STANDARD CHARACTER)**. BRUCE LANSKY, (U.S. CLS. 2, 5, 22, 23, 29, 37, 38 AND 50). SN 86-001,255. PUB. 11-26-2013. FILED 7-2-2013.
- 4,480,892. **ISTENCILS (STANDARD CHARACTER)**. STENCILS ONLINE LLC, (U.S. CLS. 2, 5, 22, 23, 29, 37, 38 AND

- 50). SN 86-001,555. PUB. 11-26-2013. FILED 7-3-2013.  
 4,480,934. **GOT PAPER? (STANDARD CHARACTER)**. NEW LEAF PAPER, INC., (U.S. CLS. 2, 5, 22, 23, 29, 37, 38 AND 50). SN 86-002,208. PUB. 11-26-2013. FILED 7-3-2013.  
 4,481,003. **KK AND DESIGN**. KAMI KUHLMAN ART, INC., (U.S. CLS. 2, 5, 22, 23, 29, 37, 38 AND 50). SN 86-002,930. PUB. 11-26-2013. FILED 7-5-2013.  
 4,481,013. **JOURNAL OF ARCHITECTURAL AND PLANNING RESEARCH (STANDARD CHARACTER)**. LOCKE SCIENCE PUBLISHING COMPANY, INCORPORATED, (U.S. CLS. 2, 5, 22, 23, 29, 37, 38 AND 50). SN 86-003,040. PUB. 11-26-2013. FILED 7-5-2013.  
 4,481,018. **HOUNDSCOOP (STANDARD CHARACTER)**. GREGG FREDMAN, (U.S. CLS. 2, 5, 22, 23, 29, 37, 38 AND 50). SN 86-003,071. PUB. 11-26-2013. FILED 7-5-2013.  
 4,481,097 ( *See Class 9 for this trademark* ).  
 4,481,117. **SAVING THE WHOLE FAMILY DISASTER PREPAREDNESS (STANDARD CHARACTER)**. THE AMERICAN VETERINARY MEDICAL FOUNDATION, (U.S. CLS. 2, 5, 22, 23, 29, 37, 38 AND 50). SN 86-004,723. PUB. 11-26-2013. FILED 7-8-2013.  
 4,481,145. **INKFORMATION (STANDARD CHARACTER)**. DON R. POWELL, (U.S. CLS. 2, 5, 22, 23, 29, 37, 38 AND 50). SN 86-005,177. PUB. 11-26-2013. FILED 7-9-2013.  
 4,481,157. **AYECON (STANDARD CHARACTER)**. RYAN GOODWIN, MULTIPLE CLASS, (INT. CLS. 16 AND 25), (U.S. CLS. 2, 5, 22, 23, 29, 37, 38, 39 AND 50). SN 86-005,344. PUB. 11-26-2013. FILED 7-9-2013.  
 4,481,159. **MISCELLANEOUS DESIGN**. RYAN GOODWIN, MULTIPLE CLASS, (INT. CLS. 16 AND 25), (U.S. CLS. 2, 5, 22, 23, 29, 37, 38, 39 AND 50). SN 86-005,381. PUB. 11-26-2013. FILED 7-9-2013.  
 4,481,210. **JAMIA (STANDARD CHARACTER)**. AMERICAN MEDICAL INFORMATICS ASSOCIATION, INC., MULTIPLE CLASS, (INT. CLS. 16 AND 41), (U.S. CLS. 2, 5, 22, 23, 29, 37, 38, 50, 100, 101 AND 107). SN 86-011,118. PUB. 11-26-2013. FILED 7-16-2013.  
 4,481,241. **MISCELLANEOUS DESIGN**. LETTUCE ENTERTAIN YOU ENTERPRISES, INC., MULTIPLE CLASS, (INT. CLS. 16, 25 AND 41), (U.S. CLS. 2, 5, 22, 23, 29, 37, 38, 39, 50, 100, 101 AND 107). SN 86-029,113. PUB. 11-26-2013. FILED 8-5-2013.

### CLASS 17—RUBBER GOODS

- 4,479,258. **SUPERFOAM (STANDARD CHARACTER)**. CALIFORNIA INNOVATIONS INC., (U.S. CLS. 1, 5, 12, 13, 35 AND 50). SN 77-790,399. PUB. 11-26-2013. FILED 7-27-2009.  
 4,479,270 ( *See Class 2 for this trademark* ).  
 4,479,285 ( *See Class 1 for this trademark* ).  
 4,479,347 ( *See Class 8 for this trademark* ).  
 4,479,400. **IHOSE THE INTELLIGENT HOSE BY VENAIR (STYLIZED)**. TECHNOSIL, GMBH, (U.S. CLS. 1, 5, 12, 13, 35 AND 50). SN 79-127,226. PUB. 11-26-2013. FILED 12-11-2012.  
 4,479,410 ( *See Class 6 for this trademark* ).  
 4,479,421. **SILO-BLOCK (STYLIZED)**. PLASTIKA KRITIS S.A., DBA PLASTIKA KRITIS S.A., (U.S. CLS. 1, 5, 12, 13, 35 AND 50). SN 79-128,194. PUB. 11-26-2013. FILED 2-15-2013.  
 4,479,428. **COMBI-SILO (STYLIZED)**. PLASTIKA KRITIS S.A., DBA PLASTIKA KRITIS S.A., (U.S. CLS. 1, 5, 12, 13, 35 AND 50). SN 79-128,665. PUB. 11-26-2013. FILED 2-15-2013.  
 4,479,516 ( *See Class 2 for this trademark* ).  
 4,479,740. **U-SILICA (STANDARD CHARACTER)**. ACCESS CHINA INDUSTRIAL TEXTILES, INC., DBA ACIT (USA), INC., MULTIPLE CLASS, (INT. CLS. 17, 22, 23 AND 24), (U.S. CLS. 1, 2, 5, 7, 12, 13, 19, 22, 35, 42, 43 AND 50). SN 85-729,811. PUB. 11-26-2013. FILED 9-14-2012.  
 4,479,918 ( *See Class 6 for this trademark* ).  
 4,480,008 ( *See Class 1 for this trademark* ).  
 4,480,009 ( *See Class 1 for this trademark* ).  
 4,480,405. **PAINT DEFENDER WWW. PAINTDEFENDER.COM AND DESIGN**. KENNETH J STOMMEL III, DBA PAINT DEFENDER, (U.S. CLS. 1, 5, 12, 13, 35 AND 50). SN

- 85-947,059. PUB. 11-26-2013. FILED 5-31-2013.  
 4,480,699. **BURGA CLIP (STANDARD CHARACTER)**. BURGA-FLEX NORTH AMERICA, INC., (U.S. CLS. 1, 5, 12, 13, 35 AND 50). SN 85-970,896. PUB. 11-26-2013. FILED 6-26-2013.  
 4,480,733. **MOTOR ON (STANDARD CHARACTER)**. ATKINS & PEARCE, INC., (U.S. CLS. 1, 5, 12, 13, 35 AND 50). SN 85-972,611. PUB. 11-26-2013. FILED 6-28-2013.

### CLASS 18—LEATHER GOODS

- 4,479,242. **JUST JAZZ JWG AND DESIGN**. GIBBS, JORGE W, MULTIPLE CLASS, (INT. CLS. 18 AND 25), (U.S. CLS. 1, 2, 3, 22, 39 AND 41). SN 76-710,276. PUB. 11-26-2013. FILED 1-13-2012.  
 4,479,272 ( *See Class 3 for this trademark* ).  
 4,479,273 ( *See Class 3 for this trademark* ).  
 4,479,283 ( *See Class 3 for this trademark* ).  
 4,479,311. **SUNAJ (STANDARD CHARACTER)**. SUNAJ B.V., MULTIPLE CLASS, (INT. CLS. 18, 25 AND 35), (U.S. CLS. 1, 2, 3, 22, 39, 41, 100, 101 AND 102). SN 79-121,325. PUB. 11-26-2013. FILED 11-1-2012.  
 4,479,319 ( *See Class 9 for this trademark* ).  
 4,479,333. **SOYA FISH (STANDARD CHARACTER)**. CALZATURIFICIO MARITAN S.P.A., AND MR. PERANI DANIELE, AND REB 2010 DI TARTUFOLI ROBERTO & C. S.A.S., MULTIPLE CLASS, (INT. CLS. 18 AND 25), (U.S. CLS. 1, 2, 3, 22, 39 AND 41). SN 79-124,042. PUB. 11-26-2013. FILED 10-4-2012.  
 4,479,340 ( *See Class 3 for this trademark* ).  
 4,479,351 ( *See Class 14 for this trademark* ).  
 4,479,358. **ARTY BRELAS AND DESIGN**. ARTY BRELAS PTY LTD, MULTIPLE CLASS, (INT. CLS. 18 AND 41), (U.S. CLS. 1, 2, 3, 22, 41, 100, 101 AND 107). SN 79-125,874. PUB. 11-26-2013. FILED 9-5-2012.  
 4,479,367 ( *See Class 3 for this trademark* ).  
 4,479,368 ( *See Class 3 for this trademark* ).  
 4,479,403. **BOYI FASHION SERVICES AND DESIGN**. QUANZHOU LIYANG SPORTBAG CO., LTD., (U.S. CLS. 1, 2, 3, 22 AND 41). SN 79-127,268. PUB. 11-26-2013. FILED 2-19-2013.  
 4,479,413 ( *See Class 9 for this trademark* ).  
 4,479,422 ( *See Class 12 for this trademark* ).  
 4,479,433 ( *See Class 16 for this trademark* ).  
 4,479,434 ( *See Class 3 for this trademark* ).  
 4,479,447 ( *See Class 14 for this trademark* ).  
 4,479,520 ( *See Class 3 for this trademark* ).  
 4,479,558 ( *See Class 3 for this trademark* ).  
 4,479,559 ( *See Class 3 for this trademark* ).  
 4,479,560 ( *See Class 3 for this trademark* ).  
 4,479,568 ( *See Class 3 for this trademark* ).  
 4,479,578 ( *See Class 3 for this trademark* ).  
 4,479,601. **MONKEY BACK (STANDARD CHARACTER)**. COATES, DONOVON, MULTIPLE CLASS, (INT. CLS. 18, 21, 25 AND 35), (U.S. CLS. 1, 2, 3, 13, 22, 23, 29, 30, 33, 39, 40, 41, 50, 100, 101 AND 102). SN 85-564,589. PUB. 10-15-2013. FILED 3-8-2012.  
 4,479,602. **MONKEY BACK AND DESIGN**. COATES, DONOVON, MULTIPLE CLASS, (INT. CLS. 18, 21, 25 AND 35), (U.S. CLS. 1, 2, 3, 13, 22, 23, 29, 30, 33, 39, 40, 41, 50, 100, 101 AND 102). SN 85-564,597. PUB. 10-15-2013. FILED 3-8-2012.  
 4,479,605 ( *See Class 9 for this trademark* ).  
 4,479,616. **BALDI (STANDARD CHARACTER)**. BALDI RE-TAIL LTD, MULTIPLE CLASS, (INT. CLS. 18, 25 AND 35), (U.S. CLS. 1, 2, 3, 22, 39, 41, 100, 101 AND 102). SN 85-601,313. PUB. 10-22-2013. FILED 4-18-2012.  
 4,479,690. **SABELT (STANDARD CHARACTER)**. FASHION S.P.A., MULTIPLE CLASS, (INT. CLS. 18 AND 25), (U.S. CLS. 1, 2, 3, 22, 39 AND 41). SN 85-663,506. PUB. 11-26-2013. FILED 6-27-2012.  
 4,479,810 ( *See Class 9 for this trademark* ).  
 4,479,883 ( *See Class 6 for this trademark* ).  
 4,479,925. **U.S. SPEC (STANDARD CHARACTER)**. SCHRECK WHOLESale, INC., MULTIPLE CLASS, (INT. CLS. 18 AND 25), (U.S. CLS. 1, 2, 3, 22, 39 AND 41). SN 85-809,497. PUB. 11-26-2013. FILED 12-21-2012.  
 4,480,108. **SUGAR SNAP (STANDARD CHARACTER)**. EVANS,

- TARAH SMITH, DBA SUGAR SNAP FILES LLC, AND DENT, STACY COOPER, DBA SUGAR SNAP FILES LLC, (U.S. CLS. 1, 2, 3, 22 AND 41). SN 85-874,430. PUB. 11-26-2013. FILED 3-13-2013.
- 4,480,321. **MIO MICHI AND DESIGN**. J.M.S. FASHION, INC., (U.S. CLS. 1, 2, 3, 22 AND 41). SN 85-935,588. PUB. 11-26-2013. FILED 5-17-2013.
- 4,480,473. **CROWN (STANDARD CHARACTER)**. DOVER SADDLERY, INC., (U.S. CLS. 1, 2, 3, 22 AND 41). SN 85-956,592. PUB. 11-26-2013. FILED 6-11-2013.
- 4,480,553. **NO WORRIES PREPPER AND DESIGN**. SHEA, DANIEL, (U.S. CLS. 1, 2, 3, 22 AND 41). SN 85-964,283. PUB. 11-26-2013. FILED 6-19-2013.
- 4,480,666 ( *See Class 9 for this trademark*).
- 4,480,911. **THRASHER (STYLIZED)**. HIGH SPEED PRODUCTIONS, INC., (U.S. CLS. 1, 2, 3, 22 AND 41). SN 86-001,859. PUB. 11-26-2013. FILED 7-3-2013.
- 4,480,952. **FÜCHSIN AVE. AND DESIGN**. FUCHSIN AVE LLC, (U.S. CLS. 1, 2, 3, 22 AND 41). SN 86-002,330. PUB. 11-26-2013. FILED 7-3-2013.
- 4,480,953. **H (STYLIZED)**. HOPKINS GOLF, INC., MULTIPLE CLASS, (INT. CLS. 18, 24, 25 AND 28), (U.S. CLS. 1, 2, 3, 22, 23, 38, 39, 41, 42 AND 50). SN 86-002,340. PUB. 11-26-2013. FILED 7-3-2013.

#### CLASS 19—NON-METALLIC BUILDING MATERIALS

- 4,479,294 ( *See Class 6 for this trademark*).
- 4,479,325 ( *See Class 6 for this trademark*).
- 4,479,456 ( *See Class 6 for this trademark*).
- 4,479,477 ( *See Class 6 for this trademark*).
- 4,479,709 ( *See Class 2 for this trademark*).
- 4,479,710 ( *See Class 2 for this trademark*).
- 4,479,792. **BUILDING TOGETHER (STANDARD CHARACTER)**. GCC RIO GRANDE, INC., (U.S. CLS. 1, 12, 33 AND 50). SN 85-769,004. PUB. 11-26-2013. FILED 11-1-2012.
- 4,479,937. **EVERITT & SCHILLING E&S CO. . PURVEYORS OF FINE TILE AND DESIGN**. EVERITT & SCHILLING, LLC, (U.S. CLS. 1, 12, 33 AND 50). SN 85-810,985. PUB. 11-26-2013. FILED 12-27-2012.
- 4,480,008 ( *See Class 1 for this trademark*).
- 4,480,009 ( *See Class 1 for this trademark*).
- 4,480,062. **RHINDOOR (STANDARD CHARACTER)**. MASONITE INTERNATIONAL CORPORATION, (U.S. CLS. 1, 12, 33 AND 50). SN 85-855,285. PUB. 11-26-2013. FILED 2-20-2013.
- 4,480,191. **POST WOODWORKING (STANDARD CHARACTER)**. POST WOODWORKING, INC., (U.S. CLS. 1, 12, 33 AND 50). SN 85-904,810. PUB. 11-26-2013. FILED 4-15-2013.
- 4,480,376. **VT INDUSTRIES AND DESIGN**. V-T INDUSTRIES, INC., (U.S. CLS. 1, 12, 33 AND 50). SN 85-944,620. PUB. 11-26-2013. FILED 5-29-2013.
- 4,480,377. **VT INDUSTRIES DIMENSIONS AND DESIGN**. V-T INDUSTRIES, INC., (U.S. CLS. 1, 12, 33 AND 50). SN 85-944,662. PUB. 11-26-2013. FILED 5-29-2013.
- 4,480,691. **LITEHOUSE (STANDARD CHARACTER)**. LITEHOUSE INTERNATIONAL, INC., DBA LITEHOUSE INTERNATIONAL, INC., (U.S. CLS. 1, 12, 33 AND 50). SN 85-970,660. PUB. 11-26-2013. FILED 6-26-2013.
- 4,480,831. **VINYLTRENDS (STANDARD CHARACTER)**. VINYLTRENDS INC., (U.S. CLS. 1, 12, 33 AND 50). SN 86-000,533. PUB. 11-26-2013. FILED 7-2-2013.
- 4,480,893. **OUR LIFE IS THE HIGHWAY (STANDARD CHARACTER)**. BLACKLIDGE IP, LLC, (U.S. CLS. 1, 12, 33 AND 50). SN 86-001,582. PUB. 11-26-2013. FILED 7-3-2013.
- 4,480,956. **AMERISECURE (STANDARD CHARACTER)**. AMERICAN OPENINGS, INC., (U.S. CLS. 1, 12, 33 AND 50). SN 86-002,356. PUB. 11-26-2013. FILED 7-3-2013.
- 4,481,107. **HF HOLLYFRONTIER (STYLIZED)**. HOLLYMARKS, LLC, (U.S. CLS. 1, 12, 33 AND 50). SN 86-004,526. PUB. 11-26-2013. FILED 7-8-2013.
- 4,481,286 ( *See Class 6 for this trademark*).

#### CLASS 20—FURNITURE AND ARTICLES NOT OTHERWISE CLASSIFIED

- 4,479,273 ( *See Class 3 for this trademark*).
- 4,479,287 ( *See Class 6 for this trademark*).
- 4,479,290 ( *See Class 3 for this trademark*).
- 4,479,291 ( *See Class 2 for this trademark*).
- 4,479,293. **MISCELLANEOUS DESIGN**. JINXIANG DU, (U.S. CLS. 2, 13, 22, 25, 32 AND 50). SN 79-116,709. PUB. 11-26-2013. FILED 6-19-2012.
- 4,479,324 ( *See Class 6 for this trademark*).
- 4,479,340 ( *See Class 3 for this trademark*).
- 4,479,347 ( *See Class 8 for this trademark*).
- 4,479,367 ( *See Class 3 for this trademark*).
- 4,479,368 ( *See Class 3 for this trademark*).
- 4,479,424 ( *See Class 11 for this trademark*).
- 4,479,427 ( *See Class 11 for this trademark*).
- 4,479,456 ( *See Class 6 for this trademark*).
- 4,479,462 ( *See Class 6 for this trademark*).
- 4,479,494. **CHICHESTER (STANDARD CHARACTER)**. NEPTUNE (EUROPE) LTD, (U.S. CLS. 2, 13, 22, 25, 32 AND 50). SN 79-134,700. PUB. 11-26-2013. FILED 6-29-2013.
- 4,479,497. **SUFFOLK (STANDARD CHARACTER)**. NEPTUNE (EUROPE) LTD, (U.S. CLS. 2, 13, 22, 25, 32 AND 50). SN 79-134,769. PUB. 11-26-2013. FILED 6-29-2013.
- 4,479,551 ( *See Class 6 for this trademark*).
- 4,479,600. **ORBIT (STANDARD CHARACTER)**. ORBIT INNOVATIVE PRODUCTS, LLC, MULTIPLE CLASS, (INT. CLS. 20 AND 21), (U.S. CLS. 2, 13, 22, 23, 25, 29, 30, 32, 33, 40 AND 50). SN 85-560,493. PUB. 8-20-2013. FILED 3-5-2012.
- 4,479,670 ( *See Class 16 for this trademark*).
- 4,479,671 ( *See Class 3 for this trademark*).
- 4,479,716. **COASTAL CHIC (STANDARD CHARACTER)**. SUSAN TYGRET, DBA COASTAL CHIC, (U.S. CLS. 2, 13, 22, 25, 32 AND 50). SN 85-700,290. PUB. 11-26-2013. FILED 8-10-2012.
- 4,479,726. **WILDENLAL (STANDARD CHARACTER)**. WILDENLAL INC., DBA WILDENLAL INC., (U.S. CLS. 2, 13, 22, 25, 32 AND 50). SN 85-718,154. PUB. 11-26-2013. FILED 8-31-2012.
- 4,479,728. **BOVER AND DESIGN**. JOANA BOVER GRASA, (U.S. CLS. 2, 13, 22, 25, 32 AND 50). SN 85-721,949. PUB. 11-26-2013. FILED 9-6-2012.
- 4,479,751. **FRED (STANDARD CHARACTER)**. LIFETIME BRANDS, INC., (U.S. CLS. 2, 13, 22, 25, 32 AND 50). SN 85-736,487. PUB. 11-26-2013. FILED 9-24-2012.
- 4,479,883 ( *See Class 6 for this trademark*).
- 4,479,960. **TUFF'E (STANDARD CHARACTER)**. BARRIER PLASTICS, INC., (U.S. CLS. 2, 13, 22, 25, 32 AND 50). SN 85-819,248. PUB. 11-26-2013. FILED 1-9-2013.
- 4,480,057. **RESTORATION SHIMS (STANDARD CHARACTER)**. BOXWOOD RESTORATION COMPANY, (U.S. CLS. 2, 13, 22, 25, 32 AND 50). SN 85-851,945. PUB. 11-26-2013. FILED 2-16-2013.
- 4,480,059. **MULTISTYLE AND DESIGN**. ANNA'S LINENS, INC., MULTIPLE CLASS, (INT. CLS. 20 AND 24), (U.S. CLS. 2, 13, 22, 25, 32, 42 AND 50). SN 85-853,088. PUB. 11-26-2013. FILED 2-18-2013.
- 4,480,182 ( *See Class 1 for this trademark*).
- 4,480,211 ( *See Class 6 for this trademark*).
- 4,480,249. **FASEAT (STANDARD CHARACTER)**. FASEAT INC., MULTIPLE CLASS, (INT. CLS. 20 AND 37), (U.S. CLS. 2, 13, 22, 25, 32, 50, 100, 103 AND 106). SN 85-923,549. PUB. 11-26-2013. FILED 5-4-2013.
- 4,480,261. **SMITHPORT CABINETRY (STANDARD CHARACTER)**. CUNNINGHAM, SR., JIMMY B., (U.S. CLS. 2, 13, 22, 25, 32 AND 50). SN 85-924,432. PUB. 11-26-2013. FILED 5-6-2013.
- 4,480,402. **AAA (STYLIZED)**. AAA FURNITURE WHOLESALE INC., (U.S. CLS. 2, 13, 22, 25, 32 AND 50). SN 85-946,749. PUB. 11-26-2013. FILED 5-30-2013.
- 4,480,440. **AROA (STANDARD CHARACTER)**. APPLIED RESEARCH OF AUSTRALIA, LTD, AKA AROA, (U.S. CLS. 2, 13, 22, 25, 32 AND 50). SN 85-951,618. PUB. 11-26-2013. FILED 6-5-2013.
- 4,480,453. **FRIIDGIE FACES AND DESIGN**. DROLET, JEAN, (U.S. CLS. 2, 13, 22, 25, 32 AND 50). SN 85-953,875. PUB. 11-26-2013. FILED 6-7-2013.
- 4,480,465. **CONDITION 1 AND DESIGN**. ROYAL CASE

- COMPANY, INC., (U.S. CLS. 2, 13, 22, 25, 32 AND 50). SN 85-955,548. PUB. 11-26-2013. FILED 6-10-2013.
- 4,480,562. **SUN ECO MANUFACTURING GROUP AND DESIGN.** PETPALS GROUP, INC., MULTIPLE CLASS, (INT. CLS. 20 AND 28), (U.S. CLS. 2, 13, 22, 23, 25, 32, 38 AND 50). SN 85-964,617. PUB. 11-26-2013. FILED 6-19-2013.
- 4,480,651. **WICKER WAREHOUSE (STANDARD CHARACTER).** WICKER WAREHOUSE INC, (U.S. CLS. 2, 13, 22, 25, 32 AND 50). SN 85-968,641. PUB. 11-26-2013. FILED 6-24-2013.
- 4,480,808. **GODPILLOW (STANDARD CHARACTER).** CYNTHIA HALLEY, (U.S. CLS. 2, 13, 22, 25, 32 AND 50). SN 86-000,250. PUB. 11-26-2013. FILED 7-2-2013.
- 4,480,812. **TEMPLEREST (STANDARD CHARACTER).** MAC TECHNOLOGIES LIMITED, (U.S. CLS. 2, 13, 22, 25, 32 AND 50). SN 86-000,270. PUB. 11-26-2013. FILED 7-2-2013.
- 4,480,871. **MISCELLANEOUS DESIGN.** DAVID HSU DESIGN, LLC, MULTIPLE CLASS, (INT. CLS. 20 AND 42), (U.S. CLS. 2, 13, 22, 25, 32, 50, 100 AND 101). SN 86-001,079. PUB. 11-26-2013. FILED 7-2-2013.
- 4,481,161. **CONTOUR CORRECT (STANDARD CHARACTER).** SOUND SLEEP PRODUCTS, INC., (U.S. CLS. 2, 13, 22, 25, 32 AND 50). SN 86-005,389. PUB. 11-26-2013. FILED 7-9-2013.
- 4,481,208. **TRANQUILITY (STANDARD CHARACTER).** AEROSPACE TECHNOLOGIES GROUP INC., (U.S. CLS. 2, 13, 22, 25, 32 AND 50). SN 86-011,021. PUB. 11-26-2013. FILED 7-16-2013.

---

#### CLASS 21—HOUSEWARES AND GLASS

- 4,479,259. **YOU GO YOU GET (STANDARD CHARACTER).** JONATHAN GURMAN, MULTIPLE CLASS, (INT. CLS. 21 AND 25), (U.S. CLS. 2, 13, 22, 23, 29, 30, 33, 39, 40 AND 50). SN 77-882,417. PUB. 11-26-2013. FILED 11-30-2009.
- 4,479,324 ( *See Class 6 for this trademark.*)
- 4,479,340 ( *See Class 3 for this trademark.*)
- 4,479,367 ( *See Class 3 for this trademark.*)
- 4,479,368 ( *See Class 3 for this trademark.*)
- 4,479,424 ( *See Class 11 for this trademark.*)
- 4,479,426. **GLASS4YOU.COM (STYLIZED).** PASABAHCE CAM SANAYI VE TICARET ANONIM SIRKETI, (U.S. CLS. 2, 13, 23, 29, 30, 33, 40 AND 50). SN 79-128,531. PUB. 11-26-2013. FILED 12-21-2012.
- 4,479,427 ( *See Class 11 for this trademark.*)
- 4,479,436. **MISCELLANEOUS DESIGN.** FUJIAN SHAOWU FULIAN CO., LTD. MULTIPLE CLASS, (INT. CLS. 21 AND 24), (U.S. CLS. 2, 13, 23, 29, 30, 33, 40, 42 AND 50). SN 79-129,062. PUB. 11-26-2013. FILED 1-11-2013.
- 4,479,473. **BD BAÑO DISEÑO ACCESORIOS PARA CUARTOS DE BAÑO (STYLIZED).** MARIANO MENOR FERNANDEZ, (U.S. CLS. 2, 13, 23, 29, 30, 33, 40 AND 50). SN 79-132,373. PUB. 11-26-2013. FILED 5-21-2013.
- 4,479,568 ( *See Class 3 for this trademark.*)
- 4,479,600 ( *See Class 20 for this trademark.*)
- 4,479,601 ( *See Class 18 for this trademark.*)
- 4,479,602 ( *See Class 18 for this trademark.*)
- 4,479,671 ( *See Class 3 for this trademark.*)
- 4,479,743. **JACOB BROMWELL (STANDARD CHARACTER).** THE BROMWELL COMPANY, (U.S. CLS. 2, 13, 23, 29, 30, 33, 40 AND 50). SN 85-733,348. PUB. 11-26-2013. FILED 9-19-2012.
- 4,479,766. **KANGOVOU (STANDARD CHARACTER).** KANGOVOU, LLC, (U.S. CLS. 2, 13, 23, 29, 30, 33, 40 AND 50). SN 85-749,155. PUB. 11-26-2013. FILED 10-9-2012.
- 4,479,874 ( *See Class 11 for this trademark.*)
- 4,479,883 ( *See Class 6 for this trademark.*)
- 4,479,908 ( *See Class 11 for this trademark.*)
- 4,480,020. **TAGSONOMA (STANDARD CHARACTER).** TRADE ASSOCIATES GROUP, LTD., (U.S. CLS. 2, 13, 23, 29, 30, 33, 40 AND 50). SN 85-836,631. PUB. 11-26-2013. FILED 1-30-2013.
- 4,480,030. **CONAIR FUSION (STANDARD CHARACTER).** CONAIR CORPORATION, (U.S. CLS. 2, 13, 23, 29, 30, 33, 40 AND 50). SN 85-841,894. PUB. 11-26-2013. FILED 2-6-2013.
- 4,480,089 ( *See Class 16 for this trademark.*)
- 4,480,190. **FRY DADS (STANDARD CHARACTER).** GLENN,

- KURT, (U.S. CLS. 2, 13, 23, 29, 30, 33, 40 AND 50). SN 85-904,528. PUB. 11-26-2013. FILED 4-15-2013.
- 4,480,201. **HELL FIRE (STANDARD CHARACTER).** PAPAN-DREA, DIANE, DBA DEVIL'S BLEND, (U.S. CLS. 2, 13, 23, 29, 30, 33, 40 AND 50). SN 85-906,234. PUB. 11-26-2013. FILED 4-16-2013.
- 4,480,211 ( *See Class 6 for this trademark.*)
- 4,480,456. **BOCO AND DESIGN.** BOCO LLC, DBA BOCO, (U.S. CLS. 2, 13, 23, 29, 30, 33, 40 AND 50). SN 85-954,585. PUB. 11-26-2013. FILED 6-8-2013.
- 4,480,479. **GLOVES FOR PEOPLE SERIOUS ABOUT GARDENING AND DESIGN.** COONEY, PETER J, TA JAYCO (UK) LTD, (U.S. CLS. 2, 13, 23, 29, 30, 33, 40 AND 50). SN 85-957,412. PUB. 11-26-2013. FILED 6-12-2013.
- 4,480,534. **CUP THAT CARES AND DESIGN.** SEA WORLD LLC, (U.S. CLS. 2, 13, 23, 29, 30, 33, 40 AND 50). SN 85-963,638. PUB. 11-26-2013. FILED 6-19-2013.
- 4,480,557 ( *See Class 3 for this trademark.*)
- 4,480,619. **HEALTHIGLASS (STANDARD CHARACTER).** CREATIONIQUE LTD, (U.S. CLS. 2, 13, 23, 29, 30, 33, 40 AND 50). SN 85-967,617. PUB. 11-26-2013. FILED 6-24-2013.
- 4,480,805 ( *See Class 16 for this trademark.*)
- 4,480,967. **ECO-CYCLE (STANDARD CHARACTER).** ECO-LIFE FOUNDATION, (U.S. CLS. 2, 13, 23, 29, 30, 33, 40 AND 50). SN 86-002,586. PUB. 11-26-2013. FILED 7-3-2013.
- 4,480,986. **GOOMBAY (STANDARD CHARACTER).** THE BUGARIE GROUP, MULTIPLE CLASS, (INT. CLS. 21, 25, 30, 32 AND 43), (U.S. CLS. 2, 13, 22, 23, 29, 30, 33, 39, 40, 45, 46, 48, 50, 100 AND 101). SN 86-002,789. PUB. 11-26-2013. FILED 7-4-2013.
- 4,481,028. **COOLSIP (STANDARD CHARACTER).** BEVERAGE CONCEPTS, INC., (U.S. CLS. 2, 13, 23, 29, 30, 33, 40 AND 50). SN 86-003,219. PUB. 11-26-2013. FILED 7-5-2013.
- 4,481,136. **JACK'S POOCH TOOTH BRUSH (STANDARD CHARACTER).** SMILE SENSATIONS LLC, (U.S. CLS. 2, 13, 23, 29, 30, 33, 40 AND 50). SN 86-005,068. PUB. 11-26-2013. FILED 7-9-2013.
- 4,481,242. **DRYRIGHT! (STANDARD CHARACTER).** ERIK LAIBE, (U.S. CLS. 2, 13, 23, 29, 30, 33, 40 AND 50). SN 86-029,258. PUB. 11-26-2013. FILED 8-5-2013.

---

#### CLASS 22—CORDAGE AND FIBERS

- 4,479,243 ( *See Class 1 for this trademark.*)
- 4,479,285 ( *See Class 1 for this trademark.*)
- 4,479,740 ( *See Class 17 for this trademark.*)
- 4,479,883 ( *See Class 6 for this trademark.*)
- 4,480,485. **RETRACT X (STANDARD CHARACTER).** WINSTON PRODUCTS LLC, (U.S. CLS. 1, 2, 7, 19, 22, 42 AND 50). SN 85-957,710. PUB. 11-26-2013. FILED 6-12-2013.

---

#### CLASS 23—YARNS AND THREADS

- 4,479,255. **EMANA (STANDARD CHARACTER).** RHODIA BRASIL LTDA, MULTIPLE CLASS, (INT. CLS. 23, 24 AND 25), (U.S. CLS. 22, 39, 42, 43 AND 50). SN 77-643,756. PUB. 9-17-2013. FILED 1-6-2009.
- 4,479,740 ( *See Class 17 for this trademark.*)
- 4,480,533. **STARBELLA ARCTIC (STANDARD CHARACTER).** UNIVERSAL YARN, INC., (U.S. CL. 43). SN 85-963,636. PUB. 11-26-2013. FILED 6-19-2013.

---

#### CLASS 24—FABRICS

- 4,479,255 ( *See Class 23 for this trademark.*)
- 4,479,340 ( *See Class 3 for this trademark.*)
- 4,479,360. **CARLUCCI DI CHIVASSO AND DESIGN.** CHIVASSO BV, MULTIPLE CLASS, (INT. CLS. 24 AND 27), (U.S. CLS. 19, 20, 37, 42 AND 50). SN 79-125,971. PUB. 11-26-2013. FILED 11-14-2012.
- 4,479,367 ( *See Class 3 for this trademark.*)

- 4,479,368 ( *See Class 3 for this trademark* ).  
 4,479,386. **TRÈFLE (STANDARD CHARACTER)**. KOKKA CO., LTD., (U.S. CLS. 42 AND 50). SN 79-126,746. PUB. 11-26-2013. FILED 1-28-2013.  
 4,479,413 ( *See Class 9 for this trademark* ).  
 4,479,436 ( *See Class 21 for this trademark* ).  
 4,479,568 ( *See Class 3 for this trademark* ).  
 4,479,587. **FILZFELT AND DESIGN**. SPINNEYBECK ENTERPRISES, INC., (U.S. CLS. 42 AND 50). SN 85-537,247. PUB. 11-26-2013. FILED 2-8-2012.  
 4,479,670 ( *See Class 16 for this trademark* ).  
 4,479,671 ( *See Class 3 for this trademark* ).  
 4,479,740 ( *See Class 17 for this trademark* ).  
 4,479,819. **SIMPLICITY (STANDARD CHARACTER)**. STAR MARKETING INTERNATIONAL INC., DBA APOLLO GROUP INC., (U.S. CLS. 42 AND 50). SN 85-779,216. PUB. 11-26-2013. FILED 11-14-2012.  
 4,479,820. **S.I.M.P.L.I.C.I.T.Y (STYLIZED)**. STAR MARKETING INTERNATIONAL INC., DBA APOLLO GROUP INC., (U.S. CLS. 42 AND 50). SN 85-779,258. PUB. 11-26-2013. FILED 11-14-2012.  
 4,479,838. **SG GLOBAL AND DESIGN**. QINGDAO SG GLOBAL PACKAGING CO., LTD., (U.S. CLS. 42 AND 50). SN 85-786,414. PUB. 11-26-2013. FILED 11-24-2012.  
 4,479,876. **ELUSION CAMO (STANDARD CHARACTER)**. LEE D. DUFRESNE, DBA ELUSION CAMO LLC, (U.S. CLS. 42 AND 50). SN 85-800,215. PUB. 11-26-2013. FILED 12-11-2012.  
 4,479,880. **RM COCO AND DESIGN**. R&M FABRICS, INC, (U.S. CLS. 42 AND 50). SN 85-801,008. PUB. 11-26-2013. FILED 12-12-2012.  
 4,479,883 ( *See Class 6 for this trademark* ).  
 4,479,972. **NGX AND DESIGN**. KATHMANDU LIMITED, (U.S. CLS. 42 AND 50). SN 85-823,167. PUB. 11-26-2013. FILED 1-15-2013.  
 4,480,059 ( *See Class 20 for this trademark* ).  
 4,480,182 ( *See Class 1 for this trademark* ).  
 4,480,397. **X-MAT (STANDARD CHARACTER)**. CB WORLDWIDE, INC., (U.S. CLS. 42 AND 50). SN 85-946,326. PUB. 11-26-2013. FILED 5-30-2013.  
 4,480,630. **COUNTRY COTTONS (STANDARD CHARACTER)**. HOGAN, WILLIAM L., (U.S. CLS. 42 AND 50). SN 85-968,086. PUB. 11-26-2013. FILED 6-24-2013.  
 4,480,667. **DRYFUZE (STANDARD CHARACTER)**. UNITING FUTURE LEGENDS LTD., (U.S. CLS. 42 AND 50). SN 85-969,303. PUB. 11-26-2013. FILED 6-25-2013.  
 4,480,953 ( *See Class 18 for this trademark* ).  
 4,481,178. **PORTOLANO AND DESIGN**. PORTOLANO PRODUCTS, INC., MULTIPLE CLASS, (INT. CLS. 24 AND 25), (U.S. CLS. 22, 39, 42 AND 50). SN 86-005,678. PUB. 11-26-2013. FILED 7-9-2013.  
 4,481,235. **IMPRESSIONS AND DESIGN**. HOME CITY INC., (U.S. CLS. 42 AND 50). SN 86-024,940. PUB. 11-26-2013. FILED 7-31-2013.
- 
- CLASS 25—CLOTHING**
- 4,479,240. **EDGE PLUS**. CHW, LLC, (U.S. CLS. 22 AND 39). SN 76-549,145. PUB. 11-26-2013. FILED 9-15-2003.  
 4,479,242 ( *See Class 18 for this trademark* ).  
 4,479,245. **MISCELLANEOUS DESIGN**. DUANGNAPA, KRISADA, (U.S. CLS. 22 AND 39). SN 76-713,438. PUB. 11-26-2013. FILED 2-11-2013.  
 4,479,255 ( *See Class 23 for this trademark* ).  
 4,479,259 ( *See Class 21 for this trademark* ).  
 4,479,261. **HOT GOSSIP (STANDARD CHARACTER)**. GOLDEN WEST FOOTWEAR, INC., (U.S. CLS. 22 AND 39). SN 77-907,438. PUB. 11-26-2013. FILED 1-7-2010.  
 4,479,272 ( *See Class 3 for this trademark* ).  
 4,479,273 ( *See Class 3 for this trademark* ).  
 4,479,283 ( *See Class 3 for this trademark* ).  
 4,479,305. **MINDFOOD (STANDARD CHARACTER)**. MICHAEL PETER MCHUGH, MULTIPLE CLASS, (INT. CLS. 25, 29, 30, 32, 35, 43 AND 44), (U.S. CLS. 22, 39, 45, 46, 48, 100, 101 AND 102). SN 79-118,855. PUB. 6-18-2013. FILED 7-18-2012.  
 4,479,307 ( *See Class 9 for this trademark* ).  
 4,479,308 ( *See Class 3 for this trademark* ).  
 4,479,311 ( *See Class 18 for this trademark* ).  
 4,479,333 ( *See Class 18 for this trademark* ).  
 4,479,340 ( *See Class 3 for this trademark* ).  
 4,479,341. **YALY (STYLIZED)**. CONG TY CO PHAN DICH VU.; DU LICH, THUONG MAI VA THOI; TRANG YALY; (YALY FASHION, TRADE, TOURISM,; SERVICE JOIN STOCK COMPANY), MULTIPLE CLASS, (INT. CLS. 25, 26 AND 35), (U.S. CLS. 22, 37, 39, 40, 42, 50, 100, 101 AND 102). SN 79-124,541. PUB. 8-20-2013. FILED 6-7-2012.  
 4,479,351 ( *See Class 14 for this trademark* ).  
 4,479,367 ( *See Class 3 for this trademark* ).  
 4,479,368 ( *See Class 3 for this trademark* ).  
 4,479,384 ( *See Class 9 for this trademark* ).  
 4,479,392. **ILUUM (STANDARD CHARACTER)**. OÛ ME SISUSTUS, MULTIPLE CLASS, (INT. CLS. 25, 28 AND 41), (U.S. CLS. 22, 23, 38, 39, 50, 100, 101 AND 107). SN 79-126,824. PUB. 11-26-2013. FILED 1-22-2013.  
 4,479,397. **MYTUXEDO (STANDARD CHARACTER)**. G & M (UK) LIMITED, (U.S. CLS. 22 AND 39). SN 79-127,038. PUB. 11-26-2013. FILED 2-1-2013.  
 4,479,398. **S D T E AND DESIGN**. DKH RETAIL LIMITED, (U.S. CLS. 22 AND 39). SN 79-127,093. PUB. 11-26-2013. FILED 12-5-2012.  
 4,479,413 ( *See Class 9 for this trademark* ).  
 4,479,423. **MISCELLANEOUS DESIGN**. ALEXEY MAXIMCHUK, MULTIPLE CLASS, (INT. CLS. 25 AND 28), (U.S. CLS. 22, 23, 38, 39 AND 50). SN 79-128,419. PUB. 11-26-2013. FILED 3-7-2013.  
 4,479,434 ( *See Class 3 for this trademark* ).  
 4,479,439. **MORTON KNIGHT (STANDARD CHARACTER)**. MORTON KNIGHT LTD, (U.S. CLS. 22 AND 39). SN 79-129,460. PUB. 11-26-2013. FILED 10-9-2012.  
 4,479,442. **GIORGIO (STYLIZED)**. CALZATURIFICIO HEROS S.R.L., (U.S. CLS. 22 AND 39). SN 79-129,576. PUB. 11-26-2013. FILED 12-17-2012.  
 4,479,447 ( *See Class 14 for this trademark* ).  
 4,479,451. **MINGHUA AND DESIGN**. HEBEI MINGHUA LEATHER CO., LTD, (U.S. CLS. 22 AND 39). SN 79-130,109. PUB. 11-26-2013. FILED 3-20-2013.  
 4,479,463. **MC ALSON AND DESIGN**. AGERTI, (U.S. CLS. 22 AND 39). SN 79-131,500. PUB. 11-26-2013. FILED 4-29-2013.  
 4,479,471. **LIVETECH AND DESIGN**. S.G.M. SUOLIFICIO S.R.L., (U.S. CLS. 22 AND 39). SN 79-132,099. PUB. 11-26-2013. FILED 5-7-2013.  
 4,479,487. **X-POLE (STANDARD CHARACTER)**. VERTICAL LEISURE LIMITED, (U.S. CLS. 22 AND 39). SN 79-133,829. PUB. 11-26-2013. FILED 12-31-2012.  
 4,479,496. **COMMON PEOPLE (STANDARD CHARACTER)**. J.M.K. CLOTHING LTD, (U.S. CLS. 22 AND 39). SN 79-134,755. PUB. 11-26-2013. FILED 7-5-2013.  
 4,479,498. **BODYPUMP (STYLIZED)**. LES MILLS INTERNATIONAL LIMITED, (U.S. CLS. 22 AND 39). SN 79-134,850. PUB. 11-26-2013. FILED 5-24-2013.  
 4,479,500. **BODYCOMBAT (STANDARD CHARACTER)**. LES MILLS INTERNATIONAL LIMITED, (U.S. CLS. 22 AND 39). SN 79-134,997. PUB. 11-26-2013. FILED 5-24-2013.  
 4,479,517. **XENSE (STANDARD CHARACTER)**. GEOX S.P.A., (U.S. CLS. 22 AND 39). SN 79-136,640. PUB. 11-26-2013. FILED 5-2-2013.  
 4,479,518. **N-INJECTECH (STANDARD CHARACTER)**. GEOX S.P.A., (U.S. CLS. 22 AND 39). SN 79-136,731. PUB. 11-26-2013. FILED 7-29-2013.  
 4,479,523. **LOLITA GIRL (STANDARD CHARACTER)**. LOLITA GIRL CLOTHING, LLC, (U.S. CLS. 22 AND 39). SN 85-044,397. PUB. 11-26-2013. FILED 5-20-2010.  
 4,479,534 ( *See Class 12 for this trademark* ).  
 4,479,552. **GDI GOD DRIVEN INDIVIDUAL (STYLIZED)**. WILLIAMS, JEREMY, (U.S. CLS. 22 AND 39). SN 85-435,942. PUB. 11-26-2013. FILED 9-29-2011.  
 4,479,558 ( *See Class 3 for this trademark* ).  
 4,479,559 ( *See Class 3 for this trademark* ).  
 4,479,560 ( *See Class 3 for this trademark* ).  
 4,479,563. **BALL SO HARD UNIVERSITY (STANDARD CHARACTER)**. BRIAN BUSSELLS, DBA BALL SO HARD UNIVERSITY, (U.S. CLS. 22 AND 39). SN 85-467,796. PUB. 12-18-2012. FILED 11-9-2011.  
 4,479,568 ( *See Class 3 for this trademark* ).

- 4,479,578 ( *See Class 3 for this trademark*).
- 4,479,583. **ART OF PATIENCE AND DESIGN**. CHUNG, DAVID, DBA PATIENCE INTERNATIONAL, AND CHUNG, SARAH, DBA PATIENCE INTERNATIONAL, (U.S. CLS. 22 AND 39). SN 85-534,334. PUB. 11-26-2013. FILED 2-6-2012.
- 4,479,601 ( *See Class 18 for this trademark*).
- 4,479,602 ( *See Class 18 for this trademark*).
- 4,479,607. **WE ARE MASSIV. (STANDARD CHARACTER)**. MASSIV LLC, (U.S. CLS. 22 AND 39). SN 85-578,779. PUB. 11-26-2013. FILED 3-23-2012.
- 4,479,610 ( *See Class 16 for this trademark*).
- 4,479,616 ( *See Class 18 for this trademark*).
- 4,479,618. **WE TANK NY (STANDARD CHARACTER)**. ROSENWACH TANK CO. LLC, (U.S. CLS. 22 AND 39). SN 85-606,282. PUB. 11-26-2013. FILED 4-24-2012.
- 4,479,690 ( *See Class 18 for this trademark*).
- 4,479,748. **HEART HEROES AND DESIGN**. HEART HEROES, INC., MULTIPLE CLASS, (INT. CLS. 25, 35, 36 AND 45), (U.S. CLS. 22, 39, 100, 101 AND 102). SN 85-734,906. PUB. 9-24-2013. FILED 9-21-2012.
- 4,479,750. **HOBOKEN M.C. (STANDARD CHARACTER)**. HOBOKEN MOTORCYCLE CLUB, (U.S. CLS. 22 AND 39). SN 85-735,936. PUB. 11-26-2013. FILED 9-23-2012.
- 4,479,782. **MALAN BRETON (STANDARD CHARACTER)**. MALAN BRETON HOLDINGS, (U.S. CLS. 22 AND 39). SN 85-762,088. PUB. 11-26-2013. FILED 10-24-2012.
- 4,479,784. **STATE OF EMOTIONS WHAT STATE ARE YOU IN (STANDARD CHARACTER)**. STATE OF EMOTIONS, (U.S. CLS. 22 AND 39). SN 85-763,981. PUB. 11-26-2013. FILED 10-25-2012.
- 4,479,787. **CUSTOM LOADOUT BY M MACHINIMA AND DESIGN**. MACHINIMA, INC., (U.S. CLS. 22 AND 39). SN 85-765,461. PUB. 11-26-2013. FILED 10-28-2012.
- 4,479,801. **MISCELLANEOUS DESIGN**. TRUSTEES OF INDIANA UNIVERSITY, THE, (U.S. CLS. 22 AND 39). SN 85-772,705. PUB. 11-26-2013. FILED 11-6-2012.
- 4,479,833 ( *See Class 9 for this trademark*).
- 4,479,855. **SIMPLY DRESSES (STANDARD CHARACTER)**. PROMGIRL, LLC, (U.S. CLS. 22 AND 39). SN 85-793,368. PUB. 11-26-2013. FILED 12-3-2012.
- 4,479,859. **TBOY CHIC (STANDARD CHARACTER)**. LIVINGSTON, LORI, (U.S. CLS. 22 AND 39). SN 85-793,992. PUB. 11-26-2013. FILED 12-4-2012.
- 4,479,860. **BEAUSKI WEAR (STANDARD CHARACTER)**. STEVEN HAILEY, (U.S. CLS. 22 AND 39). SN 85-794,901. PUB. 11-26-2013. FILED 12-5-2012.
- 4,479,864. **STAE TRU STRIVE TO ACHIEVE EVERYTHING THAT RELATES 2U (STANDARD CHARACTER)**. GUILLELY, DEVON, DBA STAE TRU, (U.S. CLS. 22 AND 39). SN 85-795,687. PUB. 11-26-2013. FILED 12-5-2012.
- 4,479,883 ( *See Class 6 for this trademark*).
- 4,479,884. **COBLESKILL THE FIGHTING TIGERS AND DESIGN**. STATE UNIVERSITY OF NEW YORK BY AND ON BEHALF OF SUNY COBLESKILL, MULTIPLE CLASS, (INT. CLS. 25 AND 41), (U.S. CLS. 22, 39, 100, 101 AND 107). SN 85-801,547. PUB. 11-26-2013. FILED 12-13-2012.
- 4,479,885. **COBLESKILL (STYLIZED)**. STATE UNIVERSITY OF NEW YORK BY AND ON BEHALF OF SUNY COBLESKILL, MULTIPLE CLASS, (INT. CLS. 25 AND 41), (U.S. CLS. 22, 39, 100, 101 AND 107). SN 85-801,554. PUB. 11-26-2013. FILED 12-13-2012.
- 4,479,900. **URBAN EMPIRE (STANDARD CHARACTER)**. CHAD KNAPP, (U.S. CLS. 22 AND 39). SN 85-804,794. PUB. 11-26-2013. FILED 12-17-2012.
- 4,479,916. **D DOLLHOUSE (STANDARD CHARACTER)**. GOTHAM LICENSING GROUP, LLC, (U.S. CLS. 22 AND 39). SN 85-807,811. PUB. 11-26-2013. FILED 12-20-2012.
- 4,479,922 ( *See Class 16 for this trademark*).
- 4,479,925 ( *See Class 18 for this trademark*).
- 4,479,930. **FUNKADELIC (STANDARD CHARACTER)**. DUUDU, LLC, (U.S. CLS. 22 AND 39). SN 85-809,915. PUB. 11-26-2013. FILED 12-23-2012.
- 4,479,944. **GARRISON ROW (STANDARD CHARACTER)**. ONEBUTTON LLC, (U.S. CLS. 22 AND 39). SN 85-813,449. PUB. 11-26-2013. FILED 12-31-2012.
- 4,479,954. **CROOKED STAVE (STANDARD CHARACTER)**. CROOKED STAVE, LLC, MULTIPLE CLASS, (INT. CLS. 25 AND 32), (U.S. CLS. 22, 39, 45, 46 AND 48). SN 85-816,962. PUB. 11-26-2013. FILED 1-7-2013.
- 4,479,976. **2POOD AND DESIGN**. 2POOD LLC, (U.S. CLS. 22 AND 39). SN 85-824,108. PUB. 11-26-2013. FILED 1-15-2013.
- 4,479,994. **ROCKLIN (STANDARD CHARACTER)**. MODELADEN HILLENBACH GMBH, (U.S. CLS. 22 AND 39). SN 85-828,924. PUB. 6-11-2013. FILED 1-22-2013.
- 4,480,001. **SEXYDRESSES.COM (STANDARD CHARACTER)**. SEXY DRESSES, LLC, MULTIPLE CLASS, (INT. CLS. 25 AND 35), (U.S. CLS. 22, 39, 100, 101 AND 102). SN 85-830,132. PUB. 11-26-2013. FILED 1-23-2013.
- 4,480,007. **THE PROPER LIFE STAY CLASSY AND DESIGN**. ZACHARIAS, DEAN M, DBA PROPER KID PROBLEMS, (U.S. CLS. 22 AND 39). SN 85-833,455. PUB. 11-26-2013. FILED 1-27-2013.
- 4,480,027. **BEBEAIR (STANDARD CHARACTER)**. BARSKI, KAREN, (U.S. CLS. 22 AND 39). SN 85-839,257. PUB. 11-26-2013. FILED 2-2-2013.
- 4,480,076. **THE SEVENTH GUILT (STANDARD CHARACTER)**. ALAN RODZEN, AND ELIZABETH KAY, (U.S. CLS. 22 AND 39). SN 85-859,608. PUB. 11-26-2013. FILED 2-25-2013.
- 4,480,081. **J. STOTT AND DESIGN**. STOTT, JONATHAN EDWIN, (U.S. CLS. 22 AND 39). SN 85-861,130. PUB. 11-26-2013. FILED 2-27-2013.
- 4,480,084. **PARTY SOBER (STANDARD CHARACTER)**. PARTY SOBER CLOTHING LLC, (U.S. CLS. 22 AND 39). SN 85-862,133. PUB. 7-23-2013. FILED 2-27-2013.
- 4,480,089 ( *See Class 16 for this trademark*).
- 4,480,090. **MISCELLANEOUS DESIGN**. ROMAN, MANDY, DBA RED TRIBE, (U.S. CLS. 22 AND 39). SN 85-864,341. PUB. 11-26-2013. FILED 3-1-2013.
- 4,480,094 ( *See Class 9 for this trademark*).
- 4,480,095. **LOOKBOOK STORE (STYLIZED)**. KE WANG, (U.S. CLS. 22 AND 39). SN 85-867,881. PUB. 8-20-2013. FILED 3-6-2013.
- 4,480,107. **FOTTENGAGA' MARIANA ISLANDS (STANDARD CHARACTER)**. KEVIN B. ROSARIO, (U.S. CLS. 22 AND 39). SN 85-873,243. PUB. 11-26-2013. FILED 3-11-2013.
- 4,480,135. **HINOMARU VINTAGE AND DESIGN**. BANPER HIT, (U.S. CLS. 22 AND 39). SN 85-884,944. PUB. 11-26-2013. FILED 3-25-2013.
- 4,480,136. **HINOMARU VINTAGE (STANDARD CHARACTER)**. BANPER HIT, (U.S. CLS. 22 AND 39). SN 85-884,945. PUB. 11-26-2013. FILED 3-25-2013.
- 4,480,137. **ANGLER WEAR AND DESIGN**. DIAZ, DANIEL, (U.S. CLS. 22 AND 39). SN 85-885,022. PUB. 11-26-2013. FILED 3-25-2013.
- 4,480,150. **LIVE BREATHE FUTBOL (STANDARD CHARACTER)**. LIVE BREATHE FUTBOL, (U.S. CLS. 22 AND 39). SN 85-888,384. PUB. 11-26-2013. FILED 3-27-2013.
- 4,480,151. **MISCELLANEOUS DESIGN**. HUMAN RIGHTS CAMPAIGN, MULTIPLE CLASS, (INT. CLS. 25 AND 35), (U.S. CLS. 22, 39, 100, 101 AND 102). SN 85-888,572. PUB. 11-26-2013. FILED 3-27-2013.
- 4,480,162. **SIMONE ROCHA (STANDARD CHARACTER)**. ROCHA, SIMONE, (U.S. CLS. 22 AND 39). SN 85-893,666. PUB. 11-26-2013. FILED 4-3-2013.
- 4,480,208. **WF WICKEDFAST (STYLIZED)**. WICKED FAST ATTIRE LLC, (U.S. CLS. 22 AND 39). SN 85-909,382. PUB. 11-26-2013. FILED 4-19-2013.
- 4,480,212. **REGASS (STANDARD CHARACTER)**. ZENG-CHENGSHI XINTANG XURI ENTERPRISE CO., LTD., (U.S. CLS. 22 AND 39). SN 85-910,190. PUB. 11-26-2013. FILED 4-21-2013.
- 4,480,216. **HAIR HUGGERS (STANDARD CHARACTER)**. HAIR HUGGERS LLC, (U.S. CLS. 22 AND 39). SN 85-911,004. PUB. 11-26-2013. FILED 4-22-2013.
- 4,480,224. **S S STEELSTRETCH (STYLIZED)**. STEELSTRETCH LLC., (U.S. CLS. 22 AND 39). SN 85-912,904. PUB. 11-26-2013. FILED 4-24-2013.
- 4,480,266. **I IK'SKLOOSIV C.C. AND DESIGN**. CUNNINGHAM JR., WILLIE C, (U.S. CLS. 22 AND 39). SN 85-925,556. PUB. 11-26-2013. FILED 5-7-2013.
- 4,480,326. **TWOTRUMPETS CUSTOM ESPADRILLES AND DESIGN**. INSTRUMENTA GROUP, LLC, (U.S. CLS. 22 AND 39). SN 85-937,982. PUB. 11-26-2013. FILED 5-21-2013.
- 4,480,331. **MISCELLANEOUS DESIGN**. BERNARD, LA'TO-

- NYA, (U.S. CLS. 22 AND 39), SN 85-939,169. PUB. 11-26-2013. FILED 5-22-2013.
- 4,480,357 ( *See Class 9 for this trademark*).
- 4,480,379. **YEPIAOPIAO (STANDARD CHARACTER)**. R.J. MAX, INC., (U.S. CLS. 22 AND 39). SN 85-944,853. PUB. 11-26-2013. FILED 5-29-2013.
- 4,480,381. **USMC AND DESIGN**. U.S. MARINE CORPS, A COMPONENT OF THE U.S. DEPARTMENT OF THE NAVY, (U.S. CLS. 22 AND 39). SN 85-944,986. PUB. 11-26-2013. FILED 5-29-2013.
- 4,480,382. **MISCELLANEOUS DESIGN**. U.S. MARINE CORPS, A COMPONENT OF THE U.S. DEPARTMENT OF THE NAVY, (U.S. CLS. 22 AND 39). SN 85-945,002. PUB. 11-26-2013. FILED 5-29-2013.
- 4,480,400. **MISCELLANEOUS DESIGN**. THE LOBSTER GUYS SW, (U.S. CLS. 22 AND 39). SN 85-946,697. PUB. 11-26-2013. FILED 5-30-2013.
- 4,480,455. **SALTY BRAH DA (STANDARD CHARACTER)**. JUDGE, KAREN ANN, (U.S. CLS. 22 AND 39). SN 85-954,516. PUB. 11-26-2013. FILED 6-8-2013.
- 4,480,461. **B RELENTLESS AND DESIGN**. TREVOR BRAZILE, (U.S. CLS. 22 AND 39). SN 85-955,230. PUB. 11-26-2013. FILED 6-10-2013.
- 4,480,493. **DREXEL UNIVERSITY AND DESIGN**. DREXEL UNIVERSITY, MULTIPLE CLASS, (INT. CLS. 25 AND 41), (U.S. CLS. 22, 39, 100, 101 AND 107). SN 85-958,693. PUB. 11-26-2013. FILED 6-13-2013.
- 4,480,494. **BODIES BY BURGOON (STANDARD CHARACTER)**. BODIES BY BURGOON, LLC, MULTIPLE CLASS, (INT. CLS. 25 AND 41), (U.S. CLS. 22, 39, 100, 101 AND 107). SN 85-958,889. PUB. 11-26-2013. FILED 6-13-2013.
- 4,480,495. **B AND DESIGN**. BODIES BY BURGOON, LLC, MULTIPLE CLASS, (INT. CLS. 25 AND 41), (U.S. CLS. 22, 39, 100, 101 AND 107). SN 85-958,893. PUB. 11-26-2013. FILED 6-13-2013.
- 4,480,496. **JAMES QUATOR (STANDARD CHARACTER)**. JAMES QUATOR LLC, (U.S. CLS. 22 AND 39). SN 85-959,013. PUB. 11-26-2013. FILED 6-13-2013.
- 4,480,508. **MOTLEY TUBE (STANDARD CHARACTER)**. BALBOA MANUFACTURING CO. LLC, (U.S. CLS. 22 AND 39). SN 85-961,505. PUB. 11-26-2013. FILED 6-17-2013.
- 4,480,510. **SHUT UP! CARTOONS (STANDARD CHARACTER)**. ALLOY DIGITAL, LLC, MULTIPLE CLASS, (INT. CLS. 25 AND 41), (U.S. CLS. 22, 39, 100, 101 AND 107). SN 85-961,893. PUB. 11-26-2013. FILED 6-17-2013.
- 4,480,542. **T TESLA AND DESIGN**. TESLA MOTORS, INC., (U.S. CLS. 22 AND 39). SN 85-963,934. PUB. 11-26-2013. FILED 6-19-2013.
- 4,480,568. **UNEVEN INDUSTRIES (STANDARD CHARACTER)**. WOMACK, EDWARD, (U.S. CLS. 22 AND 39). SN 85-964,863. PUB. 11-26-2013. FILED 6-20-2013.
- 4,480,577. **PIPE CITY (STANDARD CHARACTER)**. PIPE CITY LACROSSE LLC, (U.S. CLS. 22 AND 39). SN 85-965,235. PUB. 11-26-2013. FILED 6-20-2013.
- 4,480,604. **COLORADO A&M AGGIES A COLORADO STATE ESTABLISHED 1870 (STYLIZED)**. BOARD OF GOVERNORS OF THE COLORADO STATE UNIVERSITY SYSTEM, ACTING BY AND THROUGH COLORADO STATE UNIVERSITY, (U.S. CLS. 22 AND 39). SN 85-966,671. PUB. 11-26-2013. FILED 6-21-2013.
- 4,480,606. **COLORADO A&M A (STANDARD CHARACTER)**. BOARD OF GOVERNORS OF THE COLORADO STATE UNIVERSITY SYSTEM, ACTING BY AND THROUGH COLORADO STATE UNIVERSITY, (U.S. CLS. 22 AND 39). SN 85-966,684. PUB. 11-26-2013. FILED 6-21-2013.
- 4,480,613. **REAL G'S MOVE IN SILENCE AND DESIGN**. ALGIERZ, DANIEL L.L., (U.S. CLS. 22 AND 39). SN 85-967,318. PUB. 11-26-2013. FILED 6-22-2013.
- 4,480,615. **MISCELLANEOUS DESIGN**. FLOP HAPPY LLC, DBA FLIPSIDEZ, (U.S. CLS. 22 AND 39). SN 85-967,336. PUB. 11-26-2013. FILED 6-22-2013.
- 4,480,621. **U.S. MARINE RETIRED (STANDARD CHARACTER)**. U.S. MARINE CORPS, A COMPONENT OF THE U.S. DEPARTMENT OF THE NAVY, (U.S. CLS. 22 AND 39). SN 85-967,643. PUB. 11-26-2013. FILED 6-24-2013.
- 4,480,640. **SELCO HATTERS (STANDARD CHARACTER)**. ISRAEL COHEN & SONS INTERNATIONAL, LTD., (U.S. CLS. 22 AND 39). SN 85-968,275. PUB. 11-26-2013. FILED 6-24-2013.
- 4,480,641. **SMOKERS ONLY (STANDARD CHARACTER)**. SMOKERS'S CLUB LLC, (U.S. CLS. 22 AND 39). SN 85-968,355. PUB. 11-26-2013. FILED 6-24-2013.
- 4,480,659. **GOLDEN LION GEAR (STANDARD CHARACTER)**. GREENE, LONNELL, (U.S. CLS. 22 AND 39). SN 85-968,819. PUB. 11-26-2013. FILED 6-25-2013.
- 4,480,682. **KINGS NEVER SLEEP (STANDARD CHARACTER)**. HOULIHAN, MICHAEL, (U.S. CLS. 22 AND 39). SN 85-970,086. PUB. 11-26-2013. FILED 6-26-2013.
- 4,480,695. **MAFIA USA (STANDARD CHARACTER)**. MAFIA APPAREL INC, (U.S. CLS. 22 AND 39). SN 85-970,769. PUB. 11-26-2013. FILED 6-26-2013.
- 4,480,756. **DRILLEYS (STANDARD CHARACTER)**. DRILLEYS, LLC, (U.S. CLS. 22 AND 39). SN 85-973,956. PUB. 11-26-2013. FILED 7-1-2013.
- 4,480,758. **B C AND DESIGN**. LIMBRICK, ALBERT, (U.S. CLS. 22 AND 39). SN 85-974,003. PUB. 11-26-2013. FILED 7-1-2013.
- 4,480,770. **LMAX (STANDARD CHARACTER)**. CIVVIES INC, (U.S. CLS. 22 AND 39). SN 85-974,169. PUB. 11-26-2013. FILED 7-1-2013.
- 4,480,780 ( *See Class 16 for this trademark*).
- 4,480,810. **MISCELLANEOUS DESIGN**. CRADLE GEAR INC., (U.S. CLS. 22 AND 39). SN 86-000,264. PUB. 11-26-2013. FILED 7-2-2013.
- 4,480,828. **RAISED BY WOLVES (STANDARD CHARACTER)**. RAISE BY WOLVES, INC., DBA RAISED BY WOLVES, (U.S. CLS. 22 AND 39). SN 86-000,507. PUB. 11-26-2013. FILED 7-2-2013.
- 4,480,829. **CITE-SHOP (STANDARD CHARACTER)**. HOWARD, MARILYN, (U.S. CLS. 22 AND 39). SN 86-000,510. PUB. 11-26-2013. FILED 7-2-2013.
- 4,480,841. **SURPRISE (STANDARD CHARACTER)**. SLEEPING SKULL CORP., MULTIPLE CLASS, (INT. CLS. 25 AND 28), (U.S. CLS. 22, 23, 38, 39 AND 50). SN 86-000,673. PUB. 11-26-2013. FILED 7-2-2013.
- 4,480,845. **MARCSTAR (STANDARD CHARACTER)**. MARK BARNES, (U.S. CLS. 22 AND 39). SN 86-000,716. PUB. 11-26-2013. FILED 7-2-2013.
- 4,480,863. **DIVE UNDER (STANDARD CHARACTER)**. DIVE UNDER APPAREL LLC, (U.S. CLS. 22 AND 39). SN 86-000,921. PUB. 11-26-2013. FILED 7-2-2013.
- 4,480,880. **ROBERTO NALDI (STANDARD CHARACTER)**. RO.DI. GROUP S.R.L., (U.S. CLS. 22 AND 39). SN 86-001,288. PUB. 11-26-2013. FILED 7-2-2013.
- 4,480,890. **PRETTY PERSUASIONS (STANDARD CHARACTER)**. PRETTY PERSUASIONS, LLC, (U.S. CLS. 22 AND 39). SN 86-001,541. PUB. 11-26-2013. FILED 7-3-2013.
- 4,480,912. **DYME LYFE (STANDARD CHARACTER)**. GENOS DERWIN WILLIAMS, (U.S. CLS. 22 AND 39). SN 86-001,861. PUB. 11-26-2013. FILED 7-3-2013.
- 4,480,925. **40S & SHORTIES (STANDARD CHARACTER)**. 40S AND SHORTIES LLC, (U.S. CLS. 22 AND 39). SN 86-002,066. PUB. 11-26-2013. FILED 7-3-2013.
- 4,480,953 ( *See Class 18 for this trademark*).
- 4,480,960. **F@F (STANDARD CHARACTER)**. HOWARD, RHONDA J. PEOPLES, (U.S. CLS. 22 AND 39). SN 86-002,464. PUB. 11-26-2013. FILED 7-3-2013.
- 4,480,961 ( *See Class 9 for this trademark*).
- 4,480,975. **YOUNG MINDS CAN (STANDARD CHARACTER)**. MORRISON HOLDINGS, LLC, (U.S. CLS. 22 AND 39). SN 86-002,687. PUB. 11-26-2013. FILED 7-4-2013.
- 4,480,981. **D8N (STYLIZED)**. PONZIANI, KEVIN R., (U.S. CLS. 22 AND 39). SN 86-002,751. PUB. 11-26-2013. FILED 7-4-2013.
- 4,480,986 ( *See Class 21 for this trademark*).
- 4,480,991. **LIVE FOR LIGHTS (STANDARD CHARACTER)**. LIVE FOR LIGHTS, (U.S. CLS. 22 AND 39). SN 86-002,812. PUB. 11-26-2013. FILED 7-4-2013.
- 4,480,997. **FUCANG AND DESIGN**. FUCANG (BEIJING) CULTURE CO.,LTD., (U.S. CLS. 22 AND 39). SN 86-002,873. PUB. 11-26-2013. FILED 7-5-2013.
- 4,481,021. **DRINKING TEAM (STANDARD CHARACTER)**. DRINKINGTEAMOF.COM, (U.S. CLS. 22 AND 39). SN 86-003,102. PUB. 11-26-2013. FILED 7-5-2013.
- 4,481,023. **FIELDTRIP (STANDARD CHARACTER)**. LUNCHBOX INC., (U.S. CLS. 22 AND 39). SN 86-003,114. PUB. 11-26-2013. FILED 7-5-2013.
- 4,481,032. **SHIBBY (STANDARD CHARACTER)**. CRANLEY,

WILLIAM, AND GALLAGHER, JOHN, (U.S. CLS. 22 AND 39). SN 86-003,259. PUB. 11-26-2013. FILED 7-5-2013.

4,481,041. **BENJAMIN RAY (STANDARD CHARACTER)**. KAIMANA BEACHWEAR LLC, (U.S. CLS. 22 AND 39). SN 86-003,436. PUB. 11-26-2013. FILED 7-5-2013.

4,481,045. **SEOBEAN (STANDARD CHARACTER)**. HAN GUO YONG, (U.S. CLS. 22 AND 39). SN 86-003,496. PUB. 11-26-2013. FILED 7-6-2013.

4,481,059. **TATTOOED AND EMPLOYED (STANDARD CHARACTER)**. STEADFAST BRAND, INC., (U.S. CLS. 22 AND 39). SN 86-003,626. PUB. 11-26-2013. FILED 7-7-2013.

4,481,060. **SUPPORT TATTOOED MILITARY (STANDARD CHARACTER)**. STEADFAST BRAND, INC., (U.S. CLS. 22 AND 39). SN 86-003,627. PUB. 11-26-2013. FILED 7-7-2013.

4,481,061. **TATTOOED PARENT (STANDARD CHARACTER)**. STEADFAST BRAND, INC., (U.S. CLS. 22 AND 39). SN 86-003,629. PUB. 11-26-2013. FILED 7-7-2013.

4,481,079. **LF316 AND DESIGN**. LIFE WEAR 316, LLC, (U.S. CLS. 22 AND 39). SN 86-003,926. PUB. 11-26-2013. FILED 7-8-2013.

4,481,095. **AKWILDSTOCK (STANDARD CHARACTER)**. ALASKA WILDSTOCK TREASURY, (U.S. CLS. 22 AND 39). SN 86-004,295. PUB. 11-26-2013. FILED 7-8-2013.

4,481,130. **SKINNY BITCH APPAREL (STANDARD CHARACTER)**. TRAN, LAN, (U.S. CLS. 22 AND 39). SN 86-004,978. PUB. 11-26-2013. FILED 7-9-2013.

4,481,132. **PERKED (STANDARD CHARACTER)**. HOFFMANN, MIKE, (U.S. CLS. 22 AND 39). SN 86-004,997. PUB. 11-26-2013. FILED 7-9-2013.

4,481,141. **SKINBAIT (STANDARD CHARACTER)**. AARON D. ZAUG, MULTIPLE CLASS, (INT. CLS. 25 AND 28), (U.S. CLS. 22, 23, 38, 39 AND 50). SN 86-005,157. PUB. 11-26-2013. FILED 7-9-2013.

4,481,148. **C CONTROVERSIAL AND DESIGN**. DIAZ, JESSE, (U.S. CLS. 22 AND 39). SN 86-005,239. PUB. 11-26-2013. FILED 7-9-2013.

4,481,153. **VERSIONTWO LABORATORY (STANDARD CHARACTER)**. VERSIONTWO LABORATORY LLC, (U.S. CLS. 22 AND 39). SN 86-005,291. PUB. 11-26-2013. FILED 7-9-2013.

4,481,157 ( *See Class 16 for this trademark*).

4,481,159 ( *See Class 16 for this trademark*).

4,481,173. **PIMP C (STANDARD CHARACTER)**. ESTATE OF CHAD "PIMP C" LAMONT BUTLER, (U.S. CLS. 22 AND 39). SN 86-005,563. PUB. 11-26-2013. FILED 7-9-2013.

4,481,177. **HUNTINGTON BEACH CLUB (STANDARD CHARACTER)**. BRAND MINISTRY LLC, (U.S. CLS. 22 AND 39). SN 86-005,647. PUB. 11-26-2013. FILED 7-9-2013.

4,481,178 ( *See Class 24 for this trademark*).

4,481,201. **MISCELLANEOUS DESIGN**. SHOE SHOW, INC., (U.S. CLS. 22 AND 39). SN 86-007,500. PUB. 11-26-2013. FILED 7-11-2013.

4,481,204. **F2 FOOT FORCE (STANDARD CHARACTER)**. WARSON GROUP, INC., (U.S. CLS. 22 AND 39). SN 86-008,747. PUB. 11-26-2013. FILED 7-12-2013.

4,481,206. **TRUESPORT AND DESIGN**. UNITED STATES ANTI-DOPING AGENCY, AKA USADA, (U.S. CLS. 22 AND 39). SN 86-010,306. PUB. 11-26-2013. FILED 7-15-2013.

4,481,241 ( *See Class 16 for this trademark*).

4,481,243. **WEAR FOR LOVE/LOVE FOR WEAR (STANDARD CHARACTER)**. RBR, LLC, (U.S. CLS. 22 AND 39). SN 86-029,626. PUB. 11-26-2013. FILED 8-6-2013.

4,481,249. **GLORY RAKS (STANDARD CHARACTER)**. THOMAS R. NECAISE, (U.S. CLS. 22 AND 39). SN 86-032,351. PUB. 11-26-2013. FILED 8-8-2013.

4,481,273. **NARWHAL (STANDARD CHARACTER)**. SIERRA NEVADA BREWING CO., (U.S. CLS. 22 AND 39). SN 86-050,139. PUB. 11-26-2013. FILED 8-28-2013.

#### CLASS 26—FANCY GOODS

4,479,341 ( *See Class 25 for this trademark*).

4,479,413 ( *See Class 9 for this trademark*).

4,479,794. **THE CURLINATOR (STANDARD CHARACTER)**. LYSETTE MUTKUS, AND ERIC MUTKUS, (U.S. CLS. 37, 39, 40, 42 AND 50). SN 85-769,829. PUB. 11-26-2013. FILED

11-2-2012.

4,480,060. **OOH! AND DESIGN**. HICKS, KIMIYA, DBA OOH THAT HAIR, (U.S. CLS. 37, 39, 40, 42 AND 50). SN 85-854,144. PUB. 11-26-2013. FILED 2-19-2013.

4,480,138. **HAIRLABZ (STANDARD CHARACTER)**. HAIRLABZ, (U.S. CLS. 37, 39, 40, 42 AND 50). SN 85-885,120. PUB. 11-26-2013. FILED 3-25-2013.

4,480,195. **MISCELLANEOUS DESIGN**. PROACT SAFETY, INC., (U.S. CLS. 37, 39, 40, 42 AND 50). SN 85-905,212. PUB. 11-26-2013. FILED 4-16-2013.

4,480,308. **WEE ONES PETALS AND DESIGN**. WEE ONES, LLC, (U.S. CLS. 37, 39, 40, 42 AND 50). SN 85-933,052. PUB. 11-26-2013. FILED 5-15-2013.

4,481,279. **ULTRA (STANDARD CHARACTER)**. ROYAL IMEX INC., (U.S. CLS. 37, 39, 40, 42 AND 50). SN 86-058,357. PUB. 11-26-2013. FILED 9-6-2013.

#### CLASS 27—FLOOR COVERINGS

4,479,324 ( *See Class 6 for this trademark*).

4,479,360 ( *See Class 24 for this trademark*).

4,479,367 ( *See Class 3 for this trademark*).

4,479,368 ( *See Class 3 for this trademark*).

4,479,671 ( *See Class 3 for this trademark*).

4,480,927. **CINAR (STANDARD CHARACTER)**. CINAR HALI-CLIK A.S., (U.S. CLS. 19, 20, 37, 42 AND 50). SN 86-002,089. PUB. 11-26-2013. FILED 7-3-2013.

#### CLASS 28—TOYS AND SPORTING GOODS

4,479,273 ( *See Class 3 for this trademark*).

4,479,307 ( *See Class 9 for this trademark*).

4,479,308 ( *See Class 3 for this trademark*).

4,479,310 ( *See Class 9 for this trademark*).

4,479,317. **S. OLIVER (STANDARD CHARACTER)**. S. OLIVER BERND FREIER GMBH & CO. KG, (U.S. CLS. 22, 23, 38 AND 50). SN 79-121,824. PUB. 11-26-2013. FILED 11-12-2012.

4,479,319 ( *See Class 9 for this trademark*).

4,479,367 ( *See Class 3 for this trademark*).

4,479,368 ( *See Class 3 for this trademark*).

4,479,384 ( *See Class 9 for this trademark*).

4,479,391 ( *See Class 9 for this trademark*).

4,479,392 ( *See Class 25 for this trademark*).

4,479,406 ( *See Class 9 for this trademark*).

4,479,407 ( *See Class 9 for this trademark*).

4,479,413 ( *See Class 9 for this trademark*).

4,479,422 ( *See Class 12 for this trademark*).

4,479,423 ( *See Class 25 for this trademark*).

4,479,434 ( *See Class 3 for this trademark*).

4,479,501 ( *See Class 16 for this trademark*).

4,479,525 ( *See Class 16 for this trademark*).

4,479,526 ( *See Class 16 for this trademark*).

4,479,527. **TALKING BACTERIA JOHN, JOHN & JOHN (STANDARD CHARACTER)**. OUT FIT 7 LIMITED, (U.S. CLS. 22, 23, 38 AND 50). SN 85-189,129. PUB. 11-26-2013. FILED 12-2-2010.

4,479,540. **APFFINITY (STANDARD CHARACTER)**. SPIN MASTER LTD., (U.S. CLS. 22, 23, 38 AND 50). SN 85-343,480. PUB. 11-26-2013. FILED 6-10-2011.

4,479,626. **STICKY WICKY (STANDARD CHARACTER)**. DODDS, PETER ANDREW, (U.S. CLS. 22, 23, 38 AND 50). SN 85-617,072. PUB. 11-26-2013. FILED 5-4-2012.

4,479,627. **PLAY FACTO (STANDARD CHARACTER)**. T.IME CONTENTS CO. LTD., MULTIPLE CLASS, (INT. CLS. 28 AND 41), (U.S. CLS. 22, 23, 38, 50, 100, 101 AND 107). SN 85-618,467. PUB. 11-26-2013. FILED 5-7-2012.

4,479,635. **4DX (STYLIZED)**. CJ 4DPLEX CO., LTD., (U.S. CLS. 22, 23, 38 AND 50). SN 85-623,389. PUB. 11-26-2013. FILED 5-11-2012.

4,479,663 ( *See Class 9 for this trademark*).

4,479,699 ( *See Class 9 for this trademark*).

4,479,776 ( *See Class 12 for this trademark*).

4,479,843. **AERA T R U C K S (STYLIZED)**. AERA TRUCKS,



- INC., (U.S. CLS. 22, 23, 38 AND 50). SN 85-788,830. PUB. 11-26-2013. FILED 11-27-2012.
- 4,479,883 ( *See Class 6 for this trademark*).
- 4,479,934. **WESTERN RIVERS (STANDARD CHARACTER)**. I.P. HOLDINGS, INC., (U.S. CLS. 22, 23, 38 AND 50). SN 85-810,417. PUB. 11-26-2013. FILED 12-26-2012.
- 4,479,961. **THE-O-RING-GOLF (STANDARD CHARACTER)**. JERI'S TOYS, LLC, (U.S. CLS. 22, 23, 38 AND 50). SN 85-820,071. PUB. 11-26-2013. FILED 1-10-2013.
- 4,479,975. **TOO HOT FOR LOVE (STANDARD CHARACTER)**. METRONOME PRODUCTIONS A/S, (U.S. CLS. 22, 23, 38 AND 50). SN 85-824,060. PUB. 11-26-2013. FILED 1-15-2013.
- 4,480,033. **LIL'SHAKER (STANDARD CHARACTER)**. DILL LURES, LLC, (U.S. CLS. 22, 23, 38 AND 50). SN 85-842,613. PUB. 11-26-2013. FILED 2-6-2013.
- 4,480,128. **JOIN THE BATTLE (STANDARD CHARACTER)**. MEMORIAL SLOAN-KETTERING CANCER CENTER, (U.S. CLS. 22, 23, 38 AND 50). SN 85-881,523. PUB. 5-21-2013. FILED 3-20-2013.
- 4,480,157. **STUNT STAND (STANDARD CHARACTER)**. YEHL & JORDAN LLC, DBA CHERLEADING STUNT STAND, (U.S. CLS. 22, 23, 38 AND 50). SN 85-889,989. PUB. 11-26-2013. FILED 3-29-2013.
- 4,480,193. **MURRAY BOARDS (STANDARD CHARACTER)**. MURRAY BOARDS, LLC, (U.S. CLS. 22, 23, 38 AND 50). SN 85-904,976. PUB. 11-26-2013. FILED 4-15-2013.
- 4,480,312. **SIGN IN BLOOD (STANDARD CHARACTER)**. GOSSETT, SCOTT A., DBA SIGN IN BLOOD, (U.S. CLS. 22, 23, 38 AND 50). SN 85-934,691. PUB. 11-26-2013. FILED 5-16-2013.
- 4,480,313. **MISCELLANEOUS DESIGN**. ANDREWS + BLAINE LTD, (U.S. CLS. 22, 23, 38 AND 50). SN 85-934,788. PUB. 11-26-2013. FILED 5-17-2013.
- 4,480,334. **MERRYSTOCKINGS (STANDARD CHARACTER)**. MERRYSTOCKINGS LLC, (U.S. CLS. 22, 23, 38 AND 50). SN 85-939,510. PUB. 11-26-2013. FILED 5-22-2013.
- 4,480,393. **BOOTEE BALL AND DESIGN**. KATHRYN LOYACONO, (U.S. CLS. 22, 23, 38 AND 50). SN 85-945,935. PUB. 11-26-2013. FILED 5-30-2013.
- 4,480,401. **VOODEE BOODEE AND DESIGN**. SAX ART, INC., (U.S. CLS. 22, 23, 38 AND 50). SN 85-946,710. PUB. 11-26-2013. FILED 5-30-2013.
- 4,480,420. **TOP RANGE (STANDARD CHARACTER)**. BRIGHT LIGHT TRADING, INC., TA BRIGHT LIGHT GOLF, (U.S. CLS. 22, 23, 38 AND 50). SN 85-949,471. PUB. 11-26-2013. FILED 6-3-2013.
- 4,480,438. **MUTANT (STANDARD CHARACTER)**. MUTANT ARCHERY, LLC, (U.S. CLS. 22, 23, 38 AND 50). SN 85-951,296. PUB. 11-26-2013. FILED 6-5-2013.
- 4,480,519. **JARTS (STANDARD CHARACTER)**. POOF-SLINSKY FUNDEX LLC, (U.S. CLS. 22, 23, 38 AND 50). SN 85-962,705. PUB. 11-26-2013. FILED 6-18-2013.
- 4,480,537. **HELIX (STANDARD CHARACTER)**. STRICKLAND'S ARCHERY, (U.S. CLS. 22, 23, 38 AND 50). SN 85-963,761. PUB. 11-26-2013. FILED 6-19-2013.
- 4,480,554. **PALOOZA PACKAGE (STANDARD CHARACTER)**. BREZINA, BENJAMIN A., (U.S. CLS. 22, 23, 38 AND 50). SN 85-964,306. PUB. 11-26-2013. FILED 6-19-2013.
- 4,480,562 ( *See Class 20 for this trademark*).
- 4,480,642. **TAKE IT TO THE EXTREME (STANDARD CHARACTER)**. EXTREME RC BY RSI, LLC, (U.S. CLS. 22, 23, 38 AND 50). SN 85-968,366. PUB. 11-26-2013. FILED 6-24-2013.
- 4,480,643. **EXTREME (STANDARD CHARACTER)**. EXTREME RC BY RSI, LLC, (U.S. CLS. 22, 23, 38 AND 50). SN 85-968,371. PUB. 11-26-2013. FILED 6-24-2013.
- 4,480,737. **MULTICISE GYM (STANDARD CHARACTER)**. SER-GYM, LLC, (U.S. CLS. 22, 23, 38 AND 50). SN 85-972,860. PUB. 11-26-2013. FILED 6-28-2013.
- 4,480,751. **FLEXSTIC (STANDARD CHARACTER)**. RYCHTYK, JAMES E., (U.S. CLS. 22, 23, 38 AND 50). SN 85-973,644. PUB. 11-26-2013. FILED 6-29-2013.
- 4,480,780 ( *See Class 16 for this trademark*).
- 4,480,801. **RELIAPUTT (STANDARD CHARACTER)**. WONG, KAISER H., DBA ACCUGOLF, (U.S. CLS. 22, 23, 38 AND 50). SN 86-000,153. PUB. 11-26-2013. FILED 7-2-2013.
- 4,480,832. **KORFORMER (STANDARD CHARACTER)**. MARIA KERMATH, (U.S. CLS. 22, 23, 38 AND 50). SN 86-000,561. PUB. 11-26-2013. FILED 7-2-2013.
- 4,480,841 ( *See Class 25 for this trademark*).
- 4,480,846. **RIG WRECKERS (STYLIZED)**. CHANNA IZZO, AND EMILY GINGRAS, AND ADAM ROBITAILLE, (U.S. CLS. 22, 23, 38 AND 50). SN 86-000,732. PUB. 11-26-2013. FILED 7-2-2013.
- 4,480,865. **TIME TRIAL (STANDARD CHARACTER)**. CENTER FOR COMPUTER-ASSISTED LEGAL INSTRUCTION, (U.S. CLS. 22, 23, 38 AND 50). SN 86-000,931. PUB. 11-26-2013. FILED 7-2-2013.
- 4,480,937. **DON'T SHOOT THE MESSENGER (STANDARD CHARACTER)**. GAME DEVELOPMENT GROUP INC., (U.S. CLS. 22, 23, 38 AND 50). SN 86-002,222. PUB. 11-26-2013. FILED 7-3-2013.
- 4,480,953 ( *See Class 18 for this trademark*).
- 4,480,970. **PLAYFIT (STANDARD CHARACTER)**. BALL, BOUNCE & SPORT, INC., (U.S. CLS. 22, 23, 38 AND 50). SN 86-002,640. PUB. 11-26-2013. FILED 7-3-2013.
- 4,481,040 ( *See Class 6 for this trademark*).
- 4,481,058. **DRIVE AND SURVIVE (STANDARD CHARACTER)**. HARPER, STANLEY A., (U.S. CLS. 22, 23, 38 AND 50). SN 86-003,607. PUB. 11-26-2013. FILED 7-7-2013.
- 4,481,077. **HERO MAKER (STANDARD CHARACTER)**. HOBICO, INC., (U.S. CLS. 22, 23, 38 AND 50). SN 86-003,914. PUB. 11-26-2013. FILED 7-8-2013.
- 4,481,126. **SHENGSHOU (STYLIZED)**. SUN PING, AND YANG HUI, AND WANG DINGLIANG, (U.S. CLS. 22, 23, 38 AND 50). SN 86-004,897. PUB. 11-26-2013. FILED 7-9-2013.
- 4,481,134. **TRIAD (STANDARD CHARACTER)**. WILSON SPORTING GOODS CO., (U.S. CLS. 22, 23, 38 AND 50). SN 86-005,041. PUB. 11-26-2013. FILED 7-9-2013.
- 4,481,141 ( *See Class 25 for this trademark*).
- 4,481,207. **MOSSY OAK BRAND CAMO BIO LOGIC AND DESIGN**. HAAS OUTDOORS, INC., (U.S. CLS. 22, 23, 38 AND 50). SN 86-011,016. PUB. 11-26-2013. FILED 7-16-2013.
- 4,481,209. **FLOOD FORCE (STANDARD CHARACTER)**. SWIMWAYS CORP., (U.S. CLS. 22, 23, 38 AND 50). SN 86-011,082. PUB. 11-26-2013. FILED 7-16-2013.
- 4,481,239. **PRE GAME CHALLENGE (STANDARD CHARACTER)**. BALL, BOUNCE & SPORT, INC., (U.S. CLS. 22, 23, 38 AND 50). SN 86-026,800. PUB. 11-26-2013. FILED 8-2-2013.
- 4,481,256 ( *See Class 9 for this trademark*).
- 4,481,257 ( *See Class 9 for this trademark*).
- 4,481,269. **BRISTLETECH (STANDARD CHARACTER)**. BALL, BOUNCE & SPORT, INC., (U.S. CLS. 22, 23, 38 AND 50). SN 86-048,600. PUB. 11-26-2013. FILED 8-27-2013.
- 4,481,292. **FLEXTECH (STANDARD CHARACTER)**. BALL, BOUNCE & SPORT, INC., (U.S. CLS. 22, 23, 38 AND 50). SN 86-067,680. PUB. 11-26-2013. FILED 9-18-2013.

---

## CLASS 29—MEATS AND PROCESSED FOODS

- 4,479,254. **DI INE AND DESIGN**. DIVINE CHOCOLATE LIMITED, MULTIPLE CLASS, (INT. CLS. 29 AND 30), (U.S. CL. 46). SN 77-460,354. PUB. 11-26-2013. FILED 4-29-2008.
- 4,479,262. **IORELLINO (STANDARD CHARACTER)**. BAR IORELLINO INC., MULTIPLE CLASS, (INT. CLS. 29 AND 30), (U.S. CL. 46). SN 77-941,587. PUB. 5-7-2013. FILED 2-22-2010.
- 4,479,263. **IORELLINO AND DESIGN**. BAR IORELLINO INC., MULTIPLE CLASS, (INT. CLS. 29 AND 30), (U.S. CL. 46). SN 77-941,658. PUB. 5-7-2013. FILED 2-22-2010.
- 4,479,286. **LAILA (STANDARD CHARACTER)**. FLYING TRADE LIMITED, MULTIPLE CLASS, (INT. CLS. 29 AND 30), (U.S. CL. 46). SN 79-113,880. PUB. 8-20-2013. FILED 12-5-2011.
- 4,479,305 ( *See Class 25 for this trademark*).
- 4,479,395 ( *See Class 3 for this trademark*).
- 4,479,434 ( *See Class 3 for this trademark*).
- 4,479,459. **POPSO (STYLIZED)**. TANAKA HATSUMI, MULTIPLE CLASS, (INT. CLS. 29 AND 30), (U.S. CL. 46). SN 79-131,061. PUB. 11-26-2013. FILED 3-7-2013.
- 4,479,488. **GEGA (STANDARD CHARACTER)**. AI & CO AD, (U.S. CL. 46). SN 79-133,874. PUB. 11-26-2013. FILED 6-11-2013.
- 4,479,493. **GRIM REAPER (STANDARD CHARACTER)**. GRIM

- REAPER FOODS LIMITED, MULTIPLE CLASS, (INT. CLS. 29 AND 30), (U.S. CL. 46). SN 79-134,294. PUB. 11-26-2013. FILED 2-22-2013.
- 4,479,649 ( *See Class 5 for this trademark*).
- 4,479,738. **FIXINS "SOUTHERN STYLE GOODNESS" (STANDARD CHARACTER)**. BD&K FOODS, INC., MULTIPLE CLASS, (INT. CLS. 29 AND 30), (U.S. CL. 46). SN 85-728,982. PUB. 11-26-2013. FILED 9-14-2012.
- 4,479,758. **RIO MEKONG AND DESIGN**. SEAQUEST SEA-FOOD CORPORATION, (U.S. CL. 46). SN 85-745,087. PUB. 6-4-2013. FILED 10-3-2012.
- 4,479,777. **SAA - BOR A LA MEXICANA (STANDARD CHARACTER)**. FABI SAA INC, (U.S. CL. 46). SN 85-758,184. PUB. 11-26-2013. FILED 10-19-2012.
- 4,479,799. **HAPPYTIMES ORGANIC SUPERFOODS (STANDARD CHARACTER)**. NURTURE, INC., MULTIPLE CLASS, (INT. CLS. 29 AND 30), (U.S. CL. 46). SN 85-771,865. PUB. 10-22-2013. FILED 11-5-2012.
- 4,479,818. **MALLOW TREE AND DESIGN**. FARHI, MICHAEL, MULTIPLE CLASS, (INT. CLS. 29, 30, 31 AND 35), (U.S. CLS. 1, 46, 100, 101 AND 102). SN 85-779,137. PUB. 11-26-2013. FILED 11-14-2012.
- 4,479,878. **HEARTY HEMP SEED (STANDARD CHARACTER)**. IMAJEN, LLC, (U.S. CL. 46). SN 85-800,964. PUB. 11-26-2013. FILED 12-12-2012.
- 4,479,879. **WOW MUSHROOM (STANDARD CHARACTER)**. IMAJEN, LLC, (U.S. CL. 46). SN 85-801,007. PUB. 11-26-2013. FILED 12-12-2012.
- 4,479,894. **JUST SETI (STANDARD CHARACTER)**. SETI G LLC, MULTIPLE CLASS, (INT. CLS. 29 AND 30), (U.S. CL. 46). SN 85-803,857. PUB. 11-26-2013. FILED 12-16-2012.
- 4,479,945. **HOT- HEADZ AND DESIGN**. TECMACO INTERNATIONAL, LTD., DBA HOT-HEADZ, (U.S. CL. 46). SN 85-814,013. PUB. 11-26-2013. FILED 1-2-2013.
- 4,479,955. **ORGANIC VALLEY AND DESIGN**. COOPERATIVE REGIONS OF ORGANIC PRODUCER POOLS, (U.S. CL. 46). SN 85-817,094. PUB. 11-26-2013. FILED 1-7-2013.
- 4,479,957. **TENERY (STANDARD CHARACTER)**. LIDL STIFTUNG & CO. KG, (U.S. CL. 46). SN 85-817,785. PUB. 11-26-2013. FILED 1-8-2013.
- 4,479,979. **BLACK BRIDGE AND DESIGN**. BLACK BRIDGE FOOD CO., LTD., (U.S. CL. 46). SN 85-824,929. PUB. 11-26-2013. FILED 1-16-2013.
- 4,480,052. **HIDDEN TREASURES (STANDARD CHARACTER)**. HIDDEN TREASURES FOOD SERVICES, LLC, (U.S. CL. 46). SN 85-851,080. PUB. 11-26-2013. FILED 2-15-2013.
- 4,480,106. **EMPRESS (STANDARD CHARACTER)**. MITSUI FOODS, INC., (U.S. CL. 46). SN 85-872,956. PUB. 11-26-2013. FILED 3-11-2013.
- 4,480,110. **GAIL'S GOURMET FOODS "TREAT YOUR TASTE BUDS!" (STANDARD CHARACTER)**. GAIL'S GOURMET FOODS INC., (U.S. CL. 46). SN 85-875,618. PUB. 11-26-2013. FILED 3-13-2013.
- 4,480,155 ( *See Class 3 for this trademark*).
- 4,480,192. **LA NUESTRA TRAYENDOLE EL SABOR DE SU HOGAR AND DESIGN**. MONTALVAN'S SALES, INC., (U.S. CL. 46). SN 85-904,867. PUB. 11-26-2013. FILED 4-15-2013.
- 4,480,285. **CHAOKOH TCC AND DESIGN**. THEPPADUNG-PORN COCONUT COMPANY LIMITED, (U.S. CL. 46). SN 85-927,771. PUB. 11-26-2013. FILED 5-9-2013.
- 4,480,318. **AL SHAM AND DESIGN**. NAJIB EST, INC, (U.S. CL. 46). SN 85-935,239. PUB. 11-26-2013. FILED 5-17-2013.
- 4,480,452. **DESERT FARMS (STANDARD CHARACTER)**. DESERT FARMS INC., (U.S. CL. 46). SN 85-953,838. PUB. 11-26-2013. FILED 6-7-2013.
- 4,480,522. **LE BISTRO (STANDARD CHARACTER)**. SPECIALITIES AGRO-ALIMENTATION, (U.S. CL. 46). SN 85-963,124. PUB. 11-26-2013. FILED 6-18-2013.
- 4,480,624. **BEACH HOUSE FOODS (STANDARD CHARACTER)**. GULF SMOKED SEAFOOD, INC., (U.S. CL. 46). SN 85-967,762. PUB. 11-26-2013. FILED 6-24-2013.
- 4,480,665. **"IL NUMERO UNO" AND DESIGN**. SAN NICOLA PROSCIUTTIFICIO DEL SOLE - S.P.A., (U.S. CL. 46). SN 85-969,257. PUB. 11-26-2013. FILED 6-25-2013.
- 4,480,708. **SALEMME (STANDARD CHARACTER)**. SALEMME PEPPER LLC, DBA SALEMME PEPPER-CO., MULTIPLE CLASS, (INT. CLS. 29, 30 AND 31), (U.S. CLS. 1 AND 46). SN 85-971,418. PUB. 11-26-2013. FILED 6-27-2013.
- 4,480,743. **NOH AND DESIGN**. E & M CORP., DBA NOH FOODS OF HAWAII, MULTIPLE CLASS, (INT. CLS. 29 AND 30), (U.S. CL. 46). SN 85-973,227. PUB. 11-26-2013. FILED 6-28-2013.
- 4,480,775. **GRAB A NATURAL BOOST! (STANDARD CHARACTER)**. DOS AMIGOS BRANDS LLC, (U.S. CL. 46). SN 85-974,342. PUB. 11-26-2013. FILED 7-1-2013.
- 4,480,856. **PEACE, LOVE, AND GOOD FOOD (STANDARD CHARACTER)**. NICOLosi FOODS, INC., (U.S. CL. 46). SN 86-000,865. PUB. 11-26-2013. FILED 7-2-2013.
- 4,480,881. **NUTOLENE (STANDARD CHARACTER)**. WHOLE-SOME INTERNATIONAL, INC, (U.S. CL. 46). SN 86-001,311. PUB. 11-26-2013. FILED 7-2-2013.
- 4,480,958. **TRIMONA BULGARIAN YOGURT (STANDARD CHARACTER)**. TRIMONA FOODS INC., (U.S. CL. 46). SN 86-002,458. PUB. 11-26-2013. FILED 7-3-2013.
- 4,481,063. **GO WITH YOUR GUT (STANDARD CHARACTER)**. JACKSONS FOOD STORES, INC., (U.S. CL. 46). SN 86-003,638. PUB. 11-26-2013. FILED 7-7-2013.
- 4,481,113. **BARE FRUIT (STANDARD CHARACTER)**. BARE FRUIT, LLC, (U.S. CL. 46). SN 86-004,630. PUB. 11-26-2013. FILED 7-8-2013.
- 4,481,154. **T.J. CRISP (STANDARD CHARACTER)**. BARREL O'FUN SNACK FOODS CO., (U.S. CL. 46). SN 86-005,318. PUB. 11-26-2013. FILED 7-9-2013.
- 4,481,163. **BREAKING NEWS (STANDARD CHARACTER)**. NATURAL INTENTIONS, INC., MULTIPLE CLASS, (INT. CLS. 29 AND 30), (U.S. CL. 46). SN 86-005,413. PUB. 11-26-2013. FILED 7-9-2013.
- 4,481,254. **ALDRICH FARMS (STANDARD CHARACTER)**. JOVAN'S PURE NUTRITION, MULTIPLE CLASS, (INT. CLS. 29 AND 30), (U.S. CL. 46). SN 86-036,999. PUB. 11-26-2013. FILED 8-13-2013.
- 4,481,265. **SHOPRITE KITCHEN (STANDARD CHARACTER)**. WAKEFERN FOOD CORP., (U.S. CL. 46). SN 86-048,155. PUB. 11-26-2013. FILED 8-26-2013.

---

#### CLASS 30—STAPLE FOODS

- 4,479,254 ( *See Class 29 for this trademark*).
- 4,479,262 ( *See Class 29 for this trademark*).
- 4,479,263 ( *See Class 29 for this trademark*).
- 4,479,286 ( *See Class 29 for this trademark*).
- 4,479,305 ( *See Class 25 for this trademark*).
- 4,479,312. **CRISPY FRUIT (STYLIZED)**. NATURE ET INNOVATION, (U.S. CL. 46). SN 79-121,565. PUB. 11-26-2013. FILED 9-25-2012.
- 4,479,346. **MISCELLANEOUS DESIGN**. GENERALE BISCUIT, (U.S. CL. 46). SN 79-124,821. PUB. 8-13-2013. FILED 11-15-2012.
- 4,479,409. **CHO'RONE (STANDARD CHARACTER)**. AUGUST STORCK KG, (U.S. CL. 46). SN 79-127,495. PUB. 11-26-2013. FILED 10-18-2012.
- 4,479,429. **LINDT AND DESIGN**. CHOCOLADEFABRIKEN; LINDT & SPRÜNGLI AG, (U.S. CL. 46). SN 79-128,767. PUB. 11-26-2013. FILED 3-8-2013.
- 4,479,432. **ZAFFIRO (STANDARD CHARACTER)**. CHOCOLADEFABRIKEN; LINDT & SPRÜNGLI AG, (U.S. CL. 46). SN 79-128,867. PUB. 11-26-2013. FILED 3-18-2013.
- 4,479,457. **PEPPERON (STANDARD CHARACTER)**. COMELIAU FRANÇOIS, (U.S. CL. 46). SN 79-130,891. PUB. 11-26-2013. FILED 5-1-2013.
- 4,479,459 ( *See Class 29 for this trademark*).
- 4,479,475. **HECHAGI AND DESIGN**. NOUSBO CO., LTD., (U.S. CL. 46). SN 79-132,570. PUB. 11-26-2013. FILED 4-4-2013.
- 4,479,493 ( *See Class 29 for this trademark*).
- 4,479,561. **THE BROWNSTONE (STANDARD CHARACTER)**. BROWNSTONE GOURMET FOODS LIMITED LIABILITY COMPANY, AKA BROWNSTONE GOURMET FOODS, (U.S. CL. 46). SN 85-460,658. PUB. 11-26-2013. FILED 10-31-2011.
- 4,479,622. **EUPHORIA (STANDARD CHARACTER)**. KUSMI TEA, (U.S. CL. 46). SN 85-611,771. PUB. 11-13-2012. FILED 4-30-2012.

- 4,479,664. **THE FAJITA COMPANY (STANDARD CHARACTER)**. JOHN SOULES FOODS, INC., (U.S. CL. 46). SN 85-637,034. PUB. 11-26-2013. FILED 5-29-2012.
- 4,479,720. **BONPOP (STANDARD CHARACTER)**. QUALA, INC., (U.S. CL. 46). SN 85-708,016. PUB. 11-26-2013. FILED 8-20-2012.
- 4,479,721. **POPETAS (STANDARD CHARACTER)**. QUALA, INC., (U.S. CL. 46). SN 85-708,023. PUB. 11-26-2013. FILED 8-20-2012.
- 4,479,738 ( *See Class 29 for this trademark*).
- 4,479,779. **LINDT PICCOLI (STANDARD CHARACTER)**. CHOCOLADEFABRIKEN LINDT & SPRÜNGLI AG, (U.S. CL. 46). SN 85-758,828. PUB. 11-26-2013. FILED 10-19-2012.
- 4,479,799 ( *See Class 29 for this trademark*).
- 4,479,814. **FARINA BELLA AND DESIGN**. KARTAL GIDA SANAYI VE TICARET ANONIM SIRKETI, (U.S. CL. 46). SN 85-778,316. PUB. 11-26-2013. FILED 11-13-2012.
- 4,479,818 ( *See Class 29 for this trademark*).
- 4,479,827. **FRUIT BREAKERS (STANDARD CHARACTER)**. SCONZA CANDY COMPANY, (U.S. CL. 46). SN 85-780,889. PUB. 6-4-2013. FILED 11-16-2012.
- 4,479,828. **SHEILA G'S (STANDARD CHARACTER)**. BROWNIE BRITTLE, LLC, (U.S. CL. 46). SN 85-781,004. PUB. 11-26-2013. FILED 11-16-2012.
- 4,479,866. **ILLCHEF (STANDARD CHARACTER)**. FITZGERALD, SHEHU, (U.S. CL. 46). SN 85-796,983. PUB. 11-26-2013. FILED 12-7-2012.
- 4,479,894 ( *See Class 29 for this trademark*).
- 4,479,919. **BUONICOSI (STYLIZED)**. GALBUSERA SPA, (U.S. CL. 46). SN 85-860,370. PUB. 11-26-2013. FILED 12-20-2012.
- 4,479,923. **GALBUSERA AND DESIGN**. GALBUSERA SPA, (U.S. CL. 46). SN 85-809,060. PUB. 11-26-2013. FILED 12-21-2012.
- 4,479,968 ( *See Class 16 for this trademark*).
- 4,480,049 ( *See Class 16 for this trademark*).
- 4,480,050 ( *See Class 16 for this trademark*).
- 4,480,079. **THE 1 AND DESIGN**. VPC PIZZA IP, LLC, MULTIPLE CLASS, (INT. CLS. 30 AND 43), (U.S. CLS. 46, 100 AND 101). SN 85-860,370. PUB. 8-6-2013. FILED 2-26-2013.
- 4,480,093. **COTTON TAILS (STANDARD CHARACTER)**. TOOTSIE ROLL INDUSTRIES, LLC, (U.S. CL. 46). SN 85-867,022. PUB. 11-26-2013. FILED 3-5-2013.
- 4,480,121. **FRENCH FRY MAGIC (STANDARD CHARACTER)**. CIMINO, ANDREW M., (U.S. CL. 46). SN 85-879,651. PUB. 11-26-2013. FILED 3-19-2013.
- 4,480,146. **SILVER'S TEA (STANDARD CHARACTER)**. LONG JOHN SILVER'S, LLC, (U.S. CL. 46). SN 85-887,741. PUB. 8-20-2013. FILED 3-27-2013.
- 4,480,155 ( *See Class 3 for this trademark*).
- 4,480,164. **RED ROCK COFFEE ROASTERS AND DESIGN**. RED ROCK DISTRIBUTING LTD. COMPANY, (U.S. CL. 46). SN 85-894,721. PUB. 11-26-2013. FILED 4-3-2013.
- 4,480,235. **NICTER (STANDARD CHARACTER)**. CHRISTOPHER, MIKOVITS, DBA CHERRY VAPE, MULTIPLE CLASS, (INT. CLS. 30 AND 34), (U.S. CLS. 2, 8, 9, 17 AND 46). SN 85-915,728. PUB. 11-26-2013. FILED 4-26-2013.
- 4,480,241. **CAFFÉSTIX (STYLIZED)**. TLC TRADEMARK COMPANY, (U.S. CL. 46). SN 85-920,867. PUB. 11-26-2013. FILED 5-1-2013.
- 4,480,412. **INNISFREE AND DESIGN**. INNISFREE CORPORATION, (U.S. CL. 46). SN 85-947,665. PUB. 11-26-2013. FILED 5-31-2013.
- 4,480,430. **NATURA YOUR BODY'S NATURAL SUGAR (STANDARD CHARACTER)**. FRUCTOSE FREE PRODUCTS LLC, (U.S. CL. 46). SN 85-950,697. PUB. 11-26-2013. FILED 6-4-2013.
- 4,480,505. **PRETZEL CRAZY (STANDARD CHARACTER)**. PRETZEL CRAZY, LLC, (U.S. CL. 46). SN 85-961,031. PUB. 11-26-2013. FILED 6-16-2013.
- 4,480,544. **PERFECT BIG APPLE TRADEMARK BRAND COFFEE (STANDARD CHARACTER)**. C.N. BROWN COMPANY, DBA A.W. WALKER LAWN & GARDEN CENTER, OKAY GAS, THE BIG APPLE FOOD STORES, AND RED SHIELD, (U.S. CL. 46). SN 85-963,984. PUB. 11-26-2013. FILED 6-19-2013.
- 4,480,548. **PERFECT BIG APPLE TRADEMARK BRAND COFFEE AND DESIGN**. C.N. BROWN COMPANY, DBA A.W. WALKER LAWN & GARDEN CENTER, OKAY GAS, THE BIG APPLE FOOD STORES, THE BIG APPLE, AND RED SHIELD, (U.S. CL. 46). SN 85-964,088. PUB. 11-26-2013. FILED 6-19-2013.
- 4,480,592. **JIMMY RIFFLE (STANDARD CHARACTER)**. JIMMY RIFFLE, LLC, MULTIPLE CLASS, (INT. CLS. 30 AND 43), (U.S. CLS. 46, 100 AND 101). SN 85-965,912. PUB. 11-26-2013. FILED 6-20-2013.
- 4,480,704 ( *See Class 1 for this trademark*).
- 4,480,708 ( *See Class 29 for this trademark*).
- 4,480,725. **LUC DINH KY AND DESIGN**. PAUL LEE, MULTIPLE CLASS, (INT. CLS. 30 AND 43), (U.S. CLS. 46, 100 AND 101). SN 85-972,306. PUB. 11-26-2013. FILED 6-27-2013.
- 4,480,743 ( *See Class 29 for this trademark*).
- 4,480,749. **SWEET ARLEEN'S (STANDARD CHARACTER)**. SWEET ARLEEN'S INTERNATIONAL INC., MULTIPLE CLASS, (INT. CLS. 30, 35 AND 43), (U.S. CLS. 46, 100, 101 AND 102). SN 85-973,540. PUB. 11-26-2013. FILED 6-28-2013.
- 4,480,765. **WHAT'S IN YOUR TANK? (STANDARD CHARACTER)**. ZEMAS MADHOUSE FOODS, INC., MULTIPLE CLASS, (INT. CLS. 30 AND 35), (U.S. CLS. 46, 100, 101 AND 102). SN 85-974,079. PUB. 11-26-2013. FILED 7-1-2013.
- 4,480,766. **ZEMAS (STANDARD CHARACTER)**. ZEMAS MADHOUSE FOODS, INC., MULTIPLE CLASS, (INT. CLS. 30 AND 35), (U.S. CLS. 46, 100, 101 AND 102). SN 85-974,087. PUB. 11-26-2013. FILED 7-1-2013.
- 4,480,778. **TAMALE ADDICTION AND DESIGN**. PAREDES GROUP LLC, (U.S. CL. 46). SN 85-974,512. PUB. 11-26-2013. FILED 7-1-2013.
- 4,480,882. **GUSTINOS (STANDARD CHARACTER)**. ALIMEN-TOS EXTRUIDOS, S.A. DE C.V., (U.S. CL. 46). SN 86-001,316. PUB. 11-26-2013. FILED 7-2-2013.
- 4,480,918. **MISCELLANEOUS DESIGN**. ERIK LAIBE, (U.S. CL. 46). SN 86-002,013. PUB. 11-26-2013. FILED 7-3-2013.
- 4,480,986 ( *See Class 21 for this trademark*).
- 4,480,992. **TAKE MY TOP OFF AND PINCH ME (STANDARD CHARACTER)**. MONTANA MEX, LLC, (U.S. CL. 46). SN 86-002,823. PUB. 11-26-2013. FILED 7-4-2013.
- 4,481,005. **ANSWERFOODS (STANDARD CHARACTER)**. NUTRIENT DENSE FOODS LLC, (U.S. CL. 46). SN 86-002,954. PUB. 11-26-2013. FILED 7-5-2013.
- 4,481,015. **DULCES CHILCHOTA CAJETA GOAT MILK CANDY SPREAD AND DESIGN**. HERRERA ALE, CARLOS MANUEL, AND HERRERA ALE, ERNESTO, (U.S. CL. 46). SN 86-003,043. PUB. 11-26-2013. FILED 7-5-2013.
- 4,481,022. **ELEVATE YOUR FOOD (STANDARD CHARACTER)**. RED DUCK FOODS LLC, (U.S. CL. 46). SN 86-003,111. PUB. 11-26-2013. FILED 7-5-2013.
- 4,481,026. **GUDENHOT (STANDARD CHARACTER)**. HARGRAVES, TIM, (U.S. CL. 46). SN 86-003,160. PUB. 11-26-2013. FILED 7-5-2013.
- 4,481,034. **INFUSE YOUR MOOD (STYLIZED)**. SUN CHLOR-ELLA CORP., (U.S. CL. 46). SN 86-003,311. PUB. 11-26-2013. FILED 7-5-2013.
- 4,481,064. **GO WITH YOUR GUT (STANDARD CHARACTER)**. JACKSONS FOOD STORES, INC., (U.S. CL. 46). SN 86-003,639. PUB. 11-26-2013. FILED 7-7-2013.
- 4,481,073. **MISCELLANEOUS DESIGN**. COSMIC COFFEE COMPANY LLC, (U.S. CL. 46). SN 86-003,824. PUB. 11-26-2013. FILED 7-8-2013.
- 4,481,075. **PRINCE POLO (STANDARD CHARACTER)**. MON-DELEZ EUROPE GMBH, (U.S. CL. 46). SN 86-003,852. PUB. 11-26-2013. FILED 7-8-2013.
- 4,481,089. **CHANGE THE WAY YOU BAGEL (STANDARD CHARACTER)**. BANTAM BAGELS LLC, MULTIPLE CLASS, (INT. CLS. 30 AND 35), (U.S. CLS. 46, 100, 101 AND 102). SN 86-004,083. PUB. 11-26-2013. FILED 7-8-2013.
- 4,481,163 ( *See Class 29 for this trademark*).
- 4,481,198. **DOOMSDAY (STANDARD CHARACTER)**. IKE'S INC., (U.S. CL. 46). SN 86-006,351. PUB. 11-26-2013. FILED 7-10-2013.
- 4,481,205. **ENJOY YOUR DAY THE BIG APPLE WAY (STANDARD CHARACTER)**. C.N. BROWN COMPANY, DBA A.W. WALKER LAWN & GARDEN CENTER, OKAY GAS, THE BIG APPLE FOOD STORES, THE BIG APPLE, AND RED SHIELD, (U.S. CL. 46). SN 86-008,835. PUB. 11-26-2013. FILED 7-12-2013.
- 4,481,212. **SPIFFY TIFFY (STANDARD CHARACTER)**. IKE'S INC., (U.S. CL. 46). SN 86-012,404. PUB. 11-26-2013. FILED 7-

- 17-2013.  
 4,481,213. **PIZZLE (STANDARD CHARACTER)**. IKE'S INC., (U.S. CL. 46). SN 86-012,419. PUB. 11-26-2013. FILED 7-17-2013.  
 4,481,216. **MACACHINO (STANDARD CHARACTER)**. SUJA LIFE, LLC, DBA SUJA JUICE, MULTIPLE CLASS, (INT. CLS. 30 AND 32), (U.S. CLS. 45, 46 AND 48). SN 86-013,302. PUB. 11-26-2013. FILED 7-17-2013.  
 4,481,223. **DIRTY CANZ HOT SAUCE (STANDARD CHARACTER)**. LORITO, TIMOTHY, (U.S. CL. 46). SN 86-016,753. PUB. 11-26-2013. FILED 7-22-2013.  
 4,481,238. **THE POWERPUFF GIRLS (STANDARD CHARACTER)**. THE CARTOON NETWORK, INC., (U.S. CL. 46). SN 86-026,135. PUB. 11-26-2013. FILED 8-1-2013.  
 4,481,254 ( *See Class 29 for this trademark*).  
 4,481,266. **SHOPRITE KITCHEN (STANDARD CHARACTER)**. WAKEFERN FOOD CORP., (U.S. CL. 46). SN 86-048,165. PUB. 11-26-2013. FILED 8-26-2013.  
 4,481,272. **MISCELLANEOUS DESIGN**. B&G FOODS NORTH AMERICA, INC., (U.S. CL. 46). SN 86-049,808. PUB. 11-26-2013. FILED 8-28-2013.  
 4,481,276. **BANTAM (STANDARD CHARACTER)**. BANTAM BAGELS LLC, MULTIPLE CLASS, (INT. CLS. 30 AND 35), (U.S. CLS. 46, 100, 101 AND 102). SN 86-054,108. PUB. 11-26-2013. FILED 9-3-2013.

### CLASS 31—NATURAL AGRICULTURAL PRODUCTS

- 4,479,257. **LIL' SWEETIES AND DESIGN**. FISHER RANCH CORPORATION, (U.S. CLS. 1 AND 46). SN 77-771,561. PUB. 11-17-2009. FILED 6-30-2009.  
 4,479,271 ( *See Class 1 for this trademark*).  
 4,479,288. **JOLY RED (STANDARD CHARACTER)**. BELGISCHE FRUITVEILING,; COÖPERATIEVE VENNOOTSCHAP; MET BEPERKTE AANSPRAKELIJKHEID, (U.S. CLS. 1 AND 46). SN 79-114,530. PUB. 11-26-2013. FILED 5-11-2012.  
 4,479,329 ( *See Class 5 for this trademark*).  
 4,479,334 ( *See Class 1 for this trademark*).  
 4,479,379. **SUPER YELLOW (STANDARD CHARACTER)**. SUNTORY FLOWERS LIMITED, (U.S. CLS. 1 AND 46). SN 79-126,573. PUB. 11-26-2013. FILED 1-10-2013.  
 4,479,380. **SUPER WHITE (STANDARD CHARACTER)**. SUNTORY FLOWERS LIMITED, (U.S. CLS. 1 AND 46). SN 79-126,584. PUB. 11-26-2013. FILED 1-10-2013.  
 4,479,393. **SUPER BLUE (STANDARD CHARACTER)**. SUNTORY FLOWERS LIMITED, (U.S. CLS. 1 AND 46). SN 79-126,875. PUB. 11-26-2013. FILED 1-10-2013.  
 4,479,531. **NATURAL INSTINCT (STANDARD CHARACTER)**. PETNOLOGY USA, LLC, (U.S. CLS. 1 AND 46). SN 85-262,393. PUB. 11-26-2013. FILED 3-9-2011.  
 4,479,570. **SMALL WONDERS (STANDARD CHARACTER)**. RUSSELL'S NURSERY, (U.S. CLS. 1 AND 46). SN 85-478,151. PUB. 8-20-2013. FILED 11-21-2011.  
 4,479,617. **XLENCE (STANDARD CHARACTER)**. DANZIGER "DAN" FLOWER FARM, (U.S. CLS. 1 AND 46). SN 85-606,092. PUB. 4-16-2013. FILED 4-24-2012.  
 4,479,818 ( *See Class 29 for this trademark*).  
 4,479,967. **EDGAR ALLAN POTPOURRI (STANDARD CHARACTER)**. TUBEHEAD INC, (U.S. CLS. 1 AND 46). SN 85-821,880. PUB. 11-26-2013. FILED 1-12-2013.  
 4,480,458. **ROSSVIEW FARM CONCORD, NH AND DESIGN**. ROSS, DONALD W., DBA ROSSVIEW FARM L.L.C., (U.S. CLS. 1 AND 46). SN 85-954,749. PUB. 11-26-2013. FILED 6-9-2013.  
 4,480,482. **MISCELLANEOUS DESIGN**. SILVA CONSTRUCTION, DBA SILVA LAWN & GARDEN, (U.S. CLS. 1 AND 46). SN 85-957,621. PUB. 11-26-2013. FILED 6-12-2013.  
 4,480,708 ( *See Class 29 for this trademark*).  
 4,480,781. **BIG ZAC (STANDARD CHARACTER)**. J. W. JUNG SEED COMPANY, (U.S. CLS. 1 AND 46). SN 85-974,659. PUB. 11-26-2013. FILED 7-1-2013.  
 4,480,836. **AVOBUDDIES (STANDARD CHARACTER)**. INDEX FRESH, INC., (U.S. CLS. 1 AND 46). SN 86-000,607. PUB. 11-26-2013. FILED 7-2-2013.

- 4,480,847. **AVOBUDDIES AND DESIGN**. INDEX FRESH, INC., (U.S. CLS. 1 AND 46). SN 86-000,737. PUB. 11-26-2013. FILED 7-2-2013.  
 4,481,048. **HOT MEATS (STANDARD CHARACTER)**. COLE'S WILD BIRD PRODUCTS CO., (U.S. CLS. 1 AND 46). SN 86-003,538. PUB. 11-26-2013. FILED 7-6-2013.  
 4,481,050. **FLAMING SQUIRREL (STANDARD CHARACTER)**. COLE'S WILD BIRD PRODUCTS CO., (U.S. CLS. 1 AND 46). SN 86-003,543. PUB. 11-26-2013. FILED 7-6-2013.

### CLASS 32—LIGHT BEVERAGES

- 4,479,260. **NAMI (STANDARD CHARACTER)**. OTSUKA KAGAKU KABUSHIKI KAISHA, DBA OTSUKA CHEMICAL CO., LTD., (U.S. CLS. 45, 46 AND 48). SN 77-893,471. PUB. 10-12-2010. FILED 12-15-2009.  
 4,479,305 ( *See Class 25 for this trademark*).  
 4,479,434 ( *See Class 3 for this trademark*).  
 4,479,465. **MITROFAN LAGIDZE 1887 AND DESIGN**. JOINT-STOCK COMPANY "LAGIDZE", (U.S. CLS. 45, 46 AND 48). SN 79-131,609. PUB. 11-26-2013. FILED 4-18-2013.  
 4,479,519. **HOLY SPIRIT (STANDARD CHARACTER)**. VALGEIR TOMAS SIGURDSSON, (U.S. CLS. 45, 46 AND 48). SN 79-137,194. PUB. 11-26-2013. FILED 5-14-2013.  
 4,479,642. **OBOLON AND DESIGN**. PUBLIC JOINT STOCK COMPANY "OBOLON", (U.S. CLS. 45, 46 AND 48). SN 85-626,148. PUB. 11-26-2013. FILED 5-15-2012.  
 4,479,644. **OBOLON AND DESIGN**. PUBLIC JOINT STOCK COMPANY "OBOLON", (U.S. CLS. 45, 46 AND 48). SN 85-626,222. PUB. 11-26-2013. FILED 5-15-2012.  
 4,479,665. **PILSENER LAGER BIER BLUE GIRL EXCELSIOR AND DESIGN**. BGB INTERNATIONAL HOLDING AKTIENGESELLSCHAFT, (U.S. CLS. 45, 46 AND 48). SN 85-637,906. PUB. 5-14-2013. FILED 5-30-2012.  
 4,479,684. **TU ME TURMERICWATER TU ME TURMEICWATER AND DESIGN**. ZAIDI, NASIR J, DBA TU ME BEVERAGE COMPANY, (U.S. CLS. 45, 46 AND 48). SN 85-656,975. PUB. 11-26-2013. FILED 6-20-2012.  
 4,479,757. **ROCKY HOP IPA (STANDARD CHARACTER)**. SAW WORKS BREWING COMPANY, LLC, (U.S. CLS. 45, 46 AND 48). SN 85-744,723. PUB. 7-16-2013. FILED 10-3-2012.  
 4,479,839. **SYN CLEANSE (STANDARD CHARACTER)**. HAZEL CEBRUN, (U.S. CLS. 45, 46 AND 48). SN 85-786,418. PUB. 11-26-2013. FILED 11-24-2012.  
 4,479,948. **TRVE BREWING COMPANY (STANDARD CHARACTER)**. TRVE BREWING COMPANY LLC, DBA TRVE BREWING CO., MULTIPLE CLASS, (INT. CLS. 32 AND 43), (U.S. CLS. 45, 46, 48, 100 AND 101). SN 85-814,786. PUB. 11-26-2013. FILED 1-3-2013.  
 4,479,954 ( *See Class 25 for this trademark*).  
 4,479,959. **HOLY CITY BREWING AND DESIGN**. HOLY CITY BREWING, LLC, (U.S. CLS. 45, 46 AND 48). SN 85-818,199. PUB. 11-26-2013. FILED 1-8-2013.  
 4,479,965. **SUN KING BREWERY KING'S RESERVE SPECIALTY BEER AND DESIGN**. SUN KING BREWING COMPANY, LLC, (U.S. CLS. 45, 46 AND 48). SN 85-821,368. PUB. 6-25-2013. FILED 1-11-2013.  
 4,479,966. **SUN KING BREWERY SINK THE CLIPPER IMPERIAL ESB WWW.SUNKINGBREWING.COM AND DESIGN**. SUN KING BREWING COMPANY, LLC, (U.S. CLS. 45, 46 AND 48). SN 85-821,454. PUB. 6-25-2013. FILED 1-11-2013.  
 4,479,977. **ENERGY REDEFINED (STANDARD CHARACTER)**. BLACK BEAR ENERGY, LLC, (U.S. CLS. 45, 46 AND 48). SN 85-824,233. PUB. 11-26-2013. FILED 1-16-2013.  
 4,479,986. **POWER FRESH FRESHENS BREATH ENERGY DRINK AND DESIGN**. POWER FRESH GROUP INC, (U.S. CLS. 45, 46 AND 48). SN 85-826,378. PUB. 11-26-2013. FILED 1-18-2013.  
 4,480,222 ( *See Class 5 for this trademark*).  
 4,480,323. **ALASKAN AMBER ALT STYLE ALE (STANDARD CHARACTER)**. ALASKAN BREWING & BOTTLING CO., DBA ALASKAN BREWING CO., (U.S. CLS. 45, 46 AND 48). SN 85-936,508. PUB. 11-26-2013. FILED 5-20-2013.  
 4,480,324. **ALASKAN SUMMER KOLSCH STYLE ALE (STANDARD CHARACTER)**. ALASKAN BREWING & BOT-

- TLING CO., DBA ALASKAN BREWING CO., (U.S. CLS. 45, 46 AND 48). SN 85-936,560. PUB. 11-26-2013. FILED 5-20-2013.
- 4,480,391. **VIGILANTE IPA (STANDARD CHARACTER)**. BRIDGER BREWING COMPANY LLC, (U.S. CLS. 45, 46 AND 48). SN 85-945,649. PUB. 11-26-2013. FILED 5-29-2013.
- 4,480,419. **SOFIE PARADISI (STANDARD CHARACTER)**. FULTON STREET BREWERY LLC, (U.S. CLS. 45, 46 AND 48). SN 85-949,315. PUB. 11-26-2013. FILED 6-3-2013.
- 4,480,431. **DEMITRI'S GOURMET MIXES (STANDARD CHARACTER)**. PALLIS, DEMETRE, DBA GOURMET MIXES, INC., (U.S. CLS. 45, 46 AND 48). SN 85-950,737. PUB. 11-26-2013. FILED 6-4-2013.
- 4,480,587. **FRUITS A POPPIN (STYLIZED)**. BFC, INC., (U.S. CLS. 45, 46 AND 48). SN 85-965,625. PUB. 11-26-2013. FILED 6-20-2013.
- 4,480,680. **SMASHED PUMPKIN (STANDARD CHARACTER)**. SHIPYARD BREWING COMPANY, LLC, (U.S. CLS. 45, 46 AND 48). SN 85-970,083. PUB. 11-26-2013. FILED 6-26-2013.
- 4,480,683. **SMASHED BLUEBERRY (STANDARD CHARACTER)**. SHIPYARD BREWING COMPANY, LLC, (U.S. CLS. 45, 46 AND 48). SN 85-970,092. PUB. 11-26-2013. FILED 6-26-2013.
- 4,480,704 ( *See Class 1 for this trademark*).
- 4,480,768. **I AM BRANDS (STANDARD CHARACTER)**. I AM BRANDS, INC., MULTIPLE CLASS, (INT. CLS. 32 AND 36), (U.S. CLS. 45, 46, 48, 100, 101 AND 102). SN 85-974,103. PUB. 11-26-2013. FILED 7-1-2013.
- 4,480,785. **7B SIETE BARRIOS (STYLIZED)**. CERVEZAS EXTRA PREMIUM DE SAN LUIS, S DE RL DE CV, (U.S. CLS. 45, 46 AND 48). SN 85-974,745. PUB. 11-26-2013. FILED 7-1-2013.
- 4,480,916. **RECHARGE NATURALLY (STANDARD CHARACTER)**. SUN BEVERAGES, INC., (U.S. CLS. 45, 46 AND 48). SN 86-001,983. PUB. 11-26-2013. FILED 7-3-2013.
- 4,480,986 ( *See Class 21 for this trademark*).
- 4,481,037. **PRODUCE IN A BOTTLE (STANDARD CHARACTER)**. FARM TO FORK PRODUCE LLC, (U.S. CLS. 45, 46 AND 48). SN 86-003,363. PUB. 11-26-2013. FILED 7-5-2013.
- 4,481,084. **L'PL NAPOLEON (STANDARD CHARACTER)**. PENSACOLA BAY BREWERY, LLC, (U.S. CLS. 45, 46 AND 48). SN 86-004,040. PUB. 11-26-2013. FILED 7-8-2013.
- 4,481,216 ( *See Class 30 for this trademark*).
- 4,481,217. **BLUTRIENTS (STANDARD CHARACTER)**. SUJA LIFE, LLC, DBA SUJA JUICE, (U.S. CLS. 45, 46 AND 48). SN 86-013,307. PUB. 11-26-2013. FILED 7-17-2013.
- 4,481,218. **BERRYOXIDANT (STANDARD CHARACTER)**. SUJA LIFE, LLC, DBA SUJA JUICE, (U.S. CLS. 45, 46 AND 48). SN 86-013,316. PUB. 11-26-2013. FILED 7-17-2013.

---

### CLASS 33—WINES AND SPIRITS

- 4,479,348. **TWO CONTINENTS 2 WINES IN 1 BOX AND DESIGN**. GLOBAL WINE HOUSE OÜ, (U.S. CLS. 47 AND 49). SN 79-124,915. PUB. 11-26-2013. FILED 12-12-2012.
- 4,479,411. **LAUTERGOLD (STANDARD CHARACTER)**. LAUTERGOLD PAUL SCHUBERT GMBH, (U.S. CLS. 47 AND 49). SN 79-127,645. PUB. 11-26-2013. FILED 1-23-2013.
- 4,479,470. **INVILLA (STANDARD CHARACTER)**. BISOL DESIDERIO & FIGLI SOCIETÀ AGRICOLA S.S., (U.S. CLS. 47 AND 49). SN 79-132,043. PUB. 11-26-2013. FILED 5-31-2013.
- 4,479,481. **CAPE ROOT (STANDARD CHARACTER)**. SAINT FERDINAND GMBH, (U.S. CLS. 47 AND 49). SN 79-133,362. PUB. 11-26-2013. FILED 5-25-2013.
- 4,479,486. **GG AND DESIGN**. VERBAND DEUTSCHER PRÄDIKATSWINGÜTER E.V., MULTIPLE CLASS, (INT. CLS. 33, 35 AND 41), (U.S. CLS. 47, 49, 100, 101, 102 AND 107). SN 79-133,803. PUB. 11-26-2013. FILED 6-3-2013.
- 4,479,489. **DRINK HOUSE (STYLIZED)**. SEMERKA LIMITED, (U.S. CLS. 47 AND 49). SN 79-134,004. PUB. 11-26-2013. FILED 4-17-2013.
- 4,479,564. **VERDI SPUMANTE (STANDARD CHARACTER)**. BOSCA S.P.A., (U.S. CLS. 47 AND 49). SN 85-470,074. PUB. 10-16-2012. FILED 11-11-2011.
- 4,479,613. **DON LADISLAO (STANDARD CHARACTER)**. INVERSIONES FAMILIARES S.A., (U.S. CLS. 47 AND 49). SN

- 85-597,583. PUB. 11-26-2013. FILED 4-13-2012.
- 4,479,837. **JEAN-MARC XO VODKA AND DESIGN**. SKYY SPIRITS, LLC, (U.S. CLS. 47 AND 49). SN 85-784,856. PUB. 11-26-2013. FILED 11-21-2012.
- 4,479,867. **BLOODY BUTCHER (STANDARD CHARACTER)**. CACAO HOLDINGS, LLC, (U.S. CLS. 47 AND 49). SN 85-797,057. PUB. 11-26-2013. FILED 12-7-2012.
- 4,479,938. **TACTICAL DRINKING (STANDARD CHARACTER)**. FLASHBANG INC, (U.S. CLS. 47 AND 49). SN 85-811,391. PUB. 11-26-2013. FILED 12-27-2012.
- 4,480,023. **BLOOMERY SWEETSHINE (STANDARD CHARACTER)**. BLOOMERY PLANTATION DISTILLERY, LLC, (U.S. CLS. 47 AND 49). SN 85-838,267. PUB. 11-26-2013. FILED 2-1-2013.
- 4,480,141. **DASHFIRE (STANDARD CHARACTER)**. DASHFIRE LLC, (U.S. CLS. 47 AND 49). SN 85-885,345. PUB. 11-26-2013. FILED 3-25-2013.
- 4,480,163. **SUMMIT CREEK (STANDARD CHARACTER)**. OPOLO VINEYARDS, INC., (U.S. CLS. 47 AND 49). SN 85-894,426. PUB. 11-26-2013. FILED 4-3-2013.
- 4,480,226. **MISCELLANEOUS DESIGN**. OKUCHI SHUZO KABUSHIKIKAISHA, (U.S. CLS. 47 AND 49). SN 85-913,403. PUB. 11-26-2013. FILED 4-24-2013.
- 4,480,227. **MISCELLANEOUS DESIGN**. OKUCHI SHUZO KABUSHIKIKAISHA, (U.S. CLS. 47 AND 49). SN 85-913,434. PUB. 11-26-2013. FILED 4-24-2013.
- 4,480,531. **REFUGIO LOS 33 (STANDARD CHARACTER)**. BODEGA Y VINEDOS CASANUEVA LTDA., (U.S. CLS. 47 AND 49). SN 85-963,580. PUB. 11-26-2013. FILED 6-19-2013.
- 4,480,574. **HIGHLAND JOURNEY (STANDARD CHARACTER)**. HUNTER LAING & COMPANY LIMITED, (U.S. CLS. 47 AND 49). SN 85-965,139. PUB. 11-26-2013. FILED 6-20-2013.
- 4,480,584. **MAD MINT (STANDARD CHARACTER)**. BATCH 206 DISTILLERY, LLC, (U.S. CLS. 47 AND 49). SN 85-965,546. PUB. 11-26-2013. FILED 6-20-2013.
- 4,480,599. **SUSANNA'S VINEYARD (STANDARD CHARACTER)**. LYNN C. FRITZ, DBA LYNMAR ESTATE, (U.S. CLS. 47 AND 49). SN 85-966,295. PUB. 11-26-2013. FILED 6-21-2013.
- 4,480,612. **GENOA CELLARS (STANDARD CHARACTER)**. GENOA CELLARS LLC, (U.S. CLS. 47 AND 49). SN 85-967,236. PUB. 11-26-2013. FILED 6-22-2013.
- 4,480,732. **THE SOFTER SIDE OF SPIRITS (STANDARD CHARACTER)**. MANZANITA DISTILLING COMPANY, (U.S. CLS. 47 AND 49). SN 85-972,557. PUB. 11-26-2013. FILED 6-28-2013.
- 4,480,790. **MISCELLANEOUS DESIGN**. SHAW-ROSS INTERNATIONAL IMPORTERS, INC., (U.S. CLS. 47 AND 49). SN 85-974,956. PUB. 11-26-2013. FILED 7-1-2013.
- 4,480,859. **SMIFF, SWIRL, SIP & SAVOR (STANDARD CHARACTER)**. DONNA LYNN BASTIANON, (U.S. CLS. 47 AND 49). SN 86-000,884. PUB. 11-26-2013. FILED 7-2-2013.
- 4,480,908. **THE TURTLE CLUB AND DESIGN**. THE TURTLE CLUB, LLC, (U.S. CLS. 47 AND 49). SN 86-001,815. PUB. 11-26-2013. FILED 7-3-2013.
- 4,480,945. **CF COL FRANCESCO AND DESIGN**. SAPORI ITALIANI SRL, MULTIPLE CLASS, (INT. CLS. 33 AND 35), (U.S. CLS. 47, 49, 100, 101 AND 102). SN 86-002,274. PUB. 11-26-2013. FILED 7-3-2013.
- 4,480,957. **ROSY CHEEKS (STANDARD CHARACTER)**. SWEET CHEEKS VINEYARDS, INC., (U.S. CLS. 47 AND 49). SN 86-002,432. PUB. 11-26-2013. FILED 7-3-2013.
- 4,481,183. **THE BIG PICTURE (STANDARD CHARACTER)**. ICT INVESTMENT PROPERTIES, INC., (U.S. CLS. 47 AND 49). SN 86-005,704. PUB. 11-26-2013. FILED 7-9-2013.

---

### CLASS 34—SMOKERS' ARTICLES

- 4,479,324 ( *See Class 6 for this trademark*).
- 4,479,326. **M (STYLIZED)**. B.V. MICRES, (U.S. CLS. 2, 8, 9 AND 17). SN 79-123,729. PUB. 8-20-2013. FILED 12-11-2012.
- 4,479,415. **JAKOBSSONS DYNAMITE POWERFUL SWEDISH SNUS AND DESIGN**. GOTLANDS SNUS AB, (U.S. CLS. 2, 8, 9 AND 17). SN 79-127,815. PUB. 11-26-2013. FILED 1-11-

2013.  
 4,479,508. **MISCELLANEOUS DESIGN**. CHINA TOBACCO HUNAN; INDUSTRIAL CO., LTD., (U.S. CLS. 2, 8, 9 AND 17). SN 79-135,591. PUB. 11-26-2013. FILED 6-10-2013.  
 4,479,515. **GLIDE TEC (STANDARD CHARACTER)**. VAN NELLE TABAK NEDERLAND B.V., (U.S. CLS. 2, 8, 9 AND 17). SN 79-136,564. PUB. 11-26-2013. FILED 6-12-2013.  
 4,479,599. **LAVATUBE AND DESIGN**. JOCOR ENTERPRISES, (U.S. CLS. 2, 8, 9 AND 17). SN 85-558,290. PUB. 11-26-2013. FILED 3-2-2012.  
 4,479,624. **MALIBU AND DESIGN**. COMMONWEALTH BRANDS, INC., (U.S. CLS. 2, 8, 9 AND 17). SN 85-616,569. PUB. 11-26-2013. FILED 5-4-2012.  
 4,479,645. **ELIE BLEU (STANDARD CHARACTER)**. EBI, (U.S. CLS. 2, 8, 9 AND 17). SN 85-631,274. PUB. 5-7-2013. FILED 5-22-2012.  
 4,480,019. **FLAVOR VAPES FV AND DESIGN**. UTVG EUROPE HOLDING B.V., (U.S. CLS. 2, 8, 9 AND 17). SN 85-836,587. PUB. 7-16-2013. FILED 1-30-2013.  
 4,480,235 ( *See Class 30 for this trademark* ).  
 4,480,369. **20 MINUTES IN CHICAGO (STANDARD CHARACTER)**. 20 MINUTES CIGAR COMPANY, (U.S. CLS. 2, 8, 9 AND 17). SN 85-944,033. PUB. 11-26-2013. FILED 5-28-2013.  
 4,480,922. **XOTIC LUSH (STANDARD CHARACTER)**. UNITABAC, LLC, (U.S. CLS. 2, 8, 9 AND 17). SN 86-002,058. PUB. 11-26-2013. FILED 7-3-2013.  
 4,479,357. **MTS AND DESIGN**. SOCIETA' PER IL MERCATO; DEI TITOLI DI STATO S.P.A.; IN SHORT MTS S.P.A., MULTIPLE CLASS, (INT. CLS. 35, 36 AND 38), (U.S. CLS. 100, 101, 102 AND 104). SN 79-125,870. PUB. 11-26-2013. FILED 7-27-2012.  
 4,479,374 ( *See Class 9 for this trademark* ).  
 4,479,399 ( *See Class 9 for this trademark* ).  
 4,479,413 ( *See Class 9 for this trademark* ).  
 4,479,425. **LENGOW (STANDARD CHARACTER)**. LENGOW, MULTIPLE CLASS, (INT. CLS. 35, 38 AND 42), (U.S. CLS. 100, 101, 102 AND 104). SN 79-128,477. PUB. 11-26-2013. FILED 2-19-2013.  
 4,479,433 ( *See Class 16 for this trademark* ).  
 4,479,441 ( *See Class 9 for this trademark* ).  
 4,479,446. **P PERCEPTICS AND DESIGN**. PERCEPTICS INTERNATIONAL PTY LTD, MULTIPLE CLASS, (INT. CLS. 35 AND 41), (U.S. CLS. 100, 101, 102 AND 107). SN 79-129,821. PUB. 8-20-2013. FILED 2-6-2013.  
 4,479,447 ( *See Class 14 for this trademark* ).  
 4,479,448 ( *See Class 9 for this trademark* ).  
 4,479,469 ( *See Class 9 for this trademark* ).  
 4,479,484. **METAPS (STYLIZED)**. METAPS INC., (U.S. CLS. 100, 101 AND 102). SN 79-133,724. PUB. 11-26-2013. FILED 5-21-2013.  
 4,479,486 ( *See Class 33 for this trademark* ).  
 4,479,538 ( *See Class 9 for this trademark* ).  
 4,479,543 ( *See Class 16 for this trademark* ).  
 4,479,545 ( *See Class 12 for this trademark* ).  
 4,479,547 ( *See Class 12 for this trademark* ).  
 4,479,550. **THE BRAND CAFE (STANDARD CHARACTER)**. THE BRAND CAFE INC., MULTIPLE CLASS, (INT. CLS. 35, 36, 40, 42 AND 45), (U.S. CLS. 100, 101, 102, 103 AND 106). SN 85-420,254. PUB. 11-26-2013. FILED 9-12-2011.  
 4,479,574. **HUNGER-FREE PENNSYLVANIA (STANDARD CHARACTER)**. PENNSYLVANIA ASSOCIATION OF REGIONAL FOOD BANKS, (U.S. CLS. 100, 101 AND 102). SN 85-496,565. PUB. 11-26-2013. FILED 12-15-2011.  
 4,479,575 ( *See Class 9 for this trademark* ).  
 4,479,578 ( *See Class 3 for this trademark* ).  
 4,479,580. **LOCK SURGEON (STANDARD CHARACTER)**. A.AB LOCK SURGEON LTD., MULTIPLE CLASS, (INT. CLS. 35, 37 AND 40), (U.S. CLS. 100, 101, 102, 103 AND 106). SN 85-520,156. PUB. 11-26-2013. FILED 1-19-2012.  
 4,479,581. **DOOR & LOCK SURGEON (STANDARD CHARACTER)**. A.AB LOCK SURGEON LTD., MULTIPLE CLASS, (INT. CLS. 35, 37 AND 40), (U.S. CLS. 100, 101, 102, 103 AND 106). SN 85-520,189. PUB. 11-26-2013. FILED 1-19-2012.  
 4,479,585 ( *See Class 7 for this trademark* ).  
 4,479,596 ( *See Class 8 for this trademark* ).  
 4,479,597. **1ST CARE MD (STANDARD CHARACTER)**. OHARA, CHRIS, (U.S. CLS. 100, 101 AND 102). SN 85-555,743. PUB. 11-26-2013. FILED 2-29-2012.  
 4,479,598. **SPERRY MEDIA (STANDARD CHARACTER)**. PERRY, SCOTT E, (U.S. CLS. 100, 101 AND 102). SN 85-556,302. PUB. 8-28-2012. FILED 2-29-2012.  
 4,479,601 ( *See Class 18 for this trademark* ).  
 4,479,602 ( *See Class 18 for this trademark* ).  
 4,479,610 ( *See Class 16 for this trademark* ).  
 4,479,611. **BECOMING YOUR BEST (STANDARD CHARACTER)**. EAGLE SYSTEMS INTERNATIONAL, INC., (U.S. CLS. 100, 101 AND 102). SN 85-583,678. PUB. 11-26-2013. FILED 3-29-2012.  
 4,479,616 ( *See Class 18 for this trademark* ).  
 4,479,620. **THE COMFREE NETWORK (STANDARD CHARACTER)**. DUPPROPIO INC., MULTIPLE CLASS, (INT. CLS. 35 AND 36), (U.S. CLS. 100, 101 AND 102). SN 85-607,898. PUB. 11-26-2013. FILED 4-25-2012.  
 4,479,629. **BERSINBASICS (STANDARD CHARACTER)**. DELOITTE DEVELOPMENT LLC, (U.S. CLS. 100, 101 AND 102). SN 85-620,465. PUB. 11-26-2013. FILED 5-9-2012.  
 4,479,632 ( *See Class 9 for this trademark* ).  
 4,479,633. **ILLINOIS CITIZENS FOR ETHICS (STANDARD CHARACTER)**. ILLINOIS CITIZENS FOR ETHICS, (U.S. CLS. 100, 101 AND 102). SN 85-623,035. PUB. 6-18-2013. FILED 5-11-2012.  
 4,479,640. **ONE FIRM PUTTING ALL THE PIECES TOGETHER (STANDARD CHARACTER)**. MOSAIC STRATE-

---

## SERVICE MARKS

### CLASS 35—ADVERTISING AND BUSINESS

- 4,479,253 ( *See Class 12 for this trademark* ).  
 4,479,266 ( *See Class 10 for this trademark* ).  
 4,479,267. **TREATS UNLEASHED GOURMUTT BAKERY & BOUTIQUE AND DESIGN**. TREATS UNLEASHED, INC., (U.S. CLS. 100, 101 AND 102). SN 78-664,825. PUB. 4-28-2009. FILED 7-6-2005.  
 4,479,273 ( *See Class 3 for this trademark* ).  
 4,479,277 ( *See Class 9 for this trademark* ).  
 4,479,279 ( *See Class 9 for this trademark* ).  
 4,479,280 ( *See Class 9 for this trademark* ).  
 4,479,283 ( *See Class 3 for this trademark* ).  
 4,479,290 ( *See Class 3 for this trademark* ).  
 4,479,296 ( *See Class 16 for this trademark* ).  
 4,479,300 ( *See Class 16 for this trademark* ).  
 4,479,302. **NMI AND DESIGN**. NMI CERTIN B.V., MULTIPLE CLASS, (INT. CLS. 35 AND 42), (U.S. CLS. 100, 101 AND 102). SN 79-118,286. PUB. 11-26-2013. FILED 7-3-2012.  
 4,479,305 ( *See Class 25 for this trademark* ).  
 4,479,309. **ORÍES ART / GALERIE AND DESIGN**. ARIES, MULTIPLE CLASS, (INT. CLS. 35 AND 41), (U.S. CLS. 100, 101, 102 AND 107). SN 79-120,398. PUB. 11-26-2013. FILED 9-27-2012.  
 4,479,311 ( *See Class 18 for this trademark* ).  
 4,479,325 ( *See Class 6 for this trademark* ).  
 4,479,327 ( *See Class 5 for this trademark* ).  
 4,479,331 ( *See Class 5 for this trademark* ).  
 4,479,336. **5 S ITALY AUGMENTED AND DESIGN**. 5 SENSI DI TRUSHNIKOVA SVETLANA, MULTIPLE CLASS, (INT. CLS. 35 AND 38), (U.S. CLS. 100, 101, 102 AND 104). SN 79-124,079. PUB. 11-26-2013. FILED 12-14-2012.  
 4,479,339 ( *See Class 9 for this trademark* ).  
 4,479,341 ( *See Class 25 for this trademark* ).  
 4,479,350. **ADP ANTWERP DIAMOND PAVILION (STYLIZED)**. ANTWERP WORLD DIAMOND CENTRE.; PRIVATE STICHTING, MULTIPLE CLASS, (INT. CLS. 35, 36 AND 41), (U.S. CLS. 100, 101, 102 AND 107). SN 79-124,953. PUB. 6-11-2013. FILED 11-19-2012.  
 4,479,353 ( *See Class 7 for this trademark* ).  
 4,479,355. **BRAND BY SPONSORPAY ENGAGE. (STYLIZED)**. SPONSORPAY GMBH, MULTIPLE CLASS, (INT. CLS. 35, 38 AND 41), (U.S. CLS. 100, 101, 102, 104 AND 107). SN 79-125,324. PUB. 11-26-2013. FILED 9-21-2012.  
 4,479,356 ( *See Class 9 for this trademark* ).

- GIC PARTNERS, LLC, MULTIPLE CLASS, (INT. CLS. 35, 36 AND 41), (U.S. CLS. 100, 101, 102 AND 107). SN 85-625,115. PUB. 11-26-2013. FILED 5-14-2012.
- 4,479,641. **GENUINECARING.COM (STANDARD CHARACTER)**. FIEGEL, GARY J., (U.S. CLS. 100, 101 AND 102). SN 85-626,140. PUB. 11-26-2013. FILED 5-15-2012.
- 4,479,643. **MISCELLANEOUS DESIGN**. FIEGEL, GARY J., (U.S. CLS. 100, 101 AND 102). SN 85-626,190. PUB. 11-26-2013. FILED 5-15-2012.
- 4,479,653. **COMMUNITY HEALTH CHARITIES (STANDARD CHARACTER)**. COMMUNITY HEALTH CHARITIES, AKA CHC, (U.S. CLS. 100, 101 AND 102). SN 85-634,060. PUB. 11-26-2013. FILED S.R. 5-24-2012; AM. P.R. 9-17-2013.
- 4,479,659. **BLUE ZONES INSTITUTE (STANDARD CHARACTER)**. BLUE ZONES LLC, MULTIPLE CLASS, (INT. CLS. 35 AND 41), (U.S. CLS. 100, 101, 102 AND 107). SN 85-635,553. PUB. 5-7-2013. FILED 5-25-2012.
- 4,479,668. **ABOGADOS FUERZA (STANDARD CHARACTER)**. PROJECT WEST MEDIA, INC., (U.S. CLS. 100, 101 AND 102). SN 85-640,301. PUB. 11-26-2013. FILED 5-31-2012.
- 4,479,675. **BODYFACTORY (STANDARD CHARACTER)**. ROBERT ASHLEY GREEN, (U.S. CLS. 100, 101 AND 102). SN 85-649,291. PUB. 11-26-2013. FILED 6-12-2012.
- 4,479,680 ( *See Class 9 for this trademark*).
- 4,479,687 ( *See Class 16 for this trademark*).
- 4,479,691. **CATHOLIC PULSE (STANDARD CHARACTER)**. KNIGHTS OF COLUMBUS, MULTIPLE CLASS, (INT. CLS. 35, 41 AND 45), (U.S. CLS. 100, 101, 102 AND 107). SN 85-663,960. PUB. 11-26-2013. FILED 6-28-2012.
- 4,479,695. **M MASTERFOREX - V AND DESIGN**. ZUBENKOMAKAGONOV, VIACHESLAV VASYLYOVYCH, MULTIPLE CLASS, (INT. CLS. 35, 36 AND 38), (U.S. CLS. 100, 101, 102 AND 104). SN 85-669,081. PUB. 5-14-2013. FILED 7-5-2012.
- 4,479,696. **POD COACHING (STANDARD CHARACTER)**. AHK RECRUITMENT LIMITED, MULTIPLE CLASS, (INT. CLS. 35, 38 AND 39), (U.S. CLS. 100, 101, 102, 104 AND 105). SN 85-670,100. PUB. 7-9-2013. FILED 7-6-2012.
- 4,479,698. **PINK PIXIE AND DESIGN**. REED, CARINA DAWN, DBA PINK PIXIE, (U.S. CLS. 100, 101 AND 102). SN 85-671,097. PUB. 7-23-2013. FILED 7-8-2012.
- 4,479,704. **LABORATORY CORPORATION OF AMERICA (STANDARD CHARACTER)**. LABORATORY CORPORATION OF AMERICA HOLDINGS, MULTIPLE CLASS, (INT. CLS. 35, 38, 39 AND 44), (U.S. CLS. 100, 101, 102, 104 AND 105). SN 85-679,998. PUB. 11-26-2013. FILED 7-18-2012.
- 4,479,713. **PERCEPTION OF A DIFFERENCE (STANDARD CHARACTER)**. WZA, INC., (U.S. CLS. 100, 101 AND 102). SN 85-697,012. PUB. 11-26-2013. FILED 8-7-2012.
- 4,479,717. **BABALÚ (STANDARD CHARACTER)**. BABALU MIAMI, INC, DBA BABALU, (U.S. CLS. 100, 101 AND 102). SN 85-702,248. PUB. 11-26-2013. FILED 8-13-2012.
- 4,479,719. **LITTLE PEOPLE OF AMERICA (STANDARD CHARACTER)**. LITTLE PEOPLE OF AMERICA, INC., MULTIPLE CLASS, (INT. CLS. 35 AND 41), (U.S. CLS. 100, 101, 102 AND 107). SN 85-704,460. PUB. 11-26-2013. FILED 8-15-2012.
- 4,479,723. **BBB AND DESIGN**. BUY BUY BABY, INC., (U.S. CLS. 100, 101 AND 102). SN 85-714,997. PUB. 8-20-2013. FILED 8-28-2012.
- 4,479,734. **NATIONWIDE MEDICAL, INC. AND DESIGN**. NATIONWIDE MEDICAL, INC., (U.S. CLS. 100, 101 AND 102). SN 85-724,969. PUB. 11-26-2013. FILED 9-10-2012.
- 4,479,741. **NCPA NATIONAL COLLEGE PLAYERS ASSOCIATION AND DESIGN**. NATIONAL COLLEGE PLAYERS ASSOCIATION, MULTIPLE CLASS, (INT. CLS. 35 AND 41), (U.S. CLS. 100, 101, 102 AND 107). SN 85-731,325. PUB. 11-26-2013. FILED 9-18-2012.
- 4,479,742. **HOUSE OF CUPCAKES (STANDARD CHARACTER)**. HOUSE OF CUPCAKES, LLC, (U.S. CLS. 100, 101 AND 102). SN 85-733,009. PUB. 11-26-2013. FILED 9-19-2012.
- 4,479,744. **PORK SOCIAL (STANDARD CHARACTER)**. NATIONAL PORK BOARD, MULTIPLE CLASS, (INT. CLS. 35 AND 42), (U.S. CLS. 100, 101 AND 102). SN 85-733,583. PUB. 11-26-2013. FILED 9-20-2012.
- 4,479,747. **NEIN DER KLUB (STANDARD CHARACTER)**. SAUNDERS, JULIET N, AND ROBLES, LUIS, (U.S. CLS. 100, 101 AND 102). SN 85-734,462. PUB. 11-26-2013. FILED 9-20-2012.
- 4,479,748 ( *See Class 25 for this trademark*).
- 4,479,752. **AMOREPACIFIC K-BEAUTY (STYLIZED)**. AMOREPACIFIC CORPORATION, (U.S. CLS. 100, 101 AND 102). SN 85-737,876. PUB. 11-26-2013. FILED 9-25-2012.
- 4,479,753. **HMI PERFORMANCE INCENTIVES (STANDARD CHARACTER)**. HMI INC, DBA HMI PERFORMANCE INCENTIVES, (U.S. CLS. 100, 101 AND 102). SN 85-738,739. PUB. 11-26-2013. FILED 9-26-2012.
- 4,479,754 ( *See Class 9 for this trademark*).
- 4,479,755. **ISEE AND DESIGN**. C & E GP SPECIALISTS, INC., MULTIPLE CLASS, (INT. CLS. 35 AND 40), (U.S. CLS. 100, 101, 102, 103 AND 106). SN 85-740,326. PUB. 8-20-2013. FILED 9-27-2012.
- 4,479,756. **WEATHERSMART (STANDARD CHARACTER)**. PLANALYTICS, INC., (U.S. CLS. 100, 101 AND 102). SN 85-740,984. PUB. 11-26-2013. FILED 9-28-2012.
- 4,479,759. **ESCAPE OUTDOORS GET YOUR ADVENTURE ON (STANDARD CHARACTER)**. ESCAPE OUTDOORS, LLC, (U.S. CLS. 100, 101 AND 102). SN 85-746,637. PUB. 11-26-2013. FILED 10-5-2012.
- 4,479,764 ( *See Class 14 for this trademark*).
- 4,479,765 ( *See Class 14 for this trademark*).
- 4,479,768 ( *See Class 9 for this trademark*).
- 4,479,771. **CLARK HALL DOORS (STANDARD CHARACTER)**. DOORS BY DESIGN INTERNATIONAL, LLC, (U.S. CLS. 100, 101 AND 102). SN 85-755,179. PUB. 11-26-2013. FILED 10-16-2012.
- 4,479,778 ( *See Class 9 for this trademark*).
- 4,479,780. **URBAN GIRL ACCESSORIES (STANDARD CHARACTER)**. LG RETAIL ENTERPRISES, INC., (U.S. CLS. 100, 101 AND 102). SN 85-759,824. PUB. 11-26-2013. FILED 10-22-2012.
- 4,479,781 ( *See Class 9 for this trademark*).
- 4,479,783. **MISCELLANEOUS DESIGN**. CUREEO, LLC, (U.S. CLS. 100, 101 AND 102). SN 85-762,356. PUB. 11-26-2013. FILED 10-24-2012.
- 4,479,785. **I-STOCKIT (STANDARD CHARACTER)**. JEM INVESTMENT GROUP LLC, (U.S. CLS. 100, 101 AND 102). SN 85-765,034. PUB. 6-11-2013. FILED 10-26-2012.
- 4,479,786. **TEEN GLAMOUR GIRLS (STANDARD CHARACTER)**. GRADY, JAMES S, DBA GROUP FIVE PHOTO-SPORTS, (U.S. CLS. 100, 101 AND 102). SN 85-765,255. PUB. 11-26-2013. FILED 10-26-2012.
- 4,479,800. **SOUTHERN SALES SOLUTIONS (STANDARD CHARACTER)**. SOUTHERN SALES SOLUTIONS LLC, MULTIPLE CLASS, (INT. CLS. 35 AND 36), (U.S. CLS. 100, 101 AND 102). SN 85-772,636. PUB. 11-26-2013. FILED 11-6-2012.
- 4,479,808. **EMERGING LEADERS SUMMER INTERNSHIP PROGRAM FOR COLLEGE STUDENTS WITH DISABILITIES (STANDARD CHARACTER)**. JUST ONE BREAK, INC., DBA NATIONAL BUSINESS & DISABILITY COUNCIL, (U.S. CLS. 100, 101 AND 102). SN 85-776,048. PUB. 11-26-2013. FILED 11-9-2012.
- 4,479,813. **DESIGNSHERPA (STANDARD CHARACTER)**. NETWORK COMMUNICATIONS, INC., MULTIPLE CLASS, (INT. CLS. 35 AND 42), (U.S. CLS. 100, 101 AND 102). SN 85-777,260. PUB. 8-6-2013. FILED 11-12-2012.
- 4,479,818 ( *See Class 29 for this trademark*).
- 4,479,825. **STRATUS CONTACT SOLUTIONS (STANDARD CHARACTER)**. ILD CORP., (U.S. CLS. 100, 101 AND 102). SN 85-780,063. PUB. 5-7-2013. FILED 11-15-2012.
- 4,479,836. **SRI SIGNATURE RESEARCH INSTITUTE AND DESIGN**. SIGNATURE RESEARCH INSTITUTE, INC, MULTIPLE CLASS, (INT. CLS. 35, 41 AND 42), (U.S. CLS. 100, 101, 102 AND 107). SN 85-784,544. PUB. 11-26-2013. FILED 11-20-2012.
- 4,479,840. **MISCELLANEOUS DESIGN**. BIG BEACON, (U.S. CLS. 100, 101 AND 102). SN 85-787,904. PUB. 11-26-2013. FILED 11-27-2012.
- 4,479,841. **BIG BEACON (STANDARD CHARACTER)**. BIG BEACON, (U.S. CLS. 100, 101 AND 102). SN 85-787,910. PUB. 11-26-2013. FILED 11-27-2012.
- 4,479,850. **RATTLEBACK (STANDARD CHARACTER)**. RATTLEBACK, INC., (U.S. CLS. 100, 101 AND 102). SN 85-791,822. PUB. 11-26-2013. FILED 11-30-2012.
- 4,479,852 ( *See Class 9 for this trademark*).

- 4,479,869. **LUCID METHOD (STANDARD CHARACTER)**. BEALE COMMUNICATIONS, LLC, (U.S. CLS. 100, 101 AND 102). SN 85-797,345. PUB. 11-26-2013. FILED 12-7-2012.
- 4,479,881. **GSM OUTDOORS THINK OUTSIDE AND DESIGN**. I.P. HOLDINGS, INC., (U.S. CLS. 100, 101 AND 102). SN 85-801,103. PUB. 11-26-2013. FILED 12-12-2012.
- 4,479,898. **KDEPC (STANDARD CHARACTER)**. EICHNER, KENNETH, D. MULTIPLE CLASS, (INT. CLS. 35, 36 AND 45), (U.S. CLS. 100, 101 AND 102). SN 85-804,119. PUB. 11-26-2013. FILED 12-17-2012.
- 4,479,909. **ODYSSEY AND DESIGN**. CLAREMONT UNIVERSITY CONSORTIUM, (U.S. CLS. 100, 101 AND 102). SN 85-806,378. PUB. 11-26-2013. FILED 12-19-2012.
- 4,479,913. **WE FUEL THE AMERICAN DREAM (STANDARD CHARACTER)**. LENDIO, INC., MULTIPLE CLASS, (INT. CLS. 35, 36 AND 42), (U.S. CLS. 100, 101 AND 102). SN 85-806,900. PUB. 11-26-2013. FILED 12-19-2012.
- 4,479,924. **POLITICAL COM AND DESIGN**. POLITICAL.-COM, LLC, (U.S. CLS. 100, 101 AND 102). SN 85-809,117. PUB. 11-26-2013. FILED 12-21-2012.
- 4,479,936. **BE HEARD. BE SEEN. BE INDEPENDENT. (STANDARD CHARACTER)**. LEVAS ENTERTAINMENT, LLC, MULTIPLE CLASS, (INT. CLS. 35, 41, 42 AND 45), (U.S. CLS. 100, 101, 102 AND 107). SN 85-810,946. PUB. 11-26-2013. FILED 12-27-2012.
- 4,479,939. **OCCU (STANDARD CHARACTER)**. DRAPER MITCHELL, (U.S. CLS. 100, 101 AND 102). SN 85-811,410. PUB. 11-26-2013. FILED 12-27-2012.
- 4,479,946. **I-STOCKIT STOCK AROUND THE CLOCK! AND DESIGN**. JEM INVESTMENT GROUP LLC, (U.S. CLS. 100, 101 AND 102). SN 85-814,084. PUB. 6-4-2013. FILED 1-2-2013.
- 4,479,949 ( *See Class 9 for this trademark*).
- 4,479,962. **SDAR GREATER SAN DIEGO ASSOCIATION OF REALTORS AND DESIGN**. GREATER SAN DIEGO ASSOCIATION OF REALTORS, AKA SAN DIEGO ASSOCIATION OF REALTORS, MULTIPLE CLASS, (INT. CLS. 35 AND 41), (U.S. CLS. 100, 101, 102 AND 107). SN 85-820,442. PUB. 11-26-2013. FILED 1-10-2013.
- 4,479,968 ( *See Class 16 for this trademark*).
- 4,479,982. **CONCEPT DECOR (STANDARD CHARACTER)**. MEGA GROUP INC., (U.S. CLS. 100, 101 AND 102). SN 85-825,390. PUB. 6-18-2013. FILED 1-17-2013.
- 4,479,983. **OPEN AND DESIGN**. AMERICAN EXPRESS MARKETING & DEVELOPMENT CORP., (U.S. CLS. 100, 101 AND 102). SN 85-825,818. PUB. 11-26-2013. FILED 1-17-2013.
- 4,479,984. **OPEN (STANDARD CHARACTER)**. AMERICAN EXPRESS MARKETING & DEVELOPMENT CORP., (U.S. CLS. 100, 101 AND 102). SN 85-825,830. PUB. 11-26-2013. FILED 1-17-2013.
- 4,479,987. **FACTORYOTC (STANDARD CHARACTER)**. L. PERRIGO COMPANY, (U.S. CLS. 100, 101 AND 102). SN 85-826,739. PUB. 11-26-2013. FILED 1-18-2013.
- 4,479,991. **MR. CHECKOUT (STANDARD CHARACTER)**. MR. CHECKOUT DISTRIBUTORS INCORPORATED, (U.S. CLS. 100, 101 AND 102). SN 85-828,679. PUB. 11-26-2013. FILED 1-22-2013.
- 4,479,992. **MISCELLANEOUS DESIGN**. NATIONAL ASSOCIATION FOR RETAIL MARKETING SERVICES, MULTIPLE CLASS, (INT. CLS. 35 AND 41), (U.S. CLS. 100, 101, 102 AND 107). SN 85-828,683. PUB. 11-26-2013. FILED 1-22-2013.
- 4,479,997. **HIGH TECH ROAD SHOW (STANDARD CHARACTER)**. NATIONAL U.S.-ARAB CHAMBER OF COMMERCE, (U.S. CLS. 100, 101 AND 102). SN 85-829,383. PUB. 11-26-2013. FILED 1-22-2013.
- 4,480,001 ( *See Class 25 for this trademark*).
- 4,480,003 ( *See Class 9 for this trademark*).
- 4,480,011. **BRADY FURNITURE INDUSTRIES INC. (STYLIZED)**. LEATHER MOTION, INC., DBA BRADY FURNITURE INDUSTRIES INC., (U.S. CLS. 100, 101 AND 102). SN 85-833,987. PUB. 11-26-2013. FILED 1-28-2013.
- 4,480,018. **OBESITYHELP MAKING THE JOURNEY TOGETHER AND DESIGN**. OBESITYHELP, INC., MULTIPLE CLASS, (INT. CLS. 35 AND 44), (U.S. CLS. 100, 101 AND 102). SN 85-836,519. PUB. 11-26-2013. FILED 1-30-2013.
- 4,480,028. **CHANGING THE DIRECTION OF FLEET MAINTENANCE (STANDARD CHARACTER)**. FLEETNET AMERICA, INC., MULTIPLE CLASS, (INT. CLS. 35, 37 AND 42), (U.S. CLS. 100, 101, 102, 103 AND 106). SN 85-839,830. PUB. 11-26-2013. FILED 2-4-2013.
- 4,480,031. **ACCOUNTABLE GROWTH (STANDARD CHARACTER)**. ACCOUNTABLE GROWTH, INC., MULTIPLE CLASS, (INT. CLS. 35, 41 AND 45), (U.S. CLS. 100, 101, 102 AND 107). SN 85-842,144. PUB. 11-26-2013. FILED 2-6-2013.
- 4,480,032 ( *See Class 9 for this trademark*).
- 4,480,034. **SOLID SURFACE EXCHANGE AND DESIGN**. PHARAOH TEC INC., (U.S. CLS. 100, 101 AND 102). SN 85-843,211. PUB. 11-26-2013. FILED 2-7-2013.
- 4,480,040. **SWAMP SEAFOOD AND DESIGN**. PHILLIPS SEAFOOD, LLC, (U.S. CLS. 100, 101 AND 102). SN 85-847,837. PUB. 11-26-2013. FILED 2-12-2013.
- 4,480,045. **ODIS SOLUTION (STANDARD CHARACTER)**. ON DEMAND INTERPRETATION SERVICES, LLC, MULTIPLE CLASS, (INT. CLS. 35 AND 45), (U.S. CLS. 100, 101 AND 102). SN 85-849,133. PUB. 11-26-2013. FILED 2-13-2013.
- 4,480,049 ( *See Class 16 for this trademark*).
- 4,480,050 ( *See Class 16 for this trademark*).
- 4,480,054. **MAPYOURSTARTUP.CO CONNECT. PROMOTE. EMPOWER. AND DESIGN**. MAP YOUR STARTUP, LLC, (U.S. CLS. 100, 101 AND 102). SN 85-851,704. PUB. 11-26-2013. FILED S.R. 2-15-2013; AM. P.R. 3-5-2013.
- 4,480,058. **SEVENTY STRATEGIES AND DESIGN**. 720 STRATEGIES, LLC, MULTIPLE CLASS, (INT. CLS. 35 AND 42), (U.S. CLS. 100, 101 AND 102). SN 85-852,689. PUB. 11-26-2013. FILED 2-18-2013.
- 4,480,061. **PURE WATER FOR THE WORLD AND DESIGN**. PURE WATER FOR THE WORLD, INC., MULTIPLE CLASS, (INT. CLS. 35, 36 AND 41), (U.S. CLS. 100, 101, 102 AND 107). SN 85-855,271. PUB. 11-26-2013. FILED 2-20-2013.
- 4,480,066. **DN9999 (STANDARD CHARACTER)**. NGUYEN, DUNG, (U.S. CLS. 100, 101 AND 102). SN 85-857,558. PUB. 11-26-2013. FILED 2-22-2013.
- 4,480,069. **EAT WELL WEEK SANTA MONICA AND DESIGN**. SANTA MONICA CONVENTION AND VISITORS BUREAU, (U.S. CLS. 100, 101 AND 102). SN 85-859,040. PUB. 11-26-2013. FILED 2-25-2013.
- 4,480,087. **DW DANCERS WAREHOUSE AND DESIGN**. DANCERS WAREHOUSE INC., (U.S. CLS. 100, 101 AND 102). SN 85-863,898. PUB. 11-26-2013. FILED 3-1-2013.
- 4,480,094 ( *See Class 9 for this trademark*).
- 4,480,096. **MAGEE RANCH (STANDARD CHARACTER)**. MAGEE RANCH HOMEOWNERS ASSOCIATION, INC., (U.S. CLS. 100, 101 AND 102). SN 85-869,006. PUB. 11-26-2013. FILED 3-6-2013.
- 4,480,100. **ALEX MALAY (STANDARD CHARACTER)**. ALEX MALAY, (U.S. CLS. 100, 101 AND 102). SN 85-869,288. PUB. 11-26-2013. FILED 3-7-2013.
- 4,480,113. **MISCELLANEOUS DESIGN**. ASSOCIATED FOOD STORES, INC., (U.S. CLS. 100, 101 AND 102). SN 85-875,999. PUB. 11-26-2013. FILED 3-14-2013.
- 4,480,116. **E L EXECUTIVELEADS WE GENERATE LEADS FRANCHISEES AND DESIGN**. EXECUTIVE LEADS LLC, (U.S. CLS. 100, 101 AND 102). SN 85-877,411. PUB. 11-26-2013. FILED 3-15-2013.
- 4,480,131. **SPEED COMMERCE (STANDARD CHARACTER)**. SPEED COMMERCE, INC., (U.S. CLS. 100, 101 AND 102). SN 85-882,442. PUB. 11-26-2013. FILED 3-21-2013.
- 4,480,139. **HEROES (STANDARD CHARACTER)**. HEROES THE STORE, INC., (U.S. CLS. 100, 101 AND 102). SN 85-885,237. PUB. 11-26-2013. FILED 3-25-2013.
- 4,480,142. **BETTER INGREDIENTS FOR BETTER CHEFS (STANDARD CHARACTER)**. HOUZE, PHILIPPE L., (U.S. CLS. 100, 101 AND 102). SN 85-885,848. PUB. 11-26-2013. FILED 3-25-2013.
- 4,480,144. **Q QUICK MART THE MINI MARKET AND DESIGN**. BARRINGTON, LORD, (U.S. CLS. 100, 101 AND 102). SN 85-887,509. PUB. 11-26-2013. FILED 3-27-2013.
- 4,480,151 ( *See Class 25 for this trademark*).
- 4,480,155 ( *See Class 3 for this trademark*).
- 4,480,159. **IPAIA (STANDARD CHARACTER)**. IPCAPITAL GROUP, INC., MULTIPLE CLASS, (INT. CLS. 35 AND 45), (U.S. CLS. 100, 101 AND 102). SN 85-890,528. PUB. 11-26-2013. FILED 3-29-2013.
- 4,480,172. **BRAND + PEOPLE (STYLIZED)**. RUSSELL MIN-ARY, (U.S. CLS. 100, 101 AND 102). SN 85-897,278. PUB. 11-



- 26-2013. FILED 4-6-2013.
- 4,480,174. **FRANCHISE REVOLUTION (STANDARD CHARACTER)**, GUESTHOUSE INTERNATIONAL, L.L.C., (U.S. CLS. 100, 101 AND 102). SN 85-898,345. PUB. 11-26-2013. FILED 4-8-2013.
- 4,480,177. **TOTAL BODY EXPERTS (STANDARD CHARACTER)**, TOTAL BODY EXPERTS, LLC, (U.S. CLS. 100, 101 AND 102). SN 85-899,191. PUB. 11-26-2013. FILED 4-9-2013.
- 4,480,181. **SAGE ENTERPRISES, LLC AND DESIGN**, SAGE ENTERPRISES LLC, (U.S. CLS. 100, 101 AND 102). SN 85-900,647. PUB. 11-26-2013. FILED 4-10-2013.
- 4,480,186. **WINE SERGI AND DESIGN**, WINE SERGI & COMPANY, LLC, MULTIPLE CLASS, (INT. CLS. 35 AND 36), (U.S. CLS. 100, 101 AND 102). SN 85-902,488. PUB. 11-26-2013. FILED 4-12-2013.
- 4,480,187. **MARC DYLAN (STANDARD CHARACTER)**, MOHAMED, FRANCO, MULTIPLE CLASS, (INT. CLS. 35 AND 41), (U.S. CLS. 100, 101, 102 AND 107). SN 85-902,743. PUB. 11-26-2013. FILED 4-12-2013.
- 4,480,194. **ACUMAX INDEX (STANDARD CHARACTER)**, ACUMAX INC, MULTIPLE CLASS, (INT. CLS. 35 AND 41), (U.S. CLS. 100, 101, 102 AND 107). SN 85-905,107. PUB. 11-26-2013. FILED 4-16-2013.
- 4,480,196. **WILD BIRD CENTERS AND DESIGN**, YELLOW LEAF BRANDS, LLC, (U.S. CLS. 100, 101 AND 102). SN 85-905,335. PUB. 11-26-2013. FILED 4-16-2013.
- 4,480,197. **NEPTUNE ADVISORS (STANDARD CHARACTER)**, NEPTUNE ADVISORS, LLC, (U.S. CLS. 100, 101 AND 102). SN 85-905,394. PUB. 11-26-2013. FILED 4-16-2013.
- 4,480,198. **RCMA (STANDARD CHARACTER)**, RELIGIOUS CONFERENCE MANAGEMENT ASSOCIATION, INC., MULTIPLE CLASS, (INT. CLS. 35 AND 41), (U.S. CLS. 100, 101, 102 AND 107). SN 85-905,485. PUB. 11-26-2013. FILED 4-16-2013.
- 4,480,202. **PROSTYLINGTOOLS AND DESIGN**, NEEVA, LLC, (U.S. CLS. 100, 101 AND 102). SN 85-907,051. PUB. 11-26-2013. FILED 4-17-2013.
- 4,480,203. **STAGELEAP (STANDARD CHARACTER)**, STAGELEAP LLC, (U.S. CLS. 100, 101 AND 102). SN 85-907,322. PUB. 11-26-2013. FILED 4-17-2013.
- 4,480,209. **WINES BY JENNIFER (STANDARD CHARACTER)**, DANIEL ENTERPRISES, INC., DBA WINES BY JENNIFER, (U.S. CLS. 100, 101 AND 102). SN 85-909,653. PUB. 11-26-2013. FILED 4-19-2013.
- 4,480,210 ( *See Class 16 for this trademark*).
- 4,480,220. **SUCCESS STARTS AT THE CORE (STANDARD CHARACTER)**, SYMMETRY PARTNERS, LLC, MULTIPLE CLASS, (INT. CLS. 35 AND 36), (U.S. CLS. 100, 101 AND 102). SN 85-911,734. PUB. 11-26-2013. FILED 4-23-2013.
- 4,480,223. **AMERICAN WOOD SOURCE (STANDARD CHARACTER)**, AMERICAN WOOD SOURCE, LLC, (U.S. CLS. 100, 101 AND 102). SN 85-912,899. PUB. 11-26-2013. FILED 4-24-2013.
- 4,480,233. **MILLION HEALTH PHARMACY AND DESIGN**, MERLIN DRUG, INC., (U.S. CLS. 100, 101 AND 102). SN 85-914,530. PUB. 11-26-2013. FILED 4-25-2013.
- 4,480,246. **ANOTHER CASTLE AND DESIGN**, ANOTHER CASTLE VIDEO GAMES, (U.S. CLS. 100, 101 AND 102). SN 85-923,323. PUB. 11-26-2013. FILED 5-3-2013.
- 4,480,247. **YOUR STARTUP BUSINESS CONCIERGE (STANDARD CHARACTER)**, KARTCHNER, ASHLEY, MULTIPLE CLASS, (INT. CLS. 35 AND 42), (U.S. CLS. 100, 101 AND 102). SN 85-923,430. PUB. 11-26-2013. FILED 5-3-2013.
- 4,480,252. **RETAIL AXIS (STANDARD CHARACTER)**, RIVER MOSS TECHNOLOGIES, LLC, (U.S. CLS. 100, 101 AND 102). SN 85-923,686. PUB. 10-15-2013. FILED 5-5-2013.
- 4,480,259. **PROJECT ADVOCATES FROM DECISION TO DELIVERY (STANDARD CHARACTER)**, THE BRIGHTMILL GROUP, LLC, (U.S. CLS. 100, 101 AND 102). SN 85-924,343. PUB. 11-26-2013. FILED 5-6-2013.
- 4,480,265. **SURECARE RX (STANDARD CHARACTER)**, PHS LLC, (U.S. CLS. 100, 101 AND 102). SN 85-925,391. PUB. 10-15-2013. FILED 5-7-2013.
- 4,480,270. **HOCKENBERGS (STANDARD CHARACTER)**, HOCKENBERGS EQUIPMENT AND SUPPLY CO., INC., MULTIPLE CLASS, (INT. CLS. 35, 37 AND 42), (U.S. CLS. 100, 101, 102, 103 AND 106). SN 85-926,039. PUB. 11-26-2013. FILED 5-8-2013.
- 4,480,271. **H HOCKENBERGS AND DESIGN**, HOCKENBERGS EQUIPMENT AND SUPPLY CO., INC., MULTIPLE CLASS, (INT. CLS. 35, 37 AND 42), (U.S. CLS. 100, 101, 102, 103 AND 106). SN 85-926,057. PUB. 11-26-2013. FILED 5-8-2013.
- 4,480,279. **HARMONISE (STANDARD CHARACTER)**, SCHAWK, INC., MULTIPLE CLASS, (INT. CLS. 35 AND 40), (U.S. CLS. 100, 101, 102, 103 AND 106). SN 85-926,607. PUB. 11-26-2013. FILED 5-8-2013.
- 4,480,281. **ED ROMAN GUITARS (STANDARD CHARACTER)**, ED ROMAN ENTERPRISES, INC., (U.S. CLS. 100, 101 AND 102). SN 85-926,748. PUB. 11-26-2013. FILED 5-8-2013.
- 4,480,288. **CAMPOS EPC (STANDARD CHARACTER)**, CAMPOS EPC, LLC, MULTIPLE CLASS, (INT. CLS. 35, 37, 42 AND 45), (U.S. CLS. 100, 101, 102, 103 AND 106). SN 85-928,556. PUB. 11-26-2013. FILED 5-10-2013.
- 4,480,289. **NAPA INSTITUTE AND DESIGN**, THE NAPA INSTITUTE, MULTIPLE CLASS, (INT. CLS. 35, 41 AND 45), (U.S. CLS. 100, 101, 102 AND 107). SN 85-928,567. PUB. 11-26-2013. FILED 5-10-2013.
- 4,480,291. **MISCELLANEOUS DESIGN**, THE NAPA INSTITUTE, MULTIPLE CLASS, (INT. CLS. 35, 41 AND 45), (U.S. CLS. 100, 101, 102 AND 107). SN 85-928,622. PUB. 11-26-2013. FILED 5-10-2013.
- 4,480,292. **BIRMINGHAM JEWELRY (STANDARD CHARACTER)**, BIRMINGHAM JEWELRY, INC., (U.S. CLS. 100, 101 AND 102). SN 85-928,941. PUB. 11-26-2013. FILED 5-10-2013.
- 4,480,293. **PAUL BLANCO (STANDARD CHARACTER)**, PAUL BLANCO MANAGEMENT COMPANY, INC., (U.S. CLS. 100, 101 AND 102). SN 85-929,205. PUB. 11-26-2013. FILED 5-10-2013.
- 4,480,295. **EQUIPMENT STREET (STANDARD CHARACTER)**, NAVITAS LEASE CORP., MULTIPLE CLASS, (INT. CLS. 35 AND 36), (U.S. CLS. 100, 101 AND 102). SN 85-929,413. PUB. 11-26-2013. FILED 5-11-2013.
- 4,480,296. **EQUIPMENT STREET AND DESIGN**, NAVITAS LEASE CORP., MULTIPLE CLASS, (INT. CLS. 35 AND 36), (U.S. CLS. 100, 101 AND 102). SN 85-929,538. PUB. 11-26-2013. FILED 5-12-2013.
- 4,480,307. **CORE 24 ADMINAWARDS (STYLIZED)**, CORE24, LLC, (U.S. CLS. 100, 101 AND 102). SN 85-932,727. PUB. 11-26-2013. FILED 5-15-2013.
- 4,480,314. **ACCESS AMERICA TRANSPORT (STANDARD CHARACTER)**, ACCESS AMERICA TRANSPORT, INC., MULTIPLE CLASS, (INT. CLS. 35 AND 39), (U.S. CLS. 100, 101, 102 AND 105). SN 85-935,119. PUB. 11-26-2013. FILED 5-17-2013.
- 4,480,316. **A ACCESS AMERICA TRANSPORT AND DESIGN**, ACCESS AMERICA TRANSPORT, INC., MULTIPLE CLASS, (INT. CLS. 35 AND 39), (U.S. CLS. 100, 101, 102 AND 105). SN 85-935,153. PUB. 11-26-2013. FILED 5-17-2013.
- 4,480,332 ( *See Class 9 for this trademark*).
- 4,480,333. **SPENDTRACK (STANDARD CHARACTER)**, SUPERIOR SHARED SERVICES, INC., MULTIPLE CLASS, (INT. CLS. 35 AND 36), (U.S. CLS. 100, 101 AND 102). SN 85-939,343. PUB. 11-26-2013. FILED 5-22-2013.
- 4,480,336. **CONTINENTAL EXPRESS INC. (STANDARD CHARACTER)**, CONTINENTAL EXPRESS INC., MULTIPLE CLASS, (INT. CLS. 35 AND 39), (U.S. CLS. 100, 101, 102 AND 105). SN 85-939,681. PUB. 11-26-2013. FILED 5-22-2013.
- 4,480,343. **OILTIZER AND DESIGN**, BIG RIG NETWORK, LLC, (U.S. CLS. 100, 101 AND 102). SN 85-941,061. PUB. 11-26-2013. FILED 5-23-2013.
- 4,480,345. **IP IS ALL AROUND US (STANDARD CHARACTER)**, AMERICAN BAR ASSOCIATION, MULTIPLE CLASS, (INT. CLS. 35, 41 AND 45), (U.S. CLS. 100, 101, 102 AND 107). SN 85-941,174. PUB. 11-26-2013. FILED 5-23-2013.
- 4,480,346. **FLAME CLUB (STANDARD CHARACTER)**, WHISKEY CREEK FRANCHISE SYSTEMS, L.L.C., (U.S. CLS. 100, 101 AND 102). SN 85-941,263. PUB. 11-26-2013. FILED 5-23-2013.
- 4,480,347. **CUSTOPHARM (STANDARD CHARACTER)**, CUSTOPHARM, INC., MULTIPLE CLASS, (INT. CLS. 35, 42 AND 45), (U.S. CLS. 100, 101 AND 102). SN 85-941,305. PUB. 11-26-2013. FILED 5-23-2013.
- 4,480,351. **BMS (STANDARD CHARACTER)**, J.H. BURNS, INC., DBA BMS BURNS, (U.S. CLS. 100, 101 AND 102). SN

- 85-941,893. PUB. 11-26-2013. FILED 5-24-2013.
- 4,480,352. **S\*IDF (STYLIZED)**. THE SMALL-SCALE SUSTAINABLE INFRASTRUCTURE DEVELOPMENT FUND, INC., MULTIPLE CLASS, (INT. CLS. 35 AND 36), (U.S. CLS. 100, 101 AND 102). SN 85-941,938. PUB. 11-26-2013. FILED 5-24-2013.
- 4,480,353. **S\*IDF (STYLIZED)**. THE SMALL-SCALE SUSTAINABLE INFRASTRUCTURE DEVELOPMENT FUND, INC., MULTIPLE CLASS, (INT. CLS. 35 AND 36), (U.S. CLS. 100, 101 AND 102). SN 85-941,942. PUB. 11-26-2013. FILED 5-24-2013.
- 4,480,354. **SOCIAL MERCHANT BANK APPROACH (STANDARD CHARACTER)**. THE SMALL-SCALE SUSTAINABLE INFRASTRUCTURE DEVELOPMENT FUND, INC., MULTIPLE CLASS, (INT. CLS. 35 AND 36), (U.S. CLS. 100, 101 AND 102). SN 85-941,949. PUB. 11-26-2013. FILED 5-24-2013.
- 4,480,357 ( *See Class 9 for this trademark*).
- 4,480,358. **AIRCRAFT FLEET RECYCLING ASSOCIATION (STANDARD CHARACTER)**. AIRCRAFT FLEET RECYCLING ASSOCIATION, INC., AKA AFRA, MULTIPLE CLASS, (INT. CLS. 35, 41 AND 42), (U.S. CLS. 100, 101, 102 AND 107). SN 85-942,310. PUB. 11-26-2013. FILED 5-24-2013.
- 4,480,359. **AFRA (STANDARD CHARACTER)**. AIRCRAFT FLEET RECYCLING ASSOCIATION, INC., AKA AFRA, MULTIPLE CLASS, (INT. CLS. 35, 41 AND 42), (U.S. CLS. 100, 101, 102 AND 107). SN 85-942,364. PUB. 11-26-2013. FILED 5-24-2013.
- 4,480,385. **SMARTER SOLUTIONS AND DESIGN**. SMARTER SOLUTIONS, INC., MULTIPLE CLASS, (INT. CLS. 35 AND 41), (U.S. CLS. 100, 101, 102 AND 107). SN 85-945,315. PUB. 11-26-2013. FILED 5-29-2013.
- 4,480,389. **BRIT + CO. (STANDARD CHARACTER)**. BRIT MEDIA, INC., (U.S. CLS. 100, 101 AND 102). SN 85-945,564. PUB. 11-26-2013. FILED 5-29-2013.
- 4,480,392. **PEAK NATIONAL PROMOTIONS (STANDARD CHARACTER)**. PEAK NATIONAL PROMOTIONS, INC., (U.S. CLS. 100, 101 AND 102). SN 85-945,900. PUB. 11-26-2013. FILED 5-30-2013.
- 4,480,403 ( *See Class 9 for this trademark*).
- 4,480,404. **NOVELTYMINTS (STANDARD CHARACTER)**. DSH INDIANA, INC., (U.S. CLS. 100, 101 AND 102). SN 85-947,057. PUB. 11-26-2013. FILED 5-31-2013.
- 4,480,411 ( *See Class 9 for this trademark*).
- 4,480,422. **UNLIMITED TAXES & MORE, INC. (STANDARD CHARACTER)**. UNLIMITED TAXES & MORE LICENSING COMPANY, LLC, MULTIPLE CLASS, (INT. CLS. 35 AND 36), (U.S. CLS. 100, 101 AND 102). SN 85-949,853. PUB. 11-26-2013. FILED 6-4-2013.
- 4,480,424. **MISCELLANEOUS DESIGN**. H.K. DISTRIBUTION, L.L.C., (U.S. CLS. 100, 101 AND 102). SN 85-950,010. PUB. 11-26-2013. FILED 6-4-2013.
- 4,480,428. **NATIONAL PORK PRODUCERS COUNCIL AND DESIGN**. NATIONAL PORK PRODUCERS COUNCIL CORPORATION, (U.S. CLS. 100, 101 AND 102). SN 85-950,400. PUB. 11-26-2013. FILED 6-4-2013.
- 4,480,434. **MISCELLANEOUS DESIGN**. WEXLER PACKAGING PRODUCTS, INC., (U.S. CLS. 100, 101 AND 102). SN 85-951,033. PUB. 11-26-2013. FILED 6-5-2013.
- 4,480,436. **SERVICELINK FNF'S NATIONAL LENDER PLATFORM AND DESIGN**. FNF INTELLECTUAL PROPERTY HOLDINGS, INC., MULTIPLE CLASS, (INT. CLS. 35, 36, 42 AND 45), (U.S. CLS. 100, 101 AND 102). SN 85-951,275. PUB. 11-26-2013. FILED 6-5-2013.
- 4,480,439. **LEN STOLER (STANDARD CHARACTER)**. LEN STOLER, INC., (U.S. CLS. 100, 101 AND 102). SN 85-951,594. PUB. 11-26-2013. FILED 6-5-2013.
- 4,480,444. **WEP WEP-USA.ORG AND DESIGN**. WEP-USA, LLC, (U.S. CLS. 100, 101 AND 102). SN 85-952,528. PUB. 11-26-2013. FILED 6-6-2013.
- 4,480,445. **FULL STACK SOLUTIONS (STANDARD CHARACTER)**. OGOFF, DARREN, (U.S. CLS. 100, 101 AND 102). SN 85-952,650. PUB. 11-26-2013. FILED 6-6-2013.
- 4,480,457. **EXO CIGS (STANDARD CHARACTER)**. GHEI, SANJAY, (U.S. CLS. 100, 101 AND 102). SN 85-954,668. PUB. 11-26-2013. FILED 6-9-2013.
- 4,480,459. **TANDEM GLOBAL LOGISTICS AND DESIGN**. C.H. POWELL COMPANY, MULTIPLE CLASS, (INT. CLS. 35 AND 39), (U.S. CLS. 100, 101, 102 AND 105). SN 85-954,814. PUB. 11-26-2013. FILED 6-10-2013.
- 4,480,470. **EVERYBODY LIKES THEIR OWN BRAND (STANDARD CHARACTER)**. ZEROSKI LLC, (U.S. CLS. 100, 101 AND 102). SN 85-956,268. PUB. 11-26-2013. FILED 6-11-2013.
- 4,480,477. **CREATIVE MINDS, IGNITING SOLUTIONS. (STANDARD CHARACTER)**. IGNITE DESIGN AND ADVERTISING, (U.S. CLS. 100, 101 AND 102). SN 85-956,821. PUB. 11-26-2013. FILED 6-11-2013.
- 4,480,483. **ORANGE MONKEY PREMIUM FROZEN YOGURT AND DESIGN**. ORANGE MONKEY, INC., TA ORANGE MONKEY, (U.S. CLS. 100, 101 AND 102). SN 85-957,658. PUB. 11-26-2013. FILED 6-12-2013.
- 4,480,489. **HX5 (STANDARD CHARACTER)**. HX5, LLC., MULTIPLE CLASS, (INT. CLS. 35 AND 42), (U.S. CLS. 100, 101 AND 102). SN 85-958,281. PUB. 11-26-2013. FILED 6-12-2013.
- 4,480,491. **CHANNELEAZE (STANDARD CHARACTER)**. CHANNELEASE, INC., (U.S. CLS. 100, 101 AND 102). SN 85-958,614. PUB. 11-26-2013. FILED 6-13-2013.
- 4,480,498. **INNOVENT SOLUTIONS (STANDARD CHARACTER)**. INNOVENT SOLUTIONS, INC., (U.S. CLS. 100, 101 AND 102). SN 85-959,381. PUB. 11-26-2013. FILED 6-13-2013.
- 4,480,499. **SHORT'S MARINE AND DESIGN**. SHORT'S MARINE, INC., (U.S. CLS. 100, 101 AND 102). SN 85-959,792. PUB. 11-26-2013. FILED 6-14-2013.
- 4,480,502. **CONSOVA (STANDARD CHARACTER)**. CONSOVA CORPORATION, MULTIPLE CLASS, (INT. CLS. 35 AND 36), (U.S. CLS. 100, 101 AND 102). SN 85-960,308. PUB. 11-26-2013. FILED 6-14-2013.
- 4,480,504. **ROOT CANAL AWARENESS WEEK AND DESIGN**. AMERICAN ASSOCIATION OF ENDODONTISTS, (U.S. CLS. 100, 101 AND 102). SN 85-960,999. PUB. 11-26-2013. FILED 6-16-2013.
- 4,480,506. **LEARNING ROADS AND DESIGN**. FREEMAN INC., DBA LEARNING ROADS, (U.S. CLS. 100, 101 AND 102). SN 85-961,128. PUB. 11-26-2013. FILED 6-17-2013.
- 4,480,514. **LANGUAGE PALS (STANDARD CHARACTER)**. LANGUAGE PALS LLC, (U.S. CLS. 100, 101 AND 102). SN 85-962,325. PUB. 11-26-2013. FILED 6-18-2013.
- 4,480,518. **MEGA AID PHARMACY AND DESIGN**. MEGA AID PHARMACY I, INC., (U.S. CLS. 100, 101 AND 102). SN 85-962,650. PUB. 11-26-2013. FILED 6-18-2013.
- 4,480,520. **HOME OF THE POST-INTERVIEW THANK YOU CARDS (STANDARD CHARACTER)**. SINCERE GREETING INC, (U.S. CLS. 100, 101 AND 102). SN 85-962,744. PUB. 11-26-2013. FILED 6-18-2013.
- 4,480,523. **TALK OF THE STREETS (STANDARD CHARACTER)**. SINGLETON, NAIM Q, (U.S. CLS. 100, 101 AND 102). SN 85-963,160. PUB. 11-26-2013. FILED 6-18-2013.
- 4,480,524. **HX5 (STYLIZED)**. HX5, LLC., MULTIPLE CLASS, (INT. CLS. 35 AND 42), (U.S. CLS. 100, 101 AND 102). SN 85-963,194. PUB. 11-26-2013. FILED 6-18-2013.
- 4,480,528. **CHILE PEPPER INSTITUTE (STANDARD CHARACTER)**. NEW MEXICO STATE UNIVERSITY BOARD OF REGENTS, MULTIPLE CLASS, (INT. CLS. 35, 41 AND 42), (U.S. CLS. 100, 101, 102 AND 107). SN 85-963,352. PUB. 11-26-2013. FILED 6-18-2013.
- 4,480,536. **KADAMBA TREE FOUNDATION AND DESIGN**. KADAMBA TREE FOUNDATION, (U.S. CLS. 100, 101 AND 102). SN 85-963,738. PUB. 11-26-2013. FILED 6-19-2013.
- 4,480,539 ( *See Class 13 for this trademark*).
- 4,480,549. **WINE FROM FARMERS, NOT FACTORIES (STANDARD CHARACTER)**. WINE AUTHORITIES DURHAM, LLC, (U.S. CLS. 100, 101 AND 102). SN 85-964,096. PUB. 11-26-2013. FILED 6-19-2013.
- 4,480,550. **WINE AUTHORITIES (STANDARD CHARACTER)**. WINE AUTHORITIES DURHAM, LLC, (U.S. CLS. 100, 101 AND 102). SN 85-964,099. PUB. 11-26-2013. FILED 6-19-2013.
- 4,480,551. **WINE AUTHORITIES THE UNDERGROUND SOURCE FOR THE GREATEST VALUES IN ESTATE WINE AND DESIGN**. WINE AUTHORITIES DURHAM, LLC, (U.S. CLS. 100, 101 AND 102). SN 85-964,108. PUB. 11-26-2013. FILED 6-19-2013.
- 4,480,556. **RUUM AMERICAN KID'S WEAR (STYLIZED)**. EZRANI 2 CORP., (U.S. CLS. 100, 101 AND 102). SN 85-964,331. PUB. 11-26-2013. FILED 6-19-2013.
- 4,480,559. **SWEET PEA PROJECT (STANDARD CHARACTER)**

- TER). SWEET PEA PROJECT, (U.S. CLS. 100, 101 AND 102). SN 85-964,435. PUB. 11-26-2013. FILED 6-19-2013.
- 4,480,561. **ALYN-WEISS' MONTHLY MARKETING BRIEF (STANDARD CHARACTER)**. ALYN-WEISS & ASSOCIATES, INC., (U.S. CLS. 100, 101 AND 102). SN 85-964,465. PUB. 11-26-2013. FILED 6-19-2013.
- 4,480,578 ( *See Class 9 for this trademark*).
- 4,480,579 ( *See Class 9 for this trademark*).
- 4,480,582. **THE SAFETY STORE AT RILEY HOSPITAL FOR CHILDREN (STANDARD CHARACTER)**. THE TRUSTEES OF INDIANA UNIVERSITY, MULTIPLE CLASS, (INT. CLS. 35 AND 41), (U.S. CLS. 100, 101, 102 AND 107). SN 85-965,381. PUB. 11-26-2013. FILED 6-20-2013.
- 4,480,583. **THE IUSM SAFETY STORE (STANDARD CHARACTER)**. THE TRUSTEES OF INDIANA UNIVERSITY, MULTIPLE CLASS, (INT. CLS. 35 AND 41), (U.S. CLS. 100, 101, 102 AND 107). SN 85-965,494. PUB. 11-26-2013. FILED 6-20-2013.
- 4,480,596. **GEM AVENUE (STANDARD CHARACTER)**. FABULOUS INTERNATIONAL INC., (U.S. CLS. 100, 101 AND 102). SN 85-966,270. PUB. 11-26-2013. FILED 6-21-2013.
- 4,480,610. **DIGIMARC (STANDARD CHARACTER)**. DIGIMARC CORPORATION, MULTIPLE CLASS, (INT. CLS. 35, 42 AND 45), (U.S. CLS. 100, 101 AND 102). SN 85-967,074. PUB. 11-26-2013. FILED 6-21-2013.
- 4,480,617. **SHAVERY (STANDARD CHARACTER)**. BLOCKHEADS SHAVERY COMPANY HOLDINGS LLC, (U.S. CLS. 100, 101 AND 102). SN 85-967,437. PUB. 11-26-2013. FILED 6-23-2013.
- 4,480,620. **CRYSTAL BRIDGE TO THE FUTURE (STANDARD CHARACTER)**. NIHON DEMPMA KOGYO CO., LTD., (U.S. CLS. 100, 101 AND 102). SN 85-967,629. PUB. 11-26-2013. FILED 6-24-2013.
- 4,480,625. **AMIA INFORMATICS PROFESSIONALS. LEADING THE WAY. (STYLIZED)**. AMERICAN MEDICAL INFORMATICS ASSOCIATION, INC., MULTIPLE CLASS, (INT. CLS. 35 AND 41), (U.S. CLS. 100, 101, 102 AND 107). SN 85-967,766. PUB. 11-26-2013. FILED 6-24-2013.
- 4,480,626. **THE PARABLE GROUP (STYLIZED)**. THE PARABLE GROUP, INC., MULTIPLE CLASS, (INT. CLS. 35 AND 42), (U.S. CLS. 100, 101 AND 102). SN 85-967,894. PUB. 11-26-2013. FILED 6-24-2013.
- 4,480,627. **THE PARABLE GROUP DELIVERING YOUR STORY (STANDARD CHARACTER)**. THE PARABLE GROUP, INC., MULTIPLE CLASS, (INT. CLS. 35 AND 42), (U.S. CLS. 100, 101 AND 102). SN 85-967,910. PUB. 11-26-2013. FILED 6-24-2013.
- 4,480,629. **GREENTREE ALLIANCE HOTEL (STANDARD CHARACTER)**. GREENTREE INNS HOTEL MANAGEMENT GROUP, INC., (U.S. CLS. 100, 101 AND 102). SN 85-968,081. PUB. 11-26-2013. FILED 6-24-2013.
- 4,480,632 ( *See Class 16 for this trademark*).
- 4,480,634 ( *See Class 16 for this trademark*).
- 4,480,635. **BIG DADDY CAKERY AND DESIGN**. ENOICARAS, THOMWOOD XAVIER, (U.S. CLS. 100, 101 AND 102). SN 85-968,171. PUB. 11-26-2013. FILED 6-24-2013.
- 4,480,639. **READVENTURED (STANDARD CHARACTER)**. READVENTURED, MULTIPLE CLASS, (INT. CLS. 35 AND 41), (U.S. CLS. 100, 101, 102 AND 107). SN 85-968,257. PUB. 11-26-2013. FILED 6-24-2013.
- 4,480,644. **A AND DESIGN**. ARROW SPORTS, LLC, (U.S. CLS. 100, 101 AND 102). SN 85-968,372. PUB. 11-26-2013. FILED 6-24-2013.
- 4,480,645. **MISCELLANEOUS DESIGN**. ETHICAL ELECTRIC BENEFIT CO., (U.S. CLS. 100, 101 AND 102). SN 85-968,381. PUB. 11-26-2013. FILED 6-24-2013.
- 4,480,646. **ARROW SPORTS (STANDARD CHARACTER)**. ARROW SPORTS, LLC, (U.S. CLS. 100, 101 AND 102). SN 85-968,387. PUB. 11-26-2013. FILED 6-24-2013.
- 4,480,657. **AMOR SALES (STANDARD CHARACTER)**. BRAVO, MARIA, (U.S. CLS. 100, 101 AND 102). SN 85-968,790. PUB. 11-26-2013. FILED 6-25-2013.
- 4,480,664. **10 SPOT (STANDARD CHARACTER)**. 618 MAIN CLOTHING CORP., (U.S. CLS. 100, 101 AND 102). SN 85-969,142. PUB. 11-26-2013. FILED 6-25-2013.
- 4,480,668. **NET(NET) AHEAD OF THE MARKET, BEHIND THE DEAL. (STANDARD CHARACTER)**. NET(NET), INC., (U.S. CLS. 100, 101 AND 102). SN 85-969,308. PUB. 11-26-2013. FILED 6-25-2013.
- 4,480,681. **MEMRI (STANDARD CHARACTER)**. MIDDLE EAST MEDIA AND RESEARCH INSTITUTE, INC., MULTIPLE CLASS, (INT. CLS. 35, 41 AND 45), (U.S. CLS. 100, 101, 102 AND 107). SN 85-970,085. PUB. 11-26-2013. FILED 6-26-2013.
- 4,480,686. **LEADMAX AND DESIGN**. GRIFFIN MARKETING GROUP, INC., (U.S. CLS. 100, 101 AND 102). SN 85-970,181. PUB. 11-26-2013. FILED 6-26-2013.
- 4,480,688. **MCKENNA PRINCIPALS AND DESIGN**. THE MCKENNA PRINCIPALS, INC., MULTIPLE CLASS, (INT. CLS. 35 AND 42), (U.S. CLS. 100, 101 AND 102). SN 85-970,305. PUB. 11-26-2013. FILED 6-26-2013.
- 4,480,697. **FINDERS KEEPERS VENDOR OUTLET MALL AND DESIGN**. ADAM K. SMITH, (U.S. CLS. 100, 101 AND 102). SN 85-970,822. PUB. 11-26-2013. FILED 6-26-2013.
- 4,480,704 ( *See Class 1 for this trademark*).
- 4,480,711. **OUT OF THE BOX REWARDS (STANDARD CHARACTER)**. CMC ACQUISITIONS CORPORATION, DBA CAPITOL MARKETING CONCEPTS, INC., (U.S. CLS. 100, 101 AND 102). SN 85-971,433. PUB. 11-26-2013. FILED 6-27-2013.
- 4,480,712. **GROW YOUR BUSINESS WITH WORLD WIDE GARDEN SUPPLY COMPANY (STANDARD CHARACTER)**. THE GARDEN SPOUT LLC, (U.S. CLS. 100, 101 AND 102). SN 85-971,655. PUB. 11-26-2013. FILED 6-27-2013.
- 4,480,715. **RINGSIDE SEARCH PARTNERS (STANDARD CHARACTER)**. RINGSIDE SEARCH PARTNERS, LLC, (U.S. CLS. 100, 101 AND 102). SN 85-971,792. PUB. 11-26-2013. FILED 6-27-2013.
- 4,480,718. **BCQA (STYLIZED)**. BUILDING COMMISSIONING ASSOCIATION, MULTIPLE CLASS, (INT. CLS. 35 AND 41), (U.S. CLS. 100, 101, 102 AND 107). SN 85-971,871. PUB. 11-26-2013. FILED 6-27-2013.
- 4,480,726. **RESUME COMPANION (STANDARD CHARACTER)**. RESUME COMPANION LLC, (U.S. CLS. 100, 101 AND 102). SN 85-972,384. PUB. 11-26-2013. FILED 6-28-2013.
- 4,480,727 ( *See Class 9 for this trademark*).
- 4,480,728. **RESUME GENIUS (STANDARD CHARACTER)**. RESUME COMPANION LLC, (U.S. CLS. 100, 101 AND 102). SN 85-972,412. PUB. 11-26-2013. FILED 6-28-2013.
- 4,480,729. **RESUME WRITER DIRECT (STANDARD CHARACTER)**. RESUME COMPANION LLC, (U.S. CLS. 100, 101 AND 102). SN 85-972,414. PUB. 11-26-2013. FILED 6-28-2013.
- 4,480,731. **BLUEGRASS FOR BABIES (STANDARD CHARACTER)**. BLUEGRASS FOR BABIES, INC., (U.S. CLS. 100, 101 AND 102). SN 85-972,536. PUB. 11-26-2013. FILED 6-28-2013.
- 4,480,738. **MISCELLANEOUS DESIGN**. SINGLE TOUCH INTERACTIVE, INC., (U.S. CLS. 100, 101 AND 102). SN 85-972,937. PUB. 11-26-2013. FILED 6-28-2013.
- 4,480,744. **THIRD NATURE (STANDARD CHARACTER)**. THIRD NATURE, INC., MULTIPLE CLASS, (INT. CLS. 35 AND 42), (U.S. CLS. 100, 101 AND 102). SN 85-973,405. PUB. 11-26-2013. FILED 6-28-2013.
- 4,480,746. **RUNNING DIRTY (STANDARD CHARACTER)**. RUNNING DIRTY, LLC, (U.S. CLS. 100, 101 AND 102). SN 85-973,466. PUB. 11-26-2013. FILED 6-28-2013.
- 4,480,749 ( *See Class 30 for this trademark*).
- 4,480,752. **TURN ADVENTURE ON (STANDARD CHARACTER)**. RAMP KING, INC., (U.S. CLS. 100, 101 AND 102). SN 85-973,693. PUB. 11-26-2013. FILED 6-29-2013.
- 4,480,764. **MC MOZECONCIERGE AND DESIGN**. MOZECONCIERGE, (U.S. CLS. 100, 101 AND 102). SN 85-974,056. PUB. 11-26-2013. FILED 7-1-2013.
- 4,480,765 ( *See Class 30 for this trademark*).
- 4,480,766 ( *See Class 30 for this trademark*).
- 4,480,767. **TAKE HOME MORE, BE HOME MORE (STANDARD CHARACTER)**. ROEHL TRANSPORT, INC., (U.S. CLS. 100, 101 AND 102). SN 85-974,092. PUB. 11-26-2013. FILED 7-1-2013.
- 4,480,769. **DIAMOND HEDGE (STANDARD CHARACTER)**. DIAMOND HEDGE LLC, (U.S. CLS. 100, 101 AND 102). SN 85-974,167. PUB. 11-26-2013. FILED 7-1-2013.
- 4,480,771. **STAY GREEN OIL AND DESIGN**. STAYGREEN PARTNERS, (U.S. CLS. 100, 101 AND 102). SN 85-974,209. PUB. 11-26-2013. FILED 7-1-2013.
- 4,480,787. **SYMPHONI (STANDARD CHARACTER)**. THE SYMPHONI GROUP, LLC, (U.S. CLS. 100, 101 AND 102).

- SN 85-974,830. PUB. 11-26-2013. FILED 7-1-2013.
- 4,480,788. **REVIEWMYCONTRACT (STANDARD CHARACTER)**. REVIEWMYCONTRACT, LLC, (U.S. CLS. 100, 101 AND 102). SN 85-974,939. PUB. 11-26-2013. FILED 7-1-2013.
- 4,480,802. **UNISHOW (STANDARD CHARACTER)**. UNISHOW (USA) INC., (U.S. CLS. 100, 101 AND 102). SN 86-000,158. PUB. 11-26-2013. FILED 7-2-2013.
- 4,480,807. **FIND US BEFORE YOU SEARCH. (STANDARD CHARACTER)**. THE MCCOOL GROUP LLC, (U.S. CLS. 100, 101 AND 102). SN 86-000,233. PUB. 11-26-2013. FILED 7-2-2013.
- 4,480,822. **VIRGINIA CANDLE (STANDARD CHARACTER)**. SMITH MOUNTAIN INDUSTRIES, INC., (U.S. CLS. 100, 101 AND 102). SN 86-000,407. PUB. 11-26-2013. FILED 7-2-2013.
- 4,480,843. **SARA CAMPBELL (STANDARD CHARACTER)**. SARA CAMPBELL, LTD., MULTIPLE CLASS, (INT. CLS. 35 AND 42), (U.S. CLS. 100, 101 AND 102). SN 86-000,690. PUB. 11-26-2013. FILED 7-2-2013.
- 4,480,844. **INVEST FROM THE GROUND UP (STANDARD CHARACTER)**. CALIFORNIA URBAN FORESTS COUNCIL, MULTIPLE CLASS, (INT. CLS. 35 AND 41), (U.S. CLS. 100, 101, 102 AND 107). SN 86-000,691. PUB. 11-26-2013. FILED 7-2-2013.
- 4,480,855. **BID4ASSETS (STANDARD CHARACTER)**. BID4ASSETS, INC., (U.S. CLS. 100, 101 AND 102). SN 86-000,841. PUB. 11-26-2013. FILED 7-2-2013.
- 4,480,862. **PLAYAPY (STANDARD CHARACTER)**. BAEZ, AMY, (U.S. CLS. 100, 101 AND 102). SN 86-000,915. PUB. 11-26-2013. FILED 7-2-2013.
- 4,480,872. **COMMUNICATE WITH CONFIDENCE (STANDARD CHARACTER)**. BOOHER CONSULTANTS, LLC, MULTIPLE CLASS, (INT. CLS. 35 AND 41), (U.S. CLS. 100, 101, 102 AND 107). SN 86-001,081. PUB. 11-26-2013. FILED 7-2-2013.
- 4,480,877. **BEST OF THE BASICS (STANDARD CHARACTER)**. OVERSTOCK.COM, INC., (U.S. CLS. 100, 101 AND 102). SN 86-001,243. PUB. 11-26-2013. FILED 7-2-2013.
- 4,480,887. **FOLLAIN (STANDARD CHARACTER)**. FOLLAIN INC., (U.S. CLS. 100, 101 AND 102). SN 86-001,512. PUB. 11-26-2013. FILED 7-3-2013.
- 4,480,888 ( *See Class 9 for this trademark*).
- 4,480,891 ( *See Class 9 for this trademark*).
- 4,480,895. **UBC, ETC. (STANDARD CHARACTER)**. OCS, INCORPORATED, FORMERLY UNCLAIMED BAGGAGE CENTER, INC., (U.S. CLS. 100, 101 AND 102). SN 86-001,599. PUB. 11-26-2013. FILED 7-3-2013.
- 4,480,899. **BRAVELOVE (STANDARD CHARACTER)**. BRAVELOVE, INC., (U.S. CLS. 100, 101 AND 102). SN 86-001,668. PUB. 11-26-2013. FILED 7-3-2013.
- 4,480,900 ( *See Class 14 for this trademark*).
- 4,480,903. **G&G DISTRIBUTORS AND DESIGN**. G&G DISTRIBUTORS INC., (U.S. CLS. 100, 101 AND 102). SN 86-001,728. PUB. 11-26-2013. FILED 7-3-2013.
- 4,480,907. **CRUISEPONS (STANDARD CHARACTER)**. CORPORATE ONE INC., (U.S. CLS. 100, 101 AND 102). SN 86-001,811. PUB. 11-26-2013. FILED 7-3-2013.
- 4,480,924. **BRANDIZE (STANDARD CHARACTER)**. BRANDIZE LLC, (U.S. CLS. 100, 101 AND 102). SN 86-002,063. PUB. 11-26-2013. FILED 7-3-2013.
- 4,480,928. **SEARCH SCIENTISTS (STANDARD CHARACTER)**. FACCHIN, MICHAEL E, (U.S. CLS. 100, 101 AND 102). SN 86-002,093. PUB. 11-26-2013. FILED 7-3-2013.
- 4,480,935. **BELLA BRIDESMAID (STANDARD CHARACTER)**. BELLA BRIDESMAID FRANCHISE GROUP, LLC, (U.S. CLS. 100, 101 AND 102). SN 86-002,216. PUB. 11-26-2013. FILED 7-3-2013.
- 4,480,936. **PURESTAT (STANDARD CHARACTER)**. HAWTHORNE DIRECT INC., (U.S. CLS. 100, 101 AND 102). SN 86-002,221. PUB. 11-26-2013. FILED 7-3-2013.
- 4,480,938. **HT AND DESIGN**. HIDDEN TRACK MUSIC, LLC, (U.S. CLS. 100, 101 AND 102). SN 86-002,236. PUB. 11-26-2013. FILED 7-3-2013.
- 4,480,945 ( *See Class 33 for this trademark*).
- 4,480,950. **CONSOVA AND DESIGN**. CONSOVA CORPORATION, MULTIPLE CLASS, (INT. CLS. 35 AND 36), (U.S. CLS. 100, 101 AND 102). SN 86-002,315. PUB. 11-26-2013. FILED 7-3-2013.
- 4,480,961 ( *See Class 9 for this trademark*).
- 4,480,972. **BE MORE HEROIC (STANDARD CHARACTER)**. BE MORE HEROIC, (U.S. CLS. 100, 101 AND 102). SN 86-002,650. PUB. 11-26-2013. FILED 7-4-2013.
- 4,481,004. **DOGTUFF (STANDARD CHARACTER)**. DOGTUFF, LLC., (U.S. CLS. 100, 101 AND 102). SN 86-002,950. PUB. 11-26-2013. FILED 7-5-2013.
- 4,481,008. **PRIDEZILLAS AND DESIGN**. PRIDEZILLAS LLC, (U.S. CLS. 100, 101 AND 102). SN 86-002,995. PUB. 11-26-2013. FILED 7-5-2013.
- 4,481,019. **DEAN LYKOS CURRENCY ANTIQUES GIFTS COLLECTIBLES AND DESIGN**. DEAN LYKOS, LLC, (U.S. CLS. 100, 101 AND 102). SN 86-003,085. PUB. 11-26-2013. FILED 7-5-2013.
- 4,481,020. **MISCELLANEOUS DESIGN**. DEAN LYKOS, LLC, (U.S. CLS. 100, 101 AND 102). SN 86-003,092. PUB. 11-26-2013. FILED 7-5-2013.
- 4,481,027. **GIFT A FEAST (STANDARD CHARACTER)**. GIFT A FEAST LLC, (U.S. CLS. 100, 101 AND 102). SN 86-003,203. PUB. 11-26-2013. FILED 7-5-2013.
- 4,481,029. **W AND DESIGN**. WHOLESALE POINT, INC., (U.S. CLS. 100, 101 AND 102). SN 86-003,226. PUB. 11-26-2013. FILED 7-5-2013.
- 4,481,036. **THREE SPECKLED HENS (STANDARD CHARACTER)**. TSH PRODUCTIONS LLC, DBA THREE SPECKLED HENS, (U.S. CLS. 100, 101 AND 102). SN 86-003,362. PUB. 11-26-2013. FILED 7-5-2013.
- 4,481,070. **INTECTURAL (STANDARD CHARACTER)**. INTECTURAL, INC., (U.S. CLS. 100, 101 AND 102). SN 86-003,771. PUB. 11-26-2013. FILED 7-8-2013.
- 4,481,071. **TIPORIA (STANDARD CHARACTER)**. TIPORIA INC., MULTIPLE CLASS, (INT. CLS. 35 AND 45), (U.S. CLS. 100, 101 AND 102). SN 86-003,776. PUB. 11-26-2013. FILED 7-8-2013.
- 4,481,081. **YOU NEED THE POWER OF A PERSON! (STANDARD CHARACTER)**. FOCUS TELECOMMUNICATIONS, INC., (U.S. CLS. 100, 101 AND 102). SN 86-004,021. PUB. 11-26-2013. FILED 7-8-2013.
- 4,481,089 ( *See Class 30 for this trademark*).
- 4,481,094. **WIKICFO (STANDARD CHARACTER)**. THE STRATEGIC CFO, (U.S. CLS. 100, 101 AND 102). SN 86-004,194. PUB. 11-26-2013. FILED 7-8-2013.
- 4,481,101. **PARK & MADISON (STANDARD CHARACTER)**. PARK & MADISON LLC, (U.S. CLS. 100, 101 AND 102). SN 86-004,454. PUB. 11-26-2013. FILED 7-8-2013.
- 4,481,120. **BRANDEKKO (STANDARD CHARACTER)**. BRANDEKKO, LLC, (U.S. CLS. 100, 101 AND 102). SN 86-004,773. PUB. 11-26-2013. FILED 7-8-2013.
- 4,481,135. **TAKE COMMAND OF YOUR BUSINESS VALUE (STANDARD CHARACTER)**. CHARTED COURSE ADVISORS LLC, AKA CHARETD COURSE CONSULTING LLC, (U.S. CLS. 100, 101 AND 102). SN 86-005,059. PUB. 11-26-2013. FILED 7-9-2013.
- 4,481,138. **EVERYTHING NAUTICAL (STANDARD CHARACTER)**. EVERYTHING NAUTICAL, LLC, DBA WWW.EVERYTHINGNAUTICAL.COM, (U.S. CLS. 100, 101 AND 102). SN 86-005,090. PUB. 11-26-2013. FILED 7-9-2013.
- 4,481,139. **SUPERTABLETS (STANDARD CHARACTER)**. FUJII, SHOICHI MIKE, (U.S. CLS. 100, 101 AND 102). SN 86-005,097. PUB. 11-26-2013. FILED 7-9-2013.
- 4,481,149. **WALLET SAVER CARDS (STANDARD CHARACTER)**. HUDETZ, PAUL, (U.S. CLS. 100, 101 AND 102). SN 86-005,256. PUB. 11-26-2013. FILED 7-9-2013.
- 4,481,156. **MISCELLANEOUS DESIGN**. JOHN W. KENAGY, (U.S. CLS. 100, 101 AND 102). SN 86-005,339. PUB. 11-26-2013. FILED 7-9-2013.
- 4,481,162. **MISCELLANEOUS DESIGN**. GEHL FLOORING SUPPLY, INC., (U.S. CLS. 100, 101 AND 102). SN 86-005,409. PUB. 11-26-2013. FILED 7-9-2013.
- 4,481,166. **ENGINEERYOURHEALTH (STANDARD CHARACTER)**. MASSACHUSETTS INSTITUTE OF TECHNOLOGY, (U.S. CLS. 100, 101 AND 102). SN 86-005,481. PUB. 11-26-2013. FILED 7-9-2013.
- 4,481,186 ( *See Class 9 for this trademark*).
- 4,481,189 ( *See Class 9 for this trademark*).
- 4,481,200. **CALPACIFIC MARKETING GROUP INCORPORATED (STANDARD CHARACTER)**. CALPACIFIC MARKETING GROUP, INC., (U.S. CLS. 100, 101 AND 102). SN

86-006,828. PUB. 11-26-2013. FILED 7-10-2013.  
 4,481,225. **WE SAVE YOU MONEY (STANDARD CHARACTER)**. OVERSTOCK.COM, INC., (U.S. CLS. 100, 101 AND 102). SN 86-017,763. PUB. 11-26-2013. FILED 7-23-2013.  
 4,481,228. **FIND VALUE, GET VALUE, KEEP VALUE (STANDARD CHARACTER)**. NET(NET), INC., (U.S. CLS. 100, 101 AND 102). SN 86-022,128. PUB. 11-26-2013. FILED 7-29-2013.  
 4,481,237. **UNIFIRST U1ST AND DESIGN**. UNIFIRST CORPORATION, (U.S. CLS. 100, 101 AND 102). SN 86-026,011. PUB. 11-26-2013. FILED 8-1-2013.  
 4,481,240. **DIPOSTA AND DESIGN**. DIPOSTA, INC., MULTIPLE CLASS, (INT. CLS. 35 AND 38), (U.S. CLS. 100, 101, 102 AND 104). SN 86-026,826. PUB. 11-26-2013. FILED 8-2-2013.  
 4,481,264. **HAWAII FARM BUREAU (STANDARD CHARACTER)**. AMERICAN FARM BUREAU FEDERATION, (U.S. CLS. 100, 101 AND 102). SN 86-047,539. PUB. 11-26-2013. FILED 8-26-2013.  
 4,481,276 ( *See Class 30 for this trademark*).  
 4,481,277. **ACTIVEVIEW HDI (STANDARD CHARACTER)**. ECOLAB USA INC., MULTIPLE CLASS, (INT. CLS. 35 AND 45), (U.S. CLS. 100, 101 AND 102). SN 86-055,517. PUB. 11-26-2013. FILED 9-4-2013.

### CLASS 36—INSURANCE AND FINANCIAL

4,479,299 ( *See Class 9 for this trademark*).  
 4,479,304 ( *See Class 9 for this trademark*).  
 4,479,313. **BUDGETAIR AND DESIGN**. TRAVIX INTERNATIONAL B.V., MULTIPLE CLASS, (INT. CLS. 36, 39, 42 AND 43), (U.S. CLS. 100, 101, 102 AND 105). SN 79-121,576. PUB. 8-20-2013. FILED 7-10-2012.  
 4,479,350 ( *See Class 35 for this trademark*).  
 4,479,357 ( *See Class 35 for this trademark*).  
 4,479,374 ( *See Class 9 for this trademark*).  
 4,479,389. **GEFF (STYLIZED)**. STEFFEN MÜLLER, MULTIPLE CLASS, (INT. CLS. 36 AND 42), (U.S. CLS. 100, 101 AND 102). SN 79-126,785. PUB. 11-26-2013. FILED 1-11-2013.  
 4,479,390. **IWC INVESTMENT PARTNERS (STANDARD CHARACTER)**. IWC INVESTMENT PARTNERS FONDS-MÆGLERSELSKAB A/S, (U.S. CLS. 100, 101 AND 102). SN 79-126,791. PUB. 11-26-2013. FILED 9-28-2012.  
 4,479,413 ( *See Class 9 for this trademark*).  
 4,479,420. **FREENDEX (STYLIZED)**. MANAKHOV ANTON ANATOLIEVICH, (U.S. CLS. 100, 101 AND 102). SN 79-128,141. PUB. 11-26-2013. FILED 12-19-2012.  
 4,479,434 ( *See Class 3 for this trademark*).  
 4,479,455 ( *See Class 9 for this trademark*).  
 4,479,458. **UFX (STANDARD CHARACTER)**. UBRAND LTD., (U.S. CLS. 100, 101 AND 102). SN 79-130,949. PUB. 11-26-2013. FILED 5-8-2013.  
 4,479,460 ( *See Class 9 for this trademark*).  
 4,479,464 ( *See Class 9 for this trademark*).  
 4,479,467 ( *See Class 9 for this trademark*).  
 4,479,469 ( *See Class 9 for this trademark*).  
 4,479,499. **BMW ECOVER (STANDARD CHARACTER)**. BAYERISCHE MOTOREN WERKE AKTIENGESELLSCHAFT, (U.S. CLS. 100, 101 AND 102). SN 79-134,926. PUB. 11-26-2013. FILED 7-1-2013.  
 4,479,543 ( *See Class 16 for this trademark*).  
 4,479,550 ( *See Class 35 for this trademark*).  
 4,479,575 ( *See Class 9 for this trademark*).  
 4,479,620 ( *See Class 35 for this trademark*).  
 4,479,632 ( *See Class 9 for this trademark*).  
 4,479,640 ( *See Class 35 for this trademark*).  
 4,479,669. **RESOLUTE PORTFOLIO (STANDARD CHARACTER)**. STARR INTERNATIONAL COMPANY, INC., (U.S. CLS. 100, 101 AND 102). SN 85-640,512. PUB. 11-26-2013. FILED 6-1-2012.  
 4,479,676. **INVEST DIFFERENT (STANDARD CHARACTER)**. MHS QUINCY, INC., (U.S. CLS. 100, 101 AND 102). SN 85-649,567. PUB. 11-26-2013. FILED 6-12-2012.  
 4,479,695 ( *See Class 35 for this trademark*).  
 4,479,718. **NBH BANK (STANDARD CHARACTER)**. NATIONAL BANK HOLDINGS CORPORATION, (U.S. CLS. 100, 101 AND 102). SN 85-704,019. PUB. 11-26-2013. FILED 8-15-2012.

4,479,748 ( *See Class 25 for this trademark*).  
 4,479,788. **CARLTON INTERNATIONAL (STANDARD CHARACTER)**. BRUNO PIOTROWSKI, (U.S. CLS. 100, 101 AND 102). SN 85-766,621. PUB. 6-11-2013. FILED 10-30-2012.  
 4,479,800 ( *See Class 35 for this trademark*).  
 4,479,822. **GATOR (STANDARD CHARACTER)**. BARCLAYS BANK PLC, (U.S. CLS. 100, 101 AND 102). SN 85-779,375. PUB. 7-30-2013. FILED 11-14-2012.  
 4,479,823. **BARX GATOR (STANDARD CHARACTER)**. BARCLAYS BANK PLC, (U.S. CLS. 100, 101 AND 102). SN 85-779,394. PUB. 7-30-2013. FILED 11-14-2012.  
 4,479,848. **BANCO BILBAO VIZCAYA ARGENTARIA (STANDARD CHARACTER)**. BANCO BILBAO VIZCAYA ARGENTARIA, S.A., (U.S. CLS. 100, 101 AND 102). SN 85-791,668. PUB. 9-10-2013. FILED 11-30-2012.  
 4,479,898 ( *See Class 35 for this trademark*).  
 4,479,912. **P AND DESIGN**. JAMES G. PARKER INSURANCE ASSOCIATES, (U.S. CLS. 100, 101 AND 102). SN 85-806,699. PUB. 11-26-2013. FILED 12-19-2012.  
 4,479,913 ( *See Class 35 for this trademark*).  
 4,479,932. **XPROTECT (STANDARD CHARACTER)**. XCALIBER SOLUTIONS INC., MULTIPLE CLASS, (INT. CLS. 36 AND 45), (U.S. CLS. 100, 101 AND 102). SN 85-809,974. PUB. 11-26-2013. FILED 12-24-2012.  
 4,479,949 ( *See Class 9 for this trademark*).  
 4,479,950. **MONEYTRAC AND DESIGN**. GLOBAL PAYOUT, INC., (U.S. CLS. 100, 101 AND 102). SN 85-815,089. PUB. 8-20-2013. FILED 1-3-2013.  
 4,479,996. **NORTH AMERICAN COMPANY (STANDARD CHARACTER)**. SAMMONS FINANCIAL GROUP, INC., (U.S. CLS. 100, 101 AND 102). SN 85-829,381. PUB. 11-26-2013. FILED 1-22-2013.  
 4,479,998. **NORTH AMERICAN COMPANY FOR LIFE AND HEALTH INSURANCE (STANDARD CHARACTER)**. SAMMONS FINANCIAL GROUP, INC., (U.S. CLS. 100, 101 AND 102). SN 85-829,389. PUB. 11-26-2013. FILED 1-22-2013.  
 4,480,055. **GIVING LIBRARY AND DESIGN**. LAURA AND JOHN ARNOLD FOUNDATION, (U.S. CLS. 100, 101 AND 102). SN 85-851,722. PUB. 11-26-2013. FILED 2-15-2013.  
 4,480,061 ( *See Class 35 for this trademark*).  
 4,480,072. **BENECARD ASSOCIATION (STANDARD CHARACTER)**. BENECARD SERVICES, INC., MULTIPLE CLASS, (INT. CLS. 36 AND 41), (U.S. CLS. 100, 101, 102 AND 107). SN 85-859,383. PUB. 11-26-2013. FILED 2-25-2013.  
 4,480,073. **BENECARD ASSOCIATION AND DESIGN**. BENECARD SERVICES, INC., MULTIPLE CLASS, (INT. CLS. 36 AND 41), (U.S. CLS. 100, 101, 102 AND 107). SN 85-859,541. PUB. 11-26-2013. FILED 2-25-2013.  
 4,480,104. **BILL & MELINDA GATES FOUNDATION (STANDARD CHARACTER)**. BILL & MELINDA GATES FOUNDATION, (U.S. CLS. 100, 101 AND 102). SN 85-871,746. PUB. 11-26-2013. FILED 3-8-2013.  
 4,480,109. **E&A COMPANIES (STANDARD CHARACTER)**. HUBSON HOLDINGS, LLC, (U.S. CLS. 100, 101 AND 102). SN 85-874,572. PUB. 11-26-2013. FILED 3-13-2013.  
 4,480,129. **SAY NO TO POACHING AND DESIGN**. PRATIK PATEL, (U.S. CLS. 100, 101 AND 102). SN 85-881,853. PUB. 11-26-2013. FILED 3-20-2013.  
 4,480,133. **HILL COUNTRY STATE CHAMPIONSHIP BBQ COOKOFF SAN MARCOS AND DESIGN**. HCCO ASSOCIATION OF SAN MARCOS, TEXAS, (U.S. CLS. 100, 101 AND 102). SN 85-883,638. PUB. 11-26-2013. FILED 3-22-2013.  
 4,480,165. **JCBPLATINUM (STANDARD CHARACTER)**. JCB CO., LTD., (U.S. CLS. 100, 101 AND 102). SN 85-894,868. PUB. 9-3-2013. FILED 4-4-2013.  
 4,480,186 ( *See Class 35 for this trademark*).  
 4,480,210 ( *See Class 16 for this trademark*).  
 4,480,214. **COMPETITIVE VERIFICATION (STANDARD CHARACTER)**. ACZEL, KAROLY ZSOLT, DBA PERPETUUM CAPITAL, (U.S. CLS. 100, 101 AND 102). SN 85-910,372. PUB. 11-26-2013. FILED 4-22-2013.  
 4,480,220 ( *See Class 35 for this trademark*).  
 4,480,234. **BORN AGAIN HOMES (STANDARD CHARACTER)**. MARSILIA, RONALD, (U.S. CLS. 100, 101 AND 102). SN 85-915,639. PUB. 11-26-2013. FILED 4-26-2013.  
 4,480,268. **NEUBERGER BERMAN INTERNATIONAL EQUITY FUND (STANDARD CHARACTER)**. NEUBERGER BERMAN MANAGEMENT LLC, (U.S. CLS. 100, 101 AND

- 102). SN 85-925,675. PUB. 11-26-2013. FILED 5-7-2013.
- 4,480,290. **RECONNECTING REAL ESTATE AND HOME (STANDARD CHARACTER)**. VISION HOME BUYERS, L.L.C., (U.S. CLS. 100, 101 AND 102). SN 85-928,578. PUB. 11-26-2013. FILED 5-10-2013.
- 4,480,295 ( *See Class 35 for this trademark*).
- 4,480,296 ( *See Class 35 for this trademark*).
- 4,480,317. **R RIO MANAGEMENT GROUP (STYLIZED)**. RIO MANAGEMENT GROUP, LLC, (U.S. CLS. 100, 101 AND 102). SN 85-935,237. PUB. 11-26-2013. FILED 5-17-2013.
- 4,480,319. **ACT ACCOUNT CONTROL TECHNOLOGY, INC. AND DESIGN**. ACCOUNT CONTROL TECHNOLOGY, INC., (U.S. CLS. 100, 101 AND 102). SN 85-935,252. PUB. 11-26-2013. FILED 5-17-2013.
- 4,480,329. **SYLVAN | THIRTY (STANDARD CHARACTER)**. OAXACA INTERESTS, LLC, (U.S. CLS. 100, 101 AND 102). SN 85-938,810. PUB. 11-26-2013. FILED 5-21-2013.
- 4,480,333 ( *See Class 35 for this trademark*).
- 4,480,352 ( *See Class 35 for this trademark*).
- 4,480,353 ( *See Class 35 for this trademark*).
- 4,480,354 ( *See Class 35 for this trademark*).
- 4,480,378. **EMERIO PAYMENTS (STANDARD CHARACTER)**. EMERIO PAYMENTS, L.L.C., (U.S. CLS. 100, 101 AND 102). SN 85-944,761. PUB. 11-26-2013. FILED 5-29-2013.
- 4,480,398. **TE TIME EQUITIES INC. (STYLIZED)**. TIME EQUITIES, INC., MULTIPLE CLASS, (INT. CLS. 36 AND 37), (U.S. CLS. 100, 101, 102, 103 AND 106). SN 85-946,551. PUB. 11-26-2013. FILED 5-30-2013.
- 4,480,415. **TIERS OF RISK (STANDARD CHARACTER)**. WEST CAPITAL MANAGEMENT, INC., (U.S. CLS. 100, 101 AND 102). SN 85-948,616. PUB. 11-26-2013. FILED 6-3-2013.
- 4,480,416. **WEST CAPITAL MANAGEMENT (STANDARD CHARACTER)**. WEST CAPITAL MANAGEMENT, INC., (U.S. CLS. 100, 101 AND 102). SN 85-948,633. PUB. 11-26-2013. FILED 6-3-2013.
- 4,480,417. **WEST CAPITAL MANAGEMENT AND DESIGN**. WEST CAPITAL MANAGEMENT, INC., (U.S. CLS. 100, 101 AND 102). SN 85-948,653. PUB. 11-26-2013. FILED 6-3-2013.
- 4,480,422 ( *See Class 35 for this trademark*).
- 4,480,432. **BXA TRUSTED ADVISORS BENEFITS EXCHANGE ALLIANCE AND DESIGN**. BENEFITS EXCHANGE ALLIANCE, INC., (U.S. CLS. 100, 101 AND 102). SN 85-950,751. PUB. 11-26-2013. FILED 6-4-2013.
- 4,480,436 ( *See Class 35 for this trademark*).
- 4,480,475. **MCSCHOLARS (STANDARD CHARACTER)**. MCDONALD'S CORPORATION, (U.S. CLS. 100, 101 AND 102). SN 85-956,681. PUB. 11-26-2013. FILED 6-11-2013.
- 4,480,497. **BENEFITS SIMPLE INSURANCE SOLUTIONS TO FIT YOUR SMALL BUSINESS NEEDS (STYLIZED)**. NATIONWIDE MUTUAL INSURANCE COMPANY, (U.S. CLS. 100, 101 AND 102). SN 85-959,254. PUB. 11-26-2013. FILED 6-13-2013.
- 4,480,502 ( *See Class 35 for this trademark*).
- 4,480,509. **SIMPLE2GIVE (STANDARD CHARACTER)**. NOOTRA, INC., DBA SIMPLE2GIVE, (U.S. CLS. 100, 101 AND 102). SN 85-961,519. PUB. 11-26-2013. FILED 6-17-2013.
- 4,480,535. **KADAMBA TREE FOUNDATION AND DESIGN**. KADAMBA TREE FOUNDATION, (U.S. CLS. 100, 101 AND 102). SN 85-963,731. PUB. 11-26-2013. FILED 6-19-2013.
- 4,480,545. **THE CREDIT REPAIRMAN (STANDARD CHARACTER)**. THE CREDIT REPAIRMAN, L.L.C., (U.S. CLS. 100, 101 AND 102). SN 85-963,999. PUB. 11-26-2013. FILED 6-19-2013.
- 4,480,570. **BEFORE WE INVEST WE LISTEN (STANDARD CHARACTER)**. ELLENBECKER INVESTMENT GROUP, INC., (U.S. CLS. 100, 101 AND 102). SN 85-965,027. PUB. 11-26-2013. FILED 6-20-2013.
- 4,480,571. **BEFORE WE ADVISE WE LISTEN (STANDARD CHARACTER)**. ELLENBECKER INVESTMENT GROUP, INC., (U.S. CLS. 100, 101 AND 102). SN 85-965,035. PUB. 11-26-2013. FILED 6-20-2013.
- 4,480,572. **BEFORE WE PLAN WE LISTEN (STANDARD CHARACTER)**. ELLENBECKER INVESTMENT GROUP, INC., (U.S. CLS. 100, 101 AND 102). SN 85-965,054. PUB. 11-26-2013. FILED 6-20-2013.
- 4,480,581. **247SMART AND DESIGN**. SOUTH CAROLINA GOVERNOR'S SCHOOL FOR SCIENCE AND MATH FOUNDATION, (U.S. CLS. 100, 101 AND 102). SN 85-965,380. PUB. 11-26-2013. FILED 6-20-2013.
- 4,480,590. **PAY IT SQUARE (STANDARD CHARACTER)**. PAY IT SQUARE, (U.S. CLS. 100, 101 AND 102). SN 85-965,779. PUB. 11-26-2013. FILED 6-20-2013.
- 4,480,595. **PRIMEWAY (STANDARD CHARACTER)**. PRIMEWAY FEDERAL CREDIT UNION, (U.S. CLS. 100, 101 AND 102). SN 85-966,218. PUB. 11-26-2013. FILED 6-21-2013.
- 4,480,609. **REAL ESTATE QUEEN OF HEARTS (STANDARD CHARACTER)**. VALENTINE, SHELLY, (U.S. CLS. 100, 101 AND 102). SN 85-966,841. PUB. 11-26-2013. FILED 6-21-2013.
- 4,480,633. **NATIONAL ACTIVE AND RETIRED FEDERAL EMPLOYEES ASSOCIATION (STANDARD CHARACTER)**. NATIONAL ACTIVE AND RETIRED FEDERAL EMPLOYEES ASSOCIATION, AKA NARFE, (U.S. CLS. 100, 101 AND 102). SN 85-968,114. PUB. 11-26-2013. FILED 6-24-2013.
- 4,480,636. **CASA DE BALBOA (STANDARD CHARACTER)**. MURRAY, PAMELA, DBA CASA DE BALBOA, (U.S. CLS. 100, 101 AND 102). SN 85-968,189. PUB. 11-26-2013. FILED 6-24-2013.
- 4,480,670. **QSV SMID-CAP (STANDARD CHARACTER)**. QUANTUM CAPITAL MANAGEMENT, LLC, (U.S. CLS. 100, 101 AND 102). SN 85-969,488. PUB. 11-26-2013. FILED 6-25-2013.
- 4,480,671. **QSV SMID-CAP EQUITY (STANDARD CHARACTER)**. QUANTUM CAPITAL MANAGEMENT, LLC, (U.S. CLS. 100, 101 AND 102). SN 85-969,569. PUB. 11-26-2013. FILED 6-25-2013.
- 4,480,702. **NEW SCIENCE VENTURES AND DESIGN**. NEW SCIENCE VENTURES LLC, (U.S. CLS. 100, 101 AND 102). SN 85-971,002. PUB. 11-26-2013. FILED 6-26-2013.
- 4,480,710. **LENDING AS IT SHOULD BE. (STYLIZED)**. MCLEAN MORTGAGE CORPORATION, (U.S. CLS. 100, 101 AND 102). SN 85-971,428. PUB. 11-26-2013. FILED 6-27-2013.
- 4,480,713. **NOTRE DAME FEDERAL CREDIT UNION AND DESIGN**. NOTRE DAME FEDERAL CREDIT UNION CORPORATION, (U.S. CLS. 100, 101 AND 102). SN 85-971,679. PUB. 11-26-2013. FILED 6-27-2013.
- 4,480,714. **HFG (STYLIZED)**. HEALTHCARE FINANCE GROUP, LLC, (U.S. CLS. 100, 101 AND 102). SN 85-971,728. PUB. 11-26-2013. FILED 6-27-2013.
- 4,480,740. **AP ADVANTAGE EPAY NETWORK AND DESIGN**. GREEN PAYMENT COMPANY, LLC, (U.S. CLS. 100, 101 AND 102). SN 85-973,098. PUB. 11-26-2013. FILED 6-28-2013.
- 4,480,750. **SIENA WEALTH ADVISORS (STANDARD CHARACTER)**. HICKS, STEPHEN L., (U.S. CLS. 100, 101 AND 102). SN 85-973,591. PUB. 11-26-2013. FILED 6-29-2013.
- 4,480,768 ( *See Class 32 for this trademark*).
- 4,480,772. **INDEX LIVING (STANDARD CHARACTER)**. INDEX ENTERPRISE LLC, (U.S. CLS. 100, 101 AND 102). SN 85-974,221. PUB. 11-26-2013. FILED 7-1-2013.
- 4,480,773. **INDEX LIVING AND DESIGN**. INDEX ENTERPRISE LLC, (U.S. CLS. 100, 101 AND 102). SN 85-974,259. PUB. 11-26-2013. FILED 7-1-2013.
- 4,480,779. **OAREX (STANDARD CHARACTER)**. OAREX CAPITAL MARKETS, INC., (U.S. CLS. 100, 101 AND 102). SN 85-974,649. PUB. 11-26-2013. FILED 7-1-2013.
- 4,480,861. **MEDICAREFREEHELP (STANDARD CHARACTER)**. ARRON, NEILL, DBA MEDICAREFREEHELP, (U.S. CLS. 100, 101 AND 102). SN 86-000,912. PUB. 11-26-2013. FILED 7-2-2013.
- 4,480,873. **MISCELLANEOUS DESIGN**. ONSET FINANCIAL, INC., (U.S. CLS. 100, 101 AND 102). SN 86-001,105. PUB. 11-26-2013. FILED 7-2-2013.
- 4,480,888 ( *See Class 9 for this trademark*).
- 4,480,889. **MIDWOOD (STANDARD CHARACTER)**. MIDWOOD CAPITAL MANAGEMENT LLC, (U.S. CLS. 100, 101 AND 102). SN 86-001,535. PUB. 11-26-2013. FILED 7-3-2013.
- 4,480,891 ( *See Class 9 for this trademark*).
- 4,480,898. **WHERE YOUR INTEREST COMES FIRST! (STANDARD CHARACTER)**. FIRST FINANCIAL GROUP, LLC, (U.S. CLS. 100, 101 AND 102). SN 86-001,623. PUB. 11-26-2013. FILED 7-3-2013.
- 4,480,900 ( *See Class 14 for this trademark*).
- 4,480,942. **LUTHERAN HOUSING SUPPORT (STANDARD CHARACTER)**. THE LUTHERAN CHURCH-MISSOURI

- SYNOD, MULTIPLE CLASS, (INT. CLS. 36, 37 AND 41), (U.S. CLS. 100, 101, 102, 103, 106 AND 107). SN 86-002,256. PUB. 11-26-2013. FILED 7-3-2013.
- 4,480,943. **GROCERYSHIPS (STANDARD CHARACTER)**. SAMUEL POLK, (U.S. CLS. 100, 101 AND 102). SN 86-002,259. PUB. 11-26-2013. FILED 7-3-2013.
- 4,480,950 ( *See Class 35 for this trademark*).
- 4,480,955. **OPINICUS (STANDARD CHARACTER)**. OPINICUS CAPITAL INC, (U.S. CLS. 100, 101 AND 102). SN 86-002,352. PUB. 11-26-2013. FILED 7-3-2013.
- 4,480,963. **GOLDSTONE FINANCIAL GROUP AND DESIGN**. ANTHONY PELLEGRINO, DBA GOLDSTONE FINANCIAL GROUP, (U.S. CLS. 100, 101 AND 102). SN 86-002,516. PUB. 11-26-2013. FILED 7-3-2013.
- 4,480,966. **YOUR PASSION. YOUR REWARDS. (STANDARD CHARACTER)**. BASS PRO INTELLECTUAL PROPERTY, L.L.C., (U.S. CLS. 100, 101 AND 102). SN 86-002,572. PUB. 11-26-2013. FILED 7-3-2013.
- 4,480,968. **OWMEE (STANDARD CHARACTER)**. OWMEE, (U.S. CLS. 100, 101 AND 102). SN 86-002,614. PUB. 11-26-2013. FILED 7-3-2013.
- 4,480,985. **TRUST.SECURITY.CONFIDENCE (STANDARD CHARACTER)**. WINFIRST FINANCIAL CORP., (U.S. CLS. 100, 101 AND 102). SN 86-002,768. PUB. 11-26-2013. FILED 7-4-2013.
- 4,480,987. **SIMPLIRISK KNOW YOUR PAYMENTS AND DESIGN**. PAY LYNXS, INC., (U.S. CLS. 100, 101 AND 102). SN 86-002,794. PUB. 11-26-2013. FILED 7-4-2013.
- 4,481,068. **SEVEN RUE (STANDARD CHARACTER)**. KNUTSON, NOWELLE, (U.S. CLS. 100, 101 AND 102). SN 86-003,711. PUB. 11-26-2013. FILED 7-8-2013.
- 4,481,069. **SKYFALL (STANDARD CHARACTER)**. A & A, (U.S. CLS. 100, 101 AND 102). SN 86-003,747. PUB. 11-26-2013. FILED 7-8-2013.
- 4,481,072. **RECONNAISSANCE (STANDARD CHARACTER)**. A & A, (U.S. CLS. 100, 101 AND 102). SN 86-003,798. PUB. 11-26-2013. FILED 7-8-2013.
- 4,481,087. **CREATING AND PRESERVING WEALTH FOR GENERATIONS (STANDARD CHARACTER)**. SAGE RUTTY & CO., INC., (U.S. CLS. 100, 101 AND 102). SN 86-004,068. PUB. 11-26-2013. FILED 7-8-2013.
- 4,481,099. **OFFICIAL CREDIT UNION OF GREAT RATES (STANDARD CHARACTER)**. TYNDALL FEDERAL CREDIT UNION, (U.S. CLS. 100, 101 AND 102). SN 86-004,443. PUB. 11-26-2013. FILED 7-8-2013.
- 4,481,110. **CP (STYLIZED)**. COLUMBIA PACIFIC ADVISORS, LLC, (U.S. CLS. 100, 101 AND 102). SN 86-004,567. PUB. 11-26-2013. FILED 7-8-2013.
- 4,481,142. **TALKMARKETS (STANDARD CHARACTER)**. TALKMARKETS, LLC, (U.S. CLS. 100, 101 AND 102). SN 86-005,164. PUB. 11-26-2013. FILED 7-9-2013.
- 4,481,236. **UNISON ADVANTAGE (STANDARD CHARACTER)**. UNITEDHEALTH GROUP INCORPORATED, (U.S. CLS. 100, 101 AND 102). SN 86-025,047. PUB. 11-26-2013. FILED 7-31-2013.
- 4,481,285. **D AND DESIGN**. DYSTONIA MEDICAL RESEARCH FOUNDATION, AKA DYSTONIA FOUNDATION; DMRF, (U.S. CLS. 100, 101 AND 102). SN 86-060,598. PUB. 11-26-2013. FILED 9-10-2013.
- 4,479,434 ( *See Class 3 for this trademark*).
- 4,479,435 ( *See Class 7 for this trademark*).
- 4,479,445. **ROLLERCOASTERRESTAURANT (STANDARD CHARACTER)**. HEINEMACK, GMBH, MULTIPLE CLASS, (INT. CLS. 37, 42 AND 43), (U.S. CLS. 100, 101, 103 AND 106). SN 79-129,818. PUB. 11-26-2013. FILED 3-7-2013.
- 4,479,456 ( *See Class 6 for this trademark*).
- 4,479,477 ( *See Class 6 for this trademark*).
- 4,479,545 ( *See Class 12 for this trademark*).
- 4,479,546 ( *See Class 12 for this trademark*).
- 4,479,547 ( *See Class 12 for this trademark*).
- 4,479,566 ( *See Class 12 for this trademark*).
- 4,479,577 ( *See Class 9 for this trademark*).
- 4,479,579. **GUTTER GUYS (STANDARD CHARACTER)**. GUTTER GUYS, LLC, (U.S. CLS. 100, 103 AND 106). SN 85-514,660. PUB. 12-11-2012. FILED 1-12-2012.
- 4,479,580 ( *See Class 35 for this trademark*).
- 4,479,581 ( *See Class 35 for this trademark*).
- 4,479,582 ( *See Class 2 for this trademark*).
- 4,479,731. **NEDERVELD (STANDARD CHARACTER)**. NEDERVELD ASSOCIATES SURVEYING, INC., DBA NEDERVELD, INC., MULTIPLE CLASS, (INT. CLS. 37, 42 AND 45), (U.S. CLS. 100, 101, 103 AND 106). SN 85-724,789. PUB. 11-26-2013. FILED 9-10-2012.
- 4,479,732 ( *See Class 9 for this trademark*).
- 4,479,761. **THE SQUEAKY FLOOR DOCTOR OF AMERICA (STANDARD CHARACTER)**. ALCARAZ, RICHARD, (U.S. CLS. 100, 103 AND 106). SN 85-748,471. PUB. 11-26-2013. FILED 10-8-2012.
- 4,479,791. **HINO GSPS (STANDARD CHARACTER)**. HINO JIDOSHA KABUSHIKI KAISHA, ALSO TRADING AS HINO MOTORS, LTD., (U.S. CLS. 100, 103 AND 106). SN 85-768,895. PUB. 11-26-2013. FILED 11-1-2012.
- 4,479,974. **MISCELLANEOUS DESIGN**. IDOPE, LLC, (U.S. CLS. 100, 103 AND 106). SN 85-823,422. PUB. 11-26-2013. FILED 1-15-2013.
- 4,480,028 ( *See Class 35 for this trademark*).
- 4,480,056. **MISCELLANEOUS DESIGN**. CLEAN SWEEP OF A CO., INC., MULTIPLE CLASS, (INT. CLS. 37 AND 42), (U.S. CLS. 100, 101, 103 AND 106). SN 85-851,843. PUB. 11-26-2013. FILED 2-15-2013.
- 4,480,170. **NO EOL OBSOLESCENCE AND DESIGN**. GDCA, INC., (U.S. CLS. 100, 103 AND 106). SN 85-897,169. PUB. 11-26-2013. FILED 4-6-2013.
- 4,480,249 ( *See Class 20 for this trademark*).
- 4,480,270 ( *See Class 35 for this trademark*).
- 4,480,271 ( *See Class 35 for this trademark*).
- 4,480,288 ( *See Class 35 for this trademark*).
- 4,480,367. **POP-A-LOCK THE SECURITY PROFESSIONALS AND DESIGN**. SYSTEMFORWARD AMERICA, INC., MULTIPLE CLASS, (INT. CLS. 37, 39, 40 AND 45), (U.S. CLS. 100, 101, 103, 105 AND 106). SN 85-943,541. PUB. 11-26-2013. FILED 5-28-2013.
- 4,480,396. **WETZONE CAR WASH AND DESIGN**. WET ZONE, LP, (U.S. CLS. 100, 103 AND 106). SN 85-946,122. PUB. 11-26-2013. FILED 5-30-2013.
- 4,480,398 ( *See Class 36 for this trademark*).
- 4,480,437. **NATIONAL CATASTROPHE RESTORATION, INC. (STANDARD CHARACTER)**. NATIONAL CATASTROPHE RESTORATION, INC., (U.S. CLS. 100, 103 AND 106). SN 85-951,280. PUB. 11-26-2013. FILED 6-5-2013.
- 4,480,603. **GRADE A GRADE A HOME IMPROVEMENT AND DESIGN**. GRADE A HOME IMPROVEMENT, LLC, (U.S. CLS. 100, 103 AND 106). SN 85-966,484. PUB. 11-26-2013. FILED 6-21-2013.
- 4,480,650. **HEALTHY WAY WATERPROOFING & MOLD REMEDIATION, LLC (STANDARD CHARACTER)**. HEALTHY WAY WATERPROOFING & MOLD REMEDIATION LLC, MULTIPLE CLASS, (INT. CLS. 37 AND 40), (U.S. CLS. 100, 103 AND 106). SN 85-968,638. PUB. 11-26-2013. FILED 6-24-2013.
- 4,480,653. **SPEEDY CYCLE LUBE (STANDARD CHARACTER)**. SPEEDY CYCLE LUBE, (U.S. CLS. 100, 103 AND 106). SN 85-968,677. PUB. 11-26-2013. FILED 6-24-2013.
- 4,480,672. **HETSCO (STANDARD CHARACTER)**. HETSCO, INC., MULTIPLE CLASS, (INT. CLS. 37 AND 40), (U.S. CLS. 100, 103 AND 106). SN 85-969,618. PUB. 11-26-2013. FILED 6-25-2013.

#### CLASS 37—CONSTRUCTION AND REPAIR

- 4,479,241. **KOFILE (STANDARD CHARACTER)**. KOFILE, INC., MULTIPLE CLASS, (INT. CLS. 37, 39 AND 42), (U.S. CLS. 100, 101, 103, 105 AND 106). SN 76-709,849. PUB. 11-26-2013. FILED 11-29-2011.
- 4,479,248. **CENTRAL TEXAS CUSTOM GUTTERS (STANDARD CHARACTER)**. CENTRAL TEXAS CUSTOM GUTTERS, L.L.C., (U.S. CLS. 100, 103 AND 106). SN 76-714,173. PUB. 11-26-2013. FILED 5-17-2013.
- 4,479,275 ( *See Class 9 for this trademark*).
- 4,479,277 ( *See Class 9 for this trademark*).
- 4,479,279 ( *See Class 9 for this trademark*).
- 4,479,303 ( *See Class 7 for this trademark*).
- 4,479,325 ( *See Class 6 for this trademark*).
- 4,479,353 ( *See Class 7 for this trademark*).

- 4,480,674. **MISCELLANEOUS DESIGN**. BPZ ENERGY, LLC, MULTIPLE CLASS, (INT. CLS. 37, 40 AND 42), (U.S. CLS. 100, 101, 103 AND 106). SN 85-969,660. PUB. 11-26-2013. FILED 6-25-2013.
- 4,480,675. **BPZ ENERGY (STANDARD CHARACTER)**. BPZ ENERGY, LLC, MULTIPLE CLASS, (INT. CLS. 37, 40 AND 42), (U.S. CLS. 100, 101, 103 AND 106). SN 85-969,706. PUB. 11-26-2013. FILED 6-25-2013.
- 4,480,684. **DRYWALL 911 (STANDARD CHARACTER)**. PRUNTY, DANIEL, (U.S. CLS. 100, 103 AND 106). SN 85-970,095. PUB. 11-26-2013. FILED 6-26-2013.
- 4,480,742. **G (STYLIZED)**. THE GOLDFIELD CORPORATION, (U.S. CLS. 100, 103 AND 106). SN 85-973,213. PUB. 11-26-2013. FILED 6-28-2013.
- 4,480,857. **"JUST MAKE IT GO AWAY!" (STANDARD CHARACTER)**. MAGUIRE III, JAMES P., (U.S. CLS. 100, 103 AND 106). SN 86-000,867. PUB. 11-26-2013. FILED 7-2-2013.
- 4,480,864. **ATS RHEOSYSTEMS (STANDARD CHARACTER)**. CANNON INSTRUMENT COMPANY, (U.S. CLS. 100, 103 AND 106). SN 86-000,925. PUB. 11-26-2013. FILED 7-2-2013.
- 4,480,900 ( *See Class 14 for this trademark*).
- 4,480,910. **X-BOW (STANDARD CHARACTER)**. ULSTEIN GROUP ASA, MULTIPLE CLASS, (INT. CLS. 37 AND 42), (U.S. CLS. 100, 101, 103 AND 106). SN 86-001,837. PUB. 11-26-2013. FILED 7-3-2013.
- 4,480,913. **GASAMAT (STYLIZED)**. GASAMAT OIL CORP. OF COLORADO, (U.S. CLS. 100, 103 AND 106). SN 86-001,862. PUB. 11-26-2013. FILED 7-3-2013.
- 4,480,915. **GASAMAT (STANDARD CHARACTER)**. GASAMAT OIL CORP. OF COLORADO, (U.S. CLS. 100, 103 AND 106). SN 86-001,881. PUB. 11-26-2013. FILED 7-3-2013.
- 4,480,920. **WASHNGO AND DESIGN**. CAPIN JR, NEIL, (U.S. CLS. 100, 103 AND 106). SN 86-002,022. PUB. 11-26-2013. FILED 7-3-2013.
- 4,480,942 ( *See Class 36 for this trademark*).
- 4,480,962. **CPC (STANDARD CHARACTER)**. CPC CONSTRUCTION LLC, (U.S. CLS. 100, 103 AND 106). SN 86-002,515. PUB. 11-26-2013. FILED 7-3-2013.
- 4,480,988. **CONTINUAL EDGE (STANDARD CHARACTER)**. CONTINUAL EDGE LLC, (U.S. CLS. 100, 103 AND 106). SN 86-002,796. PUB. 11-26-2013. FILED 7-4-2013.
- 4,480,989. **KWICKSILVER WHEEL REPAIR AND RECON PROS (STYLIZED)**. KWICKSILVER SYSTEMS, LLC, (U.S. CLS. 100, 103 AND 106). SN 86-002,797. PUB. 11-26-2013. FILED 7-4-2013.
- 4,481,010 ( *See Class 9 for this trademark*).
- 4,481,171. **VALICOR (STANDARD CHARACTER)**. VALICOR, INC., MULTIPLE CLASS, (INT. CLS. 37 AND 40), (U.S. CLS. 100, 103 AND 106). SN 86-005,549. PUB. 11-26-2013. FILED 7-9-2013.
- 4,481,186 ( *See Class 9 for this trademark*).
- 4,481,189 ( *See Class 9 for this trademark*).
- 4,479,464 ( *See Class 9 for this trademark*).
- 4,479,467 ( *See Class 9 for this trademark*).
- 4,479,469 ( *See Class 9 for this trademark*).
- 4,479,542. **AIRTOUCH (STANDARD CHARACTER)**. JMM LEE PROPERTIES, LLC, (U.S. CLS. 100, 101 AND 104). SN 85-356,794. PUB. 11-26-2013. FILED 6-27-2011.
- 4,479,568 ( *See Class 3 for this trademark*).
- 4,479,575 ( *See Class 9 for this trademark*).
- 4,479,667. **CHICAGO INDEPENDENT RADIO PROJECT (STANDARD CHARACTER)**. CHICAGO INDEPENDENT RADIO PROJECT, AKA CHIRP RADIO, MULTIPLE CLASS, (INT. CLS. 38 AND 41), (U.S. CLS. 100, 101, 104 AND 107). SN 85-639,383. PUB. 11-26-2013. FILED 5-31-2012.
- 4,479,695 ( *See Class 35 for this trademark*).
- 4,479,696 ( *See Class 35 for this trademark*).
- 4,479,704 ( *See Class 35 for this trademark*).
- 4,479,745. **TM TMTV AND DESIGN**. TMTV, INC., (U.S. CLS. 100, 101 AND 104). SN 85-733,596. PUB. 8-13-2013. FILED 9-20-2012.
- 4,479,754 ( *See Class 9 for this trademark*).
- 4,479,852 ( *See Class 9 for this trademark*).
- 4,479,927. **CLEAR FIBER (STANDARD CHARACTER)**. CALIFORNIA INTERNET SOLUTIONS INC, (U.S. CLS. 100, 101 AND 104). SN 85-809,580. PUB. 11-26-2013. FILED 12-21-2012.
- 4,479,949 ( *See Class 9 for this trademark*).
- 4,479,968 ( *See Class 16 for this trademark*).
- 4,480,004. **FAN SPORTS LIVE (STANDARD CHARACTER)**. CBS RADIO INC., (U.S. CLS. 100, 101 AND 104). SN 85-831,309. PUB. 11-26-2013. FILED 1-24-2013.
- 4,480,029. **XYLLABUS (STANDARD CHARACTER)**. XYLLABUS LLC, (U.S. CLS. 100, 101 AND 104). SN 85-841,049. PUB. 11-26-2013. FILED 2-5-2013.
- 4,480,049 ( *See Class 16 for this trademark*).
- 4,480,050 ( *See Class 16 for this trademark*).
- 4,480,094 ( *See Class 9 for this trademark*).
- 4,480,167. **AZUBU TV (STANDARD CHARACTER)**. SYSK LIMITED, (U.S. CLS. 100, 101 AND 104). SN 85-896,460. PUB. 11-26-2013. FILED 4-5-2013.
- 4,480,184. **EMPLOYMENT IN THE WORLD EMPLOYERS IN THE WORLD EMPLOYMENT IN AFRICA EMPLOYERS IN AFRICA EMPLOYMENT IN GHANA EMPLOYERS IN GHANA AND DESIGN**. DOGBE, SOLOMON ADINORTEY, DBA EMPLOYMENTINTHEWORLD EMPLOYER-SINTHEWORLD EMPLOYMENTINAFRICA EMPLOYERS IN AFRICA EMPLOYMENT IN GHANA EMPLOYERS IN GHANA, (U.S. CLS. 100, 101 AND 104). SN 85-901,586. PUB. 11-26-2013. FILED 4-11-2013.
- 4,480,218. **ARDUSAT (STANDARD CHARACTER)**. NANOSATISFI, INC., (U.S. CLS. 100, 101 AND 104). SN 85-911,497. PUB. 11-26-2013. FILED 4-22-2013.
- 4,480,374. **FIND A CHURCH HOME.COM "CONNECTING GOD WITH HIS PEOPLE" AND DESIGN**. DEANS WEB BROADCASTING NETWORK, LLC, (U.S. CLS. 100, 101 AND 104). SN 85-944,522. PUB. 11-26-2013. FILED 5-29-2013.
- 4,480,375. **FIND A CHURCH HOME (STANDARD CHARACTER)**. DEANS WEB BROADCASTING NETWORK, LLC, (U.S. CLS. 100, 101 AND 104). SN 85-944,524. PUB. 11-26-2013. FILED 5-29-2013.
- 4,480,410. **FLOWROUTE (STANDARD CHARACTER)**. FLOWROUTE LLC, (U.S. CLS. 100, 101 AND 104). SN 85-947,484. PUB. 11-26-2013. FILED 5-31-2013.
- 4,480,429. **TV2 CONSULTING AND DESIGN**. TV2 CONSULTING, LLC, MULTIPLE CLASS, (INT. CLS. 38 AND 42), (U.S. CLS. 100, 101 AND 104). SN 85-950,471. PUB. 11-26-2013. FILED 6-4-2013.
- 4,480,486. **MICHIGAN CYBER RANGE MERIT NETWORK AND DESIGN**. MERIT NETWORK, INC., MULTIPLE CLASS, (INT. CLS. 38, 41 AND 42), (U.S. CLS. 100, 101, 104 AND 107). SN 85-957,742. PUB. 11-26-2013. FILED 6-12-2013.
- 4,480,513. **OCTOPI NETWORK (STANDARD CHARACTER)**. REDOXYGEN INC, (U.S. CLS. 100, 101 AND 104). SN 85-962,268. PUB. 11-26-2013. FILED 6-18-2013.
- 4,480,611 ( *See Class 9 for this trademark*).
- 4,480,747. **AMERICAN SINGING TELEGRAMS (STANDARD CHARACTER)**. AMERICAN SINGING TELEGRAMS, INC., (U.S. CLS. 100, 101 AND 104). SN 85-973,474. PUB. 11-26-2013. FILED 6-28-2013.

### CLASS 38—COMMUNICATION

- 4,479,277 ( *See Class 9 for this trademark*).
- 4,479,278 ( *See Class 9 for this trademark*).
- 4,479,280 ( *See Class 9 for this trademark*).
- 4,479,296 ( *See Class 16 for this trademark*).
- 4,479,299 ( *See Class 9 for this trademark*).
- 4,479,300 ( *See Class 16 for this trademark*).
- 4,479,310 ( *See Class 9 for this trademark*).
- 4,479,325 ( *See Class 6 for this trademark*).
- 4,479,336 ( *See Class 35 for this trademark*).
- 4,479,355 ( *See Class 35 for this trademark*).
- 4,479,356 ( *See Class 9 for this trademark*).
- 4,479,357 ( *See Class 35 for this trademark*).
- 4,479,399 ( *See Class 9 for this trademark*).
- 4,479,418 ( *See Class 9 for this trademark*).
- 4,479,419 ( *See Class 9 for this trademark*).
- 4,479,425 ( *See Class 35 for this trademark*).
- 4,479,434 ( *See Class 3 for this trademark*).
- 4,479,441 ( *See Class 9 for this trademark*).
- 4,479,448 ( *See Class 9 for this trademark*).
- 4,479,455 ( *See Class 9 for this trademark*).
- 4,479,460 ( *See Class 9 for this trademark*).



- 4,480,795. **GLOBENET (STANDARD CHARACTER)**. BRASIL TELECOM OF AMERICA, INC., (U.S. CLS. 100, 101 AND 104). SN 85-980,275. PUB. 12-18-2012. FILED 4-12-2012.
- 4,480,818. **YOU JUST GOT JOY'D! (STANDARD CHARACTER)**. GATEWAY CREATIVE BROADCASTING, INC., (U.S. CLS. 100, 101 AND 104). SN 86-000,382. PUB. 11-26-2013. FILED 7-2-2013.
- 4,480,824 ( *See Class 9 for this trademark*).
- 4,480,888 ( *See Class 9 for this trademark*).
- 4,480,891 ( *See Class 9 for this trademark*).
- 4,480,939 ( *See Class 9 for this trademark*).
- 4,480,944 ( *See Class 9 for this trademark*).
- 4,481,002. **THE AUTISM CHANNEL THE WORLD OF AUTISM IN ONE PLACE AND DESIGN**. THE AUTISM CHANNEL, INC., (U.S. CLS. 100, 101 AND 104). SN 86-002,926. PUB. 11-26-2013. FILED 7-5-2013.
- 4,481,038. **GTPLANET AND DESIGN**. GTPLANET, (U.S. CLS. 100, 101 AND 104). SN 86-003,367. PUB. 11-26-2013. FILED 7-5-2013.
- 4,481,039. **KOOBOODLE (STANDARD CHARACTER)**. STORAGE APPLIANCE CORPORATION, MULTIPLE CLASS, (INT. CLS. 38 AND 42), (U.S. CLS. 100, 101 AND 104). SN 86-003,419. PUB. 11-26-2013. FILED S.R. 7-5-2013; AM. P.R. 10-22-2013.
- 4,481,042. **KOOBOODLE THE PHOTOS YOU WANT AND DESIGN**. STORAGE APPLIANCE CORPORATION, MULTIPLE CLASS, (INT. CLS. 38 AND 42), (U.S. CLS. 100, 101 AND 104). SN 86-003,439. PUB. 11-26-2013. FILED S.R. 7-5-2013; AM. P.R. 10-22-2013.
- 4,481,046. **ICEBERG (STANDARD CHARACTER)**. PERMAGO LLC, DBA PERMAGO, (U.S. CLS. 100, 101 AND 104). SN 86-003,522. PUB. 11-26-2013. FILED 7-6-2013.
- 4,481,146. **SMITE AND DESIGN**. HI-REZ STUDIOS, INC., (U.S. CLS. 100, 101 AND 104). SN 86-005,199. PUB. 11-26-2013. FILED 7-9-2013.
- 4,481,227. **GETTINGOUT AND DESIGN**. TELMATE, MULTIPLE CLASS, (INT. CLS. 38 AND 45), (U.S. CLS. 100, 101 AND 104). SN 86-021,307. PUB. 11-26-2013. FILED 7-26-2013.
- 4,481,240 ( *See Class 35 for this trademark*).
- 4,481,244. **FOX SPORTS 1 AND DESIGN**. TWENTIETH CENTURY FOX FILM CORPORATION, (U.S. CLS. 100, 101 AND 104). SN 86-030,670. PUB. 11-26-2013. FILED 8-6-2013.
- 4,479,241 ( *See Class 37 for this trademark*).
- 4,479,274. **AUDLEY (STANDARD CHARACTER)**. AUDLEY TRAVEL GROUP LIMITED, MULTIPLE CLASS, (INT. CLS. 39 AND 43), (U.S. CLS. 100, 101 AND 105). SN 79-105,130. PUB. 11-26-2013. FILED 10-11-2011.
- 4,479,313 ( *See Class 36 for this trademark*).
- 4,479,327 ( *See Class 5 for this trademark*).
- 4,479,331 ( *See Class 5 for this trademark*).
- 4,479,434 ( *See Class 3 for this trademark*).
- 4,479,476 ( *See Class 7 for this trademark*).
- 4,479,478. **GEARBULK (STANDARD CHARACTER)**. GEARBULK HOLDING LIMITED, (U.S. CLS. 100 AND 105). SN 79-133,188. PUB. 11-26-2013. FILED 5-14-2013.
- 4,479,573. **THE CAR OF THE FUTURE WILL BE SHARED (STANDARD CHARACTER)**. AUTOSHARE - CAR SHARING NETWORK INC., (U.S. CLS. 100 AND 105). SN 85-483,674. PUB. 11-26-2013. FILED 11-30-2011.
- 4,479,619. **MOVING CARS FOR AMERICA (STANDARD CHARACTER)**. SHIPCARSNOW, (U.S. CLS. 100 AND 105). SN 85-607,456. PUB. 11-26-2013. FILED 4-25-2012.
- 4,479,696 ( *See Class 35 for this trademark*).
- 4,479,704 ( *See Class 35 for this trademark*).
- 4,479,729. **FAMILY CORD BLOOD SERVICES (STANDARD CHARACTER)**. CALIFORNIA CRYOBANK STEM CELL SERVICES, INC., MULTIPLE CLASS, (INT. CLS. 39, 40 AND 44), (U.S. CLS. 100, 101, 103, 105 AND 106). SN 85-722,129. PUB. 11-26-2013. FILED 9-6-2012.
- 4,479,816. **HONOR FLIGHT NETWORK AND DESIGN**. HONOR FLIGHT, INC., (U.S. CLS. 100 AND 105). SN 85-778,965. PUB. 11-26-2013. FILED 11-14-2012.
- 4,479,903. **EXPEDITER SERVICES AND DESIGN**. EXPEDITER SERVICES, LLC, (U.S. CLS. 100 AND 105). SN 85-805,506. PUB. 11-26-2013. FILED 12-18-2012.
- 4,479,914. **"THE BEST FOR LESS" (STANDARD CHARACTER)**. FUN FOR LESS TOURS, INC., MULTIPLE CLASS, (INT. CLS. 39, 41 AND 43), (U.S. CLS. 100, 101, 105 AND 107). SN 85-807,028. PUB. 11-26-2013. FILED 12-19-2012.
- 4,479,980. **AFFINITY AIR SERVICE (STANDARD CHARACTER)**. AFFINITY AIR SERVICE, (U.S. CLS. 100 AND 105). SN 85-825,279. PUB. 11-26-2013. FILED 1-17-2013.
- 4,480,119. **STAFFORD CREEK LODGE ANDROS, THE BAHAMAS AND DESIGN**. STAFFORD CREEK LODGE LTD, (U.S. CLS. 100 AND 105). SN 85-878,411. PUB. 11-26-2013. FILED 3-18-2013.
- 4,480,134. **PINK TRANSFER MOVING & STORAGE (STANDARD CHARACTER)**. PINK TRANSFER, INC., (U.S. CLS. 100 AND 105). SN 85-884,256. PUB. 11-26-2013. FILED 3-22-2013.
- 4,480,314 ( *See Class 35 for this trademark*).
- 4,480,316 ( *See Class 35 for this trademark*).
- 4,480,336 ( *See Class 35 for this trademark*).
- 4,480,367 ( *See Class 37 for this trademark*).
- 4,480,418. **CHEAP DUMPSTERS (STANDARD CHARACTER)**. CHEAP DUMPSTERS, (U.S. CLS. 100 AND 105). SN 85-948,839. PUB. 11-26-2013. FILED 6-3-2013.
- 4,480,450. **TANDEM GLOBAL LOGISTICS (STANDARD CHARACTER)**. C.H. POWELL COMPANY, (U.S. CLS. 100 AND 105). SN 85-953,703. PUB. 11-26-2013. FILED 6-7-2013.
- 4,480,459 ( *See Class 35 for this trademark*).
- 4,480,503. **BIG BOX STORAGE (STANDARD CHARACTER)**. BIG BOX STORAGE, INC., (U.S. CLS. 100 AND 105). SN 85-960,529. PUB. 11-26-2013. FILED 6-14-2013.
- 4,480,628. **SKINNY WIMP MOVING CO. (STANDARD CHARACTER)**. LANCE CLAUSON, DBA SKINNY WIMP MOVING CO., (U.S. CLS. 100 AND 105). SN 85-967,924. PUB. 11-26-2013. FILED 6-24-2013.
- 4,480,658. **ULTIMATE MAN AND DESIGN**. ULTIMATE EXPRESS SERVICES, CORP., MULTIPLE CLASS, (INT. CLS. 39 AND 45), (U.S. CLS. 100, 101 AND 105). SN 85-968,814. PUB. 11-26-2013. FILED 6-25-2013.
- 4,480,977. **DOIN' IT ON TOP! (STANDARD CHARACTER)**. ATKINS, CHANDLER, (U.S. CLS. 100 AND 105). SN 86-002,695. PUB. 11-26-2013. FILED 7-4-2013.
- 4,481,086. **RESORTMAN (STANDARD CHARACTER)**. TERI PIROZZI LLC, (U.S. CLS. 100 AND 105). SN 86-004,060. PUB. 11-26-2013. FILED 7-8-2013.
- 4,481,111. **CHOMP & NIBBLE (STANDARD CHARACTER)**. PAULA JANE BOGARD, (U.S. CLS. 100 AND 105). SN 86-004,587. PUB. 11-26-2013. FILED 7-8-2013.
- 4,481,114. **GET OUT OF TOWN! (STANDARD CHARACTER)**. ISRAM WHOLESALE TOURS AND TRAVEL, LTD., (U.S. CLS. 100 AND 105). SN 86-004,648. PUB. 11-26-2013. FILED 7-8-2013.

---

## CLASS 39—TRANSPORTATION AND STORAGE

---

## CLASS 40—MATERIAL TREATMENT

- HEALTH (STANDARD CHARACTER).** APHIOS CORPORATION, (U.S. CLS. 100, 103 AND 106). SN 85-634,337. PUB. 11-26-2013. FILED 5-24-2012.
- 4,479,729 ( *See Class 39 for this trademark.*)
- 4,479,755 ( *See Class 35 for this trademark.*)
- 4,479,764 ( *See Class 14 for this trademark.*)
- 4,479,765 ( *See Class 14 for this trademark.*)
- 4,479,804. **ANY ASSEMBLY (STANDARD CHARACTER).** KAYUMOV AZIZ AGZAMOVICH, DBA ANYASSEMBLY.-COM. (U.S. CLS. 100, 103 AND 106). SN 85-775,011. PUB. 11-26-2013. FILED 11-8-2012.
- 4,479,892. **JI AND DESIGN.** CHO, JAE WON, (U.S. CLS. 100, 103 AND 106). SN 85-803,547. PUB. 11-26-2013. FILED 12-14-2012.
- 4,479,952. **PRINT MORE, PAY LESS! (STANDARD CHARACTER).** DENNING, ANTHONY, (U.S. CLS. 100, 103 AND 106). SN 85-815,981. PUB. 5-28-2013. FILED 1-4-2013.
- 4,480,152 ( *See Class 9 for this trademark.*)
- 4,480,200 ( *See Class 10 for this trademark.*)
- 4,480,279 ( *See Class 35 for this trademark.*)
- 4,480,302. **ENTEX (STANDARD CHARACTER).** REED, MARK, (U.S. CLS. 100, 103 AND 106). SN 85-931,743. PUB. 11-26-2013. FILED 5-14-2013.
- 4,480,348. **SILICON360 AND DESIGN.** SILICON 360 LLC, AKA SI360, MULTIPLE CLASS, (INT. CLS. 40 AND 42), (U.S. CLS. 100, 101, 103 AND 106). SN 85-941,407. PUB. 11-26-2013. FILED 5-23-2013.
- 4,480,367 ( *See Class 37 for this trademark.*)
- 4,480,521. **ZEUS BALER (STANDARD CHARACTER).** ZEUS RECYCLING SOLUTIONS LLC, (U.S. CLS. 100, 103 AND 106). SN 85-962,923. PUB. 11-26-2013. FILED 6-18-2013.
- 4,480,588. **ID SOLUTIONS (STANDARD CHARACTER).** ID SOLUTIONS, LLC, (U.S. CLS. 100, 103 AND 106). SN 85-965,667. PUB. 11-26-2013. FILED 6-20-2013.
- 4,480,650 ( *See Class 37 for this trademark.*)
- 4,480,672 ( *See Class 37 for this trademark.*)
- 4,480,674 ( *See Class 37 for this trademark.*)
- 4,480,675 ( *See Class 37 for this trademark.*)
- 4,480,739. **FOR THE FANS (STANDARD CHARACTER).** WIZARD CREATIONS, INC., (U.S. CLS. 100, 103 AND 106). SN 85-973,002. PUB. 11-26-2013. FILED 6-28-2013.
- 4,480,776. **"IF IT'S METAL IT'S MONEY" (STANDARD CHARACTER).** ALL SCRAP METALS, LLC, (U.S. CLS. 100, 103 AND 106). SN 85-974,470. PUB. 11-26-2013. FILED 7-1-2013.
- 4,480,876. **N AND DESIGN.** NEUTEX ADVANCED ENERGY GROUP, (U.S. CLS. 100, 103 AND 106). SN 86-001,231. PUB. 11-26-2013. FILED 7-2-2013.
- 4,480,909. **VITAL FORCE TECHNOLOGY (STANDARD CHARACTER).** ENERGY TOOLS INTERNATIONAL, LLC, (U.S. CLS. 100, 103 AND 106). SN 86-001,829. PUB. 11-26-2013. FILED 7-3-2013.
- 4,480,976. **CREAT3D (STANDARD CHARACTER).** PREM Kumar, PRAVIN, AND LALVANI, AVINASH, MULTIPLE CLASS, (INT. CLS. 40 AND 42), (U.S. CLS. 100, 101, 103 AND 106). SN 86-002,688. PUB. 11-26-2013. FILED 7-4-2013.
- 4,481,024. **OPENPRINTS (STANDARD CHARACTER).** OPEN PRINTS, LLC, (U.S. CLS. 100, 103 AND 106). SN 86-003,140. PUB. 11-26-2013. FILED 7-5-2013.
- 4,481,109. **HF HOLLYFRONTIER (STYLIZED).** HOLLYMARKS, LLC, (U.S. CLS. 100, 103 AND 106). SN 86-004,548. PUB. 11-26-2013. FILED 7-8-2013.
- 4,481,171 ( *See Class 37 for this trademark.*)
- 4,479,309 ( *See Class 35 for this trademark.*)
- 4,479,310 ( *See Class 9 for this trademark.*)
- 4,479,320 ( *See Class 9 for this trademark.*)
- 4,479,323 ( *See Class 9 for this trademark.*)
- 4,479,327 ( *See Class 5 for this trademark.*)
- 4,479,331 ( *See Class 5 for this trademark.*)
- 4,479,332. **BWC BIRDIE WORKS CLUB AND DESIGN.** KABUSHIKI KAISHA DARTSLIVE; D/B/A DARTSLIVE CO., LTD., MULTIPLE CLASS, (INT. CLS. 41 AND 43), (U.S. CLS. 100, 101 AND 107). SN 79-123,992. PUB. 11-26-2013. FILED 11-16-2012.
- 4,479,340 ( *See Class 3 for this trademark.*)
- 4,479,350 ( *See Class 35 for this trademark.*)
- 4,479,352. **JEAN PEHR (STANDARD CHARACTER).** SVENSSON, JEAN PEHR CHRISTIAN, MULTIPLE CLASS, (INT. CLS. 41, 43 AND 45), (U.S. CLS. 100, 101 AND 107). SN 79-125,145. PUB. 11-26-2013. FILED 12-12-2012.
- 4,479,355 ( *See Class 35 for this trademark.*)
- 4,479,356 ( *See Class 9 for this trademark.*)
- 4,479,358 ( *See Class 18 for this trademark.*)
- 4,479,367 ( *See Class 3 for this trademark.*)
- 4,479,368 ( *See Class 3 for this trademark.*)
- 4,479,387 ( *See Class 9 for this trademark.*)
- 4,479,391 ( *See Class 9 for this trademark.*)
- 4,479,392 ( *See Class 25 for this trademark.*)
- 4,479,413 ( *See Class 9 for this trademark.*)
- 4,479,434 ( *See Class 3 for this trademark.*)
- 4,479,435 ( *See Class 7 for this trademark.*)
- 4,479,440. **BRING FUN TO LIFE (STANDARD CHARACTER).** TMS GLOBAL SERVICES PTY LTD, (U.S. CLS. 100, 101 AND 107). SN 79-129,494. PUB. 11-26-2013. FILED 3-5-2013.
- 4,479,441 ( *See Class 9 for this trademark.*)
- 4,479,446 ( *See Class 35 for this trademark.*)
- 4,479,449. **LEVELK (STANDARD CHARACTER).** LEVELK APS, (U.S. CLS. 100, 101 AND 107). SN 79-129,986. PUB. 11-26-2013. FILED 2-21-2013.
- 4,479,454 ( *See Class 9 for this trademark.*)
- 4,479,469 ( *See Class 9 for this trademark.*)
- 4,479,474. **CABOODLE (STANDARD CHARACTER).** ARCHITECTURAL INFORMATION SERVICES PTY LTD, (U.S. CLS. 100, 101 AND 107). SN 79-132,403. PUB. 11-26-2013. FILED 4-10-2013.
- 4,479,479. **V (STYLIZED).** VIRGIN ENTERPRISES LIMITED, (U.S. CLS. 100, 101 AND 107). SN 79-133,258. PUB. 11-26-2013. FILED 3-13-2013.
- 4,479,486 ( *See Class 33 for this trademark.*)
- 4,479,501 ( *See Class 16 for this trademark.*)
- 4,479,521. **CAMP VIRGINIA JAYCEE "DARE TO CARE" AND DESIGN.** CAMP VIRGINIA JAYCEE, INC., (U.S. CLS. 100, 101 AND 107). SN 85-008,692. PUB. 9-28-2010. FILED 4-7-2010.
- 4,479,528. **TALKING BACTERIA JOHN, JOHN & JOHN (STANDARD CHARACTER).** OUT FIT 7 LIMITED, (U.S. CLS. 100, 101 AND 107). SN 85-189,131. PUB. 11-26-2013. FILED 12-2-2010.
- 4,479,535 ( *See Class 16 for this trademark.*)
- 4,479,538 ( *See Class 9 for this trademark.*)
- 4,479,543 ( *See Class 16 for this trademark.*)
- 4,479,544 ( *See Class 16 for this trademark.*)
- 4,479,562. **MISCELLANEOUS DESIGN.** SWEET HIGH, INC., (U.S. CLS. 100, 101 AND 107). SN 85-460,806. PUB. 10-16-2012. FILED 10-31-2011.
- 4,479,565. **THE RIPPLE EFFECT (STANDARD CHARACTER).** KANDON UNLIMITED, INC., (U.S. CLS. 100, 101 AND 107). SN 85-472,983. PUB. 11-26-2013. FILED 11-15-2011.
- 4,479,568 ( *See Class 3 for this trademark.*)
- 4,479,575 ( *See Class 9 for this trademark.*)
- 4,479,592 ( *See Class 9 for this trademark.*)
- 4,479,593 ( *See Class 9 for this trademark.*)
- 4,479,595. **SO WHAT IF (STANDARD CHARACTER).** WEINSTEIN, ROBERT, (U.S. CLS. 100, 101 AND 107). SN 85-553,070. PUB. 11-26-2013. FILED 2-26-2012.
- 4,479,603 ( *See Class 9 for this trademark.*)
- 4,479,610 ( *See Class 16 for this trademark.*)
- 4,479,627 ( *See Class 28 for this trademark.*)
- 4,479,640 ( *See Class 35 for this trademark.*)
- 4,479,650 ( *See Class 16 for this trademark.*)
- 4,479,659 ( *See Class 35 for this trademark.*)

## CLASS 41—EDUCATION AND ENTERTAINMENT

- 4,479,273 ( *See Class 3 for this trademark.*)
- 4,479,277 ( *See Class 9 for this trademark.*)
- 4,479,279 ( *See Class 9 for this trademark.*)
- 4,479,296 ( *See Class 16 for this trademark.*)
- 4,479,298. **MAGIC SUCCESS AND DESIGN.** DI MARCEL ALEXANDER FLEISCH, (U.S. CLS. 100, 101 AND 107). SN 79-117,916. PUB. 11-26-2013. FILED 3-20-2012.
- 4,479,300 ( *See Class 16 for this trademark.*)
- 4,479,307 ( *See Class 9 for this trademark.*)

- 4,479,660. **PRINCE INSTITUTE (STANDARD CHARACTER)**. STENOGRAPH, L.L.C., (U.S. CLS. 100, 101 AND 107). SN 85-635,887. PUB. 11-26-2013. FILED 5-25-2012.
- 4,479,663 ( *See Class 9 for this trademark*).
- 4,479,667 ( *See Class 38 for this trademark*).
- 4,479,677 ( *See Class 9 for this trademark*).
- 4,479,679. **EXPLOSIVES ACADEMY (STANDARD CHARACTER)**. EXPLOSIVE ACADEMY, (U.S. CLS. 100, 101 AND 107). SN 85-650,770. PUB. 11-26-2013. FILED 6-13-2012.
- 4,479,680 ( *See Class 9 for this trademark*).
- 4,479,681. **LAKE PLACID HALF MARATHON (STANDARD CHARACTER)**. INSPIRATION SPORTS, (U.S. CLS. 100, 101 AND 107). SN 85-654,218. PUB. 11-26-2013. FILED 6-18-2012.
- 4,479,682. **CREST CONTRACTORS RECOGNIZING EXCELLENCE IN SAFETY TRAINING AWARDS AND DESIGN**. FINISHING CONTRACTORS ASSOCIATION, (U.S. CLS. 100, 101 AND 107). SN 85-654,437. PUB. 11-26-2013. FILED 6-18-2012.
- 4,479,691 ( *See Class 35 for this trademark*).
- 4,479,697. **INTERNATIONAL INSTITUTE FOR HUMAN EMPOWERMENT (STANDARD CHARACTER)**. INTERNATIONAL INSTITUTE FOR HUMAN EMPOWERMENT, (U.S. CLS. 100, 101 AND 107). SN 85-670,557. PUB. 11-26-2013. FILED 7-6-2012.
- 4,479,702 ( *See Class 16 for this trademark*).
- 4,479,707. **BOX OF CRAYONS (STANDARD CHARACTER)**. MAIDA CC INC., (U.S. CLS. 100, 101 AND 107). SN 85-686,218. PUB. 11-26-2013. FILED 7-25-2012.
- 4,479,708. **THE LAST FEEDBACK WORKSHOP YOU'LL EVER NEED (STANDARD CHARACTER)**. MAIDA CC INC., (U.S. CLS. 100, 101 AND 107). SN 85-686,233. PUB. 11-26-2013. FILED 7-25-2012.
- 4,479,712. **EL SHOW DE FERNANDO HIDALGO (STANDARD CHARACTER)**. EL SHOW DE FERNANDO LLC, (U.S. CLS. 100, 101 AND 107). SN 85-692,729. PUB. 11-26-2013. FILED 8-1-2012.
- 4,479,719 ( *See Class 35 for this trademark*).
- 4,479,722. **LEGACY YOUTH TENNIS AND EDUCATION (STANDARD CHARACTER)**. LEGACY YOUTH TENNIS AND EDUCATION, (U.S. CLS. 100, 101 AND 107). SN 85-713,303. PUB. 11-26-2013. FILED 8-27-2012.
- 4,479,733 ( *See Class 3 for this trademark*).
- 4,479,741 ( *See Class 35 for this trademark*).
- 4,479,746. **PROVIDENCE DAY SCHOOL CHARGERS AND DESIGN**. PROVIDENCE DAY SCHOOL, INC., (U.S. CLS. 100, 101 AND 107). SN 85-733,651. PUB. 11-26-2013. FILED 9-20-2012.
- 4,479,760 ( *See Class 16 for this trademark*).
- 4,479,772. **THE TOGETHER TEAM (STANDARD CHARACTER)**. BRASS TACKS LLC, (U.S. CLS. 100, 101 AND 107). SN 85-756,249. PUB. 11-26-2013. FILED 10-17-2012.
- 4,479,796. **FOOD RENEGADE (STANDARD CHARACTER)**. WONDERWORKING WORDS, (U.S. CLS. 100, 101 AND 107). SN 85-770,748. PUB. 11-26-2013. FILED 11-2-2012.
- 4,479,802. **GSVA (STANDARD CHARACTER)**. GRANVILLE STUDIO OF VISUAL ARTS, (U.S. CLS. 100, 101 AND 107). SN 85-773,664. PUB. 11-26-2013. FILED 11-7-2012.
- 4,479,805. **USA KNOCKOUTS AND DESIGN**. THE SPORTS AND ENTERTAINMENT COMPANY LLC, (U.S. CLS. 100, 101 AND 107). SN 85-775,341. PUB. 11-26-2013. FILED 11-9-2012.
- 4,479,807. **MISCELLANEOUS DESIGN**. GULLANE (THOMAS) LIMITED, (U.S. CLS. 100, 101 AND 107). SN 85-775,539. PUB. 11-26-2013. FILED 11-9-2012.
- 4,479,809. **BRAVO ZULU STUDIOS LLC (STANDARD CHARACTER)**. BRAVO ZULU STUDIOS, LLC, (U.S. CLS. 100, 101 AND 107). SN 85-776,591. PUB. 11-26-2013. FILED 11-11-2012.
- 4,479,811. **ATLANTIC UNION COLLEGE (STANDARD CHARACTER)**. ATLANTIC UNION COLLEGE, (U.S. CLS. 100, 101 AND 107). SN 85-776,948. PUB. 11-26-2013. FILED 11-12-2012.
- 4,479,815. **FIT180 (STANDARD CHARACTER)**. HEALTH & FITNESS CLINIC, LLC, DBA FIT180, (U.S. CLS. 100, 101 AND 107). SN 85-778,799. PUB. 11-26-2013. FILED 11-14-2012.
- 4,479,817. **CANAL ELLA AND DESIGN**. MGM NETWORKS LATIN AMERICA LLC, (U.S. CLS. 100, 101 AND 107). SN 85-779,131. PUB. 11-26-2013. FILED 11-14-2012.
- 4,479,832. **MEI MORGUELAN ENERGY INSTITUTE AND DESIGN**. MORGUELAN CORP., MULTIPLE CLASS, (INT. CLS. 41 AND 45), (U.S. CLS. 100, 101 AND 107). SN 85-782,406. PUB. 11-26-2013. FILED 11-19-2012.
- 4,479,833 ( *See Class 9 for this trademark*).
- 4,479,834. **CHESTERTON ACADEMY (STANDARD CHARACTER)**. CHESTERTON ACADEMY, (U.S. CLS. 100, 101 AND 107). SN 85-783,112. PUB. 11-26-2013. FILED 11-19-2012.
- 4,479,836 ( *See Class 35 for this trademark*).
- 4,479,842. **ACADEMY FOR GLOBAL CITIZENSHIP AND DESIGN**. ACADEMY FOR GLOBAL CITIZENSHIP, (U.S. CLS. 100, 101 AND 107). SN 85-788,245. PUB. 11-26-2013. FILED 11-27-2012.
- 4,479,846 ( *See Class 9 for this trademark*).
- 4,479,852 ( *See Class 9 for this trademark*).
- 4,479,853 ( *See Class 9 for this trademark*).
- 4,479,858. **THIS THAT ISH (STANDARD CHARACTER)**. ROGERS, ERIC, AND ROGERS, TONIA, (U.S. CLS. 100, 101 AND 107). SN 85-793,545. PUB. 11-26-2013. FILED 12-3-2012.
- 4,479,861. **ROYAL SONESTA (STANDARD CHARACTER)**. SONESTA INTERNATIONAL HOTELS CORPORATION, MULTIPLE CLASS, (INT. CLS. 41 AND 43), (U.S. CLS. 100, 101 AND 107). SN 85-795,067. PUB. 11-26-2013. FILED 12-5-2012.
- 4,479,871. **SEMPER SARAH (STANDARD CHARACTER)**. MARINE CHICK, LLC, (U.S. CLS. 100, 101 AND 107). SN 85-798,145. PUB. 11-26-2013. FILED 12-8-2012.
- 4,479,872. **HICKAPEDIA AND DESIGN**. BAKER, MATTHEW, (U.S. CLS. 100, 101 AND 107). SN 85-798,184. PUB. 11-26-2013. FILED 12-8-2012.
- 4,479,882 ( *See Class 9 for this trademark*).
- 4,479,883 ( *See Class 6 for this trademark*).
- 4,479,884 ( *See Class 25 for this trademark*).
- 4,479,885 ( *See Class 25 for this trademark*).
- 4,479,889. **ROSECRANCE (STANDARD CHARACTER)**. ROSECRANCE HEALTH NETWORK, MULTIPLE CLASS, (INT. CLS. 41 AND 44), (U.S. CLS. 100, 101 AND 107). SN 85-802,960. PUB. 11-26-2013. FILED 12-14-2012.
- 4,479,890. **DXPEDITION OF THE YEAR (STANDARD CHARACTER)**. SOUTHWEST OHIO DX ASSOCIATION, (U.S. CLS. 100, 101 AND 107). SN 85-803,172. PUB. 11-26-2013. FILED 12-14-2012.
- 4,479,891. **KNODAT ENT (STANDARD CHARACTER)**. SANDIFER, CARLOS, (U.S. CLS. 100, 101 AND 107). SN 85-803,459. PUB. 11-26-2013. FILED 12-14-2012.
- 4,479,895. **UNREAL AND DESIGN**. INTERNATIONAL TRADEMARK ASSOCIATION, INC., MULTIPLE CLASS, (INT. CLS. 41 AND 45), (U.S. CLS. 100, 101 AND 107). SN 85-803,949. PUB. 11-26-2013. FILED 12-17-2012.
- 4,479,896. **UNREAL (STANDARD CHARACTER)**. INTERNATIONAL TRADEMARK ASSOCIATION, INC., MULTIPLE CLASS, (INT. CLS. 41 AND 45), (U.S. CLS. 100, 101 AND 107). SN 85-803,952. PUB. 11-26-2013. FILED 12-17-2012.
- 4,479,897. **ON SCRIPTURE (STYLIZED)**. NATIONAL INTERFAITH CABLE COALITION, (U.S. CLS. 100, 101 AND 107). SN 85-804,101. PUB. 11-26-2013. FILED 12-17-2012.
- 4,479,899. **OUR CAREERS, OUR COMPANIES, OUR PERSONAL RELATIONSHIPS, AND OUR VERY LIVES SUCCEED OR FAIL GRADUALLY, THEN SUDDENLY, ONE CONVERSATION AT A TIME. (STANDARD CHARACTER)**. FIERCE, INC., (U.S. CLS. 100, 101 AND 107). SN 85-804,736. PUB. 11-26-2013. FILED 12-17-2012.
- 4,479,905. **HANDS ON HEARTS (STANDARD CHARACTER)**. CARDIOVASCULAR RESEARCH FOUNDATION, (U.S. CLS. 100, 101 AND 107). SN 85-805,726. PUB. 11-26-2013. FILED 12-18-2012.
- 4,479,910 ( *See Class 9 for this trademark*).
- 4,479,911. **LP TO GIVE TO DO TO LOVE TO SERVE AND DESIGN**. LIFE UNIVERSITY INC., (U.S. CLS. 100, 101 AND 107). SN 85-806,533. PUB. 11-26-2013. FILED 12-19-2012.
- 4,479,914 ( *See Class 39 for this trademark*).
- 4,479,915. **FUNKADELIC (STANDARD CHARACTER)**. DUUDU, LLC, (U.S. CLS. 100, 101 AND 107). SN 85-807,099. PUB. 11-26-2013. FILED 12-19-2012.
- 4,479,921. **PETER NERO AND THE HOLIDAY POPS (STANDARD CHARACTER)**. FINGER PRINCE, INC., (U.S. CLS.

- 100, 101 AND 107). SN 85-808,794. PUB. 11-26-2013. FILED 12-21-2012.
- 4,479,928. **MARVEL UNLIMITED (STANDARD CHARACTER)**. MARVEL CHARACTERS, INC., (U.S. CLS. 100, 101 AND 107). SN 85-809,648. PUB. 11-26-2013. FILED 12-21-2012.
- 4,479,936 ( *See Class 35 for this trademark*).
- 4,479,943. **THE ELLIS MARSALIS CENTER FOR MUSIC (STANDARD CHARACTER)**. NEW ORLEANS HABITAT MUSICIANS VILLAGE, INC., (U.S. CLS. 100, 101 AND 107). SN 85-813,291. PUB. 11-26-2013. FILED 12-31-2012.
- 4,479,949 ( *See Class 9 for this trademark*).
- 4,479,951. **TRULY LIVING WELL CENTER FOR NATURAL URBAN AGRICULTURE (STANDARD CHARACTER)**. TRULY LIVING WELL CENTER FOR NATURAL URBAN AGRICULTURE, (U.S. CLS. 100, 101 AND 107). SN 85-815,882. PUB. 11-26-2013. FILED 1-4-2013.
- 4,479,956 ( *See Class 9 for this trademark*).
- 4,479,962 ( *See Class 35 for this trademark*).
- 4,479,968 ( *See Class 16 for this trademark*).
- 4,479,969. **REAL PERSONAL PROTECTION (STANDARD CHARACTER)**. MANIS TACTICAL SYSTEMS LLC, (U.S. CLS. 100, 101 AND 107). SN 85-822,647. PUB. 11-26-2013. FILED 1-14-2013.
- 4,479,970 ( *See Class 16 for this trademark*).
- 4,479,985. **CLARITYED (STANDARD CHARACTER)**. SB RESEARCH, LLC, (U.S. CLS. 100, 101 AND 107). SN 85-825,846. PUB. 11-26-2013. FILED 1-17-2013.
- 4,479,992 ( *See Class 35 for this trademark*).
- 4,480,000. **QUEST 4 FITNESS (STANDARD CHARACTER)**. SHAHEEN, PAMELA J., DBA QUEST4FITNESS, (U.S. CLS. 100, 101 AND 107). SN 85-830,124. PUB. 10-15-2013. FILED 1-23-2013.
- 4,480,003 ( *See Class 9 for this trademark*).
- 4,480,005. **FAN SPORTS LIVE (STANDARD CHARACTER)**. CBS RADIO INC., (U.S. CLS. 100, 101 AND 107). SN 85-831,311. PUB. 11-26-2013. FILED 1-24-2013.
- 4,480,012. **MOTOHEROZ (STANDARD CHARACTER)**. RED-LYNX OY, (U.S. CLS. 100, 101 AND 107). SN 85-834,311. PUB. 6-18-2013. FILED 1-28-2013.
- 4,480,013. **JETSETTER GYPSY (STANDARD CHARACTER)**. JETSETTER GYPSY, (U.S. CLS. 100, 101 AND 107). SN 85-834,686. PUB. 6-25-2013. FILED 1-29-2013.
- 4,480,024. **JUMPSAFE (STANDARD CHARACTER)**. ROCKIN' JUMP HOLDINGS, LLC, (U.S. CLS. 100, 101 AND 107). SN 85-838,591. PUB. 11-26-2013. FILED 2-1-2013.
- 4,480,025. **MY STORYMAKER (STANDARD CHARACTER)**. THE TRUSTEES OF THE CARNEGIE LIBRARY OF PITTSBURGH TRUST, (U.S. CLS. 100, 101 AND 107). SN 85-838,623. PUB. 11-26-2013. FILED 2-1-2013.
- 4,480,031 ( *See Class 35 for this trademark*).
- 4,480,043. **SENDERO PARAMITA (STANDARD CHARACTER)**. AMBERT, ALBA, DBA SENDERO PARAMITA, (U.S. CLS. 100, 101 AND 107). SN 85-848,638. PUB. 11-26-2013. FILED 2-13-2013.
- 4,480,044. **THE ULTIMATE TRADERS PACKAGE (STANDARD CHARACTER)**. MARKET TRADERS INSTITUTE, INC., (U.S. CLS. 100, 101 AND 107). SN 85-848,800. PUB. 11-26-2013. FILED 2-13-2013.
- 4,480,046. **THE CARNIVAL "CHOREOGRAPHER'S BALL" (STANDARD CHARACTER)**. YSAIS, CAREY, (U.S. CLS. 100, 101 AND 107). SN 85-849,217. PUB. 11-26-2013. FILED 2-13-2013.
- 4,480,047. **DJ SMILE (STANDARD CHARACTER)**. HILL, WINSTON, (U.S. CLS. 100, 101 AND 107). SN 85-849,515. PUB. 11-26-2013. FILED 2-14-2013.
- 4,480,049 ( *See Class 16 for this trademark*).
- 4,480,050 ( *See Class 16 for this trademark*).
- 4,480,061 ( *See Class 35 for this trademark*).
- 4,480,064 ( *See Class 16 for this trademark*).
- 4,480,072 ( *See Class 36 for this trademark*).
- 4,480,073 ( *See Class 36 for this trademark*).
- 4,480,074. **ALZHEIMER'S COMMUNITY CARE (STANDARD CHARACTER)**. ALZHEIMER'S COMMUNITY CARE, INC., MULTIPLE CLASS, (INT. CLS. 41, 43, 44 AND 45), (U.S. CLS. 100, 101 AND 107). SN 85-859,573. PUB. 11-26-2013. FILED 2-25-2013.
- 4,480,085. **COULD ONE CONVERSATION CHANGE YOUR LIFE? (STANDARD CHARACTER)**. INSTITUTE FOR INTEGRATIVE NUTRITION, (U.S. CLS. 100, 101 AND 107). SN 85-863,545. PUB. 11-26-2013. FILED 2-28-2013.
- 4,480,094 ( *See Class 9 for this trademark*).
- 4,480,117. **MR. WORLDWIDE (STANDARD CHARACTER)**. ACP IP, LLC, (U.S. CLS. 100, 101 AND 107). SN 85-877,689. PUB. 11-26-2013. FILED 3-15-2013.
- 4,480,120. **SUISSE INVESTMENT BANKING (STANDARD CHARACTER)**. SUISSE IB, (U.S. CLS. 100, 101 AND 107). SN 85-878,713. PUB. 11-26-2013. FILED 3-18-2013.
- 4,480,123 ( *See Class 9 for this trademark*).
- 4,480,148. **VAST AND DESIGN**. VERMONT ASSOCIATION OF SNOW TRAVELERS, INC., AKA VAST, (U.S. CLS. 100, 101 AND 107). SN 85-888,015. PUB. 11-26-2013. FILED S.R. 3-27-2013; AM. P.R. 10-16-2013.
- 4,480,154. **PROM PROJECT (STANDARD CHARACTER)**. GIRL TALK FOUNDATION, INC., (U.S. CLS. 100, 101 AND 107). SN 85-889,149. PUB. 11-26-2013. FILED 3-28-2013.
- 4,480,155 ( *See Class 3 for this trademark*).
- 4,480,158. **LUNCH BOX BLUES (STANDARD CHARACTER)**. J.M. HIRSCH, (U.S. CLS. 100, 101 AND 107). SN 85-890,184. PUB. 11-26-2013. FILED 3-29-2013.
- 4,480,161. **HEALTH RESEARCH ASSOCIATES, INC. (STANDARD CHARACTER)**. HEALTH RESEARCH ASSOCIATES, INC., (U.S. CLS. 100, 101 AND 107). SN 85-893,240. PUB. 11-26-2013. FILED 4-2-2013.
- 4,480,178. **ML MUZIK LOUNGE AND DESIGN**. MUZIK LOUNGE, LLC, (U.S. CLS. 100, 101 AND 107). SN 85-899,858. PUB. 11-26-2013. FILED 4-10-2013.
- 4,480,187 ( *See Class 35 for this trademark*).
- 4,480,194 ( *See Class 35 for this trademark*).
- 4,480,198 ( *See Class 35 for this trademark*).
- 4,480,199 ( *See Class 9 for this trademark*).
- 4,480,210 ( *See Class 16 for this trademark*).
- 4,480,213. **NIKKI DINKI COOKING (STANDARD CHARACTER)**. NIKKI DINKI COOKING INC., (U.S. CLS. 100, 101 AND 107). SN 85-910,196. PUB. 11-26-2013. FILED 4-21-2013.
- 4,480,221 ( *See Class 9 for this trademark*).
- 4,480,225. **KAY VIDEO PRODUCTIONS (STANDARD CHARACTER)**. KOPANSKI, JOHN, (U.S. CLS. 100, 101 AND 107). SN 85-912,918. PUB. 11-26-2013. FILED 4-24-2013.
- 4,480,231. **FELICITY MOTIVATIONAL GROUP INFORMING MINDS. TRANSFORMING HEALTH. CHANGING LIVES. AND DESIGN**. FELICITY MOTIVATIONAL GROUP, INC., (U.S. CLS. 100, 101 AND 107). SN 85-914,323. PUB. 11-26-2013. FILED 4-25-2013.
- 4,480,237. **3D PRINTER WORLD (STYLIZED)**. TISCH MEDIA GROUP, INC., (U.S. CLS. 100, 101 AND 107). SN 85-918,741. PUB. 11-26-2013. FILED 4-30-2013.
- 4,480,239. **VITO VINCENT THE CAT (STANDARD CHARACTER)**. VITO VINCENT THE CAT, (U.S. CLS. 100, 101 AND 107). SN 85-919,417. PUB. 11-26-2013. FILED 4-30-2013.
- 4,480,242. **EXIT 21 MAGAZINE AND DESIGN**. EXIT 21 MAGAZINE, (U.S. CLS. 100, 101 AND 107). SN 85-921,352. PUB. 11-26-2013. FILED 5-2-2013.
- 4,480,245. **MISCELLANEOUS DESIGN**. VERBALIZEIT, INC., (U.S. CLS. 100, 101 AND 107). SN 85-922,107. PUB. 11-26-2013. FILED 5-2-2013.
- 4,480,258. **MISCELLANEOUS DESIGN**. SNOWSHOE MOUNTAIN, INC., (U.S. CLS. 100, 101 AND 107). SN 85-924,332. PUB. 11-26-2013. FILED 5-6-2013.
- 4,480,267. **EAT OAKLAND (STANDARD CHARACTER)**. COSTAIN, LEIGH, (U.S. CLS. 100, 101 AND 107). SN 85-925,609. PUB. 10-22-2013. FILED 5-7-2013.
- 4,480,269. **THE POET'S WAY AND DESIGN**. BUCHNER, DANIEL, AND BEELEY, CAROLYN, (U.S. CLS. 100, 101 AND 107). SN 85-925,802. PUB. 11-26-2013. FILED 5-7-2013.
- 4,480,275. **INTERNATIONAL LANGUAGE TRAINING INSTITUTE ILTI AND DESIGN**. INTERNATIONAL LANGUAGE TRAINING INSTITUTE INC., (U.S. CLS. 100, 101 AND 107). SN 85-926,404. PUB. 11-26-2013. FILED 5-8-2013.
- 4,480,282. **REAL PURE GOLF (STANDARD CHARACTER)**. LAS VEGAS PAIUTE TRIBE, (U.S. CLS. 100, 101 AND 107). SN 85-927,228. PUB. 11-26-2013. FILED 5-9-2013.
- 4,480,283. **CAROLINA GAMES SUMMIT (STANDARD CHARACTER)**. INFORMATION TECHNOLOGY SERVICE AND SUPPORT, INC., (U.S. CLS. 100, 101 AND 107). SN 85-927,554. PUB. 11-26-2013. FILED 5-9-2013.

- 4,480,286. **SANCTUARY SAM (STANDARD CHARACTER)**. DEPARTMENT OF COMMERCE, NATIONAL OCEANIC AND ATMOSPHERIC ADMINISTRATION, (U.S. CLS. 100, 101 AND 107). SN 85-928,378. PUB. 11-26-2013. FILED 5-10-2013.
- 4,480,289 ( *See Class 35 for this trademark*).
- 4,480,291 ( *See Class 35 for this trademark*).
- 4,480,294. **RUN3RD (STANDARD CHARACTER)**. ASTIN, SEAN PATRICK, (U.S. CLS. 100, 101 AND 107). SN 85-929,352. PUB. 11-26-2013. FILED 5-11-2013.
- 4,480,301. **HOTTEST RACE ON EARTH (STANDARD CHARACTER)**. INNOVATIVE RACING EVENTS, LLC, (U.S. CLS. 100, 101 AND 107). SN 85-931,476. PUB. 11-26-2013. FILED 5-14-2013.
- 4,480,310. **FLUX VEHO (STANDARD CHARACTER)**. PEASE, RAFAEL M., (U.S. CLS. 100, 101 AND 107). SN 85-933,658. PUB. 11-26-2013. FILED 5-16-2013.
- 4,480,337. **CYCLISMAS AND DESIGN**. CYCLISMAS, LLC, (U.S. CLS. 100, 101 AND 107). SN 85-939,821. PUB. 11-26-2013. FILED 5-22-2013.
- 4,480,344. **ISWAT (STANDARD CHARACTER)**. FISHNET SECURITY, INC., (U.S. CLS. 100, 101 AND 107). SN 85-941,116. PUB. 11-26-2013. FILED 5-23-2013.
- 4,480,345 ( *See Class 35 for this trademark*).
- 4,480,355. **A AND DESIGN**. THE ATTENTION CENTER, LLC, MULTIPLE CLASS, (INT. CLS. 41 AND 44), (U.S. CLS. 100, 101 AND 107). SN 85-942,066. PUB. 11-26-2013. FILED 5-24-2013.
- 4,480,356. **CULTURE CLUB (STANDARD CHARACTER)**. SHARON LEE, (U.S. CLS. 100, 101 AND 107). SN 85-942,138. PUB. 11-26-2013. FILED 5-24-2013.
- 4,480,357 ( *See Class 9 for this trademark*).
- 4,480,358 ( *See Class 35 for this trademark*).
- 4,480,359 ( *See Class 35 for this trademark*).
- 4,480,360. **PRODUCT POET AND DESIGN**. CHEZ CHATEAU, LLC, (U.S. CLS. 100, 101 AND 107). SN 85-942,380. PUB. 11-26-2013. FILED 5-24-2013.
- 4,480,361. **HIGHER UP PHOTOGRAPHY AND DESIGN**. HIGHER UP PHOTOGRAPHY, LLC., (U.S. CLS. 100, 101 AND 107). SN 85-942,472. PUB. 11-26-2013. FILED 5-24-2013.
- 4,480,366. **REAL GUYS FOUNDATION (STANDARD CHARACTER)**. REAL GUYS FOUNDATION, (U.S. CLS. 100, 101 AND 107). SN 85-943,344. PUB. 11-26-2013. FILED 5-28-2013.
- 4,480,372. **LEARN 1 (STANDARD CHARACTER)**. WORDSMART CORPORATION, (U.S. CLS. 100, 101 AND 107). SN 85-944,270. PUB. 11-26-2013. FILED 5-28-2013.
- 4,480,383. **YOGA ALIVE (STANDARD CHARACTER)**. YOGA ALIVE, LLC, (U.S. CLS. 100, 101 AND 107). SN 85-945,015. PUB. 11-26-2013. FILED 5-29-2013.
- 4,480,385 ( *See Class 35 for this trademark*).
- 4,480,388. **BRIT + CO. (STANDARD CHARACTER)**. BRIT MEDIA, INC., MULTIPLE CLASS, (INT. CLS. 41 AND 42), (U.S. CLS. 100, 101 AND 107). SN 85-945,559. PUB. 11-26-2013. FILED 5-29-2013.
- 4,480,394. **ROLLING STONE (STANDARD CHARACTER)**. ROLLING STONE LLC, (U.S. CLS. 100, 101 AND 107). SN 85-945,960. PUB. 11-26-2013. FILED 5-30-2013.
- 4,480,408. **MUSIC ACADEMY OF THE WEST (STANDARD CHARACTER)**. MUSIC ACADEMY OF THE WEST, (U.S. CLS. 100, 101 AND 107). SN 85-947,389. PUB. 11-26-2013. FILED 5-31-2013.
- 4,480,409. **MISCELLANEOUS DESIGN**. MUSIC ACADEMY OF THE WEST, (U.S. CLS. 100, 101 AND 107). SN 85-947,395. PUB. 11-26-2013. FILED 5-31-2013.
- 4,480,423. **PHILIP H. ANSELMO & THE ILLEGALS (STANDARD CHARACTER)**. ANSELMO, PHILIP HANSEN, (U.S. CLS. 100, 101 AND 107). SN 85-949,882. PUB. 11-26-2013. FILED 6-4-2013.
- 4,480,427. **INTEGRATIVE CANCER ANSWERS (STANDARD CHARACTER)**. PURE BODY SYSTEMS, LLC, MULTIPLE CLASS, (INT. CLS. 41 AND 44), (U.S. CLS. 100, 101 AND 107). SN 85-950,243. PUB. 11-26-2013. FILED 6-4-2013.
- 4,480,433. **LEARN BOP AND DESIGN**. LEARNBOP LLC, (U.S. CLS. 100, 101 AND 107). SN 85-950,962. PUB. 11-26-2013. FILED 6-5-2013.
- 4,480,435. **MACKOOL ONLINE (STANDARD CHARACTER)**. RICHARD J. MACKOOL, (U.S. CLS. 100, 101 AND 107). SN 85-951,223. PUB. 11-26-2013. FILED 6-5-2013.
- 4,480,463. **KINEDU (STANDARD CHARACTER)**. KINEDU, S.A.P.I. DE C.V., (U.S. CLS. 100, 101 AND 107). SN 85-955,380. PUB. 11-26-2013. FILED 6-10-2013.
- 4,480,466 ( *See Class 9 for this trademark*).
- 4,480,469. **GORDON PINES GOLF CLUB (STANDARD CHARACTER)**. LINK INTERNATIONAL INVESTMENTS, LLC, (U.S. CLS. 100, 101 AND 107). SN 85-956,152. PUB. 11-26-2013. FILED 6-11-2013.
- 4,480,486 ( *See Class 38 for this trademark*).
- 4,480,490. **C CONCEPTO PRODUCTIONS AND DESIGN**. CONCEPTO PRODUCTIONS LLC, (U.S. CLS. 100, 101 AND 107). SN 85-958,602. PUB. 11-26-2013. FILED 6-13-2013.
- 4,480,493 ( *See Class 25 for this trademark*).
- 4,480,494 ( *See Class 25 for this trademark*).
- 4,480,495 ( *See Class 25 for this trademark*).
- 4,480,510 ( *See Class 25 for this trademark*).
- 4,480,512. **CLASS ACT HOOPS (STANDARD CHARACTER)**. CLASS ACT SPORTS, LLC, (U.S. CLS. 100, 101 AND 107). SN 85-962,080. PUB. 11-26-2013. FILED 6-17-2013.
- 4,480,517. **168 HOURS RULE (STANDARD CHARACTER)**. TARA MARIE, INC., (U.S. CLS. 100, 101 AND 107). SN 85-962,412. PUB. 11-26-2013. FILED 6-18-2013.
- 4,480,528 ( *See Class 35 for this trademark*).
- 4,480,552. **CINTAS SAFETY CENTER (STANDARD CHARACTER)**. CINTAS HOLDINGS LLC, MULTIPLE CLASS, (INT. CLS. 41 AND 44), (U.S. CLS. 100, 101 AND 107). SN 85-964,168. PUB. 11-26-2013. FILED 6-19-2013.
- 4,480,555. **MISCELLANEOUS DESIGN**. BIBLICAL STUDIES FOUNDATION, DBA BIBLE.ORG, (U.S. CLS. 100, 101 AND 107). SN 85-964,327. PUB. 11-26-2013. FILED 6-19-2013.
- 4,480,558. **IGNITE360 AND DESIGN**. COMBINE360, LLC, (U.S. CLS. 100, 101 AND 107). SN 85-964,391. PUB. 11-26-2013. FILED 6-19-2013.
- 4,480,560 ( *See Class 9 for this trademark*).
- 4,480,566. **NEW YORK INSTITUTE OF PHOTOGRAPHY 100TH ANNIVERSARY AND DESIGN**. DISTANCE EDUCATION COMPANY, LLC, (U.S. CLS. 100, 101 AND 107). SN 85-964,829. PUB. 11-26-2013. FILED 6-19-2013.
- 4,480,567. **NEW YORK INSTITUTE OF PHOTOGRAPHY 100TH ANNIVERSARY AND DESIGN**. DISTANCE EDUCATION COMPANY, LLC, (U.S. CLS. 100, 101 AND 107). SN 85-964,833. PUB. 11-26-2013. FILED 6-19-2013.
- 4,480,575. **KENDORE LEARNING (STANDARD CHARACTER)**. SYLLABLES READING CENTER, INC., (U.S. CLS. 100, 101 AND 107). SN 85-965,144. PUB. 11-26-2013. FILED 6-20-2013.
- 4,480,576. **KENDORE .LEARNING. AND DESIGN**. SYLLABLES READING CENTER, INC., (U.S. CLS. 100, 101 AND 107). SN 85-965,181. PUB. 11-26-2013. FILED 6-20-2013.
- 4,480,582 ( *See Class 35 for this trademark*).
- 4,480,583 ( *See Class 35 for this trademark*).
- 4,480,589. **EQUIPMENT FOR LIVING (STANDARD CHARACTER)**. PARLOR PRESS LLC, (U.S. CLS. 100, 101 AND 107). SN 85-965,734. PUB. 11-26-2013. FILED 6-20-2013.
- 4,480,608. **MISCELLANEOUS DESIGN**. MCDONALD'S CORPORATION, (U.S. CLS. 100, 101 AND 107). SN 85-966,777. PUB. 11-26-2013. FILED 6-21-2013.
- 4,480,625 ( *See Class 35 for this trademark*).
- 4,480,631. **ITINERANT PICTURES (STANDARD CHARACTER)**. TRAUB, DANIEL, DBA ITINERANT PICTURES, (U.S. CLS. 100, 101 AND 107). SN 85-968,099. PUB. 11-26-2013. FILED 6-24-2013.
- 4,480,632 ( *See Class 16 for this trademark*).
- 4,480,634 ( *See Class 16 for this trademark*).
- 4,480,638. **RADUMUS (STANDARD CHARACTER)**. CHAD ALLEN, (U.S. CLS. 100, 101 AND 107). SN 85-968,239. PUB. 11-26-2013. FILED 6-24-2013.
- 4,480,639 ( *See Class 35 for this trademark*).
- 4,480,654. **LOVE YOUR COMPUTER AGAIN (STANDARD CHARACTER)**. REVIVERSOFT, (U.S. CLS. 100, 101 AND 107). SN 85-968,695. PUB. 11-26-2013. FILED 6-24-2013.
- 4,480,660. **DA RICH KIDZZ (STANDARD CHARACTER)**. ALK ENTERTAINMENT GROUP, (U.S. CLS. 100, 101 AND 107). SN 85-968,826. PUB. 11-26-2013. FILED 6-25-2013.
- 4,480,673. **HEART ATTACKS HAVE BEGINNINGS (STANDARD CHARACTER)**. SOCIETY OF CARDIOVASCULAR PATIENT CARE F/K/A SOCIETY OF CHEST PAIN CENTERS, (U.S. CLS. 100, 101 AND 107). SN 85-969,624.

- PUB. 11-26-2013. FILED 6-25-2013.
- 4,480,677. **ARRIVE FITNESS (STANDARD CHARACTER)**. LOPEZ, KAREN L., DBA ARRIVE FITNESS, (U.S. CLS. 100, 101 AND 107). SN 85-969,979. PUB. 11-26-2013. FILED 6-26-2013.
- 4,480,681 ( *See Class 35 for this trademark*).
- 4,480,687. **MASSIVE IDEAS AND DESIGN**. MASSIVE.IDEAS LLC, (U.S. CLS. 100, 101 AND 107). SN 85-970,265. PUB. 11-26-2013. FILED 6-26-2013.
- 4,480,689. **BSF INTERNATIONAL AND DESIGN**. BIBLE STUDY FELLOWSHIP, (U.S. CLS. 100, 101 AND 107). SN 85-970,367. PUB. 11-26-2013. FILED 6-26-2013.
- 4,480,690. **THINKING INSIDE THE BOX AND DESIGN**. ROCKHURST UNIVERSITY CONTINUING EDUCATION CENTER, INC., (U.S. CLS. 100, 101 AND 107). SN 85-970,562. PUB. 11-26-2013. FILED 6-26-2013.
- 4,480,696. **SOUL NAVIGATION (STANDARD CHARACTER)**. SOUL NAVIGATION, INC., MULTIPLE CLASS, (INT. CLS. 41 AND 45), (U.S. CLS. 100, 101 AND 107). SN 85-970,801. PUB. 11-26-2013. FILED 6-26-2013.
- 4,480,705. **THE FITNESSISTA (STANDARD CHARACTER)**. HARNEY, ANGELINA, (U.S. CLS. 100, 101 AND 107). SN 85-971,266. PUB. 11-26-2013. FILED 6-27-2013.
- 4,480,706. **SEC NETWORK (STANDARD CHARACTER)**. THE SOUTHEASTERN CONFERENCE, (U.S. CLS. 100, 101 AND 107). SN 85-971,393. PUB. 11-26-2013. FILED 6-27-2013.
- 4,480,707. **SUNSET MOONRISE (STANDARD CHARACTER)**. THE SAINT AUGUSTINE LIGHTHOUSE AND MUSEUM, INC., (U.S. CLS. 100, 101 AND 107). SN 85-971,400. PUB. 11-26-2013. FILED 6-27-2013.
- 4,480,709. **INFOSTRUCTURE (STANDARD CHARACTER)**. AMERICAN ROAD AND TRANSPORTATION BUILDERS ASSOCIATION, (U.S. CLS. 100, 101 AND 107). SN 85-971,424. PUB. 11-26-2013. FILED 6-27-2013.
- 4,480,716. **NEW FRANCE: THE OTHER COLONIAL AMERICA (STANDARD CHARACTER)**. HINMAN, WILLIAM, (U.S. CLS. 100, 101 AND 107). SN 85-971,853. PUB. 11-26-2013. FILED 6-27-2013.
- 4,480,718 ( *See Class 35 for this trademark*).
- 4,480,722. **HEARTSHIFT (STANDARD CHARACTER)**. NEUMANN, MARCY, (U.S. CLS. 100, 101 AND 107). SN 85-972,122. PUB. 11-26-2013. FILED 6-27-2013.
- 4,480,723. **RUNDLEFIT WORKOUT ANYWHERE (STANDARD CHARACTER)**. RUNDLEFIT, (U.S. CLS. 100, 101 AND 107). SN 85-972,165. PUB. 11-26-2013. FILED 6-27-2013.
- 4,480,741. **HULLABALOOZA (STYLIZED)**. TWO TONE ENTERTAINMENT, (U.S. CLS. 100, 101 AND 107). SN 85-973,144. PUB. 11-26-2013. FILED 6-28-2013.
- 4,480,748. **PRAJNA (STANDARD CHARACTER)**. JET U.S.A., INC., (U.S. CLS. 100, 101 AND 107). SN 85-973,491. PUB. 11-26-2013. FILED 6-28-2013.
- 4,480,754. **HEED (STANDARD CHARACTER)**. STANISLAV, ELIZABETH ANNE, DBA LIZZIDESIGN, (U.S. CLS. 100, 101 AND 107). SN 85-973,804. PUB. 11-26-2013. FILED 6-30-2013.
- 4,480,759. **MISCELLANEOUS DESIGN**. RANDALL, EDWIN, (U.S. CLS. 100, 101 AND 107). SN 85-974,009. PUB. 11-26-2013. FILED 7-1-2013.
- 4,480,763. **IDEA LEMON AND DESIGN**. MCGOVERN, MARTIN, AND NATHAN, RAJIV, (U.S. CLS. 100, 101 AND 107). SN 85-974,046. PUB. 11-26-2013. FILED 7-1-2013.
- 4,480,780 ( *See Class 16 for this trademark*).
- 4,480,783. **UBER UNIVERSITY (STANDARD CHARACTER)**. UBER OPERATIONS LLC, (U.S. CLS. 100, 101 AND 107). SN 85-974,670. PUB. 11-26-2013. FILED 7-1-2013.
- 4,480,784. **BENDABILITY FITNESS AND DESIGN**. AMY GUION, DBA BENDABILITY FITNESS, (U.S. CLS. 100, 101 AND 107). SN 85-974,680. PUB. 11-26-2013. FILED 7-1-2013.
- 4,480,792. **THE NEWSROOM (STANDARD CHARACTER)**. HOME BOX OFFICE, INC., (U.S. CLS. 100, 101 AND 107). SN 85-979,252. PUB. 11-26-2013. FILED 11-29-2011.
- 4,480,794. **STEEL BRIDGE SONGFEST (STANDARD CHARACTER)**. PATRICK L MACDONALD, (U.S. CLS. 100, 101 AND 107). SN 85-980,137. PUB. 11-26-2013. FILED 12-18-2012.
- 4,480,796. **PLAY HARD LIVE EASY (STANDARD CHARACTER)**. VR CPC HOLDINGS, INC., (U.S. CLS. 100, 101 AND 107). SN 85-980,462. PUB. 11-26-2013. FILED 1-9-2013.
- 4,480,817. **MISCELLANEOUS DESIGN**. MOONLYT, INC., (U.S. CLS. 100, 101 AND 107). SN 86-000,334. PUB. 11-26-2013. FILED 7-2-2013.
- 4,480,821. **BATTLEGROUNDZ (STANDARD CHARACTER)**. MARSELLA, TOM, AND MARSELLA, MEGAN, (U.S. CLS. 100, 101 AND 107). SN 86-000,405. PUB. 11-26-2013. FILED 7-2-2013.
- 4,480,826. **SUNSET (STYLIZED)**. SUNSET PUBLISHING CORPORATION, (U.S. CLS. 100, 101 AND 107). SN 86-000,487. PUB. 11-26-2013. FILED 7-2-2013.
- 4,480,827. **SUCCESSFUL LIVING BASIC TRAINING (STANDARD CHARACTER)**. PATRICIA CLASON LLC, (U.S. CLS. 100, 101 AND 107). SN 86-000,491. PUB. 11-26-2013. FILED 7-2-2013.
- 4,480,835 ( *See Class 9 for this trademark*).
- 4,480,839. **WEEKLY DOSE (STANDARD CHARACTER)**. ELLENBECKER INVESTMENT GROUP, INC., (U.S. CLS. 100, 101 AND 107). SN 86-000,653. PUB. 11-26-2013. FILED 7-2-2013.
- 4,480,840. **QUANTUM I2I (STANDARD CHARACTER)**. QUANTUM ENDEAVORS, INC., FORMERLY TRANSFORMATIONAL LEADERSHIP COACHING, INC., (U.S. CLS. 100, 101 AND 107). SN 86-000,660. PUB. 11-26-2013. FILED 7-2-2013.
- 4,480,844 ( *See Class 35 for this trademark*).
- 4,480,849. **MUNDOQ (STYLIZED)**. MUNDOQ LLC, (U.S. CLS. 100, 101 AND 107). SN 86-000,769. PUB. 11-26-2013. FILED 7-2-2013.
- 4,480,850. **H (STYLIZED)**. HYBRID ATHLETICS, LLC, (U.S. CLS. 100, 101 AND 107). SN 86-000,809. PUB. 11-26-2013. FILED 7-2-2013.
- 4,480,851. **A COLOR PARTY (STANDARD CHARACTER)**. RACE TEXAS SPORTS LLC, DBA RACE TEXAS, (U.S. CLS. 100, 101 AND 107). SN 86-000,814. PUB. 11-26-2013. FILED 7-2-2013.
- 4,480,867. **LAFAMILLYUNAIRE (STANDARD CHARACTER)**. MILLS, NATHAN, (U.S. CLS. 100, 101 AND 107). SN 86-001,019. PUB. 11-26-2013. FILED 7-2-2013.
- 4,480,872 ( *See Class 35 for this trademark*).
- 4,480,878. **20X CHALLENGE (STANDARD CHARACTER)**. U.S. TACTICAL, INC., (U.S. CLS. 100, 101 AND 107). SN 86-001,246. PUB. 11-26-2013. FILED 7-2-2013.
- 4,480,886. **KID CUT UP (STANDARD CHARACTER)**. ZICK, TIMOTHY, (U.S. CLS. 100, 101 AND 107). SN 86-001,455. PUB. 11-26-2013. FILED 7-3-2013.
- 4,480,894. **COLOR SPECTACULAR (STANDARD CHARACTER)**. CS DISTRIBUTION AND SERVICES, LLC, (U.S. CLS. 100, 101 AND 107). SN 86-001,583. PUB. 11-26-2013. FILED 7-3-2013.
- 4,480,914. **GOAL LINE (STANDARD CHARACTER)**. TITAN HOCKEY VENTURES, LLC, (U.S. CLS. 100, 101 AND 107). SN 86-001,870. PUB. 11-26-2013. FILED 7-3-2013.
- 4,480,921. **SACANIME (STANDARD CHARACTER)**. SACANIME, (U.S. CLS. 100, 101 AND 107). SN 86-002,033. PUB. 11-26-2013. FILED 7-3-2013.
- 4,480,932. **APPJAM (STANDARD CHARACTER)**. APPDYNAMICS, INC., (U.S. CLS. 100, 101 AND 107). SN 86-002,167. PUB. 11-26-2013. FILED 7-3-2013.
- 4,480,942 ( *See Class 36 for this trademark*).
- 4,480,947. **READY READERS (STANDARD CHARACTER)**. READY READERS, (U.S. CLS. 100, 101 AND 107). SN 86-002,294. PUB. 11-26-2013. FILED 7-3-2013.
- 4,480,948. **R R AND DESIGN**. READY READERS, (U.S. CLS. 100, 101 AND 107). SN 86-002,303. PUB. 11-26-2013. FILED 7-3-2013.
- 4,480,951. **DESTROY ARMADA (STANDARD CHARACTER)**. KOOKEE MONSTERS, INC., (U.S. CLS. 100, 101 AND 107). SN 86-002,329. PUB. 11-26-2013. FILED 7-3-2013.
- 4,480,954. **ICAN (STANDARD CHARACTER)**. INCREDIBLE CHILDREN'S ART NETWORK, (U.S. CLS. 100, 101 AND 107). SN 86-002,350. PUB. 11-26-2013. FILED 7-3-2013.
- 4,480,959 ( *See Class 9 for this trademark*).
- 4,480,961 ( *See Class 9 for this trademark*).
- 4,480,978. **HOT & SAXXY (STANDARD CHARACTER)**. ENCOREVISION ENTERTAINMENT PRODUCTIONS INC., (U.S. CLS. 100, 101 AND 107). SN 86-002,711. PUB. 11-26-2013. FILED 7-4-2013.

- 4,480,983. **MASUIMI MAX (STANDARD CHARACTER)**. MAX, MASUIMI, (U.S. CLS. 100, 101 AND 107). SN 86-002,758. PUB. 11-26-2013. FILED 7-4-2013.
- 4,480,994. **DON'T WANT TO COMMUNICATE! (STANDARD CHARACTER)**. BABY SIGN LANGUAGE BASICS, LLC, (U.S. CLS. 100, 101 AND 107). SN 86-002,833. PUB. 11-26-2013. FILED 7-4-2013.
- 4,480,995. **FIELD OF DREAMS DRIVE-IN THEATER (STANDARD CHARACTER)**. SAUNDERS THEATER PROPERTIES, LLC, DBA FIELD OF DREAMS DRIVE-IN THEATER, (U.S. CLS. 100, 101 AND 107). SN 86-002,837. PUB. 11-26-2013. FILED 7-4-2013.
- 4,481,007. **SESHEDUP AND DESIGN**. SESHEDUP LLC, (U.S. CLS. 100, 101 AND 107). SN 86-002,990. PUB. 11-26-2013. FILED 7-5-2013.
- 4,481,010 ( *See Class 9 for this trademark*).
- 4,481,011. **PRACTICE SAFE SOCIAL (STANDARD CHARACTER)**. CKSYME.ORG. GROUP, LLC, (U.S. CLS. 100, 101 AND 107). SN 86-003,003. PUB. 11-26-2013. FILED 7-5-2013.
- 4,481,033. **CFNMSPOT (STANDARD CHARACTER)**. PROGRAM THREE, LLC, (U.S. CLS. 100, 101 AND 107). SN 86-003,297. PUB. 11-26-2013. FILED 7-5-2013.
- 4,481,082 ( *See Class 3 for this trademark*).
- 4,481,085. **MISCELLANEOUS DESIGN**. GEIL, JASON, AND KINDLER, DAVID, (U.S. CLS. 100, 101 AND 107). SN 86-004,055. PUB. 11-26-2013. FILED 7-8-2013.
- 4,481,096. **OVERTIME ATHLETICS (STANDARD CHARACTER)**. WHELAN AND HORICH, LLC, DBA OVERTIME ATHLETICS, (U.S. CLS. 100, 101 AND 107). SN 86-004,362. PUB. 11-26-2013. FILED 7-8-2013.
- 4,481,102. **I-SIGNAL (STANDARD CHARACTER)**. ACCESS MARKETS INTERNATIONAL (AMI) PARTNERS, INC., (U.S. CLS. 100, 101 AND 107). SN 86-004,477. PUB. 11-26-2013. FILED 7-8-2013.
- 4,481,116. **BELIEVE AND DESIGN**. CALIFORNIA STATE LOTTERY, DBA CALIFORNIA LOTTERY, (U.S. CLS. 100, 101 AND 107). SN 86-004,689. PUB. 11-26-2013. FILED 7-8-2013.
- 4,481,121. **OVERTHINKING IT (STANDARD CHARACTER)**. WRATHER CREATIVE, LLC, (U.S. CLS. 100, 101 AND 107). SN 86-004,806. PUB. 11-26-2013. FILED 7-8-2013.
- 4,481,127. **ECOT (STANDARD CHARACTER)**. ELECTRONIC CLASSROOM OF TOMORROW, (U.S. CLS. 100, 101 AND 107). SN 86-004,927. PUB. 11-26-2013. FILED 7-9-2013.
- 4,481,128. **SQUADRON AND DESIGN**. SQUADRON, (U.S. CLS. 100, 101 AND 107). SN 86-004,934. PUB. 11-26-2013. FILED 7-9-2013.
- 4,481,147. **SMITE AND DESIGN**. HI-REZ STUDIOS, INC., (U.S. CLS. 100, 101 AND 107). SN 86-005,216. PUB. 11-26-2013. FILED 7-9-2013.
- 4,481,151. **TRINITY GEMS (STANDARD CHARACTER)**. KIVLEY, LOWELL, (U.S. CLS. 100, 101 AND 107). SN 86-005,273. PUB. 11-26-2013. FILED 7-9-2013.
- 4,481,167. **BURDIGALA (STANDARD CHARACTER)**. WINEVENT LLC, (U.S. CLS. 100, 101 AND 107). SN 86-005,483. PUB. 11-26-2013. FILED 7-9-2013.
- 4,481,169. **MISCELLANEOUS DESIGN**. JOHN W. KENAGY, (U.S. CLS. 100, 101 AND 107). SN 86-005,531. PUB. 11-26-2013. FILED 7-9-2013.
- 4,481,170. **BAR-T AND DESIGN**. BAR-T HOLDING, INC., MULTIPLE CLASS, (INT. CLS. 41 AND 43), (U.S. CLS. 100, 101 AND 107). SN 86-005,536. PUB. 11-26-2013. FILED 7-9-2013.
- 4,481,188. **EVAN BOGART (STANDARD CHARACTER)**. EVAN M. STACHOWSKI, (U.S. CLS. 100, 101 AND 107). SN 86-005,768. PUB. 11-26-2013. FILED 7-9-2013.
- 4,481,191. **FRONTRANGE (STANDARD CHARACTER)**. FRONTRANGE SOLUTIONS USA INC., (U.S. CLS. 100, 101 AND 107). SN 86-005,805. PUB. 11-26-2013. FILED 7-9-2013.
- 4,481,193. **FRONTRANGE AND DESIGN**. FRONTRANGE SOLUTIONS USA INC., (U.S. CLS. 100, 101 AND 107). SN 86-005,814. PUB. 11-26-2013. FILED 7-9-2013.
- 4,481,195. **FRONTRANGE THE HEAT IS ON AND DESIGN**. FRONTRANGE SOLUTIONS USA INC., (U.S. CLS. 100, 101 AND 107). SN 86-005,820. PUB. 11-26-2013. FILED 7-9-2013.
- 4,481,202. **JOYCE D. AND ANDREW J. MANDELL ACADEMY FOR TEACHERS AT THE CONNECTICUT SCIENCE CENTER AND DESIGN**. CONNECTICUT SCIENCE CENTER, INC., (U.S. CLS. 100, 101 AND 107). SN 86-007,994. PUB. 11-26-2013. FILED 7-11-2013.
- 4,481,210 ( *See Class 16 for this trademark*).
- 4,481,222. **CRIMES OF THE CENTURY (STANDARD CHARACTER)**. CABLE NEWS NETWORK, INC., (U.S. CLS. 100, 101 AND 107). SN 86-016,430. PUB. 11-26-2013. FILED 7-22-2013.
- 4,481,224. **SAINT MARY-OF-THE-WOODS COLLEGE (STANDARD CHARACTER)**. SISTERS OF PROVIDENCE OF SAINT MARY'S-OF-THE-WOODS, DBA SAINT MARY-OF-THE-WOODS COLLEGE, (U.S. CLS. 100, 101 AND 107). SN 86-017,707. PUB. 11-26-2013. FILED 7-23-2013.
- 4,481,232. **NICKMOM (STANDARD CHARACTER)**. VIACOM INTERNATIONAL INC., (U.S. CLS. 100, 101 AND 107). SN 86-023,863. PUB. 11-26-2013. FILED 7-30-2013.
- 4,481,233. **CITY MODERN (STANDARD CHARACTER)**. DWELL MEDIA, LLC, AND NEW YORK MEDIA LLC, (U.S. CLS. 100, 101 AND 107). SN 86-024,279. PUB. 11-26-2013. FILED 7-31-2013.
- 4,481,241 ( *See Class 16 for this trademark*).
- 4,481,250. **PETCENTRIC (STANDARD CHARACTER)**. SOCIETE DES PRODUITS NESTLE S.A., (U.S. CLS. 100, 101 AND 107). SN 86-033,324. PUB. 11-26-2013. FILED 8-9-2013.
- 4,481,253. **SKA FITNESS (STANDARD CHARACTER)**. SKA FITNESS, LLC, (U.S. CLS. 100, 101 AND 107). SN 86-036,231. PUB. 11-26-2013. FILED 8-13-2013.
- 4,481,255. **GUTSMACK (STANDARD CHARACTER)**. COCA-COLA COMPANY, THE, (U.S. CLS. 100, 101 AND 107). SN 86-037,307. PUB. 11-26-2013. FILED 8-14-2013.
- 4,481,258. **COURAGEOUS KIDS (STANDARD CHARACTER)**. PREVENTION FIRST, INC., (U.S. CLS. 100, 101 AND 107). SN 86-040,435. PUB. 11-26-2013. FILED 8-16-2013.
- 4,481,274. **FASHION YOUR LIFE. (STANDARD CHARACTER)**. GRAPHIQUE DE FRANCE, LTD., (U.S. CLS. 100, 101 AND 107). SN 86-052,766. PUB. 11-26-2013. FILED 8-30-2013.
- 4,481,275. **FASHION YOUR LIFE. (STYLIZED)**. GRAPHIQUE DE FRANCE, LTD., (U.S. CLS. 100, 101 AND 107). SN 86-052,787. PUB. 11-26-2013. FILED 8-30-2013.
- 4,481,278. **THE CONSUMER'S ADVOCATE (STANDARD CHARACTER)**. DN MARKS LLC, (U.S. CLS. 100, 101 AND 107). SN 86-056,142. PUB. 11-26-2013. FILED 9-4-2013.
- 4,481,281. **CRAZY 888 (STANDARD CHARACTER)**. KIZZANG, INC., (U.S. CLS. 100, 101 AND 107). SN 86-058,682. PUB. 11-26-2013. FILED 9-8-2013.
- 4,481,282. **CASH BAGS (STANDARD CHARACTER)**. KIZZANG, INC., (U.S. CLS. 100, 101 AND 107). SN 86-058,725. PUB. 11-26-2013. FILED 9-9-2013.
- 4,481,288. **LUCKY 999 (STANDARD CHARACTER)**. KIZZANG, INC., (U.S. CLS. 100, 101 AND 107). SN 86-063,574. PUB. 11-26-2013. FILED 9-13-2013.
- 4,481,289. **LUCKY 9'S (STANDARD CHARACTER)**. KIZZANG, INC., (U.S. CLS. 100, 101 AND 107). SN 86-063,578. PUB. 11-26-2013. FILED 9-13-2013.
- 4,481,296. **TASTE BY APPOINTMENT (STANDARD CHARACTER)**. BACARDI & COMPANY LIMITED, (U.S. CLS. 100, 101 AND 107). SN 86-075,204. PUB. 11-26-2013. FILED 9-26-2013.
- 4,481,297. **STUBBORN WARRIOR (STANDARD CHARACTER)**. CS DISTRIBUTION AND SERVICES, LLC, (U.S. CLS. 100, 101 AND 107). SN 86-075,392. PUB. 11-26-2013. FILED 9-26-2013.

---

## CLASS 42—SCIENTIFIC AND COMPUTER SERVICES

- 4,479,241 ( *See Class 37 for this trademark*).
- 4,479,244. **HELP SCOUT AND DESIGN**. BRIGHTWURKS, INC., (U.S. CLS. 100 AND 101). SN 76-713,309. PUB. 7-16-2013. FILED 1-28-2013.
- 4,479,251. **BLACKBIRD (STANDARD CHARACTER)**. STRATASAN, LLC, FORMERLY HEALTH DATA SOURCE, LLC, (U.S. CLS. 100 AND 101). SN 76-714,496. PUB. 11-26-2013. FILED 7-3-2013.
- 4,479,273 ( *See Class 3 for this trademark*).
- 4,479,277 ( *See Class 9 for this trademark*).

- 4,479,278 ( See Class 9 for this trademark).  
 4,479,279 ( See Class 9 for this trademark).  
 4,479,280 ( See Class 9 for this trademark).  
 4,479,283 ( See Class 3 for this trademark).  
 4,479,284 ( See Class 6 for this trademark).  
 4,479,292 ( See Class 10 for this trademark).  
 4,479,294 ( See Class 6 for this trademark).  
 4,479,302 ( See Class 35 for this trademark).  
 4,479,304 ( See Class 9 for this trademark).  
 4,479,313 ( See Class 36 for this trademark).  
 4,479,314 ( See Class 9 for this trademark).  
 4,479,325 ( See Class 3 for this trademark).  
 4,479,339 ( See Class 9 for this trademark).  
 4,479,356 ( See Class 9 for this trademark).  
 4,479,367 ( See Class 3 for this trademark).  
 4,479,368 ( See Class 3 for this trademark).  
 4,479,374 ( See Class 9 for this trademark).  
 4,479,389 ( See Class 36 for this trademark).  
 4,479,394 ( See Class 9 for this trademark).  
 4,479,399 ( See Class 9 for this trademark).  
 4,479,402 ( See Class 9 for this trademark).  
 4,479,413 ( See Class 9 for this trademark).  
 4,479,418 ( See Class 9 for this trademark).  
 4,479,419 ( See Class 9 for this trademark).  
 4,479,425 ( See Class 35 for this trademark).  
 4,479,435 ( See Class 7 for this trademark).  
 4,479,441 ( See Class 9 for this trademark).  
 4,479,445 ( See Class 37 for this trademark).  
 4,479,448 ( See Class 9 for this trademark).  
 4,479,450 ( See Class 5 for this trademark).  
 4,479,456 ( See Class 6 for this trademark).  
 4,479,469 ( See Class 9 for this trademark).  
 4,479,477 ( See Class 6 for this trademark).  
 4,479,495. **PHARMAVIZE AND DESIGN**. PHARMAVIZE, NAAMLOZE VENNOOTSCHAP, MULTIPLE CLASS, (INT. CLS. 42 AND 45), (U.S. CLS. 100 AND 101). SN 79-134,739. PUB. 11-26-2013. FILED 3-18-2013.  
 4,479,514 ( See Class 9 for this trademark).  
 4,479,538 ( See Class 9 for this trademark).  
 4,479,545 ( See Class 12 for this trademark).  
 4,479,546 ( See Class 12 for this trademark).  
 4,479,547 ( See Class 12 for this trademark).  
 4,479,550 ( See Class 35 for this trademark).  
 4,479,575 ( See Class 9 for this trademark).  
 4,479,577 ( See Class 9 for this trademark).  
 4,479,582 ( See Class 2 for this trademark).  
 4,479,603 ( See Class 9 for this trademark).  
 4,479,625. **SHOUTVU (STANDARD CHARACTER)**. YOAKAM, LLC, AND TL INDUSTRIES, INC., (U.S. CLS. 100 AND 101). SN 85-617,044. PUB. 11-26-2013. FILED 5-4-2012.  
 4,479,636. **4DX (STYLIZED)**. CJ 4DPLEX CO., LTD., (U.S. CLS. 100 AND 101). SN 85-623,446. PUB. 11-26-2013. FILED 5-11-2012.  
 4,479,673 ( See Class 14 for this trademark).  
 4,479,680 ( See Class 9 for this trademark).  
 4,479,686 ( See Class 1 for this trademark).  
 4,479,687 ( See Class 16 for this trademark).  
 4,479,693. **GISA GLOBAL INSPECTION SYSTEM ACCESS (STYLIZED)**. MIDWEST TECHNICAL INSPECTIONS, INC., (U.S. CLS. 100 AND 101). SN 85-667,935. PUB. 11-26-2013. FILED 7-3-2012.  
 4,479,715 ( See Class 9 for this trademark).  
 4,479,730. **AR & DEE DESIGN . FABRICATION BROOKLYN . NY AND DESIGN**. ROB HERSCHENFELD DESIGN INC., (U.S. CLS. 100 AND 101). SN 85-723,167. PUB. 11-26-2013. FILED 9-7-2012.  
 4,479,731 ( See Class 37 for this trademark).  
 4,479,732 ( See Class 9 for this trademark).  
 4,479,737. **FACILITY SCORECARD AND DESIGN**. FME, INC., FORMERLY FACILITY MANAGEMENT & ENGINEERING, INC., (U.S. CLS. 100 AND 101). SN 85-728,403. PUB. 11-26-2013. FILED S.R. 9-13-2012; AM. P.R. 10-9-2013.  
 4,479,744 ( See Class 35 for this trademark).  
 4,479,764 ( See Class 14 for this trademark).  
 4,479,765 ( See Class 14 for this trademark).  
 4,479,768 ( See Class 9 for this trademark).  
 4,479,778 ( See Class 9 for this trademark).  
 4,479,781 ( See Class 9 for this trademark).  
 4,479,806. **REDARROW (STANDARD CHARACTER)**. COMPLIANCE SOFTWARE, INC., (U.S. CLS. 100 AND 101). SN 85-775,527. PUB. 6-4-2013. FILED 11-9-2012.  
 4,479,812. **WEPLANWELL (STANDARD CHARACTER)**. IBOSWELL, INC., (U.S. CLS. 100 AND 101). SN 85-777,159. PUB. 11-26-2013. FILED 11-12-2012.  
 4,479,813 ( See Class 35 for this trademark).  
 4,479,830. **DOCKIT (STANDARD CHARACTER)**. CLAIMKIT LLC, (U.S. CLS. 100 AND 101). SN 85-781,448. PUB. 11-26-2013. FILED 11-16-2012.  
 4,479,835. **GET IT RIGHT (STANDARD CHARACTER)**. AFIA INC., (U.S. CLS. 100 AND 101). SN 85-784,197. PUB. 11-26-2013. FILED 11-20-2012.  
 4,479,836 ( See Class 35 for this trademark).  
 4,479,845. **SRL (STANDARD CHARACTER)**. NATIONAL NUCLEAR LABORATORY LIMITED, (U.S. CLS. 100 AND 101). SN 85-789,479. PUB. 11-26-2013. FILED 11-28-2012.  
 4,479,852 ( See Class 9 for this trademark).  
 4,479,901. **THETUDU (STANDARD CHARACTER)**. TUDU, INC., (U.S. CLS. 100 AND 101). SN 85-804,988. PUB. 11-26-2013. FILED 12-18-2012.  
 4,479,913 ( See Class 35 for this trademark).  
 4,479,929. **SAFETY + SUCCESS (STANDARD CHARACTER)**. CAPPELLO, DOMINIC, (U.S. CLS. 100 AND 101). SN 85-809,775. PUB. 11-26-2013. FILED 12-22-2012.  
 4,479,931. **XPROTECT (STANDARD CHARACTER)**. XCALIBER SOLUTIONS INC., (U.S. CLS. 100 AND 101). SN 85-809,971. PUB. 11-26-2013. FILED 12-23-2012.  
 4,479,936 ( See Class 35 for this trademark).  
 4,479,942. **CASTLE ROCK I N N O V A T I O N S AND DESIGN**. CASTLE ROCK INNOVATIONS, LLC, (U.S. CLS. 100 AND 101). SN 85-812,927. PUB. 11-26-2013. FILED 12-31-2012.  
 4,479,947. **NESTIVITY (STANDARD CHARACTER)**. NOUR-OMID, BAHRAM, (U.S. CLS. 100 AND 101). SN 85-814,110. PUB. 11-26-2013. FILED 1-2-2013.  
 4,479,953. **AFOUNDRIA (STANDARD CHARACTER)**. AFOUNDRIA, LLC, (U.S. CLS. 100 AND 101). SN 85-816,698. PUB. 11-26-2013. FILED 1-7-2013.  
 4,479,958. **IT WORKS! (STANDARD CHARACTER)**. IT WORKS! INC., (U.S. CLS. 100 AND 101). SN 85-818,066. PUB. 11-26-2013. FILED 1-8-2013.  
 4,479,981 ( See Class 9 for this trademark).  
 4,480,002. **VIRTUSWAY (STANDARD CHARACTER)**. VIRTUSWAY LLC, (U.S. CLS. 100 AND 101). SN 85-830,489. PUB. 11-26-2013. FILED 1-23-2013.  
 4,480,015. **LEWTAN (STANDARD CHARACTER)**. LEWTAN TECHNOLOGIES, INC., (U.S. CLS. 100 AND 101). SN 85-835,314. PUB. 11-26-2013. FILED 1-29-2013.  
 4,480,021. **SWIFTUNLOCKS (STANDARD CHARACTER)**. SWIFT UNLOCKS, INC., (U.S. CLS. 100 AND 101). SN 85-836,940. PUB. 8-20-2013. FILED 1-30-2013.  
 4,480,028 ( See Class 35 for this trademark).  
 4,480,056 ( See Class 37 for this trademark).  
 4,480,058 ( See Class 35 for this trademark).  
 4,480,064 ( See Class 16 for this trademark).  
 4,480,067. **CLOUDPREMISE (STANDARD CHARACTER)**. CLOUDPREMISE LLC, (U.S. CLS. 100 AND 101). SN 85-857,961. PUB. 11-26-2013. FILED 2-22-2013.  
 4,480,071. **HOME MAINTAINOR (STANDARD CHARACTER)**. NORBY, DANIEL R., (U.S. CLS. 100 AND 101). SN 85-859,307. PUB. 11-26-2013. FILED 2-25-2013.  
 4,480,077. **MISCELLANEOUS DESIGN**. TACIT KNOWLEDGE INC., (U.S. CLS. 100 AND 101). SN 85-859,728. PUB. 11-26-2013. FILED 2-25-2013.  
 4,480,080. **GENEREVIEWS (STANDARD CHARACTER)**. UNIVERSITY OF WASHINGTON, AKA UW, (U.S. CLS. 100 AND 101). SN 85-860,901. PUB. 11-26-2013. FILED 2-26-2013.  
 4,480,091. **SOCIALCAMPAIGNS AND DESIGN**. CONSTANT CONTACT, INC., (U.S. CLS. 100 AND 101). SN 85-866,693. PUB. 11-26-2013. FILED 3-5-2013.  
 4,480,122. **TACIT KNOWLEDGE (STANDARD CHARACTER)**. TACIT KNOWLEDGE INC., (U.S. CLS. 100 AND 101). SN 85-880,216. PUB. 11-26-2013. FILED 3-19-2013.  
 4,480,125. **LIFEECHO AND DESIGN**. LIFEECHO MINISTRIES, (U.S. CLS. 100 AND 101). SN 85-880,759. PUB. 11-26-2013. FILED 3-20-2013.



- 4,480,132. **SPEED COMMERCE (STANDARD CHARACTER)**. SPEED COMMERCE, INC., (U.S. CLS. 100 AND 101). SN 85-882,453. PUB. 11-26-2013. FILED 3-21-2013.
- 4,480,171. **ENDLESS POSSIBILITIES (STANDARD CHARACTER)**. SPAN ENTERPRISES, (U.S. CLS. 100 AND 101). SN 85-897,241. PUB. 11-26-2013. FILED 4-6-2013.
- 4,480,180 ( *See Class 9 for this trademark*).
- 4,480,215. **1CAPAPP (STANDARD CHARACTER)**. 1CAPAPP LLC, (U.S. CLS. 100 AND 101). SN 85-910,491. PUB. 11-26-2013. FILED 4-22-2013.
- 4,480,221 ( *See Class 9 for this trademark*).
- 4,480,228. **INSPECT 360 AND DESIGN**. INSPECT 360, (U.S. CLS. 100 AND 101). SN 85-913,696. PUB. 11-26-2013. FILED 4-24-2013.
- 4,480,236 ( *See Class 9 for this trademark*).
- 4,480,247 ( *See Class 35 for this trademark*).
- 4,480,270 ( *See Class 35 for this trademark*).
- 4,480,271 ( *See Class 35 for this trademark*).
- 4,480,276 ( *See Class 5 for this trademark*).
- 4,480,288 ( *See Class 35 for this trademark*).
- 4,480,306 ( *See Class 9 for this trademark*).
- 4,480,309. **3DENT (STANDARD CHARACTER)**. 3DENT TECHNOLOGY, LLC, (U.S. CLS. 100 AND 101). SN 85-933,244. PUB. 10-15-2013. FILED 5-15-2013.
- 4,480,320. **AGING POST (STANDARD CHARACTER)**. ELDERSCAN, LLC, (U.S. CLS. 100 AND 101). SN 85-935,302. PUB. 11-26-2013. FILED 5-17-2013.
- 4,480,322. **XEER (STANDARD CHARACTER)**. XEER INC., (U.S. CLS. 100 AND 101). SN 85-935,796. PUB. 11-26-2013. FILED 5-17-2013.
- 4,480,347 ( *See Class 35 for this trademark*).
- 4,480,348 ( *See Class 40 for this trademark*).
- 4,480,358 ( *See Class 35 for this trademark*).
- 4,480,359 ( *See Class 35 for this trademark*).
- 4,480,388 ( *See Class 41 for this trademark*).
- 4,480,390. **WEDUARY (STANDARD CHARACTER)**. BRIT MEDIA, INC., MULTIPLE CLASS, (INT. CLS. 42 AND 45), (U.S. CLS. 100 AND 101). SN 85-945,583. PUB. 11-26-2013. FILED 5-29-2013.
- 4,480,403 ( *See Class 9 for this trademark*).
- 4,480,411 ( *See Class 9 for this trademark*).
- 4,480,413. **LEAN SQUAD (STANDARD CHARACTER)**. TABBITS, INC., (U.S. CLS. 100 AND 101). SN 85-947,847. PUB. 11-26-2013. FILED 5-31-2013.
- 4,480,429 ( *See Class 38 for this trademark*).
- 4,480,436 ( *See Class 35 for this trademark*).
- 4,480,441. **INTELLEGENE GENOMICS (STANDARD CHARACTER)**. INTELLEGENE GENOMICS LLC, (U.S. CLS. 100 AND 101). SN 85-951,649. PUB. 11-26-2013. FILED 6-5-2013.
- 4,480,447. **LEAN SQUAD (STANDARD CHARACTER)**. TABBITS, INC., (U.S. CLS. 100 AND 101). SN 85-953,189. PUB. 11-26-2013. FILED 6-6-2013.
- 4,480,448. **OUR CLOUD. YOUR WAY. GUARANTEED. (STANDARD CHARACTER)**. DSM.NET, INC., (U.S. CLS. 100 AND 101). SN 85-953,401. PUB. 11-26-2013. FILED 6-7-2013.
- 4,480,467. **INSTATHIS (STANDARD CHARACTER)**. DEVELOPED SPORTS LLC, (U.S. CLS. 100 AND 101). SN 85-955,895. PUB. 11-26-2013. FILED 6-10-2013.
- 4,480,486 ( *See Class 38 for this trademark*).
- 4,480,489 ( *See Class 35 for this trademark*).
- 4,480,501. **WT WALLSTECH SOMETHING DIFFERENT AND DESIGN**. URTECHMATE INC, (U.S. CLS. 100 AND 101). SN 85-959,993. PUB. 11-26-2013. FILED 6-14-2013.
- 4,480,511. **TAXRUNNERS (STANDARD CHARACTER)**. TAX RUNNERS.COM, INC., (U.S. CLS. 100 AND 101). SN 85-961,945. PUB. 11-26-2013. FILED 6-17-2013.
- 4,480,524 ( *See Class 35 for this trademark*).
- 4,480,528 ( *See Class 35 for this trademark*).
- 4,480,538. **DB DEHN BLOOM (STYLIZED)**. DEHN BLOOM DESIGN, LLC, (U.S. CLS. 100 AND 101). SN 85-963,780. PUB. 11-26-2013. FILED 6-19-2013.
- 4,480,565. **LOUDR (STANDARD CHARACTER)**. RE:DISCOVER, INC., FORMERLY A CAPPELLA RECORDS, INC., (U.S. CLS. 100 AND 101). SN 85-964,775. PUB. 11-26-2013. FILED 6-19-2013.
- 4,480,578 ( *See Class 9 for this trademark*).
- 4,480,579 ( *See Class 9 for this trademark*).
- 4,480,597. **BETTER PC AND DESIGN**. JIMENEZ, GEORGE, (U.S. CLS. 100 AND 101). SN 85-966,275. PUB. 11-26-2013. FILED 6-21-2013.
- 4,480,600 ( *See Class 9 for this trademark*).
- 4,480,601. **VISUAL VOICE (STANDARD CHARACTER)**. GRAPHIC-FX, (U.S. CLS. 100 AND 101). SN 85-966,420. PUB. 11-26-2013. FILED 6-21-2013.
- 4,480,610 ( *See Class 35 for this trademark*).
- 4,480,618. **WRITECLICK (STANDARD CHARACTER)**. AMERICAN ACADEMY OF NEUROLOGY, (U.S. CLS. 100 AND 101). SN 85-967,447. PUB. 11-26-2013. FILED 6-23-2013.
- 4,480,626 ( *See Class 35 for this trademark*).
- 4,480,627 ( *See Class 35 for this trademark*).
- 4,480,674 ( *See Class 37 for this trademark*).
- 4,480,675 ( *See Class 37 for this trademark*).
- 4,480,688 ( *See Class 35 for this trademark*).
- 4,480,693. **POPULATION REPORTAL (STANDARD CHARACTER)**. MYCATALYST, INC., (U.S. CLS. 100 AND 101). SN 85-970,712. PUB. 11-26-2013. FILED 6-26-2013.
- 4,480,719. **SOCIETY6 (STANDARD CHARACTER)**. DEMAND MEDIA, INC., (U.S. CLS. 100 AND 101). SN 85-971,922. PUB. 11-26-2013. FILED 6-27-2013.
- 4,480,724 ( *See Class 9 for this trademark*).
- 4,480,744 ( *See Class 35 for this trademark*).
- 4,480,757. **DOCKETFISH (STANDARD CHARACTER)**. DATA INNOVATION PARTNERS LLC, (U.S. CLS. 100 AND 101). SN 85-973,970. PUB. 11-26-2013. FILED 7-1-2013.
- 4,480,789. **AIRCART (STANDARD CHARACTER)**. AIRCART, INC., (U.S. CLS. 100 AND 101). SN 85-974,953. PUB. 11-26-2013. FILED 7-1-2013.
- 4,480,806. **MOTIVESMART (STANDARD CHARACTER)**. ALCATEL-LUCENT USA INC., (U.S. CLS. 100 AND 101). SN 86-000,219. PUB. 11-26-2013. FILED 7-2-2013.
- 4,480,820. **TEKDOC (STANDARD CHARACTER)**. TEKDOC SOLUTIONS, (U.S. CLS. 100 AND 101). SN 86-000,398. PUB. 11-26-2013. FILED 7-2-2013.
- 4,480,843 ( *See Class 35 for this trademark*).
- 4,480,871 ( *See Class 20 for this trademark*).
- 4,480,905. **GO BEYOND RNA (STANDARD CHARACTER)**. ARRAYSTAR INC, (U.S. CLS. 100 AND 101). SN 86-001,779. PUB. 11-26-2013. FILED 7-3-2013.
- 4,480,906. **CLOUDN AND DESIGN**. VERIO INC., (U.S. CLS. 100 AND 101). SN 86-001,785. PUB. 11-26-2013. FILED 7-3-2013.
- 4,480,910 ( *See Class 37 for this trademark*).
- 4,480,933. **GOVBD (STANDARD CHARACTER)**. REI SYSTEMS, INC., (U.S. CLS. 100 AND 101). SN 86-002,197. PUB. 11-26-2013. FILED 7-3-2013.
- 4,480,939 ( *See Class 9 for this trademark*).
- 4,480,946. **CRAFT + STORY (STANDARD CHARACTER)**. CRAFT AND STORY LLC, (U.S. CLS. 100 AND 101). SN 86-002,279. PUB. 11-26-2013. FILED 7-3-2013.
- 4,480,964. **HELLO WORK (STANDARD CHARACTER)**. APHOTOFOLIO.COM INC., (U.S. CLS. 100 AND 101). SN 86-002,537. PUB. 11-26-2013. FILED 7-3-2013.
- 4,480,976 ( *See Class 40 for this trademark*).
- 4,480,982. **BETTERWRX (STANDARD CHARACTER)**. BETTERWRX, INC., (U.S. CLS. 100 AND 101). SN 86-002,756. PUB. 11-26-2013. FILED 7-4-2013.
- 4,480,990. **BANCSEC (STANDARD CHARACTER)**. BRADY DEVELOPMENT, INC., DBA BANCSEC, INC., (U.S. CLS. 100 AND 101). SN 86-002,798. PUB. 11-26-2013. FILED 7-4-2013.
- 4,481,010 ( *See Class 9 for this trademark*).
- 4,481,030. **ISBIS AND DESIGN**. ISBIS LLC, (U.S. CLS. 100 AND 101). SN 86-003,243. PUB. 11-26-2013. FILED 7-5-2013.
- 4,481,031. **SONGSPACE (STANDARD CHARACTER)**. AMERICAN SONGSPACE LLC, (U.S. CLS. 100 AND 101). SN 86-003,254. PUB. 11-26-2013. FILED 7-5-2013.
- 4,481,035. **MONETIZE BIG DATA (STANDARD CHARACTER)**. TRESATA, INC., DBA TRESATA, (U.S. CLS. 100 AND 101). SN 86-003,358. PUB. 11-26-2013. FILED 7-5-2013.
- 4,481,039 ( *See Class 38 for this trademark*).
- 4,481,042 ( *See Class 38 for this trademark*).
- 4,481,047. **DBAMART (STANDARD CHARACTER)**. DBAMART, (U.S. CLS. 100 AND 101). SN 86-003,527. PUB. 11-26-2013. FILED 7-6-2013.
- 4,481,049. **DIGITALAPPETITE (STANDARD CHARACTER)**. DIGITALAPPETITE LTD., (U.S. CLS. 100 AND 101). SN 86-

- 003,539. PUB. 11-26-2013. FILED 7-6-2013.
- 4,481,052. **TEAMPLAYER GAMING (STANDARD CHARACTER)**. TEAMPLAYER GAMING, LLC. (U.S. CLS. 100 AND 101). SN 86-003,562. PUB. 11-26-2013. FILED 7-6-2013.
- 4,481,053. **KEEPING EVERYTHING ON SITE IN SIGHT (STANDARD CHARACTER)**. OUT OF THE BOX SOFTWARE, LLC. (U.S. CLS. 100 AND 101). SN 86-003,563. PUB. 11-26-2013. FILED 7-6-2013.
- 4,481,054. **GTRADEPRO (STANDARD CHARACTER)**. INTREDEX, LLC, DBA INTREDEX. (U.S. CLS. 100 AND 101). SN 86-003,566. PUB. 11-26-2013. FILED 7-6-2013.
- 4,481,056. **TECHTREND (STANDARD CHARACTER)**. TECHTREND, INC., (U.S. CLS. 100 AND 101). SN 86-003,592. PUB. 11-26-2013. FILED 7-7-2013.
- 4,481,065 ( *See Class 9 for this trademark*).
- 4,481,093. **ADITOR (STANDARD CHARACTER)**. ADITALL, LLC. (U.S. CLS. 100 AND 101). SN 86-004,184. PUB. 11-26-2013. FILED 7-8-2013.
- 4,481,143. **ENROLLTRACK (STANDARD CHARACTER)**. PRINT MANAGEMENT PARTNERS, INC., DBA TOOLS FOR SCHOOLS. (U.S. CLS. 100 AND 101). SN 86-005,170. PUB. 11-26-2013. FILED 7-9-2013.
- 4,481,160. **BLOODHOUND (STANDARD CHARACTER)**. BLOODHOUND INVESTMENT RESEARCH, INC., (U.S. CLS. 100 AND 101). SN 86-005,386. PUB. 11-26-2013. FILED 7-9-2013.
- 4,481,165 ( *See Class 9 for this trademark*).
- 4,481,176. **RUNKZ (STANDARD CHARACTER)**. MINUTILLO, MICHAEL. (U.S. CLS. 100 AND 101). SN 86-005,633. PUB. 11-26-2013. FILED 7-9-2013.
- 4,481,184. **ITINIO (STANDARD CHARACTER)**. REV'D UP, INC., (U.S. CLS. 100 AND 101). SN 86-005,720. PUB. 11-26-2013. FILED 7-9-2013.
- 4,481,186 ( *See Class 9 for this trademark*).
- 4,481,189 ( *See Class 9 for this trademark*).
- 4,481,199. **RESULTS DRIVEN WEBSITES (STANDARD CHARACTER)**. INTECHNIC, (U.S. CLS. 100 AND 101). SN 86-006,499. PUB. 11-26-2013. FILED 7-10-2013.
- 4,481,219. **RESULTS ON INTERNET (STANDARD CHARACTER)**. INTECHNIC, (U.S. CLS. 100 AND 101). SN 86-014,350. PUB. 11-26-2013. FILED 7-18-2013.
- 4,481,229. **LEXISNEXIS (STANDARD CHARACTER)**. REED ELSEVIER PROPERTIES INC., (U.S. CLS. 100 AND 101). SN 86-022,168. PUB. 11-26-2013. FILED 7-29-2013.
- 4,481,248. **CHEATERVILLE "LOOK WHO'S GETTING CAUGHT WITH THEIR PANTS DOWN." AND DESIGN**. VIAVIEW, INC., (U.S. CLS. 100 AND 101). SN 86-031,560. PUB. 11-26-2013. FILED 8-7-2013.
- 4,481,262. **ADVANTAGE WORKFORCE (STANDARD CHARACTER)**. COMPEAT, INC., (U.S. CLS. 100 AND 101). SN 86-041,457. PUB. 11-26-2013. FILED 8-19-2013.
- 
- CLASS 43—HOTEL AND RESTAURANT SERVICES**
- 4,479,247. **305 PIZZA AND DESIGN**. 305 PIZZA AT MIA, LLC., (U.S. CLS. 100 AND 101). SN 76-713,703. PUB. 8-20-2013. FILED 3-14-2013.
- 4,479,273 ( *See Class 3 for this trademark*).
- 4,479,274 ( *See Class 39 for this trademark*).
- 4,479,305 ( *See Class 25 for this trademark*).
- 4,479,313 ( *See Class 36 for this trademark*).
- 4,479,332 ( *See Class 41 for this trademark*).
- 4,479,340 ( *See Class 3 for this trademark*).
- 4,479,352 ( *See Class 41 for this trademark*).
- 4,479,413 ( *See Class 9 for this trademark*).
- 4,479,434 ( *See Class 3 for this trademark*).
- 4,479,445 ( *See Class 37 for this trademark*).
- 4,479,454 ( *See Class 9 for this trademark*).
- 4,479,485. **(PETIT) (STYLIZED)**. VESPUCCI 5 S.R.L., (U.S. CLS. 100 AND 101). SN 79-133,798. PUB. 11-26-2013. FILED 5-16-2013.
- 4,479,567. **GATOR JACK'S AND DESIGN**. JAMES W PACE, (U.S. CLS. 100 AND 101). SN 85-474,020. PUB. 8-20-2013. FILED 11-16-2011.
- 4,479,639. **XIANGZUAN AND DESIGN**. SHIH-MING CHEN, (U.S. CLS. 100 AND 101). SN 85-625,028. PUB. 11-26-2013. FILED 5-14-2012.
- 4,479,824. **EVERY EMPLOYEE IS EMPOWERED TO EXCEED YOUR EXPECTATIONS! (STANDARD CHARACTER)**. HIH, INC., (U.S. CLS. 100 AND 101). SN 85-779,953. PUB. 11-26-2013. FILED 11-15-2012.
- 4,479,829. **TACOS DE ACAPULCO (STANDARD CHARACTER)**. RUIZ, FERNANDO PATRICIO, AND LOBATO, FRANCISCO RIZO, (U.S. CLS. 100 AND 101). SN 85-781,302. PUB. 11-26-2013. FILED 11-16-2012.
- 4,479,861 ( *See Class 41 for this trademark*).
- 4,479,914 ( *See Class 39 for this trademark*).
- 4,479,948 ( *See Class 32 for this trademark*).
- 4,480,017. **SERENITY RECOVERY (STANDARD CHARACTER)**. TTR GLOBAL, LLC, DBA SERENITY RECOVERY, MULTIPLE CLASS, (INT. CLS. 43 AND 44), (U.S. CLS. 100 AND 101). SN 85-835,429. PUB. 11-26-2013. FILED 1-29-2013.
- 4,480,074 ( *See Class 41 for this trademark*).
- 4,480,079 ( *See Class 30 for this trademark*).
- 4,480,097. **ADA'S CAFE (STANDARD CHARACTER)**. ADA'S CAFE, (U.S. CLS. 100 AND 101). SN 85-869,202. PUB. 11-26-2013. FILED 3-7-2013.
- 4,480,168. **BOLLINI'S PIZZERIA NAPOLETANA AND DESIGN**. BOLLINI, CHRISTIANO, (U.S. CLS. 100 AND 101). SN 85-897,007. PUB. 11-26-2013. FILED 4-5-2013.
- 4,480,232. **PARADISUS RESORTS AND DESIGN**. DORPAN, S.L., (U.S. CLS. 100 AND 101). SN 85-914,366. PUB. 8-20-2013. FILED 4-25-2013.
- 4,480,240. **H HYATT HOUSE AND DESIGN**. HYATT CORPORATION, (U.S. CLS. 100 AND 101). SN 85-920,591. PUB. 11-26-2013. FILED 5-1-2013.
- 4,480,273. **TUBBY'S STEAK N' CHEESE 1968 AND DESIGN**. TUBBY'S SUB SHOPS, INC., (U.S. CLS. 100 AND 101). SN 85-926,087. PUB. 11-26-2013. FILED 5-8-2013.
- 4,480,287. **BOSTON'S BADDEST BURGER & SANDWICH CO. (STANDARD CHARACTER)**. BOSTON'S BADDEST BURGER & SANDWICH CO., (U.S. CLS. 100 AND 101). SN 85-928,442. PUB. 11-26-2013. FILED 5-10-2013.
- 4,480,299. **POWERED BY BACON (STANDARD CHARACTER)**. BACON BROTHERS LLC, (U.S. CLS. 100 AND 101). SN 85-931,286. PUB. 11-26-2013. FILED 5-14-2013.
- 4,480,362. **G GLENMOOR AND DESIGN**. LIFE CARE ST. JOHNS, INC., MULTIPLE CLASS, (INT. CLS. 43 AND 44), (U.S. CLS. 100 AND 101). SN 85-942,768. PUB. 11-26-2013. FILED 5-25-2013.
- 4,480,395. **E ERBERT AND GERBERT'S G AND DESIGN**. E&G FRANCHISE SYSTEMS, INC., (U.S. CLS. 100 AND 101). SN 85-945,965. PUB. 11-26-2013. FILED 5-30-2013.
- 4,480,406. **SPOON UNIVERSITY AND DESIGN**. SARAH ADLER, AND MACKENZIE BARTH, (U.S. CLS. 100 AND 101). SN 85-947,079. PUB. 11-26-2013. FILED 5-31-2013.
- 4,480,471. **THE BUCKET TRADE BEER GROWLERS PROVISIONS BY BEER GEEKS FOR BEER GEEKS AND DESIGN**. THE BUCKET TRADE, LLC, (U.S. CLS. 100 AND 101). SN 85-956,510. PUB. 11-26-2013. FILED 6-11-2013.
- 4,480,507. **DIP'S GRILL AND DESIGN**. MANS A CORP., (U.S. CLS. 100 AND 101). SN 85-961,268. PUB. 11-26-2013. FILED 6-17-2013.
- 4,480,543. **BULL CITY TAP HOUSE AND DESIGN**. IMETAL INC, (U.S. CLS. 100 AND 101). SN 85-963,976. PUB. 11-26-2013. FILED 6-19-2013.
- 4,480,592 ( *See Class 30 for this trademark*).
- 4,480,655. **SANDWICH SURPRISE (STANDARD CHARACTER)**. SANDWICH SURPRISE, LLC, (U.S. CLS. 100 AND 101). SN 85-968,715. PUB. 11-26-2013. FILED 6-24-2013.
- 4,480,661. **AMERICAN ROADSIDE AND DESIGN**. AMERICAN ROADSIDE BURGERS, INC., (U.S. CLS. 100 AND 101). SN 85-968,838. PUB. 11-26-2013. FILED 6-25-2013.
- 4,480,725 ( *See Class 30 for this trademark*).
- 4,480,749 ( *See Class 30 for this trademark*).
- 4,480,819. **BIRROTECA (STANDARD CHARACTER)**. BIRROTECA MANAGEMENT, LLC, (U.S. CLS. 100 AND 101). SN 86-000,387. PUB. 11-26-2013. FILED 7-2-2013.
- 4,480,825. **RIGHT PORTION, RIGHT PRICE (STANDARD CHARACTER)**. TGI FRIDAY'S OF MINNESOTA, INC., (U.S. CLS. 100 AND 101). SN 86-000,482. PUB. 11-26-2013. FILED 7-2-2013.
- 4,480,897. **SURFBERRY (STANDARD CHARACTER)**. SURF

CAMP INC., (U.S. CLS. 100 AND 101), SN 86-001,622. PUB. 11-26-2013. FILED 7-3-2013.  
 4,480,979. **TYSONS WOODS (STANDARD CHARACTER)**. TYSONS WOODS LLC, (U.S. CLS. 100 AND 101), SN 86-002,721. PUB. 11-26-2013. FILED 7-4-2013.  
 4,480,986 ( *See Class 21 for this trademark* ).  
 4,481,012. **THE SWANKY SWINE (STANDARD CHARACTER)**. WOODLAWN COMMUNITY ACADEMY, (U.S. CLS. 100 AND 101), SN 86-003,006. PUB. 11-26-2013. FILED 7-5-2013.  
 4,481,062. **MIX & MUNCH (STANDARD CHARACTER)**. JACKSONS FOOD STORES, INC., (U.S. CLS. 100 AND 101), SN 86-003,635. PUB. 11-26-2013. FILED 7-7-2013.  
 4,481,091. **PEARL & ASH (STANDARD CHARACTER)**. PEARL & ASH LLC, (U.S. CLS. 100 AND 101), SN 86-004,123. PUB. 11-26-2013. FILED 7-8-2013.  
 4,481,104. **ROLLINGREENS (STANDARD CHARACTER)**. ROLLINGREENS LLC, (U.S. CLS. 100 AND 101), SN 86-004,489. PUB. 11-26-2013. FILED 7-8-2013.  
 4,481,170 ( *See Class 41 for this trademark* ).  
 4,481,267. **SHOPRITE KITCHEN (STANDARD CHARACTER)**. WAKEFERN FOOD CORP., (U.S. CLS. 100 AND 101), SN 86-048,197. PUB. 11-26-2013. FILED 8-26-2013.

#### CLASS 44—MEDICAL, BEAUTY AND AGRICULTURAL SERVICES

4,479,250. **EMBRACE HEALTH (STANDARD CHARACTER)**. SANTIAM MEMORIAL HOSPITAL, (U.S. CLS. 100 AND 101), SN 76-714,490. PUB. 11-26-2013. FILED 7-3-2013.  
 4,479,276. **HIQCELL (STANDARD CHARACTER)**. REGENEUS LTD, (U.S. CLS. 100 AND 101), SN 79-108,389. PUB. 11-26-2013. FILED 12-13-2011.  
 4,479,292 ( *See Class 10 for this trademark* ).  
 4,479,296 ( *See Class 16 for this trademark* ).  
 4,479,305 ( *See Class 25 for this trademark* ).  
 4,479,320 ( *See Class 9 for this trademark* ).  
 4,479,327 ( *See Class 5 for this trademark* ).  
 4,479,328 ( *See Class 5 for this trademark* ).  
 4,479,331 ( *See Class 9 for this trademark* ).  
 4,479,395 ( *See Class 3 for this trademark* ).  
 4,479,413 ( *See Class 9 for this trademark* ).  
 4,479,491. **YESTAR (STYLIZED)**. YESTAR PLASTIC SURGERY CO.,LTD, (U.S. CLS. 100 AND 101), SN 79-134,194. PUB. 11-26-2013. FILED 7-3-2013.  
 4,479,621. **SOUTHWEST HEALTHCARE SYSTEM INLAND VALLEY MEDICAL CENTER RANCHO SPRINGS MEDICAL CENTER AND DESIGN**. UHS OF DELAWARE, INC., (U.S. CLS. 100 AND 101), SN 85-610,549. PUB. 11-26-2013. FILED 4-27-2012.  
 4,479,630. **WELLNESS WITHIN (STANDARD CHARACTER)**. WELLNESS WITHIN SPA, LLC, (U.S. CLS. 100 AND 101), SN 85-621,144. PUB. 11-26-2013. FILED 5-9-2012.  
 4,479,631. **FAMILY HOSPICE & PALLIATIVE CARE AND DESIGN**. FAMILY HOSPICE AND PALLIATIVE CARE, (U.S. CLS. 100 AND 101), SN 85-621,235. PUB. 11-26-2013. FILED 5-9-2012.  
 4,479,661. **PHYSICIAN PERFORMANCE NETWORK AND DESIGN**. PHYSICIAN PERFORMANCE NETWORK, L.L.C., (U.S. CLS. 100 AND 101), SN 85-635,985. PUB. 6-25-2013. FILED 5-25-2012.  
 4,479,694 ( *See Class 10 for this trademark* ).  
 4,479,700. **ENTHRIVE AND DESIGN**. ENTHRIVE, INC., (U.S. CLS. 100 AND 101), SN 85-675,521. PUB. 11-26-2013. FILED 7-12-2012.  
 4,479,704 ( *See Class 35 for this trademark* ).  
 4,479,714. **SOCIAL COMMUNICATION BRIDGE (STANDARD CHARACTER)**. SHIPON-BLUM, DR. ELISA, AND SELECTIVE MUTISM ANXIETY RESEARCH & TREATMENT CENTER, INC., (U.S. CLS. 100 AND 101), SN 85-697,100. PUB. 11-26-2013. FILED 8-7-2012.  
 4,479,729 ( *See Class 39 for this trademark* ).  
 4,479,733 ( *See Class 3 for this trademark* ).  
 4,479,847. **DRAMA-LOOP (STANDARD CHARACTER)**. G2G HEALTH SYSTEMS INC, (U.S. CLS. 100 AND 101), SN 85-791,114. PUB. 11-26-2013. FILED 11-29-2012.

4,479,865. **TRAUMATIC EMOTIONAL OVERLAY (STANDARD CHARACTER)**. G2G HEALTH SYSTEMS INC, (U.S. CLS. 100 AND 101), SN 85-795,844. PUB. 11-26-2013. FILED 12-6-2012.  
 4,479,873. **PROGRAM FOR OPTIMAL WELLNESS AND DESIGN**. GROSSMAN, TERRY, DBA GROSSMAN WELLNESS CENTER, (U.S. CLS. 100 AND 101), SN 85-799,232. PUB. 11-26-2013. FILED 12-10-2012.  
 4,479,875. **BODY SOLUTION SYSTEMS (STANDARD CHARACTER)**. BODY SOLUTION SYSTEMS LLC, (U.S. CLS. 100 AND 101), SN 85-800,093. PUB. 11-26-2013. FILED 12-11-2012.  
 4,479,889 ( *See Class 41 for this trademark* ).  
 4,479,902. **INDULGE IN HEALTHY (STANDARD CHARACTER)**. CRUM CREEK MILLS, INC., DBA CRUM CREEK MILLS, (U.S. CLS. 100 AND 101), SN 85-805,466. PUB. 11-26-2013. FILED 12-18-2012.  
 4,479,940. **RXRELAX (STANDARD CHARACTER)**. GUPTA, AJAY, (U.S. CLS. 100 AND 101), SN 85-812,482. PUB. 11-26-2013. FILED 12-29-2012.  
 4,480,010. **ABSOLUTE HOME CARE MAKING ABSOLUTE SENSE OF HOME CARE AND DESIGN**. ABSOLUTE HOME CARE, INC., (U.S. CLS. 100 AND 101), SN 85-833,841. PUB. 11-26-2013. FILED 1-28-2013.  
 4,480,017 ( *See Class 43 for this trademark* ).  
 4,480,018 ( *See Class 35 for this trademark* ).  
 4,480,038. **TALLGRASS AND DESIGN**. TALLGRASS SURGICAL CENTER, LLC, (U.S. CLS. 100 AND 101), SN 85-844,853. PUB. 11-26-2013. FILED 2-8-2013.  
 4,480,074 ( *See Class 41 for this trademark* ).  
 4,480,078. **FIX THE CAUSE CHIROPRACTIC (STANDARD CHARACTER)**. FIX THE CAUSE PLLC, (U.S. CLS. 100 AND 101), SN 85-860,249. PUB. 11-26-2013. FILED 2-26-2013.  
 4,480,118. **HEALTHWORKS AND DESIGN**. PACIFIC RISK MANAGEMENT, (U.S. CLS. 100 AND 101), SN 85-877,724. PUB. 11-26-2013. FILED 3-15-2013.  
 4,480,173. **1101 DENTAL (STANDARD CHARACTER)**. 1101 DENTAL, PLLC, (U.S. CLS. 100 AND 101), SN 85-897,442. PUB. 11-26-2013. FILED S.R. 4-8-2013; AM. P.R. 10-4-2013.  
 4,480,243. **MY NURSE ALERT (STANDARD CHARACTER)**. NURSE ALERT, LLC, (U.S. CLS. 100 AND 101), SN 85-921,536. PUB. 11-26-2013. FILED 5-2-2013.  
 4,480,255. **PARIS PARKER (STANDARD CHARACTER)**. NEILL CORPORATION, (U.S. CLS. 100 AND 101), SN 85-924,196. PUB. 11-26-2013. FILED 5-6-2013.  
 4,480,303. **HEARTFELT CARE (STANDARD CHARACTER)**. GLACIAL RIDGE HEALTH SYSTEM, (U.S. CLS. 100 AND 101), SN 85-931,794. PUB. 11-26-2013. FILED S.R. 5-14-2013; AM. P.R. 10-10-2013.  
 4,480,355 ( *See Class 41 for this trademark* ).  
 4,480,362 ( *See Class 43 for this trademark* ).  
 4,480,364. **WFACES (STANDARD CHARACTER)**. EYE PLASTIC SURGERY, P.C., (U.S. CLS. 100 AND 101), SN 85-942,992. PUB. 11-26-2013. FILED 5-27-2013.  
 4,480,384. **CRE8MOVEMENT (STANDARD CHARACTER)**. REINHARDT, IVONNE, DBA CRE8 MOVEMENT, (U.S. CLS. 100 AND 101), SN 85-945,066. PUB. 11-26-2013. FILED 5-29-2013.  
 4,480,386. **PAMPERING WITH A PURPOSE (STANDARD CHARACTER)**. COMPLEXIONS, INC., (U.S. CLS. 100 AND 101), SN 85-945,485. PUB. 11-26-2013. FILED 5-29-2013.  
 4,480,427 ( *See Class 41 for this trademark* ).  
 4,480,449. **THE ALPHA MALE | MEDICAL INSTITUTE AND DESIGN**. ROBERT A. KOMINIAREK DO INC., (U.S. CLS. 100 AND 101), SN 85-953,653. PUB. 11-26-2013. FILED 6-7-2013.  
 4,480,462. **REALLY DOGS ...BECAUSE THEY REALLY, REALLY, REALLY US! AND DESIGN**. REALLY LOVE DOGS INC., (U.S. CLS. 100 AND 101), SN 85-955,247. PUB. 11-26-2013. FILED 6-10-2013.  
 4,480,478. **ESSENCE OF HEALING ART OF LIVING (STANDARD CHARACTER)**. BE HIVE OF HEALING MEDICAL CENTER, (U.S. CLS. 100 AND 101), SN 85-957,381. PUB. 11-26-2013. FILED 6-12-2013.  
 4,480,484. **POSITIVEMED (STANDARD CHARACTER)**. POSITIVEMED, LLC, DBA POSITIVEMED, (U.S. CLS. 100 AND 101), SN 85-957,694. PUB. 11-26-2013. FILED 6-12-2013.  
 4,480,525. **MAJESTIC SPA AND DESIGN**. CHEN, BRUCE,

- (U.S. CLS. 100 AND 101). SN 85-963,209. PUB. 11-26-2013. FILED 6-18-2013.
- 4,480,552 ( *See Class 41 for this trademark*).
- 4,480,563. **BONE AND JOINT HOSPITAL AT ST. ANTHONY AND DESIGN**. SSM HEALTH CARE OF OKLAHOMA, INC., (U.S. CLS. 100 AND 101). SN 85-964,624. PUB. 11-26-2013. FILED 6-19-2013.
- 4,480,564. **COLUMBIA ASIA AND DESIGN**. COLUMBIA PACIFIC HEALTHCARE MANAGEMENT SDN. BHD., (U.S. CLS. 100 AND 101). SN 85-964,767. PUB. 11-26-2013. FILED 6-19-2013.
- 4,480,573. **VIP PLASTIC SURGERY (STANDARD CHARACTER)**. CHRISTOPHER KHORSANDI, MD PLLC, (U.S. CLS. 100 AND 101). SN 85-965,105. PUB. 11-26-2013. FILED 6-20-2013.
- 4,480,662. **IRON MATTERS FE AND DESIGN**. AMAG PHARMACEUTICALS, INC., (U.S. CLS. 100 AND 101). SN 85-968,865. PUB. 11-26-2013. FILED 6-25-2013.
- 4,480,703. **LYLE M. BACK, M.D. (STANDARD CHARACTER)**. BACK, LYLE, (U.S. CLS. 100 AND 101). SN 85-971,033. PUB. 11-26-2013. FILED 6-26-2013.
- 4,480,755. **KOS AND DESIGN**. MCDONALD, GARY W., D.D.S., DBA KINGWOOD ORAL SURGERY, (U.S. CLS. 100 AND 101). SN 85-973,841. PUB. 11-26-2013. FILED 6-30-2013.
- 4,480,761. **ADDING MORE LIFE TO YOUR YEARS (STANDARD CHARACTER)**. RIGHT AT HOME, INC., MULTIPLE CLASS, (INT. CLS. 44 AND 45), (U.S. CLS. 100 AND 101). SN 85-974,041. PUB. 11-26-2013. FILED 7-1-2013.
- 4,480,762. **DANCESPOTTING (STANDARD CHARACTER)**. JULISA ADAMS, MA, (U.S. CLS. 100 AND 101). SN 85-974,042. PUB. 11-26-2013. FILED 7-1-2013.
- 4,480,816 ( *See Class 3 for this trademark*).
- 4,480,830. **THE GLAM ROOM SALON (STANDARD CHARACTER)**. THE GLAM ROOM SALON, (U.S. CLS. 100 AND 101). SN 86-000,529. PUB. 11-26-2013. FILED 7-2-2013.
- 4,480,858. **PELI (STANDARD CHARACTER)**. POLISHER RESEARCH INSTITUTE, (U.S. CLS. 100 AND 101). SN 86-000,875. PUB. 11-26-2013. FILED 7-2-2013.
- 4,480,941. **DETECTION TO DIAGNOSIS IN 48 HOURS. (STANDARD CHARACTER)**. THE NORWALK HOSPITAL ASSOCIATION, (U.S. CLS. 100 AND 101). SN 86-002,255. PUB. 11-26-2013. FILED 7-3-2013.
- 4,481,057. **SELF SYNTHESIZE! (STANDARD CHARACTER)**. EVOLVING INTEGRAL DEVELOPMENT, LLC, DBA SELF SYNTHESIZE!, (U.S. CLS. 100 AND 101). SN 86-003,606. PUB. 11-26-2013. FILED 7-7-2013.
- 4,481,155. **WE'RE THERE (STANDARD CHARACTER)**. SPECTRUM HEALTH, INC., MULTIPLE CLASS, (INT. CLS. 44 AND 45), (U.S. CLS. 100 AND 101). SN 86-005,328. PUB. 11-26-2013. FILED 7-9-2013.
- 4,481,197. **AFC DOCTORS EXPRESS AND URGENT CARE AND DESIGN**. IRWIN HOLDINGS, LLC, (U.S. CLS. 100 AND 101). SN 86-006,310. PUB. 11-26-2013. FILED 7-10-2013.
- 4,481,214. **MISCELLANEOUS DESIGN**. SONOLOGY HEARING AID CLINIC LLC, (U.S. CLS. 100 AND 101). SN 86-013,002. PUB. 11-26-2013. FILED 7-17-2013.
- 4,481,215. **TO IMPROVE THE QUALITY OF LIFE FOR THOSE WE SERVE (STANDARD CHARACTER)**. RIGHT AT HOME, INC., MULTIPLE CLASS, (INT. CLS. 44 AND 45), (U.S. CLS. 100 AND 101). SN 86-013,100. PUB. 11-26-2013. FILED 7-17-2013.
- 26-2013. FILED 5-24-2012.
- 4,479,691 ( *See Class 35 for this trademark*).
- 4,479,711. **IP COUNSEL AS INNOVATIVE AS YOU ARE (STANDARD CHARACTER)**. PERRY + CURRIER INC., (U.S. CLS. 100 AND 101). SN 85-691,386. PUB. 11-26-2013. FILED 7-31-2012.
- 4,479,731 ( *See Class 37 for this trademark*).
- 4,479,748 ( *See Class 25 for this trademark*).
- 4,479,832 ( *See Class 41 for this trademark*).
- 4,479,852 ( *See Class 9 for this trademark*).
- 4,479,854. **FOR THE INSURED (STANDARD CHARACTER)**. ESPINOSA JOMARRON PL, DBA ESPINOSA | JOMARRON, (U.S. CLS. 100 AND 101). SN 85-793,089. PUB. 11-26-2013. FILED 12-3-2012.
- 4,479,895 ( *See Class 41 for this trademark*).
- 4,479,896 ( *See Class 41 for this trademark*).
- 4,479,898 ( *See Class 35 for this trademark*).
- 4,479,932 ( *See Class 36 for this trademark*).
- 4,479,936 ( *See Class 35 for this trademark*).
- 4,480,031 ( *See Class 35 for this trademark*).
- 4,480,045 ( *See Class 35 for this trademark*).
- 4,480,070. **UPFORIT (STANDARD CHARACTER)**. BULOVA INVEST LTD, (U.S. CLS. 100 AND 101). SN 85-859,219. PUB. 8-13-2013. FILED 2-26-2013.
- 4,480,074 ( *See Class 41 for this trademark*).
- 4,480,086. **TOTAL ESCHEAT MANAGEMENT (STANDARD CHARACTER)**. JMS ADVISORY GROUP, LLC, (U.S. CLS. 100 AND 101). SN 85-863,839. PUB. 11-26-2013. FILED 3-1-2013.
- 4,480,101. **UNCLESAMVISA (STANDARD CHARACTER)**. HERMAN DHADE, (U.S. CLS. 100 AND 101). SN 85-869,582. PUB. 7-23-2013. FILED 3-7-2013.
- 4,480,159 ( *See Class 35 for this trademark*).
- 4,480,207. **HASSLE FREE HIPAA (STANDARD CHARACTER)**. SMB NETWORKS LLC, (U.S. CLS. 100 AND 101). SN 85-908,769. PUB. 11-26-2013. FILED 4-18-2013.
- 4,480,230. **START YOUR TRADEMARK NOW (STANDARD CHARACTER)**. TRADEMARKS INFORMATION INTERNATIONAL LLC, (U.S. CLS. 100 AND 101). SN 85-913,917. PUB. 11-26-2013. FILED 4-24-2013.
- 4,480,288 ( *See Class 35 for this trademark*).
- 4,480,289 ( *See Class 35 for this trademark*).
- 4,480,291 ( *See Class 35 for this trademark*).
- 4,480,327. **NEW ORLEANS PRIVATE PATROL (STANDARD CHARACTER)**. NEW ORLEANS PRIVATE PATROL SERVICE, INC., (U.S. CLS. 100 AND 101). SN 85-938,693. PUB. 11-26-2013. FILED 5-21-2013.
- 4,480,328. **LOUISIANA PRIVATE PATROL (STANDARD CHARACTER)**. NEW ORLEANS PRIVATE PATROL SERVICE, INC., (U.S. CLS. 100 AND 101). SN 85-938,750. PUB. 11-26-2013. FILED 5-21-2013.
- 4,480,330. **GURVICH SYSTEM (STANDARD CHARACTER)**. NEW ORLEANS PRIVATE PATROL SERVICE, INC., (U.S. CLS. 100 AND 101). SN 85-938,826. PUB. 11-26-2013. FILED 5-21-2013.
- 4,480,345 ( *See Class 35 for this trademark*).
- 4,480,347 ( *See Class 35 for this trademark*).
- 4,480,367 ( *See Class 37 for this trademark*).
- 4,480,390 ( *See Class 42 for this trademark*).
- 4,480,436 ( *See Class 35 for this trademark*).
- 4,480,468. **GARBC (STANDARD CHARACTER)**. GENERAL ASSOCIATION OF REGULAR BAPTIST CHURCHES, (U.S. CLS. 100 AND 101). SN 85-956,052. PUB. 11-26-2013. FILED 6-11-2013.
- 4,480,480. **EPN ESTATE PRESERVATION NETWORK PROTECTING TOMORROW'S LEGACY. TODAY. AND DESIGN**. PENDER, ROBERT, (U.S. CLS. 100 AND 101). SN 85-957,433. PUB. 11-26-2013. FILED 6-12-2013.
- 4,480,487. **H&R HERZFELD & RUBIN, P.C. ATTORNEYS AT LAW AND DESIGN**. HERZFELD & RUBIN, P.C., (U.S. CLS. 100 AND 101). SN 85-957,863. PUB. 11-26-2013. FILED 6-12-2013.
- 4,480,527. **KING MOTORCYCLE LAWYERS (STANDARD CHARACTER)**. AMINPOUR AND ASSOCIATES, A PROFESSIONAL CORPORATION, (U.S. CLS. 100 AND 101). SN 85-963,238. PUB. 11-26-2013. FILED 6-18-2013.
- 4,480,529. **FISHER LAW GROUP (STANDARD CHARACTER)**. JASON H. FISHER, DBA FISHER LAW GROUP, (U.S. CLS.

#### CLASS 45—PERSONAL AND LEGAL SERVICES

- 4,479,280 ( *See Class 9 for this trademark*).
- 4,479,352 ( *See Class 41 for this trademark*).
- 4,479,495 ( *See Class 42 for this trademark*).
- 4,479,543 ( *See Class 16 for this trademark*).
- 4,479,550 ( *See Class 35 for this trademark*).
- 4,479,657. **GULLAH GEECHEE CULTURAL HERITAGE CORRIDOR COMMISSION NORTH CAROLINA SOUTH CAROLINA GEORGIA FLORIDA AND DESIGN**. GULLAH GEECHEE CULTURAL HERITAGE CORRIDOR COMMISSION, (U.S. CLS. 100 AND 101). SN 85-635,012. PUB. 11-

100 AND 101). SN 85-963,475. PUB. 11-26-2013. FILED 6-18-2013.

4,480,580. **MCCLANAHAN POWERS, PLLC ATTORNEYS AT LAW AND DESIGN**. MCCLANAHAN POWERS, PLLC, (U.S. CLS. 100 AND 101). SN 85-965,364. PUB. 11-26-2013. FILED 6-20-2013.

4,480,610 ( *See Class 35 for this trademark*).

4,480,656. **DIVINE PET CARE (STANDARD CHARACTER)**. LOPEZ, KAREN L., DBA DIVINE PET CARE, (U.S. CLS. 100 AND 101). SN 85-968,760. PUB. 11-26-2013. FILED 6-25-2013.

4,480,658 ( *See Class 39 for this trademark*).

4,480,663. **DON'T WAIT, TEXT 8! (STANDARD CHARACTER)**. CELLINO & BARNES, P.C., (U.S. CLS. 100 AND 101). SN 85-969,085. PUB. 11-26-2013. FILED 6-25-2013.

4,480,669. **CATCH MATCHMAKING (STANDARD CHARACTER)**. CATCH MATCHMAKING, (U.S. CLS. 100 AND 101). SN 85-969,357. PUB. 11-26-2013. FILED 6-25-2013.

4,480,678. **LONGEVITY GUIDE (STANDARD CHARACTER)**. LONGEVITY GUIDE, LLC, (U.S. CLS. 100 AND 101). SN 85-970,063. PUB. 11-26-2013. FILED 6-26-2013.

4,480,681 ( *See Class 35 for this trademark*).

4,480,696 ( *See Class 41 for this trademark*).

4,480,745. **HEALCLICK (STANDARD CHARACTER)**. HEALCLICK LLC, (U.S. CLS. 100 AND 101). SN 85-973,424. PUB. 11-26-2013. FILED 6-28-2013.

4,480,761 ( *See Class 44 for this trademark*).

4,480,791. **INTEGRACARE (STANDARD CHARACTER)**. INTEGRACARE HOLDINGS, INC., (U.S. CLS. 100 AND 101). SN 85-979,006. PUB. 11-26-2013. FILED 11-11-2011.

4,480,834. **GOOD COUNSEL IS NO ACCIDENT (STANDARD CHARACTER)**. LIEBLING MALAMUT, LLC, (U.S. CLS. 100 AND 101). SN 86-000,570. PUB. 11-26-2013. FILED 7-2-2013.

4,480,883. **WORKING HARD FOR WORKING PEOPLE (STANDARD CHARACTER)**. ROSE, JOSEPH W., (U.S. CLS. 100 AND 101). SN 86-001,404. PUB. 11-26-2013. FILED 7-3-2013.

4,480,896. **WE GO TO WORK WHEN YOU CAN'T (STANDARD CHARACTER)**. GOLITKO & DALY PC, (U.S. CLS. 100 AND 101). SN 86-001,606. PUB. 11-26-2013. FILED 7-3-2013.

4,480,973. **POWER PLUS (STANDARD CHARACTER)**. RELIGIOUS TECHNOLOGY CENTER, (U.S. CLS. 100 AND 101). SN 86-002,675. PUB. 11-26-2013. FILED 7-4-2013.

4,481,014. **TIME FOR HOPE (STANDARD CHARACTER)**. BIBLE STUDY TIME, INC., (U.S. CLS. 100 AND 101). SN 86-003,041. PUB. 11-26-2013. FILED 7-5-2013.

4,481,016. **THE AWAKENING HOUR (STANDARD CHARACTER)**. BIBLE STUDY TIME, INC., (U.S. CLS. 100 AND 101). SN 86-003,052. PUB. 11-26-2013. FILED 7-5-2013.

4,481,071 ( *See Class 35 for this trademark*).

4,481,078. **ANNEX LAW (STANDARD CHARACTER)**. ANNEX LAW, P.A., (U.S. CLS. 100 AND 101). SN 86-003,925. PUB. 11-26-2013. FILED 7-8-2013.

4,481,155 ( *See Class 44 for this trademark*).

4,481,187. **MISCELLANEOUS DESIGN**. BARRY E. HAIMO, P.A., DBA HAIMO LAW, (U.S. CLS. 100 AND 101). SN 86-005,753. PUB. 11-26-2013. FILED 7-9-2013.

4,481,203. **TRIANGLE TRADEMARKS (STANDARD CHARACTER)**. NAGAE, SARAH ELIZABETH, (U.S. CLS. 100 AND 101). SN 86-008,339. PUB. 11-26-2013. FILED 7-11-2013.

4,481,215 ( *See Class 44 for this trademark*).

4,481,227 ( *See Class 38 for this trademark*).

4,481,245. **L 10 (STANDARD CHARACTER)**. RELIGIOUS TECHNOLOGY CENTER, (U.S. CLS. 100 AND 101). SN 86-030,749. PUB. 11-26-2013. FILED 8-7-2013.

4,481,246. **L 11 (STANDARD CHARACTER)**. RELIGIOUS TECHNOLOGY CENTER, (U.S. CLS. 100 AND 101). SN 86-030,754. PUB. 11-26-2013. FILED 8-7-2013.

4,481,247. **L 12 (STANDARD CHARACTER)**. RELIGIOUS TECHNOLOGY CENTER, (U.S. CLS. 100 AND 101). SN 86-030,759. PUB. 11-26-2013. FILED 8-7-2013.

4,481,277 ( *See Class 35 for this trademark*).

SECTION 2.—PRIOR UNITED STATES CLASSIFICATION

COLLECTIVE MEMBERSHIP MARKS

**CLASS 200—COLLECTIVE MEMBERSHIP**

4,480,949. **RUSSELL BEDFORD AND DESIGN**. RUSSELL BEDFORD INTERNATIONAL, SN 86-002,309. PUB. 11-26-2013. FILED 7-3-2013.

4,480,022. **CPEP (STANDARD CHARACTER)**. BODYZONE LLC, SN 85-837,929. PUB. 11-26-2013. FILED 1-31-2013.

4,480,217. **CRX (STANDARD CHARACTER)**. INTERNATIONAL COUNCIL OF SHOPPING CENTERS, INC., SN 85-911,117. PUB. 11-26-2013. FILED 4-22-2013.

4,480,692. **CERTIFIED CONTRACTORS AND DESIGN**. ONE-SOURCE THE BACKGROUND CHECK COMPANY, SN 85-970,690. PUB. 11-26-2013. FILED 6-26-2013.

---

CERTIFICATION MARKS

CLASS B—SERVICES

\* \* \* \* \*

# TRADEMARK REGISTRATIONS ISSUED UNDER SECTION 1(d)

The following marks have registered on the Principal Register pursuant to the intent-to-use provisions of Section 1(d) of the Trademark Act of 1946, as amended.

## SECTION 1.— INTERNATIONAL CLASSIFICATION

The short titles associated below with the international class numbers are terms designed merely for quick identification and are not an official part of the international classification. The full names of international classes are given in section 6.1 of the trademark rules of practice.

The designation "U.S. Cl." appearing in this section refers to the U.S. class in effect prior to Sep. 1, 1973 rather than the international class which applies to applications filed on or after that date. For adoption of international classification see notice in the OFFICIAL GAZETTE of Jun. 26, 1973 (911 O.G. TM 210).

### Application in more than one class

4,481,308. STAR SPEED SCAFFOLD, LLC, GLENDALE, AZ.  
SN 76-711,236. PUB. 3-5-2013, FILED 4-17-2012.

4,481,311. PHITEK SYSTEMS LIMITED, NEWMARKET,  
NEW ZEALAND. SN 77-092,471. PUB. 5-1-2012, FILED  
1-26-2007.

# STAR SPEED

THE MARK CONSISTS OF STANDARD CHARACTERS  
WITHOUT CLAIM TO ANY PARTICULAR FONT, STYLE,  
SIZE, OR COLOR.

#### CLASS 6—METAL GOODS

FOR METAL SCAFFOLDING; PORTABLE STRUCTURES USED IN CONSTRUCTING SCAFFOLDING, NAMELY, PORTABLE BUILDINGS OF METAL; SCAFFOLDING PLATFORMS, NAMELY, METAL SCAFFOLDING; SCAFFOLDING RAILINGS OF METAL; METAL CONNECTORS DECKING AND DECKING JOISTS; METAL PIPE CONNECTORS (U.S. CLS. 2, 12, 13, 14, 23, AND 50).

FIRST USE 7-0-2012; IN COMMERCE 7-0-2012.

#### CLASS 9—ELECTRICAL AND SCIENTIFIC APPARATUS

FOR SAFETY EQUIPMENT FOR USE DURING BUILDING CONSTRUCTION AND MAINTENANCE OPERATION, NAMELY, A LIFELINE SYSTEM FOR HORIZONTAL OR VERTICAL MOVEMENT TO WHICH A WORKER IS ATTACHED FOR PROTECTION AGAINST FALL HAZARDS, COMPOSED OF LINE TENSION INDICATOR, TURNBUCKLE, BARS, ANCHORS, HARNESSES, LANYARDS, CABLES, ANCHORAGE CONNECTORS, CARABINEER, LIFELINES, STANCHIONS, SHOCK ABSORBERS (U.S. CLS. 21, 23, 26, 36 AND 38).

FIRST USE 7-0-2012; IN COMMERCE 7-0-2012.

# PHITEK

THE MARK CONSISTS OF STANDARD CHARACTERS  
WITHOUT CLAIM TO ANY PARTICULAR FONT, STYLE,  
SIZE, OR COLOR.

PRIORITY CLAIMED UNDER SEC. 44(D) ON NEW ZEALAND APPLICATION NO. 752168, FILED 7-26-2006, REG. NO. 752168, DATED 5-14-2009, EXPIRES 7-26-2016.

**CLASS 9—ELECTRICAL AND SCIENTIFIC APPARATUS**

FOR APPARATUS AND INSTRUMENTS FOR MEASURING AND CHECKING SOUND WAVES, SOUND AND AUDIO SIGNALS, NAMELY, DIGITAL SIGNAL PROCESSORS, SOUND AND/OR AUDIO EQUALIZERS, ANALYZERS AND PROCESSORS, SURROUND SOUND SYSTEMS, SOUND LEVEL METERS, SOUND MIXERS, ELECTRONIC FREQUENCY CONVERTERS FOR SOUND VELOCITY, SOUND AND/OR AUDIO AMPLIFIERS, CABLES AND FIBERS TO CHECK SOUND AND/OR AUDIO; APPARATUS AND INSTRUMENTS FOR CONDUCTING, SWITCHING, TRANSFORMING, ACCUMULATING, REGULATING OR CONTROLLING ELECTRICITY, NAMELY, JACKS, PLUGS, CONNECTORS AND ELECTRICAL CONDUITS; APPARATUS FOR RECORDING, TRANSMISSION AND REPRODUCTION OF SOUND AND/OR IMAGES, NAMELY, HEADPHONES, HEADSETS, MICROPHONES, LOUDSPEAKERS, AUDIO EARPIECES, STEREO SOUND REPRODUCERS, MULTIMEDIA EQUIPMENT, NAMELY, IN-FLIGHT ENTERTAINMENT SYSTEMS COMPRISING MEDIA SERVERS, AM/FM RADIO, SATELLITE RADIO, CD, MP3 AND DVD PLAYERS, INTERCOMS, LCD DISPLAYS, SEAT DISTRIBUTION UNITS, AUDIO AND VIDEO TRANSMITTERS, RECEIVERS AND CONNECTORS, AND PERIPHERALS, AUDIO SPACIALISATION, AND SIGNAL PROCESSING EQUIPMENT, PORTABLE MUSIC PLAYERS AND TELEPHONES AND MOBILE TELEPHONES; SOFTWARE USED FOR THE INSTRUMENTATION OF SIGNALING, CHECKING, AND MANIPULATIONS OF SOUND WAVES, SOUND, IMAGE AND AUDIO SIGNALS; DATA PROCESSORS; COMPUTERS; SOUND EQUIPMENT, NAMELY, AMPLIFIERS, GRAPHIC EQUALIZERS AND SOUND CARDS FOR COMPUTERS; SOFTWARE FOR SIGNAL PROCESSING EQUIPMENT; SOFTWARE FOR RECORDING, TRANSMISSION AND REPRODUCTION OF SOUND AND/OR IMAGES INCLUDING SOFTWARE FOR ACTIVE NOISE CANCELLATION, ACTIVE NOISE REDUCTION AND SOUND MASKING FOR USE IN THE PRODUCTION AND REPRODUCTION OF MUSIC, HOME AND PORTABLE AUDIO REPRODUCTION AND SCIENTIFIC AND INDUSTRIAL AUDIO PRODUCTION AND REPRODUCTION (U.S. CLS. 21, 23, 26, 36 AND 38).

FIRST USE 5-14-2009; IN COMMERCE 11-21-2012.

**CLASS 35—ADVERTISING AND BUSINESS**

FOR WHOLESALE DISTRIBUTORSHIP SERVICES, RETAIL STORE SERVICES AND ONLINE RETAIL STORE SERVICES FEATURING APPARATUS FOR RECORDING, TRANSMISSION AND REPRODUCTION OF SOUND AND/OR IMAGES, HEADPHONES, SOUND EQUIPMENT, SOFTWARE RELATING TO RECORDING, TRANSMISSION AND REPRODUCTION OF SOUND AND/OR IMAGES, AND NOISE CANCELLATION TECHNOLOGY PRODUCTS INCLUDING PARTS, FITTINGS AND ACCESSORIES; BUSINESS ADVISORY, CONSULTANCY AND MANAGEMENT SERVICES RELATING TO THE FOREGOING; PRODUCT DEMONSTRATION SERVICES; BUSINESS MERCHANDISING DISPLAY SERVICES; ALL OF THE FOREGOING ALSO AVAILABLE ONLINE AND VIA THE INTERNET (U.S. CLS. 100, 101 AND 102).

FIRST USE 5-14-2009; IN COMMERCE 11-21-2012.

**CLASS 42—SCIENTIFIC AND COMPUTER SERVICES**

FOR PRODUCT DEVELOPMENT, DESIGN, RESEARCH, ANALYSIS, AND TESTING SERVICES RELATING TO APPARATUS FOR RECORDING, TRANSMISSION AND REPRODUCTION OF SOUND AND/OR IMAGES, HEADPHONES, SOUND EQUIPMENT, SOFTWARE RELATING TO RECORDING, TRANSMISSION AND REPRODUCTION OF SOUND AND/OR IMAGES, AND NOISE CANCELLATION TECHNOLOGY PRODUCTS INCLUDING PARTS, FITTINGS AND ACCESSORIES; ADVISORY, CONSULTANCY SERVICES RELATING TO THE FOREGOING; ALL OF THE FOREGOING ALSO AVAILABLE ONLINE AND VIA THE INTERNET (U.S. CLS. 100 AND 101).

FIRST USE 5-14-2009; IN COMMERCE 11-21-2012.

4,481,312. EDGAR RICE BURROUGHS, INC., TARZANA, CA. SN 77-263,965. PUB. 12-23-2008, FILED 8-24-2007.

**JOHN CARTER OF MARS**

THE MARK CONSISTS OF STANDARD CHARACTERS WITHOUT CLAIM TO ANY PARTICULAR FONT, STYLE, SIZE, OR COLOR.

OWNER OF U.S. REG. NO. 2,049,063.

THE NAME(S), PORTRAIT(S), AND/OR SIGNATURE(S) SHOWN IN THE MARK DOES NOT IDENTIFY A PARTICULAR LIVING INDIVIDUAL.

**CLASS 16—PAPER GOODS AND PRINTED MATTER**

FOR SERIES OF FICTION BOOKS; DESK PADS (U.S. CLS. 2, 5, 22, 23, 29, 37, 38 AND 50).

FIRST USE 1-0-2012; IN COMMERCE 2-0-2012.

**CLASS 25—CLOTHING**

FOR CLOTHING, NAMELY, SHIRTS (U.S. CLS. 22 AND 39).

FIRST USE 1-0-2012; IN COMMERCE 6-0-2012.

4,481,316. TRAVELWAY GROUP INTERNATIONAL INC., MONTREAL, QUEBEC, CANADA. SN 77-348,924. PUB. 1-24-2012, FILED 12-11-2007.

**PLANET E**

THE MARK CONSISTS OF STANDARD CHARACTERS WITHOUT CLAIM TO ANY PARTICULAR FONT, STYLE, SIZE, OR COLOR.

PRIORITY CLAIMED UNDER SEC. 44(D) ON CANADA APPLICATION NO. 1351397, FILED 6-13-2007, REG. NO. TMA812330, DATED 11-21-2011, EXPIRES 11-21-2026.

**CLASS 16—PAPER GOODS AND PRINTED MATTER**

FOR LUNCH BAGS, PENCIL CASES, BINDERS (U.S. CLS. 2, 5, 22, 23, 29, 37, 38 AND 50).

FIRST USE 2-0-2012; IN COMMERCE 2-0-2012.

**CLASS 18—LEATHER GOODS**

FOR BACKPACKS, LUGGAGE, BRIEFCASE-TYPE PORTFOLIOS (U.S. CLS. 1, 2, 3, 22 AND 41).

FIRST USE 2-0-2012; IN COMMERCE 2-0-2012.



4,481,318. GABI CONCEPTS LTD., TORONTO, ONTARIO, CANADA. SN 77-390,303. PUB. 9-20-2011, FILED 2-6-2008.

4,481,328. D2T (SOCIÉTÉ ANONYME), 78190 TRAPPES, FRANCE. SN 77-762,226. PUB. 9-11-2012, FILED 6-17-2009.

# KOKO

THE MARK CONSISTS OF STANDARD CHARACTERS WITHOUT CLAIM TO ANY PARTICULAR FONT, STYLE, SIZE, OR COLOR.

## CLASS 9—ELECTRICAL AND SCIENTIFIC APPARATUS

FOR SUNGLASSES (U.S. CLS. 21, 23, 26, 36 AND 38). FIRST USE 12-2-2013; IN COMMERCE 12-2-2013.

## CLASS 14—JEWELRY

FOR WATCHES (U.S. CLS. 2, 27, 28 AND 50). FIRST USE 12-2-2013; IN COMMERCE 12-2-2013.

4,481,322. WEBID CONSULTING LTD, LONDON, ENGLAND. SN 77-581,695. PUB. 10-19-2010, FILED 9-29-2008.

# GAYVOYAGE

THE MARK CONSISTS OF STANDARD CHARACTERS WITHOUT CLAIM TO ANY PARTICULAR FONT, STYLE, SIZE, OR COLOR.

OWNER OF CANADA REG. NO. 007349392, DATED 5-27-2009, EXPIRES 5-27-2019.

## CLASS 35—ADVERTISING AND BUSINESS

FOR ADVERTISING SERVICES, NAMELY, ONLINE ADVERTISING AND PROMOTION OF THE GOODS AND SERVICES OF OTHERS IN THE TRAVEL INDUSTRY (U.S. CLS. 100, 101 AND 102).

FIRST USE 12-10-2013; IN COMMERCE 12-10-2013.

## CLASS 39—TRANSPORTATION AND STORAGE

FOR ONLINE TRAVEL INFORMATION SERVICES, NAMELY, PROVIDING A WEBSITE FEATURING INFORMATION ON TRAVEL; ONLINE RETAIL TRAVEL AGENCY SERVICES, NAMELY, MAKING RESERVATIONS AND BOOKINGS FOR AIRLINE TICKETS AND AIRLINE TRANSPORTATION FOR OTHERS VIA THE INTERNET (U.S. CLS. 100 AND 105).

FIRST USE 12-10-2013; IN COMMERCE 12-10-2013.

## CLASS 43—HOTEL AND RESTAURANT SERVICES

FOR ONLINE RETAIL TRAVEL AGENCY SERVICES, NAMELY, MAKING HOTEL BOOKINGS AND HOTEL RESERVATIONS FOR OTHERS VIA THE INTERNET (U.S. CLS. 100 AND 101).

FIRST USE 12-10-2013; IN COMMERCE 12-10-2013.

# TEOS

THE MARK CONSISTS OF STANDARD CHARACTERS WITHOUT CLAIM TO ANY PARTICULAR FONT, STYLE, SIZE, OR COLOR.

PRIORITY CLAIMED UNDER SEC. 44(D) ON ERP CMNTY TM OFC APPLICATION NO. 3620039, FILED 12-24-2008, REG. NO. 008410706, DATED 6-9-2010, EXPIRES 6-17-2019.

THE WORDING "TEOS" HAS NO MEANING IN A FOREIGN LANGUAGE.

## CLASS 7—MACHINERY

FOR (BASED ON 44(E)) ENGINES OTHER THAN FOR LAND VEHICLES AND ENGINE COMPONENTS, NAMELY, INJECTORS, VALVE GEAR CONTROLS, BEARINGS, CATALYTIC CONVERTERS, PARTICLE FILTERS, GEAR BOXES, POWERTRAIN TRANSMISSIONS; ALL THESE PRODUCTS ARE EXCLUSIVELY INTENDED FOR RESEARCH AND DEVELOPMENT FOR A CLIENTELE OF EQUIPMENT MANUFACTURERS, VEHICLES MANUFACTURERS AND RESEARCH CENTRES (U.S. CLS. 13, 19, 21, 23, 31, 34 AND 35).

## CLASS 9—ELECTRICAL AND SCIENTIFIC APPARATUS

FOR (BASED ON 44(E)) APPLIANCES, INSTALLATIONS AND EQUIPMENT FOR MEASURING, TESTING, SIMULATING, MODELING TESTS, ANALYSIS, ACQUIRING DATA FOR TEST RIGS AND MONITORING ENGINES, POWER TRAIN UNITS AND LAND, SEA AND AIRBORNE VEHICLES, ENGINES TEST RIGS, POWER TRAIN UNITS AND, SEA AND AIRBORNE VEHICLES, ENGINES TUNING INSTALLATIONS, NAMELY, DYNAMOMETERS, ELECTRIC THROTTLE ACTUATORS, EQUIPMENT USED TO CHARGE THERMAL ENGINES AND POWERTRAINS ALL SUCH AFOREMENTIONED APPLIANCES, INSTALLATIONS AND EQUIPMENT NOT FOR USE IN SERIES VEHICLES OR SERIES ENGINES; BEING INTENDED EXCLUSIVELY FOR RESEARCH AND DEVELOPMENT FOR A CLIENTELE OF EQUIPMENT MANUFACTURERS, VEHICLES MANUFACTURERS AND RESEARCH CENTRES (U.S. CLS. 21, 23, 26, 36 AND 38).

## CLASS 12—VEHICLES

FOR (BASED ON 44(E)) INTERNAL COMBUSTION ENGINES FOR LAND VEHICLES, AND POWERTRAINS COMPRISED OF A TRANSMISSION, DRIVE SHAFTS AND DIFFERENTIALS, ALL THESE PRODUCTS ARE BEING EXCLUSIVELY INTENDED FOR RESEARCH AND DEVELOPMENT FOR A CLIENTELE OF EQUIPMENT MANUFACTURERS, VEHICLES MANUFACTURERS AND RESEARCH CENTRES (U.S. CLS. 19, 21, 23, 31, 35 AND 44).

## CLASS 37—CONSTRUCTION AND REPAIR

FOR (BASED ON 44(E)) MAINTENANCE OF VEHICLE ENGINES AND POWERTRAINS AND ENGINES, ALL THESE PRODUCTS AND SERVICES ARE EXCLUSIVELY INTENDED FOR RESEARCH AND DEVELOPMENT FOR A CLIENTELE OF EQUIPMENT MANUFACTURERS, VEHICLES MANUFACTURERS AND RESEARCH CENTRES (U.S. CLS. 100, 103 AND 106).

**CLASS 42—SCIENTIFIC AND COMPUTER SERVICES**

FOR (BASED ON USE IN COMMERCE) (BASED ON 44(E)) RESEARCH AND DEVELOPMENT AND CONSULTATION RELATED THERETO IN THE FIELD OF VEHICLE ENGINES AND POWERTRAINS THROUGH THE USE OF COMPUTING SYSTEMS, FINE TUNING, ANALYSES, TESTS, TECHNICAL PROJECT STUDY, SIMULATIONS, TECHNICAL ENGINEERING CONSULTATION, PROGRAMMING FOR COMPUTERS, EVALUATIONS, TECHNICAL ASSISTANCE, ESTIMATES, DEVELOPMENT OF REPORTS IN THE FIELD OF DESIGNING VEHICLE ENGINES AND POWERTRAINS, OF THE CHARACTERIZATION OF ARCHITECTURE OF AN ENGINE AND POWERTRAINS, OF THE CHARACTERIZATION OF PERFORMANCE OF COMPONENTS OF DRIVING AND DRIVING COMPONENTS, CALIBRATION OF AN ENGINE AND POWERTRAINS, ENGINE CONTROL AND POWERTRAINS, TEST BENCHES, POWER UNITS AND LAND VEHICLES, MARITIME AND AERONAUTICAL, REPROCESSING OF EMISSIONS, PILOTING OF BENCHES TEST; ALL THESE SERVICES ARE EXCLUSIVELY INTENDED FOR RESEARCH AND DEVELOPMENT FOR A CLIENTELE OF EQUIPMENT MANUFACTURERS, VEHICLES MANUFACTURERS AND RESEARCH CENTRES (U.S. CLS. 100 AND 101).

FIRST USE 1-10-2010; IN COMMERCE 1-10-2010.

4,481,332. AJINOMOTO CO., INC., CHUO-KU, TOKYO, JAPAN. SN 77-772,180. PUB. 12-21-2010, FILED 7-1-2009.



OWNER OF U.S. REG. NOS. 2,767,078 AND 3,015,142. THE COLOR(S) RED, YELLOW AND GREEN IS/ARE CLAIMED AS A FEATURE OF THE MARK.

THE MARK CONSISTS OF THE WORD "AJINOMOTO" WRITTEN IN STYLIZED RED LETTERS INSIDE A RIBBON WHICH IS IN THE COLORS RED, YELLOW AND GREEN. BELOW THIS DESIGN IS THE WORDING "EAT WELL, LIVE WELL." IN PLAIN BLOCK RED LETTERS OF SMALLER SIZE.

THE ENGLISH TRANSLATION OF "AJINOMOTO" IN THE MARK IS "THE ESSENCE OF TASTE".

**CLASS 29—MEATS AND PROCESSED FOODS**

FOR SOUP STOCKS; BROTH; CONCENTRATED BROTH; FISH STOCK (U.S. CL. 46).

FIRST USE 12-31-2010; IN COMMERCE 12-31-2011.

**CLASS 30—STAPLE FOODS**

FOR SAUCES; SEASONINGS (U.S. CL. 46).

FIRST USE 12-31-2010; IN COMMERCE 12-31-2011.

4,481,335. GEORGE NOROIAN, PALO ALTO, CA. SN 77-789,819. PUB. 10-5-2010, FILED 7-27-2009.

**GIANT LEAP MANAGEMENT SOLUTIONS**

THE MARK CONSISTS OF STANDARD CHARACTERS WITHOUT CLAIM TO ANY PARTICULAR FONT, STYLE, SIZE, OR COLOR.

NO CLAIM IS MADE TO THE EXCLUSIVE RIGHT TO USE "MANAGEMENT SOLUTIONS", APART FROM THE MARK AS SHOWN.

**CLASS 9—ELECTRICAL AND SCIENTIFIC APPARATUS**

FOR DOWNLOADABLE ELECTRONIC PUBLICATIONS IN THE NATURE OF LESSONS, NEWSLETTERS, SKILLS ASSESSMENT WORKSHEETS AND CHARTS OF PROGRESSION IN THE FIELD OF BUSINESS; DOWNLOADABLE ON-LINE COMPUTER SOFTWARE IN THE NATURE OF SPREADSHEETS AND TEMPLATES FOR TRACKING AND ANALYSIS OF BUSINESS PLANNING AND IMPROVEMENTS IN THE FIELD OF BUSINESS PRACTICES (U.S. CLS. 21, 23, 26, 36 AND 38).

FIRST USE 11-30-2013; IN COMMERCE 11-30-2013.

**CLASS 35—ADVERTISING AND BUSINESS**

FOR BUSINESS ADVISORY AND CONSULTING SERVICES TO BUSINESSES, NAMELY, BUSINESS PLANNING IN THE NATURE OF ANALYSIS OF CURRENT BUSINESS PRACTICE AND VIABILITY OF BUSINESS STRUCTURE AND ENVIRONMENT, IDENTIFYING AREAS OF WEAKNESS AND OPPORTUNITY AND PROVIDING ADVICE AND PLANNING THROUGH DESIGN, CREATION AND IMPLEMENTATION OF BUSINESS OBJECTIVES FOR THE PURPOSE OF ACHIEVING SHORT TERM AND LONG TERM SUCCESS AND ONGOING SUPPORT; PROVIDING A WEB SITE WHICH PROVIDES ONLINE BUSINESS TOOLS, EVALUATION AND ASSESSMENT, NAMELY, BUSINESS CASE STUDIES; MEMBERSHIP CLUB SERVICES, NAMELY, PROVIDING INFORMATION TO MEMBERS IN THE FIELD OF BUSINESS IN THE FORM OF NEWSLETTERS AND TIPS OF THE DAY/WEEK/MONTH; BUSINESS CONSULTING SERVICES VIA GROUP MEETINGS AND INDIVIDUAL CONSULTATION (U.S. CLS. 100, 101 AND 102).

FIRST USE 11-29-2012; IN COMMERCE 11-29-2012.

**CLASS 41—EDUCATION AND ENTERTAINMENT**

FOR PROVIDING A WEB SITE WHICH PROVIDES ONLINE BUSINESS TOOLS, EVALUATION AND ASSESSMENT, NAMELY, BRAINSTORMING BUSINESS EXERCISES, PEER TO PEER COACHING, AND BUSINESS ROLE PLAY GAMES AND EXERCISES; NON-DOWNLOADABLE ON-LINE PUBLICATIONS IN THE NATURE OF LESSONS, NEWSLETTERS, SKILLS ASSESSMENT WORKSHEETS AND CHARTS OF PROGRESSION IN THE FIELD OF BUSINESS; CONTINUING EDUCATION SERVICES, NAMELY, PROVIDING LIVE TELEPHONE AND ON-LINE CONTINUING PROFESSIONAL EDUCATION LESSONS IN THE FIELD OF BUSINESS; ON-LINE JOURNALS, NAMELY, BLOGS FEATURING BUSINESS; PROVIDING PODCASTS IN THE FIELD OF BUSINESS; EDUCATION SERVICES, NAMELY, ONLINE AND TELEPHONE MENTORING AND COACHING IN THE FIELD OF BUSINESS; CONDUCTING ONLINE SEMINARS IN THE FIELD OF BUSINESS PLANNING, SUCCESSION PLANNING AND FINANCIAL ANALYSIS (U.S. CLS. 100, 101 AND 107).

FIRST USE 11-30-2013; IN COMMERCE 11-30-2013.

4,481,339. AVIAT NETWORKS, INC., SANTA CLARA, CA.  
SN 77-822,193. PUB. 8-17-2010, FILED 9-8-2009.

# AVIAT

THE MARK CONSISTS OF STANDARD CHARACTERS WITHOUT CLAIM TO ANY PARTICULAR FONT, STYLE, SIZE, OR COLOR.

## CLASS 9—ELECTRICAL AND SCIENTIFIC APPARATUS

FOR WIRELESS COMMUNICATIONS SYSTEMS, NAMELY, DIGITAL MODEMS, MULTIPLEXERS, MICROWAVE RADIO TRANSMITTERS AND RECEIVERS, ANTENNAS, AND RELATED OPERATING SOFTWARE, ALL SOLD SEPARATELY, OR AS A UNIT USED TOGETHER TO INTERCONNECT STATIONS IN MOBILE NETWORKS OR PROVIDE LOCAL ACCESS TO TELECOMMUNICATIONS SYSTEMS FOR VOICE, DATA OR VIDEO SERVICES, AND MANUALS SOLD AS A UNIT; NETWORK COMPUTER SYSTEMS CONSISTING OF COMPUTER TERMINALS AND COMPUTER SOFTWARE FOR USE IN DIAGNOSTIC MONITORING, MAINTENANCE AND CONTROL OF SUCH WIRELESS COMMUNICATIONS SYSTEMS, AND MANUALS SOLD AS A UNIT; EQUIPMENT AND ACCESSORIES FOR BROADBAND WIRELESS ACCESS, NAMELY, COMPUTER HARDWARE, COMPUTER SOFTWARE FOR BROADBAND WIRELESS ACCESS, MODEMS, TELECOMMUNICATIONS SWITCHES, ANTENNAS, TELECOMMUNICATIONS TRANSMITTERS, TELECOMMUNICATIONS RECEIVERS, CIRCUIT BOARDS FOR BROADBAND WIRELESS ACCESS, WIRELESS ADAPTERS, AND WIRELESS NETWORK BRIDGES; COMPUTER HARDWARE AND SOFTWARE FOR INTERCONNECTING, MANAGING AND OPERATING LOCAL AND WIDE AREA NETWORKS; COMPUTER SOFTWARE FOR NETWORKING, NAMELY, SOFTWARE WHICH PROVIDES CONNECTIVITY, INTEROPERABILITY AND MANAGEMENT CAPABILITY AMONG NETWORKED COMPONENTS AND SYSTEMS; WIRELESS TELECOMMUNICATIONS AND ELECTRONIC EQUIPMENT, NAMELY, WIRELESS MODEMS, WIRELESS ETHERNET BRIDGES, NETWORK MULTIPLEXERS, DATA COMMUNICATION MULTIPLEXERS, RADIO MODULATORS AND DEMODULATORS, RADIO TRANSMITTERS, RADIO RECEIVERS, ANTENNAS FOR TRANSMITTING AND RECEIVING DATA IN LOCAL AREA NETWORKS, MULTIFREQUENCY SCRAMBLERS; COMPUTER SOFTWARE FOR USE IN CONTROLLING, OPERATING, MANAGING, OR MAINTAINING WIRELESS COMMUNICATIONS SYSTEMS OR WIRELESS INFRASTRUCTURE EQUIPMENT; TELECOMMUNICATIONS AND DATA NETWORKING HARDWARE, NAMELY, DEVICES FOR TRANSPORTING AND AGGREGATING VOICE, DATA, AND VIDEO COMMUNICATIONS ACROSS MULTIPLE NETWORK INFRASTRUCTURES AND COMMUNICATIONS PROTOCOLS; BROADBAND WIRELESS EQUIPMENT, NAMELY, TELECOMMUNICATIONS BASE STATION EQUIPMENT FOR CELLULAR AND FIXED NETWORKING AND COMMUNICATIONS APPLICATIONS; RADIO RECEIVERS AND TRANSMITTERS; RADIO TRANSCIEVERS (U.S. CLS. 21, 23, 26, 36 AND 38).

FIRST USE 1-27-2010; IN COMMERCE 1-27-2010.

## CLASS 35—ADVERTISING AND BUSINESS

FOR OPERATION AND ADMINISTRATION OF TELECOMMUNICATION SYSTEMS AND NETWORKS FOR OTHERS; TELECOMMUNICATIONS NETWORK MANAGEMENT SERVICES, NAMELY, THE OPERATION AND ADMINISTRATION OF TELECOMMUNICATION SYSTEMS AND NETWORKS FOR OTHERS; PROVIDING INFORMATION VIA A GLOBAL COMPUTER NETWORK IN THE FIELDS OF DATA COMMUNICATION AND RELATED TECHNOLOGIES, NAMELY, CUSTOMER PRODUCT INFORMATION ABOUT WIRELESS COMMUNICATIONS HARDWARE (U.S. CLS. 100, 101 AND 102).

FIRST USE 1-27-2010; IN COMMERCE 1-21-2010.

## CLASS 37—CONSTRUCTION AND REPAIR

FOR INSTALLATION, MAINTENANCE AND REPAIR SERVICES OF HARDWARE FOR WIRELESS COMMUNICATIONS SYSTEMS FOR OTHERS (U.S. CLS. 100, 103 AND 106).

FIRST USE 1-27-2010; IN COMMERCE 1-27-2010.

## CLASS 38—COMMUNICATION

FOR TELECOMMUNICATION CONSULTATION IN THE NATURE OF TECHNICAL CONSULTING IN THE FIELD OF AUDIO, TEXT AND VISUAL DATA TRANSMISSION AND COMMUNICATION; TELECOMMUNICATIONS CONSULTATION; PROVIDING INFORMATION VIA A GLOBAL COMPUTER NETWORK IN THE FIELDS OF DATA COMMUNICATIONS AND RELATED TECHNOLOGIES, NAMELY, WIRELESS ELECTRONIC TRANSMISSION OF VOICE SIGNALS, DATA, FACSIMILES, IMAGES AND INFORMATION (U.S. CLS. 100, 101 AND 104).

FIRST USE 1-27-2010; IN COMMERCE 1-27-2010.

## CLASS 42—SCIENTIFIC AND COMPUTER SERVICES

FOR DESIGN SERVICES FOR OTHERS IN THE FIELD OF WIRELESS COMMUNICATIONS SYSTEMS; CONSULTING SERVICES, NAMELY, DESIGN, IMPLEMENTATION AND TESTING OF WIRELESS COMMUNICATIONS SYSTEMS SOFTWARE; COMPUTER NETWORK DESIGN FOR OTHERS; TELECOMMUNICATIONS TECHNOLOGY CONSULTING SERVICES, NAMELY, THE DEVELOPMENT OF CUSTOMIZED TELECOMMUNICATIONS EQUIPMENT FOR OTHERS; RESEARCH AND DEVELOPMENT FOR NEW WIRELESS TELECOMMUNICATIONS EQUIPMENT; INSTALLATION OF SOFTWARE FOR WIRELESS WIDE AREA NETWORKS; CUSTOM DESIGN OF TELECOMMUNICATION SYSTEMS FOR OTHERS; COMPUTER SYSTEM DESIGN AND DEVELOPMENT OF HIGH-SPEED EQUIPMENT, NAMELY, COMPUTER TERMINALS FOR OPERATORS OF PUBLIC NETWORKS AND COMPANIES; COMPUTER ENGINEERING SERVICES FOR LARGE OR MEDIUM COMPUTER SYSTEM APPLICATIONS; UPDATING AND MAINTENANCE OF SOFTWARE, TECHNICAL CONSULTING AND ASSISTANCE WITH TELECOMMUNICATIONS SYSTEMS AND COMPONENTS; TELECOMMUNICATION NETWORK ENGINEERING AND TELECOMMUNICATION COMPUTER SYSTEMS ADMINISTRATION, NAMELY, COMPUTER PROGRAMMING FOR OTHERS; ENGINEERING SERVICES FOR OPERATING TELECOMMUNICATION TERMINALS; ACTING AS AN APPLICATION SERVICE PROVIDER IN THE FIELD OF KNOWLEDGE MANAGEMENT TO HOST COMPUTER APPLICATION SOFTWARE FOR SEARCHING AND RETRIEVING INFORMATION FOR DATABASES AND COMPUTER

NETWORKS; DEVELOPMENT AND DESIGN OF SOFTWARE, AND PARTICULARLY OF TELECOMMUNICATION SOFTWARE; SOFTWARE MAINTENANCE SERVICES; PROVIDING PLANNING AND ENGINEERING SERVICES IN THE FIELD OF INFORMATION AND COMMUNICATIONS NETWORKS; INSTALLATION, MAINTENANCE AND REPAIR SERVICES FOR SOFTWARE FOR WIRELESS COMMUNICATIONS SYSTEMS FOR OTHERS; CONSULTING SERVICES, NAMELY, DESIGN, IMPLEMENTATION AND TESTING OF WIRELESS COMMUNICATIONS HARDWARE (U.S. CLS. 100 AND 101).

FIRST USE 1-27-2010; IN COMMERCE 1-27-2010.

4,481,343. PFLEIDERER BETEILIGUNGS GMBH, ALTHUETTE, FED REP GERMANY. SN 77-861,037. PUB. 12-14-2010, FILED 10-30-2009.



NO CLAIM IS MADE TO THE EXCLUSIVE RIGHT TO USE "HOME", APART FROM THE MARK AS SHOWN.

THE COLOR(S) BLACK AND GREEN IS/ARE CLAIMED AS A FEATURE OF THE MARK.

THE MARK CONSISTS OF THE WORD "NATURE" IN BLACK, THE WORD "HOME" IN GREEN, A GREEN BACKGROUND COLOR BEHIND THE WORD "NATURE", A BLACK BACKGROUND COLOR BEHIND THE WORD "HOME".

#### CLASS 18—LEATHER GOODS

FOR LEATHER, AND IMITATIONS OF LEATHER, AND GOODS MADE OF THESE MATERIALS, NAMELY, PURSES, WALLETS, ANIMAL SKINS AND HIDES, TRAVELING TRUNKS, TRAVEL BAGS, UMBRELLAS, PARASOLS AND WALKING STICKS, OUTDOOR PATIO UMBRELLAS, AND UMBRELLAS IN THE NATURE OF SUNSHADES (U.S. CLS. 1, 2, 3, 22 AND 41).

FIRST USE 12-13-2013; IN COMMERCE 12-13-2013.

#### CLASS 19—NON-METALLIC BUILDING MATERIALS

FOR NON-METAL BUILDING MATERIALS, NAMELY, BRICKS, FLOOR TILES, NON-METAL ROOF TILES, NON-METAL ROOF COVERINGS, NON-METAL CLADDING FOR CONSTRUCTION AND BUILDING, WINDOWS, DOORS, FLOORS, FLOOR BOARDS OF NATURAL MATERIALS, FLOORING UNDERLAYMENTS, NON-METALLIC RIGID PIPES FOR BUILDING, NON-METALLIC TRANSPORTABLE BUILDING, PARQUET FLOORING (U.S. CLS. 1, 12, 33 AND 50).

FIRST USE 12-13-2013; IN COMMERCE 12-13-2013.

#### CLASS 20—FURNITURE AND ARTICLES NOT OTHERWISE CLASSIFIED

FOR FURNITURE; ITEMS MADE OF WOOD, RECYCLED WOOD, CORK, REED, WICKER, SHELL, AND SUBSTITUTES FOR ALL THESE ITEMS, NAMELY, UMBRELLA STANDS, VANITIES, SIDE TABLES, COUCHES, TOWEL CLOSETS, BATHROOM CABINETS, WARDROBES, STOOLS, GARDEN TABLES, GARDEN CHAIRS, LOUNGE CHAIRS, DINING TABLES, LIVING ROOM TABLES, COAT RACKS, STORAGE RACKS, SIDEBOARDS, CHEST OF DRAWERS, PICTURE FRAMES, MIRRORS, CHAIRS, BAR STOOLS, FURNITURE, NAMELY, TV AND LCD PROJECTOR RACKS, CHAIRS, BEDS, STORAGE AND ORGANIZATION SYSTEMS COMPRISED OF CLOTHES BASKETS, BEACH CHAIRS, MATTRESSES, FURNITURE MADE OF WOOD, RECYCLED WOOD, CORK, STEEL, CANE, RUSH, NATURAL RUBBER, HORN, AND RECYCLED MATERIAL COMPRISED OF RECYCLED WOOD, CORK, STEEL, CANE, RUSH, NATURAL RUBBER, HORN, LEATHER AND IMITATION LEATHER; ROCKING CHAIRS FOR KIDS, FIGURES MADE OF WOOD, CORK, CANE AND HORN (U.S. CLS. 2, 13, 22, 25, 32 AND 50).

FIRST USE 12-13-2013; IN COMMERCE 12-13-2013.

#### CLASS 24—FABRICS

FOR TEXTILES AND TEXTILE GOODS, NAMELY, TABLECLOTHS, TOWELS, TABLE RUNNERS, NAPKINS, PLACEMATS, KITCHEN TOWELS, BATH TOWELS, WASH CLOTHS, DRAPERIES, CURTAINS, KITCHEN TOWELS, PILLOW SLIPS, UNFITTED SEAT COVERS, UNFITTED FABRIC FURNITURE SLIP COVERS, WOOLEN BLANKETS, COUCH THROW BLANKETS, BED BLANKETS, BABY BLANKETS, FITTED BED SHEETS, UNFITTED BED SHEETS, CRIB SHEETS, CRIB BUMPERS, CRIB BUMPER PADS, CASHMERE BLANKETS, MATTRESS PADS, PROTECTIVE COVERS FOR MATTRESSES; QUILTS, BEDSPREADS, BED AND PLASTIC TABLE COVERS AND TABLE CLOTHS NOT OF PAPER (U.S. CLS. 42 AND 50).

FIRST USE 12-13-2013; IN COMMERCE 12-13-2013.

#### CLASS 27—FLOOR COVERINGS

FOR CARPETS, RUGS, MATS AND MATTING, LINOLEUM, DOORMATS, WALL TO WALL CARPETINGS, BATH RUGS, CARPET PADDING, NON-TEXTILE WALL HANGINGS, BATHMATS (U.S. CLS. 19, 20, 37, 42 AND 50).

FIRST USE 12-13-2013; IN COMMERCE 12-13-2013.

#### CLASS 28—TOYS AND SPORTING GOODS

FOR GAMES, TOYS AND PLAYTHINGS AND SPORTING ARTICLES, NAMELY, KIDS TOY WHEEL BARROWS, TOY TRICYCLES, KIDS STROLL CARS, KIDS BUCKETS, SHOVELS, KIDS PEDAL CARS, BOARD GAMES, CARD GAMES, STUFFED ANIMALS, STRING PUPPETS, WOOD PLAYTHINGS IN THE NATURE OF YO-YOS, PULL TOYS, AUTOMOBILES, TRUCKS, CONSTRUCTION VEHICLES, TOY FIGURES AND ANIMALS, TOY PUPPET STAGES AND CARRYING CASES, PIN-BALL MACHINES, JIGSAW PUZZLES, PUZZLES, BILLIARD EQUIPMENT, BOCCIE BALLS, DOCTORS CASES, LEATHER SOCCER BALLS, LEATHER BASKETBALLS, LEATHER FOOTBALLS, TOY FIGURES MADE OF WOOD, TOY MAGIC BAGS COMPRISED OF EQUIPMENT FOR PERFORMING MAGIC TRICKS, BALLS FOR GAMES, EQUIPMENT FOR BUILDING TOY RACE COURSES, TOY MODEL TRAIN SETS, SWINGS, DECORATIONS FOR CHRISTMAS TREES (U.S. CLS. 22, 23, 38 AND 50).

FIRST USE 12-13-2013; IN COMMERCE 12-13-2013.

4,481,349. SUNSTAR SUISSE SA, 1163 ETOY, SWITZERLAND. SN 77-882,632. PUB. 8-17-2010, FILED 11-30-2009.



OWNER OF U.S. REG. NO. 3,700,450.

THE MARK CONSISTS OF THE WORDS "SUNSTAR" AND "GUIDOR" AND A CIRCLE DESIGN WITH A PORTION OF THE RIGHT HALF OF THE CIRCLE SHOWN AS SOLID AND WITH HORIZONTAL LINES EXTENDING FROM THE SOLID PORTION ACROSS TO THE LEFT HALF OF THE CIRCLE.

#### CLASS 5—PHARMACEUTICALS

FOR DENTIFRICES FOR MEDICAL PURPOSES; MOUTH WASHES FOR MEDICAL USE; PHARMACEUTICAL PREPARATIONS FOR THE TREATMENT OF PERIODONTAL DISEASES; DENTAL MATERIALS, NAMELY, DENTAL IMPRESSION MATERIALS, DENTAL BONDING MATERIALS, DENTAL RESTORATIVE MATERIALS, DENTAL STOPPING MATERIALS FOR STOPPING TEETH, MATERIALS FOR DENTAL FILLINGS, AND MATERIALS FOR ARTIFICIAL TEETH; DIETETIC FOODS ADAPTED FOR MEDICAL PURPOSES; NUTRITIONAL SUPPLEMENTS; MEDICATED CANDIES; MEDICATED CHEWING GUM; GAUZE FOR MEDICAL AND DENTAL PURPOSES; BONE FILLING MATERIALS FOR DENTAL PURPOSES, NAMELY, BONE FILLERS CONSISTING OF LIVING MATERIALS; DIAGNOSTIC PREPARATIONS FOR MEDICAL PURPOSES, NAMELY, FOR DENTAL AND ORAL HYGIENE PURPOSES (U.S. CLS. 6, 18, 44, 46, 51 AND 52).  
FIRST USE 9-0-2012; IN COMMERCE 9-0-2012.

#### CLASS 10—MEDICAL APPARATUS

FOR ARTIFICIAL MEMBRANES USED IN GUIDED TISSUE REGENERATION IN ORAL SURGERY; ARTIFICIAL MEMBRANES USED IN GUIDED BONE REGENERATION IN ORAL SURGERY (U.S. CLS. 26, 39 AND 44).

FIRST USE 3-31-2009; IN COMMERCE 3-31-2009.

4,481,354. E-GATEMATRIX L.L.C., RESTON, VA. SN 77-892,726. PUB. 10-12-2010, FILED 12-14-2009.

EGATE SOLUTIONS

THE MARK CONSISTS OF STANDARD CHARACTERS WITHOUT CLAIM TO ANY PARTICULAR FONT, STYLE, SIZE, OR COLOR.

OWNER OF U.S. REG. NOS. 2,742,889 AND 2,742,890.

NO CLAIM IS MADE TO THE EXCLUSIVE RIGHT TO USE "SOLUTIONS", APART FROM THE MARK AS SHOWN.

#### CLASS 9—ELECTRICAL AND SCIENTIFIC APPARATUS

FOR MOBILE DEVICE, NAMELY, A HAND-HELD ELECTRONIC POINT OF SALE TERMINAL AND RELATED SOFTWARE FOR PROVIDING SECURE COMMERCIAL TRANSACTIONS AND PAYMENT AT POINT OF SALE (U.S. CLS. 21, 23, 26, 36 AND 38).

FIRST USE 11-0-2009; IN COMMERCE 11-0-2009.

#### CLASS 35—ADVERTISING AND BUSINESS

FOR TAX MANAGEMENT SERVICES; PROVISION OF BUSINESS INTELLIGENCE SERVICES; PROMOTIONS MANAGEMENT, NAMELY, PROMOTING THE SALE OF GOODS AND SERVICES OF OTHERS THROUGH ELECTRONIC COUPONING, PROMOTIONS AND DISCOUNTS; PROMOTING THE GOODS AND SERVICES OF OTHERS BY PROVIDING VOUCHERS FOR THE GOODS AND SERVICES OF OTHERS THROUGH THE USE OF AN ELECTRONIC POINT OF SALE TERMINAL; MANAGEMENT SERVICES FOR AIR, RAIL, AND SEA TRANSPORTATION COMPANIES, NAMELY, ONBOARD RETAIL STORE SERVICES FEATURING FOOD AND BEVERAGE, BILLING AND INVOICING SERVICES; ONBOARD SCHEDULING OF AIRCRAFT REPAIRS FOR OTHERS; ADVISORY SERVICES RELATING TO BUSINESS MANAGEMENT AND BUSINESS OPERATIONS IN THE FIELD OF ONBOARD AIR AND RAIL SERVICES; BUSINESS MANAGEMENT SERVICES, NAMELY, MANAGING LOGISTICS IN THE AIR AND RAIL INDUSTRY; SUPPLY CHAIN INVENTORY MANAGEMENT SERVICES, NAMELY, DATA MANAGEMENT, PERFORMANCE MEASUREMENT SERVICES IN THE NATURE OF MEASURING THE AVAILABILITY OF GOODS OF OTHERS TO ELIMINATE STOCK OUTS AND OVERSTOCKS; SALES VOLUME TRACKING FOR OTHERS, NAMELY, REPORTING INFORMATION REGARDING THE SALE OF GOODS AND SERVICES OF OTHERS (U.S. CLS. 100, 101 AND 102).

FIRST USE 1-0-2008; IN COMMERCE 1-0-2008.

#### CLASS 36—INSURANCE AND FINANCIAL

FOR FINANCIAL TRANSACTION SERVICES, NAMELY, PROVIDING SECURE COMMERCIAL TRANSACTIONS AND PAYMENT OPTIONS USING A MOBILE DEVICE AT THE POINT OF SALE; BANK RECONCILIATION SERVICES, NAMELY, ADMINISTRATION AND RECONCILIATION OF ACCOUNTS ON BEHALF OF OTHERS (U.S. CLS. 100, 101 AND 102).

FIRST USE 11-0-2009; IN COMMERCE 11-0-2009.

#### CLASS 42—SCIENTIFIC AND COMPUTER SERVICES

FOR PLANNING AND LAYOUT DESIGN FOR GALLEYS, LOADING DIAGRAMMING TO MANAGE WEIGHT AND BALANCE AND CABIN APPEARANCE (U.S. CLS. 100 AND 101).

FIRST USE 1-0-2008; IN COMMERCE 1-0-2008.

#### CLASS 43—HOTEL AND RESTAURANT SERVICES

FOR MEAL AND MENU PLANNING FOR OTHERS (U.S. CLS. 100 AND 101).

FIRST USE 1-0-2008; IN COMMERCE 1-0-2008.

4,481,355. E-GATEMATRIX L.L.C., RESTON, VA. SN 77-892,752. PUB. 10-12-2010, FILED 12-14-2009.

**CLASS 43—HOTEL AND RESTAURANT SERVICES**

FOR MEAL AND MENU PLANNING FOR OTHERS (U.S. CLS. 100 AND 101).  
FIRST USE 11-0-2009; IN COMMERCE 11-0-2009.

**EGATE SOLUTIONS TS4**

THE MARK CONSISTS OF STANDARD CHARACTERS WITHOUT CLAIM TO ANY PARTICULAR FONT, STYLE, SIZE, OR COLOR.

OWNER OF U.S. REG. NOS. 2,742,889 AND 2,742,890.

NO CLAIM IS MADE TO THE EXCLUSIVE RIGHT TO USE "SOLUTIONS", APART FROM THE MARK AS SHOWN.

**CLASS 9—ELECTRICAL AND SCIENTIFIC APPARATUS**

FOR MOBILE DEVICE, NAMELY, A HAND-HELD ELECTRONIC POINT OF SALE TERMINAL AND RELATED SOFTWARE FOR PROVIDING SECURE COMMERCIAL TRANSACTIONS AND PAYMENT AT POINT OF SALE (U.S. CLS. 21, 23, 26, 36 AND 38).

FIRST USE 11-0-2009; IN COMMERCE 11-0-2009.

**CLASS 35—ADVERTISING AND BUSINESS**

FOR TAX MANAGEMENT SERVICES; PROVISION OF BUSINESS INTELLIGENCE SERVICES; PROMOTIONS MANAGEMENT, NAMELY, PROMOTING THE SALE OF GOODS AND SERVICES OF OTHERS THROUGH ELECTRONIC COUPONING, PROMOTIONS AND DISCOUNTS; PROMOTING THE GOODS AND SERVICES OF OTHERS BY PROVIDING VOUCHERS FOR THE GOODS AND SERVICES OF OTHERS THROUGH THE USE OF AN ELECTRONIC POINT OF SALE TERMINAL; MANAGEMENT SERVICES FOR AIR, RAIL, AND SEA TRANSPORTATION COMPANIES, NAMELY, ON-BOARD RETAIL STORE SERVICES FEATURING FOOD AND BEVERAGE, BILLING AND INVOICING SERVICES; ONBOARD SCHEDULING OF AIRCRAFT REPAIRS FOR OTHERS; ADVISORY SERVICES RELATING TO BUSINESS MANAGEMENT AND BUSINESS OPERATIONS IN THE FIELD OF ONBOARD AIR AND RAIL SERVICES; BUSINESS MANAGEMENT SERVICES, NAMELY, MANAGING LOGISTICS IN THE AIR AND RAIL INDUSTRY; SUPPLY CHAIN INVENTORY MANAGEMENT SERVICES, NAMELY, DATA MANAGEMENT, PERFORMANCE MEASUREMENT SERVICES IN THE NATURE OF MEASURING THE AVAILABILITY OF GOODS OF OTHERS TO ELIMINATE STOCK OUTS AND OVERSTOCKS; SALES VOLUME TRACKING FOR OTHERS, NAMELY, REPORTING INFORMATION REGARDING THE SALE OF GOODS AND SERVICES OF OTHERS (U.S. CLS. 100, 101 AND 102).

FIRST USE 11-0-2009; IN COMMERCE 11-0-2009.

**CLASS 36—INSURANCE AND FINANCIAL**

FOR FINANCIAL TRANSACTION SERVICES, NAMELY, PROVIDING SECURE COMMERCIAL TRANSACTIONS AND PAYMENT OPTIONS USING A MOBILE DEVICE AT THE POINT OF SALE; BANK RECONCILIATION SERVICES, NAMELY, ADMINISTRATION AND RECONCILIATION OF ACCOUNTS ON BEHALF OF OTHERS (U.S. CLS. 100, 101 AND 102).

FIRST USE 11-0-2009; IN COMMERCE 11-0-2009.

**CLASS 42—SCIENTIFIC AND COMPUTER SERVICES**

FOR PLANNING AND LAYOUT DESIGN FOR GALLEYS, LOADING DIAGRAMMING TO MANAGE WEIGHT AND BALANCE AND CABIN APPEARANCE (U.S. CLS. 100 AND 101).

FIRST USE 11-0-2009; IN COMMERCE 11-0-2009.

4,481,358. GALDERMA S.A., CHAM, SWITZERLAND. SN 77-912,824. PUB. 11-2-2010, FILED 1-15-2010.

**Q-MED**

THE MARK CONSISTS OF STANDARD CHARACTERS WITHOUT CLAIM TO ANY PARTICULAR FONT, STYLE, SIZE, OR COLOR.

**CLASS 3—COSMETICS AND CLEANING PREPARATIONS**

FOR AESTHETIC AND COSMETIC PREPARATIONS, NAMELY, FOR REJUVENATION, REHYDRATION AND SMOOTHENING OF THE SKIN, AND EVENING OUT AND FILLING OUT OF WRINKLES, SCARS, LIPS, FACE AND BODY CONTOURING; FACE AND SKIN LOTION (U.S. CLS. 1, 4, 6, 50, 51 AND 52).

FIRST USE 0-0-1987; IN COMMERCE 1-4-2004.

**CLASS 5—PHARMACEUTICALS**

FOR PHARMACEUTICAL PREPARATIONS FOR DERMATOLOGICAL USE, NAMELY, A SUBSTANCE FOR REJUVENATION, REHYDRATION AND SMOOTHENING OF THE SKIN, AND EVENING AND FILLING OUT OF WRINKLES, SCARS, LIPS, FACE AND BODY CONTOURING AS WELL AS PHARMACEUTICAL PREPARATIONS FOR UROLOGICAL, GYNECOLOGICAL, ORTHOPAEDIC AND GASTRO-INTESTINAL USE (U.S. CLS. 6, 18, 44, 46, 51 AND 52).

FIRST USE 0-0-1987; IN COMMERCE 1-4-2004.

**CLASS 10—MEDICAL APPARATUS**

FOR MEDICAL DEVICES, NAMELY, INJECTABLE IMPLANTS IN THE FORM OF A NON-LIVING GEL, SOLD ALONE OR IN KITS, CONSISTING ESSENTIALLY OF INJECTION DEVICES AND/OR SYRINGES PREFILLED WITH INJECTABLE IMPLANTS IN THE FORM OF A NON-LIVING GEL, FOR REJUVENATION, REHYDRATION AND SMOOTHENING OF THE SKIN, EVENING AND FILLING OUT WRINKLES, FOLDS, SCARS, LIPS AS WELL AS FOR FACE AND BODY CONTOURING AND OTHER AESTHETIC USES, AS WELL AS FOR UROLOGICAL, GYNECOLOGICAL, ORTHOPAEDIC AND GASTRO-INTESTINAL USE; IMPLANTS IN THE FORM OF A NON-LIVING GEL FOR INJECTION FOR USE IN UROLOGICAL PROCEDURES; SYRINGES SOLD EMPTY AND/OR PREFILLED WITH INJECTABLE IMPLANTS IN THE FORM OF A NON-LIVING GEL AND INJECTION DEVICES FOR PHARMACEUTICALS (U.S. CLS. 26, 39 AND 44).

FIRST USE 0-0-1987; IN COMMERCE 1-4-2004.

4,481,359. VIRGIN ENTERPRISES LIMITED, LONDON, UNITED KINGDOM. SN 77-915,463. PUB. 10-12-2010, FILED 1-20-2010.

4,481,368. THE MISS AMERICA ORGANIZATION, LINWOOD, NJ. SN 77-948,623. PUB. 11-2-2010, FILED 3-2-2010.

## VIRGIN GALACTIC

THE MARK CONSISTS OF STANDARD CHARACTERS WITHOUT CLAIM TO ANY PARTICULAR FONT, STYLE, SIZE, OR COLOR.

OWNER OF U.S. REG. NOS. 1,413,664, 2,808,270, AND 3,535,624.

### CLASS 12—VEHICLES

FOR AIRCRAFT, AIRPLANES, SPACE VEHICLES, AND STRUCTURAL PARTS THEREFOR (U.S. CLS. 19, 21, 23, 31, 35 AND 44).

FIRST USE 7-1-2008; IN COMMERCE 7-1-2008.

### CLASS 16—PAPER GOODS AND PRINTED MATTER

FOR PICTURES; PRINTS; WRITING INSTRUMENTS; EVENT PROGRAMS; PHOTOGRAPHS; PAPER; NOTE PADS; FOLDERS; AND STATIONERY (U.S. CLS. 2, 5, 22, 23, 29, 37, 38 AND 50).

FIRST USE 6-1-2007; IN COMMERCE 6-1-2007.

### CLASS 18—LEATHER GOODS

FOR ALL-PURPOSE SPORTS BAGS; ALL-PURPOSE CARRYING BAGS (U.S. CLS. 1, 2, 3, 22 AND 41).

FIRST USE 7-1-2009; IN COMMERCE 7-1-2009.

### CLASS 25—CLOTHING

FOR CLOTHING, NAMELY, SUITS, FLIGHT SUITS, SHIRTS, T-SHIRTS, SWEATSHIRTS, TRACK SUITS, JACKETS, COATS, BLAZERS, SWEATERS, HATS, AND HEADWEAR (U.S. CLS. 22 AND 39).

FIRST USE 7-1-2009; IN COMMERCE 7-1-2009.

### CLASS 28—TOYS AND SPORTING GOODS

FOR TOY MODELS OF AIRCRAFT, AIRPLANES, SPACE VEHICLES, AND PARTS THEREFOR (U.S. CLS. 22, 23, 38 AND 50).

FIRST USE 1-1-2009; IN COMMERCE 1-1-2009.

### CLASS 39—TRANSPORTATION AND STORAGE

FOR AIR TRANSPORTATION; FREIGHT TRANSPORTATION BY AIR; TRANSPORTATION OF PASSENGERS BY AIR; AIRPORT SERVICES; LAUNCHING OF SPACE VEHICLES FOR OTHERS; TRANSPORTATION OF PASSENGERS AND FREIGHT THROUGH SPACE; SPACE TRAVEL AGENCY SERVICES, NAMELY, BOOKING OF TRANSPORTATION INTO SPACE (U.S. CLS. 100 AND 105).

FIRST USE 1-1-2007; IN COMMERCE 1-1-2007.

## MISS AMERICA

THE MARK CONSISTS OF STANDARD CHARACTERS WITHOUT CLAIM TO ANY PARTICULAR FONT, STYLE, SIZE, OR COLOR.

OWNER OF U.S. REG. NOS. 768,211, 2,776,754, AND OTHERS.

### CLASS 14—JEWELRY

FOR JEWELRY (U.S. CLS. 2, 27, 28 AND 50).

FIRST USE 0-0-1975; IN COMMERCE 0-0-1975.

### CLASS 18—LEATHER GOODS

FOR BACKPACKS, ALL PURPOSE CARRYING BAGS, HANDBAGS; LUGGAGE; LEATHER AND ARTIFICIAL LEATHER WALLETS, COIN PURSES; COSMETIC BAGS SOLD EMPTY; KNAP SACKS (U.S. CLS. 1, 2, 3, 22 AND 41).

FIRST USE 11-15-2012; IN COMMERCE 11-15-2012.

### CLASS 21—HOUSEWARES AND GLASS

FOR LUNCHBOXES; FIGURINES OF EARTHENWARE, GLASS OR PORCELAIN; GLASSWARE, NAMELY, BEVERAGE GLASSWARE; DINNERWARE, NAMELY, PLATES, CUPS, SAUCERS (U.S. CLS. 2, 13, 23, 29, 30, 33, 40 AND 50).

FIRST USE 11-15-2012; IN COMMERCE 11-15-2012.

### CLASS 25—CLOTHING

FOR CLOTHING, NAMELY, SHIRTS, PANTS, JACKETS, DRESSES, SWIMWEAR, LOUNGEWEAR, FOOTWEAR, HEADWEAR, COSTUMES, NAMELY, HALLOWEEN COSTUMES AND COSTUMES FOR USE IN CHILDREN'S DRESS UP PLAY (U.S. CLS. 22 AND 39).

FIRST USE 0-0-1940; IN COMMERCE 0-0-1940.

4,481,371. CLC RESORT DEVELOPMENTS LIMITED, DOUGLAS, ISLE OF MAN. SN 77-966,298. PUB. 10-26-2010, FILED 3-23-2010.

# CLC

THE MARK CONSISTS OF STANDARD CHARACTERS WITHOUT CLAIM TO ANY PARTICULAR FONT, STYLE, SIZE, OR COLOR.

**CLASS 35—ADVERTISING AND BUSINESS**

FOR ADVERTISING OF VACATION HOMES AND APARTMENTS; ORGANIZATION OF EXHIBITIONS FOR COMMERCIAL OR ADVERTISING PURPOSES; REAL ESTATE MARKETING SERVICES, NAMELY, PROVIDING VOUCHERS FOR THE RENTAL, LEASING OR PURCHASE OF VACATION HOMES, APARTMENTS, CONDOMINIUMS AND TIME SHARE REAL ESTATE PROPERTY; HOTEL AND RESORT MANAGEMENT FOR OTHERS (U.S. CLS. 100, 101 AND 102).

FIRST USE 10-1-2010; IN COMMERCE 10-1-2010.

**CLASS 36—INSURANCE AND FINANCIAL**

FOR ARRANGING OF LOANS; FACILITATING AND ARRANGING FOR FINANCING IN THE FIELD OF REAL ESTATE; REAL ESTATE AGENCIES; REAL ESTATE BROKERAGE AND MANAGEMENT SERVICES; RENTAL AND LEASING OF ACCOMMODATIONS IN THE NATURE OF VACATION HOMES, APARTMENTS AND CONDOMINIUMS; VACATION REAL ESTATE TIME SHARE EXCHANGE SERVICES; TRAVEL VOUCHER SERVICES, NAMELY, PROVIDING VOUCHERS FOR PAYMENT OF TRANSPORTATION EXPENSES; RENTAL AND LEASING OF VACATION HOMES, APARTMENTS AND CONDOMINIUMS (U.S. CLS. 100, 101 AND 102).

FIRST USE 2-1-2011; IN COMMERCE 2-1-2011.

**CLASS 39—TRANSPORTATION AND STORAGE**

FOR TRANSPORTATION OF PASSENGERS BY ROAD; TRAVEL ARRANGEMENT SERVICES, NAMELY, ARRANGING FOR PASSENGER TRANSPORTATION BY AIR, AIRPLANE, TRAIN, BUS, LIMOUSINE, CAR, SHIP AND BOAT; CONDUCTING SIGHTSEEING TOURS FOR OTHERS; TRAVEL AND TOUR TICKET RESERVATION SERVICE; AND PROVIDING CONSULTATION AND INFORMATION IN CONNECTION WITH ALL OF THE FOREGOING SERVICES (U.S. CLS. 100 AND 105).

FIRST USE 11-1-2011; IN COMMERCE 11-1-2011.

**CLASS 41—EDUCATION AND ENTERTAINMENT**

FOR ENTERTAINMENT AND EDUCATIONAL SERVICES FOR TRAVEL VACATIONERS, NAMELY, PROVIDING FACILITIES FOR RECREATION ACTIVITIES AND SPORTS, ARRANGING AND CONDUCTING COMPETITIONS; TRAVEL AGENCY SERVICES, NAMELY, MAKING RESERVATIONS AND BOOKINGS FOR SPORTS EVENTS, ATHLETIC EVENTS, AND ENTERTAINMENT SHOWS; ARRANGING AND CONDUCTING CONFERENCES FOR EDUCATIONAL PURPOSES REGARDING TRAVEL, REAL ESTATE AND TIME SHARE REAL ESTATE PROPERTY; RECREATIONAL VACATION CAMPS; AND PROVIDING CONSULTATION AND INFORMATION IN CONNECTION WITH ALL OF THE FOREGOING SERVICES (U.S. CLS. 100, 101 AND 107).

FIRST USE 2-1-2011; IN COMMERCE 2-1-2011.

**CLASS 43—HOTEL AND RESTAURANT SERVICES**

FOR HOTEL, RESTAURANT, BAR AND CATERING SERVICES; HOTEL ACCOMMODATION SERVICES; PROVISION OF CONFERENCE FACILITIES; TRAVEL AGENCY SERVICES, NAMELY, MAKING RESERVATIONS AND BOOKINGS FOR TEMPORARY LODGING, RESTAURANTS AND MEALS; INFORMATION AND ADVISORY SERVICES RELATING TO THE ABOVE SERVICES; AND PROVIDING CONSULTATION AND INFORMATION IN CONNECTION WITH ALL OF THE FOREGOING SERVICES (U.S. CLS. 100 AND 101).

FIRST USE 1-1-2012; IN COMMERCE 1-1-2012.

4,481,375. PROJECT MIRACLE IP HOLDINGS, LLC, NEW YORK, NY. SN 77-983,552. PUB. 6-8-2010, FILED 12-17-2009.



NO CLAIM IS MADE TO THE EXCLUSIVE RIGHT TO USE "PROJECT" AS TO INTERNATIONAL CLASS 035 AND "100% OF AFTER TAX PROFITS DONATED", APART FROM THE MARK AS SHOWN.

THE MARK CONSISTS OF FOUR CONCENTRIC CIRCLES. IN THE CENTER CIRCLE IS A REPRESENTATION OF A FEMALE CHILD WITH WINGS AND A STAR ON HER SHIRT; ON THE CIRCLE SURROUNDING THE CHILD IS THE WORDING "100% OF AFTER TAX PROFITS DONATED" AND "BE AN ANGEL"; ON THE NEXT OUTERMOST CIRCLE IS THE WORDING "PROJECT" AND "MIRACLE" WITH A STAR ON THE LEFT HAND SIDE OF THE CIRCLE AND A STAR ON THE RIGHT HAND SIDE OF THE CIRCLE; THE OUTERMOST CIRCLE IS BROKEN AND FADED.

**CLASS 3—COSMETICS AND CLEANING PREPARATIONS**

FOR ANTIBACTERIAL SKIN SOAPS; HAIR CARE PREPARATIONS; NON-MEDICATED SKIN CARE PREPARATIONS (U.S. CLS. 1, 4, 6, 50, 51 AND 52).

FIRST USE 7-31-2013; IN COMMERCE 7-31-2013.

**CLASS 5—PHARMACEUTICALS**

FOR ANTIBACTERIAL CLEANERS; ANTIBACTERIAL HANDWASH; HAND-SANITIZING PREPARATIONS (U.S. CLS. 6, 18, 44, 46, 51 AND 52).

FIRST USE 7-31-2013; IN COMMERCE 7-31-2013.

4,481,382. STRIPEY, LLC, DBA STRIPEY TOYS, DEEPHAVEN, MN. SN 85-027,761. PUB. 10-26-2010, FILED 4-30-2010.

Stripey

THE MARK CONSISTS OF STANDARD CHARACTERS WITHOUT CLAIM TO ANY PARTICULAR FONT, STYLE, SIZE, OR COLOR.



**CLASS 16—PAPER GOODS AND PRINTED MATTER**

FOR PAPER, CARDBOARD AND GOODS MADE FROM THESE MATERIALS, NAMELY, BOOKS AND MAGAZINES IN THE FIELD OF CHILDREN'S ENTERTAINMENT, TRADING CARDS; STATIONERY (U.S. CLS. 2, 5, 22, 23, 29, 37, 38 AND 50).

FIRST USE 12-20-2013; IN COMMERCE 12-20-2013.

**CLASS 28—TOYS AND SPORTING GOODS**

FOR TOYS, SPORTING GOODS AND GAMES, NAMELY, PLAY HOUSES AND BUILDING STRUCTURES WITH TOY FIGURES AND ACCESSORIES THEREFOR INCLUDING TOY FURNITURE, VEHICLES, PEOPLE, ANIMALS, AND DECOR CAPABLE OF BEING MANIPULATED TO ALLOW FOR CHILDREN'S IMAGINATIONS, SOLD INDIVIDUALLY AND IN KIT FORM; BOARD GAMES; CARD GAMES (U.S. CLS. 22, 23, 38 AND 50).

FIRST USE 4-9-2010; IN COMMERCE 4-28-2010.

4,481,385. ZION OIL & GAS, INC., DALLAS, TX. SN 85-032,723. PUB. 10-5-2010, FILED 5-7-2010.

**ZION DRILLING**

THE MARK CONSISTS OF STANDARD CHARACTERS WITHOUT CLAIM TO ANY PARTICULAR FONT, STYLE, SIZE, OR COLOR.

NO CLAIM IS MADE TO THE EXCLUSIVE RIGHT TO USE "DRILLING", APART FROM THE MARK AS SHOWN.

**CLASS 37—CONSTRUCTION AND REPAIR**

FOR DRILLING AND PUMPING OF OIL; DRILLING FOR CRUDE OIL; DRILLING OF WELLS; OIL AND GAS DRILLING; OIL PUMPING AND EXTRACTION; OIL WELL CASING, TUBING, AND DRILL PIPE INSTALLATION; OIL WELL DRILLING; PUMPING CRUDE OIL (U.S. CLS. 100, 103 AND 106).

FIRST USE 9-5-2013; IN COMMERCE 9-5-2013.

**CLASS 42—SCIENTIFIC AND COMPUTER SERVICES**

FOR OIL AND GAS WELL DRILLING SERVICES, NAMELY, PROVIDING MEASUREMENTS AND DOWN-HOLE TELEMETRY WHILE DRILLING; OIL PROSPECTING, NAMELY, WELL LOGGING AND TESTING (U.S. CLS. 100 AND 101).

FIRST USE 9-5-2013; IN COMMERCE 9-5-2013.

4,481,387. TRY SOMETHING CREATIVE, INC., SANTA MONICA, CA. SN 85-034,740. PUB. 10-19-2010, FILED 5-10-2010.

**INNOVATIVE TACHYON TOOLS**

THE MARK CONSISTS OF STANDARD CHARACTERS WITHOUT CLAIM TO ANY PARTICULAR FONT, STYLE,

SIZE, OR COLOR.

**CLASS 10—MEDICAL APPARATUS**

FOR DRUG DELIVERY PATCHES SOLD WITHOUT MEDICATION (U.S. CLS. 26, 39 AND 44).

FIRST USE 9-5-2011; IN COMMERCE 9-5-2011.

**CLASS 14—JEWELRY**

FOR NECKLACES (U.S. CLS. 2, 27, 28 AND 50).

FIRST USE 9-5-2011; IN COMMERCE 9-5-2011.

**CLASS 25—CLOTHING**

FOR ANKLE SOCKS; ANKLETS; BOXER SHORTS; BRIEFS; CAMISOLES; DRESSES; GLOVES; GLOVES AS CLOTHING; HEAD SCARVES; LONG-SLEEVED SHIRTS; MEN'S UNDERWEAR; ROBES; SCARFS; SCARVES; SHORT-SLEEVED OR LONG-SLEEVED T-SHIRTS; SHORT-SLEEVED SHIRTS; SHOULDER SCARVES; SILK SCARVES; SOCKS; T-SHIRTS; TEE SHIRTS; UNDERWEAR; WOVEN OR KNITTED UNDERWEAR (U.S. CLS. 22 AND 39).

FIRST USE 9-5-2011; IN COMMERCE 9-5-2011.

4,481,389. OTG EXPERIENCE, LLC, CHALFONT, PA. SN 85-036,576. PUB. 2-8-2011, FILED 5-12-2010.

**OTG DESIRE**

THE MARK CONSISTS OF STANDARD CHARACTERS WITHOUT CLAIM TO ANY PARTICULAR FONT, STYLE, SIZE, OR COLOR.

OWNER OF U.S. REG. NOS. 2,908,809, 3,583,951, AND OTHERS.

**CLASS 39—TRANSPORTATION AND STORAGE**

FOR THE DELIVERY OF FOOD, BEVERAGES AND OTHER ITEMS TO PASSENGER WAITING AREAS (U.S. CLS. 100 AND 105).

FIRST USE 12-6-2013; IN COMMERCE 12-6-2013.

**CLASS 43—HOTEL AND RESTAURANT SERVICES**

FOR MAKING RESTAURANT RESERVATIONS (U.S. CLS. 100 AND 101).

FIRST USE 12-6-2013; IN COMMERCE 12-6-2013.

**CLASS 45—PERSONAL AND LEGAL SERVICES**

FOR CONCIERGE SERVICES FOR OTHERS COMPRISING OF PERSONAL SHOPPING SERVICES AND MAKING OTHER REQUESTED PERSONAL AND PREFERRED SERVICE ARRANGEMENTS AND APPOINTMENTS AND PROVIDING CUSTOMER-SPECIFIC INFORMATION TO MEET INDIVIDUAL NEEDS RENDERED TOGETHER IN AN AIRPORT AND TO TRAVELERS (U.S. CLS. 100 AND 101).

FIRST USE 12-6-2013; IN COMMERCE 12-6-2013.

4,481,393. DONOVAN MARINE, INC., HARAHAN, LA. SN 85-046,194. PUB. 10-26-2010, FILED 5-24-2010.

## MARPAC XTREME

THE MARK CONSISTS OF STANDARD CHARACTERS WITHOUT CLAIM TO ANY PARTICULAR FONT, STYLE, SIZE, OR COLOR.

### CLASS 9—ELECTRICAL AND SCIENTIFIC APPARATUS

FOR LIFE JACKETS (U.S. CLS. 21, 23, 26, 36 AND 38). FIRST USE 10-8-2012; IN COMMERCE 10-8-2012.

### CLASS 25—CLOTHING

FOR SHIRTS (U.S. CLS. 22 AND 39). FIRST USE 10-8-2012; IN COMMERCE 10-8-2012.

### CLASS 28—TOYS AND SPORTING GOODS

FOR WAKE BOARDS; KNEE BOARDS; WATER SKIS; INFLATABLE INNER TUBES FOR AQUATIC RECREATIONAL USE; TOW ROPES FOR RECREATIONAL AQUATIC EQUIPMENT, NAMELY, WAKE BOARDS, KNEE BOARDS, WATER SKIS, AND INFLATABLE INNER TUBES (U.S. CLS. 22, 23, 38 AND 50). FIRST USE 10-8-2012; IN COMMERCE 10-8-2012.

### CLASS 35—ADVERTISING AND BUSINESS

FOR RETAIL STORE SERVICES FEATURING EQUIPMENT FOR AQUATIC RECREATIONAL USE; ON-LINE RETAIL STORE SERVICES FEATURING EQUIPMENT FOR AQUATIC RECREATIONAL USE (U.S. CLS. 100, 101 AND 102). FIRST USE 10-8-2012; IN COMMERCE 10-8-2012.

4,481,394. LEHR INCORPORATED, CULVER CITY, CA. SN 85-046,270. PUB. 10-26-2010, FILED 5-24-2010.

## LEHR

THE MARK CONSISTS OF STANDARD CHARACTERS WITHOUT CLAIM TO ANY PARTICULAR FONT, STYLE, SIZE, OR COLOR.

OWNER OF U.S. REG. NOS. 3,521,078 AND 3,799,878. SEC. 2(F).

### CLASS 7—MACHINERY

FOR MARINE ENGINES AND PARTS AND FITTINGS THEREOF; MULTI-PURPOSE HIGH PRESSURE WASHERS; WATER PUMPS FOR SPAS, BATHS, WHIRLPOOLS, SWIMMING POOLS, WATER FILTERING UNITS (U.S. CLS. 13, 19, 21, 23, 31, 34 AND 35). FIRST USE 6-30-2011; IN COMMERCE 9-30-2011.

### CLASS 12—VEHICLES

FOR ATVS (ALL TERRAIN VEHICLES); GO CARTS; MOPEDS; MOTOR SCOOTERS; MOTORS FOR BICYCLES (U.S. CLS. 19, 21, 23, 31, 35 AND 44). FIRST USE 1-20-2011; IN COMMERCE 1-20-2011.

4,481,395. LEHR INCORPORATED, CULVER CITY, CA. SN 85-046,292. PUB. 10-26-2010, FILED 5-24-2010.

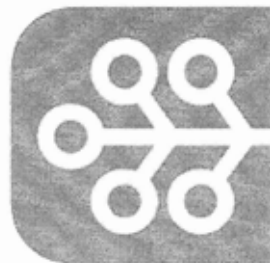

THE MARK CONSISTS OF FIVE CIRCLES CONNECTED VIA LINES.

### CLASS 7—MACHINERY

FOR MARINE ENGINES AND PARTS AND FITTINGS THEREOF; MULTI-PURPOSE HIGH PRESSURE WASHERS; WATER PUMPS FOR SPAS, BATHS, WHIRLPOOLS, SWIMMING POOLS, WATER FILTERING UNITS (U.S. CLS. 13, 19, 21, 23, 31, 34 AND 35). FIRST USE 1-20-2011; IN COMMERCE 1-20-2011.

### CLASS 12—VEHICLES

FOR ATVS (ALL TERRAIN VEHICLES); GO CARTS; MOPEDS; MOTOR SCOOTERS; MOTORS FOR BICYCLES (U.S. CLS. 19, 21, 23, 31, 35 AND 44). FIRST USE 1-20-2011; IN COMMERCE 1-20-2011.

4,481,400. BYRD, KELLY, KILL DEVIL HILLS, NC. SN 85-052,219. PUB. 10-26-2010, FILED 6-1-2010.

## SISTERS IN FAT

THE MARK CONSISTS OF STANDARD CHARACTERS WITHOUT CLAIM TO ANY PARTICULAR FONT, STYLE, SIZE, OR COLOR.

### CLASS 16—PAPER GOODS AND PRINTED MATTER

FOR GREETING CARDS (U.S. CLS. 2, 5, 22, 23, 29, 37, 38 AND 50). FIRST USE 5-1-2013; IN COMMERCE 5-1-2013.

### CLASS 25—CLOTHING

FOR HATS; SHIRTS (U.S. CLS. 22 AND 39). FIRST USE 5-1-2013; IN COMMERCE 5-1-2013.

4,481,411. EMRLOGIC SYSTEMS INCORPORATED, BURNABY, BC, CANADA. SN 85-083,833. PUB. 10-26-2010, FILED 7-13-2010.



The logo for actiV EHR features the word "acti" in a lowercase sans-serif font, followed by a stylized green checkmark that forms the letter "V", and the letters "EHR" in a bold, uppercase sans-serif font.

THE COLOR(S) BLACK, GREEN IS/ARE CLAIMED AS A FEATURE OF THE MARK.

THE MARK CONSISTS OF THE WORD "ACTIVEHR" WITH THE ACTI IN SPECIAL FORM IN BLACK, THE LETTER "V" IN STYLIZED FORM WITH 2 ARROWS IN GREEN, AND THE LETTERS "EHR" IN BLACK.

#### CLASS 9—ELECTRICAL AND SCIENTIFIC APPARATUS

FOR NETWORKED COMPUTERS, NAMELY, COMPUTER NETWORK SERVER; COMPUTER SOFTWARE FOR DIGITAL IMAGE MANAGEMENT SYSTEM IN THE FIELD OF MEDICAL IMAGE FILING (U.S. CLS. 21, 23, 26, 36 AND 38).

FIRST USE 9-3-2010; IN COMMERCE 10-8-2010.

#### CLASS 10—MEDICAL APPARATUS

FOR DIAGNOSTIC APPARATUS AND INSTRUMENTS FOR GENERAL OPHTHALMIC DISEASE CONSISTING COMPUTER HARDWARE AND COMPUTER SOFTWARE, A RETINAL CAMERA, AND A SLIT LAMP; DIAGNOSTIC APPARATUS AND INSTRUMENTS FOR GENERAL OPHTHALMIC DISEASE NETWORKED BY COMPUTERS (U.S. CLS. 26, 39 AND 44).

FIRST USE 9-30-2010; IN COMMERCE 10-8-2010.

4,481,431. GODIVA CHOCOLATIER, INC., NEW YORK, NY. SN 85-141,295. PUB. 3-15-2011, FILED 9-29-2010.

MAY YOUR LIFE BE FILLED  
WITH GODIVA

THE MARK CONSISTS OF STANDARD CHARACTERS WITHOUT CLAIM TO ANY PARTICULAR FONT, STYLE, SIZE, OR COLOR.

OWNER OF U.S. REG. NOS. 836,376, 2,273,969, AND OTHERS.

#### CLASS 30—STAPLE FOODS

FOR CHOCOLATE, COCOA, CANDY, BISCUITS, BAKERY GOODS, COFFEE (U.S. CL. 46).

FIRST USE 1-0-2011; IN COMMERCE 1-0-2011.

#### CLASS 35—ADVERTISING AND BUSINESS

FOR RETAIL SERVICES RELATED TO FOOD PRODUCTS, NAMELY, RETAIL STORE SERVICES, ONLINE RETAIL STORE SERVICES, AND RETAIL DISCOUNT STORE SERVICES, ALL FEATURING FOOD PRODUCTS (U.S. CLS. 100, 101 AND 102).

FIRST USE 1-0-2011; IN COMMERCE 1-0-2011.

4,481,432. THE LUTHERAN UNIVERSITY ASSOCIATION, INC., VALPARAISO, IN. SN 85-144,675. PUB. 9-13-2011, FILED 10-4-2010.



OWNER OF U.S. REG. NOS. 2,454,950, 2,479,369, AND OTHERS.

THE MARK CONSISTS OF A STYLIZED LETTER "V" WITH A FLAME AND SHIELD.

#### CLASS 12—VEHICLES

FOR LICENSE PLATE FRAMES (U.S. CLS. 19, 21, 23, 31, 35 AND 44).

FIRST USE 8-1-2010; IN COMMERCE 8-1-2010.

#### CLASS 20—FURNITURE AND ARTICLES NOT OTHERWISE CLASSIFIED

FOR PICTURE FRAMES (U.S. CLS. 2, 13, 22, 25, 32 AND 50).

FIRST USE 8-1-2010; IN COMMERCE 8-1-2010.

4,481,436. APL LIMITED, SCOTTSDALE, AZ. SN 85-157,404. PUB. 4-24-2012, FILED 10-20-2010.



OWNER OF U.S. REG. NOS. 1,466,626, 3,107,458, AND OTHERS.

THE MARK CONSISTS OF A RECTANGLE THAT CONTAINS THE FOLLOWING WITHIN IT: THE WORDING "APL" BENEATH AN EAGLE DESIGN, WHICH BOTH

APPEAR ON A SHIPPING CONTAINER; TO THE RIGHT OF THE SHIPPING CONTAINER IS AN IMAGE OF A SATELLITE; BELOW THE SHIPPING CONTAINER AND SATELLITE DESIGN IS THE WORDING "SMARTEMP" ABOVE A THERMOMETER DESIGN.

### CLASS 39—TRANSPORTATION AND STORAGE

FOR TRANSPORTATION AND STORAGE OF GOODS IN REFRIGERATED CONDITIONS (U.S. CLS. 100 AND 105).

FIRST USE 6-8-2010; IN COMMERCE 6-8-2010.

### CLASS 42—SCIENTIFIC AND COMPUTER SERVICES

FOR REMOTE MONITORING OF ENVIRONMENTAL CONTROL SYSTEMS FOR SHIPPING CONTAINERS (U.S. CLS. 100 AND 101).

FIRST USE 6-8-2010; IN COMMERCE 6-8-2010.

4,481,438. AMERICAN PSYCHIATRIC ASSOCIATION, ARLINGTON, VA. SN 85-161,695. PUB. 9-20-2011, FILED 10-26-2010.

# DSM-5

THE MARK CONSISTS OF STANDARD CHARACTERS WITHOUT CLAIM TO ANY PARTICULAR FONT, STYLE, SIZE, OR COLOR.

OWNER OF U.S. REG. NOS. 2,148,566, 2,838,307, AND OTHERS.

### CLASS 9—ELECTRICAL AND SCIENTIFIC APPARATUS

FOR PRE-RECORDED INSTRUCTIONAL CDS AND DVDS FEATURING INFORMATION REGARDING THE CLASSIFICATION, DESCRIPTION, DIAGNOSIS AND TREATMENT OF MENTAL DISORDERS; DOWNLOADABLE ELECTRONIC PUBLICATIONS IN THE NATURE OF REFERENCE MANUALS FEATURING INFORMATION REGARDING THE CLASSIFICATION, DESCRIPTION, DIAGNOSIS AND TREATMENT OF MENTAL DISORDERS (U.S. CLS. 21, 23, 26, 36 AND 38).

FIRST USE 6-1-2013; IN COMMERCE 6-1-2013.

### CLASS 16—PAPER GOODS AND PRINTED MATTER

FOR PRINTED EDUCATIONAL MATERIALS, NAMELY, A SERIES OF BOOKS FEATURING INFORMATION REGARDING THE CLASSIFICATION, DESCRIPTION, DIAGNOSIS AND TREATMENT OF MENTAL DISORDERS (U.S. CLS. 2, 5, 22, 23, 29, 37, 38 AND 50).

FIRST USE 5-22-2013; IN COMMERCE 5-22-2013.

### CLASS 41—EDUCATION AND ENTERTAINMENT

FOR NON-DOWNLOADABLE ELECTRONIC PUBLICATIONS IN THE NATURE OF E-BOOKS FEATURING INFORMATION REGARDING THE CLASSIFICATION, DESCRIPTION, DIAGNOSIS AND TREATMENT OF MENTAL DISORDERS (U.S. CLS. 100, 101 AND 107).

FIRST USE 6-10-2013; IN COMMERCE 6-10-2013.

4,481,439. AGROMIN CORPORATION, OXNARD, CA. SN 85-163,669. PUB. 3-29-2011, FILED 10-28-2010.



THE COLOR(S) LIGHT GREEN, DARK GREEN, LIGHT BROWN, DARK BROWN AND WHITE IS/ARE CLAIMED AS A FEATURE OF THE MARK.

THE MARK CONSISTS OF A STYLIZED LETTER "O" CONSISTING OF TWO STYLIZED LEAVES COMPRISING ROUGHLY THE UPPER TWO-THIRDS OF THE CIRCUMFERENCE (EACH LEAF IS COLORED LIGHT GREEN WITH A DARK GREEN STREAK ACROSS THE BASE AND A WHITE STREAK RUNNING FROM THE BASE HALFWAY UP THE LEAF, WITH THE LEAVES ORIENTED CLOCKWISE) AND STYLIZED SOIL COMPRISING ROUGHLY THE BOTTOM THIRD OF THE CIRCUMFERENCE, SLIGHTLY OFFSET TO THE LEFT (COLORED LIGHT BROWN WITH DARK BROWN STREAKS).

### CLASS 1—CHEMICALS

FOR COMPOST; HUMUS; POTTING SOIL; RICE BRAN; SOIL AMENDMENTS; SOIL CONDITIONERS FOR AGRICULTURAL OR HORTICULTURAL USE (U.S. CLS. 1, 5, 6, 10, 26 AND 46).

FIRST USE 9-15-2010; IN COMMERCE 9-15-2010.

### CLASS 31—NATURAL AGRICULTURAL PRODUCTS

FOR MULCH; RAW BARK (U.S. CLS. 1 AND 46).

FIRST USE 9-1-2009; IN COMMERCE 1-1-2011.

### CLASS 40—MATERIAL TREATMENT

FOR RECYCLING OF WASTE (U.S. CLS. 100, 103 AND 106).

FIRST USE 8-15-2010; IN COMMERCE 8-15-2010.

4,481,440. CBL BRANDING, LLC, BELLEVUE, WA. SN 85-168,219. PUB. 3-29-2011, FILED 11-3-2010.

# TOOL TIME

THE MARK CONSISTS OF STANDARD CHARACTERS WITHOUT CLAIM TO ANY PARTICULAR FONT, STYLE, SIZE, OR COLOR.

OWNER OF U.S. REG. NOS. 3,124,850, 3,588,996, AND OTHERS.

NO CLAIM IS MADE TO THE EXCLUSIVE RIGHT TO USE "TOOL", APART FROM THE MARK AS SHOWN.

**CLASS 7—MACHINERY**

FOR HAND HELD PORTABLE POWER TOOLS, NAMELY, DRILLS, PLANERS, SANDERS, AND GRINDERS; HAND HELD PORTABLE POWER TOOLS, NAMELY, TOOL SETS COMPRISED OF DRILLS, PLANERS, SANDERS, AND GRINDERS; BENCH AND STATIONERY POWER TOOLS, NAMELY, SAWS, DRILLS, SANDERS, AND GRINDERS (U.S. CLS. 13, 19, 21, 23, 31, 34 AND 35).

FIRST USE 6-26-2013; IN COMMERCE 6-26-2013.

**CLASS 8—HAND TOOLS**

FOR HAND HELD TOOLS, NAMELY, HAMMERS, PLIERS, SCREW DRIVERS, AND WRENCHES; HAND HELD TOOLS, NAMELY, A TOOL SET COMPRISED OF HAMMERS, PLIERS, SCREW DRIVERS, AND WRENCHES (U.S. CLS. 23, 28 AND 44).

FIRST USE 11-6-2013; IN COMMERCE 11-6-2013.

4,481,443. TRYMAX INTERNATIONAL CORPORATION LIMITED, ACTON, LONDON, UNITED KINGDOM. SN 85-175,414. PUB. 3-29-2011, FILED 11-12-2010.



THE MARK CONSISTS OF THE WORD "TRYMAX" IN STYLIZED LETTERS.

**CLASS 14—JEWELRY**

FOR PRECIOUS METALS AND THEIR ALLOYS AND GOODS IN PRECIOUS METALS OR COATED THEREWITH, NOT INCLUDED IN OTHER CLASSES, NAMELY, BADGES, BOXES, BRACELETS, ANKLE BRACELETS, BROOCHES, CHARMS, CUFF LINKS, DECORATIVE BOXES, EARRINGS, FIGURINES, HAT ORNAMENTS, JEWELRY BOXES, JEWELRY CASES, KEY CHAINS, KEY RINGS, KEY FOBs, ORNAMENTAL PINS, PENDANTS, SCULPTURES, STATUES, STATUETTES, TIE CLIPS, TIE PINS, TROPHIES; JEWELLERY, COSTUME JEWELLERY, PRECIOUS STONES; HOROLOGICAL AND CHRONOMETRIC INSTRUMENTS, NAMELY, CLOCKS AND WATCHES AND PARTS THEREFOR (U.S. CLS. 2, 27, 28 AND 50).

FIRST USE 12-0-2010; IN COMMERCE 12-0-2010.

**CLASS 28—TOYS AND SPORTING GOODS**

FOR GYMNASTIC AND SPORTING ARTICLES NOT INCLUDED IN OTHER CLASSES, NAMELY, BALANCE BEAMS, EXERCISE AND GYMNASTIC BANNERS, GYMNASTIC APPARATUS, HORIZONTAL BARS, PARALLEL BARS, POMMEL HORSES, VAULTING HORSES, SPRINGBOARDS, TRAINING STOOLS; ATHLETIC WRIST AND JOINT SUPPORTS, SPORTING GOODS AND EQUIPMENT FOR SPEED TRAINING, NAMELY, RINGS, CONES, SPEED LADDERS, COACHING STICKS, TRAINING ARCHES, ANKLE BANDS, RESISTANCE CHUTES, HURDLES, SPORTS TRAINING DEVICE TO IMPROVE STRENGTH, TONING, CONDITIONING AND BALANCE; CARRIERS SPECIALLY ADAPTED FOR SPORT BALLS (U.S. CLS. 22, 23, 38 AND 50).

FIRST USE 12-0-2010; IN COMMERCE 12-0-2010.

4,481,444. RXHEAT, LLC, CHESTERFIELD, MO. SN 85-177,030. PUB. 5-1-2012, FILED 11-15-2010.



THE MARK CONSISTS OF STANDARD CHARACTERS WITHOUT CLAIM TO ANY PARTICULAR FONT, STYLE, SIZE, OR COLOR.

**CLASS 37—CONSTRUCTION AND REPAIR**

FOR PEST CONTROL SERVICES; INSTALLATION OF TRAPS AND MONITORING DEVICES FOR PEST CONTROL AND REMEDIATION (U.S. CLS. 100, 103 AND 106).

FIRST USE 2-28-2011; IN COMMERCE 2-28-2011.

**CLASS 40—MATERIAL TREATMENT**

FOR HEAT TREATMENT OF PHYSICAL STRUCTURES FOR THE PURPOSE OF PEST CONTROL (U.S. CLS. 100, 103 AND 106).

FIRST USE 2-28-2011; IN COMMERCE 2-28-2011.

**CLASS 41—EDUCATION AND ENTERTAINMENT**

FOR EDUCATION SERVICES, NAMELY, SEMINARS AND TRAINING IN THE FIELD OF DESICCATION FOR PEST-NEUTRALIZATION AND REMEDIATION, DOCUMENT RECOVERY, MOISTURE CONTROL, MOVING AIR, REMOVING VOLATILE ORGANIC COMPOUNDS, AND DRYING HAZARDOUS EQUIPMENT IN COMMERCIAL AND RESIDENTIAL SPACES (U.S. CLS. 100, 101 AND 107).

FIRST USE 2-28-2011; IN COMMERCE 2-28-2011.

4,481,450. NU-TIER BRANDS, INC., TULSA, OK. SN 85-193,522. PUB. 8-2-2011, FILED 12-8-2010.



THE MARK CONSISTS OF STANDARD CHARACTERS WITHOUT CLAIM TO ANY PARTICULAR FONT, STYLE, SIZE, OR COLOR.

**CLASS 35—ADVERTISING AND BUSINESS**

FOR VALUE ADDED RESELLER SERVICES, NAMELY, DISTRIBUTORSHIPS FEATURING LUBRICANTS, ANTI-FREEZE, PETROLEUM RELATED CHEMICALS AND AUTOMOTIVE ACCESSORIES; BRANDING SERVICES, NAMELY, CONSULTING, DEVELOPMENT, MANAGEMENT AND MARKETING OF THE BRANDS OF LUBRICANTS, ANTI-FREEZE, PETROLEUM RELATED CHEMICALS AND AUTOMOTIVE ACCESSORIES, FOR BUSINESSES (U.S. CLS. 100, 101 AND 102).

FIRST USE 1-1-2011; IN COMMERCE 1-1-2011.

**CLASS 39—TRANSPORTATION AND STORAGE**

FOR DISTRIBUTION SERVICES, NAMELY, DELIVERY OF LUBRICANTS, ANTI-FREEZE, PETROLEUM RELATED CHEMICALS AND AUTOMOTIVE ACCESSORIES (U.S. CLS. 100 AND 105).  
FIRST USE 1-1-2011; IN COMMERCE 1-1-2011.

4,481,452. CHINA RECYCLING ENERGY CORPORATION, NO. 88 NAN GUAN ZHENG, CHINA. SN 85-196,202. PUB. 4-24-2012, FILED 12-13-2010.



NO CLAIM IS MADE TO THE EXCLUSIVE RIGHT TO USE "CHINA RECYCLING ENERGY CORPORATION", APART FROM THE MARK AS SHOWN.

THE COLOR(S) BLUE, GREEN, LIGHT BLUE, BLACK AND WHITE IS/ARE CLAIMED AS A FEATURE OF THE MARK.

THE MARK CONSISTS OF THE BLACK LETTERS "CREG" WITH A BLUE SEMI-CIRCULAR ARC ABOVE AND A GREEN SEMI-CIRCULAR ARC BELOW, ADJACENT TO THE BLACK WORDING "CHINA RECYCLING ENERGY CORPORATION" ALL OUTLINED WITH WHITE HIGHLIGHTS AND APPEARING WITHIN A LIGHT BLUE RECTANGLE.

**CLASS 36—INSURANCE AND FINANCIAL**

FOR FINANCING OF WASTE TO ENERGY RECYCLING EQUIPMENT AND DEVICES (U.S. CLS. 100, 101 AND 102).  
FIRST USE 1-6-2014; IN COMMERCE 1-6-2014.

**CLASS 40—MATERIAL TREATMENT**

FOR CUSTOM MANUFACTURE OF WASTE TO ENERGY RECYCLING EQUIPMENT AND DEVICES TO THE ORDER AND SPECIFICATION OF OTHERS; OPERATE WASTE TO ENERGY RECYCLING SYSTEMS FOR INDUSTRIAL APPLICATIONS IN THE NATURE OF ENERGY RECYCLING SERVICES, NAMELY, CAPTURING AND CONVERSION OF WASTED ENERGY INTO USEFUL ELECTRICITY AND USEFUL STEAM (U.S. CLS. 100, 103 AND 106).  
FIRST USE 1-6-2014; IN COMMERCE 1-6-2014.

**CLASS 42—SCIENTIFIC AND COMPUTER SERVICES**

FOR DESIGN OF WASTE TO ENERGY RECYCLING SYSTEMS FOR INDUSTRIAL APPLICATIONS (U.S. CLS. 100 AND 101).  
FIRST USE 1-6-2014; IN COMMERCE 1-6-2014.

4,481,454. IONETIX CORPORATION, SAN FRANCISCO, CA. SN 85-206,452. PUB. 11-29-2011, FILED 12-28-2010.



THE MARK CONSISTS OF THE WORDING "IONETIX" AND A DEPICTION OF SPIRAL COILS FORMING CIRCLES.

**CLASS 5—PHARMACEUTICALS**

FOR RADIOACTIVE ISOTOPES FOR MEDICAL USE, NAMELY, RADIO-ISOTOPE MARKERS FOR THERAPEUTIC OR DIAGNOSTIC USE (U.S. CLS. 6, 18, 44, 46, 51 AND 52).  
FIRST USE 9-26-2013; IN COMMERCE 9-26-2013.

**CLASS 9—ELECTRICAL AND SCIENTIFIC APPARATUS**

FOR CYCLOTRONS; RADIATION DETECTORS (U.S. CLS. 21, 23, 26, 36 AND 38).  
FIRST USE 9-26-2013; IN COMMERCE 9-26-2013.

**CLASS 42—SCIENTIFIC AND COMPUTER SERVICES**

FOR RESEARCH AND DEVELOPMENT SERVICES IN THE FIELD OF RADIATION DETECTION (U.S. CLS. 100 AND 101).  
FIRST USE 9-26-2013; IN COMMERCE 9-26-2013.

4,481,455. IONETIX CORPORATION, SAN FRANCISCO, CA. SN 85-206,460. PUB. 11-22-2011, FILED 12-28-2010.



THE MARK CONSISTS OF SPIRAL COILS FORMING CIRCLES.

**CLASS 5—PHARMACEUTICALS**

FOR RADIOACTIVE ISOTOPES FOR MEDICAL USE, NAMELY, RADIO-ISOTOPE MARKERS FOR THERAPEUTIC OR DIAGNOSTIC USE (U.S. CLS. 6, 18, 44, 46, 51 AND 52).  
FIRST USE 9-26-2013; IN COMMERCE 9-26-2013.

**CLASS 9—ELECTRICAL AND SCIENTIFIC APPARATUS**

FOR CYCLOTRONS; RADIATION DETECTORS (U.S. CLS. 21, 23, 26, 36 AND 38).  
FIRST USE 9-26-2013; IN COMMERCE 9-26-2013.

**CLASS 42—SCIENTIFIC AND COMPUTER SERVICES**

FOR RESEARCH AND DEVELOPMENT SERVICES IN THE FIELD OF RADIATION DETECTION (U.S. CLS. 100 AND 101).  
FIRST USE 9-26-2013; IN COMMERCE 9-26-2013.

4,481,460. SCIESSSENT LLC, WAKEFIELD, MA. SN 85-222,659. PUB. 2-14-2012, FILED 1-20-2011.

# SCIESSSENT

THE MARK CONSISTS OF STANDARD CHARACTERS WITHOUT CLAIM TO ANY PARTICULAR FONT, STYLE, SIZE, OR COLOR.

**CLASS 1—CHEMICALS**

FOR CHEMICALS USED IN INDUSTRY AS WELL AS IN AGRICULTURE, HORTICULTURE AND FORESTRY, EXCEPT FUNGICIDES, HERBICIDES, INSECTICIDES AND PARASITICIDES; ODOR ABSORBING AGENTS FOR USE IN THE MANUFACTURE OF FIBERS, YARNS, THREADS, CLOTH, FABRICS, AND TEXTILES, INCLUDING WOVENS AND NON-WOVENS, IN BULK OR STOCK FORM; ODOR ABSORBING AGENTS FOR USE IN THE MANUFACTURE OF NEWLY MANUFACTURED SEMI-FINISHED AND FINISHED GOODS AND ARTICLES OF MANUFACTURE MADE WITH FIBERS, YARNS, THREADS, CLOTH, FABRICS, AND TEXTILES INCLUDING CLOTHING, UPHOLSTERY, LINENS, BEDDING, CARPETING, CURTAINS, AND RUGS; CHEMICALS, HAVING THE ABILITY TO PREVENT OR INHIBIT THE GROWTH OF MICROBES, BACTERIA, FUNGI, MOLDS, ALGAE AND/OR VIRUSES, FOR USE IN THE MANUFACTURE AND TREATMENT OF PAPER, PLASTICS, METALS, COATINGS, BLENDS AND DISPERSIONS, LEATHER, FIBERS, FABRICS, RESINS, WOOD, AND GLASS, AND GOODS MADE OF THE FOREGOING; CHEMICALS USED AS ADDITIVES FOR IMPARTING PROPERTIES TO PREVENT OR INHIBIT THE GROWTH OF MICROBES, BACTERIA, FUNGI, MOLDS, ALGAE AND VIRUSES IN COATINGS, VARNISHES, PAINTS, MORDANTS, CEMENTITIOUS COMPOSITIONS SUCH AS CEMENTS, GROUTS, AND PLASTER, AND ARTICLES MADE OR TREATED WITH SUCH COATINGS, VARNISHES, PAINTS, MORDANTS, AND CEMENTITIOUS COMPOSITIONS (U.S. CLS. 1, 5, 6, 10, 26 AND 46).  
FIRST USE 2-22-2011; IN COMMERCE 6-1-2011.

**CLASS 5—PHARMACEUTICALS**

FOR ANTI-BACTERIAL, ANTI-MICROBIAL, AND ANTI-ODOR COMPOUNDS FOR IMPREGNATING AND INCORPORATION INTO AND FOR APPLICATION TO OR TREATMENT OF INANIMATE OBJECTS AND SURFACES FOR MEDICAL AND SANITARY PURPOSES; COMPOUND APPLIED TO AND USED IN THE TREATMENT OF TEXTILES TO PROVIDE ANTIMICROBIAL AND/OR ODOR ABSORBING PROPERTIES; ODOR ABSORBING AGENTS FOR THE TREATMENT OF FIBERS, YARNS, THREADS, CLOTH, FABRICS, AND TEXTILES, INCLUDING WOVENS AND NON-WOVENS, IN BULK OR STOCK FORM; ODOR ABSORBING AGENTS FOR THE TREATMENT OF NEWLY MANUFACTURED SEMI-FINISHED AND FINISHED GOODS AND ARTICLES OF MANUFACTURE AND OF FINISHED GOODS MADE WITH FIBERS, YARNS, THREADS, CLOTH, FABRICS, AND TEXTILES INCLUDING CLOTHING, UPHOLSTERY, LINENS, BEDDING, CARPETING, CURTAINS AND RUGS (U.S. CLS. 6, 18, 44, 46, 51 AND 52).  
FIRST USE 2-22-2011; IN COMMERCE 6-1-2011.

4,481,464. LEADER TECHNOLOGIES INCORPORATED, LEWIS CENTER, OH. SN 85-230,106. PUB. 1-3-2012, FILED 1-31-2011.



OWNER OF U.S. REG. NO. 2,848,048.

THE COLOR(S) ORANGE IS/ARE CLAIMED AS A FEATURE OF THE MARK.

THE MARK CONSISTS OF FIVE ORANGE LINES SEPARATED BY SPACES ALONG A DIAGONAL AXIS WITH GEOMETRIC SHAPES APPEARING TO BE CUT OUT FROM THE CENTER OF THE LINES.

**CLASS 38—COMMUNICATION**

FOR TELECOMMUNICATIONS SERVICES, NAMELY, ELECTRONIC TRANSMISSION OF VOICE, DATA, INFORMATION AND IMAGES (U.S. CLS. 100, 101 AND 104).  
FIRST USE 8-31-2000; IN COMMERCE 8-31-2000.

**CLASS 42—SCIENTIFIC AND COMPUTER SERVICES**

FOR COMPUTER SERVICES, NAMELY, PROVIDING AN ONLINE NON-DOWNLOADABLE SUITE OF COMPUTER SOFTWARE FOR USE IN TELECOMMUNICATIONS THAT ENABLES COLLABORATION THROUGH TRACKING, CONTEXT, AND STORAGE COMPONENTS OF TECHNOLOGY WITHIN A WEB-BASED SYSTEM, ENABLES MANAGEMENT OF TASKS, ENABLES MANAGEMENT OF COMMUNICATIONS, NAMELY, TRACKING OF INCOMING AND OUTGOING WRITTEN, ELECTRONIC, AND TELEPHONIC COMMUNICATIONS, ENABLES FILE TRANSFERS, ENABLES USE OF USER-DEFINED TOOLS, NAMELY, NEWS INTERFACES, AND ESCALATIONS OF ALERT NOTIFICATION THAT ENHANCE THE PRODUCTIVITY OF THE USER, ENABLES TEAMWORK AMONG THE USERS, ENABLES ACCESS TO USER-GENERATED DATA, AND ENABLES THE USER TO LEVERAGE ENTERPRISE KNOWLEDGE; APPLICATION SERVICE PROVIDER (ASP) FEATURING SOFTWARE TO ENABLE OR FACILITATE THE UPLOADING, DOWNLOADING, STREAMING, POSTING, DISPLAYING, BLOGGING, LINKING, SHARING OR OTHERWISE PROVIDING ELECTRONIC MEDIA OR INFORMATION OVER COMMUNICATION NETWORKS; PROVIDING A WEB SITE FEATURING TECHNOLOGY THAT ENABLES ONLINE USERS TO CREATE PERSONAL PROFILES FEATURING SOCIAL NETWORKING INFORMATION AND TO TRANSFER AND SHARE SUCH INFORMATION AMONG MULTIPLE WEBSITES (U.S. CLS. 100 AND 101).

FIRST USE 8-31-2000; IN COMMERCE 8-31-2000.

4,481,468. OCHC LLC, SHAKER HEIGHTS, OH. SN 85-243,716. PUB. 4-2-2013, FILED 2-16-2011.

**TRI-HYDRA**

THE MARK CONSISTS OF STANDARD CHARACTERS WITHOUT CLAIM TO ANY PARTICULAR FONT, STYLE, SIZE, OR COLOR.

OWNER OF U.S. REG. NO. 3,142,426.

**CLASS 3—COSMETICS AND CLEANING PREPARATIONS**

FOR NON-MEDICATED MOUTH CARE PRODUCTS FOR RELIEF OF DRY MOUTH AND ASSOCIATED SYMPTOMS AND CONDITIONS, NAMELY, TOOTH PASTE, DENTIFRICES IN THE FORM OF MOUTH OR ORAL CHEWING GUM, MOUTH OR ORAL STRIPS IN THE NATURE OF DISSOLVABLE FLAVORED EDIBLE FILMS, MOUTH OR ORAL SPRAY, RINSE, WASH, AND BREATH MINTS, BREATH FRESHENING CONFECTIONARY IN THE NATURE OF DISSOLVABLE CANDY AND CHEWING GUM, MOUTH OR ORAL MOISTURIZERS IN THE NATURE OF GELS, LIQUIDS, AND SPRAYS, DENTIFRICES, AND BREATH FRESHENERS; TOOTH PASTE; BREATH FRESHENERS, NAMELY, MOUTH OR ORAL STRIPS IN THE NATURE OF DISSOLVABLE FLAVORED EDIBLE FILMS; BREATH FRESHENERS, NAMELY, MOUTH OR ORAL SPRAY, RINSES AND MINTS; DENTIFRICES; DENTAL BLEACHING GELS; BLEACHING PREPARATIONS FOR TEETH; TOOTH POLISHING PREPARATIONS; TOOTH WHITENING PREPARATIONS; STAIN REMOVAL PREPARATIONS OF TEETH; BLEACHING PENS FOR TEETH; AND DENTURE CLEANING PREPARATIONS (U.S. CLS. 1, 4, 6, 50, 51 AND 52).

FIRST USE 12-6-2006; IN COMMERCE 12-5-2011.

**CLASS 5—PHARMACEUTICALS**

FOR MEDICATED MOUTH CARE PRODUCTS FOR RELIEF OF DRY MOUTH AND ASSOCIATED SYMPTOMS AND CONDITIONS, NAMELY, TOOTH PASTE, DRINK POWDER, DENTIFRICES IN THE FORM OF MOUTH OR ORAL CHEWING GUM, MOUTH OR ORAL STRIPS IN THE NATURE OF DISSOLVABLE FLAVORED EDIBLE FILMS, MOUTH OR ORAL SPRAY, MOUTH OR ORAL LOZENGES, MOUTH OR ORAL RINSE, MOUTH OR ORAL WASH, BREATH MINTS, MOUTH OR ORAL MINTS, MOUTH OR ORAL SANITIZER, MOUTH OR ORAL ANTISEPTIC, MOUTH OR ORAL GEL, CANDY FOR MEDICAL PURPOSES, MOUTH OR ORAL MOISTURIZERS, DENTIFRICES, PRE-MOISTENED MEDICATED WIPES FOR USE IN ORAL OR MOUTH CARE, PROPHYLAXIS PASTES, AND BREATH FRESHENERS; MEDICATED TOOTH PASTE; POWDERED NUTRITIONAL SUPPLEMENT DRINK MIX; MEDICATED MOUTH OR ORAL CHEWING GUM; MEDICINAL MOUTH OR ORAL STRIPS IN THE NATURE OF DISSOLVABLE FLAVORED EDIBLE FILMS; MOUTH OR ORAL SPRAY FOR KILLING BACTERIA AND GERMS; MEDICATED MOUTH OR ORAL LOZENGES; MEDICATED MOUTH OR ORAL RINSE; MEDICATED MOUTH OR ORAL WASH; MEDICATED BREATH MINTS; MEDICATED MOUTH OR ORAL MINTS; MEDICATED MOUTH OR ORAL SANITIZER; MOUTH OR ORAL ANTISEPTIC; MEDICATED MOUTH OR ORAL GEL; CANDY FOR MEDICAL PURPOSES; MEDICATED MOUTH OR ORAL MOISTURIZERS; MEDICATED DENTIFRICES; MEDICATED BREATH FRESHENERS; MEDICATED DENTAL GELS; MEDICATED DENTAL FLOSS; ANTI-CAVITY DENTAL COATING PREPARATIONS CONTAINING FLUORIDE; MEDICATED TEETH AND GUM SENSITIVITY PREPARATIONS; MEDICATED CANKER SORE PREPARATIONS; MEDICATED ANTI-CAVITY LIQUID AND GEL FLUORIDE TREATMENTS; PREPARATIONS IN THE NATURE OF DENTAL TABLETS, GELS, AND RINSES FOR DISCLOSING PLAQUE AND TARTAR ON THE TEETH; DISINFECTANTS FOR DENTURES; DENTURE ADHESIVE; AND TEMPORARY TOOTH FILLINGS (U.S. CLS. 6, 18, 44, 46, 51 AND 52).

FIRST USE 12-5-2006; IN COMMERCE 12-5-2006.

4,481,473. FISHER COMPANIES, LLC, MT. PLEASANT, MI. SN 85-253,043. PUB. 11-27-2012, FILED 2-28-2011.

THE MARK CONSISTS OF THE WORD "FISHER" IN STYLIZED FONT.

SEC. 2(F).

**CLASS 19—NON-METALLIC BUILDING MATERIALS**

FOR SAND; GRAVEL; STONE; CONCRETE; LIMESTONE; RIPRAP, NAMELY, STONES; HOT MIX AND COLD PATCH ASPHALT; NON-AGRICULTURAL LIME FOR USE IN CONSTRUCTION, NAMELY, BEET LIME (U.S. CLS. 1, 12, 33 AND 50).

FIRST USE 0-0-1983; IN COMMERCE 0-0-1983.

**CLASS 37—CONSTRUCTION AND REPAIR**

FOR HEAVY CONSTRUCTION CONTRACTING AND CONSTRUCTION MANAGEMENT SERVICES; CONSTRUCTION SERVICES, NAMELY, CONCRETE PAVING, SITE CLEARING, EXCAVATION, PAD PREPARATION, GRADING, AND ASPHALT PAVING SERVICES (U.S. CLS. 100, 103 AND 106).

FIRST USE 0-0-1983; IN COMMERCE 0-0-1983.



**CLASS 39—TRANSPORTATION AND STORAGE**

FOR TRUCKING SERVICES, NAMELY, HAULING OF SAND, GRAVEL, LIMESTONE, RIPRAP, CRUSHED CONCRETE, TOP SOIL, HOT MIX AND COLD PATCH ASPHALT, BULK CEMENT, ROCK SALT, WOOD CHIPS, COMPOST, BEET LIME, AGRICULTURAL LIME, ATHLETIC LIME MEAL, CONTAMINATED SOILS, SNOW, FERTILIZER AND AGRICULTURAL PRODUCTS; UTILITY SERVICES, NAMELY, PROVIDING WATER AND SEWER SERVICES (U.S. CLS. 100 AND 105).

FIRST USE 0-0-1983; IN COMMERCE 0-0-1983.

4,481,475. HOWARD SILVERS & SONS PTY LTD., CHATSWOOD, AUSTRALIA. SN 85-255,404. PUB. 2-21-2012, FILED 3-2-2011.

# PROGRIP

THE MARK CONSISTS OF STANDARD CHARACTERS WITHOUT CLAIM TO ANY PARTICULAR FONT, STYLE, SIZE, OR COLOR.

**CLASS 8—HAND TOOLS**

FOR MUDDLERS; NON-ELECTRIC ICE CRUSHERS; HAND OPERATED CHISELS; NON-ELECTRIC CARVING FORKS; MEZZULUNAS; PESTLES; PIZZA CUTTERS; AND ICE PICKS (U.S. CLS. 23, 28 AND 44).

FIRST USE 5-31-2010; IN COMMERCE 4-18-2011.

**CLASS 21—HOUSEWARES AND GLASS**

FOR SPOONS FOR STIRRING; NON-ELECTRIC GRINDERS; POTATO MASHERS; SOUP LADLES; WINE BOTTLE SPEED POURERS; SPEED POURERS FOR BOTTLES; BARBECUE GRILL SCRAPERS; WHISKS (U.S. CLS. 2, 13, 23, 29, 30, 33, 40 AND 50).

FIRST USE 5-31-2010; IN COMMERCE 4-18-2011.



PRIORITY CLAIMED UNDER SEC. 44(D) ON CANADA APPLICATION NO. 1504927, FILED 11-22-2010.

THE MARK CONSISTS OF THE WORDING "BLUEHAT" TOGETHER WITH A DESIGN ELEMENT, CONSISTING OF TWO CURVING LINES FORMING A STYLIZED HAT.

**CLASS 35—ADVERTISING AND BUSINESS**

FOR SOCIAL MEDIA STRATEGY AND MARKETING CONSULTANCY FOCUSING ON HELPING CLIENTS CREATE AND EXTEND THEIR PRODUCT AND BRAND STRATEGIES BY BUILDING VIRALLY ENGAGING MARKETING SOLUTIONS (U.S. CLS. 100, 101 AND 102).

FIRST USE 5-0-2010; IN COMMERCE 5-0-2010.

**CLASS 42—SCIENTIFIC AND COMPUTER SERVICES**

FOR COMPUTER SERVICES, NAMELY, CREATING AN ON-LINE COMMUNITY FOR MEMBERS TO PARTICIPATE IN DISCUSSIONS, GET FEEDBACK FROM THEIR PEERS, FORM VIRTUAL COMMUNITIES, AND ENGAGE IN SOCIAL NETWORKING (U.S. CLS. 100 AND 101).

FIRST USE 6-0-2009; IN COMMERCE 6-0-2009.

4,481,480. C. R. BARD, INC., MURRAY HILL, NJ. SN 85-276,131. PUB. 11-15-2011, FILED 3-24-2011.

# MY PICC

THE MARK CONSISTS OF STANDARD CHARACTERS WITHOUT CLAIM TO ANY PARTICULAR FONT, STYLE, SIZE, OR COLOR.

NO CLAIM IS MADE TO THE EXCLUSIVE RIGHT TO USE "PICC", APART FROM THE MARK AS SHOWN.

**CLASS 10—MEDICAL APPARATUS**

FOR MEDICAL DEVICES AND APPARATUS, NAMELY, PERIPHERAL INSERTED CENTRAL CATHETER KITS, COMPOSED PRIMARILY OF PERIPHERAL INSERTED CENTRAL CATHETERS AND PARTS AND FITTINGS THEREFOR AND ONE OR MORE OF THE FOLLOWING ITEMS: FENESTRATED DRAPES, PROBE COVERS, TABLE COVERS, SURGICAL GOWNS, GLOVES, CHLORHEXIDINE GLUCANATE, SHEETS, MASKS, SHOE COVERS, SURGICAL TOWEL, INTRODUCER NEEDLES, END CAPS, GAUZE, MEASURING TAPE, LIDOCAINE, SALINE, IV CATHETERS, GUIDEWIRES, FORCEPS, SCALPELS, SYRINGES, INSERTION STYLETS, HYPODERMIC NEEDLES, PREP PADS, ANCHOR AND SURGICAL TAPE, ANTIMICROBIAL PATCHES, TRANSPARENT DRESSINGS AND CATHETER STABILIZATION DEVICES (U.S. CLS. 26, 39 AND 44).

FIRST USE 8-31-2011; IN COMMERCE 8-31-2011.

**CLASS 40—MATERIAL TREATMENT**

FOR CREATING TRAYS WITH VARIOUS MEDICAL DEVICES AND MEDICAL PRODUCTS BASED ON THE ORDER AND SPECIFICATION OF CUSTOMERS (U.S. CLS. 100, 103 AND 106).

FIRST USE 8-31-2011; IN COMMERCE 8-31-2011.

4,481,482. SACKS HOLDINGS, INC., RANCHO SANTA FE, CA. SN 85-278,808. PUB. 9-11-2012, FILED 3-28-2011.

# UHEALTH

THE MARK CONSISTS OF STANDARD CHARACTERS WITHOUT CLAIM TO ANY PARTICULAR FONT, STYLE, SIZE, OR COLOR.

**CLASS 3—COSMETICS AND CLEANING PREPARATIONS**

FOR EYEWEAR CLEANING KITS COMPRISED OF CLEANING FLUID AND CLEANING CLOTHS, EYEGLASS LENS CLEANING SOLUTIONS, IMPREGNATED LENS CLEANING CLOTHS (U.S. CLS. 1, 4, 6, 50, 51 AND 52).

FIRST USE 5-30-2013; IN COMMERCE 5-30-2013.

**CLASS 9—ELECTRICAL AND SCIENTIFIC APPARATUS**

FOR EYE CARE PRODUCTS, NAMELY, EYEGLASSES, EYEGLASS CASES, CONTACT LENSES, CONTACT LENS CASES, SUNGLASSES, EYEGLASS CHAINS, EYEGLASS CORDS (U.S. CLS. 21, 23, 26, 36 AND 38).

FIRST USE 5-30-2013; IN COMMERCE 5-30-2013.

---

4,481,483. LAKE NONA PROPERTY HOLDINGS, LLC, ORLANDO, FL. SN 85-285,037. PUB. 3-12-2013, FILED 4-4-2011.

**LAUREATE PARK**

THE MARK CONSISTS OF STANDARD CHARACTERS WITHOUT CLAIM TO ANY PARTICULAR FONT, STYLE, SIZE, OR COLOR.

NO CLAIM IS MADE TO THE EXCLUSIVE RIGHT TO USE "PARK", APART FROM THE MARK AS SHOWN.

**CLASS 36—INSURANCE AND FINANCIAL**

FOR REAL ESTATE AGENCIES; REAL ESTATE BROKERAGE; REAL ESTATE LISTING; REAL ESTATE MANAGEMENT SERVICES (U.S. CLS. 100, 101 AND 102).

FIRST USE 2-28-2011; IN COMMERCE 2-28-2011.

**CLASS 37—CONSTRUCTION AND REPAIR**

FOR CONSTRUCTION SERVICES, NAMELY, PLANNING, LAYING OUT AND CONSTRUCTION OF A PLANNED RESIDENTIAL COMMUNITY; REAL ESTATE DEVELOPMENT; RESIDENTIAL AND COMMERCIAL BUILDING CONSTRUCTION (U.S. CLS. 100, 103 AND 106).

FIRST USE 2-28-2011; IN COMMERCE 2-28-2011.

---

4,481,489. INNOCENTIVE, INC., WALTHAM, MA. SN 85-295,736. PUB. 10-25-2011, FILED 4-14-2011.

**CHALLENGE DRIVEN INNOVATION**

THE MARK CONSISTS OF STANDARD CHARACTERS WITHOUT CLAIM TO ANY PARTICULAR FONT, STYLE, SIZE, OR COLOR.

**CLASS 35—ADVERTISING AND BUSINESS**

FOR BUSINESS CONSULTING AND ADVISORY SERVICES; PROVIDING A SECURE WEBSITE FOR BUSINESS PURPOSES FOR REGISTERED USERS WITHIN A CLIENT ORGANIZATION TO POST SCIENTIFIC, TECHNICAL AND BUSINESS CHALLENGES, COLLABORATE AND PROPOSE SOLUTIONS, AND PROVIDE FEEDBACK AND RECOMMENDATIONS FOR SOLUTIONS FOR OTHERS (U.S. CLS. 100, 101 AND 102).

FIRST USE 1-0-2011; IN COMMERCE 1-0-2011.

**CLASS 42—SCIENTIFIC AND COMPUTER SERVICES**

FOR DESIGNING, CREATING, MAINTAINING AND HOSTING A SECURE WEB SITE FOR REGISTERED USERS WITHIN A CLIENT ORGANIZATION TO POST SCIENTIFIC, TECHNICAL AND BUSINESS CHALLENGES, COLLABORATE AND PROPOSE SOLUTIONS, AND PROVIDE FEEDBACK AND RECOMMENDATIONS FOR SOLUTIONS FOR OTHERS; PROVIDING DATA MIGRATION SERVICES FOR CLIENT CHALLENGES IN THE NATURE OF PROVIDING TECHNICAL ADVICE TO USERS REGARDING THE POSTING OF SCIENTIFIC, TECHNICAL AND BUSINESS CHALLENGES ON AN ONLINE INTERACTIVE EXCHANGE THAT IS ACCESSIBLE TO A NETWORK OF USERS (U.S. CLS. 100 AND 101).

FIRST USE 1-0-2011; IN COMMERCE 1-0-2011.

---

4,481,492. PELLICONI & C.S.P.A., OZZANO DELL'EMILIA, ITALY. SN 85-306,917. PUB. 3-12-2013, FILED 4-28-2011.



PRIORITY CLAIMED UNDER SEC. 44(D) ON ERPNCMNTY TM OFC APPLICATION NO. 009910647, FILED 4-20-2011, REG. NO. 009910647, DATED 10-22-2012, EXPIRES 4-20-2022.

THE MARK CONSISTS OF THE LETTER "P" WITHIN A CIRCLE.

**CLASS 6—METAL GOODS**

FOR METAL CLOSURES FOR CONTAINERS, NAMELY, CROWN CAPS, TWIST CLOSURES, ALL MADE OF METAL (U.S. CLS. 2, 12, 13, 14, 23, 25 AND 50).

FIRST USE 6-0-2011; IN COMMERCE 7-0-2011.

**CLASS 20—FURNITURE AND ARTICLES NOT OTHERWISE CLASSIFIED**

FOR CONTAINER CLOSURES MADE OF PLASTIC, NAMELY, CROWN CAPS (U.S. CLS. 2, 13, 22, 25, 32 AND 50).

FIRST USE 6-0-2011; IN COMMERCE 7-0-2011.

4,481,496. PLY GEM INDUSTRIES, INC., CARY, NC. SN 85-318,415. PUB. 3-27-2012, FILED 5-11-2011.

## DESIGNED EXTERIOR

THE MARK CONSISTS OF STANDARD CHARACTERS WITHOUT CLAIM TO ANY PARTICULAR FONT, STYLE, SIZE, OR COLOR.

### CLASS 6—METAL GOODS

FOR METAL BUILDING MATERIALS, NAMELY, SOFFITS, FASCIA, TRIM, TRIM SHEET, SHUTTERS, SIDING, ROOF VENTS FOR HEATING, COOLING AND VENTILATION IN RESIDENTIAL AND COMMERCIAL BUILDINGS, GUTTER COIL, GUTTERS AND GUTTER GUARDS, ENTRY AND PATIO DOORS, WINDOWS (U.S. CLS. 2, 12, 13, 14, 23, 25 AND 50).  
FIRST USE 1-0-2010; IN COMMERCE 1-0-2010.

### CLASS 19—NON-METALLIC BUILDING MATERIALS

FOR NON-METAL BUILDING MATERIALS, NAMELY, MANUFACTURED STONE AND BRICK VENEER FOR USE ON INTERIOR AND EXTERIOR WALLS, FLOORS AND SURFACES, VINYL SIDING, POLYPROPYLENE SIDING, NON-METAL BUILDING PRODUCTS, NAMELY, SOFFIT, FASCIA, SHUTTERS, SIDING, TRIM, AND MOUNTS IN THE NATURE OF NON-METAL STRUCTURES FOR MOUNTING ELECTRICAL OUTLETS, FACETS, LIGHT FIXTURES AND METERS; NON-METAL BUILDING PRODUCTS, NAMELY, NON-METAL VENTS FOR DRYERS, FOUNDATIONS, RANGE HOODS, ROOFS AND GABLES FOR HEATING, COOLING AND VENTILATION; NON-METAL FENCE PANELS, SLATS AND PICKETS, NON-METAL FENCE POSTS, NON-METAL RAILINGS FOR FENCES, NON-METAL WINDOWS, NON-METAL PATIO DOORS AND VINYL PATIO DOORS (U.S. CLS. 1, 12, 33 AND 50).  
FIRST USE 1-0-2010; IN COMMERCE 1-0-2010.

### CLASS 42—SCIENTIFIC AND COMPUTER SERVICES

FOR HOME EXTERIOR ARCHITECTURAL DESIGN AND CONSULTING SERVICES (U.S. CLS. 100 AND 101).  
FIRST USE 1-0-2010; IN COMMERCE 1-0-2010.

4,481,497. DANA LIMITED, MAUMEE, OH. SN 85-319,246. PUB. 9-20-2011, FILED 5-12-2011.

## PEOPLE FINDING A BETTER WAY

THE MARK CONSISTS OF STANDARD CHARACTERS WITHOUT CLAIM TO ANY PARTICULAR FONT, STYLE, SIZE, OR COLOR.

OWNER OF U.S. REG. NOS. 1,834,922, 2,963,187, AND 3,034,251.

### CLASS 6—METAL GOODS

FOR METAL GASKETS FOR USE IN INTERNAL COMBUSTION ENGINES NOT FOR LAND VEHICLES (U.S. CLS. 2, 12, 13, 14, 23, 25 AND 50).  
FIRST USE 12-31-2012; IN COMMERCE 12-31-2012.

### CLASS 7—MACHINERY

FOR VEHICLE ENGINE PARTS, NAMELY, VALVE STEM SEALS AND NON-METAL GASKETS FOR USE IN INTERNAL COMBUSTION ENGINES, NON-METAL GASKETS AND NON-METAL OIL SEALS FOR VEHICLES, METAL ENGINE GASKETS FOR VEHICLES (U.S. CLS. 13, 19, 21, 23, 31, 34 AND 35).  
FIRST USE 12-31-2012; IN COMMERCE 12-31-2012.

### CLASS 12—VEHICLES

FOR LAND VEHICLE PARTS, NAMELY, AXLES AND DRIVESHAFT ASSEMBLIES AND COMPONENTS, NAMELY, YOKES, GEAR BOXES, TRANSFER CASES, AND TRANSMISSIONS; UNIVERSAL JOINTS FOR LAND VEHICLES, AND COMPONENTS THEREOF, NAMELY, JOURNAL CROSSES AND NEEDLE BEARINGS (U.S. CLS. 19, 21, 23, 31, 35 AND 44).  
FIRST USE 12-31-2012; IN COMMERCE 12-31-2012.

### CLASS 17—RUBBER GOODS

FOR ADHESIVE SEALANTS FOR GENERAL USE (U.S. CLS. 1, 5, 12, 13, 35 AND 50).  
FIRST USE 12-31-2012; IN COMMERCE 12-31-2012.

4,481,504. M & A VENTURES, LTD., DENVER, CO. SN 85-343,096. PUB. 5-22-2012, FILED 6-10-2011.

## EVERYBODYISART

THE MARK CONSISTS OF STANDARD CHARACTERS WITHOUT CLAIM TO ANY PARTICULAR FONT, STYLE, SIZE, OR COLOR.

### CLASS 38—COMMUNICATION

FOR PROVIDING INTERNET CHAT ROOMS IN THE FIELDS OF PHOTOGRAPHY, MODELING AND ART OF ANY MEDIUM (U.S. CLS. 100, 101 AND 104).  
FIRST USE 9-1-2012; IN COMMERCE 9-1-2012.

### CLASS 41—EDUCATION AND ENTERTAINMENT

FOR EDUCATIONAL SERVICES, NAMELY, PROVIDING WORKSHOPS AND SEMINARS IN THE FIELDS OF PHOTOGRAPHY, MODELING AND ART OF ANY MEDIUM; ON-LINE JOURNALS, NAMELY, BLOGS FEATURING INFORMATION, JOURNALS AND INTERNET WEBSITE COMMUNICATION PORTALS IN THE FIELDS OF PHOTOGRAPHY, MODELING AND ART OF ANY MEDIUM (U.S. CLS. 100, 101 AND 107).  
FIRST USE 9-1-2012; IN COMMERCE 9-1-2012.

4,481,507. GRIDSPEAK CORPORATION, OAKLAND, CA.  
SN 85-349,692. PUB. 3-12-2013, FILED 6-17-2011.

4,481,514. ASPEN AVIONICS, INC., ALBUQUERQUE, NM.  
SN 85-364,036. PUB. 11-6-2012, FILED 7-6-2011.



# GRIDSPEAK

THE MARK CONSISTS OF STANDARD CHARACTERS WITHOUT CLAIM TO ANY PARTICULAR FONT, STYLE, SIZE, OR COLOR.

## CLASS 35—ADVERTISING AND BUSINESS

FOR ENERGY MANAGEMENT SERVICES, NAMELY, PROVIDING A WEB-BASED ON-LINE PORTAL THAT PROVIDES CUSTOMER ACCESS TO ENERGY USAGE PATTERN INFORMATION, AND ENERGY CONSUMPTION AND USAGE DATA FOR PURPOSES OF ENERGY UTILITY ACCOUNT BUSINESS MANAGEMENT AND ENERGY USAGE MANAGEMENT; ENERGY USAGE MANAGEMENT; BUSINESS CONSULTING SERVICES FOR THE ENERGY INDUSTRY, NAMELY, WITH RELATION TO STRATEGY, MARKETING AND OPERATIONS IN THE FIELDS OF ENERGY MARKETING AND THE ENERGY TRADING MARKET; BUSINESS CONSULTING SERVICES IN THE FIELD OF ENERGY MARKET TRANSACTION MANAGEMENT; ENERGY USAGE MANAGEMENT INFORMATION SERVICES (U.S. CLS. 100, 101 AND 102).

FIRST USE 2-0-2012; IN COMMERCE 2-0-2012.

## CLASS 42—SCIENTIFIC AND COMPUTER SERVICES

FOR PROVIDING TEMPORARY USE OF NONDOWNLOADABLE COMPUTER SOFTWARE FOR ANALYZING, DISPLAYING, ORGANIZING, AGGREGATING, PERFORMING, MANAGING, AUTOMATING AND TRANSMITTING BUSINESS TRANSACTIONS AND TRADES IN THE ENERGY MARKET VIA ELECTRONIC AND OPTICAL COMMUNICATION NETWORKS AND WIRED AND WIRELESS DEVICES; PROVIDING TEMPORARY USE OF NONDOWNLOADABLE COMPUTER SOFTWARE FOR ANALYZING, DISPLAYING, ORGANIZING, AGGREGATING, COLLECTING, MANAGING, VISUALIZING, AUTOMATING AND TRANSMITTING DATA, ANALYTICS, WORKFLOW AND INFORMATION ON ENERGY, ENERGY CUSTOMERS, THE ENERGY MARKET AND THE ENERGY TRADING MARKET; PROVIDING TEMPORARY USE OF NONDOWNLOADABLE COMPUTER SOFTWARE FOR USE BY INVESTORS AND TRADERS TO TRADE, HEDGE, SPECULATE AND INVEST ON THE ENERGY TRADING MARKET (U.S. CLS. 100 AND 101).

FIRST USE 2-0-2012; IN COMMERCE 2-0-2012.

THE MARK CONSISTS OF AN IMPRESSIONISTIC LETTER "C" BUILT OUT OF RF WAVES WITH AN AIRPLANE FLYING OUT OF THE CONCAVE PART OF THE LETTER SHAPE.

## CLASS 9—ELECTRICAL AND SCIENTIFIC APPARATUS

FOR ELECTRONIC INTERFACES AND GATEWAYS, NAMELY, TELECOMMUNICATIONS AND AIRCRAFT-BASED DATA NETWORKING HARDWARE AND SOFTWARE FOR USE IN DATA NETWORKING; COMPUTER NETWORKING PRODUCTS, NAMELY, COMPUTER PROGRAMS FOR USE IN NETWORKING COMPUTERS, COMPUTER APPLICATION SOFTWARE FOR NETWORKING COMPUTERS, OPERATING SOFTWARE, AND HARDWARE, NAMELY, HUBS, SWITCHES, ROUTERS, SERVERS, AND WIRELESS, LOCAL AREA NETWORK, ETHERNET, AND UNIVERSAL SERIAL BUS ACCESS POINTS; COMMUNICATION SOFTWARE AND HARDWARE FOR PROVIDING INTERACTIVE AND INTEROPERABLE COMMUNICATIONS BETWEEN EITHER OF EQUIPMENT CERTIFIED FOR AIRWORTHINESS BY APPLICABLE GOVERNMENTAL REGULATORY BODIES AND OTHER AIRCRAFT INSTRUMENTATION AND EQUIPMENT, NAMELY, INTERCOMS, TRANSCIEVERS, THERMOMETERS, AND RADIOS, SAFETY AND WARNING INSTRUMENTATION AND EQUIPMENT, NAMELY, RADAR, TRANSPONDERS, TRAFFIC ALERT AND COLLISION AVOIDANCE SYSTEMS (TCAS), GROUND-PROXIMITY WARNING SYSTEMS (GPWS), ARINC 708, FAILURE ENUNCIATORS, AND LIGHTNING DETECTORS, FLIGHT CONTROL AND MONITORING INSTRUMENTATION AND DEVICES, NAMELY, ALTIMETERS, GPS UNITS, WIDE AREA AUGMENTATION SYSTEMS (WAAS), GLIDE SCOPES, GYROSCOPES, PITCH AND YAW INDICATORS, AND AIRSPEED INDICATORS, AND ENGINE AND POWER CONTROL DEVICES AND INSTRUMENTATION, NAMELY, TACHOMETERS, OIL AND FUEL GAUGES, AND MANIFOLD PRESSURE GAUGES, AND EITHER OF PORTABLE COMPUTING DEVICES SUCH AS PERSONAL DIGITAL ASSISTANTS, MOBILE PHONES, SMART PHONES, TOUCH SCREEN COMPUTING DEVICES, TABLET COMPUTERS, LAPTOP COMPUTERS, NETBOOK COMPUTERS, AND PERSONAL COMPUTERS AND HARDWARE AND SOFTWARE FOR PROVIDING ACCESS TO THE INTERNET; COMMUNICATION SOFTWARE AND HARDWARE FOR PROVIDING INTERACTIVE AND INTEROPERABLE COMMUNICATIONS BETWEEN PORTABLE COMPUTING DEVICES SUCH AS PERSONAL DIGITAL ASSISTANTS, MOBILE PHONES, SMART PHONES, TOUCH SCREEN COMPUTING DEVICES, TABLET COMPUTERS, LAPTOP COMPUTERS, NET BOOK COMPUTERS, AND PERSONAL COMPUTERS AND HARDWARE AND SOFTWARE FOR PROVIDING ACCESS TO THE INTERNET; COMMUNICATION SOFTWARE AND HARDWARE PROVIDING THE ABILITY TO CONNECT TO AND DISCONNECT FROM A NUMBER OF DIFFERENT COMPUTER NETWORKS AND AVIATION AND AVIONICS EQUIPMENT AND INSTRUMENTATION WITHOUT A USER VISIBLE RECONFIGURATION; COMPUTER PROGRAMS FOR PROVIDING ADAPTIVE DISPLAYS USING VARIOUS TECHNIQUES IN PORTA-

BLE COMPUTING DEVICES SUCH AS PERSONAL DIGITAL ASSISTANTS, MOBILE PHONES, SMART PHONES, TOUCH SCREEN COMPUTING DEVICES, TABLET COMPUTERS, LAPTOP COMPUTERS, NETBOOK COMPUTERS, AND PERSONAL COMPUTERS; COMPUTER HARDWARE AND SOFTWARE FOR ENCRYPTION AND DECRYPTION OF DIGITAL FILES, INCLUDING AUDIO, VIDEO, TEXT, BINARY, STILL IMAGES, GRAPHICS AND MULTIMEDIA FILES; COMPUTER SOFTWARE IN THE NATURE OF A DYNAMIC DISTRIBUTED COMPUTING INFRASTRUCTURE USED TO BUILD AND DEVELOP FLIGHT-RELATED APPLICATIONS USED OVER THE INTERNET AND ON PORTABLE COMPUTING DEVICES SUCH AS PERSONAL DIGITAL ASSISTANTS, MOBILE PHONES, SMART PHONES, TOUCH SCREEN COMPUTING DEVICES, TABLET COMPUTERS, LAPTOP COMPUTERS, NETBOOK COMPUTERS, AND PERSONAL COMPUTERS; COMPUTER SOFTWARE FOR USE IN PROVIDING A COMPUTING ENVIRONMENT IN WHICH DEVELOPMENT OF COMPUTER APPLICATIONS IS FOSTERED, ALL IN THE NATURE OF SOFTWARE FOR DEVELOPMENT OF OTHER COMPUTER PROGRAMS FOR ALL ASPECTS OF FLIGHT-RELATED ACTIVITIES, INCLUDING BEFORE, DURING, AFTER, AND BETWEEN FLIGHTS, NAMELY, COMPUTER SOFTWARE FOR USE IN CHECKING WEATHER, FINALIZING ROUTES, FINALIZING FLIGHT PLANS, FILING AND OBTAINING CLEARANCES, PREPARING FLIGHT-RELATED CHARTS, PREPARING FLIGHT DATABASES, DESTINATION AND LOGISTICS PLANNING, NOTIFYING OTHERS OF UPCOMING FLIGHTS, CONFIRMING PILOT AND AIRCRAFT AIRWORTHINESS, CONFIRMING AIRCRAFT AVAILABILITY, PLANNING FOR PASSENGER COMFORT, LOADING FLIGHT PLANS, LOADING FLIGHT CLEARANCE INFORMATION, TUNING RADIO, PROVIDING CHART AND FLIGHT DATABASE MANAGEMENT, MONITORING FUEL STATUS AND CONSUMPTION, MONITORING ENGINE CONDITION AND PERFORMANCE, AVOIDING TURBULENCE, LIGHTNING, AND INCLEMENT WEATHER, AVOIDING FLIGHT OBSTACLES SUCH AS TOWERS, MOUNTAINS, AND OTHER TALL STRUCTURES, CHECKLIST EXECUTION, POSITION REPORTING AND TRACKING, COMMUNICATING WITH PEOPLE ON THE GROUND, KEEPING PASSENGERS COMFORTABLE, MONITORING AND REGULATING ENVIRONMENTAL SYSTEMS, CLOSING FLIGHT PLANS, FACILITATING FLIGHT LOG DATA ENTRY AND VERIFICATION, ARRIVAL NOTIFICATIONS, ARRANGING GROUND TRANSPORT, PROVIDING FLIGHT REVIEWS AND DEBRIEFINGS, INCIDENT REPORTING, PROVIDING FLIGHT TREND REVIEWS, SHARING FLIGHT EXPERIENCE, DATA ANALYSIS, MAINTAINING AIRCRAFT, FACILITATING PILOT TRAINING, MAINTAINING PILOT STATUS (U.S. CLS. 21, 23, 26, 36 AND 38).

FIRST USE 7-31-2012; IN COMMERCE 7-31-2012.

#### CLASS 35—ADVERTISING AND BUSINESS

FOR BUSINESS MANAGEMENT SERVICES IN CONNECTION WITH THE ESTABLISHMENT, MANAGEMENT, SUPERVISION, AND OPERATION OF A NETWORK OF COMPUTER PROGRAMMERS DEVELOPING FLIGHT-RELATED APPLICATIONS FOR PORTABLE COMPUTING DEVICES SUCH AS PERSONAL DIGITAL ASSISTANTS, MOBILE PHONES, SMART PHONES, TOUCH SCREEN COMPUTING DEVICES, TABLET COMPUTERS, LAPTOP COMPUTERS, NETBOOK COMPUTERS, AND PERSONAL COMPUTERS; ON-LINE BUSINESS OPERATION OF A NETWORK OF COMPUTER PROGRAMMERS FOR OTHERS WHO CREATE AND DEVELOP COMPUTER PROGRAMS IN THE FIELD OF FLIGHT-RELATED APPLICATIONS FOR PORTABLE COMPUTING DEVICES SUCH AS PERSONAL DIGITAL ASSISTANTS, MOBILE PHONES, SMARTPHONES, TOUCH SCREEN COMPUTING DEVICES, TABLET COMPUTERS, LAPTOP COMPUTERS, NETBOOK COMPUTERS, AND PERSONAL COMPUTERS USED FOR AND IN CONNECTION WITH ALL ASPECTS OF FLIGHT-RELATED ACTIVITIES, INCLUDING BEFORE, DURING, AFTER, AND BETWEEN FLIGHTS, NAMELY, COMPUTER PROGRAMS OR APPLICATIONS FOR USE IN CHECKING WEATHER, FINALIZING ROUTES, FINALIZING FLIGHT PLANS, FILING AND OBTAINING CLEARANCES, PREPARING FLIGHT CHARTS, DESTINATION AND LOGISTICS

PLANNING, NOTIFYING OTHERS OF UPCOMING FLIGHTS, CONFIRMING PILOT AND AIRCRAFT AIRWORTHINESS, CONFIRMING AIRCRAFT AVAILABILITY, PLANNING FOR PASSENGER COMFORT, LOADING FLIGHT PLANS, LOADING CLEARANCE INFORMATION, TUNING RADIOS, CHART AND FLIGHT DATABASE MANAGEMENT, MONITORING FUEL STATUS AND CONSUMPTION, MONITORING ENGINE CONDITION AND PERFORMANCE, AVOIDING TURBULENCE, LIGHTNING, AND INCLEMENT WEATHER, AVOIDING FLIGHT OBSTACLES SUCH AS MOUNTAINS, TOWERS, AND TALL BUILDINGS, CHECKLIST EXECUTION, POSITION REPORTING AND TRACKING, COMMUNICATING WITH PEOPLE ON THE GROUND, KEEPING PASSENGERS COMFORTABLE, MONITORING AND REGULATING ENVIRONMENTAL SYSTEMS, CLOSING FLIGHT PLANS, FACILITATING FLIGHT LOG DATA ENTRY AND VERIFICATION, PROVIDING ARRIVAL NOTIFICATIONS, ARRANGING GROUND TRANSPORTATION, PROVIDING A FLIGHT REVIEW AND DEBRIEFING, INCIDENT REPORTING, PROVIDING FLIGHT TREND REVIEWS, SHARING FLIGHT EXPERIENCE, PROVIDING DATA ANALYSIS, MAINTAINING AIRCRAFT MAINTENANCE RECORDS AND SCHEDULES, MAINTAINING AND ENHANCING PILOT FLIGHT SKILLS VIA SIMULATIONS (U.S. CLS. 100, 101 AND 102).

FIRST USE 7-31-2011; IN COMMERCE 7-31-2011.

#### CLASS 42—SCIENTIFIC AND COMPUTER SERVICES

FOR PROVIDING AN INTERNET WEBSITE PORTAL OFFERING INTEGRATION OF A DYNAMIC DISTRIBUTED COMPUTING INFRASTRUCTURE USED TO BUILD AND DEVELOP FLIGHT-RELATED APPLICATIONS USED OVER THE INTERNET AND ON PORTABLE COMPUTING DEVICES, NAMELY, PROVIDING A WEB-BASED ONLINE PORTAL FEATURING ON-LINE NON-DOWNLOADABLE SOFTWARE FOR USE IN INTEGRATION OF A DYNAMIC DISTRIBUTED COMPUTING INFRASTRUCTURE USED TO BUILD AND DEVELOP FLIGHT-RELATED APPLICATIONS USED OVER THE INTERNET AND ON PORTABLE COMPUTING DEVICES SUCH AS PERSONAL DIGITAL ASSISTANTS, MOBILE PHONES, SMART PHONES, TOUCH SCREEN COMPUTING DEVICES, TABLET COMPUTERS, LAPTOP COMPUTERS, NETBOOK COMPUTERS, AND PERSONAL COMPUTERS; PRODUCT TESTING SERVICES FOR OTHERS CONDUCTED BY A NETWORK OF COMPUTER PROGRAMMERS IN THE FIELD OF DEVELOPING FLIGHT-RELATED APPLICATIONS, NAMELY, PRODUCT TESTING FOR FLIGHT-RELATED SOFTWARE APPLICATIONS FOR PORTABLE COMPUTING DEVICES SUCH AS PERSONAL DIGITAL ASSISTANTS, MOBILE PHONES, SMART PHONES, TOUCH SCREEN COMPUTING DEVICES, TABLET COMPUTERS, LAPTOP COMPUTERS, NETBOOK COMPUTERS, AND PERSONAL COMPUTERS SERVICES (U.S. CLS. 100 AND 101).

FIRST USE 7-31-2011; IN COMMERCE 7-31-2011.

4,481,525. CNG TRANS LTD., COLUMBUS, OH. SN 85-383,465. PUB. 9-18-2012, FILED 7-28-2011.



THE COLOR(S) GREEN, BLUE AND WHITE IS/ARE CLAIMED AS A FEATURE OF THE MARK.

THE MARK CONSISTS OF A GREEN AND BLUE LEAF WITH A STYLIZED WHITE ROADWAY, HAVING A BLUE DIVIDING LINE, FORMING THE STEM.

**CLASS 6—METAL GOODS**

FOR NATURAL GAS CONVERSION KITS, COMPRISED OF A HIGH PRESSURE METAL STORAGE CYLINDER FOR COMPRESSED GAS SOLD EMPTY, HIGH PRESSURE AND LOW PRESSURE STEEL BRAIDED LINES, A REGULATOR, VALVES, A FUEL RAIL, FUEL INJECTORS, FUEL ADAPTORS, AND AN ELECTRONIC CONTROL UNIT AND ASSOCIATED WIRING THAT CONVERTS LIGHT DUTY TRUCKS AND AUTOMOBILES INTO COMPRESSED NATURAL GAS VEHICLES (U.S. CLS. 2, 12, 13, 14, 23, 25 AND 50).

FIRST USE 8-31-2012; IN COMMERCE 8-31-2012.

**CLASS 7—MACHINERY**

FOR NATURAL GAS DISPENSING UNITS COMPRISED OF COMPRESSORS, HOSES, ELECTRIC MOTORS AND VALVES FOR REFUELING VEHICLES EQUIPPED FOR BURNING NATURAL GAS AS A TRANSPORTATION FUEL, AND COMPONENT PARTS THEREOF; VEHICLE REFUELING APPLIANCES THAT TAKES NATURAL GAS, COMPRESSES IT, AND PUMPS IT INTO A COMPRESSED NATURAL GAS VEHICLE, NAMELY, A UNIT COMPRISED OF COMPRESSORS, PUMPS, HOSES AND NOZZLES AND ALL COMPONENT PARTS THEREOF; NATURAL GAS FUELING SYSTEMS COMPRISED OF COMPRESSORS, PUMPS, HOSES AND NOZZLES AND ALL COMPONENT PARTS THEREOF (U.S. CLS. 13, 19, 21, 23, 31, 34 AND 35).

FIRST USE 8-31-2012; IN COMMERCE 8-31-2012.

**CLASS 37—CONSTRUCTION AND REPAIR**

FOR INSTALLATION, MAINTENANCE AND REPAIR OF COMPRESSED NATURAL GAS FUELING SYSTEMS AND VEHICLE REFUELING APPLIANCES; COMPRESSED NATURAL GAS STATION MAINTENANCE SERVICES (U.S. CLS. 100, 103 AND 106).

FIRST USE 8-31-2012; IN COMMERCE 8-31-2012.

4,481,533. MILWAUKEE SCHOOL OF ENGINEERING (MSOE), MILWAUKEE, WI. SN 85-400,471. PUB. 3-27-2012, FILED 8-17-2011.

**WISCONSIN STEM PATHWAYS**

THE MARK CONSISTS OF STANDARD CHARACTERS WITHOUT CLAIM TO ANY PARTICULAR FONT, STYLE, SIZE, OR COLOR.

NO CLAIM IS MADE TO THE EXCLUSIVE RIGHT TO USE "WISCONSIN STEM", APART FROM THE MARK AS SHOWN.

**CLASS 9—ELECTRICAL AND SCIENTIFIC APPARATUS**

FOR DOWNLOADABLE ELECTRONIC PUBLICATIONS IN THE NATURE OF PERIODICALS, MAGAZINES, PAMPHLETS, AND BROCHURES IN THE FIELDS OF TECHNOLOGY, SCIENCE, MATHEMATICS, ENGINEERING, AND BIOMEDICINE (U.S. CLS. 21, 23, 26, 36 AND 38).

FIRST USE 9-15-2011; IN COMMERCE 9-15-2011.

**CLASS 16—PAPER GOODS AND PRINTED MATTER**

FOR PRINTED EDUCATIONAL RESOURCE MATERIALS, CASE STUDIES, BEST PRACTICES, INTERVIEWS, AND FEATURES IN THE NATURE OF PERIODICALS, MAGAZINES, PAMPHLETS, AND BROCHURES IN THE FIELDS OF TECHNOLOGY, SCIENCE, MATHEMATICS, ENGINEERING, AND BIOMEDICINE; PRINTED EDUCATIONAL RESOURCE MATERIALS TO PROMOTE AWARENESS, PROVIDE ASSISTANCE, AND STRENGTHEN PARTNERSHIPS FOR K-12 EDUCATION AMONG EDUCATORS, PARENTS, AND INDUSTRY REPRESENTATIVES IN THE NATURE OF PERIODICALS, MAGAZINES, PAMPHLETS, AND BROCHURES IN THE FIELDS OF TECHNOLOGY, SCIENCE, MATHEMATICS, ENGINEERING, AND BIOMEDICINE (U.S. CLS. 2, 5, 22, 23, 29, 37, 38 AND 50).

FIRST USE 9-15-2011; IN COMMERCE 9-15-2011.

**CLASS 41—EDUCATION AND ENTERTAINMENT**

FOR PROVIDING ON-LINE PUBLICATIONS IN THE NATURE OF PERIODICALS, MAGAZINES, PAMPHLETS, AND BROCHURES IN THE FIELDS OF TECHNOLOGY, SCIENCE, MATHEMATICS, ENGINEERING, AND BIOMEDICINE (U.S. CLS. 100, 101 AND 107).

FIRST USE 9-15-2011; IN COMMERCE 9-15-2011.

4,481,538. HOMES FOR OUR TROOPS, INC., TAUNTON, MA. SN 85-411,707. PUB. 4-9-2013, FILED 8-31-2011.

**BUILDING HOMES, REBUILDING LIVES**

THE MARK CONSISTS OF STANDARD CHARACTERS WITHOUT CLAIM TO ANY PARTICULAR FONT, STYLE, SIZE, OR COLOR.

**CLASS 35—ADVERTISING AND BUSINESS**

FOR CHARITABLE SERVICES, NAMELY, PROMOTING PUBLIC AWARENESS OF THE NEED FOR HOMES FOR DISABLED VETERANS; CHARITABLE SERVICES, NAMELY, PROCURING AND COORDINATING PROCUREMENT OF BUILDING MATERIALS, BUILDING EQUIPMENT, PROFESSIONAL TRADESMEN AND LABOR AND VOLUNTEERS FOR BUILDING NEW HOMES FOR DISABLED VETERANS (U.S. CLS. 100, 101 AND 102).

FIRST USE 7-0-2011; IN COMMERCE 7-0-2011.

**CLASS 36—INSURANCE AND FINANCIAL**

FOR CHARITABLE SERVICES, NAMELY, PROVIDING AND COORDINATING PROCUREMENT OF DONATED LAND FOR BUILDING HOMES FOR DISABLED VETERANS, AND SUPPORTING FUNDRAISING ACTIVITIES AND ACCEPTING AND PROCURING MONETARY CHARITABLE CONTRIBUTIONS FOR BUILDING NEW HOMES FOR DISABLED VETERANS; CHARITABLE FUNDRAISING SERVICES BY MEANS OF SELLING SWEATSHIRTS, T-SHIRTS, HATS, BABY BIBS, BABY CLOTHING, TRAVEL MUGS, INSULATED BEVERAGE HOLDERS, CARDS, PENS, STICKERS, MAGNETS, MOUSE PADS, AND ORNAMENTS TO RAISE FUNDS FOR BUILDING NEW HOMES FOR DISABLED VETERANS (U.S. CLS. 100, 101 AND 102).

FIRST USE 7-0-2011; IN COMMERCE 7-0-2011.

**CLASS 37—CONSTRUCTION AND REPAIR**

FOR CHARITABLE SERVICES, NAMELY, PROVIDING NEW HOME CONSTRUCTION FOR DISABLED VETERANS; PROVIDING DONATED BUILDING MATERIALS, BUILDING EQUIPMENT, PROFESSIONAL TRADESMEN AND LABOR AND VOLUNTEERS FOR BUILDING NEW HOMES FOR DISABLED VETERANS (U.S. CLS. 100, 103 AND 106).  
FIRST USE 7-0-2011; IN COMMERCE 7-0-2011.

---

4,481,539. QUEST DIAGNOSTICS INVESTMENTS INCORPORATED, WILMINGTON, DE. SN 85-413,202. PUB. 3-12-2013, FILED 9-1-2011.

**CLASS 19—NON-METALLIC BUILDING MATERIALS**

FOR NON-METAL WINDOWS; VINYL SIDING; NON-METAL DOORS (U.S. CLS. 1, 12, 33 AND 50).  
FIRST USE 11-20-2012; IN COMMERCE 11-20-2012.

**CLASS 35—ADVERTISING AND BUSINESS**

FOR DISTRIBUTORSHIP SERVICES IN THE FIELD OF WINDOWS (U.S. CLS. 100, 101 AND 102).  
FIRST USE 11-20-2012; IN COMMERCE 11-20-2012.

---

4,481,541. LANG EXTERIOR, INC., CHICAGO, IL. SN 85-413,525. PUB. 8-28-2012, FILED 9-1-2011.

# CHOICEPATH

THE MARK CONSISTS OF STANDARD CHARACTERS WITHOUT CLAIM TO ANY PARTICULAR FONT, STYLE, SIZE, OR COLOR.

**CLASS 42—SCIENTIFIC AND COMPUTER SERVICES**

FOR PROVIDING PATHOLOGY LABORATORY SERVICES (U.S. CLS. 100 AND 101).  
FIRST USE 11-30-2011; IN COMMERCE 11-30-2011.

**CLASS 44—MEDICAL, BEAUTY AND AGRICULTURAL SERVICES**

FOR PROVIDING PATHOLOGY INFORMATION, CONSULTANCY AND ADVISORY SERVICES; MEDICAL DIAGNOSTIC TESTING, MONITORING, AND REPORTING SERVICES PERTAINING TO THE MONITORING, DIAGNOSIS AND TREATMENT OF DISEASE AND MEDICAL CONDITIONS (U.S. CLS. 100 AND 101).  
FIRST USE 11-30-2011; IN COMMERCE 11-30-2011.

---

4,481,540. LANG EXTERIOR, INC., CHICAGO, IL. SN 85-413,493. PUB. 8-28-2012, FILED 9-1-2011.

# Lang Products

THE MARK CONSISTS OF STANDARD CHARACTERS WITHOUT CLAIM TO ANY PARTICULAR FONT, STYLE, SIZE, OR COLOR.

OWNER OF U.S. REG. NO. 2,600,642.  
NO CLAIM IS MADE TO THE EXCLUSIVE RIGHT TO USE "PRODUCTS", APART FROM THE MARK AS SHOWN.  
SEC. 2(F).

**CLASS 6—METAL GOODS**

FOR METAL WINDOWS; METAL DOORS (U.S. CLS. 2, 12, 13, 14, 23, 25 AND 50).  
FIRST USE 11-20-2012; IN COMMERCE 11-20-2012.

# Lang Exterior Products

THE MARK CONSISTS OF STANDARD CHARACTERS WITHOUT CLAIM TO ANY PARTICULAR FONT, STYLE, SIZE, OR COLOR.

OWNER OF U.S. REG. NO. 2,600,642.  
NO CLAIM IS MADE TO THE EXCLUSIVE RIGHT TO USE "EXTERIOR PRODUCTS", APART FROM THE MARK AS SHOWN.  
SEC. 2(F).

**CLASS 6—METAL GOODS**

FOR METAL AND NON-METAL WINDOWS (U.S. CLS. 2, 12, 13, 14, 23, 25 AND 50).  
FIRST USE 11-20-2012; IN COMMERCE 11-20-2012.

**CLASS 19—NON-METALLIC BUILDING MATERIALS**

FOR NON-METAL WINDOWS; VINYL SIDING; NON-METAL DOORS (U.S. CLS. 1, 12, 33 AND 50).  
FIRST USE 11-20-2012; IN COMMERCE 11-20-2012.

**CLASS 35—ADVERTISING AND BUSINESS**

FOR DISTRIBUTORSHIP SERVICES IN THE FIELD OF WINDOWS (U.S. CLS. 100, 101 AND 102).  
FIRST USE 11-20-2012; IN COMMERCE 11-20-2012.

---

4,481,542. LANG EXTERIOR, INC., CHICAGO, IL. SN 85-413,541. PUB. 8-28-2012, FILED S.R. 9-1-2011; AM. P.R. 6-19-2012.

# Windows by Lang

THE MARK CONSISTS OF STANDARD CHARACTERS WITHOUT CLAIM TO ANY PARTICULAR FONT, STYLE, SIZE, OR COLOR.

OWNER OF U.S. REG. NO. 2,600,642.  
NO CLAIM IS MADE TO THE EXCLUSIVE RIGHT TO USE "WINDOWS", APART FROM THE MARK AS SHOWN.  
SEC. 2(F).

**CLASS 6—METAL GOODS**

FOR METAL WINDOWS; METAL DOORS (U.S. CLS. 2, 12, 13, 14, 23, 25 AND 50).  
FIRST USE 11-20-2012; IN COMMERCE 11-20-2012.

**CLASS 19—NON-METALLIC BUILDING MATERIALS**

FOR NON-METAL WINDOWS; VINYL SIDING; NON-METAL DOORS (U.S. CLS. 1, 12, 33 AND 50).  
FIRST USE 11-20-2012; IN COMMERCE 11-20-2012.

**CLASS 35—ADVERTISING AND BUSINESS**

FOR DISTRIBUTORSHIP SERVICES IN THE FIELD OF WINDOWS (U.S. CLS. 100, 101 AND 102).  
FIRST USE 11-20-2012; IN COMMERCE 11-20-2012.

4,481,543. LANG EXTERIOR, INC., CHICAGO, IL. SN 85-413,548. PUB. 8-28-2012, FILED 9-1-2011.

## Lang Industries

THE MARK CONSISTS OF STANDARD CHARACTERS WITHOUT CLAIM TO ANY PARTICULAR FONT, STYLE, SIZE, OR COLOR.

OWNER OF U.S. REG. NO. 2,600,642.

NO CLAIM IS MADE TO THE EXCLUSIVE RIGHT TO USE "INDUSTRIES", APART FROM THE MARK AS SHOWN.

SEC. 2(F).

**CLASS 6—METAL GOODS**

FOR METAL WINDOWS; METAL DOORS (U.S. CLS. 2, 12, 13, 14, 23, 25 AND 50).  
FIRST USE 11-20-2012; IN COMMERCE 11-20-2012.

**CLASS 19—NON-METALLIC BUILDING MATERIALS**

FOR NON-METAL WINDOWS; VINYL SIDING; NON-METAL DOORS (U.S. CLS. 1, 12, 33 AND 50).  
FIRST USE 11-20-2012; IN COMMERCE 11-20-2012.

**CLASS 35—ADVERTISING AND BUSINESS**

FOR DISTRIBUTORSHIP SERVICES IN THE FIELD OF WINDOWS (U.S. CLS. 100, 101 AND 102).  
FIRST USE 11-20-2012; IN COMMERCE 11-20-2012.

4,481,551. ATLAS ROOFING CORPORATION, MERIDIAN, MS. SN 85-423,926. PUB. 1-1-2013, FILED 9-15-2011.

## MATADOR

THE MARK CONSISTS OF STANDARD CHARACTERS WITHOUT CLAIM TO ANY PARTICULAR FONT, STYLE,

SIZE, OR COLOR.

**CLASS 17—RUBBER GOODS**

FOR INSULATING MATERIALS; RIGID INSULATION, EXPANDED POLYSTYRENE (EPS) INSULATION FOR COMMERCIAL AND RESIDENTIAL APPLICATIONS IN THE CONSTRUCTION INDUSTRY, NAMELY, EXPANDED POLYSTYRENE (EPS) INSULATION FOR GARAGE DOORS; GARAGE DOOR INSULATION KITS (U.S. CLS. 1, 5, 12, 13, 35 AND 50).  
FIRST USE 8-1-2013; IN COMMERCE 8-1-2013.

**CLASS 19—NON-METALLIC BUILDING MATERIALS**

FOR GARAGE FINISHING WALL PANELS AND CEILING PANELS (U.S. CLS. 1, 12, 33 AND 50).  
FIRST USE 8-1-2013; IN COMMERCE 8-1-2013.

4,481,553. HOBBY TOWN UNLIMITED, INC., LINCOLN, NE. SN 85-425,047. PUB. 3-19-2013, FILED 9-16-2011.



THE MARK CONSISTS OF A DESIGN FEATURING A KITE, CHESSMAN, DICE AND SPINTOP ABOVE THE WORDS "BLUE CANNON". THE GAME PIECES AND KITE ARE SUPERIMPOSED ON A SEMICIRCLE WITH A VERTICALLY STRIPED BACKGROUND. THE WORDS "BLUE CANNON" APPEAR ON A SOLID COLOR, CURVED BANNER BENEATH THE SEMICIRCLE.

**CLASS 16—PAPER GOODS AND PRINTED MATTER**

FOR PAINT BRUSHES (U.S. CLS. 2, 5, 22, 23, 29, 37, 38 AND 50).  
FIRST USE 3-5-2013; IN COMMERCE 3-5-2013.

**CLASS 28—TOYS AND SPORTING GOODS**

FOR TOYS, GAMES AND PLAYTHINGS FOR HOBBY ENTHUSIASTS, NAMELY, NON-ELECTRONIC INTERACTIVE BOARD AND CARD GAMES, DICE GAMES, ACTION SKILL GAMES, TOY WEAPONS, DRAWING TOYS AND NON-ELECTRONIC INTERACTIVE ACTION TOYS (U.S. CLS. 22, 23, 38 AND 50).  
FIRST USE 3-5-2013; IN COMMERCE 3-5-2013.

4,481,554. BUFFINI & COMPANY, CARLSBAD, CA. SN 85-425,563. PUB. 7-10-2012, FILED 9-19-2011.

## REFERRAL MAKER

THE MARK CONSISTS OF STANDARD CHARACTERS



WITHOUT CLAIM TO ANY PARTICULAR FONT, STYLE, SIZE, OR COLOR.

NO CLAIM IS MADE TO THE EXCLUSIVE RIGHT TO USE "REFERRAL", APART FROM THE MARK AS SHOWN.

#### **CLASS 9—ELECTRICAL AND SCIENTIFIC APPARATUS**

FOR COMPUTER APPLICATION SOFTWARE FOR DATABASE MANAGEMENT FOR USE IN PERSONALIZING CONTENT; COMPUTER SOFTWARE FOR USE AS A CUSTOMER RELATIONSHIP MANAGEMENT PROGRAM, NAMELY, FOR USE IN DATABASE MANAGEMENT, TRACKING OF CUSTOMER CONTACTS, REMINDERS OF SCHEDULED ACTIVITIES AND TRACKING OF RESULTS; COMPUTER SOFTWARE FOR APPLICATION AND DATABASE INTEGRATION; COMPUTER SOFTWARE THAT PROVIDES REAL-TIME, INTEGRATED BUSINESS MANAGEMENT INTELLIGENCE BY COMBINING INFORMATION FROM VARIOUS DATABASES AND PRESENTING IT IN AN EASY-TO-UNDERSTAND USER INTERFACE; SOFTWARE FOR DATABASE MANAGEMENT, CUSTOMER RELATIONSHIP MANAGEMENT, DATA TRACKING AND DATA MANAGEMENT (U.S. CLS. 21, 23, 26, 36 AND 38).  
FIRST USE 5-1-2012; IN COMMERCE 5-1-2012.

#### **CLASS 35—ADVERTISING AND BUSINESS**

FOR PROVIDING AN ON-LINE SEARCHABLE DATABASE FEATURING BUSINESS INFORMATION AND BUSINESS CONTACTS; PROVIDING AN ON-LINE COMPUTER DATABASE IN THE FIELD OF DATABASE MANAGEMENT, CUSTOMER RELATIONSHIP MANAGEMENT AND DATA TRACKING OF CUSTOMER BUSINESS CONTACTS (U.S. CLS. 100, 101 AND 102).  
FIRST USE 5-1-2012; IN COMMERCE 5-1-2012.

#### **CLASS 42—SCIENTIFIC AND COMPUTER SERVICES**

FOR PROVIDING A WEBSITE FEATURING RESOURCES, NAMELY, NON-DOWNLOADABLE SOFTWARE FOR DATABASE MANAGEMENT, TRACKING OF CUSTOMER CONTACTS, REMINDERS OF SCHEDULED ACTIVITIES AND TRACKING OF DATA, DATABASE MANAGEMENT FOR CUSTOMER RELATIONSHIP MANAGEMENT, DATA TRACKING OF CUSTOMER CONTACTS, REMINDERS OF SCHEDULED ACTIVITIES AND TRACKING OF RESULTS ; PROVIDING A WEB SITE FEATURING TEMPORARY USE OF NON-DOWNLOADABLE SOFTWARE FOR USE IN DATABASE MANAGEMENT, TRACKING OF CUSTOMER CONTACTS, REMINDERS OF SCHEDULED ACTIVITIES AND TRACKING OF RESULTS FOR CUSTOMER RELATIONSHIP MANAGEMENT (U.S. CLS. 100 AND 101).  
FIRST USE 5-1-2012; IN COMMERCE 5-1-2012.

---

4,481,559. UNITED STATES DEPARTMENT OF HOMELAND SECURITY, WASHINGTON, DC. SN 85-429,562. PUB. 9-18-2012, FILED 9-22-2011.

## Resilience STAR

THE MARK CONSISTS OF STANDARD CHARACTERS WITHOUT CLAIM TO ANY PARTICULAR FONT, STYLE, SIZE, OR COLOR.

#### **CLASS 41—EDUCATION AND ENTERTAINMENT**

FOR TRAINING AND EDUCATION SERVICES, NAMELY, CLASSES, WORKSHOPS, SEMINARS, AND CONFERENCES RELATED TO THE PROMOTION OF BUILDING RESILIENT COMMERCIAL PROPERTIES AND PRIVATE RESIDENCES, NAMELY, PROPERTIES RESISTANT TO NATURAL OR MAN-MADE HAZARDS (U.S. CLS. 100, 101 AND 107).

FIRST USE 12-31-2011; IN COMMERCE 12-31-2011.

#### **CLASS 42—SCIENTIFIC AND COMPUTER SERVICES**

FOR EVALUATION OF BUILDINGS AND PRIVATE RESIDENCES FOR THE PURPOSE OF DEPARTMENT OF HOMELAND SECURITY CERTIFICATION ALIGNED TO GENERATED RESILIENCE OPERATIONAL REQUIREMENTS; ENGINEERING CONSULTING RELATED TO THE PROMOTION OF BUILDING RESILIENT COMMERCIAL PROPERTIES AND PRIVATE RESIDENCES, NAMELY, PROPERTIES RESISTANT TO NATURAL OR MAN-MADE HAZARDS (U.S. CLS. 100 AND 101).

FIRST USE 12-31-2011; IN COMMERCE 12-31-2011.

---

4,481,561. TWINBROOK COMMONS OFFICE, L.L.C. C/O THE JBG COMPANIES, CHEVY CHASE, MD. SN 85-430,661. PUB. 3-20-2012, FILED 9-23-2011.

## THE MARK AT TWINBROOK STATION

THE MARK CONSISTS OF STANDARD CHARACTERS WITHOUT CLAIM TO ANY PARTICULAR FONT, STYLE, SIZE, OR COLOR.

NO CLAIM IS MADE TO THE EXCLUSIVE RIGHT TO USE "TWINBROOK STATION", APART FROM THE MARK AS SHOWN.

#### **CLASS 36—INSURANCE AND FINANCIAL**

FOR LEASING OF REAL ESTATE; REAL ESTATE CONSULTANCY; REAL ESTATE INVESTMENT SERVICES; REAL ESTATE MANAGEMENT SERVICES (U.S. CLS. 100, 101 AND 102).

FIRST USE 8-15-2008; IN COMMERCE 8-15-2008.

#### **CLASS 37—CONSTRUCTION AND REPAIR**

FOR REAL ESTATE DEVELOPMENT (U.S. CLS. 100, 103 AND 106).

FIRST USE 8-15-2008; IN COMMERCE 8-15-2008.

---

4,481,566. TRAVORA NETWORKS, INC., GLENDALE, CA. SN 85-434,373. PUB. 9-4-2012, FILED 9-28-2011.

## TRAVORA

THE MARK CONSISTS OF STANDARD CHARACTERS WITHOUT CLAIM TO ANY PARTICULAR FONT, STYLE,

SIZE, OR COLOR.

### CLASS 35—ADVERTISING AND BUSINESS

FOR PROVIDING COMMERCIAL INFORMATION IN THE FIELD OF MARKETING AND ADVERTISING; PROMOTING THE GOODS AND SERVICES OF OTHERS BY PREPARING AND PLACING ON-LINE ADVERTISEMENTS ON A NETWORK OF WEB PAGES ON A GLOBAL COMPUTER NETWORK, AS WELL AS VIA EMAIL; BUSINESS, ADVERTISING AND MARKETING CONSULTATION, NAMELY, MARKETING CONSULTATION AND MARKETING STRATEGIES FOR TARGETING, PLACEMENT AND DISSEMINATION OF ADVERTISEMENTS; BUSINESS MANAGEMENT, NAMELY, MANAGEMENT OF ONLINE ADVERTISING CAMPAIGNS FOR OTHERS; ON-LINE ADVERTISING AND MARKETING SERVICES; PROVIDING ADVERTISING SERVICE TO DISTRIBUTE ADVERTISEMENTS FOR DISPLAY ON THE INTERNET, NAMELY, IN WEBSITES AND EMAILS; MEDIA BUYING SERVICES FOR OTHERS, NAMELY, PLANNING, BUYING AND NEGOTIATING OF ONLINE ADVERTISING; ONLINE ADVERTISING AND MARKETING SERVICES, NAMELY, PROVIDING AN ONLINE ADVERTISING NETWORK THAT SPECIALIZES IN AUDIENCE TARGETING AND CUSTOMIZED CONTEXTUAL TARGETING FOR ONLINE ADVERTISERS AND PUBLISHERS; PREPARATION OF CUSTOM OR NON-CUSTOM ADVERTISING FOR BUSINESSES FOR DISSEMINATION VIA THE WEB AND E-MAILS; PROVIDING DEMAND CREATION AND LEAD GENERATION ACTIVITIES AND SERVICES; PROVIDING AN ON-LINE COMMERCIAL INFORMATION DIRECTORY ON THE INTERNET; PROVIDING HOTEL RATE COMPARISON INFORMATION THAT CAN BE USED FOR BOOKING TRAVEL AT ADVERTISING PARTNER WEBSITES; PROVIDING A WEBSITE OF REVIEWS, SCORES AND RANKING OF TRAVEL DESTINATIONS AND POINTS OF INTEREST THAT ARE BASED ON THE AGGREGATION OF EXPERT, AUTHORITATIVE AND USER GENERATED REVIEWS FOR COMMERCIAL PURPOSES; PROVIDING REVIEWS, SCORES AND RANKING OF TRAVEL DESTINATIONS AND POINTS OF INTEREST THAT ARE BASED ON THE AGGREGATION OF EXPERT, AUTHORITATIVE AND USER GENERATED REVIEWS FOR COMMERCIAL PURPOSES (U.S. CLS. 100, 101 AND 102).

FIRST USE 2-6-2013; IN COMMERCE 2-6-2013.

### CLASS 39—TRANSPORTATION AND STORAGE

FOR PROVIDING AN ON-LINE COMPUTER DATABASE IN THE FIELD OF TRAVEL INFORMATION SERVICES; TRAVEL INFORMATION SERVICES, NAMELY, PROVIDING PRODUCT RATE AND AVAILABILITY INFORMATION THAT CAN BE USED FOR BOOKING TRAVEL AT ADVERTISING PARTNER WEBSITES IN THE FIELD OF AIR FARE, CRUISE AND CAR RENTALS; PROVIDING INFORMATION, NEWS AND COMMENTARY IN THE FIELD OF TRAVEL; PROVIDING ONLINE LINKS TO WEBSITES OF OTHERS FEATURING TRAVEL; TRAVEL INFORMATION; PROVIDING A WEBSITE FEATURING INFORMATION ON TRAVEL; INFORMATION SERVICES, NAMELY, PROVIDING A WEB SITE FEATURING PHOTOGRAPHIC PRESENTATIONS IN THE FIELD OF TRAVEL (U.S. CLS. 100 AND 105).

FIRST USE 2-6-2013; IN COMMERCE 2-6-2013.

### CLASS 42—SCIENTIFIC AND COMPUTER SERVICES

FOR HOSTING OF DIGITAL CONTENT VIA ELECTRONIC AND OPTICAL COMMUNICATIONS NETWORKS; HOSTING AN ONLINE COMMUNITY WEBSITE FEATURING HOTEL REVIEWS; COMPUTER SERVICES, NAMELY, PROVIDING SEARCH AND RECOMMENDATION ENGINES FOR OBTAINING DATA ON A GLOBAL COMPUTER NETWORK; SOCIAL BOOKMARKING WEBSITE SERVICES, NAMELY, PROVIDING A WEBSITE FEATURING TECHNOLOGY THAT ENABLES USERS TO ORGANIZE, STORE, MANAGE, SHARE AND SEARCH FOR BOOKMARKS OF RESOURCES ONLINE; PROVIDING A WEB SITE FEATUR-

ING TECHNOLOGY THAT ENABLES USERS TO SHARE, BOOKMARK, INDEX, STORE, COLLECT AND SHOWCASE CONTENT, ARTICLES, IMAGES, CALENDARS, PRODUCTS, PROJECTS, AND OTHER INFORMATION RESOURCES IN ELECTRONIC FORM IN THE NATURE AND FIELD OF TRAVEL; COMPUTER SERVICES, NAMELY, CREATING AN ON-LINE COMMUNITY FOR REGISTERED USERS TO PARTICIPATE IN DISCUSSIONS, GET FEEDBACK FROM THEIR PEERS, FORM VIRTUAL COMMUNITIES, AND ENGAGE IN SOCIAL NETWORKING SERVICES IN THE FIELD OF TRAVEL; PROVIDING TEMPORARY USE OF ON-LINE NON-DOWNLOADABLE SOFTWARE AND APPLICATIONS FOR SCORING AND RANKING TRAVEL DESTINATIONS AND POINTS OF INTEREST BASED ON THE AGGREGATION OF EXPERT, AUTHORITATIVE AND USER GENERATED REVIEWS; PROVIDING TEMPORARY USE OF ON-LINE NON-DOWNLOADABLE SOFTWARE AND APPLICATIONS FOR PLANNING, CREATING, EDITING, DISPLAYING AND SHARING TRAVEL CLIPPINGS AND ITINERARIES; PROVIDING AN INTERACTIVE WEB SITE ALLOWING USERS THE ABILITY TO UPLOAD AND SHARE PHOTOS OF TRAVEL; PROVIDING TEMPORARY USE OF NON-DOWNLOADABLE SOFTWARE THAT ENABLES USERS TO CREATE ELECTRONIC SCRAPBOOKS OF TRAVEL PHOTOS (U.S. CLS. 100 AND 101).

FIRST USE 2-6-2013; IN COMMERCE 2-6-2013.

4,481,567. NEASI-WEBER INTERNATIONAL, LLC, VALENCIA, CA. SN 85-434,754. PUB. 4-17-2012, FILED 9-28-2011.

NWI

THE MARK CONSISTS OF STANDARD CHARACTERS WITHOUT CLAIM TO ANY PARTICULAR FONT, STYLE, SIZE, OR COLOR.

### CLASS 35—ADVERTISING AND BUSINESS

FOR CONSULTING IN THE FIELD OF BUSINESS PROJECT MANAGEMENT (U.S. CLS. 100, 101 AND 102).

FIRST USE 9-0-1997; IN COMMERCE 9-0-1997.

### CLASS 42—SCIENTIFIC AND COMPUTER SERVICES

FOR DESIGN, DEVELOPMENT, AND CONSULTING SERVICES RELATED TO SOFTWARE DEVELOPMENT (U.S. CLS. 100 AND 101).

FIRST USE 9-0-1997; IN COMMERCE 9-0-1997.

4,481,568. GORDON FOOD SERVICE INC., GRAND RAPIDS, MI. SN 85-435,140. PUB. 7-16-2013, FILED 9-29-2011.

GFS CONNECT

THE MARK CONSISTS OF STANDARD CHARACTERS WITHOUT CLAIM TO ANY PARTICULAR FONT, STYLE, SIZE, OR COLOR.

OWNER OF U.S. REG. NOS. 1,500,088, 2,908,318, AND OTHERS.

NO CLAIM IS MADE TO THE EXCLUSIVE RIGHT TO

USE "CONNECT", APART FROM THE MARK AS SHOWN.

#### CLASS 35—ADVERTISING AND BUSINESS

FOR PROVIDING AN INTERNET WEBSITE PORTAL FEATURING WHOLESALE AND RETAIL DISTRIBUTORSHIP SERVICES SPECIALIZING IN FOODS AND BEVERAGES; ONLINE INFORMATION IN THE FIELD OF RETAIL FOOD STORE SERVICES AND RELATED FOOD SERVICE CONSUMER PRODUCT INFORMATION AND BUSINESS CONSULTING SERVICES RELATING TO THE OPERATION OF FOOD SERVICES ESTABLISHMENTS, CONSUMER INFORMATION ABOUT FOOD SERVICE PRODUCTS AND BUSINESS INFORMATION IN THE NATURE OF FOOD SERVICE INDUSTRY BEST PRACTICES FOR A PROFITABLE BUSINESS (U.S. CLS. 100, 101 AND 102).

FIRST USE 2-1-2010; IN COMMERCE 2-1-2010.

#### CLASS 39—TRANSPORTATION AND STORAGE

FOR CONTRACT FOOD DELIVERY SERVICES; PROVIDING AN INTERNET WEBSITE PORTAL FEATURING ONLINE INFORMATION IN THE FIELD OF FOOD DELIVERY SERVICES (U.S. CLS. 100 AND 105).

FIRST USE 2-1-2010; IN COMMERCE 2-1-2010.

#### CLASS 43—HOTEL AND RESTAURANT SERVICES

FOR PROVIDING AN INTERNET WEBSITE PORTAL FEATURING ONLINE INFORMATION IN THE FIELD OF FOOD SERVICES, NAMELY, INFORMATION ABOUT RESTAURANTS, FOOD PREPARATION SERVICES AND PROVIDING OF FOOD AND DRINKS FOR USE BY RESTAURANTS, FOOD PREPARATION SERVICES AND PROVIDERS OF FOOD AND DRINKS (U.S. CLS. 100 AND 101).

FIRST USE 8-31-2009; IN COMMERCE 8-31-2009.

#### CLASS 44—MEDICAL, BEAUTY AND AGRICULTURAL SERVICES

FOR FOOD NUTRITION CONSULTATION (U.S. CLS. 100 AND 101).

FIRST USE 2-1-2010; IN COMMERCE 2-1-2010.

4,481,590. SONIC INNOVATIONS, INC., SOMERSET, NJ. SN 85-456,353. PUB. 4-9-2013, FILED 10-26-2011.



NO CLAIM IS MADE TO THE EXCLUSIVE RIGHT TO USE "SONIC", APART FROM THE MARK AS SHOWN.

THE MARK CONSISTS OF THE WORD "SONIC" ABOVE THE WORDING "EVERYDAY SOUNDS BETTER" WITH WAVY LINES TO THE LEFT OF THE WORDING.

#### CLASS 9—ELECTRICAL AND SCIENTIFIC APPARATUS

FOR COMPUTER OPERATING SOFTWARE FOR USE WITH HEARING AIDS AND MANUALS PACKAGED TOGETHER AS A UNIT (U.S. CLS. 21, 23, 26, 36 AND 38).

FIRST USE 10-1-2013; IN COMMERCE 10-1-2013.

#### CLASS 10—MEDICAL APPARATUS

FOR HEARING AIDS (U.S. CLS. 26, 39 AND 44).  
FIRST USE 10-1-2013; IN COMMERCE 10-1-2013.

4,481,594. DIAGNOSTIC LABORATORY OF OKLAHOMA, L.L.C., OKLAHOMA CITY, OK. SN 85-464,626. PUB. 4-9-2013, FILED 11-4-2011.



OWNER OF U.S. REG. NOS. 3,278,273, 3,543,929, AND 3,543,930.

THE MARK CONSISTS OF THE STYLIZED LETTERS "D" AND "L" WITH A SEGMENTED LETTER "O" MADE UP OF CURVED CRESCENTS.

#### CLASS 42—SCIENTIFIC AND COMPUTER SERVICES

FOR MEDICAL LABORATORY MANAGEMENT SERVICES, NAMELY, CONSULTING SERVICES AND ADVISORY SERVICES IN THE FIELD OF LABORATORY MANAGEMENT (U.S. CLS. 100 AND 101).

FIRST USE 12-7-2011; IN COMMERCE 12-7-2011.

#### CLASS 44—MEDICAL, BEAUTY AND AGRICULTURAL SERVICES

FOR MEDICAL AND TESTING SERVICES, NAMELY, PROVIDING MEDICAL DIAGNOSTIC TESTING AND MEDICAL INFORMATION REGARDING DIAGNOSTIC TESTING RESULTS, TESTING PROCEDURES, DISEASE CONDITIONS AND DISEASE PREVENTION; PROVIDING MEDICAL INFORMATION REGARDING MEDICAL AND HOSPITAL RECORDS; MEDICAL CONSULTATION SERVICES (U.S. CLS. 100 AND 101).

FIRST USE 12-7-2011; IN COMMERCE 12-7-2011.

4,481,596. YUMMYHEALTH, LLC, WHITE PLAINS, NY. SN 85-465,267. PUB. 3-20-2012, FILED 11-4-2011.

TAKING THE FIGHT OUT OF  
FOOD

THE MARK CONSISTS OF STANDARD CHARACTERS WITHOUT CLAIM TO ANY PARTICULAR FONT, STYLE, SIZE, OR COLOR.

#### CLASS 35—ADVERTISING AND BUSINESS

FOR ONLINE RETAIL STORE SERVICES FEATURING HEALTHY FOOD CHOICES AND NUTRITIONAL SUPPLEMENTS (U.S. CLS. 100, 101 AND 102).

FIRST USE 5-6-2013; IN COMMERCE 5-6-2013.

**CLASS 41—EDUCATION AND ENTERTAINMENT**

FOR EDUCATIONAL SERVICES, NAMELY, A CONTINUING PROGRAM IN THE FIELDS OF FOOD, NUTRITION AND HEALTHY EATING ACCESSIBLE BY VIDEO; EDUCATIONAL SERVICES, NAMELY, PROVIDING TRAINING AND EDUCATIONAL RESOURCES, NAMELY, DISPLAYS, DEMONSTRATIONS AND WORKSHOPS IN THE FIELDS OF FOOD, NUTRITION AND HEALTHY EATING, FOOD PREPARATION AND NUTRITION; ON-LINE ELECTRONIC NEWSLETTERS IN THE FIELDS OF FOOD, NUTRITION; AND HEALTHY EATING; ON-LINE JOURNALS, NAMELY, A BLOG FEATURING INFORMATION AND RESOURCES IN THE AREA OF FOOD, NUTRITION AND HEALTHY EATING; AND VIDEO PRODUCTION, NAMELY, PRODUCTION OF COOKING SHOWS AND EDUCATIONAL VIDEOS IN THE FIELDS OF FOOD, NUTRITION AND HEALTHY EATING (U.S. CLS. 100, 101 AND 107).

FIRST USE 5-6-2013; IN COMMERCE 5-6-2013.

**CLASS 43—HOTEL AND RESTAURANT SERVICES**

FOR PROVIDING A WEB SITE FOR USERS OF COMPUTING DEVICES CONNECTED TO LOCAL AND WORLD-WIDE COMPUTER NETWORKS WITH INFORMATION AND RESOURCES, NAMELY, NEWS REGARDING COOKING AND RECIPES AND FEATURING NON-DOWNLOADABLE EDUCATIONAL AND INSTRUCTIONAL VIDEOS IN THE FIELDS OF COOKING AND FOOD PREPARATION (U.S. CLS. 100 AND 101).

FIRST USE 5-6-2013; IN COMMERCE 5-6-2013.

4,481,599. KOVALSKY, GIL, GLEN ROCK, NJ. SN 85-471,462. PUB. 9-11-2012, FILED 11-14-2011.



NO CLAIM IS MADE TO THE EXCLUSIVE RIGHT TO USE "KITCHEN", APART FROM THE MARK AS SHOWN.

THE MARK CONSISTS OF WORDS "MODIANI" AND "KITCHENS". THE WORD "MODIANI" IS THE LARGER OF THE TWO WORDS AND CONTAINS A CIRCLE WITHIN THE SECOND LETTER OF THE WORD. THE WORD "KITCHENS" IS LOCATED UNDERNEATH THE WORD "MODIANI" AND IS CONTAINED WITHIN A RECTANGLE.

THE WORDING "MODIANI" HAS NO MEANING IN A FOREIGN LANGUAGE.

**CLASS 20—FURNITURE AND ARTICLES NOT OTHERWISE CLASSIFIED**

FOR KITCHEN CABINETS (U.S. CLS. 2, 13, 22, 25, 32 AND 50).

FIRST USE 1-2-2012; IN COMMERCE 1-2-2012.

**CLASS 35—ADVERTISING AND BUSINESS**

FOR RETAIL STORE SERVICES FEATURING KITCHEN CABINETS (U.S. CLS. 100, 101 AND 102).

FIRST USE 1-2-2012; IN COMMERCE 1-2-2012.

**CLASS 42—SCIENTIFIC AND COMPUTER SERVICES**

FOR INTERIOR DESIGN SERVICES (U.S. CLS. 100 AND 101).

FIRST USE 1-2-2012; IN COMMERCE 1-2-2012.

4,481,600. KOVALSKY, GIL, GLEN ROCK, NJ. SN 85-471,475. PUB. 9-4-2012, FILED 11-14-2011.



THE MARK CONSISTS OF THE WORD "MODIANI" CONTAINING A CIRCLE WITHIN THE SECOND LETTER OF THE WORD.

THE WORDING "MODIANI" HAS NO MEANING IN A FOREIGN LANGUAGE.

**CLASS 20—FURNITURE AND ARTICLES NOT OTHERWISE CLASSIFIED**

FOR KITCHEN CABINETS (U.S. CLS. 2, 13, 22, 25, 32 AND 50).

FIRST USE 1-12-2012; IN COMMERCE 1-12-2012.

**CLASS 35—ADVERTISING AND BUSINESS**

FOR RETAIL STORE SERVICES FEATURING KITCHEN CABINETS (U.S. CLS. 100, 101 AND 102).

FIRST USE 1-12-2012; IN COMMERCE 1-12-2012.

**CLASS 42—SCIENTIFIC AND COMPUTER SERVICES**

FOR INTERIOR DESIGN SERVICES (U.S. CLS. 100 AND 101).

FIRST USE 1-12-2012; IN COMMERCE 1-12-2012.

4,481,601. BRACKE MANUFACTURING, LLC, NEWPORT BEACH, CA. SN 85-471,593. PUB. 7-16-2013, FILED 11-14-2011.



THE MARK CONSISTS OF STANDARD CHARACTERS WITHOUT CLAIM TO ANY PARTICULAR FONT, STYLE, SIZE, OR COLOR.

**CLASS 8—HAND TOOLS**

FOR HAND OPERATED CUTTING TOOLS, NAMELY, CABLE CUTTERS; HAND TOOLS, NAMELY, HAND-HELD CRIMPING PLIERS AND PRESET TORQUE WRENCHES (U.S. CLS. 23, 28 AND 44).

FIRST USE 5-11-2012; IN COMMERCE 5-11-2012.

**CLASS 9—ELECTRICAL AND SCIENTIFIC APPARATUS**

FOR RADIO FREQUENCY AND MICROWAVE CONNECTORS OF ELECTRONIC CIRCUITS; CABLE ASSEMBLIES IN THE NATURE OF ELECTRIC CABLES, WIRES, CONDUCTORS AND CONNECTION FITTINGS THEREFOR; POWER DIVIDERS IN THE NATURE OF ELECTRICAL POWER DISTRIBUTION UNITS; ELECTRIC CABLES AND CABLE CONNECTORS; DIRECTIONAL CABLE CONNECTOR COUPLERS, CABLE ATTENUATORS, RADIO FREQUENCY TERMINATIONS COMPRISED OF ELECTRICAL RESISTORS FOR TERMINATING RADIO FREQUENCY SIGNAL; RADIO FREQUENCY ADAPTORS IN THE NATURE OF CABLE ADAPTORS FOR USE WITH RADIO FREQUENCIES; RADIO FREQUENCY AMPLIFIERS IN THE NATURE OF CABLE AMPLIFIERS FOR USE WITH RADIO FREQUENCIES; BIAS TEES IN THE NATURE OF PASSIVE COAXIAL CABLES PRIMARILY FOR INJECTING D.C. CURRENTS OR VOLTAGES INTO RADIO FREQUENCY CIRCUITS FOR POWERING RADIO FREQUENCY CIRCUITS; CABLE CONNECTORS IN THE NATURE OF BREAKOUTS AND CIRCULATORS; CABLE D.C. BLOCKS, NAMELY, ELECTRICAL TERMINATORS OF D.C. VOLTAGE; ELECTRONIC APPARATUS, NAMELY, RADIO FREQUENCY DETECTORS IN THE NATURE OF ACTIVE COAXIAL CABLES FOR MONITORING AND MEASURING SIGNAL STRENGTH FROM A RADIO FREQUENCY SOURCE AND CONVERTING RADIO FREQUENCY SIGNAL STRENGTH INTO PROPORTIONAL D.C. VOLTAGE AT ITS SOURCE; CABLE FREQUENCY AMPLIFIERS, CABLE FREQUENCY DOUBLERS IN THE NATURE OF AN AMPLIFIER; ELECTRIC CABLE FUSE HOLDERS FOR HOLDING RADIO FREQUENCY CONNECTORS; CABLE ISOLATORS IN THE NATURE OF PASSIVE 2-PORT MICROWAVE CABLES AND CABLE CONNECTORS FOR PROTECTING RADIO FREQUENCY COMPONENTS FROM EXCESSIVE CURRENT OR SIGNAL REFLECTION; CABLE LIMITERS IN THE NATURE OF BROADBAND PASSIVE DEVICES FOR RECEIVER AND RADIO FREQUENCY COMPONENT PROTECTION BY INPUT POWER LEVELING AND POWER LIMITING; MATCHING PADS, NAMELY, RESISTIVE IMPEDANCE TRANSFORMERS OR MINIMUM LOSS PADS THAT ARE PASSIVE COAXIAL COMPONENTS FOR IMPEDANCE MATCHING BETWEEN 50 OHM AND 75 OHM SYSTEMS; CABLE MIXERS, CABLE DOUBLE BALANCED MIXERS, AND CABLE FREQUENCY MIXERS, NAMELY, PASSIVE MICROWAVE CIRCUITS FOR CREATING A OUTPUT FREQUENCY FROM TWO INPUT FREQUENCIES; CABLE RADIO FREQUENCY NOISE GENERATORS FOR SUPPLYING RADIO-FREQUENCY ENERGY, CABLE PHASE TRIMMERS AND SHIFTERS, NAMELY, ADJUSTABLE PASSIVE MICROWAVE CABLE CONNECTORS DESIGNED FOR RADIO FREQUENCY APPLICATIONS FOR MATCHING TWO CABLES AND ADJUSTING THE PHASE THEREOF WITHOUT DEGRADING SIGNAL QUALITY; SINGLE WIRE ELECTRIC CABLES FOR PATCH PANELS, AND STANDARD GAIN HORNS IN THE NATURE OF FREQUENCY CONVERTERS FOR DIRECTING RADIO WAVES AT A PRECISE FREQUENCY (U.S. CLS. 21, 23, 26, 36 AND 38).

FIRST USE 5-11-2012; IN COMMERCE 5-11-2012.

4,481,603. BRACKE MANUFACTURING, LLC, NEWPORT BEACH, CA. SN 85-472,059. PUB. 7-16-2013, FILED 11-14-2011.



THE MARK CONSISTS OF A DESIGN OF AN OPEN FACED BLOCK LETTER "B" SHAPE PLACED OVER A HALF CIRCLE SHAPE, ALL WITHIN A SQUARE SHAPE OUTLINED BY A THICK BLACK LINE, ALL PLACED OVER THE TERM "BRACKE", WHICH IS UNDERLINED BY A THICK BLACK LINE.

**CLASS 8—HAND TOOLS**

FOR HAND OPERATED CUTTING TOOLS, NAMELY, CABLE CUTTERS; HAND TOOLS, NAMELY, HAND-HELD CRIMPING PLIERS AND PRESET TORQUE WRENCHES (U.S. CLS. 23, 28 AND 44).

FIRST USE 5-11-2012; IN COMMERCE 5-11-2012.

**CLASS 9—ELECTRICAL AND SCIENTIFIC APPARATUS**

FOR RADIO FREQUENCY AND MICROWAVE CONNECTORS OF ELECTRONIC CIRCUITS; CABLE ASSEMBLIES IN THE NATURE OF ELECTRIC CABLES, WIRES, CONDUCTORS AND CONNECTION FITTINGS THEREFOR; POWER DIVIDERS IN THE NATURE OF ELECTRICAL POWER DISTRIBUTION UNITS; ELECTRIC CABLES AND CABLE CONNECTORS; DIRECTIONAL CABLE CONNECTOR COUPLERS, CABLE ATTENUATORS, RADIO FREQUENCY TERMINATIONS COMPRISED OF ELECTRICAL RESISTORS FOR TERMINATING RADIO FREQUENCY SIGNAL; RADIO FREQUENCY ADAPTORS IN THE NATURE OF CABLE ADAPTORS FOR USE WITH RADIO FREQUENCIES; RADIO FREQUENCY AMPLIFIERS IN THE NATURE OF CABLE AMPLIFIERS FOR USE WITH RADIO FREQUENCIES; BIAS TEES IN THE NATURE OF PASSIVE COAXIAL CABLES PRIMARILY FOR INJECTING D.C. CURRENTS OR VOLTAGES INTO RADIO FREQUENCY CIRCUITS FOR POWERING RADIO FREQUENCY CIRCUITS; CABLE CONNECTORS IN THE NATURE OF BREAKOUTS AND CIRCULATORS; CABLE D.C. BLOCKS, NAMELY, ELECTRICAL TERMINATORS OF D.C. VOLTAGE; ELECTRONIC APPARATUS, NAMELY, RADIO FREQUENCY DETECTORS IN THE NATURE OF ACTIVE COAXIAL CABLES FOR MONITORING AND MEASURING SIGNAL STRENGTH FROM A RADIO FREQUENCY SOURCE AND CONVERTING RADIO FREQUENCY SIGNAL STRENGTH INTO PROPORTIONAL D.C. VOLTAGE AT ITS SOURCE; CABLE FREQUENCY AMPLIFIERS, CABLE FREQUENCY DOUBLERS IN THE NATURE OF AN AMPLIFIER; ELECTRIC CABLE FUSE HOLDERS FOR HOLDING RADIO FREQUENCY CONNECTORS; CABLE ISOLATORS IN THE NATURE OF PASSIVE 2-PORT MICROWAVE CABLES AND CABLE CONNECTORS FOR PROTECTING RADIO FREQUENCY COMPONENTS FROM EXCESSIVE CURRENT OR SIGNAL REFLECTION; CABLE LIMITERS IN THE NATURE OF BROADBAND PASSIVE DEVICES FOR RECEIVER AND RADIO FREQUENCY COMPONENT PROTECTION BY INPUT POWER LEVELING AND POWER LIMITING; MATCHING PADS, NAMELY, RESISTIVE IMPEDANCE

TRANSFORMERS OR MINIMUM LOSS PADS THAT ARE PASSIVE COAXIAL COMPONENTS FOR IMPEDANCE MATCHING BETWEEN 50 OHM AND 75 OHM SYSTEMS; CABLE MIXERS, CABLE DOUBLE BALANCED MIXERS, AND CABLE FREQUENCY MIXERS, NAMELY, PASSIVE MICROWAVE CIRCUITS FOR CREATING A OUTPUT FREQUENCY FROM TWO INPUT FREQUENCIES; CABLE RADIO FREQUENCY NOISE GENERATORS FOR SUPPLYING RADIO-FREQUENCY ENERGY, CABLE PHASE TRIMMERS AND SHIFTERS, NAMELY, ADJUSTABLE PASSIVE MICROWAVE CABLE CONNECTORS DESIGNED FOR RADIO FREQUENCY APPLICATIONS FOR MATCHING TWO CABLES AND ADJUSTING THE PHASE THEREOF WITHOUT DEGRADING SIGNAL QUALITY; SINGLE WIRE ELECTRIC CABLES FOR PATCH PANELS, AND STANDARD GAIN HORNS IN THE NATURE OF FREQUENCY CONVERTERS FOR DIRECTING RADIO WAVES AT A PRECISE FREQUENCY (U.S. CLS. 21, 23, 26, 36 AND 38).

FIRST USE 5-11-2012; IN COMMERCE 5-11-2012.

**CLASS 9—ELECTRICAL AND SCIENTIFIC APPARATUS**

FOR RADIO FREQUENCY AND MICROWAVE CONNECTORS OF ELECTRONIC CIRCUITS; CABLE ASSEMBLIES IN THE NATURE OF ELECTRIC CABLES, WIRES, CONDUCTORS AND CONNECTION FITTINGS THEREFOR; POWER DIVIDERS IN THE NATURE OF ELECTRICAL POWER DISTRIBUTION UNITS; ELECTRIC CABLES AND CABLE CONNECTORS; DIRECTIONAL CABLE CONNECTOR COUPLERS, CABLE ATTENUATORS, RADIO FREQUENCY TERMINATIONS COMPRISED OF ELECTRICAL RESISTORS FOR TERMINATING RADIO FREQUENCY SIGNAL; RADIO FREQUENCY ADAPTORS IN THE NATURE OF CABLE ADAPTORS FOR USE WITH RADIO FREQUENCIES; RADIO FREQUENCY AMPLIFIERS IN THE NATURE OF CABLE AMPLIFIERS FOR USE WITH RADIO FREQUENCIES; BIAS TEES IN THE NATURE OF PASSIVE COAXIAL CABLES PRIMARILY FOR INJECTING D.C. CURRENTS OR VOLTAGES INTO RADIO FREQUENCY CIRCUITS FOR POWERING RADIO FREQUENCY CIRCUITS; CABLE CONNECTORS IN THE NATURE OF BREAKOUTS AND CIRCULATORS; CABLE D.C. BLOCKS, NAMELY, ELECTRICAL TERMINATORS OF D.C. VOLTAGE; ELECTRONIC APPARATUS, NAMELY, RADIO FREQUENCY DETECTORS IN THE NATURE OF ACTIVE COAXIAL CABLES FOR MONITORING AND MEASURING SIGNAL STRENGTH FROM A RADIO FREQUENCY SOURCE AND CONVERTING RADIO FREQUENCY SIGNAL STRENGTH INTO PROPORTIONAL D.C. VOLTAGE AT ITS SOURCE; CABLE FREQUENCY AMPLIFIERS, CABLE FREQUENCY DOUBLERS IN THE NATURE OF AN AMPLIFIER; ELECTRIC CABLE FUSE HOLDERS FOR HOLDING RADIO FREQUENCY CONNECTORS; CABLE ISOLATORS IN THE NATURE OF PASSIVE 2-PORT MICROWAVE CABLES AND CABLE CONNECTORS FOR PROTECTING RADIO FREQUENCY COMPONENTS FROM EXCESSIVE CURRENT OR SIGNAL REFLECTION; CABLE LIMITERS IN THE NATURE OF BROADBAND PASSIVE DEVICES FOR RECEIVER AND RADIO FREQUENCY COMPONENT PROTECTION BY INPUT POWER LEVELING AND POWER LIMITING; MATCHING PADS, NAMELY, RESISTIVE IMPEDANCE TRANSFORMERS OR MINIMUM LOSS PADS THAT ARE PASSIVE COAXIAL COMPONENTS FOR IMPEDANCE MATCHING BETWEEN 50 OHM AND 75 OHM SYSTEMS; CABLE MIXERS, CABLE DOUBLE BALANCED MIXERS, AND CABLE FREQUENCY MIXERS, NAMELY, PASSIVE MICROWAVE CIRCUITS FOR CREATING A OUTPUT FREQUENCY FROM TWO INPUT FREQUENCIES; CABLE RADIO FREQUENCY NOISE GENERATORS FOR SUPPLYING RADIO-FREQUENCY ENERGY, CABLE PHASE TRIMMERS AND SHIFTERS, NAMELY, ADJUSTABLE PASSIVE MICROWAVE CABLE CONNECTORS DESIGNED FOR RADIO FREQUENCY APPLICATIONS FOR MATCHING TWO CABLES AND ADJUSTING THE PHASE THEREOF WITHOUT DEGRADING SIGNAL QUALITY; SINGLE WIRE ELECTRIC CABLES FOR PATCH PANELS, AND STANDARD GAIN HORNS IN THE NATURE OF FREQUENCY CONVERTERS FOR DIRECTING RADIO WAVES AT A PRECISE FREQUENCY (U.S. CLS. 21, 23, 26, 36 AND 38).

FIRST USE 5-11-2012; IN COMMERCE 5-11-2012.

4,481,604. BRACKE MANUFACTURING, LLC, NEWPORT BEACH, CA. SN 85-472,073. PUB. 7-16-2013, FILED 11-14-2011.



THE MARK CONSISTS OF A DESIGN OF AN OPEN FACED BLOCK LETTER "B" SHAPE PLACED OVER A HALF CIRCLE SHAPE, ALL WITHIN A SQUARE SHAPE OUTLINED BY A THICK BLACK LINE.

**CLASS 8—HAND TOOLS**

FOR HAND OPERATED CUTTING TOOLS, NAMELY, CABLE CUTTERS; HAND TOOLS, NAMELY, HAND-HELD CRIMPING PLIERS AND PRESET TORQUE WRENCHES (U.S. CLS. 23, 28 AND 44).

FIRST USE 5-11-2012; IN COMMERCE 5-11-2012.

4,481,610. H & N FOODS INTERNATIONAL, INC., VERNON, CA. SN 85-476,539. PUB. 10-16-2012, FILED 11-18-2011.

**H & N GROUP**

THE MARK CONSISTS OF STANDARD CHARACTERS WITHOUT CLAIM TO ANY PARTICULAR FONT, STYLE, SIZE, OR COLOR.

OWNER OF U.S. REG. NOS. 1,675,248, 2,742,413, AND

## OTHERS.

NO CLAIM IS MADE TO THE EXCLUSIVE RIGHT TO USE "GROUP", APART FROM THE MARK AS SHOWN.

**CLASS 29—MEATS AND PROCESSED FOODS**

FOR FISH AND SEAFOOD (U.S. CL. 46).  
FIRST USE 4-28-2013; IN COMMERCE 4-28-2013.

**CLASS 35—ADVERTISING AND BUSINESS**

FOR WHOLESALE DISTRIBUTORSHIPS FEATURING FISH AND SEAFOOD (U.S. CLS. 100, 101 AND 102).  
FIRST USE 12-5-2013; IN COMMERCE 12-5-2013.

4,481,622. ACCORDANT HEALTH SERVICES, LLC, WOONSOCKET, RI. SN 85-481,621. PUB. 4-30-2013, FILED 11-28-2011.

NICE

THE MARK CONSISTS OF STANDARD CHARACTERS WITHOUT CLAIM TO ANY PARTICULAR FONT, STYLE, SIZE, OR COLOR.

**CLASS 16—PAPER GOODS AND PRINTED MATTER**

FOR PRINTED MATERIALS, NAMELY, NEWSLETTERS AND EDUCATIONAL MATERIALS IN THE FIELD OF HEALTH MANAGEMENT, WHICH PROMOTE WELLNESS AND POSITIVE CLINICAL OUTCOMES WITH PROGRAM MEMBERS (U.S. CLS. 2, 5, 22, 23, 29, 37, 38 AND 50).  
FIRST USE 10-18-2011; IN COMMERCE 10-18-2011.

**CLASS 41—EDUCATION AND ENTERTAINMENT**

FOR PROVIDING ON-LINE PERIODIC NEWSLETTERS IN THE FIELD OF HEALTH MANAGEMENT, WHICH PROMOTE WELLNESS AND POSITIVE CLINICAL OUTCOMES WITH PROGRAM MEMBERS (U.S. CLS. 100, 101 AND 107).  
FIRST USE 6-26-2013; IN COMMERCE 6-26-2013.

4,481,623. DIGIGRAPH.ME, INC., VALLEY VILLAGE, CA. SN 85-482,045. PUB. 5-8-2012, FILED 11-28-2011.

DIGIDONATE

THE MARK CONSISTS OF STANDARD CHARACTERS WITHOUT CLAIM TO ANY PARTICULAR FONT, STYLE, SIZE, OR COLOR.

**CLASS 9—ELECTRICAL AND SCIENTIFIC APPARATUS**

FOR DOWNLOADABLE AUTOGRAPHED CELEBRITY PHOTOGRAPHS VIA THE INTERNET, DIGITAL AND WIRELESS NETWORKS, COMPUTERS, DIGITAL AND WIRELESS DEVICES, MOBILE COMMUNICATIONS DEVICES, HANDHELD DEVICES, CELLULAR PHONES AND SATELLITE (U.S. CLS. 21, 23, 26, 36 AND 38).  
FIRST USE 12-7-2012; IN COMMERCE 12-7-2012.

**CLASS 38—COMMUNICATION**

FOR ELECTRONIC DELIVERY OF AUTOGRAPHED CELEBRITY PHOTOGRAPHS VIA THE INTERNET, DIGITAL AND WIRELESS NETWORKS, COMPUTERS, DIGITAL AND WIRELESS DEVICES, MOBILE COMMUNICATIONS DEVICES, HANDHELD DEVICES, CELLULAR PHONES AND SATELLITE (U.S. CLS. 100, 101 AND 104).  
FIRST USE 12-7-2012; IN COMMERCE 12-7-2012.

4,481,628. FISKARS BRANDS, INC., MADISON, WI. SN 85-486,168. PUB. 4-10-2012, FILED 12-2-2011.



OWNER OF U.S. REG. NOS. 512,677, 2,279,229, AND 2,955,051.

THE MARK CONSISTS OF THE WORD "GERBER" POSITIONED ADJACENT A DRAWING OF SWORD ON TOP OF A SHIELD.

**CLASS 8—HAND TOOLS**

FOR MULTI-FUNCTION HAND TOOLS COMPRISING ALL OR A COMBINATION OF A KNIFE BLADE, PLIERS, SCREWDRIVERS, BOTTLE OPENER, CAN OPENER, SCISSORS, WIRE CUTTER, FILE, SAW BLADE, NAIL PULLER, WIRE STRIPPER, RULER; SPORT KNIVES, HUNTING KNIVES, FISHING KNIVES AND CAMPING KNIVES; HAND TOOLS, NAMELY, SPADES, SHOVELS, AXES, HAND SAWS, HATCHETS, PRUNERS, MACHETES, WIRE CUTTERS, SCISSORS, KNIFE SHARPENERS; AND SHEATHS FOR KNIVES AND MULTI-FUNCTION HAND TOOLS (U.S. CLS. 23, 28 AND 44).  
FIRST USE 9-30-2011; IN COMMERCE 9-30-2011.

**CLASS 11—ENVIRONMENTAL CONTROL APPARATUS**

FOR FLASHLIGHTS; TACTICAL FLASHLIGHTS; KEYCHAIN FLASHLIGHTS; RED LED FLASHLIGHTS FOR ILLUMINATION PURPOSES; OUTDOOR PORTABLE LIGHTING PRODUCTS, NAMELY, HEADLAMPS (U.S. CLS. 13, 21, 23, 31 AND 34).  
FIRST USE 9-30-2011; IN COMMERCE 9-30-2011.

**CLASS 13—FIREARMS**

FOR GUN CLEANING KITS COMPRISING WIPING RODS, CLEANING PATCHES, CLEANING SOLUTION, CLEANING BRUSHES, SCRAPER, CLEANING PICKS, LUBRICANT, FLASHLIGHT, AND MULTI-FUNCTION HAND TOOL HAVING PLIERS, KNIFE BLADE, SCREWDRIVERS, CAN OPENER, SCISSORS, WIRE CUTTER, FILE, AND WIRE STRIPPER (U.S. CLS. 2 AND 9).  
FIRST USE 9-30-2011; IN COMMERCE 9-30-2011.

4,481,630. QUEST DIAGNOSTICS INVESTMENTS INCORPORATED, WILMINGTON, DE. SN 85-488,665. PUB. 10-30-2012, FILED 12-6-2011.

# CLEAR SIGHT

THE MARK CONSISTS OF STANDARD CHARACTERS WITHOUT CLAIM TO ANY PARTICULAR FONT, STYLE, SIZE, OR COLOR.

## CLASS 9—ELECTRICAL AND SCIENTIFIC APPARATUS

FOR DOWNLOADABLE ELECTRONIC REPORTS FEATURING PATHOLOGISTS' MEDICAL OR CLINICAL DIAGNOSTIC TEST RESULTS AND PATHOLOGISTS' REPORTS (U.S. CLS. 21, 23, 26, 36 AND 38).  
FIRST USE 2-28-2012; IN COMMERCE 2-28-2012.

## CLASS 16—PAPER GOODS AND PRINTED MATTER

FOR PRINTED REPORTS FEATURING PATHOLOGISTS' MEDICAL OR CLINICAL DIAGNOSTIC TEST RESULTS AND PATHOLOGISTS' REPORTS (U.S. CLS. 2, 5, 22, 23, 29, 37, 38 AND 50).  
FIRST USE 2-28-2012; IN COMMERCE 2-28-2012.

4,481,636. ENERGY PRODUCTS AUSTRALIA PTY LTD, BANGALOW, NSW, AUSTRALIA. SN 85-502,842. PUB. 3-5-2013, FILED 12-23-2011.

# Wallaby

OWNER OF U.S. REG. NO. 3,147,748.  
THE MARK CONSISTS OF THE WORD "WALLABY" IN A STYLIZED DESIGN.

## CLASS 29—MEATS AND PROCESSED FOODS

FOR HEALTH FOOD BARS, NAMELY, PROCESSED FRUIT, NUT, AND SEED-BASED FOOD BARS MADE FROM NATURALLY PREPARED PRODUCTS; OIL, NAMELY, MACADAMIA NUT OIL; NUT BUTTERS; NUT AND SEED-BASED SNACK FOODS; PROTEIN BARS, NAMELY, NUT BASED FOOD BARS WITH HIGH PROTEIN CONTENT; FRUIT-BASED SNACK FOODS; PREPARED SNACKS MADE FROM DRIED FRUIT; PREPARED SNACKS MADE FROM NUTS; MACADAMIA NUTS, PROCESSED; NUT BASED SPREADS; SNACK BARS MADE PRIMARILY FROM DRIED FRUITS AND/OR NUTS (U.S. CL. 46).  
FIRST USE 12-21-2010; IN COMMERCE 12-21-2010.

## CLASS 30—STAPLE FOODS

FOR HEALTH FOOD BARS, NAMELY, GRAIN-BASED FOOD BARS MADE FROM NATURALLY PREPARED PRODUCTS; CEREAL BASED SNACK FOODS; PREPARED SNACKS FOR HUMAN CONSUMPTION MADE FROM CEREALS; RICE BASED SNACK FOODS; SNACK BARS CONSISTING PRIMARILY OF A MIXTURE OF GRAINS; SNACK FOODS CONSISTING OF CEREAL PRODUCTS; SNACKS MANUFACTURED FROM CEREALS; SNACK FOODS MADE FROM SOYA FLOUR (U.S. CL. 46).

FIRST USE 9-11-2007; IN COMMERCE 9-22-2007.

4,481,643. OPEN ACCESS TECHNOLOGY INTERNATIONAL, INC., MINNEAPOLIS, MN. SN 85-510,561. PUB. 4-24-2012, FILED 1-6-2012.



THE COLOR(S) RED, WHITE AND BLACK IS/ARE CLAIMED AS A FEATURE OF THE MARK.

THE MARK CONSISTS OF THE CONFIGURATION OF THE MARK CONSISTS OF THE WORDING "OATI" IN BLACK WITH AN INCOMPLETE CIRCLE COMPRISED OF RED OVERLAPPING RECTANGLES CIRCLES THE WORDING TO THE LEFT HAND SIDE, EMANATING FROM THE LETTER "A".

## CLASS 9—ELECTRICAL AND SCIENTIFIC APPARATUS

FOR COMPUTER APPLICATION SOFTWARE FOR COMPUTERS AND PORTABLE DEVICE FOR EXECUTING ENERGY TRADES; COMPUTER APPLICATION SOFTWARE FOR COMPUTERS AND PORTABLE DEVICES FOR EVALUATING FINANCIAL RISK MANAGEMENT FOR THE ENERGY INDUSTRY; COMPUTER APPLICATION SOFTWARE FOR COMPUTERS AND PORTABLE DEVICES FOR MANAGING SCHEDULING AND DATA TRANSMISSION; COMPUTER APPLICATION SOFTWARE FOR COMPUTERS AND PORTABLE DEVICES FOR ENERGY REGULATION COMPLIANCE MANAGEMENT; COMPUTER APPLICATION SOFTWARE FOR COMPUTERS AND PORTABLE DEVICES FOR SMART GRID MANAGEMENT, FOR CONNECTING CUSTOMERS TO AN ONLINE FORUM FOR COMMUNICATIONS PURPOSES, FOR ACCESSING ONLINE ENERGY INFORMATION AND RESOURCES, FOR MANAGING GRID OPERATIONS AND ENERGY MARKET DATA, FOR MANAGING ONLINE ENERGY TRANSACTIONS, FOR MANAGING SCHEDULING AND NETWORK OPTIMIZATION APPLICATIONS WHICH IMPROVE RELIABILITY, EFFICIENCY AND THE ECONOMICS OF POWER OPERATIONS (U.S. CLS. 21, 23, 26, 36 AND 38).  
FIRST USE 12-18-2013; IN COMMERCE 12-18-2013.



**CLASS 35—ADVERTISING AND BUSINESS**

FOR BUSINESS MANAGEMENT SERVICES FEATURING BUSINESS APPOINTMENT SCHEDULING SERVICES FOR THE ENERGY INDUSTRY, AND ENERGY INDUSTRY REGULATION COMPLIANCE MANAGEMENT SERVICES (U.S. CLS. 100, 101 AND 102).

FIRST USE 12-18-2013; IN COMMERCE 12-18-2013.

**CLASS 36—INSURANCE AND FINANCIAL**

FOR FINANCIAL SERVICES IN THE NATURE OF ENERGY TRADING; FINANCIAL RISK MANAGEMENT SERVICES FOR THE ENERGY INDUSTRY, NAMELY, MANAGING AND MEASURING RISK TYPES SUCH AS MARKET RISK, CREDIT RISK AND ENTERPRISE WIDE RISK (U.S. CLS. 100, 101 AND 102).

FIRST USE 12-18-2013; IN COMMERCE 12-18-2013.

4,481,645. JONES, BRYAN J., ST AUGUSTINE, FL. SN 85-511,543. PUB. 7-3-2012, FILED 1-9-2012.



NO CLAIM IS MADE TO THE EXCLUSIVE RIGHT TO USE "TAX INTERNATIONAL, LLC", APART FROM THE MARK AS SHOWN.

THE MARK CONSISTS OF A SQUARE CONTAINING A STYLIZED PILLAR. THERE IS A BORDER AROUND THE SQUARE. TO THE RIGHT IS THE STYLIZED TEXT "TAX" ABOVE THE STYLIZED TEXT "INTERNATIONAL, LLC". BELOW THE WORDS "INTERNATIONAL, LLC" IS THE STYLIZED TEXT "EVERYONE SHOULD BENEFIT".

**CLASS 35—ADVERTISING AND BUSINESS**

FOR ACCOUNTING SERVICES; TAX CONSULTATION (U.S. CLS. 100, 101 AND 102).

FIRST USE 3-12-2008; IN COMMERCE 3-12-2008.

**CLASS 42—SCIENTIFIC AND COMPUTER SERVICES**

FOR PROVIDING A WEBSITE FEATURING RESOURCES, NAMELY, NON-DOWNLOADABLE SOFTWARE FOR USE IN DATABASE MANAGEMENT AS IT RELATES TO TAX AND FINANCIAL DOCUMENTS (U.S. CLS. 100 AND 101).

FIRST USE 3-12-2008; IN COMMERCE 3-12-2008.

4,481,651. TREESTAND ASSASSIN LLC, NEWBURGH, IN. SN 85-523,498. PUB. 1-29-2013, FILED 1-24-2012.

**TURKEY ASSASSIN**

THE MARK CONSISTS OF STANDARD CHARACTERS WITHOUT CLAIM TO ANY PARTICULAR FONT, STYLE, SIZE, OR COLOR.

NO CLAIM IS MADE TO THE EXCLUSIVE RIGHT TO USE "TURKEY", APART FROM THE MARK AS SHOWN.

**CLASS 16—PAPER GOODS AND PRINTED MATTER**

FOR DECALS (U.S. CLS. 2, 5, 22, 23, 29, 37, 38 AND 50). FIRST USE 9-23-2012; IN COMMERCE 9-23-2012.

**CLASS 21—HOUSEWARES AND GLASS**

FOR FOAM DRINK HOLDERS (U.S. CLS. 2, 13, 23, 29, 30, 33, 40 AND 50).

FIRST USE 2-4-2012; IN COMMERCE 2-4-2012.

**CLASS 25—CLOTHING**

FOR CLOTHING, NAMELY, SHORT SLEEVE T-SHIRTS, LONG SLEEVE T-SHIRTS, SWEATSHIRTS; HEADWEAR (U.S. CLS. 22 AND 39).

FIRST USE 4-7-2012; IN COMMERCE 4-7-2012.

**CLASS 28—TOYS AND SPORTING GOODS**

FOR HUNTING GAME CALLS (U.S. CLS. 22, 23, 38 AND 50).

FIRST USE 4-23-2012; IN COMMERCE 4-23-2012.

4,481,652. PGIA HOLDINGS, LLC, WILMINGTON, DE. SN 85-525,335. PUB. 4-23-2013, FILED 1-25-2012.

**PERSONABLE**

THE MARK CONSISTS OF STANDARD CHARACTERS WITHOUT CLAIM TO ANY PARTICULAR FONT, STYLE, SIZE, OR COLOR.

**CLASS 35—ADVERTISING AND BUSINESS**

FOR INSURANCE CLAIMS AUDITING SERVICES (U.S. CLS. 100, 101 AND 102).

FIRST USE 9-30-2012; IN COMMERCE 9-30-2012.

**CLASS 36—INSURANCE AND FINANCIAL**

FOR INSURANCE ADMINISTRATION; CONSULTING AND INFORMATION CONCERNING INSURANCE; DESIGN AND DEVELOPMENT OF INSURANCE POLICIES FOR OTHERS; DESIGN AND DEVELOPMENT OF INSURANCE BROKERAGE AND INSURANCE ADMINISTRATION PROGRAMS FOR OTHERS; INSURANCE UNDERWRITING SERVICES FOR ALL TYPES OF INSURANCE; ACCIDENT INSURANCE UNDERWRITING; INSURANCE SERVICES, NAMELY, UNDERWRITING AUTOMOBILE INSURANCE; INSURANCE SERVICES, NAMELY, UNDERWRITING, ISSUANCE AND ADMINISTRATION OF AUTOMOBILE INSURANCE; INSURANCE CLAIMS ADMINISTRATION; INSURANCE CLAIMS PROCESSING; INSURANCE SERVICES, NAMELY, INSURANCE ELIGIBILITY REVIEW AND VERIFICATION AND CONSULTATION IN THE FIELD OF AUTOMOBILE INSURANCE; INSURANCE SERVICES, NAMELY, INSURANCE BROKERAGE AND INSURANCE AGENCIES; INSURANCE CONSULTATION IN THE FIELD OF AUTOMOBILE INSURANCE PRODUCTS, AUTOMOBILE INSURANCE BROKERAGE AND ANALYSIS OF AUTOMOBILE INSURANCE RISKS IN CONNECTION WITH THE ISSUANCE OF AUTOMOBILE INSURANCE PRODUCTS; PROVIDING DETAILED ANALYSIS OF FINANCIAL INFORMATION AND FINANCIAL RISK INFORMATION IN CONNECTION WITH AUTOMOBILE INSURANCE PRODUCTS FOR PERSONAL LINES; PROVIDING ANALYSIS OF FINANCIAL RISK IN CONNECTION WITH INSURANCE PRODUCTS FOR PERSONAL LINES; PROVIDING COMPARATIVE INFORMATION FOR USE BY OTHERS IN THE FIELD OF INSURANCE POLICIES, INSURANCE CLAIMS AND INSURANCE PAYMENT DATA INFORMATION; ON-LINE FINANCIAL SERVICES, NAMELY, THE ADMINISTRATION OF INSURANCE POLICIES AND CLAIMS; ELECTRONIC PROCESSING OF INSURANCE CLAIMS AND PAYMENT DATA (U.S. CLS. 100, 101 AND 102).

FIRST USE 9-30-2012; IN COMMERCE 9-30-2012.

4,481,654. PETER C. WHITTINGTON, PLANTATION, FL. SN 85-527,509. PUB. 5-7-2013, FILED 1-27-2012.



THE MARK CONSISTS OF THE LETTERS "C" AND "V" OVERLAPPING EACH OTHER.

**CLASS 18—LEATHER GOODS**

FOR SPORTS BAGS, SHOULDER BAGS, GYM BAGS, CARRYON BAGS (U.S. CLS. 1, 2, 3, 22 AND 41).  
FIRST USE 2-14-2011; IN COMMERCE 2-14-2011.

**CLASS 25—CLOTHING**

FOR BLOUSES; BELTS; CAPS; DRESSES; HATS; PANTS; SHIRTS; SHOES; T-SHIRTS; COATS; HEADBANDS; JACKETS; SHORTS; SOCKS; UNDERGARMENTS; VESTS; WRIST BANDS; SWIMWEAR (U.S. CLS. 22 AND 39).  
FIRST USE 2-14-2011; IN COMMERCE 2-14-2011.

**CLASS 32—LIGHT BEVERAGES**

FOR DRINKING WATER, BOTTLED WATER, FLAVORED WATER, SPARKLING WATER; NON-ALCOHOLIC CARBONATED BEVERAGES; ENERGY DRINKS; AND BEERS (U.S. CLS. 45, 46 AND 48).  
FIRST USE 2-14-2011; IN COMMERCE 2-14-2011.

4,481,658. SOUTHWESTERN ENERGY COMPANY, HOUSTON, TX. SN 85-530,782. PUB. 5-1-2012, FILED 2-1-2012.

THE RIGHT PEOPLE DOING THE  
RIGHT THINGS

THE MARK CONSISTS OF STANDARD CHARACTERS WITHOUT CLAIM TO ANY PARTICULAR FONT, STYLE, SIZE, OR COLOR.

OWNER OF U.S. REG. NO. 2,839,743.

**CLASS 35—ADVERTISING AND BUSINESS**

FOR PROMOTING AND MARKETING OF NATURAL GAS PRODUCTION FOR OTHERS (U.S. CLS. 100, 101 AND 102).  
FIRST USE 10-25-2013; IN COMMERCE 10-25-2013.

**CLASS 37—CONSTRUCTION AND REPAIR**

FOR DRILLING AND COLLECTION OF CRUDE OIL; DRILLING AND GATHERING OF NATURAL GAS (U.S. CLS. 100, 103 AND 106).  
FIRST USE 10-25-2013; IN COMMERCE 10-25-2013.

**CLASS 39—TRANSPORTATION AND STORAGE**

FOR STORAGE AND TRANSPORT OF NATURAL GAS (U.S. CLS. 100 AND 105).  
FIRST USE 10-25-2013; IN COMMERCE 10-25-2013.

**CLASS 40—MATERIAL TREATMENT**

FOR OIL AND NATURAL GAS PRODUCTION SERVICES (U.S. CLS. 100, 103 AND 106).  
FIRST USE 10-25-2013; IN COMMERCE 10-25-2013.

4,481,663. MARIAH MEDIA INC., SANTA FE, NM. SN 85-536,761. PUB. 3-5-2013, FILED 2-8-2012.

LIVE BRAVELY

THE MARK CONSISTS OF STANDARD CHARACTERS WITHOUT CLAIM TO ANY PARTICULAR FONT, STYLE, SIZE, OR COLOR.

**CLASS 9—ELECTRICAL AND SCIENTIFIC APPARATUS**

FOR PROVIDING DOWNLOADABLE COMPUTER SOFTWARE FEATURING INFORMATION IN THE FIELD OF SPORTS, FITNESS, RECREATION ACTIVITIES AND THE USE OF RELATED EQUIPMENT (U.S. CLS. 21, 23, 26, 36 AND 38).

FIRST USE 5-1-2012; IN COMMERCE 5-1-2012.

**CLASS 16—PAPER GOODS AND PRINTED MATTER**

FOR MAGAZINES IN THE FIELDS OF SPORTS, TRAVEL, FITNESS, RECREATION ACTIVITIES AND RELATED EQUIPMENT (U.S. CLS. 2, 5, 22, 23, 29, 37, 38 AND 50).

FIRST USE 5-1-2012; IN COMMERCE 5-1-2012.

**CLASS 41—EDUCATION AND ENTERTAINMENT**

FOR PROVIDING INFORMATION IN THE FIELDS OF SPORTS, FITNESS, RECREATION ACTIVITIES AND THE USE OF RELATED EQUIPMENT BY MEANS OF A GLOBAL COMPUTER NETWORK; PROVIDING INFORMATION IN THE FIELDS OF SPORTS, FITNESS, RECREATION ACTIVITIES AND THE USE OF RELATED EQUIPMENT BY MEANS OF MOBILE DEVICES; ENTERTAINMENT IN THE NATURE OF ON-GOING TELEVISION PROGRAMS IN THE FIELDS OF SPORTS, TRAVEL, FITNESS, RECREATION ACTIVITIES AND RELATED EQUIPMENT; TELEVISION PROGRAMMING SERVICES (U.S. CLS. 100, 101 AND 107).

FIRST USE 2-20-2013; IN COMMERCE 2-20-2013.

4,481,672. AQUEOUS MANAGEMENT GROUP, SANDY, UT. SN 85-541,015. PUB. 7-17-2012, FILED 2-13-2012.



THE COLOR(S) BLUE, ORANGE, AND BLACK IS/ARE CLAIMED AS A FEATURE OF THE MARK.

THE MARK CONSISTS OF A BLUE "V" WITH THE TOP RIGHT PART OF THE "V" BEING IN THE SHAPE OF A WATER DROP, NEXT TO THE WORD "VIZ!" IN ORANGE, ALL ON A RECTANGULAR BACKGROUND IN BLACK FADING TO BLUE IN THE LOWER RIGHT PORTION.

**CLASS 5—PHARMACEUTICALS**

FOR DIETARY AND NUTRITIONAL SUPPLEMENTS (U.S. CLS. 6, 18, 44, 46, 51 AND 52).

FIRST USE 3-12-2012; IN COMMERCE 3-12-2012.

**CLASS 35—ADVERTISING AND BUSINESS**

FOR MULTI-LEVEL MARKETING SERVICES (U.S. CLS. 100, 101 AND 102).

FIRST USE 3-12-2012; IN COMMERCE 3-12-2012.

4,481,664. AUSSIEFIT I, LLC, ST. PETERSBURG, FL. SN 85-536,826. PUB. 10-23-2012, FILED 2-8-2012.

# AUSSIEFIT

THE MARK CONSISTS OF STANDARD CHARACTERS WITHOUT CLAIM TO ANY PARTICULAR FONT, STYLE, SIZE, OR COLOR.

**CLASS 25—CLOTHING**

FOR CLOTHING, NAMELY, HATS, CAPS, SHIRTS, SWEATSHIRTS, JACKETS, SHORTS, PANTS, SWEATPANTS, SWEATBANDS AND SOCKS (U.S. CLS. 22 AND 39).

FIRST USE 9-18-2013; IN COMMERCE 9-18-2013.

**CLASS 41—EDUCATION AND ENTERTAINMENT**

FOR HEALTH CLUB SERVICES, NAMELY, PROVIDING INSTRUCTION, PERSONAL AND GROUP TRAINING, EQUIPMENT, AND FACILITIES FOR USE IN THE FIELD OF PHYSICAL EXERCISE; PHYSICAL FITNESS CONSULTATION (U.S. CLS. 100, 101 AND 107).

FIRST USE 12-20-2011; IN COMMERCE 12-20-2011.

4,481,677. STORMPATH, INC., SAN MATEO, CA. SN 85-548,932. PUB. 2-19-2013, FILED 2-21-2012.

# STORMPATH

THE MARK CONSISTS OF STANDARD CHARACTERS WITHOUT CLAIM TO ANY PARTICULAR FONT, STYLE, SIZE, OR COLOR.

**CLASS 9—ELECTRICAL AND SCIENTIFIC APPARATUS**

FOR COMPUTER SOFTWARE, NAMELY, IDENTITY MANAGEMENT AND IDENTITY SECURITY SOFTWARE FOR ENSURING THE SECURITY OF COMPUTER NETWORKS, DATABASES, COMPUTER SOFTWARE, SOFTWARE APPLICATIONS AND SOFTWARE DEVELOPMENT TOOLS; COMPUTER SOFTWARE FOR USE BY OTHERS TO MANAGE USERS, SIMPLIFY USER AUTHENTICATION AND CONTROL ACCESS TO COMPUTER NETWORKS, DATABASES, COMPUTER SOFTWARE, SOFTWARE APPLICATIONS AND SOFTWARE DEVELOPMENT TOOLS (U.S. CLS. 21, 23, 26, 36 AND 38).

FIRST USE 6-0-2012; IN COMMERCE 6-0-2012.

**CLASS 42—SCIENTIFIC AND COMPUTER SERVICES**

FOR COMPUTER CONSULTATION IN THE FIELD OF COMPUTER SECURITY; COMPUTER SECURITY SERVICES NAMELY, PROVIDING COMPUTER SECURITY SERVICE TO VERIFY USER OR MACHINE IDENTITIES, USER OR MACHINE PERMISSIONS, AND FOR THE MANAGEMENT OF USER OR MACHINE DATA; PROVIDING TEMPORARY USE OF ONLINE NON-DOWNLOADABLE SOFTWARE, NAMELY, IDENTITY MANAGEMENT AND IDENTITY SECURITY SOFTWARE FOR USE BY OTHERS FOR ENSURING THE SECURITY OF COMPUTER NETWORKS, DATABASES, COMPUTER SOFTWARE, SOFTWARE APPLICATIONS AND SOFTWARE DEVELOPMENT TOOLS; PROVIDING TEMPORARY USE OF ONLINE NON-DOWNLOADABLE SOFTWARE FOR USE BY OTHERS TO MANAGE NETWORK AND DATABASE USERS, SIMPLIFY USER AUTHENTICATION AND CONTROL ACCESS TO COMPUTER SOFTWARE, SOFTWARE APPLICATIONS AND SOFTWARE DEVELOPMENT TOOLS (U.S. CLS. 100 AND 101).

FIRST USE 6-0-2012; IN COMMERCE 6-0-2012.

**CLASS 45—PERSONAL AND LEGAL SERVICES**

FOR MONITORING OF COMPUTER SYSTEMS FOR SECURITY PURPOSES (U.S. CLS. 100 AND 101).

FIRST USE 6-0-2012; IN COMMERCE 6-0-2012.

4,481,680. STYLE HAUL, INC., LOS ANGELES, CA. SN 85-551,315. PUB. 3-12-2013, FILED 2-23-2012.

STYLEHAUL

THE MARK CONSISTS OF STANDARD CHARACTERS WITHOUT CLAIM TO ANY PARTICULAR FONT, STYLE, SIZE, OR COLOR.

**CLASS 41—EDUCATION AND ENTERTAINMENT**

FOR PROVIDING A WEBSITE FEATURING NON-DOWNLOADABLE VIDEOS IN THE FIELD OF FITNESS (U.S. CLS. 100, 101 AND 107).

FIRST USE 2-22-2011; IN COMMERCE 2-22-2011.

**CLASS 44—MEDICAL, BEAUTY AND AGRICULTURAL SERVICES**

FOR PROVIDING A WEBSITE FEATURING NON-DOWNLOADABLE VIDEOS IN THE FIELDS OF BEAUTY (U.S. CLS. 100 AND 101).

FIRST USE 2-22-2011; IN COMMERCE 2-22-2011.

**CLASS 45—PERSONAL AND LEGAL SERVICES**

FOR PROVIDING A WEBSITE FEATURING NON-DOWNLOADABLE VIDEOS IN THE FIELD OF FASHION (U.S. CLS. 100 AND 101).

FIRST USE 2-22-2011; IN COMMERCE 2-22-2011.

4,481,683. UNISONO SOLUCIONES DE NEGOCIO SA, E-28027 MADRID, SPAIN. SN 85-553,282. PUB. 2-19-2013, FILED 2-27-2012.

unisono  
business solutions

NO CLAIM IS MADE TO THE EXCLUSIVE RIGHT TO USE "BUSINESS SOLUTIONS", APART FROM THE MARK AS SHOWN.

THE MARK CONSISTS OF THE WORD "UNISONO" IN A LOWER CASE STYLIZED FONT WITH THE "DOT" ON THE LETTER "I" SLANTING TO THE RIGHT; BELOW THIS WORD APPEAR THE WORDS "BUSINESS SOLUTIONS" IN A LOWER CASE STYLIZED FONT.

THE ENGLISH TRANSLATION OF "UNISONO" IN THE MARK IS "UNISON".

**CLASS 35—ADVERTISING AND BUSINESS**

FOR ADVERTISING, MARKETING, MARKET RESEARCH; BUSINESS MANAGEMENT AND ORGANIZATION CONSULTANCY; PUBLIC RELATIONS; OFFICE FUNCTIONS (U.S. CLS. 100, 101 AND 102).

FIRST USE 7-0-2012; IN COMMERCE 7-0-2012.

**CLASS 36—INSURANCE AND FINANCIAL**

FOR BUSINESS MANAGEMENT BROKERAGE (U.S. CLS. 100, 101 AND 102).

FIRST USE 7-0-2012; IN COMMERCE 7-0-2012.

**CLASS 38—COMMUNICATION**

FOR TELECOMMUNICATIONS SERVICES, NAMELY, COMMUNICATIONS VIA MULTINATIONAL TELECOMMUNICATION NETWORKS; TELECOMMUNICATION SERVICES, NAMELY, TRANSMISSION OF VOICE, DATA, GRAPHICS, SOUND AND VIDEO BY MEANS OF BROADBAND POWER LINE OR WIRELESS NETWORKS (U.S. CLS. 100, 101 AND 104).

FIRST USE 7-0-2012; IN COMMERCE 7-0-2012.

4,481,684. UNISONO SOLUCIONES DE NEGOCIO SA, E-28027 MADRID, SPAIN. SN 85-553,315. PUB. 2-19-2013, FILED 2-27-2012.

UNISONO BUSINESS SOLUTIONS

THE MARK CONSISTS OF STANDARD CHARACTERS WITHOUT CLAIM TO ANY PARTICULAR FONT, STYLE, SIZE, OR COLOR.

NO CLAIM IS MADE TO THE EXCLUSIVE RIGHT TO USE "BUSINESS SOLUTIONS", APART FROM THE MARK AS SHOWN.

THE ENGLISH TRANSLATION OF "UNISONO" IN THE MARK IS "UNISON".

**CLASS 35—ADVERTISING AND BUSINESS**

FOR ADVERTISING, MARKETING, MARKET RESEARCH; BUSINESS MANAGEMENT AND ORGANIZATION CONSULTANCY; PUBLIC RELATIONS; OFFICE FUNCTIONS (U.S. CLS. 100, 101 AND 102).

FIRST USE 7-0-2012; IN COMMERCE 7-0-2012.

**CLASS 36—INSURANCE AND FINANCIAL**

FOR BUSINESS MANAGEMENT BROKERAGE (U.S. CLS. 100, 101 AND 102).

FIRST USE 7-0-2012; IN COMMERCE 7-0-2012.

**CLASS 38—COMMUNICATION**

FOR TELECOMMUNICATIONS SERVICES, NAMELY, COMMUNICATIONS VIA MULTINATIONAL TELECOMMUNICATION NETWORKS; TELECOMMUNICATION SERVICES, NAMELY, TRANSMISSION OF VOICE, DATA, GRAPHICS, SOUND AND VIDEO BY MEANS OF BROADBAND POWER LINE OR WIRELESS NETWORKS (U.S. CLS. 100, 101 AND 104).

FIRST USE 7-0-2012; IN COMMERCE 7-0-2012.

4,481,698. RICKMAN, STEVEN J., ATLANTA, GA. SN 85-565,555. PUB. 2-19-2013, FILED 3-9-2012.

**SOUTHSIDE STEVE'S**

THE MARK CONSISTS OF STANDARD CHARACTERS WITHOUT CLAIM TO ANY PARTICULAR FONT, STYLE, SIZE, OR COLOR.

NO CLAIM IS MADE TO THE EXCLUSIVE RIGHT TO USE "SOUTHSIDE", APART FROM THE MARK AS SHOWN.

**CLASS 25—CLOTHING**

FOR CLOTHING, NAMELY, SHIRTS AND T-SHIRTS (U.S. CLS. 22 AND 39).

FIRST USE 4-19-2008; IN COMMERCE 4-19-2008.

**CLASS 43—HOTEL AND RESTAURANT SERVICES**

FOR RESTAURANT AND BAR SERVICES (U.S. CLS. 100 AND 101).

FIRST USE 4-19-2008; IN COMMERCE 4-19-2008.

4,481,701. WISTRON CORPORATION, HSINCHU, TAIWAN. SN 85-569,618. PUB. 3-12-2013, FILED 3-14-2012.



THE COLOR(S) BLUE AND GREEN IS/ARE CLAIMED AS A FEATURE OF THE MARK.

THE MARK CONSISTS OF THE STYLIZED WORDING

"WIWYNN" WITH THE TWO "W" AND "N" LETTERS IN THE COLOR BLUE, AND THE LETTERS "I" AND "Y" IN THE COLOR GREEN.

**CLASS 9—ELECTRICAL AND SCIENTIFIC APPARATUS**

FOR COMPUTER TELEPHONY SOFTWARE OFFERING COMMUNICATION INTEGRATED TELEPHONE SYSTEM VIA INTERNET (U.S. CLS. 21, 23, 26, 36 AND 38).

FIRST USE 7-1-2013; IN COMMERCE 7-1-2013.

**CLASS 38—COMMUNICATION**

FOR ELECTRONIC TRANSMISSION OF DATA AND DOCUMENTATION VIA THE INTERNET OR OTHER COMPUTER TERMINALS; PROVIDING INTERNET ACCESS; PROVISION OF TELECOMMUNICATIONS CONNECTIONS TO ELECTRONIC COMMUNICATION NETWORKS, FOR TRANSMISSION OR RECEPTION OF AUDIO, VIDEO OR MULTIMEDIA CONTENT; PROVIDING ACCESS TO THE INTERNET AND PROVIDING TRANSMISSION OF NEWS; PROVISION OF WIRELESS TELECONFERENCE SERVICE VIA ELECTRONIC COMMUNICATION NETWORK; DELIVERY OF DIGITAL MUSIC AND VIDEO FILES OVER DIGITAL NETWORKS AND BY ELECTRONIC TRANSMISSION; MESSAGE SENDING AND RECEIVING SERVICES; PROVIDING TELECOMMUNICATION CONNECTIVITY SERVICES FOR TRANSFER OF IMAGES, MESSAGES, AUDIO, VISUAL, AUDIOVISUAL AND MULTIMEDIA WORKS; ELECTRONIC TRANSMISSION OF DATA; RENTAL OF ACCESS TIME TO GLOBAL COMPUTER NETWORKS; BROADCAST OF CABLE NEWS TELEVISION PROGRAMMES; ELECTRONIC TELECOMMUNICATIONS CONSULTATION SERVICE; NEWS AGENCY SERVICES FOR ELECTRONIC TRANSMISSION; FACSIMILE TRANSMISSION AND RETRIEVAL SERVICES; COMMUNICATION VIA OPTICAL FIBER NETWORKS; LEASING OF TELECOMMUNICATION EQUIPMENT; PROVIDING ELECTRONIC TELECOMMUNICATIONS CONNECTIONS TO A GLOBAL COMPUTER NETWORK; ELECTRONIC MAIL SERVICES; PROVIDING ELECTRONIC BULLETIN BOARDS FOR TRANSMISSION OF MESSAGES IN THE FIELD OF GENERAL INTEREST, SCIENCE, ART, FOOD AND DRINK, CULTURE, MUSIC AND PURCHASING; PROVIDING USER ACCESS TO A GLOBAL COMPUTER NETWORK; PROVIDING ELECTRONIC TELECOMMUNICATIONS CONNECTIONS; PROVIDING USER ACCESS TO ON-LINE DATA VIA COMPUTER NETWORKS IN THE FIELD OF ENTERTAINMENT, ART, MATH, MUSIC, TECHNOLOGY, ELECTRONIC GAMES, AND SPORTS EDUCATION; STREAMING OF AUDIO, VIDEO MATERIAL ON THE INTERNET; RENTAL OF TELECOMMUNICATION APPARATUS FOR TRANSMISSION OF MESSAGES; RENTAL OF TELEPHONES; RENTAL OF TELECOMMUNICATION EQUIPMENT INCLUDING TELEPHONES AND FACSIMILE APPARATUS; TRANSMISSION SERVICE BETWEEN COMPUTERS, NAMELY, PEER-TO-PEER NETWORK COMPUTER SERVICES, NAMELY, ELECTRONIC TRANSMISSION OF AUDIO, VIDEO AND OTHER DATA AND DOCUMENTS AMONG COMPUTERS; WEBCASTING SERVICES; TRANSMISSION OF DATA OR AUDIO VISUAL IMAGES VIA A GLOBAL COMPUTER NETWORK FEATURING MUSIC, SOUND AND VIDEO; ELECTRONIC TRANSMISSION OF AUDIO AND VIDEO FILES VIA GLOBAL COMPUTER NETWORK; PROVIDING ACCESS TO DATABASES FOR OTHERS TO RETRIEVE MESSAGES AND IMAGES; TRANSMISSION OF VOICE, AUDIO, VISUAL IMAGES AND DATA BY TELECOMMUNICATIONS NETWORKS, WIRELESS COMMUNICATION NETWORKS, THE INTERNET, INFORMATION SERVICES NETWORKS AND DATA NETWORKS; PROVIDING MULTIPLE USER ACCESS TO PROPRIETARY COLLECTIONS OF INFORMATION BY MEANS OF GLOBAL COMPUTER INFORMATION NETWORKS; COMMUNICATIONS BY COMPUTER TERMINALS; PROVIDING INFORMATION ABOUT TELECOMMUNICATION (U.S. CLS. 100, 101 AND 104).

FIRST USE 7-1-2013; IN COMMERCE 7-1-2013.

4,481,702. EDUCATION THROUGH MUSIC, INC., NEW YORK, NY. SN 85-570,380. PUB. 5-14-2013, FILED 3-15-2012.

4,481,707. WELLS FARGO & COMPANY, MINNEAPOLIS, MN. SN 85-577,058. PUB. 2-19-2013, FILED 3-22-2012.



THE MARK CONSISTS OF THE WORDING "EDUCATION" ABOVE THE TERMS "THROUGH MUSIC" WITH A STYLIZED DESIGN OF A KEYBOARD ABOVE TO "IC" OF "MUSIC" AND TO THE RIGHT OF THE TERM "EDUCATION".

SEC. 2(F) AS TO "EDUCATION THROUGH MUSIC".

#### **CLASS 16—PAPER GOODS AND PRINTED MATTER**

FOR PUBLICATIONS AND PRINTED MATERIALS, NAMELY, BOOKS, NEWSLETTERS, PRINTED TEACHING MATERIALS, WORKBOOKS, INSTRUCTION MANUALS, TEACHERS' MANUALS, COLORING BOOKS, ACTIVITY BOOKS, SONG BOOKS AND PRINTED CURRICULUM IN THE FIELD OF MUSIC AND EDUCATION FOR CHILDREN (U.S. CLS. 2, 5, 22, 23, 29, 37, 38 AND 50).

FIRST USE 8-28-2012; IN COMMERCE 8-28-2012.

#### **CLASS 36—INSURANCE AND FINANCIAL**

FOR CHARITABLE FUND RAISING SERVICES, NAMELY, RAISING FUNDS FOR THE DEVELOPMENT AND DISSEMINATION OF PROGRAMS AND ACADEMIC CURRICULUM INTEGRATED WITH MUSIC AND OTHER FINE ARTS FOR THE PURPOSE OF STIMULATING AND ENHANCING ACADEMIC PERFORMANCE IN CHILDREN (U.S. CLS. 100, 101 AND 102).

FIRST USE 11-15-2012; IN COMMERCE 11-15-2012.

#### **CLASS 41—EDUCATION AND ENTERTAINMENT**

FOR EDUCATIONAL SERVICES, NAMELY, THE DEVELOPMENT AND DISSEMINATION OF PROGRAMS AND ACADEMIC CURRICULUM INTEGRATED WITH MUSIC AND OTHER FINE ARTS FOR THE PURPOSE OF STIMULATING AND ENHANCING ACADEMIC PERFORMANCE IN CHILDREN (U.S. CLS. 100, 101 AND 107).

FIRST USE 11-15-2012; IN COMMERCE 11-15-2012.

THE MARK CONSISTS OF ABSTRACT IMAGE OF A HUMAN FIGURE, LEGS SHOULDER-WIDTH APART AND ARMS OUTSTRETCHED ON EITHER SIDE. BEGINNING AT SLIGHTLY ABOVE THE FIGURE'S RIGHT HAND, AND EXTENDING IN AN ARC OVER THE FIGURE'S HEAD, ENDING AT APPROXIMATELY THE FIGURE'S LEFT HAND, ARE THE FOLLOWING FOUR IMAGES: PIGGY BANK, MORTARBOARD, HOUSE, AND BRIEFCASE.

#### **CLASS 16—PAPER GOODS AND PRINTED MATTER**

FOR PRINTED EDUCATIONAL MATERIALS IN THE FIELDS OF BANKING, CREDIT, MONEY MANAGEMENT, INVESTING, INVESTMENTS, RETIREMENT, FINANCIAL MATTERS, AND FINANCIAL LITERACY (U.S. CLS. 2, 5, 22, 23, 29, 37, 38 AND 50).

FIRST USE 12-15-2011; IN COMMERCE 3-1-2012.

#### **CLASS 36—INSURANCE AND FINANCIAL**

FOR PROVIDING INFORMATION IN THE FIELDS OF BANKING, CREDIT, FINANCIAL MONEY MANAGEMENT, FINANCIAL INVESTING, FINANCIAL INVESTMENTS, FINANCIAL PLANNING FOR RETIREMENT, AND FINANCIAL MATTERS; FINANCIAL INFORMATION RELATED TO FINANCIAL LITERACY; PROVIDING A WEBSITE FEATURING FINANCIAL INFORMATION RELATED TO FINANCIAL LITERACY (U.S. CLS. 100, 101 AND 102).

FIRST USE 12-15-2011; IN COMMERCE 3-1-2012.

#### **CLASS 41—EDUCATION AND ENTERTAINMENT**

FOR EDUCATIONAL SERVICES, NAMELY, PROVIDING LIVE AND ONLINE TRAINING AND CLASSES IN THE FIELDS OF BANKING, CREDIT, MONEY MANAGEMENT, INVESTING, INVESTMENTS, RETIREMENT, AND FINANCIAL MATTERS; EDUCATIONAL SERVICES, NAMELY, PROVIDING LIVE AND ONLINE TRAINING AND CLASSES IN THE FIELD OF FINANCIAL LITERACY AND DISTRIBUTION OF COURSE MATERIALS IN CONNECTION THEREWITH (U.S. CLS. 100, 101 AND 107).

FIRST USE 12-15-2011; IN COMMERCE 3-1-2012.

4,481,711. MAGIC GOURMET TRADING INC., MILLBRAE, CA. SN 85-580,065. PUB. 9-11-2012, FILED 3-26-2012.

4,481,726. HOLMBERG, LARRY, GULLY, MN. SN 85-594,316. PUB. 3-19-2013, FILED 4-11-2012.

## MAGIC DIM SUM

THE MARK CONSISTS OF STANDARD CHARACTERS WITHOUT CLAIM TO ANY PARTICULAR FONT, STYLE, SIZE, OR COLOR.

NO CLAIM IS MADE TO THE EXCLUSIVE RIGHT TO USE "DIM SUM", APART FROM THE MARK AS SHOWN.

### CLASS 29—MEATS AND PROCESSED FOODS

FOR PROCESSED VEGETABLES; PROCESSED SEAFOOD; SHELLFISH; FROZEN OR PREPARED MEALS IN THE NATURE OF DIM SUM CONSISTING PRIMARILY OF MEAT, POULTRY, GAME, SEAFOOD, VEGETABLES AND/OR FRUIT; FROZEN OR PREPARED SOUP (U.S. CL. 46).

FIRST USE 10-23-2013; IN COMMERCE 10-23-2013.

### CLASS 30—STAPLE FOODS

FOR CAKES, CANDIES, FROZEN OR PREPARED MEALS IN THE NATURE OF DIM SUM CONSISTING PRIMARILY OF PASTA, RICE, BREAD, CEREALS, NOODLES AND/OR PASTRIES; TEA (U.S. CL. 46).

FIRST USE 10-23-2013; IN COMMERCE 10-23-2013.

---

4,481,712. DIRECT SHOT DISTRIBUTING, LLC, AMARILLO, TX. SN 85-580,208. PUB. 8-14-2012, FILED 3-26-2012.

## DIRECT SHOT

THE MARK CONSISTS OF STANDARD CHARACTERS WITHOUT CLAIM TO ANY PARTICULAR FONT, STYLE, SIZE, OR COLOR.

### CLASS 35—ADVERTISING AND BUSINESS

FOR WHOLESALE DISTRIBUTORSHIPS FEATURING A VARIETY OF PHYSICAL GOODS (U.S. CLS. 100, 101 AND 102).

FIRST USE 3-30-2012; IN COMMERCE 3-30-2012.

### CLASS 39—TRANSPORTATION AND STORAGE

FOR WAREHOUSING SERVICES, NAMELY, STORAGE, DISTRIBUTION, PICK-UP, PACKING, AND SHIPPING OF A VARIETY OF PHYSICAL GOODS (U.S. CLS. 100 AND 105).

FIRST USE 3-30-2012; IN COMMERCE 3-30-2012.

## KILLSHOT

THE MARK CONSISTS OF STANDARD CHARACTERS WITHOUT CLAIM TO ANY PARTICULAR FONT, STYLE, SIZE, OR COLOR.

### CLASS 9—ELECTRICAL AND SCIENTIFIC APPARATUS

FOR CAMERAS, NAMELY, ACTION CAMERAS AND DIGITAL VIDEO CAMERAS; HUNTING EQUIPMENT, NAMELY, GUN SCOPE MOUNTS FOR ATTACHING ACCESSORIES TO GUN SCOPES (U.S. CLS. 21, 23, 26, 36 AND 38).

FIRST USE 12-15-2012; IN COMMERCE 12-15-2012.

### CLASS 13—FIREARMS

FOR HUNTING EQUIPMENT, NAMELY, GUN MOUNTS FOR ATTACHING ACCESSORIES TO FIREARMS (U.S. CLS. 2 AND 9).

FIRST USE 12-15-2012; IN COMMERCE 12-15-2012.

### CLASS 28—TOYS AND SPORTING GOODS

FOR HUNTING EQUIPMENT, NAMELY, BOW MOUNTS FOR ATTACHING ACCESSORIES TO BOWS (U.S. CLS. 22, 23, 38 AND 50).

FIRST USE 12-15-2012; IN COMMERCE 12-15-2012.

---

4,481,730. NUAGE 8, INC., COLORADO SPRINGS, CO. SN 85-595,813. PUB. 9-4-2012, FILED 4-12-2012.

## PAX8

THE MARK CONSISTS OF STANDARD CHARACTERS WITHOUT CLAIM TO ANY PARTICULAR FONT, STYLE, SIZE, OR COLOR.

THE ENGLISH TRANSLATION OF "PAX" IN THE MARK IS "PEACE".

### CLASS 35—ADVERTISING AND BUSINESS

FOR ON-LINE RETAIL STORE SERVICES FEATURING COMPUTER SOFTWARE AND APPLICATIONS (U.S. CLS. 100, 101 AND 102).

FIRST USE 6-24-2013; IN COMMERCE 6-24-2013.

**CLASS 42—SCIENTIFIC AND COMPUTER SERVICES**

FOR COMPUTER SERVICES, NAMELY, CLOUD HOSTING PROVIDER SERVICES; CONSULTING SERVICES IN THE FIELD OF CLOUD COMPUTING; PROVIDING VIRTUAL COMPUTER SYSTEMS AND VIRTUAL COMPUTER ENVIRONMENTS THROUGH CLOUD COMPUTING; TECHNICAL CONSULTING SERVICES IN THE FIELDS OF DATACENTER ARCHITECTURE, PUBLIC AND PRIVATE CLOUD COMPUTING SOLUTIONS, AND EVALUATION AND IMPLEMENTATION OF INTERNET TECHNOLOGY AND SERVICES; TECHNICAL SUPPORT SERVICES, NAMELY, REMOTE AND ON-SITE INFRASTRUCTURE MANAGEMENT SERVICES FOR MONITORING, ADMINISTRATION AND MANAGEMENT OF PUBLIC AND PRIVATE CLOUD COMPUTING IT AND APPLICATION SYSTEMS (U.S. CLS. 100 AND 101).

FIRST USE 6-24-2013; IN COMMERCE 6-24-2013.

**CLASS 44—MEDICAL, BEAUTY AND AGRICULTURAL SERVICES**

FOR WEIGHT MANAGEMENT SERVICES, NAMELY, WEIGHT REDUCTION PLANNING SERVICES; SUPERVISION OF WEIGHT REDUCTION PROGRAMS; WEIGHT CONTROL EVALUATION SERVICES; WEIGHT CONTROL TREATMENT SERVICES (U.S. CLS. 100 AND 101).

FIRST USE 10-13-2011; IN COMMERCE 10-13-2011.

4,481,744. PARK NICOLLET HEALTH SERVICES, ST. LOUIS PARK, MN. SN 85-600,083. PUB. 3-19-2013, FILED 4-17-2012.

**FOR EVERYTHING YOU LOVE**

4,481,734. ALLEN, RHIAN, SURRY HILLS, NSW, AUSTRALIA. SN 85-596,895. PUB. 7-2-2013, FILED 4-13-2012.

THE MARK CONSISTS OF STANDARD CHARACTERS WITHOUT CLAIM TO ANY PARTICULAR FONT, STYLE, SIZE, OR COLOR.

**CLASS 41—EDUCATION AND ENTERTAINMENT**

FOR PROVIDING A WEBSITE FEATURING ONLINE MATERIALS, NAMELY, ARTICLES REGARDING HEALTH AND HEALTH CARE AND A HEALTH LIBRARY REGARDING HEALTH, WELLNESS, HEALTH CARE AND MEDICAL SERVICES INFORMATION (U.S. CLS. 100, 101 AND 107).

FIRST USE 5-0-2012; IN COMMERCE 5-0-2012.

**CLASS 44—MEDICAL, BEAUTY AND AGRICULTURAL SERVICES**

FOR HEALTH AND WELLNESS CONSULTATION SERVICES; MEDICAL AND HEALTH CARE SERVICES (U.S. CLS. 100 AND 101).

FIRST USE 5-0-2012; IN COMMERCE 5-0-2012.



PRIORITY CLAIMED UNDER SEC. 44(D) ON AUSTRALIA APPLICATION NO. 1453747, FILED 10-13-2011, REG. NO. 1453747, DATED 10-13-2011, EXPIRES 10-13-2021.

THE MARK CONSISTS OF THE WORDING "LOSEBABYWEIGHT.COM.AU" BELOW A STYLIZED IMAGE, ALL IN SILHOUETTE, OF A WOMAN PUSHING A BABY IN A BABY STROLLER.

**CLASS 35—ADVERTISING AND BUSINESS**

FOR RETAIL PHARMACY SERVICES FEATURING DIETARY PLANS AND PRODUCTS; RETAIL STORE SERVICES FEATURING DIETARY PLANS AND PRODUCTS; ONLINE RETAIL STORE SERVICES FEATURING DIETARY PLANS AND PRODUCTS (U.S. CLS. 100, 101 AND 102).

FIRST USE 10-13-2011; IN COMMERCE 10-13-2011.

**CLASS 41—EDUCATION AND ENTERTAINMENT**

FOR PROVIDING ON-LINE PUBLICATIONS, NAMELY, DIETARY PLANS IN THE NATURE OF E-BOOKS (U.S. CLS. 100, 101 AND 107).

FIRST USE 10-1-2010; IN COMMERCE 10-1-2010.

4,481,752. CARIBE TIRE, CAMANA BAY, CAYMAN ISLANDS. SN 85-602,241. PUB. 3-19-2013, FILED 4-19-2012.



NO CLAIM IS MADE TO THE EXCLUSIVE RIGHT TO USE "CARIBE TIRES", APART FROM THE MARK AS SHOWN.

THE MARK CONSISTS OF THE WORDS "CARIBE TIRES" WITH A DESIGN OF A SMALL ISLAND APPEARING UNDER THE WORD "TIRES" AND A DESIGN OF A COCONUT PALM APPEARING TO THE RIGHT OF THE WORDS "CARIBE TIRES".

THE ENGLISH TRANSLATION OF THE WORD "CARIBE" IN THE MARK IS "CARIBBEAN".



**CLASS 12—VEHICLES**

FOR TIRES; INNER TUBES FOR VEHICLE TIRES; TIRE TREADS FOR RETREADING TIRES (U.S. CLS. 19, 21, 23, 31, 35 AND 44).

FIRST USE 5-19-2012; IN COMMERCE 5-19-2012.

**CLASS 35—ADVERTISING AND BUSINESS**

FOR WHOLESALE DISTRIBUTORSHIPS FEATURING TIRES AND INNER TUBES (U.S. CLS. 100, 101 AND 102).

FIRST USE 11-14-2013; IN COMMERCE 11-14-2013.

4,481,753. BEST MADE COMPANY, LLC, NEW YORK, NY.  
SN 85-602,740. PUB. 3-19-2013, FILED 4-19-2012.

BEST  MADE

OWNER OF U.S. REG. NO. 4,130,672.

NO CLAIM IS MADE TO THE EXCLUSIVE RIGHT TO USE "BEST" AND "MADE", APART FROM THE MARK AS SHOWN.

THE MARK CONSISTS OF THE LETTER "X" IN THE SHAPE OF A CROSS BETWEEN THE WORDS "BEST" AND "MADE".

**CLASS 5—PHARMACEUTICALS**

FOR FIRST AID KITS (U.S. CLS. 6, 18, 44, 46, 51 AND 52).

FIRST USE 2-28-2010; IN COMMERCE 2-28-2010.

**CLASS 8—HAND TOOLS**

FOR AXES; AXE CARE KITS COMPRISING A DIAMOND FILE, A BASTARD FILE, LINSEED OIL, C-CLAMPS, AND COTTON RAGS; KNIVES (U.S. CLS. 28 AND 44).

FIRST USE 5-31-2009; IN COMMERCE 5-31-2009.

**CLASS 9—ELECTRICAL AND SCIENTIFIC APPARATUS**

FOR EXTENSION CORDS, COMPASSES AND TAPE MEASURES, FOLDING, GRADUATED AND TAPE RULERS; PROTECTIVE COVERS USED ON AXES BLADES; EYE GLASSES (U.S. CLS. 21, 23, 26, 36 AND 38).

FIRST USE 5-31-2012; IN COMMERCE 5-31-2012.

**CLASS 16—PAPER GOODS AND PRINTED MATTER**

FOR PENS, PENCILS, SILKSCREEN MAPS, NOTEBOOKS, CARDBOARD, CORRUGATED AND FIBERBOARD AXE BOXES, DRAFTING, DRAWING AND UN-GRADUATED RULERS (U.S. CLS. 2, 5, 22, 23, 29, 37, 38 AND 50).

FIRST USE 8-31-2012; IN COMMERCE 8-31-2012.

**CLASS 18—LEATHER GOODS**

FOR BACKPACKS, LEADS FOR ANIMALS, DUFFLE BAGS, WALLETS, CARRYING CASES, LEATHER SLING POUCHES FOR AXES, LEATHER POUCHES USED FOR AXE BLADES (U.S. CLS. 1, 2, 3, 22 AND 41).

FIRST USE 8-31-2012; IN COMMERCE 8-31-2012.

**CLASS 21—HOUSEWARES AND GLASS**

FOR BROOMS, CUPS, SCRUBBING BRUSHES, SALT CELLARS OF HORN, CUPS OF HORN, DRINKING VESSELS, SHOP WASHING BRUSHES, DRINKING GLASSES AND DINNERWARE (U.S. CLS. 2, 13, 23, 29, 30, 33, 40 AND 50).

FIRST USE 8-31-2011; IN COMMERCE 8-31-2011.

**CLASS 22—CORDAGE AND FIBERS**

FOR TENTS AND CARGO NETS (U.S. CLS. 1, 2, 7, 19, 22, 42 AND 50).

FIRST USE 4-30-2012; IN COMMERCE 4-30-2012.

**CLASS 24—FABRICS**

FOR TOWELS; BABY AND BED BLANKETS (U.S. CLS. 42 AND 50).

FIRST USE 11-30-2011; IN COMMERCE 11-30-2011.

**CLASS 25—CLOTHING**

FOR CLOTHING, NAMELY, VESTS, JACKETS, SWEATERS, BASE LAYERS, UNDERWEAR, SWEATSHIRTS, T-SHIRTS, OVERALLS, SOCKS, APRONS, PANTS, SHORTS, SWIMWEAR, GLOVES, SCARVES, SHOES, MITTENS, BANDANAS, BELTS, AND HATS (U.S. CLS. 22 AND 39).

FIRST USE 6-30-2012; IN COMMERCE 6-30-2012.

**CLASS 26—FANCY GOODS**

FOR ORNAMENTAL NOVELTY BADGES (U.S. CLS. 37, 39, 40, 42 AND 50).

FIRST USE 8-31-2011; IN COMMERCE 8-31-2011.

4,481,754. BEST MADE COMPANY, LLC, NEW YORK, NY.  
SN 85-602,748. PUB. 3-19-2013, FILED 4-19-2012.

  
MADE

OWNER OF U.S. REG. NO. 4,130,672.

THE MARK CONSISTS OF THE LETTER "X" IN THE SHAPE OF A CROSS ABOVE THE WORD "MADE".

**CLASS 18—LEATHER GOODS**

FOR BACKPACKS, DUFFLE BAGS, CARRYING CASES (U.S. CLS. 1, 2, 3, 22 AND 41).

FIRST USE 4-30-2012; IN COMMERCE 4-30-2012.

**CLASS 25—CLOTHING**

FOR CLOTHING, NAMELY, VESTS, JACKETS, SWEATERS, BASE LAYERS, UNDERWEAR, SWEATSHIRTS, T-SHIRTS, APRONS, GLOVES, SCARVES, MITTENS, BANDANAS, BELTS, AND HATS (U.S. CLS. 22 AND 39).

FIRST USE 5-31-2012; IN COMMERCE 5-31-2012.

4,481,760. WORLD RADIO NETWORK, MCALLEN, TX. SN 85-607,038. PUB. 3-19-2013, FILED 4-24-2012.

**INSPIRACOM**

THE MARK CONSISTS OF STANDARD CHARACTERS WITHOUT CLAIM TO ANY PARTICULAR FONT, STYLE, SIZE, OR COLOR.

**CLASS 38—COMMUNICATION**

FOR BROADCASTING OF RELIGIOUS RADIO PROGRAMS; INTERNET RADIO BROADCASTING SERVICES (U.S. CLS. 100, 101 AND 104).  
FIRST USE 5-31-2012; IN COMMERCE 5-31-2012.

**CLASS 41—EDUCATION AND ENTERTAINMENT**

FOR PRODUCTION AND DISTRIBUTION OF RADIO PROGRAMS; RADIO PROGRAM SYNDICATION (U.S. CLS. 100, 101 AND 107).  
FIRST USE 5-31-2012; IN COMMERCE 5-31-2012.

4,481,762. HARVARD MAINTENANCE, INC., NEW YORK, NY. SN 85-609,154. PUB. 3-19-2013, FILED 4-26-2012.

**HARVARD**  
SERVICE EXCELLENCE

OWNER OF U.S. REG. NOS. 2,825,189, 4,046,959, AND OTHERS.

NO CLAIM IS MADE TO THE EXCLUSIVE RIGHT TO USE "SERVICE EXCELLENCE", APART FROM THE MARK AS SHOWN.

THE COLOR(S) DARK BLUE IS/ARE CLAIMED AS A FEATURE OF THE MARK.

THE MARK CONSISTS OF THE TERM "HARVARD" IN DARK BLUE, WITH THE "V" IN THE FORM OF A CHECK MARK, WITH THE RIGHT SIDE EXTENDING ABOVE THE OTHER LETTERS, AND WITH "SERVICE EXCELLENCE" IN SMALLER DARK BLUE LETTERS UNDER THE LETTERS "ARVARD" OF "HARVARD".

**CLASS 35—ADVERTISING AND BUSINESS**

FOR MAIL ROOM AND MESSAGE CENTER SERVICES FOR OTHERS, NAMELY, STAFFING AND RUNNING A MAIL ROOM OR MESSAGE CENTER IN A CORPORATE OFFICE, BUILDING OR FACILITY ENVIRONMENT (U.S. CLS. 100, 101 AND 102).  
FIRST USE 11-4-2013; IN COMMERCE 11-4-2013.

**CLASS 37—CONSTRUCTION AND REPAIR**

FOR CLEANING OF BUILDINGS AND FACILITIES; MAINTENANCE AND RENOVATION OF BUILDINGS AND FACILITIES; JANITORIAL SERVICES; CARPET AND RUG CLEANING AND SHAMPOOING; WINDOW CLEANING; TRASH COLLECTION; WASTE DISPOSAL FOR OTHERS; CLEANING, BUFFING AND POLISHING OF METAL AND STONE; DOOR MAINTENANCE AND REPAIR SERVICES; FURNITURE RESTORATION, REPAIR AND MAINTENANCE; FLOOR SANDING; PEST CONTROL AND EXTERMINATION OTHER THAN FOR AGRICULTURE (U.S. CLS. 100, 103 AND 106).  
FIRST USE 11-4-2013; IN COMMERCE 11-4-2013.

**CLASS 45—PERSONAL AND LEGAL SERVICES**

FOR SECURITY GUARD SERVICES; MONITORING SECURITY SYSTEMS (U.S. CLS. 100 AND 101).  
FIRST USE 11-4-2013; IN COMMERCE 11-4-2013.

4,481,767. MILKYWAY GROUP LTD., HONG KONG, HONG KONG. SN 85-614,337. PUB. 10-23-2012, FILED 5-2-2012.

**CINAVISION**

THE COLOR(S) BLACK AND RED IS/ARE CLAIMED AS A FEATURE OF THE MARK.

THE MARK CONSISTS OF THE WORD "CINAVISION" APPEARING IN BLACK AND IN STYLIZED FONT WITH A RED DESIGN ELEMENT OVER THE LETTER "V".

**CLASS 9—ELECTRICAL AND SCIENTIFIC APPARATUS**

FOR COMPUTER ACCESSORIES, NAMELY, KEYBOARDS, MOUSE PAD, NOTEBOOK STAND, USB CABLES, USB HUBS; WORD PROCESSORS; DVD PLAYERS; VIDEO DISC PLAYERS; BLANK VIDEO DISCS; VIDEO TAPE RECORDERS; VIDEO TAPE PLAYERS; VIDEO CAMERAS; TELEVISIONS; PROJECTION TELEVISIONS; RADIOS; TRANSCEIVERS; TAPE RECORDERS; TAPE PLAYERS; HEAD PHONES; CAR STEREOS; STEREO APPLIANCES, NAMELY, TAPE PLAYERS, TAPE RECORDERS, TUNERS, AMPLIFIERS, RECORD PLAYERS, CARTRIDGES, SPEAKERS; BLANK AUDIO CASSETTE TAPES; BLANK VIDEO CASSETTE TAPES; EARPHONES; MICROPHONES; MICROPHONE MIXERS; GRAPHIC EQUALIZERS; AUDIO SPEAKERS; HIGH END AUDIO SPEAKERS; HIGH POWERED AMPLIFIERS; MICRO AND MINI COMPONENTS, NAMELY, THE MICRO AND MINI COMPONENTS OF CONSUMER ELECTRONICS PRODUCTS, NAMELY, CABLES AND PINS; MICRO AND MINI HI-FI STEREO SYSTEMS COMPRISED OF STEREOS, CD PLAYERS, LOUDSPEAKERS, AUDIO SPEAKERS, LIQUID CRYSTAL DISPLAYS AND HEADPHONES; LCD PANEL DISPLAYS; PLASMA DISPLAYS; PROJECTOR; DVD RECORDERS; DVD+HDD RECORDERS; HD DVD PLAYERS; OPTICAL DISCS PLAYERS WITH FORMAT THAT USES A BLUE-VIOLET LASER; RECORDERS WITH FORMAT THAT USES A BLUE-VIOLET LASER; HD DVD RECORDERS; HD DISPLAY PANELS; MP3 PLAYERS; DOWNLOADABLE AUDIO-VISUAL MEDIA CONTENT IN THE FIELD OF ENTERTAINMENT FEATURING LIVE ACTION MOTION PICTURES, TELEVISION SERIES, COMEDIES, AND DRAMAS; DOWNLOADABLE AUDIO-VISUAL MEDIA CONTENT IN THE FIELD OF ENTERTAINMENT FEATURING ANIMATED MOTION PICTURES, TELEVISION SERIES, COMEDIES, AND DRAMAS; COMPUTER SOFTWARE, NAMELY, COMPUTER SOFTWARE FOR STREAMING

AUDIO-VISUAL MEDIA CONTENT VIA THE INTERNET, COMPUTER SOFTWARE FOR STREAMING AND STORING AUDIO-VISUAL MEDIA CONTENT, DOWNLOADABLE AUDIO AND VIDEO PLAYERS FOR MEDIA CONTENT WITH MULTIMEDIA AND INTERACTIVE FUNCTIONS, VIDEO SEARCH AND ANNOTATION SOFTWARE, CONTENT PROTECTION SOFTWARE, DATABASE MANAGEMENT SOFTWARE, DATABASE SYNCHRONIZATION SOFTWARE; COMPUTER PROGRAMS FOR ACCESSING, BROWSING AND SEARCHING ONLINE DATABASES, SOFTWARE THAT ENABLES USERS TO PLAY AND PROGRAM ENTERTAINMENT-RELATED AUDIO, VIDEO, TEXT AND MULTI-MEDIA CONTENT; COMPUTER APPLICATION SOFTWARE FOR STREAMING AND STORING AUDIO-VISUAL MEDIA CONTENT; COMPUTER APPLICATION SOFTWARE FOR STREAMING AUDIO-VISUAL MEDIA CONTENT VIA THE INTERNET; DOWNLOADABLE COMPUTER SOFTWARE FOR STREAMING AUDIO-VISUAL MEDIA CONTENT VIA THE INTERNET; DOWNLOADABLE COMPUTER SOFTWARE FOR STREAMING AND STORING AUDIO-VISUAL MEDIA CONTENT; DOWNLOADABLE PUBLICATIONS IN THE NATURE OF BOOKS AND MAGAZINES IN THE FIELD OF ENTERTAINMENT, NAMELY, PROVISION OF INFORMATION RELATING TO MOTION PICTURES AND MUSIC, RENTAL OF ELECTRONICS IN THE NATURE OF AUDIO AND VIDEO EQUIPMENT, RENTAL OF COMPUTER GAME PROGRAMS AND VIDEO GAME PROGRAMS, RENTAL OF VIDEO EQUIPMENT FOR USE IN CONNECTION WITH VIRTUAL REALITY SOFTWARE, PROVIDING AN ON-LINE INTERACTIVE COMPUTER GAME, PRODUCTION AND DISTRIBUTION OF RADIO AND TELEVISION PROGRAMS, MOTION PICTURE FILMS, PRODUCTION OF SOUND RECORDINGS, MUSIC VIDEO PRODUCTION, PRODUCTION OF INTERACTIVE COMPACT DISCS AND CD-ROMS FEATURING MUSIC, RENTAL OF MOTION PICTURE FILMS, SOUND RECORDINGS, INTERACTIVE COMPACT DISCS AND CD-ROMS, RENTAL OF VIDEOTAPE RECORDINGS TO OTHERS FOR PUBLIC EXHIBITION, PRESENTATION OF LIVE AND PRE-RECORDED MUSIC SHOWS IN URBAN ENVIRONMENTS FOR OTHERS, GAMING, SPORT ACTIVITIES, LISTENING MUSIC, WATCHING FILM, ONLINE SHOPPING (U.S. CLS. 21, 23, 26, 36 AND 38).

FIRST USE 10-1-2012; IN COMMERCE 10-1-2012.

#### **CLASS 35—ADVERTISING AND BUSINESS**

FOR ADVERTISING; CLASSIFIED ADVERTISING SERVICES; ON-LINE RETAIL AND MAIL ORDER SERVICES; RETAIL ON-LINE DEPARTMENT STORES; RETAIL ON-LINE CONVENIENCE STORES; COMPUTERIZED ON-LINE ORDERING FEATURING GENERAL MERCHANDISE AND GENERAL CONSUMER GOODS; PROVIDING A SEARCHABLE ON-LINE ADVERTISING GUIDE FEATURING THE GOODS AND SERVICES; COMPUTERIZED ON-LINE ORDERING FEATURING GENERAL MERCHANDISE AND GENERAL CONSUMER GOODS; DISTRIBUTORSHIP SERVICES BEING THE WHOLESALE AND RETAIL SALES BY MEANS OF A COMPUTER DATABASE; DATABASE MANAGEMENT SERVICES; AUCTION SERVICES; AUCTIONEERING; THE BRINGING TOGETHER, FOR THE BENEFIT OF OTHERS, OF A VARIETY OF GOODS, ENABLING CUSTOMERS TO CONVENIENTLY VIEW, SAMPLE AND PURCHASE THOSE GOODS IN A RETAIL OUTLET; PROVIDING ONLINE MARKETPLACES FOR THE INTRODUCTION OF SELLERS AND BUYERS OF GOODS AND SERVICES; COLLECTION, ANALYSES, AND ONLINE PROVISION OF STATISTICAL, QUANTITATIVE AND QUALITATIVE BUSINESS INFORMATION REGARDING THE SALE AND RESALE OF ITEMS VIA A GLOBAL COMPUTER NETWORK; PROVIDING MARKET INFORMATION IN THE NATURE OF

EVALUATIVE FEEDBACK AND RATINGS OF SELLERS' GOODS AND SERVICES, THE VALUE AND PRICES OF SELLERS' GOODS, BUYERS' AND SELLERS' PERFORMANCE, DELIVERY, AND OVERALL EXPERIENCE IN CONNECTION THEREWITH; CUSTOMER LOYALTY SERVICES AND CUSTOMER CLUB SERVICES FOR COMMERCIAL, PROMOTIONAL AND ADVERTISING PURPOSES; WHOLESALING AND RETAILING OF ELECTRICAL APPLIANCES AND PARTS AND ACCESSORIES FOR THESE GOODS; SALE AND DISTRIBUTION OF ELECTRONICS AND ELECTRICAL EQUIPMENT (U.S. CLS. 100, 101 AND 102).

FIRST USE 10-1-2012; IN COMMERCE 10-1-2012.

#### **CLASS 38—COMMUNICATION**

FOR PROVIDING ON-LINE FACILITIES FOR REAL-TIME INTERACTION WITH OTHER COMPUTER USERS CONCERNING TOPICS OF GENERAL INTEREST; PROVIDING ON-LINE CHAT ROOMS AND ELECTRONIC BULLETIN BOARDS FOR TRANSMISSION OF MESSAGES AMONG USERS REGARDING MOVIES, MOVIE SHOW TIMES, MOVIE TRAILERS, MOVIE RATINGS AND REVIEWS, MOVIE ROLES, MOVIE PLOTS, TELEVISION SERIES, COMPUTER GAMES, VIDEO GAMES AND ENTERTAINMENT INDUSTRY NEWS, AND FOR THE TRANSMISSION OF MOVIE RATINGS AND REVIEWS AMONG USERS; ELECTRONIC TRANSMISSION AND STREAMING OF DIGITAL MEDIA CONTENT FOR OTHERS VIA GLOBAL AND LOCAL COMPUTER NETWORKS AND VIA MOBILE TELEPHONES, SMARTPHONES AND OTHER MOBILE COMMUNICATIONS DEVICES; STREAMING OF AUDIO AND VIDEO MATERIAL ON THE INTERNET AND VIA MOBILE TELEPHONES, SMARTPHONES AND OTHER MOBILE COMMUNICATIONS DEVICES; TRANSMISSION OF DOWNLOADABLE AUDIO-VISUAL MEDIA CONTENT IN THE NATURE OF FULL-LENGTH, PARTIAL-LENGTH, AND CLIPS FROM MOTION PICTURES, TELEVISION PROGRAMMING, AND VIDEOS; VIDEO-ON-DEMAND TRANSMISSION SERVICES; COMMUNICATION SERVICES, NAMELY, ENABLING USERS OF MOBILE TELEPHONES, SMARTPHONES AND OTHER MOBILE COMMUNICATIONS DEVICES TO COMMUNICATE WITH EACH OTHER REGARDING MOVIES, MOVIE SHOW TIMES, MOVIE TRAILERS, MOVIE RATINGS AND REVIEWS, MOVIE ROLES, MOVIE PLOTS, TELEVISION SERIES, ACTORS, PRODUCERS, DIRECTORS, AND ENTERTAINMENT INDUSTRY NEWS, PERSONALITIES, EVENTS, PROJECTS, PLANNED OR POTENTIAL PROJECTS AND EVENTS, AND REGARDING COMPUTER AND VIDEO GAMES; TELECOMMUNICATIONS ACCESS SERVICES; PROVIDING AN ONLINE, INTERACTIVE BULLETIN BOARD FOR THE POSTING, PROMOTION, SALE AND RESALE OF ITEMS VIA A GLOBAL COMPUTER NETWORK; PROVIDING ONLINE FACILITIES FOR REAL-TIME INTERACTION WITH OTHER COMPUTER USERS CONCERNING TOPICS OF GENERAL INTEREST; PROVIDING USER ACCESS TO A DATABASE CONTAINING NETWORK DATA AND INFORMATION (U.S. CLS. 100, 101 AND 104).

FIRST USE 10-1-2012; IN COMMERCE 10-1-2012.

#### **CLASS 41—EDUCATION AND ENTERTAINMENT**

FOR ENTERTAINMENT SERVICES IN THE NATURE OF DISTRIBUTION AND DISPLAY OF LIVE-ACTION MOTION PICTURES, TELEVISION SERIES, DRAMAS AND COMEDIES; DISTRIBUTION AND DISPLAY OF ANIMATED MOTION PICTURES, TELEVISION SERIES, DRAMAS AND COMEDIES; PRODUCTION OF LIVE-ACTION MOTION PICTURES, TELEVISION SERIES, COMEDIES AND DRAMAS; PRODUCTION OF ANIMATED MOTION PICTURES, TELEVISION SERIES, COMEDIES AND DRAMAS; PROVIDING INFORMATION FOR AND ACTUAL ENTERTAINMENT VIA AN ELECTRONIC GLOBAL COMMUNICATIONS NETWORK IN THE NATURE OF MOTION PICTURES, TELEVISION PROGRAMMING, VIDEOS, MUSIC VIDEOS, AND MUSIC; PROVIDING AN ON-LINE COMPUTER DATABASE IN THE FIELD OF ENTERTAINMENT RELATING SPECIFICALLY TO MUSIC, MOVIES, TELEVISION SERIES AND GENERAL INTEREST NEWS; PROVIDING A WEB SITE FEATURING TELEVISION PROGRAMS, MOTION PICTURES,

CURRENT EVENT AND ENTERTAINMENT NEWS, SPORTS, GAMES, COMPUTER GAMES, VIDEO GAMES, CULTURAL EVENTS, AND ENTERTAINMENT-RELATED PROGRAMS; PROVIDING NON-DOWNLOADABLE ELECTRONIC PUBLICATIONS FOR BROWSING OVER COMPUTER NETWORKS, NAMELY, BOOKS, PAMPHLETS, BROCHURES, MAGAZINES AND NEWSLETTERS ON THE SUBJECT OF ENTERTAINMENT; PROVIDING ONLINE INTERACTIVE RESOURCE AND PROGRAMMING GUIDES ON THE SUBJECTS OF MOTION PICTURES, TELEVISION PROGRAMMING AND VIDEOS; PRODUCTION AND RENTAL OF AUDIO-VISUAL WORKS, SPECIFICALLY, MOTION PICTURES, TELEVISION PROGRAMMING, VIDEOS; PROVIDING INFORMATION REGARDING MOVIES, MOVIE SHOW TIMES, MOVIE TRAILERS, MOVIE RATINGS AND REVIEWS, MOVIE ROLES, MOVIE PLOTS, ACTORS, PRODUCERS, DIRECTORS, AND MOVIE INDUSTRY NEWS AND INFORMATION REGARDING CELEBRITIES, EVENTS, PROJECTS, AND PLANNED OR POTENTIAL EVENTS AND PROJECTS VIA A WEBSITE ON THE INTERNET AND VIA MOBILE TELEPHONES, SMARTPHONES AND OTHER MOBILE COMMUNICATIONS DEVICES; PUBLICATION OF ON-LINE JOURNALS, NAMELY, BLOGS FEATURING INFORMATION REGARDING MOVIES, MOVIE SHOW TIMES, MOVIE TRAILERS, MOVIE RATINGS AND REVIEWS, TELEVISION SERIES, VIDEO GAMES, COMPUTER GAMES, AND ENTERTAINMENT INDUSTRY NEWS; PROVIDING AN INTERACTIVE DATABASE FEATURING INFORMATION ABOUT MOVIES, MOVIE SHOW TIMES, MOVIE TRAILERS, MOVIE RATINGS AND REVIEWS, MOVIE ROLES, MOVIE PLOTS, TELEVISION SERIES, COMPUTER GAMES, VIDEO GAMES, ACTORS, PRODUCERS, DIRECTORS, AND ENTERTAINMENT INDUSTRY NEWS, PERSONALITIES, EVENTS, PROJECTS, PLANNED OR POTENTIAL PROJECTS AND EVENTS ONLINE AND VIA MOBILE TELEPHONES, SMARTPHONES AND OTHER MOBILE COMMUNICATIONS DEVICES; PROVIDING FACILITIES FOR MOVIES, SHOWS, PLAYS, MUSIC OR EDUCATIONAL TRAINING; PROVIDING COMPUTER AND VIDEO GAMES ONLINE AND VIA MOBILE TELEPHONES, SMARTPHONES AND OTHER MOBILE COMMUNICATIONS DEVICES; PROVIDING INFORMATION REGARDING COMPUTER GAMES AND COMPUTER ENHANCEMENTS FOR GAMES ONLINE AND VIA MOBILE TELEPHONES, SMARTPHONES AND OTHER MOBILE COMMUNICATIONS DEVICES; CONDUCTING CONTESTS ON-LINE (U.S. CLS. 100, 101 AND 107).  
FIRST USE 10-1-2012; IN COMMERCE 10-1-2012.

#### **CLASS 42—SCIENTIFIC AND COMPUTER SERVICES**

FOR CREATION, DESIGN, DEVELOPMENT, USE, SERVICING, SUPPORT, PROVISION AND MONITORING OF COMPUTER PROGRAMS AND SOFTWARE; CONSULTING AND ADVISING ABOUT PROGRAMMING, DESIGN, DEVELOPMENT, USE AND APPLICATION OF COMPUTER PROGRAMS AND SOFTWARE; PROGRAMMING CONSULTATION USING DATA PROCESSING; IMPLEMENTATION, SERVICING, LEASING, UPDATING, OUTSOURCING AND MAINTENANCE OF COMPUTER PROGRAMS AND SOFTWARE; RESEARCH IN THE FIELD OF COMPUTER PROGRAMS AND SOFTWARE; INFORMATION SERVICES VIA A GLOBAL COMMUNICATIONS NETWORK CONCERNING COMPUTER PROGRAMS AND SOFTWARE; APPLICATION SERVICE PROVIDER SERVICES, NAMELY, PROVIDING, HOSTING, MANAGING, DEVELOPING AND MAINTAINING APPLICATIONS, SOFTWARE, WEBSITES AND DATABASES IN THE FIELDS OF ECOMMERCE, ONLINE PAYMENTS, ORDER QUEUING, WEBSITE DESIGN, DATA STORAGE, SHARED COMPUTING CAPACITY SCALING, MESSAGING SERVICES AND CALCULATION OF WEBSITE RANKING BASED ON USER TRAFFIC (U.S. CLS. 100 AND 101).  
FIRST USE 10-1-2012; IN COMMERCE 10-1-2012.

4,481,770. MERCHSOURCE, LLC, IRVINE, CA. SN 85-615,219. PUB. 9-10-2013, FILED 5-3-2012.

## VERANDA

THE MARK CONSISTS OF STANDARD CHARACTERS WITHOUT CLAIM TO ANY PARTICULAR FONT, STYLE, SIZE, OR COLOR.

#### **CLASS 11—ENVIRONMENTAL CONTROL APPARATUS**

FOR DECORATIVE WATER FOUNTAINS; DECORATIVE TABLE-TOP WATER FOUNTAINS; DECORATIVE ELECTRIC CANDLES FOR NON-ILLUMINATION PURPOSES (U.S. CLS. 13, 21, 23, 31 AND 34).  
FIRST USE 6-1-2012; IN COMMERCE 6-12-2012.

#### **CLASS 14—JEWELRY**

FOR JEWELRY ORGANIZING AND STORAGE DEVICES, NAMELY, JEWELRY BOXES (U.S. CLS. 2, 27, 28 AND 50).  
FIRST USE 6-1-2012; IN COMMERCE 6-1-2012.

#### **CLASS 20—FURNITURE AND ARTICLES NOT OTHERWISE CLASSIFIED**

FOR WALL DÉCOR, NAMELY, SHELVING; SHOE RACKS; JEWELRY ORGANIZER DISPLAYS IN THE NATURE OF JEWELRY DISPLAY STANDS, JEWELRY DISPLAY TREES, JEWELRY DOLL DISPLAY STANDS, AND WALL-MOUNTED JEWELRY DISPLAY RACKS FOR DISPLAYING AND ORGANIZING JEWELRY (U.S. CLS. 2, 13, 22, 25, 32 AND 50).  
FIRST USE 6-1-2012; IN COMMERCE 6-1-2012.

4,481,774. G&S METAL PRODUCTS COMPANY, INC., CLEVELAND, OH. SN 85-616,621. PUB. 3-5-2013, FILED 5-4-2012.

## STOW-A-WAY GRILL

THE MARK CONSISTS OF STANDARD CHARACTERS WITHOUT CLAIM TO ANY PARTICULAR FONT, STYLE, SIZE, OR COLOR.

NO CLAIM IS MADE TO THE EXCLUSIVE RIGHT TO USE "GRILL", APART FROM THE MARK AS SHOWN.

#### **CLASS 11—ENVIRONMENTAL CONTROL APPARATUS**

FOR FOLDING PORTABLE CHARCOAL, PROPANE AND GAS FIRED BARBECUES, STOVES, AND GRILLS (U.S. CLS. 13, 21, 23, 31 AND 34).  
FIRST USE 1-1-2013; IN COMMERCE 1-1-2013.

#### **CLASS 21—HOUSEWARES AND GLASS**

FOR COOKING UTENSILS, NAMELY, GRILLS (U.S. CLS. 2, 13, 23, 29, 30, 33, 40 AND 50).  
FIRST USE 1-1-2013; IN COMMERCE 1-1-2013.

4,481,778. PROMPTU SYSTEMS CORPORATION, MENLO PARK, CA. SN 85-619,523. PUB. 10-16-2012, FILED 5-8-2012.

4,481,779. PROMPTU SYSTEMS CORPORATION, MENLO PARK, CA. SN 85-619,533. PUB. 10-16-2012, FILED 5-8-2012.

# INTELLEGO

# We Understand

THE MARK CONSISTS OF STANDARD CHARACTERS WITHOUT CLAIM TO ANY PARTICULAR FONT, STYLE, SIZE, OR COLOR.

THE MARK CONSISTS OF STANDARD CHARACTERS WITHOUT CLAIM TO ANY PARTICULAR FONT, STYLE, SIZE, OR COLOR.

## **CLASS 9—ELECTRICAL AND SCIENTIFIC APPARATUS**

FOR DOWNLOADABLE COMPUTER SOFTWARE FOR SPEECH-TO-TEXT CONVERSION, SPEECH RECOGNITION, AND NATURAL LANGUAGE UNDERSTANDING; COMPUTER APPLICATION SOFTWARE FOR SPEECH-TO-TEXT CONVERSION, SPEECH RECOGNITION, AND NATURAL LANGUAGE UNDERSTANDING; VOICE ACTIVATED BROWSER AND NAVIGATOR SOFTWARE FOR RECOGNIZING VOICE COMMANDS FOR USE WITH AUTOMOTIVE AND CUSTOMER SELF-CARE APPLICATIONS, TELEVISION PROGRAMMING, TO SURF THE WORLD WIDE WEB, AND TO DOWNLOAD CONTENT VIA TELEVISION, CABLE, COMPUTER, AND WIRELESS TELECOMMUNICATIONS NETWORKS; COMPUTER HARDWARE AND COMPUTER SOFTWARE FOR RECOGNIZING VOICE COMMANDS FOR USE IN PROVIDING ACCESS TO HOST APPLICATIONS AND DATA AND FOR DOWNLOADING OF CONTENT FROM WEB BROWSERS IN NETWORK CABLE TELEVISION, AND WIRELESS TELECOMMUNICATIONS ENVIRONMENT; TELEVISION AND MOBILE TELEPHONE BROWSER AND NAVIGATOR COMPUTER SOFTWARE FOR RECOGNIZING VOICE COMMANDS AND VOICE CONTROLLED INTERFACE, NAMELY, A VOICE ACTIVATED BROWSER AND NAVIGATOR FOR VOICE ACTIVATED SERVICES SOFTWARE AND DOWNLOADING OF CONTENT AND INSTRUCTION MANUALS FOR THE AFORESAID GOODS (U.S. CLS. 21, 23, 26, 36 AND 38).

FIRST USE 2-3-2013; IN COMMERCE 2-3-2013.

## **CLASS 42—SCIENTIFIC AND COMPUTER SERVICES**

FOR COMPUTER PROGRAMMING AND SOFTWARE DESIGN FOR SPEECH-TO-TEXT SERVICES, SPEECH RECOGNITION, AND NATURAL LANGUAGE UNDERSTANDING; DEVELOPING AND MANAGING APPLICATION SOFTWARE IN THE FIELDS OF SPEECH-TO-TEXT CONVERSION, SPEECH RECOGNITION, AND NATURAL LANGUAGE UNDERSTANDING SOFTWARE FOR OTHERS; SOFTWARE AS A SERVICE (SAAS) FEATURING SOFTWARE FOR SPEECH-TO-TEXT CONVERSION, SPEECH RECOGNITION, AND NATURAL LANGUAGE UNDERSTANDING SOFTWARE (U.S. CLS. 100 AND 101).

FIRST USE 2-3-2013; IN COMMERCE 2-3-2013.

## **CLASS 9—ELECTRICAL AND SCIENTIFIC APPARATUS**

FOR DOWNLOADABLE COMPUTER SOFTWARE FOR SPEECH-TO-TEXT CONVERSION, SPEECH RECOGNITION, AND NATURAL LANGUAGE UNDERSTANDING; COMPUTER APPLICATION SOFTWARE FOR SPEECH-TO-TEXT CONVERSION, SPEECH RECOGNITION, AND NATURAL LANGUAGE UNDERSTANDING; VOICE ACTIVATED BROWSER AND NAVIGATOR SOFTWARE FOR RECOGNIZING VOICE COMMANDS FOR USE WITH AUTOMOTIVE AND CUSTOMER SELF-CARE APPLICATIONS, TELEVISION PROGRAMMING, TO SURF THE WORLD WIDE WEB, AND TO DOWNLOAD CONTENT VIA TELEVISION, CABLE, COMPUTER, AND WIRELESS TELECOMMUNICATIONS NETWORKS; COMPUTER HARDWARE AND COMPUTER SOFTWARE FOR RECOGNIZING VOICE COMMANDS FOR USE IN PROVIDING ACCESS TO HOST APPLICATIONS AND DATA AND FOR DOWNLOADING OF CONTENT FROM WEB BROWSERS IN NETWORK CABLE TELEVISION, AND WIRELESS TELECOMMUNICATIONS ENVIRONMENT; TELEVISION AND MOBILE TELEPHONE BROWSER AND NAVIGATOR COMPUTER SOFTWARE FOR RECOGNIZING VOICE COMMANDS AND VOICE CONTROLLED INTERFACE, NAMELY, A VOICE ACTIVATED BROWSER AND NAVIGATOR FOR VOICE ACTIVATED SERVICES SOFTWARE AND DOWNLOADING OF CONTENT AND INSTRUCTION MANUALS FOR THE AFORESAID GOODS (U.S. CLS. 21, 23, 26, 36 AND 38).

FIRST USE 2-3-2013; IN COMMERCE 2-3-2013.

## **CLASS 42—SCIENTIFIC AND COMPUTER SERVICES**

FOR COMPUTER PROGRAMMING AND SOFTWARE DESIGN FOR SPEECH-TO-TEXT SERVICES, SPEECH RECOGNITION, AND NATURAL LANGUAGE UNDERSTANDING; DEVELOPING AND MANAGING APPLICATION SOFTWARE IN THE FIELDS OF SPEECH-TO-TEXT CONVERSION, SPEECH RECOGNITION, AND NATURAL LANGUAGE UNDERSTANDING SOFTWARE FOR OTHERS; SOFTWARE AS A SERVICE (SAAS) FEATURING SOFTWARE FOR SPEECH-TO-TEXT CONVERSION, SPEECH RECOGNITION, AND NATURAL LANGUAGE UNDERSTANDING SOFTWARE (U.S. CLS. 100 AND 101).

FIRST USE 2-3-2013; IN COMMERCE 2-3-2013.

4,481,792. EXOTISSIMO TRAVEL GROUP, BANGKOK, THAILAND. SN 85-624,495. PUB. 12-25-2012, FILED 5-14-2012.

## SELF GUIDE

THE MARK CONSISTS OF STANDARD CHARACTERS WITHOUT CLAIM TO ANY PARTICULAR FONT, STYLE, SIZE, OR COLOR.

NO CLAIM IS MADE TO THE EXCLUSIVE RIGHT TO USE "GUIDE", APART FROM THE MARK AS SHOWN.

### CLASS 9—ELECTRICAL AND SCIENTIFIC APPARATUS

FOR COMPUTER SOFTWARE FOR ARRANGING AND PLANNING TRIPS, BOOKING SEATS FOR TRAVEL, PLANNING TOURS, AND MAKING TRAVEL AND RESTAURANT RESERVATIONS (U.S. CLS. 21, 23, 26, 36 AND 38).

FIRST USE 1-9-2012; IN COMMERCE 1-9-2012.

### CLASS 39—TRANSPORTATION AND STORAGE

FOR BOOKING OF SEATS FOR TRAVEL; TRAVEL AGENCY SERVICES, NAMELY, MAKING RESERVATIONS AND BOOKINGS FOR TRANSPORTATION; ORGANIZATION, BOOKING AND ARRANGEMENT OF EXCURSIONS, DAY TRIPS AND SIGHTSEEING TOURS; ESCORTING OF TRAVELERS; TRANSPORT OF TRAVELERS (U.S. CLS. 100 AND 105).

FIRST USE 1-9-2012; IN COMMERCE 1-9-2012.

### CLASS 43—HOTEL AND RESTAURANT SERVICES

FOR MAKING HOTEL RESERVATIONS FOR OTHERS; MAKING RESERVATIONS AND BOOKINGS FOR OTHERS FOR ACCOMMODATIONS AND MEALS AT HOTELS AND RESTAURANTS (U.S. CLS. 100 AND 101).

FIRST USE 1-9-2012; IN COMMERCE 1-9-2012.

4,481,797. CHROSZIEL GMBH, HEIMSTETTEN, FED REP GERMANY. SN 85-626,672. PUB. 4-23-2013, FILED 5-16-2012.

## CHROSZIEL

THE MARK CONSISTS OF STANDARD CHARACTERS WITHOUT CLAIM TO ANY PARTICULAR FONT, STYLE, SIZE, OR COLOR.

OWNER OF FED REP GERMANY REG. NO. 302011062763, DATED 2-16-2012, EXPIRES 11-30-2021.

THE WORDING "CHROSZIEL" HAS NO MEANING IN A FOREIGN LANGUAGE.

### CLASS 9—ELECTRICAL AND SCIENTIFIC APPARATUS

FOR PHOTOGRAPHIC, CINEMATOGRAPHIC AND OPTICAL EQUIPMENT, NAMELY, FLUID ZOOM DRIVES AND FOLLOW FOCUS FOR CAMERAS, CAMERA SUN SHADES AND SUN SHIELDS, CAMERA SUPPORTS, TRIPODS, RESTS AND MOUNTS, MATTE BOXES, MATTE BOXES WITH BELLOWS, INTERMEDIATE RINGS, CLAMP RINGS, EXTENSION RINGS AND ADAPTOR RINGS SPECIALLY ADAPTED FOR USE WITH LENSES, CAMERA AND LENS HANDLES, SLIDING PLATES AND QUICK-LOCK PLATES FOR CAMERAS, TEST PHOTOGRAPHIC PROJECTORS, COLLIMATORS, REMOTE CONTROLS FOR CAMERAS, CONNECTING CABLES AND AC ADAPTORS FOR CAMERAS AND LIGHTS, CAMERA SHOULDER SUPPORTS AND BODY-WORN CAMERA SUPPORTS, CAMERA ACCESSORY CLAMPS AND CLIPS SPECIALLY ADAPTED FOR USE WITH CAMERAS, CLAMP ADAPTORS FOR LENSES, LENS MOUNT ADAPTORS, LENS FILTER HOLDERS, OCULARS FOR ANALOG AND/OR DIGITAL RECORDING, REPRODUCING, STORING OR PROCESSING OF STILL AND/OR MOVING IMAGES AND IMAGE INFORMATION, BAYONET RINGS AND LENS REVERSAL RINGS, LENS HOODS, DISTANCE, APERTURE AND ZOOM RANGE CONTROLS FOR CAMERAS, REMOTE DIMMERS (U.S. CLS. 21, 23, 26, 36 AND 38).

FIRST USE 12-0-1975; IN COMMERCE 12-0-1975.

### CLASS 35—ADVERTISING AND BUSINESS

FOR ONLINE RETAIL AND WHOLESALE STORE SERVICES FEATURING PHOTOGRAPHIC, CINEMATOGRAPHIC AND OPTICAL EQUIPMENT (U.S. CLS. 100, 101 AND 102).

FIRST USE 11-4-2013; IN COMMERCE 11-4-2013.

4,481,798. CHROSZIEL GMBH, HEIMSTETTEN, FED REP GERMANY. SN 85-626,713. PUB. 4-23-2013, FILED 5-16-2012.

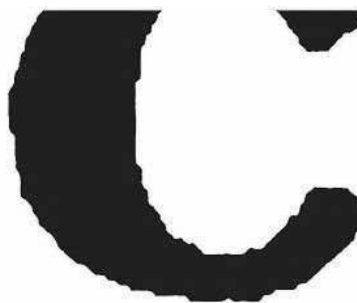

OWNER OF FED REP GERMANY REG. NO. 302011062766, DATED 2-16-2012, EXPIRES 11-30-2021.

THE MARK CONSISTS OF A STYLIZED REPRESENTATION OF THE LETTER "C" IN WHICH AN UPPER PORTION OF THE LETTER IS TRUNCATED.

**CLASS 9—ELECTRICAL AND SCIENTIFIC APPARATUS**

FOR PHOTOGRAPHIC, CINEMATOGRAPHIC AND OPTICAL EQUIPMENT, NAMELY, FLUID ZOOM DRIVES AND FOLLOW FOCUS FOR CAMERAS, CAMERA SUN SHADES AND SUN SHIELDS, CAMERA SUPPORTS, TRIPODS, RESTS AND MOUNTS, MATTE BOXES, MATTE BOXES WITH BELLOWS, INTERMEDIATE RINGS, CLAMP RINGS, EXTENSION RINGS AND ADAPTOR RINGS SPECIALLY ADAPTED FOR USE WITH LENSES, CAMERA AND LENS HANDLES, SLIDING PLATES AND QUICK-LOCK PLATES FOR CAMERAS, TEST PHOTOGRAPHIC PROJECTORS, COLLIMATORS, REMOTE CONTROLS FOR CAMERAS, CONNECTING CABLES AND AC ADAPTORS FOR CAMERAS AND LIGHTS, CAMERA SHOULDER SUPPORTS AND BODY-WORN CAMERA SUPPORTS, CAMERA ACCESSORY CLAMPS AND CLIPS SPECIALLY ADAPTED FOR USE WITH CAMERAS, CLAMP ADAPTORS FOR LENSES, LENS MOUNT ADAPTORS, LENS FILTER HOLDERS, OCULARS FOR ANALOG AND/OR DIGITAL RECORDING, REPRODUCING, STORING OR PROCESSING OF STILL AND/OR MOVING IMAGES AND IMAGE INFORMATION, BAYONET RINGS AND LENS REVERSAL RINGS, LENS HOODS, DISTANCE, APERTURE AND ZOOM RANGE CONTROLS FOR CAMERAS, REMOTE DIMMERS (U.S. CLS. 21, 23, 26, 36 AND 38).

FIRST USE 12-0-1975; IN COMMERCE 12-0-1975.

**CLASS 35—ADVERTISING AND BUSINESS**

FOR ONLINE RETAIL AND WHOLESALE STORE SERVICES FEATURING PHOTOGRAPHIC, CINEMATOGRAPHIC AND OPTICAL EQUIPMENT (U.S. CLS. 100, 101 AND 102).

FIRST USE 11-4-2013; IN COMMERCE 11-4-2013.

4,481,799. ARTPRIZE GRAND RAPIDS, GRAND RAPIDS, MI. SN 85-628,077. PUB. 3-19-2013, FILED 5-17-2012.



**ARTPRIZE**

OWNER OF U.S. REG. NOS. 3,759,223, 3,847,025, AND OTHERS.

THE MARK CONSISTS OF AN ABSTRACT SHAPE POSITIONED ABOVE THE WORD "ARTPRIZE".

**CLASS 25—CLOTHING**

FOR CLOTHING, NAMELY, T-SHIRTS, SHIRTS, BLOUSES, POLO SHIRTS, SWEATERS, HEADWEAR, SEASONAL HEADWEAR, GLOVES, SCARVES, HATS, FOOTWEAR, SOCKS, HOSIERY, SLEEPWEAR, AND OUTERWEAR, NAMELY, SWEATSHIRTS, HOODED SWEATSHIRTS, JACKETS, COATS, AND TRACK JACKETS (U.S. CLS. 22 AND 39).

FIRST USE 8-28-2012; IN COMMERCE 8-28-2012.

**CLASS 35—ADVERTISING AND BUSINESS**

FOR RETAIL AND ON-LINE GIFT SHOP SERVICES (U.S. CLS. 100, 101 AND 102).  
FIRST USE 11-13-2013; IN COMMERCE 11-13-2013.

**CLASS 41—EDUCATION AND ENTERTAINMENT**

FOR ORGANIZING, ARRANGING, AND CONDUCTING ART SHOWS, CONTESTS, AND EXHIBITIONS (U.S. CLS. 100, 101 AND 107).

FIRST USE 8-28-2012; IN COMMERCE 8-28-2012.

4,481,800. CUMMINGS RESOURCES LLC, DBA CUMMINGS SIGNS, NASHVILLE, TN. SN 85-628,378. PUB. 4-23-2013, FILED 5-17-2012.

**BRANDNEW**

THE MARK CONSISTS OF STANDARD CHARACTERS WITHOUT CLAIM TO ANY PARTICULAR FONT, STYLE, SIZE, OR COLOR.

**CLASS 37—CONSTRUCTION AND REPAIR**

FOR INSTALLATION, MAINTENANCE AND REPAIR OF SIGNS (U.S. CLS. 100, 103 AND 106).

FIRST USE 4-15-2012; IN COMMERCE 4-15-2012.

**CLASS 40—MATERIAL TREATMENT**

FOR CUSTOM CONSTRUCTION OF SIGNS (U.S. CLS. 100, 103 AND 106).

FIRST USE 4-15-2012; IN COMMERCE 4-15-2012.

4,481,805. TERRAIN MERCHANDISING LLC, PHILADELPHIA, PA. SN 85-633,466. PUB. 9-18-2012, FILED 5-23-2012.

**BOTANICULTURE**

THE MARK CONSISTS OF STANDARD CHARACTERS WITHOUT CLAIM TO ANY PARTICULAR FONT, STYLE, SIZE, OR COLOR.

**CLASS 3—COSMETICS AND CLEANING PREPARATIONS**

FOR BODY LOTION, HAND SOAP, HAND WASH, HAND CREAM (U.S. CLS. 1, 4, 6, 50, 51 AND 52).

FIRST USE 8-20-2012; IN COMMERCE 8-20-2012.

**CLASS 4—LUBRICANTS AND FUELS**

FOR CANDLES (U.S. CLS. 1, 6 AND 15).

FIRST USE 8-20-2012; IN COMMERCE 8-20-2012.

4,481,806. PARTICLE SCIENCES, INC., BETHLEHEM, PA.  
SN 85-635,295. PUB. 12-11-2012, FILED 5-25-2012.

# PEGPLUS

THE MARK CONSISTS OF STANDARD CHARACTERS WITHOUT CLAIM TO ANY PARTICULAR FONT, STYLE, SIZE, OR COLOR.

## CLASS 40—MATERIAL TREATMENT

FOR TREATMENT OF MATERIALS, NAMELY, APPLICATION OF CHEMICAL MATERIALS TO PHARMACEUTICALS AND MEDICAL DEVICE APPARATUSES FOR OTHERS; TREATMENT OF MATERIALS, NAMELY, APPLICATION OF CATIONIC POLYMER COMPOSITIONS TO PHARMACEUTICALS AND MEDICAL DEVICE APPARATUSES FOR OTHERS (U.S. CLS. 100, 103 AND 106).

FIRST USE 5-1-2012; IN COMMERCE 6-1-2012.

## CLASS 42—SCIENTIFIC AND COMPUTER SERVICES

FOR PHARMACEUTICAL DRUG DEVELOPMENT SERVICES; PHARMACEUTICAL RESEARCH SERVICES; ENGINEERING SERVICES IN THE FIELD OF MEDICAL DEVICES, PHARMACEUTICALS, PLASTICS, COSMETICS, PERSONAL CARE PRODUCTS, COATINGS, ADHESIVES AND LUBRICANTS (U.S. CLS. 100 AND 101).

FIRST USE 5-1-2012; IN COMMERCE 6-1-2012.

4,481,808. QURI, INC., KENTFIELD, CA. SN 85-636,719. PUB.  
4-23-2013, FILED 5-28-2012.

# QURI

THE MARK CONSISTS OF STANDARD CHARACTERS WITHOUT CLAIM TO ANY PARTICULAR FONT, STYLE, SIZE, OR COLOR.

THE WORDING "QURI" HAS NO MEANING IN A FOREIGN LANGUAGE.

## CLASS 35—ADVERTISING AND BUSINESS

FOR MARKET RESEARCH AND FIELD RESEARCH IN THE NATURE OF MARKET REPORTS AND STUDIES; MARKET RESEARCH AND FIELD RESEARCH IN THE NATURE OF MARKET REPORTS AND STUDIES, NAMELY, MEASURING, AUDITING, TRACKING, MONITORING, AND VERIFYING PLACEMENT, PRICING, ASSORTMENT, MERCHANDISING, ARRANGEMENT, AND DISPLAY OF PRODUCTS OR COMPETITIVE PRODUCTS, THE DISTRIBUTION AND SALES OF PRODUCTS, THE PUBLICATION AND DISPLAY OF ADVERTISING, MARKETING, AND PROMOTIONAL MATERIAL, THE EFFECTIVENESS OF ADVERTISING, MARKETING AND PROMOTIONAL MATERIAL AND INITIATIVES, AND THE CONSUMER SHOPPING EXPERIENCE; RESEARCH SERVICES IN THE NATURE OF VERIFYING, TRACKING AND MEASURING CONSUMER VIEWING OF, EXPOSURE TO, AND REACTIONS TO ADVERTISEMENTS, MARKETING AND PROMOTIONAL MATERIAL AND INITIATIVES; BUSINESS AND MARKETING CONSULTING SERVICES RELATING TO OPTIMIZING PLACEMENT, PRICING, ASSORTMENT, MERCHANDISING, ARRANGEMENT AND DISPLAY OF PRODUCTS, THE DISTRIBUTION AND SALES OF PRODUCTS, THE PUBLICATION AND DISPLAY OF ADVERTISING, MARKETING, AND PROMOTIONAL MATERIAL AND THE EFFECTIVENESS OF ADVERTISING, MARKETING AND PROMOTIONAL MATERIAL AND INITIATIVES; ADVERTISING AND MARKETING CONSULTANCY IN THE FIELD OF DEVELOPING PRODUCT MARKETING AND SALES STRATEGIES; CONSULTING SERVICES IN THE FIELDS OF ADVERTISING, MARKETING AND BRAND AWARENESS; BUSINESS AND MARKETING CONSULTING SERVICES, NAMELY, CONSULTATION IN THE FIELDS OF PRODUCT TRACKING, MONITORING AND AUDITING TO VERIFY PLACEMENT, PRICING, ASSORTMENT, MERCHANDISING, ARRANGEMENT, AND DISPLAY OF PRODUCTS OR COMPETITIVE PRODUCTS, THE DISTRIBUTION AND SALES OF PRODUCTS, THE PUBLICATION AND DISPLAY OF ADVERTISING, MARKETING, AND PROMOTIONAL MATERIAL AND THE EFFECTIVENESS OF ADVERTISING, MARKETING AND PROMOTIONAL MATERIAL AND INITIATIVES; PROVIDING STATISTICAL INFORMATION SERVICES IN THE NATURE OF MARKET REPORTS AND STUDIES, NAMELY, DATA COLLECTION, ANALYSIS, AND REPORTS ON PRODUCT AND PRODUCT-RELATED STATISTICS, AND RELATED SEASON AND DATE, TRENDS, AND DEMOGRAPHICS INFORMATION ABOUT PRODUCT PLACEMENT, PRICING, ASSORTMENT, MERCHANDISING, ARRANGEMENT, AND DISPLAY OF PRODUCTS OR COMPETITIVE PRODUCTS, THE DISTRIBUTION AND SALES OF PRODUCTS, THE PUBLICATION AND DISPLAY OF ADVERTISING, MARKETING, AND PROMOTIONAL MATERIAL AND THE EFFECTIVENESS OF ADVERTISING, MARKETING AND PROMOTIONAL MATERIAL AND INITIATIVES (U.S. CLS. 100, 101 AND 102).

FIRST USE 5-30-2012; IN COMMERCE 5-30-2012.

## CLASS 42—SCIENTIFIC AND COMPUTER SERVICES

FOR SOFTWARE AS A SERVICE (SAAS) SERVICES FEATURING SOFTWARE FOR PURPOSES OF MEASURING, AUDITING, TRACKING, MONITORING, AND VERIFYING PLACEMENT, PRICING, ASSORTMENT, MERCHANDISING, ARRANGEMENT, AND DISPLAY OF PRODUCTS OR COMPETITIVE PRODUCTS, THE DISTRIBUTION AND SALES OF PRODUCTS, THE PUBLICATION AND DISPLAY OF ADVERTISING, MARKETING, AND PROMOTIONAL MATERIAL, THE EFFECTIVENESS OF ADVERTISING, MARKETING AND PROMOTIONAL MATERIAL AND INITIATIVES, AND THE CONSUMER SHOPPING EXPERIENCE; SOFTWARE AS A SERVICE (SAAS) SERVICES FEATURING SOFTWARE FOR STATISTICAL ANALYSIS OF SALES AND MARKETING INFORMATION, NAMELY, FOR USE IN DATA COLLECTION, ANALYSIS, AND REPORTS ON PRODUCT AND PRODUCT-RELATED SALES AND MARKETING STATISTICS, AND RELATED SEASON AND DATE, TRENDS, AND DEMOGRAPHICS INFORMATION (U.S. CLS. 100 AND 101).

FIRST USE 5-30-2012; IN COMMERCE 5-30-2012.



4,481,814. COX DIGITAL EXCHANGE LLC, ATLANTA, GA. SN 85-637,957. PUB. 3-19-2013, FILED 5-30-2012.

## DEALERMATCH

THE MARK CONSISTS OF STANDARD CHARACTERS WITHOUT CLAIM TO ANY PARTICULAR FONT, STYLE, SIZE, OR COLOR.

### CLASS 9—ELECTRICAL AND SCIENTIFIC APPARATUS

FOR DOWNLOADABLE SOFTWARE IN THE NATURE OF A MOBILE APPLICATION FOR FACILITATING TRANSACTIONS, NAMELY, THE SALE AND EXCHANGE OF NEW AND USED AUTOMOBILES BETWEEN BUYERS AND SELLERS THROUGH PROVIDING BUYERS WITH INFORMATION ABOUT SELLERS, GOODS, AND/OR SERVICES (U.S. CLS. 21, 23, 26, 36 AND 38).

FIRST USE 7-0-2012; IN COMMERCE 7-0-2012.

### CLASS 35—ADVERTISING AND BUSINESS

FOR INFOMEDIARY SERVICES, NAMELY, FACILITATING TRANSACTIONS, NAMELY, THE SALE AND EXCHANGE OF NEW AND USED AUTOMOBILES BETWEEN BUYERS AND SELLERS THROUGH PROVIDING BUYERS WITH INFORMATION ABOUT SELLERS, GOODS, AND/OR SERVICES VIA THE INTERNET AND OTHER ELECTRONIC COMMUNICATIONS NETWORKS; PROVIDING AN ONLINE SEARCHABLE DATABASE OF AUTOMOBILE LISTINGS VIA THE INTERNET AND OTHER ELECTRONIC COMMUNICATIONS NETWORKS; PROFESSIONAL ONLINE NETWORKING SERVICES PROVIDED VIA THE INTERNET AND OTHER ELECTRONIC COMMUNICATIONS NETWORKS (U.S. CLS. 100, 101 AND 102).

FIRST USE 3-0-2012; IN COMMERCE 3-0-2012.

4,481,816. HEWLETT-PACKARD DEVELOPMENT COMPANY, L.P., HOUSTON, TX. SN 85-638,338. PUB. 3-19-2013, FILED 5-30-2012.

## ENTERPRISE 20/20

THE MARK CONSISTS OF STANDARD CHARACTERS WITHOUT CLAIM TO ANY PARTICULAR FONT, STYLE, SIZE, OR COLOR.

NO CLAIM IS MADE TO THE EXCLUSIVE RIGHT TO USE "ENTERPRISE", APART FROM THE MARK AS SHOWN.

### CLASS 9—ELECTRICAL AND SCIENTIFIC APPARATUS

FOR DOWNLOADABLE ELECTRONIC BOOKS IN THE FIELD OF ENTERPRISE INFORMATION TECHNOLOGY (U.S. CLS. 21, 23, 26, 36 AND 38).

FIRST USE 6-2-2012; IN COMMERCE 6-2-2012.

### CLASS 38—COMMUNICATION

FOR PROVIDING ONLINE FACILITIES FOR REAL-TIME INTERACTION WITH OTHER USERS CONCERNING TOPICS RELATING TO ENTERPRISE INFORMATION TECHNOLOGY (U.S. CLS. 100, 101 AND 104).

FIRST USE 6-2-2012; IN COMMERCE 6-2-2012.

### CLASS 42—SCIENTIFIC AND COMPUTER SERVICES

FOR PROVIDING AN INTERACTIVE WEBSITE FEATURING TECHNOLOGY THAT ALLOWS USERS TO CREATE, COLLABORATE, DISCUSS, ANNOTATE AND PUBLICLY SHARE DATA AND INFORMATION; HOSTING OF DIGITAL CONTENT ON THE INTERNET (U.S. CLS. 100 AND 101).

FIRST USE 6-2-2012; IN COMMERCE 6-2-2012.

4,481,817. SONY ONLINE ENTERTAINMENT LLC, SAN DIEGO, CA. SN 85-638,879. PUB. 5-14-2013, FILED 5-30-2012.

## SOEMOTE

THE MARK CONSISTS OF STANDARD CHARACTERS WITHOUT CLAIM TO ANY PARTICULAR FONT, STYLE, SIZE, OR COLOR.

### CLASS 9—ELECTRICAL AND SCIENTIFIC APPARATUS

FOR COMPUTER SOFTWARE FOR CONTROLLING THE FACIAL ANIMATION OF AN AVATAR IN COMPUTER GAMES (U.S. CLS. 21, 23, 26, 36 AND 38).

FIRST USE 8-7-2012; IN COMMERCE 8-7-2012.

### CLASS 41—EDUCATION AND ENTERTAINMENT

FOR ENTERTAINMENT SERVICES, NAMELY, PROVIDING AN ON-LINE COMPUTER GAME THAT ALLOWS PLAYERS TO EXERCISE CONTROL OVER THEIR AVATAR'S FACIAL ANIMATIONS (U.S. CLS. 100, 101 AND 107).

FIRST USE 8-7-2012; IN COMMERCE 8-7-2012.

4,481,818. LIVING WELL LODGES, LLC, MOUNT DORA, FL. SN 85-639,064. PUB. 11-6-2012, FILED 5-30-2012.



NO CLAIM IS MADE TO THE EXCLUSIVE RIGHT TO USE "LODGES", APART FROM THE MARK AS SHOWN.

THE COLOR(S) GREEN, RED, YELLOW, ORANGE AND BLACK IS/ARE CLAIMED AS A FEATURE OF THE MARK.

THE MARK CONSISTS OF THE WORDING "LIVING WELL LODGES" IN GREEN UPPER CASE LETTERS IN

STANDARD TYPEFACE; DIRECTLY UNDERNEATH THE DOUBLE LETTERS "LL" IN "WELL" APPEARS THE WORDING "COME FLOURISH!" IN RED SCRIPT LETTERS WITH A CAPITAL "C" FOLLOWED BY LOWER CASE LETTERS; A LARGE BUTTERFLY APPEARS ON AN ANGLE DIRECTLY ABOVE THE "LL" IN "WELL" IN YELLOW WITH ORANGE HIGHLIGHTS OUTLINED IN BLACK.

4,481,820. VALTRONIC SA, LES CHARBONNIERES, SWITZERLAND. SN 85-639,277. PUB. 3-5-2013, FILED 5-31-2012.

#### **CLASS 37—CONSTRUCTION AND REPAIR**

FOR REAL ESTATE DEVELOPMENT SERVICES IN THE FIELD OF RETIREMENT COMMUNITIES (U.S. CLS. 100, 103 AND 106).

FIRST USE 9-6-2011; IN COMMERCE 8-1-2012.

#### **CLASS 44—MEDICAL, BEAUTY AND AGRICULTURAL SERVICES**

FOR NURSING HOMES (U.S. CLS. 100 AND 101).

FIRST USE 9-6-2011; IN COMMERCE 8-1-2012.

# VALTRONIC

4,481,819. HILLPOINT CAPITAL, LLC, NEW YORK, NY. SN 85-639,157. PUB. 10-16-2012, FILED 5-31-2012.

THE MARK CONSISTS OF STANDARD CHARACTERS WITHOUT CLAIM TO ANY PARTICULAR FONT, STYLE, SIZE, OR COLOR.

OWNER OF U.S. REG. NO. 3,505,490.

## Rent intelligently

THE MARK CONSISTS OF STANDARD CHARACTERS WITHOUT CLAIM TO ANY PARTICULAR FONT, STYLE, SIZE, OR COLOR.

#### **CLASS 35—ADVERTISING AND BUSINESS**

FOR PROVIDING SERVICES TO TENANTS AND LANDLORDS, NAMELY, GATHERING, MONITORING, SCORING, RATING AND MANAGING DATA; PROVIDING ADVERTISING OPPORTUNITIES; PROVIDING A WEBSITE THROUGH WHICH PROPERTY LESSORS CAN REVIEW PROSPECTIVE TENANTS' LETTERS OF RECOMMENDATION; INVOICING SERVICES (U.S. CLS. 100, 101 AND 102).

FIRST USE 5-3-2013; IN COMMERCE 5-3-2013.

#### **CLASS 36—INSURANCE AND FINANCIAL**

FOR REAL ESTATE LISTING SERVICES FOR HOUSING RENTALS AND APARTMENT RENTALS; REAL ESTATE LISTING SERVICES FOR HOUSING RENTALS AND APARTMENT RENTALS, NAMELY, SCREENING AND BOOKING RENTAL APPOINTMENTS; ELECTRONIC FUND TRANSFERS; PROVIDING SERVICES THAT FACILITATE PROPERTY MANAGEMENT, NAMELY, EVALUATION OF REAL PROPERTY; AND PROVIDING LETTERS OF CREDIT (U.S. CLS. 100, 101 AND 102).

FIRST USE 5-3-2013; IN COMMERCE 5-3-2013.

#### **CLASS 40—MATERIAL TREATMENT**

FOR CUSTOM, MADE TO ORDER MANUFACTURE OF MEDICAL, DENTAL, AND VETERINARY DEVICES FOR THIRD PARTIES IN THE MEDICAL, DENTAL, AND VETERINARY INDUSTRIES FOR USE IN AN UNLIMITED VARIETY OF MEDICAL, DENTAL, AND VETERINARY APPLICATIONS; CUSTOM, MADE TO ORDER MANUFACTURE OF WATCH PARTS FOR THIRD PARTIES; CUSTOM, MADE TO ORDER MANUFACTURE OF PARTS AND COMPONENTS FOR THIRD PARTIES IN THE MEDICAL IMAGING, INDUSTRIAL ELECTRONICS, TRANSPORTATION, AEROSPACE, INDUSTRIAL IMAGING, AND SECURITY INDUSTRIES; TREATMENT OF ARTIFICIAL IMPLANTS FOR THIRD PARTIES; TREATMENT OF METALS FOR THIRD PARTIES; MACHINING OF ARTIFICIAL IMPLANTS FOR THIRD PARTIES; MACHINING OF PARTS FOR THIRD PARTIES (U.S. CLS. 100, 103 AND 106).

FIRST USE 1-31-2013; IN COMMERCE 1-31-2013.

#### **CLASS 42—SCIENTIFIC AND COMPUTER SERVICES**

FOR PRODUCT DEVELOPMENT OF MEDICAL, DENTAL, AND VETERINARY DEVICES FOR THIRD PARTIES IN THE MEDICAL, DENTAL, AND VETERINARY INDUSTRIES FOR USE IN AN UNLIMITED VARIETY OF MEDICAL, DENTAL, AND VETERINARY APPLICATIONS; PRODUCT DEVELOPMENT OF WATCH PARTS FOR THIRD PARTIES; PRODUCT DEVELOPMENT OF PARTS AND COMPONENTS FOR THIRD PARTIES IN THE MEDICAL IMAGING, INDUSTRIAL ELECTRONICS, TRANSPORTATION, AEROSPACE, INDUSTRIAL IMAGING, AND SECURITY INDUSTRIES; TECHNICAL PROJECT STUDY IN THE FIELD OF ELECTRONICS; DESIGN AND DEVELOPMENT OF ELECTRONIC COMPONENTS; DESIGN AND DEVELOPMENT OF ELECTRONIC APPARATUS AND DEVICES; DESIGN AND DEVELOPMENT OF COMPUTER SOFTWARE FOR OTHERS; DESIGN AND DEVELOPMENT OF ELECTRONIC COMPONENTS, ELECTRONIC DEVICES, AND COMPUTER SOFTWARE FOR OTHERS IN THE FIELDS OF MEDICINE, DENTISTRY, VETERINARY SCIENCE, MEDICAL IMAGING, INDUSTRIAL ELECTRONICS, TRANSPORTATION, AEROSPACE, INDUSTRIAL IMAGING, AND SECURITY INDUSTRIES (U.S. CLS. 100 AND 101).

FIRST USE 1-31-2013; IN COMMERCE 1-31-2013.

4,481,824. COBB CINEBISTRO, LLC, BIRMINGHAM, AL. SN 85-641,063. PUB. 11-13-2012, FILED 6-1-2012.



NO CLAIM IS MADE TO THE EXCLUSIVE RIGHT TO USE "EAT" AND "PLAY", APART FROM THE MARK AS SHOWN.

THE MARK CONSISTS OF THE WORD "SCORE" STYLIZED WITH THE "S" RESEMBLING A BOWLING PIN AND THE "O" A BOWLING BALL, OVER THE WORDS "EAT PLAY SOCIALIZE" WITH ROUND GRAPHICS OF A FORK AND KNIFE, A BILLIARDS 8-BALL AND A COCKTAIL GLASS.

#### CLASS 41—EDUCATION AND ENTERTAINMENT

FOR LIVE ENTERTAINMENT SERVICES, NAMELY, PROVIDING BOWLING LANE IN THE NATURE OF PROVIDING BOWLING ALLEYS AND BILLIARD TABLES SERVICES IN THE NATURE OF PROVIDING BILLIARD ROOMS (U.S. CLS. 100, 101 AND 107).

FIRST USE 12-6-2013; IN COMMERCE 12-6-2013.

#### CLASS 43—HOTEL AND RESTAURANT SERVICES

FOR RESTAURANT AND BAR SERVICES (U.S. CLS. 100 AND 101).

FIRST USE 12-6-2013; IN COMMERCE 12-6-2013.

4,481,832. VOQEL, INC., ALAMEDA, CA. SN 85-649,451. PUB. 4-30-2013, FILED 6-12-2012.

THE MARK CONSISTS OF THE WORD "VOQEL" IN LOWER CASE, STYLIZED LETTERING.

THE WORDING "VOQEL" HAS NO MEANING IN A FOREIGN LANGUAGE.

#### CLASS 9—ELECTRICAL AND SCIENTIFIC APPARATUS

FOR DOWNLOADABLE SOFTWARE IN THE NATURE OF A DOWNLOADABLE MOBILE APPLICATION ENABLING THE PRODUCTION, SHARING OF AND LISTENING TO VOICE-BASED CONTENT (U.S. CLS. 21, 23, 26, 36 AND 38).

FIRST USE 7-31-2013; IN COMMERCE 7-31-2013.

#### CLASS 42—SCIENTIFIC AND COMPUTER SERVICES

FOR PROVIDING TEMPORARY USE OF A MOBILE AND WEB-BASED SOFTWARE APPLICATION ENABLING THE PRODUCTION, SHARING AND LISTENING TO VOICE-BASED CONTENT (U.S. CLS. 100 AND 101).

FIRST USE 5-27-2013; IN COMMERCE 5-27-2013.

4,481,834. LIBERTY MUTUAL INSURANCE COMPANY, BOSTON, MA. SN 85-649,858. PUB. 1-29-2013, FILED 6-12-2012.



**HELMSMAN**  
MANAGEMENT SERVICES LLC

OWNER OF U.S. REG. NO. 3,103,057.

NO CLAIM IS MADE TO THE EXCLUSIVE RIGHT TO USE "MANAGEMENT SERVICES LLC", APART FROM THE MARK AS SHOWN.

THE MARK CONSISTS OF THE WORDS "HELMSMAN MANAGEMENT SERVICES LLC" BENEATH THE DESIGN OF A FLAME.

#### CLASS 35—ADVERTISING AND BUSINESS

FOR MANAGED CARE SERVICES, NAMELY, HEALTH CARE COST CONTAINMENT, HEALTH CARE UTILIZATION REVIEW AND PRE-CERTIFICATION SERVICES; HEALTH CARE COST REVIEW, COMPUTERIZED DATABASE MANAGEMENT AND ELECTRONIC PROCESSING OF HEALTH CARE INFORMATION; UTILIZATION REVIEW AND PRE-CERTIFICATION SERVICES; ANALYTICAL SERVICES IN THE FIELDS OF INSURANCE CLAIMS IN THE NATURE OF DATA COMPILING AND ANALYZING; ALL OF WHICH ARE PROVIDED IN PERSON AND/OR ONLINE (U.S. CLS. 100, 101 AND 102).

FIRST USE 5-24-2012; IN COMMERCE 5-24-2012.

#### CLASS 36—INSURANCE AND FINANCIAL

FOR THIRD PARTY INSURANCE CLAIMS ADMINISTRATION SERVICES AND CLAIMS ADJUSTMENT SERVICES PROVIDED AS PART OF PROPERTY, WORKERS COMPENSATION AND LIABILITY INSURED OR SELF-INSURED PROGRAMS; FINANCIAL RISK MANAGEMENT CONSULTATION SERVICES; ACTUARIAL SERVICES; ASSESSING INSURANCE CLAIMS FOR MEDICAL AND DISABILITY INSURANCE CLAIMS; LOSS PREVENTION AND LOSS CONTROL CONSULTATION INSURANCE SERVICES; ALL OF WHICH ARE PROVIDED IN PERSON AND/OR ON-LINE (U.S. CLS. 100, 101 AND 102).

FIRST USE 5-24-2012; IN COMMERCE 5-24-2012.

#### CLASS 45—PERSONAL AND LEGAL SERVICES

FOR CASE MANAGEMENT SERVICES, NAMELY, COORDINATION OF LEGAL SERVICES IN THE FIELD OF INSURANCE LITIGATION; ALL OF WHICH ARE PROVIDED IN PERSON AND/OR ONLINE (U.S. CLS. 100 AND 101).

FIRST USE 5-24-2012; IN COMMERCE 5-24-2012.

4,481,838. REVENUE WISE, INC., TIBURON, CA. SN 85-650,106. PUB. 3-5-2013, FILED 6-12-2012.

## REVENUE WISE

THE MARK CONSISTS OF STANDARD CHARACTERS WITHOUT CLAIM TO ANY PARTICULAR FONT, STYLE, SIZE, OR COLOR.

NO CLAIM IS MADE TO THE EXCLUSIVE RIGHT TO USE "REVENUE", APART FROM THE MARK AS SHOWN.

### CLASS 9—ELECTRICAL AND SCIENTIFIC APPARATUS

FOR EDUCATIONAL MATERIALS IN AN ELECTRONIC FORMAT, NAMELY, INTERACTIVE ONLINE PROGRAMS AND MOBILE APPLICATIONS FOR INSTRUCTION IN BUSINESS DEVELOPMENT, SALES, ENTREPRENEUR TRAINING, BRANDING, MARKETING, BUSINESS AND PRODUCT POSITIONING, ADVERTISING, SOCIAL MEDIA, BUSINESS STRATEGY, BUSINESS PLANNING, ANALYZING AND DEVELOPING BUSINESS MODELS, PROCESS DESIGN, PRODUCT AND SERVICE PRICING, ORGANIZATIONAL DEVELOPMENT, ORGANIZATIONAL PERFORMANCE IMPROVEMENT, LEADERSHIP TRAINING, MANAGEMENT TEAM DEVELOPMENT, PROFESSIONAL DEVELOPMENT AND PERSONAL GROWTH, DELIVERING PRESENTATIONS AND PUBLIC SPEAKING; VIDEOS, DVDS, AUDIO BOOKS, SALES SOFTWARE, DOWNLOADABLE E-BOOKS AND DOWNLOADABLE SPREADSHEET TEMPLATES FOR INSTRUCTION IN THE FIELDS OF BUSINESS DEVELOPMENT, SALES, ENTREPRENEUR TRAINING, BRANDING, MARKETING, BUSINESS AND PRODUCT POSITIONING, ADVERTISING, SOCIAL MEDIA, BUSINESS STRATEGY, BUSINESS PLANNING, ANALYZING AND DEVELOPING BUSINESS MODELS, PROCESS DESIGN, PRODUCT AND SERVICE PRICING, ORGANIZATIONAL DEVELOPMENT, ORGANIZATIONAL PERFORMANCE IMPROVEMENT, LEADERSHIP TRAINING, MANAGEMENT TEAM DEVELOPMENT, PROFESSIONAL DEVELOPMENT AND PERSONAL GROWTH, DELIVERING PRESENTATIONS AND PUBLIC SPEAKING (U.S. CLS. 21, 23, 26, 36 AND 38).

FIRST USE 4-9-2013; IN COMMERCE 4-9-2013.

### CLASS 16—PAPER GOODS AND PRINTED MATTER

FOR PRINTED EDUCATIONAL MATERIALS, NAMELY, BOOKS, STUDY GUIDES, WORKBOOKS, TUTORIALS AND TRAIN-THE-TRAINER GUIDES IN THE FIELDS OF BUSINESS DEVELOPMENT, SALES, ENTREPRENEUR TRAINING, BRANDING, MARKETING, POSITIONING, ADVERTISING, SOCIAL MEDIA, BUSINESS STRATEGY, BUSINESS PLANNING, ANALYZING AND DEVELOPING BUSINESS MODELS, PROCESS DESIGN, PRODUCT AND SERVICE PRICING, ORGANIZATIONAL DEVELOPMENT, ORGANIZATIONAL PERFORMANCE IMPROVEMENT, LEADERSHIP TRAINING, MANAGEMENT TEAM DEVELOPMENT, PROFESSIONAL DEVELOPMENT AND PERSONAL GROWTH, DELIVERING PRESENTATIONS AND PUBLIC SPEAKING (U.S. CLS. 2, 5, 22, 23, 29, 37, 38 AND 50).

FIRST USE 4-9-2013; IN COMMERCE 4-9-2013.

### CLASS 35—ADVERTISING AND BUSINESS

FOR CONSULTING AND ADVISORY SERVICES IN THE FIELDS OF BUSINESS DEVELOPMENT, SALES, BRANDING, MARKETING, BUSINESS AND PRODUCT POSITIONING, ADVERTISING, SOCIAL MEDIA STRATEGY, BUSINESS STRATEGY, BUSINESS PLANNING, ANALYZING AND DEVELOPING BUSINESS MODELS, BUSINESS PROCESS DESIGN, PRODUCT AND SERVICE PRICING, BUSINESS ORGANIZATIONAL DEVELOPMENT, BUSINESS ORGANIZATIONAL PERFORMANCE IMPROVEMENT, MANAGEMENT TEAM DEVELOPMENT, PROFESSIONAL DEVELOPMENT, DELIVERING BUSINESS AND MARKETING PRESENTATIONS (U.S. CLS. 100, 101 AND 102).

FIRST USE 4-9-2013; IN COMMERCE 4-9-2013.

### CLASS 41—EDUCATION AND ENTERTAINMENT

FOR COACHING IN THE FIELDS OF BUSINESS DEVELOPMENT, SALES, ENTREPRENEUR TRAINING, BRANDING, MARKETING, BUSINESS AND PRODUCT POSITIONING, ADVERTISING, SOCIAL MEDIA STRATEGY, BUSINESS STRATEGY, BUSINESS PLANNING, ANALYZING AND DEVELOPING BUSINESS MODELS, BUSINESS PROCESS DESIGN, PRODUCT AND SERVICE PRICING, BUSINESS ORGANIZATIONAL DEVELOPMENT, BUSINESS AND PERFORMANCE IMPROVEMENT, LEADERSHIP TRAINING, MANAGEMENT TEAM DEVELOPMENT, PROFESSIONAL DEVELOPMENT AND PERSONAL GROWTH, DELIVERING BUSINESS AND MARKETING PRESENTATIONS AND PUBLIC SPEAKING; CONSULTING AND ADVISORY SERVICES IN THE FIELDS OF ENTREPRENEUR TRAINING, LEADERSHIP TRAINING AND PUBLIC SPEAKING; TRAINING AND EDUCATIONAL PROGRAMS, NAMELY, CLASSES, WEBINARS, SEMINARS, WORKSHOPS AND INDIVIDUAL AND GROUP COACHING IN THE FIELDS OF BUSINESS DEVELOPMENT, SALES, ENTREPRENEUR TRAINING, BRANDING, MARKETING, BUSINESS AND PRODUCT POSITIONING, ADVERTISING, SOCIAL MEDIA, BUSINESS STRATEGY, BUSINESS PLANNING, ANALYZING AND DEVELOPING BUSINESS MODELS, BUSINESS PROCESS DESIGN, PRODUCT AND SERVICE PRICING, ORGANIZATIONAL DEVELOPMENT, ORGANIZATIONAL PERFORMANCE IMPROVEMENT, LEADERSHIP TRAINING, MANAGEMENT TEAM DEVELOPMENT, PROFESSIONAL DEVELOPMENT AND PERSONAL GROWTH, DELIVERING BUSINESS AND MARKETING PRESENTATIONS AND PUBLIC SPEAKING (U.S. CLS. 100, 101 AND 107).

FIRST USE 4-9-2013; IN COMMERCE 4-9-2013.

### CLASS 45—PERSONAL AND LEGAL SERVICES

FOR CONSULTING AND ADVISORY SERVICES IN THE FIELD OF PERSONAL GROWTH (U.S. CLS. 100 AND 101).

FIRST USE 4-9-2013; IN COMMERCE 4-9-2013.

4,481,843. ZACHRY CONSTRUCTION CORPORATION, SAN ANTONIO, TX. SN 85-652,219. PUB. 3-26-2013, FILED 6-14-2012.

## TOGETHER WE CAN DO GREAT THINGS

THE MARK CONSISTS OF STANDARD CHARACTERS WITHOUT CLAIM TO ANY PARTICULAR FONT, STYLE, SIZE, OR COLOR.

**CLASS 37—CONSTRUCTION AND REPAIR**

FOR CONSTRUCTION SERVICES, NAMELY, CONSTRUCTION PLANNING, CONSTRUCTION DESIGN, CONSTRUCTION, AND MAINTENANCE OF COMMERCIAL BUILDINGS, HOTELS, HOSPITALS, EDUCATION FACILITIES, MANUFACTURING FACILITIES, ENTERTAINMENT VENUES, BANKING FACILITIES, PHARMACEUTICAL FACILITIES, HEALTH CARE FACILITIES, CRIMINAL JUSTICE FACILITIES, GOVERNMENT EMBASSY BUILDINGS, ROADS, STREETS, HIGHWAYS, INTERCHANGES, BRIDGES, AIRPORTS, RUNWAYS, DAMS, TUNNELS, CANALS, MASS TRANSIT FACILITIES, GOVERNMENTAL BUILDINGS, DOCKS, WHARVES, POWER TRANSMISSION AND DISTRIBUTION FACILITIES, SOLAR POWER, WIND POWER, AND OTHER RENEWABLE ENERGY FACILITIES, COMMUNICATION TRANSMISSION AND DISTRIBUTION FACILITIES, PIPELINES, WATER STORAGE, TRANSMISSION AND DISTRIBUTION FACILITIES, WASTEWATER TREATMENT FACILITIES, HEAVY AND LIGHT RAIL AND ASSOCIATED STATIONS, INTERCHANGES, BRIDGES, TUNNELS, INTERMODAL FACILITIES, AND EQUIPMENT MAINTENANCE FACILITIES; BUILDING MAINTENANCE SERVICES; CONSTRUCTION MANAGEMENT; CONSTRUCTION PROJECT MANAGEMENT SERVICES; CONSTRUCTION SITE PREPARATION, NAMELY, EXCAVATION, SITE CLEARING, GRADING, AND PAVING; ENVIRONMENTAL REMEDIATION SERVICES, NAMELY, HAZARDOUS WASTE DISPOSAL SERVICES; AND MINING SERVICES, NAMELY, MINING EXTRACTION (U.S. CLS. 100, 103 AND 106).

FIRST USE 10-9-2013; IN COMMERCE 10-9-2013.

**CLASS 40—MATERIAL TREATMENT**

FOR ENVIRONMENTAL REMEDIATION SERVICES, NAMELY, TREATMENT OF SOIL, WASTE, AND/OR WATER (U.S. CLS. 100, 103 AND 106).

FIRST USE 10-9-2013; IN COMMERCE 10-9-2013.

**CLASS 37—CONSTRUCTION AND REPAIR**

FOR CONSTRUCTION SERVICES, NAMELY, CONSTRUCTION PLANNING, CONSTRUCTION DESIGN, CONSTRUCTION, AND MAINTENANCE OF COMMERCIAL BUILDINGS, HOTELS, HOSPITALS, EDUCATION FACILITIES, MANUFACTURING FACILITIES, ENTERTAINMENT VENUES, BANKING FACILITIES, PHARMACEUTICAL FACILITIES, HEALTH CARE FACILITIES, CRIMINAL JUSTICE FACILITIES, GOVERNMENT EMBASSY BUILDINGS, ROADS, STREETS, HIGHWAYS, INTERCHANGES, BRIDGES, AIRPORTS, RUNWAYS, DAMS, TUNNELS, CANALS, MASS TRANSIT FACILITIES, GOVERNMENTAL BUILDINGS, DOCKS, WHARVES, POWER TRANSMISSION AND DISTRIBUTION FACILITIES, SOLAR POWER, WIND POWER, AND OTHER RENEWABLE ENERGY FACILITIES, COMMUNICATION TRANSMISSION AND DISTRIBUTION FACILITIES, PIPELINES, WATER STORAGE, TRANSMISSION AND DISTRIBUTION FACILITIES, WASTEWATER TREATMENT FACILITIES, HEAVY AND LIGHT RAIL AND ASSOCIATED STATIONS, INTERCHANGES, BRIDGES, TUNNELS, INTERMODAL FACILITIES, AND EQUIPMENT MAINTENANCE FACILITIES; BUILDING MAINTENANCE SERVICES; CONSTRUCTION MANAGEMENT; CONSTRUCTION PROJECT MANAGEMENT SERVICES; CONSTRUCTION SITE PREPARATION, NAMELY, EXCAVATION, SITE CLEARING, GRADING, AND PAVING; ENVIRONMENTAL REMEDIATION SERVICES, NAMELY, HAZARDOUS WASTE DISPOSAL SERVICES; AND MINING SERVICES, NAMELY, MINING EXTRACTION (U.S. CLS. 100, 103 AND 106).

FIRST USE 10-9-2013; IN COMMERCE 10-9-2013.

**CLASS 40—MATERIAL TREATMENT**

FOR ENVIRONMENTAL REMEDIATION SERVICES, NAMELY, TREATMENT OF SOIL, WASTE, AND/OR WATER (U.S. CLS. 100, 103 AND 106).

FIRST USE 10-9-2013; IN COMMERCE 10-9-2013.

---

4,481,844. ZACHRY CONSTRUCTION CORPORATION, SAN ANTONIO, TX. SN 85-652,264. PUB. 3-19-2013, FILED 6-14-2012.

---

4,481,845. ZACHRY CONSTRUCTION CORPORATION, SAN ANTONIO, TX. SN 85-652,290. PUB. 3-19-2013, FILED 6-14-2012.

**THIS IS MORE THAN A JOB**

**EVERY PERSON MATTERS**

THE MARK CONSISTS OF STANDARD CHARACTERS WITHOUT CLAIM TO ANY PARTICULAR FONT, STYLE, SIZE, OR COLOR.

THE MARK CONSISTS OF STANDARD CHARACTERS WITHOUT CLAIM TO ANY PARTICULAR FONT, STYLE, SIZE, OR COLOR.

**CLASS 37—CONSTRUCTION AND REPAIR**

FOR CONSTRUCTION SERVICES, NAMELY, CONSTRUCTION PLANNING, CONSTRUCTION DESIGN, CONSTRUCTION, AND MAINTENANCE OF COMMERCIAL BUILDINGS, HOTELS, HOSPITALS, EDUCATION FACILITIES, MANUFACTURING FACILITIES, ENTERTAINMENT VENUES, BANKING FACILITIES, PHARMACEUTICAL FACILITIES, HEALTH CARE FACILITIES, CRIMINAL JUSTICE FACILITIES, GOVERNMENT EMBASSY BUILDINGS, ROADS, STREETS, HIGHWAYS, INTERCHANGES, BRIDGES, AIRPORTS, RUNWAYS, DAMS, TUNNELS, CANALS, MASS TRANSIT FACILITIES, GOVERNMENTAL BUILDINGS, DOCKS, WHARVES, POWER TRANSMISSION AND DISTRIBUTION FACILITIES, SOLAR POWER, WIND POWER, AND OTHER RENEWABLE ENERGY FACILITIES, COMMUNICATION TRANSMISSION AND DISTRIBUTION FACILITIES, PIPELINES, WATER STORAGE, TRANSMISSION AND DISTRIBUTION FACILITIES, WASTEWATER TREATMENT FACILITIES, HEAVY AND LIGHT RAIL AND ASSOCIATED STATIONS, INTERCHANGES, BRIDGES, TUNNELS, INTERMODAL FACILITIES, AND EQUIPMENT MAINTENANCE FACILITIES; BUILDING MAINTENANCE SERVICES; CONSTRUCTION MANAGEMENT; CONSTRUCTION PROJECT MANAGEMENT SERVICES; CONSTRUCTION SITE PREPARATION, NAMELY, EXCAVATION, SITE CLEARING, GRADING, AND PAVING; ENVIRONMENTAL REMEDIATION SERVICES, NAMELY, HAZARDOUS WASTE DISPOSAL SERVICES; AND MINING SERVICES, NAMELY, MINING EXTRACTION (U.S. CLS. 100, 103 AND 106).

FIRST USE 10-9-2013; IN COMMERCE 10-9-2013.

**CLASS 40—MATERIAL TREATMENT**

FOR ENVIRONMENTAL REMEDIATION SERVICES, NAMELY, TREATMENT OF SOIL, WASTE, AND/OR WATER (U.S. CLS. 100, 103 AND 106).

FIRST USE 10-9-2013; IN COMMERCE 10-9-2013.

4,481,854. MARITZ, VIVIAN SONG, SAN FRANCISCO, CA. AND KIM, YOON JUNG, REDWOOD CITY, CA. SN 85-657,864. PUB. 11-13-2012, FILED 6-21-2012.

**LITTLE SPARK**

THE MARK CONSISTS OF STANDARD CHARACTERS WITHOUT CLAIM TO ANY PARTICULAR FONT, STYLE, SIZE, OR COLOR.

**CLASS 28—TOYS AND SPORTING GOODS**

FOR CHILDREN'S EDUCATIONAL TOYS FOR DEVELOPING FINE MOTOR, ORAL LANGUAGE, NUMBERS, COUNTING, COLORS, ALPHABETS, AND COGNITIVE SKILLS (U.S. CLS. 22, 23, 38 AND 50).

FIRST USE 5-31-2012; IN COMMERCE 2-22-2013.

**CLASS 41—EDUCATION AND ENTERTAINMENT**

FOR DEVELOPING TRAINING SYSTEMS AND LEARNING METHODOLOGIES FOR OTHERS (U.S. CLS. 100, 101 AND 107).

FIRST USE 5-31-2012; IN COMMERCE 2-22-2013.

4,481,873. INTEGRYS TRANSPORTATION FUELS, LLC, CHICAGO, IL. SN 85-665,123. PUB. 3-19-2013, FILED 6-29-2012.

**MAKING CNG WORK FOR YOU**

THE MARK CONSISTS OF STANDARD CHARACTERS WITHOUT CLAIM TO ANY PARTICULAR FONT, STYLE, SIZE, OR COLOR.

OWNER OF U.S. REG. NO. 2,144,971.

NO CLAIM IS MADE TO THE EXCLUSIVE RIGHT TO USE "CNG", APART FROM THE MARK AS SHOWN.

**CLASS 4—LUBRICANTS AND FUELS**

FOR NATURAL GAS (U.S. CLS. 1, 6 AND 15).

FIRST USE 9-12-2012; IN COMMERCE 9-12-2012.

**CLASS 35—ADVERTISING AND BUSINESS**

FOR FUEL MARKETING; COMMERCIAL FEASIBILITY STUDIES IN THE FIELD OF NATURAL GAS VEHICLE REFUELING AND CONVERSION; BUSINESS SERVICES, NAMELY, OFFERING TECHNICAL ASSISTANCE IN THE ESTABLISHMENT AND/OR OPERATION OF NATURAL GAS REFUELING STATIONS AND PROCUREMENT, NAMELY, PURCHASING VEHICLE SERVICE STATIONS FOR OTHERS AND LEASING OF NATURAL GAS FUELING STATIONS AND EQUIPMENT IN CONNECTION THEREWITH; AND FLEET SUPPORT SERVICES, NAMELY, PROVIDING USAGE DATA AND ANALYSIS, AND PROVIDING FIXED AND VARIABLE PRICE NATURAL GAS (U.S. CLS. 100, 101 AND 102).

FIRST USE 9-12-2012; IN COMMERCE 9-12-2012.

**CLASS 36—INSURANCE AND FINANCIAL**

FOR FINANCING SERVICES, NAMELY, PROVIDING FINANCING FOR NATURAL GAS FUELING STATION DEVELOPMENT AND NATURAL GAS FUELING EQUIPMENT FOR FLEET OWNERS AND STATION OWNERS IN THE FIELD OF NATURAL GAS FUELING (U.S. CLS. 100, 101 AND 102).

FIRST USE 9-12-2012; IN COMMERCE 9-12-2012.

**CLASS 37—CONSTRUCTION AND REPAIR**

FOR OPERATING NATURAL GAS SERVICE STATIONS FOR VEHICLES; CONSTRUCTION OF NATURAL GAS REFUELING STATIONS (U.S. CLS. 100, 103 AND 106).

FIRST USE 9-12-2012; IN COMMERCE 9-12-2012.

**CLASS 42—SCIENTIFIC AND COMPUTER SERVICES**

FOR CONSULTING SERVICES IN THE FIELD OF TURNKEY STATION ENGINEERING, NAMELY, STATION DESIGN, STATION ENGINEERING (U.S. CLS. 100 AND 101).

FIRST USE 9-12-2012; IN COMMERCE 9-12-2012.

4,481,875. JENSEN ENTERPRISES, SPARKS, NV. SN 85-665,917. PUB. 3-5-2013, FILED 6-29-2012.

4,481,879. MUSA H. OTHMAN, SCOTTSDALE, AZ. SN 85-667,324. PUB. 9-3-2013, FILED 7-2-2012.

# VERTI-SET

THE MARK CONSISTS OF STANDARD CHARACTERS WITHOUT CLAIM TO ANY PARTICULAR FONT, STYLE, SIZE, OR COLOR.

## CLASS 19—NON-METALLIC BUILDING MATERIALS

FOR PRECAST CONCRETE CULVERTS AND PRECAST CONCRETE JOINTS THEREFOR (U.S. CLS. 1, 12, 33 AND 50).  
FIRST USE 6-27-2012; IN COMMERCE 5-0-2013.

## CLASS 45—PERSONAL AND LEGAL SERVICES

FOR LICENSING TO OTHERS OF TECHNOLOGY IN CONNECTION WITH PRECAST CULVERTS AND JOINTS (U.S. CLS. 100 AND 101).  
FIRST USE 4-0-2013; IN COMMERCE 4-0-2013.

---

4,481,876. JENSEN ENTERPRISES, SPARKS, NV. SN 85-665,928. PUB. 3-5-2013, FILED 6-29-2012.



THE MARK CONSISTS OF A VERTICAL RECTANGLE WITH A STAIR DESIGN TO THE LEFT OF A HORIZONTAL RECTANGLE CONTAINING THE TERM "VERTI-SET".

## CLASS 19—NON-METALLIC BUILDING MATERIALS

FOR PRECAST CONCRETE CULVERTS AND PRECAST CONCRETE JOINTS THEREFOR (U.S. CLS. 1, 12, 33 AND 50).  
FIRST USE 6-27-2012; IN COMMERCE 5-0-2013.

## CLASS 45—PERSONAL AND LEGAL SERVICES

FOR LICENSING TO OTHERS OF TECHNOLOGY IN CONNECTION WITH PRECAST CULVERTS AND JOINTS (U.S. CLS. 100 AND 101).  
FIRST USE 4-0-2013; IN COMMERCE 4-0-2013.

# SilverTribe

THE MARK CONSISTS OF STANDARD CHARACTERS WITHOUT CLAIM TO ANY PARTICULAR FONT, STYLE, SIZE, OR COLOR.

## CLASS 14—JEWELRY

FOR JEWELRY MADE IN WHOLE OR IN PART OF SILVER, WATCHES MADE IN WHOLE OR IN PART OF SILVER, KEY CHAINS MADE IN WHOLE OR IN PART OF SILVER, TIE CLIPS MADE IN WHOLE OR IN PART OF SILVER, AND TIE TACKS MADE IN WHOLE OR IN PART OF SILVER (U.S. CLS. 2, 27, 28 AND 50).  
FIRST USE 10-30-2001; IN COMMERCE 10-30-2001.

## CLASS 16—PAPER GOODS AND PRINTED MATTER

FOR MONEY CLIPS MADE IN WHOLE OR IN PART OF SILVER (U.S. CLS. 2, 5, 22, 23, 29, 37, 38 AND 50).  
FIRST USE 10-30-2001; IN COMMERCE 10-30-2001.

## CLASS 25—CLOTHING

FOR CLOTHING, NAMELY, T-SHIRTS, DRESSES, AND HATS; SHOES; BOLO TIES MADE IN WHOLE OR IN PART OF SILVER (U.S. CLS. 22 AND 39).  
FIRST USE 10-30-2001; IN COMMERCE 10-30-2001.

## CLASS 26—FANCY GOODS

FOR BELT BUCKLES MADE IN WHOLE OR IN PART OF SILVER, BARRETTES MADE IN WHOLE OR IN PART OF SILVER, AND HAIR ORNAMENTS IN THE FORM OF COMBS MADE IN WHOLE OR IN PART OF SILVER (U.S. CLS. 37, 39, 40, 42 AND 50).  
FIRST USE 10-30-2001; IN COMMERCE 10-30-2001.

---

4,481,890. HILL, RICHARD PATRICK, ESCONDIDO, CA. SN 85-673,315. PUB. 12-11-2012, FILED 7-10-2012.



THE MARK CONSISTS OF A STYLIZED FONT WITH THE LETTERS "TICLA" ON A DARK RECTANGULAR BACKGROUND.

## CLASS 5—PHARMACEUTICALS

FOR FIRST AID KITS; FIRST AID KITS FOR DOMESTIC OR OTHER NON-PROFESSIONAL USE; KITS COMPRISING SANITIZER GEL, DISINFECTING WIPES, SANITARY MASKS, PLASTIC GLOVES AND HAND CREAM USED FOR GERM PREVENTION; PREPARATIONS FOR REPELLING ANIMALS, BIRDS AND INSECTS (U.S. CLS. 6, 18, 44, 46, 51 AND 52).  
FIRST USE 8-8-2013; IN COMMERCE 8-8-2013.

**CLASS 8—HAND TOOLS**

FOR CUTLERY, NAMELY, FORKS, SPOONS, AND KNIVES; FOLDING KNIVES; POCKET KNIVES; SPORT KNIVES (U.S. CLS. 23, 28 AND 44).

FIRST USE 8-8-2013; IN COMMERCE 8-8-2013.

**CLASS 9—ELECTRICAL AND SCIENTIFIC APPARATUS**

FOR COMPASSES; GOGGLES FOR SPORTS; LIFE BELTS; LIFE JACKETS; LIFE PRESERVERS; LIFE SAVING RAFTS; LIFE VESTS; LIFE-BUOYS; SUNGLASSES (U.S. CLS. 21, 23, 26, 36 AND 38).

FIRST USE 8-8-2013; IN COMMERCE 8-8-2013.

**CLASS 11—ENVIRONMENTAL CONTROL APPARATUS**

FOR LANTERNS FOR LIGHTING; PORTABLE STOVES (U.S. CLS. 13, 21, 23, 31 AND 34).

FIRST USE 8-8-2013; IN COMMERCE 8-8-2013.

**CLASS 14—JEWELRY**

FOR CLOCKS AND WATCHES (U.S. CLS. 2, 27, 28 AND 50).

FIRST USE 8-8-2013; IN COMMERCE 8-8-2013.

**CLASS 18—LEATHER GOODS**

FOR BACKPACKS; BACKPACKS WITH ROLLING WHEELS; FANNY PACKS; HARD-SIDED AND SOFT-SIDED CARRY-ON BAGS AND GYM BAGS; HIKING STICKS; LUGGAGE AND TRUNKS; MILITARY DUFFLE BAGS, GARMENT BAGS FOR TRAVEL, TOTE BAGS, SHOULDER BAGS AND BACKPACKS; MOUNTAINEERING STICKS; POUCHES AND BAGS SOLD EMPTY FOR ATTACHMENT TO BACKPACKS; SACK PACKS, NAMELY, DRAWSTRING BAGS USED AS BACKPACKS; SMALL BACKPACKS; SPORTS PACKS; WAIST PACKS; WALKING STICKS (U.S. CLS. 1, 2, 3, 22 AND 41).

FIRST USE 8-8-2013; IN COMMERCE 8-8-2013.

**CLASS 20—FURNITURE AND ARTICLES NOT OTHERWISE CLASSIFIED**

FOR AIR MATTRESSES FOR USE WHEN CAMPING; BEACH CHAIRS; CAMPING FURNITURE; FURNITURE FOR CAMPING; HAIRDRESSER'S CHAIRS; INFLATABLE MATTRESSES FOR USE WHEN CAMPING; LOUNGE CHAIRS; METAL FURNITURE AND FURNITURE FOR CAMPING; NAP MATS; SLEEPING BAG PADS; SLEEPING BAGS (U.S. CLS. 2, 13, 22, 25, 32 AND 50).

FIRST USE 8-8-2013; IN COMMERCE 8-8-2013.

**CLASS 21—HOUSEWARES AND GLASS**

FOR CAMPING GRILLS; CANTEENS; COOKWARE, NAMELY, POTS AND PANS; PORTABLE COOLERS; PORTABLE ICE CHESTS FOR FOOD AND BEVERAGES (U.S. CLS. 2, 13, 23, 29, 30, 33, 40 AND 50).

FIRST USE 8-8-2013; IN COMMERCE 8-8-2013.

**CLASS 22—CORDAGE AND FIBERS**

FOR TENTS FOR MOUNTAINEERING OR CAMPING (U.S. CLS. 1, 2, 7, 19, 22, 42 AND 50).

FIRST USE 8-8-2013; IN COMMERCE 8-8-2013.

**CLASS 25—CLOTHING**

FOR BELTS; BOOTS FOR SPORT; CARGO PANTS; CLOTHING, NAMELY, BASE LAYERS; CLOTHING, NAMELY, KHAKIS; DOWN JACKETS; FOOTWEAR NOT FOR SPORTS; GLOVES AS CLOTHING; HEADBANDS FOR CLOTHING; HIKING BOOTS; HOODED SWEAT SHIRTS; HOODS; JACKETS; LEISURE SHOES; LEISURE SUITS; MEN'S AND WOMEN'S JACKETS, COATS, TROUSERS, VESTS; MOISTURE-WICKING SPORTS PANTS; MOISTURE-WICKING SPORTS SHIRTS; MOUNTAINEERING BOOTS; MOUNTAINEERING SHOES; MUFFLERS; RAIN JACKETS; RAIN WEAR; SHELL JACKETS; SHIRTS; SHORT SETS; SKI BIBS; SKI JACKETS; SKI PANTS; SNOWBOARD JACKETS; SNOWBOARD PANTS; SPORT COATS; SPORT SHIRTS; SPORTS CAPS AND HATS; SPORTS JACKETS; SPORTS JERSEYS; SPORTS JERSEYS AND BREECHES FOR SPORTS; SPORTS PANTS; SPORTS SHIRTS; SPORTS VESTS; SWEAT JACKETS; SWEAT PANTS; T-SHIRTS; TRAVEL CLOTHING CONTAINED IN A PACKAGE COMPRISING REVERSIBLE JACKETS, PANTS, SKIRTS, TOPS AND A BELT OR SCARF; WATERPROOF JACKETS AND PANTS; WIND PANTS; WIND RESISTANT JACKETS; WOMEN'S CLOTHING, NAMELY, SHIRTS, DRESSES, SKIRTS, BLOUSES; WRIST BANDS (U.S. CLS. 22 AND 39).

FIRST USE 8-8-2013; IN COMMERCE 8-8-2013.

4,481,891. JOY FOR OUR YOUTH, INC., DBA KARS4KIDS, LAKEWOOD, NJ. SN 85-674,839. PUB. 2-5-2013, FILED 7-12-2012.

**IGNORANCE IS NOT BLISS**

THE MARK CONSISTS OF STANDARD CHARACTERS WITHOUT CLAIM TO ANY PARTICULAR FONT, STYLE, SIZE, OR COLOR.

**CLASS 35—ADVERTISING AND BUSINESS**

FOR CHARITABLE SERVICES, NAMELY, ORGANIZING AND CONDUCTING VOLUNTEER PROGRAMS AND COMMUNITY SERVICE PROJECTS (U.S. CLS. 100, 101 AND 102).

FIRST USE 12-5-2012; IN COMMERCE 12-5-2012.

**CLASS 41—EDUCATION AND ENTERTAINMENT**

FOR EDUCATIONAL SERVICES, NAMELY, CONDUCTING PROGRAMS IN THE FIELD OF CHILD DEVELOPMENT (U.S. CLS. 100, 101 AND 107).

FIRST USE 12-5-2012; IN COMMERCE 12-5-2012.

4,481,892. SANTA CLARA, INC., BURLINGTON, NC. SN 85-674,881. PUB. 9-25-2012, FILED 7-12-2012.

**SMOKE CHASER**

THE MARK CONSISTS OF STANDARD CHARACTERS WITHOUT CLAIM TO ANY PARTICULAR FONT, STYLE, SIZE, OR COLOR.



NO CLAIM IS MADE TO THE EXCLUSIVE RIGHT TO USE "SMOKE", APART FROM THE MARK AS SHOWN.

**CLASS 4—LUBRICANTS AND FUELS**

FOR CANDLES (U.S. CLS. 1, 6 AND 15).  
FIRST USE 9-19-2013; IN COMMERCE 9-19-2013.

**CLASS 5—PHARMACEUTICALS**

FOR AIR DEODORIZER (U.S. CLS. 6, 18, 44, 46, 51 AND 52).  
FIRST USE 9-19-2013; IN COMMERCE 9-19-2013.

---

4,481,898. BUDDHIST COMPASSION RELIEF TZU CHI FOUNDATION, HUALIEN COUNTY, TAIWAN. SN 85-677,015. PUB. 3-5-2013, FILED 7-13-2012.

慈濟

THE MARK CONSISTS OF TWO LARGE CHINESE CHARACTERS.

THE NON-LATIN CHARACTERS IN THE MARK TRANSLITERATE TO "TZU CHI" AND THIS MEANS "LOVING AID" IN ENGLISH.

**CLASS 36—INSURANCE AND FINANCIAL**

FOR CHARITABLE FUND RAISING; CHARITABLE FUND RAISING, NAMELY, ORGANIZATION OF DONATION; TRUSTEE SERVICES; ISSUANCE OF TOKENS OF VALUE; INSURANCE BROKERAGE SERVICES; FINANCIAL SERVICES, NAMELY, FINANCIAL GUARANTEES; APPRAISAL OF ARTWORK; MANAGEMENT OF REAL ESTATE; FINANCIAL INVESTMENT BROKERAGE; TRUSTEESHIP REPRESENTATIVE SERVICES (U.S. CLS. 100, 101 AND 102).  
FIRST USE 5-14-1996; IN COMMERCE 7-15-2012.

**CLASS 38—COMMUNICATION**

FOR CABLE TELEVISION BROADCASTING; TELEVISION BROADCASTING; RADIO BROADCASTING; WIRE SERVICES, NAMELY, COMMUNICATION BY TELEGRAM; NEWS AGENCY SERVICES FOR ELECTRONIC TRANSMISSION; INTERNATIONAL TELEPHONE SERVICES; E-MAIL DATA SERVICES; SATELLITE TRANSMISSION; COMPUTER-AIDED TRANSMISSION OF MESSAGES; TRANSMISSION OF IMAGES VIA INTERNET; PROVIDING INFORMATION ON TELECOMMUNICATIONS VIA THE GLOBAL INFORMATION NETWORK; COMPUTER ON-LINE BROADCASTING SERVICES (U.S. CLS. 100, 101 AND 104).  
FIRST USE 5-14-1996; IN COMMERCE 7-15-2012.

**CLASS 41—EDUCATION AND ENTERTAINMENT**

FOR EDUCATIONAL SERVICES IN THE NATURE OF COURSES AT THE UNIVERSITY LEVEL; DANCE SCHOOL SERVICES; PUBLICATION OF BOOKS; PUBLICATION OF PERIODICALS; PRODUCTION OF TV AND RADIO PROGRAMS IN THE FIELD OF MUSIC; ENTERTAINMENT SERVICES, NAMELY, PERFORMANCE OF CONCERTS, NAMELY, MULTIMEDIA SHOWS FEATURING MUSIC; PERFORMANCE OF DRAMAS, NAMELY, TELEVISION PROGRAMS, IN THE FIELD OF MILITARY OPERATIONS; PRODUCTION OF RECORDING DISKS, VIDEO TAPES AND VIDEO DISCS; NEWS SYNDICATION REPORTING; NURSERY SCHOOLS; AFTER-SCHOOL EDUCATIONAL PROGRAMS FOR CHILDREN IN GRADES 1-6; BOOK AND PERIODICALS EDITING; PRODUCTION OF COMPUTER ANIMATED CARTOONS (U.S. CLS. 100, 101 AND 107).  
FIRST USE 5-14-1996; IN COMMERCE 7-15-2012.

**CLASS 42—SCIENTIFIC AND COMPUTER SERVICES**

FOR INTERIOR DESIGN SERVICES; DESIGN OF COMPUTER ANIMATED CARTOONS; DESIGN OF COMPUTER SOFTWARE; COMPUTER DATA PROCESSING SERVICES; PROVIDING INFORMATION ABOUT DESIGN AND DEVELOPMENT OF COMPUTER HARDWARE AND SOFTWARE, INTERIOR DESIGN, GRAPHIC ART DESIGN, FASHION DESIGN VIA A GLOBAL COMPUTER NETWORK; FASHION DESIGN CONSULTING SERVICES (U.S. CLS. 100 AND 101).  
FIRST USE 5-14-1996; IN COMMERCE 7-15-2012.

**CLASS 43—HOTEL AND RESTAURANT SERVICES**

FOR CHILD CARE SERVICES; RETIREMENT HOMES; RESTAURANTS AND CAFES SERVICES; FOOD AND DRINK CATERING SERVICES; HOTEL SERVICES; RENTAL OF CONFERENCE SITES AND CONFERENCE FACILITIES; RENTAL OF PREFABRICATED HOUSES; PET HOTELS SERVICES (U.S. CLS. 100 AND 101).  
FIRST USE 5-14-1996; IN COMMERCE 7-15-2012.

**CLASS 44—MEDICAL, BEAUTY AND AGRICULTURAL SERVICES**

FOR HOSPITALS; MEDICAL SERVICES; SENIOR CITIZENS' NURSING HOMES; MEDICAL SERVICES, NAMELY, MEDICAL TREATMENT OF CHRONIC PAIN; NURSING SERVICES; NURSING HOMES FOR THE POOR; NURSING CARE; PHARMACEUTICAL ADVICE; LANDSCAPE GARDENING FOR OTHERS; FOOD NUTRITION CONSULTING SERVICES; NURSING CENTERS (U.S. CLS. 100 AND 101).  
FIRST USE 5-14-1996; IN COMMERCE 7-15-2012.

---

4,481,911. HOMELAND HOUSEWARES, LLC, LOS ANGELES, CA. SN 85-685,821. PUB. 4-30-2013, FILED 7-24-2012.

NUTRILIVING

THE MARK CONSISTS OF STANDARD CHARACTERS WITHOUT CLAIM TO ANY PARTICULAR FONT, STYLE, SIZE, OR COLOR.

**CLASS 43—HOTEL AND RESTAURANT SERVICES**

FOR PROVIDING A WEB SITE FEATURING INFORMATION IN THE FIELD OF RECIPES RELATING TO THE CREATION OF BLENDED DRINKS AND SMOOTHIES FROM FRUITS AND VEGETABLES (U.S. CLS. 100 AND 101).

FIRST USE 3-12-2013; IN COMMERCE 3-12-2013.

**CLASS 44—MEDICAL, BEAUTY AND AGRICULTURAL SERVICES**

FOR PROVIDING A WEBSITE FEATURING INFORMATION IN THE FIELD OF HEALTH AND NUTRITION RELATING TO THE CREATION OF BLENDED DRINKS AND SMOOTHIES FROM FRUITS AND VEGETABLES (U.S. CLS. 100 AND 101).

FIRST USE 3-12-2013; IN COMMERCE 3-12-2013.

4,481,915. VIZIO, INC., IRVINE, CA. SN 85-687,280. PUB. 2-5-2013, FILED 7-26-2012.

# CO-STAR

THE MARK CONSISTS OF STANDARD CHARACTERS WITHOUT CLAIM TO ANY PARTICULAR FONT, STYLE, SIZE, OR COLOR.

**CLASS 9—ELECTRICAL AND SCIENTIFIC APPARATUS**

FOR COMPUTER HARDWARE IN THE NATURE OF DIGITAL ELECTRONIC DEVICES FOR VIEWING THE INTERNET AND THE REPRODUCTION, PROCESSING, VIEWING, AND PLAYING OF TEXT, DATA, IMAGE, AUDIO AND VIDEO FILES; COMPUTER HARDWARE AND COMPUTER SOFTWARE FOR THE REPRODUCTION, PROCESSING, AND STREAMING OF AUDIO, VIDEO, AND MULTIMEDIA CONTENT; COMPUTER HARDWARE AND SOFTWARE FOR CONTROLLING THE OPERATION OF AUDIO AND VIDEO DEVICES AND FOR VIEWING, SEARCHING, AND PLAYING AUDIO, VIDEO, TELEVISION, MOVIES, OTHER DIGITAL IMAGES, AND OTHER MULTIMEDIA CONTENT (U.S. CLS. 21, 23, 26, 36 AND 38).

FIRST USE 7-10-2012; IN COMMERCE 7-10-2012.

**CLASS 38—COMMUNICATION**

FOR STREAMING OF AUDIO, VIDEO, AND/OR MULTIMEDIA CONTENT VIA A GLOBAL COMPUTER NETWORK (U.S. CLS. 100, 101 AND 104).

FIRST USE 7-10-2012; IN COMMERCE 7-10-2012.

4,481,917. FMR LLC, BOSTON, MA. SN 85-687,878. PUB. 3-19-2013, FILED 7-26-2012.

# GURU BAR

THE MARK CONSISTS OF STANDARD CHARACTERS WITHOUT CLAIM TO ANY PARTICULAR FONT, STYLE,

SIZE, OR COLOR.

**CLASS 37—CONSTRUCTION AND REPAIR**

FOR ON-SITE, IN PERSON TECHNOLOGY SUPPORT SERVICES, NAMELY, TROUBLESHOOTING IN THE NATURE OF THE REPAIR OF COMPUTER HARDWARE; MAINTENANCE, INSTALLATION AND REPAIR OF COMPUTER HARDWARE (U.S. CLS. 100, 103 AND 106).

FIRST USE 10-17-2011; IN COMMERCE 10-17-2011.

**CLASS 41—EDUCATION AND ENTERTAINMENT**

FOR ON-SITE, IN PERSON TECHNOLOGY SUPPORT SERVICES, NAMELY, TRAINING ON COMPUTER HARDWARE AND COMPUTER SOFTWARE (U.S. CLS. 100, 101 AND 107).

FIRST USE 10-17-2011; IN COMMERCE 10-17-2011.

**CLASS 42—SCIENTIFIC AND COMPUTER SERVICES**

FOR ON-SITE, IN PERSON TECHNOLOGY SUPPORT SERVICES, NAMELY, TROUBLESHOOTING COMPUTER SOFTWARE; MAINTENANCE, INSTALLATION AND REPAIR OF COMPUTER SOFTWARE (U.S. CLS. 100 AND 101).

FIRST USE 10-17-2011; IN COMMERCE 10-17-2011.

4,481,921. 7237189 CANADA INC., TORONTO, CANADA. SN 85-689,863. PUB. 3-19-2013, FILED 7-30-2012.

# JULY

THE MARK CONSISTS OF STANDARD CHARACTERS WITHOUT CLAIM TO ANY PARTICULAR FONT, STYLE, SIZE, OR COLOR.

**CLASS 9—ELECTRICAL AND SCIENTIFIC APPARATUS**

FOR DOWNLOADABLE ELECTRONIC PUBLICATIONS IN THE NATURE OF BOOKS, JOURNALS, MAGAZINES, NEWSPAPERS AND SCIENTIFIC PUBLICATIONS IN THE NATURE OF BOOKS, JOURNALS, MAGAZINES, NEWSPAPERS, PAPERS AND ARTICLES IN THE FIELD OF ARTS AND LITERATURE, ASTRONOMY, BIOLOGICAL SCIENCES, BUSINESS ADMINISTRATION, CHEMISTRY, COMPUTER AND INFORMATION SCIENCE, EARTH SCIENCES, ECONOMICS, EDUCATIONAL SCIENCES, ELECTRICAL AND ELECTRONIC ENGINEERING, ENGINEERING, ENVIRONMENTAL SCIENCES, HUMANITIES, LAW, LINGUISTICS, MATERIALS SCIENCES, MATHEMATICS, MEDICINE AND HEALTH SCIENCES, MANAGEMENT SCIENCE, NATURAL SCIENCES, PHILOSOPHY, PHYSICS, PSYCHOLOGY, AND SOCIAL SCIENCES (U.S. CLS. 21, 23, 26, 36 AND 38).

FIRST USE 7-1-2013; IN COMMERCE 7-1-2013.

**CLASS 16—PAPER GOODS AND PRINTED MATTER**

FOR PUBLICATIONS, NAMELY, BOOKS, JOURNALS, MAGAZINES, NEWSPAPERS, PAPERS AND ARTICLES AND SCIENTIFIC PUBLICATIONS IN THE NATURE OF BOOKS, JOURNALS, MAGAZINES, NEWSPAPERS, PAPERS AND ARTICLES IN THE FIELDS OF ARTS AND LITERATURE, ASTRONOMY, BIOLOGICAL SCIENCES, BUSINESS ADMINISTRATION, CHEMISTRY, COMPUTER AND INFORMATION SCIENCE, EARTH SCIENCES, ECONOMICS, EDUCATIONAL SCIENCES, ELECTRICAL AND ELECTRONIC ENGINEERING, ENGINEERING, ENVIRONMENTAL SCIENCES, HUMANITIES, LAW, LINGUISTICS, MATERIALS SCIENCES, MATHEMATICS, MEDICINE AND HEALTH SCIENCES, MANAGEMENT SCIENCE, NATURAL SCIENCES, PHILOSOPHY, PHYSICS, PSYCHOLOGY, AND SOCIAL SCIENCES (U.S. CLS. 2, 5, 22, 23, 29, 37, 38 AND 50).  
FIRST USE 7-1-2013; IN COMMERCE 7-1-2013.

**CLASS 41—EDUCATION AND ENTERTAINMENT**

FOR ONLINE SCIENTIFIC PUBLICATIONS IN THE NATURE OF BOOKS, JOURNALS, MAGAZINES, NEWSPAPERS, PAPERS AND ARTICLES IN THE FIELDS OF ARTS AND LITERATURE, ASTRONOMY, BIOLOGICAL SCIENCES, BUSINESS ADMINISTRATION, CHEMISTRY, COMPUTER AND INFORMATION SCIENCE, EARTH SCIENCES, ECONOMICS, EDUCATIONAL SCIENCES, ELECTRICAL AND ELECTRONIC ENGINEERING, ENGINEERING, ENVIRONMENTAL SCIENCES, HUMANITIES, LAW, LINGUISTICS, MATERIALS SCIENCES, MATHEMATICS, MEDICINE AND HEALTH SCIENCES, MANAGEMENT SCIENCE, NATURAL SCIENCES, PHILOSOPHY, PHYSICS, PSYCHOLOGY, AND SOCIAL SCIENCES (U.S. CLS. 100, 101 AND 107).  
FIRST USE 7-1-2013; IN COMMERCE 7-1-2013.

4,481,924. MICROSOFT CORPORATION, REDMOND, WA. SN 85-693,023. PUB. 1-8-2013, FILED 8-1-2012.

**GALACTIC REIGN**

THE MARK CONSISTS OF STANDARD CHARACTERS WITHOUT CLAIM TO ANY PARTICULAR FONT, STYLE, SIZE, OR COLOR.

**CLASS 9—ELECTRICAL AND SCIENTIFIC APPARATUS**

FOR VIDEO GAME SOFTWARE (U.S. CLS. 21, 23, 26, 36 AND 38).  
FIRST USE 3-13-2013; IN COMMERCE 3-13-2013.

**CLASS 41—EDUCATION AND ENTERTAINMENT**

FOR PROVIDING A WEBSITE THROUGH WHICH PEOPLE LOCATE INFORMATION ABOUT VIDEO GAMES; ENTERTAINMENT SERVICES, NAMELY, PROVIDING ONLINE VIDEO GAMES (U.S. CLS. 100, 101 AND 107).  
FIRST USE 3-13-2013; IN COMMERCE 3-13-2013.

4,481,929. SCOLLO, VINCENT J., LIVERPOOL, NY. SN 85-695,119. PUB. 1-8-2013, FILED 8-3-2012.

**ROBY ROCK OUT BE YOU**

THE MARK CONSISTS OF STANDARD CHARACTERS WITHOUT CLAIM TO ANY PARTICULAR FONT, STYLE, SIZE, OR COLOR.

**CLASS 14—JEWELRY**

FOR BRACELETS MADE OF SILICONE (U.S. CLS. 2, 27, 28 AND 50).  
FIRST USE 11-0-2012; IN COMMERCE 11-0-2012.

**CLASS 25—CLOTHING**

FOR SHIRTS; SWEATSHIRTS; T-SHIRTS (U.S. CLS. 22 AND 39).  
FIRST USE 7-0-2012; IN COMMERCE 7-0-2012.

4,481,933. NAMEONIC LLC, NEW YORK, NY. SN 85-697,060. PUB. 3-12-2013, FILED 8-7-2012.

**nameonic**

THE MARK CONSISTS OF STANDARD CHARACTERS WITHOUT CLAIM TO ANY PARTICULAR FONT, STYLE, SIZE, OR COLOR.

**CLASS 9—ELECTRICAL AND SCIENTIFIC APPARATUS**

FOR COMPUTER APPLICATION SOFTWARE FOR MOBILE PHONES, NAMELY, SOFTWARE FOR SOCIAL INTRODUCTION, NETWORKING AND SOCIAL NETWORKING (U.S. CLS. 21, 23, 26, 36 AND 38).  
FIRST USE 4-7-2013; IN COMMERCE 4-7-2013.

**CLASS 45—PERSONAL AND LEGAL SERVICES**

FOR INTERNET BASED INTRODUCTION, NETWORKING AND SOCIAL NETWORKING SERVICES (U.S. CLS. 100 AND 101).  
FIRST USE 4-7-2013; IN COMMERCE 4-7-2013.

4,481,938. DIET DIRECT, INC., WILMINGTON, NC. SN 85-698,051. PUB. 1-15-2013, FILED 8-8-2012.

**MOMMYSLIM**

THE MARK CONSISTS OF STANDARD CHARACTERS WITHOUT CLAIM TO ANY PARTICULAR FONT, STYLE, SIZE, OR COLOR.

**CLASS 5—PHARMACEUTICALS**

FOR NUTRITIONAL AND DIETARY SUPPLEMENTS, WEIGHT MANAGEMENT SUPPLEMENTS (U.S. CLS. 6, 18, 44, 46, 51 AND 52).

FIRST USE 10-30-2013; IN COMMERCE 10-30-2013.

**CLASS 44—MEDICAL, BEAUTY AND AGRICULTURAL SERVICES**

FOR WEIGHT REDUCTION, DIET PLANNING AND SUPERVISION SERVICES (U.S. CLS. 100 AND 101).

FIRST USE 10-30-2013; IN COMMERCE 10-30-2013.

4,481,950. ARUNDEL BICYCLE COMPANY, LLC, FORT WORTH, TX. SN 85-703,410. PUB. 3-19-2013, FILED 8-14-2012.

ARUNDEL

THE MARK CONSISTS OF STANDARD CHARACTERS WITHOUT CLAIM TO ANY PARTICULAR FONT, STYLE, SIZE, OR COLOR.

**CLASS 12—VEHICLES**

FOR BICYCLE ACCESSORIES, NAMELY, WATER BOTTLE CAGES AND MOUNTING COMPONENTS SOLD THEREWITH, SADDLE BAGS, AIR PUMPS, HANDLEBAR GRIP TAPES (U.S. CLS. 19, 21, 23, 31, 35 AND 44).

FIRST USE 9-30-2013; IN COMMERCE 9-30-2013.

**CLASS 21—HOUSEWARES AND GLASS**

FOR WATER BOTTLES FOR BICYCLES, SOLD EMPTY (U.S. CLS. 2, 13, 23, 29, 30, 33, 40 AND 50).

FIRST USE 5-31-2005; IN COMMERCE 5-31-2005.

4,481,956. GLASSDOOR, INC., SAUSALITO, CA. SN 85-709,280. PUB. 1-22-2013, FILED 8-21-2012.

glassdoor

OWNER OF U.S. REG. NOS. 3,588,847, 3,588,848, AND 3,726,025.

THE MARK CONSISTS OF A DOOR AT AN ANGLE WITH THE WORD "GLASSDOOR" TO THE RIGHT OF THE DOOR.

**CLASS 35—ADVERTISING AND BUSINESS**

FOR ONLINE COMPUTER SERVICES, NAMELY, PROVIDING A WEBSITE THAT OFFERS THE EXCHANGE OF INFORMATION IN THE FIELD OF EMPLOYMENT, CAREERS, EMPLOYMENT OPPORTUNITIES, CAREER PLACEMENT, RECRUITMENT, JOB LISTINGS, PERSONAL ISSUES RELATED TO CAREERS AND WORK LIFE, AND JOB RESOURCES; PROVIDING AN ON-LINE SEARCHABLE DATABASE FEATURING CLASSIFIED AD LISTINGS AND EMPLOYMENT OPPORTUNITIES; CAREER NETWORKING SERVICES (U.S. CLS. 100, 101 AND 102).

FIRST USE 9-1-2010; IN COMMERCE 9-1-2010.

**CLASS 38—COMMUNICATION**

FOR PROVIDING ONLINE INTERACTIVE BULLETIN BOARDS AND ONLINE FORUMS FOR TRANSMISSION OF MESSAGES AMONG USERS OF GLOBAL COMPUTER AND WIRELESS NETWORKS CONCERNING EMPLOYERS, CAREERS AND WORK LIFE, JOB RESOURCES, SALARY INFORMATION, AND COMPENSATION AND BENEFITS (U.S. CLS. 100, 101 AND 104).

FIRST USE 9-1-2010; IN COMMERCE 9-1-2010.

**CLASS 45—PERSONAL AND LEGAL SERVICES**

FOR ONLINE SOCIAL NETWORKING SERVICES (U.S. CLS. 100 AND 101).

FIRST USE 2-0-2012; IN COMMERCE 2-0-2012.

4,481,963. INTERNATIONAL MEDICAL EQUIPMENT AND SERVICE, INC., FORT MILL, SC. SN 85-712,985. PUB. 4-2-2013, FILED 8-25-2012.



NO CLAIM IS MADE TO THE EXCLUSIVE RIGHT TO USE "TRIPLE TESTED" AND "TRIPLE WARRANTY" AND "TRIPLE RELIABILITY", APART FROM THE MARK AS SHOWN.

THE COLOR(S) GREEN, YELLOW AND WHITE IS/ARE CLAIMED AS A FEATURE OF THE MARK.

THE MARK CONSISTS OF A GLOBE DESIGN IN GREEN AND WHITE WITH THE STYLIZED LETTERS "QA3" THEREON, WITH THE LETTERS "QA" IN WHITE WITH GREEN OUTLINING, AND THE NUMBER "3" IN YELLOW WITH GREEN OUTLINING. SURROUNDING THE GLOBE DESIGN IN A CIRCULAR PATTERN APPEARS THE STYLIZED WORDING "TRIPLE TESTED, TRIPLE WARRANTY, TRIPLE RELIABILITY", IN GREEN AGAINST A WHITE BACKGROUND, ALL WITHIN AN OUTER GREEN CIRCLE.

**CLASS 10—MEDICAL APPARATUS**

FOR ELECTROMAGNETIC MEDICAL DIAGNOSTIC IMAGING APPARATUS, AND REPLACEMENT PARTS THEREFOR; NUCLEAR MEDICINE DIAGNOSTIC IMAGING APPARATUS, AND REPLACEMENT PARTS THEREFOR (U.S. CLS. 26, 39 AND 44).

FIRST USE 10-0-2012; IN COMMERCE 10-0-2012.

**CLASS 42—SCIENTIFIC AND COMPUTER SERVICES**

FOR QUALITY MANAGEMENT SERVICES, NAMELY, QUALITY EVALUATION AND ANALYSIS, QUALITY ASSURANCE, AND QUALITY CONTROL, IN THE FIELD OF MEDICAL DIAGNOSTIC IMAGING EQUIPMENT AND REPLACEMENT PARTS THEREFOR (U.S. CLS. 100 AND 101).

FIRST USE 10-0-2012; IN COMMERCE 10-0-2012.

4,481,968. BAYLOR COLLEGE OF MEDICINE, HOUSTON, TX. SN 85-714,930. PUB. 4-16-2013, FILED 8-28-2012.



4,481,966. GLIMMER BODY ART, LLC, TORRANCE, CA. SN 85-713,883. PUB. 2-19-2013, FILED 8-27-2012.



OWNER OF U.S. REG. NO. 3,594,608.

NO CLAIM IS MADE TO THE EXCLUSIVE RIGHT TO USE "BODY ART PROFESSIONAL", APART FROM THE MARK AS SHOWN.

THE MARK CONSISTS OF A LARGE STYLIZED LETTER "G" WITH THE WORDS "THE BODY ART PROFESSIONAL" DIRECTLY BELOW THE LETTER "G", ALL IN CAPITAL LETTERS.

**CLASS 16—PAPER GOODS AND PRINTED MATTER**

FOR TEMPORARY TATTOOS (U.S. CLS. 2, 5, 22, 23, 29, 37, 38 AND 50).

FIRST USE 11-4-2012; IN COMMERCE 11-4-2012.

**CLASS 35—ADVERTISING AND BUSINESS**

FOR RETAIL STORE SERVICES AND ON-LINE RETAIL STORE SERVICES FEATURING TEMPORARY TATTOO PRODUCTS (U.S. CLS. 100, 101 AND 102).

FIRST USE 11-4-2012; IN COMMERCE 11-4-2012.

**CLASS 44—MEDICAL, BEAUTY AND AGRICULTURAL SERVICES**

FOR DAY SPA SERVICES, NAMELY, PROVIDING COSMETIC APPLICATION OF TEMPORARY TATTOO PRODUCTS (U.S. CLS. 100 AND 101).

FIRST USE 11-4-2012; IN COMMERCE 11-4-2012.

THE MARK CONSISTS OF AN IMAGE WITH (1) A STYLISTIC DESIGN OF A SPACE SHUTTLE ATTACHED TO ITS ROCKET-PROPULSION CARRIER, HAVING (A) TWO SPEARS OF DIFFERENT HEIGHTS, IMMEDIATELY ADJACENT TO ONE ANOTHER AND EXTENDING VERTICALLY THROUGH THE MIDDLE OF THE IMAGE, (B) A CURVED TRIANGLE EXTENDING APPROXIMATELY ONE-THIRD ALONG THE LEFT SIDE OF THE LEFT SPEAR FROM ITS BASE AND IN THE LOWER LEFT QUADRANT OF THE IMAGE, AND (C) A SECOND, CURVED TRIANGLE EXTENDING APPROXIMATELY ONE-THIRD ALONG THE RIGHT SIDE OF THE RIGHT SPEAR FROM ITS BASE AND IN THE LOWER RIGHT QUADRANT OF THE IMAGE; (2) TWO CRESCENT SHAPES, IMMEDIATELY ADJACENT TO ONE ANOTHER, CROSSING THE SPEARS HORIZONTALLY AT THE TOP OF THE CURVED TRIANGLES IN THE LOWER TWO QUADRANTS OF THE IMAGE; (3) TWO FOURPOINTED STARS OF DIFFERENT SIZES IN THE UPPER LEFT QUADRANT OF THE IMAGE; (4) TWO FOURPOINTED STARS OF DIFFERENT SIZES IN THE LOWER RIGHT QUADRANT OF THE IMAGE, NEAR ITS CENTER; (5) A CIRCLE DEFINED BY RANDOMLY SCATTERED DOTS ON THE CENTER-RIGHT SIDE OF THE IMAGE; AND (6) A VERTICAL, STYLIZED IMAGE OF A DOUBLE HELIX IN THE UPPER-RIGHT QUADRANT OF THE IMAGE.

**CLASS 41—EDUCATION AND ENTERTAINMENT**

FOR EDUCATIONAL SERVICES, NAMELY, CONDUCTING EDUCATIONAL CONFERENCES FOR SCIENTISTS, ENGINEERS, PHYSICIANS, ASTRONAUTS, INDUSTRY LEADERS, COLLEGES AND UNIVERSITIES, AND STUDENTS IN THE FIELD OF SCIENTIFIC RESEARCH TO COLLABORATE IN THE FIELD OF BIOMEDICAL PROBLEMS ASSOCIATED WITH SPACEFLIGHT, AND TO IMPROVE HEALTH ON EARTH (U.S. CLS. 100, 101 AND 107).

FIRST USE 6-30-2011; IN COMMERCE 3-31-2013.

**CLASS 42—SCIENTIFIC AND COMPUTER SERVICES**

FOR PROVIDING FACILITIES FOR SCIENTIFIC RESEARCH FOR SCIENTISTS, ENGINEERS, PHYSICIANS, ASTRONAUTS, INDUSTRY LEADERS, COLLEGES AND UNIVERSITIES, AND STUDENTS TO COLLABORATE IN THE FIELD OF BIOMEDICAL PROBLEMS ASSOCIATED WITH SPACEFLIGHT, AND TO IMPROVE HEALTH ON EARTH (U.S. CLS. 100 AND 101).

FIRST USE 6-30-2011; IN COMMERCE 3-31-2013.

4,481,972. TRINSIC RESIDENTIAL GROUP LP, DALLAS, TX. SN 85-715,876. PUB. 2-5-2013, FILED 8-29-2012.

# AURA

THE MARK CONSISTS OF STANDARD CHARACTERS WITHOUT CLAIM TO ANY PARTICULAR FONT, STYLE, SIZE, OR COLOR.

#### CLASS 36—INSURANCE AND FINANCIAL

FOR LEASING AND MANAGEMENT OF MULTI-FAMILY HOUSING UNITS (U.S. CLS. 100, 101 AND 102). FIRST USE 9-0-2013; IN COMMERCE 9-0-2013.

#### CLASS 37—CONSTRUCTION AND REPAIR

FOR DEVELOPMENT AND CONSTRUCTION OF MULTI-FAMILY HOUSING UNITS (U.S. CLS. 100, 103 AND 106). FIRST USE 4-0-2013; IN COMMERCE 4-0-2013.

---

4,481,976. LITTLE RAPIDS CORPORATION, GREEN BAY, WI. SN 85-717,028. PUB. 2-26-2013, FILED 8-30-2012.

# GRAHAM MEDICAL

THE MARK CONSISTS OF STANDARD CHARACTERS WITHOUT CLAIM TO ANY PARTICULAR FONT, STYLE, SIZE, OR COLOR.

OWNER OF U.S. REG. NOS. 1,974,816 AND 3,114,502. NO CLAIM IS MADE TO THE EXCLUSIVE RIGHT TO USE "MEDICAL", APART FROM THE MARK AS SHOWN.

#### CLASS 16—PAPER GOODS AND PRINTED MATTER

FOR PAPER BEAUTY PRODUCTS, NAMELY, DRAPE SHEETS, COVERING GOWNS AND WAXING TABLE COVERS; PAPER PRODUCTS FOR USE IN MEDICAL AND DENTAL OFFICES, NAMELY, PAPER TOWELS (U.S. CLS. 2, 5, 22, 23, 29, 37, 38 AND 50). FIRST USE 1-1-1996; IN COMMERCE 1-1-1996.

#### CLASS 24—FABRICS

FOR PATIENT BEDDING, NAMELY, PILLOW CASES AND SHEETS; WASH CLOTHS AND HAND TOWELS FOR MEDICAL AND DENTAL USE (U.S. CLS. 42 AND 50). FIRST USE 1-1-1996; IN COMMERCE 1-1-1996.

4,481,977. LITTLE RAPIDS CORPORATION, GREEN BAY, WI. SN 85-717,047. PUB. 2-26-2013, FILED 8-30-2012.



OWNER OF U.S. REG. NOS. 1,974,816 AND 3,114,502. NO CLAIM IS MADE TO THE EXCLUSIVE RIGHT TO USE "MEDICAL", APART FROM THE MARK AS SHOWN. THE MARK CONSISTS OF "GRAHAM MEDICAL" WITH A STYLIZED FLOWER.

#### CLASS 10—MEDICAL APPARATUS

FOR MEDICAL PRODUCTS, NAMELY, EXAM TABLE ROLLS, HEAD REST ROLLS, HEADRESTS SHEETS, PROTECTIVE GOWNS, EXAM CAPES, EXAM GOWNS, EXAM SHORTS, STRETCHER SHEETS, DRAPE SHEETS, BREAST DRAPES, BEDSIDE BAGS; DENTAL PRODUCTS, NAMELY, BIBS, TRAY COVERS AND HEADREST COVERS (U.S. CLS. 26, 39 AND 44). FIRST USE 1-1-1996; IN COMMERCE 1-1-1996.

#### CLASS 16—PAPER GOODS AND PRINTED MATTER

FOR PAPER BEAUTY PRODUCTS, NAMELY, DRAPE SHEETS, COVERING GOWNS AND WAXING TABLE COVERS; PAPER PRODUCTS FOR USE IN MEDICAL AND DENTAL OFFICES, NAMELY, PAPER TOWELS (U.S. CLS. 2, 5, 22, 23, 29, 37, 38 AND 50). FIRST USE 1-1-1996; IN COMMERCE 1-1-1996.

#### CLASS 24—FABRICS

FOR PATIENT BEDDING, NAMELY, PILLOW CASES AND SHEETS; WASH CLOTHS AND HAND TOWELS FOR MEDICAL AND DENTAL USE (U.S. CLS. 42 AND 50). FIRST USE 1-1-1996; IN COMMERCE 1-1-1996.

---

4,481,978. OCEANCONNECTION, LLC, SANTA FE, NM. SN 85-717,064. PUB. 8-6-2013, FILED 8-30-2012.

# OCEANCONNECTION

THE MARK CONSISTS OF STANDARD CHARACTERS WITHOUT CLAIM TO ANY PARTICULAR FONT, STYLE, SIZE, OR COLOR.

#### CLASS 16—PAPER GOODS AND PRINTED MATTER

FOR PRINTED MATERIALS, NAMELY, TEACHING GUIDES, ACTIVITY GUIDES, RESOURCE GUIDES AND CURRICULUM GUIDES. ALL THE FOREGOING IN THE FIELDS OF OCEAN CONSERVATION AWARENESS, OCEANOGRAPHY AND MARINE BIOLOGY (U.S. CLS. 2, 5, 22, 23, 29, 37, 38 AND 50). FIRST USE 4-6-2013; IN COMMERCE 4-6-2013.

**CLASS 35—ADVERTISING AND BUSINESS**

FOR PROMOTING PUBLIC AWARENESS OF THE OCEAN CONSERVATION, OCEANOGRAPHY AND MARINE BIOLOGY (U.S. CLS. 100, 101 AND 102).  
FIRST USE 4-6-2013; IN COMMERCE 4-6-2013.

**CLASS 41—EDUCATION AND ENTERTAINMENT**

FOR PROVIDING INFORMATION RELATING TO EDUCATIONAL SERVICES FOR USE BY K-12 TEACHERS TO PROVIDE TEACHING GUIDES FOR INSTRUCTING IN THE FIELD OF SCIENCE RELATING TO OCEAN CONSERVATION AWARENESS, OCEANOGRAPHY AND MARINE BIOLOGY (U.S. CLS. 100, 101 AND 107).  
FIRST USE 4-6-2013; IN COMMERCE 4-6-2013.

4,481,986. AT&T INTELLECTUAL PROPERTY II, L.P., RENO, NV. SN 85-718,159. PUB. 11-6-2012, FILED 8-31-2012.

AIO

THE MARK CONSISTS OF STANDARD CHARACTERS WITHOUT CLAIM TO ANY PARTICULAR FONT, STYLE, SIZE, OR COLOR.

**CLASS 9—ELECTRICAL AND SCIENTIFIC APPARATUS**

FOR MOBILE PHONES; PERSONAL DIGITAL ASSISTANTS (PDA); SMARTPHONES; TABLET COMPUTER; WIRELESS COMMUNICATION DEVICE FEATURING VOICE, DATA AND IMAGE TRANSMISSION INCLUDING VOICE, TEXT AND PICTURE MESSAGING, A VIDEO AND STILL IMAGE CAMERA, ALSO FUNCTIONAL TO PURCHASE MUSIC, GAMES, VIDEO AND SOFTWARE APPLICATIONS OVER THE AIR FOR DOWNLOADING TO THE DEVICE (U.S. CLS. 21, 23, 26, 36 AND 38).  
FIRST USE 5-9-2013; IN COMMERCE 5-9-2013.

**CLASS 38—COMMUNICATION**

FOR TELECOMMUNICATION SERVICES, NAMELY, WIRELESS TELEPHONE SERVICES (U.S. CLS. 100, 101 AND 104).  
FIRST USE 5-9-2013; IN COMMERCE 5-9-2013.

4,481,988. MIDZY LLC, BELLEVUE, WA. SN 85-718,255. PUB. 2-5-2013, FILED 8-31-2012.

MIDZY

THE MARK CONSISTS OF STANDARD CHARACTERS WITHOUT CLAIM TO ANY PARTICULAR FONT, STYLE, SIZE, OR COLOR.

**CLASS 9—ELECTRICAL AND SCIENTIFIC APPARATUS**

FOR COMPUTER APPLICATION SOFTWARE FOR MOBILE PHONES, HANDHELD COMPUTERS, PERSONAL COMPUTERS, LAPTOPS, COMPUTER TABLETS, MOBILE WEBSITES, WEBSITES AND WEB APPLICATIONS, NAMELY, SOFTWARE FOR USE IN ELECTRONIC POLL CREATION, ELECTRONIC POLL SEARCHING, ELECTRONIC POLL DISPLAY, ELECTRONIC POLL RESULTS DISPLAY, ELECTRONIC POLL FEEDBACK, ELECTRONIC IDENTIFICATION OF USERS OR POPULATIONS TO TARGET FOR POLLS, ELECTRONIC TRANSMISSION OF INFORMATION FOR TARGETED POLLS TO USERS OR POPULATIONS, ELECTRONIC RECEIPT OF INPUTS FOR ELECTRONIC POLLS, ANSWERING ELECTRONIC POLLS, INDEXING ELECTRONIC POLLS, CATEGORIZING ELECTRONIC POLLS (U.S. CLS. 21, 23, 26, 36 AND 38).  
FIRST USE 3-29-2013; IN COMMERCE 3-29-2013.

**CLASS 35—ADVERTISING AND BUSINESS**

FOR PROVIDING A SEARCHABLE ONLINE WEBSITE USED FOR ELECTRONIC POLL CREATION, ELECTRONIC POLL SEARCHING, ELECTRONIC POLL DISPLAY, ELECTRONIC POLL RESULTS DISPLAY, ELECTRONIC POLL FEEDBACK, ELECTRONIC IDENTIFICATION OF USERS OR POPULATIONS TO TARGET FOR POLLS, ELECTRONIC TRANSMISSION OF INFORMATION FOR TARGETED POLLS TO USERS OR POPULATIONS, ELECTRONIC RECEIPT OF INPUTS FOR ELECTRONIC POLLS, ANSWERING ELECTRONIC POLLS, INDEXING ELECTRONIC POLLS, CATEGORIZING ELECTRONIC POLLS (U.S. CLS. 100, 101 AND 102).  
FIRST USE 3-29-2013; IN COMMERCE 3-29-2013.

4,481,992. PERFORMANCE FABRICS, INC., GRAND RAPIDS, MI. SN 85-720,818. PUB. 2-12-2013, FILED 9-5-2012.

Hex1

THE MARK CONSISTS OF STANDARD CHARACTERS WITHOUT CLAIM TO ANY PARTICULAR FONT, STYLE, SIZE, OR COLOR.

**CLASS 9—ELECTRICAL AND SCIENTIFIC APPARATUS**

FOR PROTECTIVE GLOVES FOR INDUSTRIAL USE (U.S. CLS. 21, 23, 26, 36 AND 38).  
FIRST USE 10-2-2013; IN COMMERCE 10-2-2013.

**CLASS 21—HOUSEWARES AND GLASS**

FOR GARDENING GLOVES; LIGHT DUTY UTILITY GLOVES (U.S. CLS. 2, 13, 23, 29, 30, 33, 40 AND 50).  
FIRST USE 10-2-2013; IN COMMERCE 10-2-2013.

4,481,994. HAHN, VERONICA, KNOXVILLE, TN. SN 85-721,222. PUB. 3-12-2013, FILED 9-5-2012.

## Veronica Hahn Design

THE MARK CONSISTS OF STANDARD CHARACTERS WITHOUT CLAIM TO ANY PARTICULAR FONT, STYLE, SIZE, OR COLOR.

NO CLAIM IS MADE TO THE EXCLUSIVE RIGHT TO USE "DESIGN", APART FROM THE MARK AS SHOWN.

THE NAME "VERONICA HAHN" IDENTIFIES A LIVING INDIVIDUAL WHOSE CONSENT IS OF RECORD.

### CLASS 11—ENVIRONMENTAL CONTROL APPARATUS

FOR LIGHTING FIXTURES (U.S. CLS. 13, 21, 23, 31 AND 34).

FIRST USE 8-28-2012; IN COMMERCE 7-12-2013.

### CLASS 14—JEWELRY

FOR BRACELETS; EARRINGS; JEWELRY; NECKLACES; RINGS (U.S. CLS. 2, 27, 28 AND 50).

FIRST USE 8-28-2012; IN COMMERCE 7-12-2013.

### CLASS 21—HOUSEWARES AND GLASS

FOR BOWLS; SERVING PLATTERS (U.S. CLS. 2, 13, 23, 29, 30, 33, 40 AND 50).

FIRST USE 8-28-2012; IN COMMERCE 7-12-2013.

4,481,995. PENENBERG, BRAD L., LOS ANGELES, CA. SN 85-721,492. PUB. 1-8-2013, FILED 9-5-2012.

## GALILEO POSITIONING SYSTEM

THE MARK CONSISTS OF STANDARD CHARACTERS WITHOUT CLAIM TO ANY PARTICULAR FONT, STYLE, SIZE, OR COLOR.

NO CLAIM IS MADE TO THE EXCLUSIVE RIGHT TO USE "POSITIONING SYSTEM", APART FROM THE MARK AS SHOWN.

### CLASS 9—ELECTRICAL AND SCIENTIFIC APPARATUS

FOR MEDICAL IMAGING SOFTWARE AND MEDICAL IMAGE CO-REGISTRATION SOFTWARE (U.S. CLS. 21, 23, 26, 36 AND 38).

FIRST USE 11-30-2011; IN COMMERCE 11-30-2011.

### CLASS 10—MEDICAL APPARATUS

FOR MEDICAL IMAGING SYSTEMS, NAMELY, MEDICAL X-RAY APPARATUS (U.S. CLS. 26, 39 AND 44).

FIRST USE 11-30-2011; IN COMMERCE 11-30-2011.

4,482,003. GAMMA ENTERPRISES, LLC, WEST BABYLON, NY. SN 85-724,114. PUB. 4-2-2013, FILED 9-8-2012.

## LIVE THE GAME

THE MARK CONSISTS OF STANDARD CHARACTERS WITHOUT CLAIM TO ANY PARTICULAR FONT, STYLE, SIZE, OR COLOR.

### CLASS 5—PHARMACEUTICALS

FOR DIETARY AND NUTRITIONAL SUPPLEMENTS; POWDERED NUTRITIONAL SUPPLEMENT DRINK MIX TO BOOST ENERGY; NUTRITION DRINK POWDERS, NAMELY, POWDERED NUTRITIONAL SUPPLEMENT DRINK MIX (U.S. CLS. 6, 18, 44, 46, 51 AND 52).

FIRST USE 9-30-2012; IN COMMERCE 9-30-2012.

### CLASS 32—LIGHT BEVERAGES

FOR ENERGY DRINK POWDERS; NUTRITIONAL ENERGY DRINK POWDERS, NAMELY, POWDERS USED IN THE PREPARATION OF ENERGY DRINKS; POWDERS USED IN THE PREPARATION OF SPORTS AND ENERGY DRINKS; POWDERS USED IN THE PREPARATION OF ISOTONIC SPORTS DRINKS AND SPORTS BEVERAGES (U.S. CLS. 45, 46 AND 48).

FIRST USE 9-30-2012; IN COMMERCE 9-30-2012.

4,482,004. MENASHA CORPORATION, NEENAH, WI. SN 85-724,521. PUB. 3-5-2013, FILED 9-10-2012.



OWNER OF U.S. REG. NO. 2,880,233.

THE MARK CONSISTS OF A STYLIZED LETTER "M".

### CLASS 16—PAPER GOODS AND PRINTED MATTER

FOR CORRUGATED PAPERBOARD; PRINTED PAPER LABELS; PRINTED PAPER SIGNS AND CARDBOARD FOR PACKAGING; PRINTED PAPER AND CORRUGATED PAPERBOARD MERCHANDISE POINT OF SALE DISPLAYS (U.S. CLS. 2, 5, 22, 23, 29, 37, 38 AND 50).

FIRST USE 8-24-2002; IN COMMERCE 8-24-2002.

### CLASS 35—ADVERTISING AND BUSINESS

FOR ADVERTISING SERVICES, NAMELY, PROMOTING THE GOODS AND SERVICES OF OTHERS IN A WIDE VARIETY OF FIELDS, THROUGH THE DISTRIBUTION OF PRINTED PROMOTIONAL MATERIALS, COUPON DISPENSERS, AND PROMOTIONAL AND INFORMATIONAL MATERIALS DISPENSERS; PLACING ADVERTISEMENTS FOR OTHERS; BUSINESS MARKETING CONSULTING SERVICES (U.S. CLS. 100, 101 AND 102).

FIRST USE 3-7-2013; IN COMMERCE 3-7-2013.



**CLASS 40—MATERIAL TREATMENT**

FOR MANUFACTURE OF CONTAINERS AND CONTAINER SYSTEMS TO THE ORDER AND SPECIFICATION OF OTHERS; MANUFACTURE, TO THE ORDER AND SPECIFICATION OF OTHERS, OF PROMOTIONAL MATERIALS, NAMELY, LABELS AND MERCHANDISE POINT OF SALE DISPLAYS; PRINTING ON CONTAINERS AND CONTAINER SYSTEMS FOR OTHERS; PRINTING FOR OTHERS IN THE FIELD OF PROMOTIONAL MATERIALS, NAMELY, LABELS AND MERCHANDISE POINT OF SALE DISPLAYS (U.S. CLS. 100, 103 AND 106).

FIRST USE 8-24-2002; IN COMMERCE 8-24-2002.

**CLASS 42—SCIENTIFIC AND COMPUTER SERVICES**

FOR PACKAGING DESIGN FOR OTHERS, SPECIFICALLY THE DESIGN OF CONTAINERS AND CONTAINER SYSTEMS; PACKAGING DESIGN FOR OTHERS IN THE FIELD OF PROMOTIONAL MATERIALS, NAMELY, LABELS AND MERCHANDISE POINT OF SALE DISPLAYS (U.S. CLS. 100 AND 101).

FIRST USE 8-24-2002; IN COMMERCE 8-24-2002.

**CLASS 42—SCIENTIFIC AND COMPUTER SERVICES**

FOR PACKAGING DESIGN FOR OTHERS, SPECIFICALLY THE DESIGN OF CONTAINERS AND CONTAINER SYSTEMS; PACKAGING DESIGN FOR OTHERS IN THE FIELD OF PROMOTIONAL MATERIALS, NAMELY, LABELS AND MERCHANDISE POINT OF SALE DISPLAYS (U.S. CLS. 100 AND 101).

FIRST USE 3-7-2013; IN COMMERCE 3-7-2013.

4,482,007. FIREEYE, INC., MILPITAS, CA. SN 85-725,142. PUB. 3-12-2013, FILED 9-10-2012.

4,482,005. MENASHA CORPORATION, NEENAH, WI. SN 85-724,528. PUB. 4-9-2013, FILED 9-10-2012.



OWNER OF U.S. REG. NOS. 2,867,745 AND 2,880,233.

NO CLAIM IS MADE TO THE EXCLUSIVE RIGHT TO USE "CORPORATION", APART FROM THE MARK AS SHOWN.

THE MARK CONSISTS OF A STYLIZED LETTER "M" FOLLOWED BY THE WORD "MENASHA", WITH THE WORD "CORPORATION" APPEARING BELOW "MENASHA".

**CLASS 35—ADVERTISING AND BUSINESS**

FOR ADVERTISING SERVICES, NAMELY, PROMOTING THE GOODS AND SERVICES OF OTHERS IN A WIDE VARIETY OF FIELDS, THROUGH THE DISTRIBUTION OF PRINTED PROMOTIONAL MATERIALS, COUPON DISPENSERS, AND PROMOTIONAL AND INFORMATIONAL MATERIALS DISPENSERS; PLACING ADVERTISEMENTS FOR OTHERS; BUSINESS MARKETING CONSULTING SERVICES (U.S. CLS. 100, 101 AND 102).

FIRST USE 3-7-2013; IN COMMERCE 3-7-2013.

**CLASS 40—MATERIAL TREATMENT**

FOR MANUFACTURE OF CONTAINERS AND CONTAINER SYSTEMS TO THE ORDER AND SPECIFICATION OF OTHERS; MANUFACTURE, TO THE ORDER AND SPECIFICATION OF OTHERS, OF PROMOTIONAL MATERIALS, NAMELY, LABELS AND MERCHANDISE POINT OF SALE DISPLAYS; PRINTING ON CONTAINERS AND CONTAINER SYSTEMS FOR OTHERS; PRINTING FOR OTHERS IN THE FIELD OF PROMOTIONAL MATERIALS, NAMELY, LABELS AND MERCHANDISE POINT OF SALE DISPLAYS (U.S. CLS. 100, 103 AND 106).

FIRST USE 3-7-2013; IN COMMERCE 3-7-2013.



OWNER OF U.S. REG. NOS. 3,386,418 AND 3,386,626.

THE MARK CONSISTS OF AN EYE DESIGN WITH THE WORDS "FIREEYE" TO THE RIGHT.

**CLASS 9—ELECTRICAL AND SCIENTIFIC APPARATUS**

FOR COMPUTER SOFTWARE AND HARDWARE FOR DIGITAL SECURITY; COMPUTER SECURITY PRODUCTS, NAMELY, COMPUTER PERIPHERALS; COMPUTER SOFTWARE AND COMPUTER HARDWARE FOR DETECTION, BLOCKING AND REMOVAL OF COMPUTER VIRUSES, ROOTKITS, ADVANCED PERSISTENT THREATS, MALWARE, AND MALICIOUS ATTACKS; COMPUTER SOFTWARE AND COMPUTER HARDWARE FOR REAL-TIME DETECTION, BLOCKING, REMOVAL AND REMEDIATION OF COMPUTER VIRUSES, ROOTKITS, ADVANCED PERSISTENT THREATS, MALWARE AND MALICIOUS ATTACKS; COMPUTER SOFTWARE FOR IDENTIFYING AND PREVENTING MALICIOUS ATTACKS ON COMPUTERS, COMPUTER SYSTEMS, AND DIGITAL DEVICES; COMPUTER SOFTWARE AND HARDWARE PROVIDING SECURE VIRTUAL COMPUTER SYSTEMS AND VIRTUAL COMPUTER ENVIRONMENTS (U.S. CLS. 21, 23, 26, 36 AND 38).

FIRST USE 5-0-2011; IN COMMERCE 5-0-2011.

**CLASS 42—SCIENTIFIC AND COMPUTER SERVICES**

FOR TECHNICAL SUPPORT SERVICES, NAMELY, TROUBLESHOOTING AND SUPPORT SERVICES IN THE NATURE OF DIAGNOSING COMPUTER HARDWARE AND SOFTWARE PROBLEMS, PROVIDING BACK-UP COMPUTER PROGRAMS AND FACILITIES, VIRUS REMOVAL, MAINTENANCE OF COMPUTER SOFTWARE RELATING TO COMPUTER SECURITY AND PREVENTION OF COMPUTER RISKS, UPDATING AND MAINTENANCE OF COMPUTER SOFTWARE, AND SOFTWARE INSTALLATION FOR COMPUTERS, PERIPHERALS, USB DEVICES, COMPUTER NETWORKS AND MOBILE DEVICES (U.S. CLS. 100 AND 101).

FIRST USE 5-0-2011; IN COMMERCE 5-0-2011.

4,482,010. SELECT PRODUCTS, LLC, EDMOND, OK. SN 85-726,798. PUB. 2-12-2013, FILED 9-12-2012.

## RESOURCE SAVVY

THE MARK CONSISTS OF STANDARD CHARACTERS WITHOUT CLAIM TO ANY PARTICULAR FONT, STYLE, SIZE, OR COLOR.

### CLASS 35—ADVERTISING AND BUSINESS

FOR PROVIDING CONSUMER PRODUCT INFORMATION RELATING TO THE IMPACT OF CONSUMER PRODUCTS ON ENVIRONMENTAL PRESERVATION (U.S. CLS. 100, 101 AND 102).  
FIRST USE 10-9-2013; IN COMMERCE 10-9-2013.

### CLASS 42—SCIENTIFIC AND COMPUTER SERVICES

FOR EVALUATING AND TESTING THE ENVIRONMENTAL QUALITIES AND IMPACT OF CONSUMER PRODUCTS OF OTHERS (U.S. CLS. 100 AND 101).  
FIRST USE 10-9-2013; IN COMMERCE 10-9-2013.

4,482,030. MENASHA CORPORATION, NEENAH, WI. SN 85-728,970. PUB. 3-12-2013, FILED 9-14-2012.

## THE POWER BEHIND POSSIBLE

THE MARK CONSISTS OF STANDARD CHARACTERS WITHOUT CLAIM TO ANY PARTICULAR FONT, STYLE, SIZE, OR COLOR.

### CLASS 35—ADVERTISING AND BUSINESS

FOR ADVERTISING SERVICES, NAMELY, PROMOTING THE GOODS AND SERVICES OF OTHERS IN A WIDE VARIETY OF FIELDS, THROUGH THE DISTRIBUTION OF PRINTED PROMOTIONAL MATERIALS, COUPON DISPENSERS, AND PROMOTIONAL AND INFORMATIONAL MATERIALS DISPENSERS; PLACING ADVERTISEMENTS FOR OTHERS; BUSINESS MARKETING CONSULTING SERVICES (U.S. CLS. 100, 101 AND 102).  
FIRST USE 3-7-2013; IN COMMERCE 3-7-2013.

### CLASS 40—MATERIAL TREATMENT

FOR MANUFACTURE OF CONTAINERS AND CONTAINER SYSTEMS TO THE ORDER AND SPECIFICATION OF OTHERS; MANUFACTURE, TO THE ORDER AND SPECIFICATION OF OTHERS, OF PROMOTIONAL MATERIALS, NAMELY, LABELS AND MERCHANDISE POINT OF SALE DISPLAYS; PRINTING ON CONTAINERS AND CONTAINER SYSTEMS FOR OTHERS; PRINTING FOR OTHERS IN THE FIELD OF PROMOTIONAL MATERIALS, NAMELY, LABELS AND MERCHANDISE POINT OF SALE DISPLAYS (U.S. CLS. 100, 103 AND 106).  
FIRST USE 3-7-2013; IN COMMERCE 3-7-2013.

### CLASS 42—SCIENTIFIC AND COMPUTER SERVICES

FOR PACKAGING DESIGN FOR OTHERS, SPECIFICALLY THE DESIGN OF CONTAINERS AND CONTAINER SYSTEMS; PACKAGING DESIGN FOR OTHERS IN THE FIELD OF PROMOTIONAL MATERIALS, NAMELY, LABELS AND MERCHANDISE POINT OF SALE DISPLAYS (U.S. CLS. 100 AND 101).  
FIRST USE 3-7-2013; IN COMMERCE 3-7-2013.

4,482,033. AIR METHODS CORPORATION, ENGLEWOOD, CO. SN 85-729,599. PUB. 3-19-2013, FILED 9-14-2012.

## UNITED ROTORCRAFT

THE MARK CONSISTS OF STANDARD CHARACTERS WITHOUT CLAIM TO ANY PARTICULAR FONT, STYLE, SIZE, OR COLOR.

NO CLAIM IS MADE TO THE EXCLUSIVE RIGHT TO USE "ROTORCRAFT", APART FROM THE MARK AS SHOWN.

### CLASS 37—CONSTRUCTION AND REPAIR

FOR INSTALLATION, MAINTENANCE, AND REPAIR OF AIRCRAFT INTERIORS (U.S. CLS. 100, 103 AND 106).  
FIRST USE 1-1-2013; IN COMMERCE 1-1-2013.

### CLASS 42—SCIENTIFIC AND COMPUTER SERVICES

FOR CUSTOM DEVELOPMENT OF AIRCRAFT INTERIORS (U.S. CLS. 100 AND 101).  
FIRST USE 1-1-2013; IN COMMERCE 1-1-2013.

4,482,035. PROJECT JUICE LLC, SAN FRANCISCO, CA. SN 85-730,145. PUB. 3-12-2013, FILED 9-16-2012.

## PROJECT CLEANSE

THE MARK CONSISTS OF STANDARD CHARACTERS WITHOUT CLAIM TO ANY PARTICULAR FONT, STYLE, SIZE, OR COLOR.

NO CLAIM IS MADE TO THE EXCLUSIVE RIGHT TO USE "CLEANSE", APART FROM THE MARK AS SHOWN.

**CLASS 32—LIGHT BEVERAGES**

FOR AERATED FRUIT JUICES; ALOE JUICE BEVERAGES; ALOE VERA JUICES; APPLE JUICE BEVERAGES; BEAUTY BEVERAGES, NAMELY, FRUIT JUICES AND ENERGY DRINKS CONTAINING NUTRITIONAL SUPPLEMENTS; COCONUT JUICE; FRUIT DRINKS AND FRUIT JUICES; FRUIT DRINKS AND JUICES; FRUIT JUICE; FRUIT JUICES; FRUIT JUICES AND FRUIT DRINKS; HERBAL JUICES; LEMON JUICE FOR USE IN THE PREPARATION OF BEVERAGES; MIXED FRUIT JUICE; NON-ALCOHOLIC BEVERAGES CONTAINING FRUIT JUICES; NON-ALCOHOLIC FRUIT JUICE BEVERAGES; ORANGE JUICE; PINEAPPLE JUICE BEVERAGES; PREPARED ENTREES CONSISTING OF FRUIT DRINKS AND FRUIT JUICES, FRUIT-BASED BEVERAGES, NON-ALCOHOLIC BEVERAGES CONTAINING FRUIT JUICES, NON-ALCOHOLIC FRUIT EXTRACTS USED IN THE PREPARATION OF BEVERAGES, NON-ALCOHOLIC FRUIT JUICE BEVERAGES, VEGETABLE JUICES, VEGETABLE-FRUIT JUICES AND SMOOTHIES; VEGETABLE JUICE; VEGETABLE JUICES; VEGETABLE-FRUIT JUICES (U.S. CLS. 45, 46 AND 48).

FIRST USE 10-1-2012; IN COMMERCE 10-1-2012.

**CLASS 44—MEDICAL, BEAUTY AND AGRICULTURAL SERVICES**

FOR CONDUCTING TELEPHONE AND IN-PERSON PERSONAL LIFESTYLE WELLNESS ASSESSMENTS; CONSULTING IN THE FIELD OF HEALTH AND WELLNESS TO BRING ABOUT PERSONAL HAPPINESS; CONSULTING SERVICES IN THE FIELD OF MENTAL HEALTH AND WELLNESS; COUNSELING SERVICES IN THE FIELDS OF HEALTH, HERBALISM, AND LIFESTYLE WELLNESS; COUNSELING SERVICES IN THE FIELDS OF HEALTH, NUTRITION AND LIFESTYLE WELLNESS; HEALTH CARE SERVICES, NAMELY, HEALTH AND WELLNESS PROGRAMS IN FIELD OF CHILDHOOD OBESITY; HEALTH CARE SERVICES, NAMELY, WELLNESS PROGRAMS; HEALTH SPA SERVICES FOR HEALTH AND WELLNESS OF THE BODY AND SPIRIT; HEALTH SPA SERVICES FOR HEALTH AND WELLNESS OF THE BODY AND SPIRIT OFFERED AT A HEALTH CLUB FACILITY; HEALTH SPA SERVICES FOR HEALTH AND WELLNESS OF THE BODY AND SPIRIT OFFERED AT A HEALTH RESORT; HEALTH SPA SERVICES FOR HEALTH AND WELLNESS OF THE MIND, BODY AND SPIRIT OFFERED IN OR FROM A REMOTE, MOBILE OR TEMPORARY ON-SITE LOCATION; PROVIDING A WEBSITE FEATURING CONTENT REGARDING HEALTHY LIVING AND LIFESTYLE WELLNESS; PROVIDING A WEBSITE FEATURING INFORMATION ABOUT HEALTH AND WELLNESS, NAMELY, CLEANSING THROUGH CONSUMPTION OF FOOD AND BEVERAGE; PROVIDING A WEBSITE FEATURING INFORMATION ABOUT HEALTH, WELLNESS AND NUTRITION; PROVIDING A WEBSITE FEATURING INFORMATION AND ADVICE IN THE FIELDS OF DIET, WEIGHT LOSS, DIET PLANNING AND LIFESTYLE WELLNESS; PROVIDING ASSISTANCE, FITNESS EVALUATION AND CONSULTATION TO CORPORATE CLIENTS TO HELP THEIR EMPLOYEES MAKE HEALTH, WELLNESS AND NUTRITIONAL CHANGES IN THEIR DAILY LIVING TO IMPROVE HEALTH; PROVIDING ASSISTANCE, FITNESS EVALUATION AND CONSULTATION TO INDIVIDUALS TO HELP THEM MAKE HEALTH, WELLNESS AND NUTRITIONAL CHANGES IN THEIR DAILY LIVING TO IMPROVE HEALTH; PROVIDING INFORMATION, NEWS AND COMMENTARY IN THE FIELD OF NUTRITION, HEALTH AND WELLNESS; PROVIDING ON-LINE INFORMATION, NEWS AND COMMENTARY IN THE FIELD OF HEALTH AND WELLNESS RELATING TO CLEANSING THROUGH CONSUMPTION OF FOOD AND BEVERAGE; PROVIDING WELLNESS SERVICES, NAMELY, PERSONAL ASSESSMENTS, PERSONALIZED ROUTINES, MAINTENANCE SCHEDULES, AND COUNSELING; WELLNESS AND HEALTH-RELATED CONSULTING SERVICES (U.S. CLS. 100 AND 101).

FIRST USE 10-1-2013; IN COMMERCE 10-1-2013.

4,482,065. BOUQUETTE, VIKTOR, ATLANTA, GA. SN 85-733,474. PUB. 3-12-2013, FILED 9-19-2012.

# Zavatar

THE MARK CONSISTS OF STANDARD CHARACTERS WITHOUT CLAIM TO ANY PARTICULAR FONT, STYLE, SIZE, OR COLOR.

THE WORDING "ZAVATAR" HAS NO MEANING IN A FOREIGN LANGUAGE.

**CLASS 9—ELECTRICAL AND SCIENTIFIC APPARATUS**

FOR MEDICAL SOFTWARE FOR RECEIVING AND UTILIZING HEALTH RELATED DATA AND GENERATING A HOLOGRAPHIC ELECTRONIC REPRESENTATION OF AN INDIVIDUAL DEPICTING HEALTH STATUS AND WELL BEING OF THE INDIVIDUAL AT A GIVEN TIME (U.S. CLS. 21, 23, 26, 36 AND 38).

FIRST USE 9-0-2013; IN COMMERCE 9-0-2013.

**CLASS 44—MEDICAL, BEAUTY AND AGRICULTURAL SERVICES**

FOR MEDICAL SERVICES, NAMELY, PROVIDING TREATMENT PROTOCOLS TO A PATIENT VIA UTILIZING MEDICAL SOFTWARE THAT USES HEALTH RELATED DATA TO GENERATE A HOLOGRAPHIC ELECTRONIC REPRESENTATION OF THE PATIENT TO DEPICT HEALTH STATUS AND WELL BEING OF THE PATIENT AT A GIVEN TIME (U.S. CLS. 100 AND 101).

FIRST USE 9-0-2013; IN COMMERCE 9-0-2013.

4,482,077. TIPPING POINT GAMING, LLC, LAS VEGAS, NV. SN 85-735,758. PUB. 3-12-2013, FILED 9-21-2012.

# MEGA MEGA

THE MARK CONSISTS OF STANDARD CHARACTERS WITHOUT CLAIM TO ANY PARTICULAR FONT, STYLE, SIZE, OR COLOR.

**CLASS 9—ELECTRICAL AND SCIENTIFIC APPARATUS**

FOR SOFTWARE FOR GAMING MACHINES; GAMING SOFTWARE THAT GENERATES OR DISPLAYS WAGER OUTCOMES OF GAMING MACHINES; GAMING SOFTWARE THAT GENERATES OR DISPLAYS WAGER OUTCOMES FOR GAMES OF CHANCE PLAYED ON GAMING MACHINES (U.S. CLS. 21, 23, 26, 36 AND 38).

FIRST USE 2-1-2013; IN COMMERCE 2-1-2013.

**CLASS 28—TOYS AND SPORTING GOODS**

FOR GAMING MACHINES; GAMES OF CHANCE PLAYED ON GAMING MACHINES (U.S. CLS. 22, 23, 38 AND 50).

FIRST USE 3-1-2013; IN COMMERCE 3-1-2013.

**CLASS 41—EDUCATION AND ENTERTAINMENT**

FOR GAMBLING SERVICES; WAGERING GAMING SERVICES (U.S. CLS. 100, 101 AND 107).  
FIRST USE 3-1-2013; IN COMMERCE 3-1-2013.

4,482,105. SOLAREXCHANGE.COM, LLC, CARROLLTON, TX. SN 85-738,382. PUB. 3-5-2013, FILED 9-25-2012.

**SOLAREXCHANGE.COM**

4,482,091. THERAPY SOURCE, INC., PLYMOUTH MEETING, PA. SN 85-737,413. PUB. 5-21-2013, FILED 9-25-2012.

**TheraWeb**

THE MARK CONSISTS OF STANDARD CHARACTERS WITHOUT CLAIM TO ANY PARTICULAR FONT, STYLE, SIZE, OR COLOR.

THE MARK CONSISTS OF STANDARD CHARACTERS WITHOUT CLAIM TO ANY PARTICULAR FONT, STYLE, SIZE, OR COLOR.

**CLASS 35—ADVERTISING AND BUSINESS**

FOR BUSINESS SERVICES, NAMELY, PROVIDING AN ONLINE NETWORK FOR CONTRACTORS TO RECEIVE LEADS AND BIDDING OPPORTUNITIES BY MEANS OF AN ONLINE MARKETPLACE FOR THE PURPOSE OF DEVELOPING BUSINESS FOR SOLAR ENERGY RELATED PRODUCTS; PROVIDING A WEB SITE THAT FEATURES AN ON-LINE MARKET FOR USERS TO LIST OFFERED OR WANTED PERSONAL AND BUSINESS ASSETS AND SKILLS FOR HIRE, RENT, SALE OR AUCTION TRANSACTED ON THE BASIS OF PREDEFINED PERFORMANCE AND CLOSING TERMS AND CONDITIONS; PROVIDING A WEB SITE WHEREBY BUYERS OF GOODS OR SERVICES LOCATE AND RECEIVE QUOTATIONS FROM MULTIPLE COMPETITIVE SOURCES AND SELLERS OF GOODS OR SERVICES IDENTIFY AND BID ON MULTIPLE NEW SALES OPPORTUNITIES (U.S. CLS. 100, 101 AND 102).

FIRST USE 6-30-2012; IN COMMERCE 6-30-2012.

**CLASS 41—EDUCATION AND ENTERTAINMENT**

FOR EDUCATION SERVICES, NAMELY, PROVIDING LIVE AND ON-LINE COURSES IN THE FIELD OF SPECIAL EDUCATION; EDUCATION SERVICES, NAMELY, PROVIDING TUTORING IN THE FIELD OF SPECIAL EDUCATION; EDUCATIONAL SERVICES, NAMELY, PROVIDING ONLINE INSTRUCTION IN THE FIELD OF SPECIAL EDUCATION AND THERAPIES VIA AN ONLINE WEBSITE; PROVIDING CLASSES, SEMINARS, WORKSHOPS, AND TRAINING FOR PARENTS, INSTRUCTORS, AND OTHER INDIVIDUALS IN THE FIELD OF EDUCATION FOR INDIVIDUALS WITH AUTISM AND OTHER DEVELOPMENTAL DISORDERS; PROVIDING INFORMATION RELATING TO EDUCATION SERVICES FOR CHILDREN; PROVIDING INFORMATION RELATING TO EDUCATIONAL SERVICES (U.S. CLS. 100, 101 AND 107).

FIRST USE 1-1-2008; IN COMMERCE 1-1-2008.

**CLASS 40—MATERIAL TREATMENT**

FOR PROVIDING INFORMATION AND NEWS IN THE FIELD OF SOLAR ENERGY GENERATION (U.S. CLS. 100, 103 AND 106).

FIRST USE 6-30-2012; IN COMMERCE 6-30-2012.

**CLASS 44—MEDICAL, BEAUTY AND AGRICULTURAL SERVICES**

FOR BEHAVIORAL HEALTH SERVICES; OCCUPATIONAL THERAPY SERVICES; SPEECH AND HEARING THERAPY; SPEECH PATHOLOGY THERAPY SERVICES; SPEECH THERAPY SERVICES; ART THERAPY; BODYWORK THERAPY; BODYWORK THERAPY SERVICES, NAMELY, STRUCTURAL INTEGRATION THERAPY AND MOVEMENT THERAPY; COGNITIVE THERAPY SERVICES; DANCE MOVEMENT THERAPY SERVICES; LISTENING THERAPY SERVICES; MASSAGE THERAPY SERVICES; MENTAL HEALTH THERAPY SERVICES; MUSIC THERAPY FOR PHYSICAL, PSYCHOLOGICAL AND COGNITIVE PURPOSES; MUSIC THERAPY FOR SOCIAL ASSIMILATION PURPOSES; MUSIC THERAPY SERVICES; NUTRITIONAL THERAPY SERVICES; PHYSICAL THERAPY; PHYSICAL THERAPY EVALUATION AND TREATMENT OF MOBILITY AND OTHER LIMITATIONS; PHYSICAL THERAPY EVALUATION, IDENTIFICATION, AND MANAGEMENT OF MOVEMENT DYSFUNCTION TO RESTORE, MAINTAIN, AND PROMOTE OPTIMAL PHYSICAL FUNCTION PREVENTING THE ONSET, SYMPTOMS AND PROGRESSION OF IMPAIRMENTS, FUNCTIONAL LIMITATIONS, AND DISABILITIES RESULTING FROM DISEASE, DISORDERS, CONDITIONS, OR INJURIES; PHYSICAL THERAPY IN THE NATURE OF MOVEMENT THERAPY; PSYCHOTHERAPY COMPLEMENTED BY BODY WORK, NAMELY, MYOFASCIAL PHYSICAL THERAPY TECHNIQUES; STRESS REDUCTION THERAPY (U.S. CLS. 100 AND 101).

FIRST USE 1-1-2008; IN COMMERCE 1-1-2008.

4,482,116. SASSY SPOON, LLC, CAVE CREEK, AZ. SN 85-739,392. PUB. 3-19-2013, FILED 9-26-2012.



THE NAME "JEN ARRICALE" IDENTIFIES A LIVING INDIVIDUAL WHOSE CONSENT IS OF RECORD.

THE COLOR(S) PURPLE, ORANGE, AND WHITE IS/ARE CLAIMED AS A FEATURE OF THE MARK.

THE MARK CONSISTS OF AN ORANGE CIRCLE WITH THE NAME "JEN ARRICALE" OVER THE MIDDLE OF THE CIRCLE, WITH "JEN" WRITTEN IN PURPLE SCRIPT LETTERING AND "ARRICALE" IN WHITE NON-SCRIPT LETTERING.

**CLASS 16—PAPER GOODS AND PRINTED MATTER**

FOR COOK BOOKS; LUNCH BAGS; PUBLICATIONS, NAMELY, BOOKS IN THE FIELDS OF HEALTHY LIVING THROUGH FOOD AND FITNESS (U.S. CLS. 2, 5, 22, 23, 29, 37, 38 AND 50).  
FIRST USE 4-0-2013; IN COMMERCE 4-0-2013.

**CLASS 41—EDUCATION AND ENTERTAINMENT**

FOR EDUCATIONAL SERVICES, NAMELY, CONDUCTING ONLINE INSTRUCTION IN THE FIELDS OF HEALTHY LIVING THROUGH FOOD AND FITNESS AND DISTRIBUTION OF TRAINING MATERIALS IN CONNECTION THEREWITH; EDUCATIONAL SERVICES, NAMELY, CONDUCTING INSTRUCTION THROUGH VIDEOS, BLOGS, PUBLICATIONS, AND CONSULTING IN THE FIELD OF HEALTHY LIVING THROUGH FOOD AND FITNESS; EDUCATIONAL SERVICES, NAMELY, PROVIDING ONLINE INSTRUCTION IN THE FIELD OF HEALTHY LIVING THROUGH FOOD AND FITNESS VIA AN ONLINE WEBSITE; ENTERTAINMENT IN THE NATURE OF CREATING AND PRODUCING VIDEOS AND TELEVISION SHOWS IN THE FIELD OF HEALTHY LIVING THROUGH FOOD AND FITNESS; ENTERTAINMENT SERVICES IN THE NATURE OF AN ON-GOING REALITY BASED TELEVISION PROGRAM; ENTERTAINMENT SERVICES, NAMELY, AN ON-GOING SERIES FEATURING HEALTHY LIVING THROUGH FOOD AND FITNESS PROVIDED THROUGH BROADCAST OVER TELEVISION, CABLE, SATELLITE, AUDIO, AND VIDEO MEDIA; INSTRUCTION IN THE FIELD OF HEALTHY LIVING THROUGH FOOD AND FITNESS; PERSONAL COACHING SERVICES IN THE FIELD OF HEALTHY LIVING THROUGH FOOD AND FITNESS; PHYSICAL FITNESS INSTRUCTION; PROVIDING A WEB SITE THAT FEATURES INFORMAL INSTRUCTION ON HEALTHY LIVING THROUGH FOOD AND FITNESS (U.S. CLS. 100, 101 AND 107).  
FIRST USE 4-0-2013; IN COMMERCE 4-0-2013.

**CLASS 44—MEDICAL, BEAUTY AND AGRICULTURAL SERVICES**

FOR PROVIDING A WEBSITE FEATURING CONTENT REGARDING HEALTHY LIVING AND LIFESTYLE WELLNESS (U.S. CLS. 100 AND 101).  
FIRST USE 4-0-2013; IN COMMERCE 4-0-2013.

---

4,482,119. POSITIVE LIFESTYLE INTERNATIONAL, LLC, TAMPA, FL. SN 85-740,152. PUB. 3-5-2013, FILED 9-27-2012.

**MORE LESS MORE**

THE MARK CONSISTS OF STANDARD CHARACTERS WITHOUT CLAIM TO ANY PARTICULAR FONT, STYLE, SIZE, OR COLOR.

**CLASS 29—MEATS AND PROCESSED FOODS**

FOR PREPARED AND PREPACKAGED MEALS CONSISTING PRIMARILY OF MEAT, FISH, POULTRY OR VEGETABLES (U.S. CL. 46).  
FIRST USE 2-25-2013; IN COMMERCE 2-25-2013.

**CLASS 30—STAPLE FOODS**

FOR PREPARED AND PREPACKAGED MEALS CONSISTING PRIMARILY OF PASTA OR RICE (U.S. CL. 46).  
FIRST USE 2-25-2013; IN COMMERCE 2-25-2013.

---

4,482,124. CHARTBEAT, INC., NEW YORK, NY. SN 85-740,583. PUB. 3-5-2013, FILED 9-27-2012.



THE COLOR(S) BLACK, BLUE, LIGHT BLUE, AND GREEN IS/ARE CLAIMED AS A FEATURE OF THE MARK.  
THE MARK CONSISTS OF A BLACK GAUGE NEEDLE POINTING AT A 45 DEGREE ANGLE WITH THREE HORIZONTAL BARS TO THE LEFT OF THE NEEDLE, THE TOP BAR BEING BLUE, THE MIDDLE BAR BEING LIGHT BLUE, AND THE LOWER BAR BEING GREEN.

**CLASS 9—ELECTRICAL AND SCIENTIFIC APPARATUS**

FOR COMPUTER SOFTWARE FOR COLLECTING, EDITING, ORGANIZING, MODIFYING, ANALYZING, REPORTING, STORING, AND SHARING OF INFORMATION, STATISTICS, AND DATA RELATED TO WEBSITE TRAFFIC, UNDERSTANDING AND OPTIMIZING WEBSITE USAGE, AND BEHAVIOR OF INTERNET USERS (U.S. CLS. 21, 23, 26, 36 AND 38).  
FIRST USE 4-16-2012; IN COMMERCE 4-16-2012.

**CLASS 42—SCIENTIFIC AND COMPUTER SERVICES**

FOR PROVIDING TEMPORARY USE OF NON-DOWNLOADABLE SOFTWARE FOR COLLECTING, EDITING, ORGANIZING, MODIFYING, ANALYZING, REPORTING, STORING, AND SHARING OF INFORMATION, STATISTICS, AND DATA RELATED TO WEBSITE TRAFFIC, UNDERSTANDING AND OPTIMIZING WEBSITE USAGE, AND BEHAVIOR OF INTERNET USERS (U.S. CLS. 100 AND 101).  
FIRST USE 4-16-2012; IN COMMERCE 4-16-2012.

---

4,482,125. CLIFTONLARSONALLEN, LLP, MINNEAPOLIS, MN. SN 85-741,251. PUB. 3-19-2013, FILED 9-28-2012.

**CLA INTUITION**

THE MARK CONSISTS OF STANDARD CHARACTERS WITHOUT CLAIM TO ANY PARTICULAR FONT, STYLE, SIZE, OR COLOR.

**CLASS 9—ELECTRICAL AND SCIENTIFIC APPARATUS**

FOR DOWNLOADABLE CUSTOMIZED SOFTWARE PROGRAM THAT ALLOWS INTERACTIVE MODELING OF FUTURE FINANCIAL PERFORMANCE PROJECTIONS ASSUMING VARIOUS COMBINATIONS OF SUCCESS RELATED TO AN ORGANIZATION'S KEY BUSINESS PERFORMANCE DRIVERS (U.S. CLS. 21, 23, 26, 36 AND 38).

FIRST USE 7-0-2012; IN COMMERCE 7-0-2012.

**CLASS 36—INSURANCE AND FINANCIAL**

FOR FINANCIAL CONSULTING SERVICES, NAMELY, PROVIDING A FINANCIAL PLANNING PROCESS WHICH IDENTIFIES AND MODELS THE FINANCIAL IMPACTS OF AN ORGANIZATION'S KEY BUSINESS PERFORMANCE DRIVERS AND PROVIDES FINANCIAL PERFORMANCE PROJECTIONS ASSUMING VARIOUS COMBINATIONS OF SUCCESS RELATED TO THE KEY BUSINESS PERFORMANCE DRIVERS (U.S. CLS. 100, 101 AND 102).

FIRST USE 7-0-2012; IN COMMERCE 7-0-2012.

**CLASS 42—SCIENTIFIC AND COMPUTER SERVICES**

FOR PROVIDING TEMPORARY USE OF AN ON-LINE NON-DOWNLOADABLE CUSTOMIZED SOFTWARE PROGRAM THAT ALLOWS INTERACTIVE MODELING OF FUTURE FINANCIAL PERFORMANCE PROJECTIONS ASSUMING VARIOUS COMBINATIONS OF SUCCESS RELATED TO AN ORGANIZATION'S KEY BUSINESS PERFORMANCE DRIVERS (U.S. CLS. 100 AND 101).

FIRST USE 7-0-2012; IN COMMERCE 7-0-2012.

4,482,132. AMERICAN SPORTFISHING ASSOCIATION, ALEXANDRIA, VA. SN 85-742,488. PUB. 3-19-2013, FILED 10-1-2012.

**KEEP AMERICA FISHING**

THE MARK CONSISTS OF STANDARD CHARACTERS WITHOUT CLAIM TO ANY PARTICULAR FONT, STYLE, SIZE, OR COLOR.

OWNER OF U.S. REG. NO. 3,657,085.

**CLASS 21—HOUSEWARES AND GLASS**

FOR MUGS, CUPS, EMPTY WATER BOTTLES, TRAVEL BOTTLES SOLD EMPTY (U.S. CLS. 2, 13, 23, 29, 30, 33, 40 AND 50).

FIRST USE 1-31-2011; IN COMMERCE 1-31-2011.

**CLASS 25—CLOTHING**

FOR CLOTHING, NAMELY, SHIRTS, CAPS, JACKETS, VESTS, RAINWEAR, TEE-SHIRTS, AND GLOVES (U.S. CLS. 22 AND 39).

FIRST USE 10-31-2011; IN COMMERCE 10-31-2011.

**CLASS 28—TOYS AND SPORTING GOODS**

FOR FISHING GEAR, NAMELY, FISHING LURES, RODS, AND REELS (U.S. CLS. 22, 23, 38 AND 50).

FIRST USE 3-31-2011; IN COMMERCE 3-31-2011.

4,482,147. DONALD P. GRIMES, LAGUNA NIGUEL, CA. SN 85-745,260. PUB. 3-12-2013, FILED 10-4-2012.

**Smart Women Plan Ahead**

THE MARK CONSISTS OF STANDARD CHARACTERS WITHOUT CLAIM TO ANY PARTICULAR FONT, STYLE, SIZE, OR COLOR.

**CLASS 9—ELECTRICAL AND SCIENTIFIC APPARATUS**

FOR AUDIO AND VIDEO RECORDINGS FEATURING CREATING PERSONALIZED STRATEGIES FOR ACHIEVING FINANCIAL INDEPENDENCE (U.S. CLS. 21, 23, 26, 36 AND 38).

FIRST USE 10-1-2013; IN COMMERCE 10-1-2013.

**CLASS 16—PAPER GOODS AND PRINTED MATTER**

FOR EDUCATIONAL KITS SOLD AS A UNIT IN THE FIELD OF CREATING PERSONALIZED STRATEGIES FOR ACHIEVING FINANCIAL INDEPENDENCE CONSISTING PRIMARILY OF PAMPHLETS, BOOKS, WORKBOOKS, MANUALS, AND VIDEO TAPES AND ALSO INCLUDING DVDS (U.S. CLS. 2, 5, 22, 23, 29, 37, 38 AND 50).

FIRST USE 10-1-2013; IN COMMERCE 10-1-2013.

**CLASS 36—INSURANCE AND FINANCIAL**

FOR FINANCIAL ADVISORY AND CONSULTANCY SERVICES, NAMELY, CREATING PERSONALIZED STRATEGIES FOR ACHIEVING FINANCIAL INDEPENDENCE (U.S. CLS. 100, 101 AND 102).

FIRST USE 10-1-2013; IN COMMERCE 10-1-2013.

**CLASS 41—EDUCATION AND ENTERTAINMENT**

FOR EDUCATION SERVICES, NAMELY, PROVIDING LIVE AND ON-LINE CLASSES, SEMINARS, CONFERENCES, WORKSHOPS IN THE FIELD OF CREATING PERSONALIZED STRATEGIES FOR ACHIEVING FINANCIAL INDEPENDENCE (U.S. CLS. 100, 101 AND 107).

FIRST USE 10-1-2013; IN COMMERCE 10-1-2013.

4,482,151. AUTHENTICADE LLC, NEW YORK, NY. SN 85-745,921. PUB. 3-12-2013, FILED 10-4-2012.

**CRYOKEY**

THE MARK CONSISTS OF STANDARD CHARACTERS WITHOUT CLAIM TO ANY PARTICULAR FONT, STYLE, SIZE, OR COLOR.

**CLASS 9—ELECTRICAL AND SCIENTIFIC APPARATUS**

FOR COMPUTER SOFTWARE FOR USE IN THE ENCRYPTION AND DECRYPTION OF DIGITAL FILES, INCLUDING AUDIO, VIDEO, TEXT, BINARY, STILL IMAGES, GRAPHICS AND MULTIMEDIA FILES (U.S. CLS. 21, 23, 26, 36 AND 38).

FIRST USE 2-4-2013; IN COMMERCE 2-4-2013.

**CLASS 45—PERSONAL AND LEGAL SERVICES**

FOR IDENTIFICATION VERIFICATION SERVICES, NAMELY, PROVIDING AUTHENTICATION OF PERSONAL IDENTIFICATION INFORMATION; PROVIDING USER AUTHENTICATION SERVICES IN E-COMMERCE TRANSACTIONS; AUTHENTICATION, ISSUANCE AND VALIDATION OF DIGITAL CERTIFICATES (U.S. CLS. 100 AND 101).

FIRST USE 2-4-2013; IN COMMERCE 2-4-2013.

---

4,482,152. LAVELLE INDUSTRIES, INC., BURLINGTON, WI. SN 85-746,086. PUB. 3-26-2013, FILED 10-4-2012.

**TOILET REPAIR MADE EASY**

THE MARK CONSISTS OF STANDARD CHARACTERS WITHOUT CLAIM TO ANY PARTICULAR FONT, STYLE, SIZE, OR COLOR.

NO CLAIM IS MADE TO THE EXCLUSIVE RIGHT TO USE "TOILET REPAIR", APART FROM THE MARK AS SHOWN.

**CLASS 11—ENVIRONMENTAL CONTROL APPARATUS**

FOR TOILET FLUSH VALVES; TOILET FILL VALVES (U.S. CLS. 13, 21, 23, 31 AND 34).

FIRST USE 2-23-2012; IN COMMERCE 2-8-2013.

**CLASS 17—RUBBER GOODS**

FOR TOILET TANK FLAPPERS, FLAPPER BALLS, GASKETS, WASHERS, SEALS AND SEATS, ALL MADE OF RUBBER AND PLASTIC (U.S. CLS. 1, 5, 12, 13, 35 AND 50).

FIRST USE 2-23-2012; IN COMMERCE 2-8-2013.

**CLASS 42—SCIENTIFIC AND COMPUTER SERVICES**

FOR COMPUTER SERVICES, NAMELY, PROVIDING A SEARCH PLATFORM TO ALLOW USERS TO REQUEST CONTENT FROM AND RECEIVE CONTENT IN THE FIELD OF TOILET REPAIR PRODUCTS (U.S. CLS. 100 AND 101).

FIRST USE 2-23-2012; IN COMMERCE 2-8-2013.

4,482,154. SILICON VALLEY COMMUNITY FOUNDATION, MOUNTAIN VIEW, CA. SN 85-746,210. PUB. 4-2-2013, FILED 10-4-2012.

**INNOVATE PUBLIC SCHOOLS**

THE MARK CONSISTS OF STANDARD CHARACTERS WITHOUT CLAIM TO ANY PARTICULAR FONT, STYLE, SIZE, OR COLOR.

NO CLAIM IS MADE TO THE EXCLUSIVE RIGHT TO USE "PUBLIC SCHOOLS", APART FROM THE MARK AS SHOWN.

**CLASS 35—ADVERTISING AND BUSINESS**

FOR CHARITABLE SERVICES, NAMELY, PROMOTING PUBLIC AWARENESS OF THE NEED FOR CHANGE, NEW IDEAS AND CONCEPTS FOR LEARNING IN THE EDUCATION SYSTEM; PUBLIC ADVOCACY TO PROMOTE AWARENESS IN THE FIELD OF EDUCATION REFORM; PUBLIC ADVOCACY TO PROMOTE INVOLVEMENT IN THE FIELD OF EDUCATION REFORM AND EDUCATION RESEARCH; CONSULTING SERVICES IN THE FIELD OF EDUCATION ADVOCACY ISSUES (U.S. CLS. 100, 101 AND 102).

FIRST USE 5-29-2013; IN COMMERCE 5-29-2013.

**CLASS 36—INSURANCE AND FINANCIAL**

FOR CHARITABLE FUNDRAISING AND CHARITABLE FUNDRAISING SERVICES (U.S. CLS. 100, 101 AND 102).

FIRST USE 5-29-2013; IN COMMERCE 5-29-2013.

**CLASS 41—EDUCATION AND ENTERTAINMENT**

FOR EDUCATIONAL SERVICES, NAMELY, CONDUCTING, ORGANIZING, PROVIDING, AND FACILITATING WORKSHOPS, CONFERENCES, SEMINARS, AND CLASSROOM COACHING IN THE FIELD OF ORIGINAL AND CREATIVE TEACHING PRACTICES, AND DISTRIBUTION OF COURSE MATERIAL IN CONNECTION THEREWITH; EDUCATIONAL SERVICES, NAMELY, CONDUCTING A TRAINING PROGRAM TO TEACH TECHNIQUES TO PRODUCE ORIGINAL AND CREATIVE THINKING AND ORGANIZATIONAL CHANGE; CONSULTING SERVICES IN THE FIELD OF EDUCATION REFORM ISSUES AND EDUCATION RESEARCH ISSUES (U.S. CLS. 100, 101 AND 107).

FIRST USE 3-5-2013; IN COMMERCE 3-5-2013.

---

4,482,173. FULK, CHRISTEN, BLACK MOUNTAIN, NC. SN 85-747,553. PUB. 3-12-2013, FILED 10-6-2012.

**THE SOFT SUNLIGHT**

THE MARK CONSISTS OF STANDARD CHARACTERS WITHOUT CLAIM TO ANY PARTICULAR FONT, STYLE, SIZE, OR COLOR.

**CLASS 16—PAPER GOODS AND PRINTED MATTER**

FOR STATIONERY; NOTE CARDS; POSTCARDS; CUSTOMIZABLE JOURNAL BOOKS; BLANK JOURNALS; NOTEBOOKS; STICKERS; GREETING CARDS; HOLIDAY CARDS; ANNOUNCEMENT CARDS; PAPER STOCK; PERSONALIZED PAPER (U.S. CLS. 2, 5, 22, 23, 29, 37, 38 AND 50).

FIRST USE 1-1-2011; IN COMMERCE 1-1-2011.

**CLASS 18—LEATHER GOODS**

FOR HANDBAGS; WALLETS; CLUTCH BAGS AND PURSES; TOTE BAGS (U.S. CLS. 1, 2, 3, 22 AND 41).

FIRST USE 1-1-2011; IN COMMERCE 1-1-2011.

**CLASS 24—FABRICS**

FOR BED SHEETS, FITTED BED SHEET COVERS, BED FLAT SHEETS, AND PILLOW CASES (U.S. CLS. 42 AND 50).

FIRST USE 1-1-2011; IN COMMERCE 1-1-2011.

4,482,174. PINK DOLPHIN CLOTHING, LLC, LOS ANGELES, CA. SN 85-747,557. PUB. 3-12-2013, FILED 10-6-2012.



THE MARK CONSISTS OF TWO DOLPHINS JUMPING IN TANDEM FROM OCEAN WAVES. THE DEPTH OF THE WATER IS DELINIATED BY THREE DISTINCT AREAS, EACH SHADED DIFFERENTLY TO DEMARCATATE ITS BEGINNING AND ITS END.

**CLASS 18—LEATHER GOODS**

FOR BACKPACKS, BOOK BAGS, SPORTS BAGS, WALLETS AND HANDBAGS; CARRY-ALL BAGS; DUFFEL BAGS; LEATHER AND IMITATION LEATHER BAGS; SCHOOL BAGS; TRAVEL BAGS (U.S. CLS. 1, 2, 3, 22 AND 41).

FIRST USE 1-1-2011; IN COMMERCE 1-1-2011.

**CLASS 25—CLOTHING**

FOR MEN'S, WOMEN'S AND CHILDREN'S APPAREL AND CLOTHING OF ALL TYPES, NAMELY, JERSEYS, PANTS, SHIRTS, BLOUSES, SLACKS, SHORTS, BELTS, UNDERWEAR, SOCKS, HOSIERY, SWIMWEAR, COATS, JACKETS, PULLOVERS, SWEATSHIRTS AND SWEATERS; HEADWEAR (U.S. CLS. 22 AND 39).

FIRST USE 1-1-2011; IN COMMERCE 1-1-2011.

4,482,180. SILENTLY PUBLISHING, INC., BIRMINGHAM, AL. SN 85-748,973. PUB. 3-19-2013, FILED 10-9-2012.

**Silently Publishing**

THE MARK CONSISTS OF STANDARD CHARACTERS WITHOUT CLAIM TO ANY PARTICULAR FONT, STYLE, SIZE, OR COLOR.

NO CLAIM IS MADE TO THE EXCLUSIVE RIGHT TO USE "PUBLISHING", APART FROM THE MARK AS SHOWN.

**CLASS 9—ELECTRICAL AND SCIENTIFIC APPARATUS**

FOR AUDIO BOOKS IN THE NATURE OF NOVELS; DOWNLOADABLE FICTION BOOKS ON A VARIETY OF TOPICS (U.S. CLS. 21, 23, 26, 36 AND 38).

FIRST USE 9-15-2013; IN COMMERCE 9-15-2013.

**CLASS 16—PAPER GOODS AND PRINTED MATTER**

FOR FICTION BOOKS ON A VARIETY OF TOPICS; SERIES OF FICTION BOOKS; SERIES OF FICTION WORKS, NAMELY, NOVELS AND BOOKS (U.S. CLS. 2, 5, 22, 23, 29, 37, 38 AND 50).

FIRST USE 9-15-2013; IN COMMERCE 9-15-2013.

**CLASS 41—EDUCATION AND ENTERTAINMENT**

FOR BOOK PUBLISHING; PUBLICATION OF BOOKS; PUBLISHING OF BOOKS, E-BOOKS, AUDIO BOOKS, MUSIC AND ILLUSTRATIONS (U.S. CLS. 100, 101 AND 107).

FIRST USE 9-15-2013; IN COMMERCE 9-15-2013.

4,482,182. CRABTREE & EVELYN, LTD., WOODSTOCK, CT. SN 85-749,388. PUB. 4-2-2013, FILED 10-9-2012.

**GILDED CHESTNUT**

THE MARK CONSISTS OF STANDARD CHARACTERS WITHOUT CLAIM TO ANY PARTICULAR FONT, STYLE, SIZE, OR COLOR.

NO CLAIM IS MADE TO THE EXCLUSIVE RIGHT TO USE "CHESTNUT", APART FROM THE MARK AS SHOWN.

**CLASS 3—COSMETICS AND CLEANING PREPARATIONS**

FOR REEDS AND SCENTED OILS SOLD AS A UNIT FOR USE IN ROOM SCENT DIFFUSERS; ROOM FRAGRANCING PREPARATIONS; SCENTED OILS; SCENTED ROOM SPRAYS (U.S. CLS. 1, 4, 6, 50, 51 AND 52).

FIRST USE 8-30-2013; IN COMMERCE 8-30-2013.



**CLASS 4—LUBRICANTS AND FUELS**

FOR SCENTED CANDLES (U.S. CLS. 1, 6 AND 15).  
FIRST USE 8-30-2013; IN COMMERCE 8-30-2013.

4,482,185. ACCESS ENERGY, LLC, CERRITOS, CA. SN 85-749,554. PUB. 3-19-2013, FILED 10-9-2012.

# THERMAPOWER

THE MARK CONSISTS OF STANDARD CHARACTERS WITHOUT CLAIM TO ANY PARTICULAR FONT, STYLE, SIZE, OR COLOR.

**CLASS 7—MACHINERY**

FOR GENERATOR SYSTEM FOR CONVERTING HEAT AND PRESSURE TO ELECTRICITY, COMPRISED OF A HEAT SOURCE, EVAPORATOR, TURBINE, GENERATOR, CONDENSER, PUMP, WORKING FLUID, BEARINGS AND POWER ELECTRONICS (U.S. CLS. 13, 19, 21, 23, 31, 34 AND 35).

FIRST USE 9-13-2013; IN COMMERCE 9-13-2013.

**CLASS 37—CONSTRUCTION AND REPAIR**

FOR INSTALLATION, REPAIR, AND MAINTENANCE OF ELECTRICITY GENERATORS (U.S. CLS. 100, 103 AND 106).

FIRST USE 9-13-2013; IN COMMERCE 9-13-2013.

4,482,190. NAPERSOFT, INC., NAPERVILLE, IL. SN 85-751,361. PUB. 9-3-2013, FILED 10-11-2012.

# AZUBA

THE MARK CONSISTS OF STANDARD CHARACTERS WITHOUT CLAIM TO ANY PARTICULAR FONT, STYLE, SIZE, OR COLOR.

**CLASS 38—COMMUNICATION**

FOR PROVIDING ACCESS TO A CENTRALIZED ONLINE ELECTRONIC HEALTH INFORMATION EXCHANGE (EHIE) THAT ENABLES PATIENTS, ON THEIR OWN BEHALF OR ON BEHALF OF A PARENT OR CHILD, PHYSICIANS AND OTHER HEALTHCARE PROVIDERS WITH MOBILE SMARTPHONES, TABLETS, COMPUTERS, AND DEVICES WITH INTERNET ACCESS WITH THE ABILITY TO ACCESS, VIEW, DOWNLOAD, TRANSMIT AND COMMUNICATE CLINICAL, CLAIM, PRESCRIPTION, PROCEDURE AND FINANCIAL ELECTRONIC HEALTH RECORDS (EHR) AND OTHER HEALTH AND MEDICAL CARE RELATED INFORMATION FROM SOURCES SUCH AS PERSONAL HEALTH VAULTS, COMMERCIAL AND GOVERNMENT HEALTH INSURANCE PAYERS, HEALTHCARE PROVIDERS SUCH AS PHYSICIANS AND HOSPITALS, AND OTHER ELECTRONIC HEALTH INFORMATION EXCHANGES (U.S. CLS. 100, 101 AND 104).

FIRST USE 9-1-2013; IN COMMERCE 9-1-2013.

**CLASS 42—SCIENTIFIC AND COMPUTER SERVICES**

FOR PROVIDING A CENTRALIZED ONLINE ELECTRONIC HEALTH INFORMATION EXCHANGE (EHIE) IN THE NATURE OF ONLINE NON-DOWNLOADABLE SOFTWARE THAT ENABLES PATIENTS, ON THEIR OWN BEHALF OR ON BEHALF OF A PARENT OR CHILD, PHYSICIANS AND OTHER HEALTHCARE PROVIDERS WITH MOBILE SMARTPHONES, TABLETS, COMPUTERS, AND OTHER DEVICES WITH INTERNET ACCESS WITH THE ABILITY TO ACCESS, VIEW, DOWNLOAD, TRANSMIT AND COMMUNICATE CLINICAL, CLAIM, PRESCRIPTION, PROCEDURE AND FINANCIAL ELECTRONIC HEALTH RECORDS (EHR) AND OTHER HEALTH RELATED AND MEDICAL CARE RELATED INFORMATION FROM SOURCES SUCH AS PERSONAL HEALTH VAULTS, COMMERCIAL AND GOVERNMENT HEALTH INSURANCE PAYERS, HEALTHCARE PROVIDERS SUCH AS PHYSICIANS AND HOSPITALS, AND OTHER ELECTRONIC HEALTH INFORMATION EXCHANGES; PROVIDING A CENTRALIZED ONLINE ELECTRONIC HEALTH INFORMATION EXCHANGE (EHIE) IN THE NATURE OF ONLINE NONDOWNLOADABLE SOFTWARE THAT ENABLES PHYSICIANS TO ELECTRONICALLY SHARE NOTES, LAB RESULTS, TEST RESULTS, DIAGNOSES, TREATMENT RECOMMENDATIONS AND ALERTS WITH PATIENTS AND CAREGIVERS (U.S. CLS. 100 AND 101).

FIRST USE 9-1-2013; IN COMMERCE 9-1-2013.

4,482,194. PATRICK KENNEDY, BERKELEY, CA. SN 85-751,809. PUB. 3-19-2013, FILED 10-11-2012.

# LESS BUT BETTER

THE MARK CONSISTS OF STANDARD CHARACTERS WITHOUT CLAIM TO ANY PARTICULAR FONT, STYLE, SIZE, OR COLOR.

**CLASS 37—CONSTRUCTION AND REPAIR**

FOR REAL ESTATE DEVELOPMENT (U.S. CLS. 100, 103 AND 106).

FIRST USE 8-0-2012; IN COMMERCE 8-0-2012.

**CLASS 42—SCIENTIFIC AND COMPUTER SERVICES**

FOR ARCHITECTURAL DESIGN (U.S. CLS. 100 AND 101).

FIRST USE 8-0-2012; IN COMMERCE 8-0-2012.

4,482,202. ABWIZ BIO, INC., SAN DIEGO, CA. SN 85-753,090. PUB. 4-16-2013, FILED 10-12-2012.



NO CLAIM IS MADE TO THE EXCLUSIVE RIGHT TO USE "BIO" OR "ANTIBODY", APART FROM THE MARK AS SHOWN.

THE MARK CONSISTS OF STYLIZED DESIGN IN THE NATURE OF TWO FOUR-POINT STARS AND A WAVE

DESIGN TO THE LEFT OF THE STACKED WORDS "ABWIZ BIO" ON THE TOP LINE WHERE THE "I" IN "ABWIZ" IS DOTTED WITH A FOUR-POINT STAR, AND THE WORDING "ANTIBODY WIZARD" ON THE SECOND LINE TO THE RIGHT SIDE.

#### CLASS 1—CHEMICALS

FOR BIOCHEMICALS, NAMELY, MONOCLONAL ANTIBODIES FOR IN VITRO SCIENTIFIC OR RESEARCH USE; MONOCLONAL ANTIBODIES FOR LABORATORY OR RESEARCH USE (U.S. CLS. 1, 5, 6, 10, 26 AND 46).

FIRST USE 10-28-2013; IN COMMERCE 10-28-2013.

#### CLASS 42—SCIENTIFIC AND COMPUTER SERVICES

FOR CUSTOM DESIGN AND DEVELOPMENT OF CHEMICAL REAGENTS AND BIOCHEMICAL ASSAYS; PROVIDING REAGENT SAMPLE TESTING AND DIAGNOSTIC SERVICES FOR OTHERS IN THE FIELDS OF SCIENCE AND RESEARCH RELATED THERETO (U.S. CLS. 100 AND 101).

FIRST USE 1-20-2013; IN COMMERCE 1-20-2013.

---

4,482,204. JAFFE, RUSSELL M., VIENNA, VA. SN 85-753,892. PUB. 3-5-2013, FILED 10-15-2012.

## HEALTHTIMIST

THE MARK CONSISTS OF STANDARD CHARACTERS WITHOUT CLAIM TO ANY PARTICULAR FONT, STYLE, SIZE, OR COLOR.

#### CLASS 42—SCIENTIFIC AND COMPUTER SERVICES

FOR MEDICAL AND SCIENTIFIC RESEARCH INFORMATION IN THE FIELD OF HEALTH; SCIENTIFIC RESEARCH; SCIENTIFIC RESEARCH CONSULTING IN THE FIELD OF HEALTH (U.S. CLS. 100 AND 101).

FIRST USE 8-30-2012; IN COMMERCE 10-29-2013.

#### CLASS 44—MEDICAL, BEAUTY AND AGRICULTURAL SERVICES

FOR CONSULTING SERVICES IN THE FIELD OF HEALTH; CONSULTING SERVICES IN THE FIELD OF MEDICAL CARE; CONSULTING SERVICES IN THE FIELDS OF DIAGNOSTIC MEDICAL TESTING AND NUTRITION; CONSULTING SERVICES IN THE FIELDS OF HEALTH AND NUTRITION; MEDICAL AND PHARMACEUTICAL CONSULTATION; MEDICAL CONSULTATIONS; PROVIDING HEALTH INFORMATION (U.S. CLS. 100 AND 101).

FIRST USE 8-30-2012; IN COMMERCE 10-29-2013.

4,482,206. LIBERTY MUTUAL INSURANCE COMPANY, BOSTON, MA. SN 85-754,387. PUB. 4-2-2013, FILED 10-15-2012.



THE MARK CONSISTS OF THE WORDS "BE WELL" ABOVE "FOR" ABOVE "LIFE", ALL IN LOWERCASE LETTERS, WITH THREE LEAF SHAPES IN THE BACKGROUND.

#### CLASS 36—INSURANCE AND FINANCIAL

FOR INSURANCE UNDERWRITING AND ADMINISTRATION IN THE AREAS OF LIFE, DISABILITY, AND ACCIDENT; PROCESSING INSURANCE CLAIMS; UNDERWRITING, ISSUANCE AND ADMINISTRATION OF ANNUITIES (U.S. CLS. 100, 101 AND 102).

FIRST USE 12-17-2012; IN COMMERCE 12-17-2012.

#### CLASS 44—MEDICAL, BEAUTY AND AGRICULTURAL SERVICES

FOR PROVIDING A WEBSITE FEATURING CONTENT REGARDING HEALTHY LIVING AND LIFESTYLE WELLNESS (U.S. CLS. 100 AND 101).

FIRST USE 12-17-2012; IN COMMERCE 12-17-2012.

---

4,482,208. VOLOFORCE LLC, GERMANTOWN, MD. SN 85-754,630. PUB. 3-5-2013, FILED 10-15-2012.

## REAL CADENCE

THE MARK CONSISTS OF STANDARD CHARACTERS WITHOUT CLAIM TO ANY PARTICULAR FONT, STYLE, SIZE, OR COLOR.

#### CLASS 9—ELECTRICAL AND SCIENTIFIC APPARATUS

FOR PROVIDING AN ENTERPRISE-LEVEL, WEB-BASED DOWNLOADABLE APPLICATION TO AUTOMATE REMOTE, REAL-TIME AUDITING ACTIONS AT MULTIPLE RETAIL LOCATIONS (U.S. CLS. 21, 23, 26, 36 AND 38).

FIRST USE 1-1-2013; IN COMMERCE 8-1-2013.

#### CLASS 42—SCIENTIFIC AND COMPUTER SERVICES

FOR PROVIDING AN ENTERPRISE-LEVEL, WEB-BASED NON-DOWNLOADABLE APPLICATION TO AUTOMATE REMOTE, REAL-TIME AUDITING ACTIONS AT MULTIPLE RETAIL LOCATIONS (U.S. CLS. 100 AND 101).

FIRST USE 1-1-2013; IN COMMERCE 8-1-2013.

4,482,209. WIGOT, INC., HAWTHORNE, CA. SN 85-754,683.  
PUB. 4-9-2013, FILED 10-15-2012.

# WIGOT

THE MARK CONSISTS OF STANDARD CHARACTERS WITHOUT CLAIM TO ANY PARTICULAR FONT, STYLE, SIZE, OR COLOR.

## CLASS 9—ELECTRICAL AND SCIENTIFIC APPARATUS

FOR COMPUTER APPLICATION SOFTWARE FOR COMPUTERS AND MOBILE DEVICES FOR USE IN OBTAINING INFORMATION ON LOCAL EVENTS; COMPUTER APPLICATION SOFTWARE WITH GPS FEATURES FOR USE IN GETTING DIRECTIONS TO AND LOCATING LOCAL EVENTS; COMPUTER APPLICATION SOFTWARE FOR COMPUTERS AND MOBILE DEVICES FOR USE IN OBTAINING INFORMATION ON THE GOODS AND SERVICES OF OTHERS IN THE FIELD OF FOOD, ENTERTAINMENT AND NIGHTLIFE; COMPUTER APPLICATION SOFTWARE FOR COMPUTERS AND MOBILE DEVICES FOR USE IN SEARCHING AND OBTAINING INFORMATION ON THIRD PARTY VENDORS (U.S. CLS. 21, 23, 26, 36 AND 38).  
FIRST USE 4-21-2013; IN COMMERCE 4-21-2013.

## CLASS 35—ADVERTISING AND BUSINESS

FOR PROVIDING A WEBSITE FEATURING PROMOTIONAL INFORMATION ON LOCAL EVENTS; PROVIDING A SEARCHABLE ON-LINE WEBSITE AND GUIDE FEATURING LISTINGS ON THE GOODS AND SERVICES OF OTHER VENDORS; PROVIDING A WEBSITE FEATURING INFORMATION ON THE GOODS AND SERVICES OF OTHERS IN THE FIELD OF FOOD, ENTERTAINMENT AND NIGHTLIFE; PROVIDING A WEBSITE FEATURING LISTINGS FOR AND INFORMATION ON THIRD PARTY VENDORS (U.S. CLS. 100, 101 AND 102).  
FIRST USE 4-21-2013; IN COMMERCE 4-21-2013.

## CLASS 42—SCIENTIFIC AND COMPUTER SERVICES

FOR PROVIDING A WEBSITE FEATURING A MEDIA AGGREGATOR AND SEARCH ENGINE FOR LOCAL EVENTS (U.S. CLS. 100 AND 101).  
FIRST USE 4-21-2013; IN COMMERCE 4-21-2013.

4,482,214. BUILDING BETTER AMERICA COUNSEL, MILWAUKIE, OR. SN 85-755,698. PUB. 4-9-2013, FILED 10-16-2012.



THE COLOR(S) BLUE AND RED IS/ARE CLAIMED AS A FEATURE OF THE MARK.

THE MARK CONSISTS OF ONE SMALL BLUE STAR ABOVE ONE LARGE BLUE STAR WITH ONE MEDIUM BLUE STAR COVERING THE LOWER RIGHT PORTION OF THE LARGE STAR. THREE RED WAVY STRIPES ARE CONNECTED TO THE LARGE AND MEDIUM STARS. THE

STYLIZED RED WORDING "BBAC" APPEARS TO THE RIGHT OF THE WAVES. THE COLOR WHITE REPRESENTS THE BACKGROUND AND IS NOT CLAIMED AS A FEATURE OF THE MARK.

## CLASS 35—ADVERTISING AND BUSINESS

FOR PROMOTING THE GOODS AND SERVICES OF OTHERS, NAMELY, PROMOTING THE USE OF BUILDING MATERIALS THAT ARE MADE IN AMERICA TO THOSE WHO CONSTRUCT PERMANENT STRUCTURES, NAMELY, MANUFACTURERS OF BUILDING CONSTRUCTION MATERIALS, REAL ESTATE AGENTS, AND GENERAL BUILDING CONTRACTORS (U.S. CLS. 100, 101 AND 102).  
FIRST USE 10-12-2012; IN COMMERCE 10-12-2012.

## CLASS 37—CONSTRUCTION AND REPAIR

FOR BUILDING CONSTRUCTION INFORMATION, NAMELY, INFORMATION ABOUT THE USE OF BUILDING MATERIALS THAT ARE MADE IN AMERICA TO THOSE WHO CONSTRUCT PERMANENT STRUCTURES, NAMELY, MANUFACTURERS OF BUILDING CONSTRUCTION MATERIALS, REAL ESTATE AGENTS, AND GENERAL BUILDING CONTRACTORS (U.S. CLS. 100, 103 AND 106).  
FIRST USE 10-12-2012; IN COMMERCE 10-12-2012.

4,482,219. GLENTEL INC., BURNABY, BC, CANADA. SN 85-756,225. PUB. 8-20-2013, FILED 10-17-2012.

NO CLAIM IS MADE TO THE EXCLUSIVE RIGHT TO USE "WIRELESS", APART FROM THE MARK AS SHOWN.

THE COLOR(S) BLACK AND RED IS/ARE CLAIMED AS A FEATURE OF THE MARK.

THE MARK CONSISTS OF "DIAMOND" IN BLACK WITH A DIAMOND DESIGN IN ABOVE THE "M" IN RED AND THE PHRASE "WIRELESS" IN BLACK BELOW.

**CLASS 35—ADVERTISING AND BUSINESS**

FOR RETAIL STORES AND ONLINE RETAIL STORES FEATURING CELLULAR TELEPHONES, CELLULAR ACCESSORIES AND CORDLESS TELEPHONES, VOICE PAGERS, DATA PAGERS, TWO-WAY RADIOS AND PHONES, SATELLITE RADIOS, COMPUTERS, PRINTERS, ANSWERING MACHINES, FACSIMILE EQUIPMENT, PORTABLE AND HANDHELD DIGITAL ELECTRONIC DEVICES, NAMELY, DIGITAL PERSONAL ORGANIZERS WITH BUILT-IN DATA PAGERS, MP3 PLAYERS, PERSONAL DIGITAL ASSISTANTS, DIGITAL AUDIO AND VIDEO DEVICES, PORTABLE MEDIA PLAYERS, DIGITAL ELECTRONIC DEVICES INCORPORATING COMPUTERS, DIGITAL ELECTRONIC DEVICES PROVIDING ACCESS TO THE INTERNET AND EMAIL, ELECTRONIC NOTEPADS, AND BOOK AND PERIODICAL READERS, COMPUTER GAMING MACHINES, GLOBAL POSITIONING SYSTEMS (GPS), CELLULAR FAXES, INTERCONNECT ACCESSORIES, WIRELESS INTERNET SYSTEMS, TELEPHONE AND INTERCONNECT EQUIPMENT, BATTERIES, POWER RELATED ACCESSORIES, NAMELY, BATTERY CHARGERS, ADAPTERS, SURGE PROTECTORS, POWER STRIPS, CONVERTERS AND TIMERS AND PRE-PAID CARDS FOR LONG DISTANCE TELEPHONE CALLS AND MUSIC DOWNLOADING (U.S. CLS. 100, 101 AND 102).

FIRST USE 11-0-2000; IN COMMERCE 11-0-2000.

**CLASS 36—INSURANCE AND FINANCIAL**

FOR PROVIDING EXTENDED WARRANTIES ON CONSUMER ELECTRONICS, WIRELESS COMMUNICATION DEVICES, COMPUTERS, COMPUTER ACCESSORIES AND PERIPHERALS; WIRELESS DEBIT TRANSACTION SERVICES UTILIZING MOBILE ELECTRONIC DEVICES (U.S. CLS. 100, 101 AND 102).

FIRST USE 6-2-2009; IN COMMERCE 6-2-2009.

**CLASS 38—COMMUNICATION**

FOR TELECOMMUNICATION SERVICES, NAMELY, THE PROVISION OF INFORMATION AND ADVICE WITH RESPECT TO CELLULAR SERVICE PLANS AND EMAIL SERVICES; RENTAL AND LEASING OF CELLULAR TELEPHONES AND CELLULAR ACCESSORIES; SATELLITE TELEVISION TRANSMISSION; WIRELESS TELEPHONE TELECOMMUNICATIONS SERVICES, NAMELY, WIRELESS MOBILE TELEPHONE CALLING PLANS; WIRELESS ELECTRONIC MAIL SERVICES (U.S. CLS. 100, 101 AND 104).

FIRST USE 11-0-2000; IN COMMERCE 11-0-2000.

4,482,227. ROSS METALS CORPORATION, NEW YORK, NY. SN 85-757,232. PUB. 3-26-2013, FILED 10-18-2012.

ALL THE GOLD UNDER THE SUN  
ON EARTH

THE MARK CONSISTS OF STANDARD CHARACTERS WITHOUT CLAIM TO ANY PARTICULAR FONT, STYLE, SIZE, OR COLOR.

**CLASS 35—ADVERTISING AND BUSINESS**

FOR WHOLESALE AND RETAIL STORE SERVICES AND WHOLESALE DISTRIBUTORSHIP SERVICES OF JEWELRY OF PRECIOUS METALS AND PARTS THEREFOR, JEWELRY MOUNTINGS, JEWELRY FINDINGS, AND MILL PRODUCTS (U.S. CLS. 100, 101 AND 102).

FIRST USE 8-17-2012; IN COMMERCE 8-17-2012.

**CLASS 40—MATERIAL TREATMENT**

FOR MATERIAL TREATMENT SERVICES, NAMELY, REFINING, CASTING, SMELTING, MELTING AND PROCESSING OF PRECIOUS METALS; MANUFACTURE AND CUSTOM MANUFACTURE OF JEWELRY OF PRECIOUS METALS AND PARTS THEREFOR, JEWELRY MOUNTINGS, JEWELRY FINDINGS, AND MILL PRODUCTS (U.S. CLS. 100, 103 AND 106).

FIRST USE 8-17-2012; IN COMMERCE 8-17-2012.

4,482,230. PROGRESSIVE COMPONENTS INTERNATIONAL CORPORATION, WAUCONDA, IL. SN 85-757,611. PUB. 6-4-2013, FILED 10-18-2012.

PROGRESSIVE

THE MARK CONSISTS OF STANDARD CHARACTERS WITHOUT CLAIM TO ANY PARTICULAR FONT, STYLE, SIZE, OR COLOR.

**CLASS 7—MACHINERY**

FOR INJECTION MOLDING COMPONENTS, NAMELY, PINS, BUSHINGS, INTERLOCKS, COLLAPSIBLE CORES, EXPANDABLE CAVITIES, MOLD LIFTERS, RETAINERS, UNDERCUT RELEASE ASSEMBLIES, COOLING PRODUCTS, CYLINDERS, MOLD INSERTS, BLOCKS, PUNCHES, NEEDLES, VENTS, PINCH PLATES, DIES, VACUUM BLOCKS, CAM BEARINGS, DATE STAMPS, WEAR PLATES, MOLD STRAPS, SUPPORT PILLARS, LOCATING RINGS, PRESS KNOCK-OUTS, MOLD BASES, AND MECHANICAL MOLD COUNTERS FOR COUNTING MOLD CYCLES AND/OR TRACKING MOLD ACTIVITY (U.S. CLS. 13, 19, 21, 23, 31, 34 AND 35).

FIRST USE 12-1-2003; IN COMMERCE 12-1-2003.

**CLASS 9—ELECTRICAL AND SCIENTIFIC APPARATUS**

FOR COMPUTER SOFTWARE, HARDWARE AND PHYSICAL COMPONENTS FOR INJECTION MOLDING, NAMELY, ELECTRONIC MOLD MONITORS FOR EXTRACTING, COMMUNICATING, AND VIEWING DATA OF AN INJECTION MOLDING TOOL, NAMELY, CYCLE COUNTER INFORMATION AND MOLD PERFORMANCE DATA, AND SOFTWARE FOR INJECTION TOOLING DESIGN AND PRODUCTION (U.S. CLS. 21, 23, 26, 36 AND 38).

FIRST USE 3-20-2012; IN COMMERCE 3-20-2012.

4,482,232. MOEN INCORPORATED, NORTH OLMSTED, OH. SN 85-758,023. PUB. 8-13-2013, FILED 10-18-2012.

ARRIS

THE MARK CONSISTS OF STANDARD CHARACTERS WITHOUT CLAIM TO ANY PARTICULAR FONT, STYLE, SIZE, OR COLOR.

**CLASS 6—METAL GOODS**

FOR METAL ROBE HOOKS (U.S. CLS. 2, 12, 13, 14, 23, 25 AND 50).  
FIRST USE 5-23-2013; IN COMMERCE 5-23-2013.

**CLASS 11—ENVIRONMENTAL CONTROL APPARATUS**

FOR FAUCETS, NAMELY, LAVATORY FAUCETS, ROMAN TUB FAUCETS AND FAUCET HANDLES; SHOWER AND TUB FIXTURES, NAMELY, TUB SPOUTS AND SHOWER HEADS; AND FIXTURES FOR BIDETS (U.S. CLS. 13, 21, 23, 31 AND 34).  
FIRST USE 8-2-2013; IN COMMERCE 8-2-2013.

**CLASS 20—FURNITURE AND ARTICLES NOT OTHERWISE CLASSIFIED**

FOR MAGNIFYING MIRRORS FOR THE BATHROOM (U.S. CLS. 2, 13, 22, 25, 32 AND 50).  
FIRST USE 5-23-2013; IN COMMERCE 5-23-2013.

**CLASS 21—HOUSEWARES AND GLASS**

FOR BATHROOM ACCESSORIES, NAMELY, TOWEL BARS, TOWEL RINGS, TOILET TISSUE HOLDERS (U.S. CLS. 2, 13, 23, 29, 30, 33, 40 AND 50).  
FIRST USE 5-23-2013; IN COMMERCE 5-23-2013.

4,482,248. DB ELECTRICAL, INC., KINGSPORT, TN. SN 85-761,371. PUB. 4-9-2013, FILED 10-23-2012.



NO CLAIM IS MADE TO THE EXCLUSIVE RIGHT TO USE "TOTALPOWER PARTS", APART FROM THE MARK AS SHOWN.

THE COLOR(S) GREY, WHITE, GREEN AND BLACK IS/ARE CLAIMED AS A FEATURE OF THE MARK.

THE MARK CONSISTS OF THE WORDS "TOTAL-POWER" APPEAR IN SHADED GREY OVER THE WORD "PARTS", WHICH APPEARS IN GREEN. ON THE LEFT SIDE OF THE WORD "PARTS" THERE ARE TWO INTERSECTING GEARS. THE LEFT GEAR IS SMALLER AND APPEARS IN GREY OUTLINED IN BLACK AND THE RIGHT GEAR IS WHITE OUTLINED IN BLACK. THERE ARE THREE GREY LINES APPEARING ON THE LEFT SIDE OF THE GEARS.

**CLASS 7—MACHINERY**

FOR STARTERS, NAMELY, STARTERS FOR LAND AND MARINE VEHICLE MOTORS AND ENGINES; DRIVES, NAMELY, STARTER DRIVES FOR LAND AND MARINE VEHICLE MOTORS AND ENGINES; ALTERNATORS FOR LAND AND MARINE VEHICLES, STARTER ALTERNATORS FOR LAND AND MARINE VEHICLES, REGULATORS BEING PARTS OF MACHINES AND ALTERNATOR ROTORS FOR LAND AND MARINE VEHICLES (U.S. CLS. 13, 19, 21, 23, 31, 34 AND 35).  
FIRST USE 11-15-2013; IN COMMERCE 11-15-2013.

**CLASS 9—ELECTRICAL AND SCIENTIFIC APPARATUS**

FOR ELECTRICAL GAUGES, NAMELY, ENGINE DIAGNOSTIC GAUGES, OIL PRESSURE GAUGES, OIL TEMPERATURE GAUGES, AND WATER TEMPERATURE GAUGES; SOLENOID VALVES (U.S. CLS. 21, 23, 26, 36 AND 38).  
FIRST USE 11-15-2013; IN COMMERCE 11-15-2013.

4,482,253. CRISIS MANAGEMENT CONSULTING, LLC, LA JOLLAA, CA. SN 85-762,741. PUB. 4-2-2013, FILED 10-24-2012.

**HUMBLE PEDIGREE**

THE MARK CONSISTS OF STANDARD CHARACTERS WITHOUT CLAIM TO ANY PARTICULAR FONT, STYLE, SIZE, OR COLOR.

**CLASS 35—ADVERTISING AND BUSINESS**

FOR RETAIL APPAREL STORES; RETAIL BAKERY SHOPS; RETAIL CLOTHING BOUTIQUES; RETAIL DELICATESSEN SERVICES; RETAIL FLORIST SHOPS; RETAIL FURNITURE STORES; RETAIL GIFT SHOPS; RETAIL MARKETS FEATURING HOME DECOR AND ENTERTAINING PRODUCTS; RETAIL STORE SERVICES FEATURING A WIDE VARIETY OF CONSUMER GOODS OF OTHERS; RETAIL VARIETY STORES (U.S. CLS. 100, 101 AND 102).  
FIRST USE 8-5-2013; IN COMMERCE 9-11-2013.

**CLASS 42—SCIENTIFIC AND COMPUTER SERVICES**

FOR DESIGN OF INTERIOR DECOR; HOME STAGING CONSULTATION, NAMELY, TEMPORARY INTERIOR AND EXTERIOR HOME DECORATION CONSULTATION FOR THE PURPOSE OF MAKING HOMES MORE APPEALING TO PROSPECTIVE BUYERS; INTERIOR DECORATING; INTERIOR DECORATION CONSULTATION; INTERIOR DESIGN SERVICES; INTERIOR STYLING SERVICES; SHOP INTERIOR DESIGN (U.S. CLS. 100 AND 101).  
FIRST USE 8-5-2013; IN COMMERCE 8-29-2013.

4,482,268. ELECTRIC ADVENTURE, LLC, HOWARD BEACH, NY. SN 85-767,143. PUB. 4-16-2013, FILED 10-30-2012.



NO CLAIM IS MADE TO THE EXCLUSIVE RIGHT TO USE "ELECTRIC", APART FROM THE MARK AS SHOWN.

THE COLOR(S) WHITE, GRAY, BLUE, LIGHT BLUE, YELLOW, ORANGE, PINK, RED, GREEN, LIGHT GREEN AND PURPLE IS/ARE CLAIMED AS A FEATURE OF THE MARK.

THE MARK CONSISTS OF THE WORDS "ELECTRIC ADVENTURE" IN STYLIZED FONT. THE WORD "ELEC-

TRIC" IS IN GRAY WITH LIGHT BLUE AND WHITE OUTLINING. THE WORD "ADVENTURE" IS OUTLINED IN BLACK WITH MULTI-COLORED LETTERS, NAMELY, "A" IN SHADES OF YELLOW AND ORANGE, "D" IN PINK, "V" IN BLUE, "E" IN RED, "N" IN GREEN, "T" IN ORANGE, "U" IN SHADES OF PURPLE AND PINK, "R" IN LIGHT GREEN, AND "E" IN SHADES OF YELLOW AND ORANGE.

#### CLASS 25—CLOTHING

FOR HATS; T-SHIRTS (U.S. CLS. 22 AND 39).  
FIRST USE 8-3-2013; IN COMMERCE 8-3-2013.

#### CLASS 35—ADVERTISING AND BUSINESS

FOR ENTERTAINMENT MARKETING SERVICES, NAMELY, MARKETING, PROMOTION AND ADVERTISING FOR RECORDING AND PERFORMING ARTISTS; EVENT PLANNING AND MANAGEMENT FOR MARKETING, BRANDING, PROMOTING OR ADVERTISING THE GOODS AND SERVICES OF OTHERS; PROMOTING THE NIGHT CLUBS OF OTHERS; PROVIDING MARKETING AND PROMOTION OF SPECIAL EVENTS; SPECIAL EVENT PLANNING FOR BUSINESS PURPOSES; SPECIAL EVENT PLANNING FOR COMMERCIAL, PROMOTIONAL OR ADVERTISING PURPOSES (U.S. CLS. 100, 101 AND 102).  
FIRST USE 8-3-2013; IN COMMERCE 8-3-2013.

#### CLASS 41—EDUCATION AND ENTERTAINMENT

FOR CONSULTATION IN THE FIELD OF SPECIAL EVENT PLANNING FOR SOCIAL ENTERTAINMENT PURPOSES; DISC JOCKEY SERVICES; ENTERTAINMENT IN THE NATURE OF LIVE PERFORMANCES BY DISC JOCKEYS AND ELECTRONIC DANCE MUSIC ARTISTS; ENTERTAINMENT IN THE NATURE OF VISUAL AND AUDIO PERFORMANCES BY DISC JOCKEYS AND ELECTRONIC DANCE MUSIC ARTISTS; ENTERTAINMENT IN THE NATURE OF LIVE MUSICAL PERFORMANCES; ENTERTAINMENT SERVICES IN THE NATURE OF LIVE MUSICAL PERFORMANCES; ENTERTAINMENT SERVICES IN THE NATURE OF PRESENTING LIVE MUSICAL PERFORMANCES; ENTERTAINMENT, NAMELY, LIVE MUSIC CONCERTS; LIVE PERFORMANCES BY A MUSICAL GROUP; ORGANIZATION OF EXHIBITIONS FOR MUSICAL ENTERTAINMENT; PROVIDING A WEBSITE FEATURING INFORMATION IN THE FIELD OF MUSIC AND ENTERTAINMENT; PROVIDING A WEBSITE FOR ENTERTAINMENT PURPOSES FEATURING PHOTOGRAPHS AND VIDEO ABOUT DISC JOCKEYS, ELECTRONIC DANCE MUSIC ARTISTS, AND MUSIC EVENTS AND FESTIVALS; SPECIAL EVENT PLANNING FOR SOCIAL ENTERTAINMENT PURPOSES (U.S. CLS. 100, 101 AND 107).  
FIRST USE 10-6-2012; IN COMMERCE 10-6-2012.

4,482,282. MULU, INC., ROCKVILLE, MD. SN 85-772,539.  
PUB. 7-23-2013, FILED 11-6-2012.

MULU

THE MARK CONSISTS OF STANDARD CHARACTERS WITHOUT CLAIM TO ANY PARTICULAR FONT, STYLE, SIZE, OR COLOR.

OWNER OF U.S. REG. NOS. 4,068,593 AND 4,306,325.  
THE ENGLISH TRANSLATION OF THE WORD "MULU" IN THE MARK IS "CATALOGUE".

#### CLASS 9—ELECTRICAL AND SCIENTIFIC APPARATUS

FOR COMPUTER SOFTWARE WIDGETS, NAMELY, COMPUTER SOFTWARE THAT CONNECTS CONSUMERS TO THE RETAIL WEBSITES OF OTHERS AND ALLOWS CONSUMERS TO LEARN ABOUT AND DIRECTLY PURCHASE PRODUCTS FEATURED ON THIRD-PARTY WEBSITES, WHEREBY A PORTION OF THE PROCEEDS MAY BE DONATED TO A PHILANTHROPIC ORGANIZATION (U.S. CLS. 21, 23, 26, 36 AND 38).

FIRST USE 8-0-2012; IN COMMERCE 8-0-2012.

#### CLASS 35—ADVERTISING AND BUSINESS

FOR PROMOTING THE GOODS AND SERVICES OF OTHERS BY CONNECTING CONSUMERS TO THE RETAIL WEBSITES OF OTHERS AND ALLOWING CONSUMERS TO LEARN ABOUT AND DIRECTLY PURCHASE PRODUCTS FEATURED ON THIRD-PARTY WEBSITES, WHEREBY A PORTION OF THE PROCEEDS MAY BE DONATED TO A PHILANTHROPIC ORGANIZATION; PROMOTING THE GOODS AND SERVICES OF OTHERS BY PROVIDING CURATED INTERACTIVE ADVERTISING SPACE ON DIGITAL PLATFORMS THAT ALLOWS CONSUMERS TO LEARN ABOUT AND DIRECTLY PURCHASE PRODUCTS FEATURED ON THIRD-PARTY WEBSITES, WHEREBY A PORTION OF THE PROCEEDS MAY BE DONATED TO A PHILANTHROPIC ORGANIZATION (U.S. CLS. 100, 101 AND 102).

FIRST USE 8-0-2012; IN COMMERCE 8-0-2012.

4,482,283. GENERAL BOARD OF THE CHURCH OF THE NAZARENE, LENEXA, KS. SN 85-772,883. PUB. 4-16-2013, FILED 11-6-2012.



THE MARK CONSISTS OF THE DEPICTION OF AN OPEN BOOK WITH A CROSS-EMBLAZONED BOOKMARK HANGING FROM THE FAR LEFT EDGE OF THE BOOK, WITH A DOWNWARD FACING BIRD IN FLIGHT, OR ALTERNATIVELY A FLAME, IMMEDIATELY ABOVE THE OPEN BOOK.

#### CLASS 16—PAPER GOODS AND PRINTED MATTER

FOR PUBLICATIONS, NAMELY, BROCHURES, BOOKLETS, AND TEACHING MATERIALS IN THE FIELD OF CHRISTIANITY AND RELIGION (U.S. CLS. 2, 5, 22, 23, 29, 37, 38 AND 50).

FIRST USE 6-21-2013; IN COMMERCE 6-21-2013.

#### CLASS 45—PERSONAL AND LEGAL SERVICES

FOR MINISTERIAL SERVICES (U.S. CLS. 100 AND 101).

FIRST USE 6-21-2013; IN COMMERCE 6-21-2013.

4,482,287. EMPIRE DIGITAL LLC, ORMOND BEACH, FL. SN 85-774,755. PUB. 5-7-2013, FILED 11-8-2012.

## MY KNEE GUIDE

THE MARK CONSISTS OF STANDARD CHARACTERS WITHOUT CLAIM TO ANY PARTICULAR FONT, STYLE, SIZE, OR COLOR.

NO CLAIM IS MADE TO THE EXCLUSIVE RIGHT TO USE "KNEE GUIDE", APART FROM THE MARK AS SHOWN.

### CLASS 9—ELECTRICAL AND SCIENTIFIC APPARATUS

FOR SOFTWARE AND MOBILE APPLICATIONS FOR PROVIDING HEALTH INFORMATION, ADVERTISING FOR OTHERS, A MESSAGE BOARD, AN INTERACTIVE CALENDAR, A USER PROGRAMMABLE CONTACT BOOK, A DIRECTORY OF SERVICE PROVIDERS AND SERVICE PROVIDER RATINGS (U.S. CLS. 21, 23, 26, 36 AND 38).

FIRST USE 4-1-2012; IN COMMERCE 7-19-2013.

### CLASS 35—ADVERTISING AND BUSINESS

FOR ADVERTISING SERVICES, NAMELY, PROVIDING ADVERTISING SERVICES FOR OTHERS VIA SOFTWARE AND ON A WEB SITE; PROVIDING A WEB SITE FEATURING A DIRECTORY OF MEDICAL SERVICE PROVIDERS AND RATINGS OF SUCH PROVIDERS FOR COMMERCIAL PURPOSES (U.S. CLS. 100, 101 AND 102).

FIRST USE 5-1-2013; IN COMMERCE 7-19-2013.

### CLASS 42—SCIENTIFIC AND COMPUTER SERVICES

FOR PROVIDING ONLINE, NON-DOWNLOADABLE SOFTWARE FOR USE IN PROVIDING HEALTH INFORMATION, ADVERTISING FOR OTHERS, A MESSAGE BOARD, AN INTERACTIVE CALENDAR, A USER PROGRAMMABLE CONTACT BOOK, A DIRECTORY OF SERVICE PROVIDERS AND SERVICE PROVIDER RATINGS (U.S. CLS. 100 AND 101).

FIRST USE 6-1-2013; IN COMMERCE 7-19-2013.

4,482,295. THE RISING LOTUS QIGONG, LLC, FLOWERY BRANCH, GA. SN 85-776,894. PUB. 5-7-2013, FILED 11-12-2012.



NO CLAIM IS MADE TO THE EXCLUSIVE RIGHT TO USE "QIGONG", APART FROM THE MARK AS SHOWN.

THE COLOR(S) BLACK, WHITE, PINK AND GREEN IS/ ARE CLAIMED AS A FEATURE OF THE MARK.

THE MARK CONSISTS OF A BLACK AND WHITE YIN YANG SYMBOL WITHIN A PINK LOTUS WITH A GREEN STEM. BELOW THIS IS "THE RISING LOTUS QIGONG" IN BLACK STYLIZED FONT.

### CLASS 9—ELECTRICAL AND SCIENTIFIC APPARATUS

FOR DIGITAL MEDIA, NAMELY, PRE-RECORDED DVDS, DOWNLOADABLE AUDIO AND VIDEO RECORDINGS, AND CDS FEATURING AND PROMOTING QIGONG (U.S. CLS. 21, 23, 26, 36 AND 38).

FIRST USE 5-27-2013; IN COMMERCE 5-27-2013.

### CLASS 41—EDUCATION AND ENTERTAINMENT

FOR EDUCATION SERVICES, NAMELY, PROVIDING LIVE AND ON-LINE CLASSES, SEMINARS, COURSES AND WORKSHOPS IN THE FIELD OF QIGONG (U.S. CLS. 100, 101 AND 107).

FIRST USE 0-0-2003; IN COMMERCE 0-0-2003.

4,482,333. DA VINCI'S GARAGE, LLC, SEATTLE, WA. SN 85-789,939. PUB. 4-30-2013, FILED 11-28-2012.

## TouchMail

THE MARK CONSISTS OF STANDARD CHARACTERS WITHOUT CLAIM TO ANY PARTICULAR FONT, STYLE, SIZE, OR COLOR.

### CLASS 9—ELECTRICAL AND SCIENTIFIC APPARATUS

FOR COMMUNICATION SOFTWARE FOR PROVIDING ACCESS TO THE INTERNET; COMMUNICATIONS SOFTWARE FOR CONNECTING USERS VIA MOBILE DEVICES BY E-MAIL; COMPUTER APPLICATION SOFTWARE FOR MOBILE PHONES, NAMELY, SOFTWARE FOR E-MAIL COMMUNICATIONS; COMPUTER APPLICATION SOFTWARE FOR MOBILE AND OTHER COMPUTER DEVICES, NAMELY, SOFTWARE FOR E-MAIL USE AND MANAGEMENT; COMPUTER DATABASE MANAGEMENT SOFTWARE FOR USE IN PERSONALIZING THE CONTENT OF E-MAIL COMMUNICATIONS; COMPUTER GRAPHICS SOFTWARE; COMPUTER SOFTWARE FOR COMMUNICATING WITH USERS OF HAND-HELD COMPUTERS (U.S. CLS. 21, 23, 26, 36 AND 38).

FIRST USE 6-11-2013; IN COMMERCE 6-11-2013.

### CLASS 42—SCIENTIFIC AND COMPUTER SERVICES

FOR COMPUTER SOFTWARE DESIGN AND UPDATING; DESIGN AND DEVELOPMENT OF COMPUTER SOFTWARE; PROVIDING A WEBSITE FEATURING ONLINE NON-DOWNLOADABLE SOFTWARE THAT ENABLES USERS TO READ AND MANAGE E-MAIL (U.S. CLS. 100 AND 101).

FIRST USE 6-11-2013; IN COMMERCE 6-11-2013.

4,482,334. IGNITE PAYMENTS, LLC, MOORPARK, CA. SN 85-790,316. PUB. 4-30-2013, FILED 11-29-2012.

# IGNITE

THE MARK CONSISTS OF STANDARD CHARACTERS WITHOUT CLAIM TO ANY PARTICULAR FONT, STYLE, SIZE, OR COLOR.

## CLASS 9—ELECTRICAL AND SCIENTIFIC APPARATUS

FOR COMPUTER SOFTWARE, NAMELY, ELECTRONIC FINANCIAL PLATFORM THAT ACCOMMODATES MULTIPLE TYPES OF PAYMENT AND DEBT TRANSACTIONS IN AN INTEGRATED MOBILE PHONE, PDA, AND WEB BASED ENVIRONMENT; ELECTRONIC PAYMENT TERMINAL; WIRELESS POS (POINT OF SERVICE) DEVICES (U.S. CLS. 21, 23, 26, 36 AND 38).

FIRST USE 1-0-2013; IN COMMERCE 1-0-2013.

## CLASS 35—ADVERTISING AND BUSINESS

FOR ADVERTISING, MARKETING AND PROMOTION SERVICES; ADVISORY SERVICES FOR PREPARING AND CARRYING OUT COMMERCIAL TRANSACTIONS; ASSISTANCE, ADVISORY SERVICES AND CONSULTANCY WITH REGARD TO BUSINESS PLANNING, BUSINESS ANALYSIS, BUSINESS MANAGEMENT, BUSINESS ORGANIZATION, MARKETING AND CUSTOMER ANALYSIS; CUSTOMER SERVICE MANAGEMENT FOR OTHERS; OPERATION OF TELEPHONE CALL CENTERS FOR OTHERS; PAYROLL PROCESSING SERVICES (U.S. CLS. 100, 101 AND 102).

FIRST USE 1-0-2013; IN COMMERCE 1-0-2013.

## CLASS 36—INSURANCE AND FINANCIAL

FOR CASH ADVANCE SERVICES FOR BUSINESSES AND MERCHANTS; CHECK ACCEPTANCE SERVICES; CHECK PROCESSING; CHECK VERIFICATION; CLEARING AND RECONCILING FINANCIAL TRANSACTIONS VIA A GLOBAL COMPUTER NETWORK; CREDIT CARD VERIFICATION; CURRENCY EXCHANGE SERVICES; FINANCIAL SERVICES, NAMELY, ELECTRONIC REMOTE CHECK DEPOSIT SERVICES; FINANCIAL TRANSACTION SERVICES, NAMELY, PROVIDING SECURE COMMERCIAL TRANSACTIONS AND PAYMENT OPTIONS; MERCHANT SERVICES, NAMELY, PAYMENT TRANSACTION PROCESSING SERVICES; PROVIDING AN INTERNET WEBSITE PORTAL IN THE FIELD OF FINANCIAL TRANSACTION AND PAYMENT PROCESSING SERVICES; PROVIDING FINANCIAL RISK MANAGEMENT SERVICES FOR ELECTRONIC FUNDS TRANSFER, CREDIT AND DEBIT CARD AND ELECTRONIC CHECK TRANSACTIONS VIA A GLOBAL COMPUTER NETWORK; PROVIDING STORED VALUE CARD SERVICES (U.S. CLS. 100, 101 AND 102).

FIRST USE 1-0-2013; IN COMMERCE 1-0-2013.

## CLASS 38—COMMUNICATION

FOR PROVIDING ELECTRONIC TRANSMISSION OF CREDIT CARD TRANSACTION DATA AND ELECTRONIC PAYMENT DATA VIA A GLOBAL COMPUTER NETWORK (U.S. CLS. 100, 101 AND 104).

FIRST USE 1-0-2013; IN COMMERCE 1-0-2013.

## CLASS 42—SCIENTIFIC AND COMPUTER SERVICES

FOR LEASING OF COMPUTER HARDWARE AND COMPUTER PERIPHERAL EQUIPMENT FOR USE IN POINT-OF-SALE TRANSACTIONS (U.S. CLS. 100 AND 101).

FIRST USE 1-0-2013; IN COMMERCE 1-0-2013.

## CLASS 45—PERSONAL AND LEGAL SERVICES

FOR PROVIDING FRAUD DETECTION SERVICES FOR ELECTRONIC FUNDS TRANSFER, CREDIT AND DEBIT CARD AND ELECTRONIC CHECK TRANSACTIONS VIA A GLOBAL COMPUTER NETWORK; PROVIDING USER AUTHENTICATION OF ELECTRONIC FUNDS TRANSFER, CREDIT AND DEBIT CARD AND ELECTRONIC CHECK TRANSACTIONS VIA A GLOBAL COMPUTER NETWORK (U.S. CLS. 100 AND 101).

FIRST USE 1-0-2013; IN COMMERCE 1-0-2013.

4,482,337. GOVERNMENT EMPLOYEES HEALTH ASSOCIATION, INC., INDEPENDENCE, MO. SN 85-790,586. PUB. 4-16-2013, FILED 11-29-2012.



THE MARK CONSISTS OF A STAR OUTLINE FORMED BY FIVE STYLIZED COMB OR RAKE-LIKE DESIGNS ORIENTED IN DIFFERENT DIRECTIONS.

## CLASS 36—INSURANCE AND FINANCIAL

FOR ORGANIZATION AND ADMINISTRATION OF PREFERRED PROVIDER PROGRAMS IN THE FIELD OF HEALTH (U.S. CLS. 100, 101 AND 102).

FIRST USE 9-9-2013; IN COMMERCE 9-9-2013.

## CLASS 44—MEDICAL, BEAUTY AND AGRICULTURAL SERVICES

FOR HEALTH CARE IN THE NATURE OF A HEALTH MAINTENANCE ORGANIZATION (U.S. CLS. 100 AND 101).

FIRST USE 9-9-2013; IN COMMERCE 9-9-2013.



4,482,338. OPENCONNECT SYSTEMS INCORPORATED, DALLAS, TX. SN 85-790,927. PUB. 4-30-2013, FILED 11-29-2012.

4,482,339. SOCIETY OF EXPLORATION GEOPHYSICISTS, TULSA, OK. SN 85-791,687. PUB. 5-7-2013, FILED 11-30-2012.

# WORKIQ

THE MARK CONSISTS OF STANDARD CHARACTERS WITHOUT CLAIM TO ANY PARTICULAR FONT, STYLE, SIZE, OR COLOR.

## **CLASS 9—ELECTRICAL AND SCIENTIFIC APPARATUS**

FOR COMPUTER SOFTWARE, COMPUTER PROGRAMS AND COMPUTER APPLICATIONS FOR USE BY OTHERS IN THE FIELDS OF PROCESS INTELLIGENCE, PROCESS VARIATION, AND WORKFORCE ANALYTICS, NAMELY, SOFTWARE, PROGRAMS AND APPLICATIONS USED TO DISCOVER, IDENTIFY, AUTOMATE, IMPROVE AND OPTIMIZE WORKFORCE PRODUCTIVITY, WORKFORCE PERFORMANCE, BUSINESS PROCESSES AND WORK PROCESSES (U.S. CLS. 21, 23, 26, 36 AND 38).

FIRST USE 7-1-2013; IN COMMERCE 7-1-2013.

## **CLASS 42—SCIENTIFIC AND COMPUTER SERVICES**

FOR SOFTWARE AS A SERVICE (SAAS) SERVICES, NAMELY, HOSTING SOFTWARE FOR USE BY OTHERS IN THE FIELDS OF PROCESS INTELLIGENCE, PROCESS VARIATION, AND WORKFORCE ANALYTICS, NAMELY, SOFTWARE USED TO DISCOVER, IDENTIFY, AUTOMATE, IMPROVE AND OPTIMIZE WORKFORCE PRODUCTIVITY, WORKFORCE PERFORMANCE, BUSINESS PROCESSES AND WORK PROCESSES; APPLICATION SERVICE PROVIDER, NAMELY, HOSTING, MANAGING, DEVELOPING, AND MAINTAINING APPLICATIONS, SOFTWARE, NETWORKS, AND WEBSITES IN THE FIELDS OF PROCESS INTELLIGENCE, PROCESS VARIATION, AND WORKFORCE ANALYTICS, NAMELY, APPLICATIONS, SOFTWARE, NETWORKS, AND WEBSITES USED TO DISCOVER, IDENTIFY, AUTOMATE, IMPROVE AND OPTIMIZE WORKFORCE PRODUCTIVITY, WORKFORCE PERFORMANCE, BUSINESS PROCESSES AND WORK PROCESSES; DESIGN, DEVELOPMENT, INSTALLATION, CONFIGURATION, AND PROGRAMMING OF SOFTWARE, APPLICATIONS, WEBSITES AND NETWORKS IN THE FIELDS OF PROCESS INTELLIGENCE, PROCESS VARIATION, AND WORKFORCE ANALYTICS, NAMELY, APPLICATIONS, SOFTWARE, NETWORKS, AND WEBSITES USED TO DISCOVER, IDENTIFY, AUTOMATE, IMPROVE AND OPTIMIZE WORKFORCE PRODUCTIVITY, WORKFORCE PERFORMANCE, BUSINESS PROCESSES AND WORK PROCESSES (U.S. CLS. 100 AND 101).

FIRST USE 7-1-2013; IN COMMERCE 7-1-2013.

## **INTERPRETATION**

THE MARK CONSISTS OF STANDARD CHARACTERS WITHOUT CLAIM TO ANY PARTICULAR FONT, STYLE, SIZE, OR COLOR.

## **CLASS 16—PAPER GOODS AND PRINTED MATTER**

FOR PRINTED PUBLICATIONS, NAMELY, JOURNALS CONTAINING ARTICLES IN THE FIELDS OF GEOPHYSICS AND GEOLOGY FOCUSED ON THE PRACTICE OF CHARACTERIZING THE EARTH'S SUBSURFACE THROUGH INTERPRETATION OF AVAILABLE DATA (U.S. CLS. 2, 5, 22, 23, 29, 37, 38 AND 50).

FIRST USE 8-21-2013; IN COMMERCE 8-21-2013.

## **CLASS 41—EDUCATION AND ENTERTAINMENT**

FOR ONLINE PUBLICATIONS, NAMELY, JOURNALS CONTAINING ARTICLES IN THE FIELDS OF GEOPHYSICS AND GEOLOGY FOCUSED ON THE PRACTICE OF CHARACTERIZING THE EARTH'S SUBSURFACE THROUGH INTERPRETATION OF AVAILABLE DATA (U.S. CLS. 100, 101 AND 107).

FIRST USE 7-26-2013; IN COMMERCE 7-26-2013.

---

4,482,360. GLOBALVETLINK, L.C., AMES, IA. SN 85-799,011. PUB. 8-20-2013, FILED 12-10-2012.

## **INNOVATIVE DIGITAL SOLUTIONS FOR ANIMAL HEALTH**

THE MARK CONSISTS OF STANDARD CHARACTERS WITHOUT CLAIM TO ANY PARTICULAR FONT, STYLE, SIZE, OR COLOR.

NO CLAIM IS MADE TO THE EXCLUSIVE RIGHT TO USE "DIGITAL SOLUTIONS FOR ANIMAL HEALTH", APART FROM THE MARK AS SHOWN.

## **CLASS 42—SCIENTIFIC AND COMPUTER SERVICES**

FOR COMPUTER SERVICES, NAMELY, PROVIDING TEMPORARY USE OF ONLINE NON-DOWNLOADABLE SOFTWARE FOR GENERATING SECURED REPORTS AND DATA QUERIES IN THE FIELD OF ANIMAL HEALTH, ANIMAL HEALTH REGULATIONS, AND MANAGEMENT OF ANIMAL HEALTH REGULATIONS; COMPUTER SERVICES, NAMELY, PROVIDING TEMPORARY USE OF ONLINE NON-DOWNLOADABLE SOFTWARE FOR FILING DOCUMENTS WITH REGULATORY AGENCIES; COMPUTER SERVICES, NAMELY, PROVIDING TEMPORARY USE OF ONLINE NON-DOWNLOADABLE SOFTWARE FOR OBTAINING ANIMAL PERMITS FOR TRANSPORTATION; COMPUTER SERVICES, NAMELY, PROVIDING TEMPORARY USE OF ONLINE NON-DOWNLOADABLE SOFTWARE FOR INTEGRATING AND CHECKING ACCURACY OF DIAGNOSTIC LAB DATA RELATED TO ANIMAL REG-

ULATORY CASES AND FOR BACKTRACKING EVENTS RELATED TO ANIMAL DISEASE; COMPUTER SERVICES, NAMELY, PROVIDING TEMPORARY USE OF ONLINE NON-DOWNLOADABLE SOFTWARE FOR ACCESSING LAWS AND REGULATIONS RELATED TO ANIMAL HEALTH; COMPUTER SERVICES, NAMELY, PROVIDING TEMPORARY USE OF ONLINE NON-DOWNLOADABLE SOFTWARE FOR SUBMITTING DOCUMENTS TO ANIMAL HEALTH AUTHORITIES; COMPUTER SERVICES, NAMELY, PROVIDING TEMPORARY USE OF ONLINE NON-DOWNLOADABLE SOFTWARE FOR FACILITATING SUBMISSIONS TO AND FROM DIAGNOSTIC LABS AND VETERINARIANS; COMPUTER SERVICES, NAMELY, PROVIDING TEMPORARY USE OF ONLINE NON-DOWNLOADABLE SOFTWARE FOR ACCESSING AND REVIEWING ANIMAL/OWNER/VETERINARIAN INFORMATION ONLINE, FOR RECEIVING ASSIGNED ACCESSION NUMBERS; COMPUTER SERVICES, NAMELY, PROVIDING TEMPORARY USE OF ONLINE NON-DOWNLOADABLE SOFTWARE FOR REPORTING TESTING RESULTS DIRECTLY TO VETERINARIANS; COMPUTER SERVICES, NAMELY, PROVIDING TEMPORARY USE OF ONLINE NON-DOWNLOADABLE SOFTWARE FOR ACCESSING DATABASES CONTAINING HEALTH RECORDS FOR ANIMALS BEING TRANSPORTED; COMPUTER SERVICES, NAMELY, PROVIDING TEMPORARY USE OF ONLINE NON-DOWNLOADABLE SOFTWARE FOR ASSISTING GOVERNMENT OFFICIALS IN MANAGING IMPORT/EXPORT DATA FOR THEIR STATE; COMPUTER SERVICES, NAMELY, PROVIDING TEMPORARY USE OF ONLINE NON-DOWNLOADABLE SOFTWARE FOR ASSISTING GOVERNMENT OFFICIALS IN LOCATING SOURCES OF DISEASE AND EFFICIENTLY INITIATING DISEASE CONTAINMENT; COMPUTER SERVICES, NAMELY, PROVIDING TEMPORARY USE OF ONLINE NON-DOWNLOADABLE SOFTWARE FOR ASSISTING GOVERNMENT OFFICIALS IN EMERGENCY PREPAREDNESS AND RESPONSE TIME, FOR ASSISTING LAW ENFORCEMENT OFFICIALS IN EXPEDITING INTERSTATE MOVEMENT OF ANIMALS WITH REAL TIME REPORTS; COMPUTER SERVICES, NAMELY, PROVIDING TEMPORARY USE OF ONLINE NON-DOWNLOADABLE SOFTWARE FOR PERMITTING LAW ENFORCEMENT OFFICIALS TO VIEW CERTIFICATES RELATING TO ANIMAL TRANSPORTATION; COMPUTER SERVICES, NAMELY, PROVIDING TEMPORARY USE OF ONLINE NON-DOWNLOADABLE SOFTWARE FOR ASSISTING LAW ENFORCEMENT OFFICIALS IN OBTAINING PROOF OF ANIMAL AND OWNER IDS; COMPUTER SERVICES, NAMELY, PROVIDING TEMPORARY USE OF ONLINE NON-DOWNLOADABLE SOFTWARE FOR PERMITTING LAW ENFORCEMENT OFFICIALS TO DETERMINE VALIDITY OF ANIMAL TRANSPORTATION CERTIFICATES; COMPUTER SERVICES, NAMELY, PROVIDING TEMPORARY USE OF ONLINE NON-DOWNLOADABLE SOFTWARE FOR ENABLING OWNERS OF ANIMALS TO ENSURE PROPER ANIMAL IDENTIFICATION; COMPUTER SERVICES, NAMELY, PROVIDING TEMPORARY USE OF ONLINE NON-DOWNLOADABLE SOFTWARE FOR FACILITATING THE ACQUISITION OF ANIMAL HEALTH CERTIFICATES FROM REGULATORY ENTITIES BY OWNERS OF ANIMALS; COMPUTER SERVICES, NAMELY, PROVIDING TEMPORARY USE OF ONLINE NON-DOWNLOADABLE SOFTWARE FOR ASSISTING IN OBTAINING CERTIFICATES OF VETERINARY INSPECTION FOR ALL SPECIES, FOR ANIMAL MOVEMENT TRACKING; COMPUTER SERVICES, NAMELY, PROVIDING TEMPORARY USE OF ONLINE NON-DOWNLOADABLE SOFTWARE FOR PREPARING AND OBTAINING CANINE AND FELINE TRANSFER OF OWNERSHIP DOCUMENTATION; COMPUTER SERVICES, NAMELY, PROVIDING TEMPORARY USE OF ONLINE NON-DOWNLOADABLE SOFTWARE FOR PREPARING ELECTRONIC PERMITS OF ENTRY; COMPUTER SERVICES, NAMELY, PROVIDING TEMPORARY USE OF ONLINE NON-DOWNLOADABLE SOFTWARE FOR RECORDING VACCINATIONS AND OTHER HEALTH-RELATED TREATMENTS FOR THE PURPOSE OF ASSISTING OWNERS IN TRANSPORTING ANIMALS AND PARTICIPATING IN VARIOUS FORMS OF COMMERCIAL ACTIVITY INVOLVING ANIMALS; COMPUTER SERVICES, NAMELY, PROVIDING TEMPORARY USE OF ONLINE NON-DOWNLOADABLE SOFTWARE FOR PROVIDING VETERINARY FEED DIRECTIVES RELATED TO ANIMAL HEALTH PRESCRIPTIONS AND ANIMAL HEALTH TREATMENTS

BY VETERINARIANS FOR TREATING OR PREVENTING ANIMAL DISEASES; PROVIDING A WEB-BASED SYSTEM AND ONLINE PORTAL FEATURING ONLINE NON-DOWNLOADABLE SOFTWARE THAT ENABLES VETERINARIANS TO POST, AND ANIMAL OWNERS TO ACCESS AND PRINT, DIGITAL OWNERSHIP CERTIFICATION, DIGITAL VETERINARIAN PRESCRIPTION CERTIFICATIONS, DIGITAL ANIMAL HEALTH CERTIFICATIONS, DIGITAL VETERINARIAN FEED DIRECTIVES, DIGITAL VETERINARIAN LABORATORY DIAGNOSTIC SUBMISSIONS, DIGITAL HEALTH DATA AND DOCUMENTS, NAMELY, OFFICIAL STATE VETERINARY HEALTH DOCUMENTATION, HEALTH CERTIFICATES AND PASSPORT CERTIFICATES TO FACILITATE TRANSPORT OF LIVE ANIMALS ACROSS STATE LINES (U.S. CLS. 100 AND 101).

FIRST USE 3-0-2011; IN COMMERCE 7-0-2011.

#### **CLASS 44—MEDICAL, BEAUTY AND AGRICULTURAL SERVICES**

FOR PROVIDING AN ONLINE DATABASE AND WEBSITE FEATURING INFORMATION IN THE FIELD OF ANIMAL HEALTH (U.S. CLS. 100 AND 101).

FIRST USE 3-0-2011; IN COMMERCE 7-11-2011.

---

4,482,374. EATON TECHNOLOGIES IP GMBH & CO. KG, 12529 SCHOENEFELD, FED REP GERMANY. SN 85-805,574. PUB. 6-11-2013, FILED 12-18-2012.

# INTERNORMEN

THE MARK CONSISTS OF STANDARD CHARACTERS WITHOUT CLAIM TO ANY PARTICULAR FONT, STYLE, SIZE, OR COLOR.

**CLASS 9—ELECTRICAL AND SCIENTIFIC APPARATUS**

FOR FLUID CONDITION MONITORING SYSTEMS CONSISTING PRIMARILY OF COMPUTERS AND COMPUTER SOFTWARE FOR FLUID MONITORING, PRINTERS, PUMPS, TEMPERATURE SENSORS, LASER PARTICLE SENSORS AND OIL PARAMETER SENSORS; ELECTRONIC FLUID CONDITION MONITORS FOR MEASURING PARAMETERS OF HYDRAULIC FLUID AND OIL; ELECTRONIC MOBILE FLUID CONDITION MONITOR FOR MONITORING HYDRAULIC AND LUBRICATION FLUIDS; SOLID CONTAMINANT FLUID MONITORING SYSTEM CONSISTING PRIMARILY OF A LASER PARTICLE DETECTOR, FLOW METER, AND COMPUTER HARDWARE AND SOFTWARE FOR MEASURING SOLID CONTAMINANTS; FLUID MONITORING SYSTEM FOR MEASURING FILTER CLOGGING BY MEASURING PRESSURE DIFFERENTIAL CONSISTING PRIMARILY OF A SENSOR, TEMPERATURE SENSOR, MICROPROCESSOR AND ELECTRONIC CONNECTORS; ELECTRONIC METAL PARTICLE FLUID MONITOR FOR MEASURING METAL PARTICLES IN HYDRAULIC FLUID AND OIL; ELECTRICAL MONITOR FOR DETERMINING FUNGAL INFECTION IN GRAPES; SOLID CONTAMINANTS SENSOR; WATER-IN-OIL MONITORING SENSOR; IN-LINE MONITOR FOR STATIONARY SYSTEMS FOR CONTINUOUS AND PERIODIC MONITORING OF HYDRAULIC AND LUBRICATING SYSTEMS; INDEX MEASURING SYSTEM CONSISTING PRIMARILY OF A COMPRESSOR, FLOW METER, PRESSURE SENSOR, TEMPERATURE SENSOR, CONTROLLER, DISPLAY, AND FILTER FOR MEASURING THE FILTER ABILITY OF ALIMENTARY FLUIDS, SUCH AS, JUICE, BEER, AND WINE; METAL PARTICLE SENSORS; VISCOSITY SENSORS; DIELECTRIC SENSORS; ELECTRONIC CLOGGING SENSORS; TEMPERATURE SENSORS; WATER IN OIL SENSORS; LASER PARTICLE COUNTERS; SOFTWARE FOR SELECTING FILTERS; BOTTLE SAMPLING SYSTEM CONSISTING PRIMARILY OF A MANOMETER, VALVES, AND PRESSURE DOME; OIL AND FLUID PURIFICATION SYSTEM CONSISTING PRIMARILY OF PUMPS, VALVES, WATER SENSOR, VACUUM SENSOR, CLOGGING SENSOR, AND CONTROLLER (U.S. CLS. 21, 23, 26, 36 AND 38).

FIRST USE 5-12-2011; IN COMMERCE 5-12-2011.

**CLASS 11—ENVIRONMENTAL CONTROL APPARATUS**

FOR FILTER VESSELS USED FOR FILTERING HYDRAULIC FLUID, BIODEGRADABLE HYDRAULIC FLUID, MINERAL OILS, LUBRICATING OILS, AND INFLAMMABLE FLUIDS; FILTER ELEMENTS AS PART OF FILTERS ALL FOR THE HANDLING, TREATMENT, AND PROCESSING OF LIQUIDS AND FLUIDS IN INDUSTRIAL, COMMERCIAL, AND ENVIRONMENTAL USES; FILTER UNITS FOR FILTERING, FILLING, AND FLUSHING OF HYDRAULIC SYSTEMS, OIL SERVICE SYSTEMS, AND LUBRICATION SYSTEMS; OIL PURIFICATION EQUIPMENT; FILTRATION AND LUBRICATION SYSTEM CONSISTING PRIMARILY OF FILTER ELEMENTS OF VARIOUS MATERIALS, WATERSORB FILTER ELEMENTS, INTERNAL AND EXTERNAL VALVES, PIPES, HOSES, TANKS, BREATHER FILTERS, HOUSINGS, HEATERS, MAGNET VALVES, PUMPS, MOTORS, COOLERS, TEMPERATURE, PRESSURE, WATER SATURATION, AND LEVEL INDICATORS, PARTICLE COUNTERS, METAL PARTICLE SENSORS, AND CONTROLLERS FOR SUPPLYING GEAR LUBRICATION WHILE FILTERING AND DEAERATING THE LUBRICANT ; MOBILE OFF-LINE FILTER UNITS; STATIONARY FILTER UNITS; FLUID PURIFIER SYSTEMS CONSISTING PRIMARILY OF FILTER ELEMENTS OF VARIOUS MATERIALS, WATERSORB FILTER ELEMENTS, INTERNAL AND EXTERNAL VALVES, PIPES, HOSES, TANKS, BREATHER FILTERS, HOUSINGS, HEATERS, MAGNET VALVES, PUMPS, MOTORS, COOLERS, TEMPERATURE, PRESSURE, WATER SATURATION, AND LEVEL INDICATORS, PARTICLE COUNTERS, METAL PARTICLE SENSORS, AND CONTROLLERS; HYDRAULIC FLUID FILTERS; LUBRICATING FLUID FILTERS; LUBRICATING FLUID HEATER AND COOLER FOR WIND POWER (U.S. CLS. 13, 21, 23, 31 AND 34).

FIRST USE 5-12-2011; IN COMMERCE 5-12-2011.

4,482,375. WINDSOR OAKS ASSOCIATES, L.P., LONG BEACH, CA. SN 85-805,692. PUB. 3-12-2013, FILED 12-18-2012.

**NOTRE VUE**

THE MARK CONSISTS OF STANDARD CHARACTERS WITHOUT CLAIM TO ANY PARTICULAR FONT, STYLE, SIZE, OR COLOR.

THE ENGLISH TRANSLATION OF "NOTRE VUE" IN THE MARK IS "OUR VISION" OR "OUR VIEW".

**CLASS 33—WINES AND SPIRITS**

FOR WINES (U.S. CLS. 47 AND 49).  
FIRST USE 7-1-2013; IN COMMERCE 7-1-2013.

**CLASS 40—MATERIAL TREATMENT**

FOR CUSTOM PRODUCTION OF WINE FOR OTHERS; WINERY SERVICES (U.S. CLS. 100, 103 AND 106).

FIRST USE 7-1-2013; IN COMMERCE 7-1-2013.

**CLASS 44—MEDICAL, BEAUTY AND AGRICULTURAL SERVICES**

FOR VINEYARD AND WINERY SERVICES, NAMELY, THE CULTIVATION OF GRAPES FOR OTHERS (U.S. CLS. 100 AND 101).

FIRST USE 7-1-2013; IN COMMERCE 7-1-2013.

4,482,386. TEMO TEKSTIL MODA DERI VE KONFEKSIYON YAN URUNLERI SANAYI VE TICARET LIMITED SIRKETI, ISTANBUL, TURKEY. SN 85-808,682. PUB. 5-21-2013, FILED 12-21-2012.

**Risona**

THE MARK CONSISTS OF STANDARD CHARACTERS WITHOUT CLAIM TO ANY PARTICULAR FONT, STYLE, SIZE, OR COLOR.

THE WORDING "RISONA" HAS NO MEANING IN A FOREIGN LANGUAGE.

**CLASS 14—JEWELRY**

FOR JEWELLERY (U.S. CLS. 2, 27, 28 AND 50).  
FIRST USE 8-22-2013; IN COMMERCE 8-22-2013.

**CLASS 18—LEATHER GOODS**

FOR HANDBAGS; PURSES; SATCHELS; SLING BAGS; SUITCASES; TRAVEL BAGS (U.S. CLS. 1, 2, 3, 22 AND 41).

FIRST USE 8-22-2013; IN COMMERCE 8-22-2013.

**CLASS 25—CLOTHING**

FOR BELTS; BLOUSES; BOLEROS; CARDIGANS; COATS; DRESSES; GLOVES; HATS; JACKETS; JUMPERS; SHAWLS; SHIRTS; SHOES; SKIRTS; SLEEVES WORN SEPARATE AND APART FROM BLOUSES, SHIRTS AND OTHER TOPS; SWEATERS; T-SHIRTS; TROUSERS; TUNICS; VESTS; WAISTCOATS (U.S. CLS. 22 AND 39).

FIRST USE 8-22-2013; IN COMMERCE 8-22-2013.

4,482,390. CYBERSHEATH SERVICES INTERNATIONAL, LLC, DBA CYBERSHEATH SERVICES INTERNATIONAL, LLC., GREAT FALLS, VA. SN 85-810,426. PUB. 5-28-2013, FILED 12-26-2012.

# CyberSheath

THE MARK CONSISTS OF STANDARD CHARACTERS WITHOUT CLAIM TO ANY PARTICULAR FONT, STYLE, SIZE, OR COLOR.

**CLASS 41—EDUCATION AND ENTERTAINMENT**

FOR BUSINESS TRAINING CONSULTANCY SERVICES (U.S. CLS. 100, 101 AND 107).

FIRST USE 9-17-2012; IN COMMERCE 9-17-2012.

**CLASS 42—SCIENTIFIC AND COMPUTER SERVICES**

FOR COMPUTER CONSULTATION; COMPUTER CONSULTATION IN THE FIELD OF COMPUTER SECURITY; COMPUTER SECURITY CONSULTANCY; COMPUTER SECURITY CONSULTANCY IN THE FIELD OF SCANNING AND PENETRATION TESTING OF COMPUTERS AND NETWORKS TO ASSESS INFORMATION SECURITY VULNERABILITY; COMPUTER SOFTWARE CONSULTANCY; COMPUTER SOFTWARE CONSULTING; CONSULTANCY IN THE FIELD OF SOFTWARE DESIGN; CONSULTING IN THE FIELD OF ENGINEERING; CONSULTING IN THE FIELD OF INFORMATION TECHNOLOGY; CONSULTING IN THE FIELD OF IT PROJECT MANAGEMENT; CONSULTING IN THE FIELD OF TELECOMMUNICATIONS TECHNOLOGY; CONSULTING IN THE FIELDS OF ENGINEERING AND ARCHITECTURE; CONSULTING SERVICES IN THE DESIGN AND IMPLEMENTATION OF COMPUTER-BASED INFORMATION SYSTEMS FOR BUSINESSES; CONSULTING SERVICES IN THE FIELD OF CLOUD COMPUTING; CONSULTING SERVICES IN THE FIELD OF COLLECTION OF EVIDENCE FOR FORENSIC PURPOSES; CONSULTING SERVICES IN THE FIELD OF COMPUTER-BASED INFORMATION SYSTEMS FOR BUSINESSES; CONSULTING SERVICES IN THE FIELD OF DESIGN AND DEVELOPMENT OF ENGINEERING PROCESSES; CONSULTING SERVICES IN THE FIELD OF DESIGN, SELECTION, IMPLEMENTATION AND USE OF COMPUTER HARDWARE AND SOFTWARE SYSTEMS FOR OTHERS; CONSULTING SERVICES IN THE FIELD OF SOFTWARE AS A SERVICE (SAAS); CONSULTING SERVICES IN THE FIELDS OF FORENSIC SCIENCE; CONSULTING SERVICES IN THE FIELDS OF SELECTION, IMPLEMENTATION AND USE OF COMPUTER HARDWARE AND SOFTWARE SYSTEMS FOR OTHERS; DESIGN AND DEVELOPMENT OF ELECTRONIC DATA SECURITY SYSTEMS; DEVELOPMENT OF SECURITY SYSTEMS AND CONTINGENCY PLANNING FOR INFORMATION SYSTEMS; DEVELOPMENT OF SOFTWARE FOR SECURE NETWORK OPERATIONS; INFORMATION TECHNOLOGY CONSULTING SERVICES; IT CONSULTING SERVICES; RESEARCH IN THE FIELD OF INTELLIGENCE AND SECURITY TECHNOLOGY; TECHNICAL ADVICE RE-

LATING TO OPERATION OF COMPUTERS; TECHNICAL CONSULTING SERVICES IN THE FIELDS OF DATACENTER ARCHITECTURE, PUBLIC AND PRIVATE CLOUD COMPUTING SOLUTIONS, AND EVALUATION AND IMPLEMENTATION OF INTERNET TECHNOLOGY AND SERVICES; TECHNOLOGICAL CONSULTATION IN THE TECHNOLOGY FIELD OF INFORMATION SECURITY; TESTING OF SECURITY SYSTEMS; UPDATING OF COMPUTER SOFTWARE RELATING TO COMPUTER SECURITY AND PREVENTION OF COMPUTER RISKS; CONSULTING IN THE FIELD OF CONFIGURATION MANAGEMENT FOR COMPUTER HARDWARE AND SOFTWARE; PROVIDING A SECURED-ACCESS WEBSITE THAT GIVES REGISTERED INTERNET NETWORKED INSTITUTIONS THE ABILITY TO UPLOAD, VIEW, COPY, PRINT, DOWNLOAD AND SHARE DOCUMENTS AND IMAGES FOR THE PURPOSES OF CONDUCTING CONSUMER-DRIVEN TRANSACTIONS (U.S. CLS. 100 AND 101).

FIRST USE 9-17-2012; IN COMMERCE 9-17-2012.

**CLASS 45—PERSONAL AND LEGAL SERVICES**

FOR CONSULTATION IN THE FIELD OF DATA THEFT AND IDENTITY THEFT; CONSULTATION SERVICES CONCERNING HOMELAND SAFETY AND SECURITY ISSUES; CONSULTING SERVICES IN THE FIELD OF COUNTER-TERRORISM; CONSULTING SERVICES IN THE FIELD OF HOMELAND SECURITY; CONSULTING SERVICES IN THE FIELD OF MAINTAINING THE SECURITY AND INTEGRITY OF DATABASES; CONSULTING SERVICES IN THE FIELD OF NATIONAL SECURITY; CONSULTING SERVICES IN THE FIELD OF PUBLIC SAFETY; CONSULTING SERVICES IN THE FIELD OF STATE AND FEDERAL REGULATORY COMPLIANCE REQUIREMENTS FOR PERSONNEL SAFETY; MONITORING OF COMPUTER SYSTEMS FOR SECURITY PURPOSES; MONITORING OF SECURITY SYSTEMS; MONITORING OF SECURITY SYSTEMS USED IN ELECTRONIC TRACKING FOR USE IN CONNECTION WITH HOMELAND SECURITY; PROVIDING INFORMATION CONCERNING HOMELAND SAFETY AND SECURITY ISSUES; REGULATORY COMPLIANCE CONSULTING IN THE FIELD OF INFORMATION SECURITY; SECURITY CONSULTANCY; SECURITY SERVICES, NAMELY, PROVIDING SECURITY ASSESSMENTS FOR BUSINESSES AND GOVERNMENTAL AGENCIES; SECURITY SERVICES, NAMELY, THREAT SIMULATION VULNERABILITY ANALYSIS AND MITIGATION AND EMERGENCY AND CRISIS RESPONSE; SECURITY THREAT ANALYSIS FOR PERSONAL PROTECTION PURPOSES (U.S. CLS. 100 AND 101).

FIRST USE 9-17-2012; IN COMMERCE 9-17-2012.

4,482,397. PINK DOLPHIN CLOTHING, LLC, LOS ANGELES, CA. SN 85-813,301. PUB. 3-12-2013, FILED 12-31-2012.

**LEGENDS AT OUR CRAFT**

THE MARK CONSISTS OF STANDARD CHARACTERS WITHOUT CLAIM TO ANY PARTICULAR FONT, STYLE, SIZE, OR COLOR.

**CLASS 18—LEATHER GOODS**

FOR BACKPACKS, BOOK BAGS, SPORTS BAGS, WALLETS AND HANDBAGS; CARRY-ALL BAGS; DUFFEL BAGS; LEATHER AND IMITATION LEATHER BAGS; SCHOOL BAGS; TRAVEL BAGS (U.S. CLS. 1, 2, 3, 22 AND 41).

FIRST USE 1-1-2011; IN COMMERCE 1-1-2011.

**CLASS 25—CLOTHING**

FOR MEN'S, WOMEN'S AND CHILDREN'S APPAREL AND CLOTHING OF ALL TYPES, NAMELY, JERSEYS, PANTS, SHIRTS, BLOUSES, SLACKS, SHORTS, BELTS, UNDERWEAR, SOCKS, HOSIERY, SWIMWEAR, COATS, JACKETS, PULLOVERS, SWEATSHIRTS AND SWEATERS; HEADWEAR (U.S. CLS. 22 AND 39).

FIRST USE 1-1-2011; IN COMMERCE 1-1-2011.

4,482,406. BLOW, LLC, LOS ANGELES, CA. SN 85-817,921.  
PUB. 7-16-2013, FILED 1-8-2013.

# Blow

THE MARK CONSISTS OF STANDARD CHARACTERS WITHOUT CLAIM TO ANY PARTICULAR FONT, STYLE, SIZE, OR COLOR.

**CLASS 11—ENVIRONMENTAL CONTROL APPARATUS**

FOR ELECTRIC VAPORIZERS (U.S. CLS. 13, 21, 23, 31 AND 34).

FIRST USE 4-10-2013; IN COMMERCE 4-10-2013.

**CLASS 34—SMOKERS' ARTICLES**

FOR ELECTRONIC HOOKAHS; HOOKAH PARTS, NAMELY, VAPORIZERS; HOOKAH TOBACCO; HOOKAHS (U.S. CLS. 2, 8, 9 AND 17).

FIRST USE 4-10-2013; IN COMMERCE 4-10-2013.

4,482,408. NPOD.COM, INC., STAFFORD, TX. SN 85-818,098.  
PUB. 5-21-2013, FILED 1-8-2013.

# Rich Idiot

THE MARK CONSISTS OF STANDARD CHARACTERS WITHOUT CLAIM TO ANY PARTICULAR FONT, STYLE, SIZE, OR COLOR.

**CLASS 35—ADVERTISING AND BUSINESS**

FOR ADVERTISING, PROMOTION AND MARKETING SERVICES IN THE NATURE OF E-MAIL BLAST CAMPAIGNS FOR OTHERS; BUSINESS MARKETING AND DIRECT MAIL ADVERTISING CONSULTING SERVICES; ADVERTISING AND MARKETING SERVICES, NAMELY, PROMOTING THE GOODS AND SERVICES OF OTHERS; DIRECT MAIL ADVERTISING; DIRECT MARKETING CONSULTING SERVICES; SOCIAL MEDIA MARKETING SERVICES FOR OTHERS; PAY PER CLICK (PPC) ADVERTISING MANAGEMENT SERVICES; PROMOTING, ADVERTISING AND MARKETING OF THE ON-LINE WEB SITES OF OTHERS (U.S. CLS. 100, 101 AND 102).

FIRST USE 1-1-2009; IN COMMERCE 8-1-2013.

**CLASS 41—EDUCATION AND ENTERTAINMENT**

FOR EDUCATIONAL SERVICES, NAMELY, PROVIDING SEMINARS, SEMINAR PRESENTATIONS, CLASSES AND WORKSHOPS IN THE FIELDS OF WEALTH ACCUMULATION, PERSONAL DEVELOPMENT, INVESTING AND PERSONAL FINANCE (U.S. CLS. 100, 101 AND 107).

FIRST USE 1-1-2009; IN COMMERCE 8-1-2013.

4,482,421. RMG NETWORKS, INC., SAN FRANCISCO, CA.  
SN 85-821,521. PUB. 9-10-2013, FILED 1-11-2013.

# ChalkboxTV

THE MARK CONSISTS OF STANDARD CHARACTERS WITHOUT CLAIM TO ANY PARTICULAR FONT, STYLE, SIZE, OR COLOR.

**CLASS 9—ELECTRICAL AND SCIENTIFIC APPARATUS**

FOR MEDIA PRODUCTS FOR BRANDING AND PLACE-BASED ADVERTISING, NAMELY, A MEDIA PLAYER USING A LOCAL AREA NETWORK TO DOWNLOAD THEN DELIVER MESSAGES DISPLAYED ON TELEVISION SCREENS IN PUBLIC OR PRIVATE ENVIRONMENTS, NAMELY, FOR PUBLIC URBAN DISPLAY, FITNESS CLUB DISPLAY, LOBBY DISPLAY, AND BAR AND RESTAURANT DISPLAY (U.S. CLS. 21, 23, 26, 36 AND 38).

FIRST USE 4-15-2013; IN COMMERCE 4-15-2013.

**CLASS 42—SCIENTIFIC AND COMPUTER SERVICES**

FOR PROVIDING TEMPORARY USE OF ONLINE NON-DOWNLOADABLE COMPUTER SOFTWARE FOR DISPLAYING ADVERTISEMENTS (U.S. CLS. 100 AND 101).

FIRST USE 4-15-2013; IN COMMERCE 4-15-2013.

4,482,441. THE SAMUEL ROBERTS NOBLE FOUNDATION,  
ARDMORE, OK. SN 85-828,797. PUB. 6-25-2013, FILED 1-22-2013.

# NOBLE ACADEMY

THE MARK CONSISTS OF STANDARD CHARACTERS WITHOUT CLAIM TO ANY PARTICULAR FONT, STYLE, SIZE, OR COLOR.

NO CLAIM IS MADE TO THE EXCLUSIVE RIGHT TO USE "ACADEMY", APART FROM THE MARK AS SHOWN.

**CLASS 16—PAPER GOODS AND PRINTED MATTER**

FOR BROCHURES AND INFORMATION LEAFLETS ABOUT OF AGRICULTURE, NAMELY, LABORATORY EXPERIMENTS, CLASSROOM LESSON PLANS, PLANT SCIENCE, AGRICULTURAL PRODUCTION, AGRICULTURE RESEARCH, AGRICULTURE SAFETY, CAREER CHOICES AND SCIENCE AND TECHNOLOGY (U.S. CLS. 2, 5, 22, 23, 29, 37, 38 AND 50).

FIRST USE 1-15-2013; IN COMMERCE 1-15-2013.

**CLASS 41—EDUCATION AND ENTERTAINMENT**

FOR PROVIDING EDUCATIONAL SERVICES IN THE FIELD OF AGRICULTURE, NAMELY, IN THE NATURE OF MOBILE CLASSES, WORKSHOPS AND LABORATORY EXPERIMENTS RELATING TO PLANT SCIENCE, AGRICULTURAL PRODUCTION, AGRICULTURE RESEARCH, AGRICULTURE SAFETY, CAREER CHOICES AND SCIENCE AND TECHNOLOGY (U.S. CLS. 100, 101 AND 107).

FIRST USE 1-15-2013; IN COMMERCE 1-15-2013.

4,482,445. OPM TRADING LLC, DBA KNOCKERSHOP, NORTH PALM BEACH, FL. SN 85-831,352. PUB. 6-18-2013, FILED 1-24-2013.

**KNOCKERSHOP MD**

THE MARK CONSISTS OF STANDARD CHARACTERS WITHOUT CLAIM TO ANY PARTICULAR FONT, STYLE, SIZE, OR COLOR.

**CLASS 10—MEDICAL APPARATUS**

FOR POST-SURGICAL BRAS FOR MEDICAL PURPOSES; MASTECTOMY BRAS FOR MEDICAL PURPOSES (U.S. CLS. 26, 39 AND 44).

FIRST USE 10-1-2012; IN COMMERCE 10-15-2012.

**CLASS 25—CLOTHING**

FOR ADHESIVE BRAS; BRAS; FITTED SWIMMING COSTUMES WITH BRA CUPS; MATERNITY BRAS; MOISTURE-WICKING SPORTS BRAS; SHAPEWEAR, NAMELY, BRAS; SPORTS BRA; SPORTS BRAS; STRAPLESS BRAS; UNDERGARMENTS; WOMEN'S ATHLETIC TOPS WITH BUILT-IN BRAS (U.S. CLS. 22 AND 39).

FIRST USE 8-1-2011; IN COMMERCE 9-1-2012.

4,482,455. ACUMEN FUND, INC., NEW YORK, NY. SN 85-835,573. PUB. 8-27-2013, FILED 1-29-2013.



THE MARK CONSISTS OF A PARTIAL "A" AND THE

WORDS "ACUMEN CHANGING THE WAY THE WORLD TACKLES POVERTY".

**CLASS 35—ADVERTISING AND BUSINESS**

FOR PROMOTING THE INTERESTS OF PHILANTHROPIC ORGANIZATIONS BY ENCOURAGING CHARITABLE GIVING, BY RAISING AWARENESS OF TOOLS TO ALLEVIATE POVERTY AND BY KNOWLEDGE RESEARCH TO PROVIDE INSIGHT, TOOLS AND LESSONS TO CHANGE HOW PEOPLE AND INSTITUTIONS FIGHT POVERTY; INFORMATION AGGREGATION, ANALYSIS AND REPORTING REGARDING EFFECTIVE TOOLS TO ALLEVIATE POVERTY, PUBLIC POLICY AND PUBLIC RELATIONS RESEARCH (U.S. CLS. 100, 101 AND 102).

FIRST USE 4-18-2013; IN COMMERCE 4-18-2013.

**CLASS 36—INSURANCE AND FINANCIAL**

FOR INVESTING AND INVESTMENT-RELATED SERVICES, NAMELY, CAPITAL RAISING, PORTFOLIO MANAGEMENT, FUND MANAGEMENT, INVESTMENT MANAGEMENT, INVESTMENT ADVISORY SERVICES AND INVESTMENT CONSULTATION, INCLUDING ANY OF THE FOREGOING RELATING TO PHILANTHROPIC OR SOCIAL INVESTMENTS, INCLUDING INVESTMENTS IN ORGANIZATIONS PROVIDING GOODS AND/OR SERVICES TO LOW-INCOME POPULATIONS AND THE PROVISION OF INVESTMENT ADVISORY AND INVESTMENT CONSULTATION SERVICES TO SUCH ORGANIZATIONS; CHARITABLE FUNDRAISING FOR INVESTING AND LEADERSHIP AND SOCIAL AWARENESS PROGRAMS FOR SOCIAL AND PHILANTHROPIC ORGANIZATIONS; CHARITABLE FUNDRAISING SERVICES BY MEANS OF ORGANIZING AND CONDUCTING SPECIAL EVENTS; ADVISORY AND CONSULTING SERVICES IN THE FIELD OF PHILANTHROPY CONCERNING MONETARY DONATIONS, INCLUDING IN THE FIELD OF GRANT-MAKING AND FUNDRAISING FOR CHARITABLE PURPOSES; CONSULTING SERVICES IN THE FIELD OF INVESTING IN PHILANTHROPIC OR SOCIAL INVESTMENTS (U.S. CLS. 100, 101 AND 102).

FIRST USE 4-18-2013; IN COMMERCE 4-18-2013.

**CLASS 41—EDUCATION AND ENTERTAINMENT**

FOR CHARITABLE SERVICES, NAMELY, PROVIDING TRAINING IN THE FIELDS OF LEADERSHIP DEVELOPMENT AND SOCIAL ENTREPRENEURSHIP IN THE NATURE OF APPLYING ENTREPRENEURIAL PRINCIPLES TO ORGANIZE, CREATE AND MANAGE A SOCIAL VENTURE TO ACHIEVE A DESIRED SOCIAL CHANGE THROUGH FELLOWSHIP PROGRAMS AND OUTREACH; PROVIDING INTERNSHIPS AND APRENTICESHIPS IN THE FIELD OF SOCIAL AND PHILANTHROPIC ORGANIZATION, VIA FELLOWSHIP AND OUTREACH PROGRAM FIELD PLACEMENTS, TO PROVIDE OPERATIONAL EXPERIENCE IN SUCH ORGANIZATIONS; PROVIDING GROUP COACHING IN THE FIELD OF LEADERSHIP DEVELOPMENT; WORKSHOPS AND SEMINARS IN THE FIELDS OF LEADERSHIP DEVELOPMENT AND SOCIAL ENTREPRENEURSHIP IN THE NATURE OF APPLYING ENTREPRENEURIAL PRINCIPLES TO ORGANIZE, CREATE AND MANAGE A SOCIAL VENTURE TO ACHIEVE A DESIRED SOCIAL CHANGE; EDUCATIONAL SERVICES, NAMELY, CONDUCTING SEMINARS, CONFERENCES, WORKSHOPS AND RETREATS IN THE FIELDS OF LEADERSHIP DEVELOPMENT AND SOCIAL ENTREPRENEURSHIP IN THE NATURE OF APPLYING ENTREPRENEURIAL PRINCIPLES TO ORGANIZE, CREATE AND MANAGE A SOCIAL VENTURE TO ACHIEVE A DESIRED SOCIAL CHANGE AND DISTRIBUTION OF TRAINING MATERIAL IN CONNECTION THEREWITH; BUSINESS TRAINING IN THE FIELD OF SOCIAL ENTREPRENEURSHIP IN THE NATURE OF APPLYING ENTREPRENEURIAL PRINCIPLES TO ORGANIZE, CREATE AND MANAGE A SOCIAL VENTURE TO ACHIEVE A DESIRED SOCIAL CHANGE (U.S. CLS. 100, 101 AND 107).

FIRST USE 4-18-2013; IN COMMERCE 4-18-2013.

4,482,456. ACUMEN FUND, INC., NEW YORK, NY. SN 85-835,579. PUB. 8-27-2013, FILED 1-29-2013.



THE MARK CONSISTS OF A PARTIAL CAPITAL LETTER "A".

**CLASS 35—ADVERTISING AND BUSINESS**

FOR PROMOTING THE INTERESTS OF PHILANTHROPIC ORGANIZATIONS BY ENCOURAGING CHARITABLE GIVING, BY RAISING AWARENESS OF TOOLS TO ALLEVIATE POVERTY AND BY PRODUCING AND COMPILING KNOWLEDGE RESEARCH TO PROVIDE INSIGHT, TOOLS AND LESSONS TO CHANGE HOW PEOPLE AND INSTITUTIONS FIGHT POVERTY; INFORMATION AGGREGATION, ANALYSIS AND REPORTING REGARDING EFFECTIVE TOOLS TO ALLEVIATE POVERTY, PUBLIC POLICY AND PUBLIC RELATIONS RESEARCH (U.S. CLS. 100, 101 AND 102).

FIRST USE 4-18-2013; IN COMMERCE 4-18-2013.

**CLASS 36—INSURANCE AND FINANCIAL**

FOR INVESTING AND INVESTMENT-RELATED SERVICES, NAMELY, CAPITAL RAISING, PORTFOLIO MANAGEMENT, FUND MANAGEMENT, INVESTMENT MANAGEMENT, INVESTMENT ADVISORY SERVICES AND INVESTMENT CONSULTATION, INCLUDING ANY OF THE FOREGOING RELATING TO PHILANTHROPIC OR SOCIAL INVESTMENTS, INCLUDING INVESTMENTS IN ORGANIZATIONS PROVIDING GOODS AND/OR SERVICES TO LOW-INCOME POPULATIONS AND THE PROVISION OF INVESTMENT ADVISORY AND INVESTMENT CONSULTATION SERVICES TO SUCH ORGANIZATIONS; CHARITABLE FUNDRAISING FOR INVESTING AND LEADERSHIP AND SOCIAL AWARENESS PROGRAMS FOR SOCIAL AND PHILANTHROPIC ORGANIZATIONS; CHARITABLE FUNDRAISING SERVICES BY MEANS OF ORGANIZING AND CONDUCTING SPECIAL EVENTS; ADVISORY AND CONSULTING SERVICES IN THE FIELD OF PHILANTHROPY CONCERNING MONETARY DONATIONS, INCLUDING IN THE FIELD OF GRANT-MAKING AND FUNDRAISING FOR CHARITABLE PURPOSES; CONSULTING SERVICES IN THE FIELD OF INVESTING IN PHILANTHROPIC OR SOCIAL INVESTMENTS (U.S. CLS. 100, 101 AND 102).

FIRST USE 4-18-2013; IN COMMERCE 4-18-2013.

**CLASS 41—EDUCATION AND ENTERTAINMENT**

FOR CHARITABLE SERVICES, NAMELY, PROVIDING TRAINING IN THE FIELDS OF LEADERSHIP DEVELOPMENT AND SOCIAL ENTREPRENEURSHIP IN THE NATURE OF APPLYING ENTREPRENEURIAL PRINCIPLES TO ORGANIZE, CREATE AND MANAGE A SOCIAL VENTURE TO ACHIEVE A DESIRED SOCIAL CHANGE THROUGH FELLOWSHIP PROGRAMS AND OUTREACH; PROVIDING INTERNSHIPS AND APRENTICESHIPS IN THE FIELD OF SOCIAL AND PHILANTHROPIC ORGANIZATION, VIA FELLOWSHIP AND OUTREACH PROGRAM FIELD PLACEMENTS, TO PROVIDE OPERATIONAL EXPERIENCE IN SUCH ORGANIZATIONS; PROVIDING GROUP COACHING IN THE FIELD OF LEADERSHIP DEVELOPMENT; WORKSHOPS AND SEMINARS IN THE FIELDS OF LEADERSHIP DEVELOPMENT AND SOCIAL ENTREPRENEURSHIP IN THE NATURE OF APPLYING ENTREPRENEURIAL PRINCIPLES TO ORGANIZE, CREATE AND MANAGE A SOCIAL VENTURE TO ACHIEVE A DESIRED SOCIAL CHANGE; EDUCATIONAL SERVICES, NAMELY, CONDUCTING SEMINARS, CONFERENCES, WORKSHOPS AND RETREATS IN THE FIELDS OF LEADERSHIP DEVELOPMENT AND SOCIAL ENTREPRENEURSHIP IN THE NATURE OF APPLYING ENTREPRENEURIAL PRINCIPLES TO ORGANIZE, CREATE AND MANAGE A SOCIAL VENTURE TO ACHIEVE A DESIRED SOCIAL CHANGE AND DISTRIBUTION OF TRAINING MATERIAL IN CONNECTION THEREWITH; BUSINESS TRAINING IN THE FIELD OF SOCIAL ENTREPRENEURSHIP IN THE NATURE OF APPLYING ENTREPRENEURIAL PRINCIPLES TO ORGANIZE, CREATE AND MANAGE A SOCIAL VENTURE TO ACHIEVE A DESIRED SOCIAL CHANGE (U.S. CLS. 100, 101 AND 107).

FIRST USE 4-18-2013; IN COMMERCE 4-18-2013.

4,482,459. FERRIGNO FIT LLC, LOS ANGELES, CA. SN 85-840,279. PUB. 7-9-2013, FILED 2-4-2013.

INCREDIBLY FIT

THE MARK CONSISTS OF STANDARD CHARACTERS WITHOUT CLAIM TO ANY PARTICULAR FONT, STYLE, SIZE, OR COLOR.

NO CLAIM IS MADE TO THE EXCLUSIVE RIGHT TO USE "FIT", APART FROM THE MARK AS SHOWN.

**CLASS 41—EDUCATION AND ENTERTAINMENT**

FOR PERSONAL FITNESS TRAINING SERVICES AND CONSULTANCY; PHYSICAL FITNESS CONSULTATION; PHYSICAL FITNESS INSTRUCTION; PHYSICAL FITNESS TRAINING SERVICES; PROVIDING A WEBSITE FEATURING INFORMATION ON EXERCISE AND FITNESS; PROVIDING ASSISTANCE, PERSONAL TRAINING AND PHYSICAL FITNESS CONSULTATION TO INDIVIDUALS TO HELP THEM MAKE PHYSICAL FITNESS, STRENGTH, CONDITIONING, AND EXERCISE IMPROVEMENT IN THEIR DAILY LIVING; PROVIDING INFORMATION IN THE FIELD OF EXERCISE TRAINING; PROVIDING INFORMATION ON PHYSICAL EXERCISE (U.S. CLS. 100, 101 AND 107).

FIRST USE 6-5-2013; IN COMMERCE 6-5-2013.

**CLASS 44—MEDICAL, BEAUTY AND AGRICULTURAL SERVICES**

FOR COUNSELING SERVICES IN THE FIELDS OF HEALTH, NUTRITION AND LIFESTYLE WELLNESS; PROVIDING A WEBSITE FEATURING INFORMATION ABOUT HEALTH, WELLNESS AND NUTRITION; PROVIDING ASSISTANCE, FITNESS EVALUATION AND CONSULTATION TO INDIVIDUALS TO HELP THEM MAKE HEALTH, WELLNESS AND NUTRITIONAL CHANGES IN THEIR DAILY LIVING TO IMPROVE HEALTH; PROVIDING WELLNESS SERVICES, NAMELY, PERSONAL ASSESSMENTS, PERSONALIZED ROUTINES, MAINTENANCE SCHEDULES, AND COUNSELING (U.S. CLS. 100 AND 101).

FIRST USE 6-5-2013; IN COMMERCE 6-5-2013.

4,482,460. FULLSTEP NETWORKS, S.L., MADRID, SPAIN.  
SN 85-840,584. PUB. 7-30-2013, FILED 2-5-2013.



OWNER OF U.S. REG. NOS. 3,796,745, 3,811,650, AND 3,811,651.

NO CLAIM IS MADE TO THE EXCLUSIVE RIGHT TO USE "SPEND OPTIMIZATION", APART FROM THE MARK AS SHOWN.

THE COLOR(S) RED AND BLACK IS/ARE CLAIMED AS A FEATURE OF THE MARK.

THE MARK CONSISTS OF THREE PARALLELED BANDS PLACES OF BIGGER THAN MINOR SIZE INCLINED TOWARDS THE RIGHT IN RED COLOR, BESIDE THE WORD "FULLSTEP" IN BIG BLACK LETTERS, IN THE SECOND ROW THE WORDS "SPEND OPTIMIZATION" IN SMALLER BLACK LETTERS.

**CLASS 9—ELECTRICAL AND SCIENTIFIC APPARATUS**

FOR COMPUTER SOFTWARE FOR DATABASE MANAGEMENT, WORD PROCESSING AS WELL AS FOR USE AS SPREADSHEET, USED IN IMPROVEMENT OF PURCHASING FUNCTIONS OF BUSINESS THAT MAY BE DOWNLOADED FROM A GLOBAL COMPUTER NETWORK (U.S. CLS. 21, 23, 26, 36 AND 38).

FIRST USE 12-31-2012; IN COMMERCE 12-31-2012.

**CLASS 35—ADVERTISING AND BUSINESS**

FOR ASSISTANCE, ADVICE AND CONSULTANCY WITH REGARD TO BUSINESS PLANNING, BUSINESS ANALYSIS, BUSINESS MANAGEMENT AND BUSINESS ORGANIZATION RELATING TO PURCHASING FUNCTIONS; BUSINESS ADVISORY SERVICES, NAMELY, SEARCH FOR AND SELECTION OF THE BEST POTENTIAL SUPPLIERS FOR OTHERS; BUSINESS MANAGEMENT CONSULTANCY IN THE FIELD OF PURCHASES, NAMELY, ASSISTING BUSINESSES IN IMPROVEMENT OF PURCHASING FUNCTIONS (U.S. CLS. 100, 101 AND 102).

FIRST USE 12-31-2012; IN COMMERCE 12-31-2012.

**CLASS 42—SCIENTIFIC AND COMPUTER SERVICES**

FOR DESIGN AND DEVELOPMENT OF COMPUTER SOFTWARE FOR THE IMPROVEMENTS OF PURCHASING FUNCTIONS OF BUSINESS (U.S. CLS. 100 AND 101).

FIRST USE 12-31-2012; IN COMMERCE 12-31-2012.

4,482,490. CVS PHARMACY, INC., WOONSOCKET, RI. SN 85-851,502. PUB. 8-20-2013, FILED 2-15-2013.

**JUST THE BASICS**

THE MARK CONSISTS OF STANDARD CHARACTERS WITHOUT CLAIM TO ANY PARTICULAR FONT, STYLE, SIZE, OR COLOR.

OWNER OF U.S. REG. NO. 4,123,165.

**CLASS 30—STAPLE FOODS**

FOR BEVERAGES AND DRINKS, NAMELY, ICED TEA (U.S. CL. 46).

FIRST USE 5-3-2013; IN COMMERCE 5-3-2013.

**CLASS 32—LIGHT BEVERAGES**

FOR BEVERAGES AND DRINKS, NAMELY, FRUIT DRINKS AND FRUIT JUICES, FRUIT PUNCH, AND LEMONADE (U.S. CLS. 45, 46 AND 48).

FIRST USE 5-3-2013; IN COMMERCE 5-3-2013.

4,482,492. CVS PHARMACY, INC., WOONSOCKET, RI. SN 85-851,517. PUB. 8-20-2013, FILED 2-15-2013.



OWNER OF U.S. REG. NO. 4,123,165.

THE MARK CONSISTS OF THE LETTER "b" IN SMALL SCRIPT WITH THE TERMS "JUST THE BASICS" TO THE RIGHT OF THE L SHAPE OF THE LETTER "b" AND SITTING JUST ABOVE THE ROUND PORTION OF THE LETTER "b".

**CLASS 30—STAPLE FOODS**

FOR BEVERAGES AND DRINKS, NAMELY, ICED TEA (U.S. CL. 46).

FIRST USE 5-3-2013; IN COMMERCE 5-3-2013.

**CLASS 32—LIGHT BEVERAGES**

FOR BEVERAGES AND DRINKS, NAMELY, FRUIT DRINKS AND FRUIT JUICES, FRUIT PUNCH, AND LEMONADE (U.S. CLS. 45, 46 AND 48).

FIRST USE 5-3-2013; IN COMMERCE 5-3-2013.



4,482,526. BATTLEFIELD INTERNATIONAL INC., CAYUGA, ONTARIO, CANADA. SN 85-866,039. PUB. 7-23-2013, FILED 3-4-2013.

4,482,533. LIVEYEARBOOK, INC., MADISON, WI. SN 85-866,674. PUB. 8-13-2013, FILED 3-5-2013.

# ENDUROLINK

THE MARK CONSISTS OF STANDARD CHARACTERS WITHOUT CLAIM TO ANY PARTICULAR FONT, STYLE, SIZE, OR COLOR.

**CLASS 6—METAL GOODS**

FOR METAL COUPLINGS FOR USE WITH HOSES, FUEL LINES AND GAS LINES (U.S. CLS. 2, 12, 13, 14, 23, 25 AND 50).  
FIRST USE 4-30-2008; IN COMMERCE 4-30-2008.

**CLASS 17—RUBBER GOODS**

FOR NON-METAL COUPLINGS FOR USE WITH HOSES, FUEL LINES AND GAS LINES (U.S. CLS. 1, 5, 12, 13, 35 AND 50).  
FIRST USE 4-30-2008; IN COMMERCE 4-30-2008.

---

4,482,532. LIVEYEARBOOK, INC., MADISON, WI. SN 85-866,670. PUB. 8-13-2013, FILED 3-5-2013.



THE MARK CONSISTS OF AN ELEPHANT WITH ITS TRUNK RAISED.

**CLASS 9—ELECTRICAL AND SCIENTIFIC APPARATUS**

FOR DOWNLOADABLE ELECTRONIC PUBLICATIONS, NAMELY, MEMORY BOOKS AND PHOTO ALBUMS; ELECTRONIC PUBLICATIONS, NAMELY, MEMORY BOOKS AND PHOTO ALBUMS RECORDED ON COMPUTER MEDIA (U.S. CLS. 21, 23, 26, 36 AND 38).  
FIRST USE 2-11-2013; IN COMMERCE 2-11-2013.

**CLASS 42—SCIENTIFIC AND COMPUTER SERVICES**

FOR SOFTWARE AS A SERVICE (SAAS) SERVICES FEATURING SOFTWARE FOR CREATING YEARBOOKS, MEMORY BOOKS AND PHOTO ALBUMS (U.S. CLS. 100 AND 101).  
FIRST USE 2-11-2013; IN COMMERCE 2-11-2013.

# THE POWER OF CELEBRATING MEMORIES

THE MARK CONSISTS OF STANDARD CHARACTERS WITHOUT CLAIM TO ANY PARTICULAR FONT, STYLE, SIZE, OR COLOR.

**CLASS 9—ELECTRICAL AND SCIENTIFIC APPARATUS**

FOR DOWNLOADABLE ELECTRONIC PUBLICATIONS, NAMELY, MEMORY BOOKS AND PHOTO ALBUMS; ELECTRONIC PUBLICATIONS, NAMELY, MEMORY BOOKS AND PHOTO ALBUMS RECORDED ON COMPUTER MEDIA (U.S. CLS. 21, 23, 26, 36 AND 38).  
FIRST USE 2-11-2013; IN COMMERCE 2-11-2013.

**CLASS 42—SCIENTIFIC AND COMPUTER SERVICES**

FOR SOFTWARE AS A SERVICE (SAAS) SERVICES FEATURING SOFTWARE FOR CREATING YEARBOOKS, MEMORY BOOKS AND PHOTO ALBUMS (U.S. CLS. 100 AND 101).  
FIRST USE 2-11-2013; IN COMMERCE 2-11-2013.

---

4,482,534. LIVEYEARBOOK, INC., MADISON, WI. SN 85-866,677. PUB. 8-13-2013, FILED 3-5-2013.

# LIVEALITY

THE MARK CONSISTS OF STANDARD CHARACTERS WITHOUT CLAIM TO ANY PARTICULAR FONT, STYLE, SIZE, OR COLOR.

**CLASS 9—ELECTRICAL AND SCIENTIFIC APPARATUS**

FOR DOWNLOADABLE ELECTRONIC PUBLICATIONS, NAMELY, MEMORY BOOKS AND PHOTO ALBUMS; ELECTRONIC PUBLICATIONS, NAMELY, MEMORY BOOKS AND PHOTO ALBUMS RECORDED ON COMPUTER MEDIA (U.S. CLS. 21, 23, 26, 36 AND 38).  
FIRST USE 2-11-2013; IN COMMERCE 2-11-2013.

**CLASS 42—SCIENTIFIC AND COMPUTER SERVICES**

FOR SOFTWARE AS A SERVICE (SAAS) SERVICES FEATURING SOFTWARE FOR CREATING YEARBOOKS, MEMORY BOOKS AND PHOTO ALBUMS (U.S. CLS. 100 AND 101).  
FIRST USE 2-11-2013; IN COMMERCE 2-11-2013.

4,482,535. BETTS ENVIRONMENTAL SERVICES CORPORATION, BUTLER, NJ. SN 85-866,872. PUB. 8-27-2013, FILED 3-5-2013.



THE COLOR(S) BLUE, IN VARYING SHADES, GREEN, IN VARYING SHADES, YELLOW AND WHITE IS/ARE CLAIMED AS A FEATURE OF THE MARK.

THE MARK CONSISTS OF A FLAME WITH A YELLOW TIP, THAT BLENDS INTO GREEN, AND THEN VARYING DEGREES OF BLUE. AT THE CENTER OF THE FLAME IS A SMALLER LIGHT GREEN FLAME, SEPARATED BY THE BIGGER FLAME BY WHITE. TO THE RIGHT IS THE WORD "BETTS" IN DARK BLUE.

#### CLASS 36—INSURANCE AND FINANCIAL

FOR FINANCIAL CONSULTING SERVICES IN THE FIELD OF ENVIRONMENTAL AND ALTERNATIVE ENERGY (U.S. CLS. 100, 101 AND 102).

FIRST USE 6-15-2013; IN COMMERCE 6-15-2013.

#### CLASS 37—CONSTRUCTION AND REPAIR

FOR ENVIRONMENTAL REMEDIATION SERVICES, NAMELY, SOIL EXCAVATION AND DISPOSAL OF HAZARDOUS AND NON-HAZARDOUS WASTE MATERIAL; UNDERGROUND STORAGE TANK REPAIR AND INSTALLATION; GENERAL BUILDING DEMOLITION AND SITE CONSTRUCTION; INSTALLATION OF CNG AND ALTERNATIVE FUELING SYSTEMS (U.S. CLS. 100, 103 AND 106).

FIRST USE 6-15-2013; IN COMMERCE 6-15-2013.

#### CLASS 40—MATERIAL TREATMENT

FOR GENERAL DEMOLITION SERVICES, NOT BUILDINGS; SOIL/GROUNDWATER ENVIRONMENTAL REMEDIATION SERVICES, NAMELY, TREATMENT OF SOIL AND WATER; CUSTOM MANUFACTURE OF CNG AND ALTERNATIVE FUELING SYSTEMS (U.S. CLS. 100, 103 AND 106).

FIRST USE 6-15-2013; IN COMMERCE 6-15-2013.

#### CLASS 42—SCIENTIFIC AND COMPUTER SERVICES

FOR ENVIRONMENTAL ENGINEERING CONSULTING SERVICES, NAMELY, ENVIRONMENTAL SITE ASSESSMENT, INVESTIGATION, SAMPLING AND ANALYSIS, SOIL AND GROUNDWATER INVESTIGATION; CONSULTATION SERVICES IN THE FIELD OF ALTERNATIVE ENERGY GENERATION, NAMELY, FEASIBILITY ANALYSIS; DESIGN AND ENGINEERING OF CNG AND ALTERNATIVE FUELING SYSTEMS (U.S. CLS. 100 AND 101).

FIRST USE 6-15-2013; IN COMMERCE 6-15-2013.

4,482,552. GULF COAST NUTRITIONALS, INC., NAPLES, FL. SN 85-873,913. PUB. 9-10-2013, FILED 3-12-2013.



THE MARK CONSISTS OF THE DESIGN OF A LARGE DOG AND A SMALL DOG APPEARING NEXT TO EACH OTHER WITH A HALF CIRCLE AND HORIZONTAL LINE APPEARING IN THE BACKGROUND.

#### CLASS 5—PHARMACEUTICALS

FOR NUTRITIONAL SUPPLEMENTS AND VITAMINS FOR PETS; NUTRITIONAL SUPPLEMENTS FOR PETS IN THE NATURE OF PET TREATS; DIETARY AND NUTRITIONAL SUPPLEMENTS IN THE NATURE OF PET TREATS USED FOR WEIGHT CONTROL FOR PETS; DIETARY SUPPLEMENTS FOR PETS IN THE NATURE OF PET TREATS (U.S. CLS. 6, 18, 44, 46, 51 AND 52).

FIRST USE 11-5-2012; IN COMMERCE 11-5-2012.

#### CLASS 31—NATURAL AGRICULTURAL PRODUCTS

FOR PET FOOD PRODUCTS, NAMELY, EDIBLE PET TREATS, PET FOOD, PET SNACKS, EDIBLE PET TREATS IN THE NATURE OF PET SNACKS (U.S. CLS. 1 AND 46).

FIRST USE 11-5-2012; IN COMMERCE 11-5-2012.

4,482,565. WATER-RIGHT, INC., APPLETON, WI. SN 85-877,731. PUB. 8-20-2013, FILED 3-15-2013.

# CUSTOMCARE

THE MARK CONSISTS OF STANDARD CHARACTERS WITHOUT CLAIM TO ANY PARTICULAR FONT, STYLE, SIZE, OR COLOR.

#### CLASS 11—ENVIRONMENTAL CONTROL APPARATUS

FOR WATER TREATMENT EQUIPMENT, NAMELY, WATER CONDITIONING UNITS, WATER SOFTENING UNITS, WATER FILTRATION UNITS, WATER DEALKALIZER UNITS AND WATER DEIONIZATION UNITS FOR RESIDENTIAL, COMMERCIAL AND INDUSTRIAL USE (U.S. CLS. 13, 21, 23, 31 AND 34).

FIRST USE 9-1-2013; IN COMMERCE 9-1-2013.

#### CLASS 42—SCIENTIFIC AND COMPUTER SERVICES

FOR WATER QUALITY ANALYSIS SERVICES (U.S. CLS. 100 AND 101).

FIRST USE 9-1-2013; IN COMMERCE 9-1-2013.

4,482,592. MECHANIX WEAR, INC., VALENCIA, CA. SN 85-885,317. PUB. 8-13-2013, FILED 3-25-2013.

4,482,600. GERONIMO WIND ENERGY, LLC, EDINA, MN. SN 85-887,869. PUB. 9-10-2013, FILED 3-27-2013.

## THE ORIGINAL TOUCH

THE MARK CONSISTS OF STANDARD CHARACTERS WITHOUT CLAIM TO ANY PARTICULAR FONT, STYLE, SIZE, OR COLOR.

OWNER OF U.S. REG. NO. 3,675,066.

### CLASS 9—ELECTRICAL AND SCIENTIFIC APPARATUS

FOR PROTECTIVE GLOVES FOR INDUSTRIAL USE; PROTECTIVE WORK GLOVES (U.S. CLS. 21, 23, 26, 36 AND 38).

FIRST USE 9-16-2013; IN COMMERCE 9-16-2013.

### CLASS 25—CLOTHING

FOR GLOVES (U.S. CLS. 22 AND 39).

FIRST USE 9-16-2013; IN COMMERCE 9-16-2013.

## GERONIMO ENERGY

THE MARK CONSISTS OF STANDARD CHARACTERS WITHOUT CLAIM TO ANY PARTICULAR FONT, STYLE, SIZE, OR COLOR.

OWNER OF U.S. REG. NOS. 3,894,573 AND 3,894,576.

NO CLAIM IS MADE TO THE EXCLUSIVE RIGHT TO USE "ENERGY", APART FROM THE MARK AS SHOWN.

### CLASS 40—MATERIAL TREATMENT

FOR GENERATION OF ENERGY (U.S. CLS. 100, 103 AND 106).

FIRST USE 1-25-2013; IN COMMERCE 1-25-2013.

### CLASS 42—SCIENTIFIC AND COMPUTER SERVICES

FOR DEVELOPMENT OF ENVIRONMENTALLY FRIENDLY FORMS OF ENERGY AND POWER (U.S. CLS. 100 AND 101).

FIRST USE 1-25-2013; IN COMMERCE 1-25-2013.

4,482,596. MALLOCH, CARL, BERKLEY, MA. SN 85-887,364. PUB. 8-20-2013, FILED 3-27-2013.

4,482,603. TREVA BURNS, AKA DIVASTYL, COLLEYVILLE, TX. SN 85-889,657. PUB. 9-3-2013, FILED 3-28-2013.

## PREPPERHEAD

THE MARK CONSISTS OF STANDARD CHARACTERS WITHOUT CLAIM TO ANY PARTICULAR FONT, STYLE, SIZE, OR COLOR.

### CLASS 16—PAPER GOODS AND PRINTED MATTER

FOR DECALS; STICKERS (U.S. CLS. 2, 5, 22, 23, 29, 37, 38 AND 50).

FIRST USE 11-1-2013; IN COMMERCE 11-1-2013.

### CLASS 18—LEATHER GOODS

FOR BACKPACKS, PURSES, KIT BAGS, ALL-PURPOSE CARRYING BAGS, DUFFLE BAGS (U.S. CLS. 1, 2, 3, 22 AND 41).

FIRST USE 11-1-2013; IN COMMERCE 11-1-2013.

### CLASS 25—CLOTHING

FOR CLOTHING, NAMELY, TOPS AND BOTTOMS, SHIRTS, HATS, JACKETS, SWEATSHIRTS (U.S. CLS. 22 AND 39).

FIRST USE 11-1-2013; IN COMMERCE 11-1-2013.

## DIVA STYL

THE MARK CONSISTS OF STANDARD CHARACTERS WITHOUT CLAIM TO ANY PARTICULAR FONT, STYLE, SIZE, OR COLOR.

### CLASS 9—ELECTRICAL AND SCIENTIFIC APPARATUS

FOR AUDIO AND VIDEO RECORDINGS FEATURING MUSIC AND ARTISTIC PERFORMANCES (U.S. CLS. 21, 23, 26, 36 AND 38).

FIRST USE 3-11-2011; IN COMMERCE 5-10-2011.

### CLASS 41—EDUCATION AND ENTERTAINMENT

FOR FASHION MODELING FOR ENTERTAINMENT PURPOSES (U.S. CLS. 100, 101 AND 107).

FIRST USE 2-1-2010; IN COMMERCE 3-5-2013.

### CLASS 42—SCIENTIFIC AND COMPUTER SERVICES

FOR PRODUCT DESIGN AND DEVELOPMENT IN THE FIELD OF FASHION (U.S. CLS. 100 AND 101).

FIRST USE 7-20-2010; IN COMMERCE 7-20-2011.

**CLASS 45—PERSONAL AND LEGAL SERVICES**

FOR PERSONAL STYLIST SERVICES, NAMELY, EVALUATING THE PHYSICAL ATTRIBUTES, LIFESTYLE, AND FASHION STYLES OF OTHERS AND RECOMMENDING CLOTHING AND ACCESSORIES TO ACHIEVE THE PERSONAL IMAGE DESIRED BY THE CLIENT (U.S. CLS. 100 AND 101).

FIRST USE 12-7-2011; IN COMMERCE 12-7-2011.

4,482,606. QCK LLC, CINCINNATI, OH. SN 85-890,663. PUB. 9-3-2013, FILED 3-29-2013.

**PERFECTLY ISOTONIC**

THE MARK CONSISTS OF STANDARD CHARACTERS WITHOUT CLAIM TO ANY PARTICULAR FONT, STYLE, SIZE, OR COLOR.

NO CLAIM IS MADE TO THE EXCLUSIVE RIGHT TO USE "ISOTONIC", APART FROM THE MARK AS SHOWN.

4,482,605. PAMPERO INTERNATIONAL FINANCE S. À R.L., LUXEMBOURG, LUXEMBOURG. SN 85-890,446. PUB. 9-3-2013, FILED 3-29-2013.

**Betony**

THE MARK CONSISTS OF STANDARD CHARACTERS WITHOUT CLAIM TO ANY PARTICULAR FONT, STYLE, SIZE, OR COLOR.

**CLASS 5—PHARMACEUTICALS**

FOR FLAVORED NON-ALCOHOLIC BEVERAGE CONTAINING ELECTROLYTES FOR ORAL REHYDRATION (U.S. CLS. 6, 18, 44, 46, 51 AND 52).

FIRST USE 10-29-2013; IN COMMERCE 10-29-2013.

**CLASS 32—LIGHT BEVERAGES**

FOR FLAVORED NON-ALCOHOLIC BEVERAGE CONTAINING ELECTROLYTES FOR USE AS A SPORTS DRINK (U.S. CLS. 45, 46 AND 48).

FIRST USE 10-29-2013; IN COMMERCE 10-29-2013.

**CLASS 30—STAPLE FOODS**

FOR COFFEE, TEA, COCOA, SUGAR, RICE, TAPIOCA, SAGE ARTIFICIAL COFFEE; FLOUR; CEREAL PREPARATIONS, NAMELY, READY TO EAT BREAKFAST CEREALS, PROCESSED CEREALS, CEREAL DERIVED FOOD BARS; BREAD, PASTRY; CONFECTIONERY, NAMELY, PASTILLES; EDIBLE ICES; HONEY, TREACLE; YEAST, BAKING POWDER; SALT; MUSTARD; VINEGAR; SAUCES; CONDIMENTS, NAMELY, KETCHUP, MAYONNAISE, SOY SAUCE, BARBECUE SAUCE, SALAD SAUCE, PEPPER SAUCE; ICE FOR REFRESHMENT; SANDWICHES; PIZZAS; PANCAKES; COOKIES; CAKES; RUSKS; CHOCOLATE; COCOA BASED BEVERAGES; COFFEE BASED BEVERAGES; BEVERAGES WITH A CHOCOLATE BASE; TEA BASED BEVERAGES; AND PASTA (U.S. CL. 46).

FIRST USE 5-13-2013; IN COMMERCE 5-13-2013.

4,482,612. WINDOWCRAFT, INC., GARDEN CITY PARK, NY. SN 85-892,541. PUB. 8-27-2013, FILED 4-2-2013.

**Tigerroll**

THE MARK CONSISTS OF THE WORD "TIGEROLL" IN A STYLIZED FONT.

**CLASS 35—ADVERTISING AND BUSINESS**

FOR ON-LINE ORDERING SERVICES IN THE FIELD OF RESTAURANT TAKE-OUT AND DELIVERY; RESTAURANT FRANCHISING, NAMELY, OFFERING BUSINESS MANAGEMENT ASSISTANCE IN THE ESTABLISHMENT AND/OR OPERATION OF RESTAURANTS; RESTAURANT FRANCHISING, NAMELY, OFFERING BUSINESS MANAGEMENT ASSISTANCE IN THE ESTABLISHMENT AND/OR OPERATION OF RESTAURANTS (U.S. CLS. 100, 101 AND 102).

FIRST USE 5-13-2013; IN COMMERCE 5-13-2013.

**CLASS 7—MACHINERY**

FOR MOTORS AND CLUTCHES FOR WINDOW SHADE SYSTEMS (U.S. CLS. 13, 19, 21, 23, 31, 34 AND 35).

FIRST USE 4-19-2013; IN COMMERCE 4-19-2013.

**CLASS 43—HOTEL AND RESTAURANT SERVICES**

FOR PROVIDING FOOD AND DRINK; CAFES; CAFETERIAS; CANTEENS; RESTAURANT SERVICES; SELF-SERVICE RESTAURANTS; SNACK-BARS; BAR SERVICES; CATERING SERVICES; FOOD AND DRINK CATERING; RESTAURANT SERVICES WITH FOOD TAKEAWAY SERVICES; RENTAL OF CHAIRS, TABLES, TABLE LINEN AND GLASSWARE (U.S. CLS. 100 AND 101).

FIRST USE 5-13-2013; IN COMMERCE 5-13-2013.

**CLASS 20—FURNITURE AND ARTICLES NOT OTHERWISE CLASSIFIED**

FOR HARDWARE FOR WINDOW SHADE SYSTEMS, NAMELY, NON-METAL BRACKETS AND CRANKS (U.S. CLS. 2, 13, 22, 25, 32 AND 50).

FIRST USE 4-19-2013; IN COMMERCE 4-19-2013.

4,482,615. SILVEREDGE, LLC, FORMERLY PFC PAYMENT SOLUTIONS, LLC, LOVELAND, CO. SN 85-894,967. PUB. 6-18-2013, FILED 4-4-2013.

4,482,625. FREEPORT COBALT AMERICAS LLC, PHOENIX, AZ. SN 85-899,200. PUB. 9-17-2013, FILED 4-9-2013.



THE COLOR(S) SILVER AND BLUE IS/ARE CLAIMED AS A FEATURE OF THE MARK.

THE MARK CONSISTS OF THE WORD "SILVEREDGE" IN BLUE TO THE RIGHT OF A DESIGN IN WHICH 3 SILVER TRIANGLES FORM THE SIDES OF A LARGER TRIANGLE. THE COLORS BLACK, WHITE AND/OR GRAY REPRESENT BACKGROUND, OUTLINING, SHADING AND/OR TRANSPARENT AREAS AND ARE NOT PART OF THE MARK.

#### CLASS 9—ELECTRICAL AND SCIENTIFIC APPARATUS

FOR COMPUTER APPLICATION SOFTWARE FOR MOBILE PHONES, HANDHELD COMPUTERS, TABLET COMPUTERS, NAMELY, SOFTWARE FOR FACILITATING MERCHANT ACCESS TO BUSINESS SERVICES, PAYMENT TRANSACTION PROCESSING, CREDIT CARD PROCESSING, GIFT AND LOYALTY CARD PROCESSING, INTERNET MARKETING, PROMOTION SERVICES, PAYROLL PROCESSING, PAYMENT GATEWAYS FOR CUSTOMERS, MOBILE AND POINT OF SALE PAYMENT SYSTEMS; COMPUTER SOFTWARE PLATFORMS FOR FACILITATING MERCHANT ACCESS TO BUSINESS SERVICES, PAYMENT TRANSACTION PROCESSING, CREDIT CARD PROCESSING, GIFT AND LOYALTY CARD PROCESSING, INTERNET MARKETING, PROMOTION SERVICES, PAYROLL PROCESSING, PAYMENT GATEWAYS FOR CUSTOMERS, MOBILE AND POINT OF SALE PAYMENT SYSTEMS (U.S. CLS. 21, 23, 26, 36 AND 38).

FIRST USE 4-15-2013; IN COMMERCE 4-15-2013.

#### CLASS 35—ADVERTISING AND BUSINESS

FOR VALUE-ADDED RESELLER SERVICES, NAMELY, DISTRIBUTORSHIP SERVICES FEATURING MERCHANT SERVICES, PAYMENT TRANSACTION PROCESSING SERVICES, CREDIT CARD PROCESSING SERVICES, LOYALTY PROGRAM AND SOCIAL COMMERCE PAYMENT SERVICES, PAYMENT GATEWAYS, MOBILE AND POINT OF SALE PAYMENT SYSTEMS (U.S. CLS. 100, 101 AND 102).

FIRST USE 4-15-2013; IN COMMERCE 4-15-2013.

#### CLASS 36—INSURANCE AND FINANCIAL

FOR MERCHANT SERVICES, NAMELY, PAYMENT TRANSACTION PROCESSING SERVICES (U.S. CLS. 100, 101 AND 102).

FIRST USE 4-15-2013; IN COMMERCE 4-15-2013.

## FREEPORT COBALT

THE MARK CONSISTS OF STANDARD CHARACTERS WITHOUT CLAIM TO ANY PARTICULAR FONT, STYLE, SIZE, OR COLOR.

NO CLAIM IS MADE TO THE EXCLUSIVE RIGHT TO USE "COBALT", APART FROM THE MARK AS SHOWN.

#### CLASS 1—CHEMICALS

FOR COBALT ACETATES; COBALT CARBONATES; COBALT HYDROXIDES; COBALT OXIDES; COBALT SULFATES; MIXED METAL HYDROXIDES (U.S. CLS. 1, 5, 6, 10, 26 AND 46).

FIRST USE 7-0-2013; IN COMMERCE 7-0-2013.

#### CLASS 6—METAL GOODS

FOR COBALT POWDERS; NON-FERROUS METALS, NAMELY, COBALT (U.S. CLS. 2, 12, 13, 14, 23, 25 AND 50).

FIRST USE 7-0-2013; IN COMMERCE 7-0-2013.

4,482,633. KEYSTONE PEER REVIEW ORGANIZATION, INC., HARRISBURG, PA. SN 85-904,015. PUB. 9-10-2013, FILED 4-15-2013.

OWNER OF U.S. REG. NO. 3,885,092.

THE MARK CONSISTS OF THE WORD "KEPRO".

#### CLASS 35—ADVERTISING AND BUSINESS

FOR BUSINESS MANAGEMENT SERVICES, NAMELY, INTEGRATING BEHAVIORAL HEALTH MANAGEMENT AND BEHAVIORAL HEALTH WORK-LIFE MANAGEMENT PROGRAMS FOR EMPLOYERS, EMPLOYEES, GROUP MEMBERS, AND CONSUMERS WITH OUR CARE MANAGEMENT SERVICES (U.S. CLS. 100, 101 AND 102).

FIRST USE 9-3-2013; IN COMMERCE 9-3-2013.

#### CLASS 36—INSURANCE AND FINANCIAL

FOR REVIEW OF HEALTHCARE COVERAGE REQUESTS AND BENEFITS ELIGIBILITY, NAMELY, INSURANCE CLAIMS PROCESSING (U.S. CLS. 100, 101 AND 102).

FIRST USE 9-3-2013; IN COMMERCE 9-3-2013.

4,482,639. SUNKIST GROWERS, INC., SHERMAN OAKS, CA. SN 85-908,195. PUB. 9-3-2013, FILED 4-18-2013.

4,482,654. UNIVERSITY OF CONNECTICUT, STORRS, CT. SN 85-923,850. PUB. 8-6-2013, FILED 5-6-2013.

## SUNKIST BOOST

THE MARK CONSISTS OF STANDARD CHARACTERS WITHOUT CLAIM TO ANY PARTICULAR FONT, STYLE, SIZE, OR COLOR.

OWNER OF U.S. REG. NOS. 72,087, 1,692,224, AND OTHERS.

### CLASS 29—MEATS AND PROCESSED FOODS

FOR PROCESSED EDIBLE SEEDS; PROCESSED NUTS (U.S. CL. 46).  
FIRST USE 6-15-2013; IN COMMERCE 6-15-2013.

### CLASS 31—NATURAL AGRICULTURAL PRODUCTS

FOR UNPROCESSED NUTS (U.S. CLS. 1 AND 46).  
FIRST USE 6-15-2013; IN COMMERCE 6-15-2013.



THE MARK CONSISTS OF A HUSKY DOG FACE WITH MOUTH SLIGHTLY OPEN. THE FACE IS OUTLINED IN A HEAVY BLACK LINE.

### CLASS 16—PAPER GOODS AND PRINTED MATTER

FOR DECALS; PENCILS; PENS; TEMPORARY TATTOOS (U.S. CLS. 2, 5, 22, 23, 29, 37, 38 AND 50).  
FIRST USE 7-1-2013; IN COMMERCE 7-1-2013.

### CLASS 21—HOUSEWARES AND GLASS

FOR COASTERS, NOT OF PAPER AND OTHER THAN TABLE LINEN; CUPS AND MUGS; DRINKING GLASSES; PILSNER DRINKING GLASSES; SALT AND PEPPER SHAKERS; SHOT GLASSES; SPORTS BOTTLES SOLD EMPTY; TRAINING CUPS FOR BABIES AND CHILDREN (U.S. CLS. 2, 13, 23, 29, 30, 33, 40 AND 50).  
FIRST USE 7-1-2013; IN COMMERCE 7-1-2013.

### CLASS 25—CLOTHING

FOR CAPS; COATS; GLOVES; HATS; JACKETS; JERSEYS; RAINWEAR; SCARVES; SHIRTS; SOCKS; SWEATERS; SWEATPANTS; SWEATSHIRTS; UNDERGARMENTS; UNIFORMS (U.S. CLS. 22 AND 39).  
FIRST USE 4-18-2013; IN COMMERCE 4-18-2013.

### CLASS 28—TOYS AND SPORTING GOODS

FOR BASKETBALLS; FOOTBALLS; GOLF CLUB COVERS; ORDINARY PLAYING CARDS (U.S. CLS. 22, 23, 38 AND 50).  
FIRST USE 7-1-2013; IN COMMERCE 7-1-2013.

### CLASS 41—EDUCATION AND ENTERTAINMENT

FOR EDUCATING AT UNIVERSITY OR COLLEGES; EDUCATIONAL SERVICES, NAMELY, PROVIDING COURSES OF INSTRUCTION AT THE UNIVERSITY LEVEL; ENTERTAINMENT, NAMELY, LIVE PERFORMANCES BY MUSICAL BANDS; ORGANIZING AND CONDUCTING COLLEGE SPORT COMPETITIONS AND ATHLETIC EVENTS; RESEARCH IN THE FIELD OF EDUCATION (U.S. CLS. 100, 101 AND 107).  
FIRST USE 7-1-2013; IN COMMERCE 7-1-2013.

4,482,646. FRITO-LAY NORTH AMERICA, INC., PLANO, TX. SN 85-917,240. PUB. 8-13-2013, FILED 4-29-2013.

## THRILL THEM WITH SPINE TINGLING TREATS

THE MARK CONSISTS OF STANDARD CHARACTERS WITHOUT CLAIM TO ANY PARTICULAR FONT, STYLE, SIZE, OR COLOR.

### CLASS 29—MEATS AND PROCESSED FOODS

FOR DIPS; POTATO-BASED SNACK FOODS (U.S. CL. 46).  
FIRST USE 10-2-2013; IN COMMERCE 10-2-2013.

### CLASS 30—STAPLE FOODS

FOR CORN-BASED SNACK FOODS; MULTIGRAIN-BASED SNACK FOODS; PRETZELS; SALSA (U.S. CL. 46).  
FIRST USE 10-2-2013; IN COMMERCE 10-2-2013.

4,482,670. ACADEMIXDIRECT, INC., MOUNTAIN VIEW, CA. SN 85-979,341. PUB. 9-25-2012, FILED 11-30-2011.

## SCHOOLSPOT

THE MARK CONSISTS OF STANDARD CHARACTERS WITHOUT CLAIM TO ANY PARTICULAR FONT, STYLE, SIZE, OR COLOR.

### CLASS 35—ADVERTISING AND BUSINESS

FOR ADVERTISING, MARKETING, AND PROMOTIONAL SERVICES, NAMELY, PROVIDING DEMAND CREATION AND LEAD GENERATION ACTIVITIES AND SERVICES; PROVIDING A SEARCHABLE ONLINE ADVERTISING WEBSITE FEATURING THE GOODS AND SERVICES OF OTHER VENDORS VIA THE INTERNET IN THE FIELDS OF EDUCATION, CHILD CARE, GAMES, SOFTWARE, LIBRARIES, MUSEUMS, HISTORIC SITES, K-12, COLLEGE, AND UNIVERSITY CLASSROOM INSTRUCTION INFORMATION SERVICES; PROVIDING AN ONLINE SEARCHABLE ADVERTISING DATABASE WEBSITE FEATURING THE GOODS AND SERVICES OF OTHER VENDORS VIA THE INTERNET IN THE FIELDS OF EDUCATION, CHILD CARE, COMPUTER GAMES, EDUCATIONAL SOFTWARE, LIBRARIES, MUSEUMS, AND HISTORIC SITES (U.S. CLS. 100, 101 AND 102).

FIRST USE 1-31-2012; IN COMMERCE 1-31-2012.

### CLASS 41—EDUCATION AND ENTERTAINMENT

FOR EDUCATIONAL COUNSELING SERVICES TO ASSIST STUDENTS IN PLANNING AND PREPARING FOR FURTHER EDUCATION; ENTERTAINMENT SERVICES, NAMELY, PROVIDING A WEBSITE FEATURING NON-DOWNLOADABLE ON-LINE INTERACTIVE EDUCATIONAL COMPUTER GAMES; PROVIDING AN ON-LINE SEARCHABLE DATABASE FEATURING INFORMATION ABOUT ONLINE COMPUTER GAME SOFTWARE; PROVIDING AN ON-LINE SEARCHABLE DATABASE FEATURING INFORMATION ABOUT EDUCATION; PROVIDING AN ON-LINE SEARCHABLE DATABASE FEATURING INFORMATION ABOUT GUIDED TOURS OF LIBRARIES, MUSEUMS, AND HISTORIC SITES; PROVIDING A WEBSITE FEATURING NEWS IN THE FIELD OF CURRENT EVENTS RELATING TO EDUCATION, CHILD CARE SERVICES, VIDEO GAMES, EDUCATIONAL SOFTWARE, LIBRARIES, MUSEUMS, AND HISTORIC SITES; PROVIDING A WEBSITE FEATURING INFORMATION IN THE FIELD OF EDUCATIONAL GUIDED TOURS OF LIBRARIES, MUSEUMS, AND HISTORIC SITES (U.S. CLS. 100, 101 AND 107).

FIRST USE 1-31-2012; IN COMMERCE 1-31-2012.

4,482,674. WELLPOINT, INC., INDIANAPOLIS, IN. SN 85-980,287. PUB. 8-14-2012, FILED 8-22-2011.

## WELLPOINT

THE MARK CONSISTS OF STANDARD CHARACTERS WITHOUT CLAIM TO ANY PARTICULAR FONT, STYLE, SIZE, OR COLOR.

OWNER OF U.S. REG. NOS. 2,002,076, 2,927,116, AND OTHERS.

### CLASS 35—ADVERTISING AND BUSINESS

FOR COST MANAGEMENT FOR THE HEALTH CARE BENEFIT PLANS OF OTHERS; HEALTH CARE COST CONTAINMENT; HEALTH CARE UTILIZATION REVIEW SERVICES; BUSINESS SERVICES PROVIDED TO THE HEALTH CARE AND INSURANCE INDUSTRIES, NAMELY, THE COLLECTION, REPORTING, AND ANALYSIS OF HEALTH CARE INFORMATION AND HEALTH CARE COST AND QUALITY DATA FOR BUSINESS PURPOSES (U.S. CLS. 100, 101 AND 102).

FIRST USE 4-17-2008; IN COMMERCE 4-17-2008.

### CLASS 44—MEDICAL, BEAUTY AND AGRICULTURAL SERVICES

FOR MEDICAL COUNSELING; PERSONAL MEDICAL HISTORY MANAGEMENT SERVICES, NAMELY, MAINTAINING COMPUTERIZED MEDICAL DATA, CLAIM DATA AND DATABASES CONTAINING THE MEDICAL CONDITION OF INDIVIDUALS FOR MEDICAL MANAGEMENT PURPOSES; PROVIDING AN ONLINE MEDICAL HEALTH RECORDS DATABASE; WELLNESS AND HEALTH-RELATED CONSULTING SERVICES; CONSULTING SERVICES IN THE FIELD OF MEDICAL CARE (U.S. CLS. 100 AND 101).

FIRST USE 4-17-2008; IN COMMERCE 4-17-2008.

4,482,676. GIFT CARD IMPRESSIONS, LLC, OVERLAND PARK, KS. SN 85-980,440. PUB. 1-22-2013, FILED 5-15-2012.

## FLOWER BUDDIES

THE MARK CONSISTS OF STANDARD CHARACTERS WITHOUT CLAIM TO ANY PARTICULAR FONT, STYLE, SIZE, OR COLOR.

NO CLAIM IS MADE TO THE EXCLUSIVE RIGHT TO USE "FLOWER", APART FROM THE MARK AS SHOWN.

### CLASS 9—ELECTRICAL AND SCIENTIFIC APPARATUS

FOR PAPER GIFT CARD HOLDERS FOR MAGNETICALLY ENCODED GIFT CARDS, PAPER HOLDERS SPECIALLY ADAPTED FOR HOLDING MAGNETICALLY ENCODED GIFT CARDS (U.S. CLS. 21, 23, 26, 36 AND 38).

FIRST USE 4-30-2013; IN COMMERCE 4-30-2013.

### CLASS 16—PAPER GOODS AND PRINTED MATTER

FOR PAPER GIFT CARD HOLDERS FOR NON-MAGNETICALLY ENCODED GIFT CARDS (U.S. CLS. 2, 5, 22, 23, 29, 37, 38 AND 50).

FIRST USE 4-30-2013; IN COMMERCE 4-30-2013.

4,482,678. MAXIMIZED LIVING HEALTH CENTERS, LLC, CELEBRATION, FL. AND MAX 3, LLC, CELEBRATION, FL. SN 85-980,524. PUB. 9-6-2011, FILED 4-20-2011.

## 5 ESSENTIALS

THE MARK CONSISTS OF STANDARD CHARACTERS WITHOUT CLAIM TO ANY PARTICULAR FONT, STYLE, SIZE, OR COLOR.

### CLASS 5—PHARMACEUTICALS

FOR VITAMIN, MINERAL, AND HERBAL SUPPLEMENTS, PROTEIN-BASED NUTRITIONALLY FORTIFIED SHAKES AND BEVERAGES, NUTRITIONALLY FORTIFIED BEVERAGES (U.S. CLS. 6, 18, 44, 46, 51 AND 52).

FIRST USE 1-15-2011; IN COMMERCE 1-15-2011.

### CLASS 41—EDUCATION AND ENTERTAINMENT

FOR CONDUCTING SEMINARS AND EDUCATIONAL PROGRAMS IN THE FIELD OF STRESS MANAGEMENT, PERSONAL INSPIRATION AND PHILOSOPHY, SPIRITUAL CONTROL, BIBLICAL TEACHINGS, NUTRITION, HEALTH, AND WELLNESS (U.S. CLS. 100, 101 AND 107).

FIRST USE 1-1-2013; IN COMMERCE 1-1-2013.

### CLASS 44—MEDICAL, BEAUTY AND AGRICULTURAL SERVICES

FOR CHIROPRACTIC SERVICES (U.S. CLS. 100 AND 101).

FIRST USE 1-15-2011; IN COMMERCE 1-15-2011.

4,482,679. CHURCH & DWIGHT CO., INC., EWING, NJ. SN 85-980,568. PUB. 9-4-2012, FILED 4-16-2012.

## OXICLEAN

THE MARK CONSISTS OF STANDARD CHARACTERS WITHOUT CLAIM TO ANY PARTICULAR FONT, STYLE, SIZE, OR COLOR.

OWNER OF U.S. REG. NOS. 2,430,077, 3,786,100, AND OTHERS.

### CLASS 21—HOUSEWARES AND GLASS

FOR CLEANING BRUSHES FOR HOUSEHOLD USE; CLEANING CLOTHS; CLEANING SPONGES; CLOTH FOR WIPING OR DUSTING; GLOVES FOR HOUSEHOLD PURPOSES; HOUSEHOLD SCOURING PADS; SCOURING SPONGES; SCRUBBING BRUSHES; SPONGES FOR HOUSEHOLD PURPOSES (U.S. CLS. 2, 13, 23, 29, 30, 33, 40 AND 50).

FIRST USE 10-1-2013; IN COMMERCE 10-1-2013.

### CLASS 24—FABRICS

FOR DISH CLOTHS; KITCHEN TOWELS (U.S. CLS. 42 AND 50).

FIRST USE 10-1-2013; IN COMMERCE 10-1-2013.

4,482,682. BABYQ, LLC, GRAND RAPIDS, MI. SN 85-980,645. PUB. 4-30-2013, FILED 5-4-2012.



NO CLAIM IS MADE TO THE EXCLUSIVE RIGHT TO USE "BABY", APART FROM THE MARK AS SHOWN.

THE MARK CONSISTS OF STYLIZED LOWER CASE LETTERS "BABY" FOLLOWED BY UPPER CASE BOLD STYLIZED LETTER "Q".

### CLASS 9—ELECTRICAL AND SCIENTIFIC APPARATUS

FOR COMPUTER SOFTWARE FOR MEASURING PRENATAL AND POSTNATAL DEVELOPMENT (U.S. CLS. 21, 23, 26, 36 AND 38).

FIRST USE 8-7-2012; IN COMMERCE 8-7-2012.

### CLASS 41—EDUCATION AND ENTERTAINMENT

FOR EDUCATIONAL SERVICES, NAMELY, SPEAKERS, LECTURES, WORKSHOPS, AND PRESENTATIONS IN THE FIELD OF PRENATAL, POSTNATAL DEVELOPMENT AND ENCOURAGING HEALTHY BEHAVIOR, NUTRITION, EXERCISE, AND AVOIDANCE OF SMOKING AND ALCOHOL FOR EXPECTANT MOTHERS; PROVIDING ONLINE INFORMATION IN THE FIELD OF EXERCISE; AND PROVIDING TRAINING FOR EXPECTANT MOTHERS ON SELF-MONITORING AND SELF-MEASURING OF FETAL DEVELOPMENT (U.S. CLS. 100, 101 AND 107).

FIRST USE 8-16-2013; IN COMMERCE 8-16-2013.

### CLASS 44—MEDICAL, BEAUTY AND AGRICULTURAL SERVICES

FOR PROVIDING MEDICAL INFORMATION REGARDING THE MONITORING AND MEASURING OF PRENATAL, FETAL, AND POSTNATAL DEVELOPMENT BY EXPECTANT MOTHERS, AND REGARDING HEALTHY BEHAVIOR, NUTRITION, EXERCISE, AND AVOIDANCE OF SMOKING AND ALCOHOL FOR EXPECTANT MOTHERS TO ENHANCE PRENATAL, FETAL, AND POSTNATAL DEVELOPMENT; PROVIDING ONLINE INFORMATION IN THE FIELD OF HEALTH, NUTRITION, PRENATAL, AND POSTNATAL DEVELOPMENT (U.S. CLS. 100 AND 101).

FIRST USE 8-7-2012; IN COMMERCE 8-7-2012.



4,482,687. A.E. YAYINCILIK, FILM, REKLAM, BILG. VE ORG. HIZ. LTD. STI., ISTANBUL, TURKEY. SN 85-980,737. PUB. 10-9-2012, FILED 4-18-2012.



THE MARK CONSISTS OF THE STYLIZED WORDS "BLU" AND "BOO" SEPARATED BY A DOT BETWEEN THEM. INSIDE EACH OF THE LETTERS "O" IS A DOT, INTENDED TO REPRESENT A PAIR OF EYES.

**CLASS 9—ELECTRICAL AND SCIENTIFIC APPARATUS**

FOR PORTABLE AND HANDHELD ELECTRONIC DEVICES FOR TRANSMITTING, STORING, MANIPULATING, RECORDING, AND REVIEWING TEXT, IMAGES, AUDIO, VIDEO AND DATA; AND SOFTWARE PROGRAMS FOR EDUCATIONAL AND ENTERTAINMENT PURPOSES (U.S. CLS. 21, 23, 26, 36 AND 38).  
FIRST USE 4-26-2012; IN COMMERCE 12-10-2012.

**CLASS 28—TOYS AND SPORTING GOODS**

FOR HAND-HELD ELECTRONIC VIDEO MACHINES WITH LIQUID CRYSTAL DISPLAYS FOR PLAYING GAMES AND FOR LEARNING FROM EDUCATIONAL PROGRAMS (U.S. CLS. 22, 23, 38 AND 50).  
FIRST USE 4-26-2012; IN COMMERCE 12-10-2012.

4,482,690. DEALER TIRE, LLC, CLEVELAND, OH. SN 85-980,790. PUB. 9-11-2012, FILED 11-16-2011.



THE MARK CONSISTS OF STANDARD CHARACTERS WITHOUT CLAIM TO ANY PARTICULAR FONT, STYLE, SIZE, OR COLOR.

**CLASS 35—ADVERTISING AND BUSINESS**

FOR ON-LINE RETAIL STORE SERVICES FEATURING A VARIETY OF GOODS OF OTHERS IN THE AUTOMOTIVE FIELD; COMPUTERIZED ON-LINE ORDERING SERVICES IN THE FIELD OF AUTOMOTIVE TIRES, PARTS, AND ACCESSORIES FOR OTHERS; ON-LINE DISTRIBUTORSHIP SERVICES IN THE FIELD OF AUTOMOTIVE TIRES, PARTS, AND ACCESSORIES; ONLINE RETAIL SERVICES THROUGH DIRECT SOLICITATION DIRECTED TO END-USERS IN THE FIELD OF AUTOMOTIVE TIRES, PARTS, AND ACCESSORIES; BUSINESS MARKETING CONSULTING SERVICES IN THE FIELD OF AUTOMOTIVE TIRES, PARTS, AND ACCESSORIES; ADVERTISING, MARKETING, AND PROMOTION SERVICES; APPOINTMENT SCHEDULING SERVICES FOR THE REPAIR OR SALE AND INSTALLATION OF AUTOMOTIVE TIRES, PARTS, AND ACCESSORIES FOR OTHERS VIA THE INTERNET OR OTHER COMMUNICATIONS NETWORKS; PROVIDING A SEARCHABLE DATABASE FEATURING AUTOMOTIVE AND/OR TIRE INFORMATION FOR CONSUMERS IN THE FIELD OF AUTOMOTIVE TIRES, PARTS, AND ACCESSORIES (U.S. CLS. 100, 101 AND 102).  
FIRST USE 8-20-2012; IN COMMERCE 8-20-2012.

**CLASS 36—INSURANCE AND FINANCIAL**

FOR FINANCIAL SERVICES, NAMELY, ELECTRONIC FUNDS TRANSFER VIA ELECTRONIC COMMUNICATIONS NETWORKS; CLEARING AND RECONCILING FINANCIAL TRANSACTIONS VIA ELECTRONIC COMMUNICATIONS NETWORKS; PROVIDING PAYMENT AND FINANCIAL SERVICES, NAMELY, PROCESSING AND TRANSMISSION OF BILLS AND PAYMENTS THEREOF, BILL PAYMENT SERVICES, ALL CONDUCTED VIA THE INTERNET OR OTHER COMMUNICATIONS NETWORKS (U.S. CLS. 100, 101 AND 102).  
FIRST USE 8-20-2012; IN COMMERCE 8-20-2012.

**CLASS 37—CONSTRUCTION AND REPAIR**

FOR PROVIDING AN ONLINE COMPUTERIZED DATABASE FEATURING INFORMATION ABOUT THE INSTALLATION AND MAINTENANCE OF TIRES AND AUTOMOTIVE PARTS AND ACCESSORIES; PROVIDING A SEARCHABLE DATABASE FEATURING INFORMATION IN THE FIELD OF INSTALLATION, MAINTENANCE AND REPAIR OF AUTOMOTIVE TIRES, PARTS, AND ACCESSORIES FOR OTHERS VIA THE INTERNET OR OTHER COMMUNICATIONS NETWORKS (U.S. CLS. 100, 103 AND 106).  
FIRST USE 8-20-2012; IN COMMERCE 8-20-2012.

4,482,691. DALTON-RUHLMAN VENTURE, LLC, CLEVELAND HTS., OH. SN 85-980,793. PUB. 3-12-2013, FILED 4-20-2012.



THE MARK CONSISTS OF LADLE UNDER THE VERTICAL LETTERS "D R" SEPARATED BY A DOT.

**CLASS 8—HAND TOOLS**

FOR SPOONS AND MALLETS (U.S. CLS. 23, 28 AND 44).  
FIRST USE 11-1-2011; IN COMMERCE 11-1-2011.

**CLASS 21—HOUSEWARES AND GLASS**

FOR HOUSEHOLD UTENSILS, NAMELY, POT AND PAN SCRUBBERS, POT AND PAN SCRAPERS, SPATULAS, PADDLES FOR USE IN COOKING, MAGNETIC KNIFE RACK, MAGNETIC SPICE RACK, CAKE RING, COOKWARE, POTS AND PANS, CHEESE BOARD AND SPREADER SET, SAUSAGE FORK, SLOTTED SPOONS, SERVING, BASTING AND TASTING SPOONS, WIRE BASKETS (U.S. CLS. 2, 13, 23, 29, 30, 33, 40 AND 50).  
FIRST USE 11-1-2011; IN COMMERCE 11-1-2011.

**CLASS 42—SCIENTIFIC AND COMPUTER SERVICES**

FOR CONSULTATION, INSPECTION AND QUALITY CONTROL RELATED TO THE DESIGN OF PROFESSIONAL RECORDING EQUIPMENT; INSPECTION AND QUALITY CONTROL, ALL RELATING TO THE MAKING OF SOUND RECORDINGS, TO THE TRANSFER OF SOUND RECORDINGS ONTO FILM, TO THE DUPLICATION OF AUDIO OR VIDEO RECORDINGS AND TO THE SURVEYING OF THEATERS AND OF CINEMAS FOR THE INSTALLATION OF SOUND REPRODUCING EQUIPMENT IN THEATERS AND CINEMAS; CONSULTATION FOR THE BENEFIT OF OTHERS RELATING TO THE SURVEYING OF THEATERS AND OF CINEMAS FOR THE INSTALLATION OF SOUND REPRODUCING EQUIPMENT IN THEATERS (U.S. CLS. 100 AND 101).  
FIRST USE 5-0-2012; IN COMMERCE 5-0-2012.

4,482,692. DOLBY LABORATORIES LICENSING CORPORATION, SAN FRANCISCO, CA. SN 85-980,797. PUB. 11-13-2012, FILED 2-24-2012.

**DOLBY ATMOS**

THE MARK CONSISTS OF STANDARD CHARACTERS WITHOUT CLAIM TO ANY PARTICULAR FONT, STYLE, SIZE, OR COLOR.

**CLASS 9—ELECTRICAL AND SCIENTIFIC APPARATUS**

FOR ANALOG AND DIGITAL SOUND ENHANCING APPARATUS AND SOFTWARE FOR USE IN CONNECTION WITH THE PROCESSING, RECORDING, REPRODUCTION, STREAMING, TRANSMISSION, AND RECEPTION OF ELECTRONIC OR DIGITAL SIGNALS; ALIGNMENT AND TEST EQUIPMENT FOR ELECTRONIC APPARATUS; COMPUTER PROGRAMS, COMPUTER SOFTWARE, COMPUTER HARDWARE AND COMPONENTS OF COMPUTERS AND OTHER DIGITAL DEVICES USED FOR GENERATING, PROCESSING, MEASURING, ANALYZING, RECORDING, AMPLIFYING, ENHANCING, REPRODUCING, TRANSMITTING, CONTROLLING, TESTING, RECEIVING AND PLAYING AUDIO SIGNALS, FILES AND SOUNDS, AND VISUAL SIGNALS, FILES AND IMAGES; MULTI-CHANNEL SOUND PROCESSORS; CINEMA SOUND PROCESSORS FOR MOTION PICTURE SOUND TRACKS; SURROUND ADAPTER UNITS FOR USE IN THEATERS; CINEMATOGRAPHIC EQUIPMENT, ALIGNMENT AND TEST EQUIPMENT FOR USE WITH AUDIO AND VIDEO EQUIPMENT USED IN CONNECTION WITH THE PROCESSING, RECORDING, REPRODUCTION, STREAMING, TRANSMISSION, AND RECEPTION OF ELECTRONIC OR DIGITAL SIGNALS (U.S. CLS. 21, 23, 26, 36 AND 38).  
FIRST USE 4-23-2012; IN COMMERCE 6-14-2012.

**CLASS 41—EDUCATION AND ENTERTAINMENT**

FOR EDUCATIONAL SERVICES, NAMELY, CONDUCTING TRAINING COURSES FOR AUDIO ENGINEERS AND FOR CINEMA TECHNICIANS IN THE FIELD OF MOTION PICTURE THEATRE SOUND SYSTEM INSTALLATION, OPERATION AND MAINTENANCE; CONSULTATION RELATING TO SOUND RECORDING PRODUCTION (U.S. CLS. 100, 101 AND 107).  
FIRST USE 5-0-2012; IN COMMERCE 5-0-2012.

4,482,699. DUANE READE INTERNATIONAL, LLC, NEW YORK, NY. SN 85-980,919. PUB. 11-6-2012, FILED 3-25-2011.

**UP MARKET**

THE MARK CONSISTS OF STANDARD CHARACTERS WITHOUT CLAIM TO ANY PARTICULAR FONT, STYLE, SIZE, OR COLOR.

**CLASS 29—MEATS AND PROCESSED FOODS**

FOR SOUPS; YOGURT; VEGETABLE SALADS; GARDEN SALAD; CAESAR SALAD; FRUIT-BASED FOOD BEVERAGES; PRE-CUT VEGETABLE SALAD (U.S. CL. 46).  
FIRST USE 1-10-2012; IN COMMERCE 1-10-2012.

**CLASS 30—STAPLE FOODS**

FOR COFFEE; BEVERAGES MADE OF COFFEE; TEA; CAKES; DECAFFEINATED COFFEE; ICE TEA; BREAKFAST CEREALS; FRUIT TEAS (U.S. CL. 46).  
FIRST USE 1-10-2012; IN COMMERCE 1-10-2012.

**CLASS 32—LIGHT BEVERAGES**

FOR FROZEN FRUIT BEVERAGES; FRUIT BEVERAGES; FRUIT-BASED BEVERAGES; LEMONADE; FRUIT JUICE; NON-ALCOHOLIC BEVERAGES, NAMELY, CARBONATED BEVERAGES; NON-ALCOHOLIC BEVERAGES CONTAINING FRUIT JUICES; ORANGE FLAVORED BEVERAGE; NON-ALCOHOLIC BEVERAGES, NAMELY, SODA, FRUIT JUICE, SODA POPS; SOFT DRINKS; ORANGE JUICE BEVERAGES; APPLE JUICE BEVERAGES; GRAPE JUICE BEVERAGES; POMEGRANATE JUICE BEVERAGES; CRANBERRY JUICE BEVERAGES; CRANBERRY AND APPLE MIXED JUICE BEVERAGES; CRANBERRY AND GRAPE MIXED JUICE BEVERAGES; STRAWBERRY JUICE BEVERAGES; VEGETABLE JUICE; COLAS; DRINKING WATER; FLAVORED WATER; FRUIT NECTARS; FRUIT FLAVORED BEVERAGES (U.S. CLS. 45, 46 AND 48).  
FIRST USE 1-10-2012; IN COMMERCE 1-10-2012.

## SECTION 2.— INTERNATIONAL CLASSIFICATION

The short titles associated below with the international class numbers are terms designed merely for quick identification and are not an official part of the international classification. The full names of international classes are given in section 6.1 of the trademark rules of practice.

The designation "U.S. Cl." appearing in this section refers to the U.S. class in effect prior to Sep. 1, 1973 rather than the international class which applies to applications filed on or after that date. For adoption of international classification see notice in the OFFICIAL GAZETTE of Jun. 26, 1973 (911 O.G. TM 210).

### Application in one class

#### CLASS 1—CHEMICALS

4,481,336. SAFETY-KLEEN SYSTEMS, INC., NORWELL, MA.  
SN 77-794,122. PUB. 10-5-2010, FILED 7-31-2009.

ECO POWER

THE MARK CONSISTS OF STANDARD CHARACTERS WITHOUT CLAIM TO ANY PARTICULAR FONT, STYLE, SIZE, OR COLOR.

OWNER OF U.S. REG. NO. 3,520,608.

NO CLAIM IS MADE TO THE EXCLUSIVE RIGHT TO USE "ECO", APART FROM THE MARK AS SHOWN.

FOR TRANSMISSION FLUID; HYDRAULIC FLUIDS; AND POWER STEERING FLUID (U.S. CLS. 1, 5, 6, 10, 26 AND 46).

FIRST USE 3-0-2013; IN COMMERCE 3-0-2013.

---

4,481,560. ECOBRITE, LLC, MINT HILL, NC. SN 85-429,885.  
PUB. 11-27-2012, FILED 9-22-2011.

GENERIC TRUE PRODUCTS

THE MARK CONSISTS OF STANDARD CHARACTERS WITHOUT CLAIM TO ANY PARTICULAR FONT, STYLE, SIZE, OR COLOR.

NO CLAIM IS MADE TO THE EXCLUSIVE RIGHT TO USE "GENERIC" AND "PRODUCTS", APART FROM THE MARK AS SHOWN.

FOR DEGREASING AGENTS (U.S. CLS. 1, 5, 6, 10, 26 AND 46).

FIRST USE 12-12-2011; IN COMMERCE 4-3-2012.

#### CLASS 1—(Continued).

4,481,606. NATRONX TECHNOLOGIES, LLC, PRINCETON, NJ. SN 85-475,036. PUB. 4-24-2012, FILED 11-17-2011.



NO CLAIM IS MADE TO THE EXCLUSIVE RIGHT TO USE "TECHNOLOGIES", APART FROM THE MARK AS SHOWN.

THE MARK CONSISTS OF THE WORDS "NATRONX TECHNOLOGIES" IN A STYLIZED PRESENTATION, IN WHICH THE "X" IN "NATRONX" APPEARS IN SUBSCRIPT, SUPERIMPOSED OVER A CIRCULAR GRAPHIC DESIGN.

FOR CHEMICALS FOR USE IN AIR QUALITY CONTROL APPLICATIONS (U.S. CLS. 1, 5, 6, 10, 26 AND 46).

FIRST USE 12-31-2011; IN COMMERCE 12-31-2011.

---

4,481,607. NATRONX TECHNOLOGIES, LLC, PRINCETON, NJ. SN 85-475,056. PUB. 4-24-2012, FILED 11-17-2011.

EARTH'S RESOURCES  
PROVIDING CLEANER AIR

THE MARK CONSISTS OF STANDARD CHARACTERS WITHOUT CLAIM TO ANY PARTICULAR FONT, STYLE, SIZE, OR COLOR.

NO CLAIM IS MADE TO THE EXCLUSIVE RIGHT TO USE "PROVIDING CLEANER AIR", APART FROM THE MARK AS SHOWN.

FOR CHEMICALS FOR USE IN AIR QUALITY CONTROL APPLICATIONS (U.S. CLS. 1, 5, 6, 10, 26 AND 46).

FIRST USE 12-31-2011; IN COMMERCE 12-31-2011.

**CLASS 1—(Continued).**

4,481,937. KENRICH PETROCHEMICALS, INC., BAYONNE, NJ. SN 85-697,335. PUB. 7-30-2013, FILED 8-7-2012.

# KZ

THE MARK CONSISTS OF STANDARD CHARACTERS WITHOUT CLAIM TO ANY PARTICULAR FONT, STYLE, SIZE, OR COLOR.

FOR CHEMICALS, NAMELY, COORDINATE ZIRCONATE, CYCLOHETEROATOM ZIRCONATE, COORDINATE PHOSPHITO ZIRCONATE, CYCLOHETEROATOM PYROPHOSPHATO ZIRCONATE (U.S. CLS. 1, 5, 6, 10, 26 AND 46).

FIRST USE 1-0-1983; IN COMMERCE 1-0-1984.

---

4,481,948. THE SCOTT FETZER COMPANY, WESTLAKE, OH. SN 85-701,613. PUB. 2-5-2013, FILED 8-13-2012.

# GRASS BLASTER

THE MARK CONSISTS OF STANDARD CHARACTERS WITHOUT CLAIM TO ANY PARTICULAR FONT, STYLE, SIZE, OR COLOR.

NO CLAIM IS MADE TO THE EXCLUSIVE RIGHT TO USE "GRASS", APART FROM THE MARK AS SHOWN.

FOR CHEMICAL SOLUTION WHICH CAN BE SPRAYED ON UNDERSIDE OF LAWMOWER TO LOOSEN AND REMOVE DRIED AND CAKED ON MUD, GRASS CLIPPINGS AND GRIME (U.S. CLS. 1, 5, 6, 10, 26 AND 46).

FIRST USE 4-29-2013; IN COMMERCE 4-29-2013.

---

4,481,987. BEST PRODUCTS INTERNATIONAL, INC., FLORENCE, KY. SN 85-718,229. PUB. 4-16-2013, FILED 8-31-2012.

# TRIBODYN

THE MARK CONSISTS OF STANDARD CHARACTERS WITHOUT CLAIM TO ANY PARTICULAR FONT, STYLE, SIZE, OR COLOR.

FOR CHEMICAL ADDITIVE FOR ENHANCING THE PERFORMANCE OF HYDROCARBON OIL-BASED PRODUCTS IN THE NATURE OF OILS, GREASES, AND PASTES (U.S. CLS. 1, 5, 6, 10, 26 AND 46).

FIRST USE 11-27-2013; IN COMMERCE 11-27-2013.

**CLASS 1—(Continued).**

4,482,137. VOGEL SEED & FERTILIZER, INC., DBA SPRING VALLEY TURF PRODUCTS, JACKSON, WI. SN 85-743,543. PUB. 3-19-2013, FILED 10-2-2012.

# PRO-GROW

THE MARK CONSISTS OF STANDARD CHARACTERS WITHOUT CLAIM TO ANY PARTICULAR FONT, STYLE, SIZE, OR COLOR.

FOR FERTILIZER (U.S. CLS. 1, 5, 6, 10, 26 AND 46).  
FIRST USE 2-15-2013; IN COMMERCE 2-15-2013.

---

4,482,316. CHEMQ BIOSCIENCE LLC, CARY, NC. SN 85-783,917. PUB. 4-23-2013, FILED 11-20-2012.

# VitroPrep

THE MARK CONSISTS OF STANDARD CHARACTERS WITHOUT CLAIM TO ANY PARTICULAR FONT, STYLE, SIZE, OR COLOR.

FOR DIAGNOSTIC PREPARATIONS FOR SCIENTIFIC OR RESEARCH USE; DIAGNOSTIC PREPARATIONS FOR CLINICAL OR MEDICAL LABORATORY USE; DIAGNOSTIC REAGENTS FOR CLINICAL OR MEDICAL LABORATORY USE; DIAGNOSTIC REAGENTS FOR IN VITRO USE IN BIOCHEMISTRY, CLINICAL CHEMISTRY AND MICROBIOLOGY (U.S. CLS. 1, 5, 6, 10, 26 AND 46).

FIRST USE 1-21-2013; IN COMMERCE 8-1-2013.

---

4,482,385. ACTIVE MICRO TECHNOLOGIES, LINCOLNTON, NC. SN 85-807,919. PUB. 5-14-2013, FILED 12-20-2012.

# AMTicide

THE MARK CONSISTS OF STANDARD CHARACTERS WITHOUT CLAIM TO ANY PARTICULAR FONT, STYLE, SIZE, OR COLOR.

FOR CHEMICAL ADDITIVES FOR USE IN THE MANUFACTURE OF COSMETICS (U.S. CLS. 1, 5, 6, 10, 26 AND 46).

FIRST USE 1-15-2013; IN COMMERCE 10-2-2013.

**CLASS 1—(Continued).**

4,482,447. JONATHAN GREEN & SONS, INC., FARMINGDALE, NJ. SN 85-832,547. PUB. 5-7-2013, FILED 1-25-2013.

LOVE YOUR LAWN  
LOVE YOUR SOIL

THE MARK CONSISTS OF STANDARD CHARACTERS WITHOUT CLAIM TO ANY PARTICULAR FONT, STYLE, SIZE, OR COLOR.

FOR FERTILIZER AND SOIL ENHANCER (U.S. CLS. 1, 5, 6, 10, 26 AND 46).

FIRST USE 3-7-2013; IN COMMERCE 3-8-2013.

**CLASS 1—(Continued).**

4,482,642. NEW DEAL TRADING, L.L.C., HOLLISTER, MO. SN 85-909,490. PUB. 9-10-2013, FILED 4-19-2013.

AEROMELT

THE MARK CONSISTS OF STANDARD CHARACTERS WITHOUT CLAIM TO ANY PARTICULAR FONT, STYLE, SIZE, OR COLOR.

FOR DEICING PREPARATIONS FOR USE ON AIRFIELDS, ON AIRPORT RUNWAYS, TAXIWAYS, RAMPS, APRONS, AND OTHER AIRPORT PARKING AND MOVEMENT AREAS FOR AIRCRAFT, AND ON HIGHWAYS, ROADS, STREETS, SIDEWALKS, DRIVEWAYS, PARKING LOTS, AND PARKING GARAGES (U.S. CLS. 1, 5, 6, 10, 26 AND 46).

FIRST USE 8-0-2013; IN COMMERCE 10-16-2013.

**CLASS 2—PAINTS**

4,481,980. S. C. JOHNSON & SON, INC., RACINE, WI. SN 85-717,360. PUB. 2-5-2013, FILED 8-30-2012.

MIDNIGHT CARBON

THE MARK CONSISTS OF STANDARD CHARACTERS WITHOUT CLAIM TO ANY PARTICULAR FONT, STYLE, SIZE, OR COLOR.

FOR CARPET AND FABRIC PAINT (U.S. CLS. 6, 11 AND 16).

FIRST USE 4-14-2013; IN COMMERCE 4-14-2013.

4,482,619. EDW C. LEVY CO., DEARBORN, MI. SN 85-896,405. PUB. 8-13-2013, FILED 4-5-2013.



THE COLOR(S) GREEN, LIGHT GREEN AND GRAY IS/ARE CLAIMED AS A FEATURE OF THE MARK.

THE MARK CONSISTS OF A GREEN SHIELD WITH A GRAY BORDER WITH A LIGHT GREEN LEAF ON THE INSIDE OF THE SHIELD.

FOR SOIL CONDITIONING CHEMICALS SOLD AS AN INGREDIENT OF FERTILIZERS (U.S. CLS. 1, 5, 6, 10, 26 AND 46).

FIRST USE 9-1-2013; IN COMMERCE 9-1-2013.

4,482,001. THE ARMOR ALL/STP PRODUCTS COMPANY, DANBURY, CT. SN 85-723,630. PUB. 3-12-2013, FILED 9-7-2012.

CUSTOM SHIELD

THE MARK CONSISTS OF STANDARD CHARACTERS WITHOUT CLAIM TO ANY PARTICULAR FONT, STYLE, SIZE, OR COLOR.

PRIORITY CLAIMED UNDER SEC. 44(D) ON CANADA APPLICATION NO. 1585272, FILED 7-9-2012.

FOR COATING PROTECTANT FOR VEHICLES TO PROTECT THE FINISH OF A PAINTED SURFACE AND TO ADD DECORATIVE FEATURES TO PAINTED SURFACES (U.S. CLS. 6, 11 AND 16).

FIRST USE 12-16-2012; IN COMMERCE 12-16-2012.

**CLASS 2—(Continued).**

4,482,161. CHR. HANSEN A/S, HORSHOLM, DENMARK. SN 85-747,047. PUB. 6-11-2013, FILED 10-5-2012.

# ICECOLOR

THE MARK CONSISTS OF STANDARD CHARACTERS WITHOUT CLAIM TO ANY PARTICULAR FONT, STYLE, SIZE, OR COLOR.

FOR COLORANTS AND COLOR PIGMENTS FOR USE IN THE MANUFACTURE OF FOOD, BEVERAGES, COSMETICS AND PHARMACEUTICALS (U.S. CLS. 6, 11 AND 16).

FIRST USE 9-1-2013; IN COMMERCE 9-1-2013.

4,482,163. CHR. HANSEN A/S, HORSHOLM, DENMARK. SN 85-747,134. PUB. 6-11-2013, FILED 10-5-2012.

# SWEETCOLOR

THE MARK CONSISTS OF STANDARD CHARACTERS WITHOUT CLAIM TO ANY PARTICULAR FONT, STYLE, SIZE, OR COLOR.

FOR COLORANTS AND COLOR PIGMENTS FOR USE IN THE MANUFACTURE OF FOOD, BEVERAGES, COSMETICS AND PHARMACEUTICALS (U.S. CLS. 6, 11 AND 16).

FIRST USE 9-1-2013; IN COMMERCE 9-1-2013.

**CLASS 3—COSMETICS AND CLEANING PREPARATIONS**

4,481,314. BOOTCUT BEAUTY LLC, DBA BODY LANGUAGE, DALLAS, TX. SN 77-318,013. PUB. 9-28-2010, FILED 10-31-2007.

# BODY LANGUAGE

THE MARK CONSISTS OF STANDARD CHARACTERS WITHOUT CLAIM TO ANY PARTICULAR FONT, STYLE, SIZE, OR COLOR.

OWNER OF U.S. REG. NO. 3,213,872.

**CLASS 3—(Continued).**

NO CLAIM IS MADE TO THE EXCLUSIVE RIGHT TO USE "BODY", APART FROM THE MARK AS SHOWN.

FOR BODY, SKIN CARE AND HAIR CARE PRODUCTS, NAMELY, FACIAL AND BODY SKIN CARE PRODUCTS, NAMELY, FACIAL AND BODY MOISTURIZERS, FACIAL AND BODY EXFOLIATION SCRUBS, FACIAL AND BODY WASHES, FACIAL AND BODY CLEANSERS; BODY OILS AND LOTIONS; BATH OILS; BATH SALTS; NON-MEDICATED TOILETRIES (U.S. CLS. 1, 4, 6, 50, 51 AND 52).

FIRST USE 12-30-2012; IN COMMERCE 11-21-2013.

4,481,319. CITROMAX S.A.C.I., TAFI VIEJO, ARGENTINA. SN 77-490,455. PUB. 9-25-2012, FILED 6-4-2008.

# CITROMAX

THE MARK CONSISTS OF STANDARD CHARACTERS WITHOUT CLAIM TO ANY PARTICULAR FONT, STYLE, SIZE, OR COLOR.

PRIORITY CLAIMED UNDER SEC. 44(D) ON ARGENTINA APPLICATION NO. 2817377, FILED 4-16-2008, REG. NO. 2470483, DATED 10-21-2011, EXPIRES 10-21-2021.

PRIORITY CLAIMED UNDER SEC. 44(D) ON ARGENTINA APPLICATION NO. 2817376, FILED 4-16-2008, REG. NO. 2422484, DATED 2-3-2011, EXPIRES 2-3-2021.

FOR (BASED ON USE IN COMMERCE) (BASED ON 44(E)) ESSENTIAL OILS FOR FLAVORING BEVERAGES; ESSENTIAL OILS FOR FOOD FLAVORINGS; ESSENTIAL OILS FOR PERSONAL USE; FOOD FLAVORING, BEING ESSENTIAL OILS; FOOD FLAVORINGS PREPARED FROM ESSENTIAL OILS (U.S. CLS. 1, 4, 6, 50, 51 AND 52).

FIRST USE 1-1-1998; IN COMMERCE 1-1-1998.

4,481,384. BEAUTY INNOVATION GROUP, LLC, SCOTTSDALE, AZ. SN 85-031,682. PUB. 10-5-2010, FILED 5-6-2010.

# ANGEL OF GOOD

THE MARK CONSISTS OF STANDARD CHARACTERS WITHOUT CLAIM TO ANY PARTICULAR FONT, STYLE, SIZE, OR COLOR.

FOR FRAGRANCES; HAIR CARE PREPARATIONS; NON-MEDICATED BATH PREPARATIONS; NON-MEDICATED SKIN CARE PREPARATIONS; SHOWER AND BATH GEL (U.S. CLS. 1, 4, 6, 50, 51 AND 52).

FIRST USE 11-22-2013; IN COMMERCE 11-22-2013.

**CLASS 3—(Continued).**

4,481,428. REVITA-DERM, INC., MIRAMAR, FL. SN 85-139,844. PUB. 3-8-2011, FILED 9-28-2010.

# IVITALIZE

THE MARK CONSISTS OF STANDARD CHARACTERS WITHOUT CLAIM TO ANY PARTICULAR FONT, STYLE, SIZE, OR COLOR.

FOR COSMETIC ANTI-WRINKLE CREAMS; SKIN CARE PRODUCTS, NAMELY, NON-MEDICATED SKIN CREAMS, MILKS, FLUIDS, SERUMS, LOTIONS, GELS, OILS, TONERS, CLEANSERS, PEELS, STRETCH MARK ELIMINATOR, FADE CREAMS, AND SOAPS; SKIN CARE PRODUCTS FOR THE FACE, NAMELY, NON-MEDICATED TONING AND ANTI-WRINKLE CREAMS, MILKS, FLUIDS, SERUMS, LOTIONS, GELS, OILS, TONERS, CLEANSERS, EYE LASH GROWTH SERUM, PEELS AND SOAPS; NON-MEDICATED SKIN CARE PRODUCTS FOR THE FEET, NAMELY, NON-MEDICATED FOOT CREAMS, LOTIONS, SCRUBS AND EXFOLIANTS (U.S. CLS. 1, 4, 6, 50, 51 AND 52).  
FIRST USE 5-11-2010; IN COMMERCE 5-11-2010.

4,481,446. PHYSICIANS FORMULA, INC., AZUSA, CA. SN 85-184,721. PUB. 4-26-2011, FILED 11-24-2010.

# GLOW & MOOD BOOSTING BRONZER

THE MARK CONSISTS OF STANDARD CHARACTERS WITHOUT CLAIM TO ANY PARTICULAR FONT, STYLE, SIZE, OR COLOR.

NO CLAIM IS MADE TO THE EXCLUSIVE RIGHT TO USE "BRONZER", APART FROM THE MARK AS SHOWN.  
FOR COSMETICS (U.S. CLS. 1, 4, 6, 50, 51 AND 52).  
FIRST USE 10-7-2013; IN COMMERCE 10-7-2013.

4,481,458. WILKINSON, CHRIS, SANTA BARBARA, CA. SN 85-215,460. PUB. 10-18-2011, FILED 1-11-2011.

# MANAVA

THE MARK CONSISTS OF STANDARD CHARACTERS WITHOUT CLAIM TO ANY PARTICULAR FONT, STYLE, SIZE, OR COLOR.

**CLASS 3—(Continued).**

THE WORDING "MANAVA" HAS NO MEANING IN A FOREIGN LANGUAGE.

FOR BODY AND BEAUTY CARE COSMETICS; COSMETIC CREAMS; COSMETIC CREAMS FOR SKIN CARE; COSMETIC HAND CREAMS; COSMETIC PREPARATIONS FOR BODY CARE; COSMETIC SUN MILK LOTIONS; COSMETICS; COSMETICS AND COSMETIC PREPARATIONS; LOTIONS FOR COSMETIC PURPOSES; SKIN AND BODY TOPICAL LOTIONS, CREAMS AND OILS FOR COSMETIC USE; SKIN CONDITIONING CREAMS FOR COSMETIC PURPOSES; SUN CARE LOTIONS; SUN CREAMS; SUNTAN CREAMS (U.S. CLS. 1, 4, 6, 50, 51 AND 52).

FIRST USE 12-12-2013; IN COMMERCE 12-12-2013.

4,481,463. FAROUK SYSTEMS, INC., HOUSTON, TX. SN 85-223,620. PUB. 6-7-2011, FILED 1-21-2011.

# CHI ENVIRO

THE MARK CONSISTS OF STANDARD CHARACTERS WITHOUT CLAIM TO ANY PARTICULAR FONT, STYLE, SIZE, OR COLOR.

OWNER OF U.S. REG. NOS. 2,660,257, 3,107,769, AND OTHERS.

FOR HAIR CARE PRODUCTS, NAMELY, SHAMPOOS, CONDITIONERS, HAIR SPRAYS, HAIR SHINE SPRAYS, NON-MEDICATED HAIR SMOOTHING SERUMS, NON-MEDICATED HAIR SMOOTHING TREATMENTS, AND HAIR MASKS (U.S. CLS. 1, 4, 6, 50, 51 AND 52).  
FIRST USE 1-15-2011; IN COMMERCE 1-15-2011.

4,481,465. ESTEE LAUDER INC., NEW YORK, NY. SN 85-232,018. PUB. 5-24-2011, FILED 2-2-2011.

# INTUIGEN TECHNOLOGY

THE MARK CONSISTS OF STANDARD CHARACTERS WITHOUT CLAIM TO ANY PARTICULAR FONT, STYLE, SIZE, OR COLOR.

NO CLAIM IS MADE TO THE EXCLUSIVE RIGHT TO USE "TECHNOLOGY", APART FROM THE MARK AS SHOWN.

FOR COSMETIC INGREDIENT COMPLEX SOLD AS AN INTEGRAL COMPONENT OF NON-MEDICATED SKINCARE PREPARATIONS (U.S. CLS. 1, 4, 6, 50, 51 AND 52).

FIRST USE 9-30-2013; IN COMMERCE 9-30-2013.

**CLASS 3—(Continued).**

4,481,498. ARCHIE COMIC PUBLICATIONS, INC., MARONECK, NY. SN 85-320,819. PUB. 3-12-2013, FILED 5-13-2011.

# VERONICA

THE MARK CONSISTS OF STANDARD CHARACTERS WITHOUT CLAIM TO ANY PARTICULAR FONT, STYLE, SIZE, OR COLOR.

FOR COSMETICS, PERFUMERY, SOAPS, HAIR LOTIONS; MAKE-UP; BLUSHES; LIPSTICK, SHampoos, BATH AND SHOWER GEL; BATH FOAMS, BATH LOTIONS; LOTIONS; EYE-SHADOW, EYEBROW PENCILS, MASCARA, FACE POWDER, FACE-POWDER FLUID, COSMETIC EMULSIONS, SKIN LOTION, CLEANSING CREAM, FOUNDATION, BLUSH, NAIL LACQUER, MAKE-UP PRIMER, CONCEALER, AFTER-SHAVE, BEAUTY MASKS; SHAVING SOAPS; SHAVING GELS; SHAVING FOAMS; COSMETIC CLEANSERS, TONERS AND MOISTURIZERS (U.S. CLS. 1, 4, 6, 50, 51 AND 52).

FIRST USE 1-0-2013; IN COMMERCE 1-0-2013.

**CLASS 3—(Continued).**

4,481,620. CAMELLIX, LLC, AUGUSTA, GA. SN 85-479,849. PUB. 5-8-2012, FILED 11-23-2011.

# MIGHTEAFLOW

THE MARK CONSISTS OF STANDARD CHARACTERS WITHOUT CLAIM TO ANY PARTICULAR FONT, STYLE, SIZE, OR COLOR.

FOR DENTIFRICES IN THE FORM OF CHEWING GUM; MOUTHWASH; NON-MEDICATED DENTAL RINSE; ALL THE FOREGOING CONTAINING TEA OR TEA-DERIVED SUBSTANCES (U.S. CLS. 1, 4, 6, 50, 51 AND 52).

FIRST USE 3-1-2012; IN COMMERCE 3-1-2012.

4,481,665. FOREVER SIX INCORPORATED, MELBOURNE, FL. SN 85-536,903. PUB. 8-28-2012, FILED 2-8-2012.

4,481,618. CAMELLIX, LLC, AUGUSTA, GA. SN 85-479,803. PUB. 5-1-2012, FILED 11-23-2011.



THE MARK CONSISTS OF THE STYLIZED TERM "CAMELLIX" UNDER A TURTLE DESIGN.

FOR DENTIFRICES IN THE FORM OF CHEWING GUM; HAIR CARE PREPARATIONS; LIP BALM; MOUTHWASH; NON-MEDICATED DENTAL RINSE (U.S. CLS. 1, 4, 6, 50, 51 AND 52).

FIRST USE 5-1-2012; IN COMMERCE 5-1-2012.



THE MARK CONSISTS OF THE WORDING "FOREVER SIX" BELOW THE STYLIZED DESIGN OF THE LETTER "F" MERGED TOGETHER WITH THE NUMBER "6".

FOR BATH AND BODY PRODUCTS, NAMELY, BODY BUTTER, BODY LOTION, BODY WASH, FACE SOAP (U.S. CLS. 1, 4, 6, 50, 51 AND 52).

FIRST USE 4-28-2012; IN COMMERCE 4-28-2012.



**CLASS 3—(Continued).**

4,481,693. SOLAZYME, INC., SOUTH SAN FRANCISCO, CA. SN 85-563,443. PUB. 7-24-2012, FILED 3-7-2012.

# EVERDEEP

THE MARK CONSISTS OF STANDARD CHARACTERS WITHOUT CLAIM TO ANY PARTICULAR FONT, STYLE, SIZE, OR COLOR.

FOR CREAMS, LOTIONS, AND TOPICAL PREPARATIONS, NAMELY, BODY AND FACE CREAMS, MOISTURIZING CREAMS, BEAUTY CREAMS, COSMETIC CREAMS, AND CLEANSING CREAMS; TOPICAL OINTMENTS, NAMELY, GENERAL PURPOSE NON-MEDICATED OINTMENTS; NON-MEDICATED TOILETRIES; COSMETICS (U.S. CLS. 1, 4, 6, 50, 51 AND 52).  
FIRST USE 11-6-2013; IN COMMERCE 11-6-2013.

4,481,719. MARK NADEN LLC, NEW YORK, NY. SN 85-588,039. PUB. 8-21-2012, FILED 4-3-2012.

# USE+

THE MARK CONSISTS OF STANDARD CHARACTERS WITHOUT CLAIM TO ANY PARTICULAR FONT, STYLE, SIZE, OR COLOR.

FOR BATH SOAPS; HAND SOAPS; LIQUID SOAPS; SOAPS FOR PERSONAL USE (U.S. CLS. 1, 4, 6, 50, 51 AND 52).  
FIRST USE 10-3-2013; IN COMMERCE 10-3-2013.

4,481,729. DIAMOND CHEMICAL COMPANY, INC., EAST RUTHERFORD, NJ. SN 85-595,700. PUB. 9-25-2012, FILED 4-12-2012.



OWNER OF U.S. REG. NO. 3,105,222.  
NO CLAIM IS MADE TO THE EXCLUSIVE RIGHT TO USE "CLEANING PRODUCTS", APART FROM THE MARK AS SHOWN.  
THE COLOR(S) PINK AND BLACK IS/ARE CLAIMED AS A FEATURE OF THE MARK.

**CLASS 3—(Continued).**

THE MARK CONSISTS OF A LIGHT PINK RIBBON WITHIN A LIGHT PINK CIRCLE WITH THE WORDS "PINK" AND "RIBBON" IN DARK PINK ON EITHER SIDE OF THE RIBBON AND THE WORDS "CLEANING PRODUCTS" IN BLACK BENEATH THE WORD "RIBBON".

FOR DETERGENT FOR DISHES, POTS, PANS AND KITCHEN UTENSILS; LAUNDRY DETERGENT; FABRIC SOFTENER; LAUNDRY BLEACH; HARD SURFACE CLEANER, NAMELY, CLEANERS FOR GLASS, WALLS, KITCHEN APPLIANCES, PATIO FURNITURE, COUNTERTOPS, FLOORING, TILES, SINKS, TUBS AND SHOWERS (U.S. CLS. 1, 4, 6, 50, 51 AND 52).  
FIRST USE 9-16-2013; IN COMMERCE 9-16-2013.

4,481,740. LIFE WIPES, LLC, ZIONSVILLE, IN. SN 85-598,394. PUB. 2-5-2013, FILED 4-16-2012.

# VISI CLEANSE

THE MARK CONSISTS OF STANDARD CHARACTERS WITHOUT CLAIM TO ANY PARTICULAR FONT, STYLE, SIZE, OR COLOR.

NO CLAIM IS MADE TO THE EXCLUSIVE RIGHT TO USE "CLEANSE", APART FROM THE MARK AS SHOWN.  
FOR DISPOSABLE WIPES IMPREGNATED WITH CLEANSING COMPOUNDS FOR USE ON EYE LIDS (U.S. CLS. 1, 4, 6, 50, 51 AND 52).  
FIRST USE 9-15-2012; IN COMMERCE 9-15-2012.

4,481,787. KALLAL INC., SANTA BARBARA, CA. SN 85-623,341. PUB. 10-30-2012, FILED 5-11-2012.

# SUSAN KALLAL

THE MARK CONSISTS OF STANDARD CHARACTERS WITHOUT CLAIM TO ANY PARTICULAR FONT, STYLE, SIZE, OR COLOR.

THE NAME(S), PORTRAIT(S), AND/OR SIGNATURE(S) SHOWN IN THE MARK IDENTIFIES "SUSAN KALLAL", WHOSE CONSENT(S) TO REGISTER IS MADE OF RECORD.

FOR SKIN CARE PRODUCTS, NAMELY, EYE CREAM, EYE BALM, LIP CREAM, LIP BALM, FACE CREAM, FACE OIL, FACE MOISTURIZER, BODY OIL, BODY CREAM, BODY MOISTURIZER AND FACE CLEANSER (U.S. CLS. 1, 4, 6, 50, 51 AND 52).  
FIRST USE 10-17-2013; IN COMMERCE 10-17-2013.

**CLASS 3—(Continued).**

4,481,804. MY BEST FOR U, LLC., NEW YORK, NY. SN 85-631,493. PUB. 10-16-2012, FILED 5-22-2012.

NO CLAIM IS MADE TO THE EXCLUSIVE RIGHT TO USE "BEST BEAUTY BUTTER", APART FROM THE MARK AS SHOWN.

THE MARK CONSISTS OF "B.B.B. BEST BEAUTY BUTTER" IN STYLIZED FORM UNDERLINED.

FOR HAIR OILS, NON-MEDICATED HAIR BALMS, HAIR CREAMS, HAIR LOTIONS, HAIR GELS (U.S. CLS. 1, 4, 6, 50, 51 AND 52).

FIRST USE 4-5-2013; IN COMMERCE 4-5-2013.

**CLASS 3—(Continued).**

4,481,825. GLOBAL SOURCES USA CORP, HIALEAH, FL. SN 85-644,282. PUB. 9-3-2013, FILED 6-6-2012.



4,481,811. BAM NAVIGATION, LLC, MINNEAPOLIS, MN. SN 85-637,241. PUB. 3-12-2013, FILED 5-29-2012.

THE COLOR(S) GREEN, BLUE AND GRAY IS/ARE CLAIMED AS A FEATURE OF THE MARK.

THE MARK CONSISTS OF THE TERM "SKINDEPENDENT" SHOWN IN LOWER-CASE CHARACTERS, WITH "SKIN" SHOWN IN GREEN AND "DEPENDENT" SHOWN IN BLUE, ABOVE THE PHRASE "BE YOUR OWN BRAND" SHOWN IN UPPER-CASE CHARACTERS IN GRAY.

FOR SKIN CARE PRODUCTS, NAMELY, LOTIONS, CREAMS, CLEANSERS, TONERS, MASKS, SCRUBS, GELS, AND MOISTURIZERS (U.S. CLS. 1, 4, 6, 50, 51 AND 52).

FIRST USE 3-0-2013; IN COMMERCE 3-0-2013.

THE MARK CONSISTS OF THE WORD "TONES", WITH THE LETTERS "TO" WRITTEN IN A STYLIZED FONT ABOVE THE LETTERS "NES" WRITTEN IN THE SAME STYLIZED FONT. TO THE LEFT OF THE LETTERS "TO" IS A SQUARE WITH ROUNDED EDGES, WITH A DIAGONAL LINE AND A CURVED LINE FORMING AN INTERSECTION IN THE SQUARE. THE INTERSECTING LINES CREATE FOUR UNEVEN SPACES WITHIN THE SQUARE.

FOR ACRYLIC NAIL KITS COMPRISED OF NAIL CARE PREPARATIONS, NAMELY, LIQUID NAIL CARE PREPARATIONS, ACRYLIC NAIL REMOVER SOLUTION, CUTICLE CONDITIONERS IN THE NATURE OF CUTICLE OILS, CLEANING SOLUTION USED TO REMOVE STICKY RESIDUE LEFT AFTER THE APPLICATION OF ACRYLIC NAILS, NAMELY, ULTRAVIOLET GEL NAILS, SAID RESIDUE FOUND ON NAIL TIPS, NAIL BUFFERS, ORANGE STICKS, EMERY FILES, NAIL CLIPPERS AND NIPPERS, AND WORK SURFACES, ACRYLIC POLYMER POWDERS, ACRYLIC MONOMERS, AND ACRYLIC POLYMER POWDERS, THE FOREGOING POWDERS FOR USE IN MAKING DESIGNS ON ACRYLIC NAILS, AND METHACRYLIC, ACID FREE-SUBSTANCES USED WITH ALL NAIL GELS TO IMPROVE ADHESION; AND NAIL GEL KITS COMPRISED OF GEL NAIL POLISHES THAT ARE APPLIED LIKE NAIL POLISH (U.S. CLS. 1, 4, 6, 50, 51 AND 52).

FIRST USE 11-15-2012; IN COMMERCE 11-15-2012.

**CLASS 3—(Continued).**

4,481,888. USP INC, OCEANSIDE, CA. SN 85-672,363. PUB. 3-12-2013, FILED 7-10-2012.



ENJOY

THE MARK CONSISTS OF THE STYLIZED WORD "ENJOY" WITH A STAR ABOVE THE "J".

FOR HAIR CARE PREPARATIONS, HAIR COLOR, HAIR COLOR REMOVERS, HAIR CONDITIONERS, HAIR DRESSINGS FOR MEN, HAIR DYE, HAIR EMOLLIENTS, HAIR FROSTS, HAIR GEL, HAIR LIGHTENERS, HAIR LOTIONS, HAIR MASCARA, HAIR MOUSSE, HAIR POMADES, HAIR RELAXERS, HAIR RELAXING PREPARATIONS, HAIR RINSES, HAIR SHAMPOO, HAIR SPRAY, HAIR STRAIGHTENING PREPARATIONS, HAIR STYLING PREPARATIONS, HAIR WAVING LOTION, HAIR CARE PREPARATIONS, HAIR COLOR, HAIR COLOR REMOVERS, HAIR CONDITIONERS, HAIR DRESSINGS FOR MEN, HAIR DYE, HAIR EMOLLIENTS, HAIR FROSTS, HAIR GEL, HAIR LIGHTENERS, HAIR LOTIONS, HAIR MASCARA, HAIR MOUSSE, HAIR POMADES, HAIR RELAXERS, HAIR RELAXING PREPARATIONS, HAIR RINSES, HAIR SHAMPOO, HAIR SPRAY, HAIR STRAIGHTENING PREPARATIONS, HAIR STYLING PREPARATIONS, HAIR WAVING LOTION. ; HAIR WAVING LOTION; HAIR CARE LOTIONS; GEL FOR HAIR AND FOR SCULPTING HAIR; HAIR TONICS; MOUSSE SPECIFICALLY FOR HAIR; HAIR MASCARA, SHAPING LOTION, VOLUMIZING SPRAYS, AND CLARIFYING SPRAYS (U.S. CLS. 1, 4, 6, 50, 51 AND 52).

FIRST USE 8-1-2005; IN COMMERCE 8-1-2005.

4,481,903. L'OREAL, PARIS, FRANCE. SN 85-680,366. PUB. 6-25-2013, FILED 7-18-2012.

SILK & GLOSS DUAL OIL CARE

THE MARK CONSISTS OF STANDARD CHARACTERS WITHOUT CLAIM TO ANY PARTICULAR FONT, STYLE, SIZE, OR COLOR.

NO CLAIM IS MADE TO THE EXCLUSIVE RIGHT TO USE "OIL", APART FROM THE MARK AS SHOWN.

FOR NON-MEDICATED HAIR TREATMENT PREPARATION (U.S. CLS. 1, 4, 6, 50, 51 AND 52).

FIRST USE 1-0-2013; IN COMMERCE 1-0-2013.

**CLASS 3—(Continued).**

4,482,031. L'OREAL, PARIS, FRANCE. SN 85-729,081. PUB. 4-2-2013, FILED 9-14-2012.

COLOUR RICHE

THE MARK CONSISTS OF STANDARD CHARACTERS WITHOUT CLAIM TO ANY PARTICULAR FONT, STYLE, SIZE, OR COLOR.

NO CLAIM IS MADE TO THE EXCLUSIVE RIGHT TO USE "COLOUR", APART FROM THE MARK AS SHOWN.

FOR COSMETICS (U.S. CLS. 1, 4, 6, 50, 51 AND 52).

FIRST USE 9-0-1992; IN COMMERCE 9-0-1992.

4,482,071. AMERICAN INTERNATIONAL INDUSTRIES, COMMERCE, CA. SN 85-734,547. PUB. 2-26-2013, FILED 9-20-2012.

CALLIGRAFFITI

THE MARK CONSISTS OF STANDARD CHARACTERS WITHOUT CLAIM TO ANY PARTICULAR FONT, STYLE, SIZE, OR COLOR.

FOR ADHESIVES FOR ARTIFICIAL NAILS; NAIL CARE PREPARATIONS; NAIL CREAM; NAIL ENAMEL; NAIL GEL; NAIL HARDENERS; NAIL POLISH; NAIL POLISH BASE COAT; NAIL POLISH REMOVER; NAIL POLISH TOP COAT; NAIL STRENGTHENERS; NAIL TIPS; NAIL VARNISH (U.S. CLS. 1, 4, 6, 50, 51 AND 52).

FIRST USE 3-0-2013; IN COMMERCE 3-0-2013.

4,482,073. PENDERS, PAUL, KEDAH, MALAYSIA. SN 85-735,024. PUB. 3-19-2013, FILED 9-21-2012.

LaJeram

THE MARK CONSISTS OF STANDARD CHARACTERS WITHOUT CLAIM TO ANY PARTICULAR FONT, STYLE, SIZE, OR COLOR.

THE WORDING "LAJERAM" HAS NO MEANING IN A FOREIGN LANGUAGE.

FOR SHAMPOOS, HAIR CONDITIONERS, HAIR TONERS, SKIN MOISTURIZERS, BATH OILS, BATH GELS, FACIAL CLEANSERS, FACIAL TONERS, FACE AND BODY MASKS, SOAP, EYE GELS, LIPSTICKS, MASCARAS, EYE SHADOWS, BLUSHERS, FOUNDATIONS (U.S. CLS. 1, 4, 6, 50, 51 AND 52).

FIRST USE 6-1-2013; IN COMMERCE 6-1-2013.

**CLASS 3—(Continued).**

4,482,096. RANCE' & C. S.R.L., MILANO, ITALY. SN 85-737,848. PUB. 4-23-2013, FILED 9-25-2012.

**VILLE D'ITALIA**

THE MARK CONSISTS OF STANDARD CHARACTERS WITHOUT CLAIM TO ANY PARTICULAR FONT, STYLE, SIZE, OR COLOR.

THE ENGLISH TRANSLATION OF "VILLE D'ITALIA" IN THE MARK IS "VILLAS OF ITALY".

FOR SOAPS FOR TOILET PURPOSES, BATH SALTS NOT FOR MEDICAL PURPOSES, BATH FOAMS, PERFUMES TOILET WATER, ESSENTIAL OILS FOR PERSONAL USE, HAIR LOTIONS, TALCUM POWDER FOR TOILET USE AND COSMETICS, NAMELY, LIPSTICKS, MASCARA, MAKEUP REMOVING PREPARATIONS, CLEANSING MILK FOR TOILET PURPOSES, NAIL VARNISH (U.S. CLS. 1, 4, 6, 50, 51 AND 52).

FIRST USE 1-0-2005; IN COMMERCE 1-0-2005.

4,482,097. GLAXOSMITHKLINE LLC, WILMINGTON, DE. SN 85-737,852. PUB. 3-5-2013, FILED 9-25-2012.

**SENSODYNE**

THE MARK CONSISTS OF STANDARD CHARACTERS WITHOUT CLAIM TO ANY PARTICULAR FONT, STYLE, SIZE, OR COLOR.

OWNER OF U.S. REG. NOS. 716,963, 1,860,965, AND OTHERS.

FOR NON-MEDICATED MOUTH RINSE (U.S. CLS. 1, 4, 6, 50, 51 AND 52).

FIRST USE 1-28-2013; IN COMMERCE 1-28-2013.

4,482,166. PHOENIX IMPORT & DISTRIBUTION, L.L.C., SPRING, TX. SN 85-747,195. PUB. 3-12-2013, FILED 10-5-2012.

**OBAO**

THE MARK CONSISTS OF STANDARD CHARACTERS WITHOUT CLAIM TO ANY PARTICULAR FONT, STYLE, SIZE, OR COLOR.

FOR DEODORANTS AND ANTIPERSPIRANTS (U.S. CLS. 1, 4, 6, 50, 51 AND 52).

FIRST USE 5-1-2013; IN COMMERCE 5-1-2013.

**CLASS 3—(Continued).**

4,482,216. AMERICAN INTERNATIONAL INDUSTRIES, COMMERCE, CA. SN 85-755,851. PUB. 2-26-2013, FILED 10-16-2012.

**COLORAGEOUS**

THE MARK CONSISTS OF STANDARD CHARACTERS WITHOUT CLAIM TO ANY PARTICULAR FONT, STYLE, SIZE, OR COLOR.

FOR ADHESIVES FOR AFFIXING FALSE EYELASHES; ADHESIVES FOR ARTIFICIAL NAILS; ARTIFICIAL EYELASHES; COSMETIC PREPARATIONS FOR EYE LASHES; COSMETIC PREPARATIONS FOR SKIN CARE; FACE AND BODY CREAMS; FALSE NAILS; HAIR CARE PREPARATIONS; HAIR COLOR; HAIR COLOR REMOVERS; HAIR CONDITIONER; HAIR DYE; HAIR GEL; HAIR MOUSSE; HAIR POMADES; HAIR PRODUCTS, NAMELY, THICKENING CONTROL CREAMS; HAIR SHAMPOO; HAIR SPRAY; HAIR STYLING GEL; HAND CREAMS; HAND LOTIONS; MAKEUP FOR THE FACE AND BODY; MASCARA; MOISTURIZING PREPARATIONS FOR THE SKIN; NAIL BUFFING PREPARATIONS; NAIL CARE PREPARATIONS; NAIL CREAM; NAIL ENAMEL; NAIL ENAMEL REMOVERS; NAIL GEL; NAIL HARDENERS; NAIL POLISH; NAIL POLISH BASE COAT; NAIL POLISH REMOVER; NAIL POLISH TOP COAT; NAIL TIPS; NAIL VARNISH; NON-MEDICATED SKIN CARE PREPARATIONS; SKIN BRONZER; SKIN CLEANSERS; SKIN CREAM; SKIN MOISTURIZER; SKIN TONERS; STYLING CLAY FOR HAIR (U.S. CLS. 1, 4, 6, 50, 51 AND 52).

FIRST USE 7-4-2013; IN COMMERCE 7-4-2013.

4,482,229. L'OREAL USA CREATIVE, INC., NEW YORK, NY. SN 85-757,504. PUB. 3-26-2013, FILED 10-18-2012.

**MAKEUP MOOD ENHANCER**

THE MARK CONSISTS OF STANDARD CHARACTERS WITHOUT CLAIM TO ANY PARTICULAR FONT, STYLE, SIZE, OR COLOR.

NO CLAIM IS MADE TO THE EXCLUSIVE RIGHT TO USE "MAKEUP" AND "ENHANCER", APART FROM THE MARK AS SHOWN.

FOR COSMETICS (U.S. CLS. 1, 4, 6, 50, 51 AND 52).

FIRST USE 8-14-2013; IN COMMERCE 8-14-2013.

**CLASS 3—(Continued).**

4,482,249. CHRISTOPHER, JACKIE, ARROYO GRANDE, CA. SN 85-762,107. PUB. 4-16-2013, FILED 10-24-2012.

**Sniff & Go Kit**

THE MARK CONSISTS OF STANDARD CHARACTERS WITHOUT CLAIM TO ANY PARTICULAR FONT, STYLE, SIZE, OR COLOR.

NO CLAIM IS MADE TO THE EXCLUSIVE RIGHT TO USE "KIT", APART FROM THE MARK AS SHOWN.

FOR CANINE SCENT DETECTION COMPETITION TRAINING KIT COMPRISED OF SCENTED COTTON SWABS, A PAIR OF TWEEZERS, A PLASTIC TEST TUBE, AND A SMALL TIN SOLD AS A UNIT (U.S. CLS. 1, 4, 6, 50, 51 AND 52).

FIRST USE 7-1-2011; IN COMMERCE 7-1-2011.

4,482,250. THE PROCTER & GAMBLE COMPANY, CINCINNATI, OH. SN 85-762,331. PUB. 4-9-2013, FILED 10-24-2012.

**DOWNY LIBRE ENJUAGUE**

THE MARK CONSISTS OF STANDARD CHARACTERS WITHOUT CLAIM TO ANY PARTICULAR FONT, STYLE, SIZE, OR COLOR.

OWNER OF U.S. REG. NOS. 718,074 AND 2,684,800.

NO CLAIM IS MADE TO THE EXCLUSIVE RIGHT TO USE "ENJUAGUE", APART FROM THE MARK AS SHOWN.

THE ENGLISH TRANSLATION OF "LIBRE ENJUAGUE" IN THE MARK IS "FREE RINSE".

FOR FABRIC SOFTENERS (U.S. CLS. 1, 4, 6, 50, 51 AND 52).

FIRST USE 3-31-2012; IN COMMERCE 3-31-2012.

4,482,251. THE PROCTER & GAMBLE COMPANY, CINCINNATI, OH. SN 85-762,337. PUB. 4-9-2013, FILED 10-24-2012.

**DOWNY LIBRE ENJUAGUE  
ELEGANCE**

THE MARK CONSISTS OF STANDARD CHARACTERS WITHOUT CLAIM TO ANY PARTICULAR FONT, STYLE, SIZE, OR COLOR.

OWNER OF U.S. REG. NOS. 718,074 AND 2,684,800.

NO CLAIM IS MADE TO THE EXCLUSIVE RIGHT TO USE "ENJUAGUE", APART FROM THE MARK AS SHOWN.

THE ENGLISH TRANSLATION OF "LIBRE ENJUAGUE" IN THE MARK IS "FREE RINSE".

FOR FABRIC SOFTENERS (U.S. CLS. 1, 4, 6, 50, 51 AND 52).

FIRST USE 3-31-2012; IN COMMERCE 3-31-2012.

**CLASS 3—(Continued).**

4,482,286. ZOTOS INTERNATIONAL, INC., DARIEN, CT. SN 85-773,563. PUB. 1-22-2013, FILED 11-7-2012.

**PROBEAUTE**

THE MARK CONSISTS OF STANDARD CHARACTERS WITHOUT CLAIM TO ANY PARTICULAR FONT, STYLE, SIZE, OR COLOR.

FOR HAIR GEL AND HAIR MOUSSE; HAIR STYLING PREPARATIONS; SHAMPOO-CONDITIONERS (U.S. CLS. 1, 4, 6, 50, 51 AND 52).

FIRST USE 6-1-2013; IN COMMERCE 6-1-2013.

4,482,296. FOUR SEASONS SALES AND SERVICE, INC., PARIS, TN. SN 85-777,242. PUB. 4-30-2013, FILED 11-12-2012.

**NESOI**

THE MARK CONSISTS OF STANDARD CHARACTERS WITHOUT CLAIM TO ANY PARTICULAR FONT, STYLE, SIZE, OR COLOR.

FOR COSMETIC SUNLESS AND INDOOR SUN TANNING PREPARATIONS, NAMELY, SKIN COLORING PREPARATION SOLUTION AND REFILL SKIN COLORING PREPARATION SOLUTION FOR COSMETIC PURPOSES; SUNLESS AND INDOOR SELF-TANNING PREPARATIONS; NON-MEDICATED SKIN CARE PREPARATIONS FOR ACCELERATING, EXTENDING, AND INTENSIFYING SUNLESS TANNING; NON-MEDICATED SKIN CARE PREPARATIONS, NAMELY, BARRIER SKIN CREAM, SKIN PRIMER, SKIN BRONZER, SKIN MOISTURIZER, BODY WASH, BODY SCRUB AND SKIN EXFOLIANT (U.S. CLS. 1, 4, 6, 50, 51 AND 52).

FIRST USE 11-14-2012; IN COMMERCE 11-14-2012.

4,482,353. ZYZY INC, MIAMI, FL. SN 85-796,630. PUB. 4-2-2013, FILED 12-6-2012.

**HAWK**

THE MARK CONSISTS OF STANDARD CHARACTERS WITHOUT CLAIM TO ANY PARTICULAR FONT, STYLE, SIZE, OR COLOR.

FOR COLOGNES, PERFUMES AND COSMETICS; EAU DE PERFUME; EAU DE TOILETTE AND EAU DE COLOGNE; PERFUMES AND COLOGNES; PERFUMES AND TOILET WATERS (U.S. CLS. 1, 4, 6, 50, 51 AND 52).

FIRST USE 8-15-2013; IN COMMERCE 8-15-2013.

**CLASS 3—(Continued).**

4,482,354. ZYZY INC, MIAMI, FL. SN 85-797,022. PUB. 4-2-2013, FILED 12-7-2012.

# OUTBREAK

THE MARK CONSISTS OF STANDARD CHARACTERS WITHOUT CLAIM TO ANY PARTICULAR FONT, STYLE, SIZE, OR COLOR.

FOR COLOGNES, PERFUMES AND COSMETICS; EAU DE TOILETTE AND EAU DE COLOGNE; PERFUMES AND TOILET WATERS; PERFUMES, AFTERSHAVES AND COLOGNES (U.S. CLS. 1, 4, 6, 50, 51 AND 52).

FIRST USE 8-15-2013; IN COMMERCE 8-15-2013.

4,482,355. ZYZY INC, MIAMI, FL. SN 85-797,062. PUB. 4-2-2013, FILED 12-7-2012.

# REAL PEARLS

THE MARK CONSISTS OF STANDARD CHARACTERS WITHOUT CLAIM TO ANY PARTICULAR FONT, STYLE, SIZE, OR COLOR.

FOR COLOGNES, PERFUMES AND COSMETICS; EAU DE TOILETTE AND EAU DE COLOGNE; PERFUME OILS; PERFUMES, EAU DE COLOGNES AND AFTERSHAVES (U.S. CLS. 1, 4, 6, 50, 51 AND 52).

FIRST USE 8-15-2013; IN COMMERCE 8-15-2013.

4,482,437. MODEL 21 CORP., DBA SAMANTHA BEAUTY, WESTMINSTER, CA. SN 85-827,515. PUB. 8-6-2013, FILED 1-18-2013.

# Samantha Beauty

THE MARK CONSISTS OF STANDARD CHARACTERS WITHOUT CLAIM TO ANY PARTICULAR FONT, STYLE, SIZE, OR COLOR.

**CLASS 3—(Continued).**

NO CLAIM IS MADE TO THE EXCLUSIVE RIGHT TO USE "BEAUTY", APART FROM THE MARK AS SHOWN.

FOR ADHESIVES FOR AFFIXING FALSE EYELASHES; ADHESIVES FOR FALSE EYELASHES, HAIR AND NAILS; CLEANER FOR COSMETIC BRUSHES; EYE SHADOW; FACIAL MOISTURIZER WITH SPF; FALSE EYELASHES; FRAGRANCED FACE CARE PREPARATIONS, NAMELY, FACIAL CLEANSER, MAKEUP REMOVER, MOISTURIZER, SUNBLOCK; FRAGRANCED FACIAL MOISTURIZER; LIP GLOSS; MAKE UP FOUNDATIONS; MAKE-UP KITS COMPRISED OF LIPSTICK, LIP GLOSS, EYE SHADOW, COMPACT, FOUNDATION (U.S. CLS. 1, 4, 6, 50, 51 AND 52).

FIRST USE 4-1-2013; IN COMMERCE 6-1-2013.

4,482,449. OCUSOFT, INC., RICHMOND, TX. SN 85-832,600. PUB. 6-25-2013, FILED 1-25-2013.



THE MARK CONSISTS OF THE WORD "ZORIA" WITH A STYLIZED "Z" SUPERIMPOSED OVER THE LETTER "Z" IN THE WORD "ZORIA". THE RECTANGLE IS FOR BACKGROUND PURPOSES ONLY AND IS NOT PART FOR THE MARK.

FOR COSMETIC PRODUCTS FOR EYE CARE, NAMELY, MASCARA, COSMETIC PREPARATIONS FOR ENHANCING EYE LASHES AND EYE MAKE-UP REMOVER; SKIN CARE PRODUCTS, NAMELY, FACIAL SKIN CLEANSER AND NON-MEDICATED SKIN CARE CREAMS FOR USE ON BRUISED SKIN (U.S. CLS. 1, 4, 6, 50, 51 AND 52).

FIRST USE 3-1-2013; IN COMMERCE 3-1-2013.

4,482,486. L'OREAL USA CREATIVE, INC., NEW YORK, NY. SN 85-850,262. PUB. 6-4-2013, FILED 2-14-2013.

# COLOUR FANATIC

THE MARK CONSISTS OF STANDARD CHARACTERS WITHOUT CLAIM TO ANY PARTICULAR FONT, STYLE, SIZE, OR COLOR.

FOR HAIR STYLING PREPARATION (U.S. CLS. 1, 4, 6, 50, 51 AND 52).

FIRST USE 7-1-2013; IN COMMERCE 7-1-2013.

**CLASS 3—(Continued).**

4,482,500. ORIDEL LTD., HUNTINGTON, NY. SN 85-853,392.  
PUB. 7-16-2013, FILED 2-19-2013.



THE MARK CONSISTS OF A CIRCLE HAVING AN INNER BAND AND ALTERNATING TEARDROP AND OVAL ELEMENTS EXTENDING RADIALLY FROM A CENTRAL CIRCULAR ELEMENT TO THE INNER BAND.

FOR COSMETIC CREAMS, LOTIONS, OILS, CLEANSERS, MOISTURIZERS, SUNSCREENS, FACIAL MASKS, SCRUBS, ASTRINGENTS, EXFOLIANTS AND TONERS; FACE AND BODY CREAMS, LOTIONS, OILS, CLEANSERS, MOISTURIZERS, SUNSCREENS, MASKS, SCRUBS, ASTRINGENTS, EXFOLIANTS AND TONERS; OILS FOR HAIR (U.S. CLS. 1, 4, 6, 50, 51 AND 52).  
FIRST USE 5-31-2011; IN COMMERCE 5-31-2011.

4,482,505. MANHANDS SOAP, LLC, LINCOLN, NE. SN 85-855,206. PUB. 7-30-2013, FILED 2-20-2013.

*Manly Scented Soap*

NO CLAIM IS MADE TO THE EXCLUSIVE RIGHT TO USE "SCENTED SOAP", APART FROM THE MARK AS SHOWN.

THE MARK CONSISTS OF THE WORDING "MANLY SCENTED SOAP" IN STYLIZED FONT.

FOR HANDMADE SOAP BARS (U.S. CLS. 1, 4, 6, 50, 51 AND 52).  
FIRST USE 2-28-2013; IN COMMERCE 2-28-2013.

**CLASS 3—(Continued).**

4,482,551. COTY US LLC, NEW YORK, NY. SN 85-872,599.  
PUB. 7-16-2013, FILED 3-11-2013.

OWN THE THRONE

THE MARK CONSISTS OF STANDARD CHARACTERS WITHOUT CLAIM TO ANY PARTICULAR FONT, STYLE, SIZE, OR COLOR.

FOR EAU DE PARFUM, BODY MISTS, BODY LOTIONS, SHOWER GELS, BODY SPRAYS AND DEODORANT NATURAL SPRAYS (U.S. CLS. 1, 4, 6, 50, 51 AND 52).

FIRST USE 9-1-2013; IN COMMERCE 9-1-2013.

4,482,574. SAISEI FULVIC, LLC, LOS ANGELES, CA. SN 85-879,456. PUB. 8-6-2013, FILED 3-18-2013.

SWINE ON A TWINE

THE MARK CONSISTS OF STANDARD CHARACTERS WITHOUT CLAIM TO ANY PARTICULAR FONT, STYLE, SIZE, OR COLOR.

FOR SOAPS (U.S. CLS. 1, 4, 6, 50, 51 AND 52).

FIRST USE 12-0-2012; IN COMMERCE 12-0-2012.

4,482,621. HESHELOW, KATHY, SEMINOLE, FL. SN 85-897,132. PUB. 9-3-2013, FILED 4-6-2013.

CELLULITE WHISPERER

THE MARK CONSISTS OF STANDARD CHARACTERS WITHOUT CLAIM TO ANY PARTICULAR FONT, STYLE, SIZE, OR COLOR.

NO CLAIM IS MADE TO THE EXCLUSIVE RIGHT TO USE "CELLULITE", APART FROM THE MARK AS SHOWN.

FOR CREAMS, GELS AND LOTIONS FOR CELLULITE REDUCTION (U.S. CLS. 1, 4, 6, 50, 51 AND 52).  
FIRST USE 6-13-2013; IN COMMERCE 6-13-2013.

**CLASS 3—(Continued).**

4,482,684. SEXY HAIR CONCEPTS, LLC, CHATSWORTH, CA. SN 85-980,684. PUB. 7-9-2013, FILED 3-1-2013.

**CLASS 4—(Continued).**

4,481,958. CLASSIC BRANDS, LLC, DENVER, CO. SN 85-711,644. PUB. 3-12-2013, FILED 8-23-2012.

**STYLESEXYHAIR**

THE MARK CONSISTS OF STANDARD CHARACTERS WITHOUT CLAIM TO ANY PARTICULAR FONT, STYLE, SIZE, OR COLOR.

OWNER OF U.S. REG. NOS. 2,403,396 AND 4,070,954. FOR HAIR CARE AND HAIR STYLING PRODUCTS, NAMELY, HAIR MOUSSES, HAIR SPRAYS, HAIR GELS, HAIR CREMES, HAIR WAXES, HAIR POMADES (U.S. CLS. 1, 4, 6, 50, 51 AND 52).

FIRST USE 1-26-2013; IN COMMERCE 1-26-2013.

---

4,482,689. DEMERT BRANDS, INC., LUTZ, FL. SN 85-980,776. PUB. 4-3-2012, FILED 11-21-2011.

**NOT YOUR MOTHER'S**

THE MARK CONSISTS OF STANDARD CHARACTERS WITHOUT CLAIM TO ANY PARTICULAR FONT, STYLE, SIZE, OR COLOR.

OWNER OF U.S. REG. NO. 3,815,052. FOR HAIR CARE PREPARATIONS, NAMELY, HAIR-SPRAYS, HAIR MIST, SHAMPOOS, DRY SHAMPOO, CONDITIONERS, SETTING LOTION, STYLING GEL, STYLING CREAM, STYLING SPRAY, HAIR POWDER, DETANGLER (U.S. CLS. 1, 4, 6, 50, 51 AND 52).

FIRST USE 12-7-2009; IN COMMERCE 12-7-2009.

NO CLAIM IS MADE TO THE EXCLUSIVE RIGHT TO USE "FIRE ACCENT", APART FROM THE MARK AS SHOWN.

THE COLOR(S) ORANGE AND OLIVE GREEN IS/ARE CLAIMED AS A FEATURE OF THE MARK.

THE MARK CONSISTS OF THREE ORANGE SHAPES REPRESENTING A FLAME WITH THE WORDS "FIRE ACCENT" IN OLIVE GREEN OVER THE FLAME DESIGN.

FOR DECORATIVE TABLETOP FUELED TORCHES, DECORATIVE FUELED FIRE POTS (U.S. CLS. 1, 6 AND 15).

FIRST USE 8-18-2012; IN COMMERCE 9-24-2012.

---

**CLASS 4—LUBRICANTS AND FUELS**



**CLASS 4—(Continued).**

4,482,225. VP RACING FUELS, INC., SAN ANTONIO, TX. SN 85-757,156. PUB. 3-26-2013, FILED 10-18-2012.



THE MARK CONSISTS OF UPPER TORSO AND HEAD OF A MAD SCIENTIST FIGURE, WEARING A LAB COAT WITH ONE POCKET, PORTION OF SHIRT VISIBLE WITH VERTICAL STRIPES, FLAMING HAIR FEATURES, BOTH ELBOWS UPRAISED, HOLDING LAB BEAKERS IN BOTH HANDS.

FOR FUELS, NAMELY, NITROMETHANE, NITROMETHANE BASED FUEL, FUEL CONTAINING NITROMETHANE, METHANOL, METHANOL BASED FUEL, FUEL CONTAINING METHANOL, ETHANOL FUEL, ETHANOL FUEL MIXTURES, GASOLINE, LEADED FUEL, UNLEADED FUEL, AND OXYGENATED FUEL; MOTOR OIL; SYNTHETIC AVIATION, INDUSTRIAL, MARINE, AND VEHICULAR LUBRICANTS; NON-CHEMICAL ADDITIVES FOR FUEL TREATMENT, NAMELY, OCTANE BOOSTER NON-CHEMICAL ADDITIVES; NON-CHEMICAL MOTOR OIL; AND NON-CHEMICAL MOTOR OIL ADDITIVES (U.S. CLS. 1, 6 AND 15).

FIRST USE 10-1-2011; IN COMMERCE 10-1-2011.

4,482,487. GREAT LAKES LUBRICANT CORP., FRANKLIN PARK, IL. SN 85-850,983. PUB. 7-30-2013, FILED 2-15-2013.

**PETROMERICA**

THE MARK CONSISTS OF THE TERM "PETROMERICA" UNDERLINED, WITH THE DESIGN OF A FIVE POINT STAR IN THE TOP OF THE LETTER "P", AND A SERIES OF SHORT STRAIGHT HORIZONTAL LINES IN DESCENDING SIZE ORDER TO THE RIGHT OF THE LETTER "A".

FOR MOTOR OIL; MOTOR OILS; TWO CYCLE ENGINE OIL; ENGINE OILS; HYDRAULIC OILS; HYDRAULIC OIL; DIESEL OIL; FUEL OIL; GEAR OILS; OILS FOR GEARS, TRANSMISSIONS OIL; SYNTHETIC GEAR OIL (U.S. CLS. 1, 6 AND 15).

FIRST USE 4-1-2013; IN COMMERCE 4-1-2013.

**CLASS 4—(Continued).**

4,482,658. VP RACING FUELS, INC., ELMENDORF, TX. SN 85-931,046. PUB. 8-20-2013, FILED 5-14-2013.

**FIX-IT FUEL**

THE MARK CONSISTS OF STANDARD CHARACTERS WITHOUT CLAIM TO ANY PARTICULAR FONT, STYLE, SIZE, OR COLOR.

NO CLAIM IS MADE TO THE EXCLUSIVE RIGHT TO USE "FUEL", APART FROM THE MARK AS SHOWN.

FOR FUELS (U.S. CLS. 1, 6 AND 15).

FIRST USE 6-21-2013; IN COMMERCE 6-21-2013.

**CLASS 5—PHARMACEUTICALS**

4,481,317. ALLERGAN, INC., IRVINE, CA. SN 77-368,471. PUB. 11-16-2010, FILED 1-10-2008.

**JUVEDERM VOLUMA**

THE MARK CONSISTS OF STANDARD CHARACTERS WITHOUT CLAIM TO ANY PARTICULAR FONT, STYLE, SIZE, OR COLOR.

FOR PHARMACEUTICAL PREPARATIONS FOR THE TREATMENT OF GLABELLAR LINES, FACIAL WRINKLES, ASYMMETRIES AND DEFECTS AND CONDITIONS OF THE HUMAN SKIN; BIOLOGICAL DERMAL IMPLANTS, NAMELY, VISCO-SUPPLEMENTATION SOLUTIONS FOR FILLING WRINKLES (U.S. CLS. 6, 18, 44, 46, 51 AND 52).

FIRST USE 12-2-2013; IN COMMERCE 12-2-2013.

4,481,337. PARSONS, DEWITT, MEDFIELD, MA. SN 77-812,882. PUB. 8-31-2010, FILED 8-26-2009.

**stāSAFE**

THE MARK CONSISTS OF STANDARD CHARACTERS WITHOUT CLAIM TO ANY PARTICULAR FONT, STYLE, SIZE, OR COLOR.

FOR HAND SANITIZING PREPARATIONS FOR PERSONAL AND NON-MEDICAL USE (U.S. CLS. 6, 18, 44, 46, 51 AND 52).

FIRST USE 11-0-2009; IN COMMERCE 11-0-2009.

**CLASS 5—(Continued).**

4,481,421. G R LANE HEALTH PRODUCTS LIMITED, GLOUCESTER, UNITED KINGDOM. SN 85-115,445. PUB. 9-3-2013, FILED 8-25-2010.

# JAKEMANS

THE MARK CONSISTS OF STANDARD CHARACTERS WITHOUT CLAIM TO ANY PARTICULAR FONT, STYLE, SIZE, OR COLOR.

FOR MEDICATED CONFECTIONERY; MEDICATED CONFECTIONERY CONTAINING MENTHOL; LOZENGES FOR PHARMACEUTICAL PURPOSES; PASTILLES FOR PHARMACEUTICAL PURPOSES; MEDICATED THROAT PASTILLES, THROAT LOZENGES (U.S. CLS. 6, 18, 44, 46, 51 AND 52).

FIRST USE 0-0-1907; IN COMMERCE 10-24-2008.

---

4,481,426. REED OMARY, CHICAGO, IL. AND ANDREW LARSON, CHICAGO, IL. SN 85-134,983. PUB. 8-23-2011, FILED 9-21-2010.

# MagnetoSphere

THE MARK CONSISTS OF STANDARD CHARACTERS WITHOUT CLAIM TO ANY PARTICULAR FONT, STYLE, SIZE, OR COLOR.

FOR DRUG DELIVERY AGENTS IN THE FORM OF A COATING FOR THERAPEUTIC AGENTS THAT FACILITATE THE DELIVERY OF A WIDE RANGE OF PHARMACEUTICALS; DRUG DELIVERY AGENTS IN THE FORM OF CAPSULES THAT PROVIDE CONTROLLED RELEASE OF THE ACTIVE INGREDIENTS FOR A WIDE VARIETY OF PHARMACEUTICALS; DRUG DELIVERY AGENTS IN THE FORM OF TABLETS THAT PROVIDE CONTROLLED RELEASE OF THE ACTIVE INGREDIENTS FOR A WIDE VARIETY OF PHARMACEUTICALS; PHARMACEUTICAL PREPARATIONS FOR THE PREVENTION OF CANCER; PHARMACEUTICAL PREPARATIONS FOR THE TREATMENT AND PREVENTION OF CANCER; PHARMACEUTICAL PREPARATIONS FOR THE TREATMENT OF CANCER; PHARMACEUTICAL PRODUCTS FOR THE PREVENTION AND TREATMENT OF CANCER; RADIOACTIVE PHARMACEUTICAL PREPARATIONS FOR USE IN VIVO DIAGNOSTIC OR THERAPEUTIC USE; THERAPEUTIC PHARMACEUTICAL FOR THE TREATMENT OF CANCER; TUMOR SUPPRESSING AGENTS (U.S. CLS. 6, 18, 44, 46, 51 AND 52).

FIRST USE 10-0-2011; IN COMMERCE 5-0-2013.

**CLASS 5—(Continued).**

4,481,427. REED OMARY, CHICAGO, IL. AND ANDREW LARSON, CHICAGO, IL. SN 85-135,005. PUB. 8-23-2011, FILED 9-21-2010.

# ElectroSphere

THE MARK CONSISTS OF STANDARD CHARACTERS WITHOUT CLAIM TO ANY PARTICULAR FONT, STYLE, SIZE, OR COLOR.

FOR DRUG DELIVERY AGENTS IN THE FORM OF A COATING FOR THERAPEUTIC AGENTS THAT FACILITATE THE DELIVERY OF A WIDE RANGE OF PHARMACEUTICALS; DRUG DELIVERY AGENTS IN THE FORM OF CAPSULES THAT PROVIDE CONTROLLED RELEASE OF THE ACTIVE INGREDIENTS FOR A WIDE VARIETY OF PHARMACEUTICALS; DRUG DELIVERY AGENTS IN THE FORM OF TABLETS THAT PROVIDE CONTROLLED RELEASE OF THE ACTIVE INGREDIENTS FOR A WIDE VARIETY OF PHARMACEUTICALS; PHARMACEUTICAL PREPARATIONS FOR THE PREVENTION OF CANCER; PHARMACEUTICAL PREPARATIONS FOR THE TREATMENT AND PREVENTION OF CANCER; PHARMACEUTICAL PREPARATIONS FOR THE TREATMENT OF CANCER; PHARMACEUTICAL PREPARATIONS FOR USE IN CHEMOTHERAPY; PHARMACEUTICAL PREPARATIONS FOR CANCER; PHARMACEUTICAL PRODUCTS FOR THE PREVENTION AND TREATMENT OF CANCER; THERAPEUTIC PHARMACEUTICAL FOR THE TREATMENT OF CANCER; TUMOR SUPPRESSING AGENTS (U.S. CLS. 6, 18, 44, 46, 51 AND 52).

FIRST USE 10-0-2011; IN COMMERCE 5-0-2013.

---

4,481,456. REGEN BIOSCIENCES, INC., NEW YORK, NY. AND INTELLICELL BIOSCIENCES, INC., NEW YORK, NY. SN 85-212,327. PUB. 2-28-2012, FILED 1-6-2011.

# IntelliCell

THE MARK CONSISTS OF STANDARD CHARACTERS WITHOUT CLAIM TO ANY PARTICULAR FONT, STYLE, SIZE, OR COLOR.

FOR STROMAL VASCULAR FRACTION, NAMELY, A COMBINATION OF HUMAN CELLS THAT INCLUDE STEM CELLS, DERIVED FROM ADULT ADIPOSE TISSUE AND USED TO PROVIDE REGENERATIVE MEDICAL TREATMENTS TO RESTORE, REPLACE, OR OTHERWISE HEAL HUMAN TISSUES AND ORGANS FOR USE IN SURGICAL PROCEDURES (U.S. CLS. 6, 18, 44, 46, 51 AND 52).

FIRST USE 4-4-2013; IN COMMERCE 4-4-2013.

**CLASS 5—(Continued).**

4,481,505. VETGENIX, LLC, WELLINGTON, FL. SN 85-344,400. PUB. 8-21-2012, FILED 6-13-2011.

**PAIN RELIEF FOR SERIOUS  
ATHLETES**

THE MARK CONSISTS OF STANDARD CHARACTERS WITHOUT CLAIM TO ANY PARTICULAR FONT, STYLE, SIZE, OR COLOR.

NO CLAIM IS MADE TO THE EXCLUSIVE RIGHT TO USE "PAIN RELIEF" AND "ATHLETES", APART FROM THE MARK AS SHOWN.

FOR PREPARATION FOR THE RELIEF OF PAIN (U.S. CLS. 6, 18, 44, 46, 51 AND 52).

FIRST USE 10-0-2011; IN COMMERCE 10-0-2011.

4,481,509. PBM PHARMACEUTICALS, INC., CHARLOTTESVILLE, VA. SN 85-358,659. PUB. 10-4-2011, FILED 6-28-2011.

**COMPAZINE**

THE MARK CONSISTS OF STANDARD CHARACTERS WITHOUT CLAIM TO ANY PARTICULAR FONT, STYLE, SIZE, OR COLOR.

FOR CENTRAL NERVOUS SYSTEM DEPRESSANT ESPECIALLY USEFUL AS AN ANTINAUSEANT AND SEDATIVE (U.S. CLS. 6, 18, 44, 46, 51 AND 52).

FIRST USE 9-6-2013; IN COMMERCE 9-6-2013.

4,481,515. CAN'T STOP IT, LLC, BLOOMINGTON, MN. SN 85-370,999. PUB. 3-12-2013, FILED 7-14-2011.



NO CLAIM IS MADE TO THE EXCLUSIVE RIGHT TO USE "ENERGY", APART FROM THE MARK AS SHOWN.

**CLASS 5—(Continued).**

THE MARK CONSISTS OF A STYLIZED LETTER "E" WITH A SQUARE BACKGROUND ABOVE THE STYLIZED TERM "RUPTION" AND THE WORDS "EFFERVESCENT ENERGY".

FOR DIETARY SUPPLEMENTS (U.S. CLS. 6, 18, 44, 46, 51 AND 52).

FIRST USE 7-17-2009; IN COMMERCE 8-12-2009.

4,481,573. ZHAO, SHOUMING, ARCADIA, CA. SN 85-442,894. PUB. 9-11-2012, FILED 10-9-2011.

**WBD**

THE MARK CONSISTS OF STANDARD CHARACTERS WITHOUT CLAIM TO ANY PARTICULAR FONT, STYLE, SIZE, OR COLOR.

FOR DIETARY FOOD SUPPLEMENTS; ENZYME FOOD SUPPLEMENTS; FOOD SUPPLEMENTS; FOOD SUPPLEMENTS, NAMELY, ANTI-OXIDANTS; HEALTH FOOD SUPPLEMENTS; MINERAL FOOD SUPPLEMENTS; NUTRITIONAL ADDITIVES FOR MEDICAL PURPOSES USED IN FOODS AND DIETARY SUPPLEMENTS FOR HUMAN CONSUMPTION; VITAMIN AND MINERAL PREPARATIONS FOR USE AS INGREDIENTS IN THE FOOD AND PHARMACEUTICAL INDUSTRY; VITAMINS AND DIETARY FOOD SUPPLEMENTS FOR ANIMALS (U.S. CLS. 6, 18, 44, 46, 51 AND 52).

FIRST USE 1-1-2013; IN COMMERCE 1-1-2013.

4,481,579. JBS UNITED, INC., SHERIDAN, IN. SN 85-449,765. PUB. 4-17-2012, FILED 10-18-2011.

**M-MOBILIZE**

THE MARK CONSISTS OF STANDARD CHARACTERS WITHOUT CLAIM TO ANY PARTICULAR FONT, STYLE, SIZE, OR COLOR.

FOR ANIMAL FEED SUPPLEMENTS (U.S. CLS. 6, 18, 44, 46, 51 AND 52).

FIRST USE 11-0-2011; IN COMMERCE 11-0-2011.

**CLASS 5—(Continued).**

4,481,619. CAMELLIX, LLC, AUGUSTA, GA. SN 85-479,836.  
PUB. 5-1-2012, FILED 11-23-2011.



THE MARK CONSISTS OF THE STYLIZED TERM "CAMELLIX" UNDER A TURTLE DESIGN.  
FOR ANTI-INFLAMMATORY OINTMENTS; THROAT LOZENGES (U.S. CLS. 6, 18, 44, 46, 51 AND 52).  
FIRST USE 12-1-2012; IN COMMERCE 12-1-2012.

4,481,637. PRIMARY NUTRIENTS, LLC, GREENWICH, CT.  
SN 85-503,344. PUB. 5-29-2012, FILED 12-23-2011.

**RESTORATIVE NEUROLOGY**

THE MARK CONSISTS OF STANDARD CHARACTERS WITHOUT CLAIM TO ANY PARTICULAR FONT, STYLE, SIZE, OR COLOR.  
FOR DIETARY SUPPLEMENTS (U.S. CLS. 6, 18, 44, 46, 51 AND 52).  
FIRST USE 1-5-2012; IN COMMERCE 1-5-2012.

4,481,649. VIVA LABS INC, TORONTO ONTARIO, CANADA.  
SN 85-521,164. PUB. 7-10-2012, FILED 1-20-2012.

**Omega Select**

THE MARK CONSISTS OF STANDARD CHARACTERS WITHOUT CLAIM TO ANY PARTICULAR FONT, STYLE, SIZE, OR COLOR.  
NO CLAIM IS MADE TO THE EXCLUSIVE RIGHT TO USE "OMEGA", APART FROM THE MARK AS SHOWN.  
FOR DIETARY AND NUTRITIONAL SUPPLEMENTS CONTAINING OMEGA 3 (U.S. CLS. 6, 18, 44, 46, 51 AND 52).  
FIRST USE 4-1-2012; IN COMMERCE 5-5-2012.

**CLASS 5—(Continued).**

4,481,745. RED ACE, LLC, BOULDER, CO. SN 85-600,222.  
PUB. 9-25-2012, FILED 4-17-2012.



THE COLOR(S) RED IS/ARE CLAIMED AS A FEATURE OF THE MARK.

THE MARK CONSISTS OF A SILHOUETTE OF A RED BEET, DISPLAYING A HEART-SHAPED BEET AND ITS STEMS AND LEAVES.

FOR DIETARY SUPPLEMENTS FOR ENHANCED ATHLETIC PERFORMANCE AND CIRCULATORY HEALTH (U.S. CLS. 6, 18, 44, 46, 51 AND 52).  
FIRST USE 1-10-2012; IN COMMERCE 7-1-2012.

4,481,786. PURINA ANIMAL NUTRITION LLC, SHOREVIEW, MN. SN 85-623,121. PUB. 10-9-2012, FILED 5-11-2012.

**HEIFERSMART**

THE MARK CONSISTS OF STANDARD CHARACTERS WITHOUT CLAIM TO ANY PARTICULAR FONT, STYLE, SIZE, OR COLOR.  
FOR MEDICATED ANIMAL FEED (U.S. CLS. 6, 18, 44, 46, 51 AND 52).  
FIRST USE 11-5-2012; IN COMMERCE 11-5-2012.

4,481,874. PHARMACHEM LABORATORIES, INC., KEARNY, NJ. SN 85-665,846. PUB. 11-27-2012, FILED 6-29-2012.

**BERRY-MAX**

THE MARK CONSISTS OF STANDARD CHARACTERS WITHOUT CLAIM TO ANY PARTICULAR FONT, STYLE, SIZE, OR COLOR.  
FOR DIETARY AND NUTRITIONAL SUPPLEMENTS; NUTRITIONAL SUPPLEMENTS (U.S. CLS. 6, 18, 44, 46, 51 AND 52).  
FIRST USE 8-31-2013; IN COMMERCE 8-31-2013.

**CLASS 5—(Continued).**

4,481,886. BPW SCIENCES, LP, KING OF PRUSSIA, PA. SN 85-671,882. PUB. 5-14-2013, FILED 7-9-2012.

**FUNGAL RESOLVE**

THE MARK CONSISTS OF STANDARD CHARACTERS WITHOUT CLAIM TO ANY PARTICULAR FONT, STYLE, SIZE, OR COLOR.

NO CLAIM IS MADE TO THE EXCLUSIVE RIGHT TO USE "FUNGAL", APART FROM THE MARK AS SHOWN.

FOR MEDICATED ANTI-FUNGAL CREAMS AND PREPARATIONS (U.S. CLS. 6, 18, 44, 46, 51 AND 52).

FIRST USE 12-12-2012; IN COMMERCE 12-12-2012.

---

4,482,006. OLGLESBY, JOSHUA, DAYTONA BEACH, FL. SN 85-725,091. PUB. 2-12-2013, FILED 9-10-2012.

**Fire Your Energy**

THE MARK CONSISTS OF STANDARD CHARACTERS WITHOUT CLAIM TO ANY PARTICULAR FONT, STYLE, SIZE, OR COLOR.

FOR DIETARY SUPPLEMENT BEVERAGE FOR ENERGY; HERBAL SUPPLEMENTS FOR BOOSTING ENERGY (U.S. CLS. 6, 18, 44, 46, 51 AND 52).

FIRST USE 11-1-2013; IN COMMERCE 11-1-2013.

---

4,482,011. FUSE SCIENCE, INC., MIAMI LAKES, FL. SN 85-726,808. PUB. 3-12-2013, FILED 9-12-2012.

**ALL THE ELECTROLYTES YOU  
NEED IN A SINGLE DROP**

THE MARK CONSISTS OF STANDARD CHARACTERS WITHOUT CLAIM TO ANY PARTICULAR FONT, STYLE, SIZE, OR COLOR.

FOR ANALGESICS; DIETARY SUPPLEMENTAL DRINKS IN THE NATURE OF VITAMIN AND MINERAL BEVERAGES; LIQUID VITAMIN SUPPLEMENTS; MEDICINAL PREPARATIONS FOR THE MOUTH TO BE APPLIED IN THE FORM OF DROPS, CAPSULES, TABLETS AND COMPRESSED TABLETS; NUTRITIONAL SUPPLEMENTS FOR BOOSTING ENERGY; VITAMIN AND MINERAL SUPPLEMENTS; VITAMIN DROPS; ALL GOODS CONTAINING ELECTROLYTES (U.S. CLS. 6, 18, 44, 46, 51 AND 52).

FIRST USE 9-1-2012; IN COMMERCE 12-10-2012.

**CLASS 5—(Continued).**

4,482,020. REALM LABS, LLC, DELRAY BEACH, FL. SN 85-727,898. PUB. 2-19-2013, FILED 9-13-2012.

**ZOBRIA**

THE MARK CONSISTS OF STANDARD CHARACTERS WITHOUT CLAIM TO ANY PARTICULAR FONT, STYLE, SIZE, OR COLOR.

FOR VITAMIN SUPPLEMENTS (U.S. CLS. 6, 18, 44, 46, 51 AND 52).

FIRST USE 7-21-2013; IN COMMERCE 10-10-2013.

---

4,482,036. ZHEJIANG GRACE SPINNING & WEAVING GROUP CO., LTD., ZHEJIANG, CHINA. SN 85-730,267. PUB. 2-19-2013, FILED 9-17-2012.



THE MARK CONSISTS OF THE WORDS "GRACE ORCHID" BELOW AN INCOMPLETE FLOWER DESIGN.

FOR DEPURATIVES FOR THE BODY; DIETETIC FOODS, NAMELY, PASTA, CRACKERS, ADAPTED FOR MEDICAL USE; DISINFECTANTS FOR HYGIENE PURPOSES; FOOD FOR BABIES; HYGIENIC BANDAGES; PHARMACEUTICAL PREPARATIONS FOR SKIN CARE; PREPARATIONS FOR DESTROYING VERMIN; PRESCRIPTION AND NON-PRESCRIPTION MEDICINES, NAMELY, PILLS, TABLETS, CAPSULES, CAPLETS, LIQUID DROPS, SACHETS AND PHARMACEUTICAL PREPARATIONS FOR THE TREATMENT OF CARDIOVASCULAR DISORDERS; SANITARY NAPKINS; SOLUTIONS FOR USE WITH CONTACT LENSES (U.S. CLS. 6, 18, 44, 46, 51 AND 52).

FIRST USE 5-18-2013; IN COMMERCE 5-18-2013.

**CLASS 5—(Continued).**

4,482,080. KLINE, JOSEPH, CYPRESS, TX. SN 85-736,285.  
PUB. 2-26-2013, FILED 9-24-2012.

# VHy

THE MARK CONSISTS OF STANDARD CHARACTERS WITHOUT CLAIM TO ANY PARTICULAR FONT, STYLE, SIZE, OR COLOR.

FOR DIETARY SUPPLEMENTAL DRINKS IN THE NATURE OF VITAMIN AND MINERAL BEVERAGES; FRUIT-BASED MEAL REPLACEMENT BARS FOR TREATING VITAMIN B12 DEFICIENCY THAT CAUSES FATIGUE; GUMMY VITAMINS; LIQUID VITAMIN SUPPLEMENTS; MINERAL, VITAMIN, OR NUTRITIONALLY ENHANCED WATER; MIXED VITAMIN PREPARATIONS; MULTI-VITAMIN PREPARATIONS; PRENATAL VITAMINS; VITAMIN AND MINERAL FORMED AND PACKAGED AS BARS; VITAMIN AND MINERAL PREPARATIONS FOR MEDICAL USE; VITAMIN AND MINERAL SUPPLEMENTS; VITAMIN AND MINERAL SUPPLEMENTS FOR USE AS INGREDIENTS IN THE FOOD AND PHARMACEUTICAL INDUSTRY; VITAMIN B PREPARATIONS; VITAMIN C PREPARATIONS; VITAMIN D PREPARATIONS; VITAMIN DROPS; VITAMIN ENRICHED BREAD FOR THERAPEUTIC PURPOSES; VITAMIN ENRICHED CHEWING GUM; VITAMIN ENRICHED WATER; VITAMIN FORTIFIED BEVERAGES; VITAMIN OILS FOR HUMAN CONSUMPTION; VITAMIN PREPARATIONS; VITAMIN SUPPLEMENT IN TABLET FORM FOR USE IN MAKING AN EFFERVESCENT BEVERAGE WHEN ADDED TO WATER; VITAMIN SUPPLEMENTS; VITAMIN TABLETS; VITAMINS; VITAMINS AND DIETARY FOOD SUPPLEMENTS FOR ANIMALS; VITAMINS AND VITAMIN PREPARATIONS; VITAMINS FOR PETS (U.S. CLS. 6, 18, 44, 46, 51 AND 52).

FIRST USE 5-30-2002; IN COMMERCE 8-5-2012.

4,482,136. JAFFE, RUSSELL M., VIENNA, VA. SN 85-743,466.  
PUB. 3-5-2013, FILED 10-2-2012.

# PERQ

THE MARK CONSISTS OF STANDARD CHARACTERS WITHOUT CLAIM TO ANY PARTICULAR FONT, STYLE, SIZE, OR COLOR.

OWNER OF U.S. REG. NOS. 2,461,525, 4,083,055, AND OTHERS.

FOR DIETARY AND NUTRITIONAL SUPPLEMENTS; DIETARY SUPPLEMENTS; NUTRITIONAL SUPPLEMENTS; PHARMACEUTICAL PREPARATIONS FOR THE TREATMENT OF BONE, DIGESTION, ENERGY, PAIN, WEIGHT, ENDURANCE, SLEEP, STRESS, HAIR, SKIN, AND NAIL ISSUES (U.S. CLS. 6, 18, 44, 46, 51 AND 52).

FIRST USE 10-1-2012; IN COMMERCE 10-29-2013.

**CLASS 5—(Continued).**

4,482,231. SWEET WHEAT, INC., LARGO, FL. SN 85-757,806.  
PUB. 3-26-2013, FILED 10-18-2012.

# SWEET TRIM

THE MARK CONSISTS OF STANDARD CHARACTERS WITHOUT CLAIM TO ANY PARTICULAR FONT, STYLE, SIZE, OR COLOR.

FOR DIETARY AND NUTRITIONAL SUPPLEMENTS (U.S. CLS. 6, 18, 44, 46, 51 AND 52).

FIRST USE 12-27-2012; IN COMMERCE 12-27-2012.

4,482,238. STEPHEN H. BARKOW, LAGUNA NIGUEL, CA.  
AND PAMINA E. BARKOW, LAGUNA NIGUEL, CA. SN  
85-760,132. PUB. 4-9-2013, FILED 10-22-2012.

# ILLUMINUTRI

THE MARK CONSISTS OF STANDARD CHARACTERS WITHOUT CLAIM TO ANY PARTICULAR FONT, STYLE, SIZE, OR COLOR.

THE WORDING "ILLUMINUTRI" HAS NO MEANING IN A FOREIGN LANGUAGE.

FOR NUTRITIONAL SUPPLEMENTS (U.S. CLS. 6, 18, 44, 46, 51 AND 52).

FIRST USE 10-11-2012; IN COMMERCE 11-13-2012.

4,482,364. FOLIAR NUTRIENTS, INC., CAIRO, GA. SN 85-  
800,449. PUB. 5-28-2013, FILED 12-12-2012.

# LEXX PHOS

OWNER OF U.S. REG. NO. 3,581,771.

THE COLOR(S) GREEN, GOLD, WHITE AND BLACK IS/ ARE CLAIMED AS A FEATURE OF THE MARK.

THE MARK CONSISTS OF THE BLACK LETTERS "LEXX", NEXT TO A GREEN SHIELD WITH A BLACK, GOLD AND WHITE BORDER CONTAINING THE WHITE LETTER AND SYMBOLS "-A-", NEXT TO THE BLACK LETTERS "PHOS".

FOR FUNGICIDES FOR AGRICULTURAL USE (U.S. CLS. 6, 18, 44, 46, 51 AND 52).

FIRST USE 12-10-2012; IN COMMERCE 12-10-2012.

**CLASS 5—(Continued).**

4,482,369. JAFFE, RUSSELL M., VIENNA, VA. SN 85-802,644. PUB. 3-5-2013, FILED 12-14-2012.

# YUMARA

THE MARK CONSISTS OF STANDARD CHARACTERS WITHOUT CLAIM TO ANY PARTICULAR FONT, STYLE, SIZE, OR COLOR.

FOR DIETARY AND NUTRITIONAL SUPPLEMENTS; DIETARY FOOD SUPPLEMENTS; DIETARY SUPPLEMENTS; FOOD SUPPLEMENTS; HEALTH FOOD SUPPLEMENTS; NUTRITIONAL SUPPLEMENTS; VITAMIN SUPPLEMENTS (U.S. CLS. 6, 18, 44, 46, 51 AND 52).

FIRST USE 12-12-2012; IN COMMERCE 10-29-2013.

---

4,482,370. JAFFE, RUSSELL M., VIENNA, VA. SN 85-802,646. PUB. 3-5-2013, FILED 12-14-2012.

# YOUMARA

THE MARK CONSISTS OF STANDARD CHARACTERS WITHOUT CLAIM TO ANY PARTICULAR FONT, STYLE, SIZE, OR COLOR.

FOR DIETARY AND NUTRITIONAL SUPPLEMENTS; DIETARY FOOD SUPPLEMENTS; DIETARY SUPPLEMENTS; FOOD SUPPLEMENTS; HEALTH FOOD SUPPLEMENTS; NUTRITIONAL SUPPLEMENTS; VITAMIN SUPPLEMENTS (U.S. CLS. 6, 18, 44, 46, 51 AND 52).

FIRST USE 12-12-2012; IN COMMERCE 10-29-2013.

---

4,482,376. NEW VITALITY SBP HOLDINGS, INC., CHICAGO, IL. SN 85-805,720. PUB. 6-4-2013, FILED 12-18-2012.

# BETA PROSTATE

THE MARK CONSISTS OF STANDARD CHARACTERS WITHOUT CLAIM TO ANY PARTICULAR FONT, STYLE, SIZE, OR COLOR.

OWNER OF U.S. REG. NOS. 2,287,219 AND 4,209,153.

NO CLAIM IS MADE TO THE EXCLUSIVE RIGHT TO USE "PROSTATE", APART FROM THE MARK AS SHOWN.

FOR NUTRITIONAL AND DIETARY SUPPLEMENTS USED FOR SUPPORT OF PROSTATE, URINARY, IMMUNE FUNCTION AND MEN'S SEXUAL HEALTH; NUTRITIONAL AND DIETARY SUPPLEMENTS USED FOR PROMOTING MALE HEALTH (U.S. CLS. 6, 18, 44, 46, 51 AND 52).

FIRST USE 1-12-1998; IN COMMERCE 1-12-1998.

**CLASS 5—(Continued).**

4,482,387. NOVEN THERAPEUTICS, LLC, MIAMI, FL. SN 85-809,032. PUB. 5-28-2013, FILED 12-21-2012.

# BRISDELLE

THE MARK CONSISTS OF STANDARD CHARACTERS WITHOUT CLAIM TO ANY PARTICULAR FONT, STYLE, SIZE, OR COLOR.

FOR PHARMACEUTICAL PREPARATIONS AND SUBSTANCES FOR USE IN THE TREATMENT, ALLEVIATION AND PREVENTION OF THERMOREGULATORY DYSFUNCTIONS AND VASOMOTOR SYMPTOMS INCLUDING HOT FLASHES, HOT FLUSHES, NIGHT AWAKENINGS, NIGHT SWEATS, AND SUCH DISORDERS AND CONDITIONS ASSOCIATED WITH PERIMENOPAUSE, MENOPAUSE AND HORMONAL DEFICIENCIES (U.S. CLS. 6, 18, 44, 46, 51 AND 52).

FIRST USE 10-7-2013; IN COMMERCE 10-7-2013.

---

4,482,392. WORLD HEALTH PRODUCTS, LLC, STAMFORD, CT. SN 85-810,569. PUB. 5-21-2013, FILED 12-26-2012.

# ZENTAB

THE MARK CONSISTS OF STANDARD CHARACTERS WITHOUT CLAIM TO ANY PARTICULAR FONT, STYLE, SIZE, OR COLOR.

FOR DIETARY SUPPLEMENTS; NUTRITIONAL SUPPLEMENTS (U.S. CLS. 6, 18, 44, 46, 51 AND 52).

FIRST USE 10-22-2013; IN COMMERCE 10-22-2013.

---

4,482,440. CRUCCELL BIOTECHNOLOGY INC., SAN GABRIEL, CA. SN 85-828,493. PUB. 7-16-2013, FILED 1-21-2013.



THE COLOR(S) GREEN, WHITE AND BLACK IS/ARE CLAIMED AS A FEATURE OF THE MARK.

**CLASS 5—(Continued).**

THE MARK CONSISTS OF THE WORDS "CRUCCELL LIFE" IN WHITE BEHIND A GREEN RECTANGULAR BACKGROUND FEATURING A WHITE BORDER AND OUTER BLACK BORDER. IN BETWEEN "CRUCCELL" AND "LIFE" AND SEPARATING THE RECTANGULAR BORDERS ARE TWO GREEN LEAVES. THERE ARE TWO WATER DROPLETS ON THE TOP-LEFT LEAF AND THREE WATER DROPLETS ON THE BOTTOM-RIGHT LEAF. THE WATER DROPLET REFLECTIONS ARE COLORED WHITE.

FOR DIETARY AND NUTRITIONAL SUPPLEMENTS (U.S. CLS. 6, 18, 44, 46, 51 AND 52).

FIRST USE 10-1-2013; IN COMMERCE 10-1-2013.

4,482,461. VARIED INDUSTRIES CORPORATION, MASON CITY, IA. SN 85-840,626. PUB. 7-23-2013, FILED 2-5-2013.

# TRUMAX

THE MARK CONSISTS OF STANDARD CHARACTERS WITHOUT CLAIM TO ANY PARTICULAR FONT, STYLE, SIZE, OR COLOR.

FOR ADDITIVES IN THE NATURE OF DIETARY SUPPLEMENTS FOR LIVESTOCK FEED (U.S. CLS. 6, 18, 44, 46, 51 AND 52).

FIRST USE 8-16-2013; IN COMMERCE 8-16-2013.

4,482,493. L. PERRIGO COMPANY, ALLEGAN, MI. SN 85-851,611. PUB. 4-30-2013, FILED 2-15-2013.

# 4X COMFORT FLEX

THE MARK CONSISTS OF STANDARD CHARACTERS WITHOUT CLAIM TO ANY PARTICULAR FONT, STYLE, SIZE, OR COLOR.

FOR DIETARY SUPPLEMENTS (U.S. CLS. 6, 18, 44, 46, 51 AND 52).

FIRST USE 9-30-2013; IN COMMERCE 9-30-2013.

4,482,514. ALLOSOURCE, CENTENNIAL, CO. SN 85-862,171. PUB. 7-23-2013, FILED 2-27-2013.

# AlloMend

THE MARK CONSISTS OF STANDARD CHARACTERS WITHOUT CLAIM TO ANY PARTICULAR FONT, STYLE, SIZE, OR COLOR.

**CLASS 5—(Continued).**

OWNER OF U.S. REG. NOS. 3,540,315, 3,755,371, AND 3,868,255.

FOR HUMAN ALLOGRAFT TISSUE (U.S. CLS. 6, 18, 44, 46, 51 AND 52).

FIRST USE 8-0-2013; IN COMMERCE 8-0-2013.

4,482,573. KEVIN ENGHOLDT, DBA INFINITUM HEALTH, LLC, SCOTTSDALE, AZ. SN 85-879,141. PUB. 8-20-2013, FILED 3-18-2013.

# Infinimin

THE MARK CONSISTS OF STANDARD CHARACTERS WITHOUT CLAIM TO ANY PARTICULAR FONT, STYLE, SIZE, OR COLOR.

FOR DIETARY AND NUTRITIONAL SUPPLEMENTS; MULTIVITAMIN PREPARATIONS (U.S. CLS. 6, 18, 44, 46, 51 AND 52).

FIRST USE 7-9-2013; IN COMMERCE 7-9-2013.

4,482,623. IQ FORMULATIONS, LLC, SUNRISE, FL. SN 85-898,174. PUB. 7-9-2013, FILED 4-8-2013.

# METABOLIC MAN

THE MARK CONSISTS OF STANDARD CHARACTERS WITHOUT CLAIM TO ANY PARTICULAR FONT, STYLE, SIZE, OR COLOR.

FOR DIETARY AND NUTRITIONAL SUPPLEMENTS (U.S. CLS. 6, 18, 44, 46, 51 AND 52).

FIRST USE 6-13-2013; IN COMMERCE 6-13-2013.

4,482,627. FUTUREX, INC., WHITE PLAINS, NY. SN 85-900,857. PUB. 9-17-2013, FILED 4-10-2013.

# LOVALIVER

THE MARK CONSISTS OF STANDARD CHARACTERS WITHOUT CLAIM TO ANY PARTICULAR FONT, STYLE, SIZE, OR COLOR.

THE WORDING "LOVALIVER" HAS NO MEANING IN A FOREIGN LANGUAGE.

FOR DIETARY AND NUTRITIONAL SUPPLEMENTS (U.S. CLS. 6, 18, 44, 46, 51 AND 52).

FIRST USE 6-0-2013; IN COMMERCE 6-0-2013.



**CLASS 5—(Continued).**

4,482,630. SAINTHOOD USA, PASADENA, CA. SN 85-902,228.  
PUB. 9-3-2013, FILED 4-12-2013.

**BIOTERRA HERBS**

THE MARK CONSISTS OF STANDARD CHARACTERS WITHOUT CLAIM TO ANY PARTICULAR FONT, STYLE, SIZE, OR COLOR.

NO CLAIM IS MADE TO THE EXCLUSIVE RIGHT TO USE "HERBS", APART FROM THE MARK AS SHOWN.

FOR DIETARY AND NUTRITIONAL SUPPLEMENTS CONTAINING HERBS; HERBAL SUPPLEMENTS; LIQUID HERBAL SUPPLEMENTS (U.S. CLS. 6, 18, 44, 46, 51 AND 52).

FIRST USE 10-1-2013; IN COMMERCE 10-10-2013.

**CLASS 6—(Continued).**

4,481,396. GLANTZ HOLDINGS, INC., LOUISVILLE, KY. SN 85-046,425. PUB. 10-19-2010, FILED 5-24-2010.



THE COLOR(S) BLUE, LIGHT GREEN AND WHITE IS/ ARE CLAIMED AS A FEATURE OF THE MARK.

THE MARK CONSISTS OF THE WORD "BE" IN WHITE STYLIZED LOWER CASE LETTERS WITHIN A BLUE RECTANGULAR SHAPE WITH THREE ROUNDED CORNERS AND THE UPPER LEFT CORNER EXTENDING TO A POINT, APPEARING TO THE LEFT OF THE WORD "LINE" IN STYLIZED LIGHT GREEN LETTERS WITH A CAPITALIZED "L", ALL ON A TRANSPARENT BACKGROUND.

FOR TOOLS, COMPONENTS AND SUPPLIES FOR USE IN MAKING SIGNS, NAMELY, METAL SUBSTRATES, PANELS, AND SIGN BLANKS (U.S. CLS. 2, 12, 13, 14, 23, 25 AND 50).

FIRST USE 1-1-2013; IN COMMERCE 1-1-2013.

4,482,644. THE SOTTOPELLE GROUP, LLC, AKA SOTTOPELLE, SCOTTSDALE, AZ. SN 85-912,737. PUB. 9-10-2013, FILED 4-23-2013.

**TPEL**

THE MARK CONSISTS OF STANDARD CHARACTERS WITHOUT CLAIM TO ANY PARTICULAR FONT, STYLE, SIZE, OR COLOR.

FOR HORMONE PELLETS (U.S. CLS. 6, 18, 44, 46, 51 AND 52).

FIRST USE 7-31-2013; IN COMMERCE 8-31-2013.

4,481,410. FASTENAL IP COMPANY, WINONA, MN. SN 85-070,929. PUB. 5-24-2011, FILED 6-24-2010.

**HKI**

THE MARK CONSISTS OF STANDARD CHARACTERS WITHOUT CLAIM TO ANY PARTICULAR FONT, STYLE, SIZE, OR COLOR.

FOR MACHINE WORKED METALS IN THE FORM OF UNFINISHED OR SEMIFINISHED FORGINGS; COLD AND WARM WORKED METAL PARTS, NAMELY, SCREWS, BOLTS, PIPE PLUGS AND METAL DOWEL PINS (U.S. CLS. 2, 12, 13, 14, 23, 25 AND 50).

FIRST USE 7-0-2012; IN COMMERCE 7-0-2012.

4,482,659. MONSTER ENERGY COMPANY, CORONA, CA. SN 85-933,255. PUB. 8-27-2013, FILED 5-15-2013.

**PUMP UP THE BEAST!**

THE MARK CONSISTS OF STANDARD CHARACTERS WITHOUT CLAIM TO ANY PARTICULAR FONT, STYLE, SIZE, OR COLOR.

FOR NUTRITIONAL SUPPLEMENTS IN LIQUID FORM; VITAMIN FORTIFIED BEVERAGES (U.S. CLS. 6, 18, 44, 46, 51 AND 52).

FIRST USE 3-18-2013; IN COMMERCE 3-18-2013.

4,481,422. RUTHERFORD STEEL BUILDINGS COMPANY LLC, ALLENTOWN, PA. SN 85-116,140. PUB. 2-8-2011, FILED 8-26-2010.

**THUNDERBOLT STEEL BUILDINGS**

THE MARK CONSISTS OF STANDARD CHARACTERS WITHOUT CLAIM TO ANY PARTICULAR FONT, STYLE, SIZE, OR COLOR.

NO CLAIM IS MADE TO THE EXCLUSIVE RIGHT TO USE "STEEL BUILDINGS", APART FROM THE MARK AS SHOWN.

FOR PRE-FABRICATED AND PRE-ENGINEERED STEEL BUILDINGS (U.S. CLS. 2, 12, 13, 14, 23, 25 AND 50).

FIRST USE 10-1-2013; IN COMMERCE 10-1-2013.

**CLASS 6—METAL GOODS**

**CLASS 6—(Continued).**

4,481,423. PRICESMART, INC., SAN DIEGO, CA. SN 85-123,142. PUB. 4-12-2011, FILED 9-3-2010.

# CLUB SELECT

THE MARK CONSISTS OF STANDARD CHARACTERS WITHOUT CLAIM TO ANY PARTICULAR FONT, STYLE, SIZE, OR COLOR.

OWNER OF U.S. REG. NO. 3,868,798.  
 NO CLAIM IS MADE TO THE EXCLUSIVE RIGHT TO USE "SELECT", APART FROM THE MARK AS SHOWN.  
 FOR ALUMINUM FOIL; ALUMINUM FOIL PAPER; METAL FOIL (U.S. CLS. 2, 12, 13, 14, 23, 25 AND 50).  
 FIRST USE 9-0-2013; IN COMMERCE 9-0-2013.

4,481,499. VARCO I/P, INC., HOUSTON, TX. SN 85-326,246. PUB. 10-25-2011, FILED 5-20-2011.

# THRU-KOTE

THE MARK CONSISTS OF STANDARD CHARACTERS WITHOUT CLAIM TO ANY PARTICULAR FONT, STYLE, SIZE, OR COLOR.

OWNER OF U.S. REG. NO. 2,050,081.  
 FOR METAL TUBULAR GOODS, NAMELY, TUBING AND LINE PIPE CONNECTIONS, INSERTS, AND FITTINGS (U.S. CLS. 2, 12, 13, 14, 23, 25 AND 50).  
 FIRST USE 10-25-2013; IN COMMERCE 10-25-2013.

4,481,928. STEEL AND PIPES, INC., CAGUAS, PUERTO RICO. SN 85-694,692. PUB. 2-5-2013, FILED 8-3-2012.



NO CLAIM IS MADE TO THE EXCLUSIVE RIGHT TO USE "GARAGE DOORS", APART FROM THE MARK AS SHOWN.

THE COLOR(S) WHITE, YELLOW AND BLACK IS/ARE CLAIMED AS A FEATURE OF THE MARK.  
 THE MARK CONSISTS OF A WHITE BACKGROUND

**CLASS 6—(Continued).**

WITH THE LETTERS "EZ" IN THE MIDDLE. THE LETTER "E" IS IN YELLOW WHILE THE LETTER "Z" IS IN BLACK. IN THE BOTTOM PART OF THE LETTER "E" APPEARS THE WORD "GARAGE" WRITTEN IN BLACK WHILE IN THE BOTTOM PART OF THE LETTER "Z" APPEARS THE WORD "DOORS" WRITTEN IN WHITE. BETWEEN THE WORDS "GARAGE" AND "DOORS" THERE IS A DESIGN OF A LITTLE WHITE CAR AND THE COMBINATION OF YELLOW AND BLACK COLORS BEHIND THE DESIGN OF THE CAR CREATE THE SHAPE OF A LITTLE HOUSE.

FOR METAL DOOR HARDWARE, NAMELY, NON-POWERED DOOR ACTUATORS; METAL DOOR KICK PLATES; METAL DOOR LATCHES; METAL DOOR PANELS; METAL DOOR TRIM; METAL DOOR UNITS; METAL GARAGE DOOR ROLLERS; METAL GARAGE DOORS (U.S. CLS. 2, 12, 13, 14, 23, 25 AND 50).  
 FIRST USE 1-1-2013; IN COMMERCE 1-1-2013.

4,481,935. LOGAN OUTDOOR PRODUCTS LLC, HYDE PARK, UT. SN 85-697,124. PUB. 1-15-2013, FILED 8-7-2012.

# BLACK MOUNTAIN

THE MARK CONSISTS OF STANDARD CHARACTERS WITHOUT CLAIM TO ANY PARTICULAR FONT, STYLE, SIZE, OR COLOR.

FOR GUN SAFES MADE OF METAL (U.S. CLS. 2, 12, 13, 14, 23, 25 AND 50).  
 FIRST USE 7-1-2013; IN COMMERCE 7-1-2013.

4,482,037. ZHEJIANG GRACE SPINNING & WEAVING GROUP CO., LTD., ZHEJIANG, CHINA. SN 85-730,268. PUB. 2-19-2013, FILED 9-17-2012.



THE MARK CONSISTS OF THE WORDS "GRACE ORCHID" BELOW AN INCOMPLETE FLOWER DESIGN.

FOR BUCKLES OF COMMON METAL; COMMON METALS, UNWROUGHT AND SEMI-WORKED, FOR FURTHER MANUFACTURE; METAL CHAINS; METAL CONTAINERS FOR THE STORAGE AND TRANSPORTATION OF GOODS; METAL PADLOCKS; METAL SAFES; METAL TOMBS AND METAL TOMB PLAQUES; NON-ELECTRIC CABLES AND WIRES OF COMMON METALS; UPRIGHT SIGNBOARDS OF COMMON METAL; WORKS OF ART OF COMMON METAL (U.S. CLS. 2, 12, 13, 14, 23, 25 AND 50).  
 FIRST USE 3-10-2013; IN COMMERCE 3-10-2013.

**CLASS 6—(Continued).**

4,482,400. NINGBO ZHENGHAI YONGDING FASTENER CO., LTD., ZHENHAI, NINGBO, CHINA. SN 85-814,337. PUB. 6-4-2013, FILED 1-2-2013.

YD

THE MARK CONSISTS OF STANDARD CHARACTERS WITHOUT CLAIM TO ANY PARTICULAR FONT, STYLE, SIZE, OR COLOR.

FOR METAL FASTENERS, NAMELY, NUTS, BOLTS, SCREWS, THREADED RODS, THREADED STUDS AND WASHERS (U.S. CLS. 2, 12, 13, 14, 23, 25 AND 50).

FIRST USE 10-1-2013; IN COMMERCE 10-1-2013.

4,482,577. XTRALOCK INC., SHINGLE SPRINGS, CA. SN 85-880,594. PUB. 8-27-2013, FILED 3-19-2013.

XTRALOCK

THE MARK CONSISTS OF STANDARD CHARACTERS WITHOUT CLAIM TO ANY PARTICULAR FONT, STYLE, SIZE, OR COLOR.

FOR METAL LOCKING MECHANISMS (U.S. CLS. 2, 12, 13, 14, 23, 25 AND 50).

FIRST USE 8-10-2012; IN COMMERCE 1-28-2013.

4,482,628. WILSON BUILDING PRODUCTS, LLC, CHICAGO, IL. SN 85-901,698. PUB. 9-10-2013, FILED 4-11-2013.



NO CLAIM IS MADE TO THE EXCLUSIVE RIGHT TO USE "CABLE TECH", APART FROM THE MARK AS SHOWN.

THE COLOR(S) BLACK, GRAY, BROWN, GREEN, SILVER AND WHITE IS/ARE CLAIMED AS A FEATURE OF THE MARK.

THE MARK CONSISTS OF A DRAWING OF THREE MOUNTAIN PEAKS IN BROWN, WHITE AND GRAY ABOVE TWO CURVED GREEN LINES REPRESENTING

**CLASS 6—(Continued).**

FOOTHILLS. BELOW THE GREEN LINES ARE THE STYLIZED WORDS "VISTA" IN BLACK, "VIEW" IN BROWN AND "CABLETEC" IN BLACK. THE MOUNTAIN PEAKS DRAWING, GREEN CURVED LINES AND WORDS APPEAR INSIDE TWO BLACK BRACKETS. THREE HORIZONTAL IMAGES OF METAL CABLES IN SILVER OUTLINED IN BLACK APPEAR TO THE LEFT AND RIGHT OF EACH BLACK BRACKET. THE REMAINDER OF THE WHITE IN THE MARK REPRESENTS BACKGROUND AREA AND IS NOT PART OF THE MARK.

FOR METAL HARDWARE, NAMELY, CABLE FITTINGS FOR HANDRAILS (U.S. CLS. 2, 12, 13, 14, 23, 25 AND 50).

FIRST USE 7-19-2013; IN COMMERCE 7-19-2013.

**CLASS 7—MACHINERY**

4,481,309. TOBUL ACCUMULATOR INCORPORATED, BAMBERG, SC. SN 76-712,295. PUB. 2-26-2013, FILED 8-29-2012.

SEASURE

THE MARK CONSISTS OF STANDARD CHARACTERS WITHOUT CLAIM TO ANY PARTICULAR FONT, STYLE, SIZE, OR COLOR.

FOR DEPTH COMPENSATOR FOR OFFSHORE DRILLING OPERATIONS (U.S. CLS. 13, 19, 21, 23, 31, 34 AND 35).

FIRST USE 7-8-2013; IN COMMERCE 7-8-2013.

4,481,327. KRUMREI, DAVID, MARYVILLE, TN. SN 77-754,051. PUB. 11-23-2010, FILED 6-8-2009.

RET RAM

THE MARK CONSISTS OF STANDARD CHARACTERS WITHOUT CLAIM TO ANY PARTICULAR FONT, STYLE, SIZE, OR COLOR.

NO CLAIM IS MADE TO THE EXCLUSIVE RIGHT TO USE "RAM", APART FROM THE MARK AS SHOWN.

FOR PNEUMATICALLY POWERED BATTERING RAMS (U.S. CLS. 13, 19, 21, 23, 31, 34 AND 35).

FIRST USE 6-23-2012; IN COMMERCE 6-23-2012.

**CLASS 7—(Continued).**

4,481,372. MSC SERVICES CORP., MELVILLE, NY. SN 77-968,790. PUB. 8-24-2010, FILED 3-25-2010.

# NULINE

THE MARK CONSISTS OF STANDARD CHARACTERS WITHOUT CLAIM TO ANY PARTICULAR FONT, STYLE, SIZE, OR COLOR.

FOR INDUSTRIAL MACHINE CUTTING TOOLS, NAMELY, ENDMILLS, TAPS, CARBIDE INSERTS, CARBIDE ENDMILLS, DRILLS, HAND AND GUN TABS, FACE MILLING CUTTERS, TURNING AND GROOVING TOOLS, INDEXABLE TOOL HOLDERS, TOOL BITS AND REAMERS; AIR-POWERED HAND-HELD TOOLS, NAMELY, DRILLS (U.S. CLS. 13, 19, 21, 23, 31, 34 AND 35).

FIRST USE 10-15-2010; IN COMMERCE 10-15-2010.

4,481,488. BAKER HUGHES INCORPORATED, HOUSTON, TX. SN 85-293,129. PUB. 7-24-2012, FILED 4-12-2011.

# IN-TALLIC

THE MARK CONSISTS OF STANDARD CHARACTERS WITHOUT CLAIM TO ANY PARTICULAR FONT, STYLE, SIZE, OR COLOR.

FOR DECOMPOSABLE METAL ARTICLES, NAMELY, BALLS, SEATS, PLUGS, PACKERS AND DARTS FOR USE IN OIL, GAS, CONDENSATE AND WATER WELLS, WELL BORES AND BOREHOLES; SLEEVES, SLIDING SLEEVES, VALVES, BALLS, SEATS AND SETTING TOOLS COMPRISING DECOMPOSABLE METAL FOR POSITIONING OR ACTUATING DOWNHOLE TOOLS, OR FOR CONTROLLING PRESSURE OR FLUIDS IN OIL, GAS, CONDENSATE AND WATER WELLS, WELL BORES AND BOREHOLES; PACKERS, BRIDGE PLUGS, FRACTURING PLUGS, BALLS, FRACTURING BALLS, DARTS, SLEEVES, SLIDING SLEEVES, AND VALVES COMPRISING DECOMPOSABLE METAL FOR CONTROLLING PRESSURE OR FLUID IN OIL, GAS, CONDENSATE AND WATER WELLS, WELL BORES AND BOREHOLES; PIPES, PIPEWORK AND TUBES OF METAL AND METAL PRODUCTS, NAMELY, METAL LINERS, MANDRELS, WHIPSTOCKS AND CASINGS FOR USE IN OIL, GAS, CONDENSATE AND WATER WELLS, WELL BORES AND BOREHOLES; SLIPS AND ANCHORS COMPRISING DECOMPOSABLE METAL FOR SECURING VARIOUS DOWNHOLE TOOLS IN OIL, GAS, CONDENSATE AND WATER WELLS, WELL BORES AND BOREHOLES; AND PARTS, FITTINGS AND ACCESSORIES FOR THE AFORESAID GOOD (U.S. CLS. 13, 19, 21, 23, 31, 34 AND 35).

FIRST USE 7-25-2011; IN COMMERCE 4-10-2013.

**CLASS 7—(Continued).**

4,481,544. JBS UNITED, INC., SHERIDAN, IN. SN 85-414,147. PUB. 3-13-2012, FILED 9-2-2011.

# CENTRAL NUTRITION SERVICES

THE MARK CONSISTS OF STANDARD CHARACTERS WITHOUT CLAIM TO ANY PARTICULAR FONT, STYLE, SIZE, OR COLOR.

NO CLAIM IS MADE TO THE EXCLUSIVE RIGHT TO USE "NUTRITION", APART FROM THE MARK AS SHOWN.

FOR FEED MILLS (U.S. CLS. 13, 19, 21, 23, 31, 34 AND 35).

FIRST USE 8-24-2011; IN COMMERCE 8-24-2011.

4,481,556. VAREL INTERNATIONAL IND., L.P., CARROLLTON, TX. SN 85-427,258. PUB. 8-21-2012, FILED 9-20-2011.

# ULTRALEACH

THE MARK CONSISTS OF STANDARD CHARACTERS WITHOUT CLAIM TO ANY PARTICULAR FONT, STYLE, SIZE, OR COLOR.

FOR POLYCRYSTALLINE DIAMOND COMPACT DRILL BITS; ROLLER CONE DRILL BITS AND CUTTERS FOR POLYCRYSTALLINE DIAMOND COMPACT DRILL BITS; CUTTERS FOR ROLLER CONE DRILL BITS; CUTTERS FOR DOWNHOLE DRILLING AND BORING TOOLS (U.S. CLS. 13, 19, 21, 23, 31, 34 AND 35).

FIRST USE 5-3-2013; IN COMMERCE 5-3-2013.

4,481,557. VAREL INTERNATIONAL IND., L.P., CARROLLTON, TX. SN 85-427,279. PUB. 8-21-2012, FILED 9-20-2011.

# SUPERDEEP

THE MARK CONSISTS OF STANDARD CHARACTERS WITHOUT CLAIM TO ANY PARTICULAR FONT, STYLE, SIZE, OR COLOR.

FOR POLYCRYSTALLINE DIAMOND COMPACT DRILL BITS; ROLLER CONE DRILL BITS, CUTTERS FOR POLYCRYSTALLINE DIAMOND COMPACT DRILL BITS; CUTTERS FOR ROLLER CONE DRILL BITS; CUTTERS FOR DOWNHOLE DRILLING AND BORING TOOLS (U.S. CLS. 13, 19, 21, 23, 31, 34 AND 35).

FIRST USE 5-3-2013; IN COMMERCE 5-3-2013.

**CLASS 7—(Continued).**

4,481,558. VAREL INTERNATIONAL IND., L.P., CARROLLTON, TX. SN 85-427,302. PUB. 8-21-2012, FILED 9-20-2011.

# TOTALLEACH

THE MARK CONSISTS OF STANDARD CHARACTERS WITHOUT CLAIM TO ANY PARTICULAR FONT, STYLE, SIZE, OR COLOR.

FOR POLYCRYSTALLINE DIAMOND COMPACT DRILL BITS; ROLLER CONE DRILL BITS AND CUTTERS FOR POLYCRYSTALLINE DIAMOND COMPACT DRILL BITS; CUTTERS FOR ROLLER CONE DRILL BITS; CUTTERS FOR DOWNHOLE DRILLING AND BORING TOOLS (U.S. CLS. 13, 19, 21, 23, 31, 34 AND 35).  
FIRST USE 5-3-2013; IN COMMERCE 5-3-2013.

4,481,737. POWER TECH STAPLE & NAIL, INC., MONTEREY PARK, CA. SN 85-597,505. PUB. 9-18-2012, FILED 4-13-2012.

# GREXUSA

THE MARK CONSISTS OF STANDARD CHARACTERS WITHOUT CLAIM TO ANY PARTICULAR FONT, STYLE, SIZE, OR COLOR.

OWNER OF U.S. REG. NOS. 2,644,525 AND 3,075,434.  
FOR POWER TOOLS, NAMELY, STAPLERS AND NAILERS FOR CONSTRUCTION AND INDUSTRIAL USE; AIR BRUSHES FOR APPLYING COLORING AND THE LIKE; AIR BRUSHES FOR DRAWINGS (U.S. CLS. 13, 19, 21, 23, 31, 34 AND 35).  
FIRST USE 5-1-2013; IN COMMERCE 5-1-2013.

4,481,738. POWER TECH STAPLE & NAIL, INC., MONTEREY PARK, CA. SN 85-597,528. PUB. 9-18-2012, FILED 4-13-2012.

# GREXCO

THE MARK CONSISTS OF STANDARD CHARACTERS WITHOUT CLAIM TO ANY PARTICULAR FONT, STYLE, SIZE, OR COLOR.

OWNER OF U.S. REG. NOS. 2,644,525 AND 3,075,434.  
FOR POWER TOOLS, NAMELY, STAPLERS AND NAILERS FOR CONSTRUCTION AND INDUSTRIAL USE; AIR BRUSHES FOR APPLYING COLORING AND THE LIKE; AIR BRUSHES FOR DRAWINGS, IN CLASS 7 (U.S. CLS. 13, 19, 21, 23, 31, 34 AND 35) (U.S. CLS. 13, 19, 21, 23, 31, 34 AND 35).  
FIRST USE 5-1-2013; IN COMMERCE 5-1-2013.

**CLASS 7—(Continued).**

4,482,156. GENERAL ELECTRIC COMPANY, SCHENECTADY, NY. SN 85-746,777. PUB. 3-12-2013, FILED 10-5-2012.

# GE

THE MARK CONSISTS OF STANDARD CHARACTERS WITHOUT CLAIM TO ANY PARTICULAR FONT, STYLE, SIZE, OR COLOR.

OWNER OF U.S. REG. NOS. 1,197,111, 3,399,353, AND OTHERS.

FOR ELECTRIC COFFEE GRINDERS; ELECTRIC FOOD BLENDERS; ELECTRIC FOOD GRINDERS; ELECTRIC FOOD PROCESSORS; ELECTRIC FOOD SLICERS; ELECTRIC JUICE EXTRACTORS; MECHANICAL MIXING MACHINES (U.S. CLS. 13, 19, 21, 23, 31, 34 AND 35).

FIRST USE 10-5-2012; IN COMMERCE 10-5-2012.

4,482,276. TENNANT COMPANY, MINNEAPOLIS, MN. SN 85-768,775. PUB. 3-5-2013, FILED 11-1-2012.

# TWINMAX

THE MARK CONSISTS OF STANDARD CHARACTERS WITHOUT CLAIM TO ANY PARTICULAR FONT, STYLE, SIZE, OR COLOR.

OWNER OF U.S. REG. NOS. 3,901,514 AND 3,901,515.  
FOR SURFACE MAINTENANCE MACHINES, NAMELY, ELECTRIC SWEEPERS (U.S. CLS. 13, 19, 21, 23, 31, 34 AND 35).

FIRST USE 2-28-2013; IN COMMERCE 2-28-2013.

4,482,444. LI JINCHENG, SOUTH SAN FRANCISCO, CA. SN 85-830,877. PUB. 6-11-2013, FILED 1-24-2013.

# SRACER

THE MARK CONSISTS OF THE STYLIZED WORD "SRACER" WITH THE FIRST TWO LETTERS "SR" IN LARGER SIZE.

**CLASS 7—(Continued).**

THE WORDING "SRACER" HAS NO MEANING IN A FOREIGN LANGUAGE.

FOR AIR FILTERS FOR VEHICLE MOTORS AND ENGINES; AIR-INTAKE TUBES AND FILTERS FOR AFTER-MARKET INSTALLATION OF AUTOMOTIVE ENGINES; CATALYTIC CONVERTER UNITS FOR VEHICLE EXHAUSTS; COOLING RADIATORS FOR MOTORS AND ENGINES; ENGINE EXHAUST SYSTEMS COMPRISED OF PIPES, COLLECTOR AND MUFFLER; INTERNAL COMBUSTION ENGINE PARTS, NAMELY, PISTONS; OIL FILTERS; RADIATORS FOR MOTORS AND ENGINES; SILENCERS AS PART OF VEHICLE EXHAUST SYSTEMS; SILENCERS FOR MOTORS AND ENGINES (U.S. CLS. 13, 19, 21, 23, 31, 34 AND 35).

FIRST USE 7-27-2009; IN COMMERCE 12-1-2012.

**CLASS 8—HAND TOOLS**

4,481,716. FASTENAL IP COMPANY, WINONA, MN. SN 85-586,444. PUB. 10-2-2012, FILED 4-2-2012.

---

# RVR

THE MARK CONSISTS OF STANDARD CHARACTERS WITHOUT CLAIM TO ANY PARTICULAR FONT, STYLE, SIZE, OR COLOR.

FOR HAND TOOLS, NAMELY, BIT TIPS, NUT DRIVERS, BIT TIP HOLDERS (U.S. CLS. 23, 28 AND 44).

FIRST USE 10-15-2013; IN COMMERCE 10-15-2013.

---

4,481,895. DESROCHERS, MELISSA, RUMFORD, RI. SN 85-676,535. PUB. 4-9-2013, FILED 7-13-2012.

# PICK-EASE

THE MARK CONSISTS OF STANDARD CHARACTERS WITHOUT CLAIM TO ANY PARTICULAR FONT, STYLE, SIZE, OR COLOR.

FOR TRAINING AND FEEDING UTENSIL FOR CHILDREN IN THE NATURE OF CUTLERY (U.S. CLS. 23, 28 AND 44).

FIRST USE 7-24-2013; IN COMMERCE 11-1-2013.

**CLASS 8—(Continued).**

4,481,913. EVEREADY BATTERY COMPANY, INC., ST. LOUIS MISSOURI, MO. SN 85-686,444. PUB. 4-30-2013, FILED 7-25-2012.

# HALO

THE MARK CONSISTS OF STANDARD CHARACTERS WITHOUT CLAIM TO ANY PARTICULAR FONT, STYLE, SIZE, OR COLOR.

OWNER OF U.S. REG. NO. 4,043,117.  
FOR RAZOR BLADES; RAZORS (U.S. CLS. 23, 28 AND 44).

FIRST USE 7-5-2013; IN COMMERCE 7-5-2013.

---

4,481,939. EVEREADY BATTERY COMPANY, INC., ST. LOUIS, MO. SN 85-699,510. PUB. 11-20-2012, FILED 8-9-2012.

# WILKINSON FOR WOMEN OASIS SYMPHONY

THE MARK CONSISTS OF STANDARD CHARACTERS WITHOUT CLAIM TO ANY PARTICULAR FONT, STYLE, SIZE, OR COLOR.

OWNER OF U.S. REG. NOS. 2,944,019, 3,975,827, AND OTHERS.

NO CLAIM IS MADE TO THE EXCLUSIVE RIGHT TO USE "FOR WOMEN", APART FROM THE MARK AS SHOWN.

FOR RAZORS AND RAZOR BLADES (U.S. CLS. 23, 28 AND 44).

FIRST USE 1-14-2013; IN COMMERCE 1-14-2013.

---

4,481,967. TRAMONTINA S.A., CUTLERIA, SUGAR LAND, TX. SN 85-714,699. PUB. 4-9-2013, FILED 8-28-2012.

# TRAMONTINA PROLINE

THE MARK CONSISTS OF STANDARD CHARACTERS WITHOUT CLAIM TO ANY PARTICULAR FONT, STYLE, SIZE, OR COLOR.

OWNER OF U.S. REG. NOS. 1,524,191 AND 1,528,305.  
THE WORDING "TRAMONTINA" HAS NO MEANING IN A FOREIGN LANGUAGE.

FOR STAINLESS STEEL CUTLERY, NAMELY, COOK'S KNIVES, PARING KNIVES, UTILITY KNIVES, BREAD KNIVES, SLICING KNIVES, BONING KNIVES, STEAK KNIVES, SERVING KNIVES; FLATWARE, NAMELY, FORKS, KNIVES, AND SPOONS; COOKING SPOONS; KITCHEN SCISSORS (U.S. CLS. 23, 28 AND 44).

FIRST USE 8-31-2012; IN COMMERCE 8-31-2012.

**CLASS 8—(Continued).**

4,482,043. ZHEJIANG GRACE SPINNING & WEAVING GROUP CO., LTD., ZHEJIANG, CHINA. SN 85-731,208. PUB. 2-26-2013, FILED 9-17-2012.



THE MARK CONSISTS OF THE WORDS "GRACE ORCHID" BELOW AN INCOMPLETE FLOWER DESIGN.

FOR ABRADING TOOLS; BEARD CLIPPERS; BUTCHER KNIVES; CUTLERY; GIMLETS; HAND TOOLS, NAMELY, GROOVING TOOLS; HARPOONS FOR COMMERCIAL FISHING; KNIVES; LAWN AND GARDEN TOOLS, NAMELY, CULTIVATORS; SIDE ARMS, NOT INCLUDING FIREARMS, NAMELY, HUNTING KNIVES (U.S. CLS. 23, 28 AND 44).

FIRST USE 12-15-2012; IN COMMERCE 12-15-2012.

4,482,072. VIATEK HONG KONG LIMITED, KOWLOON, HONG KONG. SN 85-734,818. PUB. 2-26-2013, FILED 9-21-2012.

Pearl

THE MARK CONSISTS OF STANDARD CHARACTERS WITHOUT CLAIM TO ANY PARTICULAR FONT, STYLE, SIZE, OR COLOR.

FOR ELECTRIC HAIR REMOVER DEVICES (U.S. CLS. 23, 28 AND 44).

FIRST USE 4-9-2013; IN COMMERCE 4-9-2013.

4,482,106. LEGACY SPORTS INTERNATIONAL, LLC, RENO, NV. SN 85-738,495. PUB. 4-2-2013, FILED 9-25-2012.

CITADEL

THE MARK CONSISTS OF STANDARD CHARACTERS WITHOUT CLAIM TO ANY PARTICULAR FONT, STYLE, SIZE, OR COLOR.

OWNER OF U.S. REG. NO. 3,607,422.

FOR FIXED BLADE KNIVES; FOLDING KNIVES; POCKET KNIVES; SPORT KNIVES; UTILITY KNIVES (U.S. CLS. 23, 28 AND 44).

FIRST USE 9-1-2013; IN COMMERCE 9-1-2013.

**CLASS 8—(Continued).**

4,482,520. RUKO LLC, BATON ROUGE, LA. SN 85-864,258. PUB. 7-23-2013, FILED 3-1-2013.

TI-TACTICAL

THE MARK CONSISTS OF STANDARD CHARACTERS WITHOUT CLAIM TO ANY PARTICULAR FONT, STYLE, SIZE, OR COLOR.

FOR AXES; DIVING KNIVES; FISHING KNIVES; FIXED BLADE KNIVES; FOLDING KNIVES; HUNTING KNIVES; JACK KNIVES; KNIVES, NAMELY, KUKRIS AND PARANGS; MACHETES; MULTI-FUNCTION HAND TOOLS COMPRISED OF KNIVES, PLIERS, SCREWDRIVERS, CAN OPENERS, FILES, SCISSORS, SAWS, WIRE STRIPPERS; PEN KNIVES; POCKET KNIVES; RAZOR KNIVES; SPORT KNIVES; THROWING KNIVES; UTILITY KNIVES (U.S. CLS. 23, 28 AND 44).

FIRST USE 4-26-2013; IN COMMERCE 4-26-2013.

**CLASS 9—ELECTRICAL AND SCIENTIFIC APPARATUS**

4,481,301. NANOPHOTON CORPORATION, OSAKA, JAPAN. SN 76-705,904. PUB. 9-20-2011, FILED 1-4-2011.



THE MARK CONSISTS OF A STYLIZED LETTER "N", WHICH IS MADE UP OF TWO VERTICAL SOLID QUADRILATERALS WITH TWO TOUCHING DIAGONAL QUADRILATERALS PARTIALLY SHADED BY DOTS IN BETWEEN AND EXTENDING OUTSIDE THE VERTICAL QUADRILATERALS.

FOR OPTICAL APPARATUS AND INSTRUMENTS, NAMELY, RAMAN MICROSCOPES; LABORATORY APPARATUS AND INSTRUMENTS, NAMELY, MICROSCOPES AND LASER MICROSCOPES; MEASURING OR TESTING MACHINES AND INSTRUMENTS, NAMELY, SCIENTIFIC INSTRUMENT ANALYZERS FOR MEASURING, TESTING, AND DETECTING LIGHT AND DISPLAYING IMAGES; MEASURING OR TESTING MACHINES AND INSTRUMENTS, NAMELY, LASERS FOR MEASURING PURPOSES (U.S. CLS. 21, 23, 26, 36 AND 38).

FIRST USE 10-10-2003; IN COMMERCE 8-28-2013.

**CLASS 9—(Continued).**

4,481,302. NANOPHOTON CORPORATION, OSAKA, JAPAN.  
SN 76-705,905. PUB. 9-20-2011, FILED 1-4-2011.



THE MARK CONSISTS OF A STYLIZED LETTER "N", WHICH IS MADE UP OF TWO VERTICAL SOLID QUADRILATERALS WITH TWO TOUCHING DIAGONAL QUADRILATERALS PARTIALLY SHADED BY GRADATION IN BETWEEN AND EXTENDING OUTSIDE THE VERTICAL QUADRILATERALS.

FOR OPTICAL APPARATUS AND INSTRUMENTS, NAMELY, RAMAN MICROSCOPES; LABORATORY APPARATUS AND INSTRUMENTS, NAMELY, MICROSCOPES AND LASER MICROSCOPES; MEASURING OR TESTING MACHINES AND INSTRUMENTS, NAMELY, SCIENTIFIC INSTRUMENT ANALYZERS FOR MEASURING, TESTING, AND DETECTING LIGHT AND DISPLAYING IMAGES; MEASURING OR TESTING MACHINES AND INSTRUMENTS, NAMELY, LASERS FOR MEASURING PURPOSES (U.S. CLS. 21, 23, 26, 36 AND 38).

FIRST USE 10-10-2003; IN COMMERCE 8-28-2013.

4,481,303. HARDY, DANNY J., LAPORTE, TX. SN 76-709,038.  
PUB. 3-19-2013, FILED 9-12-2011.

# XARDERX

THE MARK CONSISTS OF STANDARD CHARACTERS WITHOUT CLAIM TO ANY PARTICULAR FONT, STYLE, SIZE, OR COLOR.

FOR REMOVABLE PROTECTIVE EAR COVER THAT IS A COMPONENT PART OF HEADWEAR, NAMELY, CAPS AND VISORS (U.S. CLS. 21, 23, 26, 36 AND 38).

FIRST USE 4-26-2013; IN COMMERCE 4-26-2013.

**CLASS 9—(Continued).**

4,481,304. INTERNATIONAL RECTIFIER CORPORATION, EL SEGUNDO, CA. SN 76-709,305. PUB. 8-28-2012, FILED 10-4-2011.

# COOLiRDiode

OWNER OF U.S. REG. NO. 1,551,719.

THE MARK CONSISTS OF THE WORDING "COOLIR-DIODE" IN STYLIZED FONT, WHERE THE LETTERS "C","O","O","L" AND "R","D" ARE UPPERCASE AND THE LETTERS "i" AND "I","O","D","E" ARE LOWERCASE.

FOR ELECTRICAL AND ELECTRONIC CIRCUITS, ELECTRICAL AND ELECTRONIC COMPONENTS, NAMELY, TRANSISTORS, INDUCTORS, CAPACITORS AND RESISTORS, SEMICONDUCTORS AND PACKAGES ENCAPSULATING SEMICONDUCTOR DEVICES HAVING ELECTRICAL AND ELECTRONIC CIRCUITS, AND DEVICES FOR POWER CONVERSION, VOLTAGE CONVERSION, POWER MANAGEMENT AND/OR DELIVERY OF POWER, NAMELY, BUCK CONVERTERS, DC-DC CONVERTERS, AC-DC CONVERTERS, DC-AC CONVERTERS, AC-AC CONVERTERS, RECTIFIERS, POWER FACTOR CORRECTION CIRCUITS, HALF-BRIDGE CIRCUITS AND FULL-BRIDGE CIRCUITS (U.S. CLS. 21, 23, 26, 36 AND 38).

FIRST USE 5-31-2012; IN COMMERCE 5-31-2012.

4,481,307. INTERNATIONAL RECTIFIER CORPORATION, EL SEGUNDO, CA. SN 76-709,706. PUB. 8-28-2012, FILED 11-10-2011.

# PowIR'd by IR

OWNER OF U.S. REG. NO. 1,551,719.

THE MARK CONSISTS OF THE WORDING "POWIR'D BY IR" IN STYLIZED FONT, WHERE ALL LETTERS ARE LOWERCASE, EXCEPT LETTERS "P" AND "IR" WHICH ARE UPPERCASE.

FOR ELECTRICAL AND ELECTRONIC CIRCUITS, ELECTRICAL AND ELECTRONIC COMPONENTS, NAMELY, TRANSISTORS, INDUCTORS, CAPACITORS AND RESISTORS, SEMICONDUCTORS AND PACKAGES ENCAPSULATING SEMICONDUCTOR DEVICES HAVING ELECTRICAL AND ELECTRONIC CIRCUITS, AND DEVICES FOR POWER CONVERSION, VOLTAGE CONVERSION, POWER MANAGEMENT AND/OR DELIVERY OF POWER, NAMELY, BUCK CONVERTERS, DC-DC CONVERTERS, AC-DC CONVERTERS, DC-AC CONVERTERS, AC-AC CONVERTERS, RECTIFIERS, POWER FACTOR CORRECTION CIRCUITS, HALF-BRIDGE CIRCUITS AND FULL-BRIDGE CIRCUITS (U.S. CLS. 21, 23, 26, 36 AND 38).

FIRST USE 8-22-2013; IN COMMERCE 8-22-2013.



**CLASS 9—(Continued).**

4,481,324. BINDER GMBH, DBA BINDER GMBH, TUTTLINGEN, FED REP GERMANY. SN 77-696,071. PUB. 4-5-2011, FILED 3-20-2009.

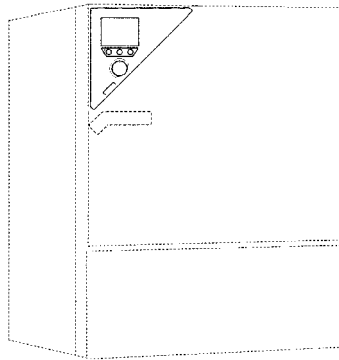

NO CLAIM IS MADE TO THE EXCLUSIVE RIGHT TO USE THE SHAPE OF THE ROUND KNOBS AND BUTTONS AND THE RECTANGULAR DISPLAY SCREEN, APART FROM THE MARK AS SHOWN.

THE MARK CONSISTS OF A TRIANGULAR THREE DIMENSIONAL CONFIGURATION OF AN ADDITIONAL PART OF THE GOODS APPEARING IN THE UPPER-LEFT CORNER OF THE FRONT DOOR OF SAID GOODS, WITH A RECTANGULAR DISPLAY IN THE MIDDLE OF ITS SURFACE, WITH A TRAPEZOID SHAPE UNDERNEATH THE DISPLAY THAT CONTAINS THREE HORIZONTALLY ALIGNED ROUND BUTTONS, A LARGE ROUND BUTTON UNDERNEATH THE TRAPEZOID SHAPE, AND A SWITCH ON THE LOWER THIRD OF THE SIDE OPPOSITE TO THE RIGHT ANGLE. MATTER SHOWN IN BROKEN LINES IS NOT CLAIMED AS A FEATURE OF THE MARK, AND SERVES ONLY TO SHOW THE PLACEMENT OF THE MARK.

SEC. 2(F).

FOR LABORATORY APPARATUS AND INSTRUMENTS, NAMELY, INCUBATORS, TEMPERATURE CHAMBERS, CLIMATIC CHAMBERS, TEST CHAMBERS, HEATING CHAMBERS, GROWTH CHAMBERS, DRYING OVENS AND HOT-AIR STERILIZERS (U.S. CLS. 21, 23, 26, 36 AND 38).

FIRST USE 5-29-2013; IN COMMERCE 5-29-2013.

4,481,329. SWISS CARGO INDUSTRIES S.A. INC., ST. JEAN, QUEBEC, CANADA. SN 77-770,371. PUB. 4-27-2010, FILED 6-29-2009.

**SWISS CARGO**

THE MARK CONSISTS OF STANDARD CHARACTERS WITHOUT CLAIM TO ANY PARTICULAR FONT, STYLE, SIZE, OR COLOR.

OWNER OF U.S. REG. NOS. 3,610,017 AND 3,610,033.

FOR CARRYING CASES FOR PORTABLE ELECTRONIC DEVICES, NAMELY, CELL PHONES, SMART PHONES, ELECTRONIC ORGANIZERS, PERSONAL DIGITAL ASSISTANTS, LAPTOPS AND NOTEBOOK COMPUTERS, AND SPECIFICALLY EXCLUDING POCKET-SIZED CARRYING CASES (U.S. CLS. 21, 23, 26, 36 AND 38).

FIRST USE 11-29-2013; IN COMMERCE 11-29-2013.

**CLASS 9—(Continued).**

4,481,330. SWISS CARGO INDUSTRIES S.A. INC., ST. JEAN, QUEBEC, CANADA. SN 77-770,414. PUB. 4-27-2010, FILED 6-29-2009.



OWNER OF U.S. REG. NOS. 3,610,017 AND 3,610,033.

THE MARK CONSISTS OF A CROSS WITHIN AN OCTAGON PRECEDING THE WORDS "SWISS CARGO", ALL OF WHICH ARE ENCIRCLED BY A LONG OVAL.

FOR CARRYING CASES FOR PORTABLE ELECTRONIC DEVICES, NAMELY, CELL PHONES, SMART PHONES, ELECTRONIC ORGANIZERS, PERSONAL DIGITAL ASSISTANTS, LAPTOPS AND NOTEBOOK COMPUTERS, AND SPECIFICALLY EXCLUDING POCKET-SIZED CARRYING CASES (U.S. CLS. 21, 23, 26, 36 AND 38).

FIRST USE 11-29-2013; IN COMMERCE 11-29-2013.

4,481,333. WARNER POWER CONVERSION LLC, WARNER, NH. SN 77-781,310. PUB. 2-16-2010, FILED 7-15-2009.

**SmarTran**

THE MARK CONSISTS OF STANDARD CHARACTERS WITHOUT CLAIM TO ANY PARTICULAR FONT, STYLE, SIZE, OR COLOR.

FOR ELECTRICAL TRANSFORMERS (U.S. CLS. 21, 23, 26, 36 AND 38).

FIRST USE 11-15-2010; IN COMMERCE 11-15-2010.

4,481,356. COMPAGNIE DES MONTRES LONGINES, FRANCILLON S.A. (LONGINES WATCH CO., FRANCILLON LTD.), SWITZERLAND. SN 77-905,257. PUB. 11-16-2010, FILED 1-5-2010.

**LONGINES**

OWNER OF U.S. REG. NO. 1,576,106.

THE MARK CONSISTS OF THE WORD, "LONGINES", IN STYLIZED FORM.

FOR SUNGLASSES, SUNGLASS FRAMES, AND CASES FOR SUNGLASSES (U.S. CLS. 21, 23, 26, 36 AND 38).

FIRST USE 6-23-1988; IN COMMERCE 11-22-2013.

**CLASS 9—(Continued).**

4,481,364. WARREN, BRINKLEY, REDWOOD CITY, CA. SN 77-920,336. PUB. 6-15-2010, FILED 1-26-2010.

# Wikitube

THE MARK CONSISTS OF STANDARD CHARACTERS WITHOUT CLAIM TO ANY PARTICULAR FONT, STYLE, SIZE, OR COLOR.

FOR DOWNLOADABLE SOFTWARE IN THE NATURE OF A MOBILE APPLICATION FOR USE IN DATABASE MANAGEMENT IN THE FIELD OF VIDEO-BASED COMMUNICATIONS (U.S. CLS. 21, 23, 26, 36 AND 38).

FIRST USE 10-0-2013; IN COMMERCE 10-0-2013.

4,481,376. OL2, INC., MOUNTAIN VIEW, CA. SN 77-983,580. PUB. 3-15-2011, FILED 6-29-2009.



OWNER OF U.S. REG. NO. 3,617,483.

THE MARK CONSISTS OF A CIRCULAR DESIGN WITH THE WORD "ONLIVE" ON THE BOTTOM.

FOR COMPUTER SOFTWARE FOR USE IN CONSUMER ELECTRONICS HARDWARE, SERVERS AND INDUSTRIAL HARDWARE, NAMELY, ELECTRONIC GAME SOFTWARE, VIDEO GAME SOFTWARE AND APPLICATION SOFTWARE FOR USE IN THREE-DIMENSIONAL ILLUSTRATION, ANIMATION, EDITING, MODELING, SPECIAL EFFECTS, DIGITAL STORAGE, DATABASE MANAGEMENT, OPERATING MEDIA PLAYERS, TRANSFERRING DATA TO AND FROM DATABASES, PREPARING ELECTRONIC SPREADSHEETS, WORD PROCESSING, ELECTRONIC MAIL, CALENDAR AND SCHEDULING, DESKTOP PUBLISHING, IMAGE EDITING, GRAPHICS CREATION AND EDITING, DRAWING, COMPUTER AIDED DESIGN AND DRAFTING, CREATION OF MULTIMEDIA PRESENTATIONS, PROJECT MANAGEMENT, CUSTOMER MANAGEMENT, BUSINESS PLANNING, DESIGNING, CREATING, MAINTAINING AND ACCESSING CUSTOMIZED INTERNAL NETWORK SITES AND INTERNET SITES, COMPILING, DEBUGGING AND CREATING INTERNAL NETWORK AND INTERNET APPLICATIONS, MEETING AND EVENT SCHEDULING AND NOTIFICATION AND FOR POSTING ANNOUNCEMENTS ON INTERNAL NETWORK SITES AND INTERNET SITES, MANAGING, VIEWING, AND EDITING FILES, DOCUMENTS, ELECTRONIC MAIL MESSAGES AND PRIVATE NETWORK AND INTERNET COMMUNICATIONS, MEETING AND EVENT SCHEDULING, MANAGING GROUP CALENDARS, TASK DELEGATION AND REPORTING, RECORDING NOTES, TRANS-

**CLASS 9—(Continued).**

FERRING DATA TO AND FROM DATA BASES AND TO AND FROM COMPUTER PROGRAMS AND COMPUTER FILES, CORRECTING TYPOGRAPHICAL AND CAPITALIZATION ERRORS, DEBUGGING, CREATING AND TESTING OTHER COMPUTER PROGRAMS, RUNNING DEVELOPMENT PROGRAMS AND APPLICATION PROGRAMS; ELECTRONIC GAME SOFTWARE AND VIDEO GAME SOFTWARE; APPLICATION SOFTWARE, NAMELY, COMPUTER SOFTWARE FOR USE IN CONSUMER ELECTRONICS HARDWARE, SERVERS AND INDUSTRIAL HARDWARE, NAMELY, ELECTRONIC GAME SOFTWARE, VIDEO GAME SOFTWARE AND APPLICATION SOFTWARE FOR USE IN THREE-DIMENSIONAL ILLUSTRATION, ANIMATION, EDITING, MODELING, SPECIAL EFFECTS, DIGITAL STORAGE, DATABASE MANAGEMENT, OPERATING MEDIA PLAYERS, TRANSFERRING DATA TO AND FROM DATABASES, PREPARING ELECTRONIC SPREADSHEETS, WORD PROCESSING, ELECTRONIC MAIL, CALENDAR AND SCHEDULING, DESKTOP PUBLISHING, IMAGE EDITING, GRAPHICS CREATION AND EDITING, DRAWING, COMPUTER AIDED DESIGN AND DRAFTING, CREATION OF MULTIMEDIA PRESENTATIONS, PROJECT MANAGEMENT, CUSTOMER MANAGEMENT, BUSINESS PLANNING, DESIGNING, CREATING, MAINTAINING AND ACCESSING CUSTOMIZED INTERNAL NETWORK SITES AND INTERNET SITES, COMPILING, DEBUGGING AND CREATING INTERNAL NETWORK AND INTERNET APPLICATIONS, MEETING AND EVENT SCHEDULING AND NOTIFICATION AND FOR POSTING ANNOUNCEMENTS ON INTERNAL NETWORK SITES AND INTERNET SITES, MANAGING, VIEWING, AND EDITING FILES, DOCUMENTS, ELECTRONIC MAIL MESSAGES AND PRIVATE NETWORK AND INTERNET COMMUNICATIONS, MEETING AND EVENT SCHEDULING, MANAGING GROUP CALENDARS, TASK DELEGATION AND REPORTING, RECORDING NOTES, TRANSFERRING DATA TO AND FROM DATA BASES AND TO AND FROM COMPUTER PROGRAMS AND COMPUTER FILES, CORRECTING TYPOGRAPHICAL AND CAPITALIZATION ERRORS, DEBUGGING, CREATING AND TESTING OTHER COMPUTER PROGRAMS, RUNNING DEVELOPMENT PROGRAMS AND APPLICATION PROGRAMS; VIDEO GAME INTERACTIVE REMOTE CONTROL UNITS; COMPONENTS FOR GAMING CONSOLES FOR USE WITH AN EXTERNAL DISPLAY SCREEN OR MONITOR, NAMELY, POSITIONAL GAME CONTROLLERS; CONSUMER ELECTRONICS PRODUCTS AND INDUSTRIAL HARDWARE, NAMELY, SATELLITE TV SET-TOP BOXES AND COMPUTER NETWORK INTERFACE DEVICES; COMPUTER NETWORK PLUG ADAPTORS AND COMMUNICATIONS SOFTWARE FOR CONNECTING COMPUTER NETWORK USERS (U.S. CLS. 21, 23, 26, 36 AND 38).

FIRST USE 6-17-2010; IN COMMERCE 6-17-2010.

4,481,377. DISNEY ENTERPRISES, INC., BURBANK, CA. SN 78-807,736. PUB. 4-24-2007, FILED 2-6-2006.

## MY FRIENDS TIGGER & POOH

THE MARK CONSISTS OF STANDARD CHARACTERS WITHOUT CLAIM TO ANY PARTICULAR FONT, STYLE, SIZE, OR COLOR.

OWNER OF U.S. REG. NOS. 2,257,705, 3,024,286, AND OTHERS.

FOR PRE-RECORDED DVDS, DIGITAL VERSATILE DISCS AND DIGITAL VIDEO DISCS FEATURING ANIMATED ENTERTAINMENT FOR CHILDREN, AND TELEVISION SHOWS (U.S. CLS. 21, 23, 26, 36 AND 38).

FIRST USE 9-16-2013; IN COMMERCE 9-16-2013.

**CLASS 9—(Continued).**

4,481,386. RUIZ, DAVID M., COSTA MESA, CA. SN 85-034,410. PUB. 10-12-2010, FILED 5-10-2010.

# CELLNOCK

THE MARK CONSISTS OF STANDARD CHARACTERS WITHOUT CLAIM TO ANY PARTICULAR FONT, STYLE, SIZE, OR COLOR.

FOR INTERCOMS (U.S. CLS. 21, 23, 26, 36 AND 38).  
FIRST USE 11-19-2013; IN COMMERCE 11-19-2013.

**CLASS 9—(Continued).**

4,481,397. GLANTZ HOLDINGS, INC., LOUISVILLE, KY. SN 85-046,427. PUB. 10-19-2010, FILED 5-24-2010.

 The logo for beLine features the word "be" in a blue, lowercase, sans-serif font, followed by "Line" in a light green, lowercase, sans-serif font. The "e" in "be" is stylized with a white dot.

THE COLOR(S) BLUE, LIGHT GREEN AND WHITE IS/ARE CLAIMED AS A FEATURE OF THE MARK.

THE MARK CONSISTS OF THE WORD "BE" IN WHITE STYLIZED LOWER CASE LETTERS WITHIN A BLUE RECTANGULAR SHAPE WITH THREE ROUNDED CORNERS AND THE UPPER LEFT CORNER EXTENDING TO A POINT, APPEARING TO THE LEFT OF THE WORD "LINE" IN STYLIZED LIGHT GREEN LETTERS WITH A CAPITALIZED "L", ALL ON A TRANSPARENT BACKGROUND.

FOR POWER SUPPLIES (U.S. CLS. 21, 23, 26, 36 AND 38).

FIRST USE 1-1-2013; IN COMMERCE 1-1-2013.

4,481,388. UNIVERSAL POWER GROUP, INC., COPPELL, TX. SN 85-035,399. PUB. 10-12-2010, FILED 5-11-2010.

# Built for Extreme Adventures

THE MARK CONSISTS OF STANDARD CHARACTERS WITHOUT CLAIM TO ANY PARTICULAR FONT, STYLE, SIZE, OR COLOR.

FOR BATTERIES (U.S. CLS. 21, 23, 26, 36 AND 38).  
FIRST USE 9-17-2013; IN COMMERCE 9-17-2013.

4,481,401. LEISURE ELECTRONICS TECHNOLOGY CO., LTD., TOKYO, JAPAN. SN 85-053,479. PUB. 5-3-2011, FILED 6-3-2010.

 The logo for LETech features the word "LETech" in a bold, black, sans-serif font. The "L" is significantly larger than the other letters. The "E" has a vertical line through its top, and the "T" has a horizontal line through its top.

THE MARK CONSISTS OF THE CAPITAL LETTERS "LET" FOLLOWED BY THE LOWERCASE LETTERS "ECH". THE LETTER "L" HAS A STRAIGHT LINE THROUGH THE FRONT PART OF THE "L" AND THE LETTER "E" HAS A STRAIGHT LINE THROUGH THE TOP PART OF THE "E".

FOR RANDOM NUMBER GENERATION DEVICE, NAMELY, COMPUTER CHIPS, PERIPHERAL COMPONENT INTERFACE (PCI) CARDS AND INTEGRATED CIRCUITS (U.S. CLS. 21, 23, 26, 36 AND 38).

FIRST USE 3-0-2008; IN COMMERCE 7-0-2013.

4,481,390. BOYERS, DAVID GRAHAM, LOS ALTOS, CA. SN 85-038,124. PUB. 10-19-2010, FILED 5-13-2010.

# PROPAD

THE MARK CONSISTS OF STANDARD CHARACTERS WITHOUT CLAIM TO ANY PARTICULAR FONT, STYLE, SIZE, OR COLOR.

FOR HANDHELD PERSONAL COMPUTERS; MOBILE COMPUTERS; PERSONAL COMPUTERS; TABLET COMPUTER (U.S. CLS. 21, 23, 26, 36 AND 38).  
FIRST USE 11-0-2013; IN COMMERCE 11-0-2013.

4,481,408. GAIAM AMERICAS, INC., LOUISVILLE, CO. SN 85-067,622. PUB. 4-19-2011, FILED 6-21-2010.

# GAIAM

THE MARK CONSISTS OF STANDARD CHARACTERS WITHOUT CLAIM TO ANY PARTICULAR FONT, STYLE, SIZE, OR COLOR.

FOR PEDOMETERS (U.S. CLS. 21, 23, 26, 36 AND 38).  
FIRST USE 9-30-2009; IN COMMERCE 9-30-2009.

**CLASS 9—(Continued).**

4,481,418. AFFYMETRIX, INC., SANTA CLARA, CA. SN 85-107,410. PUB. 7-12-2011, FILED 8-13-2010.

# ONCOSCAN

THE MARK CONSISTS OF STANDARD CHARACTERS WITHOUT CLAIM TO ANY PARTICULAR FONT, STYLE, SIZE, OR COLOR.

FOR LABORATORY EQUIPMENT, NAMELY, MICRO-ARRAYS FOR GENETIC AND GENOMIC RESEARCH USE (U.S. CLS. 21, 23, 26, 36 AND 38).

FIRST USE 9-18-2013; IN COMMERCE 9-18-2013.

4,481,434. ECHRISTIAN, INC., ESCONDIDO, CA. SN 85-152,126. PUB. 10-4-2011, FILED 10-13-2010.

**eChristian** 

THE STIPPLING IS A FEATURE OF THE MARK AND DOES NOT INDICATE COLOR.

THE MARK CONSISTS OF THE TERM "ECHRISTIAN" TO THE LEFT OF A DIAMOND-SHAPED DESIGN COMPOSED OF CIRCLES.

FOR AUDIO BOOKS IN THE FIELD OF FAITH, RELIGION, HISTORY, CULTURE AND GENERAL INTEREST, NAMELY, CURRENT NEWS EVENTS AND SELF-IMPROVEMENT; AUDIO BOOKS IN THE NATURE OF NOVELS; DIGITAL MEDIA, NAMELY, DOWNLOADABLE AUDIOBOOKS, EBOOKS FEATURING TOPICS OF GENERAL INTEREST, NAMELY, CURRENT NEWS EVENTS, FAITH AND SELF IMPROVEMENT; DOWNLOADABLE AUDIO FILES, MULTIMEDIA FILES, TEXT FILES, E-MAILS, WRITTEN DOCUMENTS, AUDIO MATERIAL, VIDEO MATERIAL FEATURING INFORMATION IN THE FORM OF DOWNLOADABLE SHORT EDUCATIONAL/TRAINING COMMUNICATIONS IN THE FIELD OF HUMAN RESOURCE DEVELOPMENT FOR THE PROMOTION OF EMPLOYEE RETENTION, CAREER GROWTH AND INCREASED PRODUCTIVITY FOR EMPLOYEES AND EMPLOYERS; DOWNLOADABLE ELECTRONIC PUBLICATIONS IN

**CLASS 9—(Continued).**

THE NATURE OF AUDIOBOOKS, EBOOKS IN THE FIELD OF FAITH, RELIGION, HISTORY, CULTURE AND GENERAL INTEREST, NAMELY, CURRENT NEWS EVENTS, FAITH AND SELF IMPROVEMENT; DOWNLOADABLE FILMS AND MOVIES FEATURING FAITH, RELIGION, HISTORY, CULTURE AND GENERAL INTEREST, NAMELY, CURRENT NEWS EVENTS, FAITH AND SELF-IMPROVEMENT; DOWNLOADABLE IMAGES FOR MOBILE PHONES; DOWNLOADABLE MP3 FILES, MP3 RECORDINGS, WEBCASTS, WEBINARS FEATURING MUSIC, AUDIO BOOKS IN THE FIELD OF FAITH, RELIGION, HISTORY, CULTURE AND GENERAL INTEREST, NAMELY, CURRENT NEWS EVENTS, FAITH AND SELF-IMPROVEMENT, AND NEWS BROADCASTS; EBOOKS; DOWNLOADABLE WEBCASTS IN THE FIELD OF FAITH, RELIGION, HISTORY, CULTURE AND GENERAL INTEREST, NAMELY, CURRENT NEWS EVENTS, FAITH AND SELF-IMPROVEMENT; NON-FICTION AUDIO BOOKS ON A VARIETY OF TOPICS (U.S. CLS. 21, 23, 26, 36 AND 38).

FIRST USE 8-1-2013; IN COMMERCE 8-1-2013.

4,481,435. UICO, INC., ELMHURST, IL. SN 85-153,603. PUB. 3-22-2011, FILED 10-15-2010.

# WATERSENSE

THE MARK CONSISTS OF STANDARD CHARACTERS WITHOUT CLAIM TO ANY PARTICULAR FONT, STYLE, SIZE, OR COLOR.

FOR TOUCH PADS; COMPUTER TOUCH SCREENS; ELECTRONIC AND ELECTRICAL CONTROLLERS FOR USE WITH TOUCH PADS AND TOUCH SCREENS; TOUCH SENSITIVE INPUT DEVICES, NAMELY, ELECTRIC CONTROL PANELS FOR INDUSTRIAL GOODS, DURABLE GOODS, AND APPLIANCES, THAT ALLOW THE USER TO INTERFACE WITH OR CONTROL THE PRODUCTS, AND SOFTWARE THEREFOR; RESISTIVE, SURFACE, OR PROJECTED CAPACITIVE TOUCH SENSING PRODUCTS THAT ARE USED FOR SWITCHING AND CONTROLLING INDUSTRIAL, APPLIANCE AND DURABLE GOODS, NAMELY, ELECTRIC TOUCH SENSOR CONTROL PANELS AND COMPONENTS IN THE NATURE OF RESISTIVE, SURFACE, OR PROJECTED CAPACITIVE SENSOR INTEGRATED CIRCUITS, ELECTRONIC INTEGRATED CIRCUIT CHIPS, TOUCH SENSOR INTEGRATED CIRCUITS, TOUCH BUTTON INTEGRATED CIRCUIT CHIPS, TOUCH SCREEN INTEGRATED CIRCUIT ELEMENTS, NAMELY, TOUCH SCREEN CONDUCTIVE FILMS; AND COMPUTER SOFTWARE TO PROVIDE AND ENHANCE THE FUNCTIONALITY OF THE TOUCH SENSOR CONTROLS AND COMPONENTS, FOR USE BY OTHER MANUFACTURERS (U.S. CLS. 21, 23, 26, 36 AND 38).

FIRST USE 12-31-2007; IN COMMERCE 12-31-2007.

**CLASS 9—(Continued).**

4,481,441. SPIELO INTERNATIONAL CANADA ULC, MONCTON, NEW BRUNSWICK, CANADA. SN 85-168,276. PUB. 3-8-2011, FILED 11-3-2010.

**BIG BIG MAGIC**

THE MARK CONSISTS OF STANDARD CHARACTERS WITHOUT CLAIM TO ANY PARTICULAR FONT, STYLE, SIZE, OR COLOR.

FOR RECONFIGURABLE CASINO AND LOTTERY GAMING EQUIPMENT, NAMELY, GAMING MACHINES AND OPERATIONAL COMPUTER GAME SOFTWARE THEREFOR (U.S. CLS. 21, 23, 26, 36 AND 38).

FIRST USE 11-5-2012; IN COMMERCE 11-5-2012.

---

4,481,478. MILLENNIUM ELECTRONICS PTY. LIMITED, EAST KEILOR, VICTORIA, AUSTRALIA. SN 85-274,857. PUB. 2-21-2012, FILED 3-23-2011.



THE MARK CONSISTS OF THE WORD "INTELLIGY" IN STYLIZED LOWER-CASE FONT ABOVE THE WORDING "SMARTERENVIRONMENTS" IN SMALLER STYLIZED LOWER-CASE FONT WITH THE WORD "SMARTER" PRESENTED IN BOLD. TO THE LEFT OF THE DOT IN THE FIRST LETTER "I" ARE TWO SMALLER DOTS OF DESCENDING SIZE.

FOR ENVIRONMENTAL MONITORING DEVICES, NAMELY, ELECTRONIC DEVICES FOR USE IN MEASURING, MONITORING AND MANAGING UTILITY USAGE IN THE HOME (U.S. CLS. 21, 23, 26, 36 AND 38).

FIRST USE 4-30-2010; IN COMMERCE 11-21-2010.

---

4,481,481. TE WIRE & CABLE LLC, SADDLE BROOK, NJ. SN 85-277,671. PUB. 10-16-2012, FILED 3-25-2011.

**ACCUFLEX**

THE MARK CONSISTS OF STANDARD CHARACTERS WITHOUT CLAIM TO ANY PARTICULAR FONT, STYLE, SIZE, OR COLOR.

FOR THERMOCOUPLE WIRE (U.S. CLS. 21, 23, 26, 36 AND 38).

FIRST USE 7-1-2011; IN COMMERCE 7-1-2011.

**CLASS 9—(Continued).**

4,481,486. SPIELO INTERNATIONAL CANADA ULC, MONCTON, NEW BRUNSWICK, CANADA. SN 85-288,585. PUB. 7-17-2012, FILED 4-7-2011.

**IN IT TO WIN IT**

THE MARK CONSISTS OF STANDARD CHARACTERS WITHOUT CLAIM TO ANY PARTICULAR FONT, STYLE, SIZE, OR COLOR.

PRIORITY CLAIMED UNDER SEC. 44(D) ON CANADA APPLICATION NO. 1521154, FILED 3-28-2011.

FOR RECONFIGURABLE CASINO AND LOTTERY GAMING EQUIPMENT, NAMELY, GAMING MACHINES AND OPERATIONAL COMPUTER GAME SOFTWARE THEREFOR (U.S. CLS. 21, 23, 26, 36 AND 38).

FIRST USE 9-24-2013; IN COMMERCE 9-24-2013.

---

4,481,490. TECHNICOLOR TRADEMARK MANAGEMENT, ISSY LES MOULINEAUX, FRANCE. SN 85-301,368. PUB. 4-3-2012, FILED 4-21-2011.

**CINESTYLE**

THE MARK CONSISTS OF STANDARD CHARACTERS WITHOUT CLAIM TO ANY PARTICULAR FONT, STYLE, SIZE, OR COLOR.

FOR PRODUCTION AND POST-PRODUCTION SOFTWARE, NAMELY, COMPUTER SOFTWARE FOR USE IN PRODUCTION EDITING AND POST-PRODUCTION EDITING SERVICES IN THE FIELD OF MUSIC, VIDEOS AND FILM (U.S. CLS. 21, 23, 26, 36 AND 38).

FIRST USE 0-0-2011; IN COMMERCE 0-0-2011.

---

4,481,494. SCOSCHE INDUSTRIES, INC., OXNARD, CA. SN 85-313,568. PUB. 9-20-2011, FILED 5-5-2011.

**LOBE DOPE**

THE MARK CONSISTS OF STANDARD CHARACTERS WITHOUT CLAIM TO ANY PARTICULAR FONT, STYLE, SIZE, OR COLOR.

FOR HEADPHONES AND EARPHONES (U.S. CLS. 21, 23, 26, 36 AND 38).

FIRST USE 1-8-2013; IN COMMERCE 1-8-2013.

**CLASS 9—(Continued).**

4,481,508. DALLAS LIGHTHOUSE FOR THE BLIND, DALLAS, TX. SN 85-350,246. PUB. 5-29-2012, FILED 6-20-2011.

**CLASS 9—(Continued).**

THE MARK CONSISTS OF A STYLIZED LEAF WITH THE WORD "ECOBIX" POSITIONED ABOVE THE LEAF, AND THE WORDS "ENERGY SAVER" POSITIONED BELOW THE LEAF.

FOR CAPACITORS (U.S. CLS. 21, 23, 26, 36 AND 38).  
FIRST USE 4-15-2012; IN COMMERCE 4-15-2012.

**ESSENTIALLY BETTER**

THE MARK CONSISTS OF STANDARD CHARACTERS WITHOUT CLAIM TO ANY PARTICULAR FONT, STYLE, SIZE, OR COLOR.

FOR REFLECTIVE AND ILLUMINATED CLOTHING FOR SAFETY PURPOSES, NAMELY, SAFETY VESTS (U.S. CLS. 21, 23, 26, 36 AND 38).

FIRST USE 9-9-2013; IN COMMERCE 9-9-2013.

4,481,511. SANTIAGO, MOACIR, SAN DIEGO, CA. SN 85-360,137. PUB. 12-20-2011, FILED 6-30-2011.

4,481,521. DISNEY ENTERPRISES, INC., BURBANK, CA. SN 85-381,581. PUB. 5-1-2012, FILED 7-26-2011.

**ASTIR TECHNOLOGIES**

THE MARK CONSISTS OF STANDARD CHARACTERS WITHOUT CLAIM TO ANY PARTICULAR FONT, STYLE, SIZE, OR COLOR.

NO CLAIM IS MADE TO THE EXCLUSIVE RIGHT TO USE "TECHNOLOGIES", APART FROM THE MARK AS SHOWN.

FOR COMPUTER APPLICATION SOFTWARE FOR INTERNET TECHNOLOGIES IN DESIGNING, DEVELOPING, AND MAINTAINING OF APPLICATIONS DEVELOPED IN WEB RELATED AND DATABASE TECHNOLOGIES (U.S. CLS. 21, 23, 26, 36 AND 38).

FIRST USE 2-11-2013; IN COMMERCE 2-11-2013.

**FRANKENWEENIE**

4,481,512. LOYA, RAMI, ROCKVILLE, MD. SN 85-360,816. PUB. 6-12-2012, FILED 6-30-2011.



NO CLAIM IS MADE TO THE EXCLUSIVE RIGHT TO USE "ENERGY SAVER", APART FROM THE MARK AS SHOWN.

THE MARK CONSISTS OF STANDARD CHARACTERS WITHOUT CLAIM TO ANY PARTICULAR FONT, STYLE, SIZE, OR COLOR.

FOR PRE-RECORDED OPTICAL AND MAGNETO-OPTICAL DISCS, CDS AND DVDS FEATURING LIVE-ACTION ENTERTAINMENT, ANIMATED ENTERTAINMENT, MUSIC; AUDIO RECORDINGS FEATURING MUSIC; DOWNLOADABLE SOUND RECORDINGS FEATURING MUSIC AND OTHER SOUNDS, ALL FOR WIRELESS COMMUNICATIONS DEVICES; AUDIO AND VISUAL RECORDINGS FEATURING LIVE-ACTION ENTERTAINMENT, ANIMATED ENTERTAINMENT, STORIES; MUSICAL RECORDINGS; MOUSE PADS; CELLULAR TELEPHONE CASES; FACE PLATES FOR CELLULAR TELEPHONES (U.S. CLS. 21, 23, 26, 36 AND 38).

FIRST USE 11-0-2012; IN COMMERCE 11-0-2012.

**CLASS 9—(Continued).**

4,481,536. LIONS GATE ENTERTAINMENT, INC., SANTA MONICA, CA. SN 85-409,089. PUB. 3-6-2012, FILED 8-27-2011.

**CLASS 9—(Continued).**

4,481,548. SHFL ENTERTAINMENT, INC., LAS VEGAS, NV. SN 85-420,604. PUB. 3-12-2013, FILED 9-12-2011.

**SENSORY MARK**

THE MARK IS A SOUND. THE MARK CONSISTS OF A HUMAN WHISTLING A G4 EIGHTH NOTE, FOLLOWED BY A BB4 EIGHTH NOTE, FOLLOWED BY AN A4 EIGHTH NOTE, FOLLOWED BY A D4 HALF NOTE, IN THE KEY OF G MINOR.

FOR COMPUTER GAME PROGRAMS, CARTRIDGES, AND CASSETTES; DVDS FEATURING FICTIONAL DRAMA; MOTION PICTURE FILMS ABOUT FICTIONAL DRAMA; PRE-RECORDED ELECTRONIC MEDIA FEATURING FICTIONAL DRAMA; DOWNLOADABLE FILES IN THE FIELD OF ENTERTAINMENT, NAMELY, RINGTONES, GRAPHICS, IMAGES, ELECTRONIC GAMES, AND MUSIC, VIA A GLOBAL COMPUTER NETWORK AND WIRELESS DEVICES; DOWNLOADABLE ELECTRONIC PUBLICATIONS IN THE NATURE OF SONG BOOKS, TABLATURE, AND SHEET MUSIC; MAGNETS; MAGNET SHEETS; MAGNETICALLY ENCODED DEBIT CARDS; MUSICAL SOUND RECORDINGS; COMPUTER STORAGE DEVICES, NAMELY, BLANK FLASH DRIVES; DIGITAL MEDIA, NAMELY, DOWNLOADABLE AUDIO AND VIDEO RECORDINGS, AND CDS FEATURING AND PROMOTING MOTION PICTURES AND DOCUMENTARIES; COVERS FOR MOBILE PHONES; AND FITTED PLASTIC FILMS KNOWN AS SKINS FOR COVERING AND PROTECTING ELECTRONIC APPARATUS, NAMELY, MOBILE PHONES, PORTABLE MUSIC PLAYERS, COMPUTERS, COMPUTER ACCESSORIES AND PERIPHERALS, PDAS, GAMING DEVICES, CAMERAS, CAMCORDERS, AND E-BOOK READERS; BACKPACKS ADAPTED FOR HOLDING COMPUTERS; CAMERA CASES; CASES FOR MOBILE PHONES; CASES FOR PDAS; CELL PHONES; COMPUTER GAMES, NAMELY, COMPUTER GAME CARTRIDGES, DISCS, AND SOFTWARE; DECORATIVE CHARMS FOR CELL PHONES; DISPOSABLE CAMERAS; ELECTRONIC DIARIES; LAPTOP CARRYING CASES; MOUSEPADS; NEON SIGNS; AND VIDEO GAMES, NAMELY, VIDEO GAME CARTRIDGES, DISCS AND SOFTWARE (U.S. CLS. 21, 23, 26, 36 AND 38).

FIRST USE 11-1-2011; IN COMMERCE 11-1-2011.



NO CLAIM IS MADE TO THE EXCLUSIVE RIGHT TO USE "DECK CHECKER", APART FROM THE MARK AS SHOWN.

THE MARK CONSISTS OF THE WORD "DECK" WITH A CHECK MARK UNDERNEATH THE "D" AND "E" AND THE WORD "CHECKER" NEXT TO THE CHECK MARK AND UNDERNEATH THE WORD "DECK" WITH THE BACK OF ONE PLAYING CARD SHOWING 4 SQUARES WITH A PLAYING CARD SUIT IN EACH SQUARE, WITH AN ACE OF HEARTS AND ACE OF SPADES TO THE LEFT AND THE ACE OF DIAMONDS AND ACE OF CLUBS TO THE RIGHT.

FOR AUTOMATED PLAYING CARD INSPECTION DEVICES FOR USE IN GAMING FOR VERIFYING DECKS OF PLAYING CARDS (U.S. CLS. 21, 23, 26, 36 AND 38).

FIRST USE 10-4-2011; IN COMMERCE 10-4-2011.

4,481,547. NEURONETICS, INC., MALVERN, PA. SN 85-419,837. PUB. 7-10-2012, FILED 9-12-2011.

4,481,571. IGT, RENO, NV. SN 85-438,150. PUB. 4-17-2012, FILED 10-3-2011.

**Precision Pulse TMS**

THE MARK CONSISTS OF STANDARD CHARACTERS WITHOUT CLAIM TO ANY PARTICULAR FONT, STYLE, SIZE, OR COLOR.

NO CLAIM IS MADE TO THE EXCLUSIVE RIGHT TO USE "PULSE TMS", APART FROM THE MARK AS SHOWN.

FOR ELECTRIC COILS, ELECTRIC CIRCUITS AND ELECTRIC CONTROL CONSOLES FOR USE WITH TRANSCRANIAL MAGNETIC STIMULATION DEVICES (U.S. CLS. 21, 23, 26, 36 AND 38).

FIRST USE 1-0-2012; IN COMMERCE 1-0-2012.

**BANDIT BUCKS**

THE MARK CONSISTS OF STANDARD CHARACTERS WITHOUT CLAIM TO ANY PARTICULAR FONT, STYLE, SIZE, OR COLOR.

FOR GAMING MACHINES, NAMELY, DEVICES WHICH ACCEPT A WAGER (U.S. CLS. 21, 23, 26, 36 AND 38).

FIRST USE 7-19-2012; IN COMMERCE 7-19-2012.

**CLASS 9—(Continued).**

4,481,592. WREN SOUND SYSTEMS, LLC, PHOENIXVILLE, PA. SN 85-457,755. PUB. 4-2-2013, FILED 10-27-2011.

**WREN SOUND SYSTEMS**

THE MARK CONSISTS OF STANDARD CHARACTERS WITHOUT CLAIM TO ANY PARTICULAR FONT, STYLE, SIZE, OR COLOR.

NO CLAIM IS MADE TO THE EXCLUSIVE RIGHT TO USE "SOUND SYSTEMS", APART FROM THE MARK AS SHOWN.

FOR LOUDSPEAKERS FOR ENTERTAINMENT SYSTEMS; LOUDSPEAKERS WITH BUILT IN AMPLIFIERS FOR ENTERTAINMENT SYSTEMS (U.S. CLS. 21, 23, 26, 36 AND 38).

FIRST USE 1-31-2013; IN COMMERCE 1-31-2013.

4,481,593. INTERNATIONAL FELLOWSHIP OF CHRISTIANS & JEWS, INC., CHICAGO, IL. SN 85-463,812. PUB. 5-1-2012, FILED 11-3-2011.



OWNER OF U.S. REG. NO. 2,345,479.

THE MARK CONSISTS OF A SILHOUETTE OF AN EAGLE IN FLIGHT INSIDE A SIX-SIDED STAR TO THE LEFT OF THE WORDING "ON WINGS OF EAGLES".

FOR PRE-RECORDED DVDS ABOUT ISSUES RELATED TO JEWISH FAITH AND TRADITIONS, JEWISH-CHRISTIAN RELATIONS, AND THE POLITICAL, ECONOMIC, SOCIAL, AND SPIRITUAL NEEDS OF JEWS FROM THE FORMER SOVIET UNION, ISRAEL, THE PEOPLE OF ISRAEL, AND JEWISH PEOPLE AROUND THE WORLD (U.S. CLS. 21, 23, 26, 36 AND 38).

FIRST USE 2-0-2013; IN COMMERCE 2-0-2013.

4,481,624. GRAPSEED MEDIA LTD., CENTRAL, HONG KONG. SN 85-482,291. PUB. 4-10-2012, FILED 11-29-2011.



OWNER OF U.S. REG. NOS. 3,998,941, 4,003,192, AND OTHERS.

NO CLAIM IS MADE TO THE EXCLUSIVE RIGHT TO USE ENGLISH FOR CHILDREN, APART FROM THE MARK AS SHOWN.

**CLASS 9—(Continued).**

THE MARK CONSISTS OF THE STYLIZED WORD "GRAPSEED" AND A VINE WITH LEAVES ON THE END RUNNING THROUGH THE LETTERS "E", "E" AND "D" IN "SEED"; UNDERNEATH IT THERE IS A NEARLY COMPLETE CIRCLE FORMING AN ARCH OVER A CIRCLE WITH TWO PRONGS AT THE BOTTOM AND THE STYLIZED WORDS "ENGLISH FOR CHILDREN".

FOR AUDIO, VISUAL AND AUDIO/VISUAL RECORDINGS FOR USE IN INSTRUCTION IN CONNECTION WITH ENGLISH LANGUAGE AND CULTURE (U.S. CLS. 21, 23, 26, 36 AND 38).

FIRST USE 2-1-2013; IN COMMERCE 5-8-2013.

4,481,629. EPIC GAMES, INC., CARY, NC. SN 85-488,103. PUB. 5-15-2012, FILED 12-6-2011.

**FORTNITE**

THE MARK CONSISTS OF STANDARD CHARACTERS WITHOUT CLAIM TO ANY PARTICULAR FONT, STYLE, SIZE, OR COLOR.

FOR VIDEO GAME SOFTWARE (U.S. CLS. 21, 23, 26, 36 AND 38).

FIRST USE 10-11-2013; IN COMMERCE 10-11-2013.

4,481,679. MEENAN, ANTHONY, DAVENPORT, IA. SN 85-549,399. PUB. 8-21-2012, FILED 2-22-2012.

**CHIROSPRING**

THE MARK CONSISTS OF STANDARD CHARACTERS WITHOUT CLAIM TO ANY PARTICULAR FONT, STYLE, SIZE, OR COLOR.

FOR COMPUTER APPLICATION SOFTWARE FOR CHIROPRACTIC OFFICES, TO ASSIST WITH SCHEDULING, BILLING, ACCOUNTING, REPORTING, PATIENT RECORDS AND DATA PROCESSING AND APPOINTMENT PROCESSING (U.S. CLS. 21, 23, 26, 36 AND 38).

FIRST USE 11-25-2013; IN COMMERCE 11-25-2013.



**CLASS 9—(Continued).**

4,481,720. SLIC GAMES, LLC, SAN JOSE, CA. SN 85-588,639. PUB. 3-12-2013, FILED 4-4-2012.

## GADZOOKERY

THE MARK CONSISTS OF STANDARD CHARACTERS WITHOUT CLAIM TO ANY PARTICULAR FONT, STYLE, SIZE, OR COLOR.

FOR WORD GAMES, NAMELY, VIDEO GAMES SOFTWARE FOR USE WITH MOBILE DEVICES, PERSONAL COMPUTERS, HOME VIDEO GAME CONSOLES, COMPUTER TABLETS; ELECTRONIC GAME PROGRAMS; DOWNLOADABLE ELECTRONIC GAME PROGRAMS; ELECTRONIC GAME SOFTWARE; COMPUTER GAME PROGRAMS; DOWNLOADABLE COMPUTER GAME PROGRAMS; INTERACTIVE GAME PROGRAMS; INTERACTIVE GAME SOFTWARE; CINEMATOGRAPHIC APPARATUS; PROTECTIVE CARRYING CASES SPECIALLY ADAPTED FOR PHONES AND HANDHELD COMPUTERS (U.S. CLS. 21, 23, 26, 36 AND 38).

FIRST USE 9-20-2012; IN COMMERCE 9-20-2012.

4,481,722. TADIRAN TELECOM (TTL), LIMITED PARTNERSHIP, PETACH TIKVA, ISRAEL. SN 85-590,866. PUB. 3-5-2013, FILED 4-6-2012.

## AEONIX

THE MARK CONSISTS OF STANDARD CHARACTERS WITHOUT CLAIM TO ANY PARTICULAR FONT, STYLE, SIZE, OR COLOR.

THE WORDING "AEONIX" HAS NO MEANING IN A FOREIGN LANGUAGE.

FOR APPARATUS, DEVICES, EQUIPMENT, SOFTWARE AND/OR APPLICATIONS, NAMELY, COMMUNICATIONS SERVERS, TELEPHONES, VIDEOPHONES, SOFTPHONES, VOICE BOXES, TELEPHONE SWITCHES, PRIVATE BRANCH EXCHANGES, PRIVATE AUTOMATIC BRANCH EXCHANGES, TELECOMMUNICATION SOFTWARES, GATEWAYS, TELECOMMUNICATION SWITCHES, TELEPHONE DISTRIBUTED SYSTEMS COMPRISED OF TELECOMMUNICATION SERVERS AND USER COMMUNICATION DEVICES, NAMELY, TELEPHONES, VIDEOPHONES, AND SOFTPHONES, FOR ACCESSING, PROCESSING, TRANSMITTING, SWITCHING, RECEIVING, MANAGING OF SOUNDS, SIGNALS, DATA, IMAGES, VIDEO, MULTIMEDIA, AND INTERNET PROTOCOL (IP) IN A WIRED AND WIRELESS TELECOMMUNICATION AND COMPUTER NETWORKS; COMMUNICATION DEVICES, NAMELY, COMMUNICATIONS SERVERS FOR PROVIDING UNIFIED COMMUNICATIONS; COMMUNICATION DEVICES, NAMELY, COMMUNICATIONS SERVERS FOR ENABLING ESTABLISHMENT OF CONFERENCE CALLS; COMMUNICATION DEVICES,

**CLASS 9—(Continued).**

NAMELY, COMMUNICATIONS SERVERS FOR PROVIDING CONTACT CENTER SERVICES; SOFTWARE AND/OR APPLICATIONS FOR THE OPERATION OF COMMUNICATIONS SERVERS, TELEPHONES, VIDEOPHONES, SOFTPHONES, VOICE BOXES, TELEPHONE SWITCHES, PRIVATE BRANCH EXCHANGES, CALL CENTERS, PRIVATE AUTOMATIC BRANCH EXCHANGES, TELECOMMUNICATION SOFTSWITCHES, GATEWAYS, SESSION INITIATION PROTOCOL (SIP) TERMINALS, DESKTOP TELEPHONES, TELECOMMUNICATION SWITCHES, TELEPHONE DISTRIBUTED SYSTEMS COMPRISED OF TELECOMMUNICATION SERVERS AND USER COMMUNICATION DEVICES, NAMELY, TELEPHONES, VIDEOPHONES, SOFTPHONES; USER MANUALS IN ELECTRONICALLY READABLE, MACHINE READABLE OR COMPUTER READABLE FORM FOR USE WITH, AND SOLD AS A UNIT WITH, ALL THE AFOREMENTIONED GOODS; INSTRUCTIONAL MANUALS PACKAGED IN ASSOCIATION WITH THE ABOVE GOODS (U.S. CLS. 21, 23, 26, 36 AND 38).

FIRST USE 11-1-2012; IN COMMERCE 11-1-2012.

4,481,751. CARDINALE ENTERTAINMENT, LOS ANGELES, CA. SN 85-602,188. PUB. 6-18-2013, FILED 4-19-2012.

## ELEVEN 34 Records

THE MARK CONSISTS OF STANDARD CHARACTERS WITHOUT CLAIM TO ANY PARTICULAR FONT, STYLE, SIZE, OR COLOR.

NO CLAIM IS MADE TO THE EXCLUSIVE RIGHT TO USE "RECORDS", APART FROM THE MARK AS SHOWN.

FOR MUSICAL RECORDINGS DISTRIBUTED BY PHYSICAL COMPACT DISC AND ALSO VIA DOWNLOADS ON THE INTERNET (U.S. CLS. 21, 23, 26, 36 AND 38).

FIRST USE 3-25-2013; IN COMMERCE 3-25-2013.

4,481,769. STREAK PRODUCTS INC., MIAMI, FL. SN 85-614,562. PUB. 5-21-2013, FILED 5-2-2012.

## TurboSkin

THE MARK CONSISTS OF STANDARD CHARACTERS WITHOUT CLAIM TO ANY PARTICULAR FONT, STYLE, SIZE, OR COLOR.

FOR SCREEN PROTECTOR FILMS, NAMELY, FITTED PLASTIC FILMS KNOWN AS SKINS FOR COVERING AND PROTECTING THE SCREENS OF ELECTRONIC APPARATUS IN THE NATURE OF COMPUTERS, LAPTOP COMPUTERS, TABLET COMPUTERS AND PORTABLE AND HANDHELD DIGITAL ELECTRONIC DEVICES (U.S. CLS. 21, 23, 26, 36 AND 38).

FIRST USE 12-8-2012; IN COMMERCE 12-8-2012.

**CLASS 9—(Continued).**

4,481,781. LOGESHWARAN JANARTHANAN, DUNNLORE, VA. SN 85-620,267. PUB. 4-16-2013, FILED 5-9-2012.

# EMPORES

THE MARK CONSISTS OF STANDARD CHARACTERS WITHOUT CLAIM TO ANY PARTICULAR FONT, STYLE, SIZE, OR COLOR.

FOR ELECTRICAL INDUCTORS; LOW PASS INDUCTOR FILTER USED IN HIGH POWER ELECTRICAL APPLICATIONS; ELECTRIC VOLTAGE TRANSFORMERS; INDUCTION VOLTAGE REGULATORS; MEDIUM VOLTAGE POWER DISTRIBUTION AND PROTECTION COMPONENT SYSTEM COMPOSED OF BREAKERS AND SWITCHGEARS; STATIC VOLTAGE REGULATORS; VOLTAGE MONITOR MODULES; VOLTAGE REGULATORS FOR ELECTRIC POWER; VOLTAGE STABILIZERS; VOLTAGE SURGE PROTECTORS; VOLTAGE SURGE SUPPRESSORS; ELECTRONIC CURRENT WAVE RECTIFIERS; ELECTRONIC VOLTAGE OPTIMIZERS; ELECTRONIC INSTRUMENT FOR DETERMINING CIRCUIT PARAMETER MEASUREMENTS; METERING AND PROTECTION INSTRUMENTS FOR TRACKING AND MONITORING ENERGY USAGE, NAMELY, ENERGY METERS, ENERGY DEMAND INDICATORS, POWER ANALYZER, POWER FACTOR INDICATORS AND CORRECTORS, FREQUENCY METERS, PROTECTION RELAYS (U.S. CLS. 21, 23, 26, 36 AND 38).

FIRST USE 9-20-2013; IN COMMERCE 9-20-2013.

4,481,793. KABUSHIKI KAISHA PFU, DBA PFU LIMITED, KAHOKU-SHI, ISHIKAWA, JAPAN. SN 85-624,613. PUB. 10-23-2012, FILED 5-14-2012.

# iNetSec Smart Finder

THE MARK CONSISTS OF STANDARD CHARACTERS WITHOUT CLAIM TO ANY PARTICULAR FONT, STYLE, SIZE, OR COLOR.

OWNER OF U.S. REG. NOS. 3,885,138 AND 3,915,740. NO CLAIM IS MADE TO THE EXCLUSIVE RIGHT TO USE "SMART", APART FROM THE MARK AS SHOWN.

FOR COMPUTER SOFTWARE AND HARDWARE FOR ENSURING THE SECURITY OF A COMPUTER NETWORK (U.S. CLS. 21, 23, 26, 36 AND 38).

FIRST USE 11-12-2010; IN COMMERCE 10-8-2013.

**CLASS 9—(Continued).**

4,481,812. GETTY IMAGES (US), INC., NEW YORK, NY. SN 85-637,823. PUB. 10-30-2012, FILED 5-29-2012.

# GTY.IM/

THE MARK CONSISTS OF STANDARD CHARACTERS WITHOUT CLAIM TO ANY PARTICULAR FONT, STYLE, SIZE, OR COLOR.

FOR DIGITAL MEDIA, DIGITAL MATERIALS, DIGITAL CONTENT, AND DOWNLOADABLE ELECTRONIC PUBLICATIONS, NAMELY, IMAGES, PICTURES, PHOTOGRAPHS, STOCK PHOTOGRAPHS, ARCHIVAL PHOTOGRAPHS, STOCK PHOTOGRAPHY PICTORIAL IMAGES, STILL IMAGES, ART REPRODUCTIONS, GRAPHIC DESIGNS, CLIP ART, NEWS IMAGES, ILLUSTRATIONS, AND OTHER DESIGN ELEMENTS, THE ABOVE MENTIONED GOODS STORED OR RECORDED ON ELECTRONIC OR COMPUTER MEDIA OR DOWNLOADABLE FROM DATABASES OR OTHER FACILITIES PROVIDED OVER GLOBAL COMPUTER NETWORKS, WIDE AREA NETWORKS, LOCAL AREA NETWORKS, OR WIRELESS NETWORKS (U.S. CLS. 21, 23, 26, 36 AND 38).

FIRST USE 5-24-2012; IN COMMERCE 5-24-2012.

4,481,836. NORMARK CORPORATION, MINNETONKA, MN. SN 85-649,984. PUB. 10-30-2012, FILED 6-12-2012.

# ICE FORCE

THE MARK CONSISTS OF STANDARD CHARACTERS WITHOUT CLAIM TO ANY PARTICULAR FONT, STYLE, SIZE, OR COLOR.

FOR MARINE DEPTH FINDERS; WATER LEVEL INDICATORS; UNDERWATER CAMERAS; BAGS FOR UNDERWATER CAMERA ENCLOSURES; BAGS SPECIALLY ADAPTED FOR UNDERWATER CAMERA HOUSINGS; UNDERWATER HOUSINGS FOR CAMERAS; UNDERWATER ENCLOSURES FOR CAMERAS; PROTECTIVE CLOTHING, NAMELY, HEATED GARMENTS IN THE NATURE OF APPAREL CONSISTING OF CARBON FIBER WHICH PRODUCES HEAT; REFLECTIVE AND ILLUMINATED CLOTHING FOR SAFETY PURPOSES; SAFETY PRODUCTS, NAMELY, EMBROIDERED REFLECTIVE PATCHES TO BE WORN ON CLOTHING; SUNGLASSES AND CASES THEREFOR (U.S. CLS. 21, 23, 26, 36 AND 38).

FIRST USE 10-1-2013; IN COMMERCE 10-1-2013.

**CLASS 9—(Continued).**

4,481,857. TEREX SOUTH DAKOTA, INC., WATERTOWN, SD. SN 85-658,205. PUB. 5-14-2013, FILED 6-21-2012.

# ShorePlug

THE MARK CONSISTS OF STANDARD CHARACTERS WITHOUT CLAIM TO ANY PARTICULAR FONT, STYLE, SIZE, OR COLOR.

FOR POWER CONNECTORS FOR LIGHT TOWERS (U.S. CLS. 21, 23, 26, 36 AND 38).  
FIRST USE 10-24-2012; IN COMMERCE 10-24-2012.

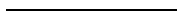

4,481,858. TEREX SOUTH DAKOTA, INC., WATERTOWN, SD. SN 85-658,215. PUB. 5-14-2013, FILED 6-21-2012.



THE MARK CONSISTS OF THE STYLIZED WORDING "SHORE" AND "PLUG" SEPARATED BY A PLUG DESIGN APPEARING ON A RECTANGULAR BACKGROUND.

FOR POWER CONNECTORS FOR LIGHT TOWERS (U.S. CLS. 21, 23, 26, 36 AND 38).  
FIRST USE 10-24-2012; IN COMMERCE 10-24-2012.



4,481,859. HEWLETT-PACKARD DEVELOPMENT COMPANY, L.P., HOUSTON, TX. SN 85-658,469. PUB. 10-30-2012, FILED 6-21-2012.

# ZBOOK

THE MARK CONSISTS OF STANDARD CHARACTERS WITHOUT CLAIM TO ANY PARTICULAR FONT, STYLE, SIZE, OR COLOR.

FOR MOBILE COMPUTER WORKSTATIONS COMPRISING NOTEBOOK COMPUTERS; COMPUTERS (U.S. CLS. 21, 23, 26, 36 AND 38).  
FIRST USE 9-10-2013; IN COMMERCE 9-10-2013.

**CLASS 9—(Continued).**

4,481,866. ASSA ABLOY AB, STOCKHOLM, SWEDEN. SN 85-662,319. PUB. 11-20-2012, FILED 6-26-2012.

# SLIMFLEX

THE MARK CONSISTS OF STANDARD CHARACTERS WITHOUT CLAIM TO ANY PARTICULAR FONT, STYLE, SIZE, OR COLOR.

FOR PASSIVE CONTACTLESS TRANSPONDERS; PLIABLE RADIO FREQUENCY IDENTIFICATION (RFID) TAGS; PLIABLE RADIO FREQUENCY IDENTIFICATION (RFID) TAGS HAVING A SURFACE WITH VISIBLE INDICIA EMBOSSED OR ENGRAVED THEREON; TORSION TOLERANT AND WEATHER RESISTANT RFID TAGS HAVING A THERMOPLASTIC ELASTOMER HOUSING FOR USE ON PRODUCT SURFACES (U.S. CLS. 21, 23, 26, 36 AND 38).  
FIRST USE 11-28-2011; IN COMMERCE 11-28-2011.



4,481,869. QUALCOMM ATHEROS, INC., SAN JOSE, CA. SN 85-663,133. PUB. 11-20-2012, FILED 6-27-2012.

# STREAMBOOST

THE MARK CONSISTS OF STANDARD CHARACTERS WITHOUT CLAIM TO ANY PARTICULAR FONT, STYLE, SIZE, OR COLOR.

FOR COMPUTER SOFTWARE PLATFORMS FOR OPTIMIZING COMMUNICATIONS IN LOCAL AREA NETWORKS AND WIDE AREA NETWORKS (U.S. CLS. 21, 23, 26, 36 AND 38).  
FIRST USE 8-1-2013; IN COMMERCE 8-1-2013.



4,481,877. MC10, INC., CAMBRIDGE, MA. SN 85-667,004. PUB. 3-5-2013, FILED 7-2-2012.

# MC10

THE MARK CONSISTS OF STANDARD CHARACTERS WITHOUT CLAIM TO ANY PARTICULAR FONT, STYLE, SIZE, OR COLOR.

FOR CONFORMAL ELECTRONIC CIRCUITS, NAMELY, ELECTRONIC CIRCUITS THAT BEND, STRETCH AND CONFORM TO THE SHAPE OF NON-PLANAR OBJECTS TO WHICH THEY ARE APPLIED (U.S. CLS. 21, 23, 26, 36 AND 38).  
FIRST USE 7-11-2013; IN COMMERCE 7-25-2013.

**CLASS 9—(Continued).**

4,481,880. SEIFERT, JERRY A., HUDSON, OH. SN 85-667,725.  
PUB. 4-23-2013, FILED 7-3-2012.

# SICOM

THE MARK CONSISTS OF STANDARD CHARACTERS WITHOUT CLAIM TO ANY PARTICULAR FONT, STYLE, SIZE, OR COLOR.

FOR HARDWARE FOR A REAR END COLLISION PREVENTION APPARATUS AND SOFTWARE USED FOR ENABLING A REAR-END COLLISION APPARATUS TO DETECT OBSTACLES (U.S. CLS. 21, 23, 26, 36 AND 38).

FIRST USE 7-5-2012; IN COMMERCE 7-5-2012.

4,481,894. CWPR LLC, PHOENIXVILLE, PA. SN 85-675,737.  
PUB. 1-1-2013, FILED 7-12-2012.

## Bath Salt Zombies

THE MARK CONSISTS OF STANDARD CHARACTERS WITHOUT CLAIM TO ANY PARTICULAR FONT, STYLE, SIZE, OR COLOR.

NO CLAIM IS MADE TO THE EXCLUSIVE RIGHT TO USE "ZOMBIES", APART FROM THE MARK AS SHOWN.

FOR MOTION PICTURE FILMS ABOUT ZOMBIES (U.S. CLS. 21, 23, 26, 36 AND 38).

FIRST USE 7-1-2012; IN COMMERCE 2-19-2013.

4,481,902. TALLEY, RODNEY, HUNTERVILLE, NC. SN 85-679,461. PUB. 1-22-2013, FILED 7-17-2012.



THE COLOR(S) TEAL, LIGHT TEAL, DARK TEAL, ORANGE, YELLOW, BLACK, AND WHITE IS/ARE CLAIMED AS A FEATURE OF THE MARK.

THE MARK CONSISTS OF A CARTOON BUG THAT IS

**CLASS 9—(Continued).**

OUTLINED IN BLACK AND HAS A TEAL HEAD AND LEGS, LIGHT TEAL WINGS THAT ARE OUTLINED IN BLACK AND HAVE BLACK LINES WITHIN THEM, DARK TEAL BOOTS, AND AN ORANGE AND YELLOW MID-SECTION. THE BUG HAS HUMAN-LIKE FACIAL FEATURES THAT ARE OUTLINED IN BLACK. THE EYES ARE BOTH BLACK AND WHITE. THE BUG HAS BLACK ANTENNAE WITH DARK TEAL DOTS AT THE TOP. BELOW THE BUG ARE THE STYLIZED TEAL WORDS "LIL' BITTY BUG".

FOR DOWNLOADABLE SOFTWARE IN THE NATURE OF A MOBILE APPLICATION FOR INSTRUCTIONAL CONTENT IN THE FIELD OF CHILD SAFETY (U.S. CLS. 21, 23, 26, 36 AND 38).

FIRST USE 5-15-2013; IN COMMERCE 5-15-2013.

4,481,925. ODASSO, VICTOR HUGO MONTERO, BAL HARBOUR, FL. SN 85-693,449. PUB. 3-26-2013, FILED 8-2-2012.

# Technics

THE MARK CONSISTS OF THE TERM "TECHNICS" APPEARING IN SYLFAEN BOLD FONT

FOR TABLET COMPUTER (U.S. CLS. 21, 23, 26, 36 AND 38).

FIRST USE 9-5-2013; IN COMMERCE 10-2-2013.

4,481,926. SOCIEDAD IBERICA DE METALES NOBLES, S.A., MADRID, SPAIN. SN 85-693,908. PUB. 1-8-2013, FILED 8-2-2012.

The logo for "simensa" is written in a lowercase, sans-serif font. The letters are blue. To the right of the word "simensa" is a circular design element that resembles a stylized globe or a lens, with a gradient from light to dark gray.

THE COLOR(S) BLUE AND GRAY IS/ARE CLAIMED AS A FEATURE OF THE MARK.

THE MARK CONSISTS OF THE WORDING "SIMENSA" DISPLAYED IN BLUE AND IN STYLIZED TEXT AND A CIRCULAR DESIGN ELEMENT DISPLAYED IN GRAY ADJACENT THE CONCLUDING "A" IN "SIMENSA".

THE WORDING "SIMENSA" HAS NO MEANING IN A FOREIGN LANGUAGE.

FOR ELECTRIC CABLES, WIRES, CONDUCTORS AND CONNECTION FITTINGS THEREFOR (U.S. CLS. 21, 23, 26, 36 AND 38).

FIRST USE 7-31-2013; IN COMMERCE 7-31-2013.

**CLASS 9—(Continued).**

4,481,941. TALLEY, RODNEY, HUNTERSVILLE, NC. SN 85-700,354. PUB. 1-22-2013, FILED 8-10-2012.



THE COLOR(S) BLUE, LIGHT BLUE, TEAL, ORANGE, YELLOW, DARK ORANGE, WHITE, AND BLACK IS/ARE CLAIMED AS A FEATURE OF THE MARK.

THE MARK CONSISTS OF A STYLIZED MALE BUG WITH A BLUE HEAD, ARMS, UPPER BODY AND LEGS. THE WINGS ARE LIGHT BLUE, WITH TEAL VEINS AND HE IS WEARING TEAL BOOTS. HE HAS WHITE EYES, WITH BLACK PUPILS, A TEAL NOSE, A BLACK OPEN MOUTH AND BLACK EYEBROWS. HE IS WEARING DARK ORANGE GLASSES AND HAS BLACK ANTENNAE WITH TEAL BULBS AT THE ENDS. THERE IS A SMALL BLACK SEMI CIRCLE AROUND THE RIGHT BULB. THE LOWER HALF OF HIS BODY FADES FROM ORANGE TO YELLOW AND THERE ARE 2 SMALL BLACK SEMI CIRCLES AROUND THE LEFT KNEE. BELOW THE BUG ARE THE DARK ORANGE STYLIZED WORDS "ITTY BITTY BUG".

FOR DOWNLOADABLE SOFTWARE IN THE NATURE OF A MOBILE APPLICATION FOR INSTRUCTIONAL CONTENT IN THE FIELD OF CHILD SAFETY (U.S. CLS. 21, 23, 26, 36 AND 38).  
FIRST USE 5-15-2013; IN COMMERCE 5-15-2013.

**CLASS 9—(Continued).**

4,481,949. LESLIE HSU LLC, SHORT HILLS, NJ. SN 85-702,817. PUB. 2-26-2013, FILED 8-14-2012.



THE MARK CONSISTS OF A DESIGN WITH THREE CLOSED LOOPS AND ONE OPEN LOOP.

FOR BAGS AND CASES SPECIALLY ADAPTED FOR HOLDING OR CARRYING HANDHELD DIGITAL ELECTRONIC DEVICES AND ACCESSORIES THEREOF; STANDS FOR HANDHELD DIGITAL ELECTRONIC DEVICES (U.S. CLS. 21, 23, 26, 36 AND 38).

FIRST USE 7-24-2012; IN COMMERCE 7-24-2012.

---

4,481,952. FLOP STUDIOS, INC., GREENWOOD VILLAGE, CO. SN 85-705,622. PUB. 2-12-2013, FILED 8-16-2012.

# Blinkies

THE MARK CONSISTS OF STANDARD CHARACTERS WITHOUT CLAIM TO ANY PARTICULAR FONT, STYLE, SIZE, OR COLOR.

FOR COMPUTER GAMING SOFTWARE, VIDEO GAME SOFTWARE, VIDEO GAME PROGRAMS, VIDEO GAME CARTRIDGES, ELECTRONIC GAME SOFTWARE, ELECTRONIC GAME PROGRAMS, ELECTRONIC COMPUTER GAME CARTRIDGES (U.S. CLS. 21, 23, 26, 36 AND 38).  
FIRST USE 10-14-2013; IN COMMERCE 10-14-2013.

**CLASS 9—(Continued).**

4,481,953. SKYERA, INC., SAN JOSE, CA. SN 85-705,661. PUB. 11-6-2012, FILED 8-16-2012.

# SKYHAWK

THE MARK CONSISTS OF STANDARD CHARACTERS WITHOUT CLAIM TO ANY PARTICULAR FONT, STYLE, SIZE, OR COLOR.

FOR COMPUTER SOFTWARE AND HARDWARE FOR ENTERPRISE SOLID-STATE STORAGE SYSTEMS (U.S. CLS. 21, 23, 26, 36 AND 38).

FIRST USE 10-15-2012; IN COMMERCE 10-15-2012.

---

4,481,955. MED X CHANGE, INC., BRADENTON, FL. SN 85-709,162. PUB. 8-27-2013, FILED 8-21-2012.

# EVOLUTIONHD

THE MARK CONSISTS OF STANDARD CHARACTERS WITHOUT CLAIM TO ANY PARTICULAR FONT, STYLE, SIZE, OR COLOR.

FOR COMPUTER HARDWARE FOR THE RECORDING OF VIDEO FOR USE IN A MEDICAL OR SURGICAL ENVIRONMENT (U.S. CLS. 21, 23, 26, 36 AND 38).

FIRST USE 3-20-2013; IN COMMERCE 3-20-2013.

---

4,481,962. POLK AUDIO, INC., BALTIMORE, MD. SN 85-712,582. PUB. 1-29-2013, FILED 8-24-2012.

# WOODBOURNE

THE MARK CONSISTS OF STANDARD CHARACTERS WITHOUT CLAIM TO ANY PARTICULAR FONT, STYLE, SIZE, OR COLOR.

FOR AUDIO SPEAKERS (U.S. CLS. 21, 23, 26, 36 AND 38).

FIRST USE 9-16-2013; IN COMMERCE 9-16-2013.

**CLASS 9—(Continued).**

4,481,982. THINKPOPS NEUROMEDIA, INC., LOS ANGELES, CA. SN 85-717,753. PUB. 2-19-2013, FILED 8-30-2012.

# Thinkpops

THE MARK CONSISTS OF STANDARD CHARACTERS WITHOUT CLAIM TO ANY PARTICULAR FONT, STYLE, SIZE, OR COLOR.

FOR COMPUTER APPLICATION SOFTWARE FOR MOBILE PHONES, NAMELY, SOFTWARE FOR IMPROVING A PERSON'S PHYSICAL AND PERSONAL PERFORMANCE; COMPUTER APPLICATION SOFTWARE FOR COMPUTERS, HANDHELD COMPUTERS, PORTABLE MEDIA PLAYERS, NAMELY, SOFTWARE FOR IMPROVING A PERSON'S PHYSICAL AND PERSONAL PERFORMANCE; COMPUTER GAME SOFTWARE; COMPUTER GAME SOFTWARE FEATURING TRAINING AND INSTRUCTION IN THE FIELD OF THE REQUISITES FOR ACHIEVING PERSONAL AND PROFESSIONAL SUCCESS, WITH EMPHASIS ON ACHIEVEMENT OF A SET OF PERSONAL, SOCIAL AND PROFESSIONAL GOALS, EMPLOYMENT OPPORTUNITIES, OWNERSHIP OF ASSETS, PERSONAL CREDENTIALS, PROFESSIONAL AND SOCIAL STATUS, AND GOOD FORTUNE; COMPUTER PROGRAMS FOR IMPROVING A PERSON'S MOODS AND PERSONAL PERFORMANCE; DOWNLOADABLE COMPUTER GRAPHICS FOR IMPROVING A PERSON'S MOODS AND PERSONAL PERFORMANCE FOR USE ON COMPUTERS, HANDHELD COMPUTERS, AND PORTABLE MEDIA PLAYERS (U.S. CLS. 21, 23, 26, 36 AND 38).

FIRST USE 12-10-2012; IN COMMERCE 12-10-2012.

---

4,481,985. BATTERY ON THE GO, INC., COCONUT CREEK, FL. SN 85-718,059. PUB. 2-5-2013, FILED 8-31-2012.

# Battery On The Go

THE MARK CONSISTS OF STANDARD CHARACTERS WITHOUT CLAIM TO ANY PARTICULAR FONT, STYLE, SIZE, OR COLOR.

NO CLAIM IS MADE TO THE EXCLUSIVE RIGHT TO USE "BATTERY", APART FROM THE MARK AS SHOWN.

FOR BATTERIES, BATTERY PACKS AND BATTERY CHARGERS FOR CONSUMER ELECTRONIC DEVICES (U.S. CLS. 21, 23, 26, 36 AND 38).

FIRST USE 5-25-2012; IN COMMERCE 5-25-2012.

**CLASS 9—(Continued).**

4,482,021. TRANSONIC SYSTEMS, INC., ITHACA, NY. SN 85-727,929. PUB. 3-5-2013, FILED 9-13-2012.

**Optima Flow-QC**

THE MARK CONSISTS OF STANDARD CHARACTERS WITHOUT CLAIM TO ANY PARTICULAR FONT, STYLE, SIZE, OR COLOR.

OWNER OF U.S. REG. NO. 3,985,357.

FOR FLOWMETERS FOR USE IN MEASURING BLOOD FLOW DURING SURGERY IN CONJUNCTION WITH CLINICAL PERIVASCULAR FLOW PROBES (U.S. CLS. 21, 23, 26, 36 AND 38).

FIRST USE 8-26-2013; IN COMMERCE 8-26-2013.

---

4,482,024. BRK BRANDS, INC., AURUORA, IL. SN 85-728,256. PUB. 2-19-2013, FILED 9-13-2012.



THE MARK CONSISTS OF THE LITERAL ELEMENT "ATOM" IN WHICH THE LETTER "O" OF THE LITERAL ELEMENT IS REPLACED WITH THE ATOM SYMBOL.

FOR SMOKE ALARM (U.S. CLS. 21, 23, 26, 36 AND 38).

FIRST USE 1-31-2013; IN COMMERCE 1-31-2013.

---

4,482,051. BIBA SYSTEMS, INC., SAN FRANCISCO, CA. SN 85-731,507. PUB. 3-12-2013, FILED 9-18-2012.

**BIBA**

THE MARK CONSISTS OF STANDARD CHARACTERS WITHOUT CLAIM TO ANY PARTICULAR FONT, STYLE, SIZE, OR COLOR.

THERE IS NO DEFINITIVE TRANSLATION OF THE WORD "BIBA" IN A FOREIGN LANGUAGE.

FOR DOWNLOADABLE SOFTWARE IN THE NATURE OF A MOBILE APPLICATION FOR IMPROVING, COORDINATING, AND FACILITATING WORK AND COMMUNICATION AMONGST TEAM MEMBERS AND FOR SCHEDULING, FACILITATING, AND CONDUCTING CONFERENCE CALLS (U.S. CLS. 21, 23, 26, 36 AND 38).

FIRST USE 12-4-2012; IN COMMERCE 12-4-2012.

**CLASS 9—(Continued).**

4,482,055. SKYHAWKE TECHNOLOGIES, LLC, RIDGE-LAND, MS. SN 85-732,025. PUB. 2-26-2013, FILED 9-18-2012.

**GIMME**

THE MARK CONSISTS OF STANDARD CHARACTERS WITHOUT CLAIM TO ANY PARTICULAR FONT, STYLE, SIZE, OR COLOR.

FOR ELECTRONIC SATELLITE TRACKING AND INFORMATION SYSTEM COMPRISING COMPUTER HARDWARE AND COMPUTER SOFTWARE USED TO DETERMINE DISTANCES ON GOLF COURSES (U.S. CLS. 21, 23, 26, 36 AND 38).

FIRST USE 2-1-2013; IN COMMERCE 2-1-2013.

---

4,482,056. SKYHAWKE TECHNOLOGIES, LLC, RIDGE-LAND, MS. SN 85-732,084. PUB. 2-26-2013, FILED 9-18-2012.

**BREEZE**

THE MARK CONSISTS OF STANDARD CHARACTERS WITHOUT CLAIM TO ANY PARTICULAR FONT, STYLE, SIZE, OR COLOR.

FOR ELECTRONIC SATELLITE TRACKING AND INFORMATION SYSTEM COMPRISING COMPUTER HARDWARE AND COMPUTER SOFTWARE USED TO DETERMINE DISTANCES ON GOLF COURSES AND FOR ACCESSING RELEVANT DATA AND STATISTICS PERTINENT THERETO (U.S. CLS. 21, 23, 26, 36 AND 38).

FIRST USE 9-10-2012; IN COMMERCE 9-10-2012.

**CLASS 9—(Continued).**

4,482,092. DAVIZTA INC., BRIDGEWATER, NJ. SN 85-737,519. PUB. 3-5-2013, FILED 9-25-2012.



THE MARK CONSISTS OF THE LETTERS "D-RIVE" IN WHICH THE "D" IS STYLIZED AS THE GREEK LETTER "DELTA".

FOR COMPUTER APPLICATION SOFTWARE FOR DESKTOP AND PORTABLE COMPUTERS, NAMELY, SOFTWARE FOR INTEGRATED BUSINESS MANAGEMENT INTELLIGENCE AND ANALYTICS THAT USES INFORMATION FROM VARIOUS DATABASES AND PRESENTS THE INFORMATION IN AN EASY-TO-UNDERSTAND USER INTERFACE; COMPUTER SOFTWARE THAT PROVIDES REAL-TIME, INTEGRATED BUSINESS MANAGEMENT INTELLIGENCE BY COMBINING INFORMATION FROM VARIOUS DATABASES AND PRESENTS SUCH INFORMATION IN AN EASY-TO-UNDERSTAND USER INTERFACE (U.S. CLS. 21, 23, 26, 36 AND 38).

FIRST USE 1-7-2013; IN COMMERCE 1-7-2013.

4,482,104. JOSE ALBERTO GABRIEL TOLEDANO MOYADO, TLAQUEPAQUE, JAL., MEXICO. SN 85-738,237. PUB. 4-2-2013, FILED 9-25-2012.



NO CLAIM IS MADE TO THE EXCLUSIVE RIGHT TO USE "ELECTRONICS", APART FROM THE MARK AS SHOWN.

THE COLOR(S) BLACK, GRAY, AND RED IS/ARE CLAIMED AS A FEATURE OF THE MARK.

THE MARK CONSISTS OF THE WORDING "SENSEY ELECTRONICS" IN BLACK; ABOVE THE WORDING APPEARS A DESIGN CONSISTING OF A STYLIZED LETTER "S" IN BLACK AND OUTLINED IN GRAY, SUPERIMPOSED ON A THIN GRAY OVAL WITH A RED CENTER; AND THE BACKGROUND OF THE MARK IS TRANSPARENT.

THE WORDING "SENSEY" HAS NO MEANING IN A FOREIGN LANGUAGE.

FOR ELECTRONIC SOUND EQUIPMENT, NAMELY, LOUDSPEAKER MANAGEMENT SYSTEM COMPRISING OF LOUDSPEAKERS, POWER AMPLIFIERS, AUDIO PROCESSORS, PLUG CONNECTORS AND AUDIO CONNECTORS, CONNECTION CABLES AND AUDIO CABLES, APPARATUS OF REPRODUCTION OF SOUND, DIGITAL AUDIO PROCESSORS, ANALOG AUDIO PROCESSORS (U.S. CLS. 21, 23, 26, 36 AND 38).

FIRST USE 11-0-2011; IN COMMERCE 11-0-2011.

**CLASS 9—(Continued).**

4,482,107. MARKS STUDIOS LLC, DECATUR, GA. SN 85-738,609. PUB. 3-26-2013, FILED 9-26-2012.

## GIMMIE GAMES

THE MARK CONSISTS OF STANDARD CHARACTERS WITHOUT CLAIM TO ANY PARTICULAR FONT, STYLE, SIZE, OR COLOR.

NO CLAIM IS MADE TO THE EXCLUSIVE RIGHT TO USE "GAMES", APART FROM THE MARK AS SHOWN.

FOR CASINO-STYLE GAME SOFTWARE AND DOWNLOADABLE CASINO-STYLE GAME SOFTWARE; CASINO-STYLE GAME SOFTWARE FOR USE IN MOBILE DEVICES (U.S. CLS. 21, 23, 26, 36 AND 38).

FIRST USE 12-7-2012; IN COMMERCE 10-11-2013.

4,482,110. THOMPSON, BRIAN, HOUSTON, TX. AND REN, TOM, BELLAIRE, TX. SN 85-738,707. PUB. 4-23-2013, FILED 9-26-2012.



THE MARK CONSISTS OF THE STYLIZED WORDING "ISTANDLE" WITH THE LETTER "I" REPRESENTING A PORTABLE STAND.

FOR COMPUTER STANDS SPECIALLY DESIGNED FOR HOLDING A COMPUTER, PRINTER AND ACCESSORIES (U.S. CLS. 21, 23, 26, 36 AND 38).

FIRST USE 8-16-2013; IN COMMERCE 8-29-2013.

4,482,120. INNOVYZE, INC., BROOMFIELD, CO. SN 85-740,259. PUB. 2-19-2013, FILED 9-27-2012.

## QUALWATCH

THE MARK CONSISTS OF STANDARD CHARACTERS WITHOUT CLAIM TO ANY PARTICULAR FONT, STYLE, SIZE, OR COLOR.

FOR COMPUTER SOFTWARE FOR ASSESSING PARAMETER TRENDS IN WATER DISTRIBUTION SYSTEMS AND DISPLAYING ANOMALIES (U.S. CLS. 21, 23, 26, 36 AND 38).

FIRST USE 3-12-2013; IN COMMERCE 3-12-2013.



**CLASS 9—(Continued).**

4,482,141. MEDIFIT CORPORATE SERVICES, INC., FLORHAM PARK, NJ. SN 85-744,091. PUB. 3-5-2013, FILED 10-2-2012.

# mActive

THE MARK CONSISTS OF STANDARD CHARACTERS WITHOUT CLAIM TO ANY PARTICULAR FONT, STYLE, SIZE, OR COLOR.

FOR COMPUTER APPLICATION SOFTWARE FOR MOBILE DEVICES, LAPTOP COMPUTERS, COMPUTERS, COMPUTER WORK STATIONS AND COMPUTER SYSTEMS, NAMELY, SOFTWARE FOR THE MANAGEMENT AND ADMINISTRATION OF FITNESS AND WELLNESS CENTER FACILITIES (U.S. CLS. 21, 23, 26, 36 AND 38).

FIRST USE 10-1-2013; IN COMMERCE 10-1-2013.

---

4,482,144. PHIGITAL, INC., MONTCLAIR, NJ. SN 85-744,249. PUB. 3-12-2013, FILED 10-2-2012.

# PHIGITAL

THE MARK CONSISTS OF STANDARD CHARACTERS WITHOUT CLAIM TO ANY PARTICULAR FONT, STYLE, SIZE, OR COLOR.

FOR DOWNLOADABLE SOFTWARE IN THE NATURE OF A MOBILE APPLICATION FEATURING TECHNOLOGY THAT ALLOWS USERS TO CONSOLIDATE AND MANAGE SOCIAL NETWORKS, ACCOUNTS, AND CONNECTIONS TO EXISTING AND EMERGING APPLICATION PROGRAMMING INTERFACES (APIS); COMMUNICATIONS SOFTWARE FOR CONNECTING AND INTERACTING USERS OF SOCIAL NETWORK; DOWNLOADABLE SOFTWARE IN THE NATURE OF A MOBILE APPLICATION FEATURING TECHNOLOGY THAT ALLOWS USERS TO PROVIDE CUSTOMER-DEFINED GENERATED CONTENT AND CONTENT OF OTHERS AUTOMATICALLY SELECTED AND CUSTOMIZED BASED THE KNOWN OR ESTIMATED GEOGRAPHICAL LOCATION OF AN INTERNET, MOBILE TELEPHONE OR OTHER WIRED OR WIRELESS DIGITAL NETWORK BASED CUSTOMER, A GIVEN TIME OR TIME INTERVAL, AN EVENT, ACTIVITY, OR ACTION AND THE NUMBER OF PARTICIPANTS AND THE WAY THOSE PARTICIPANTS ARE COLLABORATING AND COMMUNICATING (U.S. CLS. 21, 23, 26, 36 AND 38).

FIRST USE 7-1-2013; IN COMMERCE 7-1-2013.

**CLASS 9—(Continued).**

4,482,148. CAPABILITY MANAGEMENT INC, DBA ENTERPRISE EVOLVER, LATHAM, NY. SN 85-745,261. PUB. 3-26-2013, FILED 10-4-2012.



NO CLAIM IS MADE TO THE EXCLUSIVE RIGHT TO USE "ENTERPRISE", APART FROM THE MARK AS SHOWN.

THE COLOR(S) GREY, PURPLE, GREEN, RED, LIGHT BLUE, DARK BLUE, WHITE AND YELLOW IS/ARE CLAIMED AS A FEATURE OF THE MARK.

THE MARK CONSISTS OF THE WORDING "ENTERPRISE" APPEARS IN THE COLOR LIGHT BLUE, THE WORDING "EVOLVER" APPEARS IN THE COLOR WHITE, OVER A DARK BLUE RECTANGLE SURROUNDED BY SEVERAL CIRCLES APPEARING IN THE COLORS GRAY, RED, PURPLE, GREEN AND YELLOW.

FOR COMPUTER AIDED DESIGN (CAD) SOFTWARE FOR BUSINESS DESIGN, ENTERPRISE ARCHITECTURE AND BUSINESS TRANSFORMATION (U.S. CLS. 21, 23, 26, 36 AND 38).

FIRST USE 8-15-2013; IN COMMERCE 11-14-2013.

---

4,482,150. BEIJING FONENET INFORMATION TECHNOLOGY COMPANY LIMITED, BEIJING, CHINA. SN 85-745,809. PUB. 3-12-2013, FILED 10-4-2012.

# 100TV

THE MARK CONSISTS OF STANDARD CHARACTERS WITHOUT CLAIM TO ANY PARTICULAR FONT, STYLE, SIZE, OR COLOR.

FOR DOWNLOADABLE SOFTWARE, NAMELY, MOBILE APPLICATIONS FOR ACCESSING AND PLAYING VIDEO AND MUSIC CLIPS; PRE-INSTALLED MOBILE PHONE SOFTWARE FOR ACCESSING AND PLAYING VIDEO AND MUSIC CLIPS (U.S. CLS. 21, 23, 26, 36 AND 38).

FIRST USE 1-31-2012; IN COMMERCE 1-31-2012.

**CLASS 9—(Continued).**

4,482,199. TEAMQUEST CORPORATION, CLEAR LAKE, IA. SN 85-752,631. PUB. 4-2-2013, FILED 10-12-2012.

TEAMQUEST CMIS FOR STORAGE

THE MARK CONSISTS OF STANDARD CHARACTERS WITHOUT CLAIM TO ANY PARTICULAR FONT, STYLE, SIZE, OR COLOR.

OWNER OF U.S. REG. NOS. 1,696,879, 1,914,133, AND OTHERS.

NO CLAIM IS MADE TO THE EXCLUSIVE RIGHT TO USE "CMIS FOR STORAGE", APART FROM THE MARK AS SHOWN.

FOR COMPUTER SOFTWARE FOR USE IN CONNECTION WITH STORING DATA, MANAGING AND ADMINISTERING COMPUTER SYSTEMS, AND THE INSTRUCTIONAL MANUALS THEREFOR SOLD AS A UNIT (U.S. CLS. 21, 23, 26, 36 AND 38).

FIRST USE 3-25-2013; IN COMMERCE 3-25-2013.

---

4,482,228. MAX SOUND CORPORATION, HOUSTON, TX. SN 85-757,414. PUB. 4-2-2013, FILED 10-18-2012.



NO CLAIM IS MADE TO THE EXCLUSIVE RIGHT TO USE "AUDIO", APART FROM THE MARK AS SHOWN.

THE MARK CONSISTS OF THE LETTERS "MAXD" ON TOP OF THE WORDS "AUDIO PERFECTED" WITH A FACE PROFILE AND SOUND WAVES EMANATING FROM THE EAR ON THE RIGHT.

FOR COMPUTER SOFTWARE AND COMPUTER HARDWARE FOR IMPROVING SOUND QUALITY OF DIGITAL AUDIO, NAMELY, CDS, DOWNLOADABLE MP3 FILES AND MP3 RECORDINGS, DVDS AND OTHER AUDIO AND VIDEO RECORDINGS, FOR AUDIO SYSTEMS, VIDEO SYSTEMS, SOFTWARE SYSTEMS AND MOBILE PHONES BY CONTROLLING AND MANIPULATING DIGITAL AUDIO INFORMATION (U.S. CLS. 21, 23, 26, 36 AND 38).

FIRST USE 10-10-2012; IN COMMERCE 10-10-2012.

**CLASS 9—(Continued).**

4,482,233. CLIMAX TECHNOLOGY CO., LTD., TAIPEI CITY, TAIWAN. SN 85-758,066. PUB. 4-9-2013, FILED 10-18-2012.



THE MARK CONSISTS OF A CIRCULAR SHAPE COMPRISING FOUR STACKS OF THREE OVERLAID PORTIONS OF CIRCLES, AND THE STYLIZED WORDING "VESTA" WHEREIN THE E AND THE S ARE CONNECTED.

FOR SECURITY SYSTEMS AND APPARATUS, NAMELY, VIDEO CAMERAS, WIRELESS VIDEO TRANSMITTERS AND RECEIVERS, VIDEO SWITCHES AND VIDEO CAMERA CONTROLLERS, VOICE DISPLAY MONITORS, VIDEO DISPLAY MONITORS, VIDEO CAMERAS FOR PREVENTION OF BURGLARY, ELECTRONIC BURGLARPROOF LOCKS, ELECTRONIC LOCKS USING MAGNETIC CARDS, BURGLAR ALARMS, COMPUTER HARDWARE AND OPERATING SOFTWARE FOR ELECTRONIC SECURITY SYSTEMS FOR ASSET TRACKING AND MANAGEMENT, APPARATUS FOR RECORDING, TRANSMISSION OR REPRODUCTION OF SOUND OR IMAGES, ANTI-THEFT WARNING APPARATUS, ELECTRIC THEFT PREVENTION ALARM INSTALLATIONS (U.S. CLS. 21, 23, 26, 36 AND 38).

FIRST USE 5-3-2010; IN COMMERCE 5-3-2010.

---

4,482,258. SUPER SIMPLE LEARNING, INC., SEATTLE, WA. SN 85-764,115. PUB. 4-16-2013, FILED 10-25-2012.

**SUPER SIMPLE SONGS**

THE MARK CONSISTS OF STANDARD CHARACTERS WITHOUT CLAIM TO ANY PARTICULAR FONT, STYLE, SIZE, OR COLOR.

NO CLAIM IS MADE TO THE EXCLUSIVE RIGHT TO USE "SONGS", APART FROM THE MARK AS SHOWN.

FOR DIGITAL MATERIALS, NAMELY, CDS, DVDS AND DOWNLOADABLE AUDIO FILES AND ELECTRONIC BOOKS IN THE FIELDS OF CHILD EDUCATION, CHILDREN'S ENTERTAINMENT AND CHILD DEVELOPMENT (U.S. CLS. 21, 23, 26, 36 AND 38).

FIRST USE 0-0-2005; IN COMMERCE 0-0-2005.

**CLASS 9—(Continued).**

4,482,271. INNOVYZE, INC., BROOMFIELD, CO. SN 85-767,568. PUB. 2-19-2013, FILED 10-30-2012.

**SCADAMASTER**

THE MARK CONSISTS OF STANDARD CHARACTERS WITHOUT CLAIM TO ANY PARTICULAR FONT, STYLE, SIZE, OR COLOR.

FOR COMPUTER SOFTWARE THAT MANAGES THE EXCHANGE OF REAL-TIME DATA FROM SENSORS, METERS, DATA LOGGERS, AND OTHER DATA ACQUISITION SYSTEMS WITH OTHER SOFTWARE APPLICATIONS (U.S. CLS. 21, 23, 26, 36 AND 38).

FIRST USE 12-18-2012; IN COMMERCE 12-18-2012.

**CLASS 9—(Continued).**

4,482,331. TECMAP CORP., EL SEGUNDO, CA. SN 85-788,742. PUB. 7-2-2013, FILED 11-27-2012.

**TORID PULSE**

THE MARK CONSISTS OF STANDARD CHARACTERS WITHOUT CLAIM TO ANY PARTICULAR FONT, STYLE, SIZE, OR COLOR.

FOR UNDERWATER DEVICE FOR SCUBA DIVERS THAT USES PRESSURE TO CREATE AND PROPEL VARIABLY SIZED RINGS OF AIR FOR RECREATIONAL AND COMMUNICATIONS PURPOSES (U.S. CLS. 21, 23, 26, 36 AND 38).

FIRST USE 11-5-2013; IN COMMERCE 11-5-2013.

4,482,290. BATTERY ON THE GO, INC., COCONUT CREEK, FL. SN 85-775,840. PUB. 2-5-2013, FILED 11-9-2012.

**PowerBar**

THE MARK CONSISTS OF STANDARD CHARACTERS WITHOUT CLAIM TO ANY PARTICULAR FONT, STYLE, SIZE, OR COLOR.

FOR BATTERIES, BATTERY PACKS AND BATTERY CHARGERS FOR CONSUMER ELECTRONIC DEVICES (U.S. CLS. 21, 23, 26, 36 AND 38).

FIRST USE 5-25-2012; IN COMMERCE 5-25-2012.

4,482,340. BRIGHT HARVEST OVERSEAS, INC., TAIPEI CITY 11268, TAIWAN. SN 85-792,638. PUB. 7-2-2013, FILED 12-3-2012.

**Mazz**

THE MARK CONSISTS OF THE WORD "MAZZ" PLACED OVER AN OUTLINE OF A RIGHT-ANGLED TRIANGLE THAT CAN BE SEEN BENEATH THE LETTERS "MA".

FOR BAGS AND CASES SPECIALLY ADAPTED FOR HOLDING OR CARRYING PORTABLE TELEPHONES AND TELEPHONE EQUIPMENT AND ACCESSORIES; BATTERY CHARGERS; CARRYING CASES FOR PERSONAL ELECTRONIC DEVICES, NAMELY, CELL PHONES, TABLET COMPUTERS AND MP3 PLAYERS; CASES FOR MOBILE PHONES; COMPUTER DATA-EXCHANGER CABLES; ELECTRONIC PENS; FITTED PLASTIC FILMS KNOWN AS SKINS FOR COVERING AND PROVIDING A SCRATCH PROOF BARRIER OR PROTECTION FOR ELECTRONIC DEVICES, NAMELY, MP3 PLAYERS, MOBILE TELEPHONES, SMART TELEPHONES, DIGITAL CAMERAS, GLOBAL POSITIONING SYSTEMS AND PERSONAL DIGITAL ASSISTANTS; HEADPHONES; INSTRUMENT TO FACILITATE TEXT-MESSAGING IN THE NATURE OF A STYLUS-TYPE DEVICE THAT IS ATTACHED TO THE HAND FOR USE IN CONJUNCTION WITH PERSONAL DIGITAL ASSISTANTS; LAPTOP CARRYING CASES; LOUDSPEAKERS; PERSONAL STEREO; PROTECTIVE COVERS AND CASES FOR LAPTOPS; PROTECTIVE COVERS AND CASES FOR PERSONAL ELECTRONIC DEVICES, NAMELY, CELL PHONES, TABLET COMPUTERS AND MP3 PLAYERS; PROTECTIVE COVERS AND CASES FOR TABLET COMPUTERS; TABLET COMPUTER CARRYING CASES (U.S. CLS. 21, 23, 26, 36 AND 38).

FIRST USE 8-1-2013; IN COMMERCE 8-1-2013.

4,482,313. JENNIFER AHN, LOS ANGELES, CA. AND JENNIFER VANZYL, LOS ANGELES, CA. SN 85-783,329. PUB. 4-23-2013, FILED 11-19-2012.

**iThigh**

THE MARK CONSISTS OF STANDARD CHARACTERS WITHOUT CLAIM TO ANY PARTICULAR FONT, STYLE, SIZE, OR COLOR.

FOR SPECIALTY HOLSTER FOR CARRYING MOBILE PHONES; STRAPS FOR MOBILE PHONES (U.S. CLS. 21, 23, 26, 36 AND 38).

FIRST USE 7-1-2013; IN COMMERCE 7-1-2013.

**CLASS 9—(Continued).**

4,482,348. BLUTRON GROUP, DALLAS, TX. SN 85-794,327.  
PUB. 2-26-2013, FILED 12-4-2012.

# AquaTALK

THE MARK CONSISTS OF STANDARD CHARACTERS WITHOUT CLAIM TO ANY PARTICULAR FONT, STYLE, SIZE, OR COLOR.

FOR CARRYING CASES FOR CELL PHONES; CASES FOR MOBILE PHONES; CASES FOR MUSIC, AUDIO AND RELATED ELECTRONIC EQUIPMENT, NAMELY, CASES FOR AUDIO TUNERS, AUDIO RECEIVERS, AMPLIFIERS, TAPE PLAYERS, COMPACT DISC PLAYERS, MP3 CONTROLLERS/PLAYERS, AUDIO MIXERS, AUDIO SPEAKERS IN THE NATURE OF MUSIC STUDIO MONITORS, MICROPHONES, AUDIO SPEAKERS, COMPACT DISCS, AUDIO TAPES, PORTABLE COMPUTERS, ANTENNAS, PHONOGRAPHIC RECORD PLAYERS, AUDIO RECORDING EQUIPMENT, AND THE CABLES ASSOCIATED WITH ALL OF THE FOREGOING EQUIPMENT; CASES FOR TELEPHONES; CASINGS AND CASING PARTS FOR ELECTRICAL EQUIPMENT, NAMELY, HOUSING FOR SWITCHING APPARATUS; CELL PHONE CASES; PROTECTIVE COVERS AND CASES FOR CELL PHONES, LAPTOPS AND PORTABLE MEDIA PLAYERS; PROTECTIVE COVERS AND CASES FOR TABLET COMPUTERS (U.S. CLS. 21, 23, 26, 36 AND 38).

FIRST USE 10-1-2013; IN COMMERCE 10-1-2013.

4,482,351. RICHARD J. RACOSKY, BOULDER, CO. SN 85-796,182. PUB. 5-7-2013, FILED 12-6-2012.

# J2C

THE MARK CONSISTS OF STANDARD CHARACTERS WITHOUT CLAIM TO ANY PARTICULAR FONT, STYLE, SIZE, OR COLOR.

OWNER OF U.S. REG. NO. 3,875,024.  
FOR ELECTRONIC DISPLAYS, NAMELY, DIGITAL SIGNAGE; ELECTRONIC PUBLICATIONS, NAMELY, BOOKS AND NEWSLETTERS FEATURING SELF-IMPROVEMENT RECORDED ON COMPUTER MEDIA (U.S. CLS. 21, 23, 26, 36 AND 38).

FIRST USE 12-20-2013; IN COMMERCE 12-20-2013.

**CLASS 9—(Continued).**

4,482,352. NETAPP, INC., SUNNYVALE, CA. SN 85-796,389.  
PUB. 3-12-2013, FILED 12-6-2012.

# FLASH ACCEL

THE MARK CONSISTS OF STANDARD CHARACTERS WITHOUT CLAIM TO ANY PARTICULAR FONT, STYLE, SIZE, OR COLOR.

NO CLAIM IS MADE TO THE EXCLUSIVE RIGHT TO USE "FLASH", APART FROM THE MARK AS SHOWN.

FOR COMPUTER HARDWARE; COMPUTER SOFTWARE TO OPTIMIZE STORAGE NETWORK PERFORMANCE AND RELIABILITY (U.S. CLS. 21, 23, 26, 36 AND 38).

FIRST USE 8-21-2012; IN COMMERCE 7-0-2013.

4,482,363. SIVAN MICHAEL, SHATIN FOTAN, HONG KONG. SN 85-799,931. PUB. 9-17-2013, FILED 12-11-2012.

# Tabby

THE MARK CONSISTS OF STANDARD CHARACTERS WITHOUT CLAIM TO ANY PARTICULAR FONT, STYLE, SIZE, OR COLOR.

OWNER OF U.S. REG. NO. 4,056,358.

FOR ELECTRONIC WRITING TABLETS; PC TABLETS; TABLET COMPUTER (U.S. CLS. 21, 23, 26, 36 AND 38).

FIRST USE 11-1-2013; IN COMMERCE 11-1-2013.

4,482,381. EXO LABS, INC., BELLEVUE, WA. SN 85-807,016.  
PUB. 5-14-2013, FILED 12-19-2012.

# EXO LABS

THE MARK CONSISTS OF STANDARD CHARACTERS WITHOUT CLAIM TO ANY PARTICULAR FONT, STYLE, SIZE, OR COLOR.

NO CLAIM IS MADE TO THE EXCLUSIVE RIGHT TO USE "LABS", APART FROM THE MARK AS SHOWN.

FOR CAMERAS; SYSTEMS FOR USE IN DISPLAYING OBJECTS SEEN THROUGH A MICROSCOPE OR TELESCOPE, PRIMARILY COMPRISING A CAMERA, A MOUNT FOR COUPLING THE CAMERA TO AN EYEPIECE, ELECTRIC CABLES FOR COUPLING THE CAMERA TO A MONITOR, AND ASSOCIATED SOFTWARE FOR ANALYZING AND SHARING IMAGES AND DATA (U.S. CLS. 21, 23, 26, 36 AND 38).

FIRST USE 3-29-2013; IN COMMERCE 3-29-2013.

**CLASS 9—(Continued).**

4,482,382. EXO LABS, INC., BELLEVUE, WA. SN 85-807,021.  
PUB. 5-14-2013, FILED 12-19-2012.



NO CLAIM IS MADE TO THE EXCLUSIVE RIGHT TO USE "LABS", APART FROM THE MARK AS SHOWN.

THE MARK CONSISTS OF THE WORDING "EXO LABS" INSIDE A CIRCLE.

FOR CAMERAS; SYSTEMS FOR USE IN DISPLAYING OBJECTS SEEN THROUGH A MICROSCOPE OR TELESCOPE, PRIMARILY COMPRISING A CAMERA, A MOUNT FOR COUPLING THE CAMERA TO AN EYEPiece, ELECTRIC CABLES FOR COUPLING THE CAMERA TO A MONITOR, AND ASSOCIATED SOFTWARE FOR ANALYZING AND SHARING IMAGES AND DATA (U.S. CLS. 21, 23, 26, 36 AND 38).

FIRST USE 3-29-2013; IN COMMERCE 3-29-2013.

4,482,383. EXO LABS, INC., BELLEVUE, WA. SN 85-807,032.  
PUB. 5-14-2013, FILED 12-19-2012.

**IGNITE CURIOSITY**

THE MARK CONSISTS OF STANDARD CHARACTERS WITHOUT CLAIM TO ANY PARTICULAR FONT, STYLE, SIZE, OR COLOR.

FOR CAMERAS; SYSTEMS FOR USE IN DISPLAYING OBJECTS SEEN THROUGH A MICROSCOPE OR TELESCOPE, PRIMARILY COMPRISING A CAMERA, A MOUNT FOR COUPLING THE CAMERA TO AN EYEPiece, ELECTRIC CABLES FOR COUPLING THE CAMERA TO A MONITOR, AND ASSOCIATED SOFTWARE FOR ANALYZING AND SHARING IMAGES AND DATA (U.S. CLS. 21, 23, 26, 36 AND 38).

FIRST USE 3-29-2013; IN COMMERCE 3-29-2013.

**CLASS 9—(Continued).**

4,482,416. TRIAMP TECHNOLOGY, LTD., NEW TAIPEI CITY 231, TAIWAN. SN 85-820,428. PUB. 6-4-2013, FILED 1-10-2013.

# tune2air

THE MARK CONSISTS OF THE STYLIZED WORD "TUNE2AIR".

FOR TELEPHONE INTERCOMS; CAR PHONES; WIRED INTERCOMS; TELEPHONE INTERCOMS WITH LCD DISPLAY; CELL PHONES; MOBILE PHONES; VIDEO PHONES; MOBILE PHONE CRADLES WITH MOUNTING MECHANISMS; RADIO RECEIVERS; POWER AMPLIFIERS; GLOBAL POSITIONING SYSTEM (GPS); STEREO SIGNAL GENERATORS; GLOBAL POSITIONING SYSTEM (GPS) RECEIVERS; GLOBAL POSITIONING SYSTEM (GPS) TRANSMITTERS; SATELLITE SIGNAL RECEIVERS; WIRELESS HANDS-FREE CAR COMMUNICATION KITS, NAMELY, CALL DETECTORS, HEADSETS, TRANSCIVERS, AND COMMUNICATION VEHICLE ADAPTERS FOR RECEIVING WIRELESS COMMUNICATION (U.S. CLS. 21, 23, 26, 36 AND 38).

FIRST USE 8-1-2012; IN COMMERCE 8-1-2012.

4,482,454. LEADWAYS LIMITED, KOWLOON BAY, HONG KONG. SN 85-834,681. PUB. 6-18-2013, FILED 1-29-2013.

# Ringslink

THE MARK CONSISTS OF STANDARD CHARACTERS WITHOUT CLAIM TO ANY PARTICULAR FONT, STYLE, SIZE, OR COLOR.

THE WORDING "RINGSLINK" HAS NO MEANING IN A FOREIGN LANGUAGE.

FOR AUTOMATIC TELEPHONE EXCHANGE APPARATUS; COMPUTER NETWORK ADAPTERS, SWITCHES, ROUTERS AND HUBS; COMPUTER OPERATING PROGRAMS, RECORDED; COMPUTER PERIPHERAL DEVICES; CONNECTORS FOR ELECTRONIC CIRCUITS; INTEGRATED CIRCUIT CARDS AND COMPONENTS; MICROPROCESSORS; PORTABLE TELEPHONES; TELEPHONE APPARATUS; VIDEO TELEPHONES (U.S. CLS. 21, 23, 26, 36 AND 38).

FIRST USE 5-1-2013; IN COMMERCE 5-1-2013.

**CLASS 9—(Continued).**

4,482,457. MERCER (US) INC., NEW YORK, NY. SN 85-837,144. PUB. 8-13-2013, FILED 1-31-2013.

**MERCER SURVEYOR**

THE MARK CONSISTS OF STANDARD CHARACTERS WITHOUT CLAIM TO ANY PARTICULAR FONT, STYLE, SIZE, OR COLOR.

OWNER OF U.S. REG. NOS. 2,902,605, 3,313,924, AND OTHERS.

NO CLAIM IS MADE TO THE EXCLUSIVE RIGHT TO USE "SURVEYOR", APART FROM THE MARK AS SHOWN.

FOR COMPUTER SOFTWARE FOR EMPLOYEE SURVEY AND HUMAN CAPITAL RESEARCH THAT ALLOWS USERS TO SEARCH AND CUSTOMIZE SURVEY AND RESEARCH DATA (U.S. CLS. 21, 23, 26, 36 AND 38). FIRST USE 2-1-2013; IN COMMERCE 2-1-2013.

---

4,482,472. MATTEL, INC., EL SEGUNDO, CA. SN 85-843,619. PUB. 4-30-2013, FILED 2-7-2013.

**HOT WHEELS WORLD'S BEST DRIVER**

THE MARK CONSISTS OF STANDARD CHARACTERS WITHOUT CLAIM TO ANY PARTICULAR FONT, STYLE, SIZE, OR COLOR.

OWNER OF U.S. REG. NOS. 2,152,705, 3,800,912, AND OTHERS.

FOR VIDEO GAME SOFTWARE (U.S. CLS. 21, 23, 26, 36 AND 38).

FIRST USE 10-28-2013; IN COMMERCE 10-28-2013.

---

4,482,473. VOTOPIN, INC., NEW YORK, NY. SN 85-843,750. PUB. 6-25-2013, FILED 2-7-2013.

**VOTOPIN**

THE MARK CONSISTS OF STANDARD CHARACTERS WITHOUT CLAIM TO ANY PARTICULAR FONT, STYLE, SIZE, OR COLOR.

FOR COMPUTER APPLICATION SOFTWARE FOR MOBILE DEVICES WHICH FACILITATES ONLINE SERVICES FOR SHARING OPINIONS ON TOPICS, VIEWING PUBLIC OPINIONS ON A GIVEN TOPIC, AND CONNECTING WITH LIKE-MINDED USERS BASED ON OPINIONS (U.S. CLS. 21, 23, 26, 36 AND 38).

FIRST USE 4-1-2013; IN COMMERCE 10-31-2013.

**CLASS 9—(Continued).**

4,482,474. BATTERIES PLUS, LLC, HARTLAND, WI. SN 85-843,882. PUB. 6-25-2013, FILED 2-7-2013.



OWNER OF U.S. REG. NO. 3,955,295.

NO CLAIM IS MADE TO THE EXCLUSIVE RIGHT TO USE "BATTERIES", APART FROM THE MARK AS SHOWN. THE COLOR(S) GREEN AND ORANGE IS/ARE CLAIMED AS A FEATURE OF THE MARK.

THE MARK CONSISTS OF THE STYLIZED WORD "BATTERIES" IN GREEN ABOVE A PLUS SYMBOL WITH THE LEFT AND LOWER SECTION IN GREEN AND THE RIGHT AND UPPER SECTION IN ORANGE WITH AN ORANGE CIRCLE IN THE UPPER RIGHT SECTION FOLLOWED BY THE STYLIZED WORD "BULBS" IN ORANGE.

FOR BATTERIES (U.S. CLS. 21, 23, 26, 36 AND 38).

FIRST USE 9-24-2013; IN COMMERCE 9-24-2013.

---

4,482,488. UNCOMMON LLC, CHICAGO, IL. SN 85-851,075. PUB. 9-3-2013, FILED 2-15-2013.

**PERMAFROST**

THE MARK CONSISTS OF STANDARD CHARACTERS WITHOUT CLAIM TO ANY PARTICULAR FONT, STYLE, SIZE, OR COLOR.

FOR CARRYING CASES AND BAGS DESIGNED FOR STORAGE, PROTECTION AND TRANSPORTATION OF CONSUMER ELECTRONICS IN THE NATURE OF SMART PHONES, CELLULAR PHONES, MEDIA PLAYERS AND LAPTOP COMPUTERS (U.S. CLS. 21, 23, 26, 36 AND 38).

FIRST USE 2-26-2013; IN COMMERCE 2-26-2013.

---

4,482,498. AVACOMTECH INC, NATIONAL CITY, CA. SN 85-852,276. PUB. 7-9-2013, FILED 2-18-2013.

**AVACOM**

THE MARK CONSISTS OF STANDARD CHARACTERS WITHOUT CLAIM TO ANY PARTICULAR FONT, STYLE, SIZE, OR COLOR.

FOR CAMERA HARDWARE SYSTEMS FOR IP (INTERNET PROTOCOL) VIDEO SURVEILLANCE (U.S. CLS. 21, 23, 26, 36 AND 38).

FIRST USE 2-25-2013; IN COMMERCE 3-31-2013.

**CLASS 9—(Continued).**

4,482,525. LOGICUBE, INC., CHATSWORTH, CA. SN 85-865,604. PUB. 8-13-2013, FILED 3-4-2013.

**FORENSIC FALCON**

THE MARK CONSISTS OF STANDARD CHARACTERS WITHOUT CLAIM TO ANY PARTICULAR FONT, STYLE, SIZE, OR COLOR.

NO CLAIM IS MADE TO THE EXCLUSIVE RIGHT TO USE "FORENSIC", APART FROM THE MARK AS SHOWN. FOR SPECIALIZED COMPUTER-RELATED DEVICES, NAMELY, ENCLOSURES, SOFTWARE AND ELECTRONICS, FOR THE CAPTURE AND FORENSIC ANALYSIS OF DATA STORED ON COMPUTERS, HARD DISK DRIVES AND OTHER DATA STORAGE DEVICES (U.S. CLS. 21, 23, 26, 36 AND 38).

FIRST USE 6-28-2013; IN COMMERCE 6-28-2013.

**CLASS 9—(Continued).**

4,482,531. LIVEYEARBOOK, INC., MADISON, WI. SN 85-866,665. PUB. 8-13-2013, FILED 3-5-2013.

**LIVEATHLETE**

THE MARK CONSISTS OF STANDARD CHARACTERS WITHOUT CLAIM TO ANY PARTICULAR FONT, STYLE, SIZE, OR COLOR.

FOR DOWNLOADABLE ELECTRONIC PUBLICATIONS, NAMELY, MEMORY BOOKS AND PHOTO ALBUMS; ELECTRONIC PUBLICATIONS, NAMELY, MEMORY BOOKS AND PHOTO ALBUMS RECORDED ON COMPUTER MEDIA (U.S. CLS. 21, 23, 26, 36 AND 38).

FIRST USE 2-11-2013; IN COMMERCE 2-11-2013.

4,482,529. LIVEYEARBOOK, INC., MADISON, WI. SN 85-866,660. PUB. 8-13-2013, FILED 3-5-2013.

**LIVELIFESTYLE**

THE MARK CONSISTS OF STANDARD CHARACTERS WITHOUT CLAIM TO ANY PARTICULAR FONT, STYLE, SIZE, OR COLOR.

FOR DOWNLOADABLE ELECTRONIC PUBLICATIONS, NAMELY, MEMORY BOOKS AND PHOTO ALBUMS; ELECTRONIC PUBLICATIONS, NAMELY, MEMORY BOOKS AND PHOTO ALBUMS RECORDED ON COMPUTER MEDIA (U.S. CLS. 21, 23, 26, 36 AND 38).

FIRST USE 2-11-2013; IN COMMERCE 2-11-2013.

4,482,542. KARLE, STEFAN, MUNICH, FED REP GERMANY. SN 85-868,976. PUB. 7-23-2013, FILED 3-6-2013.

**SNAPBAG**

THE MARK CONSISTS OF STANDARD CHARACTERS WITHOUT CLAIM TO ANY PARTICULAR FONT, STYLE, SIZE, OR COLOR.

OWNER OF U.S. REG. NO. 4,233,949. FOR PHOTOGRAPHIC LIGHTING EQUIPMENT, NAMELY, LIGHT SHAPERS, LIGHT MODIFIERS, LIGHT FORMERS, LIGHT REFLECTORS, SOFTBOXES (U.S. CLS. 21, 23, 26, 36 AND 38).

FIRST USE 4-8-2013; IN COMMERCE 4-8-2013.

4,482,530. LIVEYEARBOOK, INC., MADISON, WI. SN 85-866,661. PUB. 8-13-2013, FILED 3-5-2013.

**LIVEORGANIZATION**

THE MARK CONSISTS OF STANDARD CHARACTERS WITHOUT CLAIM TO ANY PARTICULAR FONT, STYLE, SIZE, OR COLOR.

FOR DOWNLOADABLE ELECTRONIC PUBLICATIONS, NAMELY, MEMORY BOOKS AND PHOTO ALBUMS; ELECTRONIC PUBLICATIONS, NAMELY, MEMORY BOOKS AND PHOTO ALBUMS RECORDED ON COMPUTER MEDIA (U.S. CLS. 21, 23, 26, 36 AND 38).

FIRST USE 2-11-2013; IN COMMERCE 2-11-2013.

4,482,547. NIKON CORPORATION, TOYKO, JAPAN. SN 85-871,459. PUB. 6-11-2013, FILED 3-8-2013.

**Nikon 1**

OWNER OF U.S. REG. NOS. 569,949, 1,456,107, AND OTHERS.

**CLASS 9—(Continued).**

THE MARK CONSISTS OF THE WORD "NIKON" AND THE NUMERAL "1".

FOR MIRRORLESS CAMERA WITH INTERCHANGEABLE LENSES; CAMERAS; DIGITAL CAMERAS; CAMERA LENSES; ELECTRONIC FLASH FOR CAMERA; WIRELESS MOBILE ADAPTER FOR CAMERA; GPS UNIT FOR CAMERA; CASES FOR CAMERA; WATER-PROOF CASE FOR CAMERA; TRIPOD MOUNTING SPACER FOR CAMERA; USB CABLES; CAMERA STRAPS; ZOOM GEARS FOR CAMERAS; GRIPS FOR CAMERAS; BODY CAPS FOR CAMERAS; LENS CAPS; CAMERA LENS FILTERS AND HOODS; CAMERA MOUNTS, MOUNT ADAPTERS AND STANDS; REMOTE CONTROL FOR CAMERA; WRAPPING CLOTH FOR CAMERA; BATTERIES; BATTERY CHARGERS; RECHARGEABLE BATTERY; POWER CONNECTERS; DRY CELLS; COMPUTER SOFTWARE COMPRISED OF ELECTRONIC INSTRUCTIONAL MANUALS FOR DIGITAL CAMERAS; COMPUTER SOFTWARE FOR EDITING AND MANAGING OF PHOTOGRAPHS AND MOVIES; COMPUTER SOFTWARE FOR TRANSFERRING PHOTOGRAPHS AND MOVIES FROM A CAMERA OR MEMORY CARD TO A BACKUP FOLDER; COMPUTER SOFTWARE FOR UPLOADING PHOTOGRAPHS AND MOVIES TO AN IMAGE STORAGE AND SHARING SERVICE; COMPUTER SOFTWARE FOR ADDING GPS DATA TO PHOTOGRAPH AND MOVIE FILES; COMPUTER SOFTWARE FOR POSTING THE LOCATIONS OF PHOTOGRAPHS AND MOVIE FILES ON A WORLD MAP USING GPS DATA; RECORDED COMPACT DISCS CONTAINING SOFTWARE FOR PROCESSING, BROWSING AND EDITING PHOTOGRAPHS; ELECTRONIC PUBLICATIONS, NAMELY, INSTRUCTION MANUALS PROVIDED BY CD ROM, ALL OF THE AFOREMENTIONED ELECTRONIC PUBLICATIONS PROVIDED IN THE FIELDS OF PHOTOGRAPHY AND COMPUTER SOFTWARE (U.S. CLS. 21, 23, 26, 36 AND 38).

FIRST USE 9-21-2011; IN COMMERCE 9-21-2011.

4,482,549. HUANG JUNSHENG, GUANGDONG PROVINCE, CHINA. SN 85-872,163. PUB. 7-30-2013, FILED 3-11-2013.

# MustHD

THE MARK CONSISTS OF THE STYLIZED WORD "MUSTHD".

FOR COMPUTER MONITORS; ELECTRONIC INDICATOR BOARDS; GLOVES FOR PROTECTION AGAINST ACCIDENTS; MICROSCOPES; PHOTOCOPIERS; PROJECTION SCREENS; SATELLITE NAVIGATIONAL SYSTEM, NAMELY, A GLOBAL POSITIONING SYSTEM (GPS); SOUND RECORDING APPARATUS; SURVEYING MACHINES AND INSTRUMENTS; TAPE MEASURES; THEFT ALARMS; VIDEO SCREENS (U.S. CLS. 21, 23, 26, 36 AND 38).

FIRST USE 8-15-2013; IN COMMERCE 8-15-2013.

**CLASS 9—(Continued).**

4,482,557. ZYMBR LABS INC., CHICAGO, IL. SN 85-875,877. PUB. 7-30-2013, FILED 3-14-2013.

# kyntal

THE MARK CONSISTS OF STANDARD CHARACTERS WITHOUT CLAIM TO ANY PARTICULAR FONT, STYLE, SIZE, OR COLOR.

OWNER OF U.S. REG. NO. 4,415,907.

FOR DOWNLOADABLE SOFTWARE IN THE NATURE OF A MOBILE PHONE, SMARTPHONES, MOBILE DEVICES APPLICATION FOR DISPLAYING AND SHARING USERS PREFERENCES RELATING TO LOCATIONS, BUSINESS ORGANIZATIONS, SERVICE PROVIDERS, OBJECTS, MEDIA, OFFERS, EVENTS, BRANDS, THAT PERMIT USERS WITH COMMON INTERESTS TO INTERACT WITH OTHER USERS OR PLACES (U.S. CLS. 21, 23, 26, 36 AND 38).

FIRST USE 5-15-2013; IN COMMERCE 5-15-2013.

4,482,587. YOU TELL ME STORIES, LLC, WESTON, CT. SN 85-884,087. PUB. 8-6-2013, FILED 3-22-2013.

# WORDWINKS

THE MARK CONSISTS OF STANDARD CHARACTERS WITHOUT CLAIM TO ANY PARTICULAR FONT, STYLE, SIZE, OR COLOR.

FOR DOWNLOADABLE SOFTWARE IN THE NATURE OF A MOBILE APPLICATION FOR TEACHING ORAL LANGUAGE DEVELOPMENT; ELECTRONIC PUBLICATIONS, NAMELY, CHILDREN'S BOOKS FEATURING TRAINING AIDS FOR TEACHING ORAL LANGUAGE SKILLS AND ORAL LANGUAGE DEVELOPMENT RECORDED ON COMPUTER MEDIA (U.S. CLS. 21, 23, 26, 36 AND 38).

FIRST USE 7-1-2013; IN COMMERCE 7-1-2013.

4,482,607. CANDYWRITER, LLC, MIAMI BEACH, FL. SN 85-891,240. PUB. 8-20-2013, FILED 3-31-2013.

# YOUR MOVE

THE MARK CONSISTS OF STANDARD CHARACTERS WITHOUT CLAIM TO ANY PARTICULAR FONT, STYLE, SIZE, OR COLOR.

FOR COMPUTER GAME SOFTWARE APPLICATIONS; COMPUTER GAME SOFTWARE APPLICATIONS FOR MOBILE DEVICES (U.S. CLS. 21, 23, 26, 36 AND 38).

FIRST USE 6-0-2013; IN COMMERCE 6-0-2013.



**CLASS 9—(Continued).**

4,482,614. GOKART LABS, LLC, MINNEAPOLIS, MN. SN 85-893,915. PUB. 8-27-2013, FILED 4-3-2013.

# KINLY

THE MARK CONSISTS OF STANDARD CHARACTERS WITHOUT CLAIM TO ANY PARTICULAR FONT, STYLE, SIZE, OR COLOR.

FOR COMPUTER APPLICATION SOFTWARE FOR MOBILE PHONES AND HANDHELD COMPUTERS, NAMELY, SOFTWARE FOR USE IN SOCIAL NETWORKING (U.S. CLS. 21, 23, 26, 36 AND 38).

FIRST USE 5-31-2013; IN COMMERCE 5-31-2013.

---

4,482,631. MDM TRACK, LLC, FORT LAUDERDALE, FL. SN 85-902,287. PUB. 9-17-2013, FILED 4-12-2013.

# WIZE TRACK

THE MARK CONSISTS OF STANDARD CHARACTERS WITHOUT CLAIM TO ANY PARTICULAR FONT, STYLE, SIZE, OR COLOR.

NO CLAIM IS MADE TO THE EXCLUSIVE RIGHT TO USE "TRACK", APART FROM THE MARK AS SHOWN.

FOR GPS TRACKING DEVICES (U.S. CLS. 21, 23, 26, 36 AND 38).

FIRST USE 11-1-2013; IN COMMERCE 11-1-2013.

---

4,482,635. S. J. ELECTRO SYSTEMS, INC., DETROIT LAKES, MN. SN 85-904,745. PUB. 9-10-2013, FILED 4-15-2013.

# PRIMEX

THE MARK CONSISTS OF STANDARD CHARACTERS WITHOUT CLAIM TO ANY PARTICULAR FONT, STYLE, SIZE, OR COLOR.

FOR ENGINEERED ELECTRONIC CONTROLS FOR MOTORS FOR USE IN THE MUNICIPAL WASTEWATER MARKET (U.S. CLS. 21, 23, 26, 36 AND 38).

FIRST USE 10-7-2013; IN COMMERCE 10-7-2013.

**CLASS 9—(Continued).**

4,482,638. LIFE360, INC., SAN FRANCISCO, CA. SN 85-906,168. PUB. 6-11-2013, FILED 4-16-2013.

# LIFE360

THE MARK CONSISTS OF STANDARD CHARACTERS WITHOUT CLAIM TO ANY PARTICULAR FONT, STYLE, SIZE, OR COLOR.

FOR COMPUTER APPLICATION SOFTWARE FOR MOBILE PHONES AND HANDHELD COMPUTERS, NAMELY, SOFTWARE FOR CREATING GROUPS, GPS TRACKING, SENDING AND RECEIVING MESSAGES AND MOBILE ALERTS, AND PROVIDING INFORMATION TO USERS (U.S. CLS. 21, 23, 26, 36 AND 38).

FIRST USE 5-31-2008; IN COMMERCE 5-31-2008.

---

4,482,640. FAIR PRICE CORP, MIAMI LAKES, FL. SN 85-909,422. PUB. 9-17-2013, FILED 4-19-2013.

# Argon

THE MARK CONSISTS OF STANDARD CHARACTERS WITHOUT CLAIM TO ANY PARTICULAR FONT, STYLE, SIZE, OR COLOR.

FOR AUDIO SPEAKERS; BAGS AND CASES SPECIALLY ADAPTED FOR HOLDING OR CARRYING PORTABLE TELEPHONES AND TELEPHONE EQUIPMENT AND ACCESSORIES; BAGS FOR CAMERAS AND PHOTOGRAPHIC EQUIPMENT; CAMERA CASES; CAMERA TRIPODS; CARRYING CASES FOR CELL PHONES; CARRYING CASES FOR MOBILE COMPUTERS; CASES FOR MOBILE PHONES; CASES FOR TELEPHONES; CELL PHONE BATTERY CHARGERS; CELL PHONE BATTERY CHARGERS FOR USE IN VEHICLES; CELL PHONE CASES; CELL PHONE COVERS; CELL PHONE FACEPLATES; CELL PHONES; COMPUTER CAMERAS; COMPUTER CARRYING CASES; COMPUTER KEYBOARD CONTROLLERS; COMPUTER MONITORS; DIGITAL CAMERAS; EARPHONES AND HEADPHONES; LAPTOP CARRYING CASES; LAPTOP COMPUTER COOLING PADS; LAPTOP COMPUTERS; MEDIA PLAYERS; MP3 PLAYERS; MP4 PLAYERS; PROTECTIVE SLEEVES FOR LAPTOP COMPUTERS; TABLET COMPUTER (U.S. CLS. 21, 23, 26, 36 AND 38).

FIRST USE 5-17-2013; IN COMMERCE 7-17-2013.

**CLASS 9—(Continued).**

4,482,647. SPEEDWAY LLC, ENON, OH. SN 85-917,646. PUB. 7-23-2013, FILED 4-29-2013.

**COOL STACKS**

THE MARK CONSISTS OF STANDARD CHARACTERS WITHOUT CLAIM TO ANY PARTICULAR FONT, STYLE, SIZE, OR COLOR.

FOR COMPUTER GAME SOFTWARE; COMPUTER GAME SOFTWARE FOR USE ON MOBILE DEVICES (U.S. CLS. 21, 23, 26, 36 AND 38).

FIRST USE 7-15-2013; IN COMMERCE 7-15-2013.

4,482,697. UJAM, INC., C/O MELANIE KIDDER AT FRANK RIMERMAN, SAN FRANCISCO, CA. SN 85-980,890. PUB. 3-19-2013, FILED 9-26-2012.

**VJAM**

THE MARK CONSISTS OF STANDARD CHARACTERS WITHOUT CLAIM TO ANY PARTICULAR FONT, STYLE, SIZE, OR COLOR.

OWNER OF U.S. REG. NO. 3,965,155.

FOR COMPUTER APPLICATION SOFTWARE FOR MOBILE PHONES, PORTABLE MEDIA PLAYERS AND HANDHELD COMPUTERS, NAMELY, SOFTWARE FOR CREATING MUSICAL SOUNDTRACKS FOR VIDEOS, FOR USE IN RELATION TO SPECIAL EFFECTS OF IMAGES FOR VIDEOS AND FOR SHARING RESULTING VIDEOS THROUGH INTERNET-BASED SOCIAL NETWORKING WEBSITES; DOWNLOADABLE SOFTWARE IN THE NATURE OF A MOBILE APPLICATION FOR CREATING MUSICAL SOUNDTRACKS FOR VIDEOS, FOR USE IN RELATION TO SPECIAL EFFECTS OF IMAGES FOR VIDEOS AND FOR SHARING RESULTING VIDEOS THROUGH INTERNET-BASED SOCIAL NETWORKING WEBSITES (U.S. CLS. 21, 23, 26, 36 AND 38).

FIRST USE 12-0-2012; IN COMMERCE 12-0-2012.

**CLASS 10—MEDICAL APPARATUS****CLASS 10—(Continued).**

4,481,306. HEALTH CARE SUPPLIERS, INC., OMAHA, NE. SN 76-709,660. PUB. 5-1-2012, FILED 11-7-2011.

**ORAPRO**

THE MARK CONSISTS OF STANDARD CHARACTERS WITHOUT CLAIM TO ANY PARTICULAR FONT, STYLE, SIZE, OR COLOR.

OWNER OF U.S. REG. NO. 3,038,889.

FOR DENTAL AND ORTHODONTIC APPLIANCES, EQUIPMENT AND MATERIALS, NAMELY, ORTHODONTIC BRACKETS, ORTHODONTIC BANDS, BUCCAL TUBES, DENTAL MOUTH MIRRORS, ARELIWIRES, AND ORTHODONTIC INSTRUMENTS FOR DENTAL PURPOSE (U.S. CLS. 26, 39 AND 44).

FIRST USE 12-16-2013; IN COMMERCE 12-16-2013.

4,481,500. MAZOR ROBOTICS LTD., SO. CAESAREA IND. PARK, ISRAEL. SN 85-330,897. PUB. 5-22-2012, FILED 5-26-2011.

**RENAISSANCE**

THE MARK CONSISTS OF STANDARD CHARACTERS WITHOUT CLAIM TO ANY PARTICULAR FONT, STYLE, SIZE, OR COLOR.

FOR 3D IMAGING SOFTWARE RUNNING ON A DEDICATED COMPUTER FOR PRECISE POSITIONING OF SURGICAL INSTRUMENTS OR IMPLANTS DURING GENERAL SPINAL SURGERY IN EITHER OPEN OR PERCUTANEOUS PROCEDURES. THE SOFTWARE PROCESSES AND CONVERTS 2D FLUOROSCOPIC PROJECTIONS FROM STANDARD C-ARMS INTO VOLUMETRIC 3D IMAGES (U.S. CLS. 26, 39 AND 44).

FIRST USE 9-11-2013; IN COMMERCE 9-11-2013.

4,481,653. IMPLUS FOOTCARE, LLC, DURHAM, NC. SN 85-526,051. PUB. 5-1-2012, FILED 1-26-2012.

**PERFECT**

THE MARK CONSISTS OF STANDARD CHARACTERS WITHOUT CLAIM TO ANY PARTICULAR FONT, STYLE, SIZE, OR COLOR.

OWNER OF U.S. REG. NOS. 3,300,090, 3,803,543, AND OTHERS.

FOR HEART RATE MONITORS FOR SPORTS ACTIVITIES (U.S. CLS. 26, 39 AND 44).

FIRST USE 8-5-2013; IN COMMERCE 8-5-2013.

**CLASS 10—(Continued).**

4,481,692. DMS HOLDINGS, INC., WAUKEGAN, IL. SN 85-561,703. PUB. 2-12-2013, FILED 3-6-2012.



OWNER OF U.S. REG. NOS. 1,679,850 AND 1,865,695.  
NO CLAIM IS MADE TO THE EXCLUSIVE RIGHT TO USE "BEADS", APART FROM THE MARK AS SHOWN.  
THE MARK CONSISTS OF THE TERMS "THERA" AND "BEADS" WITH A MULTIPLE BUBBLE-LIKE IMAGE APPEARING BETWEEN THE TERMS.  
FOR MICROWAVEABLE PELLETS FOR APPLYING COLD OR MICROWAVE INDUCED HEAT IN THE THERAPEUTIC TREATMENT OF PAIN (U.S. CLS. 26, 39 AND 44).  
FIRST USE 5-1-2011; IN COMMERCE 5-1-2011.

4,481,755. JOOVY HOLDING CO., DALLAS, TX. SN 85-602,935. PUB. 4-23-2013, FILED 4-19-2012.

## CleanFlow

THE MARK CONSISTS OF STANDARD CHARACTERS WITHOUT CLAIM TO ANY PARTICULAR FONT, STYLE, SIZE, OR COLOR.  
FOR BABY BOTTLES; NIPPLES FOR BABY BOTTLES; CUPS ADAPTED FOR FEEDING BABIES AND CHILDREN; BABY BOTTLE HANDLES, NAMELY, FLEXIBLE BRACES AND RIGID BRACES FOR HOLDING A BABY BOTTLE; BABY NURSERS; PACIFIERS FOR BABIES AND HOLDERS THEREOF, NAMELY, PACIFIER CLOTH OR TETHER FOR ATTACHMENT TO INFANT PACIFIERS; FITTED NIPPLE COVERS FOR BABY BOTTLES; SEALING DISCS FOR BABY BOTTLES AND PARTS THEREOF; BREAST PUMPS; BREAST MILK STORAGE BOTTLES; BABY BOTTLE PARTS, NAMELY, FEEDING BOTTLE VALVES; FEEDING BOTTLES; BABY BOTTLE PARTS, NAMELY, NIPPLES FOR FEEDING BOTTLES; NURSING APPLIANCES, NAMELY, BREAST SHIELDS (U.S. CLS. 26, 39 AND 44).  
FIRST USE 9-13-2012; IN COMMERCE 3-25-2013.

**CLASS 10—(Continued).**

4,481,784. CRESS, JONATHAN, SANTA CRUZ, CA. SN 85-622,813. PUB. 10-23-2012, FILED 5-11-2012.

## Inforsure Eye Dropper

THE MARK CONSISTS OF STANDARD CHARACTERS WITHOUT CLAIM TO ANY PARTICULAR FONT, STYLE, SIZE, OR COLOR.  
NO CLAIM IS MADE TO THE EXCLUSIVE RIGHT TO USE "EYE DROPPER", APART FROM THE MARK AS SHOWN.  
FOR EYE DROPPERS (U.S. CLS. 26, 39 AND 44).  
FIRST USE 0-0-2012; IN COMMERCE 0-0-2012.

4,481,849. VENX, LLC, NASHVILLE, TN. SN 85-655,181. PUB. 10-2-2012, FILED 6-19-2012.

## VENX REACH

THE MARK CONSISTS OF STANDARD CHARACTERS WITHOUT CLAIM TO ANY PARTICULAR FONT, STYLE, SIZE, OR COLOR.  
THE WORDING "VENX" HAS NO MEANING IN A FOREIGN LANGUAGE.  
FOR MEDICAL DEVICE FOR THE TREATMENT OF VEINS (U.S. CLS. 26, 39 AND 44).  
FIRST USE 9-8-2013; IN COMMERCE 9-8-2013.

4,481,959. MEDECELL DO BRASIL COMÉRCIO E IMPORTAÇÃO LTDA, CENTRO-BOTUCATU-SP CEP, BRAZIL. SN 85-712,264. PUB. 8-27-2013, FILED 8-24-2012.



THE MARK CONSISTS OF THE WORD MARK "TANYX" WITH STYLIZED CURVED LINES BELOW AND TO THE RIGHT OF THE WORD.  
FOR ELECTRODES FOR MEDICAL USE; PHYSIOTHERAPY APPARATUS, NAMELY, ELECTRO STIMULATOR APPARATUS FOR RELIEF OF PAIN THROUGH ELECTRO NERVE STIMULATION; MEDICAL APPARATUS AND INSTRUMENTS FOR RELIEF OF PAIN THROUGH TRANSCUTANEOUS ELECTRICAL NERVE STIMULATION (U.S. CLS. 26, 39 AND 44).  
FIRST USE 10-7-2013; IN COMMERCE 10-7-2013.

**CLASS 10—(Continued).**

4,482,067. DEFIBTECH, LLC, CHICAGO, IL. SN 85-733,519.  
PUB. 3-19-2013, FILED 9-20-2012.

**LIFELINE PRO**

THE MARK CONSISTS OF STANDARD CHARACTERS WITHOUT CLAIM TO ANY PARTICULAR FONT, STYLE, SIZE, OR COLOR.

OWNER OF U.S. REG. NO. 2,971,702.  
NO CLAIM IS MADE TO THE EXCLUSIVE RIGHT TO USE "PRO", APART FROM THE MARK AS SHOWN.  
FOR AUTOMATED EXTERNAL DEFIBRILLATORS OF A PORTABLE TYPE (U.S. CLS. 26, 39 AND 44).  
FIRST USE 2-18-2013; IN COMMERCE 2-18-2013.

4,482,070. ORTHOMERICA PRODUCTS, INC., ORLANDO, FL. SN 85-733,970. PUB. 2-26-2013, FILED 9-20-2012.

**CA CATALINA**

THE MARK CONSISTS OF STANDARD CHARACTERS WITHOUT CLAIM TO ANY PARTICULAR FONT, STYLE, SIZE, OR COLOR.

FOR ORTHOPEDIC BRACES INCLUDING COMPONENTS THEREOF TO SUPPORT PORTIONS OF A HUMAN BODY; CLOSURE UNITS FOR TIGHTENING AN ORTHOSIS INCLUDING A MANUAL PULL MEMBER; AND ANTERIOR, POSTERIOR, AND CRUCIFORM THORATIC EXTENSIONS; PREFABRICATED ORTHOPEDIC BRACE (U.S. CLS. 26, 39 AND 44).  
FIRST USE 1-18-2013; IN COMMERCE 1-18-2013.

4,482,076. JIMMYJANE, INC., SAN FRANCISCO, CA. SN 85-735,504. PUB. 2-26-2013, FILED 9-21-2012.

**HELLO**

THE MARK CONSISTS OF STANDARD CHARACTERS WITHOUT CLAIM TO ANY PARTICULAR FONT, STYLE, SIZE, OR COLOR.

FOR ADULT SEXUAL STIMULATION AIDS, NAMELY, VIBRATORS AND PERSONAL MASSAGE UNITS; MASSAGE APPARATUS (U.S. CLS. 26, 39 AND 44).  
FIRST USE 12-17-2012; IN COMMERCE 12-17-2012.

**CLASS 10—(Continued).**

4,482,095. VASCULAR PATHWAYS, INC., NAPLES, FL. SN 85-737,751. PUB. 2-26-2013, FILED 9-25-2012.

**ACCUCATH**

THE MARK CONSISTS OF STANDARD CHARACTERS WITHOUT CLAIM TO ANY PARTICULAR FONT, STYLE, SIZE, OR COLOR.

FOR INTRAVENOUS CATHETERS (U.S. CLS. 26, 39 AND 44).  
FIRST USE 1-10-2013; IN COMMERCE 1-10-2013.

4,482,261. GENERAL ELECTRIC COMPANY, SCHENECTADY, NY. SN 85-764,767. PUB. 3-12-2013, FILED 10-26-2012.



OWNER OF U.S. REG. NOS. 1,790,247, 3,336,279, AND OTHERS.

THE MARK CONSISTS OF STYLIZED LETTERS "GE" INSIDE A CIRCLE WITH FOUR CURLICUES.

FOR INCUBATORS FOR BABIES; WARMING DEVICE FOR STABILIZING INFANT BODY TEMPERATURE FOR MEDICAL PURPOSES (U.S. CLS. 26, 39 AND 44).  
FIRST USE 3-24-2000; IN COMMERCE 3-24-2000.

4,482,262. GENERAL ELECTRIC COMPANY, SCHENECTADY, NY. SN 85-764,770. PUB. 3-12-2013, FILED 10-26-2012.

**GE**

THE MARK CONSISTS OF STANDARD CHARACTERS WITHOUT CLAIM TO ANY PARTICULAR FONT, STYLE, SIZE, OR COLOR.

**CLASS 10—(Continued).**

OWNER OF U.S. REG. NOS. 2,700,341, 4,214,749, AND OTHERS.

FOR INCUBATORS FOR BABIES; WARMING DEVICE FOR STABILIZING INFANT BODY TEMPERATURE FOR MEDICAL PURPOSES (U.S. CLS. 26, 39 AND 44).  
FIRST USE 3-24-2000; IN COMMERCE 3-24-2000.

**CLASS 10—(Continued).**

4,482,497. IDOC360, BURLEY, ID. SN 85-852,264. PUB. 7-16-2013, FILED 2-18-2013.

**THEWAVE**

THE MARK CONSISTS OF STANDARD CHARACTERS WITHOUT CLAIM TO ANY PARTICULAR FONT, STYLE, SIZE, OR COLOR.

FOR LOUPES FOR MEDICAL PURPOSES, NAMELY, HEADLAMP WITH LED TO ENABLE HANDS FREE LIGHTING FOR MEDICAL AND DENTAL USE (U.S. CLS. 26, 39 AND 44).

FIRST USE 5-1-2013; IN COMMERCE 5-1-2013.

4,482,275. HOLLISTER INCORPORATED, LIBERTYVILLE, IL. SN 85-768,446. PUB. 4-16-2013, FILED 10-31-2012.

**ANCHORFAST GUARD**

THE MARK CONSISTS OF STANDARD CHARACTERS WITHOUT CLAIM TO ANY PARTICULAR FONT, STYLE, SIZE, OR COLOR.

OWNER OF U.S. REG. NO. 3,479,124.  
NO CLAIM IS MADE TO THE EXCLUSIVE RIGHT TO USE "GUARD", APART FROM THE MARK AS SHOWN.

FOR MEDICAL AND SURGICAL DEVICES FOR ATTACHING, SECURING, AND PROTECTING MEDICAL TUBES, CATHETERS, AND DRAINS (U.S. CLS. 26, 39 AND 44).

FIRST USE 12-4-2013; IN COMMERCE 12-4-2013.

4,482,517. POMEDICAL, LLC, DBA POM MEDICAL, LLC, SIMI VALLEY, CA. SN 85-863,316. PUB. 7-23-2013, FILED 2-28-2013.



NO CLAIM IS MADE TO THE EXCLUSIVE RIGHT TO USE "OXYGEN MASK", APART FROM THE MARK AS SHOWN.

THE COLOR(S) TEAL IS/ARE CLAIMED AS A FEATURE OF THE MARK.

THE MARK CONSISTS OF THE LETTER "P", FOLLOWED BY AN OXYGEN MASK REPRESENTING THE LETTER "O", FOLLOWED BY THE LETTER "M", ABOVE A LINE UNDER WHICH "PANORAMIC OXYGEN MASK" IS WRITTEN, ALL IN TEAL.

FOR OXYGEN MASKS FOR MEDICAL USE (U.S. CLS. 26, 39 AND 44).

FIRST USE 9-17-2013; IN COMMERCE 9-17-2013.

4,482,468. SIEMENS MEDICAL INSTRUMENTS PTE. LTD., SINGAPORE, SINGAPORE. SN 85-842,431. PUB. 7-2-2013, FILED 2-6-2013.

**STRATA 2C**

THE MARK CONSISTS OF STANDARD CHARACTERS WITHOUT CLAIM TO ANY PARTICULAR FONT, STYLE, SIZE, OR COLOR.

FOR MEDICAL HEARING AIDS AND PARTS THEREOF (U.S. CLS. 26, 39 AND 44).

FIRST USE 5-0-2013; IN COMMERCE 5-0-2013.

4,482,580. TISSUEGEN, INC., DALLAS, TX. SN 85-881,787. PUB. 9-3-2013, FILED 3-20-2013.

**ELUTE**

THE MARK CONSISTS OF STANDARD CHARACTERS WITHOUT CLAIM TO ANY PARTICULAR FONT, STYLE, SIZE, OR COLOR.

FOR DRUG DELIVERY SYSTEMS MADE OF BIODEGRADABLE POLYMER FIBERS (U.S. CLS. 26, 39 AND 44).

FIRST USE 2-12-2013; IN COMMERCE 2-12-2013.

**CLASS 11—ENVIRONMENTAL CONTROL APPARATUS**

4,481,398. GLANTZ HOLDINGS, INC., LOUISVILLE, KY. SN 85-046,428. PUB. 10-19-2010, FILED 5-24-2010.

 The logo for beLine features the word "be" in a blue, lowercase, sans-serif font, followed by "Line" in a light green, lowercase, sans-serif font. The "b" and "L" are stylized with rounded corners.

THE COLOR(S) BLUE, LIGHT GREEN AND WHITE IS/ ARE CLAIMED AS A FEATURE OF THE MARK.

THE MARK CONSISTS OF THE WORD "BE" IN WHITE STYLIZED LOWER CASE LETTERS WITHIN A BLUE RECTANGULAR SHAPE WITH THREE ROUNDED CORNERS AND THE UPPER LEFT CORNER EXTENDING TO A POINT, APPEARING TO THE LEFT OF THE WORD "LINE" IN STYLIZED LIGHT GREEN LETTERS WITH A CAPITALIZED "L", ALL ON A TRANSPARENT BACKGROUND.

FOR LED LIGHTING SYSTEMS, NAMELY, LED MODULES, POWER SUPPLIES, AND WIRING; TOOLS, COMPONENTS AND SUPPLIES FOR USE IN MAKING SIGNS, NAMELY, HID AND LED BULBS, LAMPS AND FIXTURES (U.S. CLS. 13, 21, 23, 31 AND 34).

FIRST USE 1-1-2013; IN COMMERCE 1-1-2013.

4,481,406. GLANTZ HOLDINGS, INC., LOUISVILLE, KY. SN 85-064,472. PUB. 11-23-2010, FILED 6-16-2010.

 The logo for beLine features the word "be" in a black, lowercase, sans-serif font, followed by "Line" in a grey, lowercase, sans-serif font. The "b" and "L" are stylized with rounded corners.

THE MARK CONSISTS OF THE WORD "BE" IN STYLIZED LOWER CASE LETTERS WITHIN A RECTANGULAR SHAPE WITH THREE ROUNDED CORNERS AND THE UPPER LEFT CORNER EXTENDING TO A POINT, APPEARING TO THE LEFT OF THE WORD "LINE" IN STYLIZED LETTERS WITH A CAPITALIZED "L".

FOR LED LIGHTING SYSTEMS, NAMELY, LED MODULES, POWER SUPPLIES, AND WIRING; TOOLS, COMPONENTS AND SUPPLIES FOR USE IN MAKING SIGNS, NAMELY, HID AND LED BULBS, LAMPS AND FIXTURES (U.S. CLS. 13, 21, 23, 31 AND 34).

FIRST USE 1-1-2013; IN COMMERCE 1-1-2013.

4,481,445. MIDWEST TILE, MARBLE & GRANITE, INC., LINCOLN, NE. SN 85-183,892. PUB. 4-12-2011, FILED 11-23-2010.

# AGGRANITE

THE MARK CONSISTS OF STANDARD CHARACTERS WITHOUT CLAIM TO ANY PARTICULAR FONT, STYLE, SIZE, OR COLOR.

FOR SINKS (U.S. CLS. 13, 21, 23, 31 AND 34).  
FIRST USE 5-31-2011; IN COMMERCE 5-31-2011.

**CLASS 11—(Continued).**

4,481,585. INDUSTRIAS HACEB S.A., COPACABANA, COLOMBIA. SN 85-452,252. PUB. 9-11-2012, FILED 10-20-2011.

 The logo for Haceb features the word "Haceb" in a black, sans-serif font, enclosed within a black diamond-shaped border.

OWNER OF U.S. REG. NO. 3,065,642.

THE MARK CONSISTS OF THE WORD "HACEB" IN STYLIZED LETTERS INSIDE A RHOMBUS.

THE WORDING "HACEB" HAS NO MEANING IN A FOREIGN LANGUAGE.

FOR AIR CONDITIONERS; ELECTRIC COOKING OVENS; ELECTRIC STOVES; EXTRACTOR HOODS FOR KITCHENS; FREEZERS; GAS COOKING OVENS; GAS STOVES; HEATING INSTALLATIONS; HOT WATER HEATERS; MICROWAVE OVENS; REFRIGERATORS (U.S. CLS. 13, 21, 23, 31 AND 34).

FIRST USE 3-12-1962; IN COMMERCE 11-8-2011.

4,481,598. MASCO CORPORATION OF INDIANA, INDIANAPOLIS, IN. SN 85-469,041. PUB. 10-9-2012, FILED 11-10-2011.

# RIOSA

THE MARK CONSISTS OF STANDARD CHARACTERS WITHOUT CLAIM TO ANY PARTICULAR FONT, STYLE, SIZE, OR COLOR.

FOR PLUMBING PRODUCTS, NAMELY, TOILETS (U.S. CLS. 13, 21, 23, 31 AND 34).

FIRST USE 8-0-2013; IN COMMERCE 8-0-2013.

4,481,625. W. W. GRAINGER, INC., LAKE FOREST, IL. SN 85-482,349. PUB. 10-16-2012, FILED 11-29-2011.

**MORE FILTERS. MORE SIZES.  
MORE APPLICATIONS.**

THE MARK CONSISTS OF STANDARD CHARACTERS WITHOUT CLAIM TO ANY PARTICULAR FONT, STYLE, SIZE, OR COLOR.

FOR AIR FILTER UNITS FOR REMOVAL OF AIRBORNE PARTICLES FOR DOMESTIC AND INDUSTRIAL USE; BAFFLE GREASE FILTERS FOR AIR EXTRACTOR HOODS; EXHAUST VENT AIR FILTERS (U.S. CLS. 13, 21, 23, 31 AND 34).

FIRST USE 0-0-2007; IN COMMERCE 0-0-2007.

**CLASS 11—(Continued).**

4,481,727. RAB LIGHTING INC., NORTHVALE, NJ. SN 85-595,019. PUB. 9-11-2012, FILED 4-11-2012.

# LBACKUP

THE MARK CONSISTS OF STANDARD CHARACTERS WITHOUT CLAIM TO ANY PARTICULAR FONT, STYLE, SIZE, OR COLOR.

OWNER OF U.S. REG. NOS. 3,920,752 AND 3,920,753.  
FOR ELECTRIC LIGHTING FIXTURES; LED (LIGHT EMITTING DIODE) LIGHTING FIXTURES; LIGHTING FIXTURES (U.S. CLS. 13, 21, 23, 31 AND 34).  
FIRST USE 4-30-2013; IN COMMERCE 4-30-2013.

**CLASS 11—(Continued).**

4,481,830. GOLD CANYON INTERNATIONAL, L.L.C., CHANDLER, AZ. SN 85-648,391. PUB. 2-5-2013, FILED 6-11-2012.

# SCENTRIC

THE MARK CONSISTS OF STANDARD CHARACTERS WITHOUT CLAIM TO ANY PARTICULAR FONT, STYLE, SIZE, OR COLOR.

FOR ELECTRICAL SCENT DISPENSERS USED AS AIR FRESHENERS (U.S. CLS. 13, 21, 23, 31 AND 34).  
FIRST USE 10-31-2013; IN COMMERCE 10-31-2013.

4,481,736. RAB LIGHTING INC., NORTHVALE, NJ. SN 85-597,325. PUB. 9-18-2012, FILED 4-13-2012.

# LBEACON

THE MARK CONSISTS OF STANDARD CHARACTERS WITHOUT CLAIM TO ANY PARTICULAR FONT, STYLE, SIZE, OR COLOR.

OWNER OF U.S. REG. NOS. 3,920,752 AND 3,920,753.  
FOR ELECTRIC LIGHTING FIXTURES; LED (LIGHT EMITTING DIODE) LIGHTING FIXTURES; LIGHTING FIXTURES (U.S. CLS. 13, 21, 23, 31 AND 34).  
FIRST USE 5-31-2013; IN COMMERCE 5-31-2013.

4,481,900. NADFINLO PLASTICS INDUSTRY CO. LTD., QUARRY BAY, HONG KONG. SN 85-678,249. PUB. 12-11-2012, FILED 7-16-2012.

# PETER POTTY

THE MARK CONSISTS OF STANDARD CHARACTERS WITHOUT CLAIM TO ANY PARTICULAR FONT, STYLE, SIZE, OR COLOR.

OWNER OF U.S. REG. NO. 3,403,582.  
NO CLAIM IS MADE TO THE EXCLUSIVE RIGHT TO USE "POTTY", APART FROM THE MARK AS SHOWN.  
FOR TODDLER URINAL (U.S. CLS. 13, 21, 23, 31 AND 34).  
FIRST USE 5-0-2004; IN COMMERCE 10-0-2005.

4,481,742. NOMIKU, INC., SAN FRANCISCO, CA. SN 85-599,423. PUB. 9-11-2012, FILED 4-17-2012.

# Nomiku

THE MARK CONSISTS OF STANDARD CHARACTERS WITHOUT CLAIM TO ANY PARTICULAR FONT, STYLE, SIZE, OR COLOR.

FOR IMMERSION HEATERS (U.S. CLS. 13, 21, 23, 31 AND 34).  
FIRST USE 9-13-2013; IN COMMERCE 9-13-2013.

4,481,919. KOHLER CO., KOHLER, WI. SN 85-688,439. PUB. 1-1-2013, FILED 7-27-2012.

# SENSATE

THE MARK CONSISTS OF STANDARD CHARACTERS WITHOUT CLAIM TO ANY PARTICULAR FONT, STYLE, SIZE, OR COLOR.

FOR ELECTRONIC FAUCETS (U.S. CLS. 13, 21, 23, 31 AND 34).  
FIRST USE 1-31-2013; IN COMMERCE 1-31-2013.

**CLASS 11—(Continued).**

4,481,934. HQ HOMETEK INC., OCEANSIDE, NY. SN 85-697,080. PUB. 1-29-2013, FILED 8-7-2012.

DUALPLEXX

THE MARK CONSISTS OF STANDARD CHARACTERS WITHOUT CLAIM TO ANY PARTICULAR FONT, STYLE, SIZE, OR COLOR.

FOR WATER FILTRATION SYSTEMS CONSISTING OF MULTIPLE PURIFICATION FILTERS FOR DOMESTIC AND COMMERCIAL USE (U.S. CLS. 13, 21, 23, 31 AND 34).

FIRST USE 3-0-2013; IN COMMERCE 3-0-2013.

---

4,482,157. GENERAL ELECTRIC COMPANY, SCHENECTADY, NY. SN 85-746,799. PUB. 3-12-2013, FILED 10-5-2012.

GE

THE MARK CONSISTS OF STANDARD CHARACTERS WITHOUT CLAIM TO ANY PARTICULAR FONT, STYLE, SIZE, OR COLOR.

OWNER OF U.S. REG. NOS. 1,203,475, 3,280,631, AND OTHERS.

FOR CONVECTION OVENS; COOKING RINGS; DOMESTIC COOKING OVENS; DOMESTIC ELECTRIC APPLIANCES, NAMELY, FRYPANS; ELECTRIC COOKING POTS; ELECTRIC COOKTOPS; ELECTRIC DEEP FRYERS; ELECTRIC HOT PLATES; ELECTRIC KETTLES; ELECTRIC ROASTERS; ELECTRIC ROTISSERIES; ELECTRIC SLOW COOKERS; ELECTRIC STOVES; ELECTRIC TEA POTS; ELECTRIC TOASTER OVENS; ELECTRIC TOASTERS; ELECTRIC WAFFLE IRONS; GAS COOKTOPS; GAS STOVES; LED AND HID LIGHT FIXTURES; LED LUMINAIRES; SOLAR COLLECTORS; SOLAR HEAT COLLECTION PANELS; SOLAR LIGHT FIXTURES, NAMELY, INDOOR AND OUTDOOR SOLAR POWERED LIGHTING UNITS AND FIXTURES; SOLAR THERMAL INSTALLATIONS, NAMELY, SOLAR THERMAL MODULES (U.S. CLS. 13, 21, 23, 31 AND 34).

FIRST USE 10-5-2012; IN COMMERCE 10-5-2012.

**CLASS 11—(Continued).**

4,482,167. GENERAL ELECTRIC COMPANY, SCHENECTADY, NY. SN 85-747,228. PUB. 3-12-2013, FILED 10-5-2012.



OWNER OF U.S. REG. NOS. 1,051,200, 3,280,635, AND OTHERS.

THE MARK CONSISTS OF STYLIZED LETTERS "GE" INSIDE A CIRCLE WITH FOUR CURLICUES.

FOR ELECTRIC RADIANT HEATERS; GAS WATER HEATERS; HUMIDIFIERS; HYBRID WATER HEATER; LED AND HID LIGHT FIXTURES; LED LUMINAIRES; SOLAR COLLECTORS; SOLAR HEAT COLLECTION PANELS; SOLAR LIGHT FIXTURES, NAMELY, INDOOR AND OUTDOOR SOLAR POWERED LIGHTING UNITS AND FIXTURES; SOLAR THERMAL INSTALLATIONS, NAMELY, SOLAR THERMAL MODULES; WATER HEATERS (U.S. CLS. 13, 21, 23, 31 AND 34).

FIRST USE 10-5-2012; IN COMMERCE 10-5-2012.

---

4,482,176. TOTO U.S.A., INC., MORROW, GA. SN 85-748,339. PUB. 3-12-2013, FILED 10-8-2012.

PEOPLE-FIRST INNOVATION

THE MARK CONSISTS OF STANDARD CHARACTERS WITHOUT CLAIM TO ANY PARTICULAR FONT, STYLE, SIZE, OR COLOR.

FOR PLUMBING FIXTURES, NAMELY, TOILETS, BIDETS, BATHTUBS, SHOWERS, SINKS AND FAUCETS (U.S. CLS. 13, 21, 23, 31 AND 34).

FIRST USE 1-31-2012; IN COMMERCE 1-31-2012.



**CLASS 11—(Continued).**

4,482,255. LENNOX INDUSTRIES INC., RICHARDSON, TX.  
SN 85-763,533. PUB. 2-12-2013, FILED 10-25-2012.

VALUE WITHOUT COMPROMISE

THE MARK CONSISTS OF STANDARD CHARACTERS WITHOUT CLAIM TO ANY PARTICULAR FONT, STYLE, SIZE, OR COLOR.

FOR ROOFTOP HEATING, VENTILATION AND AIR CONDITIONING UNITS (U.S. CLS. 13, 21, 23, 31 AND 34).

FIRST USE 2-28-2013; IN COMMERCE 2-28-2013.

4,482,299. TASER INTERNATIONAL, INC., SCOTTSDALE, AZ. SN 85-779,059. PUB. 4-23-2013, FILED 11-14-2012.

STRIKELIGHT

THE MARK CONSISTS OF STANDARD CHARACTERS WITHOUT CLAIM TO ANY PARTICULAR FONT, STYLE, SIZE, OR COLOR.

FOR FLASHLIGHTS (U.S. CLS. 13, 21, 23, 31 AND 34).  
FIRST USE 7-11-2013; IN COMMERCE 7-11-2013.

4,482,328. NINGBO QTOP IMPORT AND EXPORT CO.,LTD, NINGBO, CHINA. SN 85-788,050. PUB. 6-11-2013, FILED 11-27-2012.

QTOP

THE MARK CONSISTS OF STANDARD CHARACTERS WITHOUT CLAIM TO ANY PARTICULAR FONT, STYLE, SIZE, OR COLOR.

THE WORD(S) "QTOP" HAS NO MEANING IN A FOREIGN LANGUAGE.

FOR LAMPS; LAMPS FOR OUTDOOR USE; LED (LIGHT EMITTING DIODE) LIGHTING FIXTURES (U.S. CLS. 13, 21, 23, 31 AND 34).

FIRST USE 6-30-2008; IN COMMERCE 7-10-2013.

**CLASS 11—(Continued).**

4,482,429. HENERGY GROUP (NORTH AMERICA) INC., BRITISH COLUMBIA, CANADA. SN 85-823,105. PUB. 8-6-2013, FILED 1-15-2013.

SUN KING

THE MARK CONSISTS OF STANDARD CHARACTERS WITHOUT CLAIM TO ANY PARTICULAR FONT, STYLE, SIZE, OR COLOR.

OWNER OF U.S. REG. NO. 4,119,605.

FOR AIR CONDITIONING INSTALLATIONS; COOKING OVENS; ELECTRIC ROASTERS; FLUORESCENT LAMP TUBES; GAS STOVES; HEATING INSTALLATIONS; LAMPS; LED (LIGHT EMITTING DIODE) LIGHTING FIXTURES; LIGHT BULBS; STREET LAMPS (U.S. CLS. 13, 21, 23, 31 AND 34).

FIRST USE 4-23-2013; IN COMMERCE 5-20-2013.

4,482,431. JST PERFORMANCE, INC., DBA RIGID INDUSTRIES, GILBERT, AZ. SN 85-823,879. PUB. 6-11-2013, FILED 1-15-2013.

SR-Q

THE MARK CONSISTS OF STANDARD CHARACTERS WITHOUT CLAIM TO ANY PARTICULAR FONT, STYLE, SIZE, OR COLOR.

FOR LIGHTS FOR VEHICLES (U.S. CLS. 13, 21, 23, 31 AND 34).

FIRST USE 5-31-2013; IN COMMERCE 5-31-2013.

4,482,540. TRACTOR SUPPLY CO. OF TEXAS, LP, BRENTWOOD, TN. SN 85-867,946. PUB. 9-3-2013, FILED 3-6-2013.



OWNER OF U.S. REG. NO. 3,475,491.

**CLASS 11—(Continued).**

THE MARK CONSISTS OF A FIVE-POINTED STAR IMPOSED ON A TRIANGLE, BOTH OF WHICH ARE INSIDE A POLYGON.

FOR ELECTRIC FANS (U.S. CLS. 13, 21, 23, 31 AND 34).

FIRST USE 4-0-2011; IN COMMERCE 4-0-2011.

---

4,482,568. NORWALK WASTEWATER EQUIPMENT COMPANY, INC., NORWALK, OH. SN 85-878,527. PUB. 6-11-2013, FILED 3-18-2013.

## Evenair

THE MARK CONSISTS OF STANDARD CHARACTERS WITHOUT CLAIM TO ANY PARTICULAR FONT, STYLE, SIZE, OR COLOR.

FOR AIR DIFFUSERS FOR WASTEWATER TREATMENT UNITS (U.S. CLS. 13, 21, 23, 31 AND 34).

FIRST USE 4-30-2013; IN COMMERCE 7-23-2013.

---

4,482,575. YOU HAU LTD., CO., NEW TAIPEI CITY, TAIWAN. SN 85-879,845. PUB. 8-6-2013, FILED 3-19-2013.



THE MARK CONSISTS OF THE STYLIZED LETTER "H" ABOVE THE LETTER "U". A DESIGN OF A HOUSE FORMS THE EMPTY SPACE BELOW THE LETTER "H" AND FORMS THE TOP RIGHT PART OF THE LETTER "U".

FOR ELECTRIC LIGHTING FIXTURES; ELECTRIC LIGHTS FOR CHRISTMAS TREES; FLASHLIGHTS; FLUORESCENT ELECTRIC LIGHT BULBS; FLUORESCENT LIGHTING TUBES; LED AND HID LIGHT FIXTURES; LED LIGHT ASSEMBLIES FOR STREET LIGHTS, SIGNS, COMMERCIAL LIGHTING, AUTOMOBILES, BUILDINGS, AND OTHER ARCHITECTURAL USES; LED LIGHTING FIXTURES FOR INDOOR AND OUTDOOR LIGHTING APPLICATIONS; LED LIGHTING SYSTEMS, NAMELY, LED MODULES, POWER SUPPLIES, AND WIRING; LIGHT BULBS; LIGHTING APPARATUS FOR VEHICLES (U.S. CLS. 13, 21, 23, 31 AND 34).

FIRST USE 3-5-2013; IN COMMERCE 3-13-2013.

**CLASS 11—(Continued).**

4,482,576. YOU HAU CO., LTD., NEW TAIPEI CITY, TAIWAN. SN 85-879,863. PUB. 8-6-2013, FILED 3-19-2013.



THE MARK CONSISTS OF THE STYLIZED LETTER "H" ABOVE THE LETTER "U" FOLLOWED BY THE WORDING "UHOUSE" UNDER THE LETTER "H". A DESIGN OF A HOUSE FORMS THE EMPTY SPACE BELOW THE LETTER "H" AND FORMS THE TOP RIGHT PART OF THE LETTER "U".

FOR ELECTRIC LIGHTING FIXTURES; ELECTRIC LIGHTS FOR CHRISTMAS TREES; FLASHLIGHTS; FLUORESCENT ELECTRIC LIGHT BULBS; FLUORESCENT LIGHTING TUBES; LED AND HID LIGHT FIXTURES; LED LIGHT ASSEMBLIES FOR STREET LIGHTS, SIGNS, COMMERCIAL LIGHTING, AUTOMOBILES, BUILDINGS, AND OTHER ARCHITECTURAL USES; LED LIGHTING FIXTURES FOR INDOOR AND OUTDOOR LIGHTING APPLICATIONS; LED LIGHTING SYSTEMS, NAMELY, LED MODULES, POWER SUPPLIES, AND WIRING; LIGHT BULBS; LIGHTING APPARATUS FOR VEHICLES (U.S. CLS. 13, 21, 23, 31 AND 34).

FIRST USE 3-5-2013; IN COMMERCE 3-13-2013.

---

4,482,581. BLUE WAVE INTERNATIONAL, LAS VEGAS, NV. SN 85-881,960. PUB. 8-6-2013, FILED 3-20-2013.

## ClearWaveAir

THE MARK CONSISTS OF STANDARD CHARACTERS WITHOUT CLAIM TO ANY PARTICULAR FONT, STYLE, SIZE, OR COLOR.

FOR AIR PURIFICATION UNITS; AIR PURIFIERS (U.S. CLS. 13, 21, 23, 31 AND 34).

FIRST USE 3-1-2013; IN COMMERCE 3-1-2013.

**CLASS 12—VEHICLES**

**CLASS 12—(Continued).**

4,481,519. MATTHIAS MAIER, BERLIN, FED REP GERMANY. SN 85-380,901. PUB. 3-12-2013, FILED 7-26-2011.

## Bella Ciao

THE MARK CONSISTS OF STANDARD CHARACTERS WITHOUT CLAIM TO ANY PARTICULAR FONT, STYLE, SIZE, OR COLOR.

THE ENGLISH TRANSLATION OF "BELLA CIAO" IN THE MARK IS "HELLO BEAUTIFUL".

FOR LAND VEHICLES; APPARATUS FOR LOCOMOTION BY LAND, NAMELY, BICYCLES (U.S. CLS. 19, 21, 23, 31, 35 AND 44).

FIRST USE 10-13-2010; IN COMMERCE 9-25-2013.

4,481,725. THE RAYMOND CORPORATION, GREENE, NY. SN 85-593,546. PUB. 7-24-2012, FILED 4-10-2012.

## PERFORMANCE WITHOUT COMPROMISE

THE MARK CONSISTS OF STANDARD CHARACTERS WITHOUT CLAIM TO ANY PARTICULAR FONT, STYLE, SIZE, OR COLOR.

FOR MATERIAL HANDLING VEHICLES, NAMELY, FORKLIFT TRUCKS, HIGH-REACH FORKLIFT TRUCKS, PEDESTRIAN CONTROLLED FORKLIFT TRUCKS AND PALLET TRUCKS, AND ORDER PICKER TRUCKS (U.S. CLS. 19, 21, 23, 31, 35 AND 44).

FIRST USE 10-15-2013; IN COMMERCE 10-15-2013.

4,481,750. CHAPARRAL BOATS, INC., NASHVILLE, GA. SN 85-601,696. PUB. 3-19-2013, FILED 4-18-2012.



THE MARK CONSISTS OF THE CHARACTERS "H2O" WITH SHADING WITHIN THE TOP AND BOTTOM OF THE LETTER "H" AND WITHIN THE BOTTOM OF THE NUMBER "2", FOLLOWED BY A BIRD DESIGN WITHIN THE LETTER "O" BOTH OF WHICH CONTAIN SHADING. THE ENTIRE MARK CASTS A SHADOW.

FOR BOATS (U.S. CLS. 19, 21, 23, 31, 35 AND 44).  
FIRST USE 9-8-2011; IN COMMERCE 9-8-2011.

**CLASS 12—(Continued).**

4,481,761. CWK FOUNDATION, SANTA ROSA, CA. SN 85-608,944. PUB. 3-12-2013, FILED 4-26-2012.

## AWESOME PRETZEL CART

THE MARK CONSISTS OF STANDARD CHARACTERS WITHOUT CLAIM TO ANY PARTICULAR FONT, STYLE, SIZE, OR COLOR.

NO CLAIM IS MADE TO THE EXCLUSIVE RIGHT TO USE "PRETZEL CART", APART FROM THE MARK AS SHOWN.

FOR CARTS (U.S. CLS. 19, 21, 23, 31, 35 AND 44).

FIRST USE 8-26-2010; IN COMMERCE 12-1-2012.

4,481,782. PILKINGTON NORTH AMERICA, INC., TOLEDO, OH. SN 85-621,337. PUB. 7-17-2012, FILED 5-10-2012.

## SARATOGA TOP

THE MARK CONSISTS OF STANDARD CHARACTERS WITHOUT CLAIM TO ANY PARTICULAR FONT, STYLE, SIZE, OR COLOR.

NO CLAIM IS MADE TO THE EXCLUSIVE RIGHT TO USE "TOP", APART FROM THE MARK AS SHOWN.

FOR GLASS PANELS FOR VEHICLES, NAMELY, GLASS WINDOWS FOR VEHICLES (U.S. CLS. 19, 21, 23, 31, 35 AND 44).

FIRST USE 9-30-2013; IN COMMERCE 9-30-2013.

4,481,828. SPACEFLIGHT, INC., TUKWILA, WA. SN 85-647,838. PUB. 5-14-2013, FILED 6-9-2012.

## Decapod

THE MARK CONSISTS OF STANDARD CHARACTERS WITHOUT CLAIM TO ANY PARTICULAR FONT, STYLE, SIZE, OR COLOR.

FOR APPARATUS FOR LOCOMOTION BY AIR AND SPACE, NAMELY, AIRBORNE PLATFORMS FOR SERVING SPACECRAFTS AND CONDUCTING SPACE APPLICATIONS, AND STRUCTURAL PARTS AND STRUCTURAL FITTINGS FOR ALL OF THE AFOREMENTIONED GOODS (U.S. CLS. 19, 21, 23, 31, 35 AND 44).

FIRST USE 8-26-2013; IN COMMERCE 8-26-2013.

**CLASS 12—(Continued).**

4,481,975. BRYSON MARTIN RACING, INC, CASTAIC, CA. SN 85-716,536. PUB. 3-5-2013, FILED 8-29-2012.



THE MARK CONSISTS OF A CIRCLE CONTAINING THE STYLIZED LETTERS "DVO" WITH A BORDER AROUND THE CIRCLE. BELOW THE CIRCLE IS THE STYLIZED TEXT "DVO" WITH A RECTANGLE AROUND THE LETTER "O" AND HALF OF THE LETTER "V". BELOW "DVO" IS THE STYLIZED TEXT "DEVELOPED SUSPENSION" WHERE THE WORD "SUSPENSION" IS ALSO INSIDE THE RECTANGLE.

FOR BICYCLE PARTS, NAMELY, FORKS AND SHOCKS (U.S. CLS. 19, 21, 23, 31, 35 AND 44). FIRST USE 7-1-2012; IN COMMERCE 10-12-2012.

**CLASS 12—(Continued).**

4,482,168. GENERAL ELECTRIC COMPANY, SCHENECTADY, NY. SN 85-747,229. PUB. 3-12-2013, FILED 10-5-2012.



OWNER OF U.S. REG. NOS. 35,089, 3,363,508, AND OTHERS.

THE MARK CONSISTS OF STYLIZED LETTERS "GE" INSIDE A CIRCLE WITH FOUR CURLICUES.

FOR AIRPLANE PROPELLERS; RAILWAY BOGIES; RAILWAY CARS; RAILWAY COUPLINGS; SCREW PROPELLERS FOR VEHICLES; TORQUE CONVERTERS FOR LAND VEHICLES; VEHICLE PROPELLERS (U.S. CLS. 19, 21, 23, 31, 35 AND 44).

FIRST USE 10-5-2012; IN COMMERCE 10-5-2012.

4,482,016. KASKAZI KAYAKS, LLC, ELLICOTT CITY, MD. SN 85-727,135. PUB. 2-12-2013, FILED 9-12-2012.

**KASKAZI**

THE MARK CONSISTS OF STANDARD CHARACTERS WITHOUT CLAIM TO ANY PARTICULAR FONT, STYLE, SIZE, OR COLOR.

FOR RECREATIONAL WATERCRAFT, NAMELY, BOATS AND STRUCTURAL PARTS THEREFOR, KAYAKS AND STRUCTURAL PARTS THEREFOR, CANOES AND STRUCTURAL PARTS THEREFOR, AND KAYAK-LIKE BOATS AND STRUCTURAL PARTS THEREFOR; KAYAK PADDLES; CANOE PADDLES; DECK BAGS ADAPTED FOR BOATS; DECK BAGS ADAPTED FOR KAYAKS; DECK BAGS ADAPTED FOR CANOES; CARTOP KAYAK AND CANOE CARRIER KITS; BOAT TRAILERS (U.S. CLS. 19, 21, 23, 31, 35 AND 44).

FIRST USE 8-30-2013; IN COMMERCE 8-30-2013.

**CONQUER YOUR TERRAIN**

THE MARK CONSISTS OF STANDARD CHARACTERS WITHOUT CLAIM TO ANY PARTICULAR FONT, STYLE, SIZE, OR COLOR.

FOR TIRES (U.S. CLS. 19, 21, 23, 31, 35 AND 44).

FIRST USE 10-8-2012; IN COMMERCE 10-8-2012.

4,482,417. LI JINCHENG, SOUTH SAN FRANCISCO, CA. SN 85-820,742. PUB. 6-11-2013, FILED 1-11-2013.

**SRACER**

THE MARK CONSISTS OF THE STYLIZED WORD "SRACER".

**CLASS 12—(Continued).**

THE WORDING "SRACER" HAS NO MEANING IN A FOREIGN LANGUAGE.

FOR AUTOMOBILE BUMPERS; AUTOMOTIVE BODY KITS COMPRISING EXTERNAL STRUCTURAL PARTS OF AUTOMOBILES; BODYWORKS FOR MOTOR VEHICLES; BRAKE DISCS FOR MOTORCYCLES; BRAKES FOR LAND VEHICLES; CHASSIS FOR MOTOR VEHICLES; CONNECTING RODS FOR LAND VEHICLES OTHER THAN PARTS OF MOTORS AND ENGINES; GEARS FOR VEHICLES; PARTS OF MOTORCYCLES, NAMELY, BRAKE CABLES; STEERING AND SUSPENSION SYSTEMS AND PARTS FOR STEERING AND SUSPENSION SYSTEMS FOR VEHICLES, NAMELY, UPPER BALL JOINTS, LOWER BALL JOINTS, BALL JOINTS WITH CONTROL ARMS, BUSHING KITS, INNER TIE ROD ENDS, OUTER TIE ROD ENDS, SLEEVES, IDLER ARMS, CENTER LINKS, STABILIZER KITS, INNER SOCKETS AND PITMAN ARMS; STEERING WHEELS FOR VEHICLES; SUSPENSION SPRINGS FOR MOTOR CARS; TURBINES FOR LAND VEHICLES; VEHICLE SEATS; VEHICLE WHEEL RIMS; WHEEL RIMS FOR MOTOR CARS (U.S. CLS. 19, 21, 23, 31, 35 AND 44).

FIRST USE 7-27-2009; IN COMMERCE 12-1-2012.

---

4,482,418. ALLIED WHEEL COMPONENTS, INC., GARDEN GROVE, CA. SN 85-821,284. PUB. 6-4-2013, FILED 1-11-2013.

**TREADSTAR**

THE MARK CONSISTS OF THE WORD "TREADSTAR" IN A STYLIZED FORM IN WHICH THE FIRST LETTER "T" IN THE MARK IS LARGER AND MORE PROMINENT THAN THE OTHER LETTERS.

FOR TIRES (U.S. CLS. 19, 21, 23, 31, 35 AND 44).

FIRST USE 2-28-2013; IN COMMERCE 2-28-2013.

---

4,482,475. GENERAL MOTORS LLC, DETROIT, MI. SN 85-844,536. PUB. 6-25-2013, FILED 2-8-2013.



OWNER OF U.S. REG. NOS. 2,232,346, 3,739,088, AND OTHERS.

THE MARK CONSISTS OF TWO FLAGS CONNECTED AT THEIR BASES, ONE CONTAINING A CHECKED FLAG DESIGN, THE OTHER CONTAINING A FLEUR DE LIS AND A BOWTIE DESIGN.

FOR MOTOR LAND VEHICLES, NAMELY, AUTOMOBILES, ENGINES THEREFOR AND STRUCTURAL PARTS THEREOF (U.S. CLS. 19, 21, 23, 31, 35 AND 44).  
FIRST USE 9-19-2013; IN COMMERCE 9-19-2013.

**CLASS 12—(Continued).**

4,482,527. TAMPA BAY RECREATION, LLC, LUTZ, FL. SN 85-866,148. PUB. 9-10-2013, FILED 3-4-2013.

**ADAMO ATTACK**

THE MARK CONSISTS OF STANDARD CHARACTERS WITHOUT CLAIM TO ANY PARTICULAR FONT, STYLE, SIZE, OR COLOR.

OWNER OF U.S. REG. NOS. 3,539,993, 3,539,994, AND 3,865,508.

THE ENGLISH TRANSLATION OF THE ITALIAN WORD "ADAMO" IN THE MARK IS "ADAM".

FOR BICYCLE SEATS (U.S. CLS. 19, 21, 23, 31, 35 AND 44).

FIRST USE 8-29-2012; IN COMMERCE 12-31-2012.

---

4,482,528. TAMPA BAY RECREATION, LLC, LUTZ, FL. SN 85-866,165. PUB. 9-10-2013, FILED 3-4-2013.

**ADAMO PEAK**

THE MARK CONSISTS OF STANDARD CHARACTERS WITHOUT CLAIM TO ANY PARTICULAR FONT, STYLE, SIZE, OR COLOR.

OWNER OF U.S. REG. NOS. 3,539,993, 3,539,994, AND 3,865,508.

THE ENGLISH TRANSLATION OF THE ITALIAN WORD "ADAMO" IN THE MARK IS "ADAM".

FOR BICYCLE SEATS (U.S. CLS. 19, 21, 23, 31, 35 AND 44).

FIRST USE 9-3-2008; IN COMMERCE 3-24-2009.

---

4,482,595. GRADY-WHITE BOATS, INC., GREENVILLE, NC. SN 85-886,904. PUB. 8-13-2013, FILED 3-26-2013.

**AIRVIEW2**

THE MARK CONSISTS OF STANDARD CHARACTERS WITHOUT CLAIM TO ANY PARTICULAR FONT, STYLE, SIZE, OR COLOR.

FOR BOATS AND STRUCTURAL PARTS THEREFOR (U.S. CLS. 19, 21, 23, 31, 35 AND 44).

FIRST USE 10-15-2013; IN COMMERCE 10-15-2013.

**CLASS 13—FIREARMS**

**CLASS 13—(Continued).**

4,481,728. WOODSELL, PHILLIP L., ELGIN, SC. AND WOODSELL, JENNY REBEKAH, ELGIN, SC. SN 85-595,605. PUB. 4-16-2013, FILED 4-12-2012.

**KILL SWITCH**

THE MARK CONSISTS OF STANDARD CHARACTERS WITHOUT CLAIM TO ANY PARTICULAR FONT, STYLE, SIZE, OR COLOR.

FOR SOUND SUPPRESSORS FOR FIREARMS (U.S. CLS. 2 AND 9).  
FIRST USE 4-1-2013; IN COMMERCE 4-1-2013.

---

4,482,039. THIBODAUX OUTDOORS, LLC, PRAIRIEVILLE, LA. SN 85-730,384. PUB. 2-19-2013, FILED 9-17-2012.

**MISS NO MORE**

THE MARK CONSISTS OF STANDARD CHARACTERS WITHOUT CLAIM TO ANY PARTICULAR FONT, STYLE, SIZE, OR COLOR.

FOR SHOOTING ACCESSORIES, NAMELY, GUN RESTS (U.S. CLS. 2 AND 9).  
FIRST USE 10-13-2012; IN COMMERCE 10-13-2012.

---

4,482,117. READYROPE, LLC, CHARLOTTESVILLE, VA. SN 85-739,711. PUB. 3-5-2013, FILED 9-27-2012.

**READYROPE**

THE MARK CONSISTS OF STANDARD CHARACTERS WITHOUT CLAIM TO ANY PARTICULAR FONT, STYLE, SIZE, OR COLOR.

FOR SLING STRAPS FOR FIREARMS (U.S. CLS. 2 AND 9).  
FIRST USE 12-15-2012; IN COMMERCE 12-15-2012.

**CLASS 13—(Continued).**

4,482,483. ISM WEAPON SYSTEMS, INC., CARMICHAELS, PA. SN 85-848,357. PUB. 7-9-2013, FILED 2-13-2013.

**Bone Orchard**

THE MARK CONSISTS OF STANDARD CHARACTERS WITHOUT CLAIM TO ANY PARTICULAR FONT, STYLE, SIZE, OR COLOR.

FOR BULLETS (U.S. CLS. 2 AND 9).  
FIRST USE 1-20-2012; IN COMMERCE 1-20-2012.

---

4,482,564. LANE, DALLAS, POCATELLO, ID. SN 85-877,530. PUB. 8-20-2013, FILED 3-15-2013.

**Lane Precision Rifles**

THE MARK CONSISTS OF STANDARD CHARACTERS WITHOUT CLAIM TO ANY PARTICULAR FONT, STYLE, SIZE, OR COLOR.

NO CLAIM IS MADE TO THE EXCLUSIVE RIGHT TO USE "PRECISION RIFLES", APART FROM THE MARK AS SHOWN.

FOR RIFLES (U.S. CLS. 2 AND 9).  
FIRST USE 7-1-2013; IN COMMERCE 7-1-2013.

---

4,482,666. LEGACY SPORTS INTERNATIONAL, LLC, RENO, NV. SN 85-977,742. PUB. 1-15-2013, FILED 5-3-2012.

**CITADEL**

THE MARK CONSISTS OF STANDARD CHARACTERS WITHOUT CLAIM TO ANY PARTICULAR FONT, STYLE, SIZE, OR COLOR.

OWNER OF U.S. REG. NO. 3,607,422.  
FOR GUN CASES (U.S. CLS. 2 AND 9).  
FIRST USE 6-1-2013; IN COMMERCE 6-1-2013.

---

**CLASS 14—JEWELRY**

**CLASS 14—(Continued).**

4,481,360. HARVEY BALL SMILE LIMITED, SHINAGAWA-KU TOKYO, JAPAN. SN 77-918,773. PUB. 6-1-2010, FILED 1-23-2010.



THE MARK CONSISTS OF A SMILEY FACE.  
FOR ALARM CLOCKS; BRACELETS; BRACELETS OF PRECIOUS METAL; BROOCHES; CHRONOMETERS; CLOCKS; CUFF LINKS; EARRINGS; FIGURES OF PRECIOUS METAL; FIGURINES OF PRECIOUS METAL; INSIGNIAS OF PRECIOUS METAL; KEY HOLDERS OF PRECIOUS METALS; KEY RINGS OF PRECIOUS METAL; NECKLACES; PRECIOUS GEMSTONES; TIE CLIPS; TIE PINS; WATCH BANDS; WATCHES; WRIST WATCHES (U.S. CLS. 2, 27, 28 AND 50).  
FIRST USE 2-27-2009; IN COMMERCE 2-27-2009.

**CLASS 14—(Continued).**

4,481,424. JACK DANIEL'S PROPERTIES, INC., SAN RAFAEL, CA. SN 85-129,461. PUB. 3-8-2011, FILED 9-14-2010.



THE NAME SHOWN IN THE MARK DOES NOT IDENTIFY A PARTICULAR LIVING INDIVIDUAL.  
THE MARK CONSISTS OF A RECTANGLE WITH A FILIGREE BORDER AND THE STYLIZED WORDING "JACK DANIEL'S TENNESSEE SOUR MASH WHISKEY". THE WORDING "OLD NO. 7 BRAND" APPEARS IN AN OVAL SHAPED DESIGN IN THE CENTER WITH A FILIGREE APPEARING AROUND THE BORDER.  
FOR ORNAMENTAL LAPEL PINS, CLOCKS, WATCHES, CUFF LINKS, NECKLACES AND BRACELETS (U.S. CLS. 2, 27, 28 AND 50).  
FIRST USE 1-19-2012; IN COMMERCE 1-19-2012.

4,481,402. CAT3, LLC, NEW YORK, NY. SN 85-057,231. PUB. 11-2-2010, FILED 6-8-2010.

**STOLIN**

THE MARK CONSISTS OF STANDARD CHARACTERS WITHOUT CLAIM TO ANY PARTICULAR FONT, STYLE, SIZE, OR COLOR.  
FOR JEWELLERY, AND WATCHES (U.S. CLS. 2, 27, 28 AND 50).  
FIRST USE 12-23-2013; IN COMMERCE 12-23-2013.

4,481,545. MBM COMPANY, INC., CHICAGO, IL. SN 85-416,739. PUB. 2-21-2012, FILED 9-7-2011.

**TOWER CLASS RINGS**

THE MARK CONSISTS OF STANDARD CHARACTERS WITHOUT CLAIM TO ANY PARTICULAR FONT, STYLE, SIZE, OR COLOR.  
NO CLAIM IS MADE TO THE EXCLUSIVE RIGHT TO USE "CLASS RINGS", APART FROM THE MARK AS SHOWN.  
FOR JEWELRY (U.S. CLS. 2, 27, 28 AND 50).  
FIRST USE 8-31-2012; IN COMMERCE 8-31-2012.

**CLASS 14—(Continued).**

4,481,576. JAYDEN STAR LLC, NEW YORK, NY. SN 85-444,400. PUB. 3-20-2012, FILED 10-11-2011.

**COUP D'ETAT**

THE MARK CONSISTS OF STANDARD CHARACTERS WITHOUT CLAIM TO ANY PARTICULAR FONT, STYLE, SIZE, OR COLOR.

FOR JEWELRY (U.S. CLS. 2, 27, 28 AND 50).  
FIRST USE 11-7-2013; IN COMMERCE 11-7-2013.

**CLASS 14—(Continued).**

4,481,756. ABADI, JOSEPH, BROOKLYN, NY. SN 85-603,612. PUB. 9-18-2012, FILED 4-20-2012.



THE MARK CONSISTS OF AN ABSTRACT SET OF LINES THAT MAKE A SHIELD. WITHIN THE SHIELD THERE IS A SEPARATE SET OF LINES THAT FORM THE PROFILE FIGURE OF A LYNX. THE LYNX'S HEAD COMES OUT OF THE SHIELD A LITTLE.

FOR BRACELETS; CUFFLINKS; EARRINGS; JEWELRY; NECKLACES; RINGS; TIE PINS; TIMEPIECES; WATCHES (U.S. CLS. 2, 27, 28 AND 50).

FIRST USE 3-1-2012; IN COMMERCE 5-1-2012.

4,481,847. UNIF, LLC, LOS ANGELES, CA. SN 85-653,382. PUB. 11-6-2012, FILED 6-15-2012.

**HELTER SKELTER**

THE MARK CONSISTS OF STANDARD CHARACTERS WITHOUT CLAIM TO ANY PARTICULAR FONT, STYLE, SIZE, OR COLOR.

FOR JEWELRY, NAMELY, RINGS, EARRINGS, BRACELETS, NECKLACES, WATCHES, AND PENDANTS (U.S. CLS. 2, 27, 28 AND 50).

FIRST USE 10-10-2013; IN COMMERCE 10-10-2013.

4,481,609. PEI LICENSING, INC., MIAMI, FL. SN 85-476,255. PUB. 4-24-2012, FILED 11-18-2011.



4,481,867. HADASSAH ZELTZER, BOSTON, MA. SN 85-662,544. PUB. 1-1-2013, FILED 6-27-2012.

**Tzedek**

OWNER OF U.S. REG. NOS. 3,323,720, 3,961,901, AND OTHERS.

NO CLAIM IS MADE TO THE EXCLUSIVE RIGHT TO USE "ORIGINAL", APART FROM THE MARK AS SHOWN.

THE MARK CONSISTS OF THE WORDS "AN ORIGINAL PENGUIN BY MUNSINGWEAR" IN STYLIZED FORMAT WITH THE "M" IN "MUNSINGWEAR" IN A DARK BACKGROUND.

FOR WATCHES, JEWELRY, NAMELY, RINGS, BRACELETS, NECKLACES, CUFFLINKS, AND TIE BARS (U.S. CLS. 2, 27, 28 AND 50).

FIRST USE 9-0-2013; IN COMMERCE 9-0-2013.

THE MARK CONSISTS OF STANDARD CHARACTERS WITHOUT CLAIM TO ANY PARTICULAR FONT, STYLE, SIZE, OR COLOR.

THE ENGLISH TRANSLATION OF "TZEDECK" IN THE MARK IS "JUSTICE" OR "SOCIAL JUSTICE".

FOR BRACELETS (U.S. CLS. 2, 27, 28 AND 50).

FIRST USE 2-1-2013; IN COMMERCE 2-1-2013.



**CLASS 14—(Continued).**

4,482,068. CHARA WEN CO., LTD., TAIPEI CITY 106, TAIWAN. SN 85-733,688. PUB. 7-9-2013, FILED 9-20-2012.



THE NAME(S), PORTRAIT(S), AND/OR SIGNATURE(S) SHOWN IN THE MARK DOES NOT IDENTIFY A PARTICULAR LIVING INDIVIDUAL.

THE COLOR(S) BLACK AND RED IS/ARE CLAIMED AS A FEATURE OF THE MARK.

THE MARK CONSISTS OF THE WORDING "CHARA WEN" SHOWN IN STYLIZED CURSIVE FONT IN THE COLOR BLACK WITH A TINY RED HEART PLACED BENEATH THE TAIL OF THE SECOND LETTER "A" IN THE WORD "CHARA".

FOR AGATE AND SARDONYX; BEADS FOR MAKING JEWELRY; BRACELETS; BROOCHES; CHARMS; DIAMONDS; EARRINGS; JEWELLERY; JEWELRY; JEWELRY CHAINS; NECKLACES; PEARLS; PINS BEING JEWELRY; PRECIOUS STONES; RINGS; SEMI-PRECIOUS STONES; SPINELS; WATCHES (U.S. CLS. 2, 27, 28 AND 50).

FIRST USE 8-28-2013; IN COMMERCE 8-28-2013.

4,482,223. PANCIS GEMS INC., MORRIS PLAINS, NJ. SN 85-757,088. PUB. 4-2-2013, FILED 10-18-2012.

**LEMON BRILLIANCE**

THE MARK CONSISTS OF STANDARD CHARACTERS WITHOUT CLAIM TO ANY PARTICULAR FONT, STYLE, SIZE, OR COLOR.

FOR JEWELRY; BRACELETS; BROOCHES; JEWELRY CHAINS; MEDALLIONS; NECKLACES; ORNAMENTS OF PRECIOUS METAL IN THE NATURE OF JEWELRY; PEARLS; PINS BEING JEWELRY; RINGS BEING JEWELRY (U.S. CLS. 2, 27, 28 AND 50).

FIRST USE 2-1-2013; IN COMMERCE 2-1-2013.

**CLASS 14—(Continued).**

4,482,264. SOLAR TIME LIMITED, KOWLOON, HONG KONG. SN 85-766,588. PUB. 3-19-2013, FILED 10-30-2012.

**Hawker Tempest**

THE MARK CONSISTS OF STANDARD CHARACTERS WITHOUT CLAIM TO ANY PARTICULAR FONT, STYLE, SIZE, OR COLOR.

FOR BRACELETS; CUFF LINKS; DIALS FOR CLOCK-AND-WATCH-MAKING; EARRINGS; JEWELLERY; MECHANICAL AND AUTOMATIC WATCHES; NECKLACES; PARTS FOR WATCHES; PENDANTS; PRECIOUS STONES; RINGS; WATCH CHAINS; WATCH STRAPS; WATCHES (U.S. CLS. 2, 27, 28 AND 50).

FIRST USE 8-1-2012; IN COMMERCE 12-15-2012.

4,482,310. NATIONAL ENTERTAINMENT COLLECTIBLES ASSOCIATION, INC., AKA NECA, HILLSIDE, NJ. SN 85-782,398. PUB. 1-22-2013, FILED 11-19-2012.



NO CLAIM IS MADE TO THE EXCLUSIVE RIGHT TO USE "CUFFS", APART FROM THE MARK AS SHOWN.

THE MARK CONSISTS OF THE WORD "LINKED" APPEARING IN FRONT OF AND DIAGONALLY OVER THE WORD "CUFFS", WITH THE "D" IN "LINKED" AND THE "C" IN "CUFFS" APPEARING AS PARTS OF A PAIR OF HANDCUFFS.

FOR BRACELETS (U.S. CLS. 2, 27, 28 AND 50).

FIRST USE 12-14-2012; IN COMMERCE 12-14-2012.

4,482,325. KWONG'S ART JEWELLERY TRADING COMPANY LIMITED, HUNG HOM, KOWLOON, HONG KONG. SN 85-787,355. PUB. 5-14-2013, FILED 11-26-2012.

**MY JEWELRY**

THE MARK CONSISTS OF STANDARD CHARACTERS WITHOUT CLAIM TO ANY PARTICULAR FONT, STYLE, SIZE, OR COLOR.

OWNER OF U.S. REG. NO. 3,071,852.

**CLASS 14—(Continued).**

NO CLAIM IS MADE TO THE EXCLUSIVE RIGHT TO USE "JEWELRY", APART FROM THE MARK AS SHOWN.

FOR PEARLS, DIAMONDS, BRACELETS, EARRINGS, PENDANTS, PLATINUM, GOLD, RUBY, SAPPHIRE, COSTUME JEWELRY, JEWELRY, PRECIOUS STONES, BANGLES, BROOCHES, JEWELRY CHAINS, ORNAMENTS, RINGS, NECKLACES, ACCESSORIES BEING JEWELRY, JEWELRY PLATED WITH PRECIOUS METALS, PERSONAL ORNAMENTS OF PRECIOUS METAL (U.S. CLS. 2, 27, 28 AND 50).

FIRST USE 2-0-2006; IN COMMERCE 6-0-2006.

---

4,482,401. ANAYA GEMS, INC., LONG ISLAND CITY, NY.  
SN 85-814,363. PUB. 5-28-2013, FILED 1-2-2013.

**SHADES OF ELEGANCE**

THE MARK CONSISTS OF STANDARD CHARACTERS WITHOUT CLAIM TO ANY PARTICULAR FONT, STYLE, SIZE, OR COLOR.

FOR GOLD, SILVER AND BRONZE JEWELRY, NAMELY, PENDANTS, EARRINGS, RINGS, BRACELETS, NECKLACES, PINS AND ANKLETS (U.S. CLS. 2, 27, 28 AND 50).

FIRST USE 1-1-2013; IN COMMERCE 1-1-2013.

---

4,482,508. EURASIA USA, INC., EAST BRUNSWICK, NJ. SN 85-858,556. PUB. 7-16-2013, FILED 2-24-2013.

**EURSA**

THE MARK CONSISTS OF STANDARD CHARACTERS WITHOUT CLAIM TO ANY PARTICULAR FONT, STYLE, SIZE, OR COLOR.

FOR SILVER, BRONZE, BRASS, AND STAINLESS STEEL JEWELRY CHAINS, NECKLACES, BRACELETS, RINGS, EARRINGS, BROOCHES AND PENDANTS (U.S. CLS. 2, 27, 28 AND 50).

FIRST USE 3-19-2013; IN COMMERCE 5-20-2013.

**CLASS 14—(Continued).**

4,482,636. FD9 GROUP, INC., LOS ANGELES, CA. SN 85-905,017. PUB. 9-3-2013, FILED 4-15-2013.



THE MARK CONSISTS OF A STYLIZED LETTER "C" FOLLOWED BY A DEGREE INSIGNIA IN SUPERSCRIPIT. FOR BRACELETS; EARRINGS; JEWELRY; NECKLACES; RINGS (U.S. CLS. 2, 27, 28 AND 50).

FIRST USE 9-1-2012; IN COMMERCE 2-1-2013.

**CLASS 15—MUSICAL INSTRUMENTS**

4,482,023. GTRC SERVICES, INC., WESTLAKE VILLAGE, CA. SN 85-728,132. PUB. 2-19-2013, FILED 9-13-2012.

**RHAPSODY**

THE MARK CONSISTS OF STANDARD CHARACTERS WITHOUT CLAIM TO ANY PARTICULAR FONT, STYLE, SIZE, OR COLOR.

FOR MUSICAL INSTRUMENTS, NAMELY, PIANOS, DIGITAL PIANOS, KEYBOARDS, PORTABLE KEYBOARDS, CONTROLLER KEYBOARDS (U.S. CLS. 2, 11 AND 36).

FIRST USE 11-15-2012; IN COMMERCE 11-15-2012.

**CLASS 15—(Continued).**

4,482,413. MALMARK, INC., PLUMSTEADVILLE, PA. SN 85-819,449. PUB. 5-28-2013, FILED 1-9-2013.

LORABELL

THE MARK CONSISTS OF STANDARD CHARACTERS WITHOUT CLAIM TO ANY PARTICULAR FONT, STYLE, SIZE, OR COLOR.

FOR MUSICAL INSTRUMENT ACCESSORIES, NAMELY, STANDS, CASES, CARRYING BAGS AND STORAGE BAGS; MUSICAL INSTRUMENTS, NAMELY, HANDBELLS (U.S. CLS. 2, 21 AND 36).

FIRST USE 6-1-2013; IN COMMERCE 6-1-2013.

**CLASS 16—PAPER GOODS AND PRINTED MATTER**

4,481,374. THE BOYS CAMP COMPANY, LLC, CHADDS FORD, PA. SN 77-983,533. PUB. 4-24-2012, FILED 3-16-2010.

BOYS CAMP

THE MARK CONSISTS OF STANDARD CHARACTERS WITHOUT CLAIM TO ANY PARTICULAR FONT, STYLE, SIZE, OR COLOR.

NO CLAIM IS MADE TO THE EXCLUSIVE RIGHT TO USE "BOYS", APART FROM THE MARK AS SHOWN.

FOR PRINT PUBLICATIONS, NAMELY, A SERIES OF FICTION BOOKS FOR BOYS IN THE FIELDS OF CONFIDENCE-BUILDING, CHARACTER DEVELOPMENT, MORALITY, AND ETHICS (U.S. CLS. 2, 5, 22, 23, 29, 37, 38 AND 50).

FIRST USE 11-6-2013; IN COMMERCE 11-6-2013.

**CLASS 16—(Continued).**

4,481,379. INDEPENDENT INSURANCE AGENTS & BROKERS OF AMERICA, INC., ALEXANDRIA, VA. SN 85-015,062. PUB. 10-25-2011, FILED 4-15-2010.



OWNER OF U.S. REG. NOS. 1,582,905, 3,200,132, AND OTHERS.

NO CLAIM IS MADE TO THE EXCLUSIVE RIGHT TO USE "INDEPENDENT INSURANCE AGENT", APART FROM THE MARK AS SHOWN.

THE MARK CONSISTS OF A STYLIZED EAGLE WITH A HALF OVAL LINE CURVING DOWNWARD FROM THE TAIL FROM LEFT TO RIGHT WITH A BIG "I" TO THE RIGHT OF THE TAIL AND THE WORDS "INDEPENDENT INSURANCE AGENT" FROM TOP TO BOTTOM TO THE RIGHT OF THE "I".

FOR MAGAZINES FEATURING NEWS, ARTICLES, STUDIES, RESEARCH, AND INFORMATION IN THE FIELD OF THE INSURANCE AND FINANCIAL SERVICES INDUSTRIES (U.S. CLS. 2, 5, 22, 23, 29, 37, 38 AND 50).

FIRST USE 8-0-2012; IN COMMERCE 8-0-2012.

4,481,380. INDEPENDENT INSURANCE AGENTS & BROKERS OF AMERICA, INC., ALEXANDRIA, VA. SN 85-015,063. PUB. 10-25-2011, FILED 4-15-2010.



The Trusted Choice

OWNER OF U.S. REG. NOS. 1,582,905, 3,200,132, AND OTHERS.

NO CLAIM IS MADE TO THE EXCLUSIVE RIGHT TO USE "INDEPENDENT INSURANCE AGENT", APART FROM THE MARK AS SHOWN.

**CLASS 16—(Continued).**

THE MARK CONSISTS OF A STYLIZED EAGLE WITH A HALF OVAL LINE CURVING DOWNWARD FROM THE TAIL FROM LEFT TO RIGHT WITH A BIG "I" TO THE RIGHT OF THE TAIL AND THE WORDS "INDEPENDENT INSURANCE AGENT" FROM TOP TO BOTTOM TO THE RIGHT OF THE "I" AND THE WORDS "THE TRUSTED CHOICE" BELOW THE HALF OVAL LINE.

FOR MAGAZINES FEATURING NEWS, ARTICLES, STUDIES, RESEARCH, AND INFORMATION IN THE FIELD OF THE INSURANCE AND FINANCIAL SERVICES INDUSTRIES (U.S. CLS. 2, 5, 22, 23, 29, 37, 38 AND 50).

FIRST USE 8-0-2012; IN COMMERCE 8-0-2012.

4,481,442. KABUSHIKI KAISHA SHUEISHA, DBA SHUEISHA INC., TOKYO, JAPAN. SN 85-174,780. PUB. 10-4-2011, FILED 11-11-2010.

---

**YU-GI-OH! 3D BONDS BEYOND  
TIME**

THE MARK CONSISTS OF STANDARD CHARACTERS WITHOUT CLAIM TO ANY PARTICULAR FONT, STYLE, SIZE, OR COLOR.

OWNER OF U.S. REG. NOS. 2,995,656, 3,071,617, AND 3,624,613.

NO CLAIM IS MADE TO THE EXCLUSIVE RIGHT TO USE "3D", APART FROM THE MARK AS SHOWN.

THE ENGLISH TRANSLATION OF THE WORDS "YU-GI-OH" IN THE MARK IS "KING OF THE GAMES".

FOR TRADING CARDS; TRADING CARD GAMES (U.S. CLS. 2, 5, 22, 23, 29, 37, 38 AND 50).

FIRST USE 2-0-2011; IN COMMERCE 2-0-2011.

4,481,471. SAZERAC NORTH AMERICA, INC., FRANKFORT, KY. SN 85-251,667. PUB. 7-19-2011, FILED 2-25-2011.



OWNER OF U.S. REG. NOS. 683,398 AND 2,329,608.  
THE MARK CONSISTS OF THE CAPITAL LETTER "B" IN A CIRCLE TO THE LEFT OF THE WORD "BARTON", WHICH IS IN ALL CAPS.

FOR PAPER PRODUCTS, NAMELY, PAPER NAPKINS, PRINTED PAPER SIGNS, PAPER BANNERS, STATIONERY, INFORMATIONAL BROCHURES IN THE FIELD OF WHISKEY PRODUCTION; PRINTED EDUCATION MATERIALS, WRITTEN ARTICLES, PRINTED PRESS AND NEWS RELEASES, AND PRINTED TOUR AND MUSEUM EXHIBIT GUIDES, ALL RELATING TO THE HISTORY OF AMERICAN WHISKEY AND THE PRODUCTION, BOTTLING AND DISTRIBUTION OF WHISKEY AND VODKA; POSTCARDS (U.S. CLS. 2, 5, 22, 23, 29, 37, 38 AND 50).

FIRST USE 11-1-2013; IN COMMERCE 11-1-2013.

**CLASS 16—(Continued).**

4,481,491. AGC, LLC, CLEVELAND, OH. SN 85-306,352. PUB. 8-23-2011, FILED 4-27-2011.

**TURBO BUTTON**

THE MARK CONSISTS OF STANDARD CHARACTERS WITHOUT CLAIM TO ANY PARTICULAR FONT, STYLE, SIZE, OR COLOR.

FOR GREETING CARDS (U.S. CLS. 2, 5, 22, 23, 29, 37, 38 AND 50).

FIRST USE 6-30-2013; IN COMMERCE 6-30-2013.

4,481,522. DISNEY ENTERPRISES, INC., BURBANK, CA. SN 85-381,597. PUB. 5-1-2012, FILED 7-26-2011.

---

**FRANKENWEENIE**

THE MARK CONSISTS OF STANDARD CHARACTERS WITHOUT CLAIM TO ANY PARTICULAR FONT, STYLE, SIZE, OR COLOR.

FOR PEN AND PENCIL CASES (U.S. CLS. 2, 5, 22, 23, 29, 37, 38 AND 50).

FIRST USE 10-0-2012; IN COMMERCE 10-0-2012.

4,481,529. YURKE, MANFRED, FAIRFAX, CA. SN 85-390,173. PUB. 2-28-2012, FILED 8-4-2011.

---

**The Glutton's Diet**

THE MARK CONSISTS OF STANDARD CHARACTERS WITHOUT CLAIM TO ANY PARTICULAR FONT, STYLE, SIZE, OR COLOR.

NO CLAIM IS MADE TO THE EXCLUSIVE RIGHT TO USE "DIET", APART FROM THE MARK AS SHOWN.

FOR WEIGHT LOSS PROGRAM KITS CONSISTING PRIMARILY OF PRINTED BOOKS ON WEIGHT LOSS AND DIETING, AND ALSO INCLUDING VITAMIN SUPPLEMENTS AND HORMONES (U.S. CLS. 2, 5, 22, 23, 29, 37, 38 AND 50).

FIRST USE 9-1-2012; IN COMMERCE 9-1-2012.

**CLASS 16—(Continued).**

4,481,564. BRASS TACKS LLC, BROOKLYN, NY. SN 85-433,895. PUB. 9-11-2012, FILED 9-28-2011.

**THE TOGETHER TEACHER**

THE MARK CONSISTS OF STANDARD CHARACTERS WITHOUT CLAIM TO ANY PARTICULAR FONT, STYLE, SIZE, OR COLOR.

NO CLAIM IS MADE TO THE EXCLUSIVE RIGHT TO USE "TEACHER", APART FROM THE MARK AS SHOWN.

FOR PRINTED MATERIALS, NAMELY, WRITTEN ARTICLES, HANDOUTS, APPOINTMENT BOOKS, CUSTOMIZABLE JOURNAL BOOKS, PERSONAL ORGANIZERS, CUSTOMIZABLE DAY/DESKTOP PLANNERS AND WORKSHEETS IN THE FIELD OF ORGANIZATIONAL MANAGEMENT (U.S. CLS. 2, 5, 22, 23, 29, 37, 38 AND 50).

FIRST USE 6-13-2012; IN COMMERCE 6-13-2012.

**CLASS 16—(Continued).**

4,481,660. THE OFFICE CLUB, INC., BOCA RATON, FL. SN 85-533,669. PUB. 3-19-2013, FILED 2-3-2012.

**OFFICE DEPOT BUSINESS SELECT**

THE MARK CONSISTS OF STANDARD CHARACTERS WITHOUT CLAIM TO ANY PARTICULAR FONT, STYLE, SIZE, OR COLOR.

OWNER OF U.S. REG. NOS. 1,939,705, 3,105,571, AND OTHERS.

NO CLAIM IS MADE TO THE EXCLUSIVE RIGHT TO USE "BUSINESS", APART FROM THE MARK AS SHOWN.

FOR PRINTED MATTER, NAMELY, PAMPHLETS, BROCHURES, FLYERS AND CATALOGS FOR OFFICE SUPPLIES, OFFICE MACHINES AND OFFICE FURNITURE (U.S. CLS. 2, 5, 22, 23, 29, 37, 38 AND 50).

FIRST USE 12-0-2010; IN COMMERCE 12-0-2010.

4,481,686. STARLUX CORPORATION, CHICAGO, IL. SN 85-557,175. PUB. 7-31-2012, FILED 3-1-2012.

**NEXTGEN**

THE MARK CONSISTS OF STANDARD CHARACTERS WITHOUT CLAIM TO ANY PARTICULAR FONT, STYLE, SIZE, OR COLOR.

FOR RECYCLED PLASTIC SHEETS FOR THE PRINTING INDUSTRY (U.S. CLS. 2, 5, 22, 23, 29, 37, 38 AND 50).

FIRST USE 10-1-2012; IN COMMERCE 10-1-2012.

4,481,710. GODSAWALLHEMADEWASVERYGOOD, LLC, BROKEN ARROW, OK. SN 85-578,735. PUB. 9-11-2012, FILED 3-23-2012.



THE MARK CONSISTS OF THE WORDING "ALL CREATION" WITH VARIOUS ANIMALS INCLUDING A FLYING BIRD, DUCK, DEER, DOG, CAT, MOUSE, RABBIT, DOLPHIN WITH WAVES AND A TURTLE INCORPORATED INTO THE WORDING.

FOR GREETING CARDS EXPRESSING VARIOUS SENTIMENTS (U.S. CLS. 2, 5, 22, 23, 29, 37, 38 AND 50).

FIRST USE 9-19-2011; IN COMMERCE 5-1-2013.

4,481,577. CAMPUS CRUSADE FOR CHRIST, INC., AKA CAMPUS CRUSADE FOR CHRIST INTERNATIONAL; CAMPUS CRUSADE FOR CHRIST; CCCI, ORLANDO, FL. SN 85-444,754. PUB. 3-6-2012, FILED 10-11-2011.

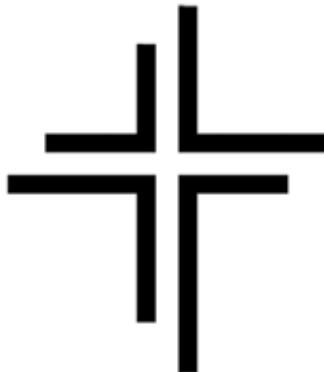

THE MARK CONSISTS OF A MODIFIED OPEN CROSS WITH THE OPPOSING ARMS OF EACH ARM SECTION OF THE CROSS BEING OF DIFFERENT LENGTHS.

FOR PAPER GOODS AND PRINTED MATTER, NAMELY, BOOKS, PAMPHLETS, BOOKLETS, NOTEBOOKS, NEWSPAPERS, BROCHURES, LEAFLETS, MAGAZINES, NEWSLETTERS, BOOKMARKS, TRAINING MANUALS, PRINTED TEACHING MATERIALS AND INSTRUCTIONAL GUIDES, FEATURING AND DEALING WITH RELIGION, SPIRITUAL, CULTURAL, AND RELIGIOUS ISSUES AND VALUES, ACHIEVING PERSONAL SPIRITUAL GROWTH, DEVELOPING CHARACTER, AND BUILDING AND STRENGTHENING RELATIONSHIPS (U.S. CLS. 2, 5, 22, 23, 29, 37, 38 AND 50).

FIRST USE 9-30-2011; IN COMMERCE 9-30-2011.

**CLASS 16—(Continued).**

4,481,747. BELAN, JOE, ERIE, PA. SN 85-601,472. PUB. 10-16-2012, FILED 4-18-2012.



THE COLOR(S) RED AND BLACK IS/ARE CLAIMED AS A FEATURE OF THE MARK.

THE MARK CONSISTS OF THE LETTERS "U" AND "R" AND THE WORD "HERE" IN BLACK LETTERING, WHERE PART OF THE "R" AND THE WORD "HERE" ARE SUPERIMPOSED OVER A RED ASYMMETRICALLY STYLIZED HEART.

FOR PUBLICATIONS, NAMELY, BOOKS, PAMPHLETS, WORKBOOKS, AND JOURNALS IN THE FIELDS OF SELF-WORTH, POSITIVE THINKING, REMEMBRANCE, RELATIONSHIPS, LOSS, AND COPING SKILLS, AND JEWELRY SOLD AS A UNIT THEREWITH, NAMELY, PINS, BROOCHES, AND MEDALLIONS (U.S. CLS. 2, 5, 22, 23, 29, 37, 38 AND 50).

FIRST USE 4-0-2013; IN COMMERCE 4-0-2013.

4,481,791. GLOBOFORCE LIMITED, DUBLIN, IRELAND. SN 85-624,071. PUB. 9-4-2012, FILED 5-14-2012.

# TALENT MAPS

THE MARK CONSISTS OF STANDARD CHARACTERS WITHOUT CLAIM TO ANY PARTICULAR FONT, STYLE, SIZE, OR COLOR.

NO CLAIM IS MADE TO THE EXCLUSIVE RIGHT TO USE "MAPS", APART FROM THE MARK AS SHOWN.

FOR PRINTED VISUALS IN THE NATURE OF CHARTS AND INFORMATION GRAPHICS THAT LEVERAGE CROWD-SOURCED RECOGNITION DATA TO PROVIDE MANAGEMENT INFORMATION ABOUT EMPLOYEE PERFORMANCE (U.S. CLS. 2, 5, 22, 23, 29, 37, 38 AND 50).

FIRST USE 5-12-2012; IN COMMERCE 5-12-2012.

**CLASS 16—(Continued).**

4,481,881. COIN ARMOUR, LLC, MONROE TOWNSHIP, NJ. SN 85-669,185. PUB. 1-1-2013, FILED 7-5-2012.



NO CLAIM IS MADE TO THE EXCLUSIVE RIGHT TO USE "COIN", APART FROM THE MARK AS SHOWN.

THE MARK CONSISTS OF A BUST OF THE STATUE OF LIBERTY WITHIN A CIRCLE, INCLUDING A SMALLER INNER CIRCLE, SURROUNDED BY AN ATOM, OR CONCENTRIC CIRCLES WITH SMALL ROUND BALLS ON THE CIRCLES WITH THE WORDS "COIN ARMOUR" BELOW THE DESIGN.

FOR COIN HOLDERS (U.S. CLS. 2, 5, 22, 23, 29, 37, 38 AND 50).

FIRST USE 1-1-2013; IN COMMERCE 1-1-2013.

4,482,044. ZHEJIANG GRACE SPINNING & WEAVING GROUP CO., LTD., ZHEJIANG, CHINA. SN 85-731,211. PUB. 2-26-2013, FILED 9-17-2012.



THE MARK CONSISTS OF THE WORDS "GRACE ORCHID" BELOW AN INCOMPLETE FLOWER DESIGN.

FOR ADHESIVE TAPES FOR STATIONERY OR HOUSEHOLD PURPOSES; FOLDERS; GEOGRAPHICAL MAPS; PACKING PAPER; PAPER; PICTURES; SCRAPBOOKS; SEALING STAMPS; TOILET PAPER (U.S. CLS. 2, 5, 22, 23, 29, 37, 38 AND 50).

FIRST USE 11-30-2012; IN COMMERCE 11-30-2012.

**CLASS 16—(Continued).**

4,482,108. E&I INTERNATIONAL, LLC, CENTENNIAL, CO. SN 85-738,659. PUB. 3-19-2013, FILED 9-26-2012.



NO CLAIM IS MADE TO THE EXCLUSIVE RIGHT TO USE "LABELS", APART FROM THE MARK AS SHOWN.

THE MARK CONSISTS OF THE STYLIZED TEXT "Z-SKINS" IN WHICH THE CHARACTERS "-SKINS" ARE SET WITHIN A RECTANGULAR BORDER AND THE LETTER "Z" IS OVERSIZED AND OVERLAPS THE RECTANGULAR BORDER. BELOW THE RECTANGULAR BORDER IS THE STYLIZED TEXT "LABELS".

FOR ADHESIVE LABELS (U.S. CLS. 2, 5, 22, 23, 29, 37, 38 AND 50).

FIRST USE 9-20-2012; IN COMMERCE 12-14-2012.

4,482,112. CREATIVELY FIT, LLC, CLARENCE CENTER, NY. SN 85-739,071. PUB. 3-5-2013, FILED 9-26-2012.

# EEEEK!

THE MARK CONSISTS OF STANDARD CHARACTERS WITHOUT CLAIM TO ANY PARTICULAR FONT, STYLE, SIZE, OR COLOR.

FOR CHILDREN'S BOOK SERIES IN THE FIELD OF CHILDHOOD HEALTH, WELLNESS, MOTIVATION AND PERSONAL DEVELOPMENT (U.S. CLS. 2, 5, 22, 23, 29, 37, 38 AND 50).

FIRST USE 12-31-2012; IN COMMERCE 12-31-2012.

4,482,175. CARDBAK, INC., SOLON, OH. SN 85-748,337. PUB. 4-2-2013, FILED 10-8-2012.

# PRESS SEAL

THE MARK CONSISTS OF STANDARD CHARACTERS WITHOUT CLAIM TO ANY PARTICULAR FONT, STYLE, SIZE, OR COLOR.

FOR PRODUCT PACKAGING MADE PRIMARILY OF PAPER, NAMELY, BLISTER TYPE PRODUCT PACKAGING (U.S. CLS. 2, 5, 22, 23, 29, 37, 38 AND 50).

FIRST USE 8-1-2011; IN COMMERCE 8-1-2011.

**CLASS 16—(Continued).**

4,482,198. HEYHOE, MARC, MIDDLETOWN, NJ. SN 85-752,598. PUB. 3-19-2013, FILED 10-12-2012.

# Littleblokes

THE MARK CONSISTS OF STANDARD CHARACTERS WITHOUT CLAIM TO ANY PARTICULAR FONT, STYLE, SIZE, OR COLOR.

FOR COMIC BOOKS; COMIC MAGAZINES; COMIC STRIPS (U.S. CLS. 2, 5, 22, 23, 29, 37, 38 AND 50).

FIRST USE 3-1-2012; IN COMMERCE 3-1-2012.

4,482,245. TWISTED SEESTERS, LLC, NORTHRIDGE, CA. SN 85-760,381. PUB. 3-26-2013, FILED 10-22-2012.

# The memo clip that *talks!*

THE MARK CONSISTS OF "THE MEMO CLIP THAT TALKS" WITH "TALKS" IN ITALICS AND UNDERLINED.

FOR MEMO CLIP INCORPORATING AN AUDIO RECORDING MODULE PERMANENTLY ATTACHED FOR LEAVING AUDIO MESSAGES (U.S. CLS. 2, 5, 22, 23, 29, 37, 38 AND 50).

FIRST USE 10-1-2012; IN COMMERCE 1-1-2013.

4,482,435. SADDLEBACK EDUCATIONAL, INC., COSTA MESA, CA. SN 85-826,171. PUB. 3-26-2013, FILED 1-17-2013.

# CAMPUS CONFESSIONS

THE MARK CONSISTS OF STANDARD CHARACTERS WITHOUT CLAIM TO ANY PARTICULAR FONT, STYLE, SIZE, OR COLOR.

FOR SERIES OF FICTION BOOKS AND TEACHER'S GUIDES IN THE FIELD OF REMEDIAL EDUCATION FOR SECONDARY AND ADULT EDUCATION; PRINTED MATTER, NAMELY, BOOKS AND TEACHING GUIDES IN THE FIELD OF REMEDIAL EDUCATION FOR SECONDARY AND ADULT EDUCATION; DOWNLOADABLE ELECTRONIC PUBLICATIONS IN THE NATURE OF ELECTRONIC BOOKS, AUDIO BOOKS AND TEACHER'S GUIDES IN THE FIELD OF REMEDIAL EDUCATION FOR SECONDARY AND ADULT EDUCATION (U.S. CLS. 2, 5, 22, 23, 29, 37, 38 AND 50).

FIRST USE 9-1-2013; IN COMMERCE 9-1-2013.

**CLASS 16—(Continued).**

4,482,507. KLUCK, JOSEPH J., SIMPSON, PA. SN 85-857,072.  
PUB. 7-30-2013, FILED 2-22-2013.



THE MARK DOES NOT IDENTIFY A LIVING INDIVIDUAL.

THE COLOR(S) YELLOW, RED, WHITE, BLACK, GREEN, ORANGE, BROWN, GREY, PURPLE, AND TEAL IS/ARE CLAIMED AS A FEATURE OF THE MARK.

THE MARK CONSISTS OF THE WORDING "JK ONIONS" IN A STYLIZED FONT AND DESIGNS. THE WORDING APPEARS AT THE BOTTOM OF THE MARK, AND THE LETTERS "JK" ARE YELLOW WITH BLACK OUTLINE AND THE WORD "ONIONS" IS GREEN WITH BLACK OUTLINES. THE COLOR WHITE APPEARS IN THE CENTER OF THE "O"'S. THE WORDING ALSO FEATURES A SHADOW OR THREE-DIMENSIONAL EFFECT RENDERED IN PURPLE WITH BLACK OUTLINES. ABOVE THE WORDING, A STYLIZED CARTOON CHARACTER APPEARS IN FRONT OF AN ORANGE CIRCLE WITH TEAL USED AS A SHADING OR THREE-DIMENSIONAL EFFECT BEHIND THE CIRCLE. THE CARTOON CHARACTER HAS A GREEN HEAD, NOSE, AND ARMS, A YELLOW AND RED MOUTH, BROWN AND GREY SHOES, AND BLACK AND WHITE EYES.

FOR CARTOON PRINTS (U.S. CLS. 2, 5, 22, 23, 29, 37, 38 AND 50).

FIRST USE 9-15-1995; IN COMMERCE 9-15-1995.

**CLASS 16—(Continued).**

4,482,626. EDUCATIONAL IDEAS, INC., DBA BALLARD & TIGHE, BREA, CA. SN 85-900,848. PUB. 9-10-2013, FILED 4-10-2013.

ELTiS

THE MARK CONSISTS OF THE STYLIZED LETTERS "ELTiS" WITH THE LETTERS, "ELTS" IN CAPS AND THE LETTER "I" IN LOWER CASE.

FOR ENGLISH LANGUAGE PROFICIENCY TEST, AN ANSWER SHEET, AND AN EXAMINER'S MANUAL SOLD TOGETHER AS A UNIT, TO BE ADMINISTERED TO INTERNATIONAL STUDENTS (U.S. CLS. 2, 5, 22, 23, 29, 37, 38 AND 50).

FIRST USE 5-0-2013; IN COMMERCE 5-0-2013.

**CLASS 17—RUBBER GOODS**

4,481,602. MARTIN RESOURCE MANAGEMENT CORPORATION, KILGORE, TX. SN 85-472,006. PUB. 10-16-2012, FILED 11-14-2011.



OWNER OF U.S. REG. NO. 3,662,397.

THE COLOR(S) BLUE AND RED IS/ARE CLAIMED AS A FEATURE OF THE MARK.

THE MARK CONSISTS OF A FANCIFUL FLAME SHAPED ELEMENT IN RED, WHEREIN A FANCIFUL "M" LETTER SHAPED DESIGN IN BLUE IS WITHIN THE FLAME ELEMENT AND BOTH THE FLAME AND LETTER ELEMENTS ABOVE A BLUE COLORED WORD "MARTIN".

FOR JOINT SEALANT FOR SEALING CONCRETE PIPE AT THE JOINTS; AND JOINT SEALANTS FOR SEALING PIPES (U.S. CLS. 1, 5, 12, 13, 35 AND 50).

FIRST USE 6-0-2013; IN COMMERCE 6-0-2013.



**CLASS 17—(Continued).**

4,482,272. BIXBY INTERNATIONAL CORPORATION, NEW-BURYPORT, MA. SN 85-767,628. PUB. 5-7-2013, FILED 10-31-2012.

**Bix**

THE MARK CONSISTS OF STANDARD CHARACTERS WITHOUT CLAIM TO ANY PARTICULAR FONT, STYLE, SIZE, OR COLOR.

FOR SEMI-WORKED SYNTHETIC PLASTIC AND SYNTHETIC PLASTIC RESINS AS SEMI-FINISHED PRODUCTS IN THE FORM OF EXTRUDED SHEETS AND FILMS (U.S. CLS. 1, 5, 12, 13, 35 AND 50).

FIRST USE 4-10-2009; IN COMMERCE 4-10-2009.

4,482,608. U.S. POLYCO INC., SPARKS, NV. SN 85-891,856. PUB. 9-3-2013, FILED 4-1-2013.



NO CLAIM IS MADE TO THE EXCLUSIVE RIGHT TO USE "U.S.", APART FROM THE MARK AS SHOWN.

THE COLOR(S) NAVY BLUE, SKY BLUE, BLUE, AND BLACK IS/ARE CLAIMED AS A FEATURE OF THE MARK.

THE MARK CONSISTS OF THE FOLLOWING: THE STYLIZED BLACK WORDING "U.S. POLYCO" ABOVE THE NAVY BLUE STYLIZED WORDING "ADHERING TO QUALITY". TO THE LEFT OF THE LITERAL ELEMENTS IS A THREE HEXAGON DESIGN FEATURING THE COLORS NAVY BLUE, SKY BLUE, AND BLUE. THE COLOR WHITE IN THE MARK IS MERELY BACKGROUND AND IS NOT CLAIMED AS A FEATURE OF THE MARK.

FOR ADHESIVE SEALANTS FOR USE IN ROOFING (U.S. CLS. 1, 5, 12, 13, 35 AND 50).

FIRST USE 11-1-2013; IN COMMERCE 11-1-2013.

**CLASS 18—LEATHER GOODS****CLASS 18—(Continued).**

4,481,361. HARVEY BALL SMILE LIMITED, SHINAGAWA-KU TOKYO, JAPAN. SN 77-918,778. PUB. 6-1-2010, FILED 1-23-2010.



THE MARK CONSISTS OF A SMILEY FACE. FOR LEATHER AND IMITATION LEATHER BAGS; LEATHER BAGS AND WALLETS; LEATHER BRIEF-CASES; PARASOLS; TRAVELING BAGS; TRUNKS; UMBRELLAS (U.S. CLS. 1, 2, 3, 22 AND 41). FIRST USE 2-27-2009; IN COMMERCE 2-27-2009.

4,481,405. GAP (APPAREL), LLC, SAN FRANCISCO, CA. SN 85-060,649. PUB. 10-12-2010, FILED 6-11-2010.

**1969**

THE MARK CONSISTS OF STANDARD CHARACTERS WITHOUT CLAIM TO ANY PARTICULAR FONT, STYLE, SIZE, OR COLOR.

OWNER OF U.S. REG. NO. 2,449,575. FOR BAGS, NAMELY, TOTE BAGS, HANDBAGS, AND ALL-PURPOSE CARRYING BAGS (U.S. CLS. 1, 2, 3, 22 AND 41).

FIRST USE 11-1-2013; IN COMMERCE 11-1-2013.

4,481,523. DISNEY ENTERPRISES, INC., BURBANK, CA. SN 85-381,609. PUB. 4-17-2012, FILED 7-26-2011.

**FRANKENWEENIE**

THE MARK CONSISTS OF STANDARD CHARACTERS WITHOUT CLAIM TO ANY PARTICULAR FONT, STYLE, SIZE, OR COLOR.

FOR BOOK BAGS (U.S. CLS. 1, 2, 3, 22 AND 41). FIRST USE 11-0-2012; IN COMMERCE 11-0-2012.

**CLASS 18—(Continued).**

4,481,552. ROCKY BRANDS WHOLESALE LLC, NELSONVILLE, OH. SN 85-424,922. PUB. 3-6-2012, FILED 9-16-2011.



OWNER OF U.S. REG. NO. 1,333,323.  
NO CLAIM IS MADE TO THE EXCLUSIVE RIGHT TO USE "SINCE 1937", APART FROM THE MARK AS SHOWN.  
THE MARK CONSISTS OF THE WORDS "GEORGIA BOOT" UNDER AN EAGLE AND MOUNTAIN DESIGN WITHIN A CIRCULAR RIBBON ON WHICH THE WORDS "SINCE 1937" APPEAR.

SEC. 2(F) "GEORGIA BOOT".  
FOR CREDIT CARD CASES AND WALLETS (U.S. CLS. 1, 2, 3, 22 AND 41).  
FIRST USE 2-1-2012; IN COMMERCE 2-1-2012.

4,481,772. BROOKLYN BASKETBALL, LLC, BROOKLYN, NY. SN 85-616,201. PUB. 10-16-2012, FILED 5-3-2012.



OWNER OF U.S. REG. NO. 4,175,932.  
NO CLAIM IS MADE TO THE EXCLUSIVE RIGHT TO USE "BROOKLYN NEW YORK", APART FROM THE MARK AS SHOWN.

**CLASS 18—(Continued).**

THE MARK CONSISTS OF A CIRCLE WITH THE DEPICTION OF A BASKETBALL IN THE CENTER OF THE CIRCLE AND THE LETTER "B" IN THE CENTER OF THE BASKETBALL WITH THE WORDS "BROOKLYN" AND "NEW YORK" AROUND THE BASKETBALL ALL INSIDE THE CIRCLE.

FOR ATHLETIC BAGS, SHOE BAGS FOR TRAVEL, OVERNIGHT BAGS, UMBRELLAS, BACKPACKS, BABY BACKPACKS, KNAPSACKS, DUFFEL BAGS, TOTE BAGS, BEACH BAGS, BEACH TOTE BAGS, DRAWSTRING POUCHES, LUGGAGE, LUGGAGE TAGS, PATIO UMBRELLAS, BEACH UMBRELLAS, VALISES, ATTACHE CASES, BILLFOLDS, WALLETS, BRIEFCASES, CANES, BUSINESS CARD CASES, BOOK BAGS, ALL PURPOSE SPORTS BAGS, GOLF UMBRELLAS, GYM BAGS, PURSES, COIN PURSES, FANNY PACKS, WAIST PACKS, COSMETIC CASES SOLD EMPTY, GARMENT BAGS FOR TRAVEL, HANDBAGS, KEY CASES, LEATHER KEY CHAINS, SUITCASES, TOILETRY CASES SOLD EMPTY, TRUNKS FOR TRAVELING AND RUCKSACKS, PET CLOTHING, PET LEASHES, AND PET COLLARS (U.S. CLS. 1, 2, 3, 22 AND 41).  
FIRST USE 4-30-2012; IN COMMERCE 4-30-2012.

4,481,815. KLEIN, JANICE S., SAN ANTONIO, FL. SN 85-638,225. PUB. 10-30-2012, FILED 5-30-2012.

## TIDYPOO

THE MARK CONSISTS OF STANDARD CHARACTERS WITHOUT CLAIM TO ANY PARTICULAR FONT, STYLE, SIZE, OR COLOR.

FOR PET ACCESSORIES, NAMELY, SPECIALLY DESIGNED CANVAS, VINYL OR LEATHER BAGS ATTACHED TO ANIMAL LEASHES FOR HOLDING SMALL ITEMS SUCH AS KEYS, CREDIT CARDS, MONEY (U.S. CLS. 1, 2, 3, 22 AND 41).  
FIRST USE 4-1-2012; IN COMMERCE 4-1-2013.

4,481,853. KELLY WYNNE WHITE, DALLAS, TX. SN 85-657,541. PUB. 3-12-2013, FILED 6-21-2012.

## KELLY WYNNE

THE MARK CONSISTS OF STANDARD CHARACTERS WITHOUT CLAIM TO ANY PARTICULAR FONT, STYLE, SIZE, OR COLOR.

THE NAME "KELLY WYNNE" IDENTIFIES THE PSEUDONYM OF "KELLY WYNNE WHITE", A LIVING INDIVIDUAL WHOSE CONSENT IS OF RECORD.  
FOR LEATHER PURSES (U.S. CLS. 1, 2, 3, 22 AND 41).  
FIRST USE 3-20-2013; IN COMMERCE 3-20-2013.

**CLASS 18—(Continued).**

4,482,045. ZHEJIANG GRACE SPINNING & WEAVING GROUP CO., LTD., ZHEJIANG, CHINA. SN 85-731,213. PUB. 2-26-2013, FILED 9-17-2012.



THE MARK CONSISTS OF THE WORDS "GRACE ORCHID" BELOW AN INCOMPLETE FLOWER DESIGN.

FOR BRIEFCASES; FITTED PROTECTIVE COVERS FOR HANDBAGS, BRIEFCASES, VALISES, SUITCASES, AND BRIEFCASE-LIKE PORTFOLIOS; FURS SOLD IN BULK; GUT FOR MAKING SAUSAGE CASINGS; LEATHER LEASHES; LEATHER, UNWROUGHT OR SEMI-WROUGHT; LUGGAGE TAGS; MUZZLES; POCKET WALLETS; UMBRELLAS; WALKING STICKS (U.S. CLS. 1, 2, 3, 22 AND 41).

FIRST USE 4-18-2013; IN COMMERCE 4-18-2013.

4,482,090. ABG ACCESSORIES, INC., ELIZABETH, NJ. SN 85-737,407. PUB. 3-5-2013, FILED 9-25-2012.

**BOWS & BONES**

THE MARK CONSISTS OF STANDARD CHARACTERS WITHOUT CLAIM TO ANY PARTICULAR FONT, STYLE, SIZE, OR COLOR.

FOR HANDBAGS (U.S. CLS. 1, 2, 3, 22 AND 41).

FIRST USE 6-0-2012; IN COMMERCE 6-0-2012.

4,482,218. AEROPOSTALE PROCUREMENT COMPANY, INC., NEW YORK, NY. SN 85-755,971. PUB. 6-11-2013, FILED 10-17-2012.

**LIVE LOVE DREAM**

THE MARK CONSISTS OF STANDARD CHARACTERS WITHOUT CLAIM TO ANY PARTICULAR FONT, STYLE, SIZE, OR COLOR.

FOR ALL-PURPOSE ATHLETIC BAGS; BACKPACKS; BEACH BAGS; COSMETIC BAGS SOLD EMPTY; HANDBAGS; MESSENGER BAGS; SHOULDER BAGS; SPORTS BAGS; TOTE BAGS; WALLETS (U.S. CLS. 1, 2, 3, 22 AND 41).

FIRST USE 3-14-2013; IN COMMERCE 3-14-2013.

**CLASS 18—(Continued).**

4,482,266. FREEFALL, LLC, DURHAM, NC. SN 85-766,918. PUB. 4-2-2013, FILED 10-30-2012.

**LIVE LIFE LARGE**

THE MARK CONSISTS OF STANDARD CHARACTERS WITHOUT CLAIM TO ANY PARTICULAR FONT, STYLE, SIZE, OR COLOR.

FOR ALL-PURPOSE SPORT AND ATHLETIC BAGS; ALL-PURPOSE CARRYING BAGS; HANDBAGS; TOTE BAGS; SPORTS PACKS; BACKPACKS (U.S. CLS. 1, 2, 3, 22 AND 41).

FIRST USE 8-28-2013; IN COMMERCE 8-28-2013.

4,482,511. ALDI INC., BATAVIA, IL. SN 85-861,490. PUB. 7-16-2013, FILED 2-27-2013.

**ROYAL CLASS**

THE MARK CONSISTS OF STANDARD CHARACTERS WITHOUT CLAIM TO ANY PARTICULAR FONT, STYLE, SIZE, OR COLOR.

FOR SUITCASES; TOILETRY BAGS SOLD EMPTY (U.S. CLS. 1, 2, 3, 22 AND 41).

FIRST USE 8-26-2013; IN COMMERCE 8-26-2013.

**CLASS 19—NON-METALLIC BUILDING MATERIALS**

4,481,453. MANUFACTURAS VITROMEX, S.A. DE C.V., SALTILLO, MEXICO. SN 85-204,487. PUB. 6-21-2011, FILED 12-22-2010.



THE COLOR(S) GREEN AND ORANGE IS/ARE CLAIMED AS A FEATURE OF THE MARK.

THE MARK CONSISTS OF THREE GREEN SQUARES AND ONE ORANGE SQUARE, ALL ARRANGED IN THE SHAPE OF A SQUARE, NEXT TO THE WORDING "CONSTRUPISO" WHERE THE DOT IN THE LETTER "I" CONSISTS OF A GREEN SQUARE.

THE WORDING "CONSTRUPISO" HAS NO MEANING IN A FOREIGN LANGUAGE.

FOR NON-METAL FLOOR AND WALL TILES; CERAMIC TILES AND SLABS (U.S. CLS. 1, 12, 33 AND 50).

FIRST USE 6-2-2009; IN COMMERCE 6-25-2009.

**CLASS 19—(Continued).**

4,481,704. CUSTOM BUILDING PRODUCTS, INC., SEAL BEACH, CA. SN 85-571,104. PUB. 9-11-2012, FILED 3-15-2012.

# XP-1

THE MARK CONSISTS OF STANDARD CHARACTERS WITHOUT CLAIM TO ANY PARTICULAR FONT, STYLE, SIZE, OR COLOR.

FOR SELF-LEVELING FLOORING UNDERLAYMENTS (U.S. CLS. 1, 12, 33 AND 50).

FIRST USE 4-0-2013; IN COMMERCE 6-0-2013.

---

4,481,723. AQUAARCH EXFILTRATION SYSTEM, LLC, JACKSONVILLE, FL. SN 85-592,267. PUB. 9-4-2012, FILED 4-9-2012.

# AquaArch

THE MARK CONSISTS OF STANDARD CHARACTERS WITHOUT CLAIM TO ANY PARTICULAR FONT, STYLE, SIZE, OR COLOR.

FOR PAVING STONES (U.S. CLS. 1, 12, 33 AND 50).

FIRST USE 3-1-2012; IN COMMERCE 5-25-2012.

---

4,481,771. AWI LICENSING COMPANY, WILMINGTON, DE. SN 85-616,030. PUB. 7-23-2013, FILED 5-3-2012.

# AMERICAN SCRAPE

THE MARK CONSISTS OF STANDARD CHARACTERS WITHOUT CLAIM TO ANY PARTICULAR FONT, STYLE, SIZE, OR COLOR.

NO CLAIM IS MADE TO THE EXCLUSIVE RIGHT TO USE "SCRAPE", APART FROM THE MARK AS SHOWN.

FOR ENGINEERED HARDWOOD FLOORING; HARDWOOD FLOORING (U.S. CLS. 1, 12, 33 AND 50).

FIRST USE 10-31-2012; IN COMMERCE 10-31-2012.

**CLASS 19—(Continued).**

4,481,780. JOHNSONITE INC., CHAGRIN FALLS, OH. SN 85-619,732. PUB. 10-9-2012, FILED 5-8-2012.

# PATRIOT

THE MARK CONSISTS OF STANDARD CHARACTERS WITHOUT CLAIM TO ANY PARTICULAR FONT, STYLE, SIZE, OR COLOR.

FOR NON-METAL FLOOR TILES AND PLANKS; NON-METAL FLOORING IN THE NATURE OF NON-METAL FLOOR TILES AND PLANKS; VINYL TILES AND VINYL FLOOR TILES; NON-METAL FLOORING; VINYL FLOORING (U.S. CLS. 1, 12, 33 AND 50).

FIRST USE 1-0-2013; IN COMMERCE 1-0-2013.

---

4,481,783. SERVUS, INC., GASTONIA, NC. SN 85-622,150. PUB. 9-3-2013, FILED 5-10-2012.

# PRODUCTS ENGINEERED TO SERVUS BETTER

THE MARK CONSISTS OF STANDARD CHARACTERS WITHOUT CLAIM TO ANY PARTICULAR FONT, STYLE, SIZE, OR COLOR.

FOR MARINE PRODUCTS, NAMELY, ABRASION RESISTANT STRIPS MADE FROM A POLYMER RESIN THAT ARE INSTALLED ONTO BOAT DOCKS TO PREVENT WEAR (U.S. CLS. 1, 12, 33 AND 50).

FIRST USE 10-31-2013; IN COMMERCE 10-31-2013.

---

4,481,837. NORMARK CORPORATION, MINNETONKA, MN. SN 85-650,001. PUB. 10-30-2012, FILED 6-12-2012.

# ICE FORCE

THE MARK CONSISTS OF STANDARD CHARACTERS WITHOUT CLAIM TO ANY PARTICULAR FONT, STYLE, SIZE, OR COLOR.

FOR ICE FISHING HOUSES NOT MADE OF METAL (U.S. CLS. 1, 12, 33 AND 50).

FIRST USE 10-1-2013; IN COMMERCE 10-1-2013.

**CLASS 19—(Continued).**

4,482,247. DAVIS INTELLECTUAL ASSETS, SAVANNAH, GA. SN 85-761,164. PUB. 6-11-2013, FILED 10-23-2012.

With:



NO CLAIM IS MADE TO THE EXCLUSIVE RIGHT TO USE "TECHNOLOGY", APART FROM THE MARK AS SHOWN.

THE MARK CONSISTS OF THE WORD "WITH:" ABOVE A BOX CONTAINING 1) THE LETTERS "KBR'S" WHERE A RAIN DROP COVERS A MAJORITY OF THE LEFT SIDE OF THE LETTER "K", 2) THE WORDS "HARD CORE." BENEATH THE LETTERS "KBR'S", AND 3) THE WORD "TECHNOLOGY" BENEATH THE WORDS "HARD CORE."

FOR PRE-FORMED SUBSTRATES FOR SHOWERS AND SHOWERS WALLS CAPABLE OF RECEIVING THE APPLICATION OF A VARIETY OF FINISHED MATERIALS, NAMELY, SHOWER ENCLOSURES, SHOWER SURROUNDS AND SHOWER PANELS (U.S. CLS. 1, 12, 33 AND 50).

FIRST USE 1-1-2013; IN COMMERCE 1-1-2013.

**CLASS 20—(Continued).**

4,481,310. OFF-LOADING TECHNOLOGIES, INC., TARRY-TOWN, NY. SN 76-712,870. PUB. 4-30-2013, FILED 11-16-2012.

**OXY-MAT**

THE MARK CONSISTS OF STANDARD CHARACTERS WITHOUT CLAIM TO ANY PARTICULAR FONT, STYLE, SIZE, OR COLOR.

FOR ADVANCED TECHNOLOGY MATTRESS AND CHAIR (U.S. CLS. 2, 13, 22, 25, 32 AND 50).  
FIRST USE 3-14-2012; IN COMMERCE 3-14-2012.

4,482,285. CHAMPION WINDOW MANUFACTURING AND SUPPLY CO., LLC, DBA CHAMPION WINDOWS, CINCINNATI, OH. SN 85-773,542. PUB. 2-5-2013, FILED 11-7-2012.



OWNER OF U.S. REG. NOS. 2,195,330, 2,195,331, AND 3,569,478.

THE STIPPLING IS A FEATURE OF THE MARK AND DOES NOT INDICATE COLOR; THE STIPPLING IS FOR SHADING PURPOSES ONLY.

THE MARK CONSISTS OF THE WORD "CHAMPION", IN ITALICIZED SANS SERIF SCRIPT, WITH A LIGHT PROFILE OF THE SECTION OF A HOUSE ROOF-LINE AND CHIMNEY ON A DARK BACKGROUND PLACED INSIDE THE LETTER "O".

FOR NON-METAL GARAGE DOORS; NON-METAL WINDOWS AND DOORS; VINYL DOORS; VINYL WINDOWS (U.S. CLS. 1, 12, 33 AND 50).

FIRST USE 5-17-2013; IN COMMERCE 5-17-2013.

4,481,348. HARVEY BALL SMILE LIMITED, SHINAGAWA-KU TOKYO, JAPAN. SN 77-873,033. PUB. 9-10-2013, FILED 11-16-2009.

**SMILE**

THE MARK CONSISTS OF THE WORDING "SMILE" IN STYLIZED FONT.

FOR ADVERTISING BALLOONS; CUSHIONS; FURNITURE, MIRRORS, PICTURE FRAMES; MATTRESSES; NON-METAL KEY RINGS; NON-METAL PEGS; PILLOWS; WINDOW BLINDS (U.S. CLS. 2, 13, 22, 25, 32 AND 50).

FIRST USE 2-27-2009; IN COMMERCE 2-27-2009.

**CLASS 20—FURNITURE AND ARTICLES NOT OTHERWISE CLASSIFIED**

**CLASS 20—(Continued).**

4,481,362. HARVEY BALL SMILE LIMITED, SHINAGAWA-KU TOKYO, JAPAN. SN 77-918,780. PUB. 6-1-2010, FILED 1-23-2010.



THE MARK CONSISTS OF A SMILEY FACE. FOR CUSHIONS; FURNITURE; MIRRORS; NON-METAL KEY RINGS; PICTURE FRAMES; PILLOWS (U.S. CLS. 2, 13, 22, 25, 32 AND 50). FIRST USE 2-27-2009; IN COMMERCE 2-27-2009.

---

4,481,391. TOP SHELF DESIGNS, INC., WEATHERFORD, OK. SN 85-038,750. PUB. 10-19-2010, FILED 5-14-2010.

# AQUASHELF

THE MARK CONSISTS OF STANDARD CHARACTERS WITHOUT CLAIM TO ANY PARTICULAR FONT, STYLE, SIZE, OR COLOR. FOR SHELVES FOR BATHTUBS AND SHOWERS (U.S. CLS. 2, 13, 22, 25, 32 AND 50). FIRST USE 10-29-2013; IN COMMERCE 10-29-2013.

---

4,481,399. HOME BOX OFFICE, INC., NEW YORK, NY. SN 85-049,508. PUB. 4-12-2011, FILED 5-27-2010.

# TRUE BLOOD

THE MARK CONSISTS OF STANDARD CHARACTERS WITHOUT CLAIM TO ANY PARTICULAR FONT, STYLE, SIZE, OR COLOR. OWNER OF U.S. REG. NOS. 3,531,720, 3,731,812, AND OTHERS. FOR PERSONAL COMPACT MIRRORS (U.S. CLS. 2, 13, 22, 25, 32 AND 50). FIRST USE 6-27-2011; IN COMMERCE 6-27-2011.

**CLASS 20—(Continued).**

4,481,413. JONES, COLUMBIA E., MARIETTA, GA. SN 85-089,439. PUB. 3-26-2013, FILED 7-21-2010.

# Pace-It Launch Pad

THE MARK CONSISTS OF STANDARD CHARACTERS WITHOUT CLAIM TO ANY PARTICULAR FONT, STYLE, SIZE, OR COLOR.

NO CLAIM IS MADE TO THE EXCLUSIVE RIGHT TO USE "PAD", APART FROM THE MARK AS SHOWN. FOR KIT CONSISTING PRIMARILY OF CLOTHES HANGER, CHAIR COVERS, FLOOR MATS AND A CHECKLIST SOLD AS A UNIT FOR USE AS A REMINDER FOR TASKS TO BE PERFORMED (U.S. CLS. 2, 13, 22, 25, 32 AND 50).

FIRST USE 8-1-2011; IN COMMERCE 8-1-2011.

---

4,481,429. ELBEE PTY LTD, BELLEVUE HILL NSW, AUSTRALIA. SN 85-140,681. PUB. 9-20-2011, FILED 9-29-2010.

# EZY-CHECK

THE MARK CONSISTS OF STANDARD CHARACTERS WITHOUT CLAIM TO ANY PARTICULAR FONT, STYLE, SIZE, OR COLOR.

PRIORITY CLAIMED UNDER SEC. 44(D) ON AUSTRALIA APPLICATION NO. 1384630, FILED 9-21-2010.

FOR NON-METAL AND NON-ELECTRIC SAFETY LOCKING DEVICES, NAMELY, CHILD SAFETY LOCKS, KEYS, LATCHES, PLUGS, AND DOOR KNOB COVERS; CABINET DOOR CATCHES, NOT OF METAL, NAMELY, CHILD SAFETY DOOR CATCHES; WINDOW CATCHES, NOT OF METAL, NAMELY, CHILD SAFETY WINDOW CATCHES; NON-METALLIC CHILD SAFETY LOCKING GATE HASPS; PORTABLE BARRIERS, NAMELY, NON-METAL SAFETY GATES FOR HOUSEHOLD USE FOR THE PROTECTION OF CHILDREN (U.S. CLS. 2, 13, 22, 25, 32 AND 50).

FIRST USE 10-30-2013; IN COMMERCE 10-30-2013.

**CLASS 20—(Continued).**

4,481,433. THE LUTHERAN UNIVERSITY ASSOCIATION, INC., VALPARAISO, IN. SN 85-144,710. PUB. 9-13-2011, FILED 10-4-2010.



OWNER OF U.S. REG. NOS. 2,454,950, 2,479,369, AND OTHERS.

THE MARK CONSISTS OF A DEPICTION OF A KNIGHT HOLDING A SHIELD FEATURING A STYLIZED LETTER "V" WITH A FLAME AND SHIELD, ABOVE AND IN FRONT OF THE WORD "VALPO" IN BLOCK LETTERS.

FOR PICTURE FRAMES (U.S. CLS. 2, 13, 22, 25, 32 AND 50).

FIRST USE 8-1-2010; IN COMMERCE 8-1-2010.

4,481,447. LEFA, INC., KING OF PRUSSIA, PA. SN 85-186,020. PUB. 11-1-2011, FILED 11-29-2010.

**IMA HOSPITALITY**

THE MARK CONSISTS OF STANDARD CHARACTERS WITHOUT CLAIM TO ANY PARTICULAR FONT, STYLE, SIZE, OR COLOR.

FOR FURNITURE (U.S. CLS. 2, 13, 22, 25, 32 AND 50). FIRST USE 9-20-2013; IN COMMERCE 9-20-2013.

**CLASS 20—(Continued).**

4,481,612. CLEAN WRAP CO., LTD., GYEONGSANGNAM-DO, REPUBLIC OF KOREA. SN 85-477,406. PUB. 8-28-2012, FILED 11-21-2011.

**ZAZEN**

THE MARK CONSISTS OF STANDARD CHARACTERS WITHOUT CLAIM TO ANY PARTICULAR FONT, STYLE, SIZE, OR COLOR.

FOR NON-METAL KEY HOLDERS; NON-METAL KEY RINGS; NON-METAL AND NON-LEATHER KEY CHAINS; NON-METAL KEY FOBBS; FURNITURE; PLASTIC CARD KEYS; INFANT WALKERS; PLAYPENS FOR BABIES; PICTURE FRAMES; NON-METAL PET KENNEL WITH PET-ACTUATED ENTRY; CUSHIONS, PILLOWS; MATTRESSES; CRADLES; SCULPTURES OF WOOD; AND DECORATIVE MOBILES (U.S. CLS. 2, 13, 22, 25, 32 AND 50).

FIRST USE 7-1-2013; IN COMMERCE 7-1-2013.

4,481,638. RICHARD DAVIS INC., LEANDER, TX. SN 85-503,695. PUB. 6-5-2012, FILED 12-26-2011.



THE COLOR(S) PINK, LIGHT PINK, AND BLACK IS/ARE CLAIMED AS A FEATURE OF THE MARK.

THE MARK CONSISTS OF A PINK HEART WITH THE TERMS "HEART SAVER 79" IN THE MIDDLE OF THE HEART, IN BLACK. THE PINK HEART HAS A LIGHTER PINK HALO SURROUNDING IT.

FOR COMMERCIAL DISPENSERS FOR PILLS OR CAPSULES SOLD EMPTY (U.S. CLS. 2, 13, 22, 25, 32 AND 50).

FIRST USE 1-24-2013; IN COMMERCE 1-24-2013.

**CLASS 20—(Continued).**

4,481,746. BF GATEMATE INC., TUCKAHOE, NY. SN 85-600,427. PUB. 9-18-2012, FILED 4-17-2012.

# Gate Mate

THE MARK CONSISTS OF STANDARD CHARACTERS WITHOUT CLAIM TO ANY PARTICULAR FONT, STYLE, SIZE, OR COLOR.

FOR NON-METAL TOOL BOXES CUSTOM DESIGNED FOR THE STORAGE OF ITEMS USED FOR TAILGATING EVENTS, NAMELY, GRILLING AND COOKING UTENSILS, EATING UTENSILS, DINNERWARE, CONDIMENTS, SEASONINGS, FOOD AND BEVERAGES (U.S. CLS. 2, 13, 22, 25, 32 AND 50).

FIRST USE 11-7-2013; IN COMMERCE 11-7-2013.

4,481,809. ASHNIC PILLOWS, LLC, WELLINGTON, FL. SN 85-637,148. PUB. 11-13-2012, FILED 5-29-2012.



NO CLAIM IS MADE TO THE EXCLUSIVE RIGHT TO USE "PILLOWS", APART FROM THE MARK AS SHOWN.

THE MARK CONSISTS OF STYLIZED INITIALS "AP" WITH THE WORDS "ASHNIC PILLOWS" PERPENDICULAR TO THE CENTER OF SUCH STYLIZED INITIALS.

THE WORDING "ASHNIC" HAS NO MEANING IN A FOREIGN LANGUAGE.

FOR ACCENT PILLOWS, NAMELY, DECORATIVE PILLOWS CONTAINING VERSES FROM THE BIBLE (U.S. CLS. 2, 13, 22, 25, 32 AND 50).

FIRST USE 12-7-2013; IN COMMERCE 12-8-2013.

4,481,810. ASHNIC PILLOWS, LLC, WELLINGTON, FL. SN 85-637,179. PUB. 11-13-2012, FILED 5-29-2012.

# ASHNIC PILLOWS

THE MARK CONSISTS OF STANDARD CHARACTERS WITHOUT CLAIM TO ANY PARTICULAR FONT, STYLE, SIZE, OR COLOR.

NO CLAIM IS MADE TO THE EXCLUSIVE RIGHT TO USE "PILLOWS", APART FROM THE MARK AS SHOWN.

**CLASS 20—(Continued).**

THE WORDING "ASHNIC" HAS NO MEANING IN A FOREIGN LANGUAGE.

FOR ACCENT PILLOWS, NAMELY, DECORATIVE PILLOWS CONTAINING VERSES FROM THE BIBLE (U.S. CLS. 2, 13, 22, 25, 32 AND 50).

FIRST USE 12-7-2013; IN COMMERCE 12-8-2013.

4,481,852. SEALY TECHNOLOGY LLC, TRINITY, NC. SN 85-656,724. PUB. 9-11-2012, FILED 6-20-2012.

# SEALY

THE MARK CONSISTS OF STANDARD CHARACTERS WITHOUT CLAIM TO ANY PARTICULAR FONT, STYLE, SIZE, OR COLOR.

OWNER OF U.S. REG. NOS. 1,733,089, 2,271,114, AND 2,953,348.

FOR BEDS FOR HOUSEHOLD PETS (U.S. CLS. 2, 13, 22, 25, 32 AND 50).

FIRST USE 5-1-2013; IN COMMERCE 5-1-2013.

4,481,868. TINY LOVE LTD., TEL AVIV, ISRAEL. SN 85-662,760. PUB. 9-11-2012, FILED 6-27-2012.

# TAKE-ALONG BOUNCER

THE MARK CONSISTS OF STANDARD CHARACTERS WITHOUT CLAIM TO ANY PARTICULAR FONT, STYLE, SIZE, OR COLOR.

OWNER OF U.S. REG. NO. 3,166,473.

NO CLAIM IS MADE TO THE EXCLUSIVE RIGHT TO USE "BOUNCER", APART FROM THE MARK AS SHOWN.

FOR BABY BOUNCERS; INFANT BOUNCERS (U.S. CLS. 2, 13, 22, 25, 32 AND 50).

FIRST USE 11-3-2013; IN COMMERCE 11-3-2013.

4,481,927. GEORGIA-PACIFIC CONSUMER PRODUCTS LP, ATLANTA, GA. SN 85-694,063. PUB. 1-22-2013, FILED 8-2-2012.

# MORNAP

THE MARK CONSISTS OF STANDARD CHARACTERS WITHOUT CLAIM TO ANY PARTICULAR FONT, STYLE, SIZE, OR COLOR.



**CLASS 20—(Continued).**

OWNER OF U.S. REG. NOS. 369,291 AND 1,869,561.  
FOR FIXED NAPKIN DISPENSERS NOT OF METAL  
(U.S. CLS. 2, 13, 22, 25, 32 AND 50).  
FIRST USE 9-30-2012; IN COMMERCE 9-30-2012.

**CLASS 20—(Continued).**

4,482,046. ZHEJIANG GRACE SPINNING & WEAVING  
GROUP CO., LTD., ZHEJIANG, CHINA. SN 85-731,214.  
PUB. 2-26-2013, FILED 9-17-2012.

4,481,990. KEIM, MAX ANDREW, STILLWATER, OK. SN 85-  
719,323. PUB. 4-2-2013, FILED 9-3-2012.



**Whole Can of Thank You**

THE MARK CONSISTS OF THE WORDS "GRACE ORCH-  
ID" BELOW AN INCOMPLETE FLOWER DESIGN.  
FOR BAMBOO POLES; BOLSTERS; DECORATIONS  
OF PLASTIC FOR FOODSTUFFS; FURNITURE; FURNI-  
TURE FITTINGS, NOT OF METAL; NON-METAL DOOR  
FITTINGS; NON-METAL PIPE AND CABLE CLIPS;  
NONMETAL AND NON-PAPER CONTAINERS FOR  
STORAGE OR TRANSPORT; PICTURE FRAMES;  
WORKS OF ART OF WOOD, WAX, PLASTER OR  
PLASTIC (U.S. CLS. 2, 13, 22, 25, 32 AND 50).  
FIRST USE 12-20-2012; IN COMMERCE 12-20-2012.

THE MARK CONSISTS OF STANDARD CHARACTERS  
WITHOUT CLAIM TO ANY PARTICULAR FONT, STYLE,  
SIZE, OR COLOR.  
NO CLAIM IS MADE TO THE EXCLUSIVE RIGHT TO  
USE "CAN", APART FROM THE MARK AS SHOWN.  
FOR NOVELTY GIFT ITEMS, NAMELY, EMPTY  
CANS (U.S. CLS. 2, 13, 22, 25, 32 AND 50).  
FIRST USE 11-4-2013; IN COMMERCE 11-4-2013.

4,482,094. NORTHWEST BEDDING CO., INC., SPOKANE,  
WA. SN 85-737,746. PUB. 3-12-2013, FILED 9-25-2012.

**i-Latex**

4,482,009. CARPENTER CO., RICHMOND, VA. SN 85-726,744.  
PUB. 2-12-2013, FILED 9-12-2012.

THE MARK CONSISTS OF STANDARD CHARACTERS  
WITHOUT CLAIM TO ANY PARTICULAR FONT, STYLE,  
SIZE, OR COLOR.  
FOR BED AND SLEEP PRODUCTS AND ACCES-  
SORIES, NAMELY, MATTRESSES CONTAINING LA-  
TEX, BOXSPRINGS CONTAINING LATEX, WOOD  
BUILT-UP PLATFORMS IN THE NATURE OF BED  
FRAMES, FORMED WIRE BOXSPRINGS CONTAINING  
LATEX, MATTRESS FOUNDATIONS CONTAINING LA-  
TEX, ADJUSTABLE POWER MATTRESS FOUNDA-  
TIONS CONTAINING LATEX AND PILLOWS  
CONTAINING LATEX (U.S. CLS. 2, 13, 22, 25, 32 AND  
50).  
FIRST USE 7-1-2013; IN COMMERCE 7-1-2013.

**ERGOSMART**

4,482,153. DIXIE CONSUMER PRODUCTS LLC, ATLANTA,  
GA. SN 85-746,116. PUB. 3-19-2013, FILED 10-4-2012.

**DIXIE ULTRA**

THE MARK CONSISTS OF STANDARD CHARACTERS  
WITHOUT CLAIM TO ANY PARTICULAR FONT, STYLE,  
SIZE, OR COLOR.  
FOR MATTRESS TOPPERS; PILLOWS (U.S. CLS. 2, 13,  
22, 25, 32 AND 50).  
FIRST USE 4-0-2013; IN COMMERCE 4-0-2013.

THE MARK CONSISTS OF STANDARD CHARACTERS  
WITHOUT CLAIM TO ANY PARTICULAR FONT, STYLE,  
SIZE, OR COLOR.

**CLASS 20—(Continued).**

OWNER OF U.S. REG. NOS. 3,231,429, 4,056,768, AND OTHERS.  
FOR PLASTIC LIDS (U.S. CLS. 2, 13, 22, 25, 32 AND 50).  
FIRST USE 11-19-2012; IN COMMERCE 11-19-2012.

4,482,234. ZHEJIANG HONGGUOCUN LEISURE GOODS CO., LTD, YONGKANG, ZHEJIANG, CHINA. SN 85-758,206. PUB. 4-30-2013, FILED 10-19-2012.



THE MARK CONSISTS OF THE WORDING "HONGGUOCUN" BELOW WHICH CHINESE CHARACTERS APPEAR WITH DEVICE CONSISTING OF MULTIPLE CIRCLES ON THE LEFT SIDE.

THE ENGLISH TRANSLATION OF THE CHINESE CHARACTERS IN THE MARK IS "RED" "FRUIT" "VILLAGE".

THE NON-LATIN CHARACTERS IN THE MARK TRANSLITERATE TO "HONG" "GUO" "CUN" AND THIS HAS NO MEANING IN A FOREIGN LANGUAGE.

FOR SEATS OF METAL; COVERS FOR CLOTHING, NAMELY, WARDROBE; SOFAS; FURNITURE OF METAL; SLEEPING BAGS FOR CAMPING; PLANT STANDS; FURNITURE; DECK CHAIRS; BAMBOO PRODUCTS EXCLUDING CAP, SEATS, MATS, NAMELY, POLES, CURTAINS, BLINDS; BEDS FOR HOUSEHOLD PETS (U.S. CLS. 2, 13, 22, 25, 32 AND 50).

FIRST USE 10-20-2012; IN COMMERCE 10-20-2012.

4,482,361. STREET PLAYERS HOLDING CORPORATION, LOS ANGELES, CA. SN 85-799,145. PUB. 2-26-2013, FILED 12-10-2012.

## Pudgy Wudgy

THE MARK CONSISTS OF STANDARD CHARACTERS WITHOUT CLAIM TO ANY PARTICULAR FONT, STYLE, SIZE, OR COLOR.

FOR PILLOWS (U.S. CLS. 2, 13, 22, 25, 32 AND 50).  
FIRST USE 6-7-2013; IN COMMERCE 6-7-2013.

**CLASS 20—(Continued).**

4,482,453. SEVILLE CLASSICS, INC., TORRANCE, CA. SN 85-834,452. PUB. 6-18-2013, FILED 1-28-2013.

## ULTRADURABLE

THE MARK CONSISTS OF STANDARD CHARACTERS WITHOUT CLAIM TO ANY PARTICULAR FONT, STYLE, SIZE, OR COLOR.

FOR BAKER'S RACKS; BOTTLE RACKS; CABINETS; CLOSET ACCESSORIES, NAMELY, SHOE RACKS; FURNITURE; METAL FURNITURE; METAL STORAGE CABINETS; OFFICE FURNITURE; RESIDENTIAL AND COMMERCIAL WROUGHT IRON FURNITURE (U.S. CLS. 2, 13, 22, 25, 32 AND 50).

FIRST USE 10-1-1995; IN COMMERCE 10-1-1995.

4,482,513. ZINUS INC., HAYWARD, CA. SN 85-861,643. PUB. 6-11-2013, FILED 2-27-2013.

## HipJoy

THE MARK CONSISTS OF STANDARD CHARACTERS WITHOUT CLAIM TO ANY PARTICULAR FONT, STYLE, SIZE, OR COLOR.

FOR BEDS, MATTRESSES, PILLOWS AND BOLSTERS (U.S. CLS. 2, 13, 22, 25, 32 AND 50).

FIRST USE 9-15-2013; IN COMMERCE 10-15-2013.

4,482,610. ZINUS INC., HAYWARD, CA. SN 85-892,202. PUB. 8-13-2013, FILED 4-1-2013.

## From Nature

THE MARK CONSISTS OF STANDARD CHARACTERS WITHOUT CLAIM TO ANY PARTICULAR FONT, STYLE, SIZE, OR COLOR.

FOR MATTRESS TOPPERS; MATTRESSES AND PILLOWS (U.S. CLS. 2, 13, 22, 25, 32 AND 50).

FIRST USE 9-15-2013; IN COMMERCE 10-1-2013.

**CLASS 20—(Continued).**

4,482,657. ZINUS INC., HAYWARD, CA. SN 85-926,766. PUB. 8-13-2013, FILED 5-8-2013.

## Chirotherapy

THE MARK CONSISTS OF STANDARD CHARACTERS WITHOUT CLAIM TO ANY PARTICULAR FONT, STYLE, SIZE, OR COLOR.

FOR MATTRESS FOUNDATIONS; MATTRESS TOPPERS; MATTRESSES AND PILLOWS (U.S. CLS. 2, 13, 22, 25, 32 AND 50).

FIRST USE 8-1-2013; IN COMMERCE 9-1-2013.

4,482,686. WALGREEN CO., DEERFIELD, IL. SN 85-980,692. PUB. 11-20-2012, FILED 5-7-2012.

## LIVING SOLUTIONS

THE MARK CONSISTS OF STANDARD CHARACTERS WITHOUT CLAIM TO ANY PARTICULAR FONT, STYLE, SIZE, OR COLOR.

FOR NON-METAL WALL ANCHORS (U.S. CLS. 2, 13, 22, 25, 32 AND 50).

FIRST USE 1-3-2013; IN COMMERCE 1-3-2013.

**CLASS 21—HOUSEWARES AND GLASS**

4,481,383. TARGET BRANDS, INC., MINNEAPOLIS, MN. SN 85-031,111. PUB. 10-5-2010, FILED 5-5-2010.

## ROOM ESSENTIALS

THE MARK CONSISTS OF STANDARD CHARACTERS WITHOUT CLAIM TO ANY PARTICULAR FONT, STYLE, SIZE, OR COLOR.

OWNER OF U.S. REG. NO. 3,251,676.

NO CLAIM IS MADE TO THE EXCLUSIVE RIGHT TO USE "ROOM", APART FROM THE MARK AS SHOWN.

FOR STEMWARE; CAKE STANDS; PITCHERS; VASES, CHIP-AND-DIP SETS COMPRISED OF SERVING BOWLS; MUG TREES; KITCHEN TOOLS AND ACCESSORIES, NAMELY, BEVERAGE STIRRERS, COOKIE JARS, THERMAL CARAFES, CARAFES, GLASS BOTTLE STOPPERS, BREAD BOXES; HOUSEHOLD UTENSILS, NAMELY, SPATULAS, TONGS, FOOD PEELERS, GRATERS, STRAINERS, TURNERS, WHISKS (U.S. CLS. 2, 13, 23, 29, 30, 33, 40 AND 50).

FIRST USE 7-31-2003; IN COMMERCE 7-31-2003.

**CLASS 21—(Continued).**

4,481,472. SAZERAC NORTH AMERICA, INC., FRANKFORT, KY. SN 85-251,676. PUB. 7-19-2011, FILED 2-25-2011.



THE MARK CONSISTS OF THE CAPITAL LETTER "B" IN A CIRCLE TO THE LEFT OF THE WORD "BARTON", WHICH IS IN ALL CAPS.

FOR GLASSWARE, NAMELY, BEVERAGE GLASSES, AND SHOT GLASSES; DRINKING FLASKS; REUSABLE PLASTIC WATER BOTTLES SOLD EMPTY; REUSABLE METAL WATER BOTTLES SOLD EMPTY; PAPER AND PLASTIC PLATES AND PAPER AND PLASTIC CUPS (U.S. CLS. 2, 13, 23, 29, 30, 33, 40 AND 50).

FIRST USE 11-4-2013; IN COMMERCE 11-4-2013.

4,481,485. UNITED INDUSTRIES CORPORATION, EARTH CITY, MO. SN 85-288,022. PUB. 8-16-2011, FILED 4-6-2011.

## ACCUSNAP

THE MARK CONSISTS OF STANDARD CHARACTERS WITHOUT CLAIM TO ANY PARTICULAR FONT, STYLE, SIZE, OR COLOR.

FOR MOUSE TRAPS AND RAT TRAPS (U.S. CLS. 2, 13, 23, 29, 30, 33, 40 AND 50).

FIRST USE 8-15-2013; IN COMMERCE 8-15-2013.

4,481,487. SOURCE INTERLINK MAGAZINES, LLC, EL SEGUNDO, CA. SN 85-290,663. PUB. 10-2-2012, FILED 4-8-2011.

## HOT ROD

THE MARK CONSISTS OF STANDARD CHARACTERS WITHOUT CLAIM TO ANY PARTICULAR FONT, STYLE, SIZE, OR COLOR.

OWNER OF U.S. REG. NOS. 2,372,437, 2,645,266, AND 3,316,211.

FOR PILL BOXES FOR PERSONAL USE (U.S. CLS. 2, 13, 23, 29, 30, 33, 40 AND 50).

FIRST USE 6-10-2011; IN COMMERCE 6-10-2011.

**CLASS 21—(Continued).**

4,481,503. OSTOVAR, VIDA, LA JOLLA, CA. SN 85-342,418.  
PUB. 11-1-2011, FILED 6-9-2011.

# HANDSTAND

THE MARK CONSISTS OF STANDARD CHARACTERS WITHOUT CLAIM TO ANY PARTICULAR FONT, STYLE, SIZE, OR COLOR.

FOR GLOVE TREES (U.S. CLS. 2, 13, 23, 29, 30, 33, 40 AND 50).

FIRST USE 10-1-2013; IN COMMERCE 10-1-2013.

**CLASS 21—(Continued).**

4,482,002. ZHU, JIASHENG, SAN JOSE, CA. AND SU, JUN, HANGZHOU, CHINA. SN 85-723,720. PUB. 8-13-2013, FILED 9-7-2012.

# O'NANO

THE MARK CONSISTS OF STANDARD CHARACTERS WITHOUT CLAIM TO ANY PARTICULAR FONT, STYLE, SIZE, OR COLOR.

FOR TOOTHBRUSHES (U.S. CLS. 2, 13, 23, 29, 30, 33, 40 AND 50).

FIRST USE 10-11-2013; IN COMMERCE 10-11-2013.

4,481,741. PLANT PURRFECT, L.L.C., LAKEWOOD, CO. SN 85-599,134. PUB. 9-4-2012, FILED 4-16-2012.

## EASY GROWING IN AND OUT

THE MARK CONSISTS OF STANDARD CHARACTERS WITHOUT CLAIM TO ANY PARTICULAR FONT, STYLE, SIZE, OR COLOR.

FOR PLANTERS FOR FLOWERS AND PLANTS (U.S. CLS. 2, 13, 23, 29, 30, 33, 40 AND 50).

FIRST USE 8-3-2013; IN COMMERCE 8-3-2013.

4,482,047. ZHEJIANG GRACE SPINNING & WEAVING GROUP CO., LTD., ZHEJIANG, CHINA. SN 85-731,216. PUB. 2-26-2013, FILED 9-17-2012.



THE MARK CONSISTS OF THE WORDS "GRACE ORCHID" BELOW AN INCOMPLETE FLOWER DESIGN.

FOR CERAMIC SCULPTURES, VASES, VESSELS, BOWLS, PLATES AND POTS; CLEANING BRUSHES FOR HOUSEHOLD USE; CLEANING, DUSTING AND POLISHING CLOTHS; COMBS; COSMETIC BRUSHES; DRINKING VESSELS; HEAT-INSULATED CONTAINERS FOR HOUSEHOLD USE; HOUSEHOLD UTENSILS, NAMELY, POT AND PAN SCRAPERS, ROLLING PINS, SPATULAS, TURNERS, WHISKS; SOAP BOXES; TOOTHBRUSHES (U.S. CLS. 2, 13, 23, 29, 30, 33, 40 AND 50).

FIRST USE 12-20-2012; IN COMMERCE 12-20-2012.

4,481,974. EDIBLE ARRANGEMENTS, LLC, WALLINGFORD, CT. SN 85-716,315. PUB. 2-5-2013, FILED 8-29-2012.

# PALMGUARD

THE MARK CONSISTS OF STANDARD CHARACTERS WITHOUT CLAIM TO ANY PARTICULAR FONT, STYLE, SIZE, OR COLOR.

FOR COOKIE CUTTERS (U.S. CLS. 2, 13, 23, 29, 30, 33, 40 AND 50).

FIRST USE 10-1-2012; IN COMMERCE 10-1-2012.

4,482,270. SCENTSY, INC., MERIDIAN, ID. SN 85-767,355. PUB. 5-21-2013, FILED 10-30-2012.

# VELATA

THE MARK CONSISTS OF STANDARD CHARACTERS WITHOUT CLAIM TO ANY PARTICULAR FONT, STYLE, SIZE, OR COLOR.

THE ENGLISH TRANSLATION OF "VELATA" IS "VEILED".

FOR HOUSEHOLD OR KITCHEN UTENSILS NOT POWERED BY ELECTRICITY, NAMELY, SPATULAS (U.S. CLS. 2, 13, 23, 29, 30, 33, 40 AND 50).

FIRST USE 9-1-2013; IN COMMERCE 9-1-2013.

**CLASS 21—(Continued).**

4,482,297. THE PROCTER & GAMBLE COMPANY, CINCINNATI, OH. SN 85-777,684. PUB. 4-16-2013, FILED 11-13-2012.

# MR. C

THE MARK CONSISTS OF STANDARD CHARACTERS WITHOUT CLAIM TO ANY PARTICULAR FONT, STYLE, SIZE, OR COLOR.

OWNER OF U.S. REG. NOS. 2,493,607, 3,544,070, AND OTHERS.

FOR HOUSEHOLD CLEANING TOOLS, NAMELY, PLASTIC-BASED CLEANING PADS (U.S. CLS. 2, 13, 23, 29, 30, 33, 40 AND 50).

FIRST USE 7-15-2013; IN COMMERCE 7-15-2013.

---

4,482,358. YOUCOPIA PRODUCTS, INC., ARLINGTON HEIGHTS, IL. SN 85-798,690. PUB. 7-2-2013, FILED 12-10-2012.

# POD STACK

THE MARK CONSISTS OF STANDARD CHARACTERS WITHOUT CLAIM TO ANY PARTICULAR FONT, STYLE, SIZE, OR COLOR.

NO CLAIM IS MADE TO THE EXCLUSIVE RIGHT TO USE "POD", APART FROM THE MARK AS SHOWN.

FOR CONTAINERS FOR HOUSEHOLD OR KITCHEN USE NOT OF PRECIOUS METAL; PORTABLE CONTAINERS FOR STORING HOUSEHOLD AND KITCHEN GOODS, NAMELY, COFFEE, TEA, AND HOT CHOCOLATE, PLASTIC RACKS WITH INDIVIDUAL STORAGE COMPARTMENTS FOR STORING SINGLE SERVINGS OF COFFEE, TEA AND HOT CHOCOLATE IN PLASTIC POD SHAPE (U.S. CLS. 2, 13, 23, 29, 30, 33, 40 AND 50).

FIRST USE 5-23-2013; IN COMMERCE 5-23-2013.

---

4,482,499. BASE BRANDS, LLC, SMYRNA, GA. SN 85-852,571. PUB. 7-9-2013, FILED 2-18-2013.

# Ditch the Disposables

THE MARK CONSISTS OF STANDARD CHARACTERS WITHOUT CLAIM TO ANY PARTICULAR FONT, STYLE, SIZE, OR COLOR.

FOR BOTTLES, SOLD EMPTY; CUPS (U.S. CLS. 2, 13, 23, 29, 30, 33, 40 AND 50).

FIRST USE 3-10-2013; IN COMMERCE 11-15-2013.

**CLASS 21—(Continued).**

4,482,550. FILTREXX INTERNATIONAL, LLC, GRAFTON, OH. SN 85-872,321. PUB. 9-10-2013, FILED 3-11-2013.

# SOILSOXX

THE MARK CONSISTS OF STANDARD CHARACTERS WITHOUT CLAIM TO ANY PARTICULAR FONT, STYLE, SIZE, OR COLOR.

OWNER OF U.S. REG. NOS. 3,745,089, 4,155,589, AND OTHERS.

FOR PLANTERS FOR FLOWERS AND PLANTS (U.S. CLS. 2, 13, 23, 29, 30, 33, 40 AND 50).

FIRST USE 11-8-2013; IN COMMERCE 11-8-2013.

---

4,482,569. SUNCE', SAN MARCOS, CA. SN 85-878,573. PUB. 8-6-2013, FILED 3-18-2013.

# Sunce

THE MARK CONSISTS OF STANDARD CHARACTERS WITHOUT CLAIM TO ANY PARTICULAR FONT, STYLE, SIZE, OR COLOR.

FOR BEVERAGE GLASSWARE; MUGS; GLASS WATER BOTTLES SOLD EMPTY (U.S. CLS. 2, 13, 23, 29, 30, 33, 40 AND 50).

FIRST USE 1-28-2013; IN COMMERCE 9-24-2013.

---

4,482,681. PSP FRANCHISING, LLC, LIVONIA, MI. SN 85-980,581. PUB. 9-6-2011, FILED 10-25-2010.

# PS+

THE MARK CONSISTS OF STANDARD CHARACTERS WITHOUT CLAIM TO ANY PARTICULAR FONT, STYLE, SIZE, OR COLOR.

FOR PET FEEDING AND DRINKING BOWLS; CAGES FOR PETS; PET GROOMING TOOLS, NAMELY, BRUSHES AND COMBS (U.S. CLS. 2, 13, 23, 29, 30, 33, 40 AND 50).

FIRST USE 10-0-2013; IN COMMERCE 10-0-2013.

---

**CLASS 22—CORDAGE AND FIBERS**

**CLASS 22—(Continued).**

4,481,621. KOVRD PRODUCTS INC., CALGARY, ALBERTA, CANADA. SN 85-480,565. PUB. 10-30-2012, FILED 11-23-2011.

---

**MADE BY PAINTERS FOR PAINTERS**

THE MARK CONSISTS OF STANDARD CHARACTERS WITHOUT CLAIM TO ANY PARTICULAR FONT, STYLE, SIZE, OR COLOR.

FOR PAINT BAGS, NAMELY, PLASTIC RE-SEALABLE BAGS FOR HOLDING AND STORING PAINT CANS (U.S. CLS. 1, 2, 7, 19, 22, 42 AND 50).

FIRST USE 12-15-2013; IN COMMERCE 12-15-2013.

---

4,481,775. NEATFREAK GROUP INC., MISSISSAUGA, ONTARIO, CANADA. SN 85-617,175. PUB. 1-8-2013, FILED 5-4-2012.

**NEATBAG**

THE MARK CONSISTS OF STANDARD CHARACTERS WITHOUT CLAIM TO ANY PARTICULAR FONT, STYLE, SIZE, OR COLOR.

OWNER OF U.S. REG. NOS. 3,891,708 AND 4,072,322.

FOR HIGH-DENSITY POLYETHYLENE PLASTIC BAGS FOR THE STORAGE AND ORGANIZING OF HOUSEHOLD ITEMS, NAMELY, RESEALABLE AND COMPRESSIBLE STORAGE BAGS WHICH BECOME COMPRESSED WHEN THE AIR INSIDE IS EVACUATED BY A VACUUM DEVICE; HIGH-DENSITY POLYETHYLENE PLASTIC BAGS FOR THE STORAGE AND ORGANIZING OF HOUSEHOLD ITEMS, NAMELY, RESEALABLE AND COMPRESSIBLE STORAGE BAGS WHICH BECOME COMPRESSED WHEN THE BAG IS ROLLED UP TO EVACUATE THE AIR (U.S. CLS. 1, 2, 7, 19, 22, 42 AND 50).

FIRST USE 1-2-2012; IN COMMERCE 3-7-2012.

---

4,482,259. BOOT ROYALTY COMPANY, L.P., FORT WORTH, TX. SN 85-764,241. PUB. 4-23-2013, FILED 10-26-2012.

**JUSTIN GOLF**

THE MARK CONSISTS OF STANDARD CHARACTERS WITHOUT CLAIM TO ANY PARTICULAR FONT, STYLE, SIZE, OR COLOR.

**CLASS 22—(Continued).**

NO CLAIM IS MADE TO THE EXCLUSIVE RIGHT TO USE "GOLF", APART FROM THE MARK AS SHOWN.

FOR SHOE BAGS FOR STORAGE (U.S. CLS. 1, 2, 7, 19, 22, 42 AND 50).

FIRST USE 9-17-2012; IN COMMERCE 10-0-2012.

---

4,482,541. TRACTOR SUPPLY CO. OF TEXAS, LP, BRENTWOOD, TN. SN 85-868,044. PUB. 9-3-2013, FILED 3-6-2013.



OWNER OF U.S. REG. NOS. 3,475,491 AND 3,806,658. THE MARK CONSISTS OF A FIVE-POINTED STAR IMPOSED ON A TRIANGLE, BOTH OF WHICH ARE INSIDE A POLYGON.

FOR TWINE (U.S. CLS. 1, 2, 7, 19, 22, 42 AND 50).

FIRST USE 2-0-2009; IN COMMERCE 2-0-2009.

**CLASS 23—YARNS AND THREADS**

---

4,482,384. J. & P. COATS, LIMITED, GLASGOW, SCOTLAND. SN 85-807,495. PUB. 5-14-2013, FILED 12-20-2012.

**SWERVE**

THE MARK CONSISTS OF STANDARD CHARACTERS WITHOUT CLAIM TO ANY PARTICULAR FONT, STYLE, SIZE, OR COLOR.

FOR YARNS FOR KNITTING AND CROCHETING (U.S. CL. 43).

FIRST USE 2-16-2012; IN COMMERCE 2-16-2012.

**CLASS 23—(Continued).**

4,482,399. UNIVERSAL YARN, INC., HARRISBURG, NC. SN 85-813,802. PUB. 5-7-2013, FILED 1-2-2013.

**STARRY NIGHTS**

THE MARK CONSISTS OF STANDARD CHARACTERS WITHOUT CLAIM TO ANY PARTICULAR FONT, STYLE, SIZE, OR COLOR.  
FOR YARN (U.S. CL. 43).  
FIRST USE 1-1-2013; IN COMMERCE 1-1-2013.

4,482,598. UNIVERSAL YARN, INC., HARRISBURG, NC. SN 85-887,714. PUB. 9-3-2013, FILED 3-27-2013.

**SUEDE CIRCLES**

THE MARK CONSISTS OF STANDARD CHARACTERS WITHOUT CLAIM TO ANY PARTICULAR FONT, STYLE, SIZE, OR COLOR.  
NO CLAIM IS MADE TO THE EXCLUSIVE RIGHT TO USE "SUEDE", APART FROM THE MARK AS SHOWN.  
FOR YARNS (U.S. CL. 43).  
FIRST USE 1-1-2013; IN COMMERCE 1-1-2013.

4,482,662. UNIVERSAL YARN, INC., HARRISBURG, NC. SN 85-940,694. PUB. 9-3-2013, FILED 5-23-2013.

**STARBELLA FLOWERS**

THE MARK CONSISTS OF STANDARD CHARACTERS WITHOUT CLAIM TO ANY PARTICULAR FONT, STYLE, SIZE, OR COLOR.  
OWNER OF U.S. REG. NOS. 4,092,265 AND 4,113,069.  
FOR YARN (U.S. CL. 43).  
FIRST USE 1-1-2013; IN COMMERCE 1-1-2013.

**CLASS 23—(Continued).**

4,482,663. UNIVERSAL YARN, INC., HARRISBURG, NC. SN 85-940,891. PUB. 8-27-2013, FILED 5-23-2013.

**STARBELLA LACE**

THE MARK CONSISTS OF STANDARD CHARACTERS WITHOUT CLAIM TO ANY PARTICULAR FONT, STYLE, SIZE, OR COLOR.  
OWNER OF U.S. REG. NO. 4,113,069.  
NO CLAIM IS MADE TO THE EXCLUSIVE RIGHT TO USE "LACE", APART FROM THE MARK AS SHOWN.  
FOR YARN (U.S. CL. 43).  
FIRST USE 1-1-2013; IN COMMERCE 1-1-2013.

**CLASS 24—FABRICS**

4,481,350. HETEX BRAMSCH GMBH, BRAMSCH, FED REP GERMANY. SN 77-882,814. PUB. 6-14-2011, FILED 11-30-2009.

**HEYTEX**

THE MARK CONSISTS OF STANDARD CHARACTERS WITHOUT CLAIM TO ANY PARTICULAR FONT, STYLE, SIZE, OR COLOR.  
OWNER OF U.S. REG. NO. 2,643,096.  
FOR FABRICS FOR THE MANUFACTURE OF TARPULINS, AWNINGS, AND INDUSTRIAL COATED CANVAS PRODUCTS (U.S. CLS. 42 AND 50).  
FIRST USE 8-17-2012; IN COMMERCE 8-17-2012.

4,481,363. HARVEY BALL SMILE LIMITED, SHINAGAWA-KU TOKYO, JAPAN. SN 77-918,782. PUB. 3-26-2013, FILED 1-23-2010.



OWNER OF U.S. REG. NO. 3,502,405.

**CLASS 24—(Continued).**

THE MARK CONSISTS OF A SMILEY FACE.

FOR BATH LINEN; BED LINEN AND TABLE LINEN; CANVAS FOR TAPESTRY OR EMBROIDERY; CLOTH LABELS; CURTAIN FABRIC; CURTAINS MADE OF TEXTILE FABRICS; HOUSEHOLD LINEN; TEXTILE FABRICS FOR LINGERIE; TOWELS (U.S. CLS. 42 AND 50).

FIRST USE 2-27-2009; IN COMMERCE 2-27-2009.

---

4,481,696. MIRACLE RESOURCES INTERNATIONAL, LLC, CHARLOTTE, NC. SN 85-565,012. PUB. 7-31-2012, FILED 3-9-2012.

**PEKA**

THE MARK CONSISTS OF STANDARD CHARACTERS WITHOUT CLAIM TO ANY PARTICULAR FONT, STYLE, SIZE, OR COLOR.

FOR DECORATIVE TEXTILE FABRICS, INCLUDING SHEETING, FLANNEL, FLEECE AND SPECIALTY FABRICS FOR USE IN TEXTILE APPLICATIONS, NAMELY, THE MANUFACTURE OF FINISHED TEXTILE PRODUCTS INCLUDING HOME FURNISHINGS, CRAFTS, GIFT ITEMS AND CLOTHING (U.S. CLS. 42 AND 50).

FIRST USE 3-9-2012; IN COMMERCE 3-9-2012.

---

4,481,850. FOUNDATIONS WORLDWIDE, INC., MEDINA, OH. SN 85-655,805. PUB. 1-29-2013, FILED 6-19-2012.

**A FRESH CLEAN CRIB EVERY  
TIME**

THE MARK CONSISTS OF STANDARD CHARACTERS WITHOUT CLAIM TO ANY PARTICULAR FONT, STYLE, SIZE, OR COLOR.

NO CLAIM IS MADE TO THE EXCLUSIVE RIGHT TO USE "CLEAN CRIB", APART FROM THE MARK AS SHOWN.

FOR FITTED CRIB COVERS IN THE NATURE OF COVERS FOR CRIB MATTRESSES (U.S. CLS. 42 AND 50).

FIRST USE 9-11-2013; IN COMMERCE 9-11-2013.

**CLASS 24—(Continued).**

4,482,022. HOMEGOODS, INC., FRAMINGHAM, MA. SN 85-728,063. PUB. 2-19-2013, FILED 9-13-2012.

**COTTONTAIL LANE**

THE MARK CONSISTS OF STANDARD CHARACTERS WITHOUT CLAIM TO ANY PARTICULAR FONT, STYLE, SIZE, OR COLOR.

FOR TABLE LINEN, TABLECLOTHS NOT OF PAPER, TABLE NAPKINS OF TEXTILE, AND FABRIC TABLE RUNNERS; KITCHEN LINENS, KITCHEN TOWELS, AND POT HOLDERS (U.S. CLS. 42 AND 50).

FIRST USE 10-2-2012; IN COMMERCE 10-2-2012.

---

4,482,048. ZHEJIANG GRACE SPINNING & WEAVING GROUP CO., LTD., ZHEJIANG, CHINA. SN 85-731,217. PUB. 2-26-2013, FILED 9-17-2012.



THE MARK CONSISTS OF THE WORDS "GRACE ORCHID" BELOW AN INCOMPLETE FLOWER DESIGN.

FOR FELTS; FITTED BED SHEETS; FITTED TOILET LID COVERS; PLACE MATS OF TEXTILE MATERIAL; QUILTS; QUILTS OF TOWELS; TEXTILE WALL HANGINGS; TOWELS MADE OF TEXTILE MATERIALS; UNFITTED FABRIC FURNITURE COVERS; WASHING MITTS (U.S. CLS. 42 AND 50).

FIRST USE 5-10-2013; IN COMMERCE 5-10-2013.

---

4,482,279. N. FITZ DESIGNS, MORRISVILLE, PA. SN 85-769,285. PUB. 4-23-2013, FILED 11-1-2012.

**Frank + LuLu**

THE MARK CONSISTS OF STANDARD CHARACTERS WITHOUT CLAIM TO ANY PARTICULAR FONT, STYLE, SIZE, OR COLOR.

FOR BED, BATH AND KITCHEN LINENS; BEACH TOWELS (U.S. CLS. 42 AND 50).

FIRST USE 10-1-2013; IN COMMERCE 10-1-2013.

**CLASS 25—CLOTHING**



**CLASS 25—(Continued).**

4,481,299. CHODECKI, JOSEPH, HONOLULU, HI. SN 76-703,478. PUB. 10-25-2011, FILED 6-22-2010.



THE COLORS BLUE, WHITE, YELLOW, BROWN, BLACK AND RED ARE CLAIMED AS A FEATURE OF THE MARK. THE MARK CONSISTS OF THE WORDING "HELLO DOGGY" IN THE COLOR RED WITH BLACK OUTLINING AND YELLOW HIGHLIGHTS, ABOVE THE DESIGN OF A DOGS HEAD AND TORSO. THE DOG'S HAIR IS IN YELLOW AND WHITE. THE EYES ARE BROWN AND THE NOSE AND MOUTH ARE BLACK. THE DOGS TONGUE IS RED AND THE TEETH ARE WHITE. THE WORDING AND DESIGN ARE ON A BLUE BACKGROUND.

FOR CLOTHING, NAMELY, T-SHIRTS, BASEBALL CAPS (U.S. CLS. 22 AND 39).

FIRST USE 4-13-2004; IN COMMERCE 1-30-2013.

4,481,305. FOGATA, BRIAN, VENTURA, CA. AND FOGATA, KATHY, VENTURA, CA. SN 76-709,554. PUB. 10-16-2012, FILED 10-27-2011.



THE MARK CONSISTS OF AN ILLUSTRATION OF A GRAIN WITH A "X" MARK SUPERIMPOSED OVER IT.

FOR CLOTHING, NAMELY, T-SHIRTS, LONG-SLEEVE SHIRTS, TANK TOPS, JACKETS, FOOTWEAR, HEADWEAR, CAPS, HATS (U.S. CLS. 22 AND 39).

FIRST USE 7-1-2012; IN COMMERCE 9-1-2012.

**CLASS 25—(Continued).**

4,481,315. RORION GRACIE, SANTA BARBARA, CA. SN 77-336,999. PUB. 11-8-2011, FILED 11-26-2007.

**GRACIE GIRL**

THE MARK CONSISTS OF STANDARD CHARACTERS WITHOUT CLAIM TO ANY PARTICULAR FONT, STYLE, SIZE, OR COLOR.

OWNER OF U.S. REG. NOS. 2,997,282, 3,091,082, AND OTHERS.

NO CLAIM IS MADE TO THE EXCLUSIVE RIGHT TO USE "GIRL", APART FROM THE MARK AS SHOWN.

FOR CLOTHING AND HEADWEAR, ACTIVEWEAR, SPORTSWEAR, NAMELY, CROP TOPS, HATS, MARTIAL ARTS UNIFORMS, SHIRTS, SPORTS SHIRTS, SWEATTOPS, SWEATSHIRTS, TANK TOPS, T-SHIRTS, TOPS, UNDERWEAR, UNDERGARMENTS (U.S. CLS. 22 AND 39).

FIRST USE 4-9-2008; IN COMMERCE 4-9-2008.

4,481,320. BLUE DRAGON INC., PASADENA, CA. SN 77-563,296. PUB. 12-4-2012, FILED 9-5-2008.

**LEVEL**

THE MARK CONSISTS OF STANDARD CHARACTERS WITHOUT CLAIM TO ANY PARTICULAR FONT, STYLE, SIZE, OR COLOR.

OWNER OF U.S. REG. NOS. 1,879,257, 3,386,240, AND OTHERS.

FOR CLOTHING, NAMELY, PANTS, JEANS, SKIRTS, SHORTS, DRESSES, JACKETS, COATS, T-SHIRTS, NONE OF WHICH ARE ASSOCIATED WITH ALCOHOLIC BEVERAGES (U.S. CLS. 22 AND 39).

FIRST USE 5-15-2013; IN COMMERCE 5-15-2013.

4,481,351. ISAAC DANIEL GROUP, INC., MIRAMAR, FL. SN 77-885,276. PUB. 10-19-2010, FILED 12-3-2009.

**QUANTUM SATELLITE  
TECHNOLOGY**

THE MARK CONSISTS OF STANDARD CHARACTERS WITHOUT CLAIM TO ANY PARTICULAR FONT, STYLE, SIZE, OR COLOR.

**CLASS 25—(Continued).**

NO CLAIM IS MADE TO THE EXCLUSIVE RIGHT TO USE "SATELLITE TECHNOLOGY", APART FROM THE MARK AS SHOWN.

FOR SHOES, FOOTWEAR, T-SHIRTS, SPORTS SHIRTS, SPORTS JERSEYS, SPORTS JACKETS, SPORTS PANTS, TRACK PANTS, SPORTS FLEECE PULLOVERS (U.S. CLS. 22 AND 39).

FIRST USE 9-14-2007; IN COMMERCE 9-14-2007.

---

4,481,365. BRAZILE, TREVOR, DECATUR, TX. SN 77-929,354. PUB. 12-28-2010, FILED 2-5-2010.

# Relentless

THE MARK CONSISTS OF STANDARD CHARACTERS WITHOUT CLAIM TO ANY PARTICULAR FONT, STYLE, SIZE, OR COLOR.

OWNER OF U.S. REG. NOS. 4,203,065 AND 4,268,597.

FOR CLOTHING, NAMELY, PANTS, TOPS, SHORTS, HATS, BELTS, FOOTWEAR AND SWEATSHIRTS (U.S. CLS. 22 AND 39).

FIRST USE 10-1-2012; IN COMMERCE 10-1-2012.

---

4,481,367. THE GOVERNMENT OF THE DISTRICT OF COLUMBIA, WASHINGTON, DC. SN 77-945,202. PUB. 9-21-2010, FILED 2-25-2010.



NO CLAIM IS MADE TO THE EXCLUSIVE RIGHT TO USE "WASHINGTON, DC", "DC", "DISTRICT OF COLUMBIA" AND THE GEOGRAPHIC REPRESENTATION OF THE DISTRICT OF COLUMBIA, APART FROM THE MARK AS SHOWN.

THE MARK CONSISTS OF A SOLID CIRCLE SHAPE WITH A GRAPHICAL DEPICTION OF THE "DISTRICT OF COLUMBIA" SUPERIMPOSED OVER THE LETTERS "DC". THE WORDS "WASHINGTON, DC", SURROUNDED BY A STAR DESIGN ON EACH SIDE, AND THE WORDS "AUTHORIZED BY THE EXECUTIVE OFFICE OF THE MAYOR OF THE DISTRICT OF COLUMBIA", FORM A BORDER AROUND THE CIRCLE.

FOR T-SHIRTS (U.S. CLS. 22 AND 39).

FIRST USE 8-16-2013; IN COMMERCE 8-16-2013.

**CLASS 25—(Continued).**

4,481,370. BROOME ALIZA OCHAYON, NEW YORK, NY. SN 77-960,893. PUB. 4-2-2013, FILED 3-17-2010.

# PROUD TO BE ME

THE MARK CONSISTS OF STANDARD CHARACTERS WITHOUT CLAIM TO ANY PARTICULAR FONT, STYLE, SIZE, OR COLOR.

FOR SHORT SLEEVE TEES; MEN'S SHORT SLEEVE TEES; GIRL'S SHORT SLEEVE TEES; BOY'S SHORT SLEEVE TEES (U.S. CLS. 22 AND 39).

FIRST USE 4-4-2011; IN COMMERCE 4-4-2011.

---

4,481,407. CHANNING BUI ALDRICH, SAN FRANCISCO, CA. SN 85-065,555. PUB. 11-30-2010, FILED 6-17-2010.

# TEMPLUM

THE MARK CONSISTS OF STANDARD CHARACTERS WITHOUT CLAIM TO ANY PARTICULAR FONT, STYLE, SIZE, OR COLOR.

FOR BELTS; BODY SHIRTS; BOTTOMS; DRESS SHIRTS; DRESSES; FABRIC SOLD AS AN INTEGRAL COMPONENT OF FINISHED CLOTHING ITEMS, NAMELY, SHIRTS, SWEATSHIRTS, DRESSES, BLOUSES, PANTS, SHORTS, UNDERGARMENTS; HATS; LONG-SLEEVED SHIRTS; PAJAMAS; PANTS; SHIRTS; SOCKS; SWEATERS; SWIMSUITS; TOPS; WEARABLE GARMENTS AND CLOTHING, NAMELY, SHIRTS (U.S. CLS. 22 AND 39).

FIRST USE 12-3-2013; IN COMMERCE 12-3-2013.

---

4,481,409. NIKE, INC., BEAVERTON, OR. SN 85-067,910. PUB. 5-10-2011, FILED 6-21-2010.



NO CLAIM IS MADE TO THE EXCLUSIVE RIGHT TO USE "ARENA", APART FROM THE MARK AS SHOWN.

THE NAME "MATT ARENA" DOES NOT IDENTIFY ANY LIVING INDIVIDUAL.

**CLASS 25—(Continued).**

THE MARK CONSISTS OF A STYLIZED DESIGN THAT SPELLS "MATT" CENTERED OVER TWO WORDS "MATT ARENA" AND DESIGN.

FOR APPAREL, NAMELY, SHIRTS, T-SHIRTS, PULL-OVERS, JACKETS (U.S. CLS. 22 AND 39).  
FIRST USE 1-13-2011; IN COMMERCE 1-13-2011.

**CLASS 25—(Continued).**

4,481,466. COOGI PARTNERS, LLC, LAKE SUCCESS, NY. SN 85-238,805. PUB. 6-28-2011, FILED 2-10-2011.

4,481,416. MUSTAFA, TYRELLE, JACKSONVILLE, FL. SN 85-095,452. PUB. 7-23-2013, FILED 7-29-2010.



# GODLIFE

THE MARK CONSISTS OF STANDARD CHARACTERS WITHOUT CLAIM TO ANY PARTICULAR FONT, STYLE, SIZE, OR COLOR.

FOR CLOTHING PRODUCTS, NAMELY, BELTS, HATS, HEADBANDS, JACKETS, JERSEYS, WRISTBANDS, T-SHIRTS, V-NECK SHIRTS, SHIRTS, PANTS, BOXER SHORTS, BRIEFS, UNDERWEAR, SWEAT SHIRTS, SHOES, SANDALS, AND CAPS (U.S. CLS. 22 AND 39).

FIRST USE 7-22-2010; IN COMMERCE 7-22-2010.

THE MARK CONSISTS OF THE STYLIZED LETTERS "CGC" WITH THE LETTERS "C" BACKWARD AND FORWARD CONNECTED BY THREE STRIPES AND AN INTERLOCKING LETTER "G"

FOR FOOTWEAR; HEADWEAR; JACKETS; PANTS; SHIRTS (U.S. CLS. 22 AND 39).

FIRST USE 8-19-2013; IN COMMERCE 8-19-2013.

4,481,461. FANTASIA ACCESSORIES, INC., NEW YORK, NY. SN 85-222,829. PUB. 8-30-2011, FILED 1-21-2011.

# LULU

THE MARK CONSISTS OF STANDARD CHARACTERS WITHOUT CLAIM TO ANY PARTICULAR FONT, STYLE, SIZE, OR COLOR.

OWNER OF U.S. REG. NOS. 3,029,550 AND 3,550,248.  
FOR APPAREL, NAMELY, LOUNGEWEAR; ATHLETIC CLOTHING, NAMELY, TRACK SUITS, SHIRTS, RUNNING SHORTS AND TOPS; WARM UP SUITS; SWEATSHIRTS; SWEATPANTS; T-SHIRTS; POLO SHIRTS; WIND SHIRTS, VESTS, JACKETS AND PANTS (U.S. CLS. 22 AND 39).  
FIRST USE 7-30-2013; IN COMMERCE 7-30-2013.

4,481,469. CORBIN, MCKENNY, AIEA, HI. SN 85-249,268. PUB. 1-15-2013, FILED 2-23-2011.

# TEAMME

THE MARK CONSISTS OF STANDARD CHARACTERS WITHOUT CLAIM TO ANY PARTICULAR FONT, STYLE, SIZE, OR COLOR.

FOR HATS; JACKETS; SHIRTS; SWEAT SHIRTS (U.S. CLS. 22 AND 39).  
FIRST USE 9-2-2013; IN COMMERCE 9-5-2013.

**CLASS 25—(Continued).**

4,481,479. PINUCCI LIMITED, LONDON, UNITED KINGDOM. SN 85-275,358. PUB. 11-8-2011, FILED 3-24-2011.



FOR BELTS; BELTS FOR CLOTHING; BOTTOMS; CAPS; CHILDREN'S HEADWEAR; CLOTHING, NAMELY, KHAKIS; FOOTWEAR; GLOVES AS CLOTHING; HEADBANDS FOR CLOTHING; HEADWEAR; JACKETS; JERSEYS; LEATHER BELTS; LEATHER HEADWEAR; MUFFLERS; TIES; TOPS; WEARABLE GARMENTS AND CLOTHING, NAMELY, SHIRTS; WOMEN'S CLOTHING, NAMELY, SHIRTS, DRESSES, SKIRTS, BLOUSES (U.S. CLS. 22 AND 39).  
FIRST USE 3-1-2011; IN COMMERCE 2-1-2013.

4,481,493. ABERCROMBIE & FITCH TRADING CO., NEW ALBANY, OH. SN 85-308,696. PUB. 10-11-2011, FILED 4-29-2011.

**GILLY HICKS BONDI BEACH**

THE MARK CONSISTS OF STANDARD CHARACTERS WITHOUT CLAIM TO ANY PARTICULAR FONT, STYLE, SIZE, OR COLOR.

OWNER OF U.S. REG. NOS. 3,836,281, 3,849,016, AND 3,849,017.

NO CLAIM IS MADE TO THE EXCLUSIVE RIGHT TO USE "BONDI BEACH", APART FROM THE MARK AS SHOWN.

THE NAME(S), PORTRAIT(S), AND/OR SIGNATURE(S) SHOWN IN THE MARK DOES NOT IDENTIFY A PARTICULAR LIVING INDIVIDUAL.

FOR LINGERIE; TOPS; UNDERGARMENTS (U.S. CLS. 22 AND 39).

FIRST USE 6-17-2009; IN COMMERCE 6-17-2009.

**CLASS 25—(Continued).**

4,481,524. DISNEY ENTERPRISES, INC., BURBANK, CA. SN 85-381,627. PUB. 4-17-2012, FILED 7-26-2011.

**FRANKENWEENIE**

THE MARK CONSISTS OF STANDARD CHARACTERS WITHOUT CLAIM TO ANY PARTICULAR FONT, STYLE, SIZE, OR COLOR.

FOR CLOTHING, NAMELY, COSTUMES FOR USE IN ROLE-PLAYING GAMES, HALLOWEEN COSTUMES; HEADWEAR (U.S. CLS. 22 AND 39).

FIRST USE 11-0-2012; IN COMMERCE 11-0-2012.

4,481,532. HBI BRANDED APPAREL ENTERPRISES, LLC, WINSTON-SALEM, NC. SN 85-395,071. PUB. 4-2-2013, FILED 8-11-2011.

**POWER COTTON**

THE MARK CONSISTS OF STANDARD CHARACTERS WITHOUT CLAIM TO ANY PARTICULAR FONT, STYLE, SIZE, OR COLOR.

NO CLAIM IS MADE TO THE EXCLUSIVE RIGHT TO USE "COTTON", APART FROM THE MARK AS SHOWN.

FOR SHIRTS, SHORTS, SWEATPANTS, SWEATSHIRTS, T-SHIRTS MADE PRIMARILY OF COTTON (U.S. CLS. 22 AND 39).

FIRST USE 1-31-2013; IN COMMERCE 1-31-2013.

4,481,549. DREW BRADY COMPANY INC., OAKVILLE, ONTARIO, CANADA. SN 85-421,089. PUB. 3-13-2012, FILED 9-13-2011.

**GENTLE GRIP**

THE MARK CONSISTS OF STANDARD CHARACTERS WITHOUT CLAIM TO ANY PARTICULAR FONT, STYLE, SIZE, OR COLOR.

NO CLAIM IS MADE TO THE EXCLUSIVE RIGHT TO USE "GRIP", APART FROM THE MARK AS SHOWN.

FOR SOCKS (U.S. CLS. 22 AND 39).

FIRST USE 10-20-2013; IN COMMERCE 10-20-2013.

**CLASS 25—(Continued).**

4,481,565. NISSAY SAO, CYPRESS, CA. SN 85-434,144. PUB. 9-11-2012, FILED 9-28-2011.



WIN EVERYTHING TODAY

THE MARK CONSISTS OF THE WORD "WET" WITH A SMALL WATERDROP NEXT TO THE "T", WITH A LARGER WATERDROP NEXT TO THE WORD, WITH THE WORDS "WIN EVERYTHING TODAY" APPEARING BELOW.

FOR CLOTHING, NAMELY, HATS, T-SHIRTS, SWEATSHIRTS, JEANS, SWIMWEAR (U.S. CLS. 22 AND 39).

FIRST USE 5-3-2013; IN COMMERCE 5-3-2013.

---

4,481,578. ROBERTS, JONATHAN, LAKE LAND, FL. SN 85-445,793. PUB. 3-27-2012, FILED 10-12-2011.

## POCKET7

THE MARK CONSISTS OF STANDARD CHARACTERS WITHOUT CLAIM TO ANY PARTICULAR FONT, STYLE, SIZE, OR COLOR.

FOR BEANIES; HOODED SWEAT SHIRTS; SHIRTS; SHIRTS AND SHORT-SLEEVED SHIRTS; SWEAT PANTS; SWEAT SHIRTS; TANK TOPS; WOMEN'S CLOTHING, NAMELY, SHIRTS, DRESSES, SKIRTS, BLOUSES (U.S. CLS. 22 AND 39).

FIRST USE 7-7-2012; IN COMMERCE 7-7-2012.

---

4,481,583. FIFTH STREET GAMING, LLC, LAS VEGAS, NV. SN 85-451,545. PUB. 3-27-2012, FILED 10-19-2011.

## DOWNTOWN GRAND

THE MARK CONSISTS OF STANDARD CHARACTERS WITHOUT CLAIM TO ANY PARTICULAR FONT, STYLE, SIZE, OR COLOR.

FOR CAPS; HATS; HEADWEAR; JACKETS; SHIRTS; T-SHIRTS (U.S. CLS. 22 AND 39).

FIRST USE 10-27-2013; IN COMMERCE 10-27-2013.

**CLASS 25—(Continued).**

4,481,611. AMERICAN SPORTS LICENSING, INC., WILMINGTON, DE. SN 85-476,778. PUB. 10-2-2012, FILED 11-18-2011.

## FIELD & STREAM

THE MARK CONSISTS OF STANDARD CHARACTERS WITHOUT CLAIM TO ANY PARTICULAR FONT, STYLE, SIZE, OR COLOR.

OWNER OF U.S. REG. NOS. 661,685, 3,109,945, AND OTHERS.

FOR SLIPPERS (U.S. CLS. 22 AND 39).

FIRST USE 10-14-2013; IN COMMERCE 10-14-2013.

---

4,481,613. SHOWTIME NETWORKS INC., NEW YORK, NY. SN 85-478,837. PUB. 5-1-2012, FILED 11-22-2011.

## HOUSE OF LIES

THE MARK CONSISTS OF STANDARD CHARACTERS WITHOUT CLAIM TO ANY PARTICULAR FONT, STYLE, SIZE, OR COLOR.

FOR APPAREL, NAMELY, SHIRTS (U.S. CLS. 22 AND 39).

FIRST USE 1-31-2012; IN COMMERCE 1-31-2012.

---

4,481,633. LACROSSE FOOTWEAR, INC., PORTLAND, OR. SN 85-492,125. PUB. 3-12-2013, FILED 12-9-2011.

## DRY-CORE

THE MARK CONSISTS OF STANDARD CHARACTERS WITHOUT CLAIM TO ANY PARTICULAR FONT, STYLE, SIZE, OR COLOR.

FOR FABRIC SOLD AS AN INTEGRAL COMPONENT OF FINISHED CLOTHING ITEMS, NAMELY, FOOTWEAR (U.S. CLS. 22 AND 39).

FIRST USE 12-31-2011; IN COMMERCE 7-31-2012.

**CLASS 25—(Continued).**

4,481,650. CW CONSULTING, INC., RENO, NV. SN 85-523,192. PUB. 6-19-2012, FILED 1-23-2012.

# CARBONERRO

THE MARK CONSISTS OF STANDARD CHARACTERS WITHOUT CLAIM TO ANY PARTICULAR FONT, STYLE, SIZE, OR COLOR.

FOR ATHLETIC APPAREL, NAMELY, SHIRTS, HATS AND CAPS (U.S. CLS. 22 AND 39).

FIRST USE 7-0-2012; IN COMMERCE 7-0-2012.

**CLASS 25—(Continued).**

4,481,666. LARRY RIVERS HILL, AKA LARRY R. HILL, PHILADELPHIA, PA. SN 85-538,922. PUB. 2-5-2013, FILED 2-9-2012.



THE MARK CONSISTS OF THE WORD, "REAL", INSIDE AN OVAL BROKEN IN TWO PLACES AND FORMED BY TWO CURVED LINES, WITH THE "R" OF THE WORD "REAL" SHOWN INSIDE A SHADED CIRCLE; ALL ABOVE THE WORDS, "REACHING EVERY ATHLETIC LEVEL", IN A STYLIZED FORM.

FOR ATHLETIC APPAREL, NAMELY, SHIRTS, PANTS, JACKETS, FOOTWEAR, HATS AND CAPS, ATHLETIC UNIFORMS (U.S. CLS. 22 AND 39).

FIRST USE 9-1-2012; IN COMMERCE 9-1-2012.

4,481,662. FIELD & STREAM LICENSES COMPANY, LLC, WESTPORT, CT. SN 85-536,065. PUB. 5-15-2012, FILED 2-7-2012.

# TRAILCORE

THE MARK CONSISTS OF STANDARD CHARACTERS WITHOUT CLAIM TO ANY PARTICULAR FONT, STYLE, SIZE, OR COLOR.

FOR CLOTHING, NAMELY, SHORTS, PANTS, SHIRTS, BIB OVERALLS; BASE LAYER CLOTHING, NAMELY, UNDERWEAR, THERMAL UNDERWEAR, UNDERGARMENTS, BASE LAYER TOPS, AND BASE LAYER BOTTOMS; SCENT CONTROL CLOTHING, NAMELY, SHIRTS, PANTS, HUNTING JACKETS, HUNTING VESTS, JACKETS, CAPS, AND OVERALLS SPECIALLY DESIGNED TO REDUCE OR CONTROL SCENT; GLOVES, GAITERS, VESTS, HEAD COVERS, NAMELY, HATS, CAPS, BANDANNAS, HEADWEAR (U.S. CLS. 22 AND 39).

FIRST USE 10-0-2013; IN COMMERCE 10-0-2013.

4,481,667. SCG POWER RANGERS LLC, LOS ANGELES, CA. SN 85-538,927. PUB. 2-19-2013, FILED 2-9-2012.



THE MARK CONSISTS OF AN INTERLOCKING DIAMOND DESIGN ACROSS THE FRONT OF A HOODED SWEATSHIRT AND AT THE BOTTOM OF THE SLEEVES. THE DESIGN FEATURES SHOWN IN DOTTED OR BROKEN LINES ARE NOT PART OF THE MARK AND SERVE ONLY TO SHOW THE POSITION OR PLACEMENT OF THE MARK.

FOR WARM UP SUITS; JOGGING SUITS; SWEAT SUITS; SWEAT SHIRTS; TOPS; PULLOVERS; SWEATERS; PLAYSUITS; JACKETS; PARKAS; WIND RESISTANT JACKETS (U.S. CLS. 22 AND 39).

FIRST USE 7-0-2013; IN COMMERCE 7-0-2013.

**CLASS 25—(Continued).**

4,481,670. ROMANO, CHASE, HOUSTON, TX. SN 85-539,986.  
PUB. 7-17-2012, FILED 2-10-2012.



THE MARK CONSISTS OF THE CAPITAL LETTERS "SM" WITH A STAR ON THE LOWER RIGHT PORTION OF THE LETTER "M".

FOR HOODED SWEATSHIRTS; PANTS; SHIRTS; SHOES; SWEATERS; T-SHIRTS (U.S. CLS. 22 AND 39).  
FIRST USE 6-7-2013; IN COMMERCE 6-7-2013.

**CLASS 25—(Continued).**

4,481,703. COLORADO ROCKIES BASEBALL CLUB, LTD., DENVER, CO. SN 85-570,775. PUB. 9-18-2012, FILED 3-15-2012.



THE MARK CONSISTS OF THE LETTERS "GJ" IN A STYLIZED TEXT FORM.

FOR CLOTHING, NAMELY, HEADWEAR, SHIRTS, INFANT WEAR (U.S. CLS. 22 AND 39).  
FIRST USE 2-26-2012; IN COMMERCE 2-26-2012.

4,481,724. UNHINGED PRODUCTIONS, LLC, MULESHOE, TX. SN 85-593,513. PUB. 9-4-2012, FILED 4-10-2012.

**FORT WORTH IT**

THE MARK CONSISTS OF STANDARD CHARACTERS WITHOUT CLAIM TO ANY PARTICULAR FONT, STYLE, SIZE, OR COLOR.

FOR CLOTHING, NAMELY, T-SHIRTS, POLO SHIRTS, BUTTON FRONT SHIRTS, SWEAT SHIRTS, DRESS SHIRTS (U.S. CLS. 22 AND 39).

FIRST USE 10-25-2013; IN COMMERCE 10-25-2013.

4,481,675. NAVARRETE, LAURA, PHILADELPHIA, PA. SN 85-547,287. PUB. 1-22-2013, FILED 2-20-2012.

היי **SPOKEN PROPHECY**  
Apparel

NO CLAIM IS MADE TO THE EXCLUSIVE RIGHT TO USE "APPAREL", APART FROM THE MARK AS SHOWN.

THE MARK CONSISTS OF THE WORDS "SPOKEN PROPHECY APPAREL" AND THE HEBREW LETTERS "HEY YUD YUD".

THE NON-LATIN CHARACTERS IN THE MARK TRANSLITERATE TO "HEY YUD YUD" AND THIS MEANS "PROPHECY AND PARALLEL UNIVERSES" IN ENGLISH.

FOR BELTS; BLAZERS; BLOUSES; COATS; DRESSES; DRESSES MADE FROM SKINS; JACKETS; JEANS; LEGGINGS; PANTS; SCARFS; SHIRTS; SHORTS; SKIRTS; SLACKS; SLEEPWEAR; SWEATERS; TANK TOPS; TROUSERS; UNDERGARMENTS; VESTS (U.S. CLS. 22 AND 39).  
FIRST USE 5-0-2012; IN COMMERCE 5-0-2012.

4,481,732. DAVID J. CHO, PLANO, TX. SN 85-596,083. PUB. 9-11-2012, FILED 4-12-2012.

**DIACRITIC**

THE MARK CONSISTS OF STANDARD CHARACTERS WITHOUT CLAIM TO ANY PARTICULAR FONT, STYLE, SIZE, OR COLOR.

FOR T-SHIRTS (U.S. CLS. 22 AND 39).  
FIRST USE 6-1-2013; IN COMMERCE 6-1-2013.

**CLASS 25—(Continued).**

4,481,757. PANZA, GINO, ST. CLOUD, FL. SN 85-603,677.  
PUB. 9-18-2012, FILED 4-20-2012.

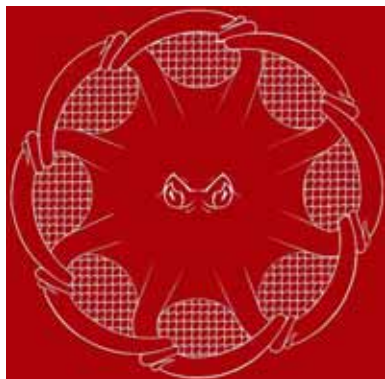

THE COLOR(S) RED AND WHITE IS/ARE CLAIMED AS A FEATURE OF THE MARK.

THE MARK CONSISTS OF AN OCTOPUS WITH EIGHT TENTACLES EXTENDING AND THAT ARE INTERCONNECTED. THE CENTER OF THE OCTOPUS PRESENTS THE OCTOPUS' EYES AND BROW. THE OPEN SPACE BETWEEN THE MAIN BODY AND TENTACLES OF THE OCTOPUS PRESENTS A WHITE NET LIKE IMAGE. THE BODY AND TENTACLES OF THE OCTOPUS ARE RED.

FOR HATS; T-SHIRTS (U.S. CLS. 22 AND 39).  
FIRST USE 11-8-2013; IN COMMERCE 11-8-2013.

4,481,789. GEORGE D. JOHNSON, NASHVILLE, TN. SN 85-623,415. PUB. 10-23-2012, FILED 5-11-2012.

## Still Pissed At Yoko

THE MARK CONSISTS OF STANDARD CHARACTERS WITHOUT CLAIM TO ANY PARTICULAR FONT, STYLE, SIZE, OR COLOR.

FOR JACKETS; SWEAT SHIRTS; T-SHIRTS (U.S. CLS. 22 AND 39).  
FIRST USE 12-15-2011; IN COMMERCE 12-15-2011.

**CLASS 25—(Continued).**

4,481,790. CAMPBELL, CHANTAY, MOUNT VERNON, NY. SN 85-623,959. PUB. 10-23-2012, FILED 5-14-2012.

## JAMAICAS DIVAZ

THE MARK CONSISTS OF STANDARD CHARACTERS WITHOUT CLAIM TO ANY PARTICULAR FONT, STYLE, SIZE, OR COLOR.

FOR CLOTHING, NAMELY, HEADWEAR, TOPS, BOTTOMS, SHIRTS, PANTS, DRESSES, TANK TOPS AND SHORTS (U.S. CLS. 22 AND 39).

FIRST USE 6-10-2012; IN COMMERCE 6-10-2012.

4,481,822. MOAB BREWERS, L.L.C., PARK CITY, UT. SN 85-640,266. PUB. 3-19-2013, FILED 5-31-2012.

## MOAB BREWERY

THE MARK CONSISTS OF STANDARD CHARACTERS WITHOUT CLAIM TO ANY PARTICULAR FONT, STYLE, SIZE, OR COLOR.

OWNER OF U.S. REG. NO. 2,660,953.  
SEC. 2(F).

FOR CLOTHING, NAMELY, TEE SHIRTS, COLLARED SHIRTS, HOODED SWEATSHIRTS, FLEECE VESTS, SOCKS, THERMAL UNDERWEAR, PANTIES, HATS, VISORS (U.S. CLS. 22 AND 39).

FIRST USE 5-5-1996; IN COMMERCE 5-5-1996.

4,481,829. MELISSA VAP LLC, WASHINGTON, DC. SN 85-647,904. PUB. 7-16-2013, FILED 6-10-2012.

## suivez-moi-jeune-homme

THE MARK CONSISTS OF STANDARD CHARACTERS WITHOUT CLAIM TO ANY PARTICULAR FONT, STYLE, SIZE, OR COLOR.

THE ENGLISH TRANSLATION OF "SUIVEZ-MOI-JEUNE-HOMME" IN THE MARK IS "FOLLOW-ME-YOUNG-MAN".

FOR BERETS; HATS; HEAD WEAR; HEADBANDS; HEADBANDS FOR CLOTHING; HEADGEAR, NAMELY, HATS, FASCINATORS, HEADBANDS, HEADPIECES, AND OTHER MILLINERY PRODUCTS, NAMELY, CAPS, BUCKET HATS, BONNETS, BOWLERS, BERETS, BANDEAUS, BEANIES, BOATERS, CLOCHES, COCKTAIL HATS, HOMBURGS, FEDORAS, JULIET CAPS, PILLBOXES, PERCHERS, SUN HATS, AND TURBINES; MILLINERY, NAMELY, FASCINATORS; SMALL HATS; WOMEN'S HATS AND HOODS (U.S. CLS. 22 AND 39).

FIRST USE 7-12-2012; IN COMMERCE 12-10-2012.



**CLASS 25—(Continued).**

4,481,831. DASHAMERICA, INC., LOUISVILLE, CO. SN 85-648,721. PUB. 10-9-2012, FILED 6-11-2012.

# X-PROJECT

THE MARK CONSISTS OF STANDARD CHARACTERS WITHOUT CLAIM TO ANY PARTICULAR FONT, STYLE, SIZE, OR COLOR.  
FOR FOOTWEAR (U.S. CLS. 22 AND 39).  
FIRST USE 5-0-2013; IN COMMERCE 5-0-2013.

4,481,839. NORMARK CORPORATION, MINNETONKA, MN. SN 85-651,540. PUB. 10-30-2012, FILED 6-14-2012.

# ICE FORCE

THE MARK CONSISTS OF STANDARD CHARACTERS WITHOUT CLAIM TO ANY PARTICULAR FONT, STYLE, SIZE, OR COLOR.  
FOR CLOTHING FOR ADULTS AND CHILDREN, NAMELY, ARM-WARMERS, BASE LAYERS, BOOTS, CAPS, COWLS, EAR-WARMERS, EARMUFFS, FLEECE BOTTOMS, FLEECE PULLOVERS, FLEECE TOPS, FLEECE VESTS, FOOT-WARMERS, GLOVES, HAND-WARMERS, HATS, HEADBANDS, HOODS, JACKETS, KNEE-WARMERS, MITTENS, MUFFLERS, MUFFS, NECK TUBES, PANTS, SCARVES, SHOULDER WRAPS FOR CLOTHING, SHIRTS, SNOWPANTS, SOCKS, SWEATERS, SWEATSHIRTS, T-SHIRTS, VESTS (U.S. CLS. 22 AND 39).  
FIRST USE 10-1-2013; IN COMMERCE 10-1-2013.

4,481,848. PIERRE NICOL CORPORATION, LOS ANGELES, CA. SN 85-654,948. PUB. 5-28-2013, FILED 6-18-2012.

# CUTIE CANDY

THE MARK CONSISTS OF STANDARD CHARACTERS WITHOUT CLAIM TO ANY PARTICULAR FONT, STYLE, SIZE, OR COLOR.  
FOR CLOTHING, NAMELY, FOOTWEAR, HEADWEAR, TOPS, BOTTOMS, SHIRTS, PANTS, SEAMLESS TOPS, SEAMLESS LEGGINGS, T-SHIRTS, JACKETS, JEANS, DRESSES, WOVEN AND KNIT CLOTHING ITEMS, NAMELY, TOPS AND BOTTOMS; MATERNITY CLOTHING, NAMELY, FOOTWEAR, HEADWEAR, TOPS, BOTTOMS, SHIRTS, PANTS, SEAMLESS TOPS, SEAMLESS LEGGINGS, T-SHIRTS, JACKETS, JEANS, DRESSES (U.S. CLS. 22 AND 39).  
FIRST USE 8-1-2013; IN COMMERCE 8-1-2013.

**CLASS 25—(Continued).**

4,481,889. RIVERS BAILEY, PAUL, COHOES, NY. SN 85-672,620. PUB. 12-11-2012, FILED 7-10-2012.

# Urban Hippie

THE MARK CONSISTS OF STANDARD CHARACTERS WITHOUT CLAIM TO ANY PARTICULAR FONT, STYLE, SIZE, OR COLOR.  
FOR ATHLETIC APPAREL, NAMELY, SHIRTS, PANTS, JACKETS, FOOTWEAR, HATS AND CAPS, ATHLETIC UNIFORMS; HOODED SWEAT SHIRTS; SHORT-SLEEVED OR LONG-SLEEVED T-SHIRTS (U.S. CLS. 22 AND 39).  
FIRST USE 8-25-2012; IN COMMERCE 8-25-2012.

4,481,905. MOORE, HOLLEY MELISSA, PENSACOLA, FL. SN 85-682,765. PUB. 4-23-2013, FILED 7-20-2012.

# COOTIES COLLECTION

THE MARK CONSISTS OF STANDARD CHARACTERS WITHOUT CLAIM TO ANY PARTICULAR FONT, STYLE, SIZE, OR COLOR.  
NO CLAIM IS MADE TO THE EXCLUSIVE RIGHT TO USE "COLLECTION", APART FROM THE MARK AS SHOWN.  
FOR CLOTHING, NAMELY, ONE PIECE GARMENTS FOR INFANTS AND CHILDREN AND T-SHIRTS (U.S. CLS. 22 AND 39).  
FIRST USE 10-25-2013; IN COMMERCE 10-25-2013.

**CLASS 25—(Continued).**

4,481,912. DIANA, ZAPATERIA INC., POMONA, CA. SN 85-685,858. PUB. 1-1-2013, FILED 7-24-2012.

**JRALF**

THE MARK CONSISTS OF STANDARD CHARACTERS WITHOUT CLAIM TO ANY PARTICULAR FONT, STYLE, SIZE, OR COLOR.

FOR MEN'S AND BOY'S WEARING APPAREL, NAMELY, T-SHIRTS, SWEATSHIRTS, TANK TOPS, WOVEN SHIRTS, SWEATERS, CARDIGANS, VESTS, JACKETS, PANTS, SWEATPANTS, JEANS, SHORTS, HATS, CAPS, COATS, SCARVES, WRIST BANDS, GLOVES, BELTS WORN WITH CLOTHING, PAJAMAS, SHOES, SOCKS, UNDERWEAR, SWIM WEAR, AND TRUNKS; AND WOMEN'S AND GIRL'S WEARING APPAREL, NAMELY, T-SHIRTS, SWEATSHIRTS, TANK TOPS, WOVEN SHIRTS, SWEATERS, CARDIGANS, VESTS, JACKETS, PANTS, SWEATPANTS, JEANS, SHORTS, HATS, CAPS, COATS, BELTS WORN WITH CLOTHING, SCARVES, WRIST BANDS, HEADBANDS, GLOVES, PAJAMAS, SHOES, SOCKS, UNDERWEAR, BRAS, SKIRTS, DRESSES, BLOUSES, SWIM WEAR, AND BIKINIS (U.S. CLS. 22 AND 39).

FIRST USE 8-24-2012; IN COMMERCE 8-24-2012.

4,481,932. DAVILA, EDWARD, GARDENA, CA. SN 85-696,717. PUB. 1-15-2013, FILED 8-7-2012.

**ART IS MY DRUG**

THE MARK CONSISTS OF STANDARD CHARACTERS WITHOUT CLAIM TO ANY PARTICULAR FONT, STYLE, SIZE, OR COLOR.

FOR CLOTHING, NAMELY, T-SHIRTS, TANK-TOPS, SWEATERS AND JACKETS (U.S. CLS. 22 AND 39).

FIRST USE 7-1-2012; IN COMMERCE 7-1-2012.

**CLASS 25—(Continued).**

4,481,989. MCWHORTER, JEREMIAH TAYLOR, PASCA-GOULA, MS. SN 85-719,130. PUB. 2-5-2013, FILED 9-2-2012.

**PELICAN REPUBLIC**

THE MARK CONSISTS OF STANDARD CHARACTERS WITHOUT CLAIM TO ANY PARTICULAR FONT, STYLE, SIZE, OR COLOR.

FOR CLOTHING FOR MEN, WOMAN AND KIDS, NAMELY, POLO SHIRTS, LONG SLEEVED SHIRTS, T-SHIRTS, JEANS, SHORTS, JACKETS, TIES, BELTS, UNDERWEAR, SWIM WEAR, AND BATHING SUITS; FOOTWEAR; HEADWEAR, NAMELY, BEANIES, HATS, AND VISORS (U.S. CLS. 22 AND 39).

FIRST USE 3-12-2013; IN COMMERCE 5-25-2013.

4,481,996. KELLEY, JEFFREY J., NEWBURYPORT, MA. SN 85-721,635. PUB. 2-12-2013, FILED 9-6-2012.



THE MARK CONSISTS OF STYLIZED WORD "FIELD-HAUS" WITH FLAG MADE PART OF THE "L" OF THE WORD.

FOR ATHLETIC APPAREL, NAMELY, SHIRTS, PANTS, JACKETS, FOOTWEAR, HATS AND CAPS, ATHLETIC UNIFORMS (U.S. CLS. 22 AND 39).

FIRST USE 6-1-2013; IN COMMERCE 6-2-2013.

**CLASS 25—(Continued).**

4,482,000. ISPORTCORP, INC., DELRAY BEACH, FL. SN 85-723,365. PUB. 3-5-2013, FILED 9-7-2012.



THE MARK CONSISTS OF THE STYLIZED LETTER "M" ABOVE THE STYLIZED LETTER "T" WITH THE WORD "MACKENTOSH" PRINTED BELOW.

FOR CLOTHING, NAMELY, SPORTS AND FITNESS GARMENTS, NAMELY, SHIRTS, SHORTS, PANTS, CAPS, SOCKS, LEGGINGS, ARM AND WRIST SLEEVES IN THE NATURE OF SWEAT BANDS, WRIST AND HEAD BANDS; COMPRESSION GARMENTS, NAMELY, SHIRTS, SHORTS, LEGGINGS, AND ARM SLEEVES IN THE NATURE OF SWEAT BANDS (U.S. CLS. 22 AND 39).

FIRST USE 7-30-2013; IN COMMERCE 7-30-2013.

4,482,012. MADISON BRANDS, INC., NEW YORK, NY. SN 85-726,876. PUB. 2-19-2013, FILED 9-12-2012.

**BROOKE LEIGH**

THE MARK CONSISTS OF STANDARD CHARACTERS WITHOUT CLAIM TO ANY PARTICULAR FONT, STYLE, SIZE, OR COLOR.

THE NAME(S), PORTRAIT(S), AND/OR SIGNATURE(S) SHOWN IN THE MARK DOES NOT IDENTIFY A PARTICULAR LIVING INDIVIDUAL.

FOR DRESSES; JACKETS; JEANS; PANTS; SHIRTS; SHORTS; T-SHIRTS; TOPS (U.S. CLS. 22 AND 39).

FIRST USE 4-27-2012; IN COMMERCE 4-27-2012.

**CLASS 25—(Continued).**

4,482,014. BERGLUND, BRIAN, NORWICH, CT. SN 85-727,023. PUB. 2-19-2013, FILED 9-12-2012.

**THREADS OF WISDOM**

THE MARK CONSISTS OF STANDARD CHARACTERS WITHOUT CLAIM TO ANY PARTICULAR FONT, STYLE, SIZE, OR COLOR.

NO CLAIM IS MADE TO THE EXCLUSIVE RIGHT TO USE "THREADS", APART FROM THE MARK AS SHOWN. FOR HATS; SHIRTS; T-SHIRTS; TANK-TOPS (U.S. CLS. 22 AND 39).

FIRST USE 4-0-2013; IN COMMERCE 4-0-2013.

4,482,017. LAFFERTY, LACEY, LAUREL, DE. SN 85-727,762. PUB. 9-3-2013, FILED 9-13-2012.

**Laff**

THE MARK CONSISTS OF STANDARD CHARACTERS WITHOUT CLAIM TO ANY PARTICULAR FONT, STYLE, SIZE, OR COLOR.

FOR HATS; HOODED SWEATSHIRTS; JACKETS; PANTS; SHORT-SLEEVED OR LONG-SLEEVED T-SHIRTS; SHORTS; SOCKS; SWEATERS; SWEATSHIRTS; T-SHIRTS; TANK TOPS; TIES (U.S. CLS. 22 AND 39).

FIRST USE 9-9-2012; IN COMMERCE 9-9-2012.

4,482,019. UNITING FUTURE LEGENDS LTD., ROAD TOWN, TORTOLA, BR.VIRGIN ISLANDS. SN 85-727,853. PUB. 3-5-2013, FILED 9-13-2012.

**Alpine Performance Gear**

THE MARK CONSISTS OF STANDARD CHARACTERS WITHOUT CLAIM TO ANY PARTICULAR FONT, STYLE, SIZE, OR COLOR.

NO CLAIM IS MADE TO THE EXCLUSIVE RIGHT TO USE "PERFORMANCE GEAR", APART FROM THE MARK AS SHOWN.

FOR ACTIVE WEAR, NAMELY, LONG AND SHORT SLEEVED T-SHIRTS, PANTS, SHORTS, TANK TOPS, PULLOVERS, PERFORMANCE AND ATHLETIC JACKETS, SKIRTS, SKORTS, SPORTS BRAS, ATHLETIC TOPS, PERFORMANCE TOPS, HEAVYWEIGHT JACKETS, SWEATERS (U.S. CLS. 22 AND 39).

FIRST USE 9-27-2012; IN COMMERCE 9-27-2012.

**CLASS 25—(Continued).**

4,482,027. EDDIE DOMANI, L.L.C., NEW YORK, NY. SN 85-728,535. PUB. 2-19-2013, FILED 9-13-2012.



THE MARK CONSISTS OF A HAWK DESIGN WITH WINGS SPREAD OUTWARDLY AND A SWORD POINTING DOWNWARD AT THE BOTTOM TAIL PORTION. A CIRCULAR PORTION IS LOCATED IN THE CENTER OF THE DRAWING.

FOR JEANS; SHIRTS; SHORTS; T-SHIRTS (U.S. CLS. 22 AND 39).

FIRST USE 3-30-2013; IN COMMERCE 3-30-2013.

**CLASS 25—(Continued).**

4,482,054. HU HOLDINGS, LLC, NEW YORK, NY. SN 85-731,525. PUB. 8-27-2013, FILED 9-18-2012.



THE MARK CONSISTS OF THE STYLIZED LETTER "H" FOLLOWED BY THE STYLIZED CHARACTER URING (I.E., LATIN LETTER "U" WITH RING ABOVE), WITH THE "U" PORTION FORMED BY THE CUPPED FINGERS OF THE DESIGN OF A HAND.

THE WORDING "HU" HAS NO MEANING IN A FOREIGN LANGUAGE.

FOR HATS; WEARABLE GARMENTS AND CLOTHING, NAMELY, SHIRTS (U.S. CLS. 22 AND 39).

FIRST USE 9-26-2012; IN COMMERCE 9-26-2012.

4,482,058. BLEVINS, RUSSELL JARID, GALT, CA. SN 85-732,152. PUB. 3-5-2013, FILED 9-18-2012.



THE MARK CONSISTS OF TEXT "F.T.W" INSIDE OF THE FORE-FINGER ON A HAND. THE HAND INCLUDES TWO EXTENDED FINGERS, WHICH REPRESENT THE NUMBER TWO BY SIGN.

FOR GLOVES; JERSEYS; PANTS (U.S. CLS. 22 AND 39).

FIRST USE 10-1-2013; IN COMMERCE 10-1-2013.

4,482,049. ZHEJIANG GRACE SPINNING & WEAVING GROUP CO., LTD., ZHEJIANG, CHINA. SN 85-731,218. PUB. 2-26-2013, FILED 9-17-2012.



THE MARK CONSISTS OF THE WORDS "GRACE ORCHID" BELOW AN INCOMPLETE FLOWER DESIGN.

FOR CAPS; GIRDLES; GLOVES; HOSIERY; LAYETTES; PANTS; RAIN WEAR; SHIRTS; SHOES; SHOWER CAPS; SKIRTS; TIES (U.S. CLS. 22 AND 39).

FIRST USE 11-10-2012; IN COMMERCE 11-10-2012.

**CLASS 25—(Continued).**

4,482,063. LORI VERBENEC, ALISO VIEJO, CA. SN 85-733,098. PUB. 3-12-2013, FILED 9-19-2012.

## Soul Threads

THE MARK CONSISTS OF STANDARD CHARACTERS WITHOUT CLAIM TO ANY PARTICULAR FONT, STYLE, SIZE, OR COLOR.

NO CLAIM IS MADE TO THE EXCLUSIVE RIGHT TO USE "THREADS", APART FROM THE MARK AS SHOWN. FOR PANTS, SKIRTS, TOPS, T-SHIRTS, SCARVES, BELTS, HATS, JACKETS, SWEATERS, SHORTS (U.S. CLS. 22 AND 39).

FIRST USE 8-15-2012; IN COMMERCE 8-1-2013.

**CLASS 25—(Continued).**

4,482,118. READYROPE, LLC, CHARLOTTESVILLE, VA. SN 85-739,716. PUB. 3-5-2013, FILED 9-27-2012.

## READYROPE

THE MARK CONSISTS OF STANDARD CHARACTERS WITHOUT CLAIM TO ANY PARTICULAR FONT, STYLE, SIZE, OR COLOR.

FOR BELTS (U.S. CLS. 22 AND 39).  
FIRST USE 1-16-2013; IN COMMERCE 1-16-2013.

4,482,069. HAMLET, JAMEL R. BROOKLYN, NY. SN 85-733,798. PUB. 2-26-2013, FILED 9-20-2012.

## ampL1FE

THE MARK CONSISTS OF STANDARD CHARACTERS WITHOUT CLAIM TO ANY PARTICULAR FONT, STYLE, SIZE, OR COLOR.

FOR ATHLETIC APPAREL, NAMELY, SHIRTS, PANTS, JACKETS, FOOTWEAR, HATS AND CAPS, ATHLETIC UNIFORMS; WRISTBANDS (U.S. CLS. 22 AND 39).

FIRST USE 7-27-2013; IN COMMERCE 7-27-2013.

4,482,121. LOOMWORKS APPAREL, INC., IRVINE, CA. SN 85-740,345. PUB. 3-5-2013, FILED 9-27-2012.

## LOUNGE AFFAIR

THE MARK CONSISTS OF STANDARD CHARACTERS WITHOUT CLAIM TO ANY PARTICULAR FONT, STYLE, SIZE, OR COLOR.

FOR LOUNGEWEAR, PAJAMAS, ROBES, SLIPPERS, UNDERWEAR, SPORTSWEAR AND PLAYWEAR, NAMELY, SHORTS, T-SHIRTS, SWEATS, PANTS, TANK TOPS, CHEMISE, CAMISOLES (U.S. CLS. 22 AND 39).

FIRST USE 4-10-2013; IN COMMERCE 4-15-2013.

4,482,088. BARE ALL SWIMWEAR, YONKERS, NY. SN 85-737,016. PUB. 3-12-2013, FILED 9-24-2012.



NO CLAIM IS MADE TO THE EXCLUSIVE RIGHT TO USE "SWIMWEAR", APART FROM THE MARK AS SHOWN.

THE MARK CONSISTS OF THE STYLIZED WORDS "BARE ALL SWIMWEAR", A SIDEWAYS TRIANGLE BIKINI TOP IN THE SHAPE OF A "B".

FOR SWIMWEAR (U.S. CLS. 22 AND 39).  
FIRST USE 7-30-2012; IN COMMERCE 9-1-2012.

4,482,122. PINNACLE BRAND GROUP, INC., SAN DIEGO, CA. SN 85-740,407. PUB. 5-7-2013, FILED 9-27-2012.

## CROSBY SQUARE

THE MARK CONSISTS OF STANDARD CHARACTERS WITHOUT CLAIM TO ANY PARTICULAR FONT, STYLE, SIZE, OR COLOR.

FOR CLOTHING, NAMELY, FOOTWEAR, BELTS (U.S. CLS. 22 AND 39).

FIRST USE 6-8-2013; IN COMMERCE 6-8-2013.

**CLASS 25—(Continued).**

4,482,127. JONES, STEPHEN, BERKELEY, CA. SN 85-741,895.  
PUB. 3-12-2013, FILED 9-28-2012.

# KUSHITES

THE MARK CONSISTS OF STANDARD CHARACTERS WITHOUT CLAIM TO ANY PARTICULAR FONT, STYLE, SIZE, OR COLOR.

FOR MEN AND WOMEN CLOTHING, NAMELY, SHIRTS, T-SHIRTS, PANTS, DRESSES, SKIRTS, SHORTS, SUITS, SWEATSUITS, BLOUSES, LINGERIE, BOXERS, SWEATERS, JACKETS, COATS, SWIM SUITS, SCARFS, TIES, SOCKS, AND BELTS; SHOES AND TENNIS SHOES; HATS (U.S. CLS. 22 AND 39).  
FIRST USE 10-5-2013; IN COMMERCE 10-5-2013.

4,482,145. CHAANTI LLC., LOS ANGELES, CA. SN 85-745,026. PUB. 3-12-2013, FILED 10-3-2012.

# SHAWLMINA

THE MARK CONSISTS OF STANDARD CHARACTERS WITHOUT CLAIM TO ANY PARTICULAR FONT, STYLE, SIZE, OR COLOR.

FOR SCARVES; SHAWLS; SHAWLS AND STOLES, FUR STOLES; KERCHIEFS; MUFFLERS (U.S. CLS. 22 AND 39).  
FIRST USE 8-5-2012; IN COMMERCE 8-29-2012.

4,482,155. AREBALO, DAVID, FONTANA, CA. SN 85-746,716.  
PUB. 3-26-2013, FILED 10-5-2012.

# Savior Brand

THE MARK CONSISTS OF STANDARD CHARACTERS WITHOUT CLAIM TO ANY PARTICULAR FONT, STYLE, SIZE, OR COLOR.

NO CLAIM IS MADE TO THE EXCLUSIVE RIGHT TO USE "BRAND", APART FROM THE MARK AS SHOWN.

FOR CLOTHING, NAMELY, T-SHIRTS, SWEAT-SHIRTS, JACKETS, HATS, BELTS, SHIRTS, BLOUSES, HOODED SWEATSHIRTS, SHOES, BEANIES, SWEAT-BANDS, PANTS, TANK TOPS AND SHORTS (U.S. CLS. 22 AND 39).  
FIRST USE 5-21-2013; IN COMMERCE 5-21-2013.

**CLASS 25—(Continued).**

4,482,160. FULTON, ADAM, PEMBROKE, GA. SN 85-747,034. PUB. 3-12-2013, FILED 10-5-2012.



THE STIPPLING IS FOR SHADING PURPOSES ONLY. THE MARK CONSISTS OF THE STYLIZED TEXT "BOW BABES" WITH A MIRROR IMAGE OF THE WORDS BEHIND THE TEXT.

FOR HATS; SHIRTS (U.S. CLS. 22 AND 39).  
FIRST USE 10-5-2012; IN COMMERCE 8-1-2013.

4,482,172. VORZIMER, ROBERT, BEVERLY HILLS, CA. SN 85-747,275. PUB. 3-12-2013, FILED 10-5-2012.



NO CLAIM IS MADE TO THE EXCLUSIVE RIGHT TO USE "DRY GOODS & SUPPLY CO.", APART FROM THE MARK AS SHOWN.

THE MARK CONSISTS OF A WING WITH A CIRCLE AROUND IT. TO THE RIGHT OF THE WING, THE WORDS "KARDINAL DRY GOODS & SUPPLY CO." APPEAR IN A STYLIZED FONT.

FOR HATS; PANTS; SHIRTS; SHORTS; SWEATERS (U.S. CLS. 22 AND 39).  
FIRST USE 11-1-2013; IN COMMERCE 11-1-2013.

4,482,181. EXPOSUREWEAR, INC., ST. FRANCISVILLE, LA. SN 85-749,299. PUB. 3-12-2013, FILED 10-9-2012.



THE MARK CONSISTS OF A STYLIZED LETTER "X".  
FOR HATS (U.S. CLS. 22 AND 39).  
FIRST USE 10-8-2013; IN COMMERCE 10-8-2013.

**CLASS 25—(Continued).**

4,482,188. THE SOCK GUYS, INC., NEW ROCHELLE, NY. SN 85-750,783. PUB. 3-19-2013, FILED 10-10-2012.

WINNER'S CHOICE

THE MARK CONSISTS OF STANDARD CHARACTERS WITHOUT CLAIM TO ANY PARTICULAR FONT, STYLE, SIZE, OR COLOR.

FOR SOCKS (U.S. CLS. 22 AND 39).  
FIRST USE 2-25-2013; IN COMMERCE 2-25-2013.

4,482,189. DAMA TALYA, LLC, METAIRIE, LA. SN 85-750,878. PUB. 4-9-2013, FILED 10-10-2012.

Dama Talya

THE MARK CONSISTS OF STANDARD CHARACTERS WITHOUT CLAIM TO ANY PARTICULAR FONT, STYLE, SIZE, OR COLOR.

THE NAME(S), PORTRAIT(S), AND/OR SIGNATURE(S) SHOWN IN THE MARK DOES NOT IDENTIFY A PARTICULAR LIVING INDIVIDUAL.

THE ENGLISH TRANSLATION OF "DAMA" IN THE MARK IS "LADY".

FOR WOMEN'S CLOTHING, NAMELY, DRESSES, SHIRTS, BLOUSES, JACKETS, PANTS, AND SHORTS (U.S. CLS. 22 AND 39).

FIRST USE 9-1-2012; IN COMMERCE 11-11-2013.

**CLASS 25—(Continued).**

4,482,195. UNDER ARMOUR, INC., BALTIMORE, MD. SN 85-751,952. PUB. 3-19-2013, FILED 10-11-2012.

STOKE YOUR FIRE

THE MARK CONSISTS OF STANDARD CHARACTERS WITHOUT CLAIM TO ANY PARTICULAR FONT, STYLE, SIZE, OR COLOR.

FOR BASELAYER BOTTOMS; BASELAYER TOPS; BEANIES; BOTTOMS; COATS; CREW NECKS; FOUL WEATHER GEAR; GLOVES; HEADBANDS; HEADGEAR, NAMELY, HATS AND CAPS; HEADWEAR; HOODED SWEAT SHIRTS; HOODED SWEATSHIRTS; JACKETS; LEGGINGS; LONG UNDERWEAR; LONG-SLEEVED SHIRTS; MOCKNECKS; MOISTURE-WICKING SPORTS PANTS; MOISTURE-WICKING SPORTS SHIRTS; PANTS; PARKAS; PULLOVERS; RAIN COATS; RAIN JACKETS; RAIN TROUSERS; RAIN WEAR; RAINCOATS; RAINWEAR; SHELL JACKETS; SHIRTS; SKI JACKETS; SKI PANTS; SKI TROUSERS; SKI WEAR; SKIWEAR; SNOW PANTS; SNOWBOARD JACKETS; SNOWBOARD PANTS; SNOWBOARD TROUSERS; SPORT SHIRTS; SPORTS PANTS; SPORTS SHIRTS; SWEAT PANTS; SWEAT SHIRTS; SWEATERS; SWEATPANTS; SWEATSHIRTS; TIGHTS; TOPS; TURTLENECKS; VESTS (U.S. CLS. 22 AND 39).

FIRST USE 6-0-2013; IN COMMERCE 6-0-2013.

4,482,200. LANE, JEFF, SACRAMENTO, CA. SN 85-752,718. PUB. 3-19-2013, FILED 10-12-2012.

HORSEPOWER UNIVERSITY

THE MARK CONSISTS OF STANDARD CHARACTERS WITHOUT CLAIM TO ANY PARTICULAR FONT, STYLE, SIZE, OR COLOR.

FOR CLOTHING, NAMELY, TOPS, BOTTOMS, HEADWEAR, FOOTWEAR, SHIRTS, PANTS, JACKETS, BEACHWEAR, JEANS, UNDERWEAR, GLOVES, SOCKS (U.S. CLS. 22 AND 39).

FIRST USE 7-28-2012; IN COMMERCE 7-28-2012.

**CLASS 25—(Continued).**

4,482,207. JAMES, BELDON S., PEORIA, AZ. SN 85-754,588.  
PUB. 3-26-2013, FILED 10-15-2012.

# BEASTKIND

THE MARK CONSISTS OF STANDARD CHARACTERS WITHOUT CLAIM TO ANY PARTICULAR FONT, STYLE, SIZE, OR COLOR.

FOR HATS; JACKETS; PANTS; SHIRTS; SHOES; SWEAT SHIRTS (U.S. CLS. 22 AND 39).  
FIRST USE 1-7-2013; IN COMMERCE 4-29-2013.

---

4,482,210. JOHN MILLS LIMITED, LONDON, UNITED KINGDOM. SN 85-754,806. PUB. 4-16-2013, FILED 10-16-2012.

# Belvia

OWNER OF ERPN CMNTY TM OFC REG. NO. 010762367, DATED 8-9-2012, EXPIRES 3-27-2022.

THE MARK CONSISTS OF THE WORD "BELVIA" WITH A HEART DESIGN FORMING THE LETTER "B" AND THE LETTERS "ELVIA" IN A STYLIZED FONT.

FOR CLOTHING, NAMELY, TOPS, BOTTOMS; UNDERWEAR (U.S. CLS. 22 AND 39).  
FIRST USE 3-12-2012; IN COMMERCE 3-12-2012.

---

4,482,220. LATITUDES INC., SULLIVAN, MO. SN 85-756,595.  
PUB. 4-9-2013, FILED 10-17-2012.

# ZEN KOMFORT BY KLOGS

THE MARK CONSISTS OF STANDARD CHARACTERS WITHOUT CLAIM TO ANY PARTICULAR FONT, STYLE, SIZE, OR COLOR.

OWNER OF U.S. REG. NOS. 2,793,210 AND 2,920,135. NO CLAIM IS MADE TO THE EXCLUSIVE RIGHT TO USE "CLOGS", APART FROM THE MARK AS SHOWN.  
FOR FOOTWEAR (U.S. CLS. 22 AND 39).  
FIRST USE 8-26-2013; IN COMMERCE 8-26-2013.

**CLASS 25—(Continued).**

4,482,221. LATITUDES INC., SULLIVAN, MO. SN 85-756,600.  
PUB. 4-9-2013, FILED 10-17-2012.



OWNER OF U.S. REG. NOS. 2,793,210 AND 2,920,135. NO CLAIM IS MADE TO THE EXCLUSIVE RIGHT TO USE "CLOGS", APART FROM THE MARK AS SHOWN.

THE MARK CONSISTS OF THE WORDING "ZEN KOMFORT BY KLOGS" IN STYLIZED LETTERING. THE LETTER "Z" OF THE WORD "ZEN" IS IN STYLIZED RELATIONSHIP TO THE WORDS "ZEN KOMFORT" AND THE WORD "KOMFORT" HAS A HORIZONTAL LINE BELOW THE WORD WITH THE WORDS "BY KLOGS" BELOW THE HORIZONTAL LINE.

FOR FOOTWEAR (U.S. CLS. 22 AND 39).  
FIRST USE 8-26-2013; IN COMMERCE 8-26-2013.

---

4,482,226. VP RACING FUELS, INC., SAN ANTONIO, TX. SN 85-757,215. PUB. 3-26-2013, FILED 10-18-2012.



THE MARK CONSISTS OF UPPER TORSO AND HEAD OF A MAD SCIENTIST FIGURE, WEARING A LAB COAT WITH ONE POCKET, PORTION OF SHIRT VISIBLE WITH VERTICAL STRIPES, FLAMING HAIR FEATURES, BOTH ELBOWS UPRAISED, HOLDING LAB BEAKERS IN BOTH HANDS.

FOR CLOTHING, NAMELY, T-SHIRTS, HATS, JACKETS, COATS, SWEATERS, SHIRTS AND SOCKS (U.S. CLS. 22 AND 39).  
FIRST USE 7-12-2009; IN COMMERCE 7-12-2009.



**CLASS 25—(Continued).**

4,482,246. GENERATION INDUSTRIES, LLC, WAKE FOREST, NC. SN 85-760,923. PUB. 4-2-2013, FILED 10-23-2012.



NO CLAIM IS MADE TO THE EXCLUSIVE RIGHT TO USE "INDUSTRIES", APART FROM THE MARK AS SHOWN.

THE MARK CONSISTS OF THE STYLIZED WORD "GENERATION" WITH THE LETTER "I" ALSO FORMING THE STYLIZED WORD "INDUSTRIES" ABOVE THE WORD "GENERATION".

FOR CLOTHING, NAMELY, SHIRTS, SHOES, HATS, SWEATPANTS AND SWEATSHIRTS (U.S. CLS. 22 AND 39).

FIRST USE 12-0-2012; IN COMMERCE 12-0-2012.

**CLASS 25—(Continued).**

4,482,291. CASTANEDA, ARTHUR J., SAN JOSE, CA. SN 85-776,274. PUB. 5-7-2013, FILED 11-9-2012.



NO CLAIM IS MADE TO THE EXCLUSIVE RIGHT TO USE "JUL", "CALIFORNIA" AND "EST 1975", APART FROM THE MARK AS SHOWN.

THE MARK CONSISTS OF A STYLIZED LICENSE PLATE WITH AN OUTLINE WITH THE WORD "JUL" IN A RECTANGLE IN THE UPPER LEFT CORNER, "CALIFORNIA" ACROSS THE UPPER MIDDLE AND "CALIFORNIA EST 1975" WITH A CIRCULAR SEAL DESIGN INSIDE A RECTANGLE IN THE UPPER RIGHT CORNER ABOVE THE WORDING "S J N 8 T V E" WITH FOUR SMALL CIRCLES IN EACH CORNER.

FOR SHIRTS (U.S. CLS. 22 AND 39).

FIRST USE 7-3-2013; IN COMMERCE 7-3-2013.

4,482,267. MARSHALL RYAN M. REDFORD, MI. SN 85-767,064. PUB. 4-16-2013, FILED 10-30-2012.



THE MARK CONSISTS OF THE WORDS "BAREFOOTED REDNECK" CENTERED OVER, A LEFT FOOTPRINT ON THE LEFT AND A RIGHT FOOTPRINT ON THE RIGHT. A GRADIENT OVAL WITH A THIN OVAL OUTLINE FOR A BACKGROUND.

FOR ATHLETIC APPAREL, NAMELY, SHIRTS, PANTS, JACKETS, FOOTWEAR, HATS AND CAPS, ATHLETIC UNIFORMS; HATS; SHORT-SLEEVED OR LONG-SLEEVED T-SHIRTS; SPORTS CAPS AND HATS; T-SHIRTS (U.S. CLS. 22 AND 39).

FIRST USE 2-5-2013; IN COMMERCE 5-20-2013.

4,482,294. QVC, INC., WEST CHESTER, PA. SN 85-776,809. PUB. 3-26-2013, FILED 11-12-2012.

## HOW SMOOTH

THE MARK CONSISTS OF STANDARD CHARACTERS WITHOUT CLAIM TO ANY PARTICULAR FONT, STYLE, SIZE, OR COLOR.

OWNER OF U.S. REG. NOS. 3,926,718 AND 4,171,831.

FOR JEANS; PANTS (U.S. CLS. 22 AND 39).

FIRST USE 9-0-2013; IN COMMERCE 9-0-2013.

**CLASS 25—(Continued).**

4,482,309. LIYIN, SHE, PUDONG, SHANGHAI, CHINA. SN 85-782,064. PUB. 4-30-2013, FILED 11-17-2012.



THE MARK CONSISTS OF A LOGO CONSISTING OF THE DESIGN OF A BORDER REPRESENTING THE OUTLINE OF A COTTON BOLL WITH AN ABSTRACT SYMBOL INSIDE CONSISTING OF A LINE IN A "U" SHAPE WITH A TWIST AT THE BOTTOM.

FOR ANKLE SOCKS; ANKLETS; SOCKS; MEN'S SOCKS; NON-SLIP SOCKS; SOCKS; SOCKS AND STOCKINGS; HOSIERY; SHOE LINERS; TIGHTS; KNEE HIGHS; KNEE-HIGH STOCKINGS; LEG WARMERS; LEGGINGS; BATH SLIPPERS; SLIPPER SOCKS; SLIPPERS; WOMEN'S FOLDABLE SLIPPERS; GLOVES FOR APPAREL; KNITTED GLOVES; MITTENS; SCARVES; BABY TOPS; BABY BODY SUITS; KNIT TOPS; KNIT DRESSES; KNITTED CAPS; LEATHER SLIPPERS (U.S. CLS. 22 AND 39).

FIRST USE 1-1-2012; IN COMMERCE 1-1-2012.

4,482,329. LONGWORTH INDUSTRIES, INC., WEST END, NC. SN 85-788,176. PUB. 4-30-2013, FILED 11-27-2012.

# LONG WILLY'S

THE MARK CONSISTS OF STANDARD CHARACTERS WITHOUT CLAIM TO ANY PARTICULAR FONT, STYLE, SIZE, OR COLOR.

FOR THERMAL UNDERWEAR, NAMELY, SHIRTS AND PANTS (U.S. CLS. 22 AND 39).

FIRST USE 1-16-2013; IN COMMERCE 7-16-2013.

**CLASS 25—(Continued).**

4,482,335. THE SOCK GUYS, INC., NEW ROCHELLE, NY. SN 85-790,431. PUB. 3-19-2013, FILED 11-29-2012.

## STUDENT'S CHOICE

THE MARK CONSISTS OF STANDARD CHARACTERS WITHOUT CLAIM TO ANY PARTICULAR FONT, STYLE, SIZE, OR COLOR.

FOR SOCKS (U.S. CLS. 22 AND 39).

FIRST USE 6-28-2013; IN COMMERCE 6-28-2013.

4,482,349. LOOMWORKS APPAREL, INC., IRVINE, CA. SN 85-794,588. PUB. 3-5-2013, FILED 12-4-2012.

## COZY ZOE

THE MARK CONSISTS OF STANDARD CHARACTERS WITHOUT CLAIM TO ANY PARTICULAR FONT, STYLE, SIZE, OR COLOR.

FOR SPORTSWEAR, NAMELY, T-SHIRTS, SHIRTS, BLOUSES, PULLOVERS, VESTS, JACKETS, SHORTS, PANTS, SWEATSHIRTS, PAJAMAS, ROBES, SHOES, SANDALS, SLIPPERS, SOCKS, STOCKINGS, TIGHTS, UNDERWEAR (U.S. CLS. 22 AND 39).

FIRST USE 6-20-2013; IN COMMERCE 6-20-2013.

4,482,377. VOORHEES, DAVID WILLIAM, FERNANDINA BEACH, FL. SN 85-805,728. PUB. 5-14-2013, FILED 12-18-2012.

## Pajama Life

THE MARK CONSISTS OF STANDARD CHARACTERS WITHOUT CLAIM TO ANY PARTICULAR FONT, STYLE, SIZE, OR COLOR.

NO CLAIM IS MADE TO THE EXCLUSIVE RIGHT TO USE "PAJAMA", APART FROM THE MARK AS SHOWN.

FOR APPAREL FOR DANCERS, NAMELY, TEE SHIRTS, SWEATSHIRTS, PANTS, LEGGINGS, SHORTS AND JACKETS; ATHLETIC APPAREL, NAMELY, SHIRTS, PANTS, JACKETS, FOOTWEAR, HATS AND CAPS, ATHLETIC UNIFORMS; BOXER BRIEFS; BOXER SHORTS; HATS; HOODED SWEATSHIRTS; PAJAMA BOTTOMS; PAJAMAS; PANTIES; PANTIES, SHORTS AND BRIEFS; SHORT-SLEEVED OR LONG-SLEEVED T-SHIRTS; SWEATSHIRTS; T-SHIRTS (U.S. CLS. 22 AND 39).

FIRST USE 5-1-2013; IN COMMERCE 5-1-2013.

**CLASS 25—(Continued).**

4,482,380. CHERY, STEPHANE, MIRAMAR, FL. SN 85-806,242. PUB. 3-19-2013, FILED 12-19-2012.



THE MARK CONSISTS OF A TIED UP PACKAGE WITH THE STYLIZED PHRASE "[C9K]" STAMPED ON THE FRONT OF IT AT AN ANGLE.

FOR BEANIES; CAPS; DENIMS; HATS; JACKETS; JEANS; PANTS; SHIRTS; SHOES; SHORTS; SOCKS; SWEAT SHIRTS; SWEATERS; T-SHIRTS (U.S. CLS. 22 AND 39).

FIRST USE 8-9-2012; IN COMMERCE 8-9-2012.

**CLASS 25—(Continued).**

NO CLAIM IS MADE TO THE EXCLUSIVE RIGHT TO USE "SOCKS", APART FROM THE MARK AS SHOWN.

FOR FLIP FLOPS; HOSIERY; SLIPPER SOCKS; SLIPPERS; SOCKS (U.S. CLS. 22 AND 39).

FIRST USE 3-30-2013; IN COMMERCE 3-30-2013.

4,482,414. MRS DESIGN, LLC, GRETN, LA. SN 85-820,018. PUB. 6-4-2013, FILED 1-10-2013.

I'm Not Old I'm Vintage

4,482,388. YU SHENG JIANG, SAN GABRIEL, CA. SN 85-809,550. PUB. 5-21-2013, FILED 12-21-2012.

JOY & CO.

THE MARK CONSISTS OF STANDARD CHARACTERS WITHOUT CLAIM TO ANY PARTICULAR FONT, STYLE, SIZE, OR COLOR.

NO CLAIM IS MADE TO THE EXCLUSIVE RIGHT TO USE "CO.", APART FROM THE MARK AS SHOWN.

FOR BLOUSES; CLOTHING SHIELDS, NAMELY, PADS APPLIED TO THE UNDERARMS OF SHIRTS, BLOUSES AND SWEATERS; SLEEVES WORN SEPARATE AND APART FROM BLOUSES, SHIRTS AND OTHER TOPS; WOMEN'S CLOTHING, NAMELY, SHIRTS, DRESSES, SKIRTS, BLOUSES (U.S. CLS. 22 AND 39).

FIRST USE 8-1-2013; IN COMMERCE 9-1-2013.

THE MARK CONSISTS OF STANDARD CHARACTERS WITHOUT CLAIM TO ANY PARTICULAR FONT, STYLE, SIZE, OR COLOR.

FOR DRESSES; HOODED SWEATSHIRTS; JACKETS; PANTS; SHORT-SLEEVED OR LONG-SLEEVED T-SHIRTS; SHORTS; SKIRTS; SWEAT PANTS; SWEATERS; SWEATSHIRTS; T-SHIRTS; TANK TOPS (U.S. CLS. 22 AND 39).

FIRST USE 10-8-2013; IN COMMERCE 10-8-2013.

4,482,422. FABLES BY BARRIE, INC, SAN DIEGO, CA. SN 85-821,745. PUB. 6-4-2013, FILED 1-11-2013.

Pony Tales

4,482,403. PS BRANDS, LLC, NEW YORK, NY. SN 85-816,915. PUB. 5-28-2013, FILED 1-7-2013.

FUNKY SOCKS

THE MARK CONSISTS OF STANDARD CHARACTERS WITHOUT CLAIM TO ANY PARTICULAR FONT, STYLE, SIZE, OR COLOR.

THE MARK CONSISTS OF STANDARD CHARACTERS WITHOUT CLAIM TO ANY PARTICULAR FONT, STYLE, SIZE, OR COLOR.

FOR BEACH COVER-UPS; BELTS; BLOUSES; BOLO TIES; BOOTS; DRESSES; HATS; HOSIERY; JACKETS; KERCHIEFS; NIPPLE COVERS, NAMELY, PASTIES; PANTS; SCARVES; SHOE STRAPS; SHOES; SHORTS; SKIRTS; SWIM WEAR; UNDERGARMENTS (U.S. CLS. 22 AND 39).

FIRST USE 1-15-2013; IN COMMERCE 1-15-2013.

**CLASS 25—(Continued).**

4,482,427. BARRETT, JOEL PATRICK, BRIGHTON, NY. SN 85-822,609. PUB. 7-16-2013, FILED 1-14-2013.



THE COLOR(S) BLACK AND BLUE IS/ARE CLAIMED AS A FEATURE OF THE MARK.

THE MARK CONSISTS OF TWO BLACK STRIPES SLANTED TO THE RIGHT AND A SINGLE CAPITAL LETTER "A" MERGING MADE UP OF TWO ADJACENT STRIPES, ONE BLUE STRIPE SLANTING RIGHT AND A BLACK STRIPE SLANTING LEFT. BELOW THE DESIGN IS THE TERM "AROQUE" IN BLACK.

THE WORDING "AROQUE" HAS NO MEANING IN A FOREIGN LANGUAGE.

FOR ATHLETIC APPAREL, NAMELY, SHIRTS, PANTS, JACKETS, FOOTWEAR, HATS AND CAPS, ATHLETIC UNIFORMS (U.S. CLS. 22 AND 39).

FIRST USE 8-1-2013; IN COMMERCE 10-1-2013.

**CLASS 25—(Continued).**

4,482,465. ALMAR LURIE, AGANA, GUAM. SN 85-841,740. PUB. 7-2-2013, FILED 2-5-2013.

**LOVINGLY ORGANICS**

THE MARK CONSISTS OF STANDARD CHARACTERS WITHOUT CLAIM TO ANY PARTICULAR FONT, STYLE, SIZE, OR COLOR.

NO CLAIM IS MADE TO THE EXCLUSIVE RIGHT TO USE "ORGANICS", APART FROM THE MARK AS SHOWN.

FOR BABIES PANTS; BABY TOPS; CHILDREN'S AND INFANT'S APPAREL, NAMELY, JUMPERS, OVERALL SLEEPWEAR, PAJAMAS, ROMPERS AND ONE-PIECE GARMENTS; CHILDREN'S HEADWEAR; INFANT AND TODDLER ONE PIECE CLOTHING; INFANT SLEEPERS; INFANT WEARABLE BLANKETS; INFANTS' SHOES AND BOOTS; INFANTS' TROUSERS; SHIRTS FOR INFANTS, BABIES, TODDLERS AND CHILDREN, ALL THE AFORESAID GOODS MADE OF ORGANIC MATERIALS (U.S. CLS. 22 AND 39).

FIRST USE 11-11-2013; IN COMMERCE 11-11-2013.

4,482,464. ALMAR LURIE, AGANA, GUAM. SN 85-841,736. PUB. 7-2-2013, FILED 2-5-2013.

**THE ORGANIC PROJECT**

THE MARK CONSISTS OF STANDARD CHARACTERS WITHOUT CLAIM TO ANY PARTICULAR FONT, STYLE, SIZE, OR COLOR.

NO CLAIM IS MADE TO THE EXCLUSIVE RIGHT TO USE "ORGANIC", APART FROM THE MARK AS SHOWN.

FOR BEACH FOOTWEAR; BELTS; BOTTOMS; BUTTON DOWN SHIRTS; CAPRIS; CARGO PANTS; COLLARED SHIRTS; DENIMS; DRESSES; GLOVES; HALTER TOPS; HEAD SCARVES; LADIES' UNDERWEAR; LONG-SLEEVED SHIRTS; MEN'S AND WOMEN'S JACKETS, COATS, TROUSERS, VESTS; PAJAMAS; PANTS; POLO SHIRTS; SCARVES; SHIRTS; SHOES; SHORTS; SKIRTS; SOCKS AND STOCKINGS; T-SHIRTS; TANK TOPS; UNDERWEAR; WOMEN'S CLOTHING, NAMELY, SHIRTS, DRESSES, SKIRTS, BLOUSES, ALL THE AFORESAID GOODS MADE OF ORGANIC MATERIALS (U.S. CLS. 22 AND 39).

FIRST USE 11-11-2013; IN COMMERCE 11-11-2013.

4,482,496. CARTE BLANCHE GROUP LLC, SANTA ANA, CA. SN 85-852,035. PUB. 7-30-2013, FILED 2-17-2013.

**Safehouse Goods Company**

THE MARK CONSISTS OF STANDARD CHARACTERS WITHOUT CLAIM TO ANY PARTICULAR FONT, STYLE, SIZE, OR COLOR.

NO CLAIM IS MADE TO THE EXCLUSIVE RIGHT TO USE "GOODS COMPANY", APART FROM THE MARK AS SHOWN.

FOR CLOTHING, FOOTWEAR, AND HEADWEAR, NAMELY, T-SHIRTS, WOVEN SHIRTS, CASUAL TOPS WITH LONG AND SHORT SLEEVES, SWEATSHIRTS, SWEATERS, JACKETS, COATS, ANORAKS, PARKAS, JEANS, PANTS, SLACKS, SHORTS, SOCKS, BELTS, ATHLETIC SHOES, SANDALS, SWIMWEAR, BOXERS, UNDERWEAR, UNDERSHIRTS, SOCKS, BASEBALL CAPS, HATS, BEANIES (U.S. CLS. 22 AND 39).

FIRST USE 10-1-2013; IN COMMERCE 10-1-2013.

**CLASS 25—(Continued).**

4,482,501. DAZZLE UP, LLC, GREENSBORO, NC. SN 85-853,970. PUB. 7-30-2013, FILED 2-19-2013.



NO CLAIM IS MADE TO THE EXCLUSIVE RIGHT TO USE "GIRL" AND CHRISTIAN FISH DESIGN, APART FROM THE MARK AS SHOWN.

THE MARK CONSISTS OF THE STYLIZED WORDS "FAITHFUL GIRL" WITH A LINE ART FISH.

FOR CAPS; HATS; HOODED SWEATSHIRTS; JACKETS; SHIRTS; SHORT-SLEEVED OR LONG-SLEEVED T-SHIRTS; SHORTS; SWEAT SHIRTS; T-SHIRTS (U.S. CLS. 22 AND 39).

FIRST USE 2-11-2013; IN COMMERCE 2-11-2013.

4,482,502. FERRARA CANDY COMPANY, OAKBROOK TERRACE, IL. SN 85-854,697. PUB. 6-25-2013, FILED 2-20-2013.

## RAIN-BLO

THE MARK CONSISTS OF STANDARD CHARACTERS WITHOUT CLAIM TO ANY PARTICULAR FONT, STYLE, SIZE, OR COLOR.

FOR CLOTHING, NAMELY, HATS, T-SHIRTS AND SWEATSHIRTS (U.S. CLS. 22 AND 39).

FIRST USE 9-1-2011; IN COMMERCE 9-1-2011.

4,482,503. FERRARA CANDY COMPANY, OAKBROOK TERRACE, IL. SN 85-854,701. PUB. 6-25-2013, FILED 2-20-2013.

## SUPER BUBBLE

THE MARK CONSISTS OF STANDARD CHARACTERS WITHOUT CLAIM TO ANY PARTICULAR FONT, STYLE, SIZE, OR COLOR.

FOR CLOTHING, NAMELY, HATS, T-SHIRTS AND SWEATSHIRTS (U.S. CLS. 22 AND 39).

FIRST USE 9-1-2011; IN COMMERCE 9-1-2011.

**CLASS 25—(Continued).**

4,482,504. FERRARA CANDY COMPANY, OAKBROOK TERRACE, IL. SN 85-854,705. PUB. 6-25-2013, FILED 2-20-2013.

## NOW AND LATER

THE MARK CONSISTS OF STANDARD CHARACTERS WITHOUT CLAIM TO ANY PARTICULAR FONT, STYLE, SIZE, OR COLOR.

FOR CLOTHING, NAMELY, HATS, T-SHIRTS AND SWEATSHIRTS (U.S. CLS. 22 AND 39).

FIRST USE 9-1-2011; IN COMMERCE 9-1-2011.

4,482,510. ROYALTY CLOTHING LLC, SAN RAMON, CA. SN 85-860,940. PUB. 8-13-2013, FILED 2-26-2013.

## Royalty Clothing

THE MARK CONSISTS OF STANDARD CHARACTERS WITHOUT CLAIM TO ANY PARTICULAR FONT, STYLE, SIZE, OR COLOR.

NO CLAIM IS MADE TO THE EXCLUSIVE RIGHT TO USE "CLOTHING", APART FROM THE MARK AS SHOWN.

FOR HATS, BEANIES, SWEATSHIRTS, T-SHIRTS, SOCKS, BELTS, WRISTBANDS, HEADBANDS, BEACHWEAR, SURF WEAR, SHIRTS, TOPS, UNDERGARMENTS, FOOTWEAR, POLO SHIRTS, DRESSES, JACKETS, VESTS, SLEEPWEAR, LOUNGEWEAR, GLOVES, SCARVES, WARM UP SUITS, BANDANAS, JEANS, CAPRIS, JERSEYS, SPORTS JERSEYS, TANK TOPS, V-NECK SWEATERS, INFANT WEAR, RAIN WEAR, SNOW WEAR, NAMELY, PARKAS, SKI JACKETS; SKI WEAR, FLEECE PULLOVERS, TOPS, BOTTOMS; UNIFORMS, WIND RESISTANT JACKETS, SUMMER WEAR, NAMELY, BEACH SHORTS, SWIM TRUNKS, BATHING SUITS, FLIP FLOPS, T-SHIRTS, SWEATERS, SWEATSHIRTS, SANDALS; YOGA WEAR, NAMELY, YOGA PANTS; NIGHT WEAR, NAMELY, NIGHT GOWNS, ROBES, SLIPPERS (U.S. CLS. 22 AND 39).

FIRST USE 1-1-2013; IN COMMERCE 11-4-2013.

4,482,524. EVENING CHIC INC., MINEOLA, NY. SN 85-865,576. PUB. 8-13-2013, FILED 3-4-2013.

## ELLIE MACKENZIE

THE MARK CONSISTS OF STANDARD CHARACTERS WITHOUT CLAIM TO ANY PARTICULAR FONT, STYLE, SIZE, OR COLOR.

**CLASS 25—(Continued).**

THE NAME "ELLIE MACKENZIE" DOES NOT IDENTIFY A PARTICULAR LIVING INDIVIDUAL.  
FOR DRESSES (U.S. CLS. 22 AND 39).  
FIRST USE 3-4-2013; IN COMMERCE 3-4-2013.

**CLASS 25—(Continued).**

4,482,643. BURNS, TREVA, DBA DIVA STYL, COLLEYVILLE, TX. SN 85-910,158. PUB. 9-3-2013, FILED 4-21-2013.

4,482,543. BELFORD INC, DBA BELA NYC, NEW YORK, NY. SN 85-869,329. PUB. 5-14-2013, FILED 3-7-2013.

Bela Nyc

THE MARK CONSISTS OF STANDARD CHARACTERS WITHOUT CLAIM TO ANY PARTICULAR FONT, STYLE, SIZE, OR COLOR.

NO CLAIM IS MADE TO THE EXCLUSIVE RIGHT TO USE "NYC", APART FROM THE MARK AS SHOWN.

THE NAME(S), PORTRAIT(S), AND/OR SIGNATURE(S) SHOWN IN THE MARK DOES NOT IDENTIFY A PARTICULAR LIVING INDIVIDUAL.

THE WORDING "BELA" HAS NO MEANING IN A FOREIGN LANGUAGE.

FOR A-SHIRTS; DRESS PANTS; KNIT JACKETS; SWEATERS (U.S. CLS. 22 AND 39).

FIRST USE 3-1-2013; IN COMMERCE 3-1-2013.

**HOT GIRL NATION**

THE MARK CONSISTS OF STANDARD CHARACTERS WITHOUT CLAIM TO ANY PARTICULAR FONT, STYLE, SIZE, OR COLOR.

FOR APPAREL FOR DANCERS, NAMELY, TEE SHIRTS, SWEATSHIRTS, PANTS, LEGGINGS, SHORTS AND JACKETS; ATHLETIC APPAREL, NAMELY, SHIRTS, PANTS, JACKETS, FOOTWEAR, HATS AND CAPS, ATHLETIC UNIFORMS; BATHING SUITS; BELTS FOR CLOTHING; BOTTOMS; GLOVES AS CLOTHING; GLOVES FOR APPAREL; HEADBANDS FOR CLOTHING; HOODS; JACKETS; JOGGING SUITS; SHORT SETS; SWIM SUITS; TOPS; TRACK SUITS; WEARABLE GARMENTS AND CLOTHING, NAMELY, SHIRTS; WOMEN'S CLOTHING, NAMELY, SHIRTS, DRESSES, SKIRTS, BLOUSES; WRIST BANDS; WRISTBANDS (U.S. CLS. 22 AND 39).

FIRST USE 7-20-2011; IN COMMERCE 7-21-2011.

4,482,671. BROOKLYN BANGERS LLC, BROOKLYN, NY. SN 85-980,005. PUB. 9-24-2013, FILED 2-13-2013.

**BROOKLYN BANGERS**

THE MARK CONSISTS OF STANDARD CHARACTERS WITHOUT CLAIM TO ANY PARTICULAR FONT, STYLE, SIZE, OR COLOR.

NO CLAIM IS MADE TO THE EXCLUSIVE RIGHT TO USE "BROOKLYN", APART FROM THE MARK AS SHOWN.

FOR CLOTHING, NAMELY, T-SHIRTS, SWEATSHIRTS, HATS, AND CAPS (U.S. CLS. 22 AND 39).

FIRST USE 8-8-2012; IN COMMERCE 8-8-2012.

4,482,594. SLATE GOLF LTD., DENVER, CO. SN 85-886,752. PUB. 8-13-2013, FILED 3-26-2013.

SLATE

4,482,685. M.X.F. DESIGNS, INC., LOS ANGELES, CA. SN 85-980,691. PUB. 10-23-2012, FILED 4-18-2012.

**NATURAL ORIGINS**

THE MARK CONSISTS OF STANDARD CHARACTERS WITHOUT CLAIM TO ANY PARTICULAR FONT, STYLE, SIZE, OR COLOR.

OWNER OF U.S. REG. NO. 3,974,979.

FOR GOLF CAPS; GOLF SHIRTS; HATS; SHIRTS; SHIRTS AND SHORT-SLEEVED SHIRTS (U.S. CLS. 22 AND 39).

FIRST USE 7-22-2013; IN COMMERCE 7-22-2013.

THE MARK CONSISTS OF STANDARD CHARACTERS WITHOUT CLAIM TO ANY PARTICULAR FONT, STYLE, SIZE, OR COLOR.

OWNER OF U.S. REG. NO. 2,625,627.

FOR CLOTHES, NAMELY, TOPS, T-SHIRTS, TANK TOPS, SKIRTS, AND DRESSES (U.S. CLS. 22 AND 39).

FIRST USE 7-11-2013; IN COMMERCE 7-11-2013.

**CLASS 26—FANCY GOODS**

4,481,425. JACK DANIEL'S PROPERTIES, INC., SAN RAFAEL, CA. SN 85-130,129. PUB. 3-8-2011, FILED 9-15-2010.



OWNER OF U.S. REG. NOS. 1,290,702, 3,055,460, AND OTHERS.

NO CLAIM IS MADE TO THE EXCLUSIVE RIGHT TO USE "BRAND", APART FROM THE MARK AS SHOWN.

THE NAME SHOWN IN THE MARK DOES NOT IDENTIFY A PARTICULAR LIVING INDIVIDUAL.

THE MARK CONSISTS OF A RECTANGLE WITH A FILIGREE BORDER AND THE STYLIZED WORDING "JACK DANIEL'S TENNESSEE SOUR MASH WHISKEY". THE WORDING "OLD NO. 7 BRAND" APPEARS IN AN OVAL SHAPED DESIGN IN THE CENTER WITH A FILIGREE APPEARING AROUND THE BORDER.

FOR BELT BUCKLES AND CLASPS FOR CLOTHING, ALL MADE OF NON-PRECIOUS METAL; ORNAMENTAL NOVELTY PINS (U.S. CLS. 37, 39, 40, 42 AND 50). FIRST USE 1-19-2012; IN COMMERCE 1-19-2012.

4,482,041. ZHEJIANG GRACE SPINNING & WEAVING GROUP CO., LTD., ZHEJIANG, CHINA. SN 85-731,197. PUB. 2-26-2013, FILED 9-17-2012.



THE MARK CONSISTS OF THE WORDS "GRACE ORCHID" BELOW AN INCOMPLETE FLOWER DESIGN.

FOR ARTIFICIAL FLOWERS; BEADS OTHER THAN FOR MAKING JEWELRY; BORDERS AND EDGINGS FOR CLOTHING; BUTTONS; COLLAR STAYS; FALSE HAIR; HAIR GRIPS; MARKING PINS; PATCHES FOR REPAIRING TEXTILE ARTICLES (U.S. CLS. 37, 39, 40, 42 AND 50).

FIRST USE 4-30-2013; IN COMMERCE 4-30-2013.

**CLASS 26—(Continued).**

4,482,404. SLI PRODUCTIONS, INC., DBA IT'S A WIG, MOONACHIE, NJ. SN 85-817,600. PUB. 5-28-2013, FILED 1-8-2013.

**My Own Part**

THE MARK CONSISTS OF STANDARD CHARACTERS WITHOUT CLAIM TO ANY PARTICULAR FONT, STYLE, SIZE, OR COLOR.

FOR HAIR EXTENSIONS; HAIR PIECES; HAIR PIECES AND WIGS; WIGS; WIGS, HAIRPIECES, AND ADD-IN AND ADD-ON HAIR ACCESSORIES CONSTRUCTED PRIMARILY OF SYNTHETIC AND/OR HUMAN HAIR (U.S. CLS. 37, 39, 40, 42 AND 50).

FIRST USE 4-9-2013; IN COMMERCE 4-9-2013.

**CLASS 27—FLOOR COVERINGS**

4,482,050. ZHEJIANG GRACE SPINNING & WEAVING GROUP CO., LTD., ZHEJIANG, CHINA. SN 85-731,220. PUB. 2-26-2013, FILED 9-17-2012.



THE MARK CONSISTS OF THE WORDS "GRACE ORCHID" BELOW AN INCOMPLETE FLOWER DESIGN.

FOR ARTIFICIAL TURF; CARPETS; FLOOR COVERINGS; FLOOR MATS; LINOLEUM; NON-SLIP MATS FOR BATHS; PERSONAL SITTING MATS; REED MATS; WALLPAPER; WALLPAPER WITH A TEXTILE COVERING (U.S. CLS. 19, 20, 37, 42 AND 50).

FIRST USE 12-10-2012; IN COMMERCE 12-10-2012.

**CLASS 28—TOYS AND SPORTING GOODS**

**CLASS 28—(Continued).**

4,481,321. ANIMAL ADVENTURE, INC., HOPKINS, MN. SN 77-571,813. PUB. 12-22-2009, FILED 9-17-2008.

**SLIDERS**

THE MARK CONSISTS OF STANDARD CHARACTERS WITHOUT CLAIM TO ANY PARTICULAR FONT, STYLE, SIZE, OR COLOR.

FOR MONKEY TOY ANIMALS NOT RELATING TO BASEBALL OR SOFTBALL, A BASEBALL OR SOFTBALL TEAM OR A SPORTS MASCOT (U.S. CLS. 22, 23, 38 AND 50).

FIRST USE 12-3-2013; IN COMMERCE 12-3-2013.

4,481,404. MYERS, BLAKE, LIVERMORE, CA. SN 85-060,222. PUB. 11-9-2010, FILED 6-11-2010.

**GR/T**

THE MARK CONSISTS OF STANDARD CHARACTERS WITHOUT CLAIM TO ANY PARTICULAR FONT, STYLE, SIZE, OR COLOR.

FOR GOLF PUTTERS (U.S. CLS. 22, 23, 38 AND 50).  
FIRST USE 11-18-2013; IN COMMERCE 11-18-2013.

4,481,448. PRIMAL VANTAGE COMPANY, INC., RANDOLPH, NJ. SN 85-188,371. PUB. 10-11-2011, FILED 12-1-2010.

**PRIMAL VANTAGE CO.**

THE MARK CONSISTS OF STANDARD CHARACTERS WITHOUT CLAIM TO ANY PARTICULAR FONT, STYLE, SIZE, OR COLOR.

NO CLAIM IS MADE TO THE EXCLUSIVE RIGHT TO USE "CO.", APART FROM THE MARK AS SHOWN.

FOR HUNTING TREE STANDS (U.S. CLS. 22, 23, 38 AND 50).

FIRST USE 5-0-2012; IN COMMERCE 5-0-2012.

**CLASS 28—(Continued).**

4,481,449. PENN FISHING TACKLE MFG. COMPANY, PHILADELPHIA, PA. SN 85-192,743. PUB. 4-12-2011, FILED 12-7-2010.

**CONFLICT**

THE MARK CONSISTS OF STANDARD CHARACTERS WITHOUT CLAIM TO ANY PARTICULAR FONT, STYLE, SIZE, OR COLOR.

FOR FISHING RODS; FISHING REELS; COMBINATIONS INCORPORATING A FISHING ROD, FISHING REEL; FISHING TACKLE (U.S. CLS. 22, 23, 38 AND 50).

FIRST USE 9-16-2013; IN COMMERCE 9-16-2013.

4,481,591. 3D MAGIC FACTORY, AUSTIN, TX. SN 85-457,137. PUB. 4-3-2012, FILED 10-26-2011.

**The GiggBellies**

THE MARK CONSISTS OF STANDARD CHARACTERS WITHOUT CLAIM TO ANY PARTICULAR FONT, STYLE, SIZE, OR COLOR.

FOR PLUSH TOYS; STUFFED AND PLUSH TOYS; STUFFED TOYS (U.S. CLS. 22, 23, 38 AND 50).

FIRST USE 10-31-2013; IN COMMERCE 10-31-2013.

4,481,695. PETERSEN, CHARLES, PAYSON, UT. SN 85-564,383. PUB. 9-18-2012, FILED 3-8-2012.

**SCOTT GOLF USA**

THE MARK CONSISTS OF STANDARD CHARACTERS WITHOUT CLAIM TO ANY PARTICULAR FONT, STYLE, SIZE, OR COLOR.

NO CLAIM IS MADE TO THE EXCLUSIVE RIGHT TO USE "GOLF USA", APART FROM THE MARK AS SHOWN.

FOR COVERS FOR GOLF CLUBS; DIVOT REPAIR TOOLS; GLOVES FOR GOLF; GOLF ACCESSORIES, NAMELY, CARRIERS AND DISPENSERS FOR GOLF BALLS; GOLF ACCESSORY POUCHES; GOLF BAGS; GOLF BALLS; GOLF CLUB GRIPS; GOLF CLUB HEADS; GOLF CLUB SHAFTS; GOLF CLUBS; GOLF FLAGS; GOLF IRONS; GOLF PUTTERS; GOLF TEES; HAND GRIPS FOR GOLF CLUBS (U.S. CLS. 22, 23, 38 AND 50).

FIRST USE 4-1-2013; IN COMMERCE 4-1-2013.



**CLASS 28—(Continued).**

4,481,743. LIMITLESS WELLNESS PROJECT LLC, BEVERLY HILLS, CA. SN 85-599,603. PUB. 9-18-2012, FILED 4-17-2012.



NO CLAIM IS MADE TO THE EXCLUSIVE RIGHT TO USE "RESISTANCE", APART FROM THE MARK AS SHOWN.

THE MARK CONSISTS OF BLOCK LETTERS "LR" WITH A SIDEWAYS FIGURE "8" DESIGN ENCOMPASSED WITHIN THE LETTER "R" AND WORDS "LIMITLESS RESISTANCE" BELOW.

FOR EXERCISE MACHINES (U.S. CLS. 22, 23, 38 AND 50).

FIRST USE 7-7-2013; IN COMMERCE 7-17-2013.

4,481,773. WONDILL FROMAN, INDIANAPOLIS, IN. SN 85-616,567. PUB. 10-9-2012, FILED 5-4-2012.

**RESURRECTION TOMB HUNT**

THE MARK CONSISTS OF STANDARD CHARACTERS WITHOUT CLAIM TO ANY PARTICULAR FONT, STYLE, SIZE, OR COLOR.

FOR EQUIPMENT SOLD AS A UNIT COMPRISING OBJECTS TO BE HIDDEN AND FOUND BY PLAYERS FOR PLAYING A GAME HAVING A RELIGIOUS THEME (U.S. CLS. 22, 23, 38 AND 50).

FIRST USE 11-13-2013; IN COMMERCE 11-13-2013.

4,481,807. MATTEL, INC., EL SEGUNDO, CA. SN 85-635,589. PUB. 4-23-2013, FILED 5-25-2012.

**ESCAPE THE CLAW**

THE MARK CONSISTS OF STANDARD CHARACTERS WITHOUT CLAIM TO ANY PARTICULAR FONT, STYLE, SIZE, OR COLOR.

**CLASS 28—(Continued).**

NO CLAIM IS MADE TO THE EXCLUSIVE RIGHT TO USE "CLAW", APART FROM THE MARK AS SHOWN.

FOR TOY FIGURES AND ACCESSORIES THEREFOR (U.S. CLS. 22, 23, 38 AND 50).

FIRST USE 10-28-2013; IN COMMERCE 10-28-2013.

4,481,840. NORMARK CORPORATION, MINNETONKA, MN. SN 85-651,595. PUB. 10-30-2012, FILED 6-14-2012.

**ICE FORCE**

THE MARK CONSISTS OF STANDARD CHARACTERS WITHOUT CLAIM TO ANY PARTICULAR FONT, STYLE, SIZE, OR COLOR.

FOR ICE FISHING EQUIPMENT, NAMELY, ICE FISHING STRIKE INDICATORS; FISH BITE ALARMS; ICE FISHING SEATS; ICE FISHING TACKLE; ICE FISHING LINE; ICE FISHING HOLE COVERS; FISH ATTRACTANTS; FISH CAGES FOR USE IN RECREATIONAL FISHING; FISHING BUOYS; FISHING LINE; FISHING LEADERS; FISHING LURES; FISHING LURE BOXES; FISHING POLES; FISHING RODS; FISHING ROD RACKS; FISHING REELS; FISHING SINKERS; FISHING SPINNERS; FISHING STOOLS; FISHING TACKLE; FISHING TACKLE CONTAINERS; FISHING WEIGHTS; HAND-HELD FISHING NETS (U.S. CLS. 22, 23, 38 AND 50).

FIRST USE 10-1-2013; IN COMMERCE 10-1-2013.

4,481,870. CADILLAC JACK, INC., DULUTH, GA. SN 85-664,040. PUB. 10-23-2012, FILED 6-28-2012.

**WILD PARROTS**

THE MARK CONSISTS OF STANDARD CHARACTERS WITHOUT CLAIM TO ANY PARTICULAR FONT, STYLE, SIZE, OR COLOR.

FOR GAMING MACHINES, NAMELY, DEVICES WHICH ACCEPT A WAGER; RECONFIGURABLE CASINO AND LOTTERY GAMING EQUIPMENT, NAMELY, GAMING MACHINES AND OPERATIONAL COMPUTER GAME SOFTWARE THEREFOR SOLD AS A UNIT (U.S. CLS. 22, 23, 38 AND 50).

FIRST USE 9-12-2013; IN COMMERCE 9-12-2013.

**CLASS 28—(Continued).**

4,481,908. MATTEL, INC., EL SEGUNDO, CA. SN 85-683,498.  
PUB. 4-30-2013, FILED 7-21-2012.

**TRACK ACES**

THE MARK CONSISTS OF STANDARD CHARACTERS WITHOUT CLAIM TO ANY PARTICULAR FONT, STYLE, SIZE, OR COLOR.

NO CLAIM IS MADE TO THE EXCLUSIVE RIGHT TO USE "TRACK", APART FROM THE MARK AS SHOWN, FOR TOY VEHICLES AND ACCESSORIES THEREFOR (U.S. CLS. 22, 23, 38 AND 50).

FIRST USE 10-28-2013; IN COMMERCE 10-28-2013.

4,481,991. FIRST COAST LOGISTICS AND BROKERAGE, LLC, DBA TRIPLE X SURFERS OUTLET, JACKSONVILLE, FL. SN 85-720,590. PUB. 2-5-2013, FILED 9-5-2012.

**TRIPLE X**

THE MARK CONSISTS OF STANDARD CHARACTERS WITHOUT CLAIM TO ANY PARTICULAR FONT, STYLE, SIZE, OR COLOR.

FOR (BASED ON USE IN COMMERCE) PADDLE SURFBOARDS; SKATEBOARD DECKS; SKATEBOARD GRIP TAPES; SKATEBOARDS; STAND-UP PADDLE BOARDS; SURF BOARDS; SURFBOARDS; BAGS ESPECIALLY DESIGNED FOR SURFBOARDS; PADDLES FOR USE WITH SURFBOARDS; SKATEBOARD PADDLE BOARDS; SKIM BOARDS; STAND-UP SURF PADDLES (U.S. CLS. 22, 23, 38 AND 50).

FIRST USE 7-1-2004; IN COMMERCE 7-1-2004.

4,482,034. GPS TAGGING SOLUTIONS, INC., JASPER, GA. SN 85-729,910. PUB. 3-26-2013, FILED 9-14-2012.

**SEEPING SALMON EGGS**

THE MARK CONSISTS OF STANDARD CHARACTERS WITHOUT CLAIM TO ANY PARTICULAR FONT, STYLE, SIZE, OR COLOR.

**CLASS 28—(Continued).**

NO CLAIM IS MADE TO THE EXCLUSIVE RIGHT TO USE "SALMON EGGS", APART FROM THE MARK AS SHOWN.

FOR ARTIFICIAL FISHING BAIT, NAMELY, ARTIFICIAL SALMON EGGS COMPRISED OF MICROCAPSULES HAVING A POLYMERIC SHELL AND AN AQUEOUS LIQUID CORE THAT PRESERVE, STORE, AND CONTROL DELIVERY OF AN ACTIVE INGREDIENT FOR USE IN FISHING; ARTIFICIAL FISHING LURES, NAMELY, MICROCAPSULES HAVING A POLYMERIC SHELL AND AN AQUEOUS LIQUID CORE THAT PRESERVE, STORE AND CONTROL DELIVERY OF AN INGREDIENT FOR USE AS LURING FISH; SCENT LURES FOR FISHING, NAMELY, MICROCAPSULES HAVING A POLYMERIC SHELL AND AN AQUEOUS LIQUID CORE THAT PRESERVE, STORE, AND CONTROL DELIVERY OF AN INGREDIENT FOR USE IN DISSIPATING SCENT FOR ATTRACTING FISH (U.S. CLS. 22, 23, 38 AND 50).

FIRST USE 9-30-2012; IN COMMERCE 9-30-2012.

4,482,038. MBS ENTERPRISES LLC, WILMINGTON, DE. SN 85-730,294. PUB. 4-2-2013, FILED 9-17-2012.

 The logo for myzenhome.com features the word "myzenhome" in a lowercase, sans-serif font. "my" is in purple, "zen" is in green, and "home" is in a lighter green. The ".com" is in a smaller, black font below "home".

NO CLAIM IS MADE TO THE EXCLUSIVE RIGHT TO USE ".COM", APART FROM THE MARK AS SHOWN.

THE COLOR(S) BLACK, GREEN AND PURPLE IS/ARE CLAIMED AS A FEATURE OF THE MARK.

THE MARK CONSISTS OF "MYZENHOME" IN STYLIZED FONT WITH "MY" AND "HOME" IN GREEN AND THE "ZEN" IN PURPLE. BELOW THIS IS ".COM" IN BLACK STYLIZED FONT.

FOR YOGA CUSHIONS (U.S. CLS. 22, 23, 38 AND 50).  
FIRST USE 5-0-2013; IN COMMERCE 5-0-2013.

4,482,042. ZHEJIANG GRACE SPINNING & WEAVING GROUP CO., LTD., ZHEJIANG, CHINA. SN 85-731,201. PUB. 2-26-2013, FILED 9-17-2012.

 The logo for Grace orchid features a stylized flower design above the words "Grace orchid" in a cursive, serif font.

THE MARK CONSISTS OF THE WORDS "GRACE ORCHID" BELOW AN INCOMPLETE FLOWER DESIGN.

FOR CHESS GAMES; CHRISTMAS TREES OF SYNTHETIC MATERIAL; FOOTBALL GLOVES; INFANT TOYS; PLAYING CARDS; PROTECTIVE SUPPORTS FOR SHOULDERS AND ELBOWS; RUNNING GLOVES; SWIMMING GLOVES; TOY WHISTLES; WORK-OUT GLOVES (U.S. CLS. 22, 23, 38 AND 50).

FIRST USE 4-10-2013; IN COMMERCE 4-10-2013.

**CLASS 28—(Continued).**

4,482,059. WHITEWATER WEST INDUSTRIES LTD., RICHMOND, BC, CANADA. SN 85-732,154. PUB. 3-5-2013, FILED S.R. 9-18-2012; AM. P.R. 1-15-2013.

# AdrenaLIM

THE MARK CONSISTS OF STANDARD CHARACTERS WITHOUT CLAIM TO ANY PARTICULAR FONT, STYLE, SIZE, OR COLOR.

THE WORDING "ADRENALIM" HAS NO MEANING IN A FOREIGN LANGUAGE.

FOR AMUSEMENT PARK RIDES AND WATER PARK RIDES (U.S. CLS. 22, 23, 38 AND 50).

FIRST USE 5-8-2013; IN COMMERCE 5-8-2013.

**CLASS 28—(Continued).**

4,482,140. SEASTAR PADDLEBOARDS & ACCESORIES, INC., HOLLYWOOD, FL. SN 85-743,806. PUB. 4-23-2013, FILED 10-2-2012.



THE MARK CONSISTS OF THE WORD "SEASTAR" DISPOSED BELOW A STARFISH AND WATER DEVICE.

FOR PADDLEBOARDS, PADDLES FOR USE WITH PADDLEBOARDS, AND ACCESSORIES, NAMELY, BAGS ESPECIALLY DESIGNED FOR PADDLEBOARDS AND PADDLEBOARD LEASHES (U.S. CLS. 22, 23, 38 AND 50).

FIRST USE 7-17-2013; IN COMMERCE 7-17-2013.

4,482,212. FASTGOLF USA LLC, CHICAGO, IL. SN 85-755,269. PUB. 3-26-2013, FILED 10-16-2012.

# kazimoto

THE MARK CONSISTS OF STANDARD CHARACTERS WITHOUT CLAIM TO ANY PARTICULAR FONT, STYLE, SIZE, OR COLOR.

FOR GOLF CLUB SHAFTS; GOLF CLUBS (U.S. CLS. 22, 23, 38 AND 50).

FIRST USE 4-13-2011; IN COMMERCE 4-13-2011.

4,482,213. FASTGOLF USA LLC, CHICAGO, IL. SN 85-755,301. PUB. 3-26-2013, FILED 10-16-2012.

# DROP SHOT

THE MARK CONSISTS OF STANDARD CHARACTERS WITHOUT CLAIM TO ANY PARTICULAR FONT, STYLE, SIZE, OR COLOR.

FOR PARLOUR GAMES (U.S. CLS. 22, 23, 38 AND 50).

FIRST USE 10-23-2013; IN COMMERCE 10-23-2013.

# UTGPOWER

THE MARK CONSISTS OF STANDARD CHARACTERS WITHOUT CLAIM TO ANY PARTICULAR FONT, STYLE, SIZE, OR COLOR.

FOR GOLF CLUB GRIPS; GOLF CLUBS; GRIP TAPES FOR GOLF CLUBS (U.S. CLS. 22, 23, 38 AND 50).

FIRST USE 4-13-2011; IN COMMERCE 4-13-2011.

**CLASS 28—(Continued).**

4,482,236. ELLIOTT, CHRIS, FRIENDSWOOD, TX. SN 85-759,313. PUB. 3-26-2013, FILED 10-20-2012.



THE MARK CONSISTS OF THE WORD "PERFEKPOKET" IS WRITTEN WHEREIN THE SECOND LETTER "K" IS APPEARING IN MIRROR IMAGE AS SHOWN IN THE MARK.

FOR SPORTS EQUIPMENT, NAMELY, A PRODUCT TO ASSIST IN BREAKING IN, MAINTAINING, PERSONALIZING AND IDENTIFYING BASEBALL, SOFTBALL AND FASTPITCH MITTS AND GLOVES REGARDLESS OF ITS CONSTRUCTION AND/OR DESIGN (U.S. CLS. 22, 23, 38 AND 50).

FIRST USE 9-18-2013; IN COMMERCE 9-18-2013.

**CLASS 28—(Continued).**

4,482,278. TOYSHOCK USA LLC, MIAMI, FL. SN 85-769,145. PUB. 5-21-2013, FILED 11-1-2012.



NO CLAIM IS MADE TO THE EXCLUSIVE RIGHT TO USE "TOY", APART FROM THE MARK AS SHOWN.

THE MARK CONSISTS OF "TOY " IN A STYLIZED FONT WITH THE WORD "SHOCK" BELOW THE WORD "TOY" ALSO IN A STYLIZED FONT.

FOR DOLLS, NAMELY, FASHION AND TALKING DOLLS; ELECTRONIC LEARNING TOYS, RADIO CONTROL TOYS, NAMELY, CARS, HELICOPTERS, AIRPLANES; MAKE-UP, ROLE PLAYING TOYS, RIDE-ON TOYS, BILLIARD TABLES, PLUSH TOYS, ACTION FIGURES, GAME TABLES, MUSICAL TOYS, BALLS FOR SPORTS, INFLATABLE TOYS, BODY BOARDS, TABLE TENNIS SET, BOWLING BALLS, PUNCHING TOYS, TENNIS RACKETS, TABLE TENNIS RACKET (U.S. CLS. 22, 23, 38 AND 50).

FIRST USE 12-15-2006; IN COMMERCE 7-8-2012.

4,482,237. SWANBERG, MANS, BROOKLYN, NY. SN 85-759,754. PUB. 3-26-2013, FILED 10-22-2012.



THE MARK CONSISTS OF STANDARD CHARACTERS WITHOUT CLAIM TO ANY PARTICULAR FONT, STYLE, SIZE, OR COLOR.

FOR PLAY HOUSES AND TOY ACCESSORIES THEREFOR (U.S. CLS. 22, 23, 38 AND 50).

FIRST USE 6-1-2013; IN COMMERCE 9-1-2013.

4,482,280. MATTEL, INC., EL SEGUNDO, CA. SN 85-769,983. PUB. 4-9-2013, FILED 11-2-2012.



THE MARK CONSISTS OF STANDARD CHARACTERS WITHOUT CLAIM TO ANY PARTICULAR FONT, STYLE, SIZE, OR COLOR.

NO CLAIM IS MADE TO THE EXCLUSIVE RIGHT TO USE "GADGET", APART FROM THE MARK AS SHOWN.

FOR GAMING EQUIPMENT, NAMELY, ELECTRONIC GAMING MACHINES AND GAMING MACHINES WITH VIDEO OUTPUT (U.S. CLS. 22, 23, 38 AND 50).

FIRST USE 2-9-2013; IN COMMERCE 9-2-2013.



THE MARK CONSISTS OF STANDARD CHARACTERS WITHOUT CLAIM TO ANY PARTICULAR FONT, STYLE, SIZE, OR COLOR.

FOR TOY ACTION FIGURES AND ACCESSORIES THEREFOR (U.S. CLS. 22, 23, 38 AND 50).

FIRST USE 10-28-2013; IN COMMERCE 10-28-2013.

**CLASS 28—(Continued).**

4,482,281. MATTEL, INC., EL SEGUNDO, CA. SN 85-770,021.  
PUB. 4-9-2013, FILED 11-2-2012.

**WRECKING BRAWL**

THE MARK CONSISTS OF STANDARD CHARACTERS WITHOUT CLAIM TO ANY PARTICULAR FONT, STYLE, SIZE, OR COLOR.

FOR TOY ACTION FIGURES AND ACCESSORIES THEREFOR; TOY ACTION FIGURE PLAYSETS AND ACCESSORIES THEREFOR (U.S. CLS. 22, 23, 38 AND 50).  
FIRST USE 10-28-2013; IN COMMERCE 10-28-2013.

4,482,301. MATTEL, INC., EL SEGUNDO, CA. SN 85-780,433.  
PUB. 4-16-2013, FILED 11-15-2012.

**GO PIGGY GO!**

THE MARK CONSISTS OF STANDARD CHARACTERS WITHOUT CLAIM TO ANY PARTICULAR FONT, STYLE, SIZE, OR COLOR.

FOR PARLOR GAMES AND BOARD GAMES (U.S. CLS. 22, 23, 38 AND 50).  
FIRST USE 10-28-2013; IN COMMERCE 10-28-2013.

4,482,302. MATTEL, INC., EL SEGUNDO, CA. SN 85-780,442.  
PUB. 4-16-2013, FILED 11-15-2012.

**WINTER WEEKEND**

THE MARK CONSISTS OF STANDARD CHARACTERS WITHOUT CLAIM TO ANY PARTICULAR FONT, STYLE, SIZE, OR COLOR.

OWNER OF U.S. REG. NOS. 3,101,602, 3,702,528, AND OTHERS.  
FOR DOLL CLOTHING AND DOLL ACCESSORIES (U.S. CLS. 22, 23, 38 AND 50).  
FIRST USE 10-28-2013; IN COMMERCE 10-28-2013.

**CLASS 28—(Continued).**

4,482,303. MATTEL, INC., EL SEGUNDO, CA. SN 85-780,445.  
PUB. 4-23-2013, FILED 11-15-2012.

**SLIDE & SPIN PUPS!**

THE MARK CONSISTS OF STANDARD CHARACTERS WITHOUT CLAIM TO ANY PARTICULAR FONT, STYLE, SIZE, OR COLOR.

NO CLAIM IS MADE TO THE EXCLUSIVE RIGHT TO USE "PUPS", APART FROM THE MARK AS SHOWN.

FOR DOLLS, DOLL CLOTHING AND DOLL ACCESSORIES; TOY ANIMAL FIGURES AND ACCESSORIES THEREFOR (U.S. CLS. 22, 23, 38 AND 50).

FIRST USE 10-28-2013; IN COMMERCE 10-28-2013.

4,482,305. MATTEL, INC., EL SEGUNDO, CA. SN 85-780,681.  
PUB. 4-23-2013, FILED 11-15-2012.

**AIR ATTACK**

THE MARK CONSISTS OF STANDARD CHARACTERS WITHOUT CLAIM TO ANY PARTICULAR FONT, STYLE, SIZE, OR COLOR.

FOR TOY FIGURES AND ACCESSORIES THEREFOR; TOY VEHICLES AND ACCESSORIES THEREFOR (U.S. CLS. 22, 23, 38 AND 50).

FIRST USE 10-28-2013; IN COMMERCE 10-28-2013.

4,482,306. MATTEL, INC., EL SEGUNDO, CA. SN 85-780,695.  
PUB. 4-23-2013, FILED 11-15-2012.

**LAUGH & LOVE BABY**

THE MARK CONSISTS OF STANDARD CHARACTERS WITHOUT CLAIM TO ANY PARTICULAR FONT, STYLE, SIZE, OR COLOR.

NO CLAIM IS MADE TO THE EXCLUSIVE RIGHT TO USE "BABY", APART FROM THE MARK AS SHOWN.

FOR DOLLS, DOLL CLOTHING AND DOLL ACCESSORIES (U.S. CLS. 22, 23, 38 AND 50).

FIRST USE 10-28-2013; IN COMMERCE 10-28-2013.

**CLASS 28—(Continued).**

4,482,307. MATTEL, INC., EL SEGUNDO, CA. SN 85-780,702.  
PUB. 4-23-2013, FILED 11-15-2012.

**DEMOLITION CLAW**

THE MARK CONSISTS OF STANDARD CHARACTERS WITHOUT CLAIM TO ANY PARTICULAR FONT, STYLE, SIZE, OR COLOR.

NO CLAIM IS MADE TO THE EXCLUSIVE RIGHT TO USE "CLAW", APART FROM THE MARK AS SHOWN.

FOR TOY ACTION FIGURES AND ACCESSORIES THEREFOR (U.S. CLS. 22, 23, 38 AND 50).

FIRST USE 10-28-2013; IN COMMERCE 10-28-2013.

---

4,482,330. MATTEL, INC., EL SEGUNDO, CA. SN 85-788,439.  
PUB. 4-30-2013, FILED 11-27-2012.

**VANTOM**

THE MARK CONSISTS OF STANDARD CHARACTERS WITHOUT CLAIM TO ANY PARTICULAR FONT, STYLE, SIZE, OR COLOR.

FOR TOY VEHICLES AND ACCESSORIES THEREFOR (U.S. CLS. 22, 23, 38 AND 50).

FIRST USE 10-28-2013; IN COMMERCE 10-28-2013.

---

4,482,332. KARSTEN MANUFACTURING CORPORATION, PHOENIX, AZ. SN 85-789,753. PUB. 4-30-2013, FILED 11-28-2012.

**ANSER T**

THE MARK CONSISTS OF STANDARD CHARACTERS WITHOUT CLAIM TO ANY PARTICULAR FONT, STYLE, SIZE, OR COLOR.

OWNER OF U.S. REG. NOS. 890,396, 4,139,704, AND 4,248,928.

FOR GOLF CLUBS (U.S. CLS. 22, 23, 38 AND 50).

FIRST USE 10-23-2013; IN COMMERCE 10-23-2013.

**CLASS 28—(Continued).**

4,482,346. KALISH, KATHERINE, MONUMENT, CO. SN 85-792,997. PUB. 5-7-2013, FILED 12-3-2012.



THE COLOR(S) RED AND GOLD IS/ARE CLAIMED AS A FEATURE OF THE MARK.

THE MARK CONSISTS OF THE WORD "LEXI" IN A STYLIZED GOLD FONT AND THE BACKGROUND OF THE MARK IS RED.

FOR CARD GAMES (U.S. CLS. 22, 23, 38 AND 50).

FIRST USE 10-1-2013; IN COMMERCE 10-1-2013.

---

4,482,389. ADRENALIN GAMING, LLC, LADERA RANCH, CA. SN 85-810,186. PUB. 6-11-2013, FILED 12-24-2012.

**Riddle in the Cash**

THE MARK CONSISTS OF STANDARD CHARACTERS WITHOUT CLAIM TO ANY PARTICULAR FONT, STYLE, SIZE, OR COLOR.

FOR A PROMOTIONAL GAME COMPRISED OF A PRIZE WHEEL AND PROMOTIONAL GAME MATERIALS (U.S. CLS. 22, 23, 38 AND 50).

FIRST USE 2-1-2013; IN COMMERCE 2-1-2013.

---

4,482,412. ALL FOR KIDZ, INC., LYNNWOOD, WA. SN 85-819,003. PUB. 6-4-2013, FILED 1-9-2013.

**Excelerator**

THE MARK CONSISTS OF STANDARD CHARACTERS WITHOUT CLAIM TO ANY PARTICULAR FONT, STYLE, SIZE, OR COLOR.

FOR YO-YOS (U.S. CLS. 22, 23, 38 AND 50).

FIRST USE 4-10-2013; IN COMMERCE 4-10-2013.

**CLASS 28—(Continued).**

4,482,433. ROUND 4 PUTTERS, LLC, POMPANO BEACH, FL.  
SN 85-824,358. PUB. 7-2-2013, FILED 1-16-2013.



NO CLAIM IS MADE TO THE EXCLUSIVE RIGHT TO USE "COMPETITION PUTTERS", APART FROM THE MARK AS SHOWN.

THE MARK CONSISTS OF THE WORDING "ROUND 4 COMPETITION PUTTERS" WITH A STYLIZED "4".

FOR GOLF PUTTERS; GOLF CLUB GRIPS; GOLF PUTTER COVERS (U.S. CLS. 22, 23, 38 AND 50).  
FIRST USE 10-1-2012; IN COMMERCE 12-20-2012.

**CLASS 28—(Continued).**

4,482,442. DIRECT INC., DBA COMMAND POST GAMES, WICHITA FALLS, TX. SN 85-829,248. PUB. 6-4-2013, FILED 1-22-2013.



THE MARK CONSISTS OF EAGLE WITH LITERAL ELEMENT "SUPREMACY" IN STYLIZED FORM WITH FIVE STARS.

FOR EQUIPMENT SOLD AS A UNIT FOR PLAYING BOARD GAMES (U.S. CLS. 22, 23, 38 AND 50).  
FIRST USE 4-29-2013; IN COMMERCE 4-29-2013.

4,482,434. TELEBRANDS CORP., FAIRFIELD, NJ. SN 85-825,939. PUB. 5-21-2013, FILED 1-17-2013.

**PERFECT POLLY**

THE MARK CONSISTS OF STANDARD CHARACTERS WITHOUT CLAIM TO ANY PARTICULAR FONT, STYLE, SIZE, OR COLOR.

FOR MOTION ACTIVATED SINGING TOY NOVELTY PARAKEET (U.S. CLS. 22, 23, 38 AND 50).  
FIRST USE 10-3-2012; IN COMMERCE 10-3-2012.

4,482,436. MATTEL, INC., EL SEGUNDO, CA. SN 85-826,682. PUB. 6-11-2013, FILED 1-18-2013.

**END OF WARS**

THE MARK CONSISTS OF STANDARD CHARACTERS WITHOUT CLAIM TO ANY PARTICULAR FONT, STYLE, SIZE, OR COLOR.

FOR TOY ACTION FIGURE ACCESSORIES (U.S. CLS. 22, 23, 38 AND 50).  
FIRST USE 10-15-2013; IN COMMERCE 10-15-2013.

4,482,476. CBS STUDIOS INC., STUDIO CITY, CA. SN 85-844,603. PUB. 7-2-2013, FILED 2-8-2013.

**TREKKIES**

THE MARK CONSISTS OF STANDARD CHARACTERS WITHOUT CLAIM TO ANY PARTICULAR FONT, STYLE, SIZE, OR COLOR.

FOR MODELED PLASTIC TOY FIGURINES; COLLECTIBLE TOY FIGURES; ACTION FIGURE TOYS; TOY FIGURES SOLD AS A UNIT WITH MARKER AND WRITING SURFACE (U.S. CLS. 22, 23, 38 AND 50).  
FIRST USE 3-1-2013; IN COMMERCE 3-1-2013.

4,482,477. ANCHOR PADDLEBOARDS, HELOTES, TX. SN 85-846,520. PUB. 7-16-2013, FILED 2-11-2013.

**Anchor Paddleboards**

THE MARK CONSISTS OF STANDARD CHARACTERS WITHOUT CLAIM TO ANY PARTICULAR FONT, STYLE, SIZE, OR COLOR.

**CLASS 28—(Continued).**

NO CLAIM IS MADE TO THE EXCLUSIVE RIGHT TO USE "PADDLEBOARDS", APART FROM THE MARK AS SHOWN.

FOR BOARDS USED IN THE PRACTICE OF WATER SPORTS; DECK GRIPS FOR SPORTS EQUIPMENT BOARDS, NAMELY, PADDLE BOARDS; PADDLE BOARDS; PADDLE SURFBOARDS; PADDLES FOR USE WITH SURFBOARDS; SELF-POWERED WATER SPORTS BOARDS; STAND-UP PADDLE BOARD CARRYING STRAPS SOLD AS A UNIT WITH THE PADDLE BOARD; STAND-UP PADDLE BOARDS; STAND-UP SURF PADDLES; SURF BOARDS; SURF PADDLES; TRACTION PADS FOR SPORTS EQUIPMENT BOARDS, NAMELY, PADDLE BOARDS; WAKE BOARDS; YOGA BOARDS (U.S. CLS. 22, 23, 38 AND 50).

FIRST USE 1-1-2013; IN COMMERCE 6-1-2013.

**CLASS 28—(Continued).**

4,482,544. BEVERIDGE MARKETING LLC, POTOMAC, MD. SN 85-870,611. PUB. 8-27-2013, FILED 3-8-2013.

PLAY TOUGH. PLAY SMART.

4,482,478. HOIST FITNESS SYSTEMS, INC., POWAY, CA. SN 85-846,908. PUB. 7-30-2013, FILED 2-11-2013.

THE MARK CONSISTS OF STANDARD CHARACTERS WITHOUT CLAIM TO ANY PARTICULAR FONT, STYLE, SIZE, OR COLOR.

FOR STICKERS, ADHESIVE STRIPS, AND ADHESIVE PATCHES FOR WEARING ON THE FACE TO REDUCE UNDER-EYE GLARE (U.S. CLS. 22, 23, 38 AND 50).

FIRST USE 10-1-2011; IN COMMERCE 10-1-2011.

# MOTIONCAGE

THE MARK CONSISTS OF STANDARD CHARACTERS WITHOUT CLAIM TO ANY PARTICULAR FONT, STYLE, SIZE, OR COLOR.

NO CLAIM IS MADE TO THE EXCLUSIVE RIGHT TO USE "CAGE", APART FROM THE MARK AS SHOWN.

FOR MANUALLY OPERATED EXERCISE EQUIPMENT (U.S. CLS. 22, 23, 38 AND 50).

FIRST USE 8-15-2013; IN COMMERCE 8-15-2013.

4,482,545. CHANG, LI-LING, TAICHUNG CITY, TAIWAN. SN 85-870,863. PUB. 8-20-2013, FILED 3-8-2013.

# 永旺

4,482,479. HOIST FITNESS SYSTEMS, INC., POWAY, CA. SN 85-846,909. PUB. 7-30-2013, FILED 2-11-2013.

# HOIST MOTIONCAGE

THE MARK CONSISTS OF STANDARD CHARACTERS WITHOUT CLAIM TO ANY PARTICULAR FONT, STYLE, SIZE, OR COLOR.

OWNER OF U.S. REG. NOS. 2,955,061 AND 4,219,568. FOR MANUALLY OPERATED EXERCISE EQUIPMENT (U.S. CLS. 22, 23, 38 AND 50).

FIRST USE 8-15-2013; IN COMMERCE 8-15-2013.

THE MARK CONSISTS OF TWO CHINESE CHARACTERS THAT TRANSLITERATE TO YONG MEANING PERMANENT IN ENGLISH AND WANG MEANING TO PROSPER IN ENGLISH.

THE NON-LATIN CHARACTERS IN THE MARK TRANSLITERATE TO YONG AND WANG AND THIS MEANS PERMANENT AND PROSPER IN ENGLISH.

FOR EXERCISE EQUIPMENT NAMELY, ROWING MACHINES; EXERCISE EQUIPMENT, NAMELY, SHOULDER STRETCHER USING RESISTANCE CABLES; EXERCISE EQUIPMENT, NAMELY, STAIR-STEPPING MACHINES; EXERCISE MACHINES; EXERCISE TREADMILLS; MANUALLY-OPERATED EXERCISE EQUIPMENT; STATIONARY EXERCISE BICYCLES; WRIST GUARDS FOR ATHLETIC USE (U.S. CLS. 22, 23, 38 AND 50).

FIRST USE 10-1-2013; IN COMMERCE 10-1-2013.



**CLASS 28—(Continued).**

4,482,637. TRAININGMASK, LLC, CADILLAC, MI. SN 85-905,062. PUB. 8-20-2013, FILED 4-16-2013.

**CLASS 28—(Continued).**

4,482,649. TRAININGMASK, LLC, CADILLAC, MI. SN 85-922,130. PUB. 8-20-2013, FILED 5-2-2013.

# Let's Get Fitter

THE MARK CONSISTS OF STANDARD CHARACTERS WITHOUT CLAIM TO ANY PARTICULAR FONT, STYLE, SIZE, OR COLOR.

FOR BODY-TRAINING APPARATUS; EXERCISE EQUIPMENT, NAMELY, RESISTANCE TRAINING EXERCISE MASKS WHICH RESTRICT AIRFLOW; MARTIAL ARTS TRAINING EQUIPMENT; PHYSICAL FITNESS EQUIPMENT, NAMELY, RESISTANCE TRAINING EXERCISE MASKS WHICH RESTRICT AIRFLOW; TRAINING APPARATUS FOR BOXING, MARTIAL ARTS, AND SIMILAR SPORTS (U.S. CLS. 22, 23, 38 AND 50).

FIRST USE 7-1-2013; IN COMMERCE 7-1-2013.

## ALTITUDE ON THE RUN

THE MARK CONSISTS OF STANDARD CHARACTERS WITHOUT CLAIM TO ANY PARTICULAR FONT, STYLE, SIZE, OR COLOR.

FOR BODY-TRAINING APPARATUS; EXERCISE EQUIPMENT, NAMELY, RESISTANCE TRAINING EXERCISE MASKS WHICH RESTRICT AIRFLOW; MARTIAL ARTS TRAINING EQUIPMENT; PHYSICAL FITNESS EQUIPMENT, NAMELY, RESISTANCE TRAINING EXERCISE MASKS WHICH RESTRICT AIRFLOW; TRAINING APPARATUS FOR BOXING, MARTIAL ARTS, AND SIMILAR SPORTS (U.S. CLS. 22, 23, 38 AND 50).

FIRST USE 7-1-2013; IN COMMERCE 7-1-2013.

4,482,650. TRAININGMASK, LLC, CADILLAC, MI. SN 85-922,132. PUB. 8-20-2013, FILED 5-2-2013.

## ALTITUDE ON THE FLY

THE MARK CONSISTS OF STANDARD CHARACTERS WITHOUT CLAIM TO ANY PARTICULAR FONT, STYLE, SIZE, OR COLOR.

FOR BODY-TRAINING APPARATUS; EXERCISE EQUIPMENT, NAMELY, RESISTANCE TRAINING EXERCISE MASKS WHICH RESTRICT AIRFLOW; MARTIAL ARTS TRAINING EQUIPMENT; PHYSICAL FITNESS EQUIPMENT, NAMELY, RESISTANCE TRAINING EXERCISE MASKS WHICH RESTRICT AIRFLOW; TRAINING APPARATUS FOR BOXING, MARTIAL ARTS, AND SIMILAR SPORTS (U.S. CLS. 22, 23, 38 AND 50).

FIRST USE 7-1-2013; IN COMMERCE 7-1-2013.

4,482,648. TRAININGMASK, LLC, CADILLAC, MI. SN 85-922,124. PUB. 8-20-2013, FILED 5-2-2013.

## RESISTANCE ON THE RUN

THE MARK CONSISTS OF STANDARD CHARACTERS WITHOUT CLAIM TO ANY PARTICULAR FONT, STYLE, SIZE, OR COLOR.

FOR BODY-TRAINING APPARATUS; EXERCISE EQUIPMENT, NAMELY, RESISTANCE TRAINING EXERCISE MASKS WHICH RESTRICT AIRFLOW; MARTIAL ARTS TRAINING EQUIPMENT; PHYSICAL FITNESS EQUIPMENT, NAMELY, RESISTANCE TRAINING EXERCISE MASKS WHICH RESTRICT AIRFLOW; TRAINING APPARATUS FOR BOXING, MARTIAL ARTS, AND SIMILAR SPORTS (U.S. CLS. 22, 23, 38 AND 50).

FIRST USE 7-1-2013; IN COMMERCE 7-1-2013.

4,482,651. TRAININGMASK, LLC, CADILLAC, MI. SN 85-922,133. PUB. 8-20-2013, FILED 5-2-2013.

## ELEVATION ON THE FLY

THE MARK CONSISTS OF STANDARD CHARACTERS WITHOUT CLAIM TO ANY PARTICULAR FONT, STYLE, SIZE, OR COLOR.

**CLASS 28—(Continued).**

OWNER OF U.S. REG. NO. 4,094,823.  
 FOR BODY-TRAINING APPARATUS; EXERCISE EQUIPMENT, NAMELY, RESISTANCE TRAINING EXERCISE MASKS WHICH RESTRICT AIRFLOW; MARTIAL ARTS TRAINING EQUIPMENT; PHYSICAL FITNESS EQUIPMENT, NAMELY, RESISTANCE TRAINING EXERCISE MASKS WHICH RESTRICT AIRFLOW; TRAINING APPARATUS FOR BOXING, MARTIAL ARTS, AND SIMILAR SPORTS (U.S. CLS. 22, 23, 38 AND 50).  
 FIRST USE 7-1-2013; IN COMMERCE 7-1-2013.

4,482,652. TRAININGMASK, LLC, CADILLAC, MI. SN 85-922,135. PUB. 8-20-2013, FILED 5-2-2013.

**ELEVATION ON THE RUN**

THE MARK CONSISTS OF STANDARD CHARACTERS WITHOUT CLAIM TO ANY PARTICULAR FONT, STYLE, SIZE, OR COLOR.  
 OWNER OF U.S. REG. NO. 4,094,823.  
 FOR BODY-TRAINING APPARATUS; EXERCISE EQUIPMENT, NAMELY, RESISTANCE TRAINING EXERCISE MASKS WHICH RESTRICT AIRFLOW; MARTIAL ARTS TRAINING EQUIPMENT; PHYSICAL FITNESS EQUIPMENT, NAMELY, RESISTANCE TRAINING EXERCISE MASKS WHICH RESTRICT AIRFLOW; TRAINING APPARATUS FOR BOXING, MARTIAL ARTS, AND SIMILAR SPORTS (U.S. CLS. 22, 23, 38 AND 50).  
 FIRST USE 7-1-2013; IN COMMERCE 7-1-2013.

4,482,668. DIRTY BIRD PRODUCTIONS, LOS ANGELES, CA. SN 85-978,375. PUB. 2-26-2013, FILED 10-19-2010.



THE MARK CONSISTS OF A CIRCLE AROUND 4 STYLIZED "G"'S.  
 FOR GOLF GLOVES (U.S. CLS. 22, 23, 38 AND 50).  
 FIRST USE 1-15-2011; IN COMMERCE 1-15-2011.

**CLASS 28—(Continued).**

4,482,696. MATTEL, INC., EL SEGUNDO, CA. SN 85-980,866. PUB. 10-23-2012, FILED 2-15-2012.



OWNER OF U.S. REG. NOS. 3,620,921 AND 3,620,922.  
 THE NAME(S), PORTRAIT(S), AND/OR SIGNATURE(S) SHOWN IN THE MARK DOES NOT IDENTIFY A PARTICULAR LIVING INDIVIDUAL.  
 THE MARK CONSISTS OF THE STYLIZED WORDING "MAX STEEL" FORMING A POLYGON ABOVE AN ABSTRACT GEOMETRIC FIGURE HAVING AN OVERALL TRIANGULAR SHAPE.  
 FOR TOYS, GAMES AND PLAYTHINGS, NAMELY, TOY VEHICLES AND ACCESSORIES THEREFOR, TOY FIGURES AND ACCESSORIES THEREFOR, ACTION FIGURES AND ACCESSORIES THEREFOR (U.S. CLS. 22, 23, 38 AND 50).  
 FIRST USE 9-2-2013; IN COMMERCE 9-2-2013.

**CLASS 29—MEATS AND PROCESSED FOODS**

4,481,531. RAJBHOG FOODS INC, FLUSHING, NY. SN 85-393,140. PUB. 4-10-2012, FILED 8-9-2011.



NO CLAIM IS MADE TO THE EXCLUSIVE RIGHT TO USE "DESI THALI", APART FROM THE MARK AS SHOWN. THE COLOR(S) YELLOW, RED, ORANGE IS/ARE CLAIMED AS A FEATURE OF THE MARK.  
 THE MARK CONSISTS OF THE ORANGE STYLIZED WORDING "DESI" WITH A RED FLOWER ABOVE THE LETTER "I". BELOW THE WORDING "DESI" IS THE RED STYLIZED WORDING "THALI" WITH AN ORANGE FLOWER ABOVE THE LETTER "I". ALL OF THE WORDING IS ON A YELLOW CIRCLE THAT RADIATES OUT INTO AN ORANGE CIRCLE THAT IS BORDERED BY A YELLOW CHAIN OF LOTUS FLOWERS. THE OUTSIDE BORDER OF THE CIRCLE IS RED.  
 THE ENGLISH TRANSLATION OF "DESI THALI" IS "PLATE OF VARIOUS INDIAN FOODS".  
 FOR FOOD PACKAGE COMBINATIONS CONSISTING PRIMARILY OF CHEESE, MEAT AND/OR PROCESSED FRUIT; FROZEN APPETIZERS CONSISTING PRIMARILY OF CHICKEN OR SEAFOOD; FROZEN PRE-PACKAGED ENTREES CONSISTING PRIMARILY OF SEAFOOD; FROZEN VEGETABLES; PRESERVED, FROZEN, DRIED OR COOKED VEGETABLES (U.S. CL. 46).  
 FIRST USE 8-9-2011; IN COMMERCE 8-9-2011.

**CLASS 29—(Continued).**

4,481,546. LB BRANDS, LLC, PORT CLYDE, ME. SN 85-419,311. PUB. 12-20-2011, FILED 9-9-2011.

## LOBSTER FOR THE 21ST CENTURY

THE MARK CONSISTS OF STANDARD CHARACTERS WITHOUT CLAIM TO ANY PARTICULAR FONT, STYLE, SIZE, OR COLOR.

NO CLAIM IS MADE TO THE EXCLUSIVE RIGHT TO USE "LOBSTER", APART FROM THE MARK AS SHOWN. FOR LOBSTERS (U.S. CL. 46).  
FIRST USE 3-31-2013; IN COMMERCE 3-31-2013.

4,481,685. SALADO SALES, INC., TEMPLE, TX. SN 85-554,533. PUB. 9-18-2012, FILED 2-28-2012.



OWNER OF U.S. REG. NOS. 3,403,435 AND 3,980,942. NO CLAIM IS MADE TO THE EXCLUSIVE RIGHT TO USE "FOODS", APART FROM THE MARK AS SHOWN.

THE MARK CONSISTS OF THE WORD "DOUBLE" OVER THE STYLIZED LETTER "S" WITH THE WORD "FOODS" BELOW IT, WITHIN AN OVAL, IMPOSED ON TOP OF A RIBBON SHAPE.

FOR BEEF JERKY (U.S. CL. 46).  
FIRST USE 8-0-2012; IN COMMERCE 8-0-2012.

4,481,709. BLAND FARMS, LLC, GLENNVILLE, GA. SN 85-578,287. PUB. 9-11-2012, FILED 3-23-2012.



OWNER OF U.S. REG. NO. 2,812,194. NO CLAIM IS MADE TO THE EXCLUSIVE RIGHT TO USE "VIDALIA BRANDS", APART FROM THE MARK AS SHOWN.

**CLASS 29—(Continued).**

THE MARK CONSISTS OF A RECTANGLE DRAWN WITH DOUBLE LINES WITH AN ONION IN A CIRCLE ATOP THE RECTANGLE WITH TWO LEAVES ON EITHER SIDE OF THE CIRCLE; THE WORD "VIDALIA" INSIDE THE RECTANGLE, THE BEGINNING "V" AND ENDING "A" LARGER THAN THE OTHER LETTERS SO THAT THE WORD AND SYMBOLS ". BRANDS ." FITS UNDER "VIDALIA" BETWEEN THE "V" AND THE LAST "A".

FOR ONION RINGS; SNACK FOODS IN THE NATURE OF VEGETABLE CHIPS, NAMELY, SWEET POTATO FRIES AND ONION PETALS (U.S. CL. 46).  
FIRST USE 10-1-2012; IN COMMERCE 10-1-2012.

4,481,717. FRITO-LAY NORTH AMERICA, INC., PLANO, TX. SN 85-586,774. PUB. 8-21-2012, FILED 4-2-2012.

## THE FLAVOR OF A LIFETIME

THE MARK CONSISTS OF STANDARD CHARACTERS WITHOUT CLAIM TO ANY PARTICULAR FONT, STYLE, SIZE, OR COLOR.

FOR FRIED PLANTAIN (U.S. CL. 46).  
FIRST USE 11-0-2012; IN COMMERCE 11-0-2012.

4,481,835. HIP CHICK FARMS, INC., SEBASTOPOL, CA. SN 85-649,949. PUB. 3-19-2013, FILED 6-12-2012.

## HIP CHICK FARMS

THE MARK CONSISTS OF STANDARD CHARACTERS WITHOUT CLAIM TO ANY PARTICULAR FONT, STYLE, SIZE, OR COLOR.

NO CLAIM IS MADE TO THE EXCLUSIVE RIGHT TO USE "FARMS", APART FROM THE MARK AS SHOWN. FOR CHICKEN, CHICKEN STRIPS, CHICKEN WINGS, CHICKEN MEATBALLS (U.S. CL. 46).  
FIRST USE 1-8-2013; IN COMMERCE 9-30-2013.

**CLASS 29—(Continued).**

4,481,973. SWISS-AMERICAN, INC., ST. LOUIS, MO. SN 85-716,158. PUB. 2-5-2013, FILED 8-29-2012.

# Barrel & Wedge

THE MARK CONSISTS OF STANDARD CHARACTERS WITHOUT CLAIM TO ANY PARTICULAR FONT, STYLE, SIZE, OR COLOR.

FOR CHEESE (U.S. CL. 46).  
FIRST USE 1-1-2013; IN COMMERCE 1-1-2013.

**CLASS 29—(Continued).**

4,482,368. SCHMALTZ RETAIL PRODUCTS, LLC, NAPERVILLE, IL. SN 85-802,586. PUB. 3-5-2013, FILED 12-13-2012.



THE MARK CONSISTS OF COW IN PROFILE FACING RIGHT STANDING ON A HORIZONTAL BAR (REPRESENTING THE GROUND) WITH GRASS WITH "SCHMACON" WRITTEN ON THE COW'S SIDE.

FOR DRIED MEAT; FRESH MEAT; LUNCHEON MEATS; MARINATED MEAT; MEAT; PACKAGED MEATS; PASTRAMI; PREPARED FOOD KITS COMPOSED OF MEAT, POULTRY, FISH, SEAFOOD, AND/OR VEGETABLES AND ALSO INCLUDING SAUCES OR SEASONINGS, READY FOR COOKING AND ASSEMBLY AS A MEAL; PREPARED MEAT; SALTED MEAT; SEASONED MEAT; SLICED MEAT (U.S. CL. 46).  
FIRST USE 12-14-2012; IN COMMERCE 12-14-2012.

4,481,998. SYSCO CORPORATION, HOUSTON, TX. SN 85-722,931. PUB. 2-19-2013, FILED 9-7-2012.



THE COLOR(S) GREEN AND ORANGE IS/ARE CLAIMED AS A FEATURE OF THE MARK.

THE MARK CONSISTS OF TWO GREEN LEAVES BELOW AN ORANGE ARC.

FOR PROCESSED VEGETABLES AND FRUITS (U.S. CL. 46).  
FIRST USE 8-1-2012; IN COMMERCE 8-1-2012.

4,482,428. R & A BAILEY & CO, DUBLIN 12, IRELAND. SN 85-822,725. PUB. 6-4-2013, FILED 1-14-2013.



OWNER OF U.S. REG. NOS. 3,790,797, 3,807,041, AND 3,888,604.

THE MARK CONSISTS OF INTERTWINED LOOPS FORMING A BACK-TO-BACK STYLIZED LETTER "B" DESIGN.

FOR COFFEE CREAMER; NON-DAIRY CREAMER (U.S. CL. 46).  
FIRST USE 6-1-2013; IN COMMERCE 6-1-2013.

4,482,165. PENNSYLVANIA CO-OPERATIVE POTATO GROWERS, INC., HARRISBURG, PA. SN 85-747,164. PUB. 7-23-2013, FILED 10-5-2012.

# PENN'S OWN

THE MARK CONSISTS OF STANDARD CHARACTERS WITHOUT CLAIM TO ANY PARTICULAR FONT, STYLE, SIZE, OR COLOR.

FOR PROCESSED VEGETABLES; PROCESSED POTATOES (U.S. CL. 46).  
FIRST USE 9-19-2013; IN COMMERCE 9-19-2013.

**CLASS 29—(Continued).**

4,482,485. SIGNATURE FOOD MARKETING, LLC, PENDERGRASS, GA. SN 85-850,049. PUB. 7-16-2013, FILED 2-14-2013.

**FISHING BUDDIES**

THE MARK CONSISTS OF STANDARD CHARACTERS WITHOUT CLAIM TO ANY PARTICULAR FONT, STYLE, SIZE, OR COLOR.

FOR FISH, NAMELY, FISH STICKS AND FISH NUGGETS, NOT LIVE (U.S. CL. 46).

FIRST USE 11-0-2013; IN COMMERCE 11-0-2013.

4,482,567. EBARS, LLC, FRANKLIN, TN. SN 85-878,484. PUB. 7-30-2013, FILED 3-18-2013.

**RUN  
RUNNERS UNEQUALED NUTRITION**

THE MARK CONSISTS OF STANDARD CHARACTERS WITHOUT CLAIM TO ANY PARTICULAR FONT, STYLE, SIZE, OR COLOR.

NO CLAIM IS MADE TO THE EXCLUSIVE RIGHT TO USE "RUNNERS" AND "NUTRITION", APART FROM THE MARK AS SHOWN.

FOR ORGANIC NUT AND SEED-BASED SNACK BARS (U.S. CL. 46).

FIRST USE 9-7-2013; IN COMMERCE 9-7-2013.

4,482,624. SIGMA ALIMENTOS, S.A. DE C.V., SAN PEDRO GARZA GARCIA, MEXICO. SN 85-898,454. PUB. 6-25-2013, FILED 4-8-2013.

**FLAVOR ON FIRE**

THE MARK CONSISTS OF STANDARD CHARACTERS WITHOUT CLAIM TO ANY PARTICULAR FONT, STYLE, SIZE, OR COLOR.

FOR SAUSAGES, NAMELY, HOT LINK SAUSAGES, SPICY SAUSAGE IN LINK FORM, SKINLESS SMOKED SAUSAGE, SKINLESS POLISH SAUSAGE, SKINLESS SAUSAGE WITH CHEESE, SKINLESS SPICY SMOKED SAUSAGE, SMOKED BREAKFAST LINK, SMOKED MAPLE BREAKFAST LINK, SMOKED SAUSAGE LOOP, POLISH SMOKED SAUSAGE LOOP; PORK SAUSAGE; SALAMIS, COTTO SALAMI; FRANKFURTERS, NAMELY, MEAT FRANKS, BEEF FRANKS, CHICKEN FRANKS, TURKEY FRANKS, CHEESE FRANKS (U.S. CL. 46).

FIRST USE 5-19-2013; IN COMMERCE 5-19-2013.

**CLASS 29—(Continued).**

4,482,660. MONSTER ENERGY COMPANY, CORONA, CA. SN 85-933,264. PUB. 8-27-2013, FILED 5-15-2013.

**PUMP UP THE BEAST!**

THE MARK CONSISTS OF STANDARD CHARACTERS WITHOUT CLAIM TO ANY PARTICULAR FONT, STYLE, SIZE, OR COLOR.

FOR DAIRY-BASED BEVERAGES; DAIRY-BASED ENERGY SHAKES (U.S. CL. 46).

FIRST USE 3-18-2013; IN COMMERCE 3-18-2013.

**CLASS 30—STAPLE FOODS**

4,481,326. S & P SYNDICATE PUBLIC COMPANY LIMITED, BANGKOK, THAILAND. SN 77-753,006. PUB. 11-9-2010, FILED 6-5-2009.

patara  
FINE THAI CUISINE

NO CLAIM IS MADE TO THE EXCLUSIVE RIGHT TO USE "FINE THAI CUISINE", APART FROM THE MARK AS SHOWN.

THE MARK CONSISTS OF "PATARA FINE THAI CUISINE" WITH "PATARA" APPEARING DIRECTLY ABOVE "FINE THAI CUISINE".

THE WORDING "PATARA" HAS NO MEANING IN A FOREIGN LANGUAGE.

FOR COOKIES, CAKE, BREAD, CHINESE LUNAR CAKE, THAI DESSERT, NAMELY, FLOUR AND/OR GRAIN BASED DESSERTS CONTAINING COCONUT MILK; THAI BAKERY DESSERTS, NAMELY, FLOUR AND/OR GRAIN BASED DESSERTS CONTAINING SYRUP, THAI BAKERY DESSERT MADE FROM RICE, TARO AND GRAIN, AND THAI CUSTARD; SAUCE; DIPPING SAUCE, SALAD DRESSING, CHILI SAUCE (U.S. CL. 46).

FIRST USE 11-20-2013; IN COMMERCE 11-20-2013.

**CLASS 30—(Continued).**

4,481,347. DISNEY ENTERPRISES, INC., BURBANK, CA. SN 77-866,417. PUB. 10-5-2010, FILED 11-5-2009.

**DISNEY FAIRIES**

THE MARK CONSISTS OF STANDARD CHARACTERS WITHOUT CLAIM TO ANY PARTICULAR FONT, STYLE, SIZE, OR COLOR.

OWNER OF U.S. REG. NOS. 3,233,781, 3,600,217, AND 3,732,806.

FOR CAKE DECORATIONS MADE OF CANDY (U.S. CL. 46).

FIRST USE 6-0-2013; IN COMMERCE 6-0-2013.

4,481,353. SUNSHINE, RICHARD, DALLAS, TX. SN 77-888,155. PUB. 9-7-2010, FILED 12-7-2009.

**CORNATO**

THE MARK CONSISTS OF STANDARD CHARACTERS WITHOUT CLAIM TO ANY PARTICULAR FONT, STYLE, SIZE, OR COLOR.

FOR CORN-BASED SNACK FOODS (U.S. CL. 46).

FIRST USE 10-1-2013; IN COMMERCE 10-1-2013.

4,481,373. HALF SWEET FOOD & BEVERAGES LLC, WASHINGTON, DC. SN 77-969,051. PUB. 8-3-2010, FILED 3-26-2010.

**Half as sweet. Twice as good.**

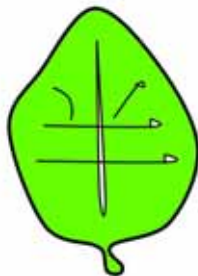

THE COLORS BLACK AND WHITE REPRESENT BACKGROUND, OUTLINING, SHADING AND/OR TRANSPARENT AREAS AND ARE NOT PART OF THE MARK.

THE COLOR(S) BLACK AND GREEN IS/ARE CLAIMED AS A FEATURE OF THE MARK.

**CLASS 30—(Continued).**

THE MARK CONSISTS OF THE WORDING "HALF AS SWEET. TWICE AS GOOD." IN BLACK LETTERING DEPICTED ABOVE A DESIGN OF A GREEN LEAF OUTLINED IN BLACK WITH THE CHINESE CHARACTER FOR THE WORD "HALF" DESIGNED TO APPEAR AS THE VEINS OF THE LEAF, ALSO IN BLACK.

THE NON-LATIN CHARACTERS IN THE MARK TRANSLITERATE TO BAHN AND THIS MEANS "HALF" IN ENGLISH.

FOR BEVERAGES MADE OF TEA; ICED TEA (U.S. CL. 46).

FIRST USE 9-10-2008; IN COMMERCE 8-4-2012.

4,481,506. BURTON, JASON, DBA CHUPACABRA CANTINA, AUSTIN, TX. SN 85-349,633. PUB. 11-29-2011, FILED 6-17-2011.



THE MARK CONSISTS OF THE WORD "CHUPACABRA" ABOVE THE DESIGN OF A GOAT HOLDING A SOMBRERO-STYLE HAT SURROUNDED BY FOUR CACTUSES. THE ENGLISH TRANSLATION OF "CHUPACABRA" IN THE MARK IS "GOAT SUCKER".

FOR HOT SAUCE; SALSA (U.S. CL. 46).

FIRST USE 1-20-2004; IN COMMERCE 12-9-2013.

4,481,513. C & F FOODS, INC., CITY OF INDUSTRY, CA. SN 85-362,008. PUB. 9-13-2011, FILED 7-1-2011.

**NATURE'S FIELDS**

THE MARK CONSISTS OF STANDARD CHARACTERS WITHOUT CLAIM TO ANY PARTICULAR FONT, STYLE, SIZE, OR COLOR.

FOR RICE (U.S. CL. 46).

FIRST USE 6-6-2013; IN COMMERCE 6-14-2013.

**CLASS 30—(Continued).**

4,481,526. CELLULAR HARMONIES, LLC, EVANSTON, IL. SN 85-385,517. PUB. 2-14-2012, FILED S.R. 7-31-2011; AM. P.R. 11-29-2011.

## Cody's Crunch

THE MARK CONSISTS OF STANDARD CHARACTERS WITHOUT CLAIM TO ANY PARTICULAR FONT, STYLE, SIZE, OR COLOR.

FOR GRANOLA (U.S. CL. 46).  
FIRST USE 5-20-2013; IN COMMERCE 7-14-2013.

4,481,570. PALETERIA LA MICHOACANA, LLC, MODESTO, CA. SN 85-436,666. PUB. 9-11-2012, FILED 9-30-2011.



NO CLAIM IS MADE TO THE EXCLUSIVE RIGHT TO USE "MINI", APART FROM THE MARK AS SHOWN.

THE COLOR(S) GREEN, YELLOW, LIGHT BLUE, ORANGE, WHITE, DARK BLUE, DARK PINK, AND PURPLE IS/ARE CLAIMED AS A FEATURE OF THE MARK.

THE MARK CONSISTS OF "MINI JUICYCREAMS" IN A STYLIZED FORMAT. THE TERM "MINI" IS DISPLAYED IN DIFFERENT COLORS: THE LETTER "M" IS SHOWN IN GREEN, THE FIRST LETTER "I" IS SHOWN IN YELLOW, THE LETTER "N" IS SHOWN IN LIGHT BLUE AND THE LAST LETTER "I" IS SHOWN IN ORANGE. EACH OF THE LETTERS IN THE TERM "MINI" HAS A WHITE AND DARK PINK SHADOW AND EACH LETTER IS OUTLINED IN DARK BLUE. THE TERM "MINI" IS OUTLINED IN YELLOW AND THE FURTHER OUTLINED IN WHITE. THERE IS A SHADOW BEHIND THE TERM "MINI". THE TERM "JUICYCREAMS" IS DISPLAYED IN WHITE. IT IS OUTLINED IN DARK PINK AND FURTHER OUTLINED IN PURPLE. THE GREY COLOR DEPICTING THE SHADOW BELOW "MINI" REPRESENTS SHADING AND IS NOT PART OF THE MARK.

FOR FROZEN CONFECTIONS, ICE CREAM BARS (U.S. CL. 46).

FIRST USE 1-27-2012; IN COMMERCE 1-30-2012.

**CLASS 30—(Continued).**

4,481,589. FRITO-LAY NORTH AMERICA, INC., PLANO, TX. SN 85-455,693. PUB. 4-3-2012, FILED 10-25-2011.

## JACKED

THE MARK CONSISTS OF STANDARD CHARACTERS WITHOUT CLAIM TO ANY PARTICULAR FONT, STYLE, SIZE, OR COLOR.

FOR CORN-BASED SNACK FOODS; TORTILLA CHIPS (U.S. CL. 46).

FIRST USE 3-0-2012; IN COMMERCE 3-0-2012.

4,481,626. KASSELER FOOD PRODUCTS, INC., MISSISSAUGA, ONTARIO, CANADA. SN 85-482,463. PUB. 4-2-2013, FILED 11-29-2011.

## ERICH'S EXTRAORDINARY BREAD CO.

THE MARK CONSISTS OF STANDARD CHARACTERS WITHOUT CLAIM TO ANY PARTICULAR FONT, STYLE, SIZE, OR COLOR.

PRIORITY CLAIMED UNDER SEC. 44(D) ON CANADA APPLICATION NO. 1545680, FILED 9-29-2011, REG. NO. TMA837367, DATED 11-30-2012, EXPIRES 11-30-2027.

NO CLAIM IS MADE TO THE EXCLUSIVE RIGHT TO USE "BREAD CO.", APART FROM THE MARK AS SHOWN. FOR BREAD (U.S. CL. 46).

FIRST USE 10-0-2013; IN COMMERCE 10-0-2013.

4,481,641. SABORMEX EUROPA, S.L., BILBAO, SPAIN. SN 85-509,445. PUB. 11-27-2012, FILED 1-5-2012.



THE MARK CONSISTS OF A CIRCLE WITH A VINE. FOR COFFEE, GROUND COFFEE, ROASTED COFFEE, COFFEE BEANS, INSTANT COFFEE, COFFEE EXTRACTS (U.S. CL. 46).

FIRST USE 8-14-2013; IN COMMERCE 8-14-2013.

**CLASS 30—(Continued).**

4,481,681. MOM BRANDS COMPANY, LAKEVILLE, MN. SN 85-552,386. PUB. 9-18-2012, FILED 2-24-2012.



OWNER OF U.S. REG. NOS. 3,971,870 AND 4,132,284.  
THE COLOR(S) DARK BLUE, BLUE, GREEN AND WHITE IS/ARE CLAIMED AS A FEATURE OF THE MARK.  
THE MARK CONSISTS OF A WHITE SQUARE WITH THE WORDS "BAG THE BOX" IN DARK BLUE WITH A DOTTED LINE IN BLUE BELOW THE WORDS "BAG THE"; THE LETTER "O" HAS A SMILEY EARTH FACE WITH EYELASHES THAT IS GREEN AND BLUE; THE WHITE SQUARE IS ENCASED IN A BLUE SQUARE WITH "BAGTHEBOX.COM" IN THE COLOR WHITE AND LOCATED VERTICALLY NEXT TO THE WHITE SQUARE.  
FOR BREAKFAST CEREAL (U.S. CL. 46).  
FIRST USE 8-0-2012; IN COMMERCE 8-0-2012.

4,481,802. JANCO, LLC, BOTHELL, WA. SN 85-630,606. PUB. 10-30-2012, FILED 5-21-2012.



NO CLAIM IS MADE TO THE EXCLUSIVE RIGHT TO USE "MEAT SAUCE", APART FROM THE MARK AS SHOWN.  
THE COLOR(S) RED AND BLACK IS/ARE CLAIMED AS A FEATURE OF THE MARK.  
THE MARK CONSISTS OF A CIRCLE WITH A SCALLOPED EDGE IN RED WITH BLACK DOTS AROUND THE PERIMETER OF THE CIRCLE. THE WORD "GO" IN DARKER RED LETTERS, THE WORDING "JONNY MEAT SAUCE APPROVED" IN BLACK IN AN ARCH INSIDE THE CIRCLE OF DOTS AND A DESIGN IN BLACK OF A MAN RIDING A MOTOR SCOOTER WITH ACCELERATION LINES SUPERIMPOSED OVER THE LETTERS "G" AND "O".  
FOR SPAGHETTI SAUCE (U.S. CL. 46).  
FIRST USE 5-21-2012; IN COMMERCE 7-24-2012.

**CLASS 30—(Continued).**

4,481,803. CARL'S JR. RESTAURANTS LLC, CARPINTERIA, CA. SN 85-630,955. PUB. 5-28-2013, FILED 5-21-2012.

# BRRRGER

THE MARK CONSISTS OF STANDARD CHARACTERS WITHOUT CLAIM TO ANY PARTICULAR FONT, STYLE, SIZE, OR COLOR.  
FOR ICE CREAM SANDWICHES FOR CONSUMPTION ON OR OFF THE PREMISES (U.S. CL. 46).  
FIRST USE 5-16-2012; IN COMMERCE 5-16-2012.

4,481,833. EFC GROUP, LLC, FORT WORTH, TX. SN 85-649,795. PUB. 9-3-2013, FILED 6-12-2012.

# STARLET

THE MARK CONSISTS OF STANDARD CHARACTERS WITHOUT CLAIM TO ANY PARTICULAR FONT, STYLE, SIZE, OR COLOR.  
FOR MIXES IN THE NATURE OF CONCENTRATES, SYRUPS OR POWDERS USED IN THE PREPARATION OF ICE CREAM; THE PRECEDING EXPRESSLY EXCLUDING MIXES FOR ICE CREAM CAKES (U.S. CL. 46).  
FIRST USE 8-18-2013; IN COMMERCE 8-18-2013.

4,481,855. MARS, INCORPORATED, MCLEAN, VA. SN 85-657,971. PUB. 2-5-2013, FILED 6-21-2012.

# COCOAPRO

THE MARK CONSISTS OF STANDARD CHARACTERS WITHOUT CLAIM TO ANY PARTICULAR FONT, STYLE, SIZE, OR COLOR.  
OWNER OF U.S. REG. NOS. 2,435,087, 2,971,666, AND OTHERS.  
FOR COFFEE (U.S. CL. 46).  
FIRST USE 5-17-2013; IN COMMERCE 5-17-2013.



**CLASS 30—(Continued).**

4,481,856. MARS, INCORPORATED, MCLEAN, VA. SN 85-658,064. PUB. 2-5-2013, FILED 6-21-2012.



OWNER OF U.S. REG. NO. 2,598,461.  
THE MARK CONSISTS OF A DESIGN OF A HAND  
HOLDING A COCOA BEAN.  
FOR COFFEE (U.S. CL. 46).  
FIRST USE 5-17-2013; IN COMMERCE 5-17-2013.

4,481,954. FIBER GOURMET, MIAMI BEACH, FL. SN 85-706,275. PUB. 1-22-2013, FILED 8-17-2012.

**THINABLES**

THE MARK CONSISTS OF STANDARD CHARACTERS  
WITHOUT CLAIM TO ANY PARTICULAR FONT, STYLE,  
SIZE, OR COLOR.  
FOR CRACKERS (U.S. CL. 46).  
FIRST USE 2-28-2013; IN COMMERCE 2-28-2013.

4,481,964. R. TWINING AND COMPANY LIMITED, LONDON, UNITED KINGDOM. SN 85-713,529. PUB. 1-29-2013, FILED 8-27-2012.

**NIGHTLY CALM**

THE MARK CONSISTS OF STANDARD CHARACTERS  
WITHOUT CLAIM TO ANY PARTICULAR FONT, STYLE,  
SIZE, OR COLOR.  
FOR TEAS AND HERBAL TEAS (U.S. CL. 46).  
FIRST USE 12-17-2012; IN COMMERCE 12-17-2012.

**CLASS 30—(Continued).**

4,482,013. FRITO-LAY NORTH AMERICA, INC., PLANO, TX. SN 85-726,955. PUB. 8-13-2013, FILED 9-12-2012.

**FOR THE BOLD**

THE MARK CONSISTS OF STANDARD CHARACTERS  
WITHOUT CLAIM TO ANY PARTICULAR FONT, STYLE,  
SIZE, OR COLOR.  
FOR CORN-BASED SNACK FOODS; TORTILLA CHIPS  
(U.S. CL. 46).  
FIRST USE 4-0-2013; IN COMMERCE 4-0-2013.

4,482,015. SIVERHUS, JOHN, WOBURN, MA. SN 85-727,084.  
PUB. 3-5-2013, FILED 9-12-2012.



THE NAME(S), PORTRAIT(S), AND/OR SIGNATURE(S)  
SHOWN IN THE MARK DOES NOT IDENTIFY A PARTI-  
CULAR LIVING INDIVIDUAL.

THE MARK CONSISTS OF THE TERM "COWBOY" IN  
STYLIZED FONT WITH A COWBOY HAT OVER THE  
LETTER "O" IN "COWBOY". WITHIN THE LETTER "O" IS  
THE WORD "GOLD" IN STYLIZED FONT. ABOVE THE  
LETTERS "BOY" IN THE WORD "COWBOY" IS THE  
WORDS "JS WHITAKERS" IN STYLIZED FONT AND  
UNDERLINED WITH A STYLIZED COWBOY PROFILE  
ENCIRCLED. BELOW "COWBOY" IS THE WORD "GOLD"  
IN STYLIZED FONT.

FOR SEASONED COATING FOR MEAT, FISH, POUL-  
TRY; SEASONED COATING MIXTURES FOR FOODS  
(U.S. CL. 46).  
FIRST USE 10-0-2012; IN COMMERCE 10-0-2012.

**CLASS 30—(Continued).**

4,482,018. BIG DUMB SUCKERS LLC, RICHMOND, VA. SN 85-727,834. PUB. 2-12-2013, FILED 9-13-2012.



THE MARK CONSISTS OF A ROOSTER.  
FOR CANDIES; LOLLIPOPS; SWEETS (U.S. CL. 46).  
FIRST USE 9-0-2012; IN COMMERCE 9-0-2012.

4,482,066. CHAZZANO LLC, FERNDALE, MI. SN 85-733,518.  
PUB. 2-26-2013, FILED 9-20-2012.

**BREW COFFEE NOT TROUBLE**

THE MARK CONSISTS OF STANDARD CHARACTERS  
WITHOUT CLAIM TO ANY PARTICULAR FONT, STYLE,  
SIZE, OR COLOR.  
FOR ROASTED COFFEE (U.S. CL. 46).  
FIRST USE 4-1-2013; IN COMMERCE 4-1-2013.

4,482,098. GLOBAL CULINARY INVESTMENTS, LLC,  
SPRING, TX. SN 85-737,949. PUB. 3-19-2013, FILED 9-25-  
2012.

**LUCA EMPANADAS**

THE MARK CONSISTS OF STANDARD CHARACTERS  
WITHOUT CLAIM TO ANY PARTICULAR FONT, STYLE,  
SIZE, OR COLOR.

NO CLAIM IS MADE TO THE EXCLUSIVE RIGHT TO  
USE "EMPANADAS", APART FROM THE MARK AS  
SHOWN.

FOR EMPANADAS AND PASTRIES (U.S. CL. 46).  
FIRST USE 9-25-2012; IN COMMERCE 9-25-2012.

**CLASS 30—(Continued).**

4,482,099. GLOBAL CULINARY INVESTMENTS, LLC,  
SPRING, TX. SN 85-737,954. PUB. 3-19-2013, FILED 9-25-  
2012.



NO CLAIM IS MADE TO THE EXCLUSIVE RIGHT TO  
USE "EMPANADAS", APART FROM THE MARK AS  
SHOWN.

THE MARK CONSISTS OF A RECTANGULAR SHAPED  
BAR WITH OVAL ENDS WHICH HAS THE WORD "EMPA-  
NADAS" INSIDE THE BAR AND THE WORD "LUCA" ON  
TOP OF THE BAR AND THE OUTLINE OF THE CLAM-  
SHAPED EDGE OF AN EMPANADA DIAGONALLY AD-  
JACENT TO THE UPPER RIGHT OF THE LETTERS "C"  
AND "A" IN THE WORD "LUCA".

FOR EMPANADAS AND PASTRIES (U.S. CL. 46).  
FIRST USE 9-25-2013; IN COMMERCE 9-25-2013.

4,482,109. SINFUL SCOOPS, LLC, WEST ORANGE, NJ. SN 85-  
738,697. PUB. 4-23-2013, FILED 9-26-2012.

**SINFUL SCOOPS**

THE MARK CONSISTS OF STANDARD CHARACTERS  
WITHOUT CLAIM TO ANY PARTICULAR FONT, STYLE,  
SIZE, OR COLOR.

NO CLAIM IS MADE TO THE EXCLUSIVE RIGHT TO  
USE "SCOOPS", APART FROM THE MARK AS SHOWN.

FOR ALCOHOL INFUSED ICE CREAM (U.S. CL. 46).  
FIRST USE 4-0-2012; IN COMMERCE 4-0-2012.

**CLASS 30—(Continued).**

4,482,419. DAHLIA WEINMAN, ANN ARBOR, MI. SN 85-821,299. PUB. 6-4-2013, FILED 1-11-2013.

**MARZIPOPS**

THE MARK CONSISTS OF STANDARD CHARACTERS WITHOUT CLAIM TO ANY PARTICULAR FONT, STYLE, SIZE, OR COLOR.

FOR CONFECTIONARY MADE OF SUGAR; LOLLIPOPS; MARZIPAN; CANDY; SWEETS (U.S. CL. 46).  
FIRST USE 4-15-2012; IN COMMERCE 9-26-2012.

---

4,482,424. FREEDULGENCE LLC, NEW YORK, NY. SN 85-822,313. PUB. 6-11-2013, FILED 1-14-2013.

**FreeDulgence**

THE MARK CONSISTS OF STANDARD CHARACTERS WITHOUT CLAIM TO ANY PARTICULAR FONT, STYLE, SIZE, OR COLOR.

FOR BAKERY GOODS, NAMELY, COOKIES CAKES AND BROWNIES; BAKERY PRODUCTS, NAMELY, SWEET BAKERY GOODS; BROWNIES; COOKIES AND CRACKERS; FROZEN COOKIE, BROWNIE AND BISOTTI DOUGH; FROZEN DOUGH FOR USE AS PIZZA, BREAD OR OTHER BREAD-TYPE PRODUCTS; GLUTEN-FREE BREAD; PROTEIN REDUCED AND GLUTEN FREE FLOUR AND BREAD (U.S. CL. 46).  
FIRST USE 8-1-2013; IN COMMERCE 8-1-2013.

---

4,482,467. LARAY'S, INC., NEW YORK, NY. SN 85-842,207. PUB. 9-17-2013, FILED 2-6-2013.

**LARAY'S**

THE MARK CONSISTS OF STANDARD CHARACTERS WITHOUT CLAIM TO ANY PARTICULAR FONT, STYLE, SIZE, OR COLOR.

FOR BAKERY PRODUCTS (U.S. CL. 46).  
FIRST USE 4-24-2013; IN COMMERCE 4-24-2013.

**CLASS 30—(Continued).**

4,482,536. FIGUEROA, ADAN, CARSON, CA. SN 85-866,914. PUB. 8-20-2013, FILED 3-5-2013.

**Coffee On Gears Organic**

THE MARK CONSISTS OF STANDARD CHARACTERS WITHOUT CLAIM TO ANY PARTICULAR FONT, STYLE, SIZE, OR COLOR.

NO CLAIM IS MADE TO THE EXCLUSIVE RIGHT TO USE "COFFEE" AND "ORGANIC", APART FROM THE MARK AS SHOWN.

FOR ORGANIC COFFEE (U.S. CL. 46).  
FIRST USE 1-2-2013; IN COMMERCE 4-15-2013.

---

4,482,578. ROB DAY, PITTSBURGH, PA. SN 85-881,200. PUB. 9-3-2013, FILED 3-20-2013.



NO CLAIM IS MADE TO THE EXCLUSIVE RIGHT TO USE "POPCORN", APART FROM THE MARK AS SHOWN.

THE MARK CONSISTS OF TWO WORDS, "GO" AND "POPCORN". THE "GO" IS CENTERED ABOVE THE WORD "POPCORN". ALL LETTERS IN BOTH WORDS ARE CAPITALIZED. THERE ARE THREE STYLIZED LINES ABOVE THE WORD "POPCORN" AND TO THE RIGHT OF THE WORD "GO", AND THERE ARE THREE STYLIZED LINES ABOVE THE WORD "POPCORN" AND TO THE LEFT OF THE WORD "GO". THERE ARE ALSO THREE STYLIZED LINES BELOW THE WORD "POPCORN".

FOR POPCORN (U.S. CL. 46).  
FIRST USE 4-1-2013; IN COMMERCE 4-1-2013.

**CLASS 30—(Continued).**

4,482,597. NEW WORLD PASTA COMPANY, HARRISBURG, PA. SN 85-887,366. PUB. 9-3-2013, FILED 3-27-2013.



OWNER OF U.S. REG. NOS. 3,282,967, 4,132,857, AND OTHERS.

NO CLAIM IS MADE TO THE EXCLUSIVE RIGHT TO USE "GLUTEN FREE", APART FROM THE MARK AS SHOWN.

THE COLOR(S) BLUE, WHITE, YELLOW IS/ARE CLAIMED AS A FEATURE OF THE MARK.

THE MARK CONSISTS OF THE TERM "RONZONI" IN WHITE AND YELLOW IN A STYLIZED BLUE RECTANGULAR BANNER WITH A YELLOW LINE BORDERING THE TOP EDGE AND A YELLOW WHEAT STALK BORDERING THE BOTTOM EDGE. ON THE LOWER PORTION OF THE TRADEMARK, THE WORDS "GLUTEN FREE" ARE REPRODUCED IN BLUE STYLIZED WRITING.

FOR GLUTEN FREE DRIED PASTA (U.S. CL. 46).

FIRST USE 7-8-2013; IN COMMERCE 7-8-2013.

4,482,632. ROYAL WINE CORPORATION, BAYONNE, NJ. SN 85-902,795. PUB. 9-3-2013, FILED 4-12-2013.

**REBECCA & ROSE**

THE MARK CONSISTS OF STANDARD CHARACTERS WITHOUT CLAIM TO ANY PARTICULAR FONT, STYLE, SIZE, OR COLOR.

FOR CANDY; CHOCOLATE AND CHOCOLATES (U.S. CL. 46).

FIRST USE 2-0-2013; IN COMMERCE 2-0-2013.

4,482,653. PARAMOUNT PICTURES CORPORATION, HOLLYWOOD, CA. SN 85-922,645. PUB. 7-30-2013, FILED 5-3-2013.

**SCOTCHY SCOTCH SCOTCH**

THE MARK CONSISTS OF STANDARD CHARACTERS WITHOUT CLAIM TO ANY PARTICULAR FONT, STYLE, SIZE, OR COLOR.

**CLASS 30—(Continued).**

NO CLAIM IS MADE TO THE EXCLUSIVE RIGHT TO USE "SCOTCH", APART FROM THE MARK AS SHOWN.

FOR FROZEN YOGURT CONFECTIONS; ICE CREAM (U.S. CL. 46).

FIRST USE 11-1-2013; IN COMMERCE 11-1-2013.

4,482,700. AMERICAN HALAL CO., INC., STAMFORD, CT. SN 85-980,962. PUB. 9-11-2012, FILED 9-23-2011.



NO CLAIM IS MADE TO THE EXCLUSIVE RIGHT TO USE "WORLD CUISINE", APART FROM THE MARK AS SHOWN.

THE MARK CONSISTS OF THE WORDS "WORLD CUISINE" AND "SAFFRON ROAD" CONTAINED IN A DESIGN BLOCK WITH ROUNDED EDGES THAT END IN POINTS AND CONTAINS A BORDER OF DOTS. THERE IS A DIAMOND DESIGN IN BETWEEN THE WORDS "WORLD CUISINE" AND "SAFFRON ROAD".

FOR BAKERY DESSERTS; WHEAT BASED SNACK FOODS; FROZEN ENTREES CONSISTING PRIMARILY OF PASTA OR RICE; SAUCES; MARINADES; FROZEN FOODS, NAMELY, GRAIN AND BREAD BASED APPETIZERS, HORS D'OEUVRES, AND CANAPÉS (U.S. CL. 46).

FIRST USE 4-30-2012; IN COMMERCE 4-30-2012.

**CLASS 31—NATURAL AGRICULTURAL PRODUCTS**

4,481,344. HUMMERT INTERNATIONAL, FORMERLY A.H. HUMMERT SEED COMPANY, EARTH CITY, MO. SN 77-861,273. PUB. 9-28-2010, FILED 10-30-2009.



THE MARK CONSISTS OF THE WORDING "COUNT-PAK" WHERE THE LETTER "C" CONTINUES TO BECOME THE LETTER "P" IN "PAK". THE WORDING "COUNT" IS TO THE LEFT OF THE TERM "PAK" AND SLIGHTLY HIGHER THAN THE WORDING "PAK".

FOR SEEDS FOR HORTICULTURAL PURPOSES (U.S. CLS. 1 AND 46).

FIRST USE 6-1-2013; IN COMMERCE 6-1-2013.

**CLASS 31—(Continued).**

4,481,785. GEOPONICA, S.A. C.V., MEXICO D.F., MEXICO.  
SN 85-622,951. PUB. 10-9-2012, FILED 5-11-2012.

# GEOPONICA

THE MARK CONSISTS OF STANDARD CHARACTERS WITHOUT CLAIM TO ANY PARTICULAR FONT, STYLE, SIZE, OR COLOR.

THE WORDING "GEOPONICA" HAS NO MEANING IN A FOREIGN LANGUAGE.

FOR FRESH FRUIT AND VEGETABLES; LIVE PLANTS; NATURAL FLOWERS (U.S. CLS. 1 AND 46).  
FIRST USE 10-31-2013; IN COMMERCE 10-31-2013.

---

4,481,871. ALLIED GENETICS LLC, NORFOLK, NE. SN 85-664,453. PUB. 11-27-2012, FILED 6-28-2012.

# VIVAMAIZE

THE MARK CONSISTS OF STANDARD CHARACTERS WITHOUT CLAIM TO ANY PARTICULAR FONT, STYLE, SIZE, OR COLOR.

FOR AGRICULTURAL SEEDS (U.S. CLS. 1 AND 46).  
FIRST USE 6-28-2012; IN COMMERCE 9-11-2012.

---

4,481,872. ALLIED GENETICS LLC, NORFOLK, NE. SN 85-664,544. PUB. 11-27-2012, FILED 6-28-2012.

# BRED FIELD TOUGH

THE MARK CONSISTS OF STANDARD CHARACTERS WITHOUT CLAIM TO ANY PARTICULAR FONT, STYLE, SIZE, OR COLOR.

FOR AGRICULTURAL SEEDS (U.S. CLS. 1 AND 46).  
FIRST USE 6-28-2012; IN COMMERCE 9-11-2012.

**CLASS 31—(Continued).**

4,482,164. PENNSYLVANIA CO-OPERATIVE POTATO GROWERS, INC., HARRISBURG, PA. SN 85-747,146.  
PUB. 7-23-2013, FILED 10-5-2012.

# PENN'S OWN

THE MARK CONSISTS OF STANDARD CHARACTERS WITHOUT CLAIM TO ANY PARTICULAR FONT, STYLE, SIZE, OR COLOR.

FOR FRESH VEGETABLES; FRESH POTATOES (U.S. CLS. 1 AND 46).

FIRST USE 9-18-2013; IN COMMERCE 9-18-2013.

---

4,482,203. NOVAFRUIT INC., ST PAUL ABBOTSFORD, QC, CANADA. SN 85-753,098. PUB. 3-19-2013, FILED 10-12-2012.



NO CLAIM IS MADE TO THE EXCLUSIVE RIGHT TO USE "FRUIT", APART FROM THE MARK AS SHOWN.

THE STIPPLING IS FOR SHADING PURPOSES ONLY.

THE COLOR(S) BLACK, RED, GREEN IS/ARE CLAIMED AS A FEATURE OF THE MARK.

THE MARK CONSISTS OF THE WORD "NOVAFRUIT" IN CAPITAL LETTERS IN BLACK, AND IN THE BACKGROUND, THE DESIGN OF A RED STRAWBERRY WITH ITS GREEN STEM.

THE ENGLISH TRANSLATION OF "NOVA" IN THE MARK IS "NEW".

FOR FRESH FRUIT (U.S. CLS. 1 AND 46).  
FIRST USE 5-31-2012; IN COMMERCE 6-1-2013.

---

4,482,439. PURINA MILLS LLC, GRAY SUMMIT, MO. SN 85-827,982. PUB. 6-18-2013, FILED 1-21-2013.

# POWERFILL

THE MARK CONSISTS OF STANDARD CHARACTERS WITHOUT CLAIM TO ANY PARTICULAR FONT, STYLE, SIZE, OR COLOR.

FOR ANIMAL FEED (U.S. CLS. 1 AND 46).  
FIRST USE 8-2-2013; IN COMMERCE 8-2-2013.

**CLASS 31—(Continued).**

4,482,618. PET PLENISH, ETTERS, PA. SN 85-895,997. PUB. 9-17-2013, FILED 4-5-2013.

# Pet Plenish

THE MARK CONSISTS OF STANDARD CHARACTERS WITHOUT CLAIM TO ANY PARTICULAR FONT, STYLE, SIZE, OR COLOR.

NO CLAIM IS MADE TO THE EXCLUSIVE RIGHT TO USE "PET", APART FROM THE MARK AS SHOWN.

FOR PET BEVERAGES (U.S. CLS. 1 AND 46).  
FIRST USE 1-1-2013; IN COMMERCE 6-1-2013.

**CLASS 32—LIGHT BEVERAGES**

4,481,313. SADDLESPRINGS BEVERAGE COMPANY, INC., CARSON, CA. SN 77-298,871. PUB. 6-9-2009, FILED 10-8-2007.

# NUTRA KIST

THE MARK CONSISTS OF STANDARD CHARACTERS WITHOUT CLAIM TO ANY PARTICULAR FONT, STYLE, SIZE, OR COLOR.

FOR FROZEN FRUIT AND VEGETABLE JUICES; FROZEN FRUIT AND VEGETABLE DRINKS; REFRIGERATED FRUIT AND VEGETABLE JUICES; REFRIGERATED FRUIT AND VEGETABLE DRINKS (U.S. CLS. 45, 46 AND 48).

FIRST USE 3-25-2006; IN COMMERCE 3-25-2006.

4,481,345. BANG BREWING COMPANY, LLC, ST. PAUL, MN. SN 77-865,653. PUB. 10-19-2010, FILED 11-5-2009.

# ONE HOP

THE MARK CONSISTS OF STANDARD CHARACTERS WITHOUT CLAIM TO ANY PARTICULAR FONT, STYLE, SIZE, OR COLOR.

NO CLAIM IS MADE TO THE EXCLUSIVE RIGHT TO USE "HOP", APART FROM THE MARK AS SHOWN.

FOR ALCOHOLIC BEVERAGES, NAMELY, BEER (U.S. CLS. 45, 46 AND 48).

FIRST USE 12-13-2013; IN COMMERCE 12-13-2013.

**CLASS 32—(Continued).**

4,481,346. BANG BREWING COMPANY, LLC, ST. PAUL, MN. SN 77-865,654. PUB. 10-19-2010, FILED 11-5-2009.

# BANG

THE MARK CONSISTS OF STANDARD CHARACTERS WITHOUT CLAIM TO ANY PARTICULAR FONT, STYLE, SIZE, OR COLOR.

FOR ALCOHOLIC BEVERAGES, NAMELY, BEER (U.S. CLS. 45, 46 AND 48).

FIRST USE 9-26-2013; IN COMMERCE 9-26-2013.

4,481,517. ALTICOR INC., ADA, MI. SN 85-378,203. PUB. 4-17-2012, FILED 7-22-2011.

# AMWAY

THE MARK CONSISTS OF STANDARD CHARACTERS WITHOUT CLAIM TO ANY PARTICULAR FONT, STYLE, SIZE, OR COLOR.

OWNER OF U.S. REG. NOS. 707,656, 727,367, AND OTHERS.

FOR CONCENTRATES, SYRUPS OR POWDERS USED IN THE PREPARATION OF NON-ALCOHOLIC FRUIT, CHOCOLATE OR VANILLA FLAVORED SOFT DRINKS; SPORTS DRINKS; ISOTONIC DRINKS AND POWDERS USED IN THE PREPARATION OF ISOTONIC SPORTS DRINKS AND SPORTS BEVERAGES; FRUIT DRINKS AND FRUIT JUICES; PREPARATIONS FOR MAKING FLAVORED WATERS OR NON-ALCOHOLIC BEVERAGES IN THE NATURE OF FRUIT JUICE, PUNCH, NON-CARBONATED FRUIT BEVERAGES AND NON-CARBONATED SOFT DRINKS; AROMATIZED BEVERAGES BASED ON FRUIT, PROTEIN, CORDIAL, SUGAR AND OTHER FLUID NUTRIENTS, NAMELY, PROTEIN DRINKS FOR USE AS FOOD FILLERS AND NOT FOR USE AS A MEAL REPLACEMENT; BEAUTY BEVERAGES, NAMELY, FRUIT JUICES CONTAINING NUTRITIONAL SUPPLEMENTS (U.S. CLS. 45, 46 AND 48).

FIRST USE 11-27-2012; IN COMMERCE 11-27-2012.

**CLASS 32—(Continued).**

4,481,562. PAIN DRINK, INC., LAS VEGAS, NV. SN 85-431,831. PUB. 8-28-2012, FILED 9-26-2011.

**TAME YOUR PAIN**

THE MARK CONSISTS OF STANDARD CHARACTERS WITHOUT CLAIM TO ANY PARTICULAR FONT, STYLE, SIZE, OR COLOR.

FOR NON-ALCOHOLIC BEVERAGES, NAMELY, ENERGY DRINKS AND SPORTS DRINKS (U.S. CLS. 45, 46 AND 48).

FIRST USE 8-12-2013; IN COMMERCE 8-12-2013.

4,481,587. CALI CRAFT BREWERY, INC., WALNUT CREEK, CA. SN 85-453,421. PUB. 4-3-2012, FILED 10-21-2011.

**CALICRAFT**

THE MARK CONSISTS OF STANDARD CHARACTERS WITHOUT CLAIM TO ANY PARTICULAR FONT, STYLE, SIZE, OR COLOR.

FOR BEERS (U.S. CLS. 45, 46 AND 48).

FIRST USE 5-24-2012; IN COMMERCE 9-5-2013.

4,481,648. A&S BREWING COLLABORATIVE LLC, BURLINGTON, VT. SN 85-518,171. PUB. 5-29-2012, FILED 1-17-2012.

**CURIOUS TRAVELER**

THE MARK CONSISTS OF STANDARD CHARACTERS WITHOUT CLAIM TO ANY PARTICULAR FONT, STYLE, SIZE, OR COLOR.

FOR BEER AND ALE (U.S. CLS. 45, 46 AND 48).

FIRST USE 3-29-2012; IN COMMERCE 3-29-2012.

**CLASS 32—(Continued).**

4,481,661. A&S BREWING COLLABORATIVE LLC, BURLINGTON, VT. SN 85-535,172. PUB. 5-29-2012, FILED 2-6-2012.

**TENACIOUS TRAVELER**

THE MARK CONSISTS OF STANDARD CHARACTERS WITHOUT CLAIM TO ANY PARTICULAR FONT, STYLE, SIZE, OR COLOR.

FOR BEER AND ALE (U.S. CLS. 45, 46 AND 48).

FIRST USE 8-15-2012; IN COMMERCE 8-15-2012.

4,481,748. BEVERAGE INNOVATIONS (INTERNATIONAL) LTD., NASSAU, NEW PROVIDENCE, BAHAMAS. SN 85-601,542. PUB. 4-9-2013, FILED 4-18-2012.

**COCO TROPICS**

THE MARK CONSISTS OF STANDARD CHARACTERS WITHOUT CLAIM TO ANY PARTICULAR FONT, STYLE, SIZE, OR COLOR.

NO CLAIM IS MADE TO THE EXCLUSIVE RIGHT TO USE "COCO", APART FROM THE MARK AS SHOWN.

FOR SOFT DRINKS; COCONUT MILK; COCONUT WATER; NON-ALCOHOLIC COCKTAIL MIXES; SMOOTHIES; FRUIT JUICE; FRUIT PUREES FOR BEVERAGE APPLICATIONS (U.S. CLS. 45, 46 AND 48).

FIRST USE 5-0-2012; IN COMMERCE 5-0-2012.

4,481,823. MOAB BREWERS, L.L.C., PARK CITY, UT. SN 85-640,273. PUB. 3-19-2013, FILED 5-31-2012.

**MOAB BREWERY**

THE MARK CONSISTS OF STANDARD CHARACTERS WITHOUT CLAIM TO ANY PARTICULAR FONT, STYLE, SIZE, OR COLOR.

OWNER OF U.S. REG. NO. 2,660,953.

NO CLAIM IS MADE TO THE EXCLUSIVE RIGHT TO USE "BREWERY", APART FROM THE MARK AS SHOWN.

FOR BEER (U.S. CLS. 45, 46 AND 48).

FIRST USE 5-5-1996; IN COMMERCE 5-5-1996.

**CLASS 32—(Continued).**

4,481,923. DOGFISH HEAD MARKETING, LLC, MILTON, DE. SN 85-691,604. PUB. 1-22-2013, FILED 7-31-2012.

**ANCIENT A L E S**

THE MARK CONSISTS OF STANDARD CHARACTERS WITHOUT CLAIM TO ANY PARTICULAR FONT, STYLE, SIZE, OR COLOR.

NO CLAIM IS MADE TO THE EXCLUSIVE RIGHT TO USE "ALES", APART FROM THE MARK AS SHOWN. FOR BEERS (U.S. CLS. 45, 46 AND 48). FIRST USE 5-4-2004; IN COMMERCE 5-4-2004.

4,482,075. BRITBEVCO, INC., IRVINE, CA. SN 85-735,492. PUB. 5-28-2013, FILED 9-21-2012.

**ENERGY INFUSED HYDRATION**

THE MARK CONSISTS OF STANDARD CHARACTERS WITHOUT CLAIM TO ANY PARTICULAR FONT, STYLE, SIZE, OR COLOR.

NO CLAIM IS MADE TO THE EXCLUSIVE RIGHT TO USE "ENERGY" AND "HYDRATION", APART FROM THE MARK AS SHOWN.

FOR PURIFIED DRINKING WATER; FLAVORED DRINKING WATER; DRINKING WATER CONTAINING VITAMINS AND MINERALS; DRINKING WATER CONTAINING CAFFEINE (U.S. CLS. 45, 46 AND 48). FIRST USE 4-25-2013; IN COMMERCE 5-6-2013.

4,482,079. KLINE, JOSEPH, CYPRESS, TX. SN 85-736,275. PUB. 2-26-2013, FILED 9-24-2012.

**ReVy**

THE MARK CONSISTS OF STANDARD CHARACTERS WITHOUT CLAIM TO ANY PARTICULAR FONT, STYLE, SIZE, OR COLOR.

FOR ENERGY DRINKS; SPORTS DRINKS (U.S. CLS. 45, 46 AND 48). FIRST USE 5-30-2002; IN COMMERCE 8-5-2012.

**CLASS 32—(Continued).**

4,482,298. 23 BOTTLES OF BEER LLC, SANTA ROSA, CA. SN 85-778,314. PUB. 2-5-2013, FILED 11-13-2012.

**SHADOW OF A DOUBT**

THE MARK CONSISTS OF STANDARD CHARACTERS WITHOUT CLAIM TO ANY PARTICULAR FONT, STYLE, SIZE, OR COLOR.

FOR BEER (U.S. CLS. 45, 46 AND 48). FIRST USE 3-8-2013; IN COMMERCE 3-8-2013.

4,482,425. HEALTHINVEST LLC, CHARLESTON, SC. SN 85-822,393. PUB. 6-11-2013, FILED 1-14-2013.

**HONEYSPARK**

THE MARK CONSISTS OF STANDARD CHARACTERS WITHOUT CLAIM TO ANY PARTICULAR FONT, STYLE, SIZE, OR COLOR.

FOR ENERGY DRINKS; FROZEN FRUIT DRINKS; FRUIT DRINKS; SMOOTHIES; SOFT DRINKS; SPORTS DRINKS; VEGETABLE-FRUIT JUICES (U.S. CLS. 45, 46 AND 48).

FIRST USE 8-14-2013; IN COMMERCE 8-14-2013.

4,482,452. THREE SHEEPS BREWING COMPANY, LLC, SHEBOYGAN, WI. SN 85-833,970. PUB. 6-25-2013, FILED 1-28-2013.

**3 Sheeps Brewing Co.**

THE MARK CONSISTS OF STANDARD CHARACTERS WITHOUT CLAIM TO ANY PARTICULAR FONT, STYLE, SIZE, OR COLOR.

NO CLAIM IS MADE TO THE EXCLUSIVE RIGHT TO USE "BREWING CO.", APART FROM THE MARK AS SHOWN.

FOR BEER (U.S. CLS. 45, 46 AND 48). FIRST USE 4-30-2012; IN COMMERCE 9-4-2013.



**CLASS 32—(Continued).**

4,482,489. CAFECITO LLC, CORAL GABLES, FL. SN 85-851,163. PUB. 7-30-2013, FILED 2-15-2013.



THE COLOR(S) BEIGE, LIGHT BEIGE, DARK RED, AND DARK GREEN. IS/ARE CLAIMED AS A FEATURE OF THE MARK.

THE MARK CONSISTS OF THE WORD "CAFECITO" IN LIGHT BEIGE LETTERS WITH A DARK RED OUTLINE BETWEEN TWO DARK GREEN LEAF DESIGNS, ALL ON A BEIGE CLOTH-LIKE BACKGROUND.

THE ENGLISH TRANSLATION OF "CAFECITO" IN THE MARK IS "LITTLE COFFEE".

FOR NON-ALCOHOLIC DRINKS, NAMELY, CAFFEINATED ENERGY SHOTS (U.S. CLS. 45, 46 AND 48).

FIRST USE 10-1-2013; IN COMMERCE 10-1-2013.

---

4,482,515. KLARBRUNN, INC., WATERTOWN, WI. SN 85-862,442. PUB. 8-20-2013, FILED 2-28-2013.

**KLARBRUNN TROPIKALS**

THE MARK CONSISTS OF STANDARD CHARACTERS WITHOUT CLAIM TO ANY PARTICULAR FONT, STYLE, SIZE, OR COLOR.

OWNER OF U.S. REG. NO. 1,572,275.

NO CLAIM IS MADE TO THE EXCLUSIVE RIGHT TO USE "TROPICALS", APART FROM THE MARK AS SHOWN.

FOR NATURALLY FLAVORED SPARKLING WATER (U.S. CLS. 45, 46 AND 48).

FIRST USE 5-7-2013; IN COMMERCE 5-7-2013.

**CLASS 32—(Continued).**

4,482,516. KLARBRUNN, INC., WATERTOWN, WI. SN 85-862,451. PUB. 9-3-2013, FILED 2-28-2013.

**KLARBRUNN VITA ICE**

THE MARK CONSISTS OF STANDARD CHARACTERS WITHOUT CLAIM TO ANY PARTICULAR FONT, STYLE, SIZE, OR COLOR.

OWNER OF U.S. REG. NO. 1,572,275.

NO CLAIM IS MADE TO THE EXCLUSIVE RIGHT TO USE "ICE", APART FROM THE MARK AS SHOWN.

FOR FLAVOR ENHANCED SPARKLING WATER (U.S. CLS. 45, 46 AND 48).

FIRST USE 4-23-2013; IN COMMERCE 4-23-2013.

---

4,482,566. PECATONICA BEER COMPANY, LLC, GRATIOT, WI. SN 85-878,266. PUB. 6-18-2013, FILED 3-17-2013.

**Nightfall Lager**

THE MARK CONSISTS OF STANDARD CHARACTERS WITHOUT CLAIM TO ANY PARTICULAR FONT, STYLE, SIZE, OR COLOR.

NO CLAIM IS MADE TO THE EXCLUSIVE RIGHT TO USE "LAGER", APART FROM THE MARK AS SHOWN.

FOR BEER, ALE, LAGER, STOUT, PORTER, SHANDY (U.S. CLS. 45, 46 AND 48).

FIRST USE 6-1-2013; IN COMMERCE 6-15-2013.

---

4,482,583. HAYMARKET BREWING COMPANY, LLC, CHICAGO, IL. SN 85-881,978. PUB. 8-20-2013, FILED 3-21-2013.

**SPEAKERSWAGON**

THE MARK CONSISTS OF STANDARD CHARACTERS WITHOUT CLAIM TO ANY PARTICULAR FONT, STYLE, SIZE, OR COLOR.

THE WORDING "SPEAKERSWAGON" HAS NO MEANING IN A FOREIGN LANGUAGE.

FOR BEER (U.S. CLS. 45, 46 AND 48).

FIRST USE 1-16-2011; IN COMMERCE 8-10-2013.

**CLASS 32—(Continued).**

4,482,599. BIG BAY BREWING, LLC, AKA BIG BAY BREWING COMPANY, SHOREWOOD, WI. SN 85-887,730. PUB. 9-10-2013, FILED 3-27-2013.

# UFER

THE MARK CONSISTS OF STANDARD CHARACTERS WITHOUT CLAIM TO ANY PARTICULAR FONT, STYLE, SIZE, OR COLOR.

THE ENGLISH TRANSLATION OF "UFER" IN THE MARK IS "SEA SHORE".

FOR BEER, ALE, LAGER, STOUT AND PORTER (U.S. CLS. 45, 46 AND 48).

FIRST USE 6-27-2013; IN COMMERCE 9-1-2013.

**CLASS 33—WINES AND SPIRITS**

4,481,338. OLIOVERDE LTD., RUTHERFORD, CA. SN 77-818,495. PUB. 9-14-2010, FILED 9-2-2009.

# VOLCANIC

THE MARK CONSISTS OF STANDARD CHARACTERS WITHOUT CLAIM TO ANY PARTICULAR FONT, STYLE, SIZE, OR COLOR.

FOR SPIRITS (U.S. CLS. 47 AND 49).

FIRST USE 11-11-2013; IN COMMERCE 11-11-2013.

4,482,629. SUNKIST GROWERS, INC., SHERMAN OAKS, CA. SN 85-901,842. PUB. 9-17-2013, FILED 4-11-2013.



OWNER OF U.S. REG. NOS. 72,087, 2,229,120, AND OTHERS.

THE MARK CONSISTS OF THE LITERAL ELEMENT "SUNKIST" OVER THE IMAGE OF A SUN WITH RAYS, AND A LEAF DOTTING THE "I" IN "SUNKIST".

FOR SOFT DRINKS (U.S. CLS. 45, 46 AND 48).  
FIRST USE 6-17-2013; IN COMMERCE 6-17-2013.

4,481,357. SUTTER HOME WINERY, INC., ST. HELENA, CA. SN 77-911,182. PUB. 10-19-2010, FILED 1-13-2010.

# SOL RIO

THE MARK CONSISTS OF STANDARD CHARACTERS WITHOUT CLAIM TO ANY PARTICULAR FONT, STYLE, SIZE, OR COLOR.

THE ENGLISH TRANSLATION OF "SOL RIO" IN THE MARK IS "SUN RIVER".

FOR ALCOHOLIC BEVERAGES EXCEPT BEERS (U.S. CLS. 47 AND 49).

FIRST USE 11-27-2013; IN COMMERCE 11-27-2013.

4,482,688. CERVECERÍA MODELO, S. DE R.L. DE C.V., C.P. 11320 MEXICO CITY, MEXICO. SN 85-980,772. PUB. 9-4-2012, FILED 9-12-2011.

# FAMILIAR

THE MARK CONSISTS OF STANDARD CHARACTERS WITHOUT CLAIM TO ANY PARTICULAR FONT, STYLE, SIZE, OR COLOR.

FOR BEER (U.S. CLS. 45, 46 AND 48).  
FIRST USE 10-1-2010; IN COMMERCE 10-1-2010.

4,481,366. GEORGE BOZIC JR., DBA BOZIC'S IMPORTS & WHOLESALE LIQUORS, CHICAGO, IL. SN 77-934,354. PUB. 9-28-2010, FILED 2-12-2010.

# SPIRIT TESLA

THE MARK CONSISTS OF STANDARD CHARACTERS WITHOUT CLAIM TO ANY PARTICULAR FONT, STYLE, SIZE, OR COLOR.

NO CLAIM IS MADE TO THE EXCLUSIVE RIGHT TO USE "SPIRIT", APART FROM THE MARK AS SHOWN.

FOR BRANDY; DISTILLED SPIRITS (U.S. CLS. 47 AND 49).

FIRST USE 4-2-2013; IN COMMERCE 4-4-2013.

**CLASS 33—(Continued).**

4,481,417. LAUGHLIN ORCHARDS, INC., CARLTON, OR.  
SN 85-100,226. PUB. 5-17-2011, FILED 8-4-2010.

**BONNIE JEAN VINEYARD**

THE MARK CONSISTS OF STANDARD CHARACTERS WITHOUT CLAIM TO ANY PARTICULAR FONT, STYLE, SIZE, OR COLOR.

NO CLAIM IS MADE TO THE EXCLUSIVE RIGHT TO USE "VINEYARD", APART FROM THE MARK AS SHOWN. THE NAME(S), PORTRAIT(S), AND/OR SIGNATURE(S) SHOWN IN THE MARK DOES NOT IDENTIFY A PARTICULAR LIVING INDIVIDUAL.

FOR WINES (U.S. CLS. 47 AND 49).  
FIRST USE 11-23-2013; IN COMMERCE 11-23-2013.

**CLASS 33—(Continued).**

4,481,518. MICHAEL-DAVID, LLC, LODI, CA. SN 85-378,568.  
PUB. 3-5-2013, FILED 7-22-2011.

**RAGE**

THE MARK CONSISTS OF STANDARD CHARACTERS WITHOUT CLAIM TO ANY PARTICULAR FONT, STYLE, SIZE, OR COLOR.

FOR WINE (U.S. CLS. 47 AND 49).  
FIRST USE 5-0-2013; IN COMMERCE 5-0-2013.

4,481,420. REVANA, MADIAH, HOUSTON, TX. SN 85-113,897. PUB. 2-15-2011, FILED 8-23-2010.

**Corazon del Sol**

THE MARK CONSISTS OF STANDARD CHARACTERS WITHOUT CLAIM TO ANY PARTICULAR FONT, STYLE, SIZE, OR COLOR.

THE ENGLISH TRANSLATION OF THE WORDS "CORAZON DEL SOL" IN THE MARK IS "HEART OF THE SUN".

FOR WINE (U.S. CLS. 47 AND 49).  
FIRST USE 7-31-2013; IN COMMERCE 7-31-2013.

4,481,537. ELSA'S MEXICAN ENTERPRISES, INC., DAYTON, OH. SN 85-409,773. PUB. 2-14-2012, FILED 8-29-2011.

**THE SKINNY JUAN**

THE MARK CONSISTS OF STANDARD CHARACTERS WITHOUT CLAIM TO ANY PARTICULAR FONT, STYLE, SIZE, OR COLOR.

OWNER OF U.S. REG. NOS. 3,352,007 AND 3,839,378.

NO CLAIM IS MADE TO THE EXCLUSIVE RIGHT TO USE "SKINNY", APART FROM THE MARK AS SHOWN. FOR PREPARED ALCOHOLIC BEVERAGES (U.S. CLS. 47 AND 49).

FIRST USE 3-18-2013; IN COMMERCE 3-18-2013.

4,481,516. DV8 CELLARS, LLC, OAK PARK, CA. SN 85-376,121. PUB. 1-17-2012, FILED 7-20-2011.

**Monaco**

THE MARK CONSISTS OF STANDARD CHARACTERS WITHOUT CLAIM TO ANY PARTICULAR FONT, STYLE, SIZE, OR COLOR.

FOR WINE FROM CALIFORNIA (U.S. CLS. 47 AND 49).  
FIRST USE 9-30-2013; IN COMMERCE 11-8-2013.

4,481,563. LNJ VINEYARDS LLC, ROSLYN HEIGHTS, NY. SN 85-431,921. PUB. 3-6-2012, FILED 9-26-2011.

**BIRTHDAY CAKE VINEYARDS**

THE MARK CONSISTS OF STANDARD CHARACTERS WITHOUT CLAIM TO ANY PARTICULAR FONT, STYLE, SIZE, OR COLOR.

NO CLAIM IS MADE TO THE EXCLUSIVE RIGHT TO USE "VINEYARDS", APART FROM THE MARK AS SHOWN.

FOR WINES (U.S. CLS. 47 AND 49).  
FIRST USE 1-0-2013; IN COMMERCE 1-0-2013.

**CLASS 33—(Continued).**

4,481,569. AMRUT DISTILLERIES LIMITED, BANGALORE, INDIA. SN 85-435,846. PUB. 3-13-2012, FILED 9-29-2011.

**TWO INDIES**

THE MARK CONSISTS OF STANDARD CHARACTERS WITHOUT CLAIM TO ANY PARTICULAR FONT, STYLE, SIZE, OR COLOR.

FOR ALCOHOLIC BEVERAGES EXCEPT BEERS; RUM (U.S. CLS. 47 AND 49).  
FIRST USE 2-1-2013; IN COMMERCE 5-9-2013.

4,481,597. FISH HAWK SPIRITS, LLC, OCALA, FL. SN 85-467,920. PUB. 4-17-2012, FILED 11-9-2011.

**FISH HAWK SPIRITS**

THE MARK CONSISTS OF STANDARD CHARACTERS WITHOUT CLAIM TO ANY PARTICULAR FONT, STYLE, SIZE, OR COLOR.

NO CLAIM IS MADE TO THE EXCLUSIVE RIGHT TO USE "SPIRITS", APART FROM THE MARK AS SHOWN. FOR SPIRITS AND LIQUEURS (U.S. CLS. 47 AND 49).  
FIRST USE 4-2-2012; IN COMMERCE 4-2-2012.

4,481,647. SNOVA, LLC, LITTLETON, CO. SN 85-516,378. PUB. 6-5-2012, FILED 1-13-2012.



THE MARK CONSISTS OF A THREE-DIMENSIONAL PEBBLED DESIGN EMBEDDED IN A GLASS BOTTLE. THE OUTLINE OF THE BOTTLE SHOWN IN BROKEN LINES SERVES TO SHOW THE POSITION OF THE MARK AND FORMS NO PART OF THE MARK.

FOR VODKA (U.S. CLS. 47 AND 49).  
FIRST USE 10-10-2013; IN COMMERCE 10-10-2013.

**CLASS 33—(Continued).**

4,481,764. SHOOTING GALLERY WINES, LLC, SAINT HELENA, CA. SN 85-612,643. PUB. 7-17-2012, FILED 4-30-2012.



THE COLOR(S) BLACK, WHITE, BLUE, GREEN AND RED IS/ARE CLAIMED AS A FEATURE OF THE MARK.

THE MARK CONSISTS OF THE LETTERS "AR" IN BLACK WITHIN A WHITE OVAL WITH A BLACK BORDER AND A SMALLER OVAL TO THE LEFT OF "AR" AND WITHIN THE OVAL WITH ONE WHITE STRIPE AND TWO BLUE STRIPES, AND A SYMBOL TO THE RIGHT OF THE "AR" AND WITHIN THE OVAL CONSISTING OF A RED STAR SUPERIMPOSED OVER A BLUE STAR WITH A GREEN CREST AND RED RIBBON CONTAINING THE WORDS "SURCULUS PERURO" WHICH APPEAR IN WHITE.

THE ENGLISH TRANSLATION OF "SURCULUS PERURO" IN THE MARK IS "SHOOTING GALLERY".  
FOR WINES (U.S. CLS. 47 AND 49).  
FIRST USE 11-1-2013; IN COMMERCE 11-1-2013.

4,481,765. HARBOR HILL FRUIT FARMS, INC., DBA GOOD HARBOR VINEYARDS, LAKE LEELANAU, MI. SN 85-613,306. PUB. 10-9-2012, FILED 5-1-2012.



good harbor  
VINEYARDS

OWNER OF U.S. REG. NO. 1,661,029.  
NO CLAIM IS MADE TO THE EXCLUSIVE RIGHT TO USE "VINEYARDS", APART FROM THE MARK AS SHOWN.

THE MARK CONSISTS OF THE LETTERS "G" AND "H" ON EACH SIDE OF A WINE BOTTLE AND THE LETTER "V" IN THE MIDDLE OF THE WINE BOTTLE WITH GRAPES, ALL WITHIN A CIRCLE ABOVE THE WORDS "GOOD HARBOR VINEYARDS".

FOR WINES, NAMELY, STILL AND SPARKLING WINES (U.S. CLS. 47 AND 49).  
FIRST USE 2-1-2012; IN COMMERCE 2-1-2012.

**CLASS 33—(Continued).**

4,481,788. ALPHONSUS J.B. RAVELLI, HOOFDDORP, NETHERLANDS. AND SURAJ-KUMAR R. RAMSAHAL, DUIVENDRECHT, NETHERLANDS. SN 85-623,361. PUB. 1-8-2013, FILED 5-11-2012.

# LAVISH

THE MARK CONSISTS OF STANDARD CHARACTERS WITHOUT CLAIM TO ANY PARTICULAR FONT, STYLE, SIZE, OR COLOR.

FOR ALCOHOLIC BEVERAGES (EXCEPT BEER); SPIRIT BASED ALCOHOLIC DRINKS, NAMELY, BLENDED SPIRITS (U.S. CLS. 47 AND 49).

FIRST USE 0-0-2010; IN COMMERCE 4-0-2013.

4,481,801. TSE. JACKSON, DBA AVIA WINERY GROUP, WOODINVILLE, WA. SN 85-629,658. PUB. 10-23-2012, FILED 5-18-2012.

# ARVIA CEO

THE MARK CONSISTS OF STANDARD CHARACTERS WITHOUT CLAIM TO ANY PARTICULAR FONT, STYLE, SIZE, OR COLOR.

FOR RED WINE (U.S. CLS. 47 AND 49).

FIRST USE 12-22-2012; IN COMMERCE 1-7-2013.

4,481,841. TRADE WIND BRANDS, LLC, JERSEY CITY, NJ. SN 85-652,049. PUB. 5-14-2013, FILED 6-14-2012.



OWNER OF U.S. REG. NO. 835,231.  
NO CLAIM IS MADE TO THE EXCLUSIVE RIGHT TO USE "COMPANY" AND "BRITISH EST. 1845 GIN LONDON DRY", APART FROM THE MARK AS SHOWN.

**CLASS 33—(Continued).**

THE NAME(S), PORTRAIT(S), AND/OR SIGNATURE(S) SHOWN IN THE MARK DOES NOT IDENTIFY A PARTICULAR LIVING INDIVIDUAL.

THE COLOR(S) DARK BLUE, WHITE AND SILVER IS/ARE CLAIMED AS A FEATURE OF THE MARK.

THE MARK CONSISTS OF A REPRESENTATION OF A BOTTLE WITH A DARK BLUE LABEL WITH THE WORDS "COCK RUSSELL AND COMPANY" WITH THE WORDS "COCK RUSSELL" AND "AND COMPANY" SEPARATED BY A STYLIZED CROWN WITH TWO CROSSES AS A DESIGN ON THE FRONT OF THE CROWN, THE WORD "BOODLES" IS SITUATED BENEATH THIS WORDING AND DESIGN AND THE NEXT LINE INCLUDES THE WORDING "BRITISH", BELOW THIS WORDING ARE THE WORDS AND DATE "EST. 1845" IN SMALL LETTERING AND ABOVE THE WORDING "GIN". THE FINAL LINE OF WORDING INCLUDES THE WORDING "LONDON DRY", ALL IN WHITE; DARK BLUE NECK WITH A WHITE CROWN AND SILVER CAP. THE BROKEN LINES DEPICTING THE SHAPE OF THE CAP, THE NECK SHAPE OF THE BOTTLE, AND THE BOTTOM OF THE BOTTLE AND ARE NOT PART OF THE MARK.

THE WORD(S) "COCK RUSSELL" HAS NO MEANING IN A FOREIGN LANGUAGE.

FOR GIN (U.S. CLS. 47 AND 49).

FIRST USE 9-6-2013; IN COMMERCE 9-6-2013.

4,481,842. TRADE WIND BRANDS, LLC, JERSEY CITY, NJ. SN 85-652,127. PUB. 3-26-2013, FILED 6-14-2012.



OWNER OF U.S. REG. NO. 835,231.

NO CLAIM IS MADE TO THE EXCLUSIVE RIGHT TO USE "COMPANY" AND "BRITISH EST. 1845 GIN LONDON DRY", APART FROM THE MARK AS SHOWN.

THE NAME(S), PORTRAIT(S), AND/OR SIGNATURE(S) SHOWN IN THE MARK DOES NOT IDENTIFY A PARTICULAR LIVING INDIVIDUAL.

THE COLOR(S) SILVER, WHITE, DARK BLUE IS/ARE CLAIMED AS A FEATURE OF THE MARK.

THE MARK CONSISTS OF A LABEL IN DARK BLUE WITH SILVER TRIM WITH THE WORDS "COCK RUSSELL AND COMPANY" WITH THE WORDS "COCK RUSSELL" AND "AND COMPANY" SEPARATED BY A STYLIZED CROWN WITH TWO CROSSES AS A DESIGN ON THE FRONT OF THE CROWN, THE WORD "BOODLES" IS SITUATED BENEATH THIS WORDING AND DESIGN AND THE NEXT LINE INCLUDES THE WORDING "BRITISH", BELOW THIS WORDING ARE THE WORDS AND DATE "EST. 1845" IN SMALL LETTERING AND ABOVE THE WORDING "GIN". THE FINAL LINE OF WORDING INCLUDES THE WORDING "LONDON DRY", ALL IN WHITE.

FOR GIN (U.S. CLS. 47 AND 49).

FIRST USE 9-6-2013; IN COMMERCE 9-6-2013.

**CLASS 33—(Continued).**

4,481,846. TRADE WIND BRANDS, LLC, JERSEY CITY, NJ. SN 85-652,445. PUB. 4-2-2013, FILED 6-14-2012.

## COCK RUSSELL AND COMPANY

THE MARK CONSISTS OF STANDARD CHARACTERS WITHOUT CLAIM TO ANY PARTICULAR FONT, STYLE, SIZE, OR COLOR.

NO CLAIM IS MADE TO THE EXCLUSIVE RIGHT TO USE "COMPANY", APART FROM THE MARK AS SHOWN. "COCK RUSSELL" DOES NOT IDENTIFY A LIVING INDIVIDUAL.

FOR GIN (U.S. CLS. 47 AND 49).  
FIRST USE 9-6-2013; IN COMMERCE 9-6-2013.

**CLASS 33—(Continued).**

4,481,909. THACKREY, SEAN HALEY, DBA THACKREY & CO., BOLINAS, CA. SN 85-684,622. PUB. 11-6-2012, FILED 7-23-2012.

## La Pleïade

THE MARK CONSISTS OF STANDARD CHARACTERS WITHOUT CLAIM TO ANY PARTICULAR FONT, STYLE, SIZE, OR COLOR.

THE ENGLISH TRANSLATION OF "LA PLEÏADE" IS "PLEIADES".

FOR WINES (U.S. CLS. 47 AND 49).  
FIRST USE 9-12-2013; IN COMMERCE 9-19-2013.

4,481,861. AUSTIN SCOTT FARMS (PTY) LTD, TULBAGH 6820, SOUTH AFRICA. SN 85-659,032. PUB. 11-27-2012, FILED 6-22-2012.

## BOBBEJAAN

THE MARK CONSISTS OF STANDARD CHARACTERS WITHOUT CLAIM TO ANY PARTICULAR FONT, STYLE, SIZE, OR COLOR.

THE ENGLISH TRANSLATION OF THE WORD "BOBBEJAAN" IN THE MARK IS "BABOON".

FOR WINES (U.S. CLS. 47 AND 49).  
FIRST USE 1-26-2012; IN COMMERCE 1-26-2012.

4,482,057. OLD VINE WINE PARTNERS LLC, NAPA, CA. SN 85-732,104. PUB. 2-26-2013, FILED 9-18-2012.

## HALLOWED GROUND

THE MARK CONSISTS OF STANDARD CHARACTERS WITHOUT CLAIM TO ANY PARTICULAR FONT, STYLE, SIZE, OR COLOR.

FOR WINE (U.S. CLS. 47 AND 49).  
FIRST USE 9-30-2013; IN COMMERCE 9-30-2013.

4,481,865. HARBOR HILL FRUIT FARMS, INC., DBA GOOD HARBOR VINEYARDS, LAKE LEELANAU, MI. SN 85-661,486. PUB. 10-16-2012, FILED 6-26-2012.

## LAKE FRONT WHITE

THE MARK CONSISTS OF STANDARD CHARACTERS WITHOUT CLAIM TO ANY PARTICULAR FONT, STYLE, SIZE, OR COLOR.

NO CLAIM IS MADE TO THE EXCLUSIVE RIGHT TO USE "WHITE", APART FROM THE MARK AS SHOWN.

FOR WINE (U.S. CLS. 47 AND 49).  
FIRST USE 7-1-2012; IN COMMERCE 7-1-2012.

4,482,146. VAILLANT PIERRE, NIAGARA FALLS, CANADA. AND ANNA ITENBERG, NIAGARA FALLS, CANADA. SN 85-745,242. PUB. 4-2-2013, FILED 10-3-2012.

## Sushi Fiesta Wine

THE MARK CONSISTS OF STANDARD CHARACTERS WITHOUT CLAIM TO ANY PARTICULAR FONT, STYLE, SIZE, OR COLOR.

NO CLAIM IS MADE TO THE EXCLUSIVE RIGHT TO USE "SUSHI", APART FROM THE MARK AS SHOWN.

FOR APERITIF WINES; FRUIT WINE; GRAPE WINE; NATURAL SPARKLING WINES; RED WINE; RED WINES; ROSE WINE; SPARKLING FRUIT WINE; SPARKLING GRAPE WINE; SPARKLING WINES; WHITE WINE; WINE; WINES; WINES AND SPARKLING WINES (U.S. CLS. 47 AND 49).

FIRST USE 11-1-2013; IN COMMERCE 11-1-2013.

**CLASS 33—(Continued).**

4,482,239. CURIOUS CORK IMPORTS, LLC, DENVER, CO.  
SN 85-760,204. PUB. 3-26-2013, FILED 10-22-2012.

**CLASS 33—(Continued).**

4,482,242. CURIOUS CORK IMPORTS, LLC, DENVER, CO.  
SN 85-760,237. PUB. 3-26-2013, FILED 10-22-2012.

**FAT LOUIS**

**MESSY BUSINESS**

THE MARK CONSISTS OF STANDARD CHARACTERS  
WITHOUT CLAIM TO ANY PARTICULAR FONT, STYLE,  
SIZE, OR COLOR.  
FOR WINE (U.S. CLS. 47 AND 49).  
FIRST USE 9-14-2012; IN COMMERCE 9-14-2012.

THE MARK CONSISTS OF STANDARD CHARACTERS  
WITHOUT CLAIM TO ANY PARTICULAR FONT, STYLE,  
SIZE, OR COLOR.  
FOR WINE (U.S. CLS. 47 AND 49).  
FIRST USE 9-14-2012; IN COMMERCE 9-14-2012.

4,482,240. CURIOUS CORK IMPORTS, LLC, DENVER, CO.  
SN 85-760,213. PUB. 3-26-2013, FILED 10-22-2012.

4,482,244. CURIOUS CORK IMPORTS, LLC, DENVER, CO.  
SN 85-760,305. PUB. 4-2-2013, FILED 10-22-2012.

**DUCK DOWN**

**GREETINGS FROM FRANCE**

THE MARK CONSISTS OF STANDARD CHARACTERS  
WITHOUT CLAIM TO ANY PARTICULAR FONT, STYLE,  
SIZE, OR COLOR.  
FOR WINE (U.S. CLS. 47 AND 49).  
FIRST USE 7-22-2013; IN COMMERCE 7-22-2013.

THE MARK CONSISTS OF STANDARD CHARACTERS  
WITHOUT CLAIM TO ANY PARTICULAR FONT, STYLE,  
SIZE, OR COLOR.  
FOR WINE (U.S. CLS. 47 AND 49).  
FIRST USE 9-14-2012; IN COMMERCE 9-14-2012.

4,482,241. CURIOUS CORK IMPORTS, LLC, DENVER, CO.  
SN 85-760,228. PUB. 3-26-2013, FILED 10-22-2012.

4,482,269. BNA WINE GROUP, LLC, NASHVILLE, TN. SN 85-  
767,354. PUB. 4-9-2013, FILED 10-30-2012.

**ROAD TO NOWHERE**

**BUTTERNUT**

THE MARK CONSISTS OF STANDARD CHARACTERS  
WITHOUT CLAIM TO ANY PARTICULAR FONT, STYLE,  
SIZE, OR COLOR.  
FOR WINE (U.S. CLS. 47 AND 49).  
FIRST USE 9-14-2012; IN COMMERCE 9-14-2012.

THE MARK CONSISTS OF STANDARD CHARACTERS  
WITHOUT CLAIM TO ANY PARTICULAR FONT, STYLE,  
SIZE, OR COLOR.  
FOR WINE (U.S. CLS. 47 AND 49).  
FIRST USE 8-0-2011; IN COMMERCE 8-0-2011.

**CLASS 33—(Continued).**

4,482,336. BRONCO WINE COMPANY, CERES, CA. SN 85-790,477. PUB. 4-30-2013, FILED 11-29-2012.

**PRIMOSOLE**

THE MARK CONSISTS OF STANDARD CHARACTERS WITHOUT CLAIM TO ANY PARTICULAR FONT, STYLE, SIZE, OR COLOR.

FOR WINE (U.S. CLS. 47 AND 49).  
FIRST USE 4-17-2013; IN COMMERCE 4-17-2013.

4,482,362. JACK DANIEL'S PROPERTIES, INC., SAN RAFAEL, CA. SN 85-799,706. PUB. 4-30-2013, FILED 12-11-2012.



NO CLAIM IS MADE TO THE EXCLUSIVE RIGHT TO USE "ESTD 1988", APART FROM THE MARK AS SHOWN.

THE MARK CONSISTS OF A CIRCULAR LOGO WITH THE WORDS "THE ORDER OF" AT THE TOP OF THE CIRCLE AND THE WORD "GENTLEMEN" AT THE BOTTOM OF THE CIRCLE. ON THE LEFT AND RIGHT SIDE OF THE CIRCULAR LOGO ARE BARREL COOPER'S HAMMERS. IN THE CENTER OF THE CIRCLE IS A BOTTLE WITH LIGHT RAYS EMANATING FROM IT. TO THE LEFT OF THE BOTTLE ARE THE NUMERALS AND LETTER "35N" WITH A LINE BELOW AND THEN THE NUMERALS AND LETTER "86W". TO THE RIGHT OF THE BOTTLE ARE TWO WATER DROPLETS. BELOW THE BOTTLE IS A BARREL SHAVING TOOL AND THE LETTERS AND NUMERALS "ESTD 1988" WITH A FILIGREE DESIGN ON EITHER SIDE.

FOR DISTILLED SPIRITS (U.S. CLS. 47 AND 49).  
FIRST USE 4-14-2013; IN COMMERCE 4-14-2013.

**CLASS 33—(Continued).**

4,482,367. QUINTESSENTIAL, LLC, NAPA, CA. SN 85-802,135. PUB. 4-16-2013, FILED 12-13-2012.

**FLORINDA**

THE MARK CONSISTS OF STANDARD CHARACTERS WITHOUT CLAIM TO ANY PARTICULAR FONT, STYLE, SIZE, OR COLOR.

FOR WINES (U.S. CLS. 47 AND 49).  
FIRST USE 10-17-2013; IN COMMERCE 10-17-2013.

4,482,372. CASTLE BRANDS INC., NEW YORK, NY. SN 85-803,351. PUB. 7-23-2013, FILED 12-14-2012.



THE MARK CONSISTS OF THE WORDS "CASTELLO MIO" IN STYLIZED FORM APPEARING WITHIN A RECTANGLE WITH ONE ANGULAR SIDE; SUPER IMPOSED ON A RECTANGLE WITH ONE ROUNDED SIDE; AND ENCLOSING 6 PARALLEL LINES; A RECTANGULAR LABEL UNDER THE WORDS AND A DIAMOND AND A CHEVRON ON THE EDGE OF THE RECTANGLE.

THE ENGLISH TRANSLATION OF "CASTELLO MIO" IN THE MARK IS "MY CASTLE".

FOR LIQUEURS (U.S. CLS. 47 AND 49).  
FIRST USE 4-16-2013; IN COMMERCE 4-16-2013.

4,482,411. HARALAMBOS VLAVIANOS, ZIMBALI, SOUTH AFRICA. SN 85-818,553. PUB. 6-11-2013, FILED 1-8-2013.

**ARRIBA**

THE MARK CONSISTS OF STANDARD CHARACTERS WITHOUT CLAIM TO ANY PARTICULAR FONT, STYLE, SIZE, OR COLOR.



**CLASS 33—(Continued).**

THE ENGLISH TRANSLATION OF "ARRIBA" IN THE MARK IS "ABOVE".  
FOR TEQUILA (U.S. CLS. 47 AND 49).  
FIRST USE 1-1-2011; IN COMMERCE 1-1-2011.

4,482,491. PROXIMO SPIRITS, INC., JERSEY CITY, NJ. SN 85-851,505. PUB. 7-9-2013, FILED 2-15-2013.

**THREE OLIVES TARTZ**

THE MARK CONSISTS OF STANDARD CHARACTERS WITHOUT CLAIM TO ANY PARTICULAR FONT, STYLE, SIZE, OR COLOR.  
OWNER OF U.S. REG. NOS. 2,464,552, 4,244,699, AND OTHERS.  
FOR VODKA (U.S. CLS. 47 AND 49).  
FIRST USE 4-30-2013; IN COMMERCE 4-30-2013.

4,482,494. BIO SHOTS LIMITED, KOWLOON, HONG KONG. SN 85-851,791. PUB. 7-30-2013, FILED 2-15-2013.



NO CLAIM IS MADE TO THE EXCLUSIVE RIGHT TO USE "SHOTS", APART FROM THE MARK AS SHOWN.  
THE MARK CONSISTS OF AN OBLONG DESIGN ABOVE THE WORDS "BIO SHOTS".  
FOR HERBAL ALCOHOLIC BEVERAGES EXCEPT BEER; ALCOHOLIC BEVERAGES OF FRUIT; HERBAL SPARKING WINES (U.S. CLS. 47 AND 49).  
FIRST USE 7-4-2013; IN COMMERCE 8-11-2013.

4,482,512. NEIMAN, DREW, NAPA, CA. AND STEWART, ERIC, NAPA, CA. SN 85-861,493. PUB. 7-16-2013, FILED 2-27-2013.

**BEVEL**

THE MARK CONSISTS OF STANDARD CHARACTERS WITHOUT CLAIM TO ANY PARTICULAR FONT, STYLE, SIZE, OR COLOR.  
FOR ALCOHOLIC BEVERAGES EXCEPT BEERS (U.S. CLS. 47 AND 49).  
FIRST USE 8-5-2013; IN COMMERCE 8-5-2013.

**CLASS 33—(Continued).**

4,482,518. BERNSTEIN, DAVID, NEW YORK, NY. SN 85-863,386. PUB. 5-7-2013, FILED 2-28-2013.

**BOTTLE2GLASS**

THE MARK CONSISTS OF STANDARD CHARACTERS WITHOUT CLAIM TO ANY PARTICULAR FONT, STYLE, SIZE, OR COLOR.  
FOR WINES (U.S. CLS. 47 AND 49).  
FIRST USE 9-18-2013; IN COMMERCE 9-18-2013.

4,482,521. THORNTON WINERY, TEMECULA, CA. SN 85-864,807. PUB. 7-23-2013, FILED 3-1-2013.

**TOOT SWEET**

THE MARK CONSISTS OF STANDARD CHARACTERS WITHOUT CLAIM TO ANY PARTICULAR FONT, STYLE, SIZE, OR COLOR.  
FOR WINE (U.S. CLS. 47 AND 49).  
FIRST USE 4-15-2013; IN COMMERCE 4-15-2013.

4,482,539. CONVICT BRANDS, LLC, GENOA, OH. SN 85-867,776. PUB. 7-23-2013, FILED 3-5-2013.



THE MARK CONSISTS OF A STYLIZED DRAGON WITH WINGS AND A POINTED TAIL, HOLDING A STRIPED BOTTLE IN ONE TALON, AND WITH A BALL AND CHAIN AROUND ITS HIND LEG.  
FOR ALCOHOLIC BEVERAGES EXCEPT BEERS; SPIRITS (U.S. CLS. 47 AND 49).  
FIRST USE 4-28-2013; IN COMMERCE 4-28-2013.

**CLASS 33—(Continued).**

4,482,558. FOUR BEARS WINERY LLC, SACRAMENTO, CA. SN 85-876,062. PUB. 8-6-2013, FILED 3-14-2013.



THE MARK CONSISTS OF A CIRCLE WITH AN "N" IN THE CENTER WHERE THE LEFT AND MIDDLE SECTIONS OF THE "N" ARE FORMED WITH LINES AND THE RIGHT PORTION OF THE "N" IS FORMED WITH A DEGREE SIGN.

FOR RED WINES; WINES (U.S. CLS. 47 AND 49).  
FIRST USE 8-6-2013; IN COMMERCE 8-6-2013.

4,482,559. FOUR BEARS WINERY LLC, SACRAMENTO, CA. SN 85-876,071. PUB. 8-6-2013, FILED 3-14-2013.



THE MARK CONSISTS OF THE WORDS "POINT NORTH" STACKED WITH THE WORD "POINT" ON TOP OF THE WORD "NORTH" AND THE WORD "NORTH" SLIGHTLY OFFSET TO THE RIGHT OF THE WORD "POINT" WITH A PARTIAL COMPASS DESIGN, PARTIALLY SURROUNDING THE "P" IN THE WORD "POINT".

FOR RED WINES; WINES (U.S. CLS. 47 AND 49).  
FIRST USE 8-6-2013; IN COMMERCE 8-6-2013.

4,482,695. BERMUDEZ INTERNATIONAL, INC., SANTIAGO, DOMINICAN REP. SN 85-980,863. PUB. 8-13-2013, FILED 1-28-2013.

# TIEGERBRAU

THE MARK CONSISTS OF STANDARD CHARACTERS WITHOUT CLAIM TO ANY PARTICULAR FONT, STYLE, SIZE, OR COLOR.

**CLASS 33—(Continued).**

THE ENGLISH TRANSLATION OF "TIEGERBRAU" IN THE MARK IS "TIGER BREW".

FOR ALCOHOLIC BEVERAGES EXCEPT BEER, NAMELY, ALCOHOLIC MALT BEVERAGES; FLAVORED BREWED MALT BEVERAGES (U.S. CLS. 47 AND 49).

FIRST USE 4-23-1992; IN COMMERCE 11-21-2012.

**CLASS 34—SMOKERS' ARTICLES**

4,481,510. JMG INTERNATIONAL, INC., SAN JOSE, CA. SN 85-359,956. PUB. 11-22-2011, FILED 6-29-2011.

# ROUND 1

THE MARK CONSISTS OF STANDARD CHARACTERS WITHOUT CLAIM TO ANY PARTICULAR FONT, STYLE, SIZE, OR COLOR.

FOR CIGARS (U.S. CLS. 2, 8, 9 AND 17).  
FIRST USE 9-0-2011; IN COMMERCE 9-0-2011.

4,481,646. REYNOLDS INNOVATIONS INC., WINSTON-SALEM, NC. SN 85-514,579. PUB. 5-22-2012, FILED 1-11-2012.

# SNUS NATION

THE MARK CONSISTS OF STANDARD CHARACTERS WITHOUT CLAIM TO ANY PARTICULAR FONT, STYLE, SIZE, OR COLOR.

OWNER OF U.S. REG. NO. 3,750,610.  
NO CLAIM IS MADE TO THE EXCLUSIVE RIGHT TO USE "SNUS", APART FROM THE MARK AS SHOWN.  
FOR SMOKELESS TOBACCO (U.S. CLS. 2, 8, 9 AND 17).

FIRST USE 9-23-2013; IN COMMERCE 9-23-2013.

4,481,735. CINCOR, INC., MIAMI, FL. SN 85-596,930. PUB. 9-4-2012, FILED 4-13-2012.

# Raices

THE MARK CONSISTS OF STANDARD CHARACTERS WITHOUT CLAIM TO ANY PARTICULAR FONT, STYLE, SIZE, OR COLOR.

OWNER OF U.S. REG. NO. 3,230,862.

**CLASS 34—(Continued).**

THE ENGLISH TRANSLATION OF "RAICES" IN THE MARK IS "ROOTS".

FOR CIGARS, CIGARILLOS, TOBACCO, SMOKELESS TOBACCO, SMOKING TOBACCO, CHEWING TOBACCO, AND CIGARETTES ALL DERIVED FROM CUBAN SEED TOBACCO (U.S. CLS. 2, 8, 9 AND 17).

FIRST USE 7-14-2013; IN COMMERCE 7-14-2013.

---

4,481,914. CABALFO, LLC, PASADENA, TX. SN 85-686,641.  
PUB. 1-1-2013, FILED 7-25-2012.

# CABAL

THE MARK CONSISTS OF STANDARD CHARACTERS WITHOUT CLAIM TO ANY PARTICULAR FONT, STYLE, SIZE, OR COLOR.

FOR CIGARS (U.S. CLS. 2, 8, 9 AND 17).

FIRST USE 9-10-2013; IN COMMERCE 9-20-2013.

---

4,482,102. K. HANSOTIA & CO., INC., TAMARAC, FL. SN 85-738,187. PUB. 2-26-2013, FILED 9-25-2012.

# SINISTER

THE MARK CONSISTS OF STANDARD CHARACTERS WITHOUT CLAIM TO ANY PARTICULAR FONT, STYLE, SIZE, OR COLOR.

FOR CIGARS (U.S. CLS. 2, 8, 9 AND 17).

FIRST USE 10-21-2013; IN COMMERCE 10-21-2013.

---

4,482,149. CRAIG A. ROSSI, LAKEWOOD, OH. SN 85-745,686.  
PUB. 3-12-2013, FILED 10-4-2012.

# La Barba

THE MARK CONSISTS OF STANDARD CHARACTERS WITHOUT CLAIM TO ANY PARTICULAR FONT, STYLE, SIZE, OR COLOR.

THE ENGLISH TRANSLATION OF "LA BARBA" IN THE MARK IS "THE BEARD".

FOR CIGARS AND CIGAR ACCESSORIES, NAMELY, CIGAR CUTTERS, ASHTRAYS, CIGAR CASES (U.S. CLS. 2, 8, 9 AND 17).

FIRST USE 10-18-2013; IN COMMERCE 10-18-2013.

**CLASS 34—(Continued).**

4,482,178. K. HANSOTIA & CO., INC., TAMARAC, FL. SN 85-748,813. PUB. 3-12-2013, FILED 10-9-2012.

# KUKRI

THE MARK CONSISTS OF STANDARD CHARACTERS WITHOUT CLAIM TO ANY PARTICULAR FONT, STYLE, SIZE, OR COLOR.

FOR CIGARS (U.S. CLS. 2, 8, 9 AND 17).

FIRST USE 11-4-2013; IN COMMERCE 11-4-2013.

---

4,482,179. K. HANSOTIA & CO., INC., TAMARAC, FL. SN 85-748,823. PUB. 2-26-2013, FILED 10-9-2012.

# BOUNTY HUNTER

THE MARK CONSISTS OF STANDARD CHARACTERS WITHOUT CLAIM TO ANY PARTICULAR FONT, STYLE, SIZE, OR COLOR.

FOR CIGARS (U.S. CLS. 2, 8, 9 AND 17).

FIRST USE 10-21-2013; IN COMMERCE 10-21-2013.

---

4,482,357. SEQUOYAH, LLC, SOUTH BOSTON, VA. SN 85-798,596. PUB. 5-28-2013, FILED 12-10-2012.

# ARROWHEAD

THE MARK CONSISTS OF STANDARD CHARACTERS WITHOUT CLAIM TO ANY PARTICULAR FONT, STYLE, SIZE, OR COLOR.

FOR ELECTRONIC-CIGARETTES: E-CIGARETTES, NAMELY, ELECTRONIC CIGARETTES (U.S. CLS. 2, 8, 9 AND 17).

FIRST USE 5-7-2013; IN COMMERCE 5-7-2013.

**CLASS 34—(Continued).**

4,482,462. CLEAR SMOKE, INC., DALLAS, TX. SN 85-840,687. PUB. 7-23-2013, FILED 2-5-2013.

My Clear Smoke Electronic  
Cigarettes

THE MARK CONSISTS OF STANDARD CHARACTERS WITHOUT CLAIM TO ANY PARTICULAR FONT, STYLE, SIZE, OR COLOR.

NO CLAIM IS MADE TO THE EXCLUSIVE RIGHT TO USE "CLEAR SMOKE ELECTRONIC CIGARETTES", APART FROM THE MARK AS SHOWN.

FOR ELECTRONIC CIGARETTES FOR USE AS AN ALTERNATIVE TO TRADITIONAL CIGARETTES (U.S. CLS. 2, 8, 9 AND 17).

FIRST USE 7-1-2012; IN COMMERCE 7-1-2012.

**CLASS 34—(Continued).**

4,482,645. NU MARK LLC, RICHMOND, VA. SN 85-914,199. PUB. 9-17-2013, FILED 4-25-2013.

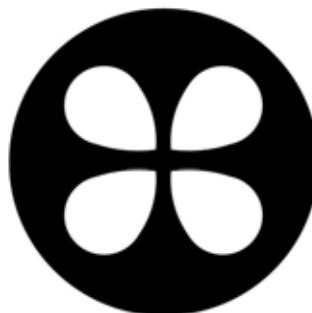

THE MARK CONSISTS OF FOUR PETAL SHAPES INSIDE A CIRCLE.

FOR TOBACCO PRODUCTS, NAMELY, ELECTRONIC CIGARETTES AND CARTOMIZERS (U.S. CLS. 2, 8, 9 AND 17).

FIRST USE 8-12-2013; IN COMMERCE 8-12-2013.

4,482,656. FUMARE INTERNATIONALE, RENO, NV. SN 85-924,909. PUB. 9-17-2013, FILED 5-7-2013.



OWNER OF U.S. REG. NO. 3,371,589. NO CLAIM IS MADE TO THE EXCLUSIVE RIGHT TO USE "CIGARS", APART FROM THE MARK AS SHOWN.

THE COLOR(S) BLACK, RED AND WHITE IS/ARE CLAIMED AS A FEATURE OF THE MARK.

THE MARK CONSISTS OF A BLACK AND RED PLAQUE DESIGN WITH A RED AND BLACK BANNER HORIZONTALLY OVERLAYING IT. THE TOP HALF OF THE PLAQUE IS BLACK AND HAS WHITE LIGHTNING SYMBOLS ON EITHER SIDE OF A RED TRIANGLE WITH A WHITE EYE ILLUSTRATION ON A BLACK BACKGROUND AND THE WHITE WORD "CIGARS" ON IT. THE BANNER APPEARS ABOVE THE WORD "CIGAR" AND BENEATH THE LIGHTNING AND TRIANGLE/EYE DESIGNS AND CONTAIN THE WHITE WORD "ILLUSIONE". THE BOTTOM HALF OF THE PLAQUE DESIGN IS RED AND CONTAINS THE WHITE WORDS "WE ARE NOT INDUSTRY STANDARD" ABOVE A WHITE STAR.

THE ENGLISH TRANSLATION OF "ILLUSIONE" IN THE MARK IS "ILLUSION".

FOR ASHTRAYS; CIGAR BOXES; CIGAR CASES; CIGAR CUTTERS; CIGAR HOLDERS; CIGAR HUMIDIFIERS; CIGAR LIGHTERS; CIGAR TUBES; CIGAR WRAPS; CIGARILLOS; CIGARS; HUMIDORS; MATCHES (U.S. CLS. 2, 8, 9 AND 17).

FIRST USE 9-1-2013; IN COMMERCE 9-1-2013.

4,482,634. NHA, INC., DBA NATIONAL HONEY ALMOND, BRISTOL, PA. SN 85-904,715. PUB. 8-27-2013, FILED 4-15-2013.

Black Don

THE MARK CONSISTS OF STANDARD CHARACTERS WITHOUT CLAIM TO ANY PARTICULAR FONT, STYLE, SIZE, OR COLOR.

FOR CIGARILLOS (U.S. CLS. 2, 8, 9 AND 17). FIRST USE 10-24-2013; IN COMMERCE 10-24-2013.

**CLASS 34—(Continued).**

**SERVICE MARKS**

**CLASS 35—ADVERTISING AND BUSINESS**

4,481,340. THE COCOA BEANS, LLC, PORT GAMBLE, WA. SN 77-824,053. PUB. 10-26-2010, FILED 9-10-2009.

**THE COCOA BEANS**

THE MARK CONSISTS OF STANDARD CHARACTERS WITHOUT CLAIM TO ANY PARTICULAR FONT, STYLE, SIZE, OR COLOR.

FOR ON-LINE RETAIL STORE SERVICES FEATURING A WIDE VARIETY OF CONSUMER GOODS OF OTHERS NOT INCLUDING COCOA BEANS OR PRODUCTS CONTAINING COCOA BEANS AS A PRIMARY INGREDIENT (U.S. CLS. 100, 101 AND 102).

FIRST USE 12-22-2010; IN COMMERCE 12-20-2013.

4,481,342. BUCHANAN, L. STEPHEN, SANTA BARBARA, CA. SN 77-845,959. PUB. 9-21-2010, FILED 10-9-2009.

**CADRE**

THE MARK CONSISTS OF STANDARD CHARACTERS WITHOUT CLAIM TO ANY PARTICULAR FONT, STYLE, SIZE, OR COLOR.

FOR PROVIDING AN ONLINE RETAIL STORE SERVICE FOR THE PURCHASE OF DENTAL EDUCATIONAL AND DENTAL CLINICAL PRODUCTS AND PROVIDING DENTAL PROFESSIONALS WITH PRODUCT INFORMATION REGARDING THE FOREGOING ITEMS OVER THE INTERNET (U.S. CLS. 100, 101 AND 102).

FIRST USE 11-7-2013; IN COMMERCE 11-7-2013.

4,481,392. THE CEMENTWORKS, LLC, NEW YORK, NY. SN 85-039,994. PUB. 10-19-2010, FILED 5-17-2010.



OWNER OF U.S. REG. NO. 3,667,372.  
THE COLOR(S) WHITE AND ORANGE IS/ARE CLAIMED AS A FEATURE OF THE MARK.

THE MARK CONSISTS OF A FOUR TIERED UPWARD FACING CEMENT BLOCK WITH THE LOWEST TIER OF THE CEMENT BLOCK PARTIALLY SHOWN. THE OUTER SECTIONS OF THE CEMENT BLOCK ARE ORANGE AND

**CLASS 35—(Continued).**

THE INNER SECTIONS OF THE CEMENT BLOCK ARE WHITE. THE CEMENT BLOCK IS POSITIONED PARTIALLY IN FRONT OF THE LOWER RIGHT HAND PORTION OF A WHITE SQUARE WHICH SERVES AS A BACKDROP FOR THE TOP THREE TIERS OF THE CEMENT BLOCK. TO THE RIGHT OF THE CEMENT BLOCK AND THE SQUARE BACKDROP IS THE WORDING "THE CEMENTBLOC" IN WHITE. THE COLOR ORANGE BEHIND BOTH THE WORD MARK AND DESIGN ELEMENTS IN THE MARK REPRESENTS BACKGROUND.

FOR PROVIDING ADVERTISING AGENCY SERVICES, PUBLIC RELATIONS AND PROMOTIONAL MARKETING SERVICES IN THE PHARMACEUTICAL AND HEALTHCARE INDUSTRIES THROUGH ALL PUBLIC COMMUNICATIONS MEANS (U.S. CLS. 100, 101 AND 102).

FIRST USE 4-1-2013; IN COMMERCE 4-1-2013.

4,481,414. UHS OF DELAWARE, INC., KING OF PRUSSIA, PA. SN 85-090,540. PUB. 10-19-2010, FILED 7-22-2010.



FOR MANAGEMENT AND BUSINESS CONSULTING SERVICES IN THE FIELD OF TRAINING AND RECRUITMENT (U.S. CLS. 100, 101 AND 102).

FIRST USE 4-0-2010; IN COMMERCE 4-0-2010.

4,481,415. UHS OF DELAWARE, INC., KING OF PRUSSIA, PA. SN 85-090,915. PUB. 10-19-2010, FILED 7-22-2010.



NO CLAIM IS MADE TO THE EXCLUSIVE RIGHT TO USE "STRATEGIC", APART FROM THE MARK AS SHOWN.

FOR MANAGEMENT AND BUSINESS CONSULTING SERVICES IN THE FIELD OF TRAINING AND RECRUITMENT (U.S. CLS. 100, 101 AND 102).

FIRST USE 4-0-2010; IN COMMERCE 4-0-2010.

**CLASS 35—(Continued).**

4,481,462. LESLIE MARGOLIN, ALTADENA, CA. SN 85-223,592. PUB. 7-3-2012, FILED 1-21-2011.

**PARTNERS TRANSFORMING  
HEALTH**

THE MARK CONSISTS OF STANDARD CHARACTERS WITHOUT CLAIM TO ANY PARTICULAR FONT, STYLE, SIZE, OR COLOR.

FOR BUSINESS MANAGEMENT CONSULTING SERVICES FOR THE HEALTH CARE INDUSTRY, NAMELY, PROVIDING INDUSTRY EXPERTISE AND SUPPLIER PARTNERSHIPS (U.S. CLS. 100, 101 AND 102).

FIRST USE 10-10-2012; IN COMMERCE 12-10-2013.

4,481,467. DOCTORCPR.COM, BEVERLY HILLS, CA. SN 85-241,399. PUB. 1-17-2012, FILED 2-14-2011.

**DoctorCPR.com Resuscitate  
Your Career Jobs and  
Classifieds for Health Care  
Professionals**

THE MARK CONSISTS OF STANDARD CHARACTERS WITHOUT CLAIM TO ANY PARTICULAR FONT, STYLE, SIZE, OR COLOR.

NO CLAIM IS MADE TO THE EXCLUSIVE RIGHT TO USE "JOBS AND CLASSIFIEDS FOR HEALTH CARE PROFESSIONALS", APART FROM THE MARK AS SHOWN.

FOR PROVIDING CLASSIFIED AD LISTINGS AND EMPLOYMENT OPPORTUNITY LISTINGS FOR HEALTH CARE PROFESSIONALS (U.S. CLS. 100, 101 AND 102).

FIRST USE 11-15-2009; IN COMMERCE 3-1-2013.

4,481,477. NATURAL SELECTION FOODS, LLC, SAN JUAN BAUTISTA, CA. SN 85-261,559. PUB. 8-23-2011, FILED 3-8-2011.

**EVERY BODY DESERVES ORGANIC**

THE MARK CONSISTS OF STANDARD CHARACTERS WITHOUT CLAIM TO ANY PARTICULAR FONT, STYLE, SIZE, OR COLOR.

FOR PROMOTING PUBLIC AWARENESS IN THE FIELD OF NUTRITION AND HEALTH; PROMOTING PUBLIC AWARENESS IN THE FIELD OF FOOD PRODUCTION AND SAFETY (U.S. CLS. 100, 101 AND 102).

FIRST USE 4-8-2012; IN COMMERCE 4-8-2012.

**CLASS 35—(Continued).**

4,481,550. WPP PROPERTIES, NEW YORK, NY. SN 85-421,264. PUB. 2-19-2013, FILED 9-13-2011.

**RLM Finsbury**

THE MARK CONSISTS OF STANDARD CHARACTERS WITHOUT CLAIM TO ANY PARTICULAR FONT, STYLE, SIZE, OR COLOR.

OWNER OF U.S. REG. NO. 3,479,011.

THE NAME(S), PORTRAIT(S), AND/OR SIGNATURE(S) SHOWN IN THE MARK DOES NOT IDENTIFY A PARTICULAR LIVING INDIVIDUAL.

FOR BUSINESS CONSULTING SERVICES, NAMELY, STRATEGIC COMMUNICATION SERVICES IN THE NATURE OF PUBLIC RELATIONS IN THE AREAS OF CORPORATE COMMUNICATIONS, CRISIS MANAGEMENT, FINANCE, INVESTOR RELATIONS, REPUTATION MANAGEMENT, CORPORATE REORGANIZATIONS AND RESTRUCTURINGS, MERGERS AND ACQUISITIONS, TRANSACTION COMMUNICATIONS, EXECUTIVE TRANSITION, GOVERNANCE, EMPLOYEE COMMUNICATIONS, STRATEGIC POSITIONING AND MARKETING, PHILANTHROPY MARKETING AND CAUSE-RELATED MARKETING; PUBLIC RELATIONS; BUSINESS CONSULTANCY SERVICES RELATED TO BUSINESS MANAGEMENT, MARKETING, BUSINESS STRATEGIES AND PUBLICITY, BUSINESS ACQUISITION AND MERGER CONSULTATION; NON-LEGAL LITIGATION COMMUNICATIONS SUPPORT SERVICES IN THE NATURE OF BUSINESS CONSULTATION, MEDIA RELATIONS SERVICES, BUSINESS RESEARCH AND MEDIA MONITORING SERVICES, NAMELY, MONITORING PRINT MEDIA, TELEVISION, RADIO, AND OTHER MEDIA FOR CUSTOMER-SPECIFIED TOPICS, GATHERING RELEVANT CONTENT ON THOSE TOPICS, AND PROVIDING DOCUMENTATION AND ANALYSIS OF THAT MEDIA CONTENT TO OTHERS FOR BUSINESS PURPOSES; PUBLICITY SERVICES, NAMELY, PROMOTING THE GOODS, SERVICES, BRAND IDENTITY AND COMMERCIAL INFORMATION AND NEWS OF THIRD PARTIES THROUGH PRINT, AUDIO, VIDEO, DIGITAL AND ON-LINE MEDIA (U.S. CLS. 100, 101 AND 102).

FIRST USE 7-19-2011; IN COMMERCE 7-19-2011.

**CLASS 35—(Continued).**

4,481,582. FIFTH STREET GAMING, LLC, LAS VEGAS, NV. SN 85-451,541. PUB. 3-27-2012, FILED 10-19-2011.

**CLASS 35—(Continued).**

4,481,635. AMERICAN PRODUCTIVITY & QUALITY CENTER, HOUSTON, TX. SN 85-501,173. PUB. 7-17-2012, FILED 12-21-2011.

**DOWNTOWN GRAND**

THE MARK CONSISTS OF STANDARD CHARACTERS WITHOUT CLAIM TO ANY PARTICULAR FONT, STYLE, SIZE, OR COLOR.

FOR RETAIL GIFT SHOPS; RETAIL STORE SERVICES FEATURING A WIDE VARIETY OF CONSUMER GOODS OF OTHERS; OPERATION OF A FREQUENT CASINO PLAYERS' INCENTIVE PROGRAM THAT ALLOWS MEMBERS TO REDEEM AWARDS FOR POINT EARNED THROUGH FREQUENT PATRONAGE; CONDUCTING BONUS CARD INCENTIVE AWARD PROGRAMS TO PROMOTE CASINO SERVICES (U.S. CLS. 100, 101 AND 102).

FIRST USE 10-27-2013; IN COMMERCE 10-27-2013.

4,481,586. MARCH MARKETING, LLC, WHEATON, IL. SN 85-452,446. PUB. 3-27-2012, FILED 10-20-2011.

**MARCH**

THE MARK CONSISTS OF STANDARD CHARACTERS WITHOUT CLAIM TO ANY PARTICULAR FONT, STYLE, SIZE, OR COLOR.

NO CLAIM IS MADE TO THE EXCLUSIVE RIGHT TO USE "LLC", APART FROM THE MARK AS SHOWN.

FOR ADVERTISING AND MARKETING SERVICES, NAMELY, PROMOTING GOODS AND SERVICES OF OTHERS THAT ARE RELEVANT TO MILITARY VETERANS AND THEIR FAMILIES (U.S. CLS. 100, 101 AND 102).

FIRST USE 5-1-2012; IN COMMERCE 5-1-2012.

4,481,627. H.M. RICHARDS, INC., ATLANTA, GA. SN 85-484,569. PUB. 5-15-2012, FILED 12-1-2011.

**ISOFA**

THE MARK CONSISTS OF STANDARD CHARACTERS WITHOUT CLAIM TO ANY PARTICULAR FONT, STYLE, SIZE, OR COLOR.

FOR RETAIL FURNITURE STORES (U.S. CLS. 100, 101 AND 102).

FIRST USE 3-23-2013; IN COMMERCE 3-23-2013.

**KNOWLEDGE ANALYTICS**

THE MARK CONSISTS OF STANDARD CHARACTERS WITHOUT CLAIM TO ANY PARTICULAR FONT, STYLE, SIZE, OR COLOR.

NO CLAIM IS MADE TO THE EXCLUSIVE RIGHT TO USE "ANALYTICS", APART FROM THE MARK AS SHOWN.

FOR BUSINESS SERVICES IN THE NATURE OF COLLECTING, PROCESSING, ARCHIVING, BENCHMARKING, QUANTIFYING, MEASURING, ORGANIZING, ASSESSING, REPORTING, AND DISTRIBUTING BUSINESS PROCESS INFORMATION AND DATA FOR USE IN BUSINESS IMPROVEMENT, BUSINESS MANAGEMENT AND BUSINESS DEVELOPMENT (U.S. CLS. 100, 101 AND 102).

FIRST USE 5-15-2012; IN COMMERCE 5-15-2012.

4,481,640. RICE, GERARD MARK, FLORISSANT, MO. SN 85-507,147. PUB. 11-20-2012, FILED 1-2-2012.

**Mobile Media Made Easy**

THE MARK CONSISTS OF STANDARD CHARACTERS WITHOUT CLAIM TO ANY PARTICULAR FONT, STYLE, SIZE, OR COLOR.

NO CLAIM IS MADE TO THE EXCLUSIVE RIGHT TO USE "MOBILE MEDIA", APART FROM THE MARK AS SHOWN.

FOR MARKETING, ADVERTISING, AND PROMOTING THE RETAIL GOODS AND SERVICES OF OTHERS THROUGH WIRELESS ELECTRONIC DEVICES (U.S. CLS. 100, 101 AND 102).

FIRST USE 2-14-2012; IN COMMERCE 8-30-2012.

**CLASS 35—(Continued).**

4,481,669. 2B4ME, INC., CORAL GABLES, FL. SN 85-539,350.  
PUB. 8-13-2013, FILED 2-10-2012.

# 2B4ME

THE MARK CONSISTS OF STANDARD CHARACTERS WITHOUT CLAIM TO ANY PARTICULAR FONT, STYLE, SIZE, OR COLOR.

FOR PROMOTING OF GOODS AND SERVICES OF OTHERS BY PROVIDING A WEBSITE FEATURING COUPONS, REBATES, PRICE-COMPARISON INFORMATION, PRODUCT REVIEWS, LINKS TO THE RETAIL WEBSITES OF OTHERS, AND DISCOUNT INFORMATION; ADVERTISING AND MARKETING SERVICES, NAMELY, PROMOTING THE BRANDS, GOODS AND SERVICES OF OTHERS; PROMOTING THE GOODS AND SERVICES OF OTHERS BY PROVIDING A WEBSITE FEATURING PRICE-COMPARISON INFORMATION, PRODUCT REVIEWS, AND DISCOUNT INFORMATION (U.S. CLS. 100, 101 AND 102).

FIRST USE 1-1-2012; IN COMMERCE 1-1-2012.

4,481,676. JONES, SHANE M, MONTEVALLO, AL. SN 85-548,082. PUB. 7-31-2012, FILED 2-21-2012.



NO CLAIM IS MADE TO THE EXCLUSIVE RIGHT TO USE "FISH", APART FROM THE MARK AS SHOWN.

THE STIPPLING IS FOR SHADING PURPOSES ONLY.

THE MARK CONSISTS OF AN OVAL WITH THE STYLIZED TEXT "THE FISH RANGER". BELOW THERE IS THE STYLIZED TEXT "THEFISHRANGER.COM".

FOR WHOLESALE AND RETAIL STORE SERVICES FEATURING FISHING TACKLE (U.S. CLS. 100, 101 AND 102).

FIRST USE 4-1-2011; IN COMMERCE 4-1-2011.

4,481,687. STRATEGIC PARTNERS, INC., CHATSWORTH, CA. SN 85-557,817. PUB. 7-30-2013, FILED 3-1-2012.

# Code Happy Store

THE MARK CONSISTS OF STANDARD CHARACTERS WITHOUT CLAIM TO ANY PARTICULAR FONT, STYLE, SIZE, OR COLOR.

**CLASS 35—(Continued).**

NO CLAIM IS MADE TO THE EXCLUSIVE RIGHT TO USE "STORE", APART FROM THE MARK AS SHOWN.

FOR ON-LINE RETAIL STORE SERVICES FEATURING CLOTHING, ACCESSORIES, PERSONAL CARE PRODUCTS, EYEWEAR, HOME FURNISHINGS, CANDLES, BOOKS, PERIODICALS, AUDIO AND VIDEO RECORDINGS, COMPUTER SOFTWARE AND MEDICAL INSTRUMENTS FOR HEALTH CARE PROFESSIONALS (U.S. CLS. 100, 101 AND 102).

FIRST USE 11-22-2013; IN COMMERCE 11-22-2013.

4,481,699. BROOKLYN BASKETBALL, LLC, BROOKLYN, NY. SN 85-568,473. PUB. 8-14-2012, FILED 3-13-2012.

# NETS SHOP

THE MARK CONSISTS OF STANDARD CHARACTERS WITHOUT CLAIM TO ANY PARTICULAR FONT, STYLE, SIZE, OR COLOR.

OWNER OF U.S. REG. NOS. 1,209,109, 2,179,495, AND 2,603,964.

NO CLAIM IS MADE TO THE EXCLUSIVE RIGHT TO USE "SHOP", APART FROM THE MARK AS SHOWN.

FOR RETAIL STORE SERVICES, COMPUTERIZED ON-LINE RETAIL STORE SERVICES, ONLINE ORDERING SERVICES, ELECTRONIC RETAIL STORE SERVICES VIA COMPUTER, AND ELECTRONIC MAIL ORDER CATALOG SERVICES, ALL FEATURING AN ARRAY OF BASKETBALL-THEMED MERCHANDISE; PROMOTING THE GOODS AND SERVICES OF OTHERS BY ARRANGING FOR SPONSORS TO AFFILIATE THESE GOODS AND SERVICES WITH A BASKETBALL PROGRAM; PROMOTING THE SALE OF GOODS AND SERVICES OF OTHERS THROUGH THE DISTRIBUTION OF PROMOTIONAL CONTESTS PROVIDED OVER THE INTERNET; CONDUCTING PUBLIC OPINION POLL SURVEYS AND PUBLIC OPINION POLL SURVEYS IN THE FIELD OF BASKETBALL FOR NON-BUSINESS, NON-MARKETING PURPOSES OVER THE INTERNET (U.S. CLS. 100, 101 AND 102).

FIRST USE 10-15-2012; IN COMMERCE 10-15-2012.

4,481,700. TRICOM INC OF MILWAUKEE, MENOMONEE FALLS, WI. SN 85-569,373. PUB. 9-25-2012, FILED 3-14-2012.



NO CLAIM IS MADE TO THE EXCLUSIVE RIGHT TO USE "NATIONAL STAFFING ALLIANCE", APART FROM THE MARK AS SHOWN.

THE MARK CONSISTS OF FOUR SMALLER SQUARES EACH WITH THREE ROUNDED OUTSIDE CORNERS AND A TRIANGULAR CUT TO THE INNERMOST CORNER,



**CLASS 35—(Continued).**

WHICH TOGETHER FORM A LARGE SQUARE THAT THEN FORMS A FOUR POINT STAR WITH THE INNERMOST CORNERS; TO THE RIGHT OF THE LARGE SQUARE IS THE WORD "NATIONAL" ATOP OF THE WORDS "STAFFING ALLIANCE", WITH THE WORDS "NATIONAL REACH, LOCAL EXPERTISE" WRITTEN UNDERNEATH IN A STRAIGHT LINE WHICH STRETCHES THE FULL LENGTH OF THE SQUARE AND WORDS ABOVE IT, IN ALL CAPS BUT SMALLER THAN THE WORDS "STAFFING ALLIANCE" ABOVE IT.

FOR ASSOCIATION SERVICES, NAMELY, PROMOTING THE SERVICES OF INDIVIDUAL MEMBERS' EMPLOYMENT SERVICES AND STAFFING BUSINESSES THROUGH A MARKETING PROGRAM; PROVIDING DATABASES OF INFORMATION IN THE FIELDS OF EXPANDED RECRUITMENT AND PUBLIC RELATIONS, FOR THE PURPOSE OF PROMOTING THE SERVICES OF INDIVIDUAL MEMBERS' EMPLOYMENT SERVICES AND STAFFING BUSINESSES (U.S. CLS. 100, 101 AND 102).

FIRST USE 6-8-2012; IN COMMERCE 6-8-2012.

---

4,481,706. MCEACHIN, MARIA, RENO, NV. SN 85-576,782. PUB. 9-11-2012, FILED 3-22-2012.

**QUALITY OVER QUANTITY**

THE MARK CONSISTS OF STANDARD CHARACTERS WITHOUT CLAIM TO ANY PARTICULAR FONT, STYLE, SIZE, OR COLOR.

FOR ONLINE RETAIL STORE SERVICES FEATURING FITNESS CLOTHING AND ACCESSORIES (U.S. CLS. 100, 101 AND 102).

FIRST USE 3-20-2013; IN COMMERCE 3-20-2013.

---

4,481,714. VIRTUOSO, LTD., FORT WORTH, TX. SN 85-582,591. PUB. 5-21-2013, FILED 3-28-2012.

**VIRTUOSO TRAVEL WEEK**

THE MARK CONSISTS OF STANDARD CHARACTERS WITHOUT CLAIM TO ANY PARTICULAR FONT, STYLE, SIZE, OR COLOR.

OWNER OF U.S. REG. NOS. 3,095,926, 3,248,601, AND OTHERS.

NO CLAIM IS MADE TO THE EXCLUSIVE RIGHT TO USE "TRAVEL WEEK", APART FROM THE MARK AS SHOWN.

FOR ORGANIZING, ARRANGING, AND CONDUCTING TRADE EXHIBITIONS IN THE FIELD OF TRAVEL; PROMOTING THE GOODS AND SERVICES OF OTHERS THROUGH THE DISTRIBUTION OF PRINTED MATERIALS AND ARRANGING NETWORKING MEETINGS BETWEEN TRAVEL SUPPLIERS AND TRAVEL AGENCIES (U.S. CLS. 100, 101 AND 102).

FIRST USE 8-12-2012; IN COMMERCE 8-12-2012.

**CLASS 35—(Continued).**

4,481,739. LIFE WIPES, LLC, ZIONSVILLE, IN. SN 85-598,390. PUB. 2-5-2013, FILED 4-16-2012.

**LIFE WIPES**  
**We'll Wipe It Out**

THE MARK CONSISTS OF STANDARD CHARACTERS WITHOUT CLAIM TO ANY PARTICULAR FONT, STYLE, SIZE, OR COLOR.

NO CLAIM IS MADE TO THE EXCLUSIVE RIGHT TO USE "WIPES", APART FROM THE MARK AS SHOWN.

FOR RETAIL STORE SERVICES FEATURING DISPOSABLE WIPES IMPREGNATED WITH CLEANSING COMPOUNDS FOR USE ON EYE LIDS (U.S. CLS. 100, 101 AND 102).

FIRST USE 9-15-2012; IN COMMERCE 9-15-2012.

---

4,481,758. E-REWARDS, INC., PLANO, TX. SN 85-605,140. PUB. 9-25-2012, FILED 4-23-2012.



NO CLAIM IS MADE TO THE EXCLUSIVE RIGHT TO USE "CLOUD COMMUNITIES", APART FROM THE MARK AS SHOWN.

THE MARK CONSISTS OF THE WORDING "CLOUD COMMUNITIES" SHOWN TO THE RIGHT OF THE DESIGN OF A CLOUD.

FOR BUSINESS AND MARKET RESEARCH SERVICES; CONDUCTING, PROCESSING AND ANALYZING QUALITATIVE AND QUANTITATIVE BUSINESS, MARKET RESEARCH AND PUBLIC OPINION RESEARCH SURVEYS; BUSINESS RESEARCH SERVICES, NAMELY, ORGANIZATION AND MANAGEMENT OF FOCUS GROUPS, PANEL GROUPS AND ONLINE, OFFLINE AND MOBILE OPINION PANEL PARTICIPANTS; BUSINESS INFORMATION SERVICES, NAMELY, DATA COLLECTION AND SAMPLING; PREPARING BUSINESS, MARKET RESEARCH AND PUBLIC OPINION SURVEY STATISTICAL REPORTS; PROVIDING A COMPUTERIZED ONLINE INTERACTIVE DATABASE FOR BUSINESS, MARKET RESEARCH AND PUBLIC OPINION SURVEYS OF SUBSCRIBERS FEATURING SURVEY DATA AND ANALYSES; CONSULTING SERVICES IN THE FIELD OF BUSINESS, MARKET RESEARCH AND PUBLIC OPINION RESEARCH SURVEYS; PROVIDING CUSTOMER AND PROSPECTIVE CUSTOMER RELATIONSHIP MANAGEMENT CONSULTATION SERVICES TO BUSINESSES; PROMOTING THE GOODS AND SERVICES OF OTHERS THROUGH THE ADMINISTRATION OF LOYALTY INCENTIVE AWARD PROGRAMS (U.S. CLS. 100, 101 AND 102).

FIRST USE 9-0-2012; IN COMMERCE 9-0-2012.

**CLASS 35—(Continued).**

4,481,759. PLANET PERSPECTIVE LLC, CHICAGO, IL. SN 85-605,522. PUB. 3-26-2013, FILED 4-23-2012.

### SIX PILLARS OF DIVERSITY AND INCLUSION

THE MARK CONSISTS OF STANDARD CHARACTERS WITHOUT CLAIM TO ANY PARTICULAR FONT, STYLE, SIZE, OR COLOR.

NO CLAIM IS MADE TO THE EXCLUSIVE RIGHT TO USE "DIVERSITY AND INCLUSION", APART FROM THE MARK AS SHOWN.

FOR PROVIDING HUMAN RESOURCES CONSULTING SERVICES IN THE FIELDS OF DIVERSITY AND INCLUSION AND ORGANIZATIONAL DEVELOPMENT; MANAGEMENT CONSULTING AND ADVISORY SERVICES IN THE AREAS OF CORPORATE GROWTH STRATEGY, INNOVATION AND GROWTH PROCESSES, ORGANIZATIONAL TRANSFORMATION, AND TALENT MANAGEMENT AND DEVELOPMENT STRATEGIES (U.S. CLS. 100, 101 AND 102).

FIRST USE 4-30-2009; IN COMMERCE 3-28-2011.

4,481,766. BERETTA U.S.A. CORP., ACCOKEEK, MD. SN 85-614,089. PUB. 9-24-2013, FILED 5-2-2012.

### CLUB 1526

THE MARK CONSISTS OF STANDARD CHARACTERS WITHOUT CLAIM TO ANY PARTICULAR FONT, STYLE, SIZE, OR COLOR.

NO CLAIM IS MADE TO THE EXCLUSIVE RIGHT TO USE "CLUB", APART FROM THE MARK AS SHOWN.

FOR MEMBERSHIP CLUB SERVICES, NAMELY, PROVIDING CONSUMER PRODUCT INFORMATION TO MEMBERS VIA PRODUCT CATALOGS AND DOWNLOADABLE CONTENT (U.S. CLS. 100, 101 AND 102).

FIRST USE 11-0-2013; IN COMMERCE 11-0-2013.

4,481,776. CUSTOMER EXPERIENCE PARTNERS, LLC, DARIEN, CT. SN 85-617,196. PUB. 9-11-2012, FILED 5-4-2012.

### Buzz Barometer

THE MARK CONSISTS OF STANDARD CHARACTERS WITHOUT CLAIM TO ANY PARTICULAR FONT, STYLE, SIZE, OR COLOR.

**CLASS 35—(Continued).**

NO CLAIM IS MADE TO THE EXCLUSIVE RIGHT TO USE "BAROMETER", APART FROM THE MARK AS SHOWN.

FOR CONDUCTING BUSINESS AND MARKET RESEARCH SURVEYS, NAMELY, PROVIDING A SURVEY OR OBSERVATION PROCESS TO EVALUATE INTERPERSONAL COMMUNICATIONS CONCERNING ANY PERSON, PRODUCT OR SERVICE (U.S. CLS. 100, 101 AND 102).

FIRST USE 1-8-2004; IN COMMERCE 8-5-2008.

4,481,795. RENTRAK CORPORATION, PORTLAND, OR. SN 85-625,019. PUB. 3-5-2013, FILED 5-14-2012.

### DIGITAL DOWNLOAD ESSENTIALS

THE MARK CONSISTS OF STANDARD CHARACTERS WITHOUT CLAIM TO ANY PARTICULAR FONT, STYLE, SIZE, OR COLOR.

NO CLAIM IS MADE TO THE EXCLUSIVE RIGHT TO USE "DIGITAL DOWNLOAD", APART FROM THE MARK AS SHOWN.

FOR AUDIENCE MEASUREMENT SERVICES IN THE MEDIA INDUSTRY FIELDS OF TELEVISION, VIDEO, INTERNET VIDEO, VIDEO-ON-DEMAND, MOVIE, MOVIE BOX OFFICE, INTERNET, BROADBAND AND MOBILE AUDIO-VIDEO BROADCAST AND STREAMED ENTERTAINMENT CONTENT, AND OTHER MEDIA CONSUMPTION; MARKET RESEARCH AND MARKET INTELLIGENCE SERVICES; BUSINESS INTELLIGENCE SERVICES; PROVIDING MARKET RESEARCH, MARKET INTELLIGENCE AND BUSINESS INTELLIGENCE SERVICES IN THE FIELDS OF MEDIA AUDIENCE MEASUREMENT AND ANALYTICS AND MEDIA AUDIENCE DATA; PROVIDING ONLINE COMPUTER DATABASES FEATURING BUSINESS INTELLIGENCE IN THE FIELD OF MEDIA AUDIENCE MEASUREMENT AND ANALYTICS AND MEDIA AUDIENCE DATA; PROVIDING ONLINE SEARCHABLE COMPUTER DATABASES FEATURING MEDIA INDUSTRY RESEARCH INFORMATION IN THE FIELD OF MEDIA AUDIENCE MEASUREMENT AND AUDIENCE DATA AND REPORT CREATION AND CALCULATION TOOLS; PROVIDING MARKET REPORTS, STUDIES, DATA, STATISTICS AND ANALYTICS RELATED TO MEDIA AUDIENCE MEASUREMENT AND AUDIENCE DATA; MEDIA MONITORING AND ANALYTICS SERVICES, NAMELY, MONITORING, REPORTING, AND ANALYZING CONSUMER CONSUMPTION OF MEDIA FOR TELEVISION, VIDEO, INTERNET VIDEO, VIDEO-ON-DEMAND, MOVIE, MOVIE BOX OFFICE, INTERNET, BROADBAND AND MOBILE AUDIO-VIDEO BROADCAST AND STREAMED ENTERTAINMENT CONTENT, AND OTHER MEDIA CONSUMPTION; MARKET RESEARCH SERVICES, NAMELY, MEDIA RESEARCH SERVICES FOR AUDIENCE VIEWERSHIP, PARTICIPATION, AND DEMOGRAPHICS; MEDIA INDUSTRY RESEARCH SERVICES IN THE FIELDS OF TELEVISION PROGRAM RATINGS, STATISTICS AND ANALYTICS, AND NEW MEDIA PRODUCT TRENDS AND DEVELOPMENTS FOR BUSINESS AND ADVERTISING PURPOSES (U.S. CLS. 100, 101 AND 102).

FIRST USE 3-31-2006; IN COMMERCE 3-31-2006.

**CLASS 35—(Continued).**

4,481,863. VERITABLE VEGETABLE COMPANY, SAN FRANCISCO, CA. SN 85-660,723. PUB. 5-21-2013, FILED 6-25-2012.

**DELIVERING ORGANIC.  
DRIVING CHANGE.**

THE MARK CONSISTS OF STANDARD CHARACTERS WITHOUT CLAIM TO ANY PARTICULAR FONT, STYLE, SIZE, OR COLOR.

NO CLAIM IS MADE TO THE EXCLUSIVE RIGHT TO USE "ORGANIC", APART FROM THE MARK AS SHOWN. FOR WHOLESALE DISTRIBUTORSHIP IN THE FIELD OF ORGANIC FOODS (U.S. CLS. 100, 101 AND 102). FIRST USE 5-31-2012; IN COMMERCE 5-31-2012.

4,481,864. VERITABLE VEGETABLE COMPANY, SAN FRANCISCO, CA. SN 85-660,817. PUB. 6-4-2013, FILED 6-25-2012.



OWNER OF U.S. REG. NOS. 2,816,610 AND 2,816,612. NO CLAIM IS MADE TO THE EXCLUSIVE RIGHT TO USE "VEGETABLE", APART FROM THE MARK AS SHOWN.

THE MARK CONSISTS OF THE STACKED WORDING "VERITABLE VEGETABLE" IN A STYLIZED FONT WITH A DEPICTION OF EARS OF CORN ENCIRCLED BY A VINE APPEARING TO THE RIGHT OF THE WORDING "VERITABLE".

FOR WHOLESALE DISTRIBUTORSHIP IN THE FIELD OF ORGANIC FOODS (U.S. CLS. 100, 101 AND 102). FIRST USE 5-31-2012; IN COMMERCE 5-31-2012.

4,481,878. WMK HOLDINGS, INC., WILMINGTON, DE. SN 85-667,036. PUB. 4-9-2013, FILED 7-2-2012.



OWNER OF U.S. REG. NO. 3,327,811.

**CLASS 35—(Continued).**

NO CLAIM IS MADE TO THE EXCLUSIVE RIGHT TO USE "GAS AND GO", APART FROM THE MARK AS SHOWN.

THE COLOR(S) RED, YELLOW, AND WHITE IS/ARE CLAIMED AS A FEATURE OF THE MARK.

THE MARK CONSISTS OF THE TERMS "WEIS", "GAS" AND "GO" IN RED WITH A WHITE "N" SURROUNDED BY A YELLOW CIRCLE.

FOR RETAIL GASOLINE SUPPLY SERVICES (U.S. CLS. 100, 101 AND 102). FIRST USE 10-1-2013; IN COMMERCE 10-1-2013.

4,481,882. MULTI-PURE INTERNATIONAL, LAS VEGAS, NV. SN 85-671,690. PUB. 4-30-2013, FILED 7-9-2012.

**PURELY KIDS**

THE MARK CONSISTS OF STANDARD CHARACTERS WITHOUT CLAIM TO ANY PARTICULAR FONT, STYLE, SIZE, OR COLOR.

NO CLAIM IS MADE TO THE EXCLUSIVE RIGHT TO USE "KIDS", APART FROM THE MARK AS SHOWN.

FOR CHARITABLE SERVICES, NAMELY, PROMOTING PUBLIC AWARENESS OF WATER CONTAMINATION AND WATER FILTRATION (U.S. CLS. 100, 101 AND 102).

FIRST USE 2-25-2012; IN COMMERCE 2-25-2012.

4,481,884. MULTI-PURE INTERNATIONAL, LAS VEGAS, NV. SN 85-671,720. PUB. 4-30-2013, FILED 7-9-2012.



THE COLOR(S) BLUE IS/ARE CLAIMED AS A FEATURE OF THE MARK.

THE MARK CONSISTS OF A BLUE WATER DROP THAT REPRESENTS OR FORMS A PERSON.

FOR CHARITABLE SERVICES, NAMELY, PROMOTING PUBLIC AWARENESS OF WATER CONTAMINATION AND WATER FILTRATION (U.S. CLS. 100, 101 AND 102).

FIRST USE 2-25-2012; IN COMMERCE 2-25-2012.

**CLASS 35—(Continued).**

4,481,893. SCOTCH & SODA B.V., 2132 PZ HOOFDDORP, NETHERLANDS. SN 85-675,046. PUB. 4-30-2013, FILED 7-12-2012.

**AMSTERDAMS BLAUW**

THE MARK CONSISTS OF STANDARD CHARACTERS WITHOUT CLAIM TO ANY PARTICULAR FONT, STYLE, SIZE, OR COLOR.

OWNER OF U.S. REG. NO. 4,062,011.

NO CLAIM IS MADE TO THE EXCLUSIVE RIGHT TO USE "AMSTERDAMS", APART FROM THE MARK AS SHOWN.

THE ENGLISH TRANSLATION OF "BLAUW" IN THE MARK IS "BLUE".

FOR ADVERTISING AND BUSINESS SERVICES, NAMELY, ADMINISTERING THE BUSINESS AFFAIRS OF FRANCHISES, ADVISING FRANCHISES ON MARKETING AND OFFERING BUSINESS ASSISTANCE IN THE ESTABLISHMENT AND OPERATION OF FRANCHISES; RETAIL STORE SERVICES, ONLINE RETAIL STORE SERVICES AND COMPUTERIZED ONLINE RETAIL STORE SERVICES IN THE FIELDS OF SOAPS, PERFUMERY, ESSENTIAL OILS, COSMETICS AND HAIR LOTIONS, PRECIOUS METALS AND THEIR ALLOYS AND GOODS IN PRECIOUS METALS OR COATED THEREWITH, NAMELY, BRACELETS, JEWELRY, CLOCKS, FIGURINES, KEY CHAINS, ORNAMENTAL PINS, WATCHES, PRECIOUS STONES, HOROLOGICAL AND CHRONOMETRIC INSTRUMENTS, LEATHER AND IMITATIONS OF LEATHER, AND GOODS MADE OF THESE MATERIALS AND NOT INCLUDED IN OTHER CLASSES, NAMELY, LEATHER AND IMITATION LEATHER BAGS, LEATHER AND IMITATION LEATHER KEY CHAINS, GOODS MADE OF LEATHER AND IMITATIONS OF LEATHER, NAMELY, ALL-PURPOSE SPORTS BAGS, SCHOOL BAGS, BOOK BAGS, CARRY-ALL BAGS, SADDLE BELTS OF LEATHER, TRUNKS AND TRAVELING BAGS, UMBRELLAS, PARASOLS, CLOTHING, NAMELY, JUMPERS, PAJAMAS, COATS, JACKETS, SWEATERS, SHIRTS, T-SHIRTS, POLO SHIRTS, PANTS, TROUSERS, SUITS, SHORTS, SCARVES, GLOVES, TIES, SOCKS, SWIMWEAR, DRESSES, SKIRTS, PULLOVERS, BLOUSES, UNDERWEAR, SPORTSWEAR, NAMELY, JOGGING SUITS, FOOTWEAR, HEADWEAR (U.S. CLS. 100, 101 AND 102).

FIRST USE 12-1-2010; IN COMMERCE 12-1-2010.

4,481,896. HEAD SOLUTIONS GROUP (US) INC., NEW YORK, NY. SN 85-676,577. PUB. 5-21-2013, FILED 7-13-2012.

**HEAD RESEARCH**

THE MARK CONSISTS OF STANDARD CHARACTERS WITHOUT CLAIM TO ANY PARTICULAR FONT, STYLE, SIZE, OR COLOR.

NO CLAIM IS MADE TO THE EXCLUSIVE RIGHT TO USE "RESEARCH", APART FROM THE MARK AS SHOWN.

FOR MARKET RESEARCH SERVICES; ADVERTISING SERVICES (U.S. CLS. 100, 101 AND 102).

FIRST USE 7-0-1991; IN COMMERCE 6-0-2003.

**CLASS 35—(Continued).**

4,481,897. HEAD SOLUTIONS GROUP (US) INC., NEW YORK, NY. SN 85-676,669. PUB. 5-21-2013, FILED 7-13-2012.

**HEAD SOLUTIONS GROUP**

THE MARK CONSISTS OF STANDARD CHARACTERS WITHOUT CLAIM TO ANY PARTICULAR FONT, STYLE, SIZE, OR COLOR.

NO CLAIM IS MADE TO THE EXCLUSIVE RIGHT TO USE "SOLUTIONS GROUP", APART FROM THE MARK AS SHOWN.

FOR MARKET RESEARCH SERVICES; ADVERTISING SERVICES (U.S. CLS. 100, 101 AND 102).

FIRST USE 3-0-2012; IN COMMERCE 3-0-2012.

4,481,907. RECYCLED PAPERBOARD TECHNICAL ASSOCIATION, ELGIN, IL. SN 85-682,971. PUB. 3-12-2013, FILED 7-20-2012.



OWNER OF U.S. REG. NO. 1,703,921.

NO CLAIM IS MADE TO THE EXCLUSIVE RIGHT TO USE "RECYCLED PAPERBOARD TECHNICAL ASSOCIATION" AND THE REPRESENTATION OF THE RECYCLING SYMBOL, APART FROM THE MARK AS SHOWN.

THE MARK CONSISTS OF CAPITAL LETTERS "RPTA" WITH THE RECYCLING SYMBOL FORMING THE INTERIOR OF THE LETTER "A" WITH A CURVED ARROW ABOVE AND BELOW THE LETTERS "RPTA" AND ALL ABOVE THE WORDS "RECYCLED PAPERBOARD TECHNICAL ASSOCIATION".

FOR ASSOCIATION SERVICES, NAMELY, PROMOTING THE INTERESTS OF THE RECYCLED PAPERBOARD INDUSTRY (U.S. CLS. 100, 101 AND 102).

FIRST USE 7-13-2012; IN COMMERCE 7-13-2012.

**CLASS 35—(Continued).**

4,481,910. OFFLINE SOLUTIONS, LLC, BOVEY, MN. SN 85-684,649. PUB. 12-4-2012, FILED 7-23-2012.



THE MARK CONSISTS OF A STYLIZED LETTER "S" SURROUNDED BY (OR CONTAINED IN) A LARGER STYLIZED LETTER "O".

FOR BUSINESS RISK MANAGEMENT CONSULTATION (U.S. CLS. 100, 101 AND 102).

FIRST USE 10-0-2011; IN COMMERCE 10-0-2011.

4,481,920. STAYPOINTS, LLC, HOOVER, AL. SN 85-688,997. PUB. 6-4-2013, FILED 7-27-2012.

STAYPOINTS

THE MARK CONSISTS OF STANDARD CHARACTERS WITHOUT CLAIM TO ANY PARTICULAR FONT, STYLE, SIZE, OR COLOR.

FOR ADMINISTRATION OF A CUSTOMER LOYALTY AND INCENTIVE REWARD PROGRAM FOR CUSTOMERS OF TEMPORARY LODGING, FEATURING THE ACCUMULATION OF POINTS BY THE PROGRAM MEMBERS AND THE SUBSEQUENT REDEMPTION OF POINTS TOWARDS FREE LODGING AND OTHER TRAVEL-RELATED BENEFITS, AS WELL AS THE ACQUISITION OF POINTS REDEEMABLE FOR CONSUMER PRODUCTS AND SERVICES AS WELL AS GIFTS AND DISCOUNTS IN AIR TRAVEL, HOTEL LODGING, RESTAURANTS, HOME APPLIANCES, AND OTHER SERVICES AND PRODUCTS (U.S. CLS. 100, 101 AND 102).

FIRST USE 2-4-2013; IN COMMERCE 2-4-2013.

**CLASS 35—(Continued).**

4,481,922. ROGOBOX LLC, MIAMI, FL. SN 85-690,695. PUB. 5-14-2013, FILED 7-30-2012.



THE MARK CONSISTS OF THE PRIMARY NAME "ROGOBOX" IN UNIQUE STYLIZED LETTERS. ON THE RIGHT OF THE PRIMARY NAME IS A UNIQUE STYLED BOX MADE UP OF 9 SMALLER STYLIZED SHADED BOXES ALIGNED BY THREE ROWS AND THREE COLUMNS. THIS BOX IS UNIQUE TO THE WORD MARK.

FOR ADVERTISING AND PROMOTIONAL SERVICES (U.S. CLS. 100, 101 AND 102).

FIRST USE 6-12-2012; IN COMMERCE 7-12-2012.

4,481,930. NATIONAL RESTAURANT ASSOCIATION, WASHINGTON, DC. SN 85-695,608. PUB. 9-3-2013, FILED 8-5-2012.



OWNER OF U.S. REG. NOS. 1,240,672, 4,144,248, AND OTHERS.

NO CLAIM IS MADE TO THE EXCLUSIVE RIGHT TO USE "KIDS" AND "RESTAURANT ASSOCIATION", APART FROM THE MARK AS SHOWN.

THE MARK CONSISTS OF THE WORDS "KIDS LIVE WELL NATIONAL RESTAURANT ASSOCIATION" WITH AN APPLE ABOVE THE LETTER "I" IN THE WORD "LIVE". TWO INTERSECTING CRESCENTS APPEAR TO THE RIGHT.

SEC. 2(F) AS TO "NATIONAL RESTAURANT ASSOCIATION".

FOR ASSOCIATION SERVICES, NAMELY, PROMOTING THE INTERESTS OF PERSONS AND BUSINESSES IN THE RESTAURANT, HOTELS AND MOTELS, AND THE HOSPITALITY INDUSTRY IN PROMOTING HEALTHY EATING, HEALTHY HABITS AND HEALTHY LIFESTYLES (U.S. CLS. 100, 101 AND 102).

FIRST USE 7-0-2012; IN COMMERCE 7-0-2012.

**CLASS 35—(Continued).**

4,481,940. YOUNG & LARAMORE, INC., INDIANAPOLIS, IN. SN 85-699,560. PUB. 1-15-2013, FILED 8-9-2012.

## LUNCH TRAIN

THE MARK CONSISTS OF STANDARD CHARACTERS WITHOUT CLAIM TO ANY PARTICULAR FONT, STYLE, SIZE, OR COLOR.

FOR ADVERTISING, MARKETING, AND PROMOTING THE GOODS AND SERVICES OF OTHERS VIA A GLOBAL COMPUTER NETWORK BY FACILITATING USERS TO COMMUNICATE, MEET AND GATHER TO PURCHASE GOODS AND SERVICES AND BY PROVIDING COUPONS AND OTHER INCENTIVES TO SUCH USERS TO PROMOTE THE PURCHASE OF GOODS AND SERVICES (U.S. CLS. 100, 101 AND 102).

FIRST USE 9-6-2013; IN COMMERCE 9-6-2013.

**CLASS 35—(Continued).**

4,481,999. SYSCO CORPORATION, HOUSTON, TX. SN 85-722,991. PUB. 2-19-2013, FILED 9-7-2012.



THE COLOR(S) GREEN AND ORANGE IS/ARE CLAIMED AS A FEATURE OF THE MARK.

THE MARK CONSISTS OF TWO GREEN LEAVES BELOW AN ORANGE ARC.

FOR DISTRIBUTORSHIP SERVICES IN THE FIELD OF FOOD TO EATING ESTABLISHMENTS (U.S. CLS. 100, 101 AND 102).

FIRST USE 8-1-2012; IN COMMERCE 8-1-2012.

4,481,942. ACTRIGHT ACTION, INC., PLAINFIELD, IN. SN 85-700,423. PUB. 1-15-2013, FILED 8-10-2012.

## ACT RIGHT

THE MARK CONSISTS OF STANDARD CHARACTERS WITHOUT CLAIM TO ANY PARTICULAR FONT, STYLE, SIZE, OR COLOR.

FOR POLITICAL ACTION COMMITTEE SERVICES, NAMELY, PROMOTING THE INTERESTS OF CONSERVATIVES IN THE FIELD OF POLITICS (U.S. CLS. 100, 101 AND 102).

FIRST USE 8-15-2013; IN COMMERCE 8-15-2013.

4,482,064. JOE FILTER, L.L.C., DBA JOE FILTER, GILBERT, AZ. SN 85-733,281. PUB. 4-9-2013, FILED 9-19-2012.

## Joe Filter

THE MARK CONSISTS OF STANDARD CHARACTERS WITHOUT CLAIM TO ANY PARTICULAR FONT, STYLE, SIZE, OR COLOR.

"JOE FILTER" DOES NOT IDENTIFY A LIVING INDIVIDUAL.

FOR ARRANGING SUBSCRIPTIONS FOR THE PROVISION OF SPECIFIC AND SIMPLE HOME MAINTENANCE TASKS SUCH AS FILTER CHANGES, BATTERY CHANGES AND SIMPLE MECHANICAL ADJUSTMENTS (U.S. CLS. 100, 101 AND 102).

FIRST USE 12-15-2012; IN COMMERCE 3-1-2013.

**CLASS 35—(Continued).**

4,482,085. THE BUDD GROUP, INC., WINSTON-SALEM, NC. SN 85-736,840. PUB. 3-26-2013, FILED 9-24-2012.

## BUDD WORKFORCE SOLUTIONS

THE MARK CONSISTS OF STANDARD CHARACTERS WITHOUT CLAIM TO ANY PARTICULAR FONT, STYLE, SIZE, OR COLOR.

OWNER OF U.S. REG. NO. 2,594,608.

NO CLAIM IS MADE TO THE EXCLUSIVE RIGHT TO USE "WORKFORCE SOLUTIONS", APART FROM THE MARK AS SHOWN.

FOR EMPLOYMENT AGENCY SERVICES, NAMELY, FILLING THE TEMPORARY AND PERMANENT STAFFING NEEDS OF BUSINESSES; EMPLOYMENT STAFFING CONSULTATION SERVICES (U.S. CLS. 100, 101 AND 102).

FIRST USE 1-1-2013; IN COMMERCE 1-1-2013.

---

4,482,086. SPONSORSHIP SCIENCE, LLC, ST. LOUIS, MO. SN 85-736,895. PUB. 2-26-2013, FILED 9-24-2012.

## OpticMODUS

THE MARK CONSISTS OF STANDARD CHARACTERS WITHOUT CLAIM TO ANY PARTICULAR FONT, STYLE, SIZE, OR COLOR.

FOR ANALYSIS OF MARKET RESEARCH DATA AND STATISTICS; COLLECTION OF MARKET RESEARCH INFORMATION; COMPUTERIZED MARKET RESEARCH SERVICES; CONSUMER MARKETING RESEARCH AND CONSULTING RELATED THERETO; MARKET ANALYSIS; MARKET ANALYSIS AND RESEARCH SERVICES; MARKET RESEARCH; MARKET RESEARCH BY MEANS OF A COMPUTER DATABASE; MARKET RESEARCH CONSULTATION; MARKET RESEARCH STUDIES; MARKETING ANALYSIS SERVICES; MARKETING RESEARCH SERVICES; MEDIA BUYING ADVICE, NAMELY, ADVISING THE CLIENT HOW MUCH MEDIA TIME, AND AT WHAT TIMES THE CLIENT SHOULD BE PURCHASING ADVERTISING; MEDIA MONITORING SERVICES, NAMELY, MONITORING PRINT MEDIA, TELEVISION, RADIO, AND OTHER MEDIA FOR CUSTOMER-SPECIFIED TOPICS, GATHERING RELEVANT CONTENT ON THOSE TOPICS, AND PROVIDING DOCUMENTATION AND ANALYSIS OF THAT MEDIA CONTENT TO OTHERS FOR BUSINESS PURPOSES; MEDIA PLANNING, NAMELY, ADVISING THE CLIENT ON THE CORRECT TIMES AND STATIONS TO ADVERTISE BASED ON MEDIA ANALYSIS OF THE MARKET FOR THAT MEDIA; PROVISION OF MARKET RESEARCH INFORMATION (U.S. CLS. 100, 101 AND 102).

FIRST USE 9-1-2012; IN COMMERCE 9-1-2012.

**CLASS 35—(Continued).**

4,482,113. METRICSTREAM, INC., PALO ALTO, CA. SN 85-739,169. PUB. 3-19-2013, FILED 9-26-2012.

## THRIVE ON RISK

THE MARK CONSISTS OF STANDARD CHARACTERS WITHOUT CLAIM TO ANY PARTICULAR FONT, STYLE, SIZE, OR COLOR.

FOR PROVIDING A WEBSITE FEATURING NON-DOWNLOADABLE BUSINESS INFORMATION VIDEOS, ARTICLE LINKS AND EVENT INFORMATION IN THE FIELD OF BUSINESS RISK MANAGEMENT COMPLEXITY, INNOVATION IN BUSINESS, ENTREPRENEURSHIP, UTILIZING BIG DATA IN BUSINESS, BUSINESS MODELS, BUSINESS LEADERSHIP, AND CORPORATE CULTURE (U.S. CLS. 100, 101 AND 102).

FIRST USE 9-25-2012; IN COMMERCE 1-24-2013.

---

4,482,114. METRICSTREAM, INC., PALO ALTO, CA. SN 85-739,179. PUB. 3-19-2013, FILED 9-26-2012.

thrive  risk  
Powered by MetricStream

OWNER OF U.S. REG. NO. 2,914,547.

NO CLAIM IS MADE TO THE EXCLUSIVE RIGHT TO USE "POWERED BY", APART FROM THE MARK AS SHOWN.

THE MARK CONSISTS OF THE WORDS "THRIVE ON RISK POWERED BY METRICSTREAM". THE WORDS "POWERED BY METRICSTREAM" APPEAR BENEATH THE WORDING "THRIVE ON RISK". THE LETTERS "O" AND "N" IN THE WORD "ON", WHICH APPEARS BETWEEN THE WORDS "THRIVE" AND "RISK", ARE WRITTEN ON RECTANGULAR AND SQUARE FIGURES RESPECTIVELY.

FOR PROVIDING A WEBSITE FEATURING NON-DOWNLOADABLE BUSINESS INFORMATION VIDEOS, ARTICLE LINKS AND EVENT INFORMATION IN THE FIELD OF BUSINESS RISK MANAGEMENT COMPLEXITY, INNOVATION IN BUSINESS, ENTREPRENEURSHIP, UTILIZING BIG DATA IN BUSINESS, BUSINESS MODELS, BUSINESS LEADERSHIP, AND CORPORATE CULTURE (U.S. CLS. 100, 101 AND 102).

FIRST USE 9-25-2012; IN COMMERCE 1-24-2013.

**CLASS 35—(Continued).**

4,482,128. MD RECOVERIES, INC., SAN DIEGO, CA. SN 85-741,955. PUB. 4-2-2013, FILED 9-29-2012.

# MASTER

THE MARK CONSISTS OF STANDARD CHARACTERS WITHOUT CLAIM TO ANY PARTICULAR FONT, STYLE, SIZE, OR COLOR.

FOR PROVIDING BUSINESS ADMINISTRATION AND MANAGEMENT SERVICES TO THE MEDICAL PROFESSIONAL AND INSTITUTIONAL MEDICAL AND HEALTHCARE INDUSTRIES, NAMELY, MEDICAL BILLING, REVENUE ACCOUNTING CYCLE MANAGEMENT, MEDICAL BUSINESS PRACTICE MANAGEMENT SERVICES, STRATEGIC BUSINESS PLANNING AND BUSINESS PROCESS DEVELOPMENT; CONDUCTING QUALITY ASSURANCE SURVEYS IN MEDICAL CLINICAL PRACTICES AND MEDICAL HEALTHCARE INSTITUTIONS TO DETERMINE SERVICE QUALITY (U.S. CLS. 100, 101 AND 102).

FIRST USE 9-24-2013; IN COMMERCE 9-24-2013.

---

4,482,129. MD RECOVERIES, INC., SAN DIEGO, CA. SN 85-741,961. PUB. 4-2-2013, FILED 9-29-2012.

# MDrecoveries

THE MARK CONSISTS OF STANDARD CHARACTERS WITHOUT CLAIM TO ANY PARTICULAR FONT, STYLE, SIZE, OR COLOR.

FOR PROVIDING BUSINESS ADMINISTRATION AND MANAGEMENT SERVICES TO THE MEDICAL PROFESSIONAL AND INSTITUTIONAL MEDICAL AND HEALTHCARE INDUSTRIES, NAMELY, MEDICAL BILLING, REVENUE ACCOUNTING CYCLE MANAGEMENT, MEDICAL BUSINESS PRACTICE MANAGEMENT SERVICES, STRATEGIC BUSINESS PLANNING AND BUSINESS PROCESS DEVELOPMENT; CONDUCTING QUALITY ASSURANCE SURVEYS IN MEDICAL CLINICAL PRACTICES AND MEDICAL HEALTHCARE INSTITUTIONS TO DETERMINE SERVICE QUALITY (U.S. CLS. 100, 101 AND 102).

FIRST USE 9-24-2013; IN COMMERCE 9-24-2013.

**CLASS 35—(Continued).**

4,482,130. MD RECOVERIES, INC., SAN DIEGO, CA. SN 85-741,965. PUB. 4-2-2013, FILED 9-29-2012.



THE COLOR(S) BLUE, GRAY AND BLACK IS/ARE CLAIMED AS A FEATURE OF THE MARK.

THE MARK CONSISTS OF THE DESIGN OF A KEYSTONE IN THE SHAPE OF A THREE-DIMENSIONAL TRIANGLE IN THE COLORS GRAY AND BLUE APPEARING ABOVE THE WORDING "MDRECOVERIES" WITH THE WORDING "MD" IN BLUE LETTERING AND THE WORDING "RECOVERIES" IN BLACK LETTERING.

FOR PROVIDING BUSINESS ADMINISTRATION AND MANAGEMENT SERVICES TO THE MEDICAL PROFESSIONAL AND INSTITUTIONAL MEDICAL AND HEALTHCARE INDUSTRIES, NAMELY, MEDICAL BILLING, REVENUE ACCOUNTING CYCLE MANAGEMENT, MEDICAL BUSINESS PRACTICE MANAGEMENT SERVICES, STRATEGIC BUSINESS PLANNING AND BUSINESS PROCESS DEVELOPMENT; CONDUCTING QUALITY ASSURANCE SURVEYS IN MEDICAL CLINICAL PRACTICES AND MEDICAL HEALTHCARE INSTITUTIONS TO DETERMINE SERVICE QUALITY (U.S. CLS. 100, 101 AND 102).

FIRST USE 9-24-2013; IN COMMERCE 9-24-2013.

---

4,482,138. NEUBERGER BERMAN GROUP LLC, NEW YORK, NY. SN 85-743,730. PUB. 3-12-2013, FILED 10-2-2012.

# ONE MATTERS

THE MARK CONSISTS OF STANDARD CHARACTERS WITHOUT CLAIM TO ANY PARTICULAR FONT, STYLE, SIZE, OR COLOR.

FOR CHARITABLE SERVICES, NAMELY, ORGANIZING AND DEVELOPING PROJECTS TO PROMOTE AWARENESS OF TREE AND ENVIRONMENTAL CONSERVATION (U.S. CLS. 100, 101 AND 102).

FIRST USE 2-4-2013; IN COMMERCE 2-4-2013.



**CLASS 35—(Continued).**

4,482,142. ZWITTE, INC., NORTH LOGAN, UT. SN 85-744,104. PUB. 3-12-2013, FILED 10-2-2012.

# ZWITTE

THE MARK CONSISTS OF STANDARD CHARACTERS WITHOUT CLAIM TO ANY PARTICULAR FONT, STYLE, SIZE, OR COLOR.

FOR ADVERTISING AND BUSINESS SERVICES, NAMELY, PROVIDING AN ONLINE WEBSITE WHERE BUSINESSES AND ADVERTISERS CAN INTERACT WITH USERS FOR THE PURPOSE OF ADVERTISING, BRANDING, PROMOTING KNOWLEDGE, AND SELLING THE USER'S PRODUCTS OR SERVICES; PROVIDING AN ONLINE WEBSITE THAT PROMOTES THE GOODS AND SERVICES OF OTHERS; ONLINE AUCTION SERVICES; ONLINE PROMOTION SERVICES WHEREIN GOODS AND SERVICES ARE PROMOTED BY ONLINE RAFFLE, AUCTIONS, CONTESTS, OR GAMES; ONLINE RETAIL STORE SERVICES FEATURING A WIDE VARIETY OF CONSUMER GOODS AND SERVICES; AND OPERATING ONLINE MARKETPLACES FOR SELLERS AND BUYERS OF GOODS AND SERVICES (U.S. CLS. 100, 101 AND 102).  
FIRST USE 7-12-2012; IN COMMERCE 7-12-2012.

4,482,169. GENERAL ELECTRIC COMPANY, SCHENECTADY, NY. SN 85-747,233. PUB. 3-12-2013, FILED 10-5-2012.



OWNER OF U.S. REG. NOS. 2,639,654, 3,166,694, AND OTHERS.

THE MARK CONSISTS OF STYLIZED LETTERS "GE" INSIDE A CIRCLE WITH FOUR CURLICUES.

FOR BUSINESS CONSULTING AND INFORMATION SERVICES; CONSULTATION IN THE FIELD OF ENERGY EFFICIENCY; CONSULTING SERVICES IN THE FIELD OF ENERGY USAGE MANAGEMENT AND ENERGY EFFICIENCY; ENERGY USAGE MANAGEMENT; ENERGY USAGE MANAGEMENT INFORMATION SERVICES (U.S. CLS. 100, 101 AND 102).  
FIRST USE 10-5-2012; IN COMMERCE 10-5-2012.

**CLASS 35—(Continued).**

4,482,186. SHAYS ARMORY DISTRIBUTORS, INC., EAST-HAMPTON, MA. SN 85-749,933. PUB. 4-9-2013, FILED 10-10-2012.

## SHAYS ARMORY DISTRIBUTORS

THE MARK CONSISTS OF STANDARD CHARACTERS WITHOUT CLAIM TO ANY PARTICULAR FONT, STYLE, SIZE, OR COLOR.

NO CLAIM IS MADE TO THE EXCLUSIVE RIGHT TO USE "ARMORY DISTRIBUTORS", APART FROM THE MARK AS SHOWN.

FOR WHOLESALE DISTRIBUTORSHIP SERVICES FEATURING FIREARMS (U.S. CLS. 100, 101 AND 102).  
FIRST USE 3-28-2013; IN COMMERCE 9-15-2013.

4,482,197. PITTSBURGH PENGUINS, L.P., PITTSBURGH, PA. SN 85-752,424. PUB. 2-26-2013, FILED 10-12-2012.

## TEAMPITTSBURGHGEAR.COM

THE MARK CONSISTS OF STANDARD CHARACTERS WITHOUT CLAIM TO ANY PARTICULAR FONT, STYLE, SIZE, OR COLOR.

FOR ONLINE RETAIL STORE SERVICES FEATURING SPORTING GOODS, CLOTHING, AND SPORTS MEMORABILIA (U.S. CLS. 100, 101 AND 102).  
FIRST USE 12-5-2012; IN COMMERCE 12-5-2012.

4,482,205. CONTINENTAL BUYING GROUP, INC., BAY HARBOR ISLANDS, FL. SN 85-754,346. PUB. 4-9-2013, FILED 10-15-2012.



NO CLAIM IS MADE TO THE EXCLUSIVE RIGHT TO USE "PREFERRED JEWELERS INTERNATIONAL", APART FROM THE MARK AS SHOWN.

THE MARK CONSISTS OF THE STYLIZED WORD "PREFERRED", A 7-POINTED STAR ADJACENT THE TOP LEFT OF THE "D" IN "PREFERRED", AND THE BLOCK LETTER WORDING "JEWELERS INTERNATIONAL" BELOW THE WORD "PREFERRED".

FOR RETAIL JEWELRY STORE SERVICES (U.S. CLS. 100, 101 AND 102).  
FIRST USE 6-12-2013; IN COMMERCE 6-12-2013.

**CLASS 35—(Continued).**

4,482,222. PARCHMENT, NATALIE, WHEATON, MD. SN 85-756,879. PUB. 4-9-2013, FILED 10-17-2012.

# Tax Guru

THE MARK CONSISTS OF STANDARD CHARACTERS WITHOUT CLAIM TO ANY PARTICULAR FONT, STYLE, SIZE, OR COLOR.

NO CLAIM IS MADE TO THE EXCLUSIVE RIGHT TO USE "TAX", APART FROM THE MARK AS SHOWN.

FOR INCOME TAX PREPARATION (U.S. CLS. 100, 101 AND 102).

FIRST USE 9-30-2012; IN COMMERCE 9-30-2012.

---

4,482,263. LIMITLESS IP HOLDINGS, LLC, CARSON CITY, NV. SN 85-764,833. PUB. 2-26-2013, FILED 10-26-2012.

# PROGRESSIVE PV

THE MARK CONSISTS OF STANDARD CHARACTERS WITHOUT CLAIM TO ANY PARTICULAR FONT, STYLE, SIZE, OR COLOR.

FOR BUSINESS INFORMATION SERVICES IN THE NATURE OF PROVIDING INFORMATION ON BUSINESS OPPORTUNITIES; BUSINESS MANAGEMENT CONSULTANCY AND ADVISORY SERVICES; BUSINESS STRATEGIC PLANNING SERVICES; DIRECT MARKETING SERVICES (U.S. CLS. 100, 101 AND 102).

FIRST USE 12-19-2011; IN COMMERCE 12-19-2011.

---

4,482,300. HAPPILABS, LLC, CHICAGO, IL. SN 85-779,077. PUB. 4-16-2013, FILED 11-14-2012.

# HappiLabs

THE MARK CONSISTS OF STANDARD CHARACTERS WITHOUT CLAIM TO ANY PARTICULAR FONT, STYLE, SIZE, OR COLOR.

FOR PROVIDING AN ON-LINE COMPUTER DATABASE IN THE FIELD OF LOCATING PRODUCTS, DESCRIBING PRODUCTS, RATING PRODUCTS, PRICING PRODUCTS, AND COMPARING PRICES OF PRODUCTS FOR THE PURPOSE OF PROVIDING BUSINESS INTELLIGENCE IN THE FIELD OF LIFE SCIENCES (U.S. CLS. 100, 101 AND 102).

FIRST USE 2-11-2013; IN COMMERCE 6-14-2013.

**CLASS 35—(Continued).**

4,482,312. TRICONN JANITORIAL, LLC, WALTHAM, MA. SN 85-782,699. PUB. 4-23-2013, FILED 11-19-2012.



NO CLAIM IS MADE TO THE EXCLUSIVE RIGHT TO USE "JANITORIAL LLC" AND "EQUIPMENT & SUPPLIES", APART FROM THE MARK AS SHOWN.

THE COLOR(S) GREEN AND BLUE IS/ARE CLAIMED AS A FEATURE OF THE MARK.

THE MARK CONSISTS OF TWO BLUE TRIANGLES SEPARATED BY A GREEN TRIANGLE FOLLOWED BY THE STYLIZED WORDS "TRICONN JANITORIAL LLC" IN BLUE AND "EQUIPMENT & SUPPLIES" IN GREEN.

FOR RETAIL STORE SERVICES FEATURING JANITORIAL CHEMICALS, JANITORIAL SUPPLIES AND JANITORIAL EQUIPMENT; ON-LINE RETAIL STORE SERVICES FEATURING JANITORIAL CHEMICALS, JANITORIAL SUPPLIES AND JANITORIAL EQUIPMENT; WHOLESALE DISTRIBUTORSHIPS FEATURING JANITORIAL CHEMICALS, JANITORIAL SUPPLIES AND JANITORIAL EQUIPMENT (U.S. CLS. 100, 101 AND 102).

FIRST USE 1-0-2013; IN COMMERCE 1-0-2013.

---

4,482,315. ADOPT-A-WATT, INC., ROYAL OAK, MI. SN 85-783,812. PUB. 5-7-2013, FILED 11-20-2012.

# AAW CouPons

NO CLAIM IS MADE TO THE EXCLUSIVE RIGHT TO USE "COUPONS", APART FROM THE MARK AS SHOWN. THE COLOR(S) BLUE IS/ARE CLAIMED AS A FEATURE OF THE MARK.

THE MARK CONSISTS OF THE WORDING "AAW COUPONS" IN A STYLIZED BLUE FONT.

FOR AN INTERACTIVE WEB SITE FOR USERS TO REVIEW AND RATE INTERNET CONTENT, PEOPLE, COMPANIES, PRODUCTS AND/OR SERVICES UTILIZING A SOFTWARE APPLICATION TO AWARD POINTS WHEREBY WEB SITE USERS ARE ELIGIBLE TO EXCHANGE POINTS EARNED FOR PROMOTIONAL ITEMS CONSISTING OF COUPONS, REBATES, DISCOUNTS OR SPECIAL OFFERINGS ON GOODS AND/OR SERVICE PROVIDED BY WEB SITE SPONSORS; PROMOTING AND MARKETING THE GOODS AND SERVICES OF OTHERS BY DISTRIBUTING ADVERTISING MATERIAL, COUPONS AND DISCOUNT OFFERS VIA TEXT MESSAGES; PROMOTING THE GOODS AND SERVICES OF OTHERS BY PROVIDING A WEBSITE FEATURING COUPONS, REBATES, PRICE-COMPARISON INFORMATION, PRODUCT REVIEWS, LINKS TO THE RETAIL WEBSITES OF OTHERS, AND DISCOUNT INFORMATION; PROMOTING THE GOODS AND SERVICES OF OTHERS BY PROVIDING AN INTERACTIVE

**CLASS 35—(Continued).**

WEBSITE WHERE USERS CAN INCREASE THE CURRENT VALUE OF AN ONLINE DISCOUNT BEING OFFERED BY PURCHASING THE GOODS AND SERVICES ASSOCIATED WITH THAT DISCOUNT IN THE FORM OF AN ONLINE COUPON, VOUCHER OR GIFT CARD; PROMOTING THE GOODS OF OTHERS, NAMELY, PROVIDING COUPONS, REBATES AND VOUCHERS FOR THE GOODS OF OTHERS; PROMOTING THE GOODS OF OTHERS, NAMELY, PROVIDING INFORMATION REGARDING DISCOUNTS, COUPONS, REBATES, VOUCHERS AND SPECIAL OFFERS FOR THE GOODS OF OTHERS; PROMOTIONAL SERVICES, NAMELY, DISTRIBUTION OF ADVERTISING FLYERS, COUPONS, CATALOGS AND PROMOTIONAL ITEMS OF OTHERS; PROMOTIONAL SERVICES, NAMELY, PROMOTING THE GOODS OF OTHERS BY MEANS OF PROVIDING ONLINE COUPONS; PROVIDING INCENTIVE AWARD PROGRAMS FOR CUSTOMERS THROUGH THE ISSUANCE AND PROCESSING OF LOYALTY COUPONS FOR FREQUENT USE OF PARTICIPATING BUSINESSES (U.S. CLS. 100, 101 AND 102).

FIRST USE 2-1-2013; IN COMMERCE 2-1-2013.

---

4,482,323. ADA COUNTY PARAMEDICS, BOISE, ID. SN 85-787,278. PUB. 7-2-2013, FILED 11-26-2012.

# VitalRide

THE MARK CONSISTS OF STANDARD CHARACTERS WITHOUT CLAIM TO ANY PARTICULAR FONT, STYLE, SIZE, OR COLOR.

FOR ADMINISTRATION OF A DISCOUNT PROGRAM FOR ENABLING PARTICIPANTS TO OBTAIN DISCOUNTS ON THE COST OF SERVICES OR RECEIVE IMPROVED SERVICES THROUGH USE OF A MEMBERSHIP CARD (U.S. CLS. 100, 101 AND 102).

FIRST USE 11-1-2012; IN COMMERCE 4-1-2012.

---

4,482,326. LIBERTY PROCUREMENT CO. INC., UNION, NJ. SN 85-787,960. PUB. 6-11-2013, FILED 11-27-2012.



OWNER OF U.S. REG. NOS. 1,830,725, 2,474,231, AND OTHERS.

THE MARK CONSISTS OF THE WORDING "BED BATH & BEYOND" IN UPPERCASE STYLIZED TEXT WITH A STYLIZED RIBBON EXTENDING TO THE RIGHT OF THE AMPERSAND.

FOR RETAIL STORE SERVICES AND COMPUTERIZED ON-LINE RETAIL STORE SERVICES FEATURING A WIDE VARIETY OF CONSUMER GOODS OF OTHERS (U.S. CLS. 100, 101 AND 102).

FIRST USE 11-13-2012; IN COMMERCE 11-13-2012.

**CLASS 35—(Continued).**

4,482,327. LIBERTY PROCUREMENT CO. INC., UNION, NJ. SN 85-787,967. PUB. 6-11-2013, FILED 11-27-2012.



OWNER OF U.S. REG. NOS. 1,830,725, 2,474,231, AND OTHERS.

THE MARK CONSISTS OF THE WORDING "BED BATH & BEYOND" IN UPPERCASE STYLIZED TEXT WITH A GINGERBREAD MAN FORMING THE LETTER "A".

FOR RETAIL STORE SERVICES AND COMPUTERIZED ON-LINE RETAIL STORE SERVICES FEATURING A WIDE VARIETY OF CONSUMER GOODS OF OTHERS (U.S. CLS. 100, 101 AND 102).

FIRST USE 11-13-2012; IN COMMERCE 11-13-2012.

---

4,482,350. ROBERT HALF INTERNATIONAL INC., MENLO PARK, CA. SN 85-794,978. PUB. 5-7-2013, FILED 12-5-2012.



OWNER OF U.S. REG. NOS. 984,708, 1,185,125, AND OTHERS.

THE NAME(S), PORTRAIT(S), AND/OR SIGNATURE(S) SHOWN IN THE MARK DOES NOT IDENTIFY A PARTICULAR LIVING INDIVIDUAL.

THE COLOR(S) RED, WHITE, AND BLACK IS/ARE CLAIMED AS A FEATURE OF THE MARK.

THE MARK CONSISTS OF THE WORDING "RH ROBERT HALF" IN STYLIZED FONT. THERE IS A RED RECTANGLE DESIGN WITH THE WHITE LETTERS "RH" IN THE CENTER. TO THE RIGHT OF THIS DESIGN IS THE STYLIZED WORDING "ROBERT HALF" IN BLACK.

FOR PROVIDING TEMPORARY, FULL-TIME AND CONTRACT EMPLOYMENT PLACEMENT STAFFING, CONSULTING AND RECRUITING SERVICES; PROVIDING INFORMATION ON EMPLOYMENT, CAREERS AND TEMPORARY STAFFING VIA A GLOBAL COMPUTER NETWORK (U.S. CLS. 100, 101 AND 102).

FIRST USE 3-0-2013; IN COMMERCE 4-0-2013.

---

4,482,378. NEW VITALITY SBP HOLDINGS, INC., CHICAGO, IL. SN 85-805,764. PUB. 6-18-2013, FILED 12-18-2012.

# BETA PROSTATE

THE MARK CONSISTS OF STANDARD CHARACTERS WITHOUT CLAIM TO ANY PARTICULAR FONT, STYLE, SIZE, OR COLOR.

OWNER OF U.S. REG. NOS. 2,287,219 AND 4,209,153.

**CLASS 35—(Continued).**

NO CLAIM IS MADE TO THE EXCLUSIVE RIGHT TO USE "PROSTATE", APART FROM THE MARK AS SHOWN.

FOR COMPUTERIZED ONLINE RETAIL STORE SERVICES IN THE FIELD OF NUTRITIONAL AND SUPPLEMENT PRODUCTS (U.S. CLS. 100, 101 AND 102).

FIRST USE 1-0-2004; IN COMMERCE 1-0-2004.

4,482,391. GENTILE, BILL, LEVITTOWN, NY. SN 85-810,496.  
PUB. 6-25-2013, FILED 12-26-2012.



NO CLAIM IS MADE TO THE EXCLUSIVE RIGHT TO USE "NEW YORK", "BROTHERHOOD" AND "MC", APART FROM THE MARK AS SHOWN.

THE MARK CONSISTS OF THE DESIGN OF A SEMI-CIRCLE THAT IS FORMED BY TWO CURVING BANNERS WITH THE STYLIZED WORDING "SOVEREIGN" IN THE TOP BANNER AND THE STYLIZED WORDING "BROTHERHOOD" IN THE BOTTOM BANNER. THE CENTER OF THE SEMI-CIRCLE HAS THE DESIGN OF A FIVE-POINTED CROWN APPEARING OVER THE DESIGN OF A CROSS WITHIN A VERTICAL OVAL APPEARING OVER THE DESIGN OF TWO BACK TO BACK HOODED MEN WITH AXES IN THEIR ARMS ALL OVER THE STYLIZED WORDING "NEW YORK." TO THE RIGHT IS THE STYLIZED WORDING "MC" APPEARING WITH TWO CONCENTRIC RECTANGLES ALL APPEARING OVER THE STYLIZED WORDING "LMTFA" APPEARING WITHIN TWO CONCENTRIC RECTANGLES.

FOR CLUB SERVICES, NAMELY, PROMOTING THE INTERESTS OF MOTORCYCLISTS (U.S. CLS. 100, 101 AND 102).

FIRST USE 2-28-2009; IN COMMERCE 2-28-2009.

4,482,393. CITIGROUP INC., NEW YORK, NY. SN 85-810,696.  
PUB. 5-14-2013, FILED 12-26-2012.

**PRIVATE PASS BEYOND**

THE MARK CONSISTS OF STANDARD CHARACTERS WITHOUT CLAIM TO ANY PARTICULAR FONT, STYLE, SIZE, OR COLOR.

**CLASS 35—(Continued).**

OWNER OF U.S. REG. NOS. 3,083,825 AND 4,013,351.

FOR PROMOTING THE GOODS AND SERVICES OF OTHERS THROUGH CREDIT CARD CUSTOMER LOYALTY, REWARD AND INCENTIVE PROGRAMS FEATURING INFORMATION AND DISCOUNTS ON SPECIAL EVENTS OFFERED TO CREDIT CARD CUSTOMERS (U.S. CLS. 100, 101 AND 102).

FIRST USE 5-31-2013; IN COMMERCE 5-31-2013.

4,482,394. BUSINESS RESOURCES INTERNATIONAL, INC., SEATTLE, WA. SN 85-811,339. PUB. 5-21-2013, FILED 12-27-2012.

**The Discipleship Lab**

THE MARK CONSISTS OF STANDARD CHARACTERS WITHOUT CLAIM TO ANY PARTICULAR FONT, STYLE, SIZE, OR COLOR.

FOR CONSULTING SERVICES IN BUSINESS LEADERSHIP DEVELOPMENT AND BUSINESS MANAGEMENT (U.S. CLS. 100, 101 AND 102).

FIRST USE 1-7-2013; IN COMMERCE 1-7-2013.

4,482,426. ATHLETA, INC., PETALUMA, CA. SN 85-822,463.  
PUB. 4-16-2013, FILED 1-14-2013.

**SWIMFINITY**

THE MARK CONSISTS OF STANDARD CHARACTERS WITHOUT CLAIM TO ANY PARTICULAR FONT, STYLE, SIZE, OR COLOR.

FOR RETAIL STORE SERVICES FEATURING SWIMWEAR; ON-LINE RETAIL STORE SERVICES AND MAIL ORDER SERVICES FEATURING SWIMWEAR (U.S. CLS. 100, 101 AND 102).

FIRST USE 2-28-2013; IN COMMERCE 2-28-2013.

**CLASS 35—(Continued).**

4,482,458. ADESA, INC., CARMEL, IN. SN 85-840,207. PUB. 6-25-2013, FILED 2-4-2013.

NOW COOL INJECTED

THE MARK CONSISTS OF STANDARD CHARACTERS WITHOUT CLAIM TO ANY PARTICULAR FONT, STYLE, SIZE, OR COLOR.

FOR AUTOMOBILE AUCTION SERVICES (U.S. CLS. 100, 101 AND 102).  
FIRST USE 4-21-2013; IN COMMERCE 4-21-2013.

---

4,482,471. ROBERT HALF INTERNATIONAL INC., MENLO PARK, CA. SN 85-843,451. PUB. 5-7-2013, FILED 2-7-2013.



OWNER OF U.S. REG. NOS. 984,708, 2,992,050, AND OTHERS.

THE NAME(S), PORTRAIT(S), AND/OR SIGNATURE(S) SHOWN IN THE MARK DOES NOT IDENTIFY A PARTICULAR LIVING INDIVIDUAL.

THE MARK CONSISTS OF A RECTANGLE DESIGN WITH THE LETTERS "RH" IN THE CENTER.

FOR PROVIDING TEMPORARY, FULL-TIME AND CONTRACT EMPLOYMENT PLACEMENT STAFFING, CONSULTING AND RECRUITING SERVICES; PROVIDING INFORMATION ON EMPLOYMENT, CAREERS AND TEMPORARY STAFFING VIA A GLOBAL COMPUTER NETWORK (U.S. CLS. 100, 101 AND 102).  
FIRST USE 3-0-2013; IN COMMERCE 4-0-2013.

**CLASS 35—(Continued).**

4,482,484. SOUTH HILL DESIGNS CORP., SCOTTSDALE, AZ. SN 85-849,928. PUB. 7-9-2013, FILED 2-14-2013.

SHARE YOUR STORY WEAR  
YOUR STORY

THE MARK CONSISTS OF STANDARD CHARACTERS WITHOUT CLAIM TO ANY PARTICULAR FONT, STYLE, SIZE, OR COLOR.

FOR MULTI-LEVEL MARKETING BUSINESS SERVICES, NAMELY, PROVIDING MARKETING AND INCOME OPPORTUNITIES TO THIRD PARTIES THROUGH THE SALE AND DISTRIBUTION OF JEWELRY AND FASHION ACCESSORIES; PARTY PLAN SERVICES, NAMELY, RETAIL SHOP-AT-HOME PARTY SERVICES IN THE FIELD OF JEWELRY AND FASHION ACCESSORIES; PHONE AND MAIL ORDER RETAIL SERVICES, CATALOG RETAIL SERVICES, AND ONLINE RETAIL STORE SERVICES, IN THE FIELDS OF JEWELRY AND FASHION ACCESSORIES; PROVIDING TECHNICAL AND PROMOTIONAL ASSISTANCE, NAMELY, PROMOTION AND MARKETING SERVICES AND RELATED CONSULTING IN CONNECTION WITH THE IN HOME RETAIL SALES BY INDEPENDENT SALES REPRESENTATIVES OF JEWELRY AND FASHION ACCESSORIES; PROVIDING AND IMPLEMENTING INCENTIVE AND AWARDS PROGRAMS FOR INDEPENDENT SALES REPRESENTATIVES TO PROMOTE THE SALE OF PRODUCTS AND SERVICES TO OTHERS AND TO RECRUIT ADDITIONAL INDEPENDENT SALES REPRESENTATIVES (U.S. CLS. 100, 101 AND 102).  
FIRST USE 10-12-2012; IN COMMERCE 10-12-2012.

---

4,482,522. IRONPLANET, INC., PLEASANTON, CA. SN 85-864,843. PUB. 7-23-2013, FILED 3-1-2013.

TRUCKPLANET

THE MARK CONSISTS OF STANDARD CHARACTERS WITHOUT CLAIM TO ANY PARTICULAR FONT, STYLE, SIZE, OR COLOR.

FOR ONLINE AUCTION SERVICES; ARRANGING AND CONDUCTING AUCTIONS; OPERATING ON-LINE MARKETPLACES FEATURING HEAVY INDUSTRIAL AND CONSTRUCTION EQUIPMENT (U.S. CLS. 100, 101 AND 102).  
FIRST USE 4-12-2013; IN COMMERCE 4-12-2013.

**CLASS 35—(Continued).**

4,482,523. GAFFOS INC, INWOOD, NY. SN 85-865,006. PUB. 7-23-2013, FILED 3-2-2013.

# GAFFOS

THE MARK CONSISTS OF STANDARD CHARACTERS WITHOUT CLAIM TO ANY PARTICULAR FONT, STYLE, SIZE, OR COLOR.

FOR ON-LINE RETAIL STORE SERVICES FEATURING EYEGLASSES, SUNGLASSES, OPTICAL GOODS (U.S. CLS. 100, 101 AND 102).

FIRST USE 7-1-2008; IN COMMERCE 7-1-2008.

---

4,482,548. SHOPCYL LLC, CHICAGO, IL. SN 85-871,642. PUB. 7-30-2013, FILED 3-8-2013.

# SOUNDSKUNK

THE MARK CONSISTS OF STANDARD CHARACTERS WITHOUT CLAIM TO ANY PARTICULAR FONT, STYLE, SIZE, OR COLOR.

FOR ON-LINE RETAIL STORE SERVICES FEATURING DOWNLOADABLE AUDIO ASSETS FOR USE IN SOUND DESIGN AND DEVELOPMENT (U.S. CLS. 100, 101 AND 102).

FIRST USE 3-5-2013; IN COMMERCE 9-10-2013.

---

4,482,562. JOBZY INC., RIVER FOREST, IL. SN 85-877,249. PUB. 8-6-2013, FILED 3-15-2013.

# JobzyMatch

THE MARK CONSISTS OF STANDARD CHARACTERS WITHOUT CLAIM TO ANY PARTICULAR FONT, STYLE, SIZE, OR COLOR.

FOR EXECUTIVE SEARCH AND PLACEMENT SERVICES; JOB AND PERSONNEL PLACEMENT; JOB PLACEMENT (U.S. CLS. 100, 101 AND 102).

FIRST USE 8-31-2012; IN COMMERCE 10-11-2013.

**CLASS 35—(Continued).**

4,482,579. COOK AND CLUTTER LLC, PORTLAND, OR. SN 85-881,679. PUB. 8-13-2013, FILED 3-20-2013.

# Quin

THE MARK CONSISTS OF STANDARD CHARACTERS WITHOUT CLAIM TO ANY PARTICULAR FONT, STYLE, SIZE, OR COLOR.

FOR RETAIL CANDY STORE (U.S. CLS. 100, 101 AND 102).

FIRST USE 7-1-2013; IN COMMERCE 7-1-2013.

---

4,482,585. VOICEGARDEN LLC, ORANGE, CA. SN 85-883,641. PUB. 8-13-2013, FILED 3-22-2013.

# VoiceGarden

THE MARK CONSISTS OF STANDARD CHARACTERS WITHOUT CLAIM TO ANY PARTICULAR FONT, STYLE, SIZE, OR COLOR.

FOR PROVIDING VOICE OVERS FOR COMMERCIALS (U.S. CLS. 100, 101 AND 102).

FIRST USE 7-31-2013; IN COMMERCE 7-31-2013.

---

4,482,586. CVS PHARMACY, INC., WOONSOCKET, RI. SN 85-883,917. PUB. 6-18-2013, FILED 3-22-2013.

# ES.CVS.COM

THE MARK CONSISTS OF STANDARD CHARACTERS WITHOUT CLAIM TO ANY PARTICULAR FONT, STYLE, SIZE, OR COLOR.

OWNER OF U.S. REG. NOS. 919,941, 3,211,443, AND OTHERS.

FOR RETAIL STORE SERVICES, NAMELY, PHARMACY, RETAIL DRUG STORE AND GENERAL MERCHANDISE STORE SERVICES, AVAILABLE ON A GLOBAL COMPUTER INFORMATION NETWORK (U.S. CLS. 100, 101 AND 102).

FIRST USE 4-15-2013; IN COMMERCE 4-15-2013.

**CLASS 35—(Continued).**

4,482,590. TELECHECK INTERNATIONAL, INC., HOUSTON, TX. SN 85-885,086. PUB. 8-13-2013, FILED 3-25-2013.

**CLASS 35—(Continued).**

4,482,601. JFD3 LLC, HOLLYWOOD, FL. SN 85-888,816. PUB. 8-27-2013, FILED 3-28-2013.

**SURERETURNS**

THE MARK CONSISTS OF STANDARD CHARACTERS WITHOUT CLAIM TO ANY PARTICULAR FONT, STYLE, SIZE, OR COLOR.

FOR BUSINESS RISK ASSESSMENT SERVICES (U.S. CLS. 100, 101 AND 102).

FIRST USE 2-13-2013; IN COMMERCE 2-13-2013.

**Executive Place**

THE MARK CONSISTS OF STANDARD CHARACTERS WITHOUT CLAIM TO ANY PARTICULAR FONT, STYLE, SIZE, OR COLOR.

FOR PROVIDING CO-WORKING FACILITIES EQUIPPED WITH OFFICE EQUIPMENT; PROVIDING FACILITIES FOR THE USE OF OFFICE EQUIPMENT AND MACHINERY; PROVIDING OFFICE FUNCTIONS; PROVIDING OFFICE SUPPORT STAFF SERVICES; PROVIDING VIRTUAL ON-LINE OFFICE SUPPORT STAFF SERVICES FOR BUSINESSES (U.S. CLS. 100, 101 AND 102).

FIRST USE 4-3-2009; IN COMMERCE 4-3-2009.

4,482,591. SYMMETRY ELECTRONICS CORPORATION, HAWTHORNE, CA. SN 85-885,303. PUB. 8-27-2013, FILED 3-25-2013.

4,482,602. TIEMART, INC., MUNDELEIN, IL. SN 85-889,636. PUB. 8-13-2013, FILED 3-28-2013.



THE MARK CONSISTS OF A STYLIZED DESIGN OF A SLICE OF PIZZA SUPERIMPOSED OVER A STYLIZED DESIGN OF A SEMICONDUCTOR.

FOR ONLINE RETAIL STORE SERVICES FEATURING ELECTRONICS IN THE NATURE OF CIRCUIT BOARDS, SEMICONDUCTORS, TRANSCEIVERS, MICROCONTROLLERS, AND, ROUTERS (U.S. CLS. 100, 101 AND 102).

FIRST USE 10-1-2013; IN COMMERCE 10-1-2013.



THE MARK CONSISTS OF A CIRCLE WITH THE DEPICTION OF FOUR NECKTIES FORMING A SWIRL PATTERN AT THE OUTER ANNULAR EDGE OF THE CIRCLE'S INNER PERIPHERY.

FOR ONLINE WHOLESALE AND RETAIL STORE AND ORDERING SERVICES FEATURING NECKTIES, BOWTIES, SCARVES, SUSPENDERS AND BELTS (U.S. CLS. 100, 101 AND 102).

FIRST USE 7-26-2013; IN COMMERCE 7-26-2013.

**CLASS 35—(Continued).**

4,482,613. IRONPLANET, INC., PLEASANTON, CA. SN 85-893,440. PUB. 7-23-2013, FILED 4-2-2013.

**TRUCKPLANET**

THE MARK CONSISTS OF STANDARD CHARACTERS WITHOUT CLAIM TO ANY PARTICULAR FONT, STYLE, SIZE, OR COLOR.

FOR ONLINE AUCTION SERVICES; ARRANGING AND CONDUCTING AUCTIONS; OPERATING ON-LINE MARKETPLACES FEATURING TRUCKS (U.S. CLS. 100, 101 AND 102).

FIRST USE 4-12-2013; IN COMMERCE 4-12-2013.

4,482,616. COLLEGEKIDSPASSITON, LLC, STUART, FL. SN 85-895,771. PUB. 9-10-2013, FILED 4-4-2013.

**COLLEGE KIDS PASS IT ON**

THE MARK CONSISTS OF STANDARD CHARACTERS WITHOUT CLAIM TO ANY PARTICULAR FONT, STYLE, SIZE, OR COLOR.

NO CLAIM IS MADE TO THE EXCLUSIVE RIGHT TO USE "COLLEGE KIDS", APART FROM THE MARK AS SHOWN.

FOR PROVIDING A WEB SITE FOR COLLEGE STUDENTS FEATURING ON-LINE CLASSIFIED ADVERTISING; ON-LINE TRADING SERVICES IN WHICH COLLEGE STUDENTS POST GOODS AND SERVICES TO BE PURCHASED BY OTHER COLLEGE STUDENTS (U.S. CLS. 100, 101 AND 102).

FIRST USE 8-7-2013; IN COMMERCE 8-7-2013.

4,482,620. JOCKEY INTERNATIONAL, INC., KENOSHA, WI. SN 85-896,466. PUB. 9-10-2013, FILED 4-5-2013.

**COMFORT STYLIST**

THE MARK CONSISTS OF STANDARD CHARACTERS WITHOUT CLAIM TO ANY PARTICULAR FONT, STYLE, SIZE, OR COLOR.

OWNER OF U.S. REG. NO. 3,175,093.

**CLASS 35—(Continued).**

NO CLAIM IS MADE TO THE EXCLUSIVE RIGHT TO USE "STYLIST", APART FROM THE MARK AS SHOWN.

FOR SHOP-AT-HOME PARTY SERVICES IN THE FIELD OF CLOTHING; RETAIL SERVICES BY DIRECT SOLICITATION BY INDEPENDENT SALES REPRESENTATIVES IN THE FIELD OF CLOTHING; AND INCENTIVE AWARD PROGRAMS FOR OTHERS TO PROMOTE THE SALE OF CLOTHING (U.S. CLS. 100, 101 AND 102). FIRST USE 7-30-2013; IN COMMERCE 7-30-2013.

4,482,641. CHATTHREADS CORPORATION, BROOKLINE, MA. SN 85-909,454. PUB. 9-10-2013, FILED 4-19-2013.

**PURCHASED**

THE MARK CONSISTS OF STANDARD CHARACTERS WITHOUT CLAIM TO ANY PARTICULAR FONT, STYLE, SIZE, OR COLOR.

FOR COMPUTERIZED MARKET RESEARCH SERVICES; MARKET OPINION POLLING STUDIES; MARKETING CONSULTING, NAMELY, DESIGN OF LONGITUDINAL STUDIES IN THE FIELD OF MARKET RESEARCH CONDUCTED USING MOBILE COMPUTING DEVICES (U.S. CLS. 100, 101 AND 102).

FIRST USE 7-17-2013; IN COMMERCE 7-17-2013.

4,482,669. ULG HOLDINGS LIMITED, TORTOLA, BR. VIRGIN ISLANDS. SN 85-979,322. PUB. 9-18-2012, FILED 3-25-2012.

 **UNITED CELLARS**

THE COLOR(S) RED AND GRAY IS/ARE CLAIMED AS A FEATURE OF THE MARK.

THE MARK CONSISTS OF THE WORDING "UNITED CELLARS" IN THE COLOR GRAY WITH A ROUNDED STYLIZED LETTER "U" IN THE COLOR RED PLACED TO THE LEFT OF THE WORDING.

FOR ONLINE RETAIL STORE OUTLET FEATURING WINE; WHOLESALE DISTRIBUTORSHIP SERVICES FEATURING WINE; ADVERTISING; MARKETING (U.S. CLS. 100, 101 AND 102).

FIRST USE 10-31-2004; IN COMMERCE 3-25-2012.



**CLASS 35—(Continued).**

4,482,680. DOW JONES & COMPANY, INC., NEW YORK, NY. SN 85-980,570. PUB. 4-5-2011, FILED 1-19-2011.

# WSJ

THE MARK CONSISTS OF STANDARD CHARACTERS WITHOUT CLAIM TO ANY PARTICULAR FONT, STYLE, SIZE, OR COLOR.

OWNER OF U.S. REG. NOS. 2,119,170, 2,575,504, AND OTHERS.

FOR ADVERTISING AND MARKETING (U.S. CLS. 100, 101 AND 102).

FIRST USE 9-6-2008; IN COMMERCE 9-6-2008.

**CLASS 36—INSURANCE AND FINANCIAL**

4,481,300. WOODMEN OF THE WORLD LIFE INSURANCE SOCIETY AND/OR OMAHA LIFE INSURANCE SOCIETY, OMAHA, NE. SN 76-703,868. PUB. 3-12-2013, FILED 7-22-2010.

## WOODMEN PROTECTOR

THE MARK CONSISTS OF STANDARD CHARACTERS WITHOUT CLAIM TO ANY PARTICULAR FONT, STYLE, SIZE, OR COLOR.

OWNER OF U.S. REG. NOS. 2,767,582, 3,647,974, AND OTHERS.

FOR UNDERWRITING OF LIFE INSURANCE (U.S. CLS. 100, 101 AND 102).

FIRST USE 11-1-2010; IN COMMERCE 11-1-2010.

4,481,334. RIO PERLA PROPERTIES, L.P., SAN ANTONIO, TX. SN 77-782,981. PUB. 10-26-2010, FILED 7-16-2009.

## LOCAL FLAVOR SINCE 1883

THE MARK CONSISTS OF STANDARD CHARACTERS WITHOUT CLAIM TO ANY PARTICULAR FONT, STYLE, SIZE, OR COLOR.

NO CLAIM IS MADE TO THE EXCLUSIVE RIGHT TO USE "SINCE 1883", APART FROM THE MARK AS SHOWN.

FOR SHOPPING CENTER SERVICES, NAMELY, RENTAL OF SHOPPING CENTER SPACE FOR USE BY RETAIL STORES AND RESTAURANTS (U.S. CLS. 100, 101 AND 102).

FIRST USE 9-0-2010; IN COMMERCE 9-0-2010.

**CLASS 36—(Continued).**

4,481,378. HEALTHCARE HIGHWAYS, LLC, PLANO, TX. SN 85-012,407. PUB. 10-5-2010, FILED 4-13-2010.

## HEALTHCARE HIGHWAYS

THE MARK CONSISTS OF STANDARD CHARACTERS WITHOUT CLAIM TO ANY PARTICULAR FONT, STYLE, SIZE, OR COLOR.

NO CLAIM IS MADE TO THE EXCLUSIVE RIGHT TO USE "HEALTHCARE", APART FROM THE MARK AS SHOWN.

FOR ORGANIZING PREFERRED PROVIDER PROGRAMS IN THE FIELD OF HEALTH CARE (U.S. CLS. 100, 101 AND 102).

FIRST USE 11-14-2013; IN COMMERCE 11-14-2013.

4,481,470. WAL-MART STORES, INC., BENTONVILLE, AR. SN 85-251,161. PUB. 7-5-2011, FILED 2-24-2011.

## GET PROTECTED

THE MARK CONSISTS OF STANDARD CHARACTERS WITHOUT CLAIM TO ANY PARTICULAR FONT, STYLE, SIZE, OR COLOR.

FOR PROVIDING EXTENDED WARRANTIES ON HAIR APPLIANCES, ELECTRIC SHAVERS, ORAL CARE APPLIANCES, CALCULATORS, LABEL MAKERS, SAFES, SHREDDERS, COIN COUNTERS, THERMAL LAMINATORS, THERMAL CUTTERS, DVD SOFTWARE, PRE-RECORDED VIDEO, VIDEO GAME HARDWARE, VIDEO GAME ACCESSORIES, COMPUTER SOFTWARE, VIDEO GAME SOFTWARE, MUSIC CDS, MUSIC DVDS, CAMERAS, CAMCORDERS, DIGITAL PHOTO FRAMES, PHOTO ACCESSORIES, PHOTO PRINTERS, PHOTO MEDIA, BATTERY OPERATED TOYS, MECHANICAL TOYS, RADIO CONTROLLED VEHICLES, TOY VEHICLES, POOLS, SWINGSETS, BATTERY OPERATED ACTION FIGURES, ELECTRONIC GAMES, MUSICAL INSTRUMENTS, BIKES, BIKE ACCESSORIES, RIDE ONS, BATTERY OPERATED EDUCATIONAL TOYS, BATTERY OPERATED DOLLS, BATTERY OPERATED PLUSH, TELESCOPES, ELECTRONIC LITTER BOX, AUTOMATIC LITTER BOX, ELECTRIC BEDDING, PET HEATERS, PET FOUNTAINS, AQUATIC HEATERS, AQUATIC PUMPS, AQUATIC CLEANERS, AQUATIC FILTERS, AQUATIC ACCESSORIES, GROOMING APPLIANCES, AIRBEDS, AIRBED PUMPS, EXERCISE EQUIPMENT, ELECTRONIC GAMES, ELECTRONIC COOLERS, FLASHLIGHTS, LANTERNS, MARINE ELECTRONICS, MARINE GPS, TROLLING MOTORS, BOAT MOTORS, CAMP STOVES, HEATERS, BINOCULARS, SPORTS OPTICS, GAME CAMERAS, TIRES, BATTERIES, AUTO VACUUMS, POLISHERS, WAXERS, COMPRESSORS, POWER WASHERS, GENERATORS, BATTERY CHARGERS, GPS, RADAR DETECTORS, STEREOs, RADIOS, SPEAKERS, AMPLIFIERS, DVD PLAYERS, LIGHTING KITS, ELECTRONIC ACCESSORIES, CB RADIOS, MAJOR APPLIANCES, BATH SCALES, HAND TOOLS, POWER TOOLS, AIR PURIFICATION, DEHUMIDIFIERS, HUMIDIFIERS, AIR CONDITIONERS, HEATERS, FIREPLACES, FANS, CEILING FANS, WATER COOLERS, WATER PURIFICATION, FIRE EXTINGUISHERS, SMOKE ALARMS, WEATHER STATIONS, SHOP VAC, VACUUMS, GARBAGE DISPO-

**CLASS 36—(Continued).**

SALS, THERMOSTATS, GARAGE DOOR OPENERS, PAINT SPRAYERS, PAINT MIXERS, HEATED COOKING APPLIANCES, ELECTRONIC COOKING APPLIANCES, KITCHEN APPLIANCES, CUTLERY, SHARPENERS, DEHYDRATORS, WINE COOLERS, REFRIGERATORS, MOWERS, TRIMMERS, BLOWERS, GRILLS, FOUNTAINS, FOUNTAIN PUMPS, PATIO FURNITURE, FIREPLACES, TRACTORS, LOG SPLITTERS, CHAIN SAWS, SNOW BLOWERS, SNOW BLADES, GO CARTS, LIGHTING, PRE-LIT TREES, PRE-LIT DECOR, OUTDOOR ANIMATED DECOR, INDOOR ANIMATED DECOR, CRAFT CUTTERS, CRAFT PRESSES, SEWING MACHINES, EMBROIDERY MACHINES, ELECTRONICS DIFFUSERS, ELECTRONIC FRAGRANCE, SHOES, BOOTS, SHOE POLISHERS, FINE JEWELRY, WATCHES, CLASS RINGS, TRAIN SETS, DIAGNOSTIC AIDS, TEMPERATURE MONITORS, BLOOD PRESSURE MONITORS, MASSAGERS, SPAS, VAPORIZERS, HUMIDIFIERS, DURABLE MEDICAL EQUIPMENT, HEARING AIDS, EYEGLASSES, SUNGLASSES, EYEWEAR ACCESSORIES, AUDIO/VISUAL ELECTRONICS AND ACCESSORIES, TELEVISIONS, COMPUTERS, HOME THEATER SYSTEMS, DVD PLAYER, SATELLITE TV HARDWARE, STEREOS, PORTABLE AUDIO HARDWARE, PORTABLE VIDEO HARDWARE, GPS, PRINTERS, CALCULATORS, READERS, TABLETS, PORTABLE TV, PORTABLE DVD PLAYERS, PC SOFTWARE, PC CONNECTIVITY, PC ROUTERS, VACUUMS, STEAM CLEANERS, FLOOR CARE APPLIANCES, VACUUM SEALERS, IRONS, STEAMERS, PREPAID CELL PHONES, PREPAID CELL PHONE ACCESSORIES, POSTPAID CELL PHONES, POSTPAID CELL PHONE AND ACCESSORIES, FAMILY RADIOS, 2-WAY RADIOS, WEATHER RADIOS, LAND LINE PHONES, VOIP ACCESSORIES, AND PHONE ACCESSORIES (U.S. CLS. 100, 101 AND 102).

FIRST USE 1-0-2011; IN COMMERCE 1-0-2011.

---

4,481,502. LOCKTON, INC., KANSAS CITY, MO. SN 85-333,992. PUB. 9-3-2013, FILED 5-31-2011.

**LOCKTON MATRIX**

THE MARK CONSISTS OF STANDARD CHARACTERS WITHOUT CLAIM TO ANY PARTICULAR FONT, STYLE, SIZE, OR COLOR.

OWNER OF U.S. REG. NOS. 2,624,149, 3,883,692, AND OTHERS.

FOR INSURANCE, RISK MANAGEMENT AND CONSULTING SERVICES IN THE FIELD OF RETIREMENT PLAN ADMINISTRATION AND FIDUCIARY COMPLIANCE, NAMELY, ASSESSMENT OF OVERALL COMPLIANCE RISKS ASSOCIATED WITH FIDUCIARY INVESTMENT PLANS (U.S. CLS. 100, 101 AND 102).

FIRST USE 2-22-2011; IN COMMERCE 2-22-2011.

**CLASS 36—(Continued).**

4,481,555. SAM GREENBERG, GUILFORD, CT. SN 85-426,422. PUB. 3-6-2012, FILED 9-19-2011.



NO CLAIM IS MADE TO THE EXCLUSIVE RIGHT TO USE "MS", "STADIUMS" OR "MULTIPLE SCLEROSIS", APART FROM THE MARK AS SHOWN.

THE MARK CONSISTS OF A SILHOUETTE OF A BUS INSIDE THE SHAPE OF A BASEBALL DIAMOND, WITH THE PHRASE "MS 4 MS" APPEARING ON THE TOP PORTION OF THE BASEBALL DIAMOND, WITH THE TERM "MISSION STADIUMS" APPEARING ALONG THE LEFT SIDE OF THE BASEBALL DIAMOND, WITH THE NUMBER "4" IN A PLAIN CIRCLE REPRESENTING HOME PLATE, AND WITH THE TERM "MULTIPLE SCLEROSIS" APPEARING ALONG THE RIGHT SIDE OF THE BASEBALL DIAMOND. TWO SMALL DIAMOND SHAPES APPEAR IN THE BASEBALL DIAMOND ON EITHER SIDE OF THE SILHOUETTE OF THE BUS.

FOR CHARITABLE FUNDRAISING TO SUPPORT MULTIPLE SCLEROSIS USING PAID TRIPS TO MAJOR LEAGUE BASEBALL STADIUMS AS PRIZES (U.S. CLS. 100, 101 AND 102).

FIRST USE 4-1-2013; IN COMMERCE 4-1-2013.

---

4,481,608. KAPITALL, INC., NEW YORK, NY. SN 85-475,726. PUB. 5-1-2012, FILED 11-17-2011.

**INVESTING FOR THE REST OF US**

THE MARK CONSISTS OF STANDARD CHARACTERS WITHOUT CLAIM TO ANY PARTICULAR FONT, STYLE, SIZE, OR COLOR.

NO CLAIM IS MADE TO THE EXCLUSIVE RIGHT TO USE "INVESTING", APART FROM THE MARK AS SHOWN.

FOR PROVISION OF A FINANCIAL EXCHANGE FOR THE TRADING OF SECURITIES, SHARES, OPTIONS, FOREIGN CURRENCIES, AND OTHER DERIVATIVE PRODUCTS; SECURITIES TRADING AND INVESTING SERVICES FOR OTHERS VIA THE INTERNET (U.S. CLS. 100, 101 AND 102).

FIRST USE 12-16-2013; IN COMMERCE 12-16-2013.

**CLASS 36—(Continued).**

4,481,678. DUTRAC COMMUNITY CREDIT UNION, DUBUQUE, IA. SN 85-549,315. PUB. 7-16-2013, FILED 2-22-2012.

# Advance

THE MARK CONSISTS OF STANDARD CHARACTERS WITHOUT CLAIM TO ANY PARTICULAR FONT, STYLE, SIZE, OR COLOR.

FOR FINANCIAL SERVICES, NAMELY, OFFERING ONLINE BUDGETING AND FINANCIAL PLANNING TOOLS FOR CONSUMERS, FEATURING AN ACCOUNT AGGREGATOR, AN INCOME AND EXPENSE ALLOCATION TRACKING SYSTEM, AND BUDGETING PLANNER, VIA AN INTERNET WEBSITE (U.S. CLS. 100, 101 AND 102).

FIRST USE 7-1-2012; IN COMMERCE 7-1-2012.

4,481,916. INSIGHT PROPERTY GROUP, LLC, ARLINGTON, VA. SN 85-687,629. PUB. 1-8-2013, FILED 7-26-2012.

# Apollo

THE MARK CONSISTS OF STANDARD CHARACTERS WITHOUT CLAIM TO ANY PARTICULAR FONT, STYLE, SIZE, OR COLOR.

FOR LEASE OF REAL ESTATE; LEASING OF APARTMENTS; LEASING OF REAL ESTATE; REAL ESTATE RENTAL SERVICES, NAMELY, RENTAL OF RESIDENTIAL HOUSING; RENTAL OF APARTMENTS; RENTAL OF APARTMENTS IN AN APARTMENT COMMUNITY; RENTING OF APARTMENTS (U.S. CLS. 100, 101 AND 102).

FIRST USE 2-2-2013; IN COMMERCE 6-26-2013.

4,481,918. ANVIL CAPITAL ADVISORS, LLC, SAN MATEO, CA. SN 85-688,061. PUB. 4-23-2013, FILED 7-26-2012.

# ANVIL CAPITAL ADVISORS

THE MARK CONSISTS OF STANDARD CHARACTERS WITHOUT CLAIM TO ANY PARTICULAR FONT, STYLE, SIZE, OR COLOR.

**CLASS 36—(Continued).**

NO CLAIM IS MADE TO THE EXCLUSIVE RIGHT TO USE "CAPITAL ADVISORS", APART FROM THE MARK AS SHOWN.

FOR FINANCIAL ADVISORY AND CONSULTANCY SERVICES; FINANCIAL SERVICES, NAMELY, ASSET MANAGEMENT SERVICES, INVESTMENT MANAGEMENT SERVICES, INVESTMENT ADVISORY SERVICES, INVESTMENT CONSULTATION AND INVESTMENT OF FUNDS FOR OTHERS; FINANCIAL SERVICES, NAMELY, WEALTH MANAGEMENT SERVICES; PROVIDING INFORMATION AND RESEARCH IN THE FIELD OF FINANCE AND FINANCIAL INVESTMENTS; INVESTMENT ADVISORY SERVICES; INVESTMENT CONSULTATION (U.S. CLS. 100, 101 AND 102).

FIRST USE 1-17-2012; IN COMMERCE 1-17-2012.

4,481,943. ACTRIGHT ACTION, INC., PLAINFIELD, IN. SN 85-700,438. PUB. 1-15-2013, FILED 8-10-2012.

# ACT RIGHT

THE MARK CONSISTS OF STANDARD CHARACTERS WITHOUT CLAIM TO ANY PARTICULAR FONT, STYLE, SIZE, OR COLOR.

FOR POLITICAL FUNDRAISING SERVICES (U.S. CLS. 100, 101 AND 102).

FIRST USE 8-15-2013; IN COMMERCE 8-15-2013.

4,481,969. HYATT CORPORATION, CHICAGO, IL. SN 85-714,968. PUB. 3-26-2013, FILED 8-28-2012.

# HYATT RESIDENCES

THE MARK CONSISTS OF STANDARD CHARACTERS WITHOUT CLAIM TO ANY PARTICULAR FONT, STYLE, SIZE, OR COLOR.

OWNER OF U.S. REG. NOS. 945,384, 1,951,219, AND OTHERS.

NO CLAIM IS MADE TO THE EXCLUSIVE RIGHT TO USE "RESIDENCES", APART FROM THE MARK AS SHOWN.

FOR REAL ESTATE SERVICES, NAMELY, RENTAL, BROKERAGE AND MANAGEMENT OF APARTMENTS, SERVICED APARTMENTS AND CONDOMINIUMS; LEASING OF COMMERCIAL REAL ESTATE; RENT COLLECTION (U.S. CLS. 100, 101 AND 102).

FIRST USE 1-0-2010; IN COMMERCE 1-0-2010.

**CLASS 36—(Continued).**

4,481,970. HYATT CORPORATION, CHICAGO, IL. SN 85-714,974. PUB. 3-26-2013, FILED 8-28-2012.

**HYATT RESIDENCE CLUB**

THE MARK CONSISTS OF STANDARD CHARACTERS WITHOUT CLAIM TO ANY PARTICULAR FONT, STYLE, SIZE, OR COLOR.

OWNER OF U.S. REG. NOS. 945,384, 1,951,219, AND OTHERS.

NO CLAIM IS MADE TO THE EXCLUSIVE RIGHT TO USE "RESIDENCE CLUB", APART FROM THE MARK AS SHOWN.

FOR REAL ESTATE SERVICES, NAMELY, RENTAL, BROKERAGE AND MANAGEMENT OF TIME-SHARE PROPERTIES; LEASING OF COMMERCIAL REAL ESTATE; RENT COLLECTION (U.S. CLS. 100, 101 AND 102).

FIRST USE 0-0-2007; IN COMMERCE 0-0-2007.

4,482,100. TANGIERS INTERNATIONAL, LTD., SLIEMA, MALTA. SN 85-738,068. PUB. 3-5-2013, FILED 9-25-2012.

**BATTLEFACE**

THE MARK CONSISTS OF STANDARD CHARACTERS WITHOUT CLAIM TO ANY PARTICULAR FONT, STYLE, SIZE, OR COLOR.

FOR INSURANCE CLAIMS ADMINISTRATION (U.S. CLS. 100, 101 AND 102).

FIRST USE 12-4-2012; IN COMMERCE 12-4-2012.

4,482,101. TANGIERS INTERNATIONAL, LTD., SLIEMA, MALTA. SN 85-738,076. PUB. 3-5-2013, FILED 9-25-2012.



THE MARK CONSISTS OF THE WORDING "BATTLEFACE" BELOW A BIRD'S HEAD FACING RIGHT.

FOR INSURANCE CLAIMS ADMINISTRATION (U.S. CLS. 100, 101 AND 102).

FIRST USE 12-4-2012; IN COMMERCE 12-4-2012.

**CLASS 36—(Continued).**

4,482,111. APPRAISAL MANAGEMENT SERVICES, LLC, MARIETTA, GA. SN 85-738,948. PUB. 3-12-2013, FILED 9-26-2012.

**VALSECURE**

THE MARK CONSISTS OF STANDARD CHARACTERS WITHOUT CLAIM TO ANY PARTICULAR FONT, STYLE, SIZE, OR COLOR.

FOR REAL ESTATE VALUATION APPRAISAL REVIEW SERVICES FOR COMPLIANCE AND RISK (U.S. CLS. 100, 101 AND 102).

FIRST USE 1-18-2012; IN COMMERCE 1-18-2012.

4,482,115. MOTYKA, KIM. GRAND BLANC, MI. SN 85-739,390. PUB. 3-5-2013, FILED 9-26-2012.

**F\*A\*C\*E**  
**Families Against Cancer**  
**Everywhere**

THE MARK CONSISTS OF STANDARD CHARACTERS WITHOUT CLAIM TO ANY PARTICULAR FONT, STYLE, SIZE, OR COLOR.

FOR CHARITABLE FOUNDATION SERVICES, NAMELY, PROVIDING FUNDRAISING ACTIVITIES AND INVESTMENT MANAGEMENT SERVICES TO SUPPORT MEDICAL EDUCATION AND RESEARCH AND PROCEDURES FOR THOSE IN NEED; CHARITABLE FOUNDATION SERVICES, NAMELY, PROVIDING FUNDRAISING ACTIVITIES TO SUPPORT MEDICAL RESEARCH AND PROCEDURES FOR THOSE IN NEED; CHARITABLE FOUNDATION SERVICES, NAMELY, PROVIDING FUNDRAISING ACTIVITIES, FUNDING, SCHOLARSHIPS AND/OR FINANCIAL ASSISTANCE FOR MEDICAL EXPENSES AND RESEARCH; CHARITABLE FOUNDATION SERVICES, NAMELY, PROVIDING FUNDRAISING ACTIVITIES, SUPPLEMENTAL FUNDING, CAPITAL IMPROVEMENT FUNDING, SCHOLARSHIPS AND FINANCIAL ASSISTANCE FOR PROGRAMS AND SERVICES OF OTHERS; CHARITABLE FUNDRAISING; CHARITABLE FUNDRAISING AND FINANCING RESEARCH FOR FINDING A CURE FOR SPINAL CORD INJURIES, BRAIN INJURIES AND NEUROLOGICAL DISORDERS; CHARITABLE FUNDRAISING BY MEANS OF CONDUCTING BOOK DRIVES WHEREIN THE BOOKS ARE LATER SOLD AND PROCEEDS DONATED TO CHARITY; CHARITABLE FUNDRAISING IN VIEW OF DISASTER PRECAUTIONS AND PREVENTION; CHARITABLE FUNDRAISING SERVICES; CHARITABLE FUNDRAISING SERVICES BY MEANS OF A BOWLING EVENT; CHARITABLE FUNDRAISING SERVICES BY MEANS OF A GOLF EVENT; CHARITABLE FUNDRAISING SERVICES BY MEANS OF AN ENTERTAINMENT EVENT; CHARITABLE FUNDRAISING SERVICES BY MEANS OF COLLECTING AND REDEMPTING RECYCLABLES FOR DONATION OF REDEMPTION PROCEEDS TO CHARITABLE ORGANIZATIONS; CHARITABLE FUNDRAISING SERVICES BY MEANS OF COLLECTING AND RESELLING USED AUTOMOBILES; CHARITABLE FUNDRAISING SERVICES BY MEANS OF MUSICAL CONCERTS; CHARITABLE FUNDRAISING SERVICES BY MEANS OF ORGANIZING AND CONDUCTING SPECIAL EVENTS; CHARITABLE FUN-

**CLASS 36—(Continued).**

DRAISING SERVICES BY MEANS OF RUNNING AND WALKING EVENTS; CHARITABLE FUNDRAISING SERVICES BY MEANS OF SELLING GOODS TO RAISE FUNDS; CHARITABLE FUNDRAISING SERVICES BY MEANS OF SELLING GOODS TO RAISE FUNDS FOR MEDICAL EXPENSES AND RESEARCH; CHARITABLE FUNDRAISING SERVICES BY MEANS OF STATIONARY BICYCLE RACES; CHARITABLE FUNDRAISING SERVICES BY MEANS OF DONATIONS; CHARITABLE FUNDRAISING SERVICES FOR PROMOTING RESEARCH, EDUCATION AND OTHER ACTIVITIES RELATING TO CANCER; CHARITABLE FUNDRAISING SERVICES FOR SENDING CHILDREN AND YOUNG ADULTS WITH DISABILITIES TO A SUMMER CAMP; CHARITABLE FUNDRAISING SERVICES FOR SENDING UNDERPRIVILEGED CHILDREN TO ONE OF SEVERAL CAMPS AROUND THE UNITED STATES WHICH ACCEPT THESE CHILDREN AT DISCOUNTED RATES FOR ONE OR MORE WEEKS; CHARITABLE FUNDRAISING SERVICES USING PROCEEDS FROM CD'S, TO PROVIDE FOOD, BLANKETS, SHELTER, OTHER RELIEF MATERIALS, BLOOD, AND FINANCIAL ASSISTANCE TO VICTIMS OF DISEASES AND DISASTERS IN THE U.S.; CHARITABLE FUNDRAISING SERVICES, BY MEANS OF ORGANIZING AND CONDUCTING FUNDRAISING FOOD TASTING EVENTS; CHARITABLE FUNDRAISING SERVICES, BY MEANS OF ORGANIZING AND CONDUCTING MUSICAL ENTERTAINMENT EVENTS FEATURING FOOD AND WINE; CHARITABLE FUNDRAISING SERVICES, NAMELY, BY PROVIDING INDIVIDUALS WITH THE INFORMATION AND OPPORTUNITY TO MAKE MONETARY DONATIONS TO THEIR FAVORITE CHARITY; CHARITABLE FUNDRAISING SERVICES, NAMELY, ELEEMOSYNARY SERVICES IN THE FIELD OF COLLECTION, MANAGEMENT, AND DISBURSEMENTS OF MONEY IN CONNECTION WITH PROGRAMS AND FACILITIES FOR THE WELFARE OF CHILDREN; CHARITABLE FUNDRAISING SERVICES, NAMELY, ORGANIZING AND CONDUCTING FUNDRAISING EVENTS TO ENCOURAGE INTERCOLLEGIATE ATHLETIC PROGRAMS; CHARITABLE FUNDRAISING SERVICES, NAMELY, RAISING FUNDS FOR COLLEGE EDUCATION COSTS; CHARITABLE FUNDRAISING SERVICES, NAMELY, SHARING PROFITS FROM NEWSPAPER SUBSCRIPTION SALES WITH NOT-FOR-PROFIT ORGANIZATIONS; CHARITABLE FUNDRAISING TO SUPPORT CANCER PATIENT MEDICAL EXPENSES; CHARITABLE SERVICES, NAMELY, ORGANIZING FUNDRAISING SERVICES AND EVENTS TO RAISE FUNDS IN THE FIELD OF CANCER RESEARCH (U.S. CLS. 100, 101 AND 102).

FIRST USE 10-30-2013; IN COMMERCE 10-30-2013.

4,482,133. HO'EA LLC, HONOLULU, HI. SN 85-742,784. PUB. 3-12-2013, FILED 10-1-2012.

HO'EA

THE MARK CONSISTS OF STANDARD CHARACTERS WITHOUT CLAIM TO ANY PARTICULAR FONT, STYLE, SIZE, OR COLOR.

THE ENGLISH TRANSLATION OF "HO'EA" IN THE MARK IS "TO ARRIVE".

FOR FINANCIAL SERVICES, NAMELY, WEALTH MANAGEMENT SERVICES (U.S. CLS. 100, 101 AND 102). FIRST USE 12-31-2012; IN COMMERCE 12-31-2012.

**CLASS 36—(Continued).**

4,482,134. HO'EA LLC, HONOLULU, HI. SN 85-742,793. PUB. 3-5-2013, FILED 10-1-2012.



THE MARK CONSISTS OF A STYLIZED DOUBLE-HULL CANOE.

FOR FINANCIAL SERVICES, NAMELY, WEALTH MANAGEMENT SERVICES (U.S. CLS. 100, 101 AND 102). FIRST USE 12-31-2012; IN COMMERCE 12-31-2012.

4,482,135. HOEA LLC, HONOLULU, HI. SN 85-742,808. PUB. 3-12-2013, FILED 10-1-2012.

Hō'ea

THE MARK CONSISTS OF THE WORDING "HO'EA". THE ENGLISH TRANSLATION OF "HO'EA" IN THE MARK IS "TO ARRIVE".

FOR FINANCIAL SERVICES, NAMELY, WEALTH MANAGEMENT SERVICES (U.S. CLS. 100, 101 AND 102). FIRST USE 12-31-2012; IN COMMERCE 12-31-2012.

**CLASS 36—(Continued).**

4,482,162. MOAC MALL HOLDINGS LLC, DBA MALL OF AMERICA, BLOOMINGTON, MN. SN 85-747,049. PUB. 3-19-2013, FILED 10-5-2012.

**ALWAYS NEW**

THE MARK CONSISTS OF STANDARD CHARACTERS WITHOUT CLAIM TO ANY PARTICULAR FONT, STYLE, SIZE, OR COLOR.

FOR LEASING AND RENTAL OF SHOPPING MALL SPACE, OFFICE SPACE, AND ENTERTAINMENT CENTER SPACE; REAL ESTATE MANAGEMENT OF COMBINATION SHOPPING MALL, OFFICE, AND ENTERTAINMENT COMPLEXES (U.S. CLS. 100, 101 AND 102).

FIRST USE 9-0-2012; IN COMMERCE 9-0-2012.

4,482,243. READYCAP COMMERCIAL, LLC, NEW YORK, NY. SN 85-760,268. PUB. 6-4-2013, FILED 10-22-2012.



NO CLAIM IS MADE TO THE EXCLUSIVE RIGHT TO USE "COMMERCIAL, LLC", APART FROM THE MARK AS SHOWN.

THE MARK CONSISTS OF THE WORD "READY" IN CAPITAL LETTERS FOLLOWED BY AN IMAGE OF A LARGE SPHERE WITH THE WORD "CAP" ON IT IN THE CAPITAL LETTERS, AND "COMMERCIAL, LLC" IN CAPITAL LETTERS LOCATED UNDERNEATH THE WORD "READY".

FOR FINANCIAL SERVICES, NAMELY, LOAN ORIGINATION SERVICES (U.S. CLS. 100, 101 AND 102).

FIRST USE 10-25-2012; IN COMMERCE 10-25-2012.

**CLASS 36—(Continued).**

4,482,252. CMFG LIFE INSURANCE COMPANY, MADISON, WI. SN 85-762,407. PUB. 2-26-2013, FILED 10-24-2012.

**Growing Your Business.  
Together.**

THE MARK CONSISTS OF STANDARD CHARACTERS WITHOUT CLAIM TO ANY PARTICULAR FONT, STYLE, SIZE, OR COLOR.

FOR FINANCIAL AND INSURANCE ADVISORY AND CONSULTING SERVICES; FINANCIAL SERVICES, NAMELY, PROVIDING AN INVESTMENT OPTION AVAILABLE FOR VARIABLE ANNUITY AND LIFE INSURANCE PRODUCTS, AND PROPRIETARY TRADING IN STOCKS, BONDS, MUTUAL FUNDS, SECURITIES, OPTIONS, EQUITIES, FIXED INCOME PRODUCTS AND ANNUITIES; FINANCIAL INVESTMENT BROKERAGE (U.S. CLS. 100, 101 AND 102).

FIRST USE 1-0-2013; IN COMMERCE 1-0-2013.

4,482,256. TIME VALUE OF MONEY, L.P., AUSTIN, TX. SN 85-763,625. PUB. 4-23-2013, FILED 10-25-2012.

**INVESTING IN GOOD PEOPLE  
FOR GOOD PEOPLE**

THE MARK CONSISTS OF STANDARD CHARACTERS WITHOUT CLAIM TO ANY PARTICULAR FONT, STYLE, SIZE, OR COLOR.

FOR FINANCIAL SERVICES, NAMELY, PROVIDING MANAGEMENT OF PRIVATELY AND PUBLICLY HELD INVESTMENTS, OPERATING MUTUAL FUNDS, INVESTMENT RESEARCH SERVICES AND ADVISORY SERVICES IN CONNECTION THEREWITH (U.S. CLS. 100, 101 AND 102).

FIRST USE 11-10-2013; IN COMMERCE 11-10-2013.

4,482,257. ALLSTATE INSURANCE COMPANY, NORTH-BROOK, IL. SN 85-763,696. PUB. 4-2-2013, FILED 10-25-2012.

**ALLSTATE**

THE MARK CONSISTS OF STANDARD CHARACTERS WITHOUT CLAIM TO ANY PARTICULAR FONT, STYLE, SIZE, OR COLOR.

OWNER OF U.S. REG. NOS. 761,091, 3,164,784, AND OTHERS.

FOR UNDERWRITING WARRANTY PROGRAMS IN THE FIELD OF AUTOMOBILE PAINT AND FABRIC (U.S. CLS. 100, 101 AND 102).

FIRST USE 1-1-2013; IN COMMERCE 1-1-2013.

**CLASS 36—(Continued).**

4,482,293. BELL HELICOPTER TEXTRON INC., FORT WORTH, TX. SN 85-776,714. PUB. 2-26-2013, FILED 11-12-2012.

# BELL

THE MARK CONSISTS OF STANDARD CHARACTERS WITHOUT CLAIM TO ANY PARTICULAR FONT, STYLE, SIZE, OR COLOR.  
OWNER OF U.S. REG. NOS. 937,437, 3,287,862, AND OTHERS.  
FOR FINANCIAL SERVICES, NAMELY, PROVIDING LOANS FOR HELICOPTERS (U.S. CLS. 100, 101 AND 102).  
FIRST USE 6-0-2005; IN COMMERCE 6-0-2005.

**CLASS 36—(Continued).**

4,482,343. COHEN ASSET MANAGEMENT, INC., BEVERLY HILLS, CA. SN 85-792,814. PUB. 4-30-2013, FILED 12-3-2012.

# Brad Cohen

THE MARK CONSISTS OF STANDARD CHARACTERS WITHOUT CLAIM TO ANY PARTICULAR FONT, STYLE, SIZE, OR COLOR.  
THE NAME, "BRAD COHEN" SHOWN IN THE MARK IDENTIFIES "BRADLEY STEPHEN COHEN", WHOSE CONSENT TO REGISTER IS MADE OF RECORD.  
FOR REAL ESTATE MANAGEMENT SERVICES (U.S. CLS. 100, 101 AND 102).  
FIRST USE 3-31-1992; IN COMMERCE 3-31-1992.

4,482,341. COHEN ASSET MANAGEMENT, INC., BEVERLY HILLS, CA. SN 85-792,796. PUB. 4-30-2013, FILED 12-3-2012.

# Brad S. Cohen

THE MARK CONSISTS OF STANDARD CHARACTERS WITHOUT CLAIM TO ANY PARTICULAR FONT, STYLE, SIZE, OR COLOR.  
THE NAME, "BRAD S. COHEN" SHOWN IN THE MARK IDENTIFIES "BRADLEY STEPHEN COHEN", WHOSE CONSENT TO REGISTER IS MADE OF RECORD.  
FOR REAL ESTATE MANAGEMENT SERVICES (U.S. CLS. 100, 101 AND 102).  
FIRST USE 3-31-1992; IN COMMERCE 3-31-1992.

4,482,344. COHEN ASSET MANAGEMENT, INC., BEVERLY HILLS, CA. SN 85-792,816. PUB. 4-30-2013, FILED 12-3-2012.

# Bradley Stephen Cohen

THE MARK CONSISTS OF STANDARD CHARACTERS WITHOUT CLAIM TO ANY PARTICULAR FONT, STYLE, SIZE, OR COLOR.  
THE NAME, "BRADLEY STEPHEN COHEN" SHOWN IN THE MARK IDENTIFIES "BRADLEY STEPHEN COHEN", WHOSE CONSENT TO REGISTER IS MADE OF RECORD.  
FOR REAL ESTATE MANAGEMENT SERVICES (U.S. CLS. 100, 101 AND 102).  
FIRST USE 3-31-1992; IN COMMERCE 3-31-1992.

4,482,342. COHEN ASSET MANAGEMENT, INC., BEVERLY HILLS, CA. SN 85-792,810. PUB. 4-30-2013, FILED 12-3-2012.

# Bradley Cohen

THE MARK CONSISTS OF STANDARD CHARACTERS WITHOUT CLAIM TO ANY PARTICULAR FONT, STYLE, SIZE, OR COLOR.  
THE NAME, "BRADLEY COHEN" SHOWN IN THE MARK IDENTIFIES "BRADLEY STEPHEN COHEN", WHOSE CONSENT TO REGISTER IS MADE OF RECORD.  
FOR REAL ESTATE MANAGEMENT SERVICES (U.S. CLS. 100, 101 AND 102).  
FIRST USE 3-31-1992; IN COMMERCE 3-31-1992.

4,482,345. COHEN ASSET MANAGEMENT, INC., BEVERLY HILLS, CA. SN 85-792,819. PUB. 4-30-2013, FILED 12-3-2012.

# Brad Stephen Cohen

THE MARK CONSISTS OF STANDARD CHARACTERS WITHOUT CLAIM TO ANY PARTICULAR FONT, STYLE, SIZE, OR COLOR.  
THE NAME, "BRAD STEPHEN COHEN" SHOWN IN THE MARK IDENTIFIES "BRADLEY STEPHEN COHEN", WHOSE CONSENT TO REGISTER IS MADE OF RECORD.  
FOR REAL ESTATE MANAGEMENT SERVICES (U.S. CLS. 100, 101 AND 102).  
FIRST USE 3-31-1992; IN COMMERCE 3-31-1992.

**CLASS 36—(Continued).**

4,482,366. METROPOLITAN LIFE INSURANCE COMPANY, NEW YORK, NY. SN 85-802,034. PUB. 5-14-2013, FILED 12-13-2012.

METLIFE PROMISE WHOLE LIFE  
SELECT 10

THE MARK CONSISTS OF STANDARD CHARACTERS WITHOUT CLAIM TO ANY PARTICULAR FONT, STYLE, SIZE, OR COLOR.

OWNER OF U.S. REG. NOS. 1,541,862 AND 4,080,231.

NO CLAIM IS MADE TO THE EXCLUSIVE RIGHT TO USE "WHOLE LIFE" AND "10", APART FROM THE MARK AS SHOWN.

FOR INSURANCE SERVICES, NAMELY, UNDERWRITING, ISSUANCE AND ADMINISTRATION OF WHOLE LIFE INSURANCE (U.S. CLS. 100, 101 AND 102). FIRST USE 4-30-2013; IN COMMERCE 4-30-2013.

4,482,371. METROPOLITAN LIFE INSURANCE COMPANY, NEW YORK, NY. SN 85-803,216. PUB. 5-7-2013, FILED 12-14-2012.

METLIFE PROMISE WHOLE LIFE  
SELECT 20

THE MARK CONSISTS OF STANDARD CHARACTERS WITHOUT CLAIM TO ANY PARTICULAR FONT, STYLE, SIZE, OR COLOR.

OWNER OF U.S. REG. NOS. 1,541,862 AND 4,080,231.

NO CLAIM IS MADE TO THE EXCLUSIVE RIGHT TO USE "WHOLE LIFE" AND "20", APART FROM THE MARK AS SHOWN.

FOR INSURANCE SERVICES, NAMELY, UNDERWRITING, ISSUANCE AND ADMINISTRATION OF WHOLE LIFE INSURANCE (U.S. CLS. 100, 101 AND 102). FIRST USE 4-30-2013; IN COMMERCE 4-30-2013.

4,482,373. METROPOLITAN LIFE INSURANCE COMPANY, NEW YORK, NY. SN 85-804,255. PUB. 5-14-2013, FILED 12-17-2012.

METLIFE PROMISE WHOLE LIFE  
SELECT 65

THE MARK CONSISTS OF STANDARD CHARACTERS WITHOUT CLAIM TO ANY PARTICULAR FONT, STYLE, SIZE, OR COLOR.

OWNER OF U.S. REG. NOS. 1,541,862 AND 4,080,231.

**CLASS 36—(Continued).**

NO CLAIM IS MADE TO THE EXCLUSIVE RIGHT TO USE "WHOLE LIFE" AND "65", APART FROM THE MARK AS SHOWN.

FOR INSURANCE SERVICES, NAMELY, UNDERWRITING, ISSUANCE AND ADMINISTRATION OF WHOLE LIFE INSURANCE (U.S. CLS. 100, 101 AND 102). FIRST USE 4-30-2013; IN COMMERCE 4-30-2013.

4,482,438. THE NATHAN CHRIS BAKER FOUNDATION, WESTMINSTER, MD. SN 85-827,867. PUB. 7-16-2013, FILED 1-21-2013.

## Go Out. Be Great.

THE MARK CONSISTS OF STANDARD CHARACTERS WITHOUT CLAIM TO ANY PARTICULAR FONT, STYLE, SIZE, OR COLOR.

FOR CHARITABLE FOUNDATION SERVICES, NAMELY, PROVIDING FINANCIAL SUPPORT TO DISADVANTAGED INDIVIDUALS IN THE UNITED STATES TO HELP PROVIDE ACADEMIC AND ATHLETIC OPPORTUNITIES TO FACILITATE EACH INDIVIDUAL'S MAXIMUM POTENTIAL (U.S. CLS. 100, 101 AND 102).

FIRST USE 9-10-2012; IN COMMERCE 9-10-2012.

4,482,482. HGGC, LLC, PALO ALTO, CA. SN 85-847,758. PUB. 7-2-2013, FILED 2-12-2013.

## HGGC

THE MARK CONSISTS OF STANDARD CHARACTERS WITHOUT CLAIM TO ANY PARTICULAR FONT, STYLE, SIZE, OR COLOR.

FOR FINANCIAL SERVICES, NAMELY, INVESTMENT ADVICE, INVESTMENT MANAGEMENT, INVESTMENT CONSULTATION AND INVESTMENT OF FUNDS FOR OTHERS (U.S. CLS. 100, 101 AND 102).

FIRST USE 3-11-2013; IN COMMERCE 3-11-2013.

4,482,537. FIRST MENASHA BANCSHARES, INC., DBA FIRST NATIONAL BANK - FOX VALLEY, NEENAH, WI. SN 85-867,151. PUB. 7-30-2013, FILED 3-5-2013.

## MORE.BETTER.FASTER.

THE MARK CONSISTS OF STANDARD CHARACTERS WITHOUT CLAIM TO ANY PARTICULAR FONT, STYLE, SIZE, OR COLOR.

FOR BANKING SERVICES (U.S. CLS. 100, 101 AND 102).

FIRST USE 4-30-2013; IN COMMERCE 4-30-2013.



**CLASS 36—(Continued).**

4,482,546. JASPER RIDGE PARTNERS, L.P., MENLO PARK, CA. SN 85-871,144. PUB. 6-4-2013, FILED 3-8-2013.

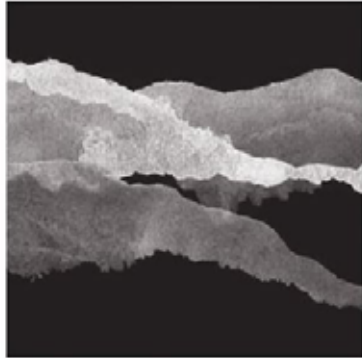

THE MARK CONSISTS OF A MOUNTAIN RANGE FOR FINANCIAL ADVISORY AND CONSULTANCY SERVICES, NAMELY, WEALTH MANAGEMENT SERVICES; FINANCIAL ANALYSIS AND CONSULTATION; INVESTMENT OF FUNDS FOR OTHERS; FINANCIAL PLANNING; FINANCIAL PORTFOLIO MANAGEMENT; FINANCIAL SERVICES, NAMELY, INVESTMENT ADVICE AND INVESTMENT CONSULTATION (U.S. CLS. 100, 101 AND 102).  
FIRST USE 4-0-2013; IN COMMERCE 4-0-2013.

**CLASS 36—(Continued).**

4,482,555. BELL PARTNERS INC., GREENSBORO, NC. SN 85-875,859. PUB. 8-13-2013, FILED 3-14-2013.

WHERE GOOD NEIGHBORS LIVE

THE MARK CONSISTS OF STANDARD CHARACTERS WITHOUT CLAIM TO ANY PARTICULAR FONT, STYLE, SIZE, OR COLOR.  
FOR LEASING OF APARTMENTS; MANAGEMENT OF APARTMENTS (U.S. CLS. 100, 101 AND 102).  
FIRST USE 6-17-2013; IN COMMERCE 6-17-2013.

4,482,554. BELL PARTNERS INC., GREENSBORO, NC. SN 85-875,852. PUB. 8-13-2013, FILED 3-14-2013.

BELL MAKES GOOD NEIGHBORS

THE MARK CONSISTS OF STANDARD CHARACTERS WITHOUT CLAIM TO ANY PARTICULAR FONT, STYLE, SIZE, OR COLOR.  
OWNER OF U.S. REG. NOS. 3,711,328 AND 3,998,252.  
FOR LEASING OF APARTMENTS; MANAGEMENT OF APARTMENTS (U.S. CLS. 100, 101 AND 102).  
FIRST USE 7-9-2013; IN COMMERCE 7-9-2013.

4,482,556. BELL PARTNERS INC., GREENSBORO, NC. SN 85-875,870. PUB. 8-13-2013, FILED 3-14-2013.

BELL IS WHERE GOOD NEIGHBORS LIVE

THE MARK CONSISTS OF STANDARD CHARACTERS WITHOUT CLAIM TO ANY PARTICULAR FONT, STYLE, SIZE, OR COLOR.  
OWNER OF U.S. REG. NOS. 3,711,328 AND 3,998,252.  
FOR LEASING OF APARTMENTS; MANAGEMENT OF APARTMENTS (U.S. CLS. 100, 101 AND 102).  
FIRST USE 6-17-2013; IN COMMERCE 6-17-2013.

**CLASS 36—(Continued).**

4,482,561. JAMES DONALD MATTHIS, II, CLINTON, NC. SN 85-877,100. PUB. 9-3-2013, FILED 3-15-2013.

# BlackBelt

THE MARK CONSISTS OF STANDARD CHARACTERS WITHOUT CLAIM TO ANY PARTICULAR FONT, STYLE, SIZE, OR COLOR.

FOR ADVICE RELATING TO INVESTMENTS; FINANCIAL ADVICE; FINANCIAL ADVICE AND CONSULTANCY SERVICES; FINANCIAL AND INVESTMENT SERVICES, NAMELY, ASSET AND INVESTMENT ACQUISITION, CONSULTATION, ADVISORY AND DEVELOPMENT; FINANCIAL AND INVESTMENT SERVICES, NAMELY, MANAGEMENT AND BROKERAGE IN THE FIELDS OF STOCKS, BONDS, OPTIONS, COMMODITIES, FUTURES AND OTHER SECURITIES, AND THE INVESTMENT OF FUNDS OF OTHERS; FINANCIAL PLANNING; FINANCIAL PLANNING AND INVESTMENT ADVISORY SERVICES; FINANCIAL PLANNING CONSULTATION; INVESTMENT BANKING SERVICES; LAND ACQUISITION, NAMELY, REAL ESTATE BROKERAGE; REAL ESTATE BROKERAGE; REAL ESTATE MANAGEMENT CONSULTATION; REAL ESTATE MANAGEMENT SERVICES (U.S. CLS. 100, 101 AND 102).

FIRST USE 1-10-2013; IN COMMERCE 12-22-2013.

---

4,482,655. KEYCORP, CLEVELAND, OH. SN 85-924,233. PUB. 9-10-2013, FILED 5-6-2013.

# KEY2FLEET

THE MARK CONSISTS OF STANDARD CHARACTERS WITHOUT CLAIM TO ANY PARTICULAR FONT, STYLE, SIZE, OR COLOR.

FOR CREDIT CARD AND PAYMENT CARD SERVICES (U.S. CLS. 100, 101 AND 102).

FIRST USE 8-22-2013; IN COMMERCE 8-22-2013.

**CLASS 36—(Continued).**

4,482,683. STEEL CASTLE PROPERTY ADVISORS, LLC, FULLERTON, CA. SN 85-980,683. PUB. 4-16-2013, FILED 11-5-2012.

# SEVONA

THE MARK CONSISTS OF STANDARD CHARACTERS WITHOUT CLAIM TO ANY PARTICULAR FONT, STYLE, SIZE, OR COLOR.

FOR APARTMENT HOUSE MANAGEMENT; BUILDING MANAGEMENT; INVESTMENT MANAGEMENT; LEASING OF APARTMENTS; LEASING OF REAL ESTATE; MANAGEMENT OF APARTMENTS; REAL ESTATE MANAGEMENT SERVICES; RENTAL OF APARTMENTS (U.S. CLS. 100, 101 AND 102).

FIRST USE 10-31-2013; IN COMMERCE 10-31-2013.

**CLASS 37—CONSTRUCTION AND REPAIR**

4,481,901. MN8 MEDIA, LLC, HEBER, UT. SN 85-679,351. PUB. 1-29-2013, FILED 7-17-2012.

# Liberty Ranch

THE MARK CONSISTS OF STANDARD CHARACTERS WITHOUT CLAIM TO ANY PARTICULAR FONT, STYLE, SIZE, OR COLOR.

NO CLAIM IS MADE TO THE EXCLUSIVE RIGHT TO USE "RANCH", APART FROM THE MARK AS SHOWN.

FOR REAL ESTATE DEVELOPMENT (U.S. CLS. 100, 103 AND 106).

FIRST USE 10-10-2013; IN COMMERCE 10-10-2013.

---

4,482,158. GENERAL ELECTRIC COMPANY, SCHENECTADY, NY. SN 85-746,807. PUB. 3-12-2013, FILED 10-5-2012.

# GE

THE MARK CONSISTS OF STANDARD CHARACTERS WITHOUT CLAIM TO ANY PARTICULAR FONT, STYLE, SIZE, OR COLOR.

**CLASS 37—(Continued).**

OWNER OF U.S. REG. NOS. 2,831,792, 3,624,272, AND OTHERS.

FOR INSTALLATION AND MAINTENANCE OF EQUIPMENT AND SYSTEMS IN THE FIELD OF TRANSPORTATION AND TRAFFIC CONTROL; MAINTENANCE AND/OR REPAIR OF TRAFFIC CONTROL EQUIPMENT; TECHNICAL SUPPORT SERVICES, NAMELY, TECHNICAL ADVICE RELATED TO THE INSTALLATION OF ADVANCED TRAIN CONTROL AND TRAFFIC SUPERVISION SYSTEMS AND SUBSYSTEMS; TECHNICAL SUPPORT SERVICES, NAMELY, TECHNICAL ADVICE RELATED TO THE REPAIR OF ADVANCED TRAIN CONTROL AND TRAFFIC SUPERVISION SYSTEMS AND SUBSYSTEMS (U.S. CLS. 100, 103 AND 106).

FIRST USE 10-5-2012; IN COMMERCE 10-5-2012.

---

4,482,170. GENERAL ELECTRIC COMPANY, SCHENECTADY, NY. SN 85-747,236. PUB. 3-12-2013, FILED 10-5-2012.



OWNER OF U.S. REG. NOS. 947,395, 4,206,544, AND OTHERS.

THE MARK CONSISTS OF STYLIZED LETTERS "GE" INSIDE A CIRCLE WITH FOUR CURLICUES.

FOR INSTALLATION, MAINTENANCE AND REPAIR OF EQUIPMENT AND SYSTEMS IN THE FIELD OF TRANSPORTATION AND TRAFFIC CONTROL; MAINTENANCE AND/OR REPAIR OF TRAFFIC CONTROL EQUIPMENT; TECHNICAL SUPPORT SERVICES, NAMELY, TECHNICAL ADVICE RELATED TO THE INSTALLATION OF ADVANCED TRAIN CONTROL AND TRAFFIC SUPERVISION SYSTEMS AND SUBSYSTEMS; TECHNICAL SUPPORT SERVICES, NAMELY, TECHNICAL ADVICE RELATED TO THE REPAIR OF ADVANCED TRAIN CONTROL AND TRAFFIC SUPERVISION SYSTEMS AND SUBSYSTEMS (U.S. CLS. 100, 103 AND 106).

FIRST USE 10-5-2012; IN COMMERCE 10-5-2012.

**CLASS 37—(Continued).**

4,482,288. SMITH, DEAN, FRANKFORT, IN. SN 85-775,018. PUB. 4-23-2013, FILED 11-8-2012.

**TIMELESS BARN COMPANY**

THE MARK CONSISTS OF STANDARD CHARACTERS WITHOUT CLAIM TO ANY PARTICULAR FONT, STYLE, SIZE, OR COLOR.

NO CLAIM IS MADE TO THE EXCLUSIVE RIGHT TO USE "BARN COMPANY", APART FROM THE MARK AS SHOWN.

FOR COMMERCIAL AND RESIDENTIAL CONSTRUCTION SERVICES, NAMELY, DISMANTLING AND RE-ERECTING OF BUILDINGS, RESTORATION OF BUILDINGS, AND CUSTOM BUILDING CONSTRUCTION (U.S. CLS. 100, 103 AND 106).

FIRST USE 3-1-2013; IN COMMERCE 3-1-2013.

---

4,482,451. PAIVA, SHELLY M., GILROY, CA. AND PAIVA, JOHN F., GILROY, CA. SN 85-832,693. PUB. 6-18-2013, FILED 1-25-2013.

**Philanthrohabbing**

THE MARK CONSISTS OF STANDARD CHARACTERS WITHOUT CLAIM TO ANY PARTICULAR FONT, STYLE, SIZE, OR COLOR.

FOR REAL ESTATE DEVELOPMENT (U.S. CLS. 100, 103 AND 106).

FIRST USE 9-5-2013; IN COMMERCE 9-5-2013.

---

4,482,563. GEOPIER FOUNDATION COMPANY, INC., DAVIDSON, NC. SN 85-877,284. PUB. 8-6-2013, FILED 3-15-2013.

**GEOPIER ARMORPACT**

THE MARK CONSISTS OF STANDARD CHARACTERS WITHOUT CLAIM TO ANY PARTICULAR FONT, STYLE, SIZE, OR COLOR.

OWNER OF U.S. REG. NOS. 3,642,756, 4,238,355, AND OTHERS.

FOR ENGINEERING CONSTRUCTION SERVICES, NAMELY, SOIL AND SUBSURFACE IMPROVEMENT, REINFORCEMENT, AND STABILIZATION (U.S. CLS. 100, 103 AND 106).

FIRST USE 6-0-2012; IN COMMERCE 6-0-2012.

**CLASS 38—COMMUNICATION**

4,481,369. ITSON INC., REDWOOD CITY, CA. SN 77-950,562. PUB. 5-18-2010, FILED 3-4-2010.



THE MARK CONSISTS OF THE WORD "ITSON" WITH AN OVAL BELOW THE LETTER "O", TWO CURVED LINES ABOVE THE LETTER "O", AND A PARTIAL CIRCLE WITH A LINE INTERSECTING THE CIRCLE IN THE LETTER "O".

FOR TELECOMMUNICATIONS SERVICES, NAMELY, THE TRANSMISSION OF VOICE, DATA, IMAGES, AUDIO, VIDEO, AND INFORMATION VIA TELEPHONE, SATELLITE, AND GLOBAL COMPUTER NETWORKS; PERSONAL COMMUNICATIONS SERVICES; WIRELESS ROAMING SERVICES; CONNECTION BY TELECOMMUNICATIONS TO A GLOBAL COMPUTER NETWORK (U.S. CLS. 100, 101 AND 104).

FIRST USE 1-16-2013; IN COMMERCE 1-16-2013.

4,481,430. NASUNI CORPORATION, NATICK, MA. SN 85-140,899. PUB. 9-13-2011, FILED 9-29-2010.

SIMPLY PUT, A BETTER NAS

THE MARK CONSISTS OF STANDARD CHARACTERS WITHOUT CLAIM TO ANY PARTICULAR FONT, STYLE, SIZE, OR COLOR.

NO CLAIM IS MADE TO THE EXCLUSIVE RIGHT TO USE "NAS", APART FROM THE MARK AS SHOWN.

FOR PROVIDING ACCESS TO THIRD PARTY DATA STORAGE PROVIDERS, NAMELY, PROVIDING USERS OF DATA STORAGE SYSTEMS WITH DOWNLOADABLE SOFTWARE THAT EXECUTES IN THE USER'S DATA STORAGE SYSTEM TOGETHER WITH A WEB-BASED MANAGEMENT INTERFACE THROUGH WHICH THE USER'S FILES ARE SECURELY DELIVERED TO AND RETRIEVED FROM THE THIRD PARTY DATA STORAGE PROVIDERS (U.S. CLS. 100, 101 AND 104).

FIRST USE 6-1-2013; IN COMMERCE 6-1-2013.

**CLASS 38—(Continued).**

4,481,534. CENTURYLINK, INC., MONROE, LA. SN 85-404,839. PUB. 10-30-2012, FILED 8-23-2011.

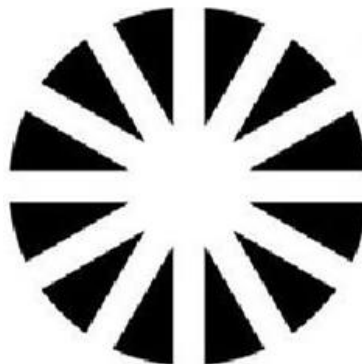

THE MARK CONSISTS OF A DESIGN IN NATURE OF TWELVE SMALL TRIANGLES ARRANGED IN A CIRCLE.

FOR HOUSEMARK FOR A FULL LINE OF TELECOMMUNICATIONS SERVICES, NAMELY, ELECTRONIC, ELECTRIC, AND DIGITAL TRANSMISSION OF VOICE, DATA, IMAGES, SIGNALS AND MESSAGES; LEASING OF TELECOMMUNICATIONS EQUIPMENT; LEASING OF TELECOMMUNICATIONS LINES; TELECOMMUNICATIONS CONSULTATION (U.S. CLS. 100, 101 AND 104).

FIRST USE 10-19-2009; IN COMMERCE 10-19-2009.

4,481,690. TWENTIETH CENTURY FOX FILM CORPORATION, LOS ANGELES, CA. SN 85-559,323. PUB. 2-5-2013, FILED 3-2-2012.

FOX STUDIOS

THE MARK CONSISTS OF STANDARD CHARACTERS WITHOUT CLAIM TO ANY PARTICULAR FONT, STYLE, SIZE, OR COLOR.

OWNER OF U.S. REG. NO. 2,140,779.

NO CLAIM IS MADE TO THE EXCLUSIVE RIGHT TO USE "STUDIOS", APART FROM THE MARK AS SHOWN.

FOR PROVIDING TELECOMMUNICATION SERVICES VIA A GLOBAL COMPUTER NETWORK, NAMELY, TRANSMISSION OF MOTION PICTURES, TELEVISION PROGRAM AND OTHER ENTERTAINMENT PROGRAMMING; ELECTRONIC TRANSMISSION OF DATA, IMAGES AND DOCUMENTS VIA COMPUTERS AND AUDIOVISUAL EQUIPMENT; PROVIDING DOWNLOADABLE STREAMING AND TRANSMISSION OF WIRELESS ENTERTAINMENT CONTENT IN THE NATURE OF AUDIOVISUAL WORKS, MOTION PICTURES, TRAILERS, TELEVISION PROGRAMMING, MUSIC, AND GAMES BY MEANS OF A GLOBAL COMPUTER NETWORK AND COMMUNICATIONS NETWORKS (U.S. CLS. 100, 101 AND 104).

FIRST USE 2-15-2002; IN COMMERCE 2-15-2002.

**CLASS 38—(Continued).**

4,481,721. BANCO DAVIVIENDA S.A., BOGOTA, D.C., COLOMBIA. SN 85-589,193. PUB. 8-21-2012, FILED 4-4-2012.



OWNER OF U.S. REG. NOS. 3,600,330, 4,080,797, AND 4,096,752.

THE COLOR(S) RED, YELLOW, BLUE, ORANGE AND BLACK IS/ARE CLAIMED AS A FEATURE OF THE MARK.

THE MARK CONSISTS OF THE DESIGN OF HOUSE IN THE SHAPE OF A MUSHROOM FOLLOWED BY THE WORD "DAVIVIENDA" IN STYLIZED LETTERS. THE COLOR RED APPEARS IN THE FRONT FAÇADE OF THE HOUSE AND IN THE WORD "DAVIVIENDA". THE COLOR YELLOW APPEARS IN THE DOOR AND IN THE WINDOW CURTAINS. THE COLOR BLUE APPEARS IN THE DOOR AND WINDOW FRAMES. THE COLOR ORANGE APPEARS IN THE ROOF AND IN MAIN ENTRANCE FLOOR OUTSIDE THE DOOR. THE COLOR BLACK APPEARS IN THE WINDOWS, IN THE FRONT DOOR KNOB AND IN THE OUTER BORDER OF THE HOUSE, OF THE FRONT DOOR AND OF THE WINDOWS.

THE WORDING "DAVIVIENDA" HAS NO MEANING IN A FOREIGN LANGUAGE.

FOR ELECTRONIC TRANSMISSION FOR OTHERS OF SECURITIES AND FINANCIAL INFORMATION VIA COMPUTER LINKING SERVICES, NAMELY, COMMUNICATING AND ROUTING TRADE INFORMATION INVOLVING ORDERS, ENTRY AND EXECUTION SERVICES, TO OTHERS VIA A GLOBAL COMPUTER NETWORK; TELECOMMUNICATION ACCESS SERVICES; TELECOMMUNICATION SERVICES, NAMELY, PROVIDING E-MAIL NOTIFICATION ALERTS VIA THE INTERNET OF RATING CHANGES THAT AFFECT FINANCIAL PORTFOLIOS; TRANSFER OF DATA BY TELECOMMUNICATIONS; TRANSMISSION OF INFORMATION BY ELECTRONIC COMMUNICATIONS NETWORKS (U.S. CLS. 100, 101 AND 104).

FIRST USE 11-30-2006; IN COMMERCE 8-31-2012.

4,481,971. PYPCZNSKI, KEVIN, BRICK, NJ. SN 85-715,524. PUB. 2-5-2013, FILED 8-29-2012.

@WEDDING

THE MARK CONSISTS OF STANDARD CHARACTERS WITHOUT CLAIM TO ANY PARTICULAR FONT, STYLE, SIZE, OR COLOR.

FOR ELECTRONIC MAIL AND MESSAGING SERVICES (U.S. CLS. 100, 101 AND 104).

FIRST USE 8-31-2012; IN COMMERCE 5-1-2013.

**CLASS 38—(Continued).**

4,482,032. CIRCLE911, LLC, CARMEL, IN. SN 85-729,498. PUB. 2-26-2013, FILED 9-14-2012.

THERE IS SAFETY IN NUMBERS

THE MARK CONSISTS OF STANDARD CHARACTERS WITHOUT CLAIM TO ANY PARTICULAR FONT, STYLE, SIZE, OR COLOR.

FOR PERSONAL NOTIFICATION SERVICES, NAMELY, SENDING EMERGENCY INFORMATION VIA TELECOMMUNICATION NETWORKS (U.S. CLS. 100, 101 AND 104).

FIRST USE 7-13-2013; IN COMMERCE 7-13-2013.

4,482,052. BIBA SYSTEMS, INC., SAN FRANCISCO, CA. SN 85-731,512. PUB. 3-12-2013, FILED 9-18-2012.

BIBA

THE MARK CONSISTS OF STANDARD CHARACTERS WITHOUT CLAIM TO ANY PARTICULAR FONT, STYLE, SIZE, OR COLOR.

THERE IS NO DEFINITIVE TRANSLATION OF THE WORD "BIBA" IN A FOREIGN LANGUAGE.

FOR VOICE OVER INTERNET PROTOCOL (VOIP) SERVICES (U.S. CLS. 100, 101 AND 104).

FIRST USE 12-4-2012; IN COMMERCE 12-4-2012.

4,482,081. ORAL ROBERTS UNIVERSITY, TULSA, OK. SN 85-736,603. PUB. 4-9-2013, FILED 9-24-2012.

GEB  
AMERICA

NO CLAIM IS MADE TO THE EXCLUSIVE RIGHT TO USE "AMERICA", APART FROM THE MARK AS SHOWN.

THE MARK CONSISTS OF THE WORD "GEB", WHEREIN THE "G" IS SLANTED AND ENCLOSED IN A BOX WITH A BLACK BACKGROUND, AND THE WORD "AMERICA" IS PLACED UNDERNEATH THE WORD "GEB".

FOR TELEVISION BROADCASTING (U.S. CLS. 100, 101 AND 104).

FIRST USE 10-1-2012; IN COMMERCE 10-1-2012.

**CLASS 38—(Continued).**

4,482,082. ORAL ROBERTS UNIVERSITY, TULSA, OK. SN 85-736,646. PUB. 4-9-2013, FILED 9-24-2012.



NO CLAIM IS MADE TO THE EXCLUSIVE RIGHT TO USE "AMERICA", APART FROM THE MARK AS SHOWN.

THE MARK CONSISTS OF THE WORD "GEB" WHEREIN THE "G" IS SLIGHTLY SLANTED AND ENCLOSED IN A BOX WITH A BLACK BACKGROUND FOLLOWED BY THE WORDS "AMERICA HELPING YOU LIVE WELL SPIRIT, MIND, BODY".

FOR TELEVISION BROADCASTING (U.S. CLS. 100, 101 AND 104).

FIRST USE 10-1-2012; IN COMMERCE 10-1-2012.

4,482,083. HOTWIRE COMMUNICATIONS, LTD., WYNNWOOD, PA. SN 85-736,648. PUB. 3-5-2013, FILED 9-24-2012.

# FISION

THE MARK CONSISTS OF STANDARD CHARACTERS WITHOUT CLAIM TO ANY PARTICULAR FONT, STYLE, SIZE, OR COLOR.

FOR BROADCASTING SERVICES AND PROVISION OF TELECOMMUNICATION ACCESS TO VIDEO AND AUDIO CONTENT PROVIDED VIA A VIDEO-ON-DEMAND SERVICE VIA THE INTERNET; COMMUNICATIONS VIA FIBER-OPTIC NETWORKS; RENTAL OF SET-TOP BOXES FOR USE WITH TELEVISIONS; TELECOMMUNICATION SERVICES, NAMELY, LOCAL AND LONG DISTANCE TRANSMISSION OF VOICE, DATA, GRAPHICS AND VIDEO BY MEANS OF BROADBAND OPTICAL OR WIRELESS NETWORKS; TELECOMMUNICATION SERVICES, NAMELY, PROVIDING INTERNET ACCESS VIA BROADBAND OPTICAL OR WIRELESS NETWORKS; TELECOMMUNICATION SERVICES, NAMELY, TRANSMISSION OF VOICE, DATA, GRAPHICS, IMAGES, AUDIO AND VIDEO BY MEANS OF TELECOMMUNICATIONS NETWORKS, WIRELESS COMMUNICATION NETWORKS, AND THE INTERNET; TELECOMMUNICATIONS SERVICES FOR PROVIDING MULTIPLE-USER ACCESS TO A GLOBAL COMPUTER NETWORK; TELECOMMUNICATIONS SERVICES, NAMELY, PROVIDING FIBER OPTIC NETWORK SERVICES; VIDEO-ON-DEMAND TRANSMISSION SERVICES (U.S. CLS. 100, 101 AND 104).

FIRST USE 5-1-2013; IN COMMERCE 5-1-2013.

**CLASS 38—(Continued).**

4,482,187. HEALTH SERVICE, LLC, ST. PAUL, MN. SN 85-750,556. PUB. 3-19-2013, FILED 10-10-2012.

# NOTICEMED

THE MARK CONSISTS OF STANDARD CHARACTERS WITHOUT CLAIM TO ANY PARTICULAR FONT, STYLE, SIZE, OR COLOR.

FOR ELECTRONIC MAIL AND MESSAGING SERVICES (U.S. CLS. 100, 101 AND 104).

FIRST USE 10-25-2012; IN COMMERCE 10-25-2012.

4,482,694. GMOB, L.L.C., HOLLADAY, UT. SN 85-980,824. PUB. 9-11-2012, FILED 9-24-2011.

# GMOB

THE MARK CONSISTS OF STANDARD CHARACTERS WITHOUT CLAIM TO ANY PARTICULAR FONT, STYLE, SIZE, OR COLOR.

FOR ELECTRONIC MAIL AND MESSAGING SERVICES (U.S. CLS. 100, 101 AND 104).

FIRST USE 6-1-2011; IN COMMERCE 6-1-2011.

**CLASS 39—TRANSPORTATION AND STORAGE**

4,481,826. ELIZABETH'S MOVING SERVICES, LLC, CHATTANOOGA, TN. SN 85-644,709. PUB. 10-30-2012, FILED 6-6-2012.

# ELIZABETH'S MOVING SERVICES, LLC

THE MARK CONSISTS OF STANDARD CHARACTERS WITHOUT CLAIM TO ANY PARTICULAR FONT, STYLE, SIZE, OR COLOR.

NO CLAIM IS MADE TO THE EXCLUSIVE RIGHT TO USE "MOVING SERVICES" AND "LLC", APART FROM THE MARK AS SHOWN.

FOR MOVING COMPANY SERVICES (U.S. CLS. 100 AND 105).

FIRST USE 9-1-2013; IN COMMERCE 9-1-2013.

**CLASS 39—(Continued).**

4,481,984. KISS CATALOG, LTD., PINE BROOK, NJ. SN 85-717,948. PUB. 3-12-2013, FILED 8-31-2012.



THE MARK CONSISTS OF THE WORD "KISS" IN A STYLIZED FONT.

FOR TRANSPORTATION SERVICES, NAMELY, SHUTTLE SERVICES BY CAR, VAN AND CHARTER BUS; AIRPORT TRANSPORTATION SERVICES, NAMELY, PROVIDING SHUTTLE SERVICES BY CAR, VAN AND CHARTER BUS; CAR SERVICE, NAMELY, CAR TRANSPORT; VAN SERVICE, NAMELY, VAN TRANSPORT; CHARTER BUS SERVICE (U.S. CLS. 100 AND 105).

FIRST USE 10-12-2013; IN COMMERCE 10-12-2013.

4,482,078. JAPAN AIRLINES CO., LTD., TOKYO, JAPAN. SN 85-736,161. PUB. 2-26-2013, FILED 9-24-2012.

**JAL New Sky Project**

THE MARK CONSISTS OF STANDARD CHARACTERS WITHOUT CLAIM TO ANY PARTICULAR FONT, STYLE, SIZE, OR COLOR.

OWNER OF U.S. REG. NOS. 968,924, 3,665,553, AND OTHERS.

NO CLAIM IS MADE TO THE EXCLUSIVE RIGHT TO USE "PROJECT", APART FROM THE MARK AS SHOWN.

FOR AIR TRANSPORT; TRANSPORTATION OF PASSENGERS AND CARGO BY AIR; PROVIDING FLIGHT ARRIVAL AND DEPARTURE INFORMATION; TRAVEL INFORMATION SERVICES (U.S. CLS. 100 AND 105).

FIRST USE 9-13-2012; IN COMMERCE 10-22-2013.

4,482,159. GENERAL ELECTRIC COMPANY, SCHENECTADY, NY. SN 85-746,808. PUB. 3-12-2013, FILED 10-5-2012.

THE MARK CONSISTS OF STANDARD CHARACTERS WITHOUT CLAIM TO ANY PARTICULAR FONT, STYLE, SIZE, OR COLOR.

**CLASS 39—(Continued).**

OWNER OF U.S. REG. NOS. 1,679,636, 3,166,687, AND OTHERS.

FOR CONSULTATION IN THE FIELD OF ENERGY DISTRIBUTION; TECHNICAL CONSULTATION IN THE FIELD OF ENERGY DISTRIBUTION AND STORAGE; TRANSPORTATION CONSULTING (U.S. CLS. 100 AND 105).

FIRST USE 10-5-2012; IN COMMERCE 10-5-2012.

4,482,171. GENERAL ELECTRIC COMPANY, SCHENECTADY, NY. SN 85-747,238. PUB. 3-12-2013, FILED 10-5-2012.



OWNER OF U.S. REG. NOS. 1,689,275, 3,166,695, AND OTHERS.

THE MARK CONSISTS OF STYLIZED LETTERS "GE" INSIDE A CIRCLE WITH FOUR CURLICUES.

FOR CONSULTATION IN THE FIELD OF ENERGY DISTRIBUTION; TECHNICAL CONSULTATION IN THE FIELD OF ENERGY DISTRIBUTION AND STORAGE; TRANSPORTATION CONSULTING (U.S. CLS. 100 AND 105).

FIRST USE 10-5-2012; IN COMMERCE 10-5-2012.

4,482,211. FREIGHTBADGER.COM, INC., SAN GABRIEL, CA. SN 85-754,854. PUB. 4-16-2013, FILED 10-16-2012.

THE MARK CONSISTS OF THE STYLIZED TEXT "FREIGHTBADGER.COM" IN WHICH THE LETTER "A" IN THE WORD "BADGER" IS REPRESENTED BY A FACE OF A BADGER.

FOR PROVIDING ONLINE FREIGHT LOGISTICS MANAGEMENT SERVICES (U.S. CLS. 100 AND 105).

FIRST USE 9-17-2013; IN COMMERCE 10-3-2013.

**CLASS 39—(Continued).**

4,482,284. GAP (APPAREL), LLC, SAN FRANCISCO, CA. SN 85-773,072. PUB. 3-5-2013, FILED 11-6-2012.

# GAP

THE MARK CONSISTS OF STANDARD CHARACTERS WITHOUT CLAIM TO ANY PARTICULAR FONT, STYLE, SIZE, OR COLOR.

FOR ON-LINE TRANSPORTATION RESERVATION AND TRAVEL TICKET RESERVATION SERVICES; WEBSITE PROVIDING TRAVEL BOOKING AND RESERVATION SERVICES FOR OTHERS (U.S. CLS. 100 AND 105).

FIRST USE 11-29-2012; IN COMMERCE 11-29-2012.

---

4,482,324. ACE PARKING MANAGEMENT, INC., SAN DIEGO, CA. SN 85-787,306. PUB. 5-21-2013, FILED 11-26-2012.



OWNER OF U.S. REG. NOS. 1,908,854, 3,823,853, AND OTHERS.

NO CLAIM IS MADE TO THE EXCLUSIVE RIGHT TO USE "TICKET" OR "PARKING", APART FROM THE MARK AS SHOWN.

THE MARK CONSISTS OF A DEPICTION OF A HAND POINTING SLIGHTLY UP, PALM OUT, WITH THE THUMB OF THE HAND HOLDING A DEPICTION OF A TICKET UPON WHICH IS PRINTED THE TERM "TICKET". IN THE BOTTOM RIGHT HAND CORNER OF THE TICKET IS A SHADED SQUARE DISPLAYING THE WORD "ACE", WITH THE WORD "PARKING" APPEARING BELOW THE SQUARE. ALL OF THE FOREGOING APPEARS WITHIN A SINGLE LINE CIRCLE.

FOR VEHICLE PARKING AND PARKING MANAGEMENT SERVICES (U.S. CLS. 100 AND 105).

FIRST USE 11-19-2012; IN COMMERCE 11-19-2012.

**CLASS 39—(Continued).**

4,482,480. PADDLE BUS CLUB, HAIKU, HI. SN 85-846,914. PUB. 7-30-2013, FILED 2-11-2013.

# PADDLE BUS CLUB

THE MARK CONSISTS OF STANDARD CHARACTERS WITHOUT CLAIM TO ANY PARTICULAR FONT, STYLE, SIZE, OR COLOR.

NO CLAIM IS MADE TO THE EXCLUSIVE RIGHT TO USE "BUS CLUB", APART FROM THE MARK AS SHOWN. FOR TRANSPORT OF PASSENGERS (U.S. CLS. 100 AND 105).

FIRST USE 10-7-2013; IN COMMERCE 10-7-2013.

**CLASS 40—MATERIAL TREATMENT**

---

4,481,298. COGNATE3 LLC, DBA COGNATE3 LLC, KIRKLAND, WA. SN 76-697,473. PUB. 9-29-2009, FILED 5-18-2009.

# GO-JUICE

THE MARK CONSISTS OF STANDARD CHARACTERS WITHOUT CLAIM TO ANY PARTICULAR FONT, STYLE, SIZE, OR COLOR.

FOR CHEMICAL TREATMENT OF STORAGE BATTERIES TO RESTORE THE BATTERY TO USEABLE CONDITION (U.S. CLS. 100, 103 AND 106).

FIRST USE 5-18-2009; IN COMMERCE 5-18-2009.



**CLASS 40—(Continued).**

4,481,530. ASHLAND LICENSING AND INTELLECTUAL PROPERTY LLC, DUBLIN, OH. SN 85-392,062. PUB. 9-11-2012, FILED 8-8-2011.

## Biobond. Improving the Sustainability of Paper

THE MARK CONSISTS OF STANDARD CHARACTERS WITHOUT CLAIM TO ANY PARTICULAR FONT, STYLE, SIZE, OR COLOR.

FOR PROVIDING PAPER TREATMENT INFORMATION ON IMPROVING WET END PERFORMANCE AND PAPER QUALITY IN THE PAPER MANUFACTURING INDUSTRY; PROVIDING PAPER TREATMENT INFORMATION ON RECOVERING STARCH FROM WASTE PAPER OR BROKE IN THE PAPER MANUFACTURING INDUSTRY; PROVIDING PAPER TREATMENT TECHNICAL SUPPORT, NAMELY, CONSULTATION SERVICES CONCERNING IMPROVING WET END PERFORMANCE AND PAPER QUALITY IN THE PAPER MANUFACTURING INDUSTRY; PROVIDING PAPER TREATMENT TECHNICAL SUPPORT, NAMELY, CONSULTATION SERVICE CONCERNING RECOVERING STARCH FROM WASTE PAPER OR BROKE IN THE PAPER MANUFACTURING INDUSTRY (U.S. CLS. 100, 103 AND 106).

FIRST USE 8-12-2012; IN COMMERCE 8-12-2012.

**CLASS 41—(Continued).**

4,481,341. PALMER, AMY, OYSTER BAY, NY. SN 77-842,911. PUB. 9-14-2010, FILED 10-6-2009.

## Tycooness

THE MARK CONSISTS OF STANDARD CHARACTERS WITHOUT CLAIM TO ANY PARTICULAR FONT, STYLE, SIZE, OR COLOR.

FOR ENTERTAINMENT SERVICES, NAMELY, PRODUCTION OF TELEVISION PROGRAMS, PRODUCTION OF TELEVISION PROGRAMS TO BE BROADCAST OVER THE INTERNET, PRODUCTION OF MULTIMEDIA FOR WEBSITES, PRODUCTION OF DOCUMENTARY AND DRAMATIC TELEVISION PROGRAMS, PRODUCTION OF TELEVISION PROGRAMS COMPRISED OF ON-CAMERA INTERVIEWS, EDUCATIONAL SERVICES, NAMELY, PERSONAL TRAINING IN RADIO, TELEVISION BROADCASTING, AND CORPORATE PRESENTATION; EDUCATION COURSES RELATING TO RADIO, TELEVISION BROADCASTING, AND CORPORATE PRESENTATIONS (U.S. CLS. 100, 101 AND 107).

FIRST USE 9-25-2013; IN COMMERCE 9-25-2013.

4,481,419. SONY ELECTRONICS INC., SAN DIEGO, CA. SN 85-111,167. PUB. 3-22-2011, FILED 8-19-2010.

## SGNL

**CLASS 41—EDUCATION AND ENTERTAINMENT**

4,481,325. GEFFEN VISIONS INTERNATIONAL, INC., BOULDER, CO. SN 77-698,087. PUB. 9-13-2011, FILED 3-24-2009.

THE MARK CONSISTS OF STANDARD CHARACTERS WITHOUT CLAIM TO ANY PARTICULAR FONT, STYLE, SIZE, OR COLOR.

FOR ENTERTAINMENT SERVICES, NAMELY, PROVIDING CONTINUING PRE-RECORDED AUDIOVISUAL PROGRAMS IN THE FORM OF SERIES FEATURING NEWS, INFORMATION, REVIEWS, COMMENTARIES, ENTERTAINMENT, AND EDUCATIONAL CONTENT ALL IN THE FIELDS OF CONSUMER ELECTRONICS, WHICH IS ACCESSIBLE OVER THE INTERNET (U.S. CLS. 100, 101 AND 107).

FIRST USE 10-0-2010; IN COMMERCE 10-0-2010.

## THE BODY AS GARDEN

4,481,437. VIDEOSERPEL, LTD., ZUG, SWITZERLAND. SN 85-161,656. PUB. 2-15-2011, FILED 10-26-2010.

THE MARK CONSISTS OF STANDARD CHARACTERS WITHOUT CLAIM TO ANY PARTICULAR FONT, STYLE, SIZE, OR COLOR.

FOR WORKSHOPS, LECTURES, AND SEMINARS IN THE FIELDS OF INTEGRATIVE MEDICINE, CANCER CARE, ONCOLOGY AND MULTI-DIMENSIONAL APPROACHES TO MEDICINE, HEALING AND WELLNESS (U.S. CLS. 100, 101 AND 107).

FIRST USE 8-0-2007; IN COMMERCE 8-0-2007.

## ROSA SALVAJE

THE MARK CONSISTS OF STANDARD CHARACTERS WITHOUT CLAIM TO ANY PARTICULAR FONT, STYLE, SIZE, OR COLOR.

**CLASS 41—(Continued).**

THE ENGLISH TRANSLATION OF "ROSA SALVAJE" IN THE MARK IS "WILD ROSE".

FOR ENTERTAINMENT SERVICES IN THE NATURE OF A CONTINUING DRAMATIC SHOW BROADCAST OVER THE INTERNET AND AN ONGOING DRAMATIC TELEVISION PROGRAM (U.S. CLS. 100, 101 AND 107).

FIRST USE 7-6-1987; IN COMMERCE 2-19-1988.

---

4,481,484. FERTITTA ACQUISITIONSCO LLC, LAS VEGAS, NV. SN 85-285,651. PUB. 12-11-2012, FILED 4-4-2011.

**ULTIMATE POKER CHAMPIONSHIP**

THE MARK CONSISTS OF STANDARD CHARACTERS WITHOUT CLAIM TO ANY PARTICULAR FONT, STYLE, SIZE, OR COLOR.

OWNER OF U.S. REG. NOS. 1,939,277, 3,052,007, AND OTHERS.

NO CLAIM IS MADE TO THE EXCLUSIVE RIGHT TO USE "POKER CHAMPIONSHIP", APART FROM THE MARK AS SHOWN.

SEC. 2(F) AS TO: "ULTIMATE".

FOR ORGANIZING AND CONDUCTING GAMING CONTESTS AND TOURNAMENTS (U.S. CLS. 100, 101 AND 107).

FIRST USE 10-11-2013; IN COMMERCE 10-11-2013.

---

4,481,527. SHFL ENTERTAINMENT, INC., LAS VEGAS, NV. SN 85-385,930. PUB. 1-24-2012, FILED 8-1-2011.

**PAIR PLUS**

THE MARK CONSISTS OF STANDARD CHARACTERS WITHOUT CLAIM TO ANY PARTICULAR FONT, STYLE, SIZE, OR COLOR.

NO CLAIM IS MADE TO THE EXCLUSIVE RIGHT TO USE "PAIR", APART FROM THE MARK AS SHOWN.

FOR ENTERTAINMENT SERVICES, NAMELY, PROVIDING GAMES OF CHANCE VIA THE INTERNET (U.S. CLS. 100, 101 AND 107).

FIRST USE 6-4-2012; IN COMMERCE 6-4-2012.

**CLASS 41—(Continued).**

4,481,535. PHI MU FRATERNITY, PEACHTREE CITY, GA. SN 85-408,583. PUB. 4-24-2012, FILED 8-26-2011.



OWNER OF U.S. REG. NOS. 2,546,029 AND 3,484,637. NO CLAIM IS MADE TO THE EXCLUSIVE RIGHT TO USE "FOUNDATION", APART FROM THE MARK AS SHOWN.

THE MARK CONSISTS OF THE TWO STYLIZED WORDS "PHI MU" AND A BADGE DESIGN CENTERED BETWEEN SAID WORDS AND APPEARING ABOVE THE WORD "FOUNDATION" AND THE WORDS "SISTERS HELPING SISTERS" IN SMALLER TYPE.

FOR EDUCATIONAL SERVICES, NAMELY, CONDUCTING SEMINARS AND WORKSHOPS ON SUBJECTS OF GENERAL INTEREST TO COLLEGIANS IN THE NATURE OF ISSUES RELATED TO LEADERSHIP, CAREERS, NETWORKING, PERSONAL DEVELOPMENT AND OTHER RELATED ISSUES AND THE DISTRIBUTION OF COURSE MATERIALS IN CONNECTION THEREWITH (U.S. CLS. 100, 101 AND 107).

FIRST USE 6-0-2013; IN COMMERCE 6-0-2013.

---

4,481,584. FIFTH STREET GAMING, LLC, LAS VEGAS, NV. SN 85-451,554. PUB. 3-27-2012, FILED 10-19-2011.

**DOWNTOWN GRAND**

THE MARK CONSISTS OF STANDARD CHARACTERS WITHOUT CLAIM TO ANY PARTICULAR FONT, STYLE, SIZE, OR COLOR.

FOR CASINOS; CONDUCTING AND PROVIDING FACILITIES FOR SPECIAL EVENTS FEATURING CASINO AND GAMING CONTESTS AND TOURNAMENTS; HEALTH CLUB SERVICES, NAMELY, PROVIDING EQUIPMENT IN THE FIELD OF PHYSICAL EXERCISE; NIGHT CLUBS; PROVIDING CASINO SERVICES FEATURING A CASINO PLAYERS REWARDS PROGRAM; PROVIDING FACILITIES FOR RECREATION ACTIVITIES; PROVIDING SWIMMING POOLS; SPECIAL EVENT PLANNING FOR SOCIAL ENTERTAINMENT PURPOSES (U.S. CLS. 100, 101 AND 107).

FIRST USE 10-27-2013; IN COMMERCE 10-27-2013.

**CLASS 41—(Continued).**

4,481,588. SHFL ENTERTAINMENT, INC., LAS VEGAS, NV.  
SN 85-454,139. PUB. 3-12-2013, FILED 10-24-2011.

**ULTIMATE TEXAS HOLD 'EM**

THE MARK CONSISTS OF STANDARD CHARACTERS WITHOUT CLAIM TO ANY PARTICULAR FONT, STYLE, SIZE, OR COLOR.

OWNER OF U.S. REG. NOS. 3,331,520, 4,061,042, AND OTHERS.

NO CLAIM IS MADE TO THE EXCLUSIVE RIGHT TO USE "TEXAS HOLD 'EM", APART FROM THE MARK AS SHOWN.

FOR ENTERTAINMENT SERVICES, NAMELY, PROVIDING ONLINE COMPUTER GAMES, INCLUDING ONLINE COMPUTER GAMES ACCESSIBLE VIA MOBILE DEVICES (U.S. CLS. 100, 101 AND 107).

FIRST USE 6-4-2012; IN COMMERCE 6-4-2012.

4,481,595. PONY BASEBALL, INC., WASHINGTON, PA. SN 85-464,639. PUB. 4-17-2012, FILED 11-4-2011.

**THOROBRED LEAGUE**

THE MARK CONSISTS OF STANDARD CHARACTERS WITHOUT CLAIM TO ANY PARTICULAR FONT, STYLE, SIZE, OR COLOR.

NO CLAIM IS MADE TO THE EXCLUSIVE RIGHT TO USE "LEAGUE", APART FROM THE MARK AS SHOWN.

FOR ORGANIZING AND MANAGING YOUTH AND YOUNG ADULT BASEBALL AND SOFTBALL ACTIVITIES (U.S. CLS. 100, 101 AND 107).

FIRST USE 10-15-2012; IN COMMERCE 10-15-2012.

4,481,614. ALVA PRODUCTIONS, INC., EDGEWATER, NJ. SN 85-479,117. PUB. 5-8-2012, FILED 11-22-2011.

**ALVA PRODUCTIONS**

THE MARK CONSISTS OF STANDARD CHARACTERS WITHOUT CLAIM TO ANY PARTICULAR FONT, STYLE, SIZE, OR COLOR.

**CLASS 41—(Continued).**

NO CLAIM IS MADE TO THE EXCLUSIVE RIGHT TO USE "PRODUCTIONS", APART FROM THE MARK AS SHOWN.

FOR EDITING OR RECORDING OF SOUNDS AND IMAGES; ENTERTAINMENT SERVICES IN THE NATURE OF DEVELOPMENT, CREATION, PRODUCTION AND POST-PRODUCTION SERVICES OF MULTIMEDIA ENTERTAINMENT CONTENT; MULTIMEDIA ENTERTAINMENT SERVICES IN THE NATURE OF RECORDING, PRODUCTION AND POST-PRODUCTION SERVICES IN THE FIELDS OF MUSIC, VIDEO, AND FILMS; POST-PRODUCTION EDITING SERVICES IN THE FIELD OF MUSIC, VIDEOS AND FILM (U.S. CLS. 100, 101 AND 107).

FIRST USE 12-3-2013; IN COMMERCE 12-3-2013.

4,481,615. ARC-INSIGHT, LLC, WORTHINGTON, OH. SN 85-479,173. PUB. 3-26-2013, FILED 11-22-2011.

**AI INSIGHT**

THE MARK CONSISTS OF STANDARD CHARACTERS WITHOUT CLAIM TO ANY PARTICULAR FONT, STYLE, SIZE, OR COLOR.

NO CLAIM IS MADE TO THE EXCLUSIVE RIGHT TO USE "AI", APART FROM THE MARK AS SHOWN.

FOR TRAINING AND EDUCATIONAL SERVICES, NAMELY, PROVIDING TRAINING AND EDUCATIONAL MATERIALS IN THE NATURE OF PRERECORDED VIDEO PROGRAMS, PRERECORDED AUDIO PROGRAMS, AND TESTS AND OTHER TEXTUAL MATERIALS OVER THE WORLD WIDE WEB, BUT NOT THROUGH IN-PERSON MEETINGS OR CONFERENCES, RELATED TO INVESTMENTS THAT ARE NOT PUBLICLY TRADED, FOR BROKER-DEALERS, SPONSORS, AND INVESTMENT ADVISORS (U.S. CLS. 100, 101 AND 107).

FIRST USE 8-0-2011; IN COMMERCE 8-0-2011.

4,481,616. BOBBI OWENS, NEW YORK, NY. AND KRISTI BERCHIN, NEW YORK, NY. SN 85-479,224. PUB. 4-17-2012, FILED 11-22-2011.

**HAPPY HOUR@**

THE MARK CONSISTS OF STANDARD CHARACTERS WITHOUT CLAIM TO ANY PARTICULAR FONT, STYLE, SIZE, OR COLOR.

FOR ENTERTAINMENT, NAMELY, THE PROVISION OF PROGRAMS FEATURING BAR AND RESTAURANT EVENTS AND PROMOTIONS DELIVERED BY TELEVISION AND THE INTERNET (U.S. CLS. 100, 101 AND 107).

FIRST USE 6-11-2013; IN COMMERCE 6-11-2013.

**CLASS 41—(Continued).**

4,481,634. DISNEY ENTERPRISES, INC., BURBANK, CA. SN 85-497,999. PUB. 10-23-2012, FILED 12-16-2011.

**UNLOCK THE MAGIC**

THE MARK CONSISTS OF STANDARD CHARACTERS WITHOUT CLAIM TO ANY PARTICULAR FONT, STYLE, SIZE, OR COLOR.

FOR EDUCATION SERVICES, NAMELY, CREATING AND DEVELOPING PROGRAMS IN THE FIELD OF ENTERTAINMENT BUSINESS, ANIMATION, ART, CULTURE, AND MEMORABILIA; EDUCATION SERVICES, NAMELY, ORGANIZING AND CONDUCTING CONFERENCES AND LECTURES IN THE FIELD OF ENTERTAINMENT AND HISTORY OF THE ENTERTAINMENT BUSINESS, ANIMATION, ART, CULTURE, AND MEMORABILIA; FAN CLUB SERVICES; PROVIDING INFORMATION VIA GLOBAL COMPUTER NETWORKS IN THE FIELD OF ENTERTAINMENT AND HISTORY OF THE ENTERTAINMENT BUSINESS; PROVISION OF ENTERTAINMENT NEWS AND ENTERTAINMENT INFORMATION VIA COMMUNICATION AND COMPUTER NETWORKS; PROVIDING ENTERTAINMENT SERVICES VIA A GLOBAL COMMUNICATION NETWORK IN THE NATURE OF WEBSITES FEATURING A WIDE VARIETY OF GENERAL INTEREST ENTERTAINMENT INFORMATION RELATING TO MOTION PICTURE FILMS, TELEVISION SHOW PROGRAMS, RELATED FILM CLIPS, PHOTOGRAPHS, AND OTHER MULTIMEDIA MATERIALS (U.S. CLS. 100, 101 AND 107).

FIRST USE 1-0-2013; IN COMMERCE 1-0-2013.

---

4,481,655. UNIVISION COMMUNICATIONS INC., LOS ANGELES, CA. SN 85-528,939. PUB. 5-15-2012, FILED 1-30-2012.

**FUTBOL CENTRAL**

THE MARK CONSISTS OF STANDARD CHARACTERS WITHOUT CLAIM TO ANY PARTICULAR FONT, STYLE, SIZE, OR COLOR.

NO CLAIM IS MADE TO THE EXCLUSIVE RIGHT TO USE "FUTBOL", APART FROM THE MARK AS SHOWN.

THE ENGLISH TRANSLATION OF THE WORD "FUTBOL" IN THE MARK IS "SOCCER".

FOR ENTERTAINMENT SERVICES, NAMELY, AN ONGOING TELEVISION SPORTS PROGRAM (U.S. CLS. 100, 101 AND 107).

FIRST USE 4-7-2012; IN COMMERCE 4-7-2012.

**CLASS 41—(Continued).**

4,481,656. THE MENTOR FACTOR LLC, BRADENTON, FL. SN 85-529,275. PUB. 7-10-2012, FILED 1-31-2012.



NO CLAIM IS MADE TO THE EXCLUSIVE RIGHT TO USE "MENTOR", APART FROM THE MARK AS SHOWN.

THE MARK CONSISTS OF STYLIZED WORDING "MENTOR FACTOR" WITH PYRAMID AND CURVED ARROW EXTENDING FROM BASE.

FOR EDUCATIONAL SERVICES, NAMELY, CONDUCTING SEMINARS, CLASSES, CONFERENCES, AND WORKSHOPS IN THE FIELDS OF FINANCIAL, BUSINESS, AND ENTREPRENEURIAL EDUCATION AND PERSONAL DEVELOPMENT (U.S. CLS. 100, 101 AND 107).

FIRST USE 6-1-2010; IN COMMERCE 6-1-2010.

---

4,481,659. MUKTI LIFE, LLC, BELLE HARBOR, NY. SN 85-532,050. PUB. 3-19-2013, FILED 2-2-2012.

**MUKTI**

THE MARK CONSISTS OF STANDARD CHARACTERS WITHOUT CLAIM TO ANY PARTICULAR FONT, STYLE, SIZE, OR COLOR.

THE ENGLISH TRANSLATION OF "MUKTI" IN THE MARK IS "ENLIGHTENMENT" OR "A STATE OF SELF-REALIZATION".

FOR CONDUCTING FITNESS CLASSES; PERSONAL FITNESS TRAINING SERVICES AND CONSULTANCY; PHYSICAL FITNESS INSTRUCTION (U.S. CLS. 100, 101 AND 107).

FIRST USE 1-1-2013; IN COMMERCE 1-1-2013.

---

4,481,673. PATRICK SELLA, BOSTON, MA. SN 85-541,160. PUB. 7-17-2012, FILED 2-13-2012.

**UNIVERSITY IV POWER**

THE MARK CONSISTS OF STANDARD CHARACTERS WITHOUT CLAIM TO ANY PARTICULAR FONT, STYLE, SIZE, OR COLOR.

NO CLAIM IS MADE TO THE EXCLUSIVE RIGHT TO USE "UNIVERSITY", APART FROM THE MARK AS SHOWN.

FOR BUSINESS TRAINING; BUSINESS TRAINING CONSULTANCY SERVICES (U.S. CLS. 100, 101 AND 107).

FIRST USE 3-5-2013; IN COMMERCE 3-5-2013.

**CLASS 41—(Continued).**

4,481,691. STORY MINING AND SUPPLY CO., LLC, SAN FRANCISCO, CA. SN 85-560,632. PUB. 2-19-2013, FILED 3-5-2012.

STORY MINING & SUPPLY CO.

---

THE MARK CONSISTS OF STANDARD CHARACTERS WITHOUT CLAIM TO ANY PARTICULAR FONT, STYLE, SIZE, OR COLOR.

FOR ENTERTAINMENT SERVICES, NAMELY, FILM AND TV SHOW PRODUCTION (U.S. CLS. 100, 101 AND 107).

FIRST USE 10-1-2013; IN COMMERCE 10-1-2013.

---

4,481,697. SAYERS, KELLY, APPLECROSS, WA, AUSTRALIA. SN 85-565,053. PUB. 3-12-2013, FILED 3-9-2012.

5PS TO PROSPERITY  
ATTRACTION PROCESS

THE MARK CONSISTS OF STANDARD CHARACTERS WITHOUT CLAIM TO ANY PARTICULAR FONT, STYLE, SIZE, OR COLOR.

FOR LIFE COACHING SERVICES IN THE FIELD OF SPIRITUALITY, VOCATION, CAREER, SELF- AND PERSONAL IMPROVEMENT AND ACHIEVING ONE'S GOALS; VOCATIONAL GUIDANCE; PROVIDING INFORMATION ABOUT EDUCATION; EDUCATIONAL AND ENTERTAINMENT SERVICES, NAMELY, PROVIDING MOTIVATIONAL AND EDUCATIONAL SPEAKERS IN THE FIELD OF SELF- AND PERSONAL IMPROVEMENT; CONDUCTING WORKSHOPS AND SEMINARS IN PERSONAL AWARENESS AND SELF- AND PERSONAL IMPROVEMENT (U.S. CLS. 100, 101 AND 107).

FIRST USE 1-1-2007; IN COMMERCE 6-1-2012.

---

4,481,715. VIRTUOSO, LTD., FORT WORTH, TX. SN 85-582,595. PUB. 5-21-2013, FILED 3-28-2012.

VIRTUOSO TRAVEL WEEK

THE MARK CONSISTS OF STANDARD CHARACTERS WITHOUT CLAIM TO ANY PARTICULAR FONT, STYLE, SIZE, OR COLOR.

OWNER OF U.S. REG. NOS. 3,095,926, 3,248,601, AND OTHERS.

**CLASS 41—(Continued).**

NO CLAIM IS MADE TO THE EXCLUSIVE RIGHT TO USE "TRAVEL WEEK", APART FROM THE MARK AS SHOWN.

FOR ENTERTAINMENT SERVICES, NAMELY, ARRANGING AND CONDUCTING AWARD CEREMONIES FOR RECOGNIZING EXCELLENCE IN TRAVEL; EDUCATIONAL SERVICES, NAMELY, PRESENTATIONS, SEMINARS AND CONFERENCES IN THE FIELD OF TRAVEL (U.S. CLS. 100, 101 AND 107).

FIRST USE 8-12-2012; IN COMMERCE 8-12-2012.

---

4,481,763. WONDER OF WOMEN, SANTA MONICA, CA. SN 85-610,026. PUB. 10-2-2012, FILED 4-27-2012.

Lipstick and Soul

THE MARK CONSISTS OF STANDARD CHARACTERS WITHOUT CLAIM TO ANY PARTICULAR FONT, STYLE, SIZE, OR COLOR.

FOR EDUCATION SERVICES, NAMELY, PROVIDING CLASSES AND RETREATS IN THE FIELD OF PERSONAL DEVELOPMENT (U.S. CLS. 100, 101 AND 107).

FIRST USE 8-8-2012; IN COMMERCE 10-6-2012.

---

4,481,777. EA DIGITAL ILLUSIONS CE AB, STOCKHOLM, SWEDEN. SN 85-618,229. PUB. 10-23-2012, FILED 5-7-2012.

BATTLEFIELD 4

THE MARK CONSISTS OF STANDARD CHARACTERS WITHOUT CLAIM TO ANY PARTICULAR FONT, STYLE, SIZE, OR COLOR.

OWNER OF U.S. REG. NOS. 3,013,448, 4,132,578, AND OTHERS.

FOR ENTERTAINMENT SERVICES, NAMELY, PROVIDING AN ON-LINE COMPUTER GAME; PROVISION OF INFORMATION RELATING TO ELECTRONIC COMPUTER GAMES PROVIDED VIA THE INTERNET (U.S. CLS. 100, 101 AND 107).

FIRST USE 10-29-2013; IN COMMERCE 10-29-2013.

**CLASS 41—(Continued).**

4,481,794. KAMHOLZ, GLENNA, COTTONWOOD HEIGHTS, UT. SN 85-624,978. PUB. 4-9-2013, FILED 5-14-2012.

**ANDREA THE GIANT**

THE MARK CONSISTS OF STANDARD CHARACTERS WITHOUT CLAIM TO ANY PARTICULAR FONT, STYLE, SIZE, OR COLOR.

THE NAME(S), PORTRAIT(S), AND/OR SIGNATURE(S) SHOWN IN THE MARK IDENTIFIES GLENNA KAMHOLZ, WHOSE CONSENT(S) TO REGISTER IS MADE OF RECORD.

FOR ENTERTAINMENT SERVICES, NAMELY, WRESTLING EXHIBITS AND PERFORMANCES BY A PROFESSIONAL WRESTLER AND ENTERTAINER (U.S. CLS. 100, 101 AND 107).

FIRST USE 4-1-2013; IN COMMERCE 4-1-2013.

4,481,796. SAUNDERS, MARLON D., STATEN ISLAND, NY. SN 85-625,118. PUB. 3-19-2013, FILED 5-14-2012.

**BLACK HONEY RECORDS**

THE MARK CONSISTS OF STANDARD CHARACTERS WITHOUT CLAIM TO ANY PARTICULAR FONT, STYLE, SIZE, OR COLOR.

NO CLAIM IS MADE TO THE EXCLUSIVE RIGHT TO USE "RECORDS", APART FROM THE MARK AS SHOWN.

FOR ENTERTAINMENT SERVICES, NAMELY, PROVIDING NON-DOWNLOADABLE PRERECORDED MUSIC, INFORMATION IN THE FIELD OF MUSIC, AND COMMENTARY AND ARTICLES ABOUT MUSIC, ALL ON-LINE VIA A GLOBAL COMPUTER NETWORK (U.S. CLS. 100, 101 AND 107).

FIRST USE 3-25-2003; IN COMMERCE 4-1-2003.

4,481,821. CAPCOM CO., LTD., OSAKA, JAPAN. SN 85-639,702. PUB. 3-5-2013, FILED 5-31-2012.

**DEAD RISING**

THE MARK CONSISTS OF STANDARD CHARACTERS WITHOUT CLAIM TO ANY PARTICULAR FONT, STYLE, SIZE, OR COLOR.

**CLASS 41—(Continued).**

OWNER OF U.S. REG. NO. 3,617,551.

FOR PROVIDING ON-LINE COMPUTER GAMES TO OTHERS VIA THE INTERNET; PROVIDING NON-DOWNLOADABLE INTERNET GAMES TO OTHERS; PROVIDING ON-LINE ELECTRONIC GAMES FOR MOBILE TELEPHONES VIA THE INTERNET; PROVIDING ON-LINE IMAGES, MOTION PICTURES, VIDEO GAMES, MUSIC VIDEOS AND MUSIC VIA THE INTERNET; PROVIDING IMAGES, MOTION PICTURES, VIDEO GAMES, MUSIC VIDEOS AND MUSIC THROUGH COMMUNICATION VIA MOBILE PHONES AND SMART PHONES; ELECTRONIC PUBLISHING SERVICES, NAMELY, ONLINE PUBLICATION OF NON-DOWNLOADABLE TEXT AND GRAPHIC WORKS OF OTHERS FEATURING COMPUTER AND VIDEO GAMES AND STRATEGIES THEREOF; PROVIDING ON-LINE NON-DOWNLOADABLE NEWSLETTERS IN THE FIELD OF COMPUTER GAMES AND VIDEO GAMES; PROVIDING ON-LINE NON-DOWNLOADABLE ELECTRONIC PUBLICATIONS AND DOCUMENTATION, NAMELY, ARTICLES AND REPORTS FEATURING COMPUTER GAME STRATEGY AND VIDEO GAME STRATEGY; ORGANIZATION OF ENTERTAINMENT COMPETITIONS FOR OTHERS, NAMELY, VIDEO GAMING COMPETITIONS, BOARD GAME COMPETITIONS, CARD GAME COMPETITIONS, MUSICAL COMPETITIONS, IMAGE AND VIDEO COMPETITIONS, DRAWING COMPETITIONS AND PAINTING COMPETITIONS; ORGANIZATION OF ON-LINE NON-DOWNLOADABLE ENTERTAINMENT COMPETITIONS FOR OTHERS, NAMELY, VIDEO GAMING COMPETITIONS, BOARD GAME COMPETITIONS, CARD GAME COMPETITIONS, MUSICAL COMPETITIONS, IMAGE AND VIDEO COMPETITIONS, DRAWING COMPETITIONS AND PAINTING COMPETITIONS; MOTION PICTURE THEATER SERVICES; PRODUCTION OF MOTION PICTURES IN THE FORM OF FILMS, VIDEO TAPES AND OPTICAL DISKS; PROVIDING RECREATIONAL FACILITIES, NAMELY, AMUSEMENT PARKS, AMUSEMENT ARCADES AND AMUSEMENT CENTERS; PROVIDING ON-LINE INTERACTIVE MULTIPLAYER GAMES; PROVIDING ONLINE INFORMATION SERVICES RELATING TO ENTERTAINMENT, NAMELY, MOVIES, MUSIC AND GAMES; PROVIDING INFORMATION ABOUT MOVIE, GAME AND MUSIC THROUGH COMMUNICATION VIA MOBILE PHONES AND SMART PHONES (U.S. CLS. 100, 101 AND 107).

FIRST USE 9-24-2010; IN COMMERCE 9-28-2010.

4,481,827. GULFSTREAM AEROSPACE CORPORATION, SAVANNAH, GA. SN 85-645,268. PUB. 8-21-2012, FILED 6-6-2012.

**STUDIO G**

THE MARK CONSISTS OF STANDARD CHARACTERS WITHOUT CLAIM TO ANY PARTICULAR FONT, STYLE, SIZE, OR COLOR.

FOR TECHNICAL TRAINING CLASSES RELATED TO AIRCRAFTS (U.S. CLS. 100, 101 AND 107).

FIRST USE 6-12-2012; IN COMMERCE 10-31-2012.

**CLASS 41—(Continued).**

4,481,851. TOP TIER FOOTBALL, LLC, KNOXVILLE, TN. SN 85-656,156. PUB. 12-4-2012, FILED 6-19-2012.

## Top Tier Football

THE MARK CONSISTS OF STANDARD CHARACTERS WITHOUT CLAIM TO ANY PARTICULAR FONT, STYLE, SIZE, OR COLOR.

NO CLAIM IS MADE TO THE EXCLUSIVE RIGHT TO USE "FOOTBALL", APART FROM THE MARK AS SHOWN.

FOR ENTERTAINMENT SERVICES IN THE NATURE OF FANTASY FOOTBALL LEAGUES; PROVIDING INFORMATION RELATING TO SPORTS AND SPORTING EVENTS; PROVIDING NEWS AND INFORMATION IN THE FIELD OF SPORTS (U.S. CLS. 100, 101 AND 107).

FIRST USE 7-1-2012; IN COMMERCE 7-1-2013.

**CLASS 41—(Continued).**

4,481,885. MULTI-PURE INTERNATIONAL, LAS VEGAS, NV. SN 85-671,732. PUB. 4-30-2013, FILED 7-9-2012.



THE COLOR(S) BLUE IS/ARE CLAIMED AS A FEATURE OF THE MARK.

THE MARK CONSISTS OF A BLUE WATER DROP THAT REPRESENTS OR FORMS A PERSON.

FOR CHARITABLE SERVICES, NAMELY, PROVIDING EDUCATIONAL MATERIALS IN THE NATURE OF WORKBOOKS, WORKSHEETS, MAGAZINES, PAMPHLETS AND KITS TO EXPERIMENT WITH WATER ADDITIVES AND FILTERS AND EDUCATIONAL PROGRAMS ON WATER CONTAMINATION AND WATER FILTRATION (U.S. CLS. 100, 101 AND 107).

FIRST USE 2-25-2012; IN COMMERCE 2-25-2012.

4,481,883. MULTI-PURE INTERNATIONAL, LAS VEGAS, NV. SN 85-671,693. PUB. 4-30-2013, FILED 7-9-2012.

## PURELY KIDS

THE MARK CONSISTS OF STANDARD CHARACTERS WITHOUT CLAIM TO ANY PARTICULAR FONT, STYLE, SIZE, OR COLOR.

NO CLAIM IS MADE TO THE EXCLUSIVE RIGHT TO USE "KIDS", APART FROM THE MARK AS SHOWN.

FOR CHARITABLE SERVICES, NAMELY, PROVIDING EDUCATIONAL MATERIALS IN THE NATURE OF WORKBOOKS, WORKSHEETS, KITS TO EXPERIMENT WITH WATER ADDITIVES AND FILTERS, AND EDUCATIONAL PROGRAMS ON WATER CONTAMINATION AND WATER FILTRATION (U.S. CLS. 100, 101 AND 107).

FIRST USE 2-25-2012; IN COMMERCE 2-25-2012.

4,481,906. GIRL SCOUTS OF THE UNITED STATES OF AMERICA, NEW YORK, NY. SN 85-682,908. PUB. 5-21-2013, FILED 7-20-2012.



OWNER OF U.S. REG. NOS. 1,318,643, 4,085,279, AND OTHERS.

NO CLAIM IS MADE TO THE EXCLUSIVE RIGHT TO USE "AWARD", APART FROM THE MARK AS SHOWN.

THE MARK CONSISTS OF A SUNBURST DESIGN SURROUNDING A STYLIZED THREE-LEAF CLOVER IN THE UPPER LEFT HAND CORNER WITH THE WORDING "GIRL SCOUT GOLD AWARD" ADJACENT TO THE RIGHT AND THE PHRASE "GOGOLD" LOCATED IMMEDIATELY BELOW WITH A FEMALE FIGURE IN PLACE OF THE LETTER "L".

FOR PROVIDING RECOGNITION AND INCENTIVES BY WAY OF AWARDS TO DEMONSTRATE OUTSTANDING SERVICE, ACHIEVEMENT AND QUALITY IN THE FIELD OF SCOUTING (U.S. CLS. 100, 101 AND 107).

FIRST USE 8-0-2012; IN COMMERCE 8-0-2012.

**CLASS 41—(Continued).**

4,481,936. TALL GRASS LLC, HORSHAM, PA. SN 85-697,282.  
PUB. 4-16-2013, FILED 8-7-2012.

# SmarText

THE MARK CONSISTS OF STANDARD CHARACTERS WITHOUT CLAIM TO ANY PARTICULAR FONT, STYLE, SIZE, OR COLOR.

FOR BOOK RENTAL SERVICES (U.S. CLS. 100, 101 AND 107).

FIRST USE 8-0-2012; IN COMMERCE 8-0-2012.

---

4,481,947. STEVENS, LAURI, NEWBURY, MA. SN 85-701,497.  
PUB. 2-5-2013, FILED 8-12-2012.

## SMILE CONFERENCE

THE MARK CONSISTS OF STANDARD CHARACTERS WITHOUT CLAIM TO ANY PARTICULAR FONT, STYLE, SIZE, OR COLOR.

NO CLAIM IS MADE TO THE EXCLUSIVE RIGHT TO USE "CONFERENCE", APART FROM THE MARK AS SHOWN.

FOR EDUCATIONAL SERVICE, NAMELY, CONDUCTING CONFERENCES FOR LAW ENFORCEMENT PROFESSIONALS TO LEARN AND NETWORK ABOUT THE USE OF SOCIAL MEDIA, INTERNET AND OPEN SOURCE TECHNOLOGY IN THEIR PROFESSION (U.S. CLS. 100, 101 AND 107).

FIRST USE 1-15-2010; IN COMMERCE 1-15-2010.

---

4,482,025. NEIGHBOR LLC, MINNEAPOLIS, MN. SN 85-728,468. PUB. 9-10-2013, FILED 9-13-2012.

## NEIGHBOR

THE MARK CONSISTS OF STANDARD CHARACTERS WITHOUT CLAIM TO ANY PARTICULAR FONT, STYLE, SIZE, OR COLOR.

FOR ANIMATION PRODUCTION SERVICES; PRODUCTION OF VISUAL EFFECTS FOR VIDEOS, DVDS, TELEVISION AND FOR INTERNET WEB SITES; SPECIAL EFFECTS ANIMATION SERVICES FOR FILM AND VIDEO (U.S. CLS. 100, 101 AND 107).

FIRST USE 8-20-2012; IN COMMERCE 11-22-2012.

**CLASS 41—(Continued).**

4,482,029. CHARLENA THORPE, SUWANEE, GA. SN 85-728,761. PUB. 3-5-2013, FILED 9-13-2012.

## INCORPORATING INNOVATION

THE MARK CONSISTS OF STANDARD CHARACTERS WITHOUT CLAIM TO ANY PARTICULAR FONT, STYLE, SIZE, OR COLOR.

FOR EDUCATIONAL SERVICES, NAMELY, CONDUCTING CLASSES, SEMINARS, CONFERENCES, WORKSHOPS IN THE FIELD OF BUSINESS DEVELOPMENT FOR NEW IDEAS AND DISTRIBUTING EDUCATIONAL MATERIAL IN CONNECTION THEREWITH (U.S. CLS. 100, 101 AND 107).

FIRST USE 11-3-2012; IN COMMERCE 11-3-2012.

---

4,482,062. ALEGENT CREIGHTON HEALTH, OMAHA, NE. AND CREIGHTON UNIVERSITY, OMAHA, NE. SN 85-732,498. PUB. 2-26-2013, FILED 9-19-2012.

## ALEGENT CREIGHTON HEALTH

THE MARK CONSISTS OF STANDARD CHARACTERS WITHOUT CLAIM TO ANY PARTICULAR FONT, STYLE, SIZE, OR COLOR.

NO CLAIM IS MADE TO THE EXCLUSIVE RIGHT TO USE "HEALTH", APART FROM THE MARK AS SHOWN.

FOR EDUCATIONAL SERVICES, NAMELY, CONDUCTING CLASSES, SEMINARS AND WORKSHOPS IN THE FIELDS OF HEALTH CARE AND MEDICAL SERVICES; PROVIDING AN ONLINE NEWSLETTER IN THE FIELDS OF HEALTH CARE AND MEDICAL SERVICES (U.S. CLS. 100, 101 AND 107).

FIRST USE 8-1-2012; IN COMMERCE 8-1-2012.

---

4,482,074. RAVENS & WOLVES, LLC, ALPHARETTA, GA. SN 85-735,488. PUB. 3-5-2013, FILED 9-21-2012.

## RAVENS & WOLVES

THE MARK CONSISTS OF STANDARD CHARACTERS WITHOUT CLAIM TO ANY PARTICULAR FONT, STYLE, SIZE, OR COLOR.

FOR ENTERTAINMENT, NAMELY, LIVE PERFORMANCES BY A MUSICAL BAND (U.S. CLS. 100, 101 AND 107).

FIRST USE 12-31-2010; IN COMMERCE 12-31-2010.



**CLASS 41—(Continued).**

4,482,084. ORAL ROBERTS UNIVERSITY, TULSA, OK. SN 85-736,741. PUB. 5-21-2013, FILED 9-24-2012.



OWNER OF U.S. REG. NO. 2,103,953.  
THE COLOR(S) DARK BLUE AND GOLD IS/ARE CLAIMED AS A FEATURE OF THE MARK.

THE MARK CONSISTS OF THE WORD "ORU" WRITTEN IN DARK BLUE ADJACENT TO A VERTICAL LINE WRITTEN IN GOLD WHICH IS ADJACENT TO THE WORDS "MAKE NO LITTLE PLANS HERE" WRITTEN IN GOLD.

FOR PROVIDING EDUCATIONAL SERVICES AT COLLEGE AND GRADUATE LEVEL COURSES OF INSTRUCTION (U.S. CLS. 100, 101 AND 107).

FIRST USE 11-1-2012; IN COMMERCE 11-1-2012.

---

4,482,126. TELEVISION FOOD NETWORK, G.P., NEW YORK, NY. SN 85-741,858. PUB. 3-19-2013, FILED 9-28-2012.

## HOME FOR DINNER

THE MARK CONSISTS OF STANDARD CHARACTERS WITHOUT CLAIM TO ANY PARTICULAR FONT, STYLE, SIZE, OR COLOR.

NO CLAIM IS MADE TO THE EXCLUSIVE RIGHT TO USE "DINNER", APART FROM THE MARK AS SHOWN.

FOR EDUCATIONAL AND ENTERTAINMENT SERVICES, NAMELY, A CONTINUING PROGRAM ABOUT FOOD AND COOKING ACCESSIBLE BY RADIO, TELEVISION, CABLE TELEVISION, THE INTERNET, WIRELESS NETWORKS, SATELLITE, AUDIO, VIDEO, AND COMPUTER NETWORKS (U.S. CLS. 100, 101 AND 107).

FIRST USE 4-7-2013; IN COMMERCE 4-7-2013.

---

4,482,131. DAVID M. INTROCASO, WASHINGTON, DC. SN 85-742,155. PUB. 5-14-2013, FILED 9-30-2012.

## THE HEALTHCARE POLICY PODCAST PRODUCED BY DAVID INTROCASO

THE MARK CONSISTS OF STANDARD CHARACTERS WITHOUT CLAIM TO ANY PARTICULAR FONT, STYLE, SIZE, OR COLOR.

NO CLAIM IS MADE TO THE EXCLUSIVE RIGHT TO USE "THE HEALTHCARE POLICY PODCAST PRODUCED BY", APART FROM THE MARK AS SHOWN.

THE NAME "DAVID INTROCASO" IDENTIFIES A LIVING INDIVIDUAL WHOSE CONSENT IS OF RECORD.

FOR ENTERTAINMENT SERVICES, NAMELY, PROVIDING PODCASTS IN THE FIELD OF HEALTH CARE POLICY (U.S. CLS. 100, 101 AND 107).

FIRST USE 11-29-2012; IN COMMERCE 11-29-2012.

**CLASS 41—(Continued).**

4,482,191. KENNETH MICKIE, FREDERICKSBURG, VA. SN 85-751,484. PUB. 3-5-2013, FILED 10-11-2012.

## TEAM GO HARD

THE MARK CONSISTS OF STANDARD CHARACTERS WITHOUT CLAIM TO ANY PARTICULAR FONT, STYLE, SIZE, OR COLOR.

FOR CONDUCTING FITNESS CLASSES; CONSULTING SERVICES IN THE FIELDS OF FITNESS AND EXERCISE; PERSONAL FITNESS TRAINING SERVICES AND CONSULTANCY; PHYSICAL FITNESS CONSULTATION; PROVIDING AN INTERACTIVE WEBSITE FEATURING INFORMATION AND LINKS RELATING TO FITNESS; PROVIDING ASSISTANCE, PERSONAL TRAINING AND PHYSICAL FITNESS CONSULTATION TO CORPORATE CLIENTS TO HELP THEIR EMPLOYEES MAKE PHYSICAL FITNESS, STRENGTH, CONDITIONING, AND EXERCISE ALTERATIONS IN THEIR DAILY LIVING; PROVIDING ASSISTANCE, PERSONAL TRAINING AND PHYSICAL FITNESS CONSULTATION TO INDIVIDUALS TO HELP THEM MAKE PHYSICAL FITNESS, STRENGTH, CONDITIONING, AND EXERCISE IMPROVEMENT IN THEIR DAILY LIVING; PROVIDING FITNESS AND EXERCISE FACILITIES (U.S. CLS. 100, 101 AND 107).

FIRST USE 8-10-2012; IN COMMERCE 9-14-2012.

---

4,482,196. BRICKHEADZ, LLC, CHESAPEAKE, VA. SN 85-752,365. PUB. 3-19-2013, FILED 10-12-2012.

## Brickheadz

THE MARK CONSISTS OF STANDARD CHARACTERS WITHOUT CLAIM TO ANY PARTICULAR FONT, STYLE, SIZE, OR COLOR.

FOR EDUCATION SERVICES, NAMELY, PROVIDING CLASSES AND EDUCATIONAL CHILDREN'S PARTIES IN THE FIELD OF CONSTRUCTION TOYS TO PROMOTE, CREATIVITY, CRITICAL THINKING, AND SOCIAL DEVELOPMENT AS WELL AS LESSONS FROM SCIENCE, TECHNOLOGY, ENGINEERING, MATH, LANGUAGE ARTS AND SOCIAL STUDIES (U.S. CLS. 100, 101 AND 107).

FIRST USE 7-22-2011; IN COMMERCE 10-31-2013.

**CLASS 41—(Continued).**

4,482,235. FILMMAKERS UNITED, N. HOLLYWOOD, CA. SN 85-759,287. PUB. 4-9-2013, FILED 10-20-2012.

**THE A-LIST HOLLYWOOD**

THE MARK CONSISTS OF STANDARD CHARACTERS WITHOUT CLAIM TO ANY PARTICULAR FONT, STYLE, SIZE, OR COLOR.

NO CLAIM IS MADE TO THE EXCLUSIVE RIGHT TO USE "HOLLYWOOD", APART FROM THE MARK AS SHOWN.

FOR ORGANIZING AND CONDUCTING AWARDS CEREMONIES THAT HONOR ACHIEVEMENTS AND EXCELLENCE IN ADVERTISING, MARKETING, AND BRANDING (U.S. CLS. 100, 101 AND 107).

FIRST USE 11-15-2013; IN COMMERCE 11-15-2013.

---

4,482,260. FOX INTERNATIONAL CHANNELS (US), INC., LOS ANGELES, CA. SN 85-764,601. PUB. 4-9-2013, FILED 10-26-2012.

**QUIERO UN CAMBIO**

THE MARK CONSISTS OF STANDARD CHARACTERS WITHOUT CLAIM TO ANY PARTICULAR FONT, STYLE, SIZE, OR COLOR.

THE ENGLISH TRANSLATION OF "QUIERO UN CAMBIO" IN THE MARK IS "I WANT A CHANGE".

FOR ENTERTAINMENT SERVICES IN THE NATURE OF A TELEVISION SERIES IN THE REALITY GENRE; PROVIDING ON-LINE INFORMATION IN THE FIELD OF TELEVISION AND VIDEO ENTERTAINMENT FEATURING REALITY TELEVISION SHOWS VIA THE INTERNET; ENTERTAINMENT SERVICES IN THE NATURE OF NON-DOWNLOADABLE VIDEOS AND IMAGES FEATURING TELEVISION SHOWS TRANSMITTED VIA THE INTERNET AND WIRELESS COMMUNICATION NETWORKS (U.S. CLS. 100, 101 AND 107).

FIRST USE 11-4-2013; IN COMMERCE 11-4-2013.

**CLASS 41—(Continued).**

4,482,273. THE EDISON INSTITUTE, DEARBORN, MI. SN 85-767,698. PUB. 4-9-2013, FILED 10-31-2012.

**TAKE IT FORWARD**

THE MARK CONSISTS OF STANDARD CHARACTERS WITHOUT CLAIM TO ANY PARTICULAR FONT, STYLE, SIZE, OR COLOR.

FOR MUSEUM SERVICES; EDUCATIONAL AND ENTERTAINMENT SERVICES, NAMELY, EXHIBITIONS, PRESENTATIONS, DEMONSTRATIONS, PERFORMANCES AND INTERACTIVE ACTIVITIES, ALL IN THE FIELDS OF HISTORY, SCIENCE, TECHNOLOGY, INNOVATION, AND INVENTION (U.S. CLS. 100, 101 AND 107).

FIRST USE 2-4-2013; IN COMMERCE 2-4-2013.

---

4,482,311. TAQEE, MICHAEL M, CHICAGO, IL. SN 85-782,527. PUB. 6-4-2013, FILED 11-19-2012.

**The 111 Black Firefighters  
of Chicago**

THE MARK CONSISTS OF STANDARD CHARACTERS WITHOUT CLAIM TO ANY PARTICULAR FONT, STYLE, SIZE, OR COLOR.

NO CLAIM IS MADE TO THE EXCLUSIVE RIGHT TO USE "BLACK FIREFIGHTERS OF CHICAGO", APART FROM THE MARK AS SHOWN.

FOR CAREER COUNSELING, NAMELY, PROVIDING ADVICE CONCERNING EDUCATION OPTIONS TO PURSUE CAREER OPPORTUNITIES; LIFE COACHING SERVICES IN THE FIELD OF CAREER DEVELOPMENT CHOICES (U.S. CLS. 100, 101 AND 107).

FIRST USE 11-19-2012; IN COMMERCE 11-19-2012.

---

4,482,320. CHAPMAN, WILLIAM GUY, LONG BEACH, NJ. SN 85-785,291. PUB. 6-11-2013, FILED 11-21-2012.



OWNER OF U.S. REG. NO. 3,317,618.  
NO CLAIM IS MADE TO THE EXCLUSIVE RIGHT TO USE "ANGLERS INN", APART FROM THE MARK AS SHOWN.

**CLASS 41—(Continued).**

THE MARK CONSISTS OF THE STYLIZED TEXT "ANGLERS INN" WITH A DESIGN OF A FISHING HOOK.

FOR SPORT FISHING SERVICES, NAMELY, SPORT FISHING GUIDE SERVICES; ORGANIZATION OF SPORT FISHING COMPETITIONS; PROVIDING SPORT FACILITIES; SPORT CAMP SERVICES; FILM PRODUCTION; PRODUCTION OF TELEVISION PROGRAMMES; RENTAL OF SPORTS EQUIPMENT EXCEPT VEHICLES (U.S. CLS. 100, 101 AND 107).

FIRST USE 1-2-2014; IN COMMERCE 1-2-2014.

**CLASS 41—(Continued).**

4,482,322. SASSY SPOON, LLC, CAVE CREEK, AZ. SN 85-786,693. PUB. 7-9-2013, FILED 11-26-2012.

4,482,321. SASSY SPOON, LLC, CAVE CREEK, AZ. SN 85-786,691. PUB. 7-23-2013, FILED 11-26-2012.



NO CLAIM IS MADE TO THE EXCLUSIVE RIGHT TO USE "LIST", APART FROM THE MARK AS SHOWN.

THE COLOR(S) RED AND WHITE IS/ARE CLAIMED AS A FEATURE OF THE MARK.

THE MARK CONSISTS OF THE WORDS "RED LIST" WITH THE LETTER "R" IN THE WORD "RED" APPEARING IN WHITE LETTERING AND ENCOMPASSED BY A RED CIRCLE, WHILE THE OTHER LETTERS APPEAR IN RED LETTERING. A DISPLACED WHITE NOTCH APPEARS ON THE LEFT SIDE OF THE CIRCLE, WITH A RED NOTCH CONNECTING TO THE WHITE NOTCH TO THE LEFT OF THE CIRCLE.

FOR EDUCATIONAL SERVICES, NAMELY, CONDUCTING ONLINE INSTRUCTION IN THE FIELDS OF HEALTHY LIVING THROUGH FOOD AND FITNESS AND DISTRIBUTION OF TRAINING MATERIALS IN CONNECTION THEREWITH; EDUCATIONAL SERVICES, NAMELY, CONDUCTING INSTRUCTION THROUGH NON-DOWNLOADABLE VIDEOS, BLOGS, PUBLICATIONS IN THE NATURE OF ONLINE ARTICLES, AND CONSULTING IN THE FIELD OF HEALTHY LIVING THROUGH FOOD AND FITNESS; EDUCATIONAL SERVICES, NAMELY, PROVIDING ONLINE INSTRUCTION IN THE FIELD OF HEALTHY LIVING THROUGH FOOD AND FITNESS VIA AN ONLINE WEBSITE; ENTERTAINMENT IN THE NATURE OF CREATING AND PRODUCING VIDEOS AND TELEVISION SHOWS IN THE FIELD OF HEALTHY LIVING THROUGH FOOD AND FITNESS; ENTERTAINMENT SERVICES IN THE NATURE OF AN ON-GOING REALITY BASED TELEVISION PROGRAM; ENTERTAINMENT SERVICES, NAMELY, AN ON-GOING SERIES FEATURING HEALTHY LIVING THROUGH FOOD AND FITNESS PROVIDED THROUGH BROADCAST OVER TELEVISION, CABLE, SATELLITE, AUDIO, AND VIDEO MEDIA; INSTRUCTION IN THE FIELD OF HEALTHY LIVING THROUGH FOOD AND FITNESS; PERSONAL COACHING SERVICES IN THE FIELD OF HEALTHY LIVING THROUGH FOOD AND FITNESS; PHYSICAL FITNESS INSTRUCTION; PROVIDING A WEB SITE THAT FEATURES INFORMAL INSTRUCTION ON HEALTHY LIVING THROUGH FOOD AND FITNESS (U.S. CLS. 100, 101 AND 107).

FIRST USE 4-0-2013; IN COMMERCE 4-0-2013.



NO CLAIM IS MADE TO THE EXCLUSIVE RIGHT TO USE "LIST", APART FROM THE MARK AS SHOWN.

THE COLOR(S) GREEN AND WHITE IS/ARE CLAIMED AS A FEATURE OF THE MARK.

THE MARK CONSISTS OF THE WORDS "GREEN LIST" WITH THE LETTER "G" IN THE WORD "GREEN" APPEARING IN WHITE LETTERING AND ENCOMPASSED BY A GREEN CIRCLE, WHILE THE OTHER LETTERS APPEAR IN GREEN LETTERING. A PLUS SYMBOL APPEARS ON THE UPPER LEFT OF THE GREEN CIRCLE, WITH THE RIGHT AND BOTTOM PORTION OF THE SYMBOL APPEARING IN WHITE, WHILE THE TOP AND LEFT OF THE SYMBOL APPEAR IN GREEN.

FOR EDUCATIONAL SERVICES, NAMELY, CONDUCTING ONLINE INSTRUCTION IN THE FIELDS OF HEALTHY LIVING THROUGH FOOD AND FITNESS AND DISTRIBUTION OF TRAINING MATERIALS IN CONNECTION THEREWITH; EDUCATIONAL SERVICES, NAMELY, CONDUCTING INSTRUCTION THROUGH NON-DOWNLOADABLE VIDEOS, BLOGS, PUBLICATIONS IN THE NATURE OF ONLINE ARTICLES, AND CONSULTING IN THE FIELD OF HEALTHY LIVING THROUGH FOOD AND FITNESS; EDUCATIONAL SERVICES, NAMELY, PROVIDING ONLINE INSTRUCTION IN THE FIELD OF HEALTHY LIVING THROUGH FOOD AND FITNESS VIA AN ONLINE WEBSITE; ENTERTAINMENT IN THE NATURE OF CREATING AND PRODUCING VIDEOS AND TELEVISION SHOWS IN THE FIELD OF HEALTHY LIVING THROUGH FOOD AND FITNESS; ENTERTAINMENT SERVICES IN THE NATURE OF AN ON-GOING REALITY BASED TELEVISION PROGRAM; ENTERTAINMENT SERVICES, NAMELY, AN ON-GOING SERIES FEATURING HEALTHY LIVING THROUGH FOOD AND FITNESS PROVIDED THROUGH BROADCAST OVER TELEVISION, CABLE, SATELLITE, AUDIO, AND VIDEO MEDIA; INSTRUCTION IN THE FIELD OF HEALTHY LIVING THROUGH FOOD AND FITNESS; PERSONAL COACHING SERVICES IN THE FIELD OF HEALTHY LIVING THROUGH FOOD AND FITNESS; PHYSICAL FITNESS INSTRUCTION; PROVIDING A WEB SITE THAT FEATURES INFORMAL INSTRUCTION ON HEALTHY LIVING THROUGH FOOD AND FITNESS (U.S. CLS. 100, 101 AND 107).

FIRST USE 4-0-2013; IN COMMERCE 4-0-2013.

**CLASS 41—(Continued).**

4,482,365. LEE, JEEHO, VIRGINIA BEACH, VA. SN 85-800,863. PUB. 5-14-2013, FILED 12-12-2012.



THE COLOR(S) BLACK, YELLOW, AND SILVER IS/ARE CLAIMED AS A FEATURE OF THE MARK.

THE MARK CONSISTS OF THE STYLIZED WORDING "JOONBI" IN YELLOW WITH SILVER AND BLACK OUTLINING WITH A BLACK AND YELLOW MORTARBOARD HAT OVER TOP OF THE LETTERS "OO" AND A BLACK TIE BETWEEN THE "OO".

THE ENGLISH TRANSLATION OF THE WORD "JOONBI" IN THE MARK IS "READY".

FOR EDUCATION SERVICES, NAMELY, TRAINING PEOPLE HOW TO IMPROVE THEIR BODY, MIND AND SPIRIT (U.S. CLS. 100, 101 AND 107).

FIRST USE 4-1-2013; IN COMMERCE 4-1-2013.

4,482,420. COUNTRY MUSIC TELEVISION, INC., NEW YORK, NY. SN 85-821,503. PUB. 6-4-2013, FILED 1-11-2013.

**SWAMP PAWN**

THE MARK CONSISTS OF STANDARD CHARACTERS WITHOUT CLAIM TO ANY PARTICULAR FONT, STYLE, SIZE, OR COLOR.

NO CLAIM IS MADE TO THE EXCLUSIVE RIGHT TO USE "PAWN", APART FROM THE MARK AS SHOWN.

FOR ENTERTAINMENT SERVICES IN THE NATURE OF CONTINUING PROGRAM SERIES, FEATURING LIVE ACTION, COMEDY AND DRAMA PROVIDED THROUGH CABLE TELEVISION, BROADCAST TELEVISION, INTERNET, VIDEO-ON-DEMAND, AND THROUGH OTHER FORMS OF TRANSMISSION MEDIA; PROVIDING ONLINE INFORMATION IN THE FIELD OF ENTERTAINMENT CONCERNING TELEVISION PROGRAMS (U.S. CLS. 100, 101 AND 107).

FIRST USE 1-27-2013; IN COMMERCE 1-27-2013.

**CLASS 41—(Continued).**

4,482,423. GRUCHIK, SEAN, LONG BEACH, NY. SN 85-821,887. PUB. 6-11-2013, FILED 1-12-2013.

**HUSTLE LOGIC**

THE MARK CONSISTS OF STANDARD CHARACTERS WITHOUT CLAIM TO ANY PARTICULAR FONT, STYLE, SIZE, OR COLOR.

FOR PROVIDING A WEBSITE FOR ENTERTAINMENT AND EDUCATION PURPOSES FEATURING PHOTOS AND QUOTATIONS ABOUT HUMAN NATURE, LIFE SITUATIONS, AND SELF-IMPROVEMENT (U.S. CLS. 100, 101 AND 107).

FIRST USE 4-9-2013; IN COMMERCE 4-9-2013.

4,482,430. ELLIS, KAREN, COSTA MESA, CA. SN 85-823,564. PUB. 6-25-2013, FILED 1-15-2013.

**PILATES NERD**

THE MARK CONSISTS OF STANDARD CHARACTERS WITHOUT CLAIM TO ANY PARTICULAR FONT, STYLE, SIZE, OR COLOR.

NO CLAIM IS MADE TO THE EXCLUSIVE RIGHT TO USE "PILATES", APART FROM THE MARK AS SHOWN.

FOR INTERACTIVE ONLINE WEB JOURNALS FEATURING COMMENTARY AND INFORMATION ON PILATES EXERCISE AND FITNESS; ON-LINE JOURNALS, NAMELY, BLOGS FEATURING COMMENTARY AND INFORMATION ON PILATES EXERCISE AND FITNESS; PROVIDING ON-LINE NEWSLETTERS FEATURING PILATES EXERCISE AND FITNESS (U.S. CLS. 100, 101 AND 107).

FIRST USE 1-15-2013; IN COMMERCE 8-16-2013.

**CLASS 41—(Continued).**

4,482,450. SASSY SPOON, LLC, CAVE CREEK, AZ. SN 85-832,665. PUB. 6-18-2013, FILED 1-25-2013.

# Jen-ify

THE MARK CONSISTS OF STANDARD CHARACTERS WITHOUT CLAIM TO ANY PARTICULAR FONT, STYLE, SIZE, OR COLOR.

FOR EDUCATIONAL SERVICES, NAMELY, CONDUCTING ONLINE INSTRUCTION IN THE FIELDS OF HEALTHY LIVING THROUGH FOOD AND FITNESS AND DISTRIBUTION OF TRAINING MATERIALS IN CONNECTION THEREWITH; EDUCATIONAL SERVICES, NAMELY, CONDUCTING INSTRUCTION THROUGH VIDEOS, BLOGS, PUBLICATIONS, AND CONSULTING IN THE FIELD OF HEALTHY LIVING THROUGH FOOD AND FITNESS; EDUCATIONAL SERVICES, NAMELY, PROVIDING ONLINE INSTRUCTION IN THE FIELD OF HEALTHY LIVING THROUGH FOOD AND FITNESS VIA AN ONLINE WEBSITE; ENTERTAINMENT IN THE NATURE OF CREATING AND PRODUCING VIDEOS AND TELEVISION SHOWS IN THE FIELD OF HEALTHY LIVING THROUGH FOOD AND FITNESS; ENTERTAINMENT SERVICES IN THE NATURE OF AN ON-GOING REALITY BASED TELEVISION PROGRAM; ENTERTAINMENT SERVICES, NAMELY, AN ON-GOING SERIES FEATURING HEALTHY LIVING THROUGH FOOD AND FITNESS PROVIDED THROUGH BROADCAST OVER TELEVISION, CABLE, SATELLITE, AUDIO, AND VIDEO MEDIA; INSTRUCTION IN THE FIELD OF HEALTHY LIVING THROUGH FOOD AND FITNESS; PERSONAL COACHING SERVICES IN THE FIELD OF HEALTHY LIVING THROUGH FOOD AND FITNESS; PHYSICAL FITNESS INSTRUCTION; PROVIDING A WEB SITE THAT FEATURES INFORMAL INSTRUCTION ON HEALTHY LIVING THROUGH FOOD AND FITNESS (U.S. CLS. 100, 101 AND 107).  
FIRST USE 4-0-2013; IN COMMERCE 4-0-2013.

4,482,463. MOVE2SAFETY, LLC, ALEXANDRIA, VA. SN 85-841,703. PUB. 6-25-2013, FILED 2-5-2013.

# Move2Safety

THE MARK CONSISTS OF STANDARD CHARACTERS WITHOUT CLAIM TO ANY PARTICULAR FONT, STYLE, SIZE, OR COLOR.

FOR EDUCATIONAL SERVICES, NAMELY, CONDUCTING CLASSES, SEMINARS, CONFERENCES, AND WORKSHOPS IN THE FIELD OF EMERGENCY PREPARATION AND DISTRIBUTION OF EDUCATIONAL MATERIALS IN CONNECTION THEREWITH (U.S. CLS. 100, 101 AND 107).  
FIRST USE 2-10-2013; IN COMMERCE 3-12-2013.

**CLASS 41—(Continued).**

4,482,495. MOVE2SAFETY, LLC, ALEXANDRIA, VA. SN 85-851,937. PUB. 6-25-2013, FILED 2-16-2013.



THE MARK CONSISTS OF DESIGN OF A SHIELD CONTAINING AN EIGHT-POINT COMPASS ON THE FACE OF THE SHIELD AND AN EAGLE PERCHED ATOP OF THE SHIELD.

FOR EDUCATIONAL SERVICES, NAMELY, CONDUCTING CLASSES, SEMINARS, CONFERENCES, AND WORKSHOPS IN THE FIELD OF EMERGENCY PREPARATION AND DISTRIBUTION OF EDUCATIONAL MATERIALS IN CONNECTION THEREWITH (U.S. CLS. 100, 101 AND 107).

FIRST USE 2-10-2013; IN COMMERCE 3-12-2013.

4,482,506. VIACOM INTERNATIONAL INC., NEW YORK, NY. SN 85-855,929. PUB. 6-25-2013, FILED 2-21-2013.

# TEENNICK TOP 10

THE MARK CONSISTS OF STANDARD CHARACTERS WITHOUT CLAIM TO ANY PARTICULAR FONT, STYLE, SIZE, OR COLOR.

OWNER OF U.S. REG. NOS. 3,911,883, 3,914,951, AND 3,914,952.

NO CLAIM IS MADE TO THE EXCLUSIVE RIGHT TO USE "TOP 10", APART FROM THE MARK AS SHOWN.

FOR ENTERTAINMENT SERVICES IN THE NATURE OF CONTINUING PROGRAM SERIES, FEATURING LIVE ACTION, COMEDY AND DRAMA PROVIDED THROUGH CABLE TELEVISION, BROADCAST TELEVISION, INTERNET, VIDEO-ON-DEMAND, AND THROUGH OTHER FORMS OF TRANSMISSION MEDIA; PROVIDING ONLINE INFORMATION IN THE FIELD OF ENTERTAINMENT CONCERNING TELEVISION PROGRAMS (U.S. CLS. 100, 101 AND 107).  
FIRST USE 12-31-2012; IN COMMERCE 12-31-2012.

**CLASS 41—(Continued).**

4,482,538. TSG DEVELOPMENTS INVESTMENTS, INC., AURORA, ONTARIO, CANADA. SN 85-867,718. PUB. 5-7-2013, FILED 3-5-2013.



NO CLAIM IS MADE TO THE EXCLUSIVE RIGHT TO USE "PAGEANT", APART FROM THE MARK AS SHOWN.

THE MARK CONSISTS OF THE IMAGE OF A TIARA WITH A HORSE APPEARING ON THE FRONT, BELOW WHICH ARE THE WORDS "MS. RACING QUEEN PAGEANT", BELOW WHICH IS THE DEPICTION OF A WOMAN, ALL SURROUNDED BY A CIRCULAR ROW OF STARS.

FOR ENTERTAINMENT IN THE NATURE OF BEAUTY PAGEANTS (U.S. CLS. 100, 101 AND 107).  
FIRST USE 3-0-2013; IN COMMERCE 3-0-2013.

4,482,560. CASAMIA EVENTS INC., BRONX, NY. SN 85-876,344. PUB. 9-3-2013, FILED 3-14-2013.



NO CLAIM IS MADE TO THE EXCLUSIVE RIGHT TO USE "EVENTS", APART FROM THE MARK AS SHOWN.

THE COLOR(S) WHITE, SILVER, BLUE AND LIGHT BLUE IS/ARE CLAIMED AS A FEATURE OF THE MARK.

THE MARK CONSISTS OF THE STYLIZED WORDING "CASAMIA" IN WHITE ABOVE THE STYLIZED WORDING "EVENTS" IN WHITE ON A BLUE BACKGROUND. THE DOT OF THE "I" IN "MIA" IS THE DESIGN AN EIGHT POINTED STAR IN WHITE. BELOW ALL OF THE WORDING IS THE DESIGN OF A WHITE BOTTLE WITH SILVER LABELS CONTAINING THE STYLIZED LETTERS "CM" IN BLUE. THE DESIGN OF VARIOUS SWIRLS, FLOWERS, LEAVES, ASTROLOGICAL BODIES, MUSICAL INSTRUMENTS AND MUSIC NOTES EMERGE FROM THE TOP OF THE BOTTLE IN WHITE AND LIGHT BLUE. THE COLOR BLUE APPEARS IN THE BACKGROUND RECTANGLE CONTAINING ALL ELEMENTS OF THE MARK.

**CLASS 41—(Continued).**

THE ENGLISH TRANSLATION OF "CASA MIA" IN THE MARK IS "MY HOUSE".

FOR PARTY PLANNING; SPECIAL EVENT PLANNING FOR SOCIAL ENTERTAINMENT PURPOSES (U.S. CLS. 100, 101 AND 107).

FIRST USE 6-1-2013; IN COMMERCE 6-1-2013.

4,482,572. BLUE SHELL GAMES LLC, SAN FRANCISCO, CA. SN 85-879,128. PUB. 8-20-2013, FILED 3-18-2013.

# LUCKY BINGO

THE MARK CONSISTS OF STANDARD CHARACTERS WITHOUT CLAIM TO ANY PARTICULAR FONT, STYLE, SIZE, OR COLOR.

NO CLAIM IS MADE TO THE EXCLUSIVE RIGHT TO USE "BINGO", APART FROM THE MARK AS SHOWN.

FOR ELECTRONIC GAMES SERVICES PROVIDED BY MEANS OF THE INTERNET (U.S. CLS. 100, 101 AND 107).

FIRST USE 4-4-2013; IN COMMERCE 4-4-2013.

4,482,582. FAMILY FORWARD, LLC, DRAPER, UT. SN 85-881,970. PUB. 8-27-2013, FILED 3-20-2013.

# FAMILY FORWARD

THE MARK CONSISTS OF STANDARD CHARACTERS WITHOUT CLAIM TO ANY PARTICULAR FONT, STYLE, SIZE, OR COLOR.

NO CLAIM IS MADE TO THE EXCLUSIVE RIGHT TO USE "FAMILY", APART FROM THE MARK AS SHOWN.

FOR EDUCATIONAL AND ENTERTAINMENT SERVICES, NAMELY, PROVIDING MOTIVATIONAL AND EDUCATIONAL SPEAKERS IN THE FIELD OF FAMILY IMPROVEMENT; EDUCATIONAL AND ENTERTAINMENT SERVICES, NAMELY, ORGANIZING AND CONDUCTING ONLINE SEMINARS AND WORKSHOPS IN THE FIELD OF FAMILY RELATIONS, PARENTHOOD AND FAMILY RECREATION; EDUCATIONAL AND ENTERTAINMENT SERVICES, NAMELY, ORGANIZING AND CONDUCTING LIVE AND ONLINE SEMINARS AND WORKSHOPS IN THE FIELD OF LEARNING TO USE TECHNOLOGY AND SOCIAL MEDIA; PROVIDING ONLINE EDUCATIONAL INFORMATION FOR CLASSES AND SEMINARS OF INSTRUCTION ALL IN THE FIELD OF STRENGTHENING FAMILY RELATIONSHIPS (U.S. CLS. 100, 101 AND 107).  
FIRST USE 8-1-2013; IN COMMERCE 8-1-2013.

**CLASS 41—(Continued).**

4,482,589. PINKALICIOUS DIVAS, INC., GILROY, CA. SN 85-884,819. PUB. 9-10-2013, FILED 3-24-2013.

**PINKALICIOUS DIVAS**

THE MARK CONSISTS OF STANDARD CHARACTERS WITHOUT CLAIM TO ANY PARTICULAR FONT, STYLE, SIZE, OR COLOR.

FOR EDUCATIONAL SERVICES, NAMELY, PROVIDING SEMINARS TO BREAST CANCER PATIENTS AND FAMILY MEMBERS IN THE FIELD OF BREAST CANCER, INCLUDING BUT NOT LIMITED TO INFORMATION REGARDING PROPER WIG FITTING, COSMETIC APPLICATION, AND DIETARY NEEDS OF CHEMOTHERAPY PATIENTS, AND FEATURING GUEST SPEAKERS FROM LOCAL BREAST CANCER CENTERS (U.S. CLS. 100, 101 AND 107).

FIRST USE 10-1-2012; IN COMMERCE 10-1-2012.

4,482,593. SK ENTERTAINMENT, INC., CHICAGO, IL. SN 85-886,068. PUB. 9-3-2013, FILED 3-25-2013.

**Mr. Man**

THE MARK CONSISTS OF STANDARD CHARACTERS WITHOUT CLAIM TO ANY PARTICULAR FONT, STYLE, SIZE, OR COLOR.

FOR ENTERTAINMENT SERVICES, NAMELY, PROVIDING ONLINE REVIEWS OF SEX-RELATED CONTENT IN MOTION PICTURES AND VIDEO PROGRAMMING (U.S. CLS. 100, 101 AND 107).

FIRST USE 7-15-2013; IN COMMERCE 9-15-2013.

4,482,604. ENCORE ENTERTAINMENT, LLC, AKA ENCORE L'AMORE EVENTS, NEWARK, OH. SN 85-890,277. PUB. 8-27-2013, FILED 3-29-2013.

**ENCORE L'AMORE EVENTS**

THE MARK CONSISTS OF STANDARD CHARACTERS WITHOUT CLAIM TO ANY PARTICULAR FONT, STYLE, SIZE, OR COLOR.

NO CLAIM IS MADE TO THE EXCLUSIVE RIGHT TO USE "EVENTS", APART FROM THE MARK AS SHOWN.

**CLASS 41—(Continued).**

THE ENGLISH TRANSLATION OF THE WORD "L'AMORE" IN THE MARK IS "LOVE".

FOR DISC JOCKEY SERVICES; RENTAL OF PORTABLE PHOTOGRAPHY AND/OR VIDEOGRAPHY BOOTHS FOR TAKING OF PICTURES AND VIDEOS (U.S. CLS. 100, 101 AND 107).

FIRST USE 7-1-2013; IN COMMERCE 7-1-2013.

4,482,609. VERIA INTERNATIONAL LIMITED, HAMILTON HM 12, BERMUDA. SN 85-891,915. PUB. 6-4-2013, FILED 4-1-2013.

**BOLLYBLAST**

THE MARK CONSISTS OF STANDARD CHARACTERS WITHOUT CLAIM TO ANY PARTICULAR FONT, STYLE, SIZE, OR COLOR.

FOR ENTERTAINMENT SERVICES, NAMELY, AN ON-GOING TELEVISION SERIES IN THE FIELD OF EXERCISE AND FITNESS (U.S. CLS. 100, 101 AND 107).

FIRST USE 9-21-2013; IN COMMERCE 9-21-2013.

4,482,664. LIVE NATION WORLDWIDE, INC., BEVERLY HILLS, CA. SN 85-941,169. PUB. 7-30-2013, FILED 5-23-2013.

**YESTIVAL**

THE MARK CONSISTS OF STANDARD CHARACTERS WITHOUT CLAIM TO ANY PARTICULAR FONT, STYLE, SIZE, OR COLOR.

FOR ENTERTAINMENT SERVICES IN THE NATURE OF A LIVE MUSIC FESTIVAL (U.S. CLS. 100, 101 AND 107).

FIRST USE 6-3-2013; IN COMMERCE 6-3-2013.

**CLASS 41—(Continued).**

4,482,665. TURNER BROADCASTING SYSTEM, INC., ATLANTA, GA. SN 85-966,175. PUB. 8-27-2013, FILED 6-21-2013.

**WHO THE HEALTH KNOWS**

THE MARK CONSISTS OF STANDARD CHARACTERS WITHOUT CLAIM TO ANY PARTICULAR FONT, STYLE, SIZE, OR COLOR.

FOR ENTERTAINMENT SERVICES, NAMELY, A MULTIMEDIA PROGRAM SERIES IN THE FIELD OF NEWS, DIET, NUTRITION, HEALTH AND WELLNESS DISTRIBUTED VIA VARIOUS PLATFORMS ACROSS MULTIPLE FORMS OF TRANSMISSION MEDIA (U.S. CLS. 100, 101 AND 107).

FIRST USE 8-19-2013; IN COMMERCE 8-19-2013.

4,482,667. SUSTAINABLE APPAREL COALITION, SAN FRANCISCO, CA. SN 85-978,176. PUB. 3-12-2013, FILED 7-23-2012.

**Higg Index**

THE MARK CONSISTS OF STANDARD CHARACTERS WITHOUT CLAIM TO ANY PARTICULAR FONT, STYLE, SIZE, OR COLOR.

NO CLAIM IS MADE TO THE EXCLUSIVE RIGHT TO USE "INDEX", APART FROM THE MARK AS SHOWN.

FOR VOCATIONAL EDUCATION IN THE FIELD OF SUSTAINABLE PRODUCT MANUFACTURING; TRAINING IN THE FIELD OF SUSTAINABLE PRODUCT MANUFACTURING (U.S. CLS. 100, 101 AND 107).

FIRST USE 7-26-2012; IN COMMERCE 7-26-2012.

4,482,677. DEMAND MEDIA, INC., SANTA MONICA, CA. SN 85-980,463. PUB. 2-5-2013, FILED 6-28-2012.

**AIRCRAFT**

THE MARK CONSISTS OF STANDARD CHARACTERS WITHOUT CLAIM TO ANY PARTICULAR FONT, STYLE, SIZE, OR COLOR.

FOR EDUCATIONAL AND ENTERTAINMENT SERVICES, NAMELY, PROVIDING ONLINE VIDEO WORKSHOPS IN THE FIELDS OF ARTS AND CRAFTS IN THE CATEGORIES OF KNITTING, NEEDLE ARTS, CROCHET, JEWELRY, SEWING, AND STAMPING; PROVIDING A WEBSITE FEATURING NON-DOWNLOADABLE VIDEOS IN THE FIELDS OF ARTS AND CRAFTS IN THE CATEGORIES OF KNITTING, NEEDLE ARTS, CROCHET, JEWELRY, SEWING AND STAMPING (U.S. CLS. 100, 101 AND 107).

FIRST USE 8-21-2013; IN COMMERCE 8-21-2013.

**CLASS 41—(Continued).**

4,482,693. DISNEY ENTERPRISES, INC., BURBANK, CA. SN 85-980,803. PUB. 3-12-2013, FILED 6-13-2011.

**WRECK-IT RALPH**

THE MARK CONSISTS OF STANDARD CHARACTERS WITHOUT CLAIM TO ANY PARTICULAR FONT, STYLE, SIZE, OR COLOR.

FOR DISTRIBUTION OF MOTION PICTURE FILMS; PRESENTATION OF SOUND AND VISUAL RECORDINGS; PROVISION OF ENTERTAINMENT, NEWS, AND ENTERTAINMENT INFORMATION VIA COMMUNICATION AND COMPUTER NETWORKS; ENTERTAINER SERVICES, NAMELY, LIVE APPEARANCES BY A PROFESSIONAL ENTERTAINER (U.S. CLS. 100, 101 AND 107).

FIRST USE 11-2-2012; IN COMMERCE 11-2-2012.

**CLASS 42—SCIENTIFIC AND COMPUTER SERVICES**

4,481,451. WIZPERT, INC., NEW YORK, NY. SN 85-194,946. PUB. 5-3-2011, FILED 12-10-2010.

**WIZPERT**

THE MARK CONSISTS OF STANDARD CHARACTERS WITHOUT CLAIM TO ANY PARTICULAR FONT, STYLE, SIZE, OR COLOR.

FOR PROVIDING A WEB SITE FEATURING TEMPORARY USE OF NON-DOWNLOADABLE SOFTWARE THAT MATCHES BUYERS, SELLERS, PROVIDERS, AND RECIPIENTS OF PERSONAL AND BUSINESS SERVICES, AND WHICH ENABLES USERS TO BUY, SELL, PROVIDE, RECEIVE, AND EXCHANGE PERSONAL AND BUSINESS SERVICES (U.S. CLS. 100 AND 101).

FIRST USE 4-0-2011; IN COMMERCE 4-0-2011.

4,481,501. RENGOLUTION, INC., PLYMOUTH, MN. SN 85-331,259. PUB. 4-17-2012, FILED 5-26-2011.

**Rengolution**

THE MARK CONSISTS OF STANDARD CHARACTERS WITHOUT CLAIM TO ANY PARTICULAR FONT, STYLE, SIZE, OR COLOR.

FOR DESIGN AND DEVELOPMENT OF COMPUTER HARDWARE AND SOFTWARE (U.S. CLS. 100 AND 101).

FIRST USE 1-0-2002; IN COMMERCE 1-0-2002.



**CLASS 42—(Continued).**

4,481,572. CAR FLIPPING, LLC, DENVER, CO. SN 85-440,820. PUB. 4-17-2012, FILED 10-6-2011.



NO CLAIM IS MADE TO THE EXCLUSIVE RIGHT TO USE "CARFLIPPING" AND ".COM", APART FROM THE MARK AS SHOWN.

THE MARK CONSISTS OF THE STYLIZED WORDS "CARFLIPPING.COM" WITH THE ARTISTIC RENDERING OF A CAR APPEARING ABOVE THE AFOREMENTIONED WORDS.

FOR COMPUTER SERVICES, NAMELY, CREATING AN ON-LINE COMMUNITY FOR REGISTERED USERS TO PARTICIPATE IN DISCUSSIONS, GET FEEDBACK FROM THEIR PEERS, FORM VIRTUAL COMMUNITIES, AND ENGAGE IN SOCIAL NETWORKING SERVICES IN THE FIELD OF CARS AND AUTOMOBILES; PROVIDING A WEBSITE FEATURING ON-LINE NON-DOWNLOADABLE SOFTWARE THAT ENABLES USERS TO POST A LISTING TO SELL A CAR AND SEARCH FOR CARS FOR SALE (U.S. CLS. 100 AND 101).

FIRST USE 12-5-2013; IN COMMERCE 12-5-2013.

**CLASS 42—(Continued).**

4,481,605. VINELOOP, LLC, MOORESTOWN, NJ. SN 85-473,062. PUB. 5-8-2012, FILED 11-15-2011.

**3 Degrees of Recommendation**

THE MARK CONSISTS OF STANDARD CHARACTERS WITHOUT CLAIM TO ANY PARTICULAR FONT, STYLE, SIZE, OR COLOR.

FOR APPLICATION SERVICE PROVIDER (ASP), NAMELY, HOSTING COMPUTER SOFTWARE APPLICATIONS OF OTHERS; PLATFORM AS A SERVICE (PAAS) FEATURING COMPUTER SOFTWARE PLATFORMS FOR NETWORKING SOCIAL NETWORK USERS; PLATFORM AS A SERVICE (PAAS) FEATURING COMPUTER SOFTWARE PLATFORMS FOR NETWORKING SOCIAL NETWORK USERS WITH COMMON INTERESTS; PLATFORM AS A SERVICE (PAAS) FEATURING COMPUTER SOFTWARE PLATFORMS FOR NETWORKING SOCIAL NETWORK USERS WITH COMMON INTERESTS TO SHARE USER GENERATED CONTENT; PLATFORM AS A SERVICE (PAAS) FEATURING COMPUTER SOFTWARE PLATFORMS FOR SOCIAL NETWORK USERS TO RATE, RANK AND REVIEW GOODS AND SERVICES ADVERTISED ON THE INTERNET; PLATFORM AS A SERVICE (PAAS) FEATURING COMPUTER SOFTWARE PLATFORMS FOR SOCIAL NETWORK USERS TO RATE, RANK AND REVIEW GOODS AND SERVICES ADVERTISED ON THE INTERNET, FOR NETWORKING SOCIAL NETWORK USERS, AND FOR ALLOWING SOCIAL NETWORKING USERS TO SEARCH AND SHARE USER GENERATED CONTENT (U.S. CLS. 100 AND 101).

FIRST USE 12-1-2013; IN COMMERCE 12-1-2013.

4,481,580. PERRY, CINDY, VERNAL, UT. SN 85-449,961. PUB. 3-27-2012, FILED 10-18-2011.



THE MARK CONSISTS OF THE WORDS "MEMORY" AND "MARK" SEPARATED BY AN IMAGE OF A PERSON WITH HANDPRINTS ABOVE THE PERSON'S OUT-STRETCHED HANDS.

FOR PROVIDING A SECURED-ACCESS WEBSITE THAT GIVES MEMBERS THE ABILITY TO ORGANIZE, STORE AND RETRIEVE PERSONAL INFORMATION (U.S. CLS. 100 AND 101).

FIRST USE 11-20-2013; IN COMMERCE 11-20-2013.

4,481,632. RADON PROTECTION SPECIALISTS, INC., BURR RIDGE, IL 60527, IL. SN 85-492,019. PUB. 5-15-2012, FILED 12-9-2011.

**LOVE THE LUNGS YOU'RE WITH**

THE MARK CONSISTS OF STANDARD CHARACTERS WITHOUT CLAIM TO ANY PARTICULAR FONT, STYLE, SIZE, OR COLOR.

FOR RADON DETECTING AND TECHNICAL AIR QUALITY MONITORING SERVICES (U.S. CLS. 100 AND 101).

FIRST USE 6-1-2012; IN COMMERCE 6-1-2012.

**CLASS 42—(Continued).**

4,481,642. PHYSICIANS LAB, INC, BOCA RATON, FL. SN 85-509,663. PUB. 10-9-2012, FILED 1-5-2012.

**STATE-OF-THE-ART SCIENCE.  
SUPERIOR SOLUTIONS.**

THE MARK CONSISTS OF STANDARD CHARACTERS WITHOUT CLAIM TO ANY PARTICULAR FONT, STYLE, SIZE, OR COLOR.

NO CLAIM IS MADE TO THE EXCLUSIVE RIGHT TO USE "STATE-OF-THE-ART-SCIENCE", APART FROM THE MARK AS SHOWN.

FOR MEDICAL LABORATORY SERVICES (U.S. CLS. 100 AND 101).

FIRST USE 9-16-2013; IN COMMERCE 9-16-2013.

4,481,644. PIXELATED BITS, LLC, MONROE, NC. SN 85-511,125. PUB. 1-29-2013, FILED 1-7-2012.



THE MARK CONSISTS OF THE WORDS "SHARE YOUR VIBES" WITH THE "O" IN "YOUR" CONTAINING A FIVE-POINTED STAR. THE STEM OF THE LETTER "B" IN "VIBES" IS DEPICTED AS THE NECK OF A GUITAR. THE "I" IN "VIBES" IS INVERTED. THE WORD "SHARE" APPEARS HORIZONTALLY ON THE HEADSTOCK OF THE GUITAR.

FOR FILE SHARING SERVICES, NAMELY, PROVIDING A WEBSITE FEATURING TECHNOLOGY THAT ALLOWS SUBSCRIBERS TO POST UPLOADED NOSTALGIC MUSIC MEMORIES OR OTHER PORTRAYALS OF MUSIC SENTIMENTS TO THE INTERNET FOR OTHERS (U.S. CLS. 100 AND 101).

FIRST USE 12-28-2011; IN COMMERCE 2-7-2013.

4,481,671. CLOUDNCO, INC., SAN FRANCISCO, CA. SN 85-540,252. PUB. 10-16-2012, FILED 2-11-2012.

**Next User**

THE MARK CONSISTS OF STANDARD CHARACTERS WITHOUT CLAIM TO ANY PARTICULAR FONT, STYLE, SIZE, OR COLOR.

**CLASS 42—(Continued).**

NO CLAIM IS MADE TO THE EXCLUSIVE RIGHT TO USE "USER", APART FROM THE MARK AS SHOWN.

FOR CONSULTING SERVICES IN THE FIELD OF SOFTWARE AS A SERVICE (SAAS); SOFTWARE AS A SERVICE (SAAS) SERVICES FEATURING SOFTWARE FOR ONLINE SUBSCRIPTION MANAGEMENT; SOFTWARE AS A SERVICE (SAAS) SERVICES FEATURING SOFTWARE IN THE FIELD OF ONLINE SUBSCRIPTION BILLING; SOFTWARE AS A SERVICE (SAAS) SERVICES, NAMELY, HOSTING SOFTWARE FOR USE BY OTHERS FOR USE IN SELLING SUBSCRIPTION ONLINE (U.S. CLS. 100 AND 101).

FIRST USE 12-12-2012; IN COMMERCE 4-2-2013.

4,481,705. CUSTOMER EXPERIENCE PARTNERS, LLC, DARIEN, CT. SN 85-572,069. PUB. 10-16-2012, FILED 3-16-2012.

**BlogDog**

THE MARK CONSISTS OF STANDARD CHARACTERS WITHOUT CLAIM TO ANY PARTICULAR FONT, STYLE, SIZE, OR COLOR.

FOR HOSTING AN ONLINE WEBSITE FEATURING SEARCH AND PROBE OF ON-LINE POSTS, NAMELY, CONDUCTING A SEARCH RELATING TO COMPLIANCE WITH LEGAL MANDATE OF ON-LINE POSTS (U.S. CLS. 100 AND 101).

FIRST USE 8-8-2004; IN COMMERCE 11-11-2012.

4,481,860. CLIQR TECHNOLOGIES, INC., SUNNYVALE, CA. SN 85-658,496. PUB. 11-27-2012, FILED 6-21-2012.

**CLIQR TECHNOLOGIES**

THE MARK CONSISTS OF STANDARD CHARACTERS WITHOUT CLAIM TO ANY PARTICULAR FONT, STYLE, SIZE, OR COLOR.

NO CLAIM IS MADE TO THE EXCLUSIVE RIGHT TO USE "TECHNOLOGIES", APART FROM THE MARK AS SHOWN.

FOR PLATFORM AS A SERVICE (PAAS) FEATURING COMPUTER SOFTWARE PLATFORMS FOR CLOUD COMPUTING; COMPUTER SERVICES, NAMELY, INTEGRATION OF PRIVATE AND PUBLIC CLOUD COMPUTING ENVIRONMENTS; CONSULTING SERVICES IN THE FIELD OF CLOUD COMPUTING; PROVIDING VIRTUAL COMPUTER SYSTEMS AND VIRTUAL COMPUTER ENVIRONMENTS THROUGH CLOUD COMPUTING; TECHNICAL CONSULTING SERVICES IN THE FIELDS OF DATA CENTER ARCHITECTURE, PUBLIC AND PRIVATE CLOUD COMPUTING SOLUTIONS, AND EVALUATION AND IMPLEMENTATION OF INTERNET TECHNOLOGY AND SERVICES; CLOUD COMPUTING FEATURING SOFTWARE FOR USE IN ON-BOARDING SOFTWARE APPLICATIONS TO CLOUD INFRASTRUCTURES AND EXECUTION MANAGEMENT OF APPLICATIONS WITHIN THE CLOUD (U.S. CLS. 100 AND 101).

FIRST USE 6-26-2012; IN COMMERCE 6-26-2012.

**CLASS 42—(Continued).**

4,481,931. PIC ME FIRST, ROYERSFORD, PA. SN 85-695,629.  
PUB. 3-5-2013, FILED 8-5-2012.

## PIC ME FIRST

THE MARK CONSISTS OF STANDARD CHARACTERS WITHOUT CLAIM TO ANY PARTICULAR FONT, STYLE, SIZE, OR COLOR.

FOR PROVIDING A MEMBERS-ONLY WEBSITE FEATURING TECHNOLOGY WHICH PROVIDES MEMBERS WITH THE ABILITY TO SUBMIT, UPLOAD, OR GRANT ACCESS TO VIEW PHOTOGRAPHS; PROVIDING A WEB SITE FEATURING TECHNOLOGY THAT ENABLES USERS TO VIEW PHOTOGRAPHS OF OTHERS WITH THE INTENDED PURPOSE OF PROVIDING A RANKING AND / OR CRITIQUE OF THE PHOTOGRAPHS; PROVIDING A WEBSITE FEATURING NON-DOWNLOADABLE SOFTWARE THAT ALLOWS A PEER USER TO VIEW ONE OR MORE SETS OF PHOTOGRAPHS OF A USER, PROVIDE CRITIQUES OR RANKINGS OF THE PHOTOGRAPHS, ALLOWS ACCESS TO PHOTOGRAPHS FOR THE PURPOSE OF DIGITAL EDITING OR ENHANCEMENT AND ALLOWS USERS TO ACCESS, COPY, OR SHARE ONE OR MORE DIGITALLY ENHANCED PHOTOGRAPHS WITH A SOCIAL MEDIA SITE; PROVIDING A WEBSITE FEATURING ON-LINE NON-DOWNLOADABLE SOFTWARE THAT ENABLES USERS TO UPLOAD AND/OR VIEW PHOTOGRAPHS; PROVIDING A WEBSITE FEATURING TECHNOLOGY THAT ENABLES USERS TO VIEW SETS OF PHOTOGRAPHS OF OTHERS; PROVIDING A WEBSITE THAT GIVES COMPUTER USERS THE ABILITY TO ACCESS PHOTOGRAPHS AND GRANT ACCESS TO PHOTOGRAPHS; PROVIDING AN INTERACTIVE WEBSITE FEATURING TECHNOLOGY THAT ALLOWS USERS TO PROVIDE OTHER USERS WITH A RANKING AND/OR CRITIQUE OF PHOTOGRAPHS (U.S. CLS. 100 AND 101).

FIRST USE 8-12-2012; IN COMMERCE 8-12-2012.

4,481,946. ZENPAYROLL, INC., SAN FRANCISCO, CA. SN 85-701,158. PUB. 3-5-2013, FILED 8-10-2012.

## DELIGHTFUL PAYROLL

THE MARK CONSISTS OF STANDARD CHARACTERS WITHOUT CLAIM TO ANY PARTICULAR FONT, STYLE, SIZE, OR COLOR.

**CLASS 42—(Continued).**

NO CLAIM IS MADE TO THE EXCLUSIVE RIGHT TO USE "PAYROLL", APART FROM THE MARK AS SHOWN.

FOR SOFTWARE AS A SERVICE (SAAS) SERVICES, NAMELY, HOSTING SOFTWARE FOR USE IN PAYROLL ADMINISTRATION, PAYROLL TAX CALCULATION, TAX REGULATION COMPLIANCE, EMPLOYEE BENEFITS ADMINISTRATION, PAYROLL PREPARATION AND ELECTRONIC PROCESSING OF HUMAN RESOURCE, ACCOUNTING AND PAYROLL DATA; SOFTWARE AS A SERVICE (SAAS) SERVICES, NAMELY, HOSTING SOFTWARE FOR USE IN PAYROLL ADMINISTRATION AND MANAGEMENT, FINANCIAL AND HUMAN RESOURCE MANAGEMENT, EMPLOYEE INFORMATION MANAGEMENT, TAX MANAGEMENT, AND FOR GENERATING REPORTS AND DOCUMENT MANAGEMENT REGARDING ALL OF THE FOREGOING (U.S. CLS. 100 AND 101).

FIRST USE 3-25-2012; IN COMMERCE 3-25-2012.

4,481,951. PRAGIN, PAVEL, SAN FRANCISCO, CA. SN 85-704,090. PUB. 8-27-2013, FILED 8-15-2012.

 The logo for CloudNoc features the word "CloudNoc" in a blue, sans-serif font. To the right of the text is a circular icon composed of a blue square with rounded corners, a white circle partially overlapping its top-right corner, and a blue square partially overlapping its bottom-left corner.

NO CLAIM IS MADE TO THE EXCLUSIVE RIGHT TO USE "CLOUDNOC", APART FROM THE MARK AS SHOWN.

THE COLOR(S) AQUA, BLUE AND WHITE IS/ARE CLAIMED AS A FEATURE OF THE MARK.

THE MARK CONSISTS OF ONE BLUE SQUARE WITH ROUNDED EDGES PARTIAL WHITE CIRCLE OUTSIDE OF THE BLUE SQUARE WITH ROUNDED EDGES AND A PARTIAL BLUE AND AQUA SQUARE WITH ROUNDED EDGES OUTSIDE OF THE PARTIAL WHITE CIRCLE AND STYLIZED TEXT "CLOUDNOC"; "CLOUD" IS IN AQUA AND "NOC" IS IN BLUE.

FOR TECHNICAL SUPPORT SERVICES, NAMELY, REMOTE AND ON-SITE INFRASTRUCTURE MANAGEMENT SERVICES FOR MONITORING, ADMINISTRATION AND MANAGEMENT OF PUBLIC AND PRIVATE CLOUD COMPUTING IT AND APPLICATION SYSTEMS (U.S. CLS. 100 AND 101).

FIRST USE 8-15-2012; IN COMMERCE 8-15-2012.

4,481,957. ZS ASSOCIATES, INC., EVANSTON, IL. SN 85-710,636. PUB. 3-5-2013, FILED 8-22-2012.

## SFE NAV-LITE

THE MARK CONSISTS OF STANDARD CHARACTERS WITHOUT CLAIM TO ANY PARTICULAR FONT, STYLE, SIZE, OR COLOR.

**CLASS 42—(Continued).**

NO CLAIM IS MADE TO THE EXCLUSIVE RIGHT TO USE "SFE", APART FROM THE MARK AS SHOWN.

FOR SOFTWARE AS A SERVICE (SAAS) FEATURING SOFTWARE COMPRISED OF DIAGNOSTIC AND PLANNING FRAMEWORKS AND TOOLS FOR IDENTIFYING, PRIORITIZING AND IMPROVING BUSINESS SALES GROWTH DRIVERS, SALES STRATEGIES AND SALES FORCE CAPABILITIES (U.S. CLS. 100 AND 101).  
FIRST USE 11-12-2012; IN COMMERCE 11-12-2012.

4,481,960. PALADIN ONLINE REPUTATION MANAGEMENT, LLC, LA PUENTE, CA. SN 85-712,285. PUB. 8-20-2013, FILED 8-24-2012.

---

## REP GOLD

THE MARK CONSISTS OF STANDARD CHARACTERS WITHOUT CLAIM TO ANY PARTICULAR FONT, STYLE, SIZE, OR COLOR.

NO CLAIM IS MADE TO THE EXCLUSIVE RIGHT TO USE "REP", APART FROM THE MARK AS SHOWN.

FOR ONLINE, NON-DOWNLOADABLE COMPUTER SOFTWARE COMPUTER SOFTWARE FOR HELPING BUSINESSES AND CONSUMERS MONITOR THEIR ONLINE REPUTATION (U.S. CLS. 100 AND 101).  
FIRST USE 7-1-2013; IN COMMERCE 7-1-2013.

4,481,979. Z-TERRA, HOUSTON, TX. SN 85-717,091. PUB. 2-5-2013, FILED 8-30-2012.

---

We give you the best image

THE MARK CONSISTS OF STANDARD CHARACTERS WITHOUT CLAIM TO ANY PARTICULAR FONT, STYLE, SIZE, OR COLOR.

FOR SEISMIC IMAGING SERVICES FOR THE OIL AND GAS INDUSTRY; COMPUTER SOFTWARE DEVELOPMENT FOR THE OIL AND GAS INDUSTRY; COMPUTER SERVICES, NAMELY, COMPUTER ANALYSIS OF SEISMIC DATA FOR THE OIL AND GAS INDUSTRY (U.S. CLS. 100 AND 101).  
FIRST USE 6-1-2013; IN COMMERCE 6-1-2013.

**CLASS 42—(Continued).**

4,481,997. AMERICAN AUTOMOBILE ASSOCIATION, INC., HEATHROW, FL. SN 85-722,082. PUB. 2-19-2013, FILED 9-6-2012.

## ROADWISE RX

THE MARK CONSISTS OF STANDARD CHARACTERS WITHOUT CLAIM TO ANY PARTICULAR FONT, STYLE, SIZE, OR COLOR.

OWNER OF U.S. REG. NOS. 3,269,160 AND 3,269,163.  
NO CLAIM IS MADE TO THE EXCLUSIVE RIGHT TO USE "RX", APART FROM THE MARK AS SHOWN.

FOR PROVIDING AN ON-LINE NON-DOWNLOADABLE SOFTWARE TOOL TO EDUCATE MOTORISTS ABOUT THE DELETERIOUS EFFECTS OF VARIOUS MEDICATIONS ON THEIR DRIVING (U.S. CLS. 100 AND 101).  
FIRST USE 9-12-2013; IN COMMERCE 9-12-2013.

4,482,008. ARCADIS CORPORATE SERVICES, INC., HIGHLANDS RANCH, CO. SN 85-725,684. PUB. 4-16-2013, FILED 9-11-2012.

---

## SITE TO SIGHT

THE MARK CONSISTS OF STANDARD CHARACTERS WITHOUT CLAIM TO ANY PARTICULAR FONT, STYLE, SIZE, OR COLOR.

FOR ENGINEERING SERVICES IN THE FIELD OF DATA COLLECTION AND MANAGEMENT FOR PROJECT SITES (U.S. CLS. 100 AND 101).  
FIRST USE 9-1-2012; IN COMMERCE 1-29-2013.

4,482,026. NEIGHBOR LLC, MINNEAPOLIS, MN. SN 85-728,479. PUB. 9-10-2013, FILED 9-13-2012.

---

## NEIGHBOR

THE MARK CONSISTS OF STANDARD CHARACTERS WITHOUT CLAIM TO ANY PARTICULAR FONT, STYLE, SIZE, OR COLOR.

FOR ANIMATION AND SPECIAL-EFFECTS DESIGN FOR OTHERS; ANIMATION DESIGN FOR OTHERS (U.S. CLS. 100 AND 101).  
FIRST USE 8-20-2012; IN COMMERCE 11-22-2012.

**CLASS 42—(Continued).**

4,482,040. BERTRAND, JR., ALLEN, LOS ALTOS, CA. SN 85-731,160. PUB. 2-26-2013, FILED 9-17-2012.

# ONESTOP

THE MARK CONSISTS OF STANDARD CHARACTERS WITHOUT CLAIM TO ANY PARTICULAR FONT, STYLE, SIZE, OR COLOR.

FOR PLATFORM AS A SERVICE (PAAS) FEATURING COMPUTER SOFTWARE PLATFORMS FOR ENABLING AND SIMPLIFYING COMMUNICATION BETWEEN THE GOVERNMENT AND USERS IN OBTAINING GOVERNMENT AND REGULATORY PERMITS, LICENSES AND APPROVALS, TO BUILD SUBDIVISIONS, RESIDENTIAL AND/OR COMMERCIAL STRUCTURES (U.S. CLS. 100 AND 101).

FIRST USE 4-26-2013; IN COMMERCE 4-26-2013.

4,482,053. BIBA SYSTEMS, INC., SAN FRANCISCO, CA. SN 85-731,514. PUB. 3-12-2013, FILED 9-18-2012.

# BIBA

THE MARK CONSISTS OF STANDARD CHARACTERS WITHOUT CLAIM TO ANY PARTICULAR FONT, STYLE, SIZE, OR COLOR.

THERE IS NO DEFINITIVE TRANSLATION OF THE WORD "BIBA" IN A FOREIGN LANGUAGE.

FOR PROVIDING AN ONLINE NON-DOWNLOADABLE INTERNET-BASED SYSTEM APPLICATION FEATURING TECHNOLOGY ENABLING USERS TO IMPROVE, COORDINATE, AND FACILITATE WORK AND COMMUNICATION AMONGST TEAM MEMBERS (U.S. CLS. 100 AND 101).

FIRST USE 6-25-2013; IN COMMERCE 6-25-2013.

4,482,139. INFOTERIA CORPORATION, TOKYO, JAPAN. SN 85-743,801. PUB. 7-2-2013, FILED 10-2-2012.

# Handbook

THE MARK CONSISTS OF STANDARD CHARACTERS WITHOUT CLAIM TO ANY PARTICULAR FONT, STYLE, SIZE, OR COLOR.

**CLASS 42—(Continued).**

OWNER OF U.S. REG. NO. 3,973,422.

FOR PROVIDING TEMPORARY USE OF ON-LINE NON-DOWNLOADABLE SOFTWARE FOR ACCESSING USER MANUALS, DICTIONARIES, CATALOGS, OPERATING INSTRUCTIONS AND OTHER REFERENCE DOCUMENTS, EXCLUDING HANDBOOKS (U.S. CLS. 100 AND 101).

FIRST USE 6-2-2009; IN COMMERCE 2-11-2013.

4,482,143. PHIGITAL, INC., MONTCLAIR, NJ. SN 85-744,248. PUB. 3-12-2013, FILED 10-2-2012.

# PHIGITAL

THE MARK CONSISTS OF STANDARD CHARACTERS WITHOUT CLAIM TO ANY PARTICULAR FONT, STYLE, SIZE, OR COLOR.

FOR PROVIDING ON-LINE NON-DOWNLOADABLE SOFTWARE FEATURING TECHNOLOGY THAT ALLOWS USERS TO CONSOLIDATE AND MANAGE SOCIAL NETWORKS, ACCOUNTS, AND CONNECTIONS TO EXISTING AND EMERGING APPLICATION PROGRAMMING INTERFACES (APIS); PROVIDING ON-LINE NON-DOWNLOADABLE SOFTWARE FEATURING TECHNOLOGY THAT PROVIDES CUSTOMER-DEFINED GENERATED CONTENT AND CONTENT OF OTHERS AUTOMATICALLY SELECTED AND CUSTOMIZED BASED ON THE KNOWN OR ESTIMATED GEOGRAPHICAL LOCATION OF AN INTERNET, MOBILE TELEPHONE OR OTHER WIRED OR WIRELESS DIGITAL NETWORK BASED CUSTOMER; PROVIDING ON-LINE NON-DOWNLOADABLE SOFTWARE FEATURING TECHNOLOGY THAT CONNECTS AND ALLOWS USERS OF SOCIAL NETWORKS TO INTERACT; PLATFORM AS A SERVICE (PAAS) FEATURING COMPUTER SOFTWARE PLATFORMS FOR ALLOWING USERS TO CONSOLIDATE AND MANAGE SOCIAL NETWORKS, ACCOUNTS, AND CONNECTIONS TO EXISTING AND EMERGING APPLICATION PROGRAMMING INTERFACES (APIS); PLATFORM AS A SERVICE (PAAS) FEATURING COMPUTER SOFTWARE PLATFORMS FOR PROVIDING CUSTOMER-DEFINED GENERATED CONTENT AND CONTENT OF OTHERS AUTOMATICALLY SELECTED AND CUSTOMIZED BASED THE KNOWN OR ESTIMATED GEOGRAPHICAL LOCATION OF AN INTERNET, MOBILE TELEPHONE OR OTHER WIRED OR WIRELESS DIGITAL NETWORK BASED CUSTOMER, A GIVEN TIME OR TIME INTERVAL, AN EVENT, ACTIVITY, OR ACTION AND THE NUMBER OF PARTICIPANTS AND THE WAY THOSE PARTICIPANTS ARE COLLABORATING AND COMMUNICATING; PLATFORM AS A SERVICE (PAAS) FEATURING COMPUTER SOFTWARE PLATFORMS FOR CONNECTING AND ALLOWING USERS OF SOCIAL NETWORKS TO INTERACT (U.S. CLS. 100 AND 101).

FIRST USE 7-1-2013; IN COMMERCE 7-1-2013.

**CLASS 42—(Continued).**

4,482,183. AMEC E&I, INC., ALPHARETTA, GA. SN 85-749,452. PUB. 5-28-2013, FILED 10-9-2012.

# ScanPlot

THE MARK CONSISTS OF STANDARD CHARACTERS WITHOUT CLAIM TO ANY PARTICULAR FONT, STYLE, SIZE, OR COLOR.

FOR ENVIRONMENTAL TESTING AND INSPECTION SERVICES; DETECTION OF CONTAMINANTS IN SOIL AND WASTE; LAND CONTAMINANT DETECTION AND MAPPING SERVICES, NAMELY, CONTAMINANT DETECTION AND MAPPING SERVICES USING AN INTEGRATED COMPUTER HARDWARE AND SOFTWARE SYSTEM FOR DETECTING, MEASURING, PROCESSING, RECORDING AND MAPPING A SURFACE BASED UPON THE CONCENTRATION(S) OF CONTAMINANTS IN THE SURFACE OF MATERIALS ASSAYED; ENGINEERING SERVICES AND CONSULTATION IN CONNECTION WITH THE DETECTION, ASSESSMENT, AND MAPPING OF CONTAMINANTS IN THE SURFACE OF MATERIALS ASSAYED; AND ENGINEERING SERVICES AND CONSULTATION IN CONNECTION WITH THE DETECTION AND MAPPING OF CONTAMINANTS IN SOIL AND WASTE (U.S. CLS. 100 AND 101).

FIRST USE 8-11-2010; IN COMMERCE 8-11-2010.

4,482,184. AMEC E&I, INC., ALPHARETTA, GA. SN 85-749,484. PUB. 5-28-2013, FILED 10-9-2012.

# ScanSort

THE MARK CONSISTS OF STANDARD CHARACTERS WITHOUT CLAIM TO ANY PARTICULAR FONT, STYLE, SIZE, OR COLOR.

FOR ENVIRONMENTAL TESTING AND INSPECTION SERVICES; CONTAMINANT DETECTION AND MECHANICAL SEGREGATION SERVICES USING AN INTEGRATED COMPUTER HARDWARE AND SOFTWARE SYSTEM FOR DETECTING, MEASURING, PROCESSING, RECORDING AND SEGREGATING SOLID OR LIQUID ENVIRONMENTAL MEDIA AND MATERIALS BASED UPON THE CONCENTRATION(S) OF CONTAMINANTS IN THE MATERIALS ASSAYED; DETECTION OF CONTAMINANTS IN SOIL AND WASTE; ENGINEERING SERVICES AND CONSULTATION IN CONNECTION WITH THE DETECTION AND REMOVAL OF CONTAMINANTS IN SOIL AND WASTE; ENGINEERING SERVICES AND CONSULTATION IN CONNECTION WITH THE DETECTION AND REMOVAL OF CONTAMINATED MATERIALS FROM MATERIALS WITH ACCEPTABLE CONCENTRATION(S) OF CONTAMINANTS (U.S. CLS. 100 AND 101).

FIRST USE 2-19-2010; IN COMMERCE 2-19-2010.

**CLASS 42—(Continued).**

4,482,201. MEMORIAL E LIBRARIES, INC., CAPE CORAL, FL. SN 85-753,049. PUB. 3-19-2013, FILED 10-12-2012.

# STARTABOOK

THE MARK CONSISTS OF STANDARD CHARACTERS WITHOUT CLAIM TO ANY PARTICULAR FONT, STYLE, SIZE, OR COLOR.

FOR PROVIDING ON-LINE, NON-DOWNLOADABLE SOFTWARE FOR CREATING, DESIGNING, IMPORTING, EDITING, INDEXING, COLLABORATING ON, CROSS REFERENCING, LOCATING, DISPLAYING AND PUBLISHING CONTENT; SOFTWARE AS A SERVICE (SAAS) SERVICES FEATURING SOFTWARE FOR CREATING, DESIGNING, IMPORTING, EDITING, INDEXING, COLLABORATING ON, CROSS REFERENCING, LOCATING, DISPLAYING AND PUBLISHING CONTENT (U.S. CLS. 100 AND 101).

FIRST USE 10-0-2012; IN COMMERCE 10-0-2012.

4,482,215. MOESEO, CARLSBAD, CA. SN 85-755,757. PUB. 4-9-2013, FILED 10-16-2012.

# MoeSeo

THE MARK CONSISTS OF STANDARD CHARACTERS WITHOUT CLAIM TO ANY PARTICULAR FONT, STYLE, SIZE, OR COLOR.

THE WORDING "MOESEO" HAS NO MEANING IN A FOREIGN LANGUAGE.

FOR HOSTING OF WEB SITES; WEB SITE DESIGN (U.S. CLS. 100 AND 101).

FIRST USE 3-29-2009; IN COMMERCE 7-1-2012.

4,482,274. QRATA, LP, HONOLULU, HI. SN 85-768,119. PUB. 5-7-2013, FILED 10-31-2012.

# Where search ends and knowledge begins!

THE MARK CONSISTS OF STANDARD CHARACTERS WITHOUT CLAIM TO ANY PARTICULAR FONT, STYLE, SIZE, OR COLOR.

FOR COMPUTER SERVICES, NAMELY, PROVIDING A WEBSITE AND SEARCH ENGINE FOR DETERMINING RELIABILITY AND/OR QUALITY OF INTERNET CONTENT PROVIDED BY THIRD PARTIES (U.S. CLS. 100 AND 101).

FIRST USE 10-31-2012; IN COMMERCE 10-31-2012.

**CLASS 42—(Continued).**

4,482,292. PEACHSTATE HEALTH MANAGEMENT LLC, DBA AEON CLINICAL LABORATORIES, GAINESVILLE, GA. SN 85-776,421. PUB. 4-16-2013, FILED 11-10-2012.

AEON CLINICAL LABORATORIES

THE MARK CONSISTS OF STANDARD CHARACTERS WITHOUT CLAIM TO ANY PARTICULAR FONT, STYLE, SIZE, OR COLOR.

NO CLAIM IS MADE TO THE EXCLUSIVE RIGHT TO USE "CLINICAL LABORATORIES", APART FROM THE MARK AS SHOWN.

FOR MEDICAL LABORATORY SERVICES (U.S. CLS. 100 AND 101).

FIRST USE 11-10-2012; IN COMMERCE 11-10-2012.

4,482,308. ZONE APPS, INC., SUDBURY, MA. SN 85-781,432. PUB. 4-23-2013, FILED 11-16-2012.

JOCK ZONE

THE MARK CONSISTS OF STANDARD CHARACTERS WITHOUT CLAIM TO ANY PARTICULAR FONT, STYLE, SIZE, OR COLOR.

NO CLAIM IS MADE TO THE EXCLUSIVE RIGHT TO USE "JOCK", APART FROM THE MARK AS SHOWN.

FOR CREATING A MOBILE ON-LINE COMMUNITY FOR RECREATIONAL ATHLETES FOR THE PURPOSE OF CONNECTING PLAYERS, TEAMS AND LEAGUES AND ORGANIZING GAME AND SPORTS ACTIVITIES LOCALLY (U.S. CLS. 100 AND 101).

FIRST USE 5-3-2013; IN COMMERCE 5-3-2013.

4,482,319. QRATA, LP, HONOLULU, HI. SN 85-785,128. PUB. 5-7-2013, FILED 11-21-2012.

Q/Rata

THE MARK CONSISTS OF STANDARD CHARACTERS WITHOUT CLAIM TO ANY PARTICULAR FONT, STYLE, SIZE, OR COLOR.

FOR COMPUTER SERVICES, NAMELY, PROVIDING A WEBSITE AND SEARCH ENGINE FOR DETERMINING RELIABILITY AND/OR QUALITY OF INTERNET CONTENT PROVIDED BY THIRD PARTIES (U.S. CLS. 100 AND 101).

FIRST USE 10-31-2012; IN COMMERCE 10-31-2012.

**CLASS 42—(Continued).**

4,482,405. PIE-SQUARES LLC, WILLIAMSPORT, PA. SN 85-817,656. PUB. 5-28-2013, FILED 1-8-2013.



THE MARK CONSISTS OF THE WORDING "COWPIE SQUARES" TO THE RIGHT OF A COW HEAD.

FOR PROVIDING A WEB SITE FEATURING TEMPORARY USE OF NON-DOWNLOADABLE SOFTWARE FOR MANAGEMENT OF FUND RAISING EVENTS (U.S. CLS. 100 AND 101).

FIRST USE 8-29-2013; IN COMMERCE 8-29-2013.

4,482,415. INTERMEZZO, INC., LAS VEGAS, NV. SN 85-820,253. PUB. 6-4-2013, FILED 1-10-2013.

INTERMEZZO

THE MARK CONSISTS OF STANDARD CHARACTERS WITHOUT CLAIM TO ANY PARTICULAR FONT, STYLE, SIZE, OR COLOR.

FOR SOFTWARE DESIGN AND DEVELOPMENT (U.S. CLS. 100 AND 101).

FIRST USE 3-14-2013; IN COMMERCE 3-14-2013.

4,482,432. ZELL, DEBORAH, LOUISVILLE, CO. SN 85-824,028. PUB. 6-4-2013, FILED 1-15-2013.

Zellist

THE MARK CONSISTS OF STANDARD CHARACTERS WITHOUT CLAIM TO ANY PARTICULAR FONT, STYLE, SIZE, OR COLOR.

FOR SOFTWARE AS A SERVICE (SAAS) SERVICES FEATURING SOFTWARE FOR USE IN BUSINESS MARKETING (U.S. CLS. 100 AND 101).

FIRST USE 12-1-2012; IN COMMERCE 7-31-2013.

**CLASS 42—(Continued).**

4,482,443. OCEANHOUSE MEDIA, INC., ENCINITAS, CA. SN 85-830,070. PUB. 6-11-2013, FILED 1-23-2013.

## Commit To 3

THE MARK CONSISTS OF STANDARD CHARACTERS WITHOUT CLAIM TO ANY PARTICULAR FONT, STYLE, SIZE, OR COLOR.

FOR PROVIDING ON-LINE NON-DOWNLOADABLE SOFTWARE FOR GOAL TRACKING (U.S. CLS. 100 AND 101).

FIRST USE 7-14-2012; IN COMMERCE 7-14-2012.

4,482,466. JD SOFTWARE, INC., SALEM, MA. SN 85-841,938. PUB. 7-2-2013, FILED 2-6-2013.

## JD SOFT

THE MARK CONSISTS OF STANDARD CHARACTERS WITHOUT CLAIM TO ANY PARTICULAR FONT, STYLE, SIZE, OR COLOR.

NO CLAIM IS MADE TO THE EXCLUSIVE RIGHT TO USE "SOFT", APART FROM THE MARK AS SHOWN.

FOR DESIGN, DEVELOPMENT, INSTALLATION AND MAINTENANCE OF SOFTWARE (U.S. CLS. 100 AND 101).

FIRST USE 10-26-2013; IN COMMERCE 10-26-2013.

4,482,469. AMERICAN ASSOCIATION OF STATE HIGHWAY AND TRANSPORTATION OFFICIALS, AKA AASHTO, WASHINGTON, DC. SN 85-843,141. PUB. 5-7-2013, FILED 2-7-2013.



OWNER OF U.S. REG. NOS. 1,282,406, 2,083,657, AND 2,653,710.

THE MARK CONSISTS OF A RECTANGLE, WITH A SOLID BORDER WHICH TOP OUTER EDGES ARE ROUNDED, CONTAINING THE DESIGN OF 3 BOLD SWEEPING DIMENSIONAL LINES IN THE RIGHT SIDE OF THE RECTANGLE AND THE WORD "P R O J E C T" CENTERED IN THE RECTANGLE UNDER THE SMALLER WORD "AASHTOWARE" WHICH IS LEFT JUSTIFIED

**CLASS 42—(Continued).**

WITH THE WORD "PROJECT", ALL INSIDE A LARGER RECTANGLE, WITH A BOLD SOLID BOTTOM BORDER, WHICH BOTTOM OUTER EDGES ARE ROUNDED, CONTAINING THE LETTERS "A A S H" STYLIZED "T" "O" CENTERED ACROSS THE BOTTOM EDGE; ALSO WITH A SMALLER SQUARE PLACED OVER THE RECTANGLES, HORIZONTALLY CENTERED AT THE LEFT BORDER, WITH A SOLID BOLD BORDER WHICH OUTER EDGES ARE ROUNDED, CONTAINING THE CENTERED LETTERS "PR".

FOR PROVIDE COMPREHENSIVE NON-DOWNLOADABLE ON-LINE FAMILY OF SOFTWARE DESIGNED TO MANAGE AND PROVIDE DECISION SUPPORT FOR THE COMPLETE LIFECYCLE OF DATA AND INFORMATION IN THE AREA OF TRANSPORTATION PROGRAM MANAGEMENT (U.S. CLS. 100 AND 101).

FIRST USE 9-1-2013; IN COMMERCE 9-1-2013.

4,482,470. AMERICAN ASSOCIATION OF STATE HIGHWAY AND TRANSPORTATION OFFICIALS, AKA AASHTO, WASHINGTON, DC. SN 85-843,165. PUB. 7-2-2013, FILED 2-7-2013.



OWNER OF U.S. REG. NOS. 1,282,406, 2,423,935, AND OTHERS.

NO CLAIM IS MADE TO THE EXCLUSIVE RIGHT TO USE "BRIDGE", APART FROM THE MARK AS SHOWN.

THE MARK CONSISTS OF A RECTANGLE, WITH A SOLID BORDER WHICH TOP OUTER EDGES ARE ROUNDED, CONTAINING THE DESIGN OF 3 BOLD SWEEPING DIMENSIONAL LINES IN THE RIGHT SIDE OF THE RECTANGLE AND THE WORD "B R I D G E" CENTERED IN THE RECTANGLE UNDER THE SMALLER WORD "AASHTOW" ARE WHICH IS LEFT JUSTIFIED WITH THE WORD BRIDGE. ALL INSIDE A LARGER RECTANGLE, WITH A BOLD SOLID BOTTOM BORDER, WHICH BOTTOM OUTER EDGES ARE ROUNDED, CONTAINING THE LETTERS "A A S H" STYLIZED "T" "O" CENTERED ACROSS THE BOTTOM EDGE. ALL WITHIN A LARGER RECTANGLE; ALSO WITH A SMALLER SQUARE PLACED OVER THE RECTANGLES, JUSTIFIED AT THE LEFT BORDER, WITH A SOLID BOLD BORDER WHICH OUTER EDGERS ARE ROUNDED, CONTAINING THE CENTERED LETTERS "BR".

FOR PROVIDE COMPREHENSIVE NON-DOWNLOADABLE ON-LINE SOFTWARE FOR THE DESIGN, RATING AND MANAGEMENT OF BRIDGES (U.S. CLS. 100 AND 101).

FIRST USE 9-1-2013; IN COMMERCE 9-1-2013.



**CLASS 42—(Continued).**

4,482,584. THE GREAT CREATE INC., ENGLEWOOD, CO.  
SN 85-883,158. PUB. 8-13-2013, FILED 3-21-2013.

**CLASS 42—(Continued).**

4,482,617. FILIGREE LLC, DBA FILIGREE, SEATTLE, WA.  
SN 85-895,895. PUB. 8-27-2013, FILED 4-4-2013.

## The Great Create

THE MARK CONSISTS OF STANDARD CHARACTERS WITHOUT CLAIM TO ANY PARTICULAR FONT, STYLE, SIZE, OR COLOR.

FOR PRODUCT DEVELOPMENT FOR OTHERS (U.S. CLS. 100 AND 101).

FIRST USE 2-1-2013; IN COMMERCE 4-1-2013.



4,482,611. REYES, JOHN ELTER, RENTON, WA. AND REYES, MARIA VICTORIA, RENTON, WA. SN 85-892,402. PUB. 9-10-2013, FILED 4-1-2013.



NO CLAIM IS MADE TO THE EXCLUSIVE RIGHT TO USE "WEBDESIGN" OR "GRAPHICS" OR "PHOTOGRAPHY" OR "HOME" OR "ABOUT" OR "BLOG" OR "PORTFOLIO" OR "CONTACTS" OR "1:4.5-6" OR "F-60-300MM", APART FROM THE MARK AS SHOWN.

THE MARK CONSISTS OF THE WORDING "JOYGIBEK . WEBDESIGN . GRAPHICS . PHOTOGRAPHY" DISPLAYED OUTSIDE A DEPICTION A CAMERA LENS. THE CAMERA LENS HAS A GLARE. THE WORDING "HOME ABOUT BLOG PORTFOLIO CONTACTS 1:4.5-6 F-60- 300MM" IS DEPICTED WITHIN THE CAMERA LENS.

FOR COMPUTER WEBSITE DESIGN (U.S. CLS. 100 AND 101).

FIRST USE 3-1-2013; IN COMMERCE 7-1-2013.

THE MARK CONSISTS OF THE WORD "FILIGREE" STYLIZED IN SPENCERIAN SCRIPT, WITH FLOURISHES ON THE CAPITAL "F", ADJACENT LOWERCASE "I", LOWERCASE "L", LOWERCASE "G", LOWERCASE "R", AND TERMINAL "E".

FOR DESIGN OF HOME PAGES; DESIGN OF HOME PAGES AND WEB SITES; DESIGN OF HOME PAGES, COMPUTER SOFTWARE AND WEB SITES; DESIGN OF HOMEPAGES AND WEBSITES; DESIGN SERVICES FOR PACKAGING; DESIGN, CREATION, HOSTING AND MAINTENANCE OF INTERNET SITES FOR THIRD PARTIES; DESIGN, CREATION, HOSTING, MAINTENANCE OF WEBSITES FOR OTHERS; DESIGNING AND DEVELOPING WEBPAGES ON THE INTERNET; DESIGNING INTERNET SITES FOR OTHERS; DESIGNING WEB PAGES FOR OTHERS; DESIGNING WEBSITES FOR ADVERTISING PURPOSES; DESIGNING WEBSITES FOR OTHERS; DESIGNING MARKETING COLLATERAL; DESIGNING, CREATING, MAINTAINING, AND HOSTING MARKETING WEBSITES FOR OTHERS; DEVELOPMENT, DESIGN AND UPDATING OF HOME PAGES; GRAPHIC ARTS DESIGN; GRAPHIC DESIGN; GRAPHIC DESIGN SERVICES; GRAPHIC DESIGN SERVICES FOR OTHERS; HOMEPAGE AND WEBPAGE DESIGN; LETTERHEAD DESIGN SERVICES; MULTI-DISCIPLINARY GRAPHIC DESIGN SERVICES; MULTI-DISCIPLINARY VISUAL DESIGN SERVICES; PACKAGING DESIGN; PACKAGING DESIGN FOR OTHERS; PROVIDING GRAPHIC AND MULTIMEDIA DESIGN SERVICES FOR THE PURPOSE OF PROMOTING THE GOODS AND SERVICES OF OTHERS; VISUAL DESIGN SERVICES IN THE NATURE OF DESIGNING VISUAL ELEMENTS FOR ON-LINE, BROADCAST, PRINT, OUTDOOR AND OTHER COMMUNICATION MEDIA; WEB SITE DESIGN; WEB SITE DESIGN CONSULTANCY; WEBSITE DESIGN AND DEVELOPMENT FOR OTHERS; WEBSITE DESIGN CONSULTANCY (U.S. CLS. 100 AND 101).

FIRST USE 6-1-2013; IN COMMERCE 6-1-2013.

**CLASS 42—(Continued).**

4,482,622. BLUMENTHAL, NOAH, SEA CLIFF, NY. AND OSTERMILLER, STEPHEN, STOW, MA. SN 85-897,831. PUB. 9-17-2013, FILED 4-8-2013.

# SWAYWHAT

THE MARK CONSISTS OF STANDARD CHARACTERS WITHOUT CLAIM TO ANY PARTICULAR FONT, STYLE, SIZE, OR COLOR.

FOR PROVIDING A WEBSITE FEATURING TECHNOLOGY THAT ENABLES USERS TO SHARE AND DISTRIBUTE CHARTS AND GRAPHS IN A WIDE VARIETY OF FIELDS (U.S. CLS. 100 AND 101).

FIRST USE 5-31-2013; IN COMMERCE 5-31-2013.

---

4,482,672. HEALTHTECH SOLUTIONS GROUP, LLC, BRENTWOOD, TN. SN 85-980,257. PUB. 2-19-2013, FILED 3-22-2012.

COLLECT MORE CASH. COLLECT  
MORE EFFICIENTLY.

THE MARK CONSISTS OF STANDARD CHARACTERS WITHOUT CLAIM TO ANY PARTICULAR FONT, STYLE, SIZE, OR COLOR.

FOR SOFTWARE AS A SERVICE (SAAS) SERVICES FEATURING COMPUTER SOFTWARE FOR USE IN REVENUE CYCLE ANALYSIS AND ACCOUNTS RECEIVABLE MANAGEMENT, NAMELY, MANAGING AND ANALYZING REVENUE STREAMS, MAXIMIZING REVENUE, AND PROCESSING AND AGGREGATING ACCOUNTS RECEIVABLE DATA IN THE FIELDS OF HOSPITAL MANAGEMENT, HEALTHCARE BUSINESS INTELLIGENCE AND DATA ANALYTICS; TECHNICAL CONSULTATION IN THE FIELDS OF COMPUTER SOFTWARE; DATA CONVERSION OF COMPUTER PROGRAM DATA OR INFORMATION; COMPUTER SOFTWARE INSTALLATION AND SETUP (U.S. CLS. 100 AND 101).

FIRST USE 1-26-2011; IN COMMERCE 1-26-2011.

**CLASS 42—(Continued).**

4,482,673. HEALTHPOCKET, INC., SUNNYVALE, CA. SN 85-980,281. PUB. 2-12-2013, FILED 9-6-2012.



THE MARK CONSISTS OF THE CAPITAL LETTER "H" ENCLOSED WITHIN AN ASYMMETRICAL RECTANGLE RESEMBLING A POCKET.

FOR PROVIDING A WEBSITE FEATURING NON-DOWNLOADABLE SOFTWARE FOR USE IN CONNECTION WITH HEALTH INSURANCE PLAN AND HEALTH CARE MANAGEMENT (U.S. CLS. 100 AND 101).

FIRST USE 11-15-2012; IN COMMERCE 11-15-2012.

---

4,482,698. TORAY KABUSHIKI KAISHA (TORAY INDUSTRIES, INC.), TOKYO, JAPAN. SN 85-980,918. PUB. 9-18-2012, FILED 11-2-2011.

# CASSIOPEIR

THE MARK CONSISTS OF STANDARD CHARACTERS WITHOUT CLAIM TO ANY PARTICULAR FONT, STYLE, SIZE, OR COLOR.

PRIORITY CLAIMED UNDER SEC. 44(D) ON JAPAN APPLICATION NO. 2011-063030, FILED 9-2-2011.

THE WORDING "CASSIOPEIR" HAS NO MEANING IN A FOREIGN LANGUAGE.

FOR TESTING, INSPECTION AND RESEARCH OF PHARMACEUTICALS (U.S. CLS. 100 AND 101).

FIRST USE 2-18-2012; IN COMMERCE 11-2-2012.

---

**CLASS 43—HOTEL AND RESTAURANT SERVICES**

**CLASS 43—(Continued).**

4,481,323. MISSION BREWERY, SAN DIEGO, CA. SN 77-644,177. PUB. 9-21-2010, FILED 1-6-2009.

**MISSION BREWING COMPANY**

THE MARK CONSISTS OF STANDARD CHARACTERS WITHOUT CLAIM TO ANY PARTICULAR FONT, STYLE, SIZE, OR COLOR.

NO CLAIM IS MADE TO THE EXCLUSIVE RIGHT TO USE "BREWING COMPANY", APART FROM THE MARK AS SHOWN.

FOR RESTAURANT, SIT DOWN FOOD SERVICE, CATERING SERVICES, TASTING ROOMS AND RESTAURANTS FEATURING HOME DELIVERY; RESTAURANT, SIT DOWN FOOD SERVICE, CATERING SERVICES, TASTING ROOMS AND RESTAURANTS FEATURING HOME DELIVERY, ALL FEATURING DRAFT BEERS (U.S. CLS. 100 AND 101).

FIRST USE 11-18-2013; IN COMMERCE 11-18-2013.

4,481,459. MENDIAS & MILTON, LLC, DBA MY FIT FOODS, AUSTIN, TX. SN 85-218,955. PUB. 6-12-2012, FILED 1-17-2011.

**My Fit Nation**

THE MARK CONSISTS OF STANDARD CHARACTERS WITHOUT CLAIM TO ANY PARTICULAR FONT, STYLE, SIZE, OR COLOR.

FOR FOOD PREPARATION SERVICES FEATURING FRESH, PROPERLY PROPORTIONED, HEALTHY MEALS DESIGNED TO FUEL METABOLISM AND BURN FAT AND MADE TO ORDER FOR DELIVERY OR PICK UP (U.S. CLS. 100 AND 101).

FIRST USE 1-20-2011; IN COMMERCE 1-20-2011.

4,481,575. OCS CONSULTANTS, INC., ORLANDO, FL. SN 85-443,286. PUB. 4-16-2013, FILED 10-10-2011.

**MIXOLOGY**<sup>101</sup>

OWNER OF U.S. REG. NO. 3,667,392.

THE MARK CONSISTS OF THE STYLIZED WORD "MIXOLOGY" FOLLOWED BY THE NUMBER "101" PLACED IN A SHADED CIRCLE ON THE UPPER CORNER OF THE LETTER "Y".

SEC. 2(F) AS TO "MIXOLOGY".

FOR RESTAURANT AND BAR SERVICES (U.S. CLS. 100 AND 101).

FIRST USE 11-12-2012; IN COMMERCE 11-12-2012.

**CLASS 43—(Continued).**

4,481,581. FIFTH STREET GAMING, LLC, LAS VEGAS, NV. SN 85-451,530. PUB. 3-27-2012, FILED 10-19-2011.

**DOWNTOWN GRAND**

THE MARK CONSISTS OF STANDARD CHARACTERS WITHOUT CLAIM TO ANY PARTICULAR FONT, STYLE, SIZE, OR COLOR.

FOR BAR SERVICES; COCKTAIL LOUNGE SERVICES; PROVIDING BANQUET AND SOCIAL FUNCTION FACILITIES FOR SPECIAL OCCASIONS; PROVISION OF CONFERENCE, EXHIBITION AND MEETING FACILITIES; PROVISION OF FACILITIES FOR CONVENTIONS; RESTAURANT SERVICES (U.S. CLS. 100 AND 101).

FIRST USE 10-27-2013; IN COMMERCE 10-27-2013.

4,481,682. MISSION YOGURT, INC., WESTMINSTER, CO. SN 85-552,403. PUB. 2-26-2013, FILED 2-24-2012.



OWNER OF U.S. REG. NO. 2,570,656.

NO CLAIM IS MADE TO THE EXCLUSIVE RIGHT TO USE "MEXICAN GRILLE", APART FROM THE MARK AS SHOWN.

THE MARK CONSISTS OF THE STYLIZED WORDS "¡QUE BUENO!" WITH THE DESIGN OF TWO OVERLAPPING CHILI PEPPERS BELOW AND THE STYLIZED WORDS "MEXICAN GRILLE" AT THE BOTTOM.

THE ENGLISH TRANSLATION OF "QUE BUENO" IN THE MARK IS "VERY GOOD" OR "THE BEST".

SEC. 2(F) AS TO "QUE BUENO".

FOR RESTAURANT SERVICES (U.S. CLS. 100 AND 101).

FIRST USE 3-31-1997; IN COMMERCE 3-31-1997.

4,481,718. GONZALEZ, JOSE JESUS, COLORADO SPRINGS, CO. SN 85-587,581. PUB. 6-4-2013, FILED 4-3-2012.

**Mi sol Vallarta**

THE MARK CONSISTS OF STANDARD CHARACTERS WITHOUT CLAIM TO ANY PARTICULAR FONT, STYLE, SIZE, OR COLOR.

**CLASS 43—(Continued).**

THE ENGLISH TRANSLATION OF "MI SOL VALLARTA" IN THE MARK IS "MY VALLARTA SUN".  
FOR RESTAURANT SERVICES (U.S. CLS. 100 AND 101).  
FIRST USE 10-1-2013; IN COMMERCE 10-1-2013.

4,481,862. ESH STRATEGIES BRANDING LLC, CHARLOTTE, NC. SN 85-660,226. PUB. 11-20-2012, FILED 6-25-2012.

**PASSIONATELY PRACTICAL**

THE MARK CONSISTS OF STANDARD CHARACTERS WITHOUT CLAIM TO ANY PARTICULAR FONT, STYLE, SIZE, OR COLOR.  
FOR HOTEL SERVICES; PROVIDING TEMPORARY HOUSING ACCOMMODATIONS (U.S. CLS. 100 AND 101).  
FIRST USE 10-23-2012; IN COMMERCE 8-5-2013.

4,481,899. STOCKMARKET BURGER INC., MARINA DEL REY, CA. SN 85-678,171. PUB. 12-18-2012, FILED 7-16-2012.



THE MARK CONSISTS OF A FIERCE BULL RIDING ON TOP OF A SWIRL. THE STYLIZED TEXT "STOCKMARKET" SITS BENEATH THE FEET OF THE BULL, SLIGHTLY BELOW THE CENTER OF THE SWIRL. THE SWIRL HAS A REVOLVING CIRCULAR MOTION WITH SHARP EDGES, UNEVEN THICKNESS EXTENDING FROM THE BODY OF THE BULL. THE BULL RIDES IN AN UPWARD POSITION.  
FOR BAR SERVICES; CAFE SERVICES; COCKTAIL LOUNGE SERVICES; COFFEE BARS; COFFEE SHOPS; COFFEE SUPPLY SERVICES FOR OFFICES; CONTRACT FOOD SERVICES; FAST-FOOD RESTAURANT SERVICES; FROZEN YOGURT SHOP SERVICES IN THE NATURE OF A RESTAURANT; MOBILE RESTAURANT SERVICES; RENTAL OF DRINK DISPENSING MACHINES; RENTAL OF DRINKING WATER DISPENSERS; RESTAURANT AND CAFE SERVICES; RESTAURANT SERVICES; TAKE-OUT RESTAURANT SERVICES; WINE BARS (U.S. CLS. 100 AND 101).  
FIRST USE 10-8-2012; IN COMMERCE 10-8-2012.

**CLASS 43—(Continued).**

4,481,904. CAFE ENTERPRISES, INC., TAYLORS, SC. SN 85-680,590. PUB. 2-19-2013, FILED 7-18-2012.

**TABLEFIELDS. GREAT FOOD.  
LOCAL ROOTS.**

THE MARK CONSISTS OF STANDARD CHARACTERS WITHOUT CLAIM TO ANY PARTICULAR FONT, STYLE, SIZE, OR COLOR.  
NO CLAIM IS MADE TO THE EXCLUSIVE RIGHT TO USE "GREAT FOOD", APART FROM THE MARK AS SHOWN.  
FOR BAR AND RESTAURANT SERVICES (U.S. CLS. 100 AND 101).  
FIRST USE 7-23-2012; IN COMMERCE 7-23-2012.

4,481,945. NEW CREASIAN, INC. ROWLETT, TX. SN 85-701,140. PUB. 2-5-2013, FILED 8-10-2012.

**Just Photastic! Vietnamese  
Cuisine, Grill & Bar**

THE MARK CONSISTS OF STANDARD CHARACTERS WITHOUT CLAIM TO ANY PARTICULAR FONT, STYLE, SIZE, OR COLOR.  
NO CLAIM IS MADE TO THE EXCLUSIVE RIGHT TO USE "VIETNAMESE CUISINE, GRILL & BAR", APART FROM THE MARK AS SHOWN.  
FOR BAR SERVICES; RESTAURANT SERVICES FEATURING VIETNAMESE FOOD (U.S. CLS. 100 AND 101).  
FIRST USE 12-2-2013; IN COMMERCE 12-2-2013.

4,481,961. MENDELSON HOSPITALITY GROUP LLC, WASHINGTON, DC. SN 85-712,384. PUB. 1-29-2013, FILED 8-24-2012.



THE MARK CONSISTS OF THE STYLIZED WORDING "BÉARNAISE" WITH A FILIGREE DESIGN BELOW THE WORDING AND TO THE LEFT OF THE LETTER "B".  
FOR BAR SERVICES; RESTAURANT SERVICES (U.S. CLS. 100 AND 101).  
FIRST USE 6-21-2013; IN COMMERCE 7-7-2013.

**CLASS 43—(Continued).**

4,481,981. PIZZA INN, INC., THE COLONY, TX. SN 85-717,637. PUB. 3-5-2013, FILED 8-30-2012.

**FRESH THE WAY YOU LIKE IT**

THE MARK CONSISTS OF STANDARD CHARACTERS WITHOUT CLAIM TO ANY PARTICULAR FONT, STYLE, SIZE, OR COLOR.

NO CLAIM IS MADE TO THE EXCLUSIVE RIGHT TO USE "FRESH", APART FROM THE MARK AS SHOWN.

FOR RESTAURANT SERVICES; CARRY-OUT RESTAURANT SERVICES (U.S. CLS. 100 AND 101).  
FIRST USE 10-26-2012; IN COMMERCE 10-26-2012.

4,481,983. BLT MANAGEMENT LLC, NEW YORK, NY. SN 85-717,947. PUB. 4-23-2013, FILED 8-31-2012.

**JUNI**

THE MARK CONSISTS OF STANDARD CHARACTERS WITHOUT CLAIM TO ANY PARTICULAR FONT, STYLE, SIZE, OR COLOR.

FOR RESTAURANT AND CATERING SERVICES (U.S. CLS. 100 AND 101).

FIRST USE 8-19-2013; IN COMMERCE 8-19-2013.

4,481,993. DESANO, SCOTT, PALM BEACH, FL. SN 85-721,124. PUB. 4-2-2013, FILED 9-5-2012.



NO CLAIM IS MADE TO THE EXCLUSIVE RIGHT TO USE "HOME OF THE WORLD FAMOUS SAN GENNARO", "PIZZA", "NAPOLETANA", "DAL 1889" AND "BAKERY", APART FROM THE MARK AS SHOWN.

THE COLOR(S) BROWN IS/ARE CLAIMED AS A FEATURE OF THE MARK.

THE MARK CONSISTS OF A LARGE CIRCLE CONTAIN-

**CLASS 43—(Continued).**

ING TWO SMALLER CIRCLES IN LIGHT BROWN, WITH THE WORDS "HOME OF THE WORLD FAMOUS SAN GENNARO" IN A DARK BROWN STYLIZED FONT ON THE OUTSIDE IN THE UPPER LEFT-SIDE OF THE CIRCLE AND THE WORD "PIZZA" IN A LIGHT BROWN STYLIZED FONT INSIDE THE LARGE CIRCLE AT THE TOP, THE WORD "NAPOLETANA" IN A DARK BROWN STYLIZED FONT INSIDE THE SMALLER CIRCLES, THE WORD "DESANO" IN A MEDIUM BROWN STYLIZED FONT THROUGH THE MIDDLE OF THE SMALLER CIRCLES, WITH THE WORD "DAL" IN DARK BROWN BELOW, AND "1889" IN DARK BROWN BENEATH, AND THE WORD "BAKERY" IN A LIGHT BROWN STYLIZED FONT LOCATED AT THE BOTTOM INSIDE THE LARGE CIRCLE.

THE ENGLISH TRANSLATION OF THE WORDS "NAPOLETANA" AND "DAL" IN THE MARK IS "NAPLES" AND "FROM".

FOR RESTAURANT SERVICES (U.S. CLS. 100 AND 101).  
FIRST USE 9-5-2012; IN COMMERCE 5-6-2013.

4,482,254. LA ALEGRE MICHOACANA, INC., EL PASO, TX. SN 85-763,022. PUB. 4-2-2013, FILED 10-25-2012.

**ALEGRE ICE CREAM**

THE MARK CONSISTS OF STANDARD CHARACTERS WITHOUT CLAIM TO ANY PARTICULAR FONT, STYLE, SIZE, OR COLOR.

NO CLAIM IS MADE TO THE EXCLUSIVE RIGHT TO USE "ICE CREAM", APART FROM THE MARK AS SHOWN.

THE ENGLISH TRANSLATION OF "ALEGRE" IN THE MARK IS "HAPPY".

FOR ICE CREAM SHOP SERVICES IN THE NATURE OF A RESTAURANT (U.S. CLS. 100 AND 101).

FIRST USE 12-29-2012; IN COMMERCE 12-29-2012.

4,482,289. PROTEUS PARTNERS, LLC, AUSTELL, GA. SN 85-775,524. PUB. 2-5-2013, FILED 11-9-2012.

**SHUT EYE HOTEL**

THE MARK CONSISTS OF STANDARD CHARACTERS WITHOUT CLAIM TO ANY PARTICULAR FONT, STYLE, SIZE, OR COLOR.

NO CLAIM IS MADE TO THE EXCLUSIVE RIGHT TO USE "HOTEL", APART FROM THE MARK AS SHOWN.

FOR PROVIDING EXTENDED-STAY HOTELS; PROVIDING TEMPORARY HOUSING ACCOMMODATIONS; RESTAURANT AND HOTEL SERVICES; SERVING FOOD AND DRINKS (U.S. CLS. 100 AND 101).

FIRST USE 4-1-2013; IN COMMERCE 4-1-2013.

**CLASS 43—(Continued).**

4,482,318. JEFFERSON DAVIS INN, LLC, LEXINGTON, KY. SN 85-784,910. PUB. 5-28-2013, FILED 11-21-2012.

## Jefferson Davis Inn

THE MARK CONSISTS OF STANDARD CHARACTERS WITHOUT CLAIM TO ANY PARTICULAR FONT, STYLE, SIZE, OR COLOR.

NO CLAIM IS MADE TO THE EXCLUSIVE RIGHT TO USE "INN", APART FROM THE MARK AS SHOWN.

FOR BAR SERVICES; RESTAURANT SERVICES (U.S. CLS. 100 AND 101).

FIRST USE 3-1-2013; IN COMMERCE 3-1-2013.

---

4,482,379. BEIANU, VALENTIN, SEATTLE, WA. SN 85-805,865. PUB. 5-14-2013, FILED 12-18-2012.

## LOVING OPTIONS

THE MARK CONSISTS OF STANDARD CHARACTERS WITHOUT CLAIM TO ANY PARTICULAR FONT, STYLE, SIZE, OR COLOR.

FOR AGENCY SERVICES FOR THE RESERVATION OF TEMPORARY ACCOMMODATION; MAKING RESERVATIONS AND BOOKINGS FOR OTHERS FOR ACCOMMODATIONS AND MEALS AT ASSISTED LIVING FACILITIES; PROVIDING ASSISTANCE TO SENIOR CITIZENS SEEKING TO DETERMINE ASSISTED LIVING FACILITIES APPROPRIATE FOR THEIR NEEDS (U.S. CLS. 100 AND 101).

FIRST USE 2-24-2013; IN COMMERCE 2-24-2013.

---

4,482,398. EGGSPRESSIONS OF NORTH AMERICA, LAFAYETTE, LA. SN 85-813,501. PUB. 5-21-2013, FILED 1-1-2013.

## BRICK & SPOON

THE MARK CONSISTS OF STANDARD CHARACTERS WITHOUT CLAIM TO ANY PARTICULAR FONT, STYLE, SIZE, OR COLOR.

FOR RESTAURANT SERVICES (U.S. CLS. 100 AND 101).

FIRST USE 3-1-2013; IN COMMERCE 3-1-2013.

**CLASS 43—(Continued).**

4,482,402. ALDO NAKAGANEKU, ARCADIA, CA. SN 85-816,581. PUB. 6-4-2013, FILED 1-7-2013.



NO CLAIM IS MADE TO THE EXCLUSIVE RIGHT TO USE "HOT N SWEET CHICKEN K-CUISINE", APART FROM THE MARK AS SHOWN.

THE MARK CONSISTS OF A CHILI PEPPER WITH ITS STEM FACING LEFT JUST ABOVE A LEFT-FACING CHICKEN'S HEAD. TO THE RIGHT OF THE LATTER IS THE STYLIZED TEXT "HOT N SWEET CHICKEN", AND BELOW THE FIRST LETTER "K" AND THE SECOND LETTER "N" IS THE STYLIZED TEXT "K-CUISINE".

FOR RESTAURANT SERVICES (U.S. CLS. 100 AND 101).

FIRST USE 7-20-2012; IN COMMERCE 7-20-2012.

---

4,482,448. SUNBURGER LLC, NEW YORK, NY. SN 85-832,564. PUB. 6-18-2013, FILED 1-25-2013.

## Grass Cow

THE MARK CONSISTS OF STANDARD CHARACTERS WITHOUT CLAIM TO ANY PARTICULAR FONT, STYLE, SIZE, OR COLOR.

FOR RESTAURANT SERVICES (U.S. CLS. 100 AND 101).

FIRST USE 5-16-2013; IN COMMERCE 5-16-2013.

---

4,482,481. ELK RIVER INVESTMENTS, INC., FLOWER MOUND, TX. SN 85-846,918. PUB. 7-2-2013, FILED 2-11-2013.

## LSA BURGER CO

THE MARK CONSISTS OF STANDARD CHARACTERS WITHOUT CLAIM TO ANY PARTICULAR FONT, STYLE, SIZE, OR COLOR.

NO CLAIM IS MADE TO THE EXCLUSIVE RIGHT TO USE "BURGER CO", APART FROM THE MARK AS SHOWN.

FOR RESTAURANT SERVICES, INCLUDING SIT-DOWN SERVICE OF FOOD AND TAKE-OUT RESTAURANT SERVICES; RESTAURANT SERVICES, NAMELY, PROVIDING OF FOOD AND BEVERAGES FOR CONSUMPTION ON AND OFF THE PREMISES (U.S. CLS. 100 AND 101).

FIRST USE 11-8-2013; IN COMMERCE 11-8-2013.

**CLASS 43—(Continued).**

4,482,519. ORION FOOD SYSTEMS, L.L.C., SIOUX FALLS, SD. SN 85-863,439. PUB. 9-3-2013, FILED 2-28-2013.

**CLASS 43—(Continued).**

4,482,675. HOTEL JV SERVICES, LLC, DALLAS, TX. SN 85-980,422. PUB. 2-7-2012, FILED 10-6-2011.

**SEARCH. BOOK. RELAX.**

THE MARK CONSISTS OF STANDARD CHARACTERS WITHOUT CLAIM TO ANY PARTICULAR FONT, STYLE, SIZE, OR COLOR.

FOR PROVIDING ONLINE REVIEWS OF HOTELS AND TEMPORARY ACCOMMODATIONS (U.S. CLS. 100 AND 101).

FIRST USE 1-1-2012; IN COMMERCE 1-1-2012.

OWNER OF U.S. REG. NOS. 3,416,227, 3,469,063, AND 3,469,064.

NO CLAIM IS MADE TO THE EXCLUSIVE RIGHT TO USE "SPORTS" OR "GRILL", APART FROM THE MARK AS SHOWN.

THE MARK CONSISTS OF THE STYLIZED WORDING "GAME TIME" WITH THE LETTERS "GT" INSIDE A CIRCLE BETWEEN THE TWO WORDS. BELOW THIS APPEAR THE WORDINGS "SPORTS" AND "GRILL" AND A FIVE-POINT STAR BETWEEN THEM, ALL AGAINST TWO OVERLAPPING TRIANGULAR BACKGROUND DESIGNS.

FOR RESTAURANT SERVICES, TAKE-OUT RESTAURANT SERVICES (U.S. CLS. 100 AND 101).

FIRST USE 3-21-2013; IN COMMERCE 3-21-2013.

**CLASS 44—MEDICAL, BEAUTY AND AGRICULTURAL SERVICES**

4,481,331. DUKE UNIVERSITY, DURHAM, NC. SN 77-771,298. PUB. 11-17-2009, FILED 6-30-2009.

**DUKE CONNECTED CARE**

THE MARK CONSISTS OF STANDARD CHARACTERS WITHOUT CLAIM TO ANY PARTICULAR FONT, STYLE, SIZE, OR COLOR.

OWNER OF U.S. REG. NOS. 2,203,764, 2,317,603, AND 2,415,817.

NO CLAIM IS MADE TO THE EXCLUSIVE RIGHT TO USE "CONNECTED CARE", APART FROM THE MARK AS SHOWN.

FOR HEALTH CARE (U.S. CLS. 100 AND 101).

FIRST USE 12-3-2012; IN COMMERCE 12-3-2012.

4,482,661. DELAWARE NORTH COMPANIES PARKS & RESORTS, INC., BUFFALO, NY. SN 85-933,587. PUB. 9-17-2013, FILED 5-16-2013.

**CABINEERING**

THE MARK CONSISTS OF STANDARD CHARACTERS WITHOUT CLAIM TO ANY PARTICULAR FONT, STYLE, SIZE, OR COLOR.

FOR LODGING SERVICES, NAMELY, RENTAL OF CABINS AND OTHER RECREATIONAL LODGING (U.S. CLS. 100 AND 101).

FIRST USE 6-30-2013; IN COMMERCE 6-30-2013.

4,481,381. MY VET CALLS, LLC, OLNEY, MD. SN 85-015,929. PUB. 9-21-2010, FILED 4-16-2010.

**MY VET CALLS**

THE MARK CONSISTS OF STANDARD CHARACTERS WITHOUT CLAIM TO ANY PARTICULAR FONT, STYLE, SIZE, OR COLOR.

FOR VETERINARY SERVICES (U.S. CLS. 100 AND 101).

FIRST USE 7-1-2013; IN COMMERCE 7-1-2013.

**CLASS 44—(Continued).**

4,481,457. INNOVATION SPECIALISTS LLC, HOUSTON, TX. SN 85-214,547. PUB. 8-30-2011, FILED 1-10-2011.



THE MARK CONSISTS OF A PSEUDO COMMENT BLOCK SEPARATED BY THE OUTLINE OF A CROSS. FOR TELEHEALTH SERVICES, NAMELY, PROVIDING HEALTHCARE AND HEALTH-RELATED INFORMATION VIA TELECOMMUNICATION TECHNOLOGIES; TELEMEDICINE SERVICES (U.S. CLS. 100 AND 101).  
FIRST USE 12-25-2010; IN COMMERCE 12-25-2010.

4,481,495. CENTENE CORPORATION, ST. LOUIS, MO. SN 85-315,583. PUB. 9-27-2011, FILED 5-9-2011.

## CENTURION

THE MARK CONSISTS OF STANDARD CHARACTERS WITHOUT CLAIM TO ANY PARTICULAR FONT, STYLE, SIZE, OR COLOR.  
FOR MANAGED HEALTH CARE SERVICES (U.S. CLS. 100 AND 101).  
FIRST USE 7-1-2013; IN COMMERCE 9-12-2013.

4,481,574. MARY KAY INC., ADDISON, TX. SN 85-443,149. PUB. 10-23-2012, FILED 10-10-2011.

## MARY KAY ONE WOMAN CAN

THE MARK CONSISTS OF STANDARD CHARACTERS WITHOUT CLAIM TO ANY PARTICULAR FONT, STYLE, SIZE, OR COLOR.  
OWNER OF U.S. REG. NOS. 817,516, 1,070,841, AND 1,215,807.

**CLASS 44—(Continued).**

THE NAME(S), PORTRAIT(S), AND/OR SIGNATURE(S) SHOWN IN THE MARK DOES NOT IDENTIFY A PARTICULAR LIVING INDIVIDUAL.

FOR GLAMOUR AND BEAUTY CONSULTATION AND ADVISORY SERVICES; PROVIDING INFORMATION IN THE FIELD OF SKIN CARE, BEAUTY CARE AND COSMETICS (U.S. CLS. 100 AND 101).  
FIRST USE 7-18-2011; IN COMMERCE 8-26-2011.

4,481,617. GRACE PLACE ADULT DAY CENTER, DBA GRACE PLACE-THE HEALTH CLUB FOR SENIORS, LEXINGTON, KY. SN 85-479,576. PUB. 5-1-2012, FILED 11-22-2011.

## AGING WITH GRACE

THE MARK CONSISTS OF STANDARD CHARACTERS WITHOUT CLAIM TO ANY PARTICULAR FONT, STYLE, SIZE, OR COLOR.  
FOR GERIATRIC HEALTH CARE MANAGEMENT SERVICES (U.S. CLS. 100 AND 101).  
FIRST USE 6-1-2012; IN COMMERCE 8-24-2013.

4,481,631. LAVI, BARBARA, WESTON, CT. SN 85-491,452. PUB. 11-6-2012, FILED 12-9-2011.

## DREAM POSITIONING SYSTEM

THE MARK CONSISTS OF STANDARD CHARACTERS WITHOUT CLAIM TO ANY PARTICULAR FONT, STYLE, SIZE, OR COLOR.  
NO CLAIM IS MADE TO THE EXCLUSIVE RIGHT TO USE "SYSTEM", APART FROM THE MARK AS SHOWN.  
FOR PSYCHOTHERAPY SERVICES (U.S. CLS. 100 AND 101).  
FIRST USE 11-4-2013; IN COMMERCE 11-4-2013.

4,481,639. COPPEDGE, CHRISTOPHER ALLEN, DENVER, CO. SN 85-504,675. PUB. 1-1-2013, FILED 12-28-2011.

## Vital Force Therapy - VFT

THE MARK CONSISTS OF STANDARD CHARACTERS WITHOUT CLAIM TO ANY PARTICULAR FONT, STYLE, SIZE, OR COLOR.



**CLASS 44—(Continued).**

NO CLAIM IS MADE TO THE EXCLUSIVE RIGHT TO USE "VITAL FORCE THERAPY", APART FROM THE MARK AS SHOWN.

FOR HOLISTIC HEALTH SERVICES (U.S. CLS. 100 AND 101).

FIRST USE 1-1-2011; IN COMMERCE 12-1-2012.

**CLASS 44—(Continued).**

4,481,694. OXFORD GLOBAL RESOURCES, INC., BEVERLY, MA. SN 85-563,452. PUB. 2-19-2013, FILED 3-7-2012.

4,481,657. AMBRY GENETICS, ALISO VIEJO, CA. SN 85-529,545. PUB. 10-16-2012, FILED 1-31-2012.



OWNER OF U.S. REG. NOS. 2,674,217, 3,807,498, AND 3,929,698.

NO CLAIM IS MADE TO THE EXCLUSIVE RIGHT TO USE "GENETICS", APART FROM THE MARK AS SHOWN.

THE MARK CONSISTS OF THE WORDING "AMBRY GENETICS" AND DESIGN. THE DESIGN CONSISTS OF FOUR WAVY LINES IN A HORIZONTAL DIRECTION EMBEDDED IN A SOLID VERTICAL RECTANGULAR BOX TO THE LEFT OF THE WORDING "AMBRY GENETICS".

FOR MEDICAL TESTING SERVICES FOR DIAGNOSTIC OR TREATMENT PURPOSES (U.S. CLS. 100 AND 101).

FIRST USE 10-0-2011; IN COMMERCE 10-0-2011.

**OXFORD HEALTHCARE IT**

THE MARK CONSISTS OF STANDARD CHARACTERS WITHOUT CLAIM TO ANY PARTICULAR FONT, STYLE, SIZE, OR COLOR.

OWNER OF U.S. REG. NOS. 2,871,112, 3,305,080, AND 3,305,081.

NO CLAIM IS MADE TO THE EXCLUSIVE RIGHT TO USE "HEALTHCARE IT", APART FROM THE MARK AS SHOWN.

FOR INFORMATION TECHNOLOGY CONSULTATION RELATING TO THE HEALTHCARE INDUSTRY (U.S. CLS. 100 AND 101).

FIRST USE 10-8-2013; IN COMMERCE 10-8-2013.

4,481,674. ANDREA DIMAURO, STONE RIDGE, NY. SN 85-544,951. PUB. 1-22-2013, FILED 2-16-2012.



THE COLOR(S) ORANGE AND WHITE IS/ARE CLAIMED AS A FEATURE OF THE MARK.

THE MARK CONSISTS OF THE WORDS "FOOD TRUTH" IN ORANGE SEPARATED BY A DEPICTION OF AN ORANGE AND WHITE CARROT. THE WORDS "EAT REAL FOOD" IN ORANGE APPEAR BELOW THE WORD "TRUTH".

FOR PROVIDING NUTRITION INFORMATION BOTH THROUGH TRADITIONAL MEANS AND ONLINE AND THROUGH MOBILE APPLICATIONS (U.S. CLS. 100 AND 101).

FIRST USE 3-0-2012; IN COMMERCE 3-0-2012.

**DR. COOPER THE PHARMACIST**

THE MARK CONSISTS OF STANDARD CHARACTERS WITHOUT CLAIM TO ANY PARTICULAR FONT, STYLE, SIZE, OR COLOR.

NO CLAIM IS MADE TO THE EXCLUSIVE RIGHT TO USE "THE PHARMACIST", APART FROM THE MARK AS SHOWN.

THE NAME(S), PORTRAIT(S), AND/OR SIGNATURE(S) SHOWN IN THE MARK IDENTIFIES A LIVING INDIVIDUAL, WHOSE CONSENT(S) TO REGISTER IS MADE OF RECORD.

FOR PROVIDING PHARMACEUTICAL CARE SERVICES, NAMELY, MEDICATION THERAPY MANAGEMENT (U.S. CLS. 100 AND 101).

FIRST USE 1-1-2013; IN COMMERCE 1-1-2013.

**CLASS 44—(Continued).**

4,481,731. ALVEOLOGIC, LLC, BRIARCLIFF MANOR, NY. SN 85-595,998. PUB. 9-4-2012, FILED 4-12-2012.

**ALVEOCENTESIS**

THE MARK CONSISTS OF STANDARD CHARACTERS WITHOUT CLAIM TO ANY PARTICULAR FONT, STYLE, SIZE, OR COLOR.

FOR DENTAL SERVICES, NAMELY, PERFORMING RESTORATIVE AND COSMETIC PROCEDURES; DENTIST SERVICES; ORAL SURGERY AND DENTAL IMPLANT SERVICES; ORTHODONTIC SERVICES (U.S. CLS. 100 AND 101).

FIRST USE 4-24-2012; IN COMMERCE 4-24-2012.

4,481,733. MULTICARE HEALTH SYSTEM, TACOMA, WA. SN 85-596,704. PUB. 4-9-2013, FILED 4-12-2012.

**KIDS CARECONNECT**

THE MARK CONSISTS OF STANDARD CHARACTERS WITHOUT CLAIM TO ANY PARTICULAR FONT, STYLE, SIZE, OR COLOR.

NO CLAIM IS MADE TO THE EXCLUSIVE RIGHT TO USE "KIDS", APART FROM THE MARK AS SHOWN.

FOR MEDICAL SERVICES; MANAGED HEALTHCARE SERVICES; INTEGRATED HEALTHCARE SERVICES (U.S. CLS. 100 AND 101).

FIRST USE 5-1-2012; IN COMMERCE 5-1-2012.

4,481,749. HERSKOVITS, SHERI, CEDARHURST, NY. SN 85-601,602. PUB. 9-11-2012, FILED 4-18-2012.

**AURORASSAGE**

THE MARK CONSISTS OF STANDARD CHARACTERS WITHOUT CLAIM TO ANY PARTICULAR FONT, STYLE, SIZE, OR COLOR.

FOR MASSAGE THERAPY SERVICES (U.S. CLS. 100 AND 101).

FIRST USE 11-3-2013; IN COMMERCE 11-3-2013.

**CLASS 44—(Continued).**

4,481,768. XAVIER, LLC, CLOVER, SC. SN 85-614,539. PUB. 10-9-2012, FILED 5-2-2012.

**XAVIER FARMS**

THE MARK CONSISTS OF STANDARD CHARACTERS WITHOUT CLAIM TO ANY PARTICULAR FONT, STYLE, SIZE, OR COLOR.

NO CLAIM IS MADE TO THE EXCLUSIVE RIGHT TO USE "FARMS", APART FROM THE MARK AS SHOWN.

FOR HORSE BREEDING AND STUD SERVICES; HORSE CARE, NAMELY, FEEDING THE HORSES OF ABSENT OWNERS; HORSE FARMS (U.S. CLS. 100 AND 101).

FIRST USE 1-1-2009; IN COMMERCE 1-1-2009.

4,482,028. MY CHOICE MEDICAL CENTER, A PROFESSIONAL MEDICAL CORPORATION, VAN NUYS, CA. SN 85-728,664. PUB. 3-12-2013, FILED 9-13-2012.



NO CLAIM IS MADE TO THE EXCLUSIVE RIGHT TO USE "MED", APART FROM THE MARK AS SHOWN.

THE MARK CONSISTS OF THE STYLIZED IMAGE OF A WOMAN, WHERE THE CURVED LINE REPRESENTING THE LEFT SIDE OF HER BODY FORMS THE LETTER "S" IN THE WORDING "SKINNY ME". BELOW THE WORD "ME" IS THE WORD "MED". THERE IS A MEASURING TAPE WRAPPED AROUND THE WAIST OF THE WOMAN, AND IT EXTENDS AS A HORIZONTAL LINE UNDER THE WORDING "SKINNY ME" AND ABOVE THE WORD "MED".

FOR PROVIDING A WEBSITE FEATURING INFORMATION AND ADVICE IN THE FIELDS OF DIET, WEIGHT LOSS, DIET PLANNING AND LIFESTYLE WELLNESS; PROVIDING WEIGHT LOSS PROGRAM SERVICES; WEIGHT MANAGEMENT SERVICES, NAMELY, PROVIDING WEIGHT LOSS AND/OR WEIGHT MAINTENANCE PROGRAMS; WEIGHT REDUCTION DIET PLANNING AND SUPERVISION (U.S. CLS. 100 AND 101).

FIRST USE 10-0-2013; IN COMMERCE 10-0-2013.

**CLASS 44—(Continued).**

4,482,060. ALEAGENT CREIGHTON HEALTH, OMAHA, NE. AND CREIGHTON UNIVERSITY, OMAHA, NE. SN 85-732,488. PUB. 2-26-2013, FILED 9-19-2012.

## ALEAGENT CREIGHTON CLINIC

THE MARK CONSISTS OF STANDARD CHARACTERS WITHOUT CLAIM TO ANY PARTICULAR FONT, STYLE, SIZE, OR COLOR.

NO CLAIM IS MADE TO THE EXCLUSIVE RIGHT TO USE "CLINIC", APART FROM THE MARK AS SHOWN. FOR MEDICAL CLINICS (U.S. CLS. 100 AND 101). FIRST USE 8-1-2012; IN COMMERCE 8-1-2012.

4,482,061. ALEAGENT CREIGHTON HEALTH, OMAHA, NE. AND CREIGHTON UNIVERSITY, OMAHA, NE. SN 85-732,492. PUB. 2-26-2013, FILED 9-19-2012.

## ALEAGENT CREIGHTON HEALTH

THE MARK CONSISTS OF STANDARD CHARACTERS WITHOUT CLAIM TO ANY PARTICULAR FONT, STYLE, SIZE, OR COLOR.

NO CLAIM IS MADE TO THE EXCLUSIVE RIGHT TO USE "HEALTH", APART FROM THE MARK AS SHOWN.

FOR MEDICAL SERVICES; HEALTH CARE SERVICES; HOSPITALS; PROVIDING A WEBSITE FEATURING MEDICAL INFORMATION; PHYSICIAN SERVICES; URGENT MEDICAL CARE CENTERS; EMERGENCY MEDICAL ASSISTANCE; PHYSICAL REHABILITATION AND PHYSICAL THERAPY SERVICES (U.S. CLS. 100 AND 101). FIRST USE 8-1-2012; IN COMMERCE 8-1-2012.

4,482,089. PROVISTA DIAGNOSTICS, INC., SCOTTSDALE, AZ. SN 85-737,097. PUB. 2-26-2013, FILED 9-24-2012.

dtectDx

THE MARK CONSISTS OF STANDARD CHARACTERS WITHOUT CLAIM TO ANY PARTICULAR FONT, STYLE, SIZE, OR COLOR.

FOR MEDICAL SERVICES, NAMELY, CANCER DETECTION; MEDICAL TESTING FOR DIAGNOSTIC OR TREATMENT PURPOSES (U.S. CLS. 100 AND 101). FIRST USE 8-1-2012; IN COMMERCE 9-24-2012.

**CLASS 44—(Continued).**

4,482,123. FLY HOLDINGS LLC, DALLAS, TX. SN 85-740,449. PUB. 3-19-2013, FILED 9-27-2012.

Fly Barbershop

THE MARK CONSISTS OF STANDARD CHARACTERS WITHOUT CLAIM TO ANY PARTICULAR FONT, STYLE, SIZE, OR COLOR.

NO CLAIM IS MADE TO THE EXCLUSIVE RIGHT TO USE "BARBERSHOP", APART FROM THE MARK AS SHOWN.

FOR BARBERSHOPS (U.S. CLS. 100 AND 101). FIRST USE 12-7-2012; IN COMMERCE 12-7-2012.

4,482,192. GENERAL ELECTRIC COMPANY, SCHENECTADY, NY. SN 85-751,767. PUB. 3-12-2013, FILED 10-11-2012.



OWNER OF U.S. REG. NOS. 1,689,275, 3,336,280, AND OTHERS.

THE MARK CONSISTS OF STYLIZED LETTERS "GE" INSIDE A CIRCLE WITH FOUR CURLICUES.

FOR MEDICAL TESTING FOR DIAGNOSTIC OR TREATMENT PURPOSES; PROVIDING A WEB SITE FEATURING MEDICAL INFORMATION; PROVIDING MEDICAL INFORMATION; RENTAL OF MEDICAL EQUIPMENT (U.S. CLS. 100 AND 101).

FIRST USE 10-11-2012; IN COMMERCE 10-11-2012.

4,482,193. GENERAL ELECTRIC COMPANY, SCHENECTADY, NY. SN 85-751,772. PUB. 3-12-2013, FILED 10-11-2012.

GE

THE MARK CONSISTS OF STANDARD CHARACTERS WITHOUT CLAIM TO ANY PARTICULAR FONT, STYLE, SIZE, OR COLOR.

**CLASS 44—(Continued).**

OWNER OF U.S. REG. NOS. 1,679,636, 3,326,351, AND OTHERS.

FOR MEDICAL TESTING FOR DIAGNOSTIC OR TREATMENT PURPOSES; PROVIDING A WEB SITE FEATURING MEDICAL INFORMATION; PROVIDING MEDICAL INFORMATION; RENTAL OF MEDICAL EQUIPMENT (U.S. CLS. 100 AND 101).

FIRST USE 10-11-2012; IN COMMERCE 10-11-2012.

4,482,217. PREFERRED DENTAL NETWORK, L.L.C., AMBLER, PA. SN 85-755,881. PUB. 4-9-2013, FILED 10-16-2012.



NO CLAIM IS MADE TO THE EXCLUSIVE RIGHT TO USE "PREFERRED DENTAL NETWORK" AND "THE NATIONS MOST EXCLUSIVE DENTAL PRACTICES", APART FROM THE MARK AS SHOWN.

THE COLOR(S) BLUE AND YELLOW IS/ARE CLAIMED AS A FEATURE OF THE MARK.

THE MARK CONSISTS OF A BLUE CIRCLE WITH A CURVED BLUE LINE AND A CURVED YELLOW LINE INSIDE WITH THE WORDS "PREFERRED DENTAL NETWORK" WRITTEN IN BLUE TO THE RIGHT OF THE CIRCLE, ONE WORD ON EACH LINE, WITH THE WORDS "THE NATIONS MOST EXCLUSIVE DENTAL PRACTICES" UNDERNEATH THE WORDS IN YELLOW. A YELLOW STAR APPEARS TO THE UPPER RIGHT OF THE DESIGN.

FOR DENTIST SERVICES; PROVIDING A WEBSITE FEATURING INFORMATION FOR DENTISTS ON THE SUBJECT OF TREATMENTS AND PROCEDURES RELATED TO DENTISTRY (U.S. CLS. 100 AND 101).

FIRST USE 3-1-2012; IN COMMERCE 3-1-2012.

4,482,224. TUTTLE, SARAH G, BEVERLY HILLS, CA. SN 85-757,132. PUB. 3-26-2013, FILED 10-18-2012.

**OLIVE AND JUNE**

THE MARK CONSISTS OF STANDARD CHARACTERS WITHOUT CLAIM TO ANY PARTICULAR FONT, STYLE, SIZE, OR COLOR.

FOR DAY SPA SERVICES, NAMELY, NAIL CARE, MANICURES, PEDICURES AND NAIL ENHANCEMENTS; MASSAGE; MESSAGES; NAIL CARE SALONS; NAIL CARE SERVICES (U.S. CLS. 100 AND 101).

FIRST USE 10-1-2012; IN COMMERCE 8-21-2013.

**CLASS 44—(Continued).**

4,482,265. ICARE MEDICAL SERVICES, LLC, KEY BISCAYNE, FL. SN 85-766,622. PUB. 4-16-2013, FILED 10-30-2012.

**ICARE**

THE MARK CONSISTS OF STANDARD CHARACTERS WITHOUT CLAIM TO ANY PARTICULAR FONT, STYLE, SIZE, OR COLOR.

FOR CONSULTING SERVICES IN THE FIELD OF MEDICAL SERVICES (U.S. CLS. 100 AND 101).

FIRST USE 8-29-2011; IN COMMERCE 8-29-2011.

4,482,304. BETHESDA HEALTH, INC., BOYNTON BEACH, FL. SN 85-780,559. PUB. 7-2-2013, FILED 11-15-2012.



NO CLAIM IS MADE TO THE EXCLUSIVE RIGHT TO USE "HEALTH", APART FROM THE MARK AS SHOWN.

THE COLOR(S) WHITE, BLACK AND BLUE IS/ARE CLAIMED AS A FEATURE OF THE MARK.

THE MARK CONSISTS OF THE FOLLOWING: STYLIZED "B" IN THE SHAPE OF A FLYING BIRD IN WHITE ON A BLUE RECTANGULAR BACKGROUND, ABOVE THE WORDING "BETHESDA HEALTH" IN BLACK.

FOR PROVIDING INPATIENT AND OUTPATIENT HOSPITAL, PHYSICIAN AND MEDICAL SERVICES IN THE FIELDS OF ONCOLOGY, GASTROENTEROLOGY, NEUROLOGY, CARDIOLOGY, ORTHOPEDICS, PEDIATRICS, OBSTETRICS, GYNECOLOGY, ENDOCRINOLOGY, PODIATRY, NEPHROLOGY, PULMONARY, PSYCHIATRY, UROLOGY, AUDIOLOGY, OPHTHALMOLOGY, OPTOMETRY, RHEUMATOLOGY, OTOLARYNGOLOGY, ALLERGY AND IMMUNOLOGY, ANESTHESIOLOGY, COSMETIC SURGERY, VASCULAR SURGERY, NEUROSURGERY, COLON AND RECTAL SURGERY, GENERAL SURGERY, DERMATOLOGY, ENDOCRINOLOGY, HEMATOLOGY, INTERNAL MEDICINE, PRIMARY CARE, PATHOLOGY, INFECTIOUS DISEASE, PAIN MANAGEMENT, BREAST HEALTH, PALLIATIVE CARE, HOSPICE CARE, EMERGENCY MEDICAL RESPONSE SERVICES, CHEMICAL DEPENDENCY AND SUBSTANCE ABUSE TREATMENT SERVICES, PHYSICAL THERAPY, MEDICAL RADIOLOGY AND IMAGING SERVICES, AND PROVIDING A WEBSITE FEATURING INFORMATION AND LINKS IN THE FIELD OF MEDICAL SERVICES AND HEALTH AND WELLNESS (U.S. CLS. 100 AND 101).

FIRST USE 9-1-2012; IN COMMERCE 9-1-2012.

**CLASS 44—(Continued).**

4,482,314. TRAVEDOC, INC., CAMBRIDGE, MA. SN 85-783,658. PUB. 4-23-2013, FILED 11-20-2012.

# TRAVEDOC

THE MARK CONSISTS OF STANDARD CHARACTERS WITHOUT CLAIM TO ANY PARTICULAR FONT, STYLE, SIZE, OR COLOR.

FOR PROVIDING A WEBSITE THAT ALLOWS INTERNATIONAL TRAVELERS TO RESEARCH, SCREEN, LOCATE, CONTACT, AND SCHEDULE APPOINTMENTS WITH HEALTH CARE PROVIDERS (U.S. CLS. 100 AND 101).

FIRST USE 5-19-2013; IN COMMERCE 5-19-2013.

**CLASS 44—(Continued).**

4,482,395. BEHAVIORAL HEALTH OF THE PALM BEACHES, INC., NORTH PALM BEACH, FL. SN 85-811,401. PUB. 6-18-2013, FILED 12-27-2012.

# B2R PALM BEACH

THE MARK CONSISTS OF STANDARD CHARACTERS WITHOUT CLAIM TO ANY PARTICULAR FONT, STYLE, SIZE, OR COLOR.

NO CLAIM IS MADE TO THE EXCLUSIVE RIGHT TO USE "PALM BEACH", APART FROM THE MARK AS SHOWN.

FOR PROVIDING SUBSTANCE ABUSE, DETOXIFICATION, AND REHABILITATION TREATMENT FOR DRUG AND ALCOHOL ADDICTED PATIENTS (U.S. CLS. 100 AND 101).

FIRST USE 1-2-2013; IN COMMERCE 1-2-2013.

4,482,317. TAYLOR J STEPHENS DDS PA, WAYZATA, MN. SN 85-784,283. PUB. 5-21-2013, FILED 11-20-2012.

# TAILWIND PEDIATRIC DENTISTRY

THE MARK CONSISTS OF STANDARD CHARACTERS WITHOUT CLAIM TO ANY PARTICULAR FONT, STYLE, SIZE, OR COLOR.

NO CLAIM IS MADE TO THE EXCLUSIVE RIGHT TO USE "PEDIATRIC DENTISTRY", APART FROM THE MARK AS SHOWN.

FOR DENTAL SERVICES, NAMELY, PEDIATRIC DENTISTRY (U.S. CLS. 100 AND 101).

FIRST USE 5-28-2013; IN COMMERCE 5-28-2013.

4,482,396. BEHAVIORAL HEALTH OF THE PALM BEACHES, INC., NORTH PALM BEACH, FL. SN 85-811,412. PUB. 6-18-2013, FILED 12-27-2012.

# BACK 2 RECOVERY

THE MARK CONSISTS OF STANDARD CHARACTERS WITHOUT CLAIM TO ANY PARTICULAR FONT, STYLE, SIZE, OR COLOR.

FOR PROVIDING SUBSTANCE ABUSE, DETOXIFICATION, AND REHABILITATION TREATMENT FOR DRUG AND ALCOHOL ADDICTED PATIENTS (U.S. CLS. 100 AND 101).

FIRST USE 1-2-2013; IN COMMERCE 1-2-2013.

4,482,359. MEDICAL FACULTY ASSOCIATES, INC., WASHINGTON, DC. SN 85-798,723. PUB. 3-5-2013, FILED 12-10-2012.

# WHEN INNOVATION & EXPERIENCE COUNT

THE MARK CONSISTS OF STANDARD CHARACTERS WITHOUT CLAIM TO ANY PARTICULAR FONT, STYLE, SIZE, OR COLOR.

FOR MEDICAL CLINICS (U.S. CLS. 100 AND 101).

FIRST USE 5-0-2010; IN COMMERCE 5-0-2010.

4,482,407. CHAUVE ENTERPRISES, LLC, NEW YORK, NY. SN 85-817,961. PUB. 9-3-2013, FILED 1-8-2013.

# BAIRE

THE MARK CONSISTS OF STANDARD CHARACTERS WITHOUT CLAIM TO ANY PARTICULAR FONT, STYLE, SIZE, OR COLOR.

FOR COSMETIC SERVICES, NAMELY, NON-PERMANENT HAIR REMOVAL; PERMANENT HAIR REMOVAL AND REDUCTION SERVICES; PERSONAL HAIR REMOVAL SERVICES (U.S. CLS. 100 AND 101).

FIRST USE 7-19-2013; IN COMMERCE 7-19-2013.

**CLASS 44—(Continued).**

4,482,409. WMK HOLDINGS, INC., WILMINGTON, DE. SN 85-818,270. PUB. 9-17-2013, FILED 1-8-2013.

**BALANCE A WEIS WAY OF LIFE**

THE MARK CONSISTS OF STANDARD CHARACTERS WITHOUT CLAIM TO ANY PARTICULAR FONT, STYLE, SIZE, OR COLOR.

OWNER OF U.S. REG. NOS. 2,426,080, 3,946,243, AND OTHERS.

FOR HEALTH CARE SERVICES, NAMELY, PROVIDING EMPLOYEE HEALTH AND WELLNESS PROGRAMS (U.S. CLS. 100 AND 101).

FIRST USE 10-1-2013; IN COMMERCE 10-1-2013.

4,482,410. WMK HOLDINGS, INC., WILMINGTON, DE. SN 85-818,275. PUB. 9-17-2013, FILED 1-8-2013.



OWNER OF U.S. REG. NOS. 2,426,080 AND 3,946,243. THE COLOR(S) BLACK, GREY, RED AND WHITE IS/ARE CLAIMED AS A FEATURE OF THE MARK.

THE MARK CONSISTS OF THE WORD "BALANCE" IN THE COLOR BLACK MIRRORED BELOW BY A REFLECTION OF THE WORD "BALANCE" IN THE COLOR GREY WITH THE WORDS "A WEIS WAY OF LIFE" BENEATH, THE WORD "WEIS" IN RED. THE WORDS "A" AND "WAY OF LIFE" APPEAR IN THE COLOR BLACK. THE COLOR WHITE APPEARS IN THE BACKGROUND.

FOR HEALTH CARE SERVICES, NAMELY, PROVIDING EMPLOYEE HEALTH AND WELLNESS PROGRAMS (U.S. CLS. 100 AND 101).

FIRST USE 10-1-2013; IN COMMERCE 10-1-2013.

4,482,509. SMITHS LAWNAGE INCENTIVES, FORT WORTH, TX. SN 85-860,427. PUB. 7-16-2013, FILED 2-26-2013.

**Lawnage**

THE MARK CONSISTS OF STANDARD CHARACTERS WITHOUT CLAIM TO ANY PARTICULAR FONT, STYLE, SIZE, OR COLOR.

**CLASS 44—(Continued).**

THE WORDING "LAWNAGE" HAS NO MEANING IN A FOREIGN LANGUAGE.

FOR LAWN CARE; LAWN MOWING SERVICES (U.S. CLS. 100 AND 101).

FIRST USE 4-1-1987; IN COMMERCE 4-1-1987.

4,482,553. SPINE IQ, GREEN BAY, WI. SN 85-874,760. PUB. 7-30-2013, FILED 3-13-2013.

**ScoliSMART Clinics**

THE MARK CONSISTS OF STANDARD CHARACTERS WITHOUT CLAIM TO ANY PARTICULAR FONT, STYLE, SIZE, OR COLOR.

NO CLAIM IS MADE TO THE EXCLUSIVE RIGHT TO USE "CLINICS", APART FROM THE MARK AS SHOWN.

FOR MEDICAL SERVICES, NAMELY, PROVIDING SCOLIOSIS TREATMENT FOR ADULTS AND CHILDREN (U.S. CLS. 100 AND 101).

FIRST USE 3-1-2013; IN COMMERCE 7-1-2013.

4,482,570. UNTATTOU, LLC, LAKEWOOD RANCH, FL. SN 85-878,630. PUB. 8-6-2013, FILED 3-18-2013.

**UnTattooU**

THE MARK CONSISTS OF STANDARD CHARACTERS WITHOUT CLAIM TO ANY PARTICULAR FONT, STYLE, SIZE, OR COLOR.

FOR LASER TATTOO REMOVAL SERVICES; LASER HAIR REMOVAL SERVICES (U.S. CLS. 100 AND 101).

FIRST USE 10-21-2013; IN COMMERCE 10-21-2013.

4,482,571. CHILDREN'S HOSPITAL AND HEALTH SYSTEM, INC., MILWAUKEE, WI. SN 85-878,832. PUB. 8-6-2013, FILED 3-18-2013.

**KIDS DESERVE THE BEST**

THE MARK CONSISTS OF STANDARD CHARACTERS WITHOUT CLAIM TO ANY PARTICULAR FONT, STYLE, SIZE, OR COLOR.

FOR PEDIATRIC HEALTH CARE SERVICES (U.S. CLS. 100 AND 101).

FIRST USE 4-2-2013; IN COMMERCE 4-2-2013.

**CLASS 45—PERSONAL AND LEGAL SERVICES**

4,481,352. BW DOCUMENTS INC., SAN FRANCISCO, CA. SN 77-887,084. PUB. 10-26-2010, FILED 12-5-2009.

**CLASS 45—(Continued).**

4,481,528. ALTICOR INC., ADA, MI. SN 85-389,563. PUB. 10-4-2011, FILED 8-4-2011.

# BLOOMWELL

THE MARK CONSISTS OF STANDARD CHARACTERS WITHOUT CLAIM TO ANY PARTICULAR FONT, STYLE, SIZE, OR COLOR.

FOR LEGAL DOCUMENT PREPARATION SERVICES (U.S. CLS. 100 AND 101).  
FIRST USE 12-21-2013; IN COMMERCE 12-21-2013.



4,481,412. SIX DEGREES CAPITAL CORPORATION, SEATTLE, WA. SN 85-085,814. PUB. 10-25-2011, FILED 7-15-2010.

# IPI

THE MARK CONSISTS OF STANDARD CHARACTERS WITHOUT CLAIM TO ANY PARTICULAR FONT, STYLE, SIZE, OR COLOR.

FOR ON-LINE SOCIAL NETWORKING SERVICES (U.S. CLS. 100 AND 101).  
FIRST USE 9-30-2013; IN COMMERCE 9-30-2013.

OWNER OF U.S. REG. NOS. 1,303,954, 2,145,912, AND OTHERS.

THE MARK CONSISTS OF A LEAF DESIGN WITHIN A SQUARE THAT IS DIVIDED DIAGONALLY FROM THE TOP RIGHT TO THE BOTTOM LEFT, ALL TO THE LEFT OF THE TERM "NUTRILITE".

FOR ORGANIZING AND CONDUCTING SUPPORT GROUPS IN THE FIELD OF WEIGHT MANAGEMENT, NUTRITION, AND EXERCISE (U.S. CLS. 100 AND 101).  
FIRST USE 3-4-2013; IN COMMERCE 3-4-2013.

4,481,520. ALTICOR INC., ADA, MI. SN 85-381,063. PUB. 10-4-2011, FILED 7-26-2011.

4,481,668. HBI BRANDED APPAREL ENTERPRISES, LLC, WINSTON-SALEM, NC. SN 85-539,050. PUB. 9-4-2012, FILED 2-10-2012.

# NUTRILITE

# L'EGGACIES

THE MARK CONSISTS OF STANDARD CHARACTERS WITHOUT CLAIM TO ANY PARTICULAR FONT, STYLE, SIZE, OR COLOR.

OWNER OF U.S. REG. NOS. 1,303,954, 2,145,912, AND OTHERS.

FOR ORGANIZING AND CONDUCTING SUPPORT GROUPS IN THE FIELD OF WEIGHT MANAGEMENT, NUTRITION, AND EXERCISE (U.S. CLS. 100 AND 101).  
FIRST USE 3-4-2013; IN COMMERCE 3-4-2013.

THE MARK CONSISTS OF STANDARD CHARACTERS WITHOUT CLAIM TO ANY PARTICULAR FONT, STYLE, SIZE, OR COLOR.

OWNER OF U.S. REG. NOS. 891,626, 1,850,354, AND OTHERS.

FOR ONLINE DISCUSSIONS, NAMELY, ONLINE SOCIAL NETWORKING SERVICES IN THE FIELD OF CLOTHING, HOSIERY, LINGERIE AND CLOTHING ACCESSORIES OFFERED BY THE BRAND OWNER (U.S. CLS. 100 AND 101).  
FIRST USE 8-19-2013; IN COMMERCE 8-19-2013.

**CLASS 45—(Continued).**

4,481,708. GREG LENTZ MINISTRIES, SALISBURY, NC. SN 85-577,808. PUB. 8-14-2012, FILED 3-23-2012.

**RESTORING THE HERITAGE**

THE MARK CONSISTS OF STANDARD CHARACTERS WITHOUT CLAIM TO ANY PARTICULAR FONT, STYLE, SIZE, OR COLOR.

FOR CHRISTIAN MINISTRY AND EVANGELISM SERVICES (U.S. CLS. 100 AND 101).

FIRST USE 6-6-2013; IN COMMERCE 6-6-2013.

4,481,813. GETTY IMAGES (US), INC., NEW YORK, NY. SN 85-637,829. PUB. 10-30-2012, FILED 5-29-2012.

**GETTY.IM/**

THE MARK CONSISTS OF STANDARD CHARACTERS WITHOUT CLAIM TO ANY PARTICULAR FONT, STYLE, SIZE, OR COLOR.

FOR LICENSING OF INTELLECTUAL PROPERTY; LICENSING OF INTELLECTUAL PROPERTY OF OTHERS; LICENSING OF INTELLECTUAL PROPERTY, NAMELY, REPRODUCTION RIGHTS FOR IMAGES, PHOTOGRAPHS, STOCK PHOTOGRAPHS, ARCHIVAL PHOTOGRAPHS, ART REPRODUCTIONS, GRAPHIC DESIGNS, CLIP ART, NEWS IMAGES, AND ILLUSTRATIONS; LICENSING OF IMAGES, PHOTOGRAPHS, STOCK PHOTOGRAPHS, ARCHIVAL PHOTOGRAPHS, ART REPRODUCTIONS, GRAPHIC DESIGNS, CLIP ART, NEWS IMAGES, AND ILLUSTRATIONS TO OTHERS VIA COMPUTER NETWORKS AND GLOBAL COMMUNICATIONS NETWORKS; LICENSING OF VISUAL CONTENT FOR OTHERS; STOCK PHOTOGRAPHY SERVICES, NAMELY, LEASING REPRODUCTION RIGHTS OF PHOTOGRAPHS AND DIGITAL CONTENT TO OTHERS (U.S. CLS. 100 AND 101).

FIRST USE 5-24-2012; IN COMMERCE 5-24-2012.

**CLASS 45—(Continued).**

4,481,887. PREPPYDOM, LLC, DBA PREPPYDOM, NEW CANAAN, CT. SN 85-672,254. PUB. 9-3-2013, FILED 7-9-2012.

**Preppydom**

THE MARK CONSISTS OF STANDARD CHARACTERS WITHOUT CLAIM TO ANY PARTICULAR FONT, STYLE, SIZE, OR COLOR.

FOR ON-LINE SOCIAL NETWORKING SERVICES; ONLINE SOCIAL NETWORKING SERVICES PROVIDED THROUGH A COMMUNITY WEBSITE; ONLINE SOCIAL NETWORKING SERVICES PROVIDED THROUGH A FASHION COMMUNITY WEBSITE; ONLINE SOCIAL NETWORKING SERVICES PROVIDED THROUGH A SPORTS COMMUNITY WEBSITE; PROVIDING A SOCIAL NETWORKING WEBSITE FOR ENTERTAINMENT PURPOSES (U.S. CLS. 100 AND 101).

FIRST USE 7-1-2013; IN COMMERCE 7-1-2013.

4,481,944. ACTRIGHT ACTION, INC., PLAINFIELD, IN. SN 85-700,455. PUB. 1-15-2013, FILED 8-10-2012.

**ACT RIGHT**

THE MARK CONSISTS OF STANDARD CHARACTERS WITHOUT CLAIM TO ANY PARTICULAR FONT, STYLE, SIZE, OR COLOR.

FOR LEGAL SERVICES FOR CONSERVATIVE ORGANIZATIONS IN FURTHERANCE OF EXERCISING FUNDAMENTAL RIGHTS (U.S. CLS. 100 AND 101).

FIRST USE 12-1-2012; IN COMMERCE 12-1-2012.

4,482,087. CIMBULIS, ILGA, MINNETONKA, MN. SN 85-736,903. PUB. 2-26-2013, FILED 9-24-2012.

**FEED PLAY LOVE PET SITTING**

THE MARK CONSISTS OF STANDARD CHARACTERS WITHOUT CLAIM TO ANY PARTICULAR FONT, STYLE, SIZE, OR COLOR.

NO CLAIM IS MADE TO THE EXCLUSIVE RIGHT TO USE "PET SITTING", APART FROM THE MARK AS SHOWN.

FOR PET SITTING (U.S. CLS. 100 AND 101).  
FIRST USE 9-15-2012; IN COMMERCE 9-15-2012.



**CLASS 45—(Continued).**

4,482,093. HOWTOFIND.ME LLC, BROOKLYN, NY. SN 85-737,607. PUB. 3-5-2013, FILED 9-25-2012.

**CLASS 45—(Continued).**

4,482,356. GRAHAM BRYAN PRITCHETT, DILLON, CO. SN 85-797,618. PUB. 5-7-2013, FILED 12-7-2012.

howtofind.me

BUBBLE MILL

THE MARK CONSISTS OF STANDARD CHARACTERS WITHOUT CLAIM TO ANY PARTICULAR FONT, STYLE, SIZE, OR COLOR.

FOR ON-LINE SOCIAL NETWORKING SERVICES (U.S. CLS. 100 AND 101).

FIRST USE 8-1-2013; IN COMMERCE 9-1-2013.

THE MARK CONSISTS OF STANDARD CHARACTERS WITHOUT CLAIM TO ANY PARTICULAR FONT, STYLE, SIZE, OR COLOR.

FOR LICENSING OF PROPRIETARY INTELLECTUAL PROPERTY AND TECHNICAL KNOW-HOW IN THE TECHNICAL FIELD OF SONIC WELDING (U.S. CLS. 100 AND 101).

FIRST USE 10-29-2013; IN COMMERCE 10-29-2013.

4,482,347. MUSE PUBLISHING, WEST PALM BEACH, FL. SN 85-793,249. PUB. 4-30-2013, FILED 12-3-2012.

4,482,588. FREEBORN & PETERS LLP, CHICAGO, IL. SN 85-884,311. PUB. 8-6-2013, FILED 3-22-2013.

Project Life 365

YOUR FUTURE IS OUR PURPOSE

THE MARK CONSISTS OF STANDARD CHARACTERS WITHOUT CLAIM TO ANY PARTICULAR FONT, STYLE, SIZE, OR COLOR.

FOR ON-LINE SOCIAL NETWORKING SERVICES (U.S. CLS. 100 AND 101).

FIRST USE 11-15-2012; IN COMMERCE 12-17-2012.

THE MARK CONSISTS OF STANDARD CHARACTERS WITHOUT CLAIM TO ANY PARTICULAR FONT, STYLE, SIZE, OR COLOR.

FOR LEGAL SERVICES (U.S. CLS. 100 AND 101).

FIRST USE 3-28-2013; IN COMMERCE 3-28-2013.

\* \* \* \* \*

PRIOR UNITED STATES CLASSIFICATION

APPLICATION IN ONE CLASS

CERTIFICATION MARKS

**CLASS A—GOODS**

4,481,403. COPPER DEVELOPMENT ASSOCIATION, NEW YORK, NY. SN 85-057,875. PUB. 4-26-2011, FILED 6-8-2010.

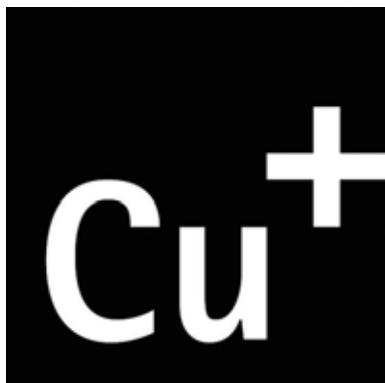

THE MARK CONSISTS OF THE CHARACTERS "CU+" PLACED IN A BOX.

THE CERTIFICATION MARK, AS USED BY PERSONS AUTHORIZED BY THE CERTIFIER, CERTIFIES THAT THE GOODS CONFORM TO THE ANTIMICROBIAL STANDARDS DESIGNATED BY THE CERTIFIER.

FOR COPPER; COPPER ALLOYS (U.S. CL. A).  
FIRST USE 3-1-2012; IN COMMERCE 3-1-2012.

THE CERTIFICATION MARK, AS INTENDED TO BE USED BY AUTHORIZED PERSONS, IS INTENDED TO CERTIFY GOODS AND SERVICES PRODUCED AND PROVIDED BY YOUNG ENTREPRENEURS.

FOR SOAPS; PERFUMERY, COSMETICS, JEWELRY, BOWLS MADE OF WOOD AND BONE, CLOTHING, FOOTWEAR, HEADGEAR, HANDBAGS, DRIED AND COOKED FRUITS AND VEGETABLES, LASSI, ICE CREAM, TEA, COCOA, PASTRIES AND CONFECTIONERIES, CONDIMENTS, FRUIT BEVERAGES AND FRUIT JUICES (U.S. CL. A).

FIRST USE 5-0-2012; IN COMMERCE 5-0-2012.

---

4,481,689. YOUTH EMPLOYMENT SUMMIT CAMPAIGN, INC., LEXINGTON, MA. SN 85-558,610. PUB. 2-12-2013, FILED 3-2-2012.



---

4,481,688. YOUTH EMPLOYMENT SUMMIT CAMPAIGN, INC., LEXINGTON, MA. SN 85-558,604. PUB. 2-12-2013, FILED 3-2-2012.

**YOUTH TRADE**

THE MARK CONSISTS OF STANDARD CHARACTERS WITHOUT CLAIM TO ANY PARTICULAR FONT, STYLE, SIZE, OR COLOR.

NO CLAIM IS MADE TO THE EXCLUSIVE RIGHT TO USE "YOUTH", APART FROM THE MARK AS SHOWN.

NO CLAIM IS MADE TO THE EXCLUSIVE RIGHT TO USE "YOUTH", APART FROM THE MARK AS SHOWN.

THE MARK CONSISTS OF THE WORDS "YOUTH TRADE" IN STYLIZED LOWERCASE LETTERS, WITH "YOUTH" PLACED DIRECTLY ABOVE "TRADE". THE BOTTOM OF THE "H" IN "YOUTH" IS CONNECTED TO THE TOP OF THE "D" IN "TRADE". TWO LEAVES APPEAR TO BE GROWING FROM THE "H" IN "YOUTH".

THE CERTIFICATION MARK, AS INTENDED TO BE USED BY AUTHORIZED PERSONS, IS INTENDED TO CERTIFY GOODS AND SERVICES PRODUCED AND PROVIDED BY YOUNG ENTREPRENEURS.

FOR SOAPS; PERFUMERY, COSMETICS, JEWELRY, BOWLS MADE OF WOOD AND BONE, CLOTHING, FOOTWEAR, HEADGEAR, HANDBAGS, DRIED AND COOKED FRUITS AND VEGETABLES, LASSI, ICE CREAM, TEA, COCOA, PASTRIES AND CONFECTIONERIES, CONDIMENTS, FRUIT BEVERAGES AND FRUIT JUICES (U.S. CL. A).

FIRST USE 5-0-2012; IN COMMERCE 5-0-2012.

4,482,446. HOW TO BE A REDHEAD LLC, HAINES CITY, FL. SN 85-832,190. PUB. 5-21-2013, FILED 1-25-2013.

4,481,474. AIR CONDITIONING CONTRACTORS OF AMERICA, ARLINGTON, VA. SN 85-255,368. PUB. 10-25-2011, FILED 3-2-2011.



NO CLAIM IS MADE TO THE EXCLUSIVE RIGHT TO USE "APPROVED", APART FROM THE MARK AS SHOWN. THE COLOR(S) PINK, RED AND BLACK IS/ARE CLAIMED AS A FEATURE OF THE MARK.

THE MARK CONSISTS OF PINK CIRCLE WITH TWO RED CIRCLES WITHIN IT. IN THE CENTER IS A RED-HEADED WOMAN WITH RED LIPS AND BLACK EYEBROWS AND EYES. BELOW HER IS "APPROVED" IN BLACK STYLIZED FONT. ABOVE AND BELOW HER IS "HOW TO BE A REDHEAD REDHEAD FRIENDLY" IN RED STYLIZED FONT.

THE CERTIFICATION MARK, AS INTENDED TO BE USED BY AUTHORIZED PERSONS, IS INTENDED TO CERTIFY THE ITEM MUST BE DESIGNED FOR SENSITIVE SKIN AND CAN NOT CAUSE ALLERGIC SKIN REACTIONS, SKIN IRRITATION, ITCHINESS OR DRYING. PRODUCT MUST COMPLIMENT RED HAIR AND A FAIR COMPLEXION. TO REFRAIN FROM SENSITIVE SKIN OUTBREAKS, THE PRODUCT MUST BE CHEMICAL FREE, AMMONIA FREE AND/OR SULFATE FREE. IF PRODUCT IS USED FOR THE SKIN, IT MUST HAVE LITTLE OR NO FRAGRANCE AND ZERO ALCOHOL.

FOR COSMETICS, BEAUTY CARE PREPARATIONS, AND FASHION CLOTHING (U.S. CL. A). FIRST USE 7-0-2013; IN COMMERCE 7-0-2013.



OWNER OF U.S. REG. NOS. 1,222,147, 2,642,630, AND 2,931,446.

NO CLAIM IS MADE TO THE EXCLUSIVE RIGHT TO USE "QUALITY ASSURED" AND "HVAC", APART FROM THE MARK AS SHOWN.

THE MARK CONSISTS OF THE LETTERS "QA" OVER THE WORD "HVAC" THAT APPEARS IN A RECTANGULAR BOX. WITH THE WORDS "ACCA QUALITY ASSURED" FORMING THE LEFT HALF OF THE "Q".

THE CERTIFICATION MARK, AS INTENDED TO BE USED BY AUTHORIZED PERSONS, IS INTENDED TO CERTIFY THAT THE PERSONS DISPLAYING THE MARK HAVE DEMONSTRATED, THROUGH THE SUCCESSFUL COMPLETION OF AN EXAM AND SELF-ASSESSMENT PROCEDURES, THAT THEY SATISFY THE CERTIFIER'S REQUIREMENTS FOR KNOWLEDGE RELATIVE TO THE INSTALLATION, MAINTENANCE AND REPAIR OF HVAC SYSTEMS.

FOR HEATING VENTILATION AND AIR CONDITIONING (HVAC) CONTRACTING SERVICES, NAMELY, INSTALLATION, MAINTENANCE AND REPAIR OF HVAC SYSTEMS (U.S. CL. B). FIRST USE 8-1-2012; IN COMMERCE 8-1-2012.

4,481,965. VE TRAIN TECHNOLOGIES, LLC, TUSCALOOSA, AL. SN 85-713,858. PUB. 8-27-2013, FILED 8-27-2012.

### RAMP Residential Apartment Manager Professional

THE MARK CONSISTS OF STANDARD CHARACTERS WITHOUT CLAIM TO ANY PARTICULAR FONT, STYLE, SIZE, OR COLOR.

NO CLAIM IS MADE TO THE EXCLUSIVE RIGHT TO USE "RESIDENTIAL APARTMENT MANAGER PROFESSIONAL", APART FROM THE MARK AS SHOWN.

#### CERTIFICATION MARKS

#### CLASS B—SERVICES

THE CERTIFICATION OF MARK, AS USED OR INTENDED TO BE USED BY PERSONS AUTHORIZED BY THE CERTIFIER, CERTIFIES OR IS INTENDED TO CERTIFY THAT THE TRAINING COURSES RECEIVING SUCH CERTIFICATION ARE OFFERED AND DELIVERED WITH QUALITY AND CONSISTENCY AND IN ACCORDANCE WITH THE GUIDELINES, CRITERIA, STANDARDS AND PROCEDURES WHICH ARE DEVELOPED, IMPLEMENTED, AND EVALUATED BY THE CERTIFIER.

FOR TRAINING SERVICES IN THE FIELD OF RESIDENTIAL APARTMENT MANAGEMENT (U.S. CL. B).  
FIRST USE 1-1-2013; IN COMMERCE 2-1-2013.

\* \* \* \* \*

# SUPPLEMENTAL REGISTER

These registrations are not subject to opposition.

## SECTION 1.— INTERNATIONAL CLASSIFICATION

The short titles associated below with the international class numbers are terms designed merely for quick identification and are not an official part of the international classification. The full names of international classes are given in section 6.1 of the trademark rules of practice.

The designation "U.S. Cl." appearing in this section refers to the U.S. class in effect prior to Sep. 1, 1973 rather than the international class which applies to applications filed on or after that date. For adoption of international classification see notice in the OFFICIAL GAZETTE of Jun. 26, 1973 (911 O.G. TM 210).

### Application in more than one class

4,482,701. STONES RIVER REGIONAL IPA, MURFREESBORO, TN. SN 76-712,730. FILED P.R. 10-31-2012; AM. S.R. 12-2-2013.

4,482,703. EARLY WARNING SERVICES, LLC, SCOTTS-DALE, AZ. SN 85-076,491. FILED P.R. 7-1-2010; AM. S.R. 10-15-2013.

#### STONES RIVER REGIONAL HEALTH FAIR

THE MARK CONSISTS OF STANDARD CHARACTERS WITHOUT CLAIM TO ANY PARTICULAR FONT, STYLE, SIZE, OR COLOR.

NO CLAIM IS MADE TO THE EXCLUSIVE RIGHT TO USE "REGIONAL HEALTH FAIR", APART FROM THE MARK AS SHOWN.

#### CLASS 35—ADVERTISING AND BUSINESS

FOR CONDUCTING TRADE FAIRS FOR COMMERCIAL AND ADVERTISING PURPOSES IN THE HEALTH CARE FIELD; ORGANIZATION OF FAIRS FOR PROMOTIONAL AND ADVERTISING PURPOSES TO PROMOTE THE HEALTH SERVICES OF A COMMUNITY-WIDE NETWORK OF PHYSICIAN PROVIDERS (U.S. CLS. 100, 101 AND 102).  
FIRST USE 11-0-2012; IN COMMERCE 11-0-2012.

#### CLASS 41—EDUCATION AND ENTERTAINMENT

FOR ENTERTAINMENT SERVICES, NAMELY, CONDUCTING HEALTH FAIRS NOT FOR COMMERCIAL PURPOSES (U.S. CLS. 100, 101 AND 107).  
FIRST USE 11-0-2012; IN COMMERCE 11-0-2012.

#### CLASS 44—MEDICAL, BEAUTY AND AGRICULTURAL SERVICES

FOR HEALTH FAIRS, NAMELY, PROVIDING HEALTH SCREENINGS SERVICES IN THE FIELD OF MULTIPLE SCREENINGS, BMI, SLEEP APNEA SCREENS, PULSE OXYGEN LEVELS, HEARING TESTS, VISION SCREENING, ASTHMA SCREENING, FOOT SCREENINGS, GLUCOSE TESTING, CHOLESTEROL SCREENINGS, BLOOD PRESSURE, LIPID PROFILE AT HEALTH FAIRS; HEALTH FAIRS, NAMELY, PROVIDING MEDICAL SCREENINGS AND PROVIDING HEALTH AND MEDICAL INFORMATION AT HEALTH FAIRS (U.S. CLS. 100 AND 101).  
FIRST USE 11-0-2012; IN COMMERCE 11-0-2012.

#### RISK INTELLIGENCE NETWORK

THE MARK CONSISTS OF STANDARD CHARACTERS WITHOUT CLAIM TO ANY PARTICULAR FONT, STYLE, SIZE, OR COLOR.

#### CLASS 36—INSURANCE AND FINANCIAL

FOR FINANCIAL RISK MANAGEMENT (U.S. CLS. 100, 101 AND 102).  
FIRST USE 8-31-2012; IN COMMERCE 8-31-2012.

#### CLASS 45—PERSONAL AND LEGAL SERVICES

FOR COLLECTION, VERIFICATION AND ANALYSIS OF CONSUMER DATA AND FINANCIAL INFORMATION TO DETECT AND PREVENT FRAUD AND IDENTITY THEFT; RISK MANAGEMENT SERVICES FOR THE DETECTION AND PREVENTION OF FRAUD (U.S. CLS. 100 AND 101).  
FIRST USE 8-31-2012; IN COMMERCE 8-31-2012.

---

4,482,712. O2 RINSE LLC, CHARLESTON, SC. SN 85-523,147. FILED P.R. 1-23-2012; AM. S.R. 12-17-2013.

## O2 Rinse

THE MARK CONSISTS OF STANDARD CHARACTERS WITHOUT CLAIM TO ANY PARTICULAR FONT, STYLE, SIZE, OR COLOR.

NO CLAIM IS MADE TO THE EXCLUSIVE RIGHT TO USE "RINSE", APART FROM THE MARK AS SHOWN.

**CLASS 3—COSMETICS AND CLEANING PREPARATIONS**

FOR MOUTH WASHES; NON-MEDICATED DENTAL RINSE; NON-MEDICATED MOUTH RINSE; NON-MEDICATED MOUTH WASH AND RINSE; NON-MEDICATED MOUTH WASHES (U.S. CLS. 1, 4, 6, 50, 51 AND 52).

FIRST USE 2-4-2011; IN COMMERCE 2-4-2011.

**CLASS 5—PHARMACEUTICALS**

FOR DENTAL RINSE; MEDICATED DENTAL RINSES; MEDICATED MOUTH CARE AND TREATMENT PREPARATIONS; MEDICATED MOUTH WASH; MEDICATED MOUTH WASHES; MOUTH CAVITY CLEANSERS (U.S. CLS. 6, 18, 44, 46, 51 AND 52).

FIRST USE 2-4-2011; IN COMMERCE 2-4-2011.

---

4,482,726. RECKITT BENCKISER LLC, PARSIPPANY, NJ. SN 85-719,487. FILED P.R. 9-4-2012; AM. S.R. 12-5-2013.

TROPICAL PLUMERIA & SWEET  
HONEYSUCKLE

THE MARK CONSISTS OF STANDARD CHARACTERS WITHOUT CLAIM TO ANY PARTICULAR FONT, STYLE, SIZE, OR COLOR.

**CLASS 3—COSMETICS AND CLEANING PREPARATIONS**

FOR PERFUMING PREPARATIONS FOR THE ATMOSPHERE, NAMELY, ROOM FRAGRANCES AND ROOM PERFUME SPRAYS; ESSENTIAL OILS; AROMATIC ESSENTIAL OILS; ESSENTIAL OILS FOR HOUSEHOLD USE; ESSENTIAL OILS FOR USE IN THE MANUFACTURE OF SCENTED PRODUCTS; ESSENTIAL OILS SOLD AS AN INTEGRAL COMPONENT OF ROOM PERFUME SPRAYS, SCENTED OILS AND AIR FRAGRANCING PREPARATIONS; ESSENTIAL OILS USED TO PRODUCE AROMAS WHEN HEATED (U.S. CLS. 1, 4, 6, 50, 51 AND 52).

FIRST USE 1-0-2013; IN COMMERCE 1-0-2013.

**CLASS 5—PHARMACEUTICALS**

FOR AIR DEODORIZING PREPARATIONS; HOUSEHOLD AND ROOM DEODORANTS; ESSENTIAL OILS SOLD AS AN INTEGRAL COMPONENT OF AIR DEODORIZING PREPARATIONS (U.S. CLS. 6, 18, 44, 46, 51 AND 52).

FIRST USE 1-0-2013; IN COMMERCE 1-0-2013.

4,482,727. MONTANI, MARK, SOUTHBRIDGE, MA. SN 85-727,820. FILED P.R. 9-13-2012; AM. S.R. 11-26-2013.

ITALIAN CHOPPERS

THE MARK CONSISTS OF STANDARD CHARACTERS WITHOUT CLAIM TO ANY PARTICULAR FONT, STYLE, SIZE, OR COLOR.

OWNER OF U.S. REG. NO. 4,211,819.

NO CLAIM IS MADE TO THE EXCLUSIVE RIGHT TO USE "CHOPPERS" FOR CLASS 012, AND "ITALIAN" FOR CLASS 025, APART FROM THE MARK AS SHOWN.

**CLASS 12—VEHICLES**

FOR MOTORCYCLES, AND STRUCTURAL AND MECHANICAL PARTS THEREFOR, ALL OF THE FOREGOING ARE MADE IN ITALY (U.S. CLS. 19, 21, 23, 31, 35 AND 44).

FIRST USE 6-29-2011; IN COMMERCE 6-29-2011.

**CLASS 25—CLOTHING**

FOR CLOTHING, NAMELY, TOPS, BOTTOMS, COMBINATIONS, JACKETS, HATS, SHIRTS, VESTS, CHAPS, BOOTS, SHOES, PANTS, GLOVES, COATS, UNDERWEAR, SOCKS (U.S. CLS. 22 AND 39).

FIRST USE 6-29-2011; IN COMMERCE 6-29-2011.

---

4,482,736. CERTIFIED RADON LLC, KANSAS CITY, MO. SN 85-826,941. FILED P.R. 1-18-2013; AM. S.R. 11-7-2013.

CERTIFIED RADON

THE MARK CONSISTS OF STANDARD CHARACTERS WITHOUT CLAIM TO ANY PARTICULAR FONT, STYLE, SIZE, OR COLOR.

NO CLAIM IS MADE TO THE EXCLUSIVE RIGHT TO USE "RADON", APART FROM THE MARK AS SHOWN.

**CLASS 37—CONSTRUCTION AND REPAIR**

FOR CRAWL SPACE ENCAPSULATION, NAMELY, INSTALLATION OF A CRAWL SPACE POLYETHYLENE BARRIER (U.S. CLS. 100, 103 AND 106).

FIRST USE 1-1-2003; IN COMMERCE 1-1-2003.

**CLASS 40—MATERIAL TREATMENT**

FOR ENVIRONMENTAL REMEDIATION SERVICES, NAMELY, EXTRACTING HARMFUL GASES FROM HOMES, SCHOOLS AND OFFICES TO PURIFY THE AIR (U.S. CLS. 100, 103 AND 106).

FIRST USE 1-1-2003; IN COMMERCE 1-1-2003.

**CLASS 42—SCIENTIFIC AND COMPUTER SERVICES**

FOR RADON DETECTING; RADON MONITORING; LABORATORY SERVICES, NAMELY, ANALYSIS OF RESULTS OF RADON MEASUREMENT (U.S. CLS. 100 AND 101).

FIRST USE 1-1-2003; IN COMMERCE 1-1-2003.

4,482,739. WEBTRENDS INC., PORTLAND, OR. SN 85-837,453. FILED P.R. 1-31-2013; AM. S.R. 10-23-2013.

# Streams

THE MARK CONSISTS OF STANDARD CHARACTERS WITHOUT CLAIM TO ANY PARTICULAR FONT, STYLE, SIZE, OR COLOR.

## CLASS 35—ADVERTISING AND BUSINESS

FOR ADVERTISING AND MARKETING SERVICES, NAMELY, DIGITAL ADVERTISING AND MARKETING SERVICES AND ELECTRONIC DATA COLLECTION OF ADVERTISING AND MARKETING DATA FROM A WEBSITE, APPLICATION OR SOFTWARE PLATFORM FOR BUSINESS PURPOSES (U.S. CLS. 100, 101 AND 102).  
FIRST USE 10-15-2012; IN COMMERCE 10-15-2012.

## CLASS 42—SCIENTIFIC AND COMPUTER SERVICES

FOR COMPUTER SERVICES, NAMELY, PROVIDING DATA INTELLIGENCE IN THE NATURE OF WEBSITE ANALYTICS THROUGH THE USE OF TEMPORARY, NON-DOWNLOADABLE COMPUTER SOFTWARE; COMPUTER PROGRAMMING AND COMPUTER SOFTWARE DESIGN FOR THE GRAPHICAL PRESENTATION OF DATA; COMPUTER SERVICES, NAMELY, PROVIDING TEMPORARY USE OF NON-DOWNLOADABLE SOFTWARE FOR COLLECTING, MEASURING, SEGMENTING AND TRANSMITTING AND REPORTING DATA OVER A COMPUTER NETWORK, FROM A WEBSITE, MOBILE DEVICE, MOBILE APPLICATION OR SOFTWARE PLATFORM IN REAL TIME (U.S. CLS. 100 AND 101).  
FIRST USE 10-15-2012; IN COMMERCE 10-15-2012.

---

4,482,744. ORGANIC FOOD INCUBATOR, LLC, LONG ISLAND CITY, NY. SN 85-841,162. FILED P.R. 2-5-2013; AM. S.R. 11-27-2013.

# Organic Food Incubator

THE MARK CONSISTS OF STANDARD CHARACTERS WITHOUT CLAIM TO ANY PARTICULAR FONT, STYLE, SIZE, OR COLOR.

NO CLAIM IS MADE TO THE EXCLUSIVE RIGHT TO USE "ORGANIC FOOD", APART FROM THE MARK AS SHOWN.

## CLASS 35—ADVERTISING AND BUSINESS

FOR BUSINESS ASSISTANCE, ADVISORY AND CONSULTING SERVICES IN THE FIELD OF FOOD AND BEVERAGE MANUFACTURING, PRODUCT MANUFACTURING, PRODUCT DEVELOPMENT, PRODUCT AND PACKAGING DESIGN, MANUFACTURING SANITATION, LICENSING, SOURCING MATERIALS AND BUSINESS AND MANUFACTURING BUDGETING; BUSINESS CONSULTANCY; BUSINESS CONSULTATION AND MANAGEMENT REGARDING MARKETING ACTIVITIES AND LAUNCHING OF NEW PRODUCTS; BUSINESS MARKETING CONSULTING SERVICES; ALL OF THESE SERVICES RELATED TO USE WITH ORGANIC FOODS (U.S. CLS. 100, 101 AND 102).  
FIRST USE 12-1-2011; IN COMMERCE 12-1-2011.

## CLASS 40—MATERIAL TREATMENT

FOR CONTRACT MANUFACTURING IN THE FIELD OF ORGANIC FOOD, BEVERAGE AND PRODUCT PACKAGING; CUSTOM MANUFACTURE OF ORGANIC FOOD AND BEVERAGE; MANUFACTURE OF ORGANIC FOOD, BEVERAGE AND ASSOCIATED PACKAGING TO ORDER AND/OR SPECIFICATION OF OTHERS; MANUFACTURING SERVICES FOR OTHERS IN THE FIELD OF ORGANIC FOOD AND BEVERAGE (U.S. CLS. 100, 103 AND 106).  
FIRST USE 12-1-2011; IN COMMERCE 12-1-2011.

## CLASS 41—EDUCATION AND ENTERTAINMENT

FOR CONDUCTING WORKSHOPS AND SEMINARS IN LAUNCHING ORGANIC FOOD PRODUCT BUSINESS, BUSINESS PLAN BASICS, BUDGET BASICS, HOW TO PRICE AND POSITION PRODUCTS, ORGANIC FOOD MANUFACTURING REQUIREMENTS, GOOD MANUFACTURING PRACTICES, SOURCING INGREDIENTS, AND COMMON MANUFACTURING TOOLS; COOKING INSTRUCTION; EDUCATION SERVICES, NAMELY, PROVIDING LIVE AND ON-LINE CLASSES AND WORKSHOPS IN THE FIELD OF ORGANIC FOOD AND BEVERAGE PRODUCTS AND BUSINESS, NAMELY, CLASSES RELATING TO PRODUCTION, MANUFACTURING SANITATION, LICENSING, SOURCING MATERIALS, MANUFACTURING ISSUES, NUTRITIONAL INFORMATION, AND COST AND BUDGETING; EDUCATION SERVICES, NAMELY, PROVIDING CLASSES AND WORKSHOPS IN THE FIELD OF ORGANIC FOOD AND BEVERAGE PRODUCT DEVELOPMENT, MANUFACTURING, MANUFACTURING SANITATION, LICENSING, SOURCING MATERIALS, MANUFACTURING ISSUES, NUTRITIONAL INFORMATION, AND COST AND BUDGETING; ALL OF THESE SERVICES RELATED SPECIFICALLY TO THE USE OF ORGANIC FOODS (U.S. CLS. 100, 101 AND 107).  
FIRST USE 12-1-2011; IN COMMERCE 12-1-2011.

## CLASS 43—HOTEL AND RESTAURANT SERVICES

FOR LEASING OF KITCHEN APPLIANCES; PROVIDING TEMPORARY KITCHEN FACILITIES; RENTAL OF COOKING APPARATUS; RENTAL OF COOKING EQUIPMENT FOR INDUSTRIAL PURPOSES; ALL OF THESE SERVICES RELATED TO USE WITH ORGANIC FOODS (U.S. CLS. 100 AND 101).  
FIRST USE 12-1-2011; IN COMMERCE 12-1-2011.

4,482,768. SASSER FAMILY HOLDINGS, INC., CHICAGO, IL. SN 85-870,027. FILED P.R. 3-7-2013; AM. S.R. 12-5-2013.

4,482,804. ARCTIC ISLAND, LLC, LAS VEGAS, NV. SN 85-945,644. FILED P.R. 5-29-2013; AM. S.R. 11-8-2013.

## WAYCROSS RAILCAR

THE MARK CONSISTS OF STANDARD CHARACTERS WITHOUT CLAIM TO ANY PARTICULAR FONT, STYLE, SIZE, OR COLOR.

NO CLAIM IS MADE TO THE EXCLUSIVE RIGHT TO USE "RAILCAR", APART FROM THE MARK AS SHOWN.

### CLASS 37—CONSTRUCTION AND REPAIR

FOR RAILCAR REPAIR AND MODIFICATION; RAILCAR CLEANING; WHEEL REPAIR; LOCOMOTIVE REPAIR AND MODIFICATION; LOCOMOTIVE WHEEL REPAIR; WHEEL STRAIGHTENING AND REPAIR (U.S. CLS. 100, 103 AND 106).

FIRST USE 0-0-2011; IN COMMERCE 0-0-2011.

### CLASS 39—TRANSPORTATION AND STORAGE

FOR RAILCAR SALVAGE SERVICES (U.S. CLS. 100 AND 105).

FIRST USE 0-0-2011; IN COMMERCE 0-0-2011.

### CLASS 42—SCIENTIFIC AND COMPUTER SERVICES

FOR RAILCAR INSPECTION SERVICES (U.S. CLS. 100 AND 101).

FIRST USE 0-0-2011; IN COMMERCE 0-0-2011.

---

4,482,779. INDIO PRODUCTS, INC., COMMERCE, CA. SN 85-887,767. FILED P.R. 3-27-2013; AM. S.R. 11-20-2013.

## NATUREL

THE MARK CONSISTS OF STANDARD CHARACTERS WITHOUT CLAIM TO ANY PARTICULAR FONT, STYLE, SIZE, OR COLOR.

THE ENGLISH TRANSLATION OF "NATUREL" IN THE MARK IS "NATURAL".

### CLASS 3—COSMETICS AND CLEANING PREPARATIONS

FOR INCENSE; ROOM FRAGRANCES; SCENTED OILS (U.S. CLS. 1, 4, 6, 50, 51 AND 52).

FIRST USE 2-0-2013; IN COMMERCE 2-0-2013.

### CLASS 4—LUBRICANTS AND FUELS

FOR CANDLES (U.S. CLS. 1, 6 AND 15).

FIRST USE 2-0-2013; IN COMMERCE 2-0-2013.

## FUNDAMERICA

THE MARK CONSISTS OF STANDARD CHARACTERS WITHOUT CLAIM TO ANY PARTICULAR FONT, STYLE, SIZE, OR COLOR.

### CLASS 36—INSURANCE AND FINANCIAL

FOR FINANCIAL SERVICES, NAMELY, SECURITIES BROKER-DEALER SERVICES, SECURITIES BROKER-DEALER SYNDICATION SERVICES, TRADING OF SECURITIES AND MUNICIPAL SECURITIES, BUSINESS FUNDRAISING AND CROWDFUNDING SERVICES, FACILITATING AND ARRANGING FOR THE FINANCING OF STARTUP AND EXISTING BUSINESSES AND PROJECTS; PRIVATE PLACEMENTS OF HEDGE FUNDS, PRIVATE EQUITY FUNDS, SECURITIES AND DERIVATIVES FOR OTHERS; PROVIDING ON-LINE BUSINESS FUNDRAISING AND CROWDFUNDING SERVICES (U.S. CLS. 100, 101 AND 102).

FIRST USE 5-24-2013; IN COMMERCE 5-24-2013.

### CLASS 42—SCIENTIFIC AND COMPUTER SERVICES

FOR SOFTWARE DESIGN AND DEVELOPMENT; SOFTWARE CUSTOMIZATION; DEVELOPING CUSTOMIZED WHITE-LABEL SOFTWARE FOR OTHERS; PROVIDING TEMPORARY USE OF ON-LINE NON-DOWNLOADABLE SOFTWARE FOR CROWDFUNDING AND FUNDRAISING APPLICATIONS (U.S. CLS. 100 AND 101).

FIRST USE 5-24-2013; IN COMMERCE 5-24-2013.

---

4,482,829. FEDERAL HOUSING FINANCE AGENCY, WASHINGTON, DC. SN 86-032,823. FILED P.R. 8-8-2013; AM. S.R. 9-26-2013.

## Home Affordable Refinance Program

THE MARK CONSISTS OF STANDARD CHARACTERS WITHOUT CLAIM TO ANY PARTICULAR FONT, STYLE, SIZE, OR COLOR.

NO CLAIM IS MADE TO THE EXCLUSIVE RIGHT TO USE "REFINANCE PROGRAM", APART FROM THE MARK AS SHOWN.



**CLASS 35—ADVERTISING AND BUSINESS**

FOR ADVERTISING SERVICES; BUSINESS INFORMATION; DISSEMINATION OF ADVERTISING MATTER; PUBLICITY; ADVERTISING MATTER, NAMELY, THE DISSEMINATION OF ADVERTISING MATERIAL RELATED TO FINANCIAL AND REAL ESTATE SERVICES IN THE FIELD OF MORTGAGE LOANS AND MORTGAGE-BASED OR MORTGAGE-RELATED SECURITIES; BUSINESS ADMINISTRATION SERVICES RELATING TO THE DRAWING UP AND DEVELOPMENT OF STANDARD RULES AND QUALIFICATIONS FOR FINANCIAL AND REAL ESTATE PROGRAMS RELATED TO MORTGAGE LOANS AND MORTGAGE-BASED OR MORTGAGE-RELATED SECURITIES (U.S. CLS. 100, 101 AND 102).

FIRST USE 4-1-2009; IN COMMERCE 4-1-2009.

**CLASS 36—INSURANCE AND FINANCIAL**

FOR PROVIDING FINANCIAL INFORMATION RELATED TO THE QUALIFICATIONS, CRITERIA AND CONDITIONS RELATED TO MORTGAGE LOANS AND MORTGAGE-BASED OR MORTGAGE-RELATED SECURITIES; AND PROVIDING EDUCATIONAL INFORMATION IN THE FIELD OF MORTGAGE LOANS AND MORTGAGE-BASED OR MORTGAGE-RELATED SECURITIES (U.S. CLS. 100, 101 AND 102).

FIRST USE 4-1-2009; IN COMMERCE 4-1-2009.

**CLASS 41—EDUCATION AND ENTERTAINMENT**

FOR ARRANGING AND CONDUCTING OF WORKSHOPS, SEMINARS, SYMPOSIUMS, MEETINGS, AND OTHER TRAINING IN THE FIELD OF MORTGAGE LOANS AND MORTGAGE-BASED OR MORTGAGE-RELATED SECURITIES; PROVIDING COURSES IN THE FIELD OF MORTGAGE LOANS AND MORTGAGE-BASED OR MORTGAGE-RELATED SECURITIES (U.S. CLS. 100, 101 AND 107).

FIRST USE 4-1-2009; IN COMMERCE 4-1-2009.

4,482,839. CONTINENTAL SPORTS SUPPLY, INC., ENGLEWOOD, CO. SN 86-039,111. FILED P.R. 8-15-2013; AM. S.R. 12-7-2013.

America's Rugby Brand

THE MARK CONSISTS OF STANDARD CHARACTERS WITHOUT CLAIM TO ANY PARTICULAR FONT, STYLE, SIZE, OR COLOR.

NO CLAIM IS MADE TO THE EXCLUSIVE RIGHT TO USE "RUGBY BRAND", APART FROM THE MARK AS SHOWN.

**CLASS 18—LEATHER GOODS**

FOR BACKPACKS; SPORTS BAGS (U.S. CLS. 1, 2, 3, 22 AND 41).

FIRST USE 7-1-2011; IN COMMERCE 7-1-2011.

**CLASS 25—CLOTHING**

FOR JACKETS; JERSEYS; RUGBY SHORTS; SHOES; WARM UP SUITS (U.S. CLS. 22 AND 39).

FIRST USE 7-1-2011; IN COMMERCE 7-1-2011.

**CLASS 28—TOYS AND SPORTING GOODS**

FOR PROTECTIVE PADDING FOR PLAYING RUGBY; RUGBY BALLS (U.S. CLS. 22, 23, 38 AND 50).

FIRST USE 7-1-2011; IN COMMERCE 7-1-2011.

4,482,847. RECYCLED BROOKLYN, INC., BROOKLYN, NY. SN 86-043,646. FILED P.R. 8-21-2013; AM. S.R. 12-10-2013.

Recycled Brooklyn

THE MARK CONSISTS OF STANDARD CHARACTERS WITHOUT CLAIM TO ANY PARTICULAR FONT, STYLE, SIZE, OR COLOR.

**CLASS 20—FURNITURE AND ARTICLES NOT OTHERWISE CLASSIFIED**

FOR FURNITURE (U.S. CLS. 2, 13, 22, 25, 32 AND 50).

FIRST USE 3-1-2010; IN COMMERCE 3-1-2010.

**CLASS 35—ADVERTISING AND BUSINESS**

FOR ON-LINE WHOLESALE AND RETAIL STORE SERVICES FEATURING FURNITURE (U.S. CLS. 100, 101 AND 102).

FIRST USE 3-1-2010; IN COMMERCE 3-1-2010.

\* \* \* \* \*

## SECTION 2.— INTERNATIONAL CLASSIFICATION

The short titles associated below with the international class numbers are terms designed merely for quick identification and are not an official part of the international classification. The full names of international classes are given in section 6.1 of the trademark rules of practice.

The designation "U.S. Cl." appearing in this section refers to the U.S. class in effect prior to Sep. 1, 1973 rather than the international class which applies to applications filed on or after that date. For adoption of international classification see notice in the OFFICIAL GAZETTE of Jun. 26, 1973 (911 O.G. TM 210).

### Application in one class

#### CLASS 1—CHEMICALS

4,482,719. CARBONXT INC., CHARLESTON, WV. SN 85-634,810. FILED P.R. 5-24-2012; AM. S.R. 12-11-2013.

# MATS-PAC

THE MARK CONSISTS OF STANDARD CHARACTERS WITHOUT CLAIM TO ANY PARTICULAR FONT, STYLE, SIZE, OR COLOR.

FOR ADSORBING CARBONS FOR THE REMOVAL OF MERCURY AND OTHER TOXINS THAT ARE PRODUCED DURING THE PROCESSING OF CARBON MATERIAL TO GENERATE POWER AND ENERGY (U.S. CLS. 1, 5, 6, 10, 26 AND 46).

FIRST USE 5-21-2013; IN COMMERCE 5-21-2013.

#### CLASS 3—(Continued).

4,482,780. HAND COVER, LLC, STOCKBRIDGE, GA. SN 85-893,285. FILED 4-2-2013.

# Hand Cover

THE MARK CONSISTS OF STANDARD CHARACTERS WITHOUT CLAIM TO ANY PARTICULAR FONT, STYLE, SIZE, OR COLOR.

NO CLAIM IS MADE TO THE EXCLUSIVE RIGHT TO USE "HAND", APART FROM THE MARK AS SHOWN.

FOR HAND LOTIONS (U.S. CLS. 1, 4, 6, 50, 51 AND 52).

FIRST USE 11-5-2013; IN COMMERCE 11-5-2013.

#### CLASS 3—COSMETICS AND CLEANING PREPARATIONS

4,482,755. TRI-COASTAL DESIGN GROUP, INC., WHARTON, NJ. SN 85-855,643. FILED P.R. 2-20-2013; AM. S.R. 12-2-2013.

# ALMOND AMARETTI

THE MARK CONSISTS OF STANDARD CHARACTERS WITHOUT CLAIM TO ANY PARTICULAR FONT, STYLE, SIZE, OR COLOR.

FOR BATH GEL; BATH SALTS; BATH SOAPS; BODY CREAM; BODY LOTION; BODY OIL; BODY SCRUB; BODY SPRAYS; BUBBLE BATH; DUSTING POWDER; FOOT SCRUBS; LIP BALM; LIP GLOSS; LIQUID SOAP; NAIL POLISH; REEDS AND SCENTED OILS SOLD AS A UNIT FOR USE IN ROOM SCENT DIFFUSERS (U.S. CLS. 1, 4, 6, 50, 51 AND 52).

FIRST USE 11-26-2013; IN COMMERCE 11-26-2013.

4,482,786. ADAM ALI ASGHAR, SHARJAH, UNITED ARAB EMIR.. SN 85-905,340. FILED P.R. 4-16-2013; AM. S.R. 12-5-2013.



The logo consists of two parts. The top part is the Arabic word 'دبي' (Dubai) written in a bold, black, stylized calligraphic font. Below it, the word 'Dubai' is written in a black, elegant, cursive script font.

OWNER OF ERPN CMNTY TM OFC REG. NO. 011739448, DATED 8-26-2013, EXPIRES 4-15-2023.

THE MARK CONSISTS OF THE TERM "DUBAI" IN A STYLIZED FONT, AND THE TERM "DUBAI" IN ARABIC ABOVE THE ENGLISH WORD "DUBAI".

THE NON-LATIN CHARACTERS IN THE MARK TRANSLITERATE TO "DUBAI" AND THIS MEANS "DUBAI" IN ENGLISH.

FOR EAU DE PERFUME (U.S. CLS. 1, 4, 6, 50, 51 AND 52).

**CLASS 3—(Continued).**

4,482,794. PUR ARGAN, LLC, CORAL SPRINGS, FL. SN 85-925,891. FILED P.R. 5-7-2013; AM. S.R. 12-5-2013.

---

## PUR ARGAN

THE MARK CONSISTS OF STANDARD CHARACTERS WITHOUT CLAIM TO ANY PARTICULAR FONT, STYLE, SIZE, OR COLOR.

FOR ANTI-AGING MOISTURIZER; COSMETIC OILS (U.S. CLS. 1, 4, 6, 50, 51 AND 52).  
FIRST USE 5-1-2013; IN COMMERCE 5-1-2013.

---

4,482,862. TRI-COASTAL DESIGN GROUP, INC., WHAR-TON, NJ. SN 86-079,858. FILED 10-1-2013.

## RASPBERRY LEMONADE

THE MARK CONSISTS OF STANDARD CHARACTERS WITHOUT CLAIM TO ANY PARTICULAR FONT, STYLE, SIZE, OR COLOR.

OWNER OF U.S. REG. NO. 4,430,345.  
FOR BATH GEL; BATH SALTS; BATH SOAPS; BODY CREAM; BODY LOTION; BODY OIL; BODY SCRUB; BODY SPRAYS; BUBBLE BATH; DUSTING POWDER; FOOT SCRUBS; LIP BALM; LIP GLOSS; LIQUID SOAP (U.S. CLS. 1, 4, 6, 50, 51 AND 52).  
FIRST USE 4-10-2012; IN COMMERCE 4-10-2012.

---

4,482,869. TRI-COASTAL DESIGN GROUP, INC., WHAR-TON, NJ. SN 86-102,591. FILED 10-27-2013.

## POMEGRANATE AND GARDENIA

THE MARK CONSISTS OF STANDARD CHARACTERS WITHOUT CLAIM TO ANY PARTICULAR FONT, STYLE, SIZE, OR COLOR.

FOR BATH GEL; BATH SALTS; BATH SOAPS; BODY CREAM; BODY LOTION; BODY OIL; BODY SCRUB; BODY SPRAYS; BUBBLE BATH; DUSTING POWDER; FOOT SCRUBS; LIP BALM; LIP GLOSS; LIQUID SOAP (U.S. CLS. 1, 4, 6, 50, 51 AND 52).  
FIRST USE 5-15-2012; IN COMMERCE 5-15-2012.

**CLASS 3—(Continued).**

4,482,870. TRI-COASTAL DESIGN GROUP, INC., WHAR-TON, NJ. SN 86-103,586. FILED 10-28-2013.

## WATERLILY PEAR

THE MARK CONSISTS OF STANDARD CHARACTERS WITHOUT CLAIM TO ANY PARTICULAR FONT, STYLE, SIZE, OR COLOR.

FOR BATH GEL; BATH SALTS; BATH SOAPS; BODY CREAM; BODY LOTION; BODY OIL; BODY SCRUB; BODY SPRAYS; BUBBLE BATH; DUSTING POWDER; FOOT SCRUBS; LIP BALM; LIP GLOSS; LIQUID SOAP (U.S. CLS. 1, 4, 6, 50, 51 AND 52).  
FIRST USE 5-10-2005; IN COMMERCE 5-10-2005.

**CLASS 5—PHARMACEUTICALS**

4,482,717. TOTAL NUTRITIONAL HOLDINGS LLC, WIL-MINGTON, DE. SN 85-608,437. FILED P.R. 4-25-2012; AM. S.R. 12-11-2013.

## ALKALINITY FRUIT

THE MARK CONSISTS OF STANDARD CHARACTERS WITHOUT CLAIM TO ANY PARTICULAR FONT, STYLE, SIZE, OR COLOR.

FOR DIETARY AND NUTRITIONAL SUPPLEMENTS (U.S. CLS. 6, 18, 44, 46, 51 AND 52).  
FIRST USE 9-1-2011; IN COMMERCE 9-1-2011.

---

4,482,718. TOTAL NUTRITIONAL HOLDINGS LLC, WIL-MINGTON, DE. SN 85-608,561. FILED P.R. 4-25-2012; AM. S.R. 12-11-2013.

## ALKALINITY GREENS

THE MARK CONSISTS OF STANDARD CHARACTERS WITHOUT CLAIM TO ANY PARTICULAR FONT, STYLE, SIZE, OR COLOR.

FOR DIETARY AND NUTRITIONAL SUPPLEMENTS (U.S. CLS. 6, 18, 44, 46, 51 AND 52).  
FIRST USE 9-1-2011; IN COMMERCE 9-1-2011.

**CLASS 5—(Continued).**

4,482,763. MEDLINE INDUSTRIES, INC., MUNDELEIN, IL.  
SN 85-863,967. FILED P.R. 3-1-2013; AM. S.R. 12-9-2013.



THE COLOR(S) PINK IS/ARE CLAIMED AS A FEATURE OF THE MARK.

THE MARK CONSISTS OF THE COLOR PINK APPLIED TO THE ENTIRE SURFACE OF THE INCONTINENCE UNDERWEAR. THE MATTER SHOWN IN THE DRAWING IN BROKEN LINES SERVES ONLY TO SHOW POSITIONING OF THE MARK AND NO CLAIM IS MADE TO IT.

FOR ADULT INCONTINENCE BRIEFS (U.S. CLS. 6, 18, 44, 46, 51 AND 52).

FIRST USE 10-3-2013; IN COMMERCE 10-3-2013.

4,482,807. NGUYEN, TUONG, WESTMINSTER, CA. SN 85-950,808. FILED P.R. 6-4-2013; AM. S.R. 11-14-2013.

**DAILY MULTICHEW**

THE MARK CONSISTS OF STANDARD CHARACTERS WITHOUT CLAIM TO ANY PARTICULAR FONT, STYLE, SIZE, OR COLOR.

FOR DIETARY AND NUTRITIONAL SUPPLEMENTS; VITAMIN AND MINERAL SUPPLEMENTS (U.S. CLS. 6, 18, 44, 46, 51 AND 52).

FIRST USE 2-1-2013; IN COMMERCE 2-1-2013.

**CLASS 5—(Continued).**

4,482,852. NATURAL EDGE HAWAII, INC., HONOLULU, HI. SN 86-047,217. FILED P.R. 8-24-2013; AM. S.R. 12-18-2013.

**Hawaiian Cleanse and Slim**

THE MARK CONSISTS OF STANDARD CHARACTERS WITHOUT CLAIM TO ANY PARTICULAR FONT, STYLE, SIZE, OR COLOR.

FOR DIETARY AND NUTRITIONAL SUPPLEMENTS; DIETARY AND NUTRITIONAL SUPPLEMENTS CONTAINING SPIRULINA; DIETARY AND NUTRITIONAL SUPPLEMENTS USED FOR WEIGHT LOSS; DIETARY SUPPLEMENT FOR ELIMINATING TOXINS FROM THE INTESTINAL TRACT; HERBAL SUPPLEMENTS; LIQUID NUTRITIONAL SUPPLEMENT; NUTRITIONAL AND DIETARY SUPPLEMENTS FORMED AND PACKAGED AS BARS; NUTRITIONAL SUPPLEMENT FOR ELIMINATING TOXINS FROM THE INTESTINAL TRACT; WEIGHT MANAGEMENT SUPPLEMENTS (U.S. CLS. 6, 18, 44, 46, 51 AND 52).

FIRST USE 5-1-2011; IN COMMERCE 5-1-2011.

4,482,857. THE TERMINIX INTERNATIONAL COMPANY LIMITED PARTNERSHIP, MEMPHIS, TN. SN 86-058,106. FILED 9-6-2013.

**ULTIMATE PROTECTION**

THE MARK CONSISTS OF STANDARD CHARACTERS WITHOUT CLAIM TO ANY PARTICULAR FONT, STYLE, SIZE, OR COLOR.

OWNER OF U.S. REG. NO. 3,374,556.  
FOR INSECTICIDES (U.S. CLS. 6, 18, 44, 46, 51 AND 52).

FIRST USE 12-18-2012; IN COMMERCE 12-18-2012.

4,482,864. VITAL PHARMACEUTICALS, INC, WESTON, FL. SN 86-089,230. FILED P.R. 10-11-2013; AM. S.R. 12-19-2013.

**BLUE RAZZ**

THE MARK CONSISTS OF STANDARD CHARACTERS WITHOUT CLAIM TO ANY PARTICULAR FONT, STYLE, SIZE, OR COLOR.

FOR NUTRITIONALLY FORTIFIED BEVERAGES (U.S. CLS. 6, 18, 44, 46, 51 AND 52).

FIRST USE 9-28-2013; IN COMMERCE 9-28-2013.

**CLASS 5—(Continued).**

4,482,872. CREATIVE MEDICAL HEALTH INC., PHOENIX, AZ. SN 86-107,222. FILED 10-31-2013.

**Bionutraceutical**

THE MARK CONSISTS OF STANDARD CHARACTERS WITHOUT CLAIM TO ANY PARTICULAR FONT, STYLE, SIZE, OR COLOR.

FOR NUTRACEUTICALS FOR USE AS A DIETARY SUPPLEMENT (U.S. CLS. 6, 18, 44, 46, 51 AND 52).  
FIRST USE 3-13-2013; IN COMMERCE 3-31-2013.

**CLASS 8—HAND TOOLS**

4,482,769. EVRIHOLDER PRODUCTS, LLC, ANAHEIM, CA. SN 85-872,051. FILED P.R. 3-10-2013; AM. S.R. 12-24-2013.

**LEAF GRABB'R**

THE MARK CONSISTS OF STANDARD CHARACTERS WITHOUT CLAIM TO ANY PARTICULAR FONT, STYLE, SIZE, OR COLOR.

FOR HAND-HELD GARDEN TOOL, NAMELY, EXTENDED REACH APPARATUS FOR LEAF DISPOSAL (U.S. CLS. 23, 28 AND 44).

FIRST USE 8-14-2013; IN COMMERCE 8-14-2013.

**CLASS 7—MACHINERY**

4,482,746. VELCON FILTERS, LLC, COLORADO SPRINGS, CO. SN 85-845,145. FILED P.R. 2-8-2013; AM. S.R. 8-7-2013.

**CLEANDiesel**

THE MARK CONSISTS OF THE TERM "CLEANDIESEL" IN STYLIZED LETTERING, WITH THE WORD "CLEAN" IN CAPITALIZED, BLOCK LETTERS THAT ARE OUTLINED BUT NOT FILLED IN, AND THE WORD "DIESEL" IN SOLID TEXT WITH A CAPITAL "D" AND THE REMAINING LETTERS IN LOWER CASE.

FOR FUEL FILTRATION SYSTEMS COMPRISING FUEL FILTERS, FUEL FILTER HOUSINGS, FILTER VESSELS AND FUEL CONDITION MONITORING PRODUCTS (U.S. CLS. 13, 19, 21, 23, 31, 34 AND 35).

FIRST USE 8-0-2012; IN COMMERCE 8-0-2012.

4,482,814. EVEREADY BATTERY COMPANY, INC., ST. LOUIS, MO. SN 85-972,123. FILED P.R. 6-27-2013; AM. S.R. 11-19-2013.

**CURVE SENSING**

THE MARK CONSISTS OF STANDARD CHARACTERS WITHOUT CLAIM TO ANY PARTICULAR FONT, STYLE, SIZE, OR COLOR.

FOR RAZOR BLADES; RAZORS (U.S. CLS. 23, 28 AND 44).

FIRST USE 1-4-2012; IN COMMERCE 1-4-2012.

4,482,795. JETECH INC, BATTLE CREEK, MI. SN 85-925,936. FILED 5-8-2013.

**JETECH**

THE MARK CONSISTS OF STANDARD CHARACTERS WITHOUT CLAIM TO ANY PARTICULAR FONT, STYLE, SIZE, OR COLOR.

FOR ULTRA HIGH AND HIGH PRESSURE PUMPS AND STRUCTURAL PARTS THEREFOR, AS MACHINE PARTS, FOR USE IN THE CHEMICAL INJECTION INDUSTRY, OIL FIELD SERVICE INDUSTRY, PETROLEUM PROCESSING INDUSTRY, REVERSE OSMOSIS AND FILTRATION INDUSTRY, MINING INDUSTRY AND WATER BLASTING INDUSTRY (U.S. CLS. 13, 19, 21, 23, 31, 34 AND 35).

FIRST USE 11-1-1990; IN COMMERCE 3-14-1991.

**CLASS 9—ELECTRICAL AND SCIENTIFIC APPARATUS**

4,482,708. TRENDTECH LLC, ROCKVILLE, MD. SN 85-479,547. FILED P.R. 11-22-2011; AM. S.R. 5-3-2012.

**Weboxx**

THE MARK CONSISTS OF STANDARD CHARACTERS WITHOUT CLAIM TO ANY PARTICULAR FONT, STYLE, SIZE, OR COLOR.

FOR DIGITAL MEDIA HUBS; DIGITAL MEDIA RECEIVERS; DIGITAL MEDIA STREAMING DEVICES; REMOTE CONTROLS FOR DIGITAL MEDIA PLAYERS (U.S. CLS. 21, 23, 26, 36 AND 38).

FIRST USE 11-18-2011; IN COMMERCE 11-18-2011.

**CLASS 9—(Continued).**

4,482,720. IVR CARE TRANSITION SYSTEMS, INC., BIRMINGHAM, AL. SN 85-671,419. FILED P.R. 7-9-2012; AM. S.R. 12-9-2013.

## IVR CARE TRANSITION SYSTEMS

THE MARK CONSISTS OF STANDARD CHARACTERS WITHOUT CLAIM TO ANY PARTICULAR FONT, STYLE, SIZE, OR COLOR.

NO CLAIM IS MADE TO THE EXCLUSIVE RIGHT TO USE "SYSTEMS", APART FROM THE MARK AS SHOWN.

FOR COMPUTER HARDWARE AND SOFTWARE, NAMELY, INTERACTIVE TELECOMMUNICATIONS COMPUTER HARDWARE AND SOFTWARE FOR MONITORING PATIENTS FOLLOWING THE TRANSITION FROM HOSPITAL CARE TO HOME-BASED CARE; INTERACTIVE TELECOMMUNICATIONS COMPUTER HARDWARE AND SOFTWARE FOR OBTAINING MEDICAL INFORMATION FROM A PATIENT AND TRANSMITTING THE MEDICAL INFORMATION TO A HEALTH CARE PROVIDER LOCATED IN A REMOTE LOCATION; INTERACTIVE TELECOMMUNICATIONS COMPUTER HARDWARE AND SOFTWARE FOR OBTAINING REAL-TIME MEDICAL INFORMATION FROM A PATIENT AND TRANSMITTING THE MEDICAL INFORMATION TO A HEALTH CARE PROVIDER LOCATED IN A REMOTE LOCATION SO THAT THE MEDICAL INFORMATION CAN BE ACCESSED AND PROCESSED IN REAL-TIME BY THE HEALTH CARE PROVIDER FOR PURPOSES OF MONITORING AND DIAGNOSING A PATIENT'S MEDICAL CONDITIONS (U.S. CLS. 21, 23, 26, 36 AND 38).

FIRST USE 11-22-2013; IN COMMERCE 11-22-2013.

4,482,724. ENVIRONMENTAL EXPRESS, INC., CHARLESTON, SC. SN 85-714,759. FILED P.R. 8-28-2012; AM. S.R. 12-31-2013.

## SOIL-CELL

THE MARK CONSISTS OF STANDARD CHARACTERS WITHOUT CLAIM TO ANY PARTICULAR FONT, STYLE, SIZE, OR COLOR.

FOR LABORATORY APPARATUS, NAMELY, SYSTEM COMPRISING OF A HEATING DEVICE AND STAINLESS STEEL SOIL EXTRACTION CELLS FOR TESTING GAS, LIQUIDS AND SOLIDS AND EXTRACTION CELLS FOR EXTRACTING ORGANIC COMPOUNDS FROM SAMPLES (U.S. CLS. 21, 23, 26, 36 AND 38).

FIRST USE 7-0-2012; IN COMMERCE 7-0-2012.

**CLASS 9—(Continued).**

4,482,730. MELROSE PR LLC, SANTA MONICA, CA. SN 85-783,347. FILED P.R. 11-19-2012; AM. S.R. 11-14-2013.

## pursecase

THE MARK CONSISTS OF STANDARD CHARACTERS WITHOUT CLAIM TO ANY PARTICULAR FONT, STYLE, SIZE, OR COLOR.

FOR CARRYING CASES FOR CELL PHONES; CARRYING CASES FOR ELECTRONIC EQUIPMENT, NAMELY, CELL PHONES; CASES FOR MOBILE PHONES; CELL PHONE CASES; PROTECTIVE COVERS AND CASES FOR CELL PHONES, LAPTOPS AND PORTABLE MEDIA PLAYERS (U.S. CLS. 21, 23, 26, 36 AND 38).

FIRST USE 2-1-2013; IN COMMERCE 2-1-2013.

4,482,732. LEBHAR-FRIEDMAN, INC., NEW YORK, NY. SN 85-793,931. FILED P.R. 12-4-2012; AM. S.R. 8-15-2013.

RESIDENTIAL BUILDING  
PRODUCTS AND TECHNOLOGY

THE MARK CONSISTS OF STANDARD CHARACTERS WITHOUT CLAIM TO ANY PARTICULAR FONT, STYLE, SIZE, OR COLOR.

FOR DOWNLOADABLE MAGAZINES IN THE FIELD OF CONSTRUCTION: MAGAZINES IN THE FIELD OF CONSTRUCTION RECORDED ON COMPUTER MEDIA (U.S. CLS. 21, 23, 26, 36 AND 38).

FIRST USE 1-28-2013; IN COMMERCE 1-28-2013.

4,482,733. LEBHAR-FRIEDMAN, INC., NEW YORK, NY. SN 85-793,945. FILED P.R. 12-4-2012; AM. S.R. 8-15-2013.



THE MARK CONSISTS OF THE WORDS "RESIDENTIAL BUILDING" ABOVE THE RECTANGULAR BOX CONTAINING THE WORDS "PRODUCTS AND TECHNOLOGY" AS WELL AS A SMALLER DIAMOND-SHAPED QUADRILATERAL.

FOR DOWNLOADABLE MAGAZINES IN THE FIELD OF CONSTRUCTION: MAGAZINES IN THE FIELD OF CONSTRUCTION RECORDED ON COMPUTER MEDIA (U.S. CLS. 21, 23, 26, 36 AND 38).

FIRST USE 1-28-2013; IN COMMERCE 1-28-2013.

**CLASS 9—(Continued).**

4,482,737. CERTIFIED RADON LLC, KANSAS CITY, MO. SN 85-827,067. FILED P.R. 1-18-2013; AM. S.R. 11-7-2013.

**RADONXPRESS**

THE MARK CONSISTS OF STANDARD CHARACTERS WITHOUT CLAIM TO ANY PARTICULAR FONT, STYLE, SIZE, OR COLOR.

FOR RADON GAS EQUIPMENT AND MATERIAL, NAMELY, RADON DETECTORS (U.S. CLS. 21, 23, 26, 36 AND 38).

FIRST USE 11-6-2013; IN COMMERCE 11-6-2013.

4,482,751. TELEADAPT LIMITED, WATFORD, HERTFORDSHIRE, UNITED KINGDOM. SN 85-848,318. FILED P.R. 2-13-2013; AM. S.R. 11-12-2013.

**CHARGEPORT**

THE MARK CONSISTS OF STANDARD CHARACTERS WITHOUT CLAIM TO ANY PARTICULAR FONT, STYLE, SIZE, OR COLOR.

FOR ELECTRICAL OUTLETS, ELECTRICAL POWER DEVICES, NAMELY, MULTIMEDIA OUTLETS; ELECTRICAL POWER CONNECTORS; ELECTRICAL APPARATUS FOR CONVERTING ONE A/C ELECTRICAL OUTLET INTO TWO A/C ELECTRICAL OUTLETS AND 2 USB SOCKETS (U.S. CLS. 21, 23, 26, 36 AND 38).

FIRST USE 10-0-2013; IN COMMERCE 10-0-2013.

4,482,754. ZELLER DESIGN, LLC, SANTA BARBARA, CA. SN 85-853,267. FILED P.R. 2-19-2013; AM. S.R. 12-5-2013.

**ChargeCard**

THE MARK CONSISTS OF STANDARD CHARACTERS WITHOUT CLAIM TO ANY PARTICULAR FONT, STYLE, SIZE, OR COLOR.

OWNER OF U.S. REG. NO. 4,316,634.

FOR CONNECTING ELECTRICAL CABLES, NAMELY, PORTABLE USB CHARGING AND DATA TRANSFER CABLE FOR MOBILE DEVICES (U.S. CLS. 21, 23, 26, 36 AND 38).

FIRST USE 2-1-2012; IN COMMERCE 7-18-2012.

**CLASS 9—(Continued).**

4,482,761. ONDAX INC., MONROVIA, CA. SN 85-861,800. FILED P.R. 2-27-2013; AM. S.R. 11-18-2013.

**THz-Raman**

THE MARK CONSISTS OF STANDARD CHARACTERS WITHOUT CLAIM TO ANY PARTICULAR FONT, STYLE, SIZE, OR COLOR.

FOR SPECTROSCOPY INSTRUMENTS AND ACCESSORIES, COMPRISED OF SPECIALIZED OPTICAL FILTERS, LASERS, DETECTORS, SENSORS, MICROSCOPES AND COMPUTER SOFTWARE AND HARDWARE, USED FOR MEASURING THE CHEMICAL COMPOSITION AND MOLECULAR STRUCTURE OF MATERIALS (U.S. CLS. 21, 23, 26, 36 AND 38).

FIRST USE 8-20-2013; IN COMMERCE 8-20-2013.

4,482,771. O'ROURKE, KEVIN, NASHVILLE, TN. SN 85-873,027. FILED P.R. 3-11-2013; AM. S.R. 12-10-2013.

**SMARTCORD**

THE MARK CONSISTS OF STANDARD CHARACTERS WITHOUT CLAIM TO ANY PARTICULAR FONT, STYLE, SIZE, OR COLOR.

FOR EXTENSION CORD WITH THERMOCHROMATIC MATERIALS; EXTENSION CORD WITH THERMAL INDICATOR (U.S. CLS. 21, 23, 26, 36 AND 38).

FIRST USE 11-26-2013; IN COMMERCE 11-26-2013.

4,482,777. IDIGIMART INC, WALNUT, CA. SN 85-886,514. FILED P.R. 3-26-2013; AM. S.R. 12-4-2013.

**Colorcase**

THE MARK CONSISTS OF STANDARD CHARACTERS WITHOUT CLAIM TO ANY PARTICULAR FONT, STYLE, SIZE, OR COLOR.

FOR CELL PHONE CASES, TABLET COMPUTER CASES, AND NOT RELATED TO OR INCLUDING CONTACT LENS CASES (U.S. CLS. 21, 23, 26, 36 AND 38).

FIRST USE 6-10-2011; IN COMMERCE 6-10-2011.

**CLASS 9—(Continued).**

4,482,815. ELBIT SYSTEMS LTD., HAIFA 31053, ISRAEL. SN 85-974,646. FILED P.R. 7-1-2013; AM. S.R. 11-28-2013.

**ZERO LATENCY**

THE MARK CONSISTS OF STANDARD CHARACTERS WITHOUT CLAIM TO ANY PARTICULAR FONT, STYLE, SIZE, OR COLOR.

OWNER OF ISRAEL REG. NO. 186000, DATED 6-5-2007, EXPIRES 12-13-2015.

OWNER OF U.S. REG. NO. 3,273,059.

FOR AN OPTICAL AND ELECTRONIC SYSTEM PRIMARILY COMPRISING AN IMAGE SOURCE, AN IMAGE DISPLAY PROCESSOR AND A PIXEL LOCATOR, FOR CORRECTING LINE OF SIGHT OF AN IMAGE DISPLAY ON A HELMET VIEWING SCREEN (U.S. CLS. 21, 23, 26, 36 AND 38).

**CLASS 9—(Continued).**

4,482,827. WEST CORPORATION, OMAHA, NE. SN 86-032,320. FILED P.R. 8-8-2013; AM. S.R. 12-9-2013.

**MobileMeet**

THE MARK CONSISTS OF STANDARD CHARACTERS WITHOUT CLAIM TO ANY PARTICULAR FONT, STYLE, SIZE, OR COLOR.

FOR COMPUTER APPLICATION SOFTWARE FOR MOBILE PHONES, PORTABLE MEDIA PLAYERS, HANDHELD COMPUTERS, NAMELY, SOFTWARE FOR VOICE AND DATA CONFERENCING, AUDIO AND VIDEO TELECONFERENCING, VOICE AND VIDEO STREAMING OF MESSAGES AND DATA, AND AUDIO AND VIDEO WEBCASTING (U.S. CLS. 21, 23, 26, 36 AND 38).

FIRST USE 6-29-2012; IN COMMERCE 10-9-2012.

4,482,816. PHYSICAL GRAPH CORPORATION, RESTON, VA. SN 85-980,928. FILED P.R. 4-10-2013; AM. S.R. 12-23-2013.

**SMARTAPPS**

THE MARK CONSISTS OF STANDARD CHARACTERS WITHOUT CLAIM TO ANY PARTICULAR FONT, STYLE, SIZE, OR COLOR.

FOR COMPUTER PROGRAMS FOR CONNECTING COMPUTERS, COMPUTER HARDWARE, COMPUTER PERIPHERAL DEVICES AND MOBILE DEVICES TO COMPUTER SOFTWARE PLATFORMS AND COMPUTER SERVICES TO REMOTELY MONITOR AND CONTROL DEVICES AND SYSTEMS IN THE HOMES AND BUSINESSES OF THE USER (U.S. CLS. 21, 23, 26, 36 AND 38).

FIRST USE 2-0-2013; IN COMMERCE 2-0-2013.

**CLASS 10—MEDICAL APPARATUS**

4,482,706. MICHAEL DISTEFANO, BERKELEY HEIGHTS, NJ. SN 85-384,325. FILED P.R. 7-29-2011; AM. S.R. 1-2-2014.

**THE MESSAGE 360**

THE MARK CONSISTS OF STANDARD CHARACTERS WITHOUT CLAIM TO ANY PARTICULAR FONT, STYLE, SIZE, OR COLOR.

NO CLAIM IS MADE TO THE EXCLUSIVE RIGHT TO USE "MESSAGE", APART FROM THE MARK AS SHOWN.

FOR HAND HELD MANUAL BODY MASSAGER (U.S. CLS. 26, 39 AND 44).

FIRST USE 11-22-2012; IN COMMERCE 11-22-2012.

4,482,823. BUCCHINO, JOAN, GARDEN CITY, NY. SN 86-028,424. FILED P.R. 8-5-2013; AM. S.R. 8-5-2013.

**SmartGAME**

THE MARK CONSISTS OF STANDARD CHARACTERS WITHOUT CLAIM TO ANY PARTICULAR FONT, STYLE, SIZE, OR COLOR.

FOR INTERACTIVE GAME PROGRAMS (U.S. CLS. 21, 23, 26, 36 AND 38).

FIRST USE 8-5-2013; IN COMMERCE 8-5-2013.

4,482,749. GLOBAL LIFT CORPORATION, BAD AXE, MI. SN 85-847,482. FILED P.R. 2-12-2013; AM. S.R. 11-29-2013.

**ROTATIONAL SERIES**

THE MARK CONSISTS OF STANDARD CHARACTERS WITHOUT CLAIM TO ANY PARTICULAR FONT, STYLE, SIZE, OR COLOR.

NO CLAIM IS MADE TO THE EXCLUSIVE RIGHT TO USE "SERIES", APART FROM THE MARK AS SHOWN.

FOR INVALID LIFTS (U.S. CLS. 26, 39 AND 44).

FIRST USE 2-1-2012; IN COMMERCE 2-1-2012.



**CLASS 10—(Continued).**

4,482,764. MEDLINE INDUSTRIES, INC., MUNDELEIN, IL.  
SN 85-863,974. FILED P.R. 3-1-2013; AM. S.R. 12-9-2013.



THE COLOR(S) PINK IS/ARE CLAIMED AS A FEATURE OF THE MARK.

THE MARK CONSISTS OF THE COLOR PINK APPLIED TO THE ENTIRE SURFACE OF THE DISPOSABLE PROTECTIVE AND PATIENT WEAR. THE MATTER SHOWN IN THE DRAWING IN BROKEN LINES SERVES ONLY TO SHOW POSITIONING OF THE MARK AND NO CLAIM IS MADE TO IT.

FOR DISPOSABLE PROTECTIVE AND PATIENT WEAR, NAMELY, ISOLATION GOWNS, PATIENT CAPES, PATIENT GOWNS, BOUFFANT CAPS, ALL FOR MEDICAL USE (U.S. CLS. 26, 39 AND 44).  
FIRST USE 10-3-2012; IN COMMERCE 10-3-2012.

4,482,773. BESTCARE, LLC, NORCROSS, GA. SN 85-875,150.  
FILED P.R. 3-13-2013; AM. S.R. 12-6-2013.

# BestLift

THE MARK CONSISTS OF STANDARD CHARACTERS WITHOUT CLAIM TO ANY PARTICULAR FONT, STYLE, SIZE, OR COLOR.

FOR INVALID LIFTS (U.S. CLS. 26, 39 AND 44).  
FIRST USE 9-1-2012; IN COMMERCE 9-1-2012.

4,482,844. FREEMAN, MATTHEW, S., DAYTON, OH. SN 86-042,204. FILED P.R. 8-19-2013; AM. S.R. 12-9-2013.

# boomboxx

THE MARK CONSISTS OF STANDARD CHARACTERS WITHOUT CLAIM TO ANY PARTICULAR FONT, STYLE, SIZE, OR COLOR.

FOR EAR PLUGS FOR NOISE REDUCTION (U.S. CLS. 26, 39 AND 44).  
FIRST USE 4-20-2013; IN COMMERCE 5-24-2013.

**CLASS 11—ENVIRONMENTAL CONTROL APPARATUS**

4,482,707. PIT BARREL COOKER COMPANY LLC, STRASBURG, CO. SN 85-388,236. FILED P.R. 8-3-2011; AM. S.R. 5-29-2012.

# PIT BARREL

THE MARK CONSISTS OF STANDARD CHARACTERS WITHOUT CLAIM TO ANY PARTICULAR FONT, STYLE, SIZE, OR COLOR.

NO CLAIM IS MADE TO THE EXCLUSIVE RIGHT TO USE "BARREL", APART FROM THE MARK AS SHOWN, FOR BARBECUES AND GRILLS (U.S. CLS. 13, 21, 23, 31 AND 34).

FIRST USE 1-25-2010; IN COMMERCE 1-25-2010.

**CLASS 12—VEHICLES**

4,482,838. ABOUNA, NAZHAT, MADISON HEIGHTS, MI. SN 86-038,834. FILED P.R. 8-15-2013; AM. S.R. 12-9-2013.

# RUCCI TIRES

THE MARK CONSISTS OF STANDARD CHARACTERS WITHOUT CLAIM TO ANY PARTICULAR FONT, STYLE, SIZE, OR COLOR.

OWNER OF U.S. REG. NO. 4,329,605.  
NO CLAIM IS MADE TO THE EXCLUSIVE RIGHT TO USE "TIRES", APART FROM THE MARK AS SHOWN, FOR TIRES (U.S. CLS. 19, 21, 23, 31, 35 AND 44).  
FIRST USE 6-0-2011; IN COMMERCE 6-0-2011.

**CLASS 14—JEWELRY**

4,482,759. COLUMBIA INSURANCE COMPANY, OMAHA, NE. SN 85-860,412. FILED P.R. 2-26-2013; AM. S.R. 12-3-2013.

# CAFÉ AU LAIT DIAMONDS

THE MARK CONSISTS OF STANDARD CHARACTERS WITHOUT CLAIM TO ANY PARTICULAR FONT, STYLE, SIZE, OR COLOR.

NO CLAIM IS MADE TO THE EXCLUSIVE RIGHT TO USE "DIAMONDS", APART FROM THE MARK AS SHOWN.

**CLASS 14—(Continued).**

THE ENGLISH TRANSLATION OF "CAFÉ AU LAIT" IN THE MARK IS "COFFEE COLORED".

FOR JEWELRY, NAMELY, RINGS, PENDANTS AND EARRINGS (U.S. CLS. 2, 27, 28 AND 50).  
FIRST USE 9-27-2013; IN COMMERCE 9-27-2013.

4,482,787. JAY GEMS, INC., DBA SIMPLY DIAMONDS, NEW YORK, NY. SN 85-906,368. FILED P.R. 4-17-2013; AM. S.R. 12-16-2013.

**BLUSH COLLECTION**

THE MARK CONSISTS OF STANDARD CHARACTERS WITHOUT CLAIM TO ANY PARTICULAR FONT, STYLE, SIZE, OR COLOR.

NO CLAIM IS MADE TO THE EXCLUSIVE RIGHT TO USE "COLLECTION", APART FROM THE MARK AS SHOWN.

FOR GEMSTONE JEWELRY; JEWELRY; PRECIOUS AND SEMI-PRECIOUS GEMS (U.S. CLS. 2, 27, 28 AND 50).

FIRST USE 5-1-2013; IN COMMERCE 6-1-2013.

**CLASS 16—PAPER GOODS AND PRINTED MATTER**

4,482,743. ANSTEDT, THEODORE R., HILLSBOROUGH, CA. AND DELIZONNA, LAURA, HILLSBOROUGH, CA. SN 85-840,874. FILED P.R. 2-5-2013; AM. S.R. 12-9-2013.

**Self-Coaching for Happiness**

THE MARK CONSISTS OF STANDARD CHARACTERS WITHOUT CLAIM TO ANY PARTICULAR FONT, STYLE, SIZE, OR COLOR.

FOR PUBLICATIONS, NAMELY, BOOKS, HANDBOOKS IN THE FIELDS OF POSITIVE PSYCHOLOGY AND HAPPINESS (U.S. CLS. 2, 5, 22, 23, 29, 37, 38 AND 50).

FIRST USE 1-1-2007; IN COMMERCE 9-25-2011.

4,482,762. MORRILL, ROBERT C., LA JOLLA, CA. AND MORRILL, JENNIFER P., LA JOLLA, CA. SN 85-862,723. FILED P.R. 2-28-2013; AM. S.R. 12-2-2013.

**PENCIL SKIRTZ**

THE MARK CONSISTS OF STANDARD CHARACTERS WITHOUT CLAIM TO ANY PARTICULAR FONT, STYLE, SIZE, OR COLOR.

**CLASS 16—(Continued).**

NO CLAIM IS MADE TO THE EXCLUSIVE RIGHT TO USE "PENCIL", APART FROM THE MARK AS SHOWN.

FOR ATTACHMENTS TO PENCILS FOR CHILDREN (U.S. CLS. 2, 5, 22, 23, 29, 37, 38 AND 50).  
FIRST USE 11-30-2013; IN COMMERCE 11-30-2013.

4,482,789. WRASMAN, ANDREW, SILVERADO, CA. SN 85-909,172. FILED P.R. 4-19-2013; AM. S.R. 12-2-2013.



THE MARK CONSISTS OF OF THE WORD "CONTRADICT" IN STYLIZED LETTERING, WHERE THE "C" CONTAINS THE OM SYMBOL WITHIN IT, THE "O" IS A YING AND YANG SYMBOL, THE "N" IS THE SHINTO SYMBOL, THE "T" IS A FLAMING CHALICE, THE "R" INCLUDES A PENTAGRAM, THE "A" IS SHOWN IN A CIRCLE WITH A VERTICAL LINE EXTENDING FROM THE BOTTOM OF THE CIRCLE TO THE MIDDLE OF THE LETTER, THE "D" IS A KOKOPELLI SYMBOL, THE "I" INCLUDES THE STAR OF DAVID, THE "C" IS THE CRESCENT STAR SYMBOL, AND THE "T" IS A CRUCIFIX.

FOR BOOKS IN THE FIELD OF INSPIRATION; BUMPER STICKERS (U.S. CLS. 2, 5, 22, 23, 29, 37, 38 AND 50).

FIRST USE 8-14-2012; IN COMMERCE 9-13-2012.

4,482,798. PAPER MONEY GUARANTY, LLC, SARASOTA, FL. SN 85-930,444. FILED P.R. 5-13-2013; AM. S.R. 12-5-2013.



OWNER OF U.S. REG. NOS. 4,142,331 AND 4,270,924.  
NO CLAIM IS MADE TO THE EXCLUSIVE RIGHT TO USE "PAPER MONEY GUARANTY", APART FROM THE MARK AS SHOWN.

THE MARK CONSISTS OF A THREE-DIMENSIONAL CONFIGURATION OF A PAPER MONEY HOLDER COMPRISING THE OVERALL RECTANGULAR SHAPE OF A CLEAR HOLDER WITH AN EMBOSSEING OR PATTERN AROUND THE BORDER OF THE PAPER MONEY HOLDER. INSIDE THE PAPER MONEY HOLDER ON THE TOP IS A RECTANGULAR LABEL WITH THE WORDING

**CLASS 16—(Continued).**

"PMG PAPER MONEY GUARANTY" & DESIGN OF SCALES. INSIDE THE PAPER MONEY HOLDER ON THE BOTTOM IS A CLEAR RECTANGULAR BOX FOR THE PAPER MONEY. THE BACKGROUND IS CLEAR AND SEALED ON ALL SIDES. THE BROKEN LINES DEPICTING THE RECTANGULAR SNAP OF THE PAPER MONEY HOLDER, INNER RECTANGLE HOLDING THE LABEL AND INNER RECTANGLE HOLDING THE PAPER MONEY INDICATE THE PLACEMENT OF THE MARK ON THE GOODS AND ARE NOT A PART OF THE MARK.

FOR PAPER MONEY HOLDERS (U.S. CLS. 2, 5, 22, 23, 29, 37, 38 AND 50).  
FIRST USE 2-16-2005; IN COMMERCE 2-16-2005.

---

4,482,801. STOREY PUBLISHING, LLC, NORTH ADAMS, MA. SN 85-933,608. FILED P.R. 5-16-2013; AM. S.R. 11-14-2013.

**Books for Self-Reliance**

THE MARK CONSISTS OF STANDARD CHARACTERS WITHOUT CLAIM TO ANY PARTICULAR FONT, STYLE, SIZE, OR COLOR.

NO CLAIM IS MADE TO THE EXCLUSIVE RIGHT TO USE "BOOKS", APART FROM THE MARK AS SHOWN.

FOR NON-FICTION BOOKS ON A VARIETY OF TOPICS (U.S. CLS. 2, 5, 22, 23, 29, 37, 38 AND 50).

FIRST USE 12-26-2012; IN COMMERCE 12-26-2012.

---

4,482,817. FIRSTFRUITS SYSTEMS INC, SAN JOSE, CA. SN 86-001,663. FILED P.R. 7-3-2013; AM. S.R. 11-15-2013.

**PHOTOTAPE**

THE MARK CONSISTS OF STANDARD CHARACTERS WITHOUT CLAIM TO ANY PARTICULAR FONT, STYLE, SIZE, OR COLOR.

FOR PACKAGING TAPE, FULL COLOR IMAGE PRINTED TAPE (U.S. CLS. 2, 5, 22, 23, 29, 37, 38 AND 50).

FIRST USE 1-1-2013; IN COMMERCE 5-1-2013.

**CLASS 16—(Continued).**

4,482,874. GRID TRAINING CORPORATION, DBA NORTHWEST LINEMAN COLLEGE, MERIDIAN, ID. SN 86-123,616. FILED P.R. 11-19-2013; AM. S.R. 12-12-2013.

**GRID TRAINING**

THE MARK CONSISTS OF STANDARD CHARACTERS WITHOUT CLAIM TO ANY PARTICULAR FONT, STYLE, SIZE, OR COLOR.

OWNER OF U.S. REG. NO. 3,942,914.

NO CLAIM IS MADE TO THE EXCLUSIVE RIGHT TO USE "TRAINING", APART FROM THE MARK AS SHOWN.

FOR PRINTED EDUCATIONAL MATERIALS IN THE FIELD OF ENERGY POWER DELIVERY, NAMELY, EDUCATIONAL MATERIALS FOR USE IN TEACHING AND TRAINING UTILITY WORKERS ON ASPECTS OF JOB PERFORMANCE AND SAFETY (U.S. CLS. 2, 5, 22, 23, 29, 37, 38 AND 50).

FIRST USE 1-25-2010; IN COMMERCE 2-1-2010.

**CLASS 18—LEATHER GOODS**

4,482,835. SHANGHAI NEOENT INDUSTRIAL CO., LTD., SHANGHAI CITY., CHINA. SN 86-038,394. FILED P.R. 8-14-2013; AM. S.R. 12-6-2013.

**Blomberg**

THE MARK CONSISTS OF THE STYLISED WORDING "BLOMBERG".

FOR ATTACHE CASES; BACKPACKS; BRIEFCASES; HANDBAGS; HAVERSACKS; LEATHER SHOPPING BAGS; LUGGAGE AND TRUNKS; POCKET WALLETS; PURSES; SPORT BAGS; STRING BAGS FOR SHOPPING; SUITCASES; TEXTILE SHOPPING BAGS; TRAVELLING BAGS; TRAVELLING TRUNKS; TRUNKS; UNFITTED VANITY CASES; VALISES; WHEELED SHOPPING BAGS (U.S. CLS. 1, 2, 3, 22 AND 41).

FIRST USE 11-20-2012; IN COMMERCE 4-20-2013.

**CLASS 24—FABRICS**

**CLASS 24—(Continued).**

4,482,709. MIAMI DOLPHINS, LTD., DAVIE, FL. SN 85-494,679. FILED P.R. 12-14-2011; AM. S.R. 12-11-2013.

**HORRIBLE HANKY**

THE MARK CONSISTS OF STANDARD CHARACTERS WITHOUT CLAIM TO ANY PARTICULAR FONT, STYLE, SIZE, OR COLOR.

NO CLAIM IS MADE TO THE EXCLUSIVE RIGHT TO USE "HANKY", APART FROM THE MARK AS SHOWN. FOR HANDKERCHIEFS (U.S. CLS. 42 AND 50). FIRST USE 12-15-2012; IN COMMERCE 12-15-2012.

---

4,482,725. BIAX-FIBERFILM CORPORATION, GREENVILLE, WI. SN 85-717,105. FILED P.R. 8-30-2012; AM. S.R. 6-24-2013.

**bi-form**

THE MARK CONSISTS OF STANDARD CHARACTERS WITHOUT CLAIM TO ANY PARTICULAR FONT, STYLE, SIZE, OR COLOR.

OWNER OF U.S. REG. NO. 4,224,910. FOR NON-WOVEN TEXTILE FABRICS (U.S. CLS. 42 AND 50). FIRST USE 9-30-2012; IN COMMERCE 11-21-2013.

**CLASS 25—CLOTHING**

4,482,704. 3D DESIGN CORPORATION, NEW YORK, NY. SN 85-094,510. FILED P.R. 7-28-2010; AM. S.R. 12-24-2013.

**IT STOPS HERE**

THE MARK CONSISTS OF STANDARD CHARACTERS WITHOUT CLAIM TO ANY PARTICULAR FONT, STYLE, SIZE, OR COLOR.

FOR WRIST BANDS (U.S. CLS. 22 AND 39). FIRST USE 2-23-2012; IN COMMERCE 2-23-2012.

**CLASS 25—(Continued).**

4,482,716. SPORT SHIRTS CONCEPTS LLC, MELBOURNE, FL. SN 85-584,693. FILED P.R. 3-30-2012; AM. S.R. 8-6-2013.

**BALLFIELD DIRT SHIRTS**

THE MARK CONSISTS OF STANDARD CHARACTERS WITHOUT CLAIM TO ANY PARTICULAR FONT, STYLE, SIZE, OR COLOR.

NO CLAIM IS MADE TO THE EXCLUSIVE RIGHT TO USE "SHIRTS", APART FROM THE MARK AS SHOWN.

FOR T-SHIRTS, JERSEYS, COLLARED SHIRTS, POLO SHIRTS, GOLF SHIRTS, CAPS, HATS, SHORTS AND PANTS (U.S. CLS. 22 AND 39). FIRST USE 6-25-2012; IN COMMERCE 3-28-2013.

---

4,482,723. U.S. MARINE CORPS, A COMPONENT OF THE U.S. DEPARTMENT OF THE NAVY, WASHINGTON, DC. SN 85-699,714. FILED P.R. 8-9-2012; AM. S.R. 4-1-2013.

**MARINES**

THE MARK CONSISTS OF STANDARD CHARACTERS WITHOUT CLAIM TO ANY PARTICULAR FONT, STYLE, SIZE, OR COLOR.

OWNER OF U.S. REG. NOS. 3,844,601, 4,087,562, AND OTHERS.

FOR HATS; SHIRTS; WEARABLE GARMENTS AND CLOTHING, NAMELY, SHIRTS (U.S. CLS. 22 AND 39). FIRST USE 8-31-2002; IN COMMERCE 8-31-2002.

**CLASS 25—(Continued).**

4,482,783. RAMIREZ, SHANNON, MAMMOTH, AZ. AND RAMIREZ, LAURIST, MAMMOTH, AZ. SN 85-901,059. FILED P.R. 4-11-2013; AM. S.R. 12-27-2013.



THE MARK CONSISTS OF A SHADED CONCENTRIC CIRCLE DESIGN FEATURING A BIOHAZARD SYMBOL WITH A SKULL IN THE MIDDLE OF IT, AND THE STYLIZED TEXT "ZOMBIE OUTBREAK RESPONSE TEAM" WRAPPED AROUND THE INTERIOR OF THE OUTER CIRCLE. TWO FIVE-POINTED STARS SEPARATE THE WORDING "ZOMBIE OUTBREAK" AND "RESPONSE TEAM".

FOR BANDANAS; BASEBALL CAPS; JACKETS; SWEATSHIRTS; T-SHIRTS; TANK TOPS; VISORS (U.S. CLS. 22 AND 39).  
FIRST USE 12-15-2012; IN COMMERCE 3-15-2013.

**CLASS 25—(Continued).**

4,482,800. BOOZE, JAYSEN, WESTMINSTER, CO. SN 85-932,944. FILED P.R. 5-15-2013; AM. S.R. 12-9-2013.



THE MARK CONSISTS OF THE LETTER "D", AN UP-SIDE-DOWN HEART, AND THE LETTER "P".  
FOR HATS; T-SHIRTS (U.S. CLS. 22 AND 39).  
FIRST USE 9-14-2009; IN COMMERCE 8-5-2010.

4,482,803. BOOZE, JAYSEN, WESTMINSTER, CO. SN 85-935,171. FILED P.R. 5-17-2013; AM. S.R. 12-9-2013.



THE MARK CONSISTS OF THE LETTER "D", A STAR, AND THE LETTER "P".  
FOR HATS; T-SHIRTS (U.S. CLS. 22 AND 39).  
FIRST USE 9-14-2009; IN COMMERCE 8-5-2010.

4,482,796. FRESHLY PICKED INC., PROVO, UT. SN 85-929,218. FILED P.R. 5-10-2013; AM. S.R. 12-10-2013.



THE MARK CONSISTS OF THE CONFIGURATION OF A CHILDREN'S SHOE FEATURING A UNIQUE FRONT PENTAGONAL SYMBOL/DESIGN HAVING A FRINGED TRIANGULAR-LIKE EDGE AS SHOWN IN THE DRAWING. THE MATTER SHOWN IN BROKEN LINES IS NOT CLAIMED FOR PURPOSES OF THIS REGISTRATION APPLICATION.

FOR FOOTWEAR (U.S. CLS. 22 AND 39).  
FIRST USE 12-0-2010; IN COMMERCE 12-0-2010.

4,482,805. THE TRUSTEES OF INDIANA UNIVERSITY, BLOOMINGTON, IN. SN 85-945,855. FILED P.R. 5-30-2013; AM. S.R. 12-2-2013.

**CRIMSON GUARD**

THE MARK CONSISTS OF STANDARD CHARACTERS WITHOUT CLAIM TO ANY PARTICULAR FONT, STYLE, SIZE, OR COLOR.  
FOR CLOTHING, NAMELY, SWEATSHIRTS, T-SHIRTS, AND HATS (U.S. CLS. 22 AND 39).  
FIRST USE 12-8-2009; IN COMMERCE 12-8-2009.

**CLASS 25—(Continued).**

4,482,837. CITIZEN, LATOYA C, HOUSTON, TX. SN 86-038,743. FILED P.R. 8-15-2013; AM. S.R. 12-6-2013.



THE MARK CONSISTS OF THE STYLIZED WORDING "[TOM.BOI] NOT JUST A PHASE...".

FOR ATHLETIC APPAREL, NAMELY, SHIRTS, PANTS, JACKETS, FOOTWEAR, HATS AND CAPS, ATHLETIC UNIFORMS; BOTTOMS; CAPS; FOOTWEAR; HATS; HEADWEAR; HOODED SWEATSHIRTS; JACKETS; SHIRTS; SWEATSHIRTS; T-SHIRTS; TOPS; UNDERWEAR; WRISTBANDS (U.S. CLS. 22 AND 39).

FIRST USE 5-1-2013; IN COMMERCE 5-1-2013.

**CLASS 25—(Continued).**

4,482,853. PANDA APPAREL LLC, DBA NEONTEES, SPRINGFIELD, NJ. SN 86-047,556. FILED P.R. 8-26-2013; AM. S.R. 12-11-2013.



THE MARK CONSISTS OF STANDARD CHARACTERS WITHOUT CLAIM TO ANY PARTICULAR FONT, STYLE, SIZE, OR COLOR.

FOR SHIRTS; SWEAT SHIRTS; T-SHIRTS; TEE SHIRTS; WEARABLE GARMENTS AND CLOTHING, NAMELY, SHIRTS (U.S. CLS. 22 AND 39).

FIRST USE 12-15-2009; IN COMMERCE 12-15-2009.

4,482,845. ARTURO SOLIS, LOS ANGELES, CA. AND BELLA BAYTLER SOLIS, LOS ANGELES, CA. SN 86-043,013. FILED P.R. 8-20-2013; AM. S.R. 12-9-2013.



THE STIPPLING IS A FEATURE OF THE MARK. THE MARK CONSISTS OF THE STYLIZED TEXT "KROOKED TREEZ" WITH THE LETTER "K" IN "KROOKED" IN LARGER LETTERING AND PLACED BACKWARD, AND ALSO FEATURING STIPPLING, WITH THE LETTER "D" IN "KROOKED" FORMED BY A PALM TREE, AND WITH THE LETTER "T" IN "TREEZ" ALSO FORMED BY A PALM TREE. THE ENTIRE WORDING AND DESIGNS FORMING THE SAME ARE ALL OUTLINED OR FEATURING SHADOWING.

FOR CLOTHING, NAMELY, T-SHIRTS, POLO SHIRTS, JERSEYS, KNIT TOPS, SWEATSHIRTS, HOODED SWEATSHIRTS, JACKETS, PANTS, SWEATPANTS, BEANIES, BASEBALL CAPS, HATS, NECKTIES, SCARVES, AND GLOVES (U.S. CLS. 22 AND 39).

FIRST USE 6-11-2012; IN COMMERCE 9-30-2012.

4,482,858. SWEET & TWISTED, COLORADO SPRINGS, CO. SN 86-067,406. FILED 9-17-2013.



THE MARK CONSISTS OF CANDY LOLLIPOP CROSS-BONES.

FOR BUTTON DOWN SHIRTS; HATS; MEN'S SOCKS; SHIRTS; SHORT-SLEEVED SHIRTS; T-SHIRTS; WEARABLE GARMENTS AND CLOTHING, NAMELY, SHIRTS; WOMEN'S CLOTHING, NAMELY, SHIRTS, DRESSES, SKIRTS, BLOUSES; WOMEN'S HATS AND HOODS (U.S. CLS. 22 AND 39).

FIRST USE 9-1-2013; IN COMMERCE 9-1-2013.

**CLASS 28—TOYS AND SPORTING GOODS**

**CLASS 28—(Continued).**

4,482,785. RAY DISTRIBUTING CO., DBA TEXAS TACKLE FACTORY, VICTORIA, TX. SN 85-901,979. FILED P.R. 4-11-2013; AM. S.R. 12-5-2013.

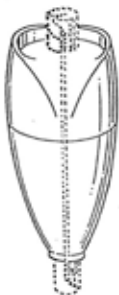

THE MARK CONSISTS OF THE CONFIGURATION OF A FISHING FLOAT HAVING AN OFF-CENTER LINE ABOUT ITS CIRCUMFERENCE. THE FLOAT IS GENERALLY CYLINDRICAL, TAPERED AT THE BOTTOM END TO SUBSTANTIALLY FORM A CONE, SLIGHTLY TAPERED AT THE TOP END, AND FORMS A LIP ABOUT A PORTION OF THE PERIMETER OF THE TOP END, CREATING A PARTIALLY CONCAVE SURFACE. THE BROKEN LINES REPRESENT THE TOP AND BOTTOM FISHING LINE GUIDES, AN INTERNAL BORE WITHIN THE FLOAT, AND A LENGTHWISE SIDE SLOT FOR HOLDING THE FISHING LINE IN PLACE, AND ARE NOT CLAIMED AS PART OF THE MARK.

FOR FISH ATTRACTANTS; FISHING FLOATS; FISHING TACKLE; FISHING TACKLE, NAMELY, BOBBERS; FLOATS FOR FISHING (U.S. CLS. 22, 23, 38 AND 50).

FIRST USE 0-0-1958; IN COMMERCE 0-0-1958.

4,482,833. HTR DEVELOPMENT, LLC, GOTHA, FL. SN 86-036,529. FILED P.R. 8-13-2013; AM. S.R. 12-3-2013.

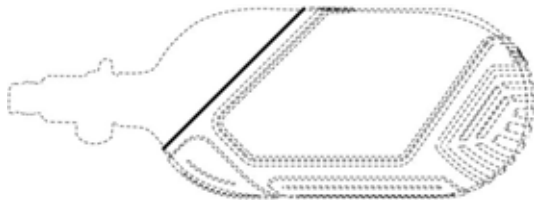

THE MARK CONSISTS OF A THREE-DIMENSIONAL DESIGN OF A PAINTBALL GAS TANK COVER AS SHOWN IN THE DRAWING. THE SOLID LINES DEPICT FEATURES THAT ARE CLAIMED AS PART OF THE MARK, NAMELY, THE DIAGONAL LINE AT THE TOP OF THE COVER. THE BROKEN LINES DEPICT THE CONTOURS OF THE GAS TANK AND OUTLINE OF THE COVER WHICH ARE NOT CLAIMED AS PART OF THE MARK.

FOR EQUIPMENT AND ACCESSORIES FOR THE SPORT OF PAINTBALL, NAMELY, GAS TANK COVERS (U.S. CLS. 22, 23, 38 AND 50).

FIRST USE 3-0-2012; IN COMMERCE 3-0-2012.

**CLASS 28—(Continued).**

4,482,848. ANDREW N. JASON, JACKSONVILLE, FL. SN 86-043,758. FILED P.R. 8-21-2013; AM. S.R. 12-9-2013.

**TRAVEL TRIVIA, U.S.A.**

THE MARK CONSISTS OF STANDARD CHARACTERS WITHOUT CLAIM TO ANY PARTICULAR FONT, STYLE, SIZE, OR COLOR.

FOR TRIVIA GAME PLAYED WITH CARDS AND GAME COMPONENTS (U.S. CLS. 22, 23, 38 AND 50).

FIRST USE 8-20-2013; IN COMMERCE 8-20-2013.

**CLASS 29—MEATS AND PROCESSED FOODS**

4,482,722. EAST COAST WINGS CORPORATION, WINSTON-SALEM, NC. SN 85-695,794. FILED P.R. 8-6-2012; AM. S.R. 11-21-2013.

**SKINNY WING**

THE MARK CONSISTS OF STANDARD CHARACTERS WITHOUT CLAIM TO ANY PARTICULAR FONT, STYLE, SIZE, OR COLOR.

NO CLAIM IS MADE TO THE EXCLUSIVE RIGHT TO USE "WING", APART FROM THE MARK AS SHOWN.

FOR POULTRY, NAMELY, BAKED CHICKEN WINGS (U.S. CL. 46).

FIRST USE 5-21-2012; IN COMMERCE 5-21-2012.

**CLASS 30—STAPLE FOODS**

4,482,702. LEN-ROSE FOOD CORP., WEST HAMPTON, NJ. SN 76-714,884. FILED P.R. 9-5-2013; AM. S.R. 12-17-2013.

**THE ORIGINAL ITALIAN KNISH**

THE MARK CONSISTS OF STANDARD CHARACTERS WITHOUT CLAIM TO ANY PARTICULAR FONT, STYLE, SIZE, OR COLOR.

NO CLAIM IS MADE TO THE EXCLUSIVE RIGHT TO USE "ITALIAN KNISH", APART FROM THE MARK AS SHOWN.

FOR KNISHES (U.S. CL. 46).

FIRST USE 5-1-2013; IN COMMERCE 5-1-2013.

**CLASS 30—(Continued).**

4,482,705. WITTENBERG, MARK, WHISTLER, BC, CANADA. SN 85-252,585. FILED P.R. 2-26-2011; AM. S.R. 12-16-2013.

**WHISTLER CHOCOLATE**

THE MARK CONSISTS OF STANDARD CHARACTERS WITHOUT CLAIM TO ANY PARTICULAR FONT, STYLE, SIZE, OR COLOR.

OWNER OF CANADA REG. NO. TMA738104, DATED 4-15-2009, EXPIRES 4-15-2024.

NO CLAIM IS MADE TO THE EXCLUSIVE RIGHT TO USE "CHOCOLATE", APART FROM THE MARK AS SHOWN.

FOR CHOCOLATE; CHOCOLATE BARS; HOT CHOCOLATE (U.S. CL. 46).

FIRST USE 11-20-2006; IN COMMERCE 11-20-2006.

4,482,790. BAKER MILLS INC., SLC, UT. SN 85-916,027. FILED P.R. 4-26-2013; AM. S.R. 12-9-2013.

**Minute Muffins**

THE MARK CONSISTS OF STANDARD CHARACTERS WITHOUT CLAIM TO ANY PARTICULAR FONT, STYLE, SIZE, OR COLOR.

NO CLAIM IS MADE TO THE EXCLUSIVE RIGHT TO USE "MUFFINS", APART FROM THE MARK AS SHOWN.

FOR MIXES FOR BAKERY GOODS; MUFFIN MIXES (U.S. CL. 46).

FIRST USE 10-10-2013; IN COMMERCE 10-10-2013.

4,482,810. PALACE FOODS, INC., READING, PA. SN 85-954,844. FILED P.R. 6-10-2013; AM. S.R. 12-19-2013.

**SAMBAR KITCHEN**

THE MARK CONSISTS OF STANDARD CHARACTERS WITHOUT CLAIM TO ANY PARTICULAR FONT, STYLE, SIZE, OR COLOR.

NO CLAIM IS MADE TO THE EXCLUSIVE RIGHT TO USE "KITCHEN", APART FROM THE MARK AS SHOWN.

FOR COOKING SAUCES INCLUDING, WITHOUT LIMITATION, TRADITIONAL INDIAN SAUCES (U.S. CL. 46).

FIRST USE 9-1-2013; IN COMMERCE 9-1-2013.

**CLASS 30—(Continued).**

4,482,813. ALOS CUISINE, LLC., NORCROSS, GA. SN 85-969,526. FILED P.R. 6-25-2013; AM. S.R. 12-9-2013.

**Salsa Fresh**

THE MARK CONSISTS OF STANDARD CHARACTERS WITHOUT CLAIM TO ANY PARTICULAR FONT, STYLE, SIZE, OR COLOR.

NO CLAIM IS MADE TO THE EXCLUSIVE RIGHT TO USE "SALSA", APART FROM THE MARK AS SHOWN.

FOR SALSA (U.S. CL. 46).

FIRST USE 1-1-2012; IN COMMERCE 1-1-2013.

4,482,841. DIRK P SWART, ITHACA, NY. SN 86-041,275. FILED P.R. 8-19-2013; AM. S.R. 12-9-2013.

**WORLD FAMOUS IN SOUTH AFRICA**

THE MARK CONSISTS OF STANDARD CHARACTERS WITHOUT CLAIM TO ANY PARTICULAR FONT, STYLE, SIZE, OR COLOR.

FOR BARBECUE SAUCE; BARBEQUE SAUCE (U.S. CL. 46).

FIRST USE 8-1-2013; IN COMMERCE 8-1-2013.

**CLASS 31—NATURAL AGRICULTURAL PRODUCTS**

4,482,713. WATERWICK B.V., 'S-GRAVENDEEL, NETHERLANDS. SN 85-542,900. FILED P.R. 2-14-2012; AM. S.R. 1-2-2014.

**WATERWICK**

THE MARK CONSISTS OF STANDARD CHARACTERS WITHOUT CLAIM TO ANY PARTICULAR FONT, STYLE, SIZE, OR COLOR.

FOR LIVE FLOWERS AND LIVING PLANTS (U.S. CLS. 1 AND 46).

FIRST USE 5-25-2013; IN COMMERCE 5-25-2013.

**CLASS 32—LIGHT BEVERAGES**



**CLASS 32—(Continued).**

4,482,735. NEW JERSEY BEVERAGE DISTRIBUTORS, LLC, EDISON, NJ. SN 85-826,427. FILED P.R. 1-18-2013; AM. S.R. 12-10-2013.

## VITAMIN DOSE

THE MARK CONSISTS OF STANDARD CHARACTERS WITHOUT CLAIM TO ANY PARTICULAR FONT, STYLE, SIZE, OR COLOR.

NO CLAIM IS MADE TO THE EXCLUSIVE RIGHT TO USE "VITAMIN", APART FROM THE MARK AS SHOWN.

FOR NON-ALCOHOLIC BEVERAGES CONTAINING VITAMINS, NAMELY, ENERGY DRINKS (U.S. CLS. 45, 46 AND 48).

FIRST USE 10-1-2013; IN COMMERCE 10-1-2013.

4,482,740. NEW JERSEY BEVERAGE DISTRIBUTORS, LLC, EDISON, NJ. SN 85-838,182. FILED P.R. 2-1-2013; AM. S.R. 12-10-2013.

## DOSE

THE MARK CONSISTS OF STANDARD CHARACTERS WITHOUT CLAIM TO ANY PARTICULAR FONT, STYLE, SIZE, OR COLOR.

FOR NON-ALCOHOLIC BEVERAGES CONTAINING VITAMINS, NAMELY, ENERGY DRINKS (U.S. CLS. 45, 46 AND 48).

FIRST USE 10-1-2013; IN COMMERCE 10-1-2013.

4,482,776. MILLERCOORS LLC, CHICAGO, IL. SN 85-880,142. FILED 3-19-2013.

## ARTÍSTICAMENTE CREADA

THE MARK CONSISTS OF STANDARD CHARACTERS WITHOUT CLAIM TO ANY PARTICULAR FONT, STYLE, SIZE, OR COLOR.

OWNER OF U.S. REG. NOS. 3,248,757 AND 4,382,480. THE ENGLISH TRANSLATION OF "ARTÍSTICAMENTE CREADA" IN THE MARK IS "ARTFULLY CRAFTED".

FOR BEER (U.S. CLS. 45, 46 AND 48).  
FIRST USE 11-1-2013; IN COMMERCE 11-1-2013.

**CLASS 32—(Continued).**

4,482,859. WYNWOOD BREWING COMPANY LLC, MIAMI, FL. SN 86-068,603. FILED 9-18-2013.

## WYNWOOD BREWING COMPANY

THE MARK CONSISTS OF STANDARD CHARACTERS WITHOUT CLAIM TO ANY PARTICULAR FONT, STYLE, SIZE, OR COLOR.

NO CLAIM IS MADE TO THE EXCLUSIVE RIGHT TO USE "BREWING COMPANY", APART FROM THE MARK AS SHOWN.

FOR BEER, ALE, LAGER, STOUT AND PORTER (U.S. CLS. 45, 46 AND 48).

FIRST USE 8-30-2013; IN COMMERCE 8-30-2013.

## SERVICE MARKS

**CLASS 35—ADVERTISING AND BUSINESS**

4,482,731. LOCAL FOOD LAB INC., STANFORD, CA. SN 85-786,543. FILED P.R. 11-25-2012; AM. S.R. 11-14-2013.

## Local Food Lab

THE MARK CONSISTS OF STANDARD CHARACTERS WITHOUT CLAIM TO ANY PARTICULAR FONT, STYLE, SIZE, OR COLOR.

NO CLAIM IS MADE TO THE EXCLUSIVE RIGHT TO USE "LAB", APART FROM THE MARK AS SHOWN.

FOR BUSINESS DEVELOPMENT SERVICES, NAMELY, PROVIDING START-UP SUPPORT FOR BUSINESSES OF OTHERS; BUSINESS SERVICES, NAMELY, MATCHING POTENTIAL PRIVATE INVESTORS WITH ENTREPRENEURS NEEDING FUNDING; NEW BUSINESS VENTURE DEVELOPMENT AND FORMATION CONSULTING SERVICES; BUSINESS PLANNING; ASSISTANCE WITH BUSINESS MANAGEMENT AND PLANNING; PROVIDING BUSINESS DEVELOPMENT SERVICES, NAMELY, OFFERING ORGANIZATIONAL AND MANAGEMENT ADVICE FOR ENTREPRENEURS THROUGH AN INCUBATOR AND EDUCATIONAL PROGRAM; BUSINESS CONCEPT EVALUATION THROUGH MARKET FEASIBILITY STUDIES; ASSISTANCE WITH BUSINESS MANAGEMENT AND PLANNING, OPERATIONS MANAGEMENT, BUSINESS MANAGEMENT CONSULTING WITH RELATION TO STRATEGY, MARKETING, SALES, OPERATION, PRODUCT DESIGN PARTICULARLY SPECIALIZING IN THE USE OF ANALYTIC AND STATISTIC MODELS FOR THE UNDERSTANDING AND PREDICTING OF CONSUMERS, BUSINESS, MARKET TRENDS AND ACTIONS; BUSINESS ACQUISITION CONSULTATION; ECONOMIC FORECASTING AND ANALYSIS (U.S. CLS. 100, 101 AND 102).

FIRST USE 9-11-2011; IN COMMERCE 5-9-2012.

**CLASS 35—(Continued).**

4,482,742. COMBINATION PRODUCT PARTNERS, INC., SOMIS, CA. SN 85-839,626. FILED P.R. 2-4-2013; AM. S.R. 11-18-2013.

## COMBINATION PRODUCT PARTNERS

THE MARK CONSISTS OF STANDARD CHARACTERS WITHOUT CLAIM TO ANY PARTICULAR FONT, STYLE, SIZE, OR COLOR.

NO CLAIM IS MADE TO THE EXCLUSIVE RIGHT TO USE "PARTNERS", APART FROM THE MARK AS SHOWN.

FOR BUSINESS CONSULTING SERVICES IN THE FIELD OF BIOTECHNOLOGY, PHARMACEUTICALS, AND MEDICAL DEVICES REGARDING REGULATORY SUBMISSION STRATEGY, DEVICE TECHNOLOGY STRATEGY DEVELOPMENT, TECHNOLOGY EVALUATION AND TECHNICAL DUE DILIGENCE, OPERATIONAL READINESS AND PROCESS IMPROVEMENT, PRODUCT RISK MANAGEMENT, HUMAN FACTORS ENGINEERING, DESIGN VALIDATION, PRODUCT CHARACTERIZATION AND DESIGN VERIFICATION, ANALYTICAL METHOD DEVELOPMENT AND TRANSFER, ASSEMBLY PROCESS DEVELOPMENT AND VALIDATION, TOOLING VALIDATION, COMPLIANCE MANAGEMENT, LIFECYCLE MANAGEMENT, AND AUDITING TO REGULATORY AND QUALITY STANDARDS (U.S. CLS. 100, 101 AND 102).

FIRST USE 2-25-2013; IN COMMERCE 2-25-2013.

---

4,482,756. KUDROSHOFF, TIMOTHY, FALLBROOK, CA. SN 85-856,004. FILED P.R. 2-21-2013; AM. S.R. 12-9-2013.

## Fish And Game Apparel

THE MARK CONSISTS OF STANDARD CHARACTERS WITHOUT CLAIM TO ANY PARTICULAR FONT, STYLE, SIZE, OR COLOR.

FOR ON-LINE RETAIL STORE SERVICES FEATURING A WIDE VARIETY OF CONSUMER GOODS OF OTHERS (U.S. CLS. 100, 101 AND 102).

FIRST USE 1-1-2009; IN COMMERCE 1-1-2009.

**CLASS 35—(Continued).**

4,482,757. POHL CONSULTING AND TRAINING, INC., ROCHELLE, IL. SN 85-859,561. FILED P.R. 2-25-2013; AM. S.R. 11-19-2013.

## Wealth Management Compliance Alliance

THE MARK CONSISTS OF STANDARD CHARACTERS WITHOUT CLAIM TO ANY PARTICULAR FONT, STYLE, SIZE, OR COLOR.

FOR BUSINESS CONSULTING SERVICES, NAMELY, CONSULTING IN THE FIELDS OF COMPLIANCE AND REGULATORY RELATIONSHIP MANAGEMENT AND ADMINISTRATION AND OPERATIONS EFFICIENCIES (U.S. CLS. 100, 101 AND 102).

FIRST USE 3-1-2013; IN COMMERCE 4-1-2013.

---

4,482,766. KEY FOOD STORES COOPERATIVE, INC., STATEN ISLAND, NY. SN 85-868,483. FILED P.R. 3-6-2013; AM. S.R. 12-9-2013.

## URBAN MARKET OF WILLIAMSBURG

THE MARK CONSISTS OF STANDARD CHARACTERS WITHOUT CLAIM TO ANY PARTICULAR FONT, STYLE, SIZE, OR COLOR.

NO CLAIM IS MADE TO THE EXCLUSIVE RIGHT TO USE "URBAN MARKET", APART FROM THE MARK AS SHOWN.

FOR SUPERMARKETS (U.S. CLS. 100, 101 AND 102).

FIRST USE 8-16-2013; IN COMMERCE 8-16-2013.

---

4,482,782. MARKETING AUTOMATION SERVICE AND SUPPORT INC., TORONTO, ONTARIO, CANADA. SN 85-900,598. FILED P.R. 4-10-2013; AM. S.R. 12-9-2013.

## REVENUE ENGINE

THE MARK CONSISTS OF STANDARD CHARACTERS WITHOUT CLAIM TO ANY PARTICULAR FONT, STYLE, SIZE, OR COLOR.

FOR CONSULTING SERVICES IN THE FIELD OF MARKETING AND SALES OF PRODUCTS AND SERVICES (U.S. CLS. 100, 101 AND 102).

FIRST USE 4-8-2013; IN COMMERCE 4-8-2013.

**CLASS 35—(Continued).**

4,482,791. SOLUTIONSRX MANAGEMENT GROUP, LLC, SANTA ROSA BEACH, FL. SN 85-919,881. FILED P.R. 5-1-2013; AM. S.R. 11-25-2013.

## FormularySolution

THE MARK CONSISTS OF STANDARD CHARACTERS WITHOUT CLAIM TO ANY PARTICULAR FONT, STYLE, SIZE, OR COLOR.

FOR COLLECTION AND COMPILATION OF INFORMATION INTO COMPUTER DATABASES IN THE FIELD OF DRUG FORMULARIES; PROVIDING AN ON-LINE COMPUTER DATABASE FOR PHARMACEUTICAL SALES FORCE MANAGEMENT FEATURING TRADE INFORMATION IN THE FIELD OF DRUG FORMULARIES (U.S. CLS. 100, 101 AND 102).  
FIRST USE 10-1-2008; IN COMMERCE 12-1-2008.

4,482,797. UNITED EGG PRODUCERS, INC., ALPHARETTA, GA. SN 85-929,239. FILED P.R. 5-10-2013; AM. S.R. 10-30-2013.

## EGG FARMERS OF AMERICA

THE MARK CONSISTS OF STANDARD CHARACTERS WITHOUT CLAIM TO ANY PARTICULAR FONT, STYLE, SIZE, OR COLOR.

NO CLAIM IS MADE TO THE EXCLUSIVE RIGHT TO USE "EGG FARMERS", APART FROM THE MARK AS SHOWN.

FOR TRADE ASSOCIATION SERVICES, NAMELY, PROMOTING THE INTERESTS OF EGG PRODUCERS (U.S. CLS. 100, 101 AND 102).  
FIRST USE 1-2-2014; IN COMMERCE 1-2-2014.

**CLASS 35—(Continued).**

4,482,818. DUJO LLC, WINTER PARK, FL. SN 86-004,592. FILED P.R. 7-8-2013; AM. S.R. 11-27-2013.

## Executive Combine

THE MARK CONSISTS OF STANDARD CHARACTERS WITHOUT CLAIM TO ANY PARTICULAR FONT, STYLE, SIZE, OR COLOR.

FOR TESTING, ANALYSIS AND EVALUATION OF THE KNOWLEDGE, SKILLS AND ABILITY OF OTHERS TO PREDICT LEADERSHIP SKILLS AND ASSESS TRAINING NEEDS OF INDIVIDUALS IN THE WORKPLACE; HUMAN RESOURCES SERVICES, NAMELY, PERSONNEL SELECTION FOR OTHERS (U.S. CLS. 100, 101 AND 102).

FIRST USE 1-5-2012; IN COMMERCE 1-5-2012.

4,482,820. FREE RANGE GRAPHICS, LLC, DBA FREE RANGE STUDIOS, WASHINGTON, DC. SN 86-011,042. FILED P.R. 7-16-2013; AM. S.R. 11-25-2013.

## E-WORKSHOPS

THE MARK CONSISTS OF STANDARD CHARACTERS WITHOUT CLAIM TO ANY PARTICULAR FONT, STYLE, SIZE, OR COLOR.

FOR ADVERTISING, MARKETING, AND PROMOTING THE GOODS AND SERVICES OF OTHERS VIA THROUGH PRINT, AUDIO, VIDEO, AND ELECTRONIC MEDIA; CONSULTATION SERVICES, NAMELY, CREATIVE AND STRATEGIC CONSULTATION REGARDING THE DEVELOPMENT AND PRODUCTION OF MARKETING CAMPAIGNS FOR OTHERS; MARKETING SERVICES, NAMELY, MARKETING SERVICES IN THE FIELD OF CONTENT STRATEGIES AND COMMUNICATION PLANS; BRANDING SERVICES, NAMELY, DEVELOPMENT OF BRANDS FOR BUSINESSES AND/OR INDIVIDUALS THROUGH THE USE OF ADVERTISING CONTENT STRATEGIES AND ADVERTISING COMMUNICATION PLANTS (U.S. CLS. 100, 101 AND 102).

FIRST USE 6-1-2013; IN COMMERCE 6-1-2013.

**CLASS 35—(Continued).**

4,482,828. HUMAN RESOURCE CONSULTANTS, LTD., DBA JOBFITSOLUTIONS, GRAND RAPIDS, MI. SN 86-032,632. FILED P.R. 8-8-2013; AM. S.R. 12-3-2013.

**HEALTH CAREER READINESS  
ASSESSMENT**

THE MARK CONSISTS OF STANDARD CHARACTERS WITHOUT CLAIM TO ANY PARTICULAR FONT, STYLE, SIZE, OR COLOR.

NO CLAIM IS MADE TO THE EXCLUSIVE RIGHT TO USE "CAREER READINESS ASSESSMENT", APART FROM THE MARK AS SHOWN.

FOR PERSONALITY TESTING FOR BUSINESS PURPOSES (U.S. CLS. 100, 101 AND 102).

FIRST USE 8-6-2013; IN COMMERCE 8-6-2013.

4,482,831. SILVERMAN, SCOTT, LOS ANGELES, CA. SN 86-033,296. FILED P.R. 8-9-2013; AM. S.R. 12-6-2013.

**MESSAGE-CENTRIC BRANDING**

THE MARK CONSISTS OF STANDARD CHARACTERS WITHOUT CLAIM TO ANY PARTICULAR FONT, STYLE, SIZE, OR COLOR.

NO CLAIM IS MADE TO THE EXCLUSIVE RIGHT TO USE "BRANDING", APART FROM THE MARK AS SHOWN.

FOR BRANDING SERVICES, NAMELY, CONSULTING, DEVELOPMENT, MANAGEMENT AND MARKETING OF BRANDS FOR BUSINESSES AND/OR INDIVIDUALS, PROVIDING CUSTOMIZED COMMUNICATION PROGRAMS TO OBTAIN CONSUMER INSIGHTS AND DEVELOP BRANDING STRATEGIES (U.S. CLS. 100, 101 AND 102).

FIRST USE 6-4-2013; IN COMMERCE 6-4-2013.

4,482,832. THE HANDCRAFTED SOAP AND COSMETIC GUILD, INC., SARATOGA SPRINGS, NY. SN 86-034,030. FILED P.R. 8-9-2013; AM. S.R. 12-3-2013.

**HANDCRAFTED SOAP &  
COSMETIC GUILD**

THE MARK CONSISTS OF STANDARD CHARACTERS WITHOUT CLAIM TO ANY PARTICULAR FONT, STYLE, SIZE, OR COLOR.

**CLASS 35—(Continued).**

NO CLAIM IS MADE TO THE EXCLUSIVE RIGHT TO USE "GUILD", APART FROM THE MARK AS SHOWN.

FOR ASSOCIATION SERVICES, NAMELY, PROMOTING THE INTERESTS OF PEOPLE WHO MAKE SOAPS AND COSMETICS; TRADE ASSOCIATION SERVICES, NAMELY, PROMOTING THE INTERESTS OF PEOPLE WHO SELL SOAPS AND COSMETICS (U.S. CLS. 100, 101 AND 102).

FIRST USE 3-30-2013; IN COMMERCE 3-30-2013.

4,482,840. THOMAS A. BLANKENSHIP, SAN ANGELO, TX. SN 86-040,930. FILED P.R. 8-18-2013; AM. S.R. 12-4-2013.

**THE GLASSES PLACE**

THE MARK CONSISTS OF STANDARD CHARACTERS WITHOUT CLAIM TO ANY PARTICULAR FONT, STYLE, SIZE, OR COLOR.

NO CLAIM IS MADE TO THE EXCLUSIVE RIGHT TO USE "GLASSES", APART FROM THE MARK AS SHOWN.

FOR RETAIL OPTICAL STORES (U.S. CLS. 100, 101 AND 102).

FIRST USE 1-1-2013; IN COMMERCE 1-1-2013.

4,482,846. HULTBERG, NELSON, DALLAS, TX. SN 86-043,587. FILED P.R. 8-21-2013; AM. S.R. 12-9-2013.

**National Independent Party**

THE MARK CONSISTS OF STANDARD CHARACTERS WITHOUT CLAIM TO ANY PARTICULAR FONT, STYLE, SIZE, OR COLOR.

NO CLAIM IS MADE TO THE EXCLUSIVE RIGHT TO USE "PARTY", APART FROM THE MARK AS SHOWN.

FOR POLITICAL PARTY SERVICES, NAMELY, PROMOTING THE INTERESTS OF A POLITICAL ORGANIZATION (U.S. CLS. 100, 101 AND 102).

FIRST USE 11-20-2012; IN COMMERCE 11-20-2012.

**CLASS 35—(Continued).**

4,482,850. BUSINESS CELL PHONE DIRECTORY, LLC, RIDGELAND, MS. SN 86-045,951. FILED P.R. 8-23-2013; AM. S.R. 12-10-2013.

**Business Cell Phone  
Directory**

THE MARK CONSISTS OF STANDARD CHARACTERS WITHOUT CLAIM TO ANY PARTICULAR FONT, STYLE, SIZE, OR COLOR.

NO CLAIM IS MADE TO THE EXCLUSIVE RIGHT TO USE "DIRECTORY", APART FROM THE MARK AS SHOWN.

FOR ADVERTISING SERVICES; ON-LINE ADVERTISING SERVICES FOR OTHERS (U.S. CLS. 100, 101 AND 102).

FIRST USE 6-14-2013; IN COMMERCE 6-18-2013.



4,482,854. NATIONAL TAX RELIEF, INC., RIVERSIDE, CA. SN 86-048,132. FILED P.R. 8-26-2013; AM. S.R. 12-10-2013.

**NATIONAL TAX RELIEF**

THE MARK CONSISTS OF STANDARD CHARACTERS WITHOUT CLAIM TO ANY PARTICULAR FONT, STYLE, SIZE, OR COLOR.

NO CLAIM IS MADE TO THE EXCLUSIVE RIGHT TO USE "TAX RELIEF", APART FROM THE MARK AS SHOWN.

FOR TAX AND TAXATION PLANNING, ADVICE, INFORMATION AND CONSULTANCY SERVICES; TAX CONSULTATION; TAX PREPARATION (U.S. CLS. 100, 101 AND 102).

FIRST USE 10-1-2012; IN COMMERCE 10-1-2012.



4,482,860. CASALE MEDIA, INC., TORONTO, ONTARIO, CANADA. SN 86-069,357. FILED 9-19-2013.

**INDEX  
EXCHANGE**

OWNER OF U.S. REG. NO. 4,381,391.

THE MARK CONSISTS OF THE STYLIZED WORDING "INDEX EXCHANGE". THE TERM "INDEX" APPEARS ABOVE THE TERM "EXCHANGE".

FOR ON-LINE ADVERTISING SERVICES FOR OTHERS (U.S. CLS. 100, 101 AND 102).

FIRST USE 1-14-2013; IN COMMERCE 1-14-2013.

**CLASS 35—(Continued).**

4,482,865. DPI ENERGY LLC, DBA TRUSMART ENERGY LLC, HOUSTON, TX. SN 86-097,292. FILED 10-21-2013.

**Evenings, Nights, &  
Mornings**

THE MARK CONSISTS OF STANDARD CHARACTERS WITHOUT CLAIM TO ANY PARTICULAR FONT, STYLE, SIZE, OR COLOR.

FOR RETAIL ELECTRICITY PROVIDER SERVICES, NAMELY, PROVIDING A SERVICE THAT ALLOWS CUSTOMERS TO PURCHASE ENERGY, NAMELY, ELECTRICITY, AND RENEWABLE ENERGY (U.S. CLS. 100, 101 AND 102).

FIRST USE 10-0-2013; IN COMMERCE 10-0-2013.



4,482,866. FERTILITY COUNCIL, LLC, THOUSAND OAKS, CA. SN 86-097,293. FILED P.R. 10-21-2013; AM. S.R. 12-24-2013.

**Fertility Council**

THE MARK CONSISTS OF STANDARD CHARACTERS WITHOUT CLAIM TO ANY PARTICULAR FONT, STYLE, SIZE, OR COLOR.

NO CLAIM IS MADE TO THE EXCLUSIVE RIGHT TO USE "FERTILITY", APART FROM THE MARK AS SHOWN.

FOR ADVERTISING, MARKETING AND PROMOTION SERVICES IN THE FIELD OF FERTILITY (U.S. CLS. 100, 101 AND 102).

FIRST USE 10-23-2012; IN COMMERCE 10-23-2012.



4,482,867. DPI ENERGY LLC, DBA TRUSMART ENERGY LLC, HOUSTON, TX. SN 86-097,312. FILED 10-21-2013.

**Nights & Weekends**

THE MARK CONSISTS OF STANDARD CHARACTERS WITHOUT CLAIM TO ANY PARTICULAR FONT, STYLE, SIZE, OR COLOR.

FOR RETAIL ELECTRICITY PROVIDER SERVICES, NAMELY, PROVIDING A SERVICE THAT ALLOWS CUSTOMERS TO PURCHASE ENERGY, NAMELY, ELECTRICITY, AND RENEWABLE ENERGY (U.S. CLS. 100, 101 AND 102).

FIRST USE 10-0-2013; IN COMMERCE 10-0-2013.



**CLASS 36—INSURANCE AND FINANCIAL**

**CLASS 36—(Continued).**

4,482,721. JOSHUA DAVID MELLBERG, LLC, DBA JD MELLBERG FINANCIAL, TUCSON, AZ. SN 85-694,741. FILED P.R. 8-3-2012; AM. S.R. 12-3-2013.

**IRA TOTAL RETURN PLAN**

THE MARK CONSISTS OF STANDARD CHARACTERS WITHOUT CLAIM TO ANY PARTICULAR FONT, STYLE, SIZE, OR COLOR.

NO CLAIM IS MADE TO THE EXCLUSIVE RIGHT TO USE "IRA" AND "PLAN", APART FROM THE MARK AS SHOWN.

FOR FINANCIAL SERVICES IN THE NATURE OF GUARANTEED INDIVIDUAL RETIREMENT ACCOUNT PLANS WHICH USE INSURANCE PRODUCTS; GUARANTEED INDIVIDUAL RETIREMENT ACCOUNT PLANS WHICH USE INSURANCE PRODUCTS (U.S. CLS. 100, 101 AND 102).

FIRST USE 8-31-2012; IN COMMERCE 8-31-2012.

4,482,748. SCHULTE, RYAN, NEWPORT BEACH, CA. SN 85-846,529. FILED P.R. 2-11-2013; AM. S.R. 12-8-2013.

**Evidence Based Investing**

THE MARK CONSISTS OF STANDARD CHARACTERS WITHOUT CLAIM TO ANY PARTICULAR FONT, STYLE, SIZE, OR COLOR.

NO CLAIM IS MADE TO THE EXCLUSIVE RIGHT TO USE "INVESTING", APART FROM THE MARK AS SHOWN.

FOR FINANCIAL PLANNING SERVICES (U.S. CLS. 100, 101 AND 102).

FIRST USE 2-11-2013; IN COMMERCE 3-31-2013.

4,482,752. FEDERALQUOTE.COM, BOCA RATON, FL. SN 85-849,458. FILED P.R. 2-13-2013; AM. S.R. 12-3-2013.

**AMERICA'S INSURANCE COMPANY**

THE MARK CONSISTS OF STANDARD CHARACTERS WITHOUT CLAIM TO ANY PARTICULAR FONT, STYLE, SIZE, OR COLOR.

**CLASS 36—(Continued).**

NO CLAIM IS MADE TO THE EXCLUSIVE RIGHT TO USE "INSURANCE COMPANY", APART FROM THE MARK AS SHOWN.

FOR INSURANCE CONSULTING IN THE FIELD OF AUTOMOBILE, LIFE, HEALTH, FIRE, DENTAL, TRAVELERS AND COMMERCIAL INSURANCE; INSURANCE INFORMATION AND CONSULTANCY; LIFE INSURANCE BROKERAGE; PROVIDING AUTOMOBILE, LIFE, HEALTH, FIRE, DENTAL, TRAVELERS AND COMMERCIAL INSURANCE RATE QUOTES (U.S. CLS. 100, 101 AND 102).

FIRST USE 10-1-2012; IN COMMERCE 10-1-2012.

4,482,753. FEDERALQUOTE.COM, BOCA RATON, FL. SN 85-850,694. FILED P.R. 2-14-2013; AM. S.R. 12-4-2013.

**FEDERAL QUOTE**

THE MARK CONSISTS OF STANDARD CHARACTERS WITHOUT CLAIM TO ANY PARTICULAR FONT, STYLE, SIZE, OR COLOR.

NO CLAIM IS MADE TO THE EXCLUSIVE RIGHT TO USE "QUOTE", APART FROM THE MARK AS SHOWN.

FOR INSURANCE CONSULTING IN THE FIELD OF AUTOMOBILE, LIFE, HEALTH, FIRE, DENTAL, TRAVELERS AND COMMERCIAL INSURANCE; INSURANCE INFORMATION AND CONSULTANCY; LIFE INSURANCE BROKERAGE; PROVIDING AUTOMOBILE, LIFE, HEALTH, FIRE, DENTAL, TRAVELERS AND COMMERCIAL INSURANCE RATE QUOTES (U.S. CLS. 100, 101 AND 102).

FIRST USE 1-1-2013; IN COMMERCE 1-1-2013.

4,482,802. MARY ANN MINCARELLI, PHOENIXVILLE, PA. SN 85-934,409. FILED P.R. 5-16-2013; AM. S.R. 12-10-2013.

**Adolescent Awareness Foundation**

THE MARK CONSISTS OF STANDARD CHARACTERS WITHOUT CLAIM TO ANY PARTICULAR FONT, STYLE, SIZE, OR COLOR.

NO CLAIM IS MADE TO THE EXCLUSIVE RIGHT TO USE "FOUNDATION", APART FROM THE MARK AS SHOWN.

FOR CHARITABLE FOUNDATION SERVICES, NAMELY, PROVIDING FUNDRAISING ACTIVITIES, FUNDING, SCHOLARSHIPS AND/OR FINANCIAL ASSISTANCE FOR PROGRAMS EDUCATING ADOLESCENTS ABOUT DRUG AND ALCOHOL ABUSE DANGERS, AWARENESS, AND CONSEQUENCES (U.S. CLS. 100, 101 AND 102).

FIRST USE 3-12-2013; IN COMMERCE 3-12-2013.

**CLASS 36—(Continued).**

4,482,824. REALTOR ASSOCIATION OF GREATER FORT LAUDERDALE INC., DBA GREATER FORT LAUDERDALE REALTORS, FORT LAUDERDALE, FL. SN 86-031,631. FILED P.R. 8-7-2013; AM. S.R. 12-11-2013.

**SOUTHFLORIDAMLS.COM**

THE MARK CONSISTS OF STANDARD CHARACTERS WITHOUT CLAIM TO ANY PARTICULAR FONT, STYLE, SIZE, OR COLOR.

FOR REAL ESTATE MULTIPLE LISTING SERVICES; PROVIDING A DATABASE OF INFORMATION ABOUT RESIDENTIAL AND COMMERCIAL REAL ESTATE LISTINGS FOR REAL ESTATE PROFESSIONALS THROUGH A WEBSITE (U.S. CLS. 100, 101 AND 102).  
FIRST USE 12-10-2010; IN COMMERCE 12-10-2010.

4,482,825. EXPANSION VENTURE CAPITAL LLC, NEW YORK, NY. SN 86-031,680. FILED P.R. 8-7-2013; AM. S.R. 11-27-2013.

**EXPANSION VENTURE CAPITAL**

THE MARK CONSISTS OF STANDARD CHARACTERS WITHOUT CLAIM TO ANY PARTICULAR FONT, STYLE, SIZE, OR COLOR.

NO CLAIM IS MADE TO THE EXCLUSIVE RIGHT TO USE "VENTURE CAPITAL", APART FROM THE MARK AS SHOWN.

FOR VENTURE CAPITAL FUNDING SERVICES; PRIVATE EQUITY FUND INVESTMENT SERVICES; FINANCIAL SERVICES, NAMELY, MONEY LENDING; FUNDS INVESTMENT (U.S. CLS. 100, 101 AND 102).  
FIRST USE 8-23-2011; IN COMMERCE 8-23-2011.

4,482,826. EXPANSION VENTURE CAPITAL LLC, NEW YORK, NY. SN 86-031,689. FILED P.R. 8-7-2013; AM. S.R. 12-2-2013.

**EXPANSION VC**

THE MARK CONSISTS OF STANDARD CHARACTERS WITHOUT CLAIM TO ANY PARTICULAR FONT, STYLE, SIZE, OR COLOR.

**CLASS 36—(Continued).**

NO CLAIM IS MADE TO THE EXCLUSIVE RIGHT TO USE "VC", APART FROM THE MARK AS SHOWN.

FOR VENTURE CAPITAL FUNDING SERVICES; PRIVATE EQUITY FUND INVESTMENT SERVICES; FINANCIAL SERVICES, NAMELY, MONEY LENDING; FUNDS INVESTMENT (U.S. CLS. 100, 101 AND 102).  
FIRST USE 8-23-2011; IN COMMERCE 8-23-2011.

4,482,834. FAYETTE ALLIANCE, INC., LEXINGTON, KY. SN 86-036,557. FILED P.R. 8-13-2013; AM. S.R. 12-5-2013.

*Bluegrass*  
**INTERNATIONAL**  
*Cup*

NO CLAIM IS MADE TO THE EXCLUSIVE RIGHT TO USE THE INDIVIDUAL TERMS "BLUEGRASS" OR "INTERNATIONAL", APART FROM THE MARK AS SHOWN.

THE MARK CONSISTS OF THE PHRASE "BLUEGRASS INTERNATIONAL CUP" WITH THE WORD "BLUEGRASS" IN CURSIVE CENTERED ON TOP OF THE WORD "INTERNATIONAL" IN CAPS WHICH HAS THE WORD "CUP" IN CURSIVE CENTERED BELOW IT.

FOR CHARITABLE FUNDRAISING; CHARITABLE FUNDRAISING SERVICES; CHARITABLE FUNDRAISING SERVICES BY MEANS OF AN ENTERTAINMENT EVENT (U.S. CLS. 100, 101 AND 102).  
FIRST USE 7-1-2007; IN COMMERCE 7-1-2007.

4,482,842. DEL REY URBAN CAPITAL, LLC, SANTA MONICA, CA. SN 86-041,842. FILED P.R. 8-19-2013; AM. S.R. 12-10-2013.

**Del Rey Urban Brokerage**

THE MARK CONSISTS OF STANDARD CHARACTERS WITHOUT CLAIM TO ANY PARTICULAR FONT, STYLE, SIZE, OR COLOR.

NO CLAIM IS MADE TO THE EXCLUSIVE RIGHT TO USE "BROKERAGE", APART FROM THE MARK AS SHOWN.

FOR REAL ESTATE BROKERAGE (U.S. CLS. 100, 101 AND 102).  
FIRST USE 8-1-2013; IN COMMERCE 8-1-2013.

**CLASS 36—(Continued).**

4,482,871. BENCH, JOHN DAVID, DBA SANTA ANA BAIL BONDS, LANCASTER, CA. SN 86-103,701. FILED P.R. 10-28-2013; AM. S.R. 12-6-2013.

## Santa Ana Bail Bonds

THE MARK CONSISTS OF STANDARD CHARACTERS WITHOUT CLAIM TO ANY PARTICULAR FONT, STYLE, SIZE, OR COLOR.

NO CLAIM IS MADE TO THE EXCLUSIVE RIGHT TO USE "BAIL BONDS", APART FROM THE MARK AS SHOWN.

FOR BAIL BONDING (U.S. CLS. 100, 101 AND 102).  
FIRST USE 6-26-2013; IN COMMERCE 7-3-2013.

---

4,482,875. FLEX WATCHES, INC., SAN DIEGO, CA. SN 86-127,195. FILED P.R. 11-22-2013; AM. S.R. 12-31-2013.

## Buy A Watch-Feed A Child

THE MARK CONSISTS OF STANDARD CHARACTERS WITHOUT CLAIM TO ANY PARTICULAR FONT, STYLE, SIZE, OR COLOR.

NO CLAIM IS MADE TO THE EXCLUSIVE RIGHT TO USE "WATCH", APART FROM THE MARK AS SHOWN.

FOR CHARITABLE FUNDRAISING SERVICES BY MEANS OF SELLING WATCHES TO RAISE FUNDS FOR HUNGRY CHILDREN (U.S. CLS. 100, 101 AND 102).  
FIRST USE 5-1-2013; IN COMMERCE 10-1-2013.

**CLASS 37—CONSTRUCTION AND REPAIR**

4,482,738. RTH, INC., LAS VEGAS, NV. SN 85-835,790. FILED P.R. 1-29-2013; AM. S.R. 11-20-2013.

## LAS VEGAS PEST CONTROL

THE MARK CONSISTS OF STANDARD CHARACTERS WITHOUT CLAIM TO ANY PARTICULAR FONT, STYLE, SIZE, OR COLOR.

NO CLAIM IS MADE TO THE EXCLUSIVE RIGHT TO USE "PEST CONTROL", APART FROM THE MARK AS SHOWN.

FOR PEST CONTROL AND EXTERMINATION OTHER THAN FOR AGRICULTURAL PURPOSES (U.S. CLS. 100, 103 AND 106).  
FIRST USE 1-31-2007; IN COMMERCE 1-31-2007.

**CLASS 39—TRANSPORTATION AND STORAGE****CLASS 39—(Continued).**

4,482,822. SIGHTSEEING TOURS MANAGEMENT, INC., MIAMI, FL. SN 86-024,674. FILED P.R. 7-31-2013; AM. S.R. 11-20-2013.

## HOMES OF THE RICH AND FAMOUS CRUISE

THE MARK CONSISTS OF STANDARD CHARACTERS WITHOUT CLAIM TO ANY PARTICULAR FONT, STYLE, SIZE, OR COLOR.

NO CLAIM IS MADE TO THE EXCLUSIVE RIGHT TO USE "CRUISE", APART FROM THE MARK AS SHOWN.

FOR ARRANGING OF TRAVEL TOURS AND CRUISES; CONDUCTING SIGHTSEEING TRAVEL TOURS BY BOAT; CONDUCTING SIGHTSEEING TRAVEL TOURS FOR OTHERS; ORGANISATION OF SIGHTSEEING TRAVEL TOURS; TRANSPORTATION OF PASSENGERS AND/OR GOODS BY BOAT; TRAVEL TOUR OPERATING AND ORGANISING; YACHT AND BOAT CHARTER SERVICES; YACHT CHARTERING SERVICES (U.S. CLS. 100 AND 105).  
FIRST USE 12-31-1960; IN COMMERCE 12-31-1960.

---

4,482,843. MARTINEZ, SAL, DENVER, CO. SN 86-042,202. FILED P.R. 8-19-2013; AM. S.R. 12-5-2013.

## Surveillance Movers

THE MARK CONSISTS OF STANDARD CHARACTERS WITHOUT CLAIM TO ANY PARTICULAR FONT, STYLE, SIZE, OR COLOR.

NO CLAIM IS MADE TO THE EXCLUSIVE RIGHT TO USE "MOVERS", APART FROM THE MARK AS SHOWN.

FOR FURNITURE MOVING; MOVING AND STORAGE OF GOODS; MOVING COMPANY SERVICES; MOVING VAN SERVICES; MOVING VAN TRANSPORT; RENTAL OF MOVING EQUIPMENT, NAMELY, PADS, STRAPS, HITCHES, DOLLIES, BOXES, CARRIERS, AND HAND TRUCKS; TRANSPORT SERVICES, NAMELY, LOCAL, INTERSTATE AND INTERNATIONAL MOVING SERVICES (U.S. CLS. 100 AND 105).  
FIRST USE 8-2-2013; IN COMMERCE 8-2-2013.

**CLASS 40—MATERIAL TREATMENT**



**CLASS 40—(Continued).**

4,482,710. ANTLER PLAQUE, WATERTOWN, SD. SN 85-511,149. FILED P.R. 1-7-2012; AM. S.R. 5-21-2013.

**ANTLER PLAQUE** 

THE MARK CONSISTS OF THE WORD "ANTLER" AND THE WORD "PLAQUE" CONSISTING OF STYLIZED LETTERS WITH DIFFERING FONT HEIGHTS AND AN ADDITIONAL SHIELD PANEL SILHOUETTE LOCATED TO THE RIGHT HAND SIDE.

FOR TAXIDERMY (U.S. CLS. 100, 103 AND 106).  
FIRST USE 12-10-2013; IN COMMERCE 12-10-2013.

**CLASS 41—(Continued).**

4,482,728. WEALTH OFF WALL STREET, LLC, SAFETY HARBOR, FL. SN 85-743,034. FILED P.R. 10-1-2012; AM. S.R. 12-28-2013.

**Mentorpreneur**

THE MARK CONSISTS OF STANDARD CHARACTERS WITHOUT CLAIM TO ANY PARTICULAR FONT, STYLE, SIZE, OR COLOR.

FOR CHARITABLE SERVICES, NAMELY, MENTORING OF CHILDREN, TEENS, ADOLESCENTS AND YOUNG ADULTS IN THE FIELD OF ENTREPRENEURSHIP; EDUCATION SERVICES, NAMELY, MENTORING IN THE FIELD OF ENTREPRENEURSHIP; PROVIDING EDUCATIONAL MENTORING SERVICES AND PROGRAMS IN THE FIELD OF ENTREPRENEURSHIP (U.S. CLS. 100, 101 AND 107).

FIRST USE 8-1-2012; IN COMMERCE 8-1-2012.

4,482,808. ACTION SYSTEMS, INC., DBA CUBICLEKEYS.COM, LOUISVILLE, KY. SN 85-951,340. FILED P.R. 6-5-2013; AM. S.R. 12-9-2013.

**CUBICLEKEYS.COM**

THE MARK CONSISTS OF STANDARD CHARACTERS WITHOUT CLAIM TO ANY PARTICULAR FONT, STYLE, SIZE, OR COLOR.

NO CLAIM IS MADE TO THE EXCLUSIVE RIGHT TO USE ".COM", APART FROM THE MARK AS SHOWN.

FOR LOCKSMITHING, NAMELY, CUSTOM FABRICATION OF REPLACEMENT KEYS AND LOCKS FOR OFFICE FURNITURE VIA THE INTERNET (U.S. CLS. 100, 103 AND 106).

FIRST USE 11-1-2007; IN COMMERCE 11-1-2007.

4,482,734. JUSTICE INITIATIVES, INC., CHARLOTTE, NC. SN 85-817,630. FILED P.R. 1-8-2013; AM. S.R. 8-19-2013.

**COURT CAMP**

THE MARK CONSISTS OF STANDARD CHARACTERS WITHOUT CLAIM TO ANY PARTICULAR FONT, STYLE, SIZE, OR COLOR.

NO CLAIM IS MADE TO THE EXCLUSIVE RIGHT TO USE "CAMP", APART FROM THE MARK AS SHOWN.

FOR SUMMER CAMPS; EDUCATIONAL SERVICES, NAMELY, CONDUCTING PROGRAMS AND PROVIDING COURSES OF INSTRUCTION IN THE FIELDS OF LEGAL AND JUDICIAL SYSTEMS AND COURSE MATERIALS DISTRIBUTED THEREWITH (U.S. CLS. 100, 101 AND 107).

FIRST USE 6-0-2009; IN COMMERCE 6-0-2009.

**CLASS 41—EDUCATION AND ENTERTAINMENT**

4,482,714. TONE IT UP, LLC, HERMOSA BEACH, CA. SN 85-545,378. FILED P.R. 2-16-2012; AM. S.R. 5-17-2013.

**FINE TONING METHOD**

THE MARK CONSISTS OF STANDARD CHARACTERS WITHOUT CLAIM TO ANY PARTICULAR FONT, STYLE, SIZE, OR COLOR.

NO CLAIM IS MADE TO THE EXCLUSIVE RIGHT TO USE "METHOD", APART FROM THE MARK AS SHOWN.

FOR EXERCISE INSTRUCTION (U.S. CLS. 100, 101 AND 107).

FIRST USE 4-0-2012; IN COMMERCE 4-0-2012.

**CLASS 41—(Continued).**

4,482,747. HORTON, KRISTY K., SPRINGFIELD, MO. SN 85-845,992. FILED P.R. 2-11-2013; AM. S.R. 12-2-2013.

**BAR CARDIO**

THE MARK CONSISTS OF STANDARD CHARACTERS WITHOUT CLAIM TO ANY PARTICULAR FONT, STYLE, SIZE, OR COLOR.

FOR ENTERTAINMENT SERVICES, NAMELY, WINE TASTINGS; HEALTH CLUB SERVICES, NAMELY, PROVIDING INSTRUCTION AND EQUIPMENT IN THE FIELD OF PHYSICAL EXERCISE; INSTRUCTION IN THE FIELD OF BALLET BARRE, YOGA AND AEROBICS; PHYSICAL FITNESS STUDIO SERVICES, NAMELY, PROVIDING EXERCISE CLASSES, BODY SCULPTING CLASSES, AND GROUP FITNESS CLASSES (U.S. CLS. 100, 101 AND 107).

FIRST USE 12-2-2013; IN COMMERCE 12-2-2013.

---

4,482,758. XPERTEVAL LLC, ATLANTA, GA. SN 85-859,693. FILED P.R. 2-25-2013; AM. S.R. 12-9-2013.

**XPERTEVAL**

THE MARK CONSISTS OF STANDARD CHARACTERS WITHOUT CLAIM TO ANY PARTICULAR FONT, STYLE, SIZE, OR COLOR.

FOR CONSULTATION AND ASSESSMENT SERVICES IN THE FIELD OF SPORTS AND SPORTS TRAINING; AND PERSONAL TRAINING AND FITNESS TRAINING SERVICES (U.S. CLS. 100, 101 AND 107).

FIRST USE 8-30-2013; IN COMMERCE 8-30-2013.

---

4,482,760. SHOW CREATORS INC., LAS VEGAS, NV. SN 85-860,744. FILED P.R. 2-26-2013; AM. S.R. 12-9-2013.

**Show Creators**

THE MARK CONSISTS OF STANDARD CHARACTERS WITHOUT CLAIM TO ANY PARTICULAR FONT, STYLE, SIZE, OR COLOR.

FOR ENTERTAINMENT SERVICES, NAMELY, MULTIMEDIA PRODUCTION SERVICES (U.S. CLS. 100, 101 AND 107).

FIRST USE 6-24-2005; IN COMMERCE 6-24-2005.

**CLASS 41—(Continued).**

4,482,770. BB DEVELOPMENT LLC, DBA OXFORD CASINO, OXFORD, ME. SN 85-872,775. FILED P.R. 3-11-2013; AM. S.R. 12-5-2013.

**OXFORD CASINO**

THE MARK CONSISTS OF STANDARD CHARACTERS WITHOUT CLAIM TO ANY PARTICULAR FONT, STYLE, SIZE, OR COLOR.

NO CLAIM IS MADE TO THE EXCLUSIVE RIGHT TO USE "CASINO", APART FROM THE MARK AS SHOWN.

FOR CASINOS; ENTERTAINMENT SERVICES, NAMELY, CASINO GAMING; GAMING SERVICES IN THE NATURE OF CASINO GAMING; PROVIDING CASINO SERVICES FEATURING A CASINO PLAYERS REWARDS PROGRAM (U.S. CLS. 100, 101 AND 107).

FIRST USE 7-1-2012; IN COMMERCE 7-1-2012.

---

4,482,774. MINNESOTA PUBLIC RADIO, ST. PAUL, MN. SN 85-875,817. FILED P.R. 3-14-2013; AM. S.R. 4-25-2013.

**YOUNG REPORTERS SERIES**

THE MARK CONSISTS OF STANDARD CHARACTERS WITHOUT CLAIM TO ANY PARTICULAR FONT, STYLE, SIZE, OR COLOR.

NO CLAIM IS MADE TO THE EXCLUSIVE RIGHT TO USE "SERIES", APART FROM THE MARK AS SHOWN.

FOR ENTERTAINMENT AND EDUCATIONAL SERVICES IN THE NATURE OF ONGOING PROGRAMS IN THE FIELDS OF NEWS, CURRENT EVENTS, COMMENTARY, DOCUMENTARIES, CULTURE, INTERVIEWS AND GENERAL HUMAN INTEREST, TO BE BROADCAST VIA RADIO AND THE INTERNET (U.S. CLS. 100, 101 AND 107).

FIRST USE 4-0-2012; IN COMMERCE 4-0-2012.

---

4,482,775. BB DEVELOPMENT LLC, DBA OXFORD CASINO, OXFORD, ME. SN 85-878,634. FILED P.R. 3-18-2013; AM. S.R. 12-5-2013.

**OXFORD REWARDS LOYALTY CLUB**

THE MARK CONSISTS OF STANDARD CHARACTERS WITHOUT CLAIM TO ANY PARTICULAR FONT, STYLE, SIZE, OR COLOR.

**CLASS 41—(Continued).**

NO CLAIM IS MADE TO THE EXCLUSIVE RIGHT TO USE "REWARDS LOYALTY CLUB", APART FROM THE MARK AS SHOWN.

FOR PROVIDING CASINO SERVICES FEATURING A CASINO PLAYERS REWARDS PROGRAM; PROVIDING CASINO SERVICES FEATURING STORED VALUE MEMBERSHIP CARDS FOR REDEEMING CASH, DISCOUNTS, AND OTHER BENEFITS (U.S. CLS. 100, 101 AND 107).

FIRST USE 7-1-2012; IN COMMERCE 7-1-2012.

---

4,482,778. VIACOM INTERNATIONAL INC., NEW YORK, NY. SN 85-887,700. FILED P.R. 3-27-2013; AM. S.R. 12-5-2013.

**FAMILIA DE CIRCO**

THE MARK CONSISTS OF STANDARD CHARACTERS WITHOUT CLAIM TO ANY PARTICULAR FONT, STYLE, SIZE, OR COLOR.

THE ENGLISH TRANSLATION OF "FAMILIA DE CIRCO" IN THE MARK IS "FAMILY CIRCUS".

FOR ENTERTAINMENT SERVICES IN THE NATURE OF CONTINUING PROGRAM SERIES, FEATURING LIVE ACTION, COMEDY AND DRAMA PROVIDED THROUGH CABLE TELEVISION, BROADCAST TELEVISION, INTERNET, VIDEO-ON-DEMAND, AND THROUGH OTHER FORMS OF TRANSMISSION MEDIA; PROVIDING ONLINE INFORMATION IN THE FIELD OF ENTERTAINMENT CONCERNING TELEVISION PROGRAMS (U.S. CLS. 100, 101 AND 107).

FIRST USE 8-14-2013; IN COMMERCE 8-14-2013.

---

4,482,781. DREXEL UNIVERSITY, PHILADELPHIA, PA. SN 85-895,543. FILED P.R. 4-4-2013; AM. S.R. 11-26-2013.

**C-SUITE CO-OP**

THE MARK CONSISTS OF STANDARD CHARACTERS WITHOUT CLAIM TO ANY PARTICULAR FONT, STYLE, SIZE, OR COLOR.

NO CLAIM IS MADE TO THE EXCLUSIVE RIGHT TO USE "CO-OP", APART FROM THE MARK AS SHOWN.

FOR EDUCATION SERVICES, PROVIDING EDUCATIONAL PROGRAMS TO DEVELOP INTERVIEWING AND PRESENTATION SKILLS AND TO DEVELOP SOUND WORK HABITS FOR WORKING WITH COMPANY EXECUTIVES (U.S. CLS. 100, 101 AND 107).

FIRST USE 9-23-2013; IN COMMERCE 9-23-2013.

**CLASS 41—(Continued).**

4,482,784. DEBORAH J. BARKER, PITTSBURGH, PA. SN 85-901,585. FILED 4-11-2013.

**BETTER BODY IMAGE**

THE MARK CONSISTS OF STANDARD CHARACTERS WITHOUT CLAIM TO ANY PARTICULAR FONT, STYLE, SIZE, OR COLOR.

FOR PERSONAL IMAGE DEVELOPMENT CONSULTING SERVICES FOR PEOPLE TO CREATE A BETTER BODY IMAGE FOR THEMSELVES (U.S. CLS. 100, 101 AND 107).

FIRST USE 3-31-2012; IN COMMERCE 11-8-2013.

---

4,482,793. TIFFEE PRODUCTIONS, INC., TULSA, OK. SN 85-924,583. FILED P.R. 5-6-2013; AM. S.R. 12-3-2013.

**Video Game Experts**

THE MARK CONSISTS OF STANDARD CHARACTERS WITHOUT CLAIM TO ANY PARTICULAR FONT, STYLE, SIZE, OR COLOR.

NO CLAIM IS MADE TO THE EXCLUSIVE RIGHT TO USE "VIDEO GAME", APART FROM THE MARK AS SHOWN.

FOR EDUCATION SERVICES, NAMELY, PROVIDING TUTORING IN THE FIELD OF VIDEO GAMES (U.S. CLS. 100, 101 AND 107).

FIRST USE 11-30-2013; IN COMMERCE 11-30-2013.

---

4,482,799. 3STUDIOSOUNDS, LLC, LOS ANGELES, CA. SN 85-930,809. FILED P.R. 5-13-2013; AM. S.R. 12-4-2013.

**ENHANCED MEDIA**

THE MARK CONSISTS OF STANDARD CHARACTERS WITHOUT CLAIM TO ANY PARTICULAR FONT, STYLE, SIZE, OR COLOR.

NO CLAIM IS MADE TO THE EXCLUSIVE RIGHT TO USE "MEDIA", APART FROM THE MARK AS SHOWN.

FOR MUSIC PRODUCTION SERVICES; SOUND RECORDINGS PRODUCTION SERVICES; MUSIC POST PRODUCTION SERVICES; SOUND RECORDINGS POST PRODUCTION SERVICES; MUSIC VIDEO PRODUCTION SERVICES (U.S. CLS. 100, 101 AND 107).

FIRST USE 1-1-2013; IN COMMERCE 1-1-2013.

**CLASS 41—(Continued).**

4,482,809. THE DACADE GROUP - YOUNG ENGINEERS LTD, REHOVOT, ISRAEL. SN 85-952,004. FILED P.R. 6-5-2013; AM. S.R. 12-9-2013.

## e2 young engineers

THE MARK CONSISTS OF STANDARD CHARACTERS WITHOUT CLAIM TO ANY PARTICULAR FONT, STYLE, SIZE, OR COLOR.

NO CLAIM IS MADE TO THE EXCLUSIVE RIGHT TO USE "YOUNG ENGINEERS", APART FROM THE MARK AS SHOWN.

FOR EDUCATION SERVICES, NAMELY, PROVIDING KINDERGARTEN THROUGH 12TH GRADE (K-12) CLASSROOM INSTRUCTION (U.S. CLS. 100, 101 AND 107).

FIRST USE 1-1-2010; IN COMMERCE 1-1-2010.

---

4,482,811. CTAEXPO, LLC, CLEVERDALE, NY. SN 85-959,944. FILED P.R. 6-14-2013; AM. S.R. 12-11-2013.

## CTAEXPO

THE MARK CONSISTS OF STANDARD CHARACTERS WITHOUT CLAIM TO ANY PARTICULAR FONT, STYLE, SIZE, OR COLOR.

FOR EDUCATIONAL SERVICES, NAMELY, ORGANIZING CONFERENCES IN THE FIELD OF FINANCIAL INVESTING TO HELP PROFESSIONAL CAPITAL RAISERS, COMMODITY TRADING ADVISORS, FOREIGN EXCHANGE TRADERS, GLOBAL MACRO HEDGE FUNDS MANAGERS AND ALLOCATORS IDENTIFY FUTURES TRADING TALENT (U.S. CLS. 100, 101 AND 107).

FIRST USE 8-26-2008; IN COMMERCE 8-26-2008.

---

4,482,812. JUST FOR KIDS, LLC, ARLINGTON, VA. SN 85-961,568. FILED P.R. 6-17-2013; AM. S.R. 1-3-2014.

## JUST FOR KIDS

THE MARK CONSISTS OF STANDARD CHARACTERS WITHOUT CLAIM TO ANY PARTICULAR FONT, STYLE, SIZE, OR COLOR.

FOR ARRANGING, ORGANIZING, CONDUCTING AND HOSTING BIRTHDAY PARTIES; GYMNASIIC INSTRUCTION; SPORTS INSTRUCTION SERVICES; YOGA INSTRUCTION (U.S. CLS. 100, 101 AND 107).

FIRST USE 1-0-2008; IN COMMERCE 1-0-2008.

**CLASS 41—(Continued).**

4,482,819. CRYSTAL, MICHAEL, WILTON, CT. SN 86-007,249. FILED P.R. 7-11-2013; AM. S.R. 11-16-2013.

## TRANSDISCIPLINARY COACHING

THE MARK CONSISTS OF STANDARD CHARACTERS WITHOUT CLAIM TO ANY PARTICULAR FONT, STYLE, SIZE, OR COLOR.

NO CLAIM IS MADE TO THE EXCLUSIVE RIGHT TO USE "COACHING", APART FROM THE MARK AS SHOWN.

FOR BUSINESS TRAINING IN THE FIELD OF LEADERSHIP DEVELOPMENT, EXECUTIVE COACHING; BUSINESS TRAINING CONSULTANCY SERVICES; COACHING SERVICES, NAMELY, ADVISING AND COUNSELLING CLIENTS ON HOW TO IMPROVE THEIR PERFORMANCE, AND THE PERFORMANCE OF THE TEAMS AND ORGANIZATIONS THEY LEAD AND MANAGE; EDUCATIONAL AND ENTERTAINMENT SERVICES, NAMELY, PROVIDING MOTIVATIONAL AND EDUCATIONAL SPEAKERS IN THE FIELD OF SELF- AND PERSONAL IMPROVEMENT (U.S. CLS. 100, 101 AND 107).

FIRST USE 8-11-2013; IN COMMERCE 8-11-2013.

---

4,482,821. CONNECTICUT BEER WHOLESALERS ASSOCIATION, INC., MYSTIC, CT. SN 86-012,867. FILED P.R. 7-17-2013; AM. S.R. 12-6-2013.

## CT BEER WEEK

THE MARK CONSISTS OF STANDARD CHARACTERS WITHOUT CLAIM TO ANY PARTICULAR FONT, STYLE, SIZE, OR COLOR.

FOR ENTERTAINMENT AND RECREATIONAL SERVICES, NAMELY, ARRANGING, ORGANIZING AND HOSTING A SERIES OF SOCIAL ENTERTAINMENT EVENTS CELEBRATING AND PROMOTING BREWING HERITAGE, REGIONAL PUBS, RESTAURANTS, WHOLESALERS, BREWERIES AND RELATED BUSINESSES (U.S. CLS. 100, 101 AND 107).

FIRST USE 5-11-2013; IN COMMERCE 5-18-2013.

---

4,482,856. ACCESS INTELLIGENCE LLC, ROCKVILLE, MD. SN 86-054,063. FILED 9-3-2013.

## DIGITAL PR AWARDS

THE MARK CONSISTS OF STANDARD CHARACTERS WITHOUT CLAIM TO ANY PARTICULAR FONT, STYLE, SIZE, OR COLOR.

**CLASS 41—(Continued).**

NO CLAIM IS MADE TO THE EXCLUSIVE RIGHT TO USE "PR AWARDS", APART FROM THE MARK AS SHOWN.  
FOR PROVIDING RECOGNITION AND INCENTIVES BY THE WAY OF AWARDS TO DEMONSTRATE EXCELLENCE IN THE FIELD OF PUBLIC RELATIONS AND COMMUNICATIONS (U.S. CLS. 100, 101 AND 107).  
FIRST USE 6-0-2010; IN COMMERCE 6-0-2010.

**CLASS 41—(Continued).**

4,482,873. RENEE-MARIE STEPHANO, PALM BEACH GARDENS, FL. SN 86-115,276. FILED P.R. 11-11-2013; AM. S.R. 12-14-2013.

4,482,863. ETSG, LLC, DBA ENERGY TRAINING SOLUTIONS, KINGWOOD, TX. SN 86-079,892. FILED P.R. 10-1-2013; AM. S.R. 12-26-2013.

**Medical Tourism Marketing  
Specialist**

**OFFSHORE CATASTROPHES**

THE MARK CONSISTS OF STANDARD CHARACTERS WITHOUT CLAIM TO ANY PARTICULAR FONT, STYLE, SIZE, OR COLOR.  
OWNER OF U.S. REG. NO. 4,277,471.  
FOR EDUCATIONAL SERVICES, NAMELY, PROVIDING TRAINING OF PROFESSIONALS FOR CERTIFICATION IN THE FIELD OF MEDICAL TOURISM MARKETING (U.S. CLS. 100, 101 AND 107).  
FIRST USE 11-11-2013; IN COMMERCE 11-11-2013.

THE MARK CONSISTS OF STANDARD CHARACTERS WITHOUT CLAIM TO ANY PARTICULAR FONT, STYLE, SIZE, OR COLOR.  
FOR EDUCATIONAL SERVICES, NAMELY, CONDUCTING COURSES, FIELD TRIPS AND WORKSHOPS IN THE FIELD OF OIL AND GAS AND DISTRIBUTION OF COURSE MATERIAL IN CONNECTION THEREWITH (U.S. CLS. 100, 101 AND 107).  
FIRST USE 12-31-2006; IN COMMERCE 12-31-2006.

**CLASS 42—SCIENTIFIC AND COMPUTER SERVICES**

4,482,745. JACKSON, KOBY, NORTH SALT LAKE, UT. SN 85-843,305. FILED P.R. 2-7-2013; AM. S.R. 11-23-2013.

4,482,868. STEPHANO, RENEE-MARIE, PALM BEACH GARDENS, FL. SN 86-099,373. FILED P.R. 10-23-2013; AM. S.R. 12-14-2013.

**Medical Tourism Marketing  
Professional**

**CallDrip**

THE MARK CONSISTS OF STANDARD CHARACTERS WITHOUT CLAIM TO ANY PARTICULAR FONT, STYLE, SIZE, OR COLOR.  
OWNER OF U.S. REG. NOS. 4,228,113 AND 4,277,471.  
FOR EDUCATIONAL SERVICES, NAMELY, PROVIDING TRAINING OF PROFESSIONALS FOR CERTIFICATION IN THE FIELD OF MARKETING MEDICAL TOURISM (U.S. CLS. 100, 101 AND 107).  
FIRST USE 8-23-2013; IN COMMERCE 8-23-2013.

THE MARK CONSISTS OF STANDARD CHARACTERS WITHOUT CLAIM TO ANY PARTICULAR FONT, STYLE, SIZE, OR COLOR.  
FOR SOFTWARE AS A SERVICE (SAAS) SERVICES, NAMELY, HOSTING SOFTWARE FOR USE BY OTHERS FOR USE IN SALES AND MARKETING (U.S. CLS. 100 AND 101).  
FIRST USE 6-1-2009; IN COMMERCE 1-1-2010.

**CLASS 42—(Continued).**

4,482,767. LOYAL ENTERPRISES LLC, NASHVILLE, TN. SN 85-869,927. FILED P.R. 3-7-2013; AM. S.R. 12-9-2013.

## Solar Site Design

THE MARK CONSISTS OF STANDARD CHARACTERS WITHOUT CLAIM TO ANY PARTICULAR FONT, STYLE, SIZE, OR COLOR.

FOR APPLICATION SERVICE PROVIDER (ASP) FEATURING SOFTWARE FOR USE BY SOLAR ENERGY PROFESSIONALS SUCH AS INSTALLERS AND BUILDERS TO MANAGE SOLAR PROJECT DEVELOPMENT, NAMELY, PROJECT DATA CAPTURE, PROJECT VIDEO CAPTURE, PROJECT IMAGE CAPTURE, DESIGN ANALYSIS AND INSTALLATION INPUT ; APPLICATION SERVICE PROVIDER, NAMELY, PROVIDING TEMPORARY USE OF ON-LINE NON-DOWNLOADABLE COMPUTER SOFTWARE FOR USE IN CUSTOMER RELATIONSHIP MANAGEMENT(CRM)IN THE FIELD OF SOLAR ENERGY; APPLICATION SERVICE PROVIDER FEATURING SOFTWARE FOR ORDER FULFILLMENT (U.S. CLS. 100 AND 101).

FIRST USE 1-1-2013; IN COMMERCE 1-1-2013.

4,482,788. ADTECH GLOBAL SOLUTIONS, INC., ALPHARETTA, GA. SN 85-906,780. FILED P.R. 4-17-2013; AM. S.R. 11-25-2013.

## GLOBAL MONITOR

THE MARK CONSISTS OF STANDARD CHARACTERS WITHOUT CLAIM TO ANY PARTICULAR FONT, STYLE, SIZE, OR COLOR.

FOR COMPUTER SOFTWARE SERVICES, NAMELY, PROVIDING THE CUSTOMIZED MONITORING AND SURVEILLANCE OF HARDWARE, SOFTWARE, TELECOMMUNICATIONS, AND NETWORKING INFRASTRUCTURE OF THIRD PARTIES, AND DELIVERY OF CUSTOMIZED ALERTS AND REPORTING OF STANDARD OR CUSTOMER-SPECIFIC KEY PERFORMANCE INDICATORS; CLOUD COMPUTING SOFTWARE SERVICES FEATURING SOFTWARE FOR USE IN THE CUSTOMIZED MONITORING AND SURVEILLANCE OF HARDWARE, SOFTWARE, TELECOMMUNICATIONS, AND NETWORKING INFRASTRUCTURE OF THIRD PARTIES, AND DELIVERY OF CUSTOMIZED ALERTS AND REPORTING OF STANDARD OR CUSTOMER-SPECIFIC KEY PERFORMANCE INDICATORS; CUSTOMIZED MONITORING AND SURVEILLANCE OF THE TECHNOLOGICAL FUNCTIONS OF THE HARDWARE, SOFTWARE, TELECOMMUNICATIONS, AND NETWORKING INFRASTRUCTURE OF THIRD PARTIES, WHICH ALSO FEATURES DELIVERY OF CUSTOMIZED ALERTS AND REPORTING OF STANDARD OR CUSTOMER-SPECIFIC KEY PERFORMANCE INDICATORS (U.S. CLS. 100 AND 101).

FIRST USE 1-17-2012; IN COMMERCE 1-17-2012.

**CLASS 42—(Continued).**

4,482,792. INCWEBS, INC., LAKELAND, FL. SN 85-920,502. FILED P.R. 5-1-2013; AM. S.R. 12-6-2013.

## BusConduct

THE MARK CONSISTS OF STANDARD CHARACTERS WITHOUT CLAIM TO ANY PARTICULAR FONT, STYLE, SIZE, OR COLOR.

FOR PROVIDING ON-LINE NON-DOWNLOADABLE SOFTWARE FOR TRACKING CONDUCT REFERRALS ON SCHOOL BUSES (U.S. CLS. 100 AND 101).

FIRST USE 9-18-2009; IN COMMERCE 9-18-2009.

4,482,806. MAINE SITE EVALUATIONS LLC, KENNEBUNK, ME. SN 85-949,947. FILED P.R. 6-4-2013; AM. S.R. 12-5-2013.

## MAINE SITE EVALUATIONS LLC

THE MARK CONSISTS OF STANDARD CHARACTERS WITHOUT CLAIM TO ANY PARTICULAR FONT, STYLE, SIZE, OR COLOR.

NO CLAIM IS MADE TO THE EXCLUSIVE RIGHT TO USE "EVALUATIONS LLC", APART FROM THE MARK AS SHOWN.

FOR DESIGN, DEVELOPMENT, AND CONSULTING SERVICES RELATED THERETO IN THE FIELD OF SEPTIC SYSTEMS (U.S. CLS. 100 AND 101).

FIRST USE 3-1-2009; IN COMMERCE 3-1-2009.

4,482,836. FUJIFILM NORTH AMERICA CORPORATION, VALHALLA, NY. SN 86-038,533. FILED P.R. 8-15-2013; AM. S.R. 12-9-2013.

## COLOR MANAGEMENT IN THE CLOUD

THE MARK CONSISTS OF STANDARD CHARACTERS WITHOUT CLAIM TO ANY PARTICULAR FONT, STYLE, SIZE, OR COLOR.

FOR SOFTWARE AS A SERVICE (SAAS) SERVICES FEATURING SOFTWARE FOR THE GRAPHIC ARTS INDUSTRY, NAMELY, SOFTWARE FOR GENERATING COLOR PROFILES, MONITORING COLOR, RE-ALIGNING PROFILES AND REPORTING AND VALIDATING ON COLOR VIA A WEB BROWSER LINKED TO A HOSTED WEB SERVER (U.S. CLS. 100 AND 101).

FIRST USE 6-27-2012; IN COMMERCE 6-27-2012.

**CLASS 42—(Continued).**

4,482,851. RAJ AMI INC., DBA OLDAPPS.COM, MILPITAS, CA. SN 86-046,477. FILED 8-23-2013.

# OLD APPS

THE MARK CONSISTS OF STANDARD CHARACTERS WITHOUT CLAIM TO ANY PARTICULAR FONT, STYLE, SIZE, OR COLOR.

NO CLAIM IS MADE TO THE EXCLUSIVE RIGHT TO USE "APPS", APART FROM THE MARK AS SHOWN.

FOR APPLICATION SERVICE PROVIDER, NAMELY, HOSTING, MANAGING, DEVELOPING, AND MAINTAINING APPLICATIONS, SOFTWARE, AND WEB SITES, IN THE FIELDS OF PERSONAL PRODUCTIVITY, WIRELESS COMMUNICATION, MOBILE INFORMATION ACCESS, AND REMOTE DATA MANAGEMENT FOR WIRELESS DELIVERY OF CONTENT TO HANDHELD COMPUTERS, LAPTOPS AND MOBILE ELECTRONIC DEVICES (U.S. CLS. 100 AND 101).

FIRST USE 8-19-2005; IN COMMERCE 8-19-2005.

**CLASS 43—HOTEL AND RESTAURANT SERVICES**

4,482,711. YE ZHANG, ROCKVILLE, MD. SN 85-517,578. FILED P.R. 1-16-2012; AM. S.R. 12-23-2013.

# Hood Hibachi

THE MARK CONSISTS OF STANDARD CHARACTERS WITHOUT CLAIM TO ANY PARTICULAR FONT, STYLE, SIZE, OR COLOR.

FOR FAST-FOOD RESTAURANT SERVICES; RESTAURANT SERVICES; RESTAURANT SERVICES FEATURING ASIAN FUSION, HIBACHI; RESTAURANT SERVICES, INCLUDING SIT-DOWN SERVICE OF FOOD AND TAKE-OUT RESTAURANT SERVICES; RESTAURANT SERVICES, NAMELY, PROVIDING OF FOOD AND BEVERAGES FOR CONSUMPTION ON AND OFF THE PREMISES (U.S. CLS. 100 AND 101).

FIRST USE 9-11-2013; IN COMMERCE 12-21-2013.

4,482,715. PHAM, JAMES N., FOUNTAIN VALLEY, CA. SN 85-547,735. FILED P.R. 2-20-2012; AM. S.R. 12-16-2013.

# CALIBASIL

THE MARK CONSISTS OF STANDARD CHARACTERS WITHOUT CLAIM TO ANY PARTICULAR FONT, STYLE, SIZE, OR COLOR.

FOR RESTAURANT SERVICES (U.S. CLS. 100 AND 101).

FIRST USE 8-15-2011; IN COMMERCE 8-15-2011.

**CLASS 43—(Continued).**

4,482,741. CREPE CONE, LLC, ATLANTA, GA. SN 85-838,705. FILED P.R. 2-1-2013; AM. S.R. 11-25-2013.

# CREPE CONE

THE MARK CONSISTS OF STANDARD CHARACTERS WITHOUT CLAIM TO ANY PARTICULAR FONT, STYLE, SIZE, OR COLOR.

NO CLAIM IS MADE TO THE EXCLUSIVE RIGHT TO USE "CONE", APART FROM THE MARK AS SHOWN.

FOR RESTAURANT SERVICES (U.S. CLS. 100 AND 101).

FIRST USE 11-21-2013; IN COMMERCE 11-21-2013.

4,482,855. WICKED WAFFLES, LLC, VIENNA, VA. SN 86-050,237. FILED P.R. 8-28-2013; AM. S.R. 11-21-2013.

# NO BUTTER. NO SYRUP.

THE MARK CONSISTS OF STANDARD CHARACTERS WITHOUT CLAIM TO ANY PARTICULAR FONT, STYLE, SIZE, OR COLOR.

FOR RESTAURANT, RESTAURANT CARRYOUT AND CATERING SERVICES (U.S. CLS. 100 AND 101).

FIRST USE 8-1-2011; IN COMMERCE 8-1-2011.

**CLASS 44—MEDICAL, BEAUTY AND AGRICULTURAL SERVICES**

4,482,729. DANIEL S. BRANDWEIN, D.P.M. AND SEAN L. KAUFMAN, D.P.M., KENILWORTH, NJ. SN 85-769,492. FILED P.R. 11-1-2012; AM. S.R. 12-17-2013.

# Innovative Physical Therapy

THE MARK CONSISTS OF STANDARD CHARACTERS WITHOUT CLAIM TO ANY PARTICULAR FONT, STYLE, SIZE, OR COLOR.

NO CLAIM IS MADE TO THE EXCLUSIVE RIGHT TO USE "PHYSICAL THERAPY", APART FROM THE MARK AS SHOWN.

FOR PHYSICAL THERAPY (U.S. CLS. 100 AND 101).

FIRST USE 6-1-2013; IN COMMERCE 6-1-2013.

**CLASS 45—(Continued).**

4,482,750. HORIZON HEALTHCARE, INC., FORMERLY ARO BEHAVIORAL HEALTHCARE, INC., BROOKFIELD, WI. SN 85-848,307. FILED P.R. 2-13-2013; AM. S.R. 12-3-2013.

**American Telehealthcare**

THE MARK CONSISTS OF STANDARD CHARACTERS WITHOUT CLAIM TO ANY PARTICULAR FONT, STYLE, SIZE, OR COLOR.  
NO CLAIM IS MADE TO THE EXCLUSIVE RIGHT TO USE "TELEHEALTHCARE", APART FROM THE MARK AS SHOWN.  
FOR HEALTHCARE (U.S. CLS. 100 AND 101).  
FIRST USE 7-0-2012; IN COMMERCE 7-0-2012.

4,482,765. HORIZON HEALTHCARE, INC., FORMERLY ARO BEHAVIORAL HEALTHCARE, INC., BROOKFIELD, WI. SN 85-865,404. FILED P.R. 3-4-2013; AM. S.R. 12-3-2013.

**American Behavioral TeleHealthcare**

THE MARK CONSISTS OF STANDARD CHARACTERS WITHOUT CLAIM TO ANY PARTICULAR FONT, STYLE, SIZE, OR COLOR.  
NO CLAIM IS MADE TO THE EXCLUSIVE RIGHT TO USE "BEHAVIORAL TELEHEALTHCARE", APART FROM THE MARK AS SHOWN.  
FOR BEHAVIORAL HEALTH SERVICES (U.S. CLS. 100 AND 101).  
FIRST USE 2-20-2013; IN COMMERCE 2-20-2013.

4,482,772. NW ALABAMA PRACTICE MANAGEMENT, LLC, SHEFFIELD, AL. SN 85-874,664. FILED P.R. 3-13-2013; AM. S.R. 12-9-2013.

**WOMEN'S HEALTH OPTIONS**

THE MARK CONSISTS OF STANDARD CHARACTERS WITHOUT CLAIM TO ANY PARTICULAR FONT, STYLE, SIZE, OR COLOR.  
FOR MEDICAL SERVICES; HEALTH CARE SERVICES, NAMELY, GYNCOLOGY, OBSTETRICS, HORMONE REPLACEMENT THERAPY AND WEIGHT MANAGEMENT SERVICES (U.S. CLS. 100 AND 101).  
FIRST USE 11-30-2011; IN COMMERCE 11-30-2011.

**CLASS 45—(Continued).**

4,482,830. CHAN, EMILY K, DBA MODERN INTEGRATIVE MEDICINE, CAMBRIDGE, MA. SN 86-032,987. FILED P.R. 8-8-2013; AM. S.R. 11-26-2013.

**Modern Integrative Medicine**

THE MARK CONSISTS OF STANDARD CHARACTERS WITHOUT CLAIM TO ANY PARTICULAR FONT, STYLE, SIZE, OR COLOR.  
NO CLAIM IS MADE TO THE EXCLUSIVE RIGHT TO USE "INTEGRATIVE MEDICINE", APART FROM THE MARK AS SHOWN.  
FOR HEALTHCARE (U.S. CLS. 100 AND 101).  
FIRST USE 2-10-2011; IN COMMERCE 2-10-2011.

4,482,849. DIGINONYMOUS LLC, SEMINOLE, FL. SN 86-045,018. FILED P.R. 8-22-2013; AM. S.R. 11-28-2013.

**DigiMed**

THE MARK CONSISTS OF STANDARD CHARACTERS WITHOUT CLAIM TO ANY PARTICULAR FONT, STYLE, SIZE, OR COLOR.  
FOR TELEMEDICINE SERVICES (U.S. CLS. 100 AND 101).  
FIRST USE 8-22-2013; IN COMMERCE 8-23-2013.

**CLASS 45—PERSONAL AND LEGAL SERVICES**

4,482,861. PCS HOLDINGS, LLC, ORLANDO, FL. SN 86-073,406. FILED P.R. 9-24-2013; AM. S.R. 12-3-2013.

**YOUR TIMESHARE TITLE CLOSER**

THE MARK CONSISTS OF STANDARD CHARACTERS WITHOUT CLAIM TO ANY PARTICULAR FONT, STYLE, SIZE, OR COLOR.  
NO CLAIM IS MADE TO THE EXCLUSIVE RIGHT TO USE "TITLE", APART FROM THE MARK AS SHOWN.  
FOR REAL ESTATE CLOSING SERVICES (U.S. CLS. 100 AND 101).  
FIRST USE 3-13-2008; IN COMMERCE 3-13-2008.



# TRADEMARK REGISTRATIONS RENEWED

The designation "U.S. Cl." appearing in this section refers to the U.S. class in effect prior to Sep. 1, 1973 rather than the international class which applies to applications filed on or after that date. For adoption of international classification see notice in the OFFICIAL GAZETTE of Jun. 26, 1973 (911 O.G. TM 210).

177,883.	RED DEER BRAND AND DESIGN. U.S. CL. 46. (INT. CL. 31). REG. 1-1-1924.	977,400.	EEZ-THRU. U.S. CL. 44. (INT. CL. 10). REG. 1-22-1974.
178,253.	TOKHEIM (STYLIZED). U.S. CL. 26. (INT. CL. 9). REG. 1-8-1924.	978,404.	FABCON. U.S. CL. 12. (INT. CL. 19). REG. 2-12-1974.
181,463.	SUPER-CEL. U.S. CL. 6. (INT. CL. 1). REG. 3-18-1924.	978,480.	STA-RITE. U.S. CLS. 21, 23 AND 31. (INT. CLS. 7, 9 AND 11). REG. 2-12-1974.
309,456.	CHIVAS (STYLIZED). U.S. CL. 49. (INT. CL. 33). REG. 1-16-1934.	978,966.	PRO-PLUG. U.S. CL. 22. (INT. CL. 28). REG. 2-19-1974.
315,061.	CLOVER LEAF BRAND. U.S. CL. 46. (INT. CLS. 1, 5, 29, 30, 31 AND 32). REG. 7-17-1934.	980,479.	MISCELLANEOUS DESIGN. U.S. CL. 49. (INT. CL. 33). REG. 3-12-1974.
577,125.	SINGER (STYLIZED). U.S. CLS. 103 AND 107 ONLY. (INT. CLS. 35 AND 41). REG. 7-7-1953.	980,999.	S & L. U.S. CL. 23. (INT. CL. 7). REG. 3-26-1974.
584,310.	POLYMEKON (STYLIZED). U.S. CL. 6. (INT. CL. 4). REG. 1-5-1954.	981,680.	MORRISON'S PETER PAN. U.S. CL. 46. (INT. CL. 30). REG. 4-2-1974.
584,323.	SLOAN. U.S. CL. 35. (INT. CL. 17). REG. 1-5-1954.	981,681.	MORRISON'S SUPER BAKERS. U.S. CL. 46. (INT. CL. 30). REG. 4-2-1974.
586,255.	CELKATE (STYLIZED). U.S. CL. 6. (INT. CL. 1). REG. 3-2-1954.	983,112.	THE MUST FOR RUST. U.S. CL. 6. (INT. CL. 1). REG. 5-7-1974.
590,496.	RUST-OLEUM. U.S. CL. 16. (INT. CL. 2). REG. 6-1-1954.	983,826.	MORRISON. U.S. CL. 23. (INT. CLS. 6, 7, 8, 9, 11, 12, 16, 21 AND 28). REG. 5-14-1974.
756,352.	IBS AND DESIGN. U.S. CL. 21. (INT. CL. 9). REG. 9-10-1963.	984,436.	DIANA. U.S. CL. 23. (INT. CL. 7). REG. 5-21-1974.
761,883.	SLIP 'N SLIDE. U.S. CL. 22. (INT. CL. 28). REG. 12-24-1963.	987,858.	CB. U.S. CL. 34. (INT. CL. 11). REG. 7-9-1974.
761,888.	GRAYMILLS. U.S. CL. 23. (INT. CL. 7). REG. 12-24-1963.	989,978.	EI (STYLIZED). U.S. CLS. 32, 37, 38, 39 AND 101 ONLY. (INT. CLS. 10, 16, 20, 25, 26 AND 35). REG. 8-6-1974.
762,134.	MELDIN. INT. CL. 1. (U.S. CL. 1). REG. 12-31-1963.	991,358.	AQUA-CEL. U.S. CL. 31. (INT. CL. 1). REG. 8-20-1974.
762,548.	LUVISKOL. U.S. CL. 6. (INT. CLS. 1, 2, 3, 4 AND 5). REG. 1-7-1964.	991,709.	VALQUA AND DESIGN. INT. CL. 17. (U.S. CL. 35). REG. 8-27-1974.
762,558.	DUR-O-SET (STYLIZED). U.S. CL. 6. (INT. CL. 1). REG. 1-7-1964.	991,917.	K KINETIC AND DESIGN. U.S. CL. 23. (INT. CL. 7). REG. 8-27-1974.
762,800.	NURSE-MATES. U.S. CL. 39. (INT. CL. 25). REG. 1-7-1964.	996,036.	AMERSTAT. INT. CL. 5. (U.S. CL. 6). REG. 10-22-1974.
762,850.	LEGACY (STYLIZED). U.S. CL. 49. (INT. CL. 33). REG. 1-7-1964.	998,144.	EXTRICATOR. U.S. CL. 23. (INT. CLS. 7 AND 8). REG. 11-12-1974.
765,315.	SLUGSTER. U.S. CL. 9. (INT. CL. 13). REG. 2-25-1964.	1,239,059.	DARWI. INT. CLS. 2 AND 16. (U.S. CLS. 16 AND 37). REG. 5-24-1983.
765,926.	BERNAT. U.S. CL. 38. (INT. CL. 16). REG. 3-3-1964.	1,243,021.	BIGELOW COOKING COMPANION AND DESIGN. INT. CL. 30. (U.S. CL. 46). REG. 6-21-1983.
766,997.	AMPCOLOY. U.S. CL. 14. (INT. CL. 6). REG. 3-24-1964.	1,243,867.	USAIR. INT. CL. 39. (U.S. CL. 105). REG. 6-28-1983.
767,589.	SPA. U.S. CL. 37. (INT. CL. 16). REG. 3-31-1964.	1,244,189.	MALLORY IGNITION AND DESIGN. INT. CL. 7 ONLY. (U.S. CLS. 21 AND 23). REG. 7-5-1983.
773,000.	KINGSFORD. U.S. CL. 1. (INT. CL. 4). REG. 7-14-1964.	1,244,459.	EVAZOTE. INT. CL. 17. (U.S. CL. 1). REG. 7-5-1983.
780,479.	SKIN-SO-SOFT. U.S. CL. 51. (INT. CL. 3). REG. 11-17-1964.	1,244,814.	CAPITOL AND DESIGN. INT. CL. 41. (U.S. CLS. 100, 101 AND 107). REG. 7-5-1983.
780,947.	KWIK TIP. U.S. CL. 23. (INT. CL. 7). REG. 12-1-1964.	1,244,815.	CAPITOL. INT. CL. 41. (U.S. CLS. 100, 101 AND 107). REG. 7-5-1983.
954,804.	WYNN'S AND DESIGN. U.S. CL. 6. (INT. CL. 1). REG. 3-13-1973.	1,245,531.	LAXMI BRAND AND DESIGN. INT. CL. 30. (U.S. CL. 46). REG. 7-12-1983.
963,858.	ROYAL BANK OF CANADA. U.S. CL. 102. (INT. CL. 36). REG. 7-10-1973.	1,248,138.	BHS. INT. CL. 7. (U.S. CLS. 13, 19, 21, 23, 31, 34 AND 35). REG. 8-16-1983.
974,384.	MISCELLANEOUS DESIGN. U.S. CL. 39. (INT. CLS. 10, 25 AND 26). REG. 12-4-1973.	1,252,895.	BLUEPRINT. INT. CL. 16. (U.S. CL. 38). REG. 10-4-1983.
975,215.	SWIM-A-THON. U.S. CL. 102. (INT. CL. 36). REG. 12-18-1973.	1,255,023.	MAGIC WAX. INT. CL. 3. (U.S. CL. 4). REG. 10-25-1983.
975,325.	TURF-FLOW. U.S. CL. 13. (INT. CL. 17). REG. 12-25-1973.	1,255,765.	ZEE. INT. CLS. 5, 9, 10 AND 16. (U.S. CLS. 18, 26, 38 AND 44). REG. 11-1-1983.
975,753.	AMSTORE. U.S. CLS. 12 AND 32 ONLY. (INT. CLS. 19 AND 20). REG. 1-1-1974.	1,255,843.	GROUT-A-MATIC. INT. CL. 7. (U.S. CL. 23). REG. 11-1-1983.
975,809.	HALOG. U.S. CL. 18. (INT. CL. 5). REG. 1-1-1974.	1,261,930.	MASTER PAK. INT. CL. 36. (U.S. CL. 102). REG. 12-20-1983.
976,038.	KA-ME (STYLIZED). U.S. CL. 46. (INT. CLS. 1, 5, 29, 30, 31 AND 32). REG. 1-1-1974.	1,262,210.	DURA-TUBE. INT. CL. 6. (U.S. CL. 14). REG. 12-27-1983.
976,355.	CHROMALINE AND DESIGN. U.S. CL. 26. (INT. CL. 9). REG. 1-8-1974.	1,262,324.	CHROMOLUX. INT. CL. 16. (U.S. CL. 37). REG. 12-27-1983.
976,471.	DIORELLA. U.S. CL. 51. (INT. CLS. 3 AND 5). REG. 1-8-1974.	1,262,384.	UNC. INT. CLS. 16, 21, 25 AND 41. (U.S. CLS. 2, 33, 37, 38, 39 AND 107). REG. 12-27-1983.
976,703.	YAESU. U.S. CLS. 21 AND 26. (INT. CL. 9). REG. 1-15-1974.	1,262,385.	WORLD CONCERN. INT. CL. 16. (U.S. CL. 38). REG. 12-27-1983.
976,848.	COLUMBIA PICTURES. U.S. CL. 38. (INT. CL. 9). REG. 1-15-1974.		

- 1,262,485. MISCELLANEOUS DESIGN. INT. CL. 25. (U.S. CL. 39). REG. 12-27-1983.
- 1,262,511. ALUMAGOAL. INT. CL. 28. (U.S. CL. 22). REG. 12-27-1983.
- 1,262,651. OPUS. INT. CLS. 36, 37 AND 42. (U.S. CLS. 100, 102 AND 103). REG. 12-27-1983.
- 1,262,834. CARTRAC. INT. CL. 7. (U.S. CL. 23). REG. 1-3-1984.
- 1,262,845. SAFE-TURN. INT. CL. 7. (U.S. CL. 23). REG. 1-3-1984.
- 1,263,196. HONEY-WAGON. INT. CL. 37. (U.S. CL. 103). REG. 1-3-1984.
- 1,263,315. SEAPREP. INT. CL. 1. (U.S. CL. 6). REG. 1-10-1984.
- 1,263,411. FP AND DESIGN. INT. CL. 7. (U.S. CL. 23). REG. 1-10-1984.
- 1,263,412. COORS. INT. CLS. 8 AND 21. (U.S. CLS. 23, 28 AND 44). REG. 1-10-1984.
- 1,263,564. COLIBRI. INT. CL. 14. (U.S. CL. 28). REG. 1-10-1984.
- 1,263,599. UNIVERSITY OF NORTH CAROLINA. INT. CLS. 16, 21, 25 AND 41. (U.S. CLS. 2, 33, 37, 38, 39 AND 107). REG. 1-10-1984.
- 1,263,624. XRC. INT. CL. 19. (U.S. CL. 12). REG. 1-10-1984.
- 1,263,736. HULA BRAND AND DESIGN. INT. CL. 30. (U.S. CL. 46). REG. 1-10-1984.
- 1,263,754. KENTUCKY CLUB CONTINENTAL BLEND AND DESIGN. INT. CL. 34. (U.S. CL. 17). REG. 1-10-1984.
- 1,263,845. CHANEL. INT. CL. 42. (U.S. CL. 101). REG. 1-10-1984.
- 1,263,897. FLOOD AND DESIGN. INT. CL. 2. (U.S. CLS. 6 AND 16). REG. 1-17-1984.
- 1,264,206. NCSU SCN AND DESIGN. INT. CLS. 16, 21, 25, 28, 41 AND 42. (U.S. CLS. 2, 5, 22, 23, 29, 33, 37, 38, 39, 50, 101 AND 107). REG. 1-17-1984.
- 1,264,243. PRADA. INT. CL. 18. (U.S. CLS. 1, 2, 3, 22 AND 41). REG. 1-17-1984.
- 1,264,262. POLYVENT. INT. CL. 19. (U.S. CL. 12). REG. 1-17-1984.
- 1,264,326. RAINBOW. INT. CL. 25. (U.S. CL. 39). REG. 1-17-1984.
- 1,264,676. EX-STRESS. INT. CL. 5. (U.S. CL. 18). REG. 1-24-1984.
- 1,264,731. EUBANKS. INT. CL. 7. (U.S. CLS. 13, 19, 21, 23, 31, 34 AND 35). REG. 1-24-1984.
- 1,265,171. MISCELLANEOUS DESIGN. INT. CLS. 29 AND 30. (U.S. CL. 46). REG. 1-24-1984.
- 1,265,200. GOLD RUSH NUGGET AND DESIGN. INT. CL. 30. (U.S. CL. 46). REG. 1-24-1984.
- 1,265,306. PORTILLO'S. INT. CL. 42. (U.S. CL. 100). REG. 1-24-1984.
- 1,265,814. TECNIFIBRE. INT. CL. 28. (U.S. CLS. 7 AND 22). REG. 1-31-1984.
- 1,266,163. TRUTZSCHLER AND DESIGN. INT. CLS. 7, 9 AND 11. (U.S. CLS. 21, 23, 26, 31 AND 34). REG. 2-7-1984.
- 1,266,350. S (STYLIZED). INT. CL. 21. (U.S. CLS. 32 AND 50). REG. 2-7-1984.
- 1,266,744. ACME. INT. CL. 1. (U.S. CL. 1). REG. 2-14-1984.
- 1,266,745. FERROSOUND. INT. CL. 1. (U.S. CL. 6). REG. 2-14-1984.
- 1,266,892. LEE BOY. INT. CL. 7. (U.S. CL. 23). REG. 2-14-1984.
- 1,267,754. POLAROTOR. INT. CL. 9. (U.S. CL. 21). REG. 2-21-1984.
- 1,268,085. SWISS VALLEY. INT. CL. 29. (U.S. CL. 46). REG. 2-21-1984.
- 1,271,395. MILLSPERSE. INT. CL. 1. (U.S. CL. 6). REG. 3-27-1984.
- 1,272,234. THE CRAB COOKER OF NEWPORT BEACH EAT LOTS A FISH AND DESIGN. INT. CL. 42. (U.S. CL. 101). REG. 3-27-1984.
- 1,272,398. MUSTANG. INT. CL. 7. (U.S. CL. 23). REG. 4-3-1984.
- 1,272,477. IBS. INT. CL. 9. (U.S. CL. 21). REG. 4-3-1984.
- 1,276,477. DONA ANTONIA. INT. CL. 33. (U.S. CL. 47). REG. 5-1-1984.
- 1,277,338. OUR PAL (STYLIZED). INT. CL. 35. (U.S. CLS. 100 AND 101). REG. 5-8-1984.
- 1,277,719. DUBOIS. INT. CL. 3. (U.S. CL. 52). REG. 5-15-1984.
- 1,280,200. MARRA BROS. DIST., INC.. INT. CL. 42. (U.S. CL. 101). REG. 5-29-1984.
- 1,283,132. GOLD 'N HOT (STYLIZED). INT. CL. 9. (U.S. CL. 21). REG. 6-26-1984.
- 1,283,922. US AND DESIGN. INT. CL. 1 ONLY. (U.S. CLS. 6 AND 10). REG. 7-3-1984.
- 1,288,371. MISCELLANEOUS DESIGN. INT. CL. 42. (U.S. CL. 100). REG. 7-31-1984.
- 1,291,782. BANICIDE. INT. CL. 5. (U.S. CL. 6). REG. 8-28-1984.
- 1,292,725. EXCELIX. INT. CL. 9. (U.S. CL. 26). REG. 9-4-1984.
- 1,295,287. METALSTITCH. INT. CL. 37. (U.S. CL. 103). REG. 9-11-1984.
- 1,300,294. DURAC. INT. CL. 9. (U.S. CL. 26). REG. 10-16-1984.
- 1,302,399. CELLUMATIC (STYLIZED). INT. CL. 7. (U.S. CL. 23). REG. 10-30-1984.
- 1,302,802. DOUBLE L. INT. CL. 28. (U.S. CL. 22). REG. 10-30-1984.
- 1,304,342. TREATS THE METAL, NOT THE OIL. INT. CL. 4. (U.S. CL. 15). REG. 11-6-1984.
- 1,304,343. JB METAL CONDITIONER. INT. CL. 4. (U.S. CL. 15). REG. 11-6-1984.
- 1,306,814. NORCO AND DESIGN. INT. CL. 7. (U.S. CL. 23). REG. 11-27-1984.
- 1,307,454. MILLION AIR (STYLIZED). INT. CL. 39. (U.S. CL. 105). REG. 11-27-1984.
- 1,307,543. SOFTWARE TO GO AND DESIGN. INT. CL. 42. (U.S. CL. 101). REG. 11-27-1984.
- 1,307,554. OMNI. INT. CL. 42. (U.S. CL. 100). REG. 11-27-1984.
- 1,310,732. ULTRA-BOND. INT. CL. 5. (U.S. CL. 44). REG. 12-25-1984.
- 1,312,268. YEAR BOOK OF EMERGENCY MEDICINE. INT. CL. 16. (U.S. CL. 38). REG. 1-1-1985.
- 1,764,185. SECRET AGENT. INT. CL. 9. (U.S. CL. 21). REG. 4-13-1993.
- 1,771,126. MISCELLANEOUS DESIGN. INT. CL. 8. (U.S. CL. 23). REG. 5-18-1993.
- 1,774,545. LAST CALL. INT. CL. 42. (U.S. CL. 101). REG. 6-1-1993.
- 1,775,086. INCOGNITO (STYLIZED). INT. CL. 9. (U.S. CLS. 2 AND 26). REG. 6-8-1993.
- 1,777,552. MUSK 15. INT. CLS. 1 AND 3. (U.S. CLS. 6 AND 51). REG. 6-22-1993.
- 1,778,137. RAPID-ROLL. INT. CL. 40. (U.S. CL. 106). REG. 6-22-1993.
- 1,778,627. THE SKIN PROTECTION SPECIALISTS. INT. CL. 5. (U.S. CL. 18). REG. 6-29-1993.
- 1,779,145. FLOWERS DIRECT. INT. CL. 35. (U.S. CL. 101). REG. 6-29-1993.
- 1,779,585. RESPONSE. INT. CL. 10. (U.S. CLS. 26, 39 AND 44). REG. 6-29-1993.
- 1,779,811. BUNRATTY IRISH POTCHEEN. INT. CL. 33. (U.S. CLS. 47 AND 49). REG. 6-29-1993.
- 1,779,813. ESTATE OF THE ART. INT. CL. 33. (U.S. CL. 47). REG. 6-29-1993.
- 1,779,858. AMERICA'S BEST CONVENTION VALUE. INT. CL. 41. (U.S. CL. 107). REG. 6-29-1993.
- 1,780,820. RX FIT. INT. CL. 10. (U.S. CL. 44). REG. 7-6-1993.
- 1,780,905. LIFEASE. INT. CL. 42. (U.S. CL. 100). REG. 7-6-1993.
- 1,781,132. TELEPERFORMANCE. INT. CLS. 16, 35 AND 38 ONLY. (U.S. CLS. 2, 5, 22, 23, 29, 37, 38, 50, 100, 101, 102 AND 104). REG. 7-13-1993.
- 1,781,582. ISLANDIA AND DESIGN. INT. CL. 29. (U.S. CL. 46). REG. 7-13-1993.
- 1,781,596. MOANA PACIFIC. INT. CL. 29. (U.S. CL. 46). REG. 7-13-1993.
- 1,783,522. SPIREX. INT. CL. 28. (U.S. CLS. 22, 23, 38 AND 50). REG. 7-20-1993.
- 1,786,298. EXPERT CALLING. INT. CL. 9. (U.S. CL. 38). REG. 8-3-1993.
- 1,786,300. INTELLIGENT CALL BLENDING. INT. CL. 9. (U.S. CL. 38). REG. 8-3-1993.
- 1,788,837. PACER II. INT. CL. 11. (U.S. CLS. 13 AND 31). REG. 8-17-1993.
- 1,790,783. PALS. INT. CLS. 41 AND 42. (U.S. CLS. 100 AND 107). REG. 8-31-1993.
- 1,793,749. NOTRAX. INT. CL. 27. (U.S. CLS. 42 AND 50). REG. 9-21-1993.
- 1,797,981. OLGA. INT. CL. 29. (U.S. CL. 46). REG. 10-12-1993.
- 1,798,827. SANYO. INT. CL. 29. (U.S. CL. 46). REG. 10-12-1993.
- 1,799,463. SAC STATE. INT. CL. 25. (U.S. CL. 39). REG. 10-19-1993.
- 1,800,950. DOLLE'S ORIGINAL SALT WATER TAFFY (STYLIZED). INT. CL. 30. (U.S. CL. 46). REG. 10-26-1993.

- 1,800,952. DOLLE'S (STYLIZED). INT. CL. 30. (U.S. CL. 46). REG. 10-26-1993.
- 1,804,527. SACRAMENTO STATE. INT. CL. 21. (U.S. CLS. 2, 30 AND 33). REG. 11-16-1993.
- 1,804,569. SACRAMENTO STATE. INT. CL. 25. (U.S. CL. 39). REG. 11-16-1993.
- 1,806,638. MEADOW-LIFE. INT. CL. 1. (U.S. CLS. 1, 5, 6, 10, 26 AND 46). REG. 11-23-1993.
- 1,807,809. DIP QUIK. INT. CL. 30. (U.S. CL. 46). REG. 11-30-1993.
- 1,810,452. CABLEWARE. INT. CL. 6. (U.S. CL. 13). REG. 12-14-1993.
- 1,810,472. CABLEWARE. INT. CL. 7. (U.S. CL. 23). REG. 12-14-1993.
- 1,810,727. THE DISPATCH. INT. CL. 16. (U.S. CL. 38). REG. 12-14-1993.
- 1,810,986. ISLAND PIT. INT. CL. 30. (U.S. CL. 46). REG. 12-14-1993.
- 1,811,118. HAYWARD BAKER. INT. CLS. 37 AND 40. (U.S. CLS. 103 AND 106). REG. 12-14-1993.
- 1,811,274. FM AND DESIGN. INT. CL. 42. (U.S. CLS. 100 AND 101). REG. 12-14-1993.
- 1,811,863. TRIVAC. INT. CL. 7. (U.S. CL. 23). REG. 12-21-1993.
- 1,811,948. TRI\*NET. INT. CL. 9. (U.S. CLS. 21 AND 26). REG. 12-21-1993.
- 1,812,050. HY HY. INT. CL. 12. (U.S. CL. 19). REG. 12-21-1993.
- 1,812,132. THE VOICE OF FRANCHISING. INT. CL. 16. (U.S. CL. 38). REG. 12-21-1993.
- 1,812,139. SPECIAL K. INT. CL. 16. (U.S. CL. 38). REG. 12-21-1993.
- 1,812,487. CGCM (STYLIZED). INT. CL. 42. (U.S. CL. 100). REG. 12-21-1993.
- 1,812,620. CR (STYLIZED). INT. CLS. 6 AND 41. (U.S. CLS. 2, 12, 13, 14, 23, 25, 50, 100, 101 AND 107). REG. 12-21-1993.
- 1,812,623. MISCELLANEOUS DESIGN. INT. CLS. 29, 30 AND 32. (U.S. CL. 46). REG. 12-21-1993.
- 1,812,694. ORIGINAL TANDEM MASTER AND DESIGN. INT. CL. 6. (U.S. CLS. 23 AND 50). REG. 12-21-1993.
- 1,812,760. ECAT. INT. CL. 9. (U.S. CL. 38). REG. 12-21-1993.
- 1,813,073. GALILEO FOOD SERVICE. INT. CL. 29. (U.S. CL. 46). REG. 12-21-1993.
- 1,813,074. GALILEO PREMIUM FOOD SERVICE. INT. CL. 29. (U.S. CL. 46). REG. 12-21-1993.
- 1,813,075. GALILEO FOOD SERVICE AND DESIGN. INT. CL. 29. (U.S. CL. 46). REG. 12-21-1993.
- 1,813,288. ROADCHEM. INT. CL. 1. (U.S. CL. 5). REG. 12-28-1993.
- 1,813,348. NEW-TAP. INT. CL. 4. (U.S. CL. 15). REG. 12-28-1993.
- 1,813,469. DRX. INT. CL. 9. (U.S. CL. 26). REG. 12-28-1993.
- 1,813,491. RXCLAIM. INT. CL. 9. (U.S. CL. 21). REG. 12-28-1993.
- 1,813,581. EAGLE. INT. CL. 9. (U.S. CL. 26). REG. 12-28-1993.
- 1,813,680. FICHEGUARD. INT. CL. 16. (U.S. CL. 37). REG. 12-28-1993.
- 1,813,728. L.A. GEAR. INT. CL. 18. (U.S. CLS. 1, 2, 3, 22 AND 41). REG. 12-28-1993.
- 1,813,759. PROCAP. INT. CL. 20. (U.S. CL. 32). REG. 12-28-1993.
- 1,813,774. PULVERIZER. INT. CL. 22. (U.S. CL. 7). REG. 12-28-1993.
- 1,813,813. ZENGARA. INT. CL. 25. (U.S. CL. 39). REG. 12-28-1993.
- 1,813,986. STUDENT ADVANTAGE. INT. CL. 35. (U.S. CL. 101). REG. 12-28-1993.
- 1,814,220. MISCELLANEOUS DESIGN. INT. CL. 42. (U.S. CL. 100). REG. 12-28-1993.
- 1,814,278. NR AND DESIGN. U.S. CL. B. REG. 12-28-1993.
- 1,814,311. SPA PH BALANCE AND DESIGN. INT. CL. 1. (U.S. CLS. 1 AND 6). REG. 12-28-1993.
- 1,814,356. FLEXR. INT. CL. 9. (U.S. CLS. 26 AND 38). REG. 12-28-1993.
- 1,814,622. GLOMAX. INT. CL. 1. (U.S. CL. 6). REG. 1-4-1994.
- 1,814,624. SOY NEWS. INT. CL. 2. (U.S. CL. 11). REG. 1-4-1994.
- 1,814,645. JOIGEL. INT. CL. 3. (U.S. CL. 52). REG. 1-4-1994.
- 1,814,734. CABLEWARE. INT. CL. 8. (U.S. CLS. 13 AND 23). REG. 1-4-1994.
- 1,814,765. MICROBORE. INT. CL. 9. (U.S. CL. 26). REG. 1-4-1994.
- 1,814,790. TONELUCK. INT. CL. 9. (U.S. CL. 21). REG. 1-4-1994.
- 1,814,803. CAPTUS. INT. CL. 10. (U.S. CL. 44). REG. 1-4-1994.
- 1,814,818. DURA-THIN. INT. CL. 10. (U.S. CL. 44). REG. 1-4-1994.
- 1,814,854. PIRANHA PROPELLERS AND DESIGN. INT. CL. 12. (U.S. CL. 19). REG. 1-4-1994.
- 1,814,867. RUMOURS. INT. CL. 14. (U.S. CL. 27). REG. 1-4-1994.
- 1,814,888. REFERRAL. INT. CL. 16. (U.S. CL. 38). REG. 1-4-1994.
- 1,814,955. CALLIOPE. INT. CL. 20. (U.S. CL. 32). REG. 1-4-1994.
- 1,814,975. HARD TAIL. INT. CL. 25. (U.S. CLS. 22 AND 39). REG. 1-4-1994.
- 1,815,043. MEGABASS (STYLIZED). INT. CL. 28. (U.S. CLS. 22, 23, 38 AND 50). REG. 1-4-1994.
- 1,815,062. TEDDY GRAHAMS. INT. CL. 30. (U.S. CL. 46). REG. 1-4-1994.
- 1,815,181. FIESTA FAMILIAR. INT. CL. 41. (U.S. CL. 107). REG. 1-4-1994.
- 1,815,294. SS SOUTHERN STATES AND DESIGN. INT. CL. 42. (U.S. CL. 101). REG. 1-4-1994.
- 1,815,314. THE BICARBONATE EXPERTS ARM & HAMMER AND DESIGN. INT. CL. 1. (U.S. CL. 6). REG. 1-4-1994.
- 1,815,333. ROTA-CLIP. INT. CL. 7. (U.S. CL. 23). REG. 1-4-1994.
- 1,815,401. HEPA-MAX. INT. CL. 11. (U.S. CL. 31). REG. 1-4-1994.
- 1,815,402. THERMO-MIXER. INT. CL. 11. (U.S. CL. 34). REG. 1-4-1994.
- 1,815,427. SUPERVANE. INT. CL. 19. (U.S. CL. 12). REG. 1-4-1994.
- 1,815,442. TRED SAFE. INT. CL. 25. (U.S. CL. 39). REG. 1-4-1994.
- 1,815,456. DRAGON SPIRIT. INT. CL. 28. (U.S. CLS. 22, 23 AND 38). REG. 1-4-1994.
- 1,815,528. METAL GLAZE. INT. CL. 1. (U.S. CL. 16). REG. 1-4-1994.
- 1,815,592. PC (STYLIZED). INT. CLS. 17 AND 19 ONLY. (U.S. CL. 12 ONLY). REG. 1-11-1994.
- 1,815,642. FORTUNE DELIGHT. INT. CLS. 5 AND 29. (U.S. CLS. 6, 18, 44, 46, 51 AND 52). REG. 1-11-1994.
- 1,815,650. KINETIC-QCL. INT. CL. 5. (U.S. CL. 18). REG. 1-11-1994.
- 1,815,657. MISCELLANEOUS DESIGN. INT. CLS. 21 AND 33 ONLY. (U.S. CLS. 2, 13, 23, 29, 30, 33, 40, 47, 49 AND 50). REG. 1-11-1994.
- 1,815,888. SOPHIA INSTITUTE PRESS. INT. CL. 16. (U.S. CLS. 2, 5, 22, 23, 29, 37, 38 AND 50). REG. 1-11-1994.
- 1,815,958. LA GEAR (STYLIZED). INT. CL. 25. (U.S. CL. 39). REG. 1-11-1994.
- 1,816,129. INTERLINK AND DESIGN. INT. CL. 36. (U.S. CLS. 100, 101 AND 102). REG. 1-11-1994.
- 1,816,163. 800-GROWERS. INT. CL. 38. (U.S. CL. 104). REG. 1-11-1994.
- 1,816,170. THE CAR CARRIER AND DESIGN. INT. CL. 39. (U.S. CLS. 100 AND 105). REG. 1-11-1994.
- 1,816,220. GATHERING OF THE VIBES. INT. CL. 41. (U.S. CL. 107). REG. 1-11-1994.
- 1,816,398. FLEER ULTRA. INT. CL. 16. (U.S. CL. 38). REG. 1-11-1994.
- 1,816,484. BAYSEAS FISH MARKET & SEAFOOD RESTAURANT (STYLIZED). INT. CL. 42. (U.S. CLS. 100 AND 101). REG. 1-11-1994.
- 1,816,533. BIO-POL. INT. CL. 1. (U.S. CL. 6). REG. 1-18-1994.
- 1,816,617. ATLANTA CUTLERY. INT. CL. 42 ONLY. (U.S. CL. 101). REG. 1-18-1994.
- 1,816,779. AKARI. INT. CL. 11. (U.S. CL. 21). REG. 1-18-1994.
- 1,817,003. ASHOKA. INT. CLS. 29 AND 30. (U.S. CL. 46). REG. 1-18-1994.
- 1,817,043. PRESIDOR. INT. CL. 30. (U.S. CL. 46). REG. 1-18-1994.
- 1,817,411. TWINSTAR AND DESIGN. INT. CL. 12. (U.S. CL. 19). REG. 1-18-1994.
- 1,817,443. SUPERSEAL. INT. CL. 17. (U.S. CLS. 5, 6 AND 35). REG. 1-18-1994.
- 1,817,452. COMFORT SERIES. INT. CL. 20. (U.S. CL. 32). REG. 1-18-1994.
- 1,817,576. 1 800 LAWLINE. INT. CL. 42. (U.S. CLS. 100 AND 101). REG. 1-18-1994.
- 1,817,728. MISCELLANEOUS DESIGN. INT. CLS. 7 AND 40 ONLY. (U.S. CLS. 23 AND 106). REG. 1-25-1994.

- 1,817,940. COASTAL TIMBERS. INT. CL. 19. (U.S. CL. 12). REG. 1-25-1994.
- 1,818,236. RECOVERCARE. INT. CL. 42. (U.S. CL. 101). REG. 1-25-1994.
- 1,818,356. GROOM MASTER. INT. CL. 7. (U.S. CLS. 13, 19, 21, 23, 31, 34 AND 35). REG. 1-25-1994.
- 1,818,409. TREASURE COVE!. INT. CL. 9. (U.S. CL. 38). REG. 1-25-1994.
- 1,818,453. C.G AND DESIGN. INT. CL. 14. (U.S. CL. 28). REG. 1-25-1994.
- 1,818,594. WELDCALL. INT. CL. 42. (U.S. CLS. 101 AND 103). REG. 1-25-1994.
- 1,818,702. DOTAREM. INT. CL. 5. (U.S. CL. 18). REG. 2-1-1994.
- 1,819,155. HOLIDAY. INT. CLS. 35, 37 AND 42. (U.S. CLS. 100, 101 AND 103). REG. 2-1-1994.
- 1,819,236. ENVIRONDEMENT. INT. CL. 40. (U.S. CL. 106). REG. 2-1-1994.
- 1,819,663. BIOSTREP (STYLIZED). INT. CL. 5. (U.S. CLS. 6 AND 18). REG. 2-8-1994.
- 1,820,328. QUALITY PRODUCTS TODAY FOR BETTER LIVING TOMORROW. INT. CL. 9 ONLY. (U.S. CL. 26). REG. 2-8-1994.
- 1,820,567. GOLD MEDAL. INT. CL. 13. (U.S. CL. 9). REG. 2-8-1994.
- 1,820,655. JOMA. INT. CL. 22. (U.S. CL. 50). REG. 2-8-1994.
- 1,820,736. MOOZZI. INT. CL. 29. (U.S. CL. 46). REG. 2-8-1994.
- 1,820,766. HIGETA. INT. CL. 30. (U.S. CL. 46). REG. 2-8-1994.
- 1,820,911. ECOSOY. INT. CL. 2. (U.S. CL. 11). REG. 2-15-1994.
- 1,821,016. BENISON AND DESIGN. INT. CL. 7. (U.S. CL. 23). REG. 2-15-1994.
- 1,821,072. PL. INT. CL. 9. (U.S. CLS. 21, 26 AND 38). REG. 2-15-1994.
- 1,822,865. PRODURA. INT. CL. 25. (U.S. CL. 39). REG. 2-22-1994.
- 1,822,942. NINA. INT. CL. 26. (U.S. CL. 40). REG. 2-22-1994.
- 1,823,347. MISCELLANEOUS DESIGN. INT. CL. 42. (U.S. CL. 101). REG. 2-22-1994.
- 1,823,770. ATTRAK. INT. CL. 25. (U.S. CLS. 22 AND 39). REG. 2-22-1994.
- 1,824,087. SQUEAK-RELIEF. INT. CL. 6. (U.S. CL. 13). REG. 3-1-1994.
- 1,824,689. SPIKEFEST. INT. CL. 41. (U.S. CL. 107). REG. 3-1-1994.
- 1,825,132. NICHIBAN AND DESIGN. INT. CL. 17. (U.S. CLS. 1, 5, 12, 13, 35 AND 50). REG. 3-8-1994.
- 1,826,474. WEIRD-OHS AND DESIGN. INT. CL. 28. (U.S. CLS. 22 AND 50). REG. 3-15-1994.
- 1,826,507. MRS. DUNSTER'S. INT. CL. 30. (U.S. CL. 46). REG. 3-15-1994.
- 1,826,569. WORKING KNOWLEDGE. INT. CL. 35. (U.S. CLS. 101 AND 107). REG. 3-15-1994.
- 1,827,191. PORVENE. INT. CL. 6. (U.S. CLS. 2, 12, 13, 14, 23, 25 AND 50). REG. 3-22-1994.
- 1,828,412. PEPPER PATCH. INT. CL. 29 ONLY. (U.S. CL. 46). REG. 3-29-1994.
- 1,829,534. HERITAGE. INT. CL. 31. (U.S. CL. 1). REG. 4-5-1994.
- 1,831,834. VU. INT. CL. 3. (U.S. CL. 51). REG. 4-19-1994.
- 1,831,850. STABILIMUM 200 AND DESIGN. INT. CL. 5. (U.S. CL. 18). REG. 4-19-1994.
- 1,831,907. LORD. INT. CL. 8. (U.S. CL. 23). REG. 4-19-1994.
- 1,833,245. MODELMAX. INT. CL. 9. (U.S. CL. 38). REG. 4-26-1994.
- 1,833,482. MISCELLANEOUS DESIGN. INT. CL. 37. (U.S. CL. 103). REG. 4-26-1994.
- 1,834,031. PANGAEA PARTNERS, LTD.. INT. CL. 36. (U.S. CLS. 101 AND 102). REG. 5-3-1994.
- 1,835,091. SANTALEX. INT. CL. 1. (U.S. CL. 6). REG. 5-10-1994.
- 1,836,692. CAPSULE. INT. CL. 11. (U.S. CLS. 31 AND 34). REG. 5-17-1994.
- 1,837,444. PRAIRIE SPIRE. INT. CL. 31. (U.S. CL. 1). REG. 5-24-1994.
- 1,837,618. REELI-KLEAN. INT. CL. 1. (U.S. CL. 6). REG. 5-31-1994.
- 1,837,812. OCU-FILM. INT. CL. 10. (U.S. CL. 44). REG. 5-31-1994.
- 1,838,381. MISCELLANEOUS DESIGN. INT. CL. 9. (U.S. CLS. 26 AND 38). REG. 5-31-1994.
- 1,838,456. KING ESTATE. INT. CL. 33. (U.S. CL. 47). REG. 5-31-1994.
- 1,838,834. VENTURE VISION. INT. CL. 36. (U.S. CLS. 100, 101 AND 102). REG. 6-7-1994.
- 1,839,449. PROMETHEAN. INT. CL. 20. (U.S. CL. 2). REG. 6-14-1994.
- 1,840,242. ANGORA. INT. CL. 3. (U.S. CLS. 6 AND 52). REG. 6-21-1994.
- 1,840,560. CT AND DESIGN. INT. CL. 19. (U.S. CL. 12). REG. 6-21-1994.
- 1,840,748. MAIN STREET MUFFINS AND DESIGN. INT. CL. 30. (U.S. CL. 46). REG. 6-21-1994.
- 1,841,045. NOAH'S BAGELS. INT. CL. 42. (U.S. CL. 100). REG. 6-21-1994.
- 1,841,492. MSRC. INT. CL. 37. (U.S. CL. 103). REG. 6-21-1994.
- 1,842,499. MISCELLANEOUS DESIGN. INT. CL. 37. (U.S. CL. 103). REG. 6-28-1994.
- 1,843,714. JIM BEAM. INT. CL. 25. (U.S. CL. 39). REG. 7-5-1994.
- 1,845,539. JETFLO. INT. CL. 11. (U.S. CLS. 13 AND 35). REG. 7-19-1994.
- 1,846,420. CARIACT. INT. CL. 1. (U.S. CLS. 1, 5 AND 6). REG. 7-26-1994.
- 1,848,515. DIACRODE. INT. CL. 9. (U.S. CL. 26). REG. 8-9-1994.
- 1,851,400. THERMACOR. INT. CL. 10. (U.S. CL. 44). REG. 8-30-1994.
- 1,852,180. TRIMBOLIC. INT. CL. 5. (U.S. CL. 18). REG. 9-6-1994.
- 1,852,963. LOK-TO-CLOCK. INT. CL. 9. (U.S. CL. 21). REG. 9-6-1994.
- 1,853,891. ACCOUNTABILITY TRAINING. INT. CL. 42. (U.S. CL. 100). REG. 9-13-1994.
- 1,854,897. PATHWAYS OF LIGHT AND DESIGN. INT. CLS. 41 AND 42. (U.S. CLS. 100 AND 107). REG. 9-20-1994.
- 1,856,863. OLE IKE'S. INT. CL. 29. (U.S. CL. 46). REG. 10-4-1994.
- 1,857,168. HI-LIFE. INT. CL. 7. (U.S. CLS. 13 AND 23). REG. 10-4-1994.
- 1,857,477. MISCELLANEOUS DESIGN. INT. CLS. 6 AND 20. (U.S. CLS. 13, 25 AND 50). REG. 10-11-1994.
- 1,859,400. FLOWER POWER. INT. CL. 3. (U.S. CL. 51). REG. 10-25-1994.
- 1,860,864. V.A.S.T.. INT. CL. 15. (U.S. CLS. 2, 21 AND 36). REG. 11-1-1994.
- 1,861,104. MEDALIST AMERICA. INT. CL. 31. (U.S. CL. 1). REG. 11-1-1994.
- 1,862,186. SHAHNAZ AYURVEDICS. INT. CL. 3. (U.S. CL. 51). REG. 11-15-1994.
- 1,862,942. FRANZ. INT. CL. 42. (U.S. CLS. 100 AND 101). REG. 11-15-1994.
- 1,863,862. FRANZ. INT. CL. 30. (U.S. CL. 46). REG. 11-22-1994.
- 1,863,863. ACE HI FEEDS AND DESIGN. INT. CL. 31. (U.S. CL. 46). REG. 11-22-1994.
- 1,864,182. MARATHON. INT. CL. 7. (U.S. CL. 23). REG. 11-22-1994.
- 1,864,498. NO MISTAKE. INT. CL. 3. (U.S. CL. 51). REG. 11-29-1994.
- 1,865,174. CUSTOMPLUS. INT. CL. 8. (U.S. CL. 23). REG. 11-29-1994.
- 1,865,248. VINTAGE. INT. CL. 12. (U.S. CL. 19). REG. 11-29-1994.
- 1,865,956. PANGAEA. INT. CL. 36. (U.S. CL. 102). REG. 12-6-1994.
- 1,867,132. MCKENZIE FARMS. INT. CL. 30. (U.S. CL. 46). REG. 12-13-1994.
- 1,867,656. MASTERSEAL. INT. CL. 20. (U.S. CL. 32). REG. 12-13-1994.
- 1,867,896. TECTO. INT. CL. 1. (U.S. CL. 6). REG. 12-20-1994.
- 1,867,956. ORTHO NUTRITION. INT. CL. 5. (U.S. CL. 18). REG. 12-20-1994.
- 1,868,166. POP-UP. INT. CLS. 11 AND 12. (U.S. CLS. 19 AND 21). REG. 12-20-1994.
- 1,868,181. PACESETTER. INT. CL. 12. (U.S. CL. 19). REG. 12-20-1994.
- 1,868,516. ABSOLUT COUNTRY OF SWEDEN KURANT AND DESIGN. INT. CL. 33. (U.S. CL. 49). REG. 12-20-1994.
- 1,868,730. DOMINICAN VILLAGE AND DESIGN. INT. CL. 42. (U.S. CL. 100). REG. 12-20-1994.
- 1,868,985. JOINT EDGE. INT. CL. 36. (U.S. CL. 102). REG. 12-20-1994.
- 1,869,435. BREATHABLES. INT. CL. 10. (U.S. CL. 44). REG. 12-27-1994.
- 1,869,803. INSEACO AND DESIGN. INT. CL. 29. (U.S. CL. 46). REG. 12-27-1994.

- 1,869,890. THE PREDICTIVE INDEX. INT. CLS. 35 AND 41. (U.S. CLS. 101 AND 107). REG. 12-27-1994.
- 1,870,846. THE ATHLETIC CONNECTION. INT. CL. 42. (U.S. CL. 101). REG. 12-27-1994.
- 2,636,529. TURF BUILDER. INT. CL. 31. (U.S. CLS. 1 AND 46). REG. 10-15-2002.
- 2,677,535. ROOTS HOME. INT. CL. 20. (U.S. CLS. 2, 13, 22, 25, 32 AND 50). REG. 1-21-2003.
- 2,711,484. PL&L PRESCOTT LAND & LIVESTOCK PRODUCING WHOLESOME FOOD TO FEED A GROWING WORLD AND DESIGN. INT. CL. 31. (U.S. CLS. 1 AND 46). REG. 4-29-2003.
- 2,717,009. CERTIFIED PROFESSIONAL BUILDING DESIGNER. U.S. CL. B. REG. 5-20-2003.
- 2,725,413. TACO MINI BIKES AND DESIGN. INT. CL. 12. (U.S. CLS. 19, 21, 23, 31, 35 AND 44). REG. 6-10-2003.
- 2,729,082. EVERY NATION PRODUCTIONS. INT. CLS. 16 AND 35 ONLY. (U.S. CLS. 2, 5, 22, 23, 29, 37, 38, 50, 100, 101 AND 102). REG. 6-24-2003.
- 2,729,469. HELI-WRAPPER (STYLIZED). INT. CL. 7. (U.S. CLS. 13, 19, 21, 23, 31, 34 AND 35). REG. 6-24-2003.
- 2,729,607. THE ORIGINAL SEARCH ENGINE. INT. CL. 16. (U.S. CLS. 2, 5, 22, 23, 29, 37, 38 AND 50). REG. 6-24-2003.
- 2,729,672. FRESH CHOICE EXPRESS AND DESIGN. INT. CL. 42. (U.S. CLS. 100 AND 101). REG. 6-24-2003.
- 2,729,974. JETMAX. INT. CL. 7. (U.S. CLS. 13, 19, 21, 23, 31, 34 AND 35). REG. 6-24-2003.
- 2,730,101. INTELLISPOT. INT. CLS. 35, 38 AND 40. (U.S. CLS. 100, 101, 102, 103, 104 AND 106). REG. 6-24-2003.
- 2,730,533. NOT RATIONAL. INT. CL. 18. (U.S. CLS. 1, 2, 3, 22 AND 41). REG. 6-24-2003.
- 2,731,284. ITAPP. INT. CLS. 9 AND 42. (U.S. CLS. 21, 23, 26, 36, 38, 100 AND 101). REG. 7-1-2003.
- 2,731,398. THREADMASTER. INT. CL. 17. (U.S. CLS. 1, 5, 12, 13, 35 AND 50). REG. 7-1-2003.
- 2,731,796. A ARCLINK AND DESIGN. INT. CL. 9. (U.S. CLS. 21, 23, 26, 36 AND 38). REG. 7-1-2003.
- 2,732,071. MLS 4 OWNERS AND DESIGN. INT. CL. 35. (U.S. CLS. 100, 101 AND 102). REG. 7-1-2003.
- 2,732,178. STAR SERVICE. INT. CL. 37. (U.S. CLS. 100, 103 AND 106). REG. 7-1-2003.
- 2,732,252. INNOVATIVE FACILITY SOLUTIONS. INT. CLS. 9 AND 42. (U.S. CLS. 21, 23, 26, 36, 38, 100 AND 101). REG. 7-1-2003.
- 2,732,564. MR MOUNTROYAL. INT. CL. 14. (U.S. CLS. 2, 27, 28 AND 50). REG. 7-1-2003.
- 2,733,027. NANONET. INT. CL. 9. (U.S. CLS. 21, 23, 26, 36 AND 38). REG. 7-1-2003.
- 2,733,116. PATRON TECHNOLOGY. INT. CL. 35. (U.S. CLS. 100, 101 AND 102). REG. 7-1-2003.
- 2,733,871. LONE WOLF. INT. CLS. 25 AND 28. (U.S. CLS. 22, 23, 38, 39 AND 50). REG. 7-8-2003.
- 2,734,012. B AND DESIGN. INT. CL. 25. (U.S. CLS. 22 AND 39). REG. 7-8-2003.
- 2,734,675. ENVIRO-PLUS. INT. CL. 31. (U.S. CLS. 1 AND 46). REG. 7-8-2003.
- 2,735,936. THE MUTUAL FUND STORE. INT. CL. 36. (U.S. CLS. 100, 101 AND 102). REG. 7-15-2003.
- 2,738,473. MINYANVILLE. INT. CL. 16. (U.S. CLS. 2, 5, 22, 23, 29, 37, 38 AND 50). REG. 7-15-2003.
- 2,738,615. MISCELLANEOUS DESIGN. INT. CL. 5. (U.S. CLS. 6, 18, 44, 46, 51 AND 52). REG. 7-15-2003.
- 2,740,901. CORE. INT. CL. 36. (U.S. CLS. 100, 101 AND 102). REG. 7-29-2003.
- 2,741,337. SOFT SAINTS AND DESIGN. INT. CL. 28. (U.S. CLS. 22, 23, 38 AND 50). REG. 7-29-2003.
- 2,747,853. DIETFIT. INT. CL. 42. (U.S. CLS. 100 AND 101). REG. 8-5-2003.
- 2,753,353. COSMIC MOMENT. INT. CL. 41. (U.S. CLS. 100, 101 AND 107). REG. 8-19-2003.
- 2,753,870. REVOLUTION. INT. CL. 17. (U.S. CLS. 1, 5, 12, 13, 35 AND 50). REG. 8-19-2003.
- 2,756,396. MOMI (STYLIZED). INT. CL. 9. (U.S. CLS. 21, 23, 26, 36 AND 38). REG. 8-26-2003.
- 2,756,597. KITCHEN TRADITIONS. INT. CLS. 8 AND 21. (U.S. CLS. 2, 13, 23, 28, 29, 30, 33, 40, 44 AND 50). REG. 8-26-2003.
- 2,762,795. HAPPY DAYS DOGGIE CAMP. INT. CL. 42. (U.S. CLS. 100 AND 101). REG. 9-9-2003.
- 2,766,227. DUALPOWER. INT. CL. 21 ONLY. (U.S. CLS. 2, 13, 23, 29, 30, 33, 40 AND 50). REG. 9-23-2003.
- 2,769,372. NICKERSNAX. INT. CL. 31. (U.S. CLS. 1 AND 46). REG. 9-30-2003.
- 2,769,501. WING WAH AND DESIGN. INT. CL. 30. (U.S. CL. 46). REG. 9-30-2003.
- 2,777,982. WHERE IMAGINATION MINGLES WITH MATTER. INT. CL. 41. (U.S. CLS. 100, 101 AND 107). REG. 10-28-2003.
- 2,784,521. CDC AND DESIGN. INT. CLS. 6 AND 20. (U.S. CLS. 2, 12, 13, 14, 22, 23, 25, 32 AND 50). REG. 11-18-2003.
- 2,787,510. WONDER BERRY MORS ORIGINAL RUSSIAN AND DESIGN. INT. CL. 32. (U.S. CLS. 45, 46 AND 48). REG. 11-25-2003.
- 2,787,654. ANTOXCARE. INT. CL. 5. (U.S. CLS. 6, 18, 44, 46, 51 AND 52). REG. 11-25-2003.
- 2,790,017. FOOTBRASIL. INT. CLS. 38 AND 41. (U.S. CLS. 100, 101, 104 AND 107). REG. 12-9-2003.
- 2,793,111. INSULICARE. INT. CL. 5. (U.S. CLS. 6, 18, 44, 46, 51 AND 52). REG. 12-9-2003.
- 2,793,138. ONLY THOSE THAT SEE THE INVISIBLE CAN DO THE IMPOSSIBLE. INT. CL. 41. (U.S. CLS. 100, 101 AND 107). REG. 12-9-2003.
- 2,793,721. THE ULTRA SYSTEM. INT. CL. 10. (U.S. CLS. 26, 39 AND 44). REG. 12-16-2003.
- 2,794,686. LIVE SOUND INTERNATIONAL AND DESIGN. INT. CL. 16. (U.S. CLS. 2, 5, 22, 23, 29, 37, 38 AND 50). REG. 12-16-2003.
- 2,794,840. THE ORIGINAL ALMOND. INT. CL. 29. (U.S. CL. 46). REG. 12-16-2003.
- 2,795,736. CAPREO. INT. CL. 12. (U.S. CLS. 19, 21, 23, 31, 35 AND 44). REG. 12-16-2003.
- 2,795,901. CCIS. INT. CL. 9. (U.S. CLS. 21, 23, 26, 36 AND 38). REG. 12-16-2003.
- 2,795,902. CCIS AND DESIGN. INT. CL. 9. (U.S. CLS. 21, 23, 26, 36 AND 38). REG. 12-16-2003.
- 2,796,412. HERB REED AND THE PLATTERS. INT. CL. 41. (U.S. CLS. 100, 101 AND 107). REG. 12-23-2003.
- 2,796,465. XTR. INT. CL. 35. (U.S. CLS. 100, 101 AND 102). REG. 12-23-2003.
- 2,796,611. TRUCKERSEDGE. INT. CL. 39 ONLY. (U.S. CLS. 100 AND 105). REG. 12-23-2003.
- 2,796,615. CREATIVE GRIDS. INT. CLS. 9 AND 16. (U.S. CLS. 2, 5, 21, 22, 23, 26, 29, 36, 37, 38 AND 50). REG. 12-23-2003.
- 2,796,629. VON ZIPPER. INT. CLS. 18 AND 25. (U.S. CLS. 1, 2, 3, 22, 39 AND 41). REG. 12-23-2003.
- 2,796,631. OMEGA PROTEIN. INT. CLS. 1, 4, 29, 31, 35 AND 40. (U.S. CLS. 1, 5, 6, 10, 15, 26, 46, 100, 101, 102, 103 AND 106). REG. 12-23-2003.
- 2,796,664. BRANDVERTISING. INT. CL. 35. (U.S. CLS. 100, 101 AND 102). REG. 12-23-2003.
- 2,796,670. HIGH OCTANE. INT. CL. 36. (U.S. CLS. 100, 101 AND 102). REG. 12-23-2003.
- 2,796,724. FINANCIAL INSTITUTION PRODUCTS CORPORATION. INT. CLS. 9, 16, 35, 41 AND 42. (U.S. CLS. 2, 5, 21, 22, 23, 26, 29, 36, 37, 38, 50, 100, 101, 102 AND 107). REG. 12-23-2003.
- 2,796,770. CASTLE AVIATION, INC.. INT. CL. 39. (U.S. CLS. 100 AND 105). REG. 12-23-2003.
- 2,796,793. BESSEMER TRUST. INT. CLS. 35 AND 36. (U.S. CLS. 100, 101 AND 102). REG. 12-23-2003.
- 2,796,794. BESSEMER. INT. CLS. 35 AND 36. (U.S. CLS. 100, 101 AND 102). REG. 12-23-2003.
- 2,796,808. NATIONAL FISH AND WILDLIFE FOUNDATION. INT. CL. 35. (U.S. CLS. 100, 101 AND 102). REG. 12-23-2003.
- 2,796,835. SUTERRA. INT. CLS. 5 AND 21. (U.S. CLS. 2, 6, 13, 18, 23, 29, 30, 33, 40, 44, 46, 50, 51 AND 52). REG. 12-23-2003.
- 2,796,877. THE CHAMPIONS FUND. INT. CL. 36. (U.S. CLS. 100, 101 AND 102). REG. 12-23-2003.
- 2,796,932. WIZARD PUBLICATIONS INC. INT. CL. 41. (U.S. CLS. 100, 101 AND 107). REG. 12-23-2003.
- 2,797,006. PRISORINE. INT. CL. 1. (U.S. CLS. 1, 5, 6, 10, 26 AND 46). REG. 12-23-2003.
- 2,797,066. LAW ENFORCEMENT EXPLORING. INT. CL. 41. (U.S. CLS. 100, 101 AND 107). REG. 12-23-2003.
- 2,797,085. SOHO COURT. INT. CLS. 35 AND 36. (U.S. CLS. 100, 101 AND 102). REG. 12-23-2003.
- 2,797,090. MEETING THE NEEDS- EXCEEDING THE EXPECTATIONS (STYLIZED). INT. CL. 9. (U.S. CLS. 21, 23, 26, 36 AND 38). REG. 12-23-2003.
- 2,797,132. RAIN ZONE. INT. CL. 18. (U.S. CLS. 1, 2, 3, 22 AND 41). REG. 12-23-2003.

- 2,797,139. DATADELIVER. INT. CLS. 35 AND 42. (U.S. CLS. 100, 101 AND 102). REG. 12-23-2003.
- 2,797,182. MISCELLANEOUS DESIGN. INT. CL. 14. (U.S. CLS. 2, 27, 28 AND 50). REG. 12-23-2003.
- 2,797,292. EAT. SPIT. BE HAPPY.. INT. CL. 29. (U.S. CL. 46). REG. 12-23-2003.
- 2,797,308. THE (STYLIZED). INT. CL. 37. (U.S. CLS. 100, 103 AND 106). REG. 12-23-2003.
- 2,797,315. EXERGEN. INT. CL. 9. (U.S. CLS. 21, 23, 26, 36 AND 38). REG. 12-23-2003.
- 2,797,355. EXERGEN. INT. CL. 42. (U.S. CLS. 100 AND 101). REG. 12-23-2003.
- 2,797,459. GREEN VIEW'S GARDEN REWARDS. INT. CL. 35. (U.S. CLS. 100, 101 AND 102). REG. 12-23-2003.
- 2,797,529. JONES KNOWLEDGE. INT. CL. 41. (U.S. CLS. 100, 101 AND 107). REG. 12-23-2003.
- 2,797,558. QUIK CART. INT. CL. 21. (U.S. CLS. 2, 13, 23, 29, 30, 33, 40 AND 50). REG. 12-23-2003.
- 2,797,579. GIUSTIZIA UMLTA ONESTA FILITALIA AND DESIGN. INT. CL. 35. (U.S. CLS. 100, 101 AND 102). REG. 12-23-2003.
- 2,797,591. KENN AIR AND DESIGN. INT. CLS. 35 AND 39. (U.S. CLS. 100, 101, 102 AND 105). REG. 12-23-2003.
- 2,797,592. KENN AIR. INT. CLS. 35 AND 39. (U.S. CLS. 100, 101, 102 AND 105). REG. 12-23-2003.
- 2,797,612. JOHN HENRY. INT. CLS. 18 AND 25. (U.S. CLS. 1, 2, 3, 22, 39 AND 41). REG. 12-23-2003.
- 2,797,644. THERMO SAVER. INT. CL. 17. (U.S. CLS. 1, 5, 12, 13, 35 AND 50). REG. 12-23-2003.
- 2,797,655. MODERNICA (STYLIZED). INT. CLS. 9 AND 20. (U.S. CLS. 2, 13, 21, 22, 23, 25, 26, 32, 36, 38 AND 50). REG. 12-23-2003.
- 2,797,673. IM ICE MARINE (STYLIZED). INT. CL. 12. (U.S. CLS. 19, 21, 23, 31, 35 AND 44). REG. 12-23-2003.
- 2,797,695. MISCELLANEOUS DESIGN. INT. CLS. 3 AND 5. (U.S. CLS. 1, 4, 6, 18, 44, 46, 50, 51 AND 52). REG. 12-23-2003.
- 2,797,696. MISCELLANEOUS DESIGN. INT. CLS. 9, 35 AND 41. (U.S. CLS. 21, 23, 26, 36, 38, 100, 101, 102 AND 107). REG. 12-23-2003.
- 2,797,745. NURSE RESPONSE AND DESIGN. INT. CL. 44. (U.S. CLS. 100 AND 101). REG. 12-23-2003.
- 2,797,774. LIFTERS LIP STANDARD CHARACTER MARK. INT. CL. 9. (U.S. CLS. 21, 23, 26, 36 AND 38). REG. 12-23-2003.
- 2,797,777. CHARKBAIT! INTERNET SPORTFISHING WWW.CHARKBAIT.COM AND DESIGN. INT. CL. 35. (U.S. CLS. 100, 101 AND 102). REG. 12-23-2003.
- 2,797,778. CHARKBAIT! INTERNET SPORTFISHING WWW.CHARKBAIT.COM AND DESIGN. INT. CL. 35. (U.S. CLS. 100, 101 AND 102). REG. 12-23-2003.
- 2,797,782. CHARKBAIT!. INT. CL. 35. (U.S. CLS. 100, 101 AND 102). REG. 12-23-2003.
- 2,797,821. FEEL SAFE. INT. CL. 42. (U.S. CLS. 100 AND 101). REG. 12-23-2003.
- 2,797,822. SAPLING. INT. CL. 14. (U.S. CLS. 2, 27, 28 AND 50). REG. 12-23-2003.
- 2,797,861. SHORTLIST STANDARD CHARACTER MARK. INT. CL. 16. (U.S. CLS. 2, 5, 22, 23, 29, 37, 38 AND 50). REG. 12-23-2003.
- 2,797,892. JOURNAL OF STATISTICAL PHYSICS. INT. CL. 16. (U.S. CLS. 2, 5, 22, 23, 29, 37, 38 AND 50). REG. 12-23-2003.
- 2,797,894. PUBLIC CHOICE. INT. CL. 16. (U.S. CLS. 2, 5, 22, 23, 29, 37, 38 AND 50). REG. 12-23-2003.
- 2,797,924. BRANDON. INT. CL. 26. (U.S. CLS. 37, 39, 40, 42 AND 50). REG. 12-23-2003.
- 2,797,964. AIKEDE AND DESIGN. INT. CL. 3. (U.S. CLS. 1, 4, 6, 50, 51 AND 52). REG. 12-23-2003.
- 2,797,977. INKTEC (STYLIZED). INT. CL. 2. (U.S. CLS. 6, 11 AND 16). REG. 12-23-2003.
- 2,798,011. ADVENTURE SPORTSMAN. INT. CL. 25. (U.S. CLS. 22 AND 39). REG. 12-23-2003.
- 2,798,042. SECRCRYPT. INT. CL. 9. (U.S. CLS. 21, 23, 26, 36 AND 38). REG. 12-23-2003.
- 2,798,055. ELITE PETITE. INT. CL. 35. (U.S. CLS. 100, 101 AND 102). REG. 12-23-2003.
- 2,798,062. ECOFLORIN. INT. CL. 5. (U.S. CLS. 6, 18, 44, 46, 51 AND 52). REG. 12-23-2003.
- 2,798,074. PENDULUM. INT. CL. 9. (U.S. CLS. 21, 23, 26, 36 AND 38). REG. 12-23-2003.
- 2,798,100. POWERCORR. INT. CL. 9. (U.S. CLS. 21, 23, 26, 36 AND 38). REG. 12-23-2003.
- 2,798,120. PLANTGARD. INT. CL. 5. (U.S. CLS. 6, 18, 44, 46, 51 AND 52). REG. 12-23-2003.
- 2,798,130. VIRGIN AND DESIGN. INT. CLS. 16, 25, 35, 38 AND 42 ONLY. (U.S. CLS. 2, 5, 22, 23, 29, 37, 38, 39, 50, 100, 101, 102 AND 104). REG. 12-23-2003.
- 2,798,152. HIPOWER AND DESIGN. INT. CL. 28. (U.S. CLS. 22, 23, 38 AND 50). REG. 12-23-2003.
- 2,798,154. INSURBANC (STYLIZED). INT. CL. 36. (U.S. CLS. 100, 101 AND 102). REG. 12-23-2003.
- 2,798,172. WISTERIA COLLECTION. INT. CL. 35. (U.S. CLS. 100, 101 AND 102). REG. 12-23-2003.
- 2,798,193. BLOKPAK 3000. INT. CL. 7. (U.S. CLS. 13, 19, 21, 23, 31, 34 AND 35). REG. 12-23-2003.
- 2,798,205. CAPITALOGIX. INT. CL. 35. (U.S. CLS. 100, 101 AND 102). REG. 12-23-2003.
- 2,798,239. CERTIFIED USB AND DESIGN. INT. CL. 9. (U.S. CLS. 21, 23, 26, 36 AND 38). REG. 12-23-2003.
- 2,798,242. IMAGINARY FORCES. INT. CLS. 25, 35 AND 42. (U.S. CLS. 22, 39, 100, 101 AND 102). REG. 12-23-2003.
- 2,798,331. ADEKA. INT. CL. 6. (U.S. CLS. 2, 12, 13, 14, 23, 25 AND 50). REG. 12-23-2003.
- 2,798,370. MISCELLANEOUS DESIGN. INT. CL. 1. (U.S. CLS. 1, 5, 6, 10, 26 AND 46). REG. 12-23-2003.
- 2,798,371. GOODRICH AND DESIGN. INT. CL. 1. (U.S. CLS. 1, 5, 6, 10, 26 AND 46). REG. 12-23-2003.
- 2,798,376. F AND DESIGN. INT. CL. 42 ONLY. (U.S. CLS. 100 AND 101). REG. 12-23-2003.
- 2,798,424. EAT RIGHT GET SMART. INT. CL. 42. (U.S. CLS. 100 AND 101). REG. 12-23-2003.
- 2,798,481. CRAFTSMAN'S CHOICE. INT. CL. 3. (U.S. CLS. 1, 4, 6, 50, 51 AND 52). REG. 12-23-2003.
- 2,798,527. S2 (STYLIZED). INT. CL. 9. (U.S. CLS. 21, 23, 26, 36 AND 38). REG. 12-23-2003.
- 2,798,569. PUTTING TUTOR. INT. CL. 28. (U.S. CLS. 22, 23, 38 AND 50). REG. 12-23-2003.
- 2,798,635. SIPARATOR. INT. CL. 9. (U.S. CLS. 21, 23, 26, 36 AND 38). REG. 12-23-2003.
- 2,798,641. WHERE IT IS AT. (STYLIZED). INT. CL. 35. (U.S. CLS. 100, 101 AND 102). REG. 12-23-2003.
- 2,798,648. BAROCYCLER. INT. CL. 9. (U.S. CLS. 21, 23, 26, 36 AND 38). REG. 12-23-2003.
- 2,798,666. FIRECAPE. INT. CL. 1. (U.S. CLS. 1, 5, 6, 10, 26 AND 46). REG. 12-23-2003.
- 2,798,676. FIRECAPE AND DESIGN. INT. CL. 1. (U.S. CLS. 1, 5, 6, 10, 26 AND 46). REG. 12-23-2003.
- 2,798,694. DELTA DOWNS. INT. CL. 41. (U.S. CLS. 100, 101 AND 107). REG. 12-23-2003.
- 2,798,702. THE PIG STOP AND DESIGN. INT. CL. 35. (U.S. CLS. 100, 101 AND 102). REG. 12-23-2003.
- 2,798,727. EYESEE360 AND DESIGN. INT. CL. 9. (U.S. CLS. 21, 23, 26, 36 AND 38). REG. 12-23-2003.
- 2,798,750. ELM DESIGN TEAM. INT. CL. 25. (U.S. CLS. 22 AND 39). REG. 12-23-2003.
- 2,798,752. PIXIM. INT. CL. 9. (U.S. CLS. 21, 23, 26, 36 AND 38). REG. 12-23-2003.
- 2,798,772. LOWRIDER AND DESIGN. INT. CL. 25. (U.S. CLS. 22 AND 39). REG. 12-23-2003.
- 2,798,774. THIRTEEN-FIFTY FOUNDATION. INT. CL. 35. (U.S. CLS. 100, 101 AND 102). REG. 12-23-2003.
- 2,798,850. SHARPER MINDS. INT. CLS. 9, 16 AND 41 ONLY. (U.S. CLS. 2, 5, 21, 22, 23, 26, 29, 36, 37, 38, 50, 100, 101 AND 107). REG. 12-23-2003.
- 2,798,996. PLASTAFLEX. INT. CL. 17. (U.S. CLS. 1, 5, 12, 13, 35 AND 50). REG. 12-23-2003.
- 2,799,024. EGYPTIAN COTTON AND DESIGN. U.S. CL. A. REG. 12-23-2003.
- 2,799,039. FLUIDIGM. INT. CLS. 7, 9, 10 AND 35. (U.S. CLS. 13, 19, 21, 23, 26, 31, 34, 35, 36, 38, 39, 44, 100, 101 AND 102). REG. 12-23-2003.
- 2,799,040. F AND DESIGN. INT. CLS. 7, 9, 10 AND 35. (U.S. CLS. 13, 19, 21, 23, 26, 31, 34, 35, 36, 38, 39, 44, 100, 101 AND 102). REG. 12-23-2003.
- 2,799,102. PREVENTING TOMORROW'S LOSSES. INT. CL. 36. (U.S. CLS. 100, 101 AND 102). REG. 12-23-2003.
- 2,799,154. JENNY JOHNS. INT. CL. 25. (U.S. CLS. 22 AND 39). REG. 12-23-2003.
- 2,799,196. HELVETOLIDE. INT. CL. 1. (U.S. CLS. 1, 5, 6, 10, 26 AND 46). REG. 12-23-2003.
- 2,799,201. FORD FIELD AND DESIGN. INT. CLS. 35, 38, 39, 41, 43 AND 45. (U.S. CLS. 100, 101, 102, 104, 105 AND 107). REG. 12-23-2003.

- 2,799,262. RST. INT. CL. 9. (U.S. CLS. 21, 23, 26, 36 AND 38). REG. 12-23-2003.
- 2,799,308. NEXT STEP. INT. CL. 9. (U.S. CLS. 21, 23, 26, 36 AND 38). REG. 12-23-2003.
- 2,799,334. LEGASUITE. INT. CL. 9. (U.S. CLS. 21, 23, 26, 36 AND 38). REG. 12-23-2003.
- 2,799,353. UNIVERSE THE SCI-FI RPG AND DESIGN. INT. CL. 28. (U.S. CLS. 22, 23, 38 AND 50). REG. 12-23-2003.
- 2,799,372. PARK AVENUE. INT. CL. 30. (U.S. CL. 46). REG. 12-23-2003.
- 2,799,477. CHICAGO CARD. INT. CL. 36. (U.S. CLS. 100, 101 AND 102). REG. 12-23-2003.
- 2,799,499. SCRATCH DJ ACADEMY. INT. CL. 41. (U.S. CLS. 100, 101 AND 107). REG. 12-23-2003.
- 2,799,501. HAWAIIAN BATH & BODY. INT. CL. 3. (U.S. CLS. 1, 4, 6, 50, 51 AND 52). REG. 12-23-2003.
- 2,799,513. 100 IDEAS. INT. CL. 16. (U.S. CLS. 2, 5, 22, 23, 29, 37, 38 AND 50). REG. 12-23-2003.
- 2,799,540. TWINCOOLING SYSTEM. INT. CL. 11. (U.S. CLS. 13, 21, 23, 31 AND 34). REG. 12-23-2003.
- 2,799,601. ICRON. INT. CLS. 9 AND 42. (U.S. CLS. 21, 23, 26, 36, 38, 100 AND 101). REG. 12-30-2003.
- 2,799,609. PASS. INT. CL. 9. (U.S. CLS. 21, 23, 26, 36 AND 38). REG. 12-30-2003.
- 2,799,669. ANTONIO MARRAS. INT. CLS. 18 AND 25 ONLY. (U.S. CLS. 1, 2, 3, 22, 39 AND 41). REG. 12-30-2003.
- 2,799,678. VELSCENIC. INT. CL. 24. (U.S. CLS. 42 AND 50). REG. 12-30-2003.
- 2,799,702. DSVIEW. INT. CL. 9. (U.S. CLS. 21, 23, 26, 36 AND 38). REG. 12-30-2003.
- 2,799,715. MISCELLANEOUS DESIGN. INT. CL. 21. (U.S. CLS. 2, 13, 23, 29, 30, 33, 40 AND 50). REG. 12-30-2003.
- 2,799,792. SMITH & HAWKEN AND DESIGN. INT. CL. 8. (U.S. CLS. 23, 28 AND 44). REG. 12-30-2003.
- 2,799,875. MISCELLANEOUS DESIGN. INT. CL. 36. (U.S. CLS. 100, 101 AND 102). REG. 12-30-2003.
- 2,800,013. BBQ 4 U. INT. CL. 11. (U.S. CLS. 13, 21, 23, 31 AND 34). REG. 12-30-2003.
- 2,800,044. SHARE THE EXPERIENCE. INT. CL. 36. (U.S. CLS. 100, 101 AND 102). REG. 12-30-2003.
- 2,800,045. SHARE THE EXPERIENCE. INT. CL. 35. (U.S. CLS. 100, 101 AND 102). REG. 12-30-2003.
- 2,800,046. ENGINE WORKS. INT. CL. 35. (U.S. CLS. 100, 101 AND 102). REG. 12-30-2003.
- 2,800,056. MISCELLANEOUS DESIGN. INT. CL. 42. (U.S. CLS. 100 AND 101). REG. 12-30-2003.
- 2,800,078. ENGINE WORKS AND DESIGN. INT. CL. 35. (U.S. CLS. 100, 101 AND 102). REG. 12-30-2003.
- 2,800,088. IU (STYLIZED). INT. CL. 21. (U.S. CLS. 2, 13, 23, 29, 30, 33, 40 AND 50). REG. 12-30-2003.
- 2,800,116. SEWELL. OBSESSED WITH SERVICE SINCE 1911. INT. CLS. 35 AND 37. (U.S. CLS. 100, 101, 102, 103 AND 106). REG. 12-30-2003.
- 2,800,177. CLIK CLAK. INT. CL. 30. (U.S. CL. 46). REG. 12-30-2003.
- 2,800,244. SECURETEC. INT. CL. 5 ONLY. (U.S. CLS. 6, 18, 44, 46, 51 AND 52). REG. 12-30-2003.
- 2,800,261. MISCELLANEOUS DESIGN. INT. CLS. 9 AND 37 ONLY. (U.S. CLS. 21, 23, 26, 36, 38, 100, 103 AND 106). REG. 12-30-2003.
- 2,800,308. THE VERA BRADLEY CLASSIC. INT. CL. 36. (U.S. CLS. 100, 101 AND 102). REG. 12-30-2003.
- 2,800,312. HURCO. INT. CLS. 7 AND 9. (U.S. CLS. 13, 19, 21, 23, 26, 31, 34, 35, 36 AND 38). REG. 12-30-2003.
- 2,800,314. STRIKE HOLD. INT. CL. 4. (U.S. CLS. 1, 6 AND 15). REG. 12-30-2003.
- 2,800,325. HURCO AND DESIGN. INT. CLS. 7 AND 9. (U.S. CLS. 13, 19, 21, 23, 26, 31, 34, 35, 36 AND 38). REG. 12-30-2003.
- 2,800,340. SEVILLANA. INT. CL. 33. (U.S. CLS. 47 AND 49). REG. 12-30-2003.
- 2,800,444. BUBBLE-OUT. INT. CL. 16. (U.S. CLS. 2, 5, 22, 23, 29, 37, 38 AND 50). REG. 12-30-2003.
- 2,800,499. SWEET MONDAY. INT. CLS. 41 AND 45. (U.S. CLS. 100, 101 AND 107). REG. 12-30-2003.
- 2,800,598. C4CAST. INT. CL. 35. (U.S. CLS. 100, 101 AND 102). REG. 12-30-2003.
- 2,800,627. HEALTHMAP. INT. CL. 42. (U.S. CLS. 100 AND 101). REG. 12-30-2003.
- 2,800,662. PREMASOL. INT. CL. 5. (U.S. CLS. 6, 18, 44, 46, 51 AND 52). REG. 12-30-2003.
- 2,800,672. SHUT UP AND TRAIN AND DESIGN. INT. CL. 25. (U.S. CLS. 22 AND 39). REG. 12-30-2003.
- 2,800,726. PIZZA AND PAJAMAS. INT. CL. 35. (U.S. CLS. 100, 101 AND 102). REG. 12-30-2003.
- 2,800,744. HOMESTEAD AND DESIGN. INT. CL. 9. (U.S. CLS. 21, 23, 26, 36 AND 38). REG. 12-30-2003.
- 2,800,750. MLB.COM AND DESIGN. INT. CL. 21. (U.S. CLS. 2, 13, 23, 29, 30, 33, 40 AND 50). REG. 12-30-2003.
- 2,800,751. MLB.COM AND DESIGN. INT. CL. 14. (U.S. CLS. 2, 27, 28 AND 50). REG. 12-30-2003.
- 2,800,752. MLB.COM AND DESIGN. INT. CL. 16. (U.S. CLS. 2, 5, 22, 23, 29, 37, 38 AND 50). REG. 12-30-2003.
- 2,800,775. ERGO COMFORT. INT. CLS. 20 AND 24. (U.S. CLS. 2, 13, 22, 25, 32, 42 AND 50). REG. 12-30-2003.
- 2,800,842. BROADVISION. INT. CLS. 35 AND 42. (U.S. CLS. 100, 101 AND 102). REG. 12-30-2003.
- 2,800,906. TRADER JOE'S FRENCH MARKET. INT. CL. 32. (U.S. CLS. 45, 46 AND 48). REG. 12-30-2003.
- 2,800,935. GUIDER SOFTIP. INT. CL. 10. (U.S. CLS. 26, 39 AND 44). REG. 12-30-2003.
- 2,800,940. CABIN SURROUND. INT. CL. 9. (U.S. CLS. 21, 23, 26, 36 AND 38). REG. 12-30-2003.
- 2,800,941. NAVA. INT. CL. 1. (U.S. CLS. 1, 5, 6, 10, 26 AND 46). REG. 12-30-2003.
- 2,800,947. CENTERPOINT. INT. CL. 9. (U.S. CLS. 21, 23, 26, 36 AND 38). REG. 12-30-2003.
- 2,801,080. NUGRAN. INT. CL. 1. (U.S. CLS. 1, 5, 6, 10, 26 AND 46). REG. 12-30-2003.
- 2,801,163. FAST FINISH. INT. CL. 29. (U.S. CL. 46). REG. 12-30-2003.
- 2,801,197. AVWORKS. INT. CL. 9. (U.S. CLS. 21, 23, 26, 36 AND 38). REG. 12-30-2003.
- 2,801,211. COOL ZONE. INT. CL. 19. (U.S. CLS. 1, 12, 33 AND 50). REG. 12-30-2003.
- 2,801,249. MAXNIBP. INT. CL. 10. (U.S. CLS. 26, 39 AND 44). REG. 12-30-2003.
- 2,801,267. THE PROFESSOR & THE SURVIVOR. INT. CL. 42 ONLY. (U.S. CLS. 100 AND 101). REG. 12-30-2003.
- 2,801,434. JUST CANOE IT!. INT. CL. 25. (U.S. CLS. 22 AND 39). REG. 12-30-2003.
- 2,801,447. COMFORT VILLAGE. INT. CL. 16. (U.S. CLS. 2, 5, 22, 23, 29, 37, 38 AND 50). REG. 12-30-2003.
- 2,801,468. MAY DOG BE WITH YOU!. INT. CLS. 16 AND 25. (U.S. CLS. 2, 5, 22, 23, 29, 37, 38, 39 AND 50). REG. 12-30-2003.
- 2,801,489. SHARPER IMAGE. INT. CLS. 16 AND 35. (U.S. CLS. 2, 5, 22, 23, 29, 37, 38, 50, 100, 101 AND 102). REG. 12-30-2003.
- 2,801,504. STUDIOBASE. INT. CL. 3. (U.S. CLS. 1, 4, 6, 50, 51 AND 52). REG. 12-30-2003.
- 2,801,529. SMILEY. INT. CL. 25. (U.S. CLS. 22 AND 39). REG. 12-30-2003.
- 2,801,544. GARDEN RIPE. INT. CL. 31. (U.S. CLS. 1 AND 46). REG. 12-30-2003.
- 2,801,640. NEW ENGLAND IN-HOUSE. INT. CL. 16. (U.S. CLS. 2, 5, 22, 23, 29, 37, 38 AND 50). REG. 12-30-2003.
- 2,801,661. KEYLESS GO. INT. CLS. 9 AND 12 ONLY. (U.S. CLS. 19, 21, 23, 26, 31, 35, 36, 38 AND 44). REG. 1-6-2004.
- 2,801,673. YOTTAYOTTA. INT. CL. 9. (U.S. CLS. 21, 23, 26, 36 AND 38). REG. 1-6-2004.
- 2,801,741. WRAP. INT. CL. 42. (U.S. CLS. 100 AND 101). REG. 1-6-2004.
- 2,801,746. GLOBE. INT. CLS. 18 AND 25. (U.S. CLS. 1, 2, 3, 22, 39 AND 41). REG. 1-6-2004.
- 2,801,749. LINUX INTERNATIONAL. INT. CLS. 41 AND 42 ONLY. (U.S. CLS. 100, 101 AND 107). REG. 1-6-2004.
- 2,801,847. MARKETNORMS. INT. CL. 35. (U.S. CLS. 100, 101 AND 102). REG. 1-6-2004.
- 2,801,849. RIP CITY COFFEE. INT. CL. 30. (U.S. CL. 46). REG. 1-6-2004.
- 2,801,853. CDG AND DESIGN. INT. CLS. 9, 35, 40, 41 AND 42. (U.S. CLS. 21, 23, 26, 36, 38, 100, 101, 102, 103, 106 AND 107). REG. 1-6-2004.
- 2,801,870. SIERRA CLUB FOUNDED 1892 AND DESIGN. INT. CL. 36. (U.S. CLS. 100, 101 AND 102). REG. 1-6-2004.
- 2,801,881. CENTER FOR AIR TOXIC METALS. INT. CL. 42. (U.S. CLS. 100 AND 101). REG. 1-6-2004.
- 2,801,890. MAXAIR. INT. CL. 11. (U.S. CLS. 13, 21, 23, 31 AND 34). REG. 1-6-2004.

- 2,801,957. DICK CARR'S BIG BANDS BALLADS & BLUES. INT. CL. 41. (U.S. CLS. 100, 101 AND 107). REG. 1-6-2004.
- 2,801,960. "Y-TIES". INT. CL. 35. (U.S. CLS. 100, 101 AND 102). REG. 1-6-2004.
- 2,801,963. MISCELLANEOUS DESIGN. INT. CL. 25. (U.S. CLS. 22 AND 39). REG. 1-6-2004.
- 2,802,117. EXERGEN. INT. CL. 10. (U.S. CLS. 26, 39 AND 44). REG. 1-6-2004.
- 2,802,147. MISCELLANEOUS DESIGN. INT. CL. 37. (U.S. CLS. 100, 103 AND 106). REG. 1-6-2004.
- 2,802,251. LOUIS PION. INT. CL. 14. (U.S. CLS. 2, 27, 28 AND 50). REG. 1-6-2004.
- 2,802,263. SCIENTIFIC ATLANTA. INT. CLS. 9 AND 37 ONLY. (U.S. CLS. 21, 23, 26, 36, 38, 100, 103 AND 106). REG. 1-6-2004.
- 2,802,287. A.S.A.P. - ACCESSIBLE SERVICES AND PRODUCTS (STYLIZED). INT. CL. 37. (U.S. CLS. 100, 103 AND 106). REG. 1-6-2004.
- 2,802,330. TRADETHRU. INT. CLS. 9 AND 42. (U.S. CLS. 21, 23, 26, 36, 38, 100 AND 101). REG. 1-6-2004.
- 2,802,485. SOUND BLASTER AND DESIGN. INT. CL. 9. (U.S. CLS. 21, 23, 26, 36 AND 38). REG. 1-6-2004.
- 2,802,551. KURYER. INT. CL. 16. (U.S. CLS. 2, 5, 22, 23, 29, 37, 38 AND 50). REG. 1-6-2004.
- 2,802,577. MULTIGUARD. INT. CL. 7. (U.S. CLS. 13, 19, 21, 23, 31, 34 AND 35). REG. 1-6-2004.
- 2,802,772. B. KLIBAN. INT. CLS. 9, 14, 16, 18, 20, 24, 25, 27 AND 28 ONLY. (U.S. CLS. 1, 2, 3, 5, 13, 19, 20, 21, 22, 23, 25, 26, 27, 28, 29, 32, 36, 37, 38, 39, 41, 42 AND 50). REG. 1-6-2004.
- 2,802,829. EAGLE BANK AND TRUST COMPANY OF MISSOURI. INT. CL. 36. (U.S. CLS. 100, 101 AND 102). REG. 1-6-2004.
- 2,802,842. THE ART OF LIGHT. INT. CL. 11. (U.S. CLS. 13, 21, 23, 31 AND 34). REG. 1-6-2004.
- 2,802,970. HEXBREAKER. INT. CL. 9. (U.S. CLS. 21, 23, 26, 36 AND 38). REG. 1-6-2004.
- 2,803,087. ARTISANS OF TEA. INT. CLS. 30 AND 35. (U.S. CLS. 46, 100, 101 AND 102). REG. 1-6-2004.
- 2,803,111. AGARENA. INT. CL. 33. (U.S. CLS. 47 AND 49). REG. 1-6-2004.
- 2,803,141. THE RETIREMENT CORPORATION OF AMERICA AND DESIGN. INT. CL. 36. (U.S. CLS. 100, 101 AND 102). REG. 1-6-2004.
- 2,803,167. GARLANDS. INT. CLS. 43 AND 44. (U.S. CLS. 100 AND 101). REG. 1-6-2004.
- 2,803,195. XHILARATION. INT. CL. 26. (U.S. CLS. 37, 39, 40, 42 AND 50). REG. 1-6-2004.
- 2,803,206. ARROW. INT. CL. 13. (U.S. CLS. 2 AND 9). REG. 1-6-2004.
- 2,803,209. ARROW PN AND DESIGN. INT. CL. 13. (U.S. CLS. 2 AND 9). REG. 1-6-2004.
- 2,803,252. POWERBALL. INT. CL. 11. (U.S. CLS. 13, 21, 23, 31 AND 34). REG. 1-6-2004.
- 2,803,297. ROTOLEASE. INT. CL. 1. (U.S. CLS. 1, 5, 6, 10, 26 AND 46). REG. 1-6-2004.
- 2,803,300. THE #1 CHOICE OF PAINTING PROFESSIONALS. INT. CL. 2. (U.S. CLS. 6, 11 AND 16). REG. 1-6-2004.
- 2,803,387. DEMANDA. INT. CL. 35. (U.S. CLS. 100, 101 AND 102). REG. 1-6-2004.
- 2,803,390. ENERGY DRINK E BLAST B BALLY TOTAL FITNESS AND DESIGN. INT. CLS. 5 AND 32. (U.S. CLS. 6, 18, 44, 45, 46, 48, 51 AND 52). REG. 1-6-2004.
- 2,803,410. ONE DIAMOND PLACE. INT. CL. 14. (U.S. CLS. 2, 27, 28 AND 50). REG. 1-6-2004.
- 2,803,451. AQUATIC MELODIES. INT. CL. 9. (U.S. CLS. 21, 23, 26, 36 AND 38). REG. 1-6-2004.
- 2,803,639. DI-MAX. INT. CL. 7. (U.S. CLS. 13, 19, 21, 23, 31, 34 AND 35). REG. 1-6-2004.
- 2,803,680. CAUGHT LAUGHING. INT. CL. 16. (U.S. CLS. 2, 5, 22, 23, 29, 37, 38 AND 50). REG. 1-6-2004.
- 2,803,692. ALFRED SHAHEEN. INT. CL. 25. (U.S. CLS. 22 AND 39). REG. 1-6-2004.
- 2,803,723. GRATE CHEF. INT. CL. 21. (U.S. CLS. 2, 13, 23, 29, 30, 33, 40 AND 50). REG. 1-6-2004.
- 2,803,784. CLEAN 'N CARRY. INT. CL. 7. (U.S. CLS. 13, 19, 21, 23, 31, 34 AND 35). REG. 1-6-2004.
- 2,803,837. NEW ENGLAND DENTAL ADMINISTRATORS, LLC (STYLIZED). INT. CL. 36. (U.S. CLS. 100, 101 AND 102). REG. 1-6-2004.
- 2,803,859. TOY FAIR TIMES. INT. CL. 16. (U.S. CLS. 2, 5, 22, 23, 29, 37, 38 AND 50). REG. 1-13-2004.
- 2,803,970. GLENCORE. INT. CLS. 1, 4, 6, 29 AND 31 ONLY. (U.S. CLS. 1, 2, 5, 6, 10, 12, 13, 14, 15, 23, 25, 26, 46 AND 50). REG. 1-13-2004.
- 2,804,015. S AND DESIGN. INT. CLS. 9, 16 AND 41. (U.S. CLS. 2, 5, 21, 22, 23, 26, 29, 36, 37, 38, 50, 100, 101 AND 107). REG. 1-13-2004.
- 2,804,241. LASALLIAN EDUCATION FUND AND DESIGN. INT. CL. 36. (U.S. CLS. 100, 101 AND 102). REG. 1-13-2004.
- 2,804,256. TELESIS. INT. CL. 3 ONLY. (U.S. CLS. 1, 4, 6, 50, 51 AND 52). REG. 1-13-2004.
- 2,804,533. CITY ROCK. INT. CL. 25. (U.S. CLS. 22 AND 39). REG. 1-13-2004.
- 2,804,949. MISCELLANEOUS DESIGN. INT. CL. 7. (U.S. CLS. 13, 19, 21, 23, 31, 34 AND 35). REG. 1-13-2004.
- 2,805,015. ARBY'S AND DESIGN. INT. CL. 43. (U.S. CLS. 100 AND 101). REG. 1-13-2004.
- 2,805,109. MCFLURRY. INT. CL. 30. (U.S. CL. 46). REG. 1-13-2004.
- 2,805,114. VIBRAMUTE. INT. CL. 15. (U.S. CLS. 2, 21 AND 36). REG. 1-13-2004.
- 2,805,277. GAMESTOP.COM. INT. CL. 41 ONLY. (U.S. CLS. 100, 101 AND 107). REG. 1-13-2004.
- 2,805,402. BUFFET MANIA. INT. CL. 9. (U.S. CLS. 21, 23, 26, 36 AND 38). REG. 1-13-2004.
- 2,805,409. WEBSERIES. INT. CL. 9. (U.S. CLS. 21, 23, 26, 36 AND 38). REG. 1-13-2004.
- 2,805,614. MOTIF-RACK. INT. CL. 9. (U.S. CLS. 21, 23, 26, 36 AND 38). REG. 1-13-2004.
- 2,805,674. THE SHOOTER. INT. CL. 7. (U.S. CLS. 13, 19, 21, 23, 31, 34 AND 35). REG. 1-13-2004.
- 2,805,733. ILINQ. INT. CLS. 35, 37 AND 42 ONLY. (U.S. CLS. 100, 101, 102, 103 AND 106). REG. 1-13-2004.
- 2,805,922. LA CARRAIA. INT. CL. 33. (U.S. CLS. 47 AND 49). REG. 1-13-2004.
- 2,806,066. MISCELLANEOUS DESIGN. INT. CL. 18 ONLY. (U.S. CLS. 1, 2, 3, 22 AND 41). REG. 1-20-2004.
- 2,806,194. RESNET. INT. CL. 35. (U.S. CLS. 100, 101 AND 102). REG. 1-20-2004.
- 2,806,319. ACRES GAMING AND DESIGN. INT. CL. 9. (U.S. CLS. 21, 23, 26, 36 AND 38). REG. 1-20-2004.
- 2,806,365. BEHIND THE BLACKBOARD. INT. CL. 42. (U.S. CLS. 100 AND 101). REG. 1-20-2004.
- 2,806,649. PROPSPEED. INT. CL. 2. (U.S. CLS. 6, 11 AND 16). REG. 1-20-2004.
- 2,806,669. SALONPAS GEL-PATCH HOT SOOTHING AND DESIGN. INT. CL. 5. (U.S. CLS. 6, 18, 44, 46, 51 AND 52). REG. 1-20-2004.
- 2,806,847. PRIALT. INT. CL. 5. (U.S. CLS. 6, 18, 44, 46, 51 AND 52). REG. 1-20-2004.
- 2,807,046. ANTIQUE APPRAISAL. INT. CL. 9. (U.S. CLS. 21, 23, 26, 36 AND 38). REG. 1-20-2004.
- 2,807,075. TARGET 100. INT. CL. 41. (U.S. CLS. 100, 101 AND 107). REG. 1-20-2004.
- 2,807,458. SCARY HAIRY. INT. CL. 28. (U.S. CLS. 22, 23, 38 AND 50). REG. 1-20-2004.
- 2,807,565. GLOBAL PROJECT SERVICES. INT. CLS. 35 AND 37. (U.S. CLS. 100, 101, 102, 103 AND 106). REG. 1-20-2004.
- 2,807,784. LILYFLORE. INT. CLS. 1 AND 3. (U.S. CLS. 1, 4, 5, 6, 10, 26, 46, 50, 51 AND 52). REG. 1-27-2004.
- 2,807,785. ALADINATE. INT. CLS. 1 AND 3. (U.S. CLS. 1, 4, 5, 6, 10, 26, 46, 50, 51 AND 52). REG. 1-27-2004.
- 2,807,829. MISCELLANEOUS DESIGN. INT. CL. 41. (U.S. CLS. 100, 101 AND 107). REG. 1-27-2004.
- 2,807,830. MISCELLANEOUS DESIGN. INT. CL. 41. (U.S. CLS. 100, 101 AND 107). REG. 1-27-2004.
- 2,807,838. REFLEX ALERTS. INT. CL. 35. (U.S. CLS. 100, 101 AND 102). REG. 1-27-2004.
- 2,807,882. SINGING WATERS MINISTRIES. INT. CL. 45. (U.S. CLS. 100 AND 101). REG. 1-27-2004.
- 2,807,996. MISCELLANEOUS DESIGN. INT. CL. 39. (U.S. CLS. 100 AND 105). REG. 1-27-2004.
- 2,808,045. THE OTHER CAPE. INT. CL. 39. (U.S. CLS. 100 AND 105). REG. 1-27-2004.
- 2,808,220. NOTTA-SOCK. INT. CL. 10. (U.S. CLS. 26, 39 AND 44). REG. 1-27-2004.
- 2,808,674. USB QUICK STICK. INT. CL. 9. (U.S. CLS. 21, 23, 26, 36 AND 38). REG. 1-27-2004.
- 2,808,813. PROTAIN. INT. CL. 1. (U.S. CLS. 1, 5, 6, 10, 26 AND 46). REG. 1-27-2004.
- 2,808,852. DELL. INT. CL. 2. (U.S. CLS. 6, 11 AND 16). REG. 1-27-2004.



- 2,809,083. MARKLINES. INT. CLS. 35 AND 42. (U.S. CLS. 100, 101 AND 102). REG. 1-27-2004.
- 2,809,113. E AND DESIGN. INT. CLS. 25 AND 28. (U.S. CLS. 22, 23, 38, 39 AND 50). REG. 1-27-2004.
- 2,809,159. RABBIT'S FOOT PRESS. INT. CL. 41. (U.S. CLS. 100, 101 AND 107). REG. 1-27-2004.
- 2,809,453. DOUBLE UP. INT. CL. 16. (U.S. CLS. 2, 5, 22, 23, 29, 37, 38 AND 50). REG. 1-27-2004.
- 2,810,803. CREATIONWISE. INT. CL. 16. (U.S. CLS. 2, 5, 22, 23, 29, 37, 38 AND 50). REG. 2-3-2004.
- 2,810,966. CORODRILL. INT. CL. 7. (U.S. CLS. 13, 19, 21, 23, 31, 34 AND 35). REG. 2-3-2004.
- 2,811,417. VEG DIPPLES. INT. CL. 29 ONLY. (U.S. CL. 46). REG. 2-3-2004.
- 2,811,890. "SEE THE LIGHT". INT. CL. 36. (U.S. CLS. 100, 101 AND 102). REG. 2-3-2004.
- 2,812,487. MISCELLANEOUS DESIGN. INT. CL. 25. (U.S. CLS. 22 AND 39). REG. 2-10-2004.
- 2,812,554. LEGEND. INT. CL. 7. (U.S. CLS. 13, 19, 21, 23, 31, 34 AND 35). REG. 2-10-2004.
- 2,812,938. JOHN C. SULLENGER VINEYARD. INT. CL. 33. (U.S. CLS. 47 AND 49). REG. 2-10-2004.
- 2,813,144. ZEST. INT. CL. 3. (U.S. CLS. 1, 4, 6, 50, 51 AND 52). REG. 2-10-2004.
- 2,813,283. ASIANDECO. INT. CLS. 35 AND 42. (U.S. CLS. 100, 101 AND 102). REG. 2-10-2004.
- 2,813,418. HUNDRED OR NOTHING. INT. CL. 9. (U.S. CLS. 21, 23, 26, 36 AND 38). REG. 2-10-2004.
- 2,813,564. LUCKY LARRY'S LOBSTERMANIA. INT. CL. 9. (U.S. CLS. 21, 23, 26, 36 AND 38). REG. 2-10-2004.
- 2,813,699. MODERN SOUL. INT. CL. 25. (U.S. CLS. 22 AND 39). REG. 2-10-2004.
- 2,813,902. DRYDOCK. INT. CL. 6. (U.S. CLS. 2, 12, 13, 14, 23, 25 AND 50). REG. 2-10-2004.
- 2,813,981. ISOMAT. INT. CL. 17. (U.S. CLS. 1, 5, 12, 13, 35 AND 50). REG. 2-10-2004.
- 2,813,986. ACUSTEP TECHNOLOGY FOR YOUR FEET AND DESIGN. INT. CLS. 9, 10, 40 AND 42. (U.S. CLS. 21, 23, 26, 36, 38, 39, 44, 100, 101, 103 AND 106). REG. 2-10-2004.
- 2,814,459. EZ PAY. INT. CL. 9. (U.S. CLS. 21, 23, 26, 36 AND 38). REG. 2-17-2004.
- 2,815,011. HOLIDAY WONDERLAND. INT. CL. 11 ONLY. (U.S. CLS. 13, 21, 23, 31 AND 34). REG. 2-17-2004.
- 2,815,516. MARKET ROAST. INT. CL. 30. (U.S. CL. 46). REG. 2-17-2004.
- 2,815,872. MEGAJACKPOTS. INT. CL. 41. (U.S. CLS. 100, 101 AND 107). REG. 2-17-2004.
- 2,816,035. BEACON ELECTRIC SUPPLY AND DESIGN. INT. CLS. 35 AND 42 ONLY. (U.S. CLS. 100, 101 AND 102). REG. 2-24-2004.
- 2,816,266. PARIO. INT. CLS. 35, 38, 40, 41 AND 42. (U.S. CLS. 100, 101, 102, 103, 104, 106 AND 107). REG. 2-24-2004.
- 2,816,356. KLC. INT. CL. 39. (U.S. CLS. 100 AND 105). REG. 2-24-2004.
- 2,816,509. CHRISTIANE NORTHRUP, M.D.. INT. CLS. 9, 16 AND 42. (U.S. CLS. 2, 5, 21, 22, 23, 26, 29, 36, 37, 38, 50, 100 AND 101). REG. 2-24-2004.
- 2,816,636. WILD DIVA. INT. CL. 25. (U.S. CLS. 22 AND 39). REG. 2-24-2004.
- 2,816,655. VETERINARY ECONOMICS HD HOSPITAL DESIGN CONFERENCE. INT. CL. 41. (U.S. CLS. 100, 101 AND 107). REG. 2-24-2004.
- 2,816,768. ARCTURA. INT. CL. 14. (U.S. CLS. 2, 27, 28 AND 50). REG. 2-24-2004.
- 2,816,892. BUTATRON. INT. CL. 5. (U.S. CLS. 6, 18, 44, 46, 51 AND 52). REG. 2-24-2004.
- 2,817,047. MISCELLANEOUS DESIGN. INT. CL. 30. (U.S. CL. 46). REG. 2-24-2004.
- 2,817,371. PROPERTY SCIENCES. INT. CLS. 36 AND 42. (U.S. CLS. 100, 101 AND 102). REG. 2-24-2004.
- 2,817,404. THINKINC.. INT. CL. 35. (U.S. CLS. 100, 101 AND 102). REG. 2-24-2004.
- 2,818,000. THE BORING RALLY. INT. CL. 41. (U.S. CLS. 100, 101 AND 107). REG. 2-24-2004.
- 2,818,160. NOT YOUR DAUGHTER'S JEANS. INT. CL. 25. (U.S. CLS. 22 AND 39). REG. 2-24-2004.
- 2,818,495. MEGA JACKPOTS (STYLIZED). INT. CL. 41. (U.S. CLS. 100, 101 AND 107). REG. 2-24-2004.
- 2,818,872. T.M. DESIGNWORKS. INT. CLS. 7 AND 12. (U.S. CLS. 13, 19, 21, 23, 31, 34, 35 AND 44). REG. 3-2-2004.
- 2,818,941. ARCHITECTS OF COMMUNICATION. INT. CLS. 35, 38, 40, 41 AND 42. (U.S. CLS. 100, 101, 102, 103, 104, 106 AND 107). REG. 3-2-2004.
- 2,819,028. MISCELLANEOUS DESIGN. INT. CLS. 5 AND 10 ONLY. (U.S. CLS. 6, 18, 26, 39, 44, 46, 51 AND 52 ONLY). REG. 3-2-2004.
- 2,819,513. PENNCHLOR. INT. CL. 5. (U.S. CLS. 6, 18, 44, 46, 51 AND 52). REG. 3-2-2004.
- 2,819,515. PENNOX. INT. CL. 5. (U.S. CLS. 6, 18, 44, 46, 51 AND 52). REG. 3-2-2004.
- 2,819,516. PENNOX 100-MR. INT. CL. 5. (U.S. CLS. 6, 18, 44, 46, 51 AND 52). REG. 3-2-2004.
- 2,819,517. PENNCHLOR 100 HI-FLO. INT. CL. 5. (U.S. CLS. 6, 18, 44, 46, 51 AND 52). REG. 3-2-2004.
- 2,819,518. PENNOX 200 HI-FLO. INT. CL. 5. (U.S. CLS. 6, 18, 44, 46, 51 AND 52). REG. 3-2-2004.
- 2,819,519. PENNOX 100 HI-FLO. INT. CL. 5. (U.S. CLS. 6, 18, 44, 46, 51 AND 52). REG. 3-2-2004.
- 2,819,520. PENNCHLOR 100-MR. INT. CL. 5. (U.S. CLS. 6, 18, 44, 46, 51 AND 52). REG. 3-2-2004.
- 2,819,575. RED BEND. INT. CL. 9. (U.S. CLS. 21, 23, 26, 36 AND 38). REG. 3-2-2004.
- 2,819,689. IFG COMPANIES AND DESIGN. INT. CL. 16. (U.S. CLS. 2, 5, 22, 23, 29, 37, 38 AND 50). REG. 3-2-2004.
- 2,819,740. PETER ALEXANDER. INT. CL. 35. (U.S. CLS. 100, 101 AND 102). REG. 3-2-2004.
- 2,819,869. RAM PARTNERS, LLC. INT. CL. 36. (U.S. CLS. 100, 101 AND 102). REG. 3-2-2004.
- 2,820,057. A&B. INT. CL. 1. (U.S. CLS. 1, 5, 6, 10, 26 AND 46). REG. 3-2-2004.
- 2,820,058. A&B EST. 1970 AND DESIGN. INT. CL. 1. (U.S. CLS. 1, 5, 6, 10, 26 AND 46). REG. 3-2-2004.
- 2,820,248. BODY CHARGER AND DESIGN. INT. CL. 28. (U.S. CLS. 22, 23, 38 AND 50). REG. 3-2-2004.
- 2,820,251. WINCONNECT (STYLIZED). INT. CL. 9. (U.S. CLS. 21, 23, 26, 36 AND 38). REG. 3-2-2004.
- 2,820,252. BETWIN (STYLIZED). INT. CL. 9. (U.S. CLS. 21, 23, 26, 36 AND 38). REG. 3-2-2004.
- 2,820,669. BETFAIR. INT. CLS. 36 AND 41. (U.S. CLS. 100, 101, 102 AND 107). REG. 3-9-2004.
- 2,820,796. POINT-N-GO. INT. CL. 9. (U.S. CLS. 21, 23, 26, 36 AND 38). REG. 3-9-2004.
- 2,820,913. ACUTEMP. INT. CL. 20. (U.S. CLS. 2, 13, 22, 25, 32 AND 50). REG. 3-9-2004.
- 2,821,653. LEO SCHACHTER DIAMONDS FOUR GENERATIONS. ONE PASSION.. INT. CL. 14. (U.S. CLS. 2, 27, 28 AND 50). REG. 3-9-2004.
- 2,821,800. LAMPPOST REALTY. INT. CL. 36. (U.S. CLS. 100, 101 AND 102). REG. 3-9-2004.
- 2,821,930. STONE MOUNTAIN. INT. CL. 35. (U.S. CLS. 100, 101 AND 102). REG. 3-16-2004.
- 2,822,104. CYBERJAMMIES. INT. CL. 25. (U.S. CLS. 22 AND 39). REG. 3-16-2004.
- 2,822,483. SC (STYLIZED). INT. CL. 1. (U.S. CLS. 1, 5, 6, 10, 26 AND 46). REG. 3-16-2004.
- 2,822,539. THE AMERICAN JOURNAL OF MANAGED CARE. INT. CLS. 16 AND 35. (U.S. CLS. 2, 5, 22, 23, 29, 37, 38, 50, 100, 101 AND 102). REG. 3-16-2004.
- 2,823,303. PERFORMANCE FLEECE. INT. CL. 25. (U.S. CLS. 22 AND 39). REG. 3-16-2004.
- 2,824,142. GUIDING YOU HOME. INT. CL. 36. (U.S. CLS. 100, 101 AND 102). REG. 3-16-2004.
- 2,824,411. NINE-STEP INTERNAL QIGONG. INT. CL. 41. (U.S. CLS. 100, 101 AND 107). REG. 3-23-2004.
- 2,825,674. PIONEER INVESTMENTS. INT. CL. 25. (U.S. CLS. 22 AND 39). REG. 3-23-2004.
- 2,826,231. MONEYPASS. INT. CL. 36. (U.S. CLS. 100, 101 AND 102). REG. 3-23-2004.
- 2,826,601. HIS TWEEZERMAN. INT. CL. 8. (U.S. CLS. 23, 28 AND 44). REG. 3-23-2004.
- 2,827,615. REOMAC. INT. CL. 35. (U.S. CLS. 100, 101 AND 102). REG. 3-30-2004.
- 2,829,118. LALA AND DESIGN. INT. CL. 29. (U.S. CL. 46). REG. 4-6-2004.
- 2,829,597. HENRY'S HARVEST. INT. CL. 30. (U.S. CL. 46). REG. 4-6-2004.
- 2,830,105. BAIN DE LUXE FOAMING BODY SCRUB AND DESIGN. INT. CL. 3. (U.S. CLS. 1, 4, 6, 50, 51 AND 52). REG. 4-6-2004.
- 2,830,152. TED DREWES. INT. CL. 30. (U.S. CL. 46). REG. 4-6-2004.
- 2,831,179. PERLE D'OR. INT. CL. 30. (U.S. CL. 46). REG. 4-13-2004.

- 2,831,213. SEGPPOS. INT. CL. 1. (U.S. CLS. 1, 5, 6, 10, 26 AND 46). REG. 4-13-2004.
- 2,833,449. BEST PRICE SELF STORAGE. INT. CL. 39. (U.S. CLS. 100 AND 105). REG. 4-13-2004.
- 2,833,609. TURF. INT. CL. 9. (U.S. CLS. 21, 23, 26, 36 AND 38). REG. 4-20-2004.
- 2,834,670. ENMOTION. INT. CL. 16. (U.S. CLS. 2, 5, 22, 23, 29, 37, 38 AND 50). REG. 4-20-2004.
- 2,834,972. ULTRASEAL MX2. INT. CL. 1. (U.S. CLS. 1, 5, 6, 10, 26 AND 46). REG. 4-20-2004.
- 2,835,400. STINGRAY. INT. CL. 10. (U.S. CLS. 26, 39 AND 44). REG. 4-20-2004.
- 2,836,723. MISCELLANEOUS DESIGN. INT. CL. 36. (U.S. CLS. 100, 101 AND 102). REG. 4-27-2004.
- 2,836,749. KASANOF'S SINCE 1898 AND DESIGN. INT. CL. 30. (U.S. CL. 46). REG. 4-27-2004.
- 2,836,904. TOOTHLOGY. INT. CLS. 16, 35 AND 42. (U.S. CLS. 2, 5, 22, 23, 29, 37, 38, 50, 100, 101 AND 102). REG. 4-27-2004.
- 2,836,998. MIN JOINT REPLACEMENT. INT. CL. 44. (U.S. CLS. 100 AND 101). REG. 4-27-2004.
- 2,836,999. MIN SURGERY. INT. CL. 44. (U.S. CLS. 100 AND 101). REG. 4-27-2004.
- 2,837,230. LEGAL RIGHTS DEFENDERS. INT. CL. 35. (U.S. CLS. 100, 101 AND 102). REG. 4-27-2004.
- 2,837,393. GAP. INT. CL. 28. (U.S. CLS. 22, 23, 38 AND 50). REG. 4-27-2004.
- 2,840,331. SIGNATURES (STYLIZED). INT. CL. 25. (U.S. CLS. 22 AND 39). REG. 5-11-2004.
- 2,842,129. EDAPTIVE (STYLIZED). INT. CL. 42. (U.S. CLS. 100 AND 101). REG. 5-18-2004.
- 2,842,790. EXODUS. INT. CL. 5. (U.S. CLS. 6, 18, 44, 46, 51 AND 52). REG. 5-18-2004.
- 2,843,299. EMT. INT. CL. 9. (U.S. CLS. 21, 23, 26, 36 AND 38). REG. 5-18-2004.
- 2,843,945. CHAMPION. INT. CL. 11. (U.S. CLS. 13, 21, 23, 31 AND 34). REG. 5-18-2004.
- 2,846,806. DR. INT. CL. 34. (U.S. CLS. 2, 8, 9 AND 17). REG. 5-25-2004.
- 2,846,909. LAMPOST REALTY AND DESIGN. INT. CL. 36. (U.S. CLS. 100, 101 AND 102). REG. 5-25-2004.
- 2,847,454. ENVAC. INT. CLS. 7 AND 37 ONLY. (U.S. CLS. 13, 19, 21, 23, 31, 34, 35, 100, 103 AND 106). REG. 6-1-2004.
- 2,847,920. SUBURBAN SIDEWINDER SLEEVE. INT. CL. 24. (U.S. CLS. 42 AND 50). REG. 6-1-2004.
- 2,848,968. UTELITE E-SOIL. INT. CL. 1. (U.S. CLS. 1, 5, 6, 10, 26 AND 46). REG. 6-1-2004.
- 2,849,080. TIME & PLACE. INT. CLS. 36, 41 AND 45. (U.S. CLS. 100, 101, 102 AND 107). REG. 6-1-2004.
- 2,849,162. EZ FENG SHUI. INT. CL. 16. (U.S. CLS. 2, 5, 22, 23, 29, 37, 38 AND 50). REG. 6-1-2004.
- 2,849,362. PERFECT SCENTS. INT. CL. 5. (U.S. CLS. 6, 18, 44, 46, 51 AND 52). REG. 6-1-2004.
- 2,850,285. ARCHVISION. INT. CL. 9. (U.S. CLS. 21, 23, 26, 36 AND 38). REG. 6-8-2004.
- 2,850,898. BURGUNDY BELLE. INT. CL. 31. (U.S. CLS. 1 AND 46). REG. 6-8-2004.
- 2,851,031. DURITE. INT. CL. 37. (U.S. CLS. 100, 103 AND 106). REG. 6-8-2004.
- 2,851,527. TAPEIAMPA AND DESIGN. INT. CL. 35. (U.S. CLS. 100, 101 AND 102). REG. 6-8-2004.
- 2,852,588. CARVING (STYLIZED). INT. CL. 12. (U.S. CLS. 19, 21, 23, 31, 35 AND 44). REG. 6-15-2004.
- 2,852,911. NETCHEM. INT. CL. 35. (U.S. CLS. 100, 101 AND 102). REG. 6-15-2004.
- 2,852,932. QUICK-TORQUE. INT. CL. 8. (U.S. CLS. 23, 28 AND 44). REG. 6-15-2004.
- 2,853,483. LUSH. INT. CL. 35. (U.S. CLS. 100, 101 AND 102). REG. 6-15-2004.
- 2,853,972. HIDDEN EXTENSION. INT. CL. 25. (U.S. CLS. 22 AND 39). REG. 6-15-2004.
- 2,854,016. RAPTOR. INT. CL. 9. (U.S. CLS. 21, 23, 26, 36 AND 38). REG. 6-15-2004.
- 2,854,622. RISO (STYLIZED). INT. CLS. 2 AND 9. (U.S. CLS. 6, 11, 16, 21, 23, 26, 36 AND 38). REG. 6-15-2004.
- 2,855,351. SUR-PLUS. INT. CL. 1. (U.S. CLS. 1, 5, 6, 10, 26 AND 46). REG. 6-15-2004.
- 2,855,885. NITORIG. INT. CL. 41. (U.S. CLS. 100, 101 AND 107). REG. 6-22-2004.
- 2,856,019. A SCROLL IN THE BARK. INT. CL. 35. (U.S. CLS. 100, 101 AND 102). REG. 6-22-2004.
- 2,856,168. ALAIR. INT. CL. 10. (U.S. CLS. 26, 39 AND 44). REG. 6-22-2004.
- 2,856,654. MORGEN SCHICK. INT. CL. 3. (U.S. CLS. 1, 4, 6, 50, 51 AND 52). REG. 6-22-2004.
- 2,857,376. RPC. INT. CL. 9. (U.S. CLS. 21, 23, 26, 36 AND 38). REG. 6-29-2004.
- 2,859,997. ALIVIO LEGAL. INT. CL. 35. (U.S. CLS. 100, 101 AND 102). REG. 7-6-2004.
- 2,862,625. OPTI-TRAK. INT. CL. 7. (U.S. CLS. 13, 19, 21, 23, 31, 34 AND 35). REG. 7-13-2004.
- 2,862,830. TWIZTID. INT. CL. 41. (U.S. CLS. 100, 101 AND 107). REG. 7-13-2004.
- 2,863,758. WEB 101. INT. CL. 41. (U.S. CLS. 100, 101 AND 107). REG. 7-13-2004.
- 2,864,183. HIGHLINE. INT. CL. 7. (U.S. CLS. 13, 19, 21, 23, 31, 34 AND 35). REG. 7-20-2004.
- 2,867,558. MYGOV. INT. CL. 42. (U.S. CLS. 100 AND 101). REG. 7-27-2004.
- 2,868,082. KODIAK LAUNCH COMPLEX. INT. CL. 39. (U.S. CLS. 100 AND 105). REG. 7-27-2004.
- 2,868,236. FAIRFIELD. INT. CL. 20. (U.S. CLS. 2, 13, 22, 25, 32 AND 50). REG. 8-3-2004.
- 2,868,780. ROLL EXPRESS. INT. CL. 40. (U.S. CLS. 100, 103 AND 106). REG. 8-3-2004.
- 2,869,148. CE TRACKER AND DESIGN. INT. CL. 9. (U.S. CLS. 21, 23, 26, 36 AND 38). REG. 8-3-2004.
- 2,869,759. SPRING CREEK RANCH. INT. CL. 37. (U.S. CLS. 100, 103 AND 106). REG. 8-3-2004.
- 2,870,087. DERMO-EXPERTISE. INT. CL. 3. (U.S. CLS. 1, 4, 6, 50, 51 AND 52). REG. 8-3-2004.
- 2,870,326. THE UMBRELLA PROJECT AND DESIGN. INT. CL. 36. (U.S. CLS. 100, 101 AND 102). REG. 8-3-2004.
- 2,871,027. ALL STAR LIMOUSINE SERVICE LTD.. INT. CL. 39. (U.S. CLS. 100 AND 105). REG. 8-10-2004.
- 2,871,091. COMBI-PEN-48. INT. CL. 5. (U.S. CLS. 6, 18, 44, 46, 51 AND 52). REG. 8-10-2004.
- 2,871,666. LOVE CHAOS & DINNER (STYLIZED). INT. CLS. 41 AND 43. (U.S. CLS. 100, 101 AND 107). REG. 8-10-2004.
- 2,872,833. FHLBANK ATLANTA AND DESIGN. INT. CL. 36. (U.S. CLS. 100, 101 AND 102). REG. 8-10-2004.
- 2,873,365. SPORTDISCUS. INT. CLS. 35, 38, 41 AND 42 ONLY. (U.S. CLS. 100, 101, 102, 104 AND 107). REG. 8-17-2004.
- 2,873,492. BIBLICAL SOLUTIONS FOR LIFE. INT. CLS. 16, 35, 41 AND 45. (U.S. CLS. 2, 5, 22, 23, 29, 37, 38, 50, 100, 101, 102 AND 107). REG. 8-17-2004.
- 2,874,102. CA'TOGA. INT. CL. 35. (U.S. CLS. 100, 101 AND 102). REG. 8-17-2004.
- 2,874,705. YAAN. INT. CL. 9. (U.S. CLS. 21, 23, 26, 36 AND 38). REG. 8-17-2004.
- 2,875,940. NAVIS. INT. CL. 36. (U.S. CLS. 100, 101 AND 102). REG. 8-24-2004.
- 2,876,242. AMOR AMOR. INT. CL. 3. (U.S. CLS. 1, 4, 6, 50, 51 AND 52). REG. 8-24-2004.
- 2,878,806. MAGIC LIFT. INT. CL. 25. (U.S. CLS. 22 AND 39). REG. 8-31-2004.
- 2,878,850. CHRISTOPHER M. STILL. INT. CL. 16. (U.S. CLS. 2, 5, 22, 23, 29, 37, 38 AND 50). REG. 8-31-2004.
- 2,879,472. SEAFOOD BLEND. INT. CL. 1. (U.S. CLS. 1, 5, 6, 10, 26 AND 46). REG. 8-31-2004.
- 2,882,743. N-DURZ. INT. CL. 19. (U.S. CLS. 1, 12, 33 AND 50). REG. 9-7-2004.
- 2,884,438. GREAT MUSEUMS. INT. CL. 41. (U.S. CLS. 100, 101 AND 107). REG. 9-14-2004.
- 2,887,948. BEHAVIORAL INTERVENTIONS. INT. CL. 42 ONLY. (U.S. CLS. 100 AND 101). REG. 9-21-2004.
- 2,888,113. MISCELLANEOUS DESIGN. INT. CLS. 5, 29 AND 32. (U.S. CLS. 6, 18, 44, 45, 46, 48, 51 AND 52). REG. 9-28-2004.
- 2,890,218. TIMESCAPE. INT. CL. 9. (U.S. CLS. 21, 23, 26, 36 AND 38). REG. 9-28-2004.
- 2,890,254. TOP MODELING YANBAL. INT. CL. 3. (U.S. CLS. 1, 4, 6, 50, 51 AND 52). REG. 9-28-2004.
- 2,890,353. CLIC YANBAL. INT. CL. 3. (U.S. CLS. 1, 4, 6, 50, 51 AND 52). REG. 9-28-2004.
- 2,891,969. SPIKE TV. INT. CL. 38. (U.S. CLS. 100, 101 AND 104). REG. 10-5-2004.
- 2,891,970. SPIKE TV. INT. CL. 41. (U.S. CLS. 100, 101 AND 107). REG. 10-5-2004.
- 2,894,141. CM AND DESIGN. INT. CL. 9. (U.S. CLS. 21, 23, 26, 36 AND 38). REG. 10-19-2004.
- 2,894,145. PAXTON & WHITFIELD. INT. CLS. 8, 20, 21, 29 AND 30 ONLY. (U.S. CLS. 2, 13, 22, 23, 25, 28, 29, 30, 32, 33, 40, 44, 46 AND 50). REG. 10-19-2004.

- 2,895,840. DIAMOND AND DESIGN. INT. CLS. 8 AND 28. (U.S. CLS. 22, 23, 28, 38, 44 AND 50). REG. 10-19-2004.
- 2,896,877. MESODOC. INT. CL. 44. (U.S. CLS. 100 AND 101). REG. 10-26-2004.
- 2,897,174. TED DREWES. INT. CL. 35. (U.S. CLS. 100, 101 AND 102). REG. 10-26-2004.
- 2,898,403. BUSINESS JET TRAVELER (STYLIZED). INT. CL. 16. (U.S. CLS. 2, 5, 22, 23, 29, 37, 38 AND 50). REG. 10-26-2004.
- 2,899,380. TOURGUIDE MIKE AUTOMATED VACATION PLANNER. INT. CL. 39. (U.S. CLS. 100 AND 105). REG. 11-2-2004.
- 2,899,468. THE DARK CHRONICLES STANDARD CHARACTER MARK. INT. CL. 16. (U.S. CLS. 2, 5, 22, 23, 29, 37, 38 AND 50). REG. 11-2-2004.
- 2,899,678. DB PENSIONEDGE. INT. CL. 36. (U.S. CLS. 100, 101 AND 102). REG. 11-2-2004.
- 2,900,829. BARTHET LAWYERS TO BUSINESS. INT. CL. 42. (U.S. CLS. 100 AND 101). REG. 11-2-2004.
- 2,900,842. EVERYONE DESERVES A GOOD MEAL. INT. CL. 43. (U.S. CLS. 100 AND 101). REG. 11-2-2004.
- 2,900,872. GO CLEAN STANDARD CHARACTER MARK. INT. CL. 3. (U.S. CLS. 1, 4, 6, 50, 51 AND 52). REG. 11-2-2004.
- 2,900,874. POLISH UP STANDARD CHARACTER MARK. INT. CL. 3. (U.S. CLS. 1, 4, 6, 50, 51 AND 52). REG. 11-2-2004.
- 2,900,875. GET GROOMED STANDARD CHARACTER MARK. INT. CL. 3. (U.S. CLS. 1, 4, 6, 50, 51 AND 52). REG. 11-2-2004.
- 2,900,876. GRIP TIGHT STANDARD CHARACTER MARK. INT. CL. 3. (U.S. CLS. 1, 4, 6, 50, 51 AND 52). REG. 11-2-2004.
- 2,901,647. SPORT SWORD AND DESIGN. INT. CL. 41. (U.S. CLS. 100, 101 AND 107). REG. 11-9-2004.
- 2,902,737. E PASS AND DESIGN. INT. CL. 36. (U.S. CLS. 100, 101 AND 102). REG. 11-16-2004.
- 2,902,748. LYMAN. INT. CL. 12. (U.S. CLS. 19, 21, 23, 31, 35 AND 44). REG. 11-16-2004.
- 2,903,412. VISUALDARKNESS. INT. CL. 42. (U.S. CLS. 100 AND 101). REG. 11-16-2004.
- 2,904,397. GOODSKY. INT. CL. 9. (U.S. CLS. 21, 23, 26, 36 AND 38). REG. 11-23-2004.
- 2,904,442. GB GOLDEN BOWL CHARBROILED TERIYAKI AND DESIGN. INT. CL. 43. (U.S. CLS. 100 AND 101). REG. 11-23-2004.
- 2,904,731. ULTIMATE E. INT. CL. 7. (U.S. CLS. 13, 19, 21, 23, 31, 34 AND 35). REG. 11-23-2004.
- 2,905,059. LASERSHARP. INT. CL. 7. (U.S. CLS. 13, 19, 21, 23, 31, 34 AND 35). REG. 11-23-2004.
- 2,906,623. GITTINGS. INT. CL. 41. (U.S. CLS. 100, 101 AND 107). REG. 11-30-2004.
- 2,906,845. INSTA-SET STANDARD CHARACTER MARK. INT. CL. 14. (U.S. CLS. 2, 27, 28 AND 50). REG. 11-30-2004.
- 2,906,873. CHEAPTV. INT. CL. 41. (U.S. CLS. 100, 101 AND 107). REG. 11-30-2004.
- 2,908,064. AMERICAN GLORY (STYLIZED). INT. CL. 39. (U.S. CLS. 100 AND 105). REG. 12-7-2004.
- 2,908,072. SEARCHALERT STANDARD CHARACTER MARK. INT. CL. 6. (U.S. CLS. 2, 12, 13, 14, 23, 25 AND 50). REG. 12-7-2004.
- 2,909,008. ECSTASEAT. INT. CL. 11. (U.S. CLS. 13, 21, 23, 31 AND 34). REG. 12-7-2004.
- 2,909,105. EZ PATH. INT. CL. 9. (U.S. CLS. 21, 23, 26, 36 AND 38). REG. 12-7-2004.
- 2,909,311. METLIFE PERSONAL INCOMEPLUS. INT. CL. 36. (U.S. CLS. 100, 101 AND 102). REG. 12-7-2004.
- 2,909,754. BULLY LOCKS AND DESIGN. INT. CL. 6. (U.S. CLS. 2, 12, 13, 14, 23, 25 AND 50). REG. 12-14-2004.
- 2,910,717. SMALL WORLD COFFEE. INT. CL. 30. (U.S. CL. 46). REG. 12-14-2004.
- 2,911,267. TIW-M STANDARD CHARACTER MARK. INT. CL. 9. (U.S. CLS. 21, 23, 26, 36 AND 38). REG. 12-14-2004.
- 2,911,723. SPECTRAGUARD. INT. CL. 42. (U.S. CLS. 100 AND 101). REG. 12-14-2004.
- 2,911,994. MULTIPLE PATHWAYS, MULTIPLE TARGETS: DRUG DISCOVERY FOR CELGENE. INT. CL. 42. (U.S. CLS. 100 AND 101). REG. 12-21-2004.
- 2,912,035. 4TRADEMARK.COM. INT. CL. 42. (U.S. CLS. 100 AND 101). REG. 12-21-2004.
- 2,912,047. COOLTOUCH VARIA. INT. CL. 10. (U.S. CLS. 26, 39 AND 44). REG. 12-21-2004.
- 2,912,090. IRODA (STYLIZED). INT. CLS. 4, 7, 11 AND 34. (U.S. CLS. 1, 2, 6, 8, 9, 13, 15, 17, 19, 21, 23, 31, 34 AND 35). REG. 12-21-2004.
- 2,912,106. SUGI. INT. CLS. 5 AND 10. (U.S. CLS. 6, 18, 26, 39, 44, 46, 51 AND 52). REG. 12-21-2004.
- 2,912,182. THE ORIGINAL URTEXT EDITION PROTECTOR. INT. CL. 16. (U.S. CLS. 2, 5, 22, 23, 29, 37, 38 AND 50). REG. 12-21-2004.
- 2,912,252. DELIGHT IN LIVING. INT. CLS. 16 AND 41. (U.S. CLS. 2, 5, 22, 23, 29, 37, 38, 50, 100, 101 AND 107). REG. 12-21-2004.
- 2,912,447. SHIP 'N' SHRED STANDARD CHARACTER MARK. INT. CL. 40. (U.S. CLS. 100, 103 AND 106). REG. 12-21-2004.
- 2,912,511. BERKLEY SQUARE STANDARD CHARACTER MARK. INT. CL. 35. (U.S. CLS. 100, 101 AND 102). REG. 12-21-2004.
- 2,912,664. WHEN YOUR SYSTEM DEMANDS QUICK ATTENTION.... INT. CL. 9. (U.S. CLS. 21, 23, 26, 36 AND 38). REG. 12-21-2004.
- 2,913,266. SOLAR SET STANDARD CHARACTER MARK. INT. CL. 17. (U.S. CLS. 1, 5, 12, 13, 35 AND 50). REG. 12-21-2004.
- 2,913,287. APOSTLES AND RENEGADES STANDARD CHARACTER MARK. INT. CLS. 16 AND 35. (U.S. CLS. 2, 5, 22, 23, 29, 37, 38, 50, 100, 101 AND 102). REG. 12-21-2004.
- 2,913,341. STEELMATE (STYLIZED). INT. CL. 9. (U.S. CLS. 21, 23, 26, 36 AND 38). REG. 12-21-2004.
- 2,913,342. MISCELLANEOUS DESIGN. INT. CL. 9. (U.S. CLS. 21, 23, 26, 36 AND 38). REG. 12-21-2004.
- 2,913,468. CANDEE FLUFF. INT. CL. 21. (U.S. CLS. 2, 13, 23, 29, 30, 33, 40 AND 50). REG. 12-21-2004.
- 2,913,861. ROGUE. INT. CL. 33. (U.S. CLS. 47 AND 49). REG. 12-21-2004.
- 2,914,040. MISCELLANEOUS DESIGN. INT. CL. 11. (U.S. CLS. 13, 21, 23, 31 AND 34). REG. 12-28-2004.
- 2,914,077. LAKEWOOD PLANTATION. INT. CL. 29. (U.S. CL. 46). REG. 12-28-2004.

\* \* \* \* \*

# TRADEMARK REGISTRATIONS CANCELED

The designation "U.S. Cl." appearing in this section refers to the U.S. class in effect prior to Sep. 1, 1973 rather than the international class which applies to applications filed on or after that date. For adoption of international classification see notice in the OFFICIAL GAZETTE of Jun. 26, 1973 (911 O.G. TM 210).

## SECTION 7(D)

- 1,731,961. FINAL FOUR STANDARD CHARACTER MARK. INT. CL. 28 ONLY. REG. 11-10-1992.
- 2,946,361. NITRO. INT. CL. 32. REG. 5-3-2005.
- 3,158,657. GOODRIDES STANDARD CHARACTER MARK. INT. CL. 42. REG. 10-17-2006.
- 3,168,478. LPS KEYPARTS STANDARD CHARACTER MARK. INT. CL. 42. REG. 11-7-2006.
- 3,249,061. WEB 'N' WALK AND DESIGN. INT. CL. 36. REG. 6-5-2007.
- 3,249,062. WEB 'N' WALK AND DESIGN. INT. CL. 38. REG. 6-5-2007.
- 3,249,063. NEWS 'N' WALK AND DESIGN. INT. CL. 16. REG. 6-5-2007.
- 3,249,064. NEWS 'N' WALK AND DESIGN. INT. CL. 41. REG. 6-5-2007.
- 3,258,844. BSI STANDARD CHARACTER MARK. INT. CLS. 19, 37 AND 42. REG. 7-3-2007.
- 3,511,159. VISUAL PRACTICE ANALYTICS STANDARD CHARACTER MARK. INT. CL. 9. REG. 10-7-2008.
- 3,577,217. AAR CUDA STANDARD CHARACTER MARK. INT. CLS. 12, 25 AND 28. REG. 2-17-2009.
- 3,793,508. VYVANSE AND DESIGN. INT. CL. 5 ONLY. REG. 5-25-2010.
- 3,830,949. OUTDOOR LIVING STORES SERVICE. STYLE. VALUE. AND DESIGN. INT. CL. 35. REG. 8-10-2010.
- 1,659,499. INFO GRAPHICS (STYLIZED). INT. CL. 9. REG. 10-8-1991.
- 1,663,585. ENJOY OUR GOOD TASTE WITH YOUR GOOD JUDGMENT. INT. CL. 33. REG. 11-5-1991.
- 1,669,332. DRIVETECH. INT. CL. 12. REG. 12-24-1991.
- 1,698,968. MARLAGO. INT. CL. 12. REG. 7-7-1992.
- 1,709,703. INTERBRONZE. INT. CL. 6. REG. 8-25-1992.
- 1,713,135. CAMEX. INT. CL. 9. REG. 9-8-1992.
- 1,717,746. LANSPEED. INT. CL. 9. REG. 9-22-1992.
- 1,732,508. A ADVANTAGE AND DESIGN. INT. CL. 7. REG. 11-17-1992.
- 1,754,620. UNIVERSITY LIFE LINK. INT. CL. 39. REG. 2-23-1993.
- 1,779,866. PROACTIVE INSTITUTE. INT. CL. 41. REG. 6-29-1993.
- 1,780,900. PROACTIVE INSTITUTE AND DESIGN. INT. CL. 41. REG. 7-6-1993.
- 1,815,592. PC (STYLIZED). INT. CLS. 1, 2, 16, 20 AND 21 ONLY. REG. 1-11-1994.
- 2,397,818. ASK SUSAN. INT. CL. 42. REG. 10-24-2000.
- 2,426,188. EQUITRIPSY. INT. CL. 42. REG. 2-6-2001.
- 2,429,740. PLATIZER. INT. CL. 9. REG. 2-20-2001.
- 2,502,643. POWERHOUSE. INT. CL. 9. REG. 10-30-2001.
- 2,566,854. PERSOGENICS CORPORATION AND DESIGN. INT. CLS. 9, 16 AND 41. REG. 5-7-2002.
- 2,648,556. MUSIC WITH MAR.. INT. CL. 9. REG. 11-12-2002.
- 2,676,703. BODY MIND SPIRIT EXPO. INT. CLS. 35 AND 41. REG. 1-21-2003.
- 2,684,132. COMPLESOFT. INT. CL. 42. REG. 2-4-2003.
- 2,699,999. MISCELLANEOUS DESIGN. INT. CL. 30. REG. 3-25-2003.
- 2,702,139. ANOTHER EYE. INT. CL. 9. REG. 4-1-2003.
- 2,718,298. STYLUS. INT. CL. 9. REG. 5-27-2003.
- 2,718,305. CHRISTMASDEPOT. INT. CL. 35. REG. 5-27-2003.
- 2,718,320. MISCELLANEOUS DESIGN. INT. CLS. 35, 41 AND 42. REG. 5-27-2003.
- 2,718,327. VISUAL ELK. INT. CL. 9. REG. 5-27-2003.
- 2,718,328. POINT. INT. CL. 1. REG. 5-27-2003.
- 2,718,353. MEDICINE ONLINE. INT. CLS. 35, 36, 38 AND 42. REG. 5-27-2003.
- 2,718,360. HOST UNIVERSAL AND DESIGN. INT. CLS. 35 AND 42. REG. 5-27-2003.
- 2,718,369. N TARA AND DESIGN. INT. CLS. 9, 38 AND 42. REG. 5-27-2003.
- 2,718,375. BARBARELLA THE MUSICAL. INT. CLS. 3, 9, 14, 16, 21, 25, 28, 32, 33, 34 AND 41. REG. 5-27-2003.
- 2,718,376. ST100. INT. CL. 9. REG. 5-27-2003.
- 2,718,377. KEY CONCEPT. INT. CL. 13. REG. 5-27-2003.
- 2,718,382. THE SCORE. INT. CLS. 38 AND 41. REG. 5-27-2003.
- 2,718,387. SEIKOH GIKEN (STYLIZED). INT. CLS. 3, 7, 9 AND 12. REG. 5-27-2003.
- 2,718,396. INTERPROSE. INT. CL. 35. REG. 5-27-2003.
- 2,718,399. UV- SYSTEM AND DESIGN. INT. CLS. 6 AND 19. REG. 5-27-2003.
- 2,718,432. PENTAMAKS. INT. CL. 42. REG. 5-27-2003.
- 2,718,467. AIRGUN. INT. CL. 12. REG. 5-27-2003.
- 2,718,479. VYXINVIEW. INT. CL. 35. REG. 5-27-2003.
- 2,718,494. SPEC-DATA. INT. CL. 16. REG. 5-27-2003.
- 2,718,497. FOR THE LOVE OF LIFE AND DESIGN. INT. CL. 42. REG. 5-27-2003.
- 2,718,499. ALONE IN THE DARK. INT. CLS. 9 AND 41. REG. 5-27-2003.

## SECTION 8

- 693,391. MASTERBILT. U.S. CL. 13. REG. 2-23-1960.
- 716,270. CF CONSOLIDATED FREIGHTWAYS (STYLIZED). U.S. CL. 105. REG. 5-30-1961.
- 895,090. M.V.P. LOFERS. U.S. CL. 39. REG. 7-21-1970.
- 955,472. AMERIPORT. U.S. CL. 105. REG. 3-13-1973.
- 1,133,670. SMOOTH WALL. INT. CL. 17. REG. 4-22-1980.
- 1,158,129. COMFORT CLOUD. INT. CL. 20. REG. 6-23-1981.
- 1,164,706. PRIMIGI. INT. CL. 25. REG. 8-11-1981.
- 1,182,269. M.V.P. JEANS. INT. CL. 25. REG. 12-15-1981.
- 1,239,946. WAESCHLE. INT. CLS. 6, 7, 9, 11, 17, 19, 20 AND 21. REG. 5-31-1983.
- 1,239,952. SILVER CLOUD (STYLIZED). INT. CLS. 6, 16, 20, 37 AND 42. REG. 5-31-1983.
- 1,240,025. MISCELLANEOUS DESIGN. INT. CLS. 9 AND 16. REG. 5-31-1983.
- 1,240,166. BIG MAX. INT. CL. 11. REG. 5-31-1983.
- 1,244,189. MALLORY IGNITION AND DESIGN. INT. CL. 9 ONLY. REG. 7-5-1983.
- 1,283,922. US AND DESIGN. INT. CL. 5 ONLY. REG. 7-3-1984.
- 1,536,651. EAGLE CREEK WHITE. INT. CL. 33. REG. 4-25-1989.
- 1,633,972. TRAKS MAX. INT. CL. 12. REG. 2-5-1991.
- 1,639,658. MARS HEPAC AND DESIGN. INT. CL. 11. REG. 4-2-1991.

- 2,718,501. SAINTE MERE AND DESIGN. INT. CL. 29. REG. 5-27-2003.
- 2,718,513. ECCOUNTING SOLUTIONS. INT. CL. 35. REG. 5-27-2003.
- 2,718,515. MYRIAD. INT. CLS. 18, 25 AND 28. REG. 5-27-2003.
- 2,718,517. AVACOR AND DESIGN. INT. CL. 5. REG. 5-27-2003.
- 2,718,520. MISCELLANEOUS DESIGN. INT. CL. 42. REG. 5-27-2003.
- 2,718,521. TOTAL CABIN CAPABILITY. INT. CLS. 37, 40 AND 42. REG. 5-27-2003.
- 2,718,525. COLORCRYPT. INT. CL. 2. REG. 5-27-2003.
- 2,718,542. REFLECT. INT. CL. 3. REG. 5-27-2003.
- 2,718,543. SAFE SPACE AND DESIGN. INT. CLS. 35, 41 AND 42. REG. 5-27-2003.
- 2,718,548. ANDERSONS GOLF PRODUCTS AND DESIGN. INT. CLS. 1 AND 5. REG. 5-27-2003.
- 2,718,561. CAPITAL MACHINE TECHNOLOGIES. INT. CLS. 35 AND 37. REG. 5-27-2003.
- 2,718,567. ESTD. 1812 LAURENT-PERRIER BRUT L.P. AND DESIGN. INT. CL. 33. REG. 5-27-2003.
- 2,718,572. UDATE.COM AND DESIGN. INT. CL. 42. REG. 5-27-2003.
- 2,718,576. CRITICAL COMMUNICATIONS. INT. CLS. 37, 41 AND 42. REG. 5-27-2003.
- 2,718,587. BIOSIS. INT. CL. 9. REG. 5-27-2003.
- 2,718,601. IT.OMICS (STYLIZED). INT. CLS. 9 AND 42. REG. 5-27-2003.
- 2,718,605. WWW.SAVAGEDESIGN.COM AND DESIGN. INT. CL. 42. REG. 5-27-2003.
- 2,718,614. PORTOFINO. INT. CL. 29. REG. 5-27-2003.
- 2,718,623. ARTISAN. INT. CL. 19. REG. 5-27-2003.
- 2,718,626. MEDDATA AND DESIGN. INT. CL. 35. REG. 5-27-2003.
- 2,718,639. JET PACK. INT. CLS. 40 AND 42. REG. 5-27-2003.
- 2,718,643. COME HOME TO COMFORT. INT. CLS. 9 AND 16. REG. 5-27-2003.
- 2,718,649. LITEFLAKE. INT. CL. 29. REG. 5-27-2003.
- 2,718,653. SHOP \*TIL IT STOPS. INT. CLS. 35 AND 36. REG. 5-27-2003.
- 2,718,655. WSI ICE. INT. CL. 42. REG. 5-27-2003.
- 2,718,665. MSF MULTIPLE SCLEROSIS FOUNDATION "A BRIGHTER TOMORROW" AND DESIGN. INT. CL. 36. REG. 5-27-2003.
- 2,718,673. MISCELLANEOUS DESIGN. INT. CL. 1. REG. 5-27-2003.
- 2,718,676. DEP AND DESIGN. INT. CLS. 9, 16 AND 41. REG. 5-27-2003.
- 2,718,683. I AV (STYLIZED). INT. CLS. 9 AND 42. REG. 5-27-2003.
- 2,718,689. GOLDEN ROSE. INT. CL. 16. REG. 5-27-2003.
- 2,718,695. TRIRIGA INTELLIGENT BUSINESS SYSTEM. INT. CL. 42. REG. 5-27-2003.
- 2,718,710. MYSTIC FAVORITES. INT. CL. 42. REG. 5-27-2003.
- 2,718,711. ECHOES STORIES. INT. CL. 16. REG. 5-27-2003.
- 2,718,723. MISCELLANEOUS DESIGN. INT. CL. 41. REG. 5-27-2003.
- 2,718,734. CONFIRMIT. INT. CLS. 9, 35 AND 42. REG. 5-27-2003.
- 2,718,739. HELLO AND DESIGN. INT. CL. 3. REG. 5-27-2003.
- 2,718,740. MISCELLANEOUS DESIGN. INT. CL. 35. REG. 5-27-2003.
- 2,718,750. GLTV AND DESIGN. INT. CL. 41. REG. 5-27-2003.
- 2,718,752. REDWOOD. INT. CL. 31. REG. 5-27-2003.
- 2,718,757. JUMEX SPORT. INT. CL. 32. REG. 5-27-2003.
- 2,718,760. HALLOWEEN SCENE. INT. CLS. 25 AND 35. REG. 5-27-2003.
- 2,718,763. M MAKINGMEMORIES AND DESIGN. INT. CL. 35. REG. 5-27-2003.
- 2,718,769. ONE TREASURE LIMITED. INT. CL. 16. REG. 5-27-2003.
- 2,718,770. K-9 KEEPER SLEEPER. INT. CL. 20. REG. 5-27-2003.
- 2,718,779. UNITED INFOXCHANGE. INT. CL. 41. REG. 5-27-2003.
- 2,718,786. AFTERSCHOOL MATTERS. INT. CL. 16. REG. 5-27-2003.
- 2,718,788. LINHOF (STYLIZED). INT. CL. 9. REG. 5-27-2003.
- 2,718,789. RESONANCE AND DESIGN. INT. CL. 42. REG. 5-27-2003.
- 2,718,798. INFO COMM ACADEMY AND DESIGN. INT. CL. 41. REG. 5-27-2003.
- 2,718,802. ABC WIDE WORLD OF SPORTS AND DESIGN. INT. CL. 41. REG. 5-27-2003.
- 2,718,803. A WORLD FIT FOR KIDS! AND DESIGN. INT. CLS. 35 AND 41. REG. 5-27-2003.
- 2,718,810. CS (STYLIZED). INT. CL. 35. REG. 5-27-2003.
- 2,718,819. JOEY POTS & PANS. INT. CLS. 29 AND 30. REG. 5-27-2003.
- 2,718,823. COMMUNITY WATCH AND DESIGN. INT. CL. 35. REG. 5-27-2003.
- 2,718,824. CONSCIOUS ACTIVISM. INT. CL. 41. REG. 5-27-2003.
- 2,718,852. THE BROADWAY LINE. INT. CL. 41. REG. 5-27-2003.
- 2,718,863. MANAGING AUTOMATION. INT. CLS. 16 AND 41. REG. 5-27-2003.
- 2,718,865. KIRBY CARD. INT. CL. 16. REG. 5-27-2003.
- 2,718,867. SNAZZI. INT. CL. 9. REG. 5-27-2003.
- 2,718,875. MISCELLANEOUS DESIGN. INT. CL. 42. REG. 5-27-2003.
- 2,718,876. MISCELLANEOUS DESIGN. INT. CL. 36. REG. 5-27-2003.
- 2,718,877. MISCELLANEOUS DESIGN. INT. CLS. 36 AND 42. REG. 5-27-2003.
- 2,718,882. GLOBALNET TRAINING. INT. CL. 41. REG. 5-27-2003.
- 2,718,890. VANILLA GRAPEFRUIT. INT. CL. 3. REG. 5-27-2003.
- 2,718,899. BIKRAM'S YOGA COLLEGE OF INDIA. INT. CLS. 9, 25 AND 41. REG. 5-27-2003.
- 2,718,908. PLAYMOUSE. INT. CL. 30. REG. 5-27-2003.
- 2,718,910. RESCON-MX. INT. CL. 5. REG. 5-27-2003.
- 2,718,911. LIQUIBID-D. INT. CL. 5. REG. 5-27-2003.
- 2,718,918. RESCON - JR.. INT. CL. 5. REG. 5-27-2003.
- 2,718,921. BUYAAMILES. INT. CL. 35. REG. 5-27-2003.
- 2,718,924. THE VANILLA BEAN CAFE AND DESIGN. INT. CLS. 25 AND 43. REG. 5-27-2003.
- 2,718,925. THE VANILLA BEAN CAFE. INT. CLS. 25 AND 43. REG. 5-27-2003.
- 2,718,927. BROWNELL. INT. CLS. 22 AND 28. REG. 5-27-2003.
- 2,718,931. STREAMLINING BUSINESS PROCESS THROUGH THE USE OF TECHNOLOGY. INT. CL. 35. REG. 5-27-2003.
- 2,718,933. CHURCHILL. INT. CL. 36. REG. 5-27-2003.
- 2,718,935. CALF-VANTAGE. INT. CL. 5. REG. 5-27-2003.
- 2,718,947. CHICKS WITH PICKS AND DESIGN. INT. CL. 41. REG. 5-27-2003.
- 2,718,948. HAMMOCKS.COM AND DESIGN. INT. CL. 35. REG. 5-27-2003.
- 2,718,954. TRIPLE SHOT BONUS. INT. CL. 41. REG. 5-27-2003.
- 2,718,957. DOUBLE TROUBLE GOLF. INT. CL. 28. REG. 5-27-2003.
- 2,718,959. PETER RABBIT SEEDLINGS. INT. CL. 16. REG. 5-27-2003.
- 2,718,967. THE WAYBACKS. INT. CL. 41. REG. 5-27-2003.
- 2,718,972. MISCELLANEOUS DESIGN. INT. CLS. 16, 35 AND 41. REG. 5-27-2003.
- 2,718,973. RUBBER SOUL. INT. CL. 41. REG. 5-27-2003.
- 2,718,975. BEAUTY & CHEMISTRY IN BALANCE. INT. CL. 3. REG. 5-27-2003.
- 2,718,976. SPY KING. INT. CL. 35. REG. 5-27-2003.
- 2,718,980. DAVIES BABIES. INT. CL. 3. REG. 5-27-2003.
- 2,719,003. MOLLY THE MILKSHAKE MAKER. INT. CL. 28. REG. 5-27-2003.
- 2,719,015. "YOUR SPARE TIME IS OUR BUSINESS" COL-PAR HOBBIES AND DESIGN. INT. CL. 35. REG. 5-27-2003.
- 2,719,021. PATRICIA HAN. INT. CL. 18. REG. 5-27-2003.
- 2,719,030. SEX GREASE. INT. CL. 5. REG. 5-27-2003.
- 2,719,035. CAL-CHECK. INT. CL. 9. REG. 5-27-2003.

- 2,719,038. ESPERANZA HEALTH CENTER AND DESIGN. INT. CL. 44. REG. 5-27-2003.
- 2,719,040. DE CORAZON A CORAZON. INT. CL. 16. REG. 5-27-2003.
- 2,719,045. SO POLISHED. INT. CL. 3. REG. 5-27-2003.
- 2,719,046. AA ANTIMA AND DESIGN. INT. CL. 14. REG. 5-27-2003.
- 2,719,052. 8 BALL EXPRESS. INT. CL. 41. REG. 5-27-2003.
- 2,719,057. AMTRAK. INT. CL. 28. REG. 5-27-2003.
- 2,719,058. TERRY DOUGLAS (STYLIZED). INT. CL. 24. REG. 5-27-2003.
- 2,719,059. CATCH A TRAIN ONLINE. INT. CL. 39. REG. 5-27-2003.
- 2,719,063. MM AND DESIGN. INT. CL. 25. REG. 5-27-2003.
- 2,719,067. SCHOOL DIRECT. INT. CL. 35. REG. 5-27-2003.
- 2,719,069. AMTRAK AND DESIGN. INT. CL. 28. REG. 5-27-2003.
- 2,719,070. AMTRAK AND DESIGN. INT. CL. 28. REG. 5-27-2003.
- 2,719,087. LNV. INT. CL. 11. REG. 5-27-2003.
- 2,719,088. LPV. INT. CL. 11. REG. 5-27-2003.
- 2,719,095. TOP 100 YOU CAN PLAY. INT. CL. 16. REG. 5-27-2003.
- 2,719,099. THUNDER BAY. INT. CL. 16. REG. 5-27-2003.
- 2,719,105. PLUNK'N DUNK. INT. CL. 28. REG. 5-27-2003.
- 2,719,109. ECIM AND DESIGN. INT. CL. 44. REG. 5-27-2003.
- 2,719,119. TAMPA BAY ONLINE. INT. CL. 41. REG. 5-27-2003.
- 2,719,123. BLACK PAGES USA AND DESIGN. INT. CL. 16. REG. 5-27-2003.
- 2,719,125. WORLD STARS. INT. CL. 28. REG. 5-27-2003.
- 2,719,133. THE MEXICAN BAR. INT. CL. 16. REG. 5-27-2003.
- 2,719,149. MOON DANCE STUDIO. INT. CL. 16. REG. 5-27-2003.
- 2,719,153. PERSPECTIVES ON SEXUAL AND REPRODUCTIVE HEALTH. INT. CL. 16. REG. 5-27-2003.
- 2,719,158. DYMOND. INT. CL. 42. REG. 5-27-2003.
- 2,719,160. BARKITECTURE. INT. CL. 36. REG. 5-27-2003.
- 2,719,170. PROGAIN AND DESIGN. INT. CL. 3. REG. 5-27-2003.
- 2,719,177. MISCELLANEOUS DESIGN. INT. CL. 3. REG. 5-27-2003.
- 2,719,178. PROGAIN AND DESIGN. INT. CL. 3. REG. 5-27-2003.
- 2,719,179. EAST COAST. INT. CL. 42. REG. 5-27-2003.
- 2,719,192. MORTGAGEWIRE. INT. CL. 41. REG. 5-27-2003.
- 2,719,201. YOUR STORAGE IS OUR BUSINESS. INT. CL. 39. REG. 5-27-2003.
- 2,719,215. MISCELLANEOUS DESIGN. INT. CL. 35. REG. 5-27-2003.
- 2,719,236. FACTORY TO FLIGHTLINE LOGISTICS. INT. CL. 35. REG. 5-27-2003.
- 2,719,259. M AFCOMAP AIR FORCE CADET OFFICER MENTOR ACTION PROGRAM AND DESIGN. INT. CLS. 14 AND 41. REG. 5-27-2003.
- 2,719,270. MUSEUM ART COLLECTION MUSEUM REAL AND DESIGN. INT. CL. 33. REG. 5-27-2003.
- 2,719,287. OUR ENERGY IS WORKING FOR YOU. INT. CL. 39. REG. 5-27-2003.
- 2,719,288. AQUARISER. INT. CL. 9. REG. 5-27-2003.
- 2,719,292. CURE. CARE. COMMITMENT. INT. CL. 44. REG. 5-27-2003.
- 2,719,311. YOU DREAM, WE WORK.. INT. CL. 44. REG. 5-27-2003.
- 2,719,312. PADDY O'PUNCH. INT. CL. 33. REG. 5-27-2003.
- 2,719,328. NAVICASE. INT. CL. 9. REG. 5-27-2003.
- 2,719,329. JUST BARLEY. INT. CL. 5. REG. 5-27-2003.
- 2,719,330. YOU NEVER FORGET YOUR FIRST GIRL. INT. CL. 32. REG. 5-27-2003.
- 2,719,336. RAISE THE NATION. INT. CL. 36. REG. 5-27-2003.
- 2,719,342. HT. INT. CL. 16. REG. 5-27-2003.
- 2,719,344. TYLOX. INT. CL. 5. REG. 5-27-2003.
- 2,719,370. OH YEAH!. INT. CL. 41. REG. 5-27-2003.
- 2,719,372. CEL. INT. CL. 35. REG. 5-27-2003.
- 2,719,373. CALIFORNIA EASTERN LABORATORIES. INT. CL. 35. REG. 5-27-2003.
- 2,719,389. LOVE IT LIVE. INT. CL. 35. REG. 5-27-2003.
- 2,719,391. NATURE'S YOUTH. INT. CL. 5. REG. 5-27-2003.
- 2,719,394. ELLIPTEC RESONANT ACTUATOR AND DESIGN. INT. CLS. 7 AND 12. REG. 5-27-2003.
- 2,719,396. GSNINET AND DESIGN. INT. CL. 38. REG. 5-27-2003.
- 2,719,400. PROJECT MANAGEMENT SLIGHTLY OUTSIDE THE BOX. INT. CL. 35. REG. 5-27-2003.
- 2,719,406. THE EMPLOYER'S NETWORK INC.. INT. CL. 35. REG. 5-27-2003.
- 2,719,413. OSTEO PEAK (STYLIZED). INT. CL. 5. REG. 5-27-2003.
- 2,719,416. CONVAQUIP BARIATRIC EQUIPMENT AND DESIGN. INT. CLS. 10 AND 12. REG. 5-27-2003.
- 2,719,422. PC 95. INT. CL. 3. REG. 5-27-2003.
- 2,719,428. KERRABOOT. INT. CLS. 5 AND 10. REG. 5-27-2003.
- 2,719,456. ROCKHOUSE ARTS AND DESIGN. INT. CLS. 16 AND 42. REG. 5-27-2003.
- 2,719,461. STREET LOCUS STREET LOCUS AND DESIGN. INT. CL. 45. REG. 5-27-2003.
- 2,719,465. REVIEW VIDEO AND DESIGN. INT. CL. 38. REG. 5-27-2003.
- 2,719,466. BAILEY FARMS AND DESIGN. INT. CL. 35. REG. 5-27-2003.
- 2,719,479. JATA AND DESIGN. INT. CLS. 41 AND 42. REG. 5-27-2003.
- 2,719,486. AVACOR. INT. CL. 5. REG. 5-27-2003.
- 2,719,491. SERVICEMASTER SITESERVICE. INT. CLS. 37, 44 AND 45. REG. 5-27-2003.
- 2,719,493. KEYWIZARD. INT. CL. 9. REG. 5-27-2003.
- 2,719,511. TRUST THE NETWORK THAT POWERS WALL STREET TO EMPOWER YOUR BUSINESS. INT. CL. 38. REG. 5-27-2003.
- 2,719,517. DORITOS AND DESIGN. INT. CL. 30. REG. 5-27-2003.
- 2,719,518. AGENNIX. INT. CL. 5. REG. 5-27-2003.
- 2,719,523. IMAGEDATA. INT. CLS. 9 AND 16. REG. 5-27-2003.
- 2,719,526. SPEEDBUMP. INT. CLS. 11 AND 40. REG. 5-27-2003.
- 2,719,544. CLEAR COMFORT. INT. CLS. 5 AND 9. REG. 5-27-2003.
- 2,719,552. THE PERFECT COUPLE. INT. CL. 20. REG. 5-27-2003.
- 2,719,564. TRAVEL-MATE. INT. CLS. 12 AND 35. REG. 5-27-2003.
- 2,719,567. NUVEONC. INT. CL. 5. REG. 5-27-2003.
- 2,719,571. CHARIOT. INT. CL. 41. REG. 5-27-2003.
- 2,719,572. COOKIES FOR BREAKFAST. INT. CL. 30. REG. 5-27-2003.
- 2,719,582. AFRO THUNDER. INT. CL. 28. REG. 5-27-2003.
- 2,719,583. GANG GREEN. INT. CL. 25. REG. 5-27-2003.
- 2,719,586. SATELLITE ADVISORS. INT. CL. 36. REG. 5-27-2003.
- 2,719,587. SATELLITE ASSET MANAGEMENT. INT. CL. 36. REG. 5-27-2003.
- 2,719,588. SATELLITE. INT. CL. 36. REG. 5-27-2003.
- 2,719,593. GREAT LAKES PENETRATION. INT. CL. 9. REG. 5-27-2003.
- 2,719,599. PASSWORD. INT. CL. 41. REG. 5-27-2003.
- 2,719,602. FETCH & FLASH. INT. CL. 28. REG. 5-27-2003.
- 2,719,605. INFECTOSTAT. INT. CL. 5. REG. 5-27-2003.
- 2,719,608. ACM (STYLIZED). INT. CL. 36. REG. 5-27-2003.
- 2,719,610. O OPERA SOFTWARE (STYLIZED). INT. CL. 9. REG. 5-27-2003.
- 2,719,615. GRIZZLY. INT. CL. 3. REG. 5-27-2003.
- 2,719,648. PLATEAU. INT. CL. 10. REG. 5-27-2003.
- 2,719,649. EN ROUTE AND DESIGN. INT. CL. 36. REG. 5-27-2003.
- 2,719,655. N COMPASS AND DESIGN. INT. CL. 35. REG. 5-27-2003.
- 2,719,664. REEL.COM. INT. CLS. 35 AND 41. REG. 5-27-2003.
- 2,719,667. COREMETRICS. INT. CL. 35. REG. 5-27-2003.
- 2,719,673. ARCHIPEL. INT. CL. 20. REG. 5-27-2003.
- 2,719,674. ARCHIPEL. INT. CL. 21. REG. 5-27-2003.
- 2,719,676. BLUE GENE. INT. CL. 9. REG. 5-27-2003.
- 2,719,680. LAW CASH.COM. INT. CL. 35. REG. 5-27-2003.
- 2,719,722. MISCELLANEOUS DESIGN. INT. CL. 33. REG. 5-27-2003.

- 2,719,724. OLDE TOWN COLLECTION. INT. CL. 11. REG. 5-27-2003.
- 2,719,731. SHIMMERSILK. INT. CL. 17. REG. 5-27-2003.
- 2,719,738. LLADRO PRIVILEGE (STYLIZED). INT. CL. 35. REG. 5-27-2003.
- 2,719,741. THROWEMABONE.COM. INT. CLS. 35 AND 42. REG. 5-27-2003.
- 2,719,744. ERADICATOR. INT. CL. 28. REG. 5-27-2003.
- 2,719,748. HOMEQ. INT. CL. 36. REG. 5-27-2003.
- 2,719,750. MOVINGINMOVINGOUT.COM. INT. CL. 35. REG. 5-27-2003.
- 2,719,752. HIGH VALUE. DELIVERED.. INT. CLS. 35 AND 39. REG. 5-27-2003.
- 2,719,756. DETONATOR. INT. CL. 9. REG. 5-27-2003.
- 2,719,757. PRINCIPLES INTO PRACTICE. INT. CL. 41. REG. 5-27-2003.
- 2,719,762. AMTRAK AND DESIGN. INT. CL. 12. REG. 5-27-2003.
- 2,719,774. MISCELLANEOUS DESIGN. INT. CL. 16. REG. 5-27-2003.
- 2,719,798. ACTIONBASE. INT. CLS. 35 AND 42. REG. 5-27-2003.
- 2,719,821. VECTRA NETVIEW. INT. CL. 36. REG. 5-27-2003.
- 2,719,822. NETCENTER. INT. CL. 36. REG. 5-27-2003.
- 2,719,841. TOUGH GUY. INT. CL. 14. REG. 5-27-2003.
- 2,719,863. TECHNOMARINE. INT. CL. 35. REG. 5-27-2003.
- 2,719,872. FRACALC. INT. CL. 9. REG. 5-27-2003.
- 2,719,881. VIRTUOSO. INT. CL. 33. REG. 5-27-2003.
- 2,719,884. SAFE AT HOME AND DESIGN. INT. CL. 4. REG. 5-27-2003.
- 2,719,899. DECRATEK. INT. CL. 19. REG. 5-27-2003.
- 2,719,900. O'DONNELL GLOW PLUGS AND DESIGN. INT. CL. 28. REG. 5-27-2003.
- 2,719,903. EXPLORATIONS. INT. CL. 16. REG. 5-27-2003.
- 2,719,920. SNAKE IN THE GRASS. INT. CL. 17. REG. 5-27-2003.
- 2,719,925. AMERICAN HERITAGE. INT. CL. 31. REG. 5-27-2003.
- 2,719,931. 5STAR FREEDOMNOW (STYLIZED). INT. CL. 36. REG. 5-27-2003.
- 2,719,949. FIBERTEC. INT. CL. 9. REG. 5-27-2003.
- 2,719,958. COBB AND DESIGN. INT. CL. 11. REG. 5-27-2003.
- 2,719,960. SHERLOCK WILLIE. INT. CL. 36. REG. 5-27-2003.
- 2,719,962. LINKSPRO. INT. CL. 28. REG. 5-27-2003.
- 2,719,979. CAMBRIDGE EXECUTIVE. INT. CL. 16. REG. 5-27-2003.
- 2,719,983. VISCARIA. INT. CL. 25. REG. 5-27-2003.
- 2,719,985. DERNIER CRI. INT. CL. 35. REG. 5-27-2003.
- 2,719,991. ASTROPAQUE. INT. CL. 16. REG. 5-27-2003.
- 2,719,994. ECONOMICSEXCHANGE. INT. CL. 41. REG. 5-27-2003.
- 2,720,003. HANGTIME. INT. CL. 28. REG. 5-27-2003.
- 2,720,005. RESOURCES COLLECTION. INT. CL. 16. REG. 5-27-2003.
- 2,720,006. CREDENTIALS COLLECTION. INT. CL. 16. REG. 5-27-2003.
- 2,720,029. RAT RODS. INT. CL. 28. REG. 5-27-2003.
- 2,720,033. VERSACLAMP. INT. CL. 10. REG. 5-27-2003.
- 2,720,034. CLS CENTURY 21 LEARNING SYSTEM AND DESIGN. INT. CL. 41. REG. 5-27-2003.
- 2,720,041. GTI SELECT. INT. CL. 35. REG. 5-27-2003.
- 2,720,073. INSTAFRAUD. INT. CL. 36. REG. 5-27-2003.
- 2,720,074. COOL MORNING AIR. INT. CL. 5. REG. 5-27-2003.
- 2,720,075. HYDRATING BOOSTER. INT. CL. 3. REG. 5-27-2003.
- 2,720,091. FLOOR MIRACLE. INT. CLS. 2 AND 3. REG. 5-27-2003.
- 2,720,099. STREAMLITE. INT. CL. 18. REG. 5-27-2003.
- 2,720,103. RAPID RESULTS. INT. CL. 5. REG. 5-27-2003.
- 2,720,104. REYNOLDS VINEYARDS. INT. CL. 33. REG. 5-27-2003.
- 2,720,108. SPRING GARDEN. INT. CL. 3. REG. 5-27-2003.
- 2,720,111. KERRISDALE PARK. INT. CL. 19. REG. 5-27-2003.
- 2,720,115. DESTINATIONS. INT. CL. 19. REG. 5-27-2003.
- 2,720,125. VIEWMAX. INT. CL. 10. REG. 5-27-2003.
- 2,720,131. BREAKTHROUGH LAW. INT. CL. 42. REG. 5-27-2003.
- 2,720,132. GLASSPACK. INT. CL. 7. REG. 5-27-2003.
- 2,720,141. READYRAMP. INT. CL. 12. REG. 5-27-2003.
- 2,720,153. SAVVYGRIP. INT. CL. 21. REG. 5-27-2003.
- 2,720,154. POLYRAD. INT. CL. 9. REG. 5-27-2003.
- 2,720,174. CYBERNOTARIO. INT. CL. 42. REG. 5-27-2003.
- 2,720,182. BROCKMANN. INT. CL. 28. REG. 5-27-2003.
- 2,720,183. INTARSIO ROMANO. INT. CL. 19. REG. 5-27-2003.
- 2,720,185. HOME INTERIOR ACCENTS (STYLIZED). INT. CL. 21. REG. 5-27-2003.
- 2,728,184. D20 MODERN. INT. CLS. 9, 16 AND 28. REG. 6-17-2003.
- 2,729,082. EVERY NATION PRODUCTIONS. INT. CL. 9 ONLY. REG. 6-24-2003.
- 2,729,238. TRAIL'S BEST AND DESIGN. INT. CL. 29. REG. 6-24-2003.
- 2,736,941. TRAXTER. INT. CLS. 12 AND 28. REG. 7-15-2003.
- 2,798,850. SHARPER MINDS. INT. CL. 44 ONLY. REG. 12-23-2003.
- 2,800,244. SECURETEC. INT. CL. 44 ONLY. REG. 12-30-2003.
- 2,801,267. THE PROFESSOR & THE SURVIVOR. INT. CLS. 16 AND 35 ONLY. REG. 12-30-2003.
- 2,802,772. B. KLIBAN. INT. CLS. 30 AND 34 ONLY. REG. 1-6-2004.
- 2,816,035. BEACON ELECTRIC SUPPLY AND DESIGN. INT. CL. 41 ONLY. REG. 2-24-2004.
- 2,819,028. MISCELLANEOUS DESIGN. INT. CLS. 1 AND 9 ONLY. REG. 3-2-2004.
- 2,847,454. ENVAC. INT. CL. 12 ONLY. REG. 6-1-2004.
- 2,849,745. ROPLAN. INT. CL. 7. REG. 6-1-2004.
- 2,901,168. MISCELLANEOUS DESIGN. INT. CL. 18. REG. 11-9-2004.
- 2,912,546. YELLOW ROSE AND DESIGN. INT. CL. 31. REG. 12-21-2004.
- 2,917,274. DISCOVER NEW YORK WITH KITT GARRETT. INT. CLS. 39 AND 41. REG. 1-11-2005.
- 2,923,458. MAGNA-TECH STANDARD CHARACTER MARK. INT. CL. 9. REG. 2-1-2005.
- 2,938,811. EZ-QUIT AND DESIGN. INT. CL. 5. REG. 4-5-2005.
- 3,000,391. REMOTEDYNAMICS TELEMATICS DEFINED AND DESIGN. INT. CL. 9. REG. 9-27-2005.
- 3,005,357. FOOTPAT. INT. CLS. 10 AND 25 ONLY. REG. 10-11-2005.
- 3,066,517. SPDE. INT. CL. 16 ONLY. REG. 3-7-2006.
- 3,225,129. THE STUDENT GLOBAL VILLAGE STANDARD CHARACTER MARK. INT. CL. 41. REG. 4-3-2007.
- 3,245,698. WEB (STYLIZED). INT. CLS. 18 AND 25. REG. 5-29-2007.
- 3,245,699. DPOF. INT. CL. 9. REG. 5-29-2007.
- 3,245,700. KARL STORZ OR-1. INT. CL. 10. REG. 5-29-2007.
- 3,245,703. WORLD STUNT AWARDS AND DESIGN. INT. CLS. 32 AND 42. REG. 5-29-2007.
- 3,245,704. BSA AND DESIGN. INT. CL. 12. REG. 5-29-2007.
- 3,245,706. BELLY BUTTON BUDDIES. INT. CL. 6. REG. 5-29-2007.
- 3,245,708. URBAN MYTH. INT. CLS. 3, 18, 25 AND 35. REG. 5-29-2007.
- 3,245,710. SOURCECORP. INT. CL. 35. REG. 5-29-2007.
- 3,245,712. MARAVILLAS NATURALES. INT. CL. 3. REG. 5-29-2007.
- 3,245,715. FAST SHELL. INT. CL. 7. REG. 5-29-2007.
- 3,245,716. MULTICATH. INT. CL. 10. REG. 5-29-2007.
- 3,245,717. LONASEN. INT. CL. 5. REG. 5-29-2007.
- 3,245,718. DAGUAFLO. INT. CL. 11. REG. 5-29-2007.
- 3,245,719. LIKE IT IS. INT. CL. 41. REG. 5-29-2007.
- 3,245,720. DISCOVERY GALA STANDARD CHARACTER MARK. INT. CLS. 35, 36 AND 41. REG. 5-29-2007.
- 3,245,721. CHILL IT WHEN YOU WANT IT!. INT. CLS. 29 AND 30. REG. 5-29-2007.
- 3,245,723. NO BUDDY. INT. CL. 9. REG. 5-29-2007.
- 3,245,724. ANGI-O'RAD. INT. CL. 10. REG. 5-29-2007.
- 3,245,725. NOVASTAR AND DESIGN. INT. CL. 36. REG. 5-29-2007.

- 3,245,726. WA-2! WATER CO. AND DESIGN. INT. CLS. 11, 35 AND 37. REG. 5-29-2007.
- 3,245,727. BOSTON TABLES POOLTABLES GAMETABLES ACCESSORIES AND DESIGN. INT. CLS. 28 AND 35. REG. 5-29-2007.
- 3,245,730. TERRA TRADITIONS STANDARD CHARACTER MARK. INT. CLS. 16 AND 35. REG. 5-29-2007.
- 3,245,731. TSA TAX SMART CENTERS OF AMERICA AND DESIGN. INT. CL. 41. REG. 5-29-2007.
- 3,245,733. NETPIA STANDARD CHARACTER MARK. INT. CLS. 38 AND 42. REG. 5-29-2007.
- 3,245,734. HYPERLABEL STANDARD CHARACTER MARK. INT. CLS. 6, 7, 9, 16, 21, 35 AND 38. REG. 5-29-2007.
- 3,245,736. FLYJET STANDARD CHARACTER MARK. INT. CL. 39. REG. 5-29-2007.
- 3,245,737. FLYJET AND DESIGN. INT. CL. 39. REG. 5-29-2007.
- 3,245,739. FAMILYCONNECT (STYLIZED). INT. CLS. 38 AND 42. REG. 5-29-2007.
- 3,245,742. BAGSFIRST AND DESIGN. INT. CLS. 16 AND 18. REG. 5-29-2007.
- 3,245,747. GILROY FOODS STANDARD CHARACTER MARK. INT. CLS. 29, 30 AND 31. REG. 5-29-2007.
- 3,245,749. DRAGON SECURITY (STYLIZED). INT. CL. 9. REG. 5-29-2007.
- 3,245,751. CHEYENNE PROFESSIONAL TATTOO EQUIPMENT AND DESIGN. INT. CLS. 2, 8 AND 44. REG. 5-29-2007.
- 3,245,752. THE CAD STORE STANDARD CHARACTER MARK. INT. CL. 42. REG. 5-29-2007.
- 3,245,754. E AND DESIGN. INT. CL. 25. REG. 5-29-2007.
- 3,245,760. BLUE BEETLE STANDARD CHARACTER MARK. INT. CL. 35. REG. 5-29-2007.
- 3,245,761. B-STREAM STANDARD CHARACTER MARK. INT. CLS. 9, 16, 35 AND 42. REG. 5-29-2007.
- 3,245,762. TRANSIT HISPANIC UNIDOS PARA VENCER SOCIETY AND DESIGN. INT. CL. 41. REG. 5-29-2007.
- 3,245,765. COOK OFF CLASSIC STANDARD CHARACTER MARK. INT. CL. 41. REG. 5-29-2007.
- 3,245,767. BLUEPLANETSMART STANDARD CHARACTER MARK. INT. CL. 21. REG. 5-29-2007.
- 3,245,769. SHINING STAR COLLECTION BY ASTRIK STANDARD CHARACTER MARK. INT. CL. 14. REG. 5-29-2007.
- 3,245,773. DOÑA EMILIA'S SOUTH AMERICAN BAR & GRILL STANDARD CHARACTER MARK. INT. CL. 43. REG. 5-29-2007.
- 3,245,774. FINDING YOUR DIRECTION TO LIVING IN HARMONY STANDARD CHARACTER MARK. INT. CLS. 43 AND 44. REG. 5-29-2007.
- 3,245,775. MAINTAIN CAMPAIGN STANDARD CHARACTER MARK. INT. CLS. 43 AND 44. REG. 5-29-2007.
- 3,245,776. PINK COCONUT TANNING BOUTIQUE STANDARD CHARACTER MARK. INT. CL. 44. REG. 5-29-2007.
- 3,245,779. NEOS AND DESIGN. INT. CL. 35. REG. 5-29-2007.
- 3,245,780. 50+ BUILDER STANDARD CHARACTER MARK. INT. CL. 16. REG. 5-29-2007.
- 3,245,782. PRIESSNITZ-BAD AND DESIGN. INT. CLS. 3, 5 AND 44. REG. 5-29-2007.
- 3,245,783. POWER GRIP STANDARD CHARACTER MARK. INT. CL. 9. REG. 5-29-2007.
- 3,245,784. THERMAWORKS STANDARD CHARACTER MARK. INT. CL. 6. REG. 5-29-2007.
- 3,245,792. GREAT PEOPLE, GREAT BOOKS, GREAT RESULTS! STANDARD CHARACTER MARK. INT. CL. 35. REG. 5-29-2007.
- 3,245,793. TIVOFLEX STANDARD CHARACTER MARK. INT. CL. 11. REG. 5-29-2007.
- 3,245,794. BROOKS-HAMEL STANDARD CHARACTER MARK. INT. CL. 13. REG. 5-29-2007.
- 3,245,797. GET THE DELUXE TREATMENT STANDARD CHARACTER MARK. INT. CLS. 6, 19, 37 AND 40. REG. 5-29-2007.
- 3,245,798. H HYPRES AND DESIGN. INT. CLS. 40 AND 42. REG. 5-29-2007.
- 3,245,799. HONG KONG PALACE SEAFOOD RESTAURANT AND DESIGN. INT. CL. 43. REG. 5-29-2007.
- 3,245,801. RASPBERTYNES AND DESIGN. INT. CL. 30. REG. 5-29-2007.
- 3,245,802. MICKMEISTER (STYLIZED). INT. CL. 41. REG. 5-29-2007.
- 3,245,803. AU'SOME FRUIT JUICE STRING FRUIT SNACKS SOUR AND DESIGN. INT. CL. 29. REG. 5-29-2007.
- 3,245,804. HYPERLINK STANDARD CHARACTER MARK. INT. CL. 38. REG. 5-29-2007.
- 3,245,805. UNITED STANDARD CHARACTER MARK. INT. CLS. 35 AND 36. REG. 5-29-2007.
- 3,245,806. ZEN BLUE STANDARD CHARACTER MARK. INT. CL. 25. REG. 5-29-2007.
- 3,245,807. FATEEZ AND DESIGN. INT. CL. 25. REG. 5-29-2007.
- 3,245,808. S SUPERIOR AND DESIGN. INT. CL. 11. REG. 5-29-2007.
- 3,245,809. COLOURVISTA AND DESIGN. INT. CLS. 2 AND 16. REG. 5-29-2007.
- 3,245,812. BESTCLAD STANDARD CHARACTER MARK. INT. CLS. 6 AND 19. REG. 5-29-2007.
- 3,245,813. ECLAD STANDARD CHARACTER MARK. INT. CLS. 6 AND 19. REG. 5-29-2007.
- 3,245,817. LET YOUR FEELINGS TRAVEL AROUND THE WORLD STANDARD CHARACTER MARK. INT. CL. 31. REG. 5-29-2007.
- 3,245,818. ORIGINAL CIN STANDARD CHARACTER MARK. INT. CL. 35. REG. 5-29-2007.
- 3,245,819. ESL MOBILE ACADEMY STANDARD CHARACTER MARK. INT. CL. 41. REG. 5-29-2007.
- 3,245,822. SMART RIBBONS STANDARD CHARACTER MARK. INT. CL. 26. REG. 5-29-2007.
- 3,245,823. BORDERS STANDARD CHARACTER MARK. INT. CL. 41. REG. 5-29-2007.
- 3,245,824. HYDROQUICK STANDARD CHARACTER MARK. INT. CL. 25. REG. 5-29-2007.
- 3,245,825. NSD AND DESIGN. INT. CL. 10. REG. 5-29-2007.
- 3,245,829. SOUTHBAY SPORTSPLEX AND DESIGN. INT. CL. 41. REG. 5-29-2007.
- 3,245,830. AUA AMERICAN UROLOGICAL ASSOCIATION FOUNDATION EDUCATION, RESEARCH, ADVOCACY AND DESIGN. INT. CLS. 35 AND 44. REG. 5-29-2007.
- 3,245,831. SAHAJ (STYLIZED). INT. CL. 43. REG. 5-29-2007.
- 3,245,832. EYE LOVE IT STANDARD CHARACTER MARK. INT. CL. 25. REG. 5-29-2007.
- 3,245,833. THE SURVIVOR GOLF CLASSIC AND DESIGN. INT. CLS. 36 AND 41. REG. 5-29-2007.
- 3,245,834. FITNESS BY PHONE (STYLIZED). INT. CL. 41. REG. 5-29-2007.
- 3,245,836. BRS SERVICES COMPANY COMMERCIAL ROOFING DIVISION STANDARD CHARACTER MARK. INT. CL. 37. REG. 5-29-2007.
- 3,245,837. GGPRESTIGE STANDARD CHARACTER MARK. INT. CLS. 35 AND 36. REG. 5-29-2007.
- 3,245,841. WESTERN OPEN STANDARD CHARACTER MARK. INT. CLS. 16, 36 AND 41. REG. 5-29-2007.
- 3,245,842. T-FLEX STANDARD CHARACTER MARK. INT. CL. 24. REG. 5-29-2007.
- 3,245,845. ITA TAEKWONDO AND DESIGN. INT. CL. 41. REG. 5-29-2007.
- 3,245,847. PURCHASENET STANDARD CHARACTER MARK. INT. CL. 35. REG. 5-29-2007.
- 3,245,848. MICRO HEALTH SOLUTIONS (STYLIZED). INT. CL. 35. REG. 5-29-2007.
- 3,245,850. LIGHTNING STANDARD CHARACTER MARK. INT. CL. 25. REG. 5-29-2007.
- 3,245,851. JAPAN THUNDER STANDARD CHARACTER MARK. INT. CL. 25. REG. 5-29-2007.



- 3,245,855. SUPER-ONE AND DESIGN. INT. CL. 19. REG. 5-29-2007.
- 3,245,856. LEASA AND DESIGN. INT. CLS. 29, 30 AND 31. REG. 5-29-2007.
- 3,245,857. WATER/WHIRL AND DESIGN. INT. CL. 41. REG. 5-29-2007.
- 3,245,858. ENDO STANDARD CHARACTER MARK. INT. CL. 9. REG. 5-29-2007.
- 3,245,859. THE RIGHT CONNECTIONS ARE EVERYTHING STANDARD CHARACTER MARK. INT. CL. 37. REG. 5-29-2007.
- 3,245,860. THE RIGHT CONNECTIONS ARE EVERYTHING STANDARD CHARACTER MARK. INT. CL. 42. REG. 5-29-2007.
- 3,245,862. MISCELLANEOUS DESIGN. INT. CL. 39. REG. 5-29-2007.
- 3,245,865. REMO SHAPERINE AND DESIGN. INT. CL. 15. REG. 5-29-2007.
- 3,245,867. USMILCOM, INC. AND DESIGN. INT. CLS. 6 AND 9. REG. 5-29-2007.
- 3,245,872. KIWI AND DESIGN. INT. CL. 33. REG. 5-29-2007.
- 3,245,873. MOVE THE BALL! STANDARD CHARACTER MARK. INT. CLS. 36 AND 41. REG. 5-29-2007.
- 3,245,874. PRAIRIE VOICE SERVICES AND DESIGN. INT. CLS. 35, 38, 39 AND 41. REG. 5-29-2007.
- 3,245,875. DSA DEBT SETTLEMENT AMERICA START YOUR FUTURE TODAY AND DESIGN. INT. CL. 36. REG. 5-29-2007.
- 3,245,878. FRED HARTEIS STANDARD CHARACTER MARK. INT. CL. 35. REG. 5-29-2007.
- 3,245,884. THE MEMPHIS MAFIA STANDARD CHARACTER MARK. INT. CL. 25. REG. 5-29-2007.
- 3,245,885. GHTC AND DESIGN. INT. CL. 5. REG. 5-29-2007.
- 3,245,886. CELEBRITY-PCF STANDARD CHARACTER MARK. INT. CL. 11. REG. 5-29-2007.
- 3,245,887. AT THE FOREFRONT OF NURSING EXCELLENCE STANDARD CHARACTER MARK. INT. CL. 44. REG. 5-29-2007.
- 3,245,888. "I LOVE YOU EVERY SECOND, OF EVERY MINUTE, OF EVERY HOUR" (STYLIZED). INT. CL. 14. REG. 5-29-2007.
- 3,245,889. S SOUND NUTRITION AND DESIGN. INT. CL. 5. REG. 5-29-2007.
- 3,245,896. BLUE-TOUCH AND DESIGN. INT. CLS. 5 AND 21. REG. 5-29-2007.
- 3,245,897. QUINCY'S BBQ STANDARD CHARACTER MARK. INT. CL. 43. REG. 5-29-2007.
- 3,245,899. OREON STANDARD CHARACTER MARK. INT. CL. 35. REG. 5-29-2007.
- 3,245,902. MAILGARRISON STANDARD CHARACTER MARK. INT. CL. 45. REG. 5-29-2007.
- 3,245,903. CHONDRO-RELIEF STANDARD CHARACTER MARK. INT. CL. 5. REG. 5-29-2007.
- 3,245,904. CHONDRO-RELIEF PLUS STANDARD CHARACTER MARK. INT. CL. 5. REG. 5-29-2007.
- 3,245,905. EASYFIT AND DESIGN. INT. CL. 42. REG. 5-29-2007.
- 3,245,906. MRS. FRIDAY'S SCRATCH RECIPE CRAB CAKES AND DESIGN. INT. CL. 29. REG. 5-29-2007.
- 3,245,909. E7F EAST SEVENTH FILMS (STYLIZED). INT. CL. 9. REG. 5-29-2007.
- 3,245,910. PS PARALEGAL SERVICES USA (STYLIZED). INT. CL. 42. REG. 5-29-2007.
- 3,245,911. NOADAGENCY.COM AND DESIGN. INT. CL. 16. REG. 5-29-2007.
- 3,245,912. LEADERS IN SPACE IMAGERY STANDARD CHARACTER MARK. INT. CL. 16. REG. 5-29-2007.
- 3,245,913. READIVAC (STYLIZED). INT. CLS. 7 AND 21. REG. 5-29-2007.
- 3,245,915. ANNONA STANDARD CHARACTER MARK. INT. CL. 43. REG. 5-29-2007.
- 3,245,917. FUEL RESCUE SAVES FUEL SAVES MONEY SAVES THE ENVIRONMENT R AND DESIGN. INT. CL. 21. REG. 5-29-2007.
- 3,245,918. FUEL RESCUE STANDARD CHARACTER MARK. INT. CL. 21. REG. 5-29-2007.
- 3,245,920. CROC AND DESIGN. INT. CLS. 9 AND 11. REG. 5-29-2007.
- 3,245,922. SONA MEDSPA REVEAL YOUR SELF (STYLIZED). INT. CL. 44. REG. 5-29-2007.
- 3,245,928. MESA TOOL STANDARD CHARACTER MARK. INT. CL. 7. REG. 5-29-2007.
- 3,245,929. LET LOOSE ENTERTAINMENT AND DESIGN. INT. CL. 9. REG. 5-29-2007.
- 3,245,932. DECOY MOTION MASTERS STANDARD CHARACTER MARK. INT. CL. 28. REG. 5-29-2007.
- 3,245,933. EMBRACING GLOBAL WOMEN STANDARD CHARACTER MARK. INT. CL. 41. REG. 5-29-2007.
- 3,245,935. TRAVEL LIBERTY STANDARD CHARACTER MARK. INT. CL. 9. REG. 5-29-2007.
- 3,245,937. AKF SERVICE ORGANIZATION AND DESIGN. INT. CL. 36. REG. 5-29-2007.
- 3,245,940. PERMA-SCROLL STANDARD CHARACTER MARK. INT. CL. 9. REG. 5-29-2007.
- 3,245,941. LIL' EARS STANDARD CHARACTER MARK. INT. CL. 9. REG. 5-29-2007.
- 3,245,942. BIG EARS STANDARD CHARACTER MARK. INT. CL. 9. REG. 5-29-2007.
- 3,245,943. 88TEE'S AND DESIGN. INT. CL. 25. REG. 5-29-2007.
- 3,245,945. GOLD 'N MOIST AND DESIGN. INT. CL. 3. REG. 5-29-2007.
- 3,245,946. BUGOUT STANDARD CHARACTER MARK. INT. CL. 12. REG. 5-29-2007.
- 3,245,952. THE AUTHORITY IN MATERIALS HANDLING STANDARD CHARACTER MARK. INT. CLS. 35 AND 37. REG. 5-29-2007.
- 3,245,955. MAKE IT BEAUTIFUL. MAKE IT WORK. STANDARD CHARACTER MARK. INT. CL. 42. REG. 5-29-2007.
- 3,245,962. JOTARA STANDARD CHARACTER MARK. INT. CL. 5. REG. 5-29-2007.
- 3,245,965. THE CROSS STITCHER AND DESIGN. INT. CL. 16. REG. 5-29-2007.
- 3,245,966. TENNESSEE THE STAGE IS SET FOR YOU AND DESIGN. INT. CL. 35. REG. 5-29-2007.
- 3,245,967. RONJON SURF SHOP (STYLIZED). INT. CL. 32. REG. 5-29-2007.
- 3,245,972. THE VISION ALLIANCE STANDARD CHARACTER MARK. INT. CL. 41. REG. 5-29-2007.
- 3,245,973. THE VISION ALLIANCE STANDARD CHARACTER MARK. INT. CL. 35. REG. 5-29-2007.
- 3,245,974. STAR BUILDERS AND DESIGN. INT. CL. 41. REG. 5-29-2007.
- 3,245,975. STAR BUILDERS STANDARD CHARACTER MARK. INT. CL. 41. REG. 5-29-2007.
- 3,245,976. PRIVACY PROBOT STANDARD CHARACTER MARK. INT. CL. 45. REG. 5-29-2007.
- 3,245,980. SALESVIEW STANDARD CHARACTER MARK. INT. CL. 9. REG. 5-29-2007.
- 3,245,982. EXHAUST-MAG STANDARD CHARACTER MARK. INT. CL. 11. REG. 5-29-2007.
- 3,245,984. LENDINGSPOT STANDARD CHARACTER MARK. INT. CL. 35. REG. 5-29-2007.
- 3,245,985. ARI INSIGHTS (STYLIZED). INT. CL. 41. REG. 5-29-2007.
- 3,245,986. LISTANYTIME.COM STANDARD CHARACTER MARK. INT. CL. 35. REG. 5-29-2007.
- 3,245,999. LITTLE TWIN STARS STANDARD CHARACTER MARK. INT. CL. 26. REG. 5-29-2007.
- 3,246,000. PACIFIC BREW STANDARD CHARACTER MARK. INT. CL. 30. REG. 5-29-2007.
- 3,246,007. RCG ONYX STANDARD CHARACTER MARK. INT. CL. 9. REG. 5-29-2007.
- 3,246,008. MISCELLANEOUS DESIGN. INT. CL. 10. REG. 5-29-2007.
- 3,246,009. MI AND DESIGN. INT. CLS. 35 AND 36. REG. 5-29-2007.
- 3,246,010. MYTONE STANDARD CHARACTER MARK. INT. CL. 2. REG. 5-29-2007.
- 3,246,012. ROMPE STANDARD CHARACTER MARK. INT. CL. 16. REG. 5-29-2007.

- 3,246,014. VERITAS AND DESIGN. INT. CL. 25. REG. 5-29-2007.
- 3,246,015. TIGHTPAC MINIVAC AND DESIGN. INT. CL. 21. REG. 5-29-2007.
- 3,246,022. THE FINANCIAL INTELLIGENCE EXPERIENCE STANDARD CHARACTER MARK. INT. CLS. 9, 36 AND 41. REG. 5-29-2007.
- 3,246,023. CAFE SELECTIONS STANDARD CHARACTER MARK. INT. CL. 30. REG. 5-29-2007.
- 3,246,024. SIMPLE SELECTIONS STANDARD CHARACTER MARK. INT. CL. 30. REG. 5-29-2007.
- 3,246,025. OJ QUENCH CLUB STANDARD CHARACTER MARK. INT. CL. 35. REG. 5-29-2007.
- 3,246,028. THE RIGHT BRAND. THE TOTAL PACKAGE. STANDARD CHARACTER MARK. INT. CL. 37. REG. 5-29-2007.
- 3,246,031. SHARE BEYOND SUNDAY STANDARD CHARACTER MARK. INT. CL. 41. REG. 5-29-2007.
- 3,246,033. MISSION WRAPS AND DESIGN. INT. CL. 30. REG. 5-29-2007.
- 3,246,034. LET YOUR IMAGINATION ROLL! STANDARD CHARACTER MARK. INT. CL. 30. REG. 5-29-2007.
- 3,246,038. THE CAL STANDARD CHARACTER MARK. INT. CLS. 9, 12, 16 AND 35. REG. 5-29-2007.
- 3,246,039. 19 SQUIRTS STANDARD CHARACTER MARK. INT. CL. 41. REG. 5-29-2007.
- 3,246,046. SET IT AND FORGET IT STANDARD CHARACTER MARK. INT. CL. 36. REG. 5-29-2007.
- 3,246,050. PROVIDING WHAT NATURE INTENDED STANDARD CHARACTER MARK. INT. CL. 31. REG. 5-29-2007.
- 3,246,056. KNOWMENOPAUSE.COM STANDARD CHARACTER MARK. INT. CL. 42. REG. 5-29-2007.
- 3,246,058. BUCK CHARGE STANDARD CHARACTER MARK. INT. CL. 5. REG. 5-29-2007.
- 3,246,064. PIXIE PRINCESS STANDARD CHARACTER MARK. INT. CL. 9. REG. 5-29-2007.
- 3,246,065. E-DRC STANDARD CHARACTER MARK. INT. CL. 35. REG. 5-29-2007.
- 3,246,066. GIRLS ON THE GO STANDARD CHARACTER MARK. INT. CL. 28. REG. 5-29-2007.
- 3,246,067. CINE PORTER AND DESIGN. INT. CL. 9. REG. 5-29-2007.
- 3,246,072. ASSISTING HANDS STANDARD CHARACTER MARK. INT. CL. 44. REG. 5-29-2007.
- 3,246,073. TACTICS STANDARD CHARACTER MARK. INT. CL. 10. REG. 5-29-2007.
- 3,246,075. CSR BETWEEN (STYLIZED). INT. CL. 9. REG. 5-29-2007.
- 3,246,076. MONIRA. INT. CL. 5. REG. 5-29-2007.
- 3,246,077. H HEIDI KLUM (STYLIZED). INT. CLS. 9 AND 14. REG. 5-29-2007.
- 3,246,081. EXPRESS EVENT CENTER AND DESIGN. INT. CLS. 41 AND 43. REG. 5-29-2007.
- 3,246,083. AHLI UNITED BANK AND DESIGN. INT. CLS. 9 AND 36. REG. 5-29-2007.
- 3,246,088. DESTINATION HEALTHCARE STAFFING AND DESIGN. INT. CL. 35. REG. 5-29-2007.
- 3,246,093. ANTIOX WITH PROPOLIS. INT. CL. 5. REG. 5-29-2007.
- 3,246,096. AUTOSHELL. INT. CLS. 10 AND 40. REG. 5-29-2007.
- 3,246,097. AUDIO BUG AND DESIGN. INT. CL. 9. REG. 5-29-2007.
- 3,246,099. MY SPACE STANDARD CHARACTER MARK. INT. CL. 20. REG. 5-29-2007.
- 3,246,100. PATRIOT'S CHOICE STANDARD CHARACTER MARK. INT. CL. 29. REG. 5-29-2007.
- 3,246,101. TIGER AIRWAYS STANDARD CHARACTER MARK. INT. CL. 39. REG. 5-29-2007.
- 3,246,104. BANDA ALAMEDA STANDARD CHARACTER MARK. INT. CL. 41. REG. 5-29-2007.
- 3,246,107. JK J & K AND DESIGN. INT. CL. 2. REG. 5-29-2007.
- 3,246,109. AMICA AUTO HOME LIFE INTEGRITY AND DESIGN. INT. CL. 36. REG. 5-29-2007.
- 3,246,111. PROSTAR AND DESIGN. INT. CLS. 18, 25 AND 28. REG. 5-29-2007.
- 3,246,115. PROVERBS 31 MINISTRIES AND DESIGN. INT. CL. 45. REG. 5-29-2007.
- 3,246,118. AMEALPEPTIDE (STYLIZED). INT. CLS. 29, 30 AND 32. REG. 5-29-2007.
- 3,246,120. POST-HASTE STANDARD CHARACTER MARK. INT. CL. 19. REG. 5-29-2007.
- 3,246,123. FUN HAWAII STANDARD CHARACTER MARK. INT. CL. 39. REG. 5-29-2007.
- 3,246,124. ME U RESPECT LOVE THINK OF ALL THINK-OF-ALL.COM AND DESIGN. INT. CL. 41. REG. 5-29-2007.
- 3,246,125. EPITAN STANDARD CHARACTER MARK. INT. CL. 3. REG. 5-29-2007.
- 3,246,126. MOBILE ENTERTAINMENT FORUM AND DESIGN. INT. CL. 38. REG. 5-29-2007.
- 3,246,127. HOUWELING'S CALIFORNIA C. HOUWELING AND DESIGN. INT. CL. 31. REG. 5-29-2007.
- 3,246,130. SUPER CELLOX STANDARD CHARACTER MARK. INT. CLS. 1 AND 9. REG. 5-29-2007.
- 3,246,131. CELLOX STANDARD CHARACTER MARK. INT. CLS. 1 AND 9. REG. 5-29-2007.
- 3,246,134. AVESTA FCW-3D STANDARD CHARACTER MARK. INT. CL. 6. REG. 5-29-2007.
- 3,246,135. FSS I3 (STYLIZED). INT. CLS. 9, 37, 41 AND 42. REG. 5-29-2007.
- 3,246,138. LYNDA REEVES (STYLIZED). INT. CLS. 16, 20, 21, 24 AND 41. REG. 5-29-2007.
- 3,246,139. LOCKJAW AND DESIGN. INT. CL. 6. REG. 5-29-2007.
- 3,246,140. GIUSFREDI STANDARD CHARACTER MARK. INT. CL. 25. REG. 5-29-2007.
- 3,246,144. K AND DESIGN. INT. CLS. 9, 16, 35 AND 41. REG. 5-29-2007.
- 3,246,146. FLUFFWEES STANDARD CHARACTER MARK. INT. CL. 28. REG. 5-29-2007.
- 3,246,148. SON TOURS AND DESIGN. INT. CL. 39. REG. 5-29-2007.
- 3,246,149. MULTIBIONTA STANDARD CHARACTER MARK. INT. CL. 5. REG. 5-29-2007.
- 3,246,151. MISCELLANEOUS DESIGN. INT. CL. 36. REG. 5-29-2007.
- 3,246,153. AMERICAN HEALTHWAYS AND DESIGN. INT. CL. 44. REG. 5-29-2007.
- 3,246,156. FREEDOM ELDERCARE STANDARD CHARACTER MARK. INT. CLS. 35, 41, 43 AND 44. REG. 5-29-2007.
- 3,246,157. MPR STANDARD CHARACTER MARK. INT. CL. 11. REG. 5-29-2007.
- 3,246,158. TASTY SPOON DESSERTS AND DESIGN. INT. CL. 30. REG. 5-29-2007.
- 3,246,159. MISCELLANEOUS DESIGN. INT. CL. 29. REG. 5-29-2007.
- 3,246,160. KING CADILLAC AND DESIGN. INT. CL. 41. REG. 5-29-2007.
- 3,246,162. BANANA BOMBER STANDARD CHARACTER MARK. INT. CL. 30. REG. 5-29-2007.
- 3,246,164. MAGIC ACADEMY STANDARD CHARACTER MARK. INT. CLS. 9 AND 28. REG. 5-29-2007.
- 3,246,165. BANCORP RHODE ISLAND STANDARD CHARACTER MARK. INT. CL. 36. REG. 5-29-2007.
- 3,246,167. PREDATOR DX2 AND DESIGN. INT. CL. 9. REG. 5-29-2007.
- 3,246,174. NAMI DOCKS STANDARD CHARACTER MARK. INT. CL. 6. REG. 5-29-2007.
- 3,246,177. IT'S A STANDARD CHARACTER MARK. INT. CL. 3. REG. 5-29-2007.
- 3,246,178. ROAMER STANDARD CHARACTER MARK. INT. CLS. 9, 16 AND 28. REG. 5-29-2007.
- 3,246,182. MISCELLANEOUS DESIGN. INT. CL. 35. REG. 5-29-2007.
- 3,246,184. STROBER BUILDING SUPPLY STANDARD CHARACTER MARK. INT. CL. 35. REG. 5-29-2007.
- 3,246,185. GRIP POLYESTER STANDARD CHARACTER MARK. INT. CL. 19. REG. 5-29-2007.

- 3,246,186. WUFO 1080 AM YOUR UNITY IN THE COMMUNITY STATION AND DESIGN. INT. CL. 41. REG. 5-29-2007.
- 3,246,187. DONE AT HOME.COM AND DESIGN. INT. CLS. 37 AND 42. REG. 5-29-2007.
- 3,246,188. DONEATHOME.COM STANDARD CHARACTER MARK. INT. CLS. 37 AND 42. REG. 5-29-2007.
- 3,246,190. CEPCA STANDARD CHARACTER MARK. INT. CLS. 7, 9, 10, 11, 38 AND 42. REG. 5-29-2007.
- 3,246,191. FOUNDATION WRESTLING STANDARD CHARACTER MARK. INT. CL. 9. REG. 5-29-2007.
- 3,246,192. SPYDER2 PLUS STANDARD CHARACTER MARK. INT. CL. 9. REG. 5-29-2007.
- 3,246,193. SELOMENT STANDARD CHARACTER MARK. INT. CLS. 16 AND 17. REG. 5-29-2007.
- 3,246,197. JOSE MOURINHO STANDARD CHARACTER MARK. INT. CLS. 3, 9, 14, 18 AND 25. REG. 5-29-2007.
- 3,246,200. ESSAY WRITER STANDARD CHARACTER MARK. INT. CL. 16. REG. 5-29-2007.
- 3,246,202. COMPLETE BEDREADY2GO BY REVMAN AND DESIGN. INT. CL. 24. REG. 5-29-2007.
- 3,246,205. BETTER LEGAL DEPARTMENT PERFORMANCE STANDARD CHARACTER MARK. INT. CLS. 35 AND 42. REG. 5-29-2007.
- 3,246,208. O AND DESIGN. INT. CL. 35. REG. 5-29-2007.
- 3,246,209. BSA BENTONVILLE SOFTWARE ASSOCIATES (STYLIZED). INT. CL. 35. REG. 5-29-2007.
- 3,246,210. FAMILIES OF LIGHT STANDARD CHARACTER MARK. INT. CLS. 41 AND 45. REG. 5-29-2007.
- 3,246,211. FAMILIES OF LIGHT FOUNDATION AND DESIGN. INT. CLS. 41 AND 45. REG. 5-29-2007.
- 3,246,215. VYTAL MC STANDARD CHARACTER MARK. INT. CL. 41. REG. 5-29-2007.
- 3,246,219. FROZENSODAPOPS JONES SODA CO. BOTTLE NOT INCLUDED! AND DESIGN. INT. CL. 30. REG. 5-29-2007.
- 3,246,220. VS AND DESIGN. INT. CL. 9. REG. 5-29-2007.
- 3,246,223. AFLEET ALEX STANDARD CHARACTER MARK. INT. CL. 25. REG. 5-29-2007.
- 3,246,224. MDG BRIDGING CLINICAL SCIENCE AND BIOMEDICAL COMMUNICATIONS AND DESIGN. INT. CLS. 35 AND 41. REG. 5-29-2007.
- 3,246,227. MORE SPACE. MORE TIME. MORE PEACE OF MIND. STANDARD CHARACTER MARK. INT. CL. 35. REG. 5-29-2007.
- 3,246,228. COUNCIL FOR RESPONSIBLE JEWELLERY PRACTICES STANDARD CHARACTER MARK. INT. CL. 14. REG. 5-29-2007.
- 3,246,229. ART OF A WOMAN STANDARD CHARACTER MARK. INT. CLS. 14, 19 AND 25. REG. 5-29-2007.
- 3,246,231. VNO:DIRECT (STYLIZED). INT. CLS. 37, 38 AND 42. REG. 5-29-2007.
- 3,246,233. MISCELLANEOUS DESIGN. INT. CLS. 35 AND 45. REG. 5-29-2007.
- 3,246,235. CONCORDIA IMPACT AND DESIGN. INT. CL. 9. REG. 5-29-2007.
- 3,246,236. TIRA STANDARD CHARACTER MARK. INT. CLS. 9 AND 42. REG. 5-29-2007.
- 3,246,238. JS (STYLIZED). INT. CL. 25. REG. 5-29-2007.
- 3,246,239. SMARTPOCKET STANDARD CHARACTER MARK. INT. CL. 9. REG. 5-29-2007.
- 3,246,241. NPY (STYLIZED). INT. CL. 9. REG. 5-29-2007.
- 3,246,245. MISCELLANEOUS DESIGN. INT. CLS. 35 AND 39. REG. 5-29-2007.
- 3,246,249. MT. CARMEL VINEYARDS STANDARD CHARACTER MARK. INT. CL. 31. REG. 5-29-2007.
- 3,246,251. PARK SUPPLY STANDARD CHARACTER MARK. INT. CL. 35. REG. 5-29-2007.
- 3,246,252. N (STYLIZED). INT. CL. 9. REG. 5-29-2007.
- 3,246,253. NAHP NATIONAL ASSOCIATION OF HISPANIC PUBLICATIONS, INC NATIONAL ASSOCIATION OF AND DESIGN. INT. CL. 35. REG. 5-29-2007.
- 3,246,254. KING'S PAWN STANDARD CHARACTER MARK. INT. CLS. 9, 28 AND 41. REG. 5-29-2007.
- 3,246,255. MOBILFIND STANDARD CHARACTER MARK. INT. CL. 9. REG. 5-29-2007.
- 3,246,256. BARKING GOOD BAKERY GOOD DOGS DESERVE GREAT TREATS! AND DESIGN. INT. CL. 31. REG. 5-29-2007.
- 3,246,257. SCANPAK STANDARD CHARACTER MARK. INT. CL. 9. REG. 5-29-2007.
- 3,246,259. SOAKED IN LUXURY STANDARD CHARACTER MARK. INT. CL. 25. REG. 5-29-2007.
- 3,246,262. PHARMACARE PHARMACY AND DESIGN. INT. CLS. 35 AND 44. REG. 5-29-2007.
- 3,246,269. VYKON AX STANDARD CHARACTER MARK. INT. CL. 9. REG. 5-29-2007.
- 3,246,270. DIRT DEMONS STANDARD CHARACTER MARK. INT. CL. 8. REG. 5-29-2007.
- 3,246,271. MUKISA CIRCLE STANDARD CHARACTER MARK. INT. CL. 21. REG. 5-29-2007.
- 3,246,276. D DIRECT RESPONSE PLUS AND DESIGN. INT. CL. 35. REG. 5-29-2007.
- 3,246,277. HIGHSPEKS STANDARD CHARACTER MARK. INT. CL. 7. REG. 5-29-2007.
- 3,246,278. CLASSIC SUBS & SUDS AND DESIGN. INT. CL. 43. REG. 5-29-2007.
- 3,246,280. GOT FLATS? STANDARD CHARACTER MARK. INT. CL. 12. REG. 5-29-2007.
- 3,246,284. NIGHTFIRE STANDARD CHARACTER MARK. INT. CL. 41. REG. 5-29-2007.
- 3,246,287. EZMAC AND DESIGN. INT. CL. 9. REG. 5-29-2007.
- 3,246,288. G G.S. GELATO GELATO & SORBET AND DESIGN. INT. CL. 30. REG. 5-29-2007.
- 3,246,291. YOUTH SMOKING PREVENTION AND DESIGN. INT. CLS. 16, 35 AND 44. REG. 5-29-2007.
- 3,246,295. NO KISSING AND DESIGN. INT. CL. 16. REG. 5-29-2007.
- 3,246,297. NO MORE "DAM" ICE! STANDARD CHARACTER MARK. INT. CL. 37. REG. 5-29-2007.
- 3,246,298. MAYOR'S ALLIANCE FOR NYC'S ANIMALS STANDARD CHARACTER MARK. INT. CLS. 35 AND 45. REG. 5-29-2007.
- 3,246,300. 6 CARD BATTLE STANDARD CHARACTER MARK. INT. CL. 9. REG. 5-29-2007.
- 3,246,301. G GETECH AND DESIGN. INT. CLS. 9, 16 AND 42. REG. 5-29-2007.
- 3,246,302. ROYAL REMODELING STANDARD CHARACTER MARK. INT. CL. 37. REG. 5-29-2007.
- 3,246,303. WORLD PLAYER STANDARD CHARACTER MARK. INT. CLS. 9 AND 16. REG. 5-29-2007.
- 3,246,304. WILDBLEU STANDARD CHARACTER MARK. INT. CLS. 24 AND 25. REG. 5-29-2007.
- 3,246,307. BARN BURNER TEXES BARBEQUE AND DESIGN. INT. CL. 43. REG. 5-29-2007.
- 3,246,308. SEO KING STANDARD CHARACTER MARK. INT. CL. 35. REG. 5-29-2007.
- 3,246,309. MOVE IT ON OVER STANDARD CHARACTER MARK. INT. CL. 9. REG. 5-29-2007.
- 3,246,312. FIRST AND DESIGN. INT. CLS. 9, 13 AND 37. REG. 5-29-2007.
- 3,246,313. ANKA SYSTEMS, INC. AND DESIGN. INT. CLS. 9 AND 42. REG. 5-29-2007.
- 3,246,314. WEAVER MULTIMEDIA GROUP STANDARD CHARACTER MARK. INT. CLS. 35, 41 AND 42. REG. 5-29-2007.
- 3,246,316. FRUTILANDIA STANDARD CHARACTER MARK. INT. CL. 43. REG. 5-29-2007.
- 3,246,317. BAMBOO BUCKS STANDARD CHARACTER MARK. INT. CLS. 9, 28 AND 41. REG. 5-29-2007.
- 3,246,318. MILLIONAIRE BY 60 STANDARD CHARACTER MARK. INT. CL. 16. REG. 5-29-2007.
- 3,246,319. NETUITIVE SERVICE ANALYZER STANDARD CHARACTER MARK. INT. CL. 9. REG. 5-29-2007.
- 3,246,322. GO TO GURL STANDARD CHARACTER MARK. INT. CL. 45. REG. 5-29-2007.
- 3,246,323. JUNAIR STANDARD CHARACTER MARK. INT. CL. 11. REG. 5-29-2007.

- 3,246,324. C AND DESIGN. INT. CLS. 35, 37, 40, 42 AND 45. REG. 5-29-2007.
- 3,246,325. ADVANTAGE FITNESS PRODUCTS TOP A TEAM AND DESIGN. INT. CL. 35. REG. 5-29-2007.
- 3,246,328. THE IRON AGGREGATE PEOPLE STANDARD CHARACTER MARK. INT. CL. 6. REG. 5-29-2007.
- 3,246,329. MATRIMONEY THE WAY TO GIVE WEDDING CASH. AND DESIGN. INT. CL. 36. REG. 5-29-2007.
- 3,246,331. GLASS CONTOUR AND DESIGN. INT. CL. 9. REG. 5-29-2007.
- 3,246,332. ADELANTE STANDARD CHARACTER MARK. INT. CL. 38. REG. 5-29-2007.
- 3,246,333. MM MEGALOMEDIA AND DESIGN. INT. CL. 41. REG. 5-29-2007.
- 3,246,334. TOADLIFE AND DESIGN. INT. CL. 16. REG. 5-29-2007.
- 3,246,336. THE SEVEN C'S STANDARD CHARACTER MARK. INT. CL. 35. REG. 5-29-2007.
- 3,246,340. POLYMATRIX STANDARD CHARACTER MARK. INT. CL. 9. REG. 5-29-2007.
- 3,246,341. GOLDEN TROPHY STANDARD CHARACTER MARK. INT. CLS. 9, 28 AND 41. REG. 5-29-2007.
- 3,246,342. MONTECITO PROPERTY COMPANY STANDARD CHARACTER MARK. INT. CL. 37. REG. 5-29-2007.
- 3,246,345. SUPERWOMAN AND DESIGN. INT. CL. 36. REG. 5-29-2007.
- 3,246,348. MISCELLANEOUS DESIGN. INT. CL. 41. REG. 5-29-2007.
- 3,246,349. WINDOW IMPROVEMENTS STANDARD CHARACTER MARK. INT. CL. 35. REG. 5-29-2007.
- 3,246,350. SOUL FOCUSED HEALING STANDARD CHARACTER MARK. INT. CL. 41. REG. 5-29-2007.
- 3,246,354. THE PARAGON STANDARD CHARACTER MARK. INT. CL. 25. REG. 5-29-2007.
- 3,246,355. UTTER COMMAND STANDARD CHARACTER MARK. INT. CL. 9. REG. 5-29-2007.
- 3,246,356. MESH SEMICONDUCTOR AND DESIGN. INT. CL. 9. REG. 5-29-2007.
- 3,246,357. PLEATHERON STANDARD CHARACTER MARK. INT. CL. 9. REG. 5-29-2007.
- 3,246,360. RENEW REFINISHING SYSTEMS AND DESIGN. INT. CL. 37. REG. 5-29-2007.
- 3,246,362. DENTAL DIVA STANDARD CHARACTER MARK. INT. CL. 25. REG. 5-29-2007.
- 3,246,363. A ALPHA DRIVING ACADEMY AND DESIGN. INT. CL. 41. REG. 5-29-2007.
- 3,246,364. AUREON LABORATORIES STANDARD CHARACTER MARK. INT. CLS. 35 AND 42. REG. 5-29-2007.
- 3,246,365. ADERANS STANDARD CHARACTER MARK. INT. CL. 44. REG. 5-29-2007.
- 3,246,368. CREDITSYNC STANDARD CHARACTER MARK. INT. CL. 9. REG. 5-29-2007.
- 3,246,369. CITY UNDER FIRE STANDARD CHARACTER MARK. INT. CLS. 9, 16, 28 AND 41. REG. 5-29-2007.
- 3,246,370. LETTER OF CREDIT REPLACEMENT PROGRAM STANDARD CHARACTER MARK. INT. CL. 36. REG. 5-29-2007.
- 3,246,371. CHOCTAW HEALTH PROFESSIONAL SERVICES STANDARD CHARACTER MARK. INT. CL. 35. REG. 5-29-2007.
- 3,246,372. SILVER ICE STANDARD CHARACTER MARK. INT. CLS. 6 AND 40. REG. 5-29-2007.
- 3,246,374. SECUASIC STANDARD CHARACTER MARK. INT. CL. 9. REG. 5-29-2007.
- 3,246,376. SPA BODY HEALTH STANDARD CHARACTER MARK. INT. CL. 5. REG. 5-29-2007.
- 3,246,378. MISCELLANEOUS DESIGN. INT. CL. 18. REG. 5-29-2007.
- 3,246,380. JUNKIN' AND DESIGN. INT. CL. 41. REG. 5-29-2007.
- 3,246,381. SK AND DESIGN. INT. CL. 35. REG. 5-29-2007.
- 3,246,383. ROBOVAULT AND DESIGN. INT. CLS. 36 AND 39. REG. 5-29-2007.
- 3,246,384. AMERICA'S #1 PROTEIN STANDARD CHARACTER MARK. INT. CL. 5. REG. 5-29-2007.
- 3,246,388. PLAYERS & BALLERS UNSTOPPABLE ATHLETE AND DESIGN. INT. CL. 25. REG. 5-29-2007.
- 3,246,391. ARABELLA STANDARD CHARACTER MARK. INT. CLS. 9 AND 42. REG. 5-29-2007.
- 3,246,392. THE H.E.A.L.T.H.E.E. FOUNDATION HELPING EDUCATE ADOLESCENT LIVES THROUGH HEALTHY EATING & EXERCISE CHUB B. BEAR CB FLOPPY FLAMINGO GLORIA GATOR VINNY THE FISH AND DESIGN. INT. CL. 16. REG. 5-29-2007.
- 3,246,393. FINDADOC STANDARD CHARACTER MARK. INT. CLS. 35 AND 44. REG. 5-29-2007.
- 3,246,394. MISCELLANEOUS DESIGN. INT. CL. 36. REG. 5-29-2007.
- 3,246,396. AROCLEAN AND DESIGN. INT. CL. 16. REG. 5-29-2007.
- 3,246,397. OBTAINABLE EXTRAVAGANCE STANDARD CHARACTER MARK. INT. CLS. 14 AND 35. REG. 5-29-2007.
- 3,246,398. WORLD'S MOST ROMANTIC JEWELERS STANDARD CHARACTER MARK. INT. CL. 35. REG. 5-29-2007.
- 3,246,399. V VICTORY MACHINES AND DESIGN. INT. CL. 7. REG. 5-29-2007.
- 3,246,400. HANDI TOTE STANDARD CHARACTER MARK. INT. CL. 12. REG. 5-29-2007.
- 3,246,402. PROVETECH:SD AND DESIGN. INT. CLS. 9, 41 AND 42. REG. 5-29-2007.
- 3,246,404. BALEBOARD STANDARD CHARACTER MARK. INT. CL. 19. REG. 5-29-2007.
- 3,246,405. DJ AWARDS STANDARD CHARACTER MARK. INT. CL. 41. REG. 5-29-2007.
- 3,246,407. EVERCLEAR STANDARD CHARACTER MARK. INT. CL. 11. REG. 5-29-2007.
- 3,246,409. QUAD FROG STANDARD CHARACTER MARK. INT. CL. 16. REG. 5-29-2007.
- 3,246,413. MISCELLANEOUS DESIGN. INT. CL. 14. REG. 5-29-2007.
- 3,246,414. THE VOICE OF THE PATIENT (STYLIZED). INT. CL. 10. REG. 5-29-2007.
- 3,246,415. ZULU ZULU AND DESIGN. INT. CL. 30. REG. 5-29-2007.
- 3,246,416. COPPENRATH & WIESE MASTER GERMAN BAKERS AND DESIGN. INT. CL. 30. REG. 5-29-2007.
- 3,246,417. RAIN TRAX AND DESIGN. INT. CL. 19. REG. 5-29-2007.
- 3,246,418. MASTER GERMAN BAKERS AND DESIGN. INT. CL. 30. REG. 5-29-2007.
- 3,246,419. MISCELLANEOUS DESIGN. INT. CL. 43. REG. 5-29-2007.
- 3,246,420. PROSPERITY MONEY AND DESIGN. INT. CL. 16. REG. 5-29-2007.
- 3,246,421. MADISON'S STANDARD CHARACTER MARK. INT. CL. 30. REG. 5-29-2007.
- 3,246,425. HOUSE OF LOUIS XV STANDARD CHARACTER MARK. INT. CL. 35. REG. 5-29-2007.
- 3,246,426. URBAN EYEWEAR STANDARD CHARACTER MARK. INT. CL. 9. REG. 5-29-2007.
- 3,246,427. FANATICAL SUPPORT IS THE DIFFERENCE AND DESIGN. INT. CLS. 35 AND 42. REG. 5-29-2007.
- 3,246,429. NETNOTES STANDARD CHARACTER MARK. INT. CL. 38. REG. 5-29-2007.
- 3,246,430. LIP RENU STANDARD CHARACTER MARK. INT. CL. 3. REG. 5-29-2007.
- 3,246,431. LIP RENEW STANDARD CHARACTER MARK. INT. CL. 3. REG. 5-29-2007.
- 3,246,433. CHARGE YOUR WATER STANDARD CHARACTER MARK. INT. CL. 32. REG. 5-29-2007.
- 3,246,434. TICKET BUS RED DE BOLETAJE PARA AUTOBÚS AND DESIGN. INT. CL. 35. REG. 5-29-2007.

- 3,246,435. MISCELLANEOUS DESIGN. INT. CLS. 41 AND 45. REG. 5-29-2007.
- 3,246,437. TELEVISION STANDARD CHARACTER MARK. INT. CL. 9. REG. 5-29-2007.
- 3,246,446. THE PLACE TO GO FOR YOUR BUSINESS TO GROW STANDARD CHARACTER MARK. INT. CL. 35. REG. 5-29-2007.
- 3,246,453. START AND DESIGN. INT. CL. 9. REG. 5-29-2007.
- 3,246,454. START AND DESIGN. INT. CL. 9. REG. 5-29-2007.
- 3,246,456. AUGENIX STANDARD CHARACTER MARK. INT. CL. 35. REG. 5-29-2007.
- 3,246,457. DIVIDEND ACHIEVERS STANDARD CHARACTER MARK. INT. CL. 16. REG. 5-29-2007.
- 3,246,458. M MARENZIO AND DESIGN. INT. CL. 25. REG. 5-29-2007.
- 3,246,460. MALLNI AND DESIGN. INT. CLS. 35 AND 42. REG. 5-29-2007.
- 3,246,462. WENDT GALLERY STANDARD CHARACTER MARK. INT. CL. 35. REG. 5-29-2007.
- 3,246,468. THE CAJUN CANDLE FACTORY STANDARD CHARACTER MARK. INT. CL. 4. REG. 5-29-2007.
- 3,246,469. ASKZEEK STANDARD CHARACTER MARK. INT. CL. 42. REG. 5-29-2007.
- 3,246,473. THE TRUTH IMPORTS, INC. STANDARD CHARACTER MARK. INT. CL. 35. REG. 5-29-2007.
- 3,246,474. FRONTRUNNER STANDARD CHARACTER MARK. INT. CL. 7. REG. 5-29-2007.
- 3,246,477. JIGSAW AND DESIGN. INT. CLS. 35 AND 41. REG. 5-29-2007.
- 3,246,478. ESI AND DESIGN. INT. CL. 39. REG. 5-29-2007.
- 3,246,480. MISCELLANEOUS DESIGN. INT. CL. 9. REG. 5-29-2007.
- 3,246,481. MINNESOTA MORNING STANDARD CHARACTER MARK. INT. CL. 9. REG. 5-29-2007.
- 3,246,482. IG AND DESIGN. INT. CL. 35. REG. 5-29-2007.
- 3,246,483. FULL-THICKNESS PPLICATOR STANDARD CHARACTER MARK. INT. CLS. 10 AND 41. REG. 5-29-2007.
- 3,246,485. LATIGA STANDARD CHARACTER MARK. INT. CL. 42. REG. 5-29-2007.
- 3,246,488. HIIC HURRICANE INSURANCE INFORMATION CENTER STANDARD CHARACTER MARK. INT. CL. 36. REG. 5-29-2007.
- 3,246,489. IPROWORKS AND DESIGN. INT. CL. 35. REG. 5-29-2007.
- 3,246,490. CONSTRUCTION CRAFT ACADEMY AND DESIGN. INT. CL. 41. REG. 5-29-2007.
- 3,246,495. RUB STANDARD CHARACTER MARK. INT. CL. 43. REG. 5-29-2007.
- 3,246,498. HURRICANE FORCE V (STYLIZED). INT. CL. 19. REG. 5-29-2007.
- 3,246,500. SCANNER CHANNEL EPLUSTV CHANNEL 7 AND DESIGN. INT. CL. 38. REG. 5-29-2007.
- 3,246,501. H AND DESIGN. INT. CLS. 35, 37, 38, 39, 42, 43 AND 44. REG. 5-29-2007.
- 3,246,502. DISCOVER THE DESERT YOU NEVER KNEW. STANDARD CHARACTER MARK. INT. CL. 35. REG. 5-29-2007.
- 3,246,503. THE DESERT IS A MYTH. STANDARD CHARACTER MARK. INT. CL. 35. REG. 5-29-2007.
- 3,246,504. NEKOFEEDEE STANDARD CHARACTER MARK. INT. CL. 21. REG. 5-29-2007.
- 3,246,507. WEEK IN REVIEW STANDARD CHARACTER MARK. INT. CL. 35. REG. 5-29-2007.
- 3,246,509. PHATASS GLASS STANDARD CHARACTER MARK. INT. CL. 21. REG. 5-29-2007.
- 3,246,512. CITY INN CONTEMPORARY HOTELS AND DESIGN. INT. CL. 43. REG. 5-29-2007.
- 3,246,514. MONEY WELL LENT STANDARD CHARACTER MARK. INT. CL. 36. REG. 5-29-2007.
- 3,246,515. INK INVASION STANDARD CHARACTER MARK. INT. CL. 2. REG. 5-29-2007.
- 3,246,516. CREDIT IS MY FRIEND STANDARD CHARACTER MARK. INT. CL. 36. REG. 5-29-2007.
- 3,246,518. SUGAR'S STANDARD CHARACTER MARK. INT. CL. 43. REG. 5-29-2007.
- 3,246,519. THE AVIATION YEAR STARTS HERE! STANDARD CHARACTER MARK. INT. CLS. 16 AND 41. REG. 5-29-2007.
- 3,246,520. SUN 'N FUN AND DESIGN. INT. CLS. 16, 25 AND 41. REG. 5-29-2007.
- 3,246,521. IS YOUR WORLD FLAT? STANDARD CHARACTER MARK. INT. CL. 42. REG. 5-29-2007.
- 3,246,523. EVERGREEN STANDARD CHARACTER MARK. INT. CL. 36. REG. 5-29-2007.
- 3,246,526. DRILWASTE PERFORMANCE SERVICES INC. STANDARD CHARACTER MARK. INT. CL. 42. REG. 5-29-2007.
- 3,246,528. S SELECT SIGNINGS A NATIONWIDE NOTARY SIGNING SERVICE (STYLIZED). INT. CL. 35. REG. 5-29-2007.
- 3,246,529. AMERICAN ARTISAN SERIES NORTH COAST BREWING COMPANY AND DESIGN. INT. CL. 32. REG. 5-29-2007.
- 3,246,530. EBONO STANDARD CHARACTER MARK. INT. CL. 28. REG. 5-29-2007.
- 3,246,531. ERIP STANDARD CHARACTER MARK. INT. CL. 45. REG. 5-29-2007.
- 3,246,532. TERRAMOTO TWO STANDARD CHARACTER MARK. INT. CL. 21. REG. 5-29-2007.
- 3,246,534. PROFESSOR FUJI'S SUDOKU STANDARD CHARACTER MARK. INT. CL. 9. REG. 5-29-2007.
- 3,246,537. MDVITAMINS AND DESIGN. INT. CLS. 5 AND 44. REG. 5-29-2007.
- 3,246,540. MISCELLANEOUS DESIGN. INT. CLS. 35, 36 AND 43. REG. 5-29-2007.
- 3,246,541. CAPTURED IN CLAY AND DESIGN. INT. CL. 19. REG. 5-29-2007.
- 3,246,543. CHECKTRACK PLUS STANDARD CHARACTER MARK. INT. CLS. 9 AND 42. REG. 5-29-2007.
- 3,246,544. ASP POOL AND SPA CO. (STYLIZED). INT. CL. 37. REG. 5-29-2007.
- 3,246,546. BETTER THAN DEDICATED STANDARD CHARACTER MARK. INT. CL. 42. REG. 5-29-2007.
- 3,246,548. FOCUSFRAME STANDARD CHARACTER MARK. INT. CLS. 35 AND 42. REG. 5-29-2007.
- 3,246,549. "CONCENTRATED EXCELLENCE" STANDARD CHARACTER MARK. INT. CLS. 29 AND 32. REG. 5-29-2007.
- 3,246,550. SANTA FE PLAZA STANDARD CHARACTER MARK. INT. CL. 36. REG. 5-29-2007.
- 3,246,551. TRÉ STELLE STANDARD CHARACTER MARK. INT. CLS. 14 AND 35. REG. 5-29-2007.
- 3,246,558. CANARY STANDARD CHARACTER MARK. INT. CLS. 1 AND 5. REG. 5-29-2007.
- 3,246,559. GLOBALSAN STANDARD CHARACTER MARK. INT. CL. 9. REG. 5-29-2007.
- 3,246,560. "YOURDREAM" TEAM STANDARD CHARACTER MARK. INT. CL. 36. REG. 5-29-2007.
- 3,246,563. RPSEA RESEARCH PARTNERSHIP TO SECURE ENERGY FOR AMERICA AND DESIGN. INT. CL. 35. REG. 5-29-2007.
- 3,246,565. CI RADAR STANDARD CHARACTER MARK. INT. CL. 35. REG. 5-29-2007.
- 3,246,566. DELPHI STANDARD CHARACTER MARK. INT. CL. 29. REG. 5-29-2007.
- 3,246,567. ARTIC ICE SYSTEMS STANDARD CHARACTER MARK. INT. CL. 11. REG. 5-29-2007.
- 3,246,569. SPINOMAX STANDARD CHARACTER MARK. INT. CL. 7. REG. 5-29-2007.
- 3,246,571. BURGUNDY BOWS STANDARD CHARACTER MARK. INT. CL. 31. REG. 5-29-2007.
- 3,246,572. PROFILE STANDARD CHARACTER MARK. INT. CL. 16. REG. 5-29-2007.
- 3,246,573. SUELTALO STANDARD CHARACTER MARK. INT. CL. 36. REG. 5-29-2007.
- 3,246,575. POWERTOOL STANDARD CHARACTER MARK. INT. CL. 8. REG. 5-29-2007.
- 3,246,576. USA EXPRESS SENDA INTERNATIONAL SERVICE AND DESIGN. INT. CL. 39. REG. 5-29-2007.

- 3,246,577. EMPIREA AND DESIGN. INT. CL. 16. REG. 5-29-2007.
- 3,246,578. TIMELESS ARCHITECTURAL REPRODUCTIONS STANDARD CHARACTER MARK. INT. CL. 19. REG. 5-29-2007.
- 3,246,581. A CUT ABOVE PREMIUM BEEF BRAND AND DESIGN. INT. CL. 29. REG. 5-29-2007.
- 3,246,582. NUCELLSYS STANDARD CHARACTER MARK. INT. CLS. 9, 12, 37 AND 42. REG. 5-29-2007.
- 3,246,583. READING, WRITING & RHYTHM THE CHELY WRIGHT FOUNDATION AND DESIGN. INT. CL. 36. REG. 5-29-2007.
- 3,246,584. MYPINK STANDARD CHARACTER MARK. INT. CL. 31. REG. 5-29-2007.
- 3,246,586. FABRIC7 STANDARD CHARACTER MARK. INT. CL. 9. REG. 5-29-2007.
- 3,246,587. Q-VISOR STANDARD CHARACTER MARK. INT. CL. 9. REG. 5-29-2007.
- 3,246,588. INTEL LEAP AHEAD STANDARD CHARACTER MARK. INT. CL. 14. REG. 5-29-2007.
- 3,246,589. CECAFI AND DESIGN. INT. CL. 19. REG. 5-29-2007.
- 3,246,592. QUANTUM AND DESIGN. INT. CL. 14. REG. 5-29-2007.
- 3,246,595. LOYALTYSHARE STANDARD CHARACTER MARK. INT. CL. 35. REG. 5-29-2007.
- 3,246,599. TOUROUS STANDARD CHARACTER MARK. INT. CL. 14. REG. 5-29-2007.
- 3,246,600. MISCELLANEOUS DESIGN. INT. CL. 33. REG. 5-29-2007.
- 3,246,601. CETINA STANDARD CHARACTER MARK. INT. CL. 4. REG. 5-29-2007.
- 3,246,605. RIPS STANDARD CHARACTER MARK. INT. CL. 9. REG. 5-29-2007.
- 3,246,607. WONDERGIRL STANDARD CHARACTER MARK. INT. CL. 41. REG. 5-29-2007.
- 3,246,608. TEAM TIARA STANDARD CHARACTER MARK. INT. CL. 41. REG. 5-29-2007.
- 3,246,609. MOBILE BEAUTY STANDARD CHARACTER MARK. INT. CL. 9. REG. 5-29-2007.
- 3,246,611. MARGARITA MATT STANDARD CHARACTER MARK. INT. CL. 40. REG. 5-29-2007.
- 3,246,621. SCOTT LEIBFRIED STANDARD CHARACTER MARK. INT. CL. 41. REG. 5-29-2007.
- 3,246,622. FAIRY DUST STANDARD CHARACTER MARK. INT. CL. 28. REG. 5-29-2007.
- 3,246,628. MOO JAVA ESPRESSO AND DESIGN. INT. CL. 43. REG. 5-29-2007.
- 3,246,629. RFID ON A DESK STANDARD CHARACTER MARK. INT. CLS. 9 AND 42. REG. 5-29-2007.
- 3,246,632. DUAL DRIVE STANDARD CHARACTER MARK. INT. CL. 7. REG. 5-29-2007.
- 3,246,635. CARBON ALUMINUM ARROW AND DESIGN. INT. CL. 28. REG. 5-29-2007.
- 3,246,637. BOCA JAVA ROASTED ON: AND DESIGN. INT. CL. 30. REG. 5-29-2007.
- 3,246,638. EVO STANDARD CHARACTER MARK. INT. CL. 9. REG. 5-29-2007.
- 3,246,639. C CITRUSOURCE INCORPORATED AND DESIGN. INT. CLS. 31 AND 35. REG. 5-29-2007.
- 3,246,640. HEAVENLY PERKS CAFE STANDARD CHARACTER MARK. INT. CL. 35. REG. 5-29-2007.
- 3,246,642. DOCONCOLOGY STANDARD CHARACTER MARK. INT. CL. 42. REG. 5-29-2007.
- 3,246,643. DYNAMIC VASCULAR ANALYSIS STANDARD CHARACTER MARK. INT. CL. 44. REG. 5-29-2007.
- 3,246,644. VISTAS INTERNATIONAL REALTY, LLC. STANDARD CHARACTER MARK. INT. CL. 36. REG. 5-29-2007.
- 3,246,645. LITTLE SLIPPER PRESS STANDARD CHARACTER MARK. INT. CL. 41. REG. 5-29-2007.
- 3,246,646. TELL ME A STORY. AND DESIGN. INT. CL. 41. REG. 5-29-2007.
- 3,246,647. THE MASTER STANDARD CHARACTER MARK. INT. CL. 16. REG. 5-29-2007.
- 3,246,652. SMREX STANDARD CHARACTER MARK. INT. CL. 44. REG. 5-29-2007.
- 3,246,653. SPORTS INTERNATIONAL AND DESIGN. INT. CL. 5. REG. 5-29-2007.
- 3,246,656. MARKET MAGIC STANDARD CHARACTER MARK. INT. CL. 35. REG. 5-29-2007.
- 3,246,657. FIS MORTGAGE CAMPUS STANDARD CHARACTER MARK. INT. CLS. 36 AND 41. REG. 5-29-2007.
- 3,246,658. B73A AND DESIGN. INT. CL. 6. REG. 5-29-2007.
- 3,246,660. ROAT CORP STANDARD CHARACTER MARK. INT. CL. 42. REG. 5-29-2007.
- 3,246,664. LINGTECH STANDARD CHARACTER MARK. INT. CLS. 9, 16, 35, 41 AND 42. REG. 5-29-2007.
- 3,246,666. H2O EVOLUTION STANDARD CHARACTER MARK. INT. CL. 11. REG. 5-29-2007.
- 3,246,667. AG+ SEEDS AND DESIGN. INT. CL. 31. REG. 5-29-2007.
- 3,246,669. THE FOREXTRADING EXPO AND DESIGN. INT. CLS. 35 AND 41. REG. 5-29-2007.
- 3,246,672. MUDDY CUP COFFEE HOUSE AND DESIGN. INT. CL. 43. REG. 5-29-2007.
- 3,246,673. C THE COLUMBUS MAGAZINE STANDARD CHARACTER MARK. INT. CL. 16. REG. 5-29-2007.
- 3,246,675. AG+ SEEDS STANDARD CHARACTER MARK. INT. CL. 31. REG. 5-29-2007.
- 3,246,676. DIGITAL IMAGER AND DESIGN. INT. CL. 9. REG. 5-29-2007.
- 3,246,678. HIGHER GROUND REALTY STANDARD CHARACTER MARK. INT. CL. 36. REG. 5-29-2007.
- 3,246,681. PALETTE PALS STANDARD CHARACTER MARK. INT. CL. 16. REG. 5-29-2007.
- 3,246,683. CREMA MORAZAN STANDARD CHARACTER MARK. INT. CL. 29. REG. 5-29-2007.
- 3,246,684. LA TIENDONA STANDARD CHARACTER MARK. INT. CL. 29. REG. 5-29-2007.
- 3,246,685. CUPPRINT (STYLIZED). INT. CLS. 1, 5, 10 AND 42. REG. 5-29-2007.
- 3,246,686. PICASSO STANDARD CHARACTER MARK. INT. CL. 9. REG. 5-29-2007.
- 3,246,687. BUYSMART STANDARD CHARACTER MARK. INT. CL. 36. REG. 5-29-2007.
- 3,246,691. WEBCEMETERIES.COM AND DESIGN. INT. CL. 35. REG. 5-29-2007.
- 3,246,692. THE MOST EXCLUSIVE GYM IN THE WORLD... IS YOURS STANDARD CHARACTER MARK. INT. CL. 35. REG. 5-29-2007.
- 3,246,694. SCHEDULECONNECT STANDARD CHARACTER MARK. INT. CL. 35. REG. 5-29-2007.
- 3,246,695. QUALITY ON THE ROLL STANDARD CHARACTER MARK. INT. CL. 40. REG. 5-29-2007.
- 3,246,697. BI-FLEX STANDARD CHARACTER MARK. INT. CLS. 7 AND 12. REG. 5-29-2007.
- 3,246,702. POTTY DOCTOR AND DESIGN. INT. CL. 35. REG. 5-29-2007.
- 3,246,703. GREENS-MATE STANDARD CHARACTER MARK. INT. CL. 28. REG. 5-29-2007.
- 3,246,706. BIODEFENSE STANDARD CHARACTER MARK. INT. CL. 5. REG. 5-29-2007.
- 3,246,707. YOUR GUIDE TO EVERYTHING REAL ESTATE STANDARD CHARACTER MARK. INT. CL. 36. REG. 5-29-2007.
- 3,246,708. GLEAU STANDARD CHARACTER MARK. INT. CL. 5. REG. 5-29-2007.
- 3,246,709. ANDY BIROL'S ARENA WHERE BUSINESS OWNERS GO TO GROW ... AND DESIGN. INT. CL. 35. REG. 5-29-2007.
- 3,246,712. XTRAX STANDARD CHARACTER MARK. INT. CL. 9. REG. 5-29-2007.
- 3,246,713. TANGLAW STANDARD CHARACTER MARK. INT. CL. 35. REG. 5-29-2007.
- 3,246,717. MISCELLANEOUS DESIGN. INT. CLS. 9, 38, 41 AND 45. REG. 5-29-2007.
- 3,246,721. FERRERO TONUS STANDARD CHARACTER MARK. INT. CL. 30. REG. 5-29-2007.
- 3,246,722. WEISEMART AND CO. STANDARD CHARACTER MARK. INT. CL. 35. REG. 5-29-2007.

- 3,246,723. COVERED STANDARD CHARACTER MARK. INT. CL. 25. REG. 5-29-2007.
- 3,246,724. ARE YOU COVERED? STANDARD CHARACTER MARK. INT. CL. 25. REG. 5-29-2007.
- 3,246,727. UN-FUR-GETTABLE STANDARD CHARACTER MARK. INT. CL. 28. REG. 5-29-2007.
- 3,246,728. FRIENDSHIP PACK STANDARD CHARACTER MARK. INT. CL. 28. REG. 5-29-2007.
- 3,246,732. ROCK MY SOUL STANDARD CHARACTER MARK. INT. CL. 41. REG. 5-29-2007.
- 3,246,735. MARATÁ AND DESIGN. INT. CL. 30. REG. 5-29-2007.
- 3,246,737. EDGE MECHANICAL SYSTEMS AND DESIGN. INT. CL. 35. REG. 5-29-2007.
- 3,246,738. REGZA STANDARD CHARACTER MARK. INT. CL. 9. REG. 5-29-2007.
- 3,246,741. NAVILIGHT STANDARD CHARACTER MARK. INT. CL. 9. REG. 5-29-2007.
- 3,246,742. REVERSE CALL NOTES STANDARD CHARACTER MARK. INT. CL. 35. REG. 5-29-2007.
- 3,246,743. BOYS NAMED SUE STANDARD CHARACTER MARK. INT. CL. 41. REG. 5-29-2007.
- 3,246,744. THIS IS MY LIFE STANDARD CHARACTER MARK. INT. CL. 25. REG. 5-29-2007.
- 3,246,745. CLEAR COMMERCIAL LENDING EASY AS RESIDENTIAL STANDARD CHARACTER MARK. INT. CL. 36. REG. 5-29-2007.
- 3,246,746. COMMERCIAL LENDING EASY AS RESIDENTIAL STANDARD CHARACTER MARK. INT. CL. 36. REG. 5-29-2007.
- 3,246,748. V-BAR STANDARD CHARACTER MARK. INT. CL. 42. REG. 5-29-2007.
- 3,246,750. TAG STANDARD CHARACTER MARK. INT. CL. 3. REG. 5-29-2007.
- 3,246,754. ESAVZ (STYLIZED). INT. CL. 35. REG. 5-29-2007.
- 3,246,756. SUNDANCE SERIES STANDARD CHARACTER MARK. INT. CL. 9. REG. 5-29-2007.
- 3,246,760. RED'S WINES & BLUES STANDARD CHARACTER MARK. INT. CL. 43. REG. 5-29-2007.
- 3,246,763. HIGH TEA AND SAVORIES STANDARD CHARACTER MARK. INT. CL. 28. REG. 5-29-2007.
- 3,246,764. CAREER GIRL STANDARD CHARACTER MARK. INT. CL. 28. REG. 5-29-2007.
- 3,246,765. BOB & DOLLY STANDARD CHARACTER MARK. INT. CL. 9. REG. 5-29-2007.
- 3,246,767. DRIVING KNIGHTS STANDARD CHARACTER MARK. INT. CL. 39. REG. 5-29-2007.
- 3,246,772. LILY7 (STYLIZED). INT. CL. 45. REG. 5-29-2007.
- 3,246,773. CITY MITTS STANDARD CHARACTER MARK. INT. CL. 9. REG. 5-29-2007.
- 3,246,775. V AND DESIGN. INT. CL. 35. REG. 5-29-2007.
- 3,246,776. MISCELLANEOUS DESIGN. INT. CL. 35. REG. 5-29-2007.
- 3,246,777. MISCELLANEOUS DESIGN. INT. CL. 35. REG. 5-29-2007.
- 3,246,781. MISCELLANEOUS DESIGN. INT. CL. 35. REG. 5-29-2007.
- 3,246,783. E 320 STANDARD CHARACTER MARK. INT. CL. 12. REG. 5-29-2007.
- 3,246,785. BABE BLVD AND DESIGN. INT. CL. 25. REG. 5-29-2007.
- 3,246,786. W A (STYLIZED). INT. CLS. 35, 37 AND 42. REG. 5-29-2007.
- 3,246,788. ZELPHYA (STYLIZED). INT. CL. 35. REG. 5-29-2007.
- 3,246,789. A LITTLE ZING STANDARD CHARACTER MARK. INT. CL. 30. REG. 5-29-2007.
- 3,246,794. RIGHTWAY REMODELING, LLC. "GETTING THE JOB DONE THE RIGHTWAY" AND DESIGN. INT. CL. 37. REG. 5-29-2007.
- 3,246,795. BROWN BEAR HARDWOOD AND DESIGN. INT. CL. 19. REG. 5-29-2007.
- 3,246,799. THE RIGHT WAY STANDARD CHARACTER MARK. INT. CL. 41. REG. 5-29-2007.
- 3,246,802. CPS STANDARD CHARACTER MARK. INT. CL. 36. REG. 5-29-2007.
- 3,246,806. TEAR IT UP (STYLIZED). INT. CL. 40. REG. 5-29-2007.
- 3,246,807. SMILES OF BEAUTY ENHANCING THE SMILE WITHIN AND DESIGN. INT. CL. 44. REG. 5-29-2007.
- 3,246,809. SERVING CANDY LOVERS SINCE 1927 STANDARD CHARACTER MARK. INT. CL. 35. REG. 5-29-2007.
- 3,246,810. CINE ROBE STANDARD CHARACTER MARK. INT. CL. 25. REG. 5-29-2007.
- 3,246,813. LTC3 TECHNOLOGY RAISING T&D EQUIPMENT CONDITION TESTING TO A HIGHER POWER. AND DESIGN. INT. CL. 17. REG. 5-29-2007.
- 3,246,815. P'CASO STANDARD CHARACTER MARK. INT. CL. 45. REG. 5-29-2007.
- 3,246,816. THROAT NOTE AND DESIGN. INT. CL. 5. REG. 5-29-2007.
- 3,246,819. AXIS OF EVIL COMEDY TOUR STANDARD CHARACTER MARK. INT. CL. 41. REG. 5-29-2007.
- 3,246,820. HORAN HORAN ASSOCIATES, INC. HORAN SECURITIES, INC. AND DESIGN. INT. CLS. 35 AND 36. REG. 5-29-2007.
- 3,246,821. IMPERFECT-(IM-PÛR-FIKT) ADJECTIVE. BEING TOTALLY SATISFIED WITH MY DIFFERENCES ACCORDING TO MY REALISTIC IMAGE OF BEAUTY. IM.PER'FECT.ION. NOUN IM.PER'FECT.LY ADVERB (STYLIZED). INT. CL. 25. REG. 5-29-2007.
- 3,246,822. GATR TECHNOLOGIES STANDARD CHARACTER MARK. INT. CL. 42. REG. 5-29-2007.
- 3,246,826. AMERICAN CLASSIC PIZZERIA CO. THE WAY PIZZAS ARE SUPPOSED TO BE! AND DESIGN. INT. CL. 43. REG. 5-29-2007.
- 3,246,827. KITCHEN DEMOCRACY STANDARD CHARACTER MARK. INT. CL. 35. REG. 5-29-2007.
- 3,246,830. PROCESS EXPO AND DESIGN. INT. CL. 35. REG. 5-29-2007.
- 3,246,832. E-ARENA STANDARD CHARACTER MARK. INT. CL. 9. REG. 5-29-2007.
- 3,246,840. PIERO ITALIAN HISTORY STANDARD CHARACTER MARK. INT. CL. 25. REG. 5-29-2007.
- 3,246,843. COURTSENSE AND DESIGN. INT. CL. 41. REG. 5-29-2007.
- 3,246,844. REEL AMERICAN REEL PERFORMANCE STANDARD CHARACTER MARK. INT. CL. 28. REG. 5-29-2007.
- 3,246,845. LIVING NUTRITION AND DESIGN. INT. CL. 16. REG. 5-29-2007.
- 3,246,846. SILVER SUNRISE STANDARD CHARACTER MARK. INT. CL. 31. REG. 5-29-2007.
- 3,246,849. REAL WORLD MBA STANDARD CHARACTER MARK. INT. CL. 41. REG. 5-29-2007.
- 3,246,850. CARESCIENCE STANDARD CHARACTER MARK. INT. CLS. 42 AND 44. REG. 5-29-2007.
- 3,246,853. RCK AND DESIGN. INT. CL. 25. REG. 5-29-2007.
- 3,246,856. SVARA STANDARD CHARACTER MARK. INT. CL. 41. REG. 5-29-2007.
- 3,246,859. ILL TRILL NEIL STANDARD CHARACTER MARK. INT. CL. 9. REG. 5-29-2007.
- 3,246,862. RICH BITCH (STYLIZED). INT. CL. 25. REG. 5-29-2007.
- 3,246,863. SMURFIT-IMAGE PAC STANDARD CHARACTER MARK. INT. CLS. 16, 40 AND 42. REG. 5-29-2007.
- 3,246,864. Q HEALTH STANDARD CHARACTER MARK. INT. CL. 16. REG. 5-29-2007.
- 3,246,867. ZPAN STANDARD CHARACTER MARK. INT. CL. 9. REG. 5-29-2007.
- 3,246,868. KERPEN STANDARD CHARACTER MARK. INT. CLS. 1, 9, 35, 37, 41 AND 42. REG. 5-29-2007.
- 3,246,870. SMURFIT-IMAGE PAC DISPLAY GROUP STANDARD CHARACTER MARK. INT. CLS. 16, 40 AND 42. REG. 5-29-2007.
- 3,246,871. R R AND DESIGN. INT. CL. 9. REG. 5-29-2007.
- 3,246,872. E-JUNKIE AND DESIGN. INT. CL. 35. REG. 5-29-2007.
- 3,246,873. ADMISSIONS ADVANTAGE STANDARD CHARACTER MARK. INT. CL. 41. REG. 5-29-2007.

- 3,246,874. MASHOOQ STANDARD CHARACTER MARK. INT. CL. 3. REG. 5-29-2007.
- 3,246,878. ACCESSOR STANDARD CHARACTER MARK. INT. CL. 36. REG. 5-29-2007.
- 3,246,879. UAA CLEARINGHOUSE AND DESIGN. INT. CL. 35. REG. 5-29-2007.
- 3,246,880. UNIQUE DIAMOND STANDARD CHARACTER MARK. INT. CL. 26. REG. 5-29-2007.
- 3,246,881. ORILED STANDARD CHARACTER MARK. INT. CLS. 9, 11 AND 42. REG. 5-29-2007.
- 3,246,885. MEDICAL MARTS STANDARD CHARACTER MARK. INT. CL. 44. REG. 5-29-2007.
- 3,246,897. NEUROPLANNING STANDARD CHARACTER MARK. INT. CL. 35. REG. 5-29-2007.
- 3,246,899. REV SERIES 1 AND DESIGN. INT. CL. 9. REG. 5-29-2007.
- 3,246,903. HOUSEINSPECT AND DESIGN. INT. CL. 42. REG. 5-29-2007.
- 3,246,905. MOGUL MOM STANDARD CHARACTER MARK. INT. CL. 16. REG. 5-29-2007.
- 3,246,908. "SELLING DALLAS... AND BEYOND!" STANDARD CHARACTER MARK. INT. CL. 36. REG. 5-29-2007.
- 3,246,909. WHEN AN EXTRAORDINARY HOME COUNTS (STYLIZED). INT. CL. 42. REG. 5-29-2007.
- 3,246,910. TECHNOLOGY OPTIMIZED. STANDARD CHARACTER MARK. INT. CL. 42. REG. 5-29-2007.
- 3,246,911. XL VIDEO AND DESIGN. INT. CLS. 41 AND 42. REG. 5-29-2007.
- 3,246,913. X-SEL AND DESIGN. INT. CL. 20. REG. 5-29-2007.
- 3,246,914. A TIMELESS ORIGINAL... STANDARD CHARACTER MARK. INT. CL. 35. REG. 5-29-2007.
- 3,246,915. ALEXIS SKYE STANDARD CHARACTER MARK. INT. CL. 41. REG. 5-29-2007.
- 3,246,918. HEALTHY WOMEN AND DESIGN. INT. CL. 44. REG. 5-29-2007.
- 3,246,921. COOKING WITH MARIE STANDARD CHARACTER MARK. INT. CL. 41. REG. 5-29-2007.
- 3,246,926. LIVE-KITCHEN.COM STANDARD CHARACTER MARK. INT. CL. 42. REG. 5-29-2007.
- 3,246,928. GRIGIOPERLA AND DESIGN. INT. CLS. 14 AND 18. REG. 5-29-2007.
- 3,246,929. CAPTAIN CROONER STANDARD CHARACTER MARK. INT. CL. 41. REG. 5-29-2007.
- 3,246,932. EBOX STANDARD CHARACTER MARK. INT. CL. 42. REG. 5-29-2007.
- 3,246,934. GREAT TRAVEL DEALS DELIVERED FRESH EVERY DAY STANDARD CHARACTER MARK. INT. CLS. 39, 40 AND 43. REG. 5-29-2007.
- 3,246,936. MISCELLANEOUS DESIGN. INT. CL. 42. REG. 5-29-2007.
- 3,246,937. ALISON NELSON'S CHOCOLATE BAR AND DESIGN. INT. CL. 35. REG. 5-29-2007.
- 3,246,939. KAANGO STANDARD CHARACTER MARK. INT. CL. 35. REG. 5-29-2007.
- 3,246,942. DER DAU AND DESIGN. INT. CL. 25. REG. 5-29-2007.
- 3,246,943. TOWN HALL MEETING STANDARD CHARACTER MARK. INT. CL. 41. REG. 5-29-2007.
- 3,246,945. THE EDEN PROJECTS A DIVISION OF CONTINENTAL NEW LIFE INTERNATIONAL AND DESIGN. INT. CL. 44. REG. 5-29-2007.
- 3,246,946. 15 EXPRESS AND DESIGN. INT. CL. 36. REG. 5-29-2007.
- 3,246,947. BRAND-TIME STANDARD CHARACTER MARK. INT. CL. 35. REG. 5-29-2007.
- 3,246,948. NEXTDAYFUNDING.COM STANDARD CHARACTER MARK. INT. CL. 36. REG. 5-29-2007.
- 3,246,950. ZENTIRA STANDARD CHARACTER MARK. INT. CL. 5. REG. 5-29-2007.
- 3,246,951. SIERRA WEDDINGS SW (STYLIZED). INT. CL. 41. REG. 5-29-2007.
- 3,246,954. MISSION MAKER STANDARD CHARACTER MARK. INT. CL. 16. REG. 5-29-2007.
- 3,246,958. RUSLOC STANDARD CHARACTER MARK. INT. CL. 41. REG. 5-29-2007.
- 3,246,962. FRECUENCIA STANDARD CHARACTER MARK. INT. CL. 41. REG. 5-29-2007.
- 3,246,964. WAITT STANDARD CHARACTER MARK. INT. CL. 14. REG. 5-29-2007.
- 3,246,965. RAW LIVING FOODS STANDARD CHARACTER MARK. INT. CL. 9. REG. 5-29-2007.
- 3,246,966. SOUTHWEST BBQ JACKS STANDARD CHARACTER MARK. INT. CL. 29. REG. 5-29-2007.
- 3,246,969. ABCSEARCH STANDARD CHARACTER MARK. INT. CL. 35. REG. 5-29-2007.
- 3,246,970. TC TECH STANDARD CHARACTER MARK. INT. CLS. 10 AND 16. REG. 5-29-2007.
- 3,246,973. MIND MECHANIC STANDARD CHARACTER MARK. INT. CL. 44. REG. 5-29-2007.
- 3,246,975. THE PENNYROYALS STANDARD CHARACTER MARK. INT. CL. 41. REG. 5-29-2007.
- 3,246,978. SUMMIT STANDARD CHARACTER MARK. INT. CL. 9. REG. 5-29-2007.
- 3,246,979. RUBY-STAR STANDARD CHARACTER MARK. INT. CL. 25. REG. 5-29-2007.
- 3,246,981. DURAMOLD STANDARD CHARACTER MARK. INT. CL. 6. REG. 5-29-2007.
- 3,246,982. DURAMOLD-7 STANDARD CHARACTER MARK. INT. CL. 6. REG. 5-29-2007.
- 3,246,983. ALL NATURAL FLAVORS AND DESIGN. INT. CL. 32. REG. 5-29-2007.
- 3,246,985. ROOTS OF FREEDOM STANDARD CHARACTER MARK. INT. CL. 16. REG. 5-29-2007.
- 3,246,986. SLEEPLEVEL STANDARD CHARACTER MARK. INT. CL. 20. REG. 5-29-2007.
- 3,246,987. ALFRED SUNG STANDARD CHARACTER MARK. INT. CL. 14. REG. 5-29-2007.
- 3,246,988. PASSION & PURPOSE CREATING INSPIRING RELATIONSHIPS AND DESIGN. INT. CL. 44. REG. 5-29-2007.
- 3,246,990. CERTIFIED RESTORATION DRYCLEANING NETWORK AND DESIGN. INT. CL. 35. REG. 5-29-2007.
- 3,246,991. CERTIFIED RESTORATION DRYCLEANING NETWORK AND DESIGN. INT. CL. 37. REG. 5-29-2007.
- 3,247,001. THERMAPOUCH AND DESIGN. INT. CL. 11. REG. 5-29-2007.
- 3,247,005. TEN-CHI KENPO STANDARD CHARACTER MARK. INT. CL. 41. REG. 5-29-2007.
- 3,247,007. NAUGHTY COCO STANDARD CHARACTER MARK. INT. CL. 41. REG. 5-29-2007.
- 3,247,008. COCO'S KITTENS STANDARD CHARACTER MARK. INT. CL. 41. REG. 5-29-2007.
- 3,247,009. MEMBER 1% FOR THE PLANET AND DESIGN. U.S. CL. 200. REG. 5-29-2007.
- 3,247,010. IBOOMERANG TOOLS THAT RETURN A PROFIT AND DESIGN. INT. CL. 42. REG. 5-29-2007.
- 3,247,014. U.S. HOME INSPECTIONS OUR INSPECTORS ARE GOOD LOOKERS AND DESIGN. INT. CL. 42. REG. 5-29-2007.
- 3,247,015. CHICKENWARE.COM AND DESIGN. INT. CL. 9. REG. 5-29-2007.
- 3,247,016. PROMTIME STANDARD CHARACTER MARK. INT. CL. 16. REG. 5-29-2007.
- 3,247,017. GLURIAD STANDARD CHARACTER MARK. INT. CL. 5. REG. 5-29-2007.
- 3,247,018. R AND DESIGN. INT. CL. 25. REG. 5-29-2007.
- 3,247,019. CC CALCOM AND DESIGN. INT. CL. 35. REG. 5-29-2007.
- 3,247,021. FIVE ROSES STANDARD CHARACTER MARK. INT. CL. 30. REG. 5-29-2007.
- 3,247,024. MISCELLANEOUS DESIGN. INT. CL. 30. REG. 5-29-2007.
- 3,247,026. INTAGIO STANDARD CHARACTER MARK. INT. CL. 35. REG. 5-29-2007.
- 3,247,028. RESORT & CASINO PECHANGA AND DESIGN. INT. CLS. 3, 4, 6, 9, 14, 16, 18, 21, 24, 25, 28, 32, 34, 41, 43 AND 44. REG. 5-29-2007.
- 3,247,035. LA VACA LOCA STANDARD CHARACTER MARK. INT. CL. 16. REG. 5-29-2007.
- 3,247,036. LA TRICOGOL STANDARD CHARACTER MARK. INT. CL. 16. REG. 5-29-2007.



- 3,247,037. Q QUADRANT DISTRIBUTION AND DESIGN. INT. CL. 36. REG. 5-29-2007.
- 3,247,038. RJM DENTALADVANTAGE STANDARD CHARACTER MARK. INT. CL. 35. REG. 5-29-2007.
- 3,247,039. RJM DENTALADVANTAGE AND DESIGN. INT. CL. 35. REG. 5-29-2007.
- 3,247,040. GSA STANDARD CHARACTER MARK. INT. CLS. 9 AND 37. REG. 5-29-2007.
- 3,247,042. SPECTRUS STANDARD CHARACTER MARK. INT. CL. 36. REG. 5-29-2007.
- 3,247,044. LOFT FOR LIFE STANDARD CHARACTER MARK. INT. CL. 25. REG. 5-29-2007.
- 3,247,045. MELLOW WALK M AND DESIGN. INT. CLS. 10 AND 25. REG. 5-29-2007.
- 3,247,046. THE LAW FIRM TO TRUST STANDARD CHARACTER MARK. INT. CL. 42. REG. 5-29-2007.
- 3,247,049. GENTLE STAR MED.SPA AND DESIGN. INT. CL. 44. REG. 5-29-2007.
- 3,247,054. SPORTS NY AND DESIGN. INT. CL. 41. REG. 5-29-2007.
- 3,247,055. CHILANGO STANDARD CHARACTER MARK. INT. CL. 16. REG. 5-29-2007.
- 3,247,056. CHILDBUILDERS AND DESIGN. INT. CL. 35. REG. 5-29-2007.
- 3,247,057. EQUITITLE STANDARD CHARACTER MARK. INT. CL. 36. REG. 5-29-2007.
- 3,247,058. MISCELLANEOUS DESIGN. INT. CLS. 30 AND 43. REG. 5-29-2007.
- 3,247,060. MISCELLANEOUS DESIGN. INT. CL. 25. REG. 5-29-2007.
- 3,247,062. IMPROVING THE HEALTH OF HEALTHCARE ENVIRONMENTS STANDARD CHARACTER MARK. INT. CL. 40. REG. 5-29-2007.
- 3,247,063. P PARTNERS GROUP UNLIMITED STANDARD CHARACTER MARK. INT. CL. 36. REG. 5-29-2007.
- 3,247,065. STORE IN STYLE THINKING INSIDE THE BOX AND DESIGN. INT. CL. 18. REG. 5-29-2007.
- 3,247,070. WELCOME TO A NATURAL OPPORTUNITY STANDARD CHARACTER MARK. INT. CL. 35. REG. 5-29-2007.
- 3,247,071. BLINGCHAT STANDARD CHARACTER MARK. INT. CL. 38. REG. 5-29-2007.
- 3,247,075. ASPM STANDARD CHARACTER MARK. INT. CL. 35. REG. 5-29-2007.
- 3,247,078. AMERICUS LOGISTICS, LLC AND DESIGN. INT. CL. 37. REG. 5-29-2007.
- 3,247,079. MANGICO STANDARD CHARACTER MARK. INT. CL. 38. REG. 5-29-2007.
- 3,247,080. MARASHINO STANDARD CHARACTER MARK. INT. CL. 41. REG. 5-29-2007.
- 3,247,081. LUNA LOU :THE SILLY THAT NEVER SLEEPS STANDARD CHARACTER MARK. INT. CL. 24. REG. 5-29-2007.
- 3,247,087. NATURES 1ST AND DESIGN. INT. CL. 29. REG. 5-29-2007.
- 3,247,089. NORDIFLEX PENMATE STANDARD CHARACTER MARK. INT. CL. 10. REG. 5-29-2007.
- 3,247,090. AMERICUS LOGISTICS, LLC AND DESIGN. INT. CL. 45. REG. 5-29-2007.
- 3,247,091. FRESH ELEMENT INNOVATIVE MARKETING CONCEPTS AND DESIGN. INT. CL. 35. REG. 5-29-2007.
- 3,247,095. NABIRAN STANDARD CHARACTER MARK. INT. CL. 40. REG. 5-29-2007.
- 3,247,098. STEAK HOUSE SHRIMP STANDARD CHARACTER MARK. INT. CL. 29. REG. 5-29-2007.
- 3,247,107. M. BAGWELL STANDARD CHARACTER MARK. INT. CLS. 16 AND 21. REG. 5-29-2007.
- 3,247,109. STAPLE ME THIN AND DESIGN. INT. CL. 44. REG. 5-29-2007.
- 3,247,113. PALLADIUM AND DESIGN. INT. CL. 19. REG. 5-29-2007.
- 3,247,114. MISCELLANEOUS DESIGN. INT. CL. 36. REG. 5-29-2007.
- 3,247,115. NEW PASSAGE STANDARD CHARACTER MARK. INT. CL. 35. REG. 5-29-2007.
- 3,247,118. MISCELLANEOUS DESIGN. INT. CL. 10. REG. 5-29-2007.
- 3,247,120. PARTYCHARLIE STANDARD CHARACTER MARK. INT. CLS. 41 AND 43. REG. 5-29-2007.
- 3,247,126. MEGA EVENT PUBLIC REAL ESTATE AUCTION STANDARD CHARACTER MARK. INT. CL. 35. REG. 5-29-2007.
- 3,247,127. MEGA EVENT STANDARD CHARACTER MARK. INT. CL. 35. REG. 5-29-2007.
- 3,247,129. THE HOMEVISION AND DESIGN. INT. CL. 35. REG. 5-29-2007.
- 3,247,132. FOR DIAMOND PERFECT PERFORMANCE STANDARD CHARACTER MARK. INT. CL. 10. REG. 5-29-2007.
- 3,247,134. BROOKS HEALTH AND FITNESS STANDARD CHARACTER MARK. INT. CLS. 41 AND 44. REG. 5-29-2007.
- 3,247,135. BRIAN WASHINGTON ENTERPRISES AND DESIGN. INT. CL. 41. REG. 5-29-2007.
- 3,247,137. TAX ADVANTAGE PERSONNEL STANDARD CHARACTER MARK. INT. CL. 35. REG. 5-29-2007.
- 3,247,138. DEDENBEAR STANDARD CHARACTER MARK. INT. CLS. 9, 11 AND 12. REG. 5-29-2007.
- 3,247,139. PHANTOMPARK STANDARD CHARACTER MARK. INT. CL. 7. REG. 5-29-2007.
- 3,247,140. CALL IT KARMA STANDARD CHARACTER MARK. INT. CL. 41. REG. 5-29-2007.
- 3,247,141. MICRONUTRA STANDARD CHARACTER MARK. INT. CL. 35. REG. 5-29-2007.
- 3,247,142. INDY DOWN FORCE AND DESIGN. INT. CL. 41. REG. 5-29-2007.
- 3,247,143. BPO PLUS STANDARD CHARACTER MARK. INT. CL. 36. REG. 5-29-2007.
- 3,247,149. GBT MOBILE STANDARD CHARACTER MARK. INT. CL. 35. REG. 5-29-2007.
- 3,247,151. NAILING IT. AND DESIGN. INT. CL. 37. REG. 5-29-2007.
- 3,247,153. ENTERTAINMENT LAW INITIATIVE AND DESIGN. INT. CL. 41. REG. 5-29-2007.
- 3,247,159. DIRT DIGGERS MOTORCYCLE CLUB AND DESIGN. INT. CL. 41. REG. 5-29-2007.
- 3,247,160. MY ECO AGENT STANDARD CHARACTER MARK. INT. CL. 36. REG. 5-29-2007.
- 3,247,161. BOARD GRIP WWW.BOARDGRIP.COM AND DESIGN. INT. CLS. 8 AND 16. REG. 5-29-2007.
- 3,247,162. ADDRESSABLE MEDIA AGGREGATION PYRAMID STANDARD CHARACTER MARK. INT. CL. 35. REG. 5-29-2007.
- 3,247,163. SMOOTH WAVE STANDARD CHARACTER MARK. INT. CLS. 3 AND 25. REG. 5-29-2007.
- 3,247,164. SILENT TREATMENT STANDARD CHARACTER MARK. INT. CL. 5. REG. 5-29-2007.
- 3,247,166. CLINIC WITH A HEART AND DESIGN. INT. CL. 44. REG. 5-29-2007.
- 3,247,172. YOU EARNED IT, NOW CLOSE IT STANDARD CHARACTER MARK. INT. CL. 36. REG. 5-29-2007.
- 3,247,174. FUSION STANDARD CHARACTER MARK. INT. CL. 9. REG. 5-29-2007.
- 3,247,178. ACERA STANDARD CHARACTER MARK. INT. CL. 42. REG. 5-29-2007.
- 3,247,179. TOT STOP 4 FAMILIES STANDARD CHARACTER MARK. INT. CL. 43. REG. 5-29-2007.
- 3,247,180. PATMONITOR STANDARD CHARACTER MARK. INT. CL. 9. REG. 5-29-2007.
- 3,247,182. SALSA & SOUL FITNESS AND DESIGN. INT. CL. 41. REG. 5-29-2007.
- 3,247,183. SANIZONE STANDARD CHARACTER MARK. INT. CL. 11. REG. 5-29-2007.
- 3,247,184. HUDSON VALLEY HERO STANDARD CHARACTER MARK. INT. CL. 35. REG. 5-29-2007.
- 3,247,187. TRUTH4SINGLES (STYLIZED). INT. CL. 9. REG. 5-29-2007.
- 3,247,192. DECIDEDLY DIFFERENT STANDARD CHARACTER MARK. INT. CL. 36. REG. 5-29-2007.

- 3,247,193. DON'T INVEST AND FORGET STANDARD CHARACTER MARK. INT. CL. 36. REG. 5-29-2007.
- 3,247,194. SAVING ROCK & ROLL ONE KID AT A TIME STANDARD CHARACTER MARK. INT. CL. 41. REG. 5-29-2007.
- 3,247,195. K TOOL STANDARD CHARACTER MARK. INT. CL. 28. REG. 5-29-2007.
- 3,247,196. K SYSTEM STANDARD CHARACTER MARK. INT. CL. 9. REG. 5-29-2007.
- 3,247,197. RFIDQ STANDARD CHARACTER MARK. INT. CL. 41. REG. 5-29-2007.
- 3,247,199. BEVERLY HILLS SURGICAL INSTITUTE STANDARD CHARACTER MARK. INT. CL. 44. REG. 5-29-2007.
- 3,247,200. THE CELLZONE STANDARD CHARACTER MARK. INT. CLS. 6 AND 35. REG. 5-29-2007.
- 3,247,202. MISCELLANEOUS DESIGN. INT. CL. 21. REG. 5-29-2007.
- 3,247,203. SNOW AND DESIGN. INT. CL. 15. REG. 5-29-2007.
- 3,247,204. ABUNDANT LIFE CREATIVE SERVICES STANDARD CHARACTER MARK. INT. CL. 41. REG. 5-29-2007.
- 3,247,207. POWERSLINGSHOT STANDARD CHARACTER MARK. INT. CL. 28. REG. 5-29-2007.
- 3,247,208. 360 TENTS AND DESIGN. INT. CLS. 22 AND 43. REG. 5-29-2007.
- 3,247,209. P P-SHIFT MORTGAGE SOLUTIONS AND DESIGN. INT. CL. 36. REG. 5-29-2007.
- 3,247,210. CHINA AND DESIGN. INT. CL. 36. REG. 5-29-2007.
- 3,247,211. MISCELLANEOUS DESIGN. INT. CL. 9. REG. 5-29-2007.
- 3,247,212. YOUTH ENTREPRENEURS AND DESIGN. INT. CLS. 36 AND 41. REG. 5-29-2007.
- 3,247,215. FRESH SLICED STANDARD CHARACTER MARK. INT. CL. 1. REG. 5-29-2007.
- 3,247,216. ALL THAT MATTERS OUTDOORS STANDARD CHARACTER MARK. INT. CL. 41. REG. 5-29-2007.
- 3,247,218. BOTTOM LINE HOME STANDARD CHARACTER MARK. INT. CL. 36. REG. 5-29-2007.
- 3,247,227. INCOMM INTERNATIONAL STANDARD CHARACTER MARK. INT. CL. 35. REG. 5-29-2007.
- 3,247,234. CUTE AS A BUTTON BABIES STANDARD CHARACTER MARK. INT. CL. 28. REG. 5-29-2007.
- 3,247,246. MASTERING THE PRINCIPLES OF BUSINESS MANAGEMENT STANDARD CHARACTER MARK. INT. CL. 41. REG. 5-29-2007.
- 3,247,247. MAKING BUSINESS MANAGEMENT A PROFESSION STANDARD CHARACTER MARK. INT. CL. 41. REG. 5-29-2007.
- 3,247,248. I LOVE YOU MIAMI FLA AND DESIGN. INT. CL. 25. REG. 5-29-2007.
- 3,247,249. COMETO.US FINDING WHAT YOU WANT, FAST (STYLIZED). INT. CL. 35. REG. 5-29-2007.
- 3,247,250. TRANSDERMAGIC STANDARD CHARACTER MARK. INT. CL. 5. REG. 5-29-2007.
- 3,247,251. TDI (STYLIZED). INT. CL. 37. REG. 5-29-2007.
- 3,247,252. FREESOFT STANDARD CHARACTER MARK. INT. CL. 42. REG. 5-29-2007.
- 3,247,253. LIBERATE YOUR LEGACY STANDARD CHARACTER MARK. INT. CL. 42. REG. 5-29-2007.
- 3,247,254. KNOWLEDGE LIBERATOR STANDARD CHARACTER MARK. INT. CL. 42. REG. 5-29-2007.
- 3,247,255. CATTMATT STANDARD CHARACTER MARK. INT. CLS. 9 AND 16. REG. 5-29-2007.
- 3,247,256. HITCHED DVOGRAPHY AND DESIGN. INT. CL. 41. REG. 5-29-2007.
- 3,247,258. RISE ABOVE STANDARD CHARACTER MARK. INT. CL. 44. REG. 5-29-2007.
- 3,247,260. FANG 4 ME STANDARD CHARACTER MARK. INT. CL. 25. REG. 5-29-2007.
- 3,247,262. WILDLIFEWORCS DATE PASSPORT CONTROL OFFICER KENYA EMBASSY AND DESIGN. INT. CL. 25. REG. 5-29-2007.
- 3,247,264. AADO ALTERNATIVE AVENUE DESIGNER OPTIONS AND DESIGN. INT. CL. 45. REG. 5-29-2007.
- 3,247,270. CASTAWAY STANDARD CHARACTER MARK. INT. CL. 16. REG. 5-29-2007.
- 3,247,271. PARAGON STANDARD CHARACTER MARK. INT. CL. 7. REG. 5-29-2007.
- 3,247,272. LITEPAY STANDARD CHARACTER MARK. INT. CL. 38. REG. 5-29-2007.
- 3,247,273. MICRO-MARKER STANDARD CHARACTER MARK. INT. CL. 7. REG. 5-29-2007.
- 3,247,274. GAMAX STANDARD CHARACTER MARK. INT. CL. 12. REG. 5-29-2007.
- 3,247,275. EXCEPTIONAL MAGAZINE STANDARD CHARACTER MARK. INT. CL. 41. REG. 5-29-2007.
- 3,247,278. TAKESHI RAMEN STANDARD CHARACTER MARK. INT. CL. 43. REG. 5-29-2007.
- 3,247,280. HFG AND DESIGN. INT. CL. 36. REG. 5-29-2007.
- 3,247,282. T M (STYLIZED). INT. CL. 8. REG. 5-29-2007.
- 3,247,283. ALLIANCE FOR MARRIAGE STANDARD CHARACTER MARK. INT. CL. 35. REG. 5-29-2007.
- 3,247,287. INTEGRITY. INGENUITY. INVALUABLE. STANDARD CHARACTER MARK. INT. CL. 42. REG. 5-29-2007.
- 3,247,289. NAKATOSH STANDARD CHARACTER MARK. INT. CL. 30. REG. 5-29-2007.
- 3,247,290. MIGHTY ONE MUSIC STANDARD CHARACTER MARK. INT. CL. 42. REG. 5-29-2007.
- 3,247,291. ONE SHOT STANDARD CHARACTER MARK. INT. CL. 9. REG. 5-29-2007.
- 3,247,292. EFFORTLESS BEAUTY STANDARD CHARACTER MARK. INT. CL. 11. REG. 5-29-2007.
- 3,247,293. HOLLA AT ME STANDARD CHARACTER MARK. INT. CL. 45. REG. 5-29-2007.
- 3,247,297. WHO U 4? STANDARD CHARACTER MARK. INT. CL. 35. REG. 5-29-2007.
- 3,247,298. MSS STANDARD CHARACTER MARK. INT. CL. 35. REG. 5-29-2007.
- 3,247,299. OPRAH BOUTIQUE STANDARD CHARACTER MARK. INT. CL. 35. REG. 5-29-2007.
- 3,247,304. ON THE WAY TO THE CURE - KOMEN ON THE GO STANDARD CHARACTER MARK. INT. CL. 35. REG. 5-29-2007.
- 3,247,306. JUSTGANO.COM STANDARD CHARACTER MARK. INT. CL. 14. REG. 5-29-2007.
- 3,247,307. LED MINIDISC LIGHT STANDARD CHARACTER MARK. INT. CL. 11. REG. 5-29-2007.
- 3,247,309. GUSHI AND DESIGN. INT. CL. 43. REG. 5-29-2007.
- 3,247,314. LIFE HAPPENS AND DESIGN. INT. CL. 35. REG. 5-29-2007.
- 3,247,316. HUNUH STANDARD CHARACTER MARK. INT. CL. 41. REG. 5-29-2007.
- 3,247,318. THE CAUSE MYTH STANDARD CHARACTER MARK. INT. CLS. 9 AND 41. REG. 5-29-2007.
- 3,247,319. ES INTERACTIVE, LLC STANDARD CHARACTER MARK. INT. CL. 38. REG. 5-29-2007.
- 3,247,321. WE LISTEN, WE RESPOND, WE CARE... WE ARE INGRAM'S NUTRITION CONSULTATIONS... LLC STANDARD CHARACTER MARK. INT. CL. 44. REG. 5-29-2007.
- 3,247,323. LEGALVIEW EVERYTHING LEGAL STANDARD CHARACTER MARK. INT. CLS. 38 AND 42. REG. 5-29-2007.
- 3,247,325. FIRST INTERNET BANK OF INDIANA STANDARD CHARACTER MARK. INT. CL. 36. REG. 5-29-2007.
- 3,247,327. XTREME O'S STANDARD CHARACTER MARK. INT. CL. 29. REG. 5-29-2007.
- 3,247,328. DEJACLICK STANDARD CHARACTER MARK. INT. CL. 9. REG. 5-29-2007.
- 3,247,329. DINNER PLATE STANDARD CHARACTER MARK. INT. CL. 21. REG. 5-29-2007.

- 3,247,332. JAVA GROOVE STANDARD CHARACTER MARK. INT. CL. 30. REG. 5-29-2007.
- 3,247,333. QLSP STANDARD CHARACTER MARK. INT. CL. 38. REG. 5-29-2007.
- 3,247,340. CHUCKERS STANDARD CHARACTER MARK. INT. CL. 28. REG. 5-29-2007.
- 3,247,345. FOX AVENUE STANDARD CHARACTER MARK. INT. CL. 25. REG. 5-29-2007.
- 3,247,347. GLYCOPURE STANDARD CHARACTER MARK. INT. CL. 3. REG. 5-29-2007.
- 3,247,349. SUN WORKS TANNING AND DESIGN. INT. CL. 44. REG. 5-29-2007.
- 3,247,350. TOP TEN GLOBAL STANDARD CHARACTER MARK. INT. CL. 35. REG. 5-29-2007.
- 3,247,351. CHARACTER VICTORY AND DESIGN. INT. CL. 25. REG. 5-29-2007.
- 3,247,352. SENTINEL STANDARD CHARACTER MARK. INT. CL. 9. REG. 5-29-2007.
- 3,247,353. ECCO STANDARD CHARACTER MARK. INT. CLS. 9 AND 42. REG. 5-29-2007.
- 3,247,354. TALKTAG STANDARD CHARACTER MARK. INT. CL. 9. REG. 5-29-2007.
- 3,247,355. THE POWER OF COMMUNITY STANDARD CHARACTER MARK. INT. CL. 36. REG. 5-29-2007.
- 3,247,356. ECOKISS STANDARD CHARACTER MARK. INT. CL. 35. REG. 5-29-2007.
- 3,247,357. FILEMATTERS! STANDARD CHARACTER MARK. INT. CL. 9. REG. 5-29-2007.
- 3,247,358. THE 400 (STYLIZED). INT. CLS. 35 AND 42. REG. 5-29-2007.
- 3,247,361. GENIUS STANDARD CHARACTER MARK. INT. CL. 10. REG. 5-29-2007.
- 3,247,364. TIPSYPY WEAR AND DESIGN. INT. CL. 14. REG. 5-29-2007.
- 3,247,365. S SENIOR SERVE A HANDS ON MISSION EXPERIENCE FOR ADULTS 55+ AND DESIGN. INT. CL. 37. REG. 5-29-2007.
- 3,247,366. CHERISH THE LOVE AND DESIGN. INT. CL. 41. REG. 5-29-2007.
- 3,247,370. WE ARE HERE TO HELP, AND WE CAN! STANDARD CHARACTER MARK. INT. CL. 36. REG. 5-29-2007.
- 3,247,371. FMG STANDARD CHARACTER MARK. INT. CL. 36. REG. 5-29-2007.
- 3,247,372. S SERVE 365 SERVE365 AND DESIGN. INT. CL. 37. REG. 5-29-2007.
- 3,247,374. RCB STANDARD CHARACTER MARK. INT. CL. 35. REG. 5-29-2007.
- 3,247,379. TEACH ONE . . . REACH MANY STANDARD CHARACTER MARK. INT. CLS. 41 AND 44. REG. 5-29-2007.
- 3,247,382. LOOK GREAT IN ANYTHING YOU WEAR STANDARD CHARACTER MARK. INT. CL. 25. REG. 5-29-2007.
- 3,247,383. LAVAND DISTRACTION BRA STANDARD CHARACTER MARK. INT. CL. 25. REG. 5-29-2007.
- 3,247,384. RE-ENERGIZE AMERICA STANDARD CHARACTER MARK. INT. CL. 35. REG. 5-29-2007.
- 3,247,385. CORTEX NETWORK MANAGEMENT PORTAL STANDARD CHARACTER MARK. INT. CL. 42. REG. 5-29-2007.
- 3,247,389. RACINGONE (STYLIZED). INT. CL. 41. REG. 5-29-2007.
- 3,247,391. ELEMENTS OF STYLE STANDARD CHARACTER MARK. INT. CL. 20. REG. 5-29-2007.
- 3,247,393. THE MERCHANTISER NEWSPAPERS "ADVERTISING NEWS CONSUMERS USE" AND DESIGN. INT. CL. 16. REG. 5-29-2007.
- 3,247,395. OPENKINGDOM STANDARD CHARACTER MARK. INT. CL. 9. REG. 5-29-2007.
- 3,247,400. WAZOO STANDARD CHARACTER MARK. INT. CLS. 35 AND 42. REG. 5-29-2007.
- 3,247,401. BLURI STANDARD CHARACTER MARK. INT. CL. 41. REG. 5-29-2007.
- 3,247,405. EVOMAIL STANDARD CHARACTER MARK. INT. CL. 35. REG. 5-29-2007.
- 3,247,407. CAL VADA AND DESIGN. INT. CL. 42. REG. 5-29-2007.
- 3,247,408. MONKEY DO STANDARD CHARACTER MARK. INT. CL. 41. REG. 5-29-2007.
- 3,247,409. AE A P E X ENDODONTICS AND DESIGN. INT. CL. 44. REG. 5-29-2007.
- 3,247,410. BIG PAW DESIGNS AND DESIGN. INT. CLS. 9, 14, 18 AND 35. REG. 5-29-2007.
- 3,247,411. WEAVENEER STANDARD CHARACTER MARK. INT. CL. 19. REG. 5-29-2007.
- 3,247,412. DI ZENO STANDARD CHARACTER MARK. INT. CL. 33. REG. 5-29-2007.
- 3,247,416. PROTECTOR PLUS STANDARD CHARACTER MARK. INT. CL. 19. REG. 5-29-2007.
- 3,247,417. ALLSTATES TOTALHIRE STANDARD CHARACTER MARK. INT. CL. 35. REG. 5-29-2007.
- 3,247,419. YIELDQUEST SELECT STANDARD CHARACTER MARK. INT. CL. 36. REG. 5-29-2007.
- 3,247,420. MARKHURD STANDARD CHARACTER MARK. INT. CL. 42. REG. 5-29-2007.
- 3,247,421. AEROMAP U.S. STANDARD CHARACTER MARK. INT. CL. 42. REG. 5-29-2007.
- 3,247,423. THE BRIDE & BLOOM STANDARD CHARACTER MARK. INT. CL. 16. REG. 5-29-2007.
- 3,247,427. B-TRAIN FILMS STANDARD CHARACTER MARK. INT. CL. 41. REG. 5-29-2007.
- 3,247,428. FULAIS STANDARD CHARACTER MARK. INT. CLS. 20 AND 21. REG. 5-29-2007.
- 3,247,432. CONNECTIONSNEWS.NET STANDARD CHARACTER MARK. INT. CL. 35. REG. 5-29-2007.
- 3,247,434. THE BONBONERIE FINE PASTRIES AND DESIGN. INT. CL. 35. REG. 5-29-2007.
- 3,247,435. MISCELLANEOUS DESIGN. INT. CLS. 20 AND 21. REG. 5-29-2007.
- 3,247,436. PUREFUN AND DESIGN. INT. CL. 28. REG. 5-29-2007.
- 3,247,437. TRAGICAL BEAST STANDARD CHARACTER MARK. INT. CL. 25. REG. 5-29-2007.
- 3,247,438. MISCELLANEOUS DESIGN. INT. CLS. 20 AND 21. REG. 5-29-2007.
- 3,247,442. CAPS STANDARD CHARACTER MARK. INT. CL. 9. REG. 5-29-2007.
- 3,247,444. WORLDWIDESAVERS.COM STANDARD CHARACTER MARK. INT. CL. 36. REG. 5-29-2007.
- 3,247,446. MOVE IT OUT AND DESIGN. INT. CL. 35. REG. 5-29-2007.
- 3,247,447. ORGANIC EXPRESSIONS STANDARD CHARACTER MARK. INT. CL. 3. REG. 5-29-2007.
- 3,247,450. OPERA HOUSE CASINO (STYLIZED). INT. CL. 41. REG. 5-29-2007.
- 3,247,451. EVOBOX STANDARD CHARACTER MARK. INT. CL. 35. REG. 5-29-2007.
- 3,247,452. PURE SOURCE AND DESIGN. INT. CL. 42. REG. 5-29-2007.
- 3,247,456. TERZA VOLTA AND DESIGN. INT. CL. 33. REG. 5-29-2007.
- 3,247,457. SOCALI SAUCES SOOO GOOD! AND DESIGN. INT. CL. 30. REG. 5-29-2007.
- 3,247,458. ALTBUILD STANDARD CHARACTER MARK. INT. CL. 35. REG. 5-29-2007.
- 3,247,459. PURSESHERPA STANDARD CHARACTER MARK. INT. CL. 18. REG. 5-29-2007.
- 3,247,460. KRYNOL STANDARD CHARACTER MARK. INT. CL. 17. REG. 5-29-2007.
- 3,247,461. K AND DESIGN. INT. CL. 9. REG. 5-29-2007.
- 3,247,462. HYH GUIDED DISCOVERY AND DESIGN. INT. CL. 41. REG. 5-29-2007.
- 3,247,465. HOLLOW POINT STANDARD CHARACTER MARK. INT. CL. 32. REG. 5-29-2007.
- 3,247,467. BENBEN STANDARD CHARACTER MARK. INT. CL. 16. REG. 5-29-2007.
- 3,247,468. Q.PRICER STANDARD CHARACTER MARK. INT. CL. 35. REG. 5-29-2007.
- 3,247,469. PUNCHWHO.COM STANDARD CHARACTER MARK. INT. CL. 35. REG. 5-29-2007.
- 3,247,470. JOOLAY STANDARD CHARACTER MARK. INT. CL. 24. REG. 5-29-2007.

- 3,247,473. THE WAY IT'S MEANT TO BE STANDARD CHARACTER MARK. INT. CL. 14. REG. 5-29-2007.
- 3,247,475. SHINJITE DESIGN STANDARD CHARACTER MARK. INT. CL. 42. REG. 5-29-2007.
- 3,247,481. P PONIARD (STYLIZED). INT. CL. 42. REG. 5-29-2007.
- 3,247,485. WWW.SHORTOFBREATHGETTESTED.ORG STANDARD CHARACTER MARK. INT. CL. 44. REG. 5-29-2007.
- 3,247,486. WWW.SHORTOFBREATHGETTESTED.ORG AIRWARENESS AND DESIGN. INT. CL. 44. REG. 5-29-2007.
- 3,247,487. P (STYLIZED). INT. CL. 42. REG. 5-29-2007.
- 3,247,488. PONIARD STANDARD CHARACTER MARK. INT. CL. 42. REG. 5-29-2007.
- 3,247,489. HOLLINK STANDARD CHARACTER MARK. INT. CL. 37. REG. 5-29-2007.
- 3,247,491. Y X (STYLIZED). INT. CLS. 9, 37, 40 AND 42. REG. 5-29-2007.
- 3,247,492. THE POINT THAT MATTERS STANDARD CHARACTER MARK. INT. CL. 35. REG. 5-29-2007.
- 3,247,494. KG AND DESIGN. INT. CL. 34. REG. 5-29-2007.
- 3,247,496. "WE REMOVE YOUR DENT...NOT YOUR FINISH!" STANDARD CHARACTER MARK. INT. CL. 37. REG. 5-29-2007.
- 3,247,497. K KERANA AND DESIGN. INT. CL. 33. REG. 5-29-2007.
- 3,247,503. SENDERO STANDARD CHARACTER MARK. INT. CL. 41. REG. 5-29-2007.
- 3,247,509. SABATHINI STANDARD CHARACTER MARK. INT. CL. 33. REG. 5-29-2007.
- 3,247,511. HEADSUP ICPM AND DESIGN. INT. CL. 42. REG. 5-29-2007.
- 3,247,512. DECORATE ON DEMAND STANDARD CHARACTER MARK. INT. CL. 35. REG. 5-29-2007.
- 3,247,513. THE REALLY WOOLLYS STANDARD CHARACTER MARK. INT. CL. 9. REG. 5-29-2007.
- 3,247,514. STRATEGYEDU STANDARD CHARACTER MARK. INT. CL. 41. REG. 5-29-2007.
- 3,247,515. SILVERNETTE STANDARD CHARACTER MARK. INT. CL. 10. REG. 5-29-2007.
- 3,247,516. SPOTTED CHICKEN STANDARD CHARACTER MARK. INT. CL. 16. REG. 5-29-2007.
- 3,247,517. MISCELLANEOUS DESIGN. INT. CL. 44. REG. 5-29-2007.
- 3,247,521. UNFADEABLE STANDARD CHARACTER MARK. INT. CL. 3. REG. 5-29-2007.
- 3,247,523. PASSPORT-2-PROPERTY STANDARD CHARACTER MARK. INT. CL. 36. REG. 5-29-2007.
- 3,247,527. BIG BUBBA'S BAD BBQ STANDARD CHARACTER MARK. INT. CLS. 25, 30 AND 43. REG. 5-29-2007.
- 3,247,533. STAGELEFT DESIGNS STANDARD CHARACTER MARK. INT. CL. 42. REG. 5-29-2007.
- 3,247,534. ALLCARDS (STYLIZED). INT. CL. 9. REG. 5-29-2007.
- 3,247,535. THOMASTECH CONNECT STANDARD CHARACTER MARK. INT. CL. 41. REG. 5-29-2007.
- 3,247,538. WE CLICK STANDARD CHARACTER MARK. INT. CL. 41. REG. 5-29-2007.
- 3,247,539. BUZZMEISTER STANDARD CHARACTER MARK. INT. CL. 25. REG. 5-29-2007.
- 3,247,542. FX.PHP STANDARD CHARACTER MARK. INT. CL. 9. REG. 5-29-2007.
- 3,247,550. EAST KING & EAST QUEEN STANDARD CHARACTER MARK. INT. CL. 39. REG. 5-29-2007.
- 3,247,551. MEDIAROLOGIST STANDARD CHARACTER MARK. INT. CL. 9. REG. 5-29-2007.
- 3,247,553. MISCELLANEOUS DESIGN. INT. CLS. 36 AND 41. REG. 5-29-2007.
- 3,247,554. TRUE COACHING CENTER STANDARD CHARACTER MARK. INT. CL. 41. REG. 5-29-2007.
- 3,247,555. MODELING TO DERIVE INSIGHTS...INSIGHTS TO DRIVE BUSINESS STANDARD CHARACTER MARK. INT. CL. 9. REG. 5-29-2007.
- 3,247,556. BECAUSE HALF IS BELOW AVERAGE STANDARD CHARACTER MARK. INT. CL. 9. REG. 5-29-2007.
- 3,247,557. I-SERV STANDARD CHARACTER MARK. INT. CL. 36. REG. 5-29-2007.
- 3,247,558. PEOPLE NOT PAPER STANDARD CHARACTER MARK. INT. CL. 35. REG. 5-29-2007.
- 3,247,559. BEYOND "WHAT IS" TO "WHAT IF" STANDARD CHARACTER MARK. INT. CL. 9. REG. 5-29-2007.
- 3,247,561. DREAM WEAVER STANDARD CHARACTER MARK. INT. CL. 5. REG. 5-29-2007.
- 3,247,562. SLEEP WALKER STANDARD CHARACTER MARK. INT. CL. 5. REG. 5-29-2007.
- 3,247,563. SIMCHA LAYELED STANDARD CHARACTER MARK. INT. CL. 44. REG. 5-29-2007.
- 3,247,565. EMPOWERING THE USER STANDARD CHARACTER MARK. INT. CL. 9. REG. 5-29-2007.
- 3,247,566. LAafa STANDARD CHARACTER MARK. INT. CL. 41. REG. 5-29-2007.
- 3,247,568. SONIAS PATTIES, INC. AND DESIGN. INT. CL. 30. REG. 5-29-2007.
- 3,247,569. CASAQ STANDARD CHARACTER MARK. INT. CL. 35. REG. 5-29-2007.
- 3,247,570. INDY PRO SERIES AND DESIGN. INT. CL. 41. REG. 5-29-2007.
- 3,247,572. PIVOTAL THOUGHTS STANDARD CHARACTER MARK. INT. CL. 16. REG. 5-29-2007.
- 3,247,574. MAKE YOUR ESCAPE STANDARD CHARACTER MARK. INT. CL. 43. REG. 5-29-2007.
- 3,247,575. LEAVING A LEGACY STANDARD CHARACTER MARK. INT. CL. 37. REG. 5-29-2007.
- 3,247,576. MARAVELLAS STANDARD CHARACTER MARK. INT. CL. 30. REG. 5-29-2007.
- 3,247,577. MONSTERSWISS.COM STANDARD CHARACTER MARK. INT. CL. 35. REG. 5-29-2007.
- 3,247,578. BECAUSE WHEN IT'S TIME TO GIVE BABY THE WORLD . . . IT'S TIME FOR BABIES "R" US STANDARD CHARACTER MARK. INT. CL. 35. REG. 5-29-2007.
- 3,247,580. MAINTENANCE IN MOTION AND DESIGN. INT. CL. 37. REG. 5-29-2007.
- 3,247,582. HYPERNIL STANDARD CHARACTER MARK. INT. CL. 5. REG. 5-29-2007.
- 3,247,584. HOMESURANCE STANDARD CHARACTER MARK. INT. CL. 35. REG. 5-29-2007.
- 3,247,588. DYN-O-COAT STANDARD CHARACTER MARK. INT. CL. 1. REG. 5-29-2007.
- 3,247,592. YOU WANT IT, YOU GOT IT. STANDARD CHARACTER MARK. INT. CL. 35. REG. 5-29-2007.
- 3,247,593. YOU DON'T NEED A DIAMOND TO BUY REAL ESTATE STANDARD CHARACTER MARK. INT. CL. 36. REG. 5-29-2007.
- 3,247,594. FIDO & FLUFFY AND DESIGN. INT. CL. 20. REG. 5-29-2007.
- 3,247,596. BEAUTY WITH INTEGRITY STANDARD CHARACTER MARK. INT. CL. 44. REG. 5-29-2007.
- 3,247,599. AF SERVICES, INC. STANDARD CHARACTER MARK. INT. CL. 45. REG. 5-29-2007.
- 3,247,600. THREE'S A PAIR STANDARD CHARACTER MARK. INT. CL. 15. REG. 5-29-2007.
- 3,247,601. IT'S A GIRL THING STANDARD CHARACTER MARK. INT. CL. 28. REG. 5-29-2007.
- 3,247,605. CALVADA STANDARD CHARACTER MARK. INT. CL. 42. REG. 5-29-2007.
- 3,247,606. U PHIT AND DESIGN. INT. CL. 25. REG. 5-29-2007.
- 3,247,607. LAVISH LIVING STANDARD CHARACTER MARK. INT. CL. 38. REG. 5-29-2007.
- 3,247,608. 1871-P2 STANDARD CHARACTER MARK. INT. CL. 9. REG. 5-29-2007.
- 3,247,611. BOZ DESIGN STANDARD CHARACTER MARK. INT. CL. 12. REG. 5-29-2007.
- 3,247,614. LATITUDE ZERO (STYLIZED). INT. CL. 25. REG. 5-29-2007.
- 3,247,615. UBO AND DESIGN. INT. CL. 9. REG. 5-29-2007.
- 3,247,616. UBO AND DESIGN. INT. CL. 41. REG. 5-29-2007.

- 3,247,617. ACTS OF LOVE FOUNDATION STANDARD CHARACTER MARK. INT. CL. 35. REG. 5-29-2007.
- 3,247,618. MUCHACHAT STANDARD CHARACTER MARK. INT. CL. 38. REG. 5-29-2007.
- 3,247,620. E AND DESIGN. INT. CL. 41. REG. 5-29-2007.
- 3,247,622. MR. BIG STANDARD CHARACTER MARK. INT. CL. 41. REG. 5-29-2007.
- 3,247,623. PYROLOK STANDARD CHARACTER MARK. INT. CL. 7. REG. 5-29-2007.
- 3,247,625. MONEY SQUAD GAMBLERS STANDARD CHARACTER MARK. INT. CL. 41. REG. 5-29-2007.
- 3,247,627. MAKE IT COUNT. AND DESIGN. INT. CLS. 35 AND 36. REG. 5-29-2007.
- 3,247,629. XTREME 2 VIDEO AND DESIGN. INT. CLS. 35 AND 41. REG. 5-29-2007.
- 3,247,636. JACLYNINTIMATES AND DESIGN. INT. CL. 25. REG. 5-29-2007.
- 3,247,637. IMAGINETOLOGY STANDARD CHARACTER MARK. INT. CL. 41. REG. 5-29-2007.
- 3,247,639. QUALITY HOME CARE YOU CAN TRUST STANDARD CHARACTER MARK. INT. CL. 45. REG. 5-29-2007.
- 3,247,641. CHAMPION NUTRITION STANDARD CHARACTER MARK. INT. CL. 5. REG. 5-29-2007.
- 3,247,642. F3 STANDARD CHARACTER MARK. INT. CL. 28. REG. 5-29-2007.
- 3,247,644. QUALITY PAYS DIVIDENDS. (STYLIZED). INT. CL. 37. REG. 5-29-2007.
- 3,247,645. ADVANCE ALWAYS STANDARD CHARACTER MARK. INT. CL. 42. REG. 5-29-2007.
- 3,247,646. NATIONAL RETIREMENT INCOME SURVIVAL TEST STANDARD CHARACTER MARK. INT. CL. 36. REG. 5-29-2007.
- 3,247,648. CLARIPATH LABORATORIES THE CLEAR CHOICE IN PATHOLOGY AND DESIGN. INT. CL. 42. REG. 5-29-2007.
- 3,247,651. ESPACIO STANDARD CHARACTER MARK. INT. CL. 41. REG. 5-29-2007.
- 3,247,655. GEEK-RAY VISION STANDARD CHARACTER MARK. INT. CL. 41. REG. 5-29-2007.
- 3,247,656. FIREGARD STANDARD CHARACTER MARK. INT. CL. 1. REG. 5-29-2007.
- 3,247,659. LUMINOUS LIQUID STANDARD CHARACTER MARK. INT. CL. 3. REG. 5-29-2007.
- 3,247,660. DRYTROL STANDARD CHARACTER MARK. INT. CL. 9. REG. 5-29-2007.
- 3,247,662. THE GOLF SHOP AND DESIGN. INT. CL. 35. REG. 5-29-2007.
- 3,247,664. SMARTER SURFING STARTS HERE STANDARD CHARACTER MARK. INT. CL. 41. REG. 5-29-2007.
- 3,247,668. WHISPER OF THE BLUE STANDARD CHARACTER MARK. INT. CL. 41. REG. 5-29-2007.
- 3,247,861. GL TRADE STANDARD CHARACTER MARK. INT. CLS. 36, 38 AND 42. REG. 5-29-2007.
- 3,247,863. FATDROP STANDARD CHARACTER MARK. INT. CL. 5. REG. 5-29-2007.
- 3,247,864. SIMPORT. INT. CL. 9. REG. 5-29-2007.
- 3,247,867. SMOKIN' RECORDS. INT. CL. 9. REG. 5-29-2007.
- 3,247,869. PAINTBALL2XTREMES. INT. CL. 41. REG. 5-29-2007.
- 3,247,871. DREAM WITH YOUR EYES WIDE OPEN STANDARD CHARACTER MARK. INT. CL. 16. REG. 5-29-2007.
- 3,247,873. STRONG AND DESIGN. INT. CL. 9. REG. 5-29-2007.
- 3,247,876. LIFE IS GOOD. INT. CLS. 14 AND 20. REG. 5-29-2007.
- 3,247,877. GAYSTOCK. INT. CLS. 36 AND 41. REG. 5-29-2007.
- 3,247,879. FUNKY FRIENDS. INT. CLS. 11, 14, 16, 20, 21 AND 24. REG. 5-29-2007.
- 3,247,887. CALENDARX. INT. CL. 16. REG. 5-29-2007.
- 3,247,891. HOMEWORK RELIEF CENTER. INT. CLS. 9 AND 16. REG. 5-29-2007.
- 3,247,892. THE ORIGINAL CALIFORNIA T-BLADE (STYLIZED). INT. CL. 21. REG. 5-29-2007.
- 3,247,895. THE ENERGY YOU CRAVE. INT. CLS. 5 AND 30. REG. 5-29-2007.
- 3,247,901. AVA. INT. CLS. 9 AND 16. REG. 5-29-2007.
- 3,247,902. CARISM. INT. CLS. 9 AND 16. REG. 5-29-2007.
- 3,247,903. TAGS AND DESIGN. INT. CL. 35. REG. 5-29-2007.
- 3,247,905. JMVU AND DESIGN. INT. CL. 41. REG. 5-29-2007.
- 3,247,906. THERUS. INT. CL. 10. REG. 5-29-2007.
- 3,247,907. ANTONIO MELANI. INT. CL. 14. REG. 5-29-2007.
- 3,247,909. GBABY STANDARD CHARACTER MARK. INT. CL. 12. REG. 5-29-2007.
- 3,247,911. PACIFIC LEISURE A DIVISION OF TREASURE GARDEN AND DESIGN. INT. CL. 18. REG. 5-29-2007.
- 3,247,912. ARCTICFLOW. INT. CL. 10. REG. 5-29-2007.
- 3,247,915. STUNT MONSTER AND DESIGN. INT. CL. 28. REG. 5-29-2007.
- 3,247,916. MONARCH MISSION. INT. CL. 19. REG. 5-29-2007.
- 3,247,921. MISCELLANEOUS DESIGN. U.S. CL. 200. REG. 5-29-2007.
- 3,247,925. TIME AND DESIGN. INT. CL. 14. REG. 5-29-2007.
- 3,247,926. FIS UNIVERSITY FIXED INCOME SECURITIES AND DESIGN. INT. CL. 41. REG. 5-29-2007.
- 3,247,928. R RESCHE AND DESIGN. INT. CL. 3. REG. 5-29-2007.
- 3,247,930. FOLBEE STANDARD CHARACTER MARK. INT. CL. 5. REG. 5-29-2007.
- 3,247,933. POWER GEMS STANDARD CHARACTER MARK. INT. CL. 14. REG. 5-29-2007.
- 3,247,934. DENTACEUTICAL STANDARD CHARACTER MARK. INT. CL. 5. REG. 5-29-2007.
- 3,247,935. THE ORIGINAL CALIFORNIA FORKDUSTER AND DESIGN. INT. CL. 21. REG. 5-29-2007.
- 3,247,936. BIG LOVE STANDARD CHARACTER MARK. INT. CLS. 9, 16, 35 AND 41. REG. 5-29-2007.
- 3,247,937. MUGGSY'S MEADOW STANDARD CHARACTER MARK. INT. CL. 41. REG. 5-29-2007.
- 3,247,938. SHAVE WHAT YOU HAVE BEEN MISSING STANDARD CHARACTER MARK. INT. CL. 9. REG. 5-29-2007.
- 3,247,939. RHEEM CORSAIRE SERIES AND DESIGN. INT. CLS. 9 AND 11. REG. 5-29-2007.
- 3,247,942. JESSICA BISHOP AND DESIGN. INT. CL. 18. REG. 5-29-2007.
- 3,247,944. KOOL JUGGS (STYLIZED). INT. CL. 7. REG. 5-29-2007.
- 3,247,946. DR. DUBS STANDARD CHARACTER MARK. INT. CL. 3. REG. 5-29-2007.
- 3,247,958. TRUEFFS STANDARD CHARACTER MARK. INT. CL. 42. REG. 5-29-2007.
- 3,247,959. THE SAVAGE NUMBER STANDARD CHARACTER MARK. INT. CL. 41. REG. 5-29-2007.
- 3,247,964. ULTRA CRT STANDARD CHARACTER MARK. INT. CL. 12. REG. 5-29-2007.
- 3,247,965. BLACK EYE STANDARD CHARACTER MARK. INT. CL. 7. REG. 5-29-2007.
- 3,247,966. NATIONAL HONOR SOCIETY NHS SCHOLARS' BOWL AND DESIGN. INT. CLS. 14 AND 25. REG. 5-29-2007.
- 3,247,967. NHS SCHOLARS' BOWL (STYLIZED). INT. CLS. 14 AND 25. REG. 5-29-2007.
- 3,247,968. RINGS OF TRUTH STANDARD CHARACTER MARK. INT. CLS. 16 AND 41. REG. 5-29-2007.
- 3,247,969. PARTNERS WITH NATURE STANDARD CHARACTER MARK. INT. CLS. 5 AND 16. REG. 5-29-2007.
- 3,247,971. AUSSIE SPORT STANDARD CHARACTER MARK. INT. CL. 6. REG. 5-29-2007.
- 3,247,972. AWAKE AND DESIGN. INT. CL. 21. REG. 5-29-2007.
- 3,247,973. EASY DUMP STANDARD CHARACTER MARK. INT. CL. 21. REG. 5-29-2007.
- 3,247,974. ONE BAND STANDARD CHARACTER MARK. INT. CL. 28. REG. 5-29-2007.
- 3,247,975. MIX IT UP MEALS STANDARD CHARACTER MARK. INT. CLS. 41 AND 43. REG. 5-29-2007.

- 3,247,976. WIPE THIS STANDARD CHARACTER MARK. INT. CL. 25. REG. 5-29-2007.
- 3,247,977. GENERAMEDIX INC. STANDARD CHARACTER MARK. INT. CLS. 35 AND 42. REG. 5-29-2007.
- 3,247,978. OUTSIDE THE BOX PUZZLES.COM (STYLIZED). INT. CL. 28. REG. 5-29-2007.
- 3,247,979. LAKESTAKE STANDARD CHARACTER MARK. INT. CL. 6. REG. 5-29-2007.
- 3,247,981. FRESH RIDE! STANDARD CHARACTER MARK. INT. CL. 28. REG. 5-29-2007.
- 3,247,982. MICROSTARS STANDARD CHARACTER MARK. INT. CLS. 28 AND 30. REG. 5-29-2007.
- 3,247,986. WALGREENS GIFT BAG TO GO! (STYLIZED). INT. CL. 16. REG. 5-29-2007.
- 3,247,988. EMERALD OF CALIFORNIA AND DESIGN. INT. CL. 29. REG. 5-29-2007.
- 3,247,993. 31 WEST STANDARD CHARACTER MARK. INT. CLS. 14, 21 AND 26. REG. 5-29-2007.
- 3,247,997. IT'S NOT READY 'TIL IT'S REDDI STANDARD CHARACTER MARK. INT. CL. 29. REG. 5-29-2007.
- 3,247,998. TOP SHAPE - THE SYSTEM STANDARD CHARACTER MARK. INT. CL. 41. REG. 5-29-2007.
- 3,248,001. MERCHANT CAPTURE AND DESIGN. INT. CL. 9. REG. 5-29-2007.
- 3,248,003. AAU OF INDIANA STANDARD CHARACTER MARK. INT. CL. 41. REG. 5-29-2007.
- 3,248,005. DREAMBLADE STANDARD CHARACTER MARK. INT. CL. 28. REG. 5-29-2007.
- 3,248,006. YATO STANDARD CHARACTER MARK. INT. CL. 3. REG. 5-29-2007.
- 3,248,007. GARSA STANDARD CHARACTER MARK. INT. CL. 33. REG. 5-29-2007.
- 3,248,009. DOC. INT. CL. 9. REG. 5-29-2007.
- 3,248,012. DANGER RANGERS. INT. CL. 16. REG. 5-29-2007.
- 3,248,013. CELLUZYME STANDARD CHARACTER MARK. INT. CL. 3. REG. 5-29-2007.
- 3,248,015. TOUGHEST SPORT ON DIRT! (STYLIZED). INT. CL. 41. REG. 5-29-2007.
- 3,248,017. GTX THE MEN'S HEALTH BIOTECH COMPANY (STYLIZED). INT. CL. 5. REG. 5-29-2007.
- 3,248,018. SPY GEAR. INT. CL. 16. REG. 5-29-2007.
- 3,248,021. GAMESA AND DESIGN. INT. CL. 30. REG. 5-29-2007.
- 3,248,023. M AND DESIGN. INT. CL. 42. REG. 5-29-2007.
- 3,248,028. PFIZER MEDNET AND DESIGN. INT. CL. 44. REG. 5-29-2007.
- 3,248,029. CHITTY CHITTY BANG BANG. INT. CL. 41. REG. 5-29-2007.
- 3,248,030. VITACANDLE. INT. CL. 4. REG. 5-29-2007.
- 3,248,033. FLEXSELECT LICENSING. INT. CL. 35. REG. 5-29-2007.
- 3,248,037. SENSUAL & LIVEABLE FOR THE CURVACEOUS WOMAN. INT. CL. 25. REG. 5-29-2007.
- 3,248,038. SENSUAL & LIVEABLE. INT. CL. 25. REG. 5-29-2007.
- 3,248,039. KOBRA. INT. CL. 10. REG. 5-29-2007.
- 3,248,040. MICHELLE K. INT. CL. 18. REG. 5-29-2007.
- 3,248,043. TABULA RASA. INT. CL. 9. REG. 5-29-2007.
- 3,248,044. UNSP. INT. CL. 9. REG. 5-29-2007.
- 3,248,045. THROWDOWN. INT. CL. 28. REG. 5-29-2007.
- 3,248,048. ASCENTIAL PROFILESTAGE. INT. CL. 9. REG. 5-29-2007.
- 3,248,049. ASCENTIAL QUALITYSTAGE. INT. CL. 9. REG. 5-29-2007.
- 3,248,050. EAU COOL. INT. CL. 11. REG. 5-29-2007.
- 3,248,052. CBS DIGITAL. INT. CLS. 41 AND 42. REG. 5-29-2007.
- 3,248,055. CANCARE. INT. CL. 1. REG. 5-29-2007.
- 3,248,056. VIRTUAL E-SCENARIO CLINIC. INT. CLS. 9 AND 41. REG. 5-29-2007.
- 3,248,057. PLUMERIA PRINCESS. INT. CLS. 9, 14, 16, 18, 20, 25 AND 28. REG. 5-29-2007.
- 3,248,058. HIGH IMPACT. INT. CL. 16. REG. 5-29-2007.
- 3,248,061. EDFOUTLOOK. INT. CL. 41. REG. 5-29-2007.
- 3,248,063. VISISAT. INT. CL. 9. REG. 5-29-2007.
- 3,248,064. CAR EXPO AND DESIGN. INT. CL. 12. REG. 5-29-2007.
- 3,248,065. CDD COMPETITIVE DRUG DEVELOPMENT STANDARD CHARACTER MARK. INT. CL. 35. REG. 5-29-2007.
- 3,248,066. PROJECT HEROES. INT. CL. 9. REG. 5-29-2007.
- 3,248,067. FOR THE BODY OF YOUR LIFE . . . INT. CL. 41. REG. 5-29-2007.
- 3,248,068. RESULTS THROUGH SERVICE EXCELLENCE. INT. CL. 35. REG. 5-29-2007.
- 3,248,069. FIRST BANK OF THE TETONS AND DESIGN. INT. CL. 36. REG. 5-29-2007.
- 3,248,070. MY FAVORITE. INT. CL. 25. REG. 5-29-2007.
- 3,248,071. KAHRIPTIC KNIGHTS PUBLISHING (KKP). INT. CL. 41. REG. 5-29-2007.
- 3,248,072. SKYSCOUT. INT. CL. 9. REG. 5-29-2007.
- 3,248,075. SLEEPING PEEL STANDARD CHARACTER MARK. INT. CL. 3. REG. 5-29-2007.
- 3,248,077. ARTES CRYSELV STANDARD CHARACTER MARK. INT. CL. 21. REG. 5-29-2007.
- 3,248,078. METROCAST SEE THE WORLD AND BEYOND... AND DESIGN. INT. CLS. 38 AND 41. REG. 5-29-2007.
- 3,248,079. NUTRIVITY FOR KIDS AND DESIGN. INT. CL. 9. REG. 5-29-2007.
- 3,248,081. WALLPAPER UNIVERSE STANDARD CHARACTER MARK. INT. CL. 9. REG. 5-29-2007.
- 3,248,083. ZANGO STANDARD CHARACTER MARK. INT. CL. 42. REG. 5-29-2007.
- 3,248,084. REGMIX STANDARD CHARACTER MARK. INT. CL. 9. REG. 5-29-2007.
- 3,248,086. OPTIMIZE YOUR DIGITAL LIFE STANDARD CHARACTER MARK. INT. CLS. 3, 7, 9 AND 21. REG. 5-29-2007.
- 3,248,087. BRAIN PREP STANDARD CHARACTER MARK. INT. CL. 41. REG. 5-29-2007.
- 3,248,088. WALK-IN WILLS AND DESIGN. INT. CL. 42. REG. 5-29-2007.
- 3,248,090. STRAWBERRY BOMB STANDARD CHARACTER MARK. INT. CL. 30. REG. 5-29-2007.
- 3,248,091. IHC INTERNATIONAL HANDYBULK CARRIERS AND DESIGN. INT. CL. 35. REG. 5-29-2007.
- 3,248,092. DYNASENSOR STANDARD CHARACTER MARK. INT. CL. 11. REG. 5-29-2007.
- 3,248,094. ACCUSTEP STANDARD CHARACTER MARK. INT. CL. 5. REG. 5-29-2007.
- 3,248,098. RODGERS ORGAN ARCHITECT STANDARD CHARACTER MARK. INT. CL. 15. REG. 5-29-2007.
- 3,248,099. ROA STANDARD CHARACTER MARK. INT. CL. 15. REG. 5-29-2007.
- 3,248,100. O4 (STYLIZED). INT. CL. 1. REG. 5-29-2007.
- 3,248,101. MARRIAGEGYM (STYLIZED). INT. CL. 41. REG. 5-29-2007.
- 3,248,102. ARCO (STYLIZED). INT. CLS. 23 AND 24. REG. 5-29-2007.
- 3,248,103. ARCOTEXTEIS AND DESIGN. INT. CL. 24. REG. 5-29-2007.
- 3,248,105. ROBOTS AND DESIGN. INT. CL. 28. REG. 5-29-2007.
- 3,248,106. OPTIFLEX STANDARD CHARACTER MARK. INT. CL. 10. REG. 5-29-2007.
- 3,248,107. INTEGRATED SURVEY SYSTEM STANDARD CHARACTER MARK. INT. CL. 42. REG. 5-29-2007.
- 3,248,108. HEAT SENTINEL STANDARD CHARACTER MARK. INT. CL. 9. REG. 5-29-2007.
- 3,248,112. THE HOPE FACTORY STANDARD CHARACTER MARK. INT. CL. 41. REG. 5-29-2007.
- 3,248,113. CAFÉ TOUS LES JOURS (STYLIZED). INT. CL. 30. REG. 5-29-2007.
- 3,248,114. CAFÉ TOUS LES JOURS (STYLIZED). INT. CL. 43. REG. 5-29-2007.
- 3,248,118. SPHERE CREATIONS STANDARD CHARACTER MARK. INT. CL. 28. REG. 5-29-2007.
- 3,248,120. PROFLEX STANDARD CHARACTER MARK. INT. CL. 20. REG. 5-29-2007.

- 3,248,121. INSPIRATIONS OF HOPE STANDARD CHARACTER MARK. INT. CL. 16. REG. 5-29-2007.
- 3,248,123. LITEC STANDARD CHARACTER MARK. INT. CL. 7. REG. 5-29-2007.
- 3,248,124. ZAPT AND DESIGN. INT. CL. 2. REG. 5-29-2007.
- 3,248,125. ZAPT AND DESIGN. INT. CL. 19. REG. 5-29-2007.
- 3,248,126. GBCBLUE STANDARD CHARACTER MARK. INT. CLS. 9, 35, 38 AND 42. REG. 5-29-2007.
- 3,248,127. NINE DEUCE STANDARD CHARACTER MARK. INT. CL. 25. REG. 5-29-2007.
- 3,248,128. HILLARD & HANSON STANDARD CHARACTER MARK. INT. CLS. 20, 21, 24 AND 27. REG. 5-29-2007.
- 3,248,130. ATA AMERICA STANDARD CHARACTER MARK. INT. CL. 36. REG. 5-29-2007.
- 3,248,135. POLITE PANDA STANDARD CHARACTER MARK. INT. CL. 28. REG. 5-29-2007.
- 3,248,136. SEXY NINE STANDARD CHARACTER MARK. INT. CL. 25. REG. 5-29-2007.
- 3,248,140. MISCELLANEOUS DESIGN. INT. CL. 45. REG. 5-29-2007.
- 3,248,143. BB BIQUINI BRASIL AND DESIGN. INT. CL. 25. REG. 5-29-2007.
- 3,248,144. KENSINGTON MARKET STANDARD CHARACTER MARK. INT. CLS. 20, 35 AND 42. REG. 5-29-2007.
- 3,248,145. SPEED FLOSS STANDARD CHARACTER MARK. INT. CL. 21. REG. 5-29-2007.
- 3,248,147. YEEBEE STANDARD CHARACTER MARK. INT. CL. 28. REG. 5-29-2007.
- 3,248,148. CREATING A RESPONSIBILITY-BASED CULTURE STANDARD CHARACTER MARK. INT. CL. 35. REG. 5-29-2007.
- 3,248,151. THORASTAT STANDARD CHARACTER MARK. INT. CL. 10. REG. 5-29-2007.
- 3,248,154. IN:LA STANDARD CHARACTER MARK. INT. CLS. 35 AND 36. REG. 5-29-2007.
- 3,248,155. EZ FEE STANDARD CHARACTER MARK. INT. CL. 36. REG. 5-29-2007.
- 3,248,159. ATLANTIC WINDSHIELD REPAIR STANDARD CHARACTER MARK. INT. CL. 37. REG. 5-29-2007.
- 3,248,160. TASHI TAI TREASURES STANDARD CHARACTER MARK. INT. CL. 18. REG. 5-29-2007.
- 3,248,161. STRATOGY STANDARD CHARACTER MARK. INT. CLS. 9, 16 AND 35. REG. 5-29-2007.
- 3,248,162. DON COFFEE STANDARD CHARACTER MARK. INT. CL. 30. REG. 5-29-2007.
- 3,248,163. FARM IQ STANDARD CHARACTER MARK. INT. CL. 9. REG. 5-29-2007.
- 3,248,164. W:INK STANDARD CHARACTER MARK. INT. CL. 35. REG. 5-29-2007.
- 3,248,165. BASO A BASO STANDARD CHARACTER MARK. INT. CL. 33. REG. 5-29-2007.
- 3,248,166. CHARMGLOW STANDARD CHARACTER MARK. INT. CL. 8. REG. 5-29-2007.
- 3,248,167. CHARMGLOW STANDARD CHARACTER MARK. INT. CL. 6. REG. 5-29-2007.
- 3,248,168. SWEET-WOOD STANDARD CHARACTER MARK. INT. CLS. 1 AND 19. REG. 5-29-2007.
- 3,248,169. STOMPER STANDARD CHARACTER MARK. INT. CL. 41. REG. 5-29-2007.
- 3,248,170. VIGO POS AND DESIGN. INT. CL. 9. REG. 5-29-2007.
- 3,248,171. MOHAWK DESIGN AT HOME STANDARD CHARACTER MARK. INT. CL. 42. REG. 5-29-2007.
- 3,248,172. BLU STANDARD CHARACTER MARK. INT. CL. 9. REG. 5-29-2007.
- 3,248,173. SCRATCH MAGIC STANDARD CHARACTER MARK. INT. CL. 3. REG. 5-29-2007.
- 3,248,174. PHONEGNOME STANDARD CHARACTER MARK. INT. CL. 9. REG. 5-29-2007.
- 3,248,176. MUD METER STANDARD CHARACTER MARK. INT. CL. 9. REG. 5-29-2007.
- 3,248,178. MISCELLANEOUS DESIGN. INT. CL. 36. REG. 5-29-2007.
- 3,248,179. ABOUT LAST NIGHT STANDARD CHARACTER MARK. INT. CL. 41. REG. 5-29-2007.
- 3,248,181. MISCELLANEOUS DESIGN. INT. CL. 16. REG. 5-29-2007.
- 3,248,182. LAGUNA BEACH THE REAL ORANGE COUNTY AND DESIGN. INT. CL. 14. REG. 5-29-2007.
- 3,248,184. BALLERS NATION STANDARD CHARACTER MARK. INT. CL. 25. REG. 5-29-2007.
- 3,248,186. FLICKA AND DESIGN. INT. CLS. 14 AND 25. REG. 5-29-2007.
- 3,248,188. PARKER LATITUDE STANDARD CHARACTER MARK. INT. CL. 16. REG. 5-29-2007.
- 3,248,190. W:INK (STYLIZED). INT. CL. 35. REG. 5-29-2007.
- 3,248,194. VERA BRADLEY MY HOME AND DESIGN. INT. CL. 21. REG. 5-29-2007.
- 3,248,200. VELCERA PHARMACEUTICALS, INC. AND DESIGN. INT. CL. 5. REG. 5-29-2007.
- 3,248,201. TRUETONE STANDARD CHARACTER MARK. INT. CL. 2. REG. 5-29-2007.
- 3,248,202. ANYWEAR FOR LOOKS THAT LAST. (STYLIZED). INT. CLS. 24 AND 25. REG. 5-29-2007.
- 3,248,205. KWARE AND DESIGN. INT. CL. 21. REG. 5-29-2007.
- 3,248,206. CREATE YOUR OWN SPECIAL EDITION STANDARD CHARACTER MARK. INT. CL. 37. REG. 5-29-2007.
- 3,248,208. HEREX STANDARD CHARACTER MARK. INT. CL. 8. REG. 5-29-2007.
- 3,248,210. WASH AWAY THE GERMS, FEEL THE SOFTNESS STANDARD CHARACTER MARK. INT. CL. 3. REG. 5-29-2007.
- 3,248,214. KING KONG AND DESIGN. INT. CL. 28. REG. 5-29-2007.
- 3,248,215. STARSONIC STANDARD CHARACTER MARK. INT. CL. 9. REG. 5-29-2007.
- 3,248,217. INTEGRATIVE MEDICAL SPECIALISTS, LLC TRUSTED PARTNERS IN ALTERNATIVE CARE AND DESIGN. INT. CL. 44. REG. 5-29-2007.
- 3,248,223. BASH & LUXE STANDARD CHARACTER MARK. INT. CL. 41. REG. 5-29-2007.
- 3,248,225. EYEINSTITUTE OF NEW YORK (STYLIZED). INT. CL. 44. REG. 5-29-2007.
- 3,248,227. ARGILO STANDARD CHARACTER MARK. INT. CL. 21. REG. 5-29-2007.
- 3,248,228. VOTE FOR PEDRO STANDARD CHARACTER MARK. INT. CL. 16. REG. 5-29-2007.
- 3,248,229. CLARITY STANDARD CHARACTER MARK. INT. CL. 18. REG. 5-29-2007.
- 3,248,230. THE OC AND DESIGN. INT. CL. 18. REG. 5-29-2007.
- 3,248,235. ON A PERSONAL NOTE STANDARD CHARACTER MARK. INT. CLS. 9 AND 16. REG. 5-29-2007.
- 3,248,237. DARKSIDE STANDARD CHARACTER MARK. INT. CL. 3. REG. 5-29-2007.
- 3,248,241. IBRACES STANDARD CHARACTER MARK. INT. CL. 10. REG. 5-29-2007.
- 3,248,242. IWIRE STANDARD CHARACTER MARK. INT. CL. 10. REG. 5-29-2007.
- 3,248,247. DRYMAX STANDARD CHARACTER MARK. INT. CL. 28. REG. 5-29-2007.
- 3,248,249. RUTHIE'S JOY STANDARD CHARACTER MARK. INT. CL. 16. REG. 5-29-2007.
- 3,248,251. CINEGOCIAR AND DESIGN. INT. CLS. 41 AND 42. REG. 5-29-2007.
- 3,248,252. SELF-CATH HYDROGEL STANDARD CHARACTER MARK. INT. CL. 10. REG. 5-29-2007.
- 3,248,253. RAYLIGHT STANDARD CHARACTER MARK. INT. CL. 5. REG. 5-29-2007.
- 3,248,255. SG3 STANDARD CHARACTER MARK. INT. CL. 42. REG. 5-29-2007.
- 3,248,256. CREME SHINE STANDARD CHARACTER MARK. INT. CL. 3. REG. 5-29-2007.
- 3,248,257. RAYLIGHT RAY OF LIGHT . RAY OF HOPE AND DESIGN. INT. CL. 5. REG. 5-29-2007.
- 3,248,261. HBC AND DESIGN. INT. CL. 20. REG. 5-29-2007.

- 3,248,262. FRANKLIN PUMP SYSTEMS STANDARD CHARACTER MARK. INT. CLS. 7 AND 9. REG. 5-29-2007.
- 3,248,264. FAMILY PLATINUM PLAN STANDARD CHARACTER MARK. INT. CLS. 35 AND 36. REG. 5-29-2007.
- 3,248,267. SCHIOPPA NORTH AMERICA AND DESIGN. INT. CL. 12. REG. 5-29-2007.
- 3,248,268. M-PACTSAFE STANDARD CHARACTER MARK. INT. CL. 19. REG. 5-29-2007.
- 3,248,271. WALK FIT AND DESIGN. INT. CL. 10. REG. 5-29-2007.
- 3,248,273. YOU DEFINE SUCCESS. WE DEFINE PERFORMANCE STANDARD CHARACTER MARK. INT. CL. 5. REG. 5-29-2007.
- 3,248,274. RAGEBALL 5 STANDARD CHARACTER MARK. INT. CL. 28. REG. 5-29-2007.
- 3,248,275. DEITY ATON STANDARD CHARACTER MARK. INT. CL. 3. REG. 5-29-2007.
- 3,248,277. EDUTRONIX STANDARD CHARACTER MARK. INT. CL. 35. REG. 5-29-2007.
- 3,248,278. CASA DE CELI AND DESIGN. INT. CL. 29. REG. 5-29-2007.
- 3,248,282. DELTA PHOTOCROMIC STANDARD CHARACTER MARK. INT. CL. 9. REG. 5-29-2007.
- 3,248,283. CALLAWAY GOLF MOBILE TOUR STANDARD CHARACTER MARK. INT. CL. 38. REG. 5-29-2007.
- 3,248,284. BOBBY BADFINGERS STANDARD CHARACTER MARK. INT. CL. 28. REG. 5-29-2007.
- 3,248,286. ESSENTIAL WEAR STANDARD CHARACTER MARK. INT. CL. 3. REG. 5-29-2007.
- 3,248,287. TRILOGY INNOVATION. STYLE. FREEDOM. AND DESIGN. INT. CL. 19. REG. 5-29-2007.
- 3,248,288. INNOVATION. STYLE. FREEDOM. STANDARD CHARACTER MARK. INT. CL. 19. REG. 5-29-2007.
- 3,248,289. SOJO AND DESIGN. INT. CLS. 4 AND 37. REG. 5-29-2007.
- 3,248,290. ALWAYS 10c STANDARD CHARACTER MARK. INT. CL. 38. REG. 5-29-2007.
- 3,248,291. MAXPDQ STANDARD CHARACTER MARK. INT. CL. 16. REG. 5-29-2007.
- 3,248,294. RECLEAR STANDARD CHARACTER MARK. INT. CL. 5. REG. 5-29-2007.
- 3,248,295. GOOD LINE STANDARD CHARACTER MARK. INT. CL. 16. REG. 5-29-2007.
- 3,248,297. KLEINFELD BRIDESMAIDS' LOFT AND DESIGN. INT. CL. 25. REG. 5-29-2007.
- 3,248,300. QUADRABLOC STANDARD CHARACTER MARK. INT. CL. 10. REG. 5-29-2007.
- 3,248,301. MM MIRROR ME ESTEEM-WEAR STANDARD CHARACTER MARK. INT. CL. 25. REG. 5-29-2007.
- 3,248,306. RX CURE (STYLIZED). INT. CL. 9. REG. 5-29-2007.
- 3,248,308. BEAR RIVER PRO JOGGER STANDARD CHARACTER MARK. INT. CL. 12. REG. 5-29-2007.
- 3,248,312. SRO STRATEGIES STANDARD CHARACTER MARK. INT. CL. 35. REG. 5-29-2007.
- 3,248,313. LOFTSTYLE STANDARD CHARACTER MARK. INT. CL. 37. REG. 5-29-2007.
- 3,248,314. ONE SHOT STANDARD CHARACTER MARK. INT. CL. 22. REG. 5-29-2007.
- 3,248,317. LOCK & LOCK SPIN STANDARD CHARACTER MARK. INT. CL. 20. REG. 5-29-2007.
- 3,248,318. CELERISSET STANDARD CHARACTER MARK. INT. CL. 9. REG. 5-29-2007.
- 3,248,319. THINLINE STANDARD CHARACTER MARK. INT. CL. 9. REG. 5-29-2007.
- 3,248,320. MAMICHULA AND DESIGN. INT. CL. 3. REG. 5-29-2007.
- 3,248,322. BIG AND DESIGN. INT. CLS. 16 AND 28. REG. 5-29-2007.
- 3,248,324. BEE HEART HEALTHY! STANDARD CHARACTER MARK. INT. CL. 30. REG. 5-29-2007.
- 3,248,325. REBECCA & DREW MANUFACTURING EST. 2004 AND DESIGN. INT. CL. 25. REG. 5-29-2007.
- 3,248,331. INSPIRED STANDARD CHARACTER MARK. INT. CLS. 9, 16 AND 41. REG. 5-29-2007.
- 3,248,332. BLOOMIN' IN THE GARDEN STANDARD CHARACTER MARK. INT. CLS. 41 AND 44. REG. 5-29-2007.
- 3,248,335. MOISSANITE IS ME STANDARD CHARACTER MARK. INT. CL. 35. REG. 5-29-2007.
- 3,248,336. SLASH STANDARD CHARACTER MARK. INT. CL. 12. REG. 5-29-2007.
- 3,248,340. WIZARD LIZARD STANDARD CHARACTER MARK. INT. CLS. 21 AND 28. REG. 5-29-2007.
- 3,248,341. BEER COMMISSIONER STANDARD CHARACTER MARK. INT. CLS. 25 AND 41. REG. 5-29-2007.
- 3,248,342. SOFT EXPRESSIONS STANDARD CHARACTER MARK. INT. CL. 27. REG. 5-29-2007.
- 3,248,343. WINTUN DINNER HOUSE STANDARD CHARACTER MARK. INT. CL. 43. REG. 5-29-2007.
- 3,248,344. PRIME MINISTER AND DESIGN. INT. CL. 25. REG. 5-29-2007.
- 3,248,351. SIGNATURE DISH STANDARD CHARACTER MARK. INT. CL. 21. REG. 5-29-2007.
- 3,248,355. LITE SEARCHEYE STANDARD CHARACTER MARK. INT. CL. 11. REG. 5-29-2007.
- 3,248,356. VONGO STANDARD CHARACTER MARK. INT. CLS. 38 AND 41. REG. 5-29-2007.
- 3,248,357. POTATOBLEN STANDARD CHARACTER MARK. INT. CL. 1. REG. 5-29-2007.
- 3,248,360. EVA STANDARD CHARACTER MARK. INT. CL. 20. REG. 5-29-2007.
- 3,248,361. CUNNINGHAM REALTY LTD. AND DESIGN. INT. CL. 36. REG. 5-29-2007.
- 3,248,362. JOMBAH STANDARD CHARACTER MARK. INT. CL. 41. REG. 5-29-2007.
- 3,248,364. AFLEET ALEX STANDARD CHARACTER MARK. INT. CLS. 16, 25, 41 AND 44. REG. 5-29-2007.
- 3,248,365. TRAIL GUIDE STANDARD CHARACTER MARK. INT. CL. 9. REG. 5-29-2007.
- 3,248,368. SAVANNA STANDARD CHARACTER MARK. INT. CL. 16. REG. 5-29-2007.
- 3,248,369. AREDUB STANDARD CHARACTER MARK. INT. CL. 25. REG. 5-29-2007.
- 3,248,370. AUGUSTE GALAN STANDARD CHARACTER MARK. INT. CL. 14. REG. 5-29-2007.
- 3,248,371. IBRACKET STANDARD CHARACTER MARK. INT. CL. 10. REG. 5-29-2007.
- 3,248,372. ITRAY STANDARD CHARACTER MARK. INT. CL. 10. REG. 5-29-2007.
- 3,248,374. CHIROPRACTIC... WHEN ALL HEALTH BREAKS LOOSE STANDARD CHARACTER MARK. INT. CL. 25. REG. 5-29-2007.
- 3,248,375. ZOOOOS STANDARD CHARACTER MARK. INT. CL. 9. REG. 5-29-2007.
- 3,248,376. REST SECURED STANDARD CHARACTER MARK. INT. CL. 42. REG. 5-29-2007.
- 3,248,379. WONDERGY STANDARD CHARACTER MARK. INT. CL. 41. REG. 5-29-2007.
- 3,248,381. SERIOUS PROTECTION STANDARD CHARACTER MARK. INT. CL. 3. REG. 5-29-2007.
- 3,248,382. WNBA BE SMART . BE FIT . BE YOURSELF AND DESIGN. INT. CL. 35. REG. 5-29-2007.
- 3,248,385. SENONIAN COMPOST STANDARD CHARACTER MARK. INT. CLS. 1 AND 5. REG. 5-29-2007.
- 3,248,386. JUGURNOT STANDARD CHARACTER MARK. INT. CLS. 25 AND 33. REG. 5-29-2007.
- 3,248,389. ARCTURUS MEDIA STANDARD CHARACTER MARK. INT. CLS. 9 AND 42. REG. 5-29-2007.
- 3,248,391. MAGPIE STANDARD CHARACTER MARK. INT. CL. 9. REG. 5-29-2007.
- 3,248,393. KICKED OUT STANDARD CHARACTER MARK. INT. CL. 41. REG. 5-29-2007.
- 3,248,396. QUICK-FEED STANDARD CHARACTER MARK. INT. CL. 8. REG. 5-29-2007.
- 3,248,397. TIDALWALK STANDARD CHARACTER MARK. INT. CL. 37. REG. 5-29-2007.



- 3,248,398. ORTHOPRO STANDARD CHARACTER MARK. INT. CL. 20. REG. 5-29-2007.
- 3,248,399. HERB-ALL STANDARD CHARACTER MARK. INT. CLS. 5 AND 29. REG. 5-29-2007.
- 3,248,401. ICS SKIN THERAPIE STANDARD CHARACTER MARK. INT. CLS. 3 AND 5. REG. 5-29-2007.
- 3,248,402. SKYKING STANDARD CHARACTER MARK. INT. CL. 28. REG. 5-29-2007.
- 3,248,404. SOCUISINE STANDARD CHARACTER MARK. INT. CL. 43. REG. 5-29-2007.
- 3,248,407. MARLADAWN STANDARD CHARACTER MARK. INT. CL. 21. REG. 5-29-2007.
- 3,248,408. TUNIT STANDARD CHARACTER MARK. INT. CLS. 25 AND 28. REG. 5-29-2007.
- 3,248,409. DESTINATION WILD STANDARD CHARACTER MARK. INT. CL. 41. REG. 5-29-2007.
- 3,248,410. TEA FORTÉ THE ART OF TEA (STYLIZED). INT. CL. 30. REG. 5-29-2007.
- 3,248,417. REMERGENT STANDARD CHARACTER MARK. INT. CL. 5. REG. 5-29-2007.
- 3,248,418. FORMULA B1 STANDARD CHARACTER MARK. INT. CL. 3. REG. 5-29-2007.
- 3,248,419. LIMA'S WHO'S WHO LICENSING RESOURCE DIRECTORY STANDARD CHARACTER MARK. INT. CL. 16. REG. 5-29-2007.
- 3,248,421. IKON PRINTCENTERPRO STANDARD CHARACTER MARK. INT. CL. 9. REG. 5-29-2007.
- 3,248,423. POLYTRAC STANDARD CHARACTER MARK. INT. CL. 7. REG. 5-29-2007.
- 3,248,424. L DAILYLEAD ALL ACCESS AND DESIGN. INT. CL. 35. REG. 5-29-2007.
- 3,248,426. LECTRAFLY STANDARD CHARACTER MARK. INT. CL. 9. REG. 5-29-2007.
- 3,248,428. THE SWEETEST, SOFTEST ROBE ON EARTH STANDARD CHARACTER MARK. INT. CL. 25. REG. 5-29-2007.
- 3,248,429. RADICA STANDARD CHARACTER MARK. INT. CL. 9. REG. 5-29-2007.
- 3,248,434. V AND DESIGN. INT. CLS. 35 AND 41. REG. 5-29-2007.
- 3,248,435. SOUL VISION WORKS STANDARD CHARACTER MARK. INT. CL. 16. REG. 5-29-2007.
- 3,248,439. MILENIO AND DESIGN. INT. CL. 25. REG. 5-29-2007.
- 3,248,443. YOGOS STANDARD CHARACTER MARK. INT. CL. 29. REG. 5-29-2007.
- 3,248,444. ALTO STANDARD CHARACTER MARK. INT. CL. 9. REG. 5-29-2007.
- 3,248,446. TIME RENEWAL STANDARD CHARACTER MARK. INT. CL. 3. REG. 5-29-2007.
- 3,248,448. MISCELLANEOUS DESIGN. INT. CL. 14. REG. 5-29-2007.
- 3,248,449. AT&T INTERNET SECURITY NEWS NETWORK STANDARD CHARACTER MARK. INT. CL. 38. REG. 5-29-2007.
- 3,248,456. DP (STYLIZED). INT. CL. 41. REG. 5-29-2007.
- 3,248,457. I WANT TO GET A HOME EQUITY LOAN STANDARD CHARACTER MARK. INT. CL. 35. REG. 5-29-2007.
- 3,248,458. VULCAN STANDARD CHARACTER MARK. INT. CL. 7. REG. 5-29-2007.
- 3,248,459. ORGANIC FOR EVERYONE MON BIO À MOI AND DESIGN. INT. CL. 29. REG. 5-29-2007.
- 3,248,463. AROUND THE WORLD HEALTHCARE STANDARD CHARACTER MARK. INT. CL. 35. REG. 5-29-2007.
- 3,248,465. ELECTRIC CASH STANDARD CHARACTER MARK. INT. CL. 9. REG. 5-29-2007.
- 3,248,466. PRIMARY INSIGHT STANDARD CHARACTER MARK. INT. CL. 36. REG. 5-29-2007.
- 3,248,467. WINDOJO STANDARD CHARACTER MARK. INT. CL. 28. REG. 5-29-2007.
- 3,248,468. 411 STANDARD CHARACTER MARK. INT. CL. 25. REG. 5-29-2007.
- 3,248,469. TALK TO ME STANDARD CHARACTER MARK. INT. CL. 3. REG. 5-29-2007.
- 3,248,470. CRIMSON PATROL STANDARD CHARACTER MARK. INT. CL. 28. REG. 5-29-2007.
- 3,248,471. SPORTSWEAR FOR YOUR FEET STANDARD CHARACTER MARK. INT. CL. 25. REG. 5-29-2007.
- 3,248,472. BULOW SHORES STANDARD CHARACTER MARK. INT. CL. 37. REG. 5-29-2007.
- 3,248,473. A PASSION FOR IMAGINATIVE SOLUTIONS STANDARD CHARACTER MARK. INT. CL. 36. REG. 5-29-2007.
- 3,248,474. IN BALANCE STANDARD CHARACTER MARK. INT. CL. 9. REG. 5-29-2007.
- 3,248,475. RALLY STANDARD CHARACTER MARK. INT. CL. 3. REG. 5-29-2007.
- 3,248,476. MIGHTY MINNOW STANDARD CHARACTER MARK. INT. CL. 9. REG. 5-29-2007.
- 3,248,478. MAKO STANDARD CHARACTER MARK. INT. CL. 9. REG. 5-29-2007.
- 3,248,479. PECKING ORDER STANDARD CHARACTER MARK. INT. CL. 28. REG. 5-29-2007.
- 3,248,480. DESIGNED WITH YOU IN MIND STANDARD CHARACTER MARK. INT. CL. 7. REG. 5-29-2007.
- 3,248,481. NEXTCLEAN AND DESIGN. INT. CL. 7. REG. 5-29-2007.
- 3,248,482. TONETAILED STANDARD CHARACTER MARK. INT. CL. 15. REG. 5-29-2007.
- 3,248,484. THERE IS ALWAYS A SEAT IN THE VIRTUAL ACADEMY STANDARD CHARACTER MARK. INT. CL. 41. REG. 5-29-2007.
- 3,248,485. SPATOPPER STANDARD CHARACTER MARK. INT. CL. 11. REG. 5-29-2007.
- 3,248,486. BUSINESS CARD SECURITY STANDARD CHARACTER MARK. INT. CL. 36. REG. 5-29-2007.
- 3,248,487. WINEGARD STANDARD CHARACTER MARK. INT. CL. 39. REG. 5-29-2007.
- 3,248,489. STIXX SUCTIONWARE DFL DESIGN FOR LIVING AND DESIGN. INT. CLS. 8 AND 21. REG. 5-29-2007.
- 3,248,490. THERE'S SOMETHING IN THE WATER. FLAVOR. STANDARD CHARACTER MARK. INT. CL. 32. REG. 5-29-2007.
- 3,248,491. PREP & PLUMP STANDARD CHARACTER MARK. INT. CL. 3. REG. 5-29-2007.
- 3,248,492. PURECARDIO STANDARD CHARACTER MARK. INT. CL. 5. REG. 5-29-2007.
- 3,248,493. AMY'S PRESENCE STANDARD CHARACTER MARK. INT. CL. 26. REG. 5-29-2007.
- 3,248,494. RENEW AND DESIGN. INT. CL. 2. REG. 5-29-2007.
- 3,248,495. WINDSHIELDSMITH STANDARD CHARACTER MARK. INT. CL. 37. REG. 5-29-2007.
- 3,248,496. TUNA TURBO STANDARD CHARACTER MARK. INT. CL. 28. REG. 5-29-2007.
- 3,248,500. QUINCE GIRL STANDARD CHARACTER MARK. INT. CLS. 16 AND 35. REG. 5-29-2007.
- 3,248,501. CROSS-FLAP STANDARD CHARACTER MARK. INT. CL. 16. REG. 5-29-2007.
- 3,248,502. SNAPPER STANDARD CHARACTER MARK. INT. CL. 9. REG. 5-29-2007.
- 3,248,503. S-2000 STANDARD CHARACTER MARK. INT. CL. 9. REG. 5-29-2007.
- 3,248,507. SPORTS ILLUSTRATED TAILGATE NATION STANDARD CHARACTER MARK. INT. CL. 16. REG. 5-29-2007.
- 3,248,510. VAXENOMICS STANDARD CHARACTER MARK. INT. CL. 9. REG. 5-29-2007.
- 3,248,511. GO! STANDARD CHARACTER MARK. INT. CL. 8. REG. 5-29-2007.
- 3,248,512. SECURE SOUNDS STANDARD CHARACTER MARK. INT. CL. 9. REG. 5-29-2007.
- 3,248,514. GET MARRIED BE HAPPY STANDARD CHARACTER MARK. INT. CL. 25. REG. 5-29-2007.
- 3,248,516. AGRASTIM STANDARD CHARACTER MARK. INT. CL. 5. REG. 5-29-2007.
- 3,248,517. LIGHTSMART STANDARD CHARACTER MARK. INT. CL. 9. REG. 5-29-2007.
- 3,248,519. MAGNALOGS STANDARD CHARACTER MARK. INT. CL. 28. REG. 5-29-2007.

- 3,248,523. MAI AND DESIGN. INT. CL. 44. REG. 5-29-2007.
- 3,248,524. MISCELLANEOUS DESIGN. INT. CL. 36. REG. 5-29-2007.
- 3,248,527. ON THE GREEN STANDARD CHARACTER MARK. INT. CL. 16. REG. 5-29-2007.
- 3,248,528. "WHAT'S YOUR FAVORITE SWEET THANG?" STANDARD CHARACTER MARK. INT. CL. 28. REG. 5-29-2007.
- 3,248,529. DELIVERING THE BEST FOR YOU AND YOUR BABY STANDARD CHARACTER MARK. INT. CL. 9. REG. 5-29-2007.
- 3,248,530. PHYTAFILM STANDARD CHARACTER MARK. INT. CL. 9. REG. 5-29-2007.
- 3,248,531. VOLTAGEVISION STANDARD CHARACTER MARK. INT. CL. 9. REG. 5-29-2007.
- 3,248,532. EFENAE STANDARD CHARACTER MARK. INT. CL. 25. REG. 5-29-2007.
- 3,248,534. A NEW APPROACH STANDARD CHARACTER MARK. INT. CL. 35. REG. 5-29-2007.
- 3,248,537. N-SCAN STANDARD CHARACTER MARK. INT. CL. 9. REG. 5-29-2007.
- 3,248,542. SHOW SYSTEM STANDARD CHARACTER MARK. INT. CL. 3. REG. 5-29-2007.
- 3,248,545. MOSIR STANDARD CHARACTER MARK. INT. CL. 9. REG. 5-29-2007.
- 3,248,547. FLATSTOPPERS STANDARD CHARACTER MARK. INT. CL. 20. REG. 5-29-2007.
- 3,248,548. NW STANDARD CHARACTER MARK. INT. CL. 3. REG. 5-29-2007.
- 3,248,549. TREAT YOURSELF BETTER STANDARD CHARACTER MARK. INT. CLS. 10 AND 21. REG. 5-29-2007.
- 3,248,553. EST. 1855 PRIME BRAND G. F SWIFT AND DESIGN. INT. CL. 29. REG. 5-29-2007.
- 3,248,555. SCHOLASTIC SUMMER READING BUZZ! AND DESIGN. INT. CL. 41. REG. 5-29-2007.
- 3,248,557. PEOPLE FIRST PROPERTY SECOND STANDARD CHARACTER MARK. INT. CL. 36. REG. 5-29-2007.
- 3,248,558. GRAFEETEEZ STANDARD CHARACTER MARK. INT. CL. 25. REG. 5-29-2007.
- 3,248,560. RECHARGEABLE BRACELETS + STANDARD CHARACTER MARK. INT. CL. 14. REG. 5-29-2007.
- 3,248,562. AMT STANDARD CHARACTER MARK. INT. CL. 18. REG. 5-29-2007.
- 3,248,564. ECOGLASS STANDARD CHARACTER MARK. INT. CL. 19. REG. 5-29-2007.
- 3,248,566. DIG THREADS STANDARD CHARACTER MARK. INT. CL. 25. REG. 5-29-2007.
- 3,248,568. MISS HENN STANDARD CHARACTER MARK. INT. CL. 28. REG. 5-29-2007.
- 3,248,569. CALLAWAY GOLF STANDARD CHARACTER MARK. INT. CL. 35. REG. 5-29-2007.
- 3,248,570. CALLAWAY STANDARD CHARACTER MARK. INT. CL. 35. REG. 5-29-2007.
- 3,248,571. RESPONSE RADIO STANDARD CHARACTER MARK. INT. CL. 35. REG. 5-29-2007.
- 3,248,572. SHEDNET INC., STANDARD CHARACTER MARK. INT. CL. 38. REG. 5-29-2007.
- 3,248,576. STICK BRICK (STYLIZED). INT. CL. 15. REG. 5-29-2007.
- 3,248,577. MISSBEHAVE STANDARD CHARACTER MARK. INT. CL. 16. REG. 5-29-2007.
- 3,248,578. IT'S A GEM AND DESIGN. INT. CL. 42. REG. 5-29-2007.
- 3,248,584. QQ (STYLIZED). INT. CL. 9. REG. 5-29-2007.
- 3,248,585. STROLL BACK INTO SHAPE. STANDARD CHARACTER MARK. INT. CL. 9. REG. 5-29-2007.
- 3,248,586. SILVER INGOT STANDARD CHARACTER MARK. INT. CL. 9. REG. 5-29-2007.
- 3,248,587. DEFENDER STANDARD CHARACTER MARK. INT. CL. 6. REG. 5-29-2007.
- 3,248,588. BASKET FORTUNE STANDARD CHARACTER MARK. INT. CL. 28. REG. 5-29-2007.
- 3,248,589. PURE MATCH STANDARD CHARACTER MARK. INT. CL. 3. REG. 5-29-2007.
- 3,248,591. CAFÉ SEPIA AND DESIGN. INT. CL. 30. REG. 5-29-2007.
- 3,248,593. MILITARY JOB ZONE TARGETED HUMAN CAPITAL SOLUTIONS AND DESIGN. INT. CL. 35. REG. 5-29-2007.
- 3,248,594. GAMETAP AND DESIGN. INT. CL. 38. REG. 5-29-2007.
- 3,248,598. BILTMORE ESTATE FOR YOUR HOME STANDARD CHARACTER MARK. INT. CL. 21. REG. 5-29-2007.
- 3,248,601. VIRTUOSO INSIGHTS STANDARD CHARACTER MARK. INT. CL. 16. REG. 5-29-2007.
- 3,248,602. SECURE TOUCH STANDARD CHARACTER MARK. INT. CL. 10. REG. 5-29-2007.
- 3,248,603. BOARD UP STANDARD CHARACTER MARK. INT. CL. 41. REG. 5-29-2007.
- 3,248,606. T3 (STYLIZED). INT. CLS. 9, 35 AND 42. REG. 5-29-2007.
- 3,248,608. SWEET POISON STANDARD CHARACTER MARK. INT. CL. 14. REG. 5-29-2007.
- 3,248,609. ONE GOD FITS ALL STANDARD CHARACTER MARK. INT. CL. 25. REG. 5-29-2007.
- 3,248,610. TODAY'S HYDRATION SENSATION STANDARD CHARACTER MARK. INT. CL. 32. REG. 5-29-2007.
- 3,248,613. ENERGIZED COCKTAIL MIX STANDARD CHARACTER MARK. INT. CL. 32. REG. 5-29-2007.
- 3,248,615. ALMOST BUTTER STANDARD CHARACTER MARK. INT. CL. 3. REG. 5-29-2007.
- 3,248,616. EPISURE STANDARD CHARACTER MARK. INT. CL. 10. REG. 5-29-2007.
- 3,248,617. S2 STANDARD CHARACTER MARK. INT. CL. 28. REG. 5-29-2007.
- 3,248,619. BRINGING AN AUTHENTIC CAFÉ TASTE TO YOU STANDARD CHARACTER MARK. INT. CL. 30. REG. 5-29-2007.
- 3,248,620. LITTLE WONDERS CHILD GROWTH & DEVELOPMENT CENTER, INC. AND DESIGN. INT. CL. 44. REG. 5-29-2007.
- 3,248,625. NATURE'S FARE STANDARD CHARACTER MARK. INT. CL. 43. REG. 5-29-2007.
- 3,248,626. MAXILEAN STANDARD CHARACTER MARK. INT. CL. 5. REG. 5-29-2007.
- 3,248,627. TIRAMISU STANDARD CHARACTER MARK. INT. CL. 25. REG. 5-29-2007.
- 3,248,630. PARTNERS IN PREVENTING SCA STANDARD CHARACTER MARK. INT. CLS. 35 AND 41. REG. 5-29-2007.
- 3,248,631. MODEUROPE STANDARD CHARACTER MARK. INT. CL. 35. REG. 5-29-2007.
- 3,248,633. FASHION HOUSE STANDARD CHARACTER MARK. INT. CL. 41. REG. 5-29-2007.
- 3,248,634. SMA+ (STYLIZED). INT. CL. 9. REG. 5-29-2007.
- 3,248,635. CUDDLENEST STANDARD CHARACTER MARK. INT. CL. 20. REG. 5-29-2007.
- 3,248,638. HOME EQUITY OF AMERICA AND DESIGN. INT. CL. 36. REG. 5-29-2007.
- 3,248,641. FREESTYLE CRUISING AND DESIGN. INT. CL. 39. REG. 5-29-2007.
- 3,248,642. SWIVEL-SPOT STANDARD CHARACTER MARK. INT. CL. 11. REG. 5-29-2007.
- 3,248,644. CELL TALK STANDARD CHARACTER MARK. INT. CL. 5. REG. 5-29-2007.
- 3,248,646. MYCOKIDZ STANDARD CHARACTER MARK. INT. CL. 5. REG. 5-29-2007.
- 3,248,647. SIMPLY DELICIOUS STANDARD CHARACTER MARK. INT. CL. 30. REG. 5-29-2007.
- 3,248,648. PEPPERIDGE FARM SIMPLY DELICIOUS STANDARD CHARACTER MARK. INT. CL. 30. REG. 5-29-2007.
- 3,248,649. MY STORY IS ON LIFETIME STANDARD CHARACTER MARK. INT. CL. 41. REG. 5-29-2007.
- 3,248,650. MY STORY IS ON LIFETIME STANDARD CHARACTER MARK. INT. CL. 38. REG. 5-29-2007.

- 3,248,651. MISCELLANEOUS DESIGN. INT. CL. 29. REG. 5-29-2007.
- 3,248,652. SHE-MOTO AND DESIGN. INT. CL. 25. REG. 5-29-2007.
- 3,248,656. BELLYTWINNS STANDARD CHARACTER MARK. INT. CL. 9. REG. 5-29-2007.
- 3,248,658. ARI STANDARD CHARACTER MARK. INT. CL. 42. REG. 5-29-2007.
- 3,248,661. VENTAIRA. INT. CL. 42. REG. 5-29-2007.
- 3,248,662. VENTAIRA AND DESIGN. INT. CL. 42. REG. 5-29-2007.
- 3,248,663. MISCELLANEOUS DESIGN. INT. CL. 25. REG. 5-29-2007.
- 3,248,666. LIQUIDIA TECHNOLOGIES AND DESIGN. INT. CLS. 1 AND 40. REG. 5-29-2007.
- 3,248,668. PLAINS ORGANIZATION FOR WIND ENERGY RESOURCES. INT. CLS. 40 AND 42. REG. 5-29-2007.
- 3,248,669. GOODMAILSYSTEMS (STYLIZED). INT. CL. 42. REG. 5-29-2007.
- 3,248,670. TRACTUS STANDARD CHARACTER MARK. INT. CL. 9. REG. 5-29-2007.
- 3,248,671. ECHRISTIANED STANDARD CHARACTER MARK. INT. CL. 41. REG. 5-29-2007.
- 3,248,673. MISCELLANEOUS DESIGN. INT. CL. 3. REG. 5-29-2007.
- 3,248,675. DIGITAL IMAGE SUBMISSION CRITERIA STANDARD CHARACTER MARK. INT. CL. 42. REG. 5-29-2007.
- 3,248,677. RASH PRO STANDARD CHARACTER MARK. INT. CL. 5. REG. 5-29-2007.
- 3,248,679. DELAWARE BUSINESS LAW & LITIGATION REPORT STANDARD CHARACTER MARK. INT. CL. 41. REG. 5-29-2007.
- 3,248,680. VOICE METER STANDARD CHARACTER MARK. INT. CL. 16. REG. 5-29-2007.
- 3,248,681. SWIVELS IN ANY DIRECTION STANDARD CHARACTER MARK. INT. CL. 20. REG. 5-29-2007.
- 3,248,682. BLOWUP STANDARD CHARACTER MARK. INT. CL. 9. REG. 5-29-2007.
- 3,248,685. NN AND DESIGN. INT. CLS. 5 AND 10. REG. 5-29-2007.
- 3,248,687. WORLD CLASS WEDDINGS AT ROBBINS BROS. AND DESIGN. INT. CL. 41. REG. 5-29-2007.
- 3,248,689. INT'LY KNOWN STANDARD CHARACTER MARK. INT. CL. 25. REG. 5-29-2007.
- 3,248,690. SLIM CARB STANDARD CHARACTER MARK. INT. CL. 30. REG. 5-29-2007.
- 3,248,692. EDISCLOSURES STANDARD CHARACTER MARK. INT. CL. 38. REG. 5-29-2007.
- 3,248,693. E-LAWYER.COM STANDARD CHARACTER MARK. INT. CL. 42. REG. 5-29-2007.
- 3,248,694. FOOT N SHOE STANDARD CHARACTER MARK. INT. CL. 3. REG. 5-29-2007.
- 3,248,695. BECAUSE WOMEN DESERVE BETTER STANDARD CHARACTER MARK. INT. CL. 25. REG. 5-29-2007.
- 3,248,700. WANNE STANDARD CHARACTER MARK. INT. CL. 15. REG. 5-29-2007.
- 3,248,706. ALASKA WEDDING GUIDE (STYLIZED). INT. CL. 41. REG. 5-29-2007.
- 3,248,707. GEMD'SIGN STANDARD CHARACTER MARK. INT. CL. 14. REG. 5-29-2007.
- 3,248,708. THE SARATOGA HOTEL & CONFERENCE CENTER (STYLIZED). INT. CL. 43. REG. 5-29-2007.
- 3,248,709. U.S. MEDICAL CONGRESS CONFERENCE & EXHIBITION STANDARD CHARACTER MARK. INT. CL. 35. REG. 5-29-2007.
- 3,248,711. SCROLL MEDIA STANDARD CHARACTER MARK. INT. CLS. 35 AND 41. REG. 5-29-2007.
- 3,248,712. THE BEER OF THE CARIBBEAN STANDARD CHARACTER MARK. INT. CL. 32. REG. 5-29-2007.
- 3,248,714. TRUSTEE LEADERSHIP DEVELOPMENT STANDARD CHARACTER MARK. INT. CL. 41. REG. 5-29-2007.
- 3,248,718. LIFE IS PRECIOUS STANDARD CHARACTER MARK. INT. CL. 25. REG. 5-29-2007.
- 3,248,719. SOFTWARE-TELEMETRY STANDARD CHARACTER MARK. INT. CLS. 9, 35, 37, 41 AND 42. REG. 5-29-2007.
- 3,248,720. SOFTWARETELEMETRIE STANDARD CHARACTER MARK. INT. CLS. 9, 35, 37, 41 AND 42. REG. 5-29-2007.
- 3,248,722. PET SHOP EXPRESS STANDARD CHARACTER MARK. INT. CL. 35. REG. 5-29-2007.
- 3,248,723. GAY BLIND DATE SEX STANDARD CHARACTER MARK. INT. CL. 41. REG. 5-29-2007.
- 3,248,724. MISCELLANEOUS DESIGN. INT. CL. 5. REG. 5-29-2007.
- 3,248,726. SONA RX STANDARD CHARACTER MARK. INT. CL. 5. REG. 5-29-2007.
- 3,248,727. ALGEBRA MODELS STANDARD CHARACTER MARK. INT. CLS. 16 AND 28. REG. 5-29-2007.
- 3,248,729. REDEVELOPMENT READY COMMUNITIES STANDARD CHARACTER MARK. INT. CL. 35. REG. 5-29-2007.
- 3,248,730. PREMIUM GREEN BAMBOO STANDARD CHARACTER MARK. INT. CL. 19. REG. 5-29-2007.
- 3,248,732. THE FLORIDA CHARTER FISHING GUIDE STANDARD CHARACTER MARK. INT. CL. 16. REG. 5-29-2007.
- 3,248,733. RAPID RESURFACE STANDARD CHARACTER MARK. INT. CL. 3. REG. 5-29-2007.
- 3,248,734. PODCAST MARKETPLACE STANDARD CHARACTER MARK. INT. CL. 35. REG. 5-29-2007.
- 3,248,735. INTELLIGENT NIC STANDARD CHARACTER MARK. INT. CL. 9. REG. 5-29-2007.
- 3,248,736. PREMIER LOG HOMES STANDARD CHARACTER MARK. INT. CL. 19. REG. 5-29-2007.
- 3,248,741. QUALITY CONFECTIONERY & FOOD PRODUCTS STANDARD CHARACTER MARK. INT. CL. 30. REG. 5-29-2007.
- 3,248,742. SUPERAWOS STANDARD CHARACTER MARK. INT. CL. 9. REG. 5-29-2007.
- 3,248,743. SAFE LOADING SYSTEM STANDARD CHARACTER MARK. INT. CL. 6. REG. 5-29-2007.
- 3,248,744. GRILL AID STANDARD CHARACTER MARK. INT. CL. 21. REG. 5-29-2007.
- 3,248,745. BROADBANDSPORTS STANDARD CHARACTER MARK. INT. CL. 41. REG. 5-29-2007.
- 3,248,746. DRY CLEAN SUPER MART STANDARD CHARACTER MARK. INT. CL. 37. REG. 5-29-2007.
- 3,248,749. TECHNOLOGY SHOWHOME STANDARD CHARACTER MARK. INT. CL. 35. REG. 5-29-2007.
- 3,248,750. PHILADELPHIA'S FAMILY NEWSPAPER STANDARD CHARACTER MARK. INT. CL. 16. REG. 5-29-2007.
- 3,248,753. DEARBORN & METRO DETROIT AREA (STYLIZED). INT. CL. 16. REG. 5-29-2007.
- 3,248,754. NEW ZEALAND FOOD WINES STANDARD CHARACTER MARK. INT. CL. 33. REG. 5-29-2007.
- 3,248,755. BRIDGER STANDARD CHARACTER MARK. INT. CL. 6. REG. 5-29-2007.
- 3,248,756. FEDERAL PROPOSALS.COM STANDARD CHARACTER MARK. INT. CL. 35. REG. 5-29-2007.
- 3,248,758. RIBBON ORIGINALS STANDARD CHARACTER MARK. INT. CL. 26. REG. 5-29-2007.
- 3,248,760. THE STEAM POT STANDARD CHARACTER MARK. INT. CL. 29. REG. 5-29-2007.
- 3,248,764. FLAT FOLD COLANDER STANDARD CHARACTER MARK. INT. CL. 21. REG. 5-29-2007.
- 3,248,766. MISCELLANEOUS DESIGN. INT. CL. 25. REG. 5-29-2007.
- 3,248,882. AVANTE STANDARD CHARACTER MARK. INT. CL. 3. REG. 6-5-2007.
- 3,248,970. GREENPRINT STANDARD CHARACTER MARK. INT. CL. 44. REG. 6-5-2007.
- 3,258,619. SUGARBAKER'S STANDARD CHARACTER MARK. INT. CL. 35. REG. 7-3-2007.

- 3,310,241. COMBI (STYLIZED). INT. CL. 9 ONLY. REG. 10-16-2007.
- 3,349,824. BE (STYLIZED). INT. CLS. 35 AND 38 ONLY. REG. 12-4-2007.
- 3,352,441. TIMI & LESLIE STANDARD CHARACTER MARK. INT. CL. 25 ONLY. REG. 12-11-2007.
- 3,353,295. IRONCLAD STANDARD CHARACTER MARK. INT. CL. 8 ONLY. REG. 12-11-2007.
- 3,359,594. WALKING ON WATER STANDARD CHARACTER MARK. INT. CLS. 9, 35 AND 45 ONLY. REG. 12-25-2007.
- 3,364,055. NATIONAL WEAR RED DAY STANDARD CHARACTER MARK. INT. CL. 25 ONLY. REG. 1-8-2008.
- 3,366,781. WORLD PEACE PARENTS STANDARD CHARACTER MARK. INT. CL. 42 ONLY. REG. 1-8-2008.
- 3,367,243. BE BLUE EQUITY AND DESIGN. INT. CLS. 35 AND 38 ONLY. REG. 1-8-2008.
- 3,373,932. CLEARASIL STANDARD CHARACTER MARK. INT. CL. 3 ONLY. REG. 1-22-2008.
- 3,497,804. P2RMIS (STYLIZED). INT. CL. 9 ONLY. REG. 9-9-2008.
- 3,247,704. MISCELLANEOUS DESIGN. INT. CLS. 9, 18 AND 25. REG. 5-29-2007.
- 3,247,705. MISCELLANEOUS DESIGN. INT. CL. 10. REG. 5-29-2007.
- 3,247,706. GCE STANDARD CHARACTER MARK. INT. CL. 36. REG. 5-29-2007.
- 3,247,707. BODY SCANNING CRM THE FUTURE OF SPECIALTY RETAILING AND DESIGN. INT. CLS. 9 AND 20. REG. 5-29-2007.
- 3,247,709. TXSUITE (STYLIZED). INT. CLS. 9, 16, 35 AND 42. REG. 5-29-2007.
- 3,247,710. COOCAROO STANDARD CHARACTER MARK. INT. CLS. 12, 25 AND 28. REG. 5-29-2007.
- 3,247,714. HANDYTRIM STANDARD CHARACTER MARK. INT. CL. 28. REG. 5-29-2007.
- 3,247,716. KLINIPATH STANDARD CHARACTER MARK. INT. CLS. 1, 5, 9, 10, 35 AND 42. REG. 5-29-2007.
- 3,247,718. WHIMORI (STYLIZED). INT. CLS. 29 AND 31. REG. 5-29-2007.
- 3,247,720. MICRON BONFIGLIOLI AND DESIGN. INT. CL. 7. REG. 5-29-2007.
- 3,247,721. DEFECTOSCAN STANDARD CHARACTER MARK. INT. CL. 9. REG. 5-29-2007.
- 3,247,723. MIDLAND STANDARD CHARACTER MARK. INT. CLS. 1, 4, 40 AND 42. REG. 5-29-2007.
- 3,247,724. CANTHAPLUS STANDARD CHARACTER MARK. INT. CL. 31. REG. 5-29-2007.
- 3,247,725. YSL SUN AND DESIGN. INT. CL. 3. REG. 5-29-2007.
- 3,247,728. LFX STANDARD CHARACTER MARK. INT. CLS. 9, 14, 18, 25, 28 AND 41. REG. 5-29-2007.
- 3,247,729. NOVONIC STANDARD CHARACTER MARK. INT. CLS. 6, 17 AND 19. REG. 5-29-2007.
- 3,247,730. JACQUES CALLEBAUT FINEST QUALITY AND DESIGN. INT. CL. 30. REG. 5-29-2007.
- 3,247,731. WORLD STRONGMANCUP W.S.M.C - FEDERATION AND DESIGN. INT. CLS. 35 AND 41. REG. 5-29-2007.
- 3,247,732. LIGHT CLIENT (STYLIZED). INT. CL. 11. REG. 5-29-2007.
- 3,247,734. DIAFACE STANDARD CHARACTER MARK. INT. CLS. 3, 8 AND 21. REG. 5-29-2007.
- 3,247,738. GROUNDFORCE STANDARD CHARACTER MARK. INT. CL. 39. REG. 5-29-2007.
- 3,247,739. BOLLYWOOD STANDARD CHARACTER MARK. INT. CL. 36. REG. 5-29-2007.
- 3,247,740. SHOESTICK STANDARD CHARACTER MARK. INT. CLS. 2 AND 3. REG. 5-29-2007.
- 3,247,741. MOLECTRA STANDARD CHARACTER MARK. INT. CL. 40. REG. 5-29-2007.
- 3,247,743. CEJ (STYLIZED). INT. CL. 9. REG. 5-29-2007.
- 3,247,744. CIWM STANDARD CHARACTER MARK. INT. CLS. 16 AND 41. REG. 5-29-2007.
- 3,247,746. VOULÉVOU? STANDARD CHARACTER MARK. INT. CL. 32. REG. 5-29-2007.
- 3,247,747. DOG GIRL BY CHIEN-CHIC DE PARIS AND DESIGN. INT. CL. 3. REG. 5-29-2007.
- 3,247,749. LALVIN EQ 54 (STYLIZED). INT. CL. 1. REG. 5-29-2007.
- 3,247,750. PRITT WAVE STANDARD CHARACTER MARK. INT. CL. 16. REG. 5-29-2007.
- 3,247,751. L'AMY LUNETTES (STYLIZED). INT. CLS. 9 AND 44. REG. 5-29-2007.
- 3,247,754. RIDDER STANDARD CHARACTER MARK. INT. CL. 29. REG. 5-29-2007.
- 3,247,755. MISCELLANEOUS DESIGN. INT. CL. 43. REG. 5-29-2007.
- 3,247,756. RUBENSLUCIANO AND DESIGN. INT. CLS. 18 AND 25. REG. 5-29-2007.
- 3,247,757. SUPERLOL STANDARD CHARACTER MARK. INT. CLS. 38 AND 45. REG. 5-29-2007.
- 3,247,758. OPTA (STYLIZED). INT. CLS. 6, 17 AND 19. REG. 5-29-2007.
- 3,247,765. DE PERICHE PERSONAL STANDARD CHARACTER MARK. INT. CL. 3. REG. 5-29-2007.
- 3,247,766. LIFRAGAR STANDARD CHARACTER MARK. INT. CL. 5. REG. 5-29-2007.

---

### SECTION 18

- 3,379,305. FUNDRAISING MADE SIMPLE STANDARD CHARACTER MARK. INT. CLS. 35 AND 36. REG. 2-5-2008.
- 3,741,685. ME-BOOK AND DESIGN. INT. CL. 35. REG. 1-26-2010.
- 4,131,711. FRANKENSIGNS STANDARD CHARACTER MARK. INT. CL. 40. REG. 4-24-2012.

---

### SECTION 71

- 3,247,672. PHCY PHARMACY INDUSTRY STANDARD CHARACTER MARK. INT. CL. 25. REG. 5-29-2007.
- 3,247,675. NATURA VITALIS STANDARD CHARACTER MARK. INT. CLS. 5 AND 35. REG. 5-29-2007.
- 3,247,676. LIFE THERAPEUTICS AND DESIGN. INT. CLS. 1, 5 AND 9. REG. 5-29-2007.
- 3,247,678. RAINBOW RED STANDARD CHARACTER MARK. INT. CL. 31. REG. 5-29-2007.
- 3,247,679. TOPOTARGET (STYLIZED). INT. CLS. 1, 5, 10, 42 AND 44. REG. 5-29-2007.
- 3,247,682. IBOSS AND DESIGN. INT. CL. 9. REG. 5-29-2007.
- 3,247,686. GLEM GAS AND DESIGN. INT. CLS. 7 AND 11. REG. 5-29-2007.
- 3,247,690. RICARDA M. (STYLIZED). INT. CLS. 14, 20 AND 21. REG. 5-29-2007.
- 3,247,691. MP3 SURROUND AND DESIGN. INT. CLS. 9, 35 AND 38. REG. 5-29-2007.
- 3,247,694. VINEX AND DESIGN. INT. CLS. 7, 9 AND 40. REG. 5-29-2007.
- 3,247,697. LE SOULIER DE SATIN STANDARD CHARACTER MARK. INT. CLS. 18 AND 25. REG. 5-29-2007.
- 3,247,698. SARFUS STANDARD CHARACTER MARK. INT. CLS. 9, 10, 38 AND 42. REG. 5-29-2007.
- 3,247,699. KAHUNET (STYLIZED). INT. CL. 9. REG. 5-29-2007.
- 3,247,702. EZY SHAID AND DESIGN. INT. CL. 16. REG. 5-29-2007.
- 3,247,703. BX BIOGENIX HEALTH & NUTRITION AND DESIGN. INT. CLS. 5, 29, 30 AND 32. REG. 5-29-2007.

- 3,247,767. CLERSUNA STANDARD CHARACTER MARK. INT. CL. 5. REG. 5-29-2007.
- 3,247,774. ECO-LUXURY STANDARD CHARACTER MARK. INT. CLS. 16, 35 AND 41. REG. 5-29-2007.
- 3,247,778. ZOOK! STANDARD CHARACTER MARK. INT. CL. 25. REG. 5-29-2007.
- 3,247,779. MISCELLANEOUS DESIGN. INT. CLS. 11, 20 AND 21. REG. 5-29-2007.
- 3,247,780. AMENDISTA STANDARD CHARACTER MARK. INT. CL. 5. REG. 5-29-2007.
- 3,247,784. NOVATIN STANDARD CHARACTER MARK. INT. CLS. 9 AND 11. REG. 5-29-2007.
- 3,247,785. ALPHA-PORT STANDARD CHARACTER MARK. INT. CL. 10. REG. 5-29-2007.
- 3,247,787. HANKYU CARGO (STYLIZED). INT. CL. 39. REG. 5-29-2007.
- 3,247,788. PRIDELED STANDARD CHARACTER MARK. INT. CL. 11. REG. 5-29-2007.
- 3,247,792. AMI AND DESIGN. INT. CLS. 8 AND 9. REG. 5-29-2007.
- 3,247,793. MY WORK PLAN JOB MANAGEMENT SOLUTION SESCOI WWW.SESCOI.COM AND DESIGN. INT. CLS. 9, 16, 35, 38 AND 42. REG. 5-29-2007.
- 3,247,794. MISSONI AND DESIGN. INT. CL. 43. REG. 5-29-2007.
- 3,247,795. MISCELLANEOUS DESIGN. INT. CLS. 9, 10 AND 11. REG. 5-29-2007.
- 3,247,796. CPC COLLABORATIVE PROCESS CONTROL AND DESIGN. INT. CL. 9. REG. 5-29-2007.
- 3,247,797. ORMEZZANO (STYLIZED). INT. CL. 25. REG. 5-29-2007.
- 3,247,799. 69° NORD BY ROYAL GREENLAND AND DESIGN. INT. CLS. 29 AND 31. REG. 5-29-2007.
- 3,247,800. SHANGHAI BEER AND DESIGN. INT. CL. 32. REG. 5-29-2007.
- 3,247,805. TRYST STANDARD CHARACTER MARK. INT. CL. 33. REG. 5-29-2007.
- 3,247,811. MISCELLANEOUS DESIGN. INT. CLS. 33 AND 43. REG. 5-29-2007.
- 3,247,812. UNAOHM STANDARD CHARACTER MARK. INT. CL. 9. REG. 5-29-2007.
- 3,247,813. MICSTICK STANDARD CHARACTER MARK. INT. CLS. 9 AND 16. REG. 5-29-2007.
- 3,247,814. GEMRIEL STANDARD CHARACTER MARK. INT. CL. 5. REG. 5-29-2007.
- 3,247,815. SEVEN CITIES STANDARD CHARACTER MARK. INT. CLS. 33, 35 AND 39. REG. 5-29-2007.
- 3,247,816. HELICOMMAND STANDARD CHARACTER MARK. INT. CLS. 9, 12 AND 28. REG. 5-29-2007.
- 3,247,817. ASPIRO AND DESIGN. INT. CL. 19. REG. 5-29-2007.
- 3,247,820. CREEBIES (STYLIZED). INT. CLS. 9, 28 AND 41. REG. 5-29-2007.
- 3,247,821. AURO STANDARD CHARACTER MARK. INT. CLS. 7, 9, 12 AND 39. REG. 5-29-2007.
- 3,247,824. SLECTRIV STANDARD CHARACTER MARK. INT. CL. 5. REG. 5-29-2007.
- 3,247,826. NAVLIGAR STANDARD CHARACTER MARK. INT. CL. 5. REG. 5-29-2007.
- 3,247,828. REVNIOM STANDARD CHARACTER MARK. INT. CL. 5. REG. 5-29-2007.
- 3,247,829. BILTRIS STANDARD CHARACTER MARK. INT. CL. 5. REG. 5-29-2007.
- 3,247,831. ATTESSE (STYLIZED). INT. CL. 20. REG. 5-29-2007.
- 3,247,832. KAMSTRUP: THERE IS ALWAYS A BETTER SOLUTION STANDARD CHARACTER MARK. INT. CLS. 9 AND 37. REG. 5-29-2007.
- 3,247,836. DRCM STANDARD CHARACTER MARK. INT. CL. 36. REG. 5-29-2007.
- 3,247,838. MISCELLANEOUS DESIGN. INT. CLS. 29, 33 AND 35. REG. 5-29-2007.
- 3,247,842. BRYLAS STANDARD CHARACTER MARK. INT. CL. 5. REG. 5-29-2007.
- 3,247,843. BABY ROO AND DESIGN. INT. CL. 18. REG. 5-29-2007.
- 3,247,844. LANCABA STANDARD CHARACTER MARK. INT. CL. 5. REG. 5-29-2007.
- 3,247,845. RYZAMPA STANDARD CHARACTER MARK. INT. CL. 5. REG. 5-29-2007.
- 3,247,846. ZENLAZ STANDARD CHARACTER MARK. INT. CL. 5. REG. 5-29-2007.
- 3,247,847. ZIMLIF STANDARD CHARACTER MARK. INT. CL. 5. REG. 5-29-2007.
- 3,247,848. VINALT STANDARD CHARACTER MARK. INT. CL. 5. REG. 5-29-2007.
- 3,247,849. AZAMPA STANDARD CHARACTER MARK. INT. CL. 5. REG. 5-29-2007.
- 3,247,850. KOLABRA STANDARD CHARACTER MARK. INT. CL. 5. REG. 5-29-2007.
- 3,247,851. NURAMPA STANDARD CHARACTER MARK. INT. CL. 5. REG. 5-29-2007.
- 3,247,852. ZAMPAZ STANDARD CHARACTER MARK. INT. CL. 5. REG. 5-29-2007.
- 3,247,853. AMPAREV STANDARD CHARACTER MARK. INT. CL. 5. REG. 5-29-2007.
- 3,247,856. PRIVID STANDARD CHARACTER MARK. INT. CL. 9. REG. 5-29-2007.
- 3,247,857. PSALMS STANDARD CHARACTER MARK. INT. CL. 33. REG. 5-29-2007.
- 3,247,858. MOSQUITO STANDARD CHARACTER MARK. INT. CL. 33. REG. 5-29-2007.
- 3,247,859. WOKITA STANDARD CHARACTER MARK. INT. CLS. 39, 41 AND 43. REG. 5-29-2007.
- 3,251,962. A ALCANTARA AND DESIGN. INT. CLS. 12, 20 AND 25 ONLY. REG. 6-12-2007.
- 3,252,037. PS PRINTSERVICES AND DESIGN. INT. CLS. 36 AND 39 ONLY. REG. 6-12-2007.
- 3,265,248. ACF AND DESIGN. INT. CLS. 3 AND 6 ONLY. REG. 7-17-2007.
- 3,265,249. ACF FIORENTINA ACF AND DESIGN. INT. CLS. 3, 6 AND 18 ONLY. REG. 7-17-2007.
- 3,356,507. WERKMAN (STYLIZED). INT. CLS. 6, 8 AND 35 ONLY. REG. 12-18-2007.
- 3,359,936. BM GROUP AND DESIGN. INT. CL. 42. REG. 12-25-2007.
- 3,359,948. ZSISKA (STYLIZED). INT. CLS. 14, 18 AND 25 ONLY. REG. 12-25-2007.
- 3,362,637. SENZ STANDARD CHARACTER MARK. INT. CLS. 18 AND 22 ONLY. REG. 1-1-2008.
- 3,431,348. PÈRE MAGLOIRE AND DESIGN. INT. CLS. 32 AND 43 ONLY. REG. 5-20-2008.

---

**INADVERTENTLY ISSUED REGISTRATION  
NUMBERS**

- 4,342,674. HELL YEAH STANDARD CHARACTER MARK. INT. CLS. 35 AND 41. REG. 5-28-2013. RESTORED TO SN 85-768,262.

\* \* \* \* \*

# TRADEMARK REGISTRATIONS AMENDED, CORRECTED, ETC.

The designation "U.S. Cl." appearing in this section refers to the U.S. class in effect prior to Sep. 1, 1973 rather than the international class which applies to applications filed on or after that date. For adoption of international classification see notice in the OFFICIAL GAZETTE of Jun. 26, 1973 (911 O.G. TM 210).

Any change to the registration will be indicated at the bottom of each entry under ELEMENTS AMENDED, CORRECTED OR RESTRICTED. With the exception of changes to the goods and services, additions to the registration will appear in asterisks and deletions of the registration will appear in brackets. Elements which are only changed will be listed with no punctuation. As to the goods/services statement, amendments to the goods/services will appear in asterisks and deletions will appear in brackets. In addition if any change to the goods/services occurs, the element "Goods/Services" will be listed under ELEMENTS AMENDED, CORRECTED OR RESTRICTED.

578,492. REG. 8-11-1953. SUNKIST GROWERS, INC. (CALIFORNIA CORPORATION) 14130 RIVERSIDE DRIVE, SHERMAN OAKS, CA, 91423, SN 71-626,009. FILED 3-5-1952. PRINCIPAL REGISTER.

969,562. REG. 10-2-1973. LEIFHEIT AKTIENGESELLSCHAFT (FED REP GERMANY CORPORATION) POSTFACH 1165, D-56371 NASSAU/LAHN, FED REP GERMANY,, SN 72-369,015. FILED 8-25-1970. PRINCIPAL REGISTER.

# SUNKIST

# LEIFHEIT

THE MARK CONSISTS OF STANDARD CHARACTERS WITHOUT CLAIM TO ANY PARTICULAR FONT, STYLE, SIZE, OR COLOR.

OWNER OF U.S. REG. NOS. 72,087, 304,659 AND OTHERS. INT. CL. 32/U.S. CL. 45

FOR CITRUS FLAVORED SOFT DRINKS AND CONCENTRATES FOR MAKING THE SAME; AND CITRUS FRUIT PRODUCTS USED AS INGREDIENTS IN SUCH SOFT DRINKS—NAMELY, [ CITRIC ACID, ] CITRUS OILS [ , AND PECTIN ] .

FIRST USE 2-8-1930; IN COMMERCE 2-8-1930.

ELEMENTS AMENDED  
MARK

735,833. REG. 8-14-1962. MHLL ENTERPRISES, LLC (DELAWARE LIMITED LIABILITY COMPANY) 2440 HIGH-POINT ROAD, SUITE 5, BEACHWOOD, OH, 44122, SN 72-125,042. FILED 7-31-1961. PRINCIPAL REGISTER.

# HomeCare

THE MARK CONSISTS OF STANDARD CHARACTERS WITHOUT CLAIM TO ANY PARTICULAR FONT, STYLE, SIZE, OR COLOR.

INT. CL. 16/U.S. CL. 2

FOR DISPOSABLE VACUUM CLEANER BAGS.  
FIRST USE 7-17-1961; IN COMMERCE 7-17-1961.

ELEMENTS AMENDED  
\*ASSIGNMENT/NAME CHANGE\*  
MARK

OWNER OF FED REP GERMANY REG. NO. 861516, DATED 10-1-1969.

OWNER OF FED REP GERMANY REG. NO. 778984, DATED 10-23-1963.

INT. CL. 7/U.S. CLS. 13, 19, 21, 23, 31, 34 AND 35

FOR CARPET SWEEPERS, AND CARPET AND UPHOLSTERY SHAMPOOING MACHINES; LAUNDRY DRYERS.

FIRST USE ; IN COMMERCE .

INT. CL. 21/U.S. CLS. 2, 13, 23, 29, 30, 33, 40 AND 50

FOR DUSTING AND CLEANING CLOTHS, MOPS, DUSTERS, WALL AND CEILING BRUSHES, CLOTHES BRUSHES, CLOTHES CLEANING DEVICES IN THE FORM OF ADHESIVE ROLLERS, SPONGE SCRUBBERS, TABLE CRUMBERS, FRINGE COMBS, BRUSH CLEANING IMPLEMENTS, POT CLEANERS, WINDOW CLEANING DEVICES OF THE NATURE OF HAND-HELD SPONGES AND SQUEEGEES, AND LINT REMOVERS.

FIRST USE ; IN COMMERCE .

ELEMENTS AMENDED  
GOODS/SERVICES  
U.S. CLASS(ES)

976,344. REG. 1-8-1974. WILLIAMS-SONOMA, INC. (DELAWARE CORPORATION) 3250 VAN NESS AVENUE, SAN FRANCISCO, CA, 94109, SN 72-445,270. FILED 1-5-1973. PRINCIPAL REGISTER.

# POTTERY BARN

THE MARK CONSISTS OF STANDARD CHARACTERS WITHOUT CLAIM TO ANY PARTICULAR FONT, STYLE, SIZE, OR COLOR.

OWNER OF U.S. REG. NO. 655,819.

INT. CL. 8/U.S. CL. 23

FOR FLATWARE—NAMELY, KNIVES, FORKS, AND SPOONS MADE OF NON-PRECIOUS METAL.

FIRST USE 4-2-1956; IN COMMERCE 4-2-1956.

ELEMENTS AMENDED  
\*ASSIGNMENT/NAME CHANGE\*

MARK

FOR RESTAURANT SERVICES.  
FIRST USE 6-0-1986; IN COMMERCE 6-0-1986.

---

1,768,963. REG. 5-4-1993. HOBICO, INC. (ILLINOIS CORPORATION), DBA GREAT PLANES MODEL DISTRIBUTORS COMPANY, 2904 RESEARCH ROAD, CHAMPAIGN, IL, 61821, SN 74-238,853. FILED 1-21-1992. PRINCIPAL REGISTER.

ELEMENTS CORRECTED  
OWNER NAME  
OWNER ADDRESS  
ENTITY

## GREAT PLANES MODEL DISTRIBUTORS

2,208,744. REG. 12-8-1998. THE MOUNTAIN CORPORATION (NEW HAMPSHIRE CORPORATION) 59 OPTICAL AVE, PO BOX 686, KEENE, NH, 03431, SN 75-363,020. FILED 9-25-1997. PRINCIPAL REGISTER.

THE MARK CONSISTS OF STANDARD CHARACTERS WITHOUT CLAIM TO ANY PARTICULAR FONT, STYLE, SIZE, OR COLOR.

## THE MOUNTAIN

NO CLAIM IS MADE TO THE EXCLUSIVE RIGHT TO USE "PLANES" AND "MODEL DISTRIBUTORS", APART FROM THE MARK AS SHOWN.

OWNER OF U.S. REG. NO. 1,775,583.  
INT. CL. 25/U.S. CLS. 22 AND 39  
FOR CLOTHING, NAMELY, T-SHIRTS AND SWEAT-SHIRTS.  
FIRST USE 9-23-1992; IN COMMERCE 9-23-1992.

SEC. 2(F).

INT. CL. 42/U.S. CL. 101

FOR WHOLESALE DISTRIBUTORSHIP SERVICES IN THE FIELD OF RADIO CONTROLLED MODELS AND ACCESSORIES THEREFOR.

FIRST USE 1-0-1973; IN COMMERCE 1-0-1973.

ELEMENTS CORRECTED  
OWNER NAME  
CITIZENSHIP

ELEMENTS AMENDED  
MARK  
DISCLAIMER

---

2,375,180. REG. 8-8-2000. THE MOUNTAIN CORPORATION (NEW HAMPSHIRE CORPORATION) 59 OPTICAL AVE, PO BOX 686, KEENE, NH, 03431, SN 75-791,348. FILED 9-2-1999. PRINCIPAL REGISTER.

1,772,713. REG. 5-25-1993. AMCOL INTERNATIONAL CORPORATION (DELAWARE CORPORATION) 2870 FORBS AVENUE, HOFFMAN ESTATES, IL, 60192, SN 74-229,428. FILED 12-9-1991. PRINCIPAL REGISTER.

## AGRO-LIG



THE MARK CONSISTS OF STANDARD CHARACTERS WITHOUT CLAIM TO ANY PARTICULAR FONT, STYLE, SIZE, OR COLOR.

OWNER OF U.S. REG. NO. 2,208,744.  
INT. CL. 25/U.S. CLS. 22 AND 39  
FOR CLOTHING NAMELY T-SHIRTS.  
FIRST USE 6-1-1997; IN COMMERCE 6-1-1997.

INT. CL. 1/U.S. CL. 10

FOR HUMIC ACID COMPOSITION FOR AGRICULTURAL USE.

FIRST USE 1-5-1989; IN COMMERCE 1-5-1989.

ELEMENTS CORRECTED  
OWNER NAME  
CITIZENSHIP

ELEMENTS AMENDED  
\*ASSIGNMENT/NAME CHANGE\*  
MARK

---

2,723,984. REG. 6-10-2003. SPECTORE CORPORATION (DELAWARE CORPORATION) 510 GOOLSBY BLVD, DEERFIELD BEACH, FL, 33442, SN 76-439,146. FILED 8-9-2002. PRINCIPAL REGISTER.

2,071,837. REG. 6-17-1997. ST. JAMES ASSOCIATES, L.P. (NEW YORK LIMITED PARTNERSHIP), DBA SMITH & WOLLENSKY, C/O FOURTH WALL RESTAURANTS, 880 THIRD AVENUE, NEW YORK, NY, 10022, SN 75-139,300. FILED 7-24-1996. PRINCIPAL REGISTER.

## THE QUINTESSENTIAL NEW YORK CITY STEAKHOUSE

## SPECTORE

INT. CL. 14/U.S. CLS. 2, 27, 28 AND 50  
FOR JEWELRY, NAMELY, RINGS, BRACELETS, NECKLACES, PENDANTS AND EARRINGS.  
FIRST USE 7-15-1983; IN COMMERCE 7-15-1983.

NO CLAIM IS MADE TO THE EXCLUSIVE RIGHT TO USE "NEW YORK CITY STEAKHOUSE", APART FROM THE MARK AS SHOWN.

INT. CL. 42/U.S. CLS. 100 AND 101

ELEMENTS CORRECTED  
ENTITY

2,730,009. REG. 6-24-2003. MCEVOY MEDIA LLC (DELAWARE LIMITED LIABILITY COMPANY) 680 SECOND STREET, SAN FRANCISCO, CA., SN 76-225,218. FILED 3-15-2001. PRINCIPAL REGISTER.

**7 X 7**

INT. CL. 16/U.S. CLS. 2, 5, 22, 23, 29, 37, 38 AND 50  
 FOR PERIODICAL PUBLICATIONS REGARDING TOPICS OF GENERAL INTEREST IN THE SAN FRANCISCO, CALIFORNIA AREA.  
 FIRST USE 9-1-2001; IN COMMERCE 9-1-2001.

ELEMENTS CORRECTED  
 OWNER NAME



2,746,987. REG. 8-5-2003. ALEMIS, ALEXANDER G. (UNITED STATES INDIVIDUAL) 12151 S. 73RD AVENUE, PALOS HEIGHTS, IL, 60463, SN 76-460,847. FILED 10-22-2002. PRINCIPAL REGISTER.

FOR COMPUTERS AND COMPUTER HARDWARE, INTEGRATED CIRCUITS, TELEVISION SET TOP BOXES, COMPUTER GAME CONSOLES, COMPUTER PERIPHERALS, AND CONSUMER ELECTRONICS EQUIPMENT, NAMELY, CAMERAS, CAMCORDERS, AUDIO AND VIDEO RECORDERS AND PLAYERS, MP3 PLAYERS, CD PLAYERS, DVD PLAYERS, CELLULAR PHONES, PERSONAL DIGITAL ASSISTANTS, AND GLOBAL POSITIONING SYSTEMS CONSISTING OF COMPUTERS, COMPUTER SOFTWARE, TRANSMITTERS, RECEIVERS, AND NETWORK INTERFACE DEVICES; AND ELECTRONIC MEASUREMENT AND TEST INSTRUMENTS FOR DESIGNING AND TESTING THE PERFORMANCE, FEATURES, COMPATIBILITY, INTEROPERABILITY, FUNCTIONALITY, COMPLIANCE AND ADHERENCE TO INDUSTRY STANDARDS OF THE FOREGOING DEVICES, COMPONENTS AND SYSTEMS; COMPUTER CABLES AND CONNECTORS; COMPUTER SOFTWARE FOR USE IN THE OPERATION OF ALL OF THE FOREGOING; COMPUTER SOFTWARE FOR TESTING THE PERFORMANCE, FEATURES, COMPATIBILITY, INTEROPERABILITY, FUNCTIONALITY, COMPLIANCE AND ADHERENCE TO INDUSTRY STANDARDS OF COMPUTERS, ELECTRONICS AND TELECOMMUNICATIONS PRODUCTS.  
 FIRST USE 8-0-2001; IN COMMERCE 8-0-2001.

ELEMENTS AMENDED  
 OWNER NAME

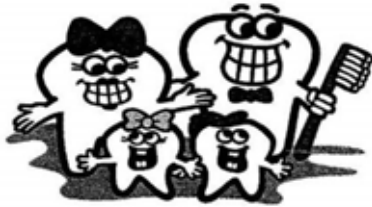

2,822,609. REG. 3-16-2004. BULL REALTY, INC. (GEORGIA CORPORATION) 50 GLENLAKE PARKWAY, SUITE 650, ATLANTA, GA, 30328, SN 76-488,842. FILED 2-5-2003. PRINCIPAL REGISTER.

INT. CL. 44/U.S. CLS. 100 AND 101  
 FOR DENTAL SERVICES.  
 FIRST USE 9-15-1997; IN COMMERCE 9-15-1997.

**BULL REALTY**

ELEMENTS AMENDED  
 \*DESCRIPTION OF MARK\*  
 MARK



2,798,239. REG. 12-23-2003. USB IMPLEMENTERS FORUM, INC. (OREGON CORPORATION) 3855 SW 153RD DRIVE, BEAVERTON, OR, 97006, SN 76-106,941. FILED 8-9-2000. PRINCIPAL REGISTER.

THE MARK CONSISTS OF STANDARD CHARACTERS WITHOUT CLAIM TO ANY PARTICULAR FONT, STYLE, SIZE, OR COLOR.  
 INT. CL. 35/U.S. CLS. 100, 101 AND 102  
 FOR ADVERTISING SERVICES IN THE FIELD OF INVESTMENT AND COMMERCIAL REAL ESTATE FOR OTHERS; REAL ESTATE MARKETING SERVICES, NAMELY, ON-LINE SERVICES FEATURING INVESTMENT AND COMMERCIAL REAL ESTATE OF OTHERS.  
 FIRST USE 3-8-2001; IN COMMERCE 3-8-2001.



INT. CL. 36/U.S. CLS. 100, 101 AND 102  
 FOR PROVIDING REAL ESTATE BROKERAGE FIRM SERVICES, NAMELY: PROVIDING INFORMATION AND PROFESSIONAL RESOURCES IN THE FIELD OF INVESTMENT AND COMMERCIAL REAL ESTATE; PROVIDING INFORMATION IN THE FIELD OF COMMERCIAL REAL ESTATE BY WAY OF LINKS TO THE WEB SITES OF INVESTMENT AND COMMERCIAL REAL ESTATE OFFERINGS OF OTHERS; PROPERTY LISTING OF INVESTMENT AND COMMERCIAL REAL ESTATE OF OTHERS; LISTING SERVICES FOR SELLERS AND BUYERS OF REAL ESTATE GOODS AND SERVICES IN THE NATURE OF INVESTMENT AND COMMERCIAL REAL ESTATE, DEMOGRAPHICS, ZONING, AND GOVERNMENT INFORMATION, NAMELY, PROVIDING APPRAISAL, AND ANALYSIS SERVICES OF INVESTMENT AND COMMERCIAL REAL ESTATE AND REAL ESTATE CONSULTATION SERVICES.  
 FIRST USE 3-8-2001; IN COMMERCE 3-8-2001.  
 INT. CL. 42/U.S. CLS. 100 AND 101

NO CLAIM IS MADE TO THE EXCLUSIVE RIGHT TO USE "CERTIFIED USB", APART FROM THE MARK AS SHOWN.  
 THE MARK CONSISTS OF A STYLIZED PLUG CONNECTOR WITH THE WORD "CERTIFIED" ON THE CORD END OF THE CONNECTOR AND THE LETTERS "USB" ON THE PLUG END OF THE CONNECTOR.  
 INT. CL. 9/U.S. CLS. 21, 23, 26, 36 AND 38



FOR PROVIDING CUSTOMIZED ON-LINE WEB PAGES FEATURING USER-DEFINED INFORMATION, WHICH INCLUDES SEARCH ENGINES AND ON-LINE WEB LINKS TO OTHER WEB SITES; PROVIDING TEMPORARY USE OF ON-LINE NON-DOWNLOADABLE SOFTWARE FOR INFORMATION REQUESTED BY CUSTOMERS, NAMELY MORTGAGE CALCULATION, MANAGEMENT, REAL ESTATE APPRAISAL, AND FINANCIAL AND GOVERNMENTAL AUTHORITY REQUIRED FORMS.  
 FIRST USE 3-8-2001; IN COMMERCE 3-8-2001.

ELEMENTS AMENDED  
 MARK

2,829,493. REG. 4-6-2004. BULL REALTY, INC. (GEORGIA CORPORATION) 50 GLENLAKE PARKWAY, SUITE 650, ATLANTA, GA, 30328, SN 76-488,841. FILED 2-5-2003. PRINCIPAL REGISTER.



THE MARK IS NOT LINED FOR COLOR.  
 INT. CL. 35/U.S. CLS. 100, 101 AND 102  
 FOR ADVERTISING SERVICES IN THE FIELD OF INVESTMENT AND COMMERCIAL REAL ESTATE FOR OTHERS; REAL ESTATE MARKETING SERVICES, NAMELY, ON-LINE SERVICES FEATURING INVESTMENT AND COMMERCIAL REAL ESTATE OF OTHERS

FIRST USE 3-8-2001; IN COMMERCE 3-8-2001.  
 INT. CL. 36/U.S. CLS. 100, 101 AND 102  
 FOR PROVIDING REAL ESTATE BROKERAGE FIRM SERVICES, NAMELY: PROVIDING INFORMATION AND PROFESSIONAL RESOURCES IN THE FIELD OF INVESTMENT AND COMMERCIAL REAL ESTATE; PROVIDING INFORMATION IN THE FIELD OF COMMERCIAL REAL ESTATE BY WAY OF LINKS TO THE WEB SITES OF INVESTMENT AND COMMERCIAL REAL ESTATE OFFERINGS OF OTHERS; PROPERTY LISTING OF INVESTMENT AND COMMERCIAL REAL ESTATE OF OTHERS; LISTING SERVICES FOR SELLERS AND BUYERS OF REAL ESTATE GOODS AND SERVICES IN THE NATURE OF INVESTMENT AND COMMERCIAL REAL ESTATE, DEMOGRAPHICS, ZONING, AND GOVERNMENT INFORMATION, NAMELY, PROVIDING APPRAISAL, AND ANALYSIS SERVICES OF INVESTMENT AND COMMERCIAL REAL ESTATE AND REAL ESTATE CONSULTATION SERVICES.

FIRST USE 3-8-2001; IN COMMERCE 3-8-2001.  
 INT. CL. 42/U.S. CLS. 100 AND 101  
 FOR PROVIDING CUSTOMIZED ON-LINE WEB PAGES FEATURING USER-DEFINED INFORMATION, WHICH INCLUDES SEARCH ENGINES AND ON-LINE WEB LINKS TO OTHER WEB SITES; PROVIDING TEMPORARY USE OF ON-LINE NON-DOWNLOADABLE SOFTWARE FOR INFORMATION REQUESTED BY CUSTOMERS, NAMELY MORTGAGE CALCULATION, MANAGEMENT, REAL ESTATE APPRAISAL, AND FINANCIAL AND GOVERNMENTAL AUTHORITY REQUIRED FORMS.  
 FIRST USE 3-8-2001; IN COMMERCE 3-8-2001.

ELEMENTS AMENDED  
 MARK

3,158,546. REG. 10-17-2006. AURORA HEALTH CARE, INC. (WISCONSIN NON-STOCK CORPORATION) 750 W. VIRGINIA STREET, MILWAUKEE, WI, 53204, SN 78-762,819. FILED 11-29-2005. PRINCIPAL REGISTER.

**AURORA**

THE MARK CONSISTS OF STANDARD CHARACTERS WITHOUT CLAIM TO ANY PARTICULAR FONT, STYLE, SIZE, OR COLOR.

OWNER OF U.S. REG. NOS. 1,979,169, 1,981,941 AND 2,639,136.

INT. CL. 35/U.S. CLS. 100, 101 AND 102  
 FOR RETAIL PHARMACY SERVICES.  
 FIRST USE 12-31-1992; IN COMMERCE 12-31-1992.  
 INT. CL. 44/U.S. CLS. 100 AND 101

FOR HEALTH CARE SERVICES; HOSPITAL SERVICES; MEDICAL SERVICES; HOME HEALTH CARE SERVICES; HOME NURSING AID SERVICES; EMERGENCY MEDICAL ASSISTANCE; AMBULANT MEDICAL CARE; MEDICAL CLINICS; MENTAL HEALTH SERVICES; SURGERY; OPHTHALMOLOGY SERVICES; OPTOMETRY SERVICES; PROVIDING HEALTH INFORMATION; PREPARATION AND DISPENSING OF MEDICATIONS; DISPENSING OF PHARMACEUTICALS; DIETARY AND NUTRITIONAL GUIDANCE; OCCUPATIONAL THERAPY SERVICES; PSYCHIATRIC SERVICES; PHYSICAL REHABILITATION; OCCUPATIONAL THERAPY SERVICES; REHABILITATION OF DRUG ADDICTED PATIENTS; REHABILITATION OF ALCOHOL ADDICTED PATIENTS; AND NUTRITION COUNSELING.

FIRST USE 12-7-1989; IN COMMERCE 12-7-1989.

ELEMENTS CORRECTED  
 ENTITY

3,229,421. REG. 4-17-2007. FORT ZUMWALT PUBLIC SCHOOL EDUCATION FOUNDATION (MISSOURI NON-PROFIT CORPORATION) 110 VIRGIL STREET, O'FALLON, MO, 63366, SN 78-859,001. FILED 4-11-2006. PRINCIPAL REGISTER.



NO CLAIM IS MADE TO THE EXCLUSIVE RIGHT TO USE "FORT ZUMWALT EDUCATION FOUNDATION", APART FROM THE MARK AS SHOWN.  
 INT. CL. 36/U.S. CLS. 100, 101 AND 102

FOR CHARITABLE FUNDRAISING SERVICES, NAMELY SOLICITING, MANAGING AND INVESTING PRIVATE DONATIONS FOR EDUCATIONAL PURPOSES; FUNDING EDUCATIONAL PROGRAMS AND PROJECTS.

FIRST USE 4-5-2006; IN COMMERCE 4-5-2006.

ELEMENTS CORRECTED  
OWNER NAME

---

3,239,374. REG. 5-8-2007. WILDLIFE LEARNING CENTER (CALIFORNIA CORPORATION) 15981 YARNELL STREET, SUITE 251, SYLMAR, CA, 91342, SN 78-912,709. FILED 6-20-2006. PRINCIPAL REGISTER.

## THE ANIMAL GUYS, INC.

THE MARK CONSISTS OF STANDARD CHARACTERS WITHOUT CLAIM TO ANY PARTICULAR FONT, STYLE, SIZE, OR COLOR.

NO CLAIM IS MADE TO THE EXCLUSIVE RIGHT TO USE "ANIMAL" AND "INC.", APART FROM THE MARK AS SHOWN.

INT. CL. 41/U.S. CLS. 100, 101 AND 107

FOR EDUCATION AND ENTERTAINMENT SERVICES, NAMELY, LECTURING ABOUT WILDLIFE TO SCHOOLS, CLUBS AND GENERAL AUDIENCES.

FIRST USE 4-0-2001; IN COMMERCE 8-29-2003.

ELEMENTS AMENDED  
OWNER NAME

---

3,240,787. REG. 5-8-2007. ST. JAMES ASSOCIATES, L.P. (NEW YORK LIMITED PARTNERSHIP), DBA SMITH & WOLLENSKY, C/O FOURTH WALL RESTAURANTS, 880 THIRD AVENUE, NEW YORK, NY, 10022, SN 78-978,149. FILED 6-25-2004. PRINCIPAL REGISTER.

## SMITH & WOLLENSKY

THE MARK CONSISTS OF STANDARD CHARACTERS WITHOUT CLAIM TO ANY PARTICULAR FONT, STYLE, SIZE, OR COLOR.

OWNER OF U.S. REG. NOS. 1,271,216 AND 1,399,014.

INT. CL. 8/U.S. CLS. 23, 28 AND 44

FOR STEAK KNIVES.

FIRST USE 0-0-1995; IN COMMERCE 0-0-1995.

INT. CL. 29/U.S. CL. 46

FOR FRESH CUTS OF BEEF, NAMELY, STEAKS.

FIRST USE 0-0-1995; IN COMMERCE 0-0-1995.

INT. CL. 30/U.S. CL. 46

FOR BARBEQUE SAUCE; STEAK SAUCE; PEPPER STEAK SAUCE AND SALAD DRESSINGS.

FIRST USE 0-0-2002; IN COMMERCE 0-0-2002.

INT. CL. 33/U.S. CLS. 47 AND 49

FOR WINE.

FIRST USE 0-0-2003; IN COMMERCE 0-0-2003.

ELEMENTS CORRECTED  
OWNER NAME

3,240,848. REG. 5-8-2007. MEDTECH PUBLISHING COMPANY, LLC (MAINE LIMITED LIABILITY COMPANY), DBA MEDTECH PUBLISHING COMPANY, 71 PINELAND DRIVE, SUITE 203, NEW GLOUCESTER, ME, 04260, SN 78-640,168. FILED P.R. 5-31-2005; AM. S.R. 1-26-2007. SUPPLEMENTAL REGISTER.

## Healthcare IT News

INT. CL. 16/U.S. CLS. 2, 5, 22, 23, 29, 37, 38 AND 50

FOR PRINTED MATERIALS, NAMELY PROVISION OF MONTHLY PERIODICAL PUBLICATIONS REGARDING HEALTHCARE INFORMATION TECHNOLOGIES AND IT MANAGEMENT FOR HEALTHCARE PROFESSIONALS.

FIRST USE 11-1-2003; IN COMMERCE 11-1-2003.

ELEMENTS CORRECTED  
OWNER NAME

---

3,293,382. REG. 9-18-2007. IV-MEDIA, LLC (DELAWARE LIMITED LIABILITY COMPANY) 9111 RIVER CREST, SUFFOLK, VA, 234331111, SN 77-088,176. FILED 1-22-2007. PRINCIPAL REGISTER.

## BostonNewsChannel

THE MARK CONSISTS OF STANDARD CHARACTERS WITHOUT CLAIM TO ANY PARTICULAR FONT, STYLE, SIZE, OR COLOR.

SEC. 2(F).

INT. CL. 38/U.S. CLS. 100, 101 AND 104

FOR PROVIDING MULTIPLE USE ACCESS TO GLOBAL COMPUTER INFORMATION NETWORKS FOR THE TRANSFER AND DISSEMINATION OF A WIDE RANGE OF INFORMATION; PROVIDING ON-LINE COMMUNICATIONS LINKS WHICH TRANSFER THE WEBSITE USER TO OTHER LOCAL AND GLOBAL WEB PAGES; STREAMING OF AUDIO MATERIAL ON THE INTERNET; STREAMING OF VIDEO MATERIAL ON THE INTERNET; TRANSMISSION OF NEWS.

FIRST USE 12-10-1997; IN COMMERCE 12-10-1997.

ELEMENTS CORRECTED  
CITIZENSHIP

---

3,294,859. REG. 9-18-2007. DIGIFLIGHT (NEVADA CORPORATION) SUITE 202, 1010 VERMONT AVE, WASHINGTON, DC, 20005, SN 78-598,782. FILED 3-31-2005. PRINCIPAL REGISTER.

## DigiFlight

THE MARK CONSISTS OF STANDARD CHARACTERS WITHOUT CLAIM TO ANY PARTICULAR FONT, STYLE, SIZE, OR COLOR.

INT. CL. 35/U.S. CLS. 100, 101 AND 102

FOR BUSINESS ACQUISITION MANAGEMENT SERVICE.  
 FIRST USE 6-0-1999; IN COMMERCE 6-0-1999.  
 INT. CL. 42/U.S. CLS. 100 AND 101  
 FOR APPLICATION SERVICE PROVIDER, NAMELY, HOSTING COMPUTER SOFTWARE APPLICATIONS OF OTHERS; COMPUTER SOFTWARE DEVELOPMENT.  
 FIRST USE 6-0-1999; IN COMMERCE 6-0-1999.

ELEMENTS CORRECTED  
 OWNER NAME



3,325,105. REG. 10-30-2007. ALLIANCE TIRE AMERICAS, INC. (DELAWARE CORPORATION) 201 EDGEWATER DRIVE, SUITE 285, WAKEFIELD, MA. 01880, SN 76-517,704. FILED 5-28-2003. PRINCIPAL REGISTER.

**HARBOURMASTER**

INT. CL. 12/U.S. CLS. 19, 21, 23, 31, 35 AND 44 FOR TIRES.  
 FIRST USE 3-0-2007; IN COMMERCE 3-0-2007.

ELEMENTS AMENDED  
 MARK



3,333,083. REG. 11-13-2007. INTEGRATED HEALTH PLAN, INC. (FLORIDA CORPORATION) 4020 PARK STREET, SUITE 103, ST. PETERSBURG, FL. 33709, SN 76-485,022. FILED 1-24-2003. PRINCIPAL REGISTER.



OWNER OF U.S. REG. NO. 3,216,701.  
 NO CLAIM IS MADE TO THE EXCLUSIVE RIGHT TO USE HEALTH PLAN, INC. AND A REPRESENTATION OF THE MAP OF THE UNITED STATES, APART FROM THE MARK AS SHOWN.  
 THE MARK CONSISTS OF A DEPICTION, IN CONTRASTING COLOR WITH THE BACKGROUND, OF THE UNITED STATES WITH THE WORDS "INTEGRATED HEALTH PLAN, INC". PARTIALLY OVERLAYING THE DEPICTION OF UNITED STATES".  
 SEC. 2(F).  
 INT. CL. 35/U.S. CLS. 100, 101 AND 102

FOR HEALTH CARE PROVIDER NETWORK SERVICES, NAMELY, DEVELOPMENT, BUSINESS MANAGEMENT AND ORGANIZATIONAL CONSULTATION AND MARKETING IN THE NATURE OF NETWORKS OF CONTRACTUAL ARRANGEMENTS BETWEEN MULTI-SPECIALTY CONTRACTED PHYSICIANS, AN-CILLARY HEALTHCARE PROVIDERS AND HOSPITALS, AND HEALTHCARE THIRD-PARTY PAYORS, INCLUDING INSURANCE PLANS; HEALTH CARE CLAIM NEGOTIATIONS, NAMELY HEALTH CARE CLAIMS BILLING NEGOTIATIONS FOR OTHERS IN THE NATURE OF ADJUSTMENTS TO BILLING FOR SERVICES PERFORMED BY OUT-OF-NETWORK HEALTHCARE PROVIDERS; RE-PRICING SERVICES, NAMELY RE-PRICING THIRD-PARTY PAYOR CLAIMS FOR OTHERS, IN THE NATURE OF ADJUSTING HEALTH CARE PROVIDER TRANSACTIONAL CHARGES TO NETWORK CONTRACTUALLY AGREED RATES; EMPLOYMENT VERIFICATION OF HEALTH CARE PROVIDER CREDENTIALS.  
 FIRST USE 1-5-2000; IN COMMERCE 1-5-2000.

ELEMENTS AMENDED  
 \*DESCRIPTION OF MARK\*  
 MARK



3,336,632. REG. 11-13-2007. BTC BROADBAND INC. (OKLAHOMA CORPORATION) 6 E. BRECKENRIDGE, BIXBY, OK. 74008, SN 78-757,436. FILED 11-18-2005. PRINCIPAL REGISTER.

**BTC BROADBAND**

THE MARK CONSISTS OF STANDARD CHARACTERS WITHOUT CLAIM TO ANY PARTICULAR FONT, STYLE, SIZE, OR COLOR.  
 NO CLAIM IS MADE TO THE EXCLUSIVE RIGHT TO USE "BROADBAND", APART FROM THE MARK AS SHOWN.  
 INT. CL. 38/U.S. CLS. 100, 101 AND 104  
 FOR TELECOMMUNICATION SERVICES, NAMELY, LOCAL AND LONG DISTANCE TRANSMISSION OF VOICE, DATA, GRAPHICS AND VIDEO BY MEANS OF TELEPHONE, [ TELEGRAPHIC ] AND CABLE TRANSMISSIONS.  
 FIRST USE 9-1-2005; IN COMMERCE 9-1-2005.

ELEMENTS AMENDED  
 GOODS/SERVICES



3,348,495. REG. 12-4-2007. FRANK BRUNCKHORST CO., L.L.C. (NEW YORK LIMITED LIABILITY COMPANY) 24 ROCK STREET, BROOKLYN, NY. 11206, SN 78-933,891. FILED 7-20-2006. PRINCIPAL REGISTER.



NO CLAIM IS MADE TO THE EXCLUSIVE RIGHT TO USE "LEMON PEPPER", APART FROM THE MARK AS SHOWN.  
 INT. CL. 29/U.S. CL. 46

FOR PROCESSED MEATS.  
FIRST USE 3-31-2006; IN COMMERCE 3-31-2006.

ELEMENTS AMENDED  
MARK  
DISCLAIMER

---

3,353,295. REG. 12-11-2007. IRONCLAD PERFORMANCE WEAR CORP. (CALIFORNIA CORPORATION) 2201 PARK PLACE, SUITE 101, EL SEGUNDO, CA, 90245, SN 78-497,598. FILED 10-11-2004. PRINCIPAL REGISTER.

FOR HOTELS, RESORT HOTELS, MAKING HOTEL RESERVATIONS FOR OTHERS; RESTAURANT AND BAR SERVICES, COCKTAIL LOUNGES.

FIRST USE 1-1-2006; IN COMMERCE 1-1-2006.  
INT. CL. 44/U.S. CLS. 100 AND 101  
FOR HEALTH SPA SERVICES FOR HEALTH AND WELLNESS OF THE BODY AND SPIRIT OFFERED AT A HEALTH RESORT.  
FIRST USE 1-1-2006; IN COMMERCE 1-1-2006.

ELEMENTS AMENDED  
MARK

---

3,361,667. REG. 1-1-2008. EKINS, CARRIE (UNITED STATES INDIVIDUAL) FUCHSBERG 3, 86500 KUTZENHAUSEN, FED REP GERMANY., SN 77-151,635. FILED 4-9-2007. PRINCIPAL REGISTER.

# IRONCLAD

# DRUMS ALIVE

THE MARK CONSISTS OF STANDARD CHARACTERS WITHOUT CLAIM TO ANY PARTICULAR FONT, STYLE, SIZE, OR COLOR.

INT. CL. 8/U.S. CLS. 23, 28 AND 44  
FOR [ TOOL BELTS ],  
FIRST USE 2-0-2006; IN COMMERCE 2-0-2006.  
INT. CL. 9/U.S. CLS. 21, 23, 26, 36 AND 38  
FOR [ KNEEPADS, ] PROTECTIVE CLOTHING.  
FIRST USE 5-0-2005; IN COMMERCE 5-0-2005.  
INT. CL. 25/U.S. CLS. 22 AND 39  
FOR GLOVES, HATS, JACKETS, PANTS, SHIRTS, SHORTS.  
FIRST USE 8-0-1998; IN COMMERCE 8-0-1998.

ELEMENTS AMENDED  
GOODS/SERVICES

---

3,359,570. REG. 12-25-2007. THE IRVINE COMPANY LLC (DELAWARE LIMITED LIABILITY COMPANY) 550 NEWPORT CENTER DRIVE, NEWPORT BEACH, CA, 92660, SN 78-713,821. FILED 9-15-2005. PRINCIPAL REGISTER.

# ISLAND HOTEL NEWPORT BEACH

THE MARK CONSISTS OF STANDARD CHARACTERS WITHOUT CLAIM TO ANY PARTICULAR FONT, STYLE, SIZE, OR COLOR.

NO CLAIM IS MADE TO THE EXCLUSIVE RIGHT TO USE "HOTEL NEWPORT BEACH", APART FROM THE MARK AS SHOWN.

INT. CL. 25/U.S. CLS. 22 AND 39  
FOR CLOTHING, NAMELY, [ T-SHIRTS, ] SHIRTS; [ TOPS, SKIRTS, SHORTS, PANTS, CAPRIS, JEANS, JACKETS, SWEAT SUITS, SWEAT SHIRTS, SWEAT SHORTS, SWEAT PANTS, LOUNGEWEAR; ROBES; UNDERWEAR; SWIM WEAR; BEACHWEAR; FOOTWEAR; SLIPPERS; ] HEADWEAR.

FIRST USE 1-1-2006; IN COMMERCE 1-1-2006.  
INT. CL. 43/U.S. CLS. 100 AND 101

THE MARK CONSISTS OF STANDARD CHARACTERS WITHOUT CLAIM TO ANY PARTICULAR FONT, STYLE, SIZE, OR COLOR.

INT. CL. 41/U.S. CLS. 100, 101 AND 107  
FOR EDUCATIONAL SERVICES, NAMELY, CONDUCTING CLASSES AND WORKSHOPS FOR FITNESS TRAINERS AND INSTRUCTORS, MEDICAL FITNESS TRAINERS AND INSTRUCTORS, AND HEALTH CARE PROVIDERS, ALL IN THE FIELDS OF FITNESS, MEDICAL FITNESS AND HEALTH CARE; PROVIDING TRAINING AND COURSES IN THE FIELDS OF FITNESS, MEDICAL FITNESS AND HEALTH CARE; PROVIDING INSTRUCTION IN THE FIELDS OF FITNESS, MEDICAL FITNESS AND HEALTH CARE.

FIRST USE 12-31-2002; IN COMMERCE 7-10-2004.

ELEMENTS CORRECTED  
OWNER NAME

---

3,367,489. REG. 1-15-2008. CURRIE ACQUISITIONS, LLC (NEVADA CORPORATION) 9453 OWENSMOUTH AVENUE, CHATSWORTH, CA, 91311, SN 76-673,334. FILED 2-28-2007. PRINCIPAL REGISTER.

# CURRIE TECHNOLOGIES

THE MARK CONSISTS OF STANDARD CHARACTERS WITHOUT CLAIM TO ANY PARTICULAR FONT, STYLE, SIZE, OR COLOR.

NO CLAIM IS MADE TO THE EXCLUSIVE RIGHT TO USE "TECHNOLOGIES", APART FROM THE MARK AS SHOWN.

INT. CL. 35/U.S. CLS. 100, 101 AND 102  
FOR DISTRIBUTORSHIP IN THE FIELD OF ELECTRIC BICYCLES, ELECTRIC TRICYCLES, AND ELECTRIC FOOT SCOOTERS.

FIRST USE 2-27-1997; IN COMMERCE 2-27-1997.

ELEMENTS AMENDED  
MARK

3,373,057. REG. 1-22-2008. LISE CHARMELE INDUSTRIE (FRANCE SOCIETE PAR ACTIONS SIMPLIFIEE) 45 RUE SAINT PIERRE DE VAISE, LYON, FRANCE, 69009, SN 78-936,818. FILED 7-25-2006. PRINCIPAL REGISTER.

**ANTINEA**

THE MARK CONSISTS OF STANDARD CHARACTERS WITHOUT CLAIM TO ANY PARTICULAR FONT, STYLE, SIZE, OR COLOR.

OWNER OF ERP N CMNTY TM OFC REG. NO. 000260737, DATED 10-14-1998.

OWNER OF U.S. REG. NO. 1,242,158. INT. CL. 25/U.S. CLS. 22 AND 39

FOR CLOTHING, NAMELY, [ FOOTWEAR, HEADWEAR, ] LADIES' LINGERIE, LADIES' UNDERWEAR, [ STOCKINGS AND TIGHTS, ] SWIMSUITS, BEACHWEAR, TROUSERS, BLOUSES, TUNICS, DRESSES, SKIRTS, SCARVES, DAY AND NIGHT LINGERIE.

FIRST USE : IN COMMERCE .

ELEMENTS AMENDED  
GOODS/SERVICES

3,417,501. REG. 4-29-2008. PURE ALASKA SALMON COMPANY, LLC (WASHINGTON LIMITED LIABILITY COMPANY) 812 WEST CONNECTICUT STREET, BELLINGHAM, WA, 98225, SN 77-246,973. FILED 8-3-2007. PRINCIPAL REGISTER.

**THINK PINK**

THE MARK CONSISTS OF STANDARD CHARACTERS WITHOUT CLAIM TO ANY PARTICULAR FONT, STYLE, SIZE, OR COLOR.

OWNER OF U.S. REG. NO. 3,200,762. INT. CL. 29/U.S. CL. 46

FOR CANNED SALMON. FIRST USE 5-1-2004; IN COMMERCE 11-1-2004.

ELEMENTS CORRECTED  
OWNER NAME

3,425,002. REG. 5-13-2008. SHALOM INTERNATIONAL CORP. (NEW JERSEY CORPORATION) 1050 AMBOY AVENUE, SUITE 1, PERTH AMBOY, NJ, 08861, SN 76-658,538. FILED 4-17-2006. PRINCIPAL REGISTER.



NO CLAIM IS MADE TO THE EXCLUSIVE RIGHT TO USE "COMPANY", APART FROM THE MARK AS SHOWN.

SEC. 2(F). INT. CL. 9/U.S. CLS. 21, 23, 26, 36 AND 38 FOR SUNGLASSES. FIRST USE 6-1-1999; IN COMMERCE 6-1-1999.

INT. CL. 18/U.S. CLS. 1, 2, 3, 22 AND 41 FOR HANDBAGS . FIRST USE 6-1-1999; IN COMMERCE 6-1-1999.

INT. CL. 26/U.S. CLS. 37, 39, 40, 42 AND 50 FOR HAIR ACCESSORIES, NAMELY, BARETTES PONYTAIL HOLDERS, BOWS, ORNAMENTAL HAIR COMBS, HAIR CLIPS AND HAIRBANDS. FIRST USE 6-1-1999; IN COMMERCE 6-1-1999.

ELEMENTS CORRECTED  
OWNER NAME

3,490,466. REG. 8-19-2008. UNITING AGAINST LUNG CANCER (NEW YORK NON-PROFIT CORPORATION) 27 UNION SQUARE WEST; SUITE 304, NEW YORK, NY, 10003, SN 78-836,626. FILED 3-14-2006. PRINCIPAL REGISTER.

**UNITING AGAINST LUNG  
CANCER**

THE MARK CONSISTS OF STANDARD CHARACTERS WITHOUT CLAIM TO ANY PARTICULAR FONT, STYLE, SIZE, OR COLOR.

NO CLAIM IS MADE TO THE EXCLUSIVE RIGHT TO USE "LUNG CANCER", APART FROM THE MARK AS SHOWN.

INT. CL. 36/U.S. CLS. 100, 101 AND 102 FOR CHARITABLE FUND RAISING . FIRST USE 5-0-2008; IN COMMERCE 5-0-2008.

ELEMENTS CORRECTED  
ENTITY

3,519,569. REG. 10-21-2008. ZAPF, CAROLINA (FED REP GERMANY INDIVIDUAL) 211 CENTRAL PARK WEST, SUITE 9K, NEW YORK, NY, 10024, SN 77-397,614. FILED 2-14-2008. PRINCIPAL REGISTER.

**CZ**

THE MARK CONSISTS OF STANDARD CHARACTERS WITHOUT CLAIM TO ANY PARTICULAR FONT, STYLE, SIZE, OR COLOR.

OWNER OF U.S. REG. NOS. 2,680,837 AND 3,094,798. INT. CL. 25/U.S. CLS. 22 AND 39

FOR CLOTHING FOR INFANTS, CHILDREN AND ADULTS, NAMELY, SWEATERS, SHIRTS, BLOUSES, JACKETS, CARDIGANS, COATS, VESTS, SKIRTS, PANTS, SHORTS, DRESSES, SCARVES, WRAPS AND HEADWEAR; KNITWEAR, NAMELY, DRESSES, SWEATERS, CARDIGANS, PANTS, SCARVES, HATS, MITTENS, SHIRTS, BATHROBES, SKIRTS AND OVERALLS; AND OUTERWEAR, NAMELY, JACKETS, PARKAS, COATS, VESTS, PANTS, SCARVES, WRAPS AND HEADWEAR, MITTENS. FIRST USE 1-31-2005; IN COMMERCE 1-31-2005.

ELEMENTS CORRECTED  
CITIZENSHIP

3,524,537. REG. 10-28-2008. WORLD OF JEANS & TOPS (CALIFORNIA CORPORATION) 10 WHATNEY, IRVINE, CA. 92618, SN 76-663,669. FILED S.R. 7-21-2006; AM. P.R. 9-2-2008. PRINCIPAL REGISTER.

3,595,432. REG. 3-24-2009. SHIRE LLC (KENTUCKY LIMITED LIABILITY COMPANY) 9200 BROOKFIELD COURT, FLORENCE, KY, 41042, SN 77-146,381. FILED 4-2-2007. PRINCIPAL REGISTER.

# INFAMOUS



THE MARK CONSISTS OF STANDARD CHARACTERS WITHOUT CLAIM TO ANY PARTICULAR FONT, STYLE, SIZE, OR COLOR.

OWNER OF U.S. REG. NO. 2,666,381.  
 INT. CL. 18/U.S. CLS. 1, 2, 3, 22 AND 41  
 FOR HANDBAGS, [ CLUTCH BAGS, ] SHOULDER BAGS, BEACH BAGS, [ OVERNIGHT BAGS, SPORTS BAGS, BRIEFCASES, KEY CHAINS OF LEATHER, CREDIT CARD CASES, CHECKBOOK HOLDERS, ] WALLETS.

FIRST USE 11-19-2007; IN COMMERCE 11-19-2007.  
 INT. CL. 25/U.S. CLS. 22 AND 39  
 FOR MEN'S, BOY'S, WOMEN'S AND GIRL'S BELTS WORN WITH CLOTHING AND SHOES; BELTS.  
 FIRST USE 11-19-2007; IN COMMERCE 11-19-2007.

ELEMENTS CORRECTED  
 OWNER NAME

INT. CL. 44/U.S. CLS. 100 AND 101  
 FOR PROVIDING MEDICAL INFORMATION IN THE FIELD OF PHARMACEUTICAL PRODUCTS AND SERVICES.  
 FIRST USE 7-0-2007; IN COMMERCE 7-0-2007.

ELEMENTS AMENDED  
 MARK

3,639,466. REG. 6-16-2009. WOWWEE GROUP LIMITED (HONG KONG CORPORATION) UNIT 301-C, ENERGY PLAZA, 92 GRANVILLE ROAD, TSIM SHA TSUI EAST, HONG KONG., SN 77-627,506. FILED 12-5-2008. PRINCIPAL REGISTER.

3,543,962. REG. 12-9-2008. WORLD OF JEANS & TOPS (CALIFORNIA CORPORATION) 10 WHATNEY, IRVINE, CA. 92618, SN 76-663,733. FILED 7-27-2006. PRINCIPAL REGISTER.

THE MARK CONSISTS OF STANDARD CHARACTERS WITHOUT CLAIM TO ANY PARTICULAR FONT, STYLE, SIZE, OR COLOR.  
 OWNER OF U.S. REG. NO. 3,570,535.  
 THE WORDING "ROVIO" HAS NO MEANING IN A FOREIGN LANGUAGE.

INT. CL. 9/U.S. CLS. 21, 23, 26, 36 AND 38  
 FOR ROBOTS FOR PERSONAL [ OR HOBBY ] USE \* AND ACCESSORIES THEREFORE, NAMELY, MOBILE WEBCAMS [ ; COMPUTER SOFTWARE FOR THE OPERATION OF MOBILE WEBCAMS VIA THE INTERNET AND VIA WIRELESS COMPUTER NETWORKS ].  
 FIRST USE 8-29-2008; IN COMMERCE 8-29-2008.

ELEMENTS AMENDED  
 GOODS/SERVICES

# DESTINED

THE MARK CONSISTS OF STANDARD CHARACTERS WITHOUT CLAIM TO ANY PARTICULAR FONT, STYLE, SIZE, OR COLOR.

INT. CL. 25/U.S. CLS. 22 AND 39  
 FOR WOMEN'S AND GIRL'S WEARING APPAREL, NAMELY, T-SHIRTS, SWEATSHIRTS, TANK TOPS, WOMEN SHIRTS, SWEATERS, CARDIGANS, VESTS, JACKETS, PANTS, SWEATPANTS, JEANS, SHORTS, HATS CAPS, COATS, BELTS WORN WITH CLOTHING, HEAD BANDS, PAJAMAS, SHOES, SOCKS, FOUNDATION GARMENTS, SKIRTS, DRESSES, BLOUSES, SWIM WEAR, BIKINIS AND BELTS.  
 FIRST USE 8-12-2008; IN COMMERCE 8-12-2008.

ELEMENTS CORRECTED  
 OWNER NAME

3,674,651. REG. 8-25-2009. STATION CASINOS LLC (NEVADA LIMITED LIABILITY COMPANY) 1505 SOUTH PAVILION CENTER DRIVE, LAS VEGAS, NV, 89135, SN 78-980,195. FILED 9-16-2004. PRINCIPAL REGISTER.

# RED ROCK CASINO RESORT SPA

THE MARK CONSISTS OF STANDARD CHARACTERS WITHOUT CLAIM TO ANY PARTICULAR FONT, STYLE, SIZE, OR COLOR.

OWNER OF U.S. REG. NOS. 2,845,193 AND 2,931,043.  
 NO CLAIM IS MADE TO THE EXCLUSIVE RIGHT TO USE "CASINO RESORT SPA", APART FROM THE MARK AS SHOWN.  
 INT. CL. 43/U.S. CLS. 100 AND 101

FOR HOTEL SERVICES.  
FIRST USE 10-6-2005; IN COMMERCE 10-6-2005.

ELEMENTS CORRECTED  
MARK  
DISCLAIMER

---

3,703,726. REG. 10-27-2009. BIO-LOGICAL CAPITAL, LLC (DELAWARE LIMITED LIABILITY COMPANY) 1555 BLAKE STREET, SUITE 450, DENVER, CO, 80202, SN 77-478,452. FILED P.R. 5-19-2008; AM. S.R. 9-14-2009. SUPPLEMENTAL REGISTER.

## BIO-LOGICAL CAPITAL

THE MARK CONSISTS OF STANDARD CHARACTERS WITHOUT CLAIM TO ANY PARTICULAR FONT, STYLE, SIZE, OR COLOR.

INT. CL. 36/U.S. CLS. 100, 101 AND 102

FOR INVESTMENT SERVICES, NAMELY, ASSET ACQUISITION, CONSULTATION, DEVELOPMENT AND MANAGEMENT SERVICES; FINANCIAL INVESTMENT IN THE FIELD OF CREATION AND MANAGEMENT OF FUNDS FOR INVESTMENT IN GREEN BUSINESS OPPORTUNITIES; FUND INVESTMENT CONSULTATION; FUNDS INVESTMENT; INVESTMENT MANAGEMENT; REAL ESTATE INVESTMENT.

FIRST USE 9-1-2008; IN COMMERCE 9-1-2008.

ELEMENTS CORRECTED  
OWNER NAME  
OWNER ADDRESS  
CITIZENSHIP  
ENTITY

---

3,710,994. REG. 11-17-2009. 3TERA, INC. (CALIFORNIA CORPORATION) SUITE 140, 27121 ALISO CREEK ROAD, ALISO VIEJO, CA, 92656, SN 77-499,875. FILED 6-16-2008. PRINCIPAL REGISTER.

## 3TERA

THE MARK CONSISTS OF STANDARD CHARACTERS WITHOUT CLAIM TO ANY PARTICULAR FONT, STYLE, SIZE, OR COLOR.

OWNER OF U.S. REG. NO. 3,124,331.

INT. CL. 38/U.S. CLS. 100, 101 AND 104

FOR PROVIDING ACCESS TO HOSTED OPERATING SYSTEMS AND COMPUTER APPLICATIONS THROUGH THE INTERNET AND ORGANIZATIONAL NETWORKS.\* NONE OF THE ABOVE SERVICES RELATING TO VOICE AND DATA CABLING APPARATUS \*.

FIRST USE 4-28-2006; IN COMMERCE 4-28-2006.

INT. CL. 42/U.S. CLS. 100 AND 101

FOR COMPUTER SERVICES, NAMELY, APPLICATION SERVICE PROVIDER SERVICES TO THIRD PARTIES FEATURING REMOTE HOSTING OF OPERATING SYSTEMS AND COMPUTER APPLICATIONS; AND COMPUTER SERVICES, NAMELY, PROVIDING VIRTUAL AND CLOUD COMPUTING ENVIRONMENTS ACCESSIBLE VIA THE INTERNET AND ORGANIZATIONAL NETWORKS FOR THE PURPOSE OF REMOTE MANAGEMENT IN THE NATURE OF CREATING AND OPERATING ON-LINE COMPUTER APPLICATIONS; PROVIDING A WEB-BASED SYSTEM AND ONLINE PORTAL FOR THIRD PARTIES TO REMOTELY MANAGE, ADMINISTER, MODIFY AND CONTROL VIRTUALIZED COMPUTING RESOURCES, DATA AND SOFTWARE APPLICATIONS IMPLEMENTED VIA DISTRIBUTED COMPUTING ENVIRONMENTS, AND TO REMOTELY MANAGE, ADMINISTER, MODIFY AND CONTROL GEOGRAPHIC DISTRIBUTION OF THE VIRTUALIZED COMPUTING RESOURCES, DATA AND SOFTWARE APPLICATIONS; PROVIDING A WEB-BASED SYSTEM AND ONLINE PORTAL FOR THIRD PARTIES TO REMOTELY MANAGE, ADMINISTER, MODIFY AND CONTROL DISASTER RECOVERY SOLUTIONS RELATING TO THEIR COMPUTER DEVICES, DATA AND SOFTWARE APPLICATIONS; PROVIDING NON-DOWNLOADABLE SOFTWARE, ACCESSIBLE OVER A GLOBAL COMPUTER NETWORK, FOR MANAGING COMPUTER APPLICATIONS AND FOR OPERATING DISTRIBUTED APPLICATIONS AND NETWORKS OF COMPUTERS; AND PROVIDING NON-DOWNLOADABLE SOFTWARE, ACCESSIBLE OVER A GLOBAL COMPUTER NETWORK, FOR ENABLING COMPUTER SYSTEM OPERATORS TO VIRTUALIZE THEIR COMPUTER SYSTEM RESOURCES, MANAGE, ADMINISTER, MODIFY, AND CONTROL THEIR VIRTUALIZED COMPUTING RESOURCES, AND ACCESS VIRTUALIZED GRID AND UTILITY COMPUTING RESOURCES, NAMELY, DISTRIBUTED CLOUD-BASED UTILITY COMPUTING RESOURCES, INFRASTRUCTURE-ONDEMAND COMPUTING RESOURCES, METERED COMPUTING UTILITY RESOURCES, VIRTUALIZED GLOBALLY DISTRIBUTED COMPUTING RESOURCES, VIRTUALIZED DATACENTER RESOURCES, READY-APPLICATION-STACK COMPUTING RESOURCES, AND HIGH-AVAILABILITY COMPUTING RESOURCES, \* NONE OF THE ABOVE SERVICES RELATING TO VOICE AND DATA CABLING APPARATUS \*.

FIRST USE 4-28-2006; IN COMMERCE 4-28-2006.

ELEMENTS CORRECTED  
GOODS/SERVICES

---

3,747,175. REG. 2-9-2010. C. V. STARR & CO., INC. (NEVADA CORPORATION) 399 PARK AVENUE, NEW YORK, NY, 10022, SN 77-135,558. FILED 3-20-2007. PRINCIPAL REGISTER.



OWNER OF U.S. REG. NOS. 2,877,409 AND 2,926,969.  
NO CLAIM IS MADE TO THE EXCLUSIVE RIGHT TO USE "& CO., INC.", APART FROM THE MARK AS SHOWN. THE NAME "CV STARR" DOES NOT IDENTIFY A LIVING INDIVIDUAL.

INT. CL. 36/U.S. CLS. 100, 101 AND 102

FOR PROPERTY AND CASUALTY INSURANCE UNDERWRITING AND AGENCY SERVICES.

FIRST USE 12-1-2008; IN COMMERCE 12-1-2008.

ELEMENTS CORRECTED  
MARK  
DISCLAIMER

3,763,594. REG. 3-23-2010. VALIANT ENTERTAINMENT, INC. (BR.VIRGIN ISLANDS COMPANY) OFFSHORE INCORPORATIONS CENTER, P.O. BOX NO. 957, ROAD TOWN, BR.VIRGIN ISLANDS., SN 77-070,164. FILED 12-22-2006. PRINCIPAL REGISTER.



THE COLOR(S) RED AND BLACK IS/ARE CLAIMED AS A FEATURE OF THE MARK.

THE MARK CONSISTS OF A STAR DESIGN ELEMENT SET UPON A CIRCLE DESIGN ELEMENT, AND THE WORD "VALIANT" ABOVE THE DESIGN ELEMENTS; THE COLOR RED APPEARS ON THE COUNTERCLOCKWISE SIDE OF EACH POINT ON THE STAR; THE COLOR BLACK APPEARS ON THE CIRCLE DESIGN ELEMENT, ON THE WORD "VALIANT", AND ON THE CLOCKWISE SIDE OF EACH POINT ON THE STAR.

INT. CL. 16/U.S. CLS. 2, 5, 22, 23, 29, 37, 38 AND 50

FOR PRINTED MATTER AND PAPER GOODS, NAMELY, BOOKS FEATURING NARRATIVE ARTWORK OR CHARACTERS FROM NARRATIVE ARTWORK, COMIC BOOKS, GRAPHIC NOVELS, COMIC STRIPS, AND MAGAZINES AND STORIES IN PRINTED FORM ALL FEATURING NARRATIVE ARTWORK OR CHARACTERS FROM NARRATIVE ARTWORK; POSTERS; ART PRINTS; TRADING CARDS; COLLECTOR'S CARDS.

FIRST USE 4-0-1990; IN COMMERCE 4-0-1990.

ELEMENTS CORRECTED  
OWNER ADDRESS

3,793,508. REG. 5-25-2010. SHIRE LLC (KENTUCKY LIMITED LIABILITY COMPANY) 9200 BROOKFIELD COURT, FLORENCE, KY, 41042, SN 77-146,317. FILED 4-2-2007. PRINCIPAL REGISTER.



THE COLOR(S) PURPLE AND GREEN IS/ARE CLAIMED AS A FEATURE OF THE MARK.

THE MARK CONSISTS OF THE WORD "VYVANSE" IN PURPLE. THE DESIGN PORTION COMPRISES A SEMICIRCULAR SHAPE COMPOSED OF FOUR ROWS OF COLORED DOTS. THE DOTS IN THE INNER TWO ROWS ARE PURPLE. THE DOTS IN THE OUTER TWO ROWS ARE GREEN.

INT. CL. 5/U.S. CLS. 6, 18, 44, 46, 51 AND 52

FOR [ PHARMACEUTICAL PREPARATIONS ACTING ON THE CENTRAL NERVOUS SYSTEM ].

FIRST USE 9-0-2009; IN COMMERCE 9-0-2009.

INT. CL. 44/U.S. CLS. 100 AND 101

FOR PROVIDING MEDICAL INFORMATION IN THE FIELD OF PHARMACEUTICAL PRODUCTS AND SERVICES.

FIRST USE 10-0-2008; IN COMMERCE 10-0-2008.

ELEMENTS AMENDED  
GOODS/SERVICES  
MARK

3,873,281. REG. 11-9-2010. FEEDBACK SPORTS, LLC (COLORADO LIMITED LIABILITY COMPANY) 420 CORPORATE CIRCLE, SUITE I, GOLDEN, CO, 80401, SN 85-003,216. FILED 3-31-2010. PRINCIPAL REGISTER.



NO CLAIM IS MADE TO THE EXCLUSIVE RIGHT TO USE "SPORTS", APART FROM THE MARK AS SHOWN.

THE MARK CONSISTS OF THE WORDS "FEEDBACK SPORTS" UNDERLINED BY A SWEEPING ARROW DESIGN.

INT. CL. 6/U.S. CLS. 2, 12, 13, 14, 23, 25 AND 50

FOR METAL BICYCLE REPAIR STANDS; METAL BICYCLE STORAGE RACKS; METAL BICYCLE WHEEL REPAIR STANDS; TOTE BAGS SPECIALLY ADAPTED FOR HOLDING OR CARRYING METAL BICYCLE REPAIR STANDS, METAL STORAGE BASKETS FOR BICYCLE STORAGE RACKS; BICYCLE REPAIR STAND METAL CLAMPS; METAL REPAIR CLAMPS FOR HOLDING ROUND TUBES; METAL BICYCLE HANDLEBAR HOLDERS FOR USE WITH BICYCLE REPAIR STANDS.

FIRST USE 6-30-2008; IN COMMERCE 9-24-2008.

INT. CL. 9/U.S. CLS. 21, 23, 26, 36 AND 38

FOR SCALES FOR WEIGHING; CALIPERS FOR MEASURING LENGTH; BICYCLE CHAIN LENGTH MEASURING GAUGES.

FIRST USE 6-30-2008; IN COMMERCE 9-24-2008.

INT. CL. 25/U.S. CLS. 22 AND 39

FOR BICYCLING CLOTHING, NAMELY, BICYCLE GLOVES, SHIRTS, HATS, CAPS, SOCKS, SHORTS, JACKETS.

FIRST USE 5-1-2005; IN COMMERCE 9-25-2005.

ELEMENTS AMENDED  
MARK

3,902,427. REG. 1-11-2011. PLAY LIMITED (JERSEY LIMITED COMPANY) ONE ESPLANADE, ST. HELIER, JERSEY, JE2 3QA, SN 77-137,668. FILED 3-22-2007. PRINCIPAL REGISTER.

## PLAYFUNDS

THE MARK CONSISTS OF STANDARD CHARACTERS WITHOUT CLAIM TO ANY PARTICULAR FONT, STYLE, SIZE, OR COLOR.

PRIORITY CLAIMED UNDER SEC. 44(D) ON ERPNCMNTY TM OFC APPLICATION NO. 005672175, FILED 2-7-2007, REG. NO. 005672175, DATED 4-7-2008, EXPIRES 2-7-2017.

INT. CL. 35/U.S. CLS. 100, 101 AND 102



FOR RETAIL SERVICES IN RELATION TO COSMETICS, PERFUMERY, BODY CARE AND BEAUTY PRODUCTS, CLEANING PRODUCTS, CANDLES, PHARMACEUTICAL PREPARATIONS, DIETETIC SUBSTANCES, CARPENTRY AND HARDWARE PRODUCTS, CUTLERY, SCIENTIFIC, ELECTRICAL AND ELECTRONIC APPARATUS AND INSTRUMENTS, APPARATUS FOR RECORDING, TRANSMISSION OR REPRODUCTION OF SOUND OR IMAGES, MAGNETIC DATA CARRIERS AND DISCS, COMPUTERS, PERIPHERALS, HARDWARE AND SOFTWARE, TELEPHONES, MOBILES, GLASSES AND OPTICS, ORTHOPEDIC PRODUCTS, HOME APPLIANCES AND AIR CONDITIONING APPARATUS, VEHICLES, BICYCLES, FIREARMS, JEWELRY AND WATCHES, MUSICAL INSTRUMENTS, PAPER, CARDBOARD AND GOODS MADE FROM THESE MATERIALS, PRINTED MATTER, PHOTOGRAPHS, STATIONERY, PAINT BRUSHES, LEATHER AND IMITATIONS OF LEATHER, AND GOODS MADE OF THESE MATERIALS, BAGS, UMBRELLAS, FURNITURE, HOUSEHOLD APPARATUS, INSTRUMENTS AND GIFTS, KITCHEN AND BATHROOM UTENSILS, CLEANING ARTICLES, GLASSWARE, PORCELAIN AND EARTHENWARE, THREADS, STRINGS, TEXTILES AND TEXTILE GOODS, FURNITURE COVERS, CLOTHING, FOOTWEAR AND HEADGEAR, CARPETS, GAMES AND PLAYTHINGS, PLAYING CARDS, GYMNASIAC AND SPORTING ARTICLES, FOOD PRODUCTS, AGRICULTURAL PRODUCTS, ANIMAL FOODSTUFFS, LIVE ANIMALS, FLOWERS, BEVERAGES AND ALCOHOLIC BEVERAGES, TOBACCO AND SMOKERS' ARTICLES IN STORES, DEPARTMENT STORES, MERCHANDISE SHOPS, VIA A MAIL ORDER CATALOGUE, INTERNET WEBSITE OR VIA TELECOMMUNICATION; ON-LINE TRADING SERVICES IN RELATION TO THE AFOREMENTIONED GOODS IN WHICH SELLER POSTS PRODUCTS TO BE AUCTIONED AND BIDDING IS DONE OVER THE INTERNET; BUSINESS CONSULTANCY SERVICES IN RELATION TO THE COMMERCIALIZATION AND TRADING OF THE AFOREMENTIONED GOODS; PROVIDING ONLINE BUSINESS DIRECTORY INFORMATION SERVICES FEATURING INFORMATION REGARDING THE BUYERS AND SELLERS OF THE AFOREMENTIONED GOODS AND THEIR RESPECTIVE TRADING HISTORY REGARDING THE AFOREMENTIONED GOODS; ADVERTISING SERVICES, INCLUDING PROMOTION, FOR THIRD PARTIES IN CONNECTION WITH THE COMMERCIALIZATION AND SALE OF THE AFOREMENTIONED GOODS; ELECTRONIC COMMERCE SERVICES, NAMELY, PROVIDING INFORMATION ABOUT PRODUCTS VIA TELECOMMUNICATION NETWORKS FOR ADVERTISING, SALES AND TRADING PURPOSES; THE ARRANGING AND CONDUCTING OF AUCTION SALES; MEDIATION SERVICES AND CONCLUSION OF COMMERCIAL TRANSACTIONS FOR OTHERS, MEDIATION OF AGREEMENTS REGARDING THE SALE AND PURCHASE OF GOODS, MEDIATION OF CONTRACTS FOR PURCHASE AND SALE OF PRODUCTS, MEDIATION OF TRADE BUSINESS FOR THIRD PARTIES IN CONNECTION WITH THE COMMERCIALIZATION AND SALE OF THE AFOREMENTIONED GOODS; PROCURING OF CONTRACTS FOR THE PURCHASE AND SALE OF GOODS; STATISTICAL EVALUATIONS OF MARKETING DATA, NAMELY, PROVIDING ANALYSES AND ONLINE DISTRIBUTION OF STATISTICAL, QUANTITATIVE AND QUALITATIVE INFORMATION REGARDING THE SALE AND RESALE OF ITEMS VIA A GLOBAL COMPUTER NETWORK; PROVIDING INFORMATION IN RELATION TO THE SALE AND TRADING OF GOODS VIA TELECOMMUNICATION NETWORKS; PROVIDING A WEBSITE WHERE USERS CAN POSTING, PROMOTE, SELL AND RESELL OF ITEMS VIA A GLOBAL COMPUTER NETWORK AND FOR THE COLLECTION AND DISSEMINATION OF STATISTICAL, QUANTITATIVE AND QUALITATIVE INFORMATION REGARDING THE SALE AND RESALE OF ITEMS VIA GLOBAL COMPUTER NETWORK.

FIRST USE ; IN COMMERCE .

INT. CL. 36/U.S. CLS. 100, 101 AND 102

FOR INSURANCE UNDERWRITING IN THE FIELD OF FINANCIAL LOSS INSURANCE, SECURITIES INSURANCE, CREDIT CARD INSURANCE, FINANCIAL INSURANCE, MONETARY LOSS INSURANCE, BUSINESS LOSS INSURANCE AND REAL ESTATE INVESTMENT INSURANCE; FINANCIAL AFFAIRS, NAMELY, FINANCIAL FORECASTING, FINANCIAL RESEARCH, FINANCIAL MANAGEMENT AND FINANCIAL PLANNING; MONETARY AFFAIRS, NAMELY, FINANCIAL FORECASTING, FINANCIAL RESEARCH, FINANCIAL MANAGEMENT AND FINANCIAL PLANNING; REAL ESTATE AFFAIRS, NAMELY, REAL ESTATE MANAGEMENT, BUYING AND SELLING REAL ESTATE, LISTING REAL ESTATE FOR SALE, REAL ESTATE INVESTMENTS; FINANCIAL CLEARING HOUSES VIA A GLOBAL COMPUTER NETWORK; PROVIDING FINANCIAL MANAGEMENT SERVICES, CREDIT CARD SERVICES AND BILL PAYMENT SERVICES VIA A GLOBAL COMPUTER NETWORK; COMPUTERIZED FINANCIAL ADVISORY SERVICES.

FIRST USE ; IN COMMERCE .

INT. CL. 38/U.S. CLS. 100, 101 AND 104

FOR E-MAIL SERVICES; VOICEMAIL SERVICES; PROVIDING EXCHANGE OF COMPUTER MAIL, ELECTRONIC DATA TRANSMISSION AND INFORMATION TRANSMISSION SERVICES; ELECTRONIC TRANSMISSION OF DATA AND DOCUMENTS AMONG USERS OF COMPUTERS; ELECTRONIC DELIVERY OF IMAGES, DATA, MUSIC, MOVIES AND TELEVISION PROGRAMS VIA THE INTERNET; PROVIDING TELECOMMUNICATION FACILITIES FOR THE PLACING OF ORDERS FOR PRODUCTS AND SERVICES VIA ELECTRONIC DATA COMMUNICATION; PROVISION OF ACCESS TO COMPUTER DATABASES; PROVISION OF ACCESS TO GLOBAL INFORMATION NETWORKS AND OTHER NETWORK SYSTEMS.

FIRST USE ; IN COMMERCE .

INT. CL. 39/U.S. CLS. 100 AND 105

FOR PACKAGING OF GOODS FOR TRANSPORTATION; GIFT DELIVERY; DELIVERY OF GOODS BY MAIL, COURIER AND SHIP; DELIVERY SERVICES, NAMELY, PARCEL DELIVERY; PACKAGING OF ARTICLES FOR TRANSPORTATION.

FIRST USE ; IN COMMERCE .

INT. CL. 42/U.S. CLS. 100 AND 101

FOR DESIGN AND DEVELOPMENT OF COMPUTER HARDWARE AND SOFTWARE FOR OTHERS; WEBSITE DESIGN, DEVELOPMENT AND HOSTING SERVICES.

FIRST USE ; IN COMMERCE .

ELEMENTS CORRECTED  
ENTITY

3,906,047. REG. 1-18-2011. ARYZTA LLC (DELAWARE LIMITED LIABILITY COMPANY) 14490 CATALINA STREET, SAN LEANDRO, CA, 94577, SN 76-696,795. FILED 4-9-2009. PRINCIPAL REGISTER.



OWNER OF U.S. REG. NOS. 691,390, 1,732,155 AND 2,272,417.

THE MARK CONSISTS OF THE TERM "PENNANT" WITHIN A DESIGN ELEMENT CONSISTING OF A BROKEN DIAMOND BORDER WITH A WHEAT PATTERN THEREIN.

INT. CL. 30/U.S. CL. 46

FOR BAKERY GOODS, NAMELY, CAKES, BROWNIES, CROISSANTS, CINNAMON ROLLS, MUFFINS, PUFF PASTRIES, AND DANISH PASTRIES; DOUGH AND BATTER FOR BAKERY GOODS; BAKING MIXES FOR BREAD, BROWNIES AND COOKIES; DRY DONUT MIX; CAKE MIXES SOLD IN BULK; FROZEN BAKED CAKES; FROZEN BREAD DOUGH; FROZEN BAKERY DOUGH AND MUFFIN BATTERS; FROZEN DOUGH; BAKERY PRODUCTS; FROZEN COOKIE DOUGH; FROZEN PUFF PASTRY; DANISH AND DANISH PASTRY DOUGH; DESSERT TOPPINGS, NAMELY, BUTTER CREAM ICING; CREAM FILLINGS FOR PASTRIES; DONUT GLAZES, DONUT SUGARS; FROZEN THAW AND SERVE BAKED COOKIES AND DRY MUFFIN MIXES .

FIRST USE 6-0-2002; IN COMMERCE 6-0-2002.

ELEMENTS CORRECTED

\*OWNER NAME\*  
 \*OWNER ADDRESS\*  
 \*CITIZENSHIP\*  
 \*ENTITY\*  
 \*DBA/AKA\*

3,989,697. REG. 7-5-2011. HEALTH BODY WORLD SUPPLY INC. (CALIFORNIA CORPORATION), DBA HBW SUPPLY, HEALTH BODY WORLD, HBW, WABBO, AND WABBO COMPANY, 474 W. ESPLANADE AVENUE, SAN JACINTO, CA, 925835006, SN 85-187,844. FILED 12-1-2010. PRINCIPAL REGISTER.



THE MARK CONSISTS OF A STYLIZED YIN AND YANG AND THREE SPACED CRESCENTS.

INT. CL. 10/U.S. CLS. 26, 39 AND 44

FOR ACUPUNCTURE EQUIPMENT; ACUPUNCTURE INSTRUMENTS; ACUPUNCTURE NEEDLES; APPARATUS FOR ACUPUNCTURE THERAPY .

FIRST USE 9-30-2010; IN COMMERCE 9-30-2010.

ELEMENTS CORRECTED

OWNER NAME  
 OWNER ADDRESS  
 DBA/AKA

4,023,400. REG. 9-6-2011. ALTURA MEDICAL, INC. (DELAWARE CORPORATION) 1120 CALLE CORDILLERA, STE. 102, SAN CLEMENTE, CA, 92673, SN 77-893,189. FILED 12-14-2009. PRINCIPAL REGISTER.

# ALTURA

THE MARK CONSISTS OF STANDARD CHARACTERS WITHOUT CLAIM TO ANY PARTICULAR FONT, STYLE, SIZE, OR COLOR.

THE ENGLISH TRANSLATION OF "ALTURA" IS "HEIGHT".

INT. CL. 10/U.S. CLS. 26, 39 AND 44

FOR MEDICAL DEVICES, NAMELY, MINIMALLY INVASIVE DEVICES FOR TREATING ABDOMINAL AORTIC ANEURYSMS .

FIRST USE 9-15-2010; IN COMMERCE 9-15-2010.

ELEMENTS AMENDED

MARK  
 [DISCLAIMER]

4,079,955. REG. 1-3-2012. ASURION, LLC (DELAWARE LIMITED LIABILITY COMPANY) SUITE 300, 648 GRASSMERE PARK, NASHVILLE, TN, 37211, SN 85-327,381. FILED 5-23-2011. PRINCIPAL REGISTER.

# RESCUE LINK

THE MARK CONSISTS OF STANDARD CHARACTERS WITHOUT CLAIM TO ANY PARTICULAR FONT, STYLE, SIZE, OR COLOR.

INT. CL. 36/U.S. CLS. 100, 101 AND 102

FOR PROVIDING EXTENDED WARRANTIES FOR IN-HOME COMPUTERS AND TELEVISIONS [, WIRELESS PHONES ] AND PORTABLE COMPUTING AND COMMUNICATION DEVICES .

FIRST USE 7-0-1997; IN COMMERCE 5-12-2011.

ELEMENTS AMENDED

GOODS/SERVICES

4,169,574. REG. 7-10-2012. PLAY LIMITED (JERSEY LIMITED COMPANY) ONE ESPLANADE, ST. HELIER, JERSEY, JE2 3QA, SN 77-125,012. FILED 3-7-2007. PRINCIPAL REGISTER.

# PLAY.COM

THE MARK CONSISTS OF STANDARD CHARACTERS WITHOUT CLAIM TO ANY PARTICULAR FONT, STYLE, SIZE, OR COLOR.

OWNER OF UNITED KINGDOM REG. NO. 2442130, DATED 12-21-2006, EXPIRES 12-21-2016.

INT. CL. 16/U.S. CLS. 2, 5, 22, 23, 29, 37, 38 AND 50

FOR PRINTED MATTER, NAMELY, NEWSPAPERS FOR GENERAL CIRCULATION, GENERAL FEATURE MAGAZINES, NOT INCLUDING THE FIELDS OF ENTERTAINMENT, VIDEO GAMES, MOVIES, MUSIC AND RELATED MERCHANDISE FOR ADOLESCENTS, YOUNG ADULTS AND ADULTS, TECHNOLOGY, SPORTS, ARTS, FASHION AND BEAUTY, CURRENT EVENTS AND CELEBRITY PROFILES; BOOKS ON GENERAL MERCHANDISE, VIDEOS, ELECTRONICS OR ACCESSORIES, TOYS, CLOTHING, MOBILE PHONES, WATCHES, TIMEPIECES, COSMETICS, TOILETRIES, BEAUTY PRODUCTS, FOOD, DRINK, SNACKS, CARS, VEHICLES, BIKES, TELEPHONES, BOOKS, GAMES, OR TRAVEL PRODUCTS; PHOTOGRAPHS; STATIONERY; ADHESIVES FOR STATIONERY OR HOUSEHOLD PURPOSES; PLASTIC MATERIALS FOR PACKAGING ARTICLES FOR PROTECTION DURING TRANSPORTATION, NAMELY, PLASTIC BUBBLE PACKS.

FIRST USE ; IN COMMERCE .

INT. CL. 35/U.S. CLS. 100, 101 AND 102

FOR THE BRINGING TOGETHER, FOR THE BENEFIT OF OTHERS, OF A VARIETY OF GOODS, ENABLING CUSTOMERS TO CONVENIENTLY VIEW AND PURCHASE THOSE GOODS IN A GENERAL MERCHANDISE SHOP, OR IN A DEPARTMENT STORE; THE BRINGING TOGETHER, FOR THE BENEFIT OF OTHERS, OF A VARIETY OF GOODS, ENABLING CUSTOMERS TO CONVENIENTLY VIEW AND PURCHASE THOSE GOODS VIA A MAIL ORDER CATALOGUE, INTERNET WEBSITE OR VIA TELECOMMUNICATIONS, ALL SPECIALIZING IN GENERAL MERCHANDISING, MUSIC, VIDEO, ELECTRONICS OR ACCESSORIES, CLOTHING, MOBILE PHONES, WATCHES, TIMEPIECES, COSMETICS, TOILETRIES, BEAUTY GOODS, FOOD, DRINK, SNACKS, CARS, VEHICLES, BIKES, TELEPHONES, BOOKS OR TRAVEL GOODS.

FIRST USE ; IN COMMERCE .

INT. CL. 39/U.S. CLS. 100 AND 105

FOR PACKAGING OF GOODS, NAMELY, PACKAGING ARTICLES FOR TRANSPORTATION; GIFT DELIVERY; WRAPPING, NAMELY, WRAPPING SERVICES FOR PACKAGE PROTECTION DURING TRAVEL; SHIPPING AND DELIVERY OF GOODS, NAMELY, DELIVERY OF PACKAGES AND LETTERS BY VARIOUS MODES OF TRANSPORTATION.

INT. CL. 41/U.S. CLS. 100, 101 AND 107

FOR PROVIDING ENTERTAINMENT, NAMELY, SPORTING AND CULTURAL EVENTS; ARRANGING FOR AND PROVIDING TICKET RESERVATIONS FOR SPORTS AND CULTURAL EVENTS.

FIRST USE ; IN COMMERCE .

ELEMENTS CORRECTED  
OWNER NAME  
ENTITY

4,172,122. REG. 7-10-2012. NUPLEX RESINS B.V. (NETHERLANDS BESLOTEN VENNOOTSCHAP (B.V.)) SYNTHESBAAN 1, 4600 AB BERGEN OP ZOOM, NETHERLANDS,, SN 77-983,146. FILED 6-8-2007. PRINCIPAL REGISTER.

# NUPLEX

THE MARK CONSISTS OF STANDARD CHARACTERS WITHOUT CLAIM TO ANY PARTICULAR FONT, STYLE, SIZE, OR COLOR.

INT. CL. 1/U.S. CLS. 1

FOR CHEMICALS FOR USE IN INDUSTRY AND SCIENCE; UNPROCESSED ARTIFICIAL RESINS FOR USE IN PAINTS, VARNISHES AND COATINGS; UNPROCESSED PLASTICS FOR USE IN PAINTS, VARNISHES AND COATINGS; FILLERS, NAMELY, WATERPROOFING CHEMICAL COMPOSITIONS FOR ARTICLES OF MASONRY, WOOD AND OTHER BUILDING AND/OR CONSTRUCTION SURFACES, IN LIQUID CHEMICAL FORM FOR USE IN CONSTRUCTION.

FIRST USE 1-0-2005; IN COMMERCE 1-0-2005.

INT. CL. 2/U.S. CLS. 6, 11 AND 16

FOR PAINTS, VARNISHES, LACQUERS; COATINGS, NAMELY, PRESERVATIVES AGAINST RUST AND AGAINST DETERIORATION OF WOOD; MORDANTS FOR USE IN TEXTILE MANUFACTURING; RAW NATURAL RESINS FOR GENERAL INDUSTRIAL USE .

FIRST USE 1-0-2005; IN COMMERCE 1-0-2005.

INT. CL. 19/U.S. CLS. 1, 12, 33 AND 50

FOR NON-METALLIC BUILDING MATERIALS, NAMELY, SYNTHETIC FLOORING MATERIALS OF SYNTHETIC RESINS, CEMENT FILLERS FOR REPAIRING.

FIRST USE 1-0-2005; IN COMMERCE 1-0-2005.

ELEMENTS CORRECTED  
ENTITY

4,173,643. REG. 7-17-2012. UNION DES ASSOCIATIONS EUROPEENNES DE FOOTBALL (UEFA) (SWITZERLAND ASSOCIATION) ROUTE DE GENEVE 46, CH-1260 NYON, SWITZERLAND,, SN 79-106,117. FILED 8-22-2011. PRINCIPAL REGISTER.

# UEFA EURO 2016

THE MARK CONSISTS OF STANDARD CHARACTERS WITHOUT CLAIM TO ANY PARTICULAR FONT, STYLE, SIZE, OR COLOR.

PRIORITY DATE OF 3-23-2011 IS CLAIMED.

OWNER OF INTERNATIONAL REGISTRATION 1099152 DATED 8-22-2011, EXPIRES 8-22-2021.

OWNER OF U.S. REG. NOS. 3,181,196, 3,537,198 AND OTHERS.

INT. CL. 16/U.S. CLS. 2, 5, 22, 23, 29, 37, 38 AND 50

FOR COLORING AND DRAWING BOOKS; CHILDREN'S ACTIVITY BOOKS; MAGAZINES; NEWSPAPERS; BOOKS AND PRINTED REVIEWS, ALL IN THE FIELD OF SPORTS PERSONALITIES AND SPORTS EVENTS; BOOKMARKERS; PRINTED TEACHING MATERIAL IN THE FIELD OF SPORTS; SCORE SHEETS; EVENT PROGRAMS; EVENT ALBUMS; PHOTOGRAPH ALBUMS; AUTOGRAPH BOOKS; PRINTED TIMETABLES; PAMPHLETS IN THE FIELD OF SPORTS PERSONALITIES AND SPORTS EVENTS; COLLECTIBLE PHOTOGRAPHS OF SPORTS PLAYERS; BUMPER STICKERS; STICKERS; ALBUMS, NAMELY, PHOTO ALBUMS AND EVENT ALBUMS; STICKER ALBUMS; POSTERS; PHOTOGRAPHS; TABLECLOTHS OF PAPER; TOWELS OF PAPER; PAPER BAGS; INVITATION CARDS; GREETING CARDS; GIFT WRAPPING PAPER; PAPER COASTERS AND PLACE MATS; GARBAGE BAGS OF PAPER AND OF PLASTICS; FOOD WRAPPING PAPER; SACHETS FOR PRESERVING FOODSTUFFS IN THE NATURE OF PLASTIC BAGS FOR PACKING FOODSTUFFS; FILTER PAPER; LABELS, NOT OF TEXTILE, NAMELY, PAPER LABELS, ADDRESS LABELS AND SHIPPING LABELS; WET DISPOSABLE WIPES NOT IMPREGNATED WITH CHEMICALS OR COMPOUNDS; TOILET PAPER; NAPKINS OF PAPER FOR REMOVING MAKE-UP; BOXES OF PAPER AND CARDBOARD FOR HANDKERCHIEF STORAGE; BABIES' DIAPERS OF PAPER; STATIONERY AND PRINTED INSTRUCTIONAL AND TEACHING MATERIAL IN THE FIELD OF SPORTS; TYPEWRITER PAPER; COPYING PAPER; ENVELOPES; NOTEPADS; PAPER FOLDERS; TISSUE PAPER; SCHOOL WRITING BOOKS; PAPER SHEETS FOR NOTE TAKING; WRITING PAPER; PAPER FOR NOTEBOOK BINDERS; [ WASTE PAPER ] \* WASTEPAPER \* BASKETS; FILES, NAMELY, CARD FILES, DOCUMENT FILES, LETTER FILES AND PAPER EXPANDING FILES; BOOK COVER PAPER; LUMINOUS PAPER; SELF-ADHESIVE PAPER FOR NOTES; PAPER-

WEIGHTS; CREPE PAPER; CLOTH PAPER IN THE NATURE OF FIBER PAPER; PAPER BADGES AND PAPER INSIGNIA IN THE NATURE OF EMBLEMS; FLAGS OF PAPER; SPORTS TEAMS FLAGS OF PAPER; WRITING INSTRUMENTS; FOUNTAIN PENS; PENCILS; BALLPOINT PENS; BALL-POINT PEN AND PENCIL SETS; FELT-TIP PENS; FIBER-TIP PENS FOR COLORING; FELT-TIP WRITING PENS; MARKING PENS, NAMELY, MARKERS; WRITING INK, INKING PADS, RUBBER STAMPS; ELECTRIC AND NON-ELECTRIC TYPEWRITERS; LITHOGRAPHS, LITHOGRAPHIC WORKS OF ART; FRAMED AND UNFRAMED PAINTINGS AND PICTURES; PAINT BOXES; ARTS AND CRAFTS PAINT KITS; COLORING PENCILS; CHALKS; PENCIL ORNAMENTS; BLOCKS FOR PRINTING; ADDRESS BOOKS; DIARIES; PERSONAL ORGANIZERS OF PAPER; ROAD MAPS; PRINTED TICKETS; PRINTED ADMISSION TICKETS, LOTTERY TICKETS; SCRATCH CARDS; BANK CHECKS; COMIC BOOKS; CALENDARS; POSTCARDS; PRINTED ADVERTISING BOARDS OF PAPER OR CARDBOARD; PAPER BANNERS; DECALCOMANIAS; ADHESIVE LABELS; OFFICE REUSITES, NAMELY, CORRECTION FLUIDS FOR DOCUMENTS, RUBBER ERASERS, PENCIL SHARPENERS, HOLDERS FOR PENS, PENCILS, AND INK, AND DESK STANDS AND CONTAINERS FOR OFFICE ARTICLES IN THE NATURE OF CORRUGATED BOARD AND PAPER CONTAINERS FOR OFFICE ARTICLES; STANDS AND CONTAINERS FOR OFFICE ARTICLES, NAMELY, CALENDAR STANDS, STANDS FOR WRITING IMPLEMENTS, STAMP STANDS, DESKTOP DOCUMENT STANDS, STORAGE CONTAINERS MADE OF PAPER OR CARDBOARD; PAPER CLIPS; THUMBSTACKS; RULERS, NAMELY, DRAFTING RULERS, DRAWING RULERS AND UNGRADUATED RULERS; ADHESIVE TAPES FOR STATIONERY, ADHESIVE TAPE DISPENSERS; STAPLES; MARKING TEMPLATES; BINDER CLIPS; HOLDERS FOR NOTE-PADS; CASES FOR VISITING CARDS; BOOKENDS; BOOK SUPPORTS IN THE NATURE OF BOOK HOLDERS; STAMPS, NAMELY, RUBBER STAMPS, SEALING STAMPS, INK STAMPS AND POSTAGE STAMPS; CREDIT CARDS WITHOUT MAGNETIC CODING, TELEPHONE CALLING CARDS, NOT MAGNETICALLY ENCODED; CASH CARDS IN THE NATURE OF DEBIT CARDS, NOT MAGNETICALLY CODED, NON-MAGNETICALLY ENCODED TRAVEL CARDS MADE OF PAPER OR CARDBOARD; NON-MAGNETICALLY ENCODED DISCOUNT CARDS FOR SHOWS MADE OF PAPER OR CARDBOARD; NON-MAGNETICALLY ENCODED CHECK GUARANTEE CARDS AND DEBIT CARDS MADE OF PAPER OR CARDBOARD; BABIES' DISPOSABLE DIAPER-PANTS OF PAPER OR CELLULOSE; BAGGAGE TAGS OF PAPER; PASSPORT CASES; TRAVELERS' BANK CHECKS; HOLDERS FOR CHECKBOOKS; METAL NOTE CLIPS IN THE NATURE OF MONEY CLIPS; SUITCASE TAGS; IDENTITY CARD HOLDERS IN THE NATURE OF DRIVER'S LICENSE HOLDERS.

FIRST USE ; IN COMMERCE .

INT. CL. 25/U.S. CLS. 22 AND 39

FOR CLOTHING, NAMELY, SHIRTS, POLO SHIRTS, SLIPOVERS, PULLOVERS, SLEEVELESS PULLOVERS, BLOUSES, TEE-SHIRTS, WAISTCOATS, SINGLET, SLEEVELESS JERSEYS, FROCKS, DRESSES, SKIRTS, SHORTS, TROUSERS; UNDERWEAR, SWEATSHIRTS, BLAZERS, JACKETS, SPORTS JACKETS, STADIUM VESTS; BATHING SUITS; SWIMWEAR; BATH-ROBES; SWEATERS; SASHES FOR WEAR; SCARVES; SHAWLS; TRACKSUITS; KNITWEAR, NAMELY, KNIT BOTTOMS, KNIT DRESSES, KNIT JACKETS, KNIT SHIRTS, KNIT SKIRTS, KNITTED CAPS, KNITTED GLOVES AND KNITTED UNDERWEAR; WATERPROOF CLOTHING, NAMELY, WATERPROOF JACKETS, PANTS AND FOOTWEAR; COATS; UNIFORMS; NECKTIES; WRIST BANDS; HEADBANDS; GLOVES; APRONS; BIBS NOT OF PAPER; PAJAMAS; PLAY SUITS FOR INFANTS AND CHILDREN; SHOES AND FOOTWEAR; SOCKS AND STOCKINGS; HEADWEAR; KNITTED CAPS; CAPS; HATS; CAPS WITH VISORS; GARTERS; BELTS; BRACES FOR CLOTHING.

FIRST USE ; IN COMMERCE .

INT. CL. 28/U.S. CLS. 22, 23, 38 AND 50

FOR GAMES AND PLAYTHINGS, NAMELY, SPORTS BALLS, PLAY BALLOONS, BALLOONS; BOARD GAMES; GAME TABLES FOR INDOOR FOOTBALL; DOLLS AND PLUSH TOYS; TOY VEHICLES; JIGSAW PUZZLES; BALLS FOR GAMES; INFLATABLE TOYS; DISC TOSS TOYS; PLAYING CARDS; CONFETTI; GYMNASTIC AND SPORTING ARTICLES, NAMELY, GYMNASTIC APPARATUS, SPORTING BOARDS AND NETS FOR SPORTING PURPOSES; SOCCER EQUIPMENT, NAMELY, SOCCER BALLS, GLOVES, KNEE GUARDS, ELBOW GUARDS, SHOULDER PROTECTORS IN THE NATURE OF PROTECTIVE SUPPORTS FOR SHOULDERS, SHIN GUARDS; SOCCER GOALS; SPORT BAGS AND CONTAINERS SPECIALLY ADAPTED FOR SPORTS EQUIPMENT FOR CARRYING SPORTS ARTICLES; PAPER AND PLASTIC PARTY HATS; ELECTRONIC GAMES OTHER THAN THOSE ADAPTED FOR USE ONLY WITH A TELEVISION SET; TOY FOAM AND RUBBER NOVELTY ITEMS, NAMELY, HANDS MADE OF RUBBER AND OF FOAM; TOY ROBOTS FOR AMUSEMENT; KITES; ROLLER SKATES; TOY SCOOTERS; SKATEBOARDS.

FIRST USE ; IN COMMERCE .

INT. CL. 32/U.S. CLS. 45, 46 AND 48

FOR NON-ALCOHOLIC BEVERAGES, NAMELY, SODA POP, SOFT DRINKS, LOW CALORIES SOFT DRINKS, DIET SOFT DRINKS, DRINKING WATER, WATER BEVERAGES, FLAVORED WATERS, ENERGY DRINKS, FRUIT DRINKS, VEGETABLE DRINKS, FRUIT JUICES AND VEGETABLE JUICES, LEMONADES AND ORANGE JUICE; SYRUPS AND POWDERS FOR MAKING NON-ALCOHOLIC BEVERAGES; MINERAL AND AERATED WATERS; ISOTONIC BEVERAGES; FRUIT AND VEGETABLE DRINKS; FRUIT AND VEGETABLE JUICES; ICED FRUIT BEVERAGES; BEER; STRONG DARK BEERS; LAGERS AND ALES; ALCOHOL-FREE OR LOW-ALCOHOL BEERS.

FIRST USE ; IN COMMERCE .

INT. CL. 36/U.S. CLS. 100, 101 AND 102

FOR ISSUING OF CREDIT CARDS AND TRAVELERS' CHECKS; FINANCIAL SERVICES, NAMELY, FINANCING SERVICES AND CREDIT RISK MANAGEMENT; BANKING SERVICES; CREDIT CARD SERVICES; FUNDS INVESTMENT; INSURANCE UNDERWRITING FOR ALL TYPES OF INSURANCE; HIRE-PURCHASE FINANCING; HIRE-PURCHASE SERVICES, NAMELY, BROKERAGE FOR HIRE-PURCHASE; FINANCIAL SPONSORSHIP OF SPORTS MEETINGS; INFORMATION SERVICES CONCERNING FINANCE AND INSURANCE, PROVIDED FROM A COMPUTER DATABASE OR VIA THE INTERNET OR ON ANY WIRELESS ELECTRONIC COMMUNICATION NETWORK; HOME BANKING SERVICES; BANKING SERVICES VIA THE INTERNET OR ON ANY WIRELESS ELECTRONIC COMMUNICATION NETWORK; PAYMENT SERVICES VIA MOBILE TELEPHONE, NAMELY, PROVIDING SECURE COMMERCIAL TRANSACTION PAYMENT OPTIONS USING A MOBILE DEVICE AT A POINT OF SALE; PAYMENT SERVICES VIA MOBILE TELEPHONE, NAMELY, ELECTRONIC PROCESSING AND TRANSMISSION OF BILL PAYMENT DATA FOR PAYMENTS; BILL PAYMENT SERVICES VIA MOBILE TELEPHONE; SAFE DEPOSIT BOX SERVICES.

FIRST USE ; IN COMMERCE .

INT. CL. 38/U.S. CLS. 100, 101 AND 104

FOR TELECOMMUNICATIONS, NAMELY, COMMUNICATIONS BY MOBILE TELEPHONES, TELEPHONE AND TELETEXT SERVICES, PROVIDING ACCESS TO DATABASES AND TELECOMMUNICATION NETWORKS; COMMUNICATIONS VIA ELECTRONIC COMPUTER TERMINALS LINKED TO TELECOMMUNICATION NETWORKS, DATA BANKS AND THE INTERNET AND VIA WIRELESS ELECTRONIC COMMUNICATION DEVICES; COMMUNICATION BY TELEGRAPH; COMMUNICATION BY TELEPHONE; COMMUNICATION BY FACSIMILE; PAGING SERVICES; PROVIDING TELEPHONE AND VIDEO CONFERENCING SERVICES; TELEVISION BROADCASTING; CABLE TELEVISION PROGRAM BROADCASTING; RADIO BROADCASTING; RADIO AND TELEVISION BROADCASTING OF SPORTS AND SPORTS EVENTS; NEWS AGENCY SERVICES FOR ELECTRONIC TRANSMISSION; OTHER MESSAGE TRANSMISSION SERVICES, NAMELY, TRANSMISSION OF MESSAGES; RENTAL OF TELEPHONES, FACSIMILE MACHINES AND OTHER TELECOMMUNICATION DEVICES; ELECTRONIC TRANSMISSION OF DATA, NAMELY, OF COMMERCIAL INTERNET PAGES ONLINE OR VIA WIRELESS ELECTRONIC COMMUNICA-

TION DEVICES; TRANSMISSION OF TELEVISION AND RADIO PROGRAMS VIA THE INTERNET AND VIA WIRELESS ELECTRONIC COMMUNICATION NETWORKS; ELECTRONIC MESSAGE TRANSMISSION; PROVIDING ACCESS TO DATABASES ON DATA COMMUNICATION SERVERS AND TO INTERNET REAL-TIME CHAT FORUMS; COMPUTER AIDED TRANSMISSION OF MESSAGES AND IMAGES; TELECOMMUNICATION VIA A FIBER-OPTIC NETWORK; PROVIDING ACCESS TO GLOBAL COMPUTER NETWORKS AND INTERACTIVE COMMUNICATIONS NETWORKS FOR ACCESS TO PRIVATE AND COMMERCIAL PURCHASING AND ORDERING SERVICES; TELECOMMUNICATION OF COMPUTER INFORMATION AND OTHER DATA, NAMELY, TELEMATIC SENDING OF INFORMATION AND DATA; TRANSMISSION OF INFORMATION VIA NATIONAL AND INTERNATIONAL NETWORKS; ELECTRONIC TRANSMISSION OF DATA IN THE NATURE OF COMPUTER PROGRAMS AND OTHER DATA; ELECTRONIC MAIL; INTERNET SERVICE PROVIDER SERVICES VIA THE GLOBAL COMMUNICATIONS NETWORKS AND VIA WIRELESS ELECTRONIC COMMUNICATION NETWORKS; PROVIDING ELECTRONIC TELECOMMUNICATION CONNECTIONS FOR TELECOMMUNICATIONS WITH A GLOBAL COMPUTER NETWORK AND WITH DATA BANKS; PROVIDING ACCESS TO DATABASES ON WEBSITES OFFERING DIGITAL MUSIC ON THE INTERNET VIA A GLOBAL COMPUTER NETWORK AND VIA WIRELESS ELECTRONIC COMMUNICATION DEVICES; PROVIDING TEMPORARY ACCESS TO DATABASES, NAMELY, RENTAL OF ACCESS TIME TO MP3 WEBSITES ON THE INTERNET VIA A GLOBAL COMPUTER NETWORK AND VIA WIRELESS ELECTRONIC COMMUNICATION DEVICES; PROVIDING TEMPORARY ACCESS TO DATABASES, NAMELY, RENTAL OF ACCESS TIME TO A DATABASE SERVER CENTER; PROVIDING TEMPORARY ACCESS TO DATABASES, NAMELY, RENTAL OF ACCESS TIME TO A COMPUTER DATABASE; ELECTRONIC TRANSMISSION OF DIGITAL MUSIC VIA TELECOMMUNICATIONS; ELECTRONIC ON-LINE TRANSMISSION OF DATA, NAMELY, TRANSMISSION OF ELECTRONIC PUBLICATIONS; ELECTRONIC TRANSMISSION OF DIGITAL MUSIC VIA THE INTERNET AND VIA WIRELESS ELECTRONIC COMMUNICATION NETWORKS; ELECTRONIC TRANSMISSION OF DIGITAL MUSIC VIA MP3 WEBSITES; SIMULCASTING BROADCAST TELEVISION FEATURING FILM RECORDINGS AND SOUND AND VIDEO RECORDINGS OVER GLOBAL COMMUNICATION NETWORKS, THE INTERNET AND WIRELESS NETWORKS; SIMULCASTING BROADCAST TELEVISION FEATURING INTERACTIVE EDUCATIONAL INFORMATION AND ENTERTAINMENT PRODUCT INFORMATION OVER GLOBAL COMMUNICATION NETWORKS, THE INTERNET AND WIRELESS NETWORKS; SIMULTANEOUS TRANSMISSION, DELIVERY, AND MANAGEMENT OF INTERACTIVE ELECTRONIC FILES CONTAINING EDUCATIONAL AND ENTERTAINMENT INFORMATION VIA GLOBAL COMPUTER NETWORKS; PROVIDING USER ACCESS TO COMPUTER GAME PROGRAMS IN DATA NETWORKS; PROVIDING ACCESS TO BLACKBOARDS, NAMELY, ELECTRONIC BULLETIN BOARD SERVICES; PROVIDING CHAT ROOMS, NAMELY, PROVIDING ON-LINE FACILITIES FOR REAL-TIME INTERACTION WITH OTHER COMPUTER USERS CONCERNING TOPICS OF GENERAL INTEREST OR TRANSMISSION OF MESSAGES VIA A GLOBAL COMPUTER NETWORK; PROVIDING TEMPORARY ACCESS TO BLACKBOARDS, NAMELY, ELECTRONIC BULLETIN BOARD SERVICES; PROVIDING INTERNET CHATROOMS; COMMUNICATIONS VIA MULTINATIONAL TELECOMMUNICATION NETWORKS DEDICATED TO RETAIL SALES BY MEANS OF INTERACTIVE COMMUNICATIONS WITH CUSTOMERS; MULTIMEDIA TELECOMMUNICATION SERVICES, NAMELY, PROVIDING TELECOMMUNICATION CONNECTIVITY SERVICES FOR TRANSFER OF MULTIMEDIA WORKS AND TRANSMISSION OF SOUND AND VISION VIA INTERACTIVE MULTIMEDIA NETWORKS; VIDEOTEXT AND TELETEXT TRANSMISSION SERVICES; SATELLITE TRANSMISSION OF INFORMATION; MICROWAVE TRANSMISSION OF INFORMATION, NAMELY, RADIO COMMUNICATION; ELECTRONIC, DIGITAL AND ELECTRONIC ANALOG TRANSMISSION OF IN-

FORMATION; TRANSMISSION OF DIGITAL INFORMATION BY CABLE, WIRE AND FIBER ACROSS ELECTRONIC COMMUNICATIONS NETWORKS; TRANSMISSION OF INFORMATION VIA MOBILE TELEPHONE, TELEPHONE, FACSIMILE MACHINE AND TELETYPEWRITER ACROSS NATIONAL AND INTERNATIONAL NETWORKS; TELECOMMUNICATION SERVICES, NAMELY, RECEIVING AND ELECTRONICALLY EXCHANGING INFORMATION, MESSAGES, IMAGES AND DATA STORED IN DATABASES ACCESSIBLE VIA TELECOMMUNICATION NETWORKS.

FIRST USE ; IN COMMERCE .

INT. CL. 41/U.S. CLS. 100, 101 AND 107

FOR EDUCATION, NAMELY, PROVIDING CLASSES, SEMINARS, WORKSHOPS AND TRAINING COURSES IN THE FIELDS OF SOCCER, SOCCER COACHING AND SOCCER OFFICIATING; PROVIDING OF TRAINING, NAMELY, ATHLETIC TRAINING SERVICES; ENTERTAINMENT IN THE NATURE OF SOCCER GAMES, MATCHES AND TOURNAMENTS; OPERATING LOTTERIES AND LOTTERY PRIZE DRAWS AND ARRANGING OF CONTESTS; BETTING SERVICES AND CASINO GAMING SERVICES RELATED TO SPORTS; HOSPITALITY SERVICES, NAMELY, CUSTOMER RECEPTION SERVICES IN THE NATURE OF ARRANGING, ORGANIZING, CONDUCTING AND HOSTING PARTIES AND SOCIAL ENTERTAINMENT EVENTS IN CONJUNCTION WITH SPORTING EVENTS; ENTERTAINMENT SERVICES IN CONNECTION WITH SPORTS EVENTS, NAMELY, ENTERTAINMENT IN THE NATURE OF LASER SHOWS, LIGHT SHOWS, AUDIO AND VISUAL PERFORMANCES, LIVE PERFORMANCES BY A MUSICAL BAND, PREPARATION OF SPECIAL EFFECTS, AND FIREWORKS DISPLAYS; SPORTING AND CULTURAL ACTIVITIES, NAMELY, ORGANIZATION OF EXHIBITIONS FOR CULTURAL OR EDUCATIONAL PURPOSES; ORGANIZATION OF SPORTING AND CULTURAL EVENTS AND ACTIVITIES; ORGANIZATION OF SPORTS COMPETITIONS; ORGANIZATION OF EVENTS RELATING TO SOCCER, NAMELY, ORGANIZATION OF COMPETITIONS AND TOURNAMENTS IN THE FIELD OF SOCCER; PROVIDING SPORTS FACILITIES; RENTAL OF VIDEO AND AUDIOVISUAL EQUIPMENT; FILM AND VIDEO TAPE PRODUCTION, DISPLAYING A SERIES OF FILMS, FILM DISTRIBUTION, AND RENTAL OF FILM RECORDINGS AND SOUND AND VIDEO TAPES; COVERAGE OF SPORTS EVENTS BROADCAST ON RADIO OR TELEVISION, NAMELY, RADIO AND TELEVISION BROADCASTING IN THE FIELD OF SPORTS EVENTS; PRODUCTION OF PROGRAMS FOR RADIO, TELEVISION AND VIDEOTAPE; ENTERTAINMENT SERVICES, NAMELY, ARRANGING FOR TICKET RESERVATIONS FOR SHOWS AND OTHER ENTERTAINMENT EVENTS; AND ENTERTAINMENT INFORMATION SERVICES IN THE FIELD OF SPORTS EVENTS AND OTHER ENTERTAINMENT INFORMATION; AND ENTERTAINMENT TICKET AGENCY SERVICES FOR SPORTS EVENTS AND ENTERTAINMENT; TIMING DURING OF SPORTS EVENTS; ARRANGING OF BEAUTY CONTESTS; INTERACTIVE ENTERTAINMENT, NAMELY, PROVIDING OF AN ONLINE QUIZ GAME IN THE FIELD OF SOCCER; INTERACTIVE ENTERTAINMENT IN THE NATURE OF FANTASY SPORTS LEAGUES; BETTING AND CASINO GAMING SERVICES ON-LINE ON THE INTERNET AND ON ANY WIRELESS ELECTRONIC COMMUNICATION NETWORK; ENTERTAINMENT INFORMATION IN THE FIELD OF SPORTS, PROVIDED ON-LINE FROM A COMPUTER DATABASE OR VIA THE INTERNET OR VIA WIRELESS ELECTRONIC COMMUNICATION NETWORK; SERVICES OF ELECTRONIC GAMES TRANSMITTED VIA THE INTERNET OR ON MOBILE TELEPHONES, NAMELY, PROVIDING ONLINE COMPUTER GAMES VIA THE INTERNET AND MOBILE TELEPHONES; PUBLICATION OF BOOKS; PUBLICATION OF BOOKS AND ELECTRONIC JOURNALS ON-LINE; AUDIO AND VIDEO RECORDING SERVICES; ANIMATION PRODUCTION SERVICES, NAMELY, PRODUCTION OF ANIMATED CARTOONS FOR THE CINEMA, AND PRODUCTION OF ANIMATED CARTOONS FOR TELEVISION; RENTAL OF SOUND AND MOTION PICTURE RECORDINGS FOR ENTERTAINMENT PURPOSES; EDUCATION INFORMATION PROVIDED ON-LINE FROM A COMPUTER DATABASE OR VIA THE INTERNET OR VIA WIRELESS ELECTRONIC COMMUNICATION NETWORK; OPERATING OF DISCUSSION GROUPS, NAMELY, CONDUCTING EDUCATIONAL

PANEL DISCUSSIONS IN THE FIELD OF SPORTS ON THE INTERNET OR ON WIRELESS ELECTRONIC COMMUNICATION NETWORKS; TRANSLATION; PHOTOGRAPHY SERVICES; PROVISION OF ENTERTAINMENT INFRASTRUCTURES, NAMELY, PROVIDING AMUSEMENT FACILITIES; PROVISION OF ENTERTAINMENT INFRASTRUCTURES, NAMELY, PROVIDING FACILITIES FOR RECREATION ACTIVITIES; PROVISION OF ENTERTAINMENT INFRASTRUCTURES, NAMELY, PROVIDING VARIOUS FACILITIES FOR AN ARRAY OF SPORTING EVENTS, SPORTS AND ATHLETIC COMPETITIONS AND AWARDS PROGRAMS; PROVISION OF ENTERTAINMENT INFRASTRUCTURES, NAMELY, PROVIDING FACILITIES FOR SPORTS TOURNAMENTS; PROVISION OF ENTERTAINMENT INFRASTRUCTURES, NAMELY, PROVIDING PLAY FACILITIES FOR CHILDREN; PROVISION OF ENTERTAINMENT INFRASTRUCTURES, NAMELY, RENTAL OF STADIUM FACILITIES.

FIRST USE ; IN COMMERCE .  
INT. CL. 43/U.S. CLS. 100 AND 101

FOR PROVIDING OF FOOD AND DRINK, SNACK-BARS; RECEPTION SERVICES, NAMELY, PROVIDING FOOD AND DRINK; FOOD AND DRINK CATERING; HOTELS; PROVIDING FOOD, DRINK AND TEMPORARY HOUSING ACCOMMODATIONS; MAKING HOTELS RESERVATIONS AND TEMPORARY ACCOMMODATION RESERVATIONS FOR OTHERS; HOSPITALITY SERVICES, NAMELY, PROVIDING FOOD AND DRINK AT SPORTS AND ENTERTAINMENT EVENTS.

FIRST USE ; IN COMMERCE .

ELEMENTS CORRECTED  
GOODS/SERVICES

4,191,461. REG. 8-14-2012. VANDANCE, LLC (NEW YORK LIMITED LIABILITY COMPANY) 16255 VENTURA BLVD., SUITE 625, ENCINO, CA, 91436, SN 85-238,842. FILED 2-10-2011. PRINCIPAL REGISTER.

# LABLAST

THE MARK CONSISTS OF STANDARD CHARACTERS WITHOUT CLAIM TO ANY PARTICULAR FONT, STYLE, SIZE, OR COLOR.

INT. CL. 41/U.S. CLS. 100, 101 AND 107

FOR EDUCATIONAL AND ENTERTAINMENT SERVICES IN THE NATURE OF PHYSICAL FITNESS EXERCISE CLASSES AND LIVE PERFORMANCES BY DANCERS, DANCE STUDIOS AND CONDUCTING DANCE FITNESS CONVENTIONS; HEALTH CLUB SERVICES, NAMELY, PROVIDING INSTRUCTION IN THE FIELD OF PHYSICAL EXERCISE.

FIRST USE 1-30-2010; IN COMMERCE 1-30-2010.

ELEMENTS CORRECTED  
OWNER NAME  
CITIZENSHIP

4,183,127. REG. 7-31-2012. TP-LINK TECHNOLOGIES CO., LTD. (CHINA CORPORATION) 1,3-5 FL S BLDG IND WKSP 24 1-4 FL N BLD, IND WKSP 28 SCI & TECH PK SHENNAN RD, NANSHAN, SHENZHEN, CHINA., SN 85-491,327. FILED 12-9-2011. PRINCIPAL REGISTER.

# TP-LINK

OWNER OF CHINA REG. NO. 8411182, DATED 7-7-2011, EXPIRES 7-6-2021.

THE MARK CONSISTS OF THE WORDS "TP-LINK", STYLIZED.

INT. CL. 42/U.S. CLS. 100 AND 101

FOR RESEARCH IN THE FIELD OF COMMUNICATION TECHNOLOGY; RESEARCH AND DEVELOPMENT OF NEW PRODUCTS FOR OTHERS; RESEARCH IN THE FIELD OF ENVIRONMENTAL PROTECTION; MATERIAL TESTING; INDUSTRIAL DESIGN; DESIGN SERVICES FOR PACKAGING; COMPUTER SOFTWARE DESIGN; MECHANICAL RESEARCH.

ELEMENTS CORRECTED  
OWNER ADDRESS

4,226,038. REG. 10-16-2012. CSEPERKALO ZOLTAN (HUNGARY INDIVIDUAL), DBA MOTORCYCLE BATTERIE DEALER, 18, FÜRTÖS, TÖKÖL, HUNGARY, 2316, SN 77-887,495. FILED 12-7-2009. PRINCIPAL REGISTER.

# MOTOBATT

THE MARK CONSISTS OF STANDARD CHARACTERS WITHOUT CLAIM TO ANY PARTICULAR FONT, STYLE, SIZE, OR COLOR.

INT. CL. 9/U.S. CLS. 21, 23, 26, 36 AND 38

FOR BATTERIES \* FOR MOTORCYCLES, SCOOTERS, UTILITY VEHICLES, ALL TERRAIN VEHICLES, PERSONAL WATERCRAFT, SNOWMOBILES, RIDING MOWERS AND POWER SPORT VEHICLES \*.

FIRST USE 11-0-2007; IN COMMERCE 7-2-2012.

ELEMENTS AMENDED  
GOODS/SERVICES

4,229,180. REG. 10-23-2012. RESINATE TECHNOLOGIES, INC. (DELAWARE CORPORATION) SUITE 250, 3588 PLYMOUTH RD., ANN ARBOR, MI, 48105, SN 85-527,372. FILED 1-27-2012. PRINCIPAL REGISTER.



NO CLAIM IS MADE TO THE EXCLUSIVE RIGHT TO USE "RESINATE MATERIALS GROUP", APART FROM THE MARK AS SHOWN.

THE MARK CONSISTS OF A CIRCLE AND THE WORDS "RESINATE MATERIALS GROUP". THE WORDS "RESINATE MATERIAL GROUP" ARE PARTIALLY PLACED OVER THE RIGHT SIDE OF THE CIRCLE.

INT. CL. 40/U.S. CLS. 100, 103 AND 106

FOR CUSTOM MANUFACTURE OF POLYURETHANE DISPERSIONS AND RESINS.

FIRST USE 5-27-2011; IN COMMERCE 5-27-2011.

ELEMENTS CORRECTED  
OWNER NAME

4,244,599. REG. 11-20-2012. TP-LINK TECHNOLOGIES CO., LTD. (CHINA CORPORATION) 1,3-5 FL S BLDG IND WKSP 24 1-4 FL N BLD, IND WKSP 28 SCI & TECH PK SHENNAN RD, NANSHAN, SHENZHEN, CHINA., SN 85-447,987. FILED 10-14-2011. PRINCIPAL REGISTER.

The logo for TP-LINK consists of the words "TP-LINK" in a bold, black, sans-serif font. The letters are closely spaced and have a slightly irregular, hand-drawn appearance.

OWNER OF U.S. REG. NO. 3,175,495.  
THE MARK CONSISTS OF THE WORDS "TP-LINK", STYLIZED.

INT. CL. 16/U.S. CLS. 2, 5, 22, 23, 29, 37, 38 AND 50

FOR WRITING PAPER; PRINTED MATTER, NAMELY, NEWSLETTERS AND BROCHURES IN THE FIELD OF NETWORKING PRODUCTS; CATALOGS FOR THE PRODUCTS IN THE FIELD OF NETWORKING PRODUCTS; ENVELOPES; NOTEBOOKS; WRITING PADS; GREETING CARDS; POSTERS; INSTRUCTION MANUALS FOR NETWORKING PRODUCTS; PAPER BAGS FOR PACKAGING; PLASTIC BAGS FOR PACKAGING; DOCUMENT FILES; STATIONERY; STICKERS; STAMP CASES; ADHESIVE TAPES FOR STATIONERY PURPOSES.

FIRST USE 5-26-1996; IN COMMERCE 12-1-2006.

ELEMENTS CORRECTED  
OWNER ADDRESS

4,262,914. REG. 12-25-2012. VICKI ARCHER (AUSTRALIA INDIVIDUAL) FLAT F, 1 EATON SQUARE, LONDON, UNITED KINGDOM, SW1W 9DA, SN 79-102,729. FILED 3-10-2011. PRINCIPAL REGISTER.

## MY DAILY CLICK

THE MARK CONSISTS OF STANDARD CHARACTERS WITHOUT CLAIM TO ANY PARTICULAR FONT, STYLE, SIZE, OR COLOR.

PRIORITY DATE OF 2-18-2011 IS CLAIMED.

OWNER OF INTERNATIONAL REGISTRATION 1091178 DATED 3-10-2011, EXPIRES 3-10-2021.

NO CLAIM IS MADE TO THE EXCLUSIVE RIGHT TO USE "DAILY", APART FROM THE MARK AS SHOWN.

INT. CL. 41/U.S. CLS. 100, 101 AND 107

FOR ONLINE JOURNALS, NAMELY, BLOGS FEATURING LIFESTYLE, CULTURE AND TRAVEL; ENTERTAINMENT SERVICES, NAMELY, BLOGS FEATURING FASHION, TRAVEL, DESIGN, LIFESTYLE AND CULTURE; PROVIDING ON-LINE NON-DOWNLOADABLE PUBLICATIONS IN THE NATURE OF BLOGS, IN THE FIELD OF LIFESTYLE, CULTURE AND TRAVEL; PROVIDING NON-DOWNLOADABLE ELECTRONIC PUBLICATIONS IN THE NATURE OF BLOGS IN THE FIELD OF FASHION, TRAVEL, DESIGN, LIFESTYLE AND CULTURE; INFORMATION RELATING TO ENTERTAINMENT, THE FIELD OF EDUCATION OR CULTURAL ACTIVITIES PROVIDED ON-LINE FROM A COMPUTER DATABASE OR THE INTERNET; ORGANIZATION OF EVENTS, EXHIBITIONS FOR CULTURAL AND ENTERTAINMENT PURPOSES; PRODUCTION OF SOUND AND VIDEO RECORDINGS; PRODUCTION OF EDUCATIONAL AND INSTRUCTIONAL MATERIALS IN THE NATURE OF BLOGS; ENTERTAINMENT SERVICES, NAMELY, PROVIDING A WEB SITE FEATURING PHOTOGRAPHIC, AUDIO, VIDEO AND PROSE PRESENTATIONS FEATURE TRAVEL, LIFESTYLE AND CULTURE; DISPLAY OF ARTISTIC WORKS IN THE NATURE OF ART EXHIBITIONS; INFORMATION, ADVICE AND CONSULTANCY IN RESPECT OF FRENCH CULTURE, NAMELY, IN THE FIELD OF CULTURE, LIFESTYLE AND TRAVEL; \* NONE OF THE FOREGOING RELATING TO LEADERSHIP, MANAGEMENT, TEAMWORK, PERSONNEL DEVELOPMENT, PERSONNEL MOTIVATION TRAINING, CAREERS AND CAREER DEVELOPMENT OR HEALTH AND HEALTHCARE INCLUDING THE CAUSES, TREATMENT AND PREVENTION OF EPILEPSY \*.

FIRST USE ; IN COMMERCE .

ELEMENTS CORRECTED  
GOODS/SERVICES

4,297,100. REG. 3-5-2013. MEDIPX, LLC (GEORGIA LIMITED LIABILITY COMPANY), DBA MEDIPX.COM, 4002 HIGHWAY 78, SUITE 530-208, LAWRENCEVILLE, GA, 30046, SN 85-431,197. FILED 9-24-2011. PRINCIPAL REGISTER.



NO CLAIM IS MADE TO THE EXCLUSIVE RIGHT TO USE "DESIGN OF THE CADUCEUS", APART FROM THE MARK AS SHOWN.

THE COLOR(S) BLUE, LIGHT BLUE, AND BLACK IS/ARE CLAIMED AS A FEATURE OF THE MARK.

THE MARK CONSISTS OF A BLUE CADUCEUS IN THE CENTER OF A LIGHT BLUE TRANSPARENT ORB OUTLINED IN BLUE ON THE LEFT SIDE OF THE WORD "MEDIPX". THE LETTERS "MEDI" ARE IN BLACK, AND "PX" ARE IN BLUE. ALL LETTERS ARE IN LOWER CASE EXCEPT THE "P" WHICH IS ALWAYS CAPITAL.

INT. CL. 35/U.S. CLS. 100, 101 AND 102

FOR ON-LINE ORDERING SERVICES FEATURING MEDICAL EQUIPMENT, MEDICAL SUPPLY. FIRST USE 7-2-2011; IN COMMERCE 7-2-2011.

ELEMENTS AMENDED  
MARK  
DESCRIPTION OF MARK

4,307,248. REG. 3-26-2013. DIE ERSTE ÖSTERREICHISCHE SPAR-CASSE PRIVATSTIFTUNG (AUSTRIA PRIVATE FOUNDATION) FRIEDRICHSTRASSE 10, A-1010 VIENNA, AUSTRIA., SN 79-111,961. FILED 10-20-2011. PRINCIPAL REGISTER.



PRIORITY DATE OF 8-4-2011 IS CLAIMED.  
OWNER OF INTERNATIONAL REGISTRATION 1113528 DATED 10-20-2011, EXPIRES 10-20-2021.  
OWNER OF U.S. REG. NOS. 4,181,430, 4,184,824 AND 4,184,825.

THE COLOR(S) BLACK AND WHITE IS/ARE CLAIMED AS A FEATURE OF THE MARK.

THE MARK CONSISTS OF A WHITE BEE ON A BLACK SQUARE BACKGROUND.

INT. CL. 4/U.S. CLS. 1, 6 AND 15

FOR [ CANDLES, WAX FOR ILLUMINATING PURPOSES, NAMELY, WAX FOR MAKING CANDLES; WAX FOR INDUSTRIAL PURPOSES, NAMELY, WAX FOR USE IN THE MANUFACTURE OF OTHER PRODUCTS ].

FIRST USE ; IN COMMERCE .

INT. CL. 6/U.S. CLS. 2, 12, 13, 14, 23, 25 AND 50

FOR METAL GOODS, NAMELY, METAL BOLTS, METAL GRATINGS; SIGNBOARDS AND MONEY BOXES OF METAL.

FIRST USE ; IN COMMERCE .

INT. CL. 9/U.S. CLS. 21, 23, 26, 36 AND 38

FOR SOUND RECORDING CARRIERS, NAMELY, COMPACT DISCS AND PRERECORDED MAGNETIC DATA CARRIERS FEATURING MUSIC; LUMINOUS SIGNS; VIDEO RECORDINGS FEATURING ANIMATED CARTOONS, PRERECORDED MAGNETIC DATA CARRIERS FEATURING ANIMATED CARTOONS.

FIRST USE ; IN COMMERCE .

INT. CL. 12/U.S. CLS. 19, 21, 23, 31, 35 AND 44

FOR MOTOR CARS, NAMELY, MOTOR CARS FOR TRANSPORT ON LAND, AUTOMOBILES.

FIRST USE ; IN COMMERCE .

INT. CL. 14/U.S. CLS. 2, 27, 28 AND 50

FOR JEWELLERY, IN PARTICULAR PINS AND BROOCHES, WRISTWATCHES, CUFF LINKS, CLOCKS AND ALARM CLOCKS.

FIRST USE ; IN COMMERCE .

INT. CL. 16/U.S. CLS. 2, 5, 22, 23, 29, 37, 38 AND 50

FOR ADDRESS STAMPS, FOLDERS FOR PAPERS, DOCUMENT FILES, ALBUMS, NAMELY, PHOTOGRAPH ALBUMS, STAMP ALBUMS; ANNOUNCEMENT CARDS BEING STATIONERY, WRISTBANDS FOR THE RETENTION OF WRITING INSTRUMENTS, STICKERS, PAPER RIBBONS, ELASTIC BANDS FOR OFFICES, ADHESIVE TAPES FOR STATIONERY OR HOUSEHOLD PURPOSES, DESK MOUNTED STATIONERY CABINETS, BAGS OF PAPER OR PLASTICS FOR PACKAGING, PRINTED COASTERS MADE OF CARDBOARD, COASTERS MADE OF PAPER FOR BEER GLASSES, PICTURES, WRITING PAPER, PRINTED TICKETS, PAPER LABELS, GREETING CARDS, SCHOOL SUPPLIES IN THE NATURE OF STATIONERY, TABLE NAPKINS OF PAPER, SEALING STAMPS, PAPER BAGS; PRINTED MATTER, NAMELY, NEWSPAPERS, MAGAZINES, BOOKS, PRINTED PERIODICALS, NEWSLETTERS, PAMPHLETS AND BROCHURES ALL IN THE FIELDS OF FINANCE, SECURITIES, OPTIONS AND OTHER FINANCIAL INSTRUMENTS; PHOTOGRAPHS; STATIONERY, IN PARTICULAR, PENCILS; TEAR-OFF NOTE PADS; DECALCOMANIAS; TYPEWRITERS AND OFFICE REQUISITES, NAMELY, WRITING PADS AND NOTE BOOKS; COMIC BOOKS; FLAGS OF PAPER; GRAPHIC REPRESENTATIONS; PRINTED INSTRUCTIONAL AND TEACHING MATERIALS IN THE FIELD OF FINANCE; PLASTIC BUBBLE PACKS FOR PACKAGING; PRINTED PROSPECTUSES IN THE NATURE OF PRINTED REPORTS FEATURING BUSINESS AND FINANCIAL INFORMATION.

FIRST USE ; IN COMMERCE .

INT. CL. 18/U.S. CLS. 1, 2, 3, 22 AND 41

FOR LEATHER AND IMITATION LEATHER, UMBRELLAS, LEATHERWARE IN THE NATURE OF TRAVELLING SETS OF LUGGAGE AND KEY CASES, TRAVELLING BAGS, RUCKSACKS, SCHOOL BAGS.

FIRST USE ; IN COMMERCE .

INT. CL. 20/U.S. CLS. 2, 13, 22, 25, 32 AND 50

FOR FURNITURE, MIRRORS, PICTURE FRAMES, SIGNBOARDS OF WOOD OR PLASTICS, BEEHIVES.

FIRST USE ; IN COMMERCE .

INT. CL. 21/U.S. CLS. 2, 13, 23, 29, 30, 33, 40 AND 50

FOR UTENSILS FOR HOUSEHOLD OR KITCHEN USE, NAMELY, POT AND PAN SCRAPERS, ROLLING PINS, SPATULAS, TURNERS, WHISKS; CONTAINERS FOR HOUSEHOLD OR KITCHEN USE; GLASSWARE, PORCELAIN WARE AND EARTHENWARE, NAMELY, DRINKING GLASSES, MUGS, PLATES, BOWLS; GOBLETTS, TEA CADDIES, BUTTER DISHES, SUGAR BOWLS, COOKIE JARS, SOAP BOXES AND POWDER COMPACTS, COOKING POT SETS, PIGGY BANKS NOT OF METAL, CUPS.

FIRST USE ; IN COMMERCE .

INT. CL. 24/U.S. CLS. 42 AND 50

FOR WOVEN FABRICS; WOVEN MATERIAL, NAMELY, WOVEN FELT; BANNERS AND FLAGS OF TEXTILE; BANNERS AND FLAGS OF CLOTH; TABLE LINEN NOT OF PAPER, TOWELS OF TEXTILE.

FIRST USE ; IN COMMERCE .

INT. CL. 25/U.S. CLS. 22 AND 39

FOR [ CLOTHING, NAMELY, SHIRTS, PANTS, JACKETS; FOOTWEAR; HEADGEAR, NAMELY, HEADWEAR, HATS, CAPS; SINGLETTS, TSHIRTS, NECKTIES ].

FIRST USE ; IN COMMERCE .

INT. CL. 26/U.S. CLS. 37, 39, 40, 42 AND 50

FOR RIBBONS, ORNAMENTAL NOVELTY BADGES.

FIRST USE ; IN COMMERCE .

INT. CL. 27/U.S. CLS. 19, 20, 37, 42 AND 50

FOR CARPETS, DOOR MATS, FLOOR MATS, TAPESTRY-STYLE WALL HANGINGS, NOT OF TEXTILE .

FIRST USE ; IN COMMERCE .

INT. CL. 28/U.S. CLS. 22, 23, 38 AND 50

FOR GAMES, NAMELY, BOARD GAMES, ACTION SKILL GAMES, CARD GAMES; TOYS, NAMELY, BATH TOYS, CRIB TOYS, ACTION FIGURES, TOY VEHICLES; GYMNASTICS APPARATUS; SPORTING GOODS, NAMELY, SPORTS BALLS; ORNAMENTS FOR CHRISTMAS TREES EXCEPT ILLUMINATION ARTICLES AND CONFECTIONERY, BALLS FOR GAMES, BINGO CARDS, DOLLS, JIGSAW PUZZLES, PLAYING CARDS.

FIRST USE ; IN COMMERCE .

INT. CL. 30/U.S. CL. 46



FOR PASTRY AND CONFECTIONERY IN THE NATURE OF CANDY, HONEY, PROPOLIS FOR HUMAN CONSUMPTION [, CHOCOLATE ].  
FIRST USE ; IN COMMERCE .

4,322,103. REG. 4-16-2013. RESINATE TECHNOLOGIES, INC. (DELAWARE CORPORATION) SUITE 230, 801 WEST ANN ARBOR TRAIL, PLYMOUTH, MI, 48170, SN 85-595,210. FILED 4-11-2012. PRINCIPAL REGISTER.

INT. CL. 32/U.S. CLS. 45, 46 AND 48  
FOR BEER, NON-ALCOHOLIC FRUIT JUICE BEVERAGES.  
FIRST USE ; IN COMMERCE .

INT. CL. 33/U.S. CLS. 47 AND 49  
FOR ALCOHOLIC BEVERAGES EXCEPT BEER, \* MEAD AND HONEY WINE \*.  
FIRST USE ; IN COMMERCE .

INT. CL. 35/U.S. CLS. 100, 101 AND 102  
FOR ADVERTISING SERVICES; BUSINESS MANAGEMENT; BUSINESS ADMINISTRATION; PUBLICATION OF PUBLICITY TEXTS; BUSINESS MANAGEMENT AND ORGANIZATION CONSULTANCY; SECRETARIAL SERVICES; MARKETING RESEARCH, CONDUCTING MARKETING STUDIES; MARKET ANALYSIS; PUBLIC RELATIONS; ARRANGING, ORGANIZING AND CONDUCTING SPECIAL EVENTS AND EXHIBITIONS FOR COMMERCIAL OR ADVERTISING PURPOSES.  
FIRST USE ; IN COMMERCE .

INT. CL. 36/U.S. CLS. 100, 101 AND 102  
FOR FINANCIAL AFFAIRS, NAMELY, BANKING AND FINANCING SERVICES, AUTOMOBILE LEASE FINANCING; MONETARY AFFAIRS, NAMELY, ELECTRONIC TRANSFER OF MONEY, MONETARY STRATEGY CONSULTATION AND RESEARCH; FINANCIAL INFORMATION AND ADVISORY SERVICES, FINANCIAL MANAGEMENT AND ANALYSIS SERVICES; SAVINGS BANK SERVICES.  
FIRST USE ; IN COMMERCE .

INT. CL. 37/U.S. CLS. 100, 103 AND 106  
FOR BUILDING CONSTRUCTION AND REPAIR; CONSTRUCTION AND INSTALLATION OF MASONRY STRUCTURES.  
FIRST USE ; IN COMMERCE .

INT. CL. 41/U.S. CLS. 100, 101 AND 107  
FOR EDUCATION SERVICES, NAMELY, PROVIDING CLASSES, SEMINARS, WORKSHOPS IN THE FIELD OF FINANCE; TRAINING SERVICES IN THE FIELD OF FINANCE; ORGANIZING COMMUNITY SPORTING AND CULTURAL EVENTS; ARRANGING AND CONDUCTING EXHIBITIONS, CONFERENCES, CONGRESSES AND SYMPOSIA FOR ENTERTAINMENT AND EDUCATIONAL PURPOSES IN THE FIELDS OF FINANCE, SPORTS AND CULTURE; PUBLICATION OF BOOKS AND PAMPHLETS; PUBLICATION OF TEXTS, OTHER THAN PUBLICITY TEXTS; PROVIDING ENTERTAINMENT INFORMATION ABOUT SPORTING AND CULTURAL EVENTS; ORGANIZATION OF SPORTS COMPETITIONS.  
FIRST USE ; IN COMMERCE .

INT. CL. 42/U.S. CLS. 100 AND 101  
FOR DESIGN AND DEVELOPMENT OF SOFTWARE; MAINTENANCE OF COMPUTER SOFTWARE.  
FIRST USE ; IN COMMERCE .

INT. CL. 43/U.S. CLS. 100 AND 101  
FOR PROVIDING FOOD AND DRINK FOR GUESTS, CATERING SERVICES; AGENCY SERVICES FOR THE RESERVATION OF TEMPORARY ACCOMMODATION.  
FIRST USE ; IN COMMERCE .

ELEMENTS CORRECTED  
GOODS/SERVICES



OWNER OF U.S. REG. NO. 4,072,131.  
THE MARK CONSISTS OF A PARTIALLY OPEN CIRCLE. THE OPENING IS POSITIONED ON THE RIGHT SIDE OF THE CIRCLE.

INT. CL. 40/U.S. CLS. 100, 103 AND 106  
FOR CUSTOM MANUFACTURING OF POLYURETHANE DISPERSIONS AND RESINS.  
FIRST USE 2-11-2013; IN COMMERCE 2-11-2013.

ELEMENTS CORRECTED  
OWNER NAME  
OWNER ADDRESS

4,325,776. REG. 4-23-2013. NIKON CORPORATION (JAPAN CORPORATION) 12-1, YURAKUCHO 1-CHOME, CHIYODA-KU, TOKYO, JAPAN., SN 85-602,083. FILED 4-19-2012. PRINCIPAL REGISTER.



THE MARK CONSISTS OF THE TERM "D3200" IN SPECIAL FORM.

INT. CL. 9/U.S. CLS. 21, 23, 26, 36 AND 38  
FOR CAMERAS; DIGITAL CAMERAS; CAMERA LENSES; BATTERIES AND BATTERY CHARGERS FOR CAMERAS AND DIGITAL CAMERAS; STRAPS FOR CAMERAS AND DIGITAL CAMERAS; COMPUTER SOFTWARE FOR EDITING, PROCESSING AND BROWSING.  
FIRST USE 5-24-2012; IN COMMERCE 5-24-2012.

ELEMENTS CORRECTED  
DATE OF FIRST USE  
DATE OF FIRST USE IN COMMERCE

4,332,177. REG. 5-7-2013. NYDJ APPAREL, LLC (NEW YORK LIMITED LIABILITY COMPANY) 5401 SOUTH SOTO STREET, VERNON, CA, 90058, SN 77-674,322. FILED 2-19-2009. PRINCIPAL REGISTER.

OWNER OF U.S. REG. NO. 2,841,567.  
THE MARK CONSISTS OF THE LETTERS "NYDJ" IN A STYLIZED FONT WRAPPED AROUND AN ABSTRACT DESIGN THAT CONSISTS OF TWO CURVED LINES.  
INT. CL. 25/U.S. CLS. 22 AND 39  
FOR CLOTHING, NAMELY, TOPS, T-SHIRTS, BLOUSES, SWEATERS, PULLOVERS, TANK TOPS AND CARDIGANS.  
FIRST USE 2-15-2013; IN COMMERCE 2-15-2013.

ELEMENTS AMENDED  
MARK

4,363,329. REG. 7-9-2013. ONE SOURCE DOCUMENT MANAGEMENT, INC. (NEW YORK CORPORATION) 905 MARCONI AVENUE, RONKONKOMA, NY, 11779, SN 85-617,305. FILED 5-4-2012. PRINCIPAL REGISTER.

THE MARK CONSISTS OF STANDARD CHARACTERS WITHOUT CLAIM TO ANY PARTICULAR FONT, STYLE, SIZE, OR COLOR.  
SEC. 2(F).  
INT. CL. 38/U.S. CLS. 100, 101 AND 104  
FOR TRANSMISSION SERVICES VIA THE INTERNET, NAMELY, WEB-BASED RECORD AND FILE TRANSFER SERVICES FOR OTHERS.  
FIRST USE 2-28-2004; IN COMMERCE 2-28-2004.

ELEMENTS CORRECTED  
OWNER NAME

4,388,613. REG. 8-20-2013. BOWDEN, CEDRICK (UNITED STATES INDIVIDUAL) 6734 ELM COURT, TAMPA, FL, 33610, SN 85-355,739. FILED 6-24-2011. PRINCIPAL REGISTER.

THE MARK CONSISTS OF STANDARD CHARACTERS WITHOUT CLAIM TO ANY PARTICULAR FONT, STYLE, SIZE, OR COLOR.  
INT. CL. 25/U.S. CLS. 22 AND 39  
FOR [ BANDANAS; BELTS; BLOUSES; BOXER SHORTS; COATS; DRESS SHIRTS; DRESSES; FOOTWEAR; GLOVES; ] HATS; [ HEADBANDS; HOSIERY; JACKETS; KNIT SHIRTS; PAJAMAS; PANTS; RAIN HATS; SCARVES; ] SHIRTS; [ SHORTS; SLEEPWEAR; SOCKS; SUITS; SWEATERS; SWEATSHIRTS; SWIM WEAR; ] T-SHIRTS [ ; TIES; UNDERWEAR; VESTS ].  
FIRST USE 8-12-2012; IN COMMERCE 11-20-2012.

ELEMENTS AMENDED  
GOODS/SERVICES

4,389,093. REG. 8-20-2013. DAI-ICHI KOGYO SEIYAKU CO., LTD. (JAPAN CORPORATION) SHIMOGYO-KU, KYOTO-SHI, 55, NISHISHICHIGO HIGASHIKUBO-CHO, KYOTO, JAPAN, 600-8873, SN 85-612,265. FILED 4-30-2012. PRINCIPAL REGISTER.

THE MARK CONSISTS OF STANDARD CHARACTERS WITHOUT CLAIM TO ANY PARTICULAR FONT, STYLE, SIZE, OR COLOR.  
INT. CL. 1/U.S. CLS. 1  
FOR POLYLACTIC RESINS.  
FIRST USE 7-30-2012; IN COMMERCE 7-30-2012.

ELEMENTS CORRECTED  
GOODS/SERVICES

4,393,342. REG. 8-27-2013. EVOLUTION CAPITAL MANAGEMENT PARTNERS LLC (OHIO LIMITED LIABILITY COMPANY) SUITE 480, 3333 RICHMOND ROAD, CLEVELAND, OH, 44122, SN 85-599,020. FILED 4-16-2012. PRINCIPAL REGISTER.

THE MARK CONSISTS OF STANDARD CHARACTERS WITHOUT CLAIM TO ANY PARTICULAR FONT, STYLE, SIZE, OR COLOR.  
INT. CL. 36/U.S. CLS. 100, 101 AND 102

FOR FINANCING SERVICES, NAMELY, PRIVATE EQUITY FINANCING AND MEZZANINE FINANCING; INVESTMENT SERVICES, NAMELY, PRIVATE EQUITY INVESTMENT SERVICES AND MEZZANINE INVESTMENT SERVICES; AND MANAGEMENT OF PRIVATE EQUITY FUNDS.

FIRST USE 1-14-2013; IN COMMERCE 1-14-2013.

ELEMENTS AMENDED  
OWNER ADDRESS

4,394,427. REG. 9-3-2013. SHINDENGEN ELECTRIC MANUFACTURING CO., LTD. (JAPAN CORPORATION) 2-1, OHTEMACHI 2-CHOME, CHIYODA-KU, TOKYO 100-0004, JAPAN., SN 79-120,002. FILED 6-15-2012. PRINCIPAL REGISTER.

## Smart-Resoic

THE MARK CONSISTS OF STANDARD CHARACTERS WITHOUT CLAIM TO ANY PARTICULAR FONT, STYLE, SIZE, OR COLOR.

PRIORITY DATE OF 12-21-2011 IS CLAIMED.

OWNER OF INTERNATIONAL REGISTRATION 1134560 DATED 6-15-2012, EXPIRES 6-15-2022.

THE WORDING "RESOIC" HAS NO MEANING IN A FOREIGN LANGUAGE.

INT. CL. 9/U.S. CLS. 21, 23, 26, 36 AND 38

FOR ELECTRONIC MACHINES, APPARATUS AND THEIR PARTS, NAMELY, INTEGRATED CIRCUITS AND SEMICONDUCTOR DEVICES.

FIRST USE ; IN COMMERCE .

ELEMENTS CORRECTED  
OWNER ADDRESS

4,402,127. REG. 9-17-2013. TUTTOCALABRIA, DI A.CELLI SRL (ITALY SOCIETA A RESPONSABILITA LIMITATA) CONTRADA MANDARANO, MARCELLINARA, I-88044 CATANZARO, ITALY., SN 79-116,050. FILED 7-23-2012. PRINCIPAL REGISTER.

## TUTTOCALABRIA

THE MARK CONSISTS OF STANDARD CHARACTERS WITHOUT CLAIM TO ANY PARTICULAR FONT, STYLE, SIZE, OR COLOR.

PRIORITY DATE OF 7-11-2012 IS CLAIMED.

OWNER OF INTERNATIONAL REGISTRATION 1124458 DATED 7-23-2012, EXPIRES 7-23-2022.

THE ENGLISH TRANSLATION OF "TUTTO" IN THE MARK IS "ALL".

INT. CL. 29/U.S. CL. 46

FOR MEAT, \* INCLUDING COPPA, PANCETTA, SAUSAGE AND SOPRESSATA AND LIMITED TO CAPOLLO DI CALABRIA, PANCETTA DI CALABRIA, SALSICCIA DI CALABRIA, SOPRESSATA DI CALABRIA, \* FISH, POULTRY AND GAME; MEAT EXTRACTS; PRESERVED, FROZEN, DRIED AND COOKED FRUITS AND VEGETABLES, \* INCLUDING ONIONS AND CLEMENTINES AND LIMITED TO CLEMENTINE DI CALABRIA AND CIPOLLA ROSSA DI TROPEA CALABRIA \*; JELLIES, JAMS, COMPOTES \* CONTAINING CLEMENTINE DI CALABRIA \*; EGGS; MILK AND MILK PRODUCTS; EXCLUDING ICE-CREAM AND FROZEN YOGURT; EDIBLE OILS AND FATS.

FIRST USE ; IN COMMERCE .

INT. CL. 30/U.S. CL. 46

FOR COFFEE, TEA, COCOA AND ARTIFICIAL COFFEE; RICE; TAPIOCA AND SAGO; FLOUR AND PREPARATIONS MADE FROM CEREALS, NAMELY, BISCUITS AND TARTS; BREAD, PASTRY AND CONFECTIONERY, NAMELY, FROZEN CONFECTIONERY AND FONDANTS \* CONTAINING LIQUIRIZIA DI CALABRIA \*; EDIBLE ICES; SUGAR, HONEY, TREATS; YEAST, BAKING-POWDER; SALT; MUSTARD; VINEGAR, SAUCES AS CONDIMENTS; SPICES; ICE.

FIRST USE ; IN COMMERCE .

ELEMENTS CORRECTED  
GOODS/SERVICES

4,412,145. REG. 10-1-2013. ONE CALL ALERT, LLC (TEXAS LIMITED LIABILITY COMPANY) 949 WAKEFIELD DR., SUITE 100, HOUSTON, TX, 77018, SN 85-720,607. FILED 9-5-2012. PRINCIPAL REGISTER.

## ONE CALL ALERT

THE MARK CONSISTS OF STANDARD CHARACTERS WITHOUT CLAIM TO ANY PARTICULAR FONT, STYLE, SIZE, OR COLOR.

NO CLAIM IS MADE TO THE EXCLUSIVE RIGHT TO USE "ALERT", APART FROM THE MARK AS SHOWN.

INT. CL. 44/U.S. CLS. 100 AND 101

FOR PERSONAL EMERGENCY MEDICAL RESPONSE SERVICES .

FIRST USE 1-3-2013; IN COMMERCE 1-3-2013.

INT. CL. 45/U.S. CLS. 100 AND 101

FOR EMERGENCY MEDICAL ALARM RESPONSE MONITORING AND NOTIFICATION SERVICES.

FIRST USE 1-3-2013; IN COMMERCE 1-3-2013.

ELEMENTS CORRECTED  
DATE OF FIRST USE

4,418,864. REG. 10-15-2013. REPORT COLLECTION INC. (CANADA CORPORATION) 5525 PARE STREET, VILLE MONT-ROYAL, QC, CANADA, H3P 1P7, SN 78-924,799. FILED 7-7-2006. PRINCIPAL REGISTER.

## RC BASIS

THE MARK CONSISTS OF STANDARD CHARACTERS WITHOUT CLAIM TO ANY PARTICULAR FONT, STYLE, SIZE, OR COLOR.

PRIORITY CLAIMED UNDER SEC. 44(D) ON CANADA APPLICATION NO. 1303910, FILED 6-2-2006, REG. NO. TMA743904, DATED 7-23-2009, EXPIRES 7-23-2024.

NO CLAIM IS MADE TO THE EXCLUSIVE RIGHT TO USE "BASICS", APART FROM THE MARK AS SHOWN.

INT. CL. 18/U.S. CLS. 1, 2, 3, 22 AND 41

FOR (BASED ON SECTION 44(E)) BAGS, NAMELY, HAND BAGS, SHOULDER BAGS, BACKPACKS, SCHOOL BAGS, LUGGAGE BAGS, FANNY PACKS, CARRY-ON BAGS, DUFFEL BAGS.

FIRST USE ; IN COMMERCE .

INT. CL. 25/U.S. CLS. 22 AND 39

FOR (BASED ON 44(E)) CLOTHING, NAMELY, SWEATERS, T-SHIRTS, CARDIGANS AND SWEATSHIRTS, (BASED ON USE IN COMMERCE) POLO SHIRTS, PANTS, SHIRTS.  
FIRST USE 1-2-2007; IN COMMERCE 1-1-2007.

ELEMENTS CORRECTED  
GOODS/SERVICES



4,425,299. REG. 10-29-2013. ION-X CORPORATION, INC. (TEXAS CORPORATION) 4455 CAMP BOWIE, SUITE 205, P.O. BOX 470083, FORT WORTH, TX, 76102, SN 85-883,747. FILED 3-22-2013. PRINCIPAL REGISTER.



THE MARK CONSISTS OF THE LETTERS "ION-X" ABOVE A STYLIZED PERSPECTIVE VIEW OF A MOLECULE.

INT. CL. 1/U.S. CLS. 1

FOR CHEMICAL PREPARATIONS, NAMELY, DEGREASING AND CLEANING SOLVENTS; DEGREASING AGENTS.

FIRST USE 1-30-2013; IN COMMERCE 1-30-2013.

INT. CL. 3/U.S. CLS. 1, 4, 6, 50, 51 AND 52

FOR DEGREASING PREPARATIONS FOR USE ON SURFACES, EQUIPMENT AND PARTS IN FOODSERVICE FACILITIES, FOOD MANUFACTURING FACILITIES, PRODUCTION FACILITIES, COMMERCIAL MANUFACTURING FACILITIES, PARKING LOTS, PARKING GARAGES, PARKING DECKS, GAS STATIONS, VEHICLE REPAIR FACILITIES AND VEHICLE SERVICE GARAGES; DEGREASING PREPARATIONS FOR USE AS A HOUSEHOLD DEGREASER.  
FIRST USE 1-30-2013; IN COMMERCE 1-30-2013.

ELEMENTS CORRECTED  
MARK

4,430,119. REG. 11-5-2013. FLOWER CHILD FOREVER, INC. (CALIFORNIA CORPORATION) 10866 WILSHIRE BOULEVARD, SUITE 1100, LOS ANGELES, CA, 90024, SN 85-980,304. FILED 3-11-2011. PRINCIPAL REGISTER.



THE MARK CONSISTS OF OVERLAPPING STYLIZED LETTERS "H", "O", AND "H", WHERE ONE LETTER "H" IS POSITIONED IN FRONT OF AND SLIGHTLY TO THE RIGHT OF AND BELOW THE LETTER "O", WHILE THE OTHER LETTER "H" IS POSITIONED BEHIND AND SLIGHTLY TO THE LEFT OF THE LETTER "O".

INT. CL. 25/U.S. CLS. 22 AND 39

FOR CLOTHING, NAMELY, DRESSES, BLOUSES, JACKETS, SHIRTS, SKIRTS, PANTS, SHORTS, T-SHIRTS, TOPS, AND TANK TOPS.

FIRST USE 7-12-2013; IN COMMERCE 7-12-2013.

ELEMENTS CORRECTED  
DATE OF FIRST USE  
DATE OF FIRST USE IN COMMERCE



4,431,811. REG. 11-12-2013. FOOTBALL NETWORKS LLC (DELAWARE LIMITED LIABILITY COMPANY) ONE COMMERCE CENTER, WILMINGTON, DE, 19899, SN 85-875,537. FILED 3-13-2013. PRINCIPAL REGISTER.



NO CLAIM IS MADE TO THE EXCLUSIVE RIGHT TO USE "FOOTBALL NETWORKS", APART FROM THE MARK AS SHOWN.

THE MARK CONSISTS OF A SOCCER BALL DRAWING WITH THE WORDING "FOOTBALL NETWORKS" IN STYLIZED LETTERS.

INT. CL. 38/U.S. CLS. 100, 101 AND 104

FOR COMMUNICATION SERVICES, NAMELY, TRANSMISSION OF VOICE, AUDIO, VISUAL IMAGES AND DATA BY TELECOMMUNICATIONS NETWORKS, WIRELESS COMMUNICATION NETWORKS, THE INTERNET, INFORMATION SERVICES NETWORKS AND DATA NETWORKS; PROVIDING TELECOMMUNICATION CONNECTIONS TO THE INTERNET OR DATABASES; TELECOMMUNICATION SERVICES, NAMELY, TRANSMISSION OF VOICE, DATA, GRAPHICS, IMAGES, AUDIO AND VIDEO BY MEANS OF TELECOMMUNICATIONS NETWORKS, WIRELESS COMMUNICATION NETWORKS, AND THE INTERNET.  
FIRST USE 3-13-2013; IN COMMERCE 3-13-2013.

ELEMENTS CORRECTED  
OWNER NAME  
OWNER ADDRESS

4,434,692. REG. 11-19-2013. SPROCKET MEDIA INC. (CALIFORNIA CORPORATION) 600 SOUTH LAKE AVENUE, PASADENA, CA, 91106, SN 85-627,617. FILED 5-16-2012. PRINCIPAL REGISTER.

## SPROCKET MEDIA

THE MARK CONSISTS OF STANDARD CHARACTERS WITHOUT CLAIM TO ANY PARTICULAR FONT, STYLE, SIZE, OR COLOR.

NO CLAIM IS MADE TO THE EXCLUSIVE RIGHT TO USE "MEDIA", APART FROM THE MARK AS SHOWN.

INT. CL. 9/U.S. CLS. 21, 23, 26, 36 AND 38

FOR COMPUTER SOFTWARE DEVELOPMENT TOOLS; COMPUTER SOFTWARE FOR USE AS AN APPLICATION PROGRAMMING INTERFACE API FOR INTEGRATION OF VIDEO OR ORIGINAL OR REPURPOSED PICTURES AND TEXT IN ANY FORMAT INTO WEBSITES; APPLICATION PROGRAMMING INTERFACE API FOR COMPUTER SOFTWARE WHICH FACILITATES ELECTRONIC COMMUNICATION SERVICES FOR ONLINE SOCIAL NETWORKING, BUILDING SOCIAL NETWORKING APPLICATIONS AND FOR ALLOWING DATA RETRIEVAL, UPLOAD, DOWNLOAD, ACCESS AND MANAGEMENT; COMPUTER SOFTWARE FOR USE IN POSTING, UPLOADING, DOWNLOADING, ACCESSING, DISPLAYING, TRANSMITTING, STREAMING, RETRIEVING, RECEIVING, REVIEWING, BLOGGING, SHARING, TAGGING, ORGANIZING, LINKING, SEARCHING, PROVIDING AND MANAGING TEXT, AUDIO, VISUAL AND MULTIMEDIA DATA AND CONTENT VIA COMPUTERS, MOBILE PHONES, WIRED AND WIRELESS COMMUNICATION DEVICES, CAMERAS, AND OPTICAL AND ELECTRONIC COMMUNICATIONS NETWORKS; COMPUTER SOFTWARE FOR USE IN INITIALIZING AND MANAGING ELECTRONIC COMMUNICATIONS FOR SOCIAL NETWORKING VIA MOBILE DEVICES; COMPUTER SOFTWARE FOR USE IN INITIALIZING AND MANAGING MULTIPLE PRIVATE, SMALL COMMUNICATIONS NETWORKS BY INVITING CONTACTS TO PARTICIPATE IN GROUPS.

FIRST USE 6-11-2008; IN COMMERCE 6-11-2008.  
INT. CL. 35/U.S. CLS. 100, 101 AND 102

FOR BUSINESS CONSULTING SERVICES IN THE FIELD OF CREATION, DELIVERY AND MEASUREMENT OF EFFECTIVENESS OF DIGITAL ADVERTISING AND MARKETING; COORDINATING AND PLACING ADVERTISING FOR OTHERS ON WIRED, MOBILE AND WIRELESS NETWORKS USING SPECIALIZED COMPUTER SOFTWARE; BUSINESS CONSULTING SERVICES, NAMELY, PROVIDING ELECTRONIC NETWORK CONSULTING AND STRATEGIC SERVICES TO ASSIST ORGANIZATIONS AND OTHERS IN USING AND BUILDING ONLINE, ELECTRONIC AND NON-ELECTRONIC INTERACTIVE ADVOCACY NETWORKS AND TOOLS SUCH AS BLOGS, VOICE OVER INTERNET PROTOCOL SERVICES, MOBILE PHONES, SOCIAL NETWORKING, PRINT AND BROADCAST MEDIA, WEBCASTING, INSTANT MESSAGING SERVICES, PODCASTS AND WIKIS FOR ADVERTISING AND MARKETING PURPOSES; BUSINESS CONSULTING SERVICES, NAMELY, MEDIA PLANNING SERVICES IN THE NATURE OF ADVISING THE CLIENT ON THE CORRECT TIMES AND STATIONS TO ADVERTISE BASED ON MEDIA ANALYSIS OF THE MARKET FOR THAT MEDIA, THE DEVELOPMENT OF ONLINE AND OFFLINE MARKETING STRATEGIES AND PLANS, BRAND CREATION AND DEVELOPMENT PLANS AND CONSULTING RELATING TO THE IMPLEMENTATION OF ALL SUCH STRATEGIES AND PLANS; CREATION OF ADVERTISING COPY FOR OTHERS, PUBLIC RELATIONS CONSULTING SERVICES AND MARKETING-RELATED PROJECT MANAGEMENT SERVICES FOR OTHERS; SOCIAL MEDIA MARKETING, NAMELY, MARKETING SERVICES FOR SOCIAL AND BUSINESS NETWORKING SERVICES AND INSTANT MESSAGING SERVICES VIA SOCIAL NETWORKS; MARKETING CONSULTATION; ADVERTISING, MARKETING, PUBLICITY, AND BUSINESS SERVICES, NAMELY, PROMOTING THE GOODS, SERVICES, AND BRAND

IDENTITY OF OTHERS THROUGH AUDIO, VIDEO, DIGITAL, AND ONLINE MEDIUM; DISSEMINATION OF ADVERTISING AND COMMERCIAL INFORMATION FOR OTHERS VIA ELECTRONIC MEDIA, NAMELY, THE GLOBAL INFORMATION COMPUTER NETWORK; PROVIDING A WEBSITE FOR BUSINESS PURPOSES WHERE ADVERTISERS, MARKETERS, AND CONTENT PROVIDERS CAN INTERACT WITH USERS FOR ADVERTISING, BRANDING, AND PROMOTING KNOWLEDGE, PRODUCTS AND SERVICES ON BEHALF OF THEMSELVES AND OTHERS, AND FOR EVALUATING AND RATING THE SAME; DEVELOPMENT OF MARKETING STRATEGIES, CONCEPTS AND TACTICS, NAMELY, AUDIENCE DEVELOPMENT, BRAND AWARENESS, CUSTOMER RELATIONS, ONLINE COMMUNITY BUILDING AND DIGITAL WORD OF MOUTH COMMUNICATIONS FOR PROMOTING THE GOODS AND SERVICES OF OTHERS AND DISTRIBUTING ADVERTISEMENTS FOR DISPLAY ON THE GLOBAL INFORMATION COMPUTER NETWORK, NAMELY, VIA SOCIAL NETWORKS, SOCIAL CONVERSATIONS OVER THE GLOBAL INFORMATION COMPUTER NETWORK, STATUS UPDATES, BLOGS, MICROBLOGS, WEBSITES, FORUMS, ELECTRONIC BULLETIN BOARDS, E-MAILS, ELECTRONIC MESSAGES, INSTANT MESSAGES, TEXT MESSAGES, AND MULTIMEDIA MESSAGES; ADVERTISING AND MARKETING CONSULTING SERVICES, NAMELY, ASSISTING MARKETERS IN IDENTIFYING, EVALUATING AND COLLABORATING WITH INDIVIDUAL MEMBERS OF ONLINE COMMUNITIES WHO INFLUENCE OR ARE CAPABLE OF INFLUENCING THE PURCHASING DECISIONS OF MEMBERS OF ONLINE COMMUNITIES; ARRANGING AND CONDUCTING INCENTIVE REWARD PROGRAMS TO PROMOTE THE SALE OF GOODS OR SERVICES OFFERED BY CLIENTS AND OTHERS, AND TO REWARD INDIVIDUAL MEMBERS OF ONLINE COMMUNITIES WHO INFLUENCE OR ARE CAPABLE OF INFLUENCING THE PURCHASING DECISIONS OF MEMBERS OF ONLINE COMMUNITIES; DESIGN OF GLOBAL INFORMATION COMPUTER NETWORK ADVERTISING, ADVERTISING, NAMELY, ADVERTISING AND ADVERTISEMENT SERVICES, ADVERTISING, MARKETING AND PROMOTION SERVICES, ONLINE ADVERTISING ON COMPUTER COMMUNICATION NETWORKS; BUSINESS ADMINISTRATION, NAMELY, ADMINISTRATION OF BUSINESS PAYROLL FOR OTHERS, BUSINESS ADMINISTRATION CONSULTANCY, BUSINESS ADMINISTRATION AND MANAGEMENT, BUSINESS ADMINISTRATION AND OFFICE WORK; OFFICE FUNCTIONS, NAMELY, PROVIDING OFFICE FUNCTIONS, PROVIDING OFFICE SUPPORT STAFF SERVICES, BUSINESS ADMINISTRATION AND OFFICE WORK FOR OTHERS; RECRUITMENT CONSULTANCY SERVICES, NAMELY, CONSULTANCY OF PERSONNEL RECRUITMENT, EMPLOYMENT RECRUITING CONSULTATION; RECRUITMENT SERVICES FOR CONSUMER, CORPORATE, PRIVATE AND INVESTMENT BANKING PERSONNEL, INFORMATION TECHNOLOGY, MANAGEMENT CONSULTANCY, BUSINESS ADMINISTRATION AND DEVELOPMENT PERSONNEL AND INFORMATION TECHNOLOGY SPECIALISTS, NAMELY, EMPLOYMENT COUNSELING AND RECRUITING, PERSONNEL PLACEMENT AND RECRUITMENT, EMPLOYMENT HIRING, RECRUITING, PLACEMENT, STAFFING AND CAREER NETWORKING SERVICES, EMPLOYMENT RECRUITING CONSULTATION, EMPLOYMENT VERIFICATION, JOB AND PERSONNEL PLACEMENT; MANAGEMENT ASSISTANCE, NAMELY, MANAGEMENT AND BUSINESS CONSULTING SERVICES IN THE FIELD OF TRAINING AND RECRUITMENT, PERSONNEL MANAGEMENT CONSULTATION, ASSISTANCE IN MANAGEMENT OF BUSINESS ACTIVITIES; PERSONNEL MANAGEMENT CONSULTANCY; EMPLOYMENT OUTPLACEMENT SERVICES; HUMAN RESOURCES SERVICES, NAMELY, SELECTION OF PERSONNEL FOR OTHERS; ADVISORY, INFORMATION AND CONSULTANCY SERVICES RELATING TO ALL THE AFORESAID SERVICES, NAMELY, BUSINESS MANAGEMENT CONSULTATION, HUMAN RESOURCES CONSULTATION, EMPLOYMENT RECRUITING CONSULTATION, MARKET RESEARCH CONSULTATION, ADVERTISING CONSULTATION, BUSINESS CONSULTING SERVICES IN THE FIELD OF TEMPORARY, PERMANENT OR CONTRACT EMPLOYMENT, PLACEMENT AND STAFFING OF IT, COMPUTER ENGINEERING AND COMPUTER AND INFORMATION TECHNOLOGY SPE-

CIALISTS; EMPLOYMENT AGENCY SERVICES, NAMELY, FILLING THE TEMPORARY AND PERMANENT STAFFING NEEDS OF BUSINESSES; EMPLOYMENT COUNSELING IN THE FIELD(S) OF TEMPORARY, PERMANENT OR CONTRACT EMPLOYMENT, PLACEMENT AND STAFFING OF IT, COMPUTER ENGINEERING AND COMPUTER AND INFORMATION TECHNOLOGY SPECIALISTS; EMPLOYMENT RECRUITING CONSULTATION; EMPLOYMENT SERVICES IN THE NATURE OF TALENT CASTING IN THE FIELD(S) OF IT, COMPUTER ENGINEERING AND/OR COMPUTER AND INFORMATION TECHNOLOGY SPECIALISTS; EMPLOYMENT STAFFING CONSULTATION SERVICES; EMPLOYMENT STAFFING IN THE FIELD OF IT, COMPUTER ENGINEERING AND/OR COMPUTER AND INFORMATION TECHNOLOGY SPECIALISTS; PROFESSIONAL STAFFING AND RECRUITING SERVICES; PROVIDING TEMPORARY AND FREELANCE STAFFING OF ADVERTISING, GRAPHIC ARTS, AND DIGITAL PROFESSIONALS, NAMELY, ILLUSTRATORS, WRITERS, PHOTOGRAPHERS, GRAPHIC DESIGNERS, WEBSITE DEVELOPERS, MULTI-MEDIA PRODUCERS, PRODUCTION ARTISTS, COMPUTER PROGRAMMERS, AND INFORMATION DATABASE MANAGERS; ADVERTISING AND MARKETING SERVICES PROVIDED BY MEANS OF A SEARCHABLE ONLINE ADVERTISING WEBSITE AND GUIDE FEATURING THE PRODUCTS AND SERVICES OF OTHER VENDORS VIA THE INTERNET, AND BY MEANS OF INDIRECT METHODS OF MARKETING COMMUNICATIONS, NAMELY, SOCIAL MEDIA, SEARCH ENGINE MARKETING, INQUIRY MARKETING, INTERNET MARKETING, MOBILE MARKETING, BLOGGING AND OTHER FORMS OF PASSIVE, SHARABLE OR VIRAL COMMUNICATIONS CHANNELS; ADVERTISING AND PUBLICITY SERVICES, NAMELY, PROMOTING THE GOODS, SERVICES, BRAND IDENTITY AND COMMERCIAL INFORMATION AND NEWS OF THIRD PARTIES THROUGH PRINT, AUDIO, VIDEO, DIGITAL AND ONLINE MEDIUM; ADVERTISING COPYWRITING; ADVERTISING SERVICES, NAMELY, CREATING CORPORATE AND BRAND IDENTITY FOR OTHERS; ADVERTISING SERVICES, NAMELY, PROMOTING THE BRANDS, GOODS AND SERVICES OF OTHERS THROUGH ALL PUBLIC COMMUNICATION MEANS; BRAND CONCEPT AND BRAND DEVELOPMENT SERVICES FOR CORPORATE AND INDIVIDUAL CLIENTS; BRAND IDENTITY CONSULTING SERVICES FOR BUSINESSES; BRANDING SERVICES, NAMELY, CONSULTING, DEVELOPMENT, MANAGEMENT AND MARKETING OF BRANDS FOR BUSINESSES; CONSULTING SERVICES IN THE FIELD OF INTERNET MARKETING; PROMOTING, ADVERTISING AND MARKETING OF THE BRANDS, PRODUCTS, SERVICES AND ONLINE WEBSITES OF INDIVIDUALS, BUSINESSES AND NONPROFIT ORGANIZATIONS; SOCIAL MEDIA STRATEGY AND MARKETING CONSULTANCY FOCUSING ON HELPING CLIENTS CREATE AND EXTEND THEIR PRODUCT AND BRAND STRATEGIES BY BUILDING VIRALLY ENGAGING MARKETING SOLUTIONS; ADVERTISING AGENCIES, NAMELY, PROMOTING THE GOODS AND SERVICES OF OTHERS; ADVERTISING, MARKETING AND PROMOTION SERVICES; ADVERTISING, PROMOTION AND MARKETING SERVICES IN THE NATURE OF E-MAIL BLAST CAMPAIGNS FOR OTHERS; MARKETING SERVICES, NAMELY, PROMOTING AND ADVERTISING THE GOODS AND SERVICES OF OTHERS THROUGH DISSEMINATION OF ADVERTISING MATERIALS ON SOCIAL NETWORKS; BUSINESS CONSULTATION AND MANAGEMENT REGARDING MARKETING ACTIVITIES AND LAUNCHING OF NEW PRODUCTS; BUSINESS MANAGEMENT CONSULTING WITH RELATION TO STRATEGY, MARKETING, PRODUCTION, PERSONNEL AND RETAIL SALE MATTERS; BUSINESS MARKETING CONSULTING SERVICES; BUSINESS MARKETING SERVICES; BUSINESS MONITORING AND CONSULTING SERVICES, NAMELY, TRACKING WEBSITES AND APPLICATIONS OF OTHERS TO PROVIDE STRATEGY, INSIGHT, MARKETING, SALES, OPERATION, PRODUCT DESIGN, PARTICULARLY SPECIALIZING IN THE USE OF ANALYTIC AND STATISTIC MODELS FOR THE UNDERSTANDING AND PREDICTING OF CONSUMERS, BUSINESSES, AND MARKET TRENDS AND ACTIONS; BUSINESS TO BUSINESS DIRECT MARKETING SERVICES; COLLECTION OF MARKET RESEARCH INFORMATION; CONSULTATION SERVICES, NAMELY, CREATIVE AND

STRATEGIC CONSULTATION REGARDING DEVELOPMENT, PRODUCTION AND IMPLEMENTATION OF MARKETING CAMPAIGNS FOR OTHERS; CREATIVE MARKETING DESIGN SERVICES; DEVELOPMENT OF MARKETING STRATEGIES AND CONCEPTS; DIRECT MARKETING ADVERTISING FOR OTHERS; DIRECT MARKETING CONSULTING SERVICES; DIRECT MARKETING SERVICES; MARKETING SERVICES, NAMELY, PROMOTING OR ADVERTISING THE GOODS AND SERVICES OF OTHERS; MARKETING, ADVERTISING, AND PROMOTING THE RETAIL GOODS AND SERVICES OF OTHERS THROUGH WIRELESS ELECTRONIC DEVICES; PLANNING, DESIGN, DEVELOPMENT, MAINTENANCE, TRACKING AND REPORTING OF ONLINE MARKETING ACTIVITIES FOR THIRD PARTIES; PROMOTING, ADVERTISING AND MARKETING ONLINE WEBSITES OF OTHERS; PROMOTING, MARKETING AND ADVERTISING THE BRANDS AND GOODS OF OTHERS RELATED TO ALL INDUSTRIES, THROUGH ALL PUBLIC AND PRIVATE COMMUNICATION MEANS, NAMELY, PROMOTING THE BRANDS AND GOODS OF OTHERS MADE IN THE UNITED STATES; PROMOTION AND MARKETING SERVICES AND RELATED CONSULTING; PROVIDING ADVERTISING, MARKETING AND PROMOTIONAL SERVICES, NAMELY, DEVELOPMENT OF ADVERTISING CAMPAIGNS FOR WEB PAGES, PRINT AND TELEVISION; PROVIDING ADVERTISING, MARKETING AND PROMOTIONAL SERVICES, NAMELY, DEVELOPMENT OF ADVERTISING CAMPAIGNS PROVIDED THROUGH CABLE TELEVISION BROADCAST, WEB CASTS, RADIO BROADCASTS, NEWSPAPERS, MAGAZINES, ONLINE BANNERS, OUTDOOR BILLBOARDS, WILD POSTINGS, BUS AND SUBWAY ADS; PROVIDING MARKETING AND PROMOTION OF SPECIAL EVENTS; CORPORATE IMAGE CONSULTING SERVICES; MARKETING SERVICES, NAMELY, PROVIDING INFORMATIONAL WEB PAGES DESIGNED TO GENERATE SALES TRAFFIC VIA HYPERLINKS TO OTHER WEBSITES; ONLINE ADVERTISING AND MARKETING SERVICES; PROMOTIONAL MARKETING SERVICES USING AUDIOVISUAL MEDIA; PAY PER CLICK (PPC) ADVERTISING MANAGEMENT SERVICES; ADVERTISING, INCLUDING PROMOTION RELATING TO THE SALE OF PRODUCTS AND SERVICES FOR THIRD PARTIES BY THE TRANSMISSION OF ADVERTISING MATERIAL AND THE DISSEMINATION OF ADVERTISING MESSAGES ON COMPUTER NETWORKS; PROVIDING INFORMATION AND PROVIDING LINKS TO WEBSITES FEATURING INFORMATION IN THE FIELDS OF INTERNSHIP PLACEMENT, EMPLOYMENT PLACEMENT, AND EXTRA-CURRICULAR EMPLOYMENT ACTIVITIES FOR EMPLOYMENT NETWORKING PURPOSES; ADVERTISING, MARKETING AND PROMOTIONAL SERVICES RELATED TO ALL INDUSTRIES FOR THE PURPOSE OF FACILITATING NETWORKING AND SOCIALIZING OPPORTUNITIES FOR BUSINESS PURPOSES; ELECTRONIC COMMERCE SERVICES, NAMELY, PROVIDING INFORMATION ABOUT PRODUCTS VIA TELECOMMUNICATION NETWORKS FOR ADVERTISING AND SALES PURPOSES; PROVIDING A WEBSITE FOR USERS WITH SPECIFIC INFORMED RECOMMENDATIONS OF SPECIFIC CONSUMER PRODUCTS AND SERVICES VALIDATED BY THE USERS' INPUTTED PREFERENCES AND SOCIAL NETWORK; PROVIDING AN ONLINE MARKETING COLLABORATION NETWORK FOR SOCIAL MEDIA AND ONLINE MARKETING PROFESSIONALS FOR THE PURPOSE OF PROMOTING THE GOODS AND SERVICES OF OTHERS; PROVIDING COMMERCIAL INFORMATION UPDATES ONLINE AND OVER A GLOBAL COMPUTER NETWORK IN THE FIELDS OF BUSINESS, COMMERCE, AND INDUSTRY; PROVIDING TEMPORARY USE OF ONLINE, NON-DOWNLOADABLE DATABASES FOR PROVIDING A USER WITH INFORMATION ON GOODS AND SERVICES FOR SALE, AND FOR LINKS TO WEBSITES OF OTHERS FOR SHARING INFORMATION ABOUT ITEM LOCATION AND GOODS AND SERVICES FOR SALE WITH OTHERS, PROVIDED VIA COMPUTERS, MOBILE PHONES, WIRED AND WIRELESS COMMUNICATION DEVICES, CAMERAS, AND OPTICAL AND ELECTRONIC COMMUNICATIONS NETWORKS.

FIRST USE 1-15-1997; IN COMMERCE 1-15-1997.

FOR PUBLISHING OF CUSTOM MAGAZINES FOR NATIONWIDE CORPORATIONS; PUBLISHING OF ELECTRONIC PUBLICATIONS; PUBLISHING OF PRINT BOOKS, BOOKS IN PERIODICAL SERIES, AND TRADE MAGAZINES.

FIRST USE 1-15-1997; IN COMMERCE 1-15-1997.

INT. CL. 42/U.S. CLS. 100 AND 101

FOR PROVIDING TEMPORARY USE OF ONLINE, NON-DOWNLOADABLE COMPUTER SOFTWARE PLATFORMS FOR DESIGNING DIGITAL ADVERTISEMENTS AND INITIATING DELIVERY COMMANDS FOR DIGITAL ADVERTISEMENTS ON WIRED, MOBILE AND WIRELESS DEVICES AND THAT MEASURE AND GENERATE REPORTS RELATING TO THE SUCCESS OF DIGITAL ADVERTISING AND MARKETING CAMPAIGNS; PROVIDING TEMPORARY USE OF ONLINE, NON-DOWNLOADABLE COMPUTER SOFTWARE FOR CREATING DIGITAL ADVERTISEMENTS FOR DISPLAY ON WIRED, MOBILE AND WIRELESS DEVICES; COMPUTER-AIDED GRAPHIC DESIGN; GRAPHIC DESIGN; GRAPHIC DESIGN SERVICES; GRAPHIC DESIGN SERVICES FOR BUSINESS LOGOS, PRODUCT PACKAGING, BOOK AND EBOOK DESIGN, INFO GRAPHICS, PROVIDING CUSTOMIZED WEB PAGES FEATURING USER-DEFINED INFORMATION ON SOCIAL NETWORKING WEBSITE; MULTIDISCIPLINARY GRAPHIC DESIGN SERVICES; WEBSITE DESIGN AND DEVELOPMENT FOR OTHERS; DATA MINING; COMPUTER SERVICES, NAMELY, CREATION, DESIGN, DEVELOPMENT, MAINTENANCE, IMPLEMENTATION AND HOSTING OF ELECTRONIC COMMERCE AND INFORMATIONAL WEBSITES, LANDING PAGES, AND MICRO WEBSITES, BLOGS AND DIGITAL PUBLICATIONS FOR THIRD PARTIES; DESIGN, DEVELOPMENT, MAINTENANCE AND IMPLEMENTATION OF COMPUTER APPLICATION SOFTWARE FOR THIRD PARTIES; COMPUTER SERVICES, NAMELY, SEARCH ENGINE OPTIMIZATION; PROVIDING CUSTOMIZED ONLINE WEB PAGES AND DATA FEEDS FEATURING USER-DEFINED INFORMATION, WHICH INCLUDES BLOG POSTS, NEW MEDIA CONTENT, OTHER ONLINE CONTENT, AND ONLINE WEB LINKS TO OTHER WEBSITES; PROVIDING TEMPORARY USE OF ONLINE, NON-DOWNLOADABLE COMPUTER DATABASE SOFTWARE FOR USE IN FACILITATING AND MANAGING SOCIAL NETWORKING; PROVIDING TEMPORARY USE OF ONLINE, NON-DOWNLOADABLE COMPUTER INSTANT MESSAGING SOFTWARE FOR USE IN FACILITATING AND MANAGING MULTIPLE PRIVATE, SMALL COMMUNICATIONS NETWORKS BY INVITING CONTACTS TO PARTICIPATE IN GROUPS; PROVIDING TEMPORARY USE OF ONLINE, NON-DOWNLOADABLE COMPUTER SOFTWARE FOR USE IN POSTING, UPLOADING, DOWNLOADING, TRANSMITTING, RETRIEVING, RECEIVING, REVIEWING, TAGGING, ORGANIZING, SEARCHING AND MANAGING TEXT, AUDIO, VISUAL AND MULTIMEDIA DATA AND CONTENT VIA COMPUTERS, MOBILE PHONES, WIRED AND WIRELESS COMMUNICATION DEVICES, CAMERAS, AND OPTICAL AND ELECTRONIC COMMUNICATIONS NETWORKS FOR ENTERTAINMENT PURPOSES; PROVIDING TEMPORARY USE OF ONLINE, NON-DOWNLOADABLE COMPUTER SOFTWARE FOR DESIGNING ADVERTISEMENTS AND PROMOTIONS ACCESSIBLE VIA COMPUTERS, MOBILE PHONES, WIRED AND WIRELESS COMMUNICATION DEVICES, CAMERAS, AND OPTICAL AND ELECTRONIC COMMUNICATIONS NETWORKS; DESIGNING, DEVELOPING, ENGINEERING, IMPLEMENTING, PROGRAMMING AND TESTING WEBSITES AND WEB PAGES FOR OTHERS; WEBPAGE DESIGN SERVICES, NAMELY, DESIGN AND RENDERING OF WEBSITE LANDING PAGES, WEBSITE SIDEBARS, AND REVEAL TABS FOR WEBPAGES; GRAPHIC DESIGN AND RENDERING OF GRAPHIC DESIGNS FOR PRINT MEDIA, NAMELY, LOGOS, BUSINESS CARDS, STATIONARY, FLYERS, COUPONS AND BROCHURES; HOSTING AN ONLINE WEBSITE, NAMELY, GEOGRAPHICALLY-TARGETED DYNAMIC MOBILE MICROSITES FEATURING CLIENT-PROVIDED CONTENT.

FIRST USE 3-16-2000; IN COMMERCE 3-16-2000.

ELEMENTS CORRECTED  
OWNER NAME

4,436,786. REG. 11-19-2013. DISNEY ENTERPRISES, INC. (DELAWARE CORPORATION) 500 SOUTH BUENA VISTA STREET, BURBANK, CA, 91521, SN 77-983,519. FILED 12-1-2008. PRINCIPAL REGISTER.



THE MARK CONSISTS OF A FANICFUL MOUSE.

INT. CL. 3/U.S. CLS. 1, 4, 6, 50, 51 AND 52

FOR COSMETICS; NON-MEDICATED TOILETRIES; FRAGRANCES FOR PERSONAL USE; ROOM FRAGRANCES.

FIRST USE 3-24-2008; IN COMMERCE 3-24-2008.

INT. CL. 9/U.S. CLS. 21, 23, 26, 36 AND 38

FOR FACE PLATES FOR CELLULAR TELEPHONES; CELLULAR TELEPHONES CASES; DECORATIVE REFRIGERATOR MAGNETS; MUSICAL RECORDINGS; VIDEO GAME CARTRIDGES; VIDEO GAME DISCS.

FIRST USE 3-25-2008; IN COMMERCE 3-25-2008.

INT. CL. 16/U.S. CLS. 2, 5, 22, 23, 29, 37, 38 AND 50

FOR APPLIQUES IN THE FORM OF DECALS; ART PRINTS; ARTS AND CRAFT PAINT KITS; AUTOGRAPH BOOKS; BALL POINT PENS; A SERIES OF FICTION BOOKS; CALENDARS; COLOR PENCILS; DECALS; DRAWING RULERS; ERASERS; FELT PENS; MEMO PADS; PEN OR PENCIL HOLDERS; PENCILS; PENCIL SHARPENERS; PEN AND PENCIL CASES; PENS; PICTURE BOOKS; RECIPE BOOKS; RUBBER STAMPS; WRITING IMPLEMENTS.

FIRST USE 3-25-2008; IN COMMERCE 3-25-2008.

INT. CL. 18/U.S. CLS. 1, 2, 3, 22 AND 41

FOR COIN PURSES; LUGGAGE TAGS; LUGGAGE; SHOPPING BAGS MADE OF TEXTILE; UMBRELLAS.

FIRST USE 3-21-2008; IN COMMERCE 3-21-2008.

INT. CL. 21/U.S. CLS. 2, 13, 23, 29, 30, 33, 40 AND 50

FOR BOWLS; CAKE MOLDS; CANDLE HOLDERS NOT OF PRECIOUS METAL; COASTERS NOT OF PAPER AND NOT BEING TABLE LINEN; COOKIE CUTTERS; CUPS; DISHES; LUNCH BOXES; MUGS; PLASTIC CUPS; PLATES; SPORTS BOTTLES SOLD EMPTY; TEA KETTLES; THERMAL INSULATED CONTAINERS FOR FOOD OR BEVERAGE; TRAYS NOT OF PRECIOUS METAL; TRIVETS.

FIRST USE 3-21-2008; IN COMMERCE 3-21-2008.

INT. CL. 24/U.S. CLS. 42 AND 50

FOR BARBECUE MITTS; BLANKET THROWS; CHILDREN'S BLANKETS; CLOTH FLAGS; FABRIC FLAGS; HOUSEHOLD LINEN; OVEN MITTS; POT HOLDERS; RECEIVING BLANKETS; THROWS.

FIRST USE 3-21-2008; IN COMMERCE 3-21-2008.

INT. CL. 28/U.S. CLS. 22, 23, 38 AND 50

FOR CHILDREN'S PLAY COSMETICS; CHRISTMAS TREE ORNAMENTS AND DECORATIONS; COLLECTIBLE TOY FIGURES; CRIB MOBILES; DOLL ACCESSORIES; JIGSAW PUZZLES; MUSIC BOX TOYS; RUBBER BALLS; SNOW GLOBES; SQUEEZE TOYS; STUFFED TOYS; TALKING TOYS; TARGET GAMES; TEDDY BEARS; TOY ACTION FIGURES AND ACCESSORIES THEREFOR; TOY FIGURES; TOY BANKS.

FIRST USE 3-25-2008; IN COMMERCE 3-25-2008.

ELEMENTS CORRECTED  
GOODS/SERVICES  
DATE OF FIRST USE  
DATE OF FIRST USE IN COMMERCE

4,437,082. REG. 11-19-2013. BOWDEN, CEDRICK (UNITED STATES INDIVIDUAL) 6734 ELM COURT, TAMPA, FL, 33610, SN 85-524,276. FILED 1-24-2012. PRINCIPAL REGISTER.

**Confidence is Universal**

THE MARK CONSISTS OF STANDARD CHARACTERS WITHOUT CLAIM TO ANY PARTICULAR FONT, STYLE, SIZE, OR COLOR.

INT. CL. 25/U.S. CLS. 22 AND 39

FOR CLOTHING, NAMELY, T-SHIRTS, [ PANTS, ] SHIRTS, [ SWEATSHIRTS, SUITS, JEANS, DRESS SHIRTS, VESTS, SWEATERS, SHORTS, SWIMWEAR, JACKETS, RAIN WEAR, BLOUSES, DRESSES, SOCKS, HOSIERY, UNDERWEAR, FOOTWEAR, PAJAMAS, SLEEPWEAR, BOXER SHORTS, BELTS, GLOVES, SCARVES, ] HATS [ , HEADBANDS, TIES ] .

FIRST USE 8-12-2012; IN COMMERCE 11-20-2012.

ELEMENTS AMENDED  
GOODS/SERVICES

4,440,667. REG. 11-26-2013. SHINY TEA CO., LTD. (TAIWAN CORPORATION) 2F, NO26, LN59, SEC5, HEWEIRD, W.CENTRALDIST, TAINAN CITY, TAIWAN., SN 85-385,280. FILED 7-29-2011. PRINCIPAL REGISTER.



NO CLAIM IS MADE TO THE EXCLUSIVE RIGHT TO USE "TEA" AND THE NON-LATIN CHARACTERS THAT TRANSLATE TO MEAN TEA, APART FROM THE MARK AS SHOWN.

THE COLOR(S) RED, WHITE AND GRAYISH/BROWN IS/ ARE CLAIMED AS A FEATURE OF THE MARK.

THE MARK CONSISTS OF A RECTANGLE DIVIDED INTO ONE RED SQUARE AND THREE SMALLER RECTANGLES BY ONE HORIZONTAL LINE AND ONE VERTICAL LINE; THE UPPER RIGHT AND LOWER LEFT RECTANGLES ARE DARK GRAYISH-BROWN; THE WORDS "SHINY TEA" APPEAR IN RED, STYLIZED FONT IN AN ARC OVER THE LOWER PORTION OF THE MAIN RECTANGLE; CHINESE CHARACTERS APPEAR IN WHITE ON THE LEFT SIDE AND UPPER RIGHT OF THE MAIN RECTANGLE.

THE ENGLISH TRANSLATION OF THE CHINESE CHARACTERS IN THE MARK IS "GUIDE" AND "TEA".

THE NON-LATIN CHARACTERS IN THE MARK TRANSLITERATE TO "XIANG" AND "CHA" AND THIS MEANS "GUIDE" AND "TEA", RESPECTIVELY, IN ENGLISH.

INT. CL. 43/U.S. CLS. 100 AND 101

FOR TEA ROOMS; CAFES; CAFETERIAS; RESTAURANTS; PROVIDING OF FOOD AND DRINK VIA A MOBILE TRUCK; SNACK BARS; FAST-FOOD RESTAURANTS.

FIRST USE 7-1-2011; IN COMMERCE 4-8-2013.

ELEMENTS CORRECTED  
\*COLOR DESCRIPTION STATEMENT\*  
MARK

DESCRIPTION OF MARK

4,445,640. REG. 12-10-2013. PLAXICA LIMITED (UNITED KINGDOM PRIVATE LIMITED COMPANY) IMPERIAL INCUBATOR., LEVEL 1 BESSEMER BUILDING., IMPERIAL COLLEGE; LONDON SW7 2AZ, UNITED KINGDOM., SN 79-122,495. FILED 5-21-2012. PRINCIPAL REGISTER.

**OPTIPURE**

THE MARK CONSISTS OF STANDARD CHARACTERS WITHOUT CLAIM TO ANY PARTICULAR FONT, STYLE, SIZE, OR COLOR.

PRIORITY DATE OF 11-21-2011 IS CLAIMED.

OWNER OF INTERNATIONAL REGISTRATION 1141216 DATED 5-21-2012, EXPIRES 5-21-2022.

INT. CL. 1/U.S. CLS. 1

FOR [ CHEMICAL PRODUCTS FOR CONVERTING SUGARS AND STARCHES TO LACTIC ACID AND LACTIDE; CHEMICALS FOR USE IN THE MANUFACTURE OF LACTIC ACID AND LACTIDE; CHEMICALS FOR USE IN THE MANUFACTURE OF BIOPLASTICS; POLYMERS FOR USE IN THE MANUFACTURE OF INDUSTRIAL PRODUCTS, CONSUMER AND HOUSEHOLD PRODUCTS, SEALANTS OR PACKAGING; UNPROCESSED POLYMERS; POLYMERS FOR USE IN THE MANUFACTURE OF MEDICAL DEVICES; ] UNPROCESSED ARTIFICIAL RESINS; UNPROCESSED PLASTICS; ALL THE AFOREMENTIONED [ GOODS NOT FOR USE IN THE BOOK BINDING INDUSTRY ] \* CHEMICALS NOT INCLUDING CHEMICALS FOR THE CULTIVATION OF MONOCRYSTALS; ALL OF THE AFOREMENTIONED CHEMICALS NOT INCLUDING CHEMICALS FOR MANUFACTURING OPTICAL GLASS FIBRES FOR OPTICAL AND ELECTRO OPTICAL SYSTEMS \*.

FIRST USE ; IN COMMERCE .

INT. CL. 40/U.S. CLS. 100, 103 AND 106

FOR MATERIAL TREATMENT SERVICES IN CONNECTION WITH RECYCLING; RECYCLING; RECYCLING OF BIOPLASTICS; WASTE PROCESSING; PROCESSING OF CELLULOSE BIOMASS; INFORMATION AND ADVISORY SERVICES RELATING TO ALL THE AFOREMENTIONED SERVICES.

INT. CL. 42/U.S. CLS. 100 AND 101

FOR SCIENTIFIC AND TECHNOLOGICAL SERVICES, NAMELY, RESEARCH AND DESIGN RELATING TO PLASTICS IN PRIMARY FORMS, POLYMERS AND CHEMICALS; INDUSTRIAL ANALYSIS OF POLYMERS, PLASTICS AND CHEMICALS AND RESEARCH SERVICES RELATING THERETO; INFORMATION AND ADVISORY SERVICES RELATING TO ALL THE AFOREMENTIONED SERVICES.

ELEMENTS CORRECTED  
GOODS/SERVICES

4,448,344. REG. 12-10-2013. MARVEL CHARACTERS, INC. (DELAWARE CORPORATION) 500 SOUTH BUENA VISTA STREET, BURBANK, CA, 91521, SN 85-525,251. FILED 1-25-2012. PRINCIPAL REGISTER.

**MARVEL XP**

THE MARK CONSISTS OF STANDARD CHARACTERS WITHOUT CLAIM TO ANY PARTICULAR FONT, STYLE, SIZE, OR COLOR.



OWNER OF U.S. REG. NOS. 1,741,813, 3,602,028 AND OTHERS.  
INT. CL. 42/U.S. CLS. 100 AND 101

FOR COMPUTER SERVICES, NAMELY, CREATING AN ON-LINE VIRTUAL COMMUNITY FOR REGISTERED USERS TO PARTICIPATE IN AND SHOWCASE THEIR SKILLS, IMPROVE THEIR TALENT, PARTICIPATE IN INCENTIVE AWARD PROGRAMS, FORM VIRTUAL COMMUNITIES, RANK USERS, ENGAGE IN SOCIAL NETWORKING; PREVIEWING COMPUTER GAMES VIA GLOBAL COMPUTER NETWORKS AND ELECTRONIC COMMUNICATION NETWORKS FOR USE IN CONNECTION WITH COMPUTERS, MOBILE COMPUTERS, MEDIA PLAYERS, CELLULAR PHONES, WIRELESS DEVICES AND PORTABLE AND HANDHELD DIGITAL ELECTRONIC DEVICES; PROVIDING TEMPORARY USE OF NON-DOWNLOADABLE SOFTWARE TO ENABLE VIEWING, PREVIEWING, ENHANCEMENTS FOR COMPUTER GAMES, ONLINE GAMES, AND GAME APPLICATIONS AND INFORMATION RELATING TO COMPUTER GAMES AND GAME ENHANCEMENTS VIA GLOBAL COMPUTER NETWORKS AND ELECTRONIC COMMUNICATION NETWORKS FOR USE IN CONNECTION WITH COMPUTERS, MOBILE COMPUTERS, MEDIA PLAYERS, CELLULAR PHONES, WIRELESS DEVICES AND PORTABLE AND HANDHELD DIGITAL ELECTRONIC DEVICES.

FIRST USE 7-31-2012; IN COMMERCE 7-31-2012.

ELEMENTS CORRECTED  
GOODS/SERVICES

4,448,413. REG. 12-10-2013. MEDIX HEALTH LLC (FLORIDA LIMITED LIABILITY COMPANY) SUITE 401, 2200 NW CORPORATE BLVD, BOCA RATON, FL, 33431, SN 85-558,518. FILED 3-2-2012. PRINCIPAL REGISTER.

**CARDIO ADVANCED**

THE MARK CONSISTS OF STANDARD CHARACTERS WITHOUT CLAIM TO ANY PARTICULAR FONT, STYLE, SIZE, OR COLOR.

NO CLAIM IS MADE TO THE EXCLUSIVE RIGHT TO USE "CARDIO", APART FROM THE MARK AS SHOWN.

INT. CL. 5/U.S. CLS. 6, 18, 44, 46, 51 AND 52

FOR DIETARY SUPPLEMENT; DIETARY SUPPLEMENT FOR HELPING TO MAINTAIN A HEALTHY HEART.

FIRST USE 5-9-2012; IN COMMERCE 5-9-2012.

ELEMENTS CORRECTED  
OWNER ADDRESS

4,449,494. REG. 12-17-2013. GASTROFIX GMBH (FED REP GERMANY LIMITED LIABILITY COMPANY) CHODOWIECKISTRASSE 17A, 10405 BERLIN, FED REP GERMANY., SN 79-123,219. FILED 4-27-2012. PRINCIPAL REGISTER.

**GASTROFIX**

THE MARK CONSISTS OF STANDARD CHARACTERS WITHOUT CLAIM TO ANY PARTICULAR FONT, STYLE, SIZE, OR COLOR.

PRIORITY DATE OF 10-31-2011 IS CLAIMED.

OWNER OF INTERNATIONAL REGISTRATION 1142859 DATED 4-27-2012, EXPIRES 4-27-2022.  
INT. CL. 9/U.S. CLS. 21, 23, 26, 36 AND 38

FOR CASH REGISTERS AND ACCOUNTING MACHINES FOR TAKING, CHECKING AND PROCESSING MONEY OR NON-CASH INSTRUMENTS OF PAYMENT SUCH AS CHEQUES, BANK CARDS, PAY CARDS [, DISKS, CD-ROMS ] OR SIMILAR FOR BILLING AND ACCOUNTING IN REGARD TO CATERING AND LODGING GUESTS, ALSO IN CONNECTION WITH SYSTEMS FOR TAKING ORDERS AND/OR INFORMATION SYSTEMS USING SUCH DATA.

FIRST USE ; IN COMMERCE .

ELEMENTS CORRECTED  
GOODS/SERVICES

4,449,669. REG. 12-17-2013. COSENTIAL, INC. (DELAWARE CORPORATION), DBA COSENTIAL, 1-800-505-7089, 207 SAN JACINTO BLVD., AUSTIN, TX, 78701, SN 85-332,571. FILED 5-27-2011. PRINCIPAL REGISTER.



THE COLOR(S) RED AND BLACK IS/ARE CLAIMED AS A FEATURE OF THE MARK.

THE MARK CONSISTS OF THE WORD "COSENTIAL" IN A UNIQUE BLACK LETTER DESIGN WITH THE EXCEPTION OF THE LETTER "I" WHICH IS COLORED RED AS A UNIQUE LOWER CASE LETTER DESIGN.

INT. CL. 42/U.S. CLS. 100 AND 101

FOR TECHNICAL SUPPORT SERVICES, NAMELY, REMOTE ADMINISTRATION AND MANAGEMENT OF IN-HOUSE AND HOSTED DATACENTER DEVICES, DATABASES AND SOFTWARE APPLICATIONS.

FIRST USE 7-20-1999; IN COMMERCE 7-20-1999.

ELEMENTS CORRECTED  
DESCRIPTION OF MARK

4,463,607. REG. 1-7-2014. LATHAM POOL PRODUCTS, INC. (DELAWARE CORPORATION) 787 WATERVLIET-SHAKER ROAD, LATHAM, NY, 12110, SN 85-706,337. FILED 8-17-2012. PRINCIPAL REGISTER.



THE MARK CONSISTS OF A STYLIZED "L" DESIGN SUPERIMPOSED OVER A CIRCLE THAT IS SUPERIMPOSED OVER ANOTHER CIRCLE, NEXT TO THE STYLIZED WORD "LATHAM".

INT. CL. 6/U.S. CLS. 2, 12, 13, 14, 23, 25 AND 50

FOR METAL SWIMMING POOLS; METAL SWIMMING POOL BUILDING MATERIALS, NAMELY, STRAIGHT AND RADIUS METAL WALL PANELS AND METAL BRACING; FITTED VINYL LINERS SPECIALLY ADAPTED FOR METAL SWIMMING POOLS.

FIRST USE 10-0-2012; IN COMMERCE 10-0-2012.

INT. CL. 19/U.S. CLS. 1, 12, 33 AND 50

FOR NON-METAL SWIMMING POOLS; NON-METAL SWIMMING POOL BUILDING MATERIALS, NAMELY, POLYMER STRAIGHT AND RADIUS WALL PANELS AND BRACING, COPING, AND PARTS AND ACCESSORIES THEREFOR, NAMELY, FITTED SWIMMING POOL LINERS SPECIALLY ADAPTED FOR NON-METAL SWIMMING POOLS, FITTED SWIMMING POOL COVERS, NON-METAL SWIMMING POOL STEPS; MOTORIZED FITTED SWIMMING POOL COVERS; FITTED SWIMMING POOL COVERS FEATURING FABRIC AND STRUCTURAL WEBBING COMPONENTS THEREFORE, SOLD AS A UNIT; POOL COVER RETRACTORS AND GUIDES FOR FITTED POOLS; FITTED POOL COVER STRUCTURAL COMPONENTS, NAMELY, BRACKETS, TRACKING, WEBBING AND LIDS; POOL COVER ROPES, NAMELY, ROPES SPECIFICALLY ADAPTED FOR USE WITH FITTED POOL COVERS; NON-METAL SWIMMING POOLS.

FIRST USE 10-0-2012; IN COMMERCE 10-0-2012.  
INT. CL. 35/U.S. CLS. 100, 101 AND 102

FOR PROVIDING A WEBSITE WITH INFORMATION ON SWIMMING POOL MANAGEMENT; PROVIDING A WEB SITE FEATURING CONSUMER INFORMATION ON SWIMMING POOLS.

FIRST USE 10-0-2012; IN COMMERCE 10-0-2012.

ELEMENTS CORRECTED  
GOODS/SERVICES

\* \* \* \* \*

# INDEX OF REGISTRANTS

FEB 11, 2014

(Registered; Renewed; Canceled; Amended, Corrected, etc.; New Certificates; 12c Publications.)

The designation "U.S. Cl." appearing in this section refers to the U.S. class in effect prior to Sep. 1, 1973 rather than the international class which applies to applications filed on or after that date. For adoption of international classification see notice in the OFFICIAL GAZETTE of Jun. 26, 1973 (911 O.G. TM 210).

.COM SOLUTIONS INC., FREMONT, CA:  
3,247,211, CANC. INT. CL. 9.  
"WIMM-BILL-DANN BRANDS CO. LTD.", MOSCOW, RUSSIAN FED., OPEN JOINT STOCK COMPANY "WIMM-BILL-DANN FOODS", MOSCOW, RUSSIAN FED.:  
2,787,510, REN. 1-8-14, INT. CL. 32.  
ÉCOLOSPHÈRE INC., MONTREAL, QUEBEC, CANADA:  
3,245,767, CANC. INT. CL. 21.  
A & A, CHEYENNE, WY:  
4,481,069, PUB. 11-26-2013, INT. CL. 36.  
4,481,072, PUB. 11-26-2013, INT. CL. 36.  
A CHEERFUL GIVER, INC., ELMER, NJ:  
3,246,914, CANC. INT. CL. 35.  
A CLASSIC TIME WATCH CO., INC., NEW YORK, NY:  
1,814,867, REN. 1-7-14, INT. CL. 14.  
A WORLD FIT FOR KIDS!, LOS ANGELES, CA:  
2,718,803, CANC. MULTIPLE CLASS, INT. CLS. 35 AND 41.  
A.AB LOCK SURGEON LTD., EDMONTON, ALBERTA, CANADA:  
4,479,580, PUB. 11-26-2013, MULTIPLE CLASS, INT. CLS. 35, 37 AND 40.  
4,479,581, PUB. 11-26-2013, MULTIPLE CLASS, INT. CLS. 35, 37 AND 40.  
A.E. YAYINCILIK, FILM, REKLAM, BILG. VE ORG. HIZ. LTD. STI., ISTANBUL, TURKEY:  
4,482,687, MULTIPLE CLASS, INT. CLS. 9 AND 28.  
A.S.V., INC., GRAND RAPIDS, MN:  
4,480,035, PUB. 11-26-2013, INT. CL. 7.  
A&B CHEMICAL COMPANY, INC., HIGHLANDS RANCH, CO:  
2,820,057, REN. 1-8-14, INT. CL. 1.  
2,820,058, REN. 1-8-14, INT. CL. 1.  
2,879,472, REN. 1-8-14, INT. CL. 1.  
A&S BREWING COLLABORATIVE LLC, BURLINGTON, VT:  
4,481,648, INT. CL. 32.  
4,481,661, INT. CL. 32.  
AAA FURNITURE WHOLESALE INC., HOUSTON, TX:  
4,480,402, PUB. 11-26-2013, INT. CL. 20.  
AAM MARKETING GROUP, INC., QUEENS VILLAGE, NY:  
3,247,293, CANC. INT. CL. 45.  
AARON D. ZAUG, BROOKINGS, SD:  
4,481,141, PUB. 11-26-2013, MULTIPLE CLASS, INT. CLS. 25 AND 28.  
AARON SHUM JEWELRY LTD, HUNG HOM, KOWLOON, HONG KONG:  
4,479,789, PUB. 11-26-2013, INT. CL. 14.  
ABADI, JOSEPH, BROOKLYN, NY:  
4,481,756, INT. CL. 14.  
ABB SCHWEIZ AG, 5400 BADEN, SWITZERLAND:  
2,799,609, REN. 1-3-14, INT. CL. 9.  
ABBOTT CARDIOVASCULAR SYSTEMS, INC., SANTA CLARA, CA:  
2,719,648, CANC. INT. CL. 10.  
ABC SPORTS, INC., NEW YORK, NY:  
2,718,802, CANC. INT. CL. 41.  
ABERCROMBIE & FITCH TRADING CO., NEW ALBANY, OH:  
4,481,493, INT. CL. 25.  
ABG ACCESSORIES, INC., ELIZABETH, NJ:  
4,482,090, INT. CL. 18.  
ABLE SOLUTIONS CORPORATION, VANCOUVER, WA:  
4,481,165, PUB. 11-26-2013, MULTIPLE CLASS, INT. CLS. 9 AND 42.  
ABLON, ROBERT J., OAKLAND, CA:  
3,247,115, CANC. INT. CL. 35.  
ABOUNA, NAZHAT, MADISON HEIGHTS, MI:  
4,482,838, INT. CL. 12.  
ABOUT A MILE, LLC, NASHVILLE, TN:  
4,479,882, PUB. 11-26-2013, MULTIPLE CLASS, INT. CLS. 9 AND 41.  
ABSOLUTE HOME CARE, INC., VALENCIA, CA:  
4,480,010, PUB. 11-26-2013, INT. CL. 44.  
ABWIZ BIO, INC., SAN DIEGO, CA:  
4,482,202, MULTIPLE CLASS, INT. CLS. 1 AND 42.  
ACADEMIXDIRECT, INC., MOUNTAIN VIEW, CA:  
4,482,670, MULTIPLE CLASS, INT. CLS. 35 AND 41.  
ACADEMY FOR GLOBAL CITIZENSHIP, CHICAGO, IL:  
4,479,842, PUB. 11-26-2013, INT. CL. 41.  
ACCEL PERFORMANCE GROUP LLC, CLEVELAND, OH:  
1,244,189, REN. 1-9-14, INT. CL. 7.  
1,244,189, CANC. INT. CL. 9.  
ACCENT PACKAGING INC., TOMBALL, TX, DBA ACCENT WIRE PRODUCTS:  
4,481,283, PUB. 11-26-2013, INT. CL. 6.  
4,481,284, PUB. 11-26-2013, INT. CL. 6.  
ACCENT PACKAGING INC., TOMBALL, TX, DBA ACCENT BUILDING MATERIALS:  
4,481,286, PUB. 11-26-2013, MULTIPLE CLASS, INT. CLS. 6 AND 19.  
ACCESS AMERICA TRANSPORT, INC., CHATTANOOGA, TN:  
4,480,314, PUB. 11-26-2013, MULTIPLE CLASS, INT. CLS. 35 AND 39.  
4,480,316, PUB. 11-26-2013, MULTIPLE CLASS, INT. CLS. 35 AND 39.  
ACCESS CHINA INDUSTRIAL TEXTILES, INC., BELLEVUE, WA, DBA ACIT (USA), INC.:  
4,479,740, PUB. 11-26-2013, MULTIPLE CLASS, INT. CLS. 17, 22, 23 AND 24.  
ACCESS ENERGY, LLC, CERRITOS, CA:  
4,482,185, MULTIPLE CLASS, INT. CLS. 7 AND 37.  
ACCESS INTELLIGENCE LLC, ROCKVILLE, MD:  
4,482,856, INT. CL. 41.  
ACCESS MARKETS INTERNATIONAL (AMI) PARTNERS, INC., NEW YORK, NY:  
4,481,102, PUB. 11-26-2013, INT. CL. 41.  
ACCESSOR CAPITAL MANAGEMENT L.P., SEATTLE, WA:  
3,246,878, CANC. INT. CL. 36.  
ACCO BRANDS CORPORATION, LAKE ZURICH, IL:  
2,719,979, CANC. INT. CL. 16.  
ACCORD INDUSTRIES, LLC, WINTER PARK, FL:  
3,248,319, CANC. INT. CL. 9.  
ACCORDANT HEALTH SERVICES, LLC, WOONSOCKET, RI:  
4,481,622, MULTIPLE CLASS, INT. CLS. 16 AND 41.  
ACCOUNT CONTROL TECHNOLOGY, INC., CANOGA PARK, CA:  
4,480,319, PUB. 11-26-2013, INT. CL. 36.  
ACCOUNTABLE GROWTH, INC., PALATINE, IL:  
4,480,031, PUB. 11-26-2013, MULTIPLE CLASS, INT. CLS. 35, 41 AND 45.

- ACCUMULATORENWERKE HOPPECKE CARL ZOELLNER & SOHN GMBH, FED REP GERMANY:  
4,479,306, PUB. 11-26-2013. INT. CL. 9.
- ACCURATE SURGICAL & SCIENTIFIC INSTRUMENTS CORPORATION, WESTBURY, NY:  
3,247,132, CANC. INT. CL. 10.
- ACCUSET TOOL CO., INC., TROY, MI:  
1,824,087, REN. 1-8-14. INT. CL. 6.
- ACE HARDWARE CORPORATION, OAK BROOK, IL:  
3,247,391, CANC. INT. CL. 20.
- ACE PARKING MANAGEMENT, INC., SAN DIEGO, CA:  
4,482,324, INT. CL. 39.
- ACERA, LLC, LEESBURG, VA:  
3,247,178, CANC. INT. CL. 42.
- ACEVEDO, MIGUEL ANGEL, NARANJITO, PUERTO RICO:  
3,247,503, CANC. INT. CL. 41.
- ACHADO PTY LTD, GOLD COAST, AUSTRALIA:  
4,479,971, PUB. 11-26-2013. INT. CL. 7.
- ACHMAR, KEVIN, DEARBORN, MI:  
3,248,753, CANC. INT. CL. 16.
- ACINO HOLDING AG, SWITZERLAND:  
4,479,450, PUB. 11-26-2013. MULTIPLE CLASS, INT. CLS. 5 AND 42.
- ACM, FRANCE:  
4,479,322, PUB. 11-26-2013. INT. CL. 3.
- ACME PRODUCTS, LAS VEGAS, NV:  
3,247,347, CANC. INT. CL. 3.
- ACOMED INDUSTRIAL CO., LTD., TAIPEI, TAIWAN:  
4,479,584, PUB. 7-30-2013. INT. CL. 10.
- ACOR ORTHOPAEDIC, INC., CLEVELAND, OH:  
1,851,400, REN. 1-8-14. INT. CL. 10.
- ACP IP, LLC, CORAL GABLES, FL:  
4,480,117, PUB. 11-26-2013. INT. CL. 41.
- ACROPRINT TIME RECORDER COMPANY, RALEIGH, NC:  
2,798,074, REN. 1-8-14. INT. CL. 9.
- ACTION SYSTEMS, INC., LOUISVILLE, KY, DBA CUBICLEKEYS.COM:  
4,482,808, INT. CL. 40.
- ACTIVE DAILY LIVING, LLC, CINCINNATI, OH:  
1,780,905, REN. 1-4-14. INT. CL. 42.
- ACTIVE MICRO TECHNOLOGIES, LINCOLN, NC:  
4,482,385, INT. CL. 1.
- ACTRIGHT ACTION, INC., PLAINFIELD, IN:  
4,481,942, INT. CL. 35.  
4,481,943, INT. CL. 36.  
4,481,944, INT. CL. 45.
- ACTS OF LOVE FOUNDATION, INC., SANTA CRUZ, CA:  
3,247,617, CANC. INT. CL. 35.
- ACUMAX INC, DEARBORN, MI:  
4,480,194, PUB. 11-26-2013. MULTIPLE CLASS, INT. CLS. 35 AND 41.
- ACUMED LLC, HILLSBORO, OR:  
4,480,185, PUB. 11-26-2013. INT. CL. 10.
- ACUMEN FUND, INC., NEW YORK, NY:  
4,482,455, MULTIPLE CLASS, INT. CLS. 35, 36 AND 41.  
4,482,456, MULTIPLE CLASS, INT. CLS. 35, 36 AND 41.
- ACZEL, KAROLY ZSOLT, BAAR, SWITZERLAND, DBA PERPETUUM CAPITAL:  
4,480,214, PUB. 11-26-2013. INT. CL. 36.
- ADA COUNTY PARAMEDICS, BOISE, ID:  
4,482,323, INT. CL. 35.
- ADA'S CAFE, PALO ALTO, CA:  
4,480,097, PUB. 11-26-2013. INT. CL. 43.
- ADAM ALI ASGHAR, SHARJAH, UNITED ARAB EMIR.:  
4,482,786, INT. CL. 3.
- ADAM INTERNATIONAL INC., CEDAR GROVE, NJ:  
3,246,642, CANC. INT. CL. 42.
- ADAM K. SMITH, PRINCETON, IN:  
4,480,697, PUB. 11-26-2013. INT. CL. 35.
- ADAMS, JASON, LOGANDALE, NV:  
4,480,874, PUB. 11-26-2013. INT. CL. 9.
- ADAPTIVE MANAGEMENT STRATEGIES, INC., LAGUNA BEACH, CA:  
3,246,742, CANC. INT. CL. 35.
- ADAPTIVE RFID, INC., WHEATON, IL:  
3,246,629, CANC. MULTIPLE CLASS, INT. CLS. 9 AND 42.
- ADERANS CO., LTD., TOKYO, JAPAN, AKA ADERANS COMPANY LIMITED:  
3,246,365, CANC. INT. CL. 44.
- ADERANS CO., LTD., SHINJUKU-KU, TOKYO, JAPAN:  
3,248,523, CANC. INT. CL. 44.
- ADERANS HAIR GOODS, INC., BEVERLY HILLS, CA:  
3,248,493, CANC. INT. CL. 26.
- ADERANS RESEARCH INSTITUTE, INC., MARIETTA, GA:  
3,248,658, CANC. INT. CL. 42.
- ADESA, INC., CARMEL, IN:  
4,482,458, INT. CL. 35.
- ADESSO, INC., WALNUT, CA:  
4,480,799, PUB. 11-26-2013. INT. CL. 9.
- ADIDAS INTERNATIONAL MARKETING B.V., AMSTERDAM ZO, NETHERLANDS:  
3,248,408, CANC. MULTIPLE CLASS, INT. CLS. 25 AND 28.  
3,248,558, CANC. INT. CL. 25.
- ADITALL, LLC, NEW YORK, NY:  
4,481,093, PUB. 11-26-2013. INT. CL. 42.
- ADOPT-A-WATT, INC., ROYAL OAK, MI:  
4,482,315, INT. CL. 35.
- ADP P2P CANADA, INC., CALGARY, CANADA:  
3,245,761, CANC. MULTIPLE CLASS, INT. CLS. 9, 16, 35 AND 42.
- ADRENALIN GAMING, LLC, LADERA RANCH, CA:  
4,482,389, INT. CL. 28.
- ADTECH GLOBAL SOLUTIONS, INC., ALPHARETTA, GA:  
4,482,788, INT. CL. 42.
- ADVANCE MAGAZINE PUBLISHERS, INC., NEW YORK, NY:  
4,480,149, PUB. 11-26-2013. INT. CL. 16.
- ADVANCED ENGINEERING DESIGN, INC., HYATTSVILLE, MD:  
3,248,670, CANC. INT. CL. 9.
- ADVANCED MEASUREMENT TECHNOLOGIES, INC., OAK RIDGE, TN, ADVANCED MEASUREMENT TECHNOLOGIES, INC., OAK RIDGE, TN:  
2,798,100, REN. 1-3-14. INT. CL. 9.
- ADVANCED PRACTICE STRATEGIES, INC., BOSTON, MA:  
4,480,140, PUB. 11-26-2013. INT. CL. 9.
- ADVANCED SOFTWARE APPLICATIONS CORPORATION, MORGAN, PA, AKA ASA CORP.:  
1,833,245, REN. 1-8-14. INT. CL. 9.
- ADVANSTAR COMMUNICATIONS INC, DULUTH, MN:  
2,816,655, REN. 1-3-14. INT. CL. 41.
- ADVANSTAR COMMUNICATIONS INC., DULUTH, MN:  
2,719,342, CANC. INT. CL. 16.
- ADVANTAMD LLC, PORTSMOUTH, NH:  
3,246,537, CANC. MULTIPLE CLASS, INT. CLS. 5 AND 44.
- ADVANTECH TECHNOLOGIES (AB), LTD., TEL AVIV, ISRAEL:  
2,719,798, CANC. MULTIPLE CLASS, INT. CLS. 35 AND 42.
- ADVERTISE.COM, INC., SHERMAN OAKS, CA:  
3,246,969, CANC. INT. CL. 35.
- ADVISORS ASSET MANAGEMENT, INC., MONUMENT, CO:  
3,247,926, CANC. INT. CL. 41.
- AERA TRUCKS, INC., SANTA BARBARA, CA:  
4,479,843, PUB. 11-26-2013. INT. CL. 28.
- AERIELLE IP HOLDINGS, LLC, CINCINNATI, OH:  
3,246,097, CANC. INT. CL. 9.
- AERO DESIGN AND MANUFACTURING COMPANY, INC., DULUTH, MN:  
2,818,000, REN. 1-7-14. INT. CL. 41.
- AERO INTERNATIONAL INC., STERLING, VA:  
2,719,236, CANC. INT. CL. 35.
- AERO-METRIC, INC., SHEBOYGAN, WI:  
3,247,420, CANC. INT. CL. 42.  
3,247,421, CANC. INT. CL. 42.
- AEROLASE CORPORATION, TARRYTOWN, NY:  
4,480,734, PUB. 11-26-2013. INT. CL. 10.
- AEROPOSTALE PROCUREMENT COMPANY, INC., NEW YORK, NY:  
4,482,218, INT. CL. 18.

AEROSPACE TECHNOLOGIES GROUP INC., BOCA RATON, FL:  
4,481,208, PUB. 11-26-2013. INT. CL. 20.

AF SERVICES, INC., OAKBROOK, IL:  
3,247,599, CANC. INT. CL. 45.

AFFINITY AIR SERVICE, FLORENCE, KY:  
4,479,980, PUB. 11-26-2013. INT. CL. 39.

AFFYMETRIX, INC., SANTA CLARA, CA:  
4,481,418, INT. CL. 9.

AFIA INC., ANN ARBOR, MI:  
4,479,835, PUB. 11-26-2013. INT. CL. 42.

AFL TELECOMMUNICATIONS, LLC, DUNCAN, SC:  
4,479,674, PUB. 11-26-2013. INT. CL. 9.

AFOUNDRIA, LLC, MURPHY, TX:  
4,479,953, PUB. 11-26-2013. INT. CL. 42.

AG+ SEEDS CO, SPENCER, IA:  
3,246,667, CANC. INT. CL. 31.  
3,246,675, CANC. INT. CL. 31.

AGC, LLC, CLEVELAND, OH:  
4,481,491, INT. CL. 16.

AGENDIA BV, AMSTERDAM, NETHERLANDS:  
3,246,685, CANC. MULTIPLE CLASS, INT. CLS. 1, 5, 10 AND 42.

AGENNIX INCORPORATED, HOUSTON, TX:  
2,719,518, CANC. INT. CL. 5.

AGERTI, BELGIUM:  
4,479,463, PUB. 11-26-2013. INT. CL. 25.

AGILENT TECHNOLOGIES, INC., SANTA CLARA, CA, CURTIN MATHESON SCIENTIFIC, INC., HOUSTON, TX:  
1,814,765, REN. 1-8-14. INT. CL. 9.

AGILENT TECHNOLOGIES, INC., SANTA CLARA, CA, POLYMER LABORATORIES LIMITED, SHROPSHIRE SY6 6AX, ENGLAND:  
1,821,072, REN. 1-6-14. INT. CL. 9.

AGING BACKWARDS, LLC, TAMPA, FL:  
4,480,637, PUB. 11-26-2013. INT. CL. 3.

AGNITIO, S.L., MADRID, SPAIN:  
4,481,017, PUB. 11-26-2013. INT. CL. 9.

AGRICULTURAL & FISHERY MARKETING CORPORATION, REPUBLIC OF KOREA:  
3,247,718.

AGRO HOLDING GMBH, FED REP GERMANY:  
4,479,345, PUB. 11-26-2013. INT. CL. 6.

AGRO STEEL WIRE GMBH, FED REP GERMANY:  
4,479,344, PUB. 11-26-2013. INT. CL. 6.

AGROMIN CORPORATION, OXNARD, CA:  
4,481,439, MULTIPLE CLASS, INT. CLS. 1, 31 AND 40.

AGROPUR COOPERATIVE, GRANBY (QUEBEC), CANADA:  
3,245,721, CANC. MULTIPLE CLASS, INT. CLS. 29 AND 30.

AHK RECRUITMENT LIMITED, BRACKNELL, BERKSHIRE, UNITED KINGDOM:  
4,479,696, PUB. 7-9-2013. MULTIPLE CLASS, INT. CLS. 35, 38 AND 39.

AHLI UNITED BANK (UK) PLC, LONDON, W1M 1AB, UNITED KINGDOM:  
3,246,083, CANC. MULTIPLE CLASS, INT. CLS. 9 AND 36.

AI & CO AD, BULGARIA:  
4,479,488, PUB. 11-26-2013. INT. CL. 29.

AIR CONDITIONING CONTRACTORS OF AMERICA, ARLINGTON, VA:  
4,481,474, U.S. CL. B.

AIR ENTERTAINMENT, INC, MINATO-KU, JAPAN, DBA G-COSMETIC CO, LTD.:  
3,246,177, CANC. INT. CL. 3.

AIR FORCE CADET OFFICER MENTOR ACTION PROGRAM, WASHINGTON, DC:  
2,719,259, CANC. MULTIPLE CLASS, INT. CLS. 14 AND 41.

AIR METHODS CORPORATION, ENGLEWOOD, CO:  
4,482,033, MULTIPLE CLASS, INT. CLS. 37 AND 42.

AIRCART, INC., SAN FRANCISCO, CA:  
4,480,789, PUB. 11-26-2013. INT. CL. 42.

AIRCRAFT FLEET RECYCLING ASSOCIATION, INC., WASHINGTON, DC, AKA AFRA:  
4,480,358, PUB. 11-26-2013. MULTIPLE CLASS, INT. CLS. 35, 41 AND 42.

4,480,359, PUB. 11-26-2013. MULTIPLE CLASS, INT. CLS. 35, 41 AND 42.

AJINOMOTO CO., INC., CHUO-KU, TOKYO, JAPAN:  
4,481,332, MULTIPLE CLASS, INT. CLS. 29 AND 30.

ALAN RODZEN, PASADENA, CA AND ELIZABETH KAY, PASADENA, CA:  
4,480,076, PUB. 11-26-2013. INT. CL. 25.

ALARH, FRANCE:  
3,247,747.

ALASKA AEROSPACE CORPORATION, ANCHORAGE, AK:  
2,808,045, REN. 1-8-14. INT. CL. 39.  
2,816,356, REN. 1-8-14. INT. CL. 39.  
2,868,082, REN. 1-8-14. INT. CL. 39.

ALASKA LIFE PUBLISHING, LLC, ANCHORAGE, AK:  
3,248,706, CANC. INT. CL. 41.

ALASKA WILDSTOCK TREASURY, CORDOVA, AK:  
4,481,095, PUB. 11-26-2013. INT. CL. 25.

ALASKAN BREWING & BOTTLING CO., JUNEAU, AK, DBA ALASKAN BREWING CO.:  
4,480,323, PUB. 11-26-2013. INT. CL. 32.  
4,480,324, PUB. 11-26-2013. INT. CL. 32.

ALBRECHT-PIAZZA, LLC, LAKEWOOD, CA, DBA MT. CARMEL VINEYARDS:  
3,246,249, CANC. INT. CL. 31.

ALCANTARA S.P.A., ITALY:  
3,251,962.

ALCARAZ, RICHARD, ORANGE, CA:  
4,479,761, PUB. 11-26-2013. INT. CL. 37.

ALCATEL-LUCENT USA INC., MURRAY HILL, NJ:  
4,480,806, PUB. 11-26-2013. INT. CL. 42.

ALDI INC., BATAVIA, IL:  
4,482,511, INT. CL. 18.

ALDO NAKAGANEKU, ARCADIA, CA:  
4,482,402, INT. CL. 43.

ALEGENT CREIGHTON HEALTH, OMAHA, NE AND CREIGHTON UNIVERSITY, OMAHA, NE:  
4,482,060, INT. CL. 44.  
4,482,061, INT. CL. 44.  
4,482,062, INT. CL. 41.

ALEMIS, ALEXANDER G., PALOS HEIGHTS, IL:  
2,746,987, AM. INT. CL. 44.

ALEX LEE, INC., HICKORY, NC, MERCHANTS DISTRIBUTORS, INC., HICKORY, NC:  
1,812,623, REN. 1-6-14. MULTIPLE CLASS, INT. CLS. 29, 30 AND 32.

ALEX MALAY, NEW IBERIA, LA:  
4,480,100, PUB. 11-26-2013. INT. CL. 35.

ALEXANDER JAMES TRIMNELL, BOURNEMOUTH, DORSET, UNITED KINGDOM:  
4,479,571, PUB. 6-11-2013. MULTIPLE CLASS, INT. CLS. 3 AND 5.

ALEXANDER PATRICK GOODE & ASSOCIATES, INC., CHICAGO, IL:  
1,239,952, CANC. MULTIPLE CLASS, INT. CLS. 6, 16, 20, 37 AND 42.

ALEXANDER PRIMAK JEWELRY, INC., NEW YORK, NY:  
3,247,473, CANC. INT. CL. 14.

ALEXEY MAXIMCHUK, RUSSIAN FED.:  
4,479,423, PUB. 11-26-2013. MULTIPLE CLASS, INT. CLS. 25 AND 28.

ALGIERZ, DANIEL L.L., LOS ANGELES, CA:  
4,480,613, PUB. 11-26-2013. INT. CL. 25.

ALIEN SKIN SOFTWARE, LLC, RALEIGH, NC:  
3,248,682, CANC. INT. CL. 9.

ALIMENTOS EXTRUIDOS, S.A. DE C.V., TLAJOMULCO, JALISCO, MEXICO:  
4,480,882, PUB. 11-26-2013. INT. CL. 30.

ALK ENTERTAINMENT GROUP, CANOGA PARK, CA:  
4,480,660, PUB. 11-26-2013. INT. CL. 41.

ALL AMERICAN RACERS, INC., SANTA ANA, CA:  
3,577,217, CANC. MULTIPLE CLASS, INT. CLS. 12, 25 AND 28.

ALL FOR KIDZ, INC., LYNNWOOD, WA:  
4,482,412, INT. CL. 28.

ALL SCRAP METALS, LLC, KENNER, LA:  
4,480,776, PUB. 11-26-2013. INT. CL. 40.

- ALL STAR LIMOUSINE SERVICE, LTD., LINDENHURST, NY:  
2,871,027. REN. 1-7-14. INT. CL. 39.
- ALL THAT MATTERS, INC., HUEYTOWN, AL:  
3,247,216, CANC. INT. CL. 41.
- ALLEGHENY GENERAL HOSPITAL, PITTSBURGH, PA:  
3,246,694, CANC. INT. CL. 35.
- ALLEGIANCE CORPORATION, MCGAW PARK, IL:  
3,246,073, CANC. INT. CL. 10.
- ALLEGIANCE EA FUND LLC, CHARLOTTE, NC:  
3,248,012, CANC. INT. CL. 16.
- ALLEN, RHIAN, SURRY HILLS, NSW, AUSTRALIA:  
4,481,734, MULTIPLE CLASS, INT. CLS. 35, 41 AND 44.
- ALLERGAN, INC., IRVINE, CA:  
4,481,317, INT. CL. 5.
- ALLFLAT CONCRETE PROFILING, INC., ENCINITAS, CA:  
3,246,521, CANC. INT. CL. 42.
- ALLIANCE FOR MARRIAGE, MINDEN, NV:  
3,247,283, CANC. INT. CL. 35.
- ALLIANCE TIRE AMERICAS, INC., WAKEFIELD, MA:  
3,325,105, AM. INT. CL. 12.
- ALLIED GENETICS LLC, NORFOLK, NE:  
4,481,871, INT. CL. 31.  
4,481,872, INT. CL. 31.
- ALLIED WHEEL COMPONENTS, INC., GARDEN GROVE, CA:  
4,482,418, INT. CL. 12.
- ALLOSOURCE, CENTENNIAL, CO:  
4,482,514, INT. CL. 5.
- ALLOY DIGITAL, LLC, NEW YORK, NY:  
4,480,510, PUB. 11-26-2013. MULTIPLE CLASS, INT. CLS. 25 AND 41.
- ALLOY RODS GLOBAL, INC., FLORENCE, SC:  
1,818,594. REN. 1-6-14. INT. CL. 42.
- ALLSTATE INSURANCE COMPANY, NORTHBROOK, IL:  
4,482,257, INT. CL. 36.
- ALLSTATES TECHNICAL SERVICES, INC., BIRMINGHAM, AL:  
3,247,417, CANC. INT. CL. 35.
- ALMAR LURIE, AGANA, GUAM:  
4,482,464, INT. CL. 25.  
4,482,465, INT. CL. 25.
- ALMAR SALES CO. INC., NEW YORK, NY:  
3,247,993, CANC. MULTIPLE CLASS, INT. CLS. 14, 21 AND 26.
- ALO JEWELRY, S.R.O., PRAHA 17000, CZECH REPUBLIC:  
4,479,764, PUB. 10-8-2013. MULTIPLE CLASS, INT. CLS. 14, 35, 40 AND 42.  
4,479,765, PUB. 10-8-2013. MULTIPLE CLASS, INT. CLS. 14, 35, 40 AND 42.
- ALOS CUISINE, LLC., NORCROSS, GA:  
4,482,813, INT. CL. 30.
- ALPHA DRIVING ACADEMY, LLC, DERWOOD, MD:  
3,246,363, CANC. INT. CL. 41.
- ALPHA ONE FOUNDATION, INC., MIAMI, FL:  
3,247,485, CANC. INT. CL. 44.  
3,247,486, CANC. INT. CL. 44.
- ALPHONSUS J.B. RAVELLI, HOOFDDORP, NETHERLANDS AND SURAJ-KUMAR R. RAMSAHAI, DUIVEN-DRECHT, NETHERLANDS:  
4,481,788, INT. CL. 33.
- ALTICOR INC., ADA, MI:  
4,481,517, INT. CL. 32.  
4,481,520, INT. CL. 45.  
4,481,528, INT. CL. 45.
- ALTURA MEDICAL, INC., SAN CLEMENTE, CA:  
4,023,400, AM. INT. CL. 10.
- ALVA PRODUCTIONS, INC., EDGEWATER, NJ:  
4,481,614, INT. CL. 41.
- ALVEOLOGIC, LLC, BRIARCLIFF MANOR, NY:  
4,481,731, INT. CL. 44.
- ALYN-WEISS & ASSOCIATES, INC., LAKEWOOD, CO:  
4,480,561, PUB. 11-26-2013. INT. CL. 35.
- ALZCHEM AG, FED REP GERMANY:  
4,479,408, PUB. 11-26-2013. MULTIPLE CLASS, INT. CLS. 1 AND 6.
- ALZHEIMER'S COMMUNITY CARE, INC., WEST PALM BEACH, FL:  
4,480,074, PUB. 11-26-2013. MULTIPLE CLASS, INT. CLS. 41, 43, 44 AND 45.
- AMAG AUSTRIA METALL AG, AUSTRIA:  
4,479,443, PUB. 11-26-2013. INT. CL. 6.
- AMAG PHARMACEUTICALS, INC., WALTHAM, MA:  
4,480,662, PUB. 11-26-2013. INT. CL. 44.
- AMATEUR ATHLETIC UNION OF THE UNITED STATES, INC., LAKE BUENA VISTA, FL:  
3,248,003, CANC. INT. CL. 41.
- AMAZON TECHNOLOGIES, INC., RENO, NV:  
4,479,852, PUB. 11-26-2013. MULTIPLE CLASS, INT. CLS. 9, 16, 35, 38, 41, 42 AND 45.
- AMAZYS HOLDING GMBH, REGENSDORF, SWITZERLAND:  
2,719,493, CANC. INT. CL. 9.
- AMBERT, ALBA, CHAPEL HILL, NC, DBA SENDERO PARAMITA:  
4,480,043, PUB. 11-26-2013. INT. CL. 41.
- AMBRY GENETICS, ALISO VIEJO, CA:  
4,481,657, INT. CL. 44.
- AMCOL INTERNATIONAL CORPROATION, HOFFMAN ESTATES, IL, AMERICAN COLLOID COMPANY, ARLINGTON HEIGHTS, IL:  
1,837,618. REN. 1-3-14. INT. CL. 1.
- AMEC E&I, INC., ALPHARETTA, GA:  
4,482,183, INT. CL. 42.  
4,482,184, INT. CL. 42.
- AMERICAN ACADEMY OF NEUROLOGY, MINNEAPOLIS, MN:  
4,480,618, PUB. 11-26-2013. INT. CL. 42.
- AMERICAN ACUPUNCTURE COUNCIL, ORANGE, CA:  
4,480,210, PUB. 11-26-2013. MULTIPLE CLASS, INT. CLS. 16, 35, 36 AND 41.
- AMERICAN AIRLINES, INC., FOR WORTH, TX:  
2,718,921, CANC. INT. CL. 35.
- AMERICAN ART DESIGN, INC, EDISON, NJ:  
3,247,467, CANC. INT. CL. 16.
- AMERICAN ASSOCIATION OF ENDODONTISTS, CHICAGO, IL:  
4,480,504, PUB. 11-26-2013. INT. CL. 35.
- AMERICAN ASSOCIATION OF STATE HIGHWAY AND TRANSPORTATION OFFICIALS, WASHINGTON, DC, AKA AASHTO:  
4,482,469, INT. CL. 42.  
4,482,470, INT. CL. 42.
- AMERICAN AUTOMOBILE ASSOCIATION, INC., HEATHROW, FL:  
4,481,997, INT. CL. 42.
- AMERICAN BAR ASSOCIATION, CHICAGO, IL:  
4,480,345, PUB. 11-26-2013. MULTIPLE CLASS, INT. CLS. 35, 41 AND 45.
- AMERICAN BROADCASTING COMPANIES, INC., NEW YORK, NY:  
3,245,719, CANC. INT. CL. 41.
- AMERICAN COLLOID COMPANY, ARLINGTON HEIGHTS, IL TO AMCOL INTERNATIONAL CORPORATION, HOFFMAN ESTATES, IL:  
1,772,713, AM. INT. CL. 1.
- AMERICAN CRUISE LINES, INC., GUILFORD, CT:  
2,908,064. REN. 1-9-14. INT. CL. 39.
- AMERICAN DIABETES ASSOCIATION, INC., ALEXANDRIA, VA:  
2,719,292, CANC. INT. CL. 44.
- AMERICAN EXPRESS MARKETING & DEVELOPMENT CORP., NEW YORK, NY:  
3,248,154, CANC. MULTIPLE CLASS, INT. CLS. 35 AND 36.  
4,479,983, PUB. 11-26-2013. INT. CL. 35.  
4,479,984, PUB. 11-26-2013. INT. CL. 35.
- AMERICAN FARM BUREAU FEDERATION, WASHINGTON, DC:  
4,481,264, PUB. 11-26-2013. INT. CL. 35.
- AMERICAN FORMULARY INC., PISCATAWAY, NJ:  
2,787,654. REN. 1-6-14. INT. CL. 5.  
2,793,111. REN. 1-6-14. INT. CL. 5.

AMERICAN HALAL CO., INC., STAMFORD, CT:  
4,482,700, INT. CL. 30.

AMERICAN HEART ASSOCIATION, INC. AND U.S. DEPARTMENT OF HEALTH & HUMAN SERVICES, DALLAS, TX:  
3,364,055, CANC. INT. CL. 25.

AMERICAN INSTITUTE FOR MANAGING DIVERSITY, INC., ATLANTA, GA:  
2,718,972, CANC. MULTIPLE CLASS, INT. CLS. 16, 35 AND 41.

AMERICAN INSTITUTE OF BUILDING DESIGN, WASHINGTON, DC, AKA AIBD:  
2,717,009, REN. 1-8-14, U.S. CL. B.

AMERICAN INSTITUTE OF PHYSICS, INC., MELVILLE, NY:  
4,480,014, PUB. 11-26-2013, INT. CL. 16.

AMERICAN INTERNATIONAL INDUSTRIES, COMMERCE, CA:  
4,482,071, INT. CL. 3.  
4,482,216, INT. CL. 3.

AMERICAN KIDNEY FUND, INC., ROCKVILLE, MD:  
3,245,937, CANC. INT. CL. 36.

AMERICAN LIFT SYSTEMS INC., ESCONDIDO, CA:  
3,247,139, CANC. INT. CL. 7.

AMERICAN MARKETING SERVICES, INC., GERMANTOWN, MD:  
3,247,393, CANC. INT. CL. 16.

AMERICAN MEDICAL INFORMATICS ASSOCIATION, INC., BETHESDA, MD:  
4,480,625, PUB. 11-26-2013, MULTIPLE CLASS, INT. CLS. 35 AND 41.  
4,481,210, PUB. 11-26-2013, MULTIPLE CLASS, INT. CLS. 16 AND 41.

AMERICAN METAL CHEMICAL CORPORATION, MEDINA, OH:  
1,867,896, REN. 1-3-14, INT. CL. 1.

AMERICAN OPENINGS, INC., TUCSON, AZ:  
4,480,956, PUB. 11-26-2013, INT. CL. 19.

AMERICAN PHYSIOLOGICAL SOCIETY, BETHESDA, MD:  
4,479,702, PUB. 11-26-2013, MULTIPLE CLASS, INT. CLS. 16 AND 41.

AMERICAN PRODUCTIVITY & QUALITY CENTER, HOUSTON, TX:  
4,481,635, INT. CL. 35.

AMERICAN PSYCHIATRIC ASSOCIATION, ARLINGTON, VA:  
4,481,438, MULTIPLE CLASS, INT. CLS. 9, 16 AND 41.

AMERICAN ROAD AND TRANSPORTATION BUILDERS ASSOCIATION, WASHINGTON, DC:  
4,480,709, PUB. 11-26-2013, INT. CL. 41.

AMERICAN ROADSIDE BURGERS, INC., CHARLOTTE, NC:  
4,480,661, PUB. 11-26-2013, INT. CL. 43.

AMERICAN SINGING TELEGRAMS, INC., LAS VEGAS, NV:  
4,480,747, PUB. 11-26-2013, INT. CL. 38.

AMERICAN SONGSPACE LLC, NASHVILLE, TN:  
4,481,031, PUB. 11-26-2013, INT. CL. 42.

AMERICAN SPORTFISHING ASSOCIATION, ALEXANDRIA, VA:  
4,482,132, MULTIPLE CLASS, INT. CLS. 21, 25 AND 28.

AMERICAN SPORTS LICENSING, INC., WILMINGTON, DE:  
3,247,662, CANC. INT. CL. 35.  
4,481,611, INT. CL. 25.

AMERICAN TRUST ADMINISTRATORS, INC., OVERLAND PARK, KS:  
3,248,130, CANC. INT. CL. 36.

AMERICAN UROLOGICAL ASSOCIATION, INC., LINTHICUM, MD:  
3,245,830, CANC. MULTIPLE CLASS, INT. CLS. 35 AND 44.

AMERICAN WOOD SOURCE, LLC, LEBANON, OH:  
4,480,223, PUB. 11-26-2013, INT. CL. 35.

AMERICUS LOGISTICS, L.L.C., GOODYEAR, AZ:  
3,247,078, CANC. INT. CL. 37.  
3,247,090, CANC. INT. CL. 45.

AMES TRUE TEMPER, INC., CAMP HILL, PA:  
3,246,400, CANC. INT. CL. 12.  
3,248,681, CANC. INT. CL. 20.

AMICA MUTUAL INSURANCE COMPANY, PROVIDENCE, RI:  
3,246,109, CANC. INT. CL. 36.

AMIGO MOBILITY INTERNATIONAL, INC., BRIDGEPORT, MI:  
2,719,564, CANC. MULTIPLE CLASS, INT. CLS. 12 AND 35.

AMINPOUR AND ASSOCIATES, A PROFESSIONAL CORPORATION, SAN DIEGO, CA:  
4,480,527, PUB. 11-26-2013, INT. CL. 45.

AMMO KAN, LLC, LARAMIE, WY:  
4,480,539, PUB. 11-26-2013, MULTIPLE CLASS, INT. CLS. 13 AND 35.

AMOREPACIFIC CORPORATION, SEOUL, REPUBLIC OF KOREA:  
4,479,703, PUB. 11-26-2013, INT. CL. 3.  
4,479,752, PUB. 11-26-2013, INT. CL. 35.

AMORIM CORK COMPOSITES, S.A., PORTUGAL:  
4,479,270, PUB. 11-26-2013, MULTIPLE CLASS, INT. CLS. 2 AND 17.

AMOS PRESS, INC., SIDNEY, OH:  
3,245,965, CANC. INT. CL. 16.

AMPCO METAL S.A., 1723 MARLY, SWITZERLAND:  
766,997, REN. 1-8-14, U.S. CL. 14 (INT. CL. 6).

AMRUT DISTILLERIES LIMITED, BANGALORE, INDIA:  
4,481,569, INT. CL. 33.

AMSTORE CORPORATION, GRAND RAPIDS, MI, AMERICAN STORE EQUIPMENT CORPORATION, MUSKOGON, MI:  
975,753, REN. 1-9-14, MULTIPLE CLASS, U.S. CLS. 12 (INT. CL. 19) AND 32 (INT. CL. 20).

AMY GUION, LOS ANGELES, CA, DBA BENDABILITY FITNESS:  
4,480,784, PUB. 11-26-2013, INT. CL. 41.

ANAYA GEMS INC., LONG ISLAND CITY, NY:  
4,481,211, PUB. 11-26-2013, INT. CL. 14.  
4,481,220, PUB. 11-26-2013, INT. CL. 14.  
4,481,221, PUB. 11-26-2013, INT. CL. 14.

ANAYA GEMS, INC., LONG ISLAND CITY, NY:  
4,482,401, INT. CL. 14.

ANCHOR PADDLEBOARDS, HELOTES, TX:  
4,482,477, INT. CL. 28.

ANDERSONS, INC., THE, MAUMEE, OH:  
2,718,548, CANC. MULTIPLE CLASS, INT. CLS. 1 AND 5.

ANDREA DIMAURO, STONE RIDGE, NY:  
4,481,674, INT. CL. 44.

ANDREW N. JASON, JACKSONVILLE, FL:  
4,482,848, INT. CL. 28.

ANDREWS + BLAINE LTD, PARSIPPANY, NJ:  
4,480,313, PUB. 11-26-2013, INT. CL. 28.

ANDY CODDING, ROME, GA:  
3,246,362, CANC. INT. CL. 25.

ANGELO LIGHTING COMPANY, PHILADELPHIA, PA:  
2,719,724, CANC. INT. CL. 11.

ANGUS PERFORMANCE ADVISORS, LLC, FORT LAUDERDALE, FL:  
4,480,833, PUB. 11-26-2013, INT. CL. 9.

ANIMAL ADVENTURE, INC., HOPKINS, MN:  
4,481,321, INT. CL. 28.

ANKA SYSTEMS, INC., MCLEAN, VA:  
3,246,313, CANC. MULTIPLE CLASS, INT. CLS. 9 AND 42.

ANNA'S LINENS, INC., COSTA MESA, CA:  
4,480,059, PUB. 11-26-2013, MULTIPLE CLASS, INT. CLS. 20 AND 24.

ANNCO, INC., NEW YORK, NY:  
3,247,044, CANC. INT. CL. 25.

ANNEX LAW, P.A., TAMPA, FL:  
4,481,078, PUB. 11-26-2013, INT. CL. 45.

ANOTHER CASTLE VIDEO GAMES, EDMONDS, WA:  
4,480,246, PUB. 11-26-2013, INT. CL. 35.

ANSELMO, PHILIP HANSEN, CHICAGO, IL:  
4,480,423, PUB. 11-26-2013, INT. CL. 41.

- ANSTEDT, THEODORE R., HILLSBOROUGH, CA AND DELIZONNA, LAURA, HILLSBOROUGH, CA:  
4,482,743, INT. CL. 16.
- ANSWER 42 HOLDINGS, INC., DENVER, CO:  
3,247,358, CANC. MULTIPLE CLASS, INT. CLS. 35 AND 42.
- ANSWERS IN GENESIS, INC., PETERSBURG, KY:  
2,810,803, REN. 1-8-14, INT. CL. 16.
- ANTHEA DONALD, ALBERT PARK VIC 3206, AUSTRALIA:  
4,479,375, PUB. 11-26-2013, INT. CL. 5.
- ANTHONY PELLEGRINO, OAKBROOK TERRACE, IL, DBA GOLDSTONE FINANCIAL GROUP:  
4,480,963, PUB. 11-26-2013, INT. CL. 36.
- ANTHONY S. MAKRIS, ALEXANDRIA, VA:  
4,480,835, PUB. 11-26-2013, MULTIPLE CLASS, INT. CLS. 9 AND 41.
- ANTLER PLAQUE, WATERTOWN, SD:  
4,482,710, INT. CL. 40.
- ANTONIO MARRAS S.R.L., ALGHERO (SS), ITALY:  
2,799,669, REN. 1-3-14, MULTIPLE CLASS, INT. CLS. 18 AND 25.
- ANTONIO MEZE, BAIJA MARE, ROMANIA:  
4,480,254, PUB. 11-26-2013, INT. CL. 9.
- ANTWERP WORLD DIAMOND CENTRE, PRIVATE STICHTING, BELGIUM:  
4,479,350, PUB. 6-11-2013, MULTIPLE CLASS, INT. CLS. 35, 36 AND 41.
- ANVIL CAPITAL ADVISORS, LLC, SAN MATEO, CA:  
4,481,918, INT. CL. 36.
- ANYWIRE CORPORATION, JAPAN:  
4,479,412, PUB. 11-26-2013, MULTIPLE CLASS, INT. CLS. 7 AND 9.
- APEX ENDODONTICS, OLD TAPPAN, NJ:  
3,247,409, CANC. INT. CL. 44.
- APHIOS CORPORATION, WOBURN, MA:  
4,479,654, PUB. 11-26-2013, INT. CL. 40.  
4,479,655, PUB. 11-26-2013, INT. CL. 40.  
4,479,656, PUB. 11-26-2013, INT. CL. 40.
- APHOTOFOLIO.COM INC., DURANGO, CO:  
4,480,964, PUB. 11-26-2013, INT. CL. 42.
- APL LIMITED, SCOTTSDALE, AZ:  
4,481,436, MULTIPLE CLASS, INT. CLS. 39 AND 42.
- APOSTOL, ANTONIO, HOLBROOK, NY:  
3,246,713, CANC. INT. CL. 35.
- APPDYNAMICS, INC., SAN FRANCISCO, CA:  
4,480,932, PUB. 11-26-2013, INT. CL. 41.  
4,481,010, PUB. 11-26-2013, MULTIPLE CLASS, INT. CLS. 9, 37, 41 AND 42.
- APPLIED GENETICS INCORPORATED DERMATICS, FREEPORT, NY:  
3,248,417, CANC. INT. CL. 5.
- APPLIED RESEARCH OF AUSTRALIA, LTD, SALISBURY SOUTH, AUSTRALIA, AKA AROA:  
4,480,440, PUB. 11-26-2013, INT. CL. 20.
- APPRAISAL MANAGEMENT SERVICES, LLC, MARIETTA, GA:  
4,482,111, INT. CL. 36.
- AQUA 2 ACQUISITION, LLC, CHARLOTTE, NC:  
3,248,206, CANC. INT. CL. 37.
- AQUAARCH EXFILTRATION SYSTEM, LLC, JACKSONVILLE, FL:  
4,481,723, INT. CL. 19.
- AQUASOL LIMITED, MARCHWOOD, SOUTHAMPTON, HAMPSHIRE, UNITED KINGDOM:  
3,246,409, CANC. INT. CL. 16.
- AQUASTAR POOL PRODUCTS, INC., SAN DIEGO, CA:  
3,246,407, CANC. INT. CL. 11.
- AQUEOUS MANAGEMENT GROUP, SANDY, UT:  
4,481,672, MULTIPLE CLASS, INT. CLS. 5 AND 35.
- ARABELLA SOFTWARE LTD., KFAR-SABA, ISRAEL:  
3,246,391, CANC. MULTIPLE CLASS, INT. CLS. 9 AND 42.
- ARBONNE INTERNATIONAL, LLC, IRVINE, CA:  
3,248,491, CANC. INT. CL. 3.
- ARBY'S IP HOLDER TRUST, ATLANTA, GA:  
2,805,015, REN. 1-6-14, INT. CL. 43.
- ARC-INSIGHT, LLC, WORTHINGTON, OH:  
4,481,615, INT. CL. 41.
- ARCADIS CORPORATE SERVICES, INC., HIGHLANDS RANCH, CO:  
4,482,008, INT. CL. 42.
- ARCH CHEMICALS, INC., NORWALK, CT:  
2,718,542, CANC. INT. CL. 3.
- ARCH PERSONAL CARE PRODUCTS, L.P., SOUTH PLAINFIELD, NJ:  
1,816,533, REN. 1-8-14, INT. CL. 1.
- ARCHIE COMIC PUBLICATIONS, INC., MAMARONECK, NY:  
4,481,498, INT. CL. 3.
- ARCHIPEL, INC., MIAMI BEACH, FL:  
2,719,673, CANC. INT. CL. 20.  
2,719,674, CANC. INT. CL. 21.
- ARCHITECTURAL INFORMATION SERVICES PTY LTD, AUSTRALIA:  
4,479,474, PUB. 11-26-2013, INT. CL. 41.
- ARCHVISION, INC., LEXINGTON, KY:  
2,850,285, REN. 1-7-14, INT. CL. 9.  
2,857,376, REN. 1-7-14, INT. CL. 9.
- ARCO TEXTEIS-EMPRESA INDUSTRIAL DE SANTO TIRSO, S.A., SANTO TIRSO, PORTUGAL:  
3,248,102, CANC. MULTIPLE CLASS, INT. CLS. 23 AND 24.  
3,248,103, CANC. INT. CL. 24.
- ARCTIC ISLAND, LLC, LAS VEGAS, NV:  
4,482,804, MULTIPLE CLASS, INT. CLS. 36 AND 42.
- ARCTURUS MEDIA, INC, MIDLAND, TX:  
3,248,389, CANC. MULTIPLE CLASS, INT. CLS. 9 AND 42.
- ARDENT OUTDOORS, INC., LEES SUMMIT, MO:  
3,246,844, CANC. INT. CL. 28.
- AREBALO, DAVID, FONTANA, CA:  
4,482,155, INT. CL. 25.
- ARENDALL, RONALD L., MAINEVILLE, OH:  
2,702,139, CANC. INT. CL. 9.
- AREXIS AB, SWEDEN:  
3,247,780.
- ARIES, FRANCE:  
4,479,309, PUB. 11-26-2013, MULTIPLE CLASS, INT. CLS. 35 AND 41.
- ARISTOCRAT TECHNOLOGIES AUSTRALIA PTY LTD, NORTH RYDE, NSW, AUSTRALIA:  
3,246,765, CANC. INT. CL. 9.
- ARMSTRONG, NORMAN, PALM SPRINGS, CA:  
3,247,005, CANC. INT. CL. 41.
- ARMY AND AIR FORCE EXCHANGE SERVICE, DALLAS, TX:  
3,246,100, CANC. INT. CL. 29.
- ARNOLD, FRANK, MIAMI, FL:  
3,248,223, CANC. INT. CL. 41.
- AROUND THE WORLD HEALTHCARE, INC., STAMFORD, CT:  
3,248,463, CANC. INT. CL. 35.
- ARRAY NETWORKS, INC., MILPITAS, CA:  
3,248,503, CANC. INT. CL. 9.
- ARRAYSTAR INC, ROCKVILLE, MD:  
4,480,905, PUB. 11-26-2013, INT. CL. 42.
- ARRIGAN, SHARON L., EVERGREEN, CO:  
3,247,332, CANC. INT. CL. 30.
- ARRIS GROUP, INC., SUWANEE, GA:  
3,248,444, CANC. INT. CL. 9.
- ARRONS, NEILL, WEST PALM BEACH, FL, DBA MEDICAREFREEHELP:  
4,480,861, PUB. 11-26-2013, INT. CL. 36.
- ARROW FASTENER CO., LLC, SADDLE BROOK, NJ:  
4,481,133, PUB. 11-26-2013, INT. CL. 8.
- ARROW SPORTS, LLC, CLEVELAND, OH:  
4,480,644, PUB. 11-26-2013, INT. CL. 35.  
4,480,646, PUB. 11-26-2013, INT. CL. 35.
- ART OF A WOMAN LLC, FREEPORT, ME:  
3,246,229, CANC. MULTIPLE CLASS, INT. CLS. 14, 19 AND 25.
- ARTIC ICE SYSTEMS REFERIGERATION HEATING AIR-CONDITIONING INC., BIG LAKE, MN:  
3,246,567, CANC. INT. CL. 11.
- ARTISAN MACHINE, INC., SOUTH BEND, IN:  
3,246,632, CANC. INT. CL. 7.



ARTPRIZE GRAND RAPIDS, GRAND RAPIDS, MI:  
4,481,799, MULTIPLE CLASS, INT. CLS. 25, 35 AND 41.

ARTURO SOLIS, LOS ANGELES, CA AND BELLA BAYTLER SOLIS, LOS ANGELES, CA:  
4,482,845, INT. CL. 25.

ARTY BRELLAS PTY LTD, AUSTRALIA:  
4,479,358, PUB. 11-26-2013. MULTIPLE CLASS, INT. CLS. 18 AND 41.

ARUNDEL BICYCLE COMPANY, LLC, FORT WORTH, TX:  
4,481,950, MULTIPLE CLASS, INT. CLS. 12 AND 21.

ARZNEIMITTEL GMBH APOTHEKER VETTER & CO. RAVENSBURG, RAVENSBURG, FED REP GERMANY:  
4,480,276, PUB. 11-26-2013. MULTIPLE CLASS, INT. CLS. 5, 7, 10 AND 42.

ARZY LLC, SAN FRANCISCO, CA:  
3,247,272, CANC. INT. CL. 38.

ASC PROMOTIONS, INC., DAYTONA BEACH, FL:  
3,247,389, CANC. INT. CL. 41.

ASCENTIAL SOFTWARE CORPORATION, WESTBORO, MA:  
3,248,048, CANC. INT. CL. 9.

ASH GROVE CEMENT COMPANY, OVERLAND PARK, KS:  
4,480,008, PUB. 11-26-2013. MULTIPLE CLASS, INT. CLS. 1, 2, 17 AND 19.  
4,480,009, PUB. 11-26-2013. MULTIPLE CLASS, INT. CLS. 1, 2, 17 AND 19.

ASHLAND LICENSING AND INTELLECTUAL PROPERTY LLC, DUBLIN, OH:  
996,036, REN. 1-7-14. INT. CL. 5.  
1,271,395, REN. 1-7-14. INT. CL. 1.  
4,481,530, INT. CL. 40.

ASHNIC PILLOWS, LLC, WELLINGTON, FL:  
4,481,809, INT. CL. 20.  
4,481,810, INT. CL. 20.

ASICS CORPORATION, KOBE, JAPAN:  
3,245,850, CANC. INT. CL. 25.

ASICS CORPORATION, CHUO-KU, KOBE 650-8555, JAPAN:  
3,245,851, CANC. INT. CL. 25.

ASIJA, SATYA PAL, SHELTON, CT:  
1,277,338, REN. 1-8-14. INT. CL. 35.

ASKZEEK, LLC, NIXA, MO:  
3,246,469, CANC. INT. CL. 42.

ASP POOL & SPA COMPANY, LLC, MACON, GA:  
3,246,544, CANC. INT. CL. 37.

ASPEN AVIONICS, INC., ALBUQUERQUE, NM:  
4,481,514, MULTIPLE CLASS, INT. CLS. 9, 35 AND 42.

ASPEN SURGICAL PRODUCTS, INC., CALEDONIA, MI:  
4,479,685, PUB. 11-26-2013. MULTIPLE CLASS, INT. CLS. 5 AND 10.

ASSA ABLOY AB, STOCKHOLM, SWEDEN:  
4,481,866, INT. CL. 9.

ASSET MANAGEMENT INTERNATIONAL, LLC, SEATTLE, WA:  
4,479,648, PUB. 5-28-2013. INT. CL. 9.

ASSISTING HANDS HOME CARE, LLC, MESA, AZ:  
3,246,072, CANC. INT. CL. 44.  
3,247,639, CANC. INT. CL. 45.

ASSOCIATED FOOD STORES, INC., SALT LAKE CITY, UT:  
4,480,113, PUB. 11-26-2013. INT. CL. 35.

ASSOCIATED LEISURE PRODUCTS, INC., NORCROSS, GA:  
1,814,311, REN. 1-8-14. INT. CL. 1.

ASSOCIATION OF REAL ESTATE OWNED MANAGERS, SACRAMENTO, CA:  
2,827,615, REN. 1-9-14. INT. CL. 35.

ASTELLAS PHARMA INC., CHUO-KU, TOKYO, JAPAN:  
4,480,263, PUB. 11-26-2013. INT. CL. 5.

ASTENJOHNSON, INC., KANATA, ONTARIO, CANADA, JWI LTD., KANATA, ONTARIO, K2K 1X2, CANADA:  
1,811,863, REN. 1-3-14. INT. CL. 7.

ASTHMATX, INC., SUNNYVALE, CA:  
2,856,168, REN. 1-6-14. INT. CL. 10.

ASTIN, SEAN PATRICK, CALABASAS, CA:  
4,480,294, PUB. 11-26-2013. INT. CL. 41.

ASURION, LLC, NASHVILLE, TN:  
4,079,955, AM. INT. CL. 36.

AT&T INTELLECTUAL PROPERTY II, L.P., RENO, NV:  
3,246,332, CANC. INT. CL. 38.  
3,248,449, CANC. INT. CL. 38.  
4,481,986, MULTIPLE CLASS, INT. CLS. 9 AND 38.

AT-MAR GLASS, INC., KENNETT SQUARE, PA:  
1,820,328, REN. 1-8-14. INT. CL. 9.

ATELA PRODUCTIONS, INC., HERNDON, VA:  
3,247,275, CANC. INT. CL. 41.

ATHLETA, INC., PETALUMA, CA:  
4,482,426, INT. CL. 35.

ATKINS & PEARCE, INC., COVINGTON, KY:  
4,480,733, PUB. 11-26-2013. INT. CL. 17.

ATKINS, CHANDLER, LAKE LUZERNE, NY:  
4,480,977, PUB. 11-26-2013. INT. CL. 39.

ATLANTA CUTLERY CORPORATION, CONYERS, GA:  
1,816,617, REN. 1-7-14. INT. CL. 42.

ATLANTIC UNION COLLEGE, SOUTH LANCASTER, MA:  
4,479,811, PUB. 11-26-2013. INT. CL. 41.

ATLAS ROOFING CORPORATION, MERIDIAN, MS:  
4,481,551, MULTIPLE CLASS, INT. CLS. 17 AND 19.

ATOLLIC AB, SE-553 18 JÖNKÖPING, SWEDEN:  
4,479,249, PUB. 11-26-2013. INT. CL. 9.

ATRIUM MEDICAL CORPORATION, HUDSON, NH:  
3,248,151, CANC. INT. CL. 10.

ATRONIC INTERNATIONAL GMBH, LÜBBECKE, FED REP GERMANY:  
3,246,164, CANC. MULTIPLE CLASS, INT. CLS. 9 AND 28.  
3,246,254, CANC. MULTIPLE CLASS, INT. CLS. 9, 28 AND 41.  
3,246,317, CANC. MULTIPLE CLASS, INT. CLS. 9, 28 AND 41.  
3,246,341, CANC. MULTIPLE CLASS, INT. CLS. 9, 28 AND 41.

ATTENDS HEALTHCARE PRODUCTS, INC., GREENVILLE, NC, HOSPOSABLE PRODUCTS, INC., SOMERVILLE, NJ:  
1,869,435, REN. 1-7-14. INT. CL. 10.

AU'SOME, INC., KWUN TONG, KOWLOON, CHINA, DBA AU'SOME CANDIES, INC. AND DBA AU'SOME SNACK NATURALLY, INC.:  
3,245,803, CANC. INT. CL. 29.

AUDI AG, INGOLSTADT, FED REP GERMANY:  
4,479,776, PUB. 11-26-2013. MULTIPLE CLASS, INT. CLS. 12 AND 28.

AUDLEY TRAVEL GROUP LIMITED, UNITED KINGDOM:  
4,479,274, PUB. 11-26-2013. MULTIPLE CLASS, INT. CLS. 39 AND 43.

AUGUST STORCK KG, FED REP GERMANY:  
4,479,409, PUB. 11-26-2013. INT. CL. 30.

AURALEE PRODUCTIONS, INC., MASSAPEQUA PARK, NY:  
2,718,760, CANC. MULTIPLE CLASS, INT. CLS. 25 AND 35.

AUREON, INC., BROOKLYN, NY:  
3,246,364, CANC. MULTIPLE CLASS, INT. CLS. 35 AND 42.

AURO INTERNATIONAL, NEW YORK, NY:  
3,247,470, CANC. INT. CL. 24.

AURORA HEALTH CARE, INC., MILWAUKEE, WI:  
3,158,546, COR. MULTIPLE CLASS, INT. CLS. 35 AND 44.

AURORA TACTICAL, LLC, SPRINGDALE, AR:  
2,854,016, REN. 1-3-14. INT. CL. 9.

AUSSIEFIT I, LLC, ST. PETERSBURG, FL:  
4,481,664, MULTIPLE CLASS, INT. CLS. 25 AND 41.

AUSTIN SCOTT FARMS (PTY) LTD, TULBAGH 6820, SOUTH AFRICA:  
4,481,861, INT. CL. 33.

AUSTRALIAN VINTAGE LIMITED, AUSTRALIA:  
3,247,805.

AUTHENTICADE LLC, NEW YORK, NY:  
4,482,151, MULTIPLE CLASS, INT. CLS. 9 AND 45.

AUTODESK, INC., SAN RAFAEL, CA:  
4,480,221, PUB. 11-26-2013. MULTIPLE CLASS, INT. CLS. 9, 41 AND 42.

AUTOMATED FINANCIAL SYSTEMS, INC., EXTON, PA:  
3,246,543, CANC. MULTIPLE CLASS, INT. CLS. 9 AND

42.  
AUTOMOTIVE RENTALS, INC., MT. LAUREL, NJ:  
3,245,985, CANC. INT. CL. 41.
- AUTOS PULLMAN, S.A. DE C.V., COLONIA SIETE DE JULIO, MEXICO:  
3,246,434, CANC. INT. CL. 35.
- AUTOSHARE - CAR SHARING NETWORK INC., TORONTO, ONTARIO, CANADA:  
4,479,573, PUB. 11-26-2013. INT. CL. 39.
- AUTUMNPAPER LIMITED, WEST SUSSEX, UNITED KINGDOM:  
4,479,578, PUB. 6-11-2013. MULTIPLE CLASS, INT. CLS. 3, 9, 14, 18, 25 AND 35.
- AVACOMTECH INC, NATIONAL CITY, CA:  
4,482,498, INT. CL. 9.
- AVACOR PRODUCTS, LLC, NEW YORK, NY:  
2,718,517, CANC. INT. CL. 5.  
2,719,486, CANC. INT. CL. 5.
- AVANTAS, LLC, OMAHA, NE:  
3,246,182, CANC. INT. CL. 35.
- AVAYA INC., BASKING RIDGE, NJ, DIGITAL SYSTEMS INTERNATIONAL, INC., REDMOND, WA:  
1,786,298. REN. 1-7-14. INT. CL. 9.  
1,786,300. REN. 1-7-14. INT. CL. 9.
- AVERY DENNISON CORPORATION, PASADENA, CA:  
1,778,137. REN. 1-4-14. INT. CL. 40.
- AVESTA WELDING AKTIEBOLAG, AVESTA, SWEDEN:  
3,246,134, CANC. INT. CL. 6.
- AVIAT NETWORKS, INC., SANTA CLARA, CA:  
4,481,339, MULTIPLE CLASS, INT. CLS. 9, 35, 37, 38 AND 42.
- AVILA, ELVIRA, CIUDAD JUAREZ, CHIHUAHUA, MEXICO:  
3,248,077, CANC. INT. CL. 21.
- AVISO DEVELOPMENT CORPORATION, LAS VEGAS, NV:  
3,248,313, CANC. INT. CL. 37.
- AVOCENT CORPORATION, HUNTSVILLE, AL:  
2,799,702. REN. 1-6-14. INT. CL. 9.  
2,801,197. REN. 1-6-14. INT. CL. 9.
- AVON PRODUCTS, INC., NEW YORK, NY:  
780,479. REN. 1-9-14. U.S. CL. 51 (INT. CL. 3).  
2,720,075, CANC. INT. CL. 3.
- AVTEX COMMERCIAL PROPERTIES, INC., GREENVILLE, SC:  
3,247,998, CANC. INT. CL. 41.
- AWACO, S.A., ZONA LIBRE DE COLON, PANAMA:  
2,732,564. REN. 1-8-14. INT. CL. 14.
- AWADA, YEHIA A, LAS VEGAS, NV:  
2,718,954, CANC. INT. CL. 41.
- AWI LICENSING COMPANY, WILMINGTON, DE:  
2,720,115, CANC. INT. CL. 19.  
4,481,771, INT. CL. 19.
- AXIOM WORLDWIDE, INC., TAMPA, FL:  
4,479,266, PUB. 4-25-2006. MULTIPLE CLASS, INT. CLS. 10, 35 AND 40.
- AXIS OF EVIL COMEDY LLC, LOS ANGELES, CA:  
3,246,819, CANC. INT. CL. 41.
- AZIENDA VINICOLA LA CARRAIA S.R.L., 05918 ORVIETO (TERNI), ITALY:  
2,805,922. REN. 1-9-14. INT. CL. 33.
- B. NACHT & COMPANY (U.K.) LIMITED, LONDON, UNITED KINGDOM:  
1,818,453. REN. 1-8-14. INT. CL. 14.
- B.V. MICRES, NETHERLANDS:  
4,479,326, PUB. 8-20-2013. INT. CL. 34.
- B&G FOODS NORTH AMERICA, INC., PARSIPPANY, NJ:  
4,481,272, PUB. 11-26-2013. INT. CL. 30.
- B-TRAIN FILMS, LLC, NEW YORK, NY:  
3,247,427, CANC. INT. CL. 41.
- BAADER NORTH AMERICA CORPORATION, KANSAS CITY, KS:  
2,804,949. REN. 1-3-14. INT. CL. 7.
- BABALU MIAMI, INC, MIAMI BEACH, FL, DBA BABALU:  
4,479,717, PUB. 11-26-2013. INT. CL. 35.
- BABY SIGN LANGUAGE BASICS, LLC, SAN DIEGO, CA:  
4,480,994, PUB. 11-26-2013. INT. CL. 41.
- BABYQ, LLC, GRAND RAPIDS, MI:  
4,482,682, MULTIPLE CLASS, INT. CLS. 9, 41 AND 44.
- BACARDI & COMPANY LIMITED, NASSAU, BAHAMAS:  
1,663,585, CANC. INT. CL. 33.
- BACARDI & COMPANY LIMITED, VADUZ, LIECHTENSTEIN:  
4,481,296, PUB. 11-26-2013. INT. CL. 41.
- BACK, LYLE, CHERRY HILL, NJ:  
4,480,703, PUB. 11-26-2013. INT. CL. 44.
- BACKRACK INC., OAKVILLE, CANADA:  
4,479,253, PUB. 11-26-2013. MULTIPLE CLASS, INT. CLS. 12 AND 35.
- BACON BROTHERS LLC, GREENVILLE, SC:  
4,480,299, PUB. 11-26-2013. INT. CL. 43.
- BAEZ, AMY, NORTH MIAMI, FL:  
4,480,862, PUB. 11-26-2013. INT. CL. 35.
- BAGGINS, INC., LOS ANGELES, CA:  
4,480,930, PUB. 11-26-2013. INT. CL. 14.
- BAILEY FARMS INC., OXFORD, NC:  
2,719,466, CANC. INT. CL. 35.
- BAKER & TAYLOR, INC., CHARLOTTE, NC:  
2,719,099, CANC. INT. CL. 16.
- BAKER HUGHES INCORPORATED, HOUSTON, TX:  
584,310. REN. 1-8-14. U.S. CL. 6 (INT. CL. 4).  
4,481,488, INT. CL. 7.
- BAKER MILLS INC., SLC, UT:  
4,482,790, INT. CL. 30.
- BAKER, MATTHEW, CHAMBERSBURG, PA:  
4,479,872, PUB. 11-26-2013. INT. CL. 41.
- BALBOA MANUFACTURING CO. LLC, SAN DIEGO, CA:  
4,480,407, PUB. 11-26-2013. INT. CL. 9.  
4,480,508, PUB. 11-26-2013. INT. CL. 25.
- BALDI RETAIL LTD, LONDON, UNITED KINGDOM:  
4,479,616, PUB. 10-22-2013. MULTIPLE CLASS, INT. CLS. 18, 25 AND 35.
- BALL, BOUNCE & SPORT, INC., ASHLAND, OH:  
4,480,970, PUB. 11-26-2013. INT. CL. 28.  
4,481,239, PUB. 11-26-2013. INT. CL. 28.  
4,481,269, PUB. 11-26-2013. INT. CL. 28.  
4,481,292, PUB. 11-26-2013. INT. CL. 28.
- BALLUUN AG, SWITZERLAND:  
4,479,280, PUB. 11-26-2013. MULTIPLE CLASS, INT. CLS. 9, 35, 38, 42 AND 45.
- BALLY TOTAL FITNESS HOLDING CORPORATION, CHICAGO, IL:  
2,720,103, CANC. INT. CL. 5.  
2,803,390. REN. 1-6-14. MULTIPLE CLASS, INT. CLS. 5 AND 32.
- BAM NAVIGATION, LLC, MINNEAPOLIS, MN:  
4,481,811, INT. CL. 3.
- BANCO BILBAO VIZCAYA ARGENTARIA, S.A., VIZCAYA, SPAIN:  
4,479,848, PUB. 9-10-2013. INT. CL. 36.
- BANCO DAVIVIENDA S.A., BOGOTA, D.C., COLOMBIA:  
4,481,721, INT. CL. 38.
- BANG BREWING COMPANY, LLC, ST. PAUL, MN:  
4,481,345, INT. CL. 32.  
4,481,346, INT. CL. 32.
- BANK OF AMERICA CORPORATION, CHARLOTTE, NC:  
3,248,486, CANC. INT. CL. 36.
- BANK OF THE WEST, LOS ANGELES, CA:  
3,248,007, CANC. INT. CL. 33.
- BANPER HIT, SAPPORO HOKKAIDO, JAPAN:  
4,480,135, PUB. 11-26-2013. INT. CL. 25.  
4,480,136, PUB. 11-26-2013. INT. CL. 25.
- BANTAM BAGELS LLC, BROOKLYN, NY:  
4,481,089, PUB. 11-26-2013. MULTIPLE CLASS, INT. CLS. 30 AND 35.  
4,481,276, PUB. 11-26-2013. MULTIPLE CLASS, INT. CLS. 30 AND 35.
- BAQI INC., ENCINO, CA:  
4,479,615, PUB. 11-26-2013. INT. CL. 3.
- BAR FIORELLINO INC., MONTREAL, QUEBEC, CANADA:  
4,479,262, PUB. 5-7-2013. MULTIPLE CLASS, INT. CLS. 29 AND 30.  
4,479,263, PUB. 5-7-2013. MULTIPLE CLASS, INT. CLS. 29 AND 30.
- BAR-T HOLDING, INC., GAITHERSBURG, MD:  
4,481,170, PUB. 11-26-2013. MULTIPLE CLASS, INT. CLS. 41 AND 43.

BARB, INC., CONCORD, CA, DBA STAGED HOMES:  
 3,247,075, CANC. INT. CL. 35.  
 BARBATO, ANGELA J., OAKLAND PARK, FL:  
 3,248,613, CANC. INT. CL. 32.  
 BARCLAYS BANK PLC, LONDON, UNITED KINGDOM:  
 2,719,748, CANC. INT. CL. 36.  
 BARCLAYS BANK PLC, LONDON E14 5HP, UNITED  
 KINGDOM:  
 4,479,822, PUB. 7-30-2013. INT. CL. 36.  
 4,479,823, PUB. 7-30-2013. INT. CL. 36.  
 BARE ALL SWIMWEAR, YONKERS, NY:  
 4,482,088, INT. CL. 25.  
 BARE FRUIT, LLC, WALNUT, CA:  
 4,481,113, PUB. 11-26-2013. INT. CL. 29.  
 BARKING GOOD BAKERY, LLC, SEATTLE, WA:  
 3,246,256, CANC. INT. CL. 31.  
 BARLEAN'S ORGANIC OILS, L.L.C., FERNDALE, WA:  
 4,480,694, PUB. 11-26-2013. INT. CL. 5.  
 BARN BURNER BARBEQUE, LLC, PASADENA, CA:  
 3,246,307, CANC. INT. CL. 43.  
 BARNET PRODUCTS CORP., ENGLEWOOD CLIFFS, NJ:  
 3,246,601, CANC. INT. CL. 4.  
 BARON DE LEY, S.A., 31587 MENDAVIA (NAVARRA),  
 SPAIN:  
 2,719,270, CANC. INT. CL. 33.  
 BARREL O'FUN SNACK FOODS CO., PERHAM, MN:  
 4,481,154, PUB. 11-26-2013. INT. CL. 29.  
 BARRETT, JOEL PATRICK, BRIGHTON, NY:  
 4,482,427, INT. CL. 25.  
 BARRIER PLASTICS, INC., RANCHO SANTA MARGAR-  
 ITA, CA:  
 4,479,960, PUB. 11-26-2013. INT. CL. 20.  
 BARRIER TECHNOLOGIES, LLC, DAVIE, FL:  
 3,248,602, CANC. INT. CL. 10.  
 BARRINGTON VENTURE HOLDING COMPANY LLC,  
 BARRINGTON, IL:  
 2,803,167. REN. 1-6-14. MULTIPLE CLASS, INT. CLS. 43  
 AND 44.  
 BARRINGTON, LORD, LOS ANGELES, CA:  
 4,480,144, PUB. 11-26-2013. INT. CL. 35.  
 BARROW MANUFACTURING COMPANY, WINDER, GA:  
 895,090, CANC. U.S. CL. 39.  
 BARROW MANUFACTURING COMPANY, INC., WINDER,  
 GA:  
 1,182,269, CANC. INT. CL. 25.  
 BARRY CALLEBAUT BELGIUM S.A., BELGIUM:  
 3,247,730.  
 BARRY E. HAIMO, P.A., FORT LAUDERDALE, FL, DBA  
 HAIMO LAW:  
 4,481,187, PUB. 11-26-2013. INT. CL. 45.  
 BARSKI, KAREN, TRUMBULL, CT:  
 4,480,027, PUB. 11-26-2013. INT. CL. 25.  
 BARTHET FIRM, THE, MIAMI, FL:  
 2,900,829. REN. 1-3-14. INT. CL. 42.  
 BASE BRANDS, LLC, SMYRNA, GA:  
 4,482,499, INT. CL. 21.  
 BASEBALL JAX, INC., JACKSONVILLE, FL:  
 3,246,238, CANC. INT. CL. 25.  
 BASF SE, 67056 LUDWIGSHAFEN AM RHEIN, FED REP  
 GERMANY:  
 762,548. REN. 1-7-14. U.S. CL. 6 (INT. CLS. 1, 2, 3, 4 AND  
 5).  
 BASS PRO INTELLECTUAL PROPERTY, L.L.C., SPRING-  
 FIELD, MO:  
 4,480,966, PUB. 11-26-2013. INT. CL. 36.  
 BASS PRO TRADEMARKS, L.L.C., SPRINGFIELD, MO:  
 3,248,496, CANC. INT. CL. 28.  
 BATCH 206 DISTILLERY, LLC, SEATTLE, WA:  
 4,480,584, PUB. 11-26-2013. INT. CL. 33.  
 BATESVILLE SERVICES, INC., BATESVILLE, IN:  
 1,839,449. REN. 1-3-14. INT. CL. 20.  
 BATH & BODY WORKS BRAND MANAGEMENT, INC.,  
 REYNOLDSBURG, OH:  
 3,248,428, CANC. INT. CL. 25.  
 3,248,469, CANC. INT. CL. 3.  
 BATTERIES PLUS, LLC, HARTLAND, WI:  
 4,482,474, INT. CL. 9.  
 BATTERY ON THE GO, INC., COCONUT CREEK, FL:  
 4,481,985, INT. CL. 9.  
 4,482,290, INT. CL. 9.  
 BATTISTONI ALESSANDRA, ITALY:  
 3,247,697.  
 BATTLEFIELD INTERNATIONAL INC., CAYUGA, ON-  
 TARIO, CANADA:  
 4,482,526, MULTIPLE CLASS, INT. CLS. 6 AND 17.  
 BAUTCH, SANDRA, MISSION, TX AND BAUTCH, DENNIS,  
 WINTERSET, IA:  
 3,247,357, CANC. INT. CL. 9.  
 BAXTER INTERNATIONAL INC., DEERFIELD, IL:  
 2,800,662. REN. 1-6-14. INT. CL. 5.  
 BAYERISCHE MOTOREN WERKE AKTIENGE-  
 SELLSCHAFT, FED REP GERMANY:  
 4,479,499, PUB. 11-26-2013. INT. CL. 36.  
 BAYLOR COLLEGE OF MEDICINE, HOUSTON, TX:  
 4,481,968, MULTIPLE CLASS, INT. CLS. 41 AND 42.  
 BB DEVELOPMENT LLC, OXFORD, ME, DBA OXFORD  
 CASINO:  
 4,482,770, INT. CL. 41.  
 4,482,775, INT. CL. 41.  
 BBA PARTICIPATIES B.V., NL-7325 WV APELDOORN,  
 NETHERLANDS:  
 4,479,353, PUB. 11-26-2013. MULTIPLE CLASS, INT. CLS.  
 7, 35 AND 37.  
 BBA VENTURES, L.L.C., ATLANTA, GA:  
 3,246,550, CANC. INT. CL. 36.  
 BBB MANAGEMENT GROUP, LLC, PHILADELPHIA, PA:  
 4,480,350, PUB. 11-26-2013. INT. CL. 1.  
 BD&K FOODS, INC., COLUMBUS, GA:  
 4,479,738, PUB. 11-26-2013. MULTIPLE CLASS, INT. CLS.  
 29 AND 30.  
 BE HIVE OF HEALING MEDICAL CENTER, LOS AN-  
 GELES, CA:  
 4,480,478, PUB. 11-26-2013. INT. CL. 44.  
 BE MORE HEROIC, VAN NUYS, CA:  
 4,480,972, PUB. 11-26-2013. INT. CL. 35.  
 BEALE COMMUNICATIONS, LLC, KIRKLAND, WA:  
 4,479,869, PUB. 11-26-2013. INT. CL. 35.  
 BEAT BROS. YOKOHAMA CO., LTD., YOKOHAMA, JA-  
 PAN:  
 3,248,184, CANC. INT. CL. 25.  
 BEATH, ANDREW, MALIBU, CA:  
 2,718,824, CANC. INT. CL. 41.  
 BEAUTY INNOVATION GROUP, LLC, SCOTTSDALE, AZ:  
 4,481,384, INT. CL. 3.  
 BEAUTY 21 COSMETICS, INC., ONTARIO, CA:  
 4,480,569, PUB. 11-26-2013. INT. CL. 3.  
 BEAUTYBANK INC., NEW YORK, NY:  
 3,247,659, CANC. INT. CL. 3.  
 BECKETT, MATTHEW, MERIDIAN, ID:  
 3,246,973, CANC. INT. CL. 44.  
 BEHAVIORAL HEALTH OF THE PALM BEACHES, INC.,  
 NORTH PALM BEACH, FL:  
 4,482,395, INT. CL. 44.  
 4,482,396, INT. CL. 44.  
 BEIANU, VALENTIN, SEATTLE, WA:  
 4,482,379, INT. CL. 43.  
 BEIJING ACT ACADEMY OF SCIENCE & TECHNOLOGY  
 APPLICATION, BEIJING, CHINA:  
 2,797,964. REN. 1-3-14. INT. CL. 3.  
 BEIJING FONENET INFORMATION TECHNOLOGY COM-  
 PANY LIMITED, BEIJING, CHINA:  
 4,482,150, INT. CL. 9.  
 BEIJING SHENGYIYAO; TECHNOLOGY & DEVELOP-  
 MENT CO., LTD., CHINA:  
 4,479,513, PUB. 11-26-2013. INT. CL. 5.  
 BEL-ART PRODUCTS, WAYNE, NJ:  
 1,300,294. REN. 1-3-14. INT. CL. 9.  
 BELAN, JOE, ERIE, PA:  
 4,481,747, INT. CL. 16.  
 BELFAST INSTITUTE OF FURTHER AND HIGHER EDU-  
 CATION, BELFAST BT1 6DJ, UNITED KINGDOM:  
 3,246,460, CANC. MULTIPLE CLASS, INT. CLS. 35 AND  
 42.  
 BELFORD INC, NEW YORK, NY, DBA BELA NYC:  
 4,482,543, INT. CL. 25.

- BELGISCHE FRUITVEILING.; COÖPERATIEVE VEN-  
NOOTSCHAP; MET BEPERKTE AANSPRAKELIJKHEID,  
BELGIUM:  
4,479,288, PUB. 11-26-2013. INT. CL. 31.
- BELL HELICOPTER TEXTRON INC., FORT WORTH, TX:  
4,482,293, INT. CL. 36.
- BELL PARTNERS INC., GREENSBORO, NC:  
4,482,554, INT. CL. 36.  
4,482,555, INT. CL. 36.  
4,482,556, INT. CL. 36.
- BELLA BRIDESMAID FRANCHISE GROUP, LLC, CHICA-  
GO, IL:  
4,480,935, PUB. 11-26-2013. INT. CL. 35.
- BELLYTWINN INTERNATIONAL, INC., BEVERLY HILLS,  
CA:  
3,248,656, CANC. INT. CL. 9.
- BEN MARKETING GROUP, STAMFORD, CT:  
3,246,947, CANC. INT. CL. 35.
- BENCH, JOHN DAVID, LANCASTER, CA, DBA SANTA  
ANA BAIL BONDS:  
4,482,871, INT. CL. 36.
- BENDER, MICHAEL R., DOVER, NJ AND LIGHTSEY,  
SCOTT T., DOVER, NJ AND TUCKER, JUSTIN M.,  
DOVER, NJ:  
3,246,975, CANC. INT. CL. 41.
- BENECARD SERVICES, INC., LAWRENCEVILLE, NJ:  
4,480,072, PUB. 11-26-2013. MULTIPLE CLASS, INT. CLS.  
36 AND 41.  
4,480,073, PUB. 11-26-2013. MULTIPLE CLASS, INT. CLS.  
36 AND 41.
- BENEFITS EXCHANGE ALLIANCE, INC., LAKE FOREST,  
CA:  
4,480,432, PUB. 11-26-2013. INT. CL. 36.
- BENISON & CO., LTD., TAIPEI, TAIWAN:  
1,821,016, REN. 1-8-14. INT. CL. 7.
- BENNIGAN'S IP, LLC, ATLANTA, GA:  
2,719,312, CANC. INT. CL. 33.
- BENOSTAN INTERNATIONAL, LTD., NEW YORK, NY:  
4,480,179, PUB. 11-26-2013. INT. CL. 3.
- BENTLEY KINETICS, INC., BEDFORD, NH:  
3,247,195, CANC. INT. CL. 28.  
3,247,196, CANC. INT. CL. 9.
- BENTONVILLE SOFTWARE ASSOCIATES, LLC, BENTON-  
VILLE, AR:  
3,246,209, CANC. INT. CL. 35.
- BERETTA U.S.A. CORP., ACCOKEEK, MD:  
4,481,766, INT. CL. 35.
- BERGLUND, BRIAN, NORWICH, CT:  
4,482,014, INT. CL. 25.
- BERK ENTERPRISES, INC., WARREN, OH, DBA BERKLEY  
SQUARE:  
2,912,511, REN. 1-8-14. INT. CL. 35.
- BERMUDEZ INTERNATIONAL, INC., SANTIAGO, DOMIN-  
ICAN REP:  
4,482,695, INT. CL. 33.
- BERNARD, LA'TONYA, BROOKLYN, NY:  
4,480,331, PUB. 11-26-2013. INT. CL. 25.
- BERNSTEIN, DAVID, NEW YORK, NY:  
4,482,518, INT. CL. 33.
- BERRY & ASSOCIATES, INC., DEXTER, MI:  
4,480,736, PUB. 11-26-2013. INT. CL. 1.
- BERTRAND, JR., ALLEN, LOS ALTOS, CA:  
4,482,040, INT. CL. 42.
- BES TECHNOLOGY INC., ALHAMBRA, CA:  
4,480,805, PUB. 11-26-2013. MULTIPLE CLASS, INT. CLS.  
16 AND 21.
- BESPOKE INNOVATIONS SARL, 1293 BELLEVUE - GENE-  
VA, SWITZERLAND:  
2,718,520, CANC. INT. CL. 42.
- BESSEMER SERVICES INC., SAN FRANCISCO, CA:  
2,796,793, REN. 1-3-14. MULTIPLE CLASS, INT. CLS. 35  
AND 36.  
2,796,794, REN. 1-3-14. MULTIPLE CLASS, INT. CLS. 35  
AND 36.
- BEST MADE COMPANY, LLC, NEW YORK, NY:  
4,481,753, MULTIPLE CLASS, INT. CLS. 5, 8, 9, 16, 18, 21,  
22, 24, 25 AND 26.  
4,481,754, MULTIPLE CLASS, INT. CLS. 18 AND 25.
- BEST PRODUCTS INTERNATIONAL, INC., FLORENCE,  
KY:  
4,481,987, INT. CL. 1.
- BESTCARE, LLC, NORCROSS, GA:  
4,482,773, INT. CL. 10.
- BETCO CORPORATION, LTD., TOLEDO, OH:  
2,720,091, CANC. MULTIPLE CLASS, INT. CLS. 2 AND 3.
- BETHESDA HEALTH, INC., BOYNTON BEACH, FL:  
4,482,304, INT. CL. 44.
- BETTERWRX, INC., CARLSBAD, CA:  
4,480,982, PUB. 11-26-2013. INT. CL. 42.
- BETTS ENVIRONMENTAL SERVICES CORPORATION,  
BUTLER, NJ:  
4,482,535, MULTIPLE CLASS, INT. CLS. 36, 37, 40 AND  
42.
- BEVERAGE CONCEPTS, INC., HIALEAH, FL:  
4,481,028, PUB. 11-26-2013. INT. CL. 21.
- BEVERAGE INNOVATIONS (INTERNATIONAL) LTD.,  
NASSAU, NEW PROVIDENCE, BAHAMAS:  
4,481,748, INT. CL. 32.
- BEVERIDGE MARKETING LLC, POTOMAC, MD:  
4,482,544, INT. CL. 28.
- BF GATEMATE INC., TUCKAHOE, NY:  
4,481,746, INT. CL. 20.
- BFC, INC., NEWNAN, GA:  
4,480,587, PUB. 11-26-2013. INT. CL. 32.
- BGB INTERNATIONAL HOLDING AKTIENGE-  
SELLSCHAFT, FURSTENTUM, LIECHTENSTEIN:  
4,479,665, PUB. 5-14-2013. INT. CL. 32.
- BI INCORPORATED, BOULDER, CO:  
2,887,948, REN. 1-6-14. INT. CL. 42.
- BIACARE CORPORATION, ZEELAND, MI:  
3,247,515, CANC. INT. CL. 10.
- BIAX-FIBERFILM CORPORATION, GREENVILLE, WI:  
4,482,725, INT. CL. 24.
- BIBA SYSTEMS, INC., SAN FRANCISCO, CA:  
4,482,051, INT. CL. 9.  
4,482,052, INT. CL. 38.  
4,482,053, INT. CL. 42.
- BIBLE STUDY FELLOWSHIP, SAN ANTONIO, TX:  
4,480,689, PUB. 11-26-2013. INT. CL. 41.
- BIBLE STUDY TIME, INC., SPARTANBURG, SC:  
4,481,014, PUB. 11-26-2013. INT. CL. 45.  
4,481,016, PUB. 11-26-2013. INT. CL. 45.
- BIBLICAL STUDIES FOUNDATION, RICHARDSON, TX,  
DBA BIBLE.ORG:  
4,480,555, PUB. 11-26-2013. INT. CL. 41.
- BID4ASSETS, INC., SILVER SPRING, MD:  
4,480,855, PUB. 11-26-2013. INT. CL. 35.
- BIG BAY BREWING, LLC, SHOREWOOD, WI, AKA BIG  
BAY BREWING COMPANY:  
4,482,599, INT. CL. 32.
- BIG BEACON, CHAMPAIGN, IL:  
4,479,840, PUB. 11-26-2013. INT. CL. 35.  
4,479,841, PUB. 11-26-2013. INT. CL. 35.
- BIG BOX STORAGE, INC., SAN DIEGO, CA:  
4,480,503, PUB. 11-26-2013. INT. CL. 39.
- BIG DUMB SUCKERS LLC, RICHMOND, VA:  
4,482,018, INT. CL. 30.
- BIG RIG NETWORK, LLC, OKLAHOMA CITY, OK:  
4,480,343, PUB. 11-26-2013. INT. CL. 35.
- BIGFOOT ENTERTAINMENT LTD., SINGAPORE, SINGA-  
PORE:  
3,245,802, CANC. INT. CL. 41.
- BILL & MELINDA GATES FOUNDATION, SEATTLE, WA:  
4,480,104, PUB. 11-26-2013. INT. CL. 36.
- BILLY LONG AUCTIONEERS, INC., SPRINGFIELD, MO:  
3,247,126, CANC. INT. CL. 35.  
3,247,127, CANC. INT. CL. 35.
- BILTBEST PRODUCTS, INC., STE. GENEVIEVE, MO:  
3,245,812, CANC. MULTIPLE CLASS, INT. CLS. 6 AND  
19.  
3,245,813, CANC. MULTIPLE CLASS, INT. CLS. 6 AND  
19.
- BIMEDA, INC., OAKBROOK TERRACE, IL:  
2,816,892, REN. 1-6-14. INT. CL. 5.  
2,842,790, REN. 1-6-14. INT. CL. 5.  
2,871,091, REN. 1-6-14. INT. CL. 5.

BINAB BIO-INNOVATION AB, ALGARAS, SWEDEN:  
2,798,120. REN. 1-6-14. INT. CL. 5.

BINDER GMBH, TUTTLINGEN, FED REP GERMANY,  
DBA BINDER GMBH:  
4,481,324. INT. CL. 9.

BINGHAM GREENEBAUM DOLL LLP, LOUISVILLE, KY:  
2,720,131. CANC. INT. CL. 42.

BIO SHOTS LIMITED, KOWLOON, HONG KONG:  
4,482,494. INT. CL. 33.

BIO-LAB, INC., LAWRENCEVILLE, GA:  
3,248,724. CANC. INT. CL. 5.

BIOAGRA LLC, HINESVILLE, GA:  
3,248,516. CANC. INT. CL. 5.

BIOCELL TECHNOLOGY, LLC, NEWPORT BEACH, CA:  
4,479,849. PUB. 11-26-2013. INT. CL. 1.  
4,479,851. PUB. 11-26-2013. INT. CL. 1.

BIOPONIC PHYTOCEUTICALS, KIHEI, HI:  
3,246,816. CANC. INT. CL. 5.

BIOSTRAND, INC., RIVER FOREST, IL:  
3,245,945. CANC. INT. CL. 3.

BIRMINGHAM JEWELRY, INC., STERLING HEIGHTS, MI:  
4,480,292. PUB. 11-26-2013. INT. CL. 35.

BIROL GROWTH CONSULTING, LLC, SOLON, OH:  
3,246,709. CANC. INT. CL. 35.

BIRROTECA MANAGEMENT, LLC, SALISBURY, MD:  
4,480,819. PUB. 11-26-2013. INT. CL. 43.

BISOL DESIDERIO & FIGLI SOCIETÀ AGRICOLA S.S.,  
ITALY:  
4,479,470. PUB. 11-26-2013. INT. CL. 33.

BITA SAVISS, INC., LOS ANGELES, CA:  
3,247,382. CANC. INT. CL. 25.  
3,247,383. CANC. INT. CL. 25.

BIXBY INTERNATIONAL CORPORATION, NEWBURY-  
PORT, MA:  
4,482,272. INT. CL. 17.

BLACK BEAR ENERGY, LLC, BETHEL, ME:  
4,479,977. PUB. 11-26-2013. INT. CL. 32.

BLACK BRIDGE FOOD CO., LTD., TAINAN CITY, TAI-  
WAN:  
4,479,979. PUB. 11-26-2013. INT. CL. 29.

BLACKBOARD INC., WASHINGTON, DC:  
2,806,365. REN. 1-9-14. INT. CL. 42.

BLACKLIDGE IP, LLC, GULFPORT, MS:  
4,480,893. PUB. 11-26-2013. INT. CL. 19.

BLACKWOOD SYSTEMS, INC., SCOTTSDALE, AZ:  
2,756,396. REN. 1-9-14. INT. CL. 9.  
2,912,664. REN. 1-6-14. INT. CL. 9.

BLAND FARMS, LLC, GLENNVILLE, GA:  
4,481,709. INT. CL. 29.

BLASCO, JOSEPH D., ORLANDO, FL:  
2,801,504. REN. 1-3-14. INT. CL. 3.

BLENDE DENTAL CORPORATION, SAN FRANCISCO, CA:  
2,719,311. CANC. INT. CL. 44.

BLEVINS, RUSSELL JARID, GALT, CA:  
4,482,058. INT. CL. 25.

BLISSWORLD LLC, NEW YORK, NY:  
3,248,075. CANC. INT. CL. 3.

BLISTEX INC., OAK BROOK, IL:  
1,778,627. REN. 1-9-14. INT. CL. 5.

BLOCKHEADS SHAVERY COMPANY HOLDINGS LLC,  
LOS ANGELES, CA:  
4,480,617. PUB. 11-26-2013. INT. CL. 35.

BLOODHOUND INVESTMENT RESEARCH, INC., EDINA,  
MN:  
4,481,160. PUB. 11-26-2013. INT. CL. 42.

BLOOMERY PLANTATION DISTILLERY, LLC, CHARLES  
TOWN, WV:  
4,480,023. PUB. 11-26-2013. INT. CL. 33.

BLOW, LLC, LOS ANGELES, CA:  
4,482,406. MULTIPLE CLASS, INT. CLS. 11 AND 34.

BLT MANAGEMENT LLC, NEW YORK, NY:  
4,481,983. INT. CL. 43.

BLUCHER GMBH, ERKRATH, FED REP GERMANY:  
3,246,130. CANC. MULTIPLE CLASS, INT. CLS. 1 AND 9.  
3,246,131. CANC. MULTIPLE CLASS, INT. CLS. 1 AND 9.

BLUE BEE INC., SANTA BARBARA, CA:  
3,245,760. CANC. INT. CL. 35.

BLUE DRAGON INC., PASADENA, CA:  
4,481,320. INT. CL. 25.

BLUE EQUITY, LLC, PUNTA GORDA, FL:  
3,349,824. CANC. MULTIPLE CLASS, INT. CLS. 35 AND  
38.  
3,367,243. CANC. MULTIPLE CLASS, INT. CLS. 35 AND  
38.

BLUE SHELL GAMES LLC, SAN FRANCISCO, CA:  
4,482,572. INT. CL. 41.

BLUE WAVE INTERNATIONAL, LAS VEGAS, NV:  
4,482,581. INT. CL. 11.

BLUE ZONES LLC, MINNEAPOLIS, MN:  
4,479,659. PUB. 5-7-2013. MULTIPLE CLASS, INT. CLS. 35  
AND 41.

BLUEGRASS FOR BABIES, INC., CINCINNATI, OH:  
4,480,731. PUB. 11-26-2013. INT. CL. 35.

BLUEHAT MARKETING INC., MONTREAL, QUEBEC,  
CANADA:  
4,481,476. MULTIPLE CLASS, INT. CLS. 35 AND 42.

BLUMENTHAL, NOAH, SEA CLIFF, NY AND OSTERMIL-  
LER, STEPHEN, STOW, MA:  
4,482,622. INT. CL. 42.

BLUTRON GROUP, DALLAS, TX:  
4,482,348. INT. CL. 9.

BM FINE ART, INC., LAGUNA BEACH, CA:  
3,246,462. CANC. INT. CL. 35.

BM S.P.A., ITALY:  
3,359,936.

BMS CELEBRATION, INC., IRVING, TX:  
2,676,703. CANC. MULTIPLE CLASS, INT. CLS. 35 AND  
41.

BNA WINE GROUP, LLC, NASHVILLE, TN:  
4,482,269. INT. CL. 33.

BOARD GRIP INC., BREA, CA:  
3,247,161. CANC. MULTIPLE CLASS, INT. CLS. 8 AND  
16.

BOARD OF GOVERNORS OF THE COLORADO STATE  
UNIVERSITY SYSTEM, ACTING BY AND THROUGH  
COLORADO STATE UNIVERSITY, DENVER, CO:  
4,480,604. PUB. 11-26-2013. INT. CL. 25.  
4,480,606. PUB. 11-26-2013. INT. CL. 25.

BOARD OF REGENTS OF THE UNIVERSITY SYSTEM OF  
GEORGIA, ATLANTA, GA, DBA GEORGIA INSTITUTE  
OF TECHNOLOGY:  
1,252,895. REN. 1-6-14. INT. CL. 16.

BOARD UP PRODUCTIONS, LLC, MIAMI, FL:  
3,248,603. CANC. INT. CL. 41.

BOBBI OWENS, NEW YORK, NY AND KRISTI BERCHIN,  
NEW YORK, NY:  
4,481,616. INT. CL. 41.

BOCKART, JORDAN L., IMLAY CITY, MI:  
3,246,795. CANC. INT. CL. 19.

BOCO LLC, HAZLETON, PA, DBA BOCO:  
4,480,456. PUB. 11-26-2013. INT. CL. 21.

BODEGA Y VINEDOS CASANUEVA LTDA., SANTIAGO,  
CHILE:  
4,480,531. PUB. 11-26-2013. INT. CL. 33.

BODEGAS MURVIEDRO, S.A., 46340 REQUENA, VALEN-  
CIA, SPAIN:  
2,803,111. REN. 1-7-14. INT. CL. 33.

BODIES BY BURGOON, LLC, ANOKA, MN:  
4,480,494. PUB. 11-26-2013. MULTIPLE CLASS, INT. CLS.  
25 AND 41.  
4,480,495. PUB. 11-26-2013. MULTIPLE CLASS, INT. CLS.  
25 AND 41.

BODY SOLUTION SYSTEMS LLC, CHESTERFIELD, MO:  
4,479,875. PUB. 11-26-2013. INT. CL. 44.

BODYZONE LLC, ALPHARETTA, GA:  
4,480,022. PUB. 11-26-2013. U.S. CL. B.

BOEHRINGER INGELHEIM INTERNATIONAL GMBH,  
FED REP GERMANY:  
4,479,502. PUB. 11-26-2013. INT. CL. 5.  
4,479,503. PUB. 11-26-2013. INT. CL. 5.

BOHUSLAVSKY, MICHAEL G., LINCOLN, NE:  
3,247,401. CANC. INT. CL. 41.

BOLLINI, CHRISTIANO, MONTEREY PARK, CA:  
4,480,168. PUB. 11-26-2013. INT. CL. 43.

- BOMBARDIER INC., VALCOURT, CANADA:  
2,736,941, CANC. MULTIPLE CLASS, INT. CLS. 12 AND 28.
- BOMIMED INC., WINNIPEG, MANITOBA, CANADA:  
4,479,524, PUB. 9-10-2013. INT. CL. 10.
- BONCZYK, FRANK, R., WORCESTER, MA:  
2,855,885. REN. 1-9-14. INT. CL. 41.
- BONFIGLIOLI RIDUTTORI S.P.A., I-40012 CALDERARA DI RENO (BO), ITALY:  
3,247,720.
- BONUTTI ORTHOPEDIC SERVICES, LTD., EFFINGHAM, IL:  
2,836,998. REN. 1-3-14. INT. CL. 44.  
2,836,999. REN. 1-3-14. INT. CL. 44.
- BOOHER CONSULTANTS, LLC, COLLEYVILLE, TX:  
4,480,872, PUB. 11-26-2013. MULTIPLE CLASS, INT. CLS. 35 AND 41.
- BOOT ROYALTY COMPANY, L.P., FORT WORTH, TX:  
2,812,487. REN. 1-3-14. INT. CL. 25.  
4,482,259, INT. CL. 22.
- BOOTCUT BEAUTY LLC, DALLAS, TX, DBA BODY LANGUAGE:  
4,481,314, INT. CL. 3.
- BOOZE, JAYSEN, WESTMINSTER, CO:  
4,482,800, INT. CL. 25.  
4,482,803, INT. CL. 25.
- BORAL ROOFING LLC, IRVINE, CA:  
3,247,916, CANC. INT. CL. 19.
- BOSCA S.P.A., CANELLI (ASTI), ITALY:  
4,479,564, PUB. 10-16-2012. INT. CL. 33.
- BOSE CORPORATION, FRAMINGHAM, MA:  
2,800,940. REN. 1-3-14. INT. CL. 9.  
2,800,947. REN. 1-3-14. INT. CL. 9.
- BOSSARD AG, SWITZERLAND:  
4,479,284, PUB. 11-26-2013. MULTIPLE CLASS, INT. CLS. 6 AND 42.
- BOSTON'S BADDEST BURGER & SANDWICH CO., STOUGHTON, MA:  
4,480,287, PUB. 11-26-2013. INT. CL. 43.
- BOTELEER, PAMELA, ALEXANDRIA, VA AND HACKLEY, FAIRFAX, ALEXANDRIA, VA:  
2,801,434. REN. 1-9-14. INT. CL. 25.
- BOTTOMLINE TECHNOLOGIES (DE) INC., PORTSMITH, NH:  
2,805,409. REN. 1-8-14. INT. CL. 9.
- BOUQUET NANTAIS PARTICIPATION, 44340, BOUGUENAIS, FRANCE:  
3,245,817, CANC. INT. CL. 31.
- BOUQUETTE, VIKTOR, ATLANTA, GA:  
4,482,065, MULTIPLE CLASS, INT. CLS. 9 AND 44.
- BOURSE DU VIN INTERNATIONAL B.V., NETHERLANDS:  
3,247,815.
- BOWDEN, CEDRICK, TAMPA, FL:  
4,388,613, AM. INT. CL. 25.  
4,437,082, AM. INT. CL. 25.
- BOWRON, MARLA, VALLEY VILLAGE, CA:  
3,248,407, CANC. INT. CL. 21.
- BOXWOOD RESTORATION COMPANY, JEFFERSON, OH:  
4,480,057, PUB. 11-26-2013. INT. CL. 20.
- BOYD COFFEE COMPANY, PORTLAND, OR:  
2,801,849. REN. 1-8-14. INT. CL. 30.  
2,815,516. REN. 1-7-14. INT. CL. 30.
- BOYD GAMING CORPORATION, LAS VEGAS, NV:  
2,798,694. REN. 1-3-14. INT. CL. 41.
- BOYERS, DAVID GRAHAM, LOS ALTOS, CA:  
4,481,390, INT. CL. 9.
- BOYS NAMED SUE, DALLAS, TX:  
3,246,743, CANC. INT. CL. 41.
- BOZ DESIGN, LLC, NEWPORT BEACH, CA:  
3,247,611, CANC. INT. CL. 12.
- BPW SCIENCES, LP, KING OF PRUSSIA, PA:  
4,481,886, INT. CL. 5.
- BPZ ENERGY, LLC, HOUSTON, TX:  
4,480,674, PUB. 11-26-2013. MULTIPLE CLASS, INT. CLS. 37, 40 AND 42.  
4,480,675, PUB. 11-26-2013. MULTIPLE CLASS, INT. CLS. 37, 40 AND 42.
- BR MARKETING GROUP, LLC, THOUSAND OAKS, CA:  
4,480,414, PUB. 11-26-2013. INT. CL. 12.
- BRACKE MANUFACTURING, LLC, NEWPORT BEACH, CA:  
4,481,601, MULTIPLE CLASS, INT. CLS. 8 AND 9.  
4,481,603, MULTIPLE CLASS, INT. CLS. 8 AND 9.  
4,481,604, MULTIPLE CLASS, INT. CLS. 8 AND 9.
- BRADKEN RESOURCES PTY LIMITED, NEW SOUTH WALES, AUSTRALIA:  
2,862,625. REN. 1-3-14. INT. CL. 7.
- BRADY DEVELOPMENT, INC., BEAVER, PA, DBA BANCSEC, INC.:  
4,480,990, PUB. 11-26-2013. INT. CL. 42.
- BRAIN WAREHOUSE LLC, RANCHO SANTA FE, CA:  
3,245,984, CANC. INT. CL. 35.  
3,247,584, CANC. INT. CL. 35.
- BRAND FARM A/S C/O IC COMPANYS A/S, COPENHAGEN S, DENMARK:  
3,246,259, CANC. INT. CL. 25.
- BRAND MINISTRY LLC, NEW YORK, NY:  
4,481,177, PUB. 11-26-2013. INT. CL. 25.
- BRANDED LLC, DALLAS, TX:  
2,756,597. REN. 1-6-14. MULTIPLE CLASS, INT. CLS. 8 AND 21.
- BRANDEKKO, LLC, ARLINGTON, VA:  
4,481,120, PUB. 11-26-2013. INT. CL. 35.
- BRANDING COST RICA, SA, SAN JOSE, COSTA RICA:  
4,480,605, PUB. 11-26-2013. MULTIPLE CLASS, INT. CLS. 3, 9 AND 16.
- BRANDIZE LLC, OVERLAND PARK, KS:  
4,480,924, PUB. 11-26-2013. INT. CL. 35.
- BRANDON FEMME, INC., CHATSWORTH, CA:  
2,797,924. REN. 1-3-14. INT. CL. 26.
- BRANDS ENVIRONMENT ESTABLISHMENT, FL-9492 ESCHEN, LIECHTENSTEIN:  
4,479,273, PUB. 12-25-2012. MULTIPLE CLASS, INT. CLS. 3, 9, 14, 18, 20, 25, 28, 35, 41, 42 AND 43.
- BRANFORD COMPANIES, INC., THE, SUMMERVILLE, SC:  
3,245,724, CANC. INT. CL. 10.
- BRASIL TELECOM OF AMERICA, INC., BOCA RATON, FL:  
4,480,795, PUB. 12-18-2012. INT. CL. 38.
- BRASS TACKS LLC, BROOKLYN, NY:  
4,479,772, PUB. 11-26-2013. INT. CL. 41.  
4,481,564, INT. CL. 16.
- BRAVELOVE, INC., DALLAS, TX:  
4,480,899, PUB. 11-26-2013. INT. CL. 35.
- BRAVO ZULU STUDIOS, LLC, JULIAN, CA:  
4,479,809, PUB. 11-26-2013. INT. CL. 41.
- BRAVO, MARIA, PICO RIVERA, CA:  
4,480,657, PUB. 11-26-2013. INT. CL. 35.
- BRAZILE, TREVOR, DECATUR, TX:  
4,481,365, INT. CL. 25.
- BRECKENRIDGE PHARMACEUTICAL, INC., BOCA RATON, FL:  
3,247,930, CANC. INT. CL. 5.
- BREZINA, BENJAMIN A, SHARPSBURG, GA:  
4,480,554, PUB. 11-26-2013. INT. CL. 28.
- BRIAN BUSSELLS, BALTIMORE, MD, DBA BALL SO HARD UNIVERSITY:  
4,479,563, PUB. 12-18-2012. INT. CL. 25.
- BRIAN WASHINGTON ENTERPRISES, ALEXANDRIA, VA:  
3,247,135, CANC. INT. CL. 41.
- BRICKHEADZ, LLC, CHESAPEAKE, VA:  
4,482,196, INT. CL. 41.
- BRICKSTREAM CORPORATION, NORCROSS, GA:  
4,480,578, PUB. 11-26-2013. MULTIPLE CLASS, INT. CLS. 9, 35 AND 42.  
4,480,579, PUB. 11-26-2013. MULTIPLE CLASS, INT. CLS. 9, 35 AND 42.
- BRICKYARD TRADEMARKS, INC., INDIANAPOLIS, IN:  
3,247,142, CANC. INT. CL. 41.  
3,247,570, CANC. INT. CL. 41.
- BRIDGER BREWING COMPANY LLC, BOZEMAN, MT:  
4,480,391, PUB. 11-26-2013. INT. CL. 32.
- BRIGGS, CHARLES J., REDDING, CA:  
3,247,340, CANC. INT. CL. 28.

BRIGHT HARVEST OVERSEAS, INC., TAIPEI CITY 11268, TAIWAN:  
4,482,340, INT. CL. 9.

BRIGHT LIGHT TRADING, INC., BUENA PARK, CA, TA BRIGHT LIGHT GOLF:  
4,480,420, PUB. 11-26-2013. INT. CL. 28.

BRIGHTWURKS, INC., BOSTON, MA:  
4,479,244, PUB. 7-16-2013. INT. CL. 42.

BRINKMANN CORPORATION, DALLAS, TX:  
1,240,166, CANC. INT. CL. 11.

BRIT MEDIA, INC., SAN FRANCISCO, CA:  
4,480,387, PUB. 11-26-2013. INT. CL. 9.  
4,480,388, PUB. 11-26-2013. MULTIPLE CLASS, INT. CLS. 41 AND 42.  
4,480,389, PUB. 11-26-2013. INT. CL. 35.  
4,480,390, PUB. 11-26-2013. MULTIPLE CLASS, INT. CLS. 42 AND 45.

BRITEBEVCO, INC., IRVINE, CA:  
4,482,075, INT. CL. 32.

BRK BRANDS, INC., AURUORA, IL:  
4,482,024, INT. CL. 9.

BROADCOM CORPORATION, IRVINE, CA:  
3,245,860, CANC. INT. CL. 28.

BROADVISION, INC., REDWOOD CITY, CA:  
2,800,842, REN. 1-9-14. MULTIPLE CLASS, INT. CLS. 35 AND 42.

BRONCO WINE COMPANY, CERES, CA:  
4,482,336, INT. CL. 33.

BROOKLYNNE DESIGNS, LLC, BALDWINVILLE, NY:  
3,246,622, CANC. INT. CL. 28.

BROOKLINE BANCORP, INC., BROOKLINE, MA:  
3,246,165, CANC. INT. CL. 36.

BROOKLYN BANGERS LLC, BROOKLYN, NY:  
4,482,671, INT. CL. 25.

BROOKLYN BASKETBALL, LLC, BROOKLYN, NY:  
4,481,699, INT. CL. 35.  
4,481,772, INT. CL. 18.

BROOME ALIZA OCHAYON, NEW YORK, NY:  
4,481,370, INT. CL. 25.

BROTHERS SERVICES COMPANY, HAMPSTEAD, MD:  
3,245,836, CANC. INT. CL. 37.

BROUSSARD, DELORIS T., HOUSTON, TX:  
3,248,121, CANC. INT. CL. 16.

BROWNELL & COMPANY, INCORPORATED, MOODUS, CT:  
2,718,927, CANC. MULTIPLE CLASS, INT. CLS. 22 AND 28.

BROWNIE BRITTLE, LLC, WEST PALM BEACH, FL:  
4,479,828, PUB. 11-26-2013. INT. CL. 30.

BROWNSTONE GOURMET FOODS LIMITED LIABILITY COMPANY, PATERSON, NJ, AKA BROWNSTONE GOURMET FOODS:  
4,479,561, PUB. 11-26-2013. INT. CL. 30.

BROX, LLC, VIRGINIA BEACH, VA:  
3,247,946, CANC. INT. CL. 3.

BRUCE LANSKY, MINNETONKA, MN:  
4,480,879, PUB. 11-26-2013. INT. CL. 16.

BRUNKE, MARC, 81245 MÜNCHEN, FED REP GERMANY:  
4,479,732, PUB. 8-20-2013. MULTIPLE CLASS, INT. CLS. 9, 37 AND 42.

BRUNO PIOTROWSKI, MIAMI, FL:  
4,479,788, PUB. 6-11-2013. INT. CL. 36.

BRUNSWICK BOWLING & BILLIARDS CORPORATION, LAKE FOREST, IL:  
978,966, REN. 1-7-14. U.S. CL. 22 (INT. CL. 28).

BRYCE INVESTMENTS PTY LTD, AUSTRALIA:  
3,247,702.

BRYNNE COGORNO, LAGUNA BEACH, CA, DBA BACKWARD PRINTS:  
4,479,856, PUB. 11-26-2013. INT. CL. 16.  
4,479,857, PUB. 11-26-2013. INT. CL. 16.

BRYSON MARTIN RACING, INC, CASTAIC, CA:  
4,481,975, INT. CL. 12.

BRZOSKA, SHELLY, CHANDLER, AZ:  
3,246,915, CANC. INT. CL. 41.

BRÜEL & KJAER SOUND & VIBRATION; MEASUREMENT A/S, DENMARK:  
4,479,399, PUB. 11-26-2013. MULTIPLE CLASS, INT. CLS. 9, 35, 38 AND 42.

BSA COMPANY LIMITED, SOUTHAMPTON, UNITED KINGDOM:  
3,245,704, CANC. INT. CL. 12.

BSH HOME APPLIANCES CORPORATION, HUNTINGTON BEACH, CA:  
3,248,092, CANC. INT. CL. 11.

BSN SPORTS, INC., FARMERS BRANCH, TX, BSN CORPORATION, DALLAS, TX:  
1,262,511, REN. 1-3-14. INT. CL. 28.

BSN SPORTS, INC., FARMERS BRANCH, TX:  
1,870,846, REN. 1-8-14. INT. CL. 42.

BTC BROADBAND INC., BIXBY, OK:  
3,336,632, AM. INT. CL. 38.

BTWISTED, INC., CLEARWATER, FL:  
4,481,001, PUB. 11-26-2013. INT. CL. 14.

BUCCHINO, JOAN, GARDEN CITY, NY:  
4,482,823, INT. CL. 9.

BUCHANAN, L. STEPHEN, SANTA BARBARA, CA:  
4,481,342, INT. CL. 35.

BUCHNER, DANIEL, CHICAGO, IL AND BEELEY, CAROLYN, HANSON, MA:  
4,480,269, PUB. 11-26-2013. INT. CL. 41.

BUDDHIST COMPASSION RELIEF TZU CHI FOUNDATION, HUALIEN COUNTY, TAIWAN:  
4,481,898, MULTIPLE CLASS, INT. CLS. 36, 38, 41, 42, 43 AND 44.

BUDDY NO LARRY INC, SAINT CLAIR SHORES, MI:  
4,480,652, PUB. 11-26-2013. INT. CL. 9.

BUDOWSKI, SUSAN M., ORLANDO, FL:  
2,397,818, CANC. INT. CL. 42.

BUFFINI & COMPANY, CARLSBAD, CA:  
4,481,554, MULTIPLE CLASS, INT. CLS. 9, 35 AND 42.

BUILDING BETTER AMERICA COUNSEL, MILWAUKIE, OR:  
4,482,214, MULTIPLE CLASS, INT. CLS. 35 AND 37.

BUILDING COMMISSIONING ASSOCIATION, BEAVERTON, OR:  
4,480,718, PUB. 11-26-2013. MULTIPLE CLASS, INT. CLS. 35 AND 41.

BULL REALTY, INC., ATLANTA, GA:  
2,822,609, AM. MULTIPLE CLASS, INT. CLS. 35, 36 AND 42.  
2,829,493, AM. MULTIPLE CLASS, INT. CLS. 35, 36 AND 42.

BULLDOG BRAND KNIFE CO., INC., CHATTANOOGA, TN:  
1,771,126, REN. 1-8-14. INT. CL. 8.

BULOVA INVEST LTD, ROAD TOWN, TORTOLA, BR. VIRGIN ISLANDS:  
4,480,070, PUB. 8-13-2013. INT. CL. 45.

BUNKER, JONATHAN CHARLES, WILLIAMSBURG, VA AND BUNKER, GINA LOUISE, WILLIAMSBURG, VA:  
3,246,794, CANC. INT. CL. 37.

BUNT, DAVID, HUEYTOWN, AL:  
3,247,015, CANC. INT. CL. 9.

BURGAFLEX NORTH AMERICA, INC., HOLLY, MI:  
4,480,699, PUB. 11-26-2013. INT. CL. 17.

BURNING GLASS INTERNATIONAL, INC., BOSTON, MA:  
4,479,778, PUB. 11-26-2013. MULTIPLE CLASS, INT. CLS. 9, 35 AND 42.

BURNS, TREVA, COLLEYVILLE, TX, DBA DIVA STYL:  
4,482,643, INT. CL. 25.

BURTON, JASON, AUSTIN, TX, DBA CHUPACABRA CANTINA:  
4,481,506, INT. CL. 30.

BUSH, ALEX BRIAN, SAMMAMISH, WA:  
4,480,257, PUB. 11-26-2013. INT. CL. 9.

BUSH, E.B. HUTT JR., BEVERLY HILLS, CA:  
3,247,936, CANC. MULTIPLE CLASS, INT. CLS. 9, 16, 35 AND 41.

BUSINESS CELL PHONE DIRECTORY, LLC, RIDGELAND, MS:  
4,482,850, INT. CL. 35.

BUSINESS RESOURCES INTERNATIONAL, INC., SEATTLE, WA:  
4,482,394, INT. CL. 35.

- BUSINESS SOFTWARE SOLUTIONS OF NJ, INC., MT. LAUREL, NJ:  
2,718,931, CANC. INT. CL. 35.
- BUTECH BUILDING TECHNOLOGY, S.A., 12540 VILLARREAL (CASTELLON), SPAIN:  
3,245,855, CANC. INT. CL. 19.
- BUTTENPAPIERFABRIK GMUND GMBH & CO. KG, 83701 GMUND AM TEGERNSEE, FED REP GERMANY:  
3,248,368, CANC. INT. CL. 16.
- BUTTONWOOD TECHNOLOGY GROUP, LLC, NEW YORK, NY:  
3,247,512, CANC. INT. CL. 35.
- BUY BUY BABY, INC., UNION, NJ:  
4,479,723, PUB. 8-20-2013. INT. CL. 35.
- BW DOCUMENTS INC., SAN FRANCISCO, CA:  
4,481,352, INT. CL. 45.
- BYRD, KELLY, KILL DEVIL HILLS, NC:  
4,481,400, MULTIPLE CLASS, INT. CLS. 16 AND 25.
- C & E GP SPECIALISTS, INC., SAN CLEMENTE, CA:  
4,479,755, PUB. 8-20-2013. MULTIPLE CLASS, INT. CLS. 35 AND 40.
- C & F FOODS, INC., CITY OF INDUSTRY, CA:  
4,481,513, INT. CL. 30.
- C. H. HANSON COMPANY, NAPERVILLE, IL:  
3,246,139, CANC. INT. CL. 6.
- C. R. BARD, INC., MURRAY HILL, NJ:  
4,481,480, MULTIPLE CLASS, INT. CLS. 10 AND 40.
- C. V. STARR & CO., INC., NEW YORK, NY:  
3,747,175, COR. INT. CL. 36.
- C.H. POWELL COMPANY, CANTON, MA:  
4,480,450, PUB. 11-26-2013. INT. CL. 39.  
4,480,459, PUB. 11-26-2013. MULTIPLE CLASS, INT. CLS. 35 AND 39.
- C.N. BROWN COMPANY, SOUTH PARIS, ME, DBA A.W. WALKER LAWN & GARDEN CENTER, OKAY GAS, THE BIG APPLE FOOD STORES, AND RED SHIELD:  
4,480,544, PUB. 11-26-2013. INT. CL. 30.
- C.N. BROWN COMPANY, SOUTH PARIS, ME, DBA A.W. WALKER LAWN & GARDEN CENTER, OKAY GAS, THE BIG APPLE FOOD STORES, THE BIG APPLE, AND RED SHIELD:  
4,480,548, PUB. 11-26-2013. INT. CL. 30.  
4,481,205, PUB. 11-26-2013. INT. CL. 30.
- C&F FOODS, CO., INC., SYOSSET, NY:  
1,820,736, REN. 1-9-14. INT. CL. 29.
- CA, INC., ISLANDIA, NY:  
3,248,033, CANC. INT. CL. 35.
- CABALFO, LLC, PASADENA, TX:  
4,481,914, INT. CL. 34.
- CABLE NEWS NETWORK, INC., ATLANTA, GA:  
4,481,222, PUB. 11-26-2013. INT. CL. 41.
- CACAO HOLDINGS, LLC, BROOKLYN, NY:  
4,479,867, PUB. 11-26-2013. INT. CL. 33.
- CACHIL DEHE BAND OF WINTUN INDIANS, COLUSA, CA:  
3,248,343, CANC. INT. CL. 43.
- CADILLAC JACK, INC., DULUTH, GA:  
4,481,870, INT. CL. 28.
- CAESARS LICENSE COMPANY, LLC, LAS VEGAS, NV:  
2,719,370, CANC. INT. CL. 41.
- CAFE ENTERPRISES, INC., TAYLORS, SC:  
4,481,904, INT. CL. 43.
- CAFECITO LLC, CORAL GABLES, FL:  
4,482,489, INT. CL. 32.
- CAISSE NATIONALE DES CAISSES D'EPARGNE ET DE PREVOYANCE (CNCE), FRANCE:  
3,247,706.
- CAIUS PAWSON, LONDON W11 2EH, UNITED KINGDOM:  
4,480,094, PUB. 11-26-2013. MULTIPLE CLASS, INT. CLS. 9, 16, 25, 35, 38 AND 41.
- CAJUN CANDLE FACTORY INC., KAPLAN, LA:  
3,246,468, CANC. INT. CL. 4.
- CAL VADA SURVEYING, INC, CORONA, CA:  
3,247,605, CANC. INT. CL. 42.
- CAL VADA SURVEYING, INC., CORONA, CA:  
3,247,407, CANC. INT. CL. 42.
- CALF-VANTAGE FEEDS, INC., EVANSVILLE, WI:  
2,718,935, CANC. INT. CL. 5.
- CALI CRAFT BREWERY, INC., WALNUT CREEK, CA:  
4,481,587, INT. CL. 32.
- CALIFORNIA COMMUNICATIONS ASSOCIATION, SACRAMENTO, CA:  
3,247,019, CANC. INT. CL. 35.
- CALIFORNIA CRYOBANK STEM CELL SERVICES, INC., LOS ANGELES, CA:  
4,479,729, PUB. 11-26-2013. MULTIPLE CLASS, INT. CLS. 39, 40 AND 44.
- CALIFORNIA EASTERN LABORATORIES, INC., SANTA CLARA, CA:  
2,719,372, CANC. INT. CL. 35.  
2,719,373, CANC. INT. CL. 35.
- CALIFORNIA INNOVATIONS INC., TORONTO, ONTARIO, CANADA:  
4,479,258, PUB. 11-26-2013. INT. CL. 17.
- CALIFORNIA INTERNET SOLUTIONS INC, VENTURA, CA:  
4,479,927, PUB. 11-26-2013. INT. CL. 38.
- CALIFORNIA STATE LOTTERY, SACRAMENTO, CA, DBA CALIFORNIA LOTTERY:  
4,481,116, PUB. 11-26-2013. INT. CL. 41.
- CALIFORNIA STATE UNIVERSITY, SACRAMENTO, SACRAMENTO, CA:  
1,799,463, REN. 1-9-14. INT. CL. 25.  
1,804,527, REN. 1-9-14. INT. CL. 21.  
1,804,569, REN. 1-9-14. INT. CL. 25.
- CALIFORNIA URBAN FORESTS COUNCIL, NOVATO, CA 94948, CA:  
4,480,844, PUB. 11-26-2013. MULTIPLE CLASS, INT. CLS. 35 AND 41.
- CALLAWAY GOLF COMPANY, CARLSBAD, CA:  
3,248,283, CANC. INT. CL. 38.  
3,248,569, CANC. INT. CL. 35.  
3,248,570, CANC. INT. CL. 35.
- CALLPOD, INC., CHICAGO, IL:  
4,480,474, PUB. 11-26-2013. INT. CL. 9.
- CALPACIFIC MARKETING GROUP, INC., OCEANSIDE, CA:  
4,481,200, PUB. 11-26-2013. INT. CL. 35.
- CALPIS CO., LTD., TOKYO, JAPAN:  
3,246,118, CANC. MULTIPLE CLASS, INT. CLS. 29, 30 AND 32.
- CALZATURIFICIO HEROS S.R.L., ITALY:  
4,479,442, PUB. 11-26-2013. INT. CL. 25.
- CALZATURIFICIO MARITAN S.P.A., ITALY AND MR. PERANI DANIELE, ITALY AND REB 2010 DI TARTUFO-LI ROBERTO & C. S.A.S., ITALY:  
4,479,333, PUB. 11-26-2013. MULTIPLE CLASS, INT. CLS. 18 AND 25.
- CAMACHO, ALFONSO, SAN DIEGO, CA:  
3,246,316, CANC. INT. CL. 43.
- CAMBRIDGE SILICON RADIO LTD., CAMBRIDGE, UNITED KINGDOM:  
3,246,075, CANC. INT. CL. 9.
- CAMELLIX, LLC, AUGUSTA, GA:  
4,481,618, INT. CL. 3.  
4,481,619, INT. CL. 5.  
4,481,620, INT. CL. 3.
- CAMELOT IMPORTING CO., INC., WESTFIELD, NJ:  
1,779,811, REN. 1-9-14. INT. CL. 33.
- CAMI RESEARCH INC., ACTON, MA:  
1,838,381, REN. 1-9-14. INT. CL. 9.
- CAMP VIRGINIA JAYCEE, INC., BLUE RIDGE, VA:  
4,479,521, PUB. 9-28-2010. INT. CL. 41.
- CAMPBELL JR., DAVID LEE, GRANBURY, TX:  
4,480,591, PUB. 11-26-2013. INT. CL. 12.
- CAMPBELL, CHANTAY, MOUNT VERNON, NY:  
4,481,790, INT. CL. 25.
- CAMPOS EPC, LLC, DENVER, CO:  
4,480,288, PUB. 11-26-2013. MULTIPLE CLASS, INT. CLS. 35, 37, 42 AND 45.
- CAMPUS CRUSADE FOR CHRIST, INC., ORLANDO, FL, AKA CAMPUS CRUSADE FOR CHRIST INTERNATIONAL; CAMPUS CRUSADE FOR CHRIST; CCCI:  
4,481,577, INT. CL. 16.
- CAN'T STOP IT, LLC, BLOOMINGTON, MN:  
4,481,515, INT. CL. 5.



CANANDAQUA WINE COMPANY, INC., CANANDAIGUA, NY:  
1,536,651, CANC. INT. CL. 33.

CANDYWRITER, LLC, MIAMI BEACH, FL:  
4,482,607, INT. CL. 9.

CANNON INSTRUMENT COMPANY, STATE COLLEGE, PA:  
4,480,864, PUB. 11-26-2013. INT. CL. 37.

CANON BUSINESS PROCESS SERVICES, INC., NEW YORK, NY:  
2,797,139. REN. 1-7-14. MULTIPLE CLASS, INT. CLS. 35 AND 42.

CANTRELL, RICHARD R., SANTA MONICA, CA AND CANTRELL, PATRICIA L., SANTA MONICA, CA, DBA HARD TAIL:  
1,814,975. REN. 1-9-14. INT. CL. 25.

CAP HOLDINGS, LLC, COLUMBUS, OH:  
3,245,727, CANC. MULTIPLE CLASS, INT. CLS. 28 AND 35.

CAPABILITY MANAGEMENT INC, LATHAM, NY, DBA ENTERPRISE EVOLVER:  
4,482,148, INT. CL. 9.

CAPCOM CO., LTD., OSAKA, JAPAN:  
4,481,821, INT. CL. 41.

CAPE FOOD AND BEVERAGE, INC, ATLANTA, GA:  
3,246,415, CANC. INT. CL. 30.

CAPELLON PHARMACEUTICALS, LTD., FORT WORTH, TX:  
2,718,910, CANC. INT. CL. 5.  
2,718,911, CANC. INT. CL. 5.  
2,718,918, CANC. INT. CL. 5.

CAPIN JR, NEIL, CORONADO, CA:  
4,480,920, PUB. 11-26-2013. INT. CL. 37.

CAPINTEC, INC., RAMSEY, NJ:  
1,814,803. REN. 1-3-14. INT. CL. 10.

CAPITAL MACHINE TECHNOLOGIES, INC., TAMPA, FL:  
2,718,561, CANC. MULTIPLE CLASS, INT. CLS. 35 AND 37.

CAPITALOGIX, INC., COPPELL, TX:  
2,798,205. REN. 1-6-14. INT. CL. 35.

CAPITOL RECORDS, INC., NEW YORK, NY:  
1,244,814. REN. 1-3-14. INT. CL. 41.  
1,244,815. REN. 1-6-14. INT. CL. 41.

CAPPELLO, DOMINIC, SANTA FE, NM:  
4,479,929, PUB. 11-26-2013. INT. CL. 42.

CAPTAIN LUCAS, INC., NEW YORK, NY:  
4,480,860, PUB. 11-26-2013. INT. CL. 9.

CAPTRON ELECTRONIC GMBH, FED REP GERMANY:  
3,247,816.

CAPTURED IN CLAY, GRAND RAPIDS, MI:  
3,246,541, CANC. INT. CL. 19.

CAR CARRIER, THE, ARCADIA, CA:  
1,816,170. REN. 1-8-14. INT. CL. 39.

CAR EXPO, INC., FREDERICKSBURG, VA:  
3,248,064, CANC. INT. CL. 12.

CAR FLIPPING, LLC, DENVER, CO:  
4,481,572, INT. CL. 42.

CARBON 612 CORPORATION, MINEOLA, NY:  
3,246,712, CANC. INT. CL. 9.

CARBONXT INC., CHARLESTON, WV:  
4,482,719, INT. CL. 1.

CARDINALE ENTERTAINMENT, LOS ANGELES, CA:  
4,481,751, INT. CL. 9.

CARDIOVASCULAR RESEARCH FOUNDATION, NEW YORK, NY:  
4,479,905, PUB. 11-26-2013. INT. CL. 41.

CARDPAK, INC., SOLON, OH:  
4,482,175, INT. CL. 16.

CAREER CONCEPTS USA INC., CARY, IL:  
3,247,558, CANC. INT. CL. 35.

CAREFUSION 2200, INC., SAN DIEGO, CA:  
2,720,033, CANC. INT. CL. 10.

CARIBBEAN DEVELOPMENT COMPANY LIMITED, CHAMPS FLEURS, TRINIDAD/TOBAGO:  
3,248,712, CANC. INT. CL. 32.

CARIBE TIRE, CAMANA BAY, CAYMAN ISLANDS:  
4,481,752, MULTIPLE CLASS, INT. CLS. 12 AND 35.

CARL JIMUKI KABUSHIKI KAISHA; (ALSO TRADING AS CARL MANUFACTURING CO., LTD.), JAPAN:  
4,479,416, PUB. 11-26-2013. INT. CL. 16.

CARL ZEISS AG, 73447 OBERKOCHEN, FED REP GERMANY:  
3,247,174, CANC. INT. CL. 9.

CARL'S JR. RESTAURANTS LLC, CARPINTERIA, CA:  
4,481,803, INT. CL. 30.

CARLE & MONTANARI S.P.A., 20089 ROZZANO (MI), ITALY:  
3,245,715, CANC. INT. CL. 7.

CARLISLE FOODSERVICE PRODUCTS, INCORPORATED, OKLAHOMA CITY, OK:  
1,813,759. REN. 1-8-14. INT. CL. 20.

CARLISLE INTANGIBLE COMPANY, SYRACUSE, NY:  
3,247,964, CANC. INT. CL. 12.

CARLISLE MANAGEMENT COMPANY, SYRACUSE, NY:  
1,633,972, CANC. INT. CL. 12.

CARLO MARCHIORI CA'TOGA, INC., CALISTOGA, CA:  
2,874,102. REN. 1-8-14. INT. CL. 35.

CARNATHAN, JOHN RICHARD JR., CHICOPEE, MA AND THOMPSON, PAMELA MAY, CHICOPEE, MA:  
3,248,071, CANC. INT. CL. 41.

CAROLINA ARTISANS L.L.C., HICKORY, NC:  
3,248,471, CANC. INT. CL. 25.

CARPENTER CO., RICHMOND, VA:  
4,482,009, INT. CL. 20.

CARR, RICHARD F., MANILUS, NY:  
2,801,957. REN. 1-9-14. INT. CL. 41.

CARSCO INC., WALDORF, MD:  
1,255,023. REN. 1-9-14. INT. CL. 3.

CARTE BLANCHE GROUP LLC, SANTA ANA, CA:  
4,482,496, INT. CL. 25.

CARTER BROTHERS, LLC, ATLANTA, GA:  
3,246,324, CANC. MULTIPLE CLASS, INT. CLS. 35, 37, 40, 42 AND 45.

CARTER HOLT HARVEY LIMITED, AUCKLAND, NEW ZEALAND:  
4,479,612, PUB. 3-5-2013. INT. CL. 16.

CAS MEDICAL SYSTEMS, INC., BRANFORD, CT:  
2,801,249. REN. 1-3-14. INT. CL. 10.

CASA GIRELLI S.P.A., 38100 TRENTO, ITALY:  
2,719,881, CANC. INT. CL. 33.

CASALE MEDIA, INC., TORONTO, ONTARIO, CANADA:  
4,482,860, INT. CL. 35.

CASAMIA EVENTS INC., BRONX, NY:  
4,482,560, INT. CL. 41.

CASE DESIGN CORPORATION, TELFORD, PA:  
2,784,521. REN. 1-7-14. MULTIPLE CLASS, INT. CLS. 6 AND 20.

CASH IS KING RACING STABLES, LLC, PHOENIXVILLE, PA:  
3,246,223, CANC. INT. CL. 25.  
3,248,364, CANC. MULTIPLE CLASS, INT. CLS. 16, 25, 41 AND 44.

CASIO KEISANKI KABUSHIKI KAISHA, SHIBUYA-KU, TOKYO, JAPAN, DBA CASIO COMPUTER CO., LTD.:  
3,248,608, CANC. INT. CL. 14.

CASTANEDA, ARTHUR J., SAN JOSE, CA:  
4,482,291, INT. CL. 25.

CASTLE AVIATION, INC., NORTH CANTON, OH:  
2,796,770. REN. 1-3-14. INT. CL. 39.

CASTLE BRANDS INC., NEW YORK, NY:  
4,482,372, INT. CL. 33.

CASTLE ROCK INNOVATIONS, LLC, CHICAGO, IL:  
4,479,942, PUB. 11-26-2013. INT. CL. 42.

CATAMARAN LLC, LISLE, IL:  
1,813,491. REN. 1-9-14. INT. CL. 9.

CATCH MATCHMAKING, LOS ANGELES, CA:  
4,480,669, PUB. 11-26-2013. INT. CL. 45.

CATHOLIC BOOK PUBLISHING CORP., TOTOWA, NJ:  
4,480,425, PUB. 11-26-2013. INT. CL. 16.  
4,480,426, PUB. 11-26-2013. INT. CL. 16.

CATHOLIC CHARITIES, ROUND LAKE, IL:  
3,247,264, CANC. INT. CL. 45.

CATLIN, DAVID, LONDON, ENGLAND:  
3,246,178, CANC. MULTIPLE CLASS, INT. CLS. 9, 16 AND 28.

- CAT3, LLC, NEW YORK, NY:  
4,481,402, INT. CL. 14.
- CB WORLDWIDE, INC., MAMMOTH LAKES, CA:  
4,480,397, PUB. 11-26-2013. INT. CL. 24.
- CBL BRANDING, LLC, BELLEVUE, WA:  
4,481,440, MULTIPLE CLASS, INT. CLS. 7 AND 8.
- CBS BROADCASTING INC., NEW YORK, NY:  
3,248,052, CANC. MULTIPLE CLASS, INT. CLS. 41 AND 42.
- CBS RADIO INC., NEW YORK, NY:  
4,480,004, PUB. 11-26-2013. INT. CL. 38.  
4,480,005, PUB. 11-26-2013. INT. CL. 41.
- CBS STUDIOS INC., NEW YORK, NY:  
3,248,179, CANC. INT. CL. 41.
- CBS STUDIOS INC., STUDIO CITY, CA:  
4,482,476, INT. CL. 28.
- CE JOHANSSON AB, SWEDEN:  
3,247,743.
- CEBON APPAREL PRIVATE LIMITED, MAHALAXMI, MUBAI - 400 011, INDIA:  
2,822,104, REN. 1-3-14. INT. CL. 25.
- CELANESE INTENATIONAL CORPORATION, IRVING, TX, CHAS. S. TANNER COMPANY, PROVIDENCE, RI:  
762,558, REN. 1-7-14. U.S. CL. 6 (INT. CL. 1).
- CELEBRITY-PCF, INC., RIVERSIDE, CA:  
3,245,886, CANC. INT. CL. 11.
- CELGENE CORPORATION, SUMMIT, NJ:  
2,911,994, REN. 1-6-14. INT. CL. 42.  
4,479,795, PUB. 9-24-2013. INT. CL. 5.
- CELLFISH MEDIA, LLC, NEW YORK, NY:  
3,247,071, CANC. INT. CL. 38.  
3,247,618, CANC. INT. CL. 38.
- CELLINO & BARNES, P.C., BUFFALO, NY:  
4,480,663, PUB. 11-26-2013. INT. CL. 45.
- CELLULAR HARMONIES, LLC, EVANSTON, IL:  
4,481,526, INT. CL. 30.
- CELTER B.V., NL-9728 XG GRONINGEN, NETHERLANDS:  
3,247,710.
- CENTENE CORPORATION, ST. LOUIS, MO:  
4,481,495, INT. CL. 44.
- CENTER FOR COMPUTER-ASSISTED LEGAL INSTRUCTION, MINNEAPOLIS, MN:  
4,480,865, PUB. 11-26-2013. INT. CL. 28.
- CENTRAL FIBER SES LLC, WELLSVILLE, KS:  
2,734,675, REN. 1-7-14. INT. CL. 31.
- CENTRAL TEXAS CUSTOM GUTTERS, L.L.C., AUSTIN, TX:  
4,479,248, PUB. 11-26-2013. INT. CL. 37.
- CENTRO INTERDISCIPLINARIO PARA EL MANEJO DE CONFLICTOS, A.C., MÉXICO, MEXICO:  
3,248,251, CANC. MULTIPLE CLASS, INT. CLS. 41 AND 42.
- CENTURION WIRELESS TECHNOLOGIES, INC., LINCOLN, NE:  
4,480,919, PUB. 11-26-2013. INT. CL. 9.
- CENTURY 21 REAL ESTATE LLC, PARSIPPANY, NJ:  
2,720,034, CANC. INT. CL. 41.
- CENTURYLINK, INC., MONROE, LA:  
4,481,534, INT. CL. 38.
- CERAMICA CARMELO FIOR LTDA., CORDEIROPOLIS, SAO PAULO, BRAZIL:  
3,246,589, CANC. INT. CL. 19.
- CEREBOS PACIFIC LIMITED, SINGAPORE, SINGAPORE:  
2,888,113, REN. 1-8-14. MULTIPLE CLASS, INT. CLS. 5, 29 AND 32.
- CERTIFIED RADON LLC, KANSAS CITY, MO:  
4,482,736, MULTIPLE CLASS, INT. CLS. 37, 40 AND 42.  
4,482,737, INT. CL. 9.
- CERTIFIED RESTORATION DRYCLEANING NETWORK, LLC, BERKLEY, MI:  
3,246,990, CANC. INT. CL. 35.  
3,246,991, CANC. INT. CL. 37.
- CERTONA CORPORATION, DEL MAR, CA:  
2,718,789, CANC. INT. CL. 42.
- CERVECERIA MODELO, S. DE R.L. DE C.V., C.P. 11320 MEXICO CITY, MEXICO:  
4,482,688, INT. CL. 32.
- CERVEZAS EXTRA PREMIUM DE SAN LUIS, S DE RL DE CV, SAN LUIS POTOSI, MEXICO:  
4,480,785, PUB. 11-26-2013. INT. CL. 32.
- CEYX TECHNOLOGIES, INC., SAN DIEGO, CA:  
3,248,517, CANC. INT. CL. 9.
- CE3000.COM, INC., SACRAMENTO, CA:  
2,869,148, REN. 1-3-14. INT. CL. 9.
- CFPI - CF CENTRE POUR LA FORMATION DES; PROFESIONNELS DE; L'INVESTISSEMENT - CONSEIL FINANCIER SA; C/O KPMG FIDES, SWITZERLAND:  
3,247,744.
- CGI INTERNATIONAL, INC., MINNEAPOLIS, MN:  
2,798,481, REN. 1-6-14. INT. CL. 3.
- CHAANTI LLC., LOS ANGELES, CA:  
4,482,145, INT. CL. 25.
- CHAD ALLEN, MERCER ISLAND, WA:  
4,480,638, PUB. 11-26-2013. INT. CL. 41.
- CHAD KNAPP, SAN DIEGO, CA:  
4,479,900, PUB. 11-26-2013. INT. CL. 25.
- CHAMPION PERFORMANCE PRODUCTS, INC., SUNRISE, FL:  
3,247,641, CANC. INT. CL. 5.
- CHAMPION WINDOW MANUFACTURING AND SUPPLY CO., LLC, CINCINNATI, OH, DBA CHAMPION WINDOWS:  
4,482,285, INT. CL. 19.
- CHAMTECH INTERPRISES, INC., SANDY, UT, AKA CHAMTECH OPERATIONS:  
4,479,798, PUB. 11-26-2013. INT. CL. 9.
- CHAN, EMILY K, CAMBRIDGE, MA, DBA MODERN INTEGRATIVE MEDICINE:  
4,482,830, INT. CL. 44.
- CHANEL, INC., NEW YORK, NY:  
1,263,845, REN. 1-7-14. INT. CL. 42.
- CHANG, LI-LING, TAICHUNG CITY, TAIWAN:  
4,482,545, INT. CL. 28.
- CHANNA IZZO, NORTH ATTLEBORO, MA AND EMILY GINGRAS, NORTH ATTLEBORO, MA AND ADAM ROBITAILLE, NORTON, MA:  
4,480,846, PUB. 11-26-2013. INT. CL. 28.
- CHANNELEASE, INC., MIAMI, FL:  
4,480,491, PUB. 11-26-2013. INT. CL. 35.
- CHANNING BUI ALDRICH, SAN FRANCISCO, CA:  
4,481,407, INT. CL. 25.
- CHAPARRAL BOATS, INC., NASHVILLE, GA:  
4,481,750, INT. CL. 12.
- CHAPARRAL COMMUNICATIONS, INC., SAN JOSE, CA:  
1,267,754, REN. 1-9-14. INT. CL. 9.
- CHAPMAN/LEONARD STUDIO EQUIPMENT, NORTH HOLLYWOOD, CA:  
1,812,050, REN. 1-6-14. INT. CL. 12.
- CHAPMAN, WILLIAM GUY, LONG BEACH, NJ:  
4,482,320, INT. CL. 41.
- CHARA WEN CO., LTD., TAIPEI CITY 106, TAIWAN:  
4,482,068, INT. CL. 14.
- CHARLENA THORPE, SUWANEE, GA:  
4,482,029, INT. CL. 41.
- CHARLES & COLVARD, LTD., MORRISVILLE, NC:  
3,248,335, CANC. INT. CL. 35.
- CHARLES M. CHAMBERS, ST. CATHARINES, ON, CANADA:  
4,479,534, PUB. 6-18-2013. MULTIPLE CLASS, INT. CLS. 12 AND 25.
- CHARTBEAT, INC., NEW YORK, NY:  
4,482,124, MULTIPLE CLASS, INT. CLS. 9 AND 42.
- CHARTED COURSE ADVISORS LLC, CHICAGO, IL, AKA CHARETD COURSE CONSUTLING LLC:  
4,481,135, PUB. 11-26-2013. INT. CL. 35.
- CHARTER DURA-BAR, INC., WOODSTOCK, IL:  
1,262,210, REN. 1-3-14. INT. CL. 6.
- CHATEL, ERICK, GLENDALE, NY, AKA ERICK SCARECROW:  
4,480,800, PUB. 11-26-2013. INT. CL. 9.
- CHATTHREADS CORPORATION, BROOKLINE, MA:  
4,482,641, INT. CL. 35.
- CHAUSSURES MELLOW WALK FOOTWEAR INC., TORONTO, ONTARIO, CANADA:  
3,247,045, CANC. MULTIPLE CLASS, INT. CLS. 10 AND

25.  
 CHAUVE ENTERPRISES, LLC, NEW YORK, NY:  
 4,482,407, INT. CL. 44.  
 CHAZZANO LLC, FERNDALE, MI:  
 4,482,066, INT. CL. 30.  
 CHEAP DUMPSTERS, ALTO, MI:  
 4,480,418, PUB. 11-26-2013. INT. CL. 39.  
 CHEEK FAMILY TRUST, MURRIETA, CA:  
 2,718,957, CANC. INT. CL. 28.  
 CHEF'N CORPORATION, SEATTLE, WA:  
 2,720,153, CANC. INT. CL. 21.  
 CHELSEA FOOTBALL CLUB LIMITED, LONDON, ENGLAND:  
 3,246,197, CANC. MULTIPLE CLASS, INT. CLS. 3, 9, 14, 18 AND 25.  
 CHEMQ BIOSCIENCE LLC, CARY, NC:  
 4,482,316, INT. CL. 1.  
 CHEN RULIN, GUANGZHOU, CHINA:  
 4,480,969, PUB. 11-26-2013. INT. CL. 10.  
 CHEN, BRUCE, IRVINE, CA:  
 4,480,525, PUB. 11-26-2013. INT. CL. 44.  
 CHEN, MIN-HUNG, TAICHUNG CITY, TAIWAN:  
 3,246,000, CANC. INT. CL. 30.  
 CHENEY, MICHAEL, PROVO, UT:  
 2,566,854, CANC. MULTIPLE CLASS, INT. CLS. 9, 16 AND 41.  
 CHENG, WAN-LIN, BROOKLYN, NY:  
 3,247,475, CANC. INT. CL. 42.  
 CHENGDU BEST DIAMOND BIT CO., LTD., CHENGDU, CHINA:  
 4,481,259, PUB. 11-26-2013. INT. CL. 7.  
 CHERNIN, JEFFREY NEAL, LOS ANGELES, CA:  
 3,246,864, CANC. INT. CL. 16.  
 CHERY, STEPHANE, MIRAMAR, FL:  
 4,482,380, INT. CL. 25.  
 CHESTERTON ACADEMY, EDINA, MN:  
 4,479,834, PUB. 11-26-2013. INT. CL. 41.  
 CHEZ CHATEAU, LLC, EAGAN, MN:  
 4,480,360, PUB. 11-26-2013. INT. CL. 41.  
 CHG MANAGEMENT, INC., SALT LAKE CITY, UT:  
 3,246,088, CANC. INT. CL. 35.  
 CHI MEI CORPORATION, JEN TE HSIANG, TAINAN HSIEN, TAIWAN:  
 2,894,141, REN. 1-7-14. INT. CL. 9.  
 CHICAGO INDEPENDENT RADIO PROJECT, CHICAGO, IL, AKA CHIRP RADIO:  
 4,479,667, PUB. 11-26-2013. MULTIPLE CLASS, INT. CLS. 38 AND 41.  
 CHICAGO TRANSIT AUTHORITY, CHICAGO, IL:  
 2,799,477, REN. 1-6-14. INT. CL. 36.  
 CHILDBUILDERS, HOUSTON, TX:  
 3,247,056, CANC. INT. CL. 35.  
 CHILDREN'S HOSPITAL AND HEALTH SYSTEM, INC., MILWAUKEE, WI:  
 4,482,571, INT. CL. 44.  
 CHILDSAFENET, INC., FAIRFAX STATION, VA:  
 3,246,348, CANC. INT. CL. 41.  
 3,246,815, CANC. INT. CL. 45.  
 CHINA INDUSTRIES LIMITED, WOLVERHAMPTON, UNITED KINGDOM:  
 4,479,663, PUB. 6-11-2013. MULTIPLE CLASS, INT. CLS. 9, 16, 28 AND 41.  
 CHINA RECYCLING ENERGY CORPORATION, NO. 88 NAN GUAN ZHENG, CHINA:  
 4,481,452, MULTIPLE CLASS, INT. CLS. 36, 40 AND 42.  
 CHINA TOBACCO HUNAN; INDUSTRIAL CO., LTD., CHINA:  
 4,479,508, PUB. 11-26-2013. INT. CL. 34.  
 CHIVAS HOLDINGS (IP) LIMITED, PAISLEY, RENFREWSHIRE, UNITED KINGDOM, CHIVAS BROTHERS, ABERDEEN, SCOTLAND:  
 309,456, REN. 1-9-14. U.S. CL. 49 (INT. CL. 33).  
 CHIVAS HOLDINGS (IP) LIMITED, PAISLEY, RENFREWSHIRE, UNITED KINGDOM:  
 4,480,155, PUB. 11-26-2013. MULTIPLE CLASS, INT. CLS. 3, 29, 30, 35 AND 41.  
 CHIVASSO BV, NETHERLANDS:  
 4,479,360, PUB. 11-26-2013. MULTIPLE CLASS, INT. CLS.  
 24 AND 27.  
 CHO, JAE WON, LOS ANGELES, CA:  
 4,479,892, PUB. 11-26-2013. INT. CL. 40.  
 CHO, SU B., LA HABRA, CA:  
 3,245,806, CANC. INT. CL. 25.  
 CHOCOLADEFABRIKEN LINDT & SPRÜNGLI AG, KILCHBERG, SWITZERLAND:  
 4,479,779, PUB. 11-26-2013. INT. CL. 30.  
 CHOCOLADEFABRIKEN; LINDT & SPRÜNGLI AG, CH-8802 KILCHBERG, SWITZERLAND:  
 4,479,429, PUB. 11-26-2013. INT. CL. 30.  
 CHOCOLADEFABRIKEN; LINDT & SPRÜNGLI AG, SWITZERLAND:  
 4,479,432, PUB. 11-26-2013. INT. CL. 30.  
 CHOCTAW NATION OF OKLAHOMA, DURANT, OK:  
 3,246,371, CANC. INT. CL. 35.  
 CHODECKI, JOSEPH, HONOLULU, HI:  
 4,481,299, INT. CL. 25.  
 CHOMP, INC., EL SEGUNDO, CA:  
 2,809,113, REN. 1-6-14. MULTIPLE CLASS, INT. CLS. 25 AND 28.  
 CHOUDHURY, BIKRAM, LOS ANGELES, CA:  
 2,718,899, CANC. MULTIPLE CLASS, INT. CLS. 9, 25 AND 41.  
 CHR. HANSEN A/S, HORSHOLM, DENMARK:  
 4,482,161, INT. CL. 2.  
 4,482,163, INT. CL. 2.  
 CHRISTIANE NORTHRUP, INC., YARMOUTH, ME:  
 2,816,509, REN. 1-8-14. MULTIPLE CLASS, INT. CLS. 9, 16 AND 42.  
 CHRISTIANITY TODAY INTERNATIONAL, CAROL STREAM, IL:  
 4,480,278, PUB. 11-26-2013. INT. CL. 16.  
 CHRISTMAS DEPOT.COM, INC., MOUNT ARLINGTON, NJ:  
 2,718,305, CANC. INT. CL. 35.  
 CHRISTOPHER BAILEY, UNITED KINGDOM:  
 4,479,283, PUB. 6-18-2013. MULTIPLE CLASS, INT. CLS. 3, 9, 14, 18, 25, 35 AND 42.  
 CHRISTOPHER KHORSANDI, MD PLLC, LAS VEGAS, NV:  
 4,480,573, PUB. 11-26-2013. INT. CL. 44.  
 CHRISTOPHER, JACKIE, ARROYO GRANDE, CA:  
 4,482,249, INT. CL. 3.  
 CHRISTOPHER, MIKOVITS, NEW ROCHELLE, NY, DBA CHERRY VAPE:  
 4,480,235, PUB. 11-26-2013. MULTIPLE CLASS, INT. CLS. 30 AND 34.  
 CHROSTOWSKI, MATT, AGOURA HILLS, CA:  
 4,480,300, PUB. 11-26-2013. INT. CL. 8.  
 CHROSZIEL GMBH, HEIMSTETTEN, FED REP GERMANY:  
 4,481,797, MULTIPLE CLASS, INT. CLS. 9 AND 35.  
 4,481,798, MULTIPLE CLASS, INT. CLS. 9 AND 35.  
 CHRYSAL INTERNATIONAL B.V., NETHERLANDS:  
 4,479,285, PUB. 11-26-2013. MULTIPLE CLASS, INT. CLS. 1, 17 AND 22.  
 CHRYSLER LLC, AUBURN HILLS, MI:  
 3,248,365, CANC. INT. CL. 9.  
 CHUNG, DAVID, HILLSBOROUGH, CA, DBA PATIENCE INTERNATIONAL AND CHUNG, SARAH, HILLSBOROUGH, CA, DBA PATIENCE INTERNATIONAL:  
 4,479,583, PUB. 11-26-2013. INT. CL. 25.  
 CHURCH & DWIGHT CO., INC., EWING, NJ:  
 1,815,314, REN. 1-9-14. INT. CL. 1.  
 4,482,679, MULTIPLE CLASS, INT. CLS. 21 AND 24.  
 CHURCHILL BRAND HOLDINGS LLC, BOSTON, MA:  
 2,718,933, CANC. INT. CL. 36.  
 CHW, LLC, CHARLOTTE, NC:  
 4,479,240, PUB. 11-26-2013. INT. CL. 25.  
 CIMBULIS, ILGA, MINNETONKA, MN:  
 4,482,087, INT. CL. 45.  
 CIMINO, ANDREW M., WEBSTER, NY:  
 4,480,121, PUB. 11-26-2013. INT. CL. 30.  
 CIN - CORPORAÇÃO INDUSTRIAL; DO NORTE, S.A., PORTUGAL:  
 4,479,516, PUB. 11-26-2013. MULTIPLE CLASS, INT. CLS. 2 AND 17.  
 CINAR HALICILIK A.S., CAGALOGLU, TURKEY:  
 4,480,927, PUB. 11-26-2013. INT. CL. 27.

- CINCOR, INC., MIAMI, FL:  
4,481,735, INT. CL. 34.
- CINE ROBE LLC, NEW YORK, NY:  
3,246,810, CANC. INT. CL. 25.
- CINTAS HOLDINGS LLC, MASON, OH:  
4,480,552, PUB. 11-26-2013. MULTIPLE CLASS, INT. CLS. 41 AND 44.
- CIPLA LIMITED, MUMBAI, INDIA:  
4,479,886, PUB. 11-26-2013. INT. CL. 5.  
4,479,887, PUB. 11-26-2013. INT. CL. 5.  
4,479,888, PUB. 11-26-2013. INT. CL. 5.
- CIRCLE911, LLC, CARMEL, IN:  
4,482,032, INT. CL. 38.
- CISCO TECHNOLOGY, INC., SAN JOSE, CA:  
2,800,261, REN. 1-6-14. MULTIPLE CLASS, INT. CLS. 9 AND 37.  
2,802,263, REN. 1-6-14. MULTIPLE CLASS, INT. CLS. 9 AND 37.
- CITGO PETROLEUM CORPORATION, HOUSTON, TX:  
3,246,028, CANC. INT. CL. 37.  
3,247,656, CANC. INT. CL. 1.
- CITIGROUP INC., NEW YORK, NY:  
4,482,393, INT. CL. 35.
- CITIZEN, LATOYA C, HOUSTON, TX:  
4,482,837, INT. CL. 25.
- CITROMAX S.A.C.I., TAFI VIEJO, ARGENTINA:  
4,481,319, INT. CL. 3.
- CITRUSOURCE INC., LONG BEACH, CA:  
3,246,639, CANC. MULTIPLE CLASS, INT. CLS. 31 AND 35.
- CITY INN LIMITED, LONDON, UNITED KINGDOM:  
3,246,512, CANC. INT. CL. 43.
- CIVVIES INC, CULVER, IN:  
4,480,770, PUB. 11-26-2013. INT. CL. 25.
- CJ CORP., SEOUL, REPUBLIC OF KOREA:  
3,248,113, CANC. INT. CL. 30.  
3,248,114, CANC. INT. CL. 43.
- CJ 4DPLEX CO., LTD., SEOUL, REPUBLIC OF KOREA:  
4,479,634, PUB. 11-26-2013. INT. CL. 7.  
4,479,635, PUB. 11-26-2013. INT. CL. 28.  
4,479,636, PUB. 11-26-2013. INT. CL. 42.
- CKSYME.ORG. GROUP, LLC, BOZEMAN, MT:  
4,481,011, PUB. 11-26-2013. INT. CL. 41.
- CLAIMKIT LLC, OVERLAND PARK, KS:  
4,479,830, PUB. 11-26-2013. INT. CL. 42.
- CLANCY, WILLIAM, NORWELL, MA, DBA HYPERTONE PERSONAL FITNESS TRAINING:  
3,248,067, CANC. INT. CL. 41.
- CLAREMONT UNIVERSITY CONSORTIUM, CLAREMONT, CO:  
4,479,909, PUB. 11-26-2013. INT. CL. 35.
- CLASS ACT SPORTS, LLC, LONG BEACH, NY:  
4,480,512, PUB. 11-26-2013. INT. CL. 41.
- CLASSIC BRANDS, LLC, DENVER, CO:  
4,481,958, INT. CL. 4.
- CLC RESORT DEVELOPMENTS LIMITED, DOUGLAS, ISLE OF MAN:  
4,481,371, MULTIPLE CLASS, INT. CLS. 35, 36, 39, 41 AND 43.
- CLEAN SWEEP OF A A CO., INC., MILLERSVILLE, MD:  
4,480,056, PUB. 11-26-2013. MULTIPLE CLASS, INT. CLS. 37 AND 42.
- CLEAN WRAP CO., LTD., GYEONGSANGNAM-DO, REPUBLIC OF KOREA:  
4,481,612, INT. CL. 20.
- CLEAR SMOKE, INC., DALLAS, TX:  
4,482,462, INT. CL. 34.
- CLEARON CORP., SOUTH CHARLESTON, WV:  
2,800,941, REN. 1-8-14. INT. CL. 1.
- CLEARWATER PAPER CORPORATION, SPOKANE, WA:  
767,589, REN. 1-7-14. U.S. CL. 37 (INT. CL. 16).
- CLEAVER-BROOKS, INC., THOMASVILLE, TX:  
987,858, REN. 1-9-14. U.S. CL. 34 (INT. CL. 11).
- CLIF BAR & COMPANY, EMERYVILLE, CA:  
3,246,159, CANC. INT. CL. 29.
- CLIFTONLARSONALLEN, LLP, MINNEAPOLIS, MN:  
4,482,125, MULTIPLE CLASS, INT. CLS. 9, 36 AND 42.
- CLIMAX TECHNOLOGY CO., LTD., TAIPEI CITY, TAIWAN:  
4,482,233, INT. CL. 9.
- CLINIC WITH A HEART, INC., LINCOLN, NE:  
3,247,166, CANC. INT. CL. 44.
- CLINICAL CARE TARGETED COMMUNICATIONS GROUP, LLC, PLAINSBORO, NJ:  
2,822,539, REN. 1-7-14. MULTIPLE CLASS, INT. CLS. 16 AND 35.
- CLIPLESS LLC, MORGANVILLE, NJ:  
4,481,067, PUB. 11-26-2013. INT. CL. 9.
- CLIQR TECHNOLOGIES, INC., SUNNYVALE, CA:  
4,481,860, INT. CL. 42.
- CLOUDNCO, INC., SAN FRANCISCO, CA:  
4,481,671, INT. CL. 42.
- CLOUDPREMISE LLC, PARKER, CO:  
4,480,067, PUB. 11-26-2013. INT. CL. 42.
- CLUB HOLDINGS, LLC, BROOMFIELD, CO:  
2,849,080, REN. 1-7-14. MULTIPLE CLASS, INT. CLS. 36, 41 AND 45.
- CMC ACQUISITIONS CORPORATION, ST. PETERSBURG, FL, DBA CAPITOL MARKETING CONCEPTS, INC.:  
4,480,711, PUB. 11-26-2013. INT. CL. 35.
- CME LLC, IRVINE, CA:  
3,248,709, CANC. INT. CL. 35.
- CMFG LIFE INSURANCE COMPANY, MADISON, WI:  
4,482,252, INT. CL. 36.
- CNG TRANS LTD., COLUMBUS, OH:  
4,481,525, MULTIPLE CLASS, INT. CLS. 6, 7 AND 37.
- COASTAL TIMBERS, INC., NEW IBERIA, LA:  
1,817,940, REN. 1-4-14. INT. CL. 19.  
1,840,560, REN. 1-4-14. INT. CL. 19.
- COATES, DONOVON, CALGARY, ALBERTA, CANADA:  
4,479,601, PUB. 10-15-2013. MULTIPLE CLASS, INT. CLS. 18, 21, 25 AND 35.  
4,479,602, PUB. 10-15-2013. MULTIPLE CLASS, INT. CLS. 18, 21, 25 AND 35.
- COBB CINEBISTRO, LLC, BIRMINGHAM, AL:  
4,481,824, MULTIPLE CLASS, INT. CLS. 41 AND 43.
- COBB INTERNATIONAL LIMITED, BROOKLYN, PRETORIA 0181, SOUTH AFRICA:  
2,719,958, CANC. INT. CL. 11.
- COCA-COLA COMPANY, THE, ATLANTA, GA:  
4,481,255, PUB. 11-26-2013. INT. CL. 41.
- COGNATE3 LLC, KIRKLAND, WA, DBA COGNATE3 LLC:  
4,481,298, INT. CL. 40.
- COHEN ASSET MANAGEMENT, INC., BEVERLY HILLS, CA:  
4,482,341, INT. CL. 36.  
4,482,342, INT. CL. 36.  
4,482,343, INT. CL. 36.  
4,482,344, INT. CL. 36.  
4,482,345, INT. CL. 36.
- COHEN FASHION OPTICAL, LLC, BOWLING GREEN, KY:  
2,719,544, CANC. MULTIPLE CLASS, INT. CLS. 5 AND 9.
- COHEN, WENDY, NEW YORK, NY:  
2,719,552, CANC. INT. CL. 20.
- COIN ARMOUR, LLC, MONROE TOWNSHIP, NJ:  
4,481,881, INT. CL. 16.
- COLA, ALAIN, EL CAJON, CA, DBA DELL'ARTE GUITARS & GYPSY JAZZ DISTRIBUTION:  
4,480,264, PUB. 11-26-2013. INT. CL. 15.
- COLE'S WILD BIRD PRODUCTS CO., KENNESAW, GA:  
4,481,048, PUB. 11-26-2013. INT. CL. 31.  
4,481,050, PUB. 11-26-2013. INT. CL. 31.
- COLGATE-PALMOLIVE COMPANY, NEW YORK, NY:  
3,248,210, CANC. INT. CL. 3.
- COLLEGEKIDSPASSITON, LLC, STUART, FL:  
4,482,616, INT. CL. 35.
- COLOPLAST A/S, COPENHAGEN, DENMARK:  
3,248,252, CANC. INT. CL. 10.
- COLORADO ROCKIES BASEBALL CLUB, LTD., DENVER, CO:  
1,812,620, REN. 1-6-14. MULTIPLE CLASS, INT. CLS. 6 AND 41.  
4,481,703, INT. CL. 25.

COLORBOK, LLC, ANN ARBOR, MI:  
2,718,763, CANC. INT. CL. 35.  
3,247,065, CANC. INT. CL. 18.

COLPAR HOBBIES INC., LAKEWOOD, CO:  
2,719,015, CANC. INT. CL. 35.

COLUMBIA INSURANCE COMPANY, OMAHA, NE, PHYLIS SHOE COMPANY, INC., LOWELL, MA:  
762,800, REN. 1-7-14, U.S. CL. 39 (INT. CL. 25).

COLUMBIA INSURANCE COMPANY, OMAHA, NE:  
4,482,759, INT. CL. 14.

COLUMBIA PACIFIC ADVISORS, LLC, SEATTLE, WA:  
4,481,110, PUB. 11-26-2013, INT. CL. 36.

COLUMBIA PACIFIC HEALTHCARE MANAGEMENT SDN. BHD., SHAH ALAM, SELANGOR DE, MALAYSIA:  
4,480,564, PUB. 11-26-2013, INT. CL. 44.

COLUMBIA PICTURES INDUSTRIES, INC., CULVER CITY, CA, COLUMBIA PICTURES INDUSTRIES, INC., NEW YORK, NY:  
976,848, REN. 1-6-14, U.S. CL. 38 (INT. CL. 9).

COMBI CORPORATION, TAITO-KU, TOKYO, JAPAN:  
3,310,241, CANC. INT. CL. 9.

COMBINATION PRODUCT PARTNERS, INC., SOMIS, CA:  
4,482,742, INT. CL. 35.

COMBINE360, LLC, CLEVELAND, OH:  
4,480,558, PUB. 11-26-2013, INT. CL. 41.

COMELIAU FRANÇOIS, B-5370 HAVELANGE, BELGIUM:  
4,479,457, PUB. 11-26-2013, INT. CL. 30.

COMERCIALIZADORA ELORO, S.A., ESTADO DE MEXICO, MEXICO:  
2,718,757, CANC. INT. CL. 32.

COMMANDITAIRE VENNOOTSCHAP HOEFIJZERFABRIEK WERKMAN & CO., NL-9721 BT GRONINGEN, NETHERLANDS:  
3,356,507.

COMMEMORATIVE AIR FORCE, MIDLAND, TX:  
1,810,727, REN. 1-8-14, INT. CL. 16.

COMMERCE TITLE AND CLOSING SERVICES, LLC, IRVINE, CA:  
2,718,875, CANC. INT. CL. 42.  
2,718,876, CANC. INT. CL. 36.  
2,718,877, CANC. MULTIPLE CLASS, INT. CLS. 36 AND 42.

COMMERCIAL DATA SYSTEMS, INC., HONOLULU, HI:  
3,245,859, CANC. INT. CL. 37.

COMMONWEALTH BRANDS, INC., BOWLING GREEN, KY:  
4,479,624, PUB. 11-26-2013, INT. CL. 34.

COMMUNITY BANKS, INC., HARRISBURG, PA:  
3,247,355, CANC. INT. CL. 36.

COMMUNITY HEALTH CHARITIES, ARLINGTON, VA, AKA CHC:  
4,479,653, PUB. 11-26-2013, INT. CL. 35.

COMPAGNIE DES MONTRES LONGINES, FRANCILLON S.A. (LONGINES WATCH CO., FRANCILLON LTD.), SWITZERLAND:  
4,481,356, INT. CL. 9.

COMPAGNIE GENERALE DE DIETETIQUE, CAEN, FRANCE:  
1,831,850, REN. 1-4-14, INT. CL. 5.

COMPEAT, INC., AUSTIN, TX:  
4,481,262, PUB. 11-26-2013, INT. CL. 42.

COMPETITIVE DRUG DEVELOPMENT LLC, JERSEY CITY, NJ:  
3,248,065, CANC. INT. CL. 35.

COMPLETE FLOORING SUPPLY CORPORATION, SUWANEE, GA:  
3,248,730, CANC. INT. CL. 19.

COMPLEWARE CORPORATION, IOWA CITY, IA:  
2,684,132, CANC. INT. CL. 42.

COMPLEXIONS, INC., ALBANY, NY:  
4,480,386, PUB. 11-26-2013, INT. CL. 44.

COMPLIANCE SOFTWARE, INC., SALT LAKE CITY, UT:  
4,479,806, PUB. 6-4-2013, INT. CL. 42.

COMPUCLEVER SYSTEMS INC., VICTORIA, BC, CANADA:  
4,481,123, PUB. 11-26-2013, INT. CL. 9.

CONAGRA FOODS FOOD INGREDIENTS COMPANY, INC., OMAHA, NE:  
3,245,747, CANC. MULTIPLE CLASS, INT. CLS. 29, 30 AND 31.

CONAGRA FOODS RDM, INC., OMAHA, NE:  
2,797,292, REN. 1-3-14, INT. CL. 29.  
3,246,023, CANC. INT. CL. 30.  
3,246,024, CANC. INT. CL. 30.  
3,247,997, CANC. INT. CL. 29.

CONAIR CORPORATION, STAMFORD, CT:  
4,480,030, PUB. 11-26-2013, INT. CL. 21.

CONCEPT THREE, L.L.C., NEW YORK, NY:  
2,734,012, REN. 1-3-14, INT. CL. 25.

CONCEPTO PRODUCTIONS LLC, AUSTIN, TX:  
4,480,490, PUB. 11-26-2013, INT. CL. 41.

CONCORDIA LUTHERAN CHURCH, SAN ANTONIO, TX:  
3,246,235, CANC. INT. CL. 9.

CONDITOREI COPPENRATH & WIESE GMBH & CO. KG, OSNABRÜCK, FED REP GERMANY:  
3,246,416, CANC. INT. CL. 30.  
3,246,418, CANC. INT. CL. 30.

CONFIRMIT AS, OSLO 0377, NORWAY:  
2,718,734, CANC. MULTIPLE CLASS, INT. CLS. 9, 35 AND 42.

CONG TY CO PHAN DICH VU.; DU LICH, THUONG MAI VA THOI; TRANG YALY; (YALY FASHION, TRADE, TOURISM.; SERVICE JOIN STOCK COMPANY), VIETNAM:  
4,479,341, PUB. 8-20-2013, MULTIPLE CLASS, INT. CLS. 25, 26 AND 35.

CONIX SYSTEMS, INC., MANCHESTER CENTER, VT:  
3,246,605, CANC. INT. CL. 9.

CONNAUGHT TECHNOLOGY CORPORATION, GREENVILLE, DE:  
3,248,510, CANC. INT. CL. 9.

CONNECTICUT BEER WHOLESALERS ASSOCIATION, INC., MYSTIC, CT:  
4,482,821, INT. CL. 41.

CONNECTICUT COMMUNITY BANK, N.A., FARMINGTON, CT:  
2,798,154, REN. 1-7-14, INT. CL. 36.

CONNECTICUT SCIENCE CENTER, INC., HARTFORD, CT:  
4,481,202, PUB. 11-26-2013, INT. CL. 41.

CONNECTICUT STUDENT LOAN FOUNDATION, ROCKY HILL, CT:  
2,719,649, CANC. INT. CL. 36.

CONNECTOR PRODUCTS, INC., CINNAMINSON, NJ:  
3,248,476, CANC. INT. CL. 9.  
3,248,478, CANC. INT. CL. 9.  
3,248,502, CANC. INT. CL. 9.

CONNELLY GPM, INC., CHICAGO, IL:  
3,246,328, CANC. INT. CL. 6.

CONNOLLY BOVE LODGE & HUTZ LLP, WILMINGTON, DE:  
3,248,679, CANC. INT. CL. 41.

CONSOLIDATED FREIGHTWAYS CORPORATION, VANCOUVER, WA:  
716,270, CANC. U.S. CL. 105.

CONSOLIDATED SEAFOODS, INCORPORATED, SAN ANTONIO, TX:  
1,816,484, REN. 1-7-14, INT. CL. 42.

CONSOVA CORPORATION, LAKEWOOD, CO:  
4,480,502, PUB. 11-26-2013, MULTIPLE CLASS, INT. CLS. 35 AND 36.  
4,480,950, PUB. 11-26-2013, MULTIPLE CLASS, INT. CLS. 35 AND 36.

CONSTANT COMPLIANCE INC, CHICAGO, IL:  
3,246,157, CANC. INT. CL. 11.

CONSTANT CONTACT, INC., WALTHAM, MA:  
4,480,091, PUB. 11-26-2013, INT. CL. 42.

CONSTRUCTION CRAFT ACADEMY, INC., MACEDONIA, OH:  
3,246,490, CANC. INT. CL. 41.

CONTINENTAL AUTOMOTIVE GMBH, HANNOVER, FED REP GERMANY:  
4,480,092, PUB. 11-26-2013, INT. CL. 9.

CONTINENTAL BUYING GROUP, INC., BAY HARBOR ISLANDS, FL:  
4,482,205, INT. CL. 35.

CONTINENTAL EXPRESS INC., SIDNEY, OH:  
4,480,336, PUB. 11-26-2013, MULTIPLE CLASS, INT. CLS.

- 35 AND 39.  
CONTINENTAL GRAPHICS CORPORATION, CYPRESS, CA, DBA CONTINENTAL DATAGRAPHICS: 2,801,853. REN. 1-8-14. MULTIPLE CLASS, INT. CLS. 9, 35, 40, 41 AND 42.
- CONTINENTAL NEW LIFE INTERNATIONAL, AZUSA, CA: 3,246,945. CANC. INT. CL. 44.
- CONTINENTAL REIFEN DEUTSCHLAND GMBH, HANNOVER, FED REP GERMANY: 3,248,336. CANC. INT. CL. 12.
- CONTINENTAL SPORTS SUPPLY, INC., ENGLEWOOD, CO: 4,482,839. MULTIPLE CLASS, INT. CLS. 18, 25 AND 28.
- CONTINUAL EDGE LLC, EDGEWATER, NJ: 4,480,988. PUB. 11-26-2013. INT. CL. 37.
- CONTRACT CONVERTING, LLC, GREENVILLE, WI: 2,868,780. REN. 1-3-14. INT. CL. 40.
- CONTROLS CORPORATION OF AMERICA, VIRGINIA BEACH, VA: 1,836,692. REN. 1-7-14. INT. CL. 11.
- CONVAQUIP INDUSTRIES, INC., ABILENE, TX: 2,719,416. CANC. MULTIPLE CLASS, INT. CLS. 10 AND 12.
- CONVICT BRANDS, LLC, GENOA, OH: 4,482,539. INT. CL. 33.
- COOGI PARTNERS, LLC, LAKE SUCCESS, NY: 4,481,466. INT. CL. 25.
- COOK AND CLUTTER LLC, PORTLAND, OR: 4,482,579. INT. CL. 35.
- COOLTOUCH, INCORPORATED, ROSEVILLE, CA: 2,912,047. REN. 1-6-14. INT. CL. 10.
- COONEY, PETER J, SOUTHAMPTON, UNITED KINGDOM, TA JAYCO (UK) LTD: 4,480,479. PUB. 11-26-2013. INT. CL. 21.
- COOPER, KRISTINE, SACRAMENTO, CA: 3,247,179. CANC. INT. CL. 43.
- COOPER, TREMAIN ODELL, CHARLOTTE, NC: 4,481,713. INT. CL. 44.
- COOPERATIVE REGIONS OF ORGANIC PRODUCER POOLS, LA FARGE, WI: 4,479,955. PUB. 11-26-2013. INT. CL. 29.
- COPAN DIAGNOSTICS, INC., MURRIETA, CA: 4,479,724. PUB. 11-26-2013. MULTIPLE CLASS, INT. CLS. 9 AND 10.
- COPERION WAESCHLE GMBH & CO. KG, WEINGARTEN, FED REP GERMANY: 1,239,946. CANC. MULTIPLE CLASS, INT. CLS. 6, 7, 9, 11, 17, 19, 20 AND 21.
- COPPEDGE, CHRISTOPHER ALLEN, DENVER, CO: 4,481,639. INT. CL. 44.
- COPPER DEVELOPMENT ASSOCIATION, NEW YORK, NY: 4,481,403. U.S. CL. A.
- CORBIN, MCKENNY, AIEA, HI: 4,481,469. INT. CL. 25.
- CORDELL BAUER, INC., SAN CLEMENTE, CA: 2,720,141. CANC. INT. CL. 12.
- CORE24, LLC, DALLAS, TX: 4,480,307. PUB. 11-26-2013. INT. CL. 35.
- CORINTHIAN MARKETING PLC, BUCKINGHAMSHIRE HP12 4HX, UNITED KINGDOM: 3,247,982. CANC. MULTIPLE CLASS, INT. CLS. 28 AND 30.
- CORNERSTONE AUTOMATION SYSTEMS, LLC, FRISCO, TX: 4,481,119. PUB. 11-26-2013. INT. CL. 7.
- CORPORATE ONE INC., GALENA, OH: 4,480,907. PUB. 11-26-2013. INT. CL. 35.
- CORPORATIVO INTERNACIONAL MEXICANO, S. DE R.L. DE C.V., MEXICO CITY, MEXICO: 3,248,021. CANC. INT. CL. 30.
- CORWAVE, FRANCE: 4,479,292. PUB. 11-26-2013. MULTIPLE CLASS, INT. CLS. 10, 42 AND 44.
- COSENTIAL, INC., AUSTIN, TX, DBA COSENTIAL: 4,449,669. COR. INT. CL. 42.
- COSMEDICAL TECHNOLOGIES, INC., DAVIE, FL: 4,479,572. PUB. 5-8-2012. INT. CL. 3.
- COSMETIC WARRIORS LIMITED, POOLE, DORSET BH15 1AB, UNITED KINGDOM: 2,853,483. REN. 1-3-14. INT. CL. 35.
- COSMIC COFFEE COMPANY LLC, SANTA CLARA, CA: 4,481,073. PUB. 11-26-2013. INT. CL. 30.
- COSMOLINK CO. LTD., CHUNGCHONGBUK-DO, REPUBLIC OF KOREA: 2,911,267. REN. 1-8-14. INT. CL. 9.
- COSTAIN, LEIGH, RICHMOND, CA: 4,480,267. PUB. 10-22-2013. INT. CL. 41.
- COTY US LLC, NEW YORK, NY: 4,482,551. INT. CL. 3.
- COUNCIL FOR ECONOMIC EDUCATION, NEW YORK, NY: 2,719,994. CANC. INT. CL. 41.
- COUNCIL FOR RESPONSIBLE JEWELLERY PRACTICES, LONDON, UNITED KINGDOM: 3,246,228. CANC. INT. CL. 14.
- COUNTRY MUSIC TELEVISION, INC., NEW YORK, NY: 4,482,420. INT. CL. 41.
- COURTSENSE, L.L.C., CRESSKILL, NJ: 3,246,843. CANC. INT. CL. 41.
- COVERALL CREW CORPORATION, VANCOUVER, B.C., CANADA: 4,480,003. PUB. 11-26-2013. MULTIPLE CLASS, INT. CLS. 9, 35 AND 41.
- COX DIGITAL EXCHANGE LLC, ATLANTA, GA: 4,481,814. MULTIPLE CLASS, INT. CLS. 9 AND 35.
- CPC CONSTRUCTION LLC, TEMPE, AZ: 4,480,962. PUB. 11-26-2013. INT. CL. 37.
- CRAB COOKER, THE, NEWPORT BEACH, CA: 1,272,234. REN. 1-9-14. INT. CL. 42.
- CRABTREE & EVELYN, LTD., WOODSTOCK, CT: 4,482,182. MULTIPLE CLASS, INT. CLS. 3 AND 4.
- CRADLE GEAR INC., BRUNSWICK HILLS, OH: 4,480,810. PUB. 11-26-2013. INT. CL. 25.
- CRAFT AND STORY LLC, GLENN HEIGHTS, TX: 4,480,946. PUB. 11-26-2013. INT. CL. 42.
- CRAIG A. ROSSI, LAKEWOOD, OH: 4,482,149. INT. CL. 34.
- CRAIG, KATHY R., MT. PLEASANT, PA: 3,245,888. CANC. INT. CL. 14.
- CRAIN ENTERPRISES, INC., MOUND CITY, IL: 3,247,291. CANC. INT. CL. 9.
- CRANLEY, WILLIAM, PLAINFIELD, IL AND GALLAGHER, JOHN, PLAINFIELD, IL: 4,481,032. PUB. 11-26-2013. INT. CL. 25.
- CRAWDAD TECHNOLOGIES, LLC, CHANDLER, AZ: 3,248,176. CANC. INT. CL. 9.
- CRAWFORD WOUNDCARE LIMITED, CHESHIRE, UNITED KINGDOM: 2,719,428. CANC. MULTIPLE CLASS, INT. CLS. 5 AND 10.
- CREATIONIQUE LTD, LONDON, UNITED KINGDOM: 4,480,619. PUB. 11-26-2013. INT. CL. 21.
- CREATIVE GRIDS USA, INC., MAUMEE, OH: 2,796,615. REN. 1-6-14. MULTIPLE CLASS, INT. CLS. 9 AND 16.
- CREATIVE INTERNATIONAL HOLIDINGS CORP., MOUNT ARLINGTON, NJ: 3,246,572. CANC. INT. CL. 16.
- CREATIVE MEDICAL HEALTH INC., PHOENIX, AZ: 4,482,872. INT. CL. 5.
- CREATIVE STRATEGIES, INC., CAMPBELL, CA: 2,718,810. CANC. INT. CL. 35.
- CREATIVE TECHNOLOGY LTD., SINGAPORE, SINGAPORE: 2,802,485. REN. 1-6-14. INT. CL. 9.
- CREATIVELY FIT, LLC, CLARENCE CENTER, NY: 4,482,112. INT. CL. 16.
- CREDIT SUISSE LIFE & PENSIONS (BERMUDA) LTD., LUXEMBOURG, LUXEMBOURG: 2,849,745. CANC. INT. CL. 7.
- CREDIT.COM, INC., SAN FRANCISCO, CA: 3,246,516. CANC. INT. CL. 36.
- CREPE CONE, LLC, ATLANTA, GA: 4,482,741. INT. CL. 43.

CRESS, JONATHAN, SANTA CRUZ, CA:  
 4,481,784, INT. CL. 10.  
 CRESTON ELECTRIC INSTRUMENTS, LLC, BURLINGTON, VT:  
 4,481,074, PUB. 11-26-2013. INT. CL. 15.  
 CREVOSHAY, PAULA, ALBUQUERQUE, NM:  
 4,480,540, PUB. 11-26-2013. INT. CL. 14.  
 CRIDER, LAKITA, GLENARDEN, MD:  
 4,479,544, PUB. 7-24-2012. MULTIPLE CLASS, INT. CLS.  
 16 AND 41.  
 CRISIS MANAGEMENT CONSULTING, LLC, LA JOLLAA, CA:  
 4,482,253, MULTIPLE CLASS, INT. CLS. 35 AND 42.  
 CRISTA MINISTRIES, SEATTLE, WA:  
 1,262,385, REN. 1-3-14. INT. CL. 16.  
 CRODA INTERNATIONAL PLC, GOOLE, EAST YORKSHIRE, UNITED KINGDOM:  
 2,797,006, REN. 1-7-14. INT. CL. 1.  
 CROOKED STAVE, LLC, DENVER, CO:  
 4,479,954, PUB. 11-26-2013. MULTIPLE CLASS, INT. CLS.  
 25 AND 32.  
 CROUSE, SHAWN, ROYAL OAK, MI:  
 2,719,593, CANC. INT. CL. 9.  
 CROWN IMPORTS LLC, CHICAGO, IL:  
 2,719,330, CANC. INT. CL. 32.  
 CROWNTYRE INDUSTRIAL CO., LTD., QINGDAO, CHINA:  
 4,480,253, PUB. 10-1-2013. INT. CL. 12.  
 CRUCCELL BIOTECHNOLOGY INC., SAN GABRIEL, CA:  
 4,482,440, INT. CL. 5.  
 CRUM CREEK MILLS, INC., BROOMALL, PA, DBA CRUM CREEK MILLS:  
 4,479,902, PUB. 11-26-2013. INT. CL. 44.  
 CRYSTAL CLEAR CREATIONS, INC., WEST CREEK, NJ:  
 3,247,976, CANC. INT. CL. 25.  
 CRYSTAL PARTNERS, INC., CAROL STREAM, IL:  
 3,245,941, CANC. INT. CL. 9.  
 3,245,942, CANC. INT. CL. 9.  
 CRYSTAL, MICHAEL, WILTON, CT:  
 4,482,819, INT. CL. 41.  
 CS DISTRIBUTION AND SERVICES, LLC, RALEIGH, NC:  
 4,480,894, PUB. 11-26-2013. INT. CL. 41.  
 4,481,297, PUB. 11-26-2013. INT. CL. 41.  
 CSEPERKALO ZOLTAN, TÖKÖL, HUNGARY, DBA MOTORCYCLE BATTERIE DEALER:  
 4,226,038, AM. INT. CL. 9.  
 CST ENTERPRISES, LLC, NEW YORK, NY:  
 1,263,564, REN. 1-9-14. INT. CL. 14.  
 CTA PRODUCTS GROUP, SOUTHAVEN, MS, DBA CTA PRODUCTS GROUP:  
 4,479,532, PUB. 11-26-2013. INT. CL. 5.  
 CTAEXPO, LLC, CLEVERDALE, NY:  
 4,482,811, INT. CL. 41.  
 CUGINI, CHRISTY, JR., MD, NAPLES, FL:  
 4,480,931, PUB. 11-26-2013. INT. CL. 9.  
 CUMMINGS RESOURCES LLC, NASHVILLE, TN, DBA CUMMINGS SIGNS:  
 4,481,800, MULTIPLE CLASS, INT. CLS. 37 AND 40.  
 CUNNINGHAM JR., WILLIE C, RADCLIFF, KY:  
 4,480,266, PUB. 11-26-2013. INT. CL. 25.  
 CUNNINGHAM REALTY LTD., HAWTHORNE, NY:  
 3,248,361, CANC. INT. CL. 36.  
 CUNNINGHAM, SR., JIMMY B., SMITHVILLE, TN:  
 4,480,261, PUB. 11-26-2013. INT. CL. 20.  
 CUREEO, LLC, CHICAGO, IL:  
 4,479,783, PUB. 11-26-2013. INT. CL. 35.  
 CURIOUS CORK IMPORTS, LLC, DENVER, CO:  
 4,482,239, INT. CL. 33.  
 4,482,240, INT. CL. 33.  
 4,482,241, INT. CL. 33.  
 4,482,242, INT. CL. 33.  
 4,482,244, INT. CL. 33.  
 CURRIE ACQUISITIONS, LLC, CHATSWORTH, CA:  
 3,367,489, AM. INT. CL. 35.  
 CUSTOM BUILDING PRODUCTS, INC., SEAL BEACH, CA:  
 4,481,704, INT. CL. 19.  
 CUSTOM MORTGAGE SERVICES, INC., ALPHARETTA, GA:  
 3,248,155, CANC. INT. CL. 36.  
 CUSTOMER EXPERIENCE PARTNERS, LLC, DARIEN, CT:  
 4,481,705, INT. CL. 42.  
 4,481,776, INT. CL. 35.  
 CUSTOMERNATION INC., LOS GATOS, CA:  
 3,246,932, CANC. INT. CL. 42.  
 CUSTOPHARM, INC., CARLSBAD, CA:  
 4,480,347, PUB. 11-26-2013. MULTIPLE CLASS, INT. CLS.  
 35, 42 AND 45.  
 CUTIMED, INC., BOUCHERVILLE, QUEBEC, CANADA:  
 4,479,590, PUB. 4-30-2013. INT. CL. 3.  
 4,479,591, PUB. 10-16-2012. INT. CL. 3.  
 CUTTING EDGE FORMULATIONS, INC., BUFORD, GA:  
 4,479,863, PUB. 11-26-2013. MULTIPLE CLASS, INT. CLS.  
 1 AND 5.  
 CVS PHARMACY, INC., WOONSOCKET, RI:  
 4,482,490, MULTIPLE CLASS, INT. CLS. 30 AND 32.  
 4,482,492, MULTIPLE CLASS, INT. CLS. 30 AND 32.  
 4,482,586, INT. CL. 35.  
 CW CONSULTING, INC., RENO, NV:  
 4,481,650, INT. CL. 25.  
 CWK FOUNDATION, SANTA ROSA, CA:  
 4,481,761, INT. CL. 12.  
 CWPR LLC, PHOENIXVILLE, PA:  
 4,481,894, INT. CL. 9.  
 CYBERSHEATH SERVICES INTERNATIONAL, LLC, GREAT FALLS, VA, DBA CYBERSHEATH SERVICES INTERNATIONAL, LLC.:  
 4,482,390, MULTIPLE CLASS, INT. CLS. 41, 42 AND 45.  
 CYBOZU, INC., JAPAN:  
 4,479,514, PUB. 11-26-2013. MULTIPLE CLASS, INT. CLS.  
 9 AND 42.  
 CYCLE PRO LLC, MOORESVILLE, NC:  
 4,480,297, PUB. 10-22-2013. INT. CL. 12.  
 CYCLISMAS, LLC, WORCESTER, MA:  
 4,480,337, PUB. 11-26-2013. INT. CL. 41.  
 CYPANY, TIGARD, OR:  
 3,247,576, CANC. INT. CL. 30.  
 CYNTHIA HALLEY, POMPANNO BEACH, FL:  
 4,480,808, PUB. 11-26-2013. INT. CL. 20.  
 C4CAST.COM, INC., PASADENA, CA:  
 2,800,598, REN. 1-8-14. INT. CL. 35.  
 D.W. SPINKS (EMBOSSING) LTD., LONDON, UNITED KINGDOM:  
 4,479,589, PUB. 7-16-2013. INT. CL. 16.  
 D' ELEGANTE, INC., CINCINNATI, OH:  
 4,480,900, PUB. 11-26-2013. MULTIPLE CLASS, INT. CLS.  
 14, 35, 36 AND 37.  
 D'ACQUISTO, ANDRAE T., CUDAHY, WI:  
 2,733,871, REN. 1-9-14. MULTIPLE CLASS, INT. CLS. 25  
 AND 28.  
 DA VINCI'S GARAGE, LLC, SEATTLE, WA:  
 4,482,333, MULTIPLE CLASS, INT. CLS. 9 AND 42.  
 DAGUA INC., QUEBEC, CANADA:  
 3,245,718, CANC. INT. CL. 11.  
 DAHLIA WEINMAN, ANN ARBOR, MI:  
 4,482,419, INT. CL. 30.  
 DAI-ICHI KOGYO SEIYAKU CO., LTD., KYOTO, JAPAN:  
 4,389,093, COR. INT. CL. 1.  
 DAIMLER AG, STUTTGART, FED REP GERMANY:  
 2,801,661, REN. 1-8-14. MULTIPLE CLASS, INT. CLS. 9  
 AND 12.  
 3,246,402, CANC. MULTIPLE CLASS, INT. CLS. 9, 41  
 AND 42.  
 3,246,582, CANC. MULTIPLE CLASS, INT. CLS. 9, 12, 37  
 AND 42.  
 3,246,697, CANC. MULTIPLE CLASS, INT. CLS. 7 AND  
 12.  
 3,246,783, CANC. INT. CL. 12.  
 DAINIPPON SUMITOMO PHARMA CO., LTD., OSAKA-SHI, OSAKA, JAPAN:  
 3,245,717, CANC. INT. CL. 5.  
 DALLAS LIGHTHOUSE FOR THE BLIND, DALLAS, TX:  
 4,481,508, INT. CL. 9.

- DALROCO INTERNATIONAL, INC., FLEURIMONT, CANADA:  
3,246,569, CANC. INT. CL. 7.
- DALTON-RUHLMAN VENTURE, LLC, CLEVELAND HTS., OH:  
4,482,691, MULTIPLE CLASS, INT. CLS. 8 AND 21.
- DAMA TALYA, LLC, METAIRIE, LA:  
4,482,189, INT. CL. 25.
- DANA BRUNNER, LLC, SACHSE, TX, DBA NOTTA-SOCK:  
2,808,220, REN. 1-9-14, INT. CL. 10.
- DANA LIMITED, MAUMEE, OH:  
4,481,497, MULTIPLE CLASS, INT. CLS. 6, 7, 12 AND 17.
- DANCERS WAREHOUSE INC., SMITHFIELD, RI:  
4,480,087, PUB. 11-26-2013, INT. CL. 35.
- DANG SHADES, SOUTHWICK, MA:  
4,479,683, PUB. 11-26-2013, INT. CL. 9.
- DANIEL DEFENSE, BLACK CREEK, GA:  
4,481,129, PUB. 11-26-2013, INT. CL. 13.
- DANIEL ENTERPRISES, INC., PARKVILLE, MO, DBA WINES BY JENNIFER:  
4,480,209, PUB. 11-26-2013, INT. CL. 35.
- DANIEL S. BRANDWEIN, D.P.M. AND SEAN L. KAUFMAN, D.P.M., KENILWORTH, NJ:  
4,482,729, INT. CL. 44.
- DANISCO A/S, DK-1001 COPENHAGEN K, DENMARK:  
4,479,271, PUB. 11-26-2013, MULTIPLE CLASS, INT. CLS. 1 AND 31.
- DANSTAR FERMENT AG, ZUG, SWITZERLAND:  
3,247,749.
- DANZIGER - "DAN" FLOWER FARM, MOSHAV MISHMAR HASHIVA, ISRAEL:  
3,246,584, CANC. INT. CL. 31.
- DANZIGER "DAN" FLOWER FARM, BEIT DAGAN, ISRAEL:  
4,479,617, PUB. 4-16-2013, INT. CL. 31.
- DARDEN, SHANI, LOS ANGELES, CA AND FERRARI, ANTHONY, LOS ANGELES, CA:  
4,480,260, PUB. 11-26-2013, INT. CL. 3.
- DARKGLASS ELECTRONICS, HELSINKI, FINLAND:  
4,481,080, PUB. 11-26-2013, INT. CL. 15.
- DARWISH, SEAN, SAN ANTONIO, TX:  
3,741,685, CANC. INT. CL. 35.
- DASHAMERICA, INC., LOUISVILLE, CO:  
4,481,831, INT. CL. 25.
- DASHFIRE LLC, SAINT PAUL, MN:  
4,480,141, PUB. 11-26-2013, INT. CL. 33.
- DATA DRIVE THRU, INC., DALLAS, TX:  
3,246,309, CANC. INT. CL. 9.
- DATA INNOVATION PARTNERS LLC, BRICE, OH:  
4,480,757, PUB. 11-26-2013, INT. CL. 42.
- DATACERT, INC., HOUSTON, TX:  
3,246,205, CANC. MULTIPLE CLASS, INT. CLS. 35 AND 42.
- DATACOLOR HOLDING AG, LUZERN, SWITZERLAND:  
3,246,192, CANC. INT. CL. 9.
- DATAGUARD USA, LLC, LAKEWOOD, CO:  
2,912,447, REN. 1-9-14, INT. CL. 40.
- DATALOGIC AUTOMATION, INC., TELFORD, PA:  
1,813,469, REN. 1-9-14, INT. CL. 9.
- DAVID C COOK, COLORADO SPRINGS, CO:  
2,718,711, CANC. INT. CL. 16.
- DAVID HSU DESIGN, LLC, WASECA, MN:  
4,480,871, PUB. 11-26-2013, MULTIPLE CLASS, INT. CLS. 20 AND 42.
- DAVID J. CHO, PLANO, TX:  
4,481,732, INT. CL. 25.
- DAVID LESLIE EMANUEL, BERKSHIRE, UNITED KINGDOM:  
4,479,568, PUB. 6-4-2013, MULTIPLE CLASS, INT. CLS. 3, 9, 14, 16, 18, 21, 24, 25, 38 AND 41.
- DAVID M. INTROCASO, WASHINGTON, DC:  
4,482,131, INT. CL. 41.
- DAVIDE MARTELLI, I-20121 MILANO, ITALY:  
3,247,672.
- DAVILA, EDWARD, GARDENA, CA:  
4,481,932, INT. CL. 25.
- DAVIS INTELLECTUAL ASSETS, SAVANNAH, GA:  
4,482,247, INT. CL. 19.
- DAVIZTA INC., BRIDGEWATER, NJ:  
4,482,092, INT. CL. 9.
- DAWN FOODS, INC., JACKSON, MI, DAWN FOOD PRODUCTS, INC., JACKSON, MI:  
1,807,809, REN. 1-3-14, INT. CL. 30.
- DAYSRING CARDS, INC., SILOAM SPRINGS, AR:  
3,247,513, CANC. INT. CL. 9.
- DAZZLE UP, LLC, GREENSBORO, NC:  
4,482,501, INT. CL. 25.
- DB ELECTRICAL, INC., KINGSPORT, TN:  
4,482,248, MULTIPLE CLASS, INT. CLS. 7 AND 9.
- DBAMART, LOUISVILLE, CO:  
4,481,047, PUB. 11-26-2013, INT. CL. 42.
- DBEST PRODUCTS INC, CARSON, CA:  
2,797,558, REN. 1-6-14, INT. CL. 21.
- DE SOTO, CARMEN E., 14000 MEXICO, D.F., MEXICO:  
2,720,174, CANC. INT. CL. 42.
- DEALER TIRE, LLC, CLEVELAND, OH:  
4,482,690, MULTIPLE CLASS, INT. CLS. 35, 36 AND 37.
- DEAN LYKOS, LLC, MELVILLE, NY:  
4,481,019, PUB. 11-26-2013, INT. CL. 35.  
4,481,020, PUB. 11-26-2013, INT. CL. 35.
- DEANS WEB BROADCASTING NETWORK, LLC, SPRING, TX:  
4,480,374, PUB. 11-26-2013, INT. CL. 38.  
4,480,375, PUB. 11-26-2013, INT. CL. 38.
- DEBORAH J. BARKER, PITTSBURGH, PA:  
4,482,784, INT. CL. 41.
- DECISIONONE CORPORATION, DEVON, PA:  
3,246,187, CANC. MULTIPLE CLASS, INT. CLS. 37 AND 42.  
3,246,188, CANC. MULTIPLE CLASS, INT. CLS. 37 AND 42.
- DECOY MOTION MASTERS, ROGERS, MN:  
3,245,932, CANC. INT. CL. 28.
- DECRANE AEROSPACE, INC., COLUMBUS, OH:  
2,718,521, CANC. MULTIPLE CLASS, INT. CLS. 37, 40 AND 42.
- DECRATEK, INC., ESCONDIDO, CA:  
2,719,899, CANC. INT. CL. 19.
- DEDENBEAR PRODUCTS, INC., PLEASANT HILL, CA:  
3,247,138, CANC. MULTIPLE CLASS, INT. CLS. 9, 11 AND 12.
- DEFIBTECH, LLC, CHICAGO, IL:  
4,482,067, INT. CL. 10.
- DEHN BLOOM DESIGN, LLC, MILL VALLEY, CA:  
4,480,538, PUB. 11-26-2013, INT. CL. 42.
- DEL REY URBAN CAPITAL, LLC, SANTA MONICA, CA:  
4,482,842, INT. CL. 36.
- DELAWARE CAPITAL FORMATION, INC., WILMINGTON, DE:  
3,248,743, CANC. INT. CL. 6.
- DELAWARE NORTH COMPANIES PARKS & RESORTS, INC., BUFFALO, NY:  
4,482,661, INT. CL. 43.
- DELAWARE RIVER PORT AUTHORITY, CAMDEN, NJ:  
955,472, CANC. U.S. CL. 105.
- DELIGHT IN LIVING, LTD., CRYSTAL LAKE, IL:  
2,912,252, REN. 1-7-14, MULTIPLE CLASS, INT. CLS. 16 AND 41.
- DELK PRODUCTS, INC., NASHVILLE, TN:  
4,481,251, PUB. 11-26-2013, INT. CL. 12.  
4,481,252, PUB. 11-26-2013, INT. CL. 12.
- DELL INC., ROUND ROCK, TX, DELL INC., ROUND ROCK, TX:  
2,808,852, REN. 1-6-14, INT. CL. 2.
- DELOITTE DEVELOPMENT LLC, HERMITAGE, TN:  
4,479,629, PUB. 11-26-2013, INT. CL. 35.
- DELUXE BUILDING SYSTEMS, INC., BERWICK, PA, FORMERLY DELUXE HOMES OF PA, INC., F/K/A DELUXE HOMES, INC.:  
3,245,797, CANC. MULTIPLE CLASS, INT. CLS. 6, 19, 37 AND 40.
- DEMAND MEDIA, INC., SANTA MONICA, CA:  
4,480,719, PUB. 11-26-2013, INT. CL. 42.  
4,482,677, INT. CL. 41.
- DEMANN, MORGEN SCHICK, NEW YORK, NY:  
2,856,654, REN. 1-9-14, INT. CL. 3.



DEMERT BRANDS, INC., LUTZ, FL:  
4,482,689, INT. CL. 3.

DEMO HOLDING S.A., L-1746, LUXEMBOURG:  
3,245,698, CANC. MULTIPLE CLASS, INT. CLS. 18 AND 25.

DEN-MAT HOLDINGS, LLC, LOMPOC, CA, DEN-MAT, INC., SANTA MARIA, CA, AKA DEN-MAT CORPORATION:  
1,310,732, REN. 1-6-14, INT. CL. 5.

DENISE LEMAY, SAINT-EUSTACHE, CANADA:  
4,479,530, PUB. 11-26-2013. MULTIPLE CLASS, INT. CLS. 3 AND 11.

DENNING, ANTHONY, ORLANDO, FL:  
4,479,952, PUB. 5-28-2013, INT. CL. 40.

DENNIS BERNARD, INC., FREEHOLD, NJ:  
3,246,575, CANC. INT. CL. 8.

DENTAL ADVANTAGE, LLC, MINNEAPOLIS, MN:  
3,247,038, CANC. INT. CL. 35.  
3,247,039, CANC. INT. CL. 35.

DENTSMART, INC., MURFREESBORO, TN:  
3,247,496, CANC. INT. CL. 37.

DEPARTMENT OF COMMERCE, NATIONAL OCEANIC AND ATMOSPHERIC ADMINISTRATION, WASHINGTON, DC:  
4,480,286, PUB. 11-26-2013, INT. CL. 41.

DER'S CUSTOM BOOTS & SHOES, INC., BROOKLYN, NY:  
3,246,942, CANC. INT. CL. 25.

DERMCARE-VET PTY LTD, QUEENSLAND, AUSTRALIA:  
4,479,725, PUB. 2-5-2013, INT. CL. 5.

DESANO, SCOTT, PALM BEACH, FL:  
4,481,993, INT. CL. 43.

DESERT FARMS INC., LOS ANGELES, CA:  
4,480,452, PUB. 11-26-2013, INT. CL. 29.

DESERT VALLEY SERVICES, INC., COACHELLA, CA:  
4,480,340, PUB. 11-26-2013, INT. CL. 16.

DESIGN FOR LIVING, LLC, NEW YORK, NY:  
3,248,489, CANC. MULTIPLE CLASS, INT. CLS. 8 AND 21.

DESIGNER PROTEIN, LLC, CARLSBAD, CA:  
3,246,384, CANC. INT. CL. 5.

DESROCHERS, MELISSA, RUMFORD, RI:  
4,481,895, INT. CL. 8.

DETROIT PISTONS BASKETBALL COMPANY, AUBURN HILLS, MI:  
3,248,456, CANC. INT. CL. 41.

DEUTSCHE TELEKOM AG, BONN, FED REP GERMANY:  
3,249,061, CANC. INT. CL. 36.  
3,249,062, CANC. INT. CL. 38.  
3,249,063, CANC. INT. CL. 16.  
3,249,064, CANC. INT. CL. 41.

DEVELOPED SPORTS LLC, ELMHURST, IL:  
4,480,467, PUB. 11-26-2013, INT. CL. 42.

DEVERNOIS S.A., FRANCE:  
4,479,351, PUB. 11-26-2013. MULTIPLE CLASS, INT. CLS. 14, 18 AND 25.

DEXTER AXLE COMPANY, ELKHART, IN:  
3,246,167, CANC. INT. CL. 9.

DI MARCEL ALEXANDER FLEISCH, BREGENZ, AUSTRIA:  
4,479,298, PUB. 11-26-2013, INT. CL. 41.

DIAGNOSTIC LABORATORY OF OKLAHOMA, L.L.C., OKLAHOMA CITY, OK:  
4,481,594, MULTIPLE CLASS, INT. CLS. 42 AND 44.

DIALEGO AG, FED REP GERMANY:  
4,479,339, PUB. 11-26-2013. MULTIPLE CLASS, INT. CLS. 9, 35 AND 42.

DIAMINTANGIBLES INTERNATIONAL, LTD., NASSAU, BAHAMAS:  
2,803,410, REN. 1-8-14, INT. CL. 14.

DIAMOND CHEMICAL COMPANY, INC., EAST RUTHERFORD, NJ:  
4,481,729, INT. CL. 3.

DIAMOND EYE MANUFACTURING, L.L.C., ATHENA, OR:  
3,247,965, CANC. INT. CL. 7.

DIAMOND FOODS, INC., STOCKTON, CA:  
3,247,988, CANC. INT. CL. 29.

DIAMOND GAME ENTERPRISES, CHATSWORTH, CA:  
4,482,277, INT. CL. 28.

DIAMOND HEDGE LLC, NEW YORK, NY:  
4,480,769, PUB. 11-26-2013, INT. CL. 35.

DIANA, ZAPATERIA INC., POMONA, CA:  
4,481,912, INT. CL. 25.

DIAZ, DANIEL, VALRICO, FL:  
4,480,137, PUB. 11-26-2013, INT. CL. 25.

DIAZ, JESSE, SANTA MONICA, CA:  
4,481,148, PUB. 11-26-2013, INT. CL. 25.

DIAZ, JOSE FELIX, CHULA VISTA, CA AND FLORES, EDUARDO GONZALO, CHULA VISTA, CA AND FLORES, EDUARDO, CHULA VISTA, CA:  
4,480,039, PUB. 11-26-2013, INT. CL. 16.

DIE ERSTE, ÖSTERREICHISCHE SPAR-CASSE PRIVAT-STIFTUNG, A-1010 VIENNA, AUSTRIA:  
4,307,248, COR. MULTIPLE CLASS, INT. CLS. 6, 9, 12, 14, 16, 18, 20, 21, 24, 26, 27, 28, 30, 32, 33, 35, 36, 37, 41, 42 AND 43.

DIEHN, DIANE K., OVERLAND PARK, KS AND FRIESEN, SHAUN M., KANSAS CITY, KS:  
3,248,217, CANC. INT. CL. 44.

DIET DIRECT, INC., WILMINGTON, NC:  
4,481,938, MULTIPLE CLASS, INT. CLS. 5 AND 44.

DIETFIT, INC., ALEXANDRIA, VA, DIETFIT, INC., ALEXANDRIA, VA:  
2,747,853, REN. 1-8-14, INT. CL. 42.

DIGIFLIGHT, WASHINGTON, DC:  
3,294,859, COR. MULTIPLE CLASS, INT. CLS. 35 AND 42.

DIGIGRAPH.ME, INC., VALLEY VILLAGE, CA:  
4,481,623, MULTIPLE CLASS, INT. CLS. 9 AND 38.

DIGIMARC CORPORATION, BEAVERTON, OR:  
4,480,610, PUB. 11-26-2013. MULTIPLE CLASS, INT. CLS. 35, 42 AND 45.

DIGINONYMOUS LLC, SEMINOLE, FL:  
4,482,849, INT. CL. 44.

DIGITAL DOMAIN 3.0, INC., VENICE, CA:  
3,247,871, CANC. INT. CL. 16.

DIGITAL EDUCATION PRODUCTIONS, INC., HALF MOON BAY, CA:  
2,718,676, CANC. MULTIPLE CLASS, INT. CLS. 9, 16 AND 41.

DIGITAL INNOVATIONS, LLC, ARLINGTON HEIGHTS, IL:  
3,248,086, CANC. MULTIPLE CLASS, INT. CLS. 3, 7, 9 AND 21.

DIGITAL MEDIA VENDING INTERNATIONAL LLC, SAN FRANCISCO, CA:  
4,480,442, PUB. 11-26-2013, INT. CL. 10.

DIGITALAPPETITE LTD., MISSISSAUGA ONTARIO, CANADA:  
4,481,049, PUB. 11-26-2013, INT. CL. 42.

DILL LURES, LLC, ZIMMERMAN, MN:  
4,480,033, PUB. 11-26-2013, INT. CL. 28.

DILLARD'S, INC., LITTLE ROCK, AR:  
3,247,907, CANC. INT. CL. 14.

DILLON, ANDREW PAUL, STERLING, IL:  
3,248,609, CANC. INT. CL. 25.

DIMPLEX THERMAL SOLUTIONS, INC., KALAMAZOO, MI:  
4,479,790, PUB. 11-26-2013, INT. CL. 11.

DIPOSTA, INC., RALEIGH, NC:  
4,481,240, PUB. 11-26-2013. MULTIPLE CLASS, INT. CLS. 35 AND 38.

DIRECT INC., WICHITA FALLS, TX, DBA COMMAND POST GAMES:  
4,482,442, INT. CL. 28.

DIRECT RESOURCE SOLUTIONS, LLC, OMAHA, NE:  
3,246,879, CANC. INT. CL. 35.

DIRECT SHOT DISTRIBUTING, LLC, AMARILLO, TX:  
4,481,712, MULTIPLE CLASS, INT. CLS. 35 AND 39.

DIRK P SWART, ITHACA, NY:  
4,482,841, INT. CL. 30.

DIRT DIGGERS MOTORCYCLE CLUB, LONG BEACH, CA:  
3,247,159, CANC. INT. CL. 41.

DIRTY BIRD PRODUCTIONS, LOS ANGELES, CA:  
4,482,668, INT. CL. 28.

DISCOVER NEW YORK, LLC, NEW YORK, NY:  
2,917,274, CANC. MULTIPLE CLASS, INT. CLS. 39 AND 41.

- DISNEY ENTERPRISES, INC., BURBANK, CA:  
3,248,393, CANC. INT. CL. 41.  
4,436,786, COR. MULTIPLE CLASS, INT. CLS. 3, 9, 16, 18,  
21, 24 AND 28.  
4,481,347, INT. CL. 30.  
4,481,377, INT. CL. 9.  
4,481,521, INT. CL. 9.  
4,481,522, INT. CL. 16.  
4,481,523, INT. CL. 18.  
4,481,524, INT. CL. 25.  
4,481,634, INT. CL. 41.  
4,482,693, INT. CL. 41.
- DISTANCE EDUCATION COMPANY, LLC, NEW YORK,  
NY:  
4,480,566, PUB. 11-26-2013. INT. CL. 41.  
4,480,567, PUB. 11-26-2013. INT. CL. 41.
- DIVE UNDER APPAREL LLC, MIAMI, FL:  
4,480,863, PUB. 11-26-2013. INT. CL. 25.
- DIVERSIFIED MATERIAL SPECIALISTS, INC., N. VENICE,  
FL, DBA DMSI INTERNATIONAL:  
4,480,476, PUB. 11-26-2013. INT. CL. 9.
- DIVINE CHOCOLATE LIMITED, LONDON, UNITED  
KINGDOM:  
4,479,254, PUB. 11-26-2013. MULTIPLE CLASS, INT. CLS.  
29 AND 30.
- DIXIE CONSUMER PRODUCTS LLC, ATLANTA, GA:  
4,482,153, INT. CL. 20.
- DJ NICHOLSON ENTERPRISES, LLC, EUREKA, MO, DBA  
NICHOLSON GOLF ENTERPRISES:  
3,248,247, CANC. INT. CL. 28.
- DJ ORTHOPEDICS, LLC, VISTA, CA:  
3,247,912, CANC. INT. CL. 10.
- DKH RETAIL LIMITED, GLOUCESTERSHIRE GL51 9NW,  
UNITED KINGDOM:  
4,479,398, PUB. 11-26-2013. INT. CL. 25.
- DMI GLOBAL INC., NANUET, NY:  
4,480,277, PUB. 11-26-2013. INT. CL. 9.
- DMS HOLDINGS, INC., WAUKEGAN, IL:  
4,481,692, INT. CL. 10.
- DN MARKS LLC, WINTER PARK, FL:  
4,481,278, PUB. 11-26-2013. INT. CL. 41.
- DOC BOB, LLC, DES MOINES, IA:  
3,248,677, CANC. INT. CL. 5.
- DOCK PRODUCTS CANADA, INC., LONDON, ONTARIO  
N6M 1A3, CANADA:  
2,813,902, REN. 1-6-14. INT. CL. 6.
- DOCTORCPR.COM, BEVERLY HILLS, CA:  
4,481,467, INT. CL. 35.
- DODDS, PETER ANDREW, BORONIA PARK, NSW, AUS-  
TRALIA:  
4,479,626, PUB. 11-26-2013. INT. CL. 28.
- DOEREN MAYHEW & CO., P.C., TROY, MI, DBA DOEREN  
MAYHEW:  
4,479,970, PUB. 11-26-2013. MULTIPLE CLASS, INT. CLS.  
16 AND 41.
- DOG TUFF, LLC., SUGAR HILL, GA:  
4,481,004, PUB. 11-26-2013. INT. CL. 35.
- DOGBE, SOLOMON ADINORTEY, WROCLAW, POLAND,  
DBA EMPLOYMENTINTHEWORLD EMPLOYER-  
SINTHEWORLD EMPLOYMENTINAFRICA EMPLOYER-  
S I N A F R I C A E M P L O Y M E N T I N G H A N A  
EMPLOYERSINGHANA:  
4,480,184, PUB. 11-26-2013. INT. CL. 38.
- DOGFISH HEAD MARKETING, LLC, MILTON, DE:  
4,481,923, INT. CL. 32.
- DOLBY LABORATORIES LICENSING CORPORATION,  
SAN FRANCISCO, CA:  
4,482,692, MULTIPLE CLASS, INT. CLS. 9, 41 AND 42.
- DOLLE'S CANDYLAND, INC., REHOBOTH BEACH, DE:  
1,800,950, REN. 1-6-14. INT. CL. 30.  
1,800,952, REN. 1-6-14. INT. CL. 30.
- DOMINICAN VILLAGE, INC., AMITYVILLE, NY:  
1,868,730, REN. 1-8-14. INT. CL. 42.
- DON R. POWELL, FARMINGTON HILLS, MI:  
4,481,145, PUB. 11-26-2013. INT. CL. 16.
- DONALD P. GRIMES, LAGUNA NIGUEL, CA:  
4,482,147, MULTIPLE CLASS, INT. CLS. 9, 16, 36 AND 41.
- DONNA LYNN BASTIANON, SANTA ROSA, CA:  
4,480,859, PUB. 11-26-2013. INT. CL. 33.
- DONOVAN MARINE, INC., HARAHAH, LA:  
4,481,393, MULTIPLE CLASS, INT. CLS. 9, 25, 28 AND 35.
- DOORS BY DESIGN INTERNATIONAL, LLC, CHAR-  
LOTTE, NC:  
4,479,771, PUB. 11-26-2013. INT. CL. 35.
- DORPAN, S.L., 07009 PALMA DE MALLORCA, SPAIN:  
4,480,232, PUB. 8-20-2013. INT. CL. 43.
- DOÑA EMILIA'S, LP., AUSTIN, TX:  
3,245,773, CANC. INT. CL. 43.
- DOS AMIGOS BRANDS LLC, SAN DIEGO, CA:  
4,480,775, PUB. 11-26-2013. INT. CL. 29.
- DOUBLE QUALITY INC., BROOKLYN, NY:  
3,248,584, CANC. INT. CL. 9.
- DOUBLEDAY ACQUISITIONS, LLC, DAYTON, OH:  
2,820,913, REN. 1-9-14. INT. CL. 20.
- DOVER SADDLERY, INC., LITTLETON, MA:  
4,480,473, PUB. 11-26-2013. INT. CL. 18.
- DOW JONES & COMPANY, INC., NEW YORK, NY:  
4,482,680, INT. CL. 35.
- DPI ENERGY LLC, HOUSTON, TX, DBA TRUSMART  
ENERGY LLC:  
4,482,865, INT. CL. 35.  
4,482,867, INT. CL. 35.
- DR. DUPHORN, JOHNSTON & COMPANY, U.S.A., INC.,  
ODESSA, FL, DBA JAMIACA HELL FIRE:  
1,810,986, REN. 1-3-14. INT. CL. 30.
- DR. DÜNNER AG, IMMENSEE, SWITZERLAND:  
3,247,969, CANC. MULTIPLE CLASS, INT. CLS. 5 AND  
16.
- DR. JOHANNES HEIDENHAIN GMBH, TRAUNREUT, FED  
REP GERMANY:  
4,480,464, PUB. 11-26-2013. INT. CL. 9.
- DRAGONLORD ENTERPRISES, INC., NORTH HILLS, CA:  
4,480,852, PUB. 11-26-2013. INT. CL. 9.
- DRAGONSOFT SECURITY ASSOCIATES, INC., CHUNG HO  
CITY, TAIPEI HSIEN, TAIWAN:  
3,245,749, CANC. INT. CL. 9.
- DRAPER MITCHELL, NEW YORK, NY:  
4,479,939, PUB. 11-26-2013. INT. CL. 35.
- DREW BRADY COMPANY INC., OAKVILLE, ONTARIO,  
CANADA:  
4,481,549, INT. CL. 25.
- DREXEL UNIVERSITY, PHILADELPHIA, PA:  
4,480,493, PUB. 11-26-2013. MULTIPLE CLASS, INT. CLS.  
25 AND 41.  
4,482,781, INT. CL. 41.
- DRILLEYS, LLC, TAMPA, FL:  
4,480,756, PUB. 11-26-2013. INT. CL. 25.
- DRILWASTE PERFORMANCE SERVICES INC., CALGARY,  
ALBERTA, CANADA:  
3,246,526, CANC. INT. CL. 42.
- DRINKINGTEAMOF.COM, RENO, NV:  
4,481,021, PUB. 11-26-2013. INT. CL. 25.
- DRIVEN RACING OIL, LLC, HUNTERSVILLE, NC:  
4,480,676, PUB. 11-26-2013. INT. CL. 1.
- DRIVING KNIGHTS LTD., CALGARY, ALBERTA, CANA-  
DA:  
3,246,767, CANC. INT. CL. 39.
- DROLET, JEAN, SALEM, NH:  
4,480,453, PUB. 11-26-2013. INT. CL. 20.
- DRUGSTORE.COM, INC., BELLEVUE, WA:  
2,830,105, REN. 1-3-14. INT. CL. 3.
- DRUM WORKSHOP, INC., OXNARD, CA:  
3,247,600, CANC. INT. CL. 15.
- DRUMBEATERS OF AMERICA INC., ELBURN, IL:  
1,817,728, REN. 1-8-14. MULTIPLE CLASS, INT. CLS. 7  
AND 40.
- DSA-DEBT SETTLEMENT AMERICA, INC., ADDISON, TX:  
3,245,875, CANC. INT. CL. 36.
- DSH INDIANA, INC., CARMEL, IN:  
4,480,404, PUB. 11-26-2013. INT. CL. 35.
- DSH NETWORKS, LAWNSDALE, CA:  
3,246,785, CANC. INT. CL. 25.
- DSM IP ASSETS B.V., HEERLEN, NETHERLANDS:  
3,248,023, CANC. INT. CL. 42.

DSM.NET, INC., LAKELAND, FL:  
4,480,448, PUB. 11-26-2013. INT. CL. 42.

DUANE READE INTERNATIONAL, LLC, NEW YORK, NY:  
4,482,699, MULTIPLE CLASS, INT. CLS. 29, 30 AND 32.

DUANGNAPA, KRISADA, LOS ANGELES, CA:  
4,479,245, PUB. 11-26-2013. INT. CL. 25.

DUBOIS CHEMICALS, INC., SHARONVILLE, OH, CHEMED CORPORATION, CINCINNATI, OH:  
1,277,719. REN. 1-3-14. INT. CL. 3.

DUJO LLC, WINTER PARK, FL:  
4,482,818, INT. CL. 35.

DUKE UNIVERSITY, DURHAM, NC:  
4,481,331, INT. CL. 44.

DULANEY, PHILIP REUEL, HUNTSVILLE, AL:  
3,248,205, CANC. INT. CL. 21.

DUMONT INSURANCE BROKERS, CORP., NEW YORK, NY:  
3,248,473, CANC. INT. CL. 36.

DUNCAN INDUSTRIES PARKING CONTROL SYSTEMS CORP., HARRISON, AR:  
1,813,581. REN. 1-8-14. INT. CL. 9.

DUNCANSON, LISA, FULLERTON, CA:  
3,246,200, CANC. INT. CL. 16.

DUNG JYUU ENTERPRISE CO., LTD., TAIPEI HSIEN, TAIWAN:  
1,817,411. REN. 1-4-14. INT. CL. 12.

DUNN-EDWARDS CORPORATION, LOS ANGELES, CA, AKA DUNN-EDWARDS:  
2,803,300. REN. 1-3-14. INT. CL. 2.

DUOIBES, ALBERT, EAST GRAND RAPIDS, MI:  
3,247,141, CANC. INT. CL. 35.

DUOMED, INC., WEST PALM BEACH, FL:  
3,247,974, CANC. INT. CL. 28.

DUPROPRIO INC., MONTREAL, QUEBEC, CANADA:  
4,479,620, PUB. 11-26-2013. MULTIPLE CLASS, INT. CLS. 35 AND 36.

DURABRAKE CO., SANTA CLARA, CA:  
4,480,037, PUB. 6-25-2013. INT. CL. 12.

DURITE U.S.A. LLC, GREAT NECK, NY:  
2,851,031. REN. 1-6-14. INT. CL. 37.

DURO-LAST, INC., SAGINAW, MI:  
2,801,211. REN. 1-9-14. INT. CL. 19.

DUTRAC COMMUNITY CREDIT UNION, DUBUQUE, IA:  
4,481,678, INT. CL. 36.

DUUDU, LLC, TALLAHASSEE, FL:  
4,479,915, PUB. 11-26-2013. INT. CL. 41.  
4,479,930, PUB. 11-26-2013. INT. CL. 25.

DVORAK, RYAN, LAKE HAVASU CITY, AZ:  
3,247,979, CANC. INT. CL. 6.

DV8 CELLARS, LLC, OAK PARK, CA:  
4,481,516, INT. CL. 33.

DWELL MEDIA, LLC, SAN FRANCISCO, CA AND NEW YORK MEDIA LLC, NEW YORK, NY:  
4,481,233, PUB. 11-26-2013. INT. CL. 41.

DYN-O-MAT, INC., JUPITER, FL:  
3,247,588, CANC. INT. CL. 1.

DYNAMIC CLINICAL SYSTEMS, INC., HANOVER, NH:  
3,248,107, CANC. INT. CL. 42.

DYNAMICLOGIC, INC., NEW YORK, NY:  
2,801,847. REN. 1-3-14. INT. CL. 35.

DYNAVOX SYSTEMS LLC, PITTSBURGH, PA:  
4,480,126, PUB. 11-26-2013. INT. CL. 9.

DYSTONIA MEDICAL RESEARCH FOUNDATION, CHICAGO, IL, AKA DYSTONIA FOUNDATION; DMRF:  
4,481,285, PUB. 11-26-2013. INT. CL. 36.

DZILVELIS, CHRISTINE, LOS ANGELES, CA:  
3,247,458, CANC. INT. CL. 35.

D2T (SOCIÉTÉ ANONYME), 78190 TRAPPES, FRANCE:  
4,481,328, MULTIPLE CLASS, INT. CLS. 7, 9, 12, 37 AND 42.

E & M CORP., HONOLULU, HI, DBA NOH FOODS OF HAWAII:  
4,480,743, PUB. 11-26-2013. MULTIPLE CLASS, INT. CLS. 29 AND 30.

E SHARE SYSTEMS INC., LANGHORNE, PA:  
3,247,249, CANC. INT. CL. 35.

E V (BABY) LIMITED, CUMBRIA, UNITED KINGDOM:  
4,479,596, PUB. 2-26-2013. MULTIPLE CLASS, INT. CLS. 8, 10, 11 AND 35.

E. & J. GALLO WINERY, MODESTO, CA:  
3,248,386, CANC. MULTIPLE CLASS, INT. CLS. 25 AND 33.

E.F.S. FUN/D, INC., BOULDER, CO, DBA EFS FUNDRAISERS - "Y-TIES":  
2,801,960. REN. 1-3-14. INT. CL. 35.

E.T. HORN COMPANY, LA MIRADA, CA:  
2,801,080. REN. 1-3-14. INT. CL. 1.

E&G FRANCHISE SYSTEMS, INC., EAU CLAIRE, WI:  
4,480,395, PUB. 11-26-2013. INT. CL. 43.

E&I INTERNATIONAL, LLC, CENTENNIAL, CO:  
4,482,108, INT. CL. 16.

E-GATEMATRIX L.L.C., RESTON, VA:  
4,481,354, MULTIPLE CLASS, INT. CLS. 9, 35, 36, 42 AND 43.  
4,481,355, MULTIPLE CLASS, INT. CLS. 9, 35, 36, 42 AND 43.

E-REWARDS, INC., PLANO, TX:  
4,481,758, INT. CL. 35.

EA DIGITAL ILLUSIONS CE AB, STOCKHOLM, SWEDEN:  
4,481,777, INT. CL. 41.

EADS DEUTSCHLAND GMBH, FED REP GERMANY:  
4,479,275, PUB. 11-26-2013. MULTIPLE CLASS, INT. CLS. 9, 12 AND 37.

EAGLE BANK AND TRUST COMPANY OF MISSOURI, IMPERIAL, MO:  
2,802,829. REN. 1-8-14. INT. CL. 36.

EAGLE SYSTEMS INTERNATIONAL, INC., OREM, UT:  
4,479,611, PUB. 11-26-2013. INT. CL. 35.

EARLY WARNING SERVICES, LLC, SCOTTSDALE, AZ:  
2,799,102. REN. 1-6-14. INT. CL. 36.  
4,482,703, MULTIPLE CLASS, INT. CLS. 36 AND 45.

EAST COAST HOME INSPECTIONS, LLC, ENFIELD, CT:  
2,719,179, CANC. INT. CL. 42.

EAST COAST WINGS CORPORATION, WINSTON-SALEM, NC:  
4,482,722, INT. CL. 29.

EASTERN CAROLINA INTERNAL MEDICINE, P.A., POLLOCKSVILLE, NC:  
2,719,109, CANC. INT. CL. 44.

EASY DUMP, INC., GLENDALE, AZ:  
3,247,973, CANC. INT. CL. 21.

EATON CORPORATION, CLEVELAND, OH:  
1,732,508, CANC. INT. CL. 7.

EATON TECHNOLOGIES IP GMBH & CO. KG, 12529 SCHOENEFELD, FED REP GERMANY:  
4,482,374, MULTIPLE CLASS, INT. CLS. 9 AND 11.

EBARS, LLC, FRANKLIN, TN:  
4,482,567, INT. CL. 29.

EBI, PARIS, FRANCE:  
4,479,645, PUB. 5-7-2013. INT. CL. 34.

EBSCO INDUSTRIES, INC., BIRMINGHAM, AL:  
989,978. REN. 1-8-14. MULTIPLE CLASS, U.S. CLS. 32 (INT. CL. 20), 37 (INT. CL. 16), 38 (INT. CL. 16), 39 (INT. CLS. 10, 25 AND 26) AND 101 (INT. CL. 35).

EBSCO INDUSTRIES, INC., BIRMINGHAM, AL:  
2,833,609. REN. 1-8-14. INT. CL. 9.

EBSCO INDUSTRIES, INC., BIRMINGHAM, AL:  
2,873,365. REN. 1-8-14. MULTIPLE CLASS, INT. CLS. 35, 38, 41 AND 42.  
3,246,064, CANC. INT. CL. 9.  
3,247,329, CANC. INT. CL. 21.

EBUS, INC., DOWNEY, CA:  
4,479,566, PUB. 11-26-2013. MULTIPLE CLASS, INT. CLS. 12 AND 37.

ECCOUNTING SOLUTIONS, LLC, SEEKONK, MA:  
2,718,513, CANC. INT. CL. 35.

ECHENIQUE, LEONARDO LUIS, BUENOS AIRES, ARGENTINA:  
4,479,529, PUB. 11-26-2013. INT. CL. 9.

ECHRISTIAN, INC., ESCONDIDO, CA:  
4,481,434, INT. CL. 9.

ECO-LIFE FOUNDATION, ESCONDIDO, CA:  
4,480,967, PUB. 11-26-2013. INT. CL. 21.

ECOBRITE, LLC, MINT HILL, NC:  
4,481,560, INT. CL. 1.

- ECOLAB USA INC., ST. PAUL, MN:  
3,248,055, CANC. INT. CL. 1.  
4,481,277, PUB. 11-26-2013. MULTIPLE CLASS, INT. CLS.  
35 AND 45.
- ECONUGENICS, INC., SANTA ROSA, CA:  
3,248,646, CANC. INT. CL. 5.
- ECOUNT, INC., CONSHOHOCKEN, PA:  
3,247,627, CANC. MULTIPLE CLASS, INT. CLS. 35 AND  
36.
- ED ROMAN ENTERPRISES, INC., LAS VEGAS, NV:  
4,480,281, PUB. 11-26-2013. INT. CL. 35.
- EDAPTIVE COMPUTING, INC., DAYTON, OH:  
2,842,129, REN. 1-6-14. INT. CL. 42.
- EDDIE DOMANI, L.L.C., NEW YORK, NY:  
4,482,027, INT. CL. 25.
- EDGAR RICE BURROUGHS, INC., TARZANA, CA:  
4,481,312, MULTIPLE CLASS, INT. CLS. 16 AND 25.
- EDGE GAMES, LLC, WILLITS, CA:  
3,248,467, CANC. INT. CL. 28.
- EDGE MECHANICAL SYSTEMS, INC., DENVER, CO:  
3,246,737, CANC. INT. CL. 35.
- EDGECAST NETWORKS, INC. SANTA MONICA, CA:  
4,479,768, PUB. 11-26-2013. MULTIPLE CLASS, INT. CLS.  
9, 35 AND 42.
- EDIBLE ARRANGEMENTS, LLC, WALLINGFORD, CT:  
4,481,974, INT. CL. 21.
- EDITION HAS MUSIC PUBLISHING CO., ST. LOUIS, MO:  
2,912,182, REN. 1-9-14. INT. CL. 16.
- EDUCATION THROUGH MUSIC, INC., NEW YORK, NY:  
4,481,702, MULTIPLE CLASS, INT. CLS. 16, 36 AND 41.
- EDUCATIONAL IDEAS, INC., BREA, CA, DBA BALLARD &  
TIGHE:  
4,482,626, INT. CL. 16.
- EDUCATIONAL TESTING SERVICE, PRINCETON, NJ:  
4,479,538, PUB. 11-26-2013. MULTIPLE CLASS, INT. CLS.  
9, 16, 35, 41 AND 42.
- EDUTRONIX, LLC, TROY, MI:  
3,248,277, CANC. INT. CL. 35.
- EDW C. LEVY CO., DEARBORN, MI:  
4,482,619, INT. CL. 1.
- EDWARDS, CHRISTOPHER M., DAYTON, NV:  
3,247,207, CANC. INT. CL. 28.
- EERIE VENTURES, LLC, COVINGTON, LA:  
4,480,780, PUB. 11-26-2013. MULTIPLE CLASS, INT. CLS.  
16, 25, 28 AND 41.
- EFC GROUP, LLC, FORT WORTH, TX:  
4,481,833, INT. CL. 30.
- EFENAE, L.L.C., SYRACUSE, UT:  
3,248,532, CANC. INT. CL. 25.
- EG INTERNATIONAL (HK) LIMITED, WCH, HONG KONG:  
4,480,594, PUB. 11-26-2013. INT. CL. 5.
- EGC ENTERPRISES, INC., CHARDON, OH:  
3,245,784, CANC. INT. CL. 6.
- EGGSPRESSIONS OF NORTH AMERICA, LAFAYETTE, LA:  
4,482,398, INT. CL. 43.
- EH PUBLISHING, INC., FRAMINGHAM, MA:  
2,794,686, REN. 1-6-14. INT. CL. 16.
- EICHNER, KENNETH, D, HOUSTON, TX:  
4,479,898, PUB. 11-26-2013. MULTIPLE CLASS, INT. CLS.  
35, 36 AND 45.
- EIDOLOGIC GMBH, RECKLINGHAUSEN, FED REP GER-  
MANY:  
3,247,180, CANC. INT. CL. 9.
- EIFFAGE TP, FRANCE:  
3,258,844, CANC. MULTIPLE CLASS, INT. CLS. 19, 37  
AND 42.
- EINIG-ZENZEN GMBH & CO. KG, KAISERSESCH, FED  
REP GERMANY:  
3,247,412, CANC. INT. CL. 33.
- EINSTEIN/NOAH BAGEL PARTNERS, INC., LAKEWOOD,  
CO, NOAH'S NEW YORK BAGELS, INC., EMERYVILLE,  
CA:  
1,841,045, REN. 1-8-14. INT. CL. 42.
- EISAI CORPORATION OF NORTH AMERICA, WOOD-  
CLIFF LAKE, NJ:  
2,719,567, CANC. INT. CL. 5.
- EISAI R&D MANAGEMENT CO., LTD., BUNKYO-KU;  
TOKYO, JAPAN:  
3,247,842.  
3,247,844.  
3,247,845.  
3,247,846.  
3,247,847.  
3,247,848.  
3,247,849.  
3,247,850.  
3,247,851.  
3,247,852.  
3,247,853.
- EKINS, CARRIE, CHICAGO, IL:  
3,361,667, COR. INT. CL. 41.
- EL SHOW DE FERNANDO LLC, MIAMI, FL:  
4,479,712, PUB. 11-26-2013. INT. CL. 41.
- ELAJ, LLC, LAGUNA HILLS, CA:  
4,480,971, PUB. 11-26-2013. INT. CL. 3.
- ELASTIC THERAPY, INC., ASHEBORO, NC:  
1,780,820, REN. 1-6-14. INT. CL. 10.
- ELBEE PTY LTD, BELLEVUE HILL NSW, AUSTRALIA:  
4,481,429, INT. CL. 20.
- ELBIT SYSTEMS LTD., HAIFA 31053, ISRAEL:  
4,482,815, INT. CL. 9.
- ELDERSCAN, LLC, COLUMBIA, MD:  
4,480,320, PUB. 11-26-2013. INT. CL. 42.
- ELECTRIC ADVENTURE, LLC, HOWARD BEACH, NY:  
4,482,268, MULTIPLE CLASS, INT. CLS. 25, 35 AND 41.
- ELECTRO-MATIC PRODUCTS CO., CHICAGO, IL:  
3,247,660, CANC. INT. CL. 9.
- ELECTRONIC CLASSROOM OF TOMORROW, COLUM-  
BUS, OH:  
4,481,127, PUB. 11-26-2013. INT. CL. 41.
- ELITE WHEEL DISTRIBUTORS INC., TAMPA, FL:  
4,480,904, PUB. 11-26-2013. INT. CL. 12.
- ELIZABETH'S MOVING SERVICES, LLC, CHATTANOOGA,  
TN:  
4,481,826, INT. CL. 39.
- ELK RIVER INVESTMENTS, INC., FLOWER MOUND, TX:  
4,482,481, INT. CL. 43.
- ELLA INTERNATIONAL, INC., TEMECULA, CA:  
3,246,430, CANC. INT. CL. 3.  
3,246,431, CANC. INT. CL. 3.
- ELLENBECKER INVESTMENT GROUP, INC., PEWAUKEE,  
WI:  
4,480,570, PUB. 11-26-2013. INT. CL. 36.  
4,480,571, PUB. 11-26-2013. INT. CL. 36.  
4,480,572, PUB. 11-26-2013. INT. CL. 36.  
4,480,839, PUB. 11-26-2013. INT. CL. 41.
- ELLER, THOMAS H., WOODACRE, CA:  
2,797,308, REN. 1-7-14. INT. CL. 37.
- ELLIOTT AUTO SUPPLY CO., INC., EAGAN, MN:  
3,247,592, CANC. INT. CL. 35.
- ELLIOTT, CHRIS, FRIENDSWOOD, TX:  
4,482,236, INT. CL. 28.
- ELLIPTEC RESONANT ACTUATOR AG, 44379 DORT-  
MUND, FED REP GERMANY:  
2,719,394, CANC. MULTIPLE CLASS, INT. CLS. 7 AND  
12.
- ELLIS, KAREN, COSTA MESA, CA:  
4,482,430, INT. CL. 41.
- ELM EHF., 101 REYKJAVIK, ICELAND:  
2,798,750, REN. 1-6-14. INT. CL. 25.
- ELSA'S MEXICAN ENTERPRISES, INC., DAYTON, OH:  
4,481,537, INT. CL. 33.
- ELSEVIER INC., WILMINGTON, DE, YEAR BOOK MEDI-  
CAL PUBLISHERS, INC., CHICAGO, IL:  
1,312,268, REN. 1-6-14. INT. CL. 16.
- ELSEVIER LIMITED, OXFORD, ENGLAND:  
2,719,158, CANC. INT. CL. 42.
- ELSTER GROUP SE, FED REP GERMANY:  
4,479,278, PUB. 11-26-2013. MULTIPLE CLASS, INT. CLS.  
9, 38 AND 42.
- EMC CORPORATION, HOPKINTON, MA:  
2,801,673, REN. 1-9-14. INT. CL. 9.
- EMERIO PAYMENTS, L.L.C., PROVO, UT:  
4,480,378, PUB. 11-26-2013. INT. CL. 36.

EMERSON ELECTRIC CO., ST. LOUIS, MO:  
3,248,396, CANC. INT. CL. 8.

EMPIRE DIGITAL LLC, ORMOND BEACH, FL:  
4,482,287, MULTIPLE CLASS, INT. CLS. 9, 35 AND 42.

EMPIREA S.R.L., NAPOLI, ITALY:  
3,246,577, CANC. INT. CL. 16.

EMPLOYER'S NETWORK INC., THE, OCALA, FL:  
2,719,406, CANC. INT. CL. 35.

EMPYREAN GLOBAL, INCORPORATED, STONE MOUNTAIN, GA:  
4,480,250, PUB. 11-26-2013. INT. CL. 9.

EMRLOGIC SYSTEMS INCORPORATED, BURNABY, BC, CANADA:  
4,481,411, MULTIPLE CLASS, INT. CLS. 9 AND 10.

ENARO SIWEL, INC., ROANOKE, VA:  
3,248,568, CANC. INT. CL. 28.

ENCAP, LLC, GREEN BAY, WI:  
2,719,925, CANC. INT. CL. 31.

ENCORE ENTERTAINMENT, LLC, NEWARK, OH, AKA ENCORE L'AMORE EVENTS:  
4,482,604, INT. CL. 41.

ENCORE SOFTWARE, INC., EL SEGUNDO, CA:  
3,246,534, CANC. INT. CL. 9.

ENCORE SOUTHEAST, INC., NEW PORT RICHEY, FL, T.L. LAY PACKING CO., KNOXVILLE, TN:  
315,061. REN. 1-8-14. U.S. CL. 46 (INT. CLS. 1, 5, 29, 30, 31 AND 32).

ENCOREVISION ENTERTAINMENT PRODUCTIONS INC., ZEPHYRHILLS, FL:  
4,480,978, PUB. 11-26-2013. INT. CL. 41.

ENEREX BOTANICALS LTD., BURNABY, BRITISH COLUMBIA, CANADA:  
3,248,726, CANC. INT. CL. 5.

ENERGY PRODUCTS AUSTRALIA PTY LTD, BANGALOW, NSW, AUSTRALIA:  
4,481,636, MULTIPLE CLASS, INT. CLS. 29 AND 30.

ENERGY TOOLS INTERNATIONAL, LLC, EAGLE POINT, OR:  
4,480,909, PUB. 11-26-2013. INT. CL. 40.

ENIVA USA, PLYMOUTH, MN:  
4,480,053, PUB. 7-9-2013. MULTIPLE CLASS, INT. CLS. 1, 3 AND 5.

ENJEUX CARRIÈRE INC., MONTREAL (QUEBEC) H4A 1E1, CANADA:  
3,247,902, CANC. MULTIPLE CLASS, INT. CLS. 9 AND 16.

ENNIS, ROY F., BIRMINGHAM, AL:  
4,479,922, PUB. 11-26-2013. MULTIPLE CLASS, INT. CLS. 16 AND 25.

ENOICARAS, THOMWOOD XAVIER, NEW YORK, NY:  
4,480,635, PUB. 11-26-2013. INT. CL. 35.

ENTEGRIS, INC., BILLERICA, MA:  
4,480,147, PUB. 11-26-2013. INT. CL. 11.

ENTERTAINMENT NETWORKS LIMITED, ALDERNEY, CHANNEL ISLANDS:  
3,246,303, CANC. MULTIPLE CLASS, INT. CLS. 9 AND 16.

ENTHRIVE, INC., TORONTO, ONTARIO, CANADA:  
4,479,700, PUB. 11-26-2013. INT. CL. 44.

ENVAC AB, SE-11226 STOCKHOLM, SWEDEN:  
2,847,454. REN. 1-6-14. MULTIPLE CLASS, INT. CLS. 7 AND 37.  
2,847,454, CANC. INT. CL. 12.

ENVIRONMENTAL EXPRESS, INC., CHARLESTON, SC:  
4,482,724, INT. CL. 9.

ENVIRONMENTAL MONITORING SYSTEMS, INC., CHARLESTON, SC:  
2,718,587, CANC. INT. CL. 9.

ENVISIONTEC, INC., DEARBORN, MI:  
4,480,685, PUB. 11-26-2013. INT. CL. 9.

ENZ (U.S.A.), INC., AURORA, IL:  
2,729,974. REN. 1-6-14. INT. CL. 7.

EPETITE, INC., BELLEVUE, WA:  
2,798,055. REN. 1-6-14. INT. CL. 35.

EPIC GAMES, INC., CARY, NC:  
4,481,629, INT. CL. 9.

EPIC HEALTH SERVICES, INC., DALLAS, TX:  
3,246,156, CANC. MULTIPLE CLASS, INT. CLS. 35, 41, 43 AND 44.

EPICENTER INNOVATIONS, INC., ROCHESTER HILLS, MI:  
3,248,426, CANC. INT. CL. 9.

EPIPHANY COMMUNICATIONS, INC., TUCSON, AZ:  
3,247,432, CANC. INT. CL. 35.

EPISCOPAL MINISTRIES TO THE AGING, INC., ELDERSBURG, MD:  
3,245,774, CANC. MULTIPLE CLASS, INT. CLS. 43 AND 44.  
3,245,775, CANC. MULTIPLE CLASS, INT. CLS. 43 AND 44.

EPITAN LIMITED, MELBOURNE, VICTORIA, AUSTRALIA:  
3,246,125, CANC. INT. CL. 3.

EQUITITLE, LLC, VIENNA, VA:  
3,247,057, CANC. INT. CL. 36.

ERB INDUSTRIES, INC., WOODSTOCK, GA:  
1,822,865. REN. 1-8-14. INT. CL. 25.

ERCO GMBH, FED REP GERMANY:  
3,247,732.

ERGO CUSTOMIZED COMFORT, INC., TUSTIN, CA:  
2,800,775. REN. 1-9-14. MULTIPLE CLASS, INT. CLS. 20 AND 24.

ERGON ASPHALT & EMULSIONS, INC., JACKSON, MS:  
4,479,709, PUB. 11-26-2013. MULTIPLE CLASS, INT. CLS. 2 AND 19.  
4,479,710, PUB. 11-26-2013. MULTIPLE CLASS, INT. CLS. 2 AND 19.

ERIE SCIENTIFIC COMPANY, PORTSMOUTH, NH:  
2,797,774. REN. 1-6-14. INT. CL. 9.

ERIK LAIBE, DOWNEY, CA:  
4,480,918, PUB. 11-26-2013. INT. CL. 30.  
4,481,242, PUB. 11-26-2013. INT. CL. 21.

ERIN M. THULL, MILWAUKEE, WI, DBA RUBY STAR:  
3,246,979, CANC. INT. CL. 25.

EROSCIENCE PHARMA INC., NEWARK, DE:  
3,247,250, CANC. INT. CL. 5.

ES INTERACTIVE, LLC, MONTE SERENO, CA:  
3,247,319, CANC. INT. CL. 38.

ESAVZ CORPORATION, MAYFIELD, KY:  
3,246,754, CANC. INT. CL. 35.

ESC BROS, INC., MEDFORD, OR:  
4,481,025, PUB. 11-26-2013. INT. CL. 9.

ESC STEEL INC., SPRING, TX:  
4,479,862, PUB. 11-26-2013. INT. CL. 6.

ESCAPE OUTDOORS, LLC, EVANS, GA:  
4,479,759, PUB. 11-26-2013. INT. CL. 35.

ESCHOLAR LLC, WHITE PLAINS, NY:  
4,480,032, PUB. 11-26-2013. MULTIPLE CLASS, INT. CLS. 9 AND 35.

ESCO CORPORATION, PORTLAND, OR:  
780,947. REN. 1-3-14. U.S. CL. 23 (INT. CL. 7).  
1,857,168. REN. 1-3-14. INT. CL. 7.

ESCOBERA LA REYNERA S.A. DE C.V., CADEREYTA, NUEVO LEÓN, MEXICO:  
3,248,882, CANC. INT. CL. 3.

ESCORTELL, RAQUEL FERNANDEZ, SALT (GIRONA), SPAIN:  
3,246,396, CANC. INT. CL. 16.

ESH STRATEGIES BRANDING LLC, CHARLOTTE, NC:  
4,481,862, INT. CL. 43.

ESL MOBILE ACADEMY, LAWRENCEVILLE, GA:  
3,245,819, CANC. INT. CL. 41.

ESMART SOURCE, INC., SUNNYVALE, CA, DBA RFID4U:  
3,247,197, CANC. INT. CL. 41.

ESPERANZA HEALTH CENTER, INC., PHILADELPHIA, PA:  
2,719,038, CANC. INT. CL. 44.

ESPIAL GROUP INC., OTTAWA, CANADA:  
3,246,638, CANC. INT. CL. 9.

ESPINOSA JOMARRON PL, MIAMI, FL, DBA ESPINOSA | JOMARRON:  
4,479,854, PUB. 11-26-2013. INT. CL. 45.

ESQUEL ENTERPRISES LIMITED, WANCHI, HONG KONG:  
3,248,202, CANC. MULTIPLE CLASS, INT. CLS. 24 AND 25.

- ESSENTIALS BRANDS, INC., NATICK, MA:  
3,352,441, CANC. INT. CL. 25.
- ESSEOQUATTRO S.P.A., ITALY:  
4,479,281, PUB. 11-26-2013. INT. CL. 16.  
4,479,282, PUB. 11-26-2013. INT. CL. 16.
- ESTATE OF CHAD "PIMP C" LAMONT BUTLER, PORT ARTHUR, TX:  
4,481,173, PUB. 11-26-2013. INT. CL. 25.
- ESTEE LAUDER INC., NEW YORK, NY:  
2,719,045, CANC. INT. CL. 3.  
4,481,465, INT. CL. 3.
- ETHICAL ELECTRIC BENEFIT CO., CHEVY CHASE, MD:  
4,480,645, PUB. 11-26-2013. INT. CL. 35.
- ETSG, LLC, KINGWOOD, TX, DBA ENERGY TRAINING SOLUTIONS:  
4,482,863, INT. CL. 41.
- EUBANKS ENGINEERING CO., ONTARIO, CA:  
1,264,731, REN. 1-8-14. INT. CL. 7.
- EUGEN LÄGLER GMBH, GÜGLINGEN-FRAUENZIMMERN, FED REP GERMANY:  
4,479,435, PUB. 11-26-2013. MULTIPLE CLASS, INT. CLS. 7, 37, 41 AND 42.
- EURAMAX CANADA, INC., BARRIE, ONTARIO, CANADA:  
3,246,417, CANC. INT. CL. 19.
- EURASIA USA, INC., EAST BRUNSWICK, NJ:  
4,482,508, INT. CL. 14.
- EUROPE BRANDS SARL, LUXEMBOURG, LUXEMBOURG:  
3,248,188, CANC. INT. CL. 16.
- EVAN M. STACHOWSKI, BELMONT, MA:  
4,481,188, PUB. 11-26-2013. INT. CL. 41.
- EVANS, TARAH SMITH, SAN CARLOS, CA, DBA SUGAR SNAP FILES LLC AND DENT, STACY COOPER, SAN CARLOS, CA, DBA SUGAR SNAP FILES LLC:  
4,480,108, PUB. 11-26-2013. INT. CL. 18.
- EVAULT, INC., SAN FRANCISCO, CA:  
4,480,724, PUB. 11-26-2013. MULTIPLE CLASS, INT. CLS. 9 AND 42.
- EVENING CHIC INC., MINEOLA, NY:  
4,482,524, INT. CL. 25.
- EVEREADY BATTERY COMPANY, INC, ST. LOUIS MISSOURI, MO:  
4,481,913, INT. CL. 8.
- EVEREADY BATTERY COMPANY, INC., ST. LOUIS, MO:  
3,248,511, CANC. INT. CL. 8.  
4,481,939, INT. CL. 8.  
4,482,814, INT. CL. 8.
- EVERETT LABORATORIES, INC., CHATHAM, NJ:  
2,738,615, REN. 1-8-14. INT. CL. 5.
- EVERITT & SCHILLING, LLC, FORT COLLINS, CO:  
4,479,937, PUB. 11-26-2013. INT. CL. 19.
- EVERRIS INTERNATIONAL B.V., HEERLEN, NETHERLANDS:  
3,248,357, CANC. INT. CL. 1.
- EVERY NATION CHURCHES, INC., BRENTWOOD, TN:  
2,729,082, REN. 1-7-14. MULTIPLE CLASS, INT. CLS. 16 AND 35.  
2,729,082, CANC. INT. CL. 9.
- EVERYTHING NAUTICAL, LLC, GREENWOOD VILLAGE, CO, DBA WWW.EVERYTHINGNAUTICAL.COM:  
4,481,138, PUB. 11-26-2013. INT. CL. 35.
- EVILIVE MUSIC LLC, LOS ANGELES, CA:  
4,480,959, PUB. 11-26-2013. MULTIPLE CLASS, INT. CLS. 9 AND 41.
- EVO SOLUTIONS, L.P., AMARILLO, TX:  
3,247,405, CANC. INT. CL. 35.
- EVOL NUTRITION ASSOCIATES, INC., HIRAM, GA:  
3,247,561, CANC. INT. CL. 5.  
3,247,562, CANC. INT. CL. 5.
- EVOLUTION CAPITAL MANAGEMENT PARTNERS LLC, CLEVELAND, OH:  
4,393,342, AM. INT. CL. 36.
- EVOLUTION ENTERTAINMENT, LLC, PROVO, UT:  
3,247,451, CANC. INT. CL. 35.
- EVOLVING INTEGRAL DEVELOPMENT, LLC, DALLAS, TX, DBA SELF SYNTHESIZE!  
4,481,057, PUB. 11-26-2013. INT. CL. 44.
- EVONIK DEGUSSA GMBH, 45128 ESSEN, FED REP GERMANY:  
2,798,666, REN. 1-6-14. INT. CL. 1.  
2,798,676, REN. 1-6-14. INT. CL. 1.
- EVONIK INDUSTRIES AG, FED REP GERMANY:  
4,479,372, PUB. 11-26-2013. MULTIPLE CLASS, INT. CLS. 1, 2 AND 5.
- EVRIHOLDER PRODUCTS, LLC, ANAHEIM, CA:  
4,482,769, INT. CL. 8.
- EWT HOLDINGS CORP., WEST PALM BEACH, FL:  
3,248,100, CANC. INT. CL. 1.
- EXCEL DISPLAY CORP., NEW BRUNSWICK, NJ:  
1,292,725, REN. 1-8-14. INT. CL. 9.
- EXECUTIVE LEADS LLC, DALLAS, TX:  
4,480,116, PUB. 11-26-2013. INT. CL. 35.
- EXERCYCLE, S.A., 01195 VITORIA (ALAVA), SPAIN:  
2,798,152, REN. 1-3-14. INT. CL. 28.
- EXERGEN CORPORATION, WATERTOWN, MA:  
2,797,315, REN. 1-3-14. INT. CL. 9.  
2,797,355, REN. 1-3-14. INT. CL. 42.  
2,802,117, REN. 1-3-14. INT. CL. 10.
- EXIT 21 MAGAZINE, BROOKLYN, NY:  
4,480,242, PUB. 11-26-2013. INT. CL. 41.
- EXMARK MANUFACTURING COMPANY INCORPORATED, BEATRICE, NE:  
3,246,474, CANC. INT. CL. 7.
- EXO LABS, INC., BELLEVUE, WA:  
4,482,381, INT. CL. 9.  
4,482,382, INT. CL. 9.  
4,482,383, INT. CL. 9.
- EXOTISSIMO TRAVEL GROUP, BANGKOK, THAILAND:  
4,481,792, MULTIPLE CLASS, INT. CLS. 9, 39 AND 43.
- EXPANSION VENTURE CAPITAL LLC, NEW YORK, NY:  
4,482,825, INT. CL. 36.  
4,482,826, INT. CL. 36.
- EXPEDITER SERVICES, LLC, MEMPHIS, TN:  
4,479,903, PUB. 11-26-2013. INT. CL. 39.
- EXPERIAN MARKETING SOLUTIONS, INC., COSTA MESA, CA:  
3,247,162, CANC. INT. CL. 35.
- EXPLOSIVE ACADEMY, BOCA RATON, FL:  
4,479,679, PUB. 11-26-2013. INT. CL. 41.
- EXPOSUREWEAR, INC., ST. FRANCISVILLE, LA:  
4,482,181, INT. CL. 25.
- EXPRESS FRANCHISE SERVICES, L.P., OKLAHOMA CITY, OK:  
3,246,081, CANC. MULTIPLE CLASS, INT. CLS. 41 AND 43.
- EXPRESS SOLUTIONS INTERNATIONAL, INC., BALTIMORE, MD:  
3,246,478, CANC. INT. CL. 39.
- EXPRESSIONALITY INC., BOSTON, MA:  
4,481,150, PUB. 11-26-2013. INT. CL. 9.
- EXPRESSO FITNESS CORPORATION, SUNNYVALE, CA:  
3,248,617, CANC. INT. CL. 28.
- EXTREME RC BY RSI, LLC, FERNDALE, MI:  
4,480,642, PUB. 11-26-2013. INT. CL. 28.  
4,480,643, PUB. 11-26-2013. INT. CL. 28.
- EXU MEDIA, LLC, NEW YORK, NY:  
4,479,677, PUB. 11-26-2013. MULTIPLE CLASS, INT. CLS. 9 AND 41.
- EYE PLASTIC SURGERY, P.C., BRYN MAWR, PA:  
4,480,364, PUB. 11-26-2013. INT. CL. 44.
- EYE TECH S.R.L. UNIPERSONALE, ITALY:  
4,479,483, PUB. 11-26-2013. INT. CL. 5.
- EYEESEE360, INC., PITTSBURGH, PA:  
2,798,727, REN. 1-3-14. INT. CL. 9.
- EZ ADVANCED SOLUTIONS, LLC, HARRISONBURG, VA:  
4,480,980, PUB. 11-26-2013. INT. CL. 12.
- EZ-QUIT, INC., BRONX, NY:  
2,938,811, CANC. INT. CL. 5.
- EZRANI 2 CORP., NEW YORK, NY:  
4,480,556, PUB. 11-26-2013. INT. CL. 35.
- FA MANAGEMENT ENTERPRISES, INC., ST. LOUIS, MO:  
2,732,178, REN. 1-8-14. INT. CL. 37.
- FABASOFT AG, LINZ, AUSTRIA:  
3,248,719, CANC. MULTIPLE CLASS, INT. CLS. 9, 35, 37,

41 AND 42.  
3,248,720, CANC. MULTIPLE CLASS, INT. CLS. 9, 35, 37,  
41 AND 42.

FABCON COMPANIES, LLC., SAVAGE, MN:  
978,404. REN. 1-6-14. U.S. CL. 12 (INT. CL. 19).

FABI SAA INC, BELLEVILLE, NJ:  
4,479,777, PUB. 11-26-2013. INT. CL. 29.

FABLES BY BARRIE, INC, SAN DIEGO, CA:  
4,482,422, INT. CL. 25.

FABRIC7 SYSTEMS, INC., MOUNTAIN VIEW, CA:  
3,246,586, CANC. INT. CL. 9.  
3,246,587, CANC. INT. CL. 9.

FABULOUS INTERNATIONAL INC., CHARLOTTE, NC:  
4,480,596, PUB. 11-26-2013. INT. CL. 35.

FACCHIN, MICHAEL E, SAN FRANCISCO, CA:  
4,480,928, PUB. 11-26-2013. INT. CL. 35.

FACET TECHNOLOGIES, INC., PEKIN, IL:  
4,479,577, PUB. 7-16-2013. MULTIPLE CLASS, INT. CLS.  
9, 37 AND 42.

FAIR ISAAC CORPORATION, MINNEAPOLIS, MN:  
3,246,368, CANC. INT. CL. 9.

FAIR PRICE CORP, MIAMI LAKES, FL:  
4,482,640, INT. CL. 9.

FAIRFIELD CHAIR COMPANY, LENOIR, NC:  
2,868,236. REN. 1-7-14. INT. CL. 20.

FALKEN TIRE CORPORATION, RANCHO CUCAMONGA,  
CA:  
4,482,177, INT. CL. 12.

FAMILIES OF LIGHT FOUNDATION, MURRAY, UT:  
3,246,210, CANC. MULTIPLE CLASS, INT. CLS. 41 AND  
45.  
3,246,211, CANC. MULTIPLE CLASS, INT. CLS. 41 AND  
45.

FAMILY FORWARD, LLC, DRAPER, UT:  
4,482,582, INT. CL. 41.

FAMILY HOSPICE AND PALLIATIVE CARE, PITTS-  
BURGH, PA:  
4,479,631, PUB. 11-26-2013. INT. CL. 44.

FANNEY, CLINTON RYAN, LAKE CITY, FL:  
3,247,437, CANC. INT. CL. 25.

FANTASIA ACCESSORIES, INC., NEW YORK, NY:  
4,481,461, INT. CL. 25.

FAREL, DAVID JEAN JULIEN, NEW YORK, NY, AKA  
JULIEN FAREL:  
4,480,557, PUB. 11-26-2013. MULTIPLE CLASS, INT. CLS.  
3, 5, 11 AND 21.

FARHI, MICHAEL, LONDON, UNITED KINGDOM:  
4,479,818, PUB. 11-26-2013. MULTIPLE CLASS, INT. CLS.  
29, 30, 31 AND 35.

FARM TO FORK PRODUCE LLC, LA JOLLA, CA:  
4,481,037, PUB. 11-26-2013. INT. CL. 32.

FAROUK SYSTEMS, INC., HOUSTON, TX:  
4,481,463, INT. CL. 3.

FASEAT INC., MISSOULA, MT:  
4,480,249, PUB. 11-26-2013. MULTIPLE CLASS, INT. CLS.  
20 AND 37.

FASHION S.P.A., TORINO, ITALY:  
4,479,690, PUB. 11-26-2013. MULTIPLE CLASS, INT. CLS.  
18 AND 25.

FASTENAL IP COMPANY, WINONA, MN:  
4,481,410, INT. CL. 6.  
4,481,716, INT. CL. 8.

FASTGOLF USA LLC, CHICAGO, IL:  
4,482,212, INT. CL. 28.  
4,482,213, INT. CL. 28.

FAYETTE ALLIANCE, INC., LEXINGTON, KY:  
4,482,834, INT. CL. 36.

FD9 GROUP, INC., LOS ANGELES, CA:  
4,482,636, INT. CL. 14.

FEDERAL CARTRIDGE COMPANY, ANOKA, MN:  
1,820,567. REN. 1-4-14. INT. CL. 13.

FEDERAL HOME LOAN BANK OF ATLANTA, ATLANTA,  
GA:  
2,872,833. REN. 1-3-14. INT. CL. 36.

FEDERAL HOUSING FINANCE AGENCY, WASHINGTON,  
DC:  
4,482,829, MULTIPLE CLASS, INT. CLS. 35, 36 AND 41.

FEDERALQUOTE.COM, BOCA RATON, FL:  
4,482,752, INT. CL. 36.  
4,482,753, INT. CL. 36.

FEEDBACK SPORTS, LLC, GOLDEN, CO:  
3,873,281, AM. MULTIPLE CLASS, INT. CLS. 6, 9 AND  
25.

FEFFERMAN, BARRY S., SAN DIEGO, CA:  
2,800,672. REN. 1-6-14. INT. CL. 25.

FEG TEXTILTECHNIK FORSCHUNGS AND ENTWICK-  
LUNGSGESELLSCHAFT MBH, AACHEN, FED REP GER-  
MANY:  
4,479,941, PUB. 11-26-2013. INT. CL. 10.

FELICITY MOTIVATIONAL GROUP, INC., BRENTWOOD,  
TN:  
4,480,231, PUB. 11-26-2013. INT. CL. 41.

FELIX FÖRSTER, FED REP GERMANY:  
3,247,721.

FELTENSTEIN, LISA, MIAMI BEACH, FL:  
2,753,353. REN. 1-7-14. INT. CL. 41.

FELTON, MARK A., SHERMAN OAKS, CA:  
3,246,420, CANC. INT. CL. 16.

FENTRESS ARCHITECTS, LTD., DENVER, CO:  
4,479,687, PUB. 11-26-2013. MULTIPLE CLASS, INT. CLS.  
16, 35 AND 42.

FERGUSON ENTERPRISES, INC., NEWPORT NEWS, VA:  
3,246,251, CANC. INT. CL. 35.

FERNANDEZ, GILBERT, CARLSBAD, CA:  
3,246,014, CANC. INT. CL. 25.  
3,247,614, CANC. INT. CL. 25.

FERRARA CANDY COMPANY, OAKBROOK TERRACE,  
IL:  
4,482,502, INT. CL. 25.  
4,482,503, INT. CL. 25.  
4,482,504, INT. CL. 25.

FERRARI S.P.A., ITALY:  
4,479,407, PUB. 11-26-2013. MULTIPLE CLASS, INT. CLS.  
9, 12 AND 28.

FERRIGNO FIT LLC, LOS ANGELES, CA:  
4,482,459, MULTIPLE CLASS, INT. CLS. 41 AND 44.

FERROTEC (USA) CORPORATION, SANTA CLARA, CA:  
1,266,745. REN. 1-3-14. INT. CL. 1.

FERSTEN KNITWEAR INC., MONTREAL, QUEBEC, CA-  
NADA:  
3,245,742, CANC. MULTIPLE CLASS, INT. CLS. 16 AND  
18.

FERTILITY COUNCIL, LLC, THOUSAND OAKS, CA:  
4,482,866, INT. CL. 35.

FERTITTA ACQUISITIONSCO LLC, LAS VEGAS, NV:  
4,481,484, INT. CL. 41.

FEUERWEAR GMBH & CO. KG, COLOGNE, FED REP  
GERMANY:  
4,479,810, PUB. 11-26-2013. MULTIPLE CLASS, INT. CLS.  
9 AND 18.

FIAT GROUP MARKETING & CORPORATE COMMUNI-  
CATIONS S.P.A., TORINO, ITALY:  
4,479,699, PUB. 11-26-2013. MULTIPLE CLASS, INT. CLS.  
9, 12, 14, 16 AND 28.

FIBER GOURMET, MIAMI BEACH, FL:  
4,481,954, INT. CL. 30.

FIDELITY NATIONAL INFORMATION SERVICES, INC.,  
JACKSONVILLE, FL:  
3,246,657, CANC. MULTIPLE CLASS, INT. CLS. 36 AND  
41.

FIEGEL, GARY J., HELLERTOWN, PA:  
4,479,641, PUB. 11-26-2013. INT. CL. 35.  
4,479,643, PUB. 11-26-2013. INT. CL. 35.

FIELD & STREAM LICENSES COMPANY, LLC, WEST-  
PORT, CT:  
4,481,662, INT. CL. 25.

FIERCE, INC., SEATTLE, WA:  
4,479,899, PUB. 11-26-2013. INT. CL. 41.

FIESTA EDUCATIVA, INC., LOS ANGELES, CA:  
1,815,181. REN. 1-7-14. INT. CL. 41.

FIFTH STREET GAMING, LLC, LAS VEGAS, NV:  
4,481,581, INT. CL. 43.  
4,481,582, INT. CL. 35.  
4,481,583, INT. CL. 25.  
4,481,584, INT. CL. 41.

- FIFTH THIRD BANCORP, CINCINNATI, OH:  
3,248,638, CANC. INT. CL. 36.
- FIGUEROA, ADAN, CARSON, CA:  
4,482,536, INT. CL. 30.
- FILEMEDIC SP. Z O.O., 31-553 KRAKÓW, POLAND:  
4,479,715, PUB. 6-4-2013. MULTIPLE CLASS, INT. CLS. 9 AND 42.
- FILIGREE LLC, SEATTLE, WA, DBA FILIGREE:  
4,482,617, INT. CL. 42.
- FILITALIA INC., PHILADELPHIA, PA, DBA FILITALIA NATIONAL:  
2,797,579. REN. 1-6-14. INT. CL. 35.
- FILLMORE CO., LTD., MUSASHINO-SHI, TOKYO, JAPAN:  
2,805,114. REN. 1-8-14. INT. CL. 15.
- FILMMAKERS UNITED, N. HOLLYWOOD, CA:  
4,482,235, INT. CL. 41.
- FILTREXX INTERNATIONAL, LLC, GRAFTON, OH:  
4,482,550, INT. CL. 21.
- FINANCIAL INSTITUTION PRODUCTS CORPORATION, MADISON, WI:  
2,796,724. REN. 1-6-14. MULTIPLE CLASS, INT. CLS. 9, 16, 35, 41 AND 42.
- FINANCIAL MANAGEMENT GROUP, INC., CINCINNATI, OH:  
3,247,370, CANC. INT. CL. 36.  
3,247,371, CANC. INT. CL. 36.
- FINANCIAL MARKETING RESOURCES, LLC, CENTENNIAL, CO:  
3,248,571, CANC. INT. CL. 35.
- FINDADOC, INC., GLEN HEAD, NY:  
3,246,393, CANC. MULTIPLE CLASS, INT. CLS. 35 AND 44.
- FINDLEY, EDWINA N., BROOKLYN, NY:  
3,247,204, CANC. INT. CL. 41.
- FINE ESTATES FROM SPAIN, INC., DEDHAM, MA:  
3,248,165, CANC. INT. CL. 33.
- FINGER PRINCE, INC., MEDIA, PA:  
4,479,921, PUB. 11-26-2013. INT. CL. 41.
- FINISHING CONTRACTORS ASSOCIATION, BETHESDA, MD:  
4,479,682, PUB. 11-26-2013. INT. CL. 41.
- FINISHING TECHNOLOGIES, INC., NEENAH, WI:  
2,863,758. REN. 1-3-14. INT. CL. 41.
- FINK, KENNETH S., RIVER EDGE, NJ:  
3,248,379, CANC. INT. CL. 41.
- FIREEYE, INC., MILPITAS, CA:  
4,482,007, MULTIPLE CLASS, INT. CLS. 9 AND 42.
- FIREFISH DESIGNS, LTD, NEW ALBANY, OH:  
3,248,635, CANC. INT. CL. 20.
- FIRENZE VIOLA S.R.L., 50137 FIRENZE, ITALY:  
3,265,248.  
3,265,249.
- FIRMENICH S.A., GENEVE 8, SWITZERLAND:  
2,799,196. REN. 1-6-14. INT. CL. 1.  
2,807,784. REN. 1-8-14. MULTIPLE CLASS, INT. CLS. 1 AND 3.  
2,807,785. REN. 1-8-14. MULTIPLE CLASS, INT. CLS. 1 AND 3.
- FIRST BANK OF IDAHO, KETCHUM, ID:  
3,248,069, CANC. INT. CL. 36.
- FIRST COAST LOGISTICS AND BROKERAGE, LLC, JACKSONVILLE, FL, DBA TRIPLE X SURFERS OUTLET:  
4,481,991, INT. CL. 28.
- FIRST FINANCIAL GROUP, LLC, CLEARWATER, FL:  
4,480,898, PUB. 11-26-2013. INT. CL. 36.
- FIRST FITNESS INTERNATIONAL, INC., CARROLLTON, TX:  
1,852,180. REN. 1-9-14. INT. CL. 5.
- FIRST INTERNET BANK OF INDIANA, INDIANAPOLIS, IN:  
3,247,325, CANC. INT. CL. 36.
- FIRST MENASHA BANCSHARES, INC., NEENAH, WI, DBA FIRST NATIONAL BANK - FOX VALLEY:  
4,482,537, INT. CL. 36.
- FIRSTENERGY CORP., AKRON, OH:  
2,719,287, CANC. INT. CL. 39.
- FIRSTFRUITS SYSTEMS INC, SAN JOSE, CA:  
4,482,817, INT. CL. 16.
- FISCHBEIN LLC, STATESVILLE, NC:  
4,480,868, PUB. 11-26-2013. INT. CL. 7.  
4,480,869, PUB. 11-26-2013. INT. CL. 7.  
4,480,870, PUB. 11-26-2013. INT. CL. 7.
- FISH HAWK SPIRITS, LLC, OCALA, FL:  
4,481,597, INT. CL. 33.
- FISHER COMPANIES, LLC, MT. PLEASANT, MI:  
4,481,473, MULTIPLE CLASS, INT. CLS. 19, 37 AND 39.
- FISHER RANCH CORPORATION, BLYTHE, CA:  
4,479,257, PUB. 11-17-2009. INT. CL. 31.
- FISHNET SECURITY, INC., OVERLAND PARK, KS:  
4,480,344, PUB. 11-26-2013. INT. CL. 41.
- FISKARS BRANDS, INC., MADISON, WI:  
4,481,628, MULTIPLE CLASS, INT. CLS. 8, 11 AND 13.
- FISKE-RUSCIANO, ROBERTA, EWING, NJ:  
3,225,129, CANC. INT. CL. 41.
- FITLIFE BRANDS, INC., OMAHA, NE:  
4,479,877, PUB. 2-26-2013. INT. CL. 5.
- FITNESS DESIGN GROUP, INC., SANTA MONICA, CA:  
3,246,325, CANC. INT. CL. 35.
- FITNESS RESOURCE - RETAIL, LLC, COTTAGE GROVE, WI:  
3,246,692, CANC. INT. CL. 35.
- FITZGERALD, SHEHU, STATEN ISLAND, NY:  
4,479,866, PUB. 11-26-2013. INT. CL. 30.
- FIVE STAR FOOD SERVICE, INC., CHATTANOOGA, TN:  
3,246,158, CANC. INT. CL. 30.
- FIX THE CAUSE PLLC, CEDAR HILL, TX:  
4,480,078, PUB. 11-26-2013. INT. CL. 44.
- FLAGEOLI CLASSIC LIMITED, LLC, LAS VEGAS, NV:  
3,248,381, CANC. INT. CL. 3.
- FLASHBANG INC, FONTANA, CA:  
4,479,938, PUB. 11-26-2013. INT. CL. 33.
- FLEETNET AMERICA, INC., CHERRYVILLE, NC:  
4,480,028, PUB. 11-26-2013. MULTIPLE CLASS, INT. CLS. 35, 37 AND 42.
- FLEX WATCHES, INC., SAN DIEGO, CA:  
4,482,875, INT. CL. 36.
- FLICKA BOUTIQUE, INC., SAN FRANCISCO, CA:  
3,248,186, CANC. MULTIPLE CLASS, INT. CLS. 14 AND 25.
- FLO COLLECTION INC., TORONTO, ONTARIO, CANADA:  
4,479,548, PUB. 11-26-2013. INT. CL. 16.
- FLOP HAPPY LLC, POTTSTOWN, PA, DBA FLIPSIDEZ:  
4,480,615, PUB. 11-26-2013. INT. CL. 25.
- FLOP STUDIOS, INC., GREENWOOD VILLAGE, CO:  
4,481,952, INT. CL. 9.
- FLORIDA PNEUMATIC MANUFACTURING CORPORATION, JUPITER, FL:  
1,263,411. REN. 1-9-14. INT. CL. 7.
- FLOWER CHILD FOREVER, INC., LOS ANGELES, CA:  
4,430,119, COR. INT. CL. 25.
- FLOWROUTE LLC, SEATTLE, WA:  
4,480,410, PUB. 11-26-2013. INT. CL. 38.
- FLUIDIGM CORPORATION, SOUTH SAN FRANCISCO, CA, FLUIDIGM CORPORATION, SOUTH SAN FRANCISCO, CA:  
2,798,376. REN. 1-6-14. INT. CL. 42.
- FLUIDIGM CORPORATION, SOUTH SAN FRANCISCO, CA:  
2,799,039. REN. 1-6-14. MULTIPLE CLASS, INT. CLS. 7, 9, 10 AND 35.  
2,799,040. REN. 1-6-14. MULTIPLE CLASS, INT. CLS. 7, 9, 10 AND 35.
- FLY HOLDINGS LLC, DALLAS, TX:  
4,482,123, INT. CL. 44.
- FLYING TRADE LIMITED, UNITED KINGDOM:  
4,479,286, PUB. 8-20-2013. MULTIPLE CLASS, INT. CLS. 29 AND 30.
- FLYJET LIMITED, WEST SUSSEX RH6 0JJ, UNITED KINGDOM:  
3,245,736, CANC. INT. CL. 39.  
3,245,737, CANC. INT. CL. 39.
- FME, INC., EVANSVILLE, IN, FORMERLY FACILITY MANAGEMENT & ENGINEERING, INC.:  
4,479,737, PUB. 11-26-2013. INT. CL. 42.
- FMR LLC, BOSTON, MA:  
4,481,917, MULTIPLE CLASS, INT. CLS. 37, 41 AND 42.



FNF INTELLECTUAL PROPERTY HOLDINGS, INC., JACKSONVILLE, FL:  
4,480,436, PUB. 11-26-2013. MULTIPLE CLASS, INT. CLS. 35, 36, 42 AND 45.

FOCAL POINT, L.L.C., CHICAGO, IL:  
2,802,842. REN. 1-6-14. INT. CL. 11.

FOCUS FRAME, INC., SAN FRANCISCO, CA:  
3,246,548, CANC. MULTIPLE CLASS, INT. CLS. 35 AND 42.

FOCUS TELECOMMUNICATIONS, INC., ELDERSBURG, MD:  
4,481,081, PUB. 11-26-2013. INT. CL. 35.

FOGATA, BRIAN, VENTURA, CA AND FOGATA, KATHY, VENTURA, CA:  
4,481,305, INT. CL. 25.

FOLEY FAMILY WINES, INC., HEALDSBURG, CA:  
1,779,813. REN. 1-8-14. INT. CL. 33.

FOLIAR NUTRIENTS, INC., CAIRO, GA:  
4,482,364, INT. CL. 5.

FOLLAIN INC., BOSTON, MA:  
4,480,887, PUB. 11-26-2013. INT. CL. 35.

FOLTZ, JIM, MINNEAPOLIS, MN:  
3,246,481, CANC. INT. CL. 9.

FOO, STEPHEN, ADDISON, TX:  
2,813,283. REN. 1-3-14. MULTIPLE CLASS, INT. CLS. 35 AND 42.

FOOD PROCESSING SUPPLIERS ASSOCIATION, MCLEAN, VA:  
3,246,830, CANC. INT. CL. 35.

FOOD SCIENCES CORPORATION, MOUNT LAUREL, NJ:  
3,247,327, CANC. INT. CL. 29.

FOOTBALL NETWORKS LLC, WILMINGTON, DE:  
4,431,811, COR. INT. CL. 38.

FOOTEN USA, LLC, LAS VEGAS, NV:  
3,248,694, CANC. INT. CL. 3.

FOR THE LOVE OF LIFE, INC., WEST PATERSON, NJ:  
2,718,497, CANC. INT. CL. 42.

FORD MOTOR COMPANY, DEARBORN, MI:  
2,799,201. REN. 1-6-14. MULTIPLE CLASS, INT. CLS. 35, 38, 39, 41, 43 AND 45.

FORENSIC SCIENCE SERVICE LIMITED, SOLIHULL, B37 7YN, UNITED KINGDOM:  
3,246,135, CANC. MULTIPLE CLASS, INT. CLS. 9, 37, 41 AND 42.

FOREVER SIX INCORPORATED, MELBOURNE, FL:  
4,481,665, INT. CL. 3.

FORSTER-LONG, LLC, DALLAS, TX:  
2,719,133, CANC. INT. CL. 16.

FORSYTHE COSMETIC GROUP, LTD., LAWRENCE, NY:  
4,480,315, PUB. 11-26-2013. INT. CL. 3.

FORT ZUMWALT PUBLIC SCHOOL EDUCATION FOUNDATION, O'FALLON, MO:  
3,229,421, COR. INT. CL. 36.

FORTE' MANAGEMENT CORPORATION, CINCINNATI, OH:  
1,288,371. REN. 1-5-14. INT. CL. 42.

FORUM D'AVIGNON, FRANCE:  
4,479,300, PUB. 11-26-2013. MULTIPLE CLASS, INT. CLS. 16, 35, 38 AND 41.

FOSTER, TERESA, BEDFORD, VA:  
4,479,988, PUB. 11-26-2013. INT. CL. 16.

FOSTER'S AUSTRALIA LIMITED, AUSTRALIA:  
3,247,800.

FOTIS AND SON IMPORTS, INC., HUNTINGTON BEACH, CA, DBA FOTIS AND SON:  
1,797,981. REN. 1-6-14. INT. CL. 29.

FOTOTEC OPTICAL INDUSTRIES LTD., SAN PO KONG, HONG KONG:  
1,713,135, CANC. INT. CL. 9.

FOUNDATIONS WORLDWIDE, INC., MEDINA, OH:  
4,481,850, INT. CL. 24.

FOUR BEARS WINERY LLC, SACRAMENTO, CA:  
4,482,558, INT. CL. 33.  
4,482,559, INT. CL. 33.

FOUR PAWS PRODUCTS LTD., HAUPPAUGE, NY:  
2,718,770, CANC. INT. CL. 20.

FOUR SEASONS SALES AND SERVICE, INC., PARIS, TN:  
4,482,296, INT. CL. 3.

FOX AVENUE, VERNON, CA:  
3,247,345, CANC. INT. CL. 25.

FOX INTERNATIONAL CHANNELS (US), INC., LOS ANGELES, CA:  
4,482,260, INT. CL. 41.

FOX SPORTS NET, INC., LOS ANGELES, CA:  
3,248,409, CANC. INT. CL. 41.

FRAGRAMATICS MANUFACTURING CO., INC., PINE BLUFF, AR:  
3,245,940, CANC. INT. CL. 9.

FRANCIS DREYFUS MUSIC, PARIS, FRANCE:  
1,240,025, CANC. MULTIPLE CLASS, INT. CLS. 9 AND 16.

FRANK BRUNCKHORST CO., L.L.C., BROOKLYN, NY:  
3,348,495, AM. INT. CL. 29.

FRANKLIN ELECTRIC CO., INC., BLUFFTON, IN:  
3,248,262, CANC. MULTIPLE CLASS, INT. CLS. 7 AND 9.

FREDERICK WARNE & CO., INC., NEW YORK, NY:  
2,718,959, CANC. INT. CL. 16.

FREE RANGE GRAPHICS, LLC, WASHINGTON, DC, DBA FREE RANGE STUDIOS:  
4,482,820, INT. CL. 35.

FREE SYSTEMS, LLC, GARDENA, CA:  
3,247,260, CANC. INT. CL. 25.

FREEBORN & PETERS LLP, CHICAGO, IL:  
4,482,588, INT. CL. 45.

FREEDULGENCE LLC, NEW YORK, NY:  
4,482,424, INT. CL. 30.

FREEFALL, LLC, DURHAM, NC:  
4,482,266, INT. CL. 18.

FREELANCE ADVENTURES INC., RIDGWAY, CO:  
2,718,947, CANC. INT. CL. 41.

FREEMAN INC., MILTON, GA, DBA LEARNING ROADS:  
4,480,506, PUB. 11-26-2013. INT. CL. 35.

FREEMAN, MATTHEW, S., DAYTON, OH:  
4,482,844, INT. CL. 10.

FREEPORT COBALT AMERICAS LLC, PHOENIX, AZ:  
4,482,625, MULTIPLE CLASS, INT. CLS. 1 AND 6.

FREEPORT-MCMORAN COPPER & GOLD, INC., PHOENIX, AZ:  
1,811,274. REN. 1-7-14. INT. CL. 42.

FREESOFT INTERNATIONAL, INC., VIENNA, VA:  
3,247,252, CANC. INT. CL. 42.  
3,247,253, CANC. INT. CL. 42.  
3,247,254, CANC. INT. CL. 42.

FREIGHTBADGER.COM, INC., SAN GABRIEL, CA:  
4,482,211, INT. CL. 39.

FREISTAAT SACHSEN, DRESDEN, FED REP GERMANY:  
2,804,015. REN. 1-3-14. MULTIPLE CLASS, INT. CLS. 9, 16 AND 41.

FREMANTLEMEDIA OPERATIONS B.V., 1217 GP HILVERSUM, NETHERLANDS:  
2,719,599, CANC. INT. CL. 41.

FRENCH BULL LLC, NEW YORK, NY:  
4,480,492, PUB. 11-26-2013. INT. CL. 16.

FREQUENCY.COM, LLP, MIAMI BEACH, FL:  
3,246,962, CANC. INT. CL. 41.

FRESH CHOICE, LLC, SANTA BARBARA, CA:  
2,729,672. REN. 1-9-14. INT. CL. 42.

FRESH ELEMENT INCORPORATED, NEWHALL, CA:  
3,247,091, CANC. INT. CL. 35.

FRESHLY PICKED INC., PROVO, UT:  
4,482,796, INT. CL. 25.

FRIEDMAN, CAROLYN R., TALLAHASSEE, FL:  
4,480,466, PUB. 11-26-2013. MULTIPLE CLASS, INT. CLS. 9 AND 41.

FRITO-LAY NORTH AMERICA, INC., PLANO, TX:  
2,719,517, CANC. INT. CL. 30.  
4,481,589, INT. CL. 30.  
4,481,717, INT. CL. 29.  
4,482,013, INT. CL. 30.  
4,482,646, MULTIPLE CLASS, INT. CLS. 29 AND 30.

- FRONTRANGE SOLUTIONS USA INC., COLORADO SPRINGS, CO:  
4,481,190, PUB. 11-26-2013. INT. CL. 9.  
4,481,191, PUB. 11-26-2013. INT. CL. 41.  
4,481,192, PUB. 11-26-2013. INT. CL. 9.  
4,481,193, PUB. 11-26-2013. INT. CL. 41.  
4,481,194, PUB. 11-26-2013. INT. CL. 9.  
4,481,195, PUB. 11-26-2013. INT. CL. 41.
- FROST & SULLIVAN, SAN ANTONIO, TX:  
2,718,863, CANC. MULTIPLE CLASS, INT. CLS. 16 AND 41.
- FRUCTOSE FREE PRODUCTS LLC, TOMKINS COVE, NY:  
4,480,430, PUB. 11-26-2013. INT. CL. 30.
- FTD.COM, INC., DOWNERS GROVE, IL:  
1,779,145, REN. 1-8-14. INT. CL. 35.
- FTR, LTD., PHOENIX, AZ:  
4,480,526, PUB. 11-26-2013. INT. CL. 9.
- FUCANG (BEIJING) CULTURE CO.,LTD., BEIJING, CHINA:  
4,480,997, PUB. 11-26-2013. INT. CL. 25.
- FUCHSIN AVE LLC, FOUNTAIN HILLS, AZ:  
4,480,952, PUB. 11-26-2013. INT. CL. 18.
- FUJI PHOTO FILM CO., LTD., KANAGAWA-KEN, JAPAN:  
3,245,699, CANC. INT. CL. 9.
- FUJI SILYSIA KAGAKU KABUSHIKI KAISHA, KASUGAISHI, AICHI-KEN, JAPAN:  
1,846,420, REN. 1-6-14. INT. CL. 1.
- FUJIAN SHAOWU FULIAN CO., LTD, CHINA:  
4,479,436, PUB. 11-26-2013. MULTIPLE CLASS, INT. CLS. 21 AND 24.
- FUJIFILM CORPORATION, TOKYO, JAPAN:  
4,479,256, PUB. 11-26-2013. INT. CL. 5.
- FUJIFILM NORTH AMERICA CORPORATION, VALHALLA, NY:  
4,482,836, INT. CL. 42.
- FUJII, SHOICHI MIKE, WHITE ROCK, BC, CANADA:  
4,481,139, PUB. 11-26-2013. INT. CL. 35.
- FUJITSU NETWORK COMMUNICATIONS, INC, RICHARDSON, TX:  
1,814,356, REN. 1-5-14. INT. CL. 9.
- FUKUDA DENSHI USA, INC., REDMOND, WA:  
3,246,414, CANC. INT. CL. 10.
- FULAIS INDUSTRIAL CO., LIMITED, HONG KONG, HONG KONG:  
3,247,428, CANC. MULTIPLE CLASS, INT. CLS. 20 AND 21.  
3,247,435, CANC. MULTIPLE CLASS, INT. CLS. 20 AND 21.  
3,247,438, CANC. MULTIPLE CLASS, INT. CLS. 20 AND 21.
- FULK, CHRISTEN, BLACK MOUNTAIN, NC:  
4,482,173, MULTIPLE CLASS, INT. CLS. 16, 18 AND 24.
- FULLEN SYSTEMS, LLC, SALINA, KS:  
2,813,986, REN. 1-9-14. MULTIPLE CLASS, INT. CLS. 9, 10, 40 AND 42.
- FULLER, NIGEL, GREENVILLE, SC:  
3,247,625, CANC. INT. CL. 41.
- FULLSTEP NETWORKS, S.L., MADRID, SPAIN:  
4,482,460, MULTIPLE CLASS, INT. CLS. 9, 35 AND 42.
- FULTON MANAGEMENT SERVICES, INC., PULASKI, NY:  
4,480,370, PUB. 11-26-2013. INT. CL. 9.
- FULTON STREET BREWERY LLC, CHICAGO, IL:  
4,480,419, PUB. 11-26-2013. INT. CL. 32.
- FULTON, ADAM, PEMBRROKE, GA:  
4,482,160, INT. CL. 25.
- FUMARE INTERNATIONALE, RENO, NV:  
4,482,656, INT. CL. 34.
- FUN FOR LESS TOURS, INC., DRAPER, UT:  
4,479,914, PUB. 11-26-2013. MULTIPLE CLASS, INT. CLS. 39, 41 AND 43.
- FUNKWORKS, INC., MACON, GA:  
3,246,378, CANC. INT. CL. 18.
- FUNMAIL INC., LIVERMORE, CA:  
3,248,081, CANC. INT. CL. 9.
- FURTHERED, INC., NEW YORK, NY:  
1,817,576, REN. 1-5-14. INT. CL. 42.
- FUSE SCIENCE, INC., MIAMI LAKES, FL:  
4,482,011, INT. CL. 5.
- FUTURE O&P DESIGN FABRICATIONS, HUTTO, TX:  
4,480,200, PUB. 11-26-2013. MULTIPLE CLASS, INT. CLS. 10 AND 40.
- FUTUREX, INC., WHITE PLAINS, NY:  
4,482,627, INT. CL. 5.
- G & A USA GROUP INC, BROOKLYN, NY:  
3,247,909, CANC. INT. CL. 12.
- G & M (UK) LIMITED, UNITED KINGDOM:  
4,479,397, PUB. 11-26-2013. INT. CL. 25.
- G R LANE HEALTH PRODUCTS LIMITED, GLOUCESTER, UNITED KINGDOM:  
4,481,421, INT. CL. 5.
- G&G DISTRIBUTORS INC., SADDLE BROOK, NJ:  
4,480,903, PUB. 11-26-2013. INT. CL. 35.
- G&S METAL PRODUCTS COMPANY, INC., CLEVELAND, OH:  
4,481,774, MULTIPLE CLASS, INT. CLS. 11 AND 21.
- GABI CONCEPTS LTD., TORONTO, ONTARIO, CANADA:  
4,481,318, MULTIPLE CLASS, INT. CLS. 9 AND 14.
- GAFFOS INC, INWOOD, NY:  
4,482,523, INT. CL. 35.
- GAIA FRANCE, S.A.R.L., F-06400 CANNES, FRANCE:  
4,479,347, PUB. 11-26-2013. MULTIPLE CLASS, INT. CLS. 8, 16, 17 AND 20.
- GAIAM AMERICAS, INC., LOUISVILLE, CO:  
4,481,408, INT. CL. 9.
- GAIL'S GOURMET FOODS INC., NIAGARA FALLS, ONTARIO, CANADA:  
4,480,110, PUB. 11-26-2013. INT. CL. 29.
- GAINER ORGANIZING LLC, CHICAGO, IL:  
3,246,227, CANC. INT. CL. 35.
- GALBUSERA SPA, 23013 COSIO VALTELLINO, ITALY:  
4,479,919, PUB. 11-26-2013. INT. CL. 30.  
4,479,923, PUB. 11-26-2013. INT. CL. 30.
- GALDERMA S.A., CHAM, SWITZERLAND:  
4,481,358, MULTIPLE CLASS, INT. CLS. 3, 5 AND 10.
- GAMAX MOTO CORPORATION, TAIPEI COUNTY 242, TAIWAN:  
3,247,274, CANC. INT. CL. 12.
- GAME DEVLEOPMENT GROUP INC., CHEVY CHASE, MD:  
4,480,937, PUB. 11-26-2013. INT. CL. 28.
- GAMESTOP, INC., GRAPEVINE, TX, GAMESTOP, INC., GRAPEVINE, TX:  
2,805,277, REN. 1-6-14. INT. CL. 41.
- GAMEWARE DEVELOPMENT LTD, UNITED KINGDOM:  
3,247,820.
- GAMMA ENTERPRISES, LLC, WEST BABYLON, NY:  
4,482,003, MULTIPLE CLASS, INT. CLS. 5 AND 32.
- GANO EXCEL INDUSTRIES SDN. BHD., IRWINDALE, CA:  
4,480,704, PUB. 11-26-2013. MULTIPLE CLASS, INT. CLS. 1, 3, 5, 30, 32 AND 35.
- GAO, YUQING, CHANGQING COUNTY, SHANDONG, CHINA:  
3,248,344, CANC. INT. CL. 25.
- GAP (APPAREL), LLC, SAN FRANCISCO, CA:  
2,837,393, REN. 1-3-14. INT. CL. 28.  
4,481,405, INT. CL. 18.  
4,482,284, INT. CL. 39.
- GARLAND COMPANY, INC., THE, CLEVELAND, OH:  
3,246,185, CANC. INT. CL. 19.
- GARMONT NA, INC., WILLISTON, VT:  
2,719,063, CANC. INT. CL. 25.
- GARZA, ROZANA, WALNUT, CA:  
3,247,018, CANC. INT. CL. 25.
- GAS TECHNOLOGY INSTITUTE, DES PLAINES, IL:  
2,720,041, CANC. INT. CL. 35.
- GASAMAT OIL CORP. OF COLORADO, BOULDER, CO:  
4,480,913, PUB. 11-26-2013. INT. CL. 37.  
4,480,915, PUB. 11-26-2013. INT. CL. 37.
- GASTROFIX GMBH, FED REP GERMANY:  
4,449,494, COR. INT. CL. 9.
- GATEWAY CREATIVE BROADCASTING, INC., DES PERES, MO:  
4,480,818, PUB. 11-26-2013. INT. CL. 38.
- GATR TECHNOLOGIES, INC., HUNTSVILLE, AL:  
3,246,822, CANC. INT. CL. 42.

GAUPP, PETER, M., ROCKFORD, MN AND GAUPP, CYNTHIA L., ROCKFORD, MN:  
2,762,795. REN. 1-3-14. INT. CL. 42.

GAVET, IAN MALCOLM, SAN ANSELMO, CA:  
3,247,521, CANC. INT. CL. 3.

GAYLORD C STOTTS, PRATT, KS, AKA JOE STOTTS:  
3,245,962, CANC. INT. CL. 5.

GBT ENTERPRISES, FORT WORTH, TX:  
3,247,149, CANC. INT. CL. 35.

GCC RIO GRANDE, INC., TIJERAS, NM:  
4,479,792, PUB. 11-26-2013. INT. CL. 19.

GCGA ACQUISITION INC., EXCELSIOR, MN AND GCGA ACQUISITIONS INC., EXCELSIOR, MN:  
2,803,723. REN. 1-8-14. INT. CL. 21.

GDCA, INC., LIVERMORE, CA:  
4,480,170, PUB. 11-26-2013. INT. CL. 37.

GEA MECHANICAL EQUIPMENT GMBH, FED REP GERMANY:  
3,247,694.

GEARBULK HOLDING LIMITED, HAMILTON HM JX, BERMUDA:  
4,479,478, PUB. 11-26-2013. INT. CL. 39.

GEBR. BRASSELER GMBH & CO. KG, LEMGO, FED REP GERMANY:  
3,248,039, CANC. INT. CL. 10.

GEE HOO INDUSTRIAL CORP., TAIPEI CITY 11166, TAIWAN:  
2,820,248. REN. 1-8-14. INT. CL. 28.

GEFFEN VISIONS INTERNATIONAL, INC., BOULDER, CO:  
4,481,325, INT. CL. 41.

GEHL FLOORING SUPPLY, INC., BUTLER, WI:  
4,481,162, PUB. 11-26-2013. INT. CL. 35.

GEHRLICHER SOLAR AG, 85609 DORNACH B. MÜNCHEN, FED REP GERMANY:  
4,479,325, PUB. 11-26-2013. MULTIPLE CLASS, INT. CLS. 6, 7, 9, 11, 19, 35, 37, 38 AND 42.

GEIL, JASON, OAK PARK, IL AND KINDLER, DAVID, OAK PARK, IL:  
4,481,085, PUB. 11-26-2013. INT. CL. 41.

GEMÜ GEBR. MÜLLER APPARATEBAU; GMBH & CO. KOMMANDITGESELLSCHAFT, FED REP GERMANY:  
4,479,410, PUB. 11-26-2013. MULTIPLE CLASS, INT. CLS. 6, 7, 9 AND 17.

GEMMA F. LAWSON, MARINA DEL REY, CA:  
3,248,578, CANC. INT. CL. 42.

GENERAL ASSOCIATION OF REGULAR BAPTIST CHURCHES, SCHAUMBURG, IL:  
4,480,468, PUB. 11-26-2013. INT. CL. 45.

GENERAL BOARD OF THE CHURCH OF THE NAZARENE, LENEXA, KS:  
4,482,283, MULTIPLE CLASS, INT. CLS. 16 AND 45.

GENERAL ELECTRIC COMPANY, SCHENECTADY, NY:  
2,805,733. REN. 1-9-14. MULTIPLE CLASS, INT. CLS. 35, 37 AND 42.  
3,248,108, CANC. INT. CL. 9.  
4,482,156, INT. CL. 7.  
4,482,157, INT. CL. 11.  
4,482,158, INT. CL. 37.  
4,482,159, INT. CL. 39.  
4,482,167, INT. CL. 11.  
4,482,168, INT. CL. 12.  
4,482,169, INT. CL. 35.  
4,482,170, INT. CL. 37.  
4,482,171, INT. CL. 39.  
4,482,192, INT. CL. 44.  
4,482,193, INT. CL. 44.  
4,482,261, INT. CL. 10.  
4,482,262, INT. CL. 10.

GENERAL GROWTH PROPERTIES, INC., CHICAGO, IL:  
3,245,837, CANC. MULTIPLE CLASS, INT. CLS. 35 AND 36.

GENERAL MILLS IP HOLDINGS I, LLC, MINNEAPOLIS, MN:  
3,248,324, CANC. INT. CL. 30.

GENERAL MOTORS LLC, DETROIT, MI:  
4,482,475, INT. CL. 12.

GENERAL SUPPLY & SERVICES, INC., DALLAS, TX, DBA GEXPRO:  
2,816,035. REN. 1-6-14. MULTIPLE CLASS, INT. CLS. 35 AND 42.  
2,816,035, CANC. INT. CL. 41.

GENERAL WIRE SPRING CO., MCKEES ROCKS, PA:  
4,479,973, PUB. 11-26-2013. INT. CL. 7.

GENERALE BISCUIT, FRANCE:  
4,479,346, PUB. 8-13-2013. INT. CL. 30.

GENERAMEDIX, INC., LIBERTY CORNER, NJ:  
3,247,977, CANC. MULTIPLE CLASS, INT. CLS. 35 AND 42.

GENERATION INDUSTRIES, LLC, WAKE FOREST, NC:  
4,482,246, INT. CL. 25.

GENESIS HEALTH, INC., JACKSONVILLE, FL:  
3,247,134, CANC. MULTIPLE CLASS, INT. CLS. 41 AND 44.

GENEVA REAL ESTATE EXCHANGE, LLC, MINNEAPOLIS, MN:  
3,248,557, CANC. INT. CL. 36.

GENFIT, LOOS, FRANCE:  
2,718,601, CANC. MULTIPLE CLASS, INT. CLS. 9 AND 42.

GENOA CELLARS LLC, WOODINVILLE, WA:  
4,480,612, PUB. 11-26-2013. INT. CL. 33.

GENOS DERWIN WILLIAMS, PARKER, CO:  
4,480,912, PUB. 11-26-2013. INT. CL. 25.

GENTILE, BILL, LEVITTOWN, NY:  
4,482,391, INT. CL. 35.

GENTLE STAR MEDSPA MEDICAL CORPORATION, INC., SAN FRANCISCO, CA:  
3,247,049, CANC. INT. CL. 44.

GEO SEMICONDUCTOR INC., SAN JOSE, CA:  
4,480,188, PUB. 11-26-2013. INT. CL. 9.

GEOFFREY, LLC, WAYNE, NJ:  
3,246,066, CANC. INT. CL. 28.  
3,247,578, CANC. INT. CL. 35.

GEOPIER FOUNDATION COMPANY, INC., DAVIDSON, NC:  
4,482,563, INT. CL. 37.

GEOPONICA, S.A. C.V., MEXICO D.F., MEXICO:  
4,481,785, INT. CL. 31.

GEORGE BOZIC JR., CHICAGO, IL, DBA BOZIC'S IMPORTS & WHOLESALE LIQUORS:  
4,481,366, INT. CL. 33.

GEORGE D. JOHNSON, NASHVILLE, TN:  
4,481,789, INT. CL. 25.

GEORGE NOROIAN, PALO ALTO, CA:  
4,481,335, MULTIPLE CLASS, INT. CLS. 9, 35 AND 41.

GEORGE R. CHABY, INC., PHILADELPHIA, PA:  
2,797,132. REN. 1-7-14. INT. CL. 18.

GEORGIA-PACIFIC CONSUMER PRODUCTS LP, ATLANTA, GA:  
2,834,670. REN. 1-8-14. INT. CL. 16.  
4,481,927, INT. CL. 20.

GEOX S.P.A., ITALY:  
4,479,517, PUB. 11-26-2013. INT. CL. 25.  
4,479,518, PUB. 11-26-2013. INT. CL. 25.

GERONIMO WIND ENERGY, LLC, EDINA, MN:  
4,482,600, MULTIPLE CLASS, INT. CLS. 40 AND 42.

GERSHKOVITCH, ELI, VANCOUVER, BRITISH COLUMBIA, CANADA:  
2,946,361, CANC. INT. CL. 32.

GET TATTLE INC., LEWES, DE:  
4,480,598, PUB. 11-26-2013. INT. CL. 9.

GETECH GROUP PLC, LEEDS, UNITED KINGDOM:  
3,246,301, CANC. MULTIPLE CLASS, INT. CLS. 9, 16 AND 42.

GETTY IMAGES (US), INC., NEW YORK, NY:  
4,481,812, INT. CL. 9.  
4,481,813, INT. CL. 45.

GHEI, SANJAY, FLORAL PARK, NY:  
4,480,457, PUB. 11-26-2013. INT. CL. 35.

GHIAM, MEHRDAD FOTOOHI, COLUMBIA, MO:  
4,479,651, PUB. 11-26-2013. INT. CL. 9.  
4,479,652, PUB. 11-26-2013. INT. CL. 9.

GIBBS, JORGE W, WOODBRIDGE, VA:  
4,479,242, PUB. 11-26-2013. MULTIPLE CLASS, INT. CLS.

- 18 AND 25.  
 GIERLINGS VELPOR - VELUDO PORTUGUES, S.A., 4825-109 AGUA LONGA, PORTUGAL:  
 2,799,678. REN. 1-3-14. INT. CL. 24.  
 GIFT A FEAST LLC, SAN FRANCISCO, CA:  
 4,481,027, PUB. 11-26-2013. INT. CL. 35.  
 GIFT CARD IMPRESSIONS, LLC, OVERLAND PARK, KS:  
 4,482,676, MULTIPLE CLASS, INT. CLS. 9 AND 16.  
 GILLETTE COMPANY, THE, BOSTON, MA:  
 1,865,174. REN. 1-9-14. INT. CL. 8.  
 3,247,163, CANC. MULTIPLE CLASS, INT. CLS. 3 AND 25.  
 GINGER LABS, INC., PALO ALTO, CA:  
 4,481,180, PUB. 11-26-2013. INT. CL. 9.  
 GIOCHI PREZIOSI S.P.A., MILANO (MI), ITALY:  
 4,479,501, PUB. 11-26-2013. MULTIPLE CLASS, INT. CLS. 16, 28 AND 41.  
 GIRL SCOUTS OF THE UNITED STATES OF AMERICA, NEW YORK, NY:  
 4,481,906, INT. CL. 41.  
 GIRL TALK FOUNDATION, INC., CHARLOTTE, NC:  
 4,480,154, PUB. 11-26-2013. INT. CL. 41.  
 GIRLS INCORPORATED, NEW YORK, NY:  
 3,247,637, CANC. INT. CL. 41.  
 GIRLS ON THE RUN INTERNATIONAL, CHARLOTTE, NC:  
 3,246,607, CANC. INT. CL. 41.  
 3,246,608, CANC. INT. CL. 41.  
 GIRVAN HENRY, GRAYSON, GA:  
 4,479,853, PUB. 11-26-2013. MULTIPLE CLASS, INT. CLS. 9 AND 41.  
 GIUSFREDI S.A.S. DI GIUSFREDI ORESTE & C., 55018 SEGROMIGNO IN MONTE (LUCCA), ITALY:  
 3,246,140, CANC. INT. CL. 25.  
 GKN DRIVETECH, INC., WALLED LAKE, MI:  
 1,669,332, CANC. INT. CL. 12.  
 GL CONSULTANTS INC., NEW YORK, NY:  
 3,247,861, CANC. MULTIPLE CLASS, INT. CLS. 36, 38 AND 42.  
 GLACIAL RIDGE HEALTH SYSTEM, GLENWOOD, MN:  
 4,480,303, PUB. 11-26-2013. INT. CL. 44.  
 GLAMORISE FOUNDATIONS, INC., NEW YORK, NY:  
 2,878,806. REN. 1-9-14. INT. CL. 25.  
 GLANTZ HOLDINGS, INC., LOUISVILLE, KY:  
 4,481,396, INT. CL. 6.  
 4,481,397, INT. CL. 9.  
 4,481,398, INT. CL. 11.  
 4,481,406, INT. CL. 11.  
 GLASSDOOR, INC., SAUSALITO, CA:  
 4,481,956, MULTIPLE CLASS, INT. CLS. 35, 38 AND 45.  
 GLASSY LLC, SIMI VALLEY, CA:  
 4,480,145, PUB. 11-26-2013. INT. CL. 9.  
 GLATCZ, CAREN, CHAGRIN FALLS, OH:  
 3,247,356, CANC. INT. CL. 35.  
 GLAXO GROUP LIMITED, GREENFORD, MIDDLESEX, UNITED KINGDOM:  
 2,718,432, CANC. INT. CL. 42.  
 GLAXOSMITHKLINE LLC, WILMINGTON, DE:  
 4,482,097, INT. CL. 3.  
 GLEM GAS S.P.A., ITALY:  
 3,247,686.  
 GLENCORE INTERNATIONAL AG, 6341 BAAR, SWITZERLAND:  
 2,803,970. REN. 1-6-14. MULTIPLE CLASS, INT. CLS. 1, 4, 6, 29 AND 31.  
 GLENN, KURT, CHANHASSEN, MN:  
 4,480,190, PUB. 11-26-2013. INT. CL. 21.  
 GLENTEL INC., BURNABY, BC, CANADA:  
 4,482,219, MULTIPLE CLASS, INT. CLS. 35, 36 AND 38.  
 GLIMMER BODY ART, LLC, TORRANCE, CA:  
 4,481,966, MULTIPLE CLASS, INT. CLS. 16, 35 AND 44.  
 GLIPTONE MANUFACTURING, INC., RONKONKOMA, NY:  
 4,479,246, PUB. 7-23-2013. INT. CL. 3.  
 GLOBAL BARBEQUE, LLC, ROSLYN, NY:  
 3,246,495, CANC. INT. CL. 43.  
 GLOBAL BUSINESS CENTER, INC., VANCOUVER, WA:  
 3,248,126, CANC. MULTIPLE CLASS, INT. CLS. 9, 35, 38 AND 42.  
 GLOBAL CASH ACCESS, INC., LAS VEGAS, NV:  
 2,719,608, CANC. INT. CL. 36.  
 GLOBAL CULINARY INVESTMENTS, LLC, SPRING, TX:  
 4,482,098, INT. CL. 30.  
 4,482,099, INT. CL. 30.  
 GLOBAL HOME PRODUCTS LLC C/O CERBERUS CAPITAL MANAGEMENT, L.P., NEW YORK, NY:  
 693,391, CANC. U.S. CL. 13.  
 GLOBAL LIFT CORPORATION, BAD AXE, MI:  
 4,482,749, INT. CL. 10.  
 GLOBAL OIL COMPANY (EUROPE) LIMITED, UNITED KINGDOM:  
 4,479,461, PUB. 11-26-2013. INT. CL. 1.  
 GLOBAL PAYOUT, INC., SAN DIEGO, CA:  
 4,479,950, PUB. 8-20-2013. INT. CL. 36.  
 GLOBAL SOURCES USA CORP, HIALEAH, FL:  
 4,481,825, INT. CL. 3.  
 GLOBAL WINE HOUSE OÜ, EE-75306 HARJUMAA, ESTONIA:  
 4,479,348, PUB. 11-26-2013. INT. CL. 33.  
 GLOBALIA HANDLING SAU, SPAIN:  
 3,247,738.  
 GLOBALNET TRAINING SOLUTIONS, L.L.C., PLANO, TX:  
 2,718,882, CANC. INT. CL. 41.  
 GLOBALVETLINK, L.C., AMES, IA:  
 4,482,360, MULTIPLE CLASS, INT. CLS. 42 AND 44.  
 GLOBE INTERNATIONAL NOMINEES PTY LTD, VICTORIA 3207, AUSTRALIA:  
 2,801,746. REN. 1-3-14. MULTIPLE CLASS, INT. CLS. 18 AND 25.  
 GLOBO COMUNICACAO E PARTICIPACOES S.A., RIO DE JANEIRO, RJ, BRAZIL:  
 2,790,017. REN. 1-6-14. MULTIPLE CLASS, INT. CLS. 38 AND 41.  
 GLOBOFORCE LIMITED, DUBLIN, IRELAND:  
 4,481,791, INT. CL. 16.  
 GLOXINIALIFE, LLC, WESTON, FL:  
 4,480,816, PUB. 11-26-2013. MULTIPLE CLASS, INT. CLS. 3, 5 AND 44.  
 GLYNLYON, INC., CHANDLER, AZ:  
 3,248,484, CANC. INT. CL. 41.  
 GMOB, L.L.C., HOLLADAY, UT:  
 4,482,694, INT. CL. 38.  
 GN OTOMETRICS A/S, TAASTRUP, DENMARK:  
 4,479,769, PUB. 11-26-2013. INT. CL. 10.  
 GN RESOUND A/S, DK-2750 BALLERUP, DENMARK:  
 3,246,096, CANC. MULTIPLE CLASS, INT. CLS. 10 AND 40.  
 GOAT ISLAND RESOURCES, LLC, SALISBURY, NC:  
 3,247,113, CANC. INT. CL. 19.  
 GODIVA CHOCOLATIER, INC., NEW YORK, NY:  
 4,481,431, MULTIPLE CLASS, INT. CLS. 30 AND 35.  
 GODSAWALLHEMADEWASVERYGOOD, LLC, BROKEN ARROW, OK:  
 4,481,710, INT. CL. 16.  
 GOKART LABS, LLC, MINNEAPOLIS, MN:  
 4,482,614, INT. CL. 9.  
 GOLD CANYON INTERNATIONAL, L.L.C., CHANDLER, AZ:  
 4,481,830, INT. CL. 11.  
 GOLD JACKSON ENTERPRISES LLC, LAGUNA HILLS, CA, DBA GJ2 GUITARS:  
 4,479,995, PUB. 11-26-2013. INT. CL. 15.  
 GOLD LINE TELEMANAGEMENT INC., RICHMOND HILL, ONTARIO, CANADA:  
 3,247,901, CANC. MULTIPLE CLASS, INT. CLS. 9 AND 16.  
 GOLD MEDAL PRODUCTS COMPANY, INC., CINCINNATI, OH:  
 2,913,468. REN. 1-6-14. INT. CL. 21.  
 GOLD TIP, INC, OREM, UT:  
 3,246,635, CANC. INT. CL. 28.  
 GOLDART INTERNATIONAL INC, NEW YORK, NY:  
 3,248,707, CANC. INT. CL. 14.  
 GOLDEN CORRAL CORPORATION, RALEIGH, NC:  
 2,900,842. REN. 1-3-14. INT. CL. 43.

GOLDEN WEST FOOTWEAR, INC., CITY OF INDUSTRY, CA:  
4,479,261, PUB. 11-26-2013. INT. CL. 25.

GOLDMAN, SACHS & CO., NEW YORK, NY:  
2,740,901. REN. 1-8-14. INT. CL. 36.

GOLDSTEIN, ROBERT N., DALLAS, TX:  
2,906,873. REN. 1-9-14. INT. CL. 41.

GOLDTOEMORETZ, LLC, STATESVILLE, NC:  
2,801,963. REN. 1-6-14. INT. CL. 25.

GOLITKO & DALY PC, INDIANAPOLIS, IN:  
4,480,896, PUB. 11-26-2013. INT. CL. 45.

GOMEZ ESPAÑA COLLIGNON, CARLO, ZAPOPAN, JALISCO, MEXICO:  
4,480,248, PUB. 11-26-2013. INT. CL. 11.

GONZALEZ, JOSE JESUS, COLORADO SPRINGS, CO:  
4,481,718, INT. CL. 43.

GOOD HARVESTS (ASIA) TRADING CO., LTD., SHEUNG WAN, HONG KONG:  
3,245,885, CANC. INT. CL. 5.

GOOD SKY ELECTRIC CO., LTD., TAICHUNG CITY, TAIWAN:  
2,904,397. REN. 1-7-14. INT. CL. 9.

GOODMAN, WILLIAM W., KALISPELL, MT:  
3,246,760, CANC. INT. CL. 43.

GOODRICH CORPORATION, CHARLOTTE, NC:  
2,798,370. REN. 1-6-14. INT. CL. 1.

GOODRICH CORPORATION, CHARLOTTE, NC, GOODRICH CORPORATION, CHARLOTTE, NC:  
2,798,371. REN. 1-6-14. INT. CL. 1.

GOODYEAR TIRE & RUBBER COMPANY, THE, AKRON, OH:  
3,158,657, CANC. INT. CL. 42.

GORDON FOOD SERVICE INC., GRAND RAPIDS, MI:  
4,481,568, MULTIPLE CLASS, INT. CLS. 35, 39, 43 AND 44.

GOSMILE, INC., EMERYVILLE, CA:  
3,248,418, CANC. INT. CL. 3.

GOSSETT, SCOTT A., MURRIETA, CA, DBA SIGN IN BLOOD:  
4,480,312, PUB. 11-26-2013. INT. CL. 28.

GOTHAM LICENSING GROUP, LLC, NEW YORK, NY:  
4,479,916, PUB. 11-26-2013. INT. CL. 25.

GOTLANDS SNUS AB, SWEDEN:  
4,479,415, PUB. 11-26-2013. INT. CL. 34.

GOVERNMENT EMPLOYEES HEALTH ASSOCIATION, INC., INDEPENDENCE, MO:  
4,482,337, MULTIPLE CLASS, INT. CLS. 36 AND 44.

GPS TAGGING SOLUTIONS, INC., JASPER, GA:  
4,482,034, INT. CL. 28.

GRACE ENGINEERED PRODUCTS, INC., DAVENPORT, IA:  
3,248,531, CANC. INT. CL. 9.

GRACE PLACE ADULT DAY CENTER, LEXINGTON, KY, DBA GRACE PLACE-THE HEALTH CLUB FOR SENIORS:  
4,481,617, INT. CL. 44.

GRADE A HOME IMPROVEMENT, LLC, DURHAM, CT:  
4,480,603, PUB. 11-26-2013. INT. CL. 37.

GRADIENT TECHNOLOGIES, LLC, MEMPHIS, TN:  
3,248,300, CANC. INT. CL. 10.

GRADIPORE LIMITED, AUSTRALIA:  
3,247,676.

GRADY-WHITE BOATS, INC., GREENVILLE, NC:  
4,482,595, INT. CL. 12.

GRADY, JAMES S, LITTLETON, CO, DBA GROUP FIVE PHOTOSPORTS:  
4,479,786, PUB. 11-26-2013. INT. CL. 35.

GRAHAM BRYAN PRITCHETT, DILLON, CO:  
4,482,356, INT. CL. 45.

GRAND TOBACCO COMPANY, LTD., YEREVAN, ARMENIA:  
2,719,841, CANC. INT. CL. 14.

GRANITE STATE LONG DISTANCE, INC., SOUTH WEARE, NH:  
2,719,396, CANC. INT. CL. 38.

GRANT SAMMY, BRICK, NJ:  
4,479,826, PUB. 11-26-2013. INT. CL. 9.

GRANVILLE STUDIO OF VISUAL ARTS, GRANVILLE, OH:  
4,479,802, PUB. 11-26-2013. INT. CL. 41.

GRAPSEED MEDIA LTD., CENTRAL, HONG KONG:  
4,481,624, INT. CL. 9.

GRAPHIC-FX, MARYVILLE, TN:  
4,480,601, PUB. 11-26-2013. INT. CL. 42.

GRAPHICAL NETWORKS LLC, BETHESDA, MD:  
4,480,180, PUB. 11-26-2013. MULTIPLE CLASS, INT. CLS. 9 AND 42.

GRAPHIQUE DE FRANCE, LTD., WOBURN, MA:  
4,481,274, PUB. 11-26-2013. INT. CL. 41.  
4,481,275, PUB. 11-26-2013. INT. CL. 41.

GRATO INC., HENDERSONVILLE, NC:  
4,479,906, PUB. 11-26-2013. INT. CL. 14.

GRAYMILLS CORPORATION, CHICAGO, IL:  
761,888. REN. 1-6-14. U.S. CL. 23 (INT. CL. 7).

GREAT LAKES LUBRICANT CORP., FRANKLIN PARK, IL:  
4,482,487, INT. CL. 4.

GREAT MUSEUMS, LLC, TWIN CITY, GA:  
2,884,438, REN. 1-3-14. INT. CL. 41.

GREAT NORTHERN EQUIPMENT DISTRIBUTING, INC., BURNSVILLE, MN:  
4,481,280, PUB. 11-26-2013. INT. CL. 7.

GREAT SOUTHERN WOOD PRESERVING, INC., ABBEVILLE, AL:  
2,882,743, REN. 1-9-14. INT. CL. 19.

GREATER PHOENIX CONVENTION & VISITORS BUREAU, PHOENIX, AZ:  
3,246,502, CANC. INT. CL. 35.  
3,246,503, CANC. INT. CL. 35.

GREATER SAN DIEGO ASSOCIATION OF REALTORS, SAN DIEGO, CA, AKA SAN DIEGO ASSOCIATION OF REALTORS:  
4,479,962, PUB. 11-26-2013. MULTIPLE CLASS, INT. CLS. 35 AND 41.

GREEN MOUNTAIN INNOVATIONS, INC., HOLLAND, NY:  
3,246,297, CANC. INT. CL. 37.

GREEN PAYMENT COMPANY, LLC, RICHMOND, VA:  
4,480,740, PUB. 11-26-2013. INT. CL. 36.

GREEN VIEW NURSERY, INC., DUNLAP, IL:  
2,797,459, REN. 1-6-14. INT. CL. 35.

GREENE, LONNELL, MADERA, CA:  
4,480,659, PUB. 11-26-2013. INT. CL. 25.

GREENTREE INNS HOTEL MANAGEMENT GROUP, INC., RANCHO CUCAMONGA, CA:  
4,480,629, PUB. 11-26-2013. INT. CL. 35.

GREG LENTZ MINISTRIES, SALISBURY, NC:  
4,481,708, INT. CL. 45.

GREGG FREDMAN, DELRAY BEACH, FL:  
4,481,018, PUB. 11-26-2013. INT. CL. 16.

GREGORY, CHRISTINE R., OVERLAND PARK, KS:  
3,248,160, CANC. INT. CL. 18.

GRID TRAINING CORPORATION, MERIDIAN, ID, DBA NORTHWEST LINEMAN COLLEGE:  
4,482,874, INT. CL. 16.

GRIDSPEAK CORPORATION, OAKLAND, CA:  
4,481,507, MULTIPLE CLASS, INT. CLS. 35 AND 42.

GRIFFIN MARKETING GROUP, INC., INDIANAPOLIS, IN:  
4,480,686, PUB. 11-26-2013. INT. CL. 35.

GRIM REAPER FOODS LIMITED, HERTFORDSHIRE, UNITED KINGDOM:  
4,479,493, PUB. 11-26-2013. MULTIPLE CLASS, INT. CLS. 29 AND 30.

GROSSMAN, TERRY, GOLDEN, CO, DBA GROSSMAN WELLNESS CENTER:  
4,479,873, PUB. 11-26-2013. INT. CL. 44.

GRUCHIK, SEAN, LONG BEACH, NY:  
4,482,423, INT. CL. 41.

GRUMA CORPORATION, IRVING, TX:  
3,246,033, CANC. INT. CL. 30.  
3,246,034, CANC. INT. CL. 30.

GRUPO SENDA AUTO TRANSPORTE SA DE CV, MONTERREY, MEXICO:  
3,246,576, CANC. INT. CL. 39.

GRUPPO ROSTIROLLA SRL, ITALY:  
4,479,453, PUB. 11-26-2013. INT. CL. 11.

GRV LIMITED LIABILITY COMPANY, MEGURO-KU, TOKYO, JAPAN:  
2,720,182, CANC. INT. CL. 28.

- GRÜNENTHAL GMBH, 52078 AACHEN, FED REP GERMANY:  
3,246,950, CANC. INT. CL. 5.
- GS GELATO & DESSERTS, INC., FORT WALTON BEACH, FL:  
3,246,288, CANC. INT. CL. 30.
- GS YUASA CORPORATION, MINAMI-KU, KYOTO-SHI, KYOTO, JAPAN:  
3,246,241, CANC. INT. CL. 9.
- GSM (TRADEMARKS) PTY LTD, BURLEIGH HEADS, QLD, AUSTRALIA:  
2,796,629. REN. 1-6-14. MULTIPLE CLASS, INT. CLS. 18 AND 25.
- GT AIRINJECT INC, JACKSONVILLE, FL:  
4,480,842, PUB. 11-26-2013. INT. CL. 7.
- GTPLANET, LONDON, KY:  
4,481,038, PUB. 11-26-2013. INT. CL. 38.
- GTRC SERVICES, INC., WESTLAKE VILLAGE, CA:  
3,248,576, CANC. INT. CL. 15.  
4,482,023, INT. CL. 15.
- GTX, INC, MEMPHIS, TN:  
3,248,017, CANC. INT. CL. 5.
- GUANGDONG HONGHUI METAL MANUFACTURE CO., LTD., KAIPING GUANGDONG, CHINA:  
4,479,554, PUB. 7-23-2013. INT. CL. 11.
- GUANGZHOU JUUYUAN BIOCHEM CO., LTD., CHINA:  
3,247,724.
- GUARD UP INC, BEDFORD, MA:  
2,901,647. REN. 1-7-14. INT. CL. 41.
- GUERBET, VILLEPINTE, FRANCE, GUERBET S.A., 93420 VILLEPINTE, FRANCE:  
1,818,702. REN. 1-4-14. INT. CL. 5.
- GUESTHOUSE INTERNATIONAL, L.L.C., HENDERSONVILLE, TN:  
4,480,174, PUB. 11-26-2013. INT. CL. 35.
- GUICHARD, ROBERT, KENTFIELD, CA:  
3,247,668, CANC. INT. CL. 41.
- GUILLERY, DEVON, MATTAPAN, MA, DBA STAE TRU:  
4,479,864, PUB. 11-26-2013. INT. CL. 25.
- GULF COAST NUTRITIONALS, INC., NAPLES, FL:  
4,482,552, MULTIPLE CLASS, INT. CLS. 5 AND 31.
- GULF SMOKED SEAFOOD, INC., PENSACOLA, FL:  
4,480,624, PUB. 11-26-2013. INT. CL. 29.
- GULFSTREAM AEROSPACE CORPORATION, SAVANNAH, GA:  
4,481,827, INT. CL. 41.
- GULLAH GEECHEE CULTURAL HERITAGE CORRIDOR COMMISSION, SULLIVANS ISLAND, SC:  
4,479,657, PUB. 11-26-2013. INT. CL. 45.
- GULLANE (THOMAS) LIMITED, LONDON, UNITED KINGDOM:  
4,479,807, PUB. 11-26-2013. INT. CL. 41.
- GUPTA, AJAY, MERRIMACK, NH:  
4,479,940, PUB. 11-26-2013. INT. CL. 44.
- GUTHRIE, BERNARD F., LAKE WORTH, FL:  
3,246,702, CANC. INT. CL. 35.
- GUTTER GUYS, LLC, STAMFORD, CT:  
4,479,579, PUB. 12-11-2012. INT. CL. 37.
- GUTTMACHER INSTITUTE, INC., NEW YORK, NY:  
2,719,153, CANC. INT. CL. 16.
- GVA KREFELD GMBH, KREFELD, FED REP GERMANY:  
4,479,492, PUB. 11-26-2013. MULTIPLE CLASS, INT. CLS. 6, 7 AND 8.
- GVBORI GROUP CO.,LTD., TORTOLA, BR.VIRGIN ISLANDS:  
4,481,122, PUB. 11-26-2013. INT. CL. 14.
- GWB FOODS, INC., BROOKLYN, NY:  
1,817,043. REN. 1-3-14. INT. CL. 30.
- G2G HEALTH SYSTEMS INC, LAS VEGAS, NV:  
4,479,847, PUB. 11-26-2013. INT. CL. 44.  
4,479,865, PUB. 11-26-2013. INT. CL. 44.
- H & N FOODS INTERNATIONAL, INC., VERNON, CA:  
4,481,610, MULTIPLE CLASS, INT. CLS. 29 AND 35.
- H.K. DISTRIBUTION, L.L.C., DEARBORN, MI:  
4,480,424, PUB. 11-26-2013. INT. CL. 35.
- H.M. RICHARDS, INC., ATLANTA, GA:  
4,481,627, INT. CL. 35.
- HAAS OUTDOORS, INC., WEST POINT, MS:  
4,481,207, PUB. 11-26-2013. INT. CL. 28.
- HABERBOSCH, JEFF, CASTLE ROCK, CO:  
3,248,746, CANC. INT. CL. 37.
- HADASSAH ZELTZER, BOSTON, MA:  
4,481,867, INT. CL. 14.
- HADDOCK, NICOLE, SASKATOON, SK, CANADA, DBA THE BODY SHOP AND KLETTE, DENYSE, SASKATOON, SK, CANADA, DBA THE BODY SHOP:  
3,245,706, CANC. INT. CL. 6.
- HAHN, VERONICA, KNOXVILLE, TN:  
4,481,994, MULTIPLE CLASS, INT. CLS. 11, 14 AND 21.
- HAIR HUGGERS LLC, FISHERS, IN:  
4,480,216, PUB. 11-26-2013. INT. CL. 25.
- HAIRDREAMS HAARHANDELSGEMSBH, A-8051 GRAZ, AUSTRIA:  
2,766,227. REN. 1-9-14. INT. CL. 21.
- HAIRLABZ, PHILADELPHIA, PA:  
4,480,138, PUB. 11-26-2013. INT. CL. 26.
- HALF SWEET FOOD & BEVERAGES LLC, WASHINGTON, DC:  
4,481,373, INT. CL. 30.
- HALL, DEBORAH L., LOMPOC, CA:  
3,246,600, CANC. INT. CL. 33.
- HALL, LAWRENCE D., MENDOTA HEIGHTS, MN:  
3,168,478, CANC. INT. CL. 42.
- HALLIBURTON ENERGY SERVICES, INC., CARROLLTON, TX:  
4,481,140, PUB. 11-26-2013. INT. CL. 1.
- HALSELL BUILDERS INC., SANTA MARIA, CA:  
3,247,151, CANC. INT. CL. 37.
- HAMILTON, SHANE T, ARLINGTON, VA:  
3,246,160, CANC. INT. CL. 41.
- HAMLET, JAMEL R, BROOKLYN, NY:  
4,482,069, INT. CL. 25.
- HAMMAD, IYAD, PARKLAND, FL:  
3,246,880, CANC. INT. CL. 26.
- HAMMER 'N' NAILS CORPORATION, MERCED, CA:  
3,247,644, CANC. INT. CL. 37.
- HAN GUO YONG, XIANGFANG DIST. HARBIN, CHINA:  
4,481,045, PUB. 11-26-2013. INT. CL. 25.
- HAN, DAPHNE, SAN GABRIEL, CA:  
3,246,862, CANC. INT. CL. 25.
- HANCOR, INC., FINDLAY, OH:  
975,325. REN. 1-6-14. U.S. CL. 13 (INT. CL. 17).
- HAND COVER, LLC, STOCKBRIDGE, GA:  
4,482,780, INT. CL. 3.
- HAND, RODNEY, DALLAS, TX:  
1,824,689. REN. 1-9-14. INT. CL. 41.
- HANDA, JASON, BURLINGTON, ONTARIO, CANADA:  
4,479,588, PUB. 11-26-2013. INT. CL. 9.
- HANDMADE TREASURES, INC., STEWARTSTOWN, PA:  
3,246,146, CANC. INT. CL. 28.
- HANDY INTERNATIONAL LTD., UNITED KINGDOM:  
3,247,714.
- HANGZHOU HU QING YU TANG; INVESTMENT CO., LTD, CHINA:  
3,247,755.
- HANGZHOU PANASIA SANITARY WARE CO., LTD, ZHEJIANG, CHINA:  
4,480,884, PUB. 11-26-2013. INT. CL. 11.
- HANKYU HANSHIN HOLDINGS, INC., JAPAN:  
3,247,787.
- HANNA INSTRUMENTS, INC., WOONSOCKET, RI:  
2,719,035, CANC. INT. CL. 9.
- HANSA METALLWERKE AG, FED REP GERMANY:  
4,479,424, PUB. 11-26-2013. MULTIPLE CLASS, INT. CLS. 11, 20 AND 21.  
4,479,427, PUB. 11-26-2013. MULTIPLE CLASS, INT. CLS. 11, 20 AND 21.
- HANSEN & CO., LTD., OSAKA, 554-0024, JAPAN:  
3,246,331, CANC. INT. CL. 9.
- HANSEN, CHRIS, PLEASANT GROVE, UT:  
3,247,542, CANC. INT. CL. 9.
- HAPE INTERNATIONAL LTD., LUZERN, SWITZERLAND:  
2,719,125, CANC. INT. CL. 28.
- HAPPILABS, LLC, CHICAGO, IL:  
4,482,300, INT. CL. 35.

HARALAMBOS VLAVIANOS, ZIMBALI, SOUTH AFRICA:  
4,482,411, INT. CL. 33.

HARBOR FOOTWEAR GROUP LTD., PORT WASHINGTON, NY:  
1,813,813, REN. 1-6-14, INT. CL. 25.

HARBOR HILL FRUIT FARMS, INC., LAKE LEEANAU, MI, DBA GOOD HARBOR VINEYARDS:  
4,481,765, INT. CL. 33.  
4,481,865, INT. CL. 33.

HARDY, DANNY J., LAPORTE, TX:  
4,481,303, INT. CL. 9.

HARGRAVES, TIM, EVANSVILLE, IN:  
4,481,026, PUB. 11-26-2013, INT. CL. 30.

HARLAND CLARKE CORP., SAN ANTONIO, TX:  
3,248,527, CANC. INT. CL. 16.

HARMAN, MARYANN K., PALM HARBOR, FL:  
2,648,556, CANC. INT. CL. 9.

HARNEY, ANGELINA, TUCSON, AZ:  
4,480,705, PUB. 11-26-2013, INT. CL. 41.

HARPER, STANLEY A., GOLDEN, CO:  
4,481,058, PUB. 11-26-2013, INT. CL. 28.

HARPO, INC., CHICAGO, IL:  
3,247,299, CANC. INT. CL. 35.

HARRIS, DAVID, WAYNE, NJ:  
2,799,372, REN. 1-6-14, INT. CL. 30.

HARRIS, NEIL JOHNSON, PENSACOLA, FL:  
3,246,859, CANC. INT. CL. 9.

HART, JOHN M., BLUFFTON, SC:  
3,248,261, CANC. INT. CL. 20.

HARTEIS, FRED, HARRISBURG, PA:  
3,245,878, CANC. INT. CL. 35.

HARTLE MEDIA VENTURES LLC, SAN FRANCISCO, CA:  
2,730,009, COR. INT. CL. 16.

HARTMAN, ROSS K., BELCHERTOWN, MA:  
4,480,940, PUB. 11-26-2013, INT. CL. 12.

HARVARD MAINTENANCE, INC., NEW YORK, NY:  
4,481,762, MULTIPLE CLASS, INT. CLS. 35, 37 AND 45.

HARVEY BALL SMILE LIMITED, SHINAGAWA-KU TOKYO, JAPAN:  
4,481,348, INT. CL. 20.  
4,481,360, INT. CL. 14.  
4,481,361, INT. CL. 18.  
4,481,362, INT. CL. 20.  
4,481,363, INT. CL. 24.

HASLAUER GMBH, D-83404 AINRING, FED REP GERMANY:  
3,245,782, CANC. MULTIPLE CLASS, INT. CLS. 3, 5 AND 44.

HAT WORLD, INC., INDIANAPOLIS, IN:  
2,804,533, REN. 1-8-14, INT. CL. 25.

HAWTHORNE DIRECT INC., FAIRFIELD, IA:  
4,480,936, PUB. 11-26-2013, INT. CL. 35.

HAWTHORNE, NATALIE D., HOUSTON, TX, DBA NH MEASURES:  
4,480,614, PUB. 11-26-2013, INT. CL. 16.

HAYMARKET BREWING COMPANY, LLC, CHICAGO, IL:  
4,482,583, INT. CL. 32.

HAYNEEDLE, INC., OMAHA, NE:  
2,718,948, CANC. INT. CL. 35.

HAYS, KENNETH A, WESTON, CT:  
1,816,220, REN. 1-8-14, INT. CL. 41.

HAYWARD BAKER INC., ODENTON, MD:  
1,811,118, REN. 1-9-14, MULTIPLE CLASS, INT. CLS. 37 AND 40.

HAZEL CEBRUN, HOUSTON, TX:  
4,479,839, PUB. 11-26-2013, INT. CL. 32.

HBI BRANDED APPAREL ENTERPRISES, LLC, WINSTON-SALEM, NC:  
4,481,532, INT. CL. 25.  
4,481,668, INT. CL. 45.

HCCO ASSOCIATION OF SAN MARCOS, TEXAS, SAN MARCOS, TX:  
4,480,133, PUB. 11-26-2013, INT. CL. 36.

HEAD SOLUTIONS GROUP (US) INC., NEW YORK, NY:  
4,481,896, INT. CL. 35.  
4,481,897, INT. CL. 35.

HEADS UP! TECHNOLOGIES, LLC, OVERLAND PARK, KS:  
3,247,511, CANC. INT. CL. 42.

HEAGY, RONALD C., ALBANY, OR:  
2,718,723, CANC. INT. CL. 41.

HEALCLICK LLC, LAS VEGAS, NV:  
4,480,745, PUB. 11-26-2013, INT. CL. 45.

HEALTH & FITNESS CLINIC, LLC, DALLAS, TX, DBA FIT180:  
4,479,815, PUB. 11-26-2013, INT. CL. 41.

HEALTH BODY WORLD SUPPLY INC., HEMET, CA, DBA HBW:  
3,989,697, COR. INT. CL. 10.

HEALTH CARE SUPPLIERS, INC., OMAHA, NE:  
4,481,306, INT. CL. 10.

HEALTH RESEARCH ASSOCIATES, INC., MOUNTLAKE TERRACE, WA:  
4,480,161, PUB. 11-26-2013, INT. CL. 41.

HEALTH SERVICE, LLC, ST. PAUL, MN:  
4,482,187, INT. CL. 38.

HEALTH SOLUTION USA, LLC, HUNTINGDON VALLEY, PA:  
4,481,181, PUB. 11-26-2013, INT. CL. 5.

HEALTHCARE FINANCE GROUP, LLC, NEW YORK, NY:  
4,480,714, PUB. 11-26-2013, INT. CL. 36.

HEALTHCARE HIGHWAYS, LLC, PLANO, TX:  
4,481,378, INT. CL. 36.

HEALTHCARE MOBILE, LLC, JERSEY CITY, NJ:  
4,480,082, PUB. 8-20-2013, INT. CL. 9.

HEALTHCARESOURCE HR, INC., WOBURN, MA:  
3,246,429, CANC. INT. CL. 38.

HEALTHINVEST LLC, CHARLESTON, SC:  
4,482,425, INT. CL. 32.

HEALTHLINE NETWORKS, INC., SAN FRANCISCO, CA, INTERMAP SYSTEMS, INC., BERKELEY, CA:  
2,800,627, REN. 1-6-14, INT. CL. 42.

HEALTHPOCKET, INC., SUNNYVALE, CA:  
4,482,673, INT. CL. 42.

HEALTHTECH SOLUTIONS GROUP, LLC, BRENTWOOD, TN:  
4,482,672, INT. CL. 42.

HEALTHWAYS, INC., NASHVILLE, TN:  
3,246,153, CANC. INT. CL. 44.

HEALTHY WAY WATERPROOFING & MOLD REMEDIATION LLC, LAKEWOOD, NJ:  
4,480,650, PUB. 11-26-2013, MULTIPLE CLASS, INT. CLS. 37 AND 40.

HEALTHY WOMEN, P.A., JUNE BEACH, FL:  
3,246,918, CANC. INT. CL. 44.

HEARST COMMUNICATIONS, INC., NEW YORK, NY:  
2,718,643, CANC. MULTIPLE CLASS, INT. CLS. 9 AND 16.

HEART HEROES, INC., OMAHA, NE:  
4,479,748, PUB. 9-24-2013, MULTIPLE CLASS, INT. CLS. 25, 35, 36 AND 45.

HEARTPAK, LTD., SAN ANTONIO, TX:  
3,248,492, CANC. INT. CL. 5.

HEBEI MINGHUA LEATHER CO., LTD, CHINA:  
4,479,451, PUB. 11-26-2013, INT. CL. 25.

HEIDELBERGER DRUCKMASCHINEN AG, HEIDELBERG, FED REP GERMANY:  
984,436, REN. 1-8-14, U.S. CL. 23 (INT. CL. 7).

HEIDI KLUM COMPANY LLC, NEW YORK, NY:  
3,246,077, CANC. MULTIPLE CLASS, INT. CLS. 9 AND 14.

HEINEMACK, GMBH, FED REP GERMANY:  
4,479,445, PUB. 11-26-2013, MULTIPLE CLASS, INT. CLS. 37, 42 AND 43.

HEJL, JEAN MARIE, AUSTIN, TX:  
3,246,921, CANC. INT. CL. 41.

HELEN OF TROY LIMITED, BELLEVILLE, ST MICHAEL, BARBADOS, WINDMERE CORPORATION, MIAMI, FL:  
1,283,132, REN. 1-3-14, INT. CL. 9.

HELIOS KLINIKEN GMBH, BERLIN, FED REP GERMANY:  
3,246,501, CANC. MULTIPLE CLASS, INT. CLS. 35, 37, 38, 39, 42, 43 AND 44.

HELP CHILDREN FOUNDATION; (STIFTUNG DES PRIVATRECHTS); VERTRETEN DURCH DEN VORSTAND; E. SACHS UND G. SACHS, 82319 STARNBERG, FED REP GERMANY:  
4,479,413, PUB. 11-26-2013, MULTIPLE CLASS, INT. CLS.

- 9, 14, 16, 18, 24, 25, 26, 28, 35, 36, 41, 42, 43 AND 44.
- HENDRICK, NILS, ALAMO, CA:  
3,247,539, CANC. INT. CL. 25.
- HENDRICKSEN, SETH, NYC, NY:  
3,245,909, CANC. INT. CL. 9.
- HENERGY GROUP (NORTH AMERICA) INC., BRITISH COLUMBIA, CANADA:  
4,482,429, INT. CL. 11.
- HENKE PROPERTY UG, FED REP GERMANY:  
4,479,303, PUB. 11-26-2013. MULTIPLE CLASS, INT. CLS. 7, 12 AND 37.
- HENKEL AG & CO. KGAA, FED REP GERMANY:  
3,247,750.
- HENKEL CORPORATION, ROCKY HILL, CT:  
2,803,297. REN. 1-3-14. INT. CL. 1.
- HENNESSY INDUSTRIES, INC., LAVERGNE, TN:  
1,262,845. REN. 1-7-14. INT. CL. 7.
- HENRY DESIGN STUDIO INC., ROSLYN, NY:  
4,480,917, PUB. 11-26-2013. INT. CL. 14.
- HENTHORN, DAVID A., ZIONSVILLE, IN:  
3,247,887, CANC. INT. CL. 16.
- HEPA CORPORATION, ANAHEIM, CA:  
1,815,401. REN. 1-9-14. INT. CL. 11.
- HERB REED ENTERPRISES, LLC, PEABODY, MA:  
2,796,412. REN. 1-6-14. INT. CL. 41.
- HERBAL VERA LLC, THE COLONY, TX:  
4,479,893, PUB. 11-26-2013. INT. CL. 5.
- HERBERIA S.P.A., ITALY:  
3,247,817.
- HERITAGE TREES, INC., JACKSONVILLE, IL:  
1,829,534. REN. 1-9-14. INT. CL. 31.  
2,850,898. REN. 1-8-14. INT. CL. 31.
- HERMAN DHADE, WEST BLOOMFIELD, MI:  
4,480,101, PUB. 7-23-2013. INT. CL. 45.
- HERMESCH, ANITA, HUNTINGTON BEACH, CA:  
3,246,124, CANC. INT. CL. 41.
- HEROES THE STORE, INC., GRAPEVINE, TX:  
4,480,139, PUB. 11-26-2013. INT. CL. 35.
- HERRERA ALE, CARLOS MANUEL, DURANGO, MEXICO AND HERRERA ALE, ERNESTO, DURANGO, MEXICO:  
4,481,015, PUB. 11-26-2013. INT. CL. 30.
- HERSKOVITS, SHERI, CEDARHURST, NY:  
4,481,749, INT. CL. 44.
- HERZFELD & RUBIN, P.C., NEW YORK, NY:  
4,480,487, PUB. 11-26-2013. INT. CL. 45.
- HESHELOW, KATHY, SEMINOLE, FL:  
4,482,621, INT. CL. 3.
- HETEX BRAMSCHE GMBH, BRAMSCHE, FED REP GERMANY:  
4,481,350, INT. CL. 24.
- HETSCO, INC., GREENWOOD, IN:  
4,480,672, PUB. 11-26-2013. MULTIPLE CLASS, INT. CLS. 37 AND 40.
- HEWLETT-PACKARD DEVELOPMENT COMPANY, L.P., HOUSTON, TX:  
4,481,816, MULTIPLE CLASS, INT. CLS. 9, 38 AND 42.  
4,481,859, INT. CL. 9.
- HEYHOE, MARC, MIDDLETOWN, NJ:  
4,482,198, INT. CL. 16.
- HGGC, LLC, PALO ALTO, CA:  
4,482,482, INT. CL. 36.
- HI-GEAR PRODUCTS, INC., HUDSON, MA:  
2,718,673, CANC. INT. CL. 1.
- HI-LINER FISHING GEAR AND TACKLE, INC., LIGHTHOUSE POINT, FL:  
2,895,840. REN. 1-8-14. MULTIPLE CLASS, INT. CLS. 8 AND 28.
- HI-REZ STUDIOS, INC., ALPHARETTA, GA:  
4,481,144, PUB. 11-26-2013. INT. CL. 9.  
4,481,146, PUB. 11-26-2013. INT. CL. 38.  
4,481,147, PUB. 11-26-2013. INT. CL. 41.
- HICKS, KIMIYA, VALLEJO, CA, DBA OOH THAT HAIR:  
4,480,060, PUB. 11-26-2013. INT. CL. 26.
- HICKS, RUTH, WAXHAW, NC:  
4,481,082, PUB. 11-26-2013. MULTIPLE CLASS, INT. CLS. 3 AND 41.
- HICKS, STEPHEN L., OKEMOS, MI:  
4,480,750, PUB. 11-26-2013. INT. CL. 36.
- HIDDEN HARBOR GROUP, L.L.C., SARASOTA, FL:  
3,247,938, CANC. INT. CL. 9.
- HIDDEN TRACK MUSIC, LLC, LOS ANGELES, CA:  
4,480,938, PUB. 11-26-2013. INT. CL. 35.
- HIDDEN TREASURES FOOD SERVICES, LLC, PATRICK, SC:  
4,480,052, PUB. 11-26-2013. INT. CL. 29.
- HIGETA SHOYU KABUSHIKI KAISHA, CHUO-KU, TOKYO, JAPAN:  
1,820,766. REN. 1-3-14. INT. CL. 30.
- HIGH BAR, LLC, REDMOND, OR, REPIPE, INC., HOUSTON, TX:  
2,805,674. REN. 1-8-14. INT. CL. 7.
- HIGH RIDGE BRANDS CO., STAMFORD, CT:  
2,813,144. REN. 1-3-14. INT. CL. 3.
- HIGH SPEED PRODUCTIONS, INC., SAN FRANCISCO, CA:  
4,480,911, PUB. 11-26-2013. INT. CL. 18.
- HIGH WEALTH ASSOCIATES LIMITED, CUASEWAY BAY, HONG KONG:  
2,719,058, CANC. INT. CL. 24.
- HIGHER UP PHOTOGRAPHY, LLC., NAPERVILLE, IL:  
4,480,361, PUB. 11-26-2013. INT. CL. 41.
- HIGHLINE MANUFACTURING LTD., VONDA, SASKATCHEWAN, CANADA:  
2,864,183. REN. 1-8-14. INT. CL. 7.
- HIH, INC., ROCKFORD, MI:  
4,479,824, PUB. 11-26-2013. INT. CL. 43.
- HILL, RICHARD PATRICK, ESCONDIDO, CA:  
4,481,890, MULTIPLE CLASS, INT. CLS. 5, 8, 9, 11, 14, 18, 20, 21, 22 AND 25.
- HILL, WINSTON, DELRAY BEACH, FL:  
4,480,047, PUB. 11-26-2013. INT. CL. 41.
- HILLPOINT CAPITAL, LLC, NEW YORK, NY:  
4,481,819, MULTIPLE CLASS, INT. CLS. 35 AND 36.
- HILLYARD ENTERPRISES, INC., ST. JOSEPH, MO:  
3,248,475, CANC. INT. CL. 3.
- HIMALAYAN INTERNATIONAL INSTITUTE OF YOGA SCIENCE AND PHILOSOPHY OF THE USA, HONESDALE, PA:  
2,799,715. REN. 1-8-14. INT. CL. 21.
- HINES NURSERIES, INC., IRVINE, CA:  
3,246,571, CANC. INT. CL. 31.
- HINMAN, WILLIAM, WINSTON-SALEM, NC:  
4,480,716, PUB. 11-26-2013. INT. CL. 41.
- HINO JIDOSHA KABUSHIKI KAISHA, ALSO TRADING AS HINO MOTORS, LTD., HINO-SHI, TOKYO, JAPAN:  
4,479,791, PUB. 11-26-2013. INT. CL. 37.
- HINTJENS, PIETER, BRUSSELS, BELGIUM:  
4,481,090, PUB. 11-26-2013. INT. CL. 9.
- HIP CHICK FARMS, INC., SEBASTOPOL, CA:  
4,481,835, INT. CL. 29.
- HIRSCHMANN AUTOMOTIVE GMBH, RANKWEIL/BREDERIS, AUSTRIA:  
4,480,051, PUB. 11-26-2013. INT. CL. 9.
- HISAMITSU PHARMACEUTICAL CO., INC., SAGA, JAPAN:  
2,806,669. REN. 1-3-14. INT. CL. 5.
- HISAMITSU PHARMACEUTICAL CO., INC., TOSU-SHI, SAGA, JAPAN:  
4,480,099, PUB. 11-26-2013. INT. CL. 5.
- HISAMITSU PHARMACEUTICAL CO., LTD., TOSU-SHI, SAGA, JAPAN:  
4,480,183, PUB. 11-26-2013. MULTIPLE CLASS, INT. CLS. 1 AND 5.
- HISPANIC FUNDING GROUP, INC., LAKE MARY, FL:  
3,247,280, CANC. INT. CL. 36.
- HISPANIC TRANSIT SOCIETY, INC., NEW YORK, NY:  
3,245,762, CANC. INT. CL. 41.
- HJC AMERICA, INC., LA HABRA, CA:  
4,481,118, PUB. 11-26-2013. INT. CL. 9.
- HK WORLDWIDE LLC, NEW YORK, NY:  
4,479,558, PUB. 3-27-2012. MULTIPLE CLASS, INT. CLS. 3, 9, 14, 18 AND 25.  
4,479,559, PUB. 3-27-2012. MULTIPLE CLASS, INT. CLS. 3, 9, 14, 18 AND 25.  
4,479,560, PUB. 3-27-2012. MULTIPLE CLASS, INT. CLS. 3, 9, 14, 18 AND 25.
- HME, INCORPORATED, WYOMING, MI:  
3,247,608, CANC. INT. CL. 9.



HMM IP COMPANY, DUBLIN, IRELAND, LEARNING COMPANY, THE, FREMONT, CA:  
 1,818,409. REN. 1-9-14. INT. CL. 9.

HMI INC, NORWOOD, MA, DBA HMI PERFORMANCE INCENTIVES:  
 4,479,753. PUB. 11-26-2013. INT. CL. 35.

HO'EA LLC, HONOLULU, HI:  
 4,482,133, INT. CL. 36.  
 4,482,134, INT. CL. 36.

HOBIBICO, INC., CHAMPAIGN, IL, DBA GREAT PLANES MODEL DISTRIBUTORS COMPANY:  
 1,768,963, AM. INT. CL. 42.

HOBIBICO, INC., CHAMPAIGN, IL:  
 4,481,077, PUB. 11-26-2013. INT. CL. 28.

HOBBY TOWN UNLIMITED, INC., LINCOLN, NE:  
 4,481,553, MULTIPLE CLASS, INT. CLS. 16 AND 28.

HOBOKEN MOTORCYCLE CLUB, JERSEY CITY, NJ:  
 4,479,750, PUB. 11-26-2013. INT. CL. 25.

HOCKENBERGS EQUIPMENT AND SUPPLY CO., INC., OMAHA, NE:  
 4,480,270, PUB. 11-26-2013. MULTIPLE CLASS, INT. CLS. 35, 37 AND 42.  
 4,480,271, PUB. 11-26-2013. MULTIPLE CLASS, INT. CLS. 35, 37 AND 42.

HOEA LLC, HONOLULU, HI:  
 4,482,135, INT. CL. 36.

HOFF, KEVIN B., WICHITA, KS:  
 3,247,316, CANC. INT. CL. 41.

HOFFMANN, MIKE, REDDING, CA:  
 4,481,132, PUB. 11-26-2013. INT. CL. 25.

HOFMANN, RICARDA M., FED REP GERMANY:  
 3,247,690.

HOGAN, WILLIAM L., LOCUST, NC:  
 4,480,630, PUB. 11-26-2013. INT. CL. 24.

HOIST FITNESS SYSTEMS, INC., POWAY, CA:  
 4,482,478, INT. CL. 28.  
 4,482,479, INT. CL. 28.

HOLIDAY STATIONSTORES, INC., MINNEAPOLIS, MN:  
 1,819,155. REN. 1-6-14. MULTIPLE CLASS, INT. CLS. 35, 37 AND 42.

HOLLAND, L.P., CRETE, IL:  
 3,247,489, CANC. INT. CL. 37.

HOLLINGSWORTH, KAREN A., DANDRIDGE, TN:  
 3,247,516, CANC. INT. CL. 16.

HOLLISTER INCORPORATED, LIBERTYVILLE, IL:  
 4,482,275, INT. CL. 10.

HOLLYMARKS, LLC, DALLAS, TX:  
 4,481,098, PUB. 11-26-2013. INT. CL. 1.  
 4,481,103, PUB. 11-26-2013. INT. CL. 4.  
 4,481,107, PUB. 11-26-2013. INT. CL. 19.  
 4,481,109, PUB. 11-26-2013. INT. CL. 40.  
 4,481,164, PUB. 11-26-2013. INT. CL. 4.

HOLLYWOOD ENTERTAINMENT CORPORATION, WILSONVILLE, OR TO MGIP, LLC, HILLSIDE, NJ:  
 2,719,664, CANC. MULTIPLE CLASS, INT. CLS. 35 AND 41.

HOLMBERG, LARRY, GULLY, MN:  
 4,481,726, MULTIPLE CLASS, INT. CLS. 9, 13 AND 28.

HOLY CITY BREWING, LLC, NORTH CHARLESTON, SC:  
 4,479,959, PUB. 11-26-2013. INT. CL. 32.

HOME BOX OFFICE, INC., NEW YORK, NY:  
 4,480,792, PUB. 11-26-2013. INT. CL. 41.  
 4,481,399, INT. CL. 20.

HOME CITY INC., EDISON, NJ:  
 4,481,235, PUB. 11-26-2013. INT. CL. 24.

HOME-CARE PRODUCTS INC., WOODHAVEN, NY TO MHL ENTERPRISES, LLC, BEACHWOOD, OH:  
 735,833, AM. U.S. CL. 2.

HOMEDEX REALTY, L.L.C., SCOTTSDALE, AZ:  
 3,246,678, CANC. INT. CL. 36.

HOMEDIRECT, INC., HILLSIDE, IL:  
 2,719,752, CANC. MULTIPLE CLASS, INT. CLS. 35 AND 39.

HOMEGOODS, INC., FRAMINGHAM, MA:  
 4,482,022, INT. CL. 24.

HOMELAND HOUSEWARES, LLC, LOS ANGELES, CA:  
 4,481,911, MULTIPLE CLASS, INT. CLS. 43 AND 44.

HOMER TLC, INC., CLAYMONT, DE:  
 3,248,166, CANC. INT. CL. 8.  
 3,248,167, CANC. INT. CL. 6.

HOMES FOR OUR TROOPS, INC., TAUNTON, MA:  
 4,481,538, MULTIPLE CLASS, INT. CLS. 35, 36 AND 37.

HONEY & IVY LLC, BROOKLYN, NY:  
 4,479,844, PUB. 5-28-2013. INT. CL. 3.

HONEY-WAGON, INC., TULSA, OK:  
 1,263,196. REN. 1-7-14. INT. CL. 37.

HONG KONG PALACE INC., ROWLAND HEIGHTS, CA:  
 3,245,799, CANC. INT. CL. 43.

HONG, YOUNG TAE, NEW YORK, NY:  
 1,822,942. REN. 1-6-14. INT. CL. 26.

HONOR FLIGHT, INC., SPRINGFIELD, OH:  
 4,479,816, PUB. 11-26-2013. INT. CL. 39.

HOOKEDGE LIMITED, LONDON SW3 6NT, UNITED KINGDOM:  
 3,247,740.

HOOKER & HOLCOMBE, INC., WEST HARTFORD, CT:  
 2,899,678. REN. 1-7-14. INT. CL. 36.

HOOKS, BRIAN P. BAYPORT, NY:  
 4,481,051, PUB. 11-26-2013. INT. CL. 6.

HOPKINS GOLF, INC., NEWPORT BEACH, CA:  
 4,480,953, PUB. 11-26-2013. MULTIPLE CLASS, INT. CLS. 18, 24, 25 AND 28.

HORAN ASSOCIATES, INC., CINCINNATI, OH AND HORN SECURITIES, INC., CINCINNATI, OH:  
 3,246,820, CANC. MULTIPLE CLASS, INT. CLS. 35 AND 36.

HORIZON HEALTHCARE, INC., BROOKFIELD, WI, FORMERLY ARO BEHAVIORAL HEALTHCARE, INC.:  
 4,482,750, INT. CL. 44.  
 4,482,765, INT. CL. 44.

HORNY TOAD, INC., LAKE OZARK, MO:  
 3,246,334, CANC. INT. CL. 16.

HORTON, KRISTY K., SPRINGFIELD, MO:  
 4,482,747, INT. CL. 41.

HOSLEY INTERNATIONAL, INC., LYNWOOD, IL:  
 2,720,185, CANC. INT. CL. 21.

HOST UNIVERSAL LIMITED, LONDON, UNITED KINGDOM:  
 2,718,360, CANC. MULTIPLE CLASS, INT. CLS. 35 AND 42.

HOT SPRINGS PACKING CO., INC., HOT SPRINGS, AR:  
 1,856,863. REN. 1-3-14. INT. CL. 29.

HOTEL JV SERVICES, LLC, DALLAS, TX:  
 4,482,675, INT. CL. 43.

HOTWIRE COMMUNICATIONS, LTD., WYNNEWOOD, PA:  
 4,482,083, INT. CL. 38.

HOUGHTON MIFFLIN HARCOURT PUBLISHING COMPANY, BOSTON, MA:  
 2,719,067, CANC. INT. CL. 35.

HOULIHAN, MICHAEL, SAN DIEGO, CA:  
 4,480,682, PUB. 11-26-2013. INT. CL. 25.

HOUSE OF CUPCAKES, LLC, S. ORANGE, NJ:  
 4,479,742, PUB. 11-26-2013. INT. CL. 35.

HOUSE OF LOUIS XV, SCOTTSDALE, AZ:  
 3,246,397, CANC. MULTIPLE CLASS, INT. CLS. 14 AND 35.  
 3,246,398, CANC. INT. CL. 35.  
 3,246,425, CANC. INT. CL. 35.

HOUSE OF RAEFORD FARMS, INC., RAEFORD, NC:  
 2,914,077. REN. 1-9-14. INT. CL. 29.

HOUSE OF SPICES (INDIA), INC., FLUSHING, NY:  
 1,245,531. REN. 1-8-14. INT. CL. 30.

HOUWELING NURSERIES OXNARD, INC., CAMARILLO, CA:  
 3,246,127, CANC. INT. CL. 31.

HOUZE, PHILIPPE L., BROOKLYN, NY:  
 4,480,142, PUB. 11-26-2013. INT. CL. 35.

HOW TO BE A REDHEAD LLC, HAINES CITY, FL:  
 4,482,446, U.S. CL. A.

HOWARD SILVERS & SONS PTY LTD., CHATSWOOD, AUSTRALIA:  
 4,481,475, MULTIPLE CLASS, INT. CLS. 8 AND 21.

HOWARD, MARILYN, TALLEVAST, FL:  
 4,480,829, PUB. 11-26-2013. INT. CL. 25.

- HOWARD, RHONDA J. PEOPLES, RANCHO CUCAMON-GA, CA:  
4,480,960, PUB. 11-26-2013. INT. CL. 25.
- HOWARTH, ANDREW, BOSTON, MA:  
3,248,351, CANC. INT. CL. 21.
- HOWTOFIND.ME LLC, BROOKLYN, NY:  
4,482,093, INT. CL. 45.
- HQ HOMETEK INC., OCEANSIDE, NY:  
4,481,934, INT. CL. 11.
- HRUBOVCAK, MICHAEL, JOSEPH, CHESTER HEIGHTS, PA:  
2,903,412, REN. 1-6-14. INT. CL. 42.
- HS PHARMACEUTICALS, SALT LAKE CITY, UT:  
3,246,093, CANC. INT. CL. 5.
- HSN IMPROVEMENTS LLC, ST. PETERSBURG, FL:  
3,246,349, CANC. INT. CL. 35.
- HTR DEVELOPMENT, LLC, GOTHA, FL:  
4,482,833, INT. CL. 28.
- HU HOLDINGS, LLC, NEW YORK, NY:  
4,482,054, INT. CL. 25.
- HU-FRIEDY MFG. CO., LLC, CHICAGO, IL:  
1,819,236, REN. 1-7-14. INT. CL. 40.
- HUANG JUNSHENG, GUANGDONG PROVINCE, CHINA:  
4,482,549, INT. CL. 9.
- HUANG SHENGWEI, YIWU CITY 322000 ZHEJIANG, CHINA:  
4,479,433, PUB. 11-26-2013. MULTIPLE CLASS, INT. CLS. 16, 18 AND 35.
- HUANG, ZIWEI, LA JOLLA, CA:  
3,248,253, CANC. INT. CL. 5.  
3,248,257, CANC. INT. CL. 5.
- HUBSON HOLDINGS, LLC, INDIANAPOLIS, IN:  
4,480,109, PUB. 11-26-2013. INT. CL. 36.
- HUDETZ, PAUL, SCHERERVILLE, IN:  
4,481,149, PUB. 11-26-2013. INT. CL. 35.
- HUGHES, PAUL E., NORTH EAST, MD:  
3,247,160, CANC. INT. CL. 36.
- HULTBERG, NELSON, DALLAS, TX:  
4,482,846, INT. CL. 35.
- HUMAN RESOURCE CONSULTANTS, LTD., GRAND RAPIDS, MI, DBA JOBFITSOLUTIONS:  
4,482,828, INT. CL. 35.
- HUMAN RIGHTS CAMPAIGN, WASHINGTON, DC:  
4,480,151, PUB. 11-26-2013. MULTIPLE CLASS, INT. CLS. 25 AND 35.
- HUMANE SOCIETY OF MISSOURI, ST. LOUIS, MO:  
2,719,160, CANC. INT. CL. 36.
- HUMMERT INTERNATIONAL, EARTH CITY, MO, FORMERLY A.H. HUMMERT SEED COMPANY:  
4,481,344, INT. CL. 31.
- HUNTER LAING & COMPANY LIMITED, GLASGOW, SCOTLAND:  
4,480,574, PUB. 11-26-2013. INT. CL. 33.
- HURCO COMPANIES, INC., INDIANAPOLIS, IN:  
2,800,312, REN. 1-6-14. MULTIPLE CLASS, INT. CLS. 7 AND 9.  
2,800,325, REN. 1-6-14. MULTIPLE CLASS, INT. CLS. 7 AND 9.
- HUSSEIN, DAVID, A, OAKLAND, CA:  
3,248,275, CANC. INT. CL. 3.
- HWACHANG KOREA COMPANY, LTD., SEOUL, REPUBLIC OF KOREA:  
4,479,649, PUB. 11-26-2013. MULTIPLE CLASS, INT. CLS. 5 AND 29.
- HX5, LLC., FORT WALTON BEACH, FL:  
4,480,489, PUB. 11-26-2013. MULTIPLE CLASS, INT. CLS. 35 AND 42.  
4,480,524, PUB. 11-26-2013. MULTIPLE CLASS, INT. CLS. 35 AND 42.
- HYATT CORPORATION, CHICAGO, IL:  
4,480,240, PUB. 11-26-2013. INT. CL. 43.  
4,481,969, INT. CL. 36.  
4,481,970, INT. CL. 36.
- HYBRID ATHLETICS, LLC, STAMFORD, CT:  
4,480,850, PUB. 11-26-2013. INT. CL. 41.
- HYBRIS AG, SWITZERLAND:  
4,479,448, PUB. 11-26-2013. MULTIPLE CLASS, INT. CLS. 9, 35, 38 AND 42.
- HYCLONE LABORATORIES, INC., LOGAN, UT:  
3,246,970, CANC. MULTIPLE CLASS, INT. CLS. 10 AND 16.
- HYPER NETWORK SOLUTIONS, LLC, WEST PALM BEACH, FL:  
3,247,863, CANC. INT. CL. 5.
- HYPRES, INC., ELMSFORD, NY:  
3,245,798, CANC. MULTIPLE CLASS, INT. CLS. 40 AND 42.
- H2O EVOLUTION INC., AUSTIN, TX:  
3,246,666, CANC. INT. CL. 11.
- I AM BRANDS, INC., HOUSTON, TX:  
4,480,768, PUB. 11-26-2013. MULTIPLE CLASS, INT. CLS. 32 AND 36.
- I DOG ENTERTAINMENT, INC. DBA JIGSAW EDITORIAL, LOS ANGELES, CA:  
3,246,477, CANC. MULTIPLE CLASS, INT. CLS. 35 AND 41.
- I VISION, LTD., FORT WORTH, TX:  
2,923,458, CANC. INT. CL. 9.
- I.P. HOLDINGS, INC., GRAND PRAIRIE, TX:  
4,479,881, PUB. 11-26-2013. INT. CL. 35.  
4,479,934, PUB. 11-26-2013. INT. CL. 28.
- I.T.A. S.R.L. INTERNATIONAL; TOBACCO AGENCY, ITALY:  
4,479,507, PUB. 11-26-2013. INT. CL. 10.
- I.T.A. S.R.L.; INTERNATIONAL TOBACCO AGENCY, ITALY:  
4,479,504, PUB. 11-26-2013. INT. CL. 10.  
4,479,505, PUB. 11-26-2013. INT. CL. 10.  
4,479,506, PUB. 11-26-2013. INT. CL. 10.  
4,479,509, PUB. 11-26-2013. INT. CL. 10.
- I/O INTERCONNECT, SANTA ANA, CA:  
3,247,534, CANC. INT. CL. 9.
- I/AV AUTOMOTIVE ENGINEERING INC., ANN ARBOR, MI:  
2,718,683, CANC. MULTIPLE CLASS, INT. CLS. 9 AND 42.
- IBASIS, INC., BURLINGTON, MA:  
3,246,012, CANC. INT. CL. 16.
- IBE BUSINESS ENTERPRISE AG, ZUG, SWITZERLAND:  
2,829,118, REN. 1-3-14. INT. CL. 29.
- IBOOMERANG.COM, INC., DAYTON, OH:  
3,247,010, CANC. INT. CL. 42.
- IBOSSWELL, INC., PRAIRIE VILLAGE, KS:  
4,479,812, PUB. 11-26-2013. INT. CL. 42.
- ICARE MEDICAL SERVICES, LLC, KEY BISCAYNE, FL:  
4,482,265, INT. CL. 44.
- ICE MARINE, READING, BERKSHIRE, UNITED KINGDOM:  
2,797,673, REN. 1-6-14. INT. CL. 12.
- ICEBERG COMMERCE INC., VANCOUVER, BC, CANADA:  
4,479,647, PUB. 11-26-2013. INT. CL. 9.
- ICELAND SEAFOOD INTERNATIONAL EHF, 104 REYKJAVIK, ICELAND, SOLUSAMBAND ISLENSKRA FISK-FRAMLEIDENDA, 101 REYKJAVIK, ICELAND:  
1,781,582, REN. 1-9-14. INT. CL. 29.
- ICK'S ENTERPRISES, INC., SOUTH GATE, CA:  
2,904,442, REN. 1-9-14. INT. CL. 43.
- ICRON TECHNOLOGIES CORPORATION, BURNABY, BRITISH COLUMBIA, CANADA:  
2,799,601, REN. 1-7-14. MULTIPLE CLASS, INT. CLS. 9 AND 42.
- ICT INVESTMENT PROPERTIES, INC., BOYNTON BEACH, FL:  
4,481,183, PUB. 11-26-2013. INT. CL. 33.
- ID SOLUTIONS, LLC, OKLAHOMA CITY, OK:  
4,480,588, PUB. 11-26-2013. INT. CL. 40.
- IDEAL LIVING HOLDINGS LIMITED, WANCHAI, HONG KONG:  
3,248,271, CANC. INT. CL. 10.
- IDEAL STANDARD INTERNATIONAL BVBA, ZAVENTEM, BELGIUM:  
2,843,945, REN. 1-8-14. INT. CL. 11.
- IDENTITY COPS INC., MONTCLAIR, NJ:  
3,245,976, CANC. INT. CL. 45.
- IDIGIMART INC, WALNUT, CA:  
4,482,777, INT. CL. 9.

IDOC360, BURLEY, ID:  
4,482,497, INT. CL. 10.

IDOPE, LLC, TALLAHASSEE, FL:  
4,479,974, PUB. 11-26-2013. INT. CL. 37.

IDT NETHERLANDS, B.V. (PUERTO RICO BRANCH), SAN JUAN, PUERTO RICO:  
3,246,573, CANC. INT. CL. 36.

IES ENTERPRISES, INC., NEW YORK, NY:  
4,479,553, PUB. 11-26-2013. INT. CL. 3.

IGI CALZATURE E TECNOLOGIE S.P.A., ELLERA, CORCIANO (PERUGIA), ITALY:  
1,164,706, CANC. INT. CL. 25.

IGNITE DESIGN AND ADVERTISING, RANCHO CUCA-MONGA, CA:  
4,480,477, PUB. 11-26-2013. INT. CL. 35.

IGNITE PAYMENTS, LLC, MOORPARK, CA:  
4,482,334, MULTIPLE CLASS, INT. CLS. 9, 35, 36, 38, 42 AND 45.

IGT, RENO, NV:  
2,802,970. REN. 1-8-14. INT. CL. 9.  
2,805,402. REN. 1-9-14. INT. CL. 9.  
2,806,319. REN. 1-9-14. INT. CL. 9.  
2,807,046. REN. 1-9-14. INT. CL. 9.  
2,813,418. REN. 1-8-14. INT. CL. 9.  
2,813,564. REN. 1-8-14. INT. CL. 9.  
2,814,459. REN. 1-8-14. INT. CL. 9.  
2,815,872. REN. 1-8-14. INT. CL. 41.  
2,818,495. REN. 1-8-14. INT. CL. 41.  
3,248,586, CANC. INT. CL. 9.  
4,481,571, INT. CL. 9.

IGYS SYSTEMS, INC., GARDEN GROVE, CA:  
1,659,499, CANC. INT. CL. 9.

IHS GLOBAL INC., ENGLEWOOD, CO:  
3,247,395, CANC. INT. CL. 9.

IKE'S INC., LAS VEGAS, NV:  
4,481,198, PUB. 11-26-2013. INT. CL. 30.  
4,481,212, PUB. 11-26-2013. INT. CL. 30.  
4,481,213, PUB. 11-26-2013. INT. CL. 30.

IKON OFFICE SOLUTIONS, INC., MALVERN, PA:  
3,248,421, CANC. INT. CL. 9.

IKONICS CORPORATION, DULUTH, MN, CHROMA-GLO, INC., DULUTH, MN:  
976,355. REN. 1-6-14. U.S. CL. 26 (INT. CL. 9).

ILD CORP., PONTE VEDRA BEACH, FL:  
4,479,825, PUB. 5-7-2013. INT. CL. 35.

ILLINOIS CITIZENS FOR ETHICS, CHICAGO, IL:  
4,479,633, PUB. 6-18-2013. INT. CL. 35.

ILLINOIS TOOL WORKS INC., GLENVIEW, IL:  
954,804. REN. 1-4-14. U.S. CL. 6 (INT. CL. 1).  
974,384. REN. 1-9-14. U.S. CL. 39 (INT. CLS. 10, 25 AND 26).

ILLINOIS TOOL WORKS INC., GLENVIEW, IL, FIBRE GLASS-EVERCOAT COMPANY, INC., CINCINNATI, OH:  
1,815,528. REN. 1-8-14. INT. CL. 1.

ILLINOIS TOOL WORKS INC., GLENVIEW, IL:  
2,719,523, CANC. MULTIPLE CLASS, INT. CLS. 9 AND 16.

IMAGINARY FORCES, L.L.C., LOS ANGELES, CA:  
2,798,242. REN. 1-7-14. MULTIPLE CLASS, INT. CLS. 25, 35 AND 42.

IMAGINE NATION BOOKS, LTD., BOULDER, CO:  
2,719,215, CANC. INT. CL. 35.

IMAJEN, LLC, LAKE OSWEGO, OR:  
4,479,878, PUB. 11-26-2013. INT. CL. 29.  
4,479,879, PUB. 11-26-2013. INT. CL. 29.

IMERYS KAOLIN, INC., ROSWELL, GA:  
1,814,622. REN. 1-3-14. INT. CL. 1.

IMERYS MINERALS CALIFORNIA, INC., SAN JOSE, CA:  
181,463. REN. 1-9-14. U.S. CL. 6 (INT. CL. 1).  
586,255. REN. 1-9-14. U.S. CL. 6 (INT. CL. 1).  
991,358. REN. 1-9-14. U.S. CL. 31 (INT. CL. 1).

IMERYS PIGMENTS, INC, ROSWELL, GA, ANGLO-AMERICAN CLAYS CORPORATION, ATLANTA, GA:  
1,266,744. REN. 1-3-14. INT. CL. 1.

IMETAL INC, HOLLY SPRINGS, NC:  
4,480,543, PUB. 11-26-2013. INT. CL. 43.

IMMUNO-MYCOLOGICS, INC., NORMAN, OK:  
4,479,773, PUB. 11-26-2013. INT. CL. 5.

IMPACT ENTERPRISES, LLC, HOLMDEL, NJ:  
2,719,021, CANC. INT. CL. 18.

IMPLUS FOOTCARE, LLC, DURHAM, NC:  
4,481,653, INT. CL. 10.

IMS GLOBAL LEARNING CONSORTIUM, INC., LAKE MARY, FL:  
4,481,158, PUB. 11-26-2013. INT. CL. 9.

IN-PLACE MACHINING CO., INC., MILWAUKEE, WI:  
1,295,287. REN. 1-8-14. INT. CL. 37.

IN-PLANT PRINTING AND MAILING ASSOCIATION, KEARNEY, MO:  
1,812,487. REN. 1-6-14. INT. CL. 42.

INCIPIO TECHNOLOGIES, INC., IRVINE, CA:  
4,480,666, PUB. 11-26-2013. MULTIPLE CLASS, INT. CLS. 9 AND 18.

INCOGNITO, INC., ROYAL OAK, MI:  
1,775,086. REN. 1-8-14. INT. CL. 9.

INCOMM INTERNATIONAL, INC., JACKSONVILLE, FL:  
3,247,227, CANC. INT. CL. 35.

INCREDIBLE CHILDREN'S ART NETWORK, SANTA BARBARA, CA:  
4,480,954, PUB. 11-26-2013. INT. CL. 41.

INCWEBS, INC., LAKELAND, FL:  
4,482,792, INT. CL. 42.

INDEPENDENT GOLF RESEARCH CORPORATION, AUSTIN, TX:  
2,798,569. REN. 1-6-14. INT. CL. 28.

INDEPENDENT INSURANCE AGENTS & BROKERS OF AMERICA, INC., ALEXANDRIA, VA:  
4,481,379, INT. CL. 16.  
4,481,380, INT. CL. 16.

INDEX ENTERPRISE LLC, JUPITER, FL:  
4,480,772, PUB. 11-26-2013. INT. CL. 36.  
4,480,773, PUB. 11-26-2013. INT. CL. 36.

INDEX FRESH, INC., RIVERSIDE, CA:  
4,480,836, PUB. 11-26-2013. INT. CL. 31.  
4,480,847, PUB. 11-26-2013. INT. CL. 31.

INDIANA MILLS & MANUFACTURING, INC., WESTFIELD, IN:  
4,480,156, PUB. 11-26-2013. INT. CL. 12.

INDIGO ORB INC, IRVINE, CA:  
3,248,616, CANC. INT. CL. 10.

INDIO PRODUCTS, INC., COMMERCE, CA:  
4,482,779, MULTIPLE CLASS, INT. CLS. 3 AND 4.

INDUSTRIA DE DISEÑO TEXTIL, S.A.; (INDITEX, S.A.), SPAIN:  
4,479,289, PUB. 11-26-2013. INT. CL. 3.

INDUSTRIAL TECHNOLOGY RESEARCH INSTITUTE, CHUTUNG, HSINCHU, 310, TAIWAN:  
3,245,824, CANC. INT. CL. 25.

INDUSTRIAS HACEB S.A., COPACABANA, COLOMBIA:  
4,481,585, INT. CL. 11.

INDUSTRIAS PIERO DE LEÓN, S.A. DE C.V., LEÓN, GUANAJUATO, MEXICO:  
3,246,840, CANC. INT. CL. 25.

INDÚSTRIAS ALIMENTÍCIAS MARATÁ LTDA., ITAPORANGA D'AJUDA, BRAZIL:  
3,246,735, CANC. INT. CL. 30.

INFINITE SQUARE S.A.S., F-75012 PARIS, FRANCE:  
4,479,277, PUB. 5-28-2013. MULTIPLE CLASS, INT. CLS. 9, 35, 37, 38, 41 AND 42.

INFOCASE, CINCINNATI, OH:  
3,245,858, CANC. INT. CL. 9.

INFOGRAMS, INC., NEW YORK, NY TO ATARI EUROPE SAS, PARIS, FRANCE:  
2,718,499, CANC. MULTIPLE CLASS, INT. CLS. 9 AND 41.

INFORMATION TECHNOLOGY SERVICE AND SUPPORT, INC., GOLDSBORO, NC:  
4,480,283, PUB. 11-26-2013. INT. CL. 41.

INFOTERIA CORPORATION, TOKYO, JAPAN:  
4,482,139, INT. CL. 42.

INGATE SYSTEMS AB, SUNDBYBERG, SWEDEN:  
2,798,635. REN. 1-7-14. INT. CL. 9.

INGENEUS INC., BELIZE CITY, BELIZE:  
3,247,164, CANC. INT. CL. 5.

- INGRAM'S NUTRITION CONSULTATIONS LLC, CLINTON TOWNSHIP, MI:  
3,247,321, CANC. INT. CL. 44.
- INK INVASION, INC., STATEN ISLAND, NY:  
3,246,515, CANC. INT. CL. 2.
- INKTEC CO., LTD., KUN PO CITY, KYUNG KI DO, REPUBLIC OF KOREA:  
2,797,977, REN. 1-6-14, INT. CL. 2.
- INLAND COATINGS CORPORATION, ADEL, IA:  
1,263,624, REN. 1-9-14, INT. CL. 19.
- INLAND PRODUCTS, INC., CARTHAGE, MO:  
2,718,649, CANC. INT. CL. 29.
- INLINGUA INTERNATIONAL AG, SWITZERLAND:  
4,479,323, PUB. 11-26-2013. MULTIPLE CLASS, INT. CLS. 9, 16 AND 41.
- INNISFREE CORPORATION, SEOUL, REPUBLIC OF KOREA:  
4,480,412, PUB. 11-26-2013. INT. CL. 30.
- INNOCENTIVE, INC., WALTHAM, MA:  
4,481,489, MULTIPLE CLASS, INT. CLS. 35 AND 42.
- INNOVATION SPECIALISTS LLC, HOUSTON, TX:  
4,481,457, INT. CL. 44.
- INNOVATIVE BIOSENSORS, INC., ROCKVILLE, MD:  
3,246,558, CANC. MULTIPLE CLASS, INT. CLS. 1 AND 5.
- INNOVATIVE RACING EVENTS, LLC, SCOTTSDALE, AZ:  
4,480,301, PUB. 11-26-2013. INT. CL. 41.
- INNOVENT SOLUTIONS, INC., IRVINE, CA:  
4,480,498, PUB. 11-26-2013. INT. CL. 35.
- INNOVISE PLC, UNITED KINGDOM:  
4,479,314, PUB. 6-25-2013. MULTIPLE CLASS, INT. CLS. 9 AND 42.
- INNOVOLT, INC., ATLANTA, GA:  
4,480,600, PUB. 11-26-2013. MULTIPLE CLASS, INT. CLS. 9 AND 42.
- INNOVYZE, INC., BROOMFIELD, CO:  
4,482,120, INT. CL. 9.  
4,482,271, INT. CL. 9.
- INPRO CORPORATION, MUSKEGO, WI:  
4,480,182, PUB. 11-26-2013. MULTIPLE CLASS, INT. CLS. 1, 20 AND 24.
- INSANITY HOUSE, INC., SAN FRANCISCO, CA:  
2,719,336, CANC. INT. CL. 36.
- INSIGHT PROPERTY GROUP, LLC, ARLINGTON, VA:  
4,481,916, INT. CL. 36.
- INSPECT 360, COLLEEVILLE, TX:  
4,480,228, PUB. 11-26-2013. INT. CL. 42.
- INSPIRATION SPORTS, LAKE PLACID, NY:  
4,479,681, PUB. 11-26-2013. INT. CL. 41.
- INSTITUTE FOR INTEGRATIVE NUTRITION, NEW YORK, NY:  
4,480,085, PUB. 11-26-2013. INT. CL. 41.
- INSTITUTE OF NUTRITION, MIAMI, FL, AKA DR. MARIBEL SANTACRUZ:  
4,480,153, PUB. 11-26-2013. INT. CL. 5.
- INSTRUMENTA GROUP, LLC, HOUSTON, TX:  
4,480,326, PUB. 11-26-2013. INT. CL. 25.
- INSURANCE INFORMATION INSTITUTE, INC., NEW YORK, NY:  
3,246,488, CANC. INT. CL. 36.
- INTAGIO GROUP, INC., THE, SAN FRANCISCO, CA:  
3,247,026, CANC. INT. CL. 35.
- INTECHNIC, MUNDELEIN, IL:  
4,481,199, PUB. 11-26-2013. INT. CL. 42.  
4,481,219, PUB. 11-26-2013. INT. CL. 42.
- INTECTURAL, INC., DULUTH, MN:  
4,481,070, PUB. 11-26-2013. INT. CL. 35.
- INTEGRACARE HOLDINGS, INC., GRAPEVINE, TX:  
4,480,791, PUB. 11-26-2013. INT. CL. 45.
- INTEGRATED HEALTH PLAN, INC., ST. PETERSBURG, FL:  
3,333,083, AM. INT. CL. 35.
- INTEGRATED PROTECTIVE COATINGS INC., EDMONTON, ALBERTA, CANADA:  
4,479,686, PUB. 11-26-2013. MULTIPLE CLASS, INT. CLS. 1, 2 AND 42.
- INTEGRYS TRANSPORTATION FUELS, LLC, CHICAGO, IL:  
4,481,873, MULTIPLE CLASS, INT. CLS. 4, 35, 36, 37 AND 42.
- INTEL CORPORATION, SANTA CLARA, CA:  
3,246,588, CANC. INT. CL. 14.
- INTELLECTUAL FLAME CO., LTD., ROAD TOWN, TORTOLA, BR. VIRGIN ISLANDS:  
4,480,623, PUB. 11-26-2013. INT. CL. 9.
- INTELLECTUAL PROPERTY INVESTMENT LIMITED, KOWLOON BAY, HONG KONG:  
3,248,340, CANC. MULTIPLE CLASS, INT. CLS. 21 AND 28.
- INTELLEGENE GENOMICS LLC, MIAMI, FL:  
4,480,441, PUB. 11-26-2013. INT. CL. 42.
- INTERCONTINENTAL GREAT BRANDS LLC, EAST HANOVER, NJ:  
1,815,062, REN. 1-7-14, INT. CL. 30.  
3,248,090, CANC. INT. CL. 30.
- INTERLINE BRANDS, INC., JACKSONVILLE, FL:  
4,480,679, PUB. 11-26-2013. MULTIPLE CLASS, INT. CLS. 6 AND 7.
- INTERMEDIUM SHOES B.V., NETHERLANDS:  
3,247,778.
- INTERMET METALS SERVICES, INC., SCHAUMBURG, IL:  
1,709,703, CANC. INT. CL. 6.
- INTERMEZZO, INC., LAS VEGAS, NV:  
4,482,415, INT. CL. 42.
- INTERNATIONAL ASSOCIATION OF FIRE FIGHTERS, WASHINGTON, DC:  
3,248,066, CANC. INT. CL. 9.
- INTERNATIONAL BUSINESS MACHINES CORPORATION, ARMONK, NY, AKA IBM CORPORATION:  
2,719,667, CANC. INT. CL. 35.
- INTERNATIONAL BUSINESS MACHINES CORPORATION, ARMONK, NY:  
2,719,676, CANC. INT. CL. 9.  
3,066,517, CANC. INT. CL. 16.
- INTERNATIONAL BUSINESS MACHINES CORPORATION, ARMONK, NY, AKA IBM CORPORATION:  
3,248,049, CANC. INT. CL. 9.
- INTERNATIONAL COMMUNICATIONS INDUSTRIES ASSOCIATION, INC., FAIRFAX, VA:  
2,718,798, CANC. INT. CL. 41.
- INTERNATIONAL COUNCIL OF SHOPPING CENTERS, INC., NEW YORK, NY:  
4,480,217, PUB. 11-26-2013. U.S. CL. B.
- INTERNATIONAL DATA GROUP, INC., FRAMINGHAM, MA:  
2,718,320, CANC. MULTIPLE CLASS, INT. CLS. 35, 41 AND 42.
- INTERNATIONAL DESIGNERS GROUP, INC., NEW YORK, NY TO WILLIAMS-SONOMA, INC., SAN FRANCISCO, CA:  
976,344, AM. U.S. CL. 23.
- INTERNATIONAL DIGITAL ENTERPRISE ALLIANCE, INC., ALEXANDRIA, VA:  
3,248,675, CANC. INT. CL. 42.
- INTERNATIONAL FELLOWSHIP OF CHRISTIANS & JEWS, INC., CHICAGO, IL:  
4,481,593, INT. CL. 9.
- INTERNATIONAL FINANCIAL GROUP, INC., HARTFORD, CT:  
2,819,689, REN. 1-7-14, INT. CL. 16.
- INTERNATIONAL FLAVORS & FRAGRANCES INC., NEW YORK, NY:  
1,777,552, REN. 1-4-14. MULTIPLE CLASS, INT. CLS. 1 AND 3.
- INTERNATIONAL FRANCHISE ASSOCIATION, WASHINGTON, DC:  
1,812,132, REN. 1-3-14, INT. CL. 16.
- INTERNATIONAL INSTITUTE FOR HUMAN EMPOWERMENT, ALBANY, NY:  
4,479,697, PUB. 11-26-2013. INT. CL. 41.
- INTERNATIONAL KNOWN LLC, CARSON, CA:  
3,248,689, CANC. INT. CL. 25.
- INTERNATIONAL LANGUAGE TRAINING INSTITUTE INC., NEW YORK, NY:  
4,480,275, PUB. 11-26-2013. INT. CL. 41.

INTERNATIONAL LICENSING INDUSTRY MERCHANDISERS ASSOCIATION, INC., NEW YORK, NY:  
3,248,419, CANC. INT. CL. 16.

INTERNATIONAL MANAGEMENT GROUP; (UK) LIMITED, UNITED KINGDOM:  
4,479,447, PUB. 11-26-2013. MULTIPLE CLASS, INT. CLS. 14, 18, 25 AND 35.

INTERNATIONAL MEDICAL EQUIPMENT AND SERVICE, INC., FORT MILL, SC:  
4,481,963, MULTIPLE CLASS, INT. CLS. 10 AND 42.

INTERNATIONAL POINT OF VIEW, SAN DIMAS, CA:  
4,479,252, PUB. 11-26-2013. INT. CL. 9.

INTERNATIONAL RECTIFIER CORPORATION, EL SEGUNDO, CA:  
4,481,304, INT. CL. 9.  
4,481,307, INT. CL. 9.

INTERNATIONAL TAEKWONDO ALLIANCE, INC., PENSACOLA, FL:  
3,245,845, CANC. INT. CL. 41.

INTERNATIONAL TRADEMARK ASSOCIATION, INC., NEW YORK, NY:  
4,479,895, PUB. 11-26-2013. MULTIPLE CLASS, INT. CLS. 41 AND 45.  
4,479,896, PUB. 11-26-2013. MULTIPLE CLASS, INT. CLS. 41 AND 45.

INTERNATIONAL VOLUNTEERS IN UROLOGY, INC., SALT LAKE CITY, UT:  
3,247,379, CANC. MULTIPLE CLASS, INT. CLS. 41 AND 44.

INTEROCEAN SEAFOODS CO., SEATTLE, WA:  
1,869,803, REN. 1-9-14. INT. CL. 29.

INTERPROSE, INC., RESTON, VA:  
2,718,396, CANC. INT. CL. 35.

INTERSTATE BATTERY SYSTEM INTERNATIONAL, INC., DALLAS, TX:  
756,352, REN. 1-6-14. U.S. CL. 21 (INT. CL. 9).  
1,272,477, REN. 1-8-14. INT. CL. 9.

INTEVAC, INC., SANTA CLARA, CA:  
3,248,545, CANC. INT. CL. 9.

INTEX RECREATION CORP., LONG BEACH, CA:  
1,868,181, REN. 1-6-14. INT. CL. 12.

INTREDEX, LLC, ORLANDO, FL, DBA INTREDEX:  
4,481,054, PUB. 11-26-2013. INT. CL. 42.

INVERSIONES FAMILIARES S.A., SANTIAGO, CHILE:  
4,479,613, PUB. 11-26-2013. INT. CL. 33.

INVESTMENT SEMINARS, INC., SARASOTA, FL:  
3,246,669, CANC. MULTIPLE CLASS, INT. CLS. 35 AND 41.

INVITE HEALTH, INC., WESTBURY, NY:  
4,480,335, PUB. 11-26-2013. INT. CL. 5.

ION-X CORPORATION, INC., FORT WORTH, TX:  
4,425,299, COR. MULTIPLE CLASS, INT. CLS. 1 AND 3.

IONETIX CORPORATION, SAN FRANCISCO, CA:  
4,481,454, MULTIPLE CLASS, INT. CLS. 5, 9 AND 42.  
4,481,455, MULTIPLE CLASS, INT. CLS. 5, 9 AND 42.

IOTTIE INC., NEW YORK, NY:  
4,480,720, PUB. 11-26-2013. INT. CL. 9.

IP TECHNOLOGY LABS, LLC, OLNEY, MD:  
4,479,803, PUB. 11-26-2013. INT. CL. 9.

IPCAPITAL GROUP, INC., WILLISTON, VT:  
4,480,159, PUB. 11-26-2013. MULTIPLE CLASS, INT. CLS. 35 AND 45.

IPROWORKS CORP., WOODLAND HILLS, CA:  
3,246,489, CANC. INT. CL. 35.

IPSEN PHARMA S.A.S., FRANCE:  
4,479,444, PUB. 11-26-2013. INT. CL. 5.

IQ FORMULATIONS, LLC, SUNRISE, FL:  
4,482,623, INT. CL. 5.

IRONCLAD PERFORMANCE WEAR CORP., EL SEGUNDO, CA:  
3,353,295, CANC. INT. CL. 8.  
3,353,295, AM. MULTIPLE CLASS, INT. CLS. 9 AND 25.

IRONPLANET, INC., PLEASANTON, CA:  
4,482,522, INT. CL. 35.  
4,482,613, INT. CL. 35.

IRWIN HOLDINGS, LLC, HOOVER, AL:  
4,481,197, PUB. 11-26-2013. INT. CL. 44.

ISAAC DANIEL GROUP, INC., MIRAMAR, FL:  
4,481,351, INT. CL. 25.

ISABELLE'S KITCHEN, INC., HARLEYSVILLE, PA:  
2,811,417, REN. 1-7-14. INT. CL. 29.

ISBIS LLC, WINTER SPRINGS, FL:  
4,481,030, PUB. 11-26-2013. INT. CL. 42.

ISIGNY SAINTE-MERE, 14230 ISIGNY-SUR-MER, FRANCE:  
2,718,501, CANC. INT. CL. 29.

ISM WEAPON SYSTEMS, INC., CARMICHAELS, PA:  
4,482,483, INT. CL. 13.

ISPORTCORP, INC., DELRAY BEACH, FL:  
4,482,000, INT. CL. 25.

ISRAEL AEROSPACE INDUSTRIES LTD., LOD, ISRAEL:  
2,803,206, REN. 1-8-14. INT. CL. 13.  
2,803,209, REN. 1-8-14. INT. CL. 13.

ISRAEL COHEN & SONS INTERNATIONAL, LTD., BROOKLYN, NY:  
4,480,640, PUB. 11-26-2013. INT. CL. 25.

ISRAEL SPECIAL KIDS FUND, NEW YORK, NY:  
3,247,563, CANC. INT. CL. 44.

ISRAM WHOLESALE TOURS AND TRAVEL, LTD., NEW YORK, NY:  
4,481,114, PUB. 11-26-2013. INT. CL. 39.

IT WORKS! INC., WASHINGTON, DC:  
4,479,958, PUB. 11-26-2013. INT. CL. 42.

ITC ENTERTAINMENT GROUP LIMITED, LONDON, UNITED KINGDOM:  
1,764,185, REN. 1-9-14. INT. CL. 9.

ITO EN (NORTH AMERICA) INC., BROOKLYN, NY:  
2,803,087, REN. 1-7-14. MULTIPLE CLASS, INT. CLS. 30 AND 35.  
3,248,591, CANC. INT. CL. 30.  
3,248,619, CANC. INT. CL. 30.

ITOHO, KOICHI, HAMAKITA-SHI, SHIZUOKA-KEN, JAPAN:  
1,815,043, REN. 1-8-14. INT. CL. 28.

ITSON INC., REDWOOD CITY, CA:  
4,481,369, INT. CL. 38.

IV-MEDIA, LLC, SUFFOLK, VA:  
3,293,382, COR. INT. CL. 38.

IVR CARE TRANSITION SYSTEMS, INC., BIRMINGHAM, AL:  
4,482,720, INT. CL. 9.

IWC INVESTMENT PARTNERS FONDSMÆGLERSELSKAB A/S, DK-1875 FREDERIKSBERG C., DENMARK:  
4,479,390, PUB. 11-26-2013. INT. CL. 36.

IZETTLER AB, SWEDEN:  
4,479,455, PUB. 11-26-2013. MULTIPLE CLASS, INT. CLS. 9, 36 AND 38.  
4,479,460, PUB. 11-26-2013. MULTIPLE CLASS, INT. CLS. 9, 36 AND 38.  
4,479,464, PUB. 11-26-2013. MULTIPLE CLASS, INT. CLS. 9, 36 AND 38.  
4,479,467, PUB. 11-26-2013. MULTIPLE CLASS, INT. CLS. 9, 36 AND 38.

19 SPORTS CORPORATION, BRANDON, FL:  
3,246,039, CANC. INT. CL. 41.

J & M INNOVATIVE PRODUCTS, LLC, WOODSCROSS, UT:  
2,852,932, REN. 1-8-14. INT. CL. 8.

J JEANNE WHERRETT, AUSTRALIA AND ARTHUR G WHERRETT, AUSTRALIA:  
4,479,452, PUB. 11-26-2013. MULTIPLE CLASS, INT. CLS. 9 AND 16.

J. & P. COATS, LIMITED, GLASGOW, SCOTLAND:  
4,482,384, INT. CL. 23.

J. A. THOMAS AND ASSOCIATES, INC., ATLANTA, GA:  
2,719,479, CANC. MULTIPLE CLASS, INT. CLS. 41 AND 42.

J. C. PENNEY PRIVATE BRANDS, INC., PLANO, TX:  
3,248,534, CANC. INT. CL. 35.

J. LLOYD INTERNATIONAL, INC., CEDAR RAPIDS, IA:  
1,826,474, REN. 1-3-14. INT. CL. 28.

J. W. JUNG SEED COMPANY, RANDOLPH, WI:  
4,480,781, PUB. 11-26-2013. INT. CL. 31.

J.H. BURNS, INC., MEDINA, OH, DBA BMS BURNS:  
4,480,351, PUB. 11-26-2013. INT. CL. 35.

J.H. FENNER & CO. LIMITED, EAST YORKSHIRE, ENGLAND:  
3,247,623, CANC. INT. CL. 7.

- J.M. HIRSCH, CONCORD, NH:  
4,480,158, PUB. 11-26-2013. INT. CL. 41.
- J.M.K. CLOTHING LTD, UNITED KINGDOM:  
4,479,496, PUB. 11-26-2013. INT. CL. 25.
- J.M.S. FASHION, INC., LOS ANGELES, CA:  
4,480,321, PUB. 11-26-2013. INT. CL. 18.
- J.R. ANDORIN, INC., MONTGOMERY, NY:  
2,797,695. REN. 1-3-14. MULTIPLE CLASS, INT. CLS. 3 AND 5.  
2,797,696. REN. 1-3-14. MULTIPLE CLASS, INT. CLS. 9, 35 AND 41.
- J.R. SIMPLOT COMPANY, BOISE, ID:  
1,861,104. REN. 1-9-14. INT. CL. 31.
- JACK DANIEL'S PROPERTIES, INC., SAN RAFAEL, CA:  
4,481,424, INT. CL. 14.  
4,481,425, INT. CL. 26.  
4,482,362, INT. CL. 33.
- JACKSON ENERGY AUTHORITY, JACKSON, TN:  
3,246,500, CANC. INT. CL. 38.
- JACKSON, KOBY, NORTH SALT LAKE, UT:  
4,482,745, INT. CL. 42.
- JACKSONS FOOD STORES, INC., MERIDIAN, ID:  
4,481,062, PUB. 11-26-2013. INT. CL. 43.  
4,481,063, PUB. 11-26-2013. INT. CL. 29.  
4,481,064, PUB. 11-26-2013. INT. CL. 30.
- JACLYN, INC., WEST NEW YORK, NJ:  
3,247,636, CANC. INT. CL. 25.
- JADA TOYS, INC., CITY OF INDUSTRY, CA:  
3,247,981, CANC. INT. CL. 28.
- JAFER LIMITED, ROAD TOWN, TORTOLA, BR.VIRGIN ISLANDS:  
2,890,254. REN. 1-6-14. INT. CL. 3.  
2,890,353. REN. 1-6-14. INT. CL. 3.
- JAFFE, RUSSELL M., VIENNA, VA:  
4,482,136, INT. CL. 5.  
4,482,204, MULTIPLE CLASS, INT. CLS. 42 AND 44.  
4,482,369, INT. CL. 5.  
4,482,370, INT. CL. 5.
- JAKKS PACIFIC, INC., MALIBU, CA:  
3,246,681, CANC. INT. CL. 16.
- JAMES DONALD MATTHIS, II, CLINTON, NC:  
4,482,561, INT. CL. 36.
- JAMES G. PARKER INSURANCE ASSOCIATES, FRESNO, CA:  
4,479,912, PUB. 11-26-2013. INT. CL. 36.
- JAMES PERRY HUNSAKER, HIGLEY, AZ:  
4,479,831, PUB. 11-26-2013. INT. CL. 13.
- JAMES QUATOR LLC, WEST CHESTER, PA:  
4,480,496, PUB. 11-26-2013. INT. CL. 25.
- JAMES W PACE, RIGBY, ID:  
4,479,567, PUB. 8-20-2013. INT. CL. 43.
- JAMES, BELDON S., PEORIA, AZ:  
4,482,207, INT. CL. 25.
- JAMES, KIMBERLY, RUTHERFORDTON, NC:  
2,719,052, CANC. INT. CL. 41.
- JANCO, LLC, BOTHELL, WA:  
4,481,802, INT. CL. 30.
- JANOME SEWING MACHINE COMPANY LIMITED, TOKYO, JAPAN:  
4,479,536, PUB. 5-14-2013. MULTIPLE CLASS, INT. CLS. 7 AND 9.  
4,479,537, PUB. 5-14-2013. MULTIPLE CLASS, INT. CLS. 7 AND 9.
- JANSON, INC., MEDIA, PA:  
3,246,903, CANC. INT. CL. 42.
- JAPAN AIRLINES CO., LTD., TOKYO, JAPAN:  
4,482,078, INT. CL. 39.
- JARAJIAN, ASDGHIG, BEVERLY HILLS, CA:  
3,245,769, CANC. INT. CL. 14.
- JASON H. FISHER, LOS ANGELES, CA, DBA FISHER LAW GROUP:  
4,480,529, PUB. 11-26-2013. INT. CL. 45.
- JASON NEULANDER, AUSTIN, TX:  
4,480,338, PUB. 11-26-2013. INT. CL. 9.  
4,480,339, PUB. 11-26-2013. INT. CL. 9.
- JASPER RIDGE PARTNERS, L.P., MENLO PARK, CA:  
4,482,546, INT. CL. 36.
- JAY GEMS, INC., NEW YORK, NY, DBA SIMPLY DIAMONDS:  
4,482,787, INT. CL. 14.
- JAYDEN STAR LLC, NEW YORK, NY:  
4,481,576, INT. CL. 14.
- JAZZ PHARMACEUTICALS INTERNATIONAL LIMITED, HAMILTON, BERMUDA:  
2,806,847. REN. 1-3-14. INT. CL. 5.
- JBS UNITED, INC., SHERIDAN, IN:  
4,481,544, INT. CL. 7.  
4,481,579, INT. CL. 5.
- JCB CO., LTD., TOKYO, JAPAN:  
4,480,165, PUB. 9-3-2013. INT. CL. 36.
- JD SOFTWARE, INC., SALEM, MA:  
4,482,466, INT. CL. 42.
- JEBCO, INC., HOLLY SPRINGS, NC:  
2,914,040. REN. 1-9-14. INT. CL. 11.
- JEFF MURRAY, DULUTH, MN, DBA JEFF MURRAY OUTDOORS, INC.:  
2,720,003, CANC. INT. CL. 28.
- JEFFERSON DAVIS INN, LLC, LEXINGTON, KY:  
4,482,318, INT. CL. 43.
- JEFFERSON YACHTS, INC., JEFFERSONVILLE, IN:  
1,698,968, CANC. INT. CL. 12.
- JEM INVESTMENT GROUP LLC, DELRAY BEACH, FL:  
4,479,785, PUB. 6-11-2013. INT. CL. 35.  
4,479,946, PUB. 6-4-2013. INT. CL. 35.
- JEN USA INC., NORTH BRUNSWICK, NJ:  
3,248,006, CANC. INT. CL. 3.
- JENNIFER AHN, LOS ANGELES, CA AND JENNIFER VANZYL, LOS ANGELES, CA:  
4,482,313, INT. CL. 9.
- JENSEN ENTERPRISES, SPARKS, NV:  
4,481,875, MULTIPLE CLASS, INT. CLS. 19 AND 45.  
4,481,876, MULTIPLE CLASS, INT. CLS. 19 AND 45.
- JEREMY J. SHELDON, MILFORD, OH:  
4,480,866, PUB. 11-26-2013. INT. CL. 16.
- JERI'S TOYS, LLC, WESTON, FL:  
4,479,961, PUB. 11-26-2013. INT. CL. 28.
- JESSICA BISHOP DESIGNS, LLC, NEENAH, WI:  
3,247,942, CANC. INT. CL. 18.
- JET U.S.A., INC., CRANBURY, NJ:  
4,480,748, PUB. 11-26-2013. INT. CL. 41.
- JETECH INC, BATTLE CREEK, MI:  
4,482,795, INT. CL. 7.
- JETSETTER GYPSY, BOYDS, MD:  
4,480,013, PUB. 6-25-2013. INT. CL. 41.
- JFD3 LLC, HOLLYWOOD, FL:  
4,482,601, INT. CL. 35.
- JFE STEEL KABUSHIKI KAISHA, TOKYO 100-0011, JAPAN:  
4,479,297, PUB. 6-18-2013. INT. CL. 6.
- JFE STEEL KABUSHIKI KAISHA, TOKYO, JAPAN:  
4,479,376, PUB. 11-26-2013. INT. CL. 6.
- JIANGSU RUTONG PETROLEUM MACHINERY; CO., LTD., CHINA:  
4,479,482, PUB. 11-26-2013. INT. CL. 7.
- JIM BEAM BRANDS CO., DEERFIELD, IL:  
1,843,714, REN. 1-4-14. INT. CL. 25.
- JIMENEZ, GEORGE, UNIONTOWN, OH:  
4,480,597, PUB. 11-26-2013. INT. CL. 42.
- JIMMY RIFFLE, LLC, NORTH MIAMI BEACH, FL:  
4,480,592, PUB. 11-26-2013. MULTIPLE CLASS, INT. CLS. 30 AND 43.
- JIMMYJANE, INC., SAN FRANCISCO, CA:  
4,482,076, INT. CL. 10.
- JINXIANG DU, FUJIAN, CHINA:  
4,479,293, PUB. 11-26-2013. INT. CL. 20.
- JMG CRANES S.R.L., ITALY:  
4,479,468, PUB. 11-26-2013. INT. CL. 7.
- JMG INTERNATIONAL, INC., SAN JOSE, CA:  
4,481,510, INT. CL. 34.
- JMM LEE PROPERTIES, LLC, BURBANK, CA:  
4,479,542, PUB. 11-26-2013. INT. CL. 38.
- JMS ADVISORY GROUP, LLC, ATLANTA, GA:  
4,480,086, PUB. 11-26-2013. INT. CL. 45.
- JOACHIM JAKOB, FED REP GERMANY:  
4,479,330, PUB. 11-26-2013. INT. CL. 7.

- JOAN'S LEGACY: THE JOAN SCARANGELLO FOUNDATION TO CONQUER LUNG CANCER, NEW YORK, NY: 3,490,466, COR. INT. CL. 36.
- JOANA BOVER GRASA, BARCELONA, SPAIN: 4,479,728, PUB. 11-26-2013. INT. CL. 20.
- JOAS ELECTRONICS CO., LTD., KYUNGKI-DO, REPUBLIC OF KOREA: 3,248,208, CANC. INT. CL. 8.
- JOBZY INC., RIVER FOREST, IL: 4,482,562, INT. CL. 35.
- JOCKEY INTERNATIONAL, INC., KENOSHA, WI: 4,482,620, INT. CL. 35.
- JOCOR ENTERPRISES, HONOLULU, HI: 4,479,599, PUB. 11-26-2013. INT. CL. 34.
- JOE FILTER, L.L.C., GILBERT, AZ, DBA JOE FILTER: 4,482,064, INT. CL. 35.
- JOE PARDUE KNIVES, INCORPORATED, HILLSTER, TX: 4,479,637, PUB. 11-26-2013. INT. CL. 8.
- JOHJOH AB, HELSINGBORG, SWEDEN: 4,479,673, PUB. 11-27-2012. MULTIPLE CLASS, INT. CLS. 14 AND 42.
- JOHN BEAN TECHNOLOGIES CORPORATION, CHICAGO, IL, PNEUMO ABEX CORPORATION, OGDEN, UT: 1,845,539, REN. 1-3-14. INT. CL. 11.
- JOHN BEAN TECHNOLOGIES CORPORATION, CHICAGO, IL: 2,820,796, REN. 1-3-14. INT. CL. 9.
- JOHN DOBOZY, GCMC BUNDALL QLD 9726, AUSTRALIA: 3,247,741.
- JOHN HANCOCK LIFE INSURANCE COMPANY (U.S.A.), BOSTON, MA, NORTH AMERICAN SECURITY LIFE INSURANCE COMPANY, BOSTON, MA: 1,838,834, REN. 1-8-14. INT. CL. 36.
- JOHN MANUFACTURING LTD., KOWLOON, HONG KONG: 3,248,355, CANC. INT. CL. 11.
- JOHN MARSHALL & COMPANY LIMITED, CHRISTCHURCH, NEW ZEALAND: 1,820,655, REN. 1-6-14. INT. CL. 22.
- JOHN MIDDLETON CO., RICHMOND, VA, CULBRO CORPORATION, NEW YORK, NY: 1,263,754, REN. 1-5-14. INT. CL. 34.
- JOHN MILLS LIMITED, LONDON, UNITED KINGDOM: 4,482,210, INT. CL. 25.
- JOHN PAUL RICHARD, INC., CALABASAS, CA: 3,248,468, CANC. INT. CL. 25.
- JOHN SOULES FOODS, INC., TYLER, TX: 4,479,664, PUB. 11-26-2013. INT. CL. 30.
- JOHN W. KENAGY, LONGVIEW, WA: 4,481,156, PUB. 11-26-2013. INT. CL. 35.  
4,481,169, PUB. 11-26-2013. INT. CL. 41.
- JOHNS MANVILLE, DENVER, CO: 1,815,427, REN. 1-8-14. INT. CL. 19.
- JOHNS MANVILLE, DENVER, CO, SCHULLER INTERNATIONAL, INC., DENVER, CO: 1,817,443, REN. 1-9-14. INT. CL. 17.
- JOHNSON & JOHNSON, NEW BRUNSWICK, NJ: 2,719,170, CANC. INT. CL. 3.  
2,719,177, CANC. INT. CL. 3.  
2,719,178, CANC. INT. CL. 3.  
2,719,344, CANC. INT. CL. 5.  
3,246,008, CANC. INT. CL. 10.  
3,246,483, CANC. MULTIPLE CLASS, INT. CLS. 10 AND 41.
- JOHNSON, JASON C., BURTONSVILLE, MD: 3,246,215, CANC. INT. CL. 41.
- JOHNSON, TALLY, PARADISE, UT: 4,480,516, PUB. 11-26-2013. INT. CL. 1.
- JOHNSON, TIMOTHY SOUTHWICK, LAKE GENEVA, WI: 3,246,929, CANC. INT. CL. 41.
- JOHNSONITE INC., CHAGRIN FALLS, OH: 2,718,623, CANC. INT. CL. 19.  
4,481,780, INT. CL. 19.
- JOIA DE MAJORCA, LTD., PARK RIDGE, IL: 2,797,182, REN. 1-7-14. INT. CL. 14.
- JOINT STOCK COMPANY "INFOTEC", RUSSIAN FED.: 4,479,279, PUB. 11-26-2013. MULTIPLE CLASS, INT. CLS. 9, 16, 35, 37, 41 AND 42.
- JOINT-STOCK COMPANY "LAGIDZE", REP OF GEORGIA: 4,479,465, PUB. 11-26-2013. INT. CL. 32.
- JONATHAN GREEN & SONS, INC., FARMINGDALE, NJ: 4,482,447, INT. CL. 1.
- JONATHAN GURMAN, WESTMOUNT, CANADA: 4,479,259, PUB. 11-26-2013. MULTIPLE CLASS, INT. CLS. 21 AND 25.
- JONES INTERNATIONAL, LTD., ENGLEWOOD, CO: 2,797,529, REN. 1-3-14. INT. CL. 41.
- JONES SODA CO. (USA) INC., SEATTLE, WA: 3,246,219, CANC. INT. CL. 30.
- JONES, BRYAN J., ST AUGUSTINE, FL: 4,481,645, MULTIPLE CLASS, INT. CLS. 35 AND 42.
- JONES, COLUMBIA E., MARIETTA, GA: 4,481,413, INT. CL. 20.
- JONES, JESSE B., ALBANY, OR: 3,245,929, CANC. INT. CL. 9.
- JONES, SHANE M, MONTEVALLO, AL: 4,481,676, INT. CL. 35.
- JONES, STEPHEN, BERKELEY, CA: 4,482,127, INT. CL. 25.
- JOOVY HOLDING CO., DALLAS, TX: 4,481,755, INT. CL. 10.
- JOSE ALBERTO GABRIEL TOLEDANO MOYADO, TLAQUEPAQUE, JAL., MEXICO: 4,482,104, INT. CL. 9.
- JOSE MARIA VARGAS UNIVERSITY LLC, COCONUT GROVE, FL: 3,247,905, CANC. INT. CL. 41.
- JOSE SANTIAGO, INC., BAYAMON, PUERTO RICO: 3,246,581, CANC. INT. CL. 29.
- JOSHUA DAVID MELLBERG, LLC, TUCSON, AZ, DBA JD MELLBERG FINANCIAL: 4,482,721, INT. CL. 36.
- JOSÉ MANUEL BEADE RIOSECO, SPAIN: 4,479,342, PUB. 11-26-2013. INT. CL. 9.
- JOURNEYS IN LIFE, LLC, ELIZABETHTON, TN AND BLAIR, PAMELA B, ELIZABETHTON, TN AND BLAIR, PAMELA B., ELIZABETHTON, TN: 3,248,718, CANC. INT. CL. 25.
- JOY FOR OUR YOUTH, INC., LAKEWOOD, NJ, DBA KARS4KIDS: 4,481,891, MULTIPLE CLASS, INT. CLS. 35 AND 41.
- JPMORGAN CHASE & CO., NEW YORK, NY: 3,246,687, CANC. INT. CL. 36.
- JRD IMC, LLC, COLLEGE POINT, NY: 2,800,056, REN. 1-9-14. INT. CL. 42.
- JÓVAN'S PURE NUTRITION, BLAINE, WA: 4,481,254, PUB. 11-26-2013. MULTIPLE CLASS, INT. CLS. 29 AND 30.
- JSJ FURNITURE CORPORATION, GRAND HAVEN, MI: 1,814,955, REN. 1-8-14. INT. CL. 20.
- JST PERFORMANCE, INC., GILBERT, AZ, DBA RIGID INDUSTRIES: 4,482,431, INT. CL. 11.
- JUDGE, KAREN ANN, OAKLAND PARK, FL: 4,480,455, PUB. 11-26-2013. INT. CL. 25.
- JULIAN SYKES, UNITED KINGDOM: 4,479,441, PUB. 11-26-2013. MULTIPLE CLASS, INT. CLS. 9, 35, 38, 41 AND 42.
- JULISA ADAMS, MA, BOULDER, CO: 4,480,762, PUB. 11-26-2013. INT. CL. 44.
- JUMBO HELMET-SPORTS S.R.L., ALESSANDRIA, ITALY: 3,246,220, CANC. INT. CL. 9.
- JUST BORN, INC., BETHLEHEM, PA: 4,480,089, PUB. 11-26-2013. MULTIPLE CLASS, INT. CLS. 16, 21 AND 25.
- JUST FOR KIDS, LLC, ARLINGTON, VA: 4,482,812, INT. CL. 41.
- JUST ONE BREAK, INC., ALBERTSON, NY, DBA NATIONAL BUSINESS & DISABILITY COUNCIL: 4,479,808, PUB. 11-26-2013. INT. CL. 35.
- JUSTICE BROTHERS, INC., DUARTE, CA: 1,304,342, REN. 1-9-14. INT. CL. 4.  
1,304,343, REN. 1-9-14. INT. CL. 4.
- JUSTICE INITIATIVES, INC., CHARLOTTE, NC: 4,482,734, INT. CL. 41.

- JVI APPRAISAL DIVISION, LLC, LAKE MARY, FL:  
3,247,143, CANC. INT. CL. 36.
- K. HANSOTIA & CO., INC., TAMARAC, FL:  
4,482,102, INT. CL. 34.  
4,482,178, INT. CL. 34.  
4,482,179, INT. CL. 34.
- KAANGO, LLC, GREENWOOD VILLAGE, CO:  
3,246,939, CANC. INT. CL. 35.
- KABUSHIKI KAISHA DARTSLIVE; D/B/A DARTSLIVE CO., LTD., JAPAN:  
4,479,332, PUB. 11-26-2013. MULTIPLE CLASS, INT. CLS. 41 AND 43.
- KABUSHIKI KAISHA MIYAKE DESIGN JIMUSHO, SHIBUYA-KU, TOKYO, JAPAN, DBA MIYAKE DESIGN STUDIO:  
4,479,604, PUB. 11-26-2013. INT. CL. 11.
- KABUSHIKI KAISHA NAMCO (NAMCO LIMITED), OTAKU, TOKYO, JAPAN:  
1,815,456. REN. 1-7-14. INT. CL. 28.
- KABUSHIKI KAISHA OYATSU COMPANY, ICHISHI-GUN, MIE, JAPAN:  
2,699,999, CANC. INT. CL. 30.
- KABUSHIKI KAISHA PFU, KAHOKU-SHI, ISHIKAWA, JAPAN, DBA PFU LIMITED:  
4,481,793, INT. CL. 9.
- KABUSHIKI KAISHA SHIMANO, SAKAI, OSAKA, JAPAN, AKA SHIMANO INC.:  
1,783,522. REN. 1-9-14. INT. CL. 28.
- KABUSHIKI KAISHA SHUEISHA, TOKYO, JAPAN, DBA SHUEISHA INC.:  
4,481,442, INT. CL. 16.
- KABUSHIKI KAISHA TOSHIBA, TOKYO, JAPAN, DBA TOSHIBA CORPORATION:  
3,246,738, CANC. INT. CL. 9.
- KADAMBA TREE FOUNDATION, WASHINGTON, DC, DC:  
4,480,535, PUB. 11-26-2013. INT. CL. 36.  
4,480,536, PUB. 11-26-2013. INT. CL. 35.
- KAHURANGI ESTATE LIMITED, UPPER MOUTERE, NELSON, NEW ZEALAND:  
3,245,872, CANC. INT. CL. 33.
- KAIMANA BEACHWEAR LLC, HONOLULU, HI:  
4,481,041, PUB. 11-26-2013. INT. CL. 25.
- KAJUFRAP SARL, LUXEMBOURG:  
4,479,373, PUB. 11-26-2013. INT. CL. 11.
- KALE, NOELLE A., BURBANK, CA AND KALE, KRISTOPHER K., BURBANK, CA:  
3,246,905, CANC. INT. CL. 16.
- KALISH, KATHERINE, MONUMENT, CO:  
4,482,346, INT. CL. 28.
- KALLAL INC., SANTA BARBARA, CA:  
4,481,787, INT. CL. 3.
- KAMHOLZ, GLENNA, COTTONWOOD HEIGHTS, UT:  
4,481,794, INT. CL. 41.
- KAMI KUHLMAN ART, INC., OMAHA, NE:  
4,481,003, PUB. 11-26-2013. INT. CL. 16.
- KAMIL HRBÁČEK, CZECH REPUBLIC:  
4,479,295, PUB. 8-20-2013. INT. CL. 9.
- KAMSTRUP A/S, DENMARK:  
3,247,832.
- KANDON UNLIMITED, INC., SAN DIEGO, CA:  
4,479,565, PUB. 11-26-2013. INT. CL. 41.
- KANEBO HOME PRODUCTS, LTD., MINATO-KU, TOKYO, JAPAN:  
3,247,928, CANC. INT. CL. 3.
- KANGADIS FOOD, INC., GLENDALE, NY:  
3,246,566, CANC. INT. CL. 29.
- KANGOVOU, LLC, RALEIGH, NC:  
4,479,766, PUB. 11-26-2013. INT. CL. 21.
- KAPITALL, INC., NEW YORK, NY:  
4,481,608, INT. CL. 36.
- KARL STORZ GMBH & CO. KG, D-78532 TUTTLINGEN, FED REP GERMANY:  
3,245,700, CANC. INT. CL. 10.
- KARL STORZ GMBH & CO. KG, FED REP GERMANY:  
4,479,414, PUB. 11-26-2013. MULTIPLE CLASS, INT. CLS. 9, 10 AND 16.  
4,479,417, PUB. 11-26-2013. MULTIPLE CLASS, INT. CLS. 10 AND 16.
- KARLE, STEFAN, MUNICH, FED REP GERMANY:  
4,482,542, INT. CL. 9.
- KARRIEM, ABDUL, DALLAS, TX:  
2,719,750, CANC. INT. CL. 35.
- KARSTEN MANUFACTURING CORPORATION, PHOENIX, AZ:  
4,482,332, INT. CL. 28.
- KARTAL GIDA SANAYI VE TICARET ANONIM SIRKETI, KARTAL ISTANBUL, TURKEY:  
4,479,814, PUB. 11-26-2013. INT. CL. 30.
- KARTCHNER, ASHLEY, SANTA BARBARA, CA:  
4,480,247, PUB. 11-26-2013. MULTIPLE CLASS, INT. CLS. 35 AND 42.
- KASEYA INTERNATIONAL LIMITED, GERMANTOWN, MD:  
3,247,461, CANC. INT. CL. 9.
- KASKAZI KAYAKS, LLC, ELLICOTT CITY, MD:  
4,482,016, INT. CL. 12.
- KASPAR RANCH HAND EQUIPMENT, LP, SHINER, TX:  
3,248,587, CANC. INT. CL. 6.
- KASSELER FOOD PRODUCTS, INC., MISSISSAUGA, ONTARIO, CANADA:  
4,481,626, INT. CL. 30.
- KATABAK CORP., SEATTLE, WA:  
3,248,745, CANC. INT. CL. 41.
- KATHLEEN FEE, BATAVIA, IL:  
4,480,368, PUB. 11-26-2013. INT. CL. 16.
- KATHMANDU LIMITED, CHRISTCHURCH, NEW ZEALAND:  
4,479,972, PUB. 11-26-2013. INT. CL. 24.
- KATHRYN LOYACONO, VICKSBURG, MS:  
4,480,393, PUB. 11-26-2013. INT. CL. 28.
- KAVANAGH, TERRY, WATERFORD, MI:  
3,247,469, CANC. INT. CL. 35.
- KAWABATA, KENNETH K., SAN BRUNO, CA:  
2,801,468. REN. 1-3-14. MULTIPLE CLASS, INT. CLS. 16 AND 25.
- KAYUMOV AZIZ AGZAMOVICH, BALTIMORE, MD, DBA ANYASSEMBLY.COM:  
4,479,804, PUB. 11-26-2013. INT. CL. 40.
- KE WANG, JINHUA, ZHEJIANG, CHINA:  
4,480,095, PUB. 8-20-2013. INT. CL. 25.
- KEE ACTION SPORTS I LLC, SEWELL, NJ:  
3,247,869, CANC. INT. CL. 41.
- KEIM, MAX ANDREW, STILLWATER, OK:  
4,481,990, INT. CL. 20.
- KELLEY, JEFFREY J., NEWBURYPORT, MA:  
4,481,996, INT. CL. 25.
- KELLOGG COMPANY, BATTLE CREEK, MI:  
1,812,139. REN. 1-3-14. INT. CL. 16.
- KELLOGG NORTH AMERICA COMPANY, BATTLE CREEK, MI:  
3,248,443, CANC. INT. CL. 29.
- KELLY WYNNE WHITE, DALLAS, TX:  
4,481,853, INT. CL. 18.
- KENN AIR CORP., GAINESVILLE, FL:  
2,797,591. REN. 1-6-14. MULTIPLE CLASS, INT. CLS. 35 AND 39.  
2,797,592. REN. 1-6-14. MULTIPLE CLASS, INT. CLS. 35 AND 39.
- KENNETH J STOMMEL III, CAMERON, NC, DBA PAINT DEFENDER:  
4,480,405, PUB. 11-26-2013. INT. CL. 17.
- KENNETH MICKIE, FREDERICKSBURG, VA:  
4,482,191, INT. CL. 41.
- KENRICH PETROCHEMICALS, INC., BAYONNE, NJ:  
4,481,937, INT. CL. 1.
- KERPEN GMBH & CO. KG, STOLBERG, FED REP GERMANY:  
3,246,868, CANC. MULTIPLE CLASS, INT. CLS. 1, 9, 35, 37, 41 AND 42.
- KETTENBACH GMBH & CO. KG, ESCHENBURG, FED REP GERMANY:  
2,912,106. REN. 1-7-14. MULTIPLE CLASS, INT. CLS. 5 AND 10.
- KEVIN B. ROSARIO, BARRIGADA, GUAM:  
4,480,107, PUB. 11-26-2013. INT. CL. 25.



KEVIN ENGHOLDT, SCOTTSDALE, AZ, DBA INFINITUM HEALTH, LLC:  
4,482,573, INT. CL. 5.

KEY FOOD STORES COOPERATIVE, INC., STATEN ISLAND, NY:  
4,482,766, INT. CL. 35.

KEYCORP, CLEVELAND, OH:  
4,482,655, INT. CL. 36.

KEYSMART, LLC, CHICAGO, IL:  
4,480,717, PUB. 11-26-2013. INT. CL. 6.

KEYSTONE GLOBAL LLC, CONGERS, NY:  
4,480,586, PUB. 11-26-2013. INT. CL. 12.

KEYSTONE PEER REVIEW ORGANIZATION, INC., HARRISBURG, PA:  
4,482,633, MULTIPLE CLASS, INT. CLS. 35 AND 36.

KILO INC., ARLINGTON, VA:  
4,480,753, PUB. 11-26-2013. INT. CL. 9.

KIM, CHOL C., BETHESDA, MD, DBA SUGAR'S:  
3,246,518, CANC. INT. CL. 43.

KIM, TRICIA, OLD BRIDGE, NJ:  
4,481,000, PUB. 11-26-2013. INT. CL. 14.

KINDNOTES, LLC, WESTMINSTER, CA:  
4,480,262, PUB. 11-26-2013. INT. CL. 16.

KINEDU, S.A.P.I. DE C.V., NUEVO LEON, MEXICO:  
4,480,463, PUB. 11-26-2013. INT. CL. 41.

KINETIC CO., INC., THE, GREENDALE, WI:  
991,917, REN. 1-9-14. U.S. CL. 23 (INT. CL. 7).

KING & PRINCE SEAFOOD CORPORATION, BRUNSWICK, GA:  
3,245,906, CANC. INT. CL. 29.

KING ESTATE WINERY LIMITED PARTNERSHIP, EUGENE, OR:  
1,838,456, REN. 1-8-14. INT. CL. 33.

KING SALMING AB, SWEDEN:  
4,479,308, PUB. 11-26-2013. MULTIPLE CLASS, INT. CLS. 3, 25 AND 28.

KING.COM LIMITED, ST.JULIAN'S STJ3140, MALTA:  
4,479,833, PUB. 9-10-2013. MULTIPLE CLASS, INT. CLS. 9, 25 AND 41.

KINGPIN ENTERTAINMENT GROUP, LLC, NEW YORK, NY:  
3,246,144, CANC. MULTIPLE CLASS, INT. CLS. 9, 16, 35 AND 41.

KINGSUN OPTOELECTRONIC CO., LTD., CHINA:  
4,479,472, PUB. 11-26-2013. INT. CL. 11.

KIPLING APPAREL CORP., WILMINGTON, DE:  
2,806,066, REN. 1-8-14. INT. CL. 18.

KISS CATALOG, LTD., PINE BROOK, NJ:  
4,481,984, INT. CL. 39.

KISS MY FACE, LLC, LOS ANGELES, CA:  
3,248,615, CANC. INT. CL. 3.

KISSOULA JEWELLERY COMPANY LIMITED, TORTOLA, BR.VIRGIN ISLANDS:  
4,480,363, PUB. 11-26-2013. INT. CL. 14.

KITE FACTORY, LTD., THE, KOWLOON, HONG KONG:  
3,248,402, CANC. INT. CL. 28.

KIVLEY, LOWELL, MCHENRY, IL:  
4,481,151, PUB. 11-26-2013. INT. CL. 41.

KIZAN INTERNATIONAL, INC., BRISBANE, CA:  
2,853,972, REN. 1-3-14. INT. CL. 25.

KIZZANG, INC., LAS VEGAS, NV:  
4,481,281, PUB. 11-26-2013. INT. CL. 41.  
4,481,282, PUB. 11-26-2013. INT. CL. 41.  
4,481,288, PUB. 11-26-2013. INT. CL. 41.  
4,481,289, PUB. 11-26-2013. INT. CL. 41.

KLARBRUNN, INC., WATERTOWN, WI:  
4,482,515, INT. CL. 32.  
4,482,516, INT. CL. 32.

KLEIN, DAVID, SEBASTOPOL, CA:  
3,246,845, CANC. INT. CL. 16.

KLEIN, DENATALE, GOLDNER, COOPER, ROSENLIEB & KIMBALL, LLP, BAKERSFIELD, CA:  
3,247,287, CANC. INT. CL. 42.

KLEIN, JANICE S., SAN ANTONIO, FL:  
4,481,815, INT. CL. 18.

KLEIN, JOY, MYRTLE BEACH, SC:  
2,719,741, CANC. MULTIPLE CLASS, INT. CLS. 35 AND 42.

KLEINFELD BRIDAL CORP., NEW YORK, NY:  
3,248,297, CANC. INT. CL. 25.

KLIBAN, JUDITH K., CORTE MADERA, CA:  
2,802,772, REN. 1-7-14. MULTIPLE CLASS, INT. CLS. 9, 14, 16, 18, 20, 24, 25, 27 AND 28.  
2,802,772, CANC. MULTIPLE CLASS, INT. CLS. 30 AND 34.

KLINE, HANS, WASHINGTON, DC:  
3,245,955, CANC. INT. CL. 42.

KLINE, JOSEPH, CYPRESS, TX:  
4,482,079, INT. CL. 32.  
4,482,080, INT. CL. 5.

KLINIPATH B.V., NETHERLANDS:  
3,247,716.

KLOTHO, INC., LOS ANGELES, CA:  
3,246,458, CANC. INT. CL. 25.

KLUCK, JOSEPH J., SIMPSON, PA:  
4,482,507, INT. CL. 16.

KLUGE, JOERN, 14513, TELTOW, FED REP GERMANY:  
3,245,751, CANC. MULTIPLE CLASS, INT. CLS. 2, 8 AND 44.

KNEFEL, MELISSA S., BRISTOW, VA:  
3,246,560, CANC. INT. CL. 36.

KNIGHTS OF COLUMBUS, NEW HAVEN, CT:  
4,479,691, PUB. 11-26-2013. MULTIPLE CLASS, INT. CLS. 35, 41 AND 45.

KNOROWSKI, CARLA, CHICAGO, IL:  
2,798,774, REN. 1-6-14. INT. CL. 35.

KNOX, JOHN, CORONA DEL MAR, CA:  
3,248,606, CANC. MULTIPLE CLASS, INT. CLS. 9, 35 AND 42.

KNUTH, DALE E., MILWAUKEE, WI:  
3,247,944, CANC. INT. CL. 7.

KNUTSON, NOWELLE, SEATTLE, WA:  
4,481,068, PUB. 11-26-2013. INT. CL. 36.

KOFILE, INC., DALLAS, TX:  
4,479,241, PUB. 11-26-2013. MULTIPLE CLASS, INT. CLS. 37, 39 AND 42.

KOHLER CO., KOHLER, WI:  
4,481,919, INT. CL. 11.

KOKKA CO., LTD., JAPAN:  
4,479,386, PUB. 11-26-2013. INT. CL. 24.

KOKOKAHN, INC., NORTH PORT, FL:  
4,480,532, PUB. 11-26-2013. INT. CL. 3.

KOMAL HERBALS, INC., SEWICKLEY, PA:  
3,248,399, CANC. MULTIPLE CLASS, INT. CLS. 5 AND 29.

KONINKLIJKE PHILIPS N.V., NETHERLANDS:  
3,247,784.  
3,247,788.  
3,247,795.  
4,479,362, PUB. 11-26-2013. INT. CL. 11.  
4,479,377, PUB. 11-26-2013. INT. CL. 10.  
4,479,378, PUB. 11-26-2013. INT. CL. 10.  
4,479,382, PUB. 11-26-2013. INT. CL. 10.  
4,479,383, PUB. 11-26-2013. INT. CL. 10.  
4,479,396, PUB. 11-26-2013. INT. CL. 10.

KOOKEE MONSTERS, INC., SAN LORENZO, CA:  
4,480,951, PUB. 11-26-2013. INT. CL. 41.

KOPANSKI, JOHN, CHICAGO, IL:  
4,480,225, PUB. 11-26-2013. INT. CL. 41.

KOROKNAY, TOM, LEXINGTON, OH:  
2,902,748, REN. 1-8-14. INT. CL. 12.

KOSE CORPORATION, CHUO-KU, TOKYO, JAPAN:  
3,247,972, CANC. INT. CL. 21.

KOSE CORPORATION, TOKYO, JAPAN:  
4,480,124, PUB. 11-26-2013. INT. CL. 3.

KOVALSKY, GIL, GLEN ROCK, NJ:  
4,481,599, MULTIPLE CLASS, INT. CLS. 20, 35 AND 42.  
4,481,600, MULTIPLE CLASS, INT. CLS. 20, 35 AND 42.

KOVRD PRODUCTS INC., CALGARY, ALBERTA, CANADA:  
4,481,621, INT. CL. 22.

KRAFT FOODS SCHWEIZ HOLDING GMBH, 6301 ZUG, SWITZERLAND:  
4,479,874, PUB. 11-26-2013. MULTIPLE CLASS, INT. CLS. 11 AND 21.  
4,479,908, PUB. 11-26-2013. MULTIPLE CLASS, INT. CLS.

- 11 AND 21.  
 KRANK AMPLIFICATION, LLC, TEMPE, AZ:  
 3,246,899, CANC. INT. CL. 9.  
 KRIKORIAN, JASON G., SAN DIEGO, CA:  
 3,246,509, CANC. INT. CL. 21.  
 KRIOS GROUP, LLC, COLLEYVILLE, TX:  
 3,248,537, CANC. INT. CL. 9.  
 KRUD KUTTER, INC., CUMMING, GA:  
 983,112, REN. 1-9-14. U.S. CL. 6 (INT. CL. 1).  
 KRUEGER, GEORGE, CHICAGO, IL:  
 3,247,140, CANC. INT. CL. 41.  
 KRUMREI, DAVID, MARYVILLE, TN:  
 4,481,327, INT. CL. 7.  
 KS KOLBENSCHMIDT GMBH, NECKARSULM, FED REP  
 GERMANY:  
 3,246,277, CANC. INT. CL. 7.  
 KSERO CORPORATION, INC., GLEN ALLEN, VA:  
 3,248,087, CANC. INT. CL. 41.  
 KSIN LUXEMBOURG III, S.A.R.L., L-1628, LUXEMBOURG:  
 577,125, REN. 1-9-14. MULTIPLE CLASS, U.S. CLS. 103  
 (INT. CL. 35) AND 107 (INT. CL. 41).  
 KUDROSHOFF, TIMOTHY, FALLBROOK, CA:  
 4,482,756, INT. CL. 35.  
 KUMHO TIRE CO., INC., SEOUL 110-857, REPUBLIC OF  
 KOREA:  
 4,479,628, PUB. 11-26-2013. INT. CL. 12.  
 KURARAY CO., LTD., OKAYAMA PREFECTURE, JAPAN:  
 4,479,727, PUB. 7-16-2013. INT. CL. 5.  
 KUSMI TEA, PARIS, FRANCE:  
 4,479,622, PUB. 11-13-2012. INT. CL. 30.  
 KWICKSILVER SYSTEMS, LLC, WASHINGTON, VA:  
 4,480,989, PUB. 11-26-2013. INT. CL. 37.  
 KWIDZINSKI, BOGDAN, MILWAUKEE, WI, DBA EURO-  
 SCIENTIFIC COMPANY:  
 2,429,740, CANC. INT. CL. 9.  
 KWONG'S ART JEWELLERY TRADING COMPANY LIM-  
 ITED, HUNG HOM, KOWLOON, HONG KONG:  
 4,482,325, INT. CL. 14.  
 L & R IMPORTS LLC, DENVER, CO:  
 3,248,754, CANC. INT. CL. 33.  
 L. L. BEAN, INC., FREEPORT, ME:  
 1,302,802, REN. 1-9-14. INT. CL. 28.  
 L. PERRIGO COMPANY, ALLEGAN, MI:  
 4,479,987, PUB. 11-26-2013. INT. CL. 35.  
 4,482,493, INT. CL. 5.  
 L.A. GEAR, INC., LOS ANGELES, CA:  
 1,813,728, REN. 1-4-14. INT. CL. 18.  
 1,815,958, REN. 1-7-14. INT. CL. 25.  
 L&R MEATS, INC., ROCHESTER, NY:  
 3,248,278, CANC. INT. CL. 29.  
 L'AMY, FRANCE:  
 3,247,751.  
 L'OREAL, PARIS, FRANCE:  
 2,870,087, REN. 1-3-14. INT. CL. 3.  
 2,876,242, REN. 1-3-14. INT. CL. 3.  
 4,481,903, INT. CL. 3.  
 4,482,031, INT. CL. 3.  
 L'OREAL USA CREATIVE, INC., NEW YORK, NY:  
 1,864,498, REN. 1-8-14. INT. CL. 3.  
 2,718,975, CANC. INT. CL. 3.  
 2,900,872, REN. 1-3-14. INT. CL. 3.  
 2,900,874, REN. 1-8-14. INT. CL. 3.  
 2,900,875, REN. 1-3-14. INT. CL. 3.  
 2,900,876, REN. 1-8-14. INT. CL. 3.  
 4,482,229, INT. CL. 3.  
 4,482,486, INT. CL. 3.  
 LA ALEGRE MICHOCANA, INC., EL PASO, TX:  
 4,482,254, INT. CL. 43.  
 LA CROSSE MCCORMICK, LLC, LA CROSSE, WI:  
 2,906,845, REN. 1-9-14. INT. CL. 14.  
 LA MONTRE HERMES S.A., 2555 BRÜGG, SWITZERLAND:  
 4,481,226, PUB. 11-26-2013. INT. CL. 14.  
 LA NICA PRODUCTS INC., MIAMI, FL:  
 3,246,683, CANC. INT. CL. 29.  
 3,246,684, CANC. INT. CL. 29.  
 LA PERLA S.R.L., BOLOGNA, ITALY:  
 3,246,928, CANC. MULTIPLE CLASS, INT. CLS. 14 AND  
 18.  
 LA TABACALERA, C. POR A., SANTO DOMINGO, DOMIN-  
 ICAN REP:  
 2,846,806, REN. 1-8-14. INT. CL. 34.  
 LABORATORIOS ZELL, S.A. DE C.V., MÉXICO, D. F.,  
 MEXICO:  
 4,480,166, PUB. 11-26-2013. INT. CL. 3.  
 LABORATORY CORPORATION OF AMERICA HOLDINGS,  
 BURLINGTON, NC:  
 4,479,704, PUB. 11-26-2013. MULTIPLE CLASS, INT. CLS.  
 35, 38, 39 AND 44.  
 LABROSSE, THOMAS J, MENOMONEE FALLS, WI:  
 3,247,080, CANC. INT. CL. 41.  
 LACROSSE FOOTWEAR, INC., PORTLAND, OR:  
 4,481,633, INT. CL. 25.  
 LADYBUGS, LLC, BOCA RATON, FL:  
 3,246,435, CANC. MULTIPLE CLASS, INT. CLS. 41 AND  
 45.  
 LAFFERTY, LACEY, LAUREL, DE:  
 4,482,017, INT. CL. 25.  
 LAKE NONA PROPERTY HOLDINGS, LLC, ORLANDO, FL:  
 4,481,483, MULTIPLE CLASS, INT. CLS. 36 AND 37.  
 LAKE VIEW LABORATORIES, INC., HORSESHOE BAY, TX:  
 4,480,593, PUB. 11-26-2013. INT. CL. 3.  
 LAMPOST REALTY CORPORATION, WILMINGTON, NC,  
 DBA LAMPPOST REALTY:  
 2,811,890, REN. 1-8-14. INT. CL. 36.  
 2,821,800, REN. 1-8-14. INT. CL. 36.  
 2,824,142, REN. 1-8-14. INT. CL. 36.  
 2,846,909, REN. 1-8-14. INT. CL. 36.  
 LANARD TOYS LTD., HONG KONG, HONG KONG:  
 2,719,003, CANC. INT. CL. 28.  
 LANCE CLAUSON, SIMI VALLEY, CA, DBA SKINNY WIMP  
 MOVING CO.:  
 4,480,628, PUB. 11-26-2013. INT. CL. 39.  
 LANCOME PARFUMS ET BEAUTE & CIE, PARIS, FRANCE:  
 3,248,548, CANC. INT. CL. 3.  
 LANDRY, LEROY, LOS ANGELES, CA, DBA LEROY'S  
 CARPETS, INSTALLATIONS, CLEANING AND REPAIR:  
 4,480,786, PUB. 11-26-2013. INT. CL. 3.  
 LANDSMAN, ALEXANDER, BROOKLYN, NY:  
 2,798,641, REN. 1-6-14. INT. CL. 35.  
 LANE, DALLAS, POCATELLO, ID:  
 4,482,564, INT. CL. 13.  
 LANE, JEFF, SACRAMENTO, CA:  
 4,482,200, INT. CL. 25.  
 LANG EXTERIOR, INC., CHICAGO, IL:  
 4,481,540, MULTIPLE CLASS, INT. CLS. 6, 19 AND 35.  
 4,481,541, MULTIPLE CLASS, INT. CLS. 6, 19 AND 35.  
 4,481,542, MULTIPLE CLASS, INT. CLS. 6, 19 AND 35.  
 4,481,543, MULTIPLE CLASS, INT. CLS. 6, 19 AND 35.  
 LANGUAGE PALS LLC, VIENNA, VA:  
 4,480,514, PUB. 11-26-2013. INT. CL. 35.  
 LANIFICIO F.LLI ORMEZZANO S.P.A., ITALY:  
 3,247,797.  
 LANXESS DEUTSCHLAND GMBH, LEVERKUSEN, FED  
 REP GERMANY:  
 3,247,460, CANC. INT. CL. 17.  
 LARAY'S, INC., NEW YORK, NY:  
 4,482,467, INT. CL. 30.  
 LARRY RIVERS HILL, PHILADELPHIA, PA, AKA LARRY  
 R. HILL:  
 4,481,666, INT. CL. 25.  
 LARSEN, LOUIS N, STUART, FL:  
 3,248,693, CANC. INT. CL. 42.  
 LARSON, DALE M., WOODINVILLE, WA:  
 2,719,571, CANC. INT. CL. 41.  
 LAS VEGAS PAIUTE TRIBE, LAS VEGAS, NV:  
 4,480,282, PUB. 11-26-2013. INT. CL. 41.  
 LASALLIAN EDUCATION FUND, NAPA, CA:  
 2,799,875, REN. 1-8-14. INT. CL. 36.  
 2,804,241, REN. 1-8-14. INT. CL. 36.  
 LASER MECHANISMS, INC., NOVI, MI:  
 4,480,901, PUB. 11-26-2013. INT. CL. 9.  
 LASHBACK HOLDINGS, LLC, ST. LOUIS, MO:  
 3,248,669, CANC. INT. CL. 42.  
 LASTRACK, LLC, KANSAS CITY, MO:  
 4,480,824, PUB. 11-26-2013. MULTIPLE CLASS, INT. CLS.

9 AND 38.  
4,480,944, PUB. 11-26-2013. MULTIPLE CLASS, INT. CLS. 9 AND 38.

LASX INDUSTRIES, INC., WHITE BEAR LAKE, MN:  
2,905,059. REN. 1-6-14. INT. CL. 7.

LATHAM POOL PRODUCTS, INC., LATHAM, NY:  
3,248,287, CANC. INT. CL. 19.  
3,248,288, CANC. INT. CL. 19.  
4,463,607, COR. MULTIPLE CLASS, INT. CLS. 6, 19 AND 35.

LATIGA, LLC, LOS ANGELES, CA:  
3,246,485, CANC. INT. CL. 42.

LATITUDES INC., SULLIVAN, MO:  
4,482,220, INT. CL. 25.  
4,482,221, INT. CL. 25.

LAUGHLIN ORCHARDS, INC., CARLTON, OR:  
4,481,417, INT. CL. 33.

LAURA AND JOHN ARNOLD FOUNDATION, HOUSTON, TX:  
4,480,055, PUB. 11-26-2013. INT. CL. 36.

LAURENT-PERRIER, 51150 TOURS SUR MARNE, FRANCE:  
2,718,567, CANC. INT. CL. 33.

LAUTERGOLD PAUL SCHUBERT GMBH, 08312 LAUTER/ERZGEBIRGE, FED REP GERMANY:  
4,479,411, PUB. 11-26-2013. INT. CL. 33.

LAVELLE INDUSTRIES, INC., BURLINGTON, WI:  
4,482,152, MULTIPLE CLASS, INT. CLS. 11, 17 AND 42.

LAVI, BARBARA, WESTON, CT:  
4,481,631, INT. CL. 44.

LAVISH LIVING, LLC, MIAMI, FL:  
3,247,607, CANC. INT. CL. 38.

LAWYER'S WEEKLY, LLC, MINNEAPOLIS, MN:  
2,801,640. REN. 1-8-14. INT. CL. 16.

LB BRANDS, LLC, PORT CLYDE, ME:  
4,481,546, INT. CL. 29.

LCP ANTI-AGING SKIN CARE, LLC, DALLAS, TX:  
3,248,286, CANC. INT. CL. 3.

LE TANNEUR & COMPAGNIE, F-19110 BORT LES ORGUES, FRANCE:  
3,247,704.

LEADER TECHNOLOGIES INCORPORATED, LEWIS CENTER, OH:  
4,481,464, MULTIPLE CLASS, INT. CLS. 38 AND 42.

LEADWAYS LIMITED, KOWLOON BAY, HONG KONG:  
4,482,454, INT. CL. 9.

LEAF & RUSHER CORPORATION, BEVERLY HILLS, CA:  
3,248,733, CANC. INT. CL. 3.

LEANIN' TREE, INC., BOULDER, CO:  
2,719,149, CANC. INT. CL. 16.

LEARNBOP LLC, PITTSBURGH, PA:  
4,480,433, PUB. 11-26-2013. INT. CL. 41.

LEARNING FOR LIFE, INC., IRVING, TX:  
2,797,066. REN. 1-3-14. INT. CL. 41.

LEARNING RESOURCES, INC., VERNON HILLS, IL:  
3,248,727, CANC. MULTIPLE CLASS, INT. CLS. 16 AND 28.

LEASA INDUSTRIES, INC., MIAMI, FL:  
3,245,856, CANC. MULTIPLE CLASS, INT. CLS. 29, 30 AND 31.

LEATHER MOTION, INC., CHICAGO, IL, DBA BRADY FURNITURE INDUSTRIES INC.:  
4,480,011, PUB. 11-26-2013. INT. CL. 35.

LEBHAR-FRIEDMAN, INC., NEW YORK, NY:  
4,482,732, INT. CL. 9.  
4,482,733, INT. CL. 9.

LEE D. DUFRESNE, BENNINGTON, VT, DBA ELUSION CAMO LLC:  
4,479,876, PUB. 11-26-2013. INT. CL. 24.

LEE, CHUNG-HOON, MAMARONECK, NY:  
3,247,306, CANC. INT. CL. 14.

LEE, HUN KOO, LA CANADA, CA:  
3,247,095, CANC. INT. CL. 40.

LEE, JEEHO, VIRGINIA BEACH, VA:  
4,482,365, INT. CL. 41.

LEFA, INC., KING OF PRUSSIA, PA:  
4,481,447, INT. CL. 20.

LEGACY SPORTS INTERNATIONAL, LLC, RENO, NV:  
4,482,106, INT. CL. 8.  
4,482,666, INT. CL. 13.

LEGACY YOUTH TENNIS AND EDUCATION, PHILADELPHIA, PA:  
4,479,722, PUB. 11-26-2013. INT. CL. 41.

LEGAL WEB TV NETWORK, LLC, PHILADELPHIA, PA:  
3,247,323, CANC. MULTIPLE CLASS, INT. CLS. 38 AND 42.

LEGEND FOOTWEAR, INC., CITY OF INDUSTRY, CA:  
2,816,636. REN. 1-7-14. INT. CL. 25.

LEHR INCORPORATED, CULVER CITY, CA:  
4,481,394, MULTIPLE CLASS, INT. CLS. 7 AND 12.  
4,481,395, MULTIPLE CLASS, INT. CLS. 7 AND 12.

LEIBFRIED, SCOTT, SANTA ANA, CA:  
3,246,621, CANC. INT. CL. 41.

LEIFHEIT AKTIENGESELLSCHAFT, D-56371 NASSAU/LAHN, FED REP GERMANY:  
969,562, AM. MULTIPLE CLASS, U.S. CLS. 7 AND 21.

LEISURE ELECTRONICS TECHNOLOGY CO., LTD., TOKYO, JAPAN:  
4,481,401, INT. CL. 9.

LEN STOLER, INC., OWINGS MILLS, MD:  
4,480,439, PUB. 11-26-2013. INT. CL. 35.

LEN-ROSE FOOD CORP., WEST HAMPTON, NJ:  
4,482,702, INT. CL. 30.

LENDIO, INC., SOUTH JORDAN, UT:  
4,479,913, PUB. 11-26-2013. MULTIPLE CLASS, INT. CLS. 35, 36 AND 42.

LENGOW, FRANCE:  
4,479,425, PUB. 11-26-2013. MULTIPLE CLASS, INT. CLS. 35, 38 AND 42.

LENIHAN, THOMAS, E. GOOSE CREEK, SC:  
4,480,454, PUB. 11-26-2013. INT. CL. 9.

LENNOX HEARTH PRODUCTS LLC, NASHVILLE, TN:  
3,245,808, CANC. INT. CL. 11.

LENNOX INDUSTRIES INC., RICHARDSON, TX:  
4,482,255, INT. CL. 11.

LEO PHARMA A/S, DENMARK:  
4,479,438, PUB. 7-9-2013. MULTIPLE CLASS, INT. CLS. 3, 5 AND 10.

LES MILLS INTERNATIONAL LIMITED, NEW ZEALAND:  
4,479,498, PUB. 11-26-2013. INT. CL. 25.  
4,479,500, PUB. 11-26-2013. INT. CL. 25.

LESESNE, CARROLL, GREENWICH, CT:  
3,248,401, CANC. MULTIPLE CLASS, INT. CLS. 3 AND 5.

LESLIE HSU LLC, SHORT HILLS, NJ:  
4,481,949, INT. CL. 9.

LESLIE MARGOLIN, ALTADENA, CA:  
4,481,462, INT. CL. 35.

LETTUCE ENTERTAIN YOU ENTERPRISES, INC., CHICAGO, IL:  
4,481,241, PUB. 11-26-2013. MULTIPLE CLASS, INT. CLS. 16, 25 AND 41.

LEVAS ENTERTAINMENT, LLC, CHALFONT, PA:  
4,479,936, PUB. 11-26-2013. MULTIPLE CLASS, INT. CLS. 35, 41, 42 AND 45.

LEVELK APS, DENMARK:  
4,479,449, PUB. 11-26-2013. INT. CL. 41.

LEWTAN TECHNOLOGIES, INC., WALTHAM, MA:  
4,480,015, PUB. 11-26-2013. INT. CL. 42.

LG ELECTRONICS INC., SEOUL 150-721, REPUBLIC OF KOREA:  
4,479,576, PUB. 6-18-2013. MULTIPLE CLASS, INT. CLS. 7, 9 AND 11.  
4,479,586, PUB. 11-26-2013. INT. CL. 11.  
4,479,594, PUB. 11-26-2013. INT. CL. 9.

LG RETAIL ENTERPRISES, INC., SAN DIEGO, CA:  
4,479,780, PUB. 11-26-2013. INT. CL. 35.

LI JIAN, SHENZHEN, MALAYSIA:  
4,480,541, PUB. 11-26-2013. INT. CL. 9.

LI JINCHENG, SOUTH SAN FRANCISCO, CA:  
4,482,417, INT. CL. 12.  
4,482,444, INT. CL. 7.

LIBERTY MUTUAL AGENCY CORPORATION, BOSTON, MA:  
1,261,930. REN. 1-7-14. INT. CL. 36.

- LIBERTY MUTUAL INSURANCE COMPANY, BOSTON, MA:  
4,481,834, MULTIPLE CLASS, INT. CLS. 35, 36 AND 45.  
4,482,206, MULTIPLE CLASS, INT. CLS. 36 AND 44.
- LIBERTY PROCUREMENT CO. INC., UNION, NJ:  
4,482,326, INT. CL. 35.  
4,482,327, INT. CL. 35.
- LIDL STIFTUNG & CO. KG, NECKARSULM, FED REP GERMANY:  
4,479,957, PUB. 11-26-2013. INT. CL. 29.
- LIEBLING MALAMUT, LLC, CHERRY HILL, NJ:  
4,480,834, PUB. 11-26-2013. INT. CL. 45.
- LIFE AND HEALTH INSURANCE FOUNDATION FOR EDUCATION, ARLINGTON, VA:  
3,247,314, CANC. INT. CL. 35.
- LIFE CARE ST. JOHNS, INC., SAINT AUGUSTINE, FL:  
4,480,362, PUB. 11-26-2013. MULTIPLE CLASS, INT. CLS. 43 AND 44.
- LIFE UNIVERSITY INC., MARIETTA, GA:  
4,479,911, PUB. 11-26-2013. INT. CL. 41.
- LIFE WEAR 316, LLC, RIVERVIEW, FL:  
4,481,079, PUB. 11-26-2013. INT. CL. 25.
- LIFE WIPES, LLC, ZIONSVILLE, IN:  
4,481,739, INT. CL. 35.  
4,481,740, INT. CL. 3.
- LIFEECHO MINISTRIES, BRANSON, MO:  
4,480,125, PUB. 11-26-2013. INT. CL. 42.
- LIFEGUARD AMERICA, L.L.C., TULSA, OK:  
3,247,517, CANC. INT. CL. 44.
- LIFETIME BRANDS, INC., GARDEN CITY, NY:  
4,479,751, PUB. 11-26-2013. INT. CL. 20.
- LIFETIME ENTERTAINMENT SERVICES, LLC, NEW YORK, NY:  
3,248,649, CANC. INT. CL. 41.  
3,248,650, CANC. INT. CL. 38.
- LIFETIME MEMORY PRODUCTS, INC., IRVINE, CA:  
2,808,674, REN. 1-3-14. INT. CL. 9.
- LIFEWAY CHRISTIAN RESOURCES OF THE SOUTHERN BAPTIST CONVENTION, NASHVILLE, TN:  
2,873,492, REN. 1-7-14. MULTIPLE CLASS, INT. CLS. 16, 35, 41 AND 45.
- LIFE360, INC., SAN FRANCISCO, CA:  
4,482,638, INT. CL. 9.
- LIGITEK ELECTRONICS CO., LTD., NEW TAIPEI CITY 238, TAIWAN:  
4,479,963, PUB. 11-26-2013. INT. CL. 9.
- LIKO RESEARCH & DEVELOPMENT AB, LULEA, SWEDEN:  
4,480,112, PUB. 11-26-2013. INT. CL. 10.
- LILYTIG LIMITED, LONDON, ENGLAND AND ROWENA STOTT (DESIGNS) LIMITED, HONITON, DEVON, ENGLAND:  
4,479,670, PUB. 6-4-2013. MULTIPLE CLASS, INT. CLS. 16, 20 AND 24.  
4,479,671, PUB. 5-21-2013. MULTIPLE CLASS, INT. CLS. 3, 8, 11, 16, 20, 21, 24 AND 27.
- LIMBRICK, ALBERT, LONG BEACH, CA:  
4,480,758, PUB. 11-26-2013. INT. CL. 25.
- LIMELIGHT NETWORKS, INC., TEMPE, AZ:  
3,248,734, CANC. INT. CL. 35.
- LIMITLESS IP HOLDINGS, LLC, CARSON CITY, NV:  
4,482,263, INT. CL. 35.
- LIMITLESS WELLNESS PROJECT LLC, BEVERLY HILLS, CA:  
4,481,743, INT. CL. 28.
- LIN, GUANZHOU, BROOKLYN, NY:  
3,245,896, CANC. MULTIPLE CLASS, INT. CLS. 5 AND 21.
- LINCOLN GLOBAL, INC., CITY OF INDUSTRY, CA:  
2,731,796, REN. 1-8-14. INT. CL. 9.
- LINGTECH A/S, DK-1366 COPENHAGEN K, DENMARK:  
3,246,664, CANC. MULTIPLE CLASS, INT. CLS. 9, 16, 35, 41 AND 42.
- LINHOF PRAZISIONS-SYSTEMTECHNIK GMBH, D-81379 MUNCHEN, FED REP GERMANY:  
2,718,788, CANC. INT. CL. 9.
- LINK INTERNATIONAL INVESTMENTS, LLC, MINONG, WI:  
4,480,469, PUB. 11-26-2013. INT. CL. 41.
- LINKS BUSINESS GROUP LLC, LAS VEGAS, NV:  
4,480,797, PUB. 4-2-2013. INT. CL. 16.
- LINUX INTERNATIONAL, AMHERST, NH:  
2,801,749, REN. 1-8-14. MULTIPLE CLASS, INT. CLS. 41 AND 42.
- LIONS GATE ENTERTAINMENT, INC., SANTA MONICA, CA:  
4,481,536, INT. CL. 9.
- LIQUI-MARK CORP., HAUPPAUGE, NY:  
2,809,453, REN. 1-6-14. INT. CL. 16.
- LIQUID ASSETS IMPORT CO., INC., WILLIAMS ISLAND, FL:  
2,719,722, CANC. INT. CL. 33.
- LIQUIDIA TECHNOLOGIES, INC., CHAPEL HILL, NC:  
3,248,666, CANC. MULTIPLE CLASS, INT. CLS. 1 AND 40.
- LISE CHARMELE INDUSTRIE, LYON, FRANCE:  
3,373,057, AM. INT. CL. 25.
- LITEHOUSE INTERNATIONAL, INC., ALBUQUERQUE, NM, DBA LITEHOUSE INTERNATIONAL, INC.:  
4,480,691, PUB. 11-26-2013. INT. CL. 19.
- LITTLE PEOPLE OF AMERICA, INC., TUSTIN, CA:  
4,479,719, PUB. 11-26-2013. MULTIPLE CLASS, INT. CLS. 35 AND 41.
- LITTLE RAPIDS CORPORATION, GREEN BAY, WI:  
4,481,976, MULTIPLE CLASS, INT. CLS. 16 AND 24.  
4,481,977, MULTIPLE CLASS, INT. CLS. 10, 16 AND 24.
- LITTLE SLIPPER PRESS, LLC, ROYAL OAK, MI:  
3,246,645, CANC. INT. CL. 41.  
3,246,646, CANC. INT. CL. 41.
- LITTLE WONDERS CHILD GROWTH & DEVELOPMENT CENTER, INC., E. NORRITON, PA:  
3,248,620, CANC. INT. CL. 44.
- LIVE BREATHE FUTBOL, GIBBSTOWN, NJ:  
4,480,150, PUB. 11-26-2013. INT. CL. 25.
- LIVE FOR LIGHTS, ATLANTA, GA:  
4,480,991, PUB. 11-26-2013. INT. CL. 25.
- LIVE NATION WORLDWIDE, INC., BEVERLY HILLS, CA:  
4,482,664, INT. CL. 41.
- LIVERITE PRODUCTS, INC., TUSTIN, CA:  
4,480,451, PUB. 11-26-2013. INT. CL. 5.
- LIVEYEARBOOK, INC., MADISON, WI:  
4,482,529, INT. CL. 9.  
4,482,530, INT. CL. 9.  
4,482,531, INT. CL. 9.  
4,482,532, MULTIPLE CLASS, INT. CLS. 9 AND 42.  
4,482,533, MULTIPLE CLASS, INT. CLS. 9 AND 42.  
4,482,534, MULTIPLE CLASS, INT. CLS. 9 AND 42.
- LIVING WELL LODGES, LLC, MOUNT DORA, FL:  
4,481,818, MULTIPLE CLASS, INT. CLS. 37 AND 44.
- LIVINGSTON, LORI, ORLANDO, FL:  
4,479,859, PUB. 11-26-2013. INT. CL. 25.
- LIYIN, SHE, PUDONG, SHANGHAI, CHINA:  
4,482,309, INT. CL. 25.
- LIZABETH SORENSEN, SCHENECTADY, NY:  
3,247,081, CANC. INT. CL. 24.
- LLADRO USA, INC., MOONACHIE, NJ:  
2,719,738, CANC. INT. CL. 35.
- LNJ VINEYARDS LLC, ROSLYN HEIGHTS, NY:  
4,481,563, INT. CL. 33.
- LO 337 IP HOLDING, LLC, LOS ANGELES, CA:  
4,480,961, PUB. 11-26-2013. MULTIPLE CLASS, INT. CLS. 9, 14, 25, 35 AND 41.
- LOCAL FOOD LAB INC., STANFORD, CA:  
4,482,731, INT. CL. 35.
- LOCK & LOCK CO., LTD., ASAN-SI, CHUNGCHEONG-NAM-DO, REPUBLIC OF KOREA:  
3,248,317, CANC. INT. CL. 20.
- LOCKE SCIENCE PUBLISHING COMPANY, INCORPORATED, CHICAGO, IL:  
4,481,013, PUB. 11-26-2013. INT. CL. 16.
- LOCKENPOCK INC., CALGARY, ALBERTA, CANADA:  
3,245,723, CANC. INT. CL. 9.

LOCKHEED MARTIN ACULIGHT CORPORATION, BETHESDA, MD:  
 3,246,686, CANC. INT. CL. 9.  
 LOCKTON, INC., KANSAS CITY, MO:  
 4,481,502, INT. CL. 36.  
 LOGAN OUTDOOR PRODUCTS LLC, HYDE PARK, UT:  
 4,481,935, INT. CL. 6.  
 LOGESHWARAN JANARTHANAN, DUNN LORING, VA:  
 4,481,781, INT. CL. 9.  
 LOGICUBE, INC., CHATSWORTH, CA:  
 4,482,525, INT. CL. 9.  
 LOLITA GIRL CLOTHING, LLC, IRVINE, CA:  
 4,479,523, PUB. 11-26-2013. INT. CL. 25.  
 LOMA VISTA MEDICAL, INC., BURLINGAME, CA:  
 4,480,075, PUB. 11-26-2013. INT. CL. 10.  
 LONDINE E.K., 81371 MÜNCHEN, FED REP GERMANY:  
 4,479,272, PUB. 11-26-2013. MULTIPLE CLASS, INT. CLS.  
 3, 18 AND 25.  
 LONG & FOSTER COMPANIES, INC., FAIRFAX, VA:  
 3,245,972, CANC. INT. CL. 41.  
 3,245,973, CANC. INT. CL. 35.  
 3,245,974, CANC. INT. CL. 41.  
 3,245,975, CANC. INT. CL. 41.  
 LONG JOHN SILVER'S, LLC, LOUISVILLE, KY:  
 4,480,146, PUB. 8-20-2013. INT. CL. 30.  
 LONG, EDWARD R., WAYNESBORO, VA:  
 2,720,154, CANC. INT. CL. 9.  
 LONGEVITY GUIDE, LLC, NEW ALBANY, OH:  
 4,480,678, PUB. 11-26-2013. INT. CL. 45.  
 LONGWORTH INDUSTRIES, INC., WEST END, NC:  
 4,482,329, INT. CL. 25.  
 LONZA SALES AG, BASEL, SWITZERLAND:  
 1,263,315, REN. 1-6-14. INT. CL. 1.  
 LONZA WALKERSVILLE, INC., WALKERSVILLE, MD,  
 BLOWHITTAKER, INC., WALKERSVILLE, MD:  
 1,815,650, REN. 1-9-14. INT. CL. 5.  
 LOOMWORKS APPAREL, INC., IRVINE, CA:  
 4,482,121, INT. CL. 25.  
 4,482,349, INT. CL. 25.  
 LOOS & CO., INC., NAPLES, FL:  
 1,810,452, REN. 1-3-14. INT. CL. 6.  
 1,810,472, REN. 1-3-14. INT. CL. 7.  
 1,814,734, REN. 1-3-14. INT. CL. 8.  
 LOPEZ, KAREN L., SAN DIEGO, CA, DBA DIVINE PET  
 CARE:  
 4,480,656, PUB. 11-26-2013. INT. CL. 45.  
 LOPEZ, KAREN L., SAN DIEGO, CA, DBA ARRIVE  
 FITNESS:  
 4,480,677, PUB. 11-26-2013. INT. CL. 41.  
 LORD COMPANY FOR TRADE AND INDUSTRY, LOS  
 ANGELES, CA:  
 1,831,907, REN. 1-8-14. INT. CL. 8.  
 LORFING, INC., HOUSTON, TX:  
 2,906,623, REN. 1-8-14. INT. CL. 41.  
 LORI VERBENEC, ALISO VIEJO, CA:  
 4,482,063, INT. CL. 25.  
 LORITO, TIMOTHY, HOLTSVILLE, NY:  
 4,481,223, PUB. 11-26-2013. INT. CL. 30.  
 LOS TRES JEFES LLC, ANAHEIM, CA:  
 4,481,115, PUB. 11-26-2013. INT. CL. 9.  
 LOUIS PION SAS, F-75008 PARIS, FRANCE:  
 2,802,251, REN. 1-8-14. INT. CL. 14.  
 LOWERMYBILLS, INC., SANTA MONICA, CA:  
 3,248,457, CANC. INT. CL. 35.  
 LOYA, RAMI, ROCKVILLE, MD:  
 4,481,512, INT. CL. 9.  
 LOYAL ENTERPRISES LLC, NASHVILLE, TN:  
 4,482,767, INT. CL. 42.  
 LOZANO, MARIO ALBERTO PEREZ, MEXICO CITY, MEX-  
 ICO:  
 2,719,615, CANC. INT. CL. 3.  
 LRA BULOW SHORES, LLC, CELEBRATION, FL:  
 3,248,472, CANC. INT. CL. 37.  
 LSI SOLUTIONS, INC., VICTOR, NY:  
 4,479,539, PUB. 11-26-2013. INT. CL. 10.  
 LU, CLIVE, HICKSVILLE, NY:  
 2,843,299, REN. 1-6-14. INT. CL. 9.  
 LU, SIMON K., BELMONT, CA:  
 3,246,599, CANC. INT. CL. 14.  
 LUBE HOLDING S.R.L., I-62010 TREIA (MC), ITALY:  
 3,247,779.  
 LUCENT TECHNOLOGIES INC., MURRAY HILL, NJ TO  
 COMMSCOPE, INC. OF NORTH CAROLINA, HICKORY,  
 NC:  
 2,502,643, CANC. INT. CL. 9.  
 LUCK'S WARE, SEAGROVE, NC:  
 3,247,202, CANC. INT. CL. 21.  
 LUCKY TIGER, LLC, MILWAUKEE, WI:  
 4,480,488, PUB. 11-26-2013. INT. CL. 3.  
 LULU BRANDS LLC, WILMINGTON, DE:  
 3,246,773, CANC. INT. CL. 9.  
 LUMASENSE TECHNOLOGIES HOLDINGS, INC., SANTA  
 CLARA, CA:  
 4,481,105, PUB. 11-26-2013. INT. CL. 9.  
 LUMI-LITE CANDLE COMPANY, INC., NORWICH, OH:  
 2,719,884, CANC. INT. CL. 4.  
 LUNA GOURMET COFFEE & TEA COMPANY, LLC,  
 DENVER, CO:  
 3,246,637, CANC. INT. CL. 30.  
 LUNARLINE, INC., ARLINGTON, VA:  
 4,479,646, PUB. 11-26-2013. INT. CL. 9.  
 LUNCHBOX INC., RENO, NV:  
 4,481,023, PUB. 11-26-2013. INT. CL. 25.  
 LUXURY CAMPS AND LODGES; OF THE WORLD SRL,  
 ITALY:  
 3,247,774.  
 LYMPHOMA RESEARCH FOUNDATION, NEW YORK, NY:  
 3,245,720, CANC. MULTIPLE CLASS, INT. CLS. 35, 36  
 AND 41.  
 LYNDA REEVES, TORONTO, ONTARIO, CANADA:  
 3,246,138, CANC. MULTIPLE CLASS, INT. CLS. 16, 20, 21,  
 24 AND 41.  
 LYNN C. FRITZ, SEBASTOPOL, CA, DBA LYNMAR ES-  
 TATE:  
 4,480,599, PUB. 11-26-2013. INT. CL. 33.  
 LYSETTE MUTKUS, WINSTON-SALEM, NC AND ERIC  
 MUTKUS, WINSTON-SALEM, NC:  
 4,479,794, PUB. 11-26-2013. INT. CL. 26.  
 M & A VENTURES, LTD., DENVER, CO:  
 4,481,504, MULTIPLE CLASS, INT. CLS. 38 AND 41.  
 M. BAGWELL ART, LLC, MONTGOMERY, AL:  
 3,247,107, CANC. MULTIPLE CLASS, INT. CLS. 16 AND  
 21.  
 M.V.M. S.R.L., ITALY:  
 4,479,301, PUB. 11-26-2013. INT. CL. 7.  
 M.X.F. DESIGNS, INC., LOS ANGELES, CA:  
 4,482,685, INT. CL. 25.  
 MAARTEN GRAVEN, NETHERLANDS:  
 4,479,454, PUB. 11-26-2013. MULTIPLE CLASS, INT. CLS.  
 9, 41 AND 43.  
 MAC TECHNOLOGIES LIMITED, RAMSEY, ISLE OF MAN:  
 4,480,809, PUB. 11-26-2013. INT. CL. 9.  
 4,480,811, PUB. 11-26-2013. INT. CL. 9.  
 4,480,812, PUB. 11-26-2013. INT. CL. 20.  
 4,480,813, PUB. 11-26-2013. INT. CL. 9.  
 4,480,814, PUB. 11-26-2013. INT. CL. 9.  
 4,480,815, PUB. 11-26-2013. INT. CL. 9.  
 MACHINIMA, INC., WEST HOLLYWOOD, CA:  
 4,479,787, PUB. 11-26-2013. INT. CL. 25.  
 MACIAS, ARTURO, JALISCO, GUADALAJARA, MEXICO:  
 3,246,104, CANC. INT. CL. 41.  
 MADE BY MAGPIE, INC., AUSTIN, TX:  
 3,248,391, CANC. INT. CL. 9.  
 MADISON BRANDS, INC., NEW YORK, NY:  
 4,482,012, INT. CL. 25.  
 MADISON'S CRUNCH, INC., HUNTINGTON, NY:  
 3,246,421, CANC. INT. CL. 30.  
 MAFIA APPAREL INC, CHATSWORTH, CA:  
 4,480,695, PUB. 11-26-2013. INT. CL. 25.  
 MAG.DR. RENATE ABPURG, AUSTRIA:  
 3,247,731.  
 MAGEE RANCH HOMEOWNERS ASSOCIATION, INC.,  
 DANVILLE, CA:  
 4,480,096, PUB. 11-26-2013. INT. CL. 35.

- MAGIC GOURMET TRADING INC., MILLBRAE, CA:  
4,481,711, MULTIPLE CLASS, INT. CLS. 29 AND 30.
- MAGRITEK HOLDINGS LIMITED, KELBURN, WELLINGTON, NEW ZEALAND:  
4,480,114, PUB. 11-26-2013. INT. CL. 9.
- MAGUIRE III, JAMES P., SANDY HOOK, CT:  
4,480,857, PUB. 11-26-2013. INT. CL. 37.
- MAHONEY'S SILVER NUGGET, INC., NORTH LAS VEGAS, NV:  
3,247,450, CANC. INT. CL. 41.
- MAIDA CC INC., TORONTO, ONTARIO, CANADA:  
4,479,707, PUB. 11-26-2013. INT. CL. 41.  
4,479,708, PUB. 11-26-2013. INT. CL. 41.
- MAIDS INTERNATIONAL, INC., THE, OMAHA, NE:  
1,262,485, REN. 1-9-14. INT. CL. 25.
- MAIN STREET GOURMET, LLC, CUYAHOGA FALLS, OH:  
1,840,748, REN. 1-8-14. INT. CL. 30.
- MAINE SITE EVALUATIONS LLC, KENNEBUNK, ME:  
4,482,806, INT. CL. 42.
- MAINTENANCE IN MOTION, L.L.C., WEST DES MOINES, IA:  
3,247,580, CANC. INT. CL. 37.
- MAJOR LEAGUE BASEBALL PROPERTIES, INC., NEW YORK, NY:  
2,800,750, REN. 1-6-14. INT. CL. 21.  
2,800,751, REN. 1-3-14. INT. CL. 14.  
2,800,752, REN. 1-3-14. INT. CL. 16.
- MAJOR SPORTS, S.A., 78810 FEUCHEROLLES, FRANCE:  
1,265,814, REN. 1-8-14. INT. CL. 28.
- MAKE A DIFFERENCE MANAGEMENT PTY. LTD., BERWICK, AUSTRALIA:  
3,248,101, CANC. INT. CL. 41.
- MALAN BRETON HOLDINGS, LOS ANGELES, CA:  
4,479,782, PUB. 11-26-2013. INT. CL. 25.
- MALLINCKRODT INC., HAZELWOOD, MO:  
2,720,125, CANC. INT. CL. 10.
- MALLOCH, CARL, BERKLEY, MA:  
4,482,596, MULTIPLE CLASS, INT. CLS. 16, 18 AND 25.
- MALLY ENTERPRISES INCORPORATED, DAVENPORT, IA:  
1,814,888, REN. 1-6-14. INT. CL. 16.
- MALMARK, INC., PLUMSTEADVILLE, PA:  
4,482,413, INT. CL. 15.
- MAMA MIO LIMITED, LONDON, UNITED KINGDOM:  
4,480,349, PUB. 11-26-2013. INT. CL. 3.
- MAMI CHULA STYLE, INC., HOMESTEAD, FL:  
3,248,320, CANC. INT. CL. 3.
- MANA PRODUCTS, INC., LONG ISLAND CITY, NY:  
3,248,256, CANC. INT. CL. 3.
- MANAGED SERVICES, INC., HOUSTON, TX:  
3,245,804, CANC. INT. CL. 38.
- MANAK JEWELS INC., SAN FRANCISCO, CA:  
4,480,760, PUB. 11-26-2013. INT. CL. 14.
- MANAKHOV ANTON ANATOLIEVICH, RUSSIAN FED.:  
4,479,420, PUB. 11-26-2013. INT. CL. 36.
- MANCHESTER UNITED LIMITED, UNITED KINGDOM:  
4,479,387, PUB. 11-26-2013. MULTIPLE CLASS, INT. CLS. 9 AND 41.
- MANDO CORPORATION, KYUNGKI-DO, REPUBLIC OF KOREA:  
4,479,701, PUB. 11-26-2013. INT. CL. 12.  
4,479,762, PUB. 11-26-2013. INT. CL. 1.  
4,479,763, PUB. 11-26-2013. INT. CL. 1.
- MANGICO INC., SCOTCH PLAINS, NJ:  
3,247,079, CANC. INT. CL. 38.
- MANHANDS SOAP, LLC, LINCOLN, NE:  
4,482,505, INT. CL. 3.
- MANIS TACTICAL SYSTEMS LLC, BLANCHARD, OK:  
4,479,969, PUB. 11-26-2013. INT. CL. 41.
- MANOS, GREGORY C., RIVERSIDE, CA:  
3,246,983, CANC. INT. CL. 32.
- MANROLAND AG, FED REP GERMANY:  
3,247,821.
- MANROLAND AG, 63075 OFFENBACH/MAIN, FED REP GERMANY:  
3,252,037.
- MANSA CORP., ROSEMEAD, CA:  
4,480,507, PUB. 11-26-2013. INT. CL. 43.
- MANUFACTURAS VITROMEX, S.A. DE C.V., SALTILLO, MEXICO:  
4,481,453, INT. CL. 19.
- MANZANITA DISTILLING COMPANY, SANTEE, CA:  
4,480,732, PUB. 11-26-2013. INT. CL. 33.
- MAP YOUR STARTUP, LLC, CORAL GABLES, FL:  
4,480,054, PUB. 11-26-2013. INT. CL. 35.
- MAPLE LEAF BAKERY INC., DES PLAINES, IL:  
2,829,597, REN. 1-6-14. INT. CL. 30.
- MAQUET S.A., FRANCE:  
3,247,785.
- MARATHON EQUIPMENT COMPANY (DELAWARE), VERNON, AL, DELAWARE CAPITAL FORMATION, INC., WILMINGTON, DE:  
2,798,193, REN. 1-6-14. INT. CL. 7.
- MARAVILLAS NATURALES, INC., BURBANK, CA:  
3,245,712, CANC. INT. CL. 3.
- MARC BAUER, WARREN, NJ:  
4,480,175, PUB. 11-26-2013. INT. CL. 9.
- MARCH MARKETING, LLC, WHEATON, IL:  
4,481,586, INT. CL. 35.
- MARCOLIN USA, INC., SCOTTSDALE, AZ:  
3,246,426, CANC. INT. CL. 9.
- MARIA KERMATH, AUSTIN, TX:  
4,480,832, PUB. 11-26-2013. INT. CL. 28.
- MARIAH MEDIA INC., SANTA FE, NM:  
4,481,663, MULTIPLE CLASS, INT. CLS. 9, 16 AND 41.
- MARIANO MENOR FERNANDEZ, SPAIN:  
4,479,473, PUB. 11-26-2013. INT. CL. 21.
- MARIN DESIGNS, INC., PRINCETON, WV:  
3,246,413, CANC. INT. CL. 14.
- MARINE AMIGO, INC, BELLE ISLE, FL:  
4,480,063, PUB. 11-26-2013. INT. CL. 8.
- MARINE CHICK, LLC, DENVER, CO:  
4,479,871, PUB. 11-26-2013. INT. CL. 41.
- MARINE SPILL RESPONSE CORPORATION, HERNDON, VA:  
1,833,482, REN. 1-8-14. INT. CL. 37.  
1,841,492, REN. 1-8-14. INT. CL. 37.  
1,842,499, REN. 1-8-14. INT. CL. 37.
- MARITZ, VIVIAN SONG, SAN FRANCISCO, CA AND KIM, YOON JUNG, REDWOOD CITY, CA:  
4,481,854, MULTIPLE CLASS, INT. CLS. 28 AND 41.
- MARK BARNES, CAPITOL HEIGHTS, MD:  
4,480,845, PUB. 11-26-2013. INT. CL. 25.
- MARK KEOUGH MINISTRIES, THE WOODLANDS, TX:  
3,247,187, CANC. INT. CL. 9.
- MARK NADEN LLC, NEW YORK, NY:  
4,481,719, INT. CL. 3.
- MARKET DAY CORPORATION, ITASCA, IL:  
3,246,789, CANC. INT. CL. 30.
- MARKET MAGIC, LLC, NEWARK, DE:  
3,246,656, CANC. INT. CL. 35.
- MARKET TRADERS INSTITUTE, INC., LAKE MARY, FL:  
4,480,044, PUB. 11-26-2013. INT. CL. 41.
- MARKETING AUTOMATION SERVICE AND SUPPORT INC., TORONTO, ONTARIO, CANADA:  
4,482,782, INT. CL. 35.
- MARKLINES CO., LTD., TOKYO, 107-0052, JAPAN:  
2,809,083, REN. 1-6-14. MULTIPLE CLASS, INT. CLS. 35 AND 42.
- MARKS STUDIOS LLC, DECATUR, GA:  
4,482,107, INT. CL. 9.
- MARKUS GISLER, SWITZERLAND:  
4,479,477, PUB. 11-26-2013. MULTIPLE CLASS, INT. CLS. 6, 9, 11, 19, 37, 40 AND 42.
- MARRA BROS. DIST., INC., MORGAN HILL, CA:  
1,280,200, REN. 1-9-14. INT. CL. 42.
- MARS SALES COMPANY, INC., GARDENA, CA, DBA MARS SALES:  
1,639,658, CANC. INT. CL. 11.
- MARS, INCORPORATED, MCLEAN, VA:  
3,247,895, CANC. MULTIPLE CLASS, INT. CLS. 5 AND 30.  
4,481,855, INT. CL. 30.  
4,481,856, INT. CL. 30.

MARSELLA, TOM, ATTELBORO, MA AND MARSELLA, MEGAN, ATTELBORO, MA:  
4,480,821, PUB. 11-26-2013. INT. CL. 41.

MARSHALL RYAN M, REDFORD, MI:  
4,482,267, INT. CL. 25.

MARSHALLS OF MA, INC., FRAMINGHAM, MA:  
2,718,653, CANC. MULTIPLE CLASS, INT. CLS. 35 AND 36.

MARSILIA, RONALD, EAST GREENWICH, RI:  
4,480,234, PUB. 11-26-2013. INT. CL. 36.

MARTIN MANUFACTURING COMPANY, LLC, ROCKY MOUNT, NC:  
3,247,118, CANC. INT. CL. 10.

MARTIN RESOURCE MANAGEMENT CORPORATION, KILGORE, TX:  
4,481,602, INT. CL. 17.

MARTINEZ, NANCY N., DALLAS, TX:  
3,246,908, CANC. INT. CL. 36.

MARTINEZ, SAL, DENVER, CO:  
4,482,843, INT. CL. 39.

MARVEL CHARACTERS, INC., MANHATTAN BEACH, CA:  
4,448,344, COR. INT. CL. 42.

MARVEL CHARACTERS, INC., BURBANK, CA:  
4,479,928, PUB. 11-26-2013. INT. CL. 41.

MARX, DONALD, ARLINGTON, VA:  
3,248,756, CANC. INT. CL. 35.

MARY ANN MINCARELLI, PHOENIXVILLE, PA:  
4,482,802, INT. CL. 36.

MARY KAY INC., ADDISON, TX:  
2,719,040, CANC. INT. CL. 16.  
4,481,574, INT. CL. 44.

MARY THE AESTHETICS, INC., SAN FRANCISCO, CA:  
3,247,596, CANC. INT. CL. 44.

MARY'S GOURMET INC., AURORA, ONTARIO, L4G 6H8, CANADA:  
3,245,801, CANC. INT. CL. 30.

MASCHINENFABRIK NIEHOFF; GMBH & CO. KG, FED REP GERMANY:  
4,479,437, PUB. 11-26-2013. INT. CL. 7.

MASCO CORPORATION OF INDIANA, INDIANAPOLIS, IN:  
4,481,598, INT. CL. 11.

MASHNEY LAW OFFICES, ANAHEIM, CA:  
3,247,046, CANC. INT. CL. 42.

MASONITE INTERNATIONAL CORPORATION, CONCORD, ONTARIO, CANADA:  
4,480,062, PUB. 11-26-2013. INT. CL. 19.

MASSACHUSETTS INSTITUTE OF TECHNOLOGY, CAMBRIDGE, MA:  
4,481,166, PUB. 11-26-2013. INT. CL. 35.

MASSIV LLC, LOS ANGELES, CA:  
4,479,607, PUB. 11-26-2013. INT. CL. 25.

MASSIVE.IDEAS LLC, DENVER, CO:  
4,480,687, PUB. 11-26-2013. INT. CL. 41.

MAST GROUP, INC., MINNEAPOLIS, MN:  
2,718,740, CANC. INT. CL. 35.

MASTER INNOVATIONS, LLC, PHILLIPSBURG, NJ:  
3,246,647, CANC. INT. CL. 16.

MASTERCHEM INDUSTRIES LLC, IMPERIAL, MO:  
3,248,201, CANC. INT. CL. 2.

MATCO INDUSTRIES INC., PICKERING, ONTARIO, CANADA:  
3,246,255, CANC. INT. CL. 9.

MATSUSHITA ELECTRIC INDUSTRIAL CO., LTD., OSAKA, JAPAN:  
3,246,190, CANC. MULTIPLE CLASS, INT. CLS. 7, 9, 10, 11, 38 AND 42.

MATTEL, INC., EL SEGUNDO, CA:  
2,720,029, CANC. INT. CL. 28.  
3,246,727, CANC. INT. CL. 28.  
3,246,728, CANC. INT. CL. 28.  
3,246,763, CANC. INT. CL. 28.  
3,246,764, CANC. INT. CL. 28.  
3,248,470, CANC. INT. CL. 28.  
4,481,807, INT. CL. 28.  
4,481,908, INT. CL. 28.  
4,482,280, INT. CL. 28.  
4,482,281, INT. CL. 28.  
4,482,301, INT. CL. 28.  
4,482,302, INT. CL. 28.  
4,482,303, INT. CL. 28.  
4,482,305, INT. CL. 28.  
4,482,306, INT. CL. 28.  
4,482,307, INT. CL. 28.  
4,482,330, INT. CL. 28.  
4,482,436, INT. CL. 28.  
4,482,472, INT. CL. 9.  
4,482,696, INT. CL. 28.

MATTHEW D. POWELL, P.A., TAMPA, FL, DBA POWELL & ASSOCIATES:  
2,797,821, REN. 1-7-14. INT. CL. 42.

MATTHIAS MAIER, BERLIN, FED REP GERMANY:  
4,481,519, INT. CL. 12.

MATTRESS FIRM, INC., HOUSTON, TX:  
3,248,398, CANC. INT. CL. 20.

MAX SOUND CORPORATION, HOUSTON, TX:  
4,482,228, INT. CL. 9.

MAX, MASUIMI, HOLLYWOOD, CA:  
4,480,983, PUB. 11-26-2013. INT. CL. 41.  
4,480,984, PUB. 11-26-2013. INT. CL. 3.

MAXI-LIFT, INC., DALLAS, TX:  
2,803,639, REN. 1-8-14. INT. CL. 7.

MAXIMIZED LIVING HEALTH CENTERS, LLC, CELEBRATION, FL AND MAX 3, LLC, CELEBRATION, FL:  
4,482,678, MULTIPLE CLASS, INT. CLS. 5, 41 AND 44.

MAXLITE, WEST CALDWELL, NJ:  
4,481,231, PUB. 11-26-2013. INT. CL. 11.  
4,481,260, PUB. 11-26-2013. INT. CL. 11.  
4,481,261, PUB. 11-26-2013. INT. CL. 11.

MAXOLY, INC., MIAMI, FL:  
3,247,248, CANC. INT. CL. 25.

MAXWELL CHASE TECHNOLOGIES, LLC, ATLANTA, GA:  
4,479,770, PUB. 11-26-2013. INT. CL. 16.

MAXWELL PETERSEN ASSOCIATES, SANTA ANA, CA, DBA MPA MEDIA:  
4,480,130, PUB. 11-26-2013. INT. CL. 16.

MAYOR'S ALLIANCE FOR NYC'S ANIMALS, INC., NEW YORK, NY:  
3,246,298, CANC. MULTIPLE CLASS, INT. CLS. 35 AND 45.

MAZOR ROBOTICS LTD., SO. CAESAREA IND. PARK, ISRAEL:  
4,481,500, INT. CL. 10.

MBM COMPANY, INC., CHICAGO, IL:  
4,481,545, INT. CL. 14.

MBS ENTERPRISES LLC, WILMINGTON, DE:  
4,482,038, INT. CL. 28.

MCCAIN FOODS USA, INC., LISLE, IL:  
3,246,966, CANC. INT. CL. 29.

MCCLANAHAN POWERS, PLLC, VIENNA, VA:  
4,480,580, PUB. 11-26-2013. INT. CL. 45.

MCDONALD, GARY W., D.D.S., KINGWOOD, TX, DBA KINGWOOD ORAL SURGERY:  
4,480,755, PUB. 11-26-2013. INT. CL. 44.

MCDONALD'S CORPORATION, OAK BROOK, IL:  
2,805,109, REN. 1-8-14. INT. CL. 30.  
4,480,475, PUB. 11-26-2013. INT. CL. 36.  
4,480,608, PUB. 11-26-2013. INT. CL. 41.

MCDOWELL, CHARLES W. III, ALPHARETTA, GA:  
3,246,022, CANC. MULTIPLE CLASS, INT. CLS. 9, 36 AND 41.

MCEACHIN, MARIA, RENO, NV:  
4,481,706, INT. CL. 35.

- MCGOVERN, MARTIN, CHICAGO, IL AND NATHAN, RAJIV, CHICAGO, IL:  
4,480,763, PUB. 11-26-2013. INT. CL. 41.
- MCGRUDER, DAVIDA V., CHICAGO, IL:  
3,246,821, CANC. INT. CL. 25.
- MCKESSON CORPORATION, SAN FRANCISCO, CA, ZEE MEDICAL PRODUCTS CO., IRVINE, CA:  
1,255,765, REN. 1-3-14. MULTIPLE CLASS, INT. CLS. 5, 9, 10 AND 16.
- MCLAUGHLIN GORMLEY KING COMPANY, MINNEAPOLIS, MN:  
4,481,293, PUB. 11-26-2013. INT. CL. 5.  
4,481,294, PUB. 11-26-2013. INT. CL. 5.
- MCLEAN MORTGAGE CORPORATION, FAIRFAX, VA:  
4,480,710, PUB. 11-26-2013. INT. CL. 36.
- MCLEAN, DONALD F., OAK PARK, IL:  
2,719,920, CANC. INT. CL. 17.
- MCPHERSON, BEVERLEY R., REDLANDS, CA:  
3,246,530, CANC. INT. CL. 28.
- MCWHORTER, JEREMIAH TAYLOR, PASCAGOULA, MS:  
4,481,989, INT. CL. 25.
- MC10, INC., CAMBRIDGE, MA:  
4,481,877, INT. CL. 9.
- MD RECOVERIES, INC., SAN DIEGO, CA:  
4,482,128, INT. CL. 35.  
4,482,129, INT. CL. 35.  
4,482,130, INT. CL. 35.
- MDG DEVELOPMENT GROUP LLC, BASKING RIDGE, NJ:  
3,246,224, CANC. MULTIPLE CLASS, INT. CLS. 35 AND 41.
- MDM TRACK, LLC, FORT LAUDERDALE, FL:  
4,482,631, INT. CL. 9.
- MDS COATING TECHNOLOGIES CORPORATION, ST. LAURENT, QUEBEC, CANADA:  
4,479,582, PUB. 11-26-2013. MULTIPLE CLASS, INT. CLS. 2, 37, 40 AND 42.
- MEADE, THOMAS, ALBUQUERQUE, NM:  
4,480,701, PUB. 11-26-2013. INT. CL. 10.
- MEASURED PROGRESS INC., DOVER, NH:  
4,479,910, PUB. 11-26-2013. MULTIPLE CLASS, INT. CLS. 9 AND 41.
- MECHANIX WEAR, INC., VALENCIA, CA:  
4,482,592, MULTIPLE CLASS, INT. CLS. 9 AND 25.
- MECO CORPORATION, GREENEVILLE, TN:  
3,247,971, CANC. INT. CL. 6.
- MED X CHANGE, INC., BRADENTON, FL:  
4,481,955, INT. CL. 9.
- MED-DATA, INC., SEATTLE, WA:  
2,718,626, CANC. INT. CL. 35.
- MEDECELL DO BRASIL COMÉRCIO E IMPORTAÇÃO LTDA, CENTRO-BOTUCATU-SP CEP, BRAZIL:  
4,481,959, INT. CL. 10.
- MEDECO SECURITY LOCKS, INC., SALEM, VA:  
1,857,477, REN. 1-8-14. MULTIPLE CLASS, INT. CLS. 6 AND 20.
- MEDERER GMBH, D-90763 FURTH, FED REP GERMANY:  
2,718,908, CANC. INT. CL. 30.
- MEDIA GENERAL COMMUNICATIONS HOLDINGS, LLC, RICHMOND, VA:  
2,719,119, CANC. INT. CL. 41.
- MEDICAL FACULTY ASSOCIATES, INC., WASHINGTON, DC:  
4,482,359, INT. CL. 44.
- MEDICAL MARTS LLC, LAS VEGAS, NV:  
3,246,885, CANC. INT. CL. 44.
- MEDICAL STAFFING SOLUTIONS, INC., ROCKLEDGE, FL:  
3,247,298, CANC. INT. CL. 35.
- MEDICINE ONLINE, INC., HUNTINGTON BEACH, CA:  
2,718,353, CANC. MULTIPLE CLASS, INT. CLS. 35, 36, 38 AND 42.
- MEDIFIT CORPORATE SERVICES, INC., FLORHAM PARK, NJ:  
4,482,141, INT. CL. 9.
- MEDIPX, LLC, LAWRENCEVILLE, GA, DBA MEDIPX-COM:  
4,297,100, AM. INT. CL. 35.
- MEDIQ N.V., UTRECHT, NETHERLANDS:  
4,479,327, PUB. 11-26-2013. MULTIPLE CLASS, INT. CLS. 5, 10, 35, 39, 41 AND 44.
- MEDIQ N.V., AS UTRECHT, NETHERLANDS:  
4,479,331, PUB. 11-26-2013. MULTIPLE CLASS, INT. CLS. 5, 10, 35, 39, 41 AND 44.
- MEDIRATE INC., BOSTON, MA:  
2,719,461, CANC. INT. CL. 45.
- MEDISO ORVOSI BEREENDEZÉS FEJLESZTŐ; ÉS SZERVÍZ KFT., H-1022 BUDAPEST, HUNGARY:  
4,479,402, PUB. 11-26-2013. MULTIPLE CLASS, INT. CLS. 9, 10 AND 42.
- MEDIX HEALTH LLC, WEST PALM BEACH, FL:  
4,448,413, COR. INT. CL. 5.
- MEDLINE INDUSTRIES, INC., MUNDELEIN, IL:  
4,482,763, INT. CL. 5.  
4,482,764, INT. CL. 10.
- MEDTECH PUBLISHING COMPANY, LLC, NEW GLOUCESTER, ME:  
3,240,848, COR. INT. CL. 16.
- MEDTRONIC, INC., MINNEAPOLIS, MN:  
3,248,630, CANC. MULTIPLE CLASS, INT. CLS. 35 AND 41.
- MEDUNITY, INC., SANDWICH, MA:  
3,246,652, CANC. INT. CL. 44.
- MEELHUYSEN, ED R, BURLESON, TX, DBA SHARPER MINDS:  
2,798,850, REN. 1-3-14. MULTIPLE CLASS, INT. CLS. 9, 16 AND 41.  
2,798,850, CANC. INT. CL. 44.
- MEENAN, ANTHONY, DAVENPORT, IA:  
4,481,679, INT. CL. 9.
- MEETIC, FRANCE:  
3,247,757.
- MEGA AID PHARMACY I, INC., BROOKLYN, NY:  
4,480,518, PUB. 11-26-2013. INT. CL. 35.
- MEGA BRANDS INTERNATIONAL, LUXEMBOURG, ZUG BRANCH, ZUG, SWITZERLAND:  
3,248,519, CANC. INT. CL. 28.
- MEGA GROUP INC., SASKATOON, SASKATCHEWAN, CANADA:  
4,479,982, PUB. 6-18-2013. INT. CL. 35.
- MEGA SUPPLY STORE LLC, HUNTINGDON VALLEY, PA:  
4,479,689, PUB. 11-26-2013. INT. CL. 11.
- MEGALOMEDIA, INC., AUSTIN, TX:  
3,246,333, CANC. INT. CL. 41.
- MELAMED, SHAIN, LOS ANGELES, CA:  
3,248,162, CANC. INT. CL. 30.
- MELISSA VAP LLC, WASHINGTON, DC:  
4,481,829, INT. CL. 25.
- MELROSE PR LLC, SANTA MONICA, CA:  
4,482,730, INT. CL. 9.
- MEMORIAL E LIBRARIES, INC., CAPE CORAL, FL:  
4,482,201, INT. CL. 42.
- MEMORIAL SLOAN-KETTERING CANCER CENTER, NEW YORK, NY:  
4,480,128, PUB. 5-21-2013. INT. CL. 28.
- MENASHA CORPORATION, NEENAH, WI:  
4,482,004, MULTIPLE CLASS, INT. CLS. 16, 35, 40 AND 42.  
4,482,005, MULTIPLE CLASS, INT. CLS. 35, 40 AND 42.  
4,482,030, MULTIPLE CLASS, INT. CLS. 35, 40 AND 42.
- MENDELSON HOSPITALITY GROUP LLC, WASHINGTON, DC:  
4,481,961, INT. CL. 43.
- MENDIAS & MILTON, LLC, AUSTIN, TX, DBA MY FIT FOODS:  
4,481,459, INT. CL. 43.
- MERCER (US) INC., NEW YORK, NY:  
4,482,457, INT. CL. 9.
- MERCHANT MEDIA, LLC, MARLBOROUGH, MA:  
3,248,642, CANC. INT. CL. 11.
- MERCHSOURCE, LLC, IRVINE, CA:  
4,481,770, MULTIPLE CLASS, INT. CLS. 11, 14 AND 20.
- MERCK KGAA, D-64293 DARMSTADT, FED REP GERMANY:  
2,718,525, CANC. INT. CL. 2.  
3,246,149, CANC. INT. CL. 5.



MERCK SANTE, 69008 LYON, FRANCE:  
3,247,017, CANC. INT. CL. 5.

MERCO HASKENSACK INC., HILLBURN, NY, DBA MERCO HASKENSACK INC.:  
2,731,398, REN. 1-5-14. INT. CL. 17.

MEREDITH CORPORATION, DES MOINES, IA:  
2,799,513, REN. 1-3-14. INT. CL. 16.

MERETE MEDICAL GMBH, BERLIN, FED REP GERMANY:  
4,479,993, PUB. 11-26-2013. INT. CL. 10.

MERGENT, INC., FORT MILL, SC:  
3,246,457, CANC. INT. CL. 16.

MERIDIANA FLY S.P.A., ITALY:  
3,247,859.

MERIT NETWORK, INC., ANN ARBOR, MI:  
4,480,486, PUB. 11-26-2013. MULTIPLE CLASS, INT. CLS. 38, 41 AND 42.

MERLIN DRUG, INC., FLUSHING, NY:  
4,480,233, PUB. 11-26-2013. INT. CL. 35.

MERRYSTOCKINGS LLC, ROSEVILLE, MN:  
4,480,334, PUB. 11-26-2013. INT. CL. 28.

MESH SEMICONDUCTOR, INC., BREINIGSVILLE, PA:  
3,246,356, CANC. INT. CL. 9.  
3,246,357, CANC. INT. CL. 9.

MESOTHERAPY ASSOCIATES, P.C., WEST ORANGE, NJ:  
2,896,877, REN. 1-8-14. INT. CL. 44.

MESSINGER, BRAD, PHILADELPHIA, PA:  
3,246,419, CANC. INT. CL. 43.

METAL MASTERS FOODSERVICE EQUIPMENT CO., INC., CLAYTON, DE:  
1,867,656, REN. 1-8-14. INT. CL. 20.

METALÚRGICA SCHIOPPA LTDA., SÃO PAULO, BRAZIL:  
3,248,267, CANC. INT. CL. 12.

METAMARK LABORATORIES, INC., CAMBRIDGE, MA:  
3,247,648, CANC. INT. CL. 42.

METAPS INC., TOKYO 160-0022, JAPAN:  
4,479,484, PUB. 11-26-2013. INT. CL. 35.

METRATECH CORP., WALTHAM, MA:  
4,480,365, PUB. 11-26-2013. INT. CL. 9.

METRICSTREAM, INC., PALO ALTO, CA:  
4,482,113, INT. CL. 35.  
4,482,114, INT. CL. 35.

METROCAST CABLEVISION OF NEW HAMPSHIRE, LLC, FRAZER, PA:  
3,248,078, CANC. MULTIPLE CLASS, INT. CLS. 38 AND 41.

METRONOME PRODUCTIONS A/S, KØBENHAVN S, DENMARK:  
4,479,975, PUB. 11-26-2013. INT. CL. 28.

METROPOLITAN LIFE INSURANCE COMPANY, NEW YORK, NY:  
2,909,311, REN. 1-6-14. INT. CL. 36.  
4,482,366, INT. CL. 36.  
4,482,371, INT. CL. 36.  
4,482,373, INT. CL. 36.

METSÄ BOARD ZANDERS GMBH, 51465 BERGISCH GLADBACH, FED REP GERMANY:  
1,262,324, REN. 1-9-14. INT. CL. 16.

METSO CORPORATION, FINLAND:  
4,479,318, PUB. 11-26-2013. MULTIPLE CLASS, INT. CLS. 7, 9 AND 11.

METZGER, DERIC, OCEANSIDE, CA:  
4,480,782, PUB. 11-26-2013. INT. CL. 14.

MEYER, ANDREA P., BOULDER, CO:  
1,826,569, REN. 1-8-14. INT. CL. 35.

MF JEWELRY, NEW YORK, NY:  
4,480,515, PUB. 11-26-2013. INT. CL. 14.

MGA ENTERTAINMENT, INC., VAN NUYS, CA:  
3,248,214, CANC. INT. CL. 28.

MGC LIMITED, BRICK, NJ, AKA ALISON NELSON'S CHOCOLATE BAR:  
3,246,937, CANC. INT. CL. 35.

MGM NETWORKS LATIN AMERICA LLC, CORAL GABLES, FL:  
4,479,817, PUB. 11-26-2013. INT. CL. 41.

MHS QUINCY, INC., QUINCY, IL:  
4,479,676, PUB. 11-26-2013. INT. CL. 36.

MIAMI DOLPHINS, LTD., DAVIE, FL:  
4,482,709, INT. CL. 24.

MIC IMPORT EXPORT, INC, MIAMI, FL, DBA VIEWMAX TECHNOLOGY:  
4,480,298, PUB. 11-26-2013. INT. CL. 9.

MICHAEL ARAM, INC., NORTH BERGEN, NJ:  
4,480,211, PUB. 11-26-2013. MULTIPLE CLASS, INT. CLS. 6, 8, 11, 20 AND 21.

MICHAEL DISTEFANO, BERKELEY HEIGHTS, NJ:  
4,482,706, INT. CL. 10.

MICHAEL PETER MCHUGH, CLOVELLY NSW 2031, AUSTRALIA:  
4,479,305, PUB. 6-18-2013. MULTIPLE CLASS, INT. CLS. 25, 29, 30, 32, 35, 43 AND 44.

MICHAEL SCHMIDT, FED REP GERMANY:  
4,479,349, PUB. 11-26-2013. MULTIPLE CLASS, INT. CLS. 3 AND 16.

MICHAEL-DAVID, LLC, LODI, CA:  
4,481,518, INT. CL. 33.

MICHEL MERCIER PRODUCTS, SOUTH PLAINFIELD, NJ, DBA M.M.P., INC.:  
4,481,179, PUB. 11-26-2013. INT. CL. 1.  
4,481,182, PUB. 11-26-2013. INT. CL. 1.

MICHIGAN SUBURBS ALLIANCE, FERNDALE, MI:  
3,248,729, CANC. INT. CL. 35.

MICRO HEALTH SOLUTIONS, L.L.C., SPRINGFIELD, MO:  
3,245,848, CANC. INT. CL. 35.

MICRONAS GMBH, FED REP GERMANY:  
3,247,813.

MICROSOFT CORPORATION, REDMOND, WA:  
3,246,453, CANC. INT. CL. 9.  
3,246,454, CANC. INT. CL. 9.  
4,480,902, PUB. 11-26-2013. INT. CL. 9.  
4,481,924, MULTIPLE CLASS, INT. CLS. 9 AND 41.

MICROVENTION, INC., TUSTIN, CA:  
3,248,106, CANC. INT. CL. 10.

MIDDLE EAST MEDIA AND RESEARCH INSTITUTE, INC., WASHINGTON, DC:  
4,480,681, PUB. 11-26-2013. MULTIPLE CLASS, INT. CLS. 35, 41 AND 45.

MIDDLESEX COUNTY UTILITIES AUTHORITY, SAYREVILLE, NJ:  
1,806,638, REN. 1-9-14. INT. CL. 1.

MIDFIRST BANK, OKLAHOMA CITY, OK:  
3,246,009, CANC. MULTIPLE CLASS, INT. CLS. 35 AND 36.

MIDWAY HOME ENTERTAINMENT INC., CHICAGO, IL:  
2,719,582, CANC. INT. CL. 28.

MIDWEST TECHNICAL INSPECTIONS, INC., HANOVER PARK, IL:  
4,479,693, PUB. 11-26-2013. INT. CL. 42.

MIDWEST TILE, MARBLE & GRANITE, INC., LINCOLN, NE:  
4,481,445, INT. CL. 11.

MIDWOOD CAPITAL MANAGEMENT LLC, BOSTON, MA:  
4,480,889, PUB. 11-26-2013. INT. CL. 36.

MIDZY LLC, BELLEVUE, WA:  
4,481,988, MULTIPLE CLASS, INT. CLS. 9 AND 35.

MIGHTY ONE MUSIC LLC, LAKE OSWEGO, OR:  
3,247,290, CANC. INT. CL. 42.

MIGUEL TORRES S.A., DEL PENEDES (BARCELONA), SPAIN:  
3,247,857.  
3,247,858.

MILKYWAY GROUP LTD., HONG KONG, HONG KONG:  
4,481,767, MULTIPLE CLASS, INT. CLS. 9, 35, 38, 41 AND 42.

MILLENNIUM ELECTRONICS PTY. LIMITED, EAST KEILOR, VICTORIA, AUSTRALIA:  
4,481,478, INT. CL. 9.

MILLERCOORS LLC, CHICAGO, IL:  
1,263,412, REN. 1-7-14. MULTIPLE CLASS, INT. CLS. 8 AND 21.  
4,482,776, INT. CL. 32.

MILLS, NATHAN, FARMINGTON, MN:  
4,480,867, PUB. 11-26-2013. INT. CL. 41.

MILNE FRUIT PRODUCTS, INC., PROSSER, WA:  
3,246,549, CANC. MULTIPLE CLASS, INT. CLS. 29 AND

32.  
MILWAUKEE SCHOOL OF ENGINEERING (MSOE), MILWAUKEE, WI:  
4,481,533, MULTIPLE CLASS, INT. CLS. 9, 16 AND 41.
- MIMRAN GROUP INC., TORONTO, ONTARIO, CANADA:  
3,246,987, CANC. INT. CL. 14.
- MINERGY LLC, MILWAUKEE, WI:  
2,720,132, CANC. INT. CL. 7.
- MINI-LAP TECHNOLOGIES, INC., DOBBS FERRY, NY:  
4,480,238, PUB. 10-1-2013, INT. CL. 10.
- MINISTRY OF TRADE AND INDUSTRY, GARDEN CITY, CAIRO, EGYPT:  
2,799,024, REN. 1-3-14, U.S. CL. A.
- MINNESOTA PUBLIC RADIO, ST. PAUL, MN:  
4,482,774, INT. CL. 41.
- MINNESOTA TRAPLINE PRODUCTS, PENNOCK, MN, DBA MINNESOTA TRAPLINE PRODUCTS:  
3,248,755, CANC. INT. CL. 6.
- MINUTILLO, MICHAEL, PROSPECT, CT:  
4,481,176, PUB. 11-26-2013, INT. CL. 42.
- MINYANVILLE PUBLISHING AND MULTIMEDIA LLC, NEW YORK, NY, MINYANVILLE PUBLISHING AND MULTIMEDIA, INC., NEW YORK, NY:  
2,738,473, REN. 1-6-14, INT. CL. 16.
- MIRACLE RESOURCES INTERNATIONAL, LLC, CHARLOTTE, NC:  
4,481,696, INT. CL. 24.
- MIRACLECORP PRODUCTS, DAYTON, OH:  
2,769,372, REN. 1-7-14, INT. CL. 31.
- MIRROR ME, INC., LOS ANGELES, CA:  
3,248,301, CANC. INT. CL. 25.
- MIS QUALITY MANAGEMENT CORP., WILMINGTON, DE:  
3,248,061, CANC. INT. CL. 41.
- MISC US TRADEMARK LTD., MISSISSAUGA, ONTARIO, CANADA:  
3,248,273, CANC. INT. CL. 5.
- MISSBEHAVE, BROOKLYN, NY:  
3,248,577, CANC. INT. CL. 16.
- MISSION BREWERY, SAN DIEGO, CA:  
4,481,323, INT. CL. 43.
- MISSION YOGURT, INC., WESTMINSTER, CO:  
4,481,682, INT. CL. 43.
- MISSONI S.P.A., ITALY:  
3,247,794.
- MITSUBISHI ELECTRIC CORPORATION, CHIYODA-KU, TOKYO, JAPAN:  
4,480,036, PUB. 11-26-2013, INT. CL. 9.
- MITSUI FOODS, INC., NORWOOD, NJ:  
4,480,106, PUB. 11-26-2013, INT. CL. 29.
- MIX IT UP, LLC, WHITE BEAR TOWNSHIP, MN:  
3,247,975, CANC. MULTIPLE CLASS, INT. CLS. 41 AND 43.
- MKW ALLOY INC., CITY OF INDUSTRY, CA:  
4,480,373, PUB. 11-26-2013, INT. CL. 12.
- MLF ENTERPRISES, SANTA MONICA, CA:  
2,719,030, CANC. INT. CL. 5.
- MLS4OWNERS.COM, INC, UNIVERSITY PLACE, WA, DBA MLS4OWNERS.COM:  
2,732,071, REN. 1-3-14, INT. CL. 35.
- MMC CORP., NEW YORK, NY:  
3,248,627, CANC. INT. CL. 25.
- MN8 MEDIA, LLC, HEBER, UT:  
4,481,901, INT. CL. 37.
- MOAB BREWERS, L.L.C., PARK CITY, UT:  
4,481,822, INT. CL. 25.  
4,481,823, INT. CL. 32.
- MOAC MALL HOLDINGS LLC, BLOOMINGTON, MN, DBA MALL OF AMERICA:  
4,482,162, INT. CL. 36.
- MOANA PACIFIC FISHERIES LIMITED, AUCKLAND, NEW ZEALAND:  
1,781,596, REN. 1-8-14, INT. CL. 29.
- MOBILE ENTERTAINMENT FORUM, LONDON, UNITED KINGDOM:  
3,246,126, CANC. INT. CL. 38.
- MODEL 21 CORP., WESTMINSTER, CA, DBA SAMANTHA BEAUTY:  
4,482,437, INT. CL. 3.
- MODELADEN HILLENBACH GMBH, BORKEN-WESEKE, FED REP GERMANY:  
4,479,994, PUB. 6-11-2013, INT. CL. 25.
- MODELING INSIGHTS, LLC, MERRICK, NY:  
3,247,551, CANC. INT. CL. 9.  
3,247,555, CANC. INT. CL. 9.  
3,247,556, CANC. INT. CL. 9.  
3,247,559, CANC. INT. CL. 9.  
3,247,565, CANC. INT. CL. 9.
- MODERN MACARONI COMPANY, LTD., HONOLULU, HI:  
1,263,736, REN. 1-9-14, INT. CL. 30.  
1,265,171, REN. 1-9-14, MULTIPLE CLASS, INT. CLS. 29 AND 30.
- MODERNICA, INC., LOS ANGELES, CA:  
2,797,655, REN. 1-6-14, MULTIPLE CLASS, INT. CLS. 9 AND 20.
- MOEN INCORPORATED, NORTH OLMSTED, OH:  
4,482,232, MULTIPLE CLASS, INT. CLS. 6, 11, 20 AND 21.
- MOESEO, CARLSBAD, CA:  
4,482,215, INT. CL. 42.
- MOET HENNESSY USA, INC., NEW YORK, NY:  
980,479, REN. 1-8-14, U.S. CL. 49 (INT. CL. 33).
- MOHAMED, FRANCO, CRYSTAL SPRINGS, MS:  
4,480,187, PUB. 11-26-2013, MULTIPLE CLASS, INT. CLS. 35 AND 41.
- MOHAWK CARPET DISTRIBUTION, INC, CHATSWORTH, GA:  
3,248,171, CANC. INT. CL. 42.
- MOKRES, JAMES A., SANTA FE, NM:  
2,719,572, CANC. INT. CL. 30.
- MOM BRANDS COMPANY, LAKEVILLE, MN:  
4,481,681, INT. CL. 30.
- MON CHONG LOONG TRADING CORP., MASPEETH, NY:  
2,718,689, CANC. INT. CL. 16.
- MONARCH & CO. LLC, ANTHEM, AZ, DBA MONARCH, REALTORS:  
3,245,986, CANC. INT. CL. 35.
- MONARCH ART PLASTICS, CO., LLC, MOUNT LAUREL, NJ:  
3,247,255, CANC. MULTIPLE CLASS, INT. CLS. 9 AND 16.
- MONCLER S.P.A., ITALY:  
4,479,319, PUB. 11-26-2013, MULTIPLE CLASS, INT. CLS. 9, 18 AND 28.
- MONDELEZ EUROPE GMBH, 8152 GLATTPARK, SWITZERLAND:  
4,481,075, PUB. 11-26-2013, INT. CL. 30.
- MONEXA SERVICES INC., VANCOUVER, BC, CANADA:  
2,731,284, REN. 1-6-14, MULTIPLE CLASS, INT. CLS. 9 AND 42.
- MONKEY DO, FONTANA, CA:  
3,247,408, CANC. INT. CL. 41.
- MONOGRAM MEAT SNACKS, LLC, MEMPHIS, TN:  
2,729,238, CANC. INT. CL. 29.
- MONSIEUR PATRICK TREVIDIC, FRANCE AND MONSIEUR PARIS JÉRÔME, FRANCE AND MONSIEUR BRACCINI FRÉDÉRIC, FRANCE:  
4,479,296, PUB. 9-3-2013, MULTIPLE CLASS, INT. CLS. 16, 35, 38, 41 AND 44.
- MONSTER ENERGY COMPANY, CORONA, CA:  
4,482,659, INT. CL. 5.  
4,482,660, INT. CL. 29.
- MONTALVAN'S SALES, INC., ONTARIO, CA:  
4,480,192, PUB. 11-26-2013, INT. CL. 29.
- MONTANA MEX, LLC, BOZEMAN, MT:  
4,480,992, PUB. 11-26-2013, INT. CL. 30.
- MONTANI, MARK, SOUTHBRIDGE, MA:  
4,482,727, MULTIPLE CLASS, INT. CLS. 12 AND 25.
- MONTECITO INVESTMENT COMPANY, LLC, JACKSONVILLE, FL:  
3,246,342, CANC. INT. CL. 37.
- MONTRES ANTIMA S.A., CH-2502 BIENNE, SWITZERLAND:  
2,719,046, CANC. INT. CL. 14.
- MOO JAVA INC., PEOSTA, IA:  
3,246,628, CANC. INT. CL. 43.
- MOOD ENTERTAINMENT INC., BUFFALO GROVE, IL:  
3,248,474, CANC. INT. CL. 9.

MOOG INC., EAST AURORA, NY:  
4,479,522, PUB. 6-4-2013. MULTIPLE CLASS, INT. CLS. 7 AND 9.

MOON VALLEY NURSERY INC, PHOENIX, AZ:  
4,480,472, PUB. 11-26-2013. INT. CL. 1.

MOONLYT, INC., NEW YORK, NY:  
4,480,817, PUB. 11-26-2013. INT. CL. 41.

MOORE PRODUCTS, INC., ATLANTA, GA:  
1,264,262. REN. 1-9-14. INT. CL. 19.

MOORE, HOLLEY MELISSA, PENSACOLA, FL:  
4,481,905, INT. CL. 25.

MOREHEAD, INC., BALDWIN, KS:  
3,248,249, CANC. INT. CL. 16.

MORGAN, ALAN, DELTA, BRITISH COLUMBIA, CANADA:  
3,247,978, CANC. INT. CL. 28.

MORGUELAN CORP., MONTEREY PARK, CA:  
4,479,832, PUB. 11-26-2013. MULTIPLE CLASS, INT. CLS. 41 AND 45.

MORIN, FLECHELLE, PACIFIC PALISADES, CA:  
3,246,295, CANC. INT. CL. 16.

MORRA, CLAUDETTE, LONDON, UNITED KINGDOM:  
3,246,874, CANC. INT. CL. 3.

MORRILL, ROBERT C., LA JOLLA, CA AND MORRILL, JENNIFER P., LA JOLLA, CA:  
4,482,762, INT. CL. 16.

MORRIS, RICHARD L JR, MIAMI BEACH, FL:  
2,912,035. REN. 1-3-14. INT. CL. 42.

MORRISON HOLDINGS, LLC, NEW YORK, NY:  
4,480,975, PUB. 11-26-2013. INT. CL. 25.

MORRISON MILLING CO., THE, SAN ANTONIO, TX:  
981,680. REN. 1-6-14. U.S. CL. 46 (INT. CL. 30).  
981,681. REN. 1-5-14. U.S. CL. 46 (INT. CL. 30).

MORRISON TEXTILE MACHINERY CO., FORT LAWN, SC,  
MORRISON MACHINE CO., PATERSON, NJ:  
983,826. REN. 1-5-14. U.S. CL. 23 (INT. CLS. 6, 7, 8, 9, 11, 12, 16, 21 AND 28).

MORTON KNIGHT LTD, UNITED KINGDOM:  
4,479,439, PUB. 11-26-2013. INT. CL. 25.

MORZEN, JOHN PAUL, POUGHKEEPSIE, NY:  
3,248,127, CANC. INT. CL. 25.

MOSAIC STRATEGIC PARTNERS, LLC, DAYTON, OH:  
4,479,640, PUB. 11-26-2013. MULTIPLE CLASS, INT. CLS. 35, 36 AND 41.

MOSS, KELLY, HENDERSON, NV:  
4,480,342, PUB. 11-26-2013. INT. CL. 16.

MOTIC INCORPORATION LTD., HONG KONG, HONG KONG:  
2,795,901. REN. 1-3-14. INT. CL. 9.  
2,795,902. REN. 1-3-14. INT. CL. 9.

MOTT, WILLIAM, S., PROVIDENCE, RI:  
3,246,336, CANC. INT. CL. 35.

MOTYKA, KIM, GRAND BLANC, MI:  
4,482,115, INT. CL. 36.

MOVADO LLC, WILMINGTON, DE:  
3,248,227, CANC. INT. CL. 21.

MOVE IT OUT, INC., MIAMI, FL:  
3,247,446, CANC. INT. CL. 35.

MOVEROLL OY, FINLAND:  
4,479,476, PUB. 11-26-2013. MULTIPLE CLASS, INT. CLS. 7, 39 AND 40.

MOVE2SAFETY, LLC, ALEXANDRIA, VA:  
4,482,463, INT. CL. 41.  
4,482,495, INT. CL. 41.

MOYER, DAVID S., BOUTTE, LA:  
3,248,341, CANC. MULTIPLE CLASS, INT. CLS. 25 AND 41.

MOYNO, INC., SPRINGFIELD, OH:  
3,247,442, CANC. INT. CL. 9.

MOZECONCIERGE, COPPELL, TX:  
4,480,764, PUB. 11-26-2013. INT. CL. 35.

MPC INC., WILMINGTON, DE:  
4,480,585, PUB. 11-26-2013. INT. CL. 11.

MPH SYSTEM SPECIALTIES, INC., DAWSONVILLE, GA:  
2,800,314. REN. 1-6-14. INT. CL. 4.

MR. CHECKOUT DISTRIBUTORS INCORPORATED, BOCA RATON, FL:  
4,479,991, PUB. 11-26-2013. INT. CL. 35.

MRS DESIGN, LLC, GRETNA, LA:  
4,482,414, INT. CL. 25.

MRS. DUNSTER'S (1996) INC., SUSSEX, NEW BRUNSWICK, CANADA, MRS. DUNSTER'S DONUTS, INC., FREDERICTON, NEW BRUNSWICK, CANADA:  
1,826,507. REN. 1-4-14. INT. CL. 30.

MSC SERVICES CORP., MELVILLE, NY:  
4,481,372, INT. CL. 7.

MTS LOGISTICS INC., NEW YORK, NY:  
2,807,996. REN. 1-7-14. INT. CL. 39.

MUCHIE'S SKIN, SOUTH MIAMI, FL:  
4,480,127, PUB. 11-26-2013. INT. CL. 3.

MUDDY CUP NEW YORK LLC., HUDSON, NY:  
3,246,672, CANC. INT. CL. 43.

MUGFORD, CARLI ELIZABETH, RICHMOND, VA:  
3,247,364, CANC. INT. CL. 14.

MUKTI LIFE, LLC, BELLE HARBOR, NY:  
4,481,659, INT. CL. 41.

MULTI TIME MACHINE, INC., LOS ANGELES, CA:  
4,480,853, PUB. 11-26-2013. INT. CL. 14.  
4,480,854, PUB. 11-26-2013. INT. CL. 14.

MULTI-PURE INTERNATIONAL, LAS VEGAS, NV:  
4,481,882, INT. CL. 35.  
4,481,883, INT. CL. 41.  
4,481,884, INT. CL. 35.  
4,481,885, INT. CL. 41.

MULTICARE HEALTH SYSTEM, TACOMA, WA:  
4,481,733, INT. CL. 44.

MULTICRAFT IMPORTS INC., OTTAWA, ONTARIO, CANADA:  
4,479,525, PUB. 4-23-2013. MULTIPLE CLASS, INT. CLS. 16 AND 28.  
4,479,526, PUB. 4-23-2013. MULTIPLE CLASS, INT. CLS. 16 AND 28.

MULTIPLE SCLEROSIS FOUNDATION, INC., FORT LAUDERDALE, FL:  
2,718,665, CANC. INT. CL. 36.

MULTIVERSE STUDIO INC., CHATSWORTH, CA:  
4,481,040, PUB. 11-26-2013. MULTIPLE CLASS, INT. CLS. 6 AND 28.

MULU, INC., ROCKVILLE, MD:  
4,482,282, MULTIPLE CLASS, INT. CLS. 9 AND 35.

MUNDOQ LLC, MIAMI BEACH, FL:  
4,480,849, PUB. 11-26-2013. INT. CL. 41.

MURRAY BOARDS, LLC, BIRMINGHAM, AL:  
4,480,193, PUB. 11-26-2013. INT. CL. 28.

MURRAY, PAMELA, CORONA DEL MAR, CA, DBA CASA DE BALBOA:  
4,480,636, PUB. 11-26-2013. INT. CL. 36.

MUSA H. OTHMAN, SCOTTSDALE, AZ:  
4,481,879, MULTIPLE CLASS, INT. CLS. 14, 16, 25 AND 26.

MUSE PUBLISHING, WEST PALM BEACH, FL:  
4,482,347, INT. CL. 45.

MUSIC ACADEMY OF THE WEST, SANTA BARBARA, CA:  
4,480,408, PUB. 11-26-2013. INT. CL. 41.  
4,480,409, PUB. 11-26-2013. INT. CL. 41.

MUSICIANS DISCOUNT WAREHOUSE, LLC, KENOSHA, WI:  
4,480,481, PUB. 11-26-2013. INT. CL. 15.

MUSTAFA, TYRELLE, JACKSONVILLE, FL:  
4,481,416, INT. CL. 25.

MUTANT ARCHERY, LLC, MEAD, WA:  
4,480,438, PUB. 11-26-2013. INT. CL. 28.

MUZIK LOUNGE, LLC, CHESAPEAKE, VA:  
4,480,178, PUB. 11-26-2013. INT. CL. 41.

MY BEST FOR U, LLC., NEW YORK, NY:  
4,481,804, INT. CL. 3.

MY CHOICE MEDICAL CENTER, A PROFESSIONAL MEDICAL CORPORATION, VAN NUYS, CA:  
4,482,028, INT. CL. 44.

MY DIAMOND PLACE, LTD., NASSAU, BAHAMAS:  
2,821,653. REN. 1-8-14. INT. CL. 14.

MY VET CALLS, LLC, OLNEY, MD:  
4,481,381, INT. CL. 44.

MYCATALYST, INC., ROCK HILL, NC:  
4,480,693, PUB. 11-26-2013. INT. CL. 42.

- MYCONE DENTAL SUPPLY CO., INC., CHERRY HILL, NJ:  
1,814,818. REN. 1-6-14. INT. CL. 10.
- MYERS, BLAKE, LIVERMORE, CA:  
4,481,404. INT. CL. 28.
- MYGOV, LLC, ADA, OK:  
2,867,558. REN. 1-7-14. INT. CL. 42.
- MYRTLE GROVE INVESTMENTS, LLC, WILMINGTON, NC:  
3,248,397. CANC. INT. CL. 37.
- N TARA, INC., JOHNSON CITY, TN:  
2,718,369. CANC. MULTIPLE CLASS, INT. CLS. 9, 38 AND 42.
- N. FITZ DESIGNS, MORRISVILLE, PA:  
4,482,279. INT. CL. 24.
- NADFINLO PLASTICS INDUSTRY CO. LTD., QUARRY BAY, HONG KONG:  
4,481,900. INT. CL. 11.
- NAGAE, SARAH ELIZABETH, RALEIGH, NC:  
4,481,203. PUB. 11-26-2013. INT. CL. 45.
- NAHABED, VASKEN, TORRANCE, CA:  
4,480,311. PUB. 11-26-2013. INT. CL. 5.
- NAJIB EST, INC, ELKRIDGE, MD:  
4,480,318. PUB. 11-26-2013. INT. CL. 29.
- NAMEONIC LLC, NEW YORK, NY:  
4,481,933. MULTIPLE CLASS, INT. CLS. 9 AND 45.
- NANCY D. DIEFFENBACH, WILMINGTON, NC:  
3,248,680. CANC. INT. CL. 16.
- NANO SCIENCE DIAGNOSTICS, INC., AUSTIN, TX:  
3,245,825. CANC. INT. CL. 10.
- NANOGEN, INC., SAN DIEGO, CA:  
3,248,685. CANC. MULTIPLE CLASS, INT. CLS. 5 AND 10.
- NANOMETRICS INCORPORATED, MILPITAS, CA:  
2,733,027. REN. 1-8-14. INT. CL. 9.
- NANOPHOTON CORPORATION, OSAKA, JAPAN:  
4,481,301. INT. CL. 9.  
4,481,302. INT. CL. 9.
- NANOSATISFI, INC., SAN FRANCISCO, CA:  
4,480,218. PUB. 11-26-2013. INT. CL. 38.  
4,480,219. PUB. 11-26-2013. INT. CL. 9.
- NANTAKA JOY, INC., LOS ANGELES, CA:  
4,480,064. PUB. 8-20-2013. MULTIPLE CLASS, INT. CLS. 16, 41 AND 42.
- NAPERSOFT, INC., NAPERVILLE, IL:  
4,482,190. MULTIPLE CLASS, INT. CLS. 38 AND 42.
- NASEEB NETWORKS, INC., SAN JOSE, CA:  
3,248,140. CANC. INT. CL. 45.
- NASUNI CORPORATION, NATICK, MA:  
4,481,430. INT. CL. 38.
- NATIONAL ACADEMY OF RECORDING ARTS & SCIENCES, INC., SANTA MONICA, CA:  
3,247,153. CANC. INT. CL. 41.
- NATIONAL ACTIVE AND RETIRED FEDERAL EMPLOYEES ASSOCIATION, ALEXANDRIA, VA, AKA NARFE:  
4,480,632. PUB. 11-26-2013. MULTIPLE CLASS, INT. CLS. 16, 35 AND 41.  
4,480,633. PUB. 11-26-2013. INT. CL. 36.  
4,480,634. PUB. 11-26-2013. MULTIPLE CLASS, INT. CLS. 16, 35 AND 41.
- NATIONAL ASSOCIATION FOR RETAIL MARKETING SERVICES, BROOMFIELD, CO:  
4,479,992. PUB. 11-26-2013. MULTIPLE CLASS, INT. CLS. 35 AND 41.
- NATIONAL ASSOCIATION OF HISPANIC PUBLICATIONS, INC, WASHINGTON, DC:  
3,246,253. CANC. INT. CL. 35.
- NATIONAL BANK HOLDINGS CORPORATION, KANSAS CITY, MO:  
4,479,718. PUB. 11-26-2013. INT. CL. 36.
- NATIONAL BOARD OF BOILER AND PRESSURE VESSEL INSPECTORS, COLUMBUS, OH:  
1,814,278. REN. 1-6-14. U.S. CL. B.
- NATIONAL CATASTROPHE RESTORATION, INC., WICHITA, KS:  
4,480,437. PUB. 11-26-2013. INT. CL. 37.
- NATIONAL CHURCH SUPPLY CO., INC., CHESTER, WV, DBA NATIONAL COMMERCIAL ENVELOPE COMPANY:  
1,813,680. REN. 1-8-14. INT. CL. 16.
- NATIONAL COALITION FOR CANCER SURVIVORSHIP, SILVER SPRING, MD:  
3,245,833. CANC. MULTIPLE CLASS, INT. CLS. 36 AND 41.  
3,245,873. CANC. MULTIPLE CLASS, INT. CLS. 36 AND 41.
- NATIONAL COLLEGE PLAYERS ASSOCIATION, NORCO, CA:  
4,479,741. PUB. 11-26-2013. MULTIPLE CLASS, INT. CLS. 35 AND 41.
- NATIONAL ENTERTAINMENT COLLECTIBLES ASSOCIATION, INC., HILLSIDE, NJ, AKA NECA:  
4,482,310. INT. CL. 14.
- NATIONAL FISH AND WILDLIFE FOUNDATION, WASHINGTON, DC:  
2,796,808. REN. 1-3-14. INT. CL. 35.
- NATIONAL INTERFAITH CABLE COALITION, NEW YORK, NY:  
4,479,897. PUB. 11-26-2013. INT. CL. 41.
- NATIONAL NUCLEAR LABORATORY LIMITED, WARRINGTON, WA3 6AE, UNITED KINGDOM:  
4,479,845. PUB. 11-26-2013. INT. CL. 42.
- NATIONAL PARK FOUNDATION, WASHINGTON, DC:  
2,800,044. REN. 1-3-14. INT. CL. 36.  
2,800,045. REN. 1-3-14. INT. CL. 35.
- NATIONAL PORK BOARD, CLIVE, IA:  
4,479,744. PUB. 11-26-2013. MULTIPLE CLASS, INT. CLS. 35 AND 42.
- NATIONAL PORK PRODUCERS COUNCIL CORPORATION, URBANDALE, IA:  
4,480,428. PUB. 11-26-2013. INT. CL. 35.
- NATIONAL RAILROAD PASSENGER CORPORATION, WASHINGTON, DC:  
2,719,057. CANC. INT. CL. 28.  
2,719,059. CANC. INT. CL. 39.  
2,719,069. CANC. INT. CL. 28.  
2,719,070. CANC. INT. CL. 28.  
2,719,762. CANC. INT. CL. 12.
- NATIONAL RESTAURANT ASSOCIATION, WASHINGTON, DC:  
4,481,930. INT. CL. 35.
- NATIONAL RIFLE ASSOCIATION OF AMERICA, FAIRFAX, VA:  
3,245,794. CANC. INT. CL. 13.
- NATIONAL SPECIALTY LIGHTING, INC., LOUISVILLE, CO:  
3,247,307. CANC. INT. CL. 11.
- NATIONAL TAX RELIEF, INC., RIVERSIDE, CA:  
4,482,854. INT. CL. 35.
- NATIONAL U.S.-ARAB CHAMBER OF COMMERCE, WASHINGTON, DC:  
4,479,997. PUB. 11-26-2013. INT. CL. 35.
- NATIONWIDE MEDICAL, INC., AGOURA HILLS, CA:  
4,479,734. PUB. 11-26-2013. INT. CL. 35.
- NATIONWIDE MUTUAL INSURANCE COMPANY, COLUMBUS, OH:  
4,480,497. PUB. 11-26-2013. INT. CL. 36.
- NATRONX TECHNOLOGIES, LLC, PRINCETON, NJ:  
4,481,606. INT. CL. 1.  
4,481,607. INT. CL. 1.
- NATURA VITALIS AG, SWITZERLAND:  
3,247,675.
- NATURAL EDGE HAWAII, INC., HONOLULU, HI:  
4,482,852. INT. CL. 5.
- NATURAL INTENTIONS, INC., FOLSOM, CA:  
4,481,163. PUB. 11-26-2013. MULTIPLE CLASS, INT. CLS. 29 AND 30.
- NATURAL ORGANIC MARKETING GROUP INC., QUEBEC CITY, PROVINCE OF QUEBEC, CANADA:  
3,248,459. CANC. INT. CL. 29.
- NATURAL RESOURCES DEFENSE COUNCIL, INC., NEW YORK, UNITED STATES:  
3,247,384. CANC. INT. CL. 35.
- NATURAL SELECTION FOODS, LLC, SAN JUAN BAUTISTA, CA:  
4,481,477. INT. CL. 35.
- NATURE ET INNOVATION, FRANCE:  
4,479,312. PUB. 11-26-2013. INT. CL. 30.

NATURE'S TABLE FRANCHISE COMPANY, ORLANDO, FL:  
3,248,610, CANC. INT. CL. 32.

NATURE'S WAY PRODUCTS, LLC, GREEN BAY, WI:  
1,264,676, REN. 1-9-14, INT. CL. 5.

NATURE'S YOUTH, INC., FRANKLIN, TN:  
2,719,391, CANC. INT. CL. 5.

NATURES BENEFIT, LITTLE FALLS, NJ, DBA HOLT MD LABS/ VON AH:  
3,246,706, CANC. INT. CL. 5.

NATURESWEET, LTD., SAN ANTONIO, TX:  
2,801,544, REN. 1-8-14, INT. CL. 31.

NATUS MEDICAL INCORPORATED, SAN CARLOS, CA:  
4,480,399, PUB. 11-26-2013, INT. CL. 10.

NAVARRETE, LAURA, PHILADELPHIA, PA:  
4,481,675, INT. CL. 25.

NAVARRO, FAUSTO E., HESPERIA, CA:  
3,248,118, CANC. INT. CL. 28.

NAVIS CAPITAL PARTNERS LIMITED, KUALA LUMPUR, MALAYSIA:  
2,875,940, REN. 1-8-14, INT. CL. 36.

NAVITAS LEASE CORP., PONTE VEDRA BEACH, FL:  
4,480,295, PUB. 11-26-2013, MULTIPLE CLASS, INT. CLS. 35 AND 36.  
4,480,296, PUB. 11-26-2013, MULTIPLE CLASS, INT. CLS. 35 AND 36.

NBA PROPERTIES, INC., NEW YORK, NY:  
2,719,389, CANC. INT. CL. 35.

NCL CORPORATION LTD., MIAMI, FL:  
3,248,641, CANC. INT. CL. 39.

NCM CO., LTD., GYEONGGI-DO, REPUBLIC OF KOREA:  
4,479,917, PUB. 11-26-2013, INT. CL. 11.

NCSOFT CORPORATION, SEOUL, REPUBLIC OF KOREA:  
3,248,043, CANC. INT. CL. 9.

NDC LABORATORIES, CARSON CITY, CA:  
3,248,294, CANC. INT. CL. 5.

NDI OFFICE FURNITURE, LLC, NASHVILLE, TN:  
3,246,913, CANC. INT. CL. 20.

NEAL, DAVID E., NOVATO, CA AND MARTIN, SUSAN P., NOVATO, CA:  
4,481,106, PUB. 11-26-2013, INT. CL. 1.

NEASI-WEBER INTERNATIONAL, LLC, VALENCIA, CA:  
4,481,567, MULTIPLE CLASS, INT. CLS. 35 AND 42.

NEATFREAK GROUP INC., MISSISSAUGA, ONTARIO, CANADA:  
4,481,775, INT. CL. 22.

NEBRASKA STATEWIDE ARBORETUM, LINCOLN, NE:  
3,246,846, CANC. INT. CL. 31.

NEDCON MAGAZININRICHTING B.V., NETHERLANDS:  
4,479,456, PUB. 11-26-2013, MULTIPLE CLASS, INT. CLS. 6, 19, 20, 37 AND 42.

NEDERVELD ASSOCIATES SURVEYING, INC., GRAND RAPIDS, MI, DBA NEDERVELD, INC.:  
4,479,731, PUB. 11-26-2013, MULTIPLE CLASS, INT. CLS. 37, 42 AND 45.

NEENAH PAPER, INC., ALPHARETTA, GA:  
2,719,991, CANC. INT. CL. 16.

NEEVA, LLC, ORLANDO, FL:  
4,480,202, PUB. 11-26-2013, INT. CL. 35.

NEGRÓN CRUZ, JOSÉ R., CATAÑO, UNITED STATES:  
3,248,439, CANC. INT. CL. 25.

NEIGHBOR LLC, MINNEAPOLIS, MN:  
4,482,025, INT. CL. 41.  
4,482,026, INT. CL. 42.

NEIL J KENNARD, AUSTRALIA AND DANIEL J KENNARD, AUSTRALIA:  
3,247,792.

NEILL CORPORATION, HAMMOND, LA:  
4,480,255, PUB. 11-26-2013, INT. CL. 44.

NEIMAN, DREW, NAPA, CA AND STEWART, ERIC, NAPA, CA:  
4,482,512, INT. CL. 33.

NEKOFEEDEE LLC, WILLISTON, VT:  
3,246,504, CANC. INT. CL. 21.

NEMIROFF INTELLECTUAL PROPERTY ESTABLISHMENT, LIECHTENSTEIN:  
3,247,838.

NEMSCHOFF CHAIRS, INC., SHEBOYGAN, WI:  
3,247,062, CANC. INT. CL. 40.

NEMZER, ARIK, HOD HASHARON, ISRAEL:  
4,479,614, PUB. 11-26-2013, INT. CL. 14.

NEOCOM TECHNOLOGIES, INC, NATCHITOCHES, LA:  
3,247,289, CANC. INT. CL. 30.

NEON RAIN INTERACTIVE, LLC, THORNTON, CO:  
3,246,926, CANC. INT. CL. 42.

NEOPERL INTERNATIONAL AG, REINACH, SWITZERLAND:  
4,479,918, PUB. 11-26-2013, MULTIPLE CLASS, INT. CLS. 6 AND 17.

NEPTUNE (EUROPE) LTD, UNITED KINGDOM:  
4,479,494, PUB. 11-26-2013, INT. CL. 20.  
4,479,497, PUB. 11-26-2013, INT. CL. 20.

NEPTUNE ADVISORS, LLC, NEEDHAM, MA:  
4,480,197, PUB. 11-26-2013, INT. CL. 35.

NERI S.P.A., ITALY:  
4,479,287, PUB. 11-26-2013, MULTIPLE CLASS, INT. CLS. 6, 11 AND 20.

NESSY LEARNING LTD., CLIFTON, BRISTOL BS82H, UNITED KINGDOM:  
4,481,131, PUB. 11-26-2013, INT. CL. 9.

NET(NET), INC., HOLLAND, MI:  
4,480,668, PUB. 11-26-2013, INT. CL. 35.  
4,481,228, PUB. 11-26-2013, INT. CL. 35.

NETAPP, INC., SUNNYVALE, CA:  
4,482,352, INT. CL. 9.

NETBLENDER, INC., ALEXANDRIA, VA:  
3,246,480, CANC. INT. CL. 9.

NETCHEM, INC., NEW BRUNSWICK, NJ:  
2,852,911, REN. 1-7-14, INT. CL. 35.

NETDIMENSIONS LIMITED, WAN CHAI, HONG KONG:  
4,479,680, PUB. 11-26-2013, MULTIPLE CLASS, INT. CLS. 9, 35, 41 AND 42.

NETPIA.COM, INC., SEOUL, REPUBLIC OF KOREA:  
3,245,733, CANC. MULTIPLE CLASS, INT. CLS. 38 AND 42.

NETUITIVE, INC., RESTON, VA:  
3,246,319, CANC. INT. CL. 9.

NETWORK COMMUNICATIONS, INC., NORCROSS, GA:  
4,479,813, PUB. 8-6-2013, MULTIPLE CLASS, INT. CLS. 35 AND 42.

NETWORK FRONTIERS, LLC, LAFAYETTE, CA:  
4,479,678, PUB. 11-26-2013, INT. CL. 9.

NEUBERGER BERMAN GROUP LLC, NEW YORK, NY:  
4,482,138, INT. CL. 35.

NEUBERGER BERMAN MANAGEMENT LLC, NEW YORK, NY:  
4,480,268, PUB. 11-26-2013, INT. CL. 36.

NEUMANN, MARCY, PRESCOTT, AZ:  
4,480,722, PUB. 11-26-2013, INT. CL. 41.

NEURONETICS, INC., MALVERN, PA:  
4,481,547, INT. CL. 9.

NEUTEX ADVANCED ENERGY GROUP, HOUSTON, TX:  
4,480,876, PUB. 11-26-2013, INT. CL. 40.

NEUTROGENA CORPORATION, LOS ANGELES, CA:  
3,248,013, CANC. INT. CL. 3.

NEW CREASIAN, INC, ROWLETT, TX:  
4,481,945, INT. CL. 43.

NEW DEAL TRADING, L.L.C., HOLLISTER, MO:  
4,482,642, INT. CL. 1.

NEW ENGLAND DENTAL ADMINISTRATORS, LLC, CONCORD, NH:  
2,803,837, REN. 1-6-14, INT. CL. 36.

NEW ENGLAND OFFICE SUPPLY, INC., BRAINTREE, MA:  
3,245,779, CANC. INT. CL. 35.

NEW HEALTH SCIENCES, INC., BETHESDA, MD:  
3,246,643, CANC. INT. CL. 44.

NEW HORIZONS FINANCIAL CENTER, WALNUT CREEK, CA:  
3,247,193, CANC. INT. CL. 36.

NEW JERSEY BEVERAGE DISTRIBUTORS, LLC, EDISON, NJ:  
4,482,735, INT. CL. 32.  
4,482,740, INT. CL. 32.

NEW LEADERS, INC., NEW YORK, NY:  
4,479,650, PUB. 11-26-2013, MULTIPLE CLASS, INT. CLS.

- 16 AND 41.  
 NEW LEAF PAPER, INC., SAN FRANCISCO, CA:  
 4,480,934, PUB. 11-26-2013. INT. CL. 16.  
 NEW MEXICO STATE UNIVERSITY BOARD OF REGENTS,  
 LAS CRUCES, NM:  
 4,480,528, PUB. 11-26-2013. MULTIPLE CLASS, INT. CLS.  
 35, 41 AND 42.  
 NEW MILLENNIUM SALES EXCHANGE, LLC, RED OAK,  
 IA:  
 3,247,087, CANC. INT. CL. 29.  
 NEW ORLEANS HABITAT MUSICIANS VILLAGE, INC.,  
 NEW ORLEANS, LA:  
 4,479,943, PUB. 11-26-2013. INT. CL. 41.  
 NEW ORLEANS PRIVATE PATROL SERVICE, INC., NEW  
 ORLEANS, LA:  
 4,480,327, PUB. 11-26-2013. INT. CL. 45.  
 4,480,328, PUB. 11-26-2013. INT. CL. 45.  
 4,480,330, PUB. 11-26-2013. INT. CL. 45.  
 NEW SCIENCE VENTURES LLC, NEW YORK, NY:  
 4,480,702, PUB. 11-26-2013. INT. CL. 36.  
 NEW TECH CUTTING TOOLS, INC., KENT, WA:  
 1,813,348, REN. 1-6-14. INT. CL. 4.  
 NEW VITALITY SBP HOLDINGS, INC., CHICAGO, IL:  
 4,482,376, INT. CL. 5.  
 4,482,378, INT. CL. 35.  
 NEW WORLD PASTA COMPANY, HARRISBURG, PA:  
 4,482,597, INT. CL. 30.  
 NEW YORK STATE ELECTRIC & GAS CORPORATION,  
 BINGHAMTON, NY:  
 2,718,823, CANC. INT. CL. 35.  
 NEW YOU MEDIA LLC, MIAMI, FL:  
 4,479,535, PUB. 11-26-2013. MULTIPLE CLASS, INT. CLS.  
 16 AND 41.  
 NEWLEN, KIMBERLY, ANN, RICHMOND, VA:  
 2,800,499, REN. 1-7-14. MULTIPLE CLASS, INT. CLS. 41  
 AND 45.  
 NEWMAN, GEORGE, POTOMAC, MD:  
 3,248,332, CANC. MULTIPLE CLASS, INT. CLS. 41 AND  
 44.  
 NEWPORT CORPORATION, IRVINE, CA:  
 1,852,963, REN. 1-8-14. INT. CL. 9.  
 NEWPORT MEDIA, INC., LAKE FOREST, CA:  
 3,246,756, CANC. INT. CL. 9.  
 NEWSOM DESIGNS, LLC, FARMER'S BRANCH, TX:  
 2,798,172, REN. 1-6-14. INT. CL. 35.  
 NEXT GENERATION BRACELETS, WOODSTOCK, GA:  
 3,248,560, CANC. INT. CL. 14.  
 NGUYEN, DUNG, ENTERPRISE, AL:  
 4,480,066, PUB. 11-26-2013. INT. CL. 35.  
 NGUYEN, TUONG, WESTMINSTER, CA:  
 4,482,807, INT. CL. 5.  
 NHA, INC., BRISTOL, PA, DBA NATIONAL HONEY AL-  
 MOND:  
 4,482,634, INT. CL. 34.  
 NICHIBAN CO., LTD., TOKYO, JAPAN:  
 1,825,132, REN. 1-5-14. INT. CL. 17.  
 NICHOLS CUSTOM CERAMICS, LLC, BOISE, ID:  
 4,480,929, PUB. 11-26-2013. INT. CL. 11.  
 NICHTER, JOE, WESTPORT, KY:  
 3,248,169, CANC. INT. CL. 41.  
 NICKEL & NICKEL VINYARDS, LLC, OAKVILLE, CA:  
 2,812,938, REN. 1-6-14. INT. CL. 33.  
 NICOLosi FOODS, INC., UNION CITY, NJ:  
 4,480,856, PUB. 11-26-2013. INT. CL. 29.  
 NIHON DEMP A KOGYO CO., LTD., SHIBUYA-KU, TOKYO,  
 JAPAN:  
 4,480,620, PUB. 11-26-2013. INT. CL. 35.  
 NIKE, INC., BEAVERTON, OR:  
 4,481,409, INT. CL. 25.  
 NIKKI DINKI COOKING INC., NEW YORK, NY:  
 4,480,213, PUB. 11-26-2013. INT. CL. 41.  
 NIKON CORPORATION, TOKYO, JAPAN:  
 4,325,776, COR. INT. CL. 9.  
 NIKON CORPORATION, TOYKO, JAPAN:  
 4,482,547, INT. CL. 9.  
 NINGBO QTOP IMPORT AND EXPORT CO.,LTD, NINGBO,  
 CHINA:  
 4,482,328, INT. CL. 11.  
 NINGBO SUNSTAR SHOCK ABSORBER CO., LTD., ZHE-  
 JIANG, CHINA:  
 4,481,124, PUB. 11-26-2013. INT. CL. 12.  
 NINGBO WANFENG BEARING CO., LTD, CHINA:  
 4,479,490, PUB. 11-26-2013. INT. CL. 7.  
 NINGBO YOUYOU INTERNATIONAL CO., LTD., NINGBO,  
 CHINA:  
 4,480,189, PUB. 11-26-2013. INT. CL. 6.  
 NINGBO ZHENGHAI YONGDING FASTENER CO., LTD.,  
 ZHENHAI, NINGBO, CHINA:  
 4,482,400, INT. CL. 6.  
 NIPPON VALQUA INDUSTRIES, LTD., TOKYO, JAPAN:  
 991,709, REN. 1-5-14. INT. CL. 17.  
 NISIMOV WATCH CO., INC., LOS ANGELES, CA:  
 4,480,965, PUB. 11-26-2013. INT. CL. 14.  
 NISSAY SAO, CYPRESS, CA:  
 4,481,565, INT. CL. 25.  
 NKOK, INC., CITY OF INDUSTRY, CA:  
 3,247,915, CANC. INT. CL. 28.  
 NLV FINANCIAL CORPORATION, MONTPELIER, VT:  
 3,248,524, CANC. INT. CL. 36.  
 NM NEVADA TRUST, LAS VEGAS, NV, NEIMAN-MARCUS  
 GROUP, INC., THE CHESTNUT HILL, MA:  
 1,774,545, REN. 1-8-14. INT. CL. 42.  
 NMI CERTIN B.V., NETHERLANDS:  
 4,479,302, PUB. 11-26-2013. MULTIPLE CLASS, INT. CLS.  
 35 AND 42.  
 NOLA3, LLC, NEW ORLEANS, LA:  
 2,719,680, CANC. INT. CL. 35.  
 NOMIKU, INC., SAN FRANCISCO, CA:  
 4,481,742, INT. CL. 11.  
 NOOTRA, INC., SHREWSBURY, NJ, DBA SIMPLE2GIVE:  
 4,480,509, PUB. 11-26-2013. INT. CL. 36.  
 NORBY, DANIEL R., MOUND, MN:  
 4,480,071, PUB. 11-26-2013. INT. CL. 42.  
 NORCO INDUSTRIES, INC., COMPTON, CA:  
 1,306,814, REN. 1-6-14. INT. CL. 7.  
 NORDAHL, MARGARET C., SEATTLE, WA:  
 3,246,707, CANC. INT. CL. 36.  
 NORMAN HAY PLC, COVENTRY, UNITED KINGDOM:  
 2,834,972, REN. 1-6-14. INT. CL. 1.  
 NORMARK CORPORATION, MINNETONKA, MN:  
 4,481,836, INT. CL. 9.  
 4,481,837, INT. CL. 19.  
 4,481,839, INT. CL. 25.  
 4,481,840, INT. CL. 28.  
 NORMET INTERNATIONAL LTD, SWITZERLAND:  
 4,479,369, PUB. 11-26-2013. INT. CL. 12.  
 4,479,370, PUB. 11-26-2013. INT. CL. 12.  
 4,479,371, PUB. 11-26-2013. INT. CL. 12.  
 NORTECH LABORATORIES INC, FARMINGDALE, NY:  
 4,481,234, PUB. 11-26-2013. INT. CL. 10.  
 NORTH AMERICAN MARINE INDUSTRIES, INC., LAMPE,  
 MO:  
 3,246,174, CANC. INT. CL. 6.  
 NORTH AMERICAN RESCUE, LLC, GREER, SC:  
 2,835,400, REN. 1-6-14. INT. CL. 10.  
 NORTH CAROLINA STATE UNIVERSITY AT RALEIGH,  
 RALEIGH, NC:  
 1,264,206, REN. 1-3-14. MULTIPLE CLASS, INT. CLS. 16,  
 21, 25, 28, 41 AND 42.  
 NORTH COAST BREWING CO., INC., FORT BRAGG, CA:  
 3,246,529, CANC. INT. CL. 32.  
 NORTH DAKOTA STATE UNIVERSITY RESEARCH FOUN-  
 DATION, FARGO, ND:  
 1,837,444, REN. 1-9-14. INT. CL. 31.  
 NORTH ISLAND CREDIT UNION, CHULA VISTA, CA:  
 3,246,329, CANC. INT. CL. 36.  
 NORTH SHORE SOAP FACTORY, INC., WAIALUA, HI:  
 2,799,501, REN. 1-6-14. INT. CL. 3.  
 NORTHERN POWER SYSTEMS, INC., BARRE, VT:  
 3,246,252, CANC. INT. CL. 9.  
 NORTHLICH, INC., CINCINNATI, OH:  
 3,246,775, CANC. INT. CL. 35.  
 3,246,776, CANC. INT. CL. 35.  
 3,246,777, CANC. INT. CL. 35.  
 3,246,781, CANC. INT. CL. 35.

NORTHSIDE DEVELOPMENT, INC., NEW YORK, NY:  
2,718,819, CANC. MULTIPLE CLASS, INT. CLS. 29 AND 30.

NORTHWEST ANTIGEN LAB, LLC, OKLAHOMA CITY, OK:  
4,480,160, PUB. 11-26-2013. INT. CL. 5.

NORTHWEST BEDDING CO., INC., SPOKANE, WA:  
4,482,094, INT. CL. 20.

NORWALK WASTEWATER EQUIPMENT COMPANY, INC., NORWALK, OH:  
4,482,568, INT. CL. 11.

NOSTALGIA PRODUCTS GROUP, LLC, GREEN BAY, WI:  
4,479,658, PUB. 11-26-2013. INT. CL. 11.

NOTRE DAME FEDERAL CREDIT UNION CORPORATION, NORTE DAME, IN:  
4,480,713, PUB. 11-26-2013. INT. CL. 36.

NOUR-OMID, BAHRAM, LOS ANGELES, CA:  
4,479,947, PUB. 11-26-2013. INT. CL. 42.

NOUSBO CO., LTD., REPUBLIC OF KOREA:  
4,479,475, PUB. 11-26-2013. INT. CL. 30.

NOVA GAMING, LLC, GREENVILLE, SC:  
3,248,465, CANC. INT. CL. 9.

NOVAFRUIT INC., ST PAUL ABBOTSFORD, QC, CANADA:  
4,482,203, INT. CL. 31.

NOVANOVAPROS, INC., MIAMI, FL:  
4,480,016, PUB. 11-26-2013. INT. CL. 9.

NOVARTIS AG, SWITZERLAND:  
3,247,824.  
3,247,826.  
3,247,828.  
3,247,829.  
4,479,510, PUB. 11-26-2013. INT. CL. 5.  
4,479,511, PUB. 11-26-2013. INT. CL. 5.

NOVARTIS AG, BASEL, SWITZERLAND:  
4,481,006, PUB. 11-26-2013. INT. CL. 5.

NOVASTAR FINANCIAL, INC., KANSAS CITY, MO:  
3,245,725, CANC. INT. CL. 36.

NOVELIS DEUTSCHLAND GMBH, GOTTINGEN, FED REP GERMANY:  
3,246,658, CANC. INT. CL. 6.

NOVEN THERAPEUTICS, LLC, MIAMI, FL:  
4,482,387, INT. CL. 5.

NOVO NORDISK HEALTH CARE AG, ZURICH, SWITZERLAND:  
3,247,089, CANC. INT. CL. 10.

NPOD.COM, INC., STAFFORD, TX:  
4,482,408, MULTIPLE CLASS, INT. CLS. 35 AND 41.

NU MARK LLC, RICHMOND, VA:  
4,482,645, INT. CL. 34.

NU-PUTTIE CORPORATION, MAYWOOD, IL:  
2,913,266, REN. 1-7-14. INT. CL. 17.

NU-TIER BRANDS, INC., TULSA, OK:  
4,481,450, MULTIPLE CLASS, INT. CLS. 35 AND 39.

NUAGE 8, INC., COLORADO SPRINGS, CO:  
4,481,730, MULTIPLE CLASS, INT. CLS. 35 AND 42.

NUPLEX RESINS B.V., 4600 AB BERGEN OP ZOOM, NETHERLANDS:  
4,172,122, COR. MULTIPLE CLASS, INT. CLS. 1, 2 AND 19.

NURSE ALERT, LLC, BRADENTON, FL:  
4,480,243, PUB. 11-26-2013. INT. CL. 44.

NURSE RESPONSE, INC., ST. LOUIS, MO:  
2,797,745, REN. 1-3-14. INT. CL. 44.

NURTURE, INC., NEW YORK, NY:  
4,479,799, PUB. 10-22-2013. MULTIPLE CLASS, INT. CLS. 29 AND 30.

NUTRAMARKS, INC, PARK CITY, UT:  
2,718,980, CANC. INT. CL. 3.

NUTRAMARKS, INC., PARK CITY, UT:  
3,248,385, CANC. MULTIPLE CLASS, INT. CLS. 1 AND 5.  
4,481,175, PUB. 11-26-2013. INT. CL. 5.

NUTRIENT DENSE FOODS LLC, WEST BLOOMFIELD, MI:  
4,481,005, PUB. 11-26-2013. INT. CL. 30.

NUTRIGENIX, LLC, HOLLYWOOD, FL:  
4,480,735, PUB. 11-26-2013. INT. CL. 5.

NUTRITION CENTER, INC., DOUGLAS, WY:  
4,479,797, PUB. 11-26-2013. INT. CL. 5.

NUTRITION DYNAMICS, INC., MAPLE PLAIN, MN:  
3,245,903, CANC. INT. CL. 5.  
3,245,904, CANC. INT. CL. 5.

NUTRITION GLOBAL, LLC, MILFORD, CT:  
3,246,653, CANC. INT. CL. 5.

NUTRIVATION, INC., VANCOUVER, WA:  
3,247,465, CANC. INT. CL. 32.

NUUN & COMPANY, INC., SEATTLE, WA:  
3,246,433, CANC. INT. CL. 32.

NVIDIA CORPORATION, SANTA CLARA, CA:  
2,719,756, CANC. INT. CL. 9.

NW ALABAMA PRACTICE MANAGEMENT, LLC, SHEFFIELD, AL:  
4,482,772, INT. CL. 44.

NYCOMED GMBH, KONSTANZ, FED REP GERMANY:  
3,246,076, CANC. INT. CL. 5.

NYDJ APPAREL, LLC, VERNON, CA:  
2,818,160, REN. 1-6-14. INT. CL. 25.  
4,332,177, AM. INT. CL. 25.

NYSE GROUP, INC., NEW YORK, NY:  
4,479,949, PUB. 11-26-2013. MULTIPLE CLASS, INT. CLS. 9, 16, 35, 36, 38 AND 41.

NÖLLE-PEPIN GMBH & BETRIEBS KG, FED REP GERMANY:  
4,479,466, PUB. 11-26-2013. INT. CL. 12.

O & M ENGINEERING, INC., ELLICOTT CITY, MD:  
2,732,252, REN. 1-8-14. MULTIPLE CLASS, INT. CLS. 9 AND 42.

O. F. MOSSBERG & SONS, INC., NORTH HAVEN, CT:  
765,315, REN. 1-9-14. U.S. CL. 9 (INT. CL. 13).

O'DONNELL, STEVEN B., SANTA FE SPRINGS, CA:  
2,719,900, CANC. INT. CL. 28.

O'MALLEY, DANIEL, BEVERLY HILLS, CA:  
3,248,079, CANC. INT. CL. 9.

O'ROURKE, KEVIN, NASHVILLE, TN:  
4,482,771, INT. CL. 9.

O'TOOLE-LINK, TERESA ANN, TUSTIN, CA:  
2,741,337, REN. 1-9-14. INT. CL. 28.

OÜ ME SISUSTUS, ESTONIA:  
4,479,392, PUB. 11-26-2013. MULTIPLE CLASS, INT. CLS. 25, 28 AND 41.

OA SYSTEMS, INC., RANCHO CUCAMONGO, CA:  
3,248,306, CANC. INT. CL. 9.

OAREX CAPITAL MARKETS, INC., CHICAGO, IL:  
4,480,779, PUB. 11-26-2013. INT. CL. 36.

OAXACA INTERESTS, LLC, DALLAS, TX:  
4,480,329, PUB. 11-26-2013. INT. CL. 36.

OBAKHAN, JESU CHARLES, MARIETTA, GA:  
4,480,042, PUB. 8-20-2013. INT. CL. 10.

OBESITYHELP, INC., IRVINE, CA:  
4,480,018, PUB. 11-26-2013. MULTIPLE CLASS, INT. CLS. 35 AND 44.

OCCIDENTAL CHEMICAL CORPORATION, DALLAS, TX:  
4,481,137, PUB. 11-26-2013. INT. CL. 1.

OCEANCONNECTION, LLC, SANTA FE, NM:  
4,481,978, MULTIPLE CLASS, INT. CLS. 16, 35 AND 41.

OCEANHOUSE MEDIA, INC., ENCINITAS, CA:  
4,482,443, INT. CL. 42.

OCEANMAX INTERNATIONAL LIMITED, AUCKLAND, NEW ZEALAND, OCEANMAX INTERNATIONAL LIMITED, AUCKLAND, NEW ZEALAND:  
2,806,649, REN. 1-3-14. INT. CL. 2.

OCHC LLC, SHAKER HEIGHTS, OH:  
4,481,468, MULTIPLE CLASS, INT. CLS. 3 AND 5.

OCS CONSULTANTS, INC., ORLANDO, FL:  
4,481,575, INT. CL. 43.

OCS, INCORPORATED, SCOTTSBORO, AL, FORMERLY UNCLAIMED BAGGAGE CENTER, INC.:  
4,480,895, PUB. 11-26-2013. INT. CL. 35.

OCT USA, INC., BUENA PARK, CA:  
2,719,413, CANC. INT. CL. 5.

OCULUS OPTIKGERAETE GMBH, WETZLAR, FED REP GERMANY:  
4,479,767, PUB. 11-26-2013. MULTIPLE CLASS, INT. CLS. 9 AND 10.

OCUSOFT, INC., RICHMOND, TX:  
4,482,449, INT. CL. 3.

- ODASSO, VICTOR HUGO MONTERO, BAL HARBOUR, FL:  
4,481,925, INT. CL. 9.
- OEL-BRACK AG, CH-5502 HUNZENSCHWIL, SWITZERLAND:  
3,247,723.
- OFF-LOADING TECHNOLOGIES, INC., TARRYTOWN, NY:  
4,481,310, INT. CL. 20.
- OFFLINE SOLUTIONS, LLC, BOVEY, MN:  
4,481,910, INT. CL. 35.
- OGOFF, DARREN, NORTH WOODMERE, NY:  
4,480,445, PUB. 11-26-2013. INT. CL. 35.
- OHARA, CHRIS, SAN ANTONIO, TX:  
4,479,597, PUB. 11-26-2013. INT. CL. 35.
- OHIO FLEXIBLE PACKAGING COMPANY, INC, SOUTH LEBANON, OH:  
3,246,695, CANC. INT. CL. 40.
- OIL STATES MCS LIMITED, UNITED KINGDOM:  
4,479,354, PUB. 11-26-2013. MULTIPLE CLASS, INT. CLS. 7 AND 9.
- OIL STATES MCS LIMITED, CUMBRIA, UNITED KINGDOM:  
4,479,359, PUB. 11-26-2013. MULTIPLE CLASS, INT. CLS. 7 AND 9.
- OK-VISE OY, FINLAND:  
4,479,512, PUB. 11-26-2013. INT. CL. 6.
- OKLAHOMA POLICY INSTITUTE, INC., TULSA, OK:  
4,480,332, PUB. 11-26-2013. MULTIPLE CLASS, INT. CLS. 9 AND 35.
- OKUCHI SHUZO KABUSHIKIKAISHA, KAGOSHIMAKEN, JAPAN:  
4,480,226, PUB. 11-26-2013. INT. CL. 33.  
4,480,227, PUB. 11-26-2013. INT. CL. 33.
- OLAAX CORP., LAKELAND, FL:  
4,481,043, PUB. 11-26-2013. INT. CL. 5.
- OLD NAVY (APPAREL), LLC, SAN FRANCISCO, CA:  
2,823,303, REN. 1-3-14. INT. CL. 25.
- OLD VINE WINE PARTNERS LLC, NAPA, CA:  
4,482,057, INT. CL. 33.
- OLGLESBY, JOSHUA, DAYTONA BEACH, FL:  
4,482,006, INT. CL. 5.
- OLIMP LABORATORIES SP. Z O.O, POLAND:  
3,247,703.
- OLIOVERDE LTD., RUTHERFORD, CA:  
4,481,338, INT. CL. 33.
- OLIVER PECAN CO. INC, SAN SABA, TX:  
3,258,619, CANC. INT. CL. 35.
- OLTMANN, J. RICHARD, BURBANK, IL:  
3,248,588, CANC. INT. CL. 28.
- OL2, INC., MOUNTAIN VIEW, CA:  
4,481,376, INT. CL. 9.
- OMEGA PROTEIN CORPORATION, HOUSTON, TX:  
4,480,102, PUB. 11-26-2013. INT. CL. 1.
- OMEGA PROTEIN, INC., HOUSTON, TX:  
2,796,631, REN. 1-3-14. MULTIPLE CLASS, INT. CLS. 1, 4, 29, 31, 35 AND 40.
- OMETRIC CORPORATION, COLUMBIA, SC:  
3,245,905, CANC. INT. CL. 42.
- OMNI HOTELS MANAGEMENT CORPORATION, DALLAS, TX:  
1,307,554, REN. 1-6-14. INT. CL. 42.
- OMNOVA SERVICES, INC., FAIRLAWN, OH:  
1,133,670, CANC. INT. CL. 17.
- OMS INVESTMENTS, INC., LOS ANGELES, CA:  
2,636,529, REN. 1-8-14. INT. CL. 31.  
3,248,970, CANC. INT. CL. 44.
- ON A PERSONAL NOTE, LITTLETON, CO:  
3,248,235, CANC. MULTIPLE CLASS, INT. CLS. 9 AND 16.
- ON DEMAND INTERPRETATION SERVICES, LLC, CONCORD, OH:  
4,480,045, PUB. 11-26-2013. MULTIPLE CLASS, INT. CLS. 35 AND 45.
- ONDAX INC., MONROVIA, CA:  
4,482,761, INT. CL. 9.
- ONE CALL ALERT, LLC, HOUSTON, TX:  
4,412,145, COR. MULTIPLE CLASS, INT. CLS. 44 AND 45.
- ONE SOURCE DOCUMENT MANAGEMENT, INC., RONKONKOMA, NY:  
4,363,329, COR. INT. CL. 38.
- ONE TREASURE LIMITED, AUSTIN, TX:  
2,718,769, CANC. INT. CL. 16.
- ONEBUTTON LLC, HOUSTON, TX:  
4,479,944, PUB. 11-26-2013. INT. CL. 25.
- ONESOURCE THE BACKGROUND CHECK COMPANY, OMAHA, NE:  
4,480,692, PUB. 11-26-2013. U.S. CL. B.
- ONNEKIKAMI, DOMINIC, LONG BEACH, CA:  
3,246,388, CANC. INT. CL. 25.
- ONSET FINANCIAL, INC., SOUTH JORDAN, UT:  
4,480,873, PUB. 11-26-2013. INT. CL. 36.
- ONSPRING DEVELOPMENTS LIMITED, ROAD TOWN, TORTOLA, BR.VIRGIN ISLANDS:  
3,245,809, CANC. MULTIPLE CLASS, INT. CLS. 2 AND 16.
- OORAH, INC., LAKEWOOD, NJ:  
2,718,865, CANC. INT. CL. 16.
- OPEN ACCESS TECHNOLOGY INTERNATIONAL, INC., MINNEAPOLIS, MN:  
4,481,643, MULTIPLE CLASS, INT. CLS. 9, 35 AND 36.
- OPEN PRINTS, LLC, CHESAPEAKE, VA:  
4,481,024, PUB. 11-26-2013. INT. CL. 40.
- OPENCONNECT SYSTEMS INCORPORATED, DALLAS, TX:  
4,482,338, MULTIPLE CLASS, INT. CLS. 9 AND 42.
- OPERA SOFTWARE ASA, OSLO, NORWAY:  
2,719,610, CANC. INT. CL. 9.
- OPINICUS CAPITAL INC. BRADENTON, FL:  
4,480,955, PUB. 11-26-2013. INT. CL. 36.
- OPM TRADING LLC, NORTH PALM BEACH, FL, DBA KNOCKERSHOP:  
4,482,445, MULTIPLE CLASS, INT. CLS. 10 AND 25.
- OPOLO VINEYARDS, INC., WESTLAKE VILLAGE, CA:  
4,480,163, PUB. 11-26-2013. INT. CL. 33.
- OPTIMO, INC., ATLANTA, GA:  
2,719,400, CANC. INT. CL. 35.
- OPUS HERITAGE, L.L.C., MINNETONKA, MN:  
1,262,651, REN. 1-3-14. MULTIPLE CLASS, INT. CLS. 36, 37 AND 42.
- ORAL ROBERTS UNIVERSITY, TULSA, OK:  
4,482,081, INT. CL. 38.  
4,482,082, INT. CL. 38.  
4,482,084, INT. CL. 41.
- ORANGE JULIUS OF AMERICA, EDINA, MN:  
3,246,025, CANC. INT. CL. 35.
- ORANGE MONKEY, INC., FALLS CHURCH, VA, TA ORANGE MONKEY:  
4,480,483, PUB. 11-26-2013. INT. CL. 35.
- ORBIT INNOVATIVE PRODUCTS, LLC, AMITYVILLE, NY:  
4,479,600, PUB. 8-20-2013. MULTIPLE CLASS, INT. CLS. 20 AND 21.
- ORBITSOUND LIMITED, LONDON EC1R 0JY, UNITED KINGDOM:  
4,479,781, PUB. 11-26-2013. MULTIPLE CLASS, INT. CLS. 9, 35 AND 42.
- OREGON BREWING COMPANY, NEWPORT, OR:  
2,913,861, REN. 1-7-14. INT. CL. 33.
- OREON, INC., KALAMAZOO, MI:  
3,245,899, CANC. INT. CL. 35.
- ORGANIC BY NATURE, INC., LONG BEACH, CA:  
2,719,329, CANC. INT. CL. 5.
- ORGANIC FOOD INCUBATOR, LLC, LONG ISLAND CITY, NY:  
4,482,744, MULTIPLE CLASS, INT. CLS. 35, 40, 41 AND 43.
- ORGILL, INC., MEMPHIS, TN:  
3,248,458, CANC. INT. CL. 7.
- ORIDEL LTD., HUNTINGTON, NY:  
4,482,500, INT. CL. 3.
- ORIENT FISHERIES INC., VERNON, CA:  
3,247,098, CANC. INT. CL. 29.
- ORIENT ROYAL CRUISE (U&C) INC., MONROE, NJ:  
3,247,550, CANC. INT. CL. 39.



ORIGINAL CALIFORNIA CAR DUSTER COMPANY, INC., CHATSWORTH, CA:  
3,247,892, CANC. INT. CL. 21.  
3,247,935, CANC. INT. CL. 21.

ORIGINAL CIN, LLC, MARS, PA:  
3,245,818, CANC. INT. CL. 35.

ORION FOOD SYSTEMS, L.L.C., SIOUX FALLS, SD:  
4,482,519, INT. CL. 43.

ORLANDO-ORANGE COUNTY EXPRESSWAY AUTHORITY, ORLANDO, FL:  
2,902,737, REN. 1-8-14, INT. CL. 36.

ORRANGE, TIMOTHY, LONGWOOD, FL:  
3,248,173, CANC. INT. CL. 3.

ORSA INSTITUTE LLC, EL PASO, TX:  
2,719,757, CANC. INT. CL. 41.

ORTHOMERICA PRODUCTS, INC., ORLANDO, FL:  
4,482,070, INT. CL. 10.

OSRAM AG, MUENCHEN, FED REP GERMANY, AKA OSRAM AKTIENGESELLSCHAFT:  
2,803,252, REN. 1-8-14, INT. CL. 11.

OSRAM SYLVANIA INC., DANVERS, MA:  
4,481,295, PUB. 11-26-2013, INT. CL. 11.

OSTOVAR, VIDA, LA JOLLA, CA:  
4,481,503, INT. CL. 21.

OTANI, HIDEKI, REEDLEY, FRESNO COUNTY, CA, DBA ORIENTAL TRADING COMPANY:  
1,798,827, REN. 1-9-14, INT. CL. 29.

OTG EXPERIENCE, LLC, CHALFONT, PA:  
4,481,389, MULTIPLE CLASS, INT. CLS. 39, 43 AND 45.

OTICON A/S, DENMARK:  
4,479,480, PUB. 11-26-2013, INT. CL. 10.

OTSUKA KAGAKU KABUSHIKI KAISHA, OSAKA, JAPAN, DBA OTSUKA CHEMICAL CO., LTD.:  
4,479,260, PUB. 10-12-2010, INT. CL. 32.

OUT FIT 7 LIMITED, CYPRUS:  
4,479,367, PUB. 11-26-2013, MULTIPLE CLASS, INT. CLS. 3, 9, 11, 14, 16, 18, 20, 21, 24, 25, 27, 28, 41 AND 42.  
4,479,368, PUB. 11-26-2013, MULTIPLE CLASS, INT. CLS. 3, 9, 11, 14, 16, 18, 20, 21, 24, 25, 27, 28, 41 AND 42.

OUT FIT 7 LIMITED, LIMASSOL, CYPRUS:  
4,479,527, PUB. 11-26-2013, INT. CL. 28.  
4,479,528, PUB. 11-26-2013, INT. CL. 41.

OUT OF THE BOX SOFTWARE, LLC, FAIRVIEW, NJ:  
4,481,053, PUB. 11-26-2013, INT. CL. 42.

OUTDOOR CAP COMPANY, INC., BENTONVILLE, AR:  
2,840,331, REN. 1-6-14, INT. CL. 25.

OUTRCO, INC., WILMINGTON, DE:  
3,248,128, CANC. MULTIPLE CLASS, INT. CLS. 20, 21, 24 AND 27.

OUTRIGGER HOTELS HAWAII, HONOLULU, HI:  
3,246,540, CANC. MULTIPLE CLASS, INT. CLS. 35, 36 AND 43.

OUTSTANDING FARMERS OF AMERICA, NFP, PEARL CITY, IL:  
1,814,220, REN. 1-8-14, INT. CL. 42.

OVER THE TOP NETWORKS INTERNATIONAL, AUSTIN, TX:  
4,479,688, PUB. 6-18-2013, INT. CL. 9.  
4,479,692, PUB. 6-18-2013, INT. CL. 9.

OVERSTOCK.COM, INC., SALT LAKE CITY, UT:  
4,480,877, PUB. 11-26-2013, INT. CL. 35.  
4,481,225, PUB. 11-26-2013, INT. CL. 35.

OWMEE, LAS VEGAS, NV:  
4,480,968, PUB. 11-26-2013, INT. CL. 36.

OWS PRODUCTS, LLC, IRVINE, CA:  
2,719,422, CANC. INT. CL. 3.

OXBOW (SOCIÉTÉ PAR ACTIONS SIMPLIFIÉE), FRANCE:  
3,247,728.

OXFORD GLOBAL RESOURCES, INC., BEVERLY, MA:  
4,481,694, INT. CL. 44.

O2 RINSE LLC, CHARLESTON, SC:  
4,482,712, MULTIPLE CLASS, INT. CLS. 3 AND 5.

P.J. LISAC & ASSOCIATES, INC., OREGON CITY, OR:  
2,794,840, REN. 1-9-14, INT. CL. 29.

PAC PAPER, INC., VANCOUVER, WA:  
4,480,700, PUB. 11-26-2013, INT. CL. 16.

PACIFIC BASIN IHC LIMITED, TORTOLA, BR. VIRGIN ISLANDS:  
3,248,091, CANC. INT. CL. 35.

PACIFIC RISK MANAGEMENT, SALINAS, CA:  
4,480,118, PUB. 11-26-2013, INT. CL. 44.

PACIFIC WORLD CORPORATION, LAKE FOREST, CA:  
3,248,589, CANC. INT. CL. 3.

PADDLE BUS CLUB, HAIKU, HI:  
4,482,480, INT. CL. 39.

PAICK INTERNATIONAL (HK) CO., LIMITED., KL, HONG KONG:  
4,480,998, PUB. 11-26-2013, INT. CL. 9.

PAIN DRINK, INC., LAS VEGAS, NV:  
4,481,562, INT. CL. 32.

PAIVA, SHELLY M., GILROY, CA AND PAIVA, JOHN F., GILROY, CA:  
4,482,451, INT. CL. 37.

PAKEMAN II, WIL F., MARICOPA, AZ:  
3,246,392, CANC. INT. CL. 16.

PALACE FOODS, INC., READING, PA:  
4,482,810, INT. CL. 30.

PALADIN ONLINE REPUTATION MANAGEMENT, LLC, LA PUENTE, CA:  
4,481,960, INT. CL. 42.

PALETERIA LA MICHOCANA, LLC, MODESTO, CA:  
4,481,570, INT. CL. 30.

PALISADE CORPORATION, ITHACA, NY, DBA PALISADE CORPORATION:  
4,479,926, PUB. 11-26-2013, INT. CL. 9.

PALLIS, DEMETRE, SEATTLE, WA, DBA GOURMET MIXES, INC.:  
4,480,431, PUB. 11-26-2013, INT. CL. 32.

PALMER, AMY, OYSTER BAY, NY:  
4,481,341, INT. CL. 41.

PAMPERO INTERNATIONAL FINANCE S. À R.L., LUXEMBOURG, LUXEMBOURG:  
4,482,605, MULTIPLE CLASS, INT. CLS. 30, 35 AND 43.

PAMS, TOM R., BIRMINGHAM, AL:  
3,248,663, CANC. INT. CL. 25.

PANCIS GEMS INC., MORRIS PLAINS, NJ:  
4,482,223, INT. CL. 14.

PANDA APPAREL LLC, SPRINGFIELD, NJ, DBA NEON-TEES:  
4,482,853, INT. CL. 25.

PANGAEA PARTNERS, LTD., WASHINGTON, DC:  
1,834,031, REN. 1-3-14, INT. CL. 36.  
1,865,956, REN. 1-3-14, INT. CL. 36.

PANOS BRANDS, L.L.C., SADDLE BROOK, NJ:  
976,038, REN. 1-6-14, U.S. CL. 46 (INT. CLS. 1, 5, 29, 30, 31 AND 32).

PANZA, GINO, ST. CLOUD, FL:  
4,481,757, INT. CL. 25.

PAPANDREA, DIANE, LAKE GENEVA, WI, DBA DEVIL'S BLEND:  
4,480,201, PUB. 11-26-2013, INT. CL. 21.

PAPER MONEY GUARANTY, LLC, SARASOTA, FL:  
4,482,798, INT. CL. 16.

PAR TECHNOLOGY CORPORATION, NEW HARTFORD, NY:  
3,248,170, CANC. INT. CL. 9.

PARADIGM ELECTRONICS INC., MISSISSAUGA, ONTARIO, CANADA:  
2,718,298, CANC. INT. CL. 9.

PARADIGM SHIFT LIFE STRATEGIES, INC., SAN FRANCISCO, CA:  
3,247,209, CANC. INT. CL. 36.

PARAGON RI LLC, LAWRENCEBURG, IN:  
3,246,354, CANC. INT. CL. 25.

PARAGON TECHNOLOGIES, INC., EASTON, PA:  
1,262,834, REN. 1-6-14, INT. CL. 7.

PARALEGAL SERVICES USA, LLC, ALLENHURST, NJ:  
3,245,910, CANC. INT. CL. 42.

PARAMOUNT PICTURES CORPORATION, HOLLYWOOD, CA:  
4,482,653, INT. CL. 30.

PARCHMENT, NATALIE, WHEATON, MD:  
4,482,222, INT. CL. 35.

- PAREDES GROUP LLC, AUSTIN, TX:  
4,480,778, PUB. 11-26-2013. INT. CL. 30.
- PARFUMS CHRISTIAN DIOR, S.A., 75008 PARIS, FRANCE:  
976,471. REN. 1-9-14. U.S. CL. 51 (INT. CLS. 3 AND 5).
- PARIO, INC., ATLANTA, GA:  
2,816,266. REN. 1-3-14. MULTIPLE CLASS, INT. CLS. 35,  
38, 40, 41 AND 42.  
2,818,941. REN. 1-6-14. MULTIPLE CLASS, INT. CLS. 35,  
38, 40, 41 AND 42.
- PARIS INCORPORATED, LAVALETTE, WV, DBA PARIS  
SIGNS:  
4,481,152, PUB. 11-26-2013. INT. CL. 9.
- PARK & MADISON LLC, MORGANTOWN, WV:  
4,481,101, PUB. 11-26-2013. INT. CL. 35.
- PARK NICOLLET HEALTH SERVICES, ST. LOUIS PARK,  
MN:  
4,481,744, MULTIPLE CLASS, INT. CLS. 41 AND 44.
- PARK, TAE J., CERRITOS, CA:  
3,245,920, CANC. MULTIPLE CLASS, INT. CLS. 9 AND  
11.
- PARKER HANNIFIN MANUFACTURING; NETHER-  
LANDS; (FILTRATION) B.V., NETHERLANDS:  
4,479,364, PUB. 11-26-2013. MULTIPLE CLASS, INT. CLS.  
7 AND 11.  
4,479,365, PUB. 11-26-2013. MULTIPLE CLASS, INT. CLS.  
7 AND 11.
- PARLOR PRESS LLC, ANDERSON, SC:  
4,480,589, PUB. 11-26-2013. INT. CL. 41.
- PARSLEY, BRIAN, CHARLOTTE, NC:  
3,248,331, CANC. MULTIPLE CLASS, INT. CLS. 9, 16  
AND 41.
- PARSONS, DEWITT, MEDFIELD, MA:  
4,481,337, INT. CL. 5.
- PARTICLE SCIENCES, INC., BETHLEHEM, PA:  
4,481,806, MULTIPLE CLASS, INT. CLS. 40 AND 42.
- PARTNERS GROUP LIMITED, INC., WALTHAM, MA:  
3,247,063, CANC. INT. CL. 36.
- PARTY SOBER CLOTHING LLC, MURRAY, UT:  
4,480,084, PUB. 7-23-2013. INT. CL. 25.
- PARTYDELAWARE.COM, LLC, WILMINGTON, DE:  
3,246,611, CANC. INT. CL. 40.
- PASABAÇE CAM SANAYI VE TICARET ANONIM SIRKE-  
TI, ISTANBUL, TURKEY:  
4,479,426, PUB. 11-26-2013. INT. CL. 21.
- PASCAL COMPANY, INC., BELLEVUE, WA:  
1,291,782. REN. 1-9-14. INT. CL. 5.
- PASTA USA, SPOKANE, WA:  
3,248,690, CANC. INT. CL. 30.
- PASTILLE, CATHERINE, SMITHFIELD, RI:  
3,248,112, CANC. INT. CL. 41.
- PATHFINDER PAYMENT SOLUTIONS, INC., COLUMBIA,  
MD:  
3,246,948, CANC. INT. CL. 36.
- PATHWAY POLYMERS INC., CHATTANOOGA, TN:  
3,246,280, CANC. INT. CL. 12.
- PATHWAYS OF LIGHT, INC., ORMOND BEACH, FL,  
PATHWAYS OF LIGHT, INC., ORMOND BEACH, FL:  
1,854,897. REN. 1-7-14. MULTIPLE CLASS, INT. CLS. 41  
AND 42.
- PATRICIA CLASON LLC, MILWAUKEE, WI:  
4,480,827, PUB. 11-26-2013. INT. CL. 41.
- PATRICK KENNEDY, BERKELEY, CA:  
4,482,194, MULTIPLE CLASS, INT. CLS. 37 AND 42.
- PATRICK L MACDONALD, STURGEON BAY, WI:  
4,480,794, PUB. 11-26-2013. INT. CL. 41.
- PATRICK SELLA, BOSTON, MA:  
4,481,673, INT. CL. 41.
- PATRON TECHNOLOGY, LLC, NEW YORK, NY:  
2,733,116. REN. 1-8-14. INT. CL. 35.
- PAUL BLANCO MANAGEMENT COMPANY, INC., SACRA-  
MENTO, CA:  
4,480,293, PUB. 11-26-2013. INT. CL. 35.
- PAUL LEE, WESTMINSTER, CA:  
4,480,725, PUB. 11-26-2013. MULTIPLE CLASS, INT. CLS.  
30 AND 43.
- PAULA JANE BOGARD, MOUNTAIN VIEW, CA:  
4,481,111, PUB. 11-26-2013. INT. CL. 39.
- PAXSON PRODUCTIONS, INC., LOS ANGELES, CA:  
3,248,009, CANC. INT. CL. 9.
- PAXTON & WHITFIELD LIMITED, LONDON SW1Y 6JE,  
UNITED KINGDOM:  
2,894,145. REN. 1-3-14. MULTIPLE CLASS, INT. CLS. 8,  
20, 21, 29 AND 30.
- PAY IT SQUARE, GRAND RAPIDS, MI:  
4,480,590, PUB. 11-26-2013. INT. CL. 36.
- PAY LYNXS, INC., ALBUQUERQUE, NM:  
4,480,987, PUB. 11-26-2013. INT. CL. 36.
- PAYMASTER, INC., BOYNTON BEACH, FL:  
4,479,632, PUB. 5-28-2013. MULTIPLE CLASS, INT. CLS.  
9, 35 AND 36.
- PBM PHARMACEUTICALS, INC., CHARLOTTESVILLE,  
VA:  
4,481,509, INT. CL. 5.
- PCS HOLDINGS, LLC, ORLANDO, FL:  
4,482,861, INT. CL. 45.
- PEACHSTATE HEALTH MANAGEMENT LLC, GAINES-  
VILLE, GA, DBA AEON CLINICAL LABORATORIES:  
4,482,292, INT. CL. 42.
- PEAK INNOVATIONS INC., RICHMOND, BRITISH CO-  
LUMBIA, CANADA:  
3,246,099, CANC. INT. CL. 20.
- PEAK NATIONAL PROMOTIONS, INC., SAFETY HARBOR,  
FL:  
4,480,392, PUB. 11-26-2013. INT. CL. 35.
- PEARISON, INC., CYNTHIANA, IN:  
2,719,983, CANC. INT. CL. 25.
- PEARL & ASH LLC, NEW YORK, NY:  
4,481,091, PUB. 11-26-2013. INT. CL. 43.
- PEARSON DENTAL SUPPLIES COMPANY, SYLMAR, CA:  
3,247,361, CANC. INT. CL. 10.
- PEARSON EDUCATION, INC., UPPER SADDLE RIVER, NJ:  
3,247,891, CANC. MULTIPLE CLASS, INT. CLS. 9 AND  
16.
- PEASE, RAFAEL M., LAKEWAY, TX:  
4,480,310, PUB. 11-26-2013. INT. CL. 41.
- PECATONICA BEER COMPANY, LLC, GRATIOT, WI:  
4,482,566, INT. CL. 32.
- PECHANGA BAND OF LUISENO MISSION INDIANS OF  
THE PECHANGA RESERVATION, CALIFORNIA, IS A  
FEDERALLY RECOGNIZED INDIAN TRIBE, TEMECU-  
LA, CA:  
3,247,028, CANC. MULTIPLE CLASS, INT. CLS. 3, 4, 6, 9,  
14, 16, 18, 21, 24, 25, 28, 32, 34, 41, 43 AND 44.
- PEDRO PERICHE ESCAMILLA, SPAIN:  
3,247,765.
- PEI LICENSING, INC., MIAMI, FL:  
2,797,612. REN. 1-6-14. MULTIPLE CLASS, INT. CLS. 18  
AND 25.  
4,481,609, INT. CL. 14.
- PELLICONI & C.S.P.A., OZZANO DELL'EMILIA, ITALY:  
4,481,492, MULTIPLE CLASS, INT. CLS. 6 AND 20.
- PENA, CHRISTIAN S., FORT LAUDERDALE, FL:  
3,247,497, CANC. INT. CL. 33.
- PENDER, ROBERT, ROUND ROCK, TX:  
4,480,480, PUB. 11-26-2013. INT. CL. 45.
- PENDERS, PAUL, KEDAH, MALAYSIA:  
4,482,073, INT. CL. 3.
- PENENBERG, BRAD L., LOS ANGELES, CA:  
4,481,995, MULTIPLE CLASS, INT. CLS. 9 AND 10.
- PENINSULA PUBLISHING, INC., NEWPORT BEACH, CA:  
3,245,780, CANC. INT. CL. 16.
- PENN FISHING TACKLE MFG. COMPANY, PHILADEL-  
PHIA, PA:  
4,481,449, INT. CL. 28.
- PENNANT FOODS COMPANY, ITASCA, IL:  
3,906,047, COR. INT. CL. 30.
- PENNFIELD OIL COMPANY, OMAHA, NE:  
2,819,513. REN. 1-8-14. INT. CL. 5.  
2,819,515. REN. 1-8-14. INT. CL. 5.  
2,819,516. REN. 1-8-14. INT. CL. 5.  
2,819,517. REN. 1-8-14. INT. CL. 5.  
2,819,518. REN. 1-8-14. INT. CL. 5.  
2,819,519. REN. 1-8-14. INT. CL. 5.  
2,819,520. REN. 1-8-14. INT. CL. 5.

PENNSYLVANIA ASSOCIATION OF REGIONAL FOOD BANKS, MCMURRAY, PA:  
4,479,574, PUB. 11-26-2013. INT. CL. 35.

PENNSYLVANIA CO-OPERATIVE POTATO GROWERS, INC., HARRISBURG, PA:  
4,482,164, INT. CL. 31.  
4,482,165, INT. CL. 29.

PENSACOLA BAY BREWERY, LLC, PENSACOLA, FL:  
4,481,084, PUB. 11-26-2013. INT. CL. 32.

PENTHOUSE DIGITAL MEDIA PRODUCTIONS, INC., BOCA RATON, FL:  
3,248,172, CANC. INT. CL. 9.

PEPPER PATCH, INC., NASHVILLE, TN:  
1,828,412, REN. 1-9-14. INT. CL. 29.

PEPPERDINE UNIVERSITY, GRAZIADIO SCHOOL OF BUSINESS AND MANAGEMENT, LOS ANGELES, CA:  
3,246,849, CANC. INT. CL. 41.

PEPPERIDGE FARM, INCORPORATED, NORWALK, CT:  
3,248,647, CANC. INT. CL. 30.  
3,248,648, CANC. INT. CL. 30.

PEPSICO, INC., PURCHASE, NY:  
3,248,490, CANC. INT. CL. 32.

PER SOMMERHEIN AB, S-181 22 LIDINGO, SWEDEN:  
2,718,399, CANC. MULTIPLE CLASS, INT. CLS. 6 AND 19.

PERCEPTICS INTERNATIONAL PTY LTD, AUSTRALIA:  
4,479,446, PUB. 8-20-2013. MULTIPLE CLASS, INT. CLS. 35 AND 41.

PERFECTLY IMPERFECT, LLC, WEST HOLLYWOOD, CA:  
3,246,609, CANC. INT. CL. 9.

PERFORMANCE COACHING INC., ROCKWOOD, ONTARIO, CANADA:  
3,247,968, CANC. MULTIPLE CLASS, INT. CLS. 16 AND 41.

PERFORMANCE FABRICS, INC., GRAND RAPIDS, MI:  
4,481,992, MULTIPLE CLASS, INT. CLS. 9 AND 21.

PERLEBERG VERLAGS GMBH, BOCHUM, FED REP GERMANY:  
3,248,322, CANC. MULTIPLE CLASS, INT. CLS. 16 AND 28.

PERMAGO LLC, NEW YORK, NY, DBA PERMAGO:  
4,481,046, PUB. 11-26-2013. INT. CL. 38.

PERRY + CURRIER INC., TORONTO, ONTARIO, CANADA:  
4,479,711, PUB. 11-26-2013. INT. CL. 45.

PERRY, CAROL, DALLAS, TX:  
3,247,410, CANC. MULTIPLE CLASS, INT. CLS. 9, 14, 18 AND 35.

PERRY, CINDY, VERNAL, UT:  
4,481,580, INT. CL. 42.

PERRY, SCOTT E, SANTA MONICA, CA:  
4,479,598, PUB. 8-28-2012. INT. CL. 35.

PEÑARREDONA, ALBERTO, MIAMI, FL:  
3,246,722, CANC. INT. CL. 35.

PET PLENISH, ETTERS, PA:  
4,482,618, INT. CL. 31.

PET SHOP EXPRESS PTY LTD, MELBOURNE, VICTORIA, AUSTRALIA:  
3,248,722, CANC. INT. CL. 35.

PETER ALEXANDER SLEEPWEAR PTY LTD, RICHMOND, VICTORIA, AUSTRALIA:  
2,819,740, REN. 1-3-14. INT. CL. 35.

PETER C. WHITTINGTON, PLANTATION, FL:  
4,481,654, MULTIPLE CLASS, INT. CLS. 18, 25 AND 32.

PETER J. BREINGAN M.D., RICHARD L. DELUCA M.D. PLLC, NEW YORK, NY:  
3,248,225, CANC. INT. CL. 44.

PETER SEITZ, D-81675 MÜNCHEN, FED REP GERMANY:  
4,479,981, PUB. 11-26-2013. MULTIPLE CLASS, INT. CLS. 9, 10 AND 42.

PETERSEN, CHARLES, PAYSON, UT:  
4,481,695, INT. CL. 28.

PETNOLOGY USA, LLC, FT. LAUDERDALE, FL:  
4,479,531, PUB. 11-26-2013. INT. CL. 31.

PETPALS GROUP, INC., CITY OF INDUSTRY, CA:  
4,480,562, PUB. 11-26-2013. MULTIPLE CLASS, INT. CLS. 20 AND 28.

PETROL III, LLC, OMAHA, NE:  
3,246,278, CANC. INT. CL. 43.

PETROLEUM EXPERTS LIMITED, EDINBURGH, UNITED KINGDOM:  
4,479,603, PUB. 6-18-2013. MULTIPLE CLASS, INT. CLS. 9, 41 AND 42.

PFIZER INC., NEW YORK, NY:  
3,248,028, CANC. INT. CL. 44.

PFLEIDERER BETEILIGUNGS GMBH, ALTHUETTE, FED REP GERMANY:  
4,481,343, MULTIPLE CLASS, INT. CLS. 18, 19, 20, 24, 27 AND 28.

PGIA HOLDINGS, LLC, WILMINGTON, DE:  
4,481,652, MULTIPLE CLASS, INT. CLS. 35 AND 36.

PGP CORPORATION, PALO ALTO, CA:  
3,248,376, CANC. INT. CL. 42.

PHAM, JAMES N., FOUNTAIN VALLEY, CA:  
4,482,715, INT. CL. 43.

PHARAOH TEC INC., LEOMINSTER, MA:  
4,480,034, PUB. 11-26-2013. INT. CL. 35.

PHARMACARE MANAGEMENT SERVICES, INC., WOON-SOCKET, RI:  
3,246,262, CANC. MULTIPLE CLASS, INT. CLS. 35 AND 44.

PHARMACHEM LABORATORIES, INC., KEARNY, NJ:  
4,481,874, INT. CL. 5.

PHARMAVIZE, NAAMLOZE VENNOOTSCHAP, BELGIUM:  
4,479,495, PUB. 11-26-2013. MULTIPLE CLASS, INT. CLS. 42 AND 45.

PHD MEDIA L.L.C., NEW YORK, NY:  
3,246,897, CANC. INT. CL. 35.

PHI MU FRATERNITY, PEACHTREE CITY, GA:  
4,481,535, INT. CL. 41.

PHIGITAL, INC., MONTCLAIR, NJ:  
4,482,143, INT. CL. 42.  
4,482,144, INT. CL. 9.

PHILIP MORRIS USA INC., RICHMOND, VA:  
3,246,291, CANC. MULTIPLE CLASS, INT. CLS. 16, 35 AND 44.

PHILLIPS SEAFOOD, LLC, PLAQUEMINE, LA:  
4,480,040, PUB. 11-26-2013. INT. CL. 35.

PHITEK SYSTEMS LIMITED, NEWMARKET, NEW ZEALAND:  
4,481,311, MULTIPLE CLASS, INT. CLS. 9, 35 AND 42.

PHOENIX GROUP HOLDINGS, LLC, WARREN, NJ:  
3,246,456, CANC. INT. CL. 35.

PHOENIX IMPORT & DISTRIBUTION, L.L.C., SPRING, TX:  
4,482,166, INT. CL. 3.

PHOENIX LIFE INSURANCE COMPANY, HARTFORD, CT:  
1,868,985, REN. 1-6-14. INT. CL. 36.

PHONE DIRECTORIES COMPANY, LP, OREM, UT:  
3,245,792, CANC. INT. CL. 35.  
3,246,446, CANC. INT. CL. 35.

PHOSPHORTECH CORPORATION, KENNESAW, GA, DBA PHOSPHORTECH CORPORATION:  
4,480,048, PUB. 11-26-2013. INT. CL. 1.

PHRESH TECHNOLOGIES, LLC, SABETHA, KS:  
3,247,215, CANC. INT. CL. 1.

PHS LLC, ILWACO, WA:  
4,480,265, PUB. 10-15-2013. INT. CL. 35.

PHYSICAL GRAPH CORPORATION, RESTON, VA:  
4,482,816, INT. CL. 9.

PHYSICIAN PERFORMANCE NETWORK, L.L.C., DALLAS, TX:  
4,479,661, PUB. 6-25-2013. INT. CL. 44.

PHYSICIANS FORMULA, INC., AZUSA, CA:  
4,481,446, INT. CL. 3.

PHYSICIANS LAB, INC, BOCA RATON, FL:  
4,481,642, INT. CL. 42.

PHYSIQUE INTERNATIONAL INC., LONG BEACH, CA:  
3,248,626, CANC. INT. CL. 5.

PIC ME FIRST, ROYERSFORD, PA:  
4,481,931, INT. CL. 42.

PIE-SQUARES LLC, WILLIAMSPORT, PA:  
4,482,405, INT. CL. 42.

PIEPER, KENNETH, C., EVERGREEN, CO:  
3,246,909, CANC. INT. CL. 42.

- PIERRE CARDIN, PARIS, FRANCE:  
4,479,340, PUB. 11-26-2013. MULTIPLE CLASS, INT. CLS. 3, 8, 18, 20, 21, 24, 25, 41 AND 43.
- PIERRE NICOL CORPORATION, LOS ANGELES, CA:  
4,481,848, INT. CL. 25.
- PIGGLY WIGGLY MIDWEST, LLC, SHEBOYGAN, WI:  
2,798,702, REN. 1-6-14. INT. CL. 35.
- PILKINGTON NORTH AMERICA, INC., TOLEDO, OH:  
4,481,782, INT. CL. 12.
- PINK COCONUT INTERNATIONAL, INC., PUYALLUP, WA:  
3,245,776, CANC. INT. CL. 44.
- PINK DOLPHIN CLOTHING, LLC, LOS ANGELES, CA:  
4,482,174, MULTIPLE CLASS, INT. CLS. 18 AND 25.  
4,482,397, MULTIPLE CLASS, INT. CLS. 18 AND 25.
- PINK TRANSFER, INC., MONROVIA, CA:  
4,480,134, PUB. 11-26-2013. INT. CL. 39.
- PINKALICIOUS DIVAS, INC., GILROY, CA:  
4,482,589, INT. CL. 41.
- PINNACLE ACTUARIAL RESOURCES, INC., BLOOMINGTON, IL:  
3,246,978, CANC. INT. CL. 9.
- PINNACLE BRAND GROUP, INC., SAN DIEGO, CA:  
4,482,122, INT. CL. 25.
- PINTSCH BUBENZER GMBH, KIRCHEN-WEHBACH, FED REP GERMANY:  
3,248,123, CANC. INT. CL. 7.
- PINUCCI LIMITED, LONDON, UNITED KINGDOM:  
4,481,479, INT. CL. 25.
- PIONEER INVESTMENT MANAGEMENT USA INC., BOSTON, MA:  
2,825,674, REN. 1-8-14. INT. CL. 25.
- PIPE CITY LACROSSE LLC, ST. LOUIS, MO:  
4,480,577, PUB. 11-26-2013. INT. CL. 25.
- PIPER PORTLAND ENTERPRISES INC., PORTLAND, OR:  
3,248,312, CANC. INT. CL. 35.
- PIRANHA PROPELLERS, INC., JACKSON, CA:  
1,814,854, REN. 1-8-14. INT. CL. 12.
- PIRELLI & C. S.P.A., MILANO, ITALY:  
3,246,038, CANC. MULTIPLE CLASS, INT. CLS. 9, 12, 16 AND 35.
- PIRELLI TYRE S.P.A., MILAN, ITALY:  
2,852,588, REN. 1-3-14. INT. CL. 12.
- PIT BARREL COOKER COMPANY LLC, STRASBURG, CO:  
4,482,707, INT. CL. 11.
- PITNEY BOWES INC., STAMFORD, CT:  
3,247,572, CANC. INT. CL. 16.
- PITTSBURGH CORNING CORPORATION, PITTSBURGH, PA:  
1,815,592, REN. 1-9-14. MULTIPLE CLASS, INT. CLS. 17 AND 19.  
1,815,592, CANC. MULTIPLE CLASS, INT. CLS. 1, 2, 16, 20 AND 21.
- PITTSBURGH PENGUINS, L.P., PITTSBURGH, PA:  
4,482,197, INT. CL. 35.
- PIXELATED BITS, LLC, MONROE, NC:  
4,481,644, INT. CL. 42.
- PIXIM, INC., MOUNTAIN VIEW, CA:  
2,798,752, REN. 1-6-14. INT. CL. 9.
- PIZZA & PAJAMAS, LLC, HADDON TOWNSHIP, NJ:  
2,800,726, REN. 1-9-14. INT. CL. 35.
- PIZZA INN, INC., THE COLONY, TX:  
4,481,981, INT. CL. 43.
- PLAINVILLE FARMS, INC., PLAINVILLE, NY:  
3,248,625, CANC. INT. CL. 43.
- PLANALYTICS, INC., BERWYN, PA:  
4,479,756, PUB. 11-26-2013. INT. CL. 35.
- PLANET PERSPECTIVE LLC, CHICAGO, IL:  
4,481,759, INT. CL. 35.
- PLANT PURRFECT, L.L.C., LAKEWOOD, CO:  
4,481,741, INT. CL. 21.
- PLASMART, INC., OTTAWA, ONTARIO, CANADA:  
4,482,103, INT. CL. 28.
- PLASTATECH ENGINEERING, LTD., SAGINAW, MI:  
2,798,996, REN. 1-6-14. INT. CL. 17.
- PLASTIKA KRITIS S.A., HERAKLION-CRETE, GREECE, DBA PLASTIKA KRITIS S.A.:  
4,479,421, PUB. 11-26-2013. INT. CL. 17.  
4,479,428, PUB. 11-26-2013. INT. CL. 17.
- PLATTS, EDWARD, SHEFFIELD, UNITED KINGDOM:  
4,479,533, PUB. 11-26-2013. INT. CL. 14.
- PLAXICA LIMITED, UNITED KINGDOM:  
4,445,640, COR. MULTIPLE CLASS, INT. CLS. 1, 40 AND 42.
- PLAY LIMITED, ST. HELIER, JERSEY:  
3,902,427, COR. MULTIPLE CLASS, INT. CLS. 35, 36, 38, 39 AND 42.  
4,169,574, COR. MULTIPLE CLASS, INT. CLS. 16, 35, 39 AND 41.
- PLEASURE PRODUCTS, LLC, ST. AUGUSTINE, FL:  
3,247,494, CANC. INT. CL. 34.
- PLIANT, LLC, SCHAUMBURG, IL:  
2,753,870, REN. 1-3-14. INT. CL. 17.
- PLY GEM INDUSTRIES, INC., CARY, NC:  
4,481,496, MULTIPLE CLASS, INT. CLS. 6, 19 AND 42.
- PM INVESTMENT VENTURES, LLC, CORAL SPRINGS, FL:  
4,481,174, PUB. 11-26-2013. INT. CL. 12.
- POHL CONSULTING AND TRAINING, INC., ROCHELLE, IL:  
4,482,757, INT. CL. 35.
- POINT S FRANCE, LYON, FRANCE:  
4,479,545, PUB. 11-26-2013. MULTIPLE CLASS, INT. CLS. 12, 35, 37 AND 42.  
4,479,547, PUB. 11-26-2013. MULTIPLE CLASS, INT. CLS. 12, 35, 37 AND 42.
- POL, VANDER MATT, GRAND RAPIDS, MI:  
2,719,456, CANC. MULTIPLE CLASS, INT. CLS. 16 AND 42.
- POLAR INDUSTRIES, INC., NEW WINDSOR, NY:  
3,246,867, CANC. INT. CL. 9.
- POLISHER RESEARCH INSTITUTE, NORTH WALES, PA:  
4,480,858, PUB. 11-26-2013. INT. CL. 44.
- POLITICAL.COM, LLC, MIAMI BEACH, FL:  
4,479,924, PUB. 11-26-2013. INT. CL. 35.
- POLK AUDIO, INC., BALTIMORE, MD:  
4,481,962, INT. CL. 9.
- POLYGANICS B.V., NETHERLANDS:  
4,479,316, PUB. 10-15-2013. INT. CL. 10.
- POMEDICAL, LLC, SIMI VALLEY, CA, DBA POM MEDICAL, LLC:  
4,482,517, INT. CL. 10.
- PONIARD PHARMACEUTICALS, INC., SEATTLE, WA:  
3,247,481, CANC. INT. CL. 42.  
3,247,487, CANC. INT. CL. 42.  
3,247,488, CANC. INT. CL. 42.
- PONY BASEBALL, INC., WASHINGTON, PA:  
4,481,595, INT. CL. 41.
- PONZIANI, KEVIN R, CENTERVILLE, OH:  
4,480,981, PUB. 11-26-2013. INT. CL. 25.
- POOF-SLINKY FUNDEX LLC, PLYMOUTH, MI:  
4,480,519, PUB. 11-26-2013. INT. CL. 28.
- PORTER LANCASTRIAN LIMITED, CHORLEY, LANCA-SHIRE, UNITED KINGDOM:  
3,246,437, CANC. INT. CL. 9.
- PORTILLO'S HOT DOGS, INC., OAK BROOK, IL:  
1,265,306, REN. 1-8-14. INT. CL. 42.
- PORTOLANO PRODUCTS, INC., NEW YORK, NY:  
4,481,178, PUB. 11-26-2013. MULTIPLE CLASS, INT. CLS. 24 AND 25.
- PORVENE DOORS, INC., MORENO VALLEY, CA, CLYDE INDUSTRIES LIMITED, NORTH SYDNEY, NSW, 2060, AUSTRALIA:  
1,827,191, REN. 1-8-14. INT. CL. 6.
- POSITIVE LIFESTYLE INTERNATIONAL, LLC, TAMPA, FL:  
4,482,119, MULTIPLE CLASS, INT. CLS. 29 AND 30.
- POSITIVEMED, LLC, HOBOKEN, NJ, DBA POSITIVEMED:  
4,480,484, PUB. 11-26-2013. INT. CL. 44.
- POST WOODWORKING, INC., DANVILLE, NH:  
4,480,191, PUB. 11-26-2013. INT. CL. 19.
- POTATOES, POTATOES, POTATOES INC., AGOURA HILLS, CA:  
3,245,897, CANC. INT. CL. 43.

POTOMAC AVIATION TECHNOLOGY CORPORATION, BOSTON, MA:  
3,248,742, CANC. INT. CL. 9.

POULSEN ROSER A/S, FREDENSBORG, DENMARK:  
2,718,752, CANC. INT. CL. 31.

POWELL, MARY HOWARD, HARRISBURG, PA:  
3,245,933, CANC. INT. CL. 41.

POWELL, WENDY, TRURO, CORNWALL, UNITED KINGDOM:  
4,480,123, PUB. 11-26-2013. MULTIPLE CLASS, INT. CLS. 9, 16 AND 41.

POWER BRANDS (FOODS), MUMBAI, INDIA:  
1,817,003, REN. 1-6-14. MULTIPLE CLASS, INT. CLS. 29 AND 30.

POWER FRESH GROUP INC, WALLINGTON, NJ:  
4,479,986, PUB. 11-26-2013. INT. CL. 32.

POWER TECH STAPLE & NAIL, INC., MONTEREY PARK, CA:  
4,481,737, INT. CL. 7.  
4,481,738, INT. CL. 7.

POWERBUSINESS ASSOCIATES INC., CAPO BEACH, CA:  
3,246,123, CANC. INT. CL. 39.

PPG ARCHITECTURAL COATINGS LLC, STRONGSVILLE, OH:  
3,246,010, CANC. INT. CL. 2.

PPG ARCHITECTURAL FINISHES, INC., PITTSBURGH, PA:  
1,263,897, REN. 1-9-14. INT. CL. 2.

PRACTICING ATTORNEYS FOR LAW STUDENTS PROGRAM, INC., NEW YORK, NY:  
1,790,783, REN. 1-8-14. MULTIPLE CLASS, INT. CLS. 41 AND 42.

PRADA S.A., LUXEMBOURG, LUXEMBOURG:  
1,264,243, REN. 1-9-14. INT. CL. 18.

PRAENDEX INCORPORATED, WELLESLEY, MA:  
1,869,890, REN. 1-8-14. MULTIPLE CLASS, INT. CLS. 35 AND 41.

PRAGIN, PAVEL, SAN FRANCISCO, CA:  
4,481,951, INT. CL. 42.

PRAIRIE INTERACTIVE MESSAGING, INC., WILMINGTON, DE:  
3,245,874, CANC. MULTIPLE CLASS, INT. CLS. 35, 38, 39 AND 41.

PRATIK PATEL, NJIRO, ARUSHA, TANZANIA:  
4,480,129, PUB. 11-26-2013. INT. CL. 36.

PREFERRED BRANDS, INC., BURNSVILLE, MN:  
3,248,342, CANC. INT. CL. 27.

PREFERRED MEAL SYSTEMS, INC., BERKELEY, IL:  
2,798,424, REN. 1-6-14. INT. CL. 42.

PREFFERREDDENTALNETWORK, L.L.C., AMBLER, PA:  
4,482,217, INT. CL. 44.

PREGIS INNOVATIVE PACKAGING, INC., DEERFIELD, IL:  
2,800,444, REN. 1-3-14. INT. CL. 16.

PREMIER LOG HOMES AND STRUCTURES, LLC, RINGGOLD, GA:  
3,248,736, CANC. INT. CL. 19.

PREMIER NUTRITION CORPORATION, SAN FRANCISCO, CA, AKA JOINT JUICE, INC.:  
4,480,222, PUB. 11-26-2013. MULTIPLE CLASS, INT. CLS. 5 AND 32.

PREMIER RESEARCH LABORATORIES, LP, AUSTIN, TX:  
3,247,933, CANC. INT. CL. 14.

PREMIER RESEARCH LABS, LP, AUSTIN, TX:  
2,719,605, CANC. INT. CL. 5.

PREMIER, INC., CHARLOTTE, NC:  
3,246,850, CANC. MULTIPLE CLASS, INT. CLS. 42 AND 44.

PREMIERE PRODUCTS, INC., LA CRESCENTA, CA:  
2,804,256, REN. 1-6-14. INT. CL. 3.

PREMIUM FINANCING SPECIALISTS, INC., NEW YORK, NY AND PREMIUM FINANCING SPECIALISTS OF THE SOUTH, INC., KANSAS CITY, MO AND PREMIUM FINANCING SPECIALISTS OF CALIFORNIA, INC., KANSAS CITY, MO:  
3,246,370, CANC. INT. CL. 36.

PREMKUMAR, PRAVIN, MOUNTAIN VIEW, CA AND LALVANI, AVINASH, DUBAI, UNITED ARAB EMIR.:  
4,480,976, PUB. 11-26-2013. MULTIPLE CLASS, INT. CLS. 40 AND 42.

PREPPYDOM, LLC, NEW CANAAN, CT, DBA PREPPYDOM:  
4,481,887, INT. CL. 45.

PRESCOTT, THOMAS S., WASHINGTON, DC:  
2,711,484, REN. 1-9-14. INT. CL. 31.

PRESSMATRIX GMBH, FED REP GERMANY:  
4,479,356, PUB. 11-26-2013. MULTIPLE CLASS, INT. CLS. 9, 35, 38, 41 AND 42.

PRESSURE BIOSCIENCES, INC., SOUTH EASTON, MA:  
2,798,648, REN. 1-8-14. INT. CL. 9.

PRETTY PERSUASIONS, LLC, DULUTH, GA:  
4,480,890, PUB. 11-26-2013. INT. CL. 25.

PRETZEL CRAZY, LLC, PITTSBURGH, PA:  
4,480,505, PUB. 11-26-2013. INT. CL. 30.

PREVENTION FIRST, INC., OCEAN, NJ:  
4,481,258, PUB. 11-26-2013. INT. CL. 41.

PRG WATCH MANUFACTORY LIMITED, TSIMSHATSUI, KOWLOON, HONG KONG:  
3,247,925, CANC. INT. CL. 14.

PRICE SELF STORAGE HOLDINGS, LLC., SAN DIEGO, CA:  
2,833,449, REN. 1-3-14. INT. CL. 39.

PRICELINE.COM INCORPORATED, NORWALK, CT:  
3,246,934, CANC. MULTIPLE CLASS, INT. CLS. 39, 40 AND 43.

PRICESMART, INC., SAN DIEGO, CA:  
4,481,423, INT. CL. 6.

PRIDEZILLAS LLC, CHICAGO, IL:  
4,481,008, PUB. 11-26-2013. INT. CL. 35.

PRIMAL VANTAGE COMPANY, INC., RANDOLPH, NJ:  
4,481,448, INT. CL. 28.

PRIMARY INSIGHT, LLC, NEW YORK, NY:  
3,248,466, CANC. INT. CL. 36.

PRIMARY NUTRIENTS, LLC, GREENWICH, CT:  
4,481,637, INT. CL. 5.

PRIME AUTOMOTIVE WAREHOUSE, LLC, OLIVE BRANCH, MS, AKA PRIME AUTOMOTIVE WAREHOUSE:  
4,479,662, PUB. 6-4-2013. MULTIPLE CLASS, INT. CLS. 1, 4, 7 AND 9.

PRIME LENDING GROUP, MARGATE, FL:  
3,246,514, CANC. INT. CL. 36.

PRIMENET DIRECT MARKETING SOLUTIONS, LLC, LARGO, FL:  
2,806,194, REN. 1-7-14. INT. CL. 35.

PRIMEWAY FEDERAL CREDIT UNION, HOUSTON, TX:  
4,480,595, PUB. 11-26-2013. INT. CL. 36.

PRINCETON BIOMEDITECH CORPORATION, MONMOUTH JUNCTION, NJ:  
1,819,663, REN. 1-8-14. INT. CL. 5.

PRINCIPE, JON, CATHEDRAL CITY, CA:  
3,245,857, CANC. INT. CL. 41.

PRINT MANAGEMENT PARTNERS, INC., DES PLAINES, IL, DBA TOOLS FOR SCHOOLS:  
4,481,143, PUB. 11-26-2013. INT. CL. 42.

PRIV-ID B.V., NETHERLANDS:  
3,247,856.

PRO-IRODA INDUSTRIES, INC., TAICHUNG HSIEN, TAIWAN:  
2,912,090, REN. 1-7-14. MULTIPLE CLASS, INT. CLS. 4, 7, 11 AND 34.

PROACT SAFETY, INC., THE WOODLANDS, TX:  
4,480,195, PUB. 11-26-2013. INT. CL. 26.

PROACTIVE INSTITUTE, COSTA MESA, CA:  
1,779,866, CANC. INT. CL. 41.  
1,780,900, CANC. INT. CL. 41.

PROCHASKA & COMPANY, INC., WILLMAR, MN:  
3,248,161, CANC. MULTIPLE CLASS, INT. CLS. 9, 16 AND 35.

PROCTER & GAMBLE COMPANY, THE, CINCINNATI, OH:  
2,720,108, CANC. INT. CL. 3.  
3,248,446, CANC. INT. CL. 3.

PROFESSIONAL BULL RIDERS, INC., COLORADO SPRINGS, CO:  
3,248,015, CANC. INT. CL. 41.

PROFESSIONAL TRANSPORT, INC., CRANSTON, RI:  
3,245,862, CANC. INT. CL. 39.

PROGRAM THREE, LLC, MIAMI, FL:  
4,481,033, PUB. 11-26-2013. INT. CL. 41.

- PROGRESSIVE COMPONENTS INTERNATIONAL CORPORATION, WAUCONDA, IL:  
4,482,230, MULTIPLE CLASS, INT. CLS. 7 AND 9.
- PROJECT JUICE LLC, SAN FRANCISCO, CA:  
4,482,035, MULTIPLE CLASS, INT. CLS. 32 AND 44.
- PROJECT MIRACLE IP HOLDINGS, LLC, NEW YORK, NY:  
4,481,375, MULTIPLE CLASS, INT. CLS. 3 AND 5.
- PROJECT WEST MEDIA, INC., NEWPORT BEACH, CA:  
4,479,668, PUB. 11-26-2013. INT. CL. 35.
- PROMGIRL, LLC, NEW YORK, NY:  
4,479,855, PUB. 11-26-2013. INT. CL. 25.
- PROMPTU SYSTEMS CORPORATION, MENLO PARK, CA:  
4,481,778, MULTIPLE CLASS, INT. CLS. 9 AND 42.  
4,481,779, MULTIPLE CLASS, INT. CLS. 9 AND 42.
- PROPELLANT TECHNOLOGIES, INC., PEACHTREE CITY, GA:  
2,719,872, CANC. INT. CL. 9.
- PROSTAR SPORTS LIMITED, LONDON, UNITED KINGDOM:  
3,246,111, CANC. MULTIPLE CLASS, INT. CLS. 18, 25 AND 28.
- PROTEUS PARTNERS, LLC, AUSTELL, GA:  
4,482,289, INT. CL. 43.
- PROVENSIS LIMITED, UNITED KINGDOM:  
4,479,328, PUB. 11-26-2013. MULTIPLE CLASS, INT. CLS. 5, 10 AND 44.
- PROVIDENCE DAY SCHOOL, INC., CHARLOTTE, NC:  
4,479,746, PUB. 11-26-2013. INT. CL. 41.
- PROVISTA DIAGNOSTICS, INC., SCOTTSDALE, AZ:  
4,482,089, INT. CL. 44.
- PROXIMO SPIRITS, INC., JERSEY CITY, NJ:  
4,482,491, INT. CL. 33.
- PRUNKA, BRIAN, BROOKLYN, NY:  
4,480,199, PUB. 11-26-2013. MULTIPLE CLASS, INT. CLS. 9 AND 41.
- PRUNTY, DANIEL, BROOKSVILLE, FL:  
4,480,684, PUB. 11-26-2013. INT. CL. 37.
- PS BRANDS, LLC, NEW YORK, NY:  
4,482,403, INT. CL. 25.
- PSC INDUSTRIES, INC., LOUISVILLE, KY:  
2,797,644, REN. 1-3-14. INT. CL. 17.
- PSE TECHNOLOGY LLC, RALEIGH, NC:  
4,479,705, PUB. 11-26-2013. INT. CL. 9.
- PSP FRANCHISING, LLC, LIVONIA, MI:  
4,482,681, INT. CL. 21.
- PUBLIC JOINT STOCK COMPANY "OBOLON", KYIV, UKRAINE:  
4,479,642, PUB. 11-26-2013. INT. CL. 32.
- PUBLIC JOINT STOCK COMPANY "OBOLON", KIEV, UKRAINE:  
4,479,644, PUB. 11-26-2013. INT. CL. 32.
- PUR ARGAN, LLC, CORAL SPRINGS, FL:  
4,482,794, INT. CL. 3.
- PURAC BIOCHEM B.V., NETHERLANDS:  
4,479,334, PUB. 11-26-2013. MULTIPLE CLASS, INT. CLS. 1, 5 AND 31.
- PURE & NATURAL COMPANY, SCOTTSDALE, AZ:  
2,720,074, CANC. INT. CL. 5.
- PURE ALASKA SALMON COMPANY, LLC, BELLINGHAM, WA:  
3,417,501, COR. INT. CL. 29.
- PURE BODY SYSTEMS, LLC, SANTA MONICA, CA:  
4,480,427, PUB. 11-26-2013. MULTIPLE CLASS, INT. CLS. 41 AND 44.
- PURE WATER FOR THE WORLD, INC., RUTLAND, VT:  
4,480,061, PUB. 11-26-2013. MULTIPLE CLASS, INT. CLS. 35, 36 AND 41.
- PUREFUN, INC., GLOUCESTER, MA:  
3,247,436, CANC. INT. CL. 28.
- PURESYS CO., LTD, REPUBLIC OF KOREA:  
4,479,337, PUB. 11-26-2013. INT. CL. 11.
- PURINA ANIMAL NUTRITION LLC, SHOREVIEW, MN:  
3,246,050, CANC. INT. CL. 31.  
3,246,058, CANC. INT. CL. 5.  
4,481,786, INT. CL. 5.
- PURINA MILLS LLC, GRAY SUMMIT, MO:  
4,482,439, INT. CL. 31.
- PURLER WRESTLING, INC, FORISTELL, MO:  
3,246,191, CANC. INT. CL. 9.
- PUSH ENTERTAINMENT, LLC, NORTH MIAMI, FL:  
4,480,560, PUB. 11-26-2013. MULTIPLE CLASS, INT. CLS. 9 AND 41.
- PYPCZNSKI, KEVIN, BRICK, NJ:  
4,481,971, INT. CL. 38.
- P31 MINISTRIES, INC., CLAYTON, MO:  
3,246,772, CANC. INT. CL. 45.
- QCK LLC, CINCINNATI, OH:  
4,482,606, MULTIPLE CLASS, INT. CLS. 5 AND 32.
- QINGDAO SG GLOBAL PACKAGING CO., LTD., SHANDONG PROVINCE, CHINA:  
4,479,838, PUB. 11-26-2013. INT. CL. 24.
- QLOGIC CORPORATION, ALISO VIEJO, CA:  
3,248,735, CANC. INT. CL. 9.
- QRATA, LP, HONOLULU, HI:  
4,482,274, INT. CL. 42.  
4,482,319, INT. CL. 42.
- QSR AUTOMATIONS, INC., LOUISVILLE, KY:  
4,480,236, PUB. 11-26-2013. MULTIPLE CLASS, INT. CLS. 9 AND 42.
- QUADRANT DISTRIBUTION, LLC, ONTARIO, CA:  
3,247,035, CANC. INT. CL. 16.  
3,247,036, CANC. INT. CL. 16.  
3,247,037, CANC. INT. CL. 36.
- QUAKER DOG, LLC, NEW YORK, NY:  
3,247,594, CANC. INT. CL. 20.
- QUALA, INC, TORTOLA, BR. VIRGIN ISLANDS:  
4,479,720, PUB. 11-26-2013. INT. CL. 30.  
4,479,721, PUB. 11-26-2013. INT. CL. 30.
- QUALCOMM ATHEROS, INC., SAN JOSE, CA:  
4,481,869, INT. CL. 9.
- QUALITY ASSURED SERVICES, INC., ORLANDO, FL:  
3,246,943, CANC. INT. CL. 41.
- QUALITY CONFECTIONERY & FOOD PRODUCTS, CASTLE ROCK, CO:  
3,248,741, CANC. INT. CL. 30.
- QUALITYSMITH, INC., WALLA WALLA, WA:  
3,248,495, CANC. INT. CL. 37.
- QUANTUM CAPITAL MANAGEMENT, LLC, NORTHFIELD, NJ:  
4,480,670, PUB. 11-26-2013. INT. CL. 36.  
4,480,671, PUB. 11-26-2013. INT. CL. 36.
- QUANTUM ENDEAVORS, INC., WINFIELD, IL, FORMERLY TRANSFORMATIONAL LEADERSHIP COACHING, INC.:  
4,480,840, PUB. 11-26-2013. INT. CL. 41.
- QUANTUM JEWELRY DISTRIBUTORS, INC., AKRON, OH:  
3,246,592, CANC. INT. CL. 14.
- QUANTUM VECTOR CORP., WOOD RIDGE, NJ:  
3,248,370, CANC. INT. CL. 14.
- QUANZHOU LIYANG SPORTBAG CO., LTD., CHINA:  
4,479,403, PUB. 11-26-2013. INT. CL. 18.
- QUEST DIAGNOSTICS INVESTMENTS INCORPORATED, WILMINGTON, DE:  
4,481,539, MULTIPLE CLASS, INT. CLS. 42 AND 44.  
4,481,630, MULTIPLE CLASS, INT. CLS. 9 AND 16.
- QUIKRETE INTERNATIONAL, INC., ATLANTA, GA:  
3,246,120, CANC. INT. CL. 19.
- QUINCE MEDIA, LLC, VAN ALSTYNE, TX:  
3,248,500, CANC. MULTIPLE CLASS, INT. CLS. 16 AND 35.
- QUINTESSENTIAL, LLC, NAPA, CA:  
4,482,367, INT. CL. 33.
- QURI, INC., KENTFIELD, CA:  
4,481,808, MULTIPLE CLASS, INT. CLS. 35 AND 42.
- QVC, INC., WEST CHESTER, PA:  
2,813,699, REN. 1-3-14. INT. CL. 25.  
4,482,294, INT. CL. 25.
- QWEST COMMUNICATIONS INTERNATIONAL INC., DENVER, CO:  
3,247,333, CANC. INT. CL. 38.  
3,247,468, CANC. INT. CL. 35.  
3,247,664, CANC. INT. CL. 41.
- R & A BAILEY & CO, DUBLIN 12, IRELAND:  
4,482,428, INT. CL. 29.

R & D SHED, L.L.C., CLEARWATER, FL, ACCON, INC., CLEARWATER, FL:  
1,868,166. REN. 1-6-14. MULTIPLE CLASS, INT. CLS. 11 AND 12.

R. C. BIGELOW INC., FAIRFIELD, CT:  
1,243,021. REN. 1-3-14. INT. CL. 30.

R. TWINING AND COMPANY LIMITED, LONDON, UNITED KINGDOM:  
4,481,964, INT. CL. 30.

R.J MAX, INC., MIAMI, FL:  
4,480,379, PUB. 11-26-2013. INT. CL. 25.

R.M.PENYAK & CO., LANSDALE, PA:  
2,802,287. REN. 1-3-14. INT. CL. 37.

R&M FABRICS, INC, CAPE GIRARDEAU, MO:  
4,479,880, PUB. 11-26-2013. INT. CL. 24.

RAB LIGHTING INC., NORTHVALE, NJ:  
4,481,727, INT. CL. 11.  
4,481,736, INT. CL. 11.

RACE TEXAS SPORTS LLC, COLLEGE STATION, TX, DBA RACE TEXAS:  
4,480,851, PUB. 11-26-2013. INT. CL. 41.

RACKSPACE US, INC., SAN ANTONIO, TX, DBA RACKSPACE MANAGED HOSTING:  
3,246,427, CANC. MULTIPLE CLASS, INT. CLS. 35 AND 42.

RADIANT OPTO-ELECTRONICS CORPORATION, KAOHSIUNG, TAIWAN:  
4,480,152, PUB. 8-27-2013. MULTIPLE CLASS, INT. CLS. 9, 11 AND 40.

RADIATION SHIELD TECHNOLOGIES, INC., CORAL GABLES, FL:  
2,799,262. REN. 1-6-14. INT. CL. 9.

RADON PROTECTION SPECIALISTS, INC., BURR RIDGE, IL 60527, IL:  
4,481,632, INT. CL. 42.

RADWARE LTD., TEL AVIV, ISRAEL:  
4,479,608, PUB. 11-26-2013. INT. CL. 9.

RADY CHILDREN'S HOSPITAL AND HEALTH CENTER, SAN DIEGO, CA:  
3,247,258, CANC. INT. CL. 44.

RAGEBALL 5 LLC, AZLE, TX:  
3,248,274, CANC. INT. CL. 28.

RAIN SHINE, LLC, MONTEBELLO, CA:  
4,480,500, PUB. 11-26-2013. INT. CL. 5.

RAINBOW S.R.L., I-60025 LORETO (AN), ITALY:  
4,479,307, PUB. 8-13-2013. MULTIPLE CLASS, INT. CLS. 9, 16, 25, 28 AND 41.

RAINBOW SANDALS, INC., SAN CLEMENTE, CA:  
1,264,326. REN. 1-8-14. INT. CL. 25.

RAINPAL MERCHANDISE LTD., NEW TAIPEI CITY, TAIWAN:  
3,245,842, CANC. INT. CL. 24.

RAISE BY WOLVES, INC., MONTREAL, CANADA, DBA RAISED BY WOLVES:  
4,480,828, PUB. 11-26-2013. INT. CL. 25.

RAISING MORE MONEY INC., SEATTLE, WA:  
2,799,308. REN. 1-6-14. INT. CL. 9.

RAJ AMI INC., MILPITAS, CA, DBA OLDAPPS.COM:  
4,482,851, INT. CL. 42.

RAJBHOG FOODS INC, FLUSHING, NY:  
4,481,531, INT. CL. 29.

RAM PARTNERS, LLC, ATLANTA, GA:  
2,819,869. REN. 1-8-14. INT. CL. 36.

RAMIREZ, SHANNON, MAMMOTH, AZ AND RAMIREZ, LAURIST, MAMMOTH, AZ:  
4,482,783, INT. CL. 25.

RAMM, KARL, LAKE FORREST, CA:  
4,480,068, PUB. 11-26-2013. MULTIPLE CLASS, INT. CLS. 7 AND 8.

RAMP KING, INC., AUSTIN, TX:  
4,480,752, PUB. 11-26-2013. INT. CL. 35.

RANBAXY LABORATORIES, INC., PRINCETON, NJ:  
975,809. REN. 1-7-14. U.S. CL. 18 (INT. CL. 5).

RANCE' & C. S.R.L., MILANO, ITALY:  
4,482,096, INT. CL. 3.

RANDALL, EDWIN, NEW YORK, NY:  
4,480,759, PUB. 11-26-2013. INT. CL. 41.

RAPID SCRUM LLC, LOS ANGELES, CA:  
4,480,923, PUB. 11-26-2013. INT. CL. 9.

RATTLEBACK, INC., COLUMBUS, OH:  
4,479,850, PUB. 11-26-2013. INT. CL. 35.

RAVENS & WOLVES, LLC, ALPHARETTA, GA:  
4,482,074, INT. CL. 41.

RAY DISTRIBUTING CO., VICTORIA, TX, DBA TEXAS TACKLE FACTORY:  
4,482,785, INT. CL. 28.

RAYTHEON COMPANY, WALTHAM, MA:  
3,247,864, CANC. INT. CL. 9.

RBR, LLC, VERNON, CA:  
4,481,243, PUB. 11-26-2013. INT. CL. 25.

RCK FOOTWEAR, INC., CITY OF INDUSTRY, CA:  
3,246,853, CANC. INT. CL. 25.

RE:DISCOVER, INC., SAN FRANCISCO, CA, FORMERLY A CAPPELLA RECORDS, INC.:  
4,480,565, PUB. 11-26-2013. INT. CL. 42.

READING, WRITING & RHYTHM, INC., BELTON, MO:  
3,246,583, CANC. INT. CL. 36.

READVENTURED, CARLSBAD, CA:  
4,480,639, PUB. 11-26-2013. MULTIPLE CLASS, INT. CLS. 35 AND 41.

READY PAC PRODUCE, INC., IRWINDALE, CA:  
2,718,614, CANC. INT. CL. 29.

READY READERS, ST. LOUIS, MO:  
4,480,947, PUB. 11-26-2013. INT. CL. 41.  
4,480,948, PUB. 11-26-2013. INT. CL. 41.

READYCAP COMMERCIAL, LLC, NEW YORK, NY:  
4,482,243, INT. CL. 36.

READYROPE, LLC, CHARLOTTESVILLE, VA:  
4,482,117, INT. CL. 13.  
4,482,118, INT. CL. 25.

REAL GUYS FOUNDATION, NEWPORT BEACH, CA:  
4,480,366, PUB. 11-26-2013. INT. CL. 41.

REALLY LOVE DOGS INC., NEW YORK, NY:  
4,480,462, PUB. 11-26-2013. INT. CL. 44.

REALM LABS, LLC, DELRAY BEACH, FL:  
4,482,020, INT. CL. 5.

REALTOR ASSOCIATION OF GREATER FORT LAUDERDALE INC., FORT LAUDERDALE, FL, DBA GREATER FORT LAUDERDALE REALTORS:  
4,482,824, INT. CL. 36.

REBECCA & DREW MANUFACTURING, LLC, NEW YORK, NY:  
3,248,325, CANC. INT. CL. 25.

REBECCA BLAESING, CUMBERLAND CENTER, ME:  
4,480,777, PUB. 11-26-2013. INT. CL. 16.

REC FINANCIAL, LLC, MESA, AZ:  
3,247,172, CANC. INT. CL. 36.

RECKITT BENCKISER LLC, PARSIPPANY, NJ:  
3,373,932, CANC. INT. CL. 3.  
4,482,726, MULTIPLE CLASS, INT. CLS. 3 AND 5.

RECOVERCARE, LLC, LOUISVILLE, KY:  
1,818,236. REN. 1-9-14. INT. CL. 42.

RECYCLED BROOKLYN, INC., BROOKLYN, NY:  
4,482,847, MULTIPLE CLASS, INT. CLS. 20 AND 35.

RECYCLED PAPERBOARD TECHNICAL ASSOCIATION, ELGIN, IL:  
4,481,907, INT. CL. 35.

RED ACE, LLC, BOULDER, CO:  
4,481,745, INT. CL. 5.

RED BEND LTD., ROSH HA'AYIN, ISRAEL:  
2,819,575. REN. 1-8-14. INT. CL. 9.

RED BULL GMBH, 5330 FUSCHL AM SEE, AUSTRIA:  
3,245,703, CANC. MULTIPLE CLASS, INT. CLS. 32 AND 42.

RED DUCK FOODS LLC, EUGENE, OR:  
4,481,022, PUB. 11-26-2013. INT. CL. 30.

RED MAPLE PRODUCT (CANADA) LTD, RICHMOND, BC V7A 2A5, CANADA:  
3,247,411, CANC. INT. CL. 19.

RED ROCK DISTRIBUTING LTD. COMPANY, ALBUQUERQUE, NM:  
4,480,164, PUB. 11-26-2013. INT. CL. 30.

RED ROCK PARTNERS, LTD, LAS VEGAS, NV:  
3,247,574, CANC. INT. CL. 43.

- RED TAIL NETWORKS, INC., SANTA BARBARA, CA:  
1,717,746, CANC. INT. CL. 9.
- REDLYNX OY, HELSINKI, FINLAND:  
4,480,012, PUB. 6-18-2013. INT. CL. 41.
- REDMOND, INCORPORATED, HEBER CITY, UT:  
4,480,274, PUB. 11-26-2013. INT. CL. 5.
- REDOXYGEN INC, SAN FRANCISCO, CA:  
4,480,513, PUB. 11-26-2013. INT. CL. 38.
- REDSTART SYSTEMS INC., BOSTON, MA:  
3,246,355, CANC. INT. CL. 9.
- REED ELSEVIER INC., NEWTON, MA:  
2,718,494, CANC. INT. CL. 16.  
3,248,631, CANC. INT. CL. 35.
- REED ELSEVIER PROPERTIES INC., WILMINGTON, DE:  
4,481,229, PUB. 11-26-2013. INT. CL. 42.
- REED OMARY, CHICAGO, IL AND ANDREW LARSON,  
CHICAGO, IL:  
4,481,426, INT. CL. 5.  
4,481,427, INT. CL. 5.
- REED, CARINA DAWN, SHERMAN OAKS, CA, DBA PINK  
PIXIE:  
4,479,698, PUB. 7-23-2013. INT. CL. 35.
- REED, CONNER & BIRDWELL, LLC, LOS ANGELES, CA:  
3,247,374, CANC. INT. CL. 35.
- REED, MARK, IOWA PARK, TX:  
4,480,302, PUB. 11-26-2013. INT. CL. 40.
- REESE & ASSOCIATES ADVERTISING, INC., WYOMISS-  
ING, PA:  
3,245,911, CANC. INT. CL. 16.
- REESE ENGINEERING LIMITED, PALMERSTON NORTH,  
NEW ZEALAND:  
2,729,469, REN. 1-3-14. INT. CL. 7.
- REGAL BELOIT AMERICA, INC., BELOIT, WI:  
2,802,577, REN. 1-3-14. INT. CL. 7.  
2,904,731, REN. 1-3-14. INT. CL. 7.
- REGEN BIOSCIENCES, INC., NEW YORK, NY AND IN-  
TELLICELL BIOSCIENCES, INC., NEW YORK, NY:  
4,481,456, INT. CL. 5.
- REGENEUS LTD, AUSTRALIA:  
4,479,276, PUB. 11-26-2013. INT. CL. 44.
- REGENTS OF THE UNIVERSITY OF MICHIGAN, THE,  
ANN ARBOR, MI:  
2,718,750, CANC. INT. CL. 41.
- REHCO, LLC, CHICAGO, IL:  
3,248,145, CANC. INT. CL. 21.
- REI SYSTEMS, INC., CHANTILLY, VA:  
4,480,933, PUB. 11-26-2013. INT. CL. 42.
- REICHERT, INC., DEPEW, NY, MENTOR O&O INC.,  
NORWELL, MA:  
1,837,812, REN. 1-6-14. INT. CL. 10.
- REINHARDT, IVONNE, LAS VEGAS, NV, DBA CRES  
MOVEMENT:  
4,480,384, PUB. 11-26-2013. INT. CL. 44.
- RELATIONSHIP AUDITS & MANAGEMENT LTD., LON-  
DON, UNITED KINGDOM:  
2,913,287, REN. 1-7-14. MULTIPLE CLASS, INT. CLS. 16  
AND 35.
- RELIGIOUS CONFERENCE MANAGEMENT ASSOCIA-  
TION, INC., INDIANAPOLIS, IN:  
4,480,198, PUB. 11-26-2013. MULTIPLE CLASS, INT. CLS.  
35 AND 41.
- RELIGIOUS TECHNOLOGY CENTER, LOS ANGELES, CA:  
4,480,973, PUB. 11-26-2013. INT. CL. 45.  
4,481,245, PUB. 11-26-2013. INT. CL. 45.  
4,481,246, PUB. 11-26-2013. INT. CL. 45.  
4,481,247, PUB. 11-26-2013. INT. CL. 45.  
4,481,290, PUB. 11-26-2013. INT. CL. 9.  
4,481,291, PUB. 11-26-2013. INT. CL. 9.
- REM SALES LLC, EAST GRANBY, CT:  
3,247,577, CANC. INT. CL. 35.
- REMEMBER THE MILK, INC., SAN FRANCISCO, CA:  
4,481,065, PUB. 11-26-2013. MULTIPLE CLASS, INT. CLS.  
9 AND 42.
- REMO, INC., VALENCIA, CA:  
3,245,865, CANC. INT. CL. 15.
- REMY COINTREAU, FRANCE:  
3,247,811.
- RENAISSANT DEVELOPMENT GROUP LLC, OAK BROOK,  
IL:  
3,247,575, CANC. INT. CL. 37.
- RENEE-MARIE STEPHANO, PALM BEACH GARDENS, FL:  
4,482,873, INT. CL. 41.
- RENEW IMAGING, INC., SAN DIEGO, CA:  
3,248,494, CANC. INT. CL. 2.
- RENEW REFINISHING SYSTEMS, INC., LAWRENCE-  
VILLE, GA:  
3,246,360, CANC. INT. CL. 37.
- RENGOLUTION, INC., PLYMOUTH, MN:  
4,481,501, INT. CL. 42.
- RENNER, THOMAS I, PLEASANT HILL, OH:  
3,245,946, CANC. INT. CL. 12.
- RENTRAK CORPORATION, PORTLAND, OR:  
4,481,795, INT. CL. 35.
- REPORT COLLECTION INC., VILLE MONT-ROYAL, QC,  
CANADA:  
4,418,864, COR. MULTIPLE CLASS, INT. CLS. 18 AND  
25.
- REPUBLIC MORTGAGE INSURANCE CO., WINSTON-  
SALEM, NC:  
2,719,822, CANC. INT. CL. 36.
- REQUESTZ SYSTEMS, LLC, CHARLOTTE, NC:  
4,480,848, PUB. 11-26-2013. INT. CL. 9.
- RESEARCH PARTNERSHIP TO SECURE ENERGY FOR  
AMERICA, SUGAR LAND, TX:  
3,246,563, CANC. INT. CL. 35.
- RESINATE TECHNOLOGIES, INC., ANN ARBOR, MI:  
4,229,180, COR. INT. CL. 40.
- RESINATE TECHNOLOGIES, INC., PLYMOUTH, MI:  
4,322,103, COR. INT. CL. 40.
- RESUME COMPANION LLC, WILMINGTON, DE:  
4,480,726, PUB. 11-26-2013. INT. CL. 35.  
4,480,728, PUB. 11-26-2013. INT. CL. 35.  
4,480,729, PUB. 11-26-2013. INT. CL. 35.
- RETAIL EXPERT, INC., BOCA RATON, FL:  
2,719,328, CANC. INT. CL. 9.
- RETIREMENT INCOME SOLUTIONS ENTERPRISE, INC.,  
ROSWELL, GA:  
3,247,646, CANC. INT. CL. 36.
- REV'D UP, INC., PHOENIX, AZ:  
4,481,184, PUB. 11-26-2013. INT. CL. 42.
- REVANA, MADAIAH, HOUSTON, TX:  
4,481,420, INT. CL. 33.
- REVENUE WISE, INC., TIBURON, CA:  
4,481,838, MULTIPLE CLASS, INT. CLS. 9, 16, 35, 41 AND  
45.
- REVIEWMYCONTRACT, LLC, OVERLAND PARK, KS:  
4,480,788, PUB. 11-26-2013. INT. CL. 35.
- REVITA-DERM, INC., MIRAMAR, FL:  
4,481,428, INT. CL. 3.
- REVIVERSOFT, WALNUT CREEK, CA:  
4,480,654, PUB. 11-26-2013. INT. CL. 41.
- REVMAN INTERNATIONAL, INC., NEW YORK, NY:  
3,246,202, CANC. INT. CL. 24.
- REX, DUPEA, BILLINGS, MT:  
3,246,826, CANC. INT. CL. 43.
- REYES, JOHN ELTER, RENTON, WA AND REYES, MARIA  
VICTORIA, RENTON, WA:  
4,482,611, INT. CL. 42.
- REYNOLDS INNOVATIONS INC., WINSTON-SALEM, NC:  
4,481,646, INT. CL. 34.
- RF DELAWARE, INC., WILMINGTON, DE:  
1,788,837, REN. 1-8-14. INT. CL. 11.
- RF-LAMBDA USA INC., SAN DIEGO, CA:  
4,480,204, PUB. 11-26-2013. INT. CL. 9.  
4,480,205, PUB. 11-26-2013. INT. CL. 9.  
4,480,206, PUB. 11-26-2013. INT. CL. 9.
- RFL ELECTRONICS INC., BOONTON TOWNSHIP, NJ:  
4,480,602, PUB. 11-26-2013. INT. CL. 9.
- RHEEM MANUFACTURING COMPANY, ATLANTA, GA:  
3,247,939, CANC. MULTIPLE CLASS, INT. CLS. 9 AND  
11.
- RHEINMETALL AIR DEFENCE AG, SWITZERLAND:  
4,479,268, PUB. 11-26-2013. MULTIPLE CLASS, INT. CLS.  
9 AND 13.



RHEINMETALL DEFENCE ELECTRONICS GMBH, BREMEN, FED REP GERMANY:  
3,246,312, CANC. MULTIPLE CLASS, INT. CLS. 9, 13 AND 37.

RHODIA BRASIL LTDA, 05804-902 SAO PAULO-SP, BRAZIL:  
4,479,255, PUB. 9-17-2013. MULTIPLE CLASS, INT. CLS. 23, 24 AND 25.

RICE, GERARD MARK, FLORISSANT, MO:  
4,481,640, INT. CL. 35.

RICE, NORMAN B, MUNROE FALLS, OH:  
3,246,813, CANC. INT. CL. 17.

RICHARD DAVIS INC., LEANDER, TX:  
4,481,638, INT. CL. 20.

RICHARD DEAN MCFARLAND, CINCINNATI, OH:  
4,480,926, PUB. 11-26-2013. INT. CL. 8.

RICHARD J. MACKOOL, ASTORIA, NY:  
4,480,435, PUB. 11-26-2013. INT. CL. 41.

RICHARD J. RACOSKY, BOULDER, CO:  
4,482,351, INT. CL. 9.

RICHARD LEEDS INTERNATIONAL, INC., NEW YORK, NY:  
2,799,154. REN. 1-6-14. INT. CL. 25.

RICHARD N. HEINZ, GLADSTONE, MI:  
3,248,547, CANC. INT. CL. 20.

RICHARD STANLEY PLATT, MILL VALLEY, CA AND LORRAINE HELEN PLATT, MILL VALLEY, CA:  
3,246,988, CANC. INT. CL. 44.

RICHARDS, KATHERINE K, AUBURN, CA, DBA FIT KIDS PUBLISHING:  
4,480,530, PUB. 11-26-2013. INT. CL. 16.

RICHMAN, DEBORAH K., HUNTINGTON, NY:  
2,718,739, CANC. INT. CL. 3.

RICK AYERS, FREDERICK, MD:  
4,480,380, PUB. 11-26-2013. INT. CL. 9.

RICKMAN, STEVEN J., ATLANTA, GA:  
4,481,698, MULTIPLE CLASS, INT. CLS. 25 AND 43.

RICOH CO., LTD., TOKYO, JAPAN:  
3,246,871, CANC. INT. CL. 9.

RIEF, EARL, SAN DIEGO, CA:  
3,246,640, CANC. INT. CL. 35.

RIGHT AT HOME, INC., OMAHA, NE:  
4,480,761, PUB. 11-26-2013. MULTIPLE CLASS, INT. CLS. 44 AND 45.  
4,481,215, PUB. 11-26-2013. MULTIPLE CLASS, INT. CLS. 44 AND 45.

RIMOWA GMBH, COLOGNE, FED REP GERMANY:  
4,479,605, PUB. 8-27-2013. MULTIPLE CLASS, INT. CLS. 9 AND 18.

RINGDNA, INC, SHERMAN OAKS, CA:  
4,480,611, PUB. 11-26-2013. MULTIPLE CLASS, INT. CLS. 9 AND 38.

RINGSIDE SEARCH PARTNERS, LLC, COLUMBUS, OH:  
4,480,715, PUB. 11-26-2013. INT. CL. 35.

RIO MANAGEMENT GROUP, LLC, SALT LAKE CITY, UT:  
4,480,317, PUB. 11-26-2013. INT. CL. 36.

RIO PERLA PROPERTIES, L.P., SAN ANTONIO, TX:  
4,481,334, INT. CL. 36.

RISO KAGAKU CORPORATION, TOKYO, JAPAN:  
2,854,622. REN. 1-8-14. MULTIPLE CLASS, INT. CLS. 2 AND 9.

RIVELLO, JOSEPH M., LOS ALAMITOS, CA:  
2,725,413. REN. 1-8-14. INT. CL. 12.

RIVER MOSS TECHNOLOGIES, LLC, BOISE, ID:  
4,480,252, PUB. 10-15-2013. INT. CL. 35.

RIVERS BAILEY, PAUL, COHOES, NY:  
4,481,889, INT. CL. 25.

RJR FASHION, INC., LA MIRADA, CA:  
4,481,066, PUB. 11-26-2013. INT. CL. 9.

RMG NETWORKS, INC., SAN FRANCISCO, CA:  
4,482,421, MULTIPLE CLASS, INT. CLS. 9 AND 42.

RMK ACCESSORIES, INC., CRANBERRY TOWNSHIP, PA:  
3,248,562, CANC. INT. CL. 18.

RMS PACKAGING, INC., PEEKSKILL, NY:  
2,719,731, CANC. INT. CL. 17.

RO.DI. GROUP S.R.L., ZOLA PREDOSA (BO), ITALY:  
4,480,880, PUB. 11-26-2013. INT. CL. 25.

ROAT CORP., FISHERS, IN:  
3,246,660, CANC. INT. CL. 42.

ROB DAY, PITTSBURGH, PA:  
4,482,578, INT. CL. 30.

ROB HERSCHENFELD DESIGN INC., BROOKLYN, NY:  
4,479,730, PUB. 11-26-2013. INT. CL. 42.

ROBBINS BROS. JEWELRY, INC., AZUSA, CA:  
3,248,687, CANC. INT. CL. 41.

ROBERT A. KOMINIAREK DO INC., SPRINGBORO, OH:  
4,480,449, PUB. 11-26-2013. INT. CL. 44.

ROBERT ASHLEY GREEN, LOS ANGELES, CA:  
4,479,675, PUB. 11-26-2013. INT. CL. 35.

ROBERT BOWNE FOUNDATION, INC., THE, NEW YORK, NY:  
2,718,786, CANC. INT. CL. 16.

ROBERT HALF INTERNATIONAL INC., MENLO PARK, CA:  
4,482,350, INT. CL. 35.  
4,482,471, INT. CL. 35.

ROBERT J. SHAW, KLAMATH FALLS, OR:  
4,480,648, PUB. 11-26-2013. INT. CL. 6.

ROBERT NEIL COOPER, WILLOW GROVE, PA:  
3,248,572, CANC. INT. CL. 38.

ROBERTS, DAVID, PERRIS, CA:  
3,248,482, CANC. INT. CL. 15.

ROBERTS, JONATHAN, LAKELAND, FL:  
4,481,578, INT. CL. 25.

ROBO VAULT, LLC, FR. LAUDERDALE, FL:  
3,246,383, CANC. MULTIPLE CLASS, INT. CLS. 36 AND 39.

ROBOT DESIGN LTD, BRIGHTON, BN1 4AP, EAST SUSSEX, UNITED KINGDOM:  
3,247,879, CANC. MULTIPLE CLASS, INT. CLS. 11, 14, 16, 20, 21 AND 24.

ROBOWSKY, GARY STUART, NEW ROCHELLE, NY:  
3,247,040, CANC. MULTIPLE CLASS, INT. CLS. 9 AND 37.

ROCHA, SIMONE, DUBLIN, IRELAND:  
4,480,162, PUB. 11-26-2013. INT. CL. 25.

ROCK-TENN SHARED SERVICES, LLC, NORCROSS, GA:  
3,248,291, CANC. INT. CL. 16.  
4,480,341, PUB. 11-26-2013. INT. CL. 7.  
4,480,443, PUB. 11-26-2013. MULTIPLE CLASS, INT. CLS. 7 AND 16.

ROCKET SOFTWARE, INC., WALTHAM, MA:  
2,799,334. REN. 1-3-14. INT. CL. 9.

ROCKHURST UNIVERSITY CONTINUING EDUCATION CENTER, INC., KANSAS CITY, MO:  
4,480,690, PUB. 11-26-2013. INT. CL. 41.

ROCKIN' JUMP HOLDINGS, LLC, PLEASANTON, CA:  
4,480,024, PUB. 11-26-2013. INT. CL. 41.

ROCKY BRANDS WHOLESALE LLC, NELSONVILLE, OH:  
4,481,552, INT. CL. 18.

RODGERS INSTRUMENTS LLC, HILLSBORO, OR:  
3,248,098, CANC. INT. CL. 15.  
3,248,099, CANC. INT. CL. 15.

ROEHL TRANSPORT, INC., MARSHFIELD, WI:  
4,480,767, PUB. 11-26-2013. INT. CL. 35.

ROEX, INC., IRVINE, CA:  
3,248,644, CANC. INT. CL. 5.

ROGERS, ERIC, CHARLOTTE, NC AND ROGERS, TONIA, CHARLOTTE, NC:  
4,479,858, PUB. 11-26-2013. INT. CL. 41.

ROGOBOX LLC, MIAMI, FL:  
4,481,922, INT. CL. 35.

ROLAND EUROPE S.P.A., ITALY:  
4,479,361, PUB. 11-26-2013. INT. CL. 15.

ROLLING STONE LLC, NEW YORK, NY:  
4,480,394, PUB. 11-26-2013. INT. CL. 41.

ROLLINGGREENS LLC, BOULDER, CO:  
4,481,104, PUB. 11-26-2013. INT. CL. 43.

ROMAN, MANDY, BROOKLYN, NY, DBA RED TRIBE:  
4,480,090, PUB. 11-26-2013. INT. CL. 25.

ROMANO, CHASE, HOUSTON, TX:  
4,481,670, INT. CL. 25.

ROMERO, CHARLE, HAYWARD, CA:  
2,719,105, CANC. INT. CL. 28.

- ROMERO, D. JOSE PASCUAL, IBIZA, SPAIN:  
3,246,405, CANC. INT. CL. 41.
- RON JON SURF SHOP OF FLA., INC., COCOA BEACH, FL:  
3,245,967, CANC. INT. CL. 32.
- RONNIE'S CERAMIC CO., INC., SAN FRANCISCO, CA:  
3,246,532, CANC. INT. CL. 21.
- ROOTS CANADA LTD., TORONTO, ONTARIO, CANADA:  
2,677,535, REN. 1-9-14, INT. CL. 20.
- RORION GRACIE, SANTA BARBARA, CA:  
4,481,315, INT. CL. 25.
- ROSCOE MEDICAL, INC., STRONGSVILLE, OH:  
4,480,041, PUB. 11-26-2013, INT. CL. 10.
- ROSE, JOSEPH W., GOLD RIVER, CA:  
4,480,883, PUB. 11-26-2013, INT. CL. 45.
- ROSECRANCE HEALTH NETWORK, ROCKFORD, IL:  
4,479,889, PUB. 11-26-2013, MULTIPLE CLASS, INT. CLS.  
41 AND 44.
- ROSEMOUNT OFFICE SYSTEMS LLC, LAKEVILLE, MN:  
3,248,360, CANC. INT. CL. 20.
- ROSEN HOTELS & RESORTS, INC., ORLANDO, FL:  
1,779,858, REN. 1-9-14, INT. CL. 41.
- ROSENBERGER OF NORTH AMERICA, LLC, LANCASTER, PA:  
3,248,634, CANC. INT. CL. 9.
- ROSENTHAL COLLINS GROUP, LLC, CHICAGO, IL:  
3,246,007, CANC. INT. CL. 9.
- ROSENWACH TANK CO. LLC, LONG ISLAND CITY, NY:  
4,479,618, PUB. 11-26-2013, INT. CL. 25.
- ROSS METALS CORPORATION, NEW YORK, NY:  
4,482,227, MULTIPLE CLASS, INT. CLS. 35 AND 40.
- ROSS, DONALD W., CONCORD, NH, DBA ROSSVIEW FARM L.L.C.:  
4,480,458, PUB. 11-26-2013, INT. CL. 31.
- ROTARY INTERNATIONAL, EVANSTON, IL:  
4,479,543, PUB. 11-26-2013, MULTIPLE CLASS, INT. CLS.  
16, 35, 36, 41 AND 45.
- ROTHBERG, SARANNE, TENAFLY, NJ:  
2,803,680, REN. 1-6-14, INT. CL. 16.
- ROUND 4 PUTTERS, LLC, POMPANO BEACH, FL:  
4,482,433, INT. CL. 28.
- ROVIRA, CAROL ANN, LAKE SAINT LOUIS, MO AND MCGARVIN, MARILYN, RUTHERFORD, NJ AND MCGARVIN, LOUISE, WAYNE, NJ:  
3,246,788, CANC. INT. CL. 35.
- ROYAL & ANCIENT LOTION, SCOTTSDALE, AZ:  
4,479,821, PUB. 11-26-2013, INT. CL. 3.
- ROYAL BANK OF CANADA, MONTREAL, PROVINCE OF, CANADA, ROYAL BANK OF CANADA, THE, MONTREAL, QUEBEC, CANADA:  
963,858, REN. 1-9-14, U.S. CL. 102 (INT. CL. 36).
- ROYAL BATTERY DISTRIBUTORS, INC., KISSIMMEE, FL, DBA ROYAL BATTERY:  
4,481,270, PUB. 11-26-2013, INT. CL. 9.
- ROYAL CASE COMPANY, INC., SHERMAN, TX:  
4,480,465, PUB. 11-26-2013, INT. CL. 20.
- ROYAL GREENLAND A/S, GREENLAND:  
3,247,799.
- ROYAL IMEX INC., SANTA FE SPRINGS, CA:  
4,481,279, PUB. 11-26-2013, INT. CL. 26.
- ROYAL REMODELING, HARROGATE, TN:  
3,246,302, CANC. INT. CL. 37.
- ROYAL TIGER PUBLISHING LIMITED, COLUMBUS, OH:  
3,246,673, CANC. INT. CL. 16.
- ROYAL WINE CORPORATION, BAYONNE, NJ:  
4,482,632, INT. CL. 30.
- ROYALTY CLOTHING LLC, SAN RAMON, CA:  
4,482,510, INT. CL. 25.
- RR INVESTMENTS, INC., DALLAS, TX, DBA MILLION AIR:  
1,307,454, REN. 1-6-14, INT. CL. 39.
- RTH, INC., LAS VEGAS, NV:  
4,482,738, INT. CL. 37.
- RUBENSLUCIANO S.R.L., ITALY:  
3,247,756.
- RUGBY DIVISION SAS, FRANCE:  
4,479,384, PUB. 11-26-2013, MULTIPLE CLASS, INT. CLS.  
9, 25 AND 28.
- RUIAN KEFENG ELECTRONIC CO., LTD., RUIAN CITY, ZHEJIANG, CHINA:  
4,481,172, PUB. 11-26-2013, INT. CL. 9.
- RUIZ, DAVID M., COSTA MESA, CA:  
4,481,386, INT. CL. 9.
- RUIZ, ELIAS, HUGHSON, CA:  
4,481,083, PUB. 11-26-2013, INT. CL. 12.
- RUIZ, FERNANDO PATRICIO, ARROYO GRANDE, CA AND LOBATO, FRANCISCO RIZO, ARROYO GRANDE, CA:  
4,479,829, PUB. 11-26-2013, INT. CL. 43.
- RUKO LLC, BATON ROUGE, LA:  
4,482,520, INT. CL. 8.
- RULE STEEL TANKS, INC., CALDWELL, ID:  
1,812,694, REN. 1-4-14, INT. CL. 6.
- RUMBLEFISH, INC., PORTLAND, OR:  
3,246,233, CANC. MULTIPLE CLASS, INT. CLS. 35 AND 45.
- RUNDLEFIT, SPOKANE, WA:  
4,480,723, PUB. 11-26-2013, INT. CL. 41.
- RUNNING DIRTY, LLC, ELKRIDGE, MD:  
4,480,746, PUB. 11-26-2013, INT. CL. 35.
- RUPERT, GIBBONS & SPIDER, INC., HEALDSBURG, CA:  
3,247,270, CANC. INT. CL. 16.
- RUSSELL BEDFORD INTERNATIONAL, LONDON, UNITED KINGDOM:  
4,480,949, PUB. 11-26-2013, U.S. CL. 200.
- RUSSELL MINARY, LOUISVILLE, CO:  
4,480,172, PUB. 11-26-2013, INT. CL. 35.
- RUSSELL'S NURSERY, AURORA, OR:  
4,479,570, PUB. 8-20-2013, INT. CL. 31.
- RUST-OLEUM BRANDS COMPANY, VERNON HILLS, IL:  
590,496, REN. 1-9-14, U.S. CL. 16 (INT. CL. 2).
- RUTHERFORD STEEL BUILDINGS COMPANY LLC, ALLENTOWN, PA:  
4,481,422, INT. CL. 6.
- RUYAN CORPORATION, BOCA RATON, FL:  
3,247,645, CANC. INT. CL. 42.
- RW INDUSTRIES LTD., OAKVILLE, ONTARIO:  
3,248,144, CANC. MULTIPLE CLASS, INT. CLS. 20, 35 AND 42.
- RWACHSBERG HOLDINGS INC., TORONTO, ONTARIO, CANADA:  
4,479,264, PUB. 4-16-2013, INT. CL. 3.
- RXHEAT, LLC, CHESTERFIELD, MO:  
4,481,444, MULTIPLE CLASS, INT. CLS. 37, 40 AND 41.
- RYAN GOODWIN, SALT LAKE CITY, UT:  
4,481,157, PUB. 11-26-2013, MULTIPLE CLASS, INT. CLS.  
16 AND 25.
- 4,481,159, PUB. 11-26-2013, MULTIPLE CLASS, INT. CLS.  
16 AND 25.
- RYCHTYK, JAMES E, HIGHLAND VILLAGE, TX:  
4,480,751, PUB. 11-26-2013, INT. CL. 28.
- S & P SYNDICATE PUBLIC COMPANY LIMITED, BANGKOK, THAILAND:  
4,481,326, INT. CL. 30.
- S. ALTMAN, SÃO PAULO, SP 05075-020, BRAZIL:  
3,248,143, CANC. INT. CL. 25.
- S. C. JOHNSON & SON, INC., RACINE, WI:  
4,481,980, INT. CL. 2.
- S. J. ELECTRO SYSTEMS, INC., DETROIT LAKES, MN:  
4,482,635, INT. CL. 9.
- S. TOUS, S.L., SPAIN:  
4,479,404, PUB. 11-26-2013, INT. CL. 3.  
4,479,405, PUB. 11-26-2013, INT. CL. 3.
- S.A. ETABLISSEMENTS DEBRISSE DULAC ET CIE, FRANCE:  
3,431,348.
- S.A.F.E. CONSULTING, LLC, JEFFERSON CITY, MO:  
3,246,531, CANC. INT. CL. 45.
- S.G.M. SUOLIFICIO S.R.L., ITALY:  
4,479,471, PUB. 11-26-2013, INT. CL. 25.
- SOLIVER BERND FREIER GMBH & CO. KG, FED REP GERMANY:  
4,479,317, PUB. 11-26-2013, INT. CL. 28.
- S.S. STEINER, INC., NEW YORK, NY:  
4,480,229, PUB. 11-26-2013, MULTIPLE CLASS, INT. CLS.  
1 AND 5.

SABORMEX EUROPA, S.L., BILBAO, SPAIN:  
4,481,641, INT. CL. 30.

SACANIME, SACRAMENTO, CA:  
4,480,921, PUB. 11-26-2013. INT. CL. 41.

SACKS HOLDINGS, INC., RANCHO SANTA FE, CA:  
4,481,482, MULTIPLE CLASS, INT. CLS. 3 AND 9.

SADDLEBACK EDUCATIONAL, INC., COSTA MESA, CA:  
4,482,435, INT. CL. 16.

SADDLESPRINGS BEVERAGE COMPANY, INC., CARSON, CA:  
4,481,313, INT. CL. 32.

SAEYANG MICROTECH CO., LTD., DAEGU, REPUBLIC OF KOREA:  
4,479,585, PUB. 11-26-2013. MULTIPLE CLASS, INT. CLS. 7, 10 AND 35.

SAFAN B.V., NETHERLANDS:  
4,479,430, PUB. 11-26-2013. INT. CL. 7.  
4,479,431, PUB. 11-26-2013. INT. CL. 7.

SAFE SPACE NYC, INC., NEW YORK, NY TO SAFE SPACE NYC, INC., NEW YORK, NY:  
2,718,543, CANC. MULTIPLE CLASS, INT. CLS. 35, 41 AND 42.

SAFETY-KLEEN SYSTEMS, INC., NORWELL, MA:  
4,481,336, INT. CL. 1.

SAGE ENTERPRISES LLC, GREELEY, CO:  
4,480,181, PUB. 11-26-2013. INT. CL. 35.

SAGE RUTTY & CO., INC., ROCHESTER, NY:  
4,481,087, PUB. 11-26-2013. INT. CL. 36.

SAHAJ DEVELOPMENT, LLC, FAYETTEVILLE, NC:  
3,245,831, CANC. INT. CL. 43.

SAINT FERDINAND GMBH, FED REP GERMANY:  
4,479,481, PUB. 11-26-2013. INT. CL. 33.

SAINT-GOBAIN ECOPHON AB, SWEDEN:  
3,247,758.

SAINT-GOBAIN PERFORMANCE PLASTICS CORPORATION, AURORA, OH:  
762,134, REN. 1-8-14. U.S. CL. 1 (INT. CLS. 1, 3, 4, 17, 18, 19, 22 AND 31).

SAINTHOOD USA, PASADENA, CA:  
4,482,630, INT. CL. 5.

SAISEI FULVIC, LLC, LOS ANGELES, CA:  
4,482,574, INT. CL. 3.

SAKO LTD, 11100 RIHIMAKI, FINLAND:  
2,718,377, CANC. INT. CL. 13.

SALADO SALES, INC., TEMPLE, TX:  
4,481,685, INT. CL. 29.

SALAVERRIA, AL, SAN FRANCISCO, CA:  
3,245,807, CANC. INT. CL. 25.

SALEEM ALI, DALLAS, TX, DBA LED MFG, USA:  
4,480,446, PUB. 11-26-2013. INT. CL. 9.

SALEMI INDUSTRIES INC., WOBURN, MA:  
3,247,200, CANC. MULTIPLE CLASS, INT. CLS. 6 AND 35.

SALEMME PEPPER LLC, MILLFORD, CT, DBA SALEMME PEPPER-CO.:  
4,480,708, PUB. 11-26-2013. MULTIPLE CLASS, INT. CLS. 29, 30 AND 31.

SALOMON S.A.S., METZ-TESSY, FRANCE:  
2,718,515, CANC. MULTIPLE CLASS, INT. CLS. 18, 25 AND 28.

SALSA & SOUL FITNESS, TAMPA, FL:  
3,247,182, CANC. INT. CL. 41.

SALTZMAN, JON M., TAMPA, FL:  
3,248,514, CANC. INT. CL. 25.

SAM GREENBERG, GUILFORD, CT:  
4,481,555, INT. CL. 36.

SAM HORSE CORPORATION, LOS ANGELES, CA:  
4,480,305, PUB. 11-26-2013. INT. CL. 9.

SAM SPORT AND MARKETING AG, SWITZERLAND:  
4,479,338, PUB. 11-26-2013. INT. CL. 9.

SAMMONS FINANCIAL GROUP, INC., WEST DES MOINES, IA:  
4,479,996, PUB. 11-26-2013. INT. CL. 36.  
4,479,998, PUB. 11-26-2013. INT. CL. 36.

SAMSONITE IP HOLDINGS S.A.R.L., L-1931 LUXEMBOURG, LUXEMBOURG:  
2,720,099, CANC. INT. CL. 18.  
3,248,229, CANC. INT. CL. 18.

SAMSUNG ELECTRONICS CO., LTD., GYEONGGI-DO, REPUBLIC OF KOREA:  
2,799,540, REN. 1-6-14. INT. CL. 11.

SAMSUNG ELECTRONICS CO., LTD., SUWON-SI, GYEONGGI-DO, REPUBLIC OF KOREA:  
3,246,239, CANC. INT. CL. 9.  
4,479,555, PUB. 11-26-2013. INT. CL. 9.  
4,479,556, PUB. 11-26-2013. INT. CL. 9.  
4,479,557, PUB. 11-26-2013. INT. CL. 9.  
4,479,569, PUB. 11-26-2013. INT. CL. 9.  
4,481,108, PUB. 11-26-2013. INT. CL. 9.

SAMUEL POLK, LOS ANGELES, CA:  
4,480,943, PUB. 11-26-2013. INT. CL. 36.

SAMUELS, HERBERT L, BROOKLYN, NY:  
3,247,452, CANC. INT. CL. 42.

SAN NICOLA PROSCIUTTIFICIO DEL SOLE - S.P.A., 43021 CORNIGLIO, PARMA, ITALY:  
4,480,665, PUB. 11-26-2013. INT. CL. 29.

SANDIFER, CARLOS, CHICAGO, IL:  
4,479,891, PUB. 11-26-2013. INT. CL. 41.

SANDISK IL LTD., KFAR SABA, ISRAEL:  
3,247,958, CANC. INT. CL. 42.

SANDVIK INTELLECTUAL PROPERTY AB, SE-811 81 SANDVIKEN, SWEDEN:  
2,810,966, REN. 1-3-14. INT. CL. 7.

SANDWICH SURPRISE, LLC, NEW YORK, NY:  
4,480,655, PUB. 11-26-2013. INT. CL. 43.

SANFORD, L.P., FREEPORT, IL:  
3,248,058, CANC. INT. CL. 16.

SANIZONE LLC, ARCADIA, CA:  
3,247,183, CANC. INT. CL. 11.

SANOFI, FRANCE:  
3,247,766.  
3,247,767.  
3,247,814.

SANRIO COMPANY, LTD., TOKYO, JAPAN:  
3,245,999, CANC. INT. CL. 26.

SANTA CLARA, INC., BURLINGTON, NC:  
4,481,892, MULTIPLE CLASS, INT. CLS. 4 AND 5.

SANTA MONICA CONVENTION AND VISITORS BUREAU, SANTA MONICA, CA:  
4,480,069, PUB. 11-26-2013. INT. CL. 35.

SANTANDER BANK, WILMINGTON, DE:  
3,247,114, CANC. INT. CL. 36.

SANTIAGO, MOACIR, SAN DIEGO, CA:  
4,481,511, INT. CL. 9.

SANTIAM MEMORIAL HOSPITAL, STAYTON, OR:  
4,479,250, PUB. 11-26-2013. INT. CL. 44.

SAPORI ITALIANI SRL, CASELLE DI ALTIVOLE TV, ITALY:  
4,480,945, PUB. 11-26-2013. MULTIPLE CLASS, INT. CLS. 33 AND 35.

SARA CAMPBELL, LTD., BOSTON, MA:  
4,480,843, PUB. 11-26-2013. MULTIPLE CLASS, INT. CLS. 35 AND 42.

SARAH ADLER, EVANSTON, IL AND MACKENZIE BARTH, EVANSTON, IL:  
4,480,406, PUB. 11-26-2013. INT. CL. 43.

SASSER FAMILY HOLDINGS, INC., CHICAGO, IL:  
4,482,768, MULTIPLE CLASS, INT. CLS. 37, 39 AND 42.

SASSY SPOON, LLC, CAVE CREEK, AZ:  
4,482,116, MULTIPLE CLASS, INT. CLS. 16, 41 AND 44.  
4,482,321, INT. CL. 41.  
4,482,322, INT. CL. 41.  
4,482,450, INT. CL. 41.

SATELLITE ASSET MANAGEMENT, L.P., NEW YORK, NY:  
2,719,586, CANC. INT. CL. 36.  
2,719,587, CANC. INT. CL. 36.  
2,719,588, CANC. INT. CL. 36.

SATELLITE INFORMATION SERVICES LIMITED, LONDON, UNITED KINGDOM:  
4,479,754, PUB. 11-26-2013. MULTIPLE CLASS, INT. CLS. 9, 35 AND 38.

SAUDER WOODWORKING CO., ARCHBOLD, OH:  
3,248,120, CANC. INT. CL. 20.

SAUNDERS THEATER PROPERTIES, LLC, LIBERTY CENTER, OH, DBA FIELD OF DREAMS DRIVE-IN THEATER:  
4,480,995, PUB. 11-26-2013. INT. CL. 41.

- SAUNDERS, JULIET N, RIVERSIDE, CA AND ROBLES, LUIS, RIVERSIDE, CA:  
4,479,747, PUB. 11-26-2013. INT. CL. 35.
- SAUNDERS, MARLON D., STATEN ISLAND, NY:  
4,481,796, INT. CL. 41.
- SAVA TRANSMÉDIA INC., MONTREAL, QUEBEC, CANADA:  
4,479,623, PUB. 11-26-2013. INT. CL. 9.
- SAVAGE DESIGN GROUP, INC, HOUSTON, TX:  
2,718,605, CANC. INT. CL. 42.
- SAVERS COMMUNITY, LLC, NEWPORT BEACH, CA:  
3,247,444, CANC. INT. CL. 36.
- SAW WORKS BREWING COMPANY, LLC, KNOXVILLE, TN:  
4,479,757, PUB. 7-16-2013. INT. CL. 32.
- SAWATZKE, TURNER C, ST. HILAIRE, MN:  
4,479,935, PUB. 11-26-2013. INT. CL. 7.
- SAX ART, INC., VALLEY STREAM, NY:  
4,480,401, PUB. 11-26-2013. INT. CL. 28.
- SAYERS, KELLY, APPECROSS, WA, AUSTRALIA:  
4,481,697, INT. CL. 41.
- SAZERAC COMPANY, INC., METAIRIE, LA, DBA WIDE WORLD IMPORTERS:  
762,850, REN. 1-9-14. U.S. CL. 49 (INT. CL. 33).
- SAZERAC NORTH AMERICA, INC., FRANKFORT, KY:  
4,481,471, INT. CL. 16.  
4,481,472, INT. CL. 21.
- SB RESEARCH, LLC, ENFIELD, CT:  
4,479,985, PUB. 11-26-2013. INT. CL. 41.
- SCANPAK INC., MONTREAL (ST-LAURENT), QUEBEC:  
3,246,257, CANC. INT. CL. 9.
- SCAR HEAL, INC., LARGO, FL:  
4,480,272, PUB. 11-26-2013. INT. CL. 3.
- SCENEWISE, INC., EL SEGUNDO, CA:  
3,248,375, CANC. INT. CL. 9.
- SCENIC HUDSON, INC., POUGHKEEPSIE, NY:  
3,247,184, CANC. INT. CL. 35.
- SCENTS SERVICE COMPANY, SAN ANTONIO, TX:  
2,849,362, REN. 1-8-14. INT. CL. 5.
- SCENTSY, INC., MERIDIAN, ID:  
4,482,270, INT. CL. 21.
- SCG POWER RANGERS LLC, LOS ANGELES, CA:  
4,481,667, INT. CL. 25.
- SCHAWK, INC., DES PLAINES, IL:  
4,480,279, PUB. 11-26-2013. MULTIPLE CLASS, INT. CLS. 35 AND 40.
- SCHEINBLUM, KEITH, A, MANHASSET, NY:  
3,248,030, CANC. INT. CL. 4.
- SCHUEERLE FAHRZEUGFABRIK GMBH, PFEDELBACH, FED REP GERMANY:  
4,479,269, PUB. 11-26-2013. MULTIPLE CLASS, INT. CLS. 7, 9 AND 12.
- SCHICK ENTERPRISES, INC., KUTZTOWN, PA:  
3,248,163, CANC. INT. CL. 9.
- SCHILLINGER, MARK, SAN RAFAEL, CA:  
3,246,799, CANC. INT. CL. 41.
- SCHMALTZ RETAIL PRODUCTS, LLC, NAPERVILLE, IL:  
4,482,368, INT. CL. 29.
- SCHNEIDER ELECTRIC INDUSTRIES SAS, FRANCE:  
3,247,796.
- SCHOLASTIC INC., NEW YORK, NY:  
3,248,555, CANC. INT. CL. 41.
- SCHOOL OF ROCK, LLC, BURR RIDGE, IL:  
3,247,194, CANC. INT. CL. 41.
- SCHRECENGOST, ADAM P, WASHINGTON, DC:  
3,247,256, CANC. INT. CL. 41.
- SCHRECK WHOLESALE, INC., CHICAGO, IL:  
4,479,925, PUB. 11-26-2013. MULTIPLE CLASS, INT. CLS. 18 AND 25.
- SCHUCO USA L.P., NEWINGTON, CT:  
3,246,498, CANC. INT. CL. 19.
- SCHULTE, RYAN, NEWPORT BEACH, CA:  
4,482,748, INT. CL. 36.
- SCHÜCO INTERNATIONAL KG, FED REP GERMANY:  
3,247,729.
- SCIENTIFIC GAMES INTERNATIONAL, INC., ALPHARETTA, GA:  
3,248,255, CANC. INT. CL. 42.
- SCIESSANT LLC, WAKEFIELD, MA:  
4,481,460, MULTIPLE CLASS, INT. CLS. 1 AND 5.
- SCOLA, CHARLES R., LAWNSDALE, CA:  
3,247,120, CANC. MULTIPLE CLASS, INT. CLS. 41 AND 43.
- SCOLLO, VINCENT J., LIVERPOOL, NY:  
4,481,929, MULTIPLE CLASS, INT. CLS. 14 AND 25.
- SCONZA CANDY COMPANY, OAKDALE, CA:  
4,479,827, PUB. 6-4-2013. INT. CL. 30.
- SCORE TELEVISION NETWORK LTD., THE, HAMILTON, ONTARIO, CANADA TO THESCORE, INC., TORONTO, ONTARIO, CANADA:  
2,718,382, CANC. MULTIPLE CLASS, INT. CLS. 38 AND 41.
- SCOSCHE INDUSTRIES, INC., OXNARD, CA:  
4,481,494, INT. CL. 9.
- SCOTCH & SODA B.V., 2132 PZ HOOFDDORP, NETHERLANDS:  
4,481,893, INT. CL. 35.
- SCRATCH MUSIC GROUP, INC., NEW YORK, NY:  
2,799,499, REN. 1-3-14. INT. CL. 41.
- SCROLL MEDIA, LLC, PASADENA, CA:  
3,248,711, CANC. MULTIPLE CLASS, INT. CLS. 35 AND 41.
- SDC SWEDENCARE AB, SWEDEN:  
4,479,329, PUB. 11-26-2013. MULTIPLE CLASS, INT. CLS. 5 AND 31.
- SEA WORLD LLC, ORLANDO, FL:  
4,480,534, PUB. 11-26-2013. INT. CL. 21.
- SEALE, MARSHALL, BIRMINGHAM, AL:  
3,248,159, CANC. INT. CL. 37.
- SEALY TECHNOLOGY LLC, TRINITY, NC:  
1,158,129, CANC. INT. CL. 20.  
1,817,452, REN. 1-6-14. INT. CL. 20.  
4,481,852, INT. CL. 20.
- SEAQUEST SEAFOOD CORPORATION, CITY OF INDUSTRY, CA:  
4,479,758, PUB. 6-4-2013. INT. CL. 29.
- SEARS BRANDS, LLC, HOFFMAN ESTATES, IL:  
2,803,784, REN. 1-3-14. INT. CL. 7.
- SEASONS SEASONING COMPANY, SHATIN, HONG KONG, TA SEASONS SEASONING CO.:  
2,817,047, REN. 1-6-14. INT. CL. 30.
- SEASTAR PADDLEBOARDS & ACCESORIES, INC., HOLLYWOOD, FL:  
4,482,140, INT. CL. 28.
- SECCOMMERCE; INFORMATIONSSYSTEME GMBH, FED REP GERMANY:  
4,479,394, PUB. 11-26-2013. MULTIPLE CLASS, INT. CLS. 9 AND 42.
- SECURE INFORMATION DEVICES, INC., BEAVER, PA:  
4,480,993, PUB. 11-26-2013. INT. CL. 9.
- SECURETEC DETEKTIONS-SYSTEME AG, NEUBIBERG, 85579, FED REP GERMANY:  
2,800,244, REN. 1-8-14. INT. CL. 5.  
2,800,244, CANC. INT. CL. 44.
- SEIFERT, JERRY A., HUDSON, OH:  
4,481,880, INT. CL. 9.
- SEIKAGAKU KOGYO KABUSHIKI KAISHA, TOKYO, JAPAN:  
2,819,028, REN. 1-6-14. MULTIPLE CLASS, INT. CLS. 5 AND 10.  
2,819,028, CANC. MULTIPLE CLASS, INT. CLS. 1 AND 9.
- SEIKO HOLDINGS KABUSHIKI KAISHA, TOKYO, JAPAN, TA SEIKO HOLDINGS CORPORATION:  
2,816,768, REN. 1-6-14. INT. CL. 14.
- SEIKOH GIKEN CO., LTD., MATSUDO-SHI, CHIBA-KEN, JAPAN:  
2,718,387, CANC. MULTIPLE CLASS, INT. CLS. 3, 7, 9 AND 12.
- SEITZ, PETER, D-81675 MUNCHEN, FED REP GERMANY:  
3,005,357, CANC. MULTIPLE CLASS, INT. CLS. 10 AND 25.
- SELAVY, L.L.C., MCKEESPORT, PA:  
3,246,809, CANC. INT. CL. 35.
- SELECT PRODUCTS, LLC, EDMOND, OK:  
4,482,010, MULTIPLE CLASS, INT. CLS. 35 AND 42.

SEMERKA LIMITED, LIMASSOL, CYPRUS:  
4,479,489, PUB. 11-26-2013. INT. CL. 33.

SENARIO LLC, WOODSTOCK, IL:  
3,248,528, CANC. INT. CL. 28.

SENETINER MORI, FLAVIO, LUJÁN, ARGENTINA:  
3,247,456, CANC. INT. CL. 33.

SENTIMENTAL TOUCH, LLC, DENVER, CO:  
4,480,169, PUB. 11-26-2013. INT. CL. 14.

SENZ TECHNOLOGIES B.V., DELFT, NETHERLANDS:  
3,362,637.

SEO KING, INC., PLANT CITY, FL:  
3,246,308, CANC. INT. CL. 35.

SEQUOYAH, LLC, SOUTH BOSTON, VA:  
4,482,357, INT. CL. 34.

SER-GYM, LLC, MIAMI, FL:  
4,480,737, PUB. 11-26-2013. INT. CL. 28.

SERGEANT'S PET CARE PRODUCTS, INC., ALLEGAN, MI:  
2,719,602, CANC. INT. CL. 28.

SERMON SHARE LLC, COWETA, OK:  
3,246,031, CANC. INT. CL. 41.

SERNA, TONY, MURPHY, TX:  
3,246,151, CANC. INT. CL. 36.

SERVE MANAGEMENT GROUP, INC., CUMMING, GA:  
3,247,365, CANC. INT. CL. 37.  
3,247,372, CANC. INT. CL. 37.

SERVICEMASTER BRANDS, L.L.C., BURLINGTON, VT:  
2,719,491, CANC. MULTIPLE CLASS, INT. CLS. 37, 44  
AND 45.

SERVUS, INC., GASTONIA, NC:  
4,481,783, INT. CL. 19.

SESCOI INTERNATIONAL, F-71000 MACON, FRANCE:  
3,247,793.

SESHEDUP LLC, LOS ANGELES, CA:  
4,481,007, PUB. 11-26-2013. INT. CL. 41.

SETI G LLC, NEW YORK, NY:  
4,479,894, PUB. 11-26-2013. MULTIPLE CLASS, INT. CLS.  
29 AND 30.

SEVERN TRENT WATER PURIFICATION, INC., COLMAR,  
PA:  
2,719,526, CANC. MULTIPLE CLASS, INT. CLS. 11 AND  
40.

SEVIC SYSTEMS LUXEMBOURG S.A., LUXEMBOURG,  
LUXEMBOURG:  
3,245,935, CANC. INT. CL. 9.

SEVILLANA IMPORTS, INC., MEDLEY, FL:  
2,800,340, REN. 1-6-14. INT. CL. 33.

SEVILLE CLASSICS, INC., TORRANCE, CA:  
4,482,453, INT. CL. 20.

SEWELL VILLAGE CADILLAC COMPANY, INC., DALLAS,  
TX:  
2,800,116, REN. 1-9-14. MULTIPLE CLASS, INT. CLS. 35  
AND 37.

SEXY DRESSES, LLC, FULLERTON, CA:  
4,480,001, PUB. 11-26-2013. MULTIPLE CLASS, INT. CLS.  
25 AND 35.

SEXY HAIR CONCEPTS, LLC, CHATSWORTH, CA:  
4,482,684, INT. CL. 3.

SHAHEEN-TUNBERG, CAMILLE, VENICE, CA:  
2,803,692, REN. 1-8-14. INT. CL. 25.

SHAHEEN, PAMELA J., ATLANTA, GA, DBA QUEST4FIT-  
NESS:  
4,480,000, PUB. 10-15-2013. INT. CL. 41.

SHAHNAZ HERBALS & SHAHNAZ AYURVEDICS, NEW  
DELHI, INDIA:  
1,859,400, REN. 1-3-14. INT. CL. 3.  
1,862,186, REN. 1-3-14. INT. CL. 3.

SHAKESPEARE COMPANY, LLC, COLUMBIA, SC:  
1,813,774, REN. 1-8-14. INT. CL. 22.

SHAKOPEE MDEWAKANTON SIOUX COMMUNITY,  
PRIOR LAKE, MN:  
2,718,710, CANC. INT. CL. 42.

SHALOM INTERNATIONAL CORP., PERTH AMBOY, NJ:  
3,425,002, COR. MULTIPLE CLASS, INT. CLS. 9, 18 AND  
26.

SHANDONG ZIBO SHANCHUAN MEDICAL INSTRU-  
MENT CO., LTD., CHINA:  
3,247,705.

SHANGHAI NEOENT INDUSTRIAL CO., LTD., SHANGHAI  
CITY., CHINA:  
4,482,835, INT. CL. 18.

SHANGHAI YIHENG TECHNOLOGY CO., LTD., SHANG-  
HAI, CHINA:  
4,480,823, PUB. 11-26-2013. INT. CL. 9.

SHANGHAI UNITED IMAGING HEALTHCARE CO.,LTD.,  
SHANGHAI, CHINA:  
4,479,381, PUB. 11-26-2013. INT. CL. 10.

SHANGYING (SHANGHAI) JEWELRY CO., LTD., SHANG-  
HAI CITY, CHINA:  
4,479,989, PUB. 11-26-2013. INT. CL. 14.

SHANK, WILLIAM, TUCSON, AZ AND SHANK, SUSAN,  
TUCSON, AZ:  
2,800,013, REN. 1-3-14. INT. CL. 11.

SHARON LEE, SAN DIEGO, CA:  
4,480,356, PUB. 11-26-2013. INT. CL. 41.

SHARP KABUSHIKI KAISHA, OSAKA, JAPAN:  
3,246,676, CANC. INT. CL. 9.

SHARP, ROGER, PASO ROBLES, CA:  
3,247,527, CANC. MULTIPLE CLASS, INT. CLS. 25, 30  
AND 43.

SHARPER IMAGE HOLDINGS LLC, WILMINGTON, DE:  
2,801,489, REN. 1-3-14. MULTIPLE CLASS, INT. CLS. 16  
AND 35.

SHAW-ROSS INTERNATIONAL IMPORTERS, INC., MIA-  
MI, FL:  
4,480,790, PUB. 11-26-2013. INT. CL. 33.

SHAYS ARMORY DISTRIBUTORS, INC., EASTHAMPTON,  
MA:  
4,482,186, INT. CL. 35.

SHE-MOTO, INC., HOLLAND, MI:  
3,248,652, CANC. INT. CL. 25.

SHEA, DANIEL, LOMA LINDA, CA:  
4,480,553, PUB. 11-26-2013. INT. CL. 18.

SHELL TRADEMARK MANAGEMENT BV, THE HAGUE,  
NETHERLANDS:  
4,480,325, PUB. 11-26-2013. INT. CL. 4.

SHENG, SHIH ZEN, HACIENDA HEIGHTS, CA AND  
ZHANG, WEN, HACIENDA HEIGHTS, CA:  
3,248,147, CANC. INT. CL. 28.

SHENZHEN EASYN TECHNOLOGY COMPANY LIMITED,  
SHENZHEN, CHINA:  
4,480,999, PUB. 11-26-2013. INT. CL. 9.

SHENZHEN NONSTOP TECHNOLOGY CO., LTD, BAO'AN,  
SHENZHEN, CHINA:  
4,480,996, PUB. 11-26-2013. INT. CL. 9.

SHENZHEN YUYACHEN COMMERCIAL AND TRADING  
CO., LTD., LUOHU DIST, SHENZHEN, CHINA:  
4,481,125, PUB. 11-26-2013. INT. CL. 3.

SHERIDAN BROADCASTING CORPORATION, PITTS-  
BURGH, PA:  
3,246,186, CANC. INT. CL. 41.

SHFL ENTERTAINMENT, INC., LAS VEGAS, NV:  
4,481,527, INT. CL. 41.  
4,481,548, INT. CL. 9.  
4,481,588, INT. CL. 41.

SHIH-MING CHEN, TAICHUNG CITY, TAIWAN:  
4,479,639, PUB. 11-26-2013. INT. CL. 43.

SHIMANO INC., SAKAI, OSAKA 590-8577, JAPAN:  
2,795,736, REN. 1-6-14. INT. CL. 12.

SHIN, DANIEL, BEVERLY HILLS, CA:  
3,247,199, CANC. INT. CL. 44.

SHIN, TAE NAM, WESTWOOD, CA:  
3,247,309, CANC. INT. CL. 43.

SHINDENGEN ELECTRIC; MANUFACTURING CO., LTD.,  
JAPAN:  
4,394,427, COR. INT. CL. 9.

SHINY TEA CO., LTD., TAINAN CITY, TAIWAN:  
4,440,667, COR. INT. CL. 43.

SHIPCARSNOW, OMAHA, NE:  
4,479,619, PUB. 11-26-2013. INT. CL. 39.

SHIPON-BLUM, DR. ELISA, JENKINTOWN, PA AND SE-  
LECTIVE MUTISM ANXIETY RESEARCH & TREAT-  
MENT CENTER, INC., JENKINTOWN, PA:  
4,479,714, PUB. 11-26-2013. INT. CL. 44.

- SHIPYARD BREWING COMPANY, LLC, PORTLAND, ME:  
4,480,680, PUB. 11-26-2013. INT. CL. 32.  
4,480,683, PUB. 11-26-2013. INT. CL. 32.
- SHIRE LLC, FLORENCE, KY:  
3,595,432, AM. INT. CL. 44.  
3,793,508, CANC. INT. CL. 5.  
3,793,508, AM. INT. CL. 44.
- SHIRLEY, MARCUS, LAWRENCEVILLE, GA:  
3,247,218, CANC. INT. CL. 36.
- SHOCK WAVES, INC., SPARKS, NV:  
2,426,188, CANC. INT. CL. 42.
- SHOE SHOW, INC., CONCORD, NC:  
4,481,201, PUB. 11-26-2013. INT. CL. 25.
- SHOOTING GALLERY WINES, LLC, SAINT HELENA, CA:  
4,481,764, INT. CL. 33.
- SHOPCYL LLC, CHICAGO, IL:  
4,482,548, INT. CL. 35.
- SHORT'S MARINE, INC., MILLSBORO, DE:  
4,480,499, PUB. 11-26-2013. INT. CL. 35.
- SHOW CREATORS INC., LAS VEGAS, NV:  
4,482,760, INT. CL. 41.
- SHOWTIME NETWORKS INC., NEW YORK, NY:  
4,481,613, INT. CL. 25.
- SIAN SING INVESTMENTS CO., LTD., TAICHUNG CITY  
402, TAIWAN:  
3,246,270, CANC. INT. CL. 8.
- SID RICHARDSON CARBON, LTD., FORT WORTH, TX,  
DBA SID RICHARDSON CARBON & ENERGY CO.:  
4,479,793, PUB. 11-26-2013. INT. CL. 1.
- SIEBEN, IRWIN, MACKLIN, SK, CANADA:  
4,479,549, PUB. 8-27-2013. INT. CL. 7.
- SIEMENS MEDICAL INSTRUMENTS PTE. LTD., SINGA-  
PORE, SINGAPORE:  
4,482,468, INT. CL. 10.
- SIERRA CLUB, SAN FRANCISCO, CA:  
2,801,870, REN. 1-8-14. INT. CL. 36.
- SIERRA NEVADA BREWING CO., CHICO, CA:  
4,481,273, PUB. 11-26-2013. INT. CL. 25.
- SIERRA WEDDINGS LLC, SOUTH LAKE TAHOE, CA:  
3,246,951, CANC. INT. CL. 41.
- SIGHTSEEING TOURS MANAGEMENT, INC., MIAMI, FL:  
4,482,822, INT. CL. 39.
- SIGMA ALIMENTOS, S.A. DE C.V., SAN PEDRO GARZA  
GARCIA, MEXICO:  
4,482,624, INT. CL. 29.
- SIGNATURE FOOD MARKETING, LLC, PENDERGRASS,  
GA:  
4,482,485, INT. CL. 29.
- SIGNATURE RESEARCH INSTITUTE, INC, LOUISVILLE,  
KY:  
4,479,836, PUB. 11-26-2013. MULTIPLE CLASS, INT. CLS.  
35, 41 AND 42.
- SIGNDEALZ CORPORATION, BOULDER, CO:  
4,481,186, PUB. 11-26-2013. MULTIPLE CLASS, INT. CLS.  
9, 35, 37 AND 42.  
4,481,189, PUB. 11-26-2013. MULTIPLE CLASS, INT. CLS.  
9, 35, 37 AND 42.
- SILBER, YOEL, NEW CITY, NY:  
3,247,016, CANC. INT. CL. 16.
- SILENTLY PUBLISHING, INC., BIRMINGHAM, AL:  
4,482,180, MULTIPLE CLASS, INT. CLS. 9, 16 AND 41.
- SILICON LABORATORIES INC., AUSTIN, TX:  
3,246,287, CANC. INT. CL. 9.
- SILICON VALLEY COMMUNITY FOUNDATION, MOUN-  
TAIN VIEW, CA:  
4,482,154, MULTIPLE CLASS, INT. CLS. 35, 36 AND 41.
- SILICON 360 LLC, MILPITAS, CA. AKA SI360:  
4,480,348, PUB. 11-26-2013. MULTIPLE CLASS, INT. CLS.  
40 AND 42.
- SILVA CONSTRUCTION, OAKLAND PARK, FL, DBA  
SILVA LAWN & GARDEN:  
4,480,482, PUB. 11-26-2013. INT. CL. 31.
- SILVER HILL FINANCIAL, LLC, CORAL GABLES, FL:  
3,246,745, CANC. INT. CL. 36.  
3,246,746, CANC. INT. CL. 36.
- SILVERBROOK RESEARCH PTY LTD, BALMAIN NSW  
2041, AUSTRALIA:  
3,245,734, CANC. MULTIPLE CLASS, INT. CLS. 6, 7, 9, 16,  
21, 35 AND 38.
- SILVEREDGE, LLC, LOVELAND, CO, FORMERLY PFC  
PAYMENT SOLUTIONS, LLC:  
4,482,615, MULTIPLE CLASS, INT. CLS. 9, 35 AND 36.
- SILVERMAN, SCOTT, LOS ANGELES, CA:  
4,482,831, INT. CL. 35.
- SIMON, SUSAN B, WAYLAND, MA:  
3,246,873, CANC. INT. CL. 41.
- SIMOVE, SHERIDAN, LONDON, ENGLAND, UNITED  
KINGDOM:  
4,480,730, PUB. 11-26-2013. INT. CL. 9.
- SIMPSON DOOR COMPANY, SEATTLE, WA:  
2,720,111, CANC. INT. CL. 19.
- SINCERE GREETING INC, BRIARCLIFF MANOR, NY:  
4,480,520, PUB. 11-26-2013. INT. CL. 35.
- SINFUL SCOOPS, LLC, WEST ORANGE, NJ:  
4,482,109, INT. CL. 30.
- SINGING WATERS MINISTRIES, ORANGEVILLE, ONTAR-  
IO, CANADA:  
2,807,882, REN. 1-3-14. INT. CL. 45.
- SINGLE TOUCH INTERACTIVE, INC., ENCINITAS, CA:  
4,480,738, PUB. 11-26-2013. INT. CL. 35.
- SINGLETON, NAIM Q, WASHINGTON, DC:  
4,480,523, PUB. 11-26-2013. INT. CL. 35.
- SINTECO IMPIANTI S.R.L., ITALY:  
4,479,343, PUB. 11-26-2013. INT. CL. 11.
- SISTERS OF PROVIDENCE OF SAINT MARY'S-OF-THE-  
WOODS, ST. MARY-OF-THE-WOODS, IN, DBA SAINT  
MARY-OF-THE-WOODS COLLEGE:  
4,481,224, PUB. 11-26-2013. INT. CL. 41.
- SITMA S.P.A., ITALY:  
4,479,366, PUB. 11-26-2013. INT. CL. 7.
- SIVAN MICHAEL, SHATIN FOTAN, HONG KONG:  
4,482,363, INT. CL. 9.
- SIVERHUS, JOHN, WOBURN, MA:  
4,482,015, INT. CL. 30.
- SIX DEGREES CAPITAL CORPORATION, SEATTLE, WA:  
4,481,412, INT. CL. 45.
- SK HOLDINGS CO., LTD., SUWON-SI, GYEONGGI-DO,  
REPUBLIC OF KOREA:  
3,246,381, CANC. INT. CL. 35.
- SK ENTERTAINMENT, INC., CHICAGO, IL:  
4,482,593, INT. CL. 41.
- SKA FITNESS, LLC, GILBERT, SC:  
4,481,253, PUB. 11-26-2013. INT. CL. 41.
- SKECHERS U.S.A., INC. II, MANHATTAN BEACH, CA:  
3,248,040, CANC. INT. CL. 18.
- SKS METAPLAST SCHEFFER-KLUTE GMBH, SUNDERN,  
FED REP GERMANY:  
2,718,467, CANC. INT. CL. 12.
- SKYERA, INC., SAN JOSE, CA:  
4,481,953, INT. CL. 9.
- SKYHAWKE TECHNOLOGIES, LLC, RIDGELAND, MS:  
4,482,055, INT. CL. 9.  
4,482,056, INT. CL. 9.
- SKYY SPIRITS, LLC, SAN FRANCISCO, CA:  
4,479,837, PUB. 11-26-2013. INT. CL. 33.
- SLATE GOLF LTD., DENVER, CO:  
4,482,594, INT. CL. 25.
- SLEEP LEVEL, LLC, LAS VEGAS, NV:  
3,246,986, CANC. INT. CL. 20.
- SLEEPING SKULL CORP., LOS ANGELES, CA:  
4,480,841, PUB. 11-26-2013. MULTIPLE CLASS, INT. CLS.  
25 AND 28.
- SLI PRODUCTIONS, INC., MOONACHIE, NJ, DBA IT'S A  
WIG:  
4,482,404, INT. CL. 26.
- SLIC GAMES, LLC, SAN JOSE, CA:  
4,481,720, INT. CL. 9.
- SLOAN VALVE COMPANY, FRANKLIN PARK, IL:  
584,323, REN. 1-6-14. U.S. CL. 35 (INT. CL. 17).
- SLOCUM, RICHARD L., EUSTIS, FL:  
3,248,530, CANC. INT. CL. 9.
- SMALL WORLD COFFEE CORP., PRINCETON, NJ:  
2,910,717, REN. 1-3-14. INT. CL. 30.
- SMART AMERICA GROUP ENTERPRISES, INC., SAN  
DIEGO, CA:  
3,245,731, CANC. INT. CL. 41.

SMARTBEAR SOFTWARE INC., BEVERLY, MA:  
3,247,328, CANC. INT. CL. 9.

SMARTBRIEF, INC., WASHINGTON, DC:  
3,248,424, CANC. INT. CL. 35.

SMARTER SOLUTIONS, INC., AUSTIN, TX:  
4,480,385, PUB. 11-26-2013. MULTIPLE CLASS, INT. CLS.  
35 AND 41.

SMB NETWORKS LLC, NORTH HAVEN, CT:  
4,480,207, PUB. 11-26-2013. INT. CL. 45.

SME FOUNDATION, ENGLEWOOD, CO:  
4,479,760, PUB. 11-26-2013. MULTIPLE CLASS, INT. CLS.  
16 AND 41.

SMILE SENSATIONS LLC, STAMFORD, CT:  
4,481,136, PUB. 11-26-2013. INT. CL. 21.

SMILES OF BEAUTY P.C., SEDONA, AZ:  
3,246,807, CANC. INT. CL. 44.

SMITH & LOVELESS, INC., LENEXA, KS:  
980,999, REN. 1-8-14. U.S. CL. 23 (INT. CL. 7).

SMITH MOUNTAIN INDUSTRIES, INC., FOREST, VA:  
4,480,822, PUB. 11-26-2013. INT. CL. 35.

SMITH-WEISSMANN, SHERRY, LYTLE CREEK, CA:  
3,247,523, CANC. INT. CL. 36.

SMITH, CLIFFORD, PINEVILLE, NC:  
4,131,711, CANC. INT. CL. 40.

SMITH, DEAN, FRANKFORT, IN:  
4,482,288, INT. CL. 37.

SMITH, EARL L., SEABORD, NC AND SMITH, PATRICIA  
M., EL CAJON, CA:  
4,479,739, PUB. 11-26-2013. INT. CL. 3.

SMITH, MARK, HUNTINGTON BEACH, CA:  
2,797,777, REN. 1-6-14. INT. CL. 35.  
2,797,778, REN. 1-6-14. INT. CL. 35.  
2,797,782, REN. 1-6-14. INT. CL. 35.

SMITHS LAWNAGE INCENTIVES, FORT WORTH, TX:  
4,482,509, INT. CL. 44.

SMOKERS'S CLUB LLC, PITTSBURGH, PA:  
4,480,641, PUB. 11-26-2013. INT. CL. 25.

SMOKIN' RECORDS INC., TORONTO, ONTARIO, CANA-  
DA:  
3,247,867, CANC. INT. CL. 9.

SMOOCH, INC., ENCINO, CA:  
3,248,766, CANC. INT. CL. 25.

SMUCKER FOODS OF CANADA CO, MARKHAM, CANA-  
DA:  
3,247,021, CANC. INT. CL. 30.

SMURFIT-STONE CONTAINER CANADA, L.P., MON-  
TREAL, QUEBEC, CANADA:  
3,246,863, CANC. MULTIPLE CLASS, INT. CLS. 16, 40  
AND 42.  
3,246,870, CANC. MULTIPLE CLASS, INT. CLS. 16, 40  
AND 42.

SNEE CHEMICAL COMPANY, HARAHAN, LA:  
4,481,185, PUB. 11-26-2013. INT. CL. 2.

SNELL LIMITED, UNITED KINGDOM:  
3,247,699.

SNOVA, LLC, LITTLETON, CO:  
4,481,647, INT. CL. 33.

SNOW STRINGED INSTRUMENTS, INC., FLUSHING, NY:  
3,247,203, CANC. INT. CL. 15.

SNOWSHOE MOUNTAIN, INC., SNOWSHOE, WV:  
4,480,258, PUB. 11-26-2013. INT. CL. 41.

SNYDER PRODUCT CONTROL, LLC, WAUKEE, IA:  
3,245,917, CANC. INT. CL. 21.  
3,245,918, CANC. INT. CL. 21.

SOAR CONSULTING, INC., NEPTUNE BEACH, FL:  
3,248,593, CANC. INT. CL. 35.

SOBONG QUANE, NEW YORK, NY:  
4,480,143, PUB. 11-26-2013. INT. CL. 3.

SOCALI INC., SAN MARCOS, CA:  
3,247,457, CANC. INT. CL. 30.

SOCIAL BOOTH, HUNTERSVILLE, NC:  
4,479,846, PUB. 11-26-2013. MULTIPLE CLASS, INT. CLS.  
9 AND 41.

SOCIALPLAY, LTD., CHESTERFIELD, ENGLAND:  
4,479,592, PUB. 9-24-2013. MULTIPLE CLASS, INT. CLS. 9  
AND 41.  
4,479,593, PUB. 9-24-2013. MULTIPLE CLASS, INT. CLS. 9  
AND 41.

SOCIEDAD IBERICA DE METALES NOBLES, S.A., MA-  
DRID, SPAIN:  
4,481,926, INT. CL. 9.

SOCIETA' PER IL MERCATO; DEI TITOLI DI STATO S.P.A.;  
IN SHORT MTS S.P.A., ITALY:  
4,479,357, PUB. 11-26-2013. MULTIPLE CLASS, INT. CLS.  
35, 36 AND 38.

SOCIETE CIVILE DU VIGNOBLE DE CHATEAU LATOUR,  
33250 PAUILLAC, FRANCE:  
1,815,657, REN. 1-6-14. MULTIPLE CLASS, INT. CLS. 21  
AND 33.

SOCIETE DES PRODUITS NESTLE S.A., 1800 VEVEY,  
SWITZERLAND:  
4,479,672, PUB. 11-26-2013. INT. CL. 5.  
4,479,978, PUB. 11-26-2013. INT. CL. 5.

SOCIETE DES PRODUITS NESTLE S.A., VEVEY, SWITZER-  
LAND:  
4,481,250, PUB. 11-26-2013. INT. CL. 41.

SOCIETE ELECTRONIQUE DE COMBREE - SELCO,  
FRANCE:  
3,247,698.

SOCIETE LABORATOIRES; D'AROMATOLOGIE APPLI-  
QUEE, FRANCE:  
4,479,395, PUB. 11-26-2013. MULTIPLE CLASS, INT. CLS.  
3, 5, 29 AND 44.

SOCIETE PARISIENNE DE PARFUMS ET COSMETIQUES,  
PARIS, FRANCE:  
3,248,542, CANC. INT. CL. 3.

SOCIETY OF CARDIOVASCULAR PATIENT CARE F/K/A  
SOCIETY OF CHEST PAIN CENTERS, DUBLIN, FL:  
4,480,673, PUB. 11-26-2013. INT. CL. 41.

SOCIETY OF EXPLORATION GEOPHYSICISTS, TULSA,  
OK:  
4,482,339, MULTIPLE CLASS, INT. CLS. 16 AND 41.

SOCIÉTÉ CORYNE DE BRUYNES, MONACO:  
4,479,321, PUB. 11-26-2013. MULTIPLE CLASS, INT. CLS.  
5 AND 10.

SODEXO, 92130 ISSY-LES-MOULINEAUX, FRANCE:  
3,248,404, CANC. INT. CL. 43.

SOFTWARE TO GO, COMPANY, SAINT PETERS, MO:  
1,307,543, REN. 1-8-14. INT. CL. 42.

SOGRAPE VINHOS, S.A., AVINTES, PORTUGAL, COMPAN-  
HIA AGRICOLA E COMERCIAL DOS VINHOS DO  
PORTO, S.A.R.L., VILA NOVA DE GAIA, PORTUGAL:  
1,276,477, REN. 1-7-14. INT. CL. 33.

SOHO COURT ASSOC. L.P., NEW YORK, NY:  
2,797,085, REN. 1-3-14. MULTIPLE CLASS, INT. CLS. 35  
AND 36.

SOHO HERO, INC., ALPHARETTA, GA:  
3,246,245, CANC. MULTIPLE CLASS, INT. CLS. 35 AND  
39.

SOLAR TIME LIMITED, KOWLOON, HONG KONG:  
4,482,264, INT. CL. 14.

SOLAREXCHANGE.COM, LLC, CARROLLTON, TX:  
4,482,105, MULTIPLE CLASS, INT. CLS. 35 AND 40.

SOLAZYME, INC., SOUTH SAN FRANCISCO, CA:  
4,481,693, INT. CL. 3.

SOLUTIONSRX MANAGEMENT GROUP, LLC, SANTA  
ROSA BEACH, FL:  
4,482,791, INT. CL. 35.

SOMNOMED LIMITED, NEW SOUTH WALES, AUSTRA-  
LIA:  
4,480,111, PUB. 11-26-2013. INT. CL. 10.

SON TOURS, INC., DULUTH, GA:  
3,246,148, CANC. INT. CL. 39.

SONA MEDSPA INTERNATIONAL, INC., CHARLOTTE,  
NC:  
3,245,922, CANC. INT. CL. 44.

SONESTA INTERNATIONAL HOTELS CORPORATION,  
NEWTON, MA:  
4,479,861, PUB. 11-26-2013. MULTIPLE CLASS, INT. CLS.  
41 AND 43.

SONIAS PATTIES, INC., MIAMI, FL:  
3,247,568, CANC. INT. CL. 30.

SONIC INNOVATIONS, INC., SOMERSET, NJ:  
4,481,590, MULTIPLE CLASS, INT. CLS. 9 AND 10.

SONNY'S ENTERPRISES, INC., TAMARAC, FL:  
4,480,088, PUB. 8-13-2013. INT. CL. 3.

- SONOLOGY HEARING AID CLINIC LLC, HOMEWOOD, AL:  
4,481,214, PUB. 11-26-2013. INT. CL. 44.
- SONOS, INC., SANTA BARBARA, CA:  
4,480,115, PUB. 11-26-2013. INT. CL. 9.
- SONS DESIGN & MANUFACTURING, INC., DALLAS, TX:  
2,719,288, CANC. INT. CL. 9.
- SONY CORPORATION, TOKYO, JAPAN:  
2,798,527. REN. 1-6-14. INT. CL. 9.
- SONY ELECTRONICS INC., SAN DIEGO, CA:  
4,481,419, INT. CL. 41.
- SONY ONLINE ENTERTAINMENT LLC, SAN DIEGO, CA:  
4,481,817, MULTIPLE CLASS, INT. CLS. 9 AND 41.
- SOPHIA INSTITUTE, MANCHESTER, NH:  
1,815,888. REN. 1-9-14. INT. CL. 16.
- SOPP, CAROL, FALLS CHURCH, VA:  
3,246,322, CANC. INT. CL. 45.
- SOREMARTEC S.A., SCHOPPACH-ARLON, BELGIUM:  
3,246,721, CANC. INT. CL. 30.
- SORGE, NICK, JR., WYANDANCH, NY:  
3,248,045, CANC. INT. CL. 28.
- SORIGUE FOUNDATION, LLEIDA, SPAIN:  
4,479,610, PUB. 11-26-2013. MULTIPLE CLASS, INT. CLS. 16, 25, 35 AND 41.
- SORMA SPA, ITALY:  
3,247,734.
- SOROKA, CYNTHIA, DEMAREST, NJ:  
2,899,468. REN. 1-7-14. INT. CL. 16.
- SOUL FOCUSED HEALING, INC., MIAMI BEACH, FL:  
3,246,350, CANC. INT. CL. 41.
- SOUL NAVIGATION, INC., ISSAQUAH, WA:  
4,480,696, PUB. 11-26-2013. MULTIPLE CLASS, INT. CLS. 41 AND 45.
- SOUND NUTRITION, INC., DOVER, ID:  
3,245,889, CANC. INT. CL. 5.
- SOUND SLEEP PRODUCTS, INC., SUMNER, WA:  
4,481,161, PUB. 11-26-2013. INT. CL. 20.
- SOUNDSPECTRUM, INC., NEW YORK, NY:  
3,246,748, CANC. INT. CL. 42.
- SOURCE INTERLINK MAGAZINES, LLC, EL SEGUNDO, CA:  
2,798,772. REN. 1-8-14. INT. CL. 25.  
4,481,487, INT. CL. 21.
- SOURCE MEDIA, INC., NEW YORK, NY, AKA AB HOLDING INC.:  
2,719,192, CANC. INT. CL. 41.
- SOURCE, INC, CANYON COUNTRY, CA:  
3,246,595, CANC. INT. CL. 35.
- SOURCECORP, INC., FLEETWOOD, PA:  
3,245,710, CANC. INT. CL. 35.
- SOUTH BOATS IOW LIMITED, GREAT YARMOUTH, UNITED KINGDOM:  
4,479,546, PUB. 8-7-2012. MULTIPLE CLASS, INT. CLS. 12, 37, 40 AND 42.
- SOUTH CAROLINA GOVERNOR'S SCHOOL FOR SCIENCE AND MATH FOUNDATION, COLUMBIA, SC:  
4,480,581, PUB. 11-26-2013. INT. CL. 36.
- SOUTH COAST HORTICULTURAL SUPPLY, INC., ALISO VIEJO, CA:  
4,480,698, PUB. 11-26-2013. INT. CL. 1.
- SOUTH DAKOTA STATE HISTORICAL SOCIETY, PIERRE, SD:  
1,823,347. REN. 1-8-14. INT. CL. 42.
- SOUTH HILL DESIGNS CORP., SCOTTSDALE, AZ:  
4,482,484, INT. CL. 35.
- SOUTHBAY SPORTSPLEX INC., CALVERTON, NY:  
3,245,829, CANC. INT. CL. 41.
- SOUTHEASTERN OIL JOBBERS COOPERATIVE, INC., BRANDON, MS:  
3,248,289, CANC. MULTIPLE CLASS, INT. CLS. 4 AND 37.
- SOUTHERN OCEAN COUNTY CHAMBER OF COMMERCE, SHIPBOTTOM, NJ:  
3,245,765, CANC. INT. CL. 41.
- SOUTHERN SALES SOLUTIONS LLC, KENNER, LA:  
4,479,800, PUB. 11-26-2013. MULTIPLE CLASS, INT. CLS. 35 AND 36.
- SOUTHERN STATES COOPERATIVE, INCORPORATED, RICHMOND, VA:  
1,815,294. REN. 1-6-14. INT. CL. 42.
- SOUTHERN TIDE, LLC, GREENVILLE, SC:  
3,247,060, CANC. INT. CL. 25.
- SOUTHWEST OHIO DX ASSOCIATION, MONROE, OH:  
4,479,890, PUB. 11-26-2013. INT. CL. 41.
- SOUTHWESTERN ENERGY COMPANY, HOUSTON, TX:  
4,481,658, MULTIPLE CLASS, INT. CLS. 35, 37, 39 AND 40.
- SOUTHWORTH COMPANY, AGAWAM, MA:  
2,720,005, CANC. INT. CL. 16.  
2,720,006, CANC. INT. CL. 16.
- SPA BODY HEALTH, INC., LAS VEGAS, NV:  
3,246,376, CANC. INT. CL. 5.
- SPACEFLIGHT, INC., TUKWILA, WA:  
4,481,828, INT. CL. 12.
- SPAN ENTERPRISES, ROCK HILL, SC:  
4,480,171, PUB. 11-26-2013. INT. CL. 42.
- SPECIAL SERVICE & SUPPLY, INC., STEAMBOAT SRPINGS, CO, EMERGENCY SQUAD TRAINING INSTITUTE, INC., CHENOA, IL:  
998,144. REN. 1-5-14. U.S. CL. 23 (INT. CLS. 7 AND 8).
- SPECIALITIES AGRO-ALIMENTATION, MILLINGTON, NJ:  
4,480,522, PUB. 11-26-2013. INT. CL. 29.
- SPECIALIZED COMMUNICATIONS CORP., SMITHSBURG, MD:  
3,246,067, CANC. INT. CL. 9.
- SPECIALTY POOL PRODUCTS, INC., EAST WINDSOR, CT:  
3,247,416, CANC. INT. CL. 19.
- SPECIFIED TECHNOLOGIES INC., SOMERVILLE, NJ:  
2,909,105. REN. 1-7-14. INT. CL. 9.
- SPECTORE CORPORATION, DEERFIELD BEACH, FL:  
2,723,984, COR. INT. CL. 14.
- SPECTRA LOGIC CORPORATION, BOULDER, CO:  
2,911,723. REN. 1-3-14. INT. CL. 42.
- SPECTRASOFT, INC., TEMPE, AZ:  
3,511,159, CANC. INT. CL. 9.
- SPECTRUM GLASS COMPANY, INC., WOODINVILLE, WA:  
1,266,350. REN. 1-6-14. INT. CL. 21.
- SPECTRUM HEALTH, INC., WEST PALM BEACH, FL:  
4,481,155, PUB. 11-26-2013. MULTIPLE CLASS, INT. CLS. 44 AND 45.
- SPECTRUS GROUP LLC, EAGLE, ID:  
3,247,042, CANC. INT. CL. 36.
- SPEED COMMERCE, INC., NEW HOPE, MN:  
4,480,131, PUB. 11-26-2013. INT. CL. 35.  
4,480,132, PUB. 11-26-2013. INT. CL. 42.
- SPEED, MARVIN B., MERIDIAN, MS:  
2,718,973, CANC. INT. CL. 41.
- SPEEDO HOLDINGS B.V., AMSTERDAM 1082 MD, NETHERLANDS:  
4,480,793, PUB. 11-26-2013. INT. CL. 9.
- SPEEDWAY LLC, ENON, OH:  
4,482,647, INT. CL. 9.
- SPEEDY CYCLE LUBE, HOUSTON, TX:  
4,480,653, PUB. 11-26-2013. INT. CL. 37.
- SPHERICAL, INC., SAN FRANCISCO, CA:  
4,480,460, PUB. 11-26-2013. INT. CL. 9.
- SPIELO INTERNATIONAL CANADA ULC, MONCTON, NEW BRUNSWICK, CANADA:  
4,481,441, INT. CL. 9.  
4,481,486, INT. CL. 9.
- SPIKE CABLE NETWORKS INC., NEW YORK, NY:  
2,891,969. REN. 1-8-14. INT. CL. 38.  
2,891,970. REN. 1-8-14. INT. CL. 41.  
3,247,655, CANC. INT. CL. 41.
- SPIN MASTER LTD., TORONTO, ONTARIO, CANADA:  
3,248,018, CANC. INT. CL. 16.  
4,479,540, PUB. 11-26-2013. INT. CL. 28.
- SPINE IQ, GREEN BAY, WI:  
4,482,553, INT. CL. 44.
- SPINNEYBECK ENTERPRISES, INC., GETZVILLE, NY:  
4,479,587, PUB. 11-26-2013. INT. CL. 24.
- SPINRITE LIMITED PARTNERSHIP, LISTOWEL, N4W 3H3, CANADA:  
765,926. REN. 1-6-14. U.S. CL. 38 (INT. CL. 16).



SPONSORPAY GMBH, FED REP GERMANY:  
4,479,355, PUB. 11-26-2013. MULTIPLE CLASS, INT. CLS. 35, 38 AND 41.

SPONSORSHIP SCIENCE, LLC, ST. LOUIS, MO:  
4,482,086, INT. CL. 35.

SPORT SHIRTS CONCEPTS LLC, MELBOURNE, FL:  
4,482,716, INT. CL. 25.

SPORTELESI, INC., SANTA ANA, CA, DBA ORTHO NUTRITION:  
1,867,956, REN. 1-8-14, INT. CL. 5.

SPORTING EXCHANGE LTD., THE, LONDON, UNITED KINGDOM:  
2,820,669, REN. 1-3-14, MULTIPLE CLASS, INT. CLS. 36 AND 41.

SPORTS MANAGEMENT WORLDWIDE, INC., PORTLAND, OR:  
3,246,832, CANC. INT. CL. 9.

SPRAY ENCLOSURE TECHNOLOGIES, RIALTO, CA:  
3,246,323, CANC. INT. CL. 11.

SPRING CREEK RANCH CLUB, LLC, COLLIERVILLE, TN:  
2,869,759, REN. 1-3-14, INT. CL. 37.

SPRINGER SCIENCE + BUSINESS MEDIA B.V., DORDRECHT, NETHERLANDS:  
2,797,892, REN. 1-3-14, INT. CL. 16.  
2,797,894, REN. 1-3-14, INT. CL. 16.

SPROCKETPRO INC., PASADENA, CA:  
4,434,692, COR. MULTIPLE CLASS, INT. CLS. 9, 35, 41 AND 42.

SPS STUDIOS, INC., BOULDER, CO:  
2,809,159, REN. 1-3-14, INT. CL. 41.

SPT TECHNOLOGY, INC., MINNEAPOLIS, MN:  
3,248,314, CANC. INT. CL. 22.

SPY KING CORPORATION, LATHRUP VILLAGE, MI:  
2,718,976, CANC. INT. CL. 35.

SPY OPTIC INC., CARLSBAD, CA:  
3,248,282, CANC. INT. CL. 9.

SQUADRON, TOLUCA LAKE, CA:  
4,481,128, PUB. 11-26-2013, INT. CL. 41.

SQUARE ENIX LIMITED, LONDON, UNITED KINGDOM:  
3,246,369, CANC. MULTIPLE CLASS, INT. CLS. 9, 16, 28 AND 41.

SRA INTERNATIONAL, INC., FAIRFAX, VA:  
3,497,804, CANC. INT. CL. 9.

SS&C TECHNOLOGIES NEW JERSEY, INC., WINDSOR, CT:  
2,802,330, REN. 1-8-14, MULTIPLE CLASS, INT. CLS. 9 AND 42.

SSM HEALTH CARE OF OKLAHOMA, INC., OKLAHOMA CITY, OK:  
4,480,563, PUB. 11-26-2013, INT. CL. 44.

ST. JAMES ASSOCIATES, L.P., NEW YORK, NY, DBA SMITH & WOLLENSKY:  
2,071,837, COR. INT. CL. 42.  
3,240,787, COR. MULTIPLE CLASS, INT. CLS. 8, 29, 30 AND 33.

ST. JUDE MEDICAL, ATRIAL FIBRILLATION DIVISION, INC., ST. PAUL, MN, DAIG CORPORATION, MINNETONKA, MN:  
1,779,585, REN. 1-6-14, INT. CL. 10.

STA-RITE INDUSTRIES, LLC, DELAVAN, WI:  
978,480, REN. 1-7-14, MULTIPLE CLASS, U.S. CLS. 21 (INT. CLS. 7 AND 9), 23 (INT. CL. 7) AND 31 (INT. CL. 11).

STAFFORD CREEK LODGE LTD, NORTH BLANKET SOUND, BAHAMAS:  
4,480,119, PUB. 11-26-2013, INT. CL. 39.

STAFFSMARTS, INC., LAGUNA HILLS, CA:  
3,246,528, CANC. INT. CL. 35.

STAGE ONE PRODUCTIONS, INC., DENVER, CO:  
2,777,982, REN. 1-9-14, INT. CL. 41.

STAGELEAP LLC, NOVI, MI:  
4,480,203, PUB. 11-26-2013, INT. CL. 35.

STAGELEFT DESIGNS, INC., VENTURA, CA:  
3,247,533, CANC. INT. CL. 42.

STAINLESSDREAMS LTD., EDMONTON, ALBERTA, CANADA:  
4,479,551, PUB. 4-9-2013, MULTIPLE CLASS, INT. CLS. 6, 11 AND 20.

STAMPIN' UP! INC., RIVERTON, UT:  
3,248,758, CANC. INT. CL. 26.

STANDARD MOTOR PRODUCTS, INC., LEWISVILLE, TX:  
2,801,890, REN. 1-6-14, INT. CL. 11.

STANISLAV, ELIZABETH ANNE, SCOTTSDALE, AZ, DBA LIZZIDESIGN:  
4,480,754, PUB. 11-26-2013, INT. CL. 41.

STAPLE ME THIN, KILLEEN, TX:  
3,247,109, CANC. INT. CL. 44.

STAR MARKETING INTERNATIONAL INC., GARDENA, CA, DBA APOLLO GROUP INC.:  
4,479,819, PUB. 11-26-2013, INT. CL. 24.  
4,479,820, PUB. 11-26-2013, INT. CL. 24.

STAR MILLING CO., PERRIS, CA:  
1,863,863, REN. 1-4-14, INT. CL. 31.

STAR SPEED SCAFFOLD, LLC, GLENDALE, AZ:  
4,481,308, MULTIPLE CLASS, INT. CLS. 6 AND 9.

STARLUX CORPORATION, CHICAGO, IL:  
4,481,686, INT. CL. 16.

STARR INTERNATIONAL COMPANY, INC., ZUG, SWITZERLAND:  
4,479,669, PUB. 11-26-2013, INT. CL. 36.

STARZ ENTERTAINMENT, LLC, ENGLEWOOD, CO:  
3,248,356, CANC. MULTIPLE CLASS, INT. CLS. 38 AND 41.

STATE OF EMOTIONS, LOS ANGELES, CA:  
4,479,784, PUB. 11-26-2013, INT. CL. 25.

STATE UNIVERSITY OF NEW YORK BY AND ON BEHALF OF SUNY COBLESKILL, COBLESKILL, NY:  
4,479,883, PUB. 11-26-2013, MULTIPLE CLASS, INT. CLS. 6, 12, 16, 18, 20, 21, 22, 24, 25, 28 AND 41.  
4,479,884, PUB. 11-26-2013, MULTIPLE CLASS, INT. CLS. 25 AND 41.  
4,479,885, PUB. 11-26-2013, MULTIPLE CLASS, INT. CLS. 25 AND 41.

STATION CASINOS, INC., LAS VEGAS, NV:  
3,674,651, COR. INT. CL. 43.

STAYGREEN PARTNERS, LAKELAND, FL:  
4,480,771, PUB. 11-26-2013, INT. CL. 35.

STAYINFRONT, INC., FAIRFIELD, NJ:  
2,718,327, CANC. INT. CL. 9.

STAYPOINTS, LLC, HOOVER, AL:  
4,481,920, INT. CL. 35.

STEADFAST BRAND, INC., ORLANDO, FL:  
4,481,059, PUB. 11-26-2013, INT. CL. 25.  
4,481,060, PUB. 11-26-2013, INT. CL. 25.  
4,481,061, PUB. 11-26-2013, INT. CL. 25.

STEAM POT, LLC, THE, BROOKEVILLE, MD:  
3,248,760, CANC. INT. CL. 29.

STEARNS PRODUCTS, INC., SIMI VALLEY, CA:  
3,247,447, CANC. INT. CL. 3.

STEARNS PACKAGING CORPORATION, MADISON, WI:  
1,840,242, REN. 1-3-14, INT. CL. 3.

STEEL AND PIPES, INC., CAGUAS, PUERTO RICO:  
4,481,928, INT. CL. 6.

STEEL CASTLE PROPERTY ADVISORS, LLC, FULLERTON, CA:  
4,482,683, INT. CL. 36.

STEEL MATE CO., LTD, ZHONGSHAN CITY, GUANGDONG PROVINCE, CHINA:  
2,913,341, REN. 1-7-14, INT. CL. 9.  
2,913,342, REN. 1-7-14, INT. CL. 9.

STEELCASE S.A., FRANCE:  
3,247,831.

STEELSTRETCH LLC., NORTH ROYALTON, OH:  
4,480,224, PUB. 11-26-2013, INT. CL. 25.

STEFFEN MÜLLER, FED REP GERMANY:  
4,479,389, PUB. 11-26-2013, MULTIPLE CLASS, INT. CLS. 36 AND 42.

STEM INT'L, MINNEAPOLIS, MN:  
3,246,954, CANC. INT. CL. 16.

STENCILS ONLINE LLC, FRANKLIN, NH:  
4,480,892, PUB. 11-26-2013, INT. CL. 16.

STENOGRAPH, L.L.C., ELMHURST, IL:  
4,479,660, PUB. 11-26-2013, INT. CL. 41.

STEPHANO, RENEE-MARIE, PALM BEACH GARDENS, FL:  
4,482,868, INT. CL. 41.

- STEPHEN H. BARKOW, LAGUNA NIGUEL, CA AND PAMINA E. BARKOW, LAGUNA NIGUEL, CA: 4,482,238, INT. CL. 5.
- STERLING ENTERTAINMENT ENTERPRISES, LLC, NEW YORK, NY: 3,247,054, CANC. INT. CL. 41.
- STEVEN HAILEY, HOUSTON, TX: 4,479,860, PUB. 11-26-2013. INT. CL. 25.
- STEVEN ZHANG, WEST COVINA, CA: 4,481,100, PUB. 11-26-2013. INT. CL. 5.
- STEVENS, LAURI, NEWBURY, MA: 4,481,947, INT. CL. 41.
- STILL, CHRISTOPHER M., TARPON SPRINGS, FL: 2,878,850, REN. 1-7-14. INT. CL. 16.
- STMICROELECTRONICS, N.V., CH-1215 GENEVA 15, SWITZERLAND: 2,718,376, CANC. INT. CL. 9.
- STOCKMARKET BURGER INC., MARINA DEL REY, CA: 4,481,899, INT. CL. 43.
- STOK, MARYAM, SHERMAN OAKS, CA: 3,247,566, CANC. INT. CL. 41.
- STOLL, BRIAN, BURNSVILLE, MN: 3,248,749, CANC. INT. CL. 35.
- STONE MOUNTAIN CARPET MILLS, INC., SAINT LOUIS, MO: 2,821,930, REN. 1-9-14. INT. CL. 35.
- STONES RIVER REGIONAL IPA, MURFREESBORO, TN: 4,482,701, MULTIPLE CLASS, INT. CLS. 35, 41 AND 44.
- STORAGE APPLIANCE CORPORATION, RICHMOND HILL, ON, CANADA: 4,481,039, PUB. 11-26-2013. MULTIPLE CLASS, INT. CLS. 38 AND 42. 4,481,042, PUB. 11-26-2013. MULTIPLE CLASS, INT. CLS. 38 AND 42.
- STOREY PUBLISHING, LLC, NORTH ADAMS, MA: 4,482,801, INT. CL. 16.
- STORMPATH, INC., SAN MATEO, CA: 4,481,677, MULTIPLE CLASS, INT. CLS. 9, 42 AND 45.
- STORY MINING AND SUPPLY CO., LLC, SAN FRANCISCO, CA: 4,481,691, INT. CL. 41.
- STOTT, JONATHAN EDWIN, AURORA, IL: 4,480,081, PUB. 11-26-2013. INT. CL. 25.
- STOUT, WILLIAM R., HOUSTON, TX: 3,248,485, CANC. INT. CL. 11.
- STOWE WOODWARD, LLC, RALEIGH, NC: 3,248,423, CANC. INT. CL. 7.
- STRATASAN, LLC, NASHVILLE, TN, FORMERLY HEALTH DATA SOURCE, LLC: 4,479,251, PUB. 11-26-2013. INT. CL. 42.
- STRATEGIC PARTNERS, INC., CHATSWORTH, CA: 4,481,687, INT. CL. 35.
- STRATEGYEDU, LLC, WINSTON SALEM, NC: 3,247,514, CANC. INT. CL. 41.
- STREAK PRODUCTS INC., MIAMI, FL: 4,481,769, INT. CL. 9.
- STREEMFIRE GMBH, AUSTRIA: 4,479,418, PUB. 11-26-2013. MULTIPLE CLASS, INT. CLS. 9, 38 AND 42. 4,479,419, PUB. 11-26-2013. MULTIPLE CLASS, INT. CLS. 9, 38 AND 42.
- STREET PLAYERS HOLDING CORPORATION, LOS ANGELES, CA: 4,482,361, INT. CL. 20.
- STRICKLAND'S ARCHERY, MONTROSE, CO: 4,480,537, PUB. 11-26-2013. INT. CL. 28.
- STRIPEY, LLC, DEEPHAVEN, MN, DBA STRIPEY TOYS: 4,481,382, MULTIPLE CLASS, INT. CLS. 16 AND 28.
- STROBER BUILDING SUPPLY IP CORP., EDISON, NJ: 3,246,184, CANC. INT. CL. 35.
- STRONG MANUFACTURING COMPANY, INC., PINE BLUFF, AR: 1,255,843, REN. 1-8-14. INT. CL. 7. 1,302,399, REN. 1-3-14. INT. CL. 7.
- STRONG NEDERLAND B.V., 3439 MC NIEUWEGEIN, NETHERLANDS: 3,247,873, CANC. INT. CL. 9.
- STRYKER CORPORATION, KALAMAZOO, MI AND STRYKER NV OPERATIONS LIMITED, DUBLIN 2, IRELAND: 2,800,935, REN. 1-8-14. INT. CL. 10.
- STUCKEY DIAMOND, INC. D/B/A THE STUCKEY COMPANY, HOUSTON, TX: 3,246,551, CANC. MULTIPLE CLASS, INT. CLS. 14 AND 35.
- STUDENT ADVANTAGE, LLC, BOSTON, MA, SOZZI, RAYMOND V. JR., BOSTON, MA, DBA STUDENT ADVANTAGE: 1,813,986, REN. 1-8-14. INT. CL. 35.
- STUDIO NETWORK SOLUTIONS, L.L.C., ST. LOUIS, MO: 3,246,559, CANC. INT. CL. 9.
- STYLE HAUL, INC., LOS ANGELES, CA: 4,481,680, MULTIPLE CLASS, INT. CLS. 41, 44 AND 45.
- SUBURBAN MACHINE CO., INC., MONTICELLO, MN: 2,847,920, REN. 1-6-14. INT. CL. 24.
- SUDDEN IMPACT RACING, FRACKVILLE, PA: 2,719,744, CANC. INT. CL. 28.
- SUISSE IB, ZURICH, SWITZERLAND: 4,480,120, PUB. 11-26-2013. INT. CL. 41.
- SUJA LIFE, LLC, SAN DIEGO, CA, DBA SUJA JUICE: 4,481,216, PUB. 11-26-2013. MULTIPLE CLASS, INT. CLS. 30 AND 32. 4,481,217, PUB. 11-26-2013. INT. CL. 32. 4,481,218, PUB. 11-26-2013. INT. CL. 32.
- SUMITOMO (SHI) CRYOGENICS OF AMERICA, INC., ALLENTOWN, PA: 1,864,182, REN. 1-8-14. INT. CL. 7.
- SUMMER INFANT (USA), INC., WOONSOCKET, RI: 3,248,512, CANC. INT. CL. 9. 3,248,529, CANC. INT. CL. 9.
- SUN 'N FUN FLY-IN, INC., LAKELAND, FL: 3,246,519, CANC. MULTIPLE CLASS, INT. CLS. 16 AND 41. 3,246,520, CANC. MULTIPLE CLASS, INT. CLS. 16, 25 AND 41.
- SUN BEVERAGES, INC., MURRIETA, CA: 4,480,916, PUB. 11-26-2013. INT. CL. 32.
- SUN CHEMICAL CORPORATION, PARSIPPANY, NJ, UNITED STATES PRINTING INK CORPORATION, EAST RUTHERFORD, NJ: 1,814,624, REN. 1-4-14. INT. CL. 2.
- SUN CHEMICAL CORPORATION, PARSIPPANY, NJ: 1,820,911, REN. 1-7-14. INT. CL. 2.
- SUN CHLORELLA CORP., KYOTO, JAPAN: 4,481,034, PUB. 11-26-2013. INT. CL. 30.
- SUN KING BREWING COMPANY, LLC, INDIANAPOLIS, IN: 4,479,965, PUB. 6-25-2013. INT. CL. 32. 4,479,966, PUB. 6-25-2013. INT. CL. 32.
- SUN PING, SHENZHEN, GUANGDONG, CHINA AND YANG HUI, JIANGSU, CHINA AND WANG DINGLIANG, SHANGHAI, CHINA: 4,481,126, PUB. 11-26-2013. INT. CL. 28.
- SUN WORKS TANNING, INC., PASADENA, CA: 3,247,349, CANC. INT. CL. 44.
- SUN, DONALD J.C., ARCADIA, CA: 2,719,962, CANC. INT. CL. 28.
- SUNAJ B.V., NETHERLANDS: 4,479,311, PUB. 11-26-2013. MULTIPLE CLASS, INT. CLS. 18, 25 AND 35.
- SUNBURGER LLC, NEW YORK, NY: 4,482,448, INT. CL. 43.
- SUNCE, SAN MARCOS, CA: 4,482,569, INT. CL. 21.
- SUNDANCE DIGITAL, INC., TEWKSBURY, MA: 3,245,980, CANC. INT. CL. 9.
- SUNJOY INDUSTRIES GROUP, INC., STEUBENVILLE, OH: 3,248,744, CANC. INT. CL. 21.
- SUNKIST GROWERS, INC., SHERMAN OAKS, CA: 578,492, AM. U.S. CL. 45. 4,482,629, INT. CL. 32. 4,482,639, MULTIPLE CLASS, INT. CLS. 29 AND 31.
- SUNMEDICA, INC., REDDING, CA: 4,479,964, PUB. 11-26-2013. INT. CL. 10.
- SUNPLUS TECHNOLOGY CO., LTD., HSIN-CHU, TAIWAN: 3,248,044, CANC. INT. CL. 9.

SUNRIDER CORPORATION, THE, TORRANCE, CA, DBA SUNRIDER INTERNATIONAL:  
1,815,642. REN. 1-7-14. MULTIPLE CLASS, INT. CLS. 5 AND 29.

SUNSET PUBLISHING CORPORATION, MENLO PARK, CA:  
4,480,826. PUB. 11-26-2013. INT. CL. 41.

SUNSHINE, RICHARD, DALLAS, TX:  
4,481,353. INT. CL. 30.

SUNSTAR AMERICAS, INC., CHICAGO, IL, JOHN O. BUTLER COMPANY, CLIFTON FORGE, VA:  
977,400. REN. 1-7-14. U.S. CL. 44 (INT. CL. 10).

SUNSTAR SUISSE SA, 1163 ETOY, SWITZERLAND:  
4,481,349. MULTIPLE CLASS, INT. CLS. 5 AND 10.

SUNTORY FLOWERS LIMITED, JAPAN:  
4,479,379. PUB. 11-26-2013. INT. CL. 31.  
4,479,380. PUB. 11-26-2013. INT. CL. 31.  
4,479,393. PUB. 11-26-2013. INT. CL. 31.

SUPER PLANNING CO., LTD., JAPAN:  
3,247,843.

SUPER SIMPLE LEARNING, INC., SEATTLE, WA:  
4,482,258. INT. CL. 9.

SUPERINK INTERNATIONAL LIMITED, KOWLOON, HONG KONG:  
3,246,107. CANC. INT. CL. 2.

SUPERIOR BAKERY, INC., NORTH GROSVENORDALE, CT:  
2,836,749. REN. 1-8-14. INT. CL. 30.

SUPERIOR MANUFACTURING GROUP, INC., CHICAGO, IL:  
1,793,749. REN. 1-3-14. INT. CL. 27.

SUPERIOR SHARED SERVICES, INC., WILLIAMSVILLE, NY:  
4,480,333. PUB. 11-26-2013. MULTIPLE CLASS, INT. CLS. 35 AND 36.

SUPERWOMAN PTY LIMITED, CRONULLA, AUSTRALIA, TA SUPERWOMAN:  
3,246,345. CANC. INT. CL. 36.

SUPPORTSPORT C.V., NETHERLANDS:  
3,247,739.

SURF CAMP INC., WILMINGTON, NC:  
4,480,897. PUB. 11-26-2013. INT. CL. 43.

SUSAN TYGRET, OKATIE, SC, DBA COASTAL CHIC:  
4,479,716. PUB. 11-26-2013. INT. CL. 20.

SUSTAINABLE APPAREL COALITION, SAN FRANCISCO, CA:  
4,482,667. INT. CL. 41.

SUTERRA LLC, LOS ANGELES, CA:  
2,796,835. REN. 1-6-14. MULTIPLE CLASS, INT. CLS. 5 AND 21.

SUTKOWSKI, JENNIFER, CAMBRIDGE, MA:  
4,480,774. PUB. 11-26-2013. INT. CL. 3.

SUTTER HOME WINERY, INC., ST. HELENA, CA:  
2,720,104. CANC. INT. CL. 33.  
4,481,357. INT. CL. 33.

SUZANNE EVANS COACHING OF SC, LLC, MURRELLS INLET, SC:  
4,342,674. CANC. IIRN. RESTORED TO S.N. 85-768,262.

SVARA NFP, EVANSTON, IL:  
3,246,856. CANC. INT. CL. 41.

SVENSSON, JEAN PEHR CHRISTIAN, NORWAY:  
4,479,352. PUB. 11-26-2013. MULTIPLE CLASS, INT. CLS. 41, 43 AND 45.

SWAIN, SCOTT, OREM, UT:  
3,246,985. CANC. INT. CL. 16.

SWANBERG, MANS, BROOKLYN, NY:  
4,482,237. INT. CL. 28.

SWAY INC, LAREDO, TX:  
4,480,546. PUB. 11-26-2013. INT. CL. 9.

SWEENEY CONTROLS COMPANY, FARGO, ND:  
2,797,090. REN. 1-3-14. INT. CL. 9.

SWEENEY, CAROLINE, SONOMA, CA:  
4,479,706. PUB. 11-26-2013. INT. CL. 16.

SWEET & TWISTED, COLORADO SPRINGS, CO:  
4,482,858. INT. CL. 25.

SWEET ARLEEN'S INTERNATIONAL INC., LOS ANGELES, CA:  
4,480,749. PUB. 11-26-2013. MULTIPLE CLASS, INT. CLS. 30, 35 AND 43.

SWEET CHEEKS VINEYARDS, INC., EUGENE, OR:  
4,480,957. PUB. 11-26-2013. INT. CL. 33.

SWEET PEA PROJECT, LEOLA, PA:  
4,480,559. PUB. 11-26-2013. INT. CL. 35.

SWEET WHEAT, INC., LARGO, FL:  
4,482,231. INT. CL. 5.

SWEETY HIGH, INC., MANHATTAN BEACH, CA:  
4,479,562. PUB. 10-16-2012. INT. CL. 41.

SWIFT BRANDS COMPANY, GREELEY, CO:  
3,248,553. CANC. INT. CL. 29.

SWIFT UNLOCKS, INC., ANAHEIM HILLS, CA:  
4,480,021. PUB. 8-20-2013. INT. CL. 42.

SWIFTVIEW, INC., PORTLAND, OR:  
3,248,692. CANC. INT. CL. 38.

SWIMC, INC., NEWARK, DE:  
4,479,606. PUB. 8-14-2012. INT. CL. 2.  
4,479,609. PUB. 8-14-2012. INT. CL. 2.

SWIMWAYS CORP., VIRGINIA BEACH, VA:  
4,481,209. PUB. 11-26-2013. INT. CL. 28.

SWINERTON INCORPORATED, SAN FRANCISCO, CA:  
2,802,147. REN. 1-3-14. INT. CL. 37.

SWISS CARGO INDUSTRIES S.A. INC., ST. JEAN, QUEBEC, CANADA:  
4,481,329. INT. CL. 9.  
4,481,330. INT. CL. 9.

SWISS VALLEY FARMS COOPERATIVE, DAVENPORT, IA, MISSISSIPPI VALLEY MILK PRODUCERS ASSOCIATION, INC., DAVENPORT, IA:  
1,268,085. REN. 1-8-14. INT. CL. 29.

SWISS-AMERICAN, INC., ST. LOUIS, MO:  
4,481,973. INT. CL. 29.

SYLLABLES READING CENTER, INC., ALPHARETTA, GA:  
4,480,575. PUB. 11-26-2013. INT. CL. 41.  
4,480,576. PUB. 11-26-2013. INT. CL. 41.

SYMMETRY ELECTRONICS CORPORATION, HAWTHORNE, CA:  
4,482,591. INT. CL. 35.

SYMMETRY MEDICAL MANUFACTURING, INC., WARSAW, IN:  
2,793,721. REN. 1-6-14. INT. CL. 10.

SYMMETRY PARTNERS, LLC, GLASTONBURY, CT:  
4,480,220. PUB. 11-26-2013. MULTIPLE CLASS, INT. CLS. 35 AND 36.

SYSCO CORPORATION, HOUSTON, TX:  
4,481,998. INT. CL. 29.  
4,481,999. INT. CL. 35.

SYSK LIMITED, TORTOLA, BR. VIRGIN ISLANDS:  
4,480,167. PUB. 11-26-2013. INT. CL. 38.

SYSTEMFORWARD AMERICA, INC., LAFAYETTE, LA:  
4,480,367. PUB. 11-26-2013. MULTIPLE CLASS, INT. CLS. 37, 39, 40 AND 45.

T.M. DESIGNWORKS, LLC, PHOENIX, OR:  
2,818,872. REN. 1-6-14. MULTIPLE CLASS, INT. CLS. 7 AND 12.

T-MOBILE USA, INC., BELLEVUE, WA:  
4,480,888. PUB. 11-26-2013. MULTIPLE CLASS, INT. CLS. 9, 35, 36 AND 38.  
4,480,891. PUB. 11-26-2013. MULTIPLE CLASS, INT. CLS. 9, 35, 36 AND 38.

T.TIME CONTENTS CO, LTD., SEOUL, REPUBLIC OF KOREA:  
4,479,627. PUB. 11-26-2013. MULTIPLE CLASS, INT. CLS. 28 AND 41.

TABITS, INC., SANDY SPRINGS, GA:  
4,480,413. PUB. 11-26-2013. INT. CL. 42.  
4,480,447. PUB. 11-26-2013. INT. CL. 42.

TAC PRODUCTS LIMITED, LONDON, UNITED KINGDOM:  
3,248,063. CANC. INT. CL. 9.

TACIT KNOWLEDGE INC., SAN FRANCISCO, CA:  
4,480,077. PUB. 11-26-2013. INT. CL. 42.  
4,480,122. PUB. 11-26-2013. INT. CL. 42.

TADIRAN TELECOM (TTL), LIMITED PARTNERSHIP, PETACH TIKVA, ISRAEL:  
4,481,722. INT. CL. 9.

TAGS, LLC, FRANKLIN, TN:  
3,247,903. CANC. INT. CL. 35.

- TAHY, STEPHEN H., PLATTSBURGH, NY:  
3,246,394, CANC. INT. CL. 36.
- TAIWAN EXTERNAL TRADE DEVELOPMENT COUNCIL,  
TAIPEI, TAIWAN:  
2,851,527. REN. 1-3-14. INT. CL. 35.
- TAIYO YUDEN CO., LTD., TOKYO, JAPAN:  
4,479,749, PUB. 11-26-2013. INT. CL. 9.
- TAKASAGO INTERNATIONAL CORPORATION, OHTA-  
KU, TOKYO, JAPAN:  
2,831,213. REN. 1-6-14. INT. CL. 1.
- TAKASAGO KORYO KOGYO KABUSHIKI KAISHA,  
OHTA-KU, TOKYO, JAPAN, TA TAKASAGO INTERNA-  
TIONAL CORPORATION:  
1,835,091. REN. 1-6-14. INT. CL. 1.
- TAKESHI CORP., PASADENA, CA:  
3,247,278, CANC. INT. CL. 43.
- TALEWORLDS ENTERTAINMENT IKISOFT.; YAZILIM  
BILGI VE ILETISIM.; EGITIM TEKNOLOJILERI.; VE  
HIZMETLERI ELEKTRONIK.; SANAYI VE TICARET  
LIMITED SIRKETI, TURKEY:  
4,479,391, PUB. 11-26-2013. MULTIPLE CLASS, INT. CLS.  
9, 28 AND 41.
- TALKMARKETS, LLC, HIGHLAND PARK, NJ:  
4,481,142, PUB. 11-26-2013. INT. CL. 36.
- TALL GRASS LLC, HORSHAM, PA:  
4,481,936, INT. CL. 41.
- TALLEY, RODNEY, HUNTERSVILLE, NC:  
4,481,902, INT. CL. 9.  
4,481,941, INT. CL. 9.
- TALLGRASS SURGICAL CENTER, LLC, TOPEKA, KS:  
4,480,038, PUB. 11-26-2013. INT. CL. 44.
- TAMPA BAY RECREATION, LLC, LUTZ, FL:  
4,482,527, INT. CL. 12.  
4,482,528, INT. CL. 12.
- TAMURA CORPORATION, TOKYO, JAPAN:  
3,248,084, CANC. INT. CL. 9.
- TANAKA HATSUMI, TOKYO 164-0014, JAPAN:  
4,479,459, PUB. 11-26-2013. MULTIPLE CLASS, INT. CLS.  
29 AND 30.
- TANGIERS INTERNATIONAL, LTD., SLIEMA, MALTA:  
4,482,100, INT. CL. 36.  
4,482,101, INT. CL. 36.
- TANIMURA & ANTLE, INC., SALINAS, CA:  
2,912,546, CANC. INT. CL. 31.
- TAQEE, MICHAEL M, CHICAGO, IL:  
4,482,311, INT. CL. 41.
- TARA MARIE, INC., NEW YORK, NY:  
4,480,517, PUB. 11-26-2013. INT. CL. 41.
- TARGET BRANDS, INC., MINNEAPOLIS, MN:  
2,799,792. REN. 1-6-14. INT. CL. 8.  
2,803,195. REN. 1-6-14. INT. CL. 26.  
4,481,383, INT. CL. 21.
- TARLOW, JUSTIN, VENICE, CA:  
3,246,015, CANC. INT. CL. 21.
- TASER INTERNATIONAL, INC., SCOTTSDALE, AZ:  
4,482,299, INT. CL. 11.
- TAVTEC LTD., 56000 YEHOUD, ISRAEL:  
4,479,388, PUB. 11-26-2013. INT. CL. 10.
- TAX ADVANTAGE PERSONNEL, INC., HARRISON, TN:  
3,247,137, CANC. INT. CL. 35.
- TAX RUNNERS.COM, INC., NEWBURGH, NY:  
4,480,511, PUB. 11-26-2013. INT. CL. 42.
- TAYLOR J STEPHENS DDS PA, WAYZATA, MN:  
4,482,317, INT. CL. 44.
- TAYLOR NELSON SOFRES PLC, LONDON, UNITED KING-  
DOM:  
2,719,655, CANC. INT. CL. 35.
- TB ADVERTISING SERVICES, AVV, NOORD, ARUBA:  
3,248,723, CANC. INT. CL. 41.
- TBF SERVICES, LLC, PALMER, AK:  
2,856,019. REN. 1-6-14. INT. CL. 35.
- TDB SYSTEMS, LLC, SPRINGFIELD, MO:  
3,248,001, CANC. INT. CL. 9.
- TE WIRE & CABLE LLC, SADDLE BROOK, NJ:  
4,481,481, INT. CL. 9.
- TEA FORTÉ, INC., CONCORD, MA:  
3,248,410, CANC. INT. CL. 30.
- TEAMPLAYER GAMING, LLC, HOUSTON, TX:  
4,481,052, PUB. 11-26-2013. INT. CL. 42.
- TEAMQUEST CORPORATION, CLEAR LAKE, IA:  
4,482,199, INT. CL. 9.
- TEAR IT UP, MISSOULA, MT:  
3,246,806, CANC. INT. CL. 40.
- TEATRO ZINZANNI, SEATTLE, WA:  
2,871,666. REN. 1-6-14. MULTIPLE CLASS, INT. CLS. 41  
AND 43.
- TECHNICAL RUBBER COMPANY, INC., JOHNSTOWN,  
OH:  
4,480,083, PUB. 11-26-2013. INT. CL. 1.
- TECHNICOLOR TRADEMARK MANAGEMENT, ISSY LES  
MOULINEAUX, FRANCE:  
4,481,490, INT. CL. 9.
- TECHNO-FAB 9000 INC., SAINT-HYACINTHE, QUEBEC,  
CANADA:  
4,479,774, PUB. 11-26-2013. INT. CL. 12.  
4,479,775, PUB. 11-26-2013. INT. CL. 12.
- TECHNOLOGY DIMENSIONS, INC., ORANGE, CA:  
3,247,251, CANC. INT. CL. 37.
- TECHNOMARINE SA, SUCCURSALE LUXEMBOURG,  
LUXEMBOURG, LUXEMBOURG:  
2,719,863, CANC. INT. CL. 35.
- TECHNOSIL, GMBH, CH-8302 KLOTEN-ZÜRICH, SWIT-  
ZERLAND:  
4,479,400, PUB. 11-26-2013. INT. CL. 17.
- TECHTREND, INC., ARLINGTON, VA:  
4,481,056, PUB. 11-26-2013. INT. CL. 42.
- TECHTRONIC FLOOR CARE TECHNOLOGY LIMITED,  
ROAD TOWN, TORTOLA, BR. VIRGIN ISLANDS:  
3,248,480, CANC. INT. CL. 7.  
3,248,481, CANC. INT. CL. 7.
- TECMACO INTERNATIONAL, LTD., STROUD, GLOUCES-  
TERSHIRE, UNITED KINGDOM, DBA HOT-HEADZ:  
4,479,945, PUB. 11-26-2013. INT. CL. 29.
- TECMAP CORP., EL SEGUNDO, CA:  
4,482,331, INT. CL. 9.
- TECORE NETWORKS, HANOVER, MD:  
4,481,076, PUB. 11-26-2013. INT. CL. 9.
- TECSEC, INCORPORATED, VIENNA, VA:  
2,798,042. REN. 1-3-14. INT. CL. 9.
- TED DREWES, INC., ST. LOUIS, MO:  
2,830,152. REN. 1-6-14. INT. CL. 30.  
2,897,174. REN. 1-6-14. INT. CL. 35.
- TEKDOC SOLUTIONS, SAUGUS, MA:  
4,480,820, PUB. 11-26-2013. INT. CL. 42.
- TEL-TRU, INC., ROCHESTER, NY, DBA TEL-TRU MANU-  
FACTURING COMPANY:  
4,481,230, PUB. 11-26-2013. INT. CL. 9.
- TELAIR INTERNATIONAL GMBH, FED REP GERMANY:  
4,479,462, PUB. 11-26-2013. MULTIPLE CLASS, INT. CLS.  
6, 7, 9 AND 20.
- TELEADAPT LIMITED, WATFORD, HERTFORDSHIRE,  
UNITED KINGDOM:  
4,482,751, INT. CL. 9.
- TELEBRANDS CORP., FAIRFIELD, NJ:  
4,482,434, INT. CL. 28.
- TELEBRANDS CORPORATION, FAIRFIELD, NJ:  
3,248,764, CANC. INT. CL. 21.
- TELECHECK INTERNATIONAL, INC., HOUSTON, TX:  
4,482,590, INT. CL. 35.
- TELEPERFORMANCE, PARIS, FRANCE, TELEPERFOR-  
MANCE, S.A., 75015 PARIS, FRANCE:  
1,781,132. REN. 1-6-14. MULTIPLE CLASS, INT. CLS. 16,  
35 AND 38.
- TELERIK, A.D., SOFIA, BULGARIA:  
2,720,073, CANC. INT. CL. 36.
- TELEVISA, S.A. DE C.V., COLONIA ZEDEC SANTA FE,  
MEXICO:  
3,247,620, CANC. INT. CL. 41.  
3,247,651, CANC. INT. CL. 41.
- TELEVISION FOOD NETWORK, G.P., NEW YORK, NY:  
4,482,126, INT. CL. 41.
- TELEEVOLUTION LLC, DANVILLE, CA:  
3,248,174, CANC. INT. CL. 9.
- TELMATE, SAN FRANCISCO, CA:  
4,481,227, PUB. 11-26-2013. MULTIPLE CLASS, INT. CLS.

- 38 AND 45.  
TELOGIS, INC., ALISO VIEJO, CA:  
3,000,391, CANC. INT. CL. 9.
- TEMO TEKSTIL MODA DERI VE KONFEKSIYON YAN URUNLERI SANAYI VE TICARET LIMITED SIRKETI, ISTANBUL, TURKEY:  
4,482,386, MULTIPLE CLASS, INT. CLS. 14, 18 AND 25.
- TENES, DARLENE, SAN JOSE, CA:  
3,247,569, CANC. INT. CL. 35.
- TENET HEALTHSYSTEM MEDICAL, INC., DALLAS, TX:  
2,807,075, REN. 1-9-14, INT. CL. 41.
- TENNANT COMPANY, MINNEAPOLIS, MN:  
4,482,276, INT. CL. 7.
- TENNESSEE DEPARTMENT OF TOURIST DEVELOPMENT, NASHVILLE, TN:  
3,245,966, CANC. INT. CL. 35.
- TERAMOTO CORPORATION LTD., OSAKA 550-0012, JAPAN:  
4,479,324, PUB. 11-26-2013. MULTIPLE CLASS, INT. CLS. 6, 12, 20, 21, 27 AND 34.
- TEREX SOUTH DAKOTA, INC., WATERTOWN, SD:  
4,481,857, INT. CL. 9.  
4,481,858, INT. CL. 9.
- TERI PIROZZI LLC, EDGARTOWN, MA:  
4,481,086, PUB. 11-26-2013. INT. CL. 39.
- TERRA TRADITIONS CORP., LOS ANGELES, CA:  
3,245,730, CANC. MULTIPLE CLASS, INT. CLS. 16 AND 35.
- TERRAIN MERCHANDISING LLC, PHILADELPHIA, PA:  
4,481,805, MULTIPLE CLASS, INT. CLS. 3 AND 4.
- TERRANOVA PAPERS, S.A., SPAIN:  
4,479,335, PUB. 11-26-2013. INT. CL. 16.
- TERRY SAVAGE PRODUCTIONS, LTD., CHICAGO, IL:  
3,247,959, CANC. INT. CL. 41.
- TESLA MOTORS, INC., PALO ALTO, CA:  
4,480,542, PUB. 11-26-2013. INT. CL. 25.
- TEXAS INSTRUMENTS INCORPORATED, DALLAS, TX:  
2,719,903, CANC. INT. CL. 16.
- TEXTRON INNOVATIONS INC., PROVIDENCE, RI:  
1,818,356, REN. 1-9-14, INT. CL. 7.
- TGI FRIDAY'S OF MINNESOTA, INC., CARROLLTON, TX:  
4,480,825, PUB. 11-26-2013. INT. CL. 43.
- THACKREY, SEAN HALEY, BOLINAS, CA, DBA THACKREY & CO.:  
4,481,909, INT. CL. 33.
- THALES ELECTRON DEVICES SAS, VELIZY-VILLACOUBLAY, FRANCE:  
1,848,515, REN. 1-9-14, INT. CL. 9.
- THE ABSOLUT COMPANY AKTIEBOLAG, STOCKHOLM, SWEDEN:  
1,868,516, REN. 1-4-14, INT. CL. 33.
- THE AMERICAN VETERINARY MEDICAL FOUNDATION, SCHAUMBURG, IL:  
4,481,117, PUB. 11-26-2013. INT. CL. 16.
- THE ANN WIGMORE FOUNDATION, INC., SAN FIDEL, NM:  
3,246,965, CANC. INT. CL. 9.
- THE ARMOR ALL/STP PRODUCTS COMPANY, DANBURY, CT:  
4,482,001, INT. CL. 2.
- THE ARTS LEAGUE OF MICHIGAN, DETROIT, MI:  
3,246,732, CANC. INT. CL. 41.
- THE ATTENTION CENTER, LLC, INDEPENDENCE, OH:  
4,480,355, PUB. 11-26-2013. MULTIPLE CLASS, INT. CLS. 41 AND 44.
- THE AUTISM CHANNEL, INC., WEST PALM BEACH, FL:  
4,481,002, PUB. 11-26-2013. INT. CL. 38.
- THE BELGIAN CHOCOLATE GROUP NV, B-2250 OLEN, BELGIUM:  
2,831,179, REN. 1-8-14, INT. CL. 30.
- THE BENEVOLINK CORPORATION, ATLANTA, GA:  
3,379,305, CANC. MULTIPLE CLASS, INT. CLS. 35 AND 36.
- THE BILTMORE COMPANY, ASHEVILLE, NC:  
3,248,598, CANC. INT. CL. 21.
- THE BLESSING BASKET PROJECT, ST. LOUIS, MO:  
3,246,271, CANC. INT. CL. 21.
- THE BONBONNERIE, INC., CINCINNATI, OH:  
3,247,434, CANC. INT. CL. 35.
- THE BOYS CAMP COMPANY, LLC, CHADDS FORD, PA:  
4,481,374, INT. CL. 16.
- THE BRAND CAFE INC., TORONTO, CANADA:  
4,479,550, PUB. 11-26-2013. MULTIPLE CLASS, INT. CLS. 35, 36, 40, 42 AND 45.
- THE BRIDE AND BLOOM LLC, TORRANCE, CA:  
3,247,423, CANC. INT. CL. 16.
- THE BRIGHTMILL GROUP, LLC, CUMMING, GA:  
4,480,259, PUB. 11-26-2013. INT. CL. 35.
- THE BROADWAY LEAGUE INC., NEW YORK, NY:  
2,718,852, CANC. INT. CL. 41.
- THE BROMWELL COMPANY, TEMPE, AZ:  
4,479,743, PUB. 11-26-2013. INT. CL. 21.
- THE BUCKET TRADE, LLC, RICHMOND, VA:  
4,480,471, PUB. 11-26-2013. INT. CL. 43.
- THE BUDD GROUP, INC., WINSTON-SALEM, NC:  
4,482,085, INT. CL. 35.
- THE BUGARIE GROUP, HALLANDALE, FL:  
4,480,986, PUB. 11-26-2013. MULTIPLE CLASS, INT. CLS. 21, 25, 30, 32 AND 43.
- THE CAD STORE, GLENDALE, AZ:  
3,245,752, CANC. INT. CL. 42.
- THE CARTOON NETWORK, INC., ATLANTA, GA:  
4,481,238, PUB. 11-26-2013. INT. CL. 30.
- THE CEMENTWORKS, LLC, NEW YORK, NY:  
4,481,392, INT. CL. 35.
- THE CHAMPIONS FUND, INC., OLDSMAR, FL:  
2,796,877, REN. 1-6-14, INT. CL. 36.
- THE CLAY AND PAINT FACTORY S.A., LIEGE, BELGIUM:  
1,239,059, REN. 1-9-14. MULTIPLE CLASS, INT. CLS. 2 AND 16.
- THE COCOA BEANS, LLC, PORT GAMBLE, WA:  
4,481,340, INT. CL. 35.
- THE COLUMBIA COLLEGE, COLUMBIA, SC:  
3,248,671, CANC. INT. CL. 41.
- THE COMPASSIONATE FRIENDS, OAK BROOK, IL:  
4,481,097, PUB. 11-26-2013. MULTIPLE CLASS, INT. CLS. 9 AND 16.
- THE CONVENTION NEWS COMPANY, INC., MIDLAND PARK, NJ:  
2,898,403, REN. 1-6-14, INT. CL. 16.
- THE CREDIT REPAIRMAN, L.L.C., ST. LOUIS, MO:  
4,480,545, PUB. 11-26-2013. INT. CL. 36.
- THE DACADE GROUP - YOUNG ENGINEERS LTD, REHOVOT, ISRAEL:  
4,482,809, INT. CL. 41.
- THE DIGITAL PROJECT FACTORY PTY. LTD., AUSTRALIA:  
4,479,310, PUB. 9-3-2013. MULTIPLE CLASS, INT. CLS. 9, 28, 38 AND 41.
- THE EASTERN COMPANY, NAUGATUCK, CT, DBA CCL SECURITY PRODUCTS:  
2,908,072, REN. 1-3-14, INT. CL. 6.
- THE EDISON INSTITUTE, DEARBORN, MI:  
4,482,273, INT. CL. 41.
- THE ENDURANCE INTERNATIONAL GROUP, INC., BURLINGTON, MA, HOMESTEAD TECHNOLOGIES INC., MENLO PARK, CA:  
2,800,744, REN. 1-8-14, INT. CL. 9.
- THE ENDURANCE INTERNATIONAL GROUP, INC., BURLINGTON, MA:  
3,246,546, CANC. INT. CL. 42.
- THE EVENING BULLETIN, INC., PHILADELPHIA, PA:  
3,248,750, CANC. INT. CL. 16.
- THE GARDEN SPOUT LLC, SANTA ROSA, CA:  
4,480,712, PUB. 11-26-2013. INT. CL. 35.
- THE GILLETTE COMPANY, BOSTON, MA:  
3,246,750, CANC. INT. CL. 3.
- THE GLAM ROOM SALON, KANSAS CITY, MO:  
4,480,830, PUB. 11-26-2013. INT. CL. 44.
- THE GOLDFIELD CORPORATION, MELBOURNE, FL:  
4,480,742, PUB. 11-26-2013. INT. CL. 37.
- THE GOVERNMENT OF THE DISTRICT OF COLUMBIA, WASHINGTON, DC:  
4,481,367, INT. CL. 25.

- THE GREAT CREATE INC., ENGLEWOOD, CO:  
4,482,584, INT. CL. 42.
- THE HANDCRAFTED SOAP AND COSMETIC GUILD,  
INC., SARATOGA SPRINGS, NY:  
4,482,832, INT. CL. 35.
- THE HARRISON GROUP, LLC, YARMOUTH, ME:  
2,807,458, REN. 1-8-14, INT. CL. 28.
- THE HILLSHIRE BRANDS COMPANY, CHICAGO, IL:  
1,813,073, REN. 1-6-14, INT. CL. 29.  
1,813,074, REN. 1-6-14, INT. CL. 29.  
1,813,075, REN. 1-6-14, INT. CL. 29.
- THE HINA GROUP HOLDINGS, PALO ALTO, CA:  
3,247,210, CANC. INT. CL. 36.
- THE HOMEVISION LLC, SPRINGFIELD, VA:  
3,247,129, CANC. INT. CL. 35.
- THE IDENTITY GROUP, INC., COLLEYVILLE, TX:  
3,246,482, CANC. INT. CL. 35.
- THE INDIVIDUAL ENTREPRENEUR; DAVYDOVA ELENA  
GRIGOREVA, RUSSIAN FED.:  
4,479,469, PUB. 11-26-2013, MULTIPLE CLASS, INT. CLS.  
9, 16, 35, 36, 38, 41 AND 42.
- THE IRVINE COMPANY LLC, NEWPORT BEACH, CA:  
3,359,570, AM. MULTIPLE CLASS, INT. CLS. 25, 43 AND  
44.
- THE ISAMU NOGUCHI FOUNDATION AND GARDEN  
MUSEUM, LONG ISLAND CITY, NY:  
1,816,779, REN. 1-8-14, INT. CL. 11.
- THE ISLER ANSWER, INC., DENVER, NJ:  
3,247,934, CANC. INT. CL. 5.
- THE KINGSFORD PRODUCTS COMPANY LLC, OAK-  
LAND, CA:  
773,000, REN. 1-9-14, U.S. CL. 1 (INT. CL. 4).
- THE LIFE IS GOOD COMPANY, BOSTON, MA:  
3,247,876, CANC. MULTIPLE CLASS, INT. CLS. 14 AND  
20.
- THE LOBSTER GUYS SW, LAS VEGAS, NV:  
4,480,400, PUB. 11-26-2013, INT. CL. 25.
- THE LUBRIZOL CORPORATION, WICKLIFFE, OH:  
2,822,483, REN. 1-3-14, INT. CL. 1.
- THE LUTHERAN CHURCH-MISSOURI SYNOD, KIRK-  
WOOD, MO:  
4,480,942, PUB. 11-26-2013, MULTIPLE CLASS, INT. CLS.  
36, 37 AND 41.
- THE LUTHERAN UNIVERSITY ASSOCIATION, INC., VAL-  
PARAISO, IN:  
4,481,432, MULTIPLE CLASS, INT. CLS. 12 AND 20.  
4,481,433, INT. CL. 20.
- THE MADDEN CORPORATION, WAIPAHU, HI, DBA  
ISLAND HERITAGE:  
3,248,057, CANC. MULTIPLE CLASS, INT. CLS. 9, 14, 16,  
18, 20, 25 AND 28.
- THE MARMON GROUP, INC., CHICAGO, IL:  
3,247,921, CANC. U.S. CL. 200.
- THE MCCOOL GROUP LLC, AMHERST, NH:  
4,480,807, PUB. 11-26-2013, INT. CL. 35.
- THE MCKENNA PRINCIPALS, INC., WOODBRIDGE, VA:  
4,480,688, PUB. 11-26-2013, MULTIPLE CLASS, INT. CLS.  
35 AND 42.
- THE MEMPHIS MAFIA, INC., MEMPHIS, TN:  
3,245,884, CANC. INT. CL. 25.
- THE MENTOR FACTOR LLC, BRADENTON, FL:  
4,481,656, INT. CL. 41.
- THE MILLS LIMITED PARTNERSHIP, CHEVY CHASE, MD:  
3,247,937, CANC. INT. CL. 41.
- THE MINER CORPORATION, NEW BRAUNFELS, TX:  
3,245,952, CANC. MULTIPLE CLASS, INT. CLS. 35 AND  
37.
- THE MISS AMERICA ORGANIZATION, LINWOOD, NJ:  
4,481,368, MULTIPLE CLASS, INT. CLS. 14, 18, 21 AND  
25.
- THE MORTGAGE STORE FINANCIAL, INC., LOS AN-  
GELES, CA:  
3,247,557, CANC. INT. CL. 36.
- THE MOUNTAIN CORPORATION, MARLBOROUGH, NH:  
2,208,744, COR. INT. CL. 25.  
2,375,180, COR. INT. CL. 25.
- THE NAPA INSTITUTE, IRVINE, CA:  
4,480,289, PUB. 11-26-2013, MULTIPLE CLASS, INT. CLS.  
35, 41 AND 45.
- 4,480,291, PUB. 11-26-2013, MULTIPLE CLASS, INT. CLS.  
35, 41 AND 45.
- THE NATHAN CHRIS BAKER FOUNDATION, WESTMIN-  
STER, MD:  
4,482,438, INT. CL. 36.
- THE NATIONAL ASSOCIATION OF SECONDARY SCHOOL  
PRINCIPALS, RESTON, VA:  
3,247,966, CANC. MULTIPLE CLASS, INT. CLS. 14 AND  
25.
- THE NATIONAL ASSOCIATION OF SECONDARY  
SCHOOL, RESTON, VA:  
3,247,967, CANC. MULTIPLE CLASS, INT. CLS. 14 AND  
25.
- THE NATIONAL CHILDBIRTH TRUST, UNITED KING-  
DOM:  
4,479,320, PUB. 11-26-2013, MULTIPLE CLASS, INT. CLS.  
9, 16, 41 AND 44.
- THE NATIONAL COLLEGIATE ATHLETIC ASSOCIATION,  
INDIANAPOLIS, IN:  
1,731,961, CANC. INT. CL. 28.
- THE NORWALK HOSPITAL ASSOCIATION, NORWALK,  
CT:  
4,480,941, PUB. 11-26-2013, INT. CL. 44.
- THE O. C. WHITE COMPANY, THREE RIVERS, MA:  
3,245,982, CANC. INT. CL. 11.
- THE OFFICE CLUB, INC., BOCA RATON, FL:  
4,481,660, INT. CL. 16.
- THE PARABLE GROUP, INC., SAN LUIS OBISPO, CA:  
4,480,626, PUB. 11-26-2013, MULTIPLE CLASS, INT. CLS.  
35 AND 42.  
4,480,627, PUB. 11-26-2013, MULTIPLE CLASS, INT. CLS.  
35 AND 42.
- THE PINK BRACELET FUND, HOUSTON, TX:  
3,248,695, CANC. INT. CL. 25.
- THE PROCTER & GAMBLE COMPANY, CINCINNATI, OH:  
4,482,250, INT. CL. 3.  
4,482,251, INT. CL. 3.  
4,482,297, INT. CL. 21.
- THE PROPERTY SCIENCES GROUP, INC., PLEASANT  
HILL, CA:  
2,817,371, REN. 1-6-14, MULTIPLE CLASS, INT. CLS. 36  
AND 42.
- THE PROVERBS 31 MINISTRY, INC., MATTHEWS, NC:  
3,246,115, CANC. INT. CL. 45.
- THE RAYMOND CORPORATION, GREENE, NY:  
4,481,725, INT. CL. 12.
- THE RETIREMENT CORPORATION OF AMERICA, CIN-  
CINNATI, OH:  
2,796,670, REN. 1-3-14, INT. CL. 36.  
2,803,141, REN. 1-3-14, INT. CL. 36.
- THE RISING LOTUS QIGONG, LLC, FLOWERY BRANCH,  
GA:  
4,482,295, MULTIPLE CLASS, INT. CLS. 9 AND 41.
- THE ROYAL BANK OF SCOTLAND GROUP PLC, UNITED  
KINGDOM:  
4,479,374, PUB. 11-26-2013, MULTIPLE CLASS, INT. CLS.  
9, 35, 36 AND 42.
- THE SAINT AUGUSTINE LIGHTHOUSE AND MUSEUM,  
INC., ST. AUGUSTINE, FL:  
4,480,707, PUB. 11-26-2013, INT. CL. 41.
- THE SAMUEL ROBERTS NOBLE FOUNDATION, ARD-  
MORE, OK:  
4,482,441, MULTIPLE CLASS, INT. CLS. 16 AND 41.
- THE SAPLING COMPANY, INC., HUNTINGDON VALLEY,  
PA:  
2,797,822, REN. 1-3-14, INT. CL. 14.
- THE SCOTT FETZER COMPANY, WESTLAKE, OH:  
3,245,913, CANC. MULTIPLE CLASS, INT. CLS. 7 AND  
21.  
4,481,948, INT. CL. 1.
- THE SIEMON COMPANY, WATERTOWN, CT:  
2,807,565, REN. 1-8-14, MULTIPLE CLASS, INT. CLS. 35  
AND 37.
- THE SMALL-SCALE SUSTAINABLE INFRASTRUCTURE  
DEVELOPMENT FUND, INC., CAMBRIDGE, MA:  
4,480,352, PUB. 11-26-2013, MULTIPLE CLASS, INT. CLS.

- 35 AND 36.  
4,480,353, PUB. 11-26-2013. MULTIPLE CLASS, INT. CLS. 35 AND 36.  
4,480,354, PUB. 11-26-2013. MULTIPLE CLASS, INT. CLS. 35 AND 36.
- THE SMEAD MANUFACTURING COMPANY, HASTINGS, MN:  
3,248,181, CANC. INT. CL. 16.
- THE SMILEY COMPANY SPRL, BRUSSELS, BELGIUM:  
2,801,529. REN. 1-7-14. INT. CL. 25.
- THE SOCK GUYS, INC., NEW ROCHELLE, NY:  
4,482,188, INT. CL. 25.  
4,482,335, INT. CL. 25.
- THE SOTTOPELLE GROUP, LLC, SCOTTSDALE, AZ, AKA SOTTOPELLE:  
4,482,644, INT. CL. 5.
- THE SOUTHEASTERN CONFERENCE, BIRMINGHAM, AL:  
4,480,706, PUB. 11-26-2013. INT. CL. 41.
- THE SPORTS AND ENTERTAINMENT COMPANY LLC, DENVER, CO:  
4,479,805, PUB. 11-26-2013. INT. CL. 41.
- THE STRATEGIC CFO, HOUSTON, TX:  
4,481,094, PUB. 11-26-2013. INT. CL. 35.
- THE STROKE GROUP, INC., LITTLETON, CO:  
3,248,056, CANC. MULTIPLE CLASS, INT. CLS. 9 AND 41.
- THE SUSAN G. KOMEN BREAST CANCER FOUNDATION, INC., DALLAS, TX:  
3,247,304, CANC. INT. CL. 35.
- THE SYMPHONI GROUP, LLC, GOODLETTSVILLE, TN:  
4,480,787, PUB. 11-26-2013. INT. CL. 35.
- THE TECHNOLOGIES ALLIANCE, INC., HOUSTON, TX:  
3,248,318, CANC. INT. CL. 9.
- THE TERMINIX INTERNATIONAL COMPANY LIMITED PARTNERSHIP, MEMPHIS, TN:  
4,482,857, INT. CL. 5.
- THE TRUSTEES OF INDIANA UNIVERSITY, BLOOMINGTON, IN:  
2,800,088. REN. 1-8-14. INT. CL. 21.  
4,480,582, PUB. 11-26-2013. MULTIPLE CLASS, INT. CLS. 35 AND 41.  
4,480,583, PUB. 11-26-2013. MULTIPLE CLASS, INT. CLS. 35 AND 41.  
4,482,805, INT. CL. 25.
- THE TRUSTEES OF THE CARNEGIE LIBRARY OF PITTSBURGH TRUST, PITTSBURGH, PA:  
4,480,025, PUB. 11-26-2013. INT. CL. 41.
- THE TRUSTEES OF THE KHEMLANI FAMILY TRUST, PALOS VERDES, CA:  
3,248,673, CANC. INT. CL. 3.
- THE TRUSTEES OF THE NERISSA H. WATKINS TRUST, PORTSMOUTH, VA:  
3,247,366, CANC. INT. CL. 41.
- THE TRUTH IMPORTS, INC., COLUMBIA, MD:  
3,246,473, CANC. INT. CL. 35.
- THE TURTLE CLUB, LLC, NAPLES, FL:  
4,480,908, PUB. 11-26-2013. INT. CL. 33.
- THE UMBRELLA PROJECT, BUCKEYE, AZ:  
2,870,326. REN. 1-7-14. INT. CL. 36.
- THE UNIVERSITY OF CHICAGO HOSPITALS, CHICAGO, IL:  
3,245,887, CANC. INT. CL. 44.
- THE UPPER DECK COMPANY, INC., CARLSBAD, CA, FLEER CORP., PHILADELPHIA, PA:  
1,816,398. REN. 1-6-14. INT. CL. 16.
- THE VANILLA BEAN CAFE, INC, POMFRET, CT:  
2,718,924, CANC. MULTIPLE CLASS, INT. CLS. 25 AND 43.
- THE VELOCITY ACADEMY, LLC, SAN DIEGO, CA:  
3,248,434, CANC. MULTIPLE CLASS, INT. CLS. 35 AND 41.
- THE WAYBACKS, LLC, SAN MATEO, CA:  
2,718,967, CANC. INT. CL. 41.
- THE WORNICK COMPANY, CINCINNATI, OH:  
3,247,001, CANC. INT. CL. 11.
- THEFIND, INC., MOUNTAIN VIEW, CA:  
4,480,727, PUB. 11-26-2013. MULTIPLE CLASS, INT. CLS. 9 AND 35.
- THEPPADUNGORN COCONUT COMPANY LIMITED, BANGKOK, THAILAND:  
4,480,285, PUB. 11-26-2013. INT. CL. 29.
- THERAPY SOURCE, INC., PLYMOUTH MEETING, PA:  
4,482,091, MULTIPLE CLASS, INT. CLS. 41 AND 44.
- THERMAVEIN LIMITED, BOLTON, UNITED KINGDOM:  
4,479,733, PUB. 8-27-2013. MULTIPLE CLASS, INT. CLS. 3, 10, 41 AND 44.
- THERMO KEYTEK LLC, WILMINGTON, MA, KEYTEK INSTRUMENT CORP., WILMINGTON, MA:  
1,812,760. REN. 1-6-14. INT. CL. 9.
- THERMO-CYCLER INDUSTRIES, INC., UNION MILLS, IN:  
1,815,402. REN. 1-8-14. INT. CL. 11.
- THERUS CORPORATION, SEATTLE, WA:  
3,247,906, CANC. INT. CL. 10.
- THESEUS PROFESSIONAL SERVICES, LLC, WESTMINSTER, MD:  
3,248,068, CANC. INT. CL. 35.
- THIBODAUZ OUTDOORS, LLC, PRAIRIEVILLE, LA:  
4,482,039, INT. CL. 13.
- THINK PLASTICS, INC., NEW HAMBURG, ONTARIO, CANADA:  
3,246,404, CANC. INT. CL. 19.
- THINKINC., CHICAGO, IL:  
2,817,404. REN. 1-7-14. INT. CL. 35.
- THINKPOPS NEUROMEDIA, INC., LOS ANGELES, CA:  
4,481,982, INT. CL. 9.
- THINSOFT PTE LTD., SINGAPORE, SINGAPORE:  
2,820,251. REN. 1-8-14. INT. CL. 9.
- THINSOFT PTE LTD., SINGAPORE, SINGAPORE:  
2,820,252. REN. 1-8-14. INT. CL. 9.
- THIRD NATURE, INC., ROGUE RIVER, OR:  
4,480,744, PUB. 11-26-2013. MULTIPLE CLASS, INT. CLS. 35 AND 42.
- THIRTEEN SIXTY, INC., CLACKAMAS, OR:  
4,479,694, PUB. 11-26-2013. MULTIPLE CLASS, INT. CLS. 10 AND 44.
- THOMAS A. BLANKENSHIP, SAN ANGELO, TX:  
4,482,840, INT. CL. 35.
- THOMAS PUBLISHING COMPANY, NEW YORK, NY:  
3,246,065, CANC. INT. CL. 35.  
3,247,535, CANC. INT. CL. 41.
- THOMAS R. NECAISE, YUKON, OK:  
4,481,249, PUB. 11-26-2013. INT. CL. 25.
- THOMAS-MCCANTS MEDIA INC, WILMINGTON, NC:  
2,719,123, CANC. INT. CL. 16.
- THOMPSON, BRIAN, HOUSTON, TX AND REN, TOM, BELLAIRE, TX:  
4,482,110, INT. CL. 9.
- THOMSON, BOULOGNE-BILLANCOURT, FRANCE:  
3,246,741, CANC. INT. CL. 9.
- THOMSON, FRANCE:  
3,247,691.
- THORNTON WINERY, TEMECULA, CA:  
4,482,521, INT. CL. 33.
- THOSE CHARACTERS FROM CLEVELAND, INC., CLEVELAND, OH:  
3,248,135, CANC. INT. CL. 28.
- THREE SHEEPS BREWING COMPANY, LLC, SHEBOYGAN, WI:  
4,482,452, INT. CL. 32.
- THWARTPOKER INC., PALO ALTO, CA:  
3,246,300, CANC. INT. CL. 9.
- THYSSENKRUPP ACCIAI SPECIALI TERNI S.P.A., TERNI, ITALY:  
3,246,372, CANC. MULTIPLE CLASS, INT. CLS. 6 AND 40.
- TI GOLF HOLDINGS INC., NEW YORK, NY:  
2,719,095, CANC. INT. CL. 16.
- TIANJIN YAAN TECHNOLOGY CO.,LTD., TIANJIN, CHINA:  
2,874,705. REN. 1-6-14. INT. CL. 9.
- TIBER, ELLIOT, PALM SPRINGS, CA:  
3,247,877, CANC. MULTIPLE CLASS, INT. CLS. 36 AND 41.
- TIEMART, INC., MUNDELEIN, IL:  
4,482,602, INT. CL. 35.

- TIFFEE PRODUCTIONS, INC., TULSA, OK:  
4,482,793, INT. CL. 41.
- TIGER AIRWAYS PTE. LTD., SINGAPORE, SINGAPORE:  
3,246,101, CANC. INT. CL. 39.
- TIME ART DEVELOPMENT LIMITED, KOWLOON, HONG KONG:  
3,245,708, CANC. MULTIPLE CLASS, INT. CLS. 3, 18, 25 AND 35.
- TIME EQUITIES, INC., NEW YORK, NY:  
4,480,398, PUB. 11-26-2013. MULTIPLE CLASS, INT. CLS. 36 AND 37.
- TIME INC., NEW YORK, NY:  
3,248,507, CANC. INT. CL. 16.
- TIME OUT GROUP LIMITED, LONDON, UNITED KINGDOM:  
2,797,861, REN. 1-6-14. INT. CL. 16.
- TIME VALUE OF MONEY, L.P., AUSTIN, TX:  
4,482,256, INT. CL. 36.
- TIMELESS ARCHITECTURAL REPRODUCTIONS, INC., ALPHARETTA, GA:  
3,246,578, CANC. INT. CL. 19.
- TIMESTAR TECHNOLOGIES, LLC, ATLANTA, GA:  
2,807,838, REN. 1-6-14. INT. CL. 35.
- TINE SA, NORWAY:  
3,247,754.
- TINY LOVE LTD., TEL AVIV, ISRAEL:  
4,481,868, INT. CL. 20.
- TIPORIA INC., BELLEVUE, WA:  
4,481,071, PUB. 11-26-2013. MULTIPLE CLASS, INT. CLS. 35 AND 45.
- TIPPER TIE, INC., APEX, NC:  
1,815,333, REN. 1-8-14. INT. CL. 7.
- TIPPING POINT GAMING, LLC, LAS VEGAS, NV:  
4,482,077, MULTIPLE CLASS, INT. CLS. 9, 28 AND 41.
- TIRA WIRELESS INC., TORONTO, ONTARIO, CANADA:  
3,246,236, CANC. MULTIPLE CLASS, INT. CLS. 9 AND 42.
- TISCH MEDIA GROUP, INC., HAYDEN, ID:  
4,480,237, PUB. 11-26-2013. INT. CL. 41.
- TISSUEGEN, INC., DALLAS, TX:  
4,482,580, INT. CL. 10.
- TITAN HOCKEY VENTURES, LLC, LOS ANGELES, CA:  
4,480,914, PUB. 11-26-2013. INT. CL. 41.
- TITAN INTERNATIONAL, INC., QUINCY, IL:  
4,479,666, PUB. 11-26-2013. INT. CL. 12.
- TITAN TOOL COMPANY, FAIRVIEW, PA:  
1,272,398, REN. 1-8-14. INT. CL. 7.
- TIVOLI LLC, SANTA ANA, CA:  
3,245,793, CANC. INT. CL. 11.
- TLC TRADEMARK COMPANY, SANTA BARBARA, CA:  
4,480,241, PUB. 11-26-2013. INT. CL. 30.
- TM 2000 & DEMANDA S/C LTDA., SÃO PAULO, BRAZIL:  
2,803,387, REN. 1-9-14. INT. CL. 35.
- TMFS HOLDINGS, LLC, OVERLAND PARK, KS:  
2,735,936, REN. 1-3-14. INT. CL. 36.
- TMS GLOBAL SERVICES PTY LTD, AUSTRALIA:  
4,479,440, PUB. 11-26-2013. INT. CL. 41.
- TMTV, INC., CHICAGO, IL:  
4,479,745, PUB. 8-13-2013. INT. CL. 38.
- TNP, L.L.C., FENTON, MO:  
3,247,058, CANC. MULTIPLE CLASS, INT. CLS. 30 AND 43.
- TOADENKA CORPORATION, JAPAN:  
4,479,385, PUB. 11-26-2013. MULTIPLE CLASS, INT. CLS. 7, 9, 12 AND 40.
- TOBUL ACCUMULATOR INCORPORATED, BAMBERG, SC:  
4,481,309, INT. CL. 7.
- TOKHEIM HOLDING B.V., AD BLADEL, NETHERLANDS:  
178,253, REN. 1-7-14. U.S. CL. 26 (INT. CL. 9).
- TOKO ELECTRIC CORPORATION, TOKYO, JAPAN:  
4,480,065, PUB. 11-26-2013. INT. CL. 9.
- TOMAZ HAM, LJUBLJANA, SLOVENIA:  
4,479,422, PUB. 11-26-2013. MULTIPLE CLASS, INT. CLS. 12, 18 AND 28.
- TOMBERLIN PRODUCT GROUP, LLC, AUGUSTA, GA:  
3,248,308, CANC. INT. CL. 12.
- TOMPKINS, BERNARD M., OMAHA, NE:  
3,246,802, CANC. INT. CL. 36.
- TONE IT UP, LLC, HERMOSA BEACH, CA:  
4,482,714, INT. CL. 41.
- TONELUCK INTERNATIONAL INVESTMENT LTD., ROAD TOWN, TORTOLA, BR. VIRGIN ISLANDS:  
1,814,790, REN. 1-6-14. INT. CL. 9.
- TOOTHOLOGY, INC., EAST ALTON, IL:  
2,836,904, REN. 1-6-14. MULTIPLE CLASS, INT. CLS. 16, 35 AND 42.
- TOOTSIE ROLL INDUSTRIES, LLC, CHICAGO, IL:  
4,480,093, PUB. 11-26-2013. INT. CL. 30.
- TOP SHELF DESIGNS, INC., WEATHERFORD, OK:  
4,481,391, INT. CL. 20.
- TOP TEN GLOBAL INCORPORATED, SAN FRANCISCO, CA:  
3,247,350, CANC. INT. CL. 35.
- TOP TIER FOOTBALL, LLC, KNOXVILLE, TN:  
4,481,851, INT. CL. 41.
- TOPOTARGET UK LIMITED, UNITED KINGDOM:  
3,247,679.
- TORAY KABUSHIKI KAISHA (TORAY INDUSTRIES, INC.), TOKYO, JAPAN:  
4,482,698, INT. CL. 42.
- TOTAL BODY EXPERTS, LLC, LOS ANGELES, CA:  
4,480,177, PUB. 11-26-2013. INT. CL. 35.
- TOTAL NUTRITIONAL HOLDINGS LLC, WILMINGTON, DE:  
4,482,717, INT. CL. 5.  
4,482,718, INT. CL. 5.
- TOTO U.S.A., INC., MORROW, GA:  
4,482,176, INT. CL. 11.
- TOUCHDOWN MARKETING, MIAMI, FL:  
4,481,112, PUB. 11-26-2013. INT. CL. 3.
- TOURGUIDEMIKE, L.L.C., PALM COAST, FL:  
2,899,380, REN. 1-6-14. INT. CL. 39.
- TOWER RAVENS LLC, NORTH LOGAN, UT:  
2,799,353, REN. 1-6-14. INT. CL. 28.
- TOY INDUSTRY ASSOCIATION, INC., NEW YORK, NY,  
TOY INDUSTRY ASSOCIATION, INC., NEW YORK, NY:  
2,803,859, REN. 1-8-14. INT. CL. 16.
- TOYSHOCK USA LLC, MIAMI, FL:  
4,482,278, INT. CL. 28.
- TP-LINK TECHNOLOGIES CO., LTD., NANSHAN, SHENZHEN, CHINA:  
4,183,127, COR. INT. CL. 42.  
4,244,599, COR. INT. CL. 16.
- TRACFONE WIRELESS, INC., MIAMI, FL:  
3,248,290, CANC. INT. CL. 38.
- TRACTOR SUPPLY CO. OF TEXAS, LP, BRENTWOOD, TN:  
4,482,540, INT. CL. 11.  
4,482,541, INT. CL. 22.
- TRADE ASSOCIATES GROUP, LTD., CHICAGO, IL:  
4,480,020, PUB. 11-26-2013. INT. CL. 21.
- TRADE IN MOTION, INC., LOS ANGELES, CA:  
1,823,770, REN. 1-9-14. INT. CL. 25.
- TRADE WIND BRANDS, LLC, JERSEY CITY, NJ:  
4,481,841, INT. CL. 33.  
4,481,842, INT. CL. 33.  
4,481,846, INT. CL. 33.
- TRADEMARKS INFORMATION INTERNATIONAL LLC, SANTA BARBARA, CA:  
4,480,230, PUB. 11-26-2013. INT. CL. 45.
- TRADEMARX INC., PASADENA, CA:  
3,247,282, CANC. INT. CL. 8.
- TRADER JOE'S COMPANY, MONROVIA, CA:  
2,800,906, REN. 1-8-14. INT. CL. 32.
- TRADEWORKS GROUP INC., THE, BRATTLEBORO, VT:  
2,798,062, REN. 1-3-14. INT. CL. 5.
- TRADWAY INTERNATIONAL TRADING, INC., SAN FRANCISCO, CA:  
3,248,295, CANC. INT. CL. 16.



TRAININGMASK, LLC, CADILLAC, MI:  
 4,482,637, INT. CL. 28.  
 4,482,648, INT. CL. 28.  
 4,482,649, INT. CL. 28.  
 4,482,650, INT. CL. 28.  
 4,482,651, INT. CL. 28.  
 4,482,652, INT. CL. 28.

TRAMONTINA S.A., CUTLERIA, SUGAR LAND, TX:  
 4,481,967, INT. CL. 8.

TRAN, LAN, LOS ANGELES, CA:  
 4,481,130, PUB. 11-26-2013. INT. CL. 25.

TRANSCORE COMMERCIAL SERVICES, LLC, BEAVER-  
 TON, OR, TC (BERMUDA) LICENSE, LTD., HAMILTON,  
 BERMUDA:  
 2,796,611. REN. 1-3-14. INT. CL. 39.

TRANSONIC SYSTEMS, INC., ITHACA, NY:  
 4,482,021, INT. CL. 9.

TRANSTAR INDUSTRIES, INC., CLEVELAND, OH:  
 2,800,046. REN. 1-8-14. INT. CL. 35.  
 2,800,078. REN. 1-8-14. INT. CL. 35.

TRAUB, DANIEL, BROOKLYN, NY, DBA ITINERANT  
 PICTURES:  
 4,480,631, PUB. 11-26-2013. INT. CL. 41.

TRAVEDOC, INC., CAMBRIDGE, MA:  
 4,482,314, INT. CL. 44.

TRAVELWAY GROUP INTERNATIONAL INC., MON-  
 TREAL, QUEBEC, CANADA:  
 4,481,316, MULTIPLE CLASS, INT. CLS. 16 AND 18.

TRAVIS DOWDY PRODUCTS, ATLANTA, GA:  
 4,481,092, PUB. 11-26-2013. INT. CL. 3.

TRAVIX INTERNATIONAL B.V., NL-1019 GM AMSTER-  
 DAM, NETHERLANDS:  
 4,479,313, PUB. 8-20-2013. MULTIPLE CLASS, INT. CLS.  
 36, 39, 42 AND 43.

TRAVORA NETWORKS, INC., GLENDALE, CA:  
 4,481,566, MULTIPLE CLASS, INT. CLS. 35, 39 AND 42.

TRAXID, LLC, FRISCO, TX:  
 4,479,735, PUB. 7-16-2013. INT. CL. 9.  
 4,479,736, PUB. 7-16-2013. INT. CL. 9.

TREASURE GARDEN INC., BALDWIN PARK, CA:  
 3,247,911, CANC. INT. CL. 18.

TREATS UNLEASHED, INC., CHESTERFIELD, MO:  
 4,479,267, PUB. 4-28-2009. INT. CL. 35.

TREESTAND ASSASSIN LLC, NEWBURGH, IN:  
 4,481,651, MULTIPLE CLASS, INT. CLS. 16, 21, 25 AND  
 28.

TRENDTECH LLC, ROCKVILLE, MD:  
 4,482,708, INT. CL. 9.

TRESATA, INC., CHARLOTTE, NC, DBA TRESATA:  
 4,481,035, PUB. 11-26-2013. INT. CL. 42.

TRESONA MULTIMEDIA, LLC, PARADISE VALLEY, AZ:  
 4,479,575, PUB. 9-24-2013. MULTIPLE CLASS, INT. CLS.  
 9, 35, 36, 38, 41 AND 42.

TREVA BURNS, COLLEYVILLE, TX, AKA DIVASTYL:  
 4,482,603, MULTIPLE CLASS, INT. CLS. 9, 41, 42 AND 45.

TREVOR BRAZILE, DECATUR, TX:  
 4,480,461, PUB. 11-26-2013. INT. CL. 25.

TRI\*NET, INC., FONTANA, CA, HALL, JAMES F., ALTA  
 LOMA, CA:  
 1,811,948. REN. 1-9-14. INT. CL. 9.

TRI-COASTAL DESIGN GROUP, INC., WHARTON, NJ:  
 4,482,755, INT. CL. 3.  
 4,482,862, INT. CL. 3.  
 4,482,869, INT. CL. 3.  
 4,482,870, INT. CL. 3.

TRIAMP TECHNOLOGY, LTD., NEW TAIPEI CITY 231,  
 TAIWAN:  
 4,482,416, INT. CL. 9.

TRIANA SKIN CARE, L.L.C., MIAMI, FL:  
 4,480,616, PUB. 11-26-2013. INT. CL. 3.

TRICOM INC OF MILWAUKEE, MENOMONEE FALLS, WI:  
 4,481,700, INT. CL. 35.

TRICONN JANITORIAL, LLC, WALTHAM, MA:  
 4,482,312, INT. CL. 35.

TRIDIUM, INC., RICHMOND, VA:  
 3,246,269, CANC. INT. CL. 9.

TRILEGIANT CORPORATION, NORWALK, CT:  
 3,248,264, CANC. MULTIPLE CLASS, INT. CLS. 35 AND  
 36.

TRIMONA FOODS INC., PORT JEFFERSON, NY:  
 4,480,958, PUB. 11-26-2013. INT. CL. 29.

TRINSIC RESIDENTIAL GROUP LP, DALLAS, TX:  
 4,481,972, MULTIPLE CLASS, INT. CLS. 36 AND 37.

TRIPPON, J. M., BELLAIRE, TX:  
 3,246,318, CANC. INT. CL. 16.

TRIRIGA INC., LAS VEGAS, NV:  
 2,718,695, CANC. INT. CL. 42.

TRISHA E. STICKLER, LAKE OSWEGO, OR:  
 3,246,964, CANC. INT. CL. 14.

TROJAN TECHNOLOGIES, LONDON, ONTARIO, CANA-  
 DA:  
 4,479,541, PUB. 11-26-2013. INT. CL. 11.

TROSMAN, INC., BEVERLY HILLS, CA:  
 2,730,533. REN. 1-9-14. INT. CL. 18.

TROUT TRUCKING CO., INC., CORPUS CHRISTI, TX:  
 4,480,026, PUB. 11-26-2013. INT. CL. 12.

TRU-FLEX METAL HOSE, LLC, WEST LEBANON, IN:  
 4,480,280, PUB. 11-26-2013. MULTIPLE CLASS, INT. CLS.  
 6 AND 7.

TRUE VALUE COMPANY, CHICAGO, IL:  
 2,815,011. REN. 1-6-14. INT. CL. 11.

TRUEBEGINNINGS, LLC, IRVING, TX:  
 3,247,554, CANC. INT. CL. 41.

TRULITE GLASS & ALUMINUM SOLUTIONS, LLC, TA-  
 MARAC, FL:  
 3,248,268, CANC. INT. CL. 19.

TRULY LIVING WELL CENTER FOR NATURAL URBAN  
 AGRICULTURE, EAST POINT, GA:  
 4,479,951, PUB. 11-26-2013. INT. CL. 41.

TRUSTEE LEADERSHIP DEVELOPMENT, INC., INDIANA-  
 POLIS, IN:  
 3,248,714, CANC. INT. CL. 41.

TRUSTEES OF INDIANA UNIVERSITY, THE, BLOOMING-  
 TON, IN:  
 4,479,801, PUB. 11-26-2013. INT. CL. 25.

TRUTZSCHLER GMBH & CO. KG, MONCHENGLADBACH  
 3, FED REP GERMANY:  
 1,266,163. REN. 1-6-14. MULTIPLE CLASS, INT. CLS. 7, 9  
 AND 11.

TRVE BREWING COMPANY LLC, DENVER, CO, DBA  
 TRVE BREWING CO.:  
 4,479,948, PUB. 11-26-2013. MULTIPLE CLASS, INT. CLS.  
 32 AND 43.

TRY SOMETHING CREATIVE, INC., SANTA MONICA, CA:  
 4,481,387, MULTIPLE CLASS, INT. CLS. 10, 14 AND 25.

TRYMAX INTERNATIONAL CORPORATION LIMITED,  
 ACTON, LONDON, UNITED KINGDOM:  
 4,481,443, MULTIPLE CLASS, INT. CLS. 14 AND 28.

TSE, JACKSON, WOODINVILLE, WA, DBA AVIA WINERY  
 GROUP:  
 4,481,801, INT. CL. 33.

TSG DEVELOPMENTS INVESTMENTS, INC., AURORA,  
 ONTARIO, CANADA:  
 4,482,538, INT. CL. 41.

TSH PRODUCTIONS LLC, TEMPLETON, CA, DBA THREE  
 SPECKLED HENS:  
 4,481,036, PUB. 11-26-2013. INT. CL. 35.

TTR GLOBAL, LLC, NEW YORK, NY, DBA SERENITY  
 RECOVERY:  
 4,480,017, PUB. 11-26-2013. MULTIPLE CLASS, INT. CLS.  
 43 AND 44.

TUBBY'S SUB SHOPS, INC., FRASER, MI:  
 4,480,273, PUB. 11-26-2013. INT. CL. 43.

TUBEHEAD INC, ALBANY, NY:  
 4,479,967, PUB. 11-26-2013. INT. CL. 31.

TUCKER-ROCKY CORPORATION, INC., WILMINGTON,  
 DE:  
 2,909,754. REN. 1-8-14. INT. CL. 6.  
 4,479,243, PUB. 11-26-2013. MULTIPLE CLASS, INT. CLS.  
 1, 6, 7, 9, 11, 12 AND 22.

TUDU, INC., NEW YORK, NY:  
 4,479,901, PUB. 11-26-2013. INT. CL. 42.

TURNER BROADCASTING SYSTEM, INC., ATLANTA, GA:  
 3,248,594, CANC. INT. CL. 38.  
 4,482,665, INT. CL. 41.

- TURNER ENTERTAINMENT NETWORKS, INC., ATLANTA, GA:  
3,246,380, CANC. INT. CL. 41.
- TUSCAN SUN RISTORANTE, INC., WESTHAMPTON BEACH, NY, DBA ANNONA:  
3,245,915, CANC. INT. CL. 43.
- TUTTLE, SARAH G, BEVERLY HILLS, CA:  
4,482,224, INT. CL. 44.
- TUTTOCALABRIA DI A.CELLI SRL, ITALY:  
4,402,127, COR. MULTIPLE CLASS, INT. CLS. 29 AND 30.
- TV2 CONSULTING, LLC, PALO ALTO, CA:  
4,480,429, PUB. 11-26-2013. MULTIPLE CLASS, INT. CLS. 38 AND 42.
- TWEEZERMAN INTERNATIONAL, LLC, PORT WASHINGTON, NY:  
2,826,601, REN. 1-8-14, INT. CL. 8.
- TWENTIETH CENTURY FOX FILM CORPORATION, LOS ANGELES, CA:  
3,248,105, CANC. INT. CL. 28.  
3,248,228, CANC. INT. CL. 16.  
3,248,633, CANC. INT. CL. 41.  
4,481,244, PUB. 11-26-2013. INT. CL. 38.  
4,481,690, INT. CL. 38.
- TWG WARRANTY GROUP, INC., CHICAGO, IL:  
3,247,462, CANC. INT. CL. 41.
- TWINBROOK COMMONS OFFICE, L.L.C. C/O THE JBG COMPANIES, CHEVY CHASE, MD:  
4,481,561, MULTIPLE CLASS, INT. CLS. 36 AND 37.
- TWISTED SEESTERS, LLC, NORTHRIDGE, CA:  
4,482,245, INT. CL. 16.
- TWISTLE, INC., ALBUQUERQUE, NM, DBA TWISTLE:  
4,480,939, PUB. 11-26-2013. MULTIPLE CLASS, INT. CLS. 9, 38 AND 42.
- TWIZTID L.L.C., LIVONIA, MI:  
2,862,830, REN. 1-6-14, INT. CL. 41.
- TWO TONE ENTERTAINMENT, BELLAIRE, TX:  
4,480,741, PUB. 11-26-2013. INT. CL. 41.
- TXS GMBH, FED REP GERMANY:  
3,247,709.
- TYCO ELECTRONICS CORPORATION, MIDDLETOWN, PA:  
3,246,340, CANC. INT. CL. 9.
- TYNDALE HOUSE PUBLISHERS, INC., CAROL STREAM, IL:  
4,480,304, PUB. 11-26-2013. MULTIPLE CLASS, INT. CLS. 9 AND 16.
- TYNDALL FEDERAL CREDIT UNION, PANAMA CITY, FL:  
4,481,099, PUB. 11-26-2013. INT. CL. 36.
- TYSON FOODS, INC., SPRINGDALE, AR:  
2,801,163, REN. 1-8-14, INT. CL. 29.
- TYSONS WOODS LLC, VIENNA, VA:  
4,480,979, PUB. 11-26-2013. INT. CL. 43.
- U.S. BANK N.A., MINNEAPOLIS, MN:  
2,826,231, REN. 1-3-14, INT. CL. 36.
- U.S. HOME INSPECTIONS, INC., LAKE RIDGE, VA:  
3,247,014, CANC. INT. CL. 42.
- U.S. MARINE CORPS, A COMPONENT OF THE U.S. DEPARTMENT OF THE NAVY, WASHINGTON, DC:  
4,480,381, PUB. 11-26-2013. INT. CL. 25.  
4,480,382, PUB. 11-26-2013. INT. CL. 25.  
4,480,607, PUB. 11-26-2013. INT. CL. 16.  
4,480,621, PUB. 11-26-2013. INT. CL. 25.  
4,482,723, INT. CL. 25.
- U.S. POLYCO INC., SPARKS, NV:  
4,482,608, INT. CL. 17.
- U.S. TACTICAL, INC., ENCINITAS, CA:  
4,480,878, PUB. 11-26-2013. INT. CL. 41.
- UBER OPERATIONS LLC, TALLAHASSEE, FL:  
4,480,783, PUB. 11-26-2013. INT. CL. 41.
- UBRAND LTD., BR.VIRGIN ISLANDS:  
4,479,458, PUB. 11-26-2013. INT. CL. 36.
- UBS AG, CH-8001 ZÜRICH, SWITZERLAND:  
3,247,836.
- UDATE.COM LIMITED, LONDON, UNITED KINGDOM:  
2,718,572, CANC. INT. CL. 42.
- UHS OF DELAWARE, INC., KING OF PRUSSIA, PA:  
4,479,621, PUB. 11-26-2013. INT. CL. 44.  
4,481,414, INT. CL. 35.  
4,481,415, INT. CL. 35.
- UICO, INC., ELMHURST, IL:  
4,481,435, INT. CL. 9.
- UIX, LLC, ROWLEY, MA:  
2,718,779, CANC. INT. CL. 41.
- UJAM, INC., C/O MELANIE KIDDER AT FRANK RIMERMANN, SAN FRANCISCO, CA:  
4,482,697, INT. CL. 9.
- ULG HOLDINGS LIMITED, TORTOLA, BR.VIRGIN ISLANDS:  
4,482,669, INT. CL. 35.
- ULSTEIN GROUP ASA, ULSTEINVIK, NORWAY:  
4,480,910, PUB. 11-26-2013. MULTIPLE CLASS, INT. CLS. 37 AND 42.
- ULTIMATE EXPRESS SERVICES, CORP., MIAMI, FL:  
4,480,658, PUB. 11-26-2013. MULTIPLE CLASS, INT. CLS. 39 AND 45.
- ULTIMATE VALUE SERVICES, INC., MISSISSAUGA, CANADA:  
4,480,974, PUB. 11-26-2013. INT. CL. 10.
- UMICORE BUILDING PRODUCTS FRANCE, BAGNOLET, FRANCE, UMICORE, 1000 BRUSSELS, BELGIUM:  
2,798,331, REN. 1-6-14, INT. CL. 6.
- UNAOHM START S.R.L., ITALY:  
3,247,812.
- UNCOMMON LLC, CHICAGO, IL:  
4,482,488, INT. CL. 9.
- UNDER ARMOUR, INC., BALTIMORE, MD:  
4,482,195, INT. CL. 25.
- UNHINGED PRODUCTIONS, LLC, MULESHOE, TX:  
4,481,724, INT. CL. 25.
- UNIF, LLC, LOS ANGELES, CA:  
4,481,847, INT. CL. 14.
- UNIFIRST CORPORATION, WILMINGTON, MA:  
4,481,237, PUB. 11-26-2013. INT. CL. 35.
- UNIFRAX I LLC, TONAWANDA, NY:  
2,813,981, REN. 1-3-14, INT. CL. 17.
- UNION DES ASSOCIATIONS EUROPÉENNES DE FOOTBALL (UEFA), SWITZERLAND:  
4,479,434, PUB. 11-26-2013. MULTIPLE CLASS, INT. CLS. 3, 4, 9, 12, 16, 18, 25, 28, 29, 32, 36, 37, 38, 39, 40, 41 AND 43.
- UNION DES ASSOCIATIONS EUROPÉENNES; DE FOOTBALL (UEFA), SWITZERLAND:  
4,173,643, COR. MULTIPLE CLASS, INT. CLS. 16, 25, 28, 32, 36, 38, 41 AND 43.
- UNION DEVELOPMENT FINANCIAL, INC., CERRITOS, CA:  
2,719,201, CANC. INT. CL. 39.
- UNION OF POLES IN AMERICA/PNA DISTRICT 17, INC., GARFIELD HTS., OH:  
2,802,551, REN. 1-7-14, INT. CL. 16.
- UNIPRO FOODSERVICE, INC., ATLANTA, GA:  
1,265,200, REN. 1-4-14, INT. CL. 30.
- UNISHOW (USA) INC., HOUSTON, TX:  
4,480,802, PUB. 11-26-2013. INT. CL. 35.
- UNISONO SOLUCIONES DE NEGOCIO SA, E-28027 MADRID, SPAIN:  
4,481,683, MULTIPLE CLASS, INT. CLS. 35, 36 AND 38.  
4,481,684, MULTIPLE CLASS, INT. CLS. 35, 36 AND 38.
- UNITABAC, LLC, MONTVILLE, NJ:  
4,480,922, PUB. 11-26-2013. INT. CL. 34.
- UNITED ARTISTS CORPORATION, BEVERLY HILLS, CA AND DANJAQ, LLC, SANTA MONICA, CA:  
3,248,029, CANC. INT. CL. 41.
- UNITED EGG PRODUCERS, INC., ALPHARETTA, GA:  
4,482,797, INT. CL. 35.
- UNITED INDUSTRIES CORPORATION, EARTH CITY, MO:  
4,481,485, INT. CL. 21.
- UNITED MEDICAL, FEDERAL WAY, WA:  
3,248,094, CANC. INT. CL. 5.
- UNITED SOUVENIR & APPAREL, INC., BELCAMP, MD:  
3,245,832, CANC. INT. CL. 25.

UNITED STATES ANTI-DOPING AGENCY, COLORADO SPRINGS, CO, AKA USADA:  
4,481,206, PUB. 11-26-2013. INT. CL. 25.

UNITED STATES BAKERY, PORTLAND, OR:  
1,862,942. REN. 1-9-14. INT. CL. 42.  
1,863,862. REN. 1-9-14. INT. CL. 30.  
1,867,132. REN. 1-9-14. INT. CL. 30.

UNITED STATES DEPARTMENT OF HOMELAND SECURITY, WASHINGTON, DC:  
4,481,559, MULTIPLE CLASS, INT. CLS. 41 AND 42.

UNITED SUPPLIERS, INC., ELDORA, IA:  
1,283,922. REN. 1-9-14. INT. CL. 1.  
1,283,922, CANC. INT. CL. 5.  
2,855,351. REN. 1-3-14. INT. CL. 1.

UNITED TALENT AGENCY, INC., BEVERLY HILLS, CA:  
3,245,805, CANC. MULTIPLE CLASS, INT. CLS. 35 AND 36.

UNITED TATTOO SUPPLY, INC., SOUTH EL MONTE, CA:  
4,480,804, PUB. 11-26-2013. INT. CL. 8.

UNITEDHEALTH GROUP INCORPORATED, MINNETONKA, MN:  
4,481,236, PUB. 11-26-2013. INT. CL. 36.

UNITING FUTURE LEGENDS LTD., ROAD TOWN, TOLLATA, BR. VIRGIN ISLANDS:  
4,480,667, PUB. 11-26-2013. INT. CL. 24.  
4,482,019, INT. CL. 25.

UNIVERSAL COOPERATIVES, INC., EAGAN, MN:  
2,718,328, CANC. INT. CL. 1.

UNIVERSAL POWER GROUP, INC., COPPELL, TX:  
4,481,388, INT. CL. 9.

UNIVERSAL STRENGTH FOUNDATION, LLC, MIAMI, FL:  
3,248,448, CANC. INT. CL. 14.

UNIVERSAL YARN, INC., HARRISBURG, NC:  
4,480,533, PUB. 11-26-2013. INT. CL. 23.  
4,482,399, INT. CL. 23.  
4,482,598, INT. CL. 23.  
4,482,662, INT. CL. 23.  
4,482,663, INT. CL. 23.

UNIVERSITY OF COLORADO HOSPITAL AUTHORITY, DENVER, CO:  
1,754,620, CANC. INT. CL. 39.

UNIVERSITY OF CONNECTICUT, STORRS, CT:  
4,482,654, MULTIPLE CLASS, INT. CLS. 16, 21, 25, 28 AND 41.

UNIVERSITY OF NORTH CAROLINA AT CHAPEL HILL, THE, CHAPEL HILL, NC:  
1,262,384. REN. 1-8-14. MULTIPLE CLASS, INT. CLS. 16, 21, 25 AND 41.  
1,263,599. REN. 1-6-14. MULTIPLE CLASS, INT. CLS. 16, 21, 25 AND 41.

UNIVERSITY OF NORTH DAKOTA ENERGY AND ENVIRONMENTAL RESEARCH CENTER 99, GRAND FORKS, ND:  
2,801,881. REN. 1-6-14. INT. CL. 42.

UNIVERSITY OF NORTH DAKOTA ENERGY AND ENVIRONMENTAL RESEARCH CENTER, GRAND FORKS, ND:  
3,248,668, CANC. MULTIPLE CLASS, INT. CLS. 40 AND 42.

UNIVERSITY OF NORTH DAKOTA RESEARCH FOUNDATION, GRAND FORKS, ND:  
3,245,823, CANC. INT. CL. 41.

UNIVERSITY OF WASHINGTON, SEATTLE, WA, AKA UW:  
4,480,080, PUB. 11-26-2013. INT. CL. 42.

UNIVERSITY PARK BAPTIST CHURCH, CHARLOTTE, NC:  
3,246,717, CANC. MULTIPLE CLASS, INT. CLS. 9, 38, 41 AND 45.

UNIVISION COMMUNICATIONS INC., LOS ANGELES, CA:  
4,481,655, INT. CL. 41.

UNLIMITED TAXES & MORE LICENSING COMPANY, LLC, HINESVILLE, GA:  
4,480,422, PUB. 11-26-2013. MULTIPLE CLASS, INT. CLS. 35 AND 36.

UNTATTOU, LLC, LAKEWOOD RANCH, FL:  
4,482,570, INT. CL. 44.

UP PHIT INC., TOMBALL, TX:  
3,247,606, CANC. INT. CL. 25.

UPCS, LLC, BRIGHTON, CO:  
4,480,103, PUB. 11-26-2013. INT. CL. 12.

URBAN BOX OFFICE, INC., NEW YORK, NY:  
3,247,615, CANC. INT. CL. 9.  
3,247,616, CANC. INT. CL. 41.

URBAN ECLIPSE LLC, LOS ANGELES, CA:  
4,480,721, PUB. 11-26-2013. INT. CL. 9.

URBAN VILLAGES, INC., DENVER, CO:  
3,703,726, COR. INT. CL. 36.

URREA, MATTHEW, ALBUQUERQUE, NM:  
3,248,088, CANC. INT. CL. 42.

URSA MAJOR MEDIA INC., RENO, NV, DBA CRAZY TOOTH STUDIO:  
4,481,263, PUB. 11-26-2013. INT. CL. 9.

URTECHMATE INC, BAYSIDE, NY:  
4,480,501, PUB. 11-26-2013. INT. CL. 42.

US AIRWAYS, INC., TEMPE, AZ:  
1,243,867. REN. 1-9-14. INT. CL. 39.

US MONEY EXPRES CO., CHICAGO, IL:  
3,246,946, CANC. INT. CL. 36.

USA BASEBALL, DURHAM, NC:  
4,480,357, PUB. 11-26-2013. MULTIPLE CLASS, INT. CLS. 9, 14, 16, 25, 35 AND 41.

USA SWIMMING FOUNDATION, COLORADO SPRINGS, CO, INTERNATIONAL SWIMMING HALL OF FAME, INC., FORT LAUDERDALE, FL:  
975,215. REN. 1-9-14. U.S. CL. 102 (INT. CL. 36).

USB IMPLEMENTERS FORUM, INC., BEAVERTON, OR:  
2,798,239. REN. 1-7-14. INT. CL. 9.  
2,798,239, AM. INT. CL. 9.

USERSCAPE, INC., POUGHKEEPSIE, NY:  
4,480,176, PUB. 11-26-2013. INT. CL. 9.

USINA FORTALEZA INDUSTRIA E COMERCIO DE MASSA FINA LTDA., BARUERI / SP, BRAZIL:  
3,248,124, CANC. INT. CL. 2.  
3,248,125, CANC. INT. CL. 19.

USMILCOM, INC., SANTA ANA, CA:  
3,245,867, CANC. MULTIPLE CLASS, INT. CLS. 6 AND 9.

USP INC, OCEANSIDE, CA:  
4,481,888, INT. CL. 3.

UTELITE CORPORATION, COALVILLE, UT:  
2,848,968. REN. 1-7-14. INT. CL. 1.

UTSCHIG, JOSEPH B., CHICAGO, IL:  
3,246,910, CANC. INT. CL. 42.

UTVG EUROPE HOLDING B.V., 2142 LD CRUQUIUS, NETHERLANDS:  
4,480,019, PUB. 7-16-2013. INT. CL. 34.

V ONE MULTIMEDIA PTE. LTD., KG UBI IND ESTATE, SINGAPORE:  
2,718,867, CANC. INT. CL. 9.

V-T INDUSTRIES, INC., HOLSTEIN, IA:  
4,480,376, PUB. 11-26-2013. INT. CL. 19.  
4,480,377, PUB. 11-26-2013. INT. CL. 19.

VAILLANT PIERRE, NIAGARA FALLS, CANADA AND ANNA ITENBERG, NIAGARA FALLS, CANADA:  
4,482,146, INT. CL. 33.

VALEANT INTERNATIONAL BERMUDA, HAMILTON, BERMUDA:  
4,479,870, PUB. 11-26-2013. INT. CL. 5.

VALENTINE CO., LTD., SEOUL, REPUBLIC OF KOREA:  
2,901,168, CANC. INT. CL. 18.

VALENTINE, SHELLY, LAKE STEVENS, WA:  
4,480,609, PUB. 11-26-2013. INT. CL. 36.

VALGARD OF PINECREST, LLP., MIAMI, FL:  
3,248,487, CANC. INT. CL. 39.

VALGEIR TOMAS SIGURDSSON, ICELAND:  
4,479,519, PUB. 11-26-2013. INT. CL. 32.

VALIANT ENTERTAINMENT, INC., ROAD TOWN, BR. VIRGIN ISLANDS:  
3,763,594, COR. INT. CL. 16.

VALICOR, INC., DEXTER, MI:  
4,481,171, PUB. 11-26-2013. MULTIPLE CLASS, INT. CLS. 37 AND 40.

VALLABHANENI, RAO S., SCHAUMBURG, IL:  
3,247,246, CANC. INT. CL. 41.  
3,247,247, CANC. INT. CL. 41.

VALLE HOLDINGS III, INC., NEW YORK, NY:  
2,719,985, CANC. INT. CL. 35.

- VALLE, STEPHEN K., BREWSTER, MA, VALLE MANAGEMENT ASSOCIATES, INC., LYNN, MA:  
1,853,891. REN. 1-9-14. INT. CL. 42.
- VALLEY SLURRY SEAL, COMPANY, W. SACRAMENTO, CA:  
1,813,288. REN. 1-9-14. INT. CL. 1.
- VALOR STUDIOS, INC., THORNTON, CO:  
4,480,105, PUB. 11-26-2013. INT. CL. 16.
- VALRHONA, TAIN-L'HERMITAGE, FRANCE:  
4,479,968, PUB. 8-13-2013. MULTIPLE CLASS, INT. CLS. 16, 30, 35, 38 AND 41.
- VALRHONA, TAIN L'HERMITAGE, FRANCE:  
4,480,049, PUB. 6-25-2013. MULTIPLE CLASS, INT. CLS. 16, 30, 35, 38 AND 41.  
4,480,050, PUB. 7-9-2013. MULTIPLE CLASS, INT. CLS. 16, 30, 35, 38 AND 41.
- VALTRONIC SA, LES CHARBONNIERES, SWITZERLAND:  
4,481,820, MULTIPLE CLASS, INT. CLS. 40 AND 42.
- VALUEVISION MEDIA, INC., EDEN PRAIRIE, MN:  
3,246,507, CANC. INT. CL. 35.
- VAN LAEKE, MARK, NORCROSS, GA:  
3,246,565, CANC. INT. CL. 35.
- VAN NELLE TABAK NEDERLAND B.V., NETHERLANDS:  
4,479,515, PUB. 11-26-2013. INT. CL. 34.
- VANCO GROUP LIMITED, ISLEWORTH, MIDDLESEX, UNITED KINGDOM:  
3,246,231, CANC. MULTIPLE CLASS, INT. CLS. 37, 38 AND 42.
- VANDANCE, LLC, ENCINO, CA:  
4,191,461, COR. INT. CL. 41.
- VANDEMAN, GEORGE, PACIFIC PALISADES, CA:  
3,245,739, CANC. MULTIPLE CLASS, INT. CLS. 38 AND 42.
- VANILLA BEAN CAFE, INC., THE, POMFRET, CT:  
2,718,925, CANC. MULTIPLE CLASS, INT. CLS. 25 AND 43.
- VANITY FAIR, INC., BOWLING GREEN, KY:  
3,248,037, CANC. INT. CL. 25.  
3,248,038, CANC. INT. CL. 25.  
3,248,070, CANC. INT. CL. 25.
- VARASTEH, STEVE, TUCSON, AZ:  
2,719,583, CANC. INT. CL. 25.
- VARCO I/P, INC., HOUSTON, TX:  
4,481,499, INT. CL. 6.
- VAREL INTERNATIONAL IND., L.P., CARROLLTON, TX:  
4,481,556, INT. CL. 7.  
4,481,557, INT. CL. 7.  
4,481,558, INT. CL. 7.
- VARIED INDUSTRIES CORPORATION, MASON CITY, IA:  
4,482,461, INT. CL. 5.
- VASCULAR PATHWAYS, INC., NAPLES, FL:  
4,482,095, INT. CL. 10.
- VAST DATA CONCEPTS, VIRGINVILLE, PA:  
3,246,691, CANC. INT. CL. 35.
- VAUGHAN INDUSTRIES, INC., DETROIT, MI:  
4,479,868, PUB. 11-26-2013. MULTIPLE CLASS, INT. CLS. 3 AND 8.
- VBW-KULTURMANAGEMENT UND VERANSTALTUNGS-GES.M.B.H, A-1060 VIENNA, AUSTRIA:  
2,718,375, CANC. MULTIPLE CLASS, INT. CLS. 3, 9, 14, 16, 21, 25, 28, 32, 33, 34 AND 41.
- VE TRAIN TECHNOLOGIES, LLC, TUSCALOOSA, AL:  
4,481,965, U.S. CL. B.
- VEKTEK, INC., EMPORIA, KS:  
3,247,271, CANC. INT. CL. 7.  
3,247,273, CANC. INT. CL. 7.
- VELCERA, INC., LANGHORNE, PA:  
3,248,200, CANC. INT. CL. 5.
- VELCON FILTERS, LLC, COLORADO SPRINGS, CO:  
4,482,746, INT. CL. 7.
- VENTAIRA PHARMACEUTICALS, INC., COLUMBUS, OH:  
3,248,661, CANC. INT. CL. 42.  
3,248,662, CANC. INT. CL. 42.
- VENTUREPARK B.V., NETHERLANDS:  
4,479,299, PUB. 11-26-2013. MULTIPLE CLASS, INT. CLS. 9, 36 AND 38.
- VENX, LLC, NASHVILLE, TN:  
4,481,849, INT. CL. 10.
- VERA BRADLEY DESIGNS, INC., FORT WAYNE, IN:  
2,800,308, REN. 1-3-14. INT. CL. 36.  
3,248,194, CANC. INT. CL. 21.
- VERBALIZEIT, INC., NEW YORK, NY:  
4,480,244, PUB. 11-26-2013. INT. CL. 9.  
4,480,245, PUB. 11-26-2013. INT. CL. 41.
- VERBAND DEUTSCHER PRÄDIKATSWEINGÜTER E.V., 55118 MAINZ, FED REP GERMANY:  
4,479,486, PUB. 11-26-2013. MULTIPLE CLASS, INT. CLS. 33, 35 AND 41.
- VERIA INTERNATIONAL LIMITED, HAMILTON HM 12, BERMUDA:  
4,482,609, INT. CL. 41.
- VERIO INC., GREENWOOD VILLAGE, CO:  
4,480,906, PUB. 11-26-2013. INT. CL. 42.
- VERITABLE VEGETABLE COMPANY, SAN FRANCISCO, CA:  
4,481,863, INT. CL. 35.  
4,481,864, INT. CL. 35.
- VERMONT ASSOCIATION OF SNOW TRAVELERS, INC., BARRE, VT, AKA VAST:  
4,480,148, PUB. 11-26-2013. INT. CL. 41.
- VERSENT GROUP LLC, KANSAS CITY, MO:  
3,245,902, CANC. INT. CL. 45.
- VERSIONTWO LABORATORY LLC, ORLANDO, FL:  
4,481,153, PUB. 11-26-2013. INT. CL. 25.
- VERTICAL LEISURE LIMITED, UNITED KINGDOM:  
4,479,487, PUB. 11-26-2013. INT. CL. 25.
- VESPUCCI 5 S.R.L., ITALY:  
4,479,485, PUB. 11-26-2013. INT. CL. 43.
- VETERAN CORPS, FAIRFAX, VA:  
3,246,208, CANC. INT. CL. 35.
- VETGENIX, LLC, WELLINGTON, FL:  
4,481,505, INT. CL. 5.
- VEZINA, SUSAN BLOCK, SHERMAN OAKS, CA:  
3,245,834, CANC. INT. CL. 41.
- VIACOM INTERNATIONAL INC., NEW YORK, NY:  
3,248,182, CANC. INT. CL. 14.  
4,481,232, PUB. 11-26-2013. INT. CL. 41.  
4,482,506, INT. CL. 41.  
4,482,778, INT. CL. 41.
- VIATEK HONG KONG LIMITED, KOWLOON, HONG KONG:  
4,482,072, INT. CL. 8.
- VIAVIEW, INC., LAS VEGAS, NV:  
4,481,248, PUB. 11-26-2013. INT. CL. 42.
- VICKI ARCHER, LONDON, UNITED KINGDOM:  
4,262,914, COR. INT. CL. 41.
- VICTORY MACHINES, LLC, GRANDVIEW, MO:  
3,246,399, CANC. INT. CL. 7.
- VIDEOSERPEL, LTD., ZUG, SWITZERLAND:  
4,481,437, INT. CL. 41.
- VIEJAS BAND OF MISSION INDIANS, ALPINE, CA:  
3,246,284, CANC. INT. CL. 41.
- VINELOOP, LLC, MOORESTOWN, NJ:  
4,481,605, INT. CL. 42.
- VINTAGE LA, MANHATTAN BEACH, CA:  
3,248,566, CANC. INT. CL. 25.
- VINTAGE TRAILERS LTD., ELKHART, IN:  
1,865,248, REN. 1-8-14. INT. CL. 12.
- VINYLTRENDS INC., KITCHENER, CANADA:  
4,480,831, PUB. 11-26-2013. INT. CL. 19.
- VIRGIN ENTERPRISES LIMITED, LONDON, UNITED KINGDOM:  
2,798,130, REN. 1-3-14. MULTIPLE CLASS, INT. CLS. 16, 25, 35, 38 AND 42.
- VIRGIN ENTERPRISES LIMITED, UNITED KINGDOM:  
4,479,479, PUB. 11-26-2013. INT. CL. 41.
- VIRGIN ENTERPRISES LIMITED, LONDON, UNITED KINGDOM:  
4,481,359, MULTIPLE CLASS, INT. CLS. 12, 16, 18, 25, 28 AND 39.
- VIRTUOSO, LTD., FORT WORTH, TX:  
3,248,601, CANC. INT. CL. 16.  
4,481,714, INT. CL. 35.  
4,481,715, INT. CL. 41.
- VIRTUSWAY LLC, MAGNA, UT:  
4,480,002, PUB. 11-26-2013. INT. CL. 42.

VISA INTERNATIONAL SERVICE ASSOCIATION, FOSTER CITY, CA, VISA, U.S.A. INC., SAN MATEO, CA:  
1,816,129. REN. 1-8-14. INT. CL. 36.

VISIBLE WORLD, INC., NEW YORK, NY:  
2,730,101. REN. 1-3-14. MULTIPLE CLASS, INT. CLS. 35, 38 AND 40.

VISIO GLOBAL SERVICES, INC., PANAMA CITY, PANAMA:  
4,480,284. PUB. 11-26-2013. INT. CL. 9.

VISION HOME BUYERS, L.L.C., DENVER, CO:  
4,480,290. PUB. 11-26-2013. INT. CL. 36.

VISION-SCIENCES, INC., ORANGEBURG, NY:  
4,480,837. PUB. 11-26-2013. INT. CL. 10.

VISION, MUTIYA, SAHAR, BROOKLYN, NY AND VISION, DAVID, JOSEPH, BROOKLYN, NY:  
3,248,435. CANC. INT. CL. 16.

VISTA METALS CORP., FONTANA, CA:  
3,246,981. CANC. INT. CL. 6.  
3,246,982. CANC. INT. CL. 6.

VISTAS INTERNATIONAL REALTY, LLC., MIAMI, FL:  
3,246,644. CANC. INT. CL. 36.

VITAL OPTIONS, STUDIO CITY, CA:  
2,801,267. REN. 1-3-14. INT. CL. 42.  
2,801,267. CANC. MULTIPLE CLASS, INT. CLS. 16 AND 35.

VITAL PHARMACEUTICALS, INC, WESTON, FL:  
4,482,864. INT. CL. 5.

VITEC GROUP PLC, THE, SUFFOLK IP33 3TB, UNITED KINGDOM:  
2,719,949. CANC. INT. CL. 9.

VITO VINCENT THE CAT, NEW YORK, NY:  
4,480,239. PUB. 11-26-2013. INT. CL. 41.

VIVA LABS INC, TORONTO ONTARIO, CANADA:  
4,481,649. INT. CL. 5.

VIVANCO GMBH, FED REP GERMANY:  
4,479,290. PUB. 11-26-2013. MULTIPLE CLASS, INT. CLS. 3, 9, 20 AND 35.

VIZIO, INC., IRVINE, CA:  
4,481,915. MULTIPLE CLASS, INT. CLS. 9 AND 38.

VN CORP., GREENVILLE, DE:  
2,719,087. CANC. INT. CL. 11.  
2,719,088. CANC. INT. CL. 11.

VOCOLLECT, INCORPORATED, PITTSBURGH, PA:  
3,247,354. CANC. INT. CL. 9.

VOESTALPINE HYTRONICS GMBH, AUSTRIA:  
4,479,294. PUB. 6-18-2013. MULTIPLE CLASS, INT. CLS. 6, 7, 9, 19 AND 42.

VOGEL SEED & FERTILIZER, INC., JACKSON, WI, DBA SPRING VALLEY TURF PRODUCTS:  
4,482,137. INT. CL. 1.

VOGEL, ROBERT A, BERKELEY, CA:  
3,246,827. CANC. INT. CL. 35.

VOICEGARDEN LLC, ORANGE, CA:  
4,482,585. INT. CL. 35.

VOIP LOGIC, LLC, WILLIAMSTOWN, MA:  
3,247,385. CANC. INT. CL. 42.

VOIP SERVICES, INC, MIAMI, FL:  
3,247,055. CANC. INT. CL. 16.

VOITH TURBO BHS GETRIEBE GMBH, SONTHOFEN, FED REP GERMANY:  
1,248,138. REN. 1-3-14. INT. CL. 7.

VOLBERG, RANDALL, PORT MOODY BRITISH COLUMBIA V3H 5E5, CANADA:  
3,246,708. CANC. INT. CL. 5.

VOLOFORCE LLC, GERMANTOWN, MD:  
4,482,208. MULTIPLE CLASS, INT. CLS. 9 AND 42.

VON MERTA, BOBBY, SANTA CLARA, CA:  
3,248,284. CANC. INT. CL. 28.

VOORHEES, DAVID WILLIAM, FERNANDINA BEACH, FL:  
4,482,377. INT. CL. 25.

VOQEL, INC., ALAMEDA, CA:  
4,481,832. MULTIPLE CLASS, INT. CLS. 9 AND 42.

VORZIMER, ROBERT, BEVERLY HILLS, CA:  
4,482,172. INT. CL. 25.

VOTIVO, LLC, SPARTANBURG, SC:  
2,718,890. CANC. INT. CL. 3.

VOTOPIN, INC., NEW YORK, NY:  
4,482,473. INT. CL. 9.

VP RACING FUELS, INC., SAN ANTONIO, TX:  
4,482,225. INT. CL. 4.  
4,482,226. INT. CL. 25.

VP RACING FUELS, INC., ELMENDORF, TX:  
4,482,658. INT. CL. 4.

VPC PIZZA IP, LLC, CHICAGO, IL:  
4,480,079. PUB. 8-6-2013. MULTIPLE CLASS, INT. CLS. 30 AND 43.

VR CPC HOLDINGS, INC., BROOMFIELD, CO:  
4,480,796. PUB. 11-26-2013. INT. CL. 41.

VT LEEBOY, INC., LINCOLNTON, NC:  
1,266,892. REN. 1-6-14. INT. CL. 7.  
2,812,554. REN. 1-8-14. INT. CL. 7.

VU SKIN SYSTEMS, INC., PITTSBURGH, PA:  
1,831,834. REN. 1-6-14. INT. CL. 3.

VYGON, 95440 ECOUEN, FRANCE:  
3,245,716. CANC. INT. CL. 10.

W. W. GRAINGER, INC., LAKE FOREST, IL:  
4,481,625. INT. CL. 11.

W.H. SMITH RETAIL HOLDINGS; LIMITED, UNITED KINGDOM:  
4,479,406. PUB. 11-26-2013. MULTIPLE CLASS, INT. CLS. 9 AND 28.

WA-2! WATER CO. LTD., VANCOUVER, BRITISH COLUMBIA, CANADA:  
3,245,726. CANC. MULTIPLE CLASS, INT. CLS. 11, 35 AND 37.

WAINSCOT MEDIA, LLC, MONTVALE, NJ:  
4,480,006. PUB. 11-26-2013. INT. CL. 16.

WAKEFERN FOOD CORP., KEASBEY, NJ:  
4,481,265. PUB. 11-26-2013. INT. CL. 29.  
4,481,266. PUB. 11-26-2013. INT. CL. 30.  
4,481,267. PUB. 11-26-2013. INT. CL. 43.

WAL-MART STORES, INC., BENTONVILLE, AR:  
1,815,442. REN. 1-6-14. INT. CL. 25.  
4,481,470. INT. CL. 36.

WALGREEN CO., DEERFIELD, IL:  
3,247,986. CANC. INT. CL. 16.  
4,482,686. INT. CL. 20.

WALHOLM, ROY W., JR., COLORADO SPRINGS, CO:  
3,245,912. CANC. INT. CL. 16.

WALKER & ZANGER, INC., SYLMAR, CA:  
2,720,183. CANC. INT. CL. 19.

WALKER ADVERTISING, INC., SAN PEDRO, CA:  
2,837,230. REN. 1-9-14. INT. CL. 35.  
2,859,997. REN. 1-9-14. INT. CL. 35.

WALKER FINANCIAL SERVICES, INC., BOWLING GREEN, KY:  
3,247,553. CANC. MULTIPLE CLASS, INT. CLS. 36 AND 41.

WALKING ON WATER FOUNDATION, NAPLES, FL:  
3,359,594. CANC. MULTIPLE CLASS, INT. CLS. 9, 35 AND 45.

WALL, TERRY, SEWELL, NJ:  
3,248,148. CANC. INT. CL. 35.

WALLMEIER, RALPH W., NORTH ATTLEBORO, MA:  
3,248,369. CANC. INT. CL. 25.

WALONG MARKETING, INC., BUENA PARK, CA:  
3,247,024. CANC. INT. CL. 30.

WAM HOLDINGS, LLC, WILLIAMSBURG, VA:  
3,830,949. CANC. INT. CL. 35.

WANG, ROGER H., SANTA ANA, CA:  
2,849,162. REN. 1-9-14. INT. CL. 16.

WANNE, THEODORE ALLEN, BELLINGHAM, WA:  
3,248,700. CANC. INT. CL. 15.

WARNER BROS. ENTERTAINMENT INC., BURBANK, CA:  
3,248,230. CANC. INT. CL. 18.

WARNER POWER CONVERSION LLC, WARNER, NH:  
4,481,333. INT. CL. 9.

WARREN, BRINKLEY, REDWOOD CITY, CA:  
4,481,364. INT. CL. 9.

WARSON GROUP, INC., ST. LOUIS, MO:  
4,481,204. PUB. 11-26-2013. INT. CL. 25.

WASHINGTON MILLS MANAGEMENT, INC., NORTH GRAFTON, MA:  
4,480,838. PUB. 11-26-2013. INT. CL. 3.

WATER PIK, INC., FORT COLLINS, CO:  
3,248,549. CANC. MULTIPLE CLASS, INT. CLS. 10 AND

21.  
 WATER-RIGHT, INC., APPLETON, WI:  
 4,482,565, MULTIPLE CLASS, INT. CLS. 11 AND 42.  
 WATERWICK B.V., 'S-GRAVENDEEL, NETHERLANDS:  
 4,482,713, INT. CL. 31.  
 WATKINS MANUFACTURING CORPORATION, VISTA,  
 CA:  
 2,803,451, REN. 1-3-14, INT. CL. 9.  
 2,909,008, REN. 1-3-14, INT. CL. 11.  
 WATSON, HORACE ANTHONY, WARWICK, BERMUDA:  
 3,248,362, CANC. INT. CL. 41.  
 WAVESONIC CORPORATION, PLANO, TX:  
 3,248,215, CANC. INT. CL. 9.  
 WAWASAN AGROLIPIDS SDN BHD, PASIR GUDANG,  
 JOHOR, MALAYSIA:  
 4,481,287, PUB. 11-26-2013, INT. CL. 5.  
 WE CLICK, LLC, ASTORIA, NY:  
 3,247,538, CANC. INT. CL. 41.  
 WEALTH OFF WALL STREET, LLC, SAFETY HARBOR, FL:  
 4,482,728, INT. CL. 41.  
 WEATHERFORD/LAMB, INC., HOUSTON, TX:  
 2,718,639, CANC. MULTIPLE CLASS, INT. CLS. 40 AND  
 42.  
 4,480,256, PUB. 11-26-2013, INT. CL. 9.  
 WEAVER PUBLICATIONS, INC., DENVER, CO:  
 3,246,314, CANC. MULTIPLE CLASS, INT. CLS. 35, 41  
 AND 42.  
 WEB.COM GROUP, INC., JACKSONVILLE, FL:  
 3,247,400, CANC. MULTIPLE CLASS, INT. CLS. 35 AND  
 42.  
 WEBB, RICHARD H, BEAVERTON, OR:  
 4,479,265, PUB. 11-26-2013, INT. CL. 9.  
 WEBID CONSULTING LTD, LONDON, ENGLAND:  
 4,481,322, MULTIPLE CLASS, INT. CLS. 35, 39 AND 43.  
 WEBTRENDS INC., PORTLAND, OR:  
 4,482,739, MULTIPLE CLASS, INT. CLS. 35 AND 42.  
 WEDO DIGITAL MARKETING LLC, NEWPORT BEACH,  
 CA:  
 4,481,009, PUB. 11-26-2013, INT. CL. 5.  
 WEE ONES, LLC, EARTH CITY, MO:  
 4,480,308, PUB. 11-26-2013, INT. CL. 26.  
 WEGNER, STEVE, NOVATO, CA:  
 2,798,011, REN. 1-6-14, INT. CL. 25.  
 WEGO LLC, NEW YORK, NY:  
 3,248,501, CANC. INT. CL. 16.  
 WEIGHT WATCHERS INTERNATIONAL, INC., NEW  
 YORK, NY:  
 3,248,651, CANC. INT. CL. 29.  
 WEINGUT ERWIN SABATHI GMBH, POESSNITZ 48, AUS-  
 TRIA:  
 3,247,509, CANC. INT. CL. 33.  
 WEINSTEIN, ROBERT, GHENT, NY:  
 4,479,595, PUB. 11-26-2013, INT. CL. 41.  
 WEL-LINE, INC., DUBLIN, VA:  
 3,248,374, CANC. INT. CL. 25.  
 WELLNESS WITHIN SPA, LLC, WOODLAND HILLS, CA:  
 4,479,630, PUB. 11-26-2013, INT. CL. 44.  
 WELLPOINT, INC., INDIANAPOLIS, IN:  
 4,482,674, MULTIPLE CLASS, INT. CLS. 35 AND 44.  
 WELLS FARGO & COMPANY, MINNEAPOLIS, MN:  
 3,246,046, CANC. INT. CL. 36.  
 WELLS FARGO & COMPANY, SAN FRANCISCO, CA:  
 3,246,523, CANC. INT. CL. 36.  
 WELLS FARGO & COMPANY, MINNEAPOLIS, MN:  
 3,248,178, CANC. INT. CL. 36.  
 4,481,707, MULTIPLE CLASS, INT. CLS. 16, 36 AND 41.  
 WELLS FARGO CAPITAL FINANCE, LLC, SANTA MON-  
 ICA, CA:  
 2,719,511, CANC. INT. CL. 38.  
 WELSH & KATZ, LTD., CHICAGO, IL:  
 3,246,936, CANC. INT. CL. 42.  
 WENDELDT, LINDA ARDELL, LA JOLLA, CA:  
 2,801,447, REN. 1-8-14, INT. CL. 16.  
 WENNA GMBH, AUSTRIA:  
 4,479,520, PUB. 11-26-2013, MULTIPLE CLASS, INT. CLS.  
 3 AND 18.  
 WEP-USA, LLC, STAMFORD, CT:  
 4,480,444, PUB. 11-26-2013, INT. CL. 35.  
 WERNER TH. WIESNER, 63505 LANGENSELBOLD, FED  
 REP GERMANY:  
 4,479,401, PUB. 11-26-2013, INT. CL. 11.  
 WEST BANCORPRATION, INC., WEST DES MOINES, IA:  
 3,247,192, CANC. INT. CL. 36.  
 WEST CAPITAL MANAGEMENT, INC., PHILADELPHIA,  
 PA:  
 4,480,415, PUB. 11-26-2013, INT. CL. 36.  
 4,480,416, PUB. 11-26-2013, INT. CL. 36.  
 4,480,417, PUB. 11-26-2013, INT. CL. 36.  
 WEST CORPORATION, OMAHA, NE:  
 3,246,276, CANC. INT. CL. 35.  
 4,482,827, INT. CL. 9.  
 WESTCON GROUP NORTH AMERICA, INC., TARRY-  
 TOWN, NY:  
 2,719,465, CANC. INT. CL. 38.  
 WESTERN GOLF ASSOCIATION, GOLF, IL:  
 3,245,841, CANC. MULTIPLE CLASS, INT. CLS. 16, 36  
 AND 41.  
 WET, SUN VALLEY, CA:  
 4,479,920, PUB. 11-26-2013, INT. CL. 11.  
 4,479,933, PUB. 11-26-2013, INT. CL. 11.  
 WET ZONE, LP, HOUSTON, TX:  
 4,480,396, PUB. 11-26-2013, INT. CL. 37.  
 WEXFORD LABS, INC., KIRKWOOD, MO:  
 4,480,649, PUB. 11-26-2013, INT. CL. 5.  
 WEXLER PACKAGING PRODUCTS, INC., HATFIELD, PA:  
 4,480,434, PUB. 11-26-2013, INT. CL. 35.  
 WHAM-O HOLDING, LTD., KOWLOON, HONG KONG:  
 761,883, REN. 1-6-14, U.S. CL. 22 (INT. CL. 28).  
 WHELAN AND HORICH, LLC, RESTON, VA, DBA OVER-  
 TIME ATHLETICS:  
 4,481,096, PUB. 11-26-2013, INT. CL. 41.  
 WHISKEY CREEK FRANCHISE SYSTEMS, L.L.C., KEAR-  
 NEY, NE:  
 4,480,346, PUB. 11-26-2013, INT. CL. 35.  
 WHITE KNIGHT COMMERCIAL FUNDING, LLC, LENA,  
 WI, DBA MIDWEST KOI AND KOI LADY PRODUCTS-  
 COM:  
 4,480,547, PUB. 11-26-2013, INT. CL. 1.  
 WHITE, GLENN, LONDONDERRY, NH AND WHITE,  
 WILLIAM, GOFFSTOWN, NH:  
 3,246,703, CANC. INT. CL. 28.  
 WHITEWATER WEST INDUSTRIES LTD., RICHMOND, BC,  
 CANADA:  
 4,482,059, INT. CL. 28.  
 WHO U 4?, LLC, FORT MILL, SC:  
 3,247,297, CANC. INT. CL. 35.  
 WHOLE FOODS MARKET IP, L.P., AUSTIN, TX:  
 3,246,162, CANC. INT. CL. 30.  
 WHOLESALE POINT, INC., BURR RIDGE, IL:  
 4,481,029, PUB. 11-26-2013, INT. CL. 35.  
 WHOLESOME INTERNATIONAL, INC, REDLANDS, CA:  
 4,480,881, PUB. 11-26-2013, INT. CL. 29.  
 WICKED FAST ATTIRE LLC, HONDO, TX:  
 4,480,208, PUB. 11-26-2013, INT. CL. 25.  
 WICKED WAFFLES, LLC, VIENNA, VA:  
 4,482,855, INT. CL. 43.  
 WICKER WAREHOUSE INC, HACKENSACK, NJ:  
 4,480,651, PUB. 11-26-2013, INT. CL. 20.  
 WIGOT, INC., HAWTHORNE, CA:  
 4,482,209, MULTIPLE CLASS, INT. CLS. 9, 35 AND 42.  
 WIH HOTELS L.L.C., NEW YORK, NY:  
 3,248,708, CANC. INT. CL. 43.  
 WILBERT FUNERAL SERVICES, INC., BROADVIEW, IL:  
 4,481,088, PUB. 11-26-2013, INT. CL. 14.  
 WILBUR-ELLIS COMPANY, SAN FRANCISCO, CA:  
 4,480,421, PUB. 8-6-2013, INT. CL. 1.  
 WILCOX INDUSTRIES CORP., PORTSMOUTH, NH:  
 3,245,783, CANC. INT. CL. 9.  
 WILD BIRD CENTERS OF AMERICA, INC., GLEN ECHO,  
 MD:  
 3,247,070, CANC. INT. CL. 35.  
 WILDBLUE LLC, SEATTLE, WA:  
 3,246,304, CANC. MULTIPLE CLASS, INT. CLS. 24 AND  
 25.

WILDENLAL INC., QUÉBEC, QC, CANADA, DBA WILD-  
ENLAL INC.:  
4,479,726, PUB. 11-26-2013. INT. CL. 20.

WILDLIFE LEARNING CENTER, SYLMAR, CA:  
3,239,374, AM. INT. CL. 41.

WILDLIFE WORKS, INC., SAUSALITO, CA:  
3,247,262, CANC. INT. CL. 25.

WILEY X, INC., LIVERMORE, CA:  
4,479,956, PUB. 11-26-2013. MULTIPLE CLASS, INT. CLS.  
9 AND 41.

WILKINSON, CHRIS, SANTA BARBARA, CA:  
4,481,458, INT. CL. 3.

WILLDAN, ANAHEIM, CA:  
3,246,786, CANC. MULTIPLE CLASS, INT. CLS. 35, 37  
AND 42.

WILLIAM L. LYON & ASSOCIATES, SACRAMENTO, CA:  
2,719,960, CANC. INT. CL. 36.

WILLIAM-MAHER, INC., NORTH FALMOUTH, MA:  
3,245,822, CANC. INT. CL. 26.

WILLIAMS COMMUNICATIONS, LLC, TULSA, OK TO  
LEVEL 3 COMMUNICATIONS, LLC, BROOMFIELD, CO:  
2,718,479, CANC. INT. CL. 35.

WILLIAMS, JEREMY, TITUSVILLE, FL:  
4,479,552, PUB. 11-26-2013. INT. CL. 25.

WILSON BUILDING PRODUCTS, LLC, CHICAGO, IL:  
4,482,628, INT. CL. 6.

WILSON SPORTING GOODS CO., CHICAGO, IL:  
3,247,601, CANC. INT. CL. 28.  
3,247,642, CANC. INT. CL. 28.  
4,481,134, PUB. 11-26-2013. INT. CL. 28.

WILSON, JAMES P., EAGLE POINT, OR:  
3,245,928, CANC. INT. CL. 7.

WILSON, SUSAN F., WINTER PARK, FL:  
3,247,234, CANC. INT. CL. 28.

WINDOWCRAFT, INC., GARDEN CITY PARK, NY:  
4,482,612, MULTIPLE CLASS, INT. CLS. 7 AND 20.

WINDROCK, INC., KNOXVILLE, TN:  
3,247,352, CANC. INT. CL. 9.  
3,247,353, CANC. MULTIPLE CLASS, INT. CLS. 9 AND  
42.

WINDSOR OAKS ASSOCIATES, L.P., LONG BEACH, CA:  
4,482,375, MULTIPLE CLASS, INT. CLS. 33, 40 AND 44.

WINE AUTHORITIES DURHAM, LLC, DURHAM, NC:  
4,480,549, PUB. 11-26-2013. INT. CL. 35.  
4,480,550, PUB. 11-26-2013. INT. CL. 35.  
4,480,551, PUB. 11-26-2013. INT. CL. 35.

WINE SERGI & COMPANY, LLC, NAPERVILLE, IL 60563,  
IL:  
4,480,186, PUB. 11-26-2013. MULTIPLE CLASS, INT. CLS.  
35 AND 36.

WINEVENT LLC, NEW YORK, NY:  
4,481,167, PUB. 11-26-2013. INT. CL. 41.

WINFIRST FINANCIAL CORP., WINCHESTER, KY:  
4,480,985, PUB. 11-26-2013. INT. CL. 36.

WING WAH FOOD MANUFACTORY LIMITED, YUEN  
LONG, NEW TERRITORIES, HONG KONG:  
2,769,501, REN. 1-3-14. INT. CL. 30.

WINGERT, JOHN, CONNELLSVILLE, PA:  
3,247,318, CANC. MULTIPLE CLASS, INT. CLS. 9 AND  
41.

WINGHAVEN MASTER ASSOCIATION, ST. LOUIS, MO:  
2,836,723, REN. 1-6-14. INT. CL. 36.

WINNING MOVES INC., DANVERS, MA:  
3,248,479, CANC. INT. CL. 28.

WINSTON PRODUCTS LLC, CLEVELAND, OH:  
4,480,485, PUB. 11-26-2013. INT. CL. 22.

WIRECO WORLDGROUP INC., KANSAS CITY, MO:  
4,480,371, PUB. 11-26-2013. INT. CL. 6.

WISTRON CORPORATION, HSINCHU, TAIWAN:  
4,481,701, MULTIPLE CLASS, INT. CLS. 9 AND 38.

WITTENBERG, MARK, WHISTLER, BC, CANADA:  
4,482,705, INT. CL. 30.

WIZARD CREATIONS, INC., BOCA RATON, FL:  
4,480,739, PUB. 11-26-2013. INT. CL. 40.

WIZARD PUBLICATIONS, INC., LIHU'E, HI:  
2,796,932, REN. 1-3-14. INT. CL. 41.

WIZARDS OF THE COAST LLC, PAWTUCKET, RI:  
2,728,184, CANC. MULTIPLE CLASS, INT. CLS. 9, 16  
AND 28.  
3,248,005, CANC. INT. CL. 28.

WIZPERT, INC., NEW YORK, NY:  
4,481,451, INT. CL. 42.

WM. G. ROE & SONS, INC., WINTER HAVEN, FL:  
177,883, REN. 1-6-14. U.S. CL. 46 (INT. CL. 31).

WMK HOLDINGS, INC., WILMINGTON, DE:  
4,481,878, INT. CL. 35.  
4,482,409, INT. CL. 44.  
4,482,410, INT. CL. 44.

WNBA ENTERPRISES, LLC, SECAUCUS, NJ:  
3,248,382, CANC. INT. CL. 35.

WOHL, JON S., BROOKLYN, NY:  
3,247,622, CANC. INT. CL. 41.

WOMACK, EDWARD, ORANGE, CA:  
4,480,568, PUB. 11-26-2013. INT. CL. 25.

WONDER OF WOMEN, SANTA MONICA, CA:  
4,481,763, INT. CL. 41.

WONDERWORKING WORDS, GEORGETOWN, TX:  
4,479,796, PUB. 11-26-2013. INT. CL. 41.

WONDILL FROMAN, INDIANAPOLIS, IN:  
4,481,773, INT. CL. 28.

WONG, FRANK CHI TAT, WALNUT, CA:  
3,247,351, CANC. INT. CL. 25.

WONG, KAISER H, TORRANCE, CA, DBA ACCUGOLF:  
4,480,801, PUB. 11-26-2013. INT. CL. 28.

WOODDELL , PHILLIP L., ELGIN, SC AND WOODDELL,  
JENNY REBEKAH, ELGIN, SC:  
4,481,728, INT. CL. 13.

WOODLAWN COMMUNITY ACADEMY, CLEARWATER,  
FL:  
4,481,012, PUB. 11-26-2013. INT. CL. 43.

WOODMEN OF THE WORLD LIFE INSURANCE SOCIETY  
AND/OR OMAHA LIFE INSURANCE SOCIETY, OMAHA,  
NE:  
4,481,300, INT. CL. 36.

WORDSMART CORPORATION, SAN DIEGO, CA:  
4,480,372, PUB. 11-26-2013. INT. CL. 41.

WORLD HEALTH PRODUCTS, LLC, STAMFORD, CT:  
4,482,392, INT. CL. 5.

WORLD OF JEANS & TOPS, IRVINE, CA:  
3,524,537, COR. MULTIPLE CLASS, INT. CLS. 18 AND  
25.  
3,543,962, COR. INT. CL. 25.

WORLD PACKAGING CORP., NORWALK, CT:  
2,800,177, REN. 1-7-14. INT. CL. 30.

WORLD PEACE PARENTS FOUNDATION, SALT LAKE  
CITY, UT:  
3,366,781, CANC. INT. CL. 42.

WORLD RADIO NETWORK, MCALLEN, TX:  
4,481,760, MULTIPLE CLASS, INT. CLS. 38 AND 41.

WORLDWIDE PRODUCTS UNLIMITED, INC., VAN NUYS,  
CA:  
4,480,875, PUB. 11-26-2013. INT. CL. 9.

WORLDWIDE PROTECTIVE PRODUCTS, LLC, BUFFALO,  
NY:  
4,479,904, PUB. 11-26-2013. INT. CL. 9.

WORLDWIDE RESPONSIBLE ACCREDITED PRODUC-  
TION, ARLINGTON, VA:  
2,801,741, REN. 1-8-14. INT. CL. 42.

WOWWEE GROUP LIMITED, TSIM SHA TSUI EAST, HONG  
KONG:  
3,639,466, AM. INT. CL. 9.

WPP PROPERTIES, NEW YORK, NY:  
4,481,550, INT. CL. 35.

WRASMAN, ANDREW, SILVERADO, CA:  
4,482,789, INT. CL. 16.

WRATHER CREATIVE, LLC, LOS ANGELES, CA:  
4,481,121, PUB. 11-26-2013. INT. CL. 41.

WREN SOUND SYSTEMS, LLC, PHOENIXVILLE, PA:  
4,481,592, INT. CL. 9.

WRIGHT, JAMES JR, ATLANTA, GA:  
3,246,744, CANC. INT. CL. 25.

WRIGHT, JAMES, JR, ATLANTA, GA:  
3,246,723, CANC. INT. CL. 25.  
3,246,724, CANC. INT. CL. 25.

WRIGHTSOFT CORPORATION, LEXINGTON, MA:  
4,480,306, PUB. 11-26-2013. MULTIPLE CLASS, INT. CLS.

- 9 AND 42.  
 WU, WILLIAM, SAN DIEGO, CA:  
 3,248,136, CANC. INT. CL. 25.  
 WUYI EARL KITCHEN SUPPLIES; CO., LTD, CHINA:  
 4,479,315, PUB. 11-26-2013. INT. CL. 8.  
 WYETH LLC, MADISON, NJ:  
 2,719,774, CANC. INT. CL. 16.  
 3,246,056, CANC. INT. CL. 42.  
 WYNN RESORTS HOLDINGS, LLC, LAS VEGAS, NV:  
 3,248,164, CANC. INT. CL. 35.  
 3,248,190, CANC. INT. CL. 35.  
 WYNWOOD BREWING COMPANY LLC, MIAMI, FL:  
 4,482,859, INT. CL. 32.  
 WZA, INC., SCOTTSDALE, AZ:  
 4,479,713, PUB. 11-26-2013. INT. CL. 35.  
 X PRODUCTS LLC, PORTLAND, OR:  
 4,479,999, PUB. 11-26-2013. INT. CL. 13.  
 X-M INDUSTRIES, INC., NORCROSS, GA, DBA X-MOLD  
 INDUSTRIES, INC.:  
 3,248,168, CANC. MULTIPLE CLASS, INT. CLS. 1 AND  
 19.  
 XAVIER, LLC, CLOVER, SC:  
 4,481,768, INT. CL. 44.  
 XCALIBER SOLUTIONS INC., FOOTHILL RANCH, CA:  
 4,479,931, PUB. 11-26-2013. INT. CL. 42.  
 4,479,932, PUB. 11-26-2013. MULTIPLE CLASS, INT. CLS.  
 36 AND 45.  
 XEER INC., OAKLAND, CA:  
 4,480,322, PUB. 11-26-2013. INT. CL. 42.  
 XENOMORPH SOFTWARE LIMITED, LONDON, UNITED  
 KINGDOM, AKA XENOMORPH:  
 2,890,218, REN. 1-9-14. INT. CL. 9.  
 XL VIDEO, INC., NORTH HOLLYWOOD, CA:  
 3,246,911, CANC. MULTIPLE CLASS, INT. CLS. 41 AND  
 42.  
 XOXO MOBILE, SAN FRANCISCO, CA:  
 4,480,622, PUB. 11-26-2013. INT. CL. 9.  
 XPERTEVAL LLC, ATLANTA, GA:  
 4,482,758, INT. CL. 41.  
 XTOOLTECH LLC, CITY OF INDUSTRY, CA:  
 4,479,907, PUB. 11-26-2013. INT. CL. 9.  
 XTR ENERGY COMPANY LIMITED, BURLINGTON ON,  
 CANADA:  
 2,796,465, REN. 1-3-14. INT. CL. 35.  
 XTRALOCK INC., SHINGLE SPRINGS, CA:  
 4,482,577, INT. CL. 6.  
 XTREME HEATERS, INC., BUFORD, GA:  
 4,480,647, PUB. 11-26-2013. INT. CL. 11.  
 XTREME 2 VIDEO INC., DALY CITY, CA:  
 3,247,629, CANC. MULTIPLE CLASS, INT. CLS. 35 AND  
 41.  
 XX PRODUCTION ONLINE GMBH, 34479 BREUNA, FED  
 REP GERMANY:  
 3,247,707.  
 XYLLABUS LLC, FARMINGTON, CT:  
 4,480,029, PUB. 11-26-2013. INT. CL. 38.  
 XZILLION BV, NL-2991 BA BARENDRECHT, NETHER-  
 LANDS:  
 4,479,291, PUB. 7-16-2013. MULTIPLE CLASS, INT. CLS.  
 2, 8, 9, 16 AND 20.  
 YAESU MUSEN CO., LTD., SHINAGAWA-KU, TOKYO,  
 JAPAN, YAESU MUSEN CO., LTD., TOKYO 146, JAPAN:  
 976,703, REN. 1-7-14. MULTIPLE CLASS, U.S. CLS. 21  
 (INT. CL. 9) AND 26 (INT. CL. 9).  
 YAMAHA CORPORATION, SHIZUOKA, JAPAN:  
 2,805,614, REN. 1-6-14. INT. CL. 9.  
 YAMCON, INC., RANCHO SANTA MARGARITA, CA:  
 3,248,072, CANC. INT. CL. 9.  
 YAN, XIN, NEW YORK, NY:  
 2,807,829, REN. 1-6-14. INT. CL. 41.  
 2,807,830, REN. 1-6-14. INT. CL. 41.  
 2,824,411, REN. 1-6-14. INT. CL. 41.  
 YARD FEEDER, LLC, HENDERSON, NV:  
 3,247,292, CANC. INT. CL. 11.  
 YE ZHANG, ROCKVILLE, MD:  
 4,482,711, INT. CL. 43.  
 YEHL & JORDAN LLC, HUTTO, TX, DBA CHEERLEADING  
 STUNT STAND:  
 4,480,157, PUB. 11-26-2013. INT. CL. 28.  
 YELLOW LEAF BRANDS, LLC, GLEN ECHO, MD:  
 4,480,196, PUB. 11-26-2013. INT. CL. 35.  
 YELLOWTAIL HOLDING B.V., NETHERLANDS:  
 4,479,304, PUB. 11-26-2013. MULTIPLE CLASS, INT. CLS.  
 9, 36 AND 42.  
 YESTAR PLASTIC SURGERY CO.,LTD, CHINA:  
 4,479,491, PUB. 11-26-2013. INT. CL. 44.  
 YI FENG MANUFACTURING COMPANY LIMITED, KOW-  
 LOON, HONG KONG:  
 4,480,803, PUB. 11-26-2013. INT. CL. 6.  
 YI-TING ENTERPRISE LTD., NEW TAIPEI CITY, TAIWAN:  
 4,480,098, PUB. 11-26-2013. INT. CL. 12.  
 YICHING CHEN, SAN MARINO, CA:  
 4,480,798, PUB. 11-26-2013. INT. CL. 5.  
 YIELDQUEST ADVISORS, LLC, ATLANTA, GA:  
 3,247,419, CANC. INT. CL. 36.  
 YNG PRODUCTIONS LLP, CYPRESS, TX:  
 3,247,007, CANC. INT. CL. 41.  
 3,247,008, CANC. INT. CL. 41.  
 YOAKAM, LLC, FOSTORIA, OH AND TL INDUSTRIES,  
 INC., NORTHWOOD, OH:  
 4,479,625, PUB. 11-26-2013. INT. CL. 42.  
 YOGA ALIVE, LLC, CINCINNATI, OH:  
 4,480,383, PUB. 11-26-2013. INT. CL. 41.  
 YONKER, MARILYN H, RANCHO MIRAGE, CA:  
 3,247,459, CANC. INT. CL. 18.  
 YOU HAU CO., LTD., NEW TAIPEI CITY, TAIWAN:  
 4,482,576, INT. CL. 11.  
 YOU HAU LTD., CO., NEW TAIPEI CITY, TAIWAN:  
 4,482,575, INT. CL. 11.  
 YOU TELL ME STORIES, LLC, WESTON, CT:  
 4,482,587, INT. CL. 9.  
 YOUCOPIA PRODUCTS, INC., ARLINGTON HEIGHTS, IL:  
 4,482,358, INT. CL. 21.  
 YOUNG & LARAMORE, INC., INDIANAPOLIS, IN:  
 4,481,940, INT. CL. 35.  
 YOUNG CHANG CO., LTD., GYEONGGI-DO 463 859, DEM  
 REP OF KOREA:  
 1,860,864, REN. 1-7-14. INT. CL. 15.  
 YOUTH EMPLOYMENT SUMMIT CAMPAIGN, INC., LEX-  
 INGTON, MA:  
 4,481,688, U.S. CL. A.  
 4,481,689, U.S. CL. A.  
 YOUTH ENTREPRENEURS OF KANSAS, INC., WITCHITA,  
 KS:  
 3,247,212, CANC. MULTIPLE CLASS, INT. CLS. 36 AND  
 41.  
 YP INTELLECTUAL PROPERTY LLC, TUCKER, GA:  
 2,729,607, REN. 1-9-14. INT. CL. 16.  
 YSAIS, CAREY, BURBANK, CA:  
 4,480,046, PUB. 11-26-2013. INT. CL. 41.  
 YU SHENG JIANG, SAN GABRIEL, CA:  
 4,482,388, INT. CL. 25.  
 YUGEN KAISHA KOBAYASHI, JAPAN:  
 3,247,678.  
 YUMMYHEALTH, LLC, WHITE PLAINS, NY:  
 4,481,596, MULTIPLE CLASS, INT. CLS. 35, 41 AND 43.  
 YURKE, MANFRED, FAIRFAX, CA:  
 4,481,529, INT. CL. 16.  
 YUYAO GOLD AUDIO PROFESSIONAL SOUND CO., LTD.,  
 ZHEJIANG PROVINCE., CHINA:  
 4,480,251, PUB. 11-26-2013. INT. CL. 9.  
 YVES SAINT LAURENT PARFUMS, FRANCE:  
 3,247,725.  
 YVO MAGNUSSON, SWITZERLAND AND ROLAND BERN-  
 HARD, SWITZERLAND:  
 3,247,746.  
 YXLON INTERNATIONAL X-RAY, GMBH, HAMBURG,  
 FED REP GERMANY:  
 3,247,491, CANC. MULTIPLE CLASS, INT. CLS. 9, 37, 40  
 AND 42.  
 YZY INC, MIAMI, FL:  
 4,482,353, INT. CL. 3.  
 4,482,354, INT. CL. 3.  
 4,482,355, INT. CL. 3.



Z-TERRA, HOUSTON, TX:  
4,481,979, INT. CL. 42.

ZACHARIAS, DEAN M, MARYVILLE, TN, DBA PROPER KID PROBLEMS:  
4,480,007, PUB. 11-26-2013. INT. CL. 25.

ZACHRY CONSTRUCTION CORPORATION, SAN ANTONIO, TX:  
4,481,843, MULTIPLE CLASS, INT. CLS. 37 AND 40.  
4,481,844, MULTIPLE CLASS, INT. CLS. 37 AND 40.  
4,481,845, MULTIPLE CLASS, INT. CLS. 37 AND 40.

ZAIDI, NASIR J, BURBANK, CA, DBA TU ME BEVERAGE COMPANY:  
4,479,684, PUB. 11-26-2013. INT. CL. 32.

ZANE, LESLIE, ARMONK, NY:  
2,796,664, REN. 1-6-14. INT. CL. 35.

ZANGO TECHNOLOGIES LLC, BELLEVUE, WA:  
3,248,083, CANC. INT. CL. 42.

ZAPF, CAROLINA, NEW YORK, NY:  
3,519,569, COR. INT. CL. 25.

ZELL, DEBORAH, LOUISVILLE, CO:  
4,482,432, INT. CL. 42.

ZELLER DESIGN, LLC, SANTA BARBARA, CA:  
4,482,754, INT. CL. 9.

ZEMAS MADHOUSE FOODS, INC., HIGHLAND PARK, IL:  
4,480,765, PUB. 11-26-2013. MULTIPLE CLASS, INT. CLS. 30 AND 35.  
4,480,766, PUB. 11-26-2013. MULTIPLE CLASS, INT. CLS. 30 AND 35.

ZENGCHENGSHI XINTANG XURI ENTERPRISE CO., LTD., GUANGDONG, CHINA:  
4,480,212, PUB. 11-26-2013. INT. CL. 25.

ZENPAYROLL, INC., SAN FRANCISCO, CA:  
4,481,946, INT. CL. 42.

ZEROSKI LLC, MOORESTOWN, NJ:  
4,480,470, PUB. 11-26-2013. INT. CL. 35.

ZEUS RECYCLING SOLUTIONS LLC, SHEBOYGAN, WI:  
4,480,521, PUB. 11-26-2013. INT. CL. 40.

ZHAO, SHOUMING, ARCADIA, CA:  
4,481,573, INT. CL. 5.

ZHEJIANG GRACE SPINNING & WEAVING GROUP CO., LTD., ZHEJIANG, CHINA:  
4,482,036, INT. CL. 5.  
4,482,037, INT. CL. 6.  
4,482,041, INT. CL. 26.  
4,482,042, INT. CL. 28.  
4,482,043, INT. CL. 8.  
4,482,044, INT. CL. 16.  
4,482,045, INT. CL. 18.  
4,482,046, INT. CL. 20.  
4,482,047, INT. CL. 21.  
4,482,048, INT. CL. 24.  
4,482,049, INT. CL. 25.  
4,482,050, INT. CL. 27.

ZHEJIANG HONGGUOCUN LEISURE GOODS CO., LTD, YONGKANG, ZHEJIANG, CHINA:  
4,482,234, INT. CL. 20.

ZHENGZHOU DANDIAN TECHNOLOGY SOFTWARE LTD., ZHENGZHOU, HENAN, CHINA:  
4,481,268, PUB. 11-26-2013. INT. CL. 9.  
4,481,271, PUB. 11-26-2013. INT. CL. 9.

ZHONGSHAN KINGJOY PHOTOGRAPHIC EQUIPMENT CO.LTD, ZHONGSHAN CITY, CHINA:  
4,481,055, PUB. 11-26-2013. INT. CL. 9.

ZHU, JIASHENG, SAN JOSE, CA AND SU, JUN, HANGZHOU, CHINA:  
4,482,002, INT. CL. 21.

ZICK, TIMOTHY, LOS ANGELES, CA:  
4,480,886, PUB. 11-26-2013. INT. CL. 41.

ZILLOW, INC., SEATTLE, WA:  
4,479,990, PUB. 5-14-2013. INT. CL. 9.

ZIMA, VADIM NIKOLAI, LYNNWOOD, WA:  
3,246,958, CANC. INT. CL. 41.

ZINUS INC., HAYWARD, CA:  
4,482,513, INT. CL. 20.  
4,482,610, INT. CL. 20.  
4,482,657, INT. CL. 20.

ZION GROUP LLC, SUGAR LAND, TX:  
3,247,582, CANC. INT. CL. 5.

ZION OIL & GAS, INC., DALLAS, TX:  
4,481,385, MULTIPLE CLASS, INT. CLS. 37 AND 42.

ZIONS BANCORPORATION, SALT LAKE CITY, UT:  
2,719,821, CANC. INT. CL. 36.

ZIPPERER, RANDALL J., MERRITT ISLAND, FL:  
3,248,732, CANC. INT. CL. 16.

ZIRCHROM SEPARATIONS, INC., ANOKA, MN:  
2,808,813, REN. 1-8-14. INT. CL. 1.

ZITRO IP S.ÀR.L., LUXEMBOURG, LUXEMBOURG:  
4,481,256, PUB. 11-26-2013. MULTIPLE CLASS, INT. CLS. 9 AND 28.  
4,481,257, PUB. 11-26-2013. MULTIPLE CLASS, INT. CLS. 9 AND 28.

ZK MORTGAGE, LP, AUSTIN, TX:  
3,247,593, CANC. INT. CL. 36.

ZONE APPS, INC., SUDBURY, MA:  
4,482,308, INT. CL. 42.

ZOOM MARKETING, PALO ALTO, CA:  
3,247,492, CANC. INT. CL. 35.

ZOTEFOAMS PLC, CROYDON, SURREY, UNITED KINGDOM, BXL PLASTICS LIMITED, LONDON, ENGLAND:  
1,244,459, REN. 1-3-14. INT. CL. 17.

ZOTOS INTERNATIONAL, INC., DARIEN, CT:  
1,814,645, REN. 1-8-14. INT. CL. 3.  
4,482,286, INT. CL. 3.

ZS ASSOCIATES, INC., EVANSTON, IL:  
4,481,957, INT. CL. 42.

ZSISKA DESIGN CO., LTD., CHA AM, PETCHBURI, THAILAND:  
3,359,948.

ZTE CORPORATION, CHINA:  
3,247,682.

ZUBENKO-MAKAGONOV, VIACHESLAV VASYLYOVYCH, KHARKIV, UKRAINE:  
4,479,695, PUB. 5-14-2013. MULTIPLE CLASS, INT. CLS. 35, 36 AND 38.

ZUMTOBEL LIGHTING GMBH, DORNBIERN, AUSTRIA:  
3,246,881, CANC. MULTIPLE CLASS, INT. CLS. 9, 11 AND 42.

ZWITTLE, INC., NORTH LOGAN, UT:  
4,482,142, INT. CL. 35.

ZYMBR LABS INC., CHICAGO, IL:  
4,482,557, INT. CL. 9.

ZYXEL COMMUNICATIONS CORP., HSIN-CHU, TAIWAN:  
3,246,374, CANC. INT. CL. 9.

1-800-FLOWERS.COM, INC., CARLE PLACE, NY:  
1,816,163, REN. 1-8-14. INT. CL. 38.  
3,245,847, CANC. INT. CL. 35.

1% FOR THE PLANET, INC., NEWBURYPORT, MA:  
3,247,009, CANC. U.S. CL. 200.

1CAPAPP LLC, CHARLOTTE, NC:  
4,480,215, PUB. 11-26-2013. INT. CL. 42.

1101 DENTAL, PLLC, GRAND FORKS, ND:  
4,480,173, PUB. 11-26-2013. INT. CL. 44.

1175856 ONTARIO LTD., MISSISSAUGA, ONTARIO L4W4Y1, CANADA:  
2,718,655, CANC. INT. CL. 42.

123-ENGINEERING & INNOVATION GMBH, HANAU, FED REP GERMANY:  
4,479,363, PUB. 11-26-2013. MULTIPLE CLASS, INT. CLS. 6, 7 AND 11.

151 PRODUCTS LIMITED, MANCHESTER, UNITED KINGDOM:  
4,480,885, PUB. 11-26-2013. INT. CL. 3.

1626219 ONTARIO LIMITED, TORONTO, ONTARIO, CANADA:  
3,248,237, CANC. INT. CL. 3.

19.5 DEGREES, NEW DELHI, INDIA:  
3,246,872, CANC. INT. CL. 35.

2B4ME, INC., CORAL GABLES, FL:  
4,481,669, INT. CL. 35.

2POOD LLC, HUNTSVILLE, AL:  
4,479,976, PUB. 11-26-2013. INT. CL. 25.

20 MINUTES CIGAR COMPANY, DETROIT, MI:  
4,480,369, PUB. 11-26-2013. INT. CL. 34.

23 BOTTLES OF BEER LLC, SANTA ROSA, CA:  
4,482,298, INT. CL. 32.

- 3 POINT DISTRIBUTION, LLC, IRVINE, CA:  
3,245,754, CANC. INT. CL. 25.
- 3 S'S LIMITED, WORCESTERSHIRE, UNITED KINGDOM:  
3,246,193, CANC. MULTIPLE CLASS, INT. CLS. 16 AND 17.
- 3CSI, LLC, NORTHVILLE, MI, DBA DIGITAL ROOTS:  
4,480,403, PUB. 11-26-2013. MULTIPLE CLASS, INT. CLS. 9, 35 AND 42.  
4,480,411, PUB. 11-26-2013. MULTIPLE CLASS, INT. CLS. 9, 35 AND 42.
- 3D DESIGN CORPORATION, NEW YORK, NY:  
4,482,704, INT. CL. 25.
- 3D MAGIC FACTORY, AUSTIN, TX:  
4,481,591, INT. CL. 28.
- 3DENT TECHNOLOGY, LLC, HOUSTON, TX:  
4,480,309, PUB. 10-15-2013. INT. CL. 42.
- 3E TECHNOLOGIES INTERNATIONAL, INC., ROCKVILLE, MD, DBA 3ETI:  
2,718,576, CANC. MULTIPLE CLASS, INT. CLS. 37, 41 AND 42.
- 3FORM, INC., SALT LAKE CITY, UT:  
3,248,564, CANC. INT. CL. 19.
- 3M COMPANY, ST. PAUL, MN:  
3,248,241, CANC. INT. CL. 10.  
3,248,242, CANC. INT. CL. 10.  
3,248,371, CANC. INT. CL. 10.  
3,248,372, CANC. INT. CL. 10.  
3,248,429, CANC. INT. CL. 9.
- 3STUDIOSOUNDS, LLC, LOS ANGELES, CA:  
4,482,799, INT. CL. 41.
- 3TERA, INC., ALISO VIEJO, CA:  
3,710,994, COR. MULTIPLE CLASS, INT. CLS. 38 AND 42.
- 305 PIZZA AT MIA, LLC., MIAMI, FL:  
4,479,247, PUB. 8-20-2013. INT. CL. 43.
- 337 TECHNOLOGY LIMITED, HONG KONG, HONG KONG:  
4,481,196, PUB. 11-26-2013. INT. CL. 9.
- 360 TENTS LLC, TEMPLE, TX:  
3,247,208, CANC. MULTIPLE CLASS, INT. CLS. 22 AND 43.
- 4TH DAY ENTERPRISES, LLC, BANGOR, ME:  
4,481,168, PUB. 11-26-2013. INT. CL. 11.
- 40S AND SHORTIES LLC, LOS ANGELES, CA:  
4,480,925, PUB. 11-26-2013. INT. CL. 25.
- 417394 ALBERTA LTD., EDMONTON, ALBERTA, AB, CANADA:  
3,248,050, CANC. INT. CL. 11.
- 5 SENSI DI TRUSHNIKOVA SVETLANA, ITALY:  
4,479,336, PUB. 11-26-2013. MULTIPLE CLASS, INT. CLS. 35 AND 38.
- 5STAR FINANCIAL LLC, ALEXANDRIA, VA:  
2,719,931, CANC. INT. CL. 36.
- 61 SOLUTIONS INC., CAMBRIDGE, MA:  
4,481,044, PUB. 11-26-2013. INT. CL. 9.
- 618 MAIN CLOTHING CORP., UNION CITY, NJ:  
4,480,664, PUB. 11-26-2013. INT. CL. 35.
- 7 COLORS LLC, AVENTURA, FL:  
2,793,138, REN. 1-6-14. INT. CL. 41.
- 720 STRATEGIES, LLC, WASHINGTON, DC:  
4,480,058, PUB. 11-26-2013. MULTIPLE CLASS, INT. CLS. 35 AND 42.
- 7237189 CANADA INC., TORONTO, CANADA:  
4,481,921, MULTIPLE CLASS, INT. CLS. 9, 16 AND 41.
- 8BITCOLLECTIVE INC., WHITE PLAINS, NY:  
4,479,638, PUB. 11-26-2013. INT. CL. 9.
- 88 TEES HAWAII, INC., HONOLULU, HI:  
3,245,943, CANC. INT. CL. 25.
- 9 MONTHS UP, 9 MONTHS DOWN, LLC, GREAT NECK, NY:  
3,248,585, CANC. INT. CL. 9.

\* \* \* \* \*